

July 8, 1960

electronics

Plumbing below is an ultrahigh-frequency diplexer, part of a communications network that kept contact with Pioneer V through millions of miles of space. For system design details see p 43

A McGraw-Hill Publication 75 Cents

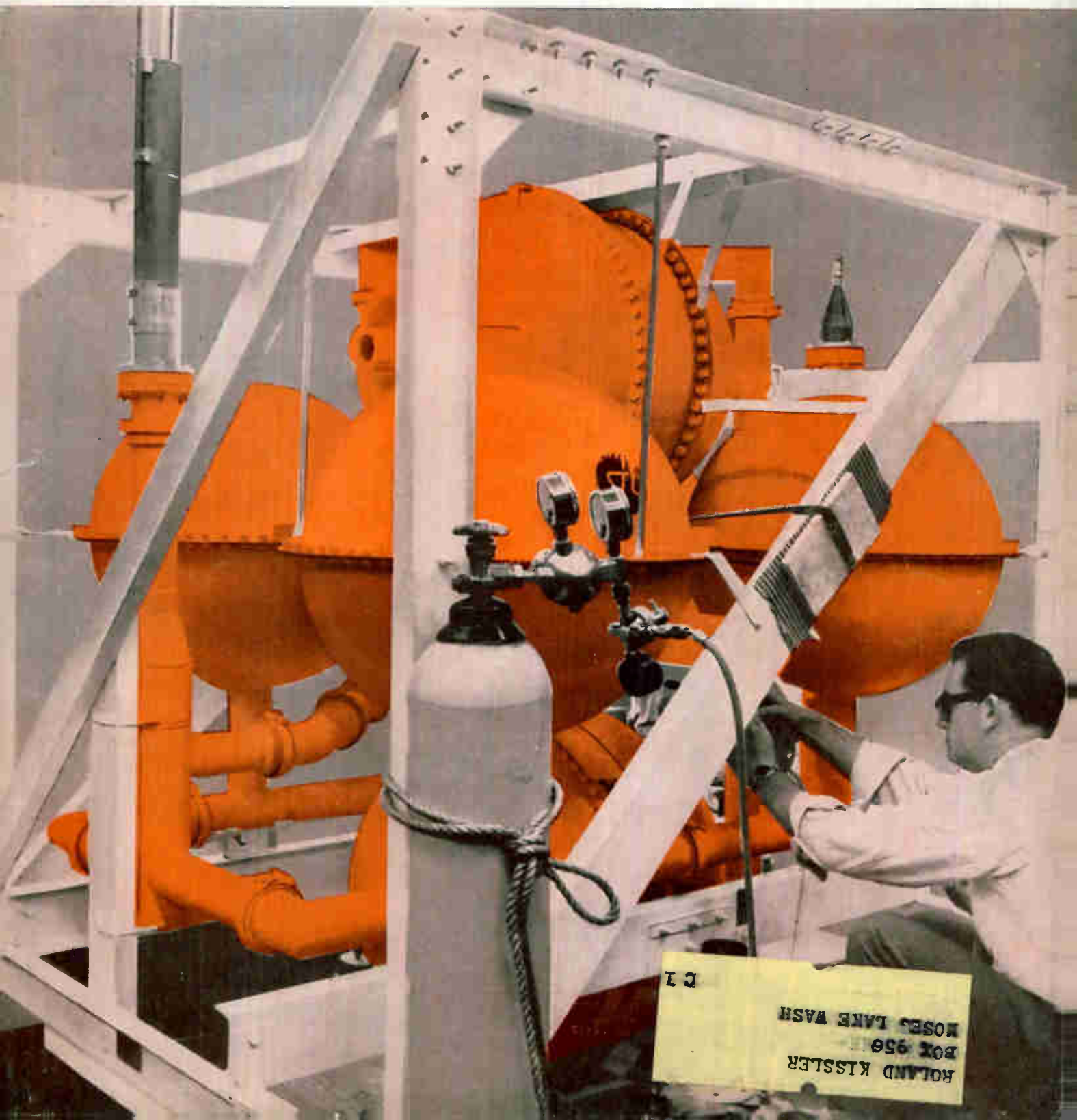



How to Control TIME, FREQUENCY and SPACE

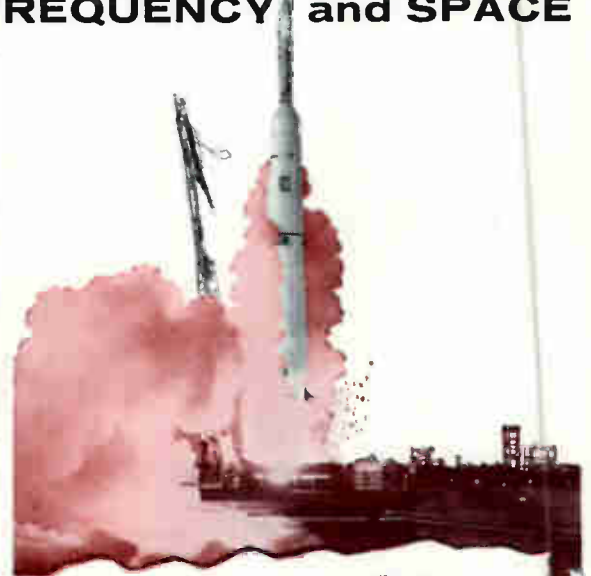

A radio-guidance system, built by Space Technology Laboratories, Inc., played an important role in the successful launching of Pioneer V. This new ground-controlled guidance system, based on doppler-shift techniques, obtains and uses velocity and position data to control the missile.

The system relies on an accurately-controlled, stable, primary frequency — instability, f-m noise, or harmonic interference in the primary frequency could impair system performance. The G-R 1112-A Standard-Frequency Multiplier was picked by STL to help generate this frequency. It serves in an important in-line role as an element of the frequency synthesizer for this radio-guidance system. STL also uses the Frequency Multiplier in its world-wide network of tracking stations.

Telemetry, missile tracking, spectroscopy and atomic-resonance investigations, radar, and navigation-systems applications are but a few of the other areas where the 1112-A and its companion frequency multiplier, the 1112-B, find use.

U.S. Sun Orbiter Right on Beam

WASHINGTON, March 12 (AP) — Pioneer V hurtled through space today toward its destined place as a tiny new sister planet between earth and Venus in a giant orbit about the sun.

Good Operation
Pioneer V was speeding away at 6,487 m.p.h. This

carried it to an estimated 213,140 miles out from earth at noon.

All equipment was reported operating perfectly. Giant radios, triggered from earth approximately once an hour, sent back loud and clear signals from which scientists computed speeds and distances.

Later today the instrument-packed space vehicle plunged into its giant five-orbit around the sun. That orbit will be a 514,000-mile circle through between the orbits of earth and the planet.

The orbit Pioneer V will reach to about 74,967,000 miles of the sun, compared to the average distance of



Type 1112-A Standard-Frequency Multiplier . . . \$1450

1-Mc, 10-Mc, and 100-Mc output frequencies are generated by separate crystal oscillators that are phase locked to the input frequency to insure extremely low f-m noise levels.

INPUT: 1-volt, 100-kc sine wave from G-R 1100-A Frequency Standard or equivalent. Can be driven by 1-Mc, 2.5-Mc, or 5-Mc standard frequency as well.

OUTPUT: 1-Mc, 10-Mc, and 100-Mc sine-wave signals; output level of each independently adjustable with maximum of 20 mw into 50 ohms.

STABILITY: Long-term stability dependent only upon driving source.

F-M NOISE: Less than 1 part in 10⁹.



Type 1112-B Standard-Frequency Multiplier . . . \$1360

1000-Mc output is generated directly by a klystron oscillator that is phase-locked to the 100-Mc input. Phase stability of the output is comparable to that of the input signal.

INPUT: 20-mw, 100-Mc sine wave from 1112-A or equivalent.

OUTPUT: 1000-Mc sine wave; at least 50 mw into a 50-ohm load.

STABILITY and F-M NOISE: Same as 1112-A.

Write For
Complete Information

GENERAL RADIO COMPANY

WEST CONCORD, MASSACHUSETTS

our 45th
year
in Electronics

NEW YORK, WOrth 4-2722
District Office in Ridgefield, N. J.
WHitney 3-3140

CHICAGO
Oak Park
Village 8-9400

PHILADELPHIA
Abington
HAncock 4-7419

WASHINGTON, O.C.
Silver Spring
JUNiper 5-1088

SAN FRANCISCO
Los Altos
WHitecliff 8-8233

LOS ANGELES
Los Angeles
HOLLYwood 9-6201

IN CANADA
Toronto
CHerry 6-2171

electronics

A McGraw-Hill Publication 75 Cents



W. W. MacDONALD, Editor

J. M. CARROLL, Managing Editor
 SENIOR ASSOCIATE EDITORS:
 Samuel Weber, Roland J. Charest.
 ASSOCIATE EDITORS: Frank Leary,
 Michael F. Tomaino, Sylvester P.
 Carter, William P. O'Brien, John
 F. Mason, William E. Bushor,
 Thomas Emma, Sy Vogel, Leslie
 Solomon, M. M. Perugini, George
 J. Flynn. ASSISTANT EDITORS:
 Michael F. Wolff, Nilo Lind-
 gren, Stanley Froud. REGIONAL
 EDITORS: Harold C. Hood (Pacific
 Coast, Los Angeles), Thomas Ma-
 guire (New England, Boston).
 MARKET RESEARCH EDITOR: Ed-
 ward DeJongh. BUYERS' GUIDE
 EDITOR: George Sideris. ART DI-
 RECTOR: Harry Phillips; Howard
 R. Berry. PRODUCTION EDITOR:
 John C. Wright, Jr. EDITORIAL
 ASSISTANTS: Gloria J. Filippone,
 Arlene Schilp, Bernice Duffy, Pa-
 tricia Martine, Lorraine Rossi, Vir-
 ginia T. Bastian, Ruth Ayres.

JAMES GIRDWOOD, Publisher

BUSINESS

New Sub Killer Opens Big Market. Here's what will be needed	28
Political Conventions Use New Gear. Amplifiers, mikes, headsets	30
Electron Accelerator Fights Cancer. 60 million electron volts	33
Six Firms Sponsor Traveling Exhibit. Novel marketing approach	38
122-Deg Picture Tubes Coming. Report on Chicago meeting	38
Crosstalk	4
Comment	6
Electronics Newsletter	11
Washington Outlook	14
Financial Roundup	21
25 Most Active Stocks	21
Market Research	24
Current Figures	24
Meetings Ahead	34

ENGINEERING

UHF high-level diplexer permits separation of 10-Kw transmitted signal from 10 ⁻¹⁸ watt received signal. See p 43	COVER
Providing Communication and Navigation for Space Probes. Network to control probes 70 million miles out By R. C. Hansen and E. R. Spangler	43
Portable Radio Uses Drift-Field Transistors. Composite a-m/f-m tuner and i-f strip featured By R. A. Santilli and H. Thanos	48
Battery Powered Converter Runs Multiplier Phototube. Voltage doublers avoid bleeder chain By R. P. Rufer	51
Using Nuclear Resonance to Sense Temperature. New instrument for telemetry By C. Dean	52
Static Inverter Delivers Regulated 3-Phase Power. Designing with silicon controlled rectifiers By M. Lilienstein	55
Remote Preamplifiers for Under Ocean Work. Are used to boost hydrophone signals By J. V. Schaefer	60
Time-Sequence Switch Safeguards Electromechanical Locks. Compact device for airborne applications By D. H. Thompson and D. Simpson	64

DEPARTMENTS

Research and Development. Multilayer Semiconductor Deposition	66
Components and Materials. New Tube Concept	70
Production Techniques. Optical Tooling Gives Precision	74
New On the Market	78
Literature of the Week	94
People and Plants	96
Index to Advertisers	106

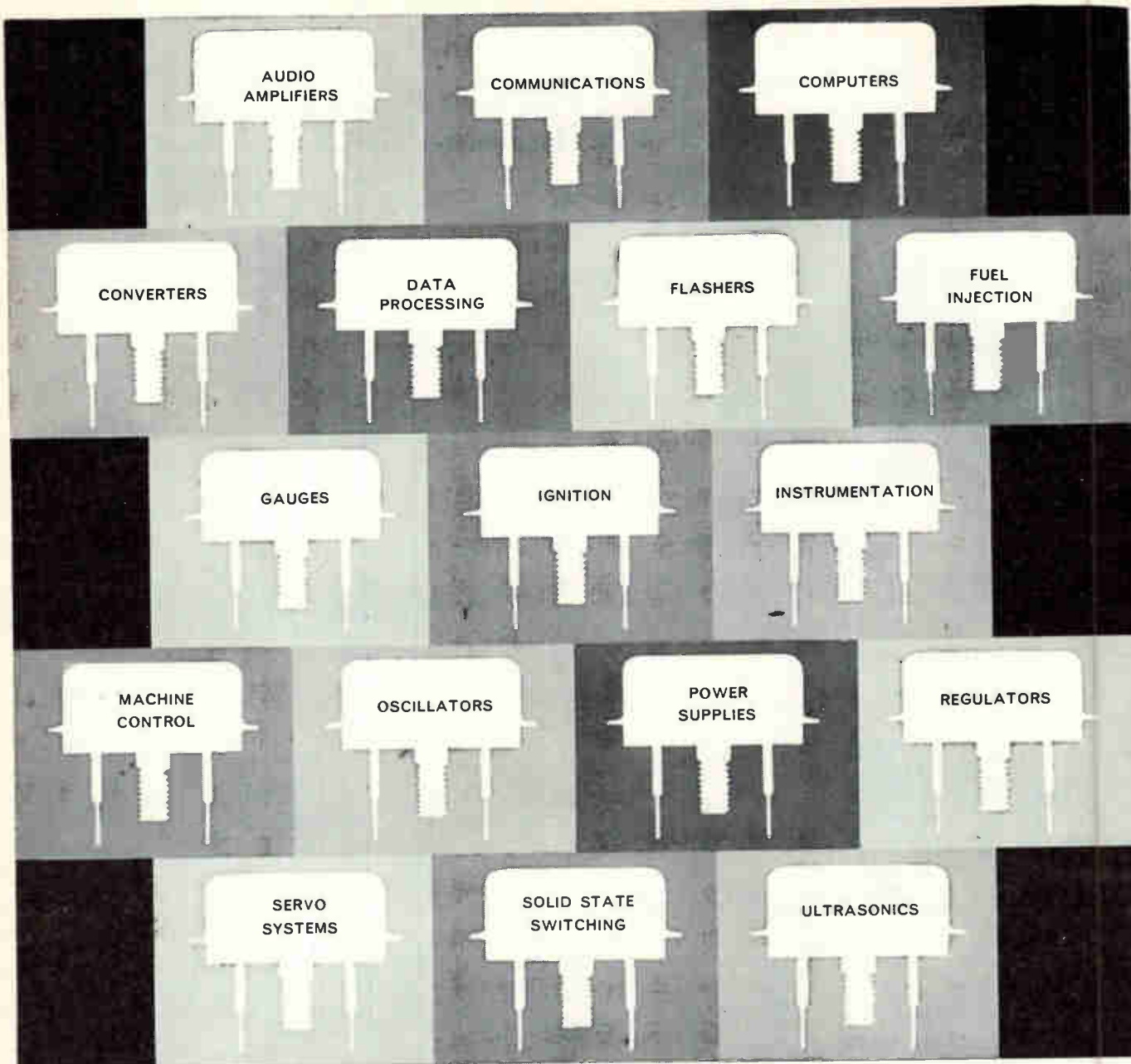

ONE TRANSISTOR - HUNDREDS OF USES

DELCO RADIO'S VERSATILE 2N174 For top performance in a wide, wide range of applications, depend on Delco Radio's 2N174.

■ This multi-purpose PNP germanium transistor is designed for general use with 28-volt power supplies, and for use with 12-volt power supplies where high reliability is desired despite the presence of voltage transients. ■ It has a high maximum emitter current of 15 amperes, a maximum collector diode rating of 80 volts and a thermal resistance below .8°C per watt. The maximum power dissipation at 71°C mounting base temperature is 30 watts. Low saturation resistance gives high efficiency in switching operations. ■ The 2N174 is versatile, rugged, reliable, stable and low priced. For more details or applications assistance on the 2N174 or other highly reliable Delco transistors, contact your nearest Delco Radio sales office.

Newark, New Jersey
1180 Raymond Boulevard
Tel.: Mitchell 2-6165

Santa Monica, California
726 Santa Monica Boulevard
Tel.: Exbrook 3-1465

Chicago, Illinois
5750 West 51st Street
Tel.: Portsmouth 7-3500

Detroit, Michigan
57 Harper Avenue
Tel.: Trinity 3-6560

Division of General Motors • Kokomo, Indiana

DELCO
RADIO
RELIABILITY

ARNOLD 6T CORES: PROTECTED AGAINST SHOCK, VIBRATION, MOISTURE, HEAT... AVAILABLE FROM STOCK

The hermetically-sealed aluminum casing method developed exclusively for Arnold 6T tape cores is packed full of advantages for you . . . *performance-improving and cost-saving advantages.*

It is compact: you can design for minimum space/weight requirements. It's extra-rigid to protect against strains. And it gives you maximum protection against environmental hazards. Arnold 6T tape cores are guaranteed against 1000-volt breakdown . . . guaranteed to meet military test specs for

resistance to shock and vibration . . . guaranteed also to meet military specs for operating temperatures. They require no additional insulation before winding, and can be vacuum-impregnated afterward.

And now a NEW Arnold service: immediate delivery on your prototype or production requirements for Deltamax 1, 2 and 4-mil Type 6T cores in the proposed EIA standard sizes (see AIEE Publication 430). A revolving stock of approximately 20,000 Deltamax cores in these sizes is ready for you

on warehouse shelves. Subject to prior sale, of course, they're available for shipment *the same day your order is received.*

Use Arnold 6T cores in *your* designs. Technical data is available; ask for Bulletin TC-101A and Supplement 2A (dated June '60). Write *The Arnold Engineering Company, Main Office and Plant, Marengo, Ill.*

ADDRESS DEPT. E-7.



ARNOLD
SPECIALISTS in MAGNETIC MATERIALS

BRANCH OFFICES and REPRESENTATIVES in PRINCIPAL CITIES • Find them FAST in the YELLOW PAGES

1938

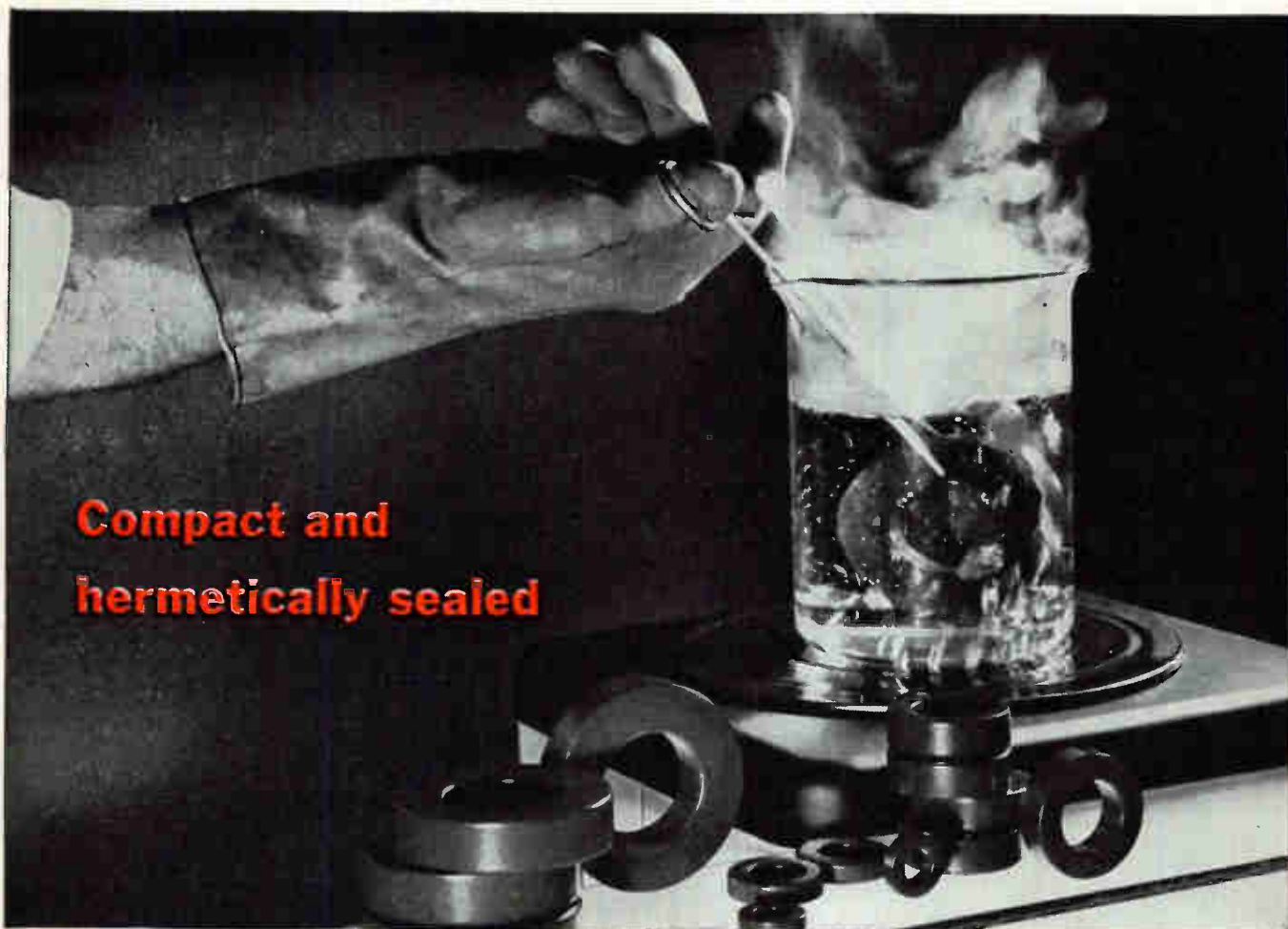

**Compact and
hermetically sealed**

Published weekly, including the ELECTRONICS BUYERS' GUIDE and REFERENCE Issue in mid-July as part of the subscription, by McGraw-Hill Publishing Company, Inc., James H. McGraw (1860-1948) Founder.

Executive, Editorial, Circulation and Advertising Offices: McGraw-Hill Building, 330 W. 42 St., New York 36, N. Y. Longacre 4-3000. Publication Office: 99-129 North Broadway, Albany 1, N. Y. See panel below for directions regarding subscriptions or change of address.

OFFICERS OF THE PUBLICATIONS DIVISION: Nelson L. Bond, President; Shelton Fisher, Wallace F. Traendly, Senior Vice Presidents; John R. Callahan, Vice President and Editorial Director; Joseph H. Allen, Vice President and Director of Advertising Sales; A. R. Venezian, Vice President and Circulation Coordinator. **OFFICERS OF THE CORPORATION:** Donald C. McGraw, President; Joseph A. Gerardi, Hugh J. Kelly, Harry L. Waddell, Executive Vice Presidents; L. Keith Goodrich, Vice President and Treasurer; John J. Cooke, Secretary.

Subscriptions are solicited only from persons engaged in theory, research, design, production, management and use of electronic equipment. **POSITION and COMPANY CONNECTION** must be indicated on subscription orders. Subscription rates for individuals within the field of the Publication: United States and United States Possessions, \$6.00 one year; \$9.00 two years; \$12.00 three years. Canada, \$10.00 one year. All other countries \$20.00 one year. Single Copies, United States, United States Possessions and Canada 75¢; Buyers' Guide \$3.00; Single Copies all other countries \$1.50; Buyers' Guide \$10.00.

Our primary aim is to provide subscribers with a useful, valuable publication. Your comments and suggestions for improvement are encouraged and will be most welcome. The publisher, upon written request from any subscriber to our New York Office, agrees to refund the part of the subscription price applying to copies not yet mailed.

Second class postage paid at Albany, N. Y. Printed in U.S.A. Copyright 1960 by McGraw-Hill Publishing Co., Inc.—All Rights Reserved. Title registered in U. S. Patent Office.

BRANCH OFFICES: 520 North Michigan Avenue, Chicago 11; 68 Post Street, San Francisco 4; McGraw-Hill House, London E. C. 4; 85 Westendstrasse, Frankfurt/Main; National Press Bldg., Washington 4, D. C.; Six Penn Center Plaza, Philadelphia 3; Four Gateway Center, Pittsburgh 22; 55 Public Square, Cleveland 13; 856 Penobscot Bldg., Detroit 26; 3615 Olive St., St. Louis 8; 350 Park Square Bldg., Boston 16; 1301 Rhodes-Haverty Bldg., Atlanta 3; 1125 West Sixth St., Los Angeles 17; 1740 Broadway, Denver 2; 901 Vaughn Bldg., Dallas 1. ELECTRONICS is indexed semiannually, in July and December, and regularly in The Engineering Index.

Subscriptions: Send subscription correspondence and change of address to Fulfillment Manager, Electronics, 330 West 42nd Street, New York 36, N. Y. Subscribers should notify Fulfillment Manager promptly of any change of address, giving old as well as new address, and including postal zone number, if any. If possible, enclose an address label from a recent issue of the magazine. Since copies are addressed one to two issues in advance, please allow one month for change of address to become effective.

Postmaster: please send form 3579 to Electronics, 330 W. 42nd St., New York 36, N. Y.



Audited Paid Circulation

CROSSTALK

SEA NOISE. Looking through the book this week you'll find (on p 60) another of what some of our editors are beginning to call nature studies. This one, written by Jan Schaefer of the U. S. Navy Electronics Lab in San Diego, Calif., is on the measurement of ambient sea noise by using remote preamplifiers with the hydrophones located on the sea bottom.

Still other basic articles are in the works. Next week there will be one on a wind velocity telemetering system. And the July 29 issue will carry a Special Report on electronic systems for probing nature—undersea, underground, living matter, our atmosphere and space. It seems right, in an age when so much electronic equipment is being designed for new uses, that we should be taking this tack.

POLITICAL CONVENTIONS. Equipment by the trailerload is moving to Chicago and Los Angeles to cover the national conventions of both political parties. (The Democrats start Monday in Los Angeles, the Republicans begin July 25 in Chicago.) With the growth in scope of the political scene, there have arisen new concepts in tv monitoring, switching, remote pickups and electronic storage and video and audio information. In some cases, the developers hint at commercial applications for their equipment, once the conventions and their special requirements are over. To learn what some of the problems are, and how broadcasters are solving them, see p 30.

Coming In Our July 15 Issue

MICROCIRCUIT FABRICATION. Electron beam techniques may bring a real breakthrough in the development of microelectronic circuits. According to speakers at the recent Alloyd Corp. symposium on electron beam processes, in Boston, such techniques may eventually allow formation of complete semiconductor circuits within a vacuum system. Bulk material would be loaded into the electron beam facility and the finished circuit would be taken out. Electron beams can be used as a heat source for microminiature machining, melting, evaporating, welding and sintering. Reporting on papers delivered at the symposium is Tom Maguire, ELECTRONICS' New England Regional Editor. His report is the cover story.

HALL-EFFECT MULTIPLIER. An interesting application of the Hall generator is described next week in an article entitled Hall-Effect Multipliers. It is authored by William Scanga, Albert Hilbinger and Carroll Barrack of Aircraft Armaments, Inc., in Cockeysville, Md. Using commercially available semiconductors and transistor amplifiers of simple design, they have developed an experimental Hall-effect multiplier that has moderate accuracy (0.1 to 1 percent), wide bandwidth (several Kc), and is relatively inexpensive. An important use of the Hall multiplier is in the computing field. Because of its unique features, the authors say, it should find wide application in transistor analog computers.

FURTHERMORE. We will be publishing an article on a multipurpose missile system test unit. Called DEE (Digital Evaluation Equipment), the system checks out the electronic subassemblies of the Hawk, Nike family, Corporal and Lacrosse missile systems and their associated ground launch and control equipment. The article was written by D. B. Dobson and L. L. Wolff of RCA in Camden, N. J.

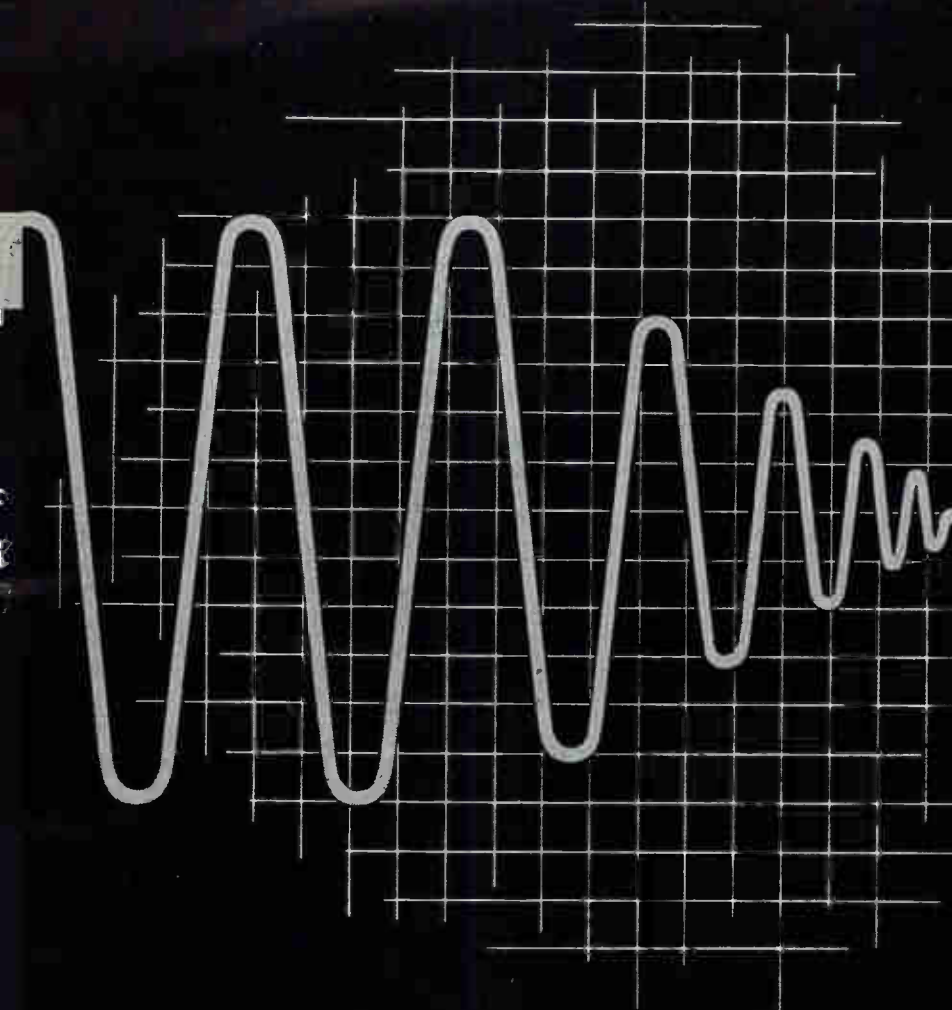

A Pair of Smoothies For Series Regulator Service

The Raytheon CK6336A and CK6528 are mechanically rugged, long-life twin power triodes. They are designed to handle large currents over a wide voltage range and at high temperatures in regulated power supplies. Zirconium coated graphite anodes, ceramic insulators, gold plated molybdenum grid wires, and hard glass envelopes are some of the advanced design features of both types.

Stringent power supply regulation requirements are no problem for these "smoothies." Get full technical data on the CK6336A and CK6528 as well as Raytheon's expanding line of high voltage rectifiers, pulse modulators, and transmitting types. Please write to: Raytheon, Industrial Components Division, 55 Chapel St., Newton 58, Mass.

For Small Order or Prototype Requirements See Your Local Franchised Raytheon Distributor.

RATINGS

	Max. Plate Voltage	Max. Plate Dissipation Watts	Max. Plate Current (per plate)	Amplification Factor
CK6336A	400	2 x 30	400 mAdc	2.7
CK6528	400	2 x 30	300 mAdc	9

RAYTHEON COMPANY

INDUSTRIAL COMPONENTS DIVISION
CIRCLE 5 ON READER SERVICE CARD

RAYTHEON CK6336A AND CK6528



FIRM FOOTING

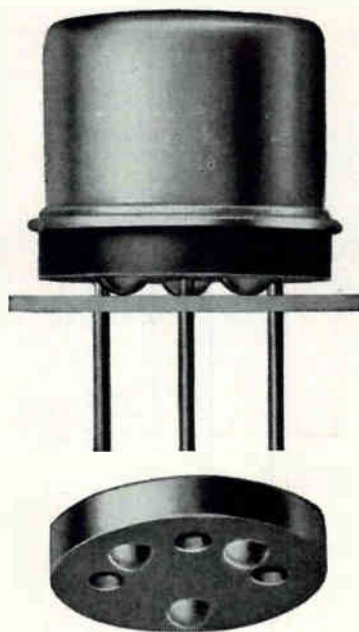

FOR TRANSISTORS

Transipads put a little

extra security into printed-circuit assemblies. For a cost you count in pennies. A Transipad mounting is rock solid. It eliminates strain on delicate leads, provides vibration-proof separation between them. It isolates the transistor case from contact with printed conductors. And, perhaps most important, it provides a built-in air space to dissipate the heat of soldering (how many transistors have you lost lately through heat shock?). Transipads come in sizes and styles to fit most transistor types; some will convert lead arrangements from in-line to pin-circle, or vice-versa; others will widen lead spacing. Samples and drawings are yours for the asking. A note or a phone call will bring them.



THE MILTON ROSS COMPANY

238 Jacksonville Road, Hatboro, Pa. Phone: OSborne 2-0551

COMMENT

Statistical Legerdemain

Thanks very much to McGraw-Hill's Department of Economics for preparing the reasoned analysis of the Eckstein Report ("Recent Economic Growth — The Numbers Game," p 30, May 27), and to you for publishing it. It's good to see a responsible publishing house expose such statistical legerdemain as was contained in the Joint Committee report—obviously to buffalo the voter. Thanks for putting the facts in a clear and honest light.

D. H. BENTON

ATLANTA

The old Scripps-Howard motto—"give light and the people will find their own way"—serves both trade and consumer press equally well.

Electronics in Japan

Just finished looking over your report on Japan and would like to extend my compliments for an article that is not only thorough and informative, but interesting reading as well . . .

IRWIN I. STEINBERG

LORAL ELECTRONICS
NEW YORK

. . . I think the Japanese run-down is one of the finest things you have published in a long time; and is a distinct contribution to today's literature on the subject.

I think that perhaps my judgment is not so much snap-judgment as it once was (in the early days) I'd endorse almost anything; same as movie stars, I guess. This bit of approval has backing. In the last three years I have been in Japan on three trips of six weeks each. . .

RALPH L. POWER
LITTLEROCK, CALIF.

Ions and Health

Ref. your article "Ions Affect Health, Behavior" in the Feb. 26 issue of ELECTRONICS (p 45), and subsequent reader comment in the May 27 issue (p 6): I have noted rather consistent correlation between the barometric pressure and

30 db gain in 200 mc RF amplifier

30 DB GAIN 16 MC BANDWIDTH IN 200 MC RF AMPLIFIER

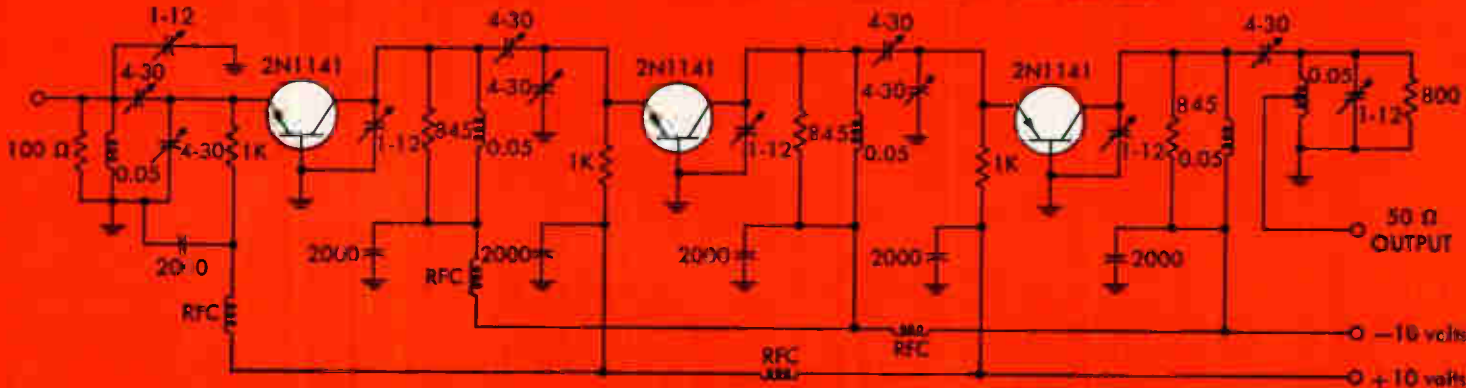

.05 μ h coils: 1 turn #14 Tinned Bus Wire; Air Core Diameter $\frac{1}{8}$ " ; All Capacitors in mmfd.
All Resistors are TI MIL-Line Precision Carbon Film; All RFC's encapsulated and self resonant @ 200 mc.

...with TI 2N1141 series germanium mesa transistors

Exceptionally high ac beta TI 2N1141 germanium mesa transistors provide 30 db gain — *with 16 mc bandwidth* — in a 200 mc RF amplifier. Ideal for your high frequency amplifiers and power oscillators, 2N1141 series diffused base transistors give you ... maximum dissipation to 750 mw ... voltage ratings to 35v at 100 μ a I_C ... 750 mc alpha cutoff.

These devices are backed by *more than 3,500,000 unit hours* of life test reliability data ... see curves below.

TYPICAL RF RESPONSE

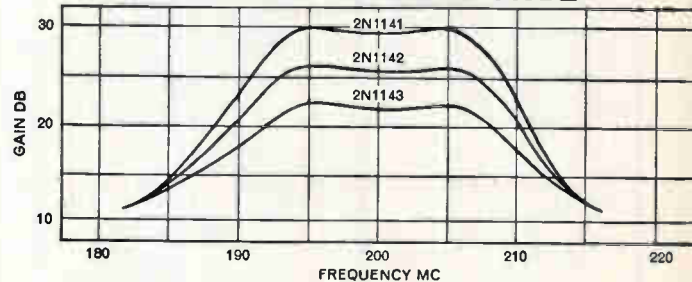

TYPICAL CHARACTERISTICS AT 25°C

	2N1141	2N1142	2N1143	unit
$f_{\alpha b}$	750	600	480	mc
C_{Tc}	1.2	1.4	1.5	μ sec
$r_{b'}$	65	80	110	ohms

UNIT TYPE 2N1142: I_{CBO} AND h_{FE} VS HOURS OF STORAGE AT +100°C

TEST LEGEND: Sample Size: 1000 units ■ Test Condition: Storage at +100°C ■ I_{C0} Measured at: $V_{CB} = -20v, I_E = 0$ ■ h_{FE} Measured at: $V_{CE} = -6v, I_C = -10ma$

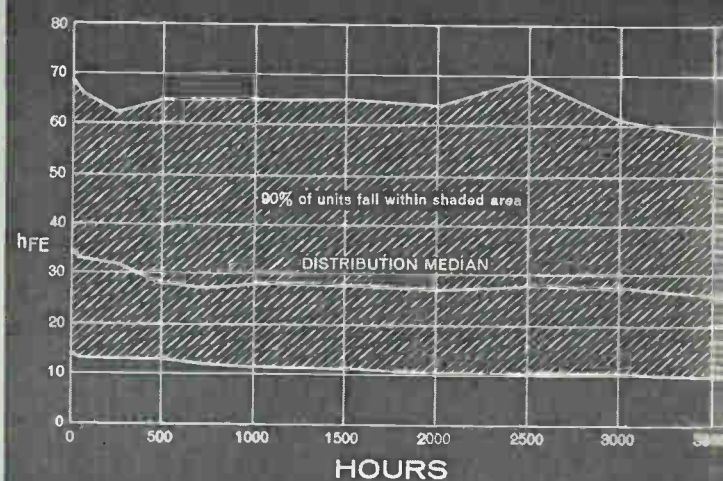
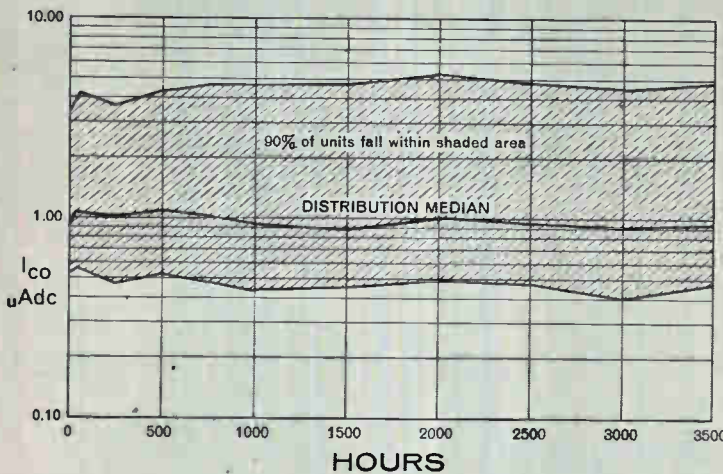

Contact your nearest TI distributor or sales office for immediate delivery.

DESIGN LEADERSHIP
IN QUALITY
GERMANIUM TRANSISTORS

TEXAS  INSTRUMENTS
INCORPORATED
SEMICONDUCTOR COMPONENTS DIVISION
13500 N. CENTRAL EXPRESSWAY
POST OFFICE BOX 312 - DALLAS, TEXAS

CIRCLE 7 ON READER SERVICE CARD



most
bugs
have
antennas

...but the reverse of the above statement is being challenged successfully at Dorne & Margolin, Inc.

It has taken insects thousands of years to evolve countless variations of antennas to suit environmental conditions and adapt them to perform specific functions perfectly. Dorne & Margolin engineers have less time at their disposal, yet they achieve similarly satisfactory end results.

And the insect world has nothing on Dorne & Margolin when it comes to all-out organization to get the job done. Meticulous as bees, determined as ants, more curious than moths... that's the approach to every problem in components or systems... aircraft or missiles, practiced by D & M engineers.

The results have been products in which we can confidently take pride... just ask our customers*. By the way, our engineers still have a healthy and creative curiosity about antenna problems. If there's one plaguing you, no matter how large... or small, drop us a line.

*A customer list is included in our Antenna Catalog. Write for your copy today.



DORNE & MARGOLIN, Inc.

WEST COAST:
1434 Westwood Boulevard
Los Angeles, California

EAST COAST:
29 New York Avenue
Westbury, L. I., New York

If you're an engineer whose creative curiosity is matched by a desire for many organizational benefits, including stock participation, contact R. E. Anderson, Chief Engineer.

wellbeing of myself and some friends...

C. C. BOPP

AVCO CORPORATION
CINCINNATI, O.

Data Links

We noted with interest your article on data communications ("Data Links Use Common Carrier," p 38, May 27). We certainly were pleased to note the reference to Collins Radio in the article, in regard to the system we have installed for the Army Signal Supply Agency.

The one negative word (which I believe the Department of Defense included in its own release) was "prototype." Our Kineplex data-communications systems have been developed and marketed for some time now; there are several systems in operation in classified government and military applications, and commercial installations are beginning to fall into place...

BEN WARNER JR.

COLLINS RADIO CO.
BURBANK, CALIF.

Neglected Area

Since you must generally be seeking new ideas for articles, why not follow a suggestion which was printed at the top of p 35 of the June 10 issue of *ELECTRONICS* (in "British Seek More Reliability Data;" the suggestion was to include "practical training courses in the electronics engineers' syllabus on how and when to use the right components")?

I heartily also endorse the idea. I feel it is the most neglected area, both in college and in journals such as you publish.

EDWARD S. IDA
MILMONT PARK, PENNA.

Pulse Generator

In our article entitled "Pulse Generator for Synchronizing Events," in the June 10 issue of *ELECTRONICS* (p 63), the amplitude of the output pulse should have been given as 40 v for open circuit and 30 v for a 90-ohm load. This high peak power is what makes this generator unusual.

ROBERT E. DANIELS
ARGONNE NATIONAL LABORATORY
ARGONNE, ILL.

EXTRA QUALITY AT NO EXTRA COST WITH BENDIX TRANSISTORS



Bendix Bulletin



Up-to-the-minute news about transistors

NEW DAP TRANSISTORS SWITCH 5 TIMES FASTER

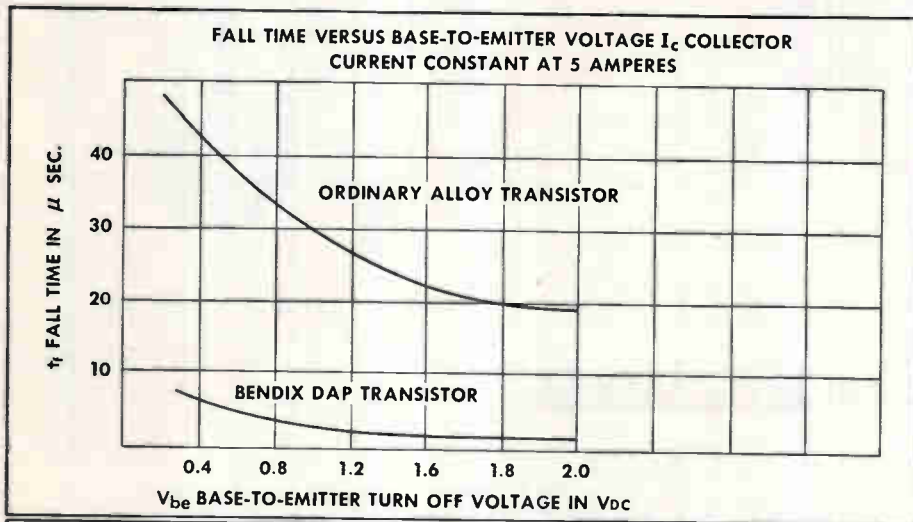

Higher breakdown than ordinary transistors also a DAP feature.

Now design engineers are freed from many of the limitations imposed by ordinary germanium alloy transistors. Bendix* germanium PNP Diffused-Alloy-Power DAP* transistors can switch up to 10 amperes with typical speeds of a microsecond.

While maintaining high collector-to-emitter breakdown voltage—up to 120 volts—the new transistors provide lower input resistance, controlled current gain, and higher cut-off frequency. Particularly suited to high current, high frequency switching, the DAP transistor's exclusive features will suggest to the design engineer many new applications which, until now, have not been feasible.

NEW BENDIX SEMICONDUCTOR CATALOG on our complete line of power transistors, power rectifiers and driver transistors available on request.

Bendix offers many challenging opportunities in semiconductor engineering and sales. Write Personnel Manager for full details.

*TRADEMARK

SEMICONDUCTOR PRODUCTS
Red Bank Division
LONG BRANCH, N. J.



West Coast Sales Office:
117 E. Providencia Avenue, Burbank, California

Midwest Sales Office:
2N565 York Road, Elmhurst, Illinois

New England Sales Office:
4 Lloyd Road, Tewksbury, Massachusetts

Export Sales Office: Bendix International Division,
205 E. 42nd Street, New York 17, New York

Canadian Affiliate: Computing Devices of Canada, Ltd.,
P. O. Box 508, Ottawa 4, Ontario, Canada

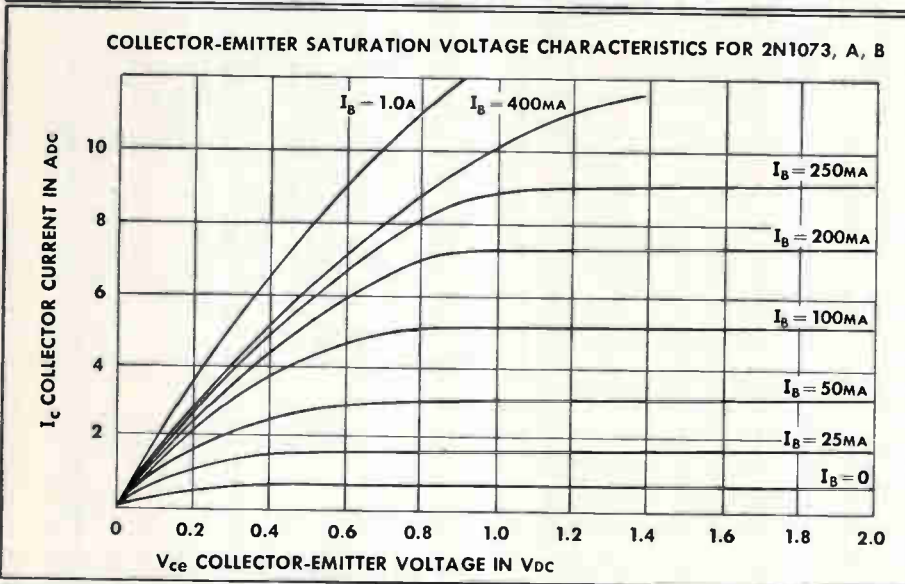

ABSOLUTE MAXIMUM RATINGS

TYPE NUMBERS	V_{ce} Vdc	V_{cb} Vdc	V_{eb} Vdc	I_c Adc	P_c W	T Storage °C	T_j °C
2N1073	-40	-40	10	10	35	-60 to +100	100
2N1073A	-80	-80					
2N1073B	-120	-120					

Ideal for such applications as: ULTRASONICS • HORIZONTAL OUTPUT AMPLIFIERS FOR TV OR CATHODE RAY TUBES • POWER CONVERTERS • HIGH CURRENT AC SWITCHING • CORE DRIVERS • HI-FI

*This unique "extra"
fifth digit...*



*...provides 100%
over-ranging...ten times
greater resolution at decade
voltage points where other 4-digit
voltmeters change ranges and lose
one full digit of resolution.*

The KIN TEL Model 501 4-digit, over-ranging digital voltmeter measures DC from ± 0.0001 to ± 1000.0 volts with $0.01\% \pm 1$ digit (of reading) accuracy. An extra fifth digit in the left decade indicates "0" or "1" to provide ten times greater resolution at decade (1, 10, 100) voltage points than standard 4-digit voltmeters. Ranging and polarity indication are entirely automatic. The measured voltage, decimal point and polarity symbol are displayed on an in-line readout in a single plane—no superimposed outlines of "off" digits.

An adjustable sensitivity control permits decreasing sensitivity to allow measurement of noisy signals. Ten-line, parallel input printers can be driven directly, and converters are available for driving other types of printers, typewriters, and card or tape punches. The input may be floated up to 25 volts DC above or below chassis ground with no degradation in performance, and up to 250 volts DC with slight decrease in accuracy. Stepping-switch drive coils are energized with DC as in telephone-type service to provide long, trouble-free operation.

The 501 is one of a complete line of KIN TEL digital instruments. Others include AC converters, AC and DC preamplifiers, ratiometers, and multi-channel input scanners.

IMPORTANT SPECIFICATIONS

Display... Six decades display 5 digits (Left digit "0" or "1" only), decimal point, polarity symbol. Ranging and polarity indication are automatic. Projection system readout employs bayonet-base lamps with 3000-hour minimum life rating. Readout contains no electronic circuitry and can be remotely mounted.

Automatic Ranges... ± 0.0001 to ± 1000.0 volts DC in four ranges: 0.0001 to 1.9999; 02.000 to 19.999; 020.00 to 199.99; 0200.0 to 1000.0

Accuracy... $0.01\% \pm 1$ digit (of reading).

Input Impedance... 10 megohms on all ranges at null.

Reference Voltage... Chopper-stabilized supply, continuously and automatically referenced to standard cell.

Stepping-Switch Drive... DC voltage within stepping-switch manufacturers rating applied by transistor drive circuit at rate of approximately 20 steps per second.

Controls... Three: on-off; sensitivity; and mode of operation (standby, normal, print auto, print remote).

Printer Drive... Built-in for parallel input printers. Automatic or remote.

Dimensions and Net Weights... Control unit: 45 lbs, 5 1/4" H x 19" W x 16" D.
Readout: 10 lbs, 3 1/2" H x 19" W x 9" D.

Price: \$2995

KIN TEL manufactures electronic instruments for measurement and control, and closed circuit TV. Representatives in all major cities. Write for detailed literature or demonstration.

5725 Kearny Villa Road, San Diego 11, California, Phone: BRowning 7-6700



ELECTRONICS NEWSLETTER

Thermoelectric Generator Undergoing Test

LIGHTWEIGHT GENERATOR designed to power space probes and satellites for periods of a year or more is now undergoing tests at Martin's Baltimore laboratories. Named SNAP-1A (system for nuclear auxiliary power), the power system is intended to put out more electricity for longer periods than other power units developed for space vehicles.

The thermoelectric device uses a tightly sealed Inconel-X capsule filled with spontaneously decaying cerium-144 pellets. Heat from the decay of the Ce-144 is directly converted into electricity by a lead telluride sheath surrounding the capsule.

The egg-shaped power supply is 3 ft long, weighs 175 lb, can produce 125 w at 28 v d-c continuously for a year, Martin spokesmen say. To shield the space-probe ground crew prior to launching, the egg is filled with two tons of mercury which is drained out five seconds before firing.

Japanese Put Off Freeing Electronics Imports

OPEN COMPETITION between Japanese and U. S. electronics industry in Japan's home market is postponed for three years by recent decision of the Ministry of International Trade & Industry. MITI decided to withdraw electronic instruments and appliances from the list of commodities subject to immediate liberalization of import restrictions, put off freeing the market for three years. This means Japanese buyers will have to continue getting Finance Ministry clearance to buy electronic goods of foreign manufacture.

In another action, MITI reestablished export quotas for transistor radios containing from three to eight transistors. The quotas have been suspended since May 10 when a flood of requests for export permission scared the ministry into action to prevent reprisal by U. S. manufacturers.

Quotas took effect last Friday, will be in force until yearend, will

not apply to f-m sets or toy radios. Quotas will be assigned on the basis of a 20-percent hike over actual exports during 1958 and 1959. Penalties, including cancellation of quota, will be imposed on any firm found violating the floor prices set Apr. 11, or evading the floor price by exporting to the U. S. and Canada through a third country.

German Firm Develops Pocket Direction-Finder

MINIATURE direction-finder, measuring 6.1 in. by 4.6 in. by 2.2 in., and weighing about 2.2 lb, has been developed by Telefunken. Receiver uses transistors and subminiature tubes, operates on a lightweight power supply, can be carried in the pocket or fastened to a belt.

Overall frequency range is 57 Kc to 20 Mc, divided into 10 bands. A separate coil cartridge is inserted for each of the bands. Set contains a ferrite antenna claimed to be adequate for taking near-field readings; larger d-f loops are provided which can be fastened to the operator's coat or carried on the shoulders.

Meter for indicating relative field strength is worn on the wrist. To find bearing, operator rotates himself for minimum signal on the meter, can also use a headphone and rotate for minimum volume.

Electronic Neuron Model Copies Nerve System

ARTIFICIAL NEURON designed to duplicate portions of the human nervous system and go through rudimentary learning processes has been developed by Aeronutronic division of Ford Motor Co. The device, called MIND (for magnetic integrator neuron duplicator), is a multiple-wound toroid of ceramic magnetic material about one fourth the size of a penny.

Unit can simulate the ability of a neuron to function more easily with repetition because of a lowered input threshold. The core has an analog-memory characteristic that integrates pulse inputs, and can be sampled without destroying the remembered data.

Pulses are read in to the "neuron"

through a winding that passes through the center hole. The core is interrogated by a small pulse sent through a fine-wire winding laid into a groove in the toroid. This pulse slightly disturbs the magnetic flux in the core, producing an output voltage across the read-in coil, but does not change or cancel the state of the core magnetization.

To date, an artificial "nerve net" has been built using several core units and transistor circuits. Aeronutronics' program aims to develop machines capable of duplicating the activities—and the reliability—of the nervous system.

U. S., Italian Interests Set Up Electronic Company

NEW ITALIAN FIRM to produce military and civilian electronic gear will be established by Raytheon and two Italian companies. The new firm, called Selenia and the second of Raytheon's ventures in Italy, will make most of the Hawk missiles assigned to Italy by NATO, also will produce radar, industrial controls and instruments. About 60 percent of the firm's work is expected to be in military production.

Joining Raytheon in the venture are Finmeccanica, a government property, and the Edison Company of Milan. Selenia will be 60-percent Italian owned, will set up shop in two existing plants, an Edison plant near Rome and a Finmeccanica shop in Fusaro, near Naples. The two plants comprise 750,000 sq ft of floor space, employ 700.

Raytheon will contribute \$3 million in capital, original technical cadres, continuing technical assistance. Present plans call for eventual replacement of the cadre of American technicians by Italians.

Japan To Make Linear Klystrons

HIGH-POWER linear klystrons, hitherto only explored as a production possibility by most of Japan's electronics manufacturers, will be manufactured by Kobe Kogyo and Nippon Electric under patent license from the Sperry division of Sperry Rand.

The contract runs five years, was approved last week by Japan's Finance Ministry. The two Japanese firms pay 2.5-percent royalty on sales.

Now available...



MILITARY TYPE

Silicon Mesa Transistors

USA 2N696
USA 2N697

Per: MIL-S-19500/99A

AT LAST YOU CAN USE these advanced types in military equipment without having to obtain "non-standard part approval". And Rheem can deliver both types in production quantities *immediately* at no increase in price.

These and *all* Rheem transistors are subjected to reliability testing which includes: 100%—300°C storage; 100%—two hermetic seal tests; 100%—temperature cycling. A sample of every lot must pass 15 environmental tests which exceed the most stringent combination of military specifications. And complete individual lot control is maintained. These tests are only part of the Rheem "Mark XII: Master Test Specification for Silicon Mesa Transistors". Applied to all Rheem transistors, "Mark XII" is the industry's tightest synthesis of reliability test specifications.

Why not get in touch with us today?

RHEEM RELIABILITY ALSO AVAILABLE IN THESE SILICON MESA TRANSISTORS . . .

VERY HIGH CURRENT FAST SWITCHING	HIGH CURRENT FAST SWITCHING	MEDIUM POWER GENERAL PURPOSE	MEDIUM POWER LOW STORAGE
RT5001	2N698	*2N497	2N1252
RT5002	2N699	*2N498	2N1253
RT5003	2N1409	*2N656	
RT5004	2N1410	*2N657	
	2N1420		
	2N1507		
	2N1613		

*Certified to meet MIL-T-19500/74 (USN)

RHEEM SEMICONDUCTOR CORPORATION

A Subsidiary of Rheem Manufacturing Company
Dept. C1, P.O. Box 1327, Mountain View, California. YOrkshire 8-9211

SALES OFFICES Western: 5150 Wilshire Boulevard, Los Angeles, WEbster 7-1844
327 Moffett Boulevard, Mountain View, Calif. YOrkshire 8-9211
Central: 6519 Nicollet Avenue, Minneapolis 23, UNion 6-8751
18450 Livernois Avenue, Detroit 21, UNiversity 3-2879
1919 N. Harlem Avenue, Chicago 38, BErkshire 7-4200
Eastern: 610 E. Palisade Avenue, Englewood, N. J., LOwell 7-4336
401 Lowell Street, Lexington, Mass., VOlunteer 2-8850 • 6132
Baltimore Boulevard, Riverdale, Md., UNion 4-4642
Export: Dage Corporation, 219 E. 44th Street, New York 17,
Murray Hill 2-6755, Cable Address: "Dagecorp"

DISTRIBUTORS Western: Avnet Corporation, 5877 Rodeo Road, Los Angeles,
UPTon 0-6141 • Avnet Electronics Corp. of Northern California,
1262 N. Lawrence Station Road, Sunnyvale, Calif., REgent 6-0300
Westates Electronics Corp., 11334 Playa Street, Culver City, Calif.,
EXmont 1-6201
Central: Allied Radio Corp., 100 Northwestern Avenue, Chicago,
HAYmarket 1-6800
Eastern: Almo Radio Co., 412-16 N. 6th Street, Philadelphia,
WA 2-5918 • Arrow Electronics Inc., 525 Jericho Turnpike,
Mineola, L. I., N. Y., PI 6-8686 • Eastern Radio Corp.,
312 Clifton Avenue, Clifton, N. J., GREgory 1-6600 • Radio Shack Corp.,
730 Commonwealth Avenue, Boston 17, REgent 4-1000





It's the
EXTRAS
that make a
GOOD tube
GREAT!

Amperex
6939

MINIATURE UHF TWIN TETRODE

with these **Amperex EXTRAS:**

- frame grid construction
- 5 watts total anode dissipation in miniature envelope
- 5½ watts useful power in load (ICAS)
- maximum ratings to 500 Mc
- gold-plated grid for low grid emission

OPERATING CONDITIONS, AMPLIFIER, CLASS C, FM

	CCS	ICAS
Frequency	500	500 MC
Plate Voltage	180	200 volts
Screen Grid Voltage	180	200 volts
Control Grid Bias	-20	-20 volts
Plate Current	2x27.5	2x30 ma
Screen Grid Current	12.5	14 ma
Control Grid Current	2x0.75	2x0.75 ma
Driving Power	1.2	1.2 watts
Plate Input Power	2x5	2x6.2 watts
Plate Dissipation	2x2.1	2x2.6 watts
Screen Grid Dissipation	2.25	2.8 watts
Output Power	5.8	7.2 watts
Useful Power in Load	5	6 watts

Other **Amperex** replacement favorites:

- 5894 High-sensitivity VHF/UHF twin tetrode; 40 watts anode dissipation
- 6360 High-sensitivity VHF/UHF twin tetrode; 14 watts anode dissipation
- 6146 High-sensitivity beam power tube
- 866AX Mercury vapor rectifier



ask your distributor
about extra-quality

Amperex
replacement tubes

Amperex ELECTRONIC CORP.
230 Duffy Avenue, Hicksville, L. I., N. Y.

WASHINGTON OUTLOOK

NAVY IS GRAPPLING with the question of how to handle purchases of electronic equipment for the Transit navigation satellite. The Transit system is scheduled to go into operation in 1962; second prototype was lofted late last month (ELECTRONICS, p 11, July 1).

The question is whether to buy operational apparatus from Johns Hopkins' Applied Physics Laboratory, the development contractor which has built virtually all the components in the test vehicles, or to seek production bids from new manufacturing contractors. General policy of Bureau of Naval Weapons, which is in charge of Transit, is to turn over production work to hardware contractors. APL, for instance, handled design and development work on the Talos and Terrier missiles before production was undertaken by Bendix and Convair respectively.

But there's a special problem with Transit which may preclude the use of outside production contractors. For one thing, large-quantity output of electronic gear is not envisaged. An operational navigation satellite system will consist of only four spheres, with orbiting lives for each satellite planned up to five years. Furthermore, the probable requirement for constant engineering refinement of the Transit point to retention of APL as production contractor.

A different contractor will be sought to build and operate the ground receiving, tracking, and computing stations planned for the operational Transit system. The function of this firm would be similar to that of Bendix, which runs the Naval Research Laboratory's space surveillance system.

IMPORTANT ELECTRONIC MARKET will be opened up for shipboard equipment to work with the Transit satellite. This will probably include a specially engineered receiving system, including an accurate time reference and navigational computer.

The Navy has held preliminary talks with potential producers, but it has yet to disclose precisely the functions which the shipboard computers must perform. Industry has consequently been unable to prepare meaningful production cost estimates. Rough figures range from \$1,500 for a computer to work out navigation fixes accurate within half a mile for commercial vessels, all the way up to \$60,000 for more precise computers to be used aboard Navy ships.

FEDERAL COMMUNICATIONS COMMISSION is expected to approve the joint application by RKO General, Zenith Radio, and Teco Inc. for an experimental on-the-air pay-tv station in Hartford, Conn. Approval for the three-year experiment could come by September.

FCC permission does not necessarily mean pay-tv is on its way. The Commission is by no means committed to the idea, has agreed only to limited tests under well-defined conditions (no interference with reception on other channels, tests to be conducted only in cities with at least three tv channels).

Even if the experiment shows that pay-tv could be a financial success, Congress may block the whole idea. An earlier FCC effort to permit tests was buried under a landslide of Congressional mail that ran 1,000 to 1 against pay-tv. Congress has gone only so far as a committee resolution permitting the FCC to authorize strictly limited tests.

The proposed Hartford system will use a decoder produced by Zenith which receives and converts uhf, unscrambles the signal and punches a billing card at the same time. Test will get underway as soon as 2,000 decoders have been installed. Zenith figures this will be about six months after FCC approval is obtained, estimates that 10,000 subscribers will be paying for tv in Hartford by the end of a year.

MEASURE FREQUENCIES TO 18 KMC

with counter accuracy

New fixed tuned hp harmonic mixers offer "low frequency" measuring ease and accuracy, have high sensitivity, obviate tuning delays.

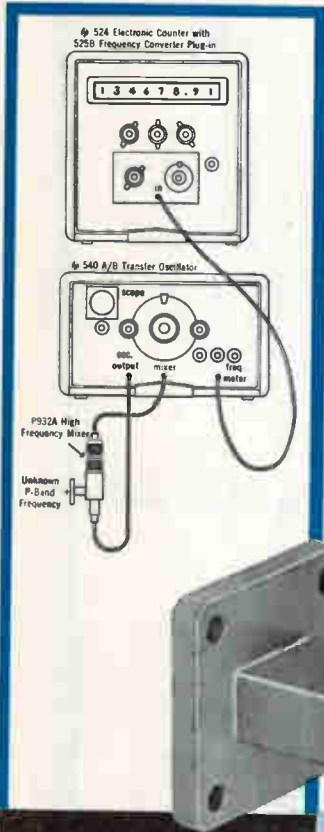

12.4 to 18 KMC P-Band New hp P932A Harmonic Mixer mounts directly in your waveguide system and operates with an hp 540A or 540B Transfer Oscillator, as indicated in the block diagram. The 540 Oscillator output is applied directly to the mixer, which generates harmonics and mixes them with the unknown waveguide frequency. The mixer's beat frequency output is applied to the 540's oscilloscope, the oscillator tuned for zero beat scope indication, and the oscillator frequency setting noted. Simple multiplication of the 540 dial frequency by the harmonic number yields the unknown to within 0.5%. Measuring the oscillator frequency on an hp 524 series counter increases accuracy of measurement on clean cw signals up to 1 part in 10^7 .

hp P932A maximum input power is 100 mw, minimum video output is 0.1 mv rms with 0 dbm input, output impedance 1000 ohms with 35 μf shunt, sensitivity approximately -10 dbm. \$250.00.

5 to 12.4 KMC New hp 934A Harmonic Mixer operates from 2 to 12.4 KMC, extends the range of the hp 540A Transfer Oscillator from 5 KMC to 12.4 KMC and offers the same advantages as the P932A, including the fixed tuned feature eliminating tedious adjustment. Maximum input power is 100 mw, typical sensitivity is -45 dbm at mid-range points, minimum video output is 0.5 mv rms (0 dbm input) and output impedance is the same as hp P932A. Model 934A \$150.00.

220 MC to 5 KMC or 12.4 KMC Hewlett-Packard 540 Transfer Oscillators (see diagram) extend the range of the hp 524 series counters to 5 KMC (hp 540A) and 12.4 KMC (hp 540B), making possible frequency measurements with counter accuracy well into the microwave region. These oscillators also measure carrier frequency of pulses, determine carrier frequency and deviation of FM signals, and measure frequency accurately despite high noise. hp 540A, \$615.00. hp 540B, \$750.00. (Rack mount models \$15.00 less.)

FREQUENCY MEASUREMENT

FREQUENCY RANGE	EQUIPMENT	TOTAL* PRICE
0 - 10 MC	524C or 524D Frequency Counter	\$2,150.00
10 - 100 MC	524C/D + 525A Converter (0-10 MC) (10-100 MC)	\$2,400.00
100 - 220 MC	524C/D + 525B Converter (0-10 MC) (100-220 MC)	\$2,400.00
220 MC - 5 KMC	524C/D + 525B (0-10 MC) (100-220 MC) + 540A Transfer Oscillator (220 MC - 5 KMC)	\$3,015.00
220 MC - 12.4 KMC	524C/D + 525B (0-10 MC) (100-220 MC) + 540A (220 MC-5 KMC) + 934A Harmonic Mixer (2-12.4 KMC)	\$3,165.00
	-or- 524C/D + 525B (0-10 MC) (100-220 MC) + 540B Transfer Oscillator (220 MC-12.4 KMC)	\$3,150.00
12.4 - 18 KMC	524C/D + 525B (0-10 MC) (100-220 MC) + 540A (220 MC - 5 KMC) + P932A Harmonic Mixer (12.4 - 18 KMC)	\$3,265.00**
	-or- 524C/D + 525B (0-10 MC) (100-220 MC) + 540B (220 MC-12.4 KMC) + P932A (12.4 - 18 KMC)	\$3,400.00

*Based on 524D Frequency Counter \$2,150.00. 524C price \$2,300.00. Counter and Transfer Oscillator prices are for cabinet mounts; rack mounts are slightly lower.

**If coverage 5-12.4 KMC is desired, add 934A, \$150.00.

Data subject to change without notice. Prices f.o.b. factory.

HEWLETT-PACKARD COMPANY

1048A Page Mill Road
Cable "HEWPACK"

Palo Alto, California, U.S.A.
Davenport 6-7000

Field representatives
in all principal areas.

HEWLETT-PACKARD S. A.
Cable "HEWPACKSA"

Rue du Vieux Billard No. 1 Geneva, Switzerland
Tel. No. (022) 26. 43. 36



NOW ...from POWER SOURCES, INC.

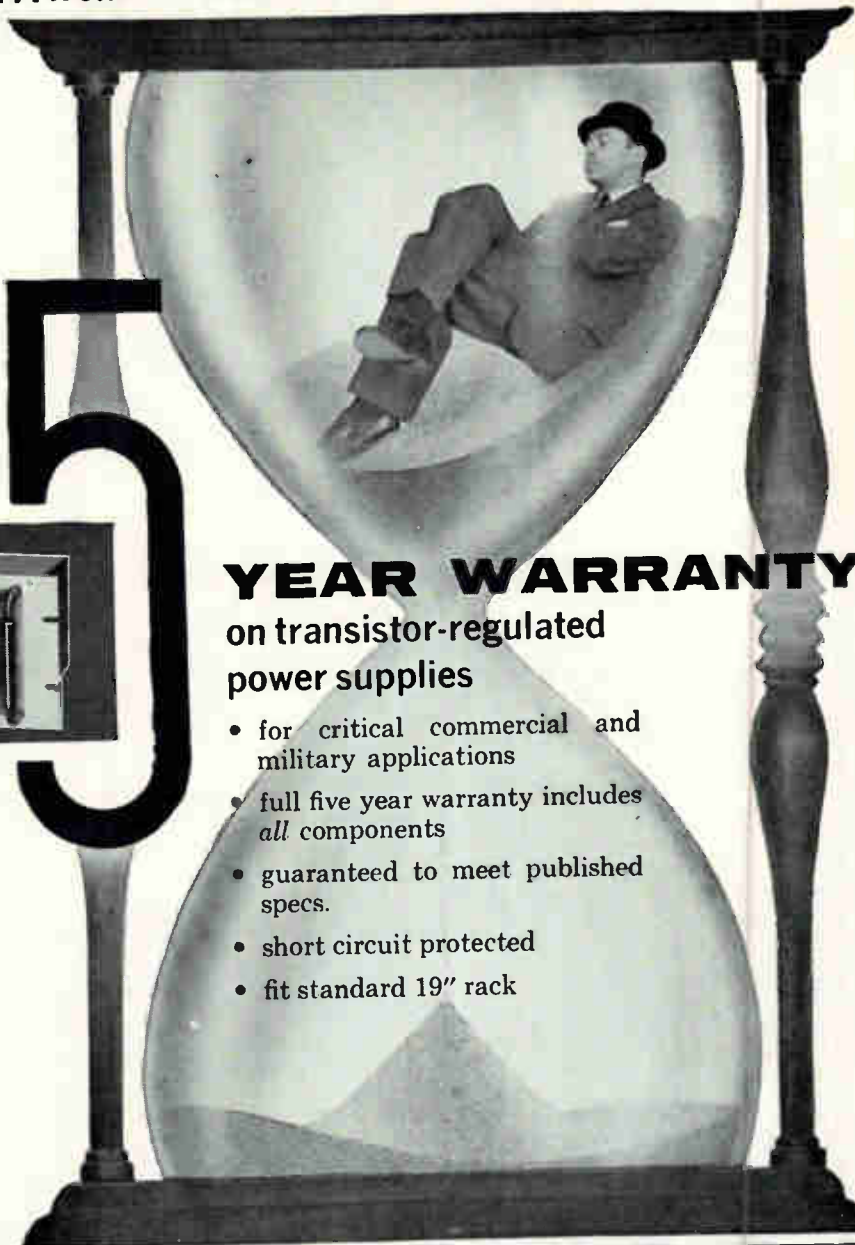

5 YEAR WARRANTY
on transistor-regulated
power supplies

- for critical commercial and military applications
- full five year warranty includes all components
- guaranteed to meet published specs.
- short circuit protected
- fit standard 19" rack

Specifications	Low Voltage			High Voltage			
	Model PS4305M	Model PS4315M	Model PS4330M	Model PS4221M	Model PS4231M	Model PS4222M	Model PS4232M
Voltage Range (VDC)	0-36	0-36	0-36	30-210	120-330	30-210	120-330
Current Range (Amps)	0-5	0-15	0-30	0.1	0.1	0-1.5	0-1.5
Regulation Against $\pm 10\%$ Line change 0 to full load	.025%	.025%	.025%	0.1%	0.1%	0.1%	0.1%
	.05%	.05%	.05%	0.1%	0.1%	0.1%	0.1%
Impedance (Ohms) DC to 100KC	.1	.02	.02	.4	.4	.2	.2
Ripple (RMS) in Millivolts	1	1	1	2	3	2	3
Panel Height	5 $\frac{1}{4}$ "	5 $\frac{1}{4}$ "	8 $\frac{3}{4}$ "	5 $\frac{1}{4}$ "	5 $\frac{1}{4}$ "	5 $\frac{1}{4}$ "	5 $\frac{1}{4}$ "
Price (See Notes)	\$545	\$890	\$1190	\$555	\$620	\$580	\$645

Note 1: If meters not desired deduct \$30 and drop "M" from model number.
 Note 2: If fixed output desired (± 5 volts) deduct \$40 and add "F" to model number followed by nominal output voltage desired.

Write for
complete
specifications

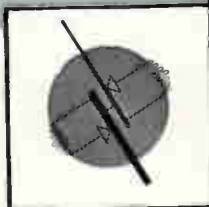

Specify POWER SOURCES BY
POWER SOURCES, INC.
BURLINGTON, MASSACHUSETTS

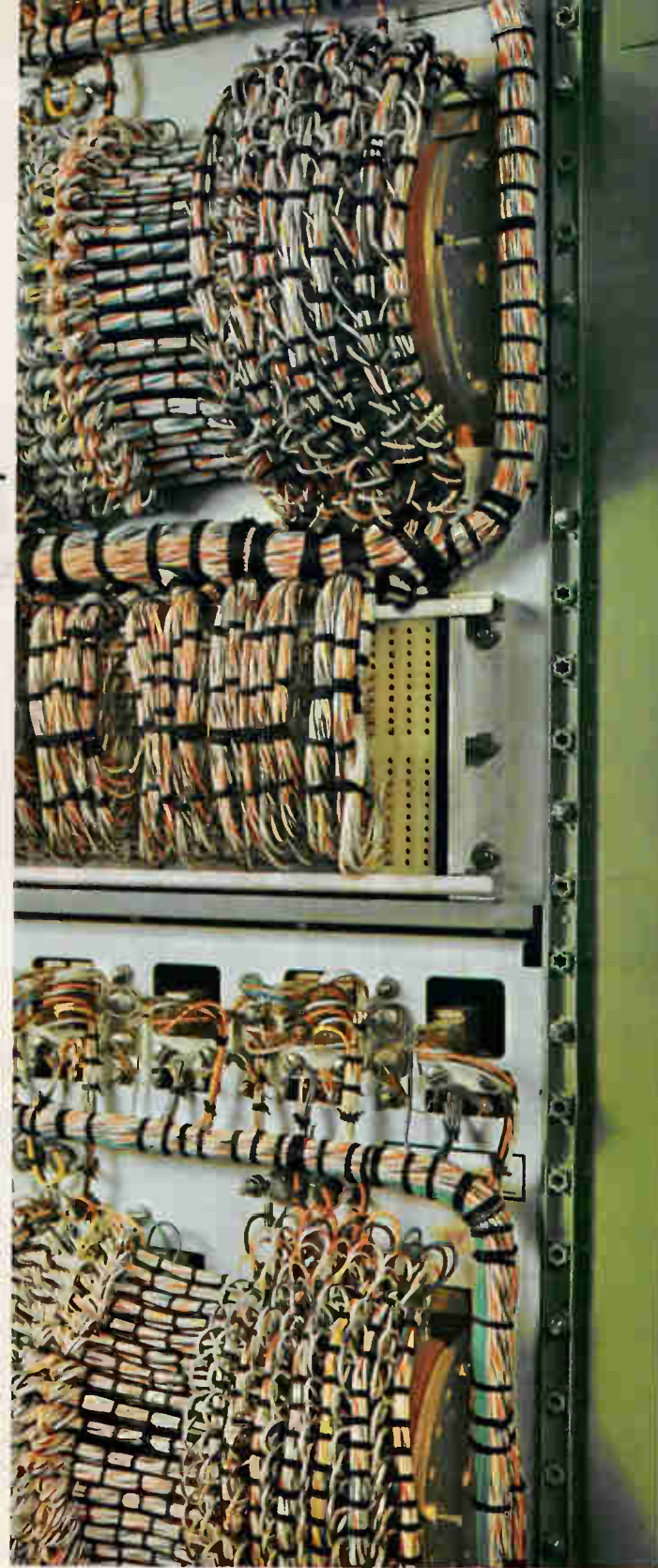

On guard against air attack—The Martin Missile Master electronic air defense system will protect ten major metropolitan areas by year's end. First installations have been delivered ahead of schedule and are now operational. According to the Army, Missile Master "will provide the most efficient and economical control and distribution of firepower available for the defense of strategic areas in the continental United States."

At 00^h 00^m 01^s GMT, July 1, 1960, Martin logged its 590,304,000th mile of space flight

MARTIN

In development test . . .

This directly-recorded Visicorder chart shows a canceller test of a number of letters through a new mail-handling machine developed by Emerson Research Laboratories for the U.S. Post Office Department. The Visicorder test took only 3 hours to solve a 3-week problem: Why letters changed speed as they went through the machine. Constant speed is necessary to register cancellation on the stamp every time. Motor speed variations, belt slippage, and letter slippage in the drive rollers were responsible. A synchronous drive motor, a timing-belt drive, and a better grade of rubber in the drive rollers were added to solve the problem at a vast saving in engineering time. The Emerson machine is designed to cancel 30,000 non-uniform letters per hour. It is under evaluation tests in the Post Office Department Laboratory, Washington, D.C.

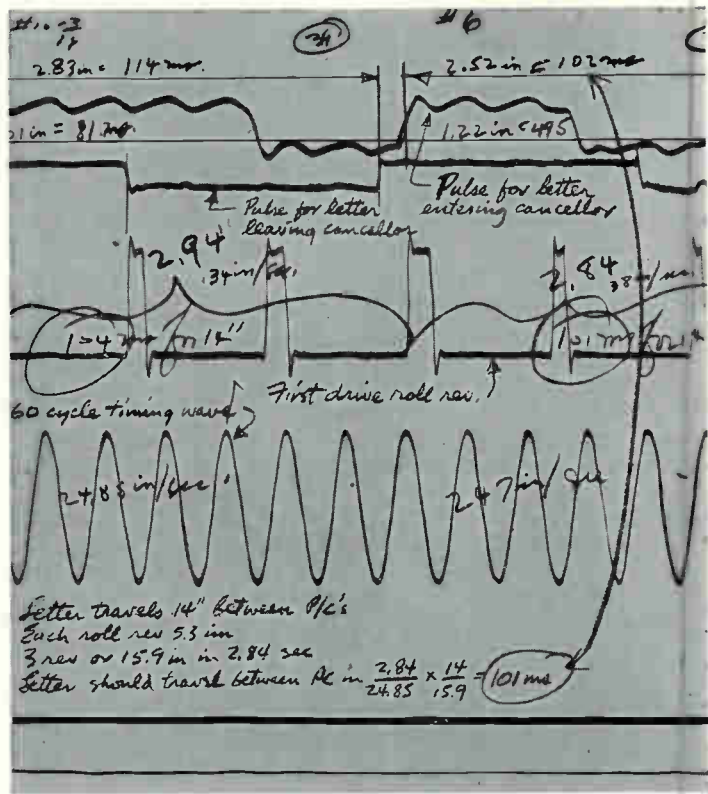

these are records of leadership

In production . . .

This comparison test of a production gyroscope was directly-recorded on a Model 906A Visicorder oscillograph by the test department of Whittaker Gyro, Van Nuys, Calif. Whittaker is a division of Telecomputing Corporation. The record shows how the Visicorder compares controlled angular velocities as a reference base to simultaneously-recorded variables, and how a dual static reference trace galvanometer simultaneously establishes a base line and a calibration line on the chart. In these and in hundreds of other scientific and industrial applications, Visicorders are bringing about new advances in product design, computing, control, rocketry, nucleonics and production.

For information on how to apply the unlimited usefulness of the Visicorder to your specific problems, phone your nearest Honeywell Industrial Sales Office.

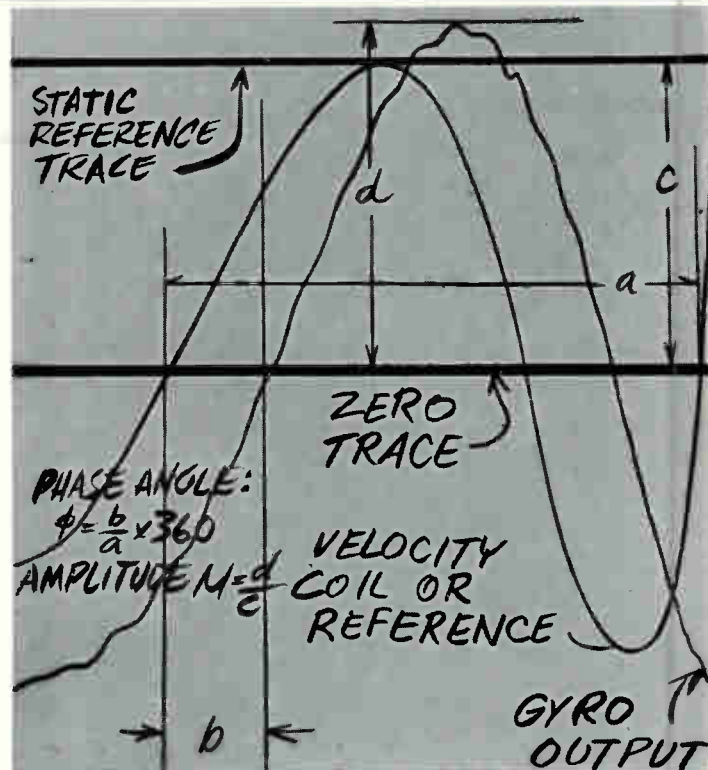

The Honeywell Visicorder provides instantly-readable, high-sensitivity data at frequencies from DC to 5000 CPS. There are models with 8, 14, or 36-channel capacities.

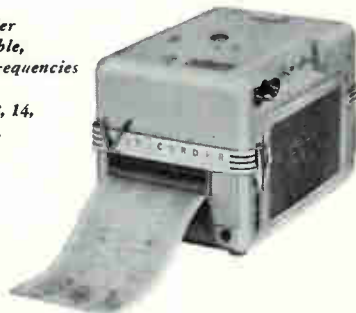

Honeywell

 Industrial Products Group

Reference Data: Write for Visicorder Bulletins 906A and 1012.

Minneapolis-Honeywell Regulator Co., Industrial Products Group, Heiland Division, 5200 E. Evans Ave., Denver 22, Colorado

Cost-cutting Carbon controls!

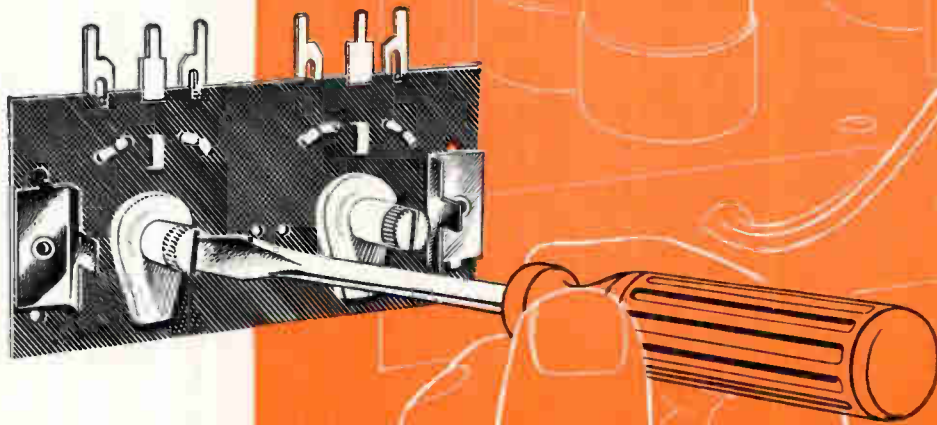

Here are strip mounted carbon controls that are masterpieces of cost-saving design. Mallory product engineers have worked out every detail of Type "EC" Carbon Controls to bring the cost DOWN . . . without sacrificing performance.

Developed primarily for back-of-chassis adjustments in TV, radio, hi-fi, and stereo designs, Mallory "EC" Controls are made with a molecularly bonded carbon composition of great density and high surface hardness. This carbon element is the same low-noise, high-stability type used in all Mallory volume controls. "EC" controls have high resistance to contamination by grease, grit, dust, or moisture in the air. Controls are available in multiple units that save on mounting costs. Units are furnished with solder or printed circuit terminals.

Mallory ingenuity in engineering controls with various types of hardware, switches and configurations can go a long way in holding control costs DOWN. We welcome the challenge of saving you money.

Mallory Controls Company
Frankfort, Indiana
a division of

P. R. MALLORY & CO. Inc.
MALLORY

See Mallory Controls Company for



wire-wound controls

vitreous resistors

power rheostats

rotary switches

plugs & jacks

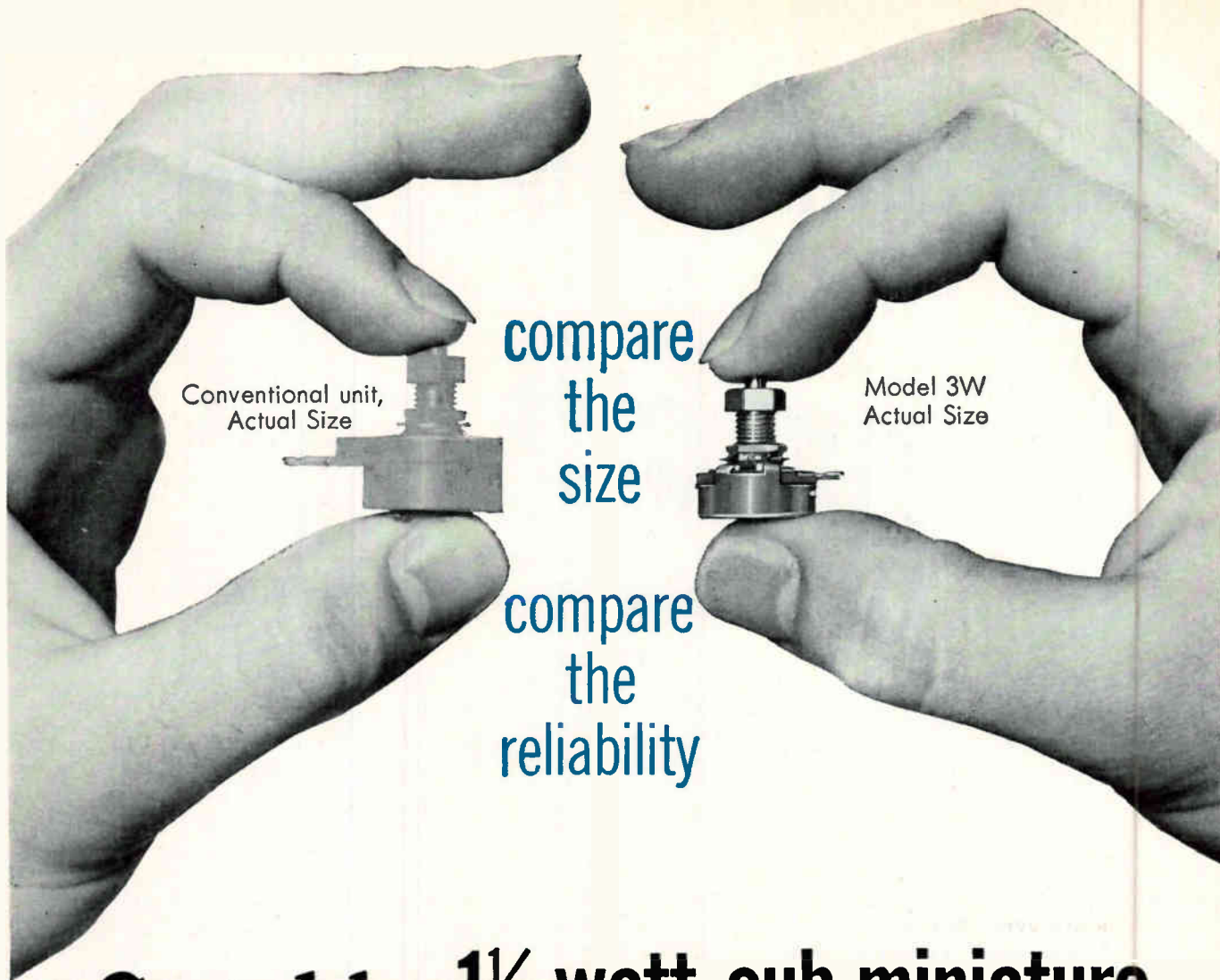

compare
the
size

compare
the
reliability

Conventional unit,
Actual Size

Model 3W
Actual Size

Centralab's 1½ watt sub-miniature Wirewound Variable Resistor

CENTRALAB'S Model 3W is the smallest 1½ watt variable resistor on the market—1/3 smaller than otherwise similar units! Designed especially for high reliability applications, it meets the environmental and electrical specifications of MIL-R-19. The Model 3W is recommended for high temperature operation up to 125°C. Its completely closed construction is designed for sealing or potting.

SPECIFICATIONS:

Dimensions: 1/16" maximum diameter over encapsulation. 5/16" depth.

Shaft: 0.125" diameter stainless steel.

Terminals: Gold-plated nickel silver.

Resistance range: 4 ohms to 30K ohms ±10%, linear taper.

Rating: 1½ watts at 40°C.

Complete specifications on the Model 3W variable resistor are given in CENTRALAB Technical Bulletin EP-891. Write for your free copy.



B-6016

The Electronics Division of Globe-Union Inc.
914G E. Keefe Avenue • Milwaukee 1, Wisconsin
Centralab Canada Ltd. • Ajax, Ontario

U.S., British Companies Sign Pacts

INTERNATIONAL COOPERATION was demonstrated this week in two agreements between major American and British electronics firms.

American Bosch Arma Corp., Hempstead, N. Y., and De Havilland Holdings Ltd., Hatfield, Hertfordshire, report the joint purchase of S. G. Brown Ltd., Watford, Hertfordshire, for an undisclosed price.

Brown, a major producer of navigation and gyroscopic equipment for the marine industry and the military, was formerly owned by the British Admiralty. Operation of the firm will be under De Havilland, a member of the Hawker Siddely Group which comprises a broad grouping of English companies engaged in the aircraft, missile and transportation fields.

Brown first became associated with American Bosch Arma in 1957 as a licensee for the sale and production of the U. S. company's subminiature gyro compass. ABA is engaged in the production of guidance systems, missile and drone telemetering equipment, and diesel fuel injection equipment.

Sprague Electric Co., North Adams, Mass., announces an agreement with Telegraph Condenser Co., Ltd., London, to exchange research, and development knowhow for the next 21 years.

The Sprague-Telegraph Condenser agreement will increase cooperation in research and manufacture between the two producers of capacitors. In addition, Sprague reports the sale of its U.K. patents and applications to TCC, together with necessary technical and engineering information.

Daystrom, Inc., Murray Hill, N. J., announces plans to redeem all 4 1/4 percent convertible subordinate debentures due March 1, 1977, for an aggregate redemption price of 106.13 percent. Each \$1,000 debenture is convertible into 30 shares of common stock through July 8, 1960. Of the original \$8,000,000 issue, \$7,774,000 in de-

bentures are outstanding. Net earnings of \$2,271,000, or \$2.48 per share, were reported for fiscal 1960.

General Mills, Inc., Minneapolis, Minn., reports the purchase of Daven Co., Livingston, N. J., and Laible Manufacturing Co., Manchester, N. H., both for an undisclosed price. Daven produces power supplies, networks, and laboratory measuring equipment, using Laible components and sub-assemblies. Both companies will retain their own names, and continue in present locations.

Avien Inc., Woodside, N. Y., reveals that negotiations are well advanced for acquisition of Electrol, Inc. of Kingston, N. Y. This will be the third acquisition for Avien in recent months, with Colvin Labs and Trident Corp. preceding. Electrol manufactures precision hydraulic systems and components for the aircraft market. Avien produces instrument systems for aero-space and undersea work. L. A. Weiss, Avien president, says the acquisition will broaden his company's market base.

25 MOST ACTIVE STOCKS

	WEEK ENDING JUNE 24			
	SHARES (IN 100's)	HIGH	LOW	CLOSE
Standard Kollsman	4,187	30 1/2	23 3/4	23 3/4
Avco Corp	4,130	15 1/2	13 3/4	14 1/2
Emerson Radio	3,882	22 1/2	16 3/4	18 1/2
Univ Controls	3,472	19 1/2	17 3/4	17 3/4
RCA	1,617	70 1/2	65 3/4	66 3/4
Lear Inc	1,394	23 1/2	21	22 1/2
Gen Tel & Elec	1,345	31 3/4	30 1/2	30 3/4
Sperry Rand	1,320	24 3/4	22 3/4	24 3/4
Collins Radio	1,098	76	68 1/2	70 1/2
Ampex	981	38 3/4	36	37
Belock Inst	836	25 3/4	22 1/2	22 3/4
Gen Inst	812	46 3/4	42	44 3/4
Int'l Tel & Tel	795	45 3/4	42 3/4	44 3/4
Gen Electric	716	94 1/4	91 3/4	94
Dynamics Corp Amer	697	12 3/4	11 1/4	11 3/4
Du Mont Labs	671	11 3/4	11	11 3/4
Reeves Sndcrt	669	9 3/4	7 3/4	8 3/4
Zenith Radio	651	125 1/4	113 1/2	124
Amer Electronics	634	19 1/4	16 3/4	16 1/2
Amer Tel & Tel	597	90 1/4	89 1/4	89 3/4
Sterling Precis	585	3 1/2	3	3
Int'l Resistance	559	41 1/2	35 1/2	36 3/4
Admiral	534	20 3/4	18 1/4	18 3/4
Philco Corp	509	32 3/4	30 3/4	30 3/4
Jetronic Ind	494	13 3/4	12 3/4	12 3/4

The above figures represent sales of electronics stocks on the New York and American Stock Exchanges. Listings are prepared exclusively for ELECTRONICS by Ira Haupt & Co., investment bankers.

Graphite Facts

by George T. Sermon, President
United Carbon Products Co.



How are you fixed for lead time?

I'm talking about *lead time* on semiconductor processing programs. The engineer you put in charge of a program knows how important that can be. Do you?

Right when a new design has been approved and the first few graphite fixtures are being ordered — that's the time to think and plan seriously about future *volume* requirements. After all, if there's no real volume potential for the design, why play with it at all?

That's why your engineer will probably tell you (if you'll listen) that your supplier of graphite parts must have ample *lead time* to tool-up properly to handle a healthy growing program most efficiently and economically. And he'll advise you to choose your source for those first few graphite pilot parts just as though you were ordering 10,000 units.

In sum—settle on the best source for tomorrow—*today*. Work with that source on a long-range basis with proper lead time *built right in*—and your program will be headed for success—right from the start. Here's the right kind of source.

UNITED carbon products co.

BOX 747

BAY CITY, MICHIGAN



Get much more information in the ...



new electronics BUYERS' GUIDE

When designs call for products in the field of electronics, the Guide solves problems *in advance*.

There's a 64-page reference section with up-to-the-minute data on markets, materials, components and applications to make product selection easier.

You'll find detailed facts about the products of nearly 700 advertisers — that's 42% more than you'll find in

any other similar guide.

Also local sales offices of manufacturers . . . the names, addresses, and phone numbers of representatives . . . complete lists of manufacturers . . . registered trade names . . . and, of course, the most complete list of electronic and related products. Tells you what you need to know *when you are ready to buy*.



A McGraw-Hill Publication • 330 West 42nd Street, New York 36, New York

HERE'S WHY CENTRICORES ARE PROBABLY THE MOST CONSISTENTLY UNIFORM CORES YOU CAN BUY:

The exceptional uniformity you get in tape-wound Centricores is not easy to come by. It's the result of painstaking precision at every stage of the manufacturing process—and, in fact, *before* manufacturing. Three principal factors help produce Centricore uniformity:

Careful classification of materials—Raw alloys are first "pedigreed"—meticulously selected, then tested for some 14 parameters, and classified by magnetic properties. We're the largest buyer of nickel alloy magnetic materials in the world... which permits us to choose material for Centricores from an unusually wide distribution of magnetic properties.

Special winding machines—We build our own machines, to die-making tolerances, for winding magnetic alloy tape into cores. We also build our own machines for applying insulating coating to the tape. These machines give us far greater uniformity in dimensions, insulation and ultimate performance of Centricores.

Closely-controlled annealing—Annealing—perhaps the most critical phase of the core-making process—is done under precisely regulated atmospheric and temperature stabilized conditions to hold Centricore magnetic performance to uniformly high levels.

Exceptional uniformity from core to core and lot to lot is further assured with Super Squaremu "79", a new high-performance alloy we've developed. It has outstanding magnetic qualities and is remarkably uniform in squareness, thermal stability and gain. Super Squaremu "79" offers an effective solution to problems of variation in magnetic performance.

WRITE FOR BULLETIN C-3

SIZE	MATERIAL	THICKNESS
1	HIGH NICKEL Hymu 80 Squaremu 79 Super Squaremu 79	.001**
THRU	LOW NICKEL Squaremu 49 Carpenter 49	THRU
225	GRAIN-ORIENTED SILICON Crystaligned Microsil	.004*

*Special sizes, shapes and thicknesses quoted on request.

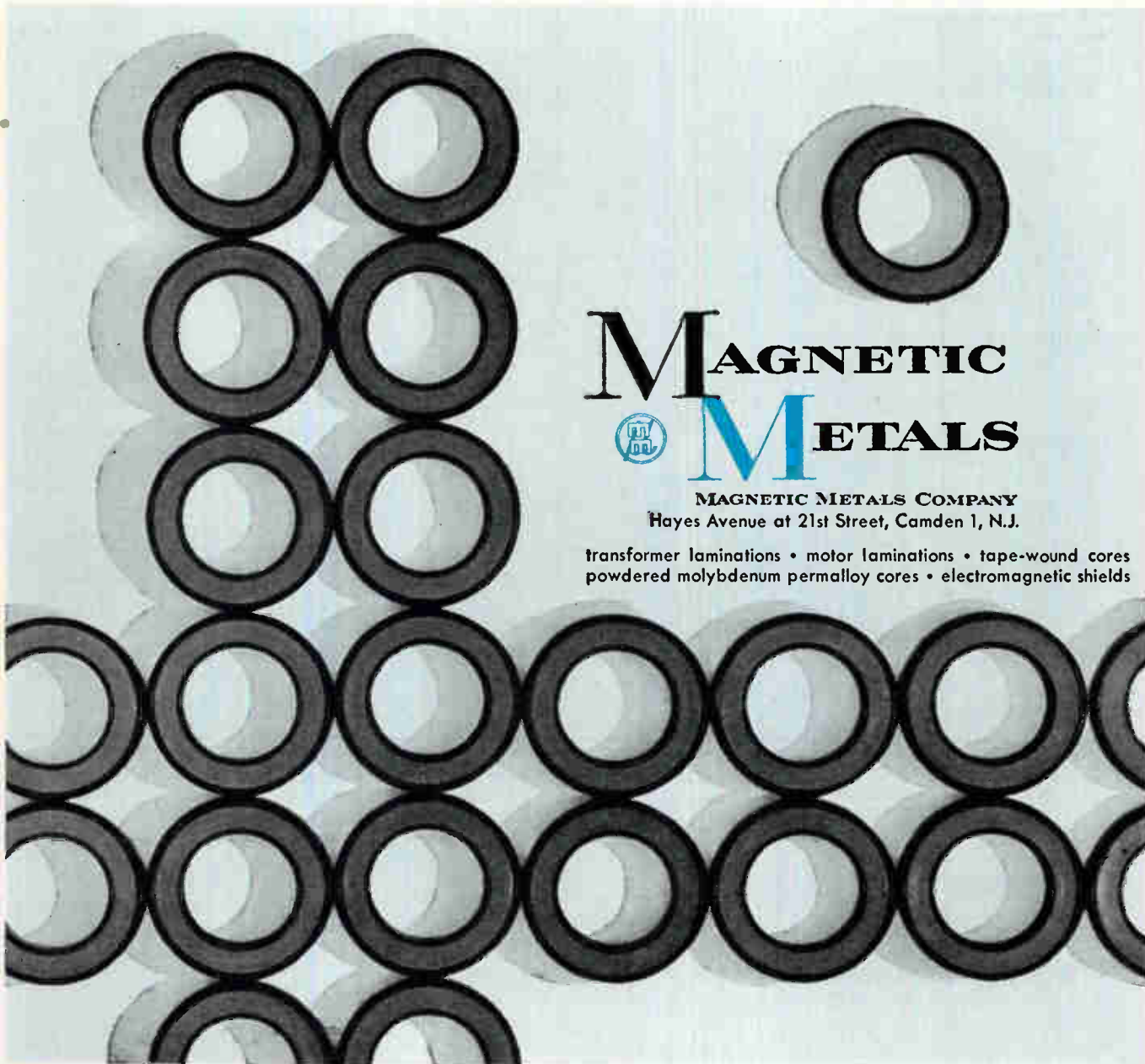



W. C. "BILL" PINE,
Hayes Chief Metal-
lurgist, reports . . .

BRAZING CALLS FOR KNOW-HOW PLUS SHOW-HOW

Pioneer of controlled atmosphere heat treating, and developer of the first electric furnace for stainless steel brazing . . . Hayes today offers you one of the most extensive lines of furnaces and atmosphere generators for all types of metal bonding operations.

Hayes "KNOW-HOW" provides a customized brazing technique which takes into consideration every aspect of the job: Selection of alloys, placing and fixturing of work, choice of atmospheres, proper time-temperature cycles. Whatever the brazing application — from aluminum (900°F range) to platinum (3400°F range) — Hayes "SHOW-HOW" then proves the technique on full production-line equipment in our lab.



The Hayes answer to your brazing problem comes to you as a *complete package*. Our engineers provide free start-up service to duplicate laboratory results in your plant . . . fully instruct your staff to assure economical, maintenance-free brazing operations. The end product: a "Results Guaranteed" furnace-atmosphere combination that helps

improve your product, increase production, and reduce costs. Write today for Bulletin 5711 B describing typical conveyor-type brazing furnace.



C. I. HAYES, INC.

845 Wellington Avenue • Cranston 10, R. I.
Established 1905



It pays to see Hayes for metallurgical guidance, lab facilities, furnaces, atmosphere generators, gas/fluid dryers.

MARKET RESEARCH

Atomic Group Releases First Survey

NUCLEAR INSTRUMENTATION SALES

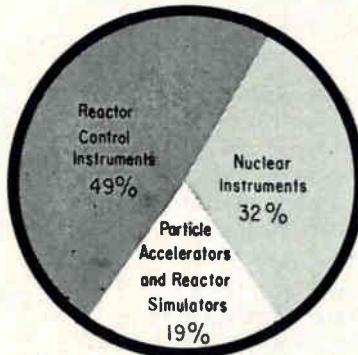

1958 Sales Total
\$ 47,100,000

Source: Atomic Industry Forum

FIRST of a continuing series of annual surveys of nuclear industry sales by the Atomic Industry Forum shows sales of nuclear instrumentation and related electronic equipment in 1958 totalled \$47.1 million.

Total includes reactor control instruments valued at \$15.0 million, nuclear instruments (radiation and detection monitoring devices) \$23.1 million and particle accelerators and simulators, \$9.0 million.

Survey information on nuclear electronics excludes sales of control and measuring devices containing radioactive isotopes, worth \$4.9 million in 1958, according to the Department of Commerce report on Atomic Energy Products.

For 1958 total nuclear industry sales were estimated at more than \$659 million, not including equipment and services of the nuclear weapons program or nuclear propulsion reactors for the naval and aircraft programs. Electronic-based items accounted for about seven percent of the estimated 1958 total.

Between 75 and 100 companies are known to make and sell radiation instruments and components.

More detailed information is contained in survey report entitled Business Statistics on the Atomic Industry 1954-1958, available from AIF offices in New York City for \$3.50. Plans call for issuance of similar survey reports in Novem-

ber of this year—on 1959 sales—and in June of 1961—on 1960 sales.

Joint survey of consolidated shipments of electronic components by Electronic Production Resources Agency and Business and Defense Services Administration, previously a semiannual count, is now a quarterly survey.

BDSA's Electronics Division, which has the responsibility of public release of information from the joint survey, will regularly issue quarterly estimates of electronics industry components sales. Because of the changeover, information on first quarter of 1960 will not be out until August, but the time lag on future quarters will be shortened to a few months or less.

Other significant changes made:

1. Companies surveyed will not be required to provide as much detail as formerly, about one-third less.
2. Co-operation by surveyed companies has been made legally mandatory.
3. Companies surveyed and others in the industry will have the same information made available to them.
4. Instruments category, previously limited to panel instruments, has been expanded to include recording, controlling and indicating instruments.

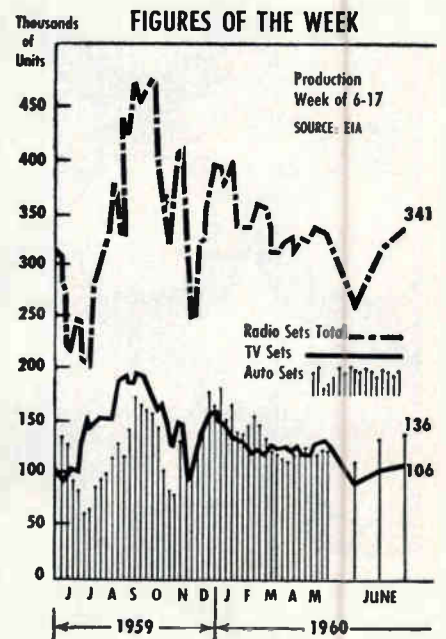

SUBMINIATURE CAPACITORS



FOR Transistor CIRCUITRY

...packaged to fit where others won't!



601PE 602

UPRIGHT MOUNTING

ENCAPSULATED IN EPOXY

Slim, trim and compact. The specially shaped winding is of extended foil construction — equal in all regards to high quality Good-All tubular designs. These two types differ in that the 602 incorporates a base of epoxy-glass laminate for flush mounting on circuit boards.

SPECIFICATIONS

DielectricMylar Film
CaseEpoxy Dip
IR at 25°C.....75,000 megohms
Voltage Rating50VDC
Temp. Range.....-55°C to +125°C
Capacity ToleranceTo ± 5%

TYPICAL 50 VOLT SIZES
TYPE 601 PE

CAP.	T	W	L
.01	.187	.310	.562
.047	.203	.531	.453
.1	.225	.650	.525
.22	.296	.718	.687
.33	.312	.812	.950



663F 663FR

EDGE MOUNTING

AXIAL OR RADIAL LEADS

These special-purpose versions of popular Good-All Type 668UW use precious space efficiently. Their ratings are conservative, and are equally suited for military and instrument grade applications.

SPECIFICATIONS

DielectricMylar Film
CasePlastic Wrap
End Fill.....Thermo-setting, epoxy
Voltage Range.....100, 200, 400 & 600VDC
Temperature Range.....-55°C to +125°C
IR at 25°C.....100,000 meg. x mfd.
Humidity Resistance.....Superior

TYPICAL 100 VOLT SIZES
TYPES 663F and 663FR

CAP.	T	W	L
.01	.125	¼	¾
.047	.140	¼	¾
.1	.171	½	¾
.47	.281	¾	1¼
1.0	.375	¾	1½



627G

617G

Hermetically Sealed

50 VOLT RATING

Ideal transistor "companions" where hermetic sealing is required. Both types are smaller than comparable MIL-C-25A designs yet exceed all requirements of this specification.

SPECIFICATIONS

DielectricMylar Film
CaseHermetically Sealed
WindingExtended Foil
IR at 25°C.....40,000 meg. x mfd.
Type 627G
Temperature Range.....Full rating to 85°C, 50% derating at 125°C
DC Voltage Rating.....50 volts only
Type 617G
Temperature Range.....Full rating to 125°C, 50% derating at 150°C
DC Voltage Rating.....50, 150, 400 & 600

TYPICAL 50 VOLT SIZES
TYPE 627G

CAP.	DIA.	L
.01	.173	2¾/32
.047	.313	2¾/32
.1	.313	2¾/32
.47	.500	1¾/16
1.0	.560	1½/16

Good-All Capacitors Are Available at Authorized Distributors

Write for detailed literature



GOOD-ALL ELECTRIC MFG. CO. OGALLALA, NEBRASKA

A SUBSIDIARY OF THOMPSON RAMO WOOLDRIDGE INC.

A MAJOR ADVANCE FROM **Transitron...**

DIFFUSED MESA TRANSISTORS FOR EVERY POWER RANGE!

...WITH ADVANCED PACKAGES, HIGH VOLTAGES,

INTERMEDIATE POWER TRANSISTORS



• **Now in stud-mounted package**

For regulated power supplies and amplifier output stages — replaces 2N1047-50 and 2N1483-86—offering low R_{cs} , good Beta linearity and voltage ratings to 120V.

Type	Maximum Power Dissipation @ 100°C (watts)	Typical DC Current Gain @ $I_c = 1$ amp	Maximum Collector Voltage (Volts)	Typical Saturation Resistance (ohms)	Typical DC Input Voltage (Volts)
2N1647	20	25	80V.	1.7 @ 1A.	2 @ 1A.
2N1648	20	25	120V.	1.7 @ 1A.	2 @ 1A.
2N1649	20	45	80V.	1.7 @ 1A.	2 @ 1A.
2N1650	20	45	120V.	1.7 @ 1A.	2 @ 1A.

WRITE FOR BULLETIN /JTE-1355S

HIGH POWER TRANSISTORS



- Available in two package styles — 11/16" hex stud mount and square flange

For regulated power supplies and amplifier output stages — replaces 2N1015-16, 2N424, 2N389, 2N1487-90 — with low R_{cs} (typical .8 ohms), good Beta linearity, high cut-off frequencies, and high voltage.

Type	Maximum Power Dissipation @ 100°C (Watts)	Maximum Collector Current (amps)	Maximum Collector Voltage (Volts)	Maximum Saturation Resistance (ohms)	Maximum DC Input Voltage (Volts)	DC Beta @ 2 amps	
						Min.	Max.
2N1616 2N1210	30	5	60	1 @ 2A.	3 @ 2A.	15	75
2N1617 2N1211	30	5	80	1 @ 2A.	3 @ 2A.	15	75
2N1618 2N1620	30	5	100	1 @ 2A.	3 @ 2A.	15	75

WRITE FOR BULLETIN /JTE-1355R

With these new transistors, Transitron offers improved performance and outstanding features in all power ratings from 100 microamps to 5 amps. Each functions in a wide operating range — permitting use of fewer types, simplifying equipment manufacture. All provide the ruggedness and reliability of mesa silicon construction. All are available now, at prices competitive with lower-performance devices.

CIRCLE 26 ON READER SERVICE CARD

COMPUTER DESIGNERS ATTENTION

Watch for announcement of Transitron's revolutionary new switching device — coming next month and at WESCON show!

Booth 2638-39

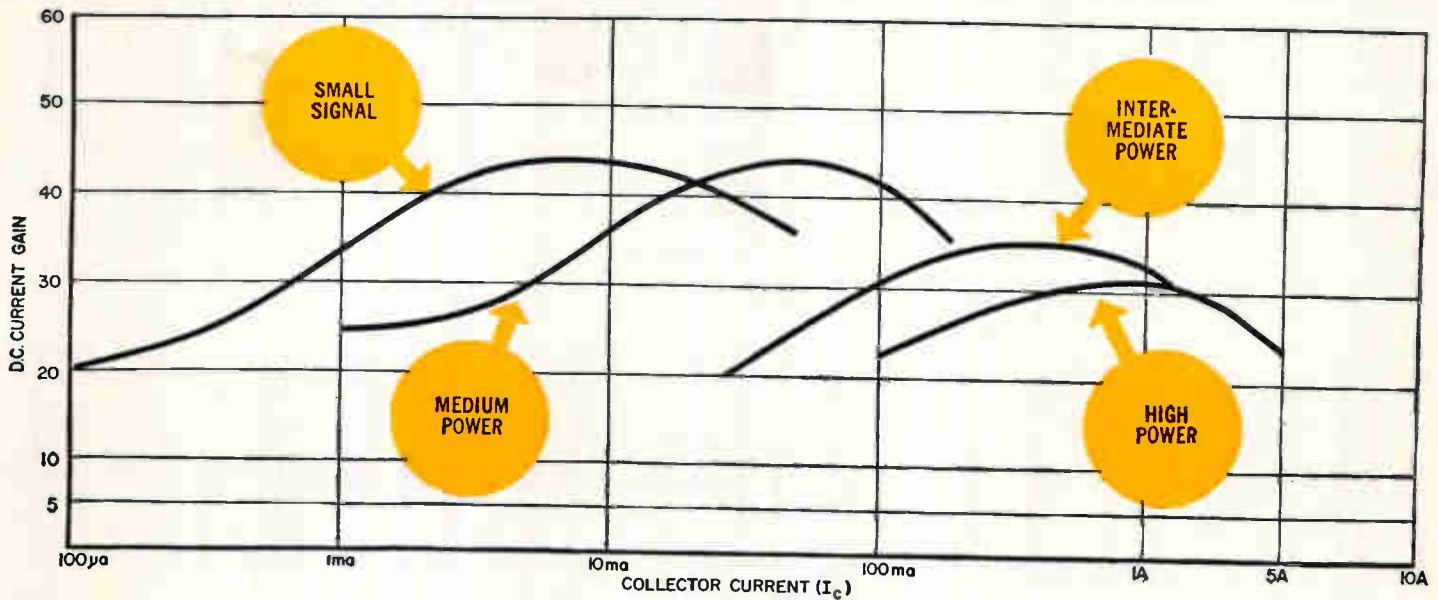

HIGH CUT-OFF FREQUENCIES, LOW R_{CS} AND BETA LINEARITY

SMALL SIGNAL TRANSISTORS



For low level high voltage switching and amplification. Replaces 2N332-2N343 with higher cut-off frequencies (30mc), lower R_{cs} , smaller sized TO-18 package, and higher voltages.

SMALL SIGNAL TO-18						
Type	Maximum Collector Voltage	Minimum DC Beta			Maximum Power Dissipation @ 25°C Ambient (mw)	Typical Saturation Resistance (ohms)
		I_c 500µa	I_c 5ma	I_c 50ma		
ST1504	60	15	20	20	300	40
ST1505	100	15	20	20	300	50

WRITE FOR BULLETIN #TE-1353T

CIRCLE 27 ON READER SERVICE CARD

MEDIUM POWER TRANSISTORS



- Collector lead isolated from case — greatly simplifying heat dissipation measures and increasing reliability
- Include highest standard voltage ratings available (to 125V) — for extra safety margin against overloads.

To replace 2N332-343, with improved high frequency characteristics, good Beta linearity, and low R_{cs} .

Type	Maximum Collector Voltage (volts)	Minimum Beta			Maximum Power Dissipation (Watts) @ 25°C Case	Maximum Saturation Resistance (ohms)
		I_c 1ma AC	I_c 5ma AC	I_c 50ma DC		
*2N339A †	60	15	25	20	1	50
*2N340A	85	15	25	20	1	70
*2N341A †	125	15	25	20	1	70
**2N1054	125	20(DC) @ 200ma			5	20
***2N696	60	20(DC) @ 150ma			2	10
****2N697	60	40(DC) @ 150ma			2	10

† Electrical equivalents available in TO-5 package as 2N1206 and 2N1207

- * WRITE FOR BULLETIN #TE-1355J1 ** WRITE FOR BULLETIN #TE-1355E-2
 *** WRITE FOR BULLETIN #TE-1355B-3 **** WRITE FOR BULLETIN #TE-1355B-4

Transitron

electronic corporation
wakefield, melrose, boston, mass.



"Leadership in Semiconductors" • SEE YOUR LOCAL AUTHORIZED DISTRIBUTOR FOR QUANTITIES FROM 1-999.

New Sub Killer Opens Big Market

Navy plans to equip 163 ships with new antisubmarine rocket. Asroc creates continuing need for sonar, computers, simulators, display, components

By JOHN F. MASON,
Associate Editor

ON BOARD *USS NORFOLK* AT SEA—Navy's newest threat to enemy submarines, the Asroc (from AntiSubmarine ROcket) that begins as a rocket and ends as either a depth charge or an acoustic-homing torpedo, will create a \$293.4 million business for the electronics industry for shipboard installation and over \$28 million for the first load of ammunition.

As part of its fleet rehabilitation and maintenance program (FRAM), the Navy plans to put Asroc installations on 163 ships, at the rate of about 50 ships per year. Each one costs \$1.8 million. More than half a dozen ships are already—or soon will be—equipped.

Each ship carries a load of eight weapons (\$22,000 each) in readiness for single or rapid-sequential firing. More can be stored below deck for reloading.

Ships that will get Asroc installations include destroyer leaders, such as the *USS Norfolk*, des-

troycor escorts, cruisers and missile ships.

Asroc was developed for Bureau of Naval Weapons at a cost of \$65 million. Naval Ordnance Test Station (NOTS) was technical director of the program with Minneapolis-Honeywell, prime contractor.

The weapon is an integrated system consisting of four main parts: an underwater sonar detection device, electronic digital fire-control computer (the first shipboard installation of a digital computer for fire control use, Navy says), eight-missile launcher, and Asroc missile or depth charge.

Here's how the system works:

Asroc-equipped ships detect a submarine at long ranges with sonar. A computer calculates its course and speed, and launches a rocket-propelled ballistic missile containing either an acoustic-homing torpedo or a depth charge. After the missile is accelerated, the rocket falls away and the payload continues its flight to the vicinity of the target.

Just prior to entering the water, the weapon sheds its airframe and prepares for water entry. The depth charge payload sinks and detonates at a predetermined depth. The torpedo payload is eased into the water by parachute and locates the submarine by an acoustical homing search pattern.

Farthest range of the four demonstration missiles fired here off the coast of Key West, Florida, from the *Norfolk* at the submerged nuclear submarine *Skate* was 5,240 yards. Asroc's maximum range is about nine miles, which provides the ships with a 250-sq.-mi. coverage. Though minimum

range is theoretically 200 yards, effecting a kill at such proximity would probably be suicidal, especially if an atomic payload were used.

The sonar detection system, built by Sangamo Electric for BuShips, is an aluminum bubble 23-ft in diameter, extending nine feet below the ship's hull.

Echoes from an enemy submarine are separated from irrelevant echoes and other noises by the sonar operator and fed into the fire-control system.

Built by Librascope div. of General Precision, the fire-control system consists of a digital computer, a geographic plotter and ballistic display dials. A succession of echoes from the enemy sub enables the computer to calculate the course, speed and future position of the enemy. Other information fed into the computer includes wind direction and velocity, air density and water temperature, and the attack-ship's speed, course, pitch and roll. These data are used to solve the intercept ballistic missile problem.

Output from the computer automatically aims the launcher, sets the missile range, and fires the missile on command. A display plotter in the computer room shows a geographic picture of the attack as would be seen from the air.

The launcher, built by Universal Match Corp., consists of two horizontal rows of four cells each. All eight cells turn together, and each pair of over/under cells elevates individually.

The launcher can cover almost a full circle about the ship while the ship remains on formation course. The use of the eight-cell launchers enables the ship to fire successive missiles at a throw of the switch.

The launcher itself is composed of electronic and hydraulic gear which reacts swiftly and precisely to instructions from the fire-control computer to set range in the

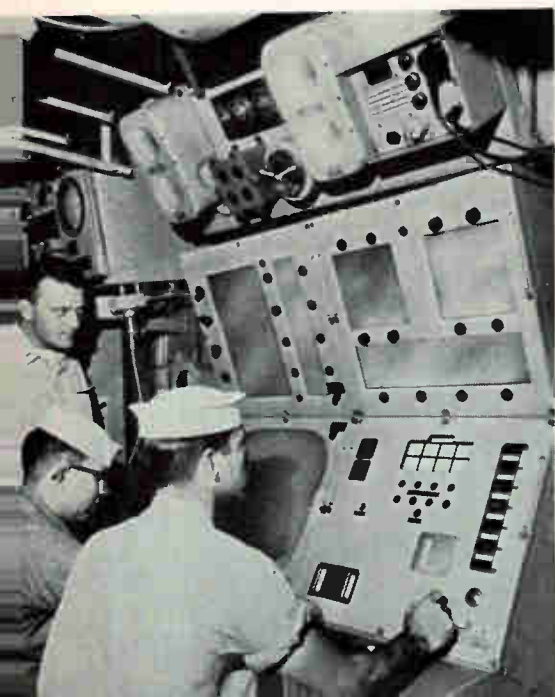

Asroc fire control system solves ballistic intercept problem with digital computer

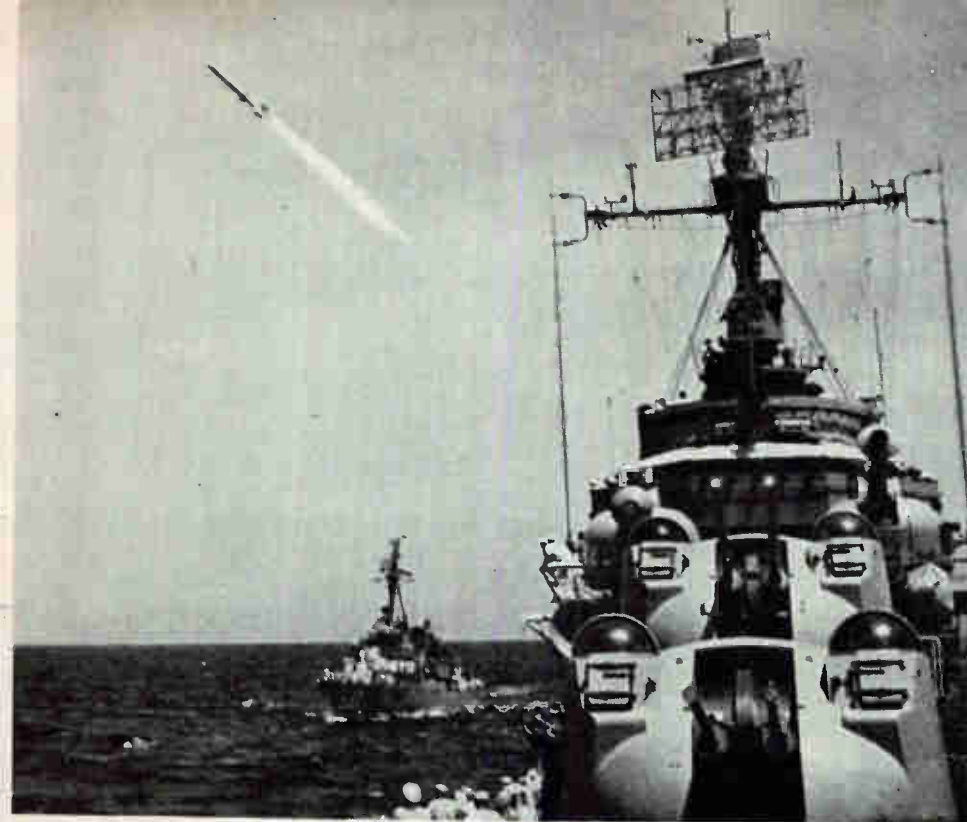

Torpedo-carrying missile hits Mach 1 on leaving USS Norfolk. After missile falls off, torpedo lowers by chute, seeks sub by acoustic homing



Technicians seal the eight missile cells of electronically controlled launcher before firing

missiles, aim them, and ignite their rocket motors.

The rocket, airframe, range control device, and payload accessories were designed, developed and produced by the NOTS-Honeywell team.

The airframe, which connects the motor and payload, consists of two lengthwise aluminum sections, hinged to open up like jaws.

In flight, a steel band holding the airframe together is severed by a small explosive charge on a signal from a timer in the missile. The airframe peels off and drops into the sea, leaving the payload to continue its ballistic trajectory.

Asroc's torpedo (the Mark 44 built by the Ordnance Department of General Electric) parachutes to the water, ejects its chute, and activated by the energizing of a seawater battery, dives to a prescribed depth. Here, by a preset pressure-measuring device, it levels out and begins to turn in a flat circle, listening passively to the sounds around it as well as actively to any returns from its own sonar transmitter.

If no noise is picked up, the torpedo begins a helical descent, in search of a target. On reaching a preset depth limit, the torpedo levels out again and begins a spiral

ascent, until it reaches its preset ceiling.

When a target is picked up, the hunt pattern is abandoned and the torpedo heads straight for the kill. Speed of the torpedo is 30 knots.

The torpedo is sensitive to both azimuth and elevation direction due to a group of specially designed transducers mounted in its nose section. When a signal reaches the transducers it strikes one set of transducers more directly than another. This produces an amplitude difference to indicate azimuth error. A phased angle difference produced when the returning signal strikes one set of transducers before reaching the other set indicates elevation error. Servo mechanisms activate the torpedo's controls.

The torpedo may be lured by any number of unwanted targets: the sea bottom, its mother ship, or—as has happened in testing—by a helicopter watching the show. Such an attack is repelled, however, when the torpedo reaches its depth or ceiling limits preset into its controls. When this happens it automatically begins a new search in the opposite direction.

If no target is detected, the power eventually runs out—this occurs in a matter of minutes—and

the torpedo settles quietly to the bottom.

The torpedo uses 26 vacuum tubes, conventional relays for switching and conventional d-c servos. It requires no gyros for roll control. Stability is maintained by placement of the centers of gravity and buoyancy, fine fin and shroud alignment and balanced propellers.

Twelve electronic test units were designed for Asroc. Honeywell designed an instrumentation control van and an instrumentation recording van that were used aboard the evaluation ship. The control van contains a control console with timing devices, panels containing switches for operating instrumentation and monitor lights for indicating the operation of critical components.

The instrumentation van contains a wide-band f-m tape system, a digital tape system, two oscillographs, a photodata panel and a range time system. Other instrumentation-system equipment includes radar and cameras for missile tracking, sound-powered phone circuits for intraship communications (called Gertrude), and a radio link for intership communications. Asroc program also includes ship and shore training gear.

Political Conventions Use New Gear

This month's national conventions impose great demands on broadcasters. New special equipment has been designed to meet the challenge

NEXT MONDAY in Los Angeles the Democrats open their national political convention. Behind the scenes, new electronic equipment will play a key role.

Tons of electronic gear have already been shipped to the Los Angeles Sports Arena. And more tons will be transported later to Chicago, where the Republicans, starting July 25, will hold their convention in the Chicago International Amphitheatre.

The bulk alone bears testimony to the growing role of electronics in coordinating the vast amount of communications required for adequate news coverage of the events.

Engineers from the major networks are now working at both sites to construct and install the broadcast, communications and coordination facilities that will be required.

Technical supervisor Robert C. Smith, of NBC's tv network operations, tells *ELECTRONICS* approximately 100,000 ft of wire and 25,000 ft of camera cable will be used in each city just to operate cameras.

Although much activity by the networks is being kept under close

wraps due to proprietary interests in special devices going to the conventions, some information has been disclosed.

From ABC, for example, *ELECTRONICS* learns that 60 newly developed video distribution amplifiers will be used at the Democratic convention and then sent to the Republican meeting by air. The units are all transistorized and specially designed for the convention.

Also making its first bow will be a transistorized r-f microphone for use by reporters on the convention floor. The mikes are of the lavalier type and measure about 1 in. in diameter and are 4½ in. long. It's reported the mikes will broadcast for 20 to 24 hours with batteries contained in the small packages.

Other ABC equipment slated for use are transceiver headsets that will allow nonbroadcast communications to be carried in two-way wireless conversations. Weighing between 2 and 3 lb, the devices have small antennas sticking up from the earphones and will allow users to talk over distances separating convention floor activities from

the various network control booths.

One NBC engineer describes the central control facilities that will operate at both conventions as a sort of "military command headquarters in which all fixed and mobile units must be coordinated."

National Broadcasting will be using 32 cameras: two with a mobile video tape unit, three with a mobile truck, one in a specially equipped limousine and a number of others in various locations.

To control the many units and keep them in sync, network engineers have developed a device that can scan each input as it arrives at Central Control, check it for sync lock in one-millionth of a second and correct it before routing it on the air. This will mean that all 32 cameras will be operable without rollover or adjustment observable at home receivers.

Also designed for convention use is a monitor panel that will allow newscasters to select any of 32 inputs for display on a four-monitor panel. The network estimates that one observer cannot watch more than four screens at a time and also choose on-the-air material at the pace the convention will require.

The new pushbutton preview system, it is felt, will allow newscasters to select their material with complete freedom from the technical difficulties that hampered them at the last conventions.

To get the most out of this new development, NBC constructed a special training mockup to allow the men who will use the equipment to stage practice operations.

Broadcasters say their tape units will also be active during the conventions. Both mobile and fixed units of NBC will be on standby operations. In addition, mobile units will be used to record spot news wherever microwave facilities for direct broadcast are lacking. It is estimated tv tape will replace 80 to 90 percent of the film coverage used at past conventions.



Training mockup is being used to allow NBC personnel to make maximum use of new techniques developed for political convention coverage

Details on CBS plans for convention coverage were not available at press time.

British Instruments Getting Global Push

INSTRUMENTMAKERS in Great Britain are busily promoting their products in markets all over the world.

On June 18, the British opened their first instruments show in the USSR at Moscow's Polytechnic Museum. Forty member firms of the British Scientific Instrument Manufacturers Association put on exhibits that ranged from signal generators, oscilloscopes and other lab gear through nuclear instrumentation to process-control instruments, gas chromatographs and emission spectrographic gear.

One U. S. firm—Beckman Instruments—showed U.K.-produced potentiometers through its British subsidiary.

Last days of the exhibition coincided with the First Congress of the International Federation of Automatic Control.

Electronic Scan Radar Holds Multiple Targets

ELECTRONICALLY STEERABLE ARRAY radar (ESAR), capable of focusing simultaneously on space vehicles or aircraft, is being developed by Bendix under \$4-million contract from USAF's Rome Air Development Center and the Advance Research Projects Agency. Five-story demonstration model of the computer-controlled ESAR will go up at the firm's radio division in Towson, Md.

Electronically steerable feature permits the system to look at a great number of objects over a wide area at one time. At the same time, the system will be able to concentrate on one particular object. Multiple search and track beams will be used to fulfill both simultaneous functions.

The model will be used to track space vehicles launched from Wallops Island, Va., and to monitor air traffic in the Baltimore-Washington airport complex.



YOUR LEAK IN PROFITS

...may be due to leaks here.....

**TODAY'S FASTEST,
MOST SENSITIVE,
NON-DESTRUCTIVE
LEAK DETECTOR IS
RADIFLO**



Positive non-destructive testing for "leakers" can be done fastest and with a minimum of handling by Automatic RADIFLO—after component production process and all seals are complete. With RADIFLO as a checkout station before product delivery, there is no need to hold up production lines. Hermetically sealed components may be tested as high as 10^{-12} cc/sec. by RADIFLO.

Employing an inert, radioactive gas under pressure, the new automatic RADIFLO offers safe (AEC approved), simple, sure,



"go-no-go" leak detection that can be programmed to keep pace with the most modern automated production facilities. Yet every single product unit can be tested without slowing production. No other test method can match RADIFLO speed, or perform with such a high degree of sensitivity.

Among manufacturers who capitalize on RADIFLO's fast, ultra-sensitive and thorough detection of "leakers" are such leaders as:

- General Electric Company
- Army Ballistic Missile Agency
- Hughes Aircraft Company
- Fairchild Semiconductor Corp.
- Western Electric Company
- Eitel-McCulloch, Inc.
- Potter & Brumfield, Inc.
- Allen-Bradley Company
- Elgin National Watch Company

If you are a component manufacturer faced with a slower, less positive and destructive method of leak detection, let us help you. Send for complete details of automatic RADIFLO testing equipment... and testing case histories which may parallel yours, where RADIFLO has been the answer.

Manufacturers with limited production contracts will be interested in RADIFLO Testing Service, now available at reasonable cost on the east and west coasts.



AMERICAN ELECTRONICS, INC.

NUCLEAR DIVISION
9459 WEST JEFFERSON BLVD., CULVER CITY, CALIFORNIA • UPTON G-4707

Sylvania announces a major breakthrough in

TUNNEL DIODES

...featuring oscillation capabilities at unusually high frequencies ...

2 KMC MINIMUM

with type D4115

3 KMC MINIMUM

with type D4115A

4 KMC MINIMUM

with type D4115B

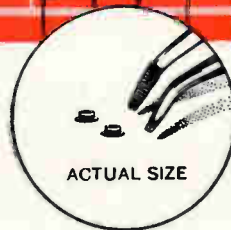
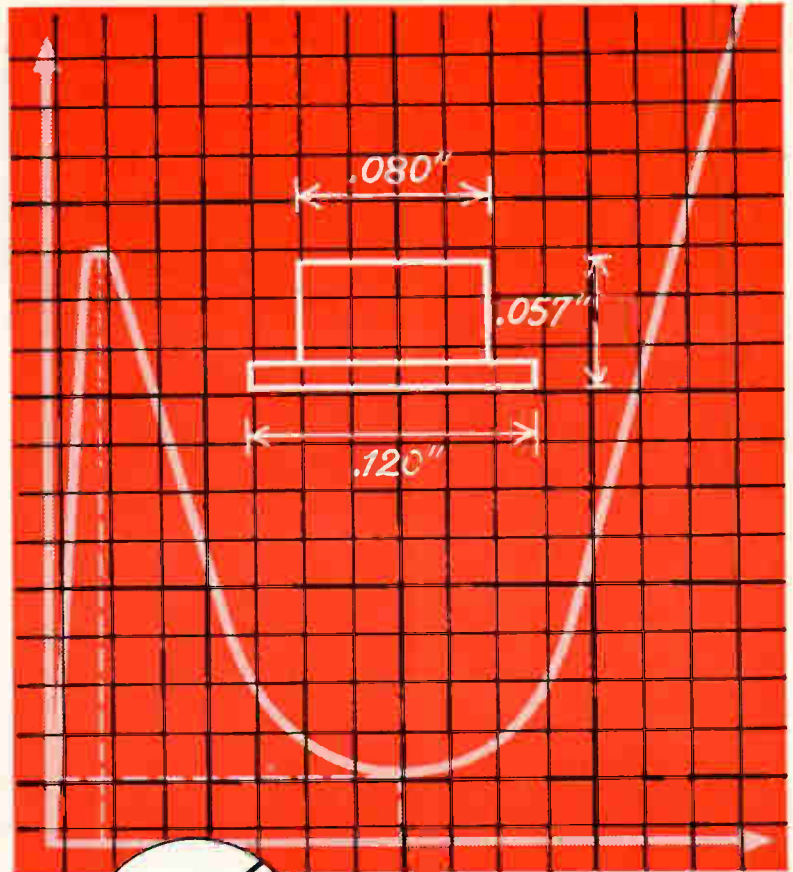

- basic package design offers potential of 10 KMC operation
- ruggedness proved—withstands 500G 1-millisecond shock test
- hermetic ceramic-to-metal seal—Sylvania tunnel units will pass MIL moisture tests

ELECTRICAL CHARACTERISTICS—SYLVANIA TUNNEL DIODES

	D4115	D4115A	D4115B
Measured Oscillation Freq.	2 KMC min. 1.8 mA typ.	3 KMC min. 1.7 mA typ.	4 KMC min. 1.6 mA typ.
I_p	5:1 min.	5:1 min.	5:1 min.
$I_p:I_v$	350 mV typ.	350 mV typ.	350 mV typ.
V_v	55 mV typ.	55 mV typ.	55 mV typ.
V_p	1 ohm typ.	2 ohm typ.	3 ohm typ.
R_s	8 μ f typ.	6 μ f typ.	4 μ f typ.
C			

Sylvania Tunnel Diodes are now available in limited quantities for engineering evaluation. Start your investigations of the exciting tunnel phenomenon with advance-design Sylvania units. For details on price and delivery, contact the Field Engineer at your nearest Sylvania Field Office.

SYLVANIA FIELD OFFICES: BALTIMORE, MD., 5301 Harford Rd., Baltimore 14, Md., Clifton 4-7333 BOSTON, MASS., 100 Sylvan Rd., Woburn, Mass. Wells 3-3500 CHICAGO, ILL., 2001 N. Cornell Ave., Melrose Park, Ill., Fillmore 5-0100 CINCINNATI, OHIO, 411 Oak St., Cincinnati, Ohio, Plaza 1-8454 DALLAS, TEXAS, 100 Fordyce St., Dallas, Texas, Riverside 1-4836 DAYTON, OHIO, 333 West First St., Dayton, Ohio, Baldwin 3-6227 LOS ANGELES, CALIF., 6505 E. Gayhart St., Los Angeles, Calif., Raymond 3-5371 NEW YORK, N. Y., 1000 Huyler St., Teterboro, N. J., Atlas 8-9484 ORLANDO, FLA., P. O. Box 7248, Orlando, Fla., Cypress 3-4289 PHILADELPHIA, PA., 4700 Parkside Ave., Philadelphia 31, Pa., Greenwood 7-5000 SAN FRANCISCO, CALIF., 1811 Adrian Rd., Burlingame, Calif., Oxford 7-3500 SENECA FALLS, N. Y., Logan 8-5881 SYRACUSE, N. Y. 5700 W. Genesee St., Camillus, N. Y., Orange 2-3111 WASHINGTON, D. C., 1200-03 Walker Bldg., 734 15 St., N. W., Republic 7-7733

SYLVANIA

Subsidiary of **GENERAL TELEPHONE & ELECTRONICS**



electronics

Technicians (right) check operation of linear accelerator and observe via closed circuit tv as patient (photo below) receives electron beam treatment



Electron Accelerator Fights Cancer

HIGH-ENERGY ELECTRONS, traveling near the speed of light, are used for ammunition in a new cancer fighting weapon, recently placed in clinical operation, at the Argonne Cancer Research Hospital, University of Chicago. Heart of the facility is a 25-ton microwave linear accelerator capable of achieving peak energy levels of 60 million electron volts. The Lineac produces a pencil-thin electron beam able to impede the growth and destroy the growing power of cancer cells to depths of 9 inches in the body.

Designed primarily to treat cancers that have not escaped from the primary site and become generalized, the device incorporates controls that enable the beam to scan the malignant area with the accuracy of a pencil tracing on paper, allowing the beam to focus on areas difficult to reach with other radiation devices. Radiation delivered to a growth is regulated precisely as to the amount and volume of tissue treated, to minimize damage to nearby healthy, but sensitive, organs.

Two 20-megawatt klystrons, each drawing 50 megawatts, produce a maximum radio-frequency power output of 20 megawatts at 2,857 Mc, accurate to one part in a million. Input power during treatment is dictated by the desired depth of penetration. To maintain power consumption at reasonable levels, the machine is operated only for 60 60-microsecond bursts a second.

A crt-like electron gun, operat-

ing at high potential, injects electrons of moderate energy (100,000 ev) into the 16-foot long, highly evacuated, accelerator tube. After 8 feet of travel down the tube they are traveling with an energy of 25 million ev; in the next 8 feet the power doubles to 50 million ev.

Control is maintained by varying the input power to the klystrons and by regulating the phasing of r-f pulses in both halves of the tube. Synchronization gives maximum energy, but continuous changes can be made to lower the level to 5 million ev.

Traveling through an unbroken vacuum system, guided by two magnets, the electron beam reaches a third magnet which turns it vertically, and directs it downward, through an aluminum window, to the patient. The third magnet also

contains a scanning device, which guides the $\frac{1}{2}$ -centimeter diameter beam along a pattern set by a pre-cut plastic template, corresponding to the shape of the malignant section. A maximum area of 8 inches square can be automatically outlined for treatment, taking roughly 10 minutes to scan. The beam may be rotated through 360 degrees for full directional coverage.

A University spokesman said that qualitatively, the electron beam achieves the same cancer-killing results as x-rays, but that the electron-gun provides the degree of control necessary for safe treatment of sensitive areas, such as near the brain. The electron beam is stable and largely free from low-energy side effects. There is a relatively low skin reaction to the radiation, although the underlying tumor receives a full dose.

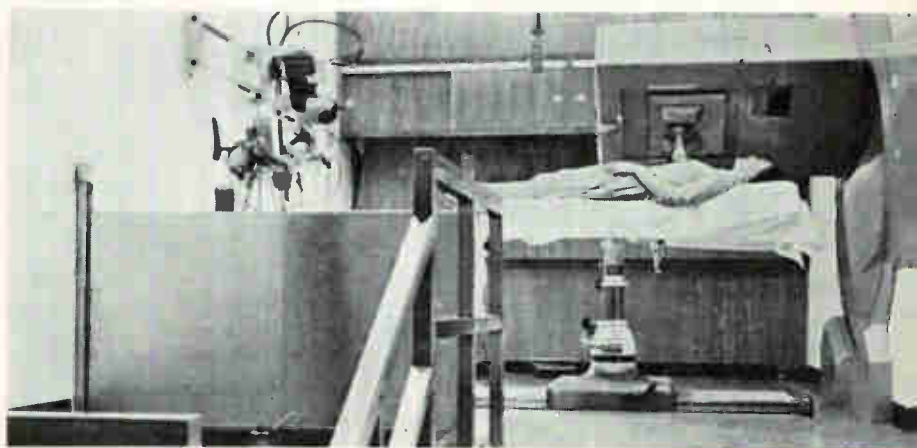

THE RIGHT COMBINATION FOR BETTER TUBING

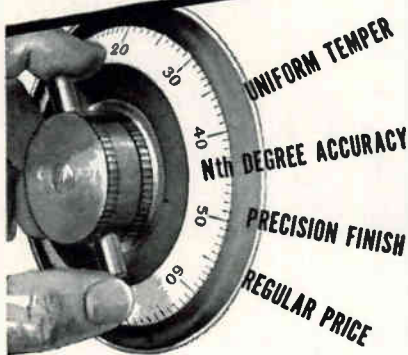

YOU GET ALL IN PRECISION TUBING

Sizes .010" O.D. to 1.125" O.D.
Copper, Brass, Nickel Alloys

• If you want to unlock the way to better product quality specify Precision Tubing. Every pound, every foot, every size or shape is made to meet the most exacting requirements and performance tests.

Precision Tubing can be produced to meet your specifications from annealed to full hard. Scientific inspection carefully checks to the Nth degree for absolute accuracy. Precision Tubing is available in clean, scratch-free finishes suitable for anodizing or plating to mirror finishes. All of this Precision Control of quality is yours at regular mill prices.

Whether you need copper, brass, aluminum, nickel or nickel alloy tubing you are sure of proved unsurpassed quality from Precision. Write for complete technical catalog to

PRECISION TUBE CO., INC.
North Wales, Pa.

Get Your Free Copy



MEETINGS AHEAD

July 20-22: Forestry, Conservation Communications Assn., Annual Conf., Hotel Duluth, Duluth, Minn.

July 21-27: Medical Electronics, International Conf., Inst. of Electrical Engineers, Olympia, London.

Aug. 1-3: Global Communications Symposium, PGCS of IRE, U.S. Sig. Corps, Statler Hilton Hotel, Wash., D. C.

Aug. 1-4: Photo-Instrumentation Symposium, Soc. of Photo Instr. Engineers, Ambassador Hotel, Los Angeles.

Aug. 8-11: American Astronautical Society, Western National, Olympic Hotel, Seattle, Wash.

Aug. 9-12: American Institute of Electrical Engineers, Pacific General, San Diego, Calif.

Aug. 15-19: High-Speed Photography, Stroboscopic Light Laboratory, MIT, Cambridge, Mass.

Aug. 22: Scientific Apparatus Makers Assoc., Market Managers, SAMA, Statler-Hilton Hotel, San Francisco.

Aug. 22-26: Thermonuclear Plasma Physics, Symposium, Oak Ridge, U.S. Atomic Energy Commission, Gallinburg, Tenn.

Aug. 23-26: Association for Computing Machinery, Nat. Conf., Marquette Univ., Milwaukee, Wisc.

Aug. 23-26: Western Electronic Show and Convention, WESCON, Memorial Sports Arena, Los Angeles.

Aug. 29-31: Metallurgy of Elemental and Compound Semiconductors, AIME, Statler Hotel, Boston.

Oct. 10-12: National Electronics Conf., Hotel Sherman, Chicago.

S
E
T
I
L
B
A
P
G
A
H
P
L
A

Systems competence in, design, implementation, structural construction, installation, operation, training, and maintenance of:



1. Space surveillance systems



2. Transportable electronics systems



3. Instrumentation, control, and switching systems



4. Telecommunications systems



5. Integrated land, sea, and air communications systems



6. Data systems



CABLE • ALPHA DALLAS

CIRCLE 28 ON READER SERVICE CARD

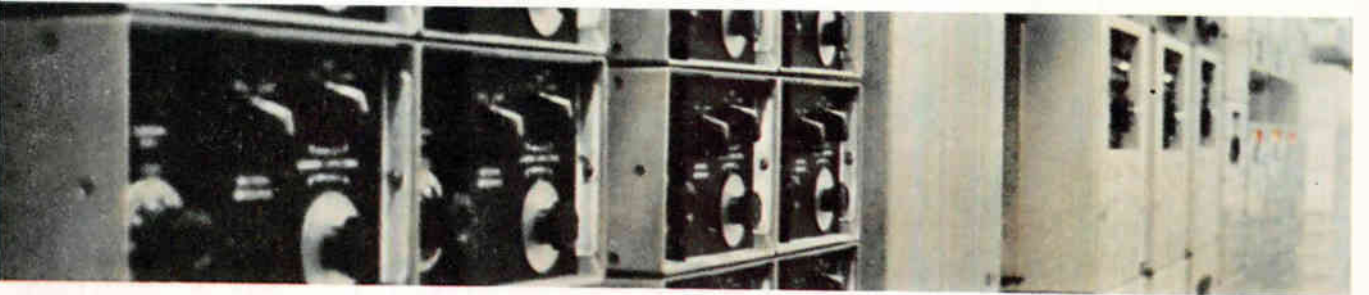
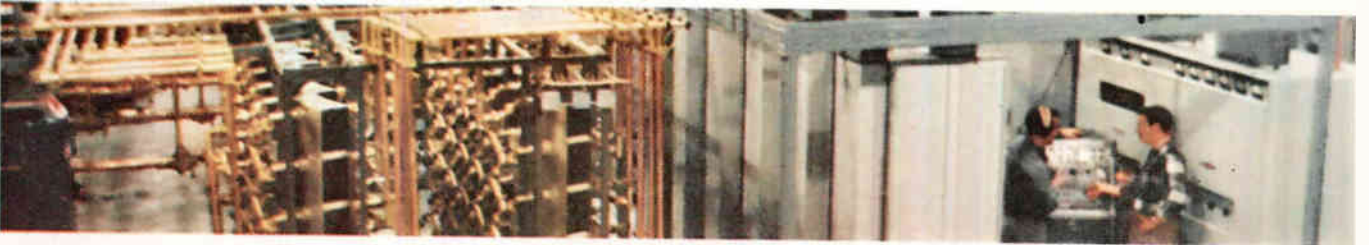
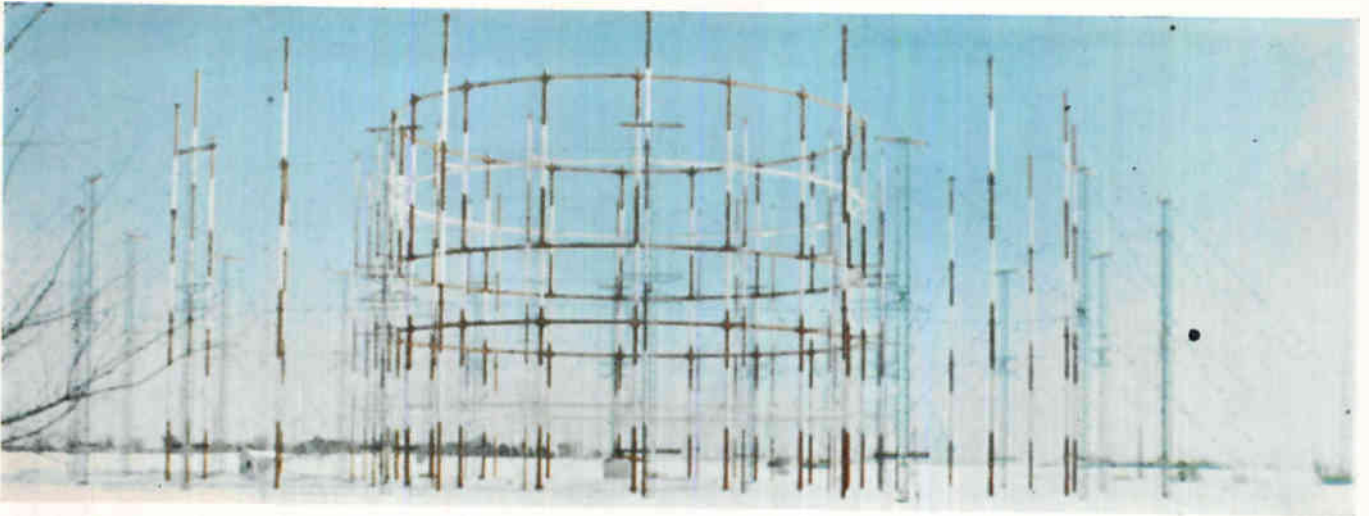

SHORT ORDER SAC's Global Voice . . . provides a vital communication link of intercontinental range with the speed and reliability necessary for positive control of modern jet aircraft. The system design concept is advanced and flexible. SHORT ORDER may be used for point-to-point communication with missile-launching sites as well as for its initial employment by the Strategic Air Command jet bomber force.



SYSTEMS DESIGNERS, ENGINEERS, CONSTRUCTORS, WORLD-WIDE • RICHAROSON, TEXAS • TELEPHONE DALLAS AOams 5-2331

July 8, 1960

CIRCLE 35 ON READER SERVICE CARD 35

Want the facts?



Elementary, my dear fellow! The design of Borg 205 Series Micropots provides one of the most reliable precision potentiometers ever produced. Originally designed for the military, the 205 is now extremely successful in many commercial applications. Linearity accuracy . . . $\pm 0.1\%$ to $\pm 0.05\%$, independent or zero-based. Total resistance . . . 1.15 to 100,000 ohms. Meets full range of military specifications . . . vibration, shock, humidity, temperature, salt spray, altitude, fungus and acceleration. Your Borg technical representative or distributor has complete information.

Ask for data sheet BED-A131.

*Borg Equipment Division,
Amphenol-Borg Electronics Corporation,
Janesville, Wisconsin. Phone Pleasant 4-6616.*

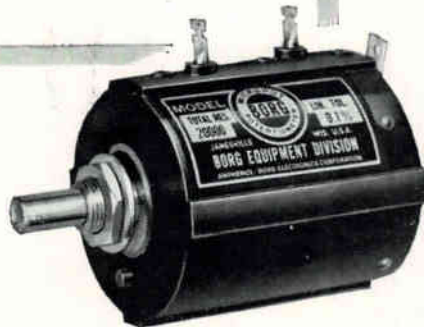

Experience—the added alloy in A-L Electrical Steels

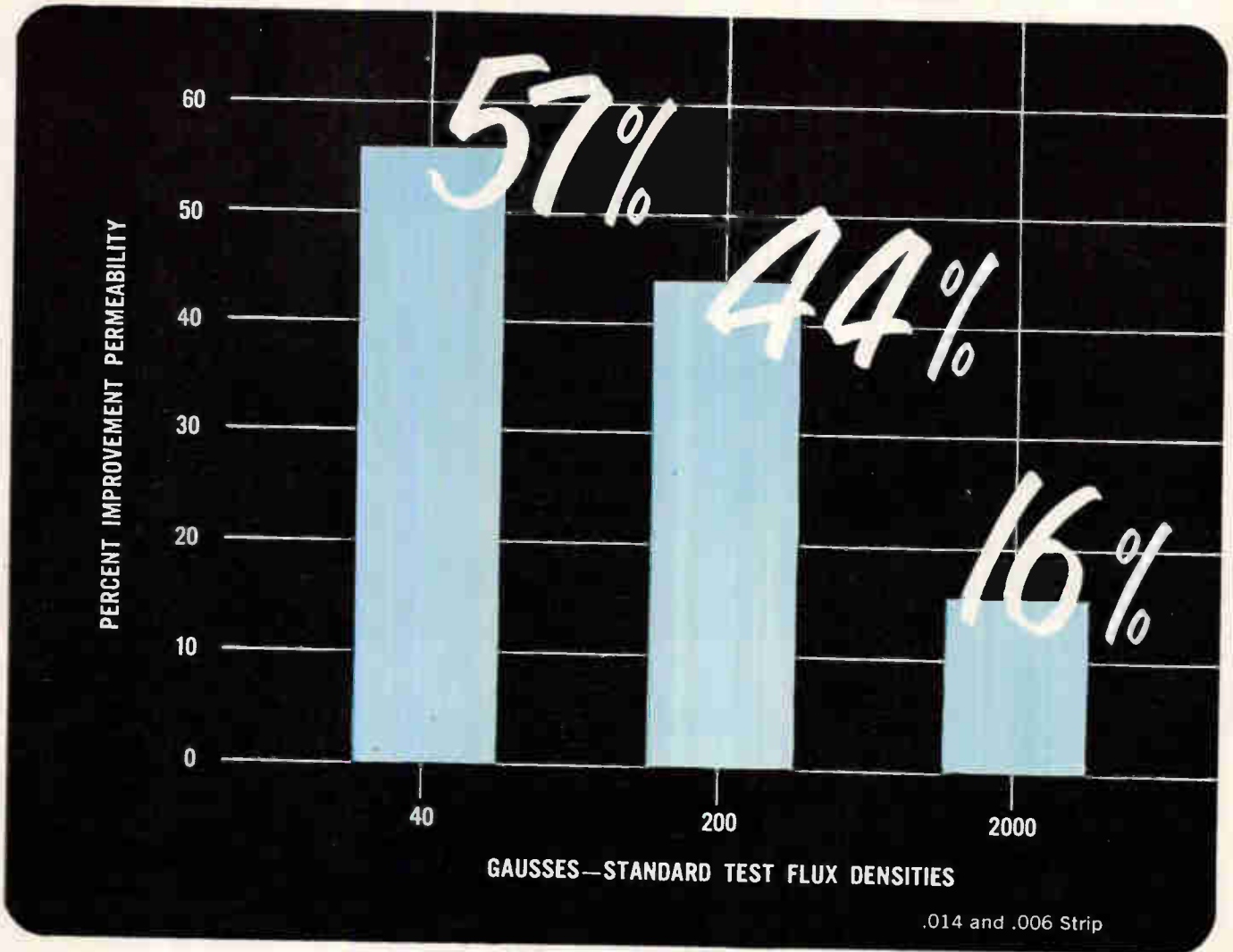

Greater permeability for Allegheny Ludlum's AL-4750...and it's guaranteed

promises more consistency, higher predictability for magnetic cores

AL-4750 nickel-iron strip now has higher *guaranteed* permeability values than ever before. For example, at 40 induction gaussses AL-4750 now has 57% higher permeability than in the past, using the standard flux density test.

This greater permeability means better consistency and predictability for magnetic core users . . . and allows careful, high performance design.

This improvement in AL-4750 is the result of Allegheny Ludlum's continuing research on electrical alloys and

nickel-bearing steels. Moly Permalloy has been similarly improved in permeability. A-L constantly researches silicon steels, including A-L's well-known grain-oriented silicon, Silectron, and other magnetic alloys.

Complete facilities for the fabrication and heat treatment of laminations are available at Allegheny Ludlum. And A-L's technical know-how guarantees you close gage tolerance, uniformity of gage throughout the coil and minimum spread of gage across the coil-width.

If you have a problem on electrical steels, laminations or magnetic material, call A-L for prompt technical assistance. Write for blue sheet EM-16 for complete data on AL-4750. *Allegheny Ludlum Steel Corporation, Oliver Building, Pittsburgh 22, Pa. Address Dept. E-7.*

WSW 7491

ALLEGHENY LUDLUM
STEELMAKERS TO THE ELECTRICAL INDUSTRY

Export distribution, Electrical Materials: AIRCO INTERNATIONAL INC., NYC 17
Export distribution, Laminations: AD. AURIEMA, NYC 4



July 8, 1960

CIRCLE 37 ON READER SERVICE CARD 37

SPRAGUE®

MODEL 500 INTERFERENCE LOCATOR



This versatile instrument is a highly sensitive interference locator—with the widest frequency range of any standard available unit! Model 500 tunes across the entire standard and FM broadcast, shortwave, and UHF-TV spectrums from 550 kc. to 220 mc. in 6 bands.

It's a compact, portable, rugged, versatile instrument—engineered and designed for most efficient operation in practical field use. It features a transistorized power supply, meter indications proportional to carrier strength as well as sensitivity of 5 microvolts minimum for 5% meter deflection over entire tuning range.

For full details, send for brochure IL-106.

SPRAGUE ELECTRIC COMPANY
35 Marshall Street, North Adams, Mass.

SPRAGUE®
THE MARK OF RELIABILITY

Six Companies Sponsor Exhibit

Instrument manufacturers to show products at five sites around New York, Philadelphia



Planning road exhibits are, left to right (seated): Bernard Schlessel, president, Panoramic Radio; William D. Marshall, vice president-sales, FXR; Simeon Weston, executive vice-president, Lambda Electronics; Marvin Steinberg, vice president-sales, Sensitive Research Instrument. Standing: Tore N. Anderson (left), executive vice president, FXR, and William R. Saylor, sales manager, General Radio

A NOVEL APPROACH to marketing electronic instruments will be seen this fall when road exhibits, featuring the developments of six instrument manufacturers, will be staged at five sites around metropolitan New York and Philadelphia.

The show has been under discussion since February this year. The firms will cooperate in publicizing and advertising the show. Company officials say that if the show is successful, other shows may be staged in other areas and that the six companies may extend their cooperative marketing efforts.

The traveling technical show will be known as the Electronic Instrument Manufacturers' Exhibit. The show will offer under one roof, an operational array of 36 complementary laboratory and production-test instruments, with ranges of from d-c to 200 Gc.

The project will be sponsored by FXR, Inc.; General Radio Company; Lambda Electronics Corp.; Panoramic Radio Products Co., Inc.; Sensitive Research Instrument Corp.; and Tektronix, Inc. Booths will be manned by company engineers.

The five exhibit areas will be:

Long Island (Garden City), Connecticut (Norwalk), New York (Poughkeepsie), northern New Jersey (Cedar Grove) and Philadelphia-Moorestown, N. J.

FXR, Woodside, N. Y., manufactures microwave equipment from 400 Mc to 220 Gc. General Radio, West Concord, Mass., has a line of over 350 items. Lambda Electronics Corp., College Point, L. I., makes power supplies. Panoramic Radio, Mt. Vernon, N. Y., produces spectrum analyzers and other automatic measurement instruments. Sensitive Research Instrument Corp., New Rochelle, N. Y., specializes in laboratory standard meters and other calibration devices. Tektronix, Portland, Ore., makes cathode-ray oscilloscopes and accessory equipment.

122-Deg Picture Tubes Coming

CHICAGO—PICTURE TUBES with wider deflection angles and shorter guns shared the spotlight with "lazybones" remote-control units at the spring conference on broadcast and television receivers held

here recently under sponsorship of the Chicago chapter of the Institute of Radio Engineers.

R. A. Bloomsburgh described work Philco has done on a 122-deg tube. Firm's first working model had an 18-in. screen, measured only $8\frac{7}{8}$ in. overall front to back. The design proved to be efficient, gave 8-w power output compared against $2\frac{1}{2}$ w for older designs. Company directed much of its effort in designing a new gun and yoke; result was a gun only $3\frac{1}{8}$ in. long and $1\frac{1}{8}$ in. outside diameter. The firm is reported to have dropped the 18-in. tube and is now working on 21-in. and 24-in. models of the wider-angle crt.

Sylvania's H. E. Smithgall discussed a crt with reduced heater-power requirements. Sylvania's work concentrated on producing a very small heater-getter unit; the result was a unit 0.011 in. thick and with 0.050-in. outside diameter. The heater operates at 775 C with 1.5 v; satisfactory emission can be maintained at 1 v. The heater requires only a 10-sec warmup.

Progress toward development of flat picture tubes was described by Edward Ramberg of RCA. Ramberg discussed the Gabor and Aiken tubes, and a third type now under development at RCA, indicated that production of any of them was at least five years away.

Ultrasonically triggered remote-control unit designed by Warwick Mfg. Co. for use on Sears' Silver-tone sets was discussed at the conference. The transmitter is an ultrasonic whistle, tuned to 39 Kc, operated by air from a plastic bulb. Varying pressure gradients resulting as the bulb is squeezed sweep the signal from about 35 Kc to about 45 Kc.

The receiver contains an electrostatic microphone, two triode-pentodes and a 5-ma d-c relay. Channel switching is performed by a small motor stepped by the relay.

Admiral described its transistorized remote-control unit, which remains on as long as the set is plugged in and thus can be used to turn the set on. Handheld striker unit puts out two separate frequencies for on and off or channel changing. Transistor circuits in the control receiver contain two detector units which discriminate between the two signal frequencies.

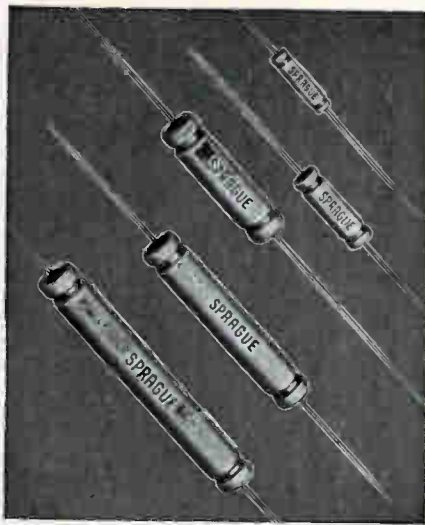

New 125C Tubular Foil Tantalex® Capacitors Discard Outer Shell

A new development by the Sprague Electric Company has eliminated the need for an extra outer shell on 125C tubular foil tantalum electrolytic capacitors. The overall size reduction is appreciable. Key to the achievement is an improved elastomer end-seal construction which does away with the need for a supplementary case to contain electrolyte seepage at higher operating temperatures.

Manufactured to exceed applicable performance requirements of Military Specification MIL-C-3965B, this new series of Sprague Tantalex Capacitors is expected to set standards of reliability for all types of military and industrial applications.

Polarized capacitors are available under the designation Type 120D in plain foil construction, and under Type 122D in etched foil construction; non-polarized units are listed as Type 121D in plain foil, and as Type 123D in etched foil designs.

Production quantities are available for prompt delivery. Pilot quantities of popular ratings may be purchased from Sprague industrial distributors.

For complete technical data, write for Bulletin 3602A to Technical Literature Section, Sprague Electric Company, 35 Marshall Street, North Adams, Massachusetts.

CIRCLE 4 ON READER SERVICE CARD

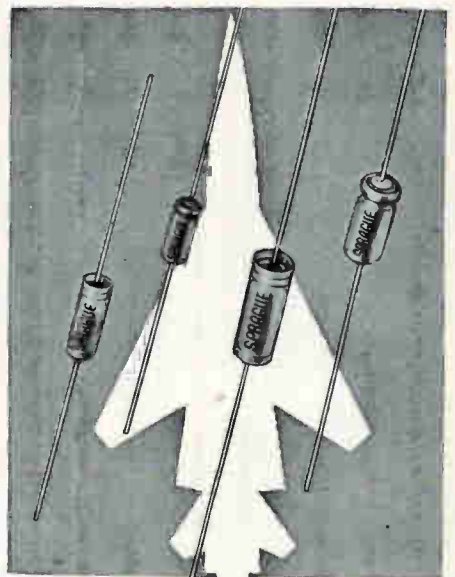

NEW WET-ANODE TANTALEX® CAPACITORS

for 125 C operation

Another Sprague "first" for military and industrial designers—Type 130D Wet-Electrolyte Tubular Sintered-Anode Tantalex Capacitors for 125 C operation without voltage derating.

The remarkable electrical stability of these capacitors is the result of *special aging*, the use of *inert materials*, and a *low diffusion seal*. Construction is designed to meet the 2000-cycle military missile vibration requirement. Shelf life is excellent.

Shoulder-less shape makes mounting on printed wiring boards easier, avoids punching slots in boards or the use of "chairs", and simplifies board wiring layout.

For complete technical data, write for Bulletin 3701 to Technical Literature Section, Sprague Electric Co., 35 Marshall St., North Adams, Massachusetts.



CIRCLE 39 ON READER SERVICE CARD 39

SCR PRICES

(C35B)

1958-1960

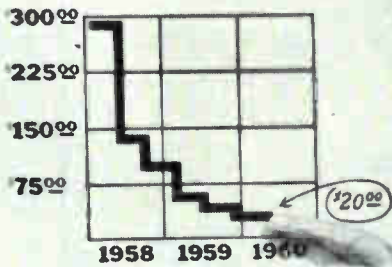

General Electric's C. G. Lloyd brings you up-to-date on the revolutionary Silicon Controlled Rectifier

The Controlled Rectifier picture changes so rapidly, information you may have obtained six months ago is now out-of-date. For this reason, C. G. Lloyd, General Manager of General Electric's Semiconductor Rectifier organization, answers here some of the questions most frequently asked — questions about a device many authorities consider the most revolutionary development since the transistor itself.

Q. Last year I looked into the SCR and found it too expensive. Has this situation changed?

Lloyd. Indeed it has. The C35B (16 amps, 200 volts) was originally introduced at \$160 in 1958, was priced at \$65 a year ago and has just now been reduced to \$20.

Q. How does the SCR compare with similar devices in prices?

Lloyd. SCR's are in the same price bracket as many germanium power transistors and actually cost less than silicon power transistors, magnetic amplifiers, many relays, thyratrons and other devices the SCR has replaced.

Q. What about associated circuitry? Doesn't that bring up the cost?

Lloyd. The drive circuits for SCR's are generally simpler than for the other devices, and in particular, protection against overvoltage and current is easier to accomplish than for power transistors — making the SCR-equipped device more reliable and much less expensive over-all.

Q. But your C35 is still too high-priced for my application, and the current rating is more than I need. What would you suggest that I do?

Lloyd. Perhaps you could use the C10B. It's rated at 4.7 amperes single phase and 6 amperes d-c and costs as low as \$11.10. Lower rated units go down to \$5.00.

Q. What else should I know about the C10?

Lloyd. Well, it has a more sensitive gate trigger and lower

leakage current. And surprisingly, even though it's smaller, it can operate at a higher temperature.

Q. The C10 sounds like it might be in the right range. How is it on power?

Lloyd. Two C10B's will control over 1 kw on 117 volts for about \$25. Compare this with any other method — power transistors, saturable reactor or thyatron.

Q. Do you have any other types?

Lloyd. We sure have! The C50 Series is a high-current unit that performs up to 50 amperes. It also has a 1000-amp. surge current rating. Then there's the C40 Series, with high-speed turn-off for inverter applications. That's an important field for the SCR.

And also there's the C36 Series. It goes to 10 amperes.

Q. General Electric has talked a lot about the SCR in the past couple of years. Have your customers brought SCR-equipped devices to market?

Lloyd. They've been doing so for a year or more and the pace of conversion to SCR devices keeps stepping up all the time. Our customers are now selling many types of SCR-equipped products. The applications are numerous. Some of the prominent ones are regulated power supplies, light dimmers, static switches, inverters, power-control circuits, radar modulators and ultra-sonic generators. And I'm sure there are many that haven't been reported back to us as yet.

Even at last year's prices many of these people found the SCR the best solution to their problems. We believe our new prices will bring in hundreds of new users.

Q. What about General Electric? Do you use the SCR?

Lloyd. Some 40 departments of General Electric are now using the SCR. Why we even use SCR's to make SCR's. Our ovens, furnaces and test fixtures are equipped with controlled rectifiers to provide very precise, reliable and low-maintenance temperature control for our processes.

To bring you completely up-to-date on the SCR, contact your General Electric SPD Sales Representative, or write Section S2570, Semiconductor Products Dept., General Electric Company, Electronics Park, Syracuse, N. Y. In Canada, 189 Dufferin St., Toronto, Ontario. Export: International General Electric, 240 East 42 St., N. Y. 17, N. Y.

GENERAL  ELECTRIC

For fast delivery at factory-low prices, see your General Electric Semiconductor Distributor.

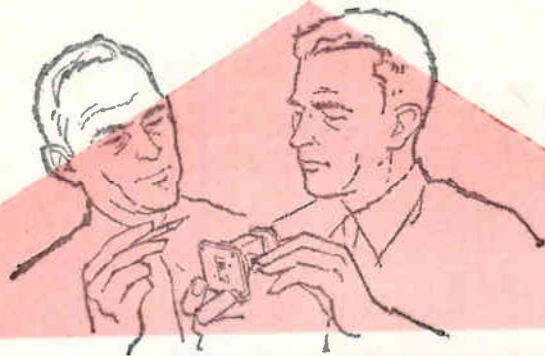

COMPREHENSIVE MICROWAVE COMPONENT CAPABILITIES

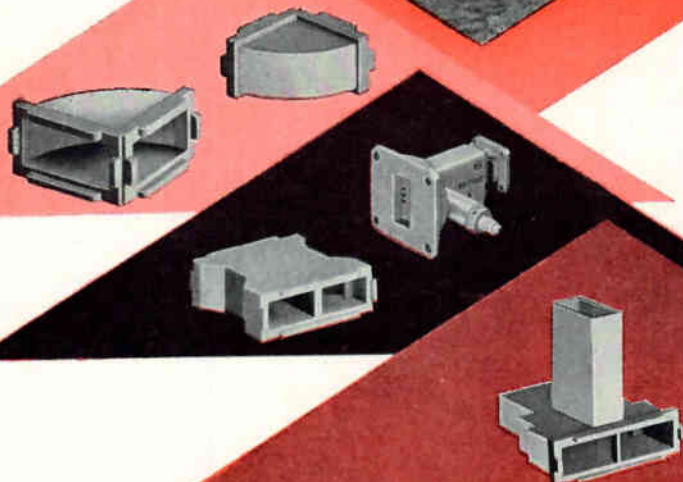

This modern three-quarter-acre plant has significantly expanded the services and production capabilities of Microwave Associates' experienced Waveguide Components Division. This new research and production facility is one of the most completely equipped on the east coast. A large 3' x 2' capacity dip-brazing unit as well as complete plating and other shop facilities are now handling both large volume and custom-engineered orders. Components are precision-machined and produced in beryllium-copper, cast and fabricated aluminum, and cast magnesium.

Over 500 microwave components for applications from 1.12 to 90.0 kMc/s are standard items. Our Sales Engineers will gladly discuss current work in sophisticated components and RF packaging with you.

A FEW OF THE MANY COMPONENTS MANUFACTURED HERE

New High-Power Varactor Harmonic Generators — excellent suppression of unwanted harmonics and record power levels are available from these solid-state harmonic generators.

New Cast Bends — Zero bend radius — 90° E and H plane bends in S through Ka bands... Each bend is compensated to a VSWR of 1.05 over its entire waveguide band.

Sidewall Hybrid Couplers (3db) and H-Plane Folded Hybrid Tees — Cast in aluminum and beryllium-copper are available in S through Ka-band models.

Two New Catalogs — Waveguide Components Short-Form Catalog (CSF-60) gives data on over 500 items of waveguide components and test equipment.

Pressure Window Catalog (12 pages) contains electrical and mechanical data on a complete line of glass-kovar, mica, and special pressure windows plus valuable installation and testing tips.

MICROWAVE ASSOCIATES, INC. Burlington, Mass. • Western Union FAX • TWX: Burlington, Mass. 942 • BRowning 2-3000
Export Sales: Microwave International Corporation, 36 West 44th St., New York, New York

Providing Communication and Navigation for SPACE PROBES

British cooperation in allowing stations at Jodrell Bank and Singapore simplified network establishment

Able Space Navigation Network is designed to control space probes up to 70 million miles away. Equipment and techniques required to obtain this capability are discussed

By R. C. HANSEN and E. R. SPANGLER, Space Technology Labs., Inc., Los Angeles, Calif.

THE NETWORK THAT maintained contact with Pioneer V over many millions of miles is today the only global network capable of communicating with and navigating deep space vehicles. This network, the Able Space Navigation Network (SpaN Net), is an integral portion of the NASA/USAF Project Able space missions¹. Created to meet the needs of the first Able-1 launch in Aug. 1958, it has since not only served for the subsequent Able launches—Pioneer I, Pioneer II, Explorer VI and Pioneer V—and other United States satellites but also for tracking Russian vehicles.

The network consists of four ground stations: Singapore, Hawaii, Cape Canaveral, Jodrell Bank; and a central control center, Los Angeles. Because of its immediate

goal in 1958, SpaN Net was initially designed within limitations of range and coverage, but a potential for growth has been included so that as space exploration becomes more extensive, the Space Navigation Network can readily keep pace. The requirements of a space navigation network and then the means by which SpaN Net met these requirements are detailed here.

For the SpaN Net to provide communications with the space probes of the present and near future, three general requirements had to be met. First, the stations had to be so located on the globe that sufficient visibility for the several types of missions would be obtained. Second, a ground data transmission link to transfer data from the stations to a central data processing station was needed.

Third, and most difficult to achieve, the r-f link from probe to ground stations had to have adequate transmission characteristics.

As far as communication from a space vehicle to the ground is concerned, the problem of providing sufficient signal can be divided into three categories: the amount of r-f power that can be generated in the space vehicle, the degree to which that power can be directed toward the ground receiver, and the efficiency of the receiving station in detecting this power in the presence of noise.

In the space vehicle, the transmitted power and the antenna gain are the important communication parameters. To increase transmitter power, it is necessary to provide a larger energy source, larger components, and heavier and

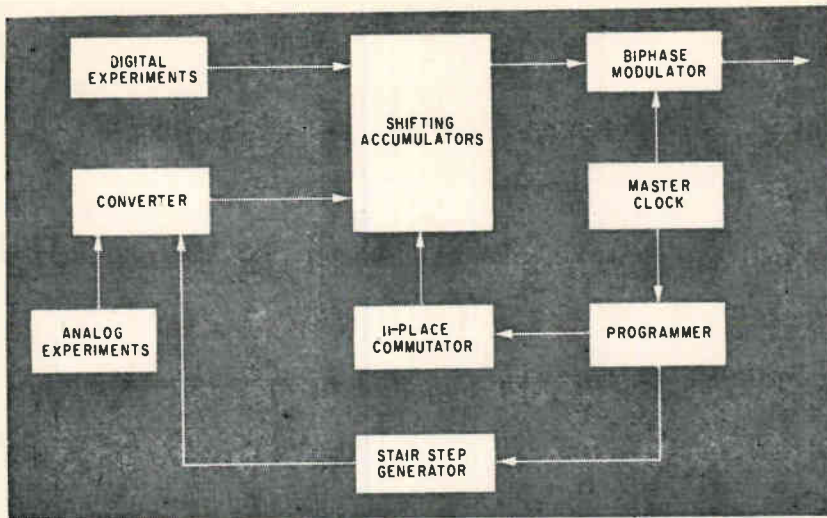

FIG. 1—Typical digital inputs to Telebit include micrometeorite and radiation particle impingements

more complex temperature control mechanisms, and/or to reduce the transmission duty cycle. All of this results in an almost linear increase in payload weight with increasing average power. Because of the limitation in weight for Able space probes, the maximum transmitter power used so far has been the 150 watts in Pioneer V.

The effective power transmitted depends, in addition, upon the directivity of the vehicle transmitting antenna. Here two problems must be recognized; on the one hand, although the effective radiated power can be increased tremendously by the use of high gain vehicle antennas, use of such antennas presupposes an ability to control the attitude of the space vehicle. On the other hand, it is generally desirable to provide failure instrumentation for space vehicles so that if an element of the system fails, it is possible to determine the cause of the failure. For this purpose, it is desirable to have a nearly omnidirectional vehicle antenna. Since at the present time vehicle attitude control is in early stages of development, and since a nearly omnidirectional antenna is highly desirable in any event, increasing the gain of the vehicle transmitting antenna has not been relied upon.

The receiving system can be improved either by increasing the receiving antenna effective area or by decreasing the effective noise temperature of the antenna and receiver. At C band, using a maser preamplifier and a very low sidelobe

antenna, a noise temperature of 18 K has been measured². This figure includes sky, waveguide and maser contributions. However, satellite transmitters are currently limited to lower frequencies by tube reliability and transistor capability. At 400 Mc, an antenna effective noise temperature of 50 K can be realized except for the small percentage of time that the antenna is pointing at the sun or at the galactic center. For this low value, parametric preamplifiers offer considerable improvement in sensitivity over conventional receiver front ends.

A trade-off study between tube power output, antenna and receiver noise temperature, antenna gain and path loss ($1/R^2$), frequency availability, and compatibility with other systems resulted in the choice of 400 Mc for the ground command transmitter, and 378 Mc for telemetry from satellite to ground.

To determine the type of ground antenna, the approximate operating frequency must first be considered. An examination of presently available transmitters and of the rate of development of efficient microwave transmitting tubes clearly underscores the necessity for an antenna capable of being changed to a different frequency region at low cost. Since multi-element antenna arrays with a large effective collecting area are essentially fixed-frequency devices, it appears that the frequency-insensitive parabolic reflector antenna is more useful.

As the size of the ground antenna is increased, the efficiency of the capture area must be maintained.

To maintain efficiency, the physical tolerances on the parabolic surface must be maintained to about $\frac{1}{16}$ of a wavelength. This type of antenna has been built in sizes up to 250 feet in diameter. For diameters larger than about 250 feet, an elaborate servo-control system for adjusting the individual surface panels as a function of the antenna elevation angle and wind loading is required. Thus, there is a point at about 250 feet beyond which there is a relatively sharp increase in mechanical complexity and cost.

Additional problems in space communications center about determining the proper method of modulating the radiated energy to obtain the most efficient and reliable means of carrying information. Basically, space communication suffers here from trying to achieve two incompatible objectives. There is the desire to transmit as much information as possible, but at the same time there is the necessity to conserve weight with the resultant fundamental limitation on transmission time and information rate³. Even for very large ground antennas, bandwidth is limited at fairly short interplanetary distances. The limitations upon bandwidth and the available power set the channel capacity and thus the rate at which information can be transmitted. An essential characteristic of a space communication system should be flexibility in bandwidth, so that when the vehicle is at short range its bandwidth can be wide, while at long ranges its bandwidth can be narrow.

A comparison of the various modulation methods shows that for space communications the most efficient system is some form of digital pulse code modulation, both from the standpoint of encoding and decoding and from the standpoint of modulation efficiency.

Additional requirements on the technique of information handling include the need for storage in the space probe, since power limitation precludes continuous transmission from distant ranges, and the need for rapid transmission of the stored information during the periods when the transmitter can operate. Moreover, it is desirable that the information arrive on the ground in a form permitting ground retransmission without significant

lapses of time and with no possible degradation of accuracy of the information.

The newer system used to transmit information to the ground is p-m/p-m where a carrier is phase-modulated with one or more subcarriers, and a typical subcarrier is digitally biphas modulated. This scheme provides the carrier needed for angle tracking and doppler determination, and gives the excellent performance of biphas modulation.

Actually, in the first series of Able space probes an f-m/p-m analog telemetry system was used. This system used a 108 Mc phase-locked receiver to achieve a lock-on sensitivity of -155 dbm with a 10-cycle locked-loop bandwidth. It had the necessary sensitivity to operate to lunar distances with a transmitted power of 100 mw at an information rate of 0.5 bit per sec.

The improved system, the digital telemetry system called Telebit, was developed for the Able-3 and -4 vehicles'. It will, at lunar distances, permit the transmission of eight bits of information per second. In addition, with airborne analog-to-digital converters, the information is quantized and digitized, so that once a message is received it will not be degraded by retransmission to the central station. Telebit also provides a transistor memory in the probe for storing the output of the experiments, so that intermittent transmission of the data is possible.

The payload portion of Telebit block diagram shown in Fig. 1,

encodes information in a form suitable for transmission, and accumulates information during periods between transmissions. It accepts both digital and analog inputs from the experiments. The analog inputs are converted by use of a 64-level digital ramp to binary numbers proportional to the analog measurements.

In addition to its functions of accumulation and analog-to-digital conversion, Telebit successively commutates data from the several experiments and thus derives a sequence of pulses which in groups characterize these experiments.

Inasmuch as it is desirable to vary the information transmission rate as the range to the payload changes, three pulse rates are provided; 1, 8, or 64 bits per second.

Where possible, the analog (vhf) and the digital (uhf) systems are both carried in the space probe to increase the versatility of the vehicle. Explorer VI carried both telemetry systems; Pioneer V carried only the digital.

Equipment provided at the four ground stations can be divided into eight general categories: antennas, diplexers, receivers, transmitters, readout and recording equipment, timers, power supply and ground-link communications.

Parabolic and helical antennas are used for space communication. Two sizes of parabolic antennas are used, 60 ft. (Hawaii) and 250 ft. (Manchester) in diameter, both for transmission and reception. The helical antennas are 21.5-turn, 5-

element arrays. All four stations employ helical arrays.

To enable the use of the same antenna for simultaneous transmission to the payload and reception from the payload, diplexers are provided at each station to separate the two signals. The high-level diplexer permits sensitive separation of the transmitted (10 Kw) and received (10^{-10} watt) signals.

This diplexer is similar to those used for television transmitters, where the visual and aural transmissions are coupled to a single antenna, but considerable simplification has been obtained by using resonant cavities as filter reactance elements.

The Manchester and Hawaii stations have high power command transmitters, and use the high-level diplexer.

The ground stations use several types of receivers for tracking and telemetry reception in the vhf or uhf range. All are phase-locked loop receivers utilizing correlation detection for recognizing weak signals, even though the signal is heavily masked by noise. The system makes use of a reference signal constructed to be a prediction of what the received signal should be; correlation techniques permit recognition of a signal that would otherwise be hidden.

As an example of receiver operation, a simplified block diagram of the Able Model 4 receiver is given in Fig. 2. As can be seen, the antenna feeds the incoming signal through a parametric amplifier and

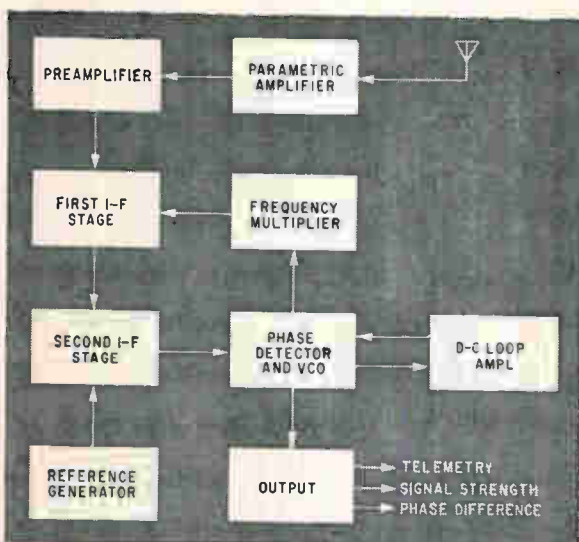
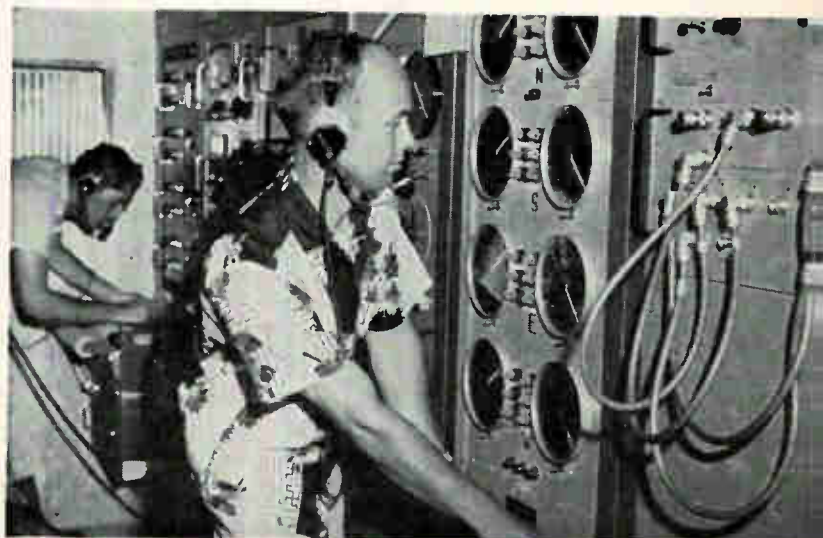
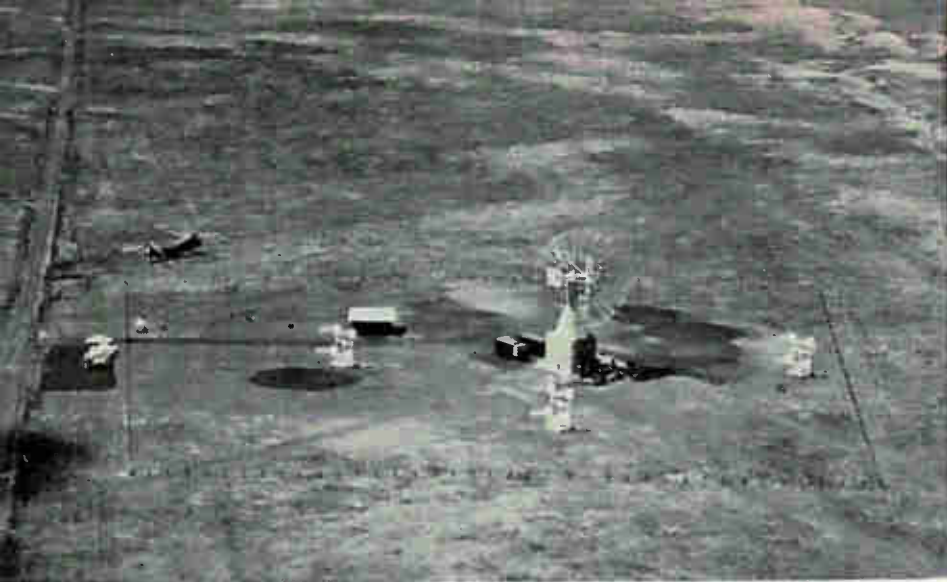

FIG. 2—Receiver has overall noise figure of 2 db, receiver carrier sensitivity of better than -160 dbm



Station manager adjusts equipment in Hawaii instrumentation van. ground station has at least one mobile van to house equipment



Unlike other three stations, Hawaiian station, which is located 40 miles south of Hilo, had to be built from scratch

a second preamplifier to the first i-f stage, where the 378-Mc frequency is mixed with a 358-Mc signal from the times-9 multiplier of the voltage controlled oscillator (vco). The resulting 20-Mc beat frequency is amplified in the first i-f amplifier and fed to the second i-f stage. Here the 20-Mc signal is mixed with a 25-Mc reference tone based on the times-5 multiplication of the 5-Mc internal reference oscillator. The resulting 5-Mc difference-frequency signal is amplified in the second i-f amplifier and then enters the phase detector.

In the phase detector a crystal filter network provides a 3-Kc band-pass filter centered at 5 Mc. This filter limits the noise bandwidth of the receiver, without appreciably attenuating the 1,024 cycle sub-carrier sideband of the carrier.

The filtered signal is limited and fed to two phase detectors to detect the amplitude of the carrier (in-phase detector) and to detect the phase modulation of the carrier (quadrature detector). The d-c voltage from the quadrature detector is a measure of the phase error between the signal and the 5-Mc reference oscillator waveform. This d-c voltage is filtered by an RC filter and then acts upon the voltage controlled oscillator to automatically tune the receiver for zero phase error.

The a-c output of the quadrature phase detector represents the telemetry phase modulation of the carrier; this signal is filtered, amplified, and fed to telemetry recording equipment.

Two principal types of trans-

mitters are used, differing principally in their power outputs (1 Kw and 10 Kw). A typical unit multiplies a 25-Mc oscillator output by two, amplifies it, and sends it to a receiver and a phase modulator. The output from the phase modulator, including an input from the command unit, is amplified, multiplied by eight, and amplified again. The 50 w, 400 Mc output of this third amplifier is raised to 10 Kw in a power amplifier and fed to the diplexer.

All telemetered data, both digital and analog, are recorded as received, along with various other items, on Ampex magnetic tape recorders running at 3.75 ips. The digital and analog forms of data are each recorded additionally in special ways.

Digital information received in the biphas-modulated form is decoded and punched into paper teletype tape, along with interlaced time signals. The decoding consists of punching into the paper tape a sequence of ONE's and ZERO's representing the original sequence of bits in the payload registers. Every minute the tape speed is doubled briefly, while four lines giving the time are inserted between five of the data lines.

Analog data from the vhf f-m/p-m telemetry are detected at the ground stations and transcribed on reproducible oscillograph paper, in parallel with the magnetic tape recording. There are two 8-channel Sanborn pen recorders for this purpose at each ground station.

The perforated tape is used to teletype quick-look digital data to

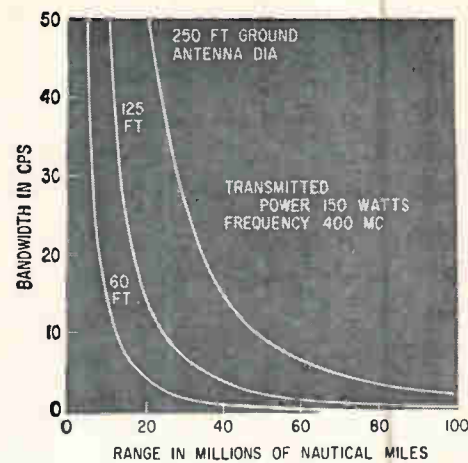

FIG. 3—Diameter of ground antenna and telemetry bandwidth effect range

Los Angeles, following which all of the data obtained are mailed.

For exact time information, the stations are provided with very-stable crystal oscillators with accuracy better than one part in 10^8 on a long-term basis.

Teletypewriters connected over commercial wires to SpaN Center are installed at each station. During launch operations, direct telephone connections to SpaN Center are also provided.

The world's largest radio telescope, the 250-foot steerable parabolic antenna of the Jodrell Bank Experimental Station, operated by the University of Manchester in England, was a natural choice for the Space Navigation Network and with the cooperation of the British was included in the network. Locating three additional stations at reasonably equidistant (in longitude) sites around the world required locations approximately 90 degrees of longitude apart beginning at the basic meridian, and, for maximum lateral coverage, as close to the equator as possible. Placing a second station with a large antenna on the opposite side of the world from Manchester would permit relatively uninterrupted coverage of a space probe as the earth turned beneath it. A feasible land mass in this general location is one of the islands of Hawaii. Since Cape Canaveral (81 degrees West) stands almost midway between Hawaii and England, and since launches generally take place there, it was also a logical choice for a site. The fourth station then had

to be opposite Florida, in the vicinity of 90 degrees East.

Having specifically located two stations, Manchester and Florida, site surveys were performed to locate the other two within the areas generally required. These surveys covered five areas of interest: radio background noise and potential radio interference, terrain and topographical features, accessibility characteristics, local services and facilities, and local political conditions.

After consideration of sites in the Philippines, New Guinea, and Australia, the cooperation of the British was further called upon by locating the Far East station in Singapore, at the Cable and Wireless, Ltd., Trafalgar Receiving Station. This location is at about 105 degrees East longitude and only about 1 degree north of the equator. The fourth station was located at the southern tip of the island of Hawaii (longitude 156 degrees West). This station began as an unoccupied and barren area.

Network operation begins before the launch of any space probe. First, nominal trajectories and antenna steering data are computed, and sent to all stations planning to track the vehicle. These are used to plan tracking periods and to aim the ground antennas until more accurate data from postlaunch tracking are available. Then, after the missile is launched, measured tracking data are teletyped to the

SpaN Center in Los Angeles, where increasingly more accurate estimates of the actual trajectory are calculated to provide refined antenna steering data to all ground stations.

As more tracking measurements are made and received, the accuracy with which the space vehicle's flight is known increases. An IBM 709 computer essentially integrates over the sum of the measurements that have been made, permitting the tracking of the vehicle to become more accurate than the individual measurements by the ground stations would permit. Thus, although the ground equipment normally has a maximum accuracy of measurement of 0.4 degree in position and 1 ft per sec in velocity, the SpaN Center within a few hours knows the vehicle's position within 0.01 degree and its velocity within 0.1 ft per sec.

Before each launch a detailed data acquisition plan is established by SpaN Center, covering the periods when the individual ground stations will track, command the various functions of the payload and record telemetry. After launch SpaN Center watches telemetered payload conditions and views these in the light of the total postlaunch conditions.

The SpaN Center serves four general purposes in the operation of the SpaN Net: it calculates trajectories from tracking data and

provides antenna steering information to the tracking stations; it monitors payload operation and directs the transmission of commands to the payload; it accepts telemetry data from the network and makes quick-look and long-range reduction and analysis of this data; and it provides a coordinating and unifying center for ground communications and operation.

Bandwidth determines the range capability of the network. The bandwidth for space communications with a payload such as Pioneer V can be found from

$$B = (P_T G_T G_R A) / [K T_o (F_N - 1) f^2 R^2 (S/N)]$$

where B is bandwidth in cps; A is a conversion factor, -37.5 db; P_T is transmitted power, 150 watts; G_T is vehicle antenna gain, typically 0 db; G_R is ground antenna gain, 47.1 db (250 ft), 34.7 db (60 ft); f is frequency in Mc, 400 Mc; R is range in nautical miles (5×10^7); F_N is noise figure of receiver and antenna (antenna 50 K, receiver 120 K; so $F_N = 2$ db); $K T_o (F_N - 1)$ is noise power per cycle; and S/N or C/N is 7.3 db for 1 percent error rate, biphase modulation.

Including -4.8 db for subcarrier level, and -10 db for cable and diplexer loss, atmospheric loss and nonoptimum equipment performance, the results shown in Fig. 3 are obtained. Here, the telemetry bandwidth is plotted against range for three antenna diameters.

The command link (ground-to-space communication) includes the 1-Kw and 10-Kw ground transmitters, but considerably less sensitive receivers. Noting these differences, the range performance can be computed as in the previous paragraph. As Fig. 5 shows, a space probe of the Able series, can be commanded to 20 million miles with a 60-foot dish, and to 70 million miles with the 250-foot dish.

REFERENCES

- (1) "Project Mercury", Report 1014 of the Committee on Aeronautical and Space Sciences, United States Senate, Dec. 1, 1959, gives a description of Able and other space missions.
- (2) R. W. De Grasse et al.—Ultra Low Noise Horn Measurements Using a Horn Reflector Antenna and a Traveling Wave Maser, *Jour Appl Phys*, 30, p 2,013, Dec. 1959.
- (3) G. E. Mueller and J. E. Taber.—An Interplanetary Communication System, *Trans IRE, SET-5*, p 196, Dec. 1959.
- (4) E. Taber.—Able-3 Payload Design, *Trans IRE MIL-3*, p 143, Oct. 1959.

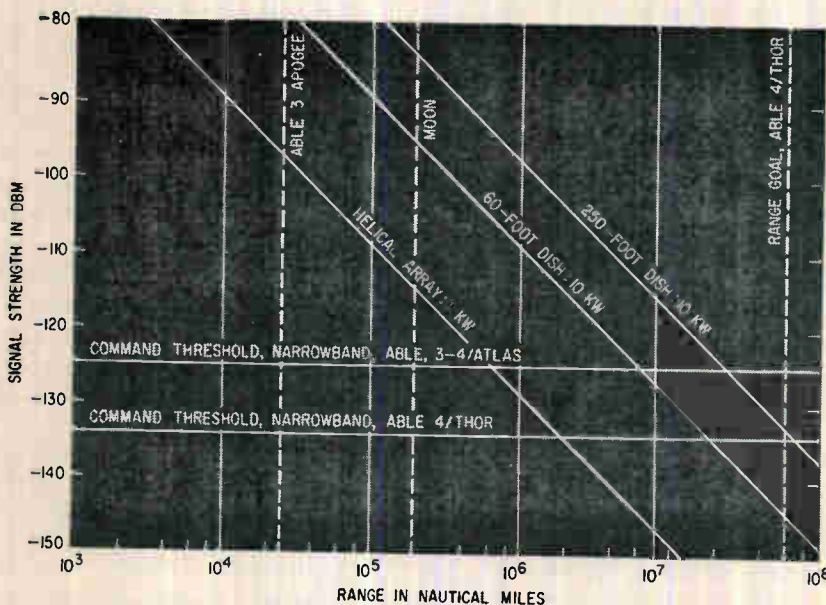

FIG. 4—Ability of network to command probes up to 70 million miles out will be tested in future Able probes

Portable Radio Uses Drift-Field Transistors

Nine transistor a-m/f-m portable uses drift-field transistors in tuner and i-f amplifier. A 25 and 140 μ v-per-meter signal produce a 20-db signal-to-noise ratio when operated on f-m or a-m respectively

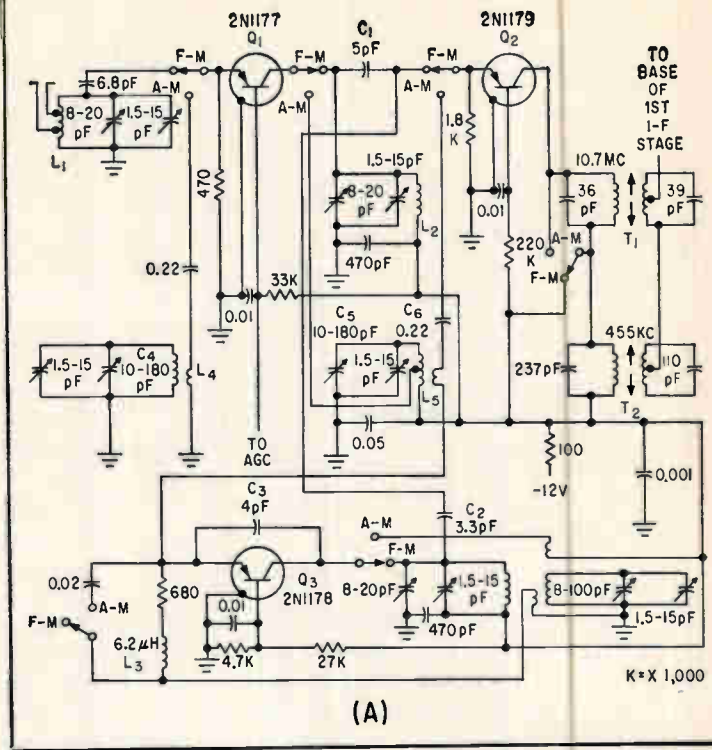

FIG. 1—Composite a-m/f-m tuner (A) and i-f strip (B) use

By R. A. SANTILLI
H. THANOS

Semiconductor and Materials Div.,
RCA, Somerville, New Jersey

DRIFT-FIELD transistors for use in the tuner and i-f-amplifier stages of f-m receivers have essentially the same construction as other drift-field transistors, except that they use smaller geometry. In addition, they require different static and dynamic characteristics to assure proper performance in their respective circuits. The combination of small physical size and the use of the drift field results in a transistor which has a small effective base width, low-feedback capacitance, high collector-breakdown voltage and is capable of oscillation and amplification in the f-m band.

The tuner of the a-m/f-m receiver shown in Fig. 1A, consists basically of r-f amplifier Q_1 , mixer Q_2 , and local oscillator Q_3 , all using drift-field transistors. These stages are switched to perform the same function on a-m as on f-m. The common-base configuration is used in all three stages because it provides higher gain than the common-emitter connection in the f-m band.¹

For f-m operation, the antenna

consists of a collapsible dipole, of which one side is grounded and the other connected to a tap on the r-f input coil L_1 .

The input and output coils of the r-f amplifier stage (L_1 and L_2) are designed to provide a match at 108 Mc. This design provides maximum circuit gain at the frequency at which the transistor gain is lowest and also provides a good signal-to-noise ratio by minimizing the input-circuit loss. An emitter current of 1.5 ma is used as the operating bias of the r-f stage because this value provides the best compromise between maximum available gain, good signal-to-noise ratios, and good agc (automatic gain control) performance.

Coupling between r-f coil L_2 and mixer Q_2 is through capacitor C_1 . This coupling results in a match between the input resistance of Q_2 and the parallel combination of Q_1 output resistance and the r-f coil parallel-tuned resistance. Mixer Q_2 is operated at an emitter current of 0.6 ma and a collector-to-base voltage of -11.1 v. An oscillator voltage of approximately 125 mv is coupled to the emitter of Q_2 through C_2 . This operating point and value of injection voltage result in minimum noise contribution and maxi-

mum gain of the mixer and also avoid any tendency of the base-to-emitter junction to become reverse-biased (squegge) because of excessive oscillator swing. First r-f transformer T_1 in the collector circuit of Q_2 is designed to provide an approximate match to the output resistance of Q_2 for increased front-end gain. For f-m operation, the primary winding of the first a-m i-f transformer T_2 is shorted to prevent spurious responses and noise from passing through the a-m portion of the i-f amplifier strip.

Oscillator Q_3 uses a grounded-base circuit and requires no phase shift in the feedback network to sustain oscillation. Careful circuit design must be used to compensate for the transconductance phase shift at the highest frequency of oscillation (118.7 Mc.). Feedback from collector to emitter is obtained through capacitor C_3 . Inductor L_3 is used in the emitter-base circuit to correct for the transconductance phase shift. A fixed value of inductance may be used because the oscillator transistor phase shift is controlled. The design of the oscillator d-c bias circuit is such that the emitter current and collector-to-base voltage vary in a prescribed manner to provide oscillator-fre-

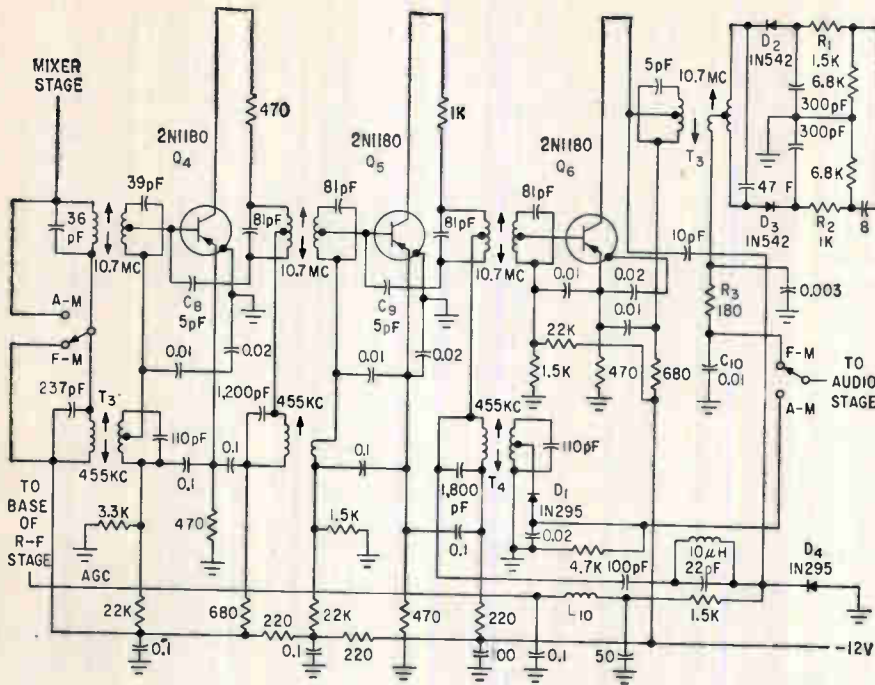

(B)

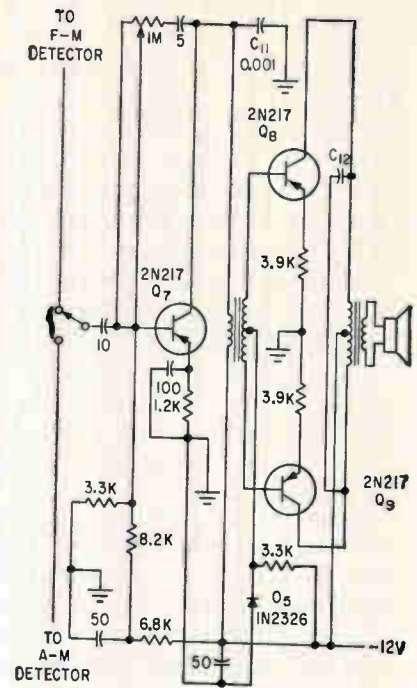

(C)

drift-field transistors. Only two i-f stages operate for a-m reception. Audio amplifier (C) has double-ended output

quency compensation with a change in supply voltage. Frequency compensation with temperature, although not included in this design, can be added by the use of a temperature-sensitive capacitor. The overall circuit gain of the front end of the receiver is 26.5 db at 88 Mc and 22.5 db at 108 Mc. The noise factor is 8 db.

For a-m operation, the r-f signal is received by the tuned circuit consisting of the ferrite-rod antenna L_s and tuning capacitor C_s . To obtain a good signal-to-noise ratio, the secondary winding of the antenna transformer is designed to match the low input impedance of the r-f stage at 1,600 Kc. The collector load consists of the tuned impedance of C_s and L_s in parallel with the reflected impedance of the mixer stage. Inductor L_s is tapped to provide adequate r-f gain with good stability and interchangeability.

The r-f signal is fed to the emitter of the mixer stage by the secondary winding of L_s , and the i-f output from the collector is fed into the primary winding of the first i-f transformer T_2 on the composite i-f amplifier strip. (For a-m operation, a switch short circuits the primary winding of first f-m transformer T_1 to prevent spurious re-

sponses from passing through the f-m portion of the i-f strip).

For a-m operation, the local oscillator is a common-base oscillator using collector-to-emitter feedback. An oscillator voltage of approximately 125 mv is coupled to the emitter of the mixer stage through C_6 . The gain of the tuner is approximately 40 db. Although considerably more than 40 db gain could be obtained, this gain is sufficient to provide an a-m sensitivity of 40 μ v per meter for an audio output of 50 mw.

The composite a-m/f-m i-f-amplifier strip², shown in Fig. 1B, consists of three drift-field transistor stages operated in the common-emitter configuration. The first two stages (Q_4 and Q_5) are neutralized for f-m operation only. Figure 2A shows the maximum available and maximum usable (based on stability considerations³) gain characteristics as functions of frequency. At 10.7 Mc, the neutralized and unneutralized gains per stage are 23 db and 20 db, respectively; at 455 Kc, gains per stage of 40 db (neutralized) and 38 db (unneutralized) may be obtained.

For good f-m selectivity, three double-tuned i-f transformers and a ratio detector are used. The de-

sign of the primary impedance of the ratio-detector transformer T_3 depends on the large-signal capabilities of the last i-f amplifier stage. This stage does not require neutralization because sufficient mismatch is provided for stability.³

A tapped primary winding cannot be used for the a-m i-f transformer because the inductance between the tap and either end of the coil would act as an r-f choke for f-m (the return for the f-m i-f coil is not bypassed). On the secondary winding, however, r-f bypass capacity C_7 is used from the return of the f-m i-f coil to the i-f emitter. The value chosen provides complete bypassing for f-m and results in a loss of only 1 db for a-m due to shunting. The total f-m i-f gain from the primary of the first f-m i-f transformer to the primary of the ratio-detector transformer is 60 db. The overall i-f bandwidth is 250 Kc at 2 times down and 900 Kc at 1,000 times down.

For a-m operation, only Q_4 and Q_5 are used, and they are operated unneutralized. In the calculation of the gain of these stages, the f-m neutralizing capacity (C_6 and C_7) must be considered as an additional feedback capacitance between the collector and base. As a result, the

maximum useable unneutralized gain shown in Fig. 2A is reduced and the amount of decrease depends on the value of the f-m neutralizing capacitor used. With the value of f-m neutralizing capacitor chosen, the maximum useable gain for two unneutralized stages is approximately 54 db (27 db per stage). The total gain from the primary of T_1 to the secondary of T_2 is approximately 50 db. The bandwidth of the i-f amplifier strip is 9 Kc at 2 times down and 40 Kc at 1,000 times down.

Point-contact germanium diode D_1 is used as the a-m detector. For the detection of small signals, maximum sensitivity and minimum distortion are obtained by passage of a forward d-c current through the diode.

A balanced ratio detector using two matched point-contact ger-

manium diodes D_2 and D_3 is used for f-m detection. Balancing resistors R_1 and R_2 provide a-m rejection for low-level signals while series resistor R_3 provides good a-m rejection for high-level signals.

Diode D_4 acts as a common age detector for both a-m and f-m operation. The diode is fed by a capacitor from the collector of the last i-f amplifier stage in each case. However, a 10.7 Mc trap is inserted in series with the a-m age line to the diode to prevent interaction between the f-m and a-m circuits. The age voltage is filtered, decoupled through r-f choke L_{11} and applied to the base of the r-f transistor.

The audio amplifier, shown in Fig. 1C, consists of a driver stage and a push-pull audio output stage. The driver uses a germanium *pn-p* alloy junction transistor Q_1 operating at a collector current of 1.5 ma

and a collector-to-emitter voltage of -10 volts. The gain of the driver stage is 44 db. The power output stage consists of Q_2 and Q_3 operated in push-pull and connected to a suitable heat sink. The output stage is capable of delivering an audio output of 1 w with less than 10 percent distortion. The bias for the output stage is established by a compensating diode D_5 which maintains an essentially constant collector idling current despite temperature or supply-voltage changes. The entire audio amplifier has a power gain of 70 db. The audio amplifier is common to both a-m and f-m and is switched to the particular detector when the tuner is switched. The standard deemphasis curve for f-m receivers is obtained through the use of C_{11} at the ratio-detector audio output, C_{12} across the driver transformer and C_{13} across the output transformer.

The sensitivity, image rejection and i-f rejection of the f-m receiver between 88 to 108 Mc is shown in Fig. 2B.

Figure 2C shows the relative power output in db on f-m operation as the input signal is varied from 2.5 μ v to 1 v.

The tuning characteristics of the f-m portion of the receiver for in-110,000 microvolts at 98 Mc is shown in Fig. 2D.

The frequency response of the f-m portion of the receiver is 3 db down at 230 cycles and 12 Kc.

Tracked sensitivity, image-rejection ratio and i-f rejection ratio as functions of frequency are shown in Fig. 2E.

The agc and noise characteristics of the receiver for a-m are shown in Fig. 2F. The receiver has a 50 db agc figure of merit (for a 5,000- μ v-per-meter reference). A signal-to-noise ratio of 20 db is obtained at approximately 140 μ v per meter. No evidence of overload was experienced for signal levels up to 500,000 μ v per meter.

REFERENCES

- (1) D. M. Griswold and V. J. Cadra. Use of the RCA-2N384 Drift Transistor as a Linear Amplifier, 1958 IRE Convention Record.
- (2) Langford-Smith, "Radiotron Designer's Handbook," 4th Edition, p 1024. RCA, Harrison, N. J. 1953.
- (3) D. D. Holmes and T. O. Stanley, Stability Considerations in Transistor IF Amplifiers, *Transistors I*, p 403, RCA, Princeton, N. J.

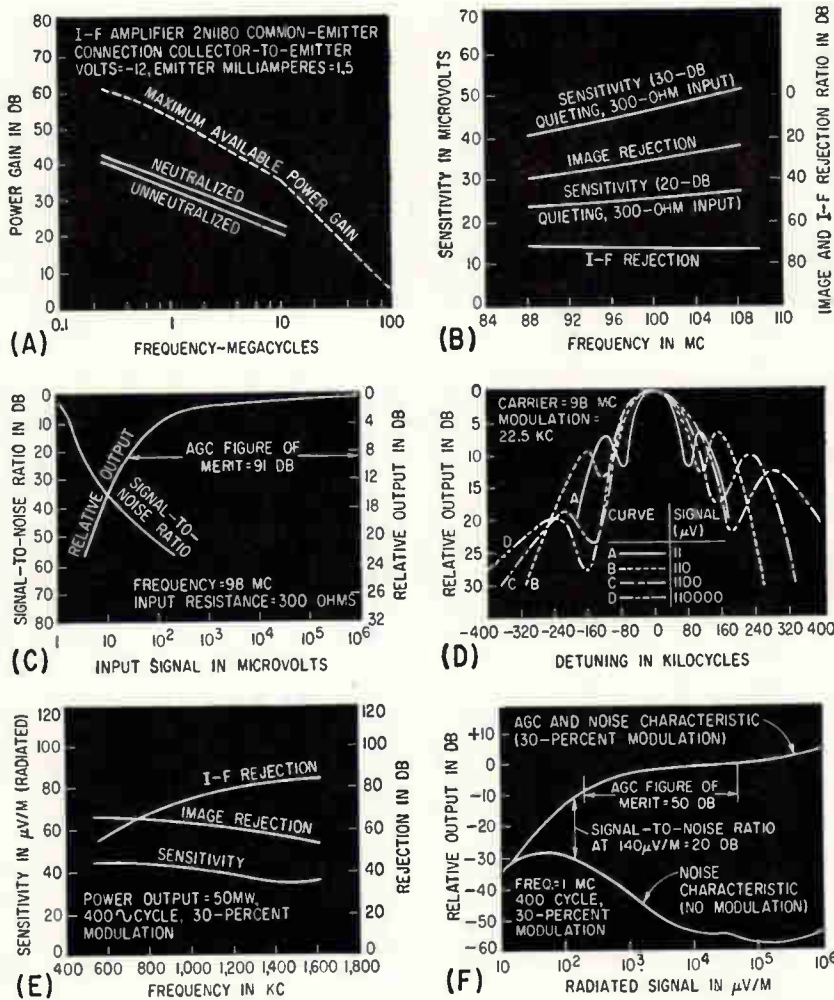

FIG. 2—Gain characteristics of 2N1180 drift transistor (A); sensitivity, image and i-f rejection for f-m (B); relative power output (C); f-m tuning characteristics (D); tracked sensitivity, image and i-f rejection as function of frequency (E); and agc and noise characteristics of a-m portion (F)

BATTERY POWERED CONVERTER RUNS MULTIPLIER PHOTOTUBE

High voltage supply is provided by a string of Cockcroft-Walton voltage doublers. Absence of bleeder resistance chain avoids quiescent current drain

By RICHARD P. RUFER, University of California, Radiation Lab, Livermore, Calif.

SOMETIMES it is desirable to operate a multiplier phototube detector where there is no readily available source of power. Since most sensitive tubes require a kilovolt or more for proper operation and since this high a potential cannot be conveniently obtained from batteries directly, a d-c to d-c converter is practical.

The conventional method of operating a multiplier phototube is to provide the individual dynode voltages by using a bleeder string from a single high voltage supply. However, this method has a constant power loss owing to the quiescent point dissipation in the bleeder resistors.

The figure shows a design which effectively overcomes the quiescent power loss and provides a more constant dynode voltage. The individual dynode voltages are obtained by multiplying the input a-c voltage through a series of half-wave doublers. This Cockcroft-Walton string charges each dynode capacitor to approximately the peak value of the a-c secondary voltage. A 9-stage multiplier phototube will require 10 such doubler stages and will be provided with a cathode-to-plate voltage of 10 times the peak-to-peak a-c voltage on the secondary.

A feature of the type of power supply shown in the figure is that each of the stages is supplied from a source whose impedance is proportional to current demand. The cathode current, which is the lowest of all the dynode currents, is supplied from the last stage of the Cockcroft-Walton string. This last doubler stage, which has the lowest

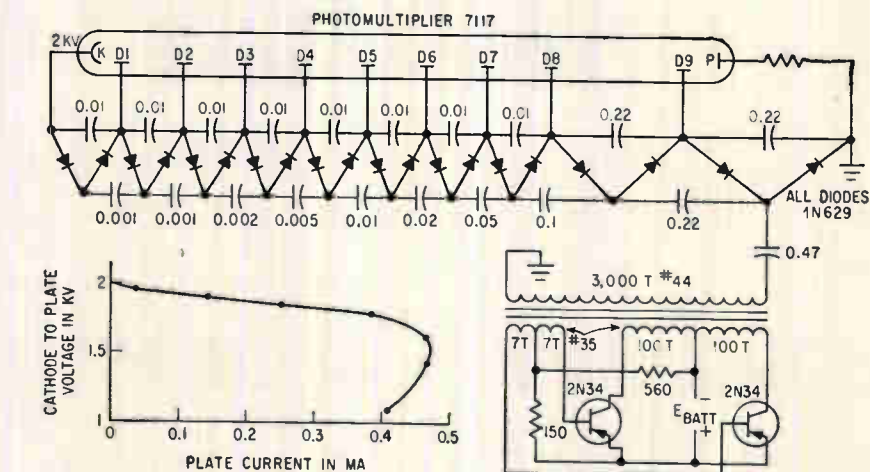

Free running oscillator gives initial boost to battery voltage which is thereafter raised by multiplier chain; regulation curve shows reasonable constancy of output up to about 0.4 ma plate current

current capabilities, is called on to provide the least current. Likewise, the plate-to-first-dynode doubler stage, which is called on to supply the load, is driven directly from the secondary of the transformer and has the best regulation.

The design of the flip-flop circuit in the power supply is conventional with the exception of its regulation. It is a magnetic coupled multivibrator in which the amount of feedback is controlled so that for a certain secondary loading the supply operates only part of the time. This results in a current limiting supply.

This type of regulation is desirable for tube operation since high quiescent currents can lower tube life.

The design shown in figure uses a 7117 tube; battery voltage ranges from 2.5 to 3 volts, using two mercury cells (2.7 volts) to

give a dynode-to-dynode voltage of 200 volts. Silicon diodes (1N629) are used in the multiplier section because of their low back current. The dynode capacitors are graded according to the current drain on each stage. The converter core is a 0.001-in. tape-wound toroid 1 inch in diameter and $\frac{3}{8}$ inch high. The power supply regulation characteristic is shown in the figure. The total current drain with no illumination is approximately 20-ma while at saturation level the current drain is 60-ma.

Silicon solar cells have been used in conjunction with Nickel-cadmium alkaline batteries to operate the tube. Using a 2.6-volt battery and six solar cells, the unit can be operated in daylight without using battery energy. A charging diode will prevent discharge of the batteries through the unilluminated solar cells.

Each trace width (frequency) corresponds to less than 2 deg C. Top trace shows central response, which represents correct temperature; lower two traces show first two sidebands

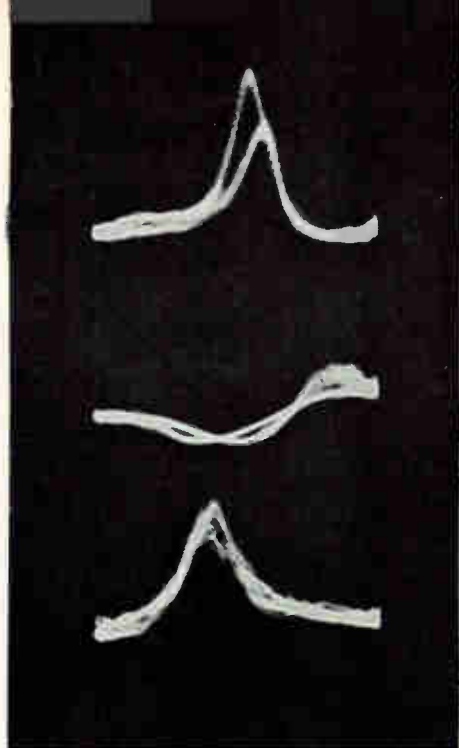

The r-f energy that a chlorine molecule absorbs depends on its temperature. This is the principle used in designing a new instrument for temperature telemetry

Using Nuclear

By CHRISTOPHER DEAN,

Associate Professor of Physics,
University of Pittsburgh,
Pittsburgh, Pa.*

USING nuclear-resonance spectra in solids, the temperature-sensing system described here maintains constant calibration as long as the electronics portion of the instrument works.

The spectra used are nuclear quadrupole resonance (NQR) r-f absorption lines whose frequencies decrease smoothly with temperature.¹ The temperature-frequency relation is determined by the molecular properties of the compound that is used as a temperature probe; thus the relation is essentially fixed for all samples of that chemical for all time. An electronic spectrometer seeks out the NQR frequency and then transmits it. Frequency measurements are made at the monitoring station, assuring that conversion to temperatures is reliable.

Although the rudimentary system that is described below is intended for measurements that are accurate to a few tenths of a degree, more elaborate equipment has been used in laboratory measurements to attain a precision of a few thousandths of a degree.² Un-

doubtedly, more complex circuits could be designed to provide comparable precision in a telemetering unit.

The NQR temperature-measuring technique has its drawbacks, but its unique properties could make it invaluable if a long-term series of measurements at an inaccessible spot were required. Such a requirement might be encountered for a permanent unmanned weather station, for long-range space exploration, or for continuous measurements on the ocean floor. For any such application the probe itself could guarantee well-calibrated telemetered data for decades, or even centuries, if the long-life electronics were available.

In converting the quantity to be measured directly into a frequency that can be telemetered, the NQR instrument resembles the nuclear- or electron-resonance magnetometers. In the nuclear magnetometer the resonance frequency is determined by the product of the magnetic field and the magnetic dipole moment of the nucleus. The NQR frequency is determined by the interaction of the electric quadrupole moment of the nucleus with the electrostatic field gradient that is produced by electrons immediately around it, that is, by the electrons in its own atom. The thermal vibrations of the molecules have the effect of smearing out the field

gradient which otherwise would be a fixed quantity for a stable molecule; thus thermal vibrations reduce the resonance frequency by an amount that depends on the average vibration amplitude.

Generally, the NQR frequency range that is involved depends on the nuclear species that is used. The spectrometer described is designed for resonances of Cl³⁵, which lie in the band of roughly 20-40 Mc for a convenient class of compounds. The particular probe compound that is chosen determines the narrower region within this band in which the resonance will lie; different molecular structures result in somewhat different electron distributions on the chlorine atoms.

An excellent choice for a probe material seems to be KClO₃. This compound is stable, has a simple singlet spectrum, and its line width is narrow relative to the rate of change of NQR frequency with temperature. For this compound, the resonance frequency is 28.2134 Mc, the line width is 500 cps, and the temperature dependence is approximately -4.8 Kc/degree, at 0 C.²

Because only the molecular structure and the local crystal structure are important, the NQR spectrum is practically independent of the size of the individual grains of the probe compound, and ordinary commercial powdered samples may be

* Now with Allied Research Associates, Inc., Boston, Mass.

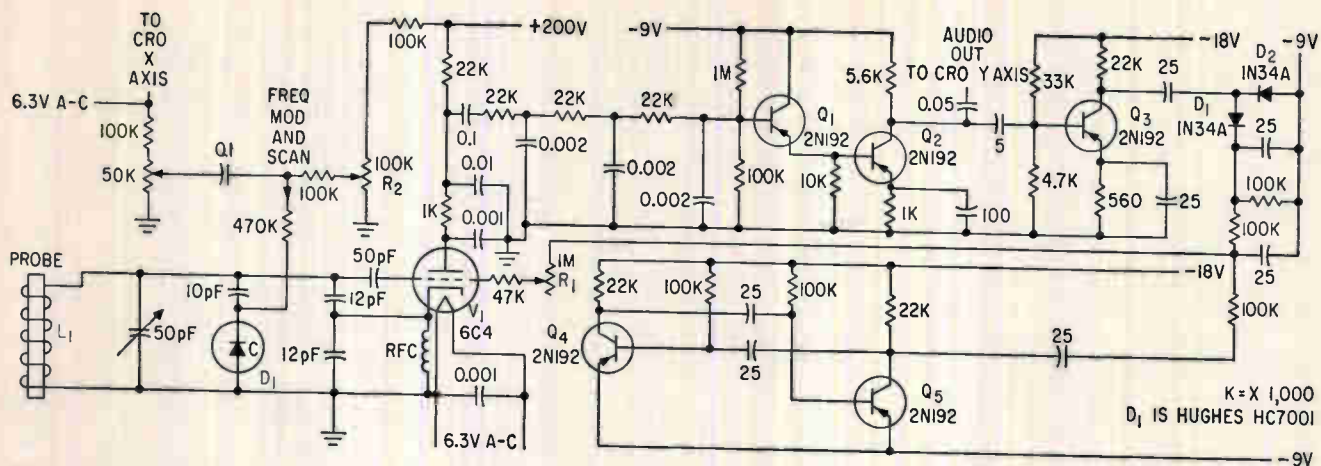

Temperature-sensing instrument is remotely located from display unit and some of its supply voltages

Resonance to Sense Temperature

used. An impurity which creates a local imperfection in the crystal structure greatly alters the NQR frequency in the adjacent molecules, increasing it for some and decreasing it for others, thus tending to broaden the observed spectral line. However in the usual commercial pure grades this effect is ordinarily so small that it can be ignored. A few studies have shown that severe radiation damage has the same effect on NQR as a high impurity level.

The NQR instrument is built around a self-quenched superregenerative r-f spectrometer. The probe material, which is contained in a 1/2-in. diam vial, is placed inside coil L_1 of the tank circuit, since it is sensitive only to the r-f magnetic field. Action of the probe can be understood by thinking of it as a separate single-tuned circuit at the NQR frequency, with a high Q to correspond to the width of the NQR absorption line, and with weak inductive coupling to the oscillator tank. If the spectrometer oscillator (V_1) is tuned to the right frequency, each oscillator pulse sets up oscillations in the probe which persist long enough to affect the starting voltage for the next oscillator pulse. In this way, signals from the probe correspond to the signal from the antenna in a superregenerative receiver, the detection processes in the two cases being

similar.³ Unlike communications receivers, the spectrometer is ordinarily operated in the coherent mode, in which the superregenerator circuit responds whenever the NQR frequency matches the frequency of any one of the components in the Fourier spectrum of the r-f pulse from the oscillator.

Other spectrometers which have been used for NQR are basically the same as grid-dip meters. In such circuits the absorption of power by the sample causes a tiny decrease in the c-w oscillation amplitude, which is then detected in a conventional manner. The simple response of such a circuit to a resonance would be preferable to the many sideband responses of the superregenerative, and undoubtedly a suitable c-w circuit could be engineered for a temperature-sensing unit. However, the c-w circuits only rarely approach the signal-to-noise ratio for NQR which the superregenerative has, and they tend to be trickier and more difficult to keep in adjustment.

After plate detection and low-pass filtering to suppress the quench frequency, the signal goes to a two-stage audio amplifier (Q_1 , Q_2) whose output signal indicates whether the spectrometer is on a nuclear resonance frequency. Audio stage Q_3 and diodes D_1 and D_2 fix the grid return voltage for V_1 , thus controlling the quench rate.

The effective gain of the superregenerative detector in the coherent mode varies strongly with the quench rate, both for circuit noise and for the slightly larger NQR responses; thus the quench can be stabilized by what is a simple audio age circuit. In the laboratory such stabilization is usually unnecessary, but it is required when large changes in ambients are anticipated or when wide r-f bands must be explored.

It is necessary to set the quench rate initially, in the coherent mode, by adjusting grid resistor R_1 . In the coherent mode the transient ringing of the tank circuit from one pulse is still above noise level when the tube is turned on for the next pulse, whereas in the incoherent mode the time between pulses is made long enough for this ringing to decay below the noise level. The transition between modes can be heard on a c-w receiver, since the r-f that is radiated by the spectrometer changes from a broad band of noise for the incoherent mode to a clean spectrum of a center frequency plus sidebands for the coherent mode. The transition can also be noted in the audio output from the spectrometer, since the effective audio gain for noise is large and fairly constant in the incoherent mode, but begins to drop rapidly and steadily as the quench rate is increased through the co-

herent region. Since the signal-to-noise ratio is relatively constant over a wide range of coherent quench rates, the adjustment is not critical.

Multivibrator Q_4 , Q_5 generates a crude slow triangular voltage which is added to the quench stabilization voltage. This triangular voltage modulates the quench rate around the average value which is set by the stabilization circuit. Thus the r-f sidebands are forced to move constantly towards and away from the center frequency, making it easy to distinguish them from the center frequency. Motion of the sidebands on the display cro shows which of the apparent resonances corresponds to the true NQR line. The resulting fluctuation of the audio gain is distracting, but it is not a serious nuisance because the noise figure is not appreciably affected. A compressor circuit with a short response time could be added after the audio output to suppress the gain fluctuations.

In this rudimentary temperature-sensing system, the two frequency-control voltage sources were not mounted on the remote chassis although they could easily have been placed on this chassis. These voltage sources provide a small 60-cps frequency modulation of the r-f and a slow scan over the range of NQR frequencies which corresponds to the possible temperatures that are expected. The sum of these voltages is applied to D_1 , a silicon voltage-sensitive capacitor in the tank circuit. The 60-cps modulation amplitude is usually set for a few kilocycles peak-to-peak-excursion. With a 60-cps voltage of the same phase on the x axis, and the audio output on the y axis of a cro, a plot of output against frequency over this narrow band may be seen (see the photograph). A slow scan applied to the x axis gives the effect of moving the complete output-against-frequency plot slowly across the field of view. In this simple system, the operator produces the scan manually, by slowly turning R_2 , a 100,000-ohm potentiometer.

In the instrument described here, the remote unit was connected to the cro by a cable. Since the audio signal is actually present

as a small modulation of the r-f that is radiated by the spectrometer, the cable connections to the measuring equipment can be replaced by a broad-band receiver. However, in practice the radiation from the spectrometer is so weak, and the audio modulation of it so small, that a power amplifier would be necessary for transmission over any appreciable distance. Probably a harmonic of the spectrometer r-f would have to be broadcast to prevent the strong signal from interfering with the operation of the spectrometer. Presumably the r-f amplifier stage could be modulated by the amplified audio signal, to provide a more realistic modulation amplitude to deal with at the receiving station.

In looking for the resonance, the central component of the r-f spectrum that is generated by the spectrometer is best located at the outset on a frequency meter, and then followed as the spectrometer gradually scans through the frequency band seeking the resonance. Some of the sideband responses to the NQR absorption are shown in the photograph (for NaClO_4 at about 29 Mc) as they appear on the cro without quench modulation by Q_4 and Q_5 ; the effect of quench modulation is to force all but the true resonance to wander back and forth across the cro. Each trace was photographed at a different time.

For a measurement of frequency, the frequency meter should be zero beat with the spectrometer at precisely the point of the 60-cps modulation cycle where the NQR absorption appears. A simple way to do this when the spectrometer is nearby is to leak some r-f from the frequency meter into the spectrometer chassis, which then detects both the zero beat frequency meter signal and the NQR signal and presents the results on the cro. The modulation of the quench frequency insures that the zero beat and the NQR signals can be kept aligned only for the correct choice of center frequencies for the two signals.

The only construction detail of particular importance is a strict adherence to the rule of short leads and clean geometry in the superregenerative stage. Any tendency toward parasitic oscillations seri-

ously impairs the performance of the instrument, apparently because of the confusion such oscillations cause at the start of each pulse, which is precisely when the detection process is occurring.

In testing this instrument, the transistor batteries were packaged with the remote unit, but the 6C4 power and the frequency control voltage were supplied to the chassis through the same cable that brings the audio output signal back to the cro. Grid resistor R_1 was set for reasonable coherence in the laboratory, and the main tuning capacitor, set to make the slow frequency scan encompass both the laboratory temperature and the outdoor temperatures. The instrument was then placed in the snow on the roof of the adjoining building, a few feet from the laboratory window. No subsequent adjustment has been required.

Although the transistor current was left on, the power can be completely shut off except when the temperature is to be measured, thus minimizing the heat that is delivered to the probe compound by the adjacent electronics. The instrument will operate properly as soon as the 6C4 heater is up to temperature and the capacitors have acquired their normal operating voltages.

This research was supported by the Air Force through the Air Force Office of Scientific Research of the Air Research and Development Command under contract No. AF 49 (638)-323 and by the National Science Foundation.

The theory and methods of NQR can be found in review articles such as those that are listed in references 4 and 5. The details of the thermometer circuit were derived from special-purpose laboratory spectrometers described recently.^{6, 7, 8}

REFERENCES

- (1) C. Dean and R. V. Pound, *J. Chem. Phys.*, 20, p 195, 1952.
- (2) G. B. Benedek and T. Kushida, *Rev. Sci. Instr.*, 28, p 92, 1957.
- (3) J. R. Whitehead, *Superregenerative Receivers*, Cambridge University Press, Cambridge, England, 1950.
- (4) T. P. Das and E. L. Hahn, "Nuclear Quadrupole Resonance Spectroscopy," Academic Press, Inc., New York, 1958.
- (5) H. G. Dehmelt, *Amer. J. Phys.*, 22, p 110, 1954.
- (6) C. Dean and M. Pollak, *Rev. Sci. Instr.*, 29, p 630, 1958.
- (7) C. Dean, *Rev. Sci. Instr.*, 29, p 1047, 1958.
- (8) Victor Rehn and C. Dean, *Rev. Sci. Instr.*, 31, p 72, 1960.

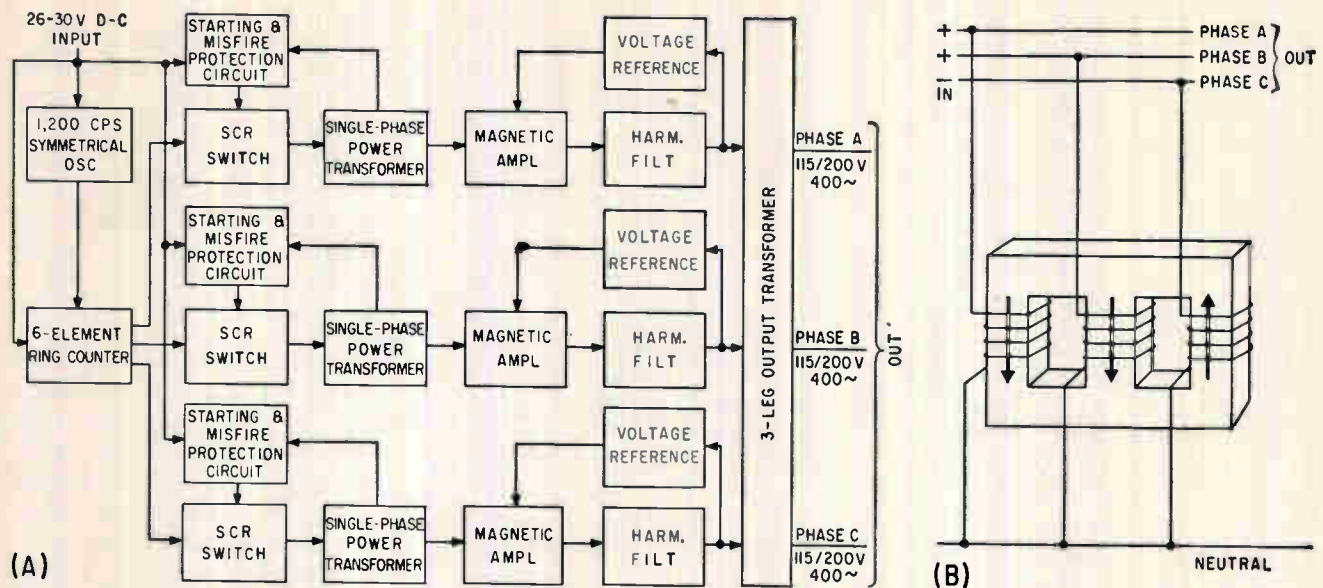

FIG. 1—Three-phase silicon controlled rectifier static inverter (A) uses three-legged autotransformer (B)

STATIC INVERTER DELIVERS REGULATED 3-PHASE POWER

Use of silicon controlled rectifier results in high overload capacity, fewer components. Magnetic amplifier as regulating reactive element yields high efficiency

By MANFRED LILIENSTEIN,

Engineering Supervisor, Precision Power Div., American Electronics, Inc., El Monte, California

THE 3-PHASE inverter described in this article uses silicon-controlled rectifiers (SCR's) in conjunction with magnetic amplifiers, static devices having many advantages over rotating devices.¹

Static devices are lighter than rotating machinery, require less servicing and have no brushes. The efficiency of static devices is considerably higher. Also, they are more rugged in the face of vibration and shock and, having no heavy components such as a rotor and a stator, lend themselves to printed circuit design and mass production methods.

Figure 1A shows that, basically, the frequency determining element is a symmetrical Hartley 1,200-cps oscillator. The oscillator pulse is fed into a six-element ring counter which consists of three flip-flops.

The ring counter supplies the control signal for three phases in proper rotation. In Fig. 1A, the SCR switch is represented by three blocks, one block for each phase. The pulse is steered into each of these SCR switches so that the state of that switch is changed at the proper timing interval.

The voltage from each SCR switch is fed to a single-phase power transformer which, in this case, transforms the voltage from 26 to approximately 150 volts. The output then goes into the magnetic amplifiers for regulation before entering the harmonic filters.

Coming out of the SCR and the power transformer is a square wave. The magamp delays part of the leading edge of the square wave slightly, and the filters attenuate the harmonics. From the filters, the output goes to the three-legged transformers.

This process regulates each of the three phases separately to 115 volts. The SCR switch itself, on the front end, is driven in the usual manner. Once every 1/2,400 second, one of these three switches changes state. When the three voltages finally reach the three-legged autotransformer, the phase between them may not be exactly 120 degrees. The three-phase autotransformer will, then, provide an exact 120-degree phase shift, provided that the three voltages are equal.

The three-phase autotransformer

is supplied by three sources. The sum of the fluxes in the three legs of this core must add up to zero, or flux will be discharged into the air. Hence, if the three voltages coming in from the left side (see Fig. 1B) are exactly equal in magnitude and approximately 120 degrees out of phase, this three-phase core will equalize the voltages to exactly 120 degrees out of phase.

If one of the three phases should be slightly more or less than 120 degrees out, the other two phases will supply reactive energy into that phase to bring it back to 120 degrees. In the event that the voltage of one of the phases, for example, from line to neutral, is not exactly equal in magnitude to the other two phases, then the vector sum still must equal zero. Individ-

ual phase regulation permits balancing of highly unbalanced loads.

Figure 2A represents the basic SCR switch consisting of switch Q_1 and switch Q_2 . Assuming that Q_1 is conducting, to bring it to the cutoff state, controlled rectifier Q_2 must begin to conduct and, at the same time, the gate signal must be removed from Q_1 . Thus, the anode current is momentarily shunted from Q_1 so that Q_1 will cutoff; this process is explained below.

Also shown in Fig. 2A is the single-phase power transformer, which brings the voltage from about 28 (or 26) volts to approximately 150 volts. The transformer is wound in a special fashion, and it is necessary for the primary to have a high series inductance. Thus, when Q_2 begins to conduct and cur-

rent starts flowing through the commutating capacitor, there is little current increase in the primary because of its high inductance, so that the anode current in Q_1 is momentarily brought to zero by a pulse through the commutating capacitor, which discharges to ground through Q_2 .

The single-phase power transformer consists of a primary, a secondary, and a tertiary. The tertiary winding has two rectifiers placed across it, which feed into the battery. The ratio of turns between the tertiary and the primary is approximately 1:1 (the tertiary has a few turns less than the primary). The purpose of the tertiary is to reduce spikes that occur across the transformer primary; these spikes will also appear across the tertiary and, hence, will be fed back into the battery. In the case illustrated by Fig. 2A, the control signal to the SCR's cannot be a pulse, but must be a square wave.

Let it be assumed that a lagging power factor load is placed on the secondary of the transformer. Assume Q_1 is conducting, the current being indicated in Fig. 2A by arrows. Then Q_2 receives a triggering signal, causing it to conduct for a moment. The result is that a surge of current passes through the commutating capacitor, and Q_1 cuts off. The lagging current still tries to pass through Q_1 which, however, has been cut off and does not receive a gate signal. Since the lagging part of the power factor current has to go some place, it spills over into the tertiary and back into the battery. Therefore, the reactive power returns to the battery, and the resistive power is supplied from the battery.

The same reasoning can also be applied to leading power factor loads. In the presence of a leading power factor, the current will reverse before Q_2 conducts; again, the reactive part of the current will spill over into the battery by way of the tertiary.

Commutation will only proceed correctly, when the transformer is not in the saturated condition. Fig. 2B shows what might occur during starts. If the SCR is turned on at a time when a full 180-degree square wave appears across Q_1 , then

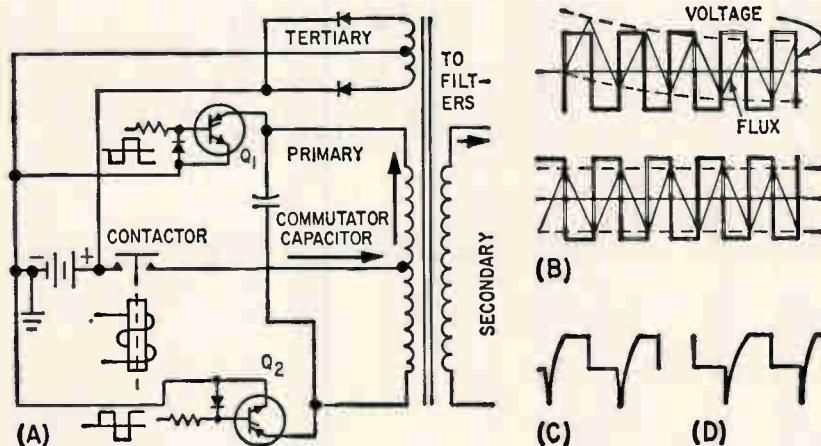

Fig. 2—Basic switching circuit (A). Transformer starting characteristics (B) show two possible conditions. Voltage waveforms in (C) and (D) are for Q_1 and Q_2 , respectively

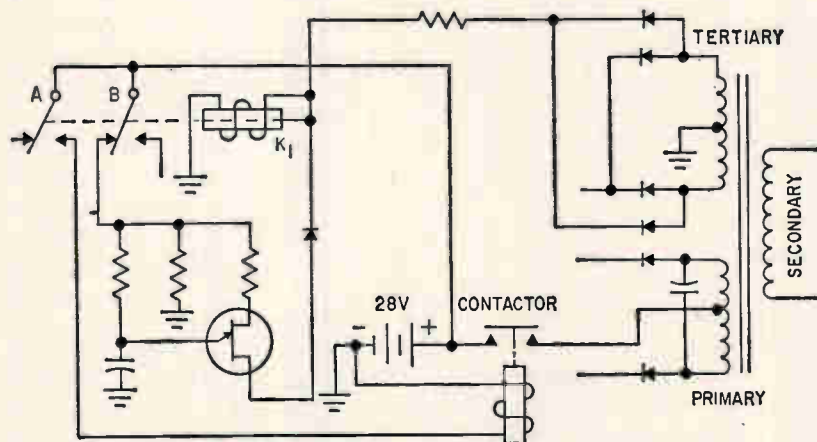

FIG. 3—Starting and protection circuit protects from misfires, double fires and overloads

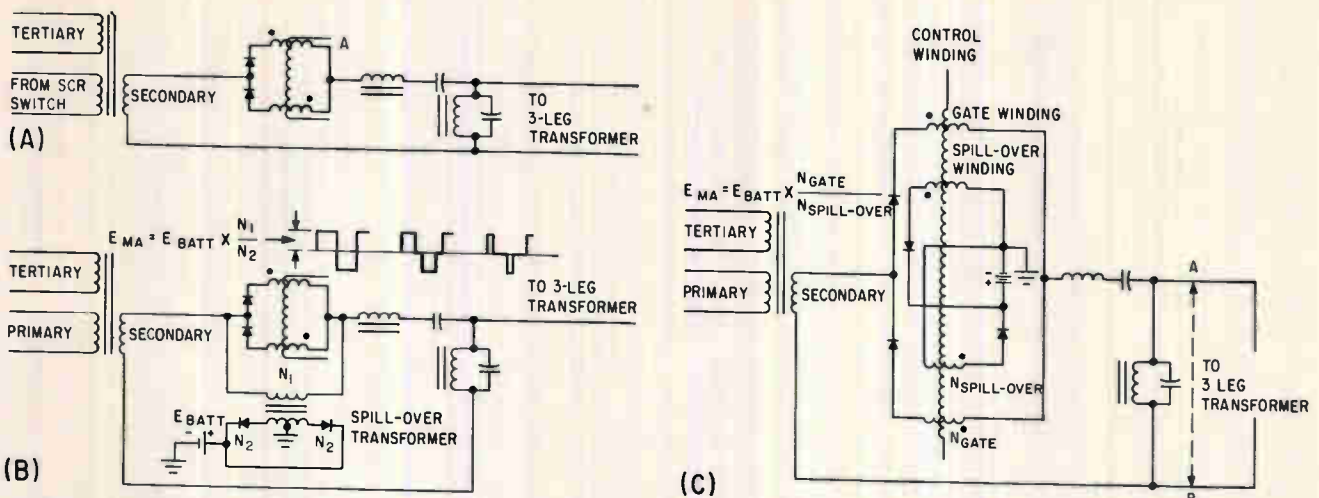

FIG. 4—Basic magnetic amplifier (A) is modified by adding external spill-over transformer (B) and then modified by adding integral limiting windings, which consist of the gate and spillover windings (C)

the transformer flux will go from zero to some certain value. Afterward, the average flux value will decay to a steady-state value. Should the SCR be turned on at a time when less than 180 degrees of square wave is applied on Q_1 , then the flux will not have this high temporary excursion. It might happen that the transformer will saturate in the first condition under turn-on. If so, no commutation will take place, and a misfire condition results. In that case, either Q_1 or Q_2 or both may conduct permanently and a short will result. The battery must be removed from the short.

Such a short is actually removed from the battery by a contactor. The contactor break time has to be related to the impedance of the battery, the overload current curve of the rectifier, the battery voltage and so forth.

It is important that the transformer be designed with a highly inductive primary and, also, that the transformer does not saturate during starts. Statistically, the number of misfires that may occur is proportional to the size of the transformer, related to the amount of iron and the number of turns on the primary.

Figures 2C and 2D show the voltage wave shapes which appear across the SCR's, when they are commutating correctly. As Q_2 goes into conduction, Q_1 gets a high negative voltage surge, which occurs as a result of the current created by the capacitor discharge. SCR Q_1 then goes into a non-conducting state, and the voltage

across Q_2 becomes twice the battery voltage or, in this case, approximately 56 volts. The rise time of the negative surge has to be shaped correctly; it should last at least 20 microseconds so that the SCR can cut off.

The importance of controlling these rectifiers with square waves is evident, because if a lagging power factor load is used and Q_2 gets a gate signal and for instance, the current is still going the way shown by the arrows although it is not yet ready to pass through Q_2 , but charges the battery via the tertiary. The gate signal has to be applied to Q_2 until the current reverses and is ready to pass through Q_2 . Therefore, in this type of circuit, pulses on the gates cannot be accepted—only square waves.

The starting and holding circuit is shown in Fig. 3. Suppose that 28 volts is being supplied to start up the unit. The voltage goes into contact B of the relay and charges the capacitor. After approximately 0.1 second, the unijunction transistor breaks over and passes a short surge into relay K_1 . The relay pulls in and contact A thereupon applies power to the contactor.

As the contactor goes in, power is applied to the SCR; as this starts switching, power comes back from the tertiary into the relay, holding the latter in. Therefore, the contactor remains in. In the event of a misfire, the tertiary will not get any a-c voltage, the relay will not remain closed, and the contactor will immediately drop out again. The opening time of the contactor

is fast enough to prevent any damage to the SCR's.

Should a permanent fault be present in the system, when the relay pulls in, no voltage will be supplied from the tertiary and the relay immediately drops out again. This action repeats itself until the fault is cleared, and the unit starts functioning correctly. Hence, the starting and holding circuit is self-protecting and self-locking. It protects itself from misfires, double fires, and overloads.

The square wave leaves the power transformer and enters the magnetic amplifier. In series with the magnetic amplifier is a combination of series and parallel filters that is effective in producing a low harmonic content, as discussed below. However, the magnetic amplifier has a thyatron-like characteristic in that it is either fully conducting or it is not conducting at all. During part of the controlled cycle, the magnetic amplifier may be in the nonconductive state. The action of the series filter is such that high voltage spikes result on point A of Fig. 4A. High losses are incurred with concomitant inefficiency.

Losses resulting from high voltage spikes can be corrected by putting a spill-over transformer across the magnetic amplifier. This spill-over transformer has a primary and a secondary. The secondary is similar to the tertiary of the power transformer connected across the battery. The voltage across the winding with N_1 (Fig. 4B) turns is equal to the voltage of the bat-

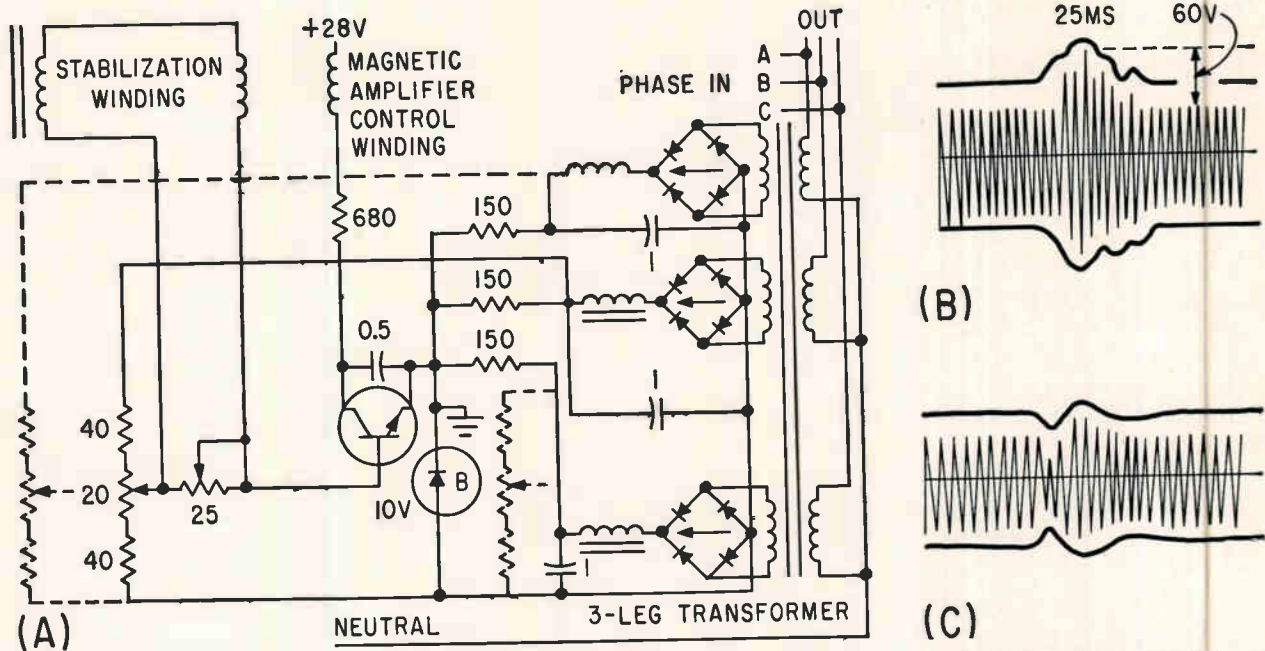

FIG. 5—Voltage regulatory circuit (A) provides 25-ms recovery time when load is switched from 2.5 amp to zero load (B) and short dip with application of load from 0 to 2.5 amp (C); vertical scale is 100 p/cm and horizontal is 25 ms/cm

tery multiplied by the turns ratio. Thus, the voltage across the magnetic amplifier momentarily cannot go any higher than the battery voltage times the turns ratio, N_1/N_2 , as indicated in Fig. 4B.

The voltage waveshapes shown in Fig. 4B appear across the magamp and are related to three different states of control. In the first one, the magamp takes up the maximum amount of voltage and cannot absorb any more than N_1/N_2 times the battery voltage. In the next one, the magnetic amplifier saturates after about two-thirds of the half-cycle and, in the third waveshape, it saturates over about one-fourth of the half-cycle. Note that no voltage spikes appear.

The spill-over transformer has, basically, the same volt-ampere rating as a magnetic amplifier. Since it is heavy and cumbersome, a spike limiting circuit is incorporated in the magnetic amplifier, which takes the place of the spill-over transformer as shown in Fig. 4C. There is a gate winding over each core, a control winding over both cores and the spillover winding wound on top of each gate winding. Again, the spill-over windings are connected like a centertap transformer and connected back into the battery by way

of a set of rectifiers.

The voltage across the gate winding is limited to the spill-over winding voltage multiplied by the turns ratio. Hence, maximum the voltage across the magamp is equal to the battery voltage times $N_{gate}/N_{spill-over}$, and no peaks can get across the magamp.

If a short circuit is placed across A and B (Fig. 4C), that is, across the output, some limiting appears desirable. Simply, the design of the series inductance and capacitance filters is such that a certain current level saturates the inductance and detunes the filter. Being detuned, the filter presents a high impedance to the 400-cps current. Thus, the maximum current that could pass through this circuit is approximated by a value which saturates the inductance.

Figure 5A shows how the inverter is regulated. On the right-hand side is the three-legged autotransformer. The regulating circuit shown is the one associated with the center phase. The autotransformer has 3 small extra windings wound on legs related to phases A, B and C; each winding supplies about 28 volts. As noted previously, the autotransformer is for phase correction. Basically, each one of the winding voltages is rectified and then placed

across a bridge. The three bridges have one common Zener diode as the non-linear element. A silicon transistor, whose base is placed on the voltage adjustment potentiometer, is used to amplify the unbalance in each bridge. If the Zener diode should drift, the three phases will drift together. Should the output increase, the base becomes slightly positive in relation to the emitter, current is drawn in this transistor, and fed through the magamp control winding. This current desaturates the magamp, reducing the output voltage. The capacitor across the collector-emitter attenuates spikes across the transistor.

Stabilization is done by using a separate winding across the control winding of the magnetic amplifier and feeding it back into the base of the transistor by means of a simple lag. A lag in the feedback is like a lead in the forward direction; it provides stabilization. Figure 5B and 5C show the recovery time of this circuit. When the load is reduced from 2.5 amperes to zero, the recovery time is 25 msec to full regulation, with an overshoot of about 60 volts. With the application of load from zero to 2.5 there is a short dip and a recovery time of about 10 msec.

Figure 6 shows the six-element ring counter. There are three flip-flops, consisting of Q_1 - Q_4 , Q_2 - Q_5 , and Q_3 - Q_6 . One transistor of each pair conducts. A pulse coming in from the oscillator every 1/2,400 second will produce either a positive pulse in one of the upper three resistors or a positive pulse 1/2,400 second later in one of the lower three resistors.

If it is assumed, for instance, that Q_1 goes into a state of cut-off, a positive voltage will appear across the collector of Q_1 . Since the 0.068- μ f capacitor supplies a time lag, a short time later a positive voltage will also appear at the base of Q_5 . The slightly-positive voltage on the base of Q_5 is not enough to bring Q_5 into the conductive region. Only the sum of this positive voltage, plus the oscillator pulse, will bring it into the conductive region. The bases of the two cutoff transistors that will not be the ones switched on, Q_1 and Q_6 , are at about -3 v (V_{be}). The base voltage (V_{be}) of the transistor getting ready to conduct (Q_5) is -1 v. The oscillator

pulse, which is of the order of $+2$ v, brings the base voltage to $+1$ v, reversing flip-flop Q_2 - Q_5 .

By having three individually regulated phases, good regulation is obtained over the load range and on unbalanced loads. Magnetic amplifiers result in a reactive element as a regulating medium and, therefore, yields high efficiency. By the combination of series and parallel tuned filters, there is an extremely low harmonic content.

The three-legged output transformer presents an added feature in that any aging of the filters, which would result in a phase shift of one phase in relation to another, would be equalized in the auto-transformer.

The unit will not be damaged by a high battery transient voltage, because a controlled rectifier can be chosen up to 400 volts inverse voltage, if needed. Therefore, 200 to 300 volts inverse voltage will give between a 100-volt and a 150-volt battery transient.

The regulated output does not vary any more than between $115\frac{1}{2}$

and 114 volts, except at $1\frac{1}{2}$ times overload. At this overload point, the output voltage is 110 volts.

The harmonic content, normally below two percent from line to neutral, is even less from line to line. The efficiencies range between 70 and 75 percent, depending on the input voltage and the load applied.

REFERENCE

(1) M. Lillienstein, A Three-Phase Static Inverter Using A Silicon-Controlled Rectifier, paper presented at the AIEE Magnetic Div., Los Angeles, Calif., Spring 1960.

BIBLIOGRAPHY

S. R. Brown and T. P. Sylvan, The Silicon Unijunction Transistor, *Electronic Design*, Jan. 8, 23, 1958.

A. A. Sorensen, Design Techniques for Static Inverters, *Electrical Manufacturing*, 64, 65; No. 1, 2, Jan., Feb., 1960. Idem, TR-59-0000-00675.

A. A. Sorensen, W. A. Manahan and E. W. Bonios, The State of the Art of Static Inverters, Space Technology Laboratories, GM-42.10-17, Aug. 1958.

Notes on the Application of the Silicon Controlled Rectifier, ECG-371-1, General Electric Company, Syracuse, N.Y., Dec., 1958.

Notes on the Application of the Silicon Unijunction Transistor, ECF-380, General Electric Company, Syracuse, N.Y., Feb., 1959.

R. P. Frenzel and F. W. Gutzwiller, Solid-State Thyristor Switches Kilowatts, *ELECTRONICS*, p 52, Mar. 28, 1958.

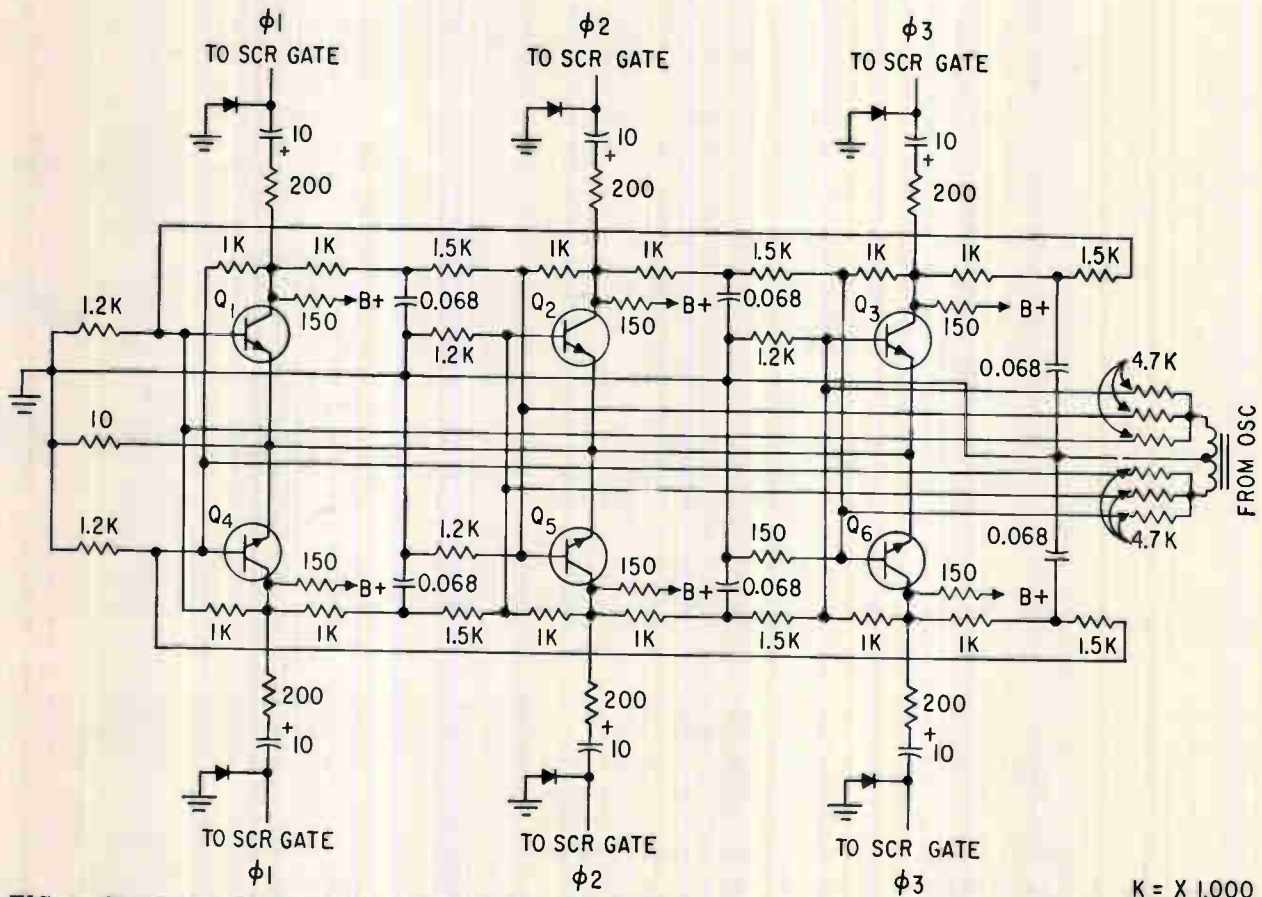
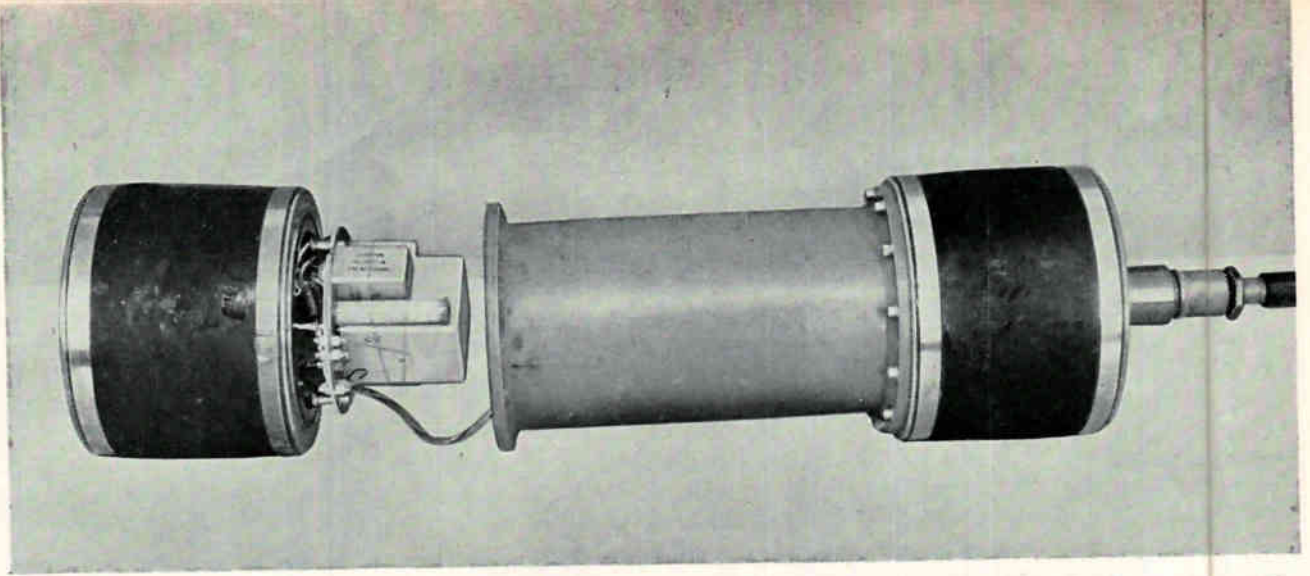

FIG. 6—Six-element ring counter consists of three flip-flops



Two hydrophones are mounted in one assembly with two preamplifiers; only one preamplifier is shown. The cable to the right can be several miles long, connects phones to monitor station on shore

REMOTE PREAMPLIFIERS For Under Ocean Work

Preamplifiers are packaged with hydrophones for ocean noise measurements. Single pair cable is used both for supplying d-c power and signal transmission

By JAN V. SCHAEFER,

U. S. Navy Electronics Lab,
San Diego, California

AMBIENT ocean noise is an important parameter in sonar system design and is the limiting factor in some cases. One phase of research on this subject consists of recording such noise for months at a time and for all types of sea conditions. Ambient noise, as distinct from man-made or biological noise, is caused by whitecaps, rain, surf, the escape of entrapped air bubbles, the motions of masses of water.

Measuring sea noise at sea state zero—the quietest condition—requires special considerations in the design of hydrophones and preamplifiers. Instrumentation allows measurements at sea state zero with signal-to-noise ratios of 15 db or greater in the audio frequency range, using cables and bottom mounted hydrophones.

Listening hydrophones used with sea cables a few miles long are generally not provided with preampli-

fiers near the hydrophones because of the extra cable conductors required and the possibility of failures.

A simple system using one cable pair for each hydrophone with preamplifiers at the shore end of the cable is therefore usually chosen even though it has serious limitations. The disadvantages are loss of information because of poor signal-to-noise ratios, lack of a way to check the operation of the hydrophones and cable after installation, and susceptibility to interfering signals generated in or picked up by the cable.

The system described here uses preamplifiers at the pickup end of the sea cable without serious decrease in reliability or great increase in the number of cable conductors required. One of the photographs shows a hydrophone assembly with preamplifier; the other shows the hydrophone support stand that is lowered to the ocean floor.

Preamplifiers with hydrophones

are connected to the signal pair as shown in Fig. 1A. The preamplifiers apply their signal output to the pair in the transverse mode and take power from the pair in the common mode. The second preamplifier and hydrophone are used in case of failure of the other channel. In addition, a third hydrophone without preamplifier is connected to the pair as a hedge—to be of limited use if both channels fail.

At least one additional cable pair is required for each cable installation for the application of known voltages at the preamplifier inputs to check or calibrate the hydrophones, and to measure gain and frequency response of preamplifiers and cable. This pair is also used to operate relays to check preamplifier and cable noise. A common conductor, to which all pairs are balanced, is used for power return.

Figure 1A shows the arrangement for one signal pair. For listening with hydrophone X_1 or X_2 , the pair is terminated at the shore end as shown at the right of Fig. 1A.

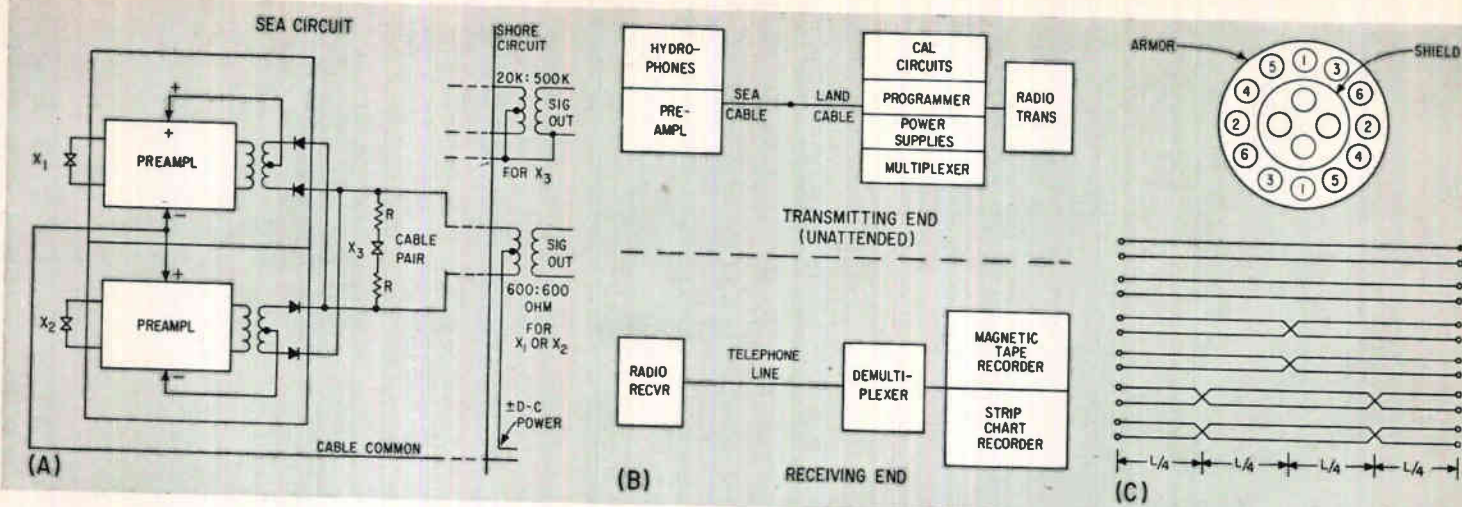

FIG. 1—In (A), the preamplifier to be monitored is selected by the polarity of the d-c power supplied. The complete system (B) uses radio transmission for continuous monitoring. Cable pairs are selected and transposed as in (C)

The d-c supply voltage, applied as a common mode, causes the rectifiers in one of the preamplifiers to conduct. The effect of hydrophone X_3 can be neglected because its output is approximately 60 db below the preamplifier output. Resistors R are included to prevent a short in X_3 from making the pair useless. The resistors do not introduce significant loss. Termination for listening to X_3 is also shown in Fig. 1A. Since X_3 produces a signal insufficient to cause conduction of the rectifiers, the preamplifiers are essentially disconnected from the pair. Output of X_3 is -90 dbv/ μ bar and capacitance is 0.25μ f.

The preamplifiers have good signal to noise ratios, long life, use the same conductors for both signal and power and operate with small power. The preamplifier circuit is shown in Fig. 2. Preamplifiers are identical except for conducting direction of diodes D_1 and D_2 .

Push-pull stages prevent oscillation, eliminate capacitors and provide good low frequency response. A tube input stage gives satisfactory signal to noise ratios. The tubes are electrometer types with high input resistance, modest power requirement and long life. Although no life test data for these tubes was used, their low transconductance (200μ mho), low μ (2), low grid current and low power

dissipation implies high reliability.

Electrometer tubes have high microphonics and flicker noise 10 or 20 db above heater-cathode types but the disadvantage is offset by the high grid resistance that may be used. Barium titanate hydrophones, of a given size, can be designed with a high voltage sensitivity and high impedance; hydrophones X_1 and X_2 have a sensitivity of -57 dbv per μ bar and capacitance of $1,500 \mu$ f.

Step-down transformer T_1 presents a low source impedance to the

first transistor stage so that its noise is below the tube noise. Feedback reduces output impedance and improves low frequency response.

The preamplifier, with 600-ohm load, has a gain of 28 db, is less than 3 db down at 10 cps and 10 Kc. Overload occurs at a sound pressure level of 23 db per μ bar, 76 db above the broadband amplifier noise.

Calibration requires insertion of a known voltage in series with the hydrophone at the preamplifier input. Since this point is not available



Tripod with hydrophones and other oceanographic equipment is being loaded onto boat. Equipment is used in research on ambient ocean noise, as distinct from man-made or biological noise



Above—Sola plate-filament transformer is built-in component of B & W Associates lie detector. It supplies plate and filament voltage regulated within $\pm 3\%$ even when line voltage varies from 100 to 130 volts . . . helps assure accurate operation in field.

Below—Railway Communications Inc. uses Sola line voltage regulator to improve performance and reliability of this Rycom combination transmitter-receiver. Regulator delivers 118 volts stabilized within $\pm 1\%$ under line voltage variations as great as $\pm 15\%$.

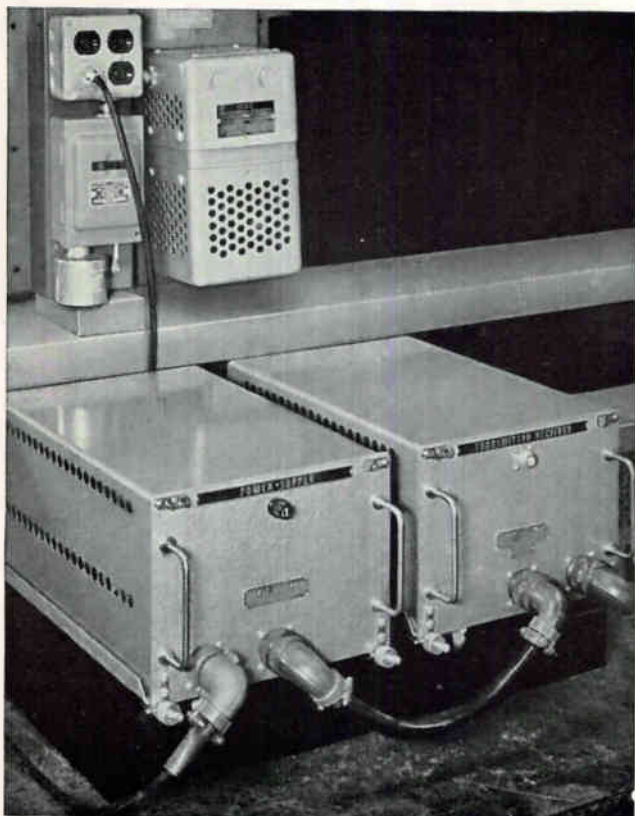

Build it in or add it on . . . Sola voltage regulation helps your equipment give full-rated performance

Whether you build it in as a component or add it on as an accessory, a Sola static-magnetic voltage regulator soon pays for itself by keeping your equipment operating at its designed capability.

These units provide a stabilized output voltage even when input voltage varies over a considerable range, and give you eight important advantages over electronic or motor-driven regulators:

1. Ultra-fast response time of 1.5 cycles or less reduces effects of transients.
2. No moving or renewable parts or routine maintenance.
3. Automatic, continuous regulation; no manual adjustments.
4. Protection against accidental short circuits and excessive overloads for unit and its load.
5. Versatility: Step-up, step-down, plate, plate-filament, transistor-voltage ratios are available to permit substitution in place of non-regulating transformers.
6. Simple, compact design; light weight.
7. High degree of isolation between input and output circuits.
8. Negligible external magnetic field.



This is the Sola Standard Sinusoidal Constant Voltage Transformer, shown in its usual accessory-type structure. It continuously regulates output voltage within $\pm 1\%$ under line voltage variations of $\pm 15\%$. Because its output is essentially a commercial sine wave (less than 3% total rms harmonic content at any load above 25% of rating), it is ideal for exacting laboratory applications and instrument calibration, and with equipment sensitive to wave shape . . . designed d-c voltage levels in the load are not affected.

The entire line of sinusoidal regulators is now available at prices formerly charged for static-magnetic regulators without the patented Sola harmonic-free circuit.



This is the Sola Normal-Harmonic Constant Voltage Transformer, shown in component-type structure, with end bells and separate capacitor. It offers the same reliability and $\pm 1\%$ regulation as Type CVS (above), and is suitable for the many applications where a commercial sine wave voltage supply is not required. It is widely used for voltage regulation on filaments, solenoids and relays.

Because prices of these normal-harmonic units have been substantially reduced, voltage regulation may now be possible in many of your applications.

Sola static-magnetic voltage regulators are available in a wide selection of mechanical structures and ratings in over 40 stock models, and your custom designs can be delivered in production quantities.



Write for Bulletin 7G-CV

SOLA ELECTRIC CO.

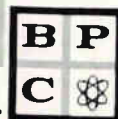

A Division of
Basic Products
Corporation

4633 West 16th Street Chicago 50, Illinois

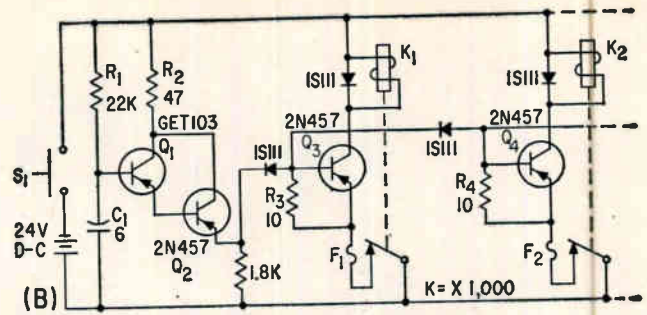
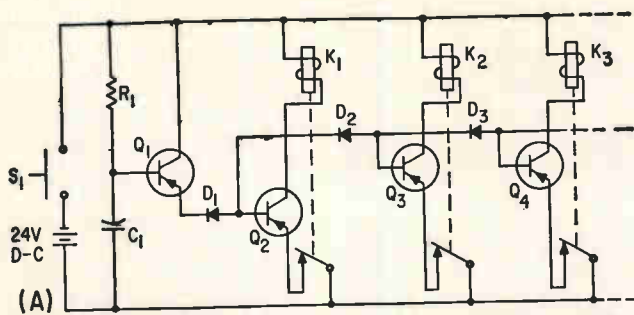

Starting from a simple circuit (A), the design of the switch progressed to the practical circuit of (B)

Time-Sequence Switch *safeguards electromechanical locks.*

Transistorized circuit operates at 10 millisecond intervals and handles highly inductive loads of 5 amp. The unit described is shock and vibration resistant

By D. H. THOMPSON
D. SIMPSON,
Microcell Ltd., London, England

A FREQUENT requirement in electronic design is for a device which will switch a number of circuits in time sequence after a starting signal. Electromechanical stepping switches and gas-filled counter tubes are often used for such applications.

A recent military requirement for a shock resistant sequential switch to release a number of solenoid operated mechanical locks at ten-millisecond intervals led to problems that could not be met with existing units, so a new design was undertaken. A miniature sequential selector switch was developed which, with a minimum number of components, can switch five-amp inductive load circuits. The unit, which had to be vibration and shock resistant, was restricted to a volume of 14 cubic inches.

The final unit, which has operated with complete reliability, uses high-current transistors, type 2N457, and operates from a 24-volt aircraft supply.

Several variations of the basic circuit have been used but the operation can be described from the simplified schematic above. A single stroke ramp generator feeds a number of switching elements each consisting of a forward biased silicon diode, a germanium power transistor and the electromechanical lock. The lock is in effect a bi-

stable relay; the mechanical action of the solenoid serves to open the relay contacts after each switching function.

On pressing the initiation switch S_1 , C_1 is initially discharged, the emitter of Q_1 is at ground potential and no base current can flow in any of the switching transistors. As C_1 charges, the voltage on the emitter of Q_1 will rise in a manner governed by diode D_1 and the base emitter circuit of Q_2 . The base current rise will be approximately exponential but because the d-c current gain (β_{d-c}) falls for large values of collector current, the latter will increase more slowly.

At the solenoid operating current of approximately 5 amp, the load emitter current of Q_1 falls to a low value determined by D_1 and D_2 in series with the base of Q_2 . The emitter voltage of Q_2 now starts rising with the ramp voltage until the second load circuit, K_2 , operates

and the process repeats until the cycle is complete.

Several refinements were necessary and a practical circuit was developed. Transistor Q_2 in (B) was added to reduce the loading on the timing circuit R_1 , C_1 when large base currents are drawn. The diodes across the solenoid clip the inductive spikes produced when the emitter circuits are broken and resistors R_2 , R_3 , etc. were added to increase the rate of rise of collector current and to increase the effective safe collector voltage of the transistors.

Resistor R_4 was added in conjunction with fuses F_1 , F_2 , etc. as a safety device and operates as follows. If any lock fails to function on maximum current due to a fault condition in the lock, R_4 will limit the base current, by bottoming transistors Q_2 and Q_3 , and hold the voltage across C_1 until one of the fuses has blown. The fuse takes a nominal 100 sec to clear and after this period the sequence will continue to completion.

In the unit described the ramp is sufficiently linear to provide adequate timing accuracy for 8 operations. If n switches are to be operated from a ramp and $0.7n$ volts is not small compared to the line voltage the use of a bootstrap circuit for linearizing the ramp is used. In this case, however, it is more difficult to limit the current in the event of a faulty lock.

One version of the 8-element unit is shown in the photo. The unit measures $4 \times 2 \times 1.7$ inches.

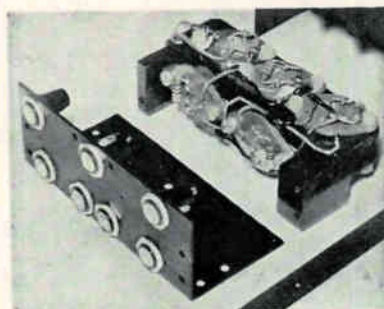

Exploded view shows front and internal layout of switch. Partial view of rear cover

"We get months more outdoor living since our plant moved here!"

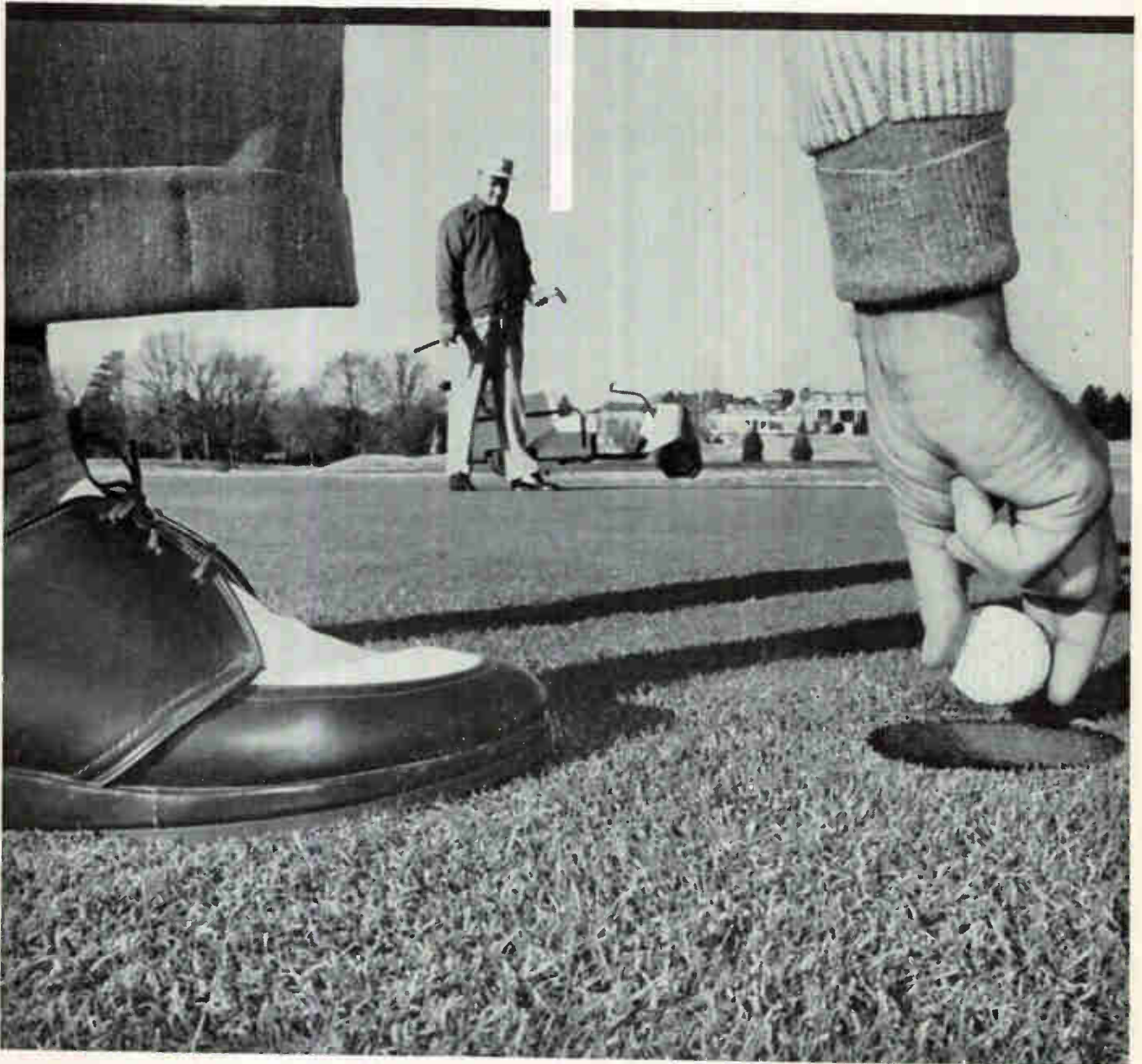

Good living and good working go hand in hand in the Richmond-Petersburg-Hopewell-Colonial Heights area of Virginia. Your golf course, your plant and your home are within minutes of each other. And the same mild Top-of-the-South climate that gives you a long, long season for outdoor fun also assures your plant 365 production days a year. ■ Ask VEPCO about the many other advantages

of this strategic industrial-commercial center, with its main line railroads and major airlines, 56 scheduled truck lines, and deep water channel to Hampton Roads and the sea. Better still, let VEPCO do some confidential site hunting for you. No cost or obligation. Write, wire or phone VEPCO today.



VIRGINIA ELECTRIC and POWER COMPANY

Clark P. Spellman, Manager—Area Development, Electric Building, Richmond 9, Virginia • Milton 9-1411

SERVING THE TOP-OF-THE-SOUTH WITH 1,990,000 KILOWATTS — DUE TO REACH 2,580,000 KILOWATTS BY 1962

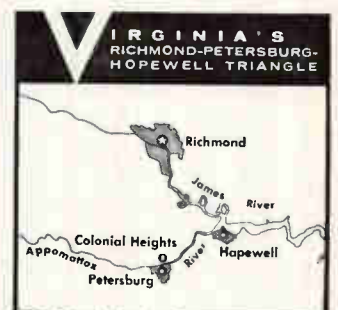

July 8, 1960

Multilayer Semiconductor Deposition

KINGSTON, N. Y.—Preparation of multiple-layer semiconductor devices by deposition of material from the vapor phase is under study at IBM laboratories here and in Poughkeepsie. The process involves placing a semiconductor source crystal and seed crystal in a heated tube and passing iodine vapor over both source and seed. The iodine picks up material from the source and deposits it on the seed.

If the source crystal is *p*-type material, a *p*-type layer will be deposited on the seed. Germanium of either polarity can be deposited on germanium, gallium arsenide or gallium phosphide. Gallium arsenide can be deposited on germanium. Silicon of either polarity can be deposited on silicon, gallium arsenide or gallium phosphide.

The process is largely experimental. So far, scientists have made good single crystals and multilayer semiconductor sandwiches for study. Working with germanium and intermetallics, diodes, capacitance diodes, tunnel diodes and transistors have been made, as well as a single-unit full adder. The single-unit adder is an

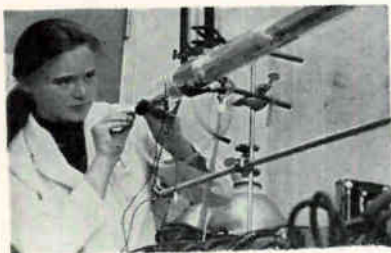
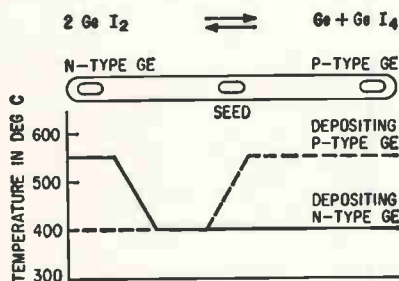

Closed-tube methods of depositing germanium of alternating polarity on a germanium substrate (top) and unloading open-tube deposition furnace after vapor-growth run

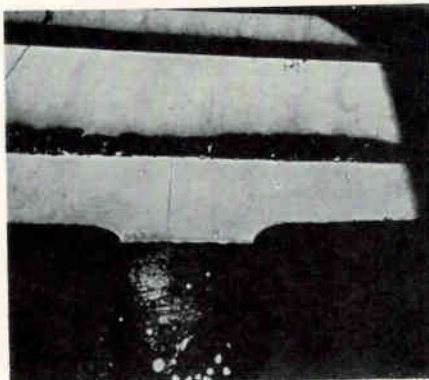

Microsection (left) of vapor-grown germanium-gallium arsenide tunnel diode and typical epitaxial (vapor) growth on the 111 crystallographic plane (right) of a silicon substrate



npn sandwich with three bridged emitters and two separate collectors each on its own *p-n* mesa.

Researchers concede that the transistors are not very good so far. Tunnel diodes of germanium and gallium arsenide have the advantage of a wider voltage swing than germanium units and a lower series resistance than gallium arsenide units.

Working with silicon and intermetallics, scientists have made and studied diodes only. They are trying to make a diode matrix on a silicon-plate substrate and also would like to make transistor matrices.

Heterogeneous junctions have resulted in higher carrier injection efficiencies and variable impurity gradients; linear, exponential and abrupt transitions are possible. Large-area *p-n* junctions useful as solar cells are also feasible.

One of the most interesting possibilities for deposited-layer semiconductors is their combination with vacuum-evaporated passive circuits in another approach to microcircuitry. Right now, the active and passive halves of a microcircuit would have to be made separately and sandwiched together since the iodine vapors used in semiconductor deposition are highly corrosive.

In one circuit approach, a matrix-perforated glass mask with 22-mil distance between holes was placed

over an *n*-type germanium substrate and *p*-type germanium was allowed to fill the holes. The glass plate was then sawed along the centerline of each row of holes and the resulting strips turned on edge. This resulted in a line of unipolar units useful as AND gates or as a shift register.

There are two deposition processes: open tube and closed tube. In the open-tube method, the iodine vapor is forced under pressure of hydrogen gas to flow from the source to seed. In the closed-tube method, (see drawing) the two sources, *p* and *n* type, are sealed with seed and iodine vapor in a glass (quartz for silicon) capsule about 25 cm long. The process works from hotter to colder. Thus, when the *n*-type germanium is heated to about 500 C, germanium iodide (GeI_2) moves towards the seed. At a lower temperature, the germanium iodide decomposes into germanium and germanium tetraiodide (GeI_4). The germanium is deposited on the seed and the germanium tetraiodide returns to the source where at the higher temperature it picks up more germanium and turns into GeI_2 .

With an *n*-type source at one end of the capsule and a *p*-type source at the other, alternate layers of *p*- and *n*-type material can be deposited on the seed by first heating one and then the other source. The semiconductor layers are de-

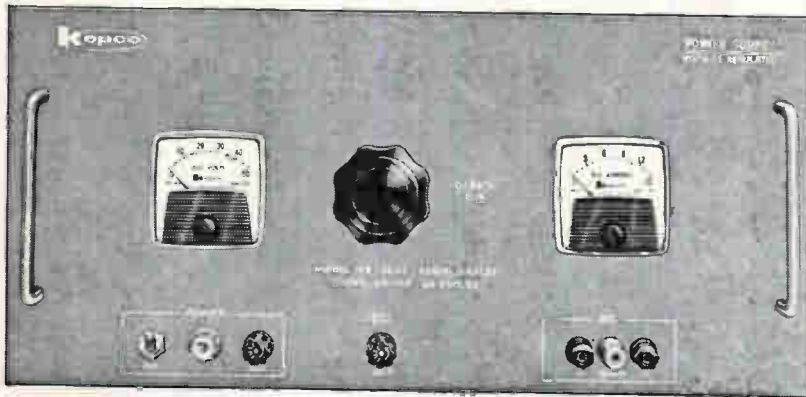

MODEL SM 36-15M

**TRANSISTORIZED
POWER SUPPLIES
IN A
NEW
HIGH
POWER
RANGE**

**UP TO 30 AMPS. DC
AT 14 VOLTS**

**UP TO 325 VOLTS DC
AT 2 AMPS.**

MODEL	DC OUTPUT VOLTS	DC OUTPUT AMPS.	REGULATION*		RIPPLE (RMS)	OUTPUT IMPEDANCE		DIMENSIONS			
			LOAD 0-MAX % or ΔV	105-125 LINE %		OHMS DC- 1KC	MAX. 1KC 100KC	W	H	D*	
SM 14-30	0-14	0-30	0.1	3 mv.	0.1	1 mv.	0.001	0.01	19"	8 3/4"	13 3/8"
SM 36-15	0-36	0-15	0.1	3 mv.	0.1	1 mv.	0.005	0.05	19"	8 3/4"	13 3/8"
SM 75-8	0-75	0-8	0.1	3 mv.	0.1	1 mv.	0.01	0.1	19"	8 3/4"	13 3/8"
SM 160-4	0-160	0-4	0.1	10 mv.	0.1	1 mv.	0.08	0.8	19"	8 3/4"	13 3/8"
SM 325-2	0-325	0-2	0.1	10 mv.	0.1	1 mv.	0.3	3.0	19"	8 3/4"	13 3/8"

* behind panel

- ▶ Line/Load regulation, Stability: Less than 0.1%.*
- ▶ Recovery time: 50 microseconds.
- ▶ Operational Simplicity: No optimizing controls, range switches.
- ▶ Output Voltage control continuously variable from 0 to maximum.
- ▶ Remote error sensing feature provides means of maintaining regulation directly at load.
- ▶ Meters optional. To specify metered units, add "M" to Model Nos. given in table.
- ▶ Moderately priced.

*0.01% REGULATION ON SPECIAL ORDER

write for complete specifications



131-38 SANFORD AVENUE • FLUSHING 55, N. Y. • IN 1-7000 • TWX # NY 4-5196

Engineering notes
from the **SM/I**
REPORTER

BY STANLEY M. INGERSOLL, Capabilities Engineer



Report No. 9
TMC 601 LOX Tanking Computer System

Typical of our extensive participation in missile fuel management is our TMC 601 the main building block in the process of obtaining a completely automatic propellant loading system for missiles. It accurately measures, controls and indicates the level of liquid oxygen in missile tanks. The computer monitors the weight of the propellant aboard a missile, compares it with the desired weight, allows for tank diameter and propellant density correction and controls the flow of propellant to the missile. A two mode control system facilitates the rapid and accurate loading of the missile. The first mode permits extremely high pumping rates until 98% capacity is reached. The second mode then controls a precise proportioning valve which fills the tank to within 0.1% accuracy and provides for continuous topping. Entirely encased in a protective cover to withstand the extreme conditions generated by a firing, the TMC 601 measures the static head of the liquid in a tank by means of a highly refined pressure transducer.

The TMC 601 does not require calibration after installation and can be easily and rapidly modified for new missile or tank configurations.

Typical Performance Specifications

Input Power	115 volts, 400 cycles, 15 watts 28 volts D. C., 2 Amps. 115 volts, 60 cycles, 100 watts (heater) 25 PSIG—clean, dry air-pneumatic supply to TR 2013
Pressure	1) Differential Pressure (liquid head) 10 PSIG (Range from 0.5 PSIG to 22 PSIG available) 2) Line Pressure 50 PSIG 3) Proof Pressure 90 PSIG
Accuracy	±0.25% under severe environmental conditions ±0.1% under normal field temperature conditions of 50°F to 125°F

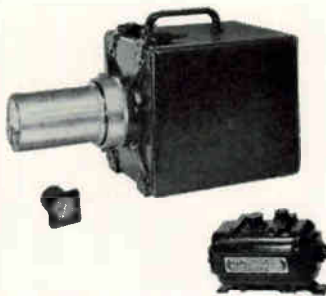
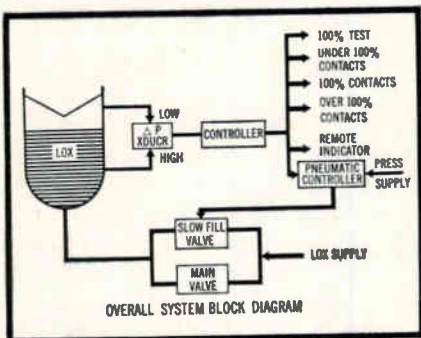

For more information and complete operating specifications, write or wire SM/I today. Address your inquiry to Stanley M. Ingersoll, Capabilities Engineer.

SM/I

SERVOMECHANISMS/INC.

Los Angeles Division
12500 Aviation Boulevard
Hawthorne, California

posited at the rate of 10 microns an hour. When pure material is deposited, the layer has only about one part in 100,000,000 of iodine. The best donor impurities are arsenic, phosphorous and antimony; donor impurities are easiest to deposit. Gallium and boron are the best acceptor impurities.

Silicon reacts with the iodine vapor at 800 to 950 C. Oxides of silicon are stable and often must be removed by hydrogen reduction. However, surface passivation is easier with silicon since both its oxides and fluorides are stable.

Bell Telephone Labs recently announced a vapor-deposited film transistor. The film is thought to be deposited by reduction of silicon tetrachloride by hydrogen. General Electric did some work in this area in 1955. Merck is working on vapor deposition in silicon. The silicon work at IBM is supported by the Signal Corps. —J.M.C.

Plasma Phenomenon May Aid Space Propulsion

PLASMA phenomenon was successfully demonstrated that may lead to development of advanced space-propulsion systems. The investigations were carried out using an experimental device called an electromagnetic plasma accelerator.

The experiments were announced by the Air Force Office of Scientific Research and Litton Industries. They were conducted as part of a research program underway since 1957.

Electromagnetic fields in the accelerator convert the gas into a conductor of electricity. The gas is formed into a donut-shaped plasmoid, which is trapped and accelerated at extremely high velocities within the fields. Acceleration occurs in a direction perpendicular to the plane of the plasmoids while maintaining the plasmoid shape.

The gas plasmoids have been photographed emerging from the experimental device.

The techniques for forming and accelerating the plasmoids originated with Litton scientists to eliminate electrode erosion, wall friction and low efficiency. These problems have been serious obsta-

cles to successful development of plasma space-propulsion systems. This approach is not limited by the containment problems that researchers have encountered in the field of plasma physics.

The experiments are continuing and it is hoped that gases can be accelerated to a sizable fraction of light velocity.

Multipurpose Computer For Transfer Functions

CROSS SPECTRAL DENSITY and transfer function computer has been designed as a general purpose instrument. Several versions of the computer allow application in many fields— aeronautical, physiological, chemical. It rapidly and accurately computes the transfer function relating to random or periodic signals.

Developed by Gulston Industries, the computer is expected to provide an economical method of compressing test and development schedules. It is designed for the type signal encountered in many practical experiments, like missile or aircraft test flights, servo checks, vibration testing, communications investigations and medical studies. Sinusoidal or other analytic or periodic signals, obtainable only under controlled conditions, are not required. The computer operates with the actual signals that result from practical tests.

The standard model covers frequencies from 3 cps to 3 Kc and operates on standard 115-volt, 60-cps power. The unit can easily be fitted into two relay racks. The computer has less than 1 percent amplitude error and less than 2 degrees phase-angle error.

Operating in a practical situation, there may be a large number of inputs and only one output. By determining the exact contribution that each input makes to the output, prediction of system behavior under other conditions can be inferred. The transfer function can find which of many inputs has an effect on a particular output, the magnitude of the effect and the degree to which the output is affected by noise. This type analysis is not always possible by inspecting time-amplitude plots.

ACTUAL SIZE

MIDGET TOOLS FOR MINIATURIZED WORK!

Midget tools for work on miniature assemblies are another Utica specialty. We have designed and stock the industry's broadest line of midget pliers and other special hand tools for working with ease in the most confined places. All are precision, finely finished tools. All are backed by famous full guarantee. See for yourself! Contact your Utica distributor or write for our latest hand tool catalog.

Utica Drop Forge & Tool Division,
Kelsey-Hayes Company,
Utica 4, New York.

tools the experts use!

New Tube Concept Simplifies Circuitry

TUBE FUNCTIONS COMBINED IN SINGLE ENVELOPE

A MINIATURE TUBE production program, now underway at General Electric's Owensboro, Ky. facility, is making a strong bid for the radio, television and hi-fi, market, and shows promise of use of new tubes for industrial controls and instrumentation. This tube program, starting with a volume production of four tube types in the fall, will eventually include some 100 tube types.

What GE has done is to package into one unit a combination of electron functions performed by as many as three separate tubes. For example, one of these tubes—and the line will be called Compactrons—is a combined oscillator, converter and intermediate frequency amplifier, that does the work of a 12BA6 and a 12BE6. And another single tube does the work of three tubes: the 35W4, 50C5 and 12AV6.

Prices have not been established for these tubes, but the savings in material and labor would eventually

make possible an estimated 20 percent lower price per function than regular tubes, and considerably lower than transistors. W. F. Greenwood, marketing manager for GE's Owensboro facilities, said that this savings would result from less complicated production methods, combined with the integration of more functions into a single unit. Greenwood predicts that the Compactron eventually may replace most present-day seven and nine-pin miniature tubes, as manufacturers continue to make progress in reducing equipment sizes to meet the small-package appeal of transistorized entertainment sets. The new tubes will be useful in color television where multi-function operation and small size would reduce bulk, expense and circuit complexity.

New metallurgical developments, leading to improved thermal efficiencies, provide important contributions to Compactron design and operation. Included in these, is a

new anode material that reduces by as much as 40 percent the heater power required by the cathode. Another development is a clad material expected to be incorporated in future designs that improves both the hot strength and thermal efficiency of cathode elements.

For television, developmental models now include a horizontal oscillator and automatic frequency control (6CG7 and 6AL5); a horizontal damping, single diode (6AX-4GTB); a vertical deflection amplifier and oscillator (6DN7); and a horizontal deflection amplifier (6D-Q6B).

A. F. Dickerson, manager of product planning at Owensboro, said that single-function designs, which would substitute for conventional tubes on a one-to-one ratio, were required either because the power requirement was close to maximum limitations for one unit, or because of the dictates of good design practice imposed by the need for high voltages in some functions.

The advantage of the single-function Compactron lies in the fact that the unit is small, and thereby affords equipment manufacturers the opportunity to produce more compact receiving sets.

General Electric's plans for broadening the line include the introduction, in the next 12 months, of approximately nine more types. Long range plans are made for integrating a wide variety of functions into one unit.

C. D. McCool, manager of product design at Owensboro, said that Compactrons now scheduled for production use tube connections in a circle 0.750 inches in diameter and a dome-shaped envelope exhausted from the bottom. The units are about 1½ inches in diam. and vary in seated heights from 1 to 2¾ inches.

Tube connections were chosen to accommodate multifunction elements within the unit. They are spaced to provide latitude in lead

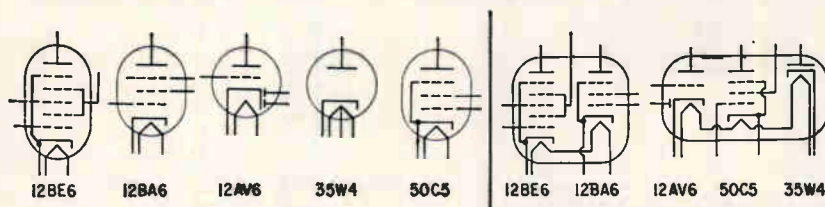
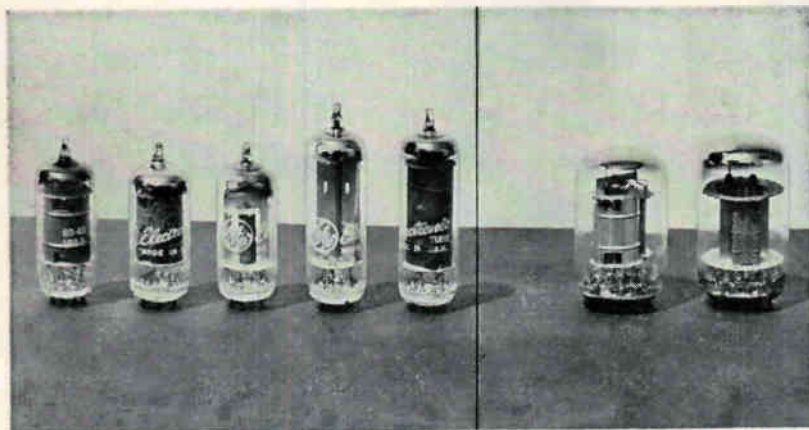

Two Compactrons are shown (right) in comparison with five miniature tubes for which they may be substituted (left). Two units combine all functions of the five tubes. Significance: reduced cost and size of electronic equipment, increased reliability due to simple networks

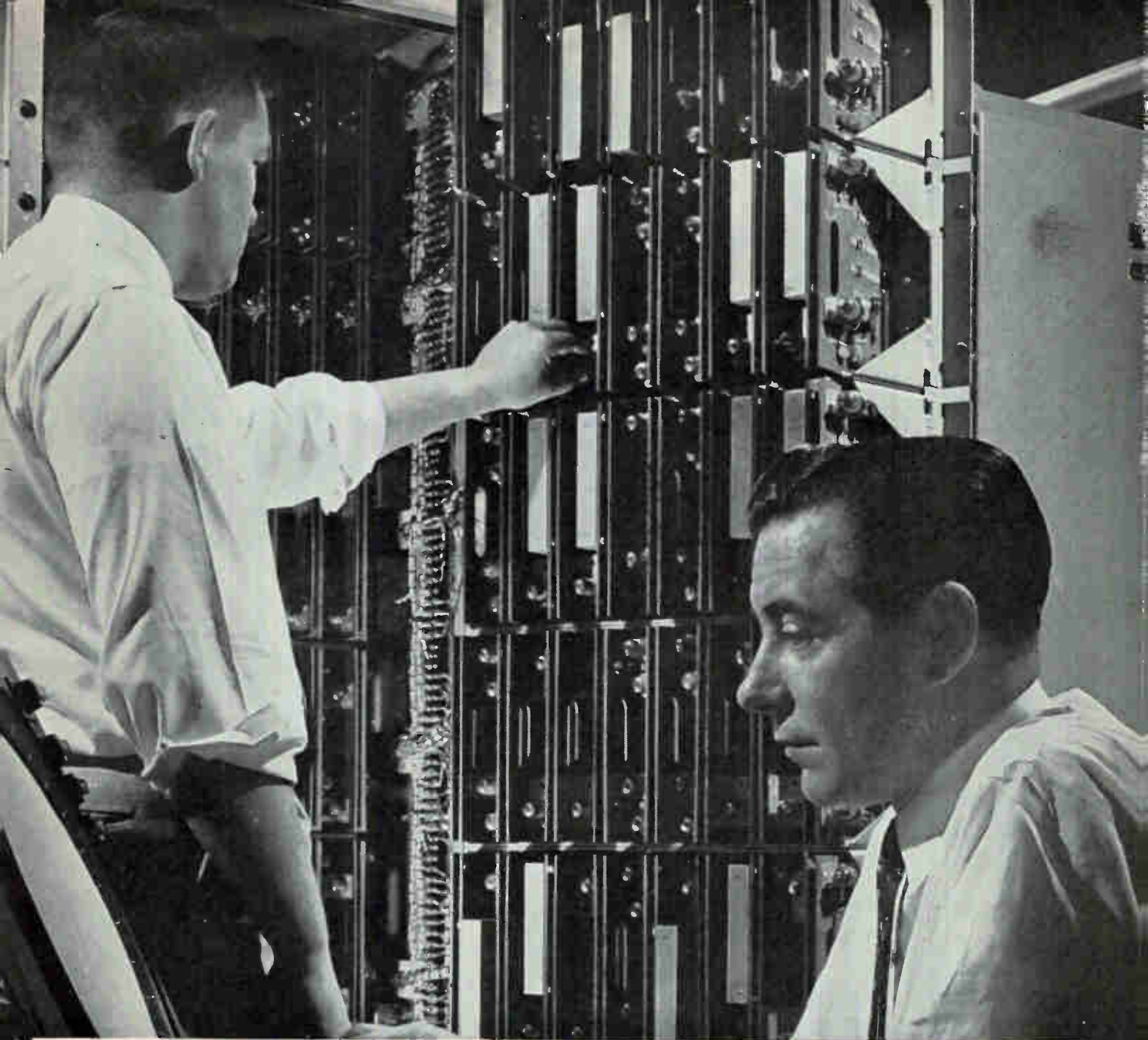

AN ACHIEVEMENT IN DEFENSE ELECTRONICS

AN/FSA-12--First to detect and process 3-D radar data automatically

The first equipment to successfully automate the processing of three-dimensional data direct from a working radar, the AN/FSA-12 (XW-1) has operated since 1958. This detector tracker has enabled General Electric to develop many improved radar techniques and equipment.

New concepts in correlation and smoothing in the track-while-scan method have been demonstrated. Delay lines applied to digital techniques

and plug-in wiring boards have been improved. New ideas in data storage and digital circuitry have been applied.

This experimental model continues to be a proving ground in research and development of advanced military electronics. A completely solid state production version of the AN/FSA-12 will soon be available for many of our nation's air defense radar sites. 176-04

Progress Is Our Most Important Product

DEFENSE ELECTRONICS DIVISION
HEAVY MILITARY ELECTRONICS DEPARTMENT • SYRACUSE, NEW YORK

GENERAL  ELECTRIC

SPECIFY

MASSA TRANSDUCERS

**FOR RELIABILITY
STABILITY
ACCURACY**

Ammonium Di-hydrogen Phosphate (ADP) crystal provides the best known piezoelectric transducer element to achieve **RELIABILITY, STABILITY** and **ACCURACY** with *Time* and *Temperature* and is therefore used exclusively in all Massa instruments for measuring acceleration, sound pressure and underwater (hydrophones) sound pressures.

The Accelerometers have Frequency Ranges up to 90,000 cps and Dynamic Ranges from .001 to 2000 g's.

*Vibration
Measurement*

ACCELEROMETERS

ADP

MICROPHONES

*Sound Pressure
Microphones*

The Massa microphones are stiffness controlled over the specified frequency ranges of 10 cps to 90,000 cps with negligible phase shift errors, making the units ideal for the accurate reproduction of acoustic transients and linear response.

The dynamic range of the microphones are linear to sound pressures in excess of 200 db. (re .0002 microbars).

Massa also manufactures associated accessories for complete Vibration and Sound Pressure Measurement Systems, available for immediate delivery.

Write for technical data sheets on Accelerometers, Sound Pressure Measurements, or Hydrophone Standards.

Other MASSA Products

RECORDING SYSTEMS

HYDROPHONES • SONAR TRANSDUCERS

MASSA
A DIVISION OF
COHU
ELECTRONICS, INC.

6 Fottler Road

HINGHAM, MASSACHUSETTS



In this pilot production operation at GE, the new tubes are preheated as above on a rotating wheel, then exhausted and sealed

separation, with a minimum of interaction at the base. The design avoids undue clustering of associated components, and the large 12-pin circle adapts to the larger 1½ in. diam. designs of high-power output.

The large diameter also adapts the devices to printed circuitry, permitting adequate isolation of the plate from other electrodes in high-voltage operation. This isolation, with two blank pins on either side of the plate connection, provides an arc rating in the order of 10,000 v d-c.

Among assembly economies possible with the new tubes is the use of an integral heater supplying as many as three separate cathodes. This eliminates four heater welds. While the heater is not a new development, this is a large-scale application where elements with three-heater functions have been combined in one continuous unit.

The new GE development was announced by I. D. Daniels, general manager of the company's component facilities at Owensboro. Daniels said that the program began several years ago and was stepped up recently, when the need became apparent for more compact circuitry than possible with present-day miniature radio tubes.

"At the same time," he added, "there existed the need to get costs down appreciably below tubes,

while preserving the performance characteristics of tubes in relation to transistors."

New Uses Boost Demand For Thimble-Size Tubes

WIDESPREAD USE of RCA's thimble-size nuvistor electron tube has resulted in an 800 percent production increase over the rate established early this year.

The high-frequency tube already is being used in tv cameras, industrial controls, radars, computer components and test equipment, and is expected to have many other applications, according to J. B. Farese, division vice president, Entertainment Tube Products.

High-speed machinery is being installed at RCA's Harrison, N. J. plant in a further effort to keep pace with the demand for nuvistors from all segments of the industry.

"As a result of the nuvistor's popularity, we are today introducing the second commercial version of the tube—the RCA-6CW4 high-mu triode which has been especially designed for use in tv and f-m tuners," Mr. Farese said.

"This tube is the heart of a 'New Vista' tuner which is used in RCA Victor's 1960-61 black-and-white television receivers. Nuvistorized tv tuner circuits make possible excellent reception in fringe areas where reception is now unsatisfactory."

The new nuvistor triode has a noise factor 2 to 4 decibels better than the usual tuner tubes used in television sets. The low noise factor, he explained, results from the low level of random electron motion in the tube.

This feature minimizes the small black and white spots or "snow" on a tv screen that are produced by tubes having a high noise factor.

Reporting on another phase of RCA's nuvistor program, Mr. Farese said engineering sampling of a developmental, small-signal general purpose tetrode (Dev. No. A-2654E) "has received excellent response."

A large number of manufacturers currently are evaluating the new tube's characteristics for its possible inclusion in new equipment.

NEW...IMPROVED...model 15A



the STRIPPIT FABRICATOR

for high-profit, low-cost punching, notching and nibbling...for prototype, short and medium production runs

FEATURING the new *Strippit Electro-Hydraulic Head* — simplified design . . . minimum number of parts . . . needs no pressurized air. Makes the 15A easier to install, simpler to maintain, more economical to operate.

punches

any round or shaped hole up to 3½" diameter in sheet material — up to ¼" mild steel.

notches

90° corners — rectangular, radii, vee and special shape edge notches — up to ⅛" capacity in mild steel.

nibbles

straight line or contour shearing up to 38" diameter circle, at 165 strokes per minute, ⅛" mild steel.

accurate, quick-set gauging

a unique, multiple-stop system for exact work positioning to any layout specifications — *in seconds*.

quick-change punches and dies

from one size to another in less than 20 seconds — within easy reach in labeled, built-in file drawers.

easy conversion

to a high speed production punching unit with the Strippit Duplicator and the Dupl-O-Scope or Microbars to punch Duplicator templates.

WRITE TODAY

for new Catalog 15A and demonstration at your own plant of the capabilities of this high-profit fabrication system.



WALES STRIPPIT INC.

225 Buell Road • Akron, New York

In Canada: Strippit Tool & Machine Company, Brampton, Ontario

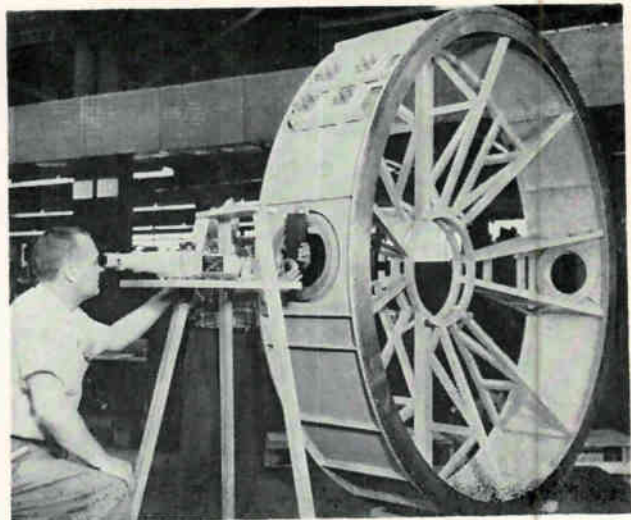
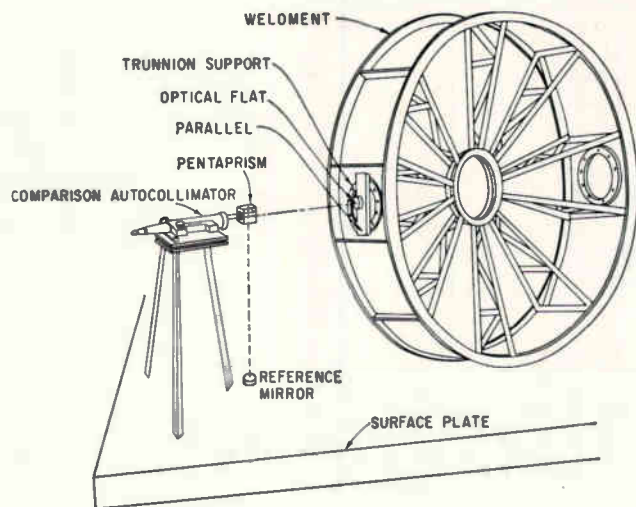

Setup for measuring position of trunnion supports with autocollimator. Photo at right shows actual operation

Optical Tooling Gives Precision to Big Parts

By ERNEST RULAND, Product Engineer, Daystrom Military Electronics Division, Archbald, Pa.

RADAR ANTENNA MOUNTS must be machined to very close tolerances to obtain precise radar tracking. Because of the size of most mounts, this presents extremely difficult problems when conventional tooling techniques are used. Optical tooling provides a solution. Furthermore, the optical instruments are universal and, unlike mechanical fixtures, can be used on many entirely different projects.

The illustrations show the use of optical tooling in preparing the weldment used as a mount in the APG-55A radar (Sperry Gyroscope Co.) for the Navy's ship-to-air Terror missile.

The weldment is more than 8 feet in diameter. Its 2 trunnion support castings must be concentric within 0.0025 inch, parallel within 0.002 inch and square to the center line of the bore within 0.001 inch. These accuracies are almost impossible to obtain with mechanical tooling. The large fixtures needed to support measuring gages and indicators deflect more than 0.001 inch from their own mass. Moving the fixtures over a surface plate to explore the castings with an indicator is, at best, very cumbersome.

Because its accuracy is not af-

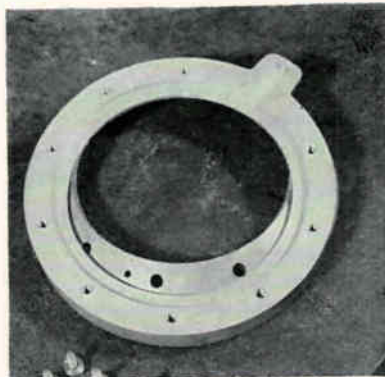

Spherical faces of trunnion support castings permit adjustments in any plane

ected by distance, optical tooling is the best technique for accurately assembling the trunnion supports in the weldment. The optical instruments required are a collimator, 2 optical mirrors and a pentaprism (a beam of light emerging from this 5-sided prism is always at 90 degrees to the entering beam regardless of the entrance angle).

Two holes bored and faced in the weldment at 180 degrees apart provide a reasonable accurate starting point for mounting the trunnion support castings. Each support consists of 2 castings with spherical surfaces, making adjustments pos-

sible in any plane. The weldment is set up on a surface plate and a height gage is used to make the axis of the bores parallel to the surface plate.

A comparison autocollimator (Davidson Manufacturing Co., West Covina, Calif.) is set up in any convenient position opposite the trunnion supports. The instrument has 2 collimators placed side by side. One half establishes a reference with the surface plate and the other half views the object being measured. The half which establishes a reference looks into the pentaprism, which deflects the line of sight exactly 90 degrees to a mirror on the surface plate. The target reflected back from the mirror establishes a reference which is exactly at right angles to the surface plate. The other half of the comparison autocollimator looks directly at a mirror held against a parallel placed across the face of the trunnion support.

Reflected images in each half of the autocollimator are compared and the angle between them measured on a micrometer dial. The autocollimator dial reading establishes the vertical angle of the trunnion support with respect to the

INFORMATION PROCESSING

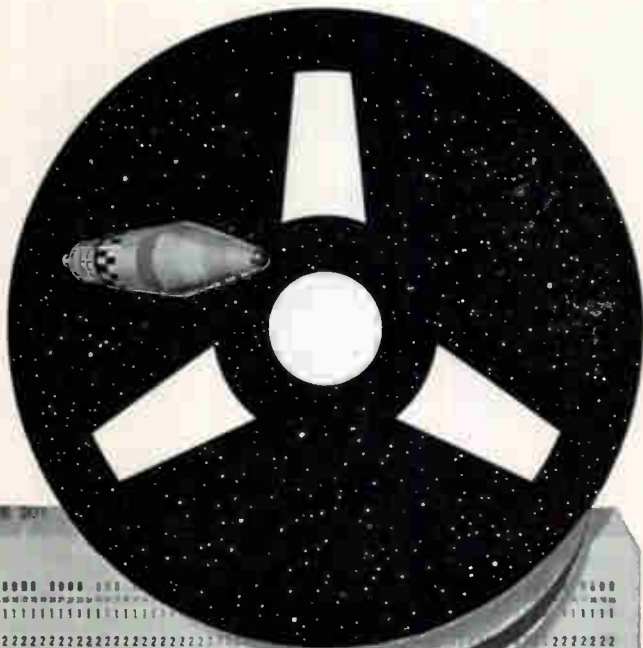

Information Processing plays a vital role in the Lockheed Missiles and Space Division's activities—from aiding basic research and development to supporting current military and commercial projects. The Division's computing facilities are among the most advanced in the country and include: two—IBM 7090; two—Sperry-Rand 1103 AF; one—Control Data Corp. 1604, in addition to a variety of other advanced peripheral equipment. Future plans include several IBM 1401 Data Processors.

Functions of Information Processing encompass: Preparing programs and operating large, high-speed digital computers; responsibility for the Division's analog computing activities—including set-up and operation of analog computers, used both as simulators and in solving problems; the reduction of highly complex and critical telemetry data received from missiles and space vehicles.

Further activities involve performing data reduction for Quality Assurance and Manufacturing, and programming of Administrative Data Processing and Financial Forecasting Problems for the entire Division.

Expanding the scope and depth of present programs in Information Processing has created positions for engineers and scientists with experience in these important areas:

DIGITAL COMPUTER SYSTEMS DEVELOPMENT including monitors, compilers and information retrieval systems.

HIGH-SPEED DIGITAL COMPUTER PROGRAMMING for satellite control, scientific computation, numerical analysis, and administrative data processing.

TRAINING PROGRAMS conducted for computer programmers and operators.

ANALOG COMPUTER OPERATION in solving complicated engineering problems.

AUTOMATIC CONVERSION of flight data and scientific information utilizing analog and digital converters and advanced automatic control devices.

FLIGHT DATA AND SYSTEMS ANALYSIS including research in complex problems, theories and methods of preflight and flight data analysis; test performance research; analysis and performance reports on testing, flight test data and data reduction.

DATA PROCESSING EQUIPMENT DESIGN including research and engineering in development of highly advanced data conversion devices.

Engineers and Scientists: Work in the broad spectrum of Information Processing functions provides constant challenge at Lockheed's Missiles and Space Division. If you are experienced in the above areas, you are invited to write: Research and Development Staff, Dept. G-22, 962 W. El Camino Real, Sunnyvale, California. U.S. Citizenship or existing Department of Defense industrial security clearance required.

Lockheed

MISSILES AND SPACE DIVISION

Systems Manager for the Navy POLARIS FBM; the Air Force AGENA Satellite in the DISCOVERER, MIDAS and SAMOS Programs; Air Force X-7; and Army KINGFISHER

SUNNYVALE, PALO ALTO, VAN NUYS, SANTA CRUZ,
SANTA MARIA, CALIFORNIA • CAPE CANAVERAL, FLORIDA
ALAMOGORDO, NEW MEXICO • HAWAII

CIRCLE 75 ON READER SERVICE CARD

Special Instruments

THAT TEST, MEASURE, REGULATE, SIMULATE



... for Regulating Relays,
and Computer Equipment



... for Testing Welds, Bonds,
Contact Resistance



... for Measuring Kilovolts

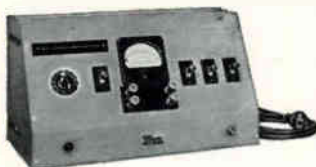

... for Servicing
Communications Systems

Current Flow Test Sets simplify the adjustment of single- and double-winding, YP, and polar-type relays and similar electromechanical devices. Accurate, pre-set values for "saturate," "operate," "non-operate," "hold," and "release" currents up to 750 ma can quickly be set up and repeatedly applied in any sequence. Ask about Shallcross Types 696 and 695.

Portable, wide-range Shallcross Milli-ohmmeters and Microhmmeters accurately measure low resistances from 0.0001 ohm to 100 ohms on linear scales. By comparing readings against pre-determined standards, defective welds, bonds, and potential failures in heavy conductors can be spotted on a "GO-NO GO" basis. Switch, relay, and circuit breaker contact resistance as well as bar-to-bar commutator resistance can also be measured. Ask about Shallcross Low Resistance Test Sets.

Dozens of standard, Shallcross Kilovoltmeters and Kilovoltmeter Multipliers are available for measuring from 1 to 30 KV. Special Corona-Protected Models measure up to 200 KV. All use stable, close-tolerance Shallcross precision wirewound resistors for long-term accuracy. Ask for details on Shallcross High Voltage Measuring Apparatus.

For over 25 years, Shallcross has been a key manufacturer of multi-purpose test instruments for telephone and communications system servicing. Types range from portable DB Meters, Tone Generators, and Fault Location Bridges, to elaborate instruments that measure every electrical property and simulate every normal condition usually encountered. Ask about Shallcross Communications Servicing Instruments.

Shallcross

OTHER SHALLCROSS PRODUCTS

Decade Resistance Boxes • Decade Voltage Dividers • Kelvin-Wheatstone Bridges
Percent Limit Bridges • Precision Wirewound Resistors • Rotary Instrument Switches
Wheatstone Bridges • Megohm-Wheatstone Bridges • Magnetic Bridges • and
dozens of custom-built instruments for laboratory, production, and field measurements

SHALLCROSS MANUFACTURING CO., 2 Preston St., Selma, N. C.

surface plate. While one operator sights the trunnion support through the autocollimator, the other operator loosens the bolts of the assembly and gently taps it until the autocollimator reads zero. The trunnion support is then secured in place.



Weldment serves as tracking radar antenna mount

The parallel and mirror are placed against the face of the other trunnion support and the same optical measurements and adjustments made. Since the angle of both trunnion supports with respect to the surface plate is now known, the angle of both supports with respect to each other can be determined.

The weldment is next laid flat on the surface plate and the process repeated in the other plane. The tolerances obtained on the trunnion support assemblies are 0.0005 inch each, or 0.001 inch combined. Similar techniques can be applied to many machining problems involving large distances.

Report Hot-Dipped Tin Most Solderable Coating

SOLDERABILITY of tin, tin alloy and other coatings for copper, brass and steel has been systematically studied by the Tin Research Institute, Greenford, Middlesex, England. Over 8,000 specimens were tested after storage periods up to 2 years.

Coatings of tin, tin-lead, tin-zinc and tin-cadmium were found to retain excellent solderability when coatings are at least 0.0003-inch thick. Hot-dipped coatings have the best solderability. To prevent zinc diffusion, brass should be plated with 0.0001 inch of copper beneath electroplated coatings and

with nickel beneath hot-dipped tin.

Flow-melting coatings on copper improves storage properties, but appears to give no advantage on steel or brass. When the coating has functions other than solderability, storage areas or containers should be clean and dry.

Cadmium coatings give satisfactory solderability. Silver and tin-nickel coatings are relatively inferior to tin and decrease the solderability of copper.

A detailed report of the study, published in England in the *Transactions of the Institute of Metal Finishing*, is available as reprints in the United States from the Institute's office in Columbus, Ohio.

Tabulating Machines Prepare Wiring Lists

PREPARATION OF WIRING lists with punched cards and tabulating machines has been used by ITT Laboratories, Nutley, N. J. The method was used to prepare lists for a binary information exchange with 16,000 circuit modules and 200,000 point-to-point wire connections. It was found to speed preparation of the lists, facilitate changes, relieve engineers of routine assignments and minimize errors.

Drawings, locating each module electrically and physically, are prepared under engineering supervision. A clerk familiar with logical notation and symbols transposes the information on keypunch-operator instruction cards. The cards designate each module's inputs, outputs, location and the logical structure of which the module is a part. Errors can be caught by comparing cards.

All pin connection data for a module is transposed to 2 punched cards, one a standard for invariants and the other for variables. Data processing machines then prepare individual cards, lists of inputs to each module and lists of all modules driven by the same module. These lists enable designers to check for overloaded modules, forbidden connections and other errors before wiring work begins. The complete wiring list is made after further sorting.

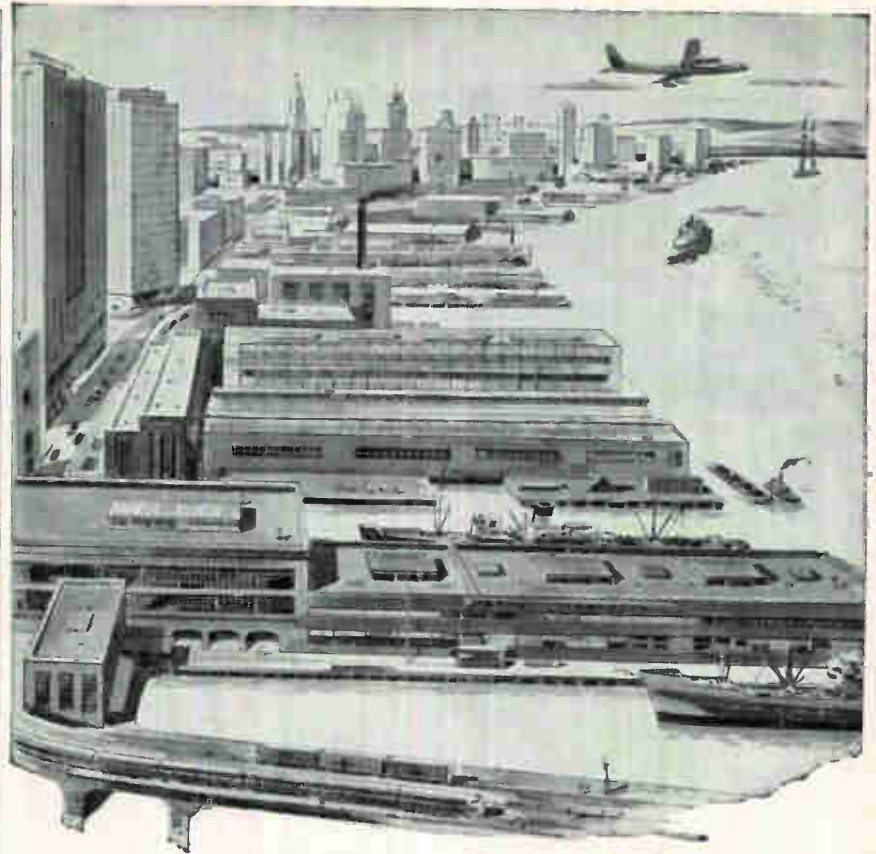

The Application of DATA PROCESSING TECHNIQUES

• • • to reduce man hours and increase production, in industrial and commercial operations, is a familiar problem to Anelex® Systems Division engineers.

This group has worked together for almost ten years, using digital techniques in the development of logical solutions to special problems of control, timing and data handling. They are also experienced in the development of specialized tracking, timing, communications and test systems for military applications.

Finished equipment required for these systems is produced by the Anelex manufacturing facility under direct supervision of the engineering group. This division is staffed by technicians and skilled craftsmen who have specialized in the production of unusual and sophisticated data processing equipment.

We will be glad to tell you frankly and promptly whether your particular requirement is within the capabilities of our Systems Division. Just write or telephone.

for further information, write or telephone

ANELEX CORPORATION

150-F CAUSEWAY ST., BOSTON 14, MASS.

ANELEX

New On The Market

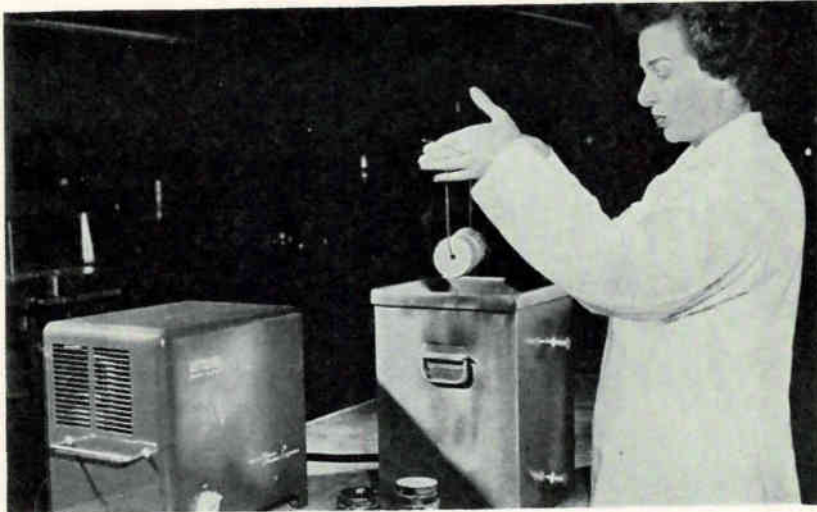

Ultrasonic Cleaner

SELF-TUNING

HERETOFORE, keeping an ultrasonic cleaner tuned to the optimum frequency for varying conditions, such as different cleaning loads and amounts of cleaning solvent, has required an operator and tuning controls. An ultrasonic cleaner which tunes itself has been developed by Powertron Ultrasonics Corp., Patterson Pl., Roosevelt Field, Garden City, N. Y.

The ultrasonic generator driving the cleaner transducer receives tuning information from a feedback transducer, both transducers being part of the transducer assembly placed in the cleaning tank. Thus, the generator circuit is extremely

simple, having but one control, an on-off switch.

Transducers are piezoelectric, operate at 28 Kc, have more than 90-percent efficiency. The generator does not have a resonating capacitor in its tank circuit; absence of this capacitor eliminates a possible trouble spot.

Self-tuning ability of the cleaner is also a safety feature; if left operating in an empty tank, it tunes itself to the lack of load, preventing the possibility of burnout.

Cost of the cleaners range from \$395 for 2-gallon size to \$2,890 for the 30-gallon size.

CIRCLE 301 ON READER SERVICE CARD

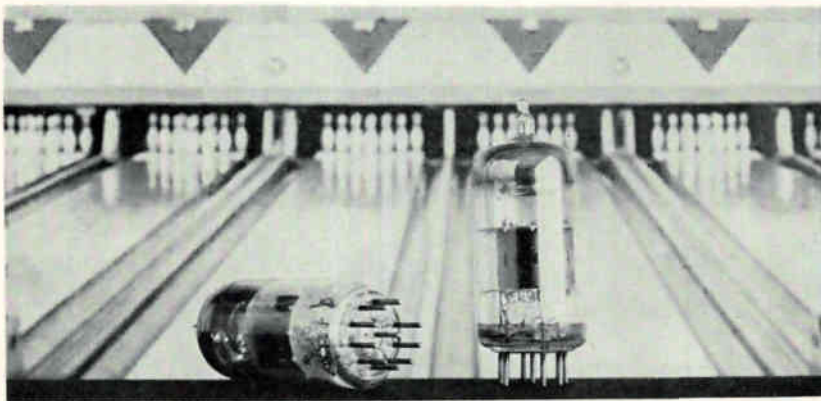

Ten Pin Tubes

MULTICIRCUIT

BY ADDING another pin at the center of the regular miniature 9-pin tube,

Sylvania Electric Products of Emmerium, Pa. is able to bring out an

additional electrode, thus combine multiple circuit functions in a single bulb or envelope.

The new design uses the regular 9-base pin arrangement of the conventional T-6½ miniature envelope with an additional pin centered in the pin circle. First tubes to incorporate the new design are a double tetrode for use as an r-f amplifier and oscillator-mixer in f-m tuners and receivers, and a triple triode for use as an r-f amplifier, oscillator-mixer and afc control. Earlier this year, Sylvania announced the 9-T9, a new design in Bantam (T-6½) electron tubes wherein a 9-pin miniature circle of pins replaces the conventional (8-pin) base.

CIRCLE 302 ON READER SERVICE CARD

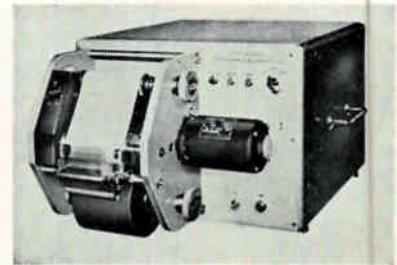

Digital Recorder

RAPID DATA TRANSFER

HIGH SPEED digital recorder can be used in check out systems, quick-look recording for digital computers, sequential time interval measurements, geophysical recording, telemetering and digital meters. Compatible with digital data sources, the model 960 records at rates to 150 lines (or words) of 32 bits each; it is manufactured by Electronic Counters, Inc., 155 Eileen Way, Syosset, N. Y.

Included are circuits to couple directly to d-c signals from flip-flops or counters. Recording control from external command signals is built in. A -10 volt input defines a logic ONE, zero volts at the input gives a logic ZERO.

The electrically sensitive recording paper travels at speeds from 2.5 to 25 inches per second for either continuous or intermittent operation. Standard paper rolls are 4½ in. by 400 feet, allow over 50,000 recordings on one loading.

Available for bench or rack mounting, the recorder is 12½ in. high, extends 16½ in. behind mounting panel; overall depth is 25 in.

SUPRAMICA® 560 ceramoplastic

from the family of the world's
most nearly perfect insulation

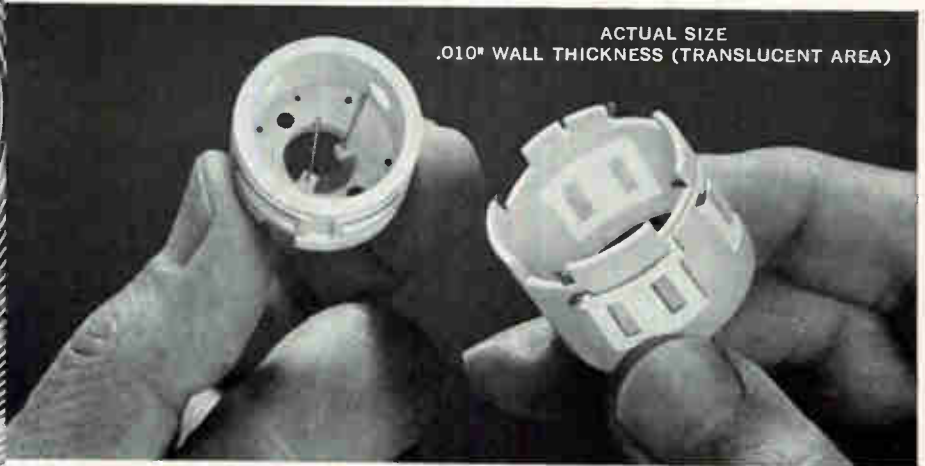

helps to maintain peak gyro efficiency

Leading gyro producers design parts made of precision-molded SUPRAMICA 560 ceramoplastic, an *exclusive formulation of MYCALEX CORPORATION OF AMERICA* capable of retaining absolute dimensional stability at a maximum temperature endurance up to +932°F (unstressed) . . . in complex but lightweight designs. These small parts function as vital components of miniature gyros . . . critical applications where the highest standards for precision accuracy must be met.

SUPRAMICA 560 ceramoplastic having the same thermal expansion coefficient of many insert metals, can tightly bond and permanently anchor gold leads, stainless steel contacts and stainless steel threaded inserts . . . in parts with wall thicknesses of only .010".

SUPRAMICA 560 ceramoplastic offers premium insulating properties with excellent economy in production scale runs. SUPRAMICA 560 ceramoplastic is but one of a family of versatile electrical and electronic insulating materials produced by MYCALEX CORPORATION OF AMERICA . . .

- MYCALEX® glass-bonded mica,
maximum temperature endurance (unstressed)—up to +700°F
heat distortion temperature * —up to +850°F
- SUPRAMICA® ceramoplastic,
maximum temperature endurance (unstressed)—up to +1550°F
heat distortion temperature * —up to +1360°F
- SYNTHAMICA® synthetic mica,
maximum temperature endurance (unstressed)—up to +2000°F

* ASTM test method D 648 (modified) at stress of 264 psi.

Write for technical information today.

General Offices and Plant: 120A Clifton Blvd., Clifton, N. J.
Executive Offices: 30 Rockefeller Plaza, New York 20, N. Y.

World's largest manufacturer of glass-bonded mica, ceramoplastic and synthetic mica products



THE FIRST SYNTHAMICA®
SYNTHETIC MICA

SINCE 1919
MYCALEX®
INSULATORS

THE FIRST SUPRAMICA®
CERAMOPLASTIC

MYCALEX
CORPORATION OF AMERICA

Standard designs include up to 32 recording channels and an ungated time mark channel. Higher data capacity and paper speeds are available on special order. Average price

for standard units is about \$2,000 with delivery 10 to 14 weeks.

CIRCLE 303 ON READER SERVICE CARD

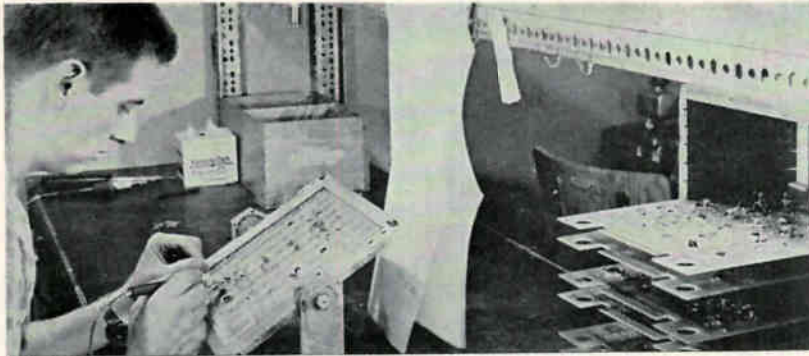

Universal Circuit Cards FOR SMALL LOT PRODUCTION

COMPUTER CIRCUIT cards can speed design and reduce lead time for short run production of computers. The cards use etched pattern that can be modified by interconnections to form any desired circuit function. Duplicate connectors are provided at the base and at the top of the cards, which are available from Librascope, Inc., 808 Western Ave., Glendale, Calif.

Components may be added to the stock cards to form logic modules, then interconnected to form the required circuits. The technique is particularly adaptable to short run and prototype production, where lead time between design and actual start of production is usually excessive.

An example of the technique is in the prefabrication of the four

data processing computers for the Federal Aviation Agency's air traffic control program. Each computer card holds 33 modules and interconnection was made after the computer design was firmed.

The technique does not result in the most compact packaging, or in a card that is adaptable to mass production. But for less than five machines, there are savings in production time and reduction in the lag between design and assembly.

The etched circuits are carried through from the base plug of each card to the top of the card where a duplicate connector is provided, permitting the card to be connected to a test instrument while still plugged into the computer.

CIRCLE 304 ON READER SERVICE CARD

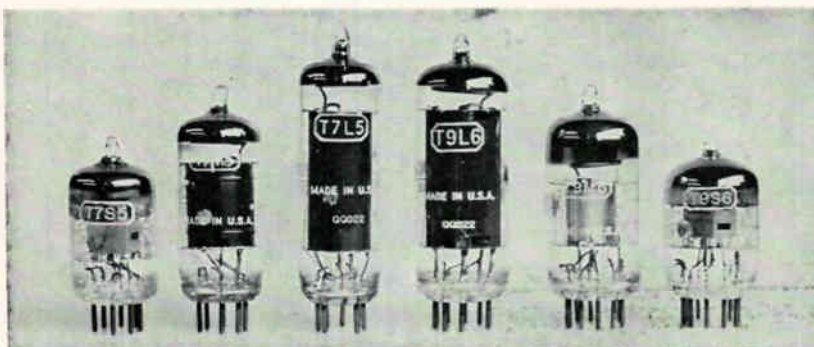

Thermal Analog Tubes FOR THERMAL DESIGN

A COMPLETE LINE of Thermions, thermal analog tubes, representing

all miniature electron tubes, is available to the electronic engineer and packaging engineer.

The devices simulate the heat generated by vacuum tubes and

give a more exact method for determining cooling requirements and reliability. Subminiature Thermions are also available.

Cooling requirements can be determined with the tubes by simulating the actual operating conditions. The analog devices are available from Research Council Inc., 151 Bear Hill Road, Waltham, Mass.

CIRCLE 305 ON READER SERVICE CARD



Flat Window Phototube FOR LOW LEVEL COUNTING

END WINDOWS of 8-inch multiplier phototube are virtually flat, allowing tubes to be used for low level radiation counting in applications requiring maximum light gathering. Tubes are essentially prototypes, interim products in a continuing development program, but are being made available now by Electronic Tube Sales Dept., Allen B. DuMont Labs., 750 Bloomfield Ave., Clifton, N. J.

The flat end screen of large diameter permits excellent optical coupling to conventional large size scintillation crystals. Initial prototypes of the K1979 were developed with technical cooperation from the Atomic Energy Commission, are now undergoing evaluation.

A 10-stage multiplier phototube with a photo cathode of S-11 spectral response, the tube's steel cone reduces radioactive background count and affords partial magnetic and electrostatic shielding. It has a focusing electrode (shield) for optimum photoelectron collection.

CIRCLE 306 ON READER SERVICE CARD

Angle Encoding System

RESOLUTION TO 0.001 DEG
ONE SHAFT REVOLUTION is divided in 360,000 parts in this high pre-



Publisher's Price, \$8.00
Club Price, \$6.80

Transistor Circuits and Applications by J. M. Carroll. Detailed information to aid in circuit design.

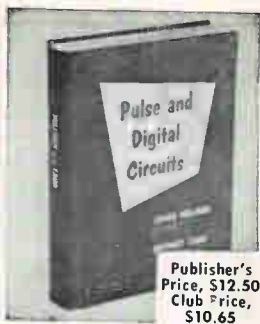

Publisher's Price, \$12.50
Club Price, \$10.65

Pulse and Digital Circuits by J. Millman and H. Taub. Explains circuits for effective system design.

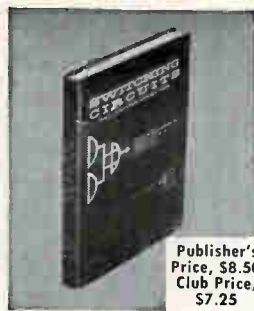

Publisher's Price, \$8.50
Club Price, \$7.25

Switching Circuits by Watts S. Humphrey, Jr. Applies switching-circuit techniques to modern network-design problems.

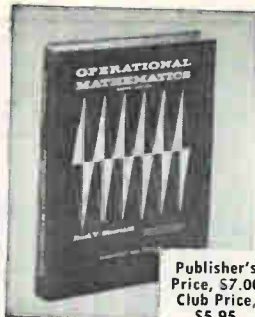

Publisher's Price, \$7.00
Club Price, \$5.95

Operational Mathematics by R. V. Churchill. Theory and applications of Laplace and other transforms.



Publisher's Price, \$12.00
Club Price, \$10.25

Electronic Measurements by F. E. Ternan and J. M. Pettit. Techniques for use in many electronic fields.



Publisher's Price, \$12.00
Club Price, \$10.25

Handbook of Semiconductor Electronics by Lloyd P. Hunter. Shows how to design and apply transistor circuits.

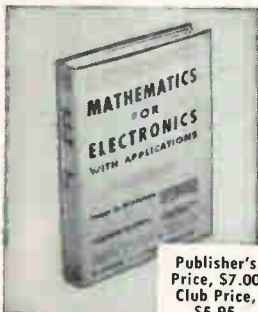

Publisher's Price, \$7.00
Club Price, \$5.95

Mathematics for Electronics with Applications by H. M. Nustelmann and F. W. Smith. For solving practical problems.



Publisher's Price, \$7.50
Club Price, \$6.40

Electronic Analog Computers by G. A. and T. M. Korn. How to design and set up problems for computers.



Publisher's Price, \$8.50
Club Price, \$7.25

Magnetic Recording Techniques by W. Earl Stewart. Gives you sound, realistic coverage of the principles of recording and reproducing processes.

To new members of the
**ELECTRONICS AND CONTROL
ENGINEERS' BOOK CLUB**

Special Introductory Offer

ANY ONE FREE

YOURS WITH A CHARTER MEMBERSHIP
AND SENT WITH YOUR FIRST SELECTION

Values from
\$7.00 to \$12.50

Select one AS A GIFT! Choose from *Electronic Measurements*, *Operational Mathematics*, *Pulse and Digital Circuits*, and six other valuable books . . . your introduction to membership in the *Electronics and Control Engineers' Book Club*.

If you're missing out on important technical literature—if today's high cost of reading curbs the growth of your library—here's the solution to your problem. *The Electronics and Control Engineers' Book Club* was organized for you, to provide an economical technical reading program that cannot fail to be of value to you.

All books are chosen by qualified editors and consultants. Their thoroughgoing understanding of the standards and values of the literature in your field guarantees the authoritativeness of the selections.

How the Club operates. Every second month you receive free of charge *The Electronics and Control Engineers' Book Bulletin* (issued six times a year).

This gives complete advance notice of the next main selection, as well as a number of alternate selections. If you want the main selection you do nothing; the book will be mailed to you. If you want an alternate selection . . . or if you want no book at all for that two-month period . . . notify the Club by returning the form and postage-paid envelope enclosed with your *Bulletin*.

We ask you to agree only to the purchase of three books in a year. Certainly out of the large number of books in your field offered in any twelve months there will be at least three you would buy anyway. By joining the Club you save yourself the bother of searching and shopping and save in cost about 15 per cent from publishers' prices.

Send no money now. Just check any two books you want—one FREE and one as your first Club selection—in the coupon below. Take advantage of this offer now, and get two books for less than the regular price of one.

THIS COUPON IS WORTH UP TO \$12.50

The Electronics and Control Engineers' Book Club
330 West 42nd Street, New York 36, N. Y., Dept. L-7-8

Please enroll me as a member of the Electronics and Control Engineers' Book Club. I am to receive my FREE book along with my first selection, both checked at the right. You will bill me for my first selection only at the special club price plus a few additional cents for postage and handling. (The Club assumes this charge on prepaid orders.) Forthcoming selections will be described to me in advance and I may decline any book. I need take only 3 selections or alternates in 12 months of membership. (This offer good in U. S. only.)

PLEASE PRINT

Name

Address

City..... Zone..... State.....

Company

NO RISK GUARANTEE: If not completely satisfied, you may return your first shipment within 10 days and your membership will be cancelled.

Check 2 books: We will send the higher priced book as your FREE book:

- Transistor Circuits and Applications, \$6.80
- Pulse and Digital Circuits, \$10.65
- Switching Circuits, \$7.25
- Operational Mathematics, \$5.95
- Electronic Measurements, \$10.25
- Handbook of Semiconductor Electronics, \$10.25
- Mathematics for Electronics with Applications, \$5.95
- Electronic Analog Computers, \$6.40
- Magnetic Recording Techniques, \$7.25

L-7-8



Raytheon Distributors Serving Key Markets Include...

Alabama
Birmingham
Forbes Distributing Company
AL 1-4104
MG Electrical Equipment Company
FAirfax 2-0449
Mobile
Forbes Electronic Distributors, Inc.
HE 2-7661

Arizona
Phoenix
Radio Specialties & Appl. Corp.
AL 8-6121

Tucson
Standard Radio Parts, Inc.
MA 3-4326

California
Burbank
Valley Electronic Supply Co.
Victoria 9-3944
Glendale
R. V. Weatherford Co.
Victoria 9-2471
Hollywood
Hollywood Radio Supply, Inc.
HO 4-8321
Inglewood
Newark Electronics Company
ORchard 7-1127
Los Angeles
Graybar Electric Company
ANgelus 3-7292
Kierulff Electronics, Inc.
RICHmond 8-2444
Oakland
Brill Electronics
TE 2-6100
Elmar Electronics
TEmplar 4-3311
Palo Alto
Zack Electronics
DA 6-5432
San Diego
Radio Parts Company
BE 9-9361
San Francisco
Fortune Electronics
UN 1-2434
Santa Monica
Santa Monica Radio Parts Corp.
EXbrook 3-8231

Colorado
Denver
Ward Terry Company
AMherst 6-3181

Connecticut
East Haven
J. V. Electronics
HOBart 9-1310

District of Columbia
Electronic Industrial Sales, Inc.
HUDson 3-5200
Kenyon Electronic Supply Company
DECatur 2-5800

Florida
Miami
East Coast Radio & Television Co.
FRanklin 1-4636
Electronic Equipment Co., Inc.
NEWton 5-0421
West Palm Beach
Goddard Distributors, Inc.
TEmples 3-5701

Illinois
Chicago
Allied Radio Corporation
HAYmarket 1-6800
Newark Electronics Corp.
STate 2-2944

Indiana
Indianapolis
Graham Electronics Supply Inc.
MElrose 4-8486

Maryland
Baltimore
Wholesale Radio Parts Co., Inc.
MUIberry 5-2134

Massachusetts
Boston
Cramer Electronics, Inc.
COpley 7-4700
DeMambro Radio Supply Co., Inc.
AL 4-9000
Lafayette Radio Corp. of Mass.
HUBbard 2-7850
Cambridge
Electrical Supply Corporation
UNiversity 4-6300

Michigan
Ann Arbor
Wedemeyer Electronic Supply Co.
NORMandy 2-4457

Detroit
Ferguson Electronic Supply Co.
WOODward 1-2262

Minnesota
Minneapolis
Electronic Expeditors, Inc.
FEderal 8-7597

**Broadcast engineers count on
the high quality performance
of Raytheon/Machlett tubes
and the complete back-up stock
and fast delivery of the
local RAYTHEON distributor!**

and at factory prices



RAYTHEON COMPANY

DISTRIBUTOR PRODUCTS DIVISION • WESTWOOD, MASS.

RECEIVING AND INDUSTRIAL TUBES • SEMICONDUCTOR PRODUCTS
MECHANICAL COMPONENTS • RAYTHEON/MACHLETT POWER TUBES
VOLTAGE REGULATORS • MICROWAVE TUBES • CAPTIVE HARDWARE

Mississippi
 Jackson
 Ellington Radio, Inc.
 FL 3-2769

Missouri
 Kansas City
 Burstein-Applebee Company
 Baltimore 1-1155

St. Louis
 Graybar Electric Co.
 Jefferson 1-4700

New Hampshire
 Concord
 Evans Radio
 Capital 5-3358

New Jersey
 Camden
 General Radio Supply Co.
 WA 2-7037

New Mexico
 Alamogordo
 Radio Specialties Company, Inc.
 HEMlock 7-0307

Albuquerque
 Radio Specialties Company, Inc.
 AM 8-3901

New York
 Buffalo
 Genesee Radio & Parts Co., Inc.
 Delaware 9661
 Wehle Electronics, Inc.
 Washington 3270

Mineola, Long Island
 Arrow Electronics, Inc.
 Pioneer 6-8686

New York City
 H. L. Dalis, Inc.
 Empire 1-1100
 Milo Electronics Corporation
 BEEKman 3-2980
 Sun Radio & Electronics Co., Inc.
 OREGon 5-8600
 Terminal Electronics, Inc.
 CHelsea 3-5200

Ohio
 Cincinnati
 United Radio Inc.
 CHerry 1-6530

Cleveland
 Main Line Cleveland, Inc.
 EXPRESS 1-4944
 Pioneer Electronic Supply Co.
 SUPERior 1-9411

Columbus
 Buckeye Electronic Distributors, Inc.
 CA 8-3265

Dayton
 Srepc, Inc.
 BAldwin 4-3871

Oklahoma
 Tulsa
 S & S Radio Supply
 LU 2-7173

Oregon
 Portland
 Lou Johnson Company, Inc.
 Capital 2-9551

Pennsylvania
 Philadelphia
 Almo Radio Company
 WALnut 2-5918
 Radio Electric Service Co.
 WALnut 5-5840

Pittsburgh
 Marks Parts Company
 FAirfax 1-3700

Reading
 The George D. Barbey Co., Inc.
 FR 6-7451

Tennessee
 Knoxville
 Bondurant Brothers Company
 3-9144

Texas
 Dallas
 Graybar Electric Company
 RIVERSide 2-6451

Houston
 Busacker Electronic Equipment Co.
 JACKson 9-4626
 Harrison Equipment Company
 CAPITAL 4-9131

Utah
 Salt Lake City
 Standard Supply Company
 EL 5-2971

Virginia
 Norfolk
 Priest Electronics
 MA 7-4534

Washington
 Seattle
 Western Electronic Company
 AT 4-0200

West Virginia
 Bluefield
 Meyers Electronics, Inc.
 DAVenport 5-9151

Wisconsin
 Milwaukee
 Electronic Expenders, Inc.
 WOODruff 4-8820

cision angle encoding system. Parallel real-time readouts are 8-4-2-1 binary coded decimal, electrical decimal and visual decimal on Nixie tubes.

The BRL-5 angle encoding system is available from United Aircraft Corporation's Norden Division, Wiley St., Milford, Conn., and

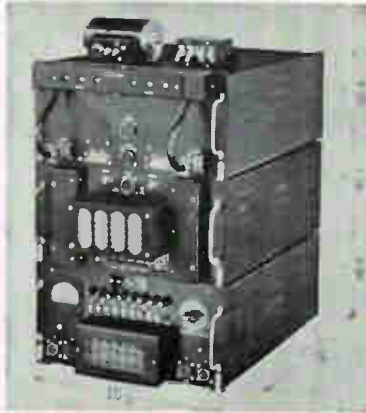

Colorado Research Corp., Bloomfield, Col.

The complete system consists of a small transducer manufactured by Norden, and an electronic package manufactured by Colorado Research. Other systems are available with pure binary resolutions from 2^{18} to 2^{21} in a single turn.

An important feature of the new electronics is its repackaging and qualification to MIL E-5400 for airborne use (a similar size ground-based package also is available).

The new system weight 150 pounds, requires 650 watts.

CIRCLE 307 ON READER SERVICE CARD

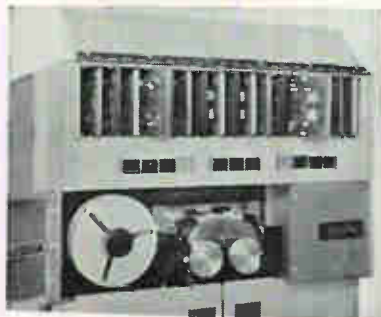

Tape Head And Guide

32 TRACKS PER INCH

CORE DESIGN of high efficiency in both playback and record allows 32 tracks per inch. With a gap length of 10 microinches, digital recordings with 6,000 flux reversals per inch are possible with the DTH 2132 Digital Magnetic Tape Head, manufactured by Shepherd Indus-

Cut, bend
 axial leads
AUTOMATICALLY,
INSTANTLY
 on diodes,
 resistors, etc.

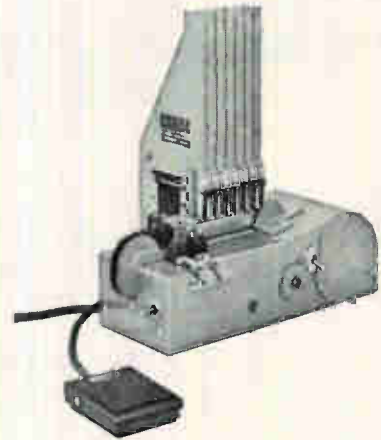

Bend-Amatic

Component Dispenser

Sample configurations

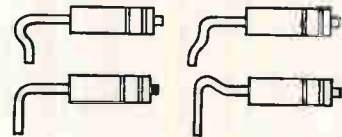

If just one of your production people repetitively cuts and bends 25 component axial leads to the same dimension, you are economically entitled to investigate the Bendamatic Dispenser. **3-DAY FREE TRIAL pay freight only; keep if satisfied; otherwise send back without obligation to buy.**

Cuts, bends, feeds up to 6 components in predetermined order for instant placement in chassis, terminal board, printed circuit. Ideal for production line use, or preforming components for inventory. Bench-top mounting; automatic or manual operation. Six bins, 48" storage capacity. Precision manufacture, simple, dependable.

Lead-to-Lead Accuracy: $\pm 0.003"$

Lead Length: 0" to 1"

Setup Time: 20 to 30 seconds

DEVELOP-AMATIC EQUIPMENT

Automatic Machines for Cost Reduction

4062 Fabian Way, Palo Alto, Calif.

Davenport 1-3376

Represented by:

W. A. Brown and Co., Orlando, Indian River, Fla.; Huntsville, Ala.; Alexandria, Va.; Winston-Salem, N.C.; Tawson, Md. The EMF Company, Chicago, Ill. Arthur T. Hatton, West Hartford, Conn.; Newtonville, Mass. G. S. Marshall Company, San Marino, Redwood City, San Diego, Calif.; Tucson, Arizona. The I. E. Robinson Co., Upper Darby, Camp Hill, Penn.; Asbury Park, New Jersey. S. Sterling Co., Detroit, Michigan, Cleveland, Ohio, Pittsburgh, Penn.

JENNINGS VACUUM RELAYS AND CAPACITORS

...when reliability counts



Jennings Vacuum Relays and Variable Capacitors play an important role in the Air Force's "Project Sideband," aimed at constant radio contact on intercontinental missions.

The high standards of reliability and performance required by the Air Force were more than met by Collins Radio Company's new 1 KW SSB system for "Project Sideband." The airborne end of the system, designated ARC-58, includes an automatically tuned antenna coupler. Jennings vacuum relay, RB3, and vacuum variable capacitor, USLS 465, are used in the coupler to match the 52 ohm impedance of the equipment with the antenna.

Jennings vacuum components were chosen for their recognized ability to withstand high voltage in limited space applications. The Type RB3 vacuum transfer relay is designed to meet peak voltages of 15 kv and rf currents to 15 amps yet it is only 3¼ inches long. The relay also has an auxiliary set of low voltage contacts for control purposes designed to operate after and release before the high voltage set. The Type USLS 465 is only 5 inches long and will withstand 10 kv at its minimum capacity of 5 mmfd and 5 kv at its maximum capacity of 465 mmfd. Both units will withstand 10G vibration to 500 cycles, 30G shock, and 50 hours salt spray.



USL-S-465
VACUUM
VARIABLE
CAPACITOR

Send for catalog literature on Jennings complete line of vacuum capacitors and relays.



TYPE RB3
VACUUM
TRANSFER
RELAY

JENNINGS RADIO MANUFACTURING CORPORATION
870 McLAUGHLIN AVE., P. O. BOX 1278 SAN JOSE 8, CALIF

Jennings

tries Inc., 103 Park Ave., Nutley, N. J.

The device is a 32-track interlaced head for 1-inch tape, employing a unique new core design which affords extremely high efficiency, both in record and playback of digital data. The gap length of this head is 10 microns, which allows its use at extremely high bit densities. With a Q of approximately 12, write current is 1 ampere turn. While the head is primarily designed for digital application, analog recording and playback is possible at frequencies up to 10 Mc.

The precision tape slot guide, model TG series, nearly eliminates tape skew and scrape-flutter. Width of the highly polished hard chrome slot is held to millionths of an inch, thus providing superior guidance with improved tape damping and start-stop characteristics. The guides fit all Shepherd Industries tape transports as well as nearly all other commercial digital tape transports.

CIRCLE 308 ON READER SERVICE CARD



Storage Oscilloscope

LARGE DISPLAY AREA

SKIATRON ELECTRONICS & TELEVISION CORP., 180 Varick St., New York 14, N. Y. Incorporating the NU-Skiatron dark trace tube, 7BEP10, the model SK1001 storage oscilloscope can retain a viewable image of transient or recurrent phenomena indefinitely, even with power to the instrument turned off. The display can be erased, however, in less than 10 sec and new data can be recorded. Simple to operate, the SK1001 has push-button selected triggered sweeps, internal voltage calibration, human-engineered thumb-wheel beam positioning, and color coordinated con-



Why "Experiment"...

with electrical protective devices

when BUSS fuses have proven their dependability?

With the many types of electrical protective devices on the market, perhaps you have asked yourself, "Which line is best for me?"

It doesn't pay to "experiment".

Protective devices that fail to protect or that open needlessly may reflect on the quality and reliability of your product — which in turn can affect your sales curve.

BUSS and FUSETRON fuses, on the other hand, do provide dependable electrical protection under all service conditions . . . and have for the last 45

years in the home, in industry and on the farm.

Electronic testing assures dependability.

Every BUSS and FUSETRON fuse is tested in a sensitive electronic device that automatically rejects any fuse not correctly calibrated, properly constructed and right in all physical dimensions.

Complete Line. There is a complete line of BUSS fuses in sizes from 1/500 ampere up . . . plus a companion line of fuse clips, blocks and holders.

If your protection problem is unusual . . . let the BUSS fuse engineers work with you and save you engineering time. If possible, they will suggest a fuse already available in local wholesalers' stock so that your products can be easily serviced wherever sold.

For more information on the complete line of BUSS and FUSETRON Small Dimension Fuses and Fuseholders, write for Bulletin SFB.

BUSSMANN MFG. DIVISION
McGraw-Edison Co.
University at Jefferson, St. Louis 7, Mo.

760

BUSS fuses are made to protect - not to blow, needlessly.

BUSS makes a complete line of fuses for home, farm, commercial, electronic, electrical, automotive and industrial use.



Spare Yourself "Site-Seeking" Safaris!



Safari clothing and equipment courtesy of Abercrombie & Fitch Co.

GPU *Site-Service*

will do all the groundwork for you!

Safaris are for African vacations. For finding the plant location that fits your requirements, use GPU *Site-Service*.

Plant location specialists at GPU headquarters and in the electric service companies have detailed information about one of the world's finest growth areas. They can answer your questions and provide, free of charge, vital data unobtainable elsewhere.

GPU *Site-Service* is the one central source of plant location information for nearly half of Pennsylvania and New Jersey. To locate your new site *without* safaris, phone, wire or write in confidence today.

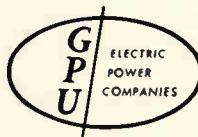

Metropolitan Edison Co.
Pennsylvania Electric Co.
New Jersey Power & Light Co.
Jersey Central Power & Light Co.



GENERAL PUBLIC UTILITIES CORPORATION

Att: Wm. J. Jamieson, Area Development Director, Dept. E-7
67 Broad St., New York 4, N. Y. Whitehall 3-5600

trols. It is expected to have wide application in research, development, testing and trouble-shooting . . . from relay engineering to medical research. Priced at \$2,500, the unit can be delivered in 30-60 days.

CIRCLE 320 ON READER SERVICE CARD



Servo Analyzer TWO MODELS

AETNA ELECTRONICS CORP., Readington Road, North Branch, N. J. Model 150A servo analyzer covers the frequency range of 0.1 to 60 cps. Model 150B covers 0.001 to 60 cps. New analyzer provides sine, square and modulated carrier output signals. A 100 to 1 attenuator is included. The analyzer will accept carrier frequencies from 50 to 5,000 cps and has an internal carrier source of 5,000 cps. The phase of the output signal can be varied over the range of ± 180 deg. Price of 150A is \$1,470; 150B is \$1,775.

CIRCLE 321 ON READER SERVICE CARD



Precision Meter PORTABLE UNIT

GREIBACH INSTRUMENTS CORP., 315 North Ave., New Rochelle, N. Y. Meter sensitivities to $0.2 \mu\text{a}$ full scale are available in a fully portable instrument, with the introduction of a new, specially-designed "slip-on" Formica carrying case, which quickly converts the model 700 from a panel to a portable unit. Unit features better than $\frac{1}{4}$ percent accuracy, multiple (to 23) ranges, and special circuitry that enables the meter to withstand overload

surges to 125,000,000 percent in some cases without impairment. Normal movement and abuse in the field will not affect the meter's sensitivity and accuracy, because the company's bifilar suspension movement is inherently rugged, absorbing shock to 500 g's.

CIRCLE 322 ON READER SERVICE CARD



Rotary Limit Switch AIRCRAFT QUALITY

LICON DIVISION, Illinois Tool Works, 6606 West Dakin St., Chicago 34, Ill., introduces the 00-304, an environment-free rotary limit switch packing a 10 ampere rating into a unit weighing less than 0.16 lb. It offers spdt single or double circuit control, dpdt four circuit control, plus installation and adjustment ease. The operating lever contains a micrometer screw for infinite operating point adjustment. A separate self-locking nut fixes the operating point to insure repeatability. Panel or screw-type mounting, plus a variety of electrical connectors add to the 00-304's versatility. Heart of the unit is Licon's type 16 subminiature switch. The tiny 16 offers a mechanical life well in excess of 20,000,000 cycles plus very high shock and vibration resistance.

CIRCLE 323 ON READER SERVICE CARD

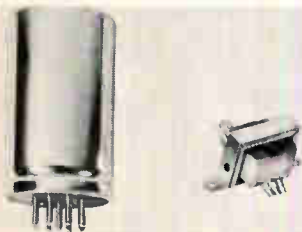

Chopper & Transformer FOR TEST AND CONTROL

JAMES ELECTRONICS INC., 4050 N. Rockwell St., Chicago 18, Ill., has

July 8, 1960

High-Purity METALS for Semi-Conductor Devices



GOLD doped with N-type or P-type elements—supplied in form of wire, sheet or ribbon and cut or stamped pieces.

INDIUM electroplated base or precious metal wires.

PLATINUM & RHODIUM-PLATINUM THERMOCOUPLE WIRES
For Temperature Control

SINCE 1901



Write for this brochure today: no obligation

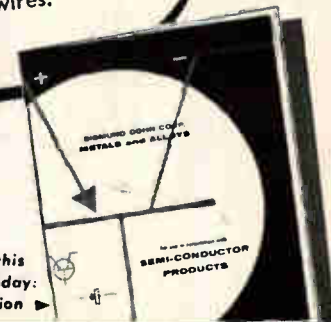

SIGMUND COHN CORP. 121 So. Columbus Ave. • Mt. Vernon, N. Y.

CIRCLE 66 ON READER SERVICE CARD

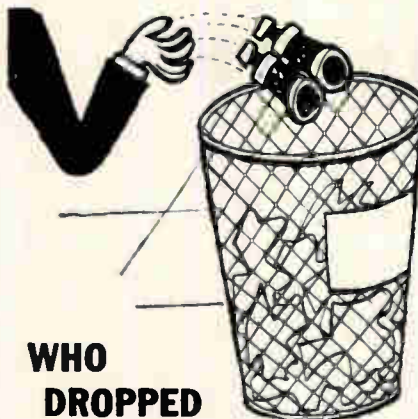

WHO DROPPED THE BINOCULARS?

With everybody watching each other along the DEW line and the Iron Curtain these days, electronics has replaced binoculars.

What's happening in the giant markets for missile controls, radar and communications equipment?

electronics tells how things are going, keeps you informed of developments as they occur. This is a good time to subscribe or renew your subscription. Just fill in box on Reader Service Card. Easy to use. Postage free.

FIND WHAT YOU NEED IN... electronics

For micro-cleaning of small parts —



jewelry, watch and instrument movements, bearings, dies, molds, etc.

BRANSON'S NEW SONOGEN[®] LGT-40

half-gallon Ultrasonic Cleaner
Self-contained, rugged, transistorized, temperature-stabilized. All stainless steel. Removable tank. 120W 110VAC input — 40W (80W peak) RF output. 14" x 7" x 13" overall height. Nationwide factory-trained service organization. Ask for Bulletin S-600.

Since 1946
The Respected Name in Ultrasonics

Branson
ULTRASONIC CORPORATION
89 BROWN HOUSE RD. • STAMFORD • CONN.

CIRCLE 87 ON READER SERVICE CARD 87

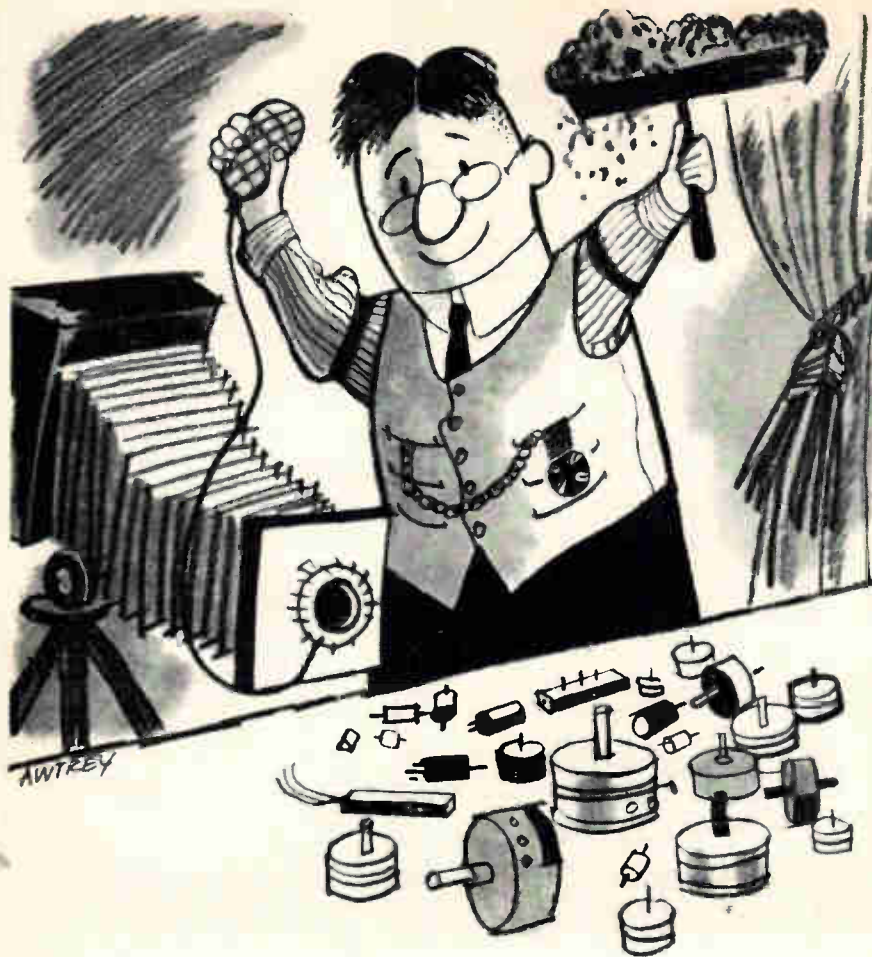

family potrait!

Met the *whole* Ace family yet? Or have your requirements to date in precision pots been only in 1/2", or wirewound? The famous Ace reliability, quality control and mass production facilities are not just limited to the above, no sir! Just consider Ace's *complete* range of standard sizes for instance — not just 1/2", 3/4", 7/8", 1 1/16", but sizes including A.I.A., up to 6"!

All these, in bushing, servo and universal mounts, in potentiometer and trimmer parameters. And . . . there are specials, multi-gangs, quick-cup-change designs, linear and non-linears and rectilinears — all in standard and special accuracies and conformities, both in wire-wound and conductive plastic. In short, when you can get Ace-quality in your every potentiometer need, get it the easy way: see your ACErep! Write for complete catalog!



This 3" AIA ACEPOT® (shown 1/3-scale) meeting all MIL specs, is available, in a range of accuracies, for prompt delivery.

See us at WESCON—Booth 924-925

ACE ELECTRONICS ASSOCIATES, INC.
99 Dover Street, Somerville 44, Mass.
SOMerset 6-5130 TMX SMVL 181 West. Union WUX

Acepot® Acetrim® Acetot® Acehm® *Reg. Appl. for

available a new chopper and associated input/output transformer specifically designed for commercial test and control applications such as d-c amplifiers, comparators, null indicators and servo systems where signals as low as 1 mv must be identified. This component combination can be used as a null indicator, modulator or demodulator. Model C-1800 chopper has low residual noise, coil voltage is $6.3 \text{ v} \pm 10$ percent rms, contact circuit is spdt and base fits standard octal socket. Life in excess of 2,500 hr can be expected in most applications. The associated series A-1500 transformers are of a unique 4 winding 8 terminal balanced design to permit step up or step down application with series or parallel impedance combinations, have electrostatic shielding between windings.

CIRCLE 324 ON READER SERVICE CARD



Multiturn Pot

INFINITE RESOLUTION

INTERNATIONAL RESISTANCE CO., 401 N. Broad St., Philadelphia 8, Pa. Type IR-150 potentiometer features a continuous slide wire resistance element giving it all the advantages of wire plus infinite resolution. Resistance tolerance on the standard unit is ± 10 percent. Linearity tolerance is 0.5 percent and the power figure is 5 w at 40 C derated to zero at 100 C. Closer tolerances are available. The 2.6 oz pot operates in a temperature range of from -55 C to 100 C and is available from 2 ohms to 35 ohms. Unit

price on quantity orders is approximately \$12, with 4-to-6 week delivery quoted.

CIRCLE 325 ON READER SERVICE CARD



Taper Pin Plugs TWO NEW TYPES

CAMBRIDGE THERMIONIC CORP., 445 Concord Ave., Cambridge 38, Mass., announces two new machined taper pin plugs, solder type (No. 2471) and solderless type (No. 2472), for use in connections of circuits of all kinds. The plugs provide a solid metal connection. They are 0.053 in. in diameter with 0.061 in. taper per in. Plugs are brass per QQ-B-626a, Comp. 22, $\frac{1}{2}$ hard, finished with 0.0002 in. silver plate plus 0.00010 in. gold plate or 0.0001 in. copper plate and 0.0005 in. electro-tin plate.

CIRCLE 326 ON READER SERVICE CARD



Magnetic Amplifier HIGH-GAIN, LOW-LEVEL

ACROMAG, INC., 22515 Telegraph Road, Southfield (Detroit), Mich. A new series of Acrostat magnetic amplifiers sense d-c signals of 1

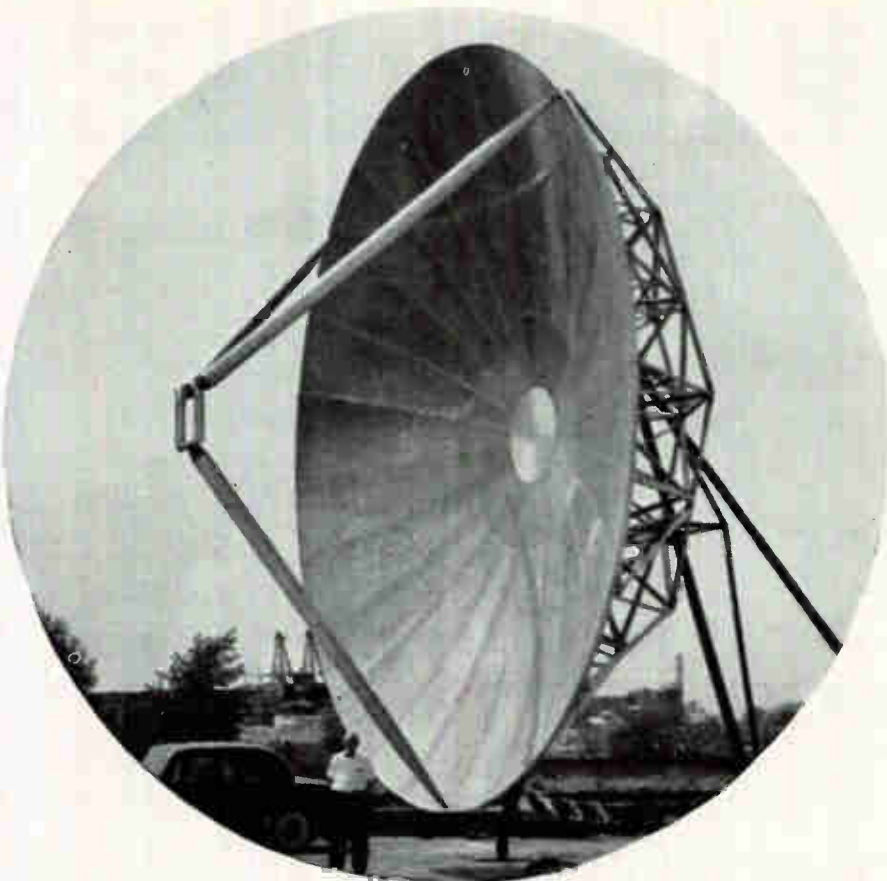

This precision 30-foot antenna has a more accurate surface than any other production parabolic reflector of comparable size.

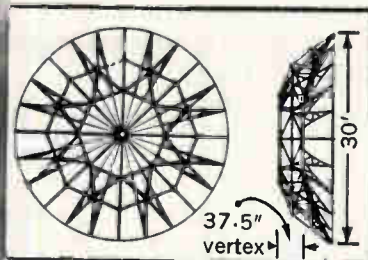

Antenna System's new solid surface, high precision 30-foot antenna (model 103) is designed to set a new standard for accuracy in the fields of radio astronomy, tropospheric scatter propagation, tracking radar, and experimental test installations. It features:

- High precision — The static surface tolerance of the first unit has been measured. The deviation from the ideal curve measured 0.033 inches RMS.
- Has an f/d ratio of 0.417 which readily adapts to a wide variety of feed systems.
- Fully machined sections are interchangeable and easy to assemble.
- Solid surface panels permit use at any frequency.
- Useable with a wide variety of feed support systems.
- Built to withstand 150 MPH wind with 4" ice.
- Can be mounted on either the top or side of a tower with azimuth and elevation adjustments, on el-az or equatorial pedestals, self-contained trailer tower mounts, or other types of mounts.

Write for specification sheet.

DESIGNERS AND MANUFACTURERS OF **A-S** ANTENNA SYSTEMS

ANTENNA SYSTEMS INC. HINGHAM, MASSACHUSETTS

AIRPAX



SERIES 500 MINIATURE MAGNETIC CIRCUIT BREAKERS

- RATINGS FROM 50 MA TO 10 AMPS
- DC, 60 CPS and 400 CPS TYPES
- MINIATURE CASE; SIZE ONLY 1 3/4" x 1 1/8" x 5/8"
- TRIP LEVEL INDEPENDENT OF TEMPERATURE

- INSTANTANEOUS OR DELAY TYPES
- HERMETICALLY SEALED
- SERIES - SHUNT - RELAY TYPES
- TWO AND THREE GANG ASSEMBLIES AVAILABLE

Positive Protection

Slightly larger than a conventional panel switch, the breaker serves as switch, fuse and relay.

Bulletin B-97 on request



CAMBRIDGE DIVISION • CAMBRIDGE, MD.

$\mu\mu\text{w}$. They feature very high gains and deliver 1 v of d-c output per μa of d-c control signal. The equivalent input drift is less than 10 μv under moderate environments, and 50 μv under severe environments. Gains are accurate to 3 percent under favorable conditions. Units are ideal for measuring weak d-c signals from thermocouples, strain gages, and other low-level signal sources. Using one amplifier in combination with a conventional 1 ma panel meter, it is possible to produce a sensitivity of 0.5 μa full scale or more with better than 2 percent accuracy.

CIRCLE 327 ON READER SERVICE CARD

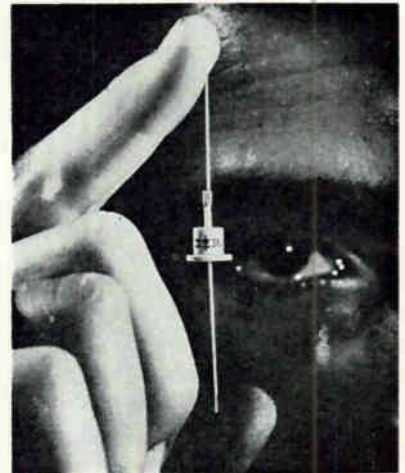

Silicon Diodes JEDEC TYPE

INTERNATIONAL RECTIFIER CORP., 1521 E. Grand Ave., El Segundo, Calif. Twenty new silicon JEDEC diode types, 100 percent tinplated for superior resistance to salt spray and to assure maximum solderability, are now available. Designed for use in applications requiring high forward conductance (to 1 ampere) and low leakage current at high temperatures (to 165 C). The 1N440 and 440B series provide d-c output currents from 300 ma to 750 ma (at 50 C) over a piv range from 100 to 500 v. Designed specifically for such applications as magnetic amplifiers and power supplies, the 1N1487-1N1492 series provides d-c output currents at 750 ma (at 25 C) over a piv range from 100 to 600 v, along with excellent forward and reverse characteristics. General purpose diodes 1N 1692-1N1695 will carry d-c output

currents of 600 ma (at 50 C) with a piv range from 100 to 400 v.
CIRCLE 328 ON READER SERVICE CARD

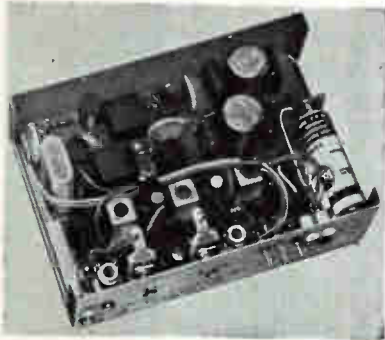

Command Receiver
TRANSISTORIZED

LEL, INC., 380 Oak St., Copiague, L. I., N. Y. Model TRR-1263 command receiver is a completely transistorized, crystal-controlled, fixed-tuned receiver designed to operate over the 5 Mc to 16 Mc range. The integral multitone decoder section provides high immunity from interference. Applications include telemetering, range safety, and missile command-destruct use.

CIRCLE 329 ON READER SERVICE CARD

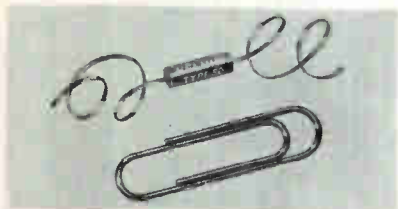

Wire-Wound Resistors
"RIBBON" LEADS

KELVIN ELECTRIC CO., 5907 Noble Ave., Van Nuys, Calif. Series 50 encapsulated, precision, wire-wound resistors are provided with "ribbon" leads designed especially for welding in microminiature circuits. This technique of assembly is faster than conventional soldering methods, and eliminates the possibility of overheating components as often occurs during soldering. Leads are 0.005 thick by 0.015 wide by 2 in. long. Available from 0.125 diameter by 0.375 long, 0.1 w, 400 K ohms, 100 v, to 0.250 diameter by 0.750 long, 0.3 w, 2.75 megohms, 400 v. Resistors exceed MIL specs, where applicable.

CIRCLE 330 ON READER SERVICE CARD

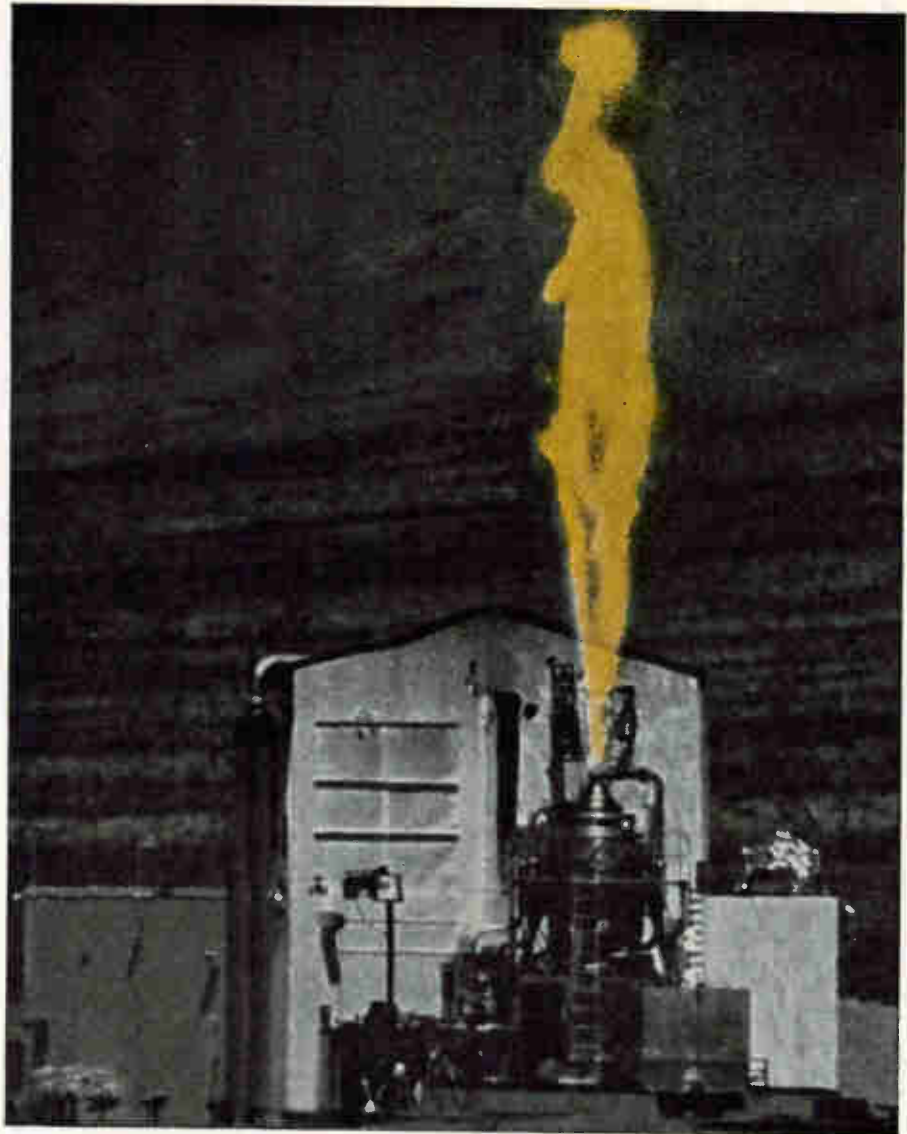

Space Propulsion for the future . . .
 from the **KIWI** family of Nuclear Reactors

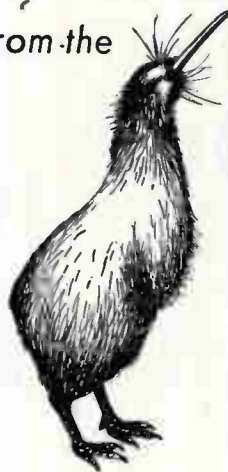

Los Alamos Scientific Laboratory has the major responsibility for research, development and testing in the AEC-NASA Rover program . . . another of the many investigations at Los Alamos into peacetime uses of nuclear energy.

PHOTO: First field test of a KIWI nuclear propulsion reactor.

*For employment information write:
 Personnel Director
 Division 60-63*

los alamos
 scientific laboratory
OF THE UNIVERSITY OF CALIFORNIA
 LOS ALAMOS, NEW MEXICO

Cable Capability



AMPHENOL

RADIO FREQUENCY
COAXIAL CABLES
and
TRANSMISSION LINES

CATALOG **W3**

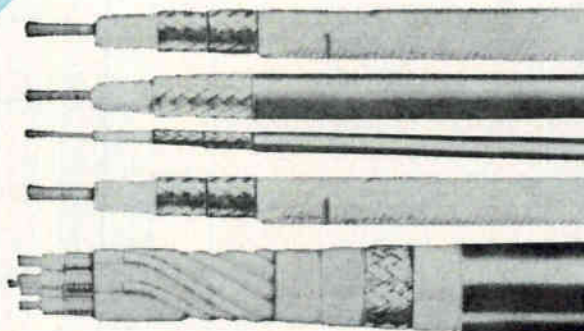

a New INDUSTRY HANDBOOK!

Catalog W3 is now available for your use, and we think you are going to like using it! The most complete collection of cable facts ever assembled, W3 promises to become a new industry handbook. For the information you need on coaxial cables send for your copy today!

AMPHENOL

AMPHENOL CABLE & WIRE DIVISION

Amphenol-Borg Electronics Corporation

8. HARLEM AVE. AT 63rd ST., CHICAGO 38, ILLINOIS

CIRCLE 94 ON READER SERVICE CARD

Literature of

TUNNEL DIODE CURVE TRACER Texas Instruments Incorporated, Geosciences & Instrumentation Division, 3609 Buffalo Speedway, Houston 6, Texas, has available a sheet describing the model 530 tunnel diode curve tracer which can create a sharp representation of the entire critical region of the forward characteristics curve of the tunnel diode under test instead of just a portion of that curve.

CIRCLE 350 ON READER SERVICE CARD

MAGNETIC LAMINATIONS G-L Electronics, Camden 5, N. J. A 36-page catalog entitled "Magnetic Laminations" contains an abundance of factual information, formulas and engineering data regarding each individual EE, EI, F, DU and W shape which is currently available from the company.

CIRCLE 351 ON READER SERVICE CARD

SERVO DESIGN SIMPLIFIED M. Ten Bosch, Inc., 80 Wheeler Ave., Pleasantville, N. Y. A 4-page brochure describes a simplified procedure and calculations necessary to obtain optimum performance from 2nd and 3rd order servo systems.

CIRCLE 352 ON READER SERVICE CARD

PILOT LIGHTS Dialight Corp., 60 Stewart Ave., Brooklyn 37, N. Y. The 256-page "Dialco Handbook of Pilot Lights" tells how to select the proper pilot light to accommodate the required lamp. Interested individuals are invited to write for a "Handbook Application Form."

CIRCLE 353 ON READER SERVICE CARD

TELE-SCAN RECORDING SYSTEMS Daystrom, Inc., Control Systems Division, Miramar Road, La Jolla, Calif., is offering technical bulletin 210 on its Tele-Scan recording systems for transmitting data to distant computer facilities via standard telephone circuits.

CIRCLE 354 ON READER SERVICE CARD

ALUMINUM ELECTROLYTICS Sprague Electric Co., North Adams, Mass. Engineering bulletin 3441B covers Compulytic aluminum electrolytics which are especially designed for power supply in-

the Week

stallations that meet the reliability requirements of both military and industrial computers and of other equipment where the same performance parameters are required.

CIRCLE 355 ON READER SERVICE CARD

ELECTRIC IMPULSE COUNTERS Landis & Gyr, Inc., 45 W. 45th St., New York 36, N. Y. A 6-page bulletin describes Sodeco Ti series heavy duty electric impulse counters. Complete technical data are given including operating instructions, execution possibilities including several circuit diagrams, electrical information for both a-c and d-c models, and dimensional data.

CIRCLE 356 ON READER SERVICE CARD

DELAY LINES Valor Instruments, Inc., 13214 Crenshaw, Gardena, Calif. An 18-page booklet describes the advantages, disadvantages and limitations of all the different types of delay lines available, including high density, lumped constant, distributed constant, magnetostrictive and ultrasonic delay lines.

CIRCLE 357 ON READER SERVICE CARD

R-I FILTERS All-Tronics, Inc., 45 Bond St., Westbury, L. I., N. Y., has published a new, expanded catalog on its line of standard radio interference filters that makes the selection of r-f filters to suit particular specifications an easy matter for the design engineer.

CIRCLE 358 ON READER SERVICE CARD

AIRBORNE POWER SUPPLIES General Electric Co., Schenectady 5, N. Y. Bulletin GEC-1494A, 2 pages, gives specifications of GE's unregulated transformer-rectifier, model 6RW102YF1A, 28 v, 200 amperes.

CIRCLE 359 ON READER SERVICE CARD

DIGITAL DATA PLOTTER Electronic Associates Inc., Long Branch, N. J. Bulletin DP6001 describes Dataplotter, its accessories and its capacity to multiply the efficiency of modern digital computers by reducing mountains of data to clear, easy-to-read charts, graphs or mechanical drawings.

CIRCLE 360 ON READER SERVICE CARD

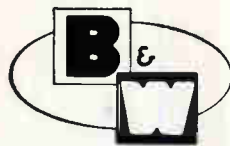

INSTRUMENTS FOR PRECISION CIRCUIT ANALYSIS

Proved in every type of service, these quality instruments are used by experts for FCC "proof-of-performance" tests and supplied as original equipment with many broadcast station installations.

Matchmaster. This versatile test equipment combines three instruments in one self-contained unit: Built-in dummy antenna, standing wave ratio indicator, direct reading RF watt meter. Model 650 (for 52 ohm line) and Model 651 (for 73 ohm line) indicate transmitter output power up to 125 watts directly. Model 52-500 gives direct readings up to 600 watts and is designed for permanent connection into 50 ohm coaxial lines such as RG-8/U.

Model 404 Linear Detector. Combined RF detection and audio bridging circuits for use with any distortion meter. 400 kc to 30 mc range with 20-30 volt RF carrier. Essentially flat frequency response from 20 to 50,000 cps.

Model 300 Frequency Meter. Measures audio frequencies to 30,000 cps in 6 ranges. Integral power supply and input level control.



MODEL 200 AUDIO OSCILLATOR

- Frequency Range: 30 to 30,000 cycles.
- Frequency Response: Better than ± 1 db. 30 to 15,000 cycles with 500 ohm load.
- Stability: Better than 1%.
- Calibration: $\pm 3.0\%$ of scale reading.
- Voltage Output: 10 volts into 500 ohm load.
- Distortion: Less than .2% at 5 volts output.



MODEL 400 DISTORTION METER

- Frequency Range: Fundamentals from 30 to 15,000 cycles. Measures Harmonics to 45,000 cycles.
- Sensitivity: .3 volts minimum input required for noise and distortion measurements.
- Calibration: Distortion measurements $\pm .5$ db. Voltage measurements: $\pm 5\%$ of full scale at 1000 cycles.
- Residual Distortion: .05%—30—15,000 cycles.
- Residual Noise: .025% or less.

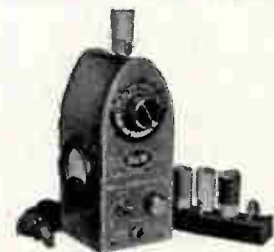

MODEL 600 DIP METER

- Covers 1.75 to 260 mc in 5 bands.
- Monitoring jack & B+ OFF switch.
- Shaped for use in hard-to-get-at places.
- Sturdy, color coded, plug-in coils.
- Adjustable. 500 microamp meter.



Barker & Williamson, Inc.

Beaver & Canal, Bristol, Penna.

Specialists in Designing and building equipment to operating specifications

B&W also design and manufacture filters for: ANTENNAS • RADIO INTERFERENCE • RADIO RANGE • UHF and VHF as well as many special types designed to performance specifications. Available to commercial or military standards.

NEW IDEAS FOR SALE!

Words and pictures tell you about the top new product ideas each week in "On the Market". Who makes 'em and what they'll do for you. Easy way to keep in touch with the latest and best.

FIND WHAT YOU NEED IN...

Another reason why it will pay you to subscribe to *electronics* (or renew your subscription) right now. Fill in the box on Reader Service Card. Easy to use. Postage free.

electronics



Itek Erecting New Headquarters

CONSTRUCTION recently began on the first stage of a multimillion dollar, seven-unit complex of buildings to house the Information Technology Center of Itek Corp., in Lexington, Mass., off Route 128.

John H. Carter, vice president and general manager of the Center, says the new complex will ultimately house up to 2,500 Itek employees and will contain the research, development, manufacturing and administration functions now carried on at three locations in nearby Waltham and Boston.

All buildings in the complex will be made up of a number of 27,000 sq ft modules—a new building block design concept. This architectural

approach makes possible units, or modules, that can be arranged to provide maximum exterior exposure for virtually all offices in the complex. Stage I, consisting of five modules, is to be ready for occupancy in about six months.

According to Carter, the units now under construction on the company-owned, 46-acre site include a T-shaped office and research building, which will be the central unit of the completed complex, and a main laboratory building.

The entire Information Technology Center will be constructed in three stages and will provide a total of 400,000 sq ft of floor space when completed.

vises the company's current research programs in magnetrons, duplexer tubes, and beam-plasma amplifiers, and will initiate new programs which will ultimately lead to the firm's entry into traveling-wave and crossed-field devices.

Prior to joining Microwave Associates, St. John was a project engineer with Watkins-Johnson Co. of Palo Alto, Calif., where he directed projects concerned with low-noise traveling-wave tubes and beam-type parametric amplifiers.

He was with Bell Telephone Laboratories, Murray Hill, N. J., from 1952 to 1959 as supervisor of a group working on research and development of low-noise traveling-wave tubes for radio-relay usage.



Microwave Associates Names R&D Director

APPOINTMENT of Grant E. St. John as director of research and development of the Tube Division of Microwave Associates, Inc., Burlington, Mass., is announced. He will super-

Syntron Building Rectifier Plant

SYNTRON COMPANY, Homer City, Pa., has begun construction of a new manufacturing plant for silicon rectifiers that will increase production eight times the present capacity. The new air-conditioned factory will add 16,000 sq ft of manufacturing area to the present operations. It will include an elaborate dust and humidity control system to insure the perfection of the finished product.

Site of the nearly half-million dollar structure is adjacent to the present rectifier plant which was completed in June 1958. Increased plans will require 80 additional persons. The plant is expected to be completed and in operation by mid-August.



Foto-Video Appoints R. D. Hamilton

FOTO-VIDEO ELECTRONICS, INC., Cedar Grove, N. J., announces the appointment of Robert D. Hamilton, formerly consulting engineer with IBM Corp. at Oswego, N. Y., as head of the systems engineering department at the company's expanding Cedar Grove operations.

While serving IBM, Hamilton was in charge of planning and specification writing for the Bomb-Nav System Test involving sighting radars, Doppler radar, data-processing, digital-computing operations, radar display and stellar inertial operations.

Prior to that, he was a senior engineer with Allen B. DuMont Laboratories, holding the post of electronic systems engineer, responsible for the scheduling and writing of creative industrial and military-

work in Southern California on the

EAGLE



ADVANCED OPPORTUNITIES FOR SENIOR ENGINEERS

Bendix-Pacific Division, North Hollywood, California, as a member of the Bendix Corporation "EAGLE" Development Team, is a major contributor to the Navy's newest air-to-air Missile "EAGLE." This weapon system is a second generation air-to-air Fleet Defense System and offers challenging design opportunities to the creative engineer.

ADVANCED POSITIONS ARE OPEN TO MEN WITH BACHELOR, MASTER AND DOCTOR DEGREES IN ELECTRICAL AND MECHANICAL ENGINEERING WITH EXPERIENCE IN ELECTRONIC CIRCUIT DESIGN AND MECHANICAL PACKAGING. OTHER HIGH-LEVEL ELECTRONIC ENGINEERING POSITIONS AVAILABLE

Please send resume to

W. C. WALKER,

ENGINEERING EMPLOYMENT MANAGER



Bendix-Pacific Division

NORTH HOLLYWOOD, CALIFORNIA



WHAT'S NEW IN COMPONENTS?

What *useable* discoveries are being made on the frontiers of electronic knowledge? Here are a few selected at random: directive long-range sonar transducer . . . high-speed ferrite memory and logic element . . . space-probe telemetry system . . . master preamplifier for X-band radar. You can never tell when one is going *your* way. This is just ONE of the reasons why you should subscribe to electronics (or renew your subscription).

Fill in box on Reader Service Card. Easy to use. Postage free.

**FIND WHAT
YOU NEED IN...
electronics**

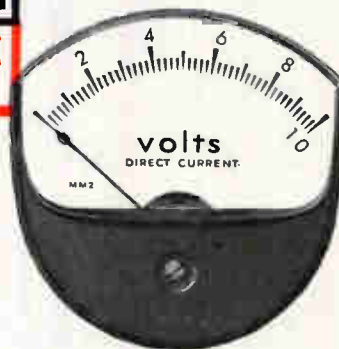

MEDALIST* meters

Combine increased readability with attractive color styling. ASA MIL 1 1/2", 2 1/2" and 3 1/2" mounting. Up to 50% longer scale in same space as conventional types. Standard and special colors. Bulletin on request. Marion Instrument Division, Minneapolis-Honeywell Regulator Co., Manchester, N.H., U.S.A. In Canada, Honeywell Controls Limited, Toronto 17, Ontario.



Honeywell



First in Control

SINCE 1889

AT WESCON, BOOTH 2722

DYNASERT

**Speeds
Component Inserting
to 10 Times
in PW Boards**

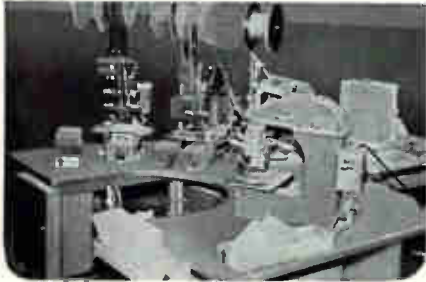

Long or short runs, Dynasert saves. Automatically feeds component, trims, bends leads, inserts, and clinches without damage to component body. Speeds model changeover. Improves board dependability.

Single or multi-stage units for highly dependable production are available. Write for descriptive 12 page booklet.

United

UNITED SHOE MACHINERY CORPORATION
140 Federal Street, Boston, Mass.
CIRCLE 202 ON READER SERVICE CARD



FOREMOST
in
ASW
SYSTEMS

EDO CORPORATION
College Point, L.I., N.Y.
Since 1925

systems proposals including tactical reconnaissance by television and other communications.



M. Landau Joins ESC Corporation

ESC CORPORATION, Palisades Park, N. J., manufacturer of delay lines, filters, wide band video transformers and other types of video networks, announces the appointment of Melvin Landau as chief mechanical engineer.

Prior to joining ESC, Landau was supervisor of mechanical design at the Bogen-Presto Corp. Before that he was design engineer with the Radio and TV Division of Westinghouse. He has also been affiliated with the Walter Kidde Co., Bendix Aviation Corp., and the Espe Mfg. Corp. in similar capacities.



Ehrismann Takes Filtors Post

RECENTLY announced was the appointment of Kurt Ehrismann as chief product engineer at Filtors, Inc., Port Washington, N. Y. He will have design and production responsibilities for the company's complete line of relays.

Ehrismann was formerly the project engineer in charge of the design and development of telephone

LINT-FREE

ACID RESISTANT · STATIC FREE



specify **ANGELICA UNIFORMS**

Wherever utmost cleanliness is a must, Angelica is the scientific choice! Engineered "down to the last thread" for full protection of delicate assemblies. Smooth monofilament fabrics create no lint—Angelica's superb tailoring allows none to gather. Acid-resistant and static free fabrics in styles for every job—comfortable, easy to launder, long wearing.

Whether you rent or buy, your Angelica representative will help you, as he has others—to choose the right garments for your needs.

Angelica
UNIFORMS

1427 OLIVE ST., ST. LOUIS 3, MO.
107 W. 48th ST., NEW YORK 36, N. Y.
177 N. MICHIGAN AVE., CHICAGO 1, ILL.
1900 W. PICO BLVD., LOS ANGELES 6, CALIF.

CIRCLE 203 ON READER SERVICE CARD
electronics

PRECISION ILLUMINATION WITH A. C. M. I. MINIATURE LAMPS

HOODED TYPE LAMPS

OPEN TYPE LAMPS

All A.C.M.I. miniature lamps are made to the most meticulous standards of physical dimension and candlepower, and can be relied on for excellent illumination and reliable service.

Miniature lamps are available in sizes from .036" to 1.125" in diameter and in voltages from 1.5 volts to 48 volts.

We invite inquiries for all types of miniature lamps. You can be sure of precision illumination with A.C.M.I. miniature lamps.

American Cystoscope Makers, Inc.

Producers of the world's smallest miniature lamps

8 PELHAM PARKWAY
PELHAM MANOR, N. Y.

FREDERICK J. WALLACE, President



CIRCLE 204 ON READER SERVICE CARD

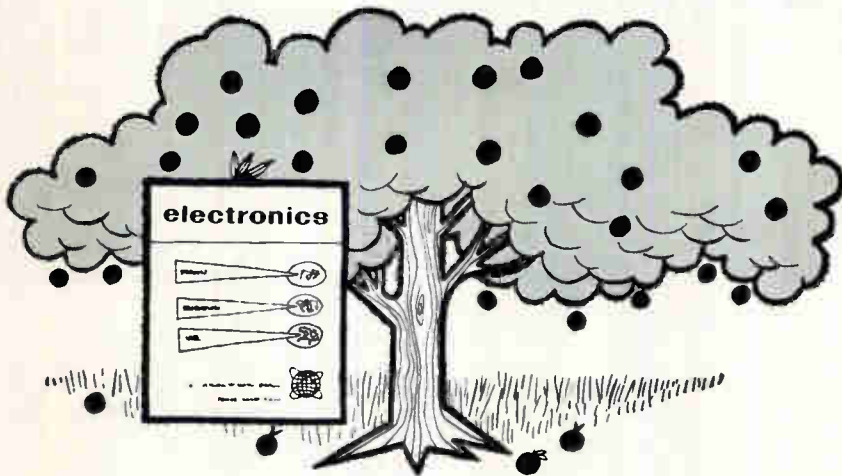

The pick of the crop!

Thumbnail summaries of sales literature on materials, components, equipment, and facilities keep you up-to-date in about 3 minutes of quick, easy reading in "Literature of the Week."

Another reason why it will pay you to subscribe to *electronics* (or renew your subscription) right now. Fill in the box on Reader Service Card. Easy to use. Postage free.

FIND WHAT YOU NEED IN...
electronics

July 8, 1960

"WHY GO PUBLIC?"

The answer to this vital question is in our informative brochure— if you need money and you are considering either a public issue or the acquisition of private capital, you'll find our services of real value.

For free informative brochure, write to:



UNDERWRITING AND
PRIVATE FINANCING
660 MADISON AVENUE
NEW YORK 21, N. Y.
TE 8-2424

CIRCLE 99 ON READER SERVICE CARD 99

"SPOOLY"
SAYS ...



Super-Temp for Fastest Delivery of HIGH TEMPERATURE MAGNET WIRE

You get the finest . . . fastest from Super-Temp. Magnet wire insulated with Teflon*, silicone or Isonel films. Ranges to +260°C. Mica films with ranges to +350°C. Complete quality control.

ALSO: Airframe Wire, Hook-up Wire, Tapes
Coaxial Cables, Miniature & Jumbo Cables
Teflon or Silicone Rubber Insulations

*DUPONT'S TFE RESIN



Save Time WITH Super-Temp

American Super-Temperature Wires, Inc.

8W. Canal Street, Winooski, Vermont • UNIVERSITY 2-9636
General Sales Office: 195 Nassau St., Princeton, N. J. • WALnut 4-4450
A Subsidiary of Havg Industries, Inc., Wilmington, Del.

• Free! Send for 1960
• Catalog, 88 pages of
• valuable data.

CIRCLE 205 ON READER SERVICE CARD

power equipment at National Pneumatic Co. and Holtzer-Cabot, Inc., in Boston. Before that he was a project engineer assigned to new products at C. P. Clare & Co., Chicago; here he designed and developed new relays and rotary switches. He has had wide experience in the design and manufacture of relays both in this country and in Switzerland, where he was production engineer for Albiswerk AG, Zurich.



Avco Promotes Harland Bass

APPOINTMENT of Harland A. Bass as chief engineer, data handling, at the Crosley Division, Avco Corp., Cincinnati, O., is announced.

Bass had been serving as assistant chief engineer, data handling. He first joined Crosley in 1940 as an engineer on military products.

COMPLEX IMPEDANCE MEASUREMENTS

$$Z = \pm R \pm jX$$

INSTANTANEOUSLY
CONTINUOUSLY
AUTOMATICALLY



VECTOR
IMPEDANCE
LOCUS
PLOTTER

TABLE OF CHARACTERISTICS

Impedance Range: (R and X, in ohms)	0-10, 0-100, 0-1,000 and 0-10,000 normal range. 0-50, 0-500, 0-5,000 and 0-50,000 extended range	Output Voltage: D. C. voltage proportional to both R and X 150 millivolts for full-scale deflection
Frequency Range:	0.1 to 150 kc/sec	Input Signal: Sinusoidal 0.5v rms, adjustable frequency
Accuracy:	± 3%—normal range ± 5%—extended range	Input Power: 105/130V, 50-60 cycle, single phase, 250W
Suppression of Origin:	5 times full scale	Weight: 74 pounds
Data Presentation:	7-inch cathode-ray tube Meter readout	Dimensions: 22-9/16" L x 17-1/8" W x 15-7/8" H
CRT Plotting Speed:	X-Y Recorder output 10-inches per second (Approx.)	

No longer is it necessary to perform the time-consuming and tedious steps of making manual adjustments to establish impedance bridge balance, tabulating data, computing the information or plotting the final data. The VILP eliminates the necessity for these procedures thereby contributing importantly to the speed and accuracy with which experimental studies of impedance can progress.

Chesapeake
INSTRUMENT CORPORATION
Shadyside, Maryland



Nytronics Appoints Chief Engineer

SIDNEY FISCH was recently appointed chief engineer of the Essex Electronics division of Nytronics, Inc. of Berkeley Heights, N. J.

In his new post, Fisch will be responsible for further development of the company's delay lines, coils, and r-f components.

RESEARCH AND DEVELOPMENT
Sonar • Ultrasonics • Wave Propagation
Shock and Vibration • Explosion Studies

INSTRUMENT MANUFACTURE
Transducers • Hydrophones • Blast Gages
Accelerometers • Electroacoustic Devices

*Opportunities in
Systems Development*



Switching logic circuits by light

In this experimental device, six photoconducting cells surround a neon lamp. The unit serves as one of the logical elements in an elementary digital device built by IBM engineers and scientists investigating light as a switching medium in logic circuits.

The Potential of Photoconductivity

Because neon-photoconductor pairs are simple, reliable and versatile in their circuit applications, they are being thoroughly studied at IBM from both theoretical and engineering viewpoints. Physicists and mathematicians are examining fundamental aspects of photoconductivity. Other scientists and engineers are looking into alternate methods by which photoconductors might become part of future low-speed computing systems.

With the advent of light on the electronic scene, there are new skills to be learned and new problems to be solved that have never before been encountered. To attack these problems, it takes the varied skills of many different types of engineers and scientists. It also takes the progressive spirit of a company very much in step with the future.

Careers in Growth Fields

Of course, your primary interest may not be photoconductivity. You may be more interested in recent IBM achievements in solid state, optics, thin films or magnetics. Whatever your aims or background, you'll find fascinating work in frontier fields at IBM's expanding research and development laboratories.

If you have a degree in engineering, mathematics or one of the physical sciences, plus experience in your field—write, briefly outlining your qualifications, to:
Manager of Technical Employment
IBM Corporation, Dept. 554S2
590 Madison Avenue, New York 22, N. Y.

IBM® INTERNATIONAL BUSINESS MACHINES CORPORATION

INERTIAL SYSTEMS DEVELOPMENT

.... there are opportunities at Honeywell Aero for the engineer or scientist who is interested in participating in this growing field of technology. While specific inertial systems experience is desirable, you may also be qualified by your background and/or related experience for activities in the inertial systems development at this time. Specific openings include:

SYSTEMS ANALYST

Mathematician or engineer with strong background in vector analysis, operational calculus, matrix algebra and related techniques. To carry out analysis of inertial systems configurations including error evaluation.

DIGITAL SYSTEMS AND LOGIC DESIGNER

Familiar with digital logic techniques at current state of the art; capable of organizing computing systems to perform various tasks including logical design and critical parameter specification.

ELECTRONIC ENGINEER

Electrical engineering degree plus experience in miniaturized semiconductor electronics development. To design servo, pickoff, and other electronics for use with gyros and accelerometers.

ENGINEERING PHYSICIST

Physicist with practical and theoretical understanding of mechanics, magnetism and electricity to analyze and develop inertial sensors of novel and original design.

To discuss these or other openings, write Mr. R. O. Maze, Chief Engineer, Marine Systems Group, Dept. 731-A, Aeronautical Division, 1433 Stinson Blvd., Minneapolis 13, Minn.

Honeywell



To explore professional opportunities in other Honeywell operations coast to coast, send your application in confidence to H. K. Eckstrom, Honeywell, Minneapolis 8, Minnesota.

SALES ENGINEER

EXCELLENT OPPORTUNITY FOR TOP MAN WITH GROWTH COMPANY

- EDUCATION:** Degree in Electrical Engineering.
EXPERIENCE: Minimum of 5 to 8 years in design and engineering of regulated power supplies, control systems, servo systems and checkout equipment.
DUTIES: Sales - Application - Engineering contacts and negotiations with industry and government.
FUTURE: Must have potential to grow with Company. Although some sales experience is desirable technical experience and executive calibre is of prime importance.

Send Resume Stating All Pertinent Data to:

MAGNETIC AMPLIFIERS DIVISION THE SIEGLER CORPORATION

632 Tinton Avenue, New York 55, N. Y.

U. S. ATOMIC ENERGY COMMISSION

needs

PATENT ENGINEERS OR ATTORNEYS

with

education or experience in

electrical engineering, electronics or physics

Salary commensurate with qualifications.

Submit detailed resume to:

U. S. Atomic Energy Commission

Chicago Operations Office

9800 South Cass Avenue, Argonne, Illinois

SEARCHLIGHT SECTION

(Classified Advertising)

BUSINESS OPPORTUNITIES

EQUIPMENT - USED or RESALE

MEASUREMENTS CORP. Pulse Generator



MEAS. CORP. MOD. 79-B PULSE GENERATOR, 60 100,000 cy + pulses, 40 usecs wd, and + sync pulses delayed 1/2 period. Can pulse modulate an external RF source and can be synched by an external sine source. This is the model preceding the current catalog model which sells for \$495.00. Brand new in original packing, with instruction book, 40 lbs. to Harrisburg, Pa. \$97.50

0.1% SORENSEN Line Voltage Regulator

±5000S brand new at a low surplus price! Output is adjustable 110-120 volts and holds the pre-set voltage to ±0.1% at line frequency, or to ±0.25% if the line frequency drifts 5%. Taps for 50 or 60 cy., 1 phase. Regulates against line changes of 95-130 V. and against load changes from 0 to 5000 VA. Max. harmonics less than 3%. Recovery time 0.15 seconds. Note that input to control circuit can be moved to actual point of use of power, to compensate for line drop. In rack cabinet 28" h, 22" wd, 15" dp. Net wt 190 lbs. Shpg wt 285 lbs FOB titles, N. Y. warehouse. Packed for export. (13 cu ft.) Catalog net price is \$895.00, less spares. Our price, new, in original packing, WITH SPARES, is only \$349.50

(For the possibility of future needs, it is smart planning to get 5 KVA capability, which works just as well at lower powers... even if present need is for low power. Compare our price with spares to regular catalog net prices without spares: \$320.00 for 1 KVA, \$480.00 for 2 KVA, \$820.00 for 3 KVA.)

FOR OPERATION ON 230 OR 480 VOLTS: Max. input at nominal 115 volts when 5 KVA is used, is 71 amps (815 VA). For use on 480/230 V lines, an 8 1/2 KVA isolating step-down transformer is required. We can get it wound to order in Los Angeles, 1 ph., fully cased, boxed for shipment: 60 cy, \$155.00, shpg wt 160 lbs. 50/60 cy, \$170.00, shpg wt 175 lbs. Check your local winders; you may do as well or better. If not, order from us FOB Los Ang.

Circle Readers Service Card for our new listing of budget stretchers selected for you from surplus.

R. E. GOODHEART CO.

P. O. Box 1220-E Beverly Hills, Calif.

CIRCLE 461 ON READER SERVICE CARD

MOTOR GENERATOR SETS

AC to DC

One 10 Kw, 3 phase, 400 cycle, 3428 RPM, direct connected brushless exciter.
 One 10 Kw, 3 phase, 400 cycle, 1200 RPM.
 One DC Generator, 1000 amp, 28.5 volt, 1800 RPM with separate exciter.
 60 cycle generators, 5 Kw and up, also control equipment, available and in stock for immediate delivery.

For more information write:

KATO ENGINEERING CO.

1415 FIRST AVENUE, MANKATO, MINNESOTA

CIRCLE 462 ON READER SERVICE CARD

lab grade TEST EQUIPMENT for sale

standard brands—military surplus (new or professionally reconditioned) experienced problem solvers and budget-cutters

ENGINEERING ASSOCIATES

434 Patterson Road Dayton 19, Ohio

CIRCLE 463 ON READER SERVICE CARD

NEED RESEARCH HELP?

We provide a full list of reference citations from past and recent published matter covering patents, chemical abstracts, government publications, and texts for your specific electronics problem.

Price per subject\$38.00
RESEARCH SERVICES
 1422 Chestnut St., Philadelphia 2, Pa.
 Room 305 LOCust 3-8542

CIRCLE 464 ON READER SERVICE CARD

electronics

ELECTRONIC

WAR TERMINATION INVENTORIES

WRITE OR WIRE FOR INFORMATION ON OUR COMPLETE LINE OF SURPLUS ELECTRONIC COMPONENTS. ALL PRICES NET F.O.B. PASADENA, CALIFORNIA

C&H SALES CO.

2176-E East Colorado St.
Pasadena 8, California
MURray 1-7393

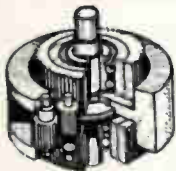

SIMPLE DIFFERENTIAL WITH BALL-BEARING SUN GEARS

The 1:1 reverse ratio spur gears are 48-tooth, 32 pitch brass with 3/16" available face. On one side, the shaft is 23.64" dia. for 11/16" and has a pin hole, then increases in dia. to .377" for the remaining 3/16" of length. On the other side, the shaft is .377 dia. 1/4" lg. 2-13/16" dia. is required to clear the body. Stock no. A6-115.....each \$15.00



SIMPLE DIFFERENTIAL WITH SPACED-OUT SUN GEARS

1:1 reverse ratio spur gears are aluminum, 3/32" face, 32 pitch, 32 tooth on one side, 48 tooth on the other. The body is 3/4" thick, but the sun gears are spaced out so that they are 1 1/2" apart. 1/4" dia. shaft on each side is 23/32" long. OA length 3 1/8". Requires 1-23/32" dia. to clear the body. Stock no. A6-124.....each \$4.50



SIMPLE DIFFERENTIAL

1:1 reverse ratio, 60 teeth on large gear; 1/4" shaft; 1 1/2" long with 1-15/16" dia. Stock no. A6-104.....each \$3.95



DUAL SIMPLE DIFFERENTIAL

1:1 reverse ratio on both. Size: 3 1/4" long x 1-7/16" dia. Shaft size: 1/8" and 5/32". Stock no. A6-107.....each \$7.50



SPERRY VERTICAL GYRO

Part #673073, Motor 115 volts, 3 phase, 400 cycle, 8 watts, 20,000 RPM. 3-minute runup, synchro pickoffs, roll 360°, pitch 85°. Synchro excitation 26 volts, 400 cycle, 150 m.a. Vertical accuracy ±1/2". Weight 3 1/2 lbs. Approx. dim. 5 3/4" L., 4 1/2" W., 4 1/2" H. Price \$35.00

MINNEAPOLIS-HONEYWELL RATE GYRO (Control Flight)

Part no. JG7005A, 115 volts A.C., 400 cycle, single phase potentiometer take off resistance 530 ohms. Speed 21,000 r.p.m. Angular momentum 2 1/2 million, CM²/sec. Weight 2 lbs. Dimensions 4-7/32 x 3-29/32 x 3-31/64. Price \$22.50

VARIABLE SPEED BALL DISC INTEGRATORS

(All Shafts Ball Bearing Supported)
No. 145 Forward & Reverse 2 1/4-0-2 1/4. Input shaft spline gear 12 teeth 9/32" dia. 3/8" long. Output shaft 15/64" dia. x 15/32" long. Control shaft 11/32" x 3/8" long. Cast aluminum construction. Approx. size 3" x 3" x 2 3/4". \$17.50
No. 146 Forward & Reverse 4-0-4. Input shaft 5/16" dia. x 3/4" long; Output shaft 15/64" dia. x 9/16" long. Control shaft 11/64" dia. x 11/16" long. Cast aluminum construction. Approx. size 4 1/2" x 4 1/2" x 4". \$18.50 ea.

SMALL DC MOTORS

(approx. size overall 3 3/4" x 1 1/4" dia.)
5067043 Delco 12 VDC PM 1" x 1" x 2", 10,000 rpm. \$7.50
5067126 Delco PM, 27 VDC, 125 RPM, Governor Controlled 15.00 ea.
5069600 Delco PM 27.5 VDC 250 rpm 12.50
#5069625 120 rpm, mfr. Delco, 27 VDC governor controlled \$15.00
5069230 Delco PM 27.5 VDC 145 rpm 15.00
5068750 Delco 27.5 VDC 160 rpm w. brake 6.50
5068571 Delco PM 27.5 VDC 10,000 rpm (1x1x2") 5.00
5069790 Delco PM, 27 VDC, 100 RPM, Governor Controlled 15.00 ea.
#5069800 575 rpm, mfr. Delco, 27 VDC, PM reversible governor controlled, equipped with 27 VDC clutch \$17.50
5072735 Delco 27 VDC 200 rpm governor controlled. 15.00
5BA10A118 GE 24 VDC 110 rpm 10.00
5BA10A137 GE 27 VDC 250 rpm reversible 10.00
5BA10A152 27 VDC 145 rpm reversible 12.50
5BA10A150, G.E., 12 VDC, 140 rpm 15.00
5BA10F1401B, G.E. 28 VDC, 215 rpm, 10 oz. in., .7 amp, contains brake 15.00
5BA10F1421, G.E. 26 VDC, 4 rpm, reversible, 6 oz. in., .65 amp 15.00

400 CYCLE PM GENERATOR

Mfgd. by T K M Electric Corp.
Model #A-12
120/208 volts, 400 cycle, 1 or 3 phase, 1 kva, pf 0.8, rpm 8,000. Approx. dim. 6" x 5 1/2". Internal spline drive. Price \$100.00

400 CYCLE 1/3 PHASE GENERATOR

115 VAC. 3 KVA. Mfg. Bogue Elect. Mod. 2800S. External excitation 107 VDC. 1.1 amp. 3450 rpm. 1" shaft. \$200.00

HONEYWELL VERTICAL GYRO MODEL JG7003A-1

115 volts, 400 cycles, single phase, 35 watts. Pitch and roll potentiometer pickoffs 890 ohms, 40 volts max. AC or DC. Speed 20,000 rpm, ang. momentum 12,500,000 gm-cm²/sec. Erection system 27 VAC, 400 cycles, time 5 min. to 1/2". Weight 5.5 lbs. Price \$35.00 each

SELSYNS-SYNCHROS



1GT cont. Trans 90/55V 60 cy.....	\$27.50
1DC Diff. Gen. 90/90V 60 cy.....	34.50
1F Syn. Mtr. 115/90V 60 cy.....	34.50
1G Gen. 115V 60 cy.....	34.50
1HDG.....	37.50
1HCT.....	37.50
1SF Syn. Mtr. 115/90V 400 cy.....	12.50
23TR4 torque receiver.....	34.50
23TR6 torque receiver.....	37.50
23CT4 control transformer.....	34.50
23CT6 control transformer.....	37.50
23CX6 control transmitter.....	37.50
7DG differential generator.....	37.50
2J1F1 Gen. 115/57.5V 400 cy.....	7.50
2J1F3 Gen. 115/57.5V 400 cy.....	10.00
2J1FA1 Gen. 115/57.5V 400 cy.....	7.50
2J1G1 57.5/57.5V 400 cy.....	5.00
2J1H1 Diff. Gen. 57.5V.....	7.50
2J5D1 Cont. Trans. 105/55V 60 cy.....	17.50
2J5F1 Cont. Trans. 105/55V 60 cy.....	17.50
2J5H1 Gen. 115/105V 60 cy.....	17.50
2J5M1 Gen. 115/57.5V 400 cy.....	17.50
5CT Cont. Trans. 90/55V 60 cy.....	17.50
5D Diff. Mtr. 90/90V 60 cy.....	34.50
5DG Diff. Gen. 90/90V 60 cy.....	34.50
5F Syn. Mtr. 115/90VAC 60 cy.....	34.50
5G Syn. Gen. 115/90VAC 60 cy.....	34.50
5HCT Cont. Trans. 90/55V 60 cy.....	37.50
5SDG Diff. Gen. 90/90V 60 cy.....	12.50
6DG Diff. Gen. 90/90V 60 cy.....	25.00
6G Syn. Gen. 115/90VAC 60 cy.....	34.50
7G Syn. Gen. 115/90VAC 60 cy.....	42.50
C56701 Type 11-4 Rep. 115V 60 cy.....	20.00
C69406-2 Type 1-1 Transm. 115V 60 cy.....	20.00
C69406 Syn. Transm. 115V 60 cy.....	20.00
C69406-1 Type 11-2 Rep. 115V 60 cy.....	20.00
C78248 Syn. Transm. 115V 60 cy.....	12.50
C78410 Repeater 11.5V 60 cy.....	20.00
FPE 49-7 Diehl servo motor. 115 volts, 60 cycle, 10 watts.....	30.00

400 CYCLE, 3 PHASE GENERATOR

BY MASTER ELECTRIC Type AG, frame 364Y, 7.5 kw, 3428 rpm, pf 95 Star connected 120/208 3 phase, 22 amps. Delta connected 120 volt single phase 66 amps. Self excited. Complete with control box, voltage regulator, AC voltmeter and frequency meter. Shaft 1" dia., 2" long, overall dim. of unit: 21"x18"x20". Price \$395.00 each

400 CYCLE PM GENERATOR

115/200 volts A.C. 1- or 3-phase, 200 watts. 4,000 r.p.m. Approx. dimensions: 4 3/4" dia.; 3" long; 1/2" shaft, AN connector. \$75.00

400 CYCLE MOTOR GENERATOR

Mfgd. by General Electric Model #SATB324E5 Output 120/208 volts AC, 400 cycle, 11.75 kva, 32.6 amp., pf .85. Input 220/440 volts AC, 60 cycle, 3 phase, 15 h.p. Unit complete with motor starter and controls. Price \$750.00

ONAN MOTOR GENERATOR SET

MG 075-G-1 Generator 115 VAC; 480 cycle; 5.3 amps; 6KW; PF 1.0; also 26 VDC; 100 watt; 3.8 amps; Driven by 115-230 VAC —2hp motor; 60 cycle; single phase; 3450 rpm; 10.5 amps. Price \$135.00

16mm SINGLE FRAME CAMERA

mfgd. by Bell & Howell (200 series) 50 ft. magazine load operates on 12 volt DC, has rotary solenoid, standard C mount, less lens and view finder, excellent for photographing records, nature study, etc. Price \$35.00 each

"TAB"

"BRUSH" SIX CHANNEL OSCILLOGRAPH



Late Model RO2661-00 six channel direct writing instantaneous recording: Eight speed transmission 1, 2, 5, 10, 25, 50, 125 & 250mm per/second chart paper. Contains six channels each 40mm width, 40 line. Chart readability 6". D.C. sensitivity approx 30v & deflection of 20mm from chart center (F.S.); 1.5V per/mm; 1.1Ma per mm at 1400 ohms DC resistance. Linearity D.C. within 1% of full chart width; AC within 2% full chart width. Frequency response recorded peak to peak of a constant V sine wave within $\pm 1/2$ chart line (mm) of nominal 40 lines from D.C. to 10 cps or within -1 chart line (mm) of nominal 10 lines from D.C. to 100 cps; Max amplitude 40 lines (mm) P to P to 40 cps; 20 lines (mm) P to P to 70 cps; 10 lines (mm) P to P to 100 cps. Chart regulation better than $1/2$ % paper drift less than $1/8$ mm. Power input 105-125V at 60 cps, 135 Watts. 19" Raek MTG. 12 1/2" hgt. 17 1/2" dpth. Sensitivity can be increased thru additional amplifiers from "brush". In like new condition cost \$2925 each. Two available at \$1500 per unit. RA2961-80 chart paper 850 ft lenth (CP \$15) per roll \$9 ea., 2 for \$15.

NEW *SILICON 750 Ma RECTIFIERS WORKING VOLTS RMS-ACV INPUT!

Order 10 or More 750Ma Deduct 10%

rms/piv 35/50 19c	rms/piv 70/100 29c	rms/piv 140/200 34c	rms/piv 210/300 43c
rms/piv 280/400 50c	rms/piv 350/500 62c	rms/piv 420/600 80c	rms/piv 490/700 95c
rms/piv 560/800 \$1.05	rms/piv 630/900 \$1.25	rms/piv 700/1000 \$1.70	rms/piv 770/1100 \$2.00

Use in Bridge or C.T. up to 1 amp DC

"TAB" Special General Purpose Silicons

400 PIV @ 300Ma 39c@, 25 for \$8.00

*Deduct 20% for Capacitive Input

EXPORTERS-OEM-DISTRIBUTORS

Write for Data & Qty Prices

Silicon Orders \$20 Shppd Prepaid U.S.A.
PROTECT THAT METER VOLTAB™ TABBATOR
Low Level Voltage Regulating Diodes
TG150 1V @ 100Ma 50c@, 3 for \$2
TM2K 2V @ 200Ma 90c@, 3 for \$2

SELENIUM 1568 VRMS RECTIFIER

High voltage half wave 2240 PIV or 1568 Rms at 75 to 100 ma. "MIL-T" Specs new G.E. Mfrgr. Size 5 1/2" L x 1 W x 1 1/2" H.
Can be used doubler, tripler, quadrupler, CT or bridge @ \$3.50, 2 for \$6.10 for \$25.00. Quantities available. Precipitator, Power Supply, School, OEMS, exp. Write qty. prices.

SELENIUM PHOTOCCELL—"SUNTAB"®

5AP Round 1 1/2"	5AP Round 1 1/2"	10AP Round 1 1/2"	15AP Round 2"	2BP Rect 3/4 x 7/16"	5BP Rect 1-7/16 x 7/8-200ua	10 BP Rect 1-11/16 x 7/8-300ua
.250ua .\$.100	.250ua .\$.100	.360ua .\$.175	.750ua .\$.300	.75ua .\$.70	\$1.35	\$1.80
					KIT ALL SIX ONE EACH	\$7.00

Order qty ten or more deduct 20%
This item shipped postpaid orders \$5 up.

"TAB" TERMS: Money Back Guarantee! Our 14th year. \$2 order F.O.B. N.Y.C. Add shpp. charges or for C.O.D. 25% Dep. Prices shown subject to change.
111 ET LIBERTY ST., N.Y. 6, N.Y.
Send 25c for Catalog
PHONE: RECTOR 2-6245

CIRCLE 468 ON READER SERVICE CARD

SPECIAL PURPOSE TUBES

OA2	.70	4PR60A	45.00	348A	2.50	5528/C6L	1.50	5896	1.50
OA3	.85	4X150A	8.85	349A	2.00	5545	15.00	5899A	2.50
OB2	.50	4X250B	32.50	350A	3.50	5557/FG-17	4.25	5902	2.35
OB3	.70	5BPIA	12.50	350B	3.50	5558/FG-32	7.50	5903	4.00
OC3	.50	5C22	16.00	352A	6.50	5559/FG-57	10.00	5932/6LWGA	5.00
OD3	.30	5CP1A	10.50	354A	10.00	5560/FG-95	15.00	5948/1754	150.00
1AD4	1.50	5LPIA	20.00	355A	10.00	5586	115.00	5956/E36A	10.00
1B24A	8.85	5R4GY	1.00	393A	3.50	5632/C3J	8.50	5963	.75
1B35A	3.50	5R4WGY	2.50	394A	2.50	5636	1.25	5964	.85
1B63A	14.00	5RP1A	10.00	396A	2.50	5639	2.00	5965	.75
C1K	6.00	5Y3WGT	1.15	398A	4.00	5642	1.50	5975	2.00
1P21	25.00	6AC7W	1.40	401A	1.50	5643	4.50	5977/6K4A	1.50
1P25	10.00	6AC7Y	1.00	403A	1.00	5644	2.50	5981/5650	25.00
1P28	20.00	6AK5W	1.00	403B	3.00	5646	2.00	5992	2.50
2-01C	12.50	6AN5WA	3.00	404A	10.00	5647	2.50	5993	4.00
2A1P1A	3.00	6A56	1.00	407A	3.50	5651	.70	6004	.50
2BP1	7.00	6A57G	2.35	408A	2.00	5654	1.15	6005/6AQ5W	1.25
2C36	3.75	6B16	30.00	409A	2.00	5656	3.50	6021	2.00
2C39	25.00	6AN6A	35.00	412A	4.00	5665	28.50	6032	25.00
2C39A	7.50	6C21	12.50	415A	3.00	5670	1.25	6037/QK-243	25.00
2C40	7.00	6C1	12.50	416B	28.85	5672	1.00	6045	1.25
2C43	7.50	6J4WA	1.50	417A	10.00	5675	7.50	6072	1.75
2C50	5.00	6J6W	17.00	418A	15.00	5676	1.25	6073	.80
2C51	1.50	6L6CAY	1.00	420A	5.00	5678	1.25	6080	3.00
2C52	1.75	6L6WGB	2.00	421A	7.50	5684	11.80	6080WA	5.00
2C53	8.50	6L6Y	1.25	422A	10.00	5685	15.00	6082	3.00
2D21	6.00	6Q5G	2.00	423A	5.00	5686	2.00	6087/5Y3WGTB	3.00
2D21W	1.00	6S17WCT	1.00	429A	9.00	5687	1.50	6098/6AR6WA	4.00
2E24	2.50	6S17WCT	1.00	450TH	40.00	5691	5.25	6099	.75
2E26	2.85	6S27WCT	.75	450TL	40.00	5692	3.50	6100/6C4WA	1.25
2J42	40.00	6V6CTY	7.5	575A	12.50	5693	3.50	6101/6J6WA	1.00
2J51	50.00	6X4W	7.5	631-P1	4.75	5705	3.00	6111A	2.00
2K25	8.00	6X5WGT	1.15	673	12.50	5706	3.00	6112	3.00
2K26	25.00	6X5WGT	150.00	676	27.50	5711	1.00	6115/QK-351	50.00
2K29	25.00	6X7F	17.50	677	32.70	5712	1.00	6130/3C45	8.50
2K30	75.00	6X8-24	1.00	715C	10.00	5719A	1.75	6134/6C7WA	2.85
2K33A	150.00	25T	7.50	719A	7.50	5720	17.00	6136/6AU6WA	1.25
2K34	100.00	26Z5W	1.25	721A	4.00	5721	125.00	6137/65K7WA	1.50
2K35	250.00	35T	7.50	722A	3.00	5725	1.00	6146	3.75
2K41	35.00	35TG	2.50	722A B	5.00	5726	.75	6152	4.50
2K42	125.00	FG-105	33.35	726B	3.25	5727	1.25	6186/6AG5WA	1.75
2K43	125.00	FG-172	17.50	750TL	87.50	5728	7.50	6189/12AU7WA	1.50
2K44	125.00	212E	25.00	807	4.00	5740	50.00	6197	1.75
2K47	125.00	244A	2.50	804	15.00	5744WA	2.75	6199	35.00
2K50	60.00	245A	3.50	805	3.50	5749	6.00	6201/12AT7WA	1.50
2X2A	1.00	249B	10.00	807	1.25	5750	1.35	6202/6X4WA	1.50
2X1000A	95.00	249C	5.00	809	3.75	5751	1.35	6211	.65
3AP1A	10.00	256R	7.50	810	12.50	5763	1.50	6216	2.75
3B24W	3.00	250TH	25.00	811A	4.75	5777	135.00	6263	9.00
3B25	3.00	252A	6.00	813	10.00	5778	150.00	6264	9.00
3B28	4.00	254A	2.00	814	1.50	5783	2.00	6265	2.25
3BPIA	7.50	257A	3.50	815	1.50	5784	2.50	6282/BL-11	50.00
3C22	30.00	259A	3.50	816	1.75	5787	2.50	6299	30.00
3C23	5.00	262B	3.50	828	7.50	5799	3.00	6336	9.00
3C24/24G	3.50	267B	7.50	829B	8.50	5800	3.50	6352	8.50
3C45	4.00	271A	10.00	832A	6.50	5801	3.00	6364	150.00
3D22	9.50	272A	4.00	836	1.10	5802	3.50	6390	175.00
3E29	5.00	274A	3.00	837	7.50	5803	2.00	6438	4.00
3J21	35.00	275A	4.00	845	7.50	5816A	1.25	6463	1.25
3J31	50.00	283A	3.50	866A	1.95	5819	45.00	6533	6.50
3K21	150.00	287A	2.50	866 JR	2.50	5824	2.50	6544	250.00
3K22	150.00	293A	4.50	872A	1.75	5828	3.00	6550	4.25
3K27	185.00	300B	5.00	884	1.00	5829WA	1.50	6626/OA2WA	2.00
3K30	75.00	304TH	30.00	913	7.50	5833	60.00	6627/OB2WA	2.00
3KP1	10.00	304TL	40.00	927	1.25	5837	60.00	6655	40.00
4-65A	15.00	310A	3.50	931A	3.00	5839	2.50	6754	10.00
4-125A	22.50	311A	2.50	959	.60	5840	2.00	6784	250.00
4-250A	36.50	313C	1.00	1000T	97.50	5845	4.85	6897	18.75
4-400A	38.00	323A	6.50	1500T	150.00	5852	2.50	6901	10.00
4-1000A	100.00	328A	2.50	1603	4.75	5854	2.00	8005	5.00
4AP10	10.00	329A	3.50	1614	2.50	5876	7.00	8013A	3.00
4B31	15.00	336A	2.50	1620	3.75	5879	1.00	8020	1.50
4C35	12.50	337A	3.50	1624	.85	5881/6LWGB	2.00	8025	3.00
4E27	8.50	339A	4.00	2000T	200.00	5886	3.00	9003	1.50
4J52	25.00	347A	1.50	2050	1.10	5894	15.00	9005	3.00

ALL TUBES ARE NEW, INDIVIDUALLY CARTONED, FULLY GUARANTEED

HARD and SOFT MAGNETRON PULSERS...

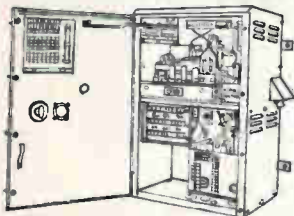

at bargain basement prices! Will drive dozens of types of Magnetrons up to 250 kw. from \$675.00

Phone: WALKER 5-6000

LIBERTY ELECTRONICS, INC.

582 BROADWAY
NEW YORK 12, N. Y.
Cables: TELSERSUP

CIRCLE 469 ON READER SERVICE CARD

Prices are FOB shipping point

Western engineers

Orders for less than \$10 cannot be processed

ELK GROVE, CALIFORNIA

SUPPLIERS OF ELECTRON TUBES SINCE 1932

"SEARCHLIGHT" Can Help You!

When you want to buy or sell used or surplus new equipment and/or accessories, or have other business wants—advertise them in the SEARCHLIGHT SECTION for quick, profitable results!

CIRCLE 470 ON READER SERVICE CARD

RAYTHEON RECTIchargERS (POWER SUPPLIES)

ALL NEW AND ORIGINAL BOXED		Filtered OC—Output	New
Regulated AC—Input			
220 V	12 V-55A		\$275.00
115 V	22-24 cells @ 6A		119.00
115 V	22-24 cells @ 3A		69.50
115 V	12 V-.5A		37.50

EXCELLENT VALUES AND LIMITED QUANTITIES

Advance Electronics

6 West Broadway • New York 7, N. Y. • Rector 2-0270

CIRCLE 471 ON READER SERVICE CARD

INDEX TO ADVERTISERS



Audited Paid Circulation

**Think
Clean**

When you think of high vacuums, you have to think clean... and if you think of exceptionally clean vacuums, without fluids or other contaminants, you have to think of UlteVac electronic vacuum pumps — made by Ultek, the only manufacturer devoted exclusively to the technology of fluidless vacuum pumping. UlteVac pumps, using no moving parts, hot filaments, or refrigeration, produce vacuums to 10⁻⁹ mm Hg and below; operate unattended for months, invulnerable to power failure. System vacuum automatically measured.



**ELECTRONIC
HIGH-
VACUUM
PUMPS**

1 to 1000 Liters/Second

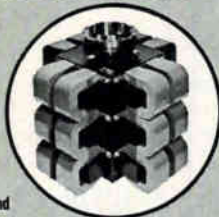

Series 327 Pump
270 Liters/Second

Also from Ultek, an exclusive line of high vacuum accessories, including:

- SORPTION ROUGHING PUMPS
 - METAL SEAL FITTINGS
- FULL CONDUCTANCE VALVES
- AMBIENT FORELINE TRAPS

Literature available (state application) from Ultek or its exclusive sales representative, Kinney Mfg. Div. of the New York Air Brake Co. Sales Offices in major U.S. cities.



920-E Commercial St., Palo Alto, Calif. - DA 1-4117

Ace Electronics Associates, Inc.	88	Ultek Corporation	106
Airpax Electronics Inc.	92	United Carbon Products Company....	21
Allegheny Ludlum Steel Corp.	87	United Shoe Machinery Corp.	98
Alpha Corporation	84, 85	Utica Drop Forge & Tool Division, Kelsey-Hayes Company	69
American Cystoscope Makers, Inc.	99		
American Electronics, Inc. Nuclear Division	81	Virginia Electric & Power Co.	65
American Super-Temperature Wires, Inc.	100		
Amperex Electronic Corp.	14	Wales Stripit Company	78
Amphenol-Borg Electronics Corp. Cable & Wire Division	94		
Anelex Corporation	77		
Angelica Uniforms	98		
Antenna Systems Inc.	91		
Arnold Engineering Co.	8		

Barker & Williamson, Inc.	95		
Bendix Corporation Bendix Pacific	97		
Semiconductor Products	9		
Bomac Laboratories, Inc. 3rd Cover			
Borg Equipment Division, Amphenol-Borg Electronics Corp.	86		
Branson Ultrasonic Corp.	87		
Bussmann Mfg. Co., Div. of McGraw Edison	85		

Centralab, a Div. of Globe-Union Inc. ..	20		
Chesapeake Instrument Corporation ..	100		
Cohn Corp., Sigmund	87		

Delco Radio	2		
Dorne & Margolin, Inc.	8		

Edo Corporation	98		
-----------------------	----	--	--

General Electric Co. Semiconductor Pdts.	40, 41		
Defense Electronics Division	71		
General Public Utilities Corp.	86		
General Radio Co. 2nd Cover			
Globus Inc.	99		
Good-all Electric Mfg. Co.	25		

Hayes, C. I.	24		
Heiland, Division of Honeywell.	18		
Hewlett Packard Co.	15		

Jennings Radio Manufacturing Corp. ..	84		
---------------------------------------	----	--	--

Kepeco Laboratories	67		
Kintel, A division of Cohu Electronics, Inc.	10		

Lockheed Aircraft Co.	75		
Los Alamos Scientific Laboratory.	98		

Magnetic Metals Company	28		
Mallory and Co., Inc., P. R.	19		
Marion Electrical Instrument Co.	97		
Martin Co., The.	17		
Massa, A Division of Cohu Electronics	72		
McGraw-Hill Book Co.	81		
Microwave Associates	42		
Mycalex Corp. of America.	79		

Power Sources, Inc.	16		
Precision Tube Company	84		

Radio Corporation of America. 4th Cover			
Raytheon Company	5, 82, 88		
Rheem Semiconductor Corp. 12.	18		
Ross Company, Milton	6		

Schmit Engineering Company	83		
Servomechanisms Inc.	68		
Shallcross Mfg. Co.	76		
Sola Electric Co.	68		
Sprague Electric Co. 88,	89		
Sylvania Electric Products, Inc. (Semiconductor Division)	82		

Texas Instruments, Incorporated Semiconductor-Components Division ..	7		
Transatron Electronic Corp. 26,	27		

CLASSIFIED ADVERTISING

F. J. Eberle, Business Mgr.

EMPLOYMENT OPPORTUNITIES 101, 102

SPECIAL SERVICES

EQUIPMENT
(Used or Surplus New)
For Sale

ADVERTISERS INDEX

Advance Electronics	105
Barry Electronics Corporation	104
C & H Sales Company	103
Engineering Associates	102
Goodheart Company, R. E.	102
Honeywell	102
International Business Machines Corp.	101
Kato Engineering Company	102
Liberty Electronics, Inc.	105
Magnetic Amplifiers, Div The Siegler Corp.	102
Radio Research Instrument Co.	104
Research Services	102
TAB	105
Universal Relay Corporation	104
U. S. Atomic Energy Commission	102
Western Engineers	105

This index and our Reader Service Numbers are published as a service. Every precaution is taken to make them accurate, but ELECTRONICS assumes no responsibilities for errors or omissions.

BRUCE A. WINNER, Advertising Sales Manager, R. S. QUINT, Assistant Advertising Sales Manager and Buyers' Guide Manager. FRED STEWART, Promotion Manager. RICHARD J. TOMLINSON, Production Manager. GEORGE E. POMEROY, Classified Manager. HUGH J. QUINN, Circulation Manager.

ADVERTISING REPRESENTATIVES

NEW YORK: Donald H. Miller, Henry M. Shaw, George F. Werner.
BOSTON: William S. Hodgkinson.
PITTSBURGH: David M. Watson.
PHILADELPHIA: Warren H. Gardner, William J. Boyle.
CHICAGO: Harvey W. Wernecke, Martin J. Galloy.
CLEVELAND: P. T. Fegley.
SAN FRANCISCO: T. H. Carmody R. C. Alcorn.
LOS ANGELES: Carl W. Dysinger, D. A. McMillan, Marshall Freeman.
DENVER: J. Patten.
ATLANTA: M. Miller.
DALLAS: Robert T. Wood.
LONDON: Edward E. Schirmer
FRANKFURT: Stanley R. Kimes.
GENEVA: Michael R. Zeynel.

Get the complete story on microwave tubes and components in these two new booklets from **BOMAC**



What's new in microwave? You'll find full information in these 2 new BOMAC booklets. One is a complete product catalog in a new, more convenient format (tubes are listed first by band, then by type) to make it easier and quicker for you to find the tube you want. The second booklet gives you facts and figures on any of BOMAC's new components and test equipment. Put together, they give you a complete, concise picture of what's new in microwave for 1960. Be sure to send for your copies today.



BOMAC laboratories, inc.

SALEM ROAD • BEVERLY, MASSACHUSETTS

Offices in major cities — A subsidiary of Varian Associates.

Leaders in the design, development and manufacture of TR, ATR, Pre-TR tubes; shutters; reference cavities; crystal protectors; silicon diodes; magnetrons; klystrons; duplexers; pressurizing windows; noise source tubes; high frequency triode oscillators; surge protectors.

A TRIUMPH OF MODERN ALCHEMY

IMPROVES PERFORMANCE OF YOUR CIRCUITS ...



N-136...

"THE NOBLER SUBSTANCE"

An extraordinary new base material designed specifically for use in electron-tube cathodes has been introduced by RCA. Designated *Alloy N-136*, it is just one of several RCA developments that achieve the alchemist's dream of making "a nobler substance from base materials."

N-136 is a precisely controlled nickel alloy produced by *vacuum melting*. Vacuum melting eliminates oxidation and allows vacuum purification before the addition of the alloying elements. It permits rigid control of the concentrations of essential elements contained in the alloy. By obviating the need for solid deoxidants, vacuum melting prevents deoxidant contamination and the formation of unwanted residues.

All this, plus timing of the melting procedures to the very second, insures excellent uniformity from melt to melt, holding cathode-base characteristics within strict limits.

Vacuum-melted N-136 is just another example of how RCA's "modern alchemists" are contributing to the design of electron tubes giving top performance with high reliability.

Find out how this and other triumphs of modern alchemy contribute to circuit dependability. Contact an RCA representative on tube types benefiting from RCA materials development.

RCA Electron Tube Division, Field Offices...EAST: Newark 2, New Jersey, 744 Broad Street, HUmboldt 5-3900 • MIDWEST: Chicago 54, Illinois, Suite 1154, Merchandise Mart Plaza, WHitehall 4-2900 • WEST: Los Angeles 22, California, 6355 E. Washington Blvd., RAYmond 3-8361



The Most Trusted Name in Electronics
RADIO CORPORATION OF AMERICA