

electronics

A MCGRAW-HILL PUBLICATION

FEBRUARY 19, 1960

PRICE SEVENTY-FIVE CENTS

Feedback Control of Spot Welding



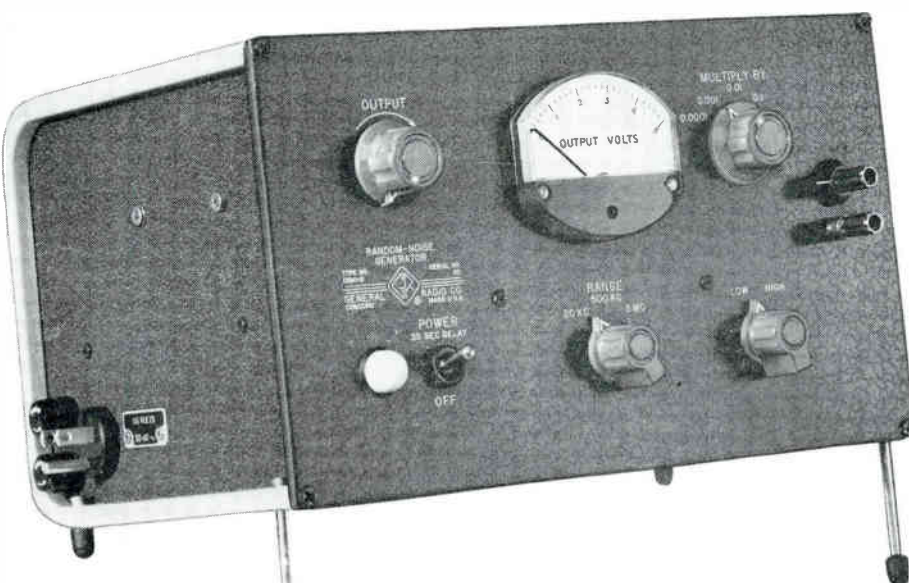

NEW Random- Noise Generator

Type 1390-B... \$295

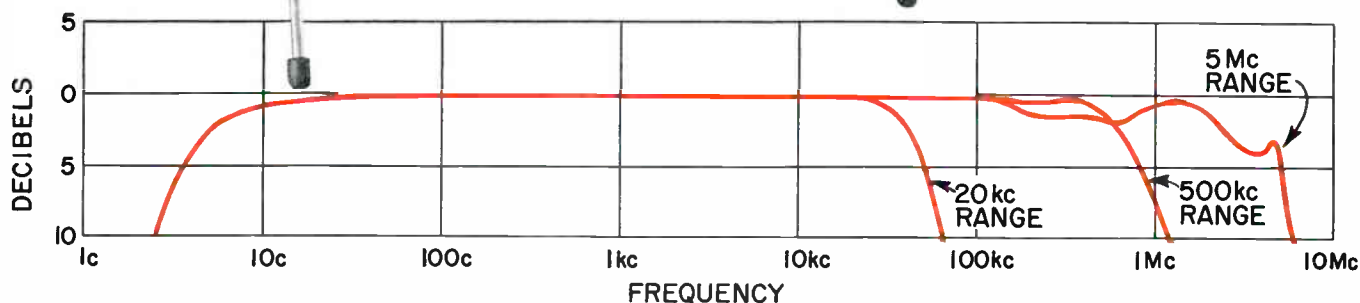

Incorporates these wanted features:

- ★ Wide-Band Noise of Uniform Spectrum Level
- ★ Three Frequency Bands — 20c to 20 kc; 20c to 500 kc; 20c to 5 Mc
- ★ High Output Level — at least 3v for 20-kc range, 2v for 500-kc range, and 1v for 5-Mc range
- ★ Extended low-frequency range down to 5 cps.
- ★ Built-in 80-db attenuator—supplements output meter to provide metered output levels from over 3 volts to below 30 μ v.
- ★ Automatic time-delay relay in on-off switch circuit insures long life for noise-producing gas tube.
- ★ Built-in extendible legs tilt panel for easy viewing.
- ★ Panel extensions supplied for relay-rack mounting.

The Random-Noise Generator's amplitude distribution closely approximates the statistical amplitude distribution of speech, music, and many other sounds and electrical disturbances which occur naturally. Consequently, this instrument is extremely useful in obtaining realistic measurements of the performance of audio-frequency equipment of all types. Moreover, since noise is a common form of interference limiting the threshold of electrical operation, a controlled noise generator can be extremely useful for measurements of communications systems and detection apparatus.

The Random-Noise Generator is also widely used to drive shake tables for mechanical testing; to test microphones and speakers in the acoustics laboratory; for study of filter characteristics; and in transmission-engineering work involving crosstalk measurements.

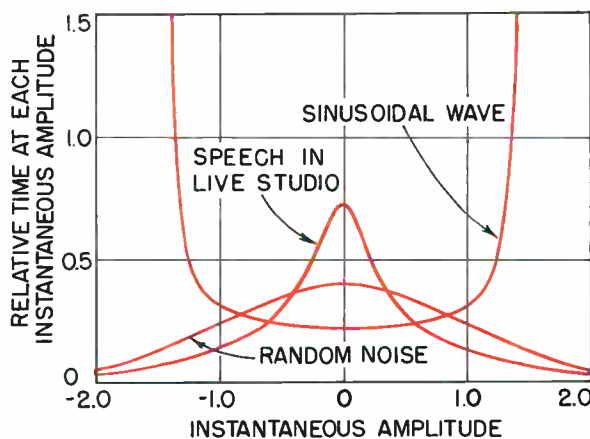

Write for Complete Information

GENERAL RADIO COMPANY

Since 1915 — Manufacturers of Electronic Apparatus for Science and Industry

WEST CONCORD, MASSACHUSETTS

NEW YORK AREA: Tel. N. Y. WOrth 4-2722, N. J. WHitney 3-3140 CHICAGO: Tel. Village 8-9400

PHILADELPHIA: Tel. HANcock 4-7419

WASHINGTON, D. C.: Tel. JUNiper 5-1088

SAN FRANCISCO: Tel. WHitecliff 8-8233

LOS ANGELES 38: Tel. HOLlywood 9-6201

In CANADA, TORONTO: Tel. CHerry 6-2171

We started selling binding posts and "banana" Type 274 Plugs in 1923, and they are still compatible with the tens of thousands of their modern counterparts sold by us this year. Incidentally, the $\frac{3}{4}$ " binding post spacing first introduced by GR is an industry standard today.

Issue at a Glance

A McGRAW-HILL PUBLICATION
Vol. 33 No. 8

JAMES GIRDWOOD, *Publisher*

W. W. MacDONALD, *Editor*

JOHN M. CARROLL, *Managing Editor*
Senior Associate Editors: Samuel Weber, Roland J. Charest

Associate Editors: Frank Leary, Michael F. Tomaino, Howard K. Janis, Sylvester P. Carter, William P. O'Brien, John F. Mason, William E. Bushor, Thomas Emma, Sy Vogel, Leslie Solomon, M. M. Perugini, George J. Flynn

Assistant Editors: Michael F. Wolff, Nilo Lindgren, Harold M. McKean, Stanley Froud

Regional Editors: Harold C. Hood (Pacific Coast, Los Angeles), Harold Harris (Midwestern, Chicago), Thomas Maguire (New England, Boston)

Market Research Editor: Edward DeJongh

Buyers' Guide Editor: George Sideris

Art Director: Harry Phillips; Howard R. Berry

Production Editor: John C. Wright, Jr.

Editorial Assistants: Gloria J. Filippone, Arlene Schilp, Bernice Duffy, Patricia Landers, Marian L. Freed, Dolores A. Fornaro, Lorraine Rossi, Dorothy Smith, Virginia T. Bastian

BRUCE A. WINNER, *Advertising Sales Manager*. R. S. Quint, *Assistant Advertising Sales Manager and Buyers' Guide Manager*. Fred Stewart, *Promotion Manager*. Richard J. Tomlinson, *Production Manager*. George E. Pomeroy, *Classified Manager*. Hugh J. Quinn, *Circulation Manager*

Advertising Representatives: New York: Donald H. Miller, Henry M. Shaw, George F. Werner. Boston: Wm. S. Hodgkinson. Pittsburgh: David M. Watson. Philadelphia: Warren H. Gardner, William J. Boyle. Chicago: Harvey W. Wernecke, Martin J. Gallay. Cleveland: P. T. Fegley. San Francisco: T. H. Carmody, R. C. Alcorn. Los Angeles: Carl W. Dysinger, D. A. McMillan, Marshall Freeman. Denver: J. Patten. Atlanta: M. Miller. Dallas: Gordon L. Jones, Robert T. Wood. London: Norman Strick. Frankfurt: Stanley Kimes. Geneva: Michael R. Zeynel

Business

Electronics Gets EE Spotlight. Report on AIEE's big meeting.....	28
New Trends in Finding Funds. Some key tips for you?.....	30
Geneva Reallocates Spectrum. First details of what was done.....	33
New Site for U.S. "Voice". Land clearing starts this week.....	34
Shoptalk	4
Business This Week.....	11
Washington Outlook	14
Financial Roundup	19
25 Most Active Stocks.....	19
Market Research	22
Current Figures	22
Meetings Ahead	36

Engineering

Settings of spot welding control used on tailgate assembly line are recorded. See p 48.....	COVER
Determining Sonar System Capability. First article of a two-part series on modern sonar.....	By G. Rand 41
Miniature Gas-Filled Tubes for High-Speed Counting. Circuits for 1-mc decade counter described.....	By K. Apel and P. Berweger 46
Feedback and NOR Logic Yield Sound Spot Welds. Control compensates for variations in conditions.....	By G. R. Archer 48
Solid-State Generator Regulator for Autos. Practical semiconductor circuit provides reliable control.....	By L. D. Clements 52
Graphical Checkout of Multivibrator Design. Determining possible causes of unstable operation.....	By C. L. Barsony 55
Radioactive Tracers Find Jet Fuel Flow Rates. Flip-flop controlled dual gate used.....	By J. D. Keys and G. E. Alexander 58
Performance Ratings of Secondary Batteries. Tables show characteristics of commonly used types.....	By P. J. Rappaport 60

Departments

Research and Development. Ultraviolet Radiometry Standard.....	64
Components and Materials. Components for the Millimeter Band....	68
Production Techniques. Simple Steps Speed Inspection.....	72
On the Market.....	76
Literature of the Week.....	95
New Books	98
Plants and People.....	100
News of Reps.....	103
Comment	104

Index to Advertisers.....110

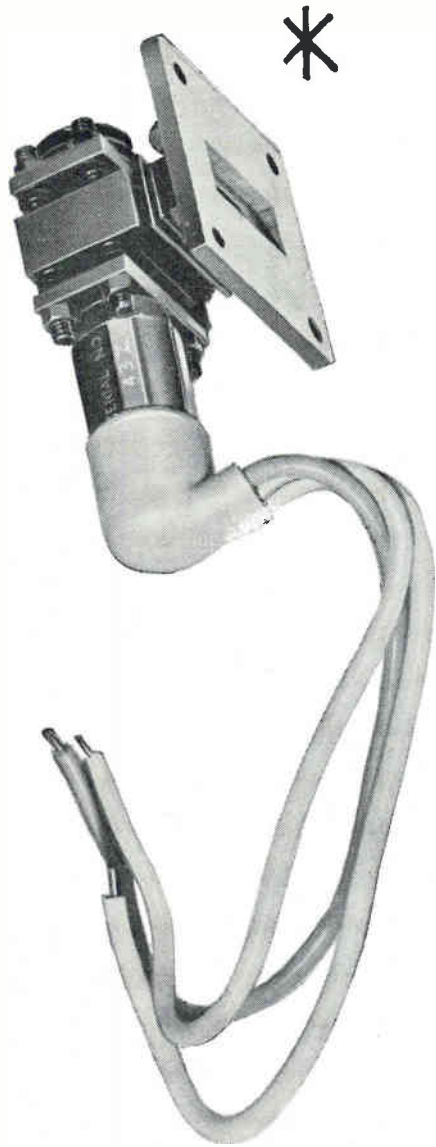

QUIET
 AS A
 MOUSE!
 OUR FORCED
 AIR-COOLED
K 350
 A TWO RESONATOR
 OSCILLATOR KLYSTRON



Specially designed for low noise characteristics, the K350 is just one of the large range of Klystrons manufactured by the **English Electric Valve Co. Ltd.** It operates in the 8500 - 10000 Mc/s range and has mechanical tuning. For data and information concerning any of our wide range of thermionic tubes for industry, write to the Company

'ENGLISH ELECTRIC'

AGENTS THROUGHOUT THE WORLD

ENGLISH ELECTRIC VALVE CO. LTD.		<i>Chelmsford, England</i> <i>Telephone: Chelmsford 3491</i>
--	--	---

ARNOLD: WIDEST SELECTION OF MO-PERMALLOY POWDER CORES FOR YOUR REQUIREMENTS

For greater design flexibility, Arnold leads the way in offering you a full range of Molybdenum Permalloy powder cores . . . 25 different sizes, from the smallest to the largest on the market, from 0.260" to 5.218" OD.

In addition to pioneering the development of the cheerio-size cores, Arnold is the exclusive producer of the largest 125 Mu core commercially available. A huge 2000-ton press is required for its manufacture, and insures its uniform physical and magnetic properties. This big core is also available in three other standard permeabilities: 60, 26 and 14 Mu.

A new high-permeability core of 147 Mu is available in most sizes.

These cores are specifically designed for low-frequency applications where the use of 125 Mu cores does not result in sufficient Q or inductance per turn. They are primarily intended for applications at frequencies below 2000 cps.

Most sizes of Arnold M-PP cores can be furnished with a controlled temperature coefficient of inductance in the range of 30 to 130° F. Many can be supplied temperature stabilized over the MIL-T-27 wide-range specification of -55 to +85° C . . . another special Arnold feature.

Graded cores are available upon special request. All popular sizes of Arnold M-PP cores are produced to a standard inductance tolerance of +

or -8%, and many of these sizes are available for immediate delivery from strategically located warehouses.

Let us supply *your* requirements for Mo-Permalloy powder cores (*Bulletin PC-104C*). Other Arnold products include the most extensive line of tape-wound cores, iron powder cores, permanent magnets and special magnetic materials in the industry. • Contact *The Arnold Engineering Co., Main Office and Plant, Marengo, Illinois.*

ADDRESS DEPT. E-02



ARNOLD

SPECIALISTS in MAGNETIC MATERIALS

BRANCH OFFICES and REPRESENTATIVES in PRINCIPAL CITIES • Find them FAST in the YELLOW PAGES

1107

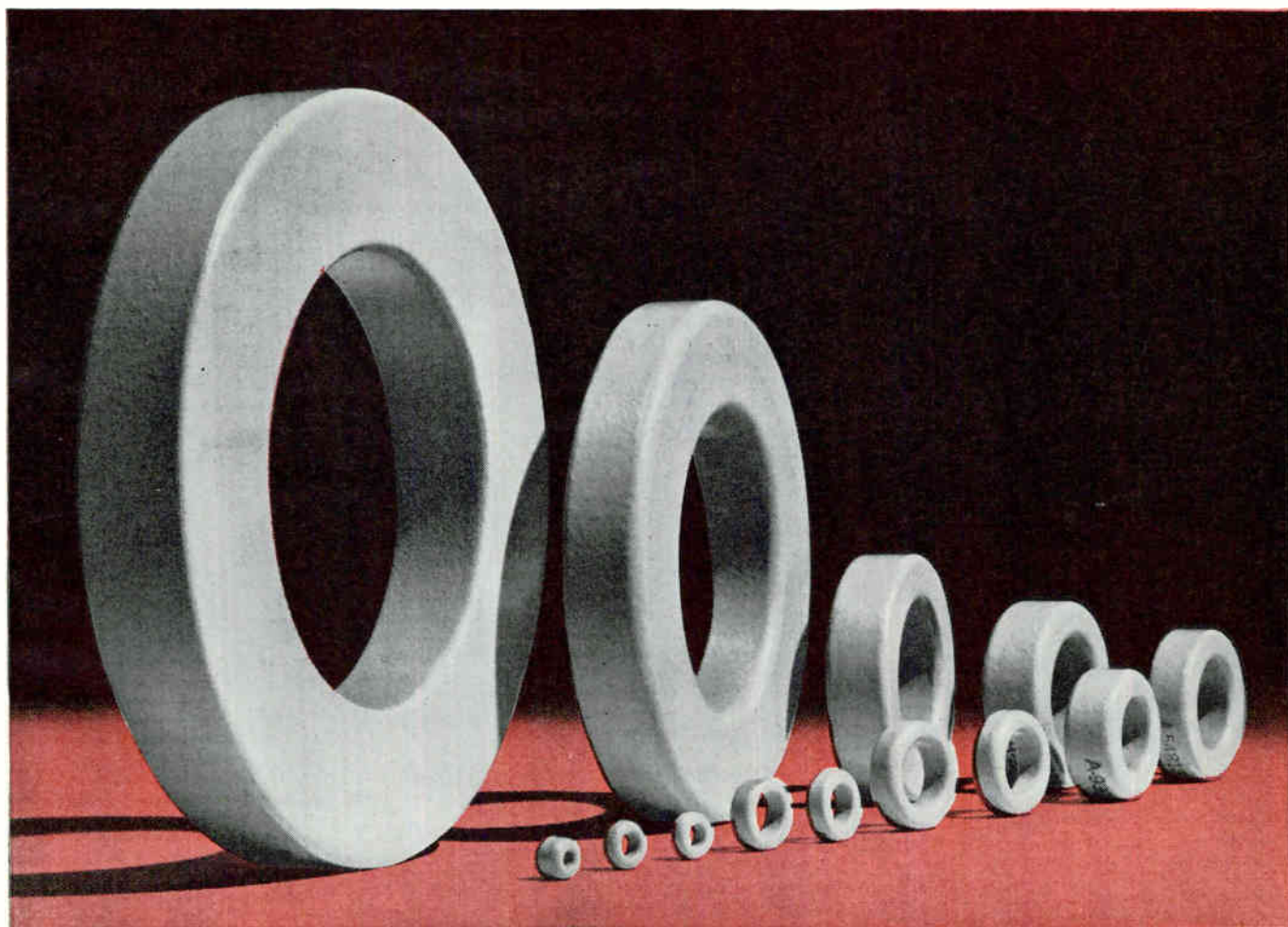

electronics

February 19, 1960 Vol. 33, No. 8

Published weekly, including the ELECTRONICS BUYERS' GUIDE and REFERENCE Issue in mid-June as part of the subscription, by McGraw-Hill Publishing Company, Inc., James H. McGraw (1860-1948) Founder.

Executive, Editorial, Circulation and Advertising Offices: McGraw-Hill Building, 330 W. 42 St., New York 36, N. Y. Longacre 4-3000. Publication Office: 99-129 North Broadway, Albany 1, N. Y.

See panel below for directions regarding subscriptions or change of address. Donald C. McGraw, President; Joseph A. Gerardi, Executive Vice President; L. Keith Goodrich, Vice President and Treasurer; John J. Cooke, Secretary; Nelson L. Bond, President, Publications Division; Shelton Fisher, Senior Vice President; John R. Callahan, Vice President and Editorial Director; Joseph H. Allen, Vice President and Director of Advertising Sales; A. R. Venezian, Vice President and Circulation Coordinator.

Single copies in the United States, U. S. possessions & Canada 75¢; \$1.50 for all other foreign countries. Buyers' Guide in the United States, U. S. possessions & Canada \$3.00; all other foreign \$10.00. Subscription rates—United States and possessions, \$6.00 a year; \$9.00 for two years; \$12.00 for three years. Canada, \$10.00 a year; \$16.00 for two years; \$20.00 for three years. All other countries, \$20.00 a year; \$30.00 for two years; \$40.00 for three years. Second class postage paid at Albany, N. Y. Printed in U.S.A. Copyright 1960 by McGraw-Hill Publishing Co., Inc.—All Rights Reserved. Title registered in U. S. Patent Office. BRANCH OFFICES: 520 North Michigan Avenue, Chicago 11; 68 Post Street, San Francisco 4; McGraw-Hill House, London E. C. 4; 85, Westendstrasse, Frankfurt/Main; National Press Bldg., Washington 4, D. C.; Six Penn Center Plaza, Philadelphia 3; 1111 Henry W. Oliver Bldg., Pittsburgh 22; 55 Public Square, Cleveland 13; 856 Penobscot Bldg., Detroit 26; 3615 Olive St., St. Louis 8; 350 Park Square Bldg., Boston 16; 1301 Rhodes-Haverty Bldg., Atlanta 3; 1125 West Sixth St., Los Angeles 17; 1740 Broadway, Denver 2; 901 Vaughn Bldg., Dallas 1. ELECTRONICS is indexed regularly in The Engineering Index.

Subscription: Address correspondence to: Fulfillment Manager, Electronics, 330 W. 42nd St., New York 36, N. Y. Allow one month for change of address, stating old as well as new address, including postal zone if any. Subscriptions are solicited only from persons engaged in theory, research, design, production, management, maintenance and use of electronics and industrial control components, parts and products. POSITION and COMPANY CONNECTION must be indicated on subscription orders.

Postmaster: please send form 3579 to Electronics, 330 W. 42nd St., New York 36, N. Y.



Member ABP and ABC

FINANCING GROWTH. The food for industrial growth of any kind is capital, and when an industry grows as fast as electronics has the internal formation of capital is sometimes impossible.

In the early years electronics as an industry found it difficult to attract capital from outside sources. The conventional sources—banks, investment houses, insurance companies—needed a guarantee of secure return which a possibly speculative industry could not offer. Now, over the years, the industry has proved its growth capability often and dramatically enough to win approval from all types of investors. But another phenomenon of recent vintage looks to us to be even more significant.

Since the war, and especially since about 1955, there have grown up highly specialized venture-capital firms with specific interest in electronics. (We have a story in this issue which discusses the operating techniques of these companies. See p 30.) These firms do not merely accept electronics investments; today they specifically seek them out.

Among the cogent facts about such firms is the presence on their staffs of electronics men, men trained in the technology, who possess the technical and business background necessary for astute judgment of an investment's worth. Firms guided by such men provide a self-pollinating facility which attracts risk capital needed for sustained expansion. At the same time, they provide guidance in a specialized field for the rest of the financial community, illustrating by the example of their own investments which operations are reasonable speculations and which are merely bad risks.

Coming In Our February 26 Issue . . .

DIELECTRIC DEVICES. As reported recently in ELECTRONICS (p 11, Jan. 22), a new class of solid-state dielectric circuit devices is being developed at England's Birmingham University. Based on the phenomenon of controlled current flow in solid insulators, the devices are expected to complement semiconductor devices in several important applications. These include operation where insensitivity to temperature changes is required, operation at moderately high voltage or impedance levels, and high-speed switching or high-frequency applications.

Next week, G. T. Wright of Birmingham's department of electrical engineering explains the operation of these new devices. He describes the conditions under which current can flow in pure cadmium sulphide and how, by careful crystal-growing techniques, these conditions have been realized. Construction and characteristics of a cadmium sulphide diode are disclosed, as are plans for a dielectric triode.

The latter is expected to be adaptable to vacuum triode-type circuits.

ELECTRO-OPTICAL AMPLIFIERS. Interest in electro-optical effects such as photoconductivity and electroluminescence is increasing because of the possibility of practical application in electronic circuits. In our next issue, G. Diemer of N. V. Philips Gloeilampenfabriken in Eindhoven, Netherlands, lists 27 power amplifiers that can be constructed by using different combinations of radiative, electric and thermal power.

Some of the latest ideas in designing power amplifiers by combining photoconductive and electroluminescent elements are also presented.

RELIABLE SILICON TRANSISTOR SWITCHING

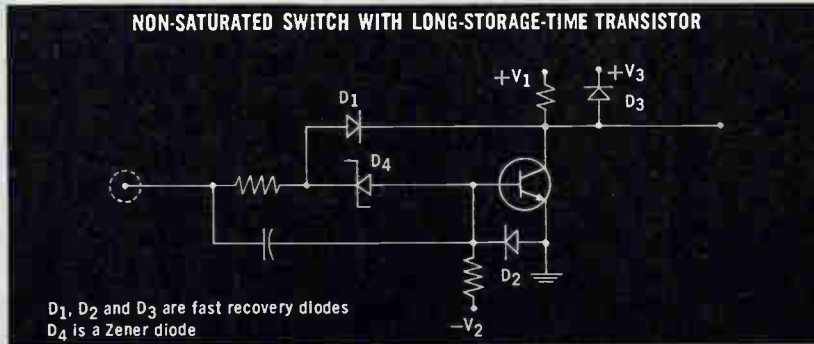

9 COMPONENTS REPLACED BY 4

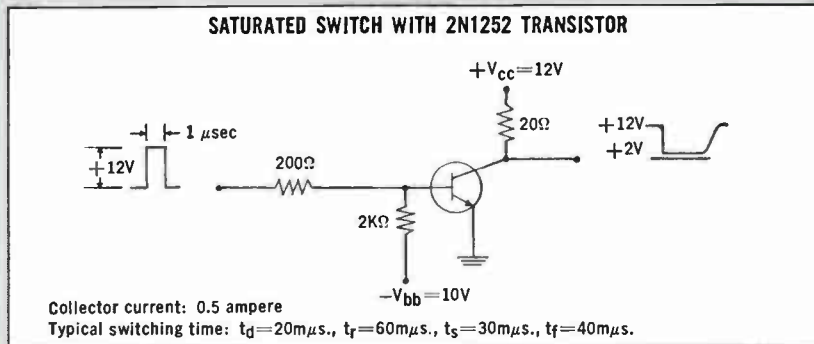

HOW? — By using Fairchild's 2N1252 or 2N1253 lowstorage silicon mesa transistors. The guaranteed low storage characteristic permits a simple saturating circuit to achieve switching speeds that previously required complex non-saturating circuits.

WHY? — Improved reliability and reduced cost — one semiconductor instead of five and fewer soldered connections. Power dissipation is only 1/3rd to 1/5th as great, making possible much higher component densities in packaging. Cost and reliability are improved all the way from development through volume production.

WHERE? — Switching circuits in general. The 2N1252 and 2N1253 are ideally suited to high-speed high-current switching applications such as magnetic-core drivers, drum and tape write drivers; high-current pulse generators and clock amplifiers. In addition, the transistors are applicable to medium-speed saturated logic circuits.

FAIRCHILD 2N1252 and 2N1253

Symbol	Characteristic	Rating	Min	Typ	Max	Test Conditions
h_{FE}	D.C. pulse current gain	2N1252 2N1253	15 30	35 45	45 90	$I_C=150mA$ $V_C=10V$
P_C	Total dissipation at 25°C case temperature	2 watts				
$V_{BE SAT.}$	Base saturation voltage			0.9V	1.3V	$I_C=150mA$ $I_B=15mA$
$V_{CE SAT.}$	Collector saturation voltage			0.6V	1.5V	$I_C=150mA$ $I_B=15mA$
h_{fe}	Small signal current gain at $f=20mc$	2N1252 2N1253	2 2.5	4 5.5		$I_C=50mA$ $V_C=10V$
I_{CBO}	Collector cutoff current			0.1 μA 100 μA	10 μA 600 μA	$V_C=20V$ $T=25^\circ C$ $V_C=20V$ $T=150^\circ C$
t_s+t_f	Turn off time			75 μs	150 μs	$I_C=150mA$ $I_{B1}=15mA$ $I_{B2}=5mA$ $R_L=40\Omega$ Pulse width—10ms

For full specifications, write Dept. A-1.



545 WHISMAN ROAD • MOUNTAIN VIEW, CALIFORNIA • YORKSHIRE 8-8161 • TWX: MOUNTAIN VIEW CAL 122
New York Area: Pioneer 1-4770 • Syracuse: Granite 2-3391 • Philadelphia Area: Turner 6-6623
Washington D.C.: National 8-7770 • Chicago: Browning 9-5680 • Los Angeles: Olander 5-6058

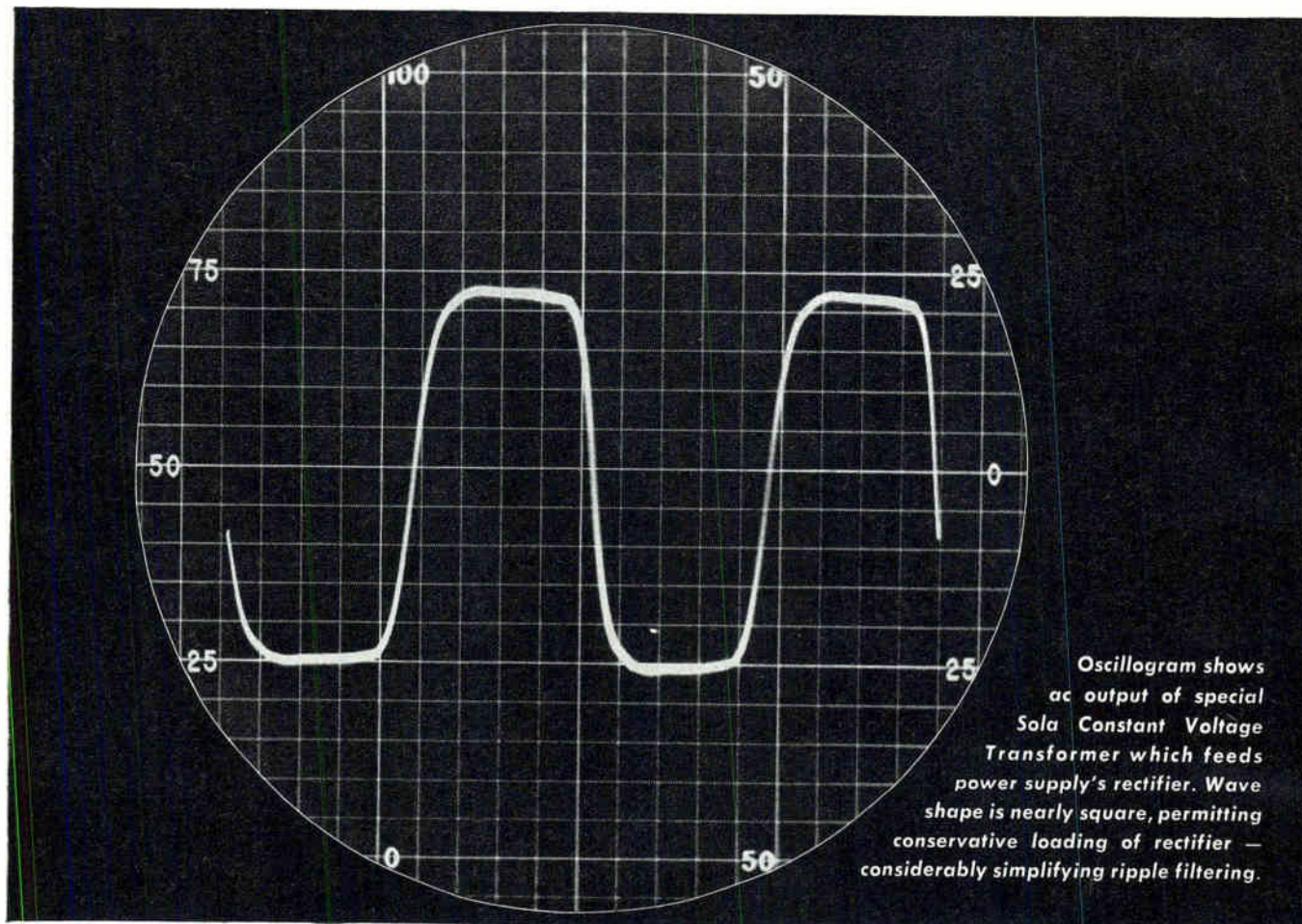

Square-wave output of special transformer gives high efficiency in Sola's regulated dc power supply

Sola engineers (men with a keen eye for a trim wave shape) designed a special constant voltage transformer having nearly a square-wave output. Then they linked the transformer with two other components to produce a regulated dc power supply which has notable efficiency.

They fed the regulated output of this transformer into a semiconductor rectifier . . . the low-peak characteristic of the square wave results in a conservative loading on the economical rectifier assembly. It can deliver considerable amounts of current as long as you don't over-voltage it—and over-volting just doesn't happen when the input to the rectifier is Sola-regulated to within $\pm 1\%$.

The rectified voltage feeds into the third component in this happy combination—the high-capacitance filter. The capacitor's filtering job is made easier because the rectified square wave contains a comparatively small

amount of ripple. Final dc output from the filter has less than 1% rms ripple . . . for many applications there is no need for a voltage-dropping, efficiency-cutting choke coil.

The Sola Constant Voltage DC Power Supply has output in the ampere range, regulates within $\pm 1\%$ even under $\pm 10\%$ line voltage variations, and is suitable for intermittent, variable, and pulse loads. It has low output impedance, is very compact, and provides about all you could ask for in maintenance-free dependability.

Hundreds of ratings of these dc power supplies have been designed and produced to meet widely varying electrical and mechanical requirements of equipment manufacturers. In addition, there are six stock variable-output models and six stock fixed-output models with ratings from 24 volts at six amps to 250 volts at one amp.

For complete data write for Bulletin 78-DC

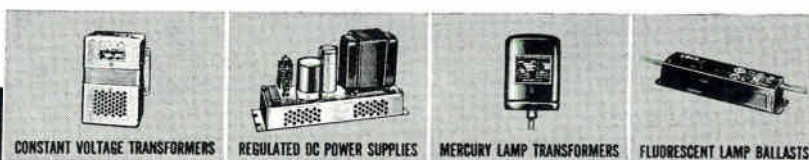
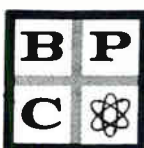

A DIVISION OF BASIC PRODUCTS CORPORATION

SOLA ELECTRIC CO., 4633 W. 16th St., Chicago 50, Ill., Blshop 2-1414 • In Canada, Sola Electric (Canada) Ltd., 377 Evans Ave., Toronto 18, Ont.



Electro Mechanical Specialties



R-B-M
Div. Essex Wire



Automatic Electric



C. P. Clare



Ebert Electronics Corp.



Collins Electronics Mfg. Corp.



Guardian Electric



Phillips Control



G-V Controls



Kurman Electric Co.



Leach Relays



Potter & Brumfield



Terado



American Monarch Corp.



Advance Relays



Monitor Relays Inc.



Struthers Dunn

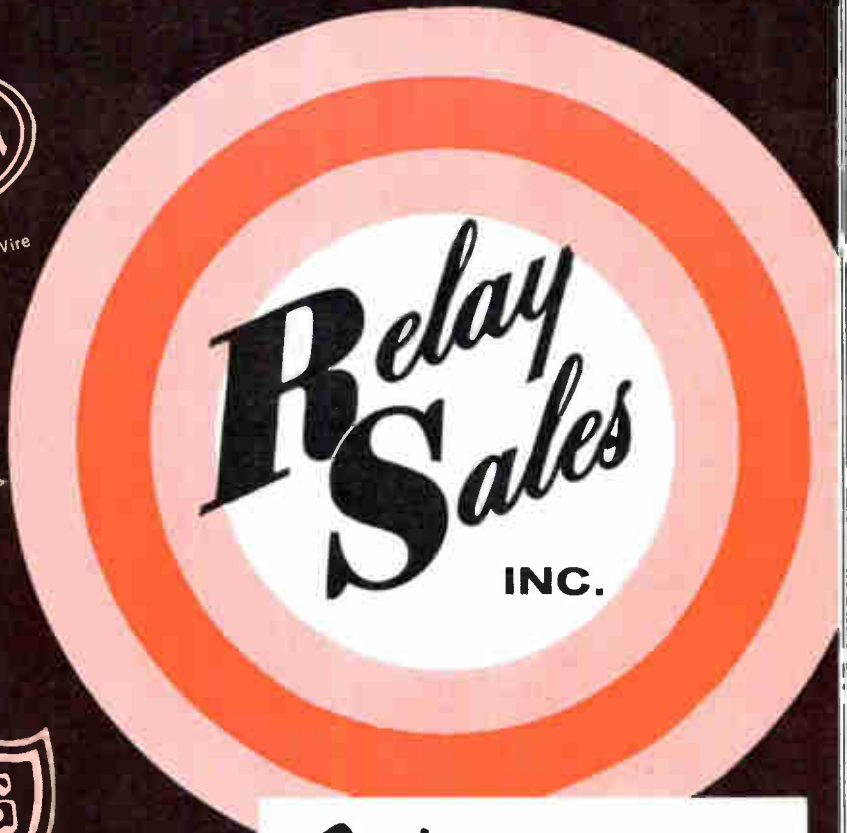

Buy All these leading lines of Relays

From this ONE catalog

Immediate delivery from stock
Factory Prices

Write for your personal copy
of this catalog TODAY!

RELAY SALES, INC.
P. O. BOX 186-A, WEST CHICAGO, ILL.

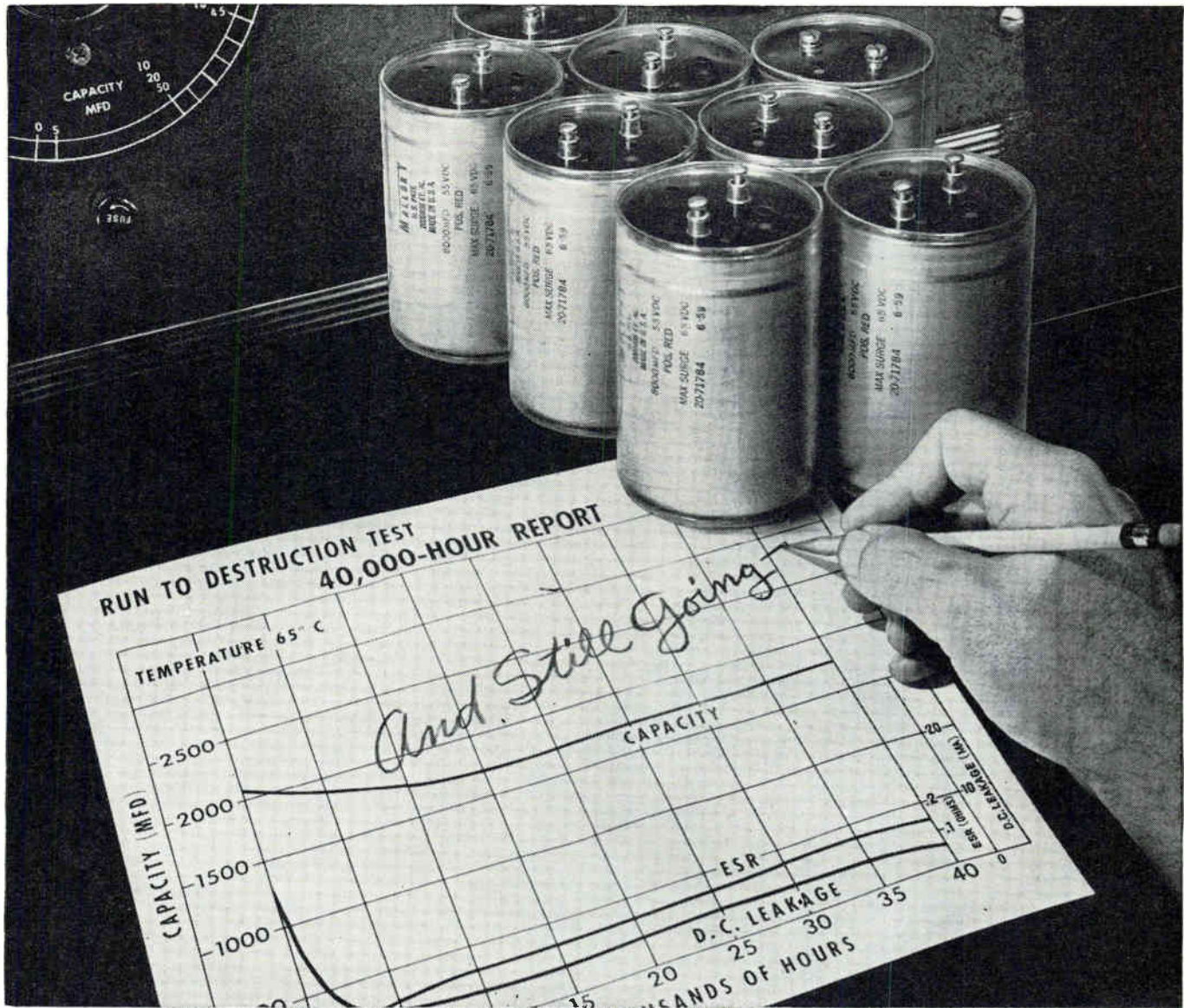

Proved reliability for computer filter circuits

For nearly five years, a group of eight 2000 mfd., 30 volt Mallory computer grade capacitors taken from a standard production lot have been winning a "run-to-destruction" test that hasn't been able to destroy them.

Not a single failure has occurred in more than 40,000 hours' operation at 65°C. Capacity, equivalent series resistance and DC leakage values,

as indicated on the test chart above, have remained virtually unchanged.

Keep this amazing record of reliability in mind when you select computer filter capacitors. Mallory makes them in ratings from 130,000 mfd., 3 volts to 1000 mfd., 400 volts . . . in standardized cases that facilitate bank mounting. Write for a copy of Bulletin 4-34, and for a consultation by one of our specialists.

See Mallory Capacitor Company for a complete line of aluminum electrolytics, tantalum electrolytics and motor capacitors.

Mallory Capacitor Co., Indianapolis 6, Ind.
a division of





BLUE Ribbons[®]

are

available

from

Authorized

AMPHENOL

Distributors

-at

Factory

Prices!

AMPHENOL

DISTRIBUTOR DIVISION

Amphenol-Borg Electronics Corporation
BROADVIEW, ILLINOIS

ELECTRONICS • FEBRUARY 19, 1960

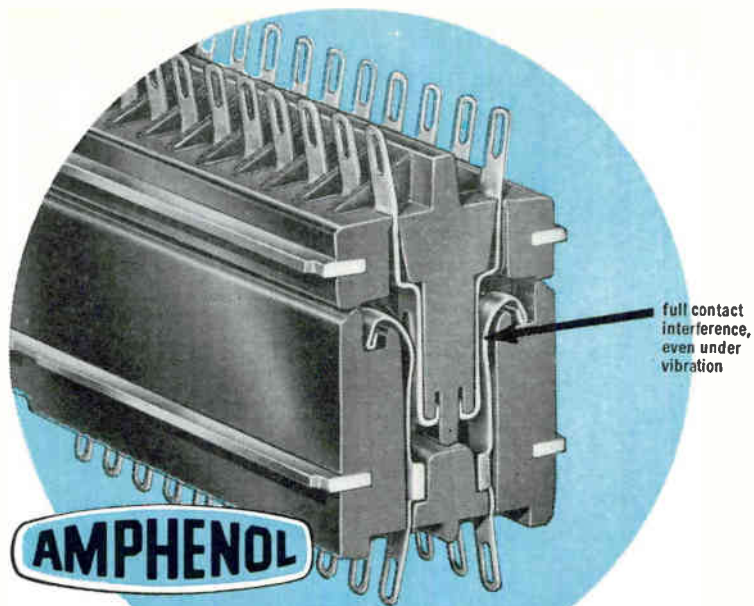

AMPHENOL

BLUE Ribbon[®]

improved ribbon contacts can't "set",
have extended mating range

Since the development of Blue Ribbon connectors by AMPHENOL in 1946, the unique, ribbon-like spring contacts that are the heart of these connectors have undergone continuing design improvements. Here are some examples of present efficiency: Blue Ribbon contacts can't be "set" or overstressed; they provide full-range electrical mating action with no intermittent contact action even under extreme vibration; a double-stub design effectively secures the contact in the dielectric; gold-over-albaloy plating withstands 500 cycles of mating without galling; mating force requirements have been reduced to 1/2 pound per contact.

Today, AMPHENOL Blue Ribbons are the optimum rack & panel connector for such applications as computers, recorders, monitors and other equipments in both commercial and military systems. Blue Ribbon reliability has proved to be outstanding.

availability

The Blue Ribbon family is large—5 different types in 8 to 32 contacts plus 50 contact circulars. Miniaturized Micro-Ribbons are also available for applications where space is a factor. Blue Ribbons have been adapted to many special needs, with the AMPHENOL Engineering Department offering continuing consulting service in the design of custom connectors based on the unique Blue Ribbon principle.

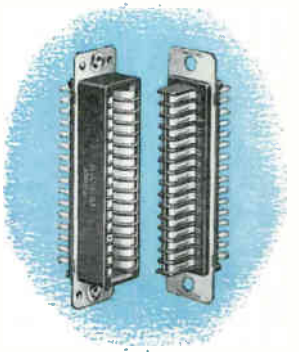

For Cataloging write to . . .

AMPHENOL

CONNECTOR DIVISION

1830 S. 54TH AVE., CHICAGO 50, ILL.

Amphenol-Borg Electronics Corporation

CIRCLE 9 ON READER SERVICE CARD

AMPLIFY MICROVOLTS WITH STABILITY... measure strain, temperature, other phenomena, to 0.1% with a KIN TEL DC amplifier

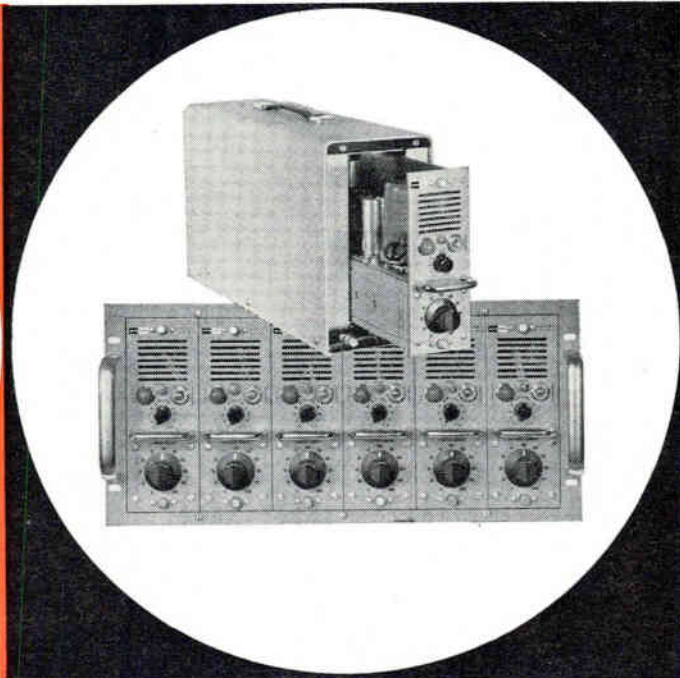
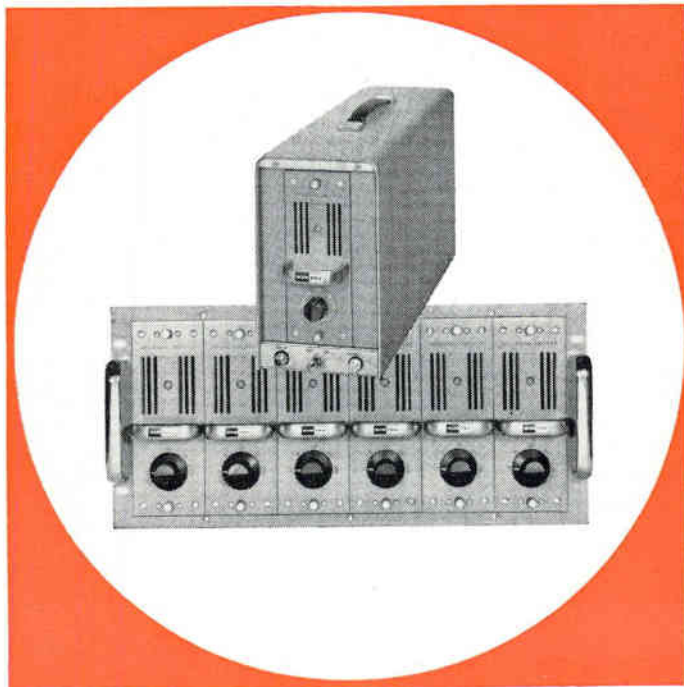

NEW...TRUE DIFFERENTIAL DC AMPLIFIERS ELIMINATE GROUND LOOP PROBLEMS...RESCUE MICROVOLT SIGNALS FROM VOLTS OF NOISE

180 db DC, 130 db 60 cycle common mode rejection with balanced or unbalanced input ■ Input completely isolated from output ■ Input and output differential and floating ■ 5 microvolt stability for thousands of hours ■ 0.05% linearity, 0.1% gain stability ■ Gain of 10 to 1000 in five steps ■ >5 megohms input, <2 ohms output impedance ■ 10 volt at 10 ma output ■ 100 cycle bandwidth ■ Integral power supply

Ideal for thermocouple amplification, the Model 114A differential DC amplifier eliminates ground loops; allows the use of a common transducer power supply; drives grounded, ungrounded or balanced loads; permits longer cable runs; and can be used inverting or non-inverting. The 114A can be mounted in either single amplifier cabinets or six amplifier 19" rack adapter modules. Prices: 114A - \$875, six amplifier module - \$295; single amplifier cabinet - \$125.

WIDEBAND, SINGLE ENDED DC AMPLIFIERS AMPLIFY DATA SIGNALS FROM DC TO 40 KC WITH 2 MICROVOLT STABILITY

±2 microvolt stability ■ <5 microvolt noise ■ 40 kc bandwidth ■ 100 KΩ input, <1 ohm output impedance ■ Gain of 20 to 1000 in ten steps with continuous 1 to 2 times variation of each step ■ ±45 V, ±40 ma output ■ 1.0% gain accuracy ■ 0.1% gain stability and linearity ■ Integral power supply

Millions of cumulative hours of operation have proved KIN TEL Model 111 series DC amplifiers to be the basic component for all data transmission, allowing simple, reliable measurement of strain, temperature and other phenomena. DC instrumentation systems - with their inherently greater accuracy, simplicity, and reliability than AC or carrier systems - are made entirely practical by the excellent dynamic performance, stability, and accuracy of KIN TEL DC amplifiers. Price: 111BF - \$625, six amplifier module - \$295, single amplifier cabinet - \$125.

5725 Kearny Villa Road, San Diego 11, Calif.

Phone: BRowing 7-6700

Representatives in all major cities



BUSINESS THIS WEEK

Computermaker Develops Automated System For Assembly of Alloy Junction Transistors

An automated transistor assembly system that turns out npn alloy junction transistors for computers at a rate of 1,800 an hour—roughly five times faster than assembly machines now in general use—has been developed by International Business Machines Corp.

The machine is expected to start operation this week at Texas Instruments Inc., a large supplier of transistors to IBM. One new IBM 7090 computer contains more than 50,000 transistors. The assembly machine has just successfully completed a month-long production test at IBM's Poughkeepsie plant.

The computermaker says transistor quality control is maintained by assembling and inspecting the transistors individually at every step in the process, as contrasted to batch manufacture. IBM says the system, which maintains tolerances of 0.0005, can be modified to produce other alloyed transistors besides npn's.

Company reports the machine covers 500 sq ft, consists of six turntables, two ovens and a welding unit. It assembles six parts, including emitter dots about 1/20 the size of a needle's eye. Other preformed parts are: collector dots, germanium disk, base tab "whisker" wires and mounting base.

Parts are fed automatically to the turntables, each of which injects one component by vacuum or gravity feed into small carbon filters or "boats." These, along with fitting plugs, position and transport parts on the conveyor belt.

It is understood the system uses three different inspection devices, the primary one being a photocell detection circuit at each turntable which signals rejection of a "boat" if it has missing or poorly positioned parts. A mechanical limit switch checks the height of the boat to prevent damage. Vacuum switch checks base washer loading unit's vibration feed to boat.

Fivefold Increase in Data-Processing Sales Seen by '65; Process-Control Unit Announced

Computer sales and developments, pointing towards record growth this year, continue to attract industry attention.

First prototype models of the Honeywell 800 data-processing system are nearing completion at the Datamatic division of Minneapolis-Honeywell in Newton Highlands, Mass. At the dedication of a new marketing and training center in nearby Wellesley, Datamatic president Walter W. Finke estimated that data-processing is already a billion-dollar-a-year business, predicted that by 1965 "it may well achieve five times the present volume."

The company reports an order backlog in excess of

\$35 million for the 800 system, which can handle a million digits a second in record-sorting, merging or file maintenance, and 30,000 additions or subtractions a second.

On the process-control front, a transistorized digital computer, the LN-3000, jointly developed by Leeds & Northrup and Philco, both of Philadelphia, will be marketed by L&N. The computer is part of a system for the electric power, metals, chemical, petrochemical and ceramics industries. With associated input-output gear its volume equals two 4-drawer files.

The computer will provide open-loop control when used for on-line data reduction and calculation of operating guides; it can also provide yes-no program control decisions and supervisory computer control over the settings for the analog controllers.

ELECTRONICS NEWSLETTER

Transistorized multiplex-carrier system which handles as many as 600 voice channels has been announced by GE's communication products department, Lynchburg, Va. The company says deliveries on "multi-million dollar commitments" will begin in the fall. GE says the single-sideband suppressed carrier system "has toll quality capable of meeting international and domestic long distance standards." To avoid transmission delay in case a component fails, the new system uses a standby unit for components in the common equipment, such as amplifiers and master oscillators.

Studies at the Microwave Laboratory of Stanford University have shown the feasibility of converting a pulsed d-c magnetic field into microwave radiation with a high order of efficiency. An experimental solid-state generator has been built using a garnet sphere. In the presence of the pulsed field, the garnet translates an input r-f signal to a higher frequency output. Although the initial results yielded only a modest translation (2,400 Mc to 2,800 Mc), it is hoped that millimeter waves may be generated by this method. As a first step, an S-band to K-band (3,000 Mc input, 20,000 Mc output) generator is being designed.

Electronic Associates, Long Branch, N. J., announces a new high-speed repetitive-operation feature for all of its PACE 231R analog computers. With repetitive operations, says the company, solutions appear as a continuous plot on a 17-in. display screen instead of being drawn on recorders whose mechanical characteristics limit plotting speeds. This means that changes in problem variables can be seen immediately on the display screen without resetting equipment and drawing additional plots. Permanent plots can be made of the final and more detailed solution in "real time." The company says computing times of 10 to 80 milliseconds are available and may be controlled from either the repetitive operation control unit or the display unit.

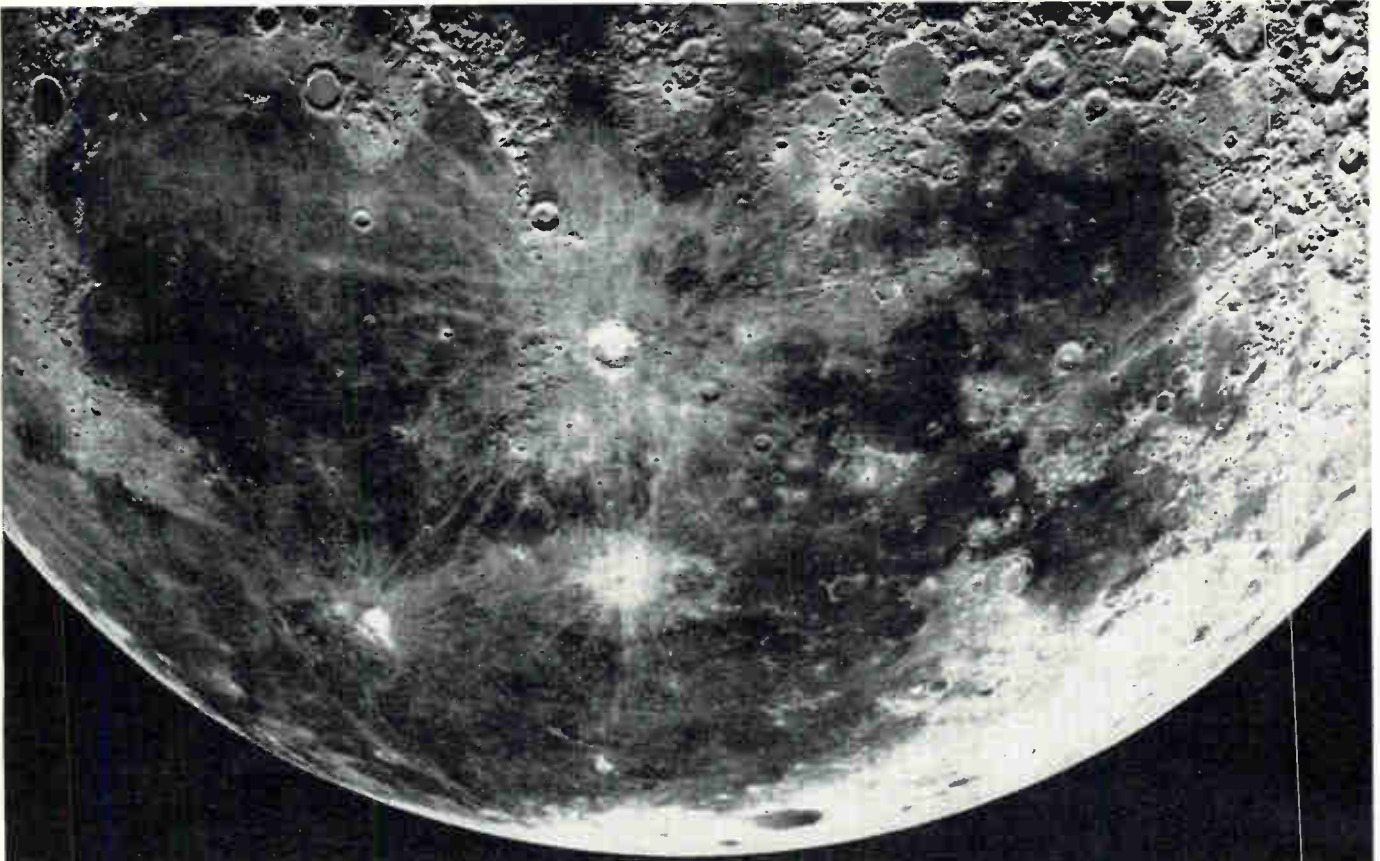

**Waters
new
pots
conquer
space**

Two new $\frac{1}{2}$ " Waters pots conquer a space problem for many a harassed space age engineer. Both require up to 25% less space behind the panel than pots having identical specifications. Available with terminals (shown), wire leads or printed circuit pins. Case lengths are only $\frac{3}{8}$ ". The new APS $\frac{1}{2}$ is designed for bushing-type mounting. The WPS $\frac{1}{2}$, designed for servo mounting, is the smallest potentiometer available for general use in rugged servo applications. Both are capable of dissipating 2 watts continuously! Reliability test reports available. Write for Bulletin APS-160.

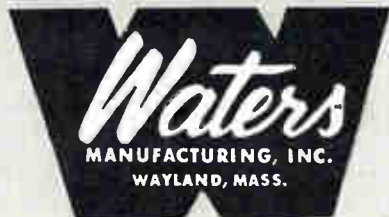

POTENTIOMETERS • SLUG TUNED COIL FORMS • RF COILS • CHOKES • POT HOOK® PANEL MOUNTS • TORQUE WATCH® GAUGES • C'TROL METER/CONTROLLER • INSTRUMENTS

New RCA Intermediate-Power Transistors feature JEDEC TO-8 case with removable heat-sink mounting flange

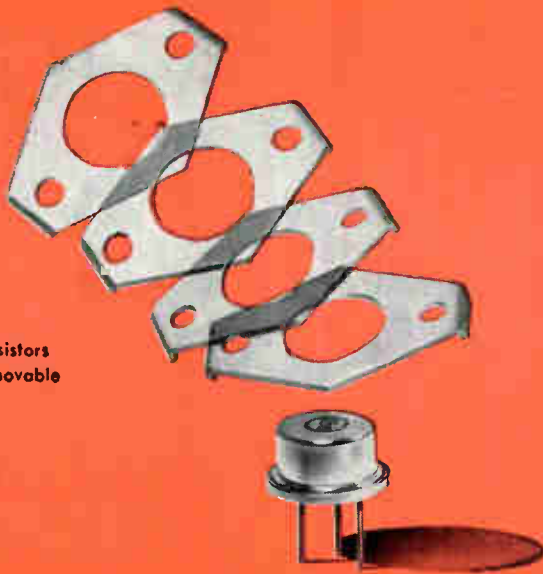

6 NEW RCA INTERMEDIATE POWER TRANSISTORS

New germanium units offer unique design flexibility for a wide variety of industrial and military applications

Now—in production quantities—six new RCA PNP germanium alloy junction transistors designed primarily for intermediate-power switching and audio-frequency industrial and military applications. Featuring 100°C maximum junction temperature and a unique case design, these new types can be used with or without the heat-sink mounting flange. With mounting flange in place, these types can dissipate 7.5 watts at 25°C case temperature; without flange, one watt at 25°C ambient temperature.

These new RCA intermediate-power transistors provide a choice of voltage ratings and beta ranges for design flexibility. They feature low saturation resistance and low leakage current.

They are particularly useful in power switching circuits such as dc-to-dc converters, inverters, choppers, solenoid drivers, and relay controls; oscillator, regulator, and pulse-amplifier circuits, and as class A and class B push-pull amplifiers for servo and other audio-frequency applications.

RCA intermediate-power germanium transistors were developed in cooperation with the U. S. Army Signal Corps on an Industrial Preparedness Measure for military devices.

Call your nearest RCA field office today for particulars on these new intermediate-power transistors. For further technical information write RCA Commercial Engineering Section B-19-NN-3, Somerville, N. J.

ELECTRICAL CHARACTERISTICS

Type	Min. V _{CE} S (I _C = -50 ma)	Min. V _{CE} O (I _C = -50 ma)	Min. V _{CE} BO (I _C BO = -250 μa)	Min. V _{EB} (I _E = -100 μa)	h _{FE} (I _C = -400 ma)
2N 1183	-35v	-20v	-45v	-20v	20-60
2N 1183A	-50v	-30v	-60v	-20v	20-60
2N 1183B	-60v	-40v	-80v	-20v	20-60
2N 1184	-35v	-20v	-45v	-20v	40-120
2N 1184A	-50v	-30v	-60v	-20v	40-120
2N 1184B	-60v	-40v	-80v	-20v	40-120

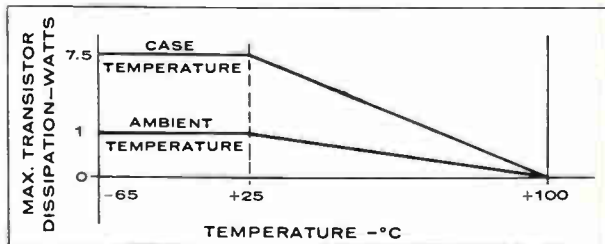

ANOTHER WAY RCA SERVES YOU THROUGH ELECTRONICS



RADIO CORPORATION OF AMERICA

SEMICONDUCTOR AND MATERIALS DIVISION

SOMERVILLE, N. J.

East: 744 Broad St., Newark, N. J., HUmboldt 5-3900 • Northeast: 64 "A" St., Needham Heights 94, Mass., HILlcrest 4-7200 • East Central: 714 New Center Bldg., Detroit 2, Mich., TRinity 5-5600 • Central: Suite 1154, Merchandise Mart Plaza, Chicago, Ill., WHitehall 4-2900 • West: 6355 East Washington Blvd., Los Angeles, Calif., RAymond 3-8361 • Southwest: 7905 Empire Freeway, Dallas 7, Texas, FLeeewood 2-8663 • Gov't: 224 N. Wilkinson Street, Dayton, Ohio, BAldwin 6-2366; 1625 "K" Street, N.W., Washington, D.C., District 7-1260

AVAILABLE, TOO, THROUGH YOUR AUTHORIZED RCA DISTRIBUTOR

Communications
Instruments
Controls
Radar
Avionics
Missiles
Mobile electronics

Need high vacuum components?

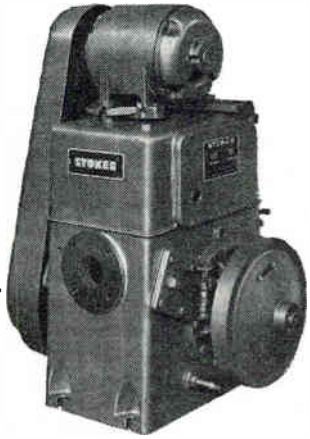

Stokes Series H Microvacs were designed by vacuum specialists . . . are industry engineered to meet your needs . . . give you more pumping capacity per dollar. The integral construction includes dynamic balancing, valves, motor, belt guard, and automatic lubrication—there are no extras to buy. A complete line of Microvacs include capacities from 17 to 500 cfm. For fast, efficient pump-down—you can depend on Stokes Microvac Series H Pumps.

STOKES makes a complete line of vacuum components . . . advance-designed and engineered to help make your vacuum systems more productive. Each unit reflects Stokes' unparalleled experience, pioneering leadership and wealth of basic vacuum technology.

The product list includes: Diffusion Pumps, Vapor Booster Pumps, Mechanical Pumps, Mechanical Booster Pumps, Vacuum Gages, and Valves.

Send for technical data on any or all . . . without obligation.

High Vacuum Division
F. J. STOKES CORP.
5565 Tabor Road, Phila. 20, Pa.

STOKES

WASHINGTON OUTLOOK

CONGRESSIONAL RECOMMENDATIONS for dealing with payola and quiz-show scandals go far beyond what many observers had expected. The report of the special House investigating subcommittee on legislative oversight strikes right at the heart of the responsibilities of station ownership.

One possible outcome: putting the powerful economic weapon of license suspension into the hands of the Federal Communications Commission. This proposal comes perilously close to censorship and may be the most vulnerable point of any bill that results from the report. FCC's only other weapon, license revocation, is so severe that it is rarely placed into use.

The committee's recommendations affecting ownership would grant far more power to FCC than the agency has ever had. Besides being able to suspend licenses for brief periods (a week or 10 days) if programs do not serve the public interest, the Commission would be empowered to license the networks and hold them responsible for network-originated programs; and to consider all applicants for a station license when a station is up for sale.

(At present, FCC must find one proposed buyer unfit before it can consider another.)

The committee also proposes to prohibit license applicants from paying off competitors to get them to withdraw; ban swapping stations without hearings; and end trafficking in licenses by prohibiting resale of a station within three years. The proposals would also establish criminal penalties for rigging, payola and plugs.

The committee will have to move fast, however, if legislation is to emerge before Congress rushes home to the campaign hustings. First a bill must be drafted; then the Committee on Legislative Oversight will hold hearings on the bill. These could be brief or drawn out, depending on how much pressure the committee feels to make good on its investigating subcommittee's recommendations. If they move along, the bill could emerge from the House in six weeks or so, leaving enough time for the Senate to act.

But note what happened to legislation introduced a year ago by the chairman of the same subcommittee, Rep. Oren Harris (D., Ark.), dealing with ethics and procedures of regulatory agencies. It was introduced on the heels of the scandal surrounding former Commissioner Richard Mack; it's still sitting in committee. Last year's bill dealt in general terms with all six agencies; the new bill would aim specifically at broadcasting, and so might meet less resistance.

Besides, it's an election year.

The committee report blisters the FCC for its "passive" attitude toward the problems of broadcasting and abandons the idea that broadcasters should regulate themselves. In other years, this might have been dismissed as just talk. This year the buildup of public indignation over the quiz-show and payola scandals may force a bill embodying most or all of the committee's recommendations—with teeth for the FCC.

- **Electronics firms figure in criticism** by the General Accounting Office of the way subcontracts are handled. GAO says major contractors have been accepting subcontractors' cost estimates uncritically, and passing on resultant high costs to the government.

Specifically, GAO has declared that four of Douglas Aircraft's subcontracts—including two with electronics companies—were found to be excessive. Douglas, the investigators said, failed to require cost data or make comparisons with earlier contracts. They recommend that the services require major contractors to exercise tighter control over subcontracts.

FOR

very accurate local time comparisons

generation of very accurate local time
with atomic or quartz oscillators

this new 113AR Clock is the ultimate

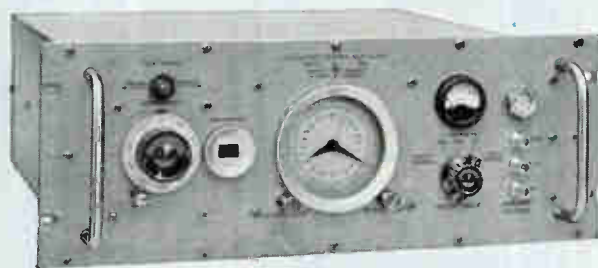

This new  113AR Frequency Divider and Clock makes possible precision time comparisons between stable oscillators and standard WWV or other transmitted time signals. This permits adjustment of frequency or time standards for greater absolute accuracy, and simplifies obtaining detailed records of drift rates, or time or frequency differences between oscillators in widely separated systems.

Propagation path errors can be averaged out and Doppler errors are virtually eliminated.

 113AR's unique optical gate (no contacts, no wear, cannot add jitter) and a directly calibrated precision phase shifter make possible the unique accuracy of the Clock providing a time comparison capability of $\pm 10 \mu\text{sec}$. Regenerative dividers, a phase-stable motor and precision gear train provide fail-safe operation not attained by pulse counting systems.

Model 113AR is conservatively designed from premium components, fully transistorized for longer standby battery operation, and meets performance requirements of MIL-E-16400. The unit is rugged, dependable and measures only 7" high.

HEWLETT-PACKARD COMPANY

1022A Page Mill Road • Palo Alto, California, U.S.A.
Cable "HEWPACK" • Davenport 5-4451

Hewlett-Packard S.A.

Rue du Vieux Billard No. 1, Geneva, Switzerland
Cable "HEWPACKSA" • Tel. No. (022) 26. 43. 36

SPECIFICATIONS

Input Frequency: 100 KC \pm 300 cps.

Input Voltage: 0.5 to 5 v rms.

Input Impedance: Approx. 300 ohms

Output Signals: (1) 1 pps, 10 v, 10 μsec rise time, approx. $20 \pm 10 \mu\text{sec}$ duration, into 5,000 ohms (2) 1 pps, 4 v, 10 μsec rise time, $100 \pm 3 \text{ msec}$ duration, from 50 ohms (3) 1 KC pulses, pos and neg, 4 v peak, 8 μsec nominal duration from approx. 5,000 ohms.

Frequency Divider: Regenerative; fail-safe.

Time Reference: Continuously adjustable, calibrated in 10 μsec increments.

Clock: Manual start, 24 hr dial.

Auxiliary Output: 1, 10 and 100 KC sine waves, 0.25 v rms from 1,200 ohms.

Power Requirements: 26 v \pm 2 v ( 724A Power Supply).

Size: 7" high, 19" wide, 19½" deep. Wt. 35 lbs.

Price: \$2,500.00 f.o.b. factory.

Data subject to change without notice.



world's largest line of electronic measuring instruments

As Environments Grow Tougher

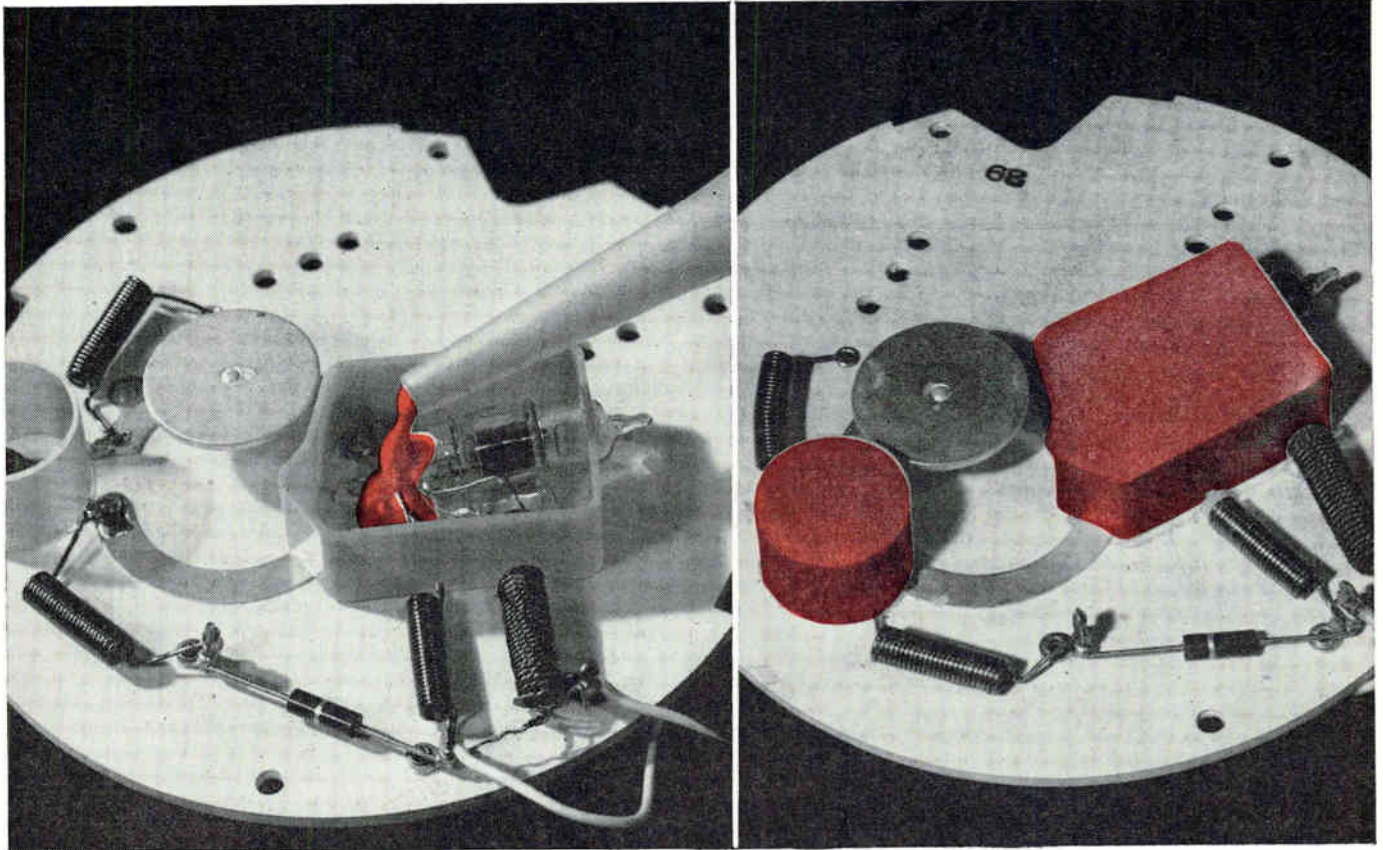

SILASTIC RTV
SILICONE RUBBER

**Supplies Both
Physical and
Electrical Protection**

The ideal encapsulating material should prevent mechanical damage to sub-assemblies and at the same time improve electrical properties. It should retain these protective qualities in all operating environments and put no stress on delicate parts. Just such a material is Silastic® RTV, the Dow Corning silicone rubber that vulcanizes at room temperature.

Take the case of the Radio Sondes manufactured by the General Instrument Corporation, Newark, N.J. These meteorological instruments linked to integral transmitters are designed to be launched from aircraft at altitudes up to 60,000 feet and speeds up to 565 knots. This means reduced air pressure and a definite hazard of arcing and corona due to the high potentials involved. It also means slipstream shock and vibration at launch.

As shown in the photos, critical areas of these Radio Sondes are encapsulated with Silastic RTV, applied with a caulking gun into reusable retainer rings. By encapsulating the most vulnerable areas with Silastic RTV, excellent protection is achieved with no degradation of power factor.

Silastic RTV is easy to apply, has good dielectric and physical properties, and resists moisture, arcing, corona, and ozone. Rapidly changing ambients will not cause Silastic RTV to put excessive stress on fragile parts . . . it remains resilient and soaks up shock. Silastic RTV is available in different consistencies, set-up time can be varied from minutes to hours, depending upon the RTV system.

Typical Properties of Silastic RTV

- Temperature range . . . (-70 to 260 C) -100 to 500 F
- Dielectric strength, volts/mil 300 to 500
- Surface resistivity at 50% relative humidity, ohms 2.8×10^{13}
- Dielectric constant, 10^6 cycles per second 2.96
- Dissipation factor, 10^6 cycles per second 0.003
- Moisture absorption after 7 days at room temperature, % + 3 to + 5

Your nearest Dow Corning office is the number one source for information and technical service on silicones.



Dow Corning

...silicones provide required service

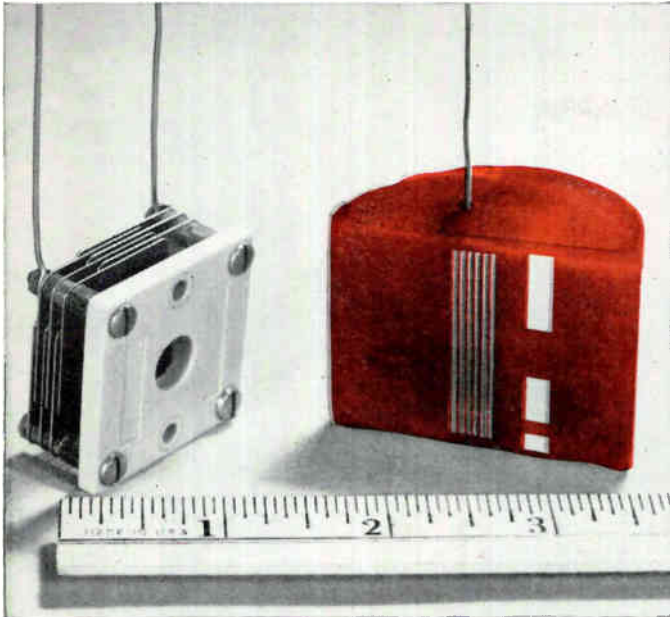

Solventless Resin For Top Heat Stability

When you need a rigid potting or encapsulating material, make sure the resin you choose is one that will keep its properties under adverse conditions. Dow Corning solventless silicone resins will withstand temperatures above 260 C (500 F). With no solvent to evaporate, they set up to a continuous bubble-free mass. The capacitor in the picture is a good example. After potting with one of these thermoset materials, it was sawed in half . . . notice the excellent void-free fill between plates. Solventless silicone resins form clear, tough solids; they accept a variety of fillers. Catalyzed pot life is over 6 months.

CIRCLE 290 ON READER SERVICE CARD

Highly Stable Diffusion Pump Fluids

Dow Corning silicone diffusion pump fluids resist oxidation even when exposed to air *at operating temperatures*. They won't decompose into gums and tars . . . can be cycled countless times. They recover far faster than organics and have very short pump-down times.

Silicone fluids produce vacua in the range of 10^{-5} to 10^{-7} mm. of mercury, are chemically inert, non-corrosive, non-toxic, free from impurities.

Shown are vacuum pump jet assemblies that were tested to breakdown on various pump fluids. The pump operating on Dow Corning fluids still had not broken down after 1,100 cycles, with exposure to air between cycles!

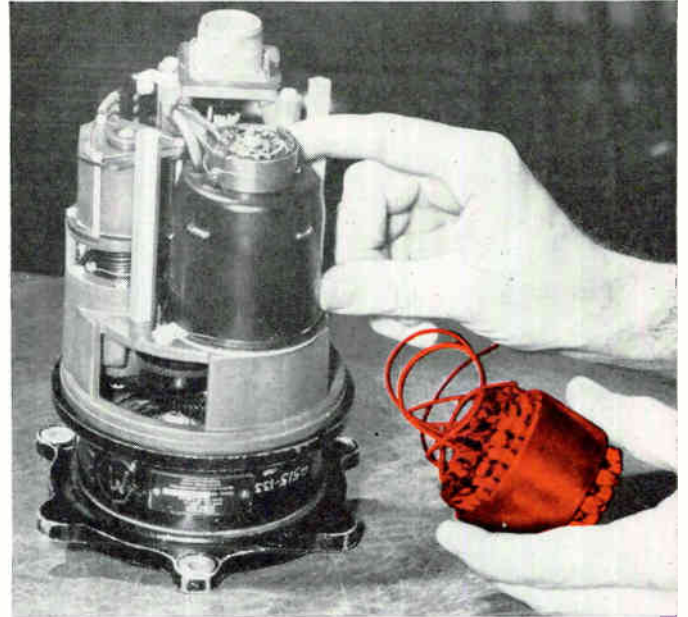

A Varnish With Greater Heat-Resistance

Dow Corning 997 Varnish permits operation at temperatures up to 250 C . . . gives electronic and electrical equipment protection against overloads, moisture, many chemicals, corrosive atmospheres and other hazards.

The unit pictured is a servo motor that actuates controls in aircraft automatic pilots. Insulated throughout with high temperature materials, and dipped in 997 Varnish, such motors have proven much more reliable operation in United Airlines planes . . . running as long as 5 years without need for replacement, as against scheduled replacement after 1000 hours for Class A insulated motors.

CIRCLE 291 ON READER SERVICE CARD

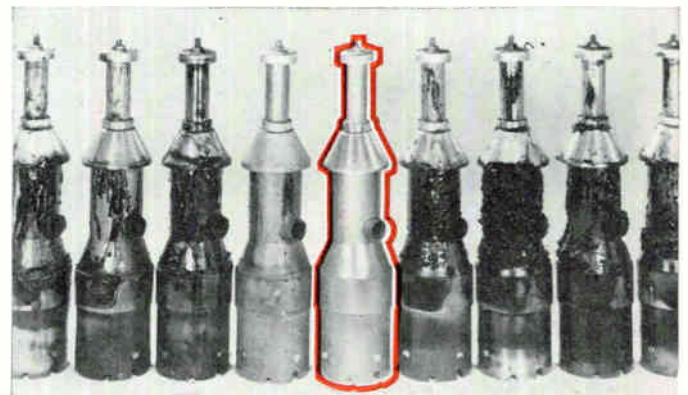

CORPORATION

MIDLAND, MICHIGAN

branches: ATLANTA BOSTON CHICAGO CLEVELAND DALLAS LOS ANGELES NEW YORK WASHINGTON, D.C.

New design features make this the ideal general purpose Signal Generator

BRC TYPE 225-A provides these unique advantages:

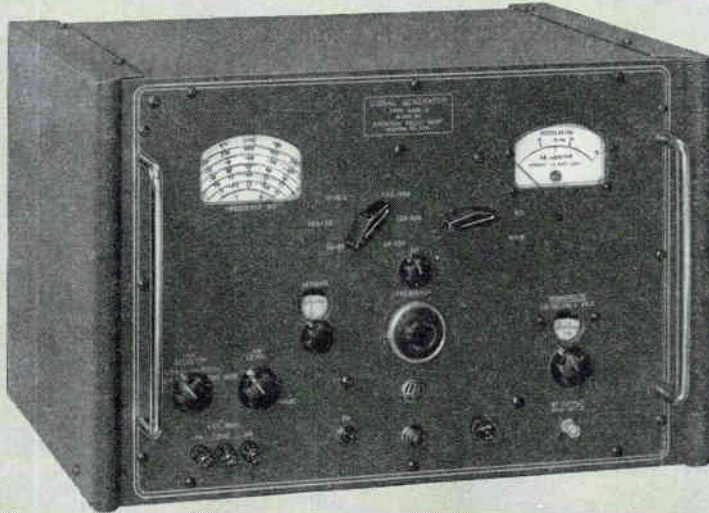

- RF settability better than $\pm 0.05\%$
- RF stability 0.001% for 5 minutes, 0.001% for 5 volt line change
- Extremely low incidental FM 0.001% at 30% AM
- FM modulation from external oscillator

SPECIFICATIONS

RF Range: 10 to 500 mc	Incidental FM: 0.001% or 1000 cps, whichever is greater, at 30% AM
RF Accuracy: $\pm 0.5\%$ (after two hour warmup)	FM Range: 0 to between 5 kc and 60 kc deviation, depending upon frequency, in the range 130 to 500 mc (from external oscillator)
RF Output: RANGE: 0.1 μv to 0.1 volts (across external 50 ohm load)	Pulse Modulation: From external source
ACCURACY: $\pm 10\%$ 0.1 to 50 K μv , 10 to 250 mc $\pm 15\%$ 0.1 to 50 K μv , 250 to 500 mc $\pm 20\%$ 0.05 to 0.1 v, 10 to 500 mc	Pulse Rise Time: $< 5 \mu\text{sec}$ 10 to 40 mc $< 3 \mu\text{sec}$ 40 to 80 mc $< 2 \mu\text{sec}$ 80 to 500 mc
AM Range: 0 to 30%	Pulse Overshoot: $< 10\%$ 10 to 100 mc $< 25\%$ 100 to 500 mc
AM Accuracy: $\pm 10\%$ at 30% AM, 10 to 250 mc $\pm 15\%$ at 30% AM, 250 to 500 mc	Modulating Oscillator: 400 and 1000 cps $\pm 10\%$
AM Distortion: 5% 10 to 250 mc 7% 250 to 500 mc	

NEW CATALOG AVAILABLE

Includes several new precision test instruments with exclusive BRC design features.

This new BRC signal generator is an outgrowth of a quarter century of experience in the design of precision electronic instruments. Ruggedly constructed for stability, reliability, and extremely low leakage, this instrument incorporates a backlash-free gear drive and a precision machined piston attenuator. Complete shielding is provided in the MOPA circuit by mounting

the oscillator and amplifier in separate aluminum castings. By simply removing cabinet end bells, it is suitable for 19" rack mounting; an important feature for system applications. Because of its unique FM modulation above 130 mc, it also provides for testing and calibrating FM communication systems in the 160 and 450 mc bands. Price: \$945. F.O.B. Boonton, N. J.

25th
ANNIVERSARY

Precision Electronic Instruments since 1934

BOONTON RADIO CORPORATION

BOONTON, NEW JERSEY, U.S.A.



Mergers Show Diversification

ALUMINUM COMPANY OF AMERICA announces acquisition of REA Magnet Wire, Ft. Wayne, Ind. The wire company will operate as an Alcoa subsidiary with no changes in personnel. Terms of the acquisition were not disclosed—just the fact that Alcoa stock was exchanged.

• American Enka Corp., Boston, announces formation of the William-Brand-Rex Division for the manufacture of specialized wire and cable. The new division will begin its corporate life with sales in excess of \$15 million. The division plans to expand research on styrene copolymers with special uhf properties. The new facility will have four manufacturing locations: West Acton, Mass., North Wingham, Conn., Willimantic, Conn., and Santa Monica, Calif.

• Gorham Manufacturing, Providence, R. I., reports plans to purchase Pickard & Burns, Inc., Needham, Mass., as a subsidiary. P&B specializes in research and development in radar, communications and radio navigation. Gorham, a leading silversmith concern, became interested in electronics some 15 years ago, according to company officials, and has a manufacturing history of precision components in microwave equipment and other areas of electronics. Pickard & Burns will operate Gorham's electronic division when the acquisition is completed.

• Mid-Eastern Electronics, Springfield, N. J., reports over-subscription of a stock issue made last month of 60,000 shares at \$2.50 a share. The firm, which manufactures specialized resistance test equipment, has an authorized capitalization of 1 million shares at a par value of 10 cents a share. The offering was made without an underwriting agent.

• Robinson Technical Products, Teterboro, N. J., discloses acquisition of Kensico Tube Co., manu-

facturer of copper pipe and tubing in small diameters. Such tubing in the so-called capillary range is used in the manufacture of instrumentation and controls of missiles and aircraft. The tube company's sales for the fiscal year just ended totaled \$7,207,000, with net income of \$269,000. These figures are up from sales of \$5,258,000 and a net income of \$166,000 the previous year.

• Hewlett-Packard, Palo Alto, Calif., reports earnings of \$3,899, 941 for the fiscal year ended Oct. 31, 1959. Sales totaled \$47,745,073, a 34-percent increase over the equivalent period the year before.

H-P president David Packard says part of the increase is due to stepped-up R&D projects which produced several new products. They accounted for a large portion of last year's sales growth.

• Federal Pacific Electric Co. approves plans to acquire all possible outstanding shares of Cornell-Dubilier Electric Corp. Stockholders have authorized 500,000 shares of 5½ percent convertible debentures, par value \$23, to be offered in exchange for the C-D common stock share-per-share.

25 MOST ACTIVE STOCKS

WEEK ENDING FEBRUARY 5

	SHARES (IN 100's)	HIGH	LOW	CLOSE
Westinghouse	982	52¼	49	51½
Gen Electric	872	90¾	85½	88½
Sperry Rand	811	24½	23	23½
RCA	730	61½	59½	60¾
Gen Tel & Elec	508	79¾	75	77¾
Collins Radio	498	60½	53¾	56¼
Elec & Mus Ind	496	7¾	7	7
Univ Controls	483	16½	15½	15¾
Int'l Tel Tel	480	35½	33½	34½
Avco Corp	389	13¾	13	13¼
Philco Corp	355	31¾	30	30
Litton Ind	320	65¾	60¾	61¼
Int'l Resistance	300	22¼	20¼	21¼
Ampex	278	105¾	99	101¼
Raytheon	277	49¾	47½	47½
Beckman Inst	270	70½	66¼	67¼
Dynmcs Corp Amer	269	115½	10¾	11
Muntz Tv	267	6	5¼	6
Gen Dynamics	243	49½	47	48½
Reeves Sndcrft	230	107½	10	10
Texas Inst	227	169¾	162¼	168½
Varian Assoc	216	43¾	40¼	42¼
Lear Inc	215	18½	16¾	167½
A B DuMont	214	9¼	8½	8½
Burroughs	213	31¼	30¼	30¼

The above figures represent sales of electronics stocks on the New York and American Stock Exchanges. Listings are prepared exclusively for ELECTRONICS by Ira Haupt & Co., investment bankers.

Graphite Facts

by George T. Sermon, President
United Carbon Products Co.



Pride, Production ...and "Sourcery"

No doubt your engineers take great pride in the semiconductor components they design to represent your company in the world market. And your engineers know: (1) that you must be able to produce in volume to meet the challenge of competition; (2) that it takes many months of development work and scheduling to get a semiconductor processing program into high gear.

Now a question. What happens if (in spite of this knowledge and the careful planning it inspires) your company's *source for graphite parts* suddenly vanishes from the scene, or for some not too mysterious reason simply cannot meet the accelerated volume requirements of a successful semiconductor program? The answer. Your program is derailed for many months. Competitively, you're in a very awkward position. And your engineers have nothing much to show for their efforts except some lingering pride in a design they know could have been a winner.

Scary story? Yes. But it *could* happen to you. It has to others. It's a very good reason why you (and your engineers) should *insist* on a competent, experienced, *insured* source for graphite parts. Here is *that* kind of source.

UNITED carbon products co.

BOX 747

BAY CITY, MICHIGAN

Gertsch frequency measuring equipment

**- double-duty units... measure
and generate with high accuracy and
stability, over wide frequency ranges**



FM3/PS-3

VHF FREQUENCY METER

Direct reading...the standard of the industry. Accurate to .001%. Frequency range: 20 to 1000 mc, with continuous coverage. Also measures harmonics down to 1 mc. Available AC and battery operated, case or rack mount.



FM-6

VHF FREQUENCY METER

Minimum accuracy and stability is .0001%. Direct reading. Measures or generates frequencies of 20 - 1,000 Mcs. May be used with external 100 kc counter to obtain accuracies approaching .00001%. Supplied case or rack mounted.



FM-4A

MICROWAVE FREQUENCY MULTIPLIER

This phase-locked oscillator transfers the accuracy and stability of a VHF driver into the microwave region, giving continuous coverage. Basic frequency range: 500 to 1000 Mcs...with harmonic output, extends to at least 30,000 Mcs. Used with the FM-3, FM-6, or FM-7. Adaptable for rack mounting.



FM-7

VHF FREQUENCY METER

Portable unit, with minimum accuracy of .0002% (direct reading) or .0001% (with correction curve) over frequency range of 20 - 1,000 Mcs. Exceeds new FCC requirements. May be used as a signal generator. Combined with the DM-3 and RFA-1, provides a complete communications servicing package.



FM-5

FREQUENCY DIVIDER

When driven by a VHF frequency meter, unit measures down to 50 kc...generates down to 200 kc, with no loss of accuracy. Measures and generates up to 20 mc, continuous coverage. Accuracy and stability: from .001% to .00001%, depending on Gertsch driver. Battery and AC operation. Available rack mounted.



DM-3C

PEAK DEVIATION METER

When combined with the FM-3, FM-6 or FM-7, enables them to also read peak modulation deviation... Completely transistorized... AC operated. Reads deviation directly with 15 kc and 7.5 kc full-scale ranges. Accuracy: 5% of full scale. Available portable, rack mounted, or combined with the FM-3, FM-6 and FM-7.

Gertsch quality construction
on all units. For complete
data, request Bulletin FM.



RFA-1

RF ATTENUATOR

A precision-built wave guide below cut-off unit, for use with the FM-3, FM-6 or FM-7. Maximum attenuation: 100 db. Minimum insertion loss: 20 db, with calibration of 3 db increments.

Gertsch

GERTSCH PRODUCTS, INC.

3211 S. La Cienega Blvd., Los Angeles 16, Calif. • Upton 0-2761 • Vermont 9-2201

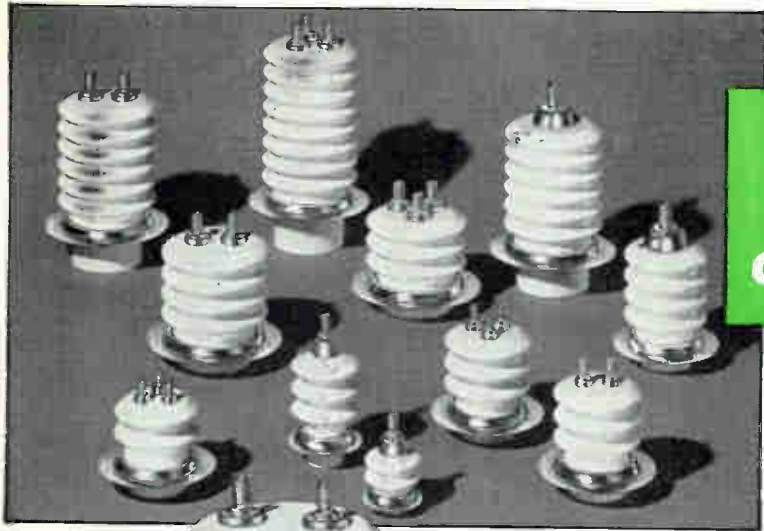

ALITE®

CERAMIC-TO-METAL SEALS

*Standard Bushings
or Special Designs*

FROM ONE COMPLETELY INTEGRATED SOURCE

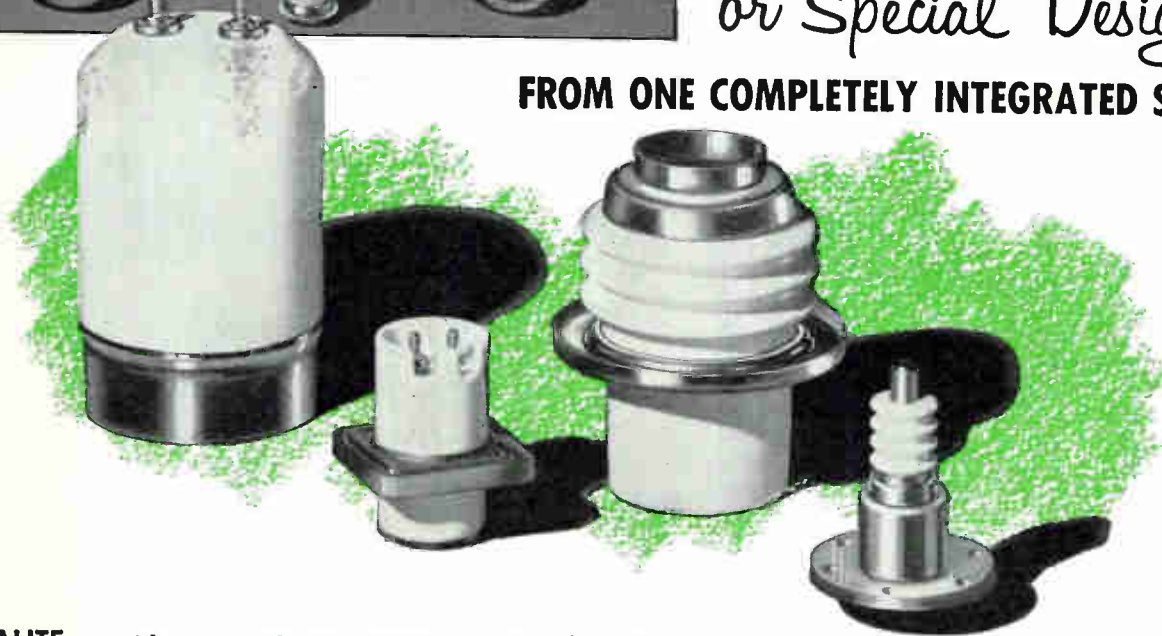

ALITE — with its completely equipped facilities for producing high quality, vacuum-tight, ceramic-to-metal seals — is geared to meet all your requirements for high alumina ceramic-metal components. From design to finished assembly, every manufacturing step — including formulating, firing, metalizing and testing — is carefully supervised in our own plant. Result: effective quality control and utmost reliability.

Hermetic seals and bushings made of high alumina Alite are recommended for electromechanical applications where service conditions are extremely severe or critical. Alite has high mechanical strength and thermal shock resistance. It maintains low-loss characteristics through a wide frequency and temperature range. It resists corrosion, abrasion and nuclear radiation. Its extra-smooth, hard, high-fired glaze assures high surface resistivity.

To simplify design problems and speed delivery, Alite high voltage terminals, feed-throughs and cable end seals are available in over 100 standard sizes. However, when specifications call for special units for unusual applications, you can rely on expert assistance from Alite engineers to help you take full advantage of Alite's superior properties.

Write us about your specific requirements today.

WRITE FOR HELPFUL FREE BULLETINS

Bulletin A-7R gives useful comparative data. Bulletin A-40 describes Alite facilities and complete line of Alite Standard Bushings.



ALITE DIVISION

U. S. STONEWARE

BOX 119

ORRVILLE, OHIO

New York Office — 60 East 42nd St.

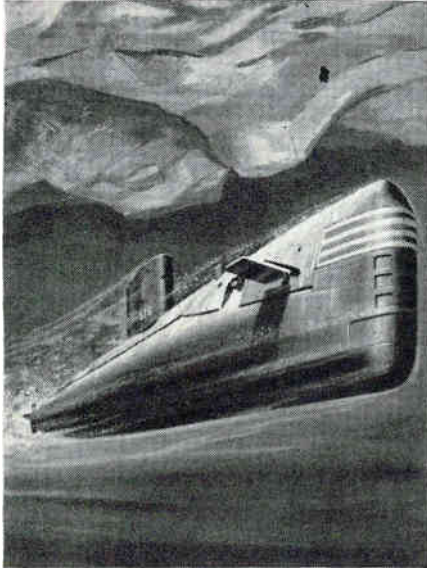

Now offering... creative careers in ordnance

Expanding operations in an exciting, growing company have created unusual career opportunities for ordnance engineers. Assignments on research and development projects will require the mature judgement of from two to ten years' experience in the field and present a combination of stimulating challenge and an ideal professional climate for contribution and personal development.

The company: the Crosley Division of Avco Corporation. There, confidence and personnel morale stem from aggressive management, a progressive approach to individual effort, and maximum support for all projects. Definite creative career opportunities are available now. Experienced personnel can choose from:

- Ballistics
- Arming and Fuzing
- Non-nuclear Weapons Systems Analysis
- Target Damage Evaluation
- Warhead Design
- Shells System Design
- Microminiature Electronic Assemblies Design
- Projectile Design

For complete information, write or call: Mr. P. B. Olney, Manager of Scientific and Administrative Personnel, Dept. E-230, Crosley Division, Avco Corporation, 1329 Arlington Street, Cincinnati 25, Ohio. Phone: KIrbv 1-6600.

Avco // **Crosley**

MARKET RESEARCH

New Look at Nuclear Sales

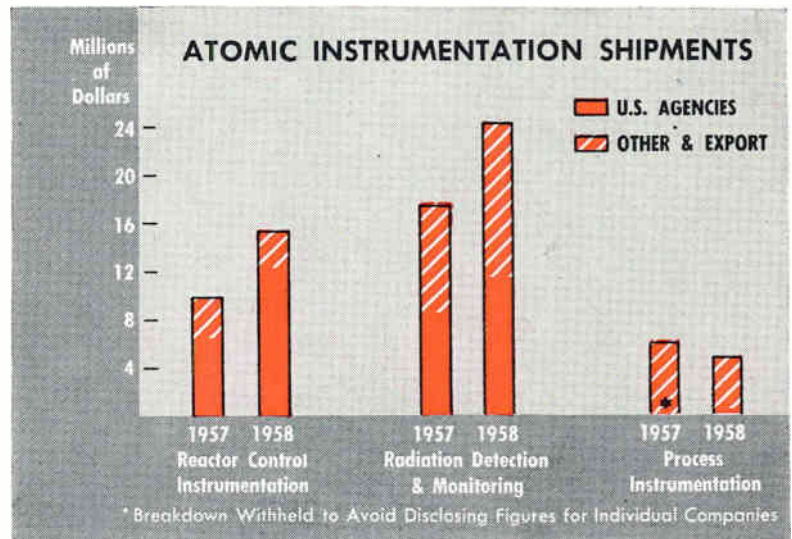

MORE THAN 44 million dollars—that was the value of nuclear instruments shipped in 1958, reveals the Bureau of Census in its recent Facts for Industry report covering atomic energy products.

This amount represents an increase of nearly 33 percent over 1957, when total nuclear instrument shipments were valued at \$33,431,000.

Nuclear instruments are used for reactor control, radiation detection and monitoring, and process control. Chart shows figures for these three categories, as well as a market breakdown indicating values shipped to U.S. government agencies and to non-government markets both at home and overseas.

Biggest jump was made by radiation detection and monitoring devices, up from \$17.5 million in 1957 to \$24.3 million in 1958, an advance of 38 percent. This group includes radiation survey, monitoring, counting and control devices. The report shows that sales of monitoring and control devices reached \$13.8 million in 1958, while counting equipment totaled \$10.4 million.

Down in 1958 were process instruments—control and measuring devices containing radioactive isotopes. These fell 22.4 percent—from \$6 million in 1957 to less than \$5 million in 1958.

Value of all atomic energy prod-

uct shipments rose from \$96 million in 1957 to \$149 million in 1958. Electronics industry share of total was 29.8 percent in 1958, against 34.8 percent in 1957.

ELECTRONICS estimates that nuclear instrumentation shipments in 1959 went up 12.4 percent over 1958 to a total of \$50 million. Our prediction for 1960 is \$60 million, up 20 percent over 1959.

More details on current sales will be available later this year when the Business and Defense Services Administration completes its special survey on nuclear instrumentation.

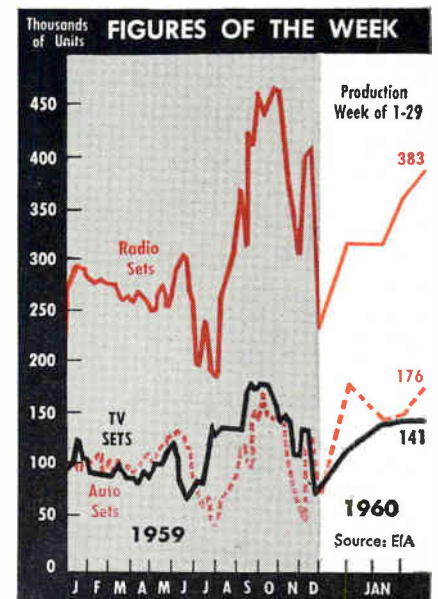

Crosley Amplifiers— Under The Polar Ice Cap

Today's Navy calls for reliability. New submarines and surface ships demand technical mastery in every phase of development. When amplifiers used in underwater torpedo fire-control systems failed after a few hours of operation, the Navy turned to Avco's Crosley Division for help.

Crosley engineering solved the problem. The product: an amplifier that operates without failure for 2000 hours or longer.

Recently the Navy decided to install Crosley amplifiers in fire-control systems aboard many of its modern vessels—including the nuclear-powered submarines *S.S. (N) Nautilus*, *S.S. (N) Skate*, *S.S. (N) Sargo* and *S.S. (N) Swordfish*. When the *Skate* made its historic journey under the Arctic ice cap in 1958, it had Crosley-made amplifiers aboard. Today, some ten different types of Crosley amplifiers are used by ships of the U.S. Navy.

Crosley's talent for design, engineering, and manufacture of transistorized amplifiers has secured an important place for this critical equipment. It is reflected in airborne television gun-sighting equipment purchased by the U.S. Air Force, in the huge FPS-26 height finder radar for perimeter defense, and in the Navy's *Polaris* missile system.

For more information on amplifiers designed and produced by Crosley, write . . . Vice President, Marketing-Defense Products, Crosley Division, Avco Corporation, Cincinnati 25, Ohio.

UNUSUAL CAREER OPPORTUNITIES FOR QUALIFIED SCIENTISTS AND ENGINEERS . . . WRITE AVCO/CROSLY TODAY.

Avco // **Crosley**

CIRCLE 23 ON READER SERVICE CARD

One of a series of midget servo amplifiers developed by Avco/Crosley for use in underwater fire-control systems.

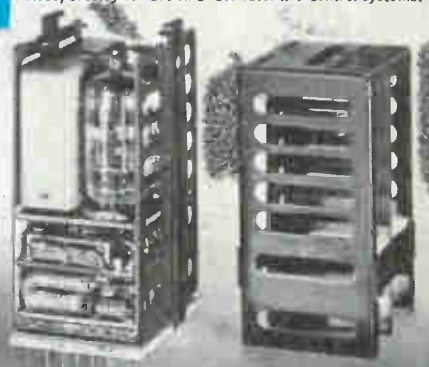

Announcing . . .

SILICON RECTIFIERS



from

DELCO RADIO

High Quality
High Performance
Extreme Reliability

From the leading manufacturer of power transistors, new Silicon Power Rectifiers to meet your most exacting requirements. Even under conditions of extreme temperatures, humidity and mechanical shock, these diffused junction rectifiers continue to function at maximum capacity! Thoroughly dependable, completely reliable—new Delco Rectifiers are an important addition to Delco Radio's high quality semiconductor line.

**Conservatively rated at 40 and 22 amperes
for continuous duty up to case temperatures of 150°C.**

	TYPE	AVG. DC CURRENT	PIV	NORMAL MAX. TEMP.	MAX. FORWARD DROP	MAX. REVERSE CURRENT
	1N1191A	22A	50V	150°C	1.2V at 60 amps.	5.0 MA
	1N1192A	22A	100V	150°C	1.2V at 60 amps.	5.0 MA
	1N1193A	22A	150V	150°C	1.2V at 60 amps.	5.0 MA
	1N1194A	22A	200V	150°C	1.2V at 60 amps.	5.0 MA
	1N1183A	40A	50V	150°C	1.1V at 100 amps.	5.0 MA
	1N1184A	40A	100V	150°C	1.1V at 100 amps.	5.0 MA
	1N1185A	40A	150V	150°C	1.1V at 100 amps.	5.0 MA
	1N1186A	40A	200V	150°C	1.1V at 100 amps.	5.0 MA

at 150°C case temperature and rated PIV

For full information and applications assistance, contact your Delco Radio representative.

Newark, New Jersey
1180 Raymond Boulevard
Tel: Mitchell 2-6165

Chicago, Illinois
5750 West 51st Street
Tel: Portsmouth 7-3500

Santa Monica, California
726 Santa Monica Boulevard
Tel: Exbrook 3-1465

Division of General Motors • Kokomo, Indiana





LFE Magnetic Amplifier controls frequency and load division between alternators. It is employed in the power supply systems of both the X-15 and B-52.

How LFE helped solve power control problems for the X-15

When the X-15 zooms to the outer fringes of the atmosphere where there is inadequate natural combustion, two auxiliary systems . . . fueled by hydrogen peroxide . . . become the sole source of power.

Electricity and hydraulic pressure produced by this 48 lb. package power the space vehicle's complete instrumentation, air conditioning, communications, guidance and operating control systems . . . from launch to touchdown.

power supply frequency despite radical variations in load and temperature extremes. Acting as a servo-controller this compact solid state device controls flow of hydrogen peroxide to the turbine and constantly corrects frequency error and load unbalance. The degree of control achieved ($\pm 0.5\%$) represents the ultimate in the present state of the art.

The reliability of the basic design has been proven in production, by LFE, of several thousand Magnetic Amplifier Controllers for the B-52. From proposal — to prototype — to production, the performance of the servo-controller dramatically exemplifies LFE's capability for meeting new problems with new concepts.

LFE designed a Magnetic Control Amplifier that maintains constant





Leadership from **E**xperience

LABORATORY FOR ELECTRONICS, INC. 1079 COMMONWEALTH AVENUE • BOSTON

ENGINEERS: LFE now offers several excellent employment opportunities in the fields of Navigation, Radar and Surveillance, Data Handling and Microwave Instrumentation.

98.5% survival

That's the life-test record of General Electric low-current

GERMANIUM LOW CURRENT	FEATURES	JEDEC or G-E TYPE NO.	PIV.	MAXIMUM I _{dc} at T°C	MAXIMUM I Cycle (60 cps) Surge	MAXIMUM Storage TEMP. °C	
	Alloyed junction type combining very low forward resistance with high back resistance	1N91	100	150ma at 55°amb.	25A	85°	
		1N92	200	100ma at 55°amb.	25A	85°	
		1N93	300	75ma at 55°amb.	25A	85°	
	Single and double-fin units	USN1N93	300	75ma at 55°amb.	25A	85°	
		1N151	100	500ma at 55°amb.	25A	85°	
		1N152	200	500ma at 55°amb.	25A	85°	
		1N153	300	500ma at 55°amb.	25A	85°	
		1N158	380	500ma at 55°amb.	25A	85°	
	Designed for high operating temperatures and low reverse current	1N315	100	100ma at 85°amb.	5A	95°	
		USAFIN315	100	100ma at 85°amb.	5A	100°	
		1N368	200	100ma at 85°amb.	10A	85°	
	Designed for maximum forward conductance at high operating temperatures (165°C)	1N536	50	500ma at 100°amb.	15A	175°	
		1N537	100	500ma at 100°amb.	15A	175°	
		1N538	200	500ma at 100°amb.	15A	175°	
		USAFIN538	200	500ma at 100°amb.	15A	175°	
		1N539	300	500ma at 100°amb.	15A	175°	
		1N540	400	500ma at 100°amb.	15A	175°	
		USAFIN540	400	500ma at 100°amb.	15A	175°	
		1N547	600	500ma at 100°amb.	15A	175°	
		1N1095	500	425ma at 100°amb.	15A	175°	
		1N1096	600	350ma at 100°amb.	15A	175°	
		Similar to 1N536 series but with very low reverse current. Ideal for magnetic amplifier applications.	1N440	100	300ma at 100°amb.	15A	175°
			1N440B	100	500ma at 100°amb.	15A	175°
	1N441		200	300ma at 100°amb.	15A	175°	
	1N441B		200	500ma at 100°amb.	15A	175°	
	1N442		300	300ma at 100°amb.	15A	175°	
	1N442B		300	500ma at 100°amb.	15A	175°	
	1N443		400	300ma at 100°amb.	15A	175°	
	1N443B		400	500ma at 100°amb.	15A	175°	
	1N444		500	300ma at 100°amb.	15A	175°	
	1N444B		500	425ma at 100°amb.	15A	175°	
	1N445		600	300ma at 100°amb.	15A	175°	
	1N445B		600	350ma at 100°amb.	15A	175°	
	Less expensive versions of 1N536 series for lower temperatures (140°C)	1N1487	100	370ma at 100°amb.	15A	150°	
		1N1488	200	370ma at 100°amb.	15A	150°	
		1N1489	300	370ma at 100°amb.	15A	150°	
		1N1490	400	370ma at 100°amb.	15A	150°	
		1N1491	500	300ma at 100°amb.	15A	150°	
		1N1492	600	250ma at 95°amb.	15A	150°	
	Lower current and temperature operation (100°C) than any of above series; very economical	1N1692	100	600ma at 100°C amb.	20A	125°	
		1N1693	200	600ma at 100°C amb.	20A	125°	
		1N1694	300	600ma at 100°C amb.	20A	125°	
		1N1695	400	600ma at 100°C amb.	20A	125°	
	Similar to 1N440B series	1N1100	100	500ma at 100°amb.	15A	175°	
		1N1101	200	500ma at 100°amb.	15A	175°	
		1N1102	300	500ma at 100°amb.	15A	175°	
		1N1103	400	500ma at 100°amb.	15A	175°	
1N599(A)		50	400ma at 100°amb.	10A	175°		
1N600(A)		100	400ma at 100°amb.	10A	175°		
1N601(A)		150	400ma at 100°amb.	10A	175°		
1N599 series similar to 1N540 series; 1N599A series similar to 1N440B series. Forward current ratings are somewhat lower.	1N602(A)	200	400ma at 100°amb.	10A	175°		
	1N603(A)	300	400ma at 100°amb.	10A	175°		
	1N604(A)	400	400ma at 100°amb.	10A	175°		
	1N605(A)	500	400ma at 100°amb.	10A	175°		
	1N606(A)	600	400ma at 100°amb.	10A	175°		
	Same as 1N540 series except stud mounted; maximum forward conductance at high operating temperatures	1N1115	100	1.5A at 85°stud.	15A	175°	
		1N1116	200	1.5A at 85°stud.	15A	175°	
		1N1117	300	1.5A at 85°stud.	15A	175°	
		1N1118	400	1.5A at 85°stud.	15A	175°	
		1N1119	500	1.5A at 85°stud.	15A	175°	
		1N1120	600	1.5A at 85°stud.	15A	175°	
	One of the first stud series, JAN1N256 units available	1N253	95	1000ma at 135°stud.	4A	150°	
		1N254	190	400ma at 135°stud.	1.5A	150°	
		1N255	380	400ma at 135°stud.	1.5A	150°	
		1N256	570	200ma at 135°stud.	1.5A	150°	
		1N550	100	800ma at 135°stud.	15A	175°	
		1N551	200	800ma at 135°stud.	15A	175°	
	Same as 1N440B series, except stud mounted; extremely low reverse current; well suited for magnetic amplifiers	1N552	300	800ma at 135°stud.	15A	175°	
		1N553	400	800ma at 135°stud.	15A	175°	
		1N554	500	600ma at 135°stud.	15A	175°	
		1N555	600	600ma at 135°stud.	15A	175°	

at 25,000 hours!

germanium rectifiers (Type 1N92); and silicon (Type 1N538)
is even higher for 10,000 hours

General Electric low-current rectifiers have earned a reputation for reliability without equal in the industry. The table below is just a sample of the numerous life test studies which prove out the superior reliability *built into* all G-E rectifiers.

Maximum Forward Conductance

General Electric low-current silicon and germanium rectifiers are designed for maximum forward conductance at high operating temperatures. High current loads are carried *without* external heat sinks. Reverse current at maximum junction temperature is maintained at an extremely low level, making these devices ideal for low-leakage applications.

Minimum Forward Voltage Drop

Minimum forward voltage drop and a hermetically sealed case have combined to produce low-current rectifiers whose reliability exceeds all known existing MIL specs. A comparative study shows that these G-E devices have the highest resistance to thermal runaway at maximum full-load operating temperatures of those products tested.

Choose the performance range you require from one of the most comprehensive low-current rectifier lines in the industry (see chart at left). Complete specifications are available from your General Electric Distributor or G-E Semiconductor District Sales Office. In Canada: Canadian General Electric Co., 189 Dufferin St., Toronto, Ontario. Export: International General Electric Co., 150 E. 42nd Street, New York, N. Y.

General Electric rectifiers are in stock at your local G-E Distributor

Survival Data From Operating and Elevated Storage Tests					
Type of Unit	PIV	Current (ma)	Type of Test	Na. of Units	*Percent Survival
1N92 Germanium	200V	100	Operating at full load	69	98.5 @ 25,000 hrs.
1N538 Silicon	200V	250	Operating at full load plus elevated storage life	83	99 @ 10,000 hrs.

*Percent survival = $\frac{\text{na. of good units} \times 100}{\text{total na. tested}}$

SILICON LOW CURRENT	FEATURES	JEDEC or G-E TYPE NO.	PIV.	MAXIMUM Idc at T°C	MAXIMUM 1 Cycle (60 cps) Surge	MAXIMUM Storage TEMP. °C
		 <p>A widely used line similar in most respects to 1N1115 series</p>		IN332	400	400ma at 150°stud.
IN333	400			200ma at 150°stud.	10A	170°
<p>IN607 series similar to 1N1115 series; IN607A series similar to 1N550 series</p>		IN334	300	400ma at 150°stud.	15A	170°
		IN335	300	200ma at 150°stud.	10A	170°
		IN336	200	400ma at 150°stud.	15A	170°
		IN337	200	200ma at 150°stud.	10A	170°
		IN339	100	400ma at 150°stud.	15A	170°
		IN340	100	200ma at 150°stud.	10A	170°
		IN341	400	400ma at 150°stud.	15A	170°
		IN342	400	200ma at 150°stud.	10A	170°
		IN343	300	400ma at 150°stud.	15A	170°
		IN344	300	200ma at 150°stud.	10A	170°
		IN345	200	400ma at 150°stud.	15A	170°
		IN346	200	200ma at 150°stud.	10A	170°
		IN348	100	400ma at 150°stud.	15A	170°
		IN349	100	200ma at 150°stud.	10A	170°
		IN607(A)	50	800ma at 135°stud.	15A	170°
		IN608(A)	100	800ma at 135°stud.	15A	170°
IN609(A)	150	800ma at 135°stud.	15A	170°		
IN610(A)	200	800ma at 135°stud.	15A	170°		
IN611(A)	300	800ma at 135°stud.	15A	170°		
IN612(A)	400	800ma at 135°stud.	15A	170°		
IN613(A)	500	600ma at 135°stud.	15A	170°		
IN614(A)	600	600ma at 135°stud.	15A	170°		
SILICON MEDIUM CURRENT	<p>Stud Mounted Cells. Designed for 2 to 20 ampere range. High junction temperature ratings, very low forward voltage drop and thermal resistance.</p>	IN2154	50	25A at 145°stud.	300A	200°
		IN2155	100	25A at 145°stud.	300A	200°
		IN2156	200	25A at 145°stud.	300A	200°
		IN2157	300	25A at 145°stud.	300A	200°
		IN2158	400	25A at 145°stud.	300A	200°
		IN2159	500	25A at 145°stud.	300A	200°
		IN2160	600	25A at 145°stud.	300A	200°

GENERAL ELECTRIC

Semiconductor Products Dept., Electronics Park, Syracuse, N. Y.

Electronics Gets EE Spotlight

Recent AIEE meeting featured more than tubes vs transistors debate:
Our industry was called in from the wings and given a starring role

NEW YORK—EMERGENCE of electronics into the spotlight was one of the salient features of the five-day Winter General Meeting of the American Institute of Electrical Engineers, held at the Statler-Hilton here earlier this month.

More than 5,000 engineers attended the meeting, which presented 350 papers in 121 technical sessions and symposia. Sessions this year were devoted to such subjects as electronic components, computers, infrared devices, missiles, radio and television, nucleonics, molecular electronics (microelectronics) and new power generation systems involving electronic techniques.

AIEE has traditionally been a fairly conservative organization, emphasizing in its big conferences discussions of conventional electrical technology and deemphasizing electronics. The conservative framework remains—GE's chief electric-utility executive, C. H. Linder, was elected 1960-61 president, for example—but a new spirit of interest in electronics now pervades the organization.

Tubes vs Transistors

One sign of the new attitude was an extensive debate on the respective merits of tubes and transistors. Behind this open debate was a great deal of subrosa discussion that has been going on in engineering circles about a military slowdown in specifying use of semiconductor devices.

One of the chief complaints of many potential users of transistors in the military and industrial fields is that comprehensive life data are not available, and that manufacturers' specifications remain too broad. The short history of semiconductor devices is responsible for this lack; new techniques for designing around transistor weaknesses are helping to overcome the problem.

E. R. Jervis, of ARINC Research Corp., in his paper delivered at the

AIEE meeting, took the thesis that "electron tubes will be used for a long time to come in special applications—provided a new attitude is taken in the evaluation of electron-tube applications and in the design of tubes to fit such applications." Long life and endurance to varying environments are currently more easily obtained with tubes than with solid-state devices, Jervis pointed out.

Westinghouse engineers E. E. Echeneman and S. K. Waldorf compared the advantages and disadvantages of the two classes of devices. They noted especially that the high electrical resistance between tube elements eases the problem of isolating circuits from each other, and that tubes can be operated at very high voltages. Operating temperatures for tubes can exceed 175 C, the upper limit for most semiconductors.

On the other hand, transistors require no heater power, have little mass and small volume, and thus are more resistant to shock and vibration. Certain types of transistors perform very well at low voltages.

General Electric's R. E. Moe pointed out some of the shortcomings of transistors, including these:

- ". . . Characteristics are far more sensitive to changes in temperature . . .
- ". . . Increasingly difficult to build for operation above 500 kc . . .
- "Although relatively free of microphonics and variable leakage-path noise . . . transistors have an inherently higher random-noise output.
- ". . . Properties are more difficult to control in production.
- ". . . Definitely vulnerable to high-energy gamma radiation."

In the healthy atmosphere of a public debate, the general consensus was that each device has its own valuable niche, but that reliable engineering and design procedures still require more exact specifica-

tions and more reliability data for transistors.

Microelectronics

The means for achieving smaller circuit packages were also hot topics for both public and private discussion.

Hughes Semiconductor engineers described the field of microelectronics as embracing activities which point toward reducing circuit size by three or four orders of magnitude, improving reliability by two or more orders of magnitude, and reducing power levels by three orders of magnitude. They discussed the evolution of microelectronics from the stage of subminiature circuit packs, through the formation of active and passive components directly on circuit stripes, to the growing of functional circuits *en bloc*.

The Hughes spokesmen also envisaged a fourth stage of development, still in the future, in which complete systems would be grown just as microelectronic function blocks are now. These systems would emulate the brain and use techniques borrowed from neuron chemistry and the biological sciences (see box).

Space Technology

Missiles, rockets and space provided the takeoff point for several papers. A high-speed wide-chart recorder for use in rocket testing and industrial controls was described in one paper; the recorder uses a sensitive null-balancing potentiometer circuit.

A Convair Astronautics engineer discussed a two-channel data link to hook a digital computer to an analog simulator used in the Atlas program. Applied Science Corp. of Princeton, N. J., disclosed a new pulse-duration modulation telemetering system; principal advantage of pdm, the ASCOP spokesmen said, was low susceptibility to noise error and dropout.

Electrostatic propulsion for space vehicles was discussed by A. J. Gale of High Voltage Engineering. Gale said that electrostatic thrust systems using ionic or colloidal materials "represents one of the most practical approaches we can envisage today."

Industrial and Commercial Uses

Speakers at the meeting discussed computer and automatic-control applications for chemical and petroleum industries. A Humble Oil engineer pointed out that use of analog computers "is now in its infancy" in petroleum refining, and that analysis of refinery problems would disclose many more uses. (Digital computers are also used in a few refineries for control purposes).

Other papers discussed computer uses in the railroad industry for controlling the use of a heavily travelled single-track main line, and for analyzing performance of new train designs; and electronic control and data-accumulation techniques used in metal refining.

A Minneapolis-Honeywell engi-

neer discussed automatic logging equipment for use in television transmitting stations. He reported that three, stations—WTOP and WMAL in Washington, D. C., and KFI in Los Angeles—are already logging transmitter parameters automatically, and that National Association of Broadcasters has asked the Federal Communications Commission for a ruling that the log charts are acceptable as the official station log.

Also in the radio-tv field, M. T. Decker of National Bureau of Standards' Boulder, Colo., laboratories discussed the use of commercial uhf television sets for reception of tv signals broadcast from aircraft. His report covered a study of airborne educational tv, and suggests that special equipment will be needed at both ends for maximum transmission power and low receiver noise. At certain distances, Decker says, diversity receiving antennas may be needed.

Education

Engineering education was the subject of a symposium which fea-

tured a discussion of undergraduate training by M. L. Manning of South Dakota State College.

Manning pointed out that new technological fields have added new dimensions to engineering knowledge, making the reform of conventional curricula "long overdue." Distinctions between mechanical, civil and electrical engineering "have practically vanished," the educator says, adding: "The basic principles of engineering analysis, together with science and mathematics, can easily occupy a full four-year program if the humanities and social studies are included."

Remarking on the new points of view emerging in engineering science, Manning predicted that detailed specialization will be deferred to the graduate level; that nonengineering subjects—language, fine arts, social sciences—will receive greater emphasis in the undergraduate curriculum; that shop courses will be transferred to technician training; and that present textbooks, which will be completely outdated within a short time, will be rewritten.

Reliability Through Redundancy

INTERRELATIONS between problems of electronic design and some of the techniques of nature in the design of the nervous system were explored at a special symposium "Reliability Through Redundancy" during the recent AIEE meeting. In a nutshell:

Electronic computers and communications systems fall short of the human brain and nervous system in performance. A human being can accept many parallel inputs, register some, reject others. Information can be cross-referenced at several levels and related data stored in the memory can be added to pertinent inputs. Memory access and cross-referencing take more time than in electronic systems, but the use of parallel paths and multilevel referencing, coupled with memory access by partial or incomplete index, more than make up for loss of speed. The human memory can absorb as much as 10^9 bits of information.

Neurons are the basic building blocks of the body's communications system. They accept "excite" or "inhibit" inputs arriving from other neurons by way of axon extensions. Output from the neuron is a computed function of net inputs.

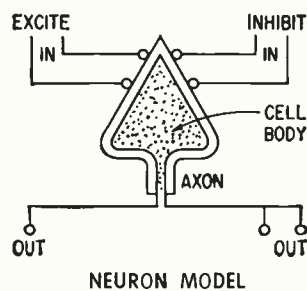

NEURON MODEL

Voltage difference between inside and outside of the neuron is about 100 mv; the distributed capacitance of the neuron is charged to this voltage.

A neuron may originate a nerve impulse or block it; thus it may be thought of as both generator and amplifier with variable bias. A change of voltage across one neuron is transmitted by its axon extensions to other neurons. Enough bias—which can come from habit, hypnosis, or inhibit inputs from other neurons—can prevent a cell from responding to its excite inputs.

Some nerve cells are unidirectional; most pass signals in both directions. Inputs must exceed the bias threshold to be accepted by the cell. In the equivalent electronic circuit, each time

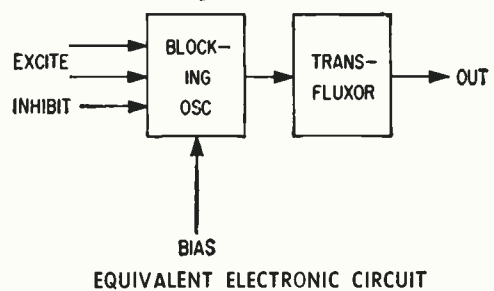

EQUIVALENT ELECTRONIC CIRCUIT

the blocking oscillator receives an input that exceeds the bias level, it steps the transfluxor; eventually the magnetic state of the transfluxor is stepped high enough to couple an exciting or inhibiting signal to the next stage.

The brain and nervous system learn by interconnecting. The computer of the future may be built of a random mass of tiny cells—cryotrons, perhaps—which will be "taught" sequential and parallel interconnections by catalysts and stimuli of various types and thereby develop its own system of second- and third-order feedbacks as the human system does. Such a system would have the high redundancy figure of "natural" design, and equivalent functional reliability.

New Trends in Finding Funds

Electronics companies' increasing needs for money to grow on are bringing about changes in capital funding procedures and methods

NEED FOR GROWTH CAPITAL is bringing the electronics industry and the nation's financial community closer together as the new decade starts.

Increasingly evident this week is the two-way nature of traffic going on in this regard. On one hand, small companies are seeking funds to finance expansion. On the other, financial organizations are seeking growth situations to put their money into.

In the early days of the electronics industry, growth capital was often hard to come by. One reason for this was the reluctance of conservative financing organizations to deal with an industry they did not thoroughly understand.

Trend to Specialty

Today, the situation is quite changed. There is a trend to specialized funding firms thoroughly

conversant with the industry. Venture-capital organizations now employ specialists in electronics, and even bankers are showing increased interest in expanding into electronics.

In addition, both electronics men and financiers are finding government assistance being made available to them in a number of circumstances.

One example of new financing methods may be found in Electronics Capital Corporation's operations. This San Diego, Calif., company was formed to make portions of the Small Business Investment Act work for the electronics industry. Under this act, passed in 1958, firms like ECC are entitled to a considerable tax advantage which works to the benefit of investors and companies receiving funds through such channels.

Here's how financing through ECC works:

A company wanting additional capital will submit itself to a thorough investigation. Because of the relative youth of the electronics industry, the new, small firm often has little if any previous history of sales and earnings. Investigators must therefore rely on their knowledge of the industry to evaluate the potential of new product development or research programs.

(President of ECC is Charles Salik who gained his experience through radio station KCBQ and tv channel 10 in San Diego and boosted both into profitable properties. Executive vice president Richard Silberman was formerly president of a major electronics manufacturing division, and C. A. Wetherall, senior technical officer, was at one time chief engineer of an electronics firm and prior to that, assistant chief engineer for Convair.

(In addition, members of the board of directors includes Dr. Joseph M. Petit, dean of Stanford University's school of engineering.)

Once evaluation is completed, the amount of capital required is established. In attempts to avoid a "shoe-string" budget which may hamper one phase of company operation at the expense of another, the amount of capital is made adequate beyond the mere necessities. The finance firm receives a portion of convertible debentures and a representation on the company's board of directors.

Small Business Emphasis

Financing provided must be for a minimum period of five years, and since non-incorporated companies cannot issue convertible debentures, the California company may deal only with corporations in the Small Business category.

According to law, Small Businesses are defined as those having



Learning before investing, R. T. Silberman (left) of Electronics Capital Corp. gets details on scan converter tube from Francis Salgo, president of General Electrodynamics

total assets of less than \$5 million, and average profit over the past three years of less than \$150,000.

As the fortunes of a company improve to remove it from this category, the lender will redeem the convertible debentures held and recycle the monies thus obtained.

Licensed less than a year, ECC (ELECTRONICS, p 21, June 12, '59) has made the following fund advances:

- Potter Instruments, \$750,000 in 7-year debentures
- General Electrodynamics, \$400,000 in 7-year debentures
- Vega Electronics, \$300,000, convertible debentures for 68 percent of common stock.
- Cain & Co., \$300,000 in 6-year convertible debentures plus \$100,000 through a long-term loan.
- Electronic Energy Conversion, \$1,250,000 in 6-year debentures convertible into 60 percent of common stock.

Electronics Favored

Somewhat similar in organization to ECC is Midwest Technical Development Corp., Minneapolis. MTDC now holds equities in electronics companies in these amounts: \$29,300 — Soroban Engineering; \$150,000 — Avien; \$9,600 — Minco Products; \$150,000 — National Semiconductor; \$43,000 — Talax. Other companies in the MTDC portfolio are Narda Ultrasonics, Washington Machine & Tool and Lumen, Inc.

In addition to large-scale operations, such as ECC and MTDC, there is evidence that venture-capital firms specializing in electronics may grow more numerous.

An example of such a firm is Electronics Funding Corp. in New York. This firm has a board of directors composed mostly of electronics men and is backed up by financial specialists. EF makes capital available usually through purchase and leaseback of capital equipment.

In addition, but not necessarily the prime object of operation, is the fact that if the small electronics firm flourishes, interest in common stock may be in order for the funding firm. Along with financing capital investments, the company also supplies management advice.

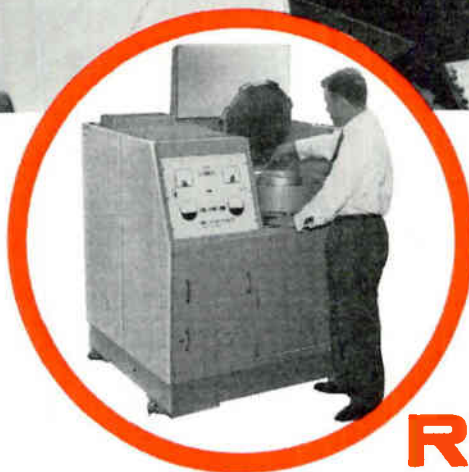

*fastest, most sensitive,
economical way to
DETECT "LEAKERS"
in hermetically
sealed components*

RADIFLO

Leading manufacturers of hermetically sealed components have installed RADIFLO and proven it to be the most sensitive, fastest and economical method of leak detection available for mass production.

100 TIMES MORE SENSITIVE—Components can be tested as high as 10^{-12} cc/sec. Super-sensitive RADIFLO reveals microscopic imperfections often undetected by less critical test methods.

TESTS NON-DESTRUCTIVELY—Rejected components need not be scrapped. The RADIFLO test method allows less-than-perfect components to be used in non-critical applications.

CAN BE PROGRAMMED AND AUTOMATED—Automatic programming feature permits modern automated mass production inspection of entire output, with immense savings in production time and labor.

ELIMINATES HUMAN ERROR—Components under test by RADIFLO are subjected to inert, radioactive gas, under pressure. During a "soaking" time the gas is forced into all existing leaks in the units. Then an air wash removes radioactive material from external surfaces. Each component is then placed in a scintillation counter for "go-no-go" inspection. A pre-selected acceptance leak rate allows non-technical workers to perform the test without error.

These leading manufacturers are among the many RADIFLO users:

SYLVANIA ELECTRIC PRODUCTS, INC.
GENERAL ELECTRIC COMPANY
Syracuse, N.Y. and Waynesboro, Va.
BULOVA WATCH COMPANY
HUGHES AIRCRAFT COMPANY
Tucson, Ariz. and Middletown, Pa.
WESTERN ELECTRIC COMPANY
ELGIN NATIONAL WATCH COMPANY
NIPPON ELECTRIC COMPANY

U. S. ARMY ORDNANCE, Frankford Arsenal
EITEL-McCULLOCH, INC.
U. S. ARMY CHEMICAL CORPS,
Research and Development Command
POTTER & BRUMFIELD, INC.
FAIRCHILD SEMICONDUCTOR CORP.
ALLEN-BRADLEY COMPANY
ARMY BALLISTIC MISSILE AGENCY

Let us help with your component leak problems. Write for complete details of automatic RADIFLO testing equipment. Manufacturers with limited production volume will be interested in RADIFLO TESTING SERVICE—now available at low cost on the east and west coasts.



AMERICAN ELECTRONICS, INC.

NUCLEAR DIVISION

9459 WEST JEFFERSON BOULEVARD, CULVER CITY, CALIFORNIA

SUBMINIATURE CAPACITORS



FOR Transistor CIRCUITRY

...packaged to fit where others won't!



601PE 602

UPRIGHT MOUNTING

ENCAPSULATED IN EPOXY

Slim, trim and compact. The specially shaped winding is of extended foil construction — equal in all regards to high quality Good-All tubular designs. These two types differ in that the 602 incorporates a base of epoxy-glass laminate for flush mounting on circuit boards.

SPECIFICATIONS

DielectricMylar Film
CaseEpoxy Dip
IR at 25°C75,000 megohms
Voltage Rating50VDC
Temp. Range.....-55°C to +125°C
Capacity Tolerance To ± 5%

TYPICAL 50 VOLT SIZES
TYPE 601 PE

CAP.	T	W	L
.01	.187	.310	.562
.047	.203	.531	.453
.1	.225	.650	.525
.22	.296	.718	.687
.33	.312	.812	.950



663F 663FR

EDGE MOUNTING

AXIAL OR RADIAL LEADS

These special-purpose versions of popular Good-All Type 663UW use precious space efficiently. Their ratings are conservative, and are equally suited for military and instrument grade applications.

SPECIFICATIONS

DielectricMylar Film
CasePlastic Wrap
End Fill.....Thermo-setting epoxy
Voltage Range100, 200, 400 & 600VDC
Temperature Range.....-55°C to +125°C
IR at 25°C.....100,000 meg. x mfd.
Humidity Resistance.....Superior

TYPICAL 100 VOLT SIZES
TYPES 663F and 663FR

CAP.	T	W	L
.01	.125	1/4	5/8
.047	.140	1/4	3/4
.1	.171	5/32	3/4
.47	.281	5/8	1 1/4
1.0	.375	3/4	1 1/2



627G

617G

Hermetically Sealed

50 VOLT RATING

Ideal transistor "companions" where hermetic sealing is required. Both types are smaller than comparable MIL-C-25A designs yet exceed all requirements of this specification.

SPECIFICATIONS

DielectricMylar Film
CaseHermetically Sealed
WindingExtended Foil
IR at 25°C40,000 meg. x mfd.

Type 627G

Temperature Range.....Full rating to 85°C, 50% derating at 125°C
DC Voltage Rating.....50 volts only

Type 617G

Temperature Range.....Full rating to 125°C, 50% derating at 150°C
DC Voltage Rating.....50, 150, 400 & 600

TYPICAL 50 VOLT SIZES
TYPE 627G

CAP.	DIA.	L
.01	.173	2 3/32
.047	.313	2 3/32
.1	.313	2 3/32
.47	.500	1 1/8
1.0	.560	1 1/32

Good-All Capacitors Are Available at Authorized Distributors

Write for detailed literature



GOOD-ALL ELECTRIC MFG. CO. OGALLALA, NEBRASKA

A LEADING MANUFACTURER OF TUBULAR, CERAMIC DISC AND ELECTROLYTIC CAPACITORS

KEY CHANGES IN BANDS

- New earth-space and space-research bands allocated
- Radioastronomy listed in table for first time
- Radionavigation radar frequencies separated from location radar
- New broadcast-television allocation set up at 12 kmc
- Spectrum 4—27.5 mc survives with minor changes

Geneva Reallocates Spectrum

International conference draws up major frequency and technical regulations affecting space age. U. S. proposals are well supported

THE IMPORTANCE of what was done in Geneva is becoming clear this week.

Significant changes in the radio spectrum resulted from decisions of the Ordinary Administrative Radio Conference held for four months in late 1959.

Approximately 625 delegates and advisors were present, representing 80-odd countries of the International Telecommunication Union.

Final acts of the conference consist of 45 articles of new regulations, grouped into 11 chapters and containing 1,629 paragraphs, 27 appendices, 15 resolutions and 36 recommendations.

Work of the conference was reported by Paul D. Miles, executive secretary, Interdepart Radio Advisory Committee, Office of Civil and Defense Mobilization, at the Winter General Meeting of the American Institute of Electrical Engineers held in New York City this month.

Frequency Table

In his review, Miles said: "No substantive change was made between 4 and 27.5 mc. This is considered one of the most important accomplishments of the U. S. delegation, which was instructed to op-

pose vigorously any change in that portion of the table.

"The world had just brought its frequency into conformity with the Atlantic City table, at great effort and expense, and further experience was considered to be necessary before making changes. Furthermore, it was feared that should any change be made, it would be for the benefit of high-frequency broadcasting at the expense of the fixed service which the United States could not afford."

An outstanding feature of the new table, according to Miles, was the separation of the uses of radar for radionavigation from other uses of radar, by effecting a series of allocations to a new radiolocation service. The proposal originated with the U. S. delegation.

Frequencies for Space

With the advent of space study, two new services were added to the table. Radioastronomy, allocations for which must be bands in which weak signals of cosmic origin can be received, was assigned 1,400-1,427 mc.

Another new service, earth-space and space research, of particular interest to U. S. and Russian delegates, was allocated narrow bands

at 10.004 and 20 mc and 40, 136.5, 183.6, 400.5, 1,428, 1,705, 2,295, 5,252 and 8,450 mc.

Further affecting the microwave region was an allocation at 12 kmc for a broadcast-tv band. The proposal was made by West Germany.

Low frequencies also came up for conference consideration. A new standard frequency was designated at 20 kc and maritime radionavigation in the American Region was provided for in the bands 70-90 and 110-130 kc. The Atlantic City allocations table for long-distance radionavigation in the bands 90-110 and 1,800-2,000 were preserved.

Technical Regulations

Miles reported new regulations in the technical field. A new article provides for more formal coordination of the proposed assignment of frequencies for standard frequency and time broadcasts in order to assure world-wide coverage without serious deterioration of the service in those areas now adequately served. Also adopted by the conference was a system of band numbering in which the band number is the exponent of 10 where the upper limit of the band is $3 \times 10^{\text{band number}}$ per second.

NEW SPRAGUE MODEL 500 INTERFERENCE LOCATOR

PORTABLE, VERSATILE
UNIT PINPOINTS SOURCE
OF INTERFERENCE

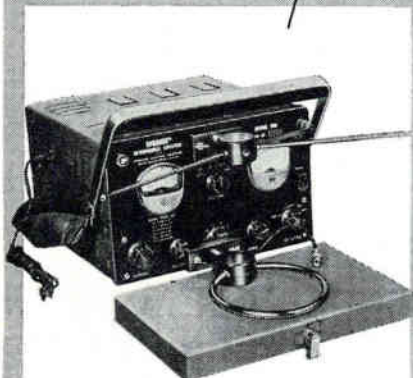

This improved instrument is a compact, rugged and highly sensitive interference locator—with the widest frequency range of any standard available unit.

New improvements in Model 500 include: *greatly increased sensitivity*, meter indications proportional to carrier strength, transistorized power supply. Engineered and designed for practical, easy-to-operate field use, it is the ideal instrument for rapid pinpointing of interference sources by electric utility linemen and industrial trouble shooters. Model 500 tunes across the entire standard and FM broadcast, shortwave, and VHF-TV spectrums from 540 Kc to 216 Mc. For full details send for brochure IL-102.

SPRAGUE ELECTRIC COMPANY
35 MARSHALL ST. • NORTH ADAMS, MASS.

SPRAGUE[®]
THE MARK OF RELIABILITY

New Site For U. S.

Ground is being cleared this week for Voice of America's new \$25-million base in No. Carolina

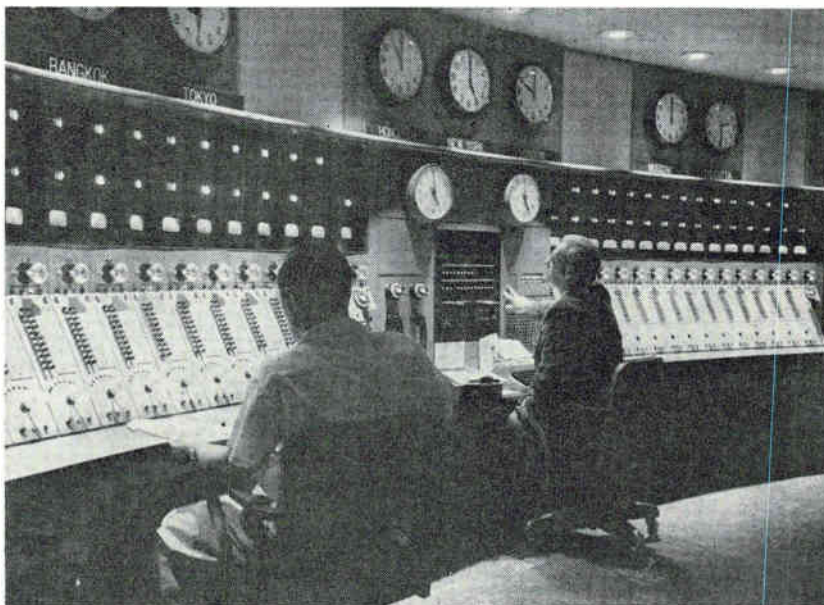

Master control panel in VOA's Washington studios can select from 100 program inputs, handle 26 different outputs at once. It will channel program fare to new facilities in Greenville, N. C.

A TOTAL OF 22 TRANSMITTERS and 93 antennas having a power capability of 4,820,000 watts are scheduled for installation at Greenville, N. C., by 1962, according to U. S. Information Agency.

This week in Greenville, land is being cleared on some 4,000 acres in preparation for the new Voice of America installation. When completed, the site will house six 500-kw transmitters supplied by Continental Electronics, Dallas, Tex.; six 250-kw transmitters by General Electric; six 50-kw units by Gates Radio and four 5-kw transmitters by Technical Materiel.

Antennas for this equipment will be supplied by Smith Electronics, Inc., Cleveland, while over-all design for the entire site is responsibility of the Austin Co., also of Cleveland.

Consolidation Planned

The Voice of America plans call for eventual consolidation of all east coast transmissions at the new facilities. These will replace a number of others now scattered along the eastern seaboard.

The North Carolina site was selected after a study which considered about 30 possible locations. Optimum signal propagation and freedom from interference with other radio transmissions were the prime factors leading to choice of the Carolina area.

The new facilities, including two transmitter stations and a receiving center, will be built on three sites located approximately 18 miles apart in a triangular pattern surrounding Greenville. This arrangement is designed to allow transmitter and receiver operations to be conducted without interfering with each other. Each transmitter building will be situated on a site of 2,700 acres. The receiver site will occupy 650 acres. All facilities will be linked by microwave and telegraph circuits.

In addition, connections will be provided with VOA studios in Washington, D. C., by long-distance telephone lines.

Auxiliary Facilities

The receiving center will contain short-wave radio receivers, tape re-

"Voice"

orders and teletype equipment. It will serve as headquarters for the entire installation and will handle relay traffic to the two transmission sites.

Signals from each of the 93 transmitting antennas will be beamed at specific target areas abroad. Antenna types will include rhombic, curtain and log periodic types. They will be arranged in a horseshoe pattern and will range in height from 50 to 375 ft.

Because of their geographic location, the antennas are being designed to withstand Atlantic hurricane winds of up to 120 miles per hour. Tower construction will use up about 3,000 tons of steel.

In anticipation of problems due to the unusually high amount of r-f activity at the site, system engineers paid much attention to binding and shielding, as well as grounding. All metals in the building structures will be electrically bonded and grounded.

Thimble-size Tube Goes in Production

A PRODUCTION CAPACITY of several million units annually was the goal this week as the RCA Electron Tube division expanded commercial output of the firm's nuvistor, new thimble-size electron tube (ELECTRONICS, p 70, April 3, 1959).

Price of the triode to RCA's equipment customers is \$1.96.

Douglas Y. Smith, vice president and general manager of the division, said the metal-ceramic tube's features include:

Low-voltage operation; low heater drain; very high transconductance at low plate voltage and current (11,500 microhms at 75 volts and 10.5 milliamperes); exceptional uniformity of characteristics from tube to tube; very high input impedance; high perveance; ability to operate at all altitudes at full ratings; small size and weight: metal shell only 8/10 of an inch long including peripheral lugs for indexing; less than 1/2 inch in diameter; 1/15 ounce (1.9 grams).

New Cup-Type Tantalum Capacitors Offer Major Improvements

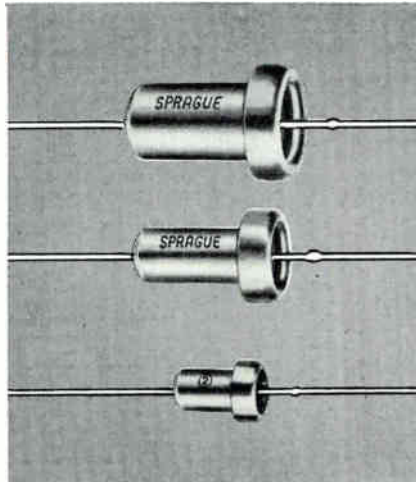

Sprague "Cup-Type" Liquid-Electrolyte Sintered-Anode Tantalex® Capacitors offer circuit designers several major improvements in the use of cup capacitors: larger values of capacitance in small physical size; elimination of fluctuation in capacitance during operation; and elimination of "early failures" from internal short-circuiting.

Rated for -55 to +85 C operation without voltage derating (to +100C with 15% derating), these capacitors promise long operating life, long shelf life, outstanding capacitance stability, and very low leakage currents.

Sprague "cup" capacitors are available in two series: Type 131D for industrial, communication, and general military equipment; Type 132D for the severe vibration requirements and close performance parameters of military aircraft and missiles.

For complete technical data, write for Bulletin 3710A to Technical Literature Section, Sprague Electric Company, 000 Marshall Street, North Adams, Mass.

CIRCLE 214 ON READER SERVICE CARD

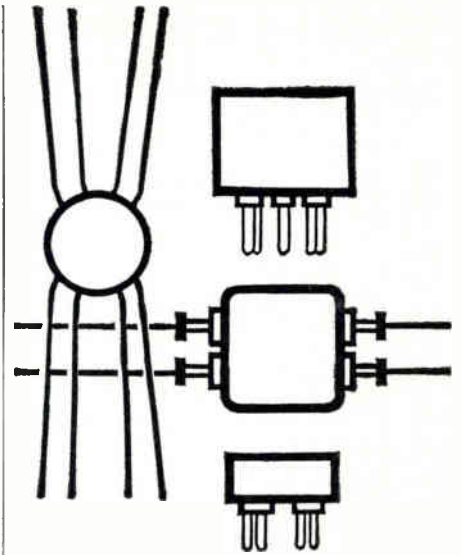

Sprague offers standard and special

PULSE TRANSFORMERS

for military and commercial applications

Standard or special... military or commercial... in any size or shape... Sprague Pulse Transformers are designed to give top performance... in high-speed computer circuits, pulse inversion circuits, impedance matching circuits, blocking oscillator circuits, and many others.

Special designs for high acceleration, high ambient temperatures or minified circuits can be furnished to suit requirements. Units are also available in lower-cost commercial housings.

For engineering assistance on your pulsetransformer problems, write to Special Products Division, Sprague Electric Company, Union St., North Adams, Mass.



CIRCLE 35 ON READER SERVICE CARD

NOT NEW, but...



...proved by millions in use over several years! IERC TR type Heat-dissipating Electron Tube Shields are still the only effective heat-dissipating tube shield designed for retrofitting equipment having JAN bases.

Present TR's are unchanged from the original version introduced — and over the years, nothing has equalled their cooling and retention qualities. The greatly extended tube life and reliability provided by IERC TR's is acknowledged by the entire industry.

IERC's TR's have been right for the job — right from the start. For immediate, increased tube life and reliability — retrofit now with IERC TR Shields.



Free IERC Tube Shield Guide, listing TR Shields, is available by writing Dept. TR for your copy.

International Electronic Research Corporation
145 West Magnolia Boulevard, Burbank, California

MEETINGS AHEAD

Feb. 19-23: Component Parts and Electronic Tubes, International Exhibition, Porte de Versailles, Place Balard, Paris.

Feb. 25-26: Scintillation Counter Symposium, AIEE, AEC, IRE, NBS, Hotel Shoreham, Washington, D. C.

Mar. 17-18: Synchro Design and Testing Symposium, Bureau of Naval Weapons, Dept. of Navy, Dept. of Commerce Auditorium, Washington, D. C.

Mar. 21-24: Institute of Radio Engineers, International Convention, Coliseum & Waldorf-Astoria Hotel, New York City.

Mar. 24-25: Human Factors in Electronics, PGHF of IRE, Bell Labs Auditorium, New York City.

Apr. 3-7: National Assoc. of Broadcasters, Engineering Conf. Committee, NAB, Conrad Hilton Hotel, Chicago.

Apr. 3-8: Nuclear Congress, EJC, PGNS of IRE, New York Coliseum, New York City.

Apr. 11-13: Protective Relay Engineers, Annual, A&M College of Texas, College Station, Texas.

Apr. 11-14: Weather Radar Conference, American Meteorological Society and Stanford Research Institute, San Francisco.

Apr. 18-19: Electronic Data Processing, ARS, Hotel Alms, Cincinnati, O.

Apr. 19-21: Active Networks & Feedback Systems, International Symposium, Department of Defense Research Agencies, IRE, Engineering Societies Bldg., New York City.

May 2-4: National Aeronautical Electronics Conference, Electronics Probes the Universe, NAECON, IRE, Biltmore and Miami-Pick Hotels, Dayton, O.

Aug. 23-26: Western Electronic Show and Convention, WESCON, Ambassador Hotel & Memorial Sports Arena, Los Angeles.

There's more news in ON the MARKET, PLANTS and PEOPLE and other departments beginning on p 76.

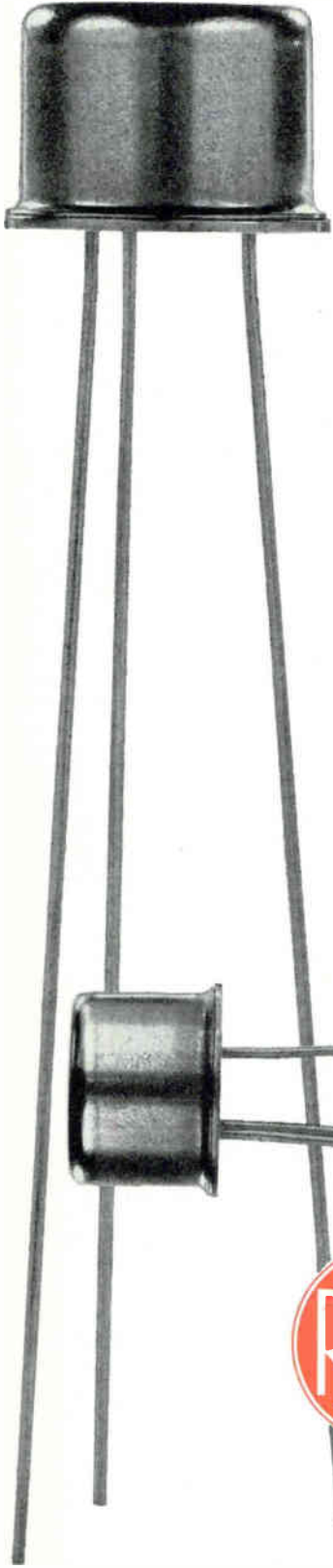

**RHEEM / SILICON
MESA
TRANSISTORS**

2N696 - 2N697

Utmost versatility, maximum reliability,
25 millimicrosecond switching, 5 ohm
saturation resistance, 2 watt dissipation

PRODUCTION QUANTITIES FROM STOCK



RHEEM SEMICONDUCTOR CORPORATION
A SUBSIDIARY OF RHEEM MANUFACTURING COMPANY
Dept. A1, P. O. Box 1327, Mountain View, California • YORKSHIRE 8-8391
Eastern Regional Office: 610 E. Palisade Ave., Englewood, N. J. • LOWELL 7-4336

6257

Earth-to-space ferry

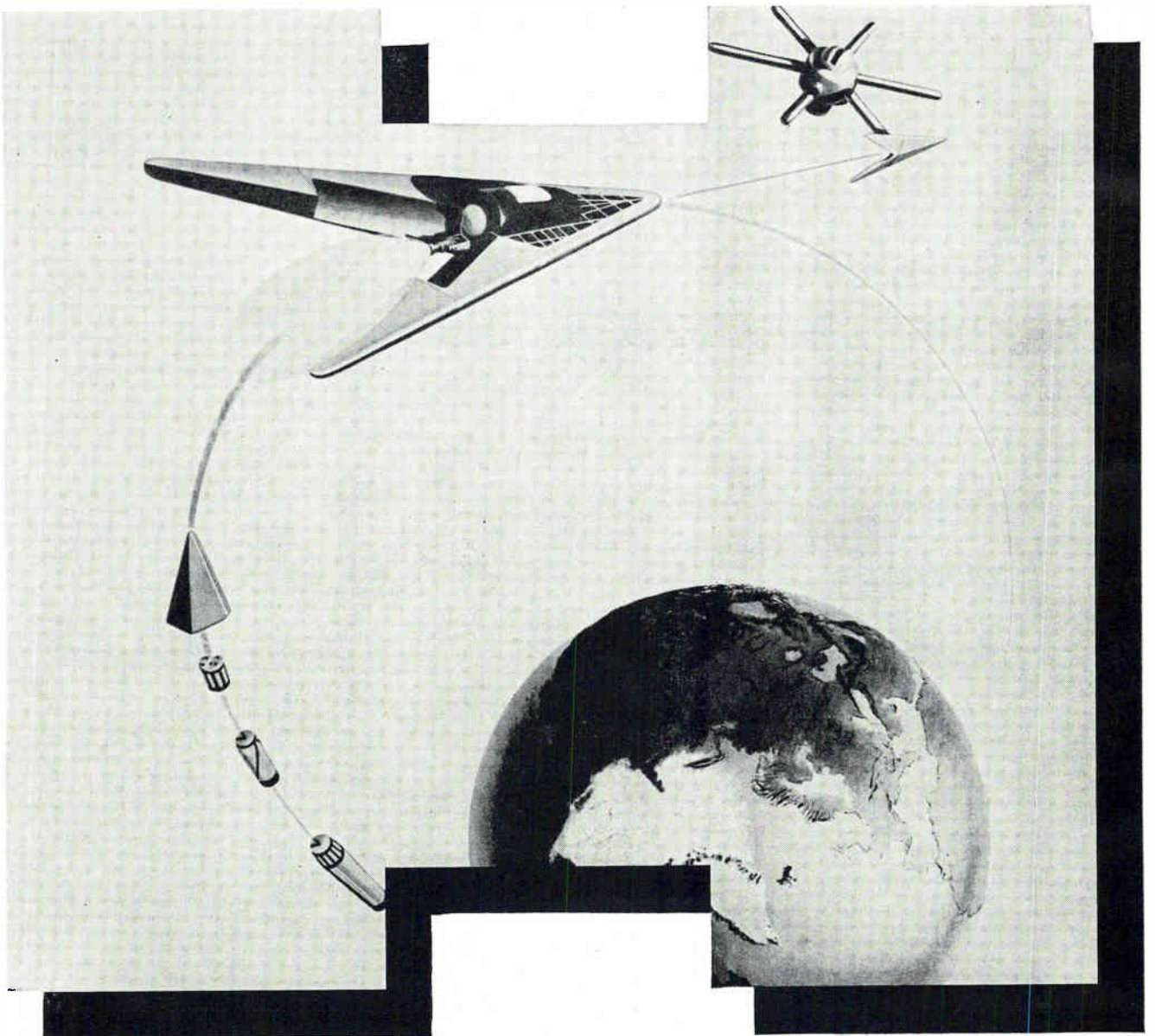

for Astronauts

Combining the features of a space ship, guided missile and a conventional airplane, the new Space Ferry was designed by Hughes-Lockheed Project teams to shuttle men and materials between earth and outer space.

The Space Ferry would carry a pilot and 3 commuters. Payload would be about 14,000 pounds; cargo could vary from flight to flight.

Taking off from earth the Space Ferry would orbit at 300 to 500 miles, rendezvous with other space craft, transfer passengers and cargo, and return to earth... all on a routine schedule.

The Hughes-designed Navigation and Guidance System would utilize an inertial platform and a digital computer. It would automatically control boost to orbit, bringing the Ferry to within 20 to 50 miles of its destination.

The Hughes Attitude and Flight Path Control System would incorporate several novel features: A space attitude and translation control system, based on velocity feedbacks, would give the pilot easy control for



"Vest Pocket Air Defense System"—Hughes mobile digital computer and display unit, linked to a Hughes 3-D scanning radar antenna, assigns enemy targets to missile batteries.

"Paramp" (parametric amplifier) developed by Hughes research engineers and scientists, can double effective range of today's radar units.

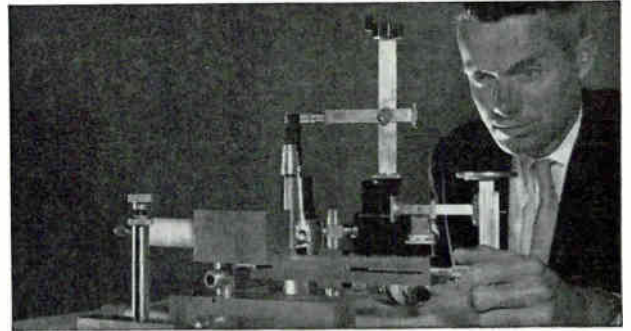

rendezvous and final soft contact with the platform. For re-entry and flight in atmosphere, the system would use structural temperature as a signal for automatic control during the critical heating phase. The resulting maneuver eliminates the characteristic skipping oscillations of uncontrolled re-entries. Either pitch or bank (or both) maneuvers would be selected with elevons as primary controls.

The new Space Ferry reflects the many stimulating outlets available to Hughes engineers. Other projects include nuclear electronics, spatial communications systems, advanced airborne electronics systems, three-dimensional radar systems, new semiconductor materials, electron storage tubes...and many others.

A diversity of advanced projects, a history of continued growth, technically oriented company philosophy — these factors make Hughes the ideal environment for engineers interested in building a rewarding future.

Newly instituted programs at Hughes have created immediate openings for engineers experienced in the following areas:

Electroluminescence	Equipment Engineering
Infra-red	Microwave & Storage Tubes
Plasma Physics	Communications Systems
Digital Computers	Micro Electronics
Reliability & Quality Assurance	Engineering Writing
Systems Design & Analysis	Circuit Design & Evaluation

*Write in confidence to Mr. R. A. Martin
Hughes General Offices, Bldg. 6-D2, Culver City, Calif.*

the West's leader in advanced ELECTRONICS

HUGHES

HUGHES AIRCRAFT COMPANY
Culver City, El Segundo, Fullerton, Newport Beach, Malibu,
Santa Barbara, Oceanside and Los Angeles, California
Tucson, Arizona

© 1960. H. A. C.



electronics

FEBRUARY 19, 1960

Sonar is the most effective method available for submarine hunting

Determining Sonar System Capability

Range parameters of modern active and passive sonar systems under various operational and sea conditions can be calculated with the aid of equations and charts given in this article

By **GEORGE RAND**, Sperry Gyroscope Company, Great Neck, New York

RANGE OF WORLD WAR II active sonar sets was several thousand yards under ideal conditions. Improvements since then have increased the range considerably but it is still a relatively short range technique, especially when compared to radar.

Water is a very complex medium for the transmission of sound; temperature, salinity and pressure affect sound velocity and thus cause complex transmission anomalies. Saline and pressure effects are negligible in most cases but temperature layers are troublesome. These thermal gradients cause the sound rays to be refracted or reflected, producing sound shadow zones that are hiding places for submarines. The shadow zones are not impenetrable to sound but, because of severe attenuation, the amount

of power needed to probe the zones is very large.

The thermal gradients show wide variations with sea states, seasons of the year, time of the day, weather, and geography. Sonar conditions can thus change radically during a tactical situation, and the alert submarine skipper will take full advantage of these factors. Possible shadow zones resulting from the upward and downward refraction of sound waves by temperature and pressure effects are shown in the ray diagrams of Fig. 1.

At depths of several thousand feet, the sound ray patterns are more stable with time, and the downward bending due to the lower temperatures combines with the upward bending resulting from the increase in pressure to form sound channels. The

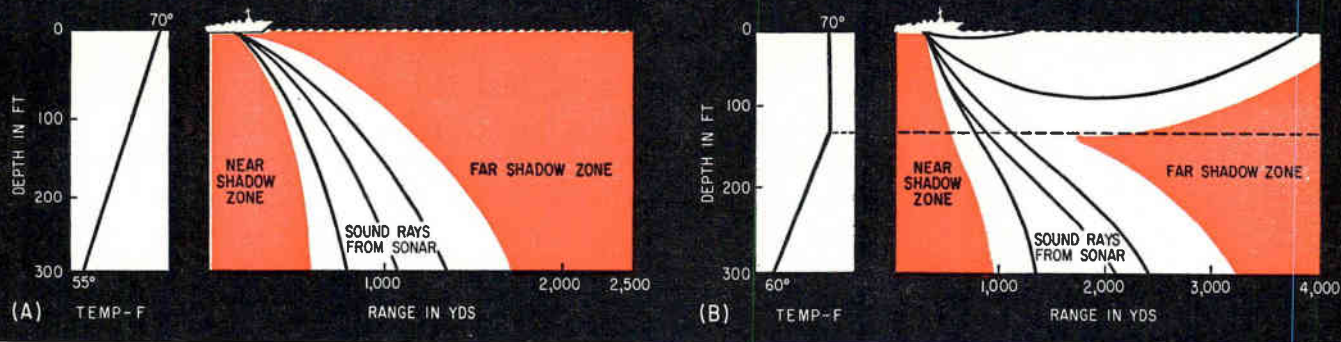

FIG. 1—The shadow zones, created by temperature changes in the ocean depths, are effective hiding places for submarines. The shadows are not impenetrable to sonar but more power is needed to find objects in such regions

sound waves are constrained to remain in these channels, and the intensity decreases more in the form of cylindrical spreading than spherical spreading. Low frequency signals travel in these channels for hundreds of miles without appreciable attenuation. These deep sound channels are employed for ship rescue work by exploding depth charges in the channels and monitoring the sonar signals at shore stations. Range and bearing of the signaling ship are determined by triangulation.

PROPAGATION LOSSES—The propagation loss of sound in water is composed of two portions: attenuation, which is a function of frequency and range, and spreading, a function of range only. Attenuation varies widely with conditions and geographical areas but a nominal value is, $\alpha = 0.20f + 0.00015f^2$, where α is in db/1,000 yards and f is the frequency in kc.

Spreading loss is a square law relationship; the intensity for a passive listening system (one-way transmission) varies inversely as the square of the distance, and for an echo-ranging (two-way transmission), it varies inversely as the fourth power of the distance between source and target. Since intensity is related to pressure by a square relationship, the sound pressure varies inversely with distance for the passive case and inversely with the square of the distance for the echo-ranging case. The unit of pressure commonly used in sonar work is the dyne per square centimeter, or microbar.

The range of a sonar set is limited by the intensity of the received signal or echo, which must be of sufficient amplitude to be recognizable above the limiting background noise. The limiting noise may be caused by sea state, marine life, own ship (self-produced), electronic circuitry, or reverberation.

PASSIVE SONAR EQUATION—For passive sonar,

Table 1—Definitions of Sea States

SEA STATE	DESCRIPTION	WAVE HEIGHT (FT)
0	Calm Sea	0-1
1	Smooth Sea	1-2
2	Slight Waves	2-3
3	Moderate Sea	3-5
4	Rough Sea	5-8
5	Very Rough Sea	8-12
6	High Sea	12-20
7	Very High Sea	20-40
8	Precipitous Sea	40+

the propagation equation can be expressed as $N_w = N_r - N_i + DI_r - R_d$ where N_w = propagation loss = $20 \log R + \alpha R + 60$, in db; N_r = radiated noise of target, in db referred to 1 microbar/yard in a 1-cycle band; DI_r = receiving directivity index in db (a function of the hydrophone array); N_i = background noise level in db referred to 1 microbar/yard in a 1-cycle band; R_d = recognition differential in db; α = attenuation coefficient in db/1,000 yards; and R = range from hydrophone to target in thousands of yards.

Radiated noise of the target, N_r , represents the target noise field as measured at a distant point. For a submarine traveling at 6 knots at periscope depth, the nominal value of N_r at 10 kc is +12 db, referred to 1 microbar in a 1-cycle band at 1 yard. Noise data for other vessels is given in Fig. 2.

Background noise is the limiting factor in the

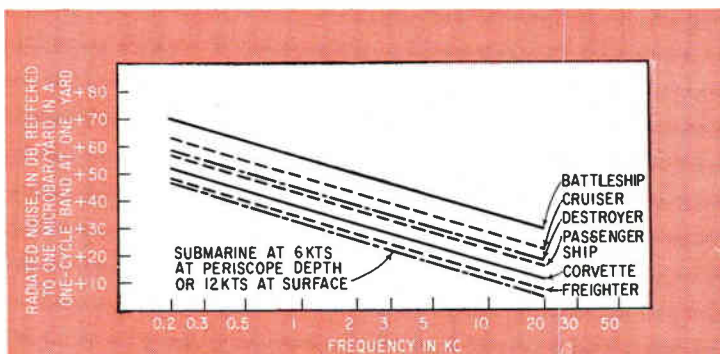

FIG. 2—Radiated noise of representative vessels at normal cruising speed

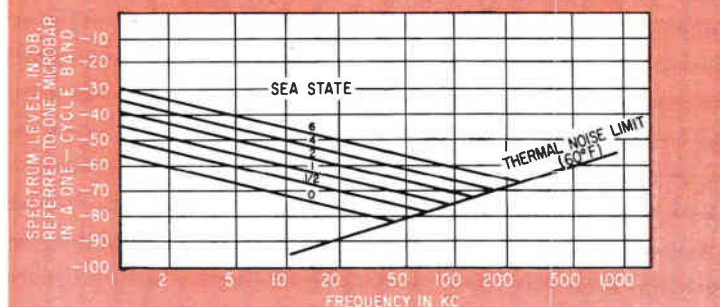

FIG. 3—Noise generated by the sea is a function of surface turbulence. See Table 1 for definition of sea state

system. Normal ocean disturbances, such as the the impact of masses of water and the escape of entrapped air bubbles, is called sea state noise and has the values shown in Fig. 3; sea state is defined in Table I.

The recognition differential, R_d , is defined as the excess signal necessary for a sonar operator to detect a signal above the limiting noise of the system. In an automatic system for detecting a broadband signal against a background of broadband noise, values of R_d between 3 and 6 db have been measured. Recognition differential is determined by the physical properties of the signal, the character of the background noise, the type of sonar gear and the skill of the observer.

ACTIVE SONAR EQUATION—The equation for echo ranging sonar is in the following form: $2N_w = SL + DI_r - N_r + T_s - Bw - R_d$, where SL = source level of equipment, in db referred to 1 microbar at one yard; T_s = target strength, in db; Bw = bandwidth of the receiving system, in db referred to 1 cycle.

The source level, SL , of the equipment is the sound pressure level at a distance of 1 yard from the transducer in water: $SL = 71.6 + DI_r + 10\log P_{in} + 10\log E$, where DI_r = transmitting directivity index in db; P_{in} = electrical power input to transducer in db referred to 1 watt; E = electroacoustic efficiency of transducer where $E \leq 1$.

The factor 71.6 db represents the surface area of a unit-radius sphere and the radiation resistance of sea water. A perfectly efficient point source would thus produce a pressure of 71.6 db (referred to 1 microbar) at 1 yard for an input of 1 watt.

The target strength, T_s , expresses the pressure level reflected by the target and is a function of the type, size, shape and nature of the target as well as of its aspect or orientation. For a perfectly reflecting sphere of 2 yards radius, the target strength is 0 db. Thus, if the yard is used as the unit of length, the target strength is the echo level of the target in db above the echo level from a sphere 2 yards in radius.

The measured target strength of an average beam-aspect submarine lies between 20 and 25 db; for bow-stern aspect, the value is 5 to 10 db, and for oblique aspect, T_s is 15 to 20 db. The target strength of surface ships varies between 10 and 25 db for oblique aspect; for beam aspect it is between 15 and 35 db.

The term Bw represents the receiving system bandwidth. Generally, the wider the bandwidth, the greater will be the noise pickup of the sonar.

As in passive sonar systems, the recognition differential R_d for an active equipment is determined by the characteristics of the system and by the human operator if one is used. The recognition differential for the human ear for 800 cycle audio pulses is plotted in Fig. 4 as a function of pulse length.

The sonar propagation equation for depth sounding equipment, where the ocean floor is the reflecting

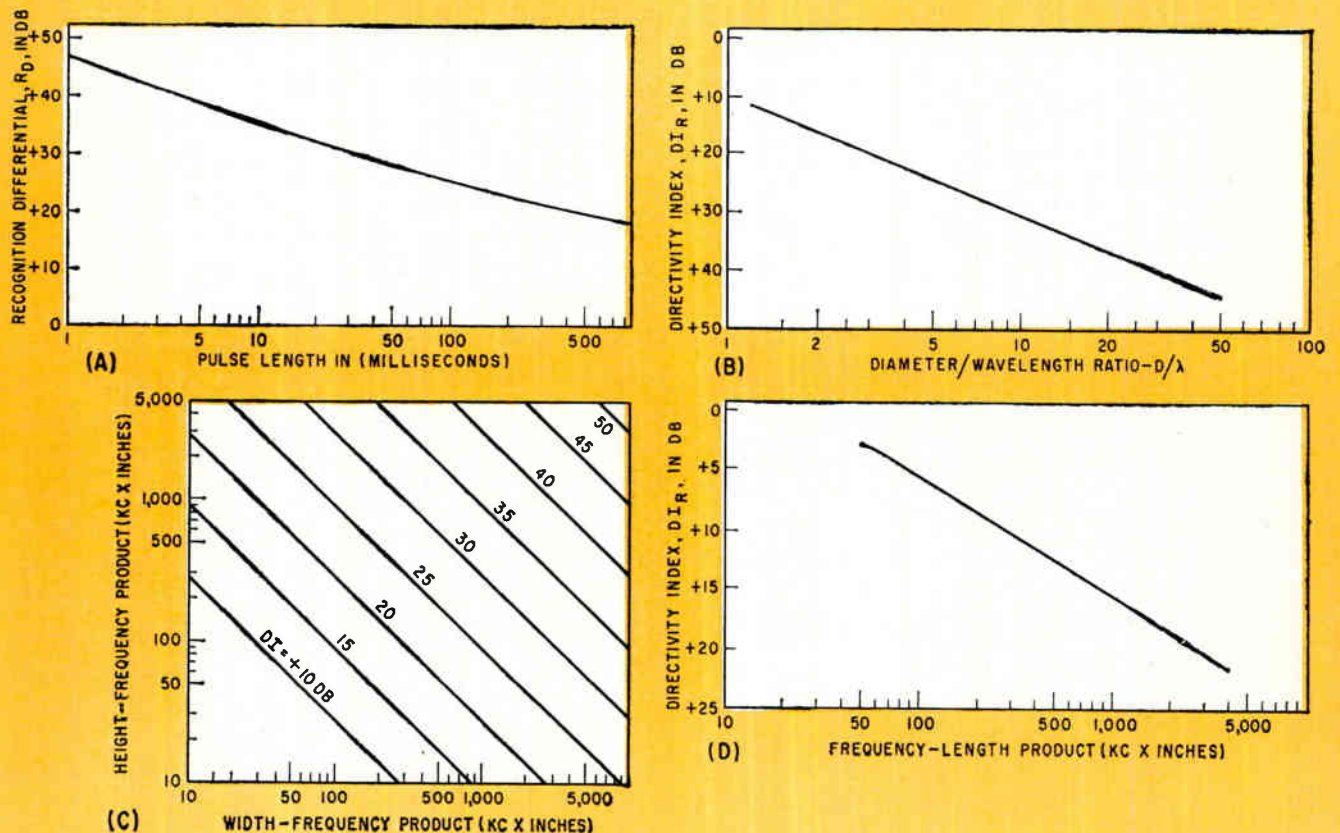

FIG. 4—Plotted in (A) is the recognition differential for various length pulses with 800-cps modulation. The directivity index of a baffled circular piston radiator in salt water is plotted in (B). The directivity index of a baffled rectangular radiator in salt water (C); directivity index of a line source in salt water (D)

target, is of the same general form as the echo-ranging equation except that the propagation loss portion is significantly different. It can be shown by wave acoustics that a submarine or similar object in the ocean looks like a point source when viewed from large distances, and the inverse square law of intensity spreading is applicable; acoustic waves reaching a transducer far away from the target come from essentially the same direction. For depth sounding, however, the ocean floor is a reflector of infinite extent—it reflects the acoustic wave front as would a mirror—and the propagation loss, $2N_w$, is $20\log 2R + 2\alpha R + 60$. Thus, when applying the echo-ranging equation to a depth sounder, the effective target strength becomes a function of the water depth and can be stated as: $T_s = 20\log R + 54 + L_b$, where L_b is the bottom reflection coefficient.

The directivity index of a transducer is analogous to the gain of a radar antenna, and is widely used in transducer and sonar equipment design. The directivity index determines the source level of the system as well as the ability of the transducer to discriminate against isotropic noise. For a projector, the directivity index is defined as $10\log$ of the ratio of the intensity of the radiated sound at a remote point in a free field on the principal axis to the average intensity of the sound transmitted through a sphere passing through the remote point and concentric with the transducer. The DI thus indicates the fraction of the sound energy sent out in the desired direction. For an omnidirectional transducer, the DI would be zero; a large DI indicates a highly directional beam.

EFFECTS OF NOISE—The magnitude of the noise plays an important part in the range capability of the sonar equipment and often is the limiting parameter. Ocean noise can be either man-made, such as ship noise, or natural, from wind, sea state, or ocean life. For echo-ranging sonar, noise plays a masking role; in passive sonar, self or ambient noise has a masking effect while target ship noise serves as the signal being detected.

Sea noise can be classified as ambient noise and self-noise. Ambient noise is inherent in the sea and

is caused by surf, whitecaps, rain, impact of masses of water, and escape of entrapped air bubbles; other ambient sea noises are biological, caused by fish, shrimp and other sea life. Self-noise originates in the ship or system. It consists of the noise generated by the movement of the ship through the water, the slapping of waves against the ship, the impact of air bubbles; mechanical motions of ship vibration, propeller cavitation, machinery and engine noise; circuit noise such as hum, microphonics, tube noise, circuit instability and transients.

The mechanism of sea noise is still not clearly understood although the effects of wind force and sea state have been determined. The spectrum level of sea noise decreases at a rate of about 5 db per octave of frequency as shown in Fig. 3 but wide fluctuations and variations occur; a heavy rainstorm increases overall sea noise level by 20 db.

Thermal noise results from the molecular agitation in water and is proportional to the absolute temperature. Because of its low magnitude, it can usually be disregarded, but it represents the lower limit of water noise. Biological noise is usually not significant, particularly in the case of echo-ranging sonar, since it usually occurs in shallow water. Snapping shrimp, however, produce an incessantly intense noise and have been known to mask sonar equipments.

For many centuries, fish have been hunted by the sound they produce; Aristotle and Athenaeus, in the second or third century B.C., spoke of sound-producing fishes. The frequency spectrum of fish sounds extends from about 50 cycles to 5 kc, with most of the energy concentrated in the lower end of this range. Besides shrimp, drumfish and croakers, other noisy species are groupers, pompano, sea robins, porpoise, toad fish, sea lions, seals, crabs and lobsters. Generally, marine life sounds like squeaks, honks, clicks, groans, barks, and moans. Fish noise builds up shortly before dusk, reaches its peak within an hour or so after sunset, then slowly declines. Fig. 5 shows the spectra of biological and traffic noise in harbors.

Snapping shrimp, when present in large numbers, produce a noise that from a distance sounds like the sizzle of frying fat. Closer in, the sounds are like burning twigs or radio static crashes. The main components of the shrimp sounds lie between 1.5 and 20 kc.

Shrimp noise is nearly constant throughout the year but a slight diurnal variation occurs, with night noise being slightly higher than daytime noise.

The self-noise of surface vessels and submarines increases with speed but frequency falls off at a rate of 6 or 8 db per octave. The exact magnitude and rate of increase of this noise varies with the particular ship and indicates the efficiency of its noise reducing measures. A submarine can reduce its self and radiated noise by perhaps 20 db by proceeding at a very slow, patrol quiet speed. The use of streamlined acoustic transducer domes can reduce self noise as much as 20 db and at the same time reduce the hydrodynamic drag considerably.

ILLUSTRATIVE PROBLEM—To demonstrate its use, the sonar equation will be applied to the following hypothetical situation.

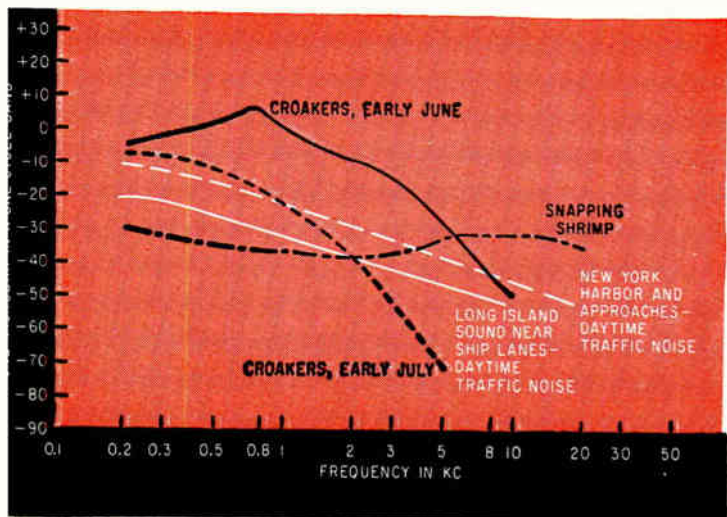

FIG. 5—Noise spectrum of representative sea life, and ship and harbor traffic

An echo-ranging sonar, operating at 24 kc, is mounted aboard a destroyer. A scanning transducer, having an active diameter of 18 inches and an active height of 15 inches, is used for both transmission and reception; all of the 48 active staves or elements are paralleled during transmission (thus being equivalent to a line radiator) and during reception the signals from 16 staves (120 degree sector) are electrically delayed by a scanning switch assembly to form a directional beam. The electrical power output of the system is 20 kw; the transducer efficiency is 36 percent. The pulse length is 100 millisecc, and the sonar operator will use the audio portion (800 cps) of the equipment to obtain target data on a periscope-depth submarine whose target strength is assumed to be 15 db.

Under slow speed operation, the limiting background noise is that caused by the breaking and pounding of the ocean waves, with a magnitude equivalent to sea state 4. It is further assumed that no severe transmission anomalies are present. What is the detection range of this sonar equipment under the conditions specified?

Solution: The directivity index of the transducer is first calculated. For transmitting, Fig. 4 D is used to obtain a value of 10.8 db, which results from a frequency-length product of 360 kc-inches (24 kc x 15 inches). During reception, the signals from 16 staves are delayed to form effectively a rectangular array having a width of approximately 15.6 inches and a height of 15 inches (represents the active height of the transducer).

With the chart of Fig. 4 C, the receiving directivity is determined to be approximately 26.5 db (width-frequency product is 374.4 kc-inches and height-frequency product is 360 kc-inches).

The source level is calculated to be:

$$SL = 71.6 + 10.8 + 10 \log 20,000 + 10 \log 0.36$$

$$SL = 71.6 + 10.8 + 43 - 4.4 = 121 \text{ db}$$

All the sonar parameters have now been determined with the exception of the recognition differential, which varies with the type of equipment as well as the proficiency of the operator. Based on empirical data of Fig. 4A, a value of +25 db will be used for the term $(Bw + R_p)$ and represents the recognition differential of the human ear for 800 cps tones at a pulse length of 100 millisecc. The detection range of the equipment can now be estimated from the echo-ranging equation:

$$2N_w = SL + DI_T - N_J + T_S - (Bw + R_p)$$

$$= 121 + 26.5 + 57 + 15 - 25 = 194.5 \text{ db}$$

$$N_w = 97.3 \text{ db} = 20 \log R + \alpha R + 60$$

From Fig. 6, range R at 24 kc is estimated to be 4,800 yards.

The optimum sonar system parameters for obtaining maximum detection range have to be determined from analytical, empirical and practical considerations. Once the design specifications for a particular sonar equipment have been established, the optimum frequency for maximum range can be calculated from the sonar equation.

A helpful chart for calculating sonar ranges is given in Fig. 6, which presents the sonar propagation loss, N_w , in graphical form. This chart is particularly useful for estimating the effect of the vari-

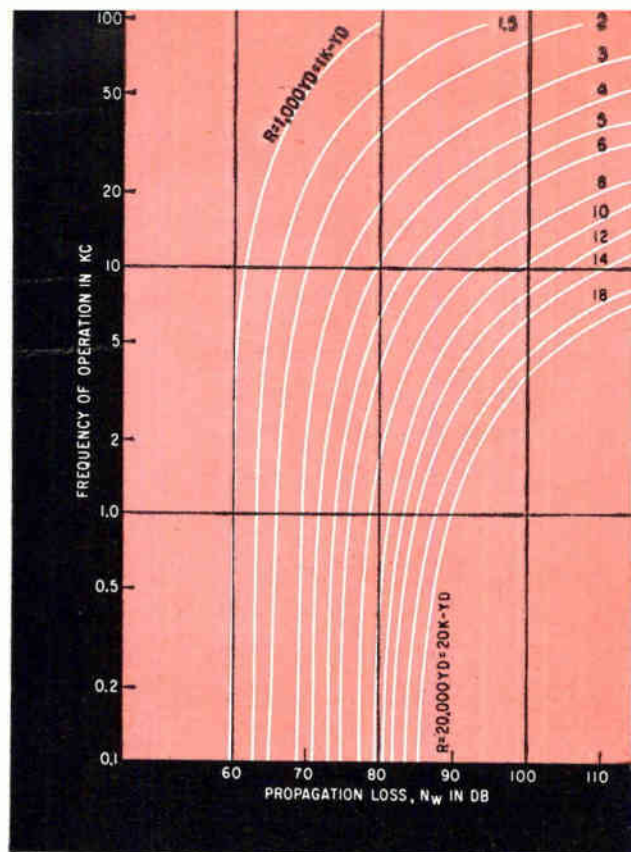

FIG. 6—Nominal sonar propagation loss, N_w , as a function of frequency of operation

ous sonar parameters on sonar range. As an example, if the source level in the illustrative problem is reduced by 6 db (halved), the propagation loss, N_w , would become 94.3 db. Entering this number (the intersection of the 94.3 db N_w abscissa with the 24 kc ordinate) on Fig. 6, the revised sonar range of approximately 4,400 yards is read on the range curves. Similarly, if an increase of 4 db occurs in the limiting background noise, the range would be reduced from 4,800 yards to approximately 4,500 yards. The charts of Fig. 6 are of course also applicable to the calculation of passive sonar ranges since the numerical value of the nominal propagation loss is identical for passive and active operation.

A further indication of the range capability of a sonar system is the value of its figure of merit. This number represents an expression of system performance (equipment plus operator) under standard search conditions. The ability of an operator to detect an artificial, injected echo is determined while carrying out normal search procedures. The echo level is programmed, increasing at a rate to correspond to that of a true submarine approaching under an assumed, realistic tactical situation.

Additional data required for the figure-of-merit are the equipment source level, which is measured by lowering a calibrated hydrophone over the side of the ship, and the receiving response of the system, which is determined by having a projector produce a known sound pressure in the water. The significance of the figure-of-merit can perhaps be realized from the work underway by the U. S. Navy to modify existing sonar equipment to improve figure-of-merit, or more directly, source level. When implemented in the Fleet, these modifications will cost approximately 5,000 dollars for each decibel gain.

Miniature Gas-Filled Tubes

Counting rates up to 1 mc can be achieved with new type of tube. Life expectancy exceeds 25,000 hours. Here are some typical circuits

By K. APEL and P. BERWEGER, Elesta Ag, Bad Ragaz, Switzerland

INVESTIGATIONS into the physics of gas-filled stepping-tubes have led to the development of new miniature gas-filled decade counters. Besides possessing the advantages of conventional gas counter tubes (which include visual indication of count, and reliability) these new tubes offer uncritical single-pulse drive and, in one type, a counting speed of up to 1 mc. Tests show a life expectancy in excess of 25,000 hours under suitable operating conditions.

Tube Operation

These tubes each consist of a cylindrical anode surrounded by 20 cathodes. Figure 1 gives a symbolic representation of the anode cylinder and the arrangement of the cathodes.

The ten main cathodes (0 to 9) are individually brought out to base pins. They are either connected directly to ground or, if electrical readout is desired, to cathode resistors such as R_1 to R_{10} . The ten auxiliary cathodes, which are each situated between two main cathodes, are connected together and

grounded through R_{11} . Resistor R_{11} is considerably larger than each cathode resistor.

In operation, a negative pulse input steps the glow from cathode to cathode. Assume a stable glow discharge resting on *main cathode 1*, producing a drop of about 300 v between anode and cathode. Anode resistor R_{12} determines the operating current. The two auxiliary cathodes neighboring *cathode 1* are in the immediate vicinity of the discharge and act as probes. Probe current through R_{11} establishes a positive bias of 15 to 25 v. This bias prevents the discharge from shifting to another cathode.

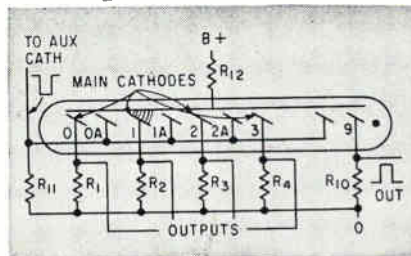
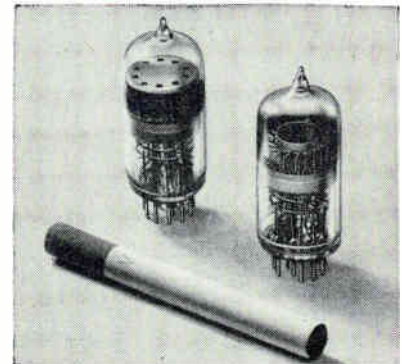

FIG. 1—This schematic representation of tube does not show all cathodes



200-kc tube (left) and 1-mc tube (right)

A negative input pulse affects only the auxiliary cathode on the right of *main cathode 1* because the geometrical arrangement is such that this auxiliary cathode reaches directly into the glow-discharge, and is therefore heavily pre-ionized. Anode potential drops, extinguishing the discharge on *cathode 1*. At the end of the negative-pulse input the voltage at the auxiliary cathodes rises to the level set by the drop across R_{11} , pushing the discharge to *main cathode 2*.

Successive negative input pulses step the glow to successive main

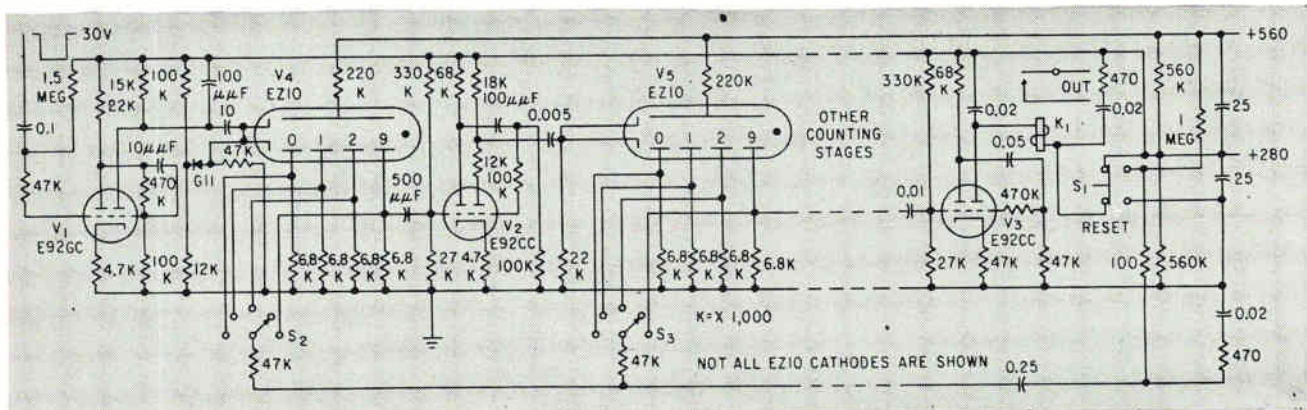

FIG. 2—Counting stages between V_4 and V_5 are same as V_2 - V_3 counting stage

For High-Speed Counting

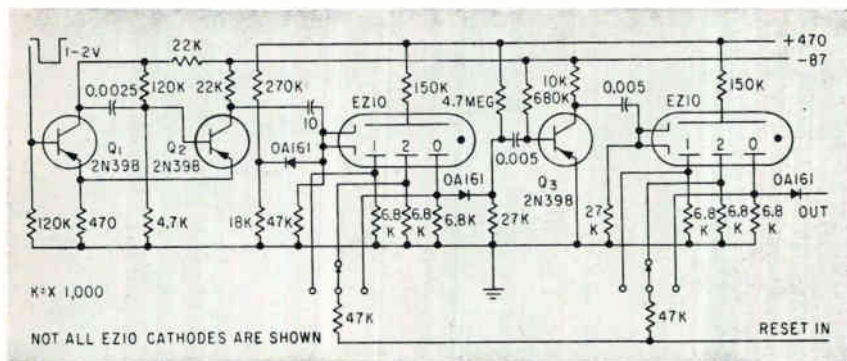

FIG. 3—Output pulse may trigger a counting-stage input section identical to Q_2

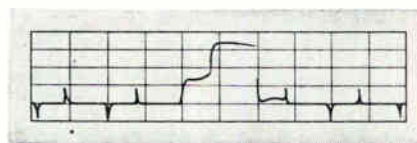

FIG. 4—Pulse duration across resistor of final cathode (Fig. 3) is 50 μ sec, peak amplitude 6.8 v

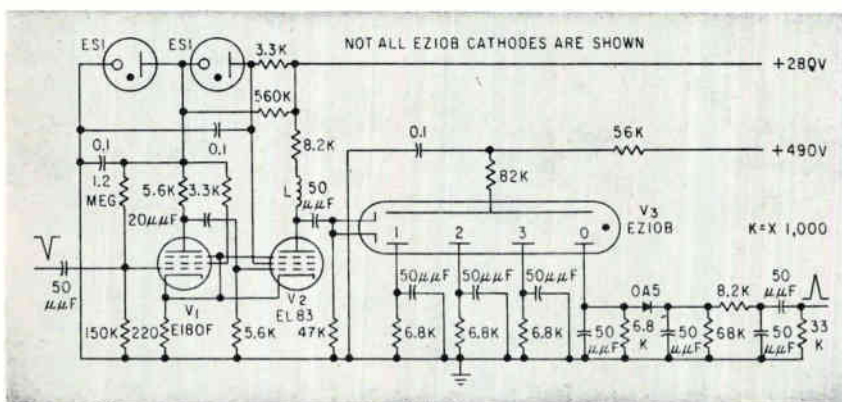

FIG. 5—Input to V_3 may be as high as 1 mc

cathodes. The voltages which appear across the cathode resistors may be used in computing and control applications.

Counting 100 Kc

Figure 2 shows a counter for frequencies up to 100 kc. The input stage is a Schmitt trigger and the stages between counter tubes are monostable multivibrators. Input of an interstage multivibrator such as V_2 comes from cathode 9 of the preceding counter tube and is triggered by the trailing edge of the pulse caused by the discharge leaving cathode 9.

By pressing switch S_1 , an operator applies a negative pulse to cathodes selected by switches S_2 and S_3 , forcing the glow discharge on them and thus resetting the counter.

One simple application of the counter consists of producing an output after a desired number of counts. The counter is initially re-

set to the complement of the desired number (for example, 6 is the complement of 4). When the count reaches 0, the output pulse from the last counter tube triggers V_3 , which energizes output relay K_1 .

Counting 50 Kc

Figure 3 shows a counter for frequencies up to 50 kc. This counter uses the same tube, capable of operating up to 200 kc, as is used in the 100-kc counter. Input stage Q_1-Q_2 is a Schmitt trigger. The diode circuit at the input of interstage amplifier Q_3 clips the base of the cathode pulse shown in Fig. 4. The left-hand pedestal is caused by the probe current of the main cathode while the discharge rests on the preceding auxiliary cathode during the transfer pulse.

1-Mc Operation

To increase the counting speed of the tube type that has been de-

scribed, the main problems were finding a suitable filling gas and reducing the tube capacitances.

The gas used is Hydrogen, which has low ionization and deionization times. Considerable difficulties were encountered by its tendency to produce oscillations. A special type of cathode was developed to get stable discharge conditions.

Low tube capacitances are important, since an 82,000-ohm anode resistor is necessary for proper functioning of the counter tube. This counting tube, which is used in the 1-mc circuit of Fig. 5, resembles in its basic construction the previously described tube.

Monostable multivibrator V_1-V_2 is triggered by 5-v negative pulses. At the L -compensated anode load of V_2 is an 0.5- μ sec pulse which is sufficiently large to step V_3 . The RC coupling used in conjunction with the L compensation produces a 150 v peak, 0.5- μ sec, step pulse.

Cathode resistors of V_3 are bridged by capacitances to reduce the effects of the capacitive coupling between main cathodes and auxiliary cathodes. The network at cathode 0 also separates the output pulse from the capacitance-coupled driving pulses.

Reliable operation up to more than 1 mc was realized, with the anode current of the counting tube ranging from 1.3 to 1.6 ma.

BIBLIOGRAPHY

- H. L. v. Gugelberg, Eine Neue Dekadische Zahlrohre mit Kalten Kathoden, *Helv. Phys. Acta*, 26, Fasciculus sextus, 1953.
- J. H. L. McAsulan and K. J. Brimley, Polycathode Counter Tube Applications, *ELECTRONICS*, p 138, Nov. 1953.
- Chaplin and R. Williamson, Dekatrons and Electromechanical Registers Operated by Transistors, *Proc IEE*, 105, 21, Part B, p 231, May 1958.
- Elesta Technical Communications, Neuentwicklungen im Rohrenbau, Nr. 14, 1960.

Feedback and NOR Logic Yield Sound Spot Welds

Control compensates for variations met in spot welding. Counter provides accurate sequencing and automatic lock-out prevents substandard welds

By G. R. ARCHER, Chief Engineer, Electronic Controls Section, The Budd Co., Philadelphia, Pa.

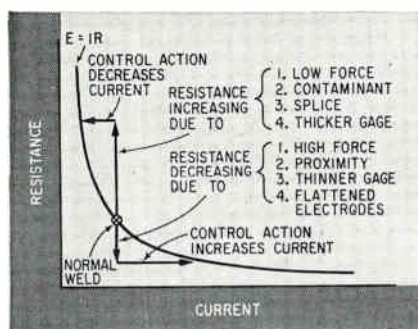

FIG. 1—Voltage constraint compensates for in-process variations found in spot welding

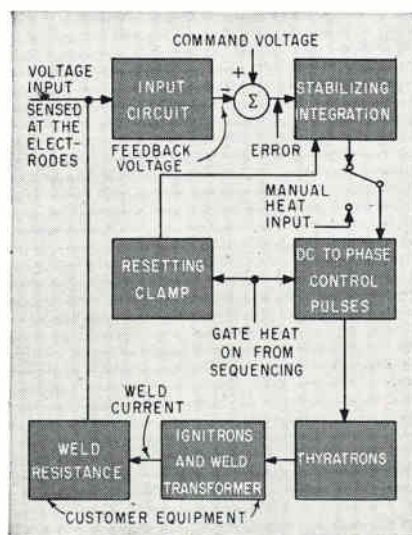

FIG. 2—Block diagram of heat control circuit shows feedback nature of the control

CONSISTENCY AND RELIABILITY of spot welds can now be easily obtained over long periods without testing and inspecting of sample welds. A new control system, called voltage constraint, uses the voltage across a spot weld to obtain the correct fusion temperature under varied conditions.

Voltage Constraint Control

Voltage constraint is based on an analytical determination of the final temperature that will be attained in a spot weld. This final temperature is related to the voltage developed across a spot weld. The control compares the voltage developed across each individual weld with a previously determined command voltage indicative of the proper temperatures for welding. To weld and create a cast nugget requires that the metal reach melting temperature. Because voltage can be mathematically related to temperature, this melting requirement yields a virtually foolproof technique for the control of welds.

Figure 1 shows how voltage constraint corrects current to compensate for ordinary in-process variations that affect spot welding. Normal weld will have a certain current and resistance that produce a given voltage E . By Ohm's law, a number of combinations of current and resistance will produce the same value of E , which accordingly is plotted as a hyperbola.

Some in-process variations increase the weld resistance. With the same current passing through a spot weld having an increased resistance, an increased voltage is

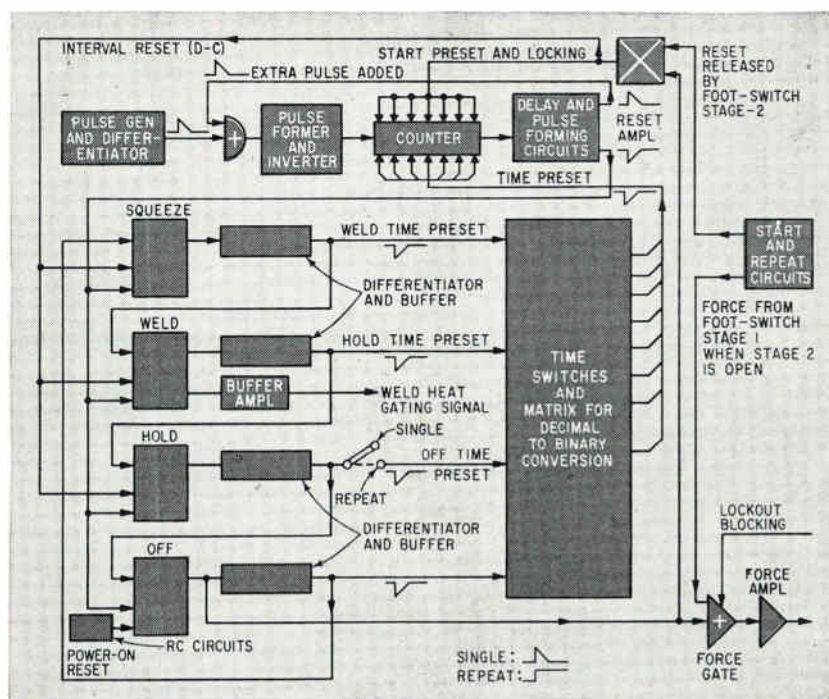
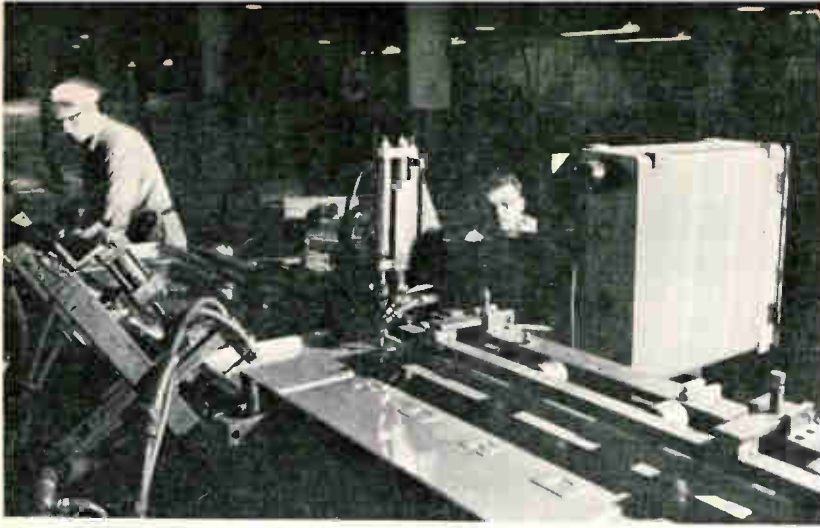

FIG. 3—Budd Monotronic Control uses simple sequencing system (NEMA 3-B)



THE FRONT COVER—Comparison test between conventional (left) and voltage constraint (right) spot welding controls shows excessive expulsion of parent metal which is uncorrectable with conventional methods

sensed by leads connected to the weld electrodes. In this case the control decreases the current for these in-process variations in order to produce a sound weld without excess heating. Correspondingly, some in-process variations cause the weld's resistance to decrease. Here, the control increases the current, utilizing the decreased voltage signal that occurs.

System Operation

The block diagram of the heat control system, Fig. 2, indicates how the weld's resistance is actually enclosed in a loop and how the technique of voltage constraint provides automatic heat control.

Voltage sensed across each actual weld is applied to the input circuit where it is prepared for comparison with a previously set command voltage. Any difference between the command voltage and the actual voltage is applied to the integrating circuit, which stabilizes the system and provides for a correction that increases with time—depending upon any error between the desired and actual weld voltage. This error is then brought down to zero.

Output of the integrator is a d-c signal indicative of the amount of heat required for a good weld. This d-c signal is fed into a d-c to phase-angle control circuit that provides phase-shifted pulses. These pulses are applied to the thyratrons, which, in turn, ignite the pool of mercury in large ignitron tubes to send primary current into a weld transformer. The secondary of the weld transformer provides a much

larger current to the actual weld area. This current, in passing through the weld resistance, produces the voltage that serves as the input to the main control loop.

Heat is gated on and off in accordance with a sequencing control. The gate from the sequencing is also used to reset the integrating circuit between welds, so that each weld establishes a heat setting, depending on its own individual conditions. There is no relation between the heat used for one weld and the heat used for the next.

Figure 3 gives the block diagram of the sequencing operation for the control. Weld controls require sev-

eral intervals during which force and heat are actuated. One of the simplest of these is the sequencing system shown in the diagram. A squeeze interval precedes the application of heat, and accommodates whatever lags are present in the hydraulic or pneumatic force-producing system. On the conclusion of the squeeze interval, the weld heat is actuated for another short interval. During this weld interval, the main heat control is turned on. After the weld interval is concluded, a hold interval ensues. During the hold time, the weld is allowed to coalesce with force maintained. If a repeat schedule is desired, an off interval allows for no force for a period of time, during which the work is repositional.

Operation of the sequencing system is from either one- or two-stage initiation switches. When two-stage initiation switches are used, force can be produced during the operation of the first stage. The first stage can also release force, unless the second stage is closed. When the second stage is closed, the off interval is in an ON position, (producing no force) and is applied to a NOR circuit, along with the signal from the second stage. This NOR circuit removes a setting from the counter so that three counts can elapse. The counter having been maintained in a set position of 197,

EFFECTIVENESS OF SPOT WELDING

Few industrial processes are so commonly used as resistance spot welding. As an economical technique for the fastening of two metallic parts, resistance spot welding and its counterparts, seam and roll spot welding, provide simple and efficient joining under normal conditions.

Electrical current, when passed between two metal parts, generates a large amount of heat at the central interface, where a contact resistance exists. This heat, in flowing outward, produces a molten zone which when cooled bonds the two parts together.

The basis efficiency of spot welding lies in the fact that heat is generated between the two parts, so that the bond between the two metal parts is formed from the inside out, in distinction to riveting or other fastening techniques, where the attachments are made from the outside in.

Among the problems hitherto encountered in the industrial use of spot welding, is the fact that there are no established techniques whereby a spot weld can be inspected nondestructively. The making of a spot weld is dependent on the contact resistance between two sheets, and contact resistances are notoriously erratic.

The main causes of variation in quality of spot welds are: variation in the way two parts fit together; variation in the contour and shape of the electrodes used in introducing the current; variation in the spacing between two welds; variation in the surface finish of the two parts; and variations in line voltage, force, and reactance in the spot welding machine that produce adverse effects in the output of a production spot-welding schedule.

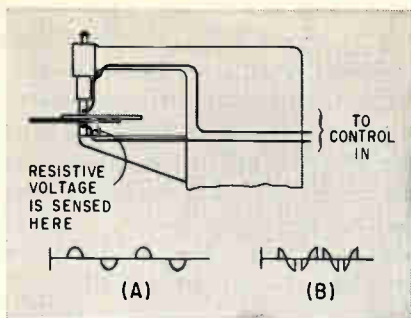

FIG. 4—Resistive voltage (A) is added to inductive voltage (B)

the three counts allow for any bouncing of the switch. After these three counts the counter carries.

The final output of the counter when it reaches the count of 200 comes as it resets to zero. A pulse-forming circuit then presents a pulse to all of the interval multivibrators. Only the off multivibrator is in an ON position, because of its reset, and it is accordingly turned OFF. A differentiator senses the turning off of the multivibrator and gives as its output a pulse that is used to preset the squeeze interval and to actuate the squeeze multivibrator.

Time switches on the front of the sequencing panel are set according to the desired time interval. The time interval is expressed in counts of 60-cycle cycles. Suppose that a squeeze of 15 cycles is desired. Setting 15 into the switches on the front panel of the sequencing unit allows the pulse going through these switches to set into the counter a count of 199 - 15 or 184. Three hundred microseconds after the counter carries, the delay circuit produces an extra pulse, which provides the same function as a carry in ordinary subtraction. The extra pulse is then added into the counter to produce a total of 184 + 1 or 185 pulses in the counter within 300 microseconds after the start of the squeeze interval.

Fifteen 60-cycle pulses then come into the counter, allowing it to reach its maximum capacity of 200 counts. Again the counter carries. The squeeze interval is now the only one of the four in the ON position; accordingly, the squeeze multivibrator is reset. The differentiator and buffer detect its turning off, presetting the weld interval time and starting the weld interval. In this manner the four intervals

—squeeze, weld, hold and off—form a ring counter, which in repeat operation permits these intervals to follow one another serially. When any of the interval switches are set for zero counts, 199 is preset into the counter, and 300 microseconds later the extra pulse carries the counter out to 200. Thus, any interval can be omitted within the practical limit that zero counts amount to 300 microseconds. Since an individual cycle lasts over 16,000 microseconds, the 300 microseconds taken for near zero is not an appreciable interval.

Circuit Design

In resistance spot welding a wide variety of power levels and signal types are encountered. Currents of from 10,000 to 20,000 amp are usual at the secondary of the weld transformer, yet the power consumed by the main control unit is less than 50 volt-amperes. The system employs techniques common to both digital and analog computing.

Because the voltage-sensing leads from the welding electrodes are looped back in parallel with the main current-carrying path of the welding tool (Fig. 4) an inductive voltage pickup (B in Fig. 4) is created by the mutual inductance between the sensing leads and the main tool. The resistive voltage A is added to this inductive voltage.

Even a small inductance creates a large voltage which may be 10 times the resistive voltage.

In this control the inductive signal is eliminated in the circuit shown in Fig. 5. The weld voltage (containing both A and B of Fig. 4) is passed through a transformer and synchronously rectified. This rectified signal is applied as an input to an operational amplifier (V_1 and V_2) through R_1 . A negative command voltage, is set by the COMMAND pot and fed into the operational amplifier through R_2 .

To hold the voltage at the input grid of V_1 close to zero, the currents flowing through the two input resistors must be very nearly equal. Any difference between these currents is supplied by a current coming from feedback capacitor C_1 .

Output of the operational amplifier is the integral of the difference between the command voltage and the resistive input voltage. The inductive voltage fed into this amplifier is also integrated. Due to the inversion of the operational amplifier, this inductive voltage appears as a series of negative-going pulses. These pulses, however, are zero during the interval when the signal from the operational amplifier is used and, thus, do not effect operation of the automatic heat control.

The circuits employed in the operational amplifier, which has a

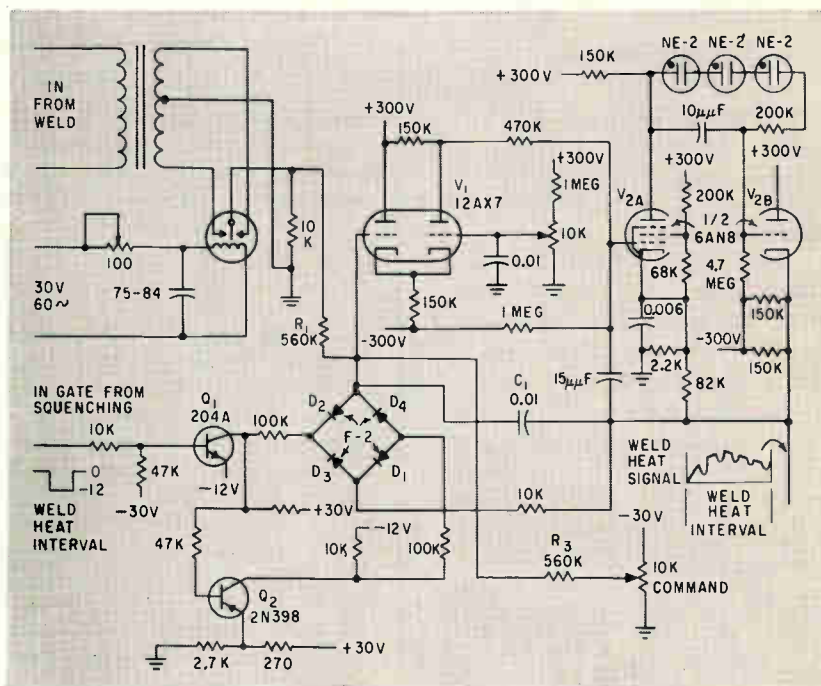

FIG. 5—Partial schematic of heat control unit shows how integrator output is clamped by gate from sequence circuit

gain of about 40,000 and a band width extending from d-c to nearly 100 kc, are of standard design. They utilize direct coupling between stages. Integration leaves a positive voltage on the amplifier at the end of the weld interval.

During the interval between welds, the output of the integrator is clamped at close to zero volts by the clamp circuit, which includes diodes D_1 to D_n . These diodes are in a normally conducting state during the interval between welds, since the transistors Q_1 and Q_2 are biased so as to be normally conducting. An input from the weld gate goes from zero to -12 v and cuts off Q_1 , which in turn cuts off Q_2 . This action causes the diodes to open-circuit, allowing the integrator to perform naturally.

Sequence Circuit

The most accurate technique available for timing an interval is that of counting uniformly spaced pulses. Although the building of counters from vacuum tubes is now a standard technique, transistors are used extensively in the control. The 20 double-triode vacuum tubes that would have been necessary if tubes were used represented an appreciable amount of filament power and a possible loss in reliability.

NOR Logic Elements

The count-type sequencing system utilizes submodular NOR circuits. These NOR circuits are combined two at a time to form multivibrators of two different types, flip-flops and binaries.

The NOR circuits are also used as logical elements. They have advantages over diode logic and other types in that each stage embodies a decision-making element plus gain. Thus, the output from any one stage can drive several following stages of logic.

Twenty-six NOR elements are used in the sequencing system. Because of the logical structure of the design, the sequence can be allowed to grow outward to include a larger-capacity counter or more intervals, such as would be required for additional control functions. The sequence system can also be integrated into over-all production processes where complicated logical decisions must be made on a reliable, repetitive basis.

In the overall control, it is possible to set the heat anywhere from the minimum at which the ignitrons will fire reliably to the maximum that the large weld transformer will pass. Occasionally, severe process variations require heat beyond the range available to the control. In cases like this, the control locks out and terminates the heat signal and the force, so that the operator is prohibited from further welding.

This lock-out can take place in either of two directions. When the control requires less current than can be delivered reliably (even the minimum available current being excessive) burning might ensue. In this situation, termed hot lock-out, a lamp is lighted in addition to force and heat functions being inhibited. In the opposite situation,

controls. At standard forces, the strengths are very nearly the same for both types. As the electrode force is decreased, conventional control produces a stronger weld, but only at the expense of making the weld hotter than usual. Further decreases in electrode force will cause eight out of ten welds to expel or spit, and ultimately the welds become so hot as to give negligible strength because of excessive expulsion of the metal.

Control

Voltage constraint control, on the other hand, senses that with reduced electrode force there is effectively less area through which current can flow. To produce the same sound nugget as obtained with normal electrode force, less current is applied, and less weld strength results. But when the electrode force is increased, the voltage constraint control senses the greater weld area produced, and automatically increases the current to produce a larger weld, and hence a stronger weld. Conventional control in the same circumstances cannot exploit this possibility, but averages the same current over a larger area, thus producing a lower-strength weld. A similar phenomenon occurs for electrode wear.

Since voltage constraint control locks out on either cold or hot welds, the need for destructive testing disappears, as well as the need for redundant welding—up to now a necessary form of weld insurance.

Applications

In both the automotive and air-frame industry, this new control points toward a renaissance of resistance spot welding because of the greatly increased reliability thus provided, particularly where configurations cannot be nondestructively inspected or tested. Every weld represents a unit of cost in time and materials. By reducing the total weld number through the use of these controls, the design engineer can specify fewer welds and still increase overall reliability and unit strength.

In these and other metal-fabricating applications the new unit will serve as an in-process quality-control device surpassing all other known quality control methods used in any type of welding.

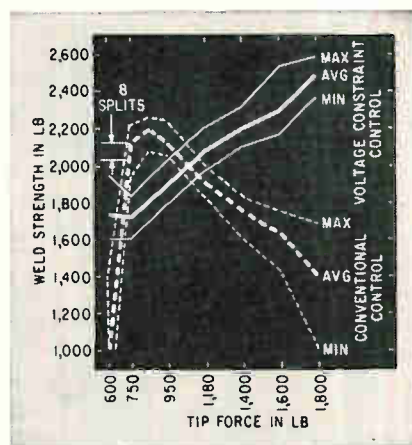

FIG. 6—Graph indicates reliability of new control as tip force increases

where even the maximum available current from the transformer is not sufficient, a cold lock-out occurs to prevent a cold weld.

Any extreme process variation will cause lock-out. There are cases where contaminants between the two sheets have been sensed by the control. Here, even the minimum current generated too high a voltage and would have caused damage to the work if the control had not locked out. In other cases, flattening of the electrodes, or any other low-resistance phenomena, required more current than was available from the transformer, causing the control to lock out as an indication of a substandard weld.

Figure 6 shows the effect of varying force on weld strength for both voltage constraint and conventional

Solid-State Generator Regulator for Autos

Circuit using only semiconductors and resistors performs functions of conventional generator regulator. Two transistors and a diode regulate voltage; a transistor limits current; and a diode protects against reverse current

By LEONARD D. CLEMENTS, Consultants & Designers, Inc., New York, N. Y.

GENERATOR REGULATORS in contemporary automobiles are electromechanical devices designed to regulate generator voltage, limit maximum generator current to a safe value and prevent current flow from the battery through the generator when the generator voltage falls below the battery voltage. These functions are accomplished by voltage regulating, current limiting and cutout relays, respectively.

Severity of mobile service aggravates many of the problems inherent in relays. Pull-in of relays is affected by shock and the wide temperature extremes encountered. Armature springs used to calibrate relay pull-in change characteristics as the result of continual flexing, aging and temperature effects. Relay contacts stick because of mechanical defects or fusing and eventually deteriorate from mechanical wear and arcing.

To avoid these difficulties, an automobile generator regulator has been constructed in which the active elements are transistors and semiconductor diodes. Several regulator designs were built and tested. The circuit shown in Fig. 1 proved to be the best compromise based on performance, currently available semiconductor components and costs consistent with restrictions imposed by a price conscious market.

Voltage Regulator

Principal components associated with the voltage regulation portion of the circuit are transistors Q_1

and Q_2 , Zener diode D_2 , and a sampling network consisting of resistors R_8 and R_{10} , and potentiometer R_0 . Resistor R_5 limits maximum base current of Q_2 to a safe value during abnormal conditions, such as occur when the generator is overloaded. Resistor R_{11} provides a path for the collector leakage current of Q_1 . Resistor R_1 reduces the collector dissipation in Q_2 but can be eliminated if a transistor having a higher collector dissipation rating is substituted for the 2N333.

Zener diode D_2 provides a reference voltage, e , against which the regulated output voltage is compared. Current is supplied to D_2 through resistor R_6 .

Transistor Q_2 is connected as a difference detector with its base held at the constant voltage e and its emitter connected to sample a fraction of the regulated voltage, V_L , by means of the tap on potentiometer R_0 . During operation, the emitter of Q_2 is more negative than its base resulting in a forward, or

conducting, base bias current I_{b2} .

Regulated voltage V_L is related to the reference voltage e by the equation $V_L = e(r_1 + r_2)/r_2$ which is an approximation to the actual conditions existing. In this equation it is assumed that voltage drop from I_{b2} in the base resistance of Q_2 and R_2 is zero and that the emitter current I_{e2} , which must flow in the sampling network, does not alter the emitter voltage sampled by Q_2 .

The extent to which these conditions can be approached is dependent upon achieving high current gain in Q_1 and Q_2 , and choosing the sampling network resistors to have as low a resistance as practical considerations permit. Also, the generator field winding must be designed to best utilize the optimum dynamic range of Q_1 and Q_2 .

Actual regulation obtained is shown in Fig. 2. Rapid decay of load voltage near 35 amps shown on Fig. 2A results from the current limiting feature of the circuit and should not be mistaken for the

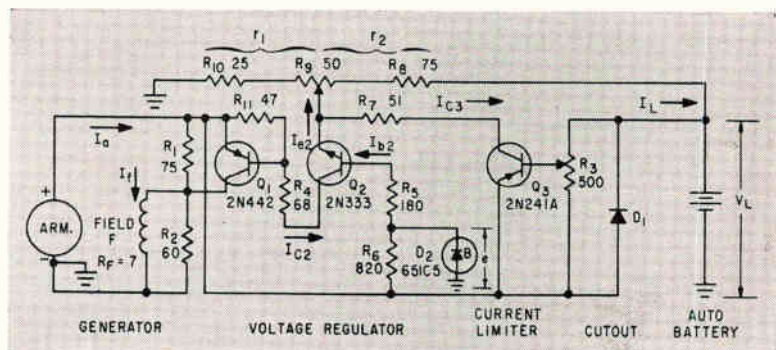

FIG. 1—Generator-regulator is not temperature compensated because different automobile electrical systems require individual selection of compensation parameters

normal voltage regulation curve. Further improvement of regulation can be obtained if positive feedback proportional to load current is introduced. This modification is not shown but would require that the generator operate with its low side ungrounded.

Temperature Compensation

Wide temperature extremes found in automotive applications require some form of thermally sensitive compensation for the effect of temperature upon transistors Q_1 and Q_2 and Zener diode D_2 . If the voltage of D_2 is chosen near 5 volts, the voltage drift caused by D_2 will be negligible. As an alternate solution, D_2 can be chosen to have a temperature coefficient which will at least partly offset the voltage drift caused by transistors Q_1 and Q_2 .

In addition to collector leakage current compensation, it is also necessary to compensate for the thermal characteristic of the base-emitter diode. Since both of these factors act to increase the output voltage, it is possible to compensate for them by using a single compensating method. For example, a negative temperature coefficient can be introduced into the r_1 portion of the sampling network by using a suitably chosen thermistor connected in series or in parallel with resistor R_3 .

The nonlinear characteristic of a thermistor does not permit total compensation at all temperatures but this is tolerable since the required stability is not particularly severe. Since the desired characteristic of the incremental change of load voltage with respect to temperature is negative as shown in

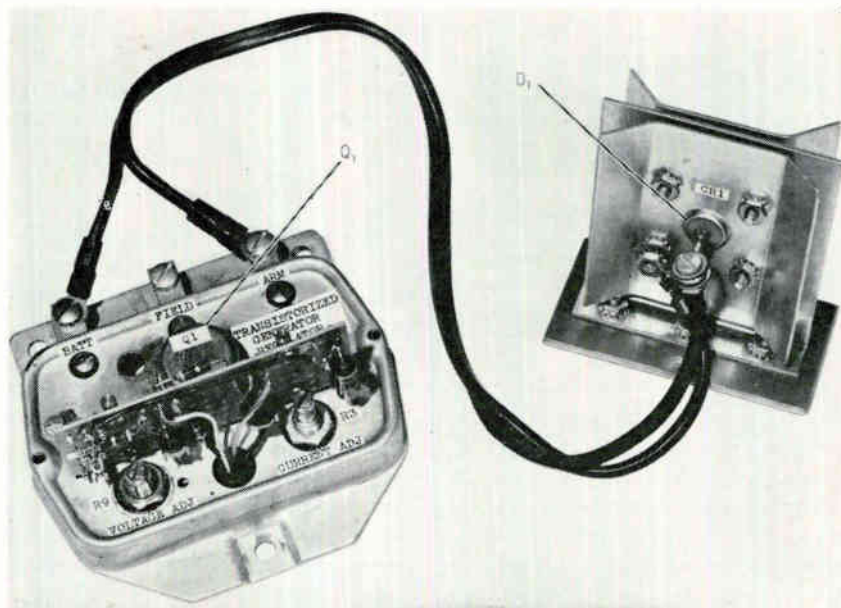

Field-test version of solid-state regulator. Power transistor Q_1 is electrically insulated from chassis by mica washer. Separate finned heat sink for cutout diode D_1 is electrically isolated by glass-epoxy mounting pad

Fig. 3, it is necessary to overcompensate the regulator. This condition often proves easier to attain than a flat characteristic when using thermistors for temperature compensation.

Field Test Circuit

Because the circuit in Fig. 1 was designed for use in several different automobile electric systems which require individual selection of the compensation parameters, it does not include temperature compensation. Any compensation used must be adjusted to compensate for the characteristics of the entire automobile electrical system.

A silicon transistor was chosen for Q_2 to obtain the required collector dissipation rating of approximately 100 milliwatts at 80 C in a miniature package. Where space

requirements permit the use of power transistor case sizes, it would be possible to substitute germanium units such as the 2N95, 2N326 or LT-5165L.

The only requirement for Q_2 is that it be an *npn* unit with the required beta and collector ratings. Beta values greater than 25 are suitable. Use of a germanium unit for Q_2 will require increased thermal compensation for collector leakage current but less compensation for base-emitter diode conductance temperature variations. Accordingly, the substitution of a germanium for a silicon transistor does not necessarily imply that better temperature compensation techniques are required.

Engine compartment heating effects on the circuit have not been conclusively evaluated. Two units were placed in field test and results in cool weather were satisfactory, although some thermally induced voltage drift was found. This drift could have been corrected by use of thermistors.

Current Limiter

Principal components associated with current limiting are transistor Q_3 , resistor R_7 and potentiometer R_8 . Diode D_1 is indirectly involved in current limiting since the voltage drop across it is a function of load current. Potentiometer R_8

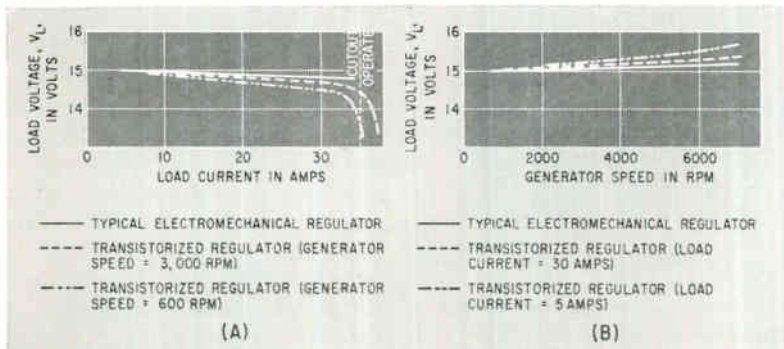

FIG. 2—Regulation afforded by regulator as a function of load current (A) and generator speed (B). Data were obtained using a standard 15-volt generator

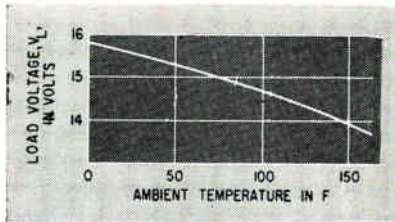

FIG. 3—Typical voltage versus temperature characteristics required by automobile electrical system

is connected across D_1 , and a fraction of the voltage across D_1 and R_3 is applied to the base emitter-circuit of Q_3 by the wiper arm of R_3 .

Proper adjustment of R_3 makes the base bias on Q_3 insufficient to cause conduction for load currents of less than 35 amps. When the load current reaches 35 amps, sufficient base bias is available and collector conduction starts.

Most of the collector current flows through r_2 by way of R_2 . The increased voltage drop across r_2 attempts to cut off Q_3 , thereby reducing the generator voltage and limiting the load current. Current limits at 35 amps and will not exceed 38 amps for further increases in speed or reductions of load resistance.

A test performed with the load short-circuited and the generator speed increased from 500 to 3,000 rpm showed that load current increased only 3 amps above the 35-amp value. To obtain these results the current gain of Q_3 should be at least 35 for the value of R_2 shown. Resistor R_2 limits the maximum collector dissipation in Q_3 , but its value should be kept as low as possible to achieve good limiting.

It is not necessary to temperature compensate Q_3 to maintain calibration of the current limiting level since 5 or 10 percent variation is permissible in the average automobile electrical system. Although no separate compensation was attempted, it is worthwhile to note that utilization of the voltage drop across D_1 provides some measure of temperature compensation.

Figure 4 shows rectifier characteristics at several temperatures. The tendency of Q_3 to conduct at lower input voltage as temperature increases is offset by lower voltage across D_1 . Unfortunately, successful utilization of this characteristic

requires a large heat sink to insure that the temperature rise of D_1 is essentially caused by the ambient temperature rather than by the power it dissipates.

Cutout Diode

During periods when the generator voltage is lower than the battery voltage, reverse current is prevented by silicon rectifier D_1 . Advantages of using a rectifier are that it prevents all reverse current (whereas a cutout relay typically requires several amps of reverse current before pull-in) and it does not require calibration, thus will never go out of adjustment. These advantages outweigh the disadvantage of the internal power dissipated in D_1 , which may reach 40 watts when load current is at the maximum of 35 amps. Under most conditions the load current is considerably less than 35 amps; therefore, the use of a rectifier is not unreasonable.

Permissible reverse leakage current in D_1 can be as high as 150 ma without adversely discharging the battery during typical inoperative periods. Thus, the rectifier used can be a low cost unit or even a rectifier rejected for most other electronic applications if it is rated to carry the maximum load current (usually 35 amps). A unit rated at 25 piv installed in a 12-volt electrical system affords a satisfactory measure of protection against failure resulting from normal transients in the electrical system.

Heat developed in D_1 requires that it be mounted on a separate

heat sink apart from the remainder of the circuit. This requirement is not a disadvantage since a production model would incorporate D_1 into the generator. Field tests were performed with D_1 mounted on a separate heat sink and located approximately one foot away from the rest of the circuit.

Possible Improvements

Although the circuit configuration shown in the photograph sufficed for field tests, it would be desirable to utilize printed circuit techniques and automated assembly for the production models. Except for diode D_1 and transistor Q_1 , all components including the heavy gage metal terminal bars can be mounted on printed circuit boards.

Transistor Q_1 can be mounted on the metal regulator base using a mica washer insulator and then soldered to the printed circuit board during assembly. Diode D_1 must be mounted on a heat sink which is kept a foot or more away from the regulator when installed in the automobile. The heat sink can be made much smaller than that shown in the photograph if a good thermal contact with the automobile body or generator is provided.

Adjustment of the solid-state regulator can be automated since the two potentiometers need only be turned until the desired voltage or current limiting levels agree with predetermined references. This is simpler and more accurate than the corresponding operation on electromechanical regulators where mechanical stops and springs must be bent to obtain adjustments.

Applications

For industrial and military applications which are not so severely limited by cost, a more complex circuit is justifiable. Regulation which is less than 0.25 percent and control of several kilowatts are relatively easy to achieve. Moreover, the solid-state regulator does not generate r-f interference and response speed is limited only by generator inductance. By suitably modifying the circuit in Fig. 1, it is also possible to regulate alternators; however, the alternator must have a wound field and a ripple filter must be added.

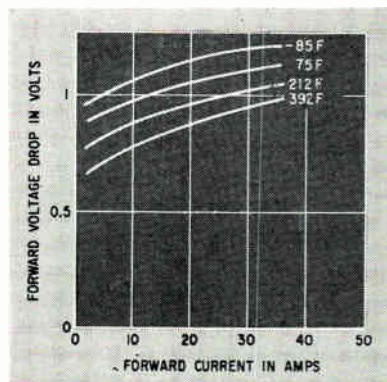

FIG. 4—Cutout silicon rectifier voltage-current characteristics as a function of temperature. Temperatures shown will approximate ambient when infinite heat sink is used

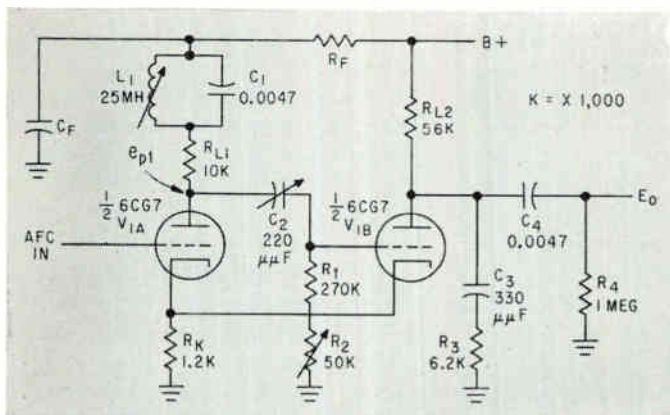

FIG. 1—Typical television horizontal-sweep multivibrator

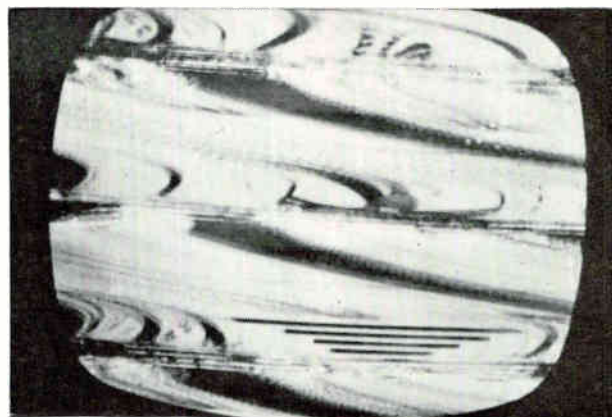

FIG. 2—Mode-hopping condition

Graphical Checkout of Multivibrator Design

Techniques used here to design a sweep oscillator may also be used in analogous problems to predict possible sources of trouble

By C. L. BARSONY, Dominion Electrohome Industries, Ltd., Kitchener, Ontario

THIS ARTICLE describes a graphical method of solving multivibrator instability problems such as are encountered in television receivers and possibly other synchronized sweep devices.

The circuit to be analyzed is a cathode coupled multivibrator which includes a noise-immunizing tuned circuit in the plate circuit of its first triode (Fig. 1). Circuit measurements described are largely independent of the type of afc system used, which is a balanced dual-diode dual-pulse-fed system.

Causes of Instability

Unstable horizontal-multivibrator operation in television receivers can occur as a result of several factors.

A feedback loop from the horizontal output transformer, or driver and damper tubes to the tuner or i-f strip can cause instability. In some cases poor component layout

results in serious harmonic radiation. The harmonic frequency could be strong enough to pull the horizontal frequency, especially when the signal is absent or weak. These are mechanical considerations.

Underdamping of the afc feedback loop of the horizontal system can cause instability. A partial factor only, this effect can be made worse if the oscillator system is too sensitive to changes in afc voltage. Evidence of this effect is the extended interval required for the sweep to return to line frequency after a heavy noise burst.

Other instability-causing possibilities are variation of oscillator tube cutoff characteristics and of components, and improper oscillator alignment with no margin for adjustment.

Effects of Instability

Figure 2 shows the mode-hopping condition, manifested by a se-

ries of alternating dark and bright horizontal lines. The oscillator's frequency changes from zero to approximately sweep frequency, depending on afc damping.

Figure 3 indicates the back-locked, or false-phased, condition. Since the multivibrator transfer function is non-continuous in one region, it can cause two distinct points of operation for the oscillator. That is, the oscillator can operate at either or both points. As the figure shows, the horizontal blanking interval can become visible on the raster under this condition.

Figure 4 indicates the frequency-shifting condition. This condition is similar to mode-hopping. Oscillator frequency now changes from sweep frequency to some higher frequency. As shown, the higher frequency shift causes the raster to appear as though horizontal ripples were passing through

it. Once again, the afc damping is inadequate since rapid change of transfer function allows the oscillator to hunt. This aberration is not back-locking since normally it is not seen. If circuit constants vary, however, it is possible that this condition could become predominant.

Transfer Function

The oscillator can be regarded as a black box in which for each value of (afc) control voltage, E_c , at the input, there is a specific output frequency, f_{osc} ; that is f_{osc} is a function of E_c . If this transfer function is used as the index of stable operation of the multivibrator, one can plot graphs showing how to optimize oscillator operation in a given circuit. As will be shown, the transfer function must be continuous, with no irregularities. It will also be shown how causes of instability can be explained by use of the transfer function.

Analysis

Figure 5 shows the relationship between a variation in the cathode resistor and the transfer function. Observe the change in function with a -14.2 to $+26.6$ -percent variation in R_k . Oscillator sensitivity (cps/grid volt) decreases with an increase in R_k . At approximately -1.6 v d-c there is an apparent discontinuity in the R_{ks} curve at which sensitivity is infinite. In this region, a small change in control voltage causes a very large change in oscillator frequency. This condition is extremely undesirable.

It is quite possible that through an error in system adjustment,

such as a shift in frequency provided by stabilizer coil L_s , this discontinuity can be brought very close or right to sweep frequency. The condition occurring in Fig. 3 then becomes apparent on the television receiver screen.

Fig. 6 shows how the transfer function changes with different plate resistances; here R_k is held constant at 1,200 ohms. For a change of -18.4 to 19.8 percent, the apparent oscillator sensitivity below the reference frequency of 15,750 cps remains essentially unchanged. For $R_{L1} = 12,100$ ohms, sensitivity is almost infinite at -2 v d-c and for $R_{L1} = 8,240$ ohms, sensitivity is again infinite but with a negative slope at 5.6 v d-c. This change is to be expected since we are now varying the total plate impedance of the circuit, which is composed of the parallel-tuned circuit and R_{L1} .

At the -3.2 v d-c region, a discontinuity occurs. Since changes such as a change in stabilizing inductance can shift operation to this region, the condition of Fig. 3 may occur.

In obtaining Fig. 7, 6CG7 tubes with different cutoff characteristics were used for V_{1B} , but the free-running center frequency (normally set at $+1.0$ v d-c) was not readjusted. Cathode and plate resistances are left at normal values and the cutoff characteristic of V_{1A} was the same for the three tubes. Note that a discontinuity occurs in the region of -3.3 v d-c on the sharp-cutoff triode curve. The oscillator sensitivity is apparently the same for tubes (V_{1B}) having dif-

ferent cutoff characteristics.

Figure 8 shows curves obtained by readjusting the free-running frequency of the oscillator, using the stabilizing coil to compensate for V_{1A} 's cutoff characteristics. If the pull-in range of the oscillator is unbalanced toward the high side, as it is for the remote-cutoff tube, the afc damping may be insufficient and the condition shown in Fig. 4 results. Once again a small change in afc control voltage produces a large change in oscillator frequency.

For the sharp cutoff curves, there are two possible unstable regions. These are the false phase condition at the upper end and the mode-hop condition at the lower end. Note that the oscillator pull-in range is an important factor.

Figure 9 illustrates how critical adjustment of the stabilizing coil can affect the oscillator free-running frequency. Turning the slug in and out of the coil by one turn corresponds to a change in center frequency of ± 365 cps. By drawing a horizontal line through 15,750 cps (sweep frequency), we may obtain the magnitude of afc correction voltage and the slopes of the transfer functions around sweep frequency which are caused by a shift of value of the stabilizing inductance.

In Fig. 10 the damping of the stabilizing coil is varied, thereby altering its Q . Noise immunity (the ratio between pulse and sine wave components of e_{r1}) of the circuit is a function of the Q of the system; the greater the Q , the better the noise immunity. As the Q becomes progressively greater, oscillator

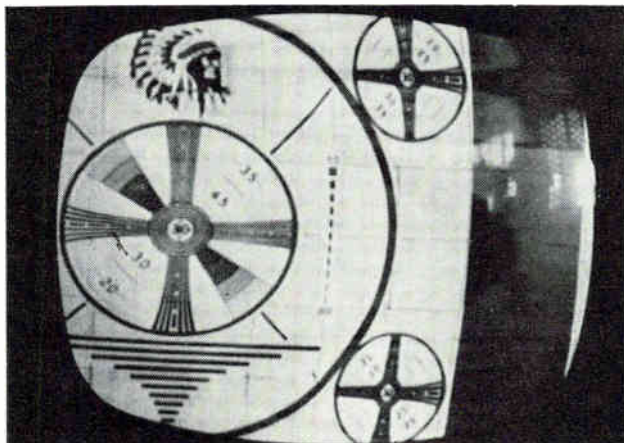

FIG. 3—Back-locked condition

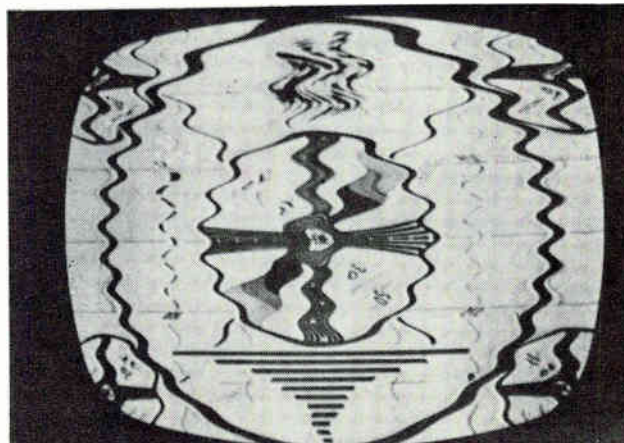

FIG. 4—Frequency-shifting condition

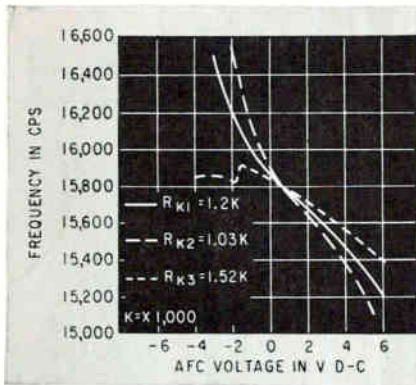

FIG. 5—Change in transfer function with R_k variation; other parameters constant

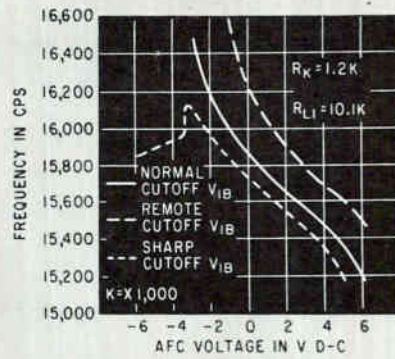

FIG. 7—Shift of transfer function for V_{1B} tubes with different cutoff characteristics

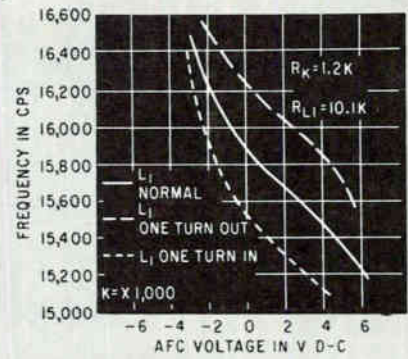

FIG. 9—Shift of transfer function with a small change in position of tuning slug

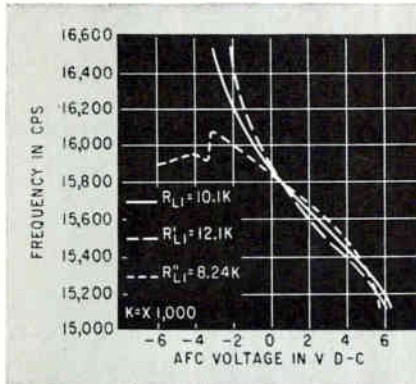

FIG. 6—Change in transfer function with R_{L1} variation; other parameters held constant

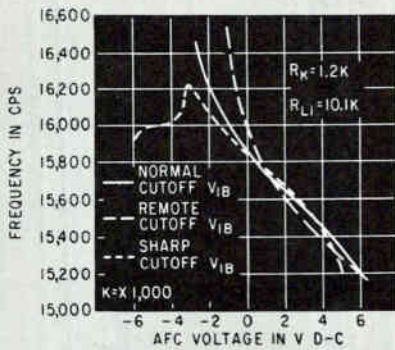

FIG. 8—Change of transfer function for different-cutoff-characteristic V_{1B} 's when center frequency is set by L_1

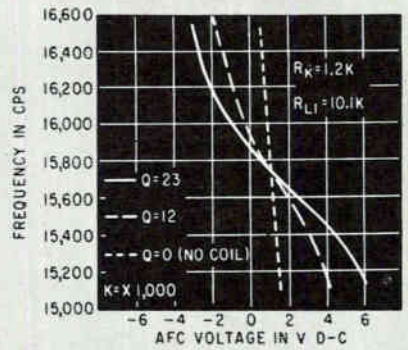

FIG. 10—Comparison of transfer functions obtained with different stabilizing coils. R_k and R_L are held constant

sensitivity is decreased. An increase in the sine wave component results and the afc damping factor becomes less critical since the slope of the oscillator curve is less pronounced.

Adjustment of Pull-in Range

Once a continuous transfer function which suits the given conditions of oscillator sensitivity and required noise immunity is obtained, the curve can be used to plot the pull-in range bandwidth and balance.

For a dual pulse fed, balanced phase detector afc system, the pull-in range balance is approximately determined by the relative amplitude of pulses fed to the phase detector. By varying sync splitter plate and cathode resistors (R_1 and R_2 of Fig. 11A), the pulse amplitudes, hence pull-in range balance, can be controlled. By varying the horizontal sync frequency of a signal source, two frequencies can be obtained at which the horizontal multivibrator locks into synchro-

nism. These frequencies can be plotted directly on the transfer function, as in Fig. 11B, above and below the center frequency.

The pull-in range can be adjusted for the proper value. In this case, the feedback sawtooth amplitude controls the pull-in range.

Conclusions

The effect of circuit parameter variation can readily be seen from

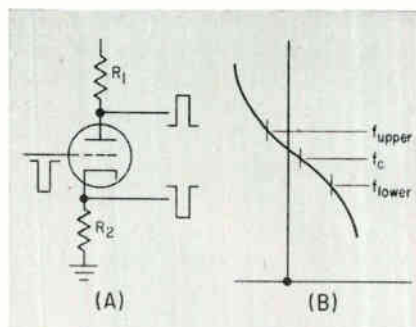

FIG. 11—Sync phase splitter pulses go to phase detector (not shown) which compares reference volts from sweep and delivers afc control volts to sweep

plotted curves. Upper and lower limit cutoff tubes can be determined from production units, and the oscillator circuit can be adjusted to accommodate them by making either C_2 or R_1 (Fig. 1) variable.

The effect of using the stabilizing inductance as a frequency adjustment can readily be seen as a shift in slope of the transfer function. This proves to be especially disadvantageous when the pull-in range is unbalanced towards the high end, as the frequency shift effect comes into being. By the same token, if the unbalance occurs towards the low end, mode-hopping is more probable.

I wish to express my thanks to Dominion Electrohome Industries for all the staff and plant assistance afforded me in writing this paper.

BIBLIOGRAPHY

- K. Clegg, Cathode Coupled Multivibrator Operation, *Proc IRE*, June 1950.
- W. J. Gruen, Theory of AFC Synchronization, *Proc IRE*, Aug 1953.
- Line Synchronization with Automatic Phase Control, *Electronic Applications*, 17, No. 4, 1956/1957.
- A. Schure, "Multivibrators", Rider Publications.

Radioactive Tracers Find

Simultaneous gating of oscillator and radiation detector permits recording of flow rate of jet fuel containing radioactive tracer. Reliable transistor circuit can be used for other time-interval measurements

By J. D. KEYS and G. E. ALEXANDER, Department of Mines and Technical Surveys, Ottawa, Ontario, Canada

DURING THE COURSE of investigations using radioactive tracers to measure flow rates of liquids, a circuit was required to measure time intervals of about 25 milliseconds. The particular application involved is the measurement of the rate of flow of fuel to a jet engine. Previous methods used to measure flow rates^{1, 2} are considered unsuitable either from the instrumentation point of view, or, in the case of the total-count method, the flow rates encountered are too great.

The circuit developed for this purpose uses a Geiger tube as the detecting element. A transistor switch circuit is operated by an initiating pulse, and it controls gate circuits for the oscillator and Geiger amplifier circuits.

The first gate permits output from an oscillator to be recorded, and the second gate permits output from the Geiger tube to pass to a scaling circuit. After a predetermined number of pulses, the scaling circuit feeds back its output to the switch circuit to close the two gates. Time interval is derived from the recorder based on the known oscillator frequency.

Operating Principle

A block diagram of the overall circuit is shown in Fig. 1. The operating cycle is initiated by a trigger pulse that is amplified by the trigger amplifier and applied to the switch circuit. The switch circuit performs two simultaneous functions. The first is to open the gate for the crystal-controlled oscillator,

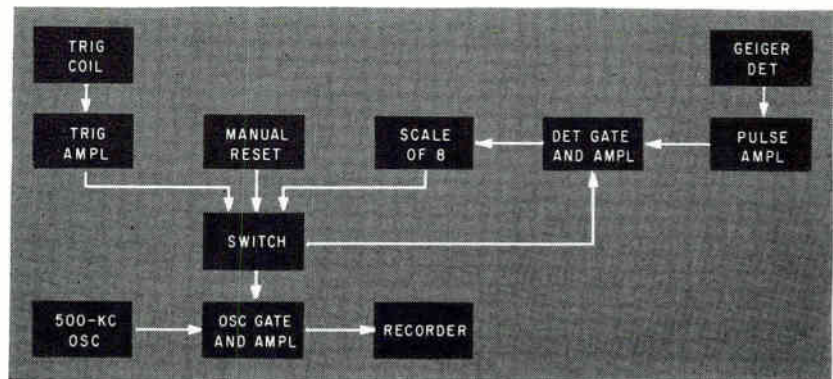

FIG. 1—Switch opens gates for detector and oscillator outputs

permitting oscillator output to be applied to the recorder. The second is to open the gate controlling the detector amplifier, permitting output from the Geiger tube to pass into the scaling circuit, which is of conventional design.³

Output from the scaling circuit is fed back to the switch circuit, which closes the two gates previously opened. The time elapsed between the initiating trigger and the closing pulse from the scaling circuit is read out from the recording device. Thus, the time interval depends upon the pulse rate delivered by the Geiger tube, which depends in turn on the fuel flow rate.

The scaling circuit acts as a discriminator against random background. Depending on the time interval to be measured, scales of 2, 4 or 8 may be used to prevent spurious radiation from closing the gates prematurely. When the radioactive tracer passes the detector, the rapidly increased count rate is sufficient to create an output pulse from

the last binary stage of the scaler. This output actuates the switch circuit.

A manual reset is incorporated into the circuit for use in applications where the time interval is terminated mechanically rather than by pulses from a Geiger tube.

Switch and Gates

The switch circuit consists of a bistable flip-flop circuit, which is shown in Fig. 2. With the circuit in the ready condition, no current flows to the collector of Q_1 , which is at a potential of -5 v. In this state, point A, which is coupled to the detector and oscillator gates, is at -2.6 v. This voltage is sufficient to keep the gates closed. In this case, the gates are closed when Q_2 and Q_3 are conducting and shunting the signals applied to their collectors to the zero line.

The switch is triggered into the opposite state by a negative pulse of at least -2.8 v applied to the collector of Q_1 . When transistor Q_1 is

Jet Fuel Flow Rates

conducting, the potential on its collector rises to -0.5 v, and the collector of Q_2 is cut off.

With the switch in this state, the potential at point A falls to -4.8 v. This drop in potential is applied to the bases of gate transistors Q_3 and Q_5 , cutting them off.

The circuit remains in this condition until a positive pulse from the scaling circuit is applied to the base of transistor Q_1 . This increase in the potential on the base of Q_1 cuts this transistor off again. Collector potential falls to -5 v and transistor Q_2 again conducts. The drop in collector potential is again coupled to the bases of gate transistors Q_3 and Q_5 , causing them to conduct which effectively closes the gates again. Since the scaling circuit gate is closed, pulses from the Geiger tube are shunted through Q_5 and no longer arrive at the scaling circuit. Therefore, the scaling circuit remains in the ready or reset condition.

The switch circuit is very stable and its operation is relatively independent of the pulse shape with one exception. The leading edge of the pulse must be sharp. Some overshoot can be tolerated because a positive pulse appearing on the collector of transistor Q_1 has no effect

on the operation of the circuit.

The circuits of the oscillator and detector gates are also shown in Fig. 2. In the ready condition, the base of transistor Q_3 is at a potential of $+0.53$ v. Because transistor Q_3 is conducting under these conditions, the potential on its collector is zero volts and output from the oscillator remains shunted to the zero line.

When the switch circuit is triggered to its ON state, voltage at the base of Q_3 falls to $+0.50$ v. This slight drop in base voltage is sufficient to cut Q_3 off. Voltage on the collector of Q_3 rises to $+1.8$ v, raising voltage on the base of Q_4 to the same level. Therefore, oscillator output appearing at the base of Q_4 is amplified and fed to the recorder.

The pulse transformer in the collector circuit of Q_4 serves two purposes. The first function is to increase the output to the level necessary to actuate the recording instrument, which is a commercial scaling unit with a $1\text{-}\mu\text{s}$ input strip. The second purpose served by the pulse transformer is to provide isolation for the recorder.

The operation of the detector gate is exactly the same as that of the oscillator gate. However, an additional feature is incorporated in

the detector gate—the insertion of a 10,000-ohm tapped resistor from the collector of gate transistor Q_5 to the zero line, rather than the fixed resistor used with the oscillator gate. Use of a tapped resistor permits some control over pulse height appearing at the base of detector amplifier Q_6 .

Performance

The circuit described has been in operation for several months, both in and out of the laboratory. Its performance has proved to be very reliable. The particular application in connection with measuring flow rates of jet fuel with radioactive tracers is only one of many for which the circuit is suitable.

The contribution of G. G. Eichholz, in the form of many discussions during development of the circuit, is gratefully acknowledged.

REFERENCES

- (1) W. H. Gauvin, I. S. Pasternak, L. B. Torobin and L. Yaffe, A Radioactive Tracer Technique for Particle Velocity Measurement in Solid-Gas Systems, Technical Report Series, Pulp and Paper Research Institute of Canada, Feb. 1959.
- (2) D. E. Hull, The Total-Count Technique: A New Principle in Flow Measurements, *Int J Appl Rad and Isotopes*, 4, No. 3, 1, 1958.
- (3) T. A. Prugh, Junction Transistor Switching Circuits, *ELECTRONICS*, 28, No. 1, p 168, 1955.

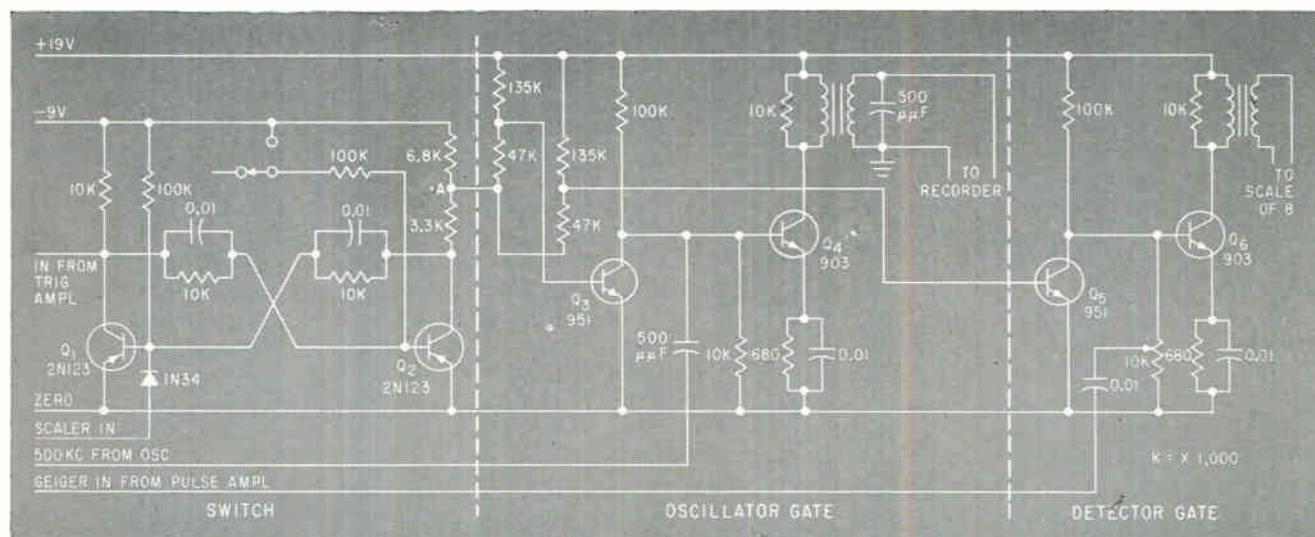

FIG. 2—When multivibrator is switched ON, Q_3 and Q_5 are switched off so that oscillator and Geiger tube inputs are amplified

Table I—Energy Output from 6 Battery Types as Functions of Temperature and Discharge Rate

	Discharge Rate	Temp in deg F	Pb-Acid	Ni-Cd pocket plate	Ni-Cd sintered plate	Ni-Fe	Zn-AgO	Cd-2AgO
	5-hr	80	11.4	6	15	15	52.8	24.6
	1-hr		8.4	4.8	11.6	9.3	45.8	19.8
	15-min		6.8	2.9	9.9	39	15.6
Energy output per unit weight in watt-hours per pound based on 20-percent voltage drop	5-hr	0	5.4	4.2	11.5	39.4	0.9
	1-hr		3.9	3.1	9.9	33	6.6
	15-min		2.9	1.7	8.7	24.6	12.1
	5-hr	-40	3.7	3.2	9	10.7
	1-hr		2.5	2.4	8.4	7.7
	15-min		1.5	0.9	5.3
	5-hr	80	0.83	0.47	1.08	1.16	3.36	1.57
	1-hr		0.61	0.38	0.84	0.73	2.92	1.26
	15-min		0.49	0.23	0.72	2.48	0.99
Energy output per unit volume in watt-hour per cubic inch based on 20-percent voltage drop	5-hr	0	0.39	0.33	0.83	2.51	1.33
	1-hr		0.28	0.24	0.72	2.1	1.06
	15-min		0.21	0.13	0.63	1.57	0.77
	5-hr	-40	0.27	0.25	0.65	0.68
	1-hr		0.18	0.19	0.61	0.49
	15-min		0.11	0.07	0.38

Performance Ratings Of Secondary Batteries

Detailed charts present a wide range of characteristics for each battery type to help the designer choose a battery for a specific application

By PAUL J. RAPPAPORT, U. S. Army Signal Research and Development Laboratory, Ft. Monmouth, N. J.

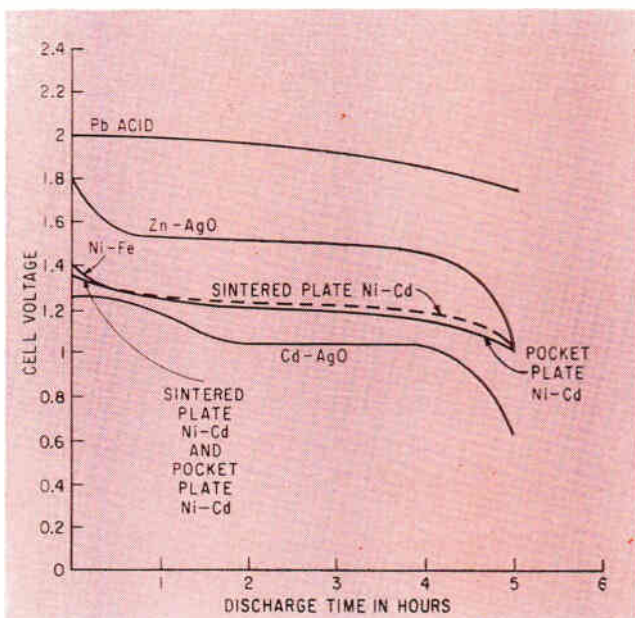

FIG. 1—Voltage-time curves for secondary batteries discharged at 5-hr rate at temperature 80 F

SINCE NO SINGLE secondary, or rechargeable, battery possesses every desirable characteristic, there are a number of standpoints from which a battery's suitability may be judged. This article attempts to give an overall appraisal of various secondary battery types.

The curves of Fig. 1 compare batteries on the basis of their discharge characteristics. Table I relates the energy that can be obtained from each to the conditions under which the battery is discharged. A battery's efficiency depends markedly upon such factors as temperature and discharge rate.

Table II demonstrates a range of electrical and mechanical properties, as well as listing some battery manufacturers. In both tables, the dashes indicate that the battery cannot be used under the conditions specified.

BIBLIOGRAPHY

David Linden and Arthur F. Daniel, New Batteries For The Space Age, ELECTRONICS, p 59, July 18, 1958.

(Continued on p 62)

A PARTIAL LISTING OF INDUSTRY'S

WIDEST LINE!

SILICON CONTROLLED RECTIFIERS

IN FULL PRODUCTION

10 AND 16 AMPERE TYPES



ACTUAL SIZE

The International Rectifier "Thyrode" Silicon Controlled Rectifier is a three-junction, hermetically sealed semi-conductor device that will block positive anode to cathode voltage as does a thyatron. When a signal is applied to its third (gate) lead, the device rapidly switches to a conducting state and provides the low forward voltage drop of a typical medium power silicon rectifier. Current flow may then be halted, by reversal or removal of the anode voltage. This simplicity of control makes the "Thyrode" applicable to a wide range of control and switching uses.

Absolute Max. Ratings (at 30°C; 50 to 100 cps, resistive or inductive load)

Int'l Type Number	Max. Rep. PIV, Volts	RMS Input (Sin.) Volts	Average Forward Current Amps	Surge Current (1 Cycle) Amps	Min. Forward Breakover Voltage, Volts	Max. Forward & Reverse Leakage, Ma		Gate Power, Watts		Gate Current Ma		Forward Gate Voltage, Volts		Max. Forward Volt. Drop, 1 Cycle Volts
						Peak	Average	Peak	Average	Peak	Max. to fire	Peak	Max. to fire	
10 Ampere Rated Series, Operating Temperature Range: -30°C to +85°C														
X10RC2	20	14	10	125	20	45	22	5	0.5	2000	85	10	5	1.25
X10RC3	30	21	10	125	30	40	20	5	0.5	2000	85	10	5	1.25
X10RC5	50	35	10	125	50	35	18	5	0.5	2000	85	10	5	1.25
X10RC7	70	50	10	125	70	30	15	5	0.5	2000	85	10	5	1.25
X10RC10	100	70	10	125	100	25	12.5	5	0.5	2000	85	10	5	1.25
X10RC15	150	105	10	125	150	13	6	5	0.5	2000	85	10	5	1.25
X10RC20	200	140	10	125	200	12	6	5	0.5	2000	85	10	5	1.25
16 Ampere Rated Series, Operating Temperature Range: -30°C to +105°C														
X16RC2	20	14	16	125	20	45	6.5	5	0.5	2000	50	10	3	.90
X16RC3	30	21	16	125	30	40	6.5	5	0.5	2000	50	10	3	.90
X16RC5	50	35	16	125	50	35	6.5	5	0.5	2000	50	10	3	.90
X16RC7	70	50	16	125	70	30	6.5	5	0.5	2000	50	10	3	.90
X16RC10	100	70	16	125	100	25	6.5	5	0.5	2000	50	10	3	.90
X16RC15	150	105	16	125	150	13	6	5	0.5	2000	50	10	3	.90
X16RC20	200	140	16	125	200	12	6	5	0.5	2000	50	10	3	.90

FOR DETAILED TECHNICAL DATA, CIRCLE READER-SERVICE CARD NO. 19.

SPECIFY THE LEADING LINE...

All standard Controlled Rectifier types are available "off the shelf" from strategically located International Rectifier Authorized Industrial Distributors and through our Industrial Representatives throughout the world.

INTERNATIONAL RECTIFIER



SYMBOL OF QUALITY IN SEMICONDUCTORS

RECTIFIER

INTERNATIONAL RECTIFIER CORPORATION: EL SEGUNDO, CALIFORNIA • PHONE OREGON 8-6281 • CABLE RECTUSA

BRANCH OFFICES: NEW YORK CITY: 1580 LEMOINE, FORT LEE, N. J.: WINDSOR 7-3311 • SYRACUSE, NEW YORK: 2366 JAMES STREET, HEMPSTEAD 7-8495 • CHICAGO, ILLINOIS: 205 W. WACKER DRIVE, FRANKLIN 2-3888 • CAMBRIDGE, MASS.: 17 DUNSTER ST., UNIVERSITY 4-6520 • ARDMORE, PENNSYLVANIA: SUBURBAN SQUARE BLDG., MIDWAY 9-1428 • BERKLEY, MICHIGAN: 1799 COOLIDGE HIGHWAY, LINCOLN 8-1144 • CANADA: 15B1 BANK ST., OTTAWA, ONTARIO, REGENT 3-6880

CIRCLE 61 ON READER SERVICE CARD

(Continued from p 60)

TABLE II—Comparison of Performance of Six Battery Types

Characteristics	Pb-Acid	Ni-Cd pocket plate	Ni-Cd sintered plate	Ni-Fe	Zn-AgO	Cd-AgO
Open circuit voltage of charged cell	2.1	1.3	1.3	1.4	1.8	1.4
Average discharge voltage at 1-hr rate ^a	80 F 1.86 0 F 1.84 -40 F 1.72	1.05 1 0.75	1.18 1.15 1.08	0.85	1.43 1.27	0.99 0.95 0.77
Voltage range for constant-current charging	2-2.6	1.3-1.7	1.3-1.7	1.5-1.8	1.6-2.1	1.2-1.7
Constant-current charging at 80 F	10 hr rate to constant voltage	5 hr rate for 7 hrs	5 hr rate for 7 hrs	5 hr rate for 7 hrs	20-hr rate to 2.1 v	20-hr rate to 1.7 v
Time to 50% capacity retention	80 F 55 days 125 F 7 days 160 F ¼ day	300 days 17 days 4 days	300 days 17 days 4 days	25 days	Over 2 yrs (Estimated) 115 days 58 days	Over 2 yrs 115 days (estimated) 58 days
Cycle life ^b	250-500	Over 2,000	Over 2,000	Over 2,000	100-250	300-500
Major advantages	Low cost, general availability, good life cycle	Excellent cycle life, reliable, rugged	Excellent cycle life, reliable, good low temp. charge/discharge performance, rugged	Excellent cycle life, reliable, rugged	Excellent energy output per unit weight and volume	Good energy output per unit weight and volume, good cycle life
Major disadvantages	Sulphates on discharged stand, cannot be charged at sub-zero temp.	Poor high rate and low temperature performance	High cost	Poor charge retention and low temperature performance	High cost, poor cycle life and low temperature performance	High cost
Partial list of manufacturers	Gould-National Batteries, Inc. Depew, N.Y. Electric Storage Battery Company Philadelphia, Pa. and many others	Gould-National Batteries, Inc., Nicad Division, Easthampton, Mass. Nife, Inc., Copiague, L. I.	Sonotone Corp., Elmsford, N.Y. Gould-National Batteries, Inc., Nicad Division, Easthampton, Mass. Gulton Industries Inc., Nicad Division, Metuchen, N.J. The Eagle-Pitcher Co., Joplin, Mo. Nife, Inc., Copiague, L. I.	Thomas A. Edison Industries, McGraw-Edison Co. Storage Battery Division, West Orange, N. J.	Yardney Electric Corp., New York, N.Y. Electric Storage Battery Co., Philadelphia, Pa. The Eagle-Picher Co., Joplin, Mo. Frank R. Cook Co. Denver, Colorado	Yardney Electric Corp., New York, N.Y.

Key: ^a Figures based on 20-percent drop in voltage during the discharge period.
^b Battery life depends largely upon the depth to which it is discharged during each cycle. In the cases where an upper limit is given, this limit indicates the number of cycles to be expected on a shallow discharge.

NOW YOU CAN SPECIFY SPERRY FOR 2N327A 2N328A 2N329A 2N330A

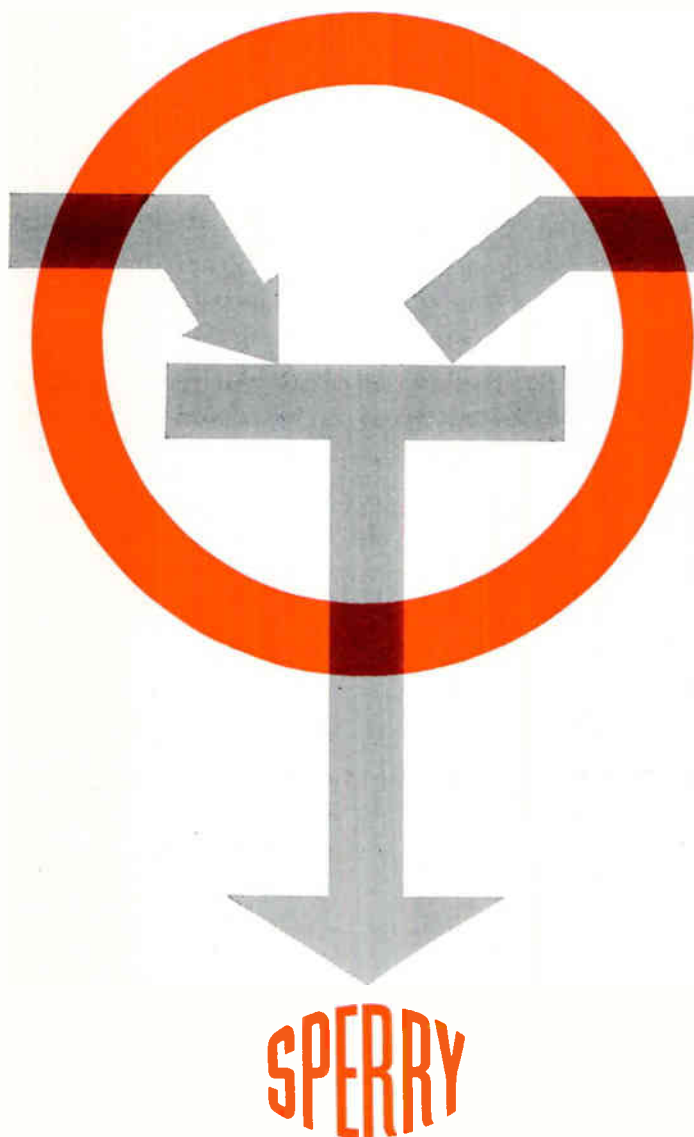

SILICON PNP TRANSISTORS IN PRODUCTION QUANTITIES

Newly-added to the world's widest line of general-purpose PNP silicon transistors, these popular types are available immediately for your audio, switching and control applications.

More than an additional production source for these devices, you will find Sperry Semiconductor to be the source, with new standards of quality and reliability.

Like all other Sperry transistors, these units feature new low levels of I_{CO} and are baked at 200°C for 200 hours for utmost stability. For immediate delivery on the 2N327A series, contact the nearest Sperry sales office as listed below.

And don't forget these other recently-announced types for which you can now SPECIFY SPERRY:

2N1034	2N1219
2N1035	2N1220
2N1036	2N1221
2N1037	2N1222
2N1275	2N1223

SPERRY SEMICONDUCTOR DIVISION, SPERRY RAND CORPORATION, SOUTH NORWALK, CONNECTICUT
Call or write: Sperry Semiconductor, Wilson Avenue, SOUTH NORWALK, Conn., VOLunteer 6-1641; in NEW YORK PLaza 2-0885;
3555 W. Peterson Ave., CHICAGO 45, Ill., KEystone 9-1776; 2200 East Imperial Highway, EL SEGUNDO, Calif., OREGon 8-6226.

Ultraviolet Radiometry Standard

BLACK BODY developed at the National Bureau of Standards shows potentialities as a standard of ultraviolet radiation. Preliminary results indicate that radiant energy from the black body corresponds closely with that predicted by Planck's law for an ideal radiator.

A tungsten ribbon lamp has been used by the Bureau as an approximate standard of spectral radiant energy in the near ultraviolet, visible and near infrared regions. This standard, instead of being based on an absolute measurement of spectral emission, is evaluated in terms of temperature (based on pyrometric observations) and emissivity of the tungsten ribbon. However, in an approximately ideal

black-box radiator, intensity is greater than that from any other body at the same temperature, radiations are essentially independent of radiator material and variations with temperature and wavelength can be calculated from Planck's law.

Development of such a standard has been difficult, however, primarily because materials have not been available that could withstand the high temperatures necessary for emission of measurable energy in the ultraviolet spectral region.

New materials for use at high temperatures were applied in constructing this black body. Among advances that made this development possible is a shielded r-f generator that produces negligible

interference in the operation of photoelectric amplifier systems. Equally important are high-purity graphite and insulating materials with chemical and physical stability characteristics at high temperatures.

Construction

Experiments to determine optimum dimensions for the graphite black body are still under way. Promising results have been obtained with a cylindrical enclosure 4½ in. long and 1½ in. in diameter, with walls ⅜ in. thick. The exit end of the tube has a ⅜-in. opening shielded by a conical graphite end-piece ⅜ in. long, which contains a second similar opening.

The black body is heated by an induction method in a 6-turn water-cooled coil, powered at 450 kc by an r-f generator. The graphite tube is insulated by tightly packed boron powder in a high-temperature porcelain container. An alundum ceramic tube between the graphite core and porcelain container increases physical stability. By enclosing this furnace in an airtight helium-filled chamber, oxidation of the graphite at high temperatures is considerably reduced.

Distribution of radiant energy at various temperatures is detected by a double quartz prism spectroradiometer. Two aluminized mirrors (one plane, one spherical) focus an image of the black body opening on the slit of the optical system. Spectral energy is detected by a photomultiplier, then amplified and recorded on a strip chart.

Results

Data were obtained with this arrangement for black body temperatures from 2,000 to above 2,600 degrees K—measured with an optical pyrometer. Except at the highest temperatures, little depreciation of the graphite core occurred.

In comparing the radiation of this graphite enclosure at temperatures near 2,000 K with calculations based on Planck's law, it was found that radiation output closely ap-

Triangular Waveguide Antenna

By NAOMI KASHIWABARA, U. S. Navy Electronics Laboratory, San Diego, Calif.

SLOTS placed in the hypotenuse face of an isosceles right triangular waveguide form another shape for slotted radiating waveguides. Side lobes are down 20 db and back lobe is down 15 db at 1,060 mc.

The waveguide, shown in an official photograph of the U. S. Navy, is more rigid and easier to construct than large conventional slotted waveguide cross sections. Its rigidity is expected to be significant in developing low-frequency antennas.

When the dominant mode is propagated along the isosceles right-triangular waveguide, current on the hypotenuse face is identical with that on the broad face of a rectangular guide. The dominant mode can be analyzed into a vector addition of TE_{10} and TE_{01} modes in a square-sectioned waveguide, both modes being of equal intensity and in phase.

Energy is introduced into the antenna by a monopole probe 3 inches long placed perpendicular to a leg surface at its center line. The external end of the probe is attached to a UG 58A/U adapter for connection to flexible coaxial cable.

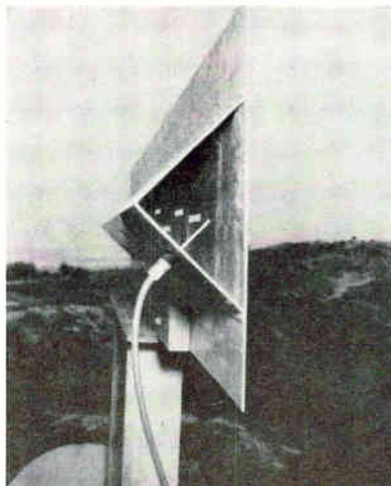

Easily constructed triangular waveguide forms rigid slotted waveguide antenna

The end beyond the eight radiating slots is terminated by microwave absorbent hairflex 10 inches thick backed by a shorting plate. The voltage standing wave ratio of this matching load was 1.24. Input vswr at the adapter of 1.7 was obtained by matching a shorting plunger near the input probe. No further attempt was made to match impedance.



HB GROUP

*voltage
regulated
power
supplies*

0-325 VDC IN 3 1/2" PANEL

MODEL	DC OUTPUT VOLTS	DC OUTPUT CURRENT	RIPPLE	AC * OUTPUT
HB-2	0-325	200 ma.	0.003V	EACH SUPPLY HAS TWO UNREGULATED 6.5 VAC OUTPUTS AT 6 AMPS.
HB-4	0-325	400 ma.	0.003V	
HB-6	0-325	600 ma.	0.003V	

*Series connected: 13V CT — 6 Amps. Parallel connected: 6.5V — 12 Amps (3% additional voltage provided to compensate for voltage drops in connecting cable)

ORDERING INFORMATION:

Units without meters use model numbers indicated in table. To include meters add M to the Model No.

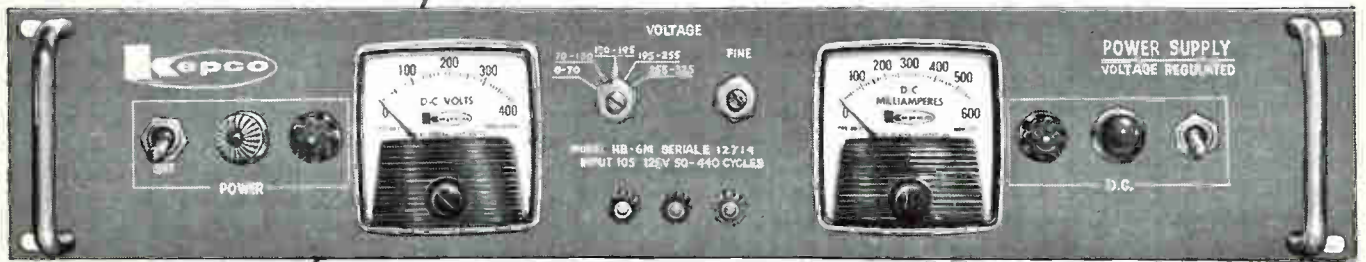

TWICE AS MUCH POWER IN THE SAME RACK SPACE



a
new
Kepco
design

*write for
complete
specifications*

KEPCO, INC. 131-38 SANFORD AVENUE • FLUSHING 55, N. Y. • IN 1-7000 • TWX # NY 4-5196

NEW

twin contact miniature DC-AC choppers



Eleven types, both single and double pole.
Long life.
Low noise level.
Extreme reliability.

LOW LEAKAGE
LOW NOISE
STABLE NULL

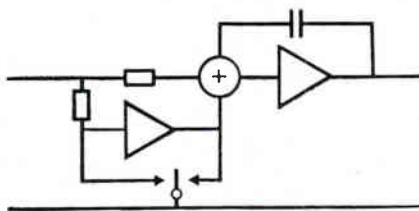

B



Write for Catalog 515-B

STEVENS INCORPORATED ARNOLD

QUALITY SINCE 1943

7 ELKINS ST., SOUTH BOSTON 27, MASS.

S/A 1623

proximates that of an ideal black body. Calculations based on physical characteristics of the graphite tube support this conclusion.

Dynamic Testers For Transistors

By L. G. SANDS, Ridgewood, N. J.

TRANSISTORS are operated as oscillators in two recently developed dynamic transistor testers. Open, shorted or excessively leaky transistors will not oscillate. In the Seco model 100, a neon lamp glows to indicate oscillation. In the Kierluff model K & K, a miniature loudspeaker provides audible indication of oscillation.

Neon Indicator Type

In Fig. 1, the transistor is operated as a blocking oscillator. An operable transistor should oscillate with R_1 set at zero. If S_1 is on, the NE-51 neon lamp glows.

Transistor gain can be measured by adjusting R_1 away from zero to reduce base current. When the transistor stops oscillating, the position of the calibrated knob of R_1 is noted.

An external a-c voltmeter or vtvm could be connected at the output to measure output voltage of an oscillating transistor with S_1 at off. An oscilloscope could also be connected to observe waveform as well as measure output voltage. The oscillating frequency ranges from 50 to 12,000 cps depending on the transistor and the setting of R_1 .

Switch S_2 is normally closed. When testing power transistors, S_2 is opened, inserting R_2 in series with the emitter circuit. A dpdt switch, not shown in Fig. 1, reverses battery polarity to permit testing npn transistors. Since bat-

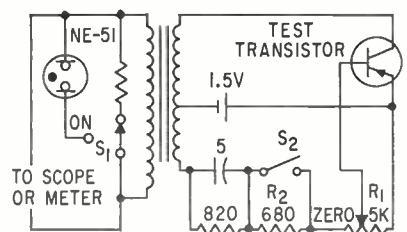

FIG. 1—Blocking oscillator-type transistor tester provides visual indication of oscillation

tery potential is only 1.5 volts, transistors are not damaged when connected improperly.

In the loudspeaker-type tester, shown in Fig. 2, collector current is fed through the feedback winding of transformer T_1 , to produce oscillation in the audio frequency range. Adjustment of feedback is controlled by R_1 . The audible indicator, a miniature loudspeaker, is fed through transformer T_2 .

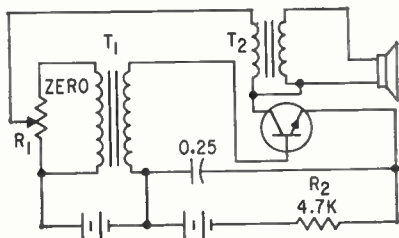

FIG. 2—Oscillating test transistor provides aural indication with small loudspeaker

When R_1 is at zero (maximum feedback), a transistor that is not open, shorted or leaky should produce audible oscillations when the *nnp-pnp* switch (not shown) is set for correct battery polarity. As R_1 is adjusted to reduce feedback, oscillation stops at some point indicated by the absence of a tone from the loudspeaker. The setting of R_1 is noted. Small transistors will oscillate over as much as 70 percent of the R_1 scale, while power transistors cover as much as 50 percent.

Runaway transistors can be detected by reversing the *nnp-pnp* switch to stop oscillation for a few seconds, and then flipping the switch back to its correct position. If the transistor oscillates at a different frequency or will not resume oscillation, the transistor is a runaway. Also, if frequency changes without changing the setting of R_1 , it can generally be assumed that the transistor is a runaway.

The speaker-type tester is provided with two front panel sockets for accommodating small and power transistors. The neon type is provided with a front panel transistor socket as well as three retractable clip leads for connection to lead-type transistors. This tester can also be used for testing transistors without removing them from their own circuits.

Both testers are useful for matching transistors.



NEW RACK PANEL OSCILLOSCOPE

with Identical X and Y Amplifiers

**GREATER SENSITIVITY...
STABILITY... COMPACTNESS...
than any scope in its class!**

7" SCOPE PERFORMANCE

... in less space from new ETC $4\frac{1}{2} \times 5\frac{1}{2}$ " rectangular C-R tube. Bezel adapter fits all standard cameras.

IDENTICAL AMPLIFIERS

... for X and Y axis simplify precise studies of phase shift and servo mechanisms.

RACK MOUNTING

... in only 16" depth by 7" high. Fits standard relay racks with doors closed.

New Model K-11-R — outstanding in performance, price and size—sets new standards for general-purpose oscilloscopes. Identical, high-sensitivity horizontal and vertical amplifiers have less than 3% phase shift below 100 kc. A built-in calibrator and wide range of accurate sweep speeds simplify measurements of voltage and time without external patching.

Carefully miniaturized, but with reliability foremost in mind, the K-11-R is built around a compact new ETC rectangular C-R tube that gives the same raster area as a conventional 7" round tube.

Write for complete specifications

PERFORMANCE BRIEFS

X AND Y AMPLIFIERS

Sensitivity: 500 $\mu\text{v}/\text{cm}$ to 150 v/cm .
Stability: 1 mv/hr after warmup.
Bandwidth: DC to 300 kc.
Attenuator: 15 calibrated ranges.
Coupling: DC or AC, balanced or unbalanced thru panel or rear receptacle for console operation.

CALIBRATED SWEEP

Linear-Sweep Time Base: 3% acc.
Calibrated from 100 msec/cm to 1 $\mu\text{sec}/\text{cm}$. Uncalibrated from 1 sec/cm to 2 $\mu\text{sec}/\text{cm}$.
Trigger Sync: Int., Ext., or Line an voltage rise from 0.023 $\mu\text{sec}/\text{v}$ to 20 msec/v .

CALIBRATOR

Internal, line frequency square-wave at 400 millivolts peak-to-peak.

Price: \$650.00 f. o. b. Phila., Pa.

electronic tube corporation

1200 E. MERMAID LANE • PHILADELPHIA 18, PA. • CHestnut Hill 7-6800
Headquarters for SINGLE- and MULTI-BEAM SCOPES and dependable C-R Tubes ... since 1937
Visit Us At The I.R.E. Show—Booths 3112-3113

Components for the Millimeter Band

TENTATIVE SPECIFICATIONS on a series of Carcinotron tubes for the millimeter range, covering a frequency from 37 to 100 kmc, was released to *ELECTRONICS* by American Radio Company of New York City a subsidiary of Compagnie Generale de T. S. F. (See Table I). This series of millimeter-wave tubes was developed at C. S. F.'s research center at Corbeville, France where some outstanding work in the area of extremely short waves (10 to 0.1 mm) and extremely high frequencies (30 to 300 kmc and up) is being accomplished.

Reflex Klystron

Technical information on a new millimeter reflex klystron was also received from Raytheon's Microwave and Power Tube Division at Waltham, Mass. This tuned reflex klystron oscillator, Raytheon's QK673, was designed for operation in the 88 to 92 kmc range and has a minimum output of 3 milliwatts. The r-f output is through waveguide sealed by a mica window. The output flange mates with a standard UG387/U flange.

One of the limitations connected with work in the millimeter wave area has been imposed by the klystrons and magnetrons, and recently methods have been sought for improving tube efficiencies. Up until rather recently, the Amprex DX 151 was the only available commer-

Table I—Carcinotron Tube Characteristics

	COE-8060	COE-6045	COE-1637	COE-3833	COE-3330
Line Volt	1,000-3,700v	1,000-2,500v	2,200-5,200v	2,500-4,800v	2,500-4,500v
Band	37-50 kmc	50-65 kmc	65-80 kmc	80-90 kmc	90-100 kmc
Cathode Curr	15-30 ma	20-30 ma	20-30 ma	25-50 ina	25-40 ma
Anode Volt	400 v	400 v	400 v	1,100 v	1,100 v
Heater Volt	6.3 v	6.3 v	6.3 v	6.3 v	6.3 v
Heater Curr	1.5 amp	1.5 amp	1.5 amp	1.5 amp	3 amp
Weight	7.3 kg	7.3 kg	7.53 kg	7.4 kg	7.3 kg

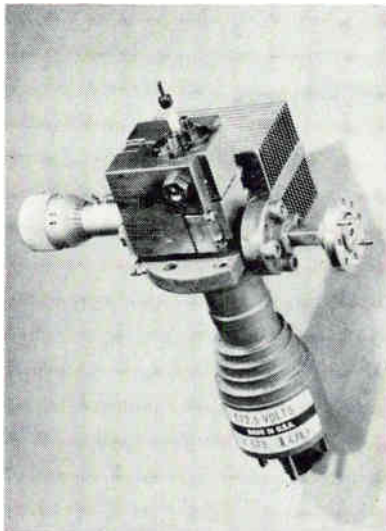

FIG. 2—Type QK 673, a mechanically tuned reflex klystron designed for operation in the 88 to 92 kmc range, was developed by Raytheon, Waltham, Mass.

Another available tube is the Amprex DX-164 for 75 kmc that has a pulse length of 0.1 microseconds. Amprex Electronics Corp. of Hicksville L. I., N. Y. recently described an interesting tube, their 7093, in connection with the design of high-resolution radar. The tube operates at 35 kmc. This permits a reasonable antenna size. The tube delivers 25 kw of power and several watts of average power. But most important, the 7093 can operate at pulse lengths of 0.02 microseconds. Small, light and rugged, this may be an ideal tube to help solve problems in airborne and marine radar.

Millimeter Crystal

Security declassification has made possible release of information regarding development of a millimeter crystal by the Special Components Department of Philco's Lansdale Division, Penn.

Now commercially available is the Philco 1N2792, a 4.3 mm crystal which was developed with U. S. Signal Corps support. The mixer diode makes useful the 70 kmc band. Designed primarily for high-resolution radar applications, it is of integral waveguide construction. The diode is mounted in a section of RG-98U waveguide.

The germanium device features a true hermetic seal, and uses a patented shock-resistant anchor whisker construction. Philco spokesmen say that the greatest difficulty

cial tube for the 60 to 75 kmc area. And the design of high-resolution radars presented power output problems.

Limitations of some of the conventional tubes have been described in the literature, and so have recent conventional microwave tube techniques.^{1,2} Last year I. Kaufman reported the spectacular results obtained with the RPB 3-27A magnetron, developed at the Columbia Radiation Laboratory. One of the highest frequencies reported in the literature is the Karp 200 kmc backward-wave oscillator.³

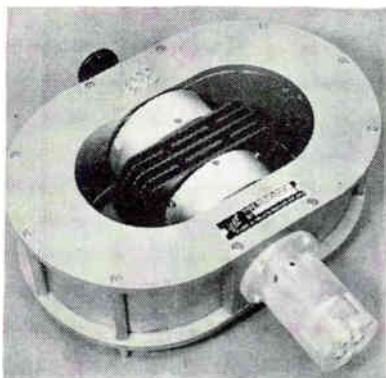

FIG. 1—Type COE 6045 carcinotron, designed for operation in the 50 to 65 kmc range, was developed by Compagnie Generale de T. S. F. of Paris, France



AN ACHIEVEMENT
IN DEFENSE
ELECTRONICS

HOW A 6-YEAR-OLD RADAR STAYS YOUNG

A six-year operational veteran, the FPS-6 is still the principal height-finder for air defense. Fundamentally sound design and built-in capacity for improvement enable General Electric to keep this radar "young."

Contrasted with earlier versions, today's FPS-6 features height line display as a full-time trace. Indicator calibration, sector scan, performance monitoring and azimuth blanking are automatic. The nod angle, formerly fixed, has been made variable to attain more hits per target. A new ferrite isolator increases magnetron life and stability. Noise figure has been improved by nearly 1.5 db.

The sustained effectiveness of this radar at operational sites during six years of a rapidly changing air defense environment is truly an achievement in defense electronics. 227-4

Progress Is Our Most Important Product

GENERAL  ELECTRIC

DEFENSE ELECTRONICS DIVISION
HEAVY MILITARY ELECTRONICS DEPARTMENT

MASSA

Announces

40 MM AMPLITUDE with RECTILINEAR INK RECORDINGS



Portable
two channel Meterite
Model BSA-250

- 40 mm amplitude • Frequency Response, DC to 120 cps • Rectilinear recordings on economical ink chart paper (save more than \$3000 in 200 operating hours over other rectilinear charts, running at an average chart speed of 50 mm/sec.) • Choice of interchangeable plug-in

preamplifiers* • Transistorized driver amplifiers with individual power supplies • 6 Chart speeds .5 to 200 mm/sec. • Event marker with internal push button control.

INC., HINGHAM, MA

**MORE DATA
PER DOLLAR**

MASSA DIVISION CO

ACTUAL
REPRODUCTION
ON 40 MM
CHART PAPER

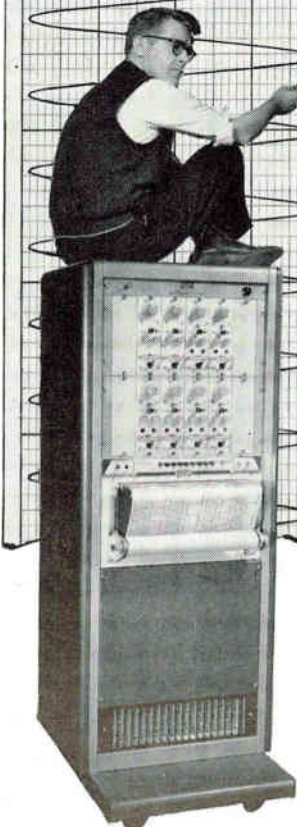

Eight channel recording system,
Model BSA-850

- 40 mm amplitude • Frequency response DC to 120 cps • Rectilinear recordings on economical ink chart paper (save more than \$6000 in 200 operating hours over other rectilinear charts, running at an average chart speed of 50 mm/sec.) • Choice of interchangeable plug-in preamplifiers* • Transistorized driver amplifiers with individual power supplies • 18 speeds push button controls .5 cm/hr to 200 mm/sec.

* **PREAMPLIFIERS** — All Massa Recording Systems are designed to accept a wide choice of plug-in Preamplifiers to satisfy every recording requirement.

Other MASSA Products
RECORDING SYSTEMS
ACCELEROMETERS
MICROPHONES
HYDROPHONES
TRANSDUCERS



6 FOTTLER ROAD

HINGHAM, MASSACHUSETTS

overcome was the extremely small junction required (on the order of two microns radius).

Continued development under a Signal Corp contract calls for investigation of application of microtech electrochemical techniques to the millimeter device. Preliminary results indicate the evolution of an even more sensitive crystal.

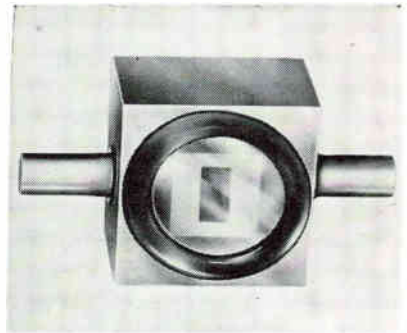

FIG. 3—Type 1N2792, a 4.3 mm crystal developed by Philco's Lansdale Division

Also in developmental stage is a specialized broad-band ridge waveguide millimeter video detector, not yet commercially available.

Frequency Multipliers

Perhaps the most significant work in the program at DeMornay-Bonardi of Pasadena, California, according to their assistant chief engineer E. R. Draper, has been in the field of frequency multipliers. All of their test work had to be accomplished using harmonic multiples of available low-frequency tubes. The best conversion efficiency obtainable was required to get a usable signal from inherently low-power tubes. Their DB-350 series of crystal multipliers is the outgrowth of this requirement. A new structure was employed which placed the crystal directly in the output waveguide and for greater efficiency a shunt arm movable short was added. All of their DB multipliers with inputs of 26.5 kmc and higher employ this technique.

Utilizing Harmonics

In the DeMernay-Bonardi laboratory, they have been using a British Elliott B-579 klystron. Using a special multiplier, they were able to utilize the 3rd and 4th harmonics. This allowed power above 100 kmc with as much as 38 dbm.

This multiplier will be available later in the year.

REFERENCES

- (1) P. D. Coleman and R. C. Becker, Millimeter Wave Generation, *IRE Transactions on Microwave Theory and Techniques*, vol MTT-7, p 42-61, Jan., 1959.
- (2) I. Kaufman, The Band Between Microwave and Infrared Regions, *Proc IRE*, p 381-396, Mar., 1959.
- (3) A. Karp, Backward Wave Oscillator Experiments at 100 to 200 kmc, *Proc IRE*, vol 45, 496-503, Apr., 1957.

Epoxy Resins For Encapsulation

A FAMILY of unique epoxy resins that displays novel structure, reactivity and curing characteristics has been developed and is now being introduced by Food Machinery and Chemical Corporation's Epoxy Department in N. Y. C. Known as the OXIRON Series, these materials are different in many ways from contemporary resins being offered to the plastics industry.

Applications

These resins are expected to find use in insulation, lamination, molding, adhesives, and coatings.

Preferred curing agents for epoxies in insulating and encapsulating applications are anhydrides. The OXIRON resins react readily with anhydrides and combine excellent electrical properties with stability at high temperatures. Further, they can be cured at relatively low temperatures, thereby providing processing advantages and reducing the chance of thermal damage to electronic components.

The new resins exhibit low shrinkage and low exotherm on cure. The latter is of major importance in large castings and laminates. These properties, combined with low temperature curability and lower density than conventional epoxies, make the resins ideally suited to casting and tooling applications.

The new resins will wet glass fibers readily and show good adhesion on cure. Laminates with excellent strength to weight ratio can be prepared under low pressure in relatively short cure cycles. OXIRON polyamine cure systems show long pot life, suggesting wet lay-up and prepreg use with built-in storageability.

design engineering
... operational
... off-the-shelf



An Arnoux power supply going into a canister for the Atlas propellant utilization system.

Arnoux's fast moving story... What's New in power supplies

NEW POWER SUPPLIES FOR
guidance
flight control
fire control and
airborne computers
VCO's and SCO's
rf amplifiers
and transmitters
precision reference-voltage sources
missile checkout
radar systems

Arnoux has consistently proved its versatility and reliability in providing either a few prototypes or thousands of power supplies—*quality in quantity*.

In fact, wherever reliability and design integrity are taken for granted, *there* you'll find Arnoux power supplies, static converters, and inverters.

For airborne applications and for GSE, Arnoux power supplies have these outstanding features: precision regulation... temperature stability... low ripple... tight packaging... light weight... and they meet, exceed, or are qualified under specification MIL-E-5272A.

For highly precise, static and dynamic regulation of line and load changes when accuracy is vital, Arnoux power supplies provide a wide range of output voltage and current. Depending on specific models, this range is from 5 to 500 vdc and from 30 ma to 15 amperes. Bulletin 102.

Arnoux Corporation

11924 W. Washington Blvd. • Los Angeles 66, California

ARNOUX

phonetically, say Are'new

POWER SUPPLIES



Simple Steps Speed Inspection

INSPECTING SMALL LOTS of various components can be done simultaneously by the same work crew when work is segregated into equal time chores. The following methods are used by United States Testing Co., Inc., Hoboken, N. J.

A supervisor assigns a serial number to each component in a lot. The numbers are supplied on strips of tape. Pressure sensitive vinyl tape is normally used and glass cloth tape is used when the component is to be tested at high temperature. The tape is applied to the body or lead of the part. The number identifies the component in all records.

After visual inspection of workmanship and manufacturer's coding, part dimensions are measured. Calipers may be used, but the firm prefers a fixture like that in Fig. 1 for tubular parts. Parts can be rotated in the fixture to determine out-of-roundness.

The gage is calibrated so it will read zero at the nominal dimension of the part. The gap between the gage block and stop is opened by the push bar. As the push bar is released, the spring loading presses



Component inspection line. Each operator performs a separate test. Parts are passed on in corrugated tote trays

the block against the part. The gage pin follows the end of the spring-loaded bar. The adjustable stop limits the gap opening to protect the gage.

Tote trays with corrugated aluminum bottoms are used to keep work sorted out. The corrugations keep tubular components neatly separated. Test steps are noted on slips of papers pasted to ends of the

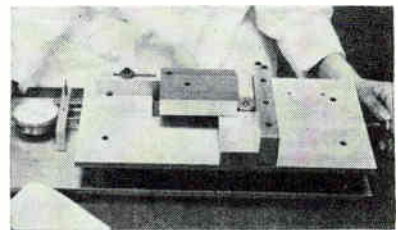

Diameters of tubular parts are measured on this gage

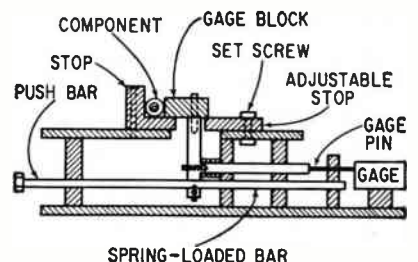

FIG. 1—Details of tubular parts gage

Die Makers Get Private Offices



Remodeled tool room at Magnetic Metals Co., Camden, N. J., has each toolmaker's surface grinder, gages and special tools in an air conditioned, soundproofed booth with a luminous ceiling and a lock on the door. The booths eliminate distractions, enable toolmakers to hear better the "kiss" of their grinding wheels and also enhance craftsmanship and employee loyalty, the firm reports. The booths, seen along rear walls, incorporate improvements made during a 2-year trial of a single booth

trays, so trays may be stacked. Detailed work sheets are placed in folders in the trays.

After preliminary electrical inspections, components are placed in environmental test fixtures. These are frequently modular in design (ELECTRONICS, p 86, Nov. 27, 1959) so that loading and testing can also be handled on an assembly line basis.

In addition to fixtures previously described, an easy-loading fixture is used for load life testing of axial

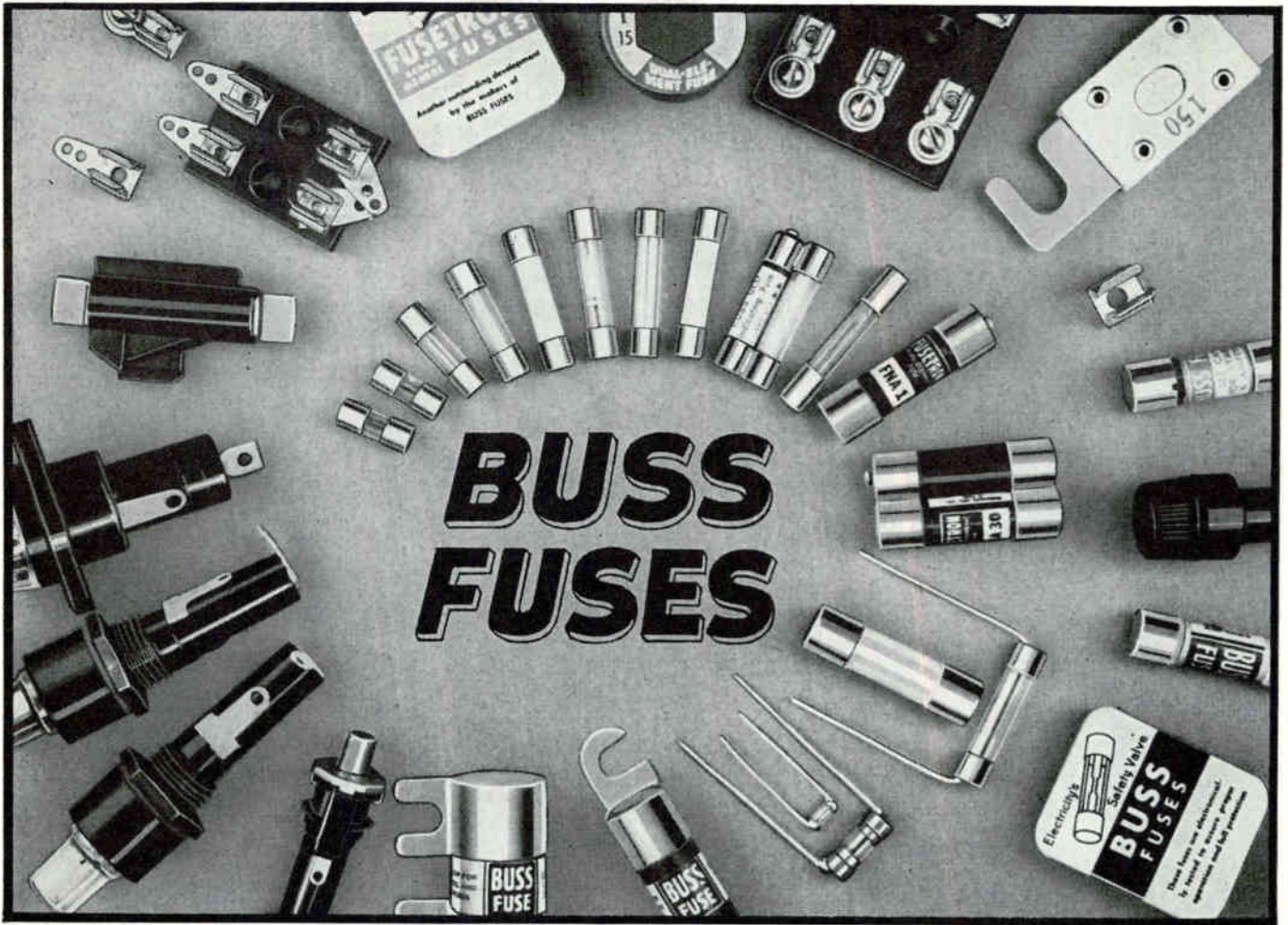

TWO-WAY PROTECTION

Dependable BUSS Fuses safeguard both your product . . . and helps enhance its reputation for quality

When you specify BUSS or FUSETRON fuses for the products you manufacture, you not only provide the finest electrical protection possible — but you also help protect your company's reputation for quality products.

Remember: No matter how good your product is, a poor quality fuse that opens needlessly deprives a customer of the use of your device, — or a fuse that does not protect may permit costly damage to occur. In either case you may lose a customer's goodwill and future business.

Why take the risk when you know you can depend on BUSS and FUSETRON fuses?

Every fuse is tested in a sensitive electronic device that automatically rejects any fuse not correctly calibrated, properly constructed and right in all physical dimensions.

BUSS — the one source for all your fuse needs . . .

To meet all your fuse needs, the BUSS line is most complete, — including a companion group of fuse clips, blocks and holders.

To help you on special problems in electrical protection . . .

BUSS places at your service the facilities of the world's largest fuse research laboratory and its engineering staff. If possible, our engineers will help you select a fuse readily available in local wholesalers' stocks so that your products can be easily serviced.

For more information on BUSS and FUSETRON Small Dimension fuses and fuseholders, write for bulletin SFB.

BUSSMANN MFG. DIVISION,
McGraw-Edison Co.
University at Jefferson, St. Louis 7, Mo.

260

BUSS fuses are made to protect - not to blow, needlessly.

BUSS makes a complete line of fuses for home, farm, commercial, electronic, electrical, automotive and industrial use.



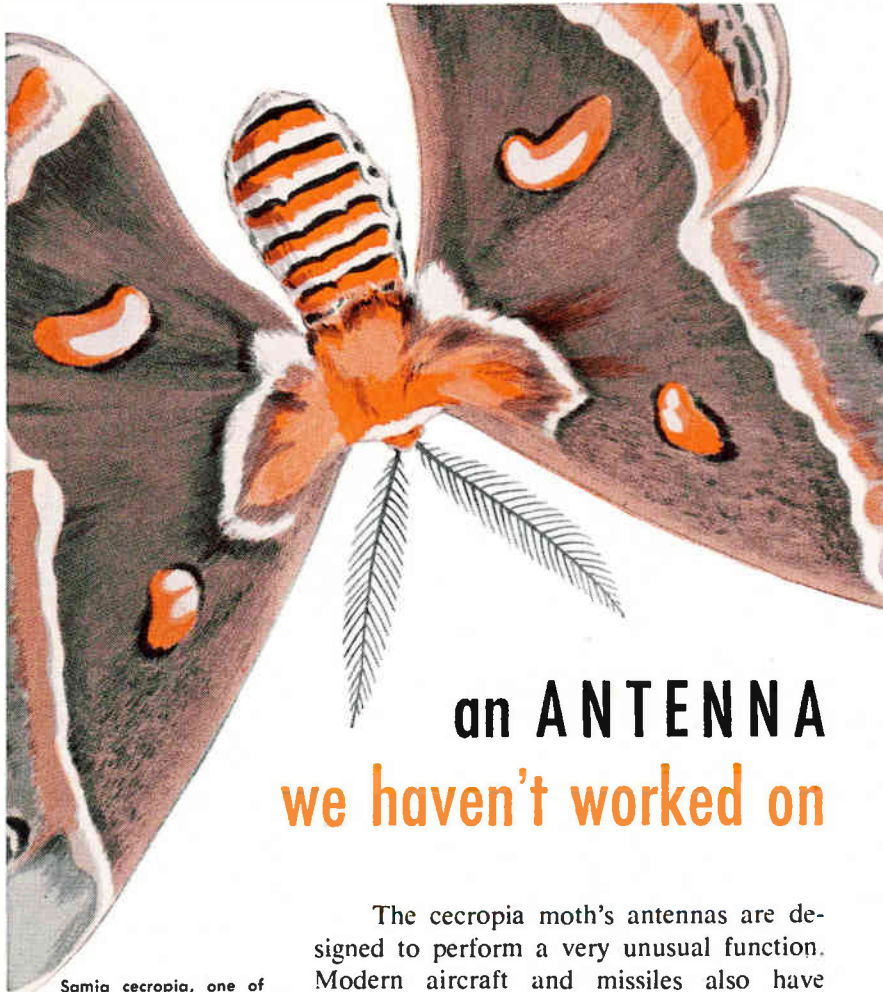

Samia cecropia, one of the largest American moths. The bushy antennae are covered with organs of smell and enable the male to locate his mate by odor from as far away as three miles.

an ANTENNA we haven't worked on

The cecropia moth's antennae are designed to perform a very unusual function. Modern aircraft and missiles also have unique requirements demanding specialized knowledge and capability.

In applying its special capabilities, Dorne & Margolin has never failed to provide practical solutions to its clients' RF systems problems.

So, when faced with an RF systems problem, think about D & M. An existing design or an easily adapted production model meeting your requirements may be available from us at low cost and great savings in time.

A comprehensive Antenna Catalog is yours on request.

Excellent positions in a growing organization affording opportunities for stock participation, as well as many other benefits, are offered to engineers. Contact R. E. Anderson, Chief Engineer.



DORNE & MARGOLIN, Inc.

WEST COAST:
1434 Westwood Boulevard
Los Angeles 24, California

EAST COAST:
29 New York Avenue
Westbury, L. I., N. Y.

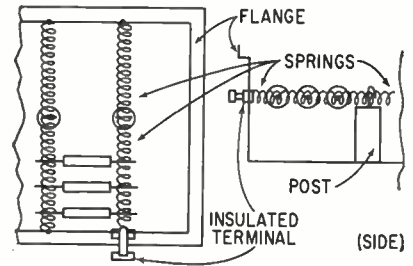

FIG. 2—Top and side views of load life test fixture

lead components. Tightly-wound coil springs are stretched slightly and hung in an open top aluminum box (Fig. 2). Springs are hung in pairs. One is grounded and the other attached to insulated terminals for power connections. Components are loaded by slipping leads between the coils. Code numbers of components in the box and test directions are taped to the front of the box. The tops of the boxes are flanged to permit stacking.

Apothecary Weights Gage Brush Contact

ABSOLUTE MEASUREMENT of brush contact force can be made by simply hanging apothecary weights on the brush until contact is interrupted. The total weight of weights and hanger indicates force.

The fixture illustrated (Fig. 1) permits this type of test to be made on brushes mounted in a variety of block styles. The block is mounted

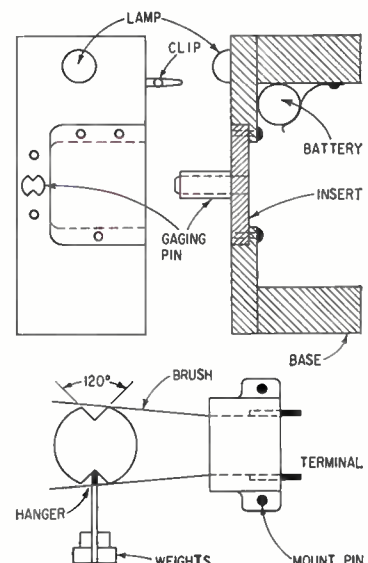
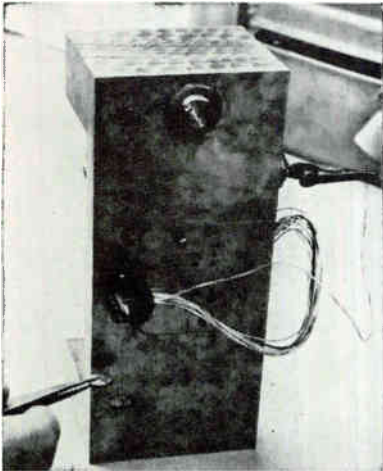
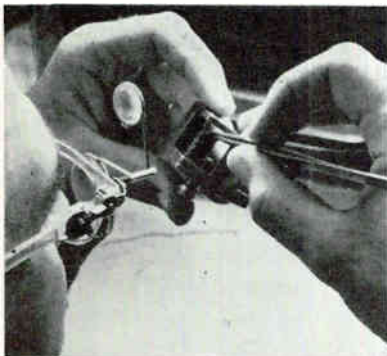

FIG. 1—Gaging pins and inserts to hold brush blocks are removable

on taper pins at the gaging pin, or on the insert by inserting pins through the block into the drilled holes. The insert is removable so it can be slipped out for loading, or changed. Gaging pins are also changeable.



Gage in use. Light goes out when contact is interrupted



Brush shape is adjusted with this fixture

V-grooves in the gaging pin permit the hangar to be positioned at the normal contact point without disturbing contact. The light goes out when the brush pulls away from contact position.

The brushes shown are made by Electro Tec Corp., South Hackensack, N. J., for slip ring assemblies. They are constructed by spotwelding short lengths of noble metal wire to lead wires or terminals. A series of brushes are aligned in take-apart molds and molded into the brush block. When brushes require curvature at the contact point, they are placed in a mandrel fixture and formed by hand. Some types of brushes require harnessed leads and these are prepared on a miniature harness board.

AIRPAX

Coaxial Chopper

for Automatic Direction Finding Equipment

AIRPAX TYPE 199
Double-Pole Double-Throw

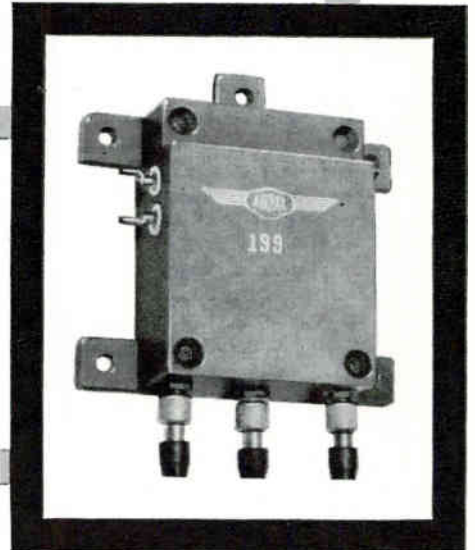

Designed for use in the 100 to 400 megacycle range, the chopper samples two incoming signal sources for a single load or distributes a low level signal to two loads in a periodic manner. Switching frequency is 100 cycles per second.

The voltage standing wave ratio (VSWR) is held below 1.2 by design of the cavity in which the switching contacts operate.

Type 199 has a phase angle of 30° and a dwell time of 160° . It operates effectively throughout a temperature range of -65°C to $+125^\circ\text{C}$. Available from stock.



AIRPAX ELECTRONICS
INCORPORATED
JACKTOWN ROAD, CAMBRIDGE, MD.

CM14

On The Market

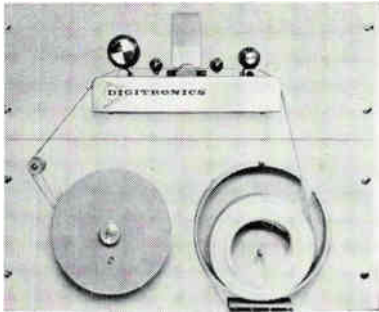

Spooler Unit for tape reader

DIGITRONICS CORP., Albertson Ave., Albertson, L. I., N. Y. Model 4533 Dykor spooler unit provides a take-up reel for a minimum of 300 ft of punched paper or Mylar tape. The 6-in. diameter reel unit can be used with standard Dykor photoelectric readers for operating speeds up to

300 characters/sec if fast stop requirements are to be met. In addition to the take-up reel, there is a feed bin. Together they maintain the single loading and unloading of tape which is characteristic of the in-line feed of the Dykor readers. Unit mounts on standard 19 in. relay racks directly beneath the reader and requires 8 $\frac{3}{4}$ in. of panel.

CIRCLE 301 ON READER SERVICE CARD

Trimming Pot for missile use

WELLS INDUSTRIES CORP., 6880 Troost Ave., N. Hollywood, Calif. TVR-050 series trimming pot is available in 14 standard resistance ranges from 10 ohms to 50 K, and features a molded plastic case for high dielectric strength. Insulating boots on the leads reduce breakage

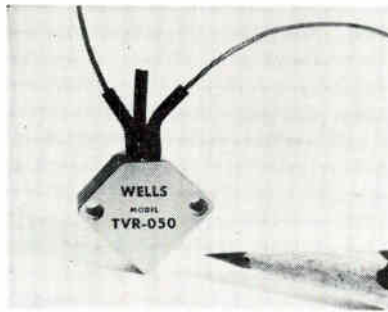

and provide better separation. Basic power rating is 1 w. Unit meets Mil-Specs for temperature, vibration, shock and humidity. Other features include worm and gear adjustment, with high friction loading to eliminate back-lash, and circular resistance element to provide greater resolution and thermal stability.

CIRCLE 302 ON READER SERVICE CARD

Clutches and Brakes subminiature

GUIDANCE CONTROLS CORP., 110 Duffy Ave., Hicksville, L. I., N. Y. Part of a new line of clutches and brakes is the CB-6 clutch brake which has a power consumption of 1.2 w and weighs only 0.75 oz. In-

put inertia is 0.0025 oz in.², and output inertia is 0.0019 oz in.². Output torque (both energized and de-energized) is 2 oz in. min. while breakaway torque is 0.05 oz in. (energized). Engagement time is 3 millisecc max. and maximum recommended speed is 5,000 rpm.

CIRCLE 303 ON READER SERVICE CARD

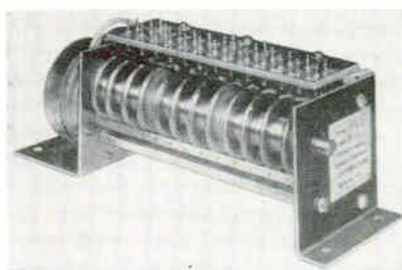
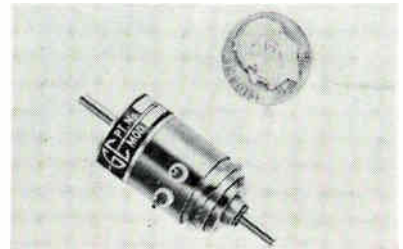

Program Timer high accuracy

EAGLE SIGNAL Co., Moline, Ill. The HYS repeat cycle timer measures only 2 $\frac{1}{2}$ by 2 $\frac{1}{2}$ by 7 in. but contains 12 spdt independently adjustable and removable load switches. Motor operates on 115 v, 60 cycle power.

Time cycle is 90 sec. Built for ground support equipment, the timer will withstand vibration of 0.060 in. double amplitude displacement from 5 to 55 cps and shock of 30 g's for 11 millisecc. Extra large cams allow time settings with an accuracy of 1 percent or better.

CIRCLE 304 ON READER SERVICE CARD

Amplifier-Demodulator transistorized

PLUG-IN INSTRUMENTS, INC., 1416 Lebanon Road, Nashville, Tenn. Model S-4004-P plug-in amplifier-demodulator is designed for applications requiring a phase-sensitive

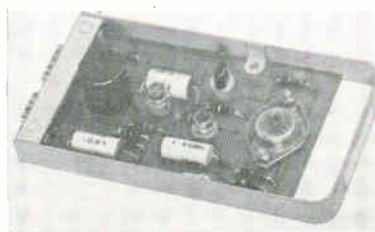

d-c output voltage for an a-c input signal. It can be used with carrier frequencies from 3 kc to better than 30 kc. Output currents of ± 15 ma or greater into a 50 ohm load can be obtained. It requires only 40 ma of negative 24 v d-c power. Linearity of the circuit is better than ± 1 per-

United Eyelets

Lowest Cost Fastener You can buy

Low initial cost per thousand, low installed cost with highly engineered high speed United Eyeletting machines, and you have an unbeatable combination you can put to work saving money. They will join dissimilar materials, can be clinched tightly to fasten, or lightly to function as a pivot.

They can be used as a bearing, or as a terminal. With ceramics, plastics, and glass special machine device helps minimize fracturing. You can get them from stock in a wide range of sizes, colors, and metals. A host of special diameters, lengths, shapes can also be made to solve your individual problem.

See our catalog in Sweets' Design File or write us today to investigate the possibilities of utilizing lowest cost United Eyelets for your product.

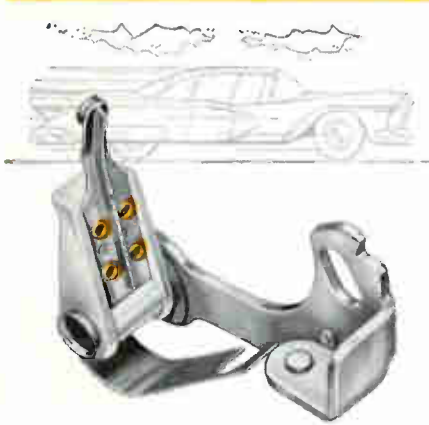

High speed fastening of 2 eyelets simultaneously cuts costs on automotive ignition breaker point assembly.



Eyelet does double duty as fastener for wind shield, bearing for spark wheel. Does both jobs well for only a fraction of a cent.

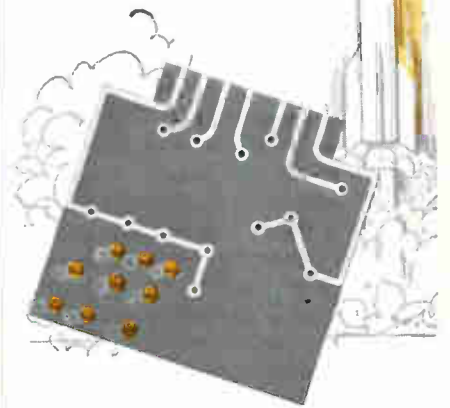

For high altitude or on the ground, funnel flange eyelets provide positive means for making reliable thru-connections on two-sided printed wiring boards.

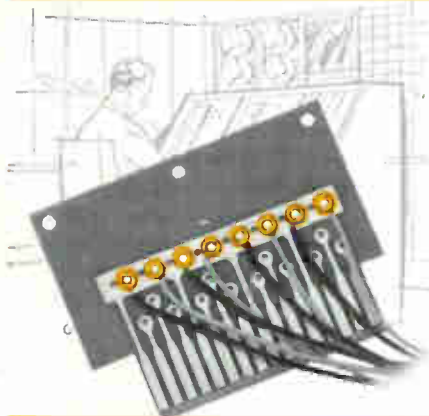

JUST plug it in — United Standardized eyelets hold wires by compression on multi-contact computer part. Tight hold eliminates soldering time and bulk.



Before you say "hello", eyelets are working for you on our most popular method of communication. Try them on a new application — perhaps they'll prove as indispensable as your telephone.



You can avoid the inevitable commercial with the T.V. Selector Switch and still enjoy the silent utility and performance of eyelets on the switch itself.

Free Eyelet Slide Selector helps determine which eyelet you need with given grip and hole diameter.

United

UNITED SHOE MACHINERY CORPORATION

Boston 7, Massachusetts

BRANCH OFFICES: Chicago, 600 W. Jackson Blvd. • Cleveland, 740 Superior Ave., N.W. • Columbus, 487 S. High St. • Cincinnati, 407 Gilbert Ave. • Dallas, 1210 Old Gate Lane
Harrisburg, 20 S. Fourth St. • Johnson City, 19 Jennison Ave. • Los Angeles, 1826 S. Hope St. • Milwaukee, 2362 N. Stanley Pl. • Nashville, 320 Main St. • New York, 1 W. 16th St.
Philadelphia, 2100 Arch St. • St. Louis, 2200 Washington Ave.

The A. W. Haydon Co. designed this series of repeat cycle timers for engineers with tricky timing problems and tight budgets. The low unit price on quantity runs will surprise you...and the savings we can offer on very large volume production sometimes surprises us! ■ Yet there has been no sacrifice in quality...it's all in the design. Special spring switches are supported in molded contact blocks; cams, cam followers and gears are molded nylon for long service life and extremely quiet operation. Two printed circuit cables supply internal wiring to 12 output circuits, and parallel cam shafts provide two cycling speeds. ■ The A. W. Haydon Co. guarantees this repeat cycle timer for at least one year, con-

tinuous operation, and it will actually run for much longer. ■ The unit shown operates at 115V, 60 CPS, 2.5 watts power input. Its switch has been tested for 2 years (125 million cycles at 2 amps resistive 10VAC, 60 CPS) and is rated for 2.5 amp or a 7.0 amp inrush lamp load. ■ To be sure, other variations are available. A. W. Haydon will be delighted to quote these long life, low cost repeat cycle timers in any one of 125 standard speeds, 5 voltage ratings and 3 power supplies.

All have Jones type terminal plugs for fast installation, and a quick-change motor mounting forease of motor replacement. A clear plastic dust cover helps reduce noise level to a whisper. Write for information on your particular requirement.

LONG LIFE LOW COST REPEAT CYCLE TIMERS

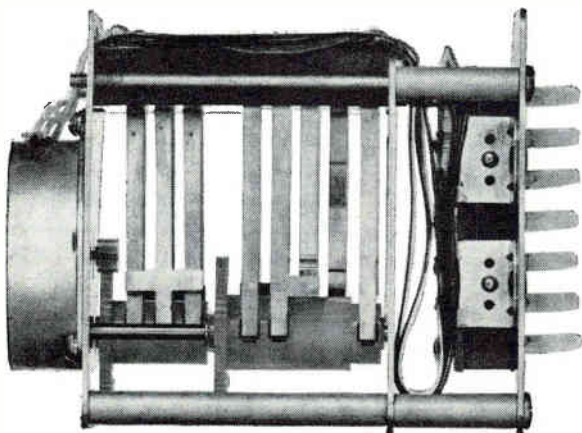

AWH HAYDON
THE COMPANY
235 North Elm Street, Waterbury 20, Connecticut

cent. Overall gain (d-c output/a-c rms input) is approximately 41. The demodulator is essentially free of zero drift.

CIRCLE 305 ON READER SERVICE CARD



Lighthouse Triode high mu

GENERAL ELECTRIC Co., Schenectady 5, N. Y. The new GL-6897 coplanar ceramic lighthouse triode is designed for reliable long life c-w operation. It has a typical power output of 20 w at 1,850 mc with 33 percent plate efficiency, plate current of 100 ma, plate voltage of 600 v, and r-f drive power of 2.5 w. It is shock tested to 400 g's, and can be purchased to specification MIL-E-1/1037A. It is available in production quantities for microwave frequency communications service applications in grounded-grid, power amplifier, oscillator or frequency multiplier circuits. In such service, it will operate at frequencies up to 2,900 mc.

CIRCLE 306 ON READER SERVICE CARD

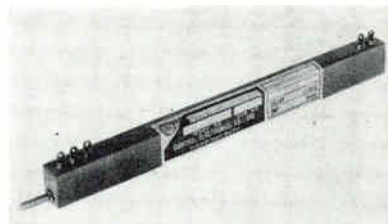

Delay Line magnetostrictive

CONTROL ELECTRONICS Co., INC., 10 Stepar Place, Huntington Station, N. Y., announces a variable magnetostrictive delay line with delays ranging from 2 to 20 μ sec and featuring infinite resolution. Model VM-1020 accepts input pulse voltages of 5 v peak and input pulse widths of 1 μ sec \pm 0.2 μ sec. Output pulse voltage is in the order of 10 mv. Spurious response is kept 17

VELOCITY
LVsyn



DISPLACEMENT
Models 580 (top)
and 581 (bottom)

Precision Transducers

FROM
SANBORN

Linear motion transducers available from Sanborn Company now include the compact, ready-to-use flange-mounted *Model 580* and threaded *581* "probe-styles" for displacements as small as 0.00002" . . . thirty models (shielded and unshielded) of the rugged *Linearsyn* differential transformer for strokes from ± 0.005 " to ± 1.0 ", displacements as small as 0.000001" . . . and twelve models of the *LVsyn* for producing a DC voltage proportional to a linear velocity. Features of the *580-581* probe-style units include 0.5% linearity; basic sensitivity at 2400 cps of 2.4 volts output/inch displacement/volt excitation; built-in output level adjustment, phase shift and temperature change compensation; carbide-tipped stainless steel contact rod riding in jeweled bearings. Both the *LVsyn* and *Linearsyn* transducers are extremely durable units, immersible in working fluids, introduce little or no friction, and have infinite resolution. Standard *Linearsyn* coil lengths range from 0.564" to 6.88", *LVsyn* coil lengths from 3.16" to 22.75".

For differential and single-ended pressure measurements, *Series 267 and 268* transducers for operation in a carrier system offer sensitivities of 40 uv/mm Hg/volt excitation and 40 uv/0.1 mm Hg/volt excitation. Compact, Monel cases have standard Luer connectors.

Contact your local Sanborn Sales-Engineering Representative for bulletins containing complete facts or write the Sanborn Industrial Division in Waltham. Sanborn Sales-Engineering Representatives are located in principal cities throughout the U. S., Canada and foreign countries.

SANBORN COMPANY
INDUSTRIAL DIVISION
175 Wyman St., Waltham 54, Mass.



PRESSURE
Series 267, 268

*for long stroke, high pressure,
high temperature requirements . . .*

. . . special-order *LVsyn* and *Linearsyn* displacement transducers can be supplied. Strokes up to 20" are possible. . . pressure ratings up to 5000 psi, when transducer is submerged in a high pressure medium. . . operating temperature ranges as wide as -65°F to $+450^{\circ}\text{F}$. Consult factory, stating your requirements.



**Best way to get
reliable
soldered connections**

Weller[®] soldering
irons with
MAGNASTAT
temperature control

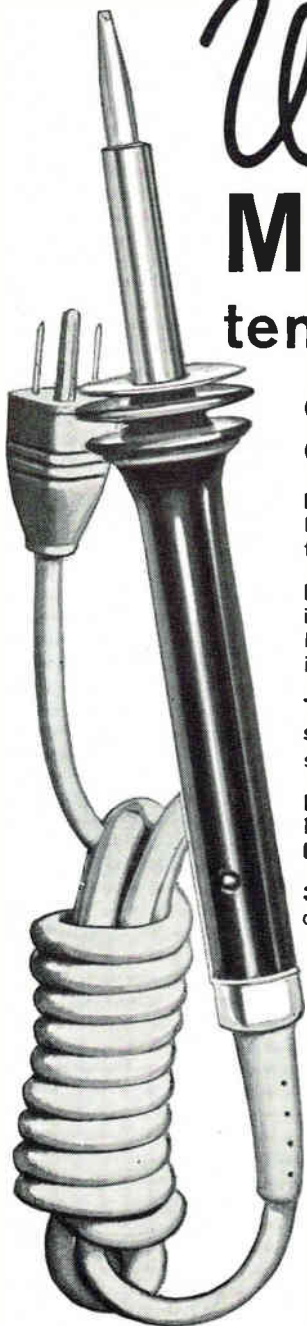

**ONLY WELLER MAGNASTAT IRONS
OFFER ALL THESE ADVANTAGES:**

Less than half the weight of uncontrolled irons. Handle also remains cool. This means less operator fatigue and increased production.

Rapid heat transfer assures maximum efficiency in performance. In many instances the exclusive Magnastat design permits the use of a lower wattage iron than otherwise required.

Tip temperature automatically remains constant. It's magnetically maintained for more reliable soldering, less tip redressing, less down time.

Expertly fabricated of finest materials. Each Magnastat iron is individually inspected and tested before it leaves the Weller plant.

3-wire grounding cord plugs into handle, reduces cord maintenance.

New 55-Watt Pencil-Type Model

MODEL TC-55 controlled low temperature iron. Tip temperature controlled to 700°F. **\$900** list

Other Weller Magnastat Soldering Irons:

MODEL TC-40—40 watts, for printed circuits, etc. **\$900** list

MODEL TC-60—60 watts, for medium electrical soldering **\$1000** list

MODEL TC-120—120 watts, for heavy electrical soldering **\$1150** list

SOLD THROUGH FRANCHISED DISTRIBUTORS

A few franchised territories are available to qualified distributors. For details write to C. R. Robertson, Vice President.

WELLER ELECTRIC CORP. 601 STONE'S CROSSING RD.
EASTON, PA.

db down. Input and output impedance is 700 ohms. Line conforms to all applicable MIL specs. Operating temperature range is from -55 C to +85 C. Weight is 3 oz; dimensions, $\frac{3}{8}$ in. high, $\frac{1}{8}$ in. wide, 7 in. long and a $\frac{1}{4}$ in. shaft diameter.

CIRCLE 307 ON READER SERVICE CARD

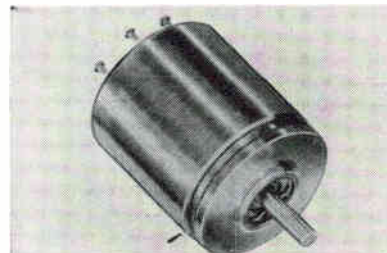

**Generator
variable frequency**

CEDAR ENGINEERING, Division of Control Data Corp., 5806 W. 36th St., Minneapolis 16, Minn. Type 3200 variable frequency generator is a miniature p-m type generator which provides a two-phase a-c output voltage. The voltage amplitude and frequency vary in direct proportion to the shaft speed. It is used for a reference generator to provide information on the rotational speed and angular position of a shaft, as in constant-velocity servo systems. Also, it is used on other systems such as for circular sweep generation on a crt, utilizing the two-phase output phase relationship to position the beam on the scope face.

CIRCLE 308 ON READER SERVICE CARD

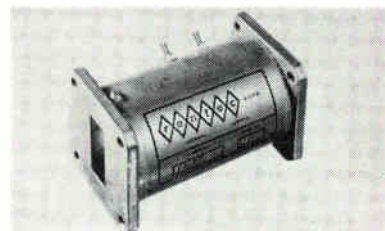

**Phase Shifter
X-band**

RANTEC CORP., Calabasas, Calif. Model PX 105 X-band temperature compensated ferrite phase shifter produces ± 90 deg of phase shift, maintaining absolute phase stability within ± 15 deg over the temperature range -10 C to +100 C. Special matching techniques are

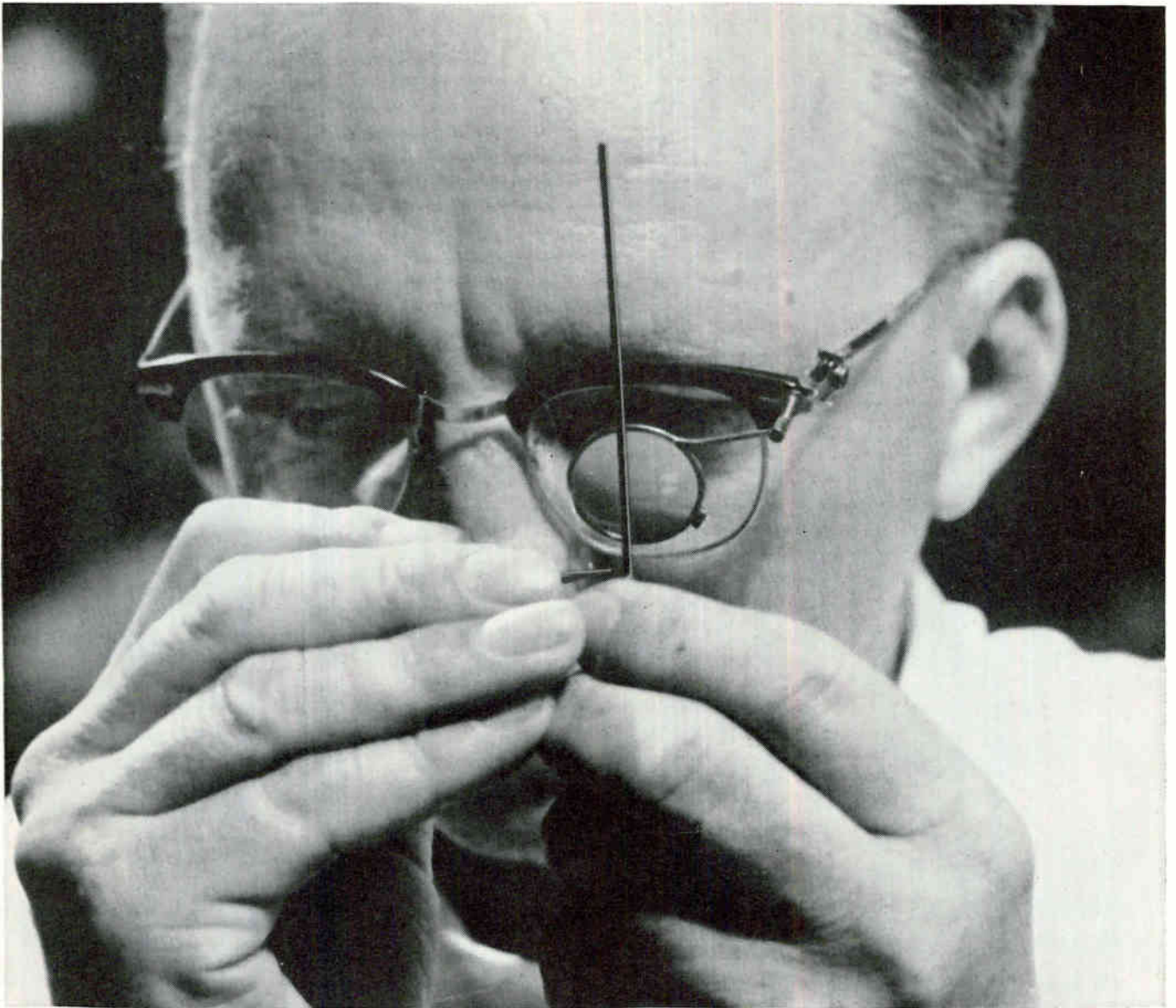

*Constant
surveillance
is your
assurance of
Borg reliability*

The technician in the photo above is inspecting a .001" wire which is wound around the mandrel he is holding. This hair-like wire will become the resistance element for a Borg 900 Series Micropot Potentiometer. Because the resistance element is the most important single part of any potentiometer, every 900 Series Micropot

element is carefully inspected during and after winding . . . one more reason for the Borg 900 Series Micropot reputation for high reliability. Write for complete military and commercial specifications.



ASK FOR DATA SHEETS
BED-A128, BED-A129 AND BED-A130

BORG EQUIPMENT DIVISION
Amphenol-Borg Electronics Corporation
Janesville, Wisconsin

Micropot Potentiometers • Turns-Counting Microdials • Sub-Fractional Horsepower Motors • Frequency and Time Standards

YOKE DISTORTION

your problem?



Uniform magnetic fields
Produced in Celco
Precision
Deflection
Yokes
Minimize
**SPOT
DISTORTION**



Exclusive Celco core materials make it possible to achieve faster recovery times, minimum hysteresis, high linearities and maximum sensitivities.

Contact Celco Engineering Department for a fast solution to all your yoke problems.

Celco produces a complete line of standard or special commercial and military precision deflection yokes.

Celco

Constantine Engineering
Laboratories Co.

Main Plant: MAHWAN, N. J. DAVIS 7-1123

- Pacific Division - Cucamonga, Calif. - YUkon 2-2688
- Central Division, Lanesboro, Pa. - Ulysses 3-3500
- Southern Division, Miami, Fla. - Wilson 5-2164

utilized which maintain the input vswr less than 1.15:1 for all control coil current ranges over the temperature range specified. Control coil impedance is 200 ohms and requires 100 ma current for maximum phase shift. Unit is rated at 2 kw peak, 2 w average.

CIRCLE 309 ON READER SERVICE CARD



Voltage Regulator transistorized

POWER-TRONIC SYSTEMS, INC., 10 Pine Court, New Rochelle, N. Y. This transistorized regulator is designed to operate in ambients of -55 to $+125$ C and to meet MIL-E-5272. Available output voltages are between 35 and 150 v d-c at load currents up to 500 ma. Regulation is 0.1 percent for input variations of ± 20 percent and load variations from zero to full load. Models with 0.05 percent regulation are also available. Unit measures $2\frac{1}{2}$ by $2\frac{1}{2}$ by $2\frac{3}{4}$ in. and weighs 15 oz.

CIRCLE 310 ON READER SERVICE CARD



Flip-Flop Tester package unit

COMPUTER CONTROL Co., INC., 983 Concord St., Framingham, Mass. Model FT-10 has been designed as a complete test facility for the transistorized static flip-flop model FS-10. Unit consists of control switches, a microammeter, and oscilloscope test points. The tester, which can be mounted in any spare

Short Term
Frequency Stability
measured with
High Accuracy

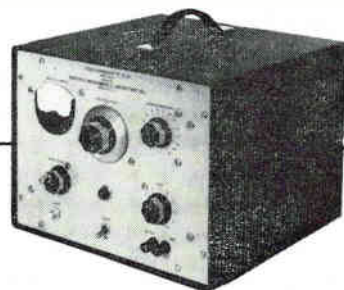

THE AIL TYPE 392B

Frequency Stability Tester for Checking Drift, Jitter, Jitter rate

- Checks L- and S- band oscillator performance
- Responds to input levels as low as -45 dbm
- Checks frequency stability to 1 part in 10^9 .

It is particularly useful for the measurement of MTI Stalo stability during the short time interval when Stalo drift may cause erroneous target information. It operates in the approximate bands of 1120 to 1700 mc and 2600 to 3200 mc. The AIL type 392B provides rapid design and production checks. Compact, lightweight and portable it is ideal for field testing.

Write for descriptive literature.



**AIRBORNE
INSTRUMENTS
LABORATORY**

DEER PARK, LONG ISLAND, NEW YORK
A DIVISION
OF CUTLER-HAMMER, INC.

CIRCLE 201 ON READER SERVICE CARD
FEBRUARY 19, 1960 • ELECTRONICS



General Electric announces a revolutionary OLD product

DUMET—THE 47 YEAR OLD MATERIAL THAT'S INVADING THE SEMICONDUCTOR FIELD—Ever since General Electric developed Dumet in 1913, it's been used in billions of light bulbs and electronic tubes. Why? Because Dumet and soft glass have compatible coefficients of expansion. So, in today's red-hot semiconductor field, Dumet fits right in. It carries the current, makes a *better* seal for the "glass package". And Dumet is a good conductor to help carry off heat. You can get Dumet on spools, in coils, in straight pieces cut to length, and in finished lead wires (at right).

SEMICONDUCTOR LEAD WIRES are also available from General Electric. Practically any combination of metals can be used...Dumet, molybdenum, gold-plated molybdenum, copper, nickel and nickel-plated iron, nickel-plated copper, Kovar and platinum . . . all made to your specifications, from as many as 5 pieces welded together. Special attention is always given to good weld strength and close dimensional tolerances. For more information on Dumet and G-E lead wires, write: General Electric Co., Lamp Metals and Compo-

nents Dept. E-20, 21800 Tungsten Rd., Cleveland 17, Ohio. (In Canada, write: Canadian General Electric Co. Ltd., Component Sales, 221 Dufferin St., Toronto 3, Ontario.)



Dumet has a nickel-iron core, a copper sheath, and is brazed with a strip of platers' brass. It's available on spools, in coils, as cut pieces, or as the seal material in multiple-welded part leads.

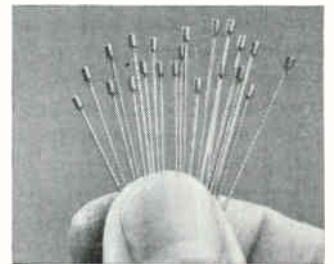

General Electric will help design your semiconductor leads. Send us your print, an idea of the material you'd like to use, and any questions on the design and use of G-E Dumet and lead wires.

Progress Is Our Most Important Product

GENERAL  ELECTRIC

How to Slash Costs Assembling PW BOARDS

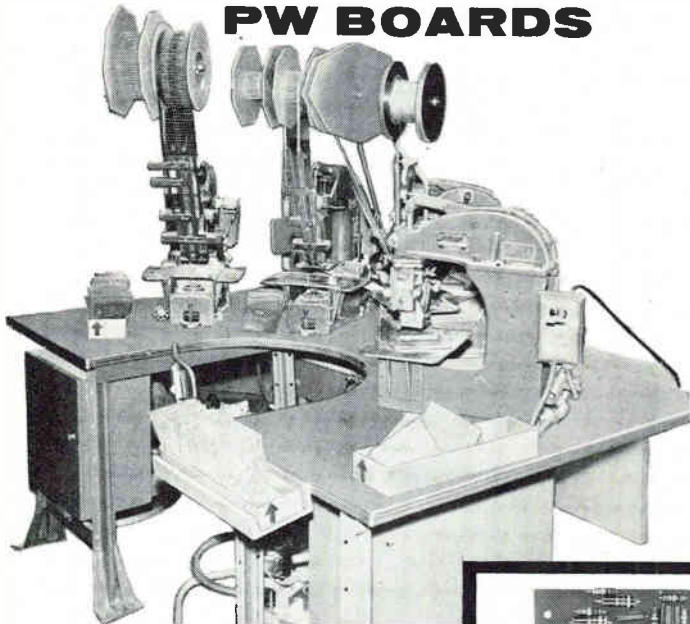

Thoughtful board design allows use of fixtures for high production rates and eliminates undesirable P. W. board handling.

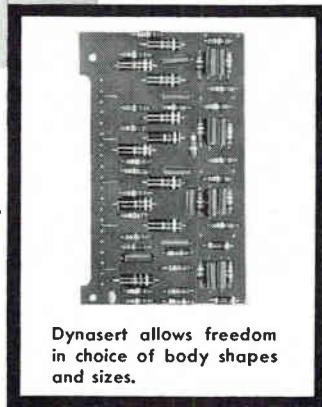

Dynasert allows freedom in choice of body shapes and sizes.

DYNASERT® component inserting machines increase production up to 8 times over hand component inserting

Because DYNASERT machines do all these jobs — feed, trim, form leads, insert and clinch — and do it at one stroke uniformly, they can cut component inserting costs as much as 8 times compared to hand inserting. Convenient placement of bench machines in multiples can help your operators achieve maximum efficiency.

One manufacturer producing 100 boards daily found that 3,000 components could be assembled in a few hours. Savings paid for the machines in less than a year. Fully automatic lines are available which can produce up to 9,600 complete boards per shift. Work force is 1/20th of that previously required for the same volume on a hand assembly basis.

Set all types of axial lead components with highly engineered, dependable production DYNASERT Machines. Available either as a single bench mount unit or multiple unit conveyors. Send coupon today for more information about cutting costs with DYNASERT equipment.

United

UNITED SHOE MACHINERY CORPORATION
140 FEDERAL STREET, BOSTON, MASS. Liberty 2-9100

United Shoe Machinery Corporation
140 Federal Street, Boston 7, Massachusetts

Gentlemen:

- Please send me your illustrated booklet "Dynasert Production Equipment for Electronics."
- Please have representative call to tell us how we may use mechanized assembly.

Name..... Title.....
Company.....
Street.....
City..... State.....

T-Bloc slot, requires -16 v at 65 ma, and 1 mc clock pulses, both of which are furnished on the T-Bloc. The flip-flop to be tested is plugged into the female connector provided on the FT-10. The tester exercises the flip-flop and provides an indication of its condition on the self-contained microammeter. Price is \$450.

CIRCLE 311 ON READER SERVICE CARD



Jack for panel use

NEMS-CLARKE, 919 Jesup-Blair Drive, Silver Spring, Md. Type 925 jack is similar to the former type 964; the difference being in the provision of a BNC connector mounted on the back of the type 925. The heavy silver plated contact surfaces of this jack are protected with a gold flash. Type 925 jack is designed primarily for use in types 921, 928, and 929 jack panels.

CIRCLE 312 ON READER SERVICE CARD

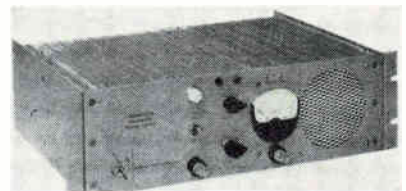

D-C Supply 125-150 v

POWER SOURCES, INC., Burlington, Mass. Designed to provide a stable regulated source of 125-150 v d-c, PS4018 is a transistorized supply for general purpose use. Load current range is 0-1.5 amperes, operating from a nominal input of 105-125v a-c. Output varies less than $\pm 0.2\text{ v}$ for line changes of $\pm 10\text{ v}$, with load held constant. It is regulated so that there is less than 0.2 v change in the output for load changes from zero to full rated current. Ripple and noise figure is less than 2 mv rms. Efficiency of the



**There's
going to be
a meeting**

Who's going to get together and *what* are they going to talk about?

Electronics men are meeting all over the country to talk about everything from ultrasonics to quantum electronics.

electronics tells you where and when "Meetings Ahead" ... gives you the highlights later on.

Another reason why it will pay you to subscribe to *electronics* (or renew your subscription) right now. Fill in the box on Reader Service Card. Easy to use. Postage free.

FIND WHAT YOU NEED IN...

electronics



**INDUCTION
SOLDERING
UNIT**



FOR SMALL PARTS AND ASSEMBLIES

Simplifies, improves and speeds up component production. Provides local heat to otherwise inaccessible spots. Safe and simple. Max. power input 775 watts, 100 watts standby; 115 volts, 60 cycles. 15 3/4" x 21 1/2" x 15". 150 lbs. Bulletin on request. Marion Instrument Division, Minneapolis-Honeywell Regulator Co., Manchester, N.H., U.S.A. In Canada, Honeywell Controls Limited, Toronto 17, Ontario.

Honeywell

**75th
PI
YEAR**

ENGINEERING THE FUTURE



First in Control
SINCE 1888

CIRCLE 202 ON READER SERVICE CARD



BENDIX-PACIFIC

in Southern California

needs **ENGINEERS** *with*

DOCTORS' - MASTERS' - BACHELORS'

DEGREES

*for electrical, mechanical and systems work in fields of
Instrumentation — Telemetry*

*Anti-Submarine Detection Systems/Operations Research
Missile and Aircraft Fluid Controls.*

Please send resume to MR. RALPH LAMM,
DIRECTOR OF ENGINEERING

*Other High-Level Electronic
Engineering Positions Available*



DIVISION OF BENDIX AVIATION CORPORATION

NORTH HOLLYWOOD, CALIFORNIA

Get Rocket-Fast Shipment from world's largest STOCK of Stainless Steel Fasteners



No long countdowns here. Allmetal stainless fasteners are stockpiled in advance—ready to go on your order. Fasteners in Commercial, AN, MS specs. You get fast delivery, precision quality, plus mass production economy when buying direct from stock.

Special fasteners also fabricated to your exact requirements on extremely short notice. Full range of raw materials assures prompt service. Simply send blueprint or specifications.

Pins • Bolts • Nuts • Screws (including slotted and Phillips—magnetic and non-magnetic)
• Washers • Cotters • Rivets • Rods • Studs • etc.

PHONE OR WRITE for prompt quotation or shipment. Send for catalog.

ALLMETAL®

SCREW PRODUCTS COMPANY, INC.

Manufacturers of Stainless Fasteners Since 1929

821 Stewart Avenue, Garden City, L.I., N.Y.
 Phone: Pioneer 1-1200 TWX GCY 603

Midwest Division
 6424 W. Belmont Avenue, Chicago 34, Illinois
 Phone: AVenue 2-3232 TWX CG 3185

West Coast Division—Office and Warehouse
 5822 West Washington Blvd., Culver City, Calif.
 Phone: WEbster 3-9595 TWX LA 1472

supply is 65 percent at full rated load. A 30-sec h-v delay can be provided on request where it is desirable to protect vacuum tubes powered by this unit.

CIRCLE 313 ON READER SERVICE CARD

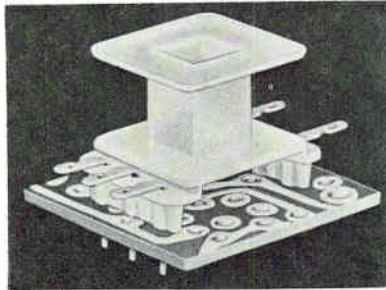

P-C Bobbin cost saving

AMERICAN MOLDED PRODUCTS CO., 2727 W. Chicago Ave., Chicago 22, Ill., announces a new printed circuit transformer and relay bobbin. The lugs are embedded in nylon for permanent location. It is especially designed to prevent wire breakage. It is claimed that the introduction of this product in the electronic field will eliminate the cost and assembly of the terminal board. Samples are available.

CIRCLE 314 ON READER SERVICE CARD



Missile Battery 10-ampere-hr unit

YARDNEY ELECTRIC CORP., 40 Leonard St., New York, N. Y. A rechargeable silver-zinc power pack, model 338-R-2 Silvercel battery has a nominal voltage of 28 v when discharging at 45 amperes in 12 minutes. It can also be discharged at 60 amperes, or at lower rates. It has a volume of 239 cu in. and weighs 15 lb. Dry shelf life is a minimum of two years. Battery has met test specifications of MIL E 5272: up to 5 g's vibration; 15 g's, 11 millisecc in all directions mechanical shock; - 65 F low temperature;

JERROLD

R. F. Test Equipment

Quantitative Measurements Using Sweep Frequency Techniques



Model 900A—THE MOST VERSATILE SWEEP GENERATOR \$1,260.00

CENTER FREQUENCY—VHF 0.5 to 400 MC
 UHF 275 to 1000 MCS—SWEEP WIDTH—up to 400 MCS—FLATNESS—±0.5 db over widest sweep!



Model 707—ULTRA FLAT SWEEP GENERATOR \$795.00

Featuring ±5/100 db flatness—Plug-in osc. heads*; variable sweep rates from 1/min. to 60/sec.; all electronic sweep fundamental frequencies; sweep width min. of 1% to 120% of C.F.

*Heads available within the spectrum 2 to 265 MCS

Models 601/602—PORTABLE GENERAL PURPOSE \$295.00

COVERAGE—Model 601—12 to 220 MCS. Model 602—4 to 112 MCS—FLATNESS—±0.5 db OUTPUT—up to 2.5 V RMS WIDTH—1% to 120% of C.F.



Model FD-30 \$250.00

High speed DPDT coaxial switch permitting oscilloscope measurements without calibration—all measurements referenced continuously against standard attenuators.



Model AV-50

Variable Precision Attenuator \$150.00

Long life rotary switches; dual wiping silver contacts on "Kei-F" dielectric. 0-62.5 db in ½ db steps; DC to 500 MCS.

Write for catalog and technical Newsletter series on measurements using sweep frequency techniques. Prices and data subject to change without notice.

JERROLD ELECTRONICS CORPORATION
 Industrial Products Division Dept. IE-4

The Jerrold Building, Philadelphia 32, Pa.

Jerrold Electronics (Canada) Ltd., Toronto
 Export Representative: Rocke International, N.Y. 16, N.Y.

CIRCLE 203 ON READER SERVICE CARD
 FEBRUARY 19, 1960 • ELECTRONICS



GEORGIA DELIVERS A COMPLETE PACKAGE DEAL

Georgia has become one of America's top leaders in production and industrial growth. A great labor pool, capable of learning new skills, provide new industries with an important tool for future planning and expansion.

Georgia's educational and recreational facilities, abundant water and power, healthy year-round climate . . . all combine to make it good business to produce in Georgia.

Nearby growing markets and unlimited transportation facilities are vital, important parts of Georgia's COMPLETE PACKAGE FOR INDUSTRY . . . a package that delivers the needed ingredients for profitable year-round operations in an increasing competitive era.

Write today for information on a package deal (including financing) to fit your needs.



ABIT MASSEY, Director
GEORGIA DEPARTMENT OF COMMERCE
100 State Capitol Building • Atlanta, Georgia

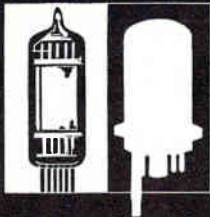

ONE IN A SERIES

*Bendix
Craftsmanship
at work for you*

SPECIALLY BUILT HARD GLASS TUBES THAT WITHSTAND SEVERE CONDITIONS



6094
BEAM POWER AMPLIFIER

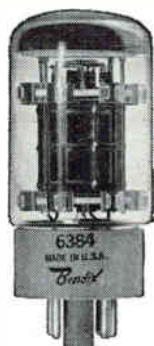

6384
BEAM POWER AMPLIFIER



6754
FULL-WAVE RECTIFIER

- Ideal for modern high-performance aircraft and missiles.

- Processing at higher vacuum and under the higher heat permitted by the hard glass reduces gas and contamination and provides greater operating stability at higher temperatures.

- Ceramic element separators prevent emission loss from high heat and vibration.

- Solid aluminum oxide heater-cathode insulator eliminates shorts, reduces leakage.

For complete line of tubes, write RED BANK DIVISION, BENDIX AVIATION CORPORATION, EATONTOWN, NEW JERSEY.

ELECTRICAL RATINGS*	6094 Beam Power Amplifier	6384 Beam Power Amplifier	6754 Full Wave Rectifier
Heater Voltage (AC or DC)**	6.3 volts	6.3 volts	6.3 volts
Heater Current	0.6 amp.	1.2 amp.	1.0 amp.
Plate Voltage (Maximum DC)	300 volts	750 volts	350 volts
Screen Voltage (Maximum DC)	275 volts	325 volts	—
Peak Plate Voltage (Max. Instantaneous)	550 volts	750 volts	—
Plate Dissipation (Absolute Max.)	14.0 watts	30 watts	—
Screen Dissipation (Absolute Max.)	—	—	—
Heater-Cathode Voltage (Max.)	2.0 watts	3.5 watts	—
Grid Resistance (Maximum)	≈ 450 volts	≈ 450 volts	≈ 500 volts
Grid Voltage (Maximum)	0.1 Megohm	.1 Megohm	—
(Minimum)	5.0 volts	0 volts	—
	-200 volts	-200 volts	—
Cathode Warm-up Time	45 sec.	45 sec.	45 sec.

*For greatest life expectancy, avoid designs which apply all maximums simultaneously.

**Voltage should not fluctuate more than ±5%.

MECHANICAL DATA	6094	6384	6754
Base	Miniature 9-Pin	Octal T-11	Miniature 9-Pin
Bulb	T-6½	T-11	T-6½
Maximum Over-all Length	2½"	3½"	2½"
Maximum Seated Height	2½"	2½"	2½"
Maximum Diameter	¾"	1½"	¾"
Mounting Position	Any	Any	Any
Maximum Altitude	80,000 ft.	80,000 ft.	80,000 ft.
Maximum Bulb Temperature	300°C	300°C	300°C
Maximum Impact Shock	500G	500G	500G
Maximum Vibrational Acceleration	50G	50G	50G

160 F high temperature; 95 per cent humidity at 160 F; 55,000 ft at 80 F high altitude.

CIRCLE 315 ON READER SERVICE CARD

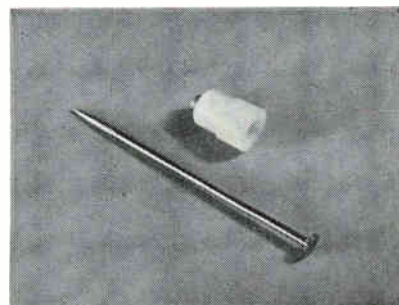

Diminutive Jack and test joint

SEAELECTRO CORP., 139 Hoyt St., Mamaroneck, N. Y. Type SKT-30 Press-Fit diminutive jack accepts a 0.040 in. diameter probe as a jack or handy external test point. Low contact resistance is assured by the heavily gold-flashed beryllium-copper contact members and connection lug, while the dielectric qualities of virgin Teflon provide excellent insulation in minimum bulk. Unit combines all the advantages of one-piece installation, minimum size, extreme ruggedness and proven reliability.

CIRCLE 316 ON READER SERVICE CARD

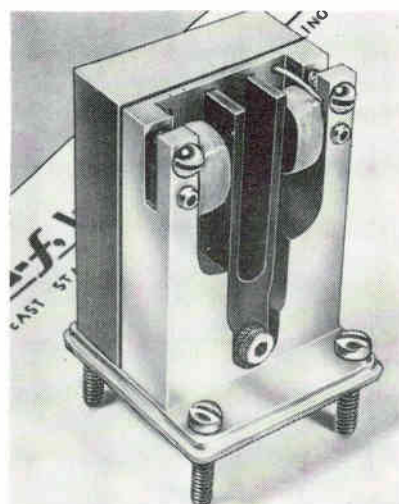

Oscillator tuning fork type

DELTA-F, INC., 113 E. State St., Geneva, Ill. The DFO-51 transistorized tuning fork oscillator is available at any frequency in the range of 360 to 10,000 cps with an ac-

SPECIAL-PURPOSE TUBES DEPARTMENT

Red Bank Division

EATONTOWN, NEW JERSEY



West Coast Sales & Service: 117 E. Providencia Ave., Burbank, Calif.

Export Sales & Service: Bendix International Division, 205 E. 42nd St., New York 17, N. Y.

Canadian Distributor: Computing Devices of Canada, Ltd., P. O. Box 508, Ottawa 4, Ontario

"Telephone Quality" Stromberg-Carlson RELAYS

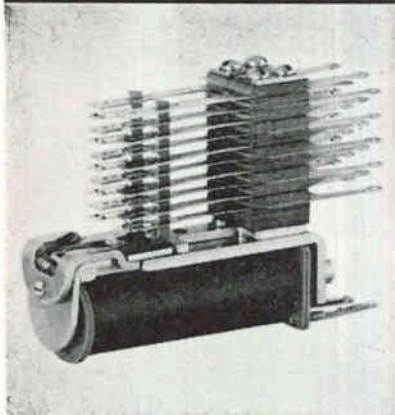

...to meet your
electromechanical
switching needs

These are the very same twin-contact relays proven outstandingly successful through many years of precise, exacting operation in the telephone industry.

The following regular types are representative of our complete line:

Type A: a general-purpose relay with up to 20 Form "A" spring combinations.

Type B: a gang-type relay with up to 60 Form "A" spring combinations.

Type BB: accommodates up to 100 Form "A" spring combinations.

Type C: two relays on the same frame. A must where space is at a premium.

Type E: same characteristics as the Type A, plus universal mounting arrangement. Interchangeable with many other makes.

Types A, B and E are available in high-voltage models (insulation withstands 1500 volts A. C.) for test equipment and other high-voltage applications.

Details and specifications are in our complete relay catalog, available on request. Write to Telecommunication Industrial Sales.

STROMBERG-CARLSON
A DIVISION OF GENERAL DYNAMICS
114 Carlson Road • Rochester 3, N. Y.

CIRCLE 204 ON READER SERVICE CARD

curacy of ± 0.005 percent (50 ppm). It operates over a temperature range of -55 to $+125$ C with an output power of 3 v rms across a 10,000 ohm load. Package size is $1\frac{1}{2}$ by $1\frac{1}{2}$ by $2\frac{1}{4}$ in. tall with the circuit completely encapsulated in Silastic RTV. Entire unit is hermetically sealed. With a specified supply voltage of 20 and 30 v, the DFO-51 will provide a sine wave with less than 10 percent distortion and an amplitude stability of ± 10 percent.

CIRCLE 317 ON READER SERVICE CARD



Crystal Can Relay four-pole

BRANSON CORP., 41 S. Jefferson Road, Whippany, N. J. Type AR, available in the mounting shown and many others, meets MIL Spec requirements for 125 C and 2,000 cps environments. With contacts rated at 2 amperes the 4pdt micro-miniature relay is said to out-perform identically sized 2-pole models. A real space and weight saver for the missile and aircraft industries, it uses gold plated silver alloy contacts for dry or wet circuit applications. It is available with hook terminals, leads or as a plug-in unit.

CIRCLE 318 ON READER SERVICE CARD



Coaxial Attenuator variable unit

MERRIMAC RESEARCH AND DEVELOPMENT, INC., 517 Lyons Ave., Irvington 11, N. J. Model AE-6 wideband coaxial variable attenuator has flat attenuation vs frequency characteristics and zero insertion loss. Frequency range is 4-7 kmc; insertion loss, less than 0.5 db; attenua-



BORIDES for modern industry

Leadership in high temperature technology, symbolized by the NORTON FIREBIRD, has made possible the production of the borides of chromium, titanium and zirconium in tonnage quantities.

In the METAL INDUSTRY, aluminum manufacturers utilize the low electrical resistivity and high resistance to attack by aluminum and cryolite that borides of titanium and zirconium provide. Borides are ideal boron sources for super alloys and nuclear steels. . . ROCKET ENGINE manufacturers take advantage of the superior resistance to erosion and corrosion at high temperatures that zirconium boride offers.

NORTON borides, because of their unusual properties, are being examined closely at Research and Development level as shapes and coatings for many applications.

In addition, borides of calcium, molybdenum, and vanadium are available on a limited basis for evaluation. If you have a specific requirement, let's hear about it. Write NORTON COMPANY, Electro-Chemical Division, 681 New Bond St., Worcester 6, Mass.

Send for booklet
on borides and
other Norton
Electro-Chemicals.



NORTON
ELECTRO-CHEMICALS

GIFTS OF THE FIREBIRD: compounds of silicon
zirconium • boron • aluminum • magnesium
titanium • chromium • including many borides
carbides • nitrides • oxides

75 Years of...
Making better products...
to make your products better

CIRCLE 89 ON READER SERVICE CARD 89

Ideal for
ANTENNA CONNECTIONS
PHOTO-CELL WORK
MICROPHONE CONNECTIONS

JONES SHIELDED TYPE PLUGS & SOCKETS



LOW LOSS PLUGS AND SOCKETS FOR HIGH FREQUENCY CONNECTIONS. SUPPLIED IN 1 AND 2 CONTACT TYPES:

101 Series can be furnished with 1/4", .290", 5/16", 3/8" or 1/2" ferrule or cable entrance. Knurled nut securely fastens unit together. Plugs have ceramic insulation and sockets have bakelite. Quality construction. Fine finish. Assembly meets Navy specifications. For full details and engineering data ask for Jones Catalog No. CS-22

JONES MEANS
Proven Quality

Jones HOWARD B. JONES DIVISION
 CINCH MANUFACTURING COMPANY
 CHICAGO 24, ILLINOIS
 DIVISION OF UNITED-CARR FASTENER CORP.

CIRCLE 205 ON READER SERVICE CARD

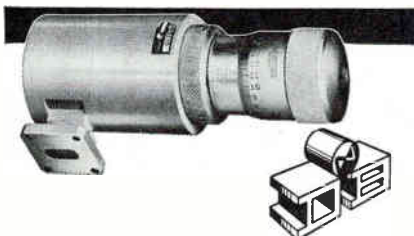

BROAD BAND CAVITY WAVEMETERS

*—gas filled for
 sustained accuracy*

Accuracy is so high these instruments may be used as secondary standards. Units are unaffected by changes in humidity, altitude or barometric pressure. Only 12 sizes serve from 2.6 KMC to 140 KMC. You save budget money on the number of sizes needed. Literature on request.

DE MORNAY  BONARDI

DE MORNAY—BONARDI
 780 SOUTH ARROYO PARKWAY • PASADENA, CALIF.

90 CIRCLE 90 ON READER SERVICE CARD

tion variation vs frequency, less than ± 5 percent in db; power handling, 4 w average; vswr, 1.5 maximum. Units provide 40 db of attenuation over the frequency range and special variations with up to 100 db of attenuation and other types of coaxial attenuators can be provided.

CIRCLE 319 ON READER SERVICE CARD



Dual Flip-Flop low-speed

DIGITAL EQUIPMENT CORP., Maynard, Mass. Type 4209 flip-flop package contains two identical flip-flops with built-in output amplifiers. Operating at speeds up to 500 kc, it is one of eleven units in a new series of system building blocks. Each of the two flip-flops in the 4209 has a direct and gated input to the zero and one side, and each has one pulse gate internally connected to the gated one input terminal. The static-type flip-flops used have continuous d-c output signals, so actions need not occur at any fixed clock rate. Priced at \$79, unit is ideal in buffer and control register applications.

CIRCLE 320 ON READER SERVICE CARD



Receiver-Decoder all transistor

BABCOCK RADIO ENGINEERING, INC., 1640 Monrovia Ave., Costa Mesa, Calif. BCR-39 receiver-decoder features crystal controlled frequency coverage over the range of 400 to 550 mc. It is specifically designed

for missile command destruct use where minimum weight and size plus low power consumption is required. Unit is completely compatible with transmitting and coding equipment now in use at missile launching facilities. Maximum security is provided by special logic performance of the included 3-channel decoder action. An input signal of 5 μ v or less will command destruct. Power consumption is 2.5 w. Outside dimensions of the unit are 2 1/2 by 4 1/4 by 5 1/2 in., and weight is 2 lb.

CIRCLE 321 ON READER SERVICE CARD



Amplifier System transistorized

LAWRENCE INC., P. O. Box 5106, Seven Oaks Station, Detroit 35, Mich. Model RC-1225 Road Commander is a transistorized mobile p-a amplifier engineered to deliver a crisp, clear audio signal instantaneously. Output power: 25 w on 12.6 v. Response: optimized for maximum intelligibility—400 to 6,000 cps. Gain: 103 db. Distortion: less than 10 percent at full-rated output. Controls: microphone gain; radio gain; on-off, radio, p-a selector. Size: 6 1/2 in. by 5 1/2 in. by 3 1/4 in. Output impedance: 16 ohms. Input impedance: 150-200 ohms.

CIRCLE 322 ON READER SERVICE CARD



Delay Line Box variable unit

VALOR INSTRUMENTS INC., 13214 Crenshaw Blvd., Gardena, Calif. Model 443B3 variable delay line box delivers any delay up to 0.79 μ sec

FEBRUARY 19, 1960 • ELECTRONICS

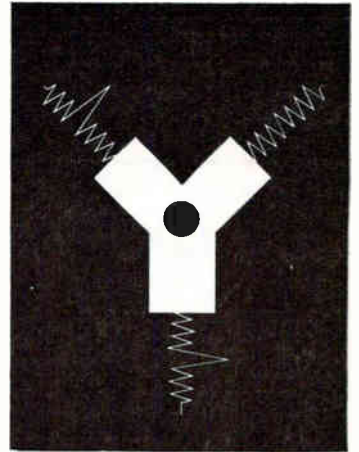
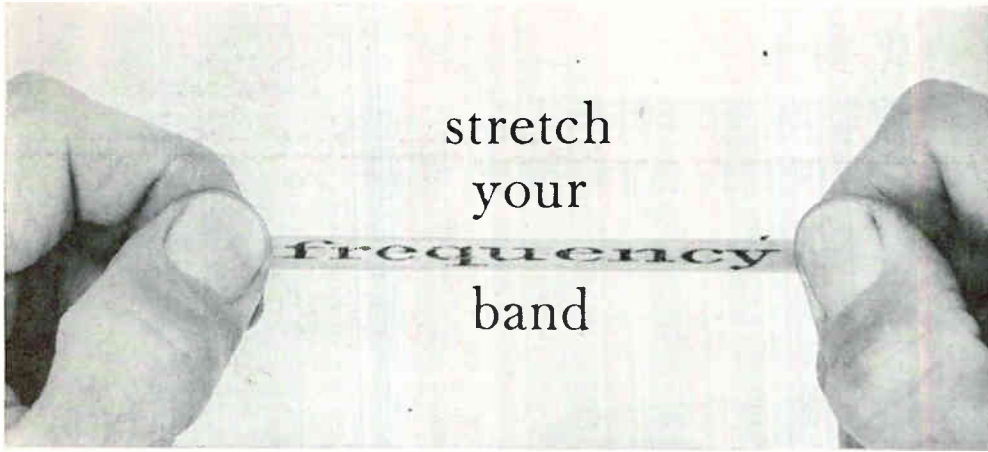

with new Hughes "20-20" Circulators!

With 20% bandwidth and over 20 db isolation, the new Hughes "Y" and "T" Circulators are ideally suited for microwave reception and transmission applications. They also give you small size and weight...without sacrifice in performance. C- and X-Band models are available today!

For information on the new "20-20" Circulators, or other advanced microwave components, please write Microwave Products Department, Advanced Program Development, Hughes Aircraft Company, Culver City 8, California. Or, phone UPTon 0-7111, Ext. 6919.

	Model C-201A	Model X-230A (Illustrated)
Frequency:	4.9-6.2 Kmc	8.0-9.8 Kmc
Isolation:	20 db	20 db
Insertion Loss:	0.3 db	0.3 db
Input VSWR:	1.10	1.20
Power Capacity:	10 Kw peak 100W avg (Min.)	3 Kw peak 50W avg (Min.)

ALSO AVAILABLE: Miniaturized S- and L- Band Coaxial Circulators. New, extremely small (1" x 2" x 8") circulators with bandwidths to 10%, over 20 db isolation, and 0.5 db insertion loss are now available.

Creating a new world with ELECTRONICS

HUGHES

© 1960, HUGHES AIRCRAFT COMPANY
MICROWAVE PRODUCTS

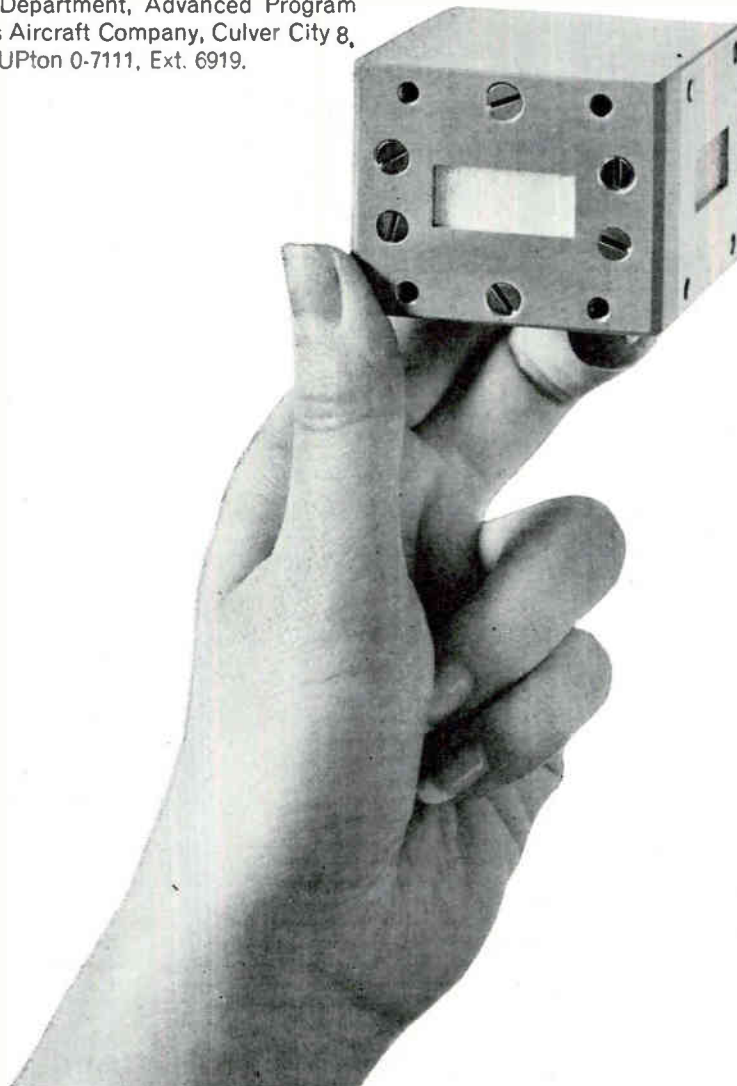



NEW Time Delay Relays

INSTANTANEOUS RESET... VOLTAGE-TEMPERATURE COMPENSATED

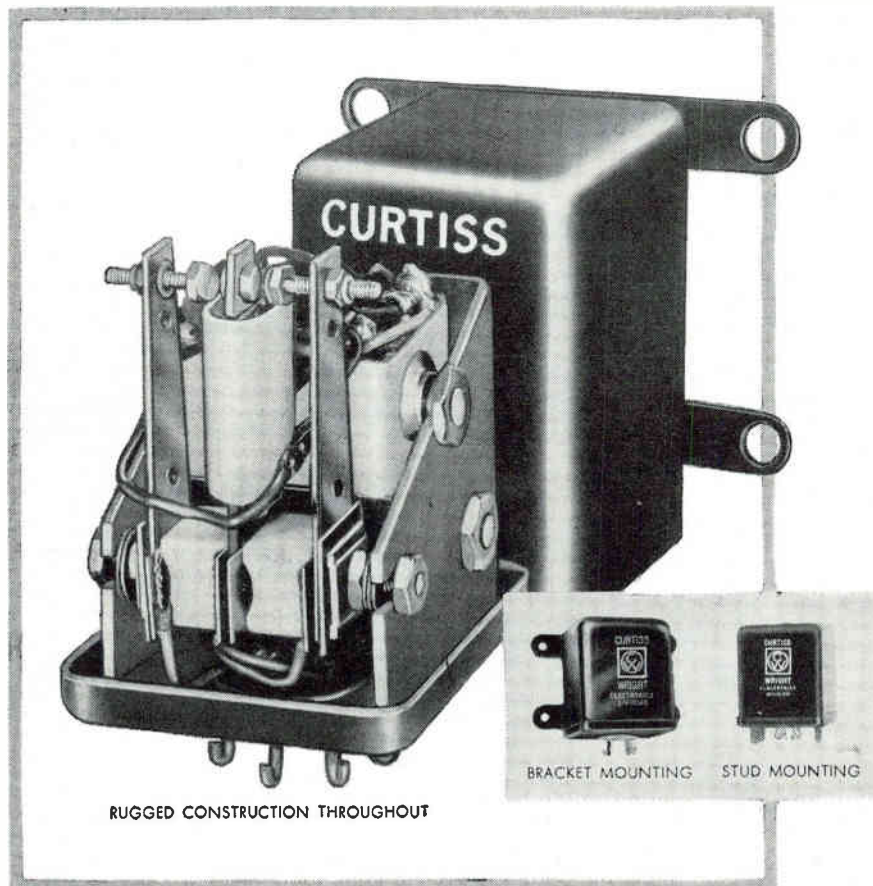

RUGGED CONSTRUCTION THROUGHOUT

Designed with an instantaneous reset feature, these relays provide the same time delay for a series of cycles when temperature and voltage vary.

They are pre-set from 3 to 180 seconds, are chatter-free and will withstand severe shock and vibration. Because of this unique combination of features, these relays are now being used in such new circuit applications as:

- Sequential timing for missiles
- Automatic reset on digital readout equipment
- Oscillator stabilization
- Overload protection
- Computer sequencing



"DM" SERIES STEPPING MOTORS

Curtiss-Wright Stepping Motors convert digital pulses into mechanical work or motion. Units are bi-directional with high starting torque.

Write for complete Components Catalog 260 to help you select Curtiss-Wright electronic components for use where dependability is of prime importance.

COMPONENTS DEPARTMENT • ELECTRONICS DIVISION

CURTISS WRIGHT

CORPORATION • EAST PATERSON, N. J.

TIME DELAY RELAYS • DELAY LINES • ROTARY SOLENOIDS • DIGITAL MOTORS • TIMING DEVICES • DUAL RELAYS • SOLID STATE COMPONENTS

92 CIRCLE 92 ON READER SERVICE CARD

with an accuracy of 0.8 percent of the maximum delay by means of binary switching. Reflections are eliminated because the unused portion of the unit is disconnected from the circuit by means of the switching arrangement. Rise time is 0.05 μ sec for the maximum delay and decreases as lesser delays are used; impedance, 100 ohms; attenuation, 3.5 percent; size, 3 by 3 by 5 in. Unit was designed to assist R&D engineers in determining the specifications of the delay line that will provide optimum characteristics for a given circuit.

CIRCLE 323 ON READER SERVICE CARD

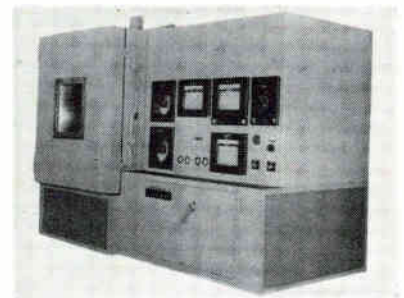

Test Chamber 64 cu ft

CONRAD, INC., 141 Jefferson St., Holland, Mich. The F164 test chamber simulates space flight, temperature, and vacuum conditions. It will produce any temperature or humidity encountered on earth. The test chamber will simulate missile flight pressures up to 350,000 ft altitude (about 66 miles). Altitude equivalent of 100,000 ft can be attained at 25,000 ft per minute climb rate.

CIRCLE 324 ON READER SERVICE CARD

Precision Pot conductive plastic

ACE ELECTRONICS ASSOCIATES, INC., 99 Dover St., Somerville 44, Mass. The Acemho conductive plastic potentiometer measures 1 1/8 in. It is available in both standard servo and bushing configurations. It has infinite resolution, extremely low noise, and very long operational life. Unit meets all applicable MIL specs. A new technical bulletin gives full electrical and mechanical specifications.

CIRCLE 325 ON READER SERVICE CARD

FEBRUARY 19, 1960 • ELECTRONICS

Literature of the Week

BWO TUBES. Polytechnic Research & Development Co., Inc., 202 Tillary St., Brooklyn 1, N. Y. *PRD Report* Vol. 6, No. 4, discusses the voltage and modulation requirements needed to power backward wave oscillators.

CIRCLE 350 ON READER SERVICE CARD

ANALOG FUNCTION GENERATOR. Link Aviation, Inc., Binghamton, N. Y., has published a bulletin describing the model 201 analog function generator, an electromechanical analog computer developed for arbitrary function generation of one variable expressed as a function of one or more independent variables.

CIRCLE 351 ON READER SERVICE CARD

RADAR & COMMUNICATIONS. Designers for Industry, Inc., 4241 Fulton Parkway, Cleveland 9, Ohio. A 19-page brochure illustrates electronic projects completed for the Defense Department and commercial clients.

CIRCLE 352 ON READER SERVICE CARD

TACHOMETER. Airpax Electronics Inc., Seminole Division, Fort Lauderdale, Fla. Bulletin F-53 describes a completely self-contained electronic tachometer, the TACH-PAK, having an accuracy of better than 0.25 percent.

CIRCLE 353 ON READER SERVICE CARD

CONNECTORS. H. H. Buggie Division, Burndy Corp., Toledo, Ohio. A 16-page condensed catalog featuring standard lines of electronic connectors has been released.

CIRCLE 354 ON READER SERVICE CARD

FRAME GRID TUBES. Ampere Electronic Corp., 230 Duffy Ave., Hicksville, L. I., N. Y., has available an illustrated 13-page booklet which describes how frame grid tubes for tv applications are manufactured and lists the specifications of these tubes.

CIRCLE 355 ON READER SERVICE CARD

SEMICONDUCTOR SLICING MACHINE. The DoAll Co., Des Plaines, Ill., has available litera-

LABORATORY ACCURACY for Production Line Testing...

Provides ratios of 3-to-1 step up to 10^{-3} step down.

0.001% Ratio Accuracy at a 1000:1 step down; this is terminal linearity of 1 part in 10,000,000.

Easy-to-read, in-line numbers on sloping panel.

Transient Suppression: Instant read-out; circuit safety.

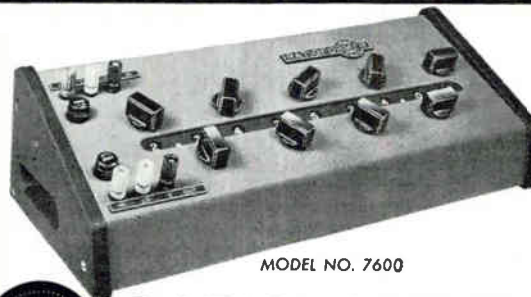

MODEL NO. 7600



RATIOFORMER

Ruggedly built, the OEKO Ratioformer provides over 300 million steps of precision ratio. The high input impedance, low output impedance, and extremely low phase shift make the OEKO Ratioformer a versatile and adaptable instrument.

eliminate calculating and transcription errors



MODEL NO. 7500



DEVIAFORMER

The OEKO Deviaformer gives direct readout of percent of deviation from specified voltage ratios. Used with a precision AC voltage divider such as the OEKO Ratioformer (or other ratio standard), it reduces the measurement to a % answer with extreme accuracy. Transformers, synchros, resolvers, computers, and meters can be tested on a simple "go/no-go" basis. Under rugged production line testing conditions, the accuracy level is maintained to 0.001%.

A specialized design of the Osborne Ratioformer is now in use in one of the major Missile programs.



WRITE for illustrated folder.

OSBORNE electronic sales corp.

712 S. E. Hawthorne Blvd., Portland 14, Oregon
13105 S. Crenshaw, Hawthorne, California

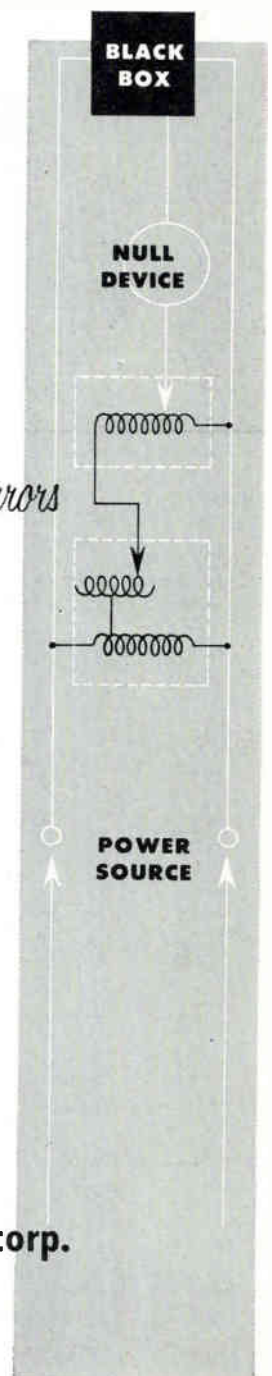

KEY to your assembly planning . . .



MOLCOTE® Metallized Coating for Ceramics

Now is a good time to get acquainted with MOLCOTE in your assembly planning. A metallized coating firmly bonded to ceramic, MOLCOTE presents a surface to which a metal part or other metallized ceramic parts may be soldered or brazed easily, quickly . . . effectively.

MOLCOTE is ideal for a wide variety of assembly applications. For example, it

- . . . can be used effectively with copper brazing.
- . . . can be immersed in a wide variety of molten brazing alloys for extended periods of time.
- . . . permits excellent dimensional control.
- . . . offers high bond strength,

MOLCOTE surfaces are supplied ready for use for soldering and brazing applications in any temperature range up to 2000° F. MOLCOTE bonds are exceptionally strong with a tensile strength exceeding 10,000 psi.

Frenchtown Engineering Bulletin 1155 contains complete details and data on MOLCOTE Metallized Coating for Ceramics. We'd be pleased to send you a copy for use in your assembly planning. A good time to write for it is *NOW*.



frenchtown PORCELAIN COMPANY
FRENCHTOWN, NEW JERSEY

ture describing the Microtom-atic, a precision production slicing and dicing machine for hard, brittle, friable materials.

CIRCLE 356 ON READER SERVICE CARD

POWER STACK ASSEMBLIES.

Radio Receptor Co., Inc., 240 Wythe Ave., Brooklyn 11, N. Y. Bulletin 308, four pages, is a listing of selected power stack assemblies, ranging from 3 to 30 kw d-c output, using the new selenium Tri-Amp rectifiers.

CIRCLE 357 ON READER SERVICE CARD

TEST EQUIPMENT.

Cubic Corp., 5575 Kearny Villa Road, San Diego, Calif. A 4-page shortform catalog and 5 individual flyers describe transistorized test equipment, power measuring equipment and microwave instrumentation.

CIRCLE 358 ON READER SERVICE CARD

TRANSISTORS.

General Transistor Corp., 91-27 138th Place, Jamaica 35, N. Y. The 16-page brochure G-200 describes its complete line of *pnp* and *npn* transistors most widely used by original equipment manufacturers.

CIRCLE 359 ON READER SERVICE CARD

INSTRUMENTS.

Keithley Instruments, Inc., 12415 Euclid Ave., Cleveland 6, Ohio. The 1960 catalog describes and illustrates instruments for electronic, biological and chemical measurement and control.

CIRCLE 360 ON READER SERVICE CARD

SERVO SYSTEM SIMULATOR.

Servo Corp. of America, 111 New South Road, Hicksville, L. I., N. Y. A new servo design report explains application of the Servolab servo system simulator to the design of a wide variety of control systems for industrial process controls, flight instrumentation systems, guided missiles, ground support systems, nuclear reactor controls, and others.

CIRCLE 361 ON READER SERVICE CARD

CAPACITOR.

Ohmite Mfg. Co., 3668 W. Howard St., Skokie, Ill. Engineering bulletin 1004 deals with a new, straight-cylindrical, wet-electrolytic, sintered tantalum slug capacitor.

CIRCLE 362 ON READER SERVICE CARD

ARE YOU PROPERLY GEARED FOR MINIATURIZATION?

LEVIN® TURRET LATHES
PRODUCE SMALL INSTRUMENT PARTS BETTER



A complete Turret Lathe for small parts. Particularly useful for second operation work.

Maximum collet capacity 5/16". Standard models provided with self indexing, six position turret, collet closer, double tool cross slide and variable speed control.

For full details of Turret Lathes and other Instrument Lathes send for catalog T.

Louis Levin & Son, Inc., 3610 So. Broadway, Los Angeles 7, Calif.

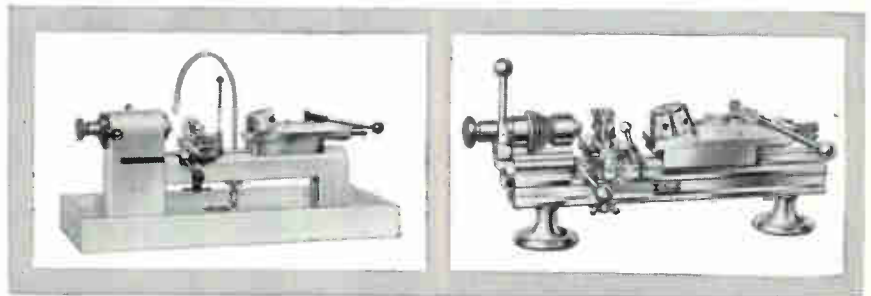
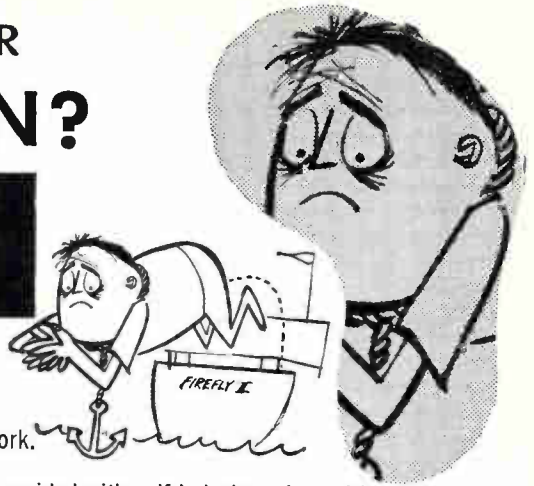

CIRCLE 208 ON READER SERVICE CARD



Rugged

S.S.B

The RACAL TRA.55 Radiotelephone, with an output of 60 W P.E.P., includes 4 pre-set channels from 3 to 12 Mc/s, and is suitable for R.T. keyed tone telegraphy with full D.S.B. compatibility. It is suitable for 100/125 and 200/250 V input at 40-60 c/s using a maximum of 300 W.

JUST ONE OF THE RACAL RANGE: Get details too of the TA.83 and TA.104 transmitters (500 W and 60 W), the TA.99 and TA.84 linear amplifiers (1 kW and 5 kW) and the S.S.B. receivers type RA.87 and RA.101.

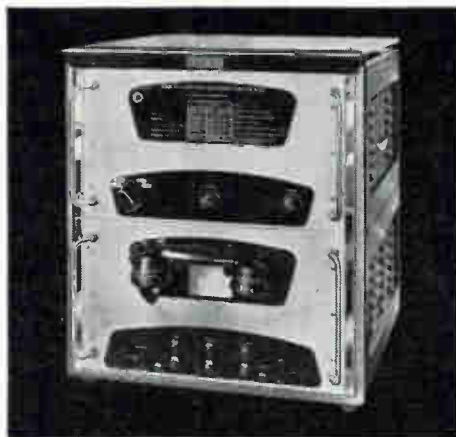

Transportable

*The RACAL TRA 55
60 watt Radiotelephone
- the answer to your
field communication
problems.*

It gives high performance and reliable operation. It needs minimum maintenance in field HF links anywhere in the world. It is easily used by unskilled personnel. And it costs so little to buy. The TRA.55 is typical of the growing range of RACAL S.S.B. equipment.

Write for details to:

MR. W. J. ZULLO Racal's representative in the United States. Room 409, Esso Building, 261, Constitution Avenue, N.W., Washington 1, D.C., or 104, Highland Avenue, Somerville 43, Mass.

or write direct to: RACAL ENGINEERING LTD., BRACKNELL, BERKSHIRE, ENGLAND

RACAL

Engineers! Designers!
**THERE IS NO SUBSTITUTE
 FOR RELIABILITY!**

Specify—
**PERFORMANCE
 PROVEN "MAG MOD"**

MAGNETIC MODULATORS

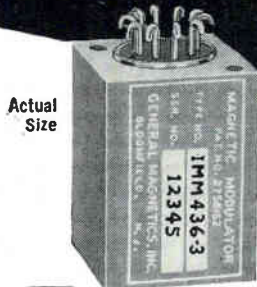

Actual
 Size



For complete
 specifications and
 application data on "Mag Mod"
 Miniature and Standard
 Components, call or write.

Miniaturized design permits engineers to employ these new components in transistorized printed circuit assemblies and wafer type structures. All models offer maximum reliability, fully ruggedized construction and conform to MIL-T-27A specifications.

- COMPLETE RELIABILITY
- INFINITE LIFE
- FASTER RESPONSE TIME
- NEGLIGIBLE HYSTERESIS
- EXTREME STABILITY
 (Ambient Temp. Range
 from -75° to +135°C)
- COMPACT SIZE
- LIGHTWEIGHT

Typical circuit applications for Magnetic Modulators are algebraic addition, subtraction, multiplying, raising to a power, controlling amplifier gains, mechanical chopper replacement in DC to fundamental frequency conversion, filtering and low signal level amplification.

GENERAL MAGNETICS • INC

135 BLOOMFIELD AVENUE
 BLOOMFIELD, NEW JERSEY
 Telephone: Pilgrim 8-2400

CIRCLE 209 ON READER SERVICE CARD

NEW BOOKS

Vacuum Valves In Pulse Technique

By P. A. NEETESON

The Macmillan Co., New York,
 1959, 202 p, \$5.50.

THIS second edition four years after its original publication establishes the book's value and enables the author to add a section on blocking oscillator analysis. Unfortunately, the title is lacking in definition, suggesting a general survey of pulse techniques — whereas the book is concerned primarily with fundamentals.

The first third of the book deals mathematically with the vacuum tube as a switching element. This section is complete in itself and analyzes the ability of diodes, triodes and pentodes to handle fast-changing waveforms. A thorough analysis of the multivibrator follows in the next 100-odd pages, and a new section on blocking oscillators completes the book. Emphasis throughout is on basics, not applications.

Operational calculus is developed from first principles in an early chapter and tailored to meet the needs of the study. This is done very lucidly and is well worth reading for its own sake. The author has succeeded in trimming the trees so that the wood is clearly visible. Overall, the mathematics should present no difficulties to graduates or college seniors.

A generous bibliography lists over 40 texts and abstracts. With the distilled content of these augmenting the author's extensive analysis, the book becomes a valuable addition to the literature on pulse technique fundamentals. Its low price will put it within reach of anyone interested.—S.F.

THUMBNAIL REVIEWS

Electrical Engineering for Professional Engineers' Examinations. McGraw-Hill Book Co., Inc., New York, 1959, 448 p, \$9.50. This book is designed to prepare license candidates for the electrical engineering examination for profession engineer in the various states. Refresher material presented includes theory and methods of applications, scores of

Temperature measured
 Electrically, Instantly
 with Model T-1



For contact or immersion. Solids, liquids or gases—Instant reading. Accurate to 1/2°C. Range minus 20° to plus 180°C. A Siemens product. For production, laboratory, maintenance or field applications. Utilizes handy probe, 1/2" in diameter. Case included. ^{•Literature}

AMERESCO, INC.
 3 Center Avenue, Little Falls, N. J.

SINCE
 1925

EDO CORPORATION
 College Point, L.I., N.Y.

CIRCLE 206 ON READER SERVICE CARD

questions typical of those asked on examinations and a new treatment of electronics. Also given are a clear list of the seven basic requirements for licensure in any state and a non-technical, easy-to-read summary of all the various state registration laws.

Effects of Nuclear Radiation on Men and Materials. By T. C. Helvey, John F. Rider Publisher, Inc., 1959, 56 p, \$1.80. Technological and biological problems occasioned by the application of nuclear energy and solution of same are discussed without recourse to mathematics. Of particular interest to electronics men is the chapter devoted to radiation effects, both good and bad, on materials.

Dictionary of Atomic Terminology. By L. Lettenmeyer, Philosophical Library, Inc., New York, 1959, 298 p, \$6. This dictionary gives essential scientific and technical terms employed in connection with atomic and nuclear physics, reactor engineering, radiation physics and the like. As well as English terms, corresponding German, French and Italian spellings are given. A comprehensive index makes it possible to find the English equivalent of any German, French or Italian term quickly.

Waves and the Ear. By W. A. Van Bergeijk, J. R. Pierce and E. E. David, Jr., Doubleday & Co., Inc., New York, 1960, 235 p, \$0.95. Written primarily for students, this book discusses physical nature of sound waves and the physiology of the ear itself. Text blends together latest findings of acoustics, anatomy, electronics, psychology, hydromechanics, zoology, phonetics, and audio engineering.

The Dynamics of Particles. By A. G. Webster, Dover Publications, Inc., New York, 1959, 588 p, \$2.35. Originally written in 1904 and out of print for over 35 years, this book is a comprehensive work on the dynamics of particles and of rigid, elastic and fluid bodies. Serves as an excellent source for background essential in studies in motion, rocketry and aerodynamics. Fair knowledge of calculus is assumed, but not of differential equations or higher analysis.

Master Receiving-Picture Tube Substitution Guidebook. By H. A. Middleton, John F. Rider Publisher, Inc., New York, 1959, 343 p, \$7.45. Compilation of 5,100 American receiving tube and 825 American picture tube substitutions, as well as 325 American-European and almost the same number European-American receiving tube equivalents. Laboratory technicians and radio-television repairmen will find this book a valuable aid in their work.



360° of versatility

Gamewell SG-270 Precision Rotary Switch.

A precious metal ring is the heart of a Gamewell Style SG-270 Precision Rotary Switch.

This perfect circle of metal may be cut into as many angular segments or positions as desired . . . providing the precise basis for a highly versatile switching component . . . can be assembled with potentiometer sections if desired.

Custom designed, the SG-270 switch is ideal for circuit sampling, sequencing, programming, digital generators, etc. Connections to the segments are made through terminals adjacent to the segments on the periphery of the housing. Precious metal rings and brushes provide smooth, trouble-free action with either Make Before Break (MBB) or Break Before Make (BBM) contacts. Multiple gangs can be assembled to provide multi-pole switches. Cased in special plastic, the SG-270 switch is inherently fungus resistant . . . stable at high temperatures . . . sizes $\frac{5}{8}$ " — $1\frac{1}{4}$ " — $1\frac{5}{8}$ " — 2" — 3" — 5" diameter in various mounting styles. It can be used with confidence over a wide range of environmental requirements. Write, stating requirements, to THE GAMEWELL COMPANY, 1384 Chestnut Street, Newton Upper Falls 64, Massachusetts.



Precision Potentiometers
"Integrals of High Performance"

CIRCLE 217 ON READER SERVICE CARD



WHO DROPPED THE BINOCULARS?

With everybody watching each other along the DEW line and the Iron Curtain these days, electronics has replaced binoculars.

What's happening in the giant markets for missile controls, radar and communications equipment?

electronics tells how things are going, keeps you informed of developments as they occur. This is a good time to subscribe or renew your subscription. Just fill in box on Reader Service Card. Easy to use. Postage free.

FIND WHAT YOU NEED IN... electronics

**WHITNEY-JENSEN
UNIVERSAL BRAKE**

Straight • Box & Pan • Radius Bending

**48" LENGTH UPPER BEAM OPENS
BY EITHER HANDLE**

CHANGE NOSE BARS ONLY, FOR ALL TYPES OF BENDING—NO OTHER ADJUSTMENTS NECESSARY

STRAIGHT 	Nose Bars 16" long attach to upper beam for straight bending. Use one, two, or three Bars or combine with other fingers in set-up.
BOX & PAN 	Fingers of various widths can be clamped to upper beam as desired for one or several sequence folds. Standard sizes, 1 1/2", 2", 3", 4", 6".
RADIUS 	Radius fingers for clamping to upper beam are all 4" wide, can be furnished to specified radii. Combinable for multi-use set-up.

Write Us Now for Complete Information and Prices
WHITNEY METAL TOOL COMPANY
722 Forbes St., Rockford, Ill.



Dietrich: 'gentle..AFTER work'

CHAIRMAN of Los Angeles' fast-growing Houston Fearless Corp. is hard-driving financial wizard Noah Dietrich, one-time big gun of Howard Hughes' vast \$800-million-per-year enterprises. Dietrich, together with New York financier Richard Woike and Emmet Steele (former manager of military relations for Litton), gained control of the 30-year-old company a year ago through purchase of \$1.4-million in notes and convertible debentures, and is using it as a nucleus about which to cluster a compatible group of space age companies. Prime emphasis is on electronics.

His philosophy: Small electronics firms, often inadequately financed and questionably managed, are in for tough sledding with increased competition ahead. Large monolithic companies will be increasingly hampered by inflexibility in a fast-changing technology. The answer lies, he feels, in an aggregation of medium-sized companies with decentralized research, engineering, manufacturing and sales groups, but able to tap the parent company for financial and legal assistance. Under such an arrangement, he predicts, companies up against a \$2-million annual sales barrier can up that gross by a factor of 3 to 5.

In line with this theory, Dietrich announced HF's first acquisition in November: Federal Machine Tool Co. of Boston, manufacturer of electronic components, chemical process control equipment, and microwave gear for food processing. Negotiations with several other electronics firms are in progress, with more acquisitions imminent.

Dietrich also sits as chairman of the board of Tool Research and Engineering Corp. (Compton, Calif.), possessor of a process for producing missile and aircraft stainless steel honeycomb, and is active in the management of Mathews Mfg. Co., a Los Angeles firm which uses an advanced technique for cold extrusion of steel. Whether these two will be pulled into the Houston Fearless complex remains to be seen.

Born 70 years ago in Wisconsin, Dietrich began his career as a bank teller and accountant, went to work for Hughes in 1925 as an executive assistant.

The father of two sons and three daughters, the youngest of whom is 13, Dietrich is a sports car fan with a one-track mind—he owns three Facel Vegas. He takes pride in his active status in Los Angeles civic affairs, and his post on the advisory committee for Notre Dame.

He admits to the reputation of a hard man at Hughes, but gained his associates' respect as a top-flight administrator. A Houston Fearless executive recently introduced his boss as "a gentle, likeable guy—AFTER the work is finished, the product delivered, and a healthy profit shown."



Name Johnston Vice President

WILLIAM H. COOLEY, president of Television Shares Management Corp., principal underwriter and investment manager for the more than \$300 million Television-Electronics Fund, Inc., announces the appointment of Paul A. Johnston as vice president.

Johnston has been director of information for the management corporation for the past four years and will continue in that capacity as an officer of the company.



Gardner Sets Up New Company

FLOYD M. GARDNER, formerly associate director of research at Interstate Electronics Corp., has an-



NEED PRODUCT INFO? LOOK IN THE NEW

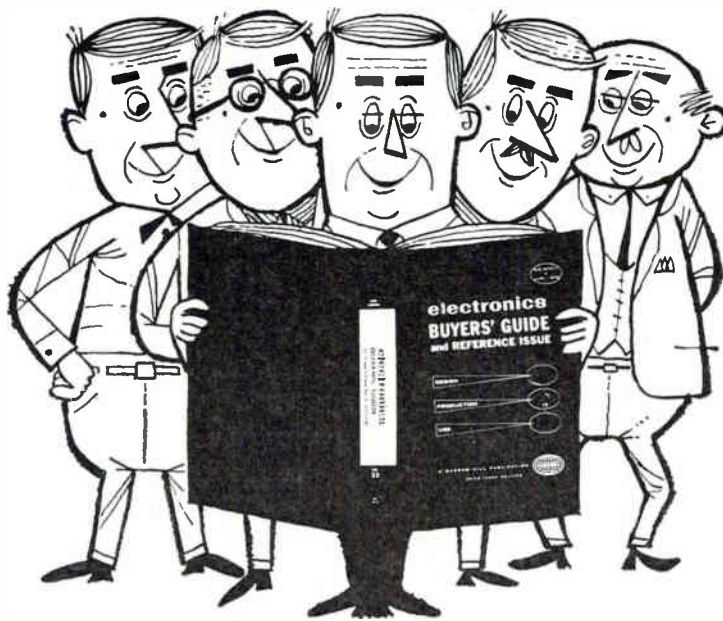

electronics BUYERS' GUIDE

You'll find detailed facts about the products of almost 700 different advertisers — that's 42% more than you'll find in any other electronics directory.

There's also 64 pages of reference data about markets, materials and design — vital information for all working in electronics. Also local sales offices of man-

ufacturers . . . the names, addresses and phone numbers of representatives . . . complete lists of manufacturers . . . registered trade names . . . and also, of course, the most complete listing of all electronic and related products. Tells what you want to know . . . *when you're ready to buy.*



A McGraw-Hill Publication • 330 West 42nd Street, New York 36, New York

ELECTRONICS • FEBRUARY 19, 1960



E.M.I. MULTIPLIER PHOTOTUBES

For scintillation counters, spectrophotometry, flying spot scanning. The range of phototubes made by E.M.I. is one of the largest in the world. It includes end-window types of 1" to 15" diameter, with S10, S11, S13 and S20 cathodes, with 10 to 14 dynodes of venetian blind type or of box and grid or focused construction. Tubes for C¹⁴ and H³ Scintillation counting, also very low dark-current types, are an E.M.I. speciality. Tubes can also be produced to special order.

FULL DETAILS
OF ALL TYPES FROM:

H. L. Hoffman & Co., Inc.

35 OLD COUNTRY ROAD · WESTBURY · N.Y.
TEL: EDGEWOOD 4-5600

nounced the formation of Gardner Research Co. in Orange, Calif. New firm will provide electronics consulting services to government and industry.



Wyle Acquires East Coast Lab

FRANK S. WYLE, president of Wyle Laboratories, El Segundo, Calif., has announced expansion of missile-aircraft components testing operations to the East Coast, through his acquisition of Parameters, Inc., a testing firm with plant facilities in New Hyde Park, N. Y.

The newly-acquired company will be known as Wyle-Parameters, Inc., and will continue its present operations at the same address.



Daystrom Hires T. W. Waldrop

THOMAS W. WALDROP has joined Daystrom, Inc., Control Systems

SWITCH TO TECH LABS

for
*Precision Electrical
Resistance Instruments*

STEPPING SWITCHES

for automation,
telemetry,
remote control

- Rugged
- Dependable
- Hermetically sealed if desired

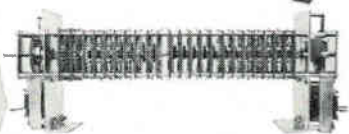

ROTARY SWITCHES

for all electronic
equipment

- Meets or exceeds government specs.
- Printed circuit and special designs

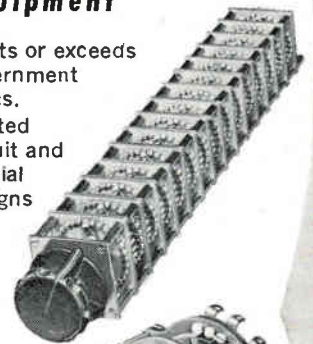

- Quick deliveries
- Long life
- All sizes



CAM SWITCHES

for counting and control

- Decade switch
- Control switch
- Decimal to binary converter



PALISADES PARK,
NEW JERSEY

division, LaJolla, Calif., as systems coordinator. His instrument background includes nine years with Republic Flow Meter Co. where he served as district sales manager of their Atlanta and New Orleans offices, in charge of all field sales, service and systems engineering.

During the past year, Waldrop headed up new product development planning under Republic's Engineering & Research division.

News of Reps

Harrel, Inc., New York, N. Y., has appointed Edward Magnuson Co. of Chicago, Ill., as engineering sales reps for its line of proportional temperature controllers, gyro spin motor supplies, relay amplifiers, and other accessories for high precision gyros. Territory will be Indiana, Minnesota, Wisconsin, Iowa, and Illinois.

Durant Mfg. Co., Milwaukee, Wisc., recently appointed M. R. Snyder Co. of Charlotte, N. C., as the sales rep in North and South Carolina for the company's line of instrument and industrial counters.

Lumatron Electronics, Inc., Westbury, N. Y., has announced the appointment of three western reps as part of its expanding marketing program.

California, Nevada and Arizona will be covered by Instruments for Measurements of Hollywood, Calif. Sales in Washington and Oregon will be handled by Paramount Agencies of Seattle, Wash. Brooks Feeger Associates of Albuquerque, N. M., will cover New Mexico, Colorado, Utah and Wyoming.

The Roy Attaway Co., engineering rep for Waterman Products Co., manufacturer of cathode-ray tubes, electronic testing equipment, and accessories, recently moved to new quarters in Decatur, Ga.

V. T. Rupp Co., Los Angeles, Calif., is appointed sales rep for Analab Instrument Corp., Cedar Grove, N. J., to cover California, Arizona, New Mexico, Nevada, and El Paso County in Texas.

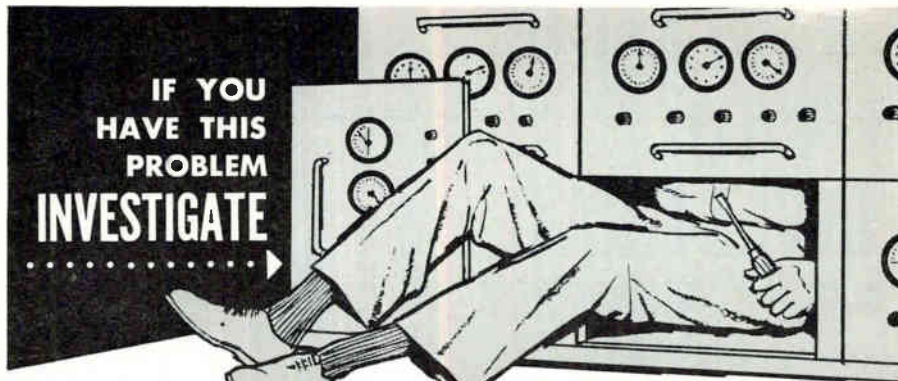

U.S. TOP QUALITY TRANSISTORS

Proven Reliability for all Applications

US Transistor's complete range of commercial and industrial transistors are applicable for every purpose. Separately designed series offer the characteristics that will suit your individual requirements.

All the transistors listed in the adjoining table have welded hermetic seals and meet or exceed mechanical and environmental requirements.

Small Signal Audio and Low Speed Switching Transistors	Extended Audio and Medium Speed Switching Transistors	Radio Transistors I.F. and Oscillator	Medium and High Speed Switching Transistors (Computer)
2N362	2N519	2N481	2N404
2N363	2N520	2N482	2N315
2N464	2N521	2N483	2N317
2N465	2N522	2N484	2N425
2N466	2N523	2N485	2N426
2N467		2N486	2N1343
			2N1344
2N531		2N413	2N1345
2N532		2N414	2N1200
2N533		2N416	2N1281
		2N417	2N1347
2N650			2N1346
2N651			2N1201
2N652			2N1282
2N653			2N1284
2N654			2N1353
2N655			2N1354
			2N1355
			2N1356
			2N1357

Write today for engineering data sheets or personal application assistance.



U. S. TRANSISTOR CORP.

149 Eileen Way, Syosset, L. I., N. Y. • WAlnut 1-5800

CIRCLE 211 ON READER SERVICE CARD

#479

Platinum
ALLOY

POTENTIOMETER WIRE

Potentiometers wound with our #479 Platinum Alloy Wire have exceptionally low noise level, even after extended periods of shelf life...

They can be depended upon for excellent wear characteristics.



SINCE 1901

SIGMUND COHN CORP.

121 SOUTH COLUMBUS AVENUE,
MOUNT VERNON, N. Y.

3 REASONS TO INVESTIGATE *atkins & merrill* NOW

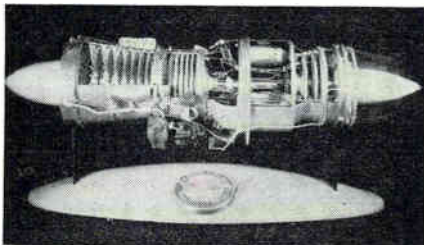

1 The finest industrial scale models made to your specification provide incomparable training and engineering aids.

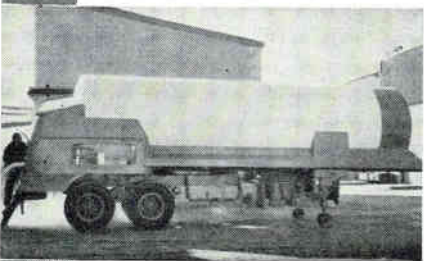

2 Reinforced Plastics production of structural parts, radomes, housings, mock-ups, etc., for superior strength-weight ratio, corrosion resistance, design flexibility and many economic advantages.



3 Design Service to help you produce a new product better, quicker, at less cost.



Write for free literature and indicate category of interest so that we may help you better, quicker.

49 Post Road, So. Sudbury, Mass.
1749 Placentia Ave., Anaheim, Calif.

COMMENT

Instrument Show

For the last five years we have organized the annual International Instrument Show. This show has become so much a part of the calendar that we are now busy disappointing would-be visitors who assume that 1960 will see the sixth in the series.

To appreciate the reason why there is no IIS this year, it is necessary to recap its origin. The idea was conceived in 1955 when all of the then-existing "big shows" were national rather than international. However, this year there is certainly no reason why any British engineer should not be able to compare products from overseas in at least one British show . . .

CYRIL J. MITCHELL

B & K LABORATORIES LTD.
LONDON

Blind-Landing Gear

It seems to me that the author of the article "FAA to Test Blind-Landing Gear" (p 36, Dec. 18 '59) has oversimplified his description of the ILS (instrument landing system), and by so doing may create an incorrect impression.

"A ground transmitter emits a single electronic glidepath and the pilot stays on this track—horizontally and vertically—by merely keeping two needles centered on the cockpit display." I believe that there are two transmitters, for a localizer and for the glidepath. The localizer provides a track horizontally and the glidepath provides a track vertically. Each track is displayed by its corresponding cross-pointer needle. It is true that, to follow the two tracks, the pilot keeps the two needles centered.

"Or, in planes equipped with an autopilot, that system will keep him lined up horizontally with the runway." I believe that an automatic approach coupler has two channels, one for localizer and one for glidepath. The localizer signal acts to control the autopilot rudder channel so as to steer the plane on the localizer track. The glidepath signal acts to control the autopilot pitch channel and the engine throttle so as to follow the glide-

3300°F

- Ceramic Metallizing
- Sintering
- Silicon Depositing and Diffusing
- Heat Treating Exotic Metals

A Compact, Economical-to-Operate Unit featuring molybdenum-wound elements . . . the Hayes Type M-Y Furnace is ideal for high-temperature, close-tolerance work requiring uniform heats from 2700° to the 3300° F. range.

For Research or Production, versatile Hayes Type M-Y furnace is ready-built for a variety of reducing, non-oxidizing, or inert atmospheres . . . dry forming gas, dissociated ammonia, hydrogen, nitrogen, or argon. M-Y features include: (1) moly-wound muffle for maximum length of temp. uniformity, (2) water-jacketed cooling sections

HAYES TYPE
M-Y "MOLY" FURNACE

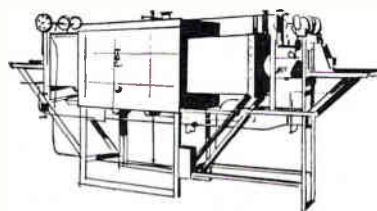

with precise temp. regulators for optimum control of atmosphere cooling, (3) extended insulated throat areas to minimize thermal shock, (4) special atmosphere arrangements to obviate atmosphere contamination, and (5) automatic feed mechanisms.

Results Guaranteed! The Hayes answer to your high-temperature heat treating problem — whether it involves *ceramics, electronics, or metallurgy* — includes *customized techniques, correct placing and fixturing of work, proper atmosphere selection, and precise time-temperature cycles.* To improve your product, increase production, and reduce costs, do it the Hayes way.

WRITE for M-Y
Furnace BULLETIN
5805 today.



C. I. HAYES, INC.

Wellington Avenue • Cranston 10, R. I.
Established 1905

ELECTRIC HEAT TREATING FURNACES

It pays to see Hayes for metallurgical guidance, lab facilities, furnaces, atmos. generators, gas/liquid dryers.

CIRCLE 210 ON READER SERVICE CARD
FEBRUARY 19, 1960 • ELECTRONICS

think

"we'll turn to

**TRANSCO
for**

ANTENNAS

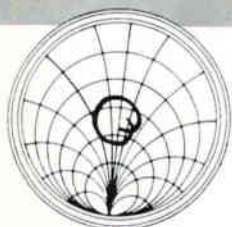

**because Transco builds
antennas and systems
to meet every need."**

Resourceful engineering, advanced lab techniques plus complete environmental test facilities always give the pattern, band, frequency and reliability required.

Since 1947 Transco has designed, developed and built a wide variety of quality airborne antennas — for almost every application.

"ANTENNAS IN ACTION"

Transco developed all antennas for Douglas' Thor I.C.B.M.

To know more about Transco Antennas and how they solve your current antenna problems write for complete catalog.

TRANSCO
PRODUCTS INC.

12210 NEBRASKA AVENUE
LOS ANGELES 25, CALIFORNIA

CIRCLE 213 ON READER SERVICE CARD
ELECTRONICS • FEBRUARY 19, 1960

path. Thus the plane is lined up horizontally and vertically on the proper path to touchdown.

I am bringing these points to your attention only because I feel that **ELECTRONICS** is tops in its field and is noted for the technical accuracy of its articles. Misleading statements can confuse the reader who is trying to learn something.

Of course, that brings up a pet peeve of mine. I feel that technical magazines should devote more effort toward explanation of basic principles and a little less space for very advanced techniques that are of value only to a specialized few.

This is the first time I have been impelled to write this kind of letter in ten years of reading **ELECTRONICS**. Probably will be the last for another ten years!

HARVEY A. SENIOR
SANDY HOOK, CONN.

We're happy to print reader Senior's amplifying comments, and grateful for his compliments. As to printing explanations of basic principles: we try to do that insofar as the material is not trivial and bears on the field of interest of any article. But we feel that an interpretive engineering publication has an important function to fulfill in serving a broad and burgeoning technology such as electronics. That function is broad-banding, widening the scope and horizon of our readers by bringing them reports on techniques and advances in other allied areas of the technology. One of our daily problems is just arriving at the right mix of the fundamental and the advanced, the general and the specific, the detailed and the broad-gage.

Minify

Regarding the comment about the cumbersome word *miniaturize* (Comment, p 104, Jan. 22): I'll stick with it simply because it's familiar and conveys a mutually understood meaning. It's tough enough to keep up with new factual developments without complicating things by setting up new rules for describing the facts.

W. E. COLVIN
VALLEY FORGE, PA.

TRANSIST -O- CHECK



**Model 302
\$49.75**

... MAKES TRANSISTOR TESTING FAST AND SIMPLE

Designed for rapid, easy testing of low and medium power transistors, the Model 302 Transist-O-Check performs all essential checks of testers costing far more, requires no tables, bias or voltage adjustments. ■ Checks shorts, DC beta, I_{cbo} , I_{ceo} ■ Only $7\frac{1}{4}$ " by $4\frac{3}{8}$ " by $4\frac{1}{8}$ ", weighs less than 2 pounds ■ Self contained 5 volt mercury battery ■ Sensitive 50 microampere meter for current measurements ■ Standard 3-pin socket for plug-in connections, plus novel lay-in clips for untrimmed and special base transistors.

write for data or order direct
from **COMPONENTS DIVISION**

**TRANSISTOR
SPECIALTIES
INC.**

**TERMINAL DRIVE, PLAINVIEW,
LONG ISLAND, NEW YORK
telephone WELLS 5-8700**

Transistor test equipment of all types, as well as special designs engineered and manufactured for particular applications. Our staff is available for consultation on your requirements.

ELECTRONIC EQUIPMENT DISTRIBUTORS

Lafayette Radio

INDUSTRIAL
ELECTRONICS
DIVISION

proudly announces

**its appointment as
franchised distributor for**



GENERAL RADIO Variac®

Continuously-Adjustable Autotransformers with Exclusive DURATRAK (Pat. Pending) Contact Surface.

Factory Prices Up to 99 Pieces

Write or call for specifications to DEPT. EN, at any of the following addresses. Ask for your FREE copy of LAFAYETTE RADIO'S complete catalog of electronic parts and equipment.

165-08 Liberty Avenue
Jamaica 33, N. Y.
AXtel 1-7000
TWX: NY4-933

100 Sixth Ave.
New York 13, N. Y.
WOrth 6-5300
TWX: NY1-648

110 Federal St.
Boston 10, Mass.
HHubbard 2-7850
TWX: BS447U

139 W. 2nd St.
Plainfield, N. J.
Plainfield 6-4718

24 Central Ave.
Newark, N. J.
Market 2-1661

CIRCLE 219 ON READER SERVICE CARD



We are the Distributors' Supplier... Selling

TO DISTRIBUTORS ONLY

Transitube has become widely known as the supplier for all major brand

INDUSTRIAL ELECTRON TUBES and SEMI-CONDUCTORS

to meet rigid government and commercial specifications. Whether your requirements are 1 or 1000... our three modern warehouses, stocked with a current and comprehensive inventory, insure you off-the-shelf delivery at great savings.

Our sales department invites Distributors' inquiries on: POWER • ROCKET • BROADCAST • KLYSTRONS • IGNITRONS • MAGNETRONS • THYRATRONS • RECTIFIERS • RUGGEDIZED • TRANSMITTING • SUBMINIATURES • PHOTOMULTIPLIERS • SPECIAL PURPOSE • CATHODE RAY TUBES • TRANSISTORS

TransiTube
inc.

114 LIBERTY ST., N. Y. 6 • W0 4-0252-3-4

106 CIRCLE 106 ON READER SERVICE CARD

do you know
what's expected
from
semi-conductor
materials?

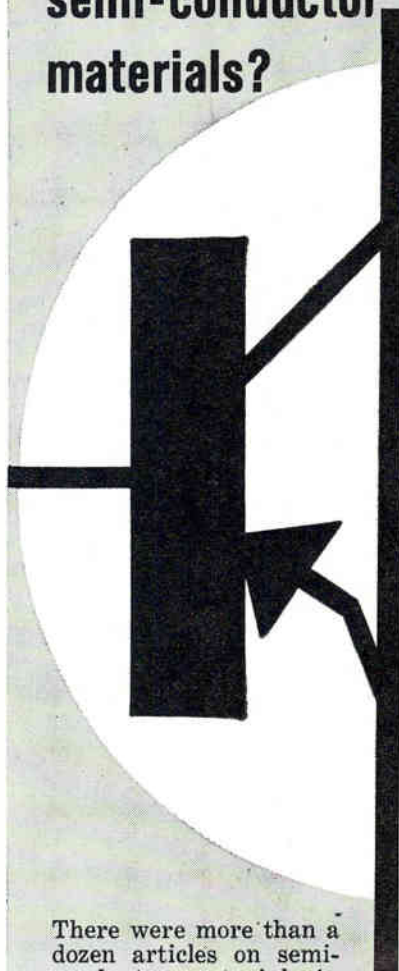

There were more than a dozen articles on semi-conductor materials in **electronics** in recent months. Each was specially edited to give you all key facts, ideas or trends—and there's more coming! Accurate **electronics'** reporting tells you what's happening now... what's *expected* in materials and components. Don't miss dozens of articles on basic subjects edited to keep you informed, help make your research, development, sales and marketing plans pay off. It pays to subscribe to **electronics** (or renew). Fill in box on Reader Service Card now. Easy to use. Postage free.

**FIND WHAT
YOU NEED IN
electronics**

FEBRUARY 19, 1960 • ELECTRONICS

Join General Electric's Electronics Laboratory In Exploiting a Major State-of-the-Art Advance Promising Long-Term Impact on Many Technologies

THERMOPLASTIC RECORDING

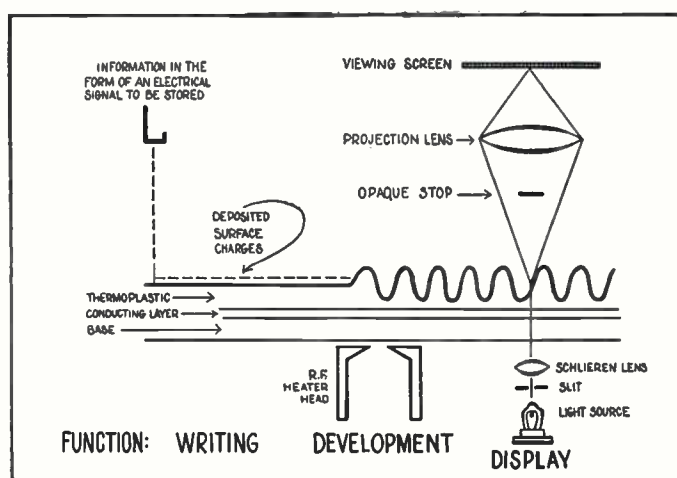

BREAKTHROUGHS are frequently talked about, infrequently accomplished. An article appearing in the December issue of *The Journal of Applied Physics*, written by Dr. W. E. Glenn of General Electric's Research Laboratory, has stimulated the imagination of the scientific/technological community. Titled *Thermoplastic Recording*, it describes a revolutionary new method of recording electrical signals. This process makes it possible for information to be written at extremely high density by means of an electron beam on a film consisting of a low melting thermoplastic material. Data can be projected as a black and white or full color image, or it can be converted to an electrical signal. The tape can be readily erased and reused. Summarizing, *Thermoplastic Recording* provides the equivalent of a high resolution, reusable "photographic" film developed by non-chemical means in the fraction of a second.

New Programs Utilizing invention and innovation, the Electronics Laboratory at Syracuse, New York is now engaged in a growing number of programs proving the feasibility of this new process for military and commercial applications which include direct image photography, projection displays, wideband analogue recording, sonar and radio signal correlation and processing.

Anti-Submarine Warfare Program Another program of current interest includes efforts devoted to submarine detection and classifica-

tion by means other than sonar, secure underwater communications and submarine-aircraft communication.

Professional Opportunities Highly creative and experienced engineers and physicists are required to accomplish the objectives of these ambitious programs. Major areas of professional interest should include one or more of the following areas listed to the right. †

A reprint of Dr. Glenn's article describing in detail the Thermoplastic Recording Process is available upon request.

- GEOMETRICAL, PHYSICAL AND ELECTRON OPTICS
- CIRCUIT DESIGN
- MECHANICAL DESIGN
- VACUUM TECHNOLOGY
- FEEDBACK THEORY • RADAR
- OCEANOGRAPHY • TELEVISION
- SOUND PROPAGATION
- SURFACE PHYSICS • SONAR
- IR PHENOMENA

Additional openings in these areas:

- MATERIALS • CIRCUITS
- DEVICES • SYSTEMS
- EQUIPMENT

For further information on current openings write in strict confidence to Mr. Robert Mason, Dept. 69-WG

ELECTRONICS LABORATORY

GENERAL ELECTRIC

ELECTRONICS PARK, SYRACUSE, N. Y.

**New Gateway to Achievement
in Astronautics and Aeronautics**

**Republic Aviation's
New Research & Development Center**

Engineers and scientists whose minds are challenged by unsolved problems across the entire spectrum of technologies concerned with space exploration and upper atmosphere flight, are invited to inquire about the exceptional facilities for both theoretical and experimental investigations provided by Republic's new Research and Development Center (scheduled to open Spring 1960).

Openings at all levels (including top level supervisory) in nearly every area of Electronics related to Advanced Flight & Weapons Technology:

Navigation & Guidance Systems / Radar Systems / Information Theory / Radio Astronomy / Solid State & Thermionic Devices / Microwave Circuitry & Components / Countermeasures / Digital Computer Development / Radome & Antenna Design / Miniaturization-Transistorization / Radiation & Propagation (RF, IR, UV) / Telemetry-SSB Technique / Receiver & Transmitter Design

Please forward resumes to: Mr. George R. Hickman
Technical Employment Manager, Dept. 11B-3



REPUBLIC AVIATION

Farmingdale, Long Island, New York

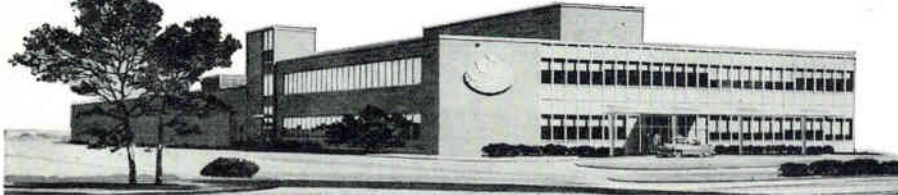

CONTACTS

**FOR THE FIELD OF
ELECTRONICS**

**"HOW TO MAKE MONEY
IN
Mobile Radio Maintenance"**

**AUTHORITATIVE GUIDEBOOK
ABOUT THE BOOM IN TWO-WAY MOBILE-RADIO.
GIVES FACTS, FIGURES, PAY RATES,
WRITE TODAY!**



LAMPKIN LABORATORIES, INC. Instruments Div. BRADENTON, FLA.

CIRCLE 460 ON READER SERVICE CARD

*"Put Yourself in the
Other Fellow's Place"*

**TO EMPLOYERS
TO EMPLOYEES**

Letters written offering Employment or applying for same are written with the hope of satisfying a current need. An answer, regardless of whether it is favorable or not, is usually expected.

MR. EMPLOYER, won't you remove the mystery about the status of an employee's application by acknowledging all applicants and not just the promising candidates.

MR. EMPLOYEE you, too, can help by acknowledging applications and job offers. This would encourage more companies to answer position wanted ads in this section.

We make this suggestion in a spirit of helpful cooperation between employers and employees.

This section will be the more useful to all as a result of this consideration.

Classified Advertising Division

McGraw-Hill Publishing Co., Inc.
330 West 42nd St., New York 36, N. Y.

ENGINEERS — SCIENTISTS

**MORE AND MORE COMPANIES
are continually coming to us for help!
WHY DON'T YOU?**

S.E.E. client companies are wide in variety—large and small—with opportunities at all levels, as diverse as "the state of the art". Employers pay placement fee and relocation costs. If you are interested in advancement—

Send Resume to:

**SCIENTISTS, ENGINEERS &
EXECUTIVES, Inc.**

1026-17th St. N.W., Washington 6, D. C.

**GYRO DEVELOPMENT ENGINEER
\$14,000**

Develop precision gyro systems including all mechanical problems. Dynamic growing organization with ever improving program of expansion. Advantage of excellent suburban living. Fee and expenses paid. Confidentially handled.

MONARCH PERSONNEL
28 East Jackson Chicago 4, Illinois

**ELECTRICAL ENGINEERS
PHYSICISTS**

Excellent openings for EE's and physicists—with or without experience—to enter electron tube field in the following areas: photosensitive cathode ray, X-ray and power tubes.

Please write or phone collect Mr. H. E. Nevins (Flerside 8-7511),



Laboratories, Inc.
1063 Hope St., Stamford, Conn.

PROJECT ENGINEER

SALARY \$14,000 PER YEAR

Will supervise Infrared group. Physics degree preferred, and should be familiar with the state of the art on systems, components, techniques, etc. Any experience in noise analysis helpful. Company client will assume all employment expense.

ESQUIRE PERSONNEL, INC.
202 South State St., Chicago 4, Ill.

SELLING OPPORTUNITIES WANTED

Looking for a Rep.? Conn. Sales By Grad.
Engr. Box 768 New Haven, Conn.

**EMPLOYMENT
OPPORTUNITY RATES**

The Advertisements in this section include all employment opportunities—executive, management, technical, selling, office, skilled, manual, etc.

- Positions Vacant
- Positions Wanted
- Part Time Work
- Selling Opportunities Wanted
- Selling Opportunities Offered
- Civil Service Opportunities
- Employment Agencies
- Employment Services
- Labor Bureaus

DISPLAYED

The advertising rate is \$34.33 per inch for all advertising appearing on other than a contract basis. Contract rates quoted on request. An advertising inch is measured 1/8" vertically on a column—3 columns—30 inches to a page. Subject to Agency Commission.

UNDISPLAYED

\$2.40 per line, minimum 3 lines. To figure advance payment count 5 average words as a line. Box Numbers—counts as 1 line. Position Wanted ads are 1/2 of above rate. Discount of 10% if full payment is made in advance for 4 consecutive insertions. Not subject to Agency Commission.

Send **NEW ADS** or inquiries to Classified Advertising Division of

ELECTRONICS, P. O. Box 12, N. Y. 36, N. Y.

new openings in Florida with Vitro

 Vitro Laboratories' Florida operation, Vitro Weapons Services, is rapidly expanding its technical staff to operate the nation's newest missile test range, the EGLIN GULF TEST RANGE.

High level supervisory and staff opportunities exist at five Florida locations: 1. Fort Walton Beach; 2. Port St. Joe; 3. Tarpon Springs; 4. Naples and 5. Key West.



ELECTRONIC ENGINEERS — with degree(s) and several years experience in Automatic Tracking Radar, Electronic Instrumentation, Phase Comparison Space Positioning Systems, Data Recording and Conversion, Telemetry or Missile Range Instrumentation.



RADAR TECHNICIANS — with training and experience in one or more of the following radar systems: MSQ-1, MSQ-1A, FPS-16, Nike, M-33, MPS-9, SCR-584, CPS-6, FPS-3 and FPS-20.



ELECTRONIC TECHNICIANS — with a solid background in electronics and several years experience in Telemetry, Data Converters, Oscillograph Recorders or Range Electronic Instrumentation.



For your opportunity to relocate in Florida with an electronics industry leader, address a confidential resume to D. D. Cox, Personnel Director, Vitro Weapons Services, 119 East Main Street, Fort Walton Beach, Florida, Dept. AW.



DIVISION OF VITRO CORPORATION OF AMERICA
Other Laboratories at West Orange, N. J., and Silver Spring, Md.

PRELIMINARY DEVELOPMENT SENIOR ENGINEERING SPECIALISTS

Honeywell Aero Preliminary Development Staff has several openings for technically qualified and mature engineers with significant military system development experience. Each man will provide guidance and support in his specialty to Honeywell design projects for the best use of advanced techniques in development of new airborne systems. These staff positions offer scope for original personal contributions and will require active participation in the formulation and execution of Division engineering programs. Among the openings are:

WEAPON DELIVERY AND CONTROL SYSTEMS SPECIALIST

Background of system and computer development for bombing, fire control, or navigation. Firsthand experience with system analysis, tie-in requirements, analog and digital computers, operations analysis, and weapon effectiveness evaluation.

DETECTION SYSTEMS SPECIALIST

Primary background of airborne radar development in one or more areas such as AMTI, Doppler, pulse Doppler, automatic tracking, and countermeasures. Experience in infrared or communications will be valuable. Experience should include system analysis, design requirements, equipment development, and performance evaluation.

ELECTRONIC CIRCUIT AND PACKAGING SPECIALIST

Background of circuit design for advanced control and computation equipment. Should be familiar with dc, low frequency, pulse and rf techniques. Must be able to establish sound analytical basis for circuit design to specific levels of reliability and performance. Must be experienced with solid state devices and prepared to contribute to Aero Division work on microcircuit techniques.

To discuss openings for these and other specialties, write or phone

J. R. Rogers, Chief Engineer
Preliminary Development Staff,
Dept. 365B.

Honeywell

AERONAUTICAL DIVISION
2600 Ridgway Road,
Minneapolis 14, Minnesota

To explore professional opportunities in other Honeywell operations coast to coast, send your application in confidence to H. K. Eckstrom, Honeywell, Minneapolis 8, Minnesota.

SEARCHLIGHT SECTION

(Classified Advertising)

BUSINESS OPPORTUNITIES

EQUIPMENT - USED or RESALE

DISPLAYED RATE

The advertising rate is \$24.75 per inch for all advertising appearing on other than a contract basis. Contract rates quoted on request. AN ADVERTISING INCH is measured 1/8 inch vertically on one column, 3 columns—30 inches—to a page. EQUIPMENT WANTED or FOR SALE ADVERTISEMENTS acceptable only in Displayed Style.

UNDISPLAYED RATE

\$2.40 a line, minimum 3 lines. To figure advance payment count 5 average words as a line.

BOX NUMBERS count as one line additional in undisplayed ads.

DISCOUNT of 10% if full payment is made in advance for four consecutive insertions of undisplayed ads (not including proposals).

MANAGEMENT PERSONNEL

with limited capital

and/or INNOVATIONS

Successful ventures require interdependent specialization under modern economic conditions.

Profitable investment outlets may exist in association with people who possess both proven backgrounds and innovations.

Write for further information to

BENHARD ASSOCIATES
1123 Western Saving Fund Bldg.
Phila. 7, Pa.

CIRCLE 461 ON READER SERVICE CARD

PLATING SPECIALISTS

for the

ELECTRONICS INDUSTRY

Gold, Silver, Nickel, Tin, Cadmium PLATING to any thickness.

PALUMBO BROS., INC.
347 Ferry St. Newark 5, N. J.
M Arket 2-5060 • Est. 1915

CIRCLE 462 ON READER SERVICE CARD

LOOKING FOR USED/SURPLUS ELECTRONIC EQUIPMENT/COMPONENTS?

For an up-to-date listing of such equipment see Searchlight Section of Feb. 12th

FOR ADDITIONAL INFORMATION

About Classified Advertising,
Contact The McGraw-Hill
Office Nearest You.

ATLANTA, 3— 1301 Rhodes-Haverty Bldg. Jackson 3-6951 M. H. MILLER BOSTON, 16— 350 Park Square Hubbard 2-7160 M. J. HOSMER CHICAGO, 11— 520 No. Michigan Ave. MOnawk 4-5800 W. HIGGINS CLEVELAND, 13— 1164 Illuminating Bldg. Superior 1-7000 W. B. SULLIVAN DALLAS, 2— 1712 Commerce St., Vaughan Bldg. Riverside 7-5117 GORDON JONES— F. E. HOLLAND DENVER, 2— 1700 Broadway, Tower Bldg. ALpine 5-2981 J. PATTEN	DETROIT, 26 856 Penobscot Bldg. Woodward 2-1793 J. R. PIERCE LOS ANGELES, 17 1125 W. 6th St. HUntley 2-5450 C. YDCOM NEW YORK 36— 500 Fifth Ave. OXford 5-5959 H. T. BUCHANAN— R. P. LAWLESS— T. W. BENDER PHILADELPHIA, 3— Six Penn Center Plaza LOcust 8-4330 H. W. BOZARTH— H. NICHOLSON ST. LOUIS, 8— 3615 Olive St. JEfferson 5-4867 SAN FRANCISCO, 4— 68 Post St. DOuglas 2-1600 S. HUBBARD
--	--

Give your products
MORE RELIABILITY and
BETTER PERFORMANCE with

FREED
QUALITY

AVAILABLE FROM STOCK
 FOR IMMEDIATE DELIVERY

**HERMETICALLY SEALED
 MIL-T-27A
 PULSE TRANSFORMERS**

- Maximum power efficiency and optimum pulse performance.
- For use in blocking oscillator, interstage coupling and low level output circuits.
- Ruggedized construction — Grade 4.
- Series or parallel connection of windings for optimum turns ratio.



Cat. No.	MIL Type	Pulse Voltage Kilovolts	Char. Imp. Ohms
MPT-1	TF4RX35YY	0.25/0.25/0.25	250
MPT-2	TF4RX35YY	0.25/0.25	250
MPT-3	TF4RX35YY	0.5/0.5/0.5	250
MPT-4	TF4RX35YY	0.5/0.5	250
MPT-5	TF4RX35YY	0.5/0.5/0.5	500
MPT-6	TF4RX35YY	0.5/0.5	500
MPT-7	TF4RX35YY	0.7/0.7/0.7	200
MPT-8	TF4RX35YY	0.7/0.7	200
MPT-9	TF4RX35YY	1.0/1.0/1.0	200
MPT-10	TF4RX35YY	1.0/1.0	200
MPT-11	TF4RX35YY	1.0/1.0/1.0	500
MPT-12	TF4RX35YY	0.15/0.15/0.3/0.3	700

**Ruggedized,
 MIL STANDARD
 POWER & FILAMENT TRANSFORMERS**
 Primary 105/115/125 V 50-60~

Cat. No.	Appl.	MIL Std.	MIL Type
MGP 1	Plate & Fil.	90026	TF4RX03MA001
MGP 2	Plate & Fil.	90027	TF4RX03JB002
MGP 3	Plate & Fil.	90028	TF4RX03KB006
MGP 4	Plate & Fil.	90029	TF4RX03LB003
MGP 5	Plate & Fil.	90030	TF4RX03MB004
MGP 6	Plate	90031	TF4RX02KB001
MGP 7	Plate	90032	TF4RX02LB002
MGP 8	Plate	90036	TF4RX02NB003
MGF 1	Filament	90016	TF4RX01EB002
MGF 2	Filament	90017	TF4RX01GB003
MGF 3	Filament	90018	TF4RX01FB004
MGF 4	Filament	90019	TF4RX01HB005
MGF 5	Filament	90020	TF4RX01FB006
MGF 6	Filament	90021	TF4RX01GB007
MGF 7	Filament	90022	TF4RX01JB008
MGF 8	Filament	90023	TF4RX01KB009
MGF 9	Filament	90024	TF4RX01JB012
MGF 10	Filament	90025	TF4RX01KB013

WRITE FOR FURTHER INFORMATION ON THESE UNITS OR SPECIAL DESIGNS.
 Send for NEW 48 page transformer catalog. Also ask for complete laboratory test instrument catalog.

**FREED
 TRANSFORMER CO., INC.**

1722 Weirfield Street
 Brooklyn (Ridgewood) 27, New York

INDEX TO ADVERTISERS

• Airborne Instruments Laboratories....	82	Mallory & Co., Inc., P. R.....	8
• Airpax Products Co.	75	Marion Instrument Co., Div. of Minneapolis-Honeywell Regulator Co.....	85
• All Metal Screw Products Co., Inc.....	86	• Massa Laboratories, Inc. (Cohu).....	70
• Ameresco, Inc.	98		
• American Electronics Inc.	31		
• Amphenol-Borg Electronics Corp. Distributor Division	9	Norton Company	89
• Connector Division	9		
• Arnold Engineering Co., The.....	3	Osborne Electronics Sales Corp.....	95
• Arnoux Corp.	71		
• Atkins & Merrill Inc.	104		
• Avco Corporation, Crosley Division.....	22, 23		
• Bendix Aviation Corp. Bendix Pacific	85	Racal Engineering Ltd.	97
• Red Bank Tubes.....	88	• Radio Corporation of America	4th Cover, 13
Bomac Laboratories, Inc.	3rd Cover	• Relay Sales, Inc.	7
• Boonton Radio Corp.	18	• Rheem Semiconductor Corp.....	37
• Borg Equipment Division, Amphenol-Borg Electronics Corporation.....	81		
• Bussmann Mfg. Co., Div. of McGraw Edison	73		
• Celco-Constantine Engineering Laboratories	82	• Sanborn Company	79
• Clifton Precision Products Co., Inc.....	40	• Sola Electric Co.	6
• Cohn Sigmund, Corp.	103	• Sperry-Rand Corp. Semiconductor Division	63
• Curtiss-Wright Corp.	92	• Sprague Electric Co.	34, 35
		• Stevens-Arnold, Inc.	66
		• Stokes Corp., Machine, F. J.	14
		• Stromberg-Carlson Electronics Div. of General Dynamics Corp.	89
Delco Radio	24	Tech Laboratories	102
• DeMornay-Bonardi	90	Tranco Products, Inc.	105
Dorne & Margolin, Inc.	74	Transistor Specialties, Inc.	105
Dow Corning Corp.	16, 17	Transitube, Inc.	106
Edo Corporation	98	United Carbon Products Co.	19
Electrolic Tube Corporation	67	United Shoe Machinery Corp.....	77, 84
English Electric Valve Co., Ltd.....	2	U. S. Stoneware	21
		U. S. Transistor Corp.....	103
• Fairchild Semiconductor Corp.....	5	Waters Manufacturing, Inc.	12
• Freed Transformer Co., Inc.....	110	Weller Electric Co.	80
• Frechtown Porcelain Co.	96	Whitney Metal Tool Co.	99
• Gamewell Co.	99		
• General Electric Co. Semiconductor Products	26, 27, 83		
• Heavy Military Electronics Dept.....	69		
• General Magnetics, Inc.	98		
• General Radio Co.	2nd Cover		
Georgia Department of Commerce.....	87		
Gertsch Products	20		
Good-all Electric Mfg. Co.....	32		
• Haydon Co., Inc., A. W.	78		
• Hayes, Inc., C. L.	104		
• Hewlett Packard Co.	15		
• Hoffman & Co., Inc., H. L.	102		
• Hughes Aircraft Co.....	38, 39, 91		
International Electronic Research Corp.	36		
• International Rectifier Corp.	61		
• Jerrold Electronics Corp.....	86		
• Jones, Howard B., Division of United Carr Fastener Corp.	90		
• Kepco Laboratories	65		
• Kintel, Division of Cohu Electronics..	10		
• Laboratory for Electronics, Inc.....	25		
• Lafayette Radio	102		
• Lampkin Laboratories, Inc.	104		
• Levin & Son, Inc., Louis.....	97		

CLASSIFIED ADVERTISING
 F. J. Eberle, Business Mgr.

EMPLOYMENT OPPORTUNITIES 107-109
 SPECIAL SERVICES

BUSINESS OPPORTUNITIES

ADVERTISERS INDEX

Benhard Associates	109
Esquire Personnel, Inc.	108
General Electric Company	107
Honeywell, Aeronautical Div.	109
Machlett Laboratories, Inc.	108
Monarch Personnel	108
Polumbo Bros., Inc.	109
Republic Aviation	108
Scientists, Engineers & Executives Inc....	108
Vitro Weapons Services	109

• See advertisement in the June, 1959 Mid-Month ELECTRONICS BUYERS GUIDE for complete line of products or services.

This Index and our Reader Service Numbers are published as a service. Every precaution is taken to make them accurate, but ELECTRONICS assumes no responsibilities for errors or omissions.