

JUNE 26, 1959

MORNINGSIDE COLLEGE  
LIBRARY  
ST. CITY, IOWA

# electronics

A MCGRAW-HILL PUBLICATION

VOL. 32, No. 26

PRICE SEVENTY-FIVE CENTS

## Infrared Tracks Earth Satellites



New design 50 ohm attenuator  
**0 to 132 db in 1 db steps—  
 DC to 500 MC**



**-hp- 355A/B Attenuators**

$\frac{1}{4}$  db accuracy full range for low attenuation values. Maximum error at full attenuation 2 db. "One-knob" control. Super compact design—size approximately  $2\frac{1}{2}$ " x  $2\frac{1}{2}$ " x 6".

These are characteristics of the new, rugged, simple -hp- 355A/B attenuators.

-hp- 355A provides 0 to 12 db in 1 db steps. -hp- 355B provides 0 to 120 db in decade steps. Together, 132 db of attenuation from DC to 500 MC is available, with simplest possible controls, pre-

mium accuracy, and no complex setup. A solid-shield 50 ohm connector may be used to interconnect the two attenuators.

These new -hp- attenuators have balanced capacities and completely shielded sections. They are enclosed in a sturdy metal case, yet weigh only  $1\frac{1}{2}$  pounds.

Ask your -hp- representative to show you these practical, minimum-space attenuators this week.

**SPECIFICATIONS**

**Attenuation:** -hp- 355A, 12 db in 1 db steps. -hp- 355B, 120 db in 10 db steps

**Frequency Range:** DC to 500 MC

**Overall Accuracy:** -hp- 355A,  $\pm 0.25$  db, DC to 500 MC. -hp- 355B,  $\pm 1$  db, DC to 250 MC,  $\pm 2$  db, 250 to 500 MC

**Nominal Impedance:** 50 ohms

**Maximum SWR:** 1.2 to 250 MC, 1.5 to 500 MC

**Max. Insertion Loss:** 0 at DC, 0.4 db at 60 MC, 1 db at 250 MC, 1.5 db at 500 MC

**Power Dissipation:** 0.5 watt average; 350 v peak

**Connectors:** BNC

**Size:**  $2\text{-}3/16$ " wide,  $2\text{-}5/8$ " high, 6" long. Net weight  $1\frac{1}{2}$  pounds

**Price:** -hp- 355A, \$125.00. -hp- 355B, \$125.00

*Data subject to change without notice. Prices f.o.b. factory*

**HEWLETT-PACKARD COMPANY**

4643A PAGE MILL ROAD • PALO ALTO, CALIFORNIA, U.S.A.  
 CABLE "HEWPACK" • DAVENPORT 5-4451  
 FIELD ENGINEERS IN ALL PRINCIPAL AREAS

 offers over 350 quality electronic test instruments

## Issue at a Glance

A MCGRAW-HILL PUBLICATION  
Vol. 32 No. 26

JAMES GIRDWOOD, *Publisher*

W. W. MacDONALD, *Editor*

JOHN M. CARROLL, *Managing Editor*

*Associate Editors:* Frank Leary, Michael F. Tomaino, Howard K. Janis, Sylvester P. Carter, Roland J. Charest, William P. O'Brien, George Sideris, John F. Mason, William E. Bushor, Ronald K. Jurgen, Thomas Emma, Samuel Weber, Sy Vogel, Leslie Solomon, M. M. Perugini.

*Pacific Coast Editor (Los Angeles)* Harold C. Hood; *Midwestern Editor (Chicago)* Harold Harris; *New England Editor (Boston)* Thomas Maguire.

*Art Director,* Harry Phillips, Roy Thompsen.

*Production Editor,* John C. Wright, Jr., Bernice Duffy, Jean L. Matin.

*Market Research,* Edward DeJongh, Marilyn Koren.

*Editorial Assistants,* Gloria J. Filippone, Arlene Schilp, Patricia Landers, Catherine McDermott, Eleanor Schaefer, Carol Weaver.

**BRUCE A. WINNER**, *Advertising Sales Manager.* R. S. Quint, *Assistant Advertising Sales Manager and Buyers' Guide Manager.* Fred Stewart, *Promotion Manager.* Frank H. Ward, *Business Manager.* George E. Pomeroy, *Classified Manager.* Hugh J. Quinn, *Circulation Manager.*

*New York:* Donald H. Miller, Henry M. Shaw, William J. Boyle. *Boston:* Wm. S. Hodgkinson. *Philadelphia:* Warren H. Gardner. *Chicago:* Harvey W. Wernecke, Martin J. Gallay. *Cleveland:* P. T. Fegley. *San Francisco:* T. H. Carmody, R. C. Alcorn. *Los Angeles:* Carl W. Dysinger, D. A. McMillan. *Denver:* J. Patten. *Atlanta:* M. Miller. *Dallas:* Gordon L. Jones, Robert T. Wood. *London:* E. E. Schirmer. *Frankfurt:* Michael R. Zeynel.

### Business

How Military Sees In Dark. New systems probe space and oceans...	20
Business Is Good, But...Magnetic record makers speak out.....	23
Space Challenges Engineers. Missile Industry Conference report...	26
Communications' Top Needs. Gen. Le May lists what's wanted.....	31
Shoptalk .....	4
Electronics Newsletter .....	11
Washington Outlook .....	12
Financial Roundup .....	15
Over The Counter.....	15
Market Research .....	16
Current Figures .....	16
Meetings Ahead .....	32

### Engineering

Multiple-cell infrared computating detector being set up for experiments in tracking earth satellites. See p 38.....	COVER
Semiconductor Devices for Microminiaturization. One hundred million parts per cu ft....By J. T. Wallmark and S. CM. Marcus	35
Detecting Low-Level Infrared Energy. Discussion of multiple-cell arrangements..... By H. Dubner, J. Schwartz and S. Shapiro	38
Monitoring Radioisotope Tracers in Industry. Field instrument is simple, economical.....By F. E. Armstrong and E. A. Pavelka	42
Thin Magnetic Films for Digital Computer Memories. Advantages of planar and cylindrical magnetic spot arrays..By D. O. Smith	44
Transistor Radar Sweep Circuits Using Low Power. Design of compact plan-position-indicator sweep circuit.....By C. E. Veazie	46
High-Speed Multiplexing with Closed-Ring Counters. In telemetering, computing and medicine.....By K. L. Berns and B. E. Bishop	48
Fast Switching for Industrial Control. Operation of solid controlled rectifier and other a-c controllers.....By A. Gutterman	51
Network Transformations in Wave Filter Design. Useful charts for circuit designers .....	52
Transformerless A-C Filament Supplies. Nomogram determines capacitor size for tube heater supply.....By F. G. Kelly	56

### Departments

Research and Development. Wax Models Speed Antenna Design....	58
Components and Materials. Flexible Coaxial Cable Takes 1,000 F....	64
Production Techniques. Induction Brazing in Inert Gases.....	68
On the Market.....	72
Literature of the Week.....	78
Plants and People.....	80
News of Reps.....	82
Comment .....	84
Index to Advertisers.....	90



# NATVAR

# ISOLASTANE<sup>®</sup> TUBING and TAPE



**RESILIENT,  
ELASTIC**

— for sharp bends  
and irregular  
surfaces



**HEAT  
RESISTANT**

— for continuous perform-  
ance at temperatures up  
to 155°C

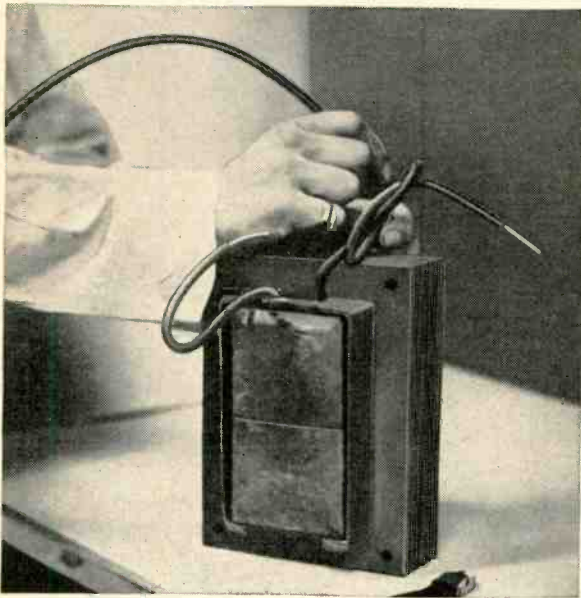

◀ Natvar Isolastane Fiberglass base tubing and bias tape ▼ fit snugly when applied, and retain their elasticity at continuous operating temperatures up to 155°C. They withstand higher temperatures during manufacturing processes without embrittlement.

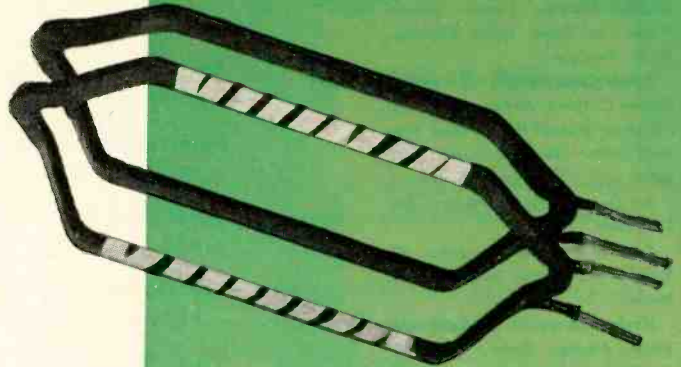

\*ISOLASTANE is Natvar's new elastomeric isocyanate type coating for Fiberglass braid and tape. Reg. U.S. Pat. Off.



### Natvar Products

- Varnished cambric—sheet and tape
- Varnished canvas and duck—sheet and tape
- Varnished silk and special rayon—sheet and tape
- Varnished papers—rope and kraft—sheet and tape
- Varnished, silicone varnished and silicone rubber coated Fiberglass\*—sheet and tape
- Slot cell combinations, Aboglas<sup>®</sup>
- Isoglas<sup>®</sup> sheet and tape
- Isolastane<sup>®</sup> sheet, tape, tubing and sleeving
- Vinyl coated and silicone rubber coated Fiberglass tubing and sleeving
- Extruded vinyl tubing and tape
- Styroflex<sup>®</sup> flexible polystyrene tape
- Extruded identification markers

\*T.M. (Reg. U.S. Pat. Off.) OCF Corp.  
We will be very happy to supply information on any of our products on request.

Natvar Isolastane is now making important savings possible. It makes it unnecessary to use expensive Class H materials to solve temperature problems during the manufacture of products which do not require Class H rating

### Isolastane is outstanding in its

- ELASTICITY (EXTENSIBILITY)
- RESISTANCE TO HEAT
- RESISTANCE TO CRAZING AND CRACKING
- RESISTANCE TO SOLVENTS, INCLUDING THE ASKARELS
- TOUGHNESS AND ABRASION RESISTANCE
- WET DIELECTRIC STRENGTH
- LOW TEMPERATURE FLEXIBILITY
- FUNGISTATIC QUALITIES

Full technical data and samples are available on request.

# NATVAR CORPORATION

FORMERLY THE NATIONAL VARNISHED PRODUCTS CORPORATION

TELEPHONE

FULTON 8-8800

CABLE ADDRESS

NATVAR: RAHWAY, N. J.

201 RANDOLPH AVENUE • WOODBRIDGE, NEW JERSEY

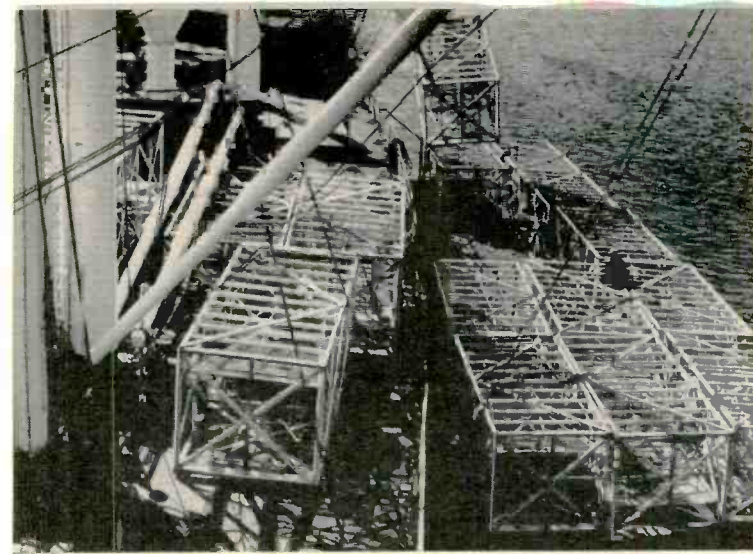

What you should know about

# KENNEDY FIELD ENGINEERING SERVICE

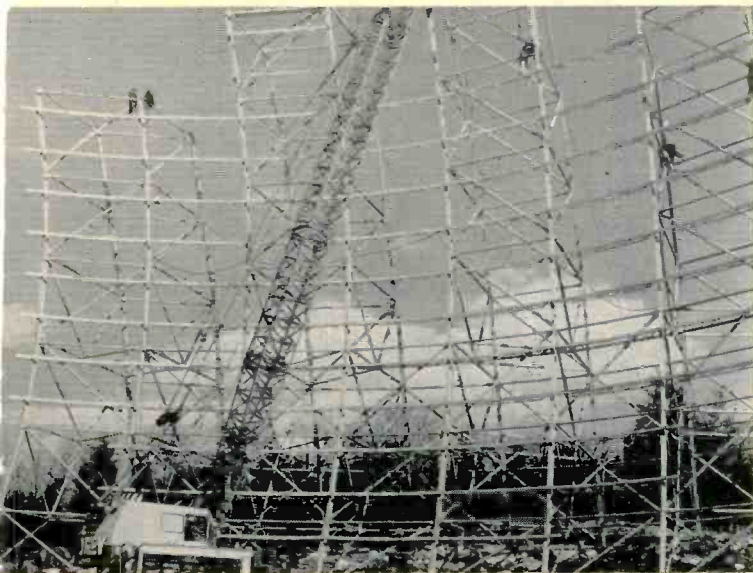
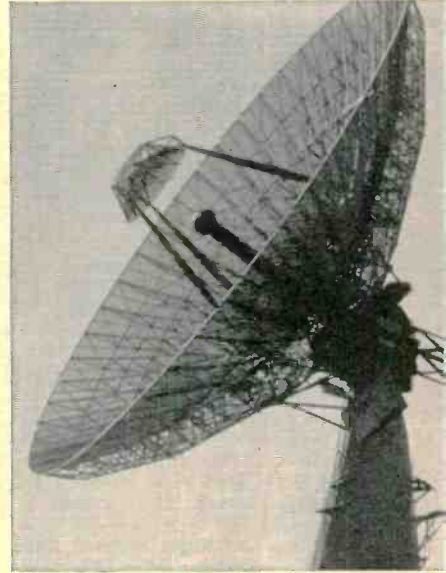

**O**VER the years Kennedy has expanded its facilities to meet the needs of the antenna industry . . . and today provides a complete field engineering service geared to solve the complex problems of antenna systems installation.

This service, conducted by thoroughly experienced Kennedy field engineers and technicians, includes site selection assembly, erection, trouble shooting and checkout, customer liaison, and on-the-job training for systems personnel in operation and maintenance.

An important fact is underlined here: that Kennedy capability in antenna systems is *total* capability.



ANTENNA EQUIPMENT

**D. S. KENNEDY & CO.**

COHASSET, MASSACHUSETTS Evergreen 3-1200

*West Coast Affiliate . . .*  
**SATELLITE KENNEDY, INC.** of CALIFORNIA  
 P. O. Box 7711, Monterey, California — Frontier 3-2461  
*Down-to-earth SOLUTIONS to out-of-this-world PROBLEMS*  
 Tracking Antennas-Radio Telescopes-Radar Antennas  
 "Trans-Horizon" Antennas-Tropospheric Scatter  
 Ionospheric Scatter

# SHOPTALK . . . editorial

## electronics

June 26, 1959 Vol. 32, No. 26

Published weekly, with an additional annual BUYERS' GUIDE and REFERENCE Issue in mid-June, by McGraw-Hill Publishing Company, Inc., James H. McGraw (1860-1948) Founder.

Executive, Editorial, Circulation and Advertising Offices: McGraw-Hill Building, 330 W. 42 St., New York 36, N. Y. Longacre 4-3000. Publication Office: 99-129 North Broadway, Albany 1, N. Y.

See panel below for directions regarding subscriptions or change of address. Donald C. McGraw, President; Joseph A. Gerardi, Executive Vice President; L. Keith Goodrich, Vice President and Treasurer; John J. Cooke, Secretary; Nelson L. Bond, President, Publications Division; Shelton Fisher, Senior Vice President; Ralph B. Smith, Vice President and Editorial Director; Joseph H. Allen, Vice President and Director of Advertising Sales; A. R. Venezian, Vice President and Circulation Coordinator.

Single copies in the United States, U. S. possessions & Canada 75¢; \$1.50 for all other foreign countries. Buyers' Guide in the United States, U. S. possessions & Canada \$3.00; all other foreign \$10.00. Subscription rates—United States and possessions, \$6.00 a year; \$9.00 for two years; \$12.00 for three years. Canada, \$10.00 a year; \$16.00 for two years; \$20.00 for three years. All other countries, \$20.00 a year; \$30.00 for two years; \$40.00 for three years. Second class postage paid at Albany, N. Y. Printed in U.S.A. Copyright 1959 by McGraw-Hill Publishing Co., Inc.—All Rights Reserved. Title registered in U. S. Patent Office. BRANCH OFFICES: 520 North Michigan Avenue, Chicago 11; 68 Post Street, San Francisco 4; McGraw-Hill House, London E. C. 4; 85, Westendstrasse, Frankfurt/Main; National Press Bldg., Washington 4, D. C.; Six Penn Center Plaza, Philadelphia 3; 1111 Henry W. Oliver Bldg., Pittsburgh 22; 55 Public Square, Cleveland 13; 856 Penobscot Bldg., Detroit 26; 3615 Olive St., St. Louis 8; 350 Park Square Bldg., Boston 16; 1301 Rhodes-Haverty Bldg., Atlanta 3; 1125 West Sixth St., Los Angeles 17; 1740 Broadway, Denver 2; 901 Vaughn Bldg., Dallas 1. ELECTRONICS is indexed regularly in The Engineering Index.

Subscription: Address correspondence to: Fulfillment Manager, Electronics, 330 W. 42nd St., New York 36, N. Y. Allow one month for change of address, stating old as well as new address, including postal zone if any. Subscriptions are solicited only from persons engaged in theory, research, design, production, management, maintenance and use of electronics and industrial control components, parts and products. POSITION and COMPANY CONNECTION must be indicated on subscription orders.

Postmaster: please send form 3579 to Electronics, 330 W. 42nd St., New York 36, N. Y.



Member ABP and ABC

**SEE-IN-DARK SYSTEMS.** As any tip-toeing husband who has ever come home late knows, there are many ways of avoiding furniture in the dark. But they are out of our domain. What we're reporting on this week is serious and new: low-light-level television. It provides eyes for nuclear submarines and space vehicles. It is also used in radio astronomy and gunfire-control work.

Seeing in the dark or semi-dark is important to our military people. Our story, "How Military Sees In Dark," begins on p. 20. Associate Editor Mason was the moving force behind it.

Low-light-level tv devices give night vision far better than the human eye's. The Army is very interested and active in this field. So is the Navy's Bureau of Aeronautics. Companies are getting new contracts. All of which adds up to bright prospects for see-in-dark systems.

**PROSPERITY & PROBLEMS.** It's troublesome but true: prosperity and problems often skip down the business street hand-in-hand. This is happening these days in the magnetic recording industry.

Tape sales show signs of jumping by 200,000—from 450,000 to 650,000 units—this year, says the Magnetic Recording Industry Association. In fact, MRIA thinks the jump could even be more of a whopper, way up to 750,000. Whatever the final figure, prospects are pleasing.

Now, enter problems. The magnetic recording industry faces four big ones—the stereo disk, the tape cartridge, the excise tax (buried but not completely dead) and Japanese importations.

To find out who thinks what—and why—ELECTRONICS' Midwestern Editor Harris went to prime sources, executives in the industry. They spoke frankly. What they said appears in the article "Business Is Good, But . . ." It appears on p. 23.

### Coming In Our July 3 Issue . . .

**COMMUNICATIONS AND THE IGY.** Two years ago, 30,000 scientists and technicians of 66 nations launched a cooperative effort which is unparalleled in modern history. The knowledge of the earth's environment which has been garnered in this tremendous project will have profound effects on man's future scientific achievements. Although obscured by more spectacular experiments such as Vanguard, much valuable data was obtained with rockets launched to perform ionospheric and solar studies.

Next week, Associate Editor Leary discusses the significance of the tons of IGY data now reposing in three world data centers. You'll learn how movement of air masses, earth's magnetic field, weather, solar activity and the behavior of the ionosphere affect world communications.

**MAGNETIC PULSER.** Small size and reliable operation are achieved in a radar pulse generator by use of transistors and magnetic cores. According to Arthur Krinitz of MIT's Servomechanisms Lab, use of these solid-state devices as a substitute for conventional thyratrons or vacuum-tube amplifiers provides indefinitely long life for such a circuit.

**THERE'S MORE.** Other highlights of next week's issue include: a device for measuring light intensity by controlling the discharge rate of a blocking oscillator; details of the pulse generator used with the B3 Stellarator for thermonuclear power experiments; a discussion of resonant-ring diplexing techniques for scatter communications and a useful reference sheet for the calculation of radar interference.

# RAYTHEON

reliable silicon **RECTIFIERS**  
silicon and germanium **DIODES**

rate first choice for your circuits



**Raytheon diffused junction Silicon Rectifiers** for missile and other critical applications were the first to be put into mass production. They are outstanding for high forward conductance, exceptional reverse recovery. Many meet requirements of MIL-E-ID.

**Raytheon Bonded Silicon Diodes** feature low reverse current, high forward conductance and excellent stability in high temperature applications. All are subject to environmental quality control. Twenty-seven types cover every need.

**Raytheon Germanium Diodes** meet the highest standards of quality, uniformity and performance. Both gold bonded and point contact constructions are available in a wide range of characteristics.



**Raytheon Circuit-Paks** are compact, encapsulated sub-assemblies of Diodes, Rectifiers, Transistors and other components for uses such as Phase Comparators, Bridges, Choppers, Flip-Flops, etc. They save space, speed assembly and assure Raytheon reliability.



**SEMICONDUCTOR DIVISION**

New York, Plaza 9-3900 • Boston, Hillcrest 4-6700  
Chicago, National 5-4000 • Los Angeles, Normandy 5-4221  
Baltimore, Southfield 1-1237 • Cleveland, Winton 1-7716  
Kansas City, Plaza 3-5330 • Orlando, Garden 3-1553

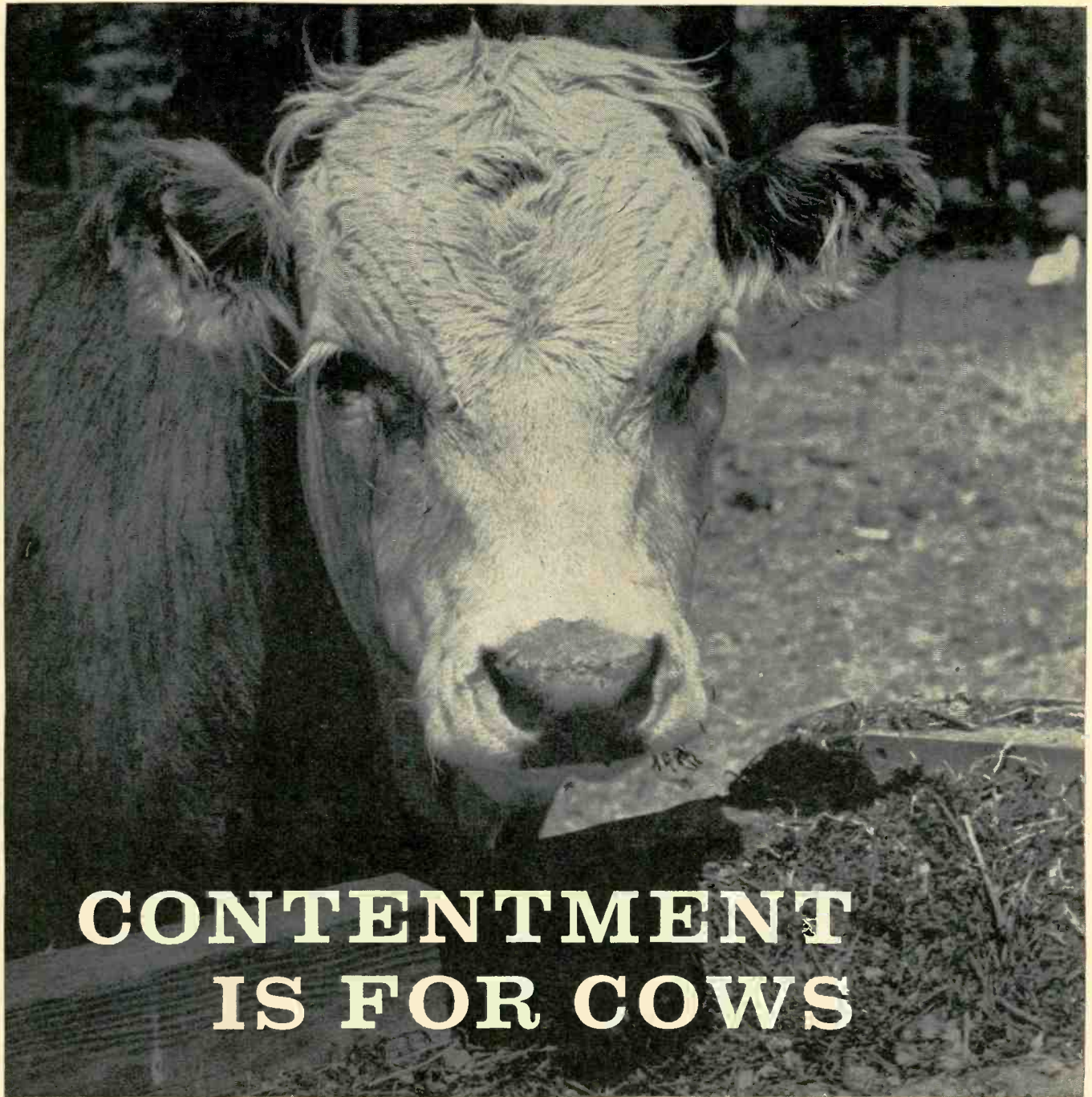

# CONTENTMENT IS FOR COWS

Recently our engineering department came up with an improvement in a miniature precision potentiometer which had been ordered consistently by one of our customers. Although the original design had more than met the customer's specifications, we filled his next order with the improved version — at no increase in cost! This is but one example of how Waters' alertness to the need of constant research and experimentation is advantageous to all concerned. We are never content with any potentiometer we make, regardless of how well it meets, or even exceeds, specifications. Ask for Waters Catalog PF1258 — we believe you will be favorably impressed.

### Twice as many pots in the same panel space!

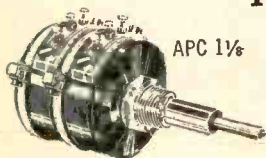

APC 1 1/2

The APC 1 1/2 permits mounting two 1 1/2" diameter pots in tandem rather than side by side . . . saves panel space, simplifies design. Concentric shafts can be rotated independently by a dual knob, concentric gears, or other simple means. For single hole or servo mounting. With stops, or continuous rotation of either or both elements. Also available with 3/8" diameter (type APC 3/8). Either size can be supplied with the same specifications as Waters standard RT 3/8 and AP 1 1/2 potentiometers. Write for Bulletin 459-2.

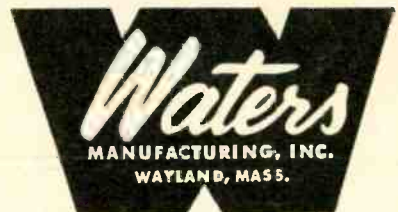

POTENTIOMETERS • SLUG TUNED COIL FORMS • RF COILS • CHOKES • POT HOOK® PANEL MOUNTS • TORQUE WATCH® GAUGES • CTRL METER/CONTROLLER - INSTRUMENTS



# more "Building Blocks" for digital data systems

## DYMEC MULTI-PURPOSE AND SPECIAL-PURPOSE COUNTERS

Readily adaptable to remote operation, automatic programming.

Many accessories and couplers are available, as well as multiple input and output arrangements. Dymec specializes in designing and manufacturing advanced counters and counter systems.

### DY-2500 COMPUTING DIGITAL INDICATOR

RPM, flow, pressure, speed, frequency — all may be read easily in direct numeric form with the DY-2500 and appropriate transducers. Features of the extremely versatile DY-2500 include: 5-digit readout, 4 or 5 preset decades, gate time adjustable from 0.0001 to 9.9999 seconds in 0.1 msec steps (other ranges available), frequency range 1 cps to 120 kc (220 kc optional), crystal accuracy, input sensitivity 0.2 v rms (5 mv optional), recorder and b-c-d output, built-in self-check. Price: \$1330 to \$1425. Also DY-2500N with "nixie" in-line readout. Price \$1525 to \$1600. (Both models available in cabinet or rack mount.)

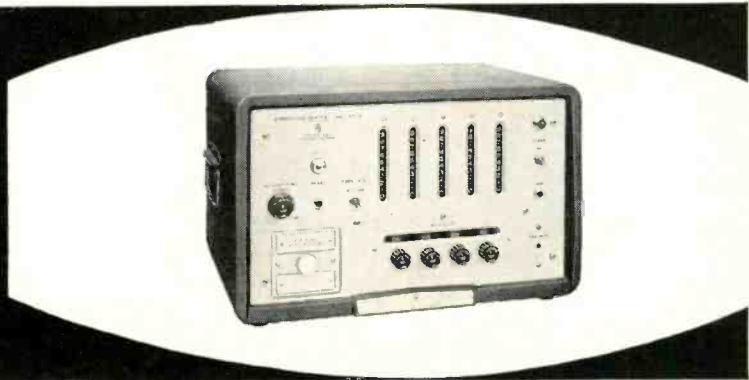

### DY-2507 DUAL PRESET COUNTER

Precise control and monitoring of machine processes, automatic limit control and warning, sorting, packaging, automatic coil winding, equipment programming, go/no-go testing — these are typical production and research assignments which the DY-2507 performs dependably and accurately. The DY-2507 provides an output when either of two preset values is reached, or exceeded. Output is continuous or pulsed; reset is manual or automatic. Presetting is on front panel, or remote. Available with 3 to 6 decades. Price: \$700 to \$895 (rack mount only).

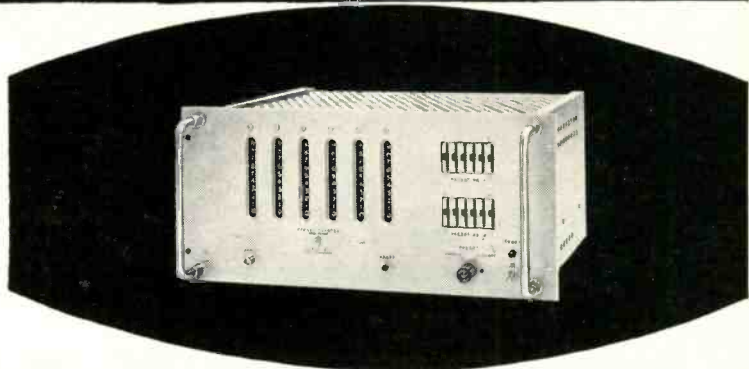

### DY-2503A/B FM/FM TELEMETERING COUNTERS

Simplify telemetering operations! An original Dymec contribution. Normalized indications of FM/FM sub-carrier signal period. Six-place indication displays ratio between input signal period and channel mid-band period. 18 channels selected by pushbuttons; equal resolution on all channels, 1 part in 100,000 or 1 part in 10,000 with 1.0 or 0.1 second sampling time (front panel control). Digital recorder output. Model DY-2503B is similar to the DY-2503A but includes a function selector and multiplier controls. Price: DY-2503A (cabinet mount) \$1650, (rack mount) \$1630. DY-2503B (rack mount only) \$1800.

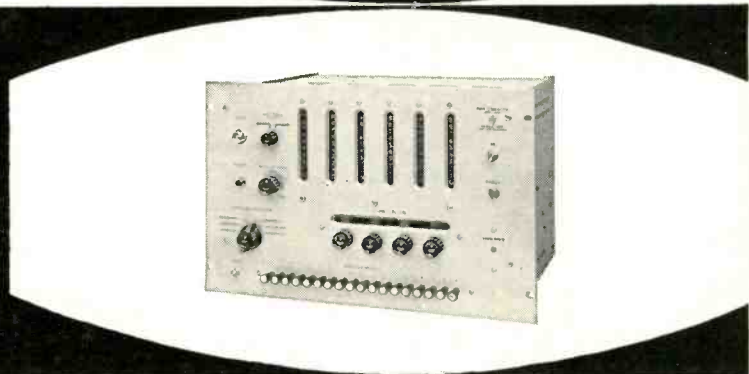

Data subject to change without notice. Prices f.o.b. factory.

Write for engineering data sheets on the above.

## DYMEC, INC.

Dept. E6, 395 Page Mill Road · Palo Alto, Calif., U.S.A.  
DAvenport 6-1755

Field representatives in all principal areas



# NEW DC-to-30 MC

## DUAL-BEAM Oscilloscope with Independent X and Y Deflection

### TYPE 555

#### SWEEP DELAY

Same signal displayed simultaneously on slow sweep (upper beam) and fast sweep (lower beam) shows both coarse and fine structure of waveform.

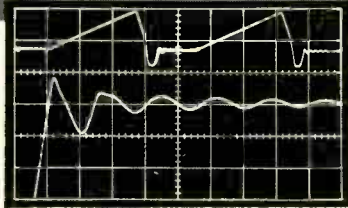

Two electron beams, each with its own X and Y deflection systems, help make possible a highly versatile dual-beam oscilloscope.

Either of the two time-base generators in the Type 555 can deflect either beam for dual and single displays, and either can deflect both beams for a dual display on the same time base. Time-base units are the plug-in type to facilitate instrument maintenance.

With one time-base generator functioning as a delay generator, the start of any sweep generated by the other can be held off for a selected time interval with a high degree of accuracy. Both the original display and the delayed display can be observed at the same time. The "triggered" feature can be used to obtain a jitter-free delayed display of signals with inherent jitter.

Signal-handling versatility is provided by nine available types of plug-in preamplifiers, any combination of which can be used in the two fast-rise vertical channels. In addition to the many application areas opened with Tektronix plug-in preamplifiers, a three-channel or four-channel display is available through use of the time-sharing characteristics of Type C-A Dual-Trace Units in one or both channels.

Please call your Tektronix Field Engineer or Representative for complete specifications.

### Characteristics

#### INDEPENDENT ELECTRON BEAMS

Separate vertical and horizontal deflection of both beams.

#### FAST-RISE MAIN VERTICAL AMPLIFIERS

Passbands—dc-to-30 mc with Type K Units.

Risetimes—12  $\mu$ sec with Type K Units.

All Tektronix Plug-In Preamplifiers can be used in both vertical channels for signal-handling versatility.

#### WIDE-RANGE TIME-BASE GENERATORS

Either time-base generator can be used to deflect either or both beams.

Sweep ranges—0.1  $\mu$ sec/cm to 12 sec/cm. 5 x magnifiers increase calibrated sweep rates to 0.02  $\mu$ sec/cm.

#### SWEEP DELAY—Two modes of operation.

Triggered—Delayed sweep started by signal under observation.

Conventional—Delayed sweep started by delayed trigger.

Delay range—0.5  $\mu$ sec to 50 sec in 24 calibrated steps, with continuous calibrated adjustment between steps.

#### HIGH WRITING RATE

10-KV Accelerating potential provides bright traces at low repetition rates and in one-shot application.

#### REGULATED POWER SUPPLY

All dc voltages electronically regulated.  
Heater voltages also regulated.

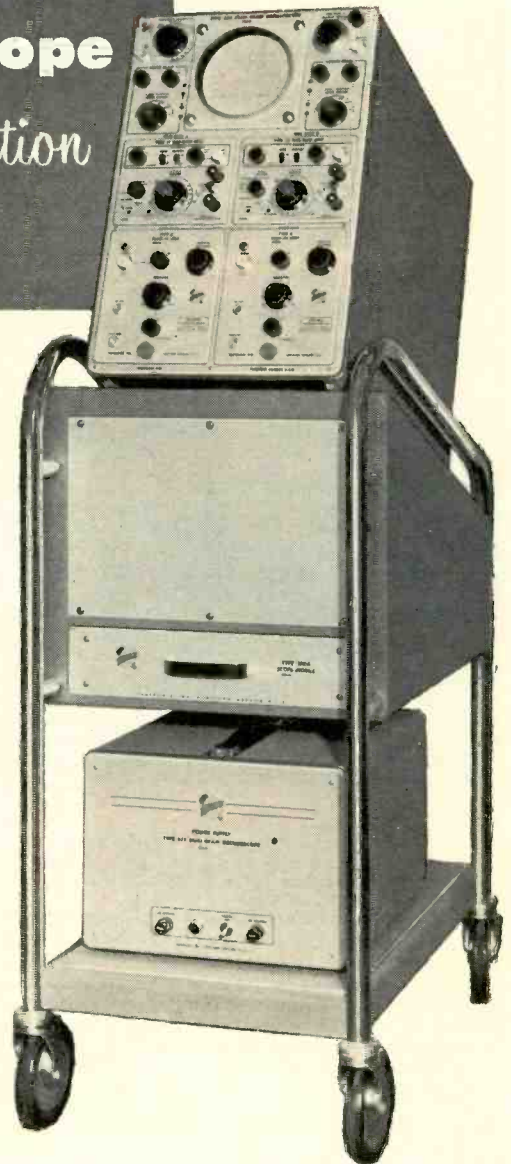

**PRICE, Type 555** without plug-in preamplifiers . . . \$2600

Includes Indicator Unit, Power Supply Unit, 2 Time-Base Units,  
4 Probes, Time-Base Extension.

**Type 500A Scope-Mobile**

(as shown with Type 555) . . . . . \$100

**Type 500/53 Scope-Mobile**

(with supporting cradles for plug-in preamplifiers) . \$110  
Prices f.o.b. factory

## Tektronix, Inc.

P. O. Box 831 • Portland 7, Oregon

Phone CYPres 2-2611 • TWX-PD 311 • Cable: TEKTRONIX

**TEKTRONIX FIELD OFFICES:** Albertson, L.I., N.Y. • Albuquerque • Atlanta, Ga. • Bronxville, N.Y. • Buffalo • Cleveland • Dallas • Dayton • Elmwood Park, Ill. • Endwell, N.Y. • Houston • Lathrup Village, Mich. • East Los Angeles • West Los Angeles • Minneapolis • Mission, Kansas • Newtonville, Mass. • Orlando, Fla. • Palo Alto, Calif. • Philadelphia • Phoenix • San Diego • St. Petersburg, Fla. • Syracuse • Towson, Md. • Union, N.J. • Washington, D.C. • Willowdale, Ont.

**TEKTRONIX ENGINEERING REPRESENTATIVES:** Hawthorne Electronics, Portland, Oregon • Seattle, Wash.; Hytronic Measurements, Denver, Colo.; Salt Lake City, Utah.

Tektronix is represented in 20 overseas countries by qualified engineering organizations.

*Tektronix manufactures twenty other laboratory oscilloscopes,  
ten of which are also available as rack-mounting instruments.*

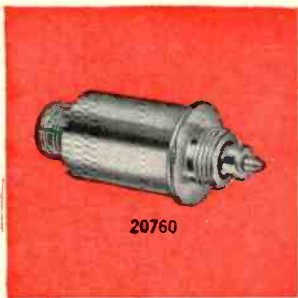

20760

**true hermetically sealed solenoids**

*Just like a sealed vacuum tube! True hermetic sealing around a solenoid... glass seal terminals, lugs, and connectors. All welded and brazed construction. Completely plated after assembly. Exceed most requirements of military specification MIL-S-4040 (USAF). Priced at approximately the same level as conventional types.*



20479

**high-temperature solenoids**

*These modern new solenoids give you a reasonable life expectancy at temperatures as high as 350° C. A by-product of hermetic sealing. Class H insulation combined with inert gas filling add those necessary extra few degrees needed in your temperature limits... make these solenoids exceptional high-quality, high-temperature units.*

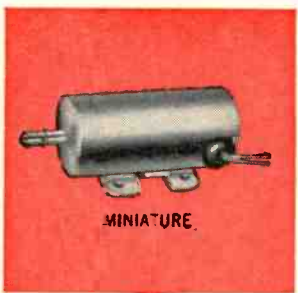
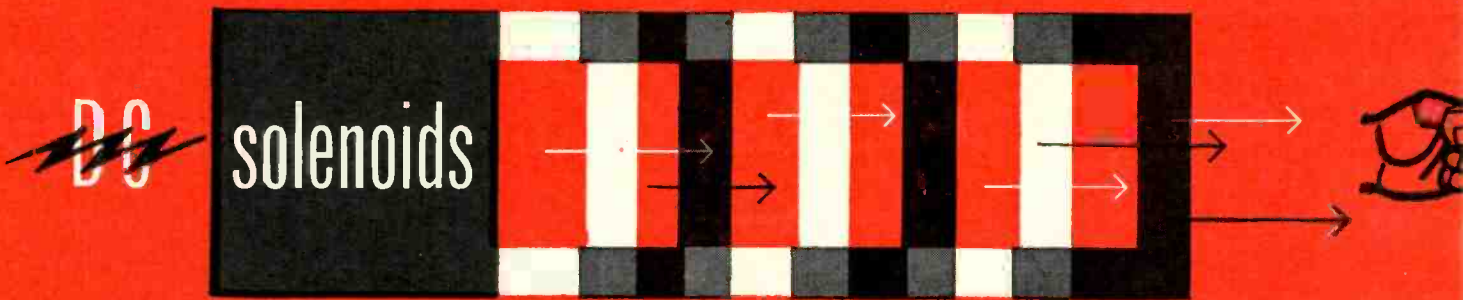

MINIATURE

**... and those unusual specialties you look for!**

*Having trouble finding solenoid specialties? Here at Cannon, we'd like to help you. Standard production now includes multiple-strip solenoids for keyboard operation, locking types requiring no holding current, and miniatures and sub-miniatures 1/2" diameter. In addition, our expanded solenoid engineering department is ready to serve you at any time.*



1700 10  
16928 19621  
conventional d.c. solenoids in many designs give you positive action and absolute reliability

**CANNON PLUGS**



**CANNON ELECTRIC CO., 3208 Humboldt St., Los Angeles 31, Calif.**  
Please refer to Dept. 120  
Factories in Los Angeles, Salem, Mass., Toronto, London, Melbourne. Manufacturing licensees in Paris and Tokyo. Representatives and distributors in all principal cities. See your Telephone Yellow Book.

Please ask for latest SR-S releases and/or Solenoid Bulletin.



**Electronics companies make the  
Electronics Buyers' Guide  
and Reference Issue  
accurate, complete, authentic...**



For nineteen years, firms in the electronics industry have made direct contributions to the accuracy, completeness and authenticity of the BUYERS' GUIDE.

Recently, the staff of the BUYERS' GUIDE decided to award plaques to express appreciation to those in the industry who had made direct contributions to improve the product listings. The photograph above represents a few of the awards that have been made.

The awarding of the plaques is but one indication of how the BUYERS' GUIDE evolved over the years... a *cooperative effort between the publication and the industry it serves.*

Only through years of experience can a buyers' guide reflect the needs of an industry as complex and dynamic as electronics... one more reason why the BUYERS' GUIDE is the ONE accepted product and data book in the field.

Published mid-year as the 53rd issue of **electronics**

A MCGRAW-HILL PUBLICATION

330 WEST 42ND STREET, NEW YORK 36, N. Y.

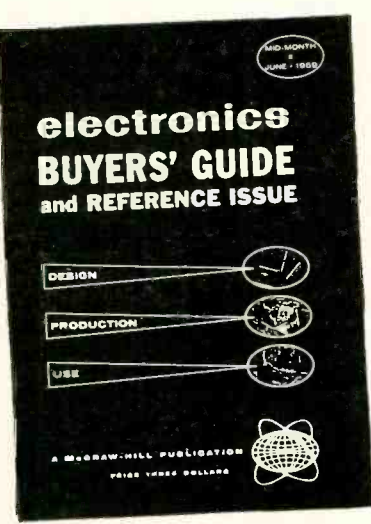

# ELECTRONICS NEWSLETTER

**100-WATT THERMOELECTRIC GENERATOR** has been developed by Westinghouse Electric for the Air Research and Development Command. Known as TAP-100 (terrestrial auxiliary power, 100 watts), the new generator is said to put out 10 times as much electricity as similar devices. "Such a source of thermoelectricity could, for example, power electronic installations in isolated areas of the world," says Rome ADC commander Brig. Gen. D. P. Graul. Unit weighs 40 lbs and is about the size of a medicine ball. Says Westinghouse v-p S. W. Herwald: "No longer is there any question about the feasibility of thermoelectricity as a useful method of electric power generation."

*Digilock telemetry system being developed by Space Electronics Corp. for Jet Propulsion Laboratory will transmit up to 25,000 data samples per second. Five-pound unit consuming 3-5 watts is expected to bridge more than 100 million miles.*

**SATELLITE INTERCEPTOR STUDY** will be undertaken by RCA's Missile Electronics and Control Dept. under a \$600,000 program financed by the Advanced Research Projects Agency. Six-month study aims to find out if a defense can be developed against an enemy-operated satellite. ARPA Director Roy Johnson hopes the study will produce data for developing an interceptor system that could operate before 1970.

**RADAR SYSTEMS WORTH \$47 MILLION** will be developed and produced by the Air Force under contracts awarded to Sperry Gyroscope. The high-powered air search radar will be part of the Continental Aircraft Control and Warning System which seeks and identifies air-breathing missiles and aircraft. Sperry had been named last year by Rome Air Force Depot as system manager for the radar, designated AN/FPS-35.

**AIRBORNE RECONNAISSANCE SYSTEM** versatile enough to be integrated into several existing aircraft will be planned and developed under a \$38.9-million prime contract just awarded to Airborne Instruments Laboratory by the Air Materiel Command. The electronic system, AN/ASM-1, will be developed for the Aerial Reconnaissance Laboratory, Wright Air Development Center, O. AIL is responsible for antennas and automatic receivers; Sperry—tactical support and training equipment; Aerojet—infrared gear; Filtron—r-f equipment; Haller, Raymond and Brown—human factors, operational environment and user requirements; Raytheon—semiautomatic receiver gear; Sylvania—data processing; Temco—weapons systems integration and flight testing.

**NEXT BRITISH COMPUTER GENERATION** will get financial support from the National Research and Development Corp., a semiofficial body that exploits new inventions and patents. Two major

firms, Ferranti and EMI Electronics, will get an undisclosed amount of aid from NRDC for two machines slated to appear in 1961 or 1962. Atlas, the new Ferranti machine, will use Manchester University research ideas. It will have multiple time-sharing facilities at speeds 100 times faster than the present Ferranti Mercury, whose addition time on floating point operation is 180 microseconds. Emidec 3400, to be developed by EMI out of its 2400 series, is also expected to offer more multiplexing facilities; speeds will be up a factor of ten over the 2400 series, whose addition time is 35 microseconds.

*B-70 electronic shield will be developed and built by the Air Arm division of Westinghouse Electric under a multimillion-dollar contract from North American Aviation, weapon system contractor for the intercontinental bomber. Defensive system will use electro-magnetic and other techniques to make an attack "difficult if not impossible." Electronic gear is packaged in plug-in units.*

**PASSIVE AIRBORNE DETECTION** and ranging system which correlates data for armament control is being developed by the Astrionics division of Fairchild Engine and Airplane Corp. Firm just got first increment under a \$3-million program for Hughes Aircraft, prime contractor for Air Force armament control equipment. Contract calls for development and prototype production of Fairchild's PACOR (passive correlation) system for several combat aircraft. Preliminary work was done last year under a \$300,000 AF contract. System is understood to be a refinement of the company's civilian passive detection and ranging system (PADAR) being tested for the Federal Aviation Agency as a midair collision avoidance system (ELECTRONICS, p 11, June 5).

**BEACON FOR FREEFALLING CAPSULE** has been developed by GE's Missile and Space Vehicle Dept. Designed to withstand shocks of more than 5,000 g, it was developed to aid recovery of data capsules after they freefall 25,000 ft from a reentering nose cone. Uhf signals from the 18-oz beacon have been picked up more than 100 mi away; two pound mercury-cell power supply lasts about one and a half days.

*Missile checkout subsystem to be developed by Epsco-West under a contract from Douglas Aircraft will switch one or more of 225 inputs into a missile's guidance circuitry. Signals simulate different environmental stimuli. If missile fails in test, computer rechecks and isolates fault.*

**SOLID FUEL ROCKET MOTORS** will be tested with a new data acquisition system to be built by Minneapolis-Honeywell. Navy's Allegany Ballistics Laboratory will use the system to monitor and record temperature, pressure, force, strain, vibration and other variables, and process the data for further analysis.

# NEW BARNSTEAD WATER RE-PURIFYING SYSTEM



**PRODUCES PURE WATER  
of 10,000,000 ohms  
ELECTRICAL RESISTANCE**

Equipment consists of Barnstead Demineralizer, organic removal cartridge, and mixed-bed cartridge for removal of organic matter and mineral impurities. The Barnstead® MF® Submicron Filter removes particles down to 0.45 micron. The distilled water storage tank is equipped with a Barnstead Ventgard® which purifies the air entering the storage tank. Keeps distilled water pure by removing all air-borne bacteria, dust, gases, mist etc. Re-circulates and re-purifies the distilled water to 10,000,000 ohms electrical resistance. Also removes organic contamination.

Compact in size . . . fits under laboratory table or bench. Ideal for use in pilot plant operations, where ultra pure water is required for lab tests, for experimental work in semiconductor field, crystal growth experiments etc.

### NEW PURE WATER LITERATURE

If you need Pure Water, either in Laboratory amounts or production quantities, come to Barnstead with your problem . . . Pure Water Specialists Since 1878. Write for literature on Stills, Demineralizers, MF Submicron Filters.

**Barnstead**  
STILL AND STERILIZER CO.

Lanesville Terrace • Boston 31, Mass.

<b>BOSTON</b> Jamaica 4-3100	<b>SAN FRANCISCO</b> Templebar 2-5391	<b>CHICAGO</b> Mulberry 5-8180
<b>PHILADELPHIA</b> Locust 8-1796	<b>NEW YORK</b> Kingsbridge 8-1557	<b>LOS ANGELES</b> Ryan 6-6622

**B** PURE WATER  
EQUIPMENT  
FOR EVERY  
PURE WATER NEED

# WASHINGTON OUTLOOK

WASHINGTON—NEXT BIG SPENDING BOOM in the missile business will be for faster research and development on the Nike-Zeus anti-ICBM system.

The Administration's new "Master Plan" earmarks \$157 million extra to the Zeus program for fiscal 1960. This is in addition to roughly \$300 million set aside in the original budget.

In effect, the Administration is allowing the Army to use the extra funds the House of Representatives has already voted for the project. The House tacked on \$200 million to the Army's appropriation for both Zeus and general hardware procurement—without specifying how much for each project.

The additional budget allocation falls far short of the \$700-million increase the Army has fought for unsuccessfully. The Army wants to start tooling up for production of Zeus components and subsystems this year.

Many electronics companies will gain from the latest decision to speed R&D work on Zeus. Western Electric and Bell Telephone Labs, of course, are the project prime contractors and technical managers.

Other important electronics contractors: Sperry Rand, working on the system's target track transmitters; RCA, acquisition radar transmitters; Ryan Aeronautical, the missile-borne seeker; Goodyear Aircraft, acquisition transmitter-receiver antennas; Lear, stable platform; Allis-Chalmers, target track antenna drives; Armstrong Cork, development of an artificial dielectric; and Firestone, instrument environmental tests.

But on the more controversial end of the air defense program—anti-aircraft missiles—the Administration's new "Master Plan" still leaves the outlook very much up in the clouds.

The Pentagon proposes to cut scheduled expenditures for the rival Army Nike-Hercules and Air Force Bomarc missiles by a total of some \$1.5 billion over the next five years. This is believed to be a reduction of about 25 percent in scheduled spending for production and base construction for the two missiles.

The planned budget cut breaks down roughly this way: \$900 million for Bomarc (Westinghouse is the guidance contractor) and \$600 million for Nike-Hercules (Western Electric).

The Bomarc is getting the bigger trimming only because the scheduled rate of spending for the project is much higher than for the Nike-Hercules, a missile already in volume production and now deployed at operational sites spotted across the country. The first Bomarc unit will not be operational until later this year.

Prospects for the two projects—especially for Nike-Hercules—are still uncertain. Many influential lawmakers are skeptical about the Administration's decision to continue production—even at a sharply reduced rate.

Senator Henry Jackson (D., Wash.), for instance, says spending any more money on anti-aircraft defenses is "throwing money down the drain." Jackson and other critics argue that the threat of a Russian bomber attack has diminished so much that there's no justification for continued production. Nearly \$3.7 billion has been spent so far on both Nike-Ajax and Hercules, about \$1.9 billion for Bomarc.

The House has already cut funds for Bomarc production by about one-third, while the Senate Armed Services Committee has called the Nike-Hercules "virtually obsolete" and ordered a freeze on base construction.

It's still very likely that Congress will make even more severe cuts in budgets for one or both of the anti-aircraft missiles.

АВТОМАТИЧЕСКИЙ ПЕРЕВОД  
ВЫЧИСЛИТЕЛЬНЫЕ МАШИНЫ  
СПОСОБСТВУЮТ ИССЛЕДОВА-  
НИЮ ЯЗЫКОВ

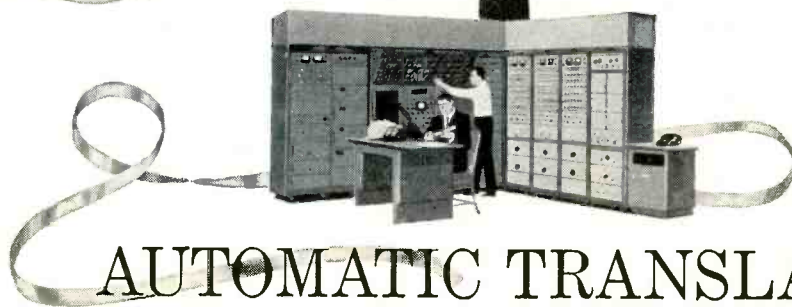

## AUTOMATIC TRANSLATION

*Computing machines aid language research at Ramo-Wooldridge*

To formulate rules for automatic language translation is an enormously subtle and complex project. Yet significant progress is being made. During the past year of research at Ramo-Wooldridge over 60,000 words of Russian text have been translated and analyzed using an electronic computer. From the beginning several hundred syntactic and semantic rules have been used to remove ambiguities that are otherwise present in "word for word" translation. Our present computer program for automatic translation is a considerable improvement over earlier attempts.

Apart from the question of translation itself, electronic computers are invaluable for language research. The expansion of existing knowledge of the rules of language, through statistical analysis, is made practical by mechanized procedures. A clear symbiosis between linguistics and computer technology has emerged.

Automatic translation research is one of many R-W activities addressed to problems of communication of

scientific information. These problems are increasing at an accelerating pace. In this area, as in others, scientists and engineers find at Ramo-Wooldridge challenging career opportunities in fields important to the advance of human knowledge. *The areas of activity listed below are those in which R-W is now engaged and in which openings also exist:*

- Missile electronics systems
- Advanced radio and wireline communications
- Information processing systems
- Anti-submarine warfare
- Air navigation and traffic control
- Analog and digital computers
- Infrared systems
- Electronic reconnaissance and countermeasures
- Basic and applied physical-research

*For a copy of our brochure or other information, write to Mr. Donald L. Pyke.*



**RAMO-WOOLDRIDGE**

P. O. BOX 90534, AIRPORT STATION • LOS ANGELES 45, CALIFORNIA  
a division of **Thompson Ramo Wooldridge Inc.**



North  
Electric  
Visioneering  
Looks Beyond  
Tomorrow

North "visioneering" is an engineering concept that couples the accumulated experience of 75 years with vision that looks beyond the immediate future in developing systems to increase man's productivity, make man's life more comfortable and add immeasurably to the security of man's present and future.

The dramatic story of significant North Electric Company contributions to system development and engineering will open whole new areas of thought on how North "visioneering" can be applied to extend the scope of your capabilities beyond today's boundaries.

A copy of "North Electric System Concepts" booklet is yours for the asking—write Dept. IB, North Electric Company, Galion, Ohio.

Control Systems • Communications • Electronics

INDUSTRIAL DIVISION

**NORTH ELECTRIC COMPANY**

497 SOUTH MARKET STREET • GALION, OHIO





# New Stock Issues Climbing

NEW OFFERINGS of electronics stocks have been frequent during the first half of this year. It's expected the May-June period, however, may be marked as the most active to date in this regard.

• **Allied Instruments**, Houston, Tex., has filed a letter of notification with Securities and Exchange Commission for 100,000 shares of common stock to be offered at \$3 a share without underwriting. Money will be used for advertising, inventory and working capital.

• **American Television and Radio**, St. Paul, Minn., offers 100,000 shares of common stock at \$3 a share without underwriting. Proceeds will be used for general corporate purposes. This is ATR's first stock offering.

• **Associated Testing Laboratories**, Boston, specialist in environmental testing, reports an issue of 166,666 shares of common stock at \$3 a share as being oversubscribed. The issue was brought out at the end of last month by G. O'Neil & Co. and Hooker & Fay. Proceeds will pay for moving plant facilities and purchase of R&D equipment.

• **Avnet Electronics**, Westbury, N. Y., is offering 175,000 shares of common stock at \$5.75 a share through M. G. Kletz & Co. Recent information is that the issue is oversubscribed. Funds made available will be used to expand product lines.

• **Burndy Corporation**, Norwalk, Conn., reports that June 3 issue of 152,000 shares of common stock is now oversubscribed. Initial offering was at \$17.75 a share. The proceeds will be used to retire debts incurred in expansion.

• **Fanon Electronic Industries**, Brooklyn, N. Y., manufacturer of stereo and intercommunication gear, has registration pending with SEC for 150,000 shares of

common stock to be offered at \$3 a share. Funds will be used to retire debts and for general corporate purposes.

• **Hermes Electronics Co.**, Cambridge, Mass., reports oversubscription of 150,000 shares of common stock made available June 2 at \$4.50 a share. The firm, which manufactures crystal filters, digital units and stable frequency sources, will use most of the proceeds to retire debts and the balance for general corporate purposes.

• **Telecomputing Corp.**, Los Angeles, advises that its offering of 500,000 shares of common stock at \$13.25 a share is now oversubscribed. The monies will be applied to retire a series of debts.

• **Ideal Precision Meter Co.**, Brooklyn, N. Y., plans to issue 137,500 shares of common stock for public offering at \$3.75 a share. The firm makes indicating equipment for electronic and electrical systems, as well as marine and auto panels.

## 25 MOST ACTIVE STOCKS

WEEK ENDING JUNE 12

	SHARES (IN 100's)	HIGH	LOW	CLOSE
Zenith Radio	1,487	133¾	116¾	130½
Raytheon	1,319	56½	51½	52
Intl Tel & Tel	1,180	39	36	38¾
Avco Corp	1,108	15½	14½	15½
SPerry Rand	979	25½	24½	25½
RCA	935	65½	61	63½
Emerson	792	21¾	17¾	20¼
Gen Dynamics	656	58½	53½	58½
Gen Electric	619	81¾	77½	81
Gen Tel & Tel	592	67¼	63	66
Texas Instr	506	127¾	117¼	126¼
Philco	465	32¾	29¼	31¼
Beckman Instr	438	61½	55¾	58¾
Westinghouse	405	93½	88¾	92½
Litton	387	109½	97¼	105½
Burroughs	379	37½	34½	36½
Elec & Mus Ind	379	7½	6½	7
Standard Coil	350	19¾	17¼	18¾
Intl Resistance	320	17¾	15¼	17
Lear	318	15	14	14¾
Gen Instr	312	31¾	27½	29½
Dyn Co of Amer	262	10¾	9¾	10
Natl Research	252	30½	26	27¾
Admiral	248	24½	22½	23½
IBM	248	488	385½	439

The above figures represent sales of electronics stocks on the New York and American Stock Exchanges. Listings are prepared exclusively for ELECTRONICS by Ira Haupt & Co.

## PLUG-IN Instruments

# SAVE

- ★ design time ★ panel space
- ★ fabrication time ★ cost
- ★ maintenance

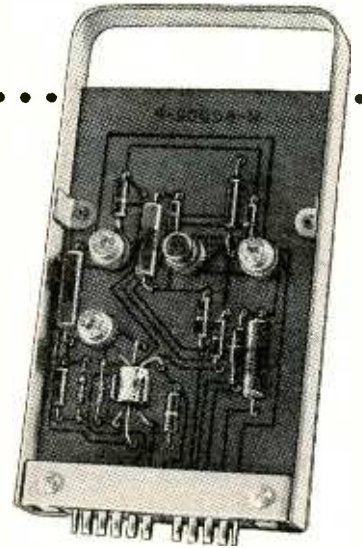

The efficient, flexible, trouble-free performance of new PLUG-IN Instruments means SAVINGS for you! SAVE valuable time, SAVE valuable space, SAVE on installation cost and maintenance. Use Plug-ins . . . and profit!

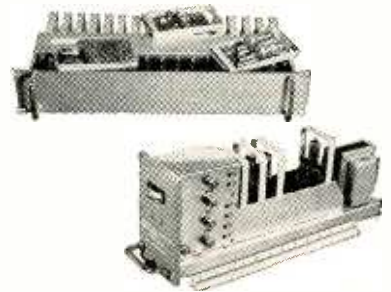

STANDARD TRANSISTOR AND VACUUM TUBE CIRCUITS AND MODULAR HARDWARE

- ★ DC and AC Amplifiers
- ★ Phase Shift Amplifiers
- ★ Oscillators
- ★ Flip-Flops—Gates—Switches
- ★ Frequency Selective Amplifiers
- ★ Filters
- ★ Delay Circuits and Delay Relays
- ★ Sensitive Relays
- ★ Power Supplies

Write for complete information on how you can SAVE . . . with these analog and digital circuits.

**PLUG-IN** // INSTRUMENTS, INC.  
1416 Lebanon Road  
NASHVILLE 10, TENNESSEE

# NEW PROGRAMS

have created

# IMMEDIATE OPENINGS

for top quality engineers  
with experience in —

- Preliminary Analysis
- Aerodynamics
- Flight Dynamics
- Structural Dynamics
- Aero-Thermodynamics
- Flight Simulation
- Space Communication
- Space Instrumentation
- Radar Systems & Techniques
- Electronic Countermeasures
- Guidance
- Instrumentation
- Electronics Test Design
- Computing
- Reliability
- Human Factors

Well paid jobs for qualified people.  
Relocating expenses paid.  
For information on these and other engineering positions, write:

**B. J. Ralph, Dept. 451-E**  
Missile Division  
North American Aviation, Inc.  
12214 Lakewood Blvd.  
Downey, California

**MISSILE DIVISION**   
NORTH AMERICAN AVIATION, INC.

## MARKET RESEARCH

JAPANESE ELECTRONICS PRODUCTION, 1958

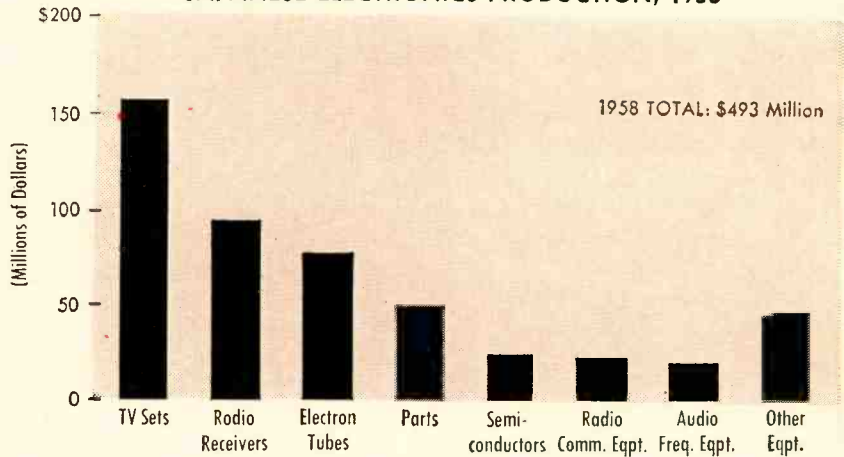

## Japan's Output Rises 40%

JAPANESE electronics production for 1958 amounted to \$493 million, according to customs statistics released by the Japanese Ministry of Finance. Total for 1958 represents a rise of 40 percent over 1957 production, worth \$352.1 million. Since 1956, production value has more than doubled. Dollar volume that year was \$226.1 million.

Dollar value of tv set output comprises 31.6 percent of last year's total volume. Production of 1.2 million sets in 1958 was reported below the current and still-growing demand for television receivers among the Japanese.

Approximately 5.27 million radio receivers, worth \$94.16 million, were produced last year. Of total set output, some 61 percent were portables (3,214,700 units). Among the portable radio group, 91 percent, or 2,925,377 units, were transistorized.

In the components area, transistors have made most prominent strides. Unit production for 1955 amounted to a meager 85,000 transistors. In 1958, 26,730,000 transistors, mostly germanium, were made. During the intervening years—1956 and 1957—transistor production totaled 560,000 and 5,740,000 units respectively.

Demand for electron tubes has also been growing. Last year's production, valued at \$77.4 million, comprises 58 million receiving tubes, of which 78 percent were miniature types. Cathode ray tube output stood at 1.45 million units, an increase of 63 percent over pro-

duction of 908,000 cathode ray types in 1957. Microwave tubes and a large number of transmitting tubes of various output are also being made.

Japanese exports in 1958 amounted to \$45 million, 9.1 percent of total electronics production. Following table shows breakdown of export categories:

	\$ Millions	% of Total
Radios . . . . .	\$33.89	75.3
Parts . . . . .	4.64	10.3
Tubes . . . . .	2.34	5.2
Amplifiers & Microphones	1.39	3.1
Others . . . . .	2.74	6.1
	<b>\$45.00</b>	<b>100.0%</b>

Largest importer of Japanese electronic products was the United States, receiving 46 percent of total, or \$20.7 million in 1958.

Recent release shows first quarter 1959 exports to the United States totaled \$8 million. Dollar volume in 1958 for similar three-month period amounted to \$2.1 million.

## FIGURES OF THE WEEK

### LATEST WEEKLY PRODUCTION FIGURES

(Source: EIA)	June 5, 1959	May 8, 1959	Change From One Year Ago
Television sets	119,089	106,359	+71.9%
Radio sets (ex. auto)	276,604	244,083	+76.3%
Auto sets	131,156	111,747	+168.3%

### STOCK PRICE AVERAGES

(Standard & Poor's)	June 10, 1959	May 13, 1959	Change From One Year Ago
Electronics mfrs.	90.66	98.65	+70.7%
Radio & tv mfrs.	111.61	111.68	+134.8%
Broadcasters	96.52	105.00	+55.5%

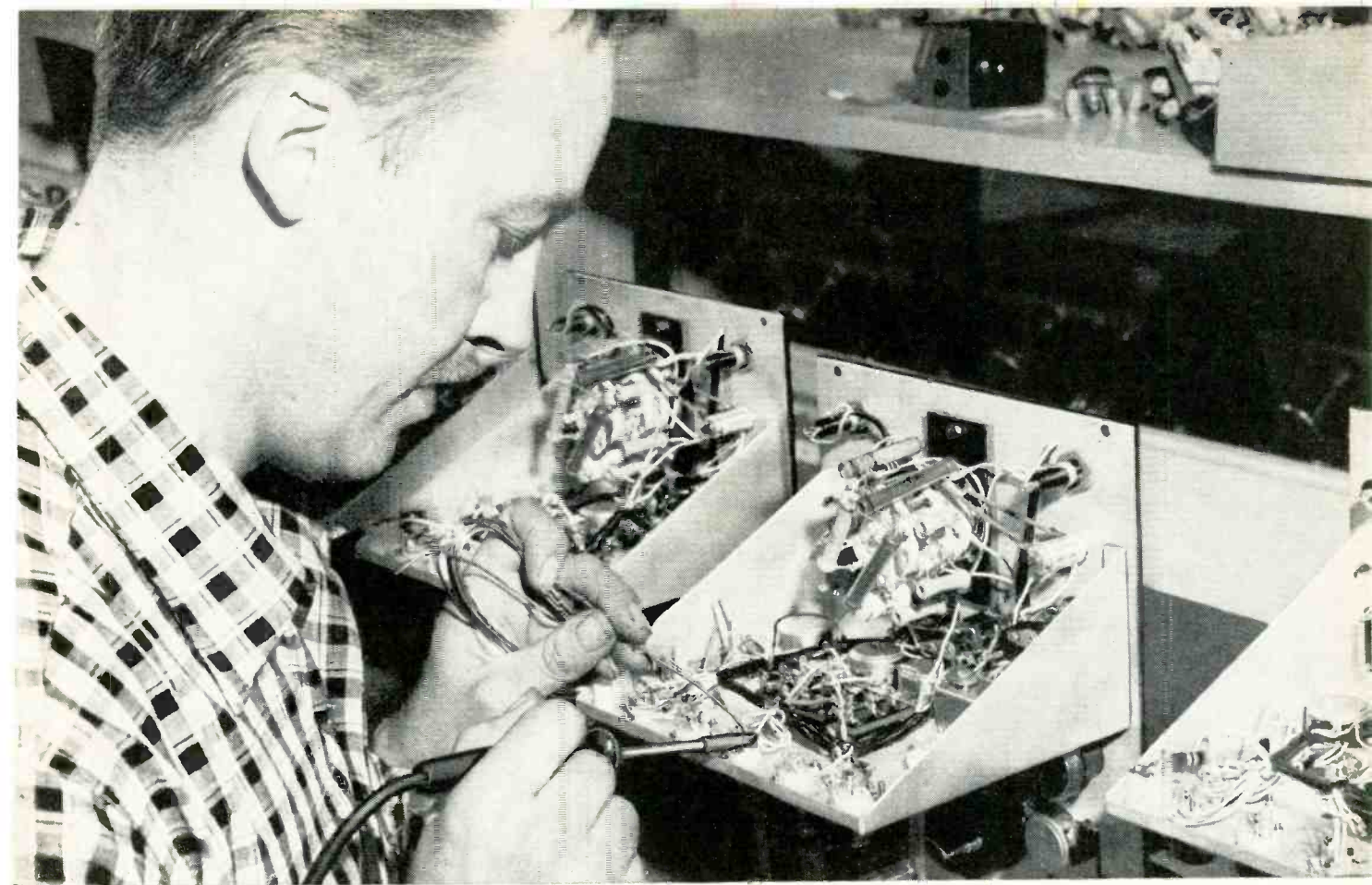

"BEST IRON WE'VE HAD in the plant," says William Fish, a production supervisor of General Radio, Cambridge, Mass. This company has switched to G-E Midget irons for soldering both

delicate and heavy joints in their Type 1862-B Megohmmeters —jobs which formerly required both a heavy and a light iron. G-E Midget iron's light weight also helps reduce fatigue.

## 50 G-E Midget irons do work of 100 former irons at General Radio Co., boost production 25%

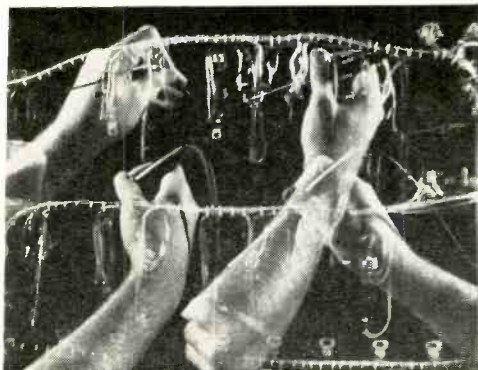

**FASTER HEAT RECOVERY** and lower maintenance of G-E soldering irons have been proved by many manufacturers under their own production conditions—along with competitive soldering irons. If you would like to compare General Electric irons with the irons you are now using, call your G-E distributor.



**DELIVERY TODAY** is now possible on popular soldering irons and other General Electric heaters and devices from a local distributor near your plant. Your replacement inventory may be reduced. For the name of your nearest stocking distributor for G-E heaters and devices, call your General Electric Apparatus Sales Office.



**SAVINGS ACHIEVED** by several users and information about the construction features of General Electric soldering irons are included in a new bulletin, "Save While You Solder," GED-3553. For a copy, call your G-E distributor or write Section 724-3, General Electric Company, Schenectady 5, New York.

**GENERAL**  **ELECTRIC**

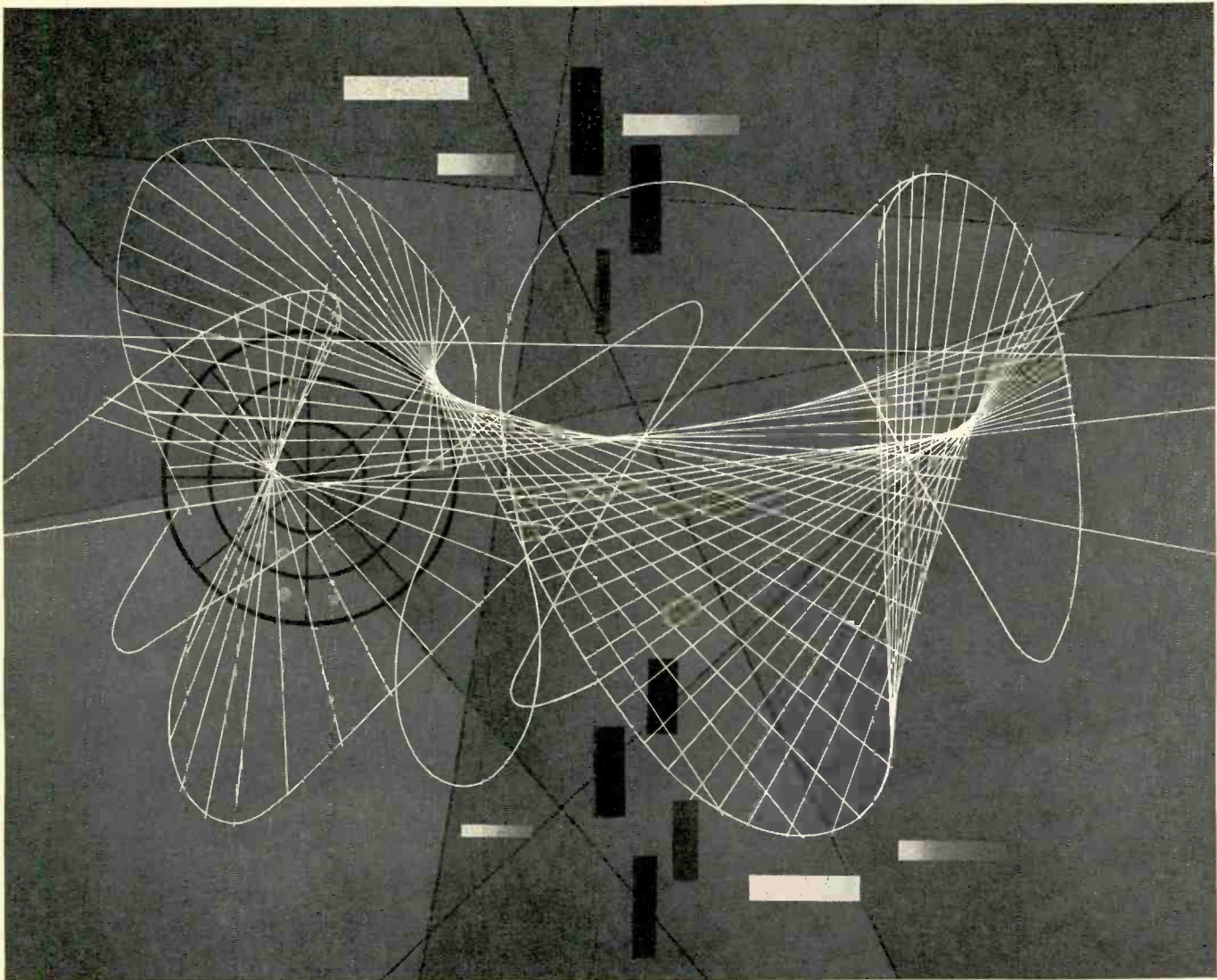

## WHEN A COMPANY OUTGROWS ITS NAME

As the domestic research organization of the world-wide International Telephone and Telegraph Corporation, we are carrying on our tradition of pioneering in electronics. As our engineering responsibilities have increased so our organization has grown. Today, in addition to our main laboratories in New Jersey, laboratories in Ft. Wayne, Chicago and in California are pursuing projects of great magnitude and importance.

You will find in our staff the same fine creative thinking and engineering imagination which brought distinction to our old names. Formerly Federal Telecommunication Laboratories and Farnsworth Electronics research laboratories, our names have been changed to identify us clearly with our parent company, and to reflect our expanded responsibilities and growth.

Electronic engineers will find here opportunity to express initiative and competence in such areas as long range radar systems, digital computer applications to data processing and communications, space technology, microwave tube research and missile systems instrumentation. We are continuing our work in air navigation and control, and in electronic systems . . . and making new contributions to electronic theory and techniques. In fact, it would be hard to find another research organization that offers the engineer such a wide scope of activities.

*Engineers interested in discussing professional positions with our staff are invited to write Mr. T. C. Allen, Manager, Professional Staff Relations.*

## ITT LABORATORIES

*A Division of International Telephone and Telegraph Corporation*

500 Washington Avenue, Nutley, New Jersey

Ft. Wayne, Indiana • Chicago, Illinois • Palo Alto, California • San Fernando, California



# Solving switch problems fast . . .

your job . . . and **Centralab's**

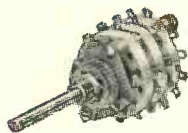

**Series 100:** 1 $\frac{1}{16}$ " diameter  
Rating: 0.5 amp. at 6 VDC,  
100 ma at 110 VAC  
Breakdown: 750 V. R.M.S.  
Up to 12 positions/section

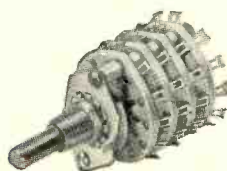

**Series 20:** 1 $\frac{1}{16}$ " diameter  
Rating: 2 amp. at 15 VDC,  
150 ma at 110 VAC  
Breakdown: 1500 V. R.M.S.  
Up to 12 positions/section

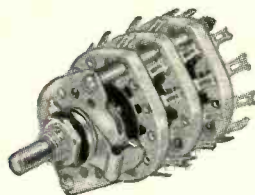

**Series 275:** 1 $\frac{1}{8}$ " diameter  
Rating: 2 amp. at 15 VDC,  
150 ma at 110 VAC  
Breakdown: 1500 V. R.M.S.  
Up to 23 positions/section

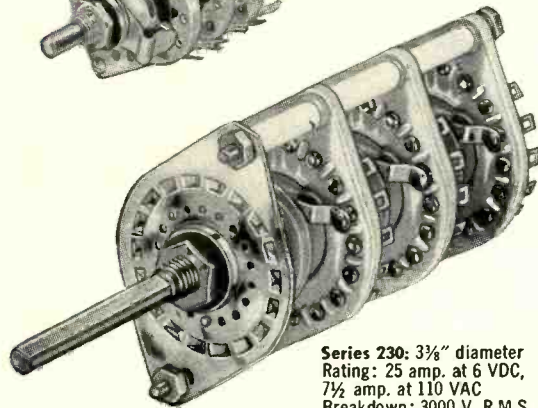

**Series 230:** 3 $\frac{1}{8}$ " diameter  
Rating: 25 amp. at 6 VDC,  
7 $\frac{1}{2}$  amp. at 110 VAC  
Breakdown: 3000 V. R.M.S.  
Up to 24 positions/section

Your switch problems can be solved quickly and efficiently at CENTRALAB. No matter how unusual or difficult the switch, you can get samples fast, quotations fast, and production fast! This is a result of years of specialized experience and superior facilities for designing and manufacturing a wide variety of switch types.

Typical of the extensive range of units available to you are the four CENTRALAB ceramic section switches shown here. These switches, and many others, are also available with phenolic sections, for economy applications, or where a larger number of positions is required.

## DESIGN AIDS FOR ENGINEERS

CENTRALAB's unique Switch Visualizer, which simulates actual switch operation, will help you simplify and speed up switch design. Used in conjunction with our detailed layout sheets (available for all CENTRALAB switch types), they greatly facilitate your job in switch design (and ours, too). Write for them today—along with a copy of CENTRALAB Switch Catalog 42-405.

# Centralab

P-5917

A Division of Globe-Union Inc.  
914F E. KEEFE AVE • MILWAUKEE 1, WIS.  
In Canada: 669 Bayview Avenue, Toronto 17, Ontario

VARIABLE RESISTORS • ELECTRONIC SWITCHES • PACKAGED ELECTRONIC CIRCUITS • CERAMIC CAPACITORS • ENGINEERED CERAMICS

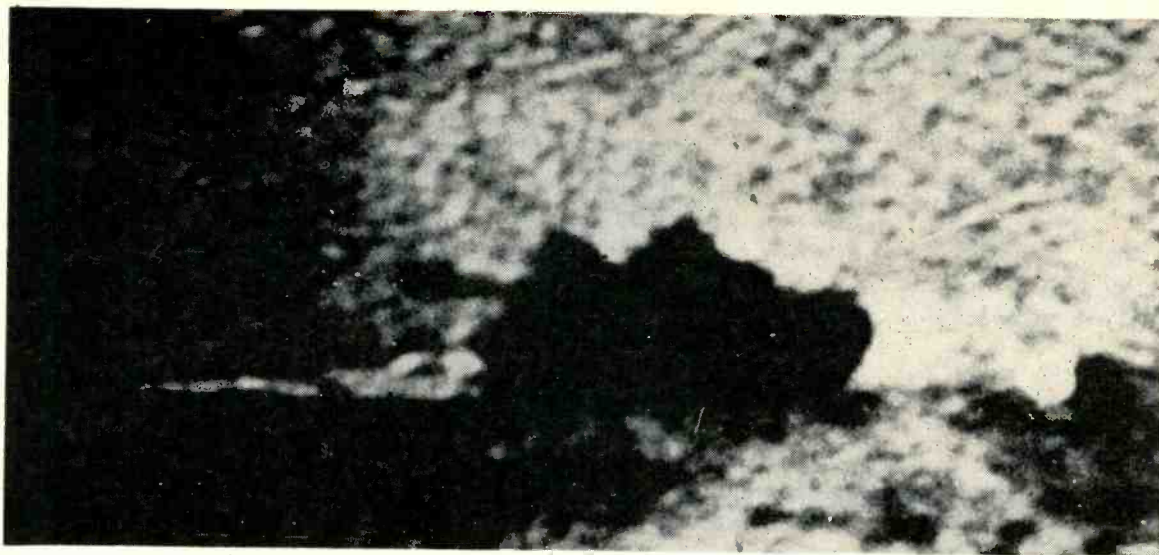

Sneaking up 750 yds away, Army tank is caught by Bendix-GE tv camera system, illustrating . . .

# How Military Sees In Dark

Low-light-level television furnishes eyes for nuclear submarines and space vehicles. Also used in radio astronomy and special fire-control

LOW-LIGHT-LEVEL TV devices that provide night-time vision far better than the human eye will soon go into two more weapon systems.

These latest developments are additional signs of an increasingly-important military trend now taking place: using see-in-dark systems to probe space and oceans.

One new device is being ordered by Army Ordnance, the other by the Navy's Bureau of Aeronautics.

Army Ordnance has contracted Aircraft Armaments to develop an electro-visual fire control system for tanks. Du Mont Laboratories will design the electro-visual portion.

The system sights targets several thousand yards away—twice the range of the naked eye. Data is processed by an analog computer.

## Making Prototype

The initial award for the first phase of the project amounts to \$491,506. Part of Project Eve—Army's program to develop night-time vision and sighting devices for ordnance equipment—a prototype is scheduled for evaluation this year.

Du Mont is also working on a low-light-level tv system for Navy's Bureau of Aeronautics for anti-submarine patrol. Advantages over

radar are twofold: the system is passive and also provides an actual picture instead of a blip that must be interpreted.

Though the system for BuAer is basically for observation, it may conceivably be converted into a fire control system at a later date. Initial contract amount is \$230,000. By next month, Du Mont will be working on seven low-light-level military programs with applications ranging from space to underwater.

## Other Systems

A number of companies are active in low-light-level tv work.

Bendix-Friez' work includes: development, for Army tanks, of a tv system that was eventually used by Navy on the nuclear submarine *Skate* during its transpolar cruise; and other classified contracts with Army, Navy and Air Force.

Hallamore Electronics is working on a tv system for drones. Admiral has an R&D contract with Army Signal Corps, Fort Monmouth, N. J., for a transistorized system for aerial and ground reconnaissance. The system has been undergoing field tests since late last year.

RCA's World War II work included development of the Sniper

Scope, an image converter sensitive to infrared. More recently, the firm produced an intensifier orthicon used for astronomical photography. Current projects are classified.

## Tv Fire Control

Westinghouse has, to date, concentrated more on development of sensing devices than complete weapons systems, according to a company spokesman. The Baltimore division, however, is now interested in moving into full weapons systems responsibility.

Besides several active military contracts held by the tube division, more advanced equipment is under development at the Pittsburgh Research Laboratory.

An electron-scanned, signal-generating, visible-image pick-up tube is being developed. It uses the phenomenon of electron bombardment induced conductivity, giving the tube the name EBICON. This tube is expected to be more sensitive than the image orthicon, according to a company spokesman.

Also being developed is a light image intensifier using a series of plane parallel, transmission secondary-emission thin film systems. This is called TSEM (transmission

secondary emission multiplier). This technique is different from the image orthicon in that it does not produce a tv signal but produces a bright image which can be viewed directly.

#### Trying New Approach

Another approach being studied at the University of Michigan, MIT, Princeton and the University of Rochester, uses the light chamber technique employed in high energy physics. The principle involves directing a high energy particle to a scintillation crystal where its path through the crystal will produce a weak trace of light. This light is amplified by means of a light image intensifier and photographed.

Westinghouse is providing such a light intensifier tube which is used in this application.

General Electric is working on a number of applications. Those not already mentioned include: night vehicle movements, aircraft, commercial broadcasting and satellite tracking.

GE's Z-5294 image orthicon, used in Bendix's system for the *Skate*, as well as in Aircraft Armament's and Du Mont's systems, has a high-gain target and an S-10 photo surface.

Key to its low-light-level operation is a newly developed high-gain thin-film target of special design. Only millionths of an inch thick, the target has an inherent ability to inhibit sideways leakage, thus preventing distortion of the image. This target functions on the basis of electronic conduction rather than the sodium ion conduction principle used in the targets of other image orthicons.

#### New Imo Performance

The new target material used in the Z-5294 has much higher lateral resistivity than is the case in standard glass targets. This enables the target to store a charge pattern longer and allows the use of slower scanning frame rates. Integration periods as long as one second have been demonstrated, but the tube is capable of even longer integration periods. The storage application permits attaining additional sensitivity by the use of low frame rates

(Continued on p 23)

*This can't be FIREBAN...*



## New Taylor FIREBAN 321 Laminated Plastic is self-extinguishing in only 3 seconds

Electrical faults in appliances, TV sets, radios, motors and other electrical devices frequently lead to fires—and these fires lead to complete destruction of the equipment, sometimes extensive damage to the facilities surrounding it. Taylor FIREBAN 321 is designed to retard fire. Self-extinguishing in only 3 seconds—it is an effective barrier against the spread of flame. In addition, this flame-retardant laminated plastic has excellent moisture resistance, excellent electrical resistance after exposure to high humidity, and good mechanical properties; also offers low dielectric losses. These properties help prevent the electrical faults that lead to fires. Write TAYLOR FIBRE CO., Norristown 40, Pa., for complete details.

# Taylor

LAMINATED PLASTICS VULCANIZED FIBRE

TYPE 9234-4550 2PDT, 2AMP, MAGNETIC LATCH RELAY

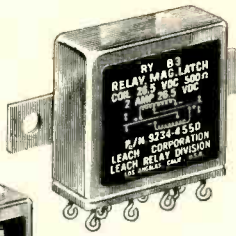

(BRACKET MOUNTING, SOLDER HOOK TERMINALS, HERMETICALLY SEALED)

TYPE 9200-5091 2PDT, 2AMP, RELAY

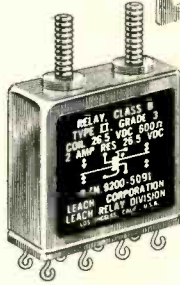

(STUD MOUNTING, SOLDER HOOK TERMINALS, HERMETICALLY SEALED)

TYPE 9280-5072 2PDT, 2AMP, RELAY

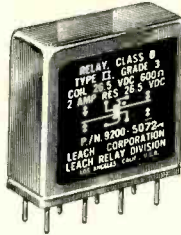

(PLUG-IN OR PRINTED CIRCUIT MOUNTING, HERMETICALLY SEALED)

# LEACH SUBMINIATURE CRYSTAL CAN RELAYS

(SHOWN ABOVE...ACTUAL SIZE)

**torture-tested  
to perfection  
for big  
relay performance**

These sensitive Leach subminiature relays deliver big relay performance... in a crystal can size that makes them ideal for use in missile control circuits in airborne or ground equipment and in computer and printed circuits.

Torture-tested to perfection in the Leach Production Reliability Center, these subminiatures are designed to meet the critical extremes of vibration, shock and other stringent environmental requirements in military and commercial applications.

They meet the specifications of both MIL-R-25018 and MIL-R-5757C—as well as MIL-R-6106C, including the minimum current test requirements.

Uniform contact pressure and overtravel are guaranteed for the life of these balanced-armature relays. They are available in a wide range of socket, stud and bracket mountings to meet specific customer requirements.

Write today for Leach Crystal Can Relay Brochure containing specifications, typical ratings and other information on these sub-miniatures! Or contact your nearest Leach sales representative to discuss your specific subminiature relay requirements.

RELIABILITY  **LOOK TO LEACH**  
RELAY DIVISION...LEACH CORPORATION  
5915 AVALON BOULEVARD, LOS ANGELES 3

DISTRICT OFFICES AND FIELD REPRESENTATIVES IN PRINCIPAL CITIES OF U. S. AND CANADA • EXPORT: LEACH CORP., INTERNATIONAL DIVISION





Store showrooms, like this one at Harvey Radio in New York City, stimulate sales

## Magnetic Recorder Makers Say

# Business Is Good, But . . .

CHICAGO—The Magnetic Recording Industry Association expects sales of 650,000 to 750,000 tape units, representing \$140 million volume at the retail level, in the U.S. during 1959. (450,000 units were sold in '58.) Simultaneously,

it faces four major challenges in technology and finance.

"The sales volume represents a possible increase of 20 to 30 percent over the slump we had when tape cartridges and stereo disks hit us simultaneously," says Herbert L. Brown, newly elected MRIA president.

Brown, vice president and manager of Ampex Audio Inc., says the magnetic recording industry faces four big problems—the stereo disk, the tape cartridge, the excise tax (buried but not completely dead) and Japanese importations.

Pointing out that "tape is a long way from dead," Brown notes "it had a recession. The stereo disk is the best thing that ever happened to magnetic tape. A year ago tape's potential audience was perhaps 5 million. Today 95 million Americans—or 54.4 percent of our population—are aware of stereo. These are the people who have phonographs in their homes.

"MRIA must encourage the transition to tape by continued emphasis on (1) traditional reasons for superiority of tape over disk, and (2) recent improvements in both quality and economy of tape."

### Searches for Answer

W. W. Wetzel, vice president of Minnesota Mining & Manufacturing Co.'s Magnetic Products div., told *ELECTRONICS*:

"The recording industry has been

looking forward to a practical tape cartridge for some years. We are just one of the firms trying to come up with the right answer. During the past five years we have built several experimental models. Our ultimate aim is to offer for sale a cartridge that will be fully automatic. The nature of research and product development makes it impossible to say how much longer that will take".

### Points to Protection

Irving Rossman, Pentron president and retiring MRIA president, told *ELECTRONICS* that "reel to reel magnetic recordings is the basis of our entire industry. There is compatibility in reel to reel tape that protects dealer and customer within the framework of its operation. It makes change and improvement possible—and it does this without obsoleting present libraries or equipment.

"In years to come, the cartridge may well become the new medium with a new standard in magnetic recording industry, but that will not be today, tomorrow or the next year. In the meantime our industry is solidly behind marketing tape recorders and recorded music on reel to reel at the accepted speed of 7½ ips."

"Regarding excise taxes," Brown says, "Congress may again try to place an excise tax on magnetic tape

(Continued on p 26)

## Sees in Dark . . .

(Continued from p 21)

or by beam pulsing.

The target has a higher secondary emission ratio than the standard image orthicon target. This fact, combined with the lower lateral leakage of the new target, results in an overall tube gain of about 17 times greater than the GL-5820 at 200 lines limiting resolution.

The electronic conduction mechanism used in the new target eliminates target depletion with life.

The Z-5294 is identical to standard broadcast orthicons with respect to size, configuration and socket connections and can be used in existing equipments without modifications. However, the tube is up to 100 times more sensitive when used in a specially-adapted tv camera.

GE has Army contracts to develop other sensitive thin-film targets, and is ruggedizing the tube for space vehicles and other high g applications.

# NEW!

## FAR TOUGHER CABLE JACKET



Resinite  
EP-145  
VINYL

*For Missiles, Aircraft, Ground Control*

*Resists abrasion **31** times better than neoprene!*

Wherever cable is subjected to rough treatment and extreme climatic conditions, new Resinite EP-145 Vinyl Jacket will really take it! Exceeds all important specs of MIL-R-6855, Class II, Grade 60, synthetic rubber and MIL-I-3930A. Readily applied by standard pneumatic or chemical dilutant methods. ¼" to 1½" I.D. Black. Other sizes and colors on special order. Ask your Resinite distributor or write for samples and performance data.

Also available as a polyvinyl chloride **COMPOUND**, Borden 5410, for extruded jackets. Excellent extrusion characteristics.

**Resinite** 

Resinite Department — The *Borden* CHEMICAL COMPANY  
Plants: North Andover, Mass. • Santa Barbara, Calif.

### 7 WAYS BETTER

- 1 Excellent abrasion resistance. 31 times better than neoprene by actual test. (Taber calibrade H-22 wheels.)
- 2 Lighter. Easier handling. Higher strength allows thinner walls.
- 3 No deterioration from gasoline or oil. Exposure actually increases tensile strength.
- 4 Superior cold bend and impact properties — lower than -100°F.
- 5 Smooth, glossy surface does not rub off or smudge.
- 6 Fungus resistant.
- 7 Flame proof. Outstanding self-extinguishing characteristics.

# HOW TO BUILD A BATTERY BOX WITH RESISTORS...

it's easy with a

## Regatron Programmable Power Supply

Shunt the programming terminals of a Regatron Programmable Power Supply with a resistor, and you've set the output voltage to 1/1000 of the resistor's value. Yet the resistor carries no load current, does not affect regulation or maximum output current capabilities. Several resistors and a multiple-position switch make a compact "battery box" for the voltages you use most often . . . it's as simple as that.

In addition, you'll find that Regatron Programmable Power Supplies have all the other advanced features you would expect in a versatile laboratory instrument; super-regulation, vernier as well as main voltage control, and more. Compare a Regatron Programmable Power Supply with any other d-c power source, batteries included. You'll find you won't settle for less.

Regatron Programmable Power Supplies are available in voltage ranges covering 0-50 V dc, 0-100 V dc, 0-300 V dc, and 0-600 V dc. Current ratings are up to 3A, depending on model. Request Bulletins 350 and 765.

*(Various models without the programming feature are also available in voltage ranges up to 1000 V and currents up to 1 ampere.)*

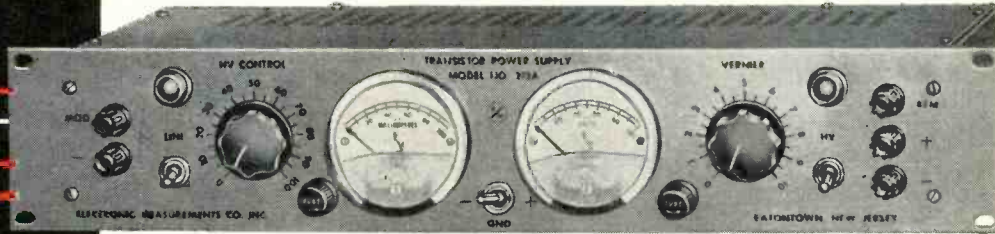
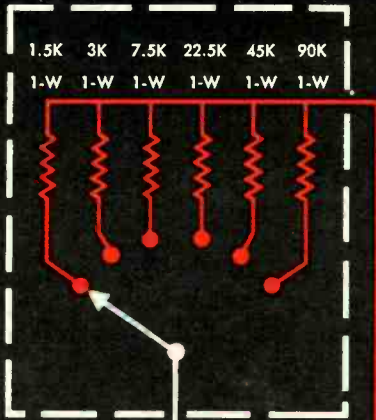

REGULATED D-C OUTPUT  
1.5V 3V 7.5V 22.5V 45V 90V

### TRANSISTOR TYPES

MODEL NUMBER	OUTPUT		REGULATION				MAXIMUM RIPPLE IN MV
	Voltage	Current	LINE 105-125 V AC 50-60 CPS		NO LOAD TO FULL LOAD		
			%	V	%	V	
212A <sup>1</sup>	0-100 V DC	0-100 MA	0.15	0.05	0.1	0.05	1/2
2-212A <sup>1</sup> EQUIVALENT TO TWO MODEL 212A's. OUTPUTS MAY BE USED IN SERIES, PARALLEL, OR INDEPENDENTLY.							
224A <sup>1</sup>	0-100 V DC	0-200 MA	0.15	0.05	0.1	0.05	1
220A	0-50 V DC	0-500 MA	0.1	0.05	0.1	0.05	1
221A	0-100 V DC	0-500 MA	0.1	0.05	0.1	0.05	1
213A	0-50 V DC	0-1 AMP	0.1	0.05	0.1	0.05	1
214A	0-100 V DC	0-1 AMP	0.1	0.05	0.1	0.05	1
215A	0-50 V DC	0-3 AMP	0.1	0.05	0.1	0.05	1
218A	0-100 V DC	0-3 AMP	0.1	0.05	0.1	0.05	1

<sup>1</sup>. Modulation input provided for measurement of transistor parameters by small signal method.

© REGISTERED U.S. PATENT OFFICE. PATENTS ISSUED AND PENDING.



**ELECTRONIC MEASUREMENTS COMPANY, INCORPORATED**  
EATONTOWN • NEW JERSEY

# Space Challenges

Missile Industry Conference discusses electronics' important role in tomorrow's space age

WASHINGTON—The key role of electronics in the space age and the challenges to the electronics engineer were constantly emphasized

recently in the National Rocket Club's Second Missile Industry Conference here.

It's possible that within five or ten years a vast collection of large and small, manned and unmanned, scientific, commercial and military satellites and satellite groups forming a large, diversified space system, will have to be maintained and kept in operational condition.

This picture of the future was presented to military and industry specialists by rocket expert Walter R. Dornberger, Bell Aircraft's engineering director and one-time chief of Germany's wartime rocket program.

## Business is Good . . .

(Continued from p 23)

recorders. We defeated it last time. Had it passed and become law, we estimated it would have cost the industry \$5 million in the past year. That is very close to the total net profit for the industry for that period."

### "We've Been Had"

On importation of magnetic tape recording equipment from Japan, Brown said: "Here normal competitive rules don't seem to apply. Perhaps it isn't so much that their wage scale is one-seventh of ours. The thing that really gets us is their complete indifference about copying the other man's work. To undercut us on price is bad, but when it is done by a machine that looks identical to a made-in-America model—right down to the logotype—then I say that we have been had.

"Other industries have not found an easy answer to competing with the low-cost production of Japanese companies. It appears MRIA should work with other associations on this common problem. In addition, individual MRIA member companies can obtain considerable protection by filing and securing a design patent. This cost is nominal—under \$200—and will protect styling features of their equipment".

Chairman of MRIA's standards committee, C. J. LeBel, vice president of Audio Devices Inc., informed the group that work was continuing on standardizing dimensions for recorded magnetic tracks, reproducing characteristics for 7½ and 3¾ ips units and other areas of tape recording where lack of standards add needlessly to engineering design and development work.

### Satellite Missiles?

He warned of the threat of Russia's nuclear missiles fired from satellites.

"We are neglecting space weapons development and putting too much emphasis on the peaceful conquest of space," he said. "Russia may get hundreds of bombs or space-to-ground missiles together with thousands of decoys into permanent and calculated orbits cir-

## Electronic Cooking



French electronic oven that cooks 7 lb of meat in six minutes is now on the market in France for just over \$1,000. Cooking frequency is 2,400 mc. Unit draws 3.5 kw, operates on 110, 220 or 380 v a-c. Electronic circuitry is similar to that of American electronic ovens but employs a different regulation system and includes refinements that lower power consumption

TWO OUTSTANDING  
HIGH-TEMPERATURE  
MAGNET WIRES



*Tetroc*

FOR CONTINUOUS OPERATION AT  
HOTTEST SPOT TEMPERATURES  
UP TO 200°C



*Ceroc*

FOR CONTINUOUS OPERATION AT  
HOTTEST SPOT TEMPERATURES  
UP TO 250°C

For continuous operation at hottest spot temperatures up to 200°C (392°F) and up to 250°C (482°F) for short periods of time—depend upon TETROC—an all Teflon-insulated wire available in both single and heavy coatings.

CEROC is Sprague's recommendation for continuous operation at hottest spot temperatures up to 250°C (482°F) and up to 300°C (572°F) for short periods of time. Ceroc has a flexible ceramic base insulation with either single silicone or single or heavy Teflon overlays. The ceramic base stops "cut-through" sometimes found in windings of all-fluorocarbon wire. Both Tetroc and Ceroc magnet wires provide extremely high space factors.

Write for Engineering Bulletins 405 (Tetroc Wires) and 400A (Ceroc Wires).

SPRAGUE ELECTRIC COMPANY  
35 Marshall Street, North Adams, Mass.

**SPRAGUE**®

THE MARK OF RELIABILITY

# Engineers

cling the globe from all directions and at different altitudes, each one passing over the U. S. at least every 24 hours.

"When the bombs reach the right altitude, the technical possibility exists to ignite the retro-rockets and send missiles to specific targets in the U. S."

## Points Out Needs

In satellite communications, Elmer Engstrom, senior executive vice president, RCA, pointed out that we face many of the problems of power supply, propulsion, guidance and data handling that relates to all space systems.

Engstrom said there is a growing need for increased communication facilities of a "broad-band" nature for spanning long distances. Three approaches to intercontinental communications are being considered today, using both passive satellites and active repeaters.

The simplest approach is the "passive satellite chain" comprising two dozen or more large aluminized balloons placed in a polar orbit at an altitude of some 3,000 miles. It would give a reflecting surface between ground-based terminals for many services simultaneously.

With two dozen such satellites appropriately positioned, transoceanic relay service on a multitude of frequencies would be possible some 99 percent of the time, he said.

At present, equipment needed to place a tv or radio satellite in orbit is not too expensive, according to David B. Smith, vice president of Philco Corp. The real expense is rocketry and its inherent guidance and ground support gear, he said.

## Names Three Fields

The electronics industry can be expected to make contributions to space-age production in three fields, said Wm. F. Long, Electronic Industries Association marketing data department manager:

1. Design and fabrication of the payload. 2. Data acquisition, reduction and transmission. 3. Guidance and control. But he added, "it is in the area of guidance and control that the greatest impact will be felt by the electronics industry."

## Subminiature - Metal-Clad Paper Capacitors in Hermetically Sealed Metal Cases

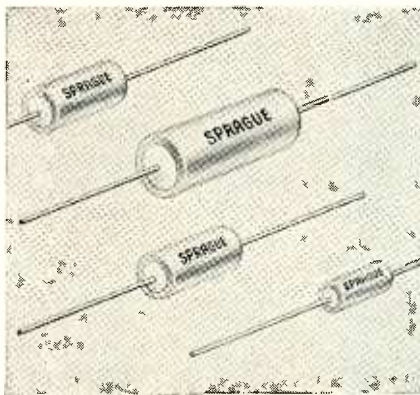

Since their introduction by Sprague in 1948, Subminiature Paper Capacitors of the general design shown here have become the most widely used of all paper capacitors in military and industrial electronic equipment. Constant improvement through new techniques and processes have kept them on the forefront of commercial capacitor development.

Electrically and mechanically, these Subminiature Paper Capacitors are designed to more than meet the high performance requirements of MIL-C-25A. The Sprague impregnants used are either wax (temperature-capacitance stabilized) or Vitamin Q®. The wax-impregnated capacitors are suitable for operation over a temperature range of  $-40^{\circ}\text{C}$  to  $+85^{\circ}\text{C}$ . The Vitamin Q units are available in two ranges:  $-55^{\circ}\text{C}$  to  $+85^{\circ}\text{C}$  and  $-55^{\circ}\text{C}$  to  $+125^{\circ}\text{C}$ . Positive hermetic closure of the metal cases for both is assured by glass-to-metal solder-seal terminals.

For complete technical data on Sprague's full line of Subminiature Paper Capacitors, write for Engineering Bulletin 2110 to Technical Literature Section, Sprague Electric Company, 35 Marshall Street, North Adams, Massachusetts.

CIRCLE NO. 45 READER SERVICE CARD

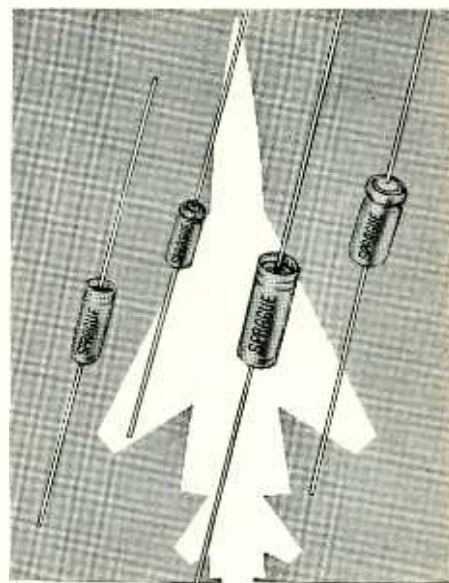

## NEW WET-ANODE TANTALEX® CAPACITORS

for 125 C operation

Another Sprague "first" for military and industrial designers—Type 130D Wet-Electrolyte Tubular Sintered-Anode Tantalex Capacitors for 125 C operation without voltage derating.

The remarkable electrical stability of these capacitors is the result of *special aging*, the use of *inert materials*, and a *low diffusion seal*. Construction is designed to meet the 2000-cycle military missile vibration requirement. Shelf life is excellent.

Shoulder-less shape makes mounting on printed wiring boards easier, avoids punching slots in boards or the use of "chairs", and simplifies board wiring layout.

For complete technical data, write for Bulletin 3701 to Technical Literature Section, Sprague Electric Co., 35 Marshall St., North Adams, Massachusetts.

**SPRAGUE**®  
THE MARK OF RELIABILITY

CIRCLE NO. 27 READER SERVICE CARD 27

# How CDF Di-Clad<sup>®</sup> can solve your printed-circuit problems

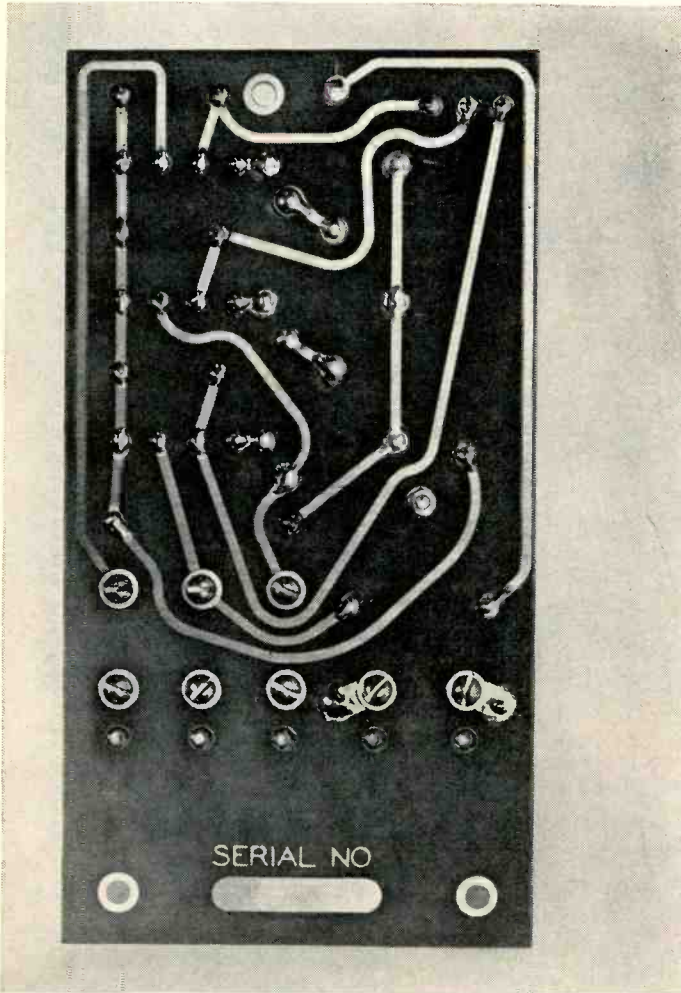

**High strength-to-weight ratio.** This printed-wiring board for a phase-failure relay was designed with CDF Di-Clad 28E (epoxy resin laminated with medium-weave glass cloth) for high mechanical strength, very low moisture-absorption, and good insulation resistance. Details upon request.

The CDF line of copper-clad laminates in all grades is now known by a new name—Di-Clad. Di-Clad grades meet the varying needs of design, production, and operation of electronic equipment. Grades other than those described are also available.

**Di-Clad 2350.** An economy paper-base phenolic grade having good tensile, flexural, compressive, and impact strength. Adequate for most non-critical printed circuit applications. Can be cold punched and sheared up to 5/64 of an inch in thickness.

**Di-Clad 112T.** A Teflon\* glass-fabric laminate offering the best dielectric properties over a wide temperature and frequency range.

Send us your requirements and let our engineers help you select the right grade for your application.

\*Du Pont trademark for its tetrafluoroethylene resin.



## CONTINENTAL-DIAMOND FIBRE

A SUBSIDIARY OF THE *Buhl* COMPANY • NEWARK 16, DEL.  
In Canada: 46 Hollinger Road, Toronto 16, Ont.

### TYPICAL Di-Clad PROPERTY VALUES

	Di-Clad 2350	Di-Clad 26 (NEMA XXXP)	Di-Clad 28 (NEMA XXXP)	Di-Clad 28E (NEMA G-10)	Di-Clad 112T Teflon*
BOND STRENGTH—0.0014" foil (lbs. reqd. to separate 1" width of foil from laminate)	6 to 10	6 to 10	6 to 10	8 to 12	4 to 8
MAXIMUM CONTINUOUS OPERATING TEMPERATURE (Deg. C.)	120	120	120	150	200
DIELECTRIC STRENGTH (Maximum voltage per mil for 1/16" thickness)	800	900	850	650	700
INSULATION RESISTANCE (Megohms) 96 hrs. at 35°C. & 90% RH (ASTM D257, Fig. 3)	500	150,000	600,000	100,000	75,000
DIELECTRIC CONSTANT 10 <sup>6</sup> Cycles	4.5	4.0	3.6	4.9	2.6
DISSIPATION FACTOR 10 <sup>6</sup> Cycles	0.040	0.026	0.027	0.019	0.0015
ARC-RESISTANCE (Seconds)	5	10	10	130	180
TENSILE STRENGTH (psi.)	18,000	16,000	12,000	48,000	23,000
FLEXURAL STRENGTH (psi.)	27,000	21,000	18,000	70,000	13,000
IZOD IMPACT STRENGTH edgewise (ft. lbs. per inch of notch)	0.80	0.45	0.42	12.0	6.0
COMPRESSIVE STRENGTH flatwise (psi.)	32,000	28,000	25,000	62,000	20,000
BASE MATERIAL OF LAMINATE	Paper	Paper	Paper	Medium-weave, medium-weight glass cloth	Fine-weave, medium-weight glass cloth
COLOR OF UNCLAD LAMINATE	Natural	Natural greenish	Natural	Natural	Natural

All these standard grades are available with 0.0014" and 0.0028" or thicker electrolytic or rolled copper foil on one or both surfaces. Other metal foils and other resin-and-base combinations can be supplied on special order.

\*Du Pont Trademark

# *advanced* PRECISION COMPUTING RESOLVERS for Cascaded Resolver Systems

## SIZE 8 FEEDBACK WINDING RESOLVERS



These resolvers are designed for use with transistorized amplifiers and permit the solution of spherical triangles in a size 8 cascaded resolver chain.

Functions of the spherical triangle which can be produced are indicated in the schematic below. More complex trigonometric functions, as well as systems involving coordinate axis transformation, can be generated with the use of these resolvers.

Accuracy: Functional error .1% or less; winding perp.  $\pm 5'$ . Electrical

characteristics: Input voltage 13.7v (compensator);  $Z_{ro} 234 + j596$ ;  $Z_{so} 244 + j548$ ;  $Z_{compensator} 237 + j553$ ; max. null voltage 1 mv/v.

cal characteristics: Input voltage 13.7v (compensator);  $Z_{ro} 234 + j596$ ;  $Z_{so} 244 + j548$ ;  $Z_{compensator} 237 + j553$ ; max. null voltage 1 mv/v.

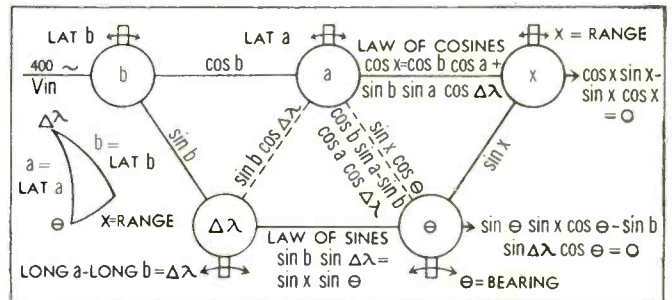

## SIZE 11 AMPLIFIERLESS RESOLVER FOR ANGULAR DATA TRANSMISSION



These size 11 resolvers incorporate an integral transformer which simulates a resolver function at maximum coupling. They are used in the typical chain application indicated below for angular data transmission. In this particular application, the output information can be servoed at either end of the chain.

Quick disconnect allows ease in harnessing.

Accuracy:  $\pm 5'$  of arc or less; winding perp.  $\pm 5'$ . Electrical characteristics: Input to EITHER rotor or stator. Input voltage 115v1600~; output voltage 110v both stator and rotor as primary; phase shift (stator primary) 1.1°; phase shift (rotor primary) 1.9°;  $Z_{so}$  (nom.)  $990 + j13500$ ;  $Z_{ro}$  (nom.)  $1150 + j13500$ .

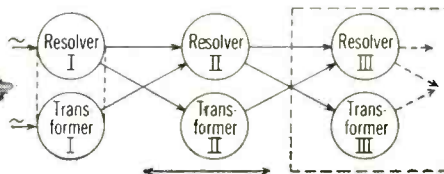
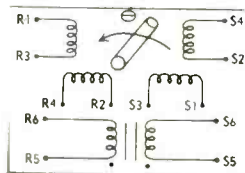

## SIZE 11 RESOLVER TRIMMED FOR ZERO PHASE SHIFT CONTAINS ALL COMPENSATION IN 2 1/4" LENGTH



The YZC-11-E-1 precision computing resolver has been developed for use in a cascaded, amplifierless resolver system at 900~.

These units have been trimmed to provide zero phase shift and compensated for transformation ratio stability, under temperature, when working into their iterative impedance.

Accuracy: Functional error .1% or less; winding perp.  $\pm 5'$ . Electrical characteristics: Input voltage (stator) 40v900~; output voltage (rotor) 33.2v; phase shift 0; max. null voltage 1 mv/v.

Also ready for delivery is an equivalent, compatible pancake resolver. By its use, differential information from an inertial platform may be obtained and introduced into the system.

ENGINEERS — Join the leader in the rotating components field. Write David D. Brown, Director of Personnel, Dept. J7

**eppe** CLIFTON PRECISION PRODUCTS Co., INC.  
CLIFTON HEIGHTS, PENNSYLVANIA

Sales Office: 9014 W. Chester Pike, Upper Darby, Pa. — Hilltop 9-1200, TWX Flanders, Pa. 1122 — or our Representatives

# Fast, Precision Analysis

— of Overall Telemetering  
Systems Performance

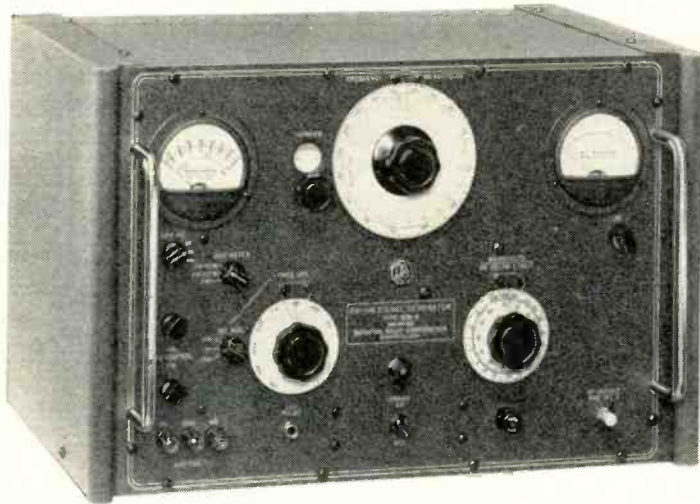

## NEW TYPE 202-G FM-AM SIGNAL GENERATOR

- features Internal  
RDB Modulating  
Frequencies
- blankets  
the 215-260MC  
Telemetering Band
- cabinet or Rack  
Mounting

### S P E C I F I C A T I O N S

**RF Range:**  
195 to 270 MC

**RF Accuracy:**  
±0.5% (after 1 hour warmup)

**RF Output:**  
RANGE: 0.1  $\mu$ v to 0.2 volts (across  
external 50 ohm load)  
ACCURACY: ±10% approximately

**AM Ranges:**  
INTERNAL: 0-50%  
EXTERNAL: 0-100%

**AM Distortion:**  
 $\leq$  5% at 30%  
 $\leq$  8% at 50%  
 $\leq$  20% at 100%

**FM Range:**  
INTERNAL: 0-240 KC  
EXTERNAL: 0-240 KC

**FM Distortion:**  
 $\leq$  2% at 75 KC  
 $\leq$  10% at 240 KC

**Spurious FM:**  
Total RMS spurious FM from 60  
cps power source is at least 50  
db below 75KC.

**Pulse Modulation:**  
From external source

**Pulse Rise Time:**  
 $\leq$  0.25  $\mu$  sec.

**Pulse Decay Time:**  
 $\leq$  0.8  $\mu$  sec.

**Modulating Oscillator  
Frequencies:**  
 50 cps 3.9KC  
 400 cps 10.5KC  
 730 cps 30 KC  
 1700 cps 70 KC

Eighteen years of specialized experience in the design of FM Signal Generators has been applied to the new Type 202-G Signal Generator—a versatile and uniquely suitable instrument for the critical analysis of overall telemetering systems performance. Outstanding features of the 202-G include precision electrical and mechanical design, maximum reliability and special convenience features that simplify telemetering systems tests and calibration. Eight standard RDB audio modulating frequencies are available for internal FM or AM modulation; provision for simultaneous FM and AM modulation is incorporated. A precision, backlash-free gear train provides 2200 vernier logging divisions over the range from 195 to 270 Mc. - \$1100.00 F.O.B. Boonton, N. J.

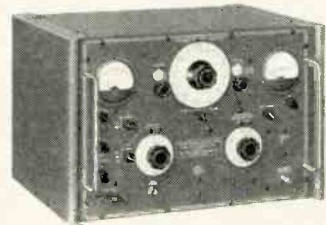

## Type 202-E Signal Generator for FM & TV Receiver Designers —

A precision laboratory instrument covering the entire FM and TV Broadcast Bands. Rf range 54 to 216MC. Price: \$1125.00. F.O.B. Boonton, N. J.

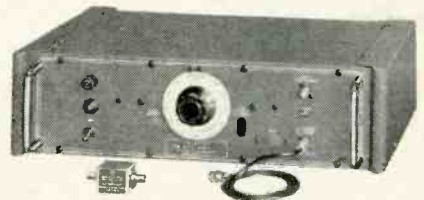

## Type 207-E Univerter For use with the 202-E —

Provides extended coverage from 0.1MC to 55MC. Price: \$430.00. F.O.B. Boonton, N. J.

25th  
ANNIVERSARY

Precision Electronic Instruments since 1934



**BOONTON RADIO  
CORPORATION**

BOONTON, NEW JERSEY, U.S.A.





Amateur radio station K4NNA/3 gets a between-sessions workout during Armed Forces Communications and Electronics Association's annual meeting

## Communications' Top Needs

Gen. LeMay, speaking at AFC&E Association's convention, lists required improvements

WASHINGTON—Our communications are continually lagging behind the needs of our rapidly expanding operational requirements for national defense.

This was the warning of General Curtis E. Le May, vice chief of staff, USAF, speaking at the keynote luncheon of the Armed Forces Communications and Electronics Association's 1959 convention here.

He cited a few examples of improvements which are required:

Improved reliability and security in our cryptographic devices for voice, data, and pictures; range extension of our tropospheric scatter systems, and more extensive channelization of these systems; increased speed for record type communications; and a reliable worldwide voice capability.

### Breakthroughs Near

The communications satellite, Gen. Le May believes, holds great promise. Breakthroughs are close in other areas, he said, and now is the time to convert them into useful communications equipment.

Among the many exhibits was Raytheon's first public demonstration of a new electronic "sky-writing" radar system that can keep tabs on the fastest jet and conventional aircraft flights. A combination of advanced radar and tv techniques, it gives to air traffic

controllers a bright "scope" picture showing the plane's direction, speed, and position simultaneously.

Another exhibit occupied the front lawn of the hotel—the first public demonstration of the Army's much-heralded global radio communications system—the AN/TSC-16—providing more voice and teletypewriter circuits than ever before in a ground-air transportable system for limited wars.

The high-speed radio communications system can be transported by air or moved overland. Within operational range of 1,000 to 2,000 mi, the equipment links the field commander directly with the Army's global communications system.

Consisting of a single-sideband 10 kw transmitter and receiving equipment, the "central" is contained in two vans, which, with tractors and power trailers, weigh about 70,000 lb. The system can load into three C-124 aircraft, and be airborne within 12 hours.

Another exhibit was Chicago's Aerial Industries' electro-optical system, designed to bring into a single, centralized display any combination of electrical or mechanical instrumentation information.

The VIP—for Visual Integrated Presentation—is designed, according to company officials, for aircraft, high performance subs, surface ships and space vehicles.

**Now—**  
**NO plate too small—**  
213B  
**NO panel too big**

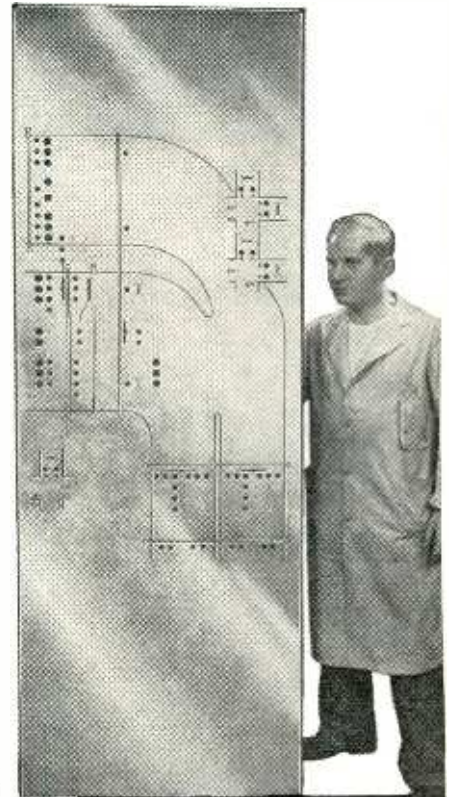

**NO**  
**size limits**  
**on engraving**

**ENGRAVES 18"x6" RECTANGLE  
 IN ONE SET-UP**

- Takes up only 2 feet of bench space
- Engraving chassis can be detached from base and placed directly on workpiece of any dimension
- Self-centering workholder cuts down set-up time
- Heavy duty cutter spindle

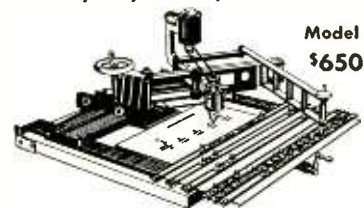

Model I-R  
**\$650.00**

Request our 28-page illustrated catalog ZR-3 on your business letterhead.

**new hermes** ENGRAVING MACHINE CORP.  
 134 West 14th Street, New York 11, N. Y.

## TERMINALS and CONNECTORS FOR HIGH PRODUCTION APPLICATIONS



- **Save Wiring Time**
- **Speed Production**
- **Cut Assembly Costs**

**MINIATURE TUBULAR TERMINALS**—Save time and labor in printed circuit assembly. Snap in instantly and hold firmly until permanently soldered.

**RECEPTACLES AND CONNECTORS**—Fit quickly and firmly. For use with Malco Tubular Terminals and for similar quick connect and disconnect applications.

**WRAP-A-WIRE TERMINALS**—Quickly inserted. Exclusive staked clinch-type feature locks terminal firmly until permanently soldered.

**SOLDER LUGS AND INTERLOCK CONNECTORS**—Especially designed for production line assembly operations. Interlocks are ideal for interlocking printed circuits or flybacks, as speaker lead connectors or as transformer mounting lugs.

**SPECIAL TERMINALS AND CONTACTS**—Malco Manufacturing Company has complete facilities to furnish practically any design or construction to fit individual requirements.

**MALCOMATIC\* MACHINES**—Designed for high volume production, these machines automatically insert, crimp or stake. They pay for themselves in time and labor costs, greatly speed assembly.

*\*Request Bulletin 581. Send b/p or specs and annual requirements for quote.*

*\*Registered Trade Name*

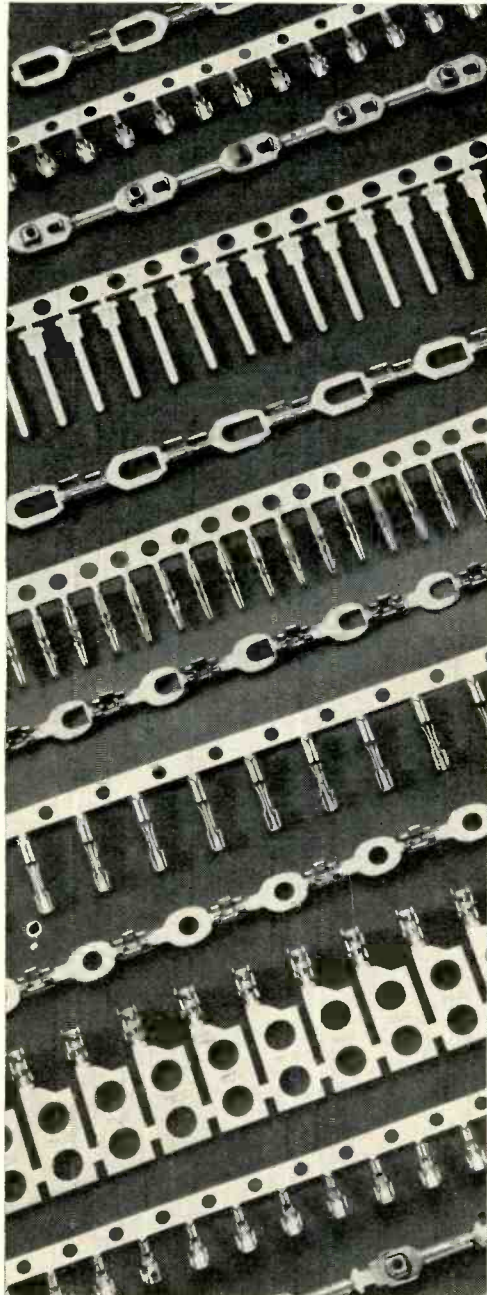

# Malco MANUFACTURING COMPANY

4023 WEST LAKE STREET

CHICAGO 24, ILLINOIS

## MEETINGS AHEAD

June 24-27: Medical Electronics, International Conf., UNESCO, CIOMS, PGME of IRE, Rockefeller Inst., UNESCO House, Paris.

June 29-July 1: Military Electronics, National Convention, PG MIL of IRE, Sheraton-Park Hotel, Wash., D. C.

July 1-5: Television Convention, International, British Institution of Radio Engineers, Univ. of Cambridge, England.

July 30-31: Computers & Data Processing, Denver Research Inst., Stanley Hotel, Estes Park, Colo.

Aug. 17—Ultrasonics, National Symposium, PGUE of IRE, Stanford Univ., Palo Alto, Calif.

Aug. 18-21: Western Electronics Show and Convention, WESCON, Cow Palace, San Francisco.

Aug. 23-Sept. 5: British National Radio & Tv Exhibition, British Radio Industry Council, Earls Court, London.

Aug. 31-Sept. 1: Elemental and Compound Semiconductors, Tech. Conf., AIME, Statler Hotel, Boston.

Sept. 1-3: Association for Computing Machinery, National Conf., MIT, Cambridge, Mass.

Sept. 14-16: Quantum Electronics, Resonance Phenomenon, Office of Naval Research, Shawanga Lodge, Bloomington, N. Y.

Sept. 15-17: Electronic Exposition, Twin Cities Electronic Wholesalers Assoc., Municipal Auditorium, Minneapolis.

Sept. 17-18: Nuclear Radiation, Effects on Semiconductor, Working Group on Semiconductor Devices, USASRD, Western Union Auditorium, N. Y. C.

Sept. 21-25: Instrument-Automation Conf. & Exhibit, ISA, International Amphitheater, Chicago.

Sept. 23-25: Non-Linear Magnetics and Magnetic Amplifiers, AIEE, ISA, PGIE of IRE, Shoreham Hotel, Wash., D. C.

Sept. 23-25: Residual Gases in Electron Tubes and Related High-Vacuum Systems, International Symposium, Italian Society of Physics, Como, Italy.

Oct. 12-15: National Electronics Conference, IRE, AIEE, EIA, SEMPTE, Sherman Hotel, Chicago.

Mar. 21-24, 1960: Institute of Radio Engineers, National Convention, Coliseum & Waldorf-Astoria Hotel, N. Y. C.

There's more news in ON the MARKET, PLANTS and PEOPLE and other departments beginning on p 72.

AN  
AIRBORNE TV  
SYSTEM  
FOR  
RECONNAISSANCE

# ALPHA

Developed by Temco Electronics under Navy contract, Alpha is an airborne transmitting and receiving television system. Used in conjunction with a video tape recorder, Alpha permits simultaneous real-time viewing and video recording of visual TV information during flights.

Transmitter is mounted in an advance or search aircraft . . . receiving system can be carried by a stand-off aircraft or in a fixed or mobile ground installation at ranges of 100 miles or more. Alpha is one of the many electronic systems under development by Temco Electronics.

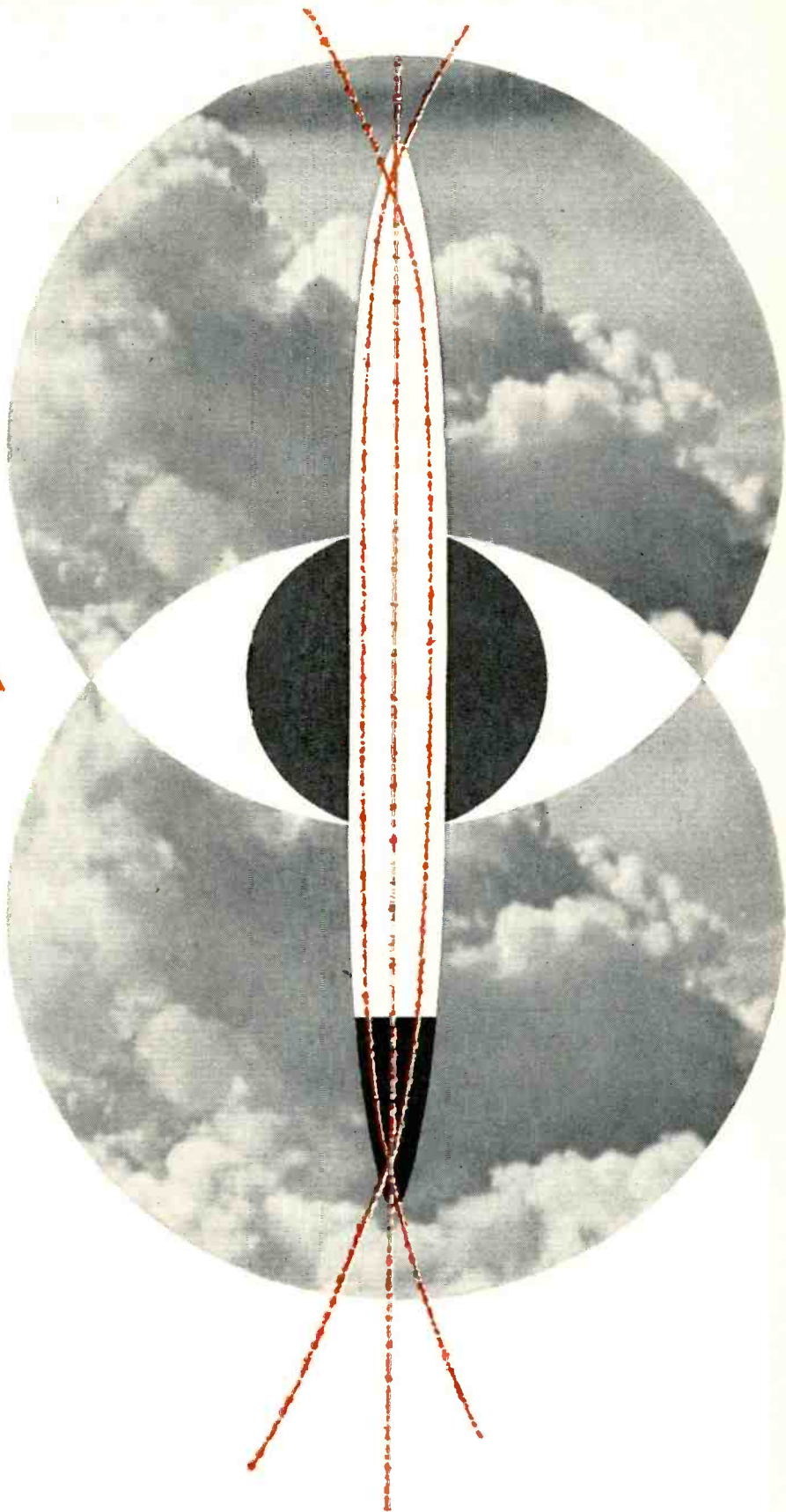

TEMCO

ELECTRONICS

A division of TEMCO AIRCRAFT CORPORATION • DALLAS 22, TEXAS

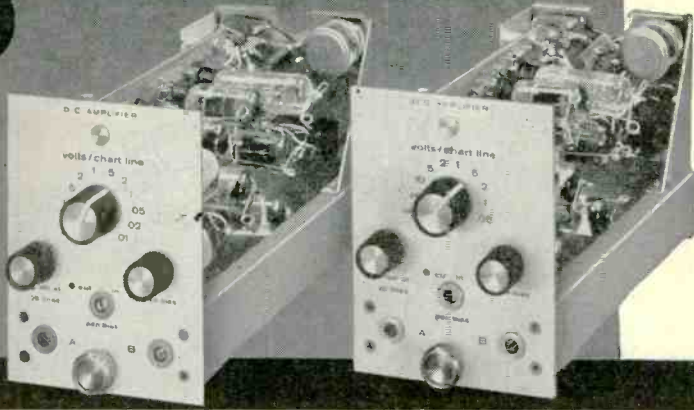
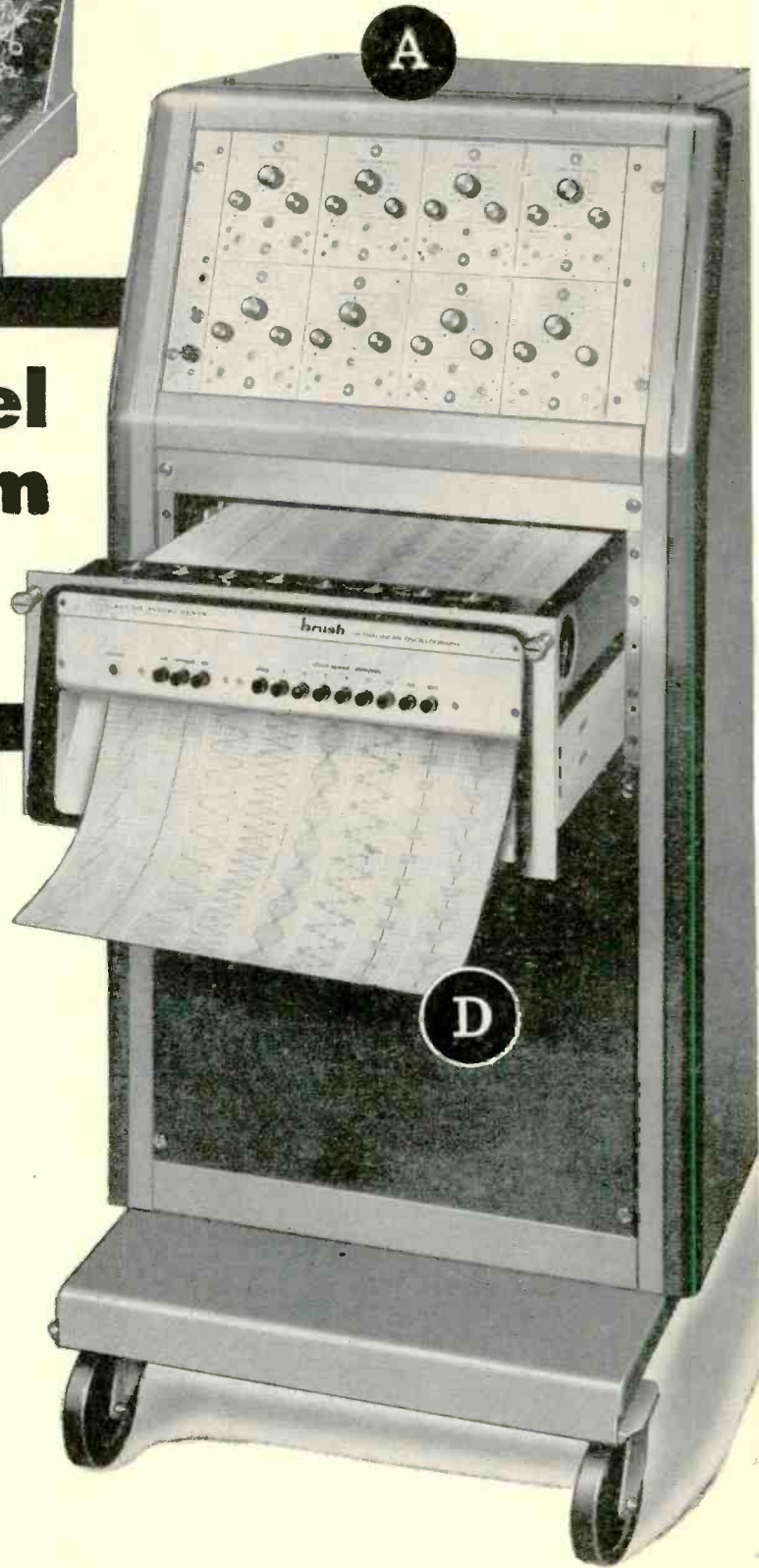
**B****A**

# Brush 6-8 channel recording system

RECTILINEAR . . . COMPACT  
PRECISE . . . SIMPLIFIED!

**T**HE new Brush 6-8 channel recorders are designed to give highest reliability and preciseness to readouts for telemetry, computer, ground control and other data gathering systems—with a maximum of simplicity.

**A** Complete 6 or 8 channel system includes slide mounted oscillograph—signal conditioning amplifiers—requires only 20" of rack height.

**B** Interchangeable plug-in signal conditioners. In addition to amplification, four important functions are provided: high input impedance, zero suppression, attenuation and calibration.

**C** "Pull-out" horizontal writing table permits convenient annotation, reading and control—without removing chart paper or turning off recorder.

**D** Rectilinear presentation gives clear, uniform and reproducible traces for simplified analysis and interpretation. Excellent resolution at all amplitudes and recording speeds.

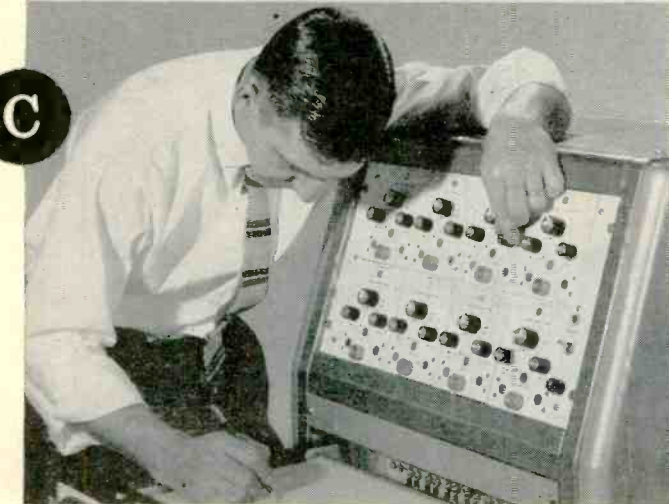
**D****C**

For further details or application assistance, contact your Brush factory branch or engineering representative.

**brush** INSTRUMENTS  
DIVISION OF

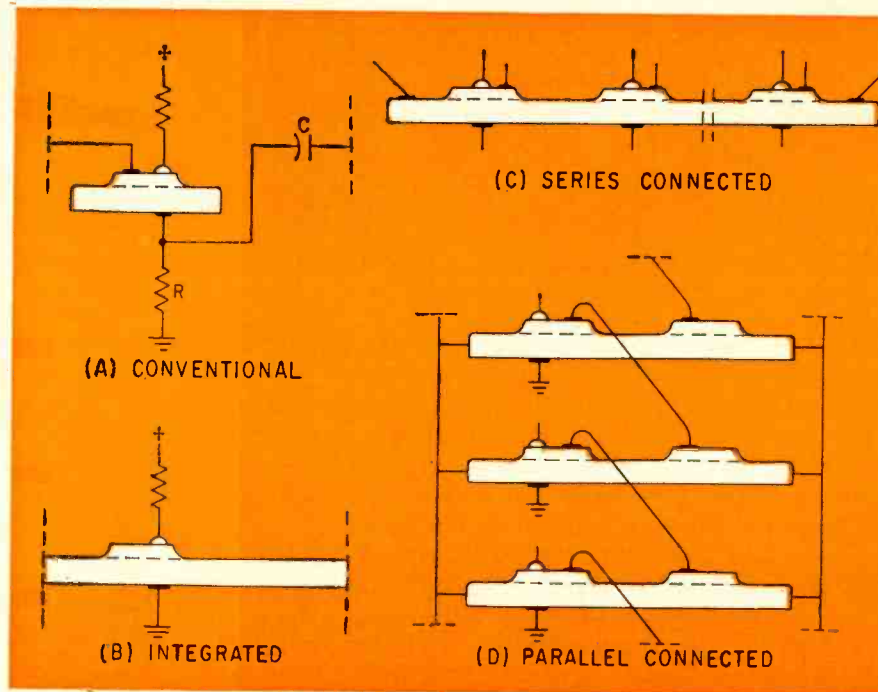

FIG. 1—Conventional shift register stage uses u-c coupling (A) and integrated stage uses germanium delay bar (B). Series-connected integrated shift register shown in (C) and parallel-connected shown in (D)

# Semiconductor Devices for Microminiaturization

Integrated semiconductor devices allow true microminiature electronic devices to be built with a packing density of approximately  $10^8$  parts per cubic foot. Method of use in logic circuits explained

By **J. T. WALLMARK**,  
RCA Laboratories, Princeton, N. J.

and **S. M. MARCUS**,  
RCA Defense Electronic Prod. Div., Camden, N. J.

GREAT INTEREST has been focused on the use of solid-state phenomena for various circuit functions in electronic equipment. In addition to the conventional circuit functions, such use may lead to new and unusual effects that cannot easily be achieved with conventional components.<sup>1</sup>

In an integrated semiconductor device, active and passive components are incorporated in a single piece of semiconductor material with no interconnecting metallic leads.

The main advantage of the integrated semicon-

ductor device is the extremely compact form that makes possible true microminiature electronic components that may be built to a packing density of approximately  $10^9$  parts per cubic foot.

**INTEGRATED SHIFT REGISTER**—One stage of the shift register shown in Fig. 1A consists of a thyristor<sup>2</sup>, a device that exhibits a negative resistance characteristic within a certain range of current and voltage and, therefore, may be used as a bistable element to store one digit. This digit may be shifted

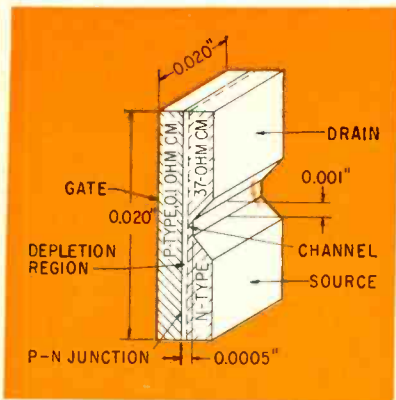

FIG. 2—Unipolar transistor showing method of construction

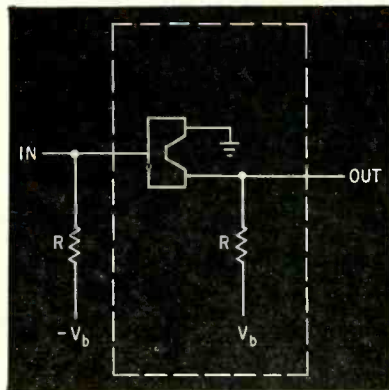

FIG. 3—Basic building block direct-coupled unipolar transistor logic device

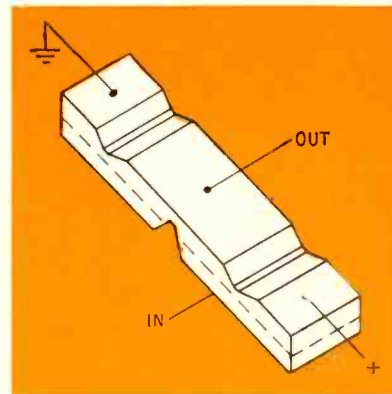

FIG. 4—Integrated basic building block combining two unipolar transistors

to the adjacent stage turning it ON. The R-C circuit which in effect turns all stages OFF. From the stage that was ON, a pulse is sent through an R-C circuit to the adjacent stage turning it ON. The R-C circuit should have a time constant long enough to store this information while the stages themselves are being cleared to make ready to receive new information. This constitutes temporary storage.

In Fig. 1B, the R-C circuit has been replaced by a semiconductor delay line consisting of a small bar of germanium. The shift pulse is applied along this bar and sends minority carriers from the ON stage down the bar. The minority carriers are collected at the end of the bar after a time equal to the transit time and are used to trigger the next stage ON.

The complete shift register may take the forms shown in Fig. 1C and D, which show two versions: elements arranged in series and elements arranged in parallel. The parallel arrangement, although slightly more complicated, reduces the shrinkage problem in fabrication.

**UNIPOLAR LOGIC**—A second integrated device<sup>4</sup> utilizing the unipolar transistor<sup>4</sup> is called the direct-coupled unipolar transistor logic, or DCUTL.

The unipolar transistor, one version of which is

shown in Fig. 2, operates as follows: when a reverse bias is applied to the gate contact, the depletion layer of the p-n junction grows and encroaches on the channel region making it narrower until the resistance from the source to drain becomes of the order of 10 to 100 megohms. When the reverse bias is reduced, the depletion layer retreats from the channel region and the resistance from source to drain reduces to approximately 5,000 ohms. At the same time, the gate is insulated from the source-drain by a reverse-biased junction constituting a high resistance, which in silicon is approximately 100 megohms.

The unipolar transistor is in effect a voltage-controlled relay and may be used as such in the construction of logic systems. The high-frequency cutoff for the unipolar transistor shown in Fig. 2 is 10 mc.

Figure 3 shows a basic DCUTL building block. The unit consists of a unipolar transistor with associated output and input load resistors. As these building blocks are used in arrays consisting of large numbers of units in series and parallel, the output resistor of one stage may be the input resistor of the next stage. The value of the output resistor of the basic building block is not too different from that of the channel resistance of the unipolar transistor.

A second unipolar transistor may be substituted for the load resistance if its channel width is made slightly smaller to obtain the correct resistance value. The resistance of the unipolar transistor element is highly nonlinear, which is desirable in that it insures more positive switching action. The building block then becomes the device shown in Fig. 4.

**LOGIC CIRCUIT USE**—Figure 5 shows a multiple AND circuit consisting of four active and one passive unipolar elements. When no signal is applied to the input gate contacts, all gates attain a large negative voltage shutting OFF all elements. When one or more gates are driven to a less negative voltage, the corresponding channel resistances shift from high to low value turning ON the elements. However, the output voltage will remain highly positive until all gates are biased to a small negative voltage. In this case the output voltage becomes a small positive voltage corresponding to ON.

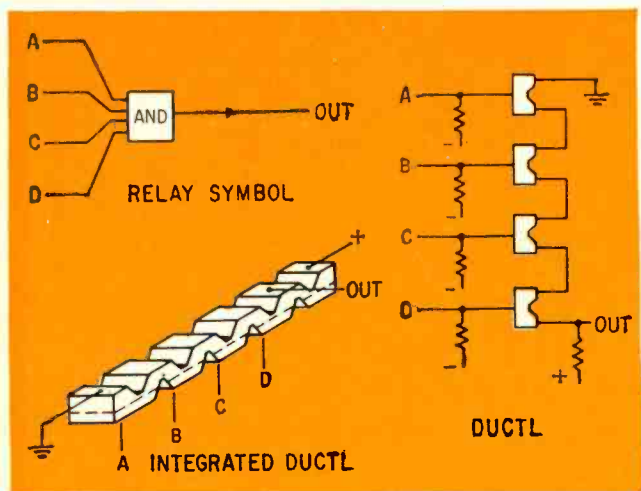

FIG. 5—Multiple AND gate consisting of four active and one passive unipolar elements

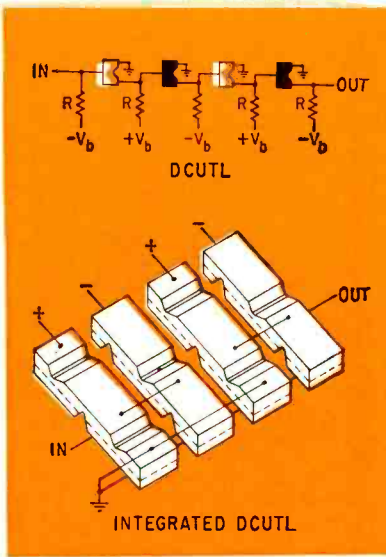

FIG. 6—Series connected DCUTL device using complementary symmetry

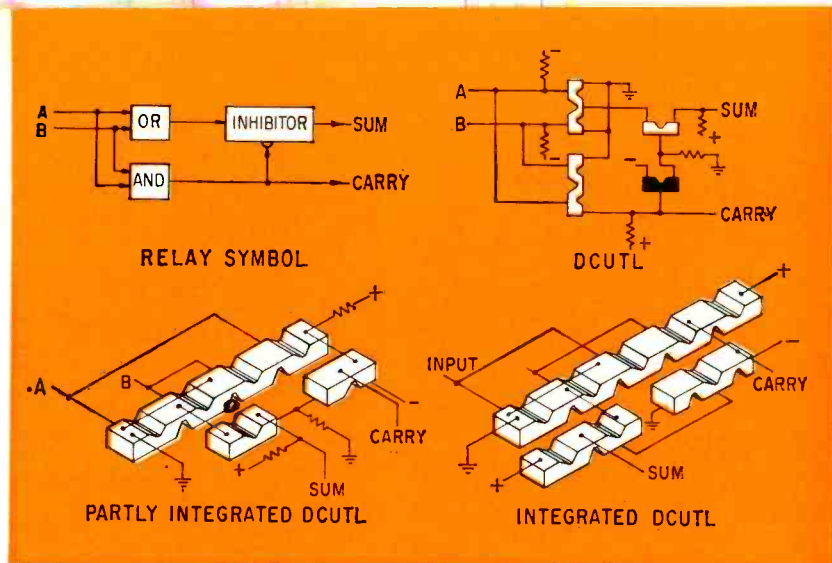

FIG. 7—Half adder using DCUTL elements adds two digits and supplies sum and carry as two output pulses

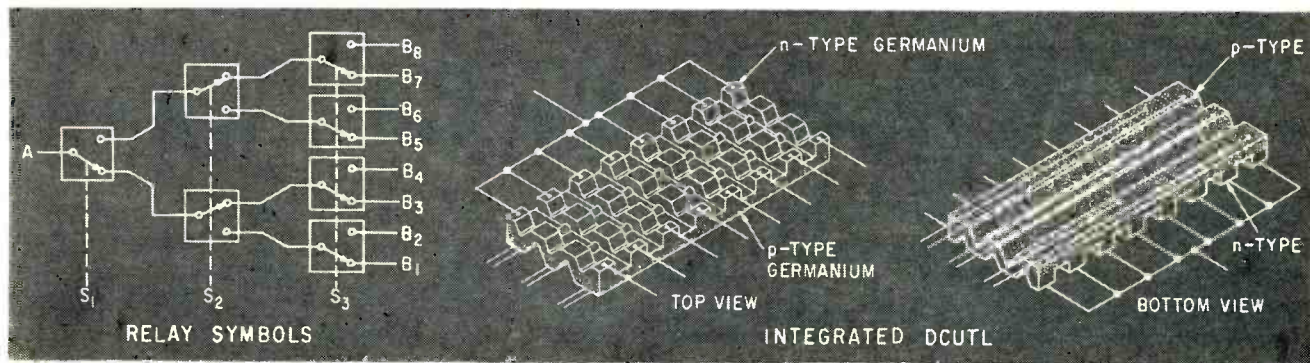

FIG. 8—Three-stage transfer tree used for addressing different parts of a computer memory. It is made up of 24 unipolar elements connected in eight rows of three elements each

One important requirement of the building block is that a pulse passing from one end to the other does not deteriorate but retains its shape and height.

Analyses of a series chain of stages, such as those shown in Fig. 6, showed that voltages corresponding to ON and OFF are stable and propagate unchanged even through an infinite chain. This means that the unipolar element serves as a logic element, amplifier and limiter.

Noise at the input is not passed along as unipolar elements amplify only signals above a certain level and reject signals below that level. Noise remains at a low level even through an infinite chain.

In the series chain shown in Fig. 6, alternate elements have complementary symmetry; *n*-type base elements alternate with *p*-type base elements and the voltage polarity alternates. This keeps the junctions reverse-biased at all times.

**HALF-ADDER**—The half-adder shown in Fig. 7 consists of three small pieces of silicon treated to contain a few active and passive unipolar elements mounted on a thin piece of insulator carrying the printed circuit connections between the elements and the power supply. This half-adder adds two digits in the form of ON or OFF pulses supplied to the two inputs and delivers the sum and eventual carry as two output pulses. This function is conventionally performed by a score of transistors, resistor and capacitors.

A more complex circuit known as a transfer tree

is shown in Fig. 8. This unit, used to address different parts of a computer memory, is made of 24 unipolar elements connected in eight rows of three elements each. The gates of the unipolar transistors are connected to three flip-flop circuits (not shown in the figure) that give large negative bias to the gates corresponding to OFF, while the other gates are given a small negative bias corresponding to ON.

In this manner, one and only one row of unipolar elements will be all ON, connecting the input to one of the outputs. The other rows will have at least one element in the OFF condition thus disconnecting all other outputs. By setting the flip-flops in different states, the input may be connected to any one of the eight outputs. This principle may be extended to larger numbers if desired.

The load resistances, which again would be integrated into the device, are not shown in the figure.

Entire logic portions of a digital computer may contain nothing but integrated devices in which small silicon elements are sandwiched between ceramic insulating wafers and the sandwiches stacked.

More complex circuit functions, such as tuned circuits may also be incorporated in integrated devices.

#### REFERENCES

- (1) E. W. Herold, Future Circuit Aspects of Solid-State Phenomena, *Proc IRE*, 45, p 1,463, 1957.
- (2) C. W. Mueller and J. Hilibrand, The Thyristor—A New High-Speed Switching Transistor, *Trans IRE*, ED-5, p 2, 1958.
- (3) J. T. Wallmark and S. M. Marcus, Integrated Devices Using Direct-Coupled Unipolar Transistor Logic, *Trans IRE*, EC, June 1959.
- (4) W. Shockley, A Unipolar Field-Effect Transistor, *Proc IRE*, 40, p 1,365, 1952.

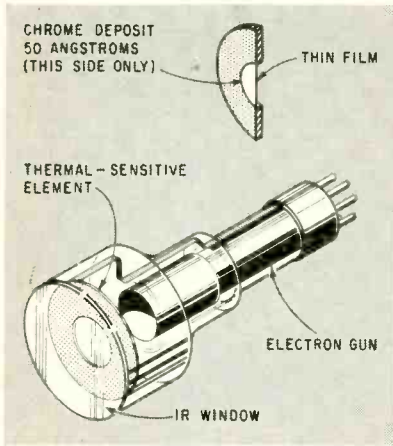

FIG. 1—Infrared thermal-imaging vidicon

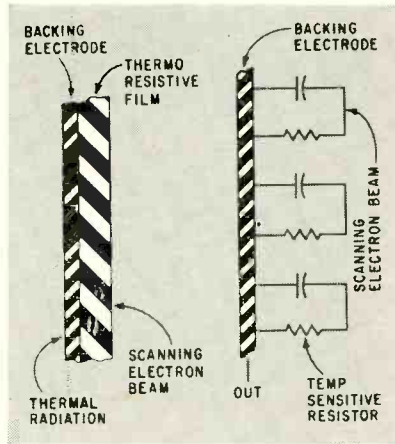

FIG. 2—Sensitive film composition

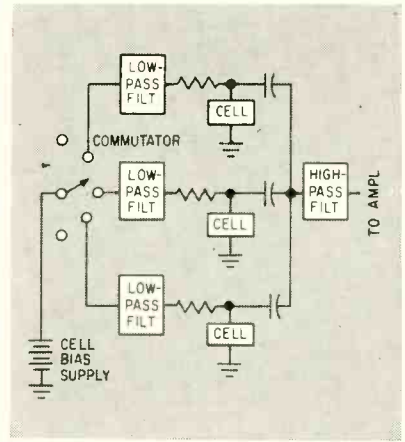

FIG. 3—Cell bias commutation technique

# Detecting Low-Level

ONE TECHNIQUE that would permit use of multiple infrared detectors without increasing greatly the electronic circuits required is the infrared vidicon. As yet, such a tube does not exist.

Figure 1 is a sketch of a proposed infrared thermal vidicon. Instead

of the thermal-sensitive element shown, the sensitive surface could be photoconductive with the film material dependent on the desired wavelength band.

As envisioned, such a vidicon would be small. It would consist almost entirely of a standard electron

gun facing the back of the sensitive element. The element located behind the infrared window would consist of a thin film coated with a transparent electrically conductive front surface. The film behaves like a large number of independent detectors—possibly 250,000 detectors per sq in. of sensitive surface.

The equivalent circuit of the sensitive film is shown in Fig. 2. In circuit of Fig. 2 each equivalent detector is connected to a leaky capacitor. When commutated by the electron beam, the back surface is brought to cathode potential. Between commutations, the potential across the film reduces toward that defined by the bias on the front surface. Rate of capacitor discharge is defined by the value of the capacitance and of the parallel resistance. Resistance, in turn, is defined by the radiation incident on the surface. The signal voltage integrates for the commutation period which is selected as less than the R-C time constant.

A thermal imaging vidicon would, for many applications, be an ideal search device. Unfortunately, problems inherent in its manufacture because of lack of proper materials may be expected to prevent complete success in its development in the near future.

Work has been done to develop techniques which use as much of the vidicon principle as possible while staying within the present



THE FRONT COVER—Closeup of CODES shows some of the parallel-tuned tank circuits



Multiple-cell infrared detectors have increased sensitivity compared to single-cell systems and require less optical-mechanical equipment. But these advantages tend to be offset by a need for more complex electronics. Here are ways, however, that allow you to have your cake and eat it, too

By **H. DUBNER**, Manager, and **J. SCHWARTZ** and **S. SHAPIRO**, Research Consultants, Advanced Development Laboratory, Avion Div., ACF Industries, Inc., Paramus, N. J.

# Infrared Energy

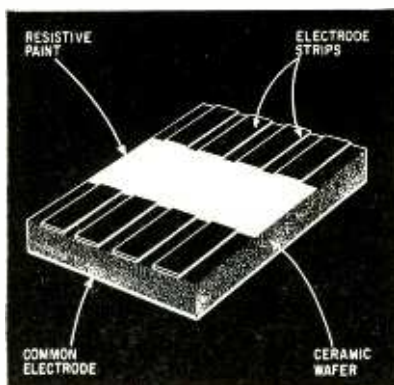

FIG. 4—Ceramic filter with printed R-C circuit on its face

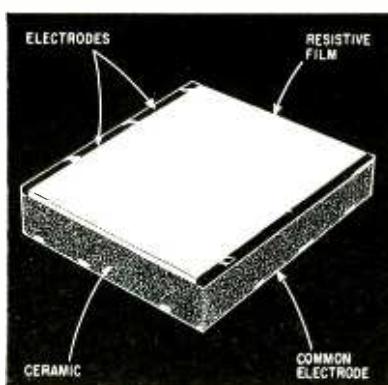

FIG. 5—Distributed R-C filter is 1 by 1 by 0.01 in.

sults. The transient involved in turning on a cell is about a million times greater than the threshold signal obtained from a cell. Some means of filtering the bias had to be devised to cut down these transients.

With an applied bias of 100 v, at least 10 stages of filtering would be required to reduce the transient to a tolerable level. Outcome of such a requirement is that each cell would contain a vast number of associated components. An obvious question then arises. What has been gained by using only a single amplifier? The answer is that there is need for a more compact filter.

A compact filter which performs the necessary reduction of transients is shown in Fig. 4. It is a ceramic wafer with printed R-C circuitry on its face. Wafer material is barium titanate with a dielectric

state-of-the-art materials, detectors and electronics. These techniques seek to approximate the basic vidicon advantages of multiple elements with high sensitivity, integration or storage for an entire frame and signal processing which minimizes electronic complexity.

## Search Techniques

In performing a search function, progression from single cell to vidicon follows this path: single cell; multiple cell, multiple amplifier; multiple cell, single amplifier; mosaic infrared tube and vidicon.

The ultimate vidicon has been discussed. The multiple cell, multiple amplifier design will not be discussed because of its direct approach and because of the degree of electronic complexity involved. The remaining two techniques—multi-

ple cell, single amplifier and the mosaic infrared tube—will be treated.

In solving the problems attendant to use of the multiple cell, single amplifier technique, three approaches have been used—bias commutation, frequency multiplexing and low-level a-c commutation.

## Bias Commutation

Cell bias commutation is illustrated in Fig. 3. Many cells are fed into the same amplifier. Only three are shown here. It should be noted that if all the cells are operative at the same time, the effect would be similar to use of one large cell, considering resolution and signal-to-noise relationships.

In commutating the bias of the cells so that only one cell is on at any one time, a serious problem re-

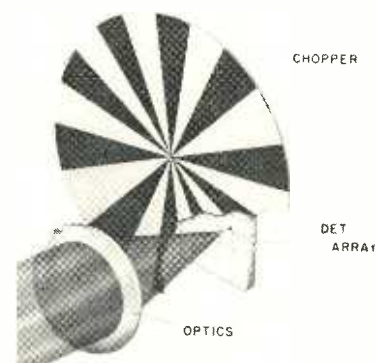

FIG. 6—Bias commutation system

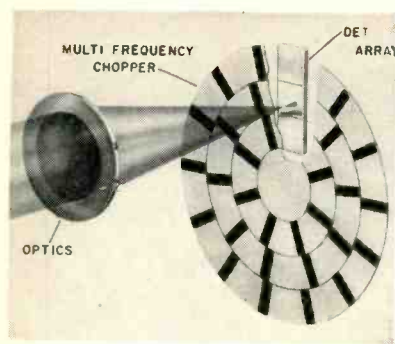

FIG. 7—Multifrequency system

constant of about 8,000. A 1 by 1 in. square wafer with a thickness of 0.01 in. produces for each capacitance a value of about  $0.01 \mu\text{f}$ . Only four R-C sections are shown but 10 such sections could be applied to a one-in. square.

Logical extension in number of filter sections results in a distributed filter which behaves as a transmission line. A distributed R-C filter as shown in Fig. 5 was developed. In construction, the ceramic is heated and on one surface a common electrode of conducting material is fused. On the opposite surface, a high-resistive coating of palladium is metalized to the barium titanate. Frequency response is adequate for use with a system which commutates the bias on 25 cells every second. For an input chopping frequency of 1,000 cps, sufficient transient attenuation is obtained while still permitting signal energy to pass.

An artist's conception of a bias commutated system is shown in Fig. 6. Infrared energy is collected and focused on the detector array through an optical system. The rotating wheel, the chopper with equal alternate opaque and transparent sectors to infrared energy, modulates the focused energy impinging on the detectors at a frequency of 1,000 cps. Sampling of the cell output is accomplished as shown in Fig. 3.

The bias commutation method provides for a mechanical rather than an electrical improvement. It does not provide improved sensitivity because only one cell at a time is in use. An advantage in having only one cell on at a time is that it permits use of higher than normal bias. This feature can be important when used in systems which have

high noise levels from sources other than the cells.

Figure 7 illustrates the method by which frequency multiplexing may be used to reduce complexity of an infrared system. The focal-plane chopper may have a configuration as shown in Fig. 7 which modulates energy on the separate cells at different frequencies. The detector array consists of a vertical row of cells with each cell placed behind one concentric row of the chopper. Number of transparent and opaque sectors on the chopper is varied from cell to cell to yield a different chopping frequency on each cell.

Method of processing the signal from each cell is shown in Fig. 8. Although only three cells are shown, many more may be used. Output of each cell is connected to a tank circuit tuned to the specific frequency of cell operation. A secondary winding is added to the inductor. This secondary is connected in series with those from the other cells, providing a summation of all of the chopped frequencies. All frequencies are then applied to one broadband low-level amplifier with a response sufficient to pass the several

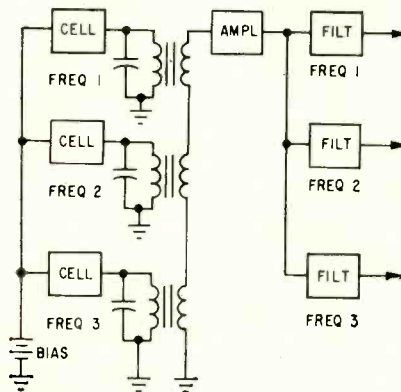

FIG. 8—Frequency multiplexing signal processing technique

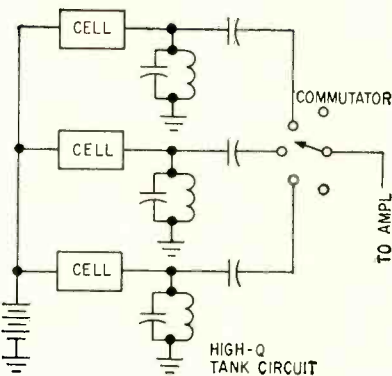

FIG. 9—A-c commutation

different chopped frequencies.

Separation is effected at the amplifier output by sharply tuned filters for each frequency channel. Because of filtering before summation of input signals, the signal-to-noise ratio of each output is that of the separate cell.

In this manner, a frequency multiplexing technique becomes a simple and powerful method of reducing the number of components in a multielement system. A limitation on its use is that all frequencies must be in the range in which signal-to-noise ratio is high.

### Low-Level Commutation

A-c commutation is the third application of the multicell single-amplifier technique. A mechanical commutator is connected directly to the cell output. Output of the commutator drives the amplifier.

Usual use of mechanical commutators to commutate d-c preclude operation in the mv range and are not considered for switching microvolts at high impedance.

Analysis of the source of commutator noise indicates that it is primarily the result of poor contact between the wiper arm and each segment. If used for signal detection in which no d-c is commutated and where high accuracy of commutation is not required, noise from this source will be proportional to signal and will not interfere with commutation. The only remaining noise is the contact potential developed by the difference in materials between the wiper and commutator segments.

In the a-c commutation system developed, no attempt was made to pass d-c through the commutator. As shown in Fig. 9, a blocking capacitor is included which charges up to the contact potential so that the only noise remaining is of a random quantity because of variation in contact potential. This amount of random noise is in the order of a few microvolts and generally below the cell noise.

In operation, as shown in Fig. 9, the chopping frequency will appear in the tuned high-Q tank circuits. All cells may be operative at the same frequency. The tank circuit with its narrow bandwidth performs a dual function. It stores energy for a period of time and it dis-

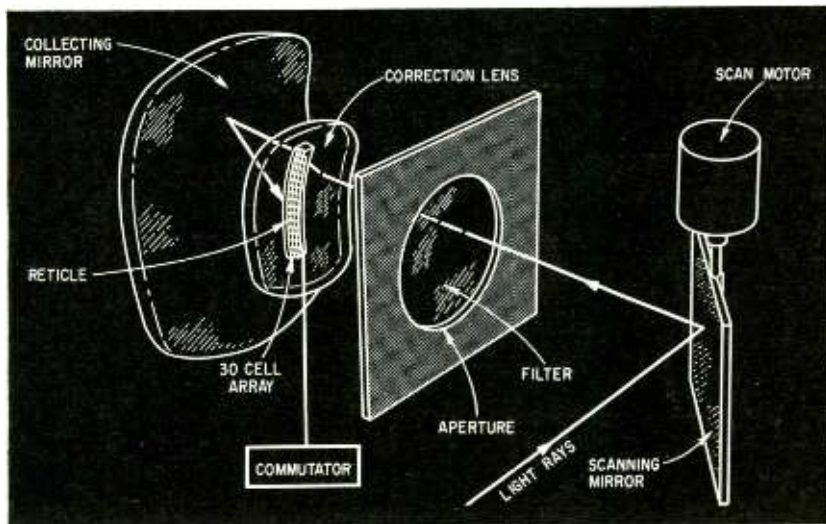

FIG. 10—Major portions of CODES (Commutating Detector Set)

criminate against noise. Infinite impedance of the blocking capacitor to d-c prevents d-c from entering the commutator contacts. But energy in the tank circuit is discharged and appears across a resistance at the amplifier input.

Constant amplitude of the a-c signal from the cell, varying at the chopping rate, is fed to the tank or storage circuit where it builds up with the characteristic rise time of the storage element. Sampling the tank circuit creates the pulse which drives the amplifier.

The CODES (Commutating Detector Set) employing these principles contains the major portions shown in Fig. 10. In operation, a scanning mirror is rocked by a motor. Radiation is collected on the primary scanning mirror and is transmitted in a path indicated by the arrows in the figure.

Optical configuration is a concentric optical system with spherical surfaces on the correcting lens and collecting mirror. All rays focus onto a curved reticle surface behind which a 30-cell array is located. The 30 lead-sulfide cells provide for a system which can scan a 40 by 90 deg field in  $\frac{1}{3}$  sec. A high-speed commutator samples the storage circuits which are 30 parallel-tuned tanks driven by cell signals. Energy stored during an integration period is unloaded when the commutator arm contacts a tank circuit and this energy is applied to an amplifier.

Theoretical sensitivity of the set is  $\sqrt{30}$  or about  $5\frac{1}{2}$  times better than an equivalent single-cell unit which

scans the same field in the same time. In actual practice, sensitivity is somewhat poorer because of various practical difficulties.<sup>1</sup> The equipment weighs 15 lb and uses a five-transistor signal amplifier.

#### Mosaic Infrared Tube

The mosaic infrared tube is the final technique using multiple detectors. A sketch of a possible tube of this type is shown in Fig. 11. The unit would use electronic scanning with a multiple set of detectors—about 1,000 per sq in.—and would also integrate and store for an entire frame. Method of constructing the mosaic is such that it can be manufactured with present-day techniques.

Precommutation integration and electron-beam scanning of a vidicon are incorporated in the mosaic infrared tube. But it does not require use of uniform high-resistive photoconductive material. The mosaic is constructed of glass wafers each

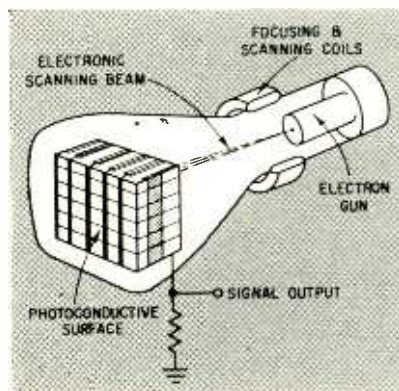

FIG. 11—Mosaic infrared tube

with typical dimensions of 1 by 1 by 0.1 in.

Glass is coated with a silver compound which is then fired into the glass. Barium titanate is fired onto the glass surface forming the capacitive element of the distributed filter. Resistive portion of the filter is a coating of palladium deposited onto the barium surface. The photoconductive material is the next deposit after which each cell and its R-C circuit is separated by a thin line cut. The electron beam scans the surface at the rear of the block illustrated and output is obtained across the resistance shown.

Method of operation is indicated in Fig. 12. For detection of point targets, the image is modulated synchronously with the a-c excitation.

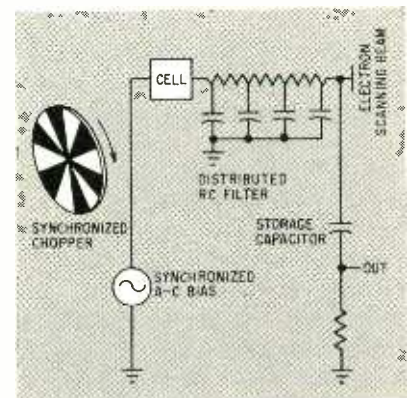

FIG. 12—Mosaic infrared tube equivalent circuit

The cell on which the point target is imaged on the positive bias cycle will not be the same cell on which the target is imaged on the negative bias cycle. The difference in cell resistance between positive and negative cycles results in a net direct voltage on the storage capacitor. This voltage will integrate for a period of time, depending on the R-C time constant. Amplitude of the signal will be in proportion to target-to-background contrast. In the absence of a target, and assuming a uniform background, no net direct voltage will be generated. The a-c signal is attenuated by the distributed filter. Voltage on the storage capacitor is commutated by the electron beam.

#### REFERENCE

- (1) S. Shapiro and H. Dubner, CODES Commutating Detection System, Avion Report No. 1054, Jan. 5, 1959.

# Monitoring Radioisotope

Battery-operated radiation monitors record radioactivity level of flowing liquids or gases under field conditions. Unit described has battery life in excess of 300 hours and uses economical circular chart recorder

By F. E. ARMSTRONG and E. A. PAVELKA,

Div. of Petroleum, Bureau of Mines, U. S. Dept. of Interior, Bartlesville, Oklahoma

USE OF RADIOACTIVE ISOTOPES as tracers in the petroleum industry often involves monitoring the radioactivity level of flowing liquids or gases over relatively long periods of time. In many instances, location of monitoring points is such that reliable power is not available. Often no housing is available for the monitoring instrument and it is subjected to wide extremes of temperature and humidity. The proximity of heavy moving machinery may impose severe shock and vibration problems. As operation by untrained personnel is an occasional necessity, a minimum of controls or adjustments is desirable. The instrument described in this article was designed for field use under such conditions.

## Recorder

Choice of a recorder was dictated primarily by cost considerations. A strip-chart recorder would have been satisfactory from an operational standpoint, but the cost of such units was more than twice that of the circular recorder used. The clock-stopping type of instrument<sup>1</sup> has a number of inherent faults. If an ordinary 12-hour clock is used, some method of eliminating ambiguity of indications is necessary, unless the device is attended at least twice during each 24-hour period. More important is the lack of quantitative data, particularly with an exposed and unshielded radiation unit. Variation in background count due to fallout, radon buildup or other phenomena can cause excursions of more than 3 to

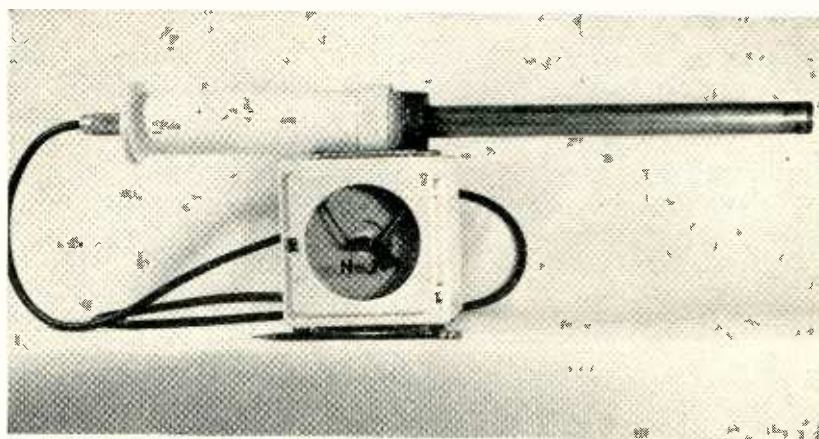

Detection head includes high-voltage power supply and pulse amplifier in hermetically-sealed case. Remainder of circuit and recorder is mounted within housing

10 times a normal reading. This in turn causes false alarms and will deactivate the unit until it is reset. Operations type recorders<sup>2</sup> eliminate this difficulty but still do not present data that would allow analysis of the variation in radioactivity and determination of its cause.

## Detection Unit

Figure 1 shows the circuit diagram of the detection unit. The Geiger-Muller counter is a brass-wall, bismuth-coated-cathode unit operating at 1,100 v. The normal background counting rate is about 300 cpm. Sensitivity is such that when used as dipping counters in a liquid volume of 7 liters, a concentration of  $10^{-10}$  curies per milliliter (0.1 microcurie per liter) of Iodine<sup>131</sup> yields a counting rate slightly more than 200 cpm above background.

A potted commercial high-volt-

age unit is used to supply high voltage for the counter. Considerable variation of required input power occurs among different supply units. The average unit requires 100-mw input power to supply 11 mw of high-voltage power. The 100-mw input power is more than half of the total power requirement for the battery recording unit. Improvement of efficiency in this portion of the equipment would yield substantial gains in battery life.

The G-M counter pulse is approximately 5 v in amplitude. To prevent overloading of transistor  $Q_1$ , with accompanying pulse-width variations, voltage divider  $R_1$  and  $R_2$  reduces the input pulse to 0.5 v. Diode  $D_1$  across the primary of transformer  $T$ , damps out any ringing. Transistor  $Q_1$  operates with no bias and draws little or no quiescent current.

The output pulse is 0.75 v in amplitude and 20  $\mu$ sec wide. The im-

# Tracers in Industry

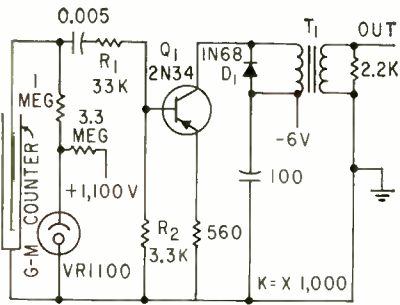

FIG. 1—Geiger-Muller counter receives its high voltage from potted unit

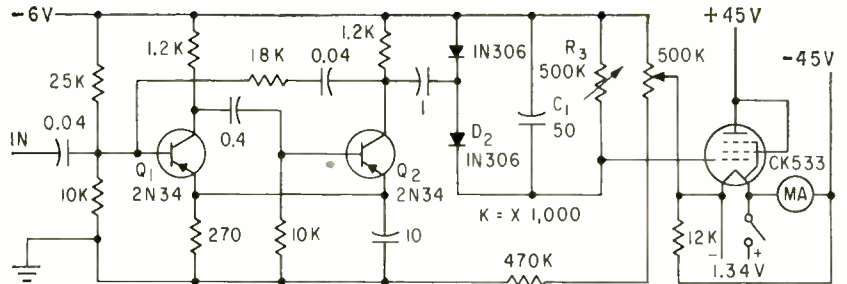

FIG. 2—Two-transistor one-shot multivibrator output signal is integrated and displayed on recording meter

pedance at the output transformer secondary is sufficiently low so that no crosstalk occurs when driving 500-ft lengths of unshielded 4-conductor cables, provided the cables are terminated in 2,000 ohms or less.

## Counting-Rate Meter

The counting-rate meter shown in Fig. 2, uses two transistors in an integrating circuit and a vacuum-tube recorder-drive circuit. The vacuum-tube output circuit was used because of the high quiescent current demands of suitable transistor output circuits. The single-ended tube circuit is sufficiently stable so that overall system drift is less than 10 percent.

The counting-rate circuit consists of transistors  $Q_1$  and  $Q_2$  in a one-shot multivibrator circuit whose output is a 4.5-v, 260- $\mu$ sec square pulse. This pulse charges integrating capacitor  $C_1$  through diode  $D_2$ . The multivibrator requires a 0.1-v pulse for reliable triggering. Since several times this voltage is avail-

able from the detection unit, no input amplifier is required.

Linear response in a counting-rate integrating circuit requires that the charging-pulse amplitude be very large with respect to the range of voltage over which the integrating capacitor voltage will swing. In this application, non-linearity in the higher portion of the instruments range is desired; therefore the integrating capacitor is allowed to charge nearly to the maximum pulse voltage at full scale. The resultant response curve is shown in Fig. 3. The instrument is linear over a little more than the first half of the scale and essentially logarithmic over the remainder. This allows small variations of interest to be seen without losing the record if an unexpected large amount of radioactivity appears. Because only changes in radioactivity level rather than absolute measurement are of interest, the rate meter is not calibrated. Variable-discharge resistor  $R_3$  allows the instrument range to be continuously adjusted to permit setting the recorder to  $\frac{1}{4}$  to  $\frac{1}{3}$  full scale regardless of background variations at various locations. When absolute readings are required, the instrument may be calibrated with either a standard source or a pulse generator.

A mercury cell supplies filament current to the triode-connected output stage. With a plate supply of 45 v, the  $E_p/I_p$  curve is linear over a wide range although tube ratings are exceeded by a factor of 2. Five mercury batteries supply the plate

voltage. The batteries will operate the unit almost 1,000 hours under normal operating conditions except for the battery powering the transistor multivibrator and the high-voltage supply. This battery, which is mounted on the outside of the assembly for ease of replacement, is good for 250 to 300 hours of operation.

## Performance

The instrument has been operated continuously for as long as three weeks and the overall drift did not exceed 10 percent. Half of this drift is caused by battery aging and the remainder is thermal drift. Most of the drift could be corrected by adding a zener diode to the 6-v circuit. This would take an additional 20 to 40 mw of power. Range changes of approximately 10 to 1 may be made with the adjustable discharge resistor across the integration capacitor. Changes of larger magnitude than this require that the duration of the charging pulse output from the multivibrator be shortened by changing the R-C feedback elements.

Although this instrument was designed specifically for use in the application of radioisotope tracers to petroleum production, it is adaptable to many other field problems which require continuous recording of similar information.

## REFERENCES

- (1) R. Farmer and O. Reiner, Jr., Determining Arrival Time of Radioactive Fallout, *ELECTRONICS*, 31, p 76, Aug. 1, 1958.
- (2) R. Rhody, T. Evans and C. Ford, Inexpensive, Rapid, Automatic Recorder, *Nucleonics*, 14, May, 1956.

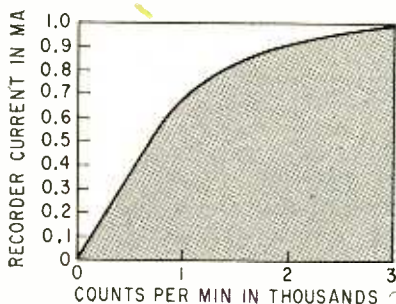

FIG. 3—Recorder response is linear for approximately the first half scale and essentially logarithmic over the remainder

# Thin Magnetic Films for

High speed, large capacity and manufacturing economy are potential advantages of tiny dots of magnetic alloys deposited on planes and cylinders

By DONALD O. SMITH, Staff Member, Lincoln Laboratory, Massachusetts Institute of Technology, Lexington, Mass.

**THIN MAGNETIC FILMS** several hundred Angstroms ( $10^{-8}$  cm) thick have considerable potential as memory elements in digital computers. Advantages sought are high speed, large capacity and manufacturing economy. All three are most likely to be simultaneously realized to the fullest extent by depositing the film on a plane substrate. However, films deposited on solid and hollow cylinders may also find useful application.

**SWITCHING**—High speed switching is achieved in two ways. Sequential rotation of the atomic magnetic moments in the form of moving ferromagnetic domain walls is a process which can be made fast by applying relatively large fields to high-coercive-force materials. Simultaneous rotation of all atomic magnetic moments is a process which clearly represents the fastest possible switch-

ing per unit of drive field.

Geometrical considerations make wall motion more likely in cylinders. Simultaneous rotation is easily achieved in planar films. Plane geometry is much more compatible with broad-band strip transmission line techniques than cylindrical geometry.

**MANUFACTURE** — Capacity and economy are closely related. The simplicity of vacuum or electrodeposition of planar arrays of magnetic spots and the attendant simplicity of planar wiring indicate that the ultimate in capacity and economy will be achieved with planes rather than cylinders. Typical characteristics of magnetic films and cores are summarized in Tables I and II.

Production of a planar array is shown schematically in Fig. 1. As the alloy is vapor deposited through the mask onto the substrate, a d-c magnetic field establishes an easy axis of magnetization. This provides the bistable character necessary for storage of information. Memory spots are currently spaced 100 per square inch (0.05 inch diameter spots). Information storage has been demonstrated at densities of 10,000 per square inch (0.005 inch spots). Use of such dense arrays awaits the development of wiring techniques which are practical at such small dimensions.

The work reported was performed at Lincoln Laboratory, a research center operated by MIT with the joint support of the U.S. Army, Navy and Air Force.

## REFERENCES

- (1) M. S. Blois, Jr., Preparation of Thin Magnetic Films and their Properties, *J Appl Phys* 26, p 975, 1955.
- (2) D. O. Smith, Static and Dynamic Behavior of Thin Permalloy Films, *J Appl Phys* 29, p 264, 1958; Anisotropy in Permalloy Films, *J Appl Phys* 30, April, 1959.
- (3) C. D. Olson and A. V. Pohm, Flux Reversal in Thin Films of 82 Percent Ni, 18 Percent Fe, *J Appl Phys* 29, p 274, 1958.
- (4) J. Raffel, Operating Characteristics of a Thin Film Memory, *J Appl Phys* 30, April, 1959.
- (5) H. J. Williams, R. C. Sherwood, F. G. Foster and E. M. Kelley, Magnetic Writing in MnBi Films, *J Appl Phys* 28, p 1181, 1957.
- (6) L. Mayer, Magnetic Writing with an Electron Beam, *J Appl Phys* 29, p 1454, 1958.
- (7) D. A. Meier, A Millimicrosecond Magnetic Switching and Storage Element, *J Appl Phys* 30, April, 1959.
- (8) S. J. Schwartz and J. S. Sallo, Electrodeposited Twistor and Bit Wire Components, *Digest of Technical Papers, Solid-State Circuits Conference, Philadelphia, February, 1959.*
- (9) R. McMahon, The Mechanics of Fast Switching Ferrites, *Group Report 32-107*, MIT Lincoln Laboratory, Lexington, Mass., 1958 (not generally available).

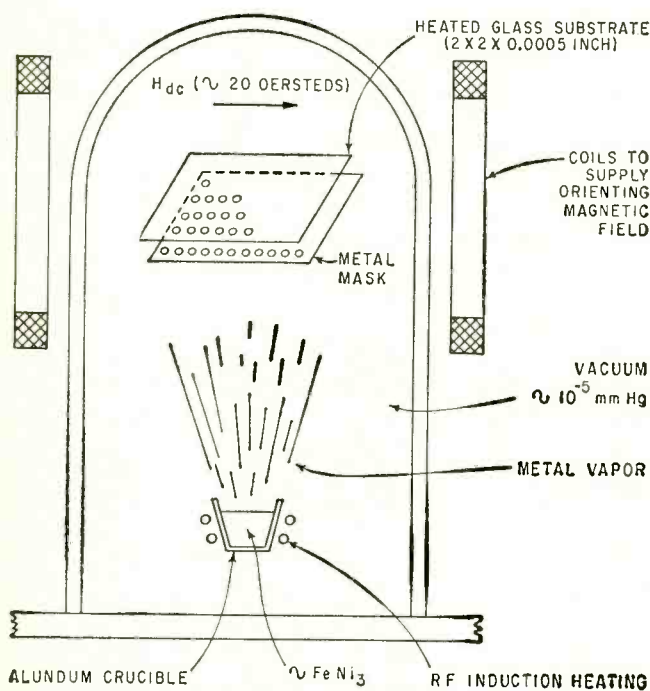

FIG. 1—Vacuum deposition of a planar array of memory spots

# Digital Computer Memories

Table I—Present and Probable Properties of Ferrite Cores and Planar Magnetic Films

Property	Ferrite Cores		Planar Magnetic Films	
	Present	Probable	Present	Probable
Switching Speed	1 $\mu$ sec	0.1 $\mu$ sec using partial switching <sup>b</sup>	0.1 $\mu$ sec	0.01 $\mu$ sec
Drive Power	800 ma into 50 ohms (tube drive) <sup>a</sup>	Comparable to present	400 ma into 5 ohms (transistor drive)	much less as spot dia reduced
Oper Temp	up to 50 C	same	at least 100 C	same
Physical Size	0.05 inch dia	same	0.05 inch dia 700 Å thick	0.005 inch dia 200 Å thick
Voltage Output	100 mv at 1 $\mu$ sec switch	100 mv at 0.1 $\mu$ sec switch	2 mv at 0.1 $\mu$ sec switch	~0.1 mv at 0.01 $\mu$ sec switch
Life	indefinitely long	same	no aging effects yet noticed	
Number in a System	2,500,000	probably not any greater	320	may reach many millions
Cost	~5¢ per bit	somewhat cheaper	not available commercially	should become very cheap
Fabrication	hand wiring	partially automated	hand wiring	largely automated

(a) For memory of 2.5 million cores (b) Reference 9

Table II—Comparison of Planar and Cylindrical Magnetic Films

Substrate Shape	Direction of Preferred Magnetization	Material	Method of Production	Coercive Force	Possible Applications	Switching Mode and Speed	Ref
Plane	uniaxial in plane	Permalloy (~20 Fe, 80 Ni)	Vacuum or electro-deposited in presence of magnetic field	~2 oersted	memory	simultaneous rotation, ~0.01 $\mu$ sec @ 2 oe drive	1 2 3 4
	normal to plane	MnBi	separate layers of Mn and Bi vacuum deposited and annealed at 350 C	very high, ~5,000 oe	display: Kerr magneto-optical effect memory: Curie pt writing		5 6
Cylindrical	parallel to axis	~Fe	electrodeposition	~20 oe	memory	walls ~0.1 $\mu$ sec @ 20 oe drive	7
	spiraling around axis	~25 Fe, 75 Ni + some Mo	electrodeposition onto spirally worked substrate	~10 oe	memory	walls ~0.1 $\mu$ sec @ 20 oe drive	8

# Transistorized Radar Sweep

High duty factor ppi sweep circuit features efficient and simple gated clamp, extremely linear push-pull d-c amplifier and novel use of silicon transistors to prevent thermal runaway. Total power consumption is less than 35 watts

By CHARLES E. VEAZIE, Electronics Department, The Martin Co., Baltimore, Md.

**T**RANSISTORIZED CRT DEFLECTION CIRCUITS for use in radar and television sets can be made much smaller and require far less power than their vacuum-tube counterparts. The unit to be described was designed for a 50-deg deflection radar crt and uses transistors with recovery times of approximately 100  $\mu$ sec. Power consumption is less than 35 w, (not including crt) and provisions are included to blank the crt during flyback time. Figure 1 shows a block diagram of the sweep system.

The circuit shown in Fig. 2 makes use of emitter-follower  $Q_4$  between triggered transistor  $Q_3$  and the width-controlling R-C network to assure a fast rise and fall time.

## Sweep Generator

The sweep generator shown in Fig. 3 generates a voltage that rises at a constant rate during the off time of the monostable multivibrator, and is held at zero voltage during the on time. A portion of the output voltage of this circuit is fed back through  $R_1$  to the center tap of two-section integrating capacitor  $C_1$ , to permit control of the sweep voltage linearity. The output of this circuit is coupled to the sweep amplifier by two cascaded emitter-followers  $Q_7$  and  $Q_8$  to match the impedances of the two circuits.

The resolver is driven by power transistor  $Q_{11}$ . As power transistors have a large  $I_{co}$  and are subject to thermal runaway, silicon transistor  $Q_{10}$  is used as a directly connected emitter-follower to drive transistor  $Q_{11}$ . The amplified  $I_{co}$  of silicon transistor  $Q_{10}$  is comparable to the  $I_{co}$  of transistor  $Q_{11}$ . When they are connected in this configuration, the

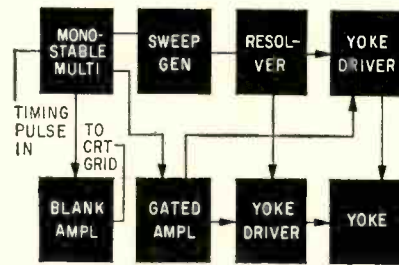

FIG. 1—Trigger pulse initiates the sweep. Resolver is driven by antenna rotation to generate rotating ppi sweep. Crt is blanked during flyback time

$I_{co}$  of  $Q_{11}$  is cancelled, thus preventing thermal runaway at normal temperatures.

## Yoke Driver

In a high duty factor ppi sweep, the spot starts at the center of the ppi screen and moves radially outward to the edge of the screen, then rapidly flies back. For accurate range measurements this sweep must always start from the exact center of the ppi screen. It is necessary for the sweep current to change from a fixed reference value, and return rapidly to this reference value at the end of the sweep. This condition requires a yoke with a

fast recovery time and an efficient clamp circuit.

The recovery time of a yoke is the time required for the voltage induced by the rapidly changing yoke current during the beam fly-back time to collapse to zero.

The requirements for an efficient clamping circuit are a short time constant charging source and a long time constant discharging circuit. The short time constant charging source is obtained by push-pull emitter-followers  $Q_{12}$  and  $Q_{13}$  of Fig. 4 connected between the resolver secondary circuits and the push-pull clamping circuit. The long time constant discharging circuit consists of a high resistance voltage dividing network.

To present a high impedance load to the voltage dividing network, two-stage, common collector d-c amplifier  $Q_{10}$  and  $Q_{17}$  drives the push-pull power amplifiers  $Q_{13}$  and  $Q_{12}$  to furnish the sweep current to the deflection yoke. To prevent thermal run-away of the power amplifiers, transistors  $Q_{11}$  and  $Q_{15}$ , which follow the clamping circuit voltage divider, are silicon npn units.

The other winding of the deflec-

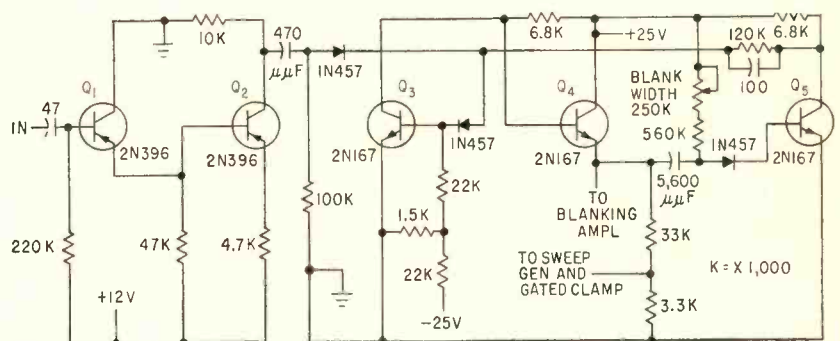

FIG. 2—Monostable multivibrator converts timing signal to narrow pulse of accurately controlled width



# Circuits Using Low Power

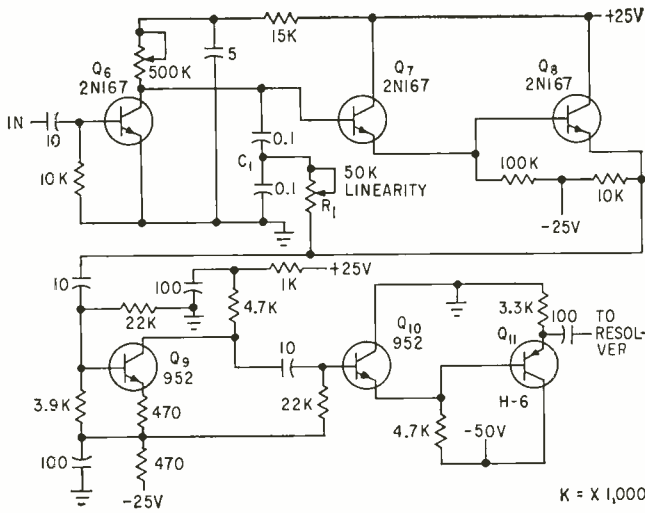

FIG. 3—The sweep generator accepts the pulse from the monostable multivibrator and generates the signal for the sweep resolver

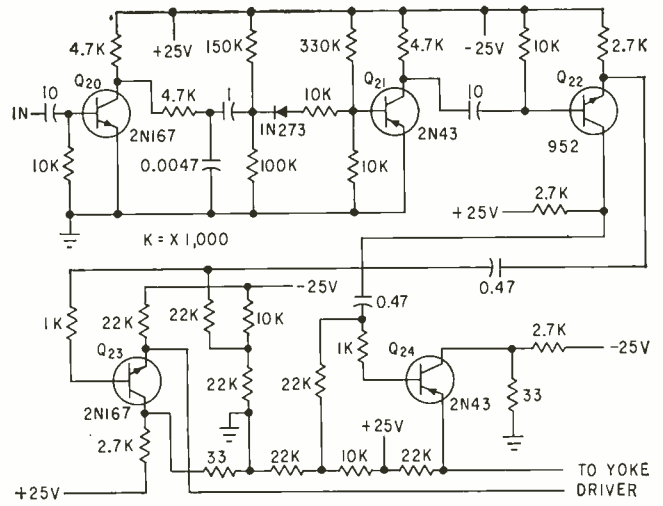

FIG. 5—Gated clamp uses the monostable multivibrator signal to generate reference level for the yoke driver

tion yoke is driven by a similar circuit, excited by the sweep voltage from the other secondary winding of the resolver.

## Gated Clamp

The voltage applied to a ppi deflection yoke driver circuit is a function of  $\sin \theta$ , or  $\cos \theta$ , where  $\theta$  varies from 0 to 180 deg. A single polarity clamp cannot be used so it is necessary to clamp both polarities during the clamping period and remove the clamp during the sweep period.

The gated clamp circuit is used

to clamp the sweep signal voltage to a reference voltage during the clamping time at the end of the sweep, and to remove the clamp during the sweep.

The clamp circuit uses a pair of diodes  $D_1$ - $D_2$  and  $D_3$ - $D_4$ , connected in opposite polarity to each signal line. During the sweep time these diodes are reverse biased by a pair of transistors  $Q_{23}$  and  $Q_{24}$  of Fig. 5, and they cannot conduct. During the clamping period, transistors  $Q_{23}$  and  $Q_{24}$  are driven into saturation by the control gate from the monostable multivibrator. This re-

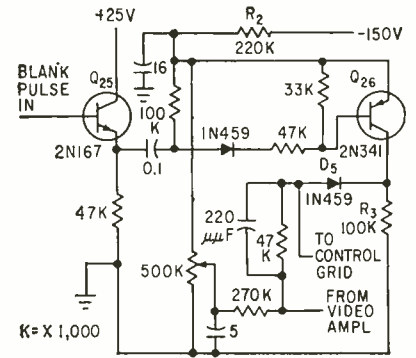

FIG. 6—Blanking amplifier blanks the crt during flyback time

moves the reverse bias from the clamping diodes, clamping the signal to the reference voltage.

## Blanking Amplifier

The blanking amplifier shown in Fig. 6 amplifies the blanking pulse from the monostable multivibrator to the level required to blank the crt screen during fly-back time. This circuit uses high-voltage transistor  $Q_{26}$ . The emitter is connected to -150 v through resistance  $R_2$ . The collector is connected to the crt control grid through diode  $D_5$ , and to ground through resistance  $R_3$ . Transistor  $Q_{26}$  is normally nonconducting, and is driven into saturation by the blanking pulse thus applying a high negative voltage to the crt control grid and cutting off the beam.

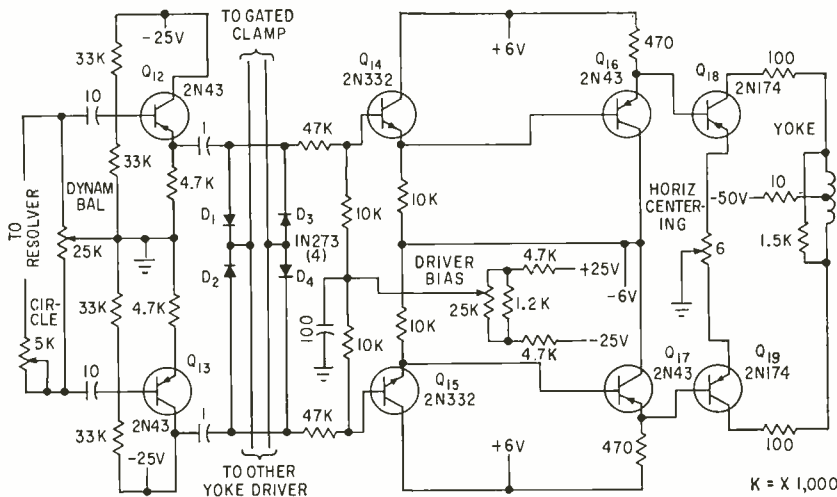
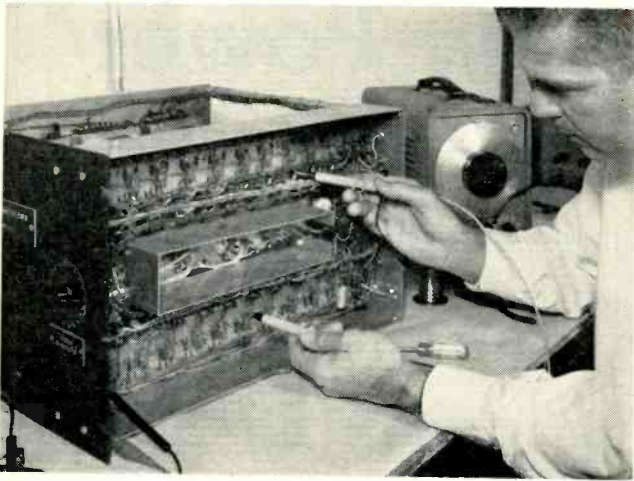

FIG. 4—Yoke driver accepts sine or cosine output of sweep resolver and clamps to reference level from gated clamp. Resolver signal drives deflection yoke



Checking output of one flip-flop stage. Maintenance of multiplexer is eased by use of plug-in units

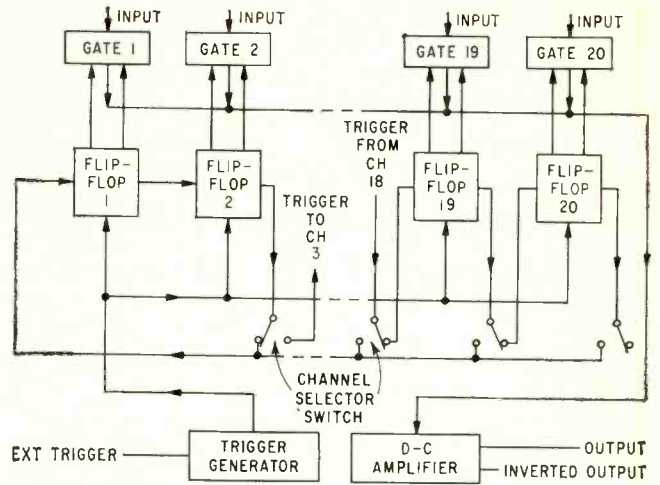

FIG. 1—Multiplexer uses 20 identical flip-flops and gates to sample data. Channel selector switch can be set for two to 20 inputs

# High-Speed Multiplexing

**M**ULTIPLEXING on a time-sharing basis in the measurement of electrical and physical phenomena has become increasingly important in recent years. Applications have been found for this method of sampling in telemetry, medical electronics and data processing. Multiplexing increases the number of items which can be sampled by a given system and permits virtually simultaneous measurement of a number of phenomena if the multiplexer samples at a high rate.

The limited sampling speed and short life of a mechanical-switch type of multiplexer make it highly unsatisfactory for use with data computers and other high-speed data-handling devices. The block diagram of an electronic multiplexer used in place of a mechanical multiplexer in high-speed and long-life applications is shown in Fig. 1.

## Multiplexer

Essentially, the multiplexer is a variable speed multichannel electronic switch connected in a closed-ring configuration. It consists of 20 semiconductor diode gates, each of which is controlled by a vacuum tube flip-flop. Only one gate is able to pass a signal at a given time. The open condition propagates from gate to gate sequentially around the ring, in step with externally ap-

plied trigger pulses.

At a 50-kc trigger rate, the multiplexer will accommodate signal inputs to the gates within the range of  $-15$  v to  $+15$  v. As the trigger rate decreases, the maximum allowable signal amplitude increases until at 17 kc the amplitude can be  $\pm 45$  v.

A front-panel control is provided so that the ring may be closed through any number of channels from two through 20. All the gates are connected to a common output which feeds into a stabilized d-c amplifier. The amplifier isolates the gates from the output load and provides additional output power.

## Trigger Generator

The trigger generator,  $V_{21}$  and  $V_{22A}$ , shown in Fig. 2 consists of a voltage comparator followed by an amplifier-inverter. This circuit accommodates a wide range of input wave shapes and repetition rates and delivers an output pulse of almost constant amplitude and width.

In response to a positive trigger, the voltage comparator produces a positive pulse due to the sudden interruption of current through  $L_1$ . Negative overshoot is not important, but positive overshoot would have the same effect as false trigger pulses. For this reason  $D_1$  is used to inhibit ringing. Resistor  $R_1$  is placed in series with  $D_1$  to lower the loop time constant,  $L/R$ , to al-

low the circuit time to recover between trigger pulses at the higher triggering rates. Resistor  $R_1$  is made as large as possible to speed recovery, but not so large that the effectiveness of  $D_1$  is compromised in preventing ringing.

Next, the pulse is passed through the amplifier-inverter stage,  $V_{22A}$ . In its quiescent state this stage is biased beyond cutoff. The positive pulse from the plate of  $V_{21B}$  brings the amplifier-inverter out of cutoff and produces a negative pulse at the plate of  $V_{22A}$ . The amplifier-inverter is actually driven to saturation. This action, combined with the fact that the stage is cut off between pulses, produces a pulse more rectangular than the one at the plate of  $V_{21B}$ . These pulses are applied to the grid of the switch tube  $V_{22B}$  to initiate the stepping action of the flip-flop ring.

## Flip-Flop Ring

The ring consists of 20 identical flip-flops which operate in a conventional sequential fashion and control the passage of signals through 20 gates. Only one flip-flop can be in a set condition at a given time; the rest must be in a reset condition.

The set condition is that condition which exists when the  $A$  side of a flip-flop is conducting and the  $B$  side is cut off. A flip-flop is considered reset if the  $A$  side is cut off

This twenty-channel electronic switch samples from 2 to 20 voltage sources at a rate as high as 50,000 cps. A flip-flop ring actuates diode gates in step with trigger pulses. Output data can be used to feed data-processing equipment and to drive recording instruments

By **KENNETH L. BERNs** and **BRUCE E. BISHOP**,  
Instrumentation Division, U. S. Naval Ordnance Laboratory, Corona, California

# With Closed-Ring Counters

and the *B* side is conducting.

The levels of the flip-flop supply voltages are +65 v and -160 v. These levels are chosen so that excursion of the flip-flop plates is approximately symmetrical around

ground. Direct coupling between the gates and the flip-flop plates makes it possible to hold a given gate in either an open or a closed state for an indefinite time.

Assume that the flip-flop ring is

in a stable state only when any one flip-flop is set and all the others are reset. The cathodes of the *A* side of all flip-flops are connected in common to a single 22,000-ohm resistor  $R_2$ . The other end of  $R_2$  is

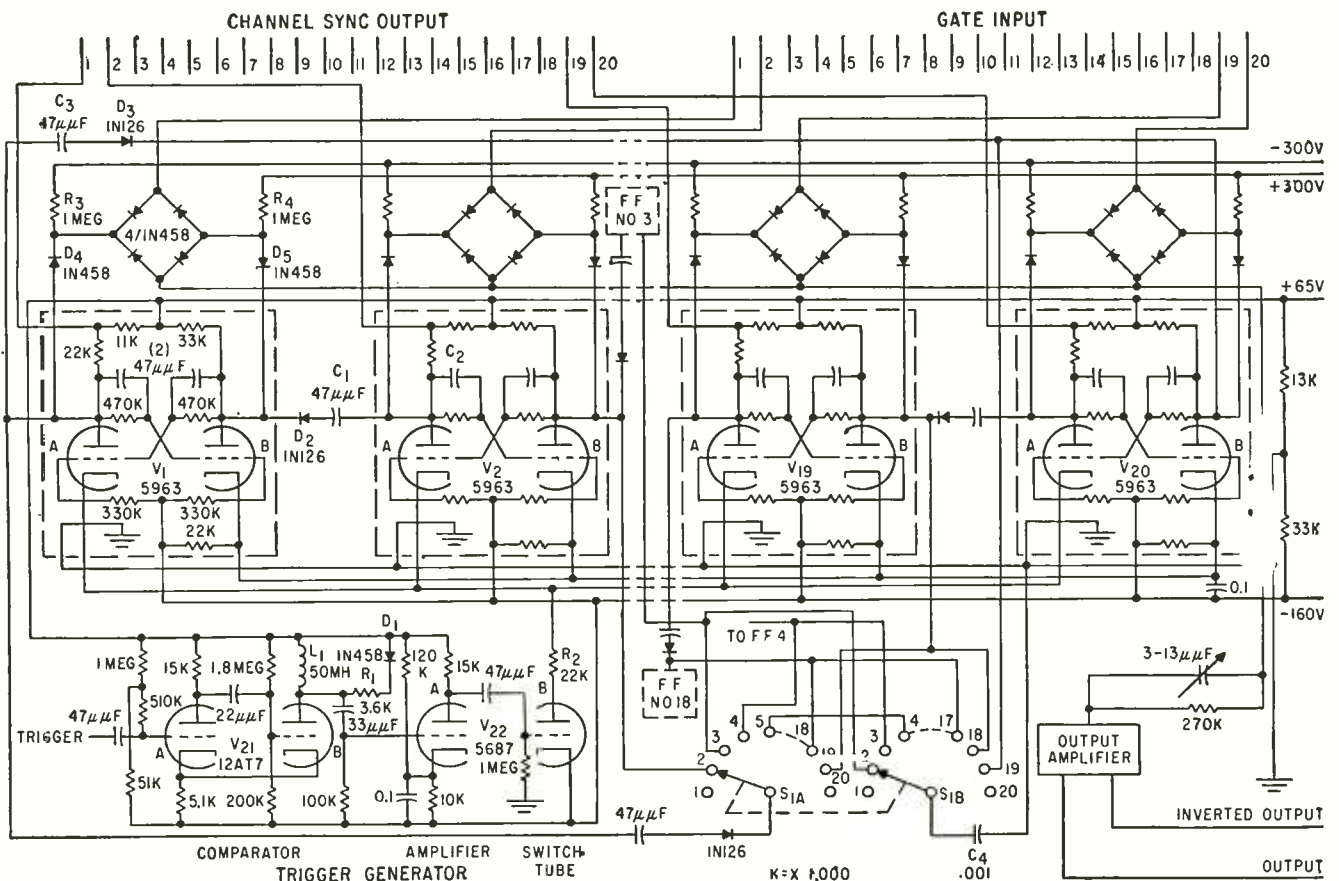

FIG. 2—Outputs of gates differ by less than 50 millivolts for same input signal. Multiplexer uses trigger amplitudes up to 100 v and trigger widths up to half of the trigger rate period

connected to the plate of the switch tube,  $V_{2B}$ , the cathode of which is connected to  $-160$  v. When not being pulsed, the switch tube is conducting heavily and there is only a small potential difference between its plate and cathode. Thus  $R_2$  is essentially connected between the common cathode line and  $-160$  v.

The  $B$ -side cathodes are also connected to a common line, but each stage has an individual 22,000-ohm resistor between its cathode and  $-160$  v. The effective resistance between these cathodes and  $-160$  v is equal to the parallel combination of the 20 cathode resistors, or about 1,100 ohms. If the ring is in a stable state, at any given time only one flip-flop will be conducting on the  $A$  side, and the 19 others will be conducting on the  $B$  side. The total current on the  $B$  side will be 19 times the current of any one stage, but the total resistance in the  $B$  cathodes will be one-twentieth of the value of a single resistor. Therefore, the cathode voltage of the  $B$  sides will be almost the same as the cathode voltage of the  $A$  sides.

Not more than one of the  $A$  sides can conduct at a given time since the added current would raise the cathode voltage of the  $A$  sides and result in an unstable condition. A flip-flop can exist only in one of two stable states; it cannot be partly on or partly off.

### Ring-Stepping Action

The set condition is propagated from one flip-flop to another around the ring in the following manner. Assume that  $V_1$  is set and all the other flip-flops are reset. A negative pulse on the grid of the switch tube,  $V_{2B}$ , will momentarily interrupt the current in this tube, thereby interrupting the current through the  $A$  side of  $V_1$ . This current interruption causes the plate of  $V_{1A}$  to go positive, and through normal flip-flop action the plate of  $V_{1B}$  goes negative. The waveform at the plate of  $V_{1B}$  is coupled through  $D_2$  and  $C_1$  to the plate of  $V_{2A}$  and, at the same time, differentiated by the plate resistors of  $V_{2A}$  and  $C_1$ . The differentiated waveform is then passed through  $C_2$  to the grid of  $V_{2B}$ . This initiates the flip-flop action which ends with  $V_{2A}$  in a con-

ducting state and  $V_{2B}$  nonconducting. The set condition, therefore, has been transferred from  $V_1$  to  $V_2$ . In this manner the output of one flip-flop triggers the next in line until the set condition has been propagated completely around the closed ring.

The ring can be closed through any number of channels from two to 20, depending on the position of the two-pole, 20-position switch. Switch 1A is connected so that the  $B$  side of any flip-flop from  $V_2$  through  $V_{10}$  can be selected and the interstage trigger routed from that point back to the  $A$  side of  $V_1$  to complete the closed ring. To complete the ring of 20, the switch is moved to a blank position and the interstage trigger is returned through the permanent coupling,  $C_3$  and  $D_3$ , connected between stage 20 and stage 1.

### Inhibiting Capacitor

When fewer than 20 flip-flops are included in the closed ring, the inhibiting capacitor  $C_i$  ensures that flip-flops outside the ring will not be triggered. Consider the case where the ring is closed at stage 18. Even though an interstage trigger is transferred from stage 18 to both stage 1 and stage 19 simultaneously, only stage 1 will be triggered to the set condition because  $C_i$  prevents the plate of  $V_{10B}$  from moving fast enough to complete the normal flip-flop action. Without  $C_i$ , action of the ring would be erratic and unpredictable.

Stage 20 is permanently coupled to stage 1 to make certain the interstage trigger is captured within the closed loop. Assume that stage 20 is coupled to stage 1 through the switch and that the ring is closed to include only the first 10 stages. Also assume that when the multiplexer is first turned on, stage 11 is the first to fall into the set condition. Now, as the multiplexer is triggered, the set condition propagates down the ring to stage 20. Obviously, the interstage trigger cannot return to stage 1 through the switch since the switch is connected to stage 10. Therefore, unless coupling from stage 20 to stage 1 is provided through another interstage capacitor and diode, it is uncertain which of the flip-flops would assume the set condition after 20.

With permanent coupling provided between stage 20 and stage 1, the interstage trigger will always be captured inside the closed ring regardless of which stage assumes the set condition when the multiplexer is initially turned on.

### Gates

When the flip-flop is set, the switch diodes  $D_4$  and  $D_5$  connected between the flip-flop and the 4-diode gate are biased in a nonconducting state which isolates the gate from the flip-flop. At the same time, voltages applied through  $R_3$  and  $R_4$  bias the four gate diodes in the conducting direction, resulting in a low impedance path from input terminal to output terminal, opening the gate. With the flip-flop reset, the switch diodes are biased in their forward direction allowing application of the plate voltages to the gate diodes. The gate diodes are now biased in their reverse direction, forming a high-impedance path from input to output, closing the gate.

The gate output exhibits some attenuation and zero offset (the voltage appearing at the output terminal with the input at ground potential). These effects are kept small by attention to certain design considerations. If the values of  $R_3$  and  $R_4$  are high compared with the forward resistance of the bridge diodes, it can be shown that a signal applied to the gate input terminal will be attenuated by the factor  $R_L/(R + R_L)$ . Resistance  $R_L$  is the load resistance and  $R$  is the forward resistance of one diode in the bridge. To keep attenuation low, high-conductance diodes operating above the knee of the forward conductance characteristic are used and load resistance is kept high.

Zero offset can be explained by visualizing each of the diodes in the conducting bridge as a small battery and resistor in series. The battery represents the forward voltage drop and the resistor represents the forward resistance of the diode. Clearly, zero offset will be present at the output terminal unless the circuit elements and the supply voltages are balanced. In actual operation, the zero offset is not excessive if reasonable care is taken in selecting components.

# Fast Switching for Industrial Control

Solid-state controlled rectifiers, saturable reactors, magnetic amplifiers, thyratrons and ignitrons—here is a summary of how they are used for fast, automatic, variable control of a-c power

By **ARTHUR GUTTERMAN**, President, Fairfield Engineering Corp., Springdale, Conn.

**S**OLID-STATE controlled rectifiers are the latest addition to devices generally available for high-speed, variable control of 60 to 400-cps a-c power. Their operation is similar to that of the other devices described in Table I.

All five devices are *off* during part of the a-c cycle, turn the line *on* to the load during the half-cycle and turn *off* when line polarity changes so current flows in one direction. Each output waveform shows a vertical rise when fired. *On* time is controlled by selection of the firing point in the half cycle.

Two switches connected back-to-back provide full wave a-c. In a bridge or center-tapped transformer, they supply full wave, pulsating d-c across the load. The d-c can be filtered to desired smoothness.

The controlled rectifier's forward firing point is determined by a d-c control signal in the gate. Without a signal, it will not fire and represents an open circuit. When the gate current exceeds a minimum, the rectifier fires and conducts for the balance of that half cycle. Power is controlled by varying the triggering point during the half-cycle.

Controlled rectifiers and thyratrons use an auxiliary device to generate the firing pulse. Thyratrons, in turn, can be used to fire ignitrons. Firing point of magnetic amplifiers and saturable reactors is set by amount of current through the control winding.

Control signals can be a-c or d-c voltages or currents, a-c and d-c combined, or multiple inputs of a-c, d-c, or a-c and d-c combined. Magnetic amplifiers will accept all of these. Saturable reactors accept all but a-c, unless a-c is rectified.

Controlled rectifiers and thyratrons need a precisely-timed trigger or phase shifting device. Magnetic amplifiers are well-suited for this triggering since they supply a steep vertical wavefront. The amplifier can pass on, sum up or average one or more inputs from transducers, synchros and other devices. A magnetic amplifier between the anode and the gate of a controlled rectifier prevents gate current or voltage from exceeding safe values. All that is needed is a coil in series with a rectifier. Another compact arrangement uses an isolating transformer and a limiting device, providing faster response.

Table I—General Characteristics of High-Speed Power Control Devices

Device	Power Level Range (kw)	Current Range (amp)	Max Voltage Level	Life (in 1,000 hrs)	Oper Temp Range (C)	Voltage Drop (v)	Efficiency (per cent)	Gain	Control	Size, Wt (per kw)	Comparative Cost
Saturable Reactor	1,000's	1,000's	500-1,000	over 100	very wide	5-15	95	low	d-c current	high	moderate
Magnetic Amplifier	100's	100's	200-600	10-100	-65 to +200	5-15	95	high	a-c or d-c cur	high	high
Thyatron	10's	up to 40	1,500-10,000	10-50	-65 to +150	8-12	95	high	phase shifter	moderate	moderate
Ignitron	1,000's	200-500	3,000-20,000	10-20	~ room temp	15	95	low	phase shifter & thyr	moderate	moderate
Controlled Rectifier	10's	up to 50	400	10-100	-65 to +125	0.5-1.5	99	high	phase shifter	very low	high
Cont Rect (future)	1,000's	100's	1,000-5,000	over 100	-65 to +200	0.5-1.5	99	high	phase shifter	very low	very low

# Network Transformations For Wave Filter Design

Tedious network calculations are simplified by useful charts which enable circuit designers to change configuration of two-terminal networks but retain impedance characteristic, and also to alter the element values without changing the configuration or impedance characteristics

By **ANATOL ZVEREV**, and **HERMAN BLINCHIKOFF**,  
Electronics Division, Carrier Microwave Department,  
Westinghouse Electric Corp., Baltimore, Md.

**I**N THE DESIGN of electric wave filters, phase-splitting networks, transformers, preemphasis and deemphasis networks, series and parallel combinations of inductors and capacitors are used to obtain desirable performance. These combinations, commonly referred to as dipoles, may contain from 2 to 6 elements depending on the complexity of the network required.

It is often necessary for the circuit designer to change the configuration of the network employed during development. Sometimes a change is necessary to minimize the high voltages which appear across

the elements of a series circuit at resonance. Some dipoles possess better properties for envelope transmission. These do not introduce much nonlinear distortion and are therefore more suitable for electric wave filters and amplitude correcting networks.

## Changing Configuration

The circuit designer is often required to change the element values of a network while preserving the configuration and the impedance characteristic. On the other hand, he may wish to change the configuration while retaining the imped-

ance characteristic. This may involve some tedious calculations or experimental manipulation.

The charts on the following pages are designed to minimize the time and effort for making such network transformations. Figures 1 through 14 show all possible transformations involving three and four element networks which use a minimum number of coils and capacitors to realize a particular impedance function. These are known as canonic networks. Below each figure are the necessary equations for performing the transformation.

The next chart shows the various impedance functions which are characteristic of each of the networks. The final chart lists the applicable equations for calculating the resonant frequencies associated with each network.

Use of the charts is straightforward, involving simple substitution into the various equations. This method, used as a substitute for the conventional methods of synthesis avoids the algebraic manipulations involved in expansion of partial fractions. The charts usually provide more choices of realizable dipole elements and hence can be regarded as a useful tool in everyday engineering practice.

## SYMBOL KEY

The equations describing the element values of some of the networks can be clarified by the use of more simplified notations. This has been done in the charts by substitution of symbols for some of the more complicated relationships. These symbols represent the following expressions.

(1) The coefficients  $A$ ,  $B$ ,  $D$ , and  $E$  represent various combinations of  $L$  and  $C$ . They can be determined from the applicable equations on the chart.

(2)  $W = A(A - P^2)/P(AD - PE)$        $X = (A - P^2)/(E - PD)$   
 $Y = (AD - PE)/(A - P^2)$        $Z = P(E - PD)/(A - P^2)$

where  $P = \frac{B + \sqrt{B^2 - 4A}}{2}$

(3)  $Q = L_3C_3 + L_3C_4 + L_4C_4 + \sqrt{(L_3C_3 + L_3C_4 + L_4C_4)^2 - 4L_3L_4C_3C_4}$

(4)  $S = L_3C_3 + L_4C_3 + L_4C_4 + \sqrt{(L_3C_3 + L_4C_3 + L_4C_4)^2 - 4L_3L_4C_3C_4}$

EQUIVALENT NETWORKS		EQUIVALENT NETWORKS			
Z-CHARACTERISTIC I	<p>1</p> <p>(A)</p> $L_1 = L_2 \left( \frac{C_3}{C_3 + C_4} \right)^2$ $C_1 = C_4 (1 + C_4 / C_3)$ $C_2 = C_3 + C_4$	<p>2</p> <p>(B)</p> $L_2 = L_1 \left[ (C_1 + C_2) / C_2 \right]^2$ $C_3 = C_2 / (1 + C_1 / C_2)$ $C_4 = C_2 / (1 + C_2 / C_1)$	Z-CHARACTERISTIC III	<p>6</p> <p>(A)</p> $L_1 = W \quad L_2 = X$ $C_1 = Y \quad C_2 = Z$ $A = L_3 L_4 C_3 C_4$ $B = L_3 C_3 + L_4 C_4 + L_3 C_4$ $E = L_3 C_3 C_4 \quad D = C_4$	<p>7</p> <p>(B)</p> $L_3 = (L_1 C_1 - L_2 C_2)^2 / (L_1 + L_2) (C_1 + C_2)^2$ $L_4 = L_1 L_2 / (L_1 + L_2)$ $C_3 = C_1 C_2 (C_1 + C_2) (L_1 + L_2)^2 / (L_1 C_1 - L_2 C_2)^2$ $C_4 = C_1 + C_2$
	Z-CHARACTERISTIC II	<p>2</p> <p>(A)</p> $L_1 = L_4 / (1 + L_3 / L_4)$ $L_2 = L_4 / (1 + L_4 / L_3)$ $C_1 = C_2 \left[ (L_3 + L_1) / L_4 \right]^2$		<p>3</p> <p>(B)</p> $L_3 = L_2 (1 + L_2 / L_1)$ $L_4 = L_1 + L_2$ $C_2 = C_1 \left[ L_1 / (L_1 + L_2) \right]^2$	Z-CHARACTERISTIC III
Z-CHARACTERISTIC III		<p>3</p> <p>(A)</p> $L_0 = L_2$ $C_0 = C_2 C_3 / (C_2 + C_3)$ $L_1 = L_3 (1 + C_3 / C_2)^2$ $C_1 = C_2 / (1 + C_3 / C_2)$	<p>4</p> <p>(B)</p> $L_2 = L_0$ $C_2 = C_1 + C_0$ $L_3 = L_1 \left[ C_1 / (C_1 + C_0) \right]^2$ $C_3 = C_0 (1 + C_0 / C_1)$	Z-CHARACTERISTIC III	
	Z-CHARACTERISTIC III	<p>4</p> <p>(A)</p> $L_0 = L_2 + L_3$ $L_1 = L_2 (1 + L_2 / L_3)$ $C_0 = C_2$ $C_1 = C_3 \left[ L_3 / (L_2 + L_3) \right]^2$	<p>5</p> <p>(B)</p> $L_2 = L_1 L_0 / (L_1 + L_0)$ $L_3 = L_0^2 / (L_1 + L_0)$ $C_2 = C_0$ $C_3 = C_1 \left[ (L_1 + L_0) / L_0 \right]^2$		Z-CHARACTERISTIC IV
Z-CHARACTERISTIC III		<p>5</p> <p>(A)</p> $L_1 = W \quad L_2 = X$ $C_1 = Y \quad C_2 = Z$ $A = L_4 L_3 C_4 C_3$ $B = L_4 C_4 + L_3 C_3 + L_4 C_3$ $E = L_3 C_4 C_3$ $D = C_4 + C_3$	<p>6</p> <p>(B)</p> $L_4 = L_1 L_2 / L_1 + L_2$ $L_3 = (L_1^2 C_1 + L_2^2 C_2)^2 / (L_1 + L_2) (L_1 C_1 - L_2 C_2)^2$ $C_4 = C_1 C_2 (L_1 + L_2)^2 / L_1^2 C_1 + L_2^2 C_2$ $C_3 = (L_1 C_1 - L_2 C_2)^2 / L_1^2 C_1 + L_2^2 C_2$	Z-CHARACTERISTIC IV	

(Continued on p 54)

		EQUIVALENT NETWORKS		EQUIVALENT NETWORKS			
Z-CHARACTERISTIC IV	11	<p>(A)</p> $L_1 = \frac{(L_3 + L_4)(L_3 L_4^3 C_4^2)}{[C_3(L_3 + L_4)^2 + L_4^2 C_4]^2}$ $L_2 = L_3 + L_4$ $C_1 = C_3 \left[ 1 + \frac{C_3}{C_4} \left( \frac{L_3 + L_4}{L_4} \right)^2 \right]$ $C_2 = C_3 \left[ 1 + \frac{C_4}{C_3} \left( \frac{L_4}{L_3 + L_4} \right)^2 \right]$	<p>(B)</p> $L_4 = L_2 / 1 + \frac{L_1}{L_2} \left( \frac{C_1 + C_2}{C_2} \right)^2$ $L_3 = L_2 / 1 + \frac{L_2}{L_1} \left( \frac{C_2}{C_1 + C_2} \right)^2$ $C_3 = C_1 C_2 / (C_1 + C_2)$ $C_4 = \frac{[L_1(C_1 + C_2)^2 + L_2 C_2^2]^2}{L_2^2 C_2^2 (C_1 + C_2)}$	Z-CHARACTERISTIC IV	13	<p>(A)</p> $C_1 = W \quad C_2 = X$ $L_1 = Y \quad L_2 = Z$ $A = L_3 C_3 L_4 C_4$ $B = L_3 C_3 + L_4 C_4 + L_3 L_4$ $E = L_3 L_4 C_3$ $D = L_3 + L_4$	<p>(B)</p> $L_3 = \frac{(L_1 C_1 - L_2 C_2)^2}{L_1 C_1^2 + L_2 C_2^2}$ $L_4 = \frac{L_1 L_2 (C_1 + C_2)^2}{L_1 C_1^2 + L_2 C_2^2}$ $C_3 = \frac{(L_1 C_1^2 + L_2 C_2^2)^2}{(L_1 C_1 - L_2 C_2)^2 (C_1 + C_2)}$ $C_4 = C_1 C_2 / (C_1 + C_2)$
	Z-CHARACTERISTIC IV	12	<p>(A)</p> $C_1 = W \quad C_2 = X$ $L_1 = Y \quad L_2 = Z$ $A = L_3 L_4 C_3 C_4$ $B = C_4 L_4 + C_3 L_3 + L_4 C_3$ $E = L_3 L_4 C_3$ $D = L_4$		<p>(B)</p> $L_3 = \frac{L_1 L_2 (L_1 + L_2) (C_1 + C_2)^2}{(L_1 C_1 - L_2 C_2)^2}$ $L_4 = L_1 + L_2$ $C_3 = \frac{(L_1 C_1 - L_2 C_2)^2}{(C_1 + C_2) (L_1 + L_2)^2}$ $C_4 = C_1 C_2 / (C_1 + C_2)$	Z-CHARACTERISTIC IV	14

IMPEDANCE CHARACTERISTICS

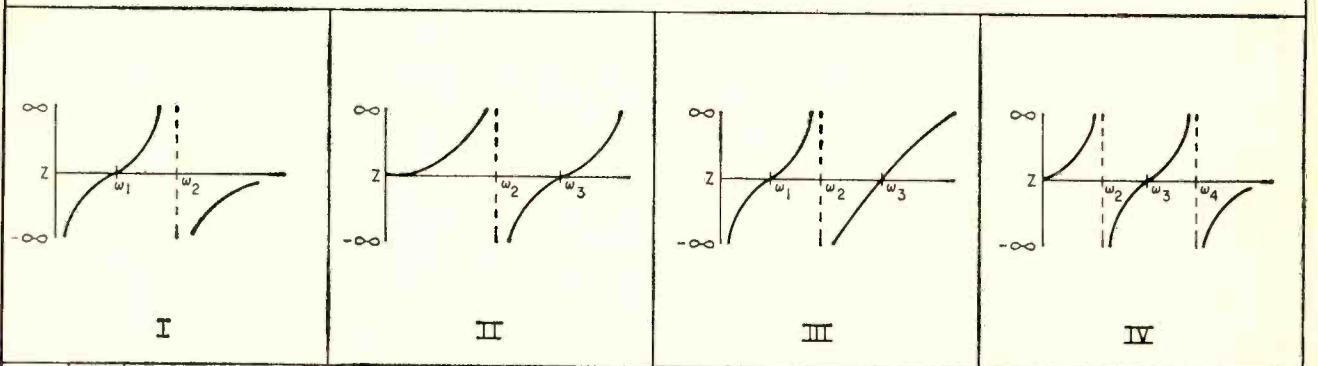

Z-CHAR	FIG	FREQUENCY EQUATIONS			
		$\omega_1^2$	$\omega_2^2$	$\omega_3^2$	$\omega_4^2$
I	1A	$1/L_1(C_1 + C_2)$			
I	1B	$1/L_2 C_3$			
II	2A		$1/L_1 C_1$		
II	2B		$(C_3 + C_4) / L_2 C_3 C_4$		
III	5A	$1/L_2 C_2$			
III	6B	$2/Q$	$1/(L_3 + L_4) C_2$		
III	7B	$2/S$	$(C_1 + C_2) / (L_1 + L_2) C_1 C_2$		
III	5B	$2/S$	$1/L_3 C_3$		
IV	12A		$1/(L_3 + L_4) C_3$		
IV	12B		$(C_3 + C_4) / L_3 C_3 C_4$		
IV	13B		$1/L_2 C_2$		
IV	14B		$2/S$		
			$2/S$		
			$2/S$		
			$1/L_4 C_4$		
			$(L_3 + L_4) / C_3 L_3 L_4$		
			$1/L_3 (C_3 + C_4)$		
					$1/L_1 C_1$
					$S/2 L_4 C_4 L_3 C_3$
					$S/2 L_4 C_4 L_3 C_3$
					$S/2 L_4 C_4 L_3 C_3$





**NOW**

**3**

**NEW TRANSISTOR  
BASE ASSEMBLIES**



**TYPE 519**

**SPECIFICATIONS**

- .071 Pin Circle
- .018 Pin Diameter
- .500 Pin Below Flange
- .138 Eyelet Body Diameter
- .200 Eyelet Flange Diameter
- .010 Kovar Mat'l
- with or without ground pin or blind pin



**TYPE 520**

**SPECIFICATIONS**

- .100 Pin Centers
- .018 Pin Diameter
- .500 Pin Below Flange
- .443 Flange Diameter
- #6-32NC Copper Stud
- .012 Kovar Mat'l



**TYPE 521**

**SPECIFICATIONS**

- .100 Pin Circle
- .018 Pin Diameter
- .500 Pin Below Flange
- .166 Eyelet Body Diameter
- .210 Eyelet Flange Diameter
- .008 Kovar Mat'l
- with or without ground pin or blind pin

These new transistor bases supplement Constantin's expanding line of semiconductor base designs now numbering well over 500 configurations.

By far the largest existing selection, many of these designs are available on open tooling.

**Original Equipment Manufacturers:**  
**Design and Packaging Engineers:** Let us help solve your problems. The engineering facilities, skills and experience responsible for these designs stand ready to help you grow.



*L.L. Constantin & Co.*

RT. 46, LODI, N. J.

SADDLE BROOK, N. J.

**MANUFACTURING  
ENGINEERS**



# Transformerless Supplies

Heater voltage for one- or two-tube circuits can be obtained from line supply by placing capacitor in series with heater circuit. This technique eliminates much of the power dissipated by series dropping resistors

By **F. G. KELLY**, Senior Electronic Engineer, Hallamore Electronics Co., Anaheim, Calif.

**O**CCASIONALLY, it is desirable to avoid using transformers or dropping resistors for one- or two-tube circuit heater supplies. In such cases, a nonelectrolytic type capacitor may be used in series with the tube heater, as shown in Fig. 1, to drop the line voltage to the required level.

The nomogram in Fig. 2 aids the rapid determination of the capacitor size from the equation  $C = I_h \times 10^6 / [2 \pi f (117 - E_h)]$ , where  $C$  is in  $\mu\text{f}$ ,  $I_h$  is heater current in amp,  $f$  is power line frequency in cps and  $E_h$  is heater voltage.

### Example

Assume that a 12AU7 will be operated with the series-connected heater connection at 12.6 v at 150 ma from a 60-cps source. From 60 on the  $f$  scale extend a line through the 150 on the  $I_h$  scale to the middle scale. From this point draw a line to 12.6 on the voltage scale to intersect the capacitor scale at 3.8  $\mu\text{f}$ .

When the line frequency is 400 or 60 cps, as in this case, the first step may be omitted and the nomogram can be entered on the proper side of the middle scale at the pertinent heater current.

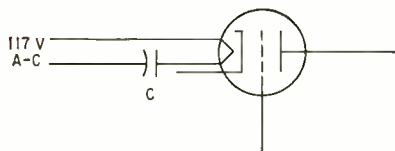

FIG. 1—Basic voltage dropping circuit

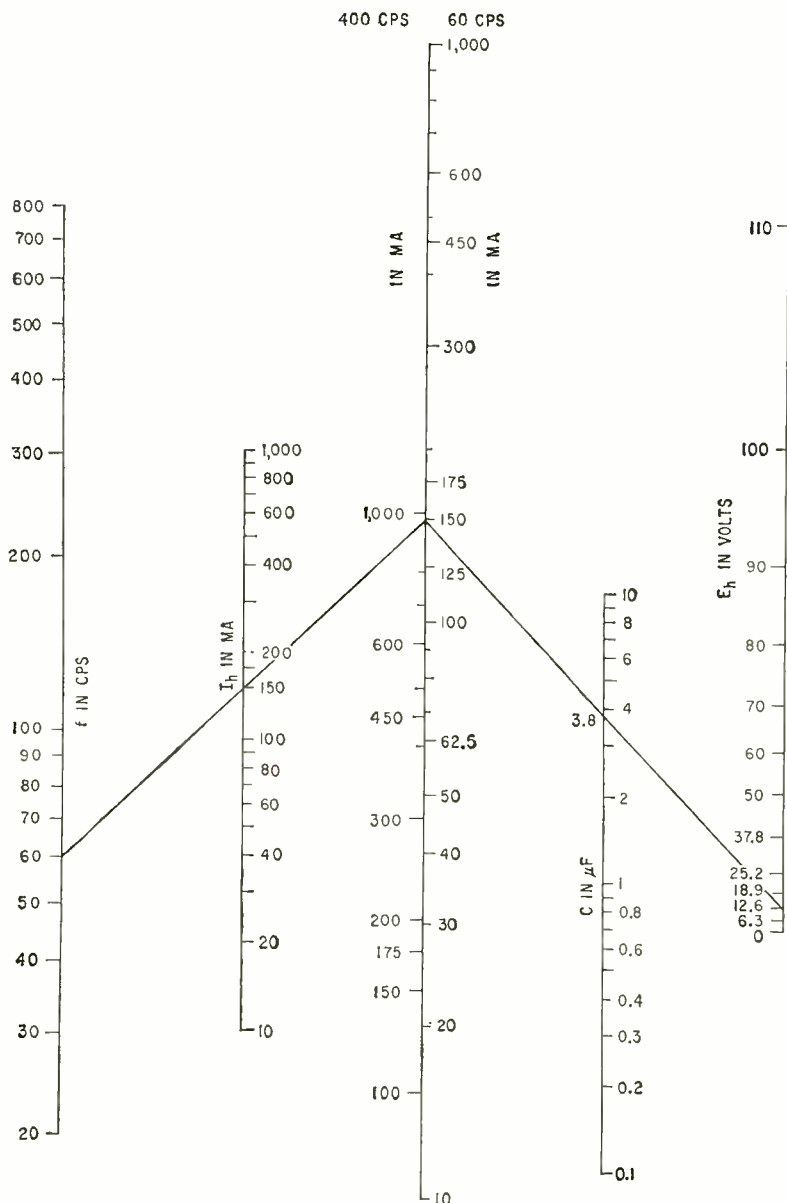
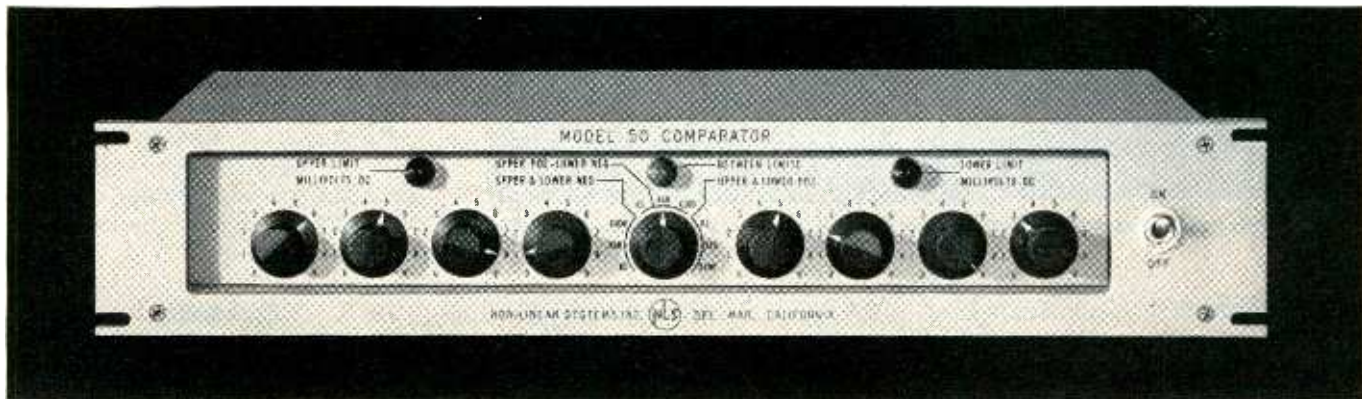

FIG. 2—Nomogram aids solving of equation for dropping capacitor reactance

# INSTANT INDICATION OF VOLTAGE TOLERANCE



## *with the NLS 50 Go/No-Go Voltage Comparator*

Here's a new method for determining whether or not an input voltage is within prescribed limits . . . and to do so quickly, easily and accurately! Just set the front panel dials of the NLS 50 Voltage Comparator to read any two voltages within the range of  $\pm 0.001$  to  $\pm 999.9$  volts. Apply the voltage under test and in 90 milliseconds the NLS 50 gives a clear go/no-go indication of voltage tolerance. Watch the limit lamps on the front panel. If the green "Between Limits" lamp lights, the applied voltage lies within the pre-set limits. If either of the red lamps light—"Upper Limit" or "Lower Limit"—the voltage under test is too high or too low.

With a sensitivity of 0.005% and its limit settings precise to  $\pm 0.01\%$ , the NLS 50 Voltage Comparator outperforms any other type of voltage limit detector. It's transistorized, too . . . for reliability and ruggedness. And it's so compact . . . the only limit detector complete in one package. Comparison amplifier, limit setters, reference supplies and range multiplier are all included in the one instrument, a 3½-in. high unit that fits conveniently into a standard 19-in. rack.

In addition to giving visual warning to the operator, the NLS 50 gives go/no-go commands to such electrical devices as cut-off relays, sorting chutes, data printers, tape or card

punches, and audible warning equipment. Extremely versatile, the instrument may be used as a high-accuracy voltmeter without modification and may be adapted easily to detect resistance limits.

The broad applications of the NLS 50 Voltage Comparator include the following:

- Automatic checkout of missiles and electronic systems.
- High-speed, high-accuracy warning systems involving any parameter that can be converted to voltage (speed, temperature, liquid level, distance, angle, acceleration, magnetism, weight, pressure, flow, light or other radiation flux).
- Automatic component test equipment for testing resistors, relays, diodes, transistors, vacuum tubes, batteries, tachometers, motors, speed regulators and slip rings.
- Automatic process control, receiving inspection, production quality control.

Write today for more detailed information concerning the capabilities, applications and operation of the new NLS 50 Go/No-Go Voltage Comparator.

PRICE \$1775<sup>00</sup> COMPLETE • F.O.B. DEL MAR



*Originators of the Digital Voltmeter*

**non-linear systems, inc.**

DEL MAR (San Diego), CALIFORNIA

NLS — Digital Instruments That Work . . . And Work . . . And Work!

# Wax Models Speed Antenna Design

By WILLIS E. JUNKER, Electronics Engineer, Convair Div. of General Dynamics Corp., San Diego, Calif.

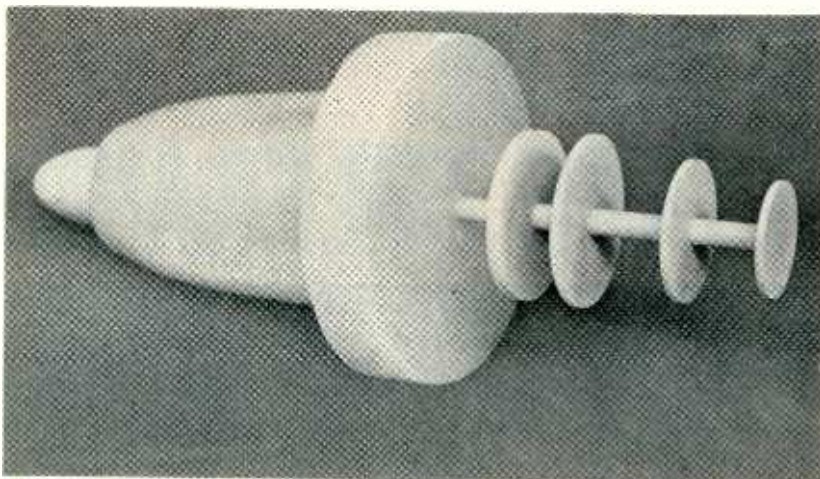

Dielectric structure formed of paraffin permits fast, low-cost tests of radical antenna designs

DESIGNING broadband dielectric antennas usually requires choosing physical parameters dictated either by experience or standard data. The narrow choice limits freedom to experiment with radical designs.

While having a valid engineering basis, radical designs in many cases are neglected because of fabrication costs and time required. When standard design approach is not feasible, materials such as Teflon or polystyrene are used or a highly involved mathematical analysis is programmed, requiring expensive computer time.

Our antenna research group recently faced a problem requiring rigid antenna design parameters beyond the scope of standard approaches. A low-cost, fast solution was evolved using household paraffin (wax) as the dielectric material. Ordinary paraffin has a dielectric constant similar to Teflon.

Paraffin provided a highly flexible medium that permitted minor changes and eliminated need for special orders for dielectric materials. The only tools required are a small sharp knife and a metal straight edge. If the actual process of forming the wax structure is controlled with reasonable care, there is a high degree of repeatability.

The product was a broadband coaxial feed lens based on a design

for which a mathematical analysis would have been time-consuming and costly. The first models were crudely made, using almost any available form close to the desired shape. The model was then either shaped with a knife or wax was added. The models did not give symmetrical patterns, but they did provide keys to techniques of pattern synthesis that later permitted fabrication of efficient polyrods and lenses.

In a polyrod or lens, homogeneity of the dielectric is important. Air bubbles, impurities and fractures yield spurious results in the radiation pattern, generally characterized by unbalanced side lobes or an asymmetrical main beam.

### Pattern Check

If the rod is mounted in a circular guide, the rod can be rotated and the pattern checked. Rotation will either increase or decrease unbalance of the side lobes. Faults that cause an asymmetrical main beam can be rotated out so that a perfectly balanced main beam is obtained if there is only one fault causing the asymmetry.

With proper construction, the radiation pattern will be the true pattern, which can be checked by rotating the rod to several positions and comparing patterns. Unbalance in the pattern can be attrib-

uted to a fault in the wax if the pattern range is free of reflections.

To eliminate these sources of error, a specially constructed mold was made from Hydracal, a low shrinkage plaster. One-quarter inch from the inner surface, a nickel heating wire was imbedded in a spiral fashion around the mold. By concentrating the number of turns in the heating element at the top of the mold, temperature gradient from top to bottom caused the lower portion of the mold to cool first. This arrangement allows all air in the liquid to escape instead of being trapped below a prematurely solidified upper surface.

### Preheating

The form was preheated for an hour before pouring the wax into it. When air bubbles stopped coming to the surface, the heating element was turned off and the wax allowed to cool overnight.

Silicone grease, applied to the inner walls of the mold prior to the preheating, facilitated removal of the form. The grease has a melting point much higher than wax, eliminating danger of the grease combining with the wax to form impurities.

The coat of grease must be very thin and even to avoid causing small ridges in the product. The usual requirement for a one-percent draft in the mold is eliminated. The mold can be fabricated in one piece with vertical walls, eliminating seam lines and reducing cost.

Improper cooling of the poured wax can easily ruin the product. For large items, two methods of cooling were found satisfactory. In one method, the wax is cooled at room temperature for a period of not less than twenty-four hours. The other, blowing precooled air over the mold, is difficult and may result in fractures or distortions caused by too rapid cooling.

Paraffin molding is impractical for small vhf polyrods or lenses. Even moderate handling causes deformation and low repeatability. For small items, the cost of Teflon

*first in  
Performance  
Reliability  
and Quality*

# Kepeco

## TRANSISTORIZED V.R.P.S.\*

\*VOLTAGE  
REGULATED  
POWER  
SUPPLIES

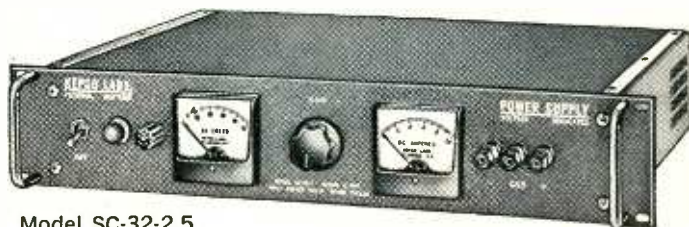

Model SC-32-2.5



Model  
SC-18-2M

**0.1% REGULATION  
STABILITY**

MODEL	DC OUTPUT VOLTS	DC OUTPUT AMPS.
SC-18-0.5	0-18	0-0.5
SC-18-1	0-18	0-1
SC-18-2	0-18	0-2
SC-18-4	0-18	0-4
SC-36-0.5	0-36	0-0.5
SC-36-1	0-36	0-1
SC-36-2	0-36	0-2
SC-3672-0.5	36-72	0-0.5
SC-3672-1	36-72	0-1

the most  
complete  
line of  
POWER  
SUPPLIES

**Kepeco**  
offers more than  
120 standard voltage  
regulated power supplies  
covering a wide range  
of transistor, tube  
and magnetic types.

For complete specifications,  
write for Brochure B-591



Model  
PSC-10-2

**0.01% REGULATION  
STABILITY**

MODEL	DC OUTPUT VOLTS	DC OUTPUT AMPS.
SC-32-0.5	0-32	0-0.5
SC-32-1	0-32	0-1
SC-32-1.5	0-32	0-1.5
2SC-32-1.5	0-32	0-1.5
DUAL OUTPUT	0-32	0-1.5
SC-32-2.5	0-32	0-2.5
SC-32-5	0-32	0-5
SC-32-10	0-32	0-10
SC-32-15	0-32	0-15
SC-60-2	0-60	0-2
SC-60-5	0-60	0-5
2SC-100-0.2	0-100	0-0.2
DUAL OUTPUT	0-100	0-0.2
SC-150-1	0-150	0-1
SC-300-1	0-300	0-1

**0.02% REGULATION  
STABILITY**

**COMPACT PACKAGE TYPE**

MODEL	DC OUTPUT VOLTS	DC OUTPUT AMPS.
PSC- 5-2	0- 7.5	2
PSC-10-2	7.5-12.5	2
PSC-15-2	12.5-17.5	2
PSC-20-2	17.5-22.5	2
PSC-28-1	22.5-32.5	1
PSC-38-1	32.5-42.5	1



**Kepeco INC.**

131-38 SANFORD AVENUE • FLUSHING 55, N.Y. • INDEPENDENCE 1-7000

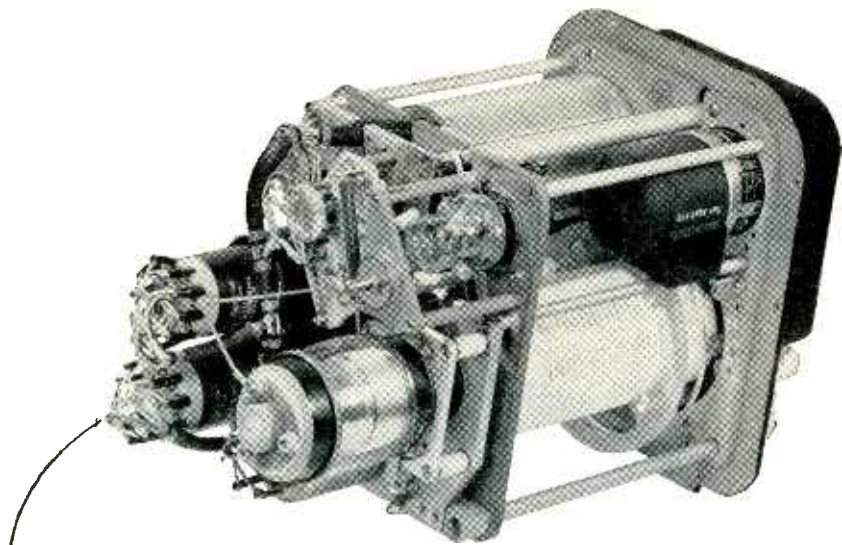

## JENNINGS VACUUM RELAYS AND CAPACITORS

*...when reliability counts*



*Jennings Vacuum Relays and Variable Capacitors play an important role in the Air Force's "Project Sideband," aimed at constant radio contact on intercontinental missions.*

The high standards of reliability and performance required by the Air Force were more than met by Collins Radio Company's new 1 KW SSB system for "Project Sideband." The airborne end of the system, designated ARC-58, includes an automatically tuned antenna coupler. Jennings vacuum relay, RB3, and vacuum variable capacitor, USLS 465, are used in the coupler to match the 52 ohm impedance of the equipment with the antenna.

Jennings vacuum components were chosen for their recognized ability to withstand high voltage in limited space applications. The Type RB3 vacuum

transfer relay is designed to meet peak voltages of 15 kv and rf currents to 15 amps yet it is only 3¼ inches long. The relay also has an auxiliary set of low voltage contacts for control purposes designed to operate after and release before the high voltage set. The Type USLS 465 is only 5 inches long and will withstand 10 kv at its minimum capacity of 5 mmfd and 5 kv at its maximum capacity of 465 mmfd. Both units will withstand 10G vibration to 500 cycles, 30G shock, and 50 hours salt spray.

**Send for catalog literature on Jennings complete line of vacuum capacitors and relays.**



USL-S-465  
VACUUM  
VARIABLE  
CAPACITOR



TYPE RB3  
VACUUM  
TRANSFER  
RELAY

JENNINGS RADIO MANUFACTURING CORPORATION  
970 McLAUGHLIN AVE., P. O. BOX 1278 SAN JOSE 8, CALIF

*Jennings*

is low and its use is recommended.

The author wishes to acknowledge the assistance of G. Regnier.

## Setup Measures Resistor Noise

METHOD has been developed by the National Bureau of Standards to evaluate the noise quality of fixed composition resistors. Noise quality of a resistor is determined by measuring the increase in the mean fluctuation voltage at the terminals of a sample resistor when d-c is passed through it.

Two meters in the test set, one indicating average noise and one applied d-c, can be read in db for readily computing an index of noise quality or conversion gain.

All resistors exhibit noise which appears as a fluctuating voltage at their terminals. Spectral density of their thermal noise depends only on temperature and resistance. When d-c is passed through a granular-type resistor, an additional fluctuating voltage, called current noise, appears at the resistor terminals. Spectral density of current noise depends on type of resistive material, fabricating process and structure, and size and shape of the resistor. In general, spectral density is also a function of frequency. For a typical resistor at 1,000 cps, current noise spectral density may be 1,000 times thermal noise spectral density.

### Test Set

The noise test set consists principally of modified, readily available laboratory measuring equipment. A shielded box holds the resistor under test. The set accommodates resistors over the range of at least 100 ohms to 20 megohms, and provides an adjustable d-c power source having maximum voltage of about 400 v with currents up to 100 ma.

The test set measures conversion gain, the quantity recommended for evaluating noise quality. Conversion gain is the ratio of available current noise power to applied d-c power in db. It is a measure of the efficiency with which a resistor converts applied d-c power to noise—the more efficient the conversion,

the poorer the noise quality.

The center frequency of the pass band used in measuring conversion gain is 1,000 cps. Since current noise varies inversely with frequency, measurement of conversion gain would be expected to vary in a similar manner.

#### Operation

The test set measures current noise in terms of rms voltage across the resistor. The instrumentation is so arranged that the value of the conversion may be calculated from attenuator settings and meter readings. Where current noise is small compared to noise in the measuring system, a correction is introduced.

Separate units of the system are connected with shielded cables. A variable d-c supply furnishes d-c loading power to the test resistor through an isolating resistor. This resistor, wire wound so that it does not generate current noise, prevents low output impedance of the d-c supply from effectively shorting the terminals of the test resistor. D-c voltage applied to the test resistor is measured by an electrometer with a specially calibrated scale. Its extremely high input impedance permits simultaneous measurement of d-c voltage and noise.

A modified sound level meter—essentially an a-c voltmeter—contains a high-gain amplifier with a narrow pass band centered at 1,000 cps. It has an output measuring circuit consisting of a linear detector, integrator and meter for reading mean detector current. A signal generator, with associated voltmeter and attenuator and a dividing network in the resistor holder, comprise a calibrating circuit.

In determining conversion gain of a resistor sample, the equipment is first calibrated. Noise present in both the resistor and measuring circuit is then measured before applying d-c power to the resistor. The resulting observation indicates background or set noise. A second noise measurement is made while d-c power is applied to the resistor. This result indicates set noise plus current noise. Current noise is computed from the difference between set and total noise. When combined with measured d-c power used, it gives the value of conversion gain.

# FOR THE MOST DELICATE MOVING JOBS IN THE WORLD

## BEKINS *Certified* ELECTRONICS MOVING SERVICE

To meet the challenge of the fast-growing Electronics industry, Bekins has invested heavily to provide safe, swift transportation for delicate, costly electronic equipment. To guarantee efficient, extra-careful handling, Bekins has developed a special Certified Electronics Moving Service.

CERTIFIED TRAINED MEN  
CERTIFIED SUPERVISION  
CERTIFIED ELECTRONICS VANS  
CERTIFIED MOVAMATIC EQUIPMENT



**BEKINS**  
Since 1891  
**VAN LINES CO.**  
Electronics Moving Division

CERTIFIED SERVICE MAKES THE DIFFERENCE

# Flexible Coaxial Cable Takes 1,000 F

By CHARLES CAMILLO, Chief Engineer, Cable and Wire Division, Amphenol-Borg Electronics Corporation, Chicago

A MAJOR BREAKTHROUGH in cable design is a highly flexible coaxial cable that can withstand 1,000 F temperatures generated in manned supersonic and hypersonic air-breathing vehicles.

Developed by the Cable and Wire Division of the Amphenol-Borg Electronics Corp., each cable is a completely sealed r-f transmission system that consists of inner and outer conductors separated by a dielectric of modified semi-solid silica. Over all is a protective sealed metallic convoluted jacket. Each end of the cable is sealed at the factory with a hermetic seal that incorporates screw threads for r-f connectors.

Electrical and physical information on the new high-temperature cable is given in Table I. Electrical performance compares favorably with standard coaxial cables. Characteristic impedance, capacitance per foot and velocity ratio are the



Attenuation values of cable system are being determined at 1,000 F. Cable system has been inserted in oven at left. Impedance transformers are shown at each end of the assembly

**Table I—Cable Characteristics**

Cable overall dia.....	0.525 in.
Capacitance .....	30 $\mu$ f/ft. nom.
Characteristic impedance..	50 $\pm$ 2 ohms
Connectors*	
Weight of Type N plug...	2.5 oz. ea.
Corona extinction....	1,000 v rms min.
Dielectric strength...	3,500 v rms min.
Flexibility.. bend dia.	10 $\times$ dia. of cable
Lengths available .....	up to 200 ft.
Nuclear radiation resist....	excellent
Velocity ratio .....	69 percent nom.
Weight of cable.....	17.5 lbs/100 ft.

\* Other connector types will be available.

**Table II—Attenuation vs Freq**

Freq. (mc/sec)	Attenuation in db/ft.		
	68 F	700 F	1,000 F
100	2.3	4	5
200	3.3	5.5	6.9
400	5	8.2	10
1,000	10	16	19
2,000	19.8	na	34
3,000	30	40	48

same as for cables with Teflon dielectrics.

Attenuation values are given in Table II. Attenuation versus frequency at room temperature is typical of standard coaxial cables. At 700 F and 1,000 F, the attenuation rises to values well within practical limits.

Since the cable is factory-terminated, uniformity of performance is vastly improved. The system

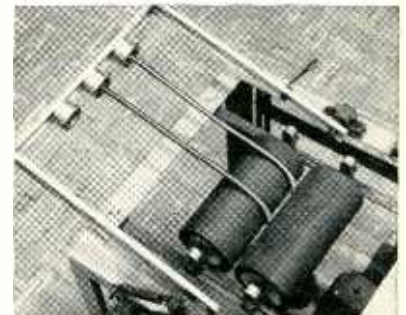

Cable has been flexed 30,000 times over 10X mandrels of flexing-endurance machine without dielectric deterioration



Close-up of complete assembly. Center contact screws on the threaded extension of center conductor in hermetically-sealed termination. Connector body screws on directly to termination. Bodies and contacts are interchangeable male or female Series N, C or SC

vswr is therefore not subject to varying methods of assembly of cable and connectors.

### Flexibility

An important design feature of the cable is its extreme flexibility. Flexing and endurance tests were conducted per MIL-C-915 with samples being bent first 90 deg. in one direction and then 90 deg. in the opposite direction over five-inch diameter mandrels. After 30,000 cycles the dielectric showed no



**Where other materials fail  
our work begins...**

# The world's most NEARLY PERFECT electronic insulation materials . . . . .

Whatever your high temperature needs—to 1550°F—there is a Mycalex insulation to meet them . . . each offering a *unique combination* of special advantages for electronic design: the *plus* factors of the inorganics *and* the design latitudes of the organics!

**MYCALEX® glass-bonded mica**—formulations of high quality natural mica and electrical grade glasses, with high dielectric strength, total dimensional stability, high arc resistance, high temperature resistance. Depending on their formulation, they can be machined or molded to exacting tolerances, inserts can be permanently molded in or cemented in—the thermal expansion of MYCALEX being close to that of stainless steel.

**SUPRAMICA® ceramoplastics**—advanced formulations of synthetic mica and high temperature glasses, created for insulation applications at operating temperatures up to 1550°F. They have a thermal expansion coefficient close to that of stainless steel. They are available in moldable or machinable types . . . both offering *total* dimensional stability.

**SUPRAMICA 555**—Precision-molded insulation, for operating temperatures to 700°F.

**SUPRAMICA 560**—Precision-molded insulation, for operating temperatures to 932°F. (500°C.)

**MYCALEX 410**—Precision-molded insulation, for operating temperatures to 600°F.

**MYCALEX 410X**—Lightweight precision-molded insulation material.

**SUPRAMICA 500**—Machinable insulation, for operating temperatures to 850°F.

**SUPRAMICA 620**—Machinable insulation, for operating temperatures to 1550°F.

**MYCALEX 385**—Machinable insulation, for operating temperatures to 700°F.

**MYCALEX 400**—Machinable insulation, for operating temperatures to 800°F.

*General Offices and Plant: 120-D Clifton Blvd., Clifton, N.J.  
Executive Offices: 30 Rockefeller Plaza, New York 20, N.Y.*

WORLD'S LARGEST MANUFACTURER OF GLASS-BONDED MICA AND CERAMOPLASTIC PRODUCTS

ELECTRONICS • JUNE 26, 1959

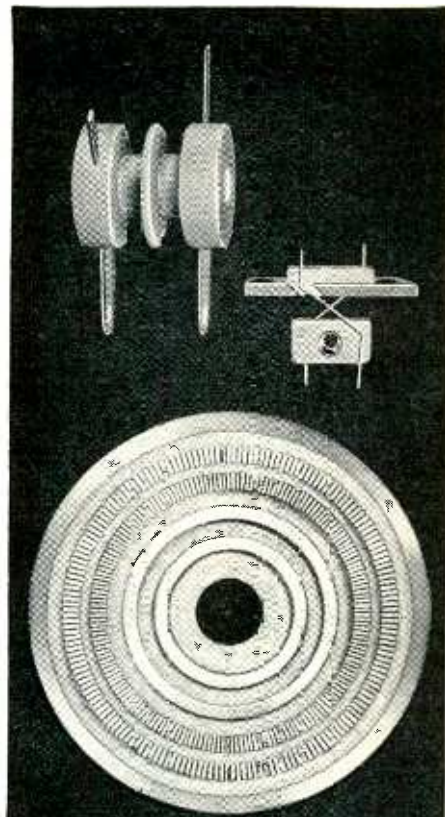

FOR PRECISION-MOLDED PARTS

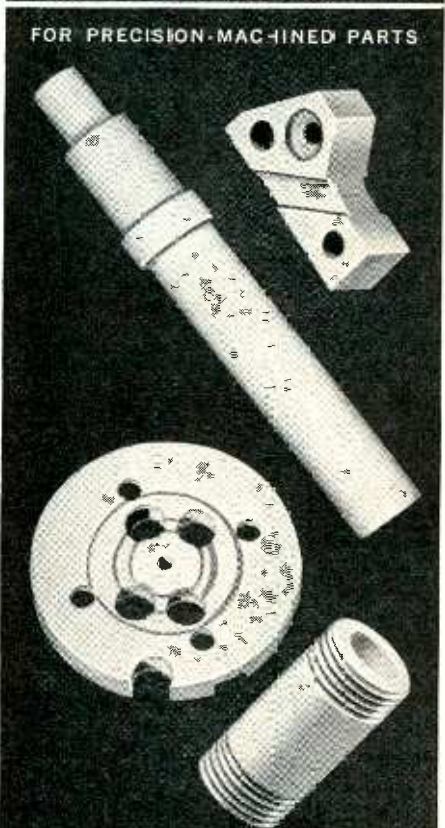

FOR PRECISION-MACHINED PARTS

**MYCALEX**  
CORPORATION OF AMERICA

THE FINEST SYNTHAMICA SYNTHETIC MICA  
SINCE 1919 MYCALEX THE INSULATOR  
THE FINEST SUPRAMICA CERAMOPLASTIC

CIRCLE NO. 65 READER SERVICE CARD 65

## Bristol miniature pressure switch

features ultra-reliable precision pressure element. Exclusive design provides outstanding resistance to shock, vibration, acceleration and overpressures.

These Bristol miniatures, widely proved in modern aircraft, are designed for switching electrical circuits in response to pressure changes in air, fuels, lubricants, hydraulic fluids, other gases and liquids.

Bristol's specially designed Ni-Span element is silver brazed to the stainless steel base assuring greater reliability than ordinary soft-soldered construction. Result: accurate, reliable, repeatable performance in any position, at temperatures from  $-65^{\circ}\text{F}$  to  $+250^{\circ}\text{F}$ , and under Mil Spec environmental requirements.

Write for Bulletin AV2010 on Bristol Miniature Gage and Absolute, Adjustable and Differential Switches. The Bristol Company, Aircraft Components Division, 152 Bristol Road, Waterbury 20, Conn.

B. 44



### SPECIFICATIONS (Fixed pressure setting models)

**Normal Working Range** — 0 to 100 psi absolute, gage, or differential

**Burst Pressure** — exceeds 250% of normal working pressure

**Electrical Ratings** — 5 amp at 125 v, 60 cycle, inductive or resistive  
4 amp at 30 vdc resistive  
2.5 amp at 30 vdc inductive

**Dielectric Strength** — 500 v rms between terminals and from terminals to case (MIL-S-8801)

**Life at Rated Electrical Load** — 40,000 cycles at 125 vac  
25,000 cycles at 28 vdc

**High Temperature Exposure & Operating** — (MIL-S-8801)  $250^{\circ}\text{F}$

**Low Temperature Exposure & Operating** — (MIL-S-8801)  $-65^{\circ}\text{F}$

**Shock, 30 g, 3 axes** — (MIL-S-8801) no change

**Vibration** — (MIL-S-8801) no contact chatter, no switch damage

300-600 cpm at 0.050" d.a. — set point change — none  
operating differential change — none

600-4500 cpm at 0.036" d.a. — set point change —  $1/4$  psi  
operating differential change —  $1/2$  psi

4500-30,000 cpm at 10 g — set point change —  $1/4$  psi  
operating differential change —  $1/2$  psi

Diameter — 1-5/16

**BRISTOL** FINE PRECISION INSTRUMENTS  
FOR OVER 69 YEARS

change in physical characteristics or insulation resistance.

Bending over the 10X mandrel required very little force and the bend diameter has no effect on the performance of the system.

As a completely sealed r-f transmission system, this cable design fixes the responsibility of critical assembly of numerous components upon one manufacturer and provides increased reliability. Particularly important in r-f, this approach has been utilized with considerable success in ECM systems for the Air Force.

## High-Fired Ceramic

PURE BERYLLIUM OXIDE, a high-fired ceramic body, is now available for use in applications at close to 4,600 F. Thermal conductivity about that of brass, coupled with a high electrical resistivity, make this material suitable for applications in wave guide windows, electron-tube spacers, heat sink and reactor moderator applications, and many other critical electronic areas.

High-density ceramic bodies, such as pure beryllium oxide, are available from National Beryllia Corp., North Bergen, N. J. Their trade name for beryllium oxide is Berlox.

In the nuclear fission field, Berlox atoms present small cross sections to neutrons similar to carbon and oxygen and are particularly suitable for reactor moderators since the neutrons produced are moderately scattered by beryllia and become available for additional reactions.

## Image Intensifier

LIGHT IMAGES as low as  $10^{-7}$  foot-candles can be intensified over 1,000 times with the Westinghouse Type WL-7257, now available from the Westinghouse Electronic Tube Division, Elmira, New York.

Most important use of the new device may be in the nuclear field, where the tube will permit photographic records of atomic particle reactions. Two University of Michigan physicists, M. L. Perl and L. W. Jones, have already used the tube in a luminescent chamber system to produce photographs of light from



the path of a single atomic particle.

In astronomy, the image tube can further intensify the output of giant telescopes when viewing very faint stars, or it could be used in satellites to obtain pictures of distant stars and galaxies.

Four of the tubes, feeding into each other with lenses, would be able to produce a picture of a single photoelectron.

Electrical and mechanical data of this tube are presented below.

**TABLE I**  
**Image Tube, WL-7257**

ELECTRICAL	
Gain with 30kv on anode screen, approx. image minification gain.....	25
Light quantum gain:	
with 2,870 k tungsten input.....	50
with actinic blue input.....	100
Optical minification ratio.....	5 to 1
Input resolution.....	75 line pairs/in.
Photocathode illumination threshold for imaging.....	approx $10^{-7}$ ft.C
MECHANICAL	
Max. dia.....	8-11/16 in.
Max. length.....	15 3/4 in.
Max. use photocathode dia.....	5 in.
Max. use output screen dia.....	1 in.
Net weight.....	6 1/8 lbs.
MAXIMUM RATES	
Absolute max values	
Anode screen to photocathode v.....	30 max kv
Peak pulse anode screen current.....	1 max. ma
TYPICAL OPERATING CONDITIONS	
Photocathode and first lens element grounded.....	
Anode screen voltage.....	20 to 30 kv
Fifth lens element.....	13.9 to 16.4 percent of anode v.
Fourth lens element.....	40 percent of 5th lens element v.
Third lens element.....	8 percent of 5th lens element v.
Second lens element.....	3 percent of 5th lens element v.
Approx. anode screen current with: $10^{-3}$ foot candle input to tube.....	1 to 2 $\mu$ amps

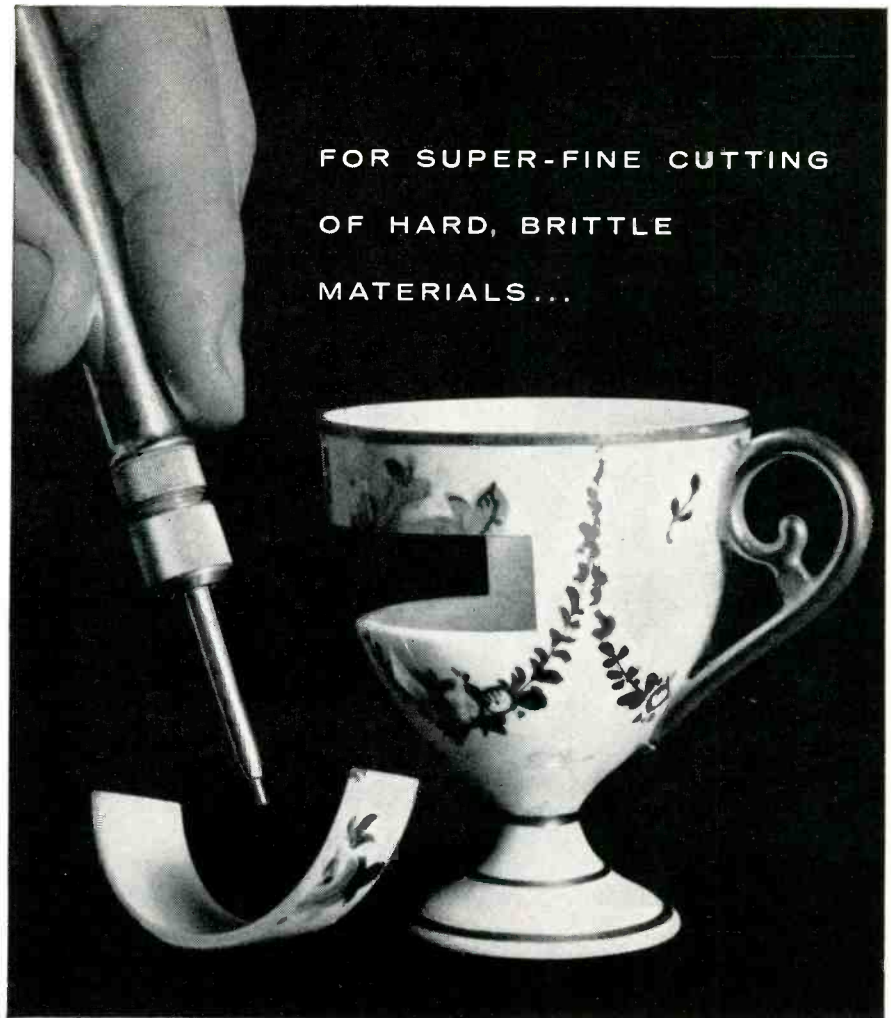

FOR SUPER-FINE CUTTING  
OF HARD, BRITTLE  
MATERIALS...

## THE *S.S. White* Industrial Airbrasive Unit

We don't recommend slicing up the family's fine Limoge China, but this does illustrate the precisely controlled cutting action of the S. S. White Airbrasive Unit. Note how clean the edge is, and how the delicate ceramic decoration is unharmed.

The secret of the Airbrasive is an accurate stream of non-toxic abrasive, gas-propelled through a small, easy-to-use nozzle. The result is a completely *cool* and *shockless* cutting or abrading of even the most fragile hard materials.

Airbrasive has amazing flexibility of operation in the lab or on an automated production line. Use the same tool to frost a large area or to make a cut as fine as .008"!. . . printed circuits... shaping and drilling of germanium and other crystals... deburring fine needles... cleaning off oxide coatings... wire-stripping potentiometers... engraving glass, minerals, ceramics. Jobs that were previously thought impossible are now being done.



Send us samples and specs on your difficult jobs and let us test them for you.

SEND FOR BULLETIN 5705A... complete information.

# *S.S. White*



S. S. White Industrial Division  
Dept. EU, 10 East 40th Street, New York 16, N. Y.  
Western Office: 1839 West Pico Boulevard, Los Angeles 6, California

# Induction Brazing in Inert Gases



Terminals are soldered into 2 gyroscope pickoff and null adjustment housings. Operation takes 10 seconds at temperature of 400 F

HIGH-FREQUENCY INDUCTION brazing, soldering, sintering or tempering of components can be carried out in inert gas atmospheres through a bell jar setup equipped with automatic controls.

The facility shown is used at Raytheon's Missile Systems Division, Lowell, Mass. There are 4 similar setups on a single work table. Each setup operates independently.

All 4 stations are supplied heating power from a 7.5 kw h-f generator. Power used is preset at each station by a local rheostat. Each station has an air-operated switch controlled by the timer. The air cylinder drives a V-block contact.

With bell jar raised, the fixture is



Typical components brazed and soldered in bell jar setup. Parts are shown above assemblies at lower left and right



Bell jar in raised position

loaded. When the operator presses a start button, an air cylinder lowers the jar. When the jar is seated on the O-ring seal, a pin in the jar support base contacts a switch. The switch sets off a Multi-flex timer.

The timer turns on nitrogen gas, then hydrogen for preset periods. Gas flow is controlled by solenoid valves. The nitrogen valve is normally open and the hydrogen valve is normally closed. If power fails, nitrogen will automatically purge the system.

Gases are introduced through a ring-shaped diffusion plate in the top of the jar, to reduce turbulence.

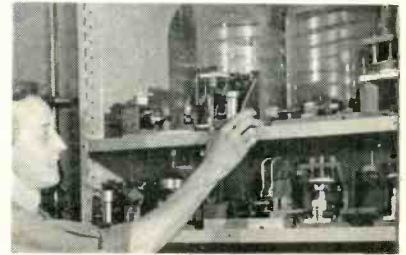

Standardized fixtures permit quick changeover from one setup to another

Circular holes in the plate below the fixture allows gases to exit.

The timer next times the heating cycle, purges the jar and raises the bell jar while it is being purged with nitrogen gas. Complete changeover from job to job can be done in 2 or 3 minutes. Operating temperatures can be varied from 90 F to over 5,000 F. Temperatures and operating times at each station are monitored with a potentiometer-type recorder.

## Mold Glass Fiber into Small Instrument Cases

THREE YEARS of testing and use under various field conditions demonstrate that molded glass fiber instrument housings will withstand the severe environments of industrial process instrumentation, according to Warminster Fiberglass Co., Hatboro, Pa.

Glass fiber reinforced resins are premixed and molded when housings are too small, or too complex in shape for conventional laminating.

Molded compounds are not as strong as laminates, but this can be somewhat compensated for with added thickness. Advantages over metal cases are cited as permanent corrosion resistance, no painting, insulation, light weight, lower tooling and assembly cost.

The firm prefers glass fiber to other reinforcing fibers because of its dimensional and dielectric stability, resistance to heat, fungus, flame and moisture. Glass strands

# HOW TO MEASURE ATTENUATION

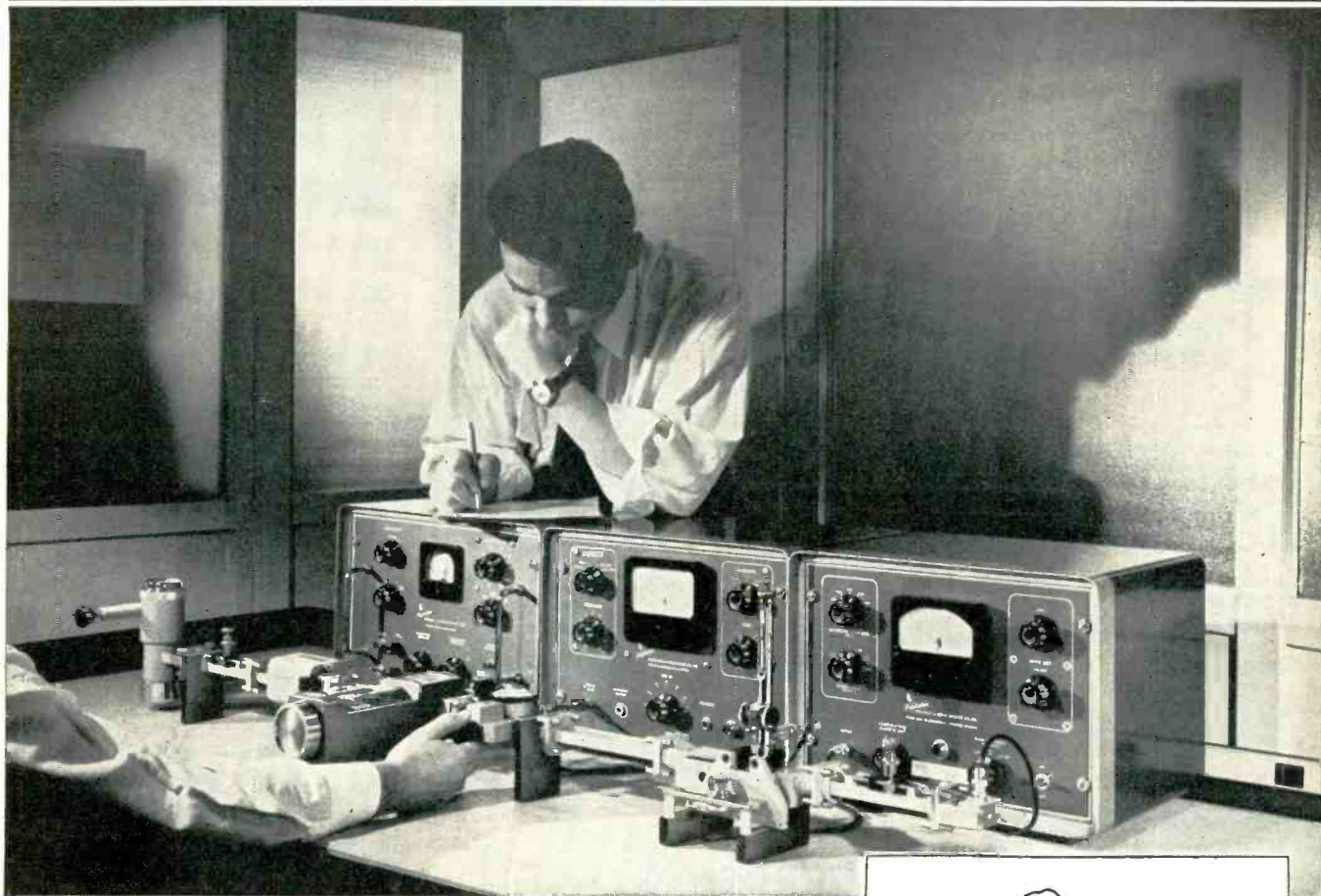

This microwave bench set-up is for the measurement of attenuation by the RF SUBSTITUTION method. Other techniques could have been shown, but this represents one of the simplest, easiest to use methods known.

The one main point we would like to stress is: regardless of the kind of measurements made, the quality of the test equipment used is of the utmost importance. That's why PRD has concentrated on producing the widest range of the most precise microwave test equipment available anywhere in the world.

In the RF SUBSTITUTION method, the PRD 195-B Precision Gauge Attenuator is used as a standard and calibrated for the frequency at which the attenuation is to be measured. The PRD 195-B is set at some value of attenuation greater than the unknown. Its reading and the output power level of the line shown on the PRD 650-B Power Bridge are both recorded. The unknown is then inserted into the line thereby changing the output level, and the PRD 195-B is readjusted to return the power level to its original value. The attenuation of the unknown is simply the difference between the two readings of the PRD 195-B.

**Sound Simple?** Sure it is, but even more important it's accurate. The PRD 195-B has a guaranteed calibration accuracy of  $\pm 0.2$  db.

The precision and ease of operation of all of the products shown in this example are typical of each of over 300 PRD microwave test instruments currently produced. For detailed specifications of the products shown in the measurement bench, write:

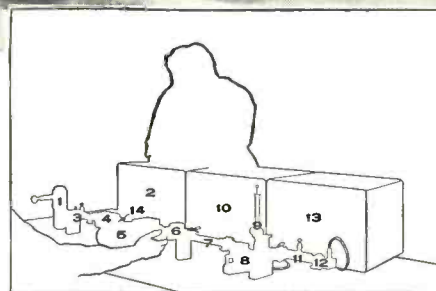

## TEST INSTRUMENTS USED IN THIS X-BAND ATTENUATION BENCH

- 1—703 Shielded Tube Mount, catalog page F-8
- 2—809 Klystron Power Supply, catalog page F-10
- 3—303-A Slide Screw Tuner, catalog page B-14
- 4—1203 Waveguide Ferrite Isolator, catalog page A-21
- 5—535 Frequency Meter, catalog page D-12
- 6—195-B Precision Gauge Attenuator, catalog page A-5
- 7—UNKNOWN represented by a 140 Fixed Waveguide Attenuator, catalog page A-11
- 8—203-D Slotted Section, catalog page B-11
- 9—250-A Broadband Probe, catalog page B-12
- 10—277-A Standing Wave Amplifier, catalog page E-7
- 11—303-A Slide Screw Tuner, catalog page B-14
- 12—643 Waveguide Thermistor Mount, catalog page E-9
- 13—650-B Power Bridge, catalog page E-13
- 14—159-A Level Set Attenuator, catalog page A-17

## MICROWAVE ENGINEERS-SCIENTISTS

Positions offering stimulating challenges with unlimited potential are now open at PRD. Please address all inquiries to Mr. A. E. Spruck, PRD, 202 Tillary Street, Brooklyn 1, New York.



## Polytechnic Research and Development Co., Inc.

202 Tillary Street, Brooklyn 1, New York. Telephone: ULster 2-6800  
West Coast Office: 2639 So. La Cienega Blvd., Los Angeles 34, California. Telephone: TExas 0-1940

*Special problems in attenuation and other related measurements? Contact our Applications Engineering Department.*

# TELREX LABORATORIES

Designers and Manufacturers of

## COMMUNICATION ARRAYS FOR THE ARMED FORCES and Commercial Service

"TRI-BAND"®  
MODEL  
XCYST  
111420

Rotatable  
52 ohm  
Single-  
Transmission-  
Line Array

Power rating—  
1.5 Kw., 100% A.M.

(Higher ratings  
available)

### Specifications:

Gain 11Mc.-8.0 db, F/B 24 db, E-Plane B-W 1/2 Power—66°  
Gain 14Mc.-8.4 db, F/B 24 db, E-Plane B-W 1/2 Power—60°  
Gain 20Mc.-8.6 db, F/B 24 db, E-Plane B-W 1/2 Power—56°  
Wind surface—13.36 sq. ft. Load at 100 mph.—423 lbs.  
Turning radius—23 ft. Container size—12"x12"x14"  
Antenna weight—160 lbs. Shipping weight 200 lbs.  
Antenna rated design with 1/2" radial ice—110 mph.

Calibrated for easy assembly to specifications and center frequency of your choice. Custom Quality construction throughout. Suggested rotor for above — Telrex Model 500-RIS.

Also available: Over 172 off-the-shelf fixed or rotatable high-performance arrays. 7Mc. to 600Mc. Mono, Duo, Tri and Multi-band individually fed or single line feed, and medium to extra heavy duty rotor-indicator control systems, rotated masts, and towers.

For information or to order, phone  
PROspect 5-7252  
or write  
Department SC.

ANTENNAS  
SINCE  
1921

Communication and TV Antennas  
**telrex LABORATORIES**

ASBURY PARK 25, NEW JERSEY, U.S.A.

• Telrex is equipped to design and supply to our specifications or yours, Broad-band or single frequency, fixed or rotary arrays for communications, FM, TV, scatter-propagation, etc.

• Consultants and suppliers to communication firms, universities, propagation laboratories and the Armed Forces.

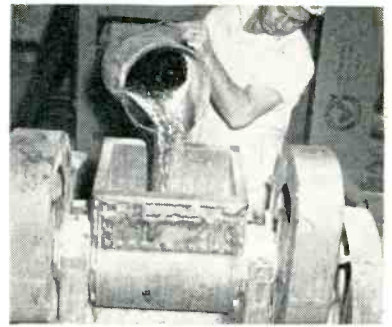

Resin mix is loaded into dough mixer

1/4 inch in length, or longer are used. Impact strength increases with fiber length, up to 1 inch. Beyond 1 inch, tensile and flexural strength is enhanced, but the mix is difficult to compound and for most applications the additional strength is not required.

A typical formulation is 22 parts glass fiber, 27 parts polyester resin, 40 parts clay filler, 5 parts precipitated calcium carbonate, 1 part zinc stearate, Benzoyl peroxide catalyst and colorants. This is thoroughly mixed in 100-pound batches in a dough mixer.

The proper charge for the mold is determined. A typical large instrument case weighs 2.7 pounds and has a 1-pound cover. A small case requires about 1 pound.

Cases are molded in dies heated to 275 F to 325 F. Both male and female dies are heated. Ram pressures up to 150 tons are used. A small case would require about 80 tons. The molding press operator



Glass fiber is added to resin mix

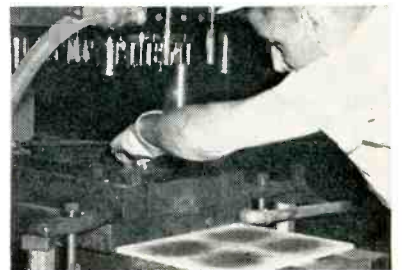

Weighed lumps of mix are placed in cavities of female die

## PREVENTS ENTANGLING COMPONENTS

## CABLE RETRACTOR

Withdrawal of a chassis for service and its return to position no longer presents the old bugaboo of cable entanglement with and damage to tubes and components in the chassis immediately below it.

This new cable retractor's double action maintains a constant tension and correct suspension of cable at all times—permits adequate cable length for full extension and tilting of chassis without hazard of snagging.

May be used with all types of chassis or drawer slides, is adjustable to fit varying chassis lengths, is simple to install, and has proven thoroughly reliable in operation.

Mounts on rear support rails on standard 1 3/4" hole increments. Cadmium plated cold rolled steel.

Write for complete data

ORegion 8-7827

**WESTERN DEVICES, INC.**

600 W. FLORENCE AVE., INGLEWOOD, CALIF.

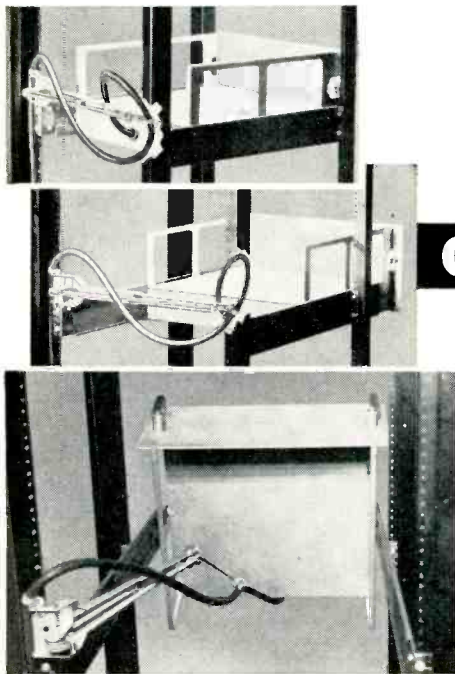

### CABLE RETRACTOR INSTALLED

One support rail is shown cut away to more clearly illustrate complete absence of cable sag at every stage.  
TOP—installation with slide closed  
MIDDLE—chassis partly withdrawn  
BOTTOM—slide extended, chassis tilted

### ONE SOURCE...

for VENTILATED RELAY RACK CABINETS,  
CONTROL CONSOLES, BLOWERS, CHASSIS,  
"CHASSIS-TRAK", RELATED COMPONENTS

can generally remove the excess flash from the part with a gloved thumb. Flash in cored holes is also broken off with his thumb.



Four meter cases are caught on fiber board as they drop off male die

The molded case sticks to the male die. It is freed by knockouts and caught as it falls from the die. The molding cycle is about 2.5 to 3 minutes, including dwell time of 1 minute 15 seconds.

All holes are cored in the dies, to avoid difficult machining. Side holes are cored by separate hydraulic rams during the dwell. The molds also provide for molded-in inserts to support instrument components that require frequent removal for adjustment or service.

## Bonded Wires Form Wire Stripping Brush



Brushes installed on wire stripper

WIRE STRIPPING brushes whose wires are encased in a bonding medium will strip enameled, plastic, fiber, glass fiber, asbestos and other types of wire insulation with only light pressure, according to The Osborn Manufacturing Co., Cleveland, Ohio.

The unusual construction of the brushes minimizes uneven brush wear and prevents loading of insulation material. The brushes leave a light scratch finish on the conductors. The brush also is reported to perform efficiently in operations which utilize rotary files, abrasive stones and belts, tumbling and shot blasting.

# atlee CLIPS GAIN IN HOLDING POWER

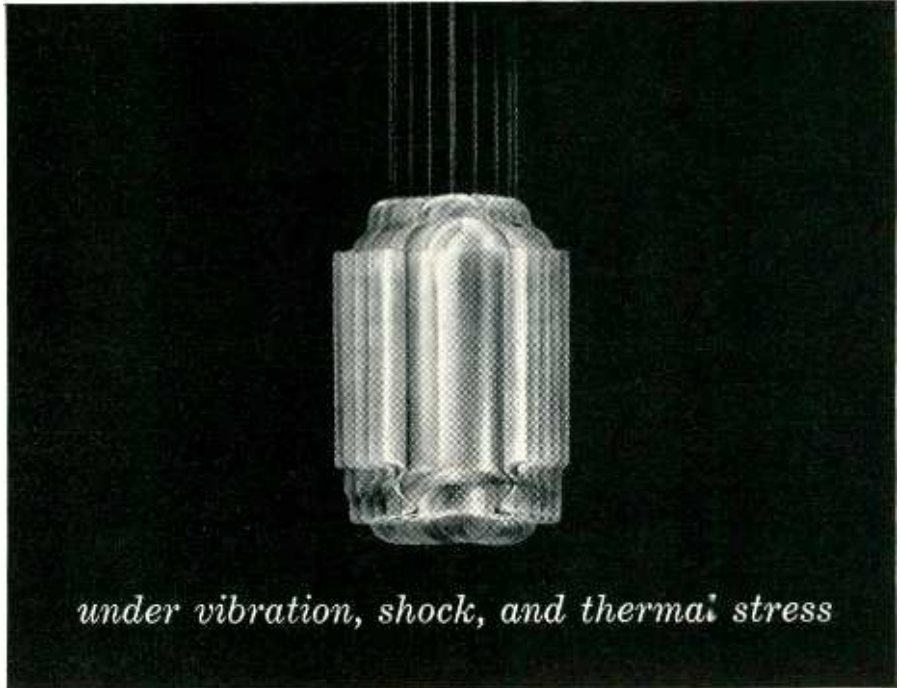

*under vibration, shock, and thermal stress*

**TESTS PROVE IT . . . tests conducted independently by some of the nation's most critical users of component holders.\***

*the TESTS:*

- vibration at 500 cps 90 G peak, and at 2,000 cps 65 G peak, for one minute
- 1,750 impact shocks at 200 G, perpendicular to and also along the axis of the holder
- 100 complete cycles of component insertion and withdrawal
- above tests repeated after 15 minutes exposure to temperature of 500°F.

*the RESULTS:*

- no visible shifting of the component in the holder
- no resonant frequencies developing under vibration
- temperature had no effect on dynamic holding power
- insertion-withdrawals had no effect on dynamic holding power
- force required to dislodge component *increased* during tests

*the REASONS:*

- severe vibration and shock cause the material of the holder to flex slightly, producing a closer "set" of the holder surfaces to the contours of the held component.

**atlee** component holders *start out* with a tighter-than-usual grip . . . because of proper contours, construction and materials. As environmental stresses increase, this holding power automatically increases to meet the greater demand . . . because the holders actually mold themselves to the components. Here is an equipment designer's dream come true: the greater the stress, the *greater* the security.

**DESIGN FOR RELIABILITY WITH atlee** — a complete line of superior heat-dissipating holders and shields of all types, plus the experience and skill to help you solve unusual problems of holding and cooling electronic components.

\* Names on request.

**ATLAS E-E CORPORATION**  
47 PROSPECT STREET • WOBURN, MASS.

# On The Market

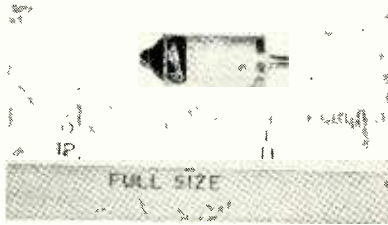

## Pressure Switch transistor size

CENTURY ELECTRONICS & INSTRUMENTS, INC., Box 6216, Tulsa, Okla. Now available for use in all types of systems, this new  $\frac{1}{4}$  oz transistor size pressure switch is designed for

surge, leak and variance detection. Setting limits are 1 to 100 psig; operating range, 1 to 500 psig; temperature,  $-65$  F to  $+250$  F; proof pressure, 3,000 psig; burst pressure, 5,000 psig; vibration, 0 to 2,000 cps at 10 g.

**CIRCLE NO. 200 READER SERVICE CARD**

## Blade Antenna for L-band

CANOGA DIVISION UNDERWOOD CORP., 15330 Oxnard St., Van Nuys, Calif. Model 9955 blade antenna for the 1400 mc telemetry band is designed for high speed aircraft and missile applications. The polarization is

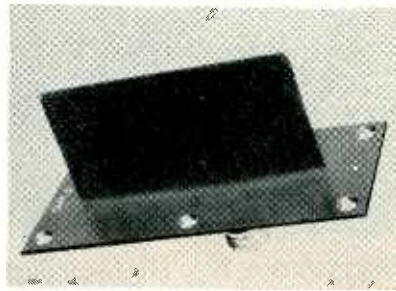

perpendicular to the mounting surface and the resulting radiation pattern is circular. The antenna has a maximum vswr of 1.5 over a 25 percent frequency band, is 3.55 in. long, extends 1.70 in. from the skin of the airframe, and weighs 7 oz.

**CIRCLE NO. 201 READER SERVICE CARD**

## Waveguide RSWI compact unit

POLYTECHNIC RESEARCH & DEVELOPMENT CO., INC., 202 Tillary St., Brooklyn, N. Y. The new PRD waveguide rotary standing wave indicator greatly simplifies the measurement of vswr, reflection coefficient angle, hence impedance, in the low frequency range. Operating by

means of a probe rotating in the plane of circular polarization of a waveguide, the waveguide rswi provides a nonambiguous read-out of the sign of reactive components. Small, compact, and lightweight with an insertion length of only 10 in., it eliminates the need for bulky slotted sections or reflectometers in the large waveguide sizes.

**CIRCLE NO. 202 READER SERVICE CARD**

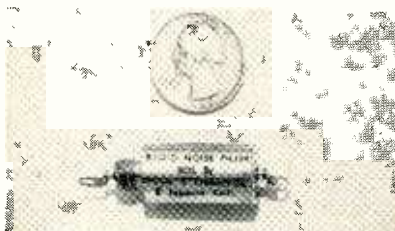
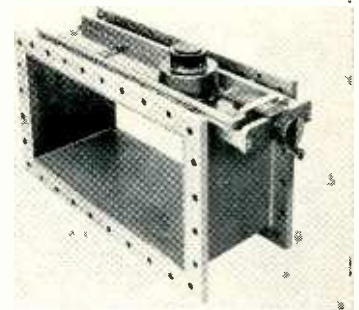

## Radio Noise Filter subminiature

DOUBLE-"E" PRODUCTS Co., 208 Standard St., El Segundo, Calif., announces a radio interference filter featuring a case  $\frac{1}{8}$  in. in diameter,  $1\frac{1}{8}$  in. long. Model 5838 is

rated at up to 2 amperes at 28 v d-c to 105 C, and will filter most d-c motors to the requirements of MIL-I-6181B. Unit has a  $\frac{1}{8}$ -24 threaded mounting bushing and may be screwed into a panel or held in place with a nut and lockwasher.

**CIRCLE NO. 203 READER SERVICE CARD**

## Bearing Tester all-electronic

BEARING INSPECTION, INC., 3311 E. Gage Ave., Huntington Park, Calif. Bearings used in radar instrumentation, tape recording mechanisms, computers, memory drums, gyros, and servo systems can be checked



easily and accurately with the model BA-22 electronic bearing tester. New instrument detects and pinpoints hidden faults as small as 1-millionth of an inch in size, without bearing disassembly. Aircraft and missile bearings up to 14 in. in diameter are checked with very high accuracy. Oscilloscope display



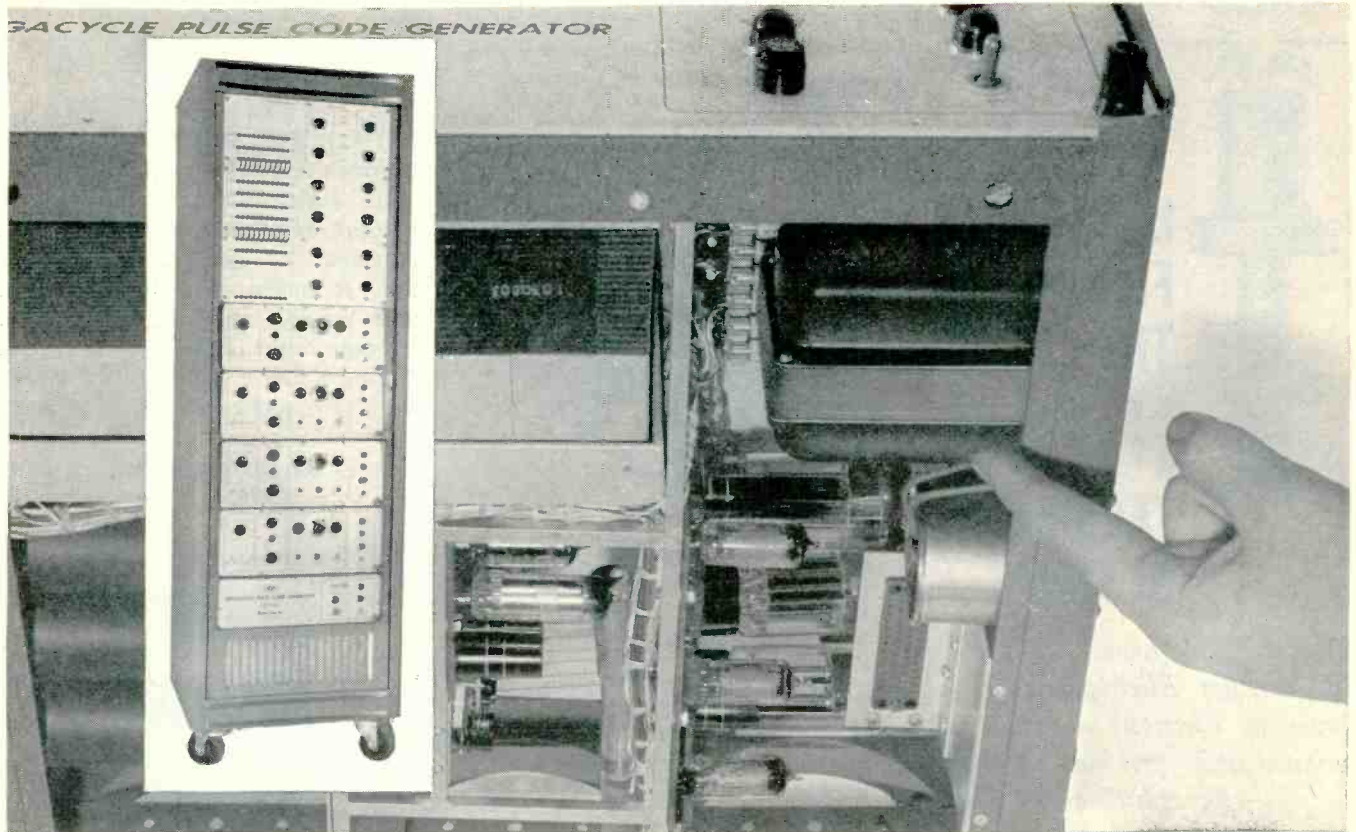

*Sola Constant Voltage Filament Transformer is an integral part of this Electro-Pulse, Inc. Megacycle Pulse Code Generator. It provides regulated filament voltage for reliable operation of the equipment and for full life of its electron tubes.*

## Sola transformer regulates filament voltage within $\pm 1\%$ —protects tubes from inrush currents and line transients

Fluctuations in supply voltage for electron tube filaments can be costly . . . in shortened tube life . . . in substandard performance . . . in equipment downtime. Electro-Pulse, Inc. solved its filament voltage problems through this straightforward approach: the company's Megacycle Pulse Code Generator includes a Sola Constant Voltage Filament Transformer built-in as part of its power supply.

This versatile unit does the step-down job of a conventional transformer and it also regulates the filament supply — a task that ordinary filament transformers don't pretend to do. Filament voltages are stabilized to within  $\pm 1\%$  even with line voltage variations as great as  $\pm 15\%$ . Its current-limiting characteristic protects tubes from cold inrush currents upon starting—as well as from line transients. It is a simple, reliable static-

magnetic regulator with automatic and virtually instantaneous action. Variations in input voltage are usually corrected within 1.5 cycles. There are no tubes or moving parts, and no manual adjustment or maintenance is necessary.

The filament voltage regulator illustrated is only one of a complete line of Sola Constant Voltage Transformers having wide application in electrical and electronic devices. They include such special types as harmonic-free, plate-filament, and adjustable output units—all provide the benefits of regulated input voltage. More than 40 ratings of these compact, economical regulators are available from stock, and Sola manufactures custom-designed units (in production quantities) to meet special needs.

For complete data write for Bulletin 7F-CVF-269

Sola Electric Co., 4633 W. 16th St., Chicago 50, Ill., Bishop 2-1414 • Offices in principal cities • In Canada, Sola Electric (Canada) Ltd., 24 Canmotor Ave., Toronto 18, Ont.

# SOLA



CONSTANT VOLTAGE TRANSFORMERS



REGULATED DC POWER SUPPLIES



MERCURY LAMP TRANSFORMERS



FLUORESCENT LAMP BALLASTS

A DIVISION OF BASIC PRODUCTS CORPORATION

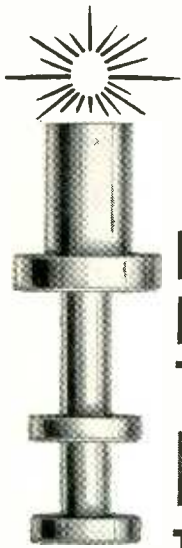

## LOOKING FOR THE IDEAL TERMINAL SETTER?

**STOP.** You've found it. A Black & Webster Electropunch or full automatic Electroset can solve your terminal setting problems **\$135<sup>00</sup>** — for as little as



**SHORT RUNS:** Electropunch — sets hand fed terminals twice as fast as conventional methods. All electric. Foot switch operated.

**LONG RUNS:** Electroset — automatically feeds and sets terminals up to 3600 per hour. All electric. Customized to your needs.



### WHAT'S YOUR PROBLEM?

Black & Webster can help. Send sample terminal and requirements.

Write today for free 12-page catalog describing our complete line of production tools.

**BLACK & WEBSTER, INC.**

Dept. E, 570 Pleasant Street  
Watertown, Massachusetts

is combined with audible signal, and simple dial settings insure reliable operation.

**CIRCLE NO. 204 READER SERVICE CARD**

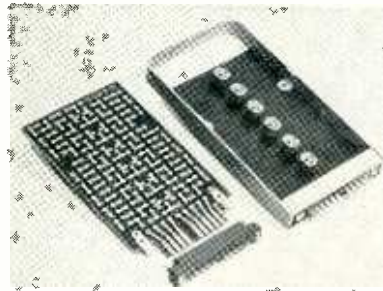

### Blank P-C Cards plug-in type

PLUG-IN INSTRUMENTS, INC., 1416 Lebanon Road, Nashville, Tenn., has introduced a new line of blank printed circuit cards for use in fabricating small quantities of transistor plug-in circuits. The plug-in cards provide engineers in plants and laboratories an excellent means of assembling a neat transistorized circuit quickly and conveniently.

**CIRCLE NO. 205 READER SERVICE CARD**



### Rotary Relay rugged device

COUCH ORDNANCE, INC., 3 Arlington St., North Quincy, Mass. Type 4C is a small hermetically sealed 4pdt d-c relay which features a contact rating of 5 amperes at 30 v d-c. While retaining the resistance to shock and vibration that characterizes the type 4A, the 4C has a heavier contact structure to make and break larger currents. Environmental specifications call for unit operation at ambient temperatures up to 125 C; vibration is specified to 2,000 cps at 20 g acceleration.

**CIRCLE NO. 206 READER SERVICE CARD**

### Voltage Regulator solid state

RATIGAN ELECTRONICS INC., 425 W. Cypress St., Glendale 4, Calif. A solid state, 500 va, 3-phase a-c voltage regulator operates in all extremes of sub and supersonic use. It measures 3½ by 4 by 6 in. and weighs approximately 6 lb. Voltage input is 100-130 v a-c, producing a 115 v a-c output ±1 percent. Frequency range is 380-420 cps.

**CIRCLE NO. 207 READER SERVICE CARD**

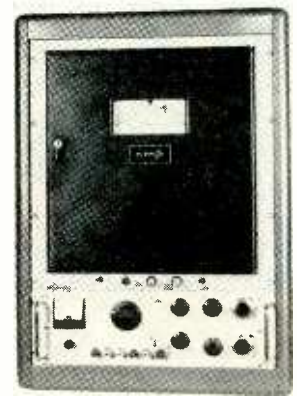

### Strain Indicator precision instrument

BYTREX CORP., 294 Centre St., Newton 58, Mass. A new, versatile, automatic strain indicator, the model LC-261 features the resolution (0.005 percent), linearity (0.02 percent), repeatability (0.01 percent) and absolute accuracy (0.05 percent) required of a precision standard for calibration and linearity testing of high quality strain gage transducers.

**CIRCLE NO. 208 READER SERVICE CARD**

### Potentiometer 25-turn unit

LITTON INDUSTRIES, Potentiometer Division, 215 S. Fulton Ave., Mt. Vernon, N. Y., has introduced a 25-turn pot furnished in a length only slightly longer than most 10-turn units. The MD20-25 meets or exceeds all military specifications for potentiometers, with 0.0075 percent linearity and 0.005 percent resolution, a Litton production standard for this 2-in. model.

**CIRCLE NO. 209 READER SERVICE CARD**

## NEW GENISCO MINIATURE ACCELEROMETER

The new Model GMA Accelerometer is a fluid damped, potentiometer output instrument, particularly suited for flight and fire control and telemetering applications. Now in production.

Weights only  
3 ounces;  
measures just  
1 1/8" x 1" x 1 1/8"!

### Brief Specifications

Range:  $\pm 0.5$  g to  $\pm 100$  g's  
Natural Frequency: 12 cps to 75 cps  
Linearity:  $\pm 1\%$  of full scale  
Damping: Nominally 0.7 of critical at 75°F.  
Temperature: Operates to specifications between  $-20^\circ\text{F}$  and  $+185^\circ\text{F}$ .  
Vibration: 10 g's, 10-20,000 cps, any axis  
Shock: 50 g's for 7 ms, any axis



MODEL GMA

Send for complete specifications  
to the Instrument Division:

**Genisco**  
INCORPORATED

2233 Federal Avenue, Los Angeles 64, California

CIRCLE NO. 94 READER SERVICE CARD

## MEET TOM EMMA

Associate Editor, electronics  
FINANCE EXPERT



Thomas Emma, BA, Columbia, is a U.S. Naval Reserve officer who was formerly a technical writer with IT&T. Tom prepares "Financial Roundup"—a regular weekly business feature. In the coming months Tom will be concerned with radio communications, but he will be specifically involved with spectrum useage problems. To keep abreast of finance in electronics, turn to Tom's weekly coverage of latest developments. To subscribe or renew your subscription, fill in box on Reader Service Card. Easy to use. Postage free.



A McGraw-Hill Publication  
West 42nd Street, New York 36, N. Y.

Opportunity  
at  
M & C  
Nuclear

*Electronics  
Engineer*

Expansion of our rapidly-growing R & D program has created an excellent opening for an electronics engineer. Education should include a B.S. or M.S. in Electrical Engineering. This is a challenging, highly-interesting position that includes the designing of specialized instruments for nondestructive tests. A thorough knowledge of Circuitry is essential. Applicant will specialize on electromagnetic testing and do some ultrasonic development. He must have a keen interest in applied research as well as the ability to plan, perform and interpret research experiments. He will have the opportunity to report results in the form of publications.

The man we select will receive an attractive starting salary. Employee benefits include group insurance, educational assistance program and profit-sharing plans.

We are the nation's first privately-owned nuclear fuel company, offering unlimited opportunities for advancement and growth. Located in lovely suburban Massachusetts with easy access to Cape Cod and Narragansett Bay.

Send complete resumé to Mr. Tom Fowler.

**M & C NUCLEAR, INC.**

BOX 898, ATTLEBORO, MASSACHUSETTS

A subsidiary of Texas Instruments Incorporated

**POWER SUPPLIES**



**RS 110**

MODEL RS 110  
0-110V DC  
@ 0-100MA

**\$103.00**

**SPECIFICATIONS**

**Filament Output:** 6.3 volts CT AC  
@ 3 amperes (unregulated).  
**Current Range:** 0-100 milliamperes,  
continuous duty; floating output.  
**Ripple and Noise:** 3 millivolts  
peak-to-peak maximum.  
**D.C. Voltage Range:**  
0-110 volts, continuously adjustable.  
**Transient Response:** Less than 50  
millivolts no load to full load.  
**Input Voltage:** 105-125 volts,  
55-400 cps, AC.  
**Internal Impedance:** Less than 1 ohm.  
**Load Regulation:** 0.1%  
**Line Regulation:** 0.1%  
**Dimensions:**  
7 1/4" x 5 1/2" x 5 3/4" height overall  
RACK MOUNTED \$128.00  
RACK MOUNTED  
WITH METERS \$156.00

*model	voltage range	current ma	filament volts/amps	dimensions h" w" d"	price
RS 205				5 x 4 1/8 x 6 1/2	\$ 49.50
RM 205	150-225	0-50	6.3/3	3 1/2 x 19 x 8 5/8	99.50
RR 205				3 1/2 x 19 x 8 5/8	69.50
RS 305				5 x 4 1/8 x 6 1/2	49.50
RM 305	225-325	0-50	6.3/3	3 1/2 x 19 x 8 5/8	99.50
RR 305				3 1/2 x 19 x 8 5/8	69.50
RS 217A				6 1/2 x 5 1/2 x 7 1/4	79.50
RM 217A	150-225	0-175	6.3/8	5 1/4 x 19 x 9 1/4	134.50
RR 217A				5 1/4 x 19 x 9 1/4	99.50
RS 317				6 1/2 x 5 1/2 x 7 1/4	79.50
RM 317	225-325	0-175	6.3/8	5 1/4 x 19 x 9 1/4	134.50
RR 317				5 1/4 x 19 x 9 1/4	99.50
RS 410A				6 1/2 x 5 1/2 x 7 1/4	105.00
RM 410A	400-550	0-100	6.3/8	5 1/4 x 19 x 9 1/4	148.00
RR 410A				5 1/4 x 19 x 9 1/4	130.00
RS 210				5 1/2 x 5 1/2 x 7 1/4	77.50
RM 210	100-200	0-100	6.3/3	5 1/4 x 19 x 8	132.50
RR 210				5 1/4 x 19 x 8	97.50

**CIRCLE NO. 95 READER SERVICE CARD**

**OTHER MODULES**

- For EASY substitution — bench, rack or OEM
- Floating output
- Barrier Type Terminal Strip 55-400 CPS

**PROBLEM SOLUTION COST** precision assembly, inspection  
**UNITRON 3-D stereo microscope**  
as low as **\$110**

Both models offer . . . sharp clear erect image • large depth of focus • wide field • long working distance • interpupillary and diopter adjustments • rack and pinion focusing • coated optics

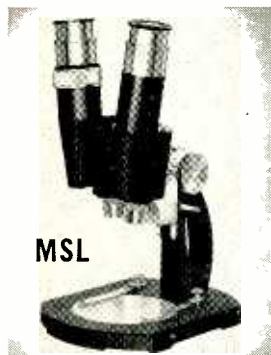

**MSL**

**MSL** — a precision, budget priced instrument. Vertical binocular body. Choice of single magnification from 5X to 45X. Extra eyepieces for additional powers, \$19.50 per pair. **\$110**

**MSHL** — a versatile general purpose instrument with a wide range of magnifications. Inclined binocular body, revolving nosepiece for rapid interchange of objectives. Model MSHL-1 with objectives: 1X, 2X, 3X; eyepieces: 8X, 12X, 15X; magnification range: 8X-45X. Other magnification ranges available. **\$267**



**MSHL**

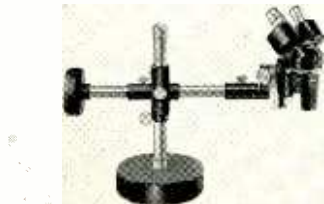

**ACCESSORY STAND** — For use with binocular head and focusing mechanism of either Model MSL or MSHL. Price (stand only), \$75.

**UNITRON**  
INSTRUMENT DIVISION of UNITED SCIENTIFIC CO.  
204-206 MILK STREET • BOSTON 9, MASS.

Please rush UNITRON's Microscope Catalog 45 R-4

Name \_\_\_\_\_  
Company \_\_\_\_\_  
Address \_\_\_\_\_  
City \_\_\_\_\_ State \_\_\_\_\_

AVAILABLE FOR 10 DAY FREE TRIAL — THE TREND IS TO UNITRON

**Literature of**

**MATERIALS**

**Transistor Mica Washer.** Ford Radio & Mica Corp., 536 63rd St., Brooklyn 20, N. Y. Fifteen basic insulating washers to be used with popular types of transistors and diodes are described in the new bulletin 2955.

**CIRCLE NO. 220 READER SERVICE CARD**

**COMPONENTS**

**Computer Transistors.** General Transistor Corp., 91-27 138th Place, Jamaica 35, N. Y. Brochure G-140A describes types 2N315A-317A *pnp* and 2N356A-358A *npn* germanium alloy transistors for applications where high speed, high current switching is of paramount importance.

**CIRCLE NO. 221 READER SERVICE CARD**

**Electromagnetic Damp Servomotor.** Helipot Division of Beckman Instruments, Inc., 2500 Fullerton Road, Fullerton, Calif. Servo-brief 1583 contains a fund of technical data concerning the use of inertia and velocity damped servomotors.

**CIRCLE NO. 222 READER SERVICE CARD**

**Subminiature Ceramic Capacitors.** Mucon Corp., 9 St. Francis St., Newark 5, N. J., announces the new catalog J-1, which describes in a four page brochure its complete line of subminiature ceramic capacitors made in 12 types of ceramic material.

**CIRCLE NO. 223 READER SERVICE CARD**

**EQUIPMENT**

**Instrumentation.** Dymec, Inc., 395 Page Mill Road, Palo Alto, Calif. A 4-page folder discusses complete digital instrumentation with standard, compatible, building-block instruments.

**CIRCLE NO. 224 READER SERVICE CARD**

**Transistorized Power Supplies.** Electronic Measurements Co. of Red Bank, Eatontown, N. J. Bulletin No. 721 describes and illus-

# the Week

brates an integrated series of regulated transistorized power supplies. Specifications are given for over 40 different models.

**CIRCLE NO. 225 READER SERVICE CARD**

**Strip-Chart Recorders.** Varian Associates, 611 Hansen Way, Palo Alto, Calif. An 8-page brochure describes strip-chart recorders that combine exceptional versatility with light weight and compactness.

**CIRCLE NO. 226 READER SERVICE CARD**

**Millivolt/Ammeter.** Weston Instruments, Division of Daystrom, Inc., Newark 12, N. J. Bulletin 06-208-A describes the model 1477 zero load electronic millivolt/ammeter. Unit described is priced at \$355.

**CIRCLE NO. 227 READER SERVICE CARD**

**Magnetic Tape Recorder.** Consolidated Electrodynamics Corp., 360 Sierra Madre Villa, Pasadena, Calif. An illustrated 4-page brochure describes the type 5-701 magnetic tape recorder for data acquisition systems where high precision is required with minimum size and weight.

**CIRCLE NO. 228 READER SERVICE CARD**

## FACILITIES

**Electrical Connectors.** The Deutsch Co., 7000 Avalon Blvd., Los Angeles 3, Calif., has available a brochure showing its facilities for the volume production of precision connectors for the critical demands of advanced military and industrial systems.

**CIRCLE NO. 229 READER SERVICE CARD**

**Systems Facilities.** Western Gear Corp., P. O. 182, Lynwood, Calif. Bulletin 5900-SMD details the company's engineering, manufacturing, research, testing and organizational capabilities for major systems in the aviation, electrical, electronic, marine and military fields. For a copy, write on your letterhead.

ELECTRONICS • JUNE 26, 1959



# SHRINK or SWIM

*making little bridges out of big ones*

Riding the trend toward smaller cars and thinner wristwatches, we shrewdly surmised that some forward-looking engineers might favor size reduction in rectifier bridges. Fortunately, the means for shrinking bridge dimensions is at hand: our new Redtop<sup>®</sup> insulated base silicon rectifier. Redtop's superior heat transfer ability permits efficient operation with less bridge area.\* What's more, you get forward and reverse ratings that top the field. Then there are the plus benefits of integral insulation: No washer hardware assembly. No shorting of a series of diodes through faulty insulation assembly. Send us your bridge requirements and we'll show you how compact we can make it. Want a REDTOP data sheet?

\*



**BRADLEY SEMICONDUCTOR CORPORATION**

*Formerly Bradley Laboratories Inc.*

Bradley

275 WELTON STREET, NEW HAVEN 11, CONNECTICUT

CIRCLE NO. 79 READER SERVICE CARD 79

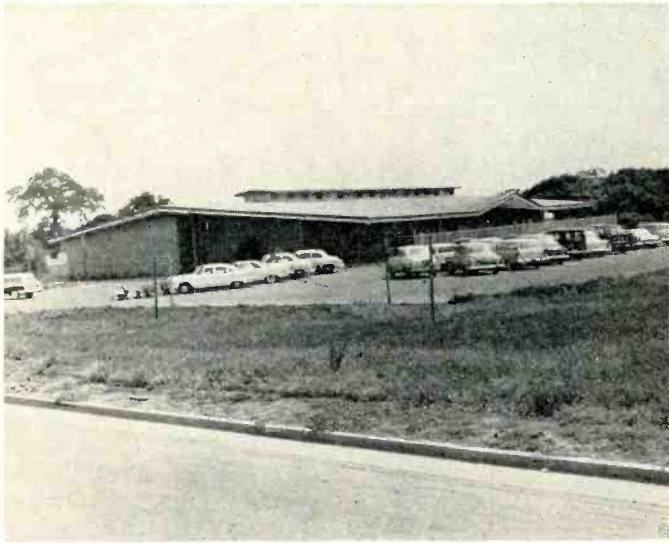

## Watkins-Johnson Expands Fast

WATKINS-JOHNSON Co., one of Palo Alto's newest electronics firms, moved into its new 22,000 sq ft building (picture) last August, now plans to break ground in July for two more structures which will double its floor space.

Formed to deal with research, development, and manufacture of microwave electronic devices, the company grossed \$105,000 in 1958, expects sales of \$1 million this year, and predicts three times that volume in 1960.

W-J's first production item, the Helitron tube, is a voltage-tuned oscillator in the frequency range above 200 mc. Characteristics are light weight, low power requirements, and capability of instantaneously tuning over a wide range of microwave frequencies. The company's next family of products will include low noise travelling wave tubes, K-band high power backward wave tubes, and parametric amplifier devices.

While the personnel total is currently growing at the rate of 15 percent per month, management does not expect production to ever reach true "assembly line proportions." The company will produce relatively small numbers of many different types of highly specialized equipment. "It'll be almost a model shop type of production," reports president Dean A. Watkins.

Watkins is continuing in his position as associate director of Stanford University Electronics Laboratory. Company vice president H. Richard Johnson was head of the microwave tube department at Hughes Aircraft, prior to joining Watkins to form the new firm.

Initial capitalization by Kern County Land Company, which holds 49 percent of the stock, was \$1.1 million.

## Lawrence Joins Deutsch Company

APPOINTMENT of Roland Lawrence as director of engineering and research for The Deutsch Co., Electronic Components Division, has been announced.

He will head up the entire research, design and development work of the electronic components operations including the DM and DS line of miniature electrical con-



nectors. Greatly expanded facilities for this work are being set aside in the new Deutsch plant, now under construction in Banning, Calif.

Lawrence comes to his new position directly from Douglas Aircraft Co., Inc., where he has worked for the past 18 years, most recently as supervisor of electronic design liaison on the DC-8 program.



## Hoffman Hires D. S. Noble

DAVID S. NOBLE was recently appointed a senior scientist at Hoffman Electronics Corporation's new Science Center in Santa Barbara, Calif. He comes to Hoffman from Trionics Corp., Madison, Wisc., and will be concerned primarily with research in the fields of data processing, computers, and automation devices.

As director of Trionics' electronics laboratory, Noble set up and equipped the company's electronics and instrumentation section. Prior to that he was a senior research engineer for the Aeronautical Division of Minneapolis-Honeywell Regulator Co., St. Paul, Minn., where he specialized in digital inertial guidance techniques and computer systems.

## Name Sprecher Engineering Mgr.

APPOINTMENT of Newell Sprecher to the position of engineering manager of the Audio Development Co., Minneapolis, Minn., manufacturer of transformers and other

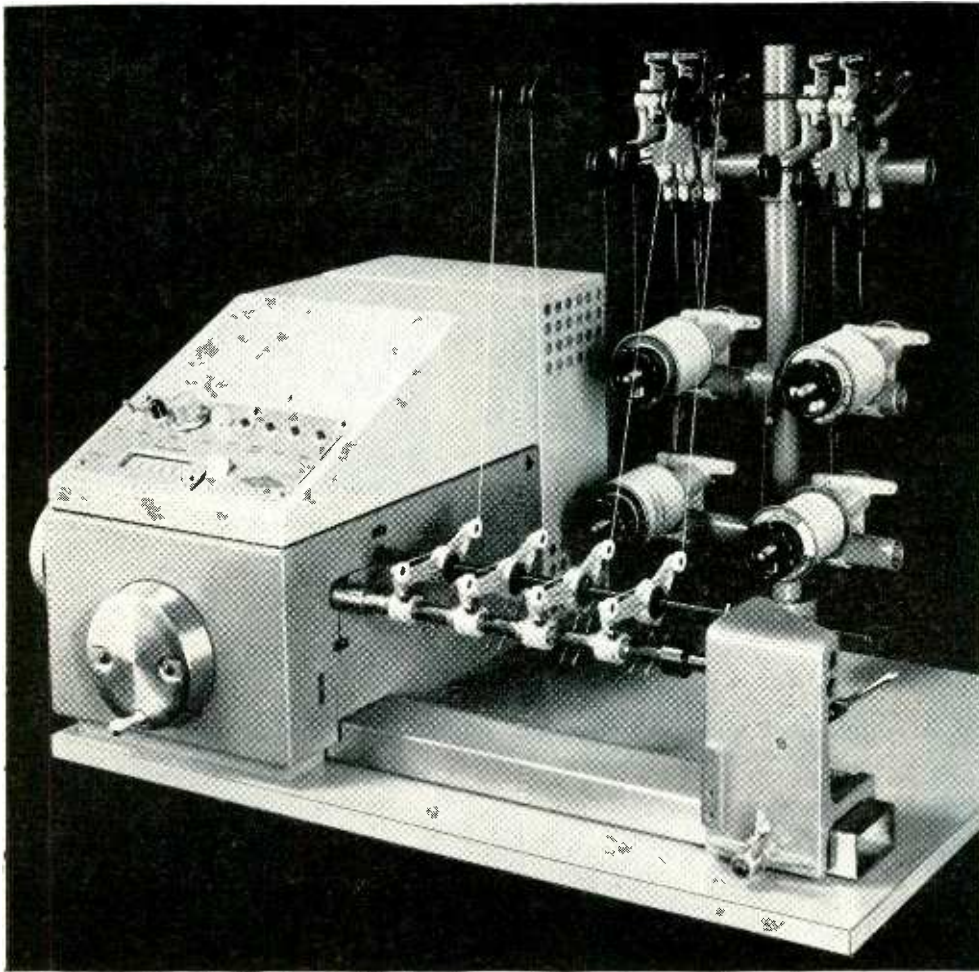

The No. 111 Cross-Winds  
These or any other  
Universal Type Coil



Flyback



Pie-Wound



Linearity



Constant pitch progressive



Variable pitch progressive

## For Widest Versatility in Cross-Wound Coil Production... The Leesona® No. 111 Coil Winder

Equipped with a progressive coil attachment, the Leesona No. 111 can be used for high speed winding of variable and constant pitch progressive coils. And an optional pie-winding attachment automatically indexes coils from  $3/32''$  to  $1/2''$  between coil centers.

Besides versatility, plenty of other advantages are built into the No. 111 Cross-Winder. The change gears can be dropped into position on fixed

centers, without tools, for quick set-up and proper meshing — a Leesona time-saving exclusive.

Also, breakage of fine wire by abrupt starts is eliminated. An electronic drive starts the arbor slowly, gradually accelerates to full pre-set speed and maintains a constant speed rate for uniform wire tension and coil density.

Winding coils singly or in multiple, the No. 111 produces coils up to  $3\frac{1}{2}''$

diameter . . . at high speeds . . . accurately and uniformly . . . reduces rejects . . . is simple to set up, run and maintain. Get further facts by sending for the No. 111 Bulletin.

23B.8.7

Universal Winding Company  
P. O. Box 1605, Providence 1  
Rhode Island, Dept. 126

Please send me:

Bulletin on the Leesona No. 111  
Coil Winder

Name.....Title.....

Company.....

City.....Zone....State.....



**UNIVERSAL WINDING COMPANY**

FOR WINDING COILS IN QUANTITY . . . ACCURATELY . . . AUTOMATICALLY

... USE LEESONA WINDING MACHINES

# D-C POWER

Precisely Regulated for  
Missile Testing and  
General Use



**CHRISTIE**

## SILICON POWER SUPPLIES

available in 30 standardized and militarized models from 30 to 1500 amps... 6 to 135 volts. CHRISTIE'S QUALITY CONTROL is approved by the A.E.C., leading aircraft and missile manufacturers.

Write For Bulletin AC-58-A

**CHRISTIE  
ELECTRIC CORP.**

3410 W. 67th Street  
Los Angeles 43, Calif.

electronic components, is announced. He has been with the company since 1951 in sales engineering and management capacities. Prior to that he was associated with Midwest Engineering Development Co.



## Kohler Joins Daven Co.

APPOINTMENT of Emil Kohler to the design and development staff of The Daven Co., Livingston, N. J., is announced. He will be project engineer, in charge of development on transistorized power supplies and various other transistorized power equipment.

Kohler's past experience includes senior engineering functions for the Bogue Electric Mfg. Co., where he was responsible for the development of important innovations in the electromechanical, ultrasonic and semiconductor fields; installation and service supervisor for the RCA Service Co.; and supervisor of the prototype section of the ESC Corp.

## News of Reps

WYCO Metal Products, North Hollywood, Calif., has added new reps. The companies and territories are: Gerber Sales, Inc. of Brookline, Mass., covering Massachusetts, Rhode Island, Connecticut, Vermont, New Hampshire and Maine; Edwin A. Schulz Co. of Indianapolis, Ind., covering Indiana and Kentucky; Leo Jacobson & Co. of Buffalo, N. Y., covering the state of

## A Personal Invitation to ENGINEERS



from **ROBERT McCULLOCH**  
President

"If you would like to be a member of a select corps of Engineers, working for an interesting, growing company... in one of the country's most stimulating areas... I invite you to write to Temco. Temco's growth is sound and planned, its products are diversified and challenging, our facilities are modern. Every benefit, for you professionally and in good living for you and your family, is here. Below are some of the areas in which jobs are open now."

### ANTENNA DEVELOPMENT

Graduate Electronics Engineer or Physicist to perform analysis and design of antenna, microwave, and propagation systems for use in missile guidance and reconnaissance. Individual will be responsible for performing investigations in new types and concepts of transmitting and receiving antennas for both pulsed and CW signals, and the adaptations of these studies to current use in Electronic Development projects.

### ELECTRONIC PRODUCTS AND SYSTEMS (Sales Engineer)

Opportunity exists for graduate Electronics Engineer with eight to ten years of industry and military service background in sales and/or design of electronic products and systems, emphasizing radar, antennae, and computers. As Sales Engineer, he will contact military agencies and commercial organizations for determination of electronic products and systems requirements.

Write **BILL G. HICKEY**

Supervisor Technical Employment  
Room 606F, P. O. Box 6191

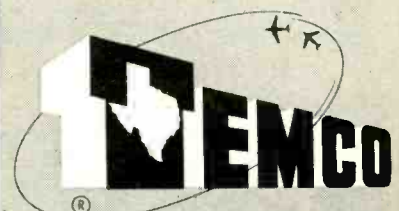

AIRCRAFT CORPORATION • DALLAS 22, TEXAS



New York except New York City; K. C. Kurcaw & Co. of Detroit, Mich., covering the state of Michigan.

Appointment of two manufacturers' rep firms was recently announced by Silicon Transistor Corp., Carle Place, L. I., N. Y., manufacturer of silicon transistors and diodes for the military electronics industry. Reps are: Jack Berman Co. of Los Angeles, for southern California; and D. Dolin Sales of Chicago, for the Chicago area and eastern Wisconsin.

Electro Networks, Inc., Syracuse, N. Y., manufacturer of electric wave filters and toroidal components, recently named Naylor Electric Co. of Syracuse as its upstate New York rep, and Everett Sales Engineering Co. of Manhasset, N. Y., as its metropolitan New York sales agent.

The Wayne B. Palioca Co., manufacturers' rep with offices in Lexington, Mass., announces the addition to its staff of Edmond J. Courtney. He will cover the New England states for those electronics firms represented by the company.

Stackpole Carbon Co., St. Marys, Pa., has added two West Coast reps for its line of fixed and variable composition resistors, slide switches, ferrites, composition capacitors, and ceramic magnets. In the northwestern states, sales will be handled by the Burt C. Porter Co. of Seattle, Wash. In the central and northern California areas, the company will be represented by Eichorn & Melchior, Inc. of San Francisco, Calif.

Richard Purinton, Inc., of Lexington, Mass., now represents Chicago Telephone Supply Corp., Elkart, Ind., in Massachusetts, Connecticut, Vermont and New Hampshire. Rep organization is offering the entire CTS line of military and commercial composition and wirewound variable resistors as well as the recently developed tube saver and bobbinless precision wire fixed resistor lines.

*This is not an offer of these Securities for sale. The offer is made only by the Prospectus.*

90,000 Shares

## Electronic Engineering Company of California

Common Stock

(\$1 Par Value)

Price \$13 per Share

*Copies of the Prospectus may be obtained in any State in which this announcement is circulated from only such of the underwriters as may lawfully offer these securities in such State.*

Kidder, Peabody & Co.  
Incorporated

Paine, Webber, Jackson & Curtis

Dean Witter & Co.

Bingham, Walter & Hurry, Inc.

Blunt Ellis & Simmons

Clement A. Evans & Company

Hill Richards & Co.

Lester, Ryons & Co.

Irving Lundborg & Co.

McDonald & Company

Mitchum, Jones & Templeton

Pacific Northwest Company

Rauscher, Pierce & Co., Inc.

Wagenseller & Durst, Inc.

June 10, 1959.

CIRCLE NO. 96 READER SERVICE CARD

*Ideal for*  
ANTENNA CONNECTIONS  
PHOTO-CELL WORK  
MICROPHONE CONNECTIONS

## JONES

SHIELDED TYPE  
PLUGS & SOCKETS



LOW LOSS PLUGS AND SOCKETS FOR HIGH FREQUENCY CONNECTIONS. SUPPLIED IN 1 AND 2 CONTACT TYPES:

101 Series can be furnished with 1/4", .290", 5/16", 3/8" or 1/2" ferrule or cable entrance. Knurled nut securely fastens unit together. Plugs have ceramic insulation and sockets have bakelite. Quality construction. Fine finish. Assembly meets Navy specifications. For full details and engineering data ask for Jones Catalog No. CS-22

**JONES MEANS**  
Proven Quality

HOWARD B. JONES DIVISION  
CINCOR MANUFACTURING COMPANY  
CHICAGO 24, ILLINOIS  
DIVISION OF UNITED-CARR FASTENERS CORP.

CIRCLE NO. 97 READER SERVICE CARD



## ELECTRICAL COIL WINDINGS

- Encapsulated
- Bobbin
- Paper Interleave
- Cotton Interweave
- Form Wound
- High Temperature

Send us your coil specifications for quotation.

TRANSFORMERS MADE TO ORDER

## THE DANO ELECTRIC COMPANY

MAIN STREET • WINSTED, CONN.

CIRCLE NO. 83 READER SERVICE CARD 83



## Beattie Oscilloscope DIRECT VIEW Oscilloscope Recording Camera

Now, get a direct view with both eyes of the cathode ray tube while you're recording. No mirrors — full, clear vision. The new Beattie Direct-View Oscilloscope is the most versatile instrument of its kind — actually three cameras in one — and the only system to offer all these important features:

- Direct binocular view of CRT.
- Non-reversed image.
- Camera swings back for easy access to lens and shutter, or lifts off completely. Can be rotated.
- Available with large Polaroid® Land back or electrically-pulsed 35mm or 70mm camera for automatic, remote operation. Adapters for film pack or sheet film available.
- Continuous motion magazines available for 35mm and 70mm models.
- Electric shutter actuator optional with Polaroid® Land model.
- Attaches easily to bezel of 5" CRT. Adaptable to other sizes. No special tools.

"Polaroid"® by Polaroid Corp.

Write today for full details



1000 N. Olive St., Anaheim, California  
Branch: 437 Fifth Ave., New York, N.Y.

## COMMENT

### Pulse Circuit

... Concerning the article "Calibrated Source of Millimicrosecond Pulses" by E. J. Martin (p 56, Apr. 17) ...

I feel it is necessary to mention that the measurement of pulse amplitude by the means provided must be made while the mercury relay  $S_1$  is inoperative. Otherwise the result of the measurement will be related to the average value of the voltage appearing on the slide arm of the potentiometer  $R_2$ , and not to the required peak value of this voltage. The average value resulting when the relay  $S_1$  is driven by a 60-cps supply, for example, is dependent to an unhandy degree on the settings of the range multiplier switch and potentiometer  $R_2$  as well as on the magnetic characteristics of the relay.

In this laboratory, a requirement for a continuous automatic record of pulse-induced effects versus the applied pulse amplitude has necessitated the use of a peak holding device in place of the voltage-measuring potentiometer described.

K. C. SMITH  
MCLENNAN LABORATORY  
UNIVERSITY OF TORONTO  
TORONTO, ONT.

... Mr. Smith is, of course, absolutely correct in his statement that accurate measurement of pulse amplitude can be obtained only when the mercury switch is inoperative. The fact that this was not mentioned specifically in the article is an oversight on my part.

Although we have been aware of this limitation on the pulser, until now we have not been particularly concerned about it since our work, unlike Mr. Smith's, has not required a *continuous* record of pulse amplitude ...

E. J. MARTIN  
UNIVERSITY OF KANSAS RESEARCH  
FOUNDATION  
LAWRENCE, KANS.

### Time Delay

I wish to call your attention to what I consider a complete misnomer in an article I submitted to you. The article was published in your May 1 edition (p 62) under

the title "Circuit Provides Dual Relay." I feel that the word *Relay* is completely misleading. The central idea of the article is that two time delays can be obtained from a circuit containing only two active elements.

H. P. BROCKMAN  
WESTINGHOUSE ELECTRIC CORP.  
BALTIMORE

Author Brockman catches us with a typographical error glaring. The title should, of course, have read "Circuit Provides Dual Delay."

### Challenge of Space

For several weeks I have intended writing to you to thank you for the article "The Challenge of Space" (p 65, Apr. 24). I find it extremely useful because of the tremendous amount of information you have condensed in a very readable form for future reference.

I can recall a few years after World War II, while I was working for the Department of Defense in Washington, that the Air Force contracted with a private agency to prepare at considerable expense a similar document with respect to the then existing missile activity.

I think you have done a real service.

RICHARD M. EMBERSON  
ASSOCIATED UNIVERSITIES INC.  
NEW YORK

### Abbreviations

In your Mar. 13 issue (p 126) you use the symbol *mc* for, presumably, megacycles per second, and in the next line you use the symbol *mw* which presumably refers to milliwatts. I would have thought it would have been easier for your readers if you adopted the internationally agreed symbol of capital M for megacycle. Can you not take the lead in this?

H. T. GREATOREX  
BRITISH BROADCASTING CORP.  
LONDON, W 1

We cannot find any record of international agreement on this point to which U.S. is a party. To add to the confusion, the letter M is used (in this country at least) to stand for 1,000 (as an ohm designation on potentiometers, for instance).



ENGINEERS • SCIENTISTS

General Electric's Heavy Military Electronics Dept.

# AWARDED CONTRACT FOR Systems Integration, Engineering, and Management of... **AIR WEAPONS CONTROL SYSTEM 212L**

*A universal electronic control system to meet the vast problem of Air Defense  
outside of the Continental United States*

Systems-oriented engineers and scientists will appreciate the broadband technical challenge of the Air Weapons Control System 212L. There are important openings for men who are experienced in:  
WEAPONS SYSTEMS ANALYSIS • MATHEMATICAL ANALYSIS OF ENGINEERING PROBLEMS • COMPUTER PROGRAMMING • MILITARY COMMUNICATION SYSTEMS • RADAR SYSTEMS • WEAPONS CONTROL SYSTEMS • ELECTRONIC CIRCUITRY • INDUSTRIAL & MILITARY PSYCHOLOGY.

● Working in close cooperation with the USAF, it is Heavy Military's responsibility to integrate all subsystems—data acquisition, communications, data processing and display—plus various defensive weapons into a well coordinated and efficient operating system.

**VERSATILE AIR CONTROL APPLICATIONS** The revolutionary 212L can be used to defend a single airfield, or, by linking control sites together, it could be used in a limited action to provide air control for an area the size of Alaska. Similarly, by linking the capabilities of countries together, a system could be provided for the air control of an en-

tire continent. Designed for both fixed and mobile applications, the 212L will be used primarily outside the U. S. since the SAGE system is used for the defense of this country.

#### **HMED IS ALSO DESIGNING THE "HEART" OF THE SYSTEM**

In addition to its prime mission of providing systems management, HMED will design, develop and produce the data processing and display subsystem which is the "heart" of the 212L. Capable of rapidly and automatically detecting and tracking air targets, the subsystem operates without human assistance, except under unusual circumstances.

#### **OTHER FAR-RANGING PROGRAMS AT HEAVY MILITARY**

*At the present time additional far-ranging programs are being pursued in diverse and important areas at HMED:*

- Fixed & Mobile Radar
- Shipborne Radar
- Underwater Detection Systems
- Missile Guidance
- Data Handling Systems
- Communications

Individuals with experience in systems analysis or specific equipment design in the areas listed above are invited to forward their resume in complete confidence to Mr. George Callender, Div. 69WY

HEAVY MILITARY ELECTRONICS DEPARTMENT  
**GENERAL ELECTRIC**  
COURT STREET SYRACUSE, N. Y.

*Explore new areas  
at IBM in*

**MXAT+HEM**

At IBM, creative mathematicians are discovering important, new applications of mathematics in the electronic computer field. Long before actual construction of IBM's unique Magnetic Character Sensing Machine, for example, mathematicians were at work on a mathematical model, testing both the over-all design and the logic circuitry needed for character recognition. In another project, mathematicians employed large-scale computers to simulate, in a matter of weeks, eight years of engineering work which have yet to begin. Currently under study are vehicular penetration problems involving thousands of variables. Projects of this sort demand keen, discerning minds. If you have a flair for creative mathematics, you're the man we want to talk to.

You will enjoy unusual professional freedom and the support of a wealth of systems know-how. Comprehensive education programs are available, plus the assistance of specialists of many disciplines. Working independently or as a member of a small team, your contributions are quickly recognized and rewarded. This is a unique opportunity for a career with a company that has an outstanding growth record.

**CAREERS AVAILABLE IN THESE AREAS...**

Analog & digital computers	Experimental techniques	Probability theory
Applied mathematics	Field theory	Reliability
Circuit design	Human factors engineering	Scientific programming
Communications theory	Logic	Solid state
Computer system design & analysis	Mathematical & numerical analysis	Statistics
Control system research	Operations research	Switching theory
		Theoretical physics

**Qualifications:** B.S., M.S., or Ph.D. in Mathematics, Physics, Statistics, Engineering Science, or Electrical Engineering — and proven ability to assume important technical responsibilities in your sphere of interest.

## ASSIGNMENTS NOW OPEN INCLUDE...

**MATHEMATICIAN:** to handle mathematical analysis of advanced scientific computer programming for solution of systems problems, differential equations, probability-type problems, photogrammetry problems.

**STATISTICIAN:** to solve analysis-of-variance and multiple-regression type problems; to design experiments for various engineering applications and select form of statistical analysis of greatest value; to give statistical support to engineering departments in such areas as reliability analysis and human factors engineering by developing statistical programs for the IBM 704. Statistical experience in engineering problems and thorough knowledge of statistical distribution functions necessary.

**RESEARCH MATHEMATICIAN:** to investigate statistical problems in control system research on digital computer; to study control problems of analog to digital conversion, with particular reference to matrix problems; to apply experience with networks, statistics, or communications theory to problems in computer design; to solve problems involving switching theory, probability and information theory, and coding.

# ATICS

**APPLIED MATHEMATICIAN:** to undertake assignments involving knowledge of feedback control theory, data systems theory, servomechanisms, information theory, statistical models, heat flow, circuitry, magnetics, probability.

**MATHEMATICIAN-PROGRAMMER:** to specify and program elements of a sophisticated automatic programming system. Must have considerable experience in automatic programming research.

**OPERATIONAL PROGRAMMER:** to develop computer program techniques for real-time military applications, using game theory and systems simulation.

**OPERATIONS RESEARCH MATHEMATICIAN:** to evaluate closed loop systems consisting of computers, radar displays, and inertial equipment; to simulate advanced weapons systems in order to evaluate alternate design concepts; to analyze and design electromechanical systems, studying targets, tactics, and operational effectiveness. Experience in applying advanced mathematical techniques to weapons systems analysis and evaluation. Knowledge of probability and linear programming techniques.

For details, write, outlining background and interests, to:  
**Mr. R. E. Rodgers, Dept. 554 F4**  
 IBM Corporation  
 590 Madison Avenue  
 New York 22, N. Y.

# IBM®

INTERNATIONAL BUSINESS MACHINES CORPORATION

*Achievement in Action  
 at Avco ... for*

## SCIENTISTS AND ENGINEERS

**Achievement is habit at Avco!**  
**A leader in the field of atmospheric re-entry, Avco is now providing significant contributions to basic and applied research in Space and Missile Technology.**

*Supervisory, Senior and Junior positions are available in these areas:*

- ELECTRONICS
- MATHEMATICS
- PHYSICS
- CHEMISTRY
- MATERIALS
- FLIGHT TEST ENGINEERING
- DESIGN ENGINEERING
- PRODUCT ENGINEERING
- AERODYNAMICS
- APPLIED MECHANICS
- THERMODYNAMICS AND HEAT TRANSFER

*Attractive working environment outside of metropolitan Boston. The large, fully equipped, modern laboratory is close to Boston educational institutions and cultural events. The division offers a liberal educational assistance program for advanced study.*

Forward your inquiry to:

**E. W. Stupack,**  
 Manager, Personnel Relations  
 Dept. E-6

**AVCO**  
*Research & Advanced Development*

201 Lowell St., Wilmington, Mass.

# PHILCO

FAMOUS FOR **QUALITY** THE WORLD OVER

**has immediate opportunities for  
Electronic Engineers  
& Scientists  
IN PHILADELPHIA, PA.**

**COMMUNICATIONS SYSTEMS**

Systems Analysis, UHF & VHF Development, Receivers & Transmitters  
Transistorization, Microwave Development, Telemetry  
Pulse Circuit Techniques, IF & Video Circuitry, Miniaturization

**WEAPONS SYSTEMS & RADAR**

Advanced Systems, Systems Analysis, Guidance & Navigation  
Radar Development, Data Transmission, Display Development  
Missile Fuzing, Aerodynamics, Applied Mechanics

**ELECTRONIC DATA PROCESSING**

Product Planning, Systems Analysis, Memory Development  
Input and Output, Test & Evaluation, Production Engineering  
Programming, Field Service Engineers, Instructors & Writers

Send Confidential Resume to Mr. J. R. Barr, Engineering Employment Manager

**PHILCO** Government and Industrial Division  
4730 Wissahickon Avenue, Philadelphia 44, Pa.

## PROPOSAL ENGINEERS

You will determine government requirements, recommend the tone and contents and participate in the preparation of technical proposals and make presentations to customers. You must have a BSEE and some systems experience in communications, surface radar, airborne radar, ordnance radar or underseas warfare.

## FIELD REPRESENTATIVES

You will participate in proposal preparation and perform proposal liaison functions. You should have a BSEE and five to ten years' experience representing the electronics industry to government procurement agencies.

*These positions are with one of the country's leading military electronics companies. Relocation assistance and full modern benefits. Please send detailed resume to*

P-1826 ELECTRONICS  
Class Adv. Div., P. O. Box 12, N. Y. 36, N. Y.

## ELECTRONIC ENGINEERS UNUSUAL OPPORTUNITY

Growing Midwest manufacturer of closed circuit television seeks experienced electronic engineers to permit further growth and diversification. As a small organization we must have top flight engineers and designers who can expect to be amply rewarded for their accomplishments.

Background should include three to four years of video circuit design, pulse techniques, r-f, camera tube circuitry, or similar activity.

Company has an impressive record of achievement in industrial applications and has a sound financial background.

Please send complete resume with references to:

**General Manager, Electronics Division  
Diamond Power Specialty Corporation  
Lancaster, Ohio**

## INFRARED RADIATION RES. & DEV. ELECTRONIC ENGINEER

To work on unusual applications. Infrared experience desirable but not essential. Unique opportunity for a capable man seeking new horizons. Small, autonomous group in old, diversified company.

THE WARNER & SWASEY CO.  
CONTROL INSTRUMENT DIV.  
34 W. 33 St., New York 1.

## CIRCUIT DESIGN ENGINEERS

\$12,000-\$14,000

Start in newly expanding organization holding prime contracts offering unlimited future potential. Quick action. Company pays fees and expenses.

MONARCH PERSONNEL  
28 E. Jackson Blvd. Chicago 11, Illinois

## SERVO ENGINEERS

\$12,000-\$15,000

Client desires engineers with 5 or more years experience in closed loop, highly stabilized control systems. These systems used on electronic manufacturing equipment. Company assumes interviewing, moving and agency expenses. Mail resume in confidence.

ESQUIRE PERSONNEL  
202 South State Street. Chicago 4, Illinois

ADDRESS BOX NO. REPLIES TO: Box No.  
Classified Adv. Div. of this publication.  
Send to office nearest you.  
NEW YORK 36: P. O. BOX 12  
CHICAGO 11: 520 N. Michigan Ave.  
SAN FRANCISCO 4: 68 Post St.

## POSITION WANTED

**Electrical Engineer, BSEE, Age 37, Reg. PE,** electro-medical and data presentation development experience and patents. Desires work in electro-medical or sonar development. PW-1920, Electronics.

## Your Inquiries to Advertisers Will Have Special Value . . .

—for you—the advertiser—and the publisher, if you mention this publication. Advertisers value highly this evidence of the publication you read. Satisfied advertisers enable the publishers to secure more advertisers and—more advertisers mean more information on more products or better service—more value—to YOU.

## Communication Engineers

### Immediate Staff Build-Up on New, Integrated **COMMERCIAL & MILITARY** PRODUCT DESIGN PROGRAMS

at General Electric's  
Communication Products Dept.  
in Lynchburg, Virginia

Serving both industrial and military customers, the Communication Products Department offers engineers a unique type of professional stimulation—through participation in *integrated* design and production programs in advanced communication systems.

Industrial products of Microwave Radio Relay, Mobile and Powerline Carrier Current communication systems comprise the major portion of Department sales. These are often related to other projects for the Department of Defense, such as our contract for design and manufacture of a 24 channel tropospheric scatter system.

Engineers here frequently have the opportunity to contribute to both types of programs.

**Immediate openings for men with Project Engineering or Group Leading experience in these areas:**

PARAMETRIC DEVICES • TUNNEL EFFECT DEVICES • MICROMINIATURIZATION • MICROWAVE CIRCUITRY AND PLUMBING • TRANSISTOR CIRCUITS • PIEZOELECTRIC AND ELECTROMECHANICAL FILTERS • DATA TRANSMISSION SYSTEMS • MULTIPLEX SYSTEMS • TROPOSPHERIC AND METEORIC SCATTER • PRINTED CIRCUITS

Write for data sheets on the Department and literature describing the attractive residential city of Lynchburg. Address Mr. Arthur Guy, Section 69-WY.

COMMUNICATION PRODUCTS DEPT.  
**GENERAL ELECTRIC**

Mountain View Road  
Lynchburg, Virginia

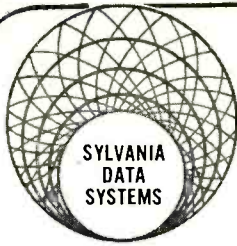

SECOND IN A SERIES

# The Role of Mathematics in the Security of Nations...

A Problem that is challenging creative minds  
at Sylvania's Data Systems Operations

Throughout the pages of recorded history, mathematics has guarded man against the forces of nature and human enemies. For example, one of the earliest applications of applied mathematics was the nilometer used by the priests of ancient

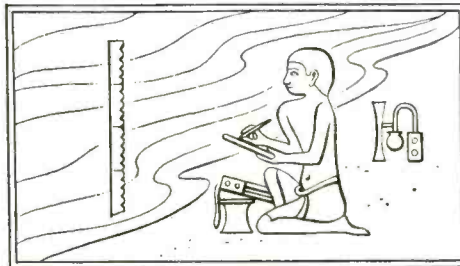

Egypt to record the rising waters of the Nile. This simple device warned the populace of devastating floods. 5,500 years later mathematics still stands between man and destruction from a far graver danger — enemy ICBMs.

At Sylvania's Data Systems Operations, advanced research and development programs are under way to expand use of this common language of science and thereby extend man's capabilities across broad technological areas. Indica-

tive of the significant programs now under way are the data processing phase of BMEWS, the USAF's Ballistic Missile Early Warning System, and MOBIDIC, first large-scale, *mobile* digital computer designed and developed for the U. S. Army Signal Corps.

Sylvania's interest is in senior men of extremely high professional capabilities, who have the initiative to formulate their own research approaches and provide

the leadership required to make major advances in computer programming. These men should have a minimum of 5 years' experience, possess an advanced degree (PhD preferred), and be able to project their thinking beyond present technological constrictions. There are immediate positions for:

- SENIOR MATHEMATICIAN
- SENIOR COMPUTER PROGRAMMER — Real-Time Systems
- SENIOR COMPUTER PROGRAMMER — Research

Please send resume to J. B. Dewing

**DATA SYSTEMS OPERATIONS**

**SYLVANIA** ELECTRONIC SYSTEMS  
A DIVISION OF SYLVANIA ELECTRIC PRODUCTS INC.



189 B Street — Needham 94, Massachusetts

*Farrington*



# ENGINEERS

Continued long range expansion at Farrington Mfg. Company and its affiliate, Intelligent Machines Research Corporation, is creating unlimited R & D engineering opportunities. Originator of Automated Credit Identification equipment such as Charga-Plate, Farrington/IMR has developed Scandex, the only optical scanning character-sensing system now in actual operation. IMR's work is virtually all in the commercial/business field.

We need graduate engineers at all levels from recent graduates to Ph. D's. Requires strong interests and backgrounds in digital circuits, optics, electro-mechanical devices, amplifiers, triggers, logic gates. Will connect business machines with character sensing machines, and develop new methods of scanning or logic, experimentation and evaluation of components and sub-assemblers.

For ambitious engineers we have challenging openings in the Boston and the Washington, D. C. areas. Both are ideal locations with their proximity to top educational and cultural resources, fine medical facilities and diversified recreational areas.

*If you are seeking engineering challenge, satisfaction with your work and promotion potential, send full resume in complete confidence to W. P. de Mille, Director of Industrial Relations.*

**Farrington MANUFACTURING CO.**  
New England Industrial Center  
NEEDHAM HEIGHTS 94, MASS.

## ENGINEERING SUPERVISOR—ELECTRICAL DEVELOPMENT

Supervise General Headquarters Laboratory group for development of machine control systems and automatic test equipment, including tape, numerical and feed-back types. Primarily for various commercial divisions of the company.

Requires degree in Electrical Engineering with some graduate study preferred, and eight to ten years' design experience in this field. Should include knowledge of application of magamps and transistors to above work, plus some experience with digital and analog computers.

Send resume and salary requirement to:

Mr. R. L. Sauer

WESTINGHOUSE ELECTRIC CORPORATION

P. O. Box 2278

PITTSBURGH 30, PENNSYLVANIA

## PHOTOSURFACES PHYSICIST OR ENGINEER

Expanding midwest Corporation manufacturing television pickup tubes and photosensitive devices, as well as a complete line of television equipment, seeks a competent technical man to head the tube development laboratory.

Applicant must be well grounded in photo-sensitive surfaces, their development, formation and measurement. Should have thorough background in high vacuum technique, tube design, electron optics and associated skills.

Send complete resume to:

General Manager, Electronics Division,  
Diamond Power Specialty Corporation,  
Box 415, Lancaster, Ohio

## ELECTRONIC ENGINEERS

New electronics division of an established aircraft and missile firm offers ground floor opportunities for all levels of engineers. Design, systems & circuit analysis for section heads and project engineers.

Reply in confidence to: John Allen  
6 N. Michigan Ave., Room 708, Chicago 2, Ill.  
Financial 6-1155

**SALES MANAGER**—To direct all marketing activities of small manufacturer of VHF television distribution equipment, low noise and specialized amplifiers. Must have engineering education and substantial successful sales management experience. Considerable travel. Located in small academic community in mountains of Central Pennsylvania for delightful living and family raising. Growth opportunity. Salary and stock option. Apply to Mr. James R. Palmer, Community Engineering Corporation, Box 824, State College, Penna.



**MANUFACTURERS' REPRESENTATIVES**  
IN THE ELECTRONIC INDUSTRY  
CONTRACT RATES GIVEN ON REQUEST. WRITE  
**ELECTRONICS**

**SAMUEL K. MACDONALD, INC.**  
manufacturers representatives over 25 years  
1531 SPRUCE STREET, PHILA. 2, PA.

Territory: Pennsylvania • New Jersey  
Delaware • Maryland  
Virginia • West Virginia  
District of Columbia  
Other Offices: Pittsburgh  
Baltimore  
Washington, D.C.

## SEARCHLIGHT SECTION

(Classified Advertising)

BUSINESS OPPORTUNITIES

EQUIPMENT - USED or RESALE

### DISPLAYED RATE

The advertising rate is \$24.75 per inch for all advertising appearing on other than a contract basis. Contract rates quoted on request. AN ADVERTISING INCH is measured  $\frac{1}{8}$  inch vertically on one column, 3 columns—30 inches—to a page. EQUIPMENT WANTED or FOR SALE ADVERTISEMENTS acceptable only in Displayed Style.

### UNDISPLAYED RATE

\$2.40 a line, minimum 3 lines. To figure advance payment count 5 average words as a line. PROPOSALS, \$2.40 a line an insertion. BOX NUMBERS count as one line additional in undisplayed ads. DISCOUNT of 10% if full payment is made in advance for four consecutive insertions of undisplayed ads (not including proposals).

We are Distributors and carry Full Stock for Immediate Delivery

NEON and MINIATURE LAMPS  
Merkle-Korff Geared Motors in all speeds  
Wheeler Sound Powered Telephones  
Veeder Root Counters—Micro Switches  
Guardian Electric Relays & Solenoids  
Timing Devices by Industrial Timer Corp.  
Linemaster Footswitches—Etc.

**Potter & Brumfield, inc.**

We have practically all types of Relays in large quantities, ready to deliver.—No waiting.  
See our large ad in March 13, 1959 issue page 314

**BLAN**  
EST. 1923

INCLUDE POSTAGE  
64B Dey St.  
New York 7  
N. Y.

WANTED:

**ALLEN-BRADLEY**

RESISTORS

POTENTIOMETERS

CAPACITORS

ANY VALUES and TYPES

**LEGRI S COMPANY**

391 Riverdale Ave. Yonkers 5, N. Y.

## SURPLUS PARTS & SYSTEMS

Radar Set AN/FPS-4, Transmitter CDE 52362, Radar Set AN/TRC-12, FM T-R T30/TRC8 230-250MC, Magnetrons QK221, Height Indicator CPS-6B, Radar FPS3, CPS-5, 714AY, Telephone Carrier Systems CF2A & CF2B, X Band Radar Set TPS/10D, Miscellaneous Electronic Surplus and Scrap.

ELECTRO-TIMER, INC. Box 587 W. Caldwell, N. J.

**PROFESSIONAL SERVICES**

ERCO RADIO LABORATORIES, INC.

Radio Communications Equipment  
Engineering - Design - Development - Production  
Our 30th Year in Air to Ground Communication and Radio Beacons  
Garden City • Long Island • New York



# ELECTRONIC

WAR TERMINATION INVENTORIES

WRITE OR WIRE FOR INFORMATION ON OUR COMPLETE LINE OF SURPLUS ELECTRONIC COMPONENTS. ALL PRICES NET F.O.B. PASADENA, CALIFORNIA

# C&H SALES CO.

2176-E East Colorado St.  
Pasadena 8, California  
RYan 1-7393

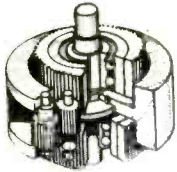

### SIMPLE DIFFERENTIAL WITH BALL-BEARING SUN GEARS

The 1:1 reverse ratio spur gears are 48-tooth, 32 pitch brass with 3/16" available face. On one side, the shaft is .2364" dia. for 11/16" and has a pin hole, then increases in dia. to .377" for the remaining 3/16" of length. On the other side, the shaft is .377 dia. 1/4" lg. 2-13/16" dia. is required to clear the body. Stock no. A6-115.....each \$15.00

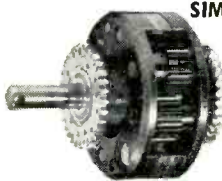

### SIMPLE DIFFERENTIAL WITH SPACED-OUT SUN GEARS

1:1 reverse ratio spur gears are aluminum, 3/32" face, 32 pitch, 32 tooth on one side, 48 tooth on the other. The body is 3/4" thick, but the sun gears are spaced out so that they are 1 1/2" apart. 1/4" dia. shaft on each side is 23/32" long. OA length 3 1/8". Requires 1-23/32" dia. to clear the body. Stock no. A6-124.....each \$4.50

### SIMPLE DIFFERENTIAL

1:1 reverse ratio, 60 teeth on large gear; 1/4" shaft. Size: 3" long with 1-15/16" dia. Stock no. A6-104.....each \$3.95

### DUAL SIMPLE DIFFERENTIAL

1:1 reverse ratio on both. Size: 3 1/4" long x 1-7/16" dia. Shaft size: 1/8" and 5/32". Stock no. A6-107.....each \$7.50

### SPERRY VERTICAL GYRO



Part #653265. Motor 115 volts, 3 phase, 400 cycle, 8 watts, 20,000 RPM. 3-minute runup, synchro pickoffs, roll 360°, pitch 85°. Synchro excitation 26 volts, 400 cycle, 150 m.a. Vertical accuracy ±1/2". Weight 3 1/2 lbs. Approx. dim. 5 3/4" L., 4 1/2" W., 4 1/2" H. Price \$35.00

### 400 CYCLE, 3 PHASE GENERATOR

BY MASTER ELECTRIC Type AG, frame 364Y, 7.5 kw, 3428 rpm, pf .95. Star connected 120/208 3 phase 22 amps. Delta connected 120 volt single phase 66 amps. Self excited. Complete with control box, voltage regulator, AC voltmeter and frequency meter. Shaft 1" dia., 2" long; overall dim. of unit: 21"x18"x20". Price \$395.00 each

### SYNCHROS SERVOS

- 1CT cont. Trans 90/55V 60 cy. \$34.50
- 1DG Diff. Gen. 90/90V 60 cy. 34.50
- 1F Syn. Mtr. 115/90V 60 cy. 34.50
- 16 Gen. 115V 60 cy. 34.50
- 1 HDG 37.50
- 1-1CT 37.50
- 1HG 37.50
- 13F Syn. Mtr. 115/90V 400 cy. 12.50
- 5T Cont. Trans. 90/55V 60 cy. 34.50
- 5J Diff. Mtr. 90/90V 60 cy. 34.50
- 5JG Diff. Gen. 90/90V 60 cy. 34.50
- 5F Syn. Mtr. 115/90VAC 60 cy. 34.50
- 53 Syn. Gen. 115/90VAC 60 cy. 34.50
- 5HCT Cont. Trans. 90/55V 60 cy. 37.50
- 5SDG Diff. Gen. 90/90V 400 cy. 12.50
- 6DG Diff. Gen. 90/90V 60 cy. 25.00
- 6G Syn. Gen. 115/90VAC 60 cy. 34.50
- 7G Syn. Gen. 115/90VAC 60 cy. 42.50
- 7DG differential generator, 90/90 volts, 60 cycle 37.50
- C56701 Type 11-4 Rep. 115V 60 cy. 20.00
- C69405-2 Type 1-1 Transm. 115V 60 cy. 20.00
- C69406 Syn. Transm. 115V 60 cy. 20.00
- C69406-1 Type 11-2 Rep. 115V 60 cy. 20.00
- C76166 Volt. Rec. 115V 60 cy. 10.00
- C78248 Syn. Transm. 115V 60 cy. 12.50
- C78249 Syn. Diff. 115V 60 cy. 5.00
- C78410 Repeater 115V 60 cy. 20.00
- C78863 Repeater 115V 60 cy. 7.50
- C79331 Transm. Type 1-4 115V 60 cy. 20.00
- 851 Bendix Autosyn Mtr. 22V 60 cy. 7.50
- 403 Kollsman Autosyn Mtr. 32V 60 cy. 7.50
- \*PE-25-11 Diehl Servo 75/115 v 60 cy. 12.50
- \*PE 49-7 Diehl servo motor, 115 volts, 60 cycle, 10 watts 30.00
- \*PE-43-1 Resolver 400 cy. 19.50
- \*JE-43-9 Resolver 115V 400 cy. 15.00
- R110-2A Kearfott Cont. Mfr. 17.50
- R111-2A 20.00
- R112-2D-B 22.50
- R200-1-A Kearfott Cont. Trans. 15.00
- R220-1 Kearfott Receiver 20.00
- R235-1D Kearfott Resolver 20.00
- AY201-2B 15.00
- AY201-3B 12.50
- AY201S-1B 15.00
- AY221-34 10.00

### HONEYWELL VERTICAL GYRO MODEL JG7003A-1

115 volts, 400 cycles, single phase, 35 watts. Pitch and roll potentiometer pickoffs 890 ohms, 40 volts max. AC or DC. Speed 20,000 rpm, ang. momentum 12,500,000 gm-cm<sup>2</sup>/sec. VAC- tion system 27 VAC. 400 cycles, time 5 min. to 1/2". Weight 5.5 lbs. Price \$35.00 each

### OPERATIONAL DC AMPLIFIER WITH BROWN INSTRUMENT CHOPPER

AM-1023 Made by Gilfillan Bros., Inc. Useful for computers . . . for polarity inversion . . . for isolation . . . and to amplify voltages from DC to 10 cps. Useful closed-loop gain is from 0.1 to 500. Maximum output range is from -150 v to +150 v. Drift less than 10 mv/hour. Input point tends to go to ground potential because of the feedback loop and internal circuitry; therefore determines the input impedance. Accuracy of the gain figure is important in instrumentation. It is the closed-loop gain divided by the open-loop-gain of 200,000; accuracy to match, a predetermined gain of 500 is accurate to 1/4%, and lesser gains exceed the accuracy of practicable obtainable resistors. The amplifier is complete with tubes, chopper and circuit diagram. The circuit diagram gives the voltages to be furnished by an external power supply. The Brown Converter ("For Continuous Balance System") is the late type 6-pin plug-in with twin side connector. Complete amplifier unit.....\$49.50

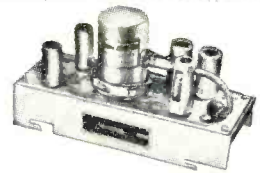

### MINNEAPOLIS-HONEYWELL RATE GYRO (Control Flight)



Part no. JG7005A, 115 volts A.C., 400 cycle, single phase potentiometer take off resistance 530 ohms. Speed 21,000 r.p.m. Angular momentum 2 1/2 million, CM<sup>2</sup>/sec. Weight 2 lbs. Dimensions 4-7/32 x 3-29/32 x 3-31/64. Price \$22.50

### VARIABLE SPEED BALL DISC INTEGRATORS

- No. 145 Forward & Reverse 2 1/4-0-2 1/4. Input shaft spline gear 12 teeth 9/32" dia. 3/8" long. Output shaft 15/64" dia. x 15/32" long. Control shaft 11/32" x 3/8" long. Cast aluminum construction. Approx. size 3" x 3" x 2 3/4".....\$17.50
- No. 146 Forward & Reverse 4-0-4. Input shaft 5/16" dia. x 3/4" long; Output shaft 15/64" dia. x 9/16" long. Control shaft 11/64" dia. x 11/16" long. Cast aluminum construction. Approx. size 4 1/2" x 4 1/2" x 4". (All Shafts Ball Bearing Supported) \$18.50 ea.

### SMALL DC MOTORS



- (approx. size overall 3 3/4" x 1 1/4" dia.):
- 5067043 Delco 12 VDC PM 1" x 1" x 2", 10,000 rpm. \$7.50
- 5067126 Delco PM, 27 VDC, 125 RPM, Governor Controlled 15.00 ea.
- 5069600 Delco PM 27.5 VDC 250 rpm 12.50
- 5069230 Delco PM 27.5 VDC 145 rpm 15.00
- 5068750 Delco 27.5 VDC 160 rpm w. brake 6.50
- 5068571 Delco PM 27.5 VDC 10,000 rpm (1 1/2"x2") 5.00
- 5069790 Delco PM, 27 VDC, 100 RPM, Governor Controlled 15.00 ea.
- 5072735 Delco 27 VDC 200 rpm governor controlled. 15.00
- 5BA10A118 GE 24 VDC 110 rpm 10.00
- 5BA10AJ37 GE 27 VDC 250 rpm reversible 10.00
- 5BA10AJ52 27 VDC 145 rpm reversible 12.50
- 5BA10AJ50, G.E., 12 VDC, 140 rpm 15.00
- 5BA10FJ401B, G.E. 28 VDC, 215 rpm, 10 oz. in., .7 amp, contains brake 15.00
- 5BA10FJ421, G.E. 26 VDC, 4 rpm, reversible, 6 oz. in., .65 amp 15.00
- S. S. FD6-21 Diehl 24 VDC PM 10,000 rpm. 1" x 1" x 2". 4.00

You are there - with Cinema...

# Professor CLYDE BEATNIK

(Somewhere way out)



**Q.**—"Hello, Professor, are you working on some new electronic experiment?"

**A.**—"Not me, Daddy, that stuff I don't dig. And I'm no Prof, just call me Clyde."

**Q.**—"If you're not a Professor, what are you doing with a CINEMA Terminal Board Switch?"

**A.**—"Man, I thought it was one of those crazy small vibraharpes we could use in our jumpin' combo."

**Q.**—"Oh, are you a musician?"

**A.**—"I'm not Governor Nelson Rockefeller, friend."

**Q.**—"Do you think everybody should take up music as a hobby?"

**A.**—"Beats me, Dad, but if they do let me know if you hear of a good vibraharp player."



Maybe it's not a vibraharp, Clyde, but it sure is sweet music to laboratory problems. For

**CINEMA ENGINEERING'S** instrument switches use a time-saving Terminal Board design. Four years of engineering permits the advance planning of modular harness layouts in **CINEMA'S** CETE and NETE switches. Each terminal is individually identified, thereby saving costly last-minute supervision and eliminating guesswork. They're ideal for moderate and complex switching and wiring applications. Write for our catalog 17S today.



## CINEMA ENGINEERING

DIVISION AEROVOX CORPORATION

1100 CHESTNUT • BURBANK, CALIF.

# INDEX TO ADVERTISERS

Atlas E-E Corporation .....	71	Radio Corporation of American....	4th Cover
Barnstead Still & Sterilizer Corp.....	12	Ramo-Woolldridge Division of Thompson Ramo Woolldridge, Inc. ....	13
Beattie-Coleman Inc. ....	84	Raytheon Mfg. Co. ....	5
Bekins Van Lines Co. ....	63	Resinite Dept., The Borden Chemical Co. ....	24
Black & Webster, Inc. ....	74	Sola Electric Co. ....	73
Boonton Radio Corporation .....	30	Sprague Electric Co. ....	26, 27
Bradley Semiconductor Corporation ....	79	Taylor Fibre Co. ....	21
Bristol Company .....	66	Tektronix, Inc. ....	8
Brush Instruments, Div. of Clevite Corp. ....	34	Telrex Laboratories .....	70
Cannon Electric Co. ....	9	Temco Aircraft Corp. ....	33, 82
Centralab, A Division of Globe Union Inc. ....	19	Trauselectronics .....	78
Christie Electric Corp. ....	82	Unltron Instrument Division of United Scientific Co. ....	78
Cinema Engineering .....	92	Universal Winding Company.....	81
Clifton Precision Products, Co., Inc....	29	Waters Manufacturing, Inc. ....	6
Constantin & Co., L. L. ....	55	Western Devices, Inc. ....	70
Continental-Diamond Fibre, A Subsidiary of the Budd Company .....	28	White, S. S. ....	67
Dano Electric Company, The .....	83		
Dymec, Inc. ....	7		
Electronic Measurements Co., Inc.....	25		
General Electric Company Apparatus Dept. ....	17	Professional Services .....	90
Genisco, Inc. ....	77		
Hewlett-Packard Company.....	2nd Cover	Manufacturers' Representatives .....	90
International Telephone & Telegraph Corp. ....	18		
Jennings Radio Mfg. Corp.....	60	CLASSIFIED ADVERTISING F. J. Eberle, Business Mgr.	
Jones, Howard, B., Division of Cinch Mfg. Co. ....	83	EMPLOYMENT OPPORTUNITIES...85-90	
Kennedy & Co., D. S. ....	3	EQUIPMENT (Used or Surplus New) For Sale .....	90, 91
Kepeco, Inc. ....	59	WANTED Equipment .....	90
Kidder, Peabody & Co. ....	83	ADVERTISERS INDEX	
Kintel a Division of Cohu Electronics, Inc. ....	3rd Cover	Allen, John .....	90
Lench Corporation .....	22	Avco Research & Advanced Development.	87
M & C Nuclear Inc. ....	77	Blan .....	90
MacDonald Inc., Samuel K. ....	90	C & H Sales Co. ....	91
Maleo Mfg. Company .....	32	Community Engineering Corp. ....	90
Mycelox Corporation of America.....	65	Diamond Power Specialty Corp.....	88, 90
Natvar Corporation .....	2	Electro-Timer, Inc. ....	90
New Hermes Engraving Machine Co. ....	31	Esquire Personnel .....	88
Non-Linear Systems, Inc. ....	57	Farrington Manufacturing Co. ....	90
North American Aviation, Inc. ....	16	General Electric Co. ....	85, 89
North Electric Company .....	14	International Business Machines Corp.86,	87
Plug-In Instruments, Inc. ....	15	Legri S Co. ....	90
Polytechnic Research and Development Co., Inc. ....	69	Monarch Personnel .....	88
		Philco Corp. Government & Industrial Div. ....	88
		Radio Research Instrument Co. ....	90
		Sylvania Electric Products Inc. ....	89
		Warner & Swasey Research Corp., The...	88
		Westinghouse Electric Corp. ....	90

This index is published as a service. Every care is taken to make it accurate, but ELECTRONICS assumes no responsibilities for errors or omissions.

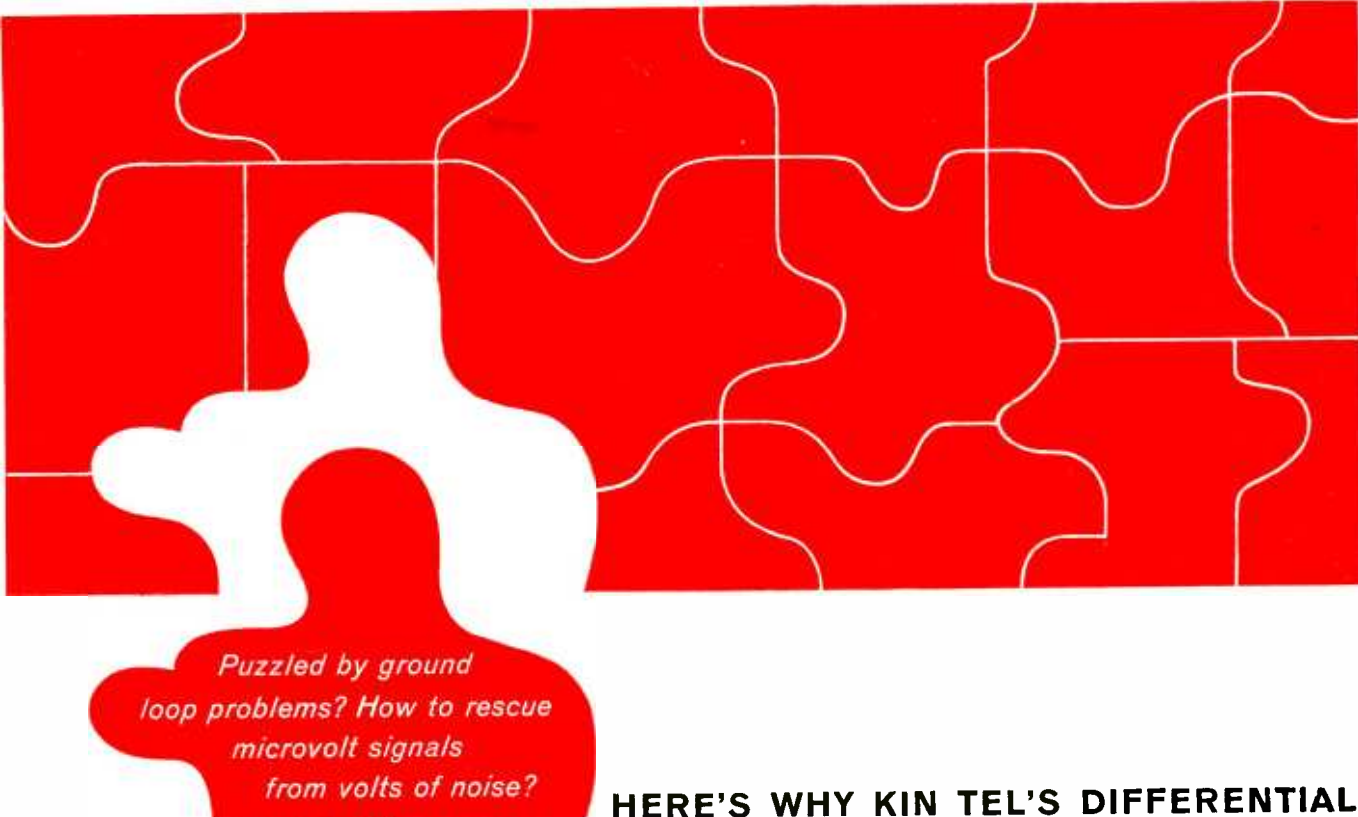

*Puzzled by ground  
loop problems? How to rescue  
microvolt signals  
from volts of noise?*

## HERE'S WHY KIN TEL'S DIFFERENTIAL DC AMPLIFIERS FIT IN INSTRUMENTATION SYSTEMS

180 db DC, 130 db 60 cycle common mode rejection with balanced or unbalanced input ■ Input completely isolated from output ■ Input and output differential and floating ■ 5 microvolt stability for thousands of hours ■ .05% linearity, 0.1% gain stability ■ Gain of 10 to 1000 in five steps ■ >5 megohms input, <2 ohms output impedance ■ 100 cycle bandwidth ■ Integral power supply

These are just a few of the many outstanding features of the Model 114A differential DC amplifier...features that make this amplifier *really work* in instrumentation systems...features that will help solve *your* instrumentation problems today.

Ideal for thermocouple amplification, the 114A eliminates ground loop problems; allows the use of a common transducer power supply; permits longer cable runs; drives grounded, ungrounded or balanced loads, and can be used inverting or non-inverting. Price \$875.

For additional information and technical literature on this exceptional instrument, write or call KIN TEL – the world's largest manufacturer of precision, chopper-stabilized DC instruments.

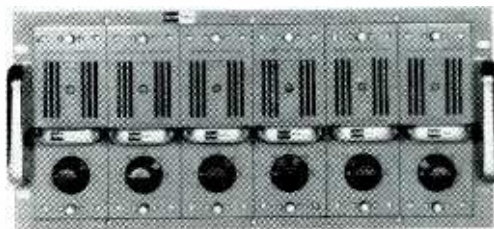

KIN TEL 114A  
differential DC amplifiers  
...convenient, interchangeable  
plug-in mounting in  
either 6-amplifier 19" rack  
mount modules or single-  
amplifier cabinets.

5725 Kearny Villa Road, San Diego 11, Calif.  
Phone: BRowning 7-6700  
Representatives in all major cities

**KIN TEL**  
A DIVISION OF  
**COHU**  
ELECTRONICS, INC.

Remarkable  
Cathode  
Advance...

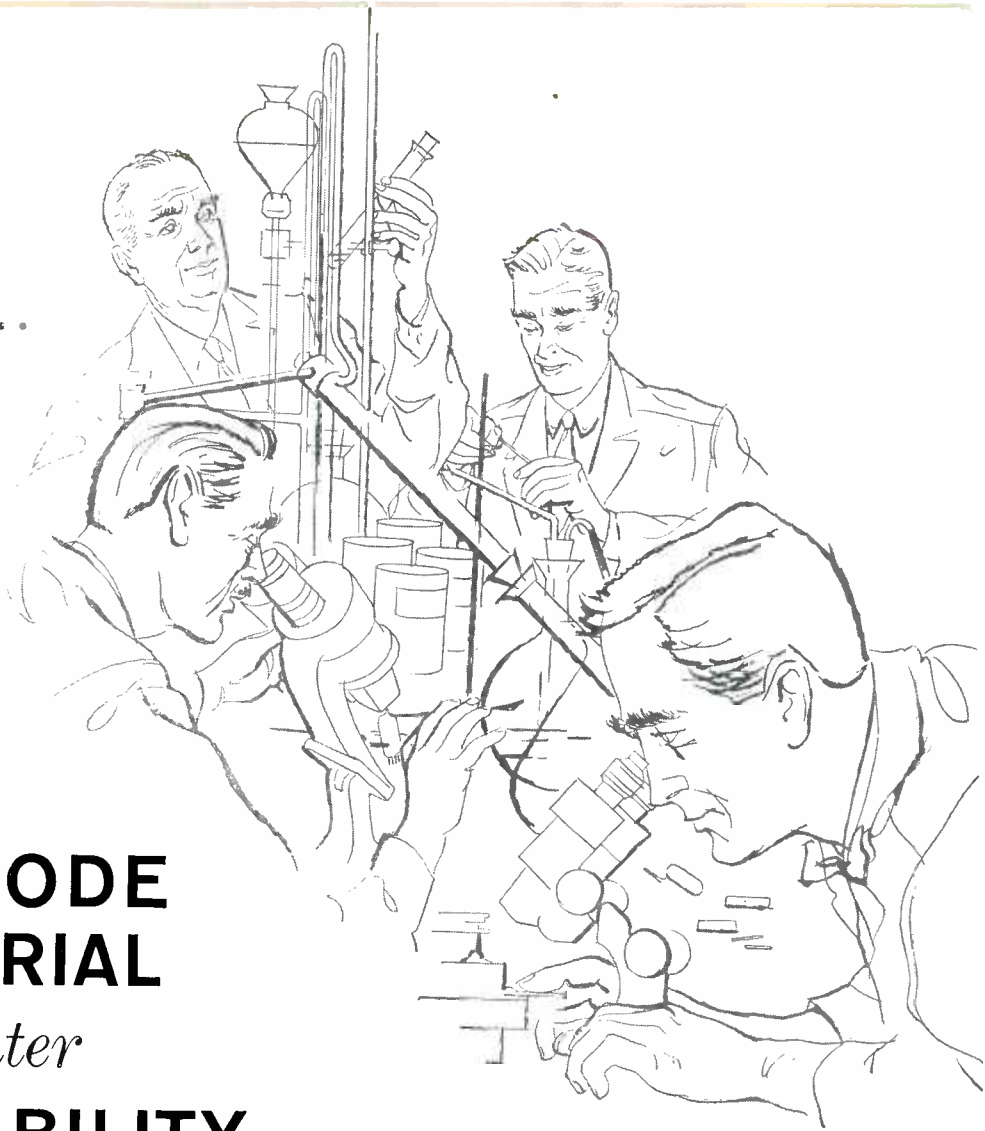
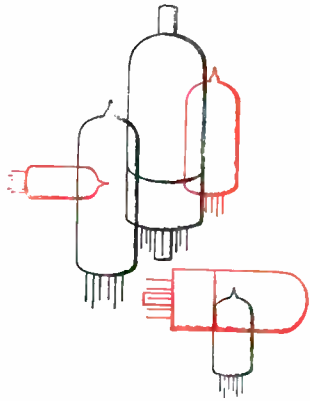

*vacuum-melted*

## **N-132 CATHODE BASE MATERIAL**

*brings you greater*

## **TUBE RELIABILITY**

N-132 cathode base material, produced by a vacuum-melting process...an RCA development...is a new and extraordinary base composition for cathodes. N-132 makes possible substantial improvements in cathode uniformity, contributing significantly to the reliability and performance of Electron Tubes.

Vacuum-melting reduces the level of contaminants such as copper and sulphur. It also permits rigid controls to be placed on the presence of essential elements such as carbon, magnesium, manganese, silicon, and titanium. As a result, this process yields exceptional uniformity from one melt to another, therefore holding cathode characteristics within strict limits. In addition, the "process" reduces the deoxidizing agents usually employed in processing nickel "batches". This minimizes the possibility of gaseous contamination as the cathode material heats and ages, assuring long term, reliable performance in high impedance circuits.

RCA Tubes utilizing N-132 Cathode material can add a greater element of reliability to your circuits. Ask your RCA Representative—he'll be glad to prove the point.

#### **RCA FIELD OFFICES**

**EAST:** 744 Broad Street  
Newark 2, New Jersey  
HUmboldt 5-3900

**MIDWEST:** Suite 1154  
Merchandise Mart Plaza  
Chicago 54, Illinois  
WHitehall 4-2900

**WEST:** 6355 E. Washington Blvd.  
Los Angeles 22, California  
RAYmond 3-8361



**RADIO CORPORATION OF AMERICA**

**Electron Tube Division**

**Harrison, N. J.**

MAY 29, 1959

# electronics

A MCGRAW-HILL PUBLICATION

VOL. 32, No. 22

PRICE SEVENTY-FIVE CENTS



*Special*

**Designing for Reliability**

NOBINGSIDE COLLEGE  
LIBRARY  
STOON CITY 6 JANE

*This new precision DC VTVM is also  
a wide range, precision ohmmeter and ammeter!*



# 1% accuracy 100 $\mu$ v to 1,000 volts!

Also 2% accuracy, 1  $\mu$ a to  
1 amp full scale.

Measures 0.02 ohms to  
5,000 megohms.

No zero adjustment. 1 minute  
warm-up.

Floating chassis. \$1,000 worth  
of convenience for \$350!

Haven't you wished for one compact, simple instrument that would make *precision* dc voltage, dc current and resistance measurements over a wide range?

The new  $\text{hp}$  412A is it! In its VTVM circuit, the 412A uses an exclusive  $\text{hp}$  photo-chopper instead of old-style mechanical vibrators—no drift, no 60 cps pickup. Input is floating, with resistance increasing from 10 megohms on the 1 mv range to 200 megohms on ranges above 100 mv. Current and voltage ranges have a 10 db sequence for

maximum readability and overlap. The ohmmeter is a modified Kelvin bridge eliminating lead resistance error; you measure resistance accurately on hook-up wire sections as short as 6".

Model 412A also includes a 1 v or 1 ma recorder output, and 3 separate probes. Call your  $\text{hp}$  rep today for a demonstration on your bench. Price, \$350.

#### HEWLETT-PACKARD COMPANY

1001H PAGE MILL ROAD • PALO ALTO, CALIFORNIA, U.S.A.  
CABLE "HEWPACK" • DAVENPORT 5-4451  
FIELD REPRESENTATIVES IN ALL PRINCIPAL AREAS



#### $\text{hp}$ 400L LOGARITHMIC VOLTMETER—\$325

New  $\text{hp}$  voltmeter covers 10 cps to 4 MC; accuracy high as  $\pm 2\%$  of reading or 1% of full scale. Voltage range 0.3 mv to 300 v, 12 ranges, 1-3-10 sequence. Max. full scale sensitivity 1 mv. Large 5" true log voltage scale, linear 12 db scale, generous overlap. High stability, high input impedance. Also useful as amplifier for small signals, or to monitor waveforms.



#### $\text{hp}$ 400H PRECISION VOLTMETER—\$325

Extreme accuracy as high as  $\pm 1\%$  to 500 KC,  $\pm 2\%$  to 1 MC,  $\pm 5\%$  full range. Frequency coverage 10 cps to 4 MC. Large 5" meter with precision mirror scale. Voltage range 0.1 mv to 300 v; max. full scale sensitivity 1 mv. High 10 megohm input impedance minimizes circuit disturbances. Amplifier with 56 db feedback insures lasting stability. Reads direct in db or volts.



#### $\text{hp}$ 400D WIDE RANGE VOLTMETER—\$225

Highest quality, extremely versatile. Covers 10 cps to 4 MC. Highly sensitive, accurate to within  $\pm 2\%$  to 1 MC. Measures 0.1 mv to 300 v; max. full scale sensitivity 1 mv. Reads direct in dbm. High 10 megohm input impedance virtually eliminates circuit loading. 56 db amplifier feedback insures high stability and freedom from change due to external conditions.

*Data subject to change without notice. Prices f.o.b. factory*

5028



**complete precision voltage measuring equipment**