

# electronics

engineering edition

Batteries for  
Space Age . . . 59

Analyzing  
Brain Waves . 68



## RECEIVER CONTROLS CRYSTAL LAPPING

. . . page 66



# TO MAKE YOUR EQUIPMENT SMALLER YET MORE RELIABLE

## REVOLUTIONARY TRANSISTOR\* TRANSFORMERS, HERMETIC TO MIL-T-27

Conventional miniaturized transistor transformers have inherently poor electrical characteristics, perform with insufficient reliability and are woefully inadequate for many applications. The radical design of the new UTC DO-T and DI-T transistor transformers provides unprecedented power handling capacity and reliability, coupled with extremely small size.

### TYPICAL DO-T PERFORMANCE CURVES

Power curves based on setting output power at 1 KC, then maintaining same input level over frequency range.

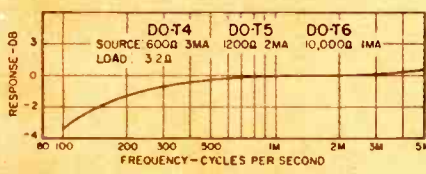
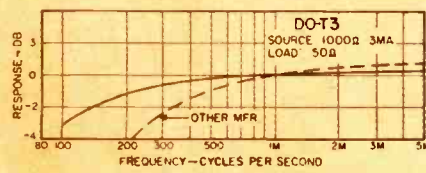
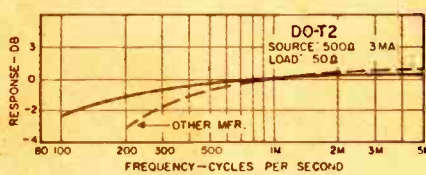
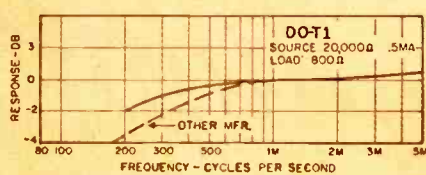
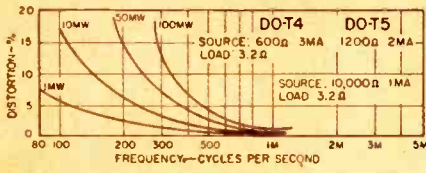
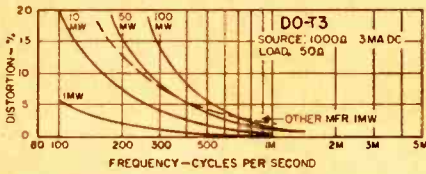
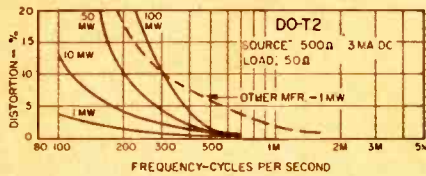
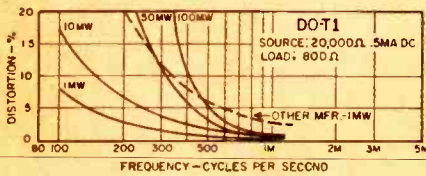

## DO-T



1/16 Dia. x 1 1/2, 1/10 Oz.

High Power Rating ... up to 100 times greater.

Excellent Response ... twice as good.

Low Distortion ... reduced 80%.

High Efficiency ... up to 30% better.

Moisture Proof ... hermetic to MIL-T-27A.

Rugged ... completely cased.

Anchored Leads ... will stand 10 lb. pull, plastic leads for printed circuits.

## DI-T

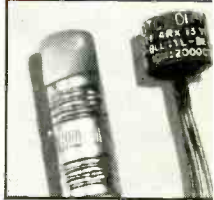

1/16 Dia. x 1/4, 1/20 Oz.

To fully appreciate DO-T transistor transformers, the curves indicate their performance compared to that of similar size units now on the market. DI-T transformers are still smaller in size. Power rating and other characteristics are identical to DO-T, but low frequency response (3 db down point) is 30% higher in frequency. Units can be used for different impedances than those shown, keeping in mind that impedance ratio is constant. Lower source impedance will improve response and level ratings ... higher source will reduce them. Units may be used reversed, input to secondary.

DO-T No.	MIL Type	Application	Pri. Imp.	D.C. Ma. in Pri.	Sec. Imp.	Pri. Res.	Level Mw.	DI-T No.
DO-T1	TF4RX13YY	Interstage	20,000 30,000	.5 5	800 1200	850	50	
DO-T2	TF4RX17YY	Output	500 600	3 3	50 60	60	100	DI-T1
DO-T3	TF4RX13YY	Output	1000 1200	3 3	50 60	115	100	DI-T1
DO-T4	TF4RX17YY	Output	600	3	3.2	60	100	
DO-T5	TF4RX13YY	Output	1200	2	3.2	115	100	
DO-T6	TF4RX13YY	Output	10,000	1	3.2	1000	100	
DO-T7	TF4RX16YY	Input	200,000	0	1000	8500	25	
DO-T8	TF4RX20YY	Reactor 3.5 Hys. @ 2 Ma. DC, 1 Hy @ 5 Ma. DC (DI-T8 is 2.5 Hy @ 2 Ma.)				630		DI-T1
DO-T9	TF4RX13YY	Output or driver	10,000 12,500	1 1	500 CT 600 CT	800	100	DI-T1
DO-T10	TF4RX13YY	Driver	10,000 12,500	1 1	1200 CT 1500 CT	800	100	DI-T1
DO-T11	TF4RX13YY	Driver	10,000 12,000	1 1	2000 CT 2500 CT	800	100	DI-T1
DO-T12	TF4RX17YY	Single or PP output	150 CT 200 CT	10 10	12 16	11	500	
DO-T13	TF4RX17YY	Single or PP output	300 CT 400 CT	7 7	12 16	20	500	
DO-T14	TF4RX17YY	Single or PP output	600 CT 800 CT	5 5	12 16	43	500	
DO-T15	TF4RX17YY	Single or PP output	800 CT 1070 CT	4 4	12 16	51	500	
DO-T16	TF4RX13YY	Single or PP output	1000 CT 1330 CT	3.5 3.5	12 16	71	500	
DO-T17	TF4RX13YY	Single or PP output	1500 CT 2000 CT	3 3	12 16	108	500	
DO-T18	TF4RX13YY	Single or PP output	7500 CT 10,000 CT	1 1	12 16	505	500	
DO-T19	TF4RX17YY	Output to line	300 CT	7	600	19	500	DI-T1
DO-T20	TF4RX17YY	Output or matching to line	500 CT	5.5	600	31	500	DI-T1
DO-T21	TF4RX17YY	Output to line	900 CT	4	600	53	500	
DO-T22	TF4RX13YY	Output to line	1500 CT	3	600	86	500	DI-T1
DO-T23	TF4RX13YY	Interstage	20,000 CT 30,000 CT	.5 .5	800 CT 1200 CT	850	100	DI-T1
DO-T24	TF4RX16YY	Input (usable for chopper service)	200,000 CT	0	1000 CT	8500	25	
DO-T25	TF4RX13YY	Interstage	10,000 CT 12,000 CT	1 1	1500 CT 1800 CT	800	100	
DO-T26	TF4RX20YY	Reactor 6 Hy. @ 2 Ma. DC, 1.5 Hy. @ 5 Ma. DC				2100		
DO-T27	TF4RX20YY	Reactor 1.25 Hy. @ 2 Ma. DC, .5 Hy. @ 11 Ma. DC				100		
DO-TSH		Drawn Hipermalloy shield and cover for DO-T's, provides 25 to 30 db shielding.						

\*DCMA shown is for single ended usage (under 5% distortion—100MW—1KC) ... for push pull, DCMA can be any balanced value taken by .5W transistors (under 5% distortion—500MW—1KC)

\*DO-T units have been designed for transistor application only ... not for vacuum tube service. Patents Pending

SPECIAL UNITS AVAILABLE TO YOUR SPECIFICATIONS.

## UNITED TRANSFORMER CORP.

150 Varick Street, New York 13, N. Y.

PACIFIC MFG. DIVISION: 4008 W. JEFFERSON BLVD., LOS ANGELES 16, CALIF.  
EXPORT DIVISION: 13 EAST 40th STREET, NEW YORK 16, N. Y. CABLES: "ARLAB"

H. W. MATEER, *Publisher*

W. W. MacDONALD, *Editor*

*Managing Editor*, John M. Carroll.

*Feature Editor*, John Markus.

*Associate Editors*: John M. Kinn, Jr., Frank Leary, Michael F. Tomaino, Howard K. Janis, Sylvester P. Carter, Haig A. Manoogian, Roland J. Charest, William P. O'Brien, George Sideris, Edward DeJongh, John F. Mason, William E. Bushor, Ronald K. Jurgen, Thomas Emmo, Patrick J. Lahey, Samuel Weber.

*Pacific Coast Editor* (Los Angeles) Harold C. Hood; *Midwestern Editor* (Chicago) Harold Harris; *New England Editor* (Boston) Thomas Maguire.

*Art Director*, Harry Phillips, Roy Thompson.

*Production Editor*, John C. Wright, Jr., Bernice Duffy, Jean L. Matin.

*Editorial Assistants*: Gloria J. Filippone, Arlene Schilp, Noreen Hennessy, Patricia Landers, Catherine McDermott.

**JAMES GIRDWOOD**, *Advertising Sales Manager*, R. S. Quint, *Assistant Advertising Sales Manager and Buyer's Guide Manager*. Fred Stewart, *Promotion Manager*. Frank H. Ward, *Business Manager*. George E. Pomeroy, *Classified Manager*. Jean Heiges, *Research*.

*New York*: Donald H. Miller, Henry M. Shaw, Martin J. Galloy. *Boston*: Wm. S. Hodgkinson. *Philadelphia*: James T. Hauptli. *Chicago*: Bruce Winner. *Cleveland*: Warren H. Gardner. *San Francisco*: T. H. Carmody, R. C. Alcorn. *Los Angeles*: Carl D. Dysinger, D. A. McMillan. *Denver*: J. Patten. *Atlanta*: M. Miller. *Dallas*: Gordon L. Jones. *London*: Herbert Lagler. *Frankfurt*: Michael R. Zeynel.

## Issue at a Glance

**Receiver Controls Crystal Lapping.** Radio receiver at Union Thermolectric is tuned to desired frequency of crystal and to lapping plates. It actuates control to shut off lapping equipment when frequency is reached. See p 66 .....COVER

**Business Briefs** ..... p 7

Electronics Newsletter	7	Military Electronics	14
Figures of the Week	7	Electron Plasma in Outer Space?	14
Taxi Radar Spots Planes	8	Counter Monitors Blind Assemblies	16
Subs to Get New Antisub Rockets	8	Financial Roundup	16
Ferromagnetic Films Promising	12	Station Tries Stereo Multiplex	16
Washington Outlook	12	Sky Sentinels Use Computer	18
New Simulator	14	Business Band Starts Aug. 1	18
Japan Producing Better Mark IV	14	New Avalanche Devices Pushed	18
Meetings Ahead	18		

**New Batteries for the Space Age.** The 150-year old battery is taking new forms under the impetus of missile applications. The latest developments are described and data to aid in the selection of batteries for missiles are presented ..... p 59  
By D. Linden and A. F. Daniel

**Trigger Circuit Controls Quartz Crystal Lapping.** Quartz crystal lapping is automatically stopped when crystal thickness corresponds to the desired crystal frequency ..... p 66  
By J. F. Brumback, R. E. Bennett and R. P. Chalker

**Computer Analyzes Brain Waveforms.** New approach to brain-wave analysis charts behavior of irregular electrical waveforms emitted by the brain ..... p 68  
By Carl J. Zaander

**How Transistor Circuits Protect Atomic Reactors.** Fully transistorized trip system automatically shuts down atomic reactor when an ion chamber malfunctions or a circuit component fails ..... p 73  
By E. J. Wade and D. S. Davidson

**Push-Pull Amplifiers Drive Speaker Directly.** Single-ended push-pull output of 10-watt amplifier directly drives voice coil of speaker ..... p 76  
By J. Rodrigues De Miranda

**Half-Adders Drive Simultaneous Computer.** Matrix-type switching reduces the number of active transistor logic elements required to perform binary addition to seven ..... p 80  
F. B. Maynard

**DIGEST continued**

**Diode Cuts Transistor Cutoff-Current Drift.** Thermal drift caused by amplified variations in  $I_{co}$  are compensated with diode connected across emitter-base junction of grounded-emitter amplifier..... p 83  
By **Henri H. Hoge**

**Tube Noise Factor Chart.** Tube noise factor is read directly in decibels without conversion to power ratios..... p 84  
By **L. P. A. DeBacker**

**Electrons At Work**..... p 86

Unit Telemeters Scalp Voltages... p 86 By <i>R. W. Vreeland, L. A. Williams, C. L. Yeager, MD. and J. Henderson, Jr.</i>	Transistor Preamp Has Low Noise... p 92 By <i>Rene N. Foss</i>
Circuit Detects Open Fuses..... p 86 By <i>John Maroz</i>	TV Camera Preamp Uses Transistors..... p 94
	Noise Charts Aid Engineers..... p 96

British Tv Link To Use TWT'S... p 96

**Component Design**..... p 98

Box Shaped Tube Envelope..... 98	10 Tube For Night Reconnaissance... 98
Counting By Frequency Division... 98	Ceramic Receiving Tube Report... 101

**Production Techniques**..... p 106

Flame Jets Anneal Tubes..... p 106 By <i>W. Harold Small</i>	Spray Contacts, Clip-on Leads... p 108 By <i>C. C. Martindell</i>
Design Trends..... p 106	

**New Products**..... p 114

**Literature of the Week**..... p 132

**Plants and People**..... p 134

**News of Reps**..... p 140

**New Books**..... p 142

**Comment**..... p 148

**Index to Advertisers**..... p 159

# electronics

July 18, 1958 Vol. 31, No. 29

Published weekly, with alternating engineering and business editions, and with a BUYERS' GUIDE issue in mid-June, by McGraw-Hill Publishing Company, Inc., James H. McGraw (1860-1948) Founder.

Executive, Editorial, Circulation and Advertising Offices: McGraw-Hill Building, 330 W. 42 St., New York 36, N. Y. Longacre 4-3000.

Publication Office 99-129 North Broadway, Albany 1, N. Y. See panel below for directions regarding subscription or change of address. Donald C. McGraw, President; Joseph A. Gerardi, Executive Vice President; L. Keith Goodrich, Vice President and Treasurer; John J. Cooke, Secretary; Nelson Bond, Executive Vice President, Publications Division; Ralph B. Smith, Vice President and Editorial Director; Joseph H. Allen, Vice President and Director of Advertising Sales; A. R. Venezian, Vice President and Circulation Coordinator.

Single copies \$1.00 for Engineering Edition and 50¢ for Business Edition in United States and possessions, and Canada; \$2.00 and \$1.00 for all other foreign countries. Buyers' Guide \$3.00. Subscription rates—United States and possessions, \$6.00 a year; \$9.00 for two years; \$12.00 for three years. Canada, \$10.00 a year; \$16 for two years; \$20.00 for three years. All other countries, \$20.00 a year; \$30.00 for two years; \$40.00 for three years. Second class mail privileges authorized at Albany, N. Y. Printed in U.S.A. Copyright 1958 by McGraw-Hill Publishing Co., Inc.—All Rights Reserved. Title registered in U. S. Patent Office. BRANCH OFFICES: 520 North Michigan Avenue, Chicago 11; 68 Post Street, San Francisco 4; McGraw-Hill House, London E. C. 4; 15, Landgrat-Wilhelm, Frankfurt Main; National Press Bldg., Washington 4, D. C.; Six Penn Center Plaza, Philadelphia 3; 1111 Henry W. Oliver Bldg., Pittsburgh 22; 55 Public Square, Cleveland 33; 856 Penobscot Bldg., Detroit 26; 3615 Olive St., St. Louis 8; 350 Park Square Bldg., Boston 16; 1321 Rhodes Haverly Bldg., Atlanta 3; 1125 West Sixth St., Los Angeles 17; 1740 Broadway, Denver 2. ELECTRONICS is indexed regularly in The Engineering Index.

Subscriptions: Address correspondence to: Fulfillment Manager, Electronics, 330 W. 42nd St., New York 36, N. Y. Allow one month for changes of address, stating old as well as new address. Subscriptions are solicited only from persons engaged in theory, research, design, production, management, maintenance and use of electronics and industrial control components, parts and products. Position and company connection must be indicated on subscription orders.

Postmaster: please send form 3579 to Electronics, 330 W. 42nd St., New York 36, N. Y.



Member ABP and ABC

# TAKE YOUR PICK FROM . . . THE SPRAGUE TRANSI-LYTIC\* FAMILY

of **tiny** electrolytic capacitors  
for every requirement in entertainment electronics . . .  
pocket radios, wireless microphones, miniature tape  
recorders, auto receivers

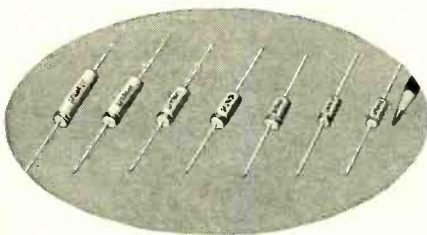

## LITTL-LYTIC\* CAPACITORS

Sprague's new Type 30D hermetically-sealed aluminum-encased capacitors are the *tinest* electrolytic capacitors made to date . . . and their performance is better than ever. Their remarkable reliability is the result of a new manufacturing technique in which *all the terminal connections are welded. No pressure joints . . . no "open circuits" with the passage of time.* And check this for ultra-low leakage current: for a 2  $\mu\text{f}$ , 6 volt capacitor . . . only 1.0  $\mu\text{a}$  max.; for a 300  $\mu\text{f}$ , 6 volt capacitor . . . 3.5  $\mu\text{a}$  max.! Engineering Bulletin No. 3110 gives the complete story. 85°C standard.

\*Trademark

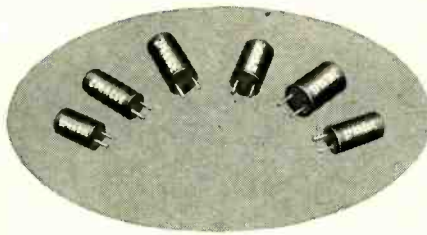

## VERTI-LYTIC\* CAPACITORS

These space-saving Type 89D 'lytics are designed for easy manual upright mounting on printed wiring boards. Keyed terminals assure fast mounting and correct polarity. No reworking on the assembly line. Sturdy pre-molded phenolic shell with resin end-fill gives excellent protection against drying-out of the electrolyte or the entry of external moisture. The phenolic case eliminates the necessity for additional insulation. Reasonably priced for mass production receivers. Engineering Bulletin No. 3060 lists standard ratings with performance data.

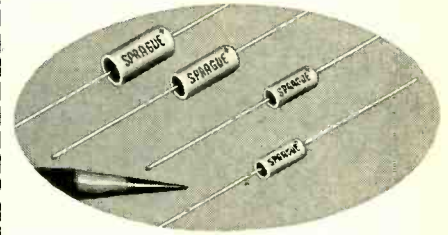

## Cera-lytic\* CAPACITORS

The ideal capacitor for applications where low cost is the primary consideration is Sprague's new Type 31D. Capacitor sections are housed in a dense steatite tube with resin end-fill to provide protection against mechanical damage and atmospheric humidity. This construction results in excellent capacitor performance for all miniature electronic circuits. Size for size, they're the smallest the industry has produced in a ceramic-cased aluminum electrolytic. Engineering Bulletin No. 3010 details standard ratings and gives performance data.

**FOR ENGINEERING BULLETINS** on the industry's first complete line of subminiature aluminum electrolytic capacitors, write Technical Literature Section, Sprague Electric Company, 35 Marshall Street, North Adams, Massachusetts.

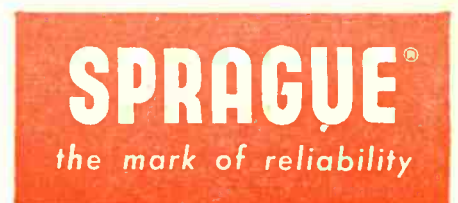

### SPRAGUE COMPONENTS:

CAPACITORS • RESISTORS • MAGNETIC COMPONENTS • TRANSISTORS • INTERFERENCE FILTERS • PULSE NETWORKS • HIGH TEMPERATURE MAGNET WIRE • PRINTED CIRCUITS

# HOT AS HELL



## ... and tough to survive in.

Building this kind of toughness into hydraulic, electronic, and electro-mechanical equipment is part of the job presently going on at Bendix-Pacific. High temperature environmental facilities provide operating conditions up to 1200°F for the evaluation of components and systems. These facilities play a key role in the successful development of the Bendix-Pacific hydraulic flight control system components for the B-58 and in the solution of the heat transfer and dissipation problem in the ATLAS telemetry system.

The high temperature problem area is one of many in which Bendix-Pacific is helping to advance the frontiers of airborne equipment performance.

*Diversity of systems and products provides diversity of opportunity for skilled engineers at Bendix-Pacific. You are invited to write R. A. Lamm, Director of Engineering, for information about Bendix-Pacific and your future.*

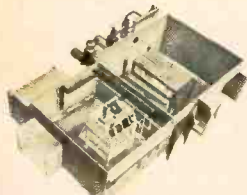

High temperature test facility at Bendix-Pacific

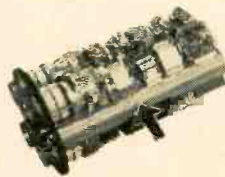

Bendix designed heat sink in the Atlas telemeter



DIVISION OF BENDIX AVIATION CORPORATION

NORTH HOLLYWOOD, CALIFORNIA

**ADVANCED THINKING FOR SYSTEMS AND PRODUCTS IN AIRBORNE RADAR . . . HYDRAULICS . . . MISSILE GUIDANCE . . . ELECTRO-MECHANICS . . . DECCA NAVIGATION . . . SONAR . . . TELEMETRY.**

# now

## A Complete Line of Magnetic Voltage Regulators

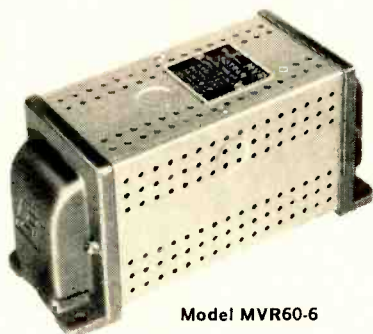

Model MVR60-6

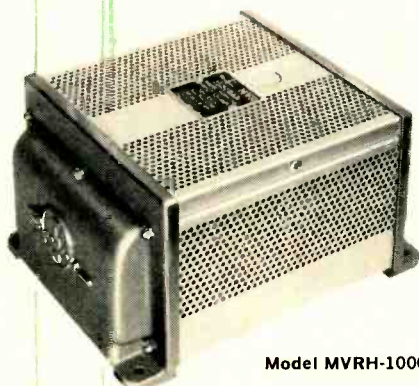

Model MVRH-1000

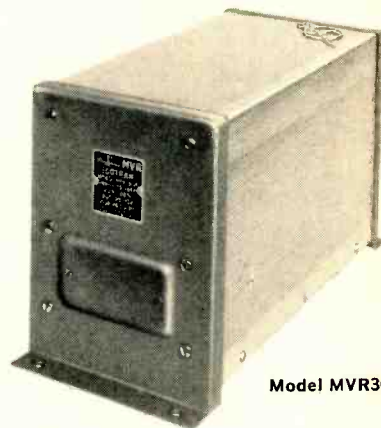

Model MVR30

## SORENSEN MAGNETIC VOLTAGE REGULATORS

Cover the Full Range—30 to 2000 Volt-Amps...

Better Regulation and Fast Response...Smaller and Lighter

Excellent voltage regulation that's constant within  $\pm 0.5\%$  against any line change from 95 to 130 VAC—with operation that is instantaneous, automatic, continuous, and protected against overload damage—Sorensen MVR's blanket the low and medium power levels.

Supplied in fifteen standard models that range from 30 to 2000 VA rating, these Sorensen regulators can be mounted in any position. Ideal for bench or shop use, or for inclusion as a component in your product lines to improve performance and life.

These MVR's are available in three basic designs.

1. Basic Line Regulators, providing minimum-cost, general-purpose, highly reliable regulation of RMS voltage, from 30 to 2000 VA.
2. MVR Filament Regulators, providing regulated and isolated 6.3 volt filament supply for vacuum tubes; outputs from 30 to 500 volt-amps. Also a model with 12.6 filament supply and 60 VA rating.
3. Harmonic Filtered Regulators (MVRH). Lowest distortion of any regulator of similar design. Recommended for critical applications requiring precise waveform.



CONTROLLED POWER  
FOR RESEARCH AND INDUSTRY

"MVR"

### AC REGULATORS

	VA RANGE	MODEL	% REGULATION LINE LOAD	OUTPUT VOLTS FREQ. PHASE	RESPONSE TIME CYCLES	% DISTORTION FULL LOAD	INPUT VOLTS 60 CPS-1 $\phi$
MAGNETIC VOLTAGE REGULATORS "MVR"	30	MVR30	$\pm 0.5$	$\pm 0.87$	115 60 1 2	18	95-130
	60	MVR60	"	$\pm 0.75$	" " " "	20	"
	120	MVR120	"	$\pm 0.75$	" " " "	18	"
	250	MVR250	"	$\pm 0.5$	" " " "	20	"
	500	MVR500	"	$\pm 0.5$	" " " "	20	"
	1000	MVR1000	"	$\pm 0.5$	" " " "	20	"
	2000	MVR2000	"	$\pm 0.5$	" " " "	20	"
HARMONIC FILTERED "MVRH"	120	MVRH120	"	0.5	" " " "	3	"
	250	MVRH250	"	0.7	" " " "	3	"
	500	MVRH500	"	0.9	" " " "	3	"
	1000	MVRH1000	"	0.9	" " " "	3	"
FILAMENT REGULATORS "MVR"	30VA 6.3V 5amps	MVR30-6	"	2.5	6.3 " " "	20	"
	60 " 6.3" 10 "	MVR60-6	"	3	6.3 " " "	20	"
	60 " 12.6" 5 "	MVR60-12	"	3	12.6 " " "	20	"
	500 " 6.3" 80 "	MVR500-6	"	2.5	6.3 " " "	20	"

Complete information on the full line of MVR's is waiting at your Sorensen representative, or will gladly be mailed on your request to:

SORENSEN & COMPANY, Inc.  
Richards Avenue, South Norwalk, Connecticut

In Europe, contact Sorensen-Ardag, •Eichstrasse 29, Zurich, Switzerland, for all products including 50 cycle, 220 volt equipment

YOUR COMPUTER DESIGNS ARE BETTER  
 YOUR COMPUTERS PERFORM BETTER  
 when you draw from this comprehensive  
 range of



RELIABLE

# COMPUTER TRANSISTORS

Raytheon PNP Germanium Fusion-Alloy Computer Transistors are approved for military applications. They provide:

- $H_{FE}$  control at high currents
- High voltage ratings
- Fast switching speed
- Low saturation resistance
- Temperature range  $-65^{\circ}\text{C}$  to  $+85^{\circ}\text{C}$

### ONE AMPERE, HIGH FREQUENCY, HIGH GAIN SWITCH

JEDEC-30 Type	Punch through Voltage min.	$f_{\alpha b}$ ave. Mc	$H_{FE1}$	$H_{FE2}$	$I_{CO}$ at $-12\text{V}$ $I_C = -1\text{mA}$ $V_{CB} = -6\text{V}$	$r_{b'}$ ohms	$C_{ob}$ $\mu\text{f}$
			ave. $I_B = 1\text{mA}$ $V_{CE} = -0.25\text{V}$	ave. $I_B = 10\text{mA}$ $V_{CE} = -0.35\text{V}$			
<b>2N658</b>	-24	5	50	40	2.5	60	12
<b>2N659</b>	-20	10	70	55	2.5	65	12
<b>2N660</b>	-16	15	90	65	2.5	70	12
<b>2N661</b>	-12	20	120	75	2.5	75	12
<b>2N662</b>	-16	8	30 min	50	2.5	65	12

### MEDIUM CURRENT, HIGH FREQUENCY, HIGH GAIN SWITCH

JETEC-30 Type	$V_{CE}$ max. volts	$f_{\alpha b}$ ave. Mc	$H_{FE1}$ ave. $I_B = 1\text{ma}$ $V_{CE} = -0.25\text{V}$	$H_{FE2}$ ave. $I_B = 10\text{ma}$ $V_{CE} = -0.35\text{V}$	Rise Time* max. $\mu\text{sec}$
<b>2N404</b>	-24	12	30 min.	—	—
<b>2N425</b>	-20	4	30	18	1.0
<b>2N426</b>	-18	6	40	24	0.55
<b>2N427</b>	-15	11	55	30	0.44
<b>2N428</b>	-12	17	80	40	0.33

\* $I_C = 50\text{ma}$ ;  $I_B = 5\text{ma}$ ;  $R_L = 200\ \Omega$ ;  $I_B = 5\text{ma}$ ; Grounded Emitter Circuit

SUBMIN Type	$V_{CE}$ max. volts	$f_{\alpha b}$ ave. Mc	$H_{FE1}$ ave. $I_B = 1\text{ma}$ $V_{CE} = -0.25\text{V}$	$H_{FE2}$ ave. $I_B = 10\text{ma}$ $V_{CE} = -0.35\text{V}$	Rise Time* max. $\mu\text{sec}$
<b>CK25</b>	-20	4	30	18	1.0
<b>CK26</b>	-18	6	40	24	0.55
<b>CK27</b>	-15	11	55	30	0.44
<b>CK28</b>	-12	17	80	40	0.33

Ratings at  $25^{\circ}\text{C}$  unless otherwise indicated  
 Dissipation Coefficients: For 1 Amp types, in air  $0.35^{\circ}\text{C}/\text{mW}$ ; infinite sink  $0.18^{\circ}\text{C}/\text{mW}$   
 For med. current types, in air  $0.40^{\circ}\text{C}/\text{mW}$ ; infinite sink  $0.18^{\circ}\text{C}/\text{mW}$   
 For submin types, in air  $0.75^{\circ}\text{C}/\text{mW}$ ; infinite sink  $0.35^{\circ}\text{C}/\text{mW}$

designed for computer service

made for computer service

tested for computer service

proved dependable in computer service

PREFERRED by computer designers

**RAYTHEON** SEMICONDUCTOR DIVISION  
 Silicon and Germanium Diodes and Transistors • Silicon Rectifiers

Newton, Mass.....55 Chapel St., Bldg 4-7500  
 New York:.....589 Fifth Ave., Plaza 9-3900  
 Chicago: 9501 Grand Ave., Franklin Park, NAtional 5-6130  
 Los Angeles: 5236 Santa Monica Blvd., NOrmandy 5-4221



# ELECTRONICS NEWSLETTER

**ELECTRON EMISSION** with energy running into hundreds of billions of electron volts is reported by Soviet astronomers. They say this energy, many times more than the energy that can be produced by the most powerful accelerator, is coming from recently discovered nebulae. This question—and a varied assortment of others bearing on basic electronic research—will be discussed at next month's meeting in Moscow of the International Astronomical Union.

**GENEVA TECHNICAL DISCUSSIONS** on means of detecting and identifying nuclear tests point up the importance of the physicist-electronics engineer in solving the cold war's technological problems. James B. Fisk, head of the U.S. delegation, was a theoretical physicist when he joined Bell Telephone Laboratories in 1939. During the war when the potentialities of microwave magnetrons for high-frequency radar were discovered, Fisk headed a development group. Later, he was in charge of Bell's electronics and solid-state research.

In 1947-48 he was director of research for the Atomic Energy Commission. Back at Bell, he took charge of research in physical science and moved up the ladder, becoming executive v-p and director in 1955.

**THERMISTOR FIRE DETECTION** system will go into the baggage compartments of the Boeing 707 jet airliner. System will sense overheating

or fire and transmit a warning to the crew, says Fenwal, Inc., the manufacturer. Climbing market for thermistors is seen by manufacturers; they say space age demands call for more use of temperature sensing systems. Reported under development: a system installed on the leading edges of a plane's wings. This would permit temperature observation at speeds that might cause unsafe heating conditions.

**NEW CLASS OF MAGNETIC OXIDES**, structurally different from ferrites, is reported by laboratories in France and here. The materials are transparent rare-earth-iron garnets whose internal magnetic domain structure can be seen with a polarizing microscope.

Most completely studied member of the new garnet family is yttrium iron garnet. It has Curie temperature of 545 K and spontaneous magnetization at zero temperature.

**CIVIL AERONAUTICS ADMINISTRATION** has announced a \$2,475,794 program to improve 50 CAA-operated airport surveillance radar (ASR) units. Texas Instruments, Inc., will provide 50 kits to modernize earlier manufactured ASR-2 and ASR-3 radar equipment; four kits will be provided for use with ASR-1 gear.

The improvement kits will provide a better moving target indicator, says the CAA. Delivery will start in December 1959, and will be completed by June 1960.

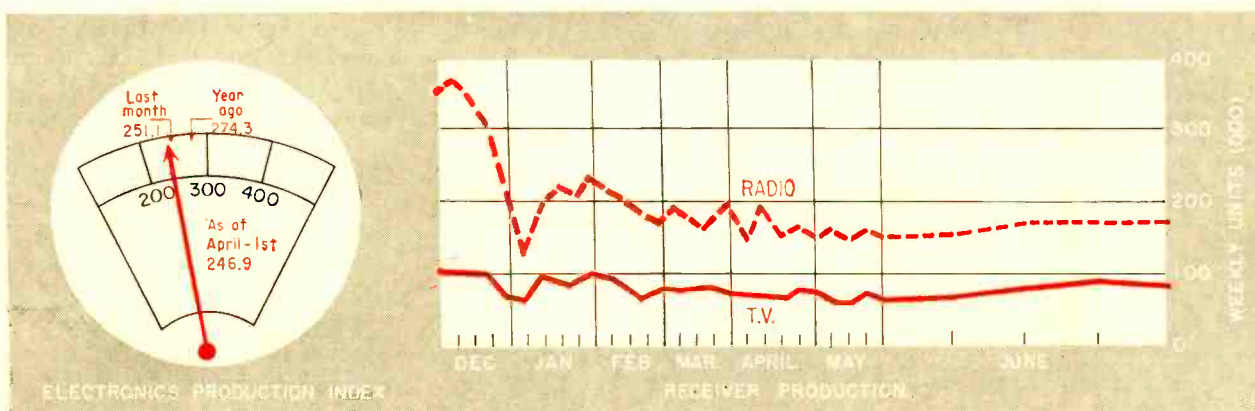

## FIGURES OF THE WEEK

### RECEIVER PRODUCTION

(Source: EIA)	June 27, '58	June 20, '58	June 28, '57
Television sets, total	77,290	81,999	117,337
Radio sets, total	161,764	160,531	200,242
Auto sets	57,928	55,453	80,129

### STOCK PRICE AVERAGES

(Source: Standard & Poor's)	July 2, '58	June 25, '58	July 3, '57
Radio-tv & electronics	49.26	47.98	52.88
Radio broadcasters	62.62	61.79	65.88

## FIGURES OF THE YEAR

	1958	1957	Percent Change
Receiving tube sales	117,596,000	153,011,000	-23.1
Transistor production	11,895,032	6,899,000	+72.4
Cathode-ray tube sales	2,403,182	2,952,318	-18.6
Television set production	1,523,858	1,835,975	-17.0
Radio set production	3,532,066	5,075,180	-30.4
TV set sales	1,690,101	2,020,876	-16.4
Radio set sales (excl. auto)	1,895,951	2,362,068	-19.7

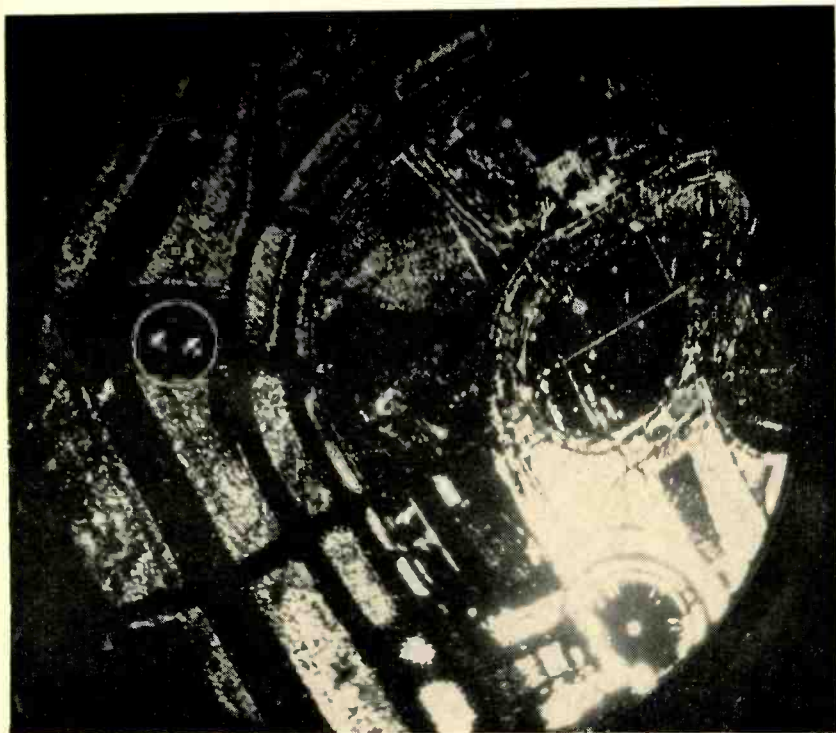

Four-engine craft waiting for tower clearance are seen on taxi radar scope

## Taxi Radar Spots Planes

Airport surface detection equipment helps air controllers by showing ground activity

AIR CONTROLLERS at New York's busy International Airport are now using high-precision all-weather "taxi radar" to control aircraft and miscellaneous traffic on the ground. The airport surface detection equipment (ASDE) installed last month atop the 170-ft control tower at Idlewild presents a clear picture of the 5,000-acre grounds, shows fixed objects, ground vehicles, aircraft, even men and birds.

ASDE is a short-range K-band radar developed and manufactured by Airborne Instruments Laboratory. The Mineola, N.Y., firm, a division of Cutler-Hammer, Inc., expects to sell the equipment to airport operators and the military for around \$200,000.

Angular and range discrimination of ASDE is precise enough to show controllers the shape of a plane half a mile away, even spotting the engines (picture). The system can resolve targets to 10 ft in range, 0.25 deg in azimuth. It achieves this precision by sending

out short pulses on a narrow beam at a rapid repetition rate.

The transmitter produces 0.02- $\mu$  sec pulses at 50-kw peak power and at a rep rate of 14,400 pulses a second. The horn-fed double-curved reflector produces a beam 0.25 deg wide and 1 deg high at half-power points, rotates at 60 rpm to provide continuous surveillance.

Bandwidth of receiver i-f's is 100 mc, with 50-mc video stages. Ppi display uses a 16-in. aluminized flat-face tube which can resolve 1,000 lines. Maximum presentation range is 3 miles per radius (the set's maximum range is about 4 miles), although the presentation can be off-centered.

From the control room, operator can select vertical or circular polarization of the transmitted beam. Circular polarization cancels much of the clutter due to rain, keeps ASDE on the air in all kinds of weather.

The ASDE system was in-

stalled at MacArthur Airport in Suffolk Co., N. Y., for evaluation. Controllers have been known to complain about its sharp-sightedness. They've picked up crows flying over MacArthur a mile away. Once they sent a truck out to investigate a "dangerous object" which showed up on the scope but was not visible through a ground haze to the tower. They found a man walking along the runway.

## Subs to Get New Antisub Rockets

WASHINGTON—NAVY's new super-secret antisubmarine weapon, SUBROC, will have one of the most complex electronic systems ever developed. That is what industry spokesmen are saying this week, although the Navy won't discuss details of the new weapon.

Navy recently awarded a \$65-million contract to Goodyear Aircraft Co. to develop a complete weapon system, including production and tooling methods. Goodyear will work with Navy's Ordnance Lab., Kearfott of Clifton, N. J., and Librascope of Glendale, Calif., on the project.

The new weapon system will initially be installed in submarines, including the new Polaris-toting subs. Later it may be put on surface ships as well. It is designed to detect enemy submarines at long range, compute their course and speed, and fire a missile to destroy them. The missile will be fired from underwater, then rise to the surface and be propelled through the air by a powerful solid fueled rocket to enemy sub's vicinity. Rocket then drops off and nuclear warhead reenters water, homes on target.

Ultimate goal is to get the weapon system perfected so it can detect and kill enemy subs up to 200-mile ranges. Ranges to 2,000 miles are being talked about for the missile itself. Idea is that the weapon can also be used against enemy shore targets. Estimates are that 20 to 40 of the weapons can be carried in a submarine.

Control system for SUBROC will be a modified version of Goodyear's Atran system now used in Air

(Continued on p 12)

NEW  
DIODE  
SPEEDS  
VOICES—

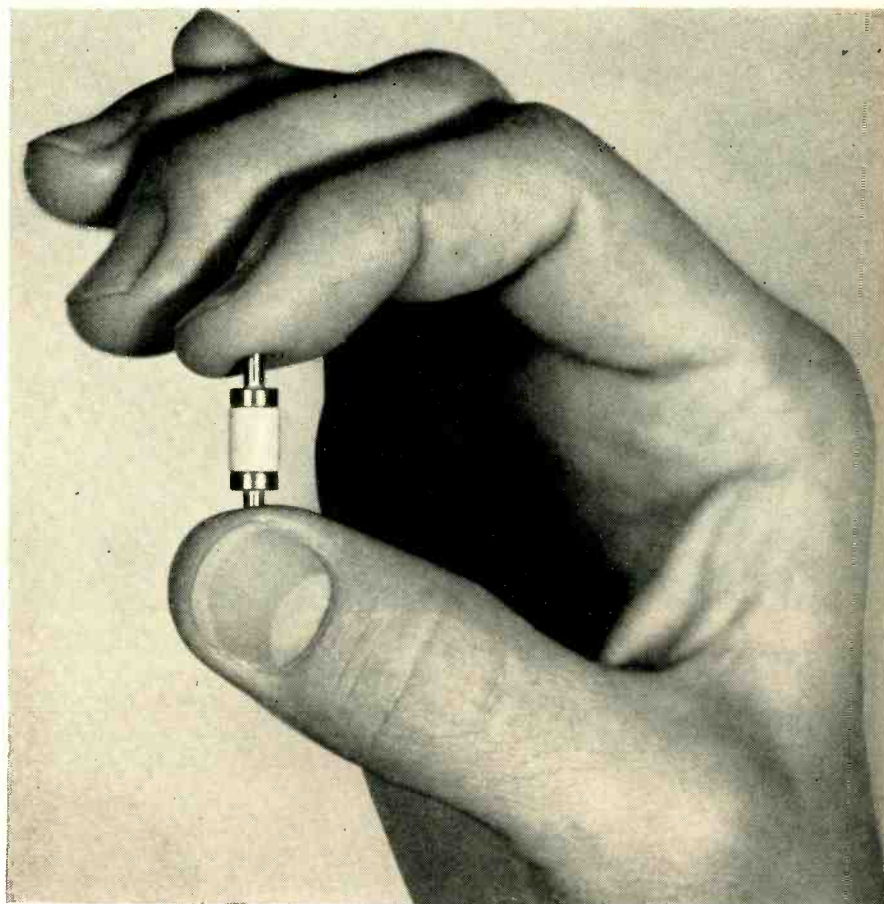

AT 6,000,000,000 C. P. S.

How the radio art can be improved through solid state science is illustrated by a recent development at Bell Telephone Laboratories. To make voice signals travel by microwaves they must first be "converted"—caused to vibrate at billions of cycles per second. To date, it has been possible to accomplish this conversion only at the cost of appreciable loss of signal energy. Could a more efficient converter be provided?

In the field of solid state science it was known—as a laboratory curiosity—that semiconductor diodes can be made not only to convert the frequency of signals, but also to amplify them. At Bell Laboratories Dr. Arthur Uhler, Jr., and his associates calculated that this amplifying action could be put to practical use. They proved the point by developing a junction diode converter which can deliver up to 40 times as much signal energy as previous converters.

This efficient new converter will be applied in a new Bell System microwave highway able to transmit thousands of telephone conversations and a dozen television programs simultaneously at six billion cycles per second. In other forms it is being developed, under Signal Corps contract, for radar and military communications where more efficient frequency conversion can also be used to advantage.

This development is an example of the many different ways in which Bell Laboratories works to improve your telephone service and communications at large.



**BELL TELEPHONE LABORATORIES**

WORLD CENTER OF COMMUNICATIONS RESEARCH AND DEVELOPMENT



**Push-button convenience.** New line switch for Mallory controls turns TV or radio sets on and off at a touch . . . eliminates need for volume adjustment, reduces wear on carbon element. Other new ideas include push-pull line switches, economical strip-type multiple controls, printed circuit controls, and controls with special low-end taper for transistor circuits.



**Entertainment as you drive.** Pioneer in vibrators, Mallory introduced the first commercial vibrator over 25 years ago . . . has long been the leader in vibrators for auto radios. Continuing developments by Mallory produce new refinements in vibrator designs for mobile communication equipment and other vacuum-tube battery-powered products.

# How Mallory Components

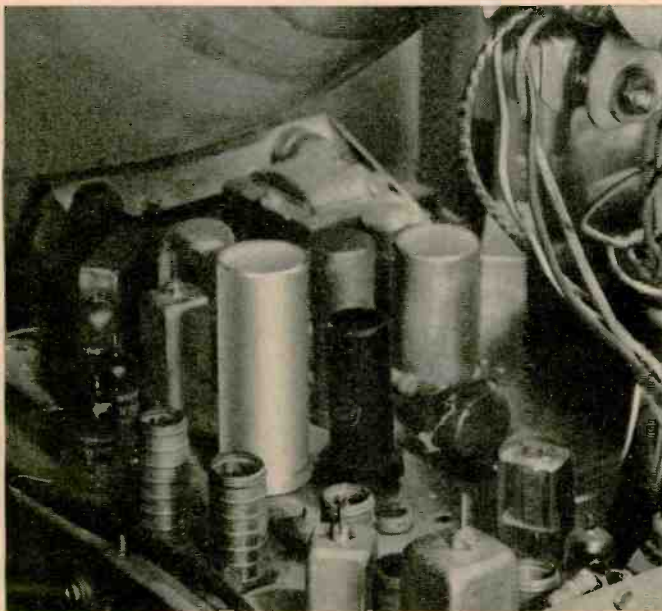

**Hum-free filtering.** Etched cathode construction of Mallory FP electrolytics—the original 85° Capacitor—prevents annoying filter hum from developing. Mallory miniature capacitors, including subminiature tantalum types and commercial models, help to spark the trend to compact size of equipment.

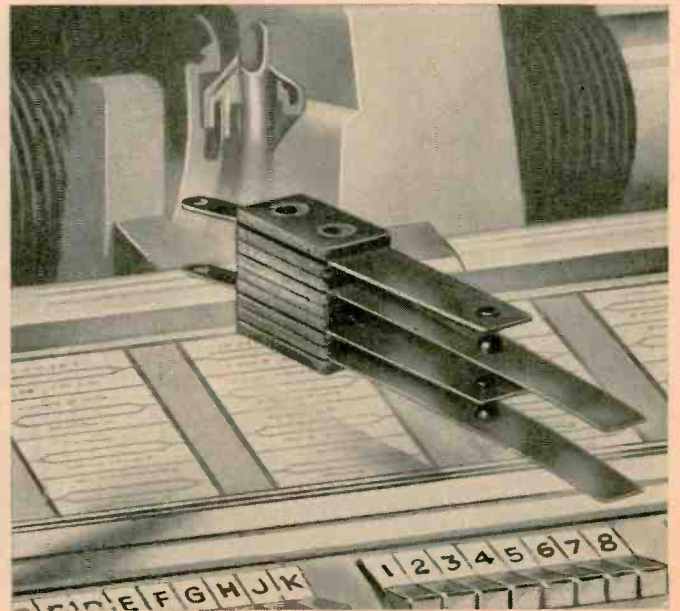

**Economy and performance in switches.** Special Mallory contact alloys, applied by Mallory contact engineers, assure long life and low production costs in selector switches, relays and control devices. Our contact assembly department can make complete backing member and contact assemblies to your specifications.



**Entertainment in miniature.** New pocket-size transistor radios and miniature tape recorders are made even smaller, by designing around tiny, powerful Mallory mercury batteries. Pioneered and constantly refined by Mallory, mercury batteries are ideal for use with transistors, because of their constant energy discharge. For vacuum-tube equipment, Mallory zinc-carbon batteries give superior service backed by over 40 years of dry cell progress.

# and Engineering Assistance

## *Serve the Electronic Entertainment Industry*

When you're designing electronic entertainment equipment, you can rely on Mallory precision components and application engineering to help you add extra values of performance, convenience and enjoyment to your products.

For use in home, portable and automobile radios . . . television receivers . . . tape recorders . . . hi-fi systems . . . coin-operated record players . . . sound movie equipment and many others, Mallory makes a wide line of components which have set the standard of quality of the industry for over thirty years. Constant research builds new ideas into Mallory products which make possible new features in your designs.

Want to make your designs smaller? See what you can accomplish by using Mallory miniature capacitors, mercury batteries, controls. Want greater dependability? You can add extra service life with Mallory FP electrolytics, controls, vibrators, resistors, contact metals. Want maximum economy? Check the cost-saving possibilities of Mallory strip-type controls, switches and contact assemblies.

Because we make such a broad line of components, we can give you comprehensive engineering help in using various types of components together, so as to obtain best overall performance and economy. Call us today for a consultation on your new designs.

#### Serving Industry with These Products:

**Electromechanical** — Resistors • Switches • Tuning Devices • Vibrators  
**Electrochemical** — Capacitors • Mercury and Zinc-Carbon Batteries  
**Metallurgical** — Contacts • Special Metals • Welding Materials

Parts distributors in all major cities stock Mallory standard components for your convenience.

**Expect more . . . get more from**



Force's supersonic air breathing surface-to-surface missile Mace.

Navy is putting top priority and high hopes on its SUBROC system. Reason is that the threat of Russian missile carrying submarines is one of the biggest facing the U.S. today. Reports are that the Russians have 700-mile missiles now being installed on submarines. And, there is a good chance that they either have or are close to having nuclear powered subs.

Best guess at present is that the Russians have a fleet of some 500 submarines, ranging from those built during World War II to the latest snorkel types. But, up to now, the U.S. has not had an effective combat weapon against them. Although sonar detection has been extended to estimates of around 100 miles, weapons to kill subs have been relatively short ranged.

Even with SUBROC, Navy still has one big problem to solve. That is in identifying objects detected at long ranges.

## Ferromagnetic Films Promising

DALLAS—STUDIES of thin ferromagnetic films today promise important developments in solid state electronics.

This prediction was made recently by Gordon K. Teal, assistant vice president and director of research, Texas Instruments, Inc. Speaking at TI's dedication of its new \$5 million plant for transistor and semiconductor production here, Teal added:

"Efforts in transistor electronics are now concentrated primarily on achieving reproducibility within narrow specifications, improving certain parameters, increasing reliability and lowering cost."

Mervin J. Kelly, president, Bell Telephone Laboratories, called "surface control the challenge to the main technological deficiencies." He expressed confidence "continuing research will bring a full understanding of the surface effects."

Mark Shepherd, Jr., vice president of TI's Semiconductor-Components div., predicted product

## WASHINGTON OUTLOOK

THE LABOR DEPT. has begun the first Walsh-Healey Act minimum-wage determination proceeding in the electronics industry. This is law authorizing the Secy. of Labor to set minimum wage rates for government contractors based on prevailing wages in the respective industry.

**Officials in the Electronic Industries Assn. are concerned that the Labor Dept.'s action will raise the whole wage level in the industry. The electronics industry is one of the few major industries for which the Labor Dept. has never set Walsh-Healey rates.**

Right now, electronics manufacturers in government production are legally required to pay only the \$1-an-hour minimum wage rate set under the Fair Labor Standards Act which covers all companies in interstate commerce.

The department is breaking the industry down into three major segments—electron tubes and semiconductors, other electronic components and assembled end-items. Walsh-Healey minimum wage rates will be set individually for each field.

- A Bureau of Labor Statistics wage survey is now under way among manufacturers of electron tubes and semiconductors based on June 1958 payrolls. Some 200 companies are being covered, according to the Labor Dept.'s preliminary estimate.

BLS' electron tube and semiconductor wage survey will not be completed for several months. Near year's end, the Labor Dept. will hold public hearings on the BLS findings.

Following the hearings, the Secy. of Labor will announce the official minimum rates. Clauses requiring government contractors to pay the wages will then be inserted in all military electronic procurement awards.

- The Labor Dept. plans to make a wage survey among manufacturers of other electronic components in the fall and to conduct the Walsh-Healey public hearings on this segment of the industry some time in mid-1959. The minimum-wage determination proceedings for assembled electronic end-items will be conducted later on—the Labor Dept. is still in the talking stage on these plans.

Electronics industry spokesmen stress regional variations in the industry's wage scales in their discussions with the Labor Dept. Under the law, the Secy. of Labor has the discretion to set minimum wages on either a geographic or industry-wide basis. The Department's policy is to determine minimum rates on an industry-wide basis where there is industry-wide competition.

- Defense Secy. McElroy—concerned over what one of his aides calls "needless apprehensions over contract stretchouts, delayed billings, postponed contract settlements and other financial problems in the Pentagon"—has issued an unprecedented order to the services: go ahead with all procurement in "normal fashion." This includes authority to start on fiscal 1959 projects even before the appropriation mechanics have been completed, allowing for monthly contract awards at one-twelfth the amounts shown in the budget.

# AMPLIFY MICROVOLTS WITH STABILITY... measure strain, temperature, other phenomena, to 0.1% with a KIN TEL DC amplifier

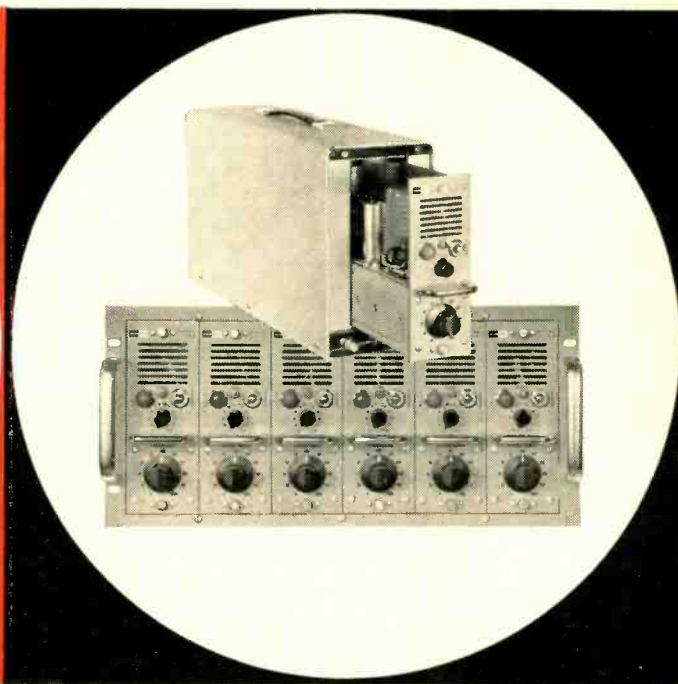
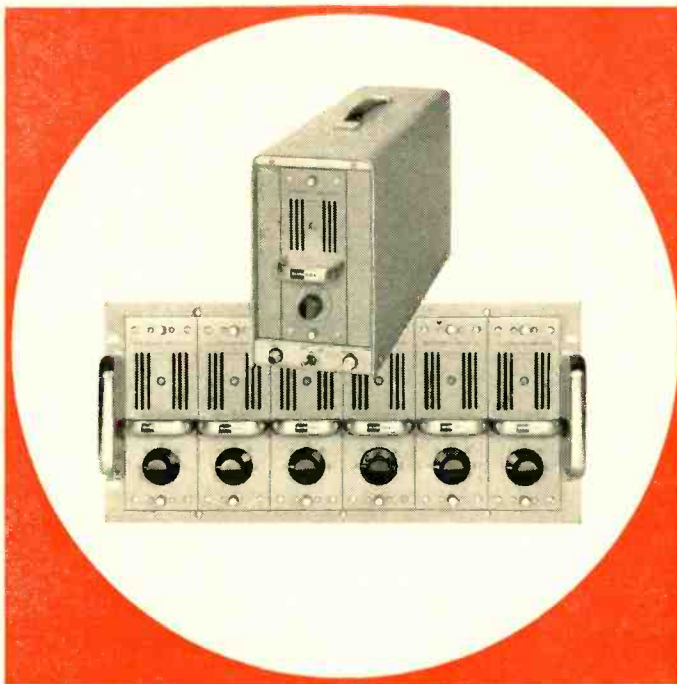

## NEW...TRUE DIFFERENTIAL DC AMPLIFIERS ELIMINATE GROUND LOOP PROBLEMS...RESCUE MICROVOLT SIGNALS FROM VOLTS OF NOISE

160 db DC, 120 db 60 cycle common mode rejection with balanced or unbalanced input ■ Input completely isolated from output ■ Input and output differential and floating ■ 5 microvolt stability for thousands of hours ■ 0.05% linearity, 0.1% gain stability ■ Gain of 10 to 1000 in five steps ■ >5 megohms input, <2 ohms output impedance ■ 10 volt at 10 ma output ■ 120 cycle bandwidth ■ Integral power supply

Ideal for thermocouple amplification, the Model 114A differential DC amplifier eliminates ground loops; allows the use of a common transducer power supply; drives grounded, ungrounded or balanced loads; permits longer cable runs; and can be used inverting or non-inverting. The 114A can be mounted in either single amplifier cabinets or six amplifier 19" rack adapter modules. Price: 114A - \$775; six amplifier module - \$200; single amplifier cabinet - \$125.

## WIDEBAND, SINGLE ENDED DC AMPLIFIERS AMPLIFY DATA SIGNALS FROM DC TO 40 KC WITH 2 MICROVOLT STABILITY

±2 microvolt stability ■ <5 microvolt noise ■ 40 kc bandwidth ■ 100 KΩ input, <1 ohm output impedance ■ Gain of 20 to 1000 in ten steps with continuous 1 to 2 times variation of each step ■ ±45 V, ±40 ma output ■ 1.0% gain accuracy ■ 0.1% gain stability and linearity ■ Integral power supply

Millions of cumulative hours of operation have proved KIN TEL Model 111 series DC amplifiers to be the basic component for all data transmission, allowing simple, reliable measurement of strain, temperature and other phenomena. DC instrumentation systems - with their inherently greater accuracy, simplicity, and reliability than AC or carrier systems - are made entirely practical by the excellent dynamic performance, stability, and accuracy of KIN TEL DC amplifiers. Price: 111BF - \$575; six amplifier module - \$200; single amplifier cabinet - \$125.

5725 Kearny Villa Road, San Diego 11, California  
WESCON SHOW - Booths 1413, 1414, 1458, 1459.

**KIN TEL**  
A Division of Cohu Electronics, Inc.

development through practical adaptation of the "systems concept" to industrial requirements.

## Japan Producing Better Mark IV

JAPAN'S Mark IV transistorized digital computer, developed and recently improved by the government's Electro-Technical Laboratory (ELECTRONICS, p 50, Apr 4 and p 34, May 2), went into production this month at the Nippon Electric Co.

In Tokyo the company has denied an earlier production estimate of 3,000 units by the end of 1958.

Nippon Electric's chief engineer, Tsutomu Degawa, told ELECTRONICS the firm was reinvestigating the domestic and world markets.

Improved version of the Mark IV being produced, the NEAC-2201, is said to have a memory unit with two sets of storage systems: one of 1,000 words with an average access time of 2.5 millisecond and the other of 400 words with average access time of 1.7 millisecond.

Arithmetic and control unit of the improved Mark IV consists of 600 junction transistors and 7,000 germanium diodes compared to the original's 400 and 4,400 respectively. Power consumption is up from 300 to 400 w. Computer can accept 62 different instructions with one and a half address code and two index registers.

Price of the new unit has not been set but it's estimated at about \$70,000, slightly more than the

## New Simulator



Discussing operation of Bendix Computer's three-dimensional flight simulator. Unit holds model of missile or aircraft undergoing test

## MILITARY ELECTRONICS

• **Input system for SAGE**, which translates incoming information from radar units into computer language, uses 11,471 vacuum tubes. The system, produced by Bendix as a subcontractor to IBM, includes the electronic equipment that receives the long-range radar signals via telephone lines or microwave relay; the gap-filler radar input; the "Cross-Tell" equipment that makes it possible for one SAGE direction center to "talk" to another; and the manual input equipment enabling AF personnel to communicate with the computer.

• **Radiation detection instruments for Explorer IV** are products of the State University of Iowa's physics department. Scientific goal of the new equipment is more precise measurements of the unexpectedly intense radiation discovered through apparatus aboard Explorers I and III. The new satellite's detection instruments are designed to handle the great counting

rates and perhaps to distinguish the type of charged particles from the sun.

• **Infrared missile tracking gear** recently underwent a month-long triservice test program at Patrick AFB, Fla. Sponsor was the Air Research and Development Command. Test crews located on eleven missile range picket ships, four aircraft and two islands along AFMTC's 5,000 mi missile range tracked and measured shapes of missiles launched from Cape Canaveral.

Evaluation of findings will be studied at a symposium late this summer by the participating organizations which include: AF Cambridge Research Center, AF Proving Ground Center, Army Ballistic Missile Agency, Naval Research Laboratory, Aerojet-General, Barnes Engineering and RCA. University of Michigan has assigned two groups to the program and Wright Air Development Center has assigned four.

estimate for the original Mark IV.

Meanwhile, the government laboratory which developed the

computer is now working on a Mark V., says Shigeru Takahashi, chief of ETL's circuits section.

## Electron Plasma In Space?

LOS ANGELES—It's believed now there is a high-altitude plasma of fast-traveling electrons in outer space. Doubts are expressed as to whether human space voyagers can exist in such an area.

These facts were revealed here recently at the American Rocket Society's semiannual meeting.

They were in a report by JPL's W. H. Pickering. He talked on "What IGY Has Told Us About Space." Indications of an electron plasma, he said, were among unexpected findings from Explorer I's cosmic ray experiment.

Saturation of counting equipment by high-density x-rays at certain altitudes indicated plasma presence, he said, with the electrons trapped by the earth's electromagnetic field.

In another news development, it was reported that plasma jets, which have been used on the ground to simulate missile reentry conditions (ELECTRONICS, p 19, Nov. 10, 1957), are now being thoroughly investigated as propulsion engines.

Air Force Office of Scientific Research has awarded a research contract to Vitro Laboratories division of Vitro Corp. of America. The firm is conducting a program to investigate possible applications of the high intensity electric arc to propulsion.

Research will be directed toward ion propulsion engine types with exhaust velocities between those of chemical fuels and accelerated ion beams. Some experts have proposed that plasma jets may bridge the gap



The Hughes HA7500 Series **silicon**

**pnp**

**transistors**

*Ideal for:*

**Differential Amplifiers.** Because significantly, the spread for any characteristic of a given type is small. Matching becomes easy with this kind of uniformity.

**Low Level Choppers.** Because switching characteristics are excellent. Saturation resistances are low; emitter and collector reverse currents are low; emitter to base reverse voltages are high.

**D.C. Amplifiers.** Because variation of characteristics within a type is small. These variations are also little affected by temperature.

**Audio Oscillators, Multivibrators, Flip-Flops.** Because, once again, uniformity becomes significant, as well as the unusual stability of each type. Replacement can be accomplished without loss of effectiveness.

**Servo Circuitry, Medium Power Amplification, Phase Detection, Voltage Regulation, Power Control.** Because this series has versatility. Both low and high level operation become practical.



These multi-use transistors have the advantages inherent to all silicon devices plus the typical Hughes advantages of ruggedness and reliability. They have a unique coaxial configuration, developed at Hughes to permit the maximum flow of heat from the crystal through the package while providing an extremely sturdy internal structure. Significantly, this configuration is ideal for machine insertion on printed boards. Dimensions: body length, .396 inch; body diameter, .343 inch.

*For details of the various types, please write: Hughes Products, Semiconductor Division, International Airport Station, Los Angeles 45, California.*

HUGHES



SEMICONDUCTORS

Creating a new world with ELECTRONICS

**HUGHES PRODUCTS**

© 1958, Hughes Aircraft Company

between chemical and ionic propulsion.

Plasma jets are created when a high intensity arc is fired in a fluid, creating temperatures of about 7,000 C and ionizing much of the gas. The ions can be accelerated by building up thermal pressure or electromagnetically.



Vital part is made radioactive before assembly. Then a Geiger . . .

## Counter Monitors Fuze Assemblies

ARMY ORDNANCE CORPS is now checking out an instrument which automatically inspects artillery shell fuze heads to make sure they contain an essential firing pin support which cannot be seen after assembly.

Before assembly, the supports are plated with radioactive silver. After fuze heads are assembled, the instrument's Geiger counter checks each for radioactivity and rejects those which are not radioactive. Instrument is called the Atomonitor.

The same method can be used to check electronic assemblies and components for vital parts, according to Nuclear Corp. of America. The firm built the instrument and its conveyor for the Army for \$20,000.

Inspection rate is up to 3,000 fuze heads an hour. Counters keep track of heads inspected and rejected and will also sound an alarm if the reject rate goes over a predetermined maximum.

Absence of a firing pin support could cause a fuze to function prematurely. Inspection formerly was done by trained personnel who shook the fuze heads and listened for a click which meant the firing pin was seated properly.

## FINANCIAL ROUNDUP

• **Thompson Products** and its affiliate, **Ramo-Wooldridge Corp.** announce plans to merge. The two firms will be absorbed by a new company to be known as **Thompson Ramo Wooldridge Corp.** Thompson Products had owned 57½ percent of R-W's common stock. Remainder of stock will be purchased for 271,455 shares of common stock in the new firm. Number of new shares to be given holders of Thompson stock was not available at press time. Main purpose of the merger is to turn more of the R-W "think factory" products into hardware. TRW will employ about 20,000, will have assets of \$200 million and expects 1958 sales in excess of \$300 million.

• **Rockwell Manufacturing Co.** privately places \$18 million of 4 percent sinking fund debentures through Kuhn, Loeb & Co., New York City investment banking firm.

• **National Science Foundation**

and **International Business Machines Corp.** approve plans to aid **National Economic Bureau's** research project using electronic computers to analyze business conditions. Purpose of the grants, funds from NSF and assistance from IBM, is to help bureau extend its business cycle research program.

• **Haveg Industries**, a diversified firm active in many business areas including electronics, plans to acquire **American Super-Temperature Wires** of Winooski, Vt. Haveg proposes to give about 21,600 shares of its stock in payment. Stock was recently selling on the New York Stock Exchange at around 34 dollars.

**American Super-Temperature** produces specialty wires for high-temperature electronic work. High temperature components are among Haveg's many product lines. Haveg also plans to acquire **American Super-Temperature Wires** of Puerto Rico, a subsidiary of the Vermont firm.

## Station Tries Stereo Multiplex

COMPATIBLE single-frequency stereophonic broadcasting moved a step closer to reality recently with the successful completion of tests at station KGLA (FM) in Los Angeles. Previously broadcasters have transmitted stereophonically by putting one channel on a-m and the other on f-m, requiring the listener to have two different receivers.

Transmitter equipment was provided by Crosby Laboratories, of Hicksville, L. I., and Harkins Radio of Phoenix, Ariz.

Using the Crosby sum and difference technique together with the Harkins multiplex system, the sum of the audio voltages generated by microphones A and B is applied to the main channel.

The voltage difference of A minus B is applied to the subchannel. This method provides the compatible feature whereby the mon-

aural listener is not deprived of a correct presentation of signal.

Key to this method of stereo reception is a special adapter designed by Crosby. This is a five-tube unit which in effect sorts out the scrambled signal received from the station, and splits it into its original A and B components.

Pilot production of adapters has been started, and negotiations are underway with a number of receiver manufacturers for consumer production.

Initial price for adapter units will range from \$50 to \$75 with a decrease in price expected to evolve as the market grows, firm says.

A design possibility mentioned by some manufacturers is a radio resembling current a-m/f-m receivers which would exclude the a-m circuit, and have the stereo adapter in its place.

Present estimated cost for equip-

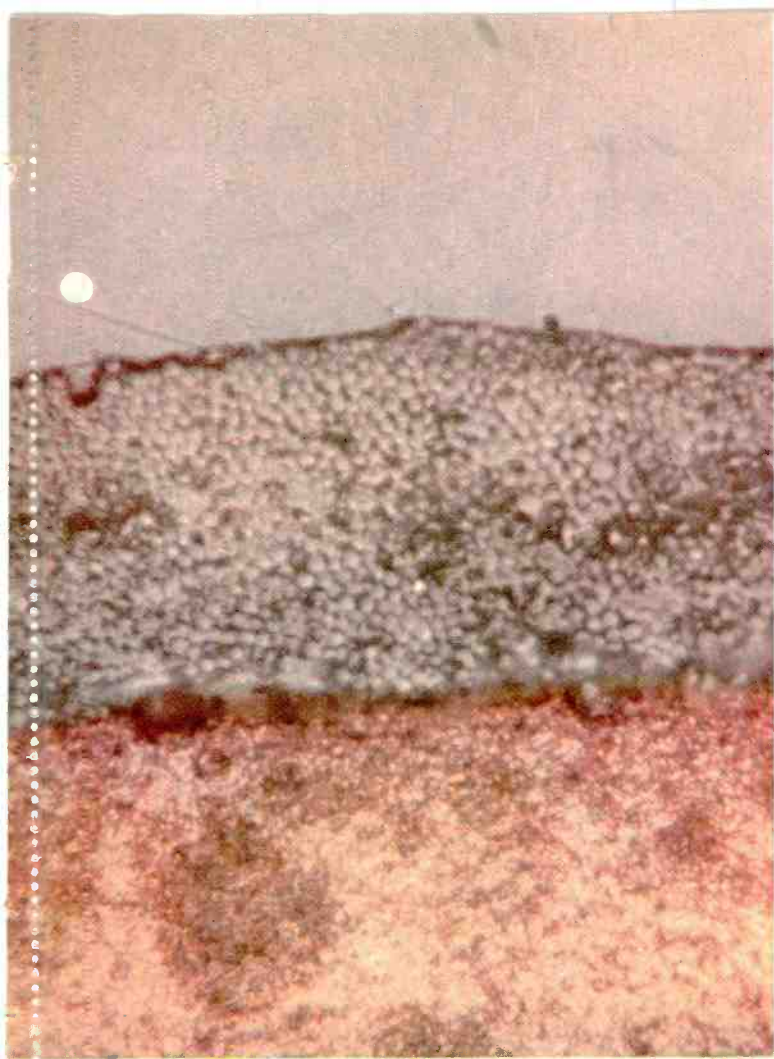

**VITROTEX**, magnified approximately 400X. The lower layer is the copper wire; the upper layer, the glass insulation. The glass fiber-ends appear as small circles in the photograph. The sections between fibers are occupied by bonding varnish. Notice the fibers are close together, well distributed.

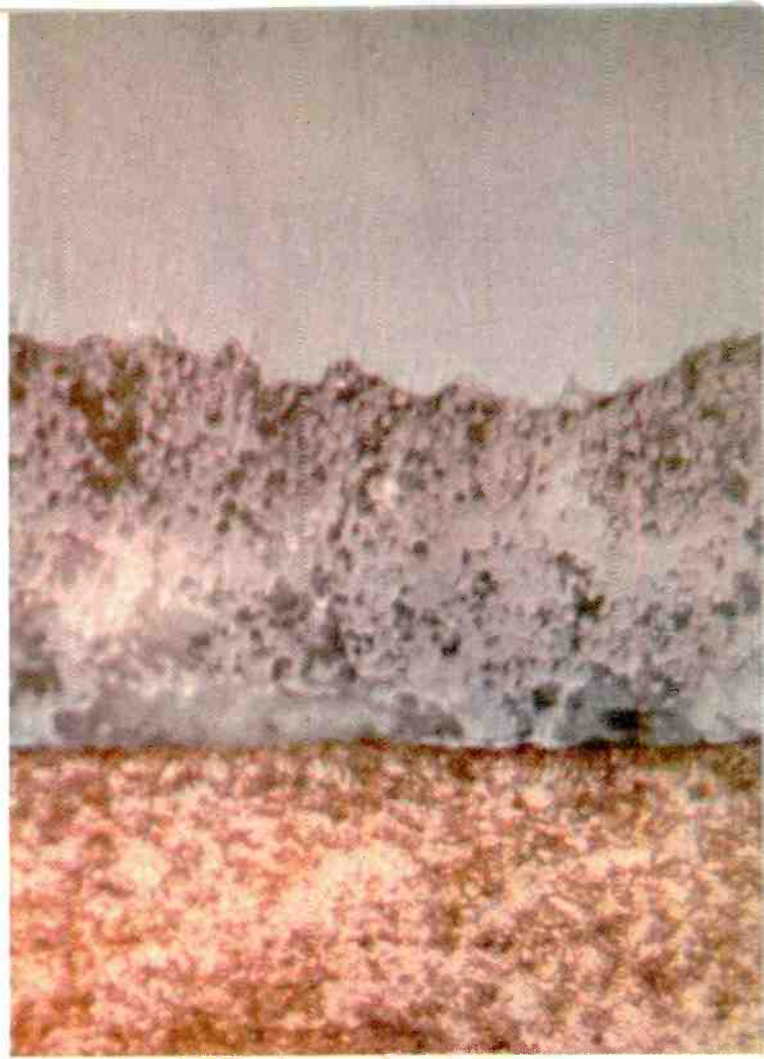

**VITROTEX-D**, magnified approximately 400X. The upper layer consists of glass fibers in fused Dacron\*. Notice the even distribution which provides uniform insulation value—no large "islands" where fibers are missing.

\*Reg. U. S. Pat. Off., DuPont

## Let these Anaconda photomicrographs help you select high-temperature Magnet Wire with glass-type insulation

These two longitudinal sections of Anaconda magnet wires have been blown up 400 times—to show you the difference between Anaconda Vitrotex and Vitrotex-D (both 130°C—AIEE Class B).

Maximum high-temperature protection in glass-type insulation depends on the proportion of the glass fibers present. Maximum resistance to winding damage, however, can call for reducing the number of glass fibers and adding a "damage reducing" agent such as Dacron.

This is essentially the difference between Vitrotex and Vitrotex-D.

Anaconda provides both—in complete size ranges, in rounds, squares and rectangles. You, the designer, must weigh the need for insulation and heat-resistance against those properties which affect windability.

Vitrotex, as the left-hand photograph shows, consists of all glass fibers—therefore, where winding damage is controllable, Vitrotex offers you greater insulation value.

Sometimes, however, the risk of winding damage cannot be avoided. For these situations, Anaconda offers Vitrotex-D. The

Dacron acts as a bonding agent—holds the fibers in place and protects them during winding.

The pictures above show more than the difference in glass-fiber content. They show how Anaconda engineering and manufacturing care provide uniform fiber distribution in both types . . . how each has been designed to do a different job—and do it well!

Ask the Man from Anaconda for additional details on (1) Vitrotex, (2) Vitrotex-D, (3) Silotext (180°C—AIEE Class H) and (4) Silotex-Dt. See "Anaconda" in your phone book, in most principal cities, or write: Anaconda Wire & Cable Company, 25 Broadway, New York 4, N. Y.

†Reg. U. S. Pat. Off.

SEE THE  
MAN FROM **ANACONDA**<sup>®</sup>  
FOR **MAGNET WIRE**

For more details on the characteristics of Vitrotex and Vitrotex-D, please turn the page—

**ANATHERM** 155°C (AIEE Class F)  
high temperature resistance



**NYFORM** 105°C (AIEE Class A)  
superior windability



**PLAIN ENAMEL** 105°C (AIEE Class A)  
low-cost enameled magnet wire

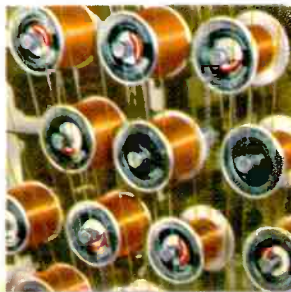

**FORMVAR** 105°C (AIEE Class A)  
established dependability



**ANALAC** 105°C (AIEE Class A)  
solderable magnet wire

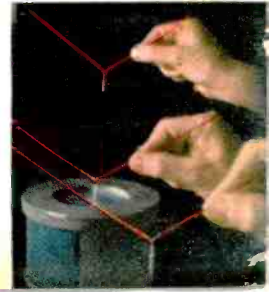

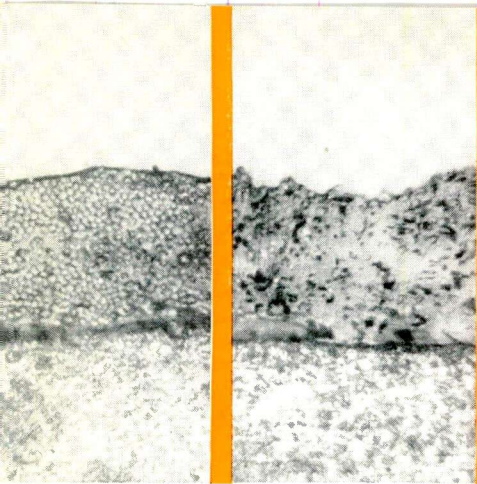

# MAGNET WIRE DATA SHEET

from  
Anaconda Wire & Cable Co.

## IMPORTANT FACTS FOR YOUR WORK...

### ... about **Anaconda Vitrotex** 130°C (AIEE Class B) Magnet Wire

**HIGH TEMPERATURE OVERLOAD PROTECTION.** Even under severe overload conditions, Vitrotex provides protection. This exceptional high-temperature resistance is Vitrotex's outstanding advantage—and can be put to use even in totally enclosed applications.

**REDUCTION IN FRAME SIZE.** Because of the higher temperature stability, excellent space factor (compared with cotton), and the high heat conductivity of the glass fibers, Vitrotex-wound motors and generators can be produced in smaller frame sizes for equal rating or with increased ratings in comparable size frames.

#### TECHNICAL PROPERTIES

**MECHANICAL PROPERTIES.** Vitrotex has the necessary abrasion-resistance for most winding applications. It is suitable wherever controllable winding is possible. Vitrotex possesses remarkable space factor, especially when considering its ability to withstand high operating temperatures. Single Vitrotex has a space factor better than single cotton of equal gage. Double Vitrotex has a space factor better than double cotton of equal gage. Vitrotex has good "mesh" factor—windings expand no more than other insulations so that special precautions are unnecessary in design of windings.

**ELECTRICAL PROPERTIES.** Vitrotex is offered as a 130°C (AIEE Class B) magnet wire. Its high-grade organic bonding varnish plus the glass, give Vitrotex high electrical qualities. Vitrotex will retain sufficiently high dielectric strength to operate satisfactorily at temperatures above the destruction point of organic fiber insulation. At high relative humidity, Vitrotex retains its dielectric strength to a marked degree.

**CHEMICAL PROPERTIES.** Vitrotex is compatible with most Class B bonding varnishes and materials. Windings with Vitrotex can be baked after impregnation at temperatures that would destroy ordinary insulations. Windings can be impregnated with commercial varnishes or other compounds by standard methods. While the glass fibers themselves will not absorb liquids or compounds, the interspaces of the insulation will take up and retain the impregnant. Allows great latitude in design.

**THERMAL PROPERTIES.** Vitrotex is a 130°C (AIEE Class B) magnet wire by definition. However, the precise temperature at which Vitrotex wire can be operated will depend on the design of the apparatus. For example, Vitrotex is excellent for use in dry-type transformers under Group 2 NEMA classification for operation at 150°C hottest spot. Under severe overload conditions where all bond and varnish are destroyed, the inorganic glass remains to protect against shorting.

### ... about **Anaconda Vitrotex-D** 130°C (AIEE Class B) Magnet Wire

**WINDABILITY.** Vitrotex-D is a high-temperature AIEE Class B magnet wire with special abrasion-resistance properties. Where a controllable winding operation is not possible (making the use of all glass insulation impractical), Vitrotex-D is recommended.

**PRECAUTION:** Dacron is a polyester. Therefore the use of this wire is limited to ventilated equipment.

#### TECHNICAL PROPERTIES

**MECHANICAL PROPERTIES.** Vitrotex-D exhibits superior abrasion-resistance. It is ideally suited to those situations where a high-temperature Class B magnet wire is needed, but where the winding operations from the standpoint of abrasion, small bending radii or forming stresses are too severe to permit the use of all glass insulated wire. Use of Vitrotex-D on rectangulars results in thinner insulation and thus improves space factor.

**ELECTRICAL PROPERTIES.** As in the case of Vitrotex, Vitrotex-D is offered as a 130°C (AIEE Class B) magnet wire. The same high-grade, organic bonding varnish is used in Vitrotex-D as in Vitrotex—giving this wire similar high electrical properties.

**CHEMICAL PROPERTIES.** The chemical properties of Vitrotex-D are similar to those of Vitrotex except, since Dacron is a polyester, care should be taken in the selection of the proper varnish.

**THERMAL PROPERTIES.** Vitrotex-D shows the same general thermal properties as Vitrotex—with excellent aging and heat-resistance. Since less glass is present in the covering, less protection is provided under severe overload conditions.

SEE THE MAN FROM  
**ANACONDA**<sup>®</sup>  
FOR  
**MAGNET WIRE**

Anaconda Wire & Cable Company, 25 Broadway, New York 4, N. Y.

# HIGH TEMPERATURE COMPONENTS

by

# Waters

## POTENTIOMETERS

### ROTARY TRIMMERS



AP 1/2



RT 7/8

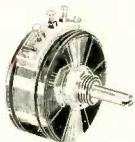

AP 1-1/16

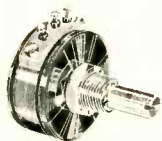

AP 1-1/8

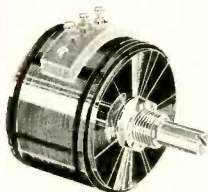

AP 1-5/8

The Waters' complete line of rotary trimmer and miniature precision potentiometers is derated to 125° C standard and is **NOW AVAILABLE TO 150° C.**

**ROTARY TRIMMER POTENTIOMETERS** are built, tested and certified\* to rigid military environmental specifications and are available in a wide variety of mechanical configurations: ganged, tapped, with various electrical and mechanical angles, locking bushings, anti-rotation pins, "O" ring seals, custom shafts, or with the new Waters concentric shaft construction that provides two pots on a single mounting with two separate controls.

**MINIATURE PRECISION POTENTIOMETERS** are built, tested and certified\* to such rugged specifications as: AIA, RETMA, JAN-R-19, MIL-E-5272A, and other applicable military specifications. This new line of single-turn pots packs Waters quality, performance and reliability into smaller-than-ever size.

\*Complete data on request. Write for the new potentiometer catalog.

### MINIATURE PRECISION

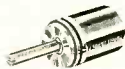

WP 1/2



WP 7/8

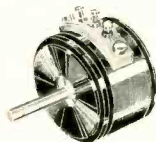

WP 1-1/16

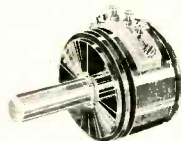

WP 1-1/8

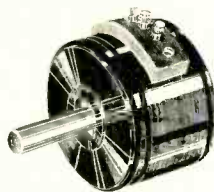

WP 1-5/8

**New!**

**"HOT POT" precision potentiometer**  
1 watt at 200° C

This new high temperature pot is now available for consideration in your high temperature circuit designs. Built in a stainless steel, 1" x 3/4" case. The "HOT POT" with its welded construction offers the ultimate in high temperature component reliability. Element is wound on a ceramic core.

Complete information on request.

## EPOXY ENCAPSULATED CHOKES & COILS

### AVAILABLE TO 125° C

The new Waters family of epoxy encapsulated chokes offers a wide range of inductances from 0.1µh to 200.0MH. Among the wide variety of physical configurations is a flat side type with axial leads for use in printed circuits. It also provides an index surface for automated production. With heavier components, printed circuit mechanical mounting leads are provided for extreme shock and vibration isolation.

A tubular model is provided with leads at one end for use in printed circuit or conventional high temperature applications.

Included in the new encapsulated choke family is a complete line conforming to MIL-C-15305A, Grade 1, Class B.

Shielded encapsulated chokes, which mount with two 6-32 spade bolts are also available. Write for the new encapsulated choke catalog.



CPA — Epoxy Encapsulated — Aluminum Can



CPD — Epoxy Encapsulated

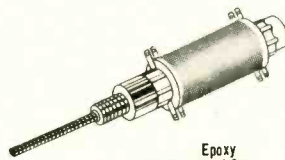

Epoxy Encapsulated Slug-tuned coil form

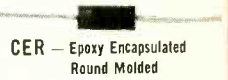

CER — Epoxy Encapsulated Round Molded



CES — Epoxy Encapsulated Flat Bottom



CPC — Epoxy Encapsulated — Flat Bottom with Leads



CCA — Epoxy Case — Axial Leads



CCS — Epoxy Case — Leads Single Ended



CPS — Vinyl Sleeve



CCT — Epoxy Encapsulated — Ceramic Sleeve

**New!**

## RIBBED CERAMIC SLUG-TUNED COIL FORMS

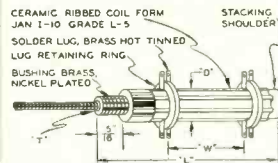

New rugged ceramic coil forms. Ribbed construction permits leads to be brought under windings to lugs, eliminates loose leads. Retractable type bushing allows core to enter bushing providing more effective winding area. Unique internal permanent-tension device eliminates loose parts. New design permits forms to be stacked, or have bushings on each end for double tuned coils. Special windings can be supplied to meet your specifications. Wide choice of slugs available for various frequency ranges.

Write for the new coil form catalog.

# Waters

Potentiometers, Pot Hook® Panel Mounts, Panel Meters, Epoxy Encapsulated Chokes, RF Coils, Slug-Tuned Coil Forms, Torque Watch® Gauges, Instruments, Potentiometer Test Equipment

**MANUFACTURING INC.**  
Wayland, Massachusetts



ping an f-m station for compatible stereocasting is about \$5,000. In addition to the KGLA installation, Fordham University's WFUV, as well as station WBAI, New York, say they're planning to begin compatible stereo operations.

Petitions for rulemaking have been submitted to FCC in connection with compatible stereo. If approved, a set of standards will be established to define the shape of what one broadcaster calls "the sound of the future."

## MEETINGS AHEAD

July 24-25: Computers and Data Processing, Denver Research Inst. Annual Symposium, Albany Hotel, Denver, Col.

July 29-31: Airlines Electronic Engineering Committee, AEEC, Cosmopolitan Hotel, Denver, Col.

Aug. 1-3: Texas Electronic Clinic and Fair, Statler-Hilton Hotel, Dallas, Texas.

Aug. 6-8: Special Tech. Conf. on Non-linear Magnetics and Magnetic Amplifiers, AIEE, Hotel Statler, Los Angeles.

Aug. 13-15: Conf. on Electronics Standards and Measurements, AIEE, IEE, NBC, National Bureau of Standards Labs., Boulder, Col.

Aug. 13-15: Conf. on Electronics Industrial Applications of X-ray Analysis, Denver, Col.

Aug. 18-23: International Conf. on Semiconductors, International Union of Pure and Applied Physics, Rochester, N. Y. Contact: M. H. Hebb, GE, P.O. Box 1088, Schenectady, N. Y.

Aug. 19-22: Western Electronic Show and Convention, Los Angeles, Calif., WESCON, IRE, WCEMA, Pan Pacific Auditorium, Ambassador Hotel, L. A.

Aug. 21-23: Annual Emporium Section Meeting, IRE, Contact: D. L. Vergason, Sylvania Electric, Emporium, Pa.

Aug. 25-29: Electronic Properties of Metals at Low Temperatures, International Union of Pure and Applied Physics, Geneva, N. Y. Contact: M. D. Fiske, GE, P.O. Box 1088, Schenectady, N. Y.

Aug. 26-Sept. 6: British National Radio Show, Radio Industry Council, Earls Court, London.

Sept. 1-7: Int'l Conf. for Analog Computations, Strasbourg, France.

Sept. 3-5: Application of Electrical Insulation, First National Conf., AIEE, NEMA, Cleveland, Ohio.

Sept. 12-13: Communications Conf., IRE, Sheraton Monroe Hotel, Cedar Rapids, Iowa.

Sept. 15-19: Thirteenth Annual Instrument-Automation Conf. and Exhibit, ISA, Philadelphia Convention Hall, Philadelphia, Pa.

Sept. 18-19: National Assoc. of Broadcasters, Fall Conf., Buena Vista Hotel, Biloxi, Miss.

## Business Band Starts Aug. 1

TWO WEEKS from today, August 1, the FCC-established Business Radio Service goes into effect. Eligible is "any person engaged in a commercial activity."

Others that will benefit by the action are educational, philanthropic and ecclesiastical institutions as well as hospitals, clinics and medical associations.

The new Business Radio Service (ELECTRONICS, p 18, May 30) absorbs the Low Power Industrial Service and portions of the Special Industrial and the Citizens Radio Services.

To set up the new service, FCC reallocated 6.550 mc in the 460 to 470-mc band from the Citizens Radio Service to the Industrial Radio Service.

Commission has also retained 2.450 mc in the same spectrum area for the Citizens Radio Service. Of this, 1.900 mc are being held in reserve for possible future allocation.

Pending future developments, class B Citizens Stations will be allowed to operate within a 4.950-mc portion of the band centered approximately on 465 mc.

Other sections of the commission action provide for regular assignment of all industrial frequencies in the 450 to 470-mc band, and reduction of channel spacing in that portion of the spectrum as well as in the 27.23 to 27.28 and 162 to 174-mc bands.

Also established by the same ruling are the Manufacturer's Radio Service for manufacturers and the Telephone Maintenance Radio Service for common carriers.

## New Avalanche Devices Pushed

RUSSIAN SEMICONDUCTOR experts report that precise calculations of avalanche processes are helping to create important new devices. These devices promise operation at frequencies "hundreds of times higher than at present".

Physics institute of USSR Academy of Sciences says avalanche processes result from shock-ionization caused by electrons in strong electric fields. Processes are said to take place within one billionth of a second.

## Sky Sentinels Use Computer



Air Defense officers at SAGE Command Post, McGuire AFB, N. J., watch the air situation over New York and Philadelphia areas. IBM computer presents an up-to-the-second visual display of air activities

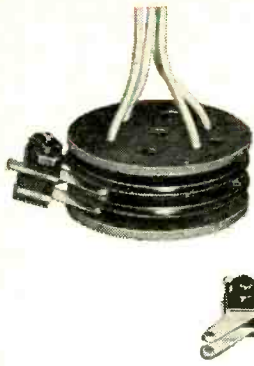

**D. E.  
MAKEPEACE  
DIVISION**

## FOR SLIP RING APPLICATIONS

**SLIP RINGS** . . . Diameter from  $\frac{1}{32}$ " to 48" and larger. Rings are plastic molded, electroplated, electroformed or fabricated. Annular or cylindrical rings are formed of both solid and laminated metals. **SLIP RING ASSEMBLIES** . . . All sizes 1 to 400 circuits. Performance closely approaches that of a uniform cable. Crosstalk between circuits similar to shielded cable; impedance match at video frequencies like matched coaxial cable; at radio frequencies sufficiently close for many applications. D. E. Makepeace Division, Attleboro, Mass.

CIRCLE 151 READERS SERVICE CARD



**AMERSIL  
QUARTZ  
DIVISION**

## FOR ULTRAVIOLET TRANSMISSION

**AMERSIL FUSED QUARTZ** . . . Ideal for use in high ultraviolet transmission applications and as laboratory ware, ranging from plain tubing to many intricate fabrications. Ingots and plates available in general commercial quality as well as in three special optical grades: **OPTOSIL**®, practically bubble-free—very slight granular structure; **HOMOSIL**®, completely free of bubbles—just the faintest traces of granular structure; and **ULTRASIL**®, completely homogenized—increased UV transmission.

Amersil Quartz Division, 685 Ramsey Avenue, Hillside, N. J.

CIRCLE 152 READERS SERVICE CARD



**CHEMICAL  
DIVISION**

## FOR PURIFYING AND PURIDRYING

**DEOXO**® PURIFIER . . . provides low-cost catalytic purification of hydrogen and other gases to the extent of less than one part oxygen per million. Requires no operating expense, no maintenance, no reactivation, no auxiliary heating, no water cooler. **DEOXO**® DUAL PURIDRYER . . . combines continuously-operating, dual tower, automatically-run drying unit with the features of Deoxo Purifier—catalytically produces pure, dry hydrogen, so pure it contains less than one part oxygen per million, so dry that it has a dew point of better than  $-100^{\circ}$  F.

Chemical Division, 113 Astor Street, Newark 2, N. J.

CIRCLE 153 READERS SERVICE CARD

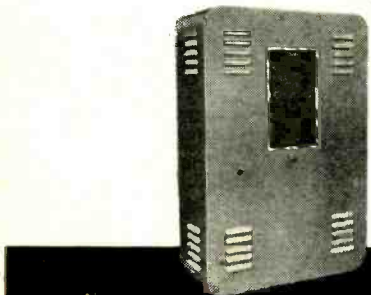

**ENGELHARD INDUSTRIES, INC.**

✱

113 ASTOR STREET  
NEWARK 2, NEW JERSEY.

# BALANCED ARMATURE RELAYS with POSITIVE MAGNETIC LATCHING

The new Leach magnetic latch relay assures positive latching under the most severe conditions of shock, acceleration and vibration in airborne and electronic applications.

This revolutionary magnetic latch relay has two coils and a large, permanent magnet. Leach's exclusive balanced armature and contacts are held in position magnetically—corresponding to the last coil energized.



## MAGNETIC LATCH RELAY

Type 9228 4 PDT, 5 amp, 3 amp, microamp

### FEATURES

Available in a variety of types from 2 PDT to 6 PDT  
Contact ratings from micro-amp to 15 amp  
Hermetically sealed and 100% seal-tested  
Choice of stud, bracket or plug-in mountings  
Solder lug, plug-in or potted lead terminals  
Solid or bifurcated contacts  
Coils for dc or ac applications

### TYPICAL RATINGS

Normal operating voltages—ac and dc—6-115 volts  
Contact ratings @ 28 vdc or 115 vac single phase  
Resistive—3 amp @ 125°C  
—5 amp @ 85°C (dc only)  
Inductive—1.5 amp  
Motor load—1.5 amp  
Rated duty—continuous  
Minimum operating cycles—100,000  
Weight—approx. 0.35  
Shock—50 G's  
Vibration—15 G's to 2,000 cps  
Temperature range—-70°C to +125°C

Applicable specifications—MIL-R-6106C Class A5, A8, B8, minimum current tests applicable—MIL-R-5757B Class A and B  
Mention your special requirements such as microamp switching, high vibration, special mountings.

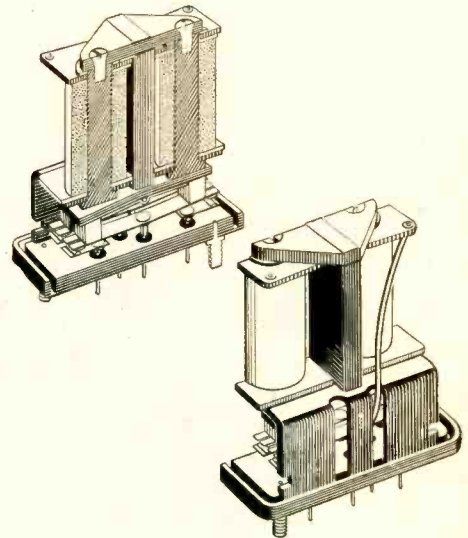

SEE FOR YOURSELF how Leach magnetic latch relays surpass all others in positive latching and in electrical and environmental specifications. Write today for catalog and complete information.

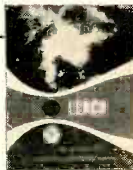

## LEACH RELAY

# LEACH

A division of

## CORPORATION

5915 Avalon Boulevard, Los Angeles 3



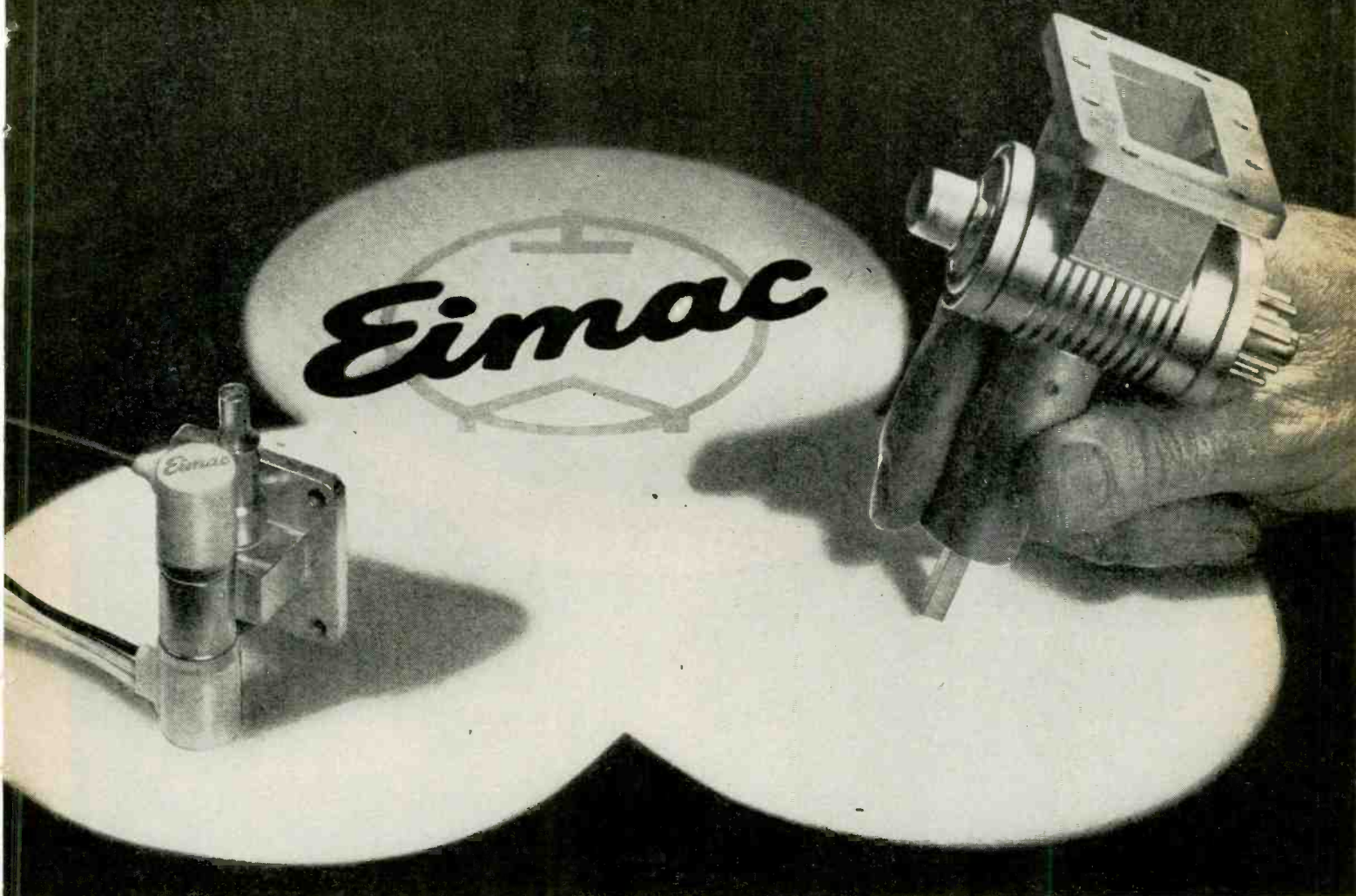

1K20 Series X and K Band Klystron (left)  
1K125C Series C Band Klystron (right)

## Eimac Announces... Six New Ceramic Reflex Klystrons

Two important frequency ranges in the C, X and K bands are now covered by Eimac ceramic reflex klystrons. Eimac's advanced stacked ceramic design gives these tubes exceptional ruggedness and frequency stability.

The four new tubes of the 1K20 series cover 8500 to 11,700 Mc. at power levels to 50 milliwatts. These tubes are specifically designed for use in the severe vibration and temperature environment of air-borne and missile radar systems. They will withstand vibration levels of 15G in any reference plane with less than 100 kilocycle frequency deviation. Rated for use at any altitude, the 1K20 series tubes are conservatively rated at +250°C seal temperature. A new non-contacting, non-microphonic tuner permits noise-free tuning of the tubes through their complete ranges. Low beam voltage requirement and simple

radiation cooling minimize the weight and complexity of associated equipment.

Two new C-band tubes comprising the 1K125 series cover 3700 to 5000 Mc. Power levels up to 2 watts make these tubes ideal for reliable broadband point-to-point communication. Tuning by dielectric slug rather than variable RF gap avoids sensitivity to shock and vibration. Integral-finned cooler and higher operating temperature ratings minimize cooling requirements.

Eimac know-how in the field of ceramic-metal tube design now brings compactness, ruggedness, high performance and reliability to these important microwave frequencies.

For further information request a copy of the brochure  
"A New Line of Eimac Reflex Klystrons"

**EITEL-McCULLOUGH, INC.**  
SAN BRUNO, CALIFORNIA

Cable Address: EIMAC, SAN BRUNO

*Eimac First for ceramic reflex klystrons*



### GENERAL CHARACTERISTICS

Type	Freq. Range Mc.	Beam Voltage	Power Output Range	Reflector Voltage
1K125CA	3700-4400	1000 Vdc	1.5 to 2.0 W	0 to -500 Vdc
1K125CB	4400-5000	1000 Vdc	2.0 to 2.3 W	0 to -500 Vdc
1K20XS	8500-9300	300 Vdc	25 to 50 mW	0 to -250 Vdc
1K20XK	9200-10,000	300 Vdc	25 to 50 mW	0 to -250 Vdc
1K20XD	10,000-10,800	300 Vdc	25 to 50 mW	0 to -250 Vdc
1K20KA	10,700-11,700	300 Vdc	25 to 50 mW	0 to -250 Vdc

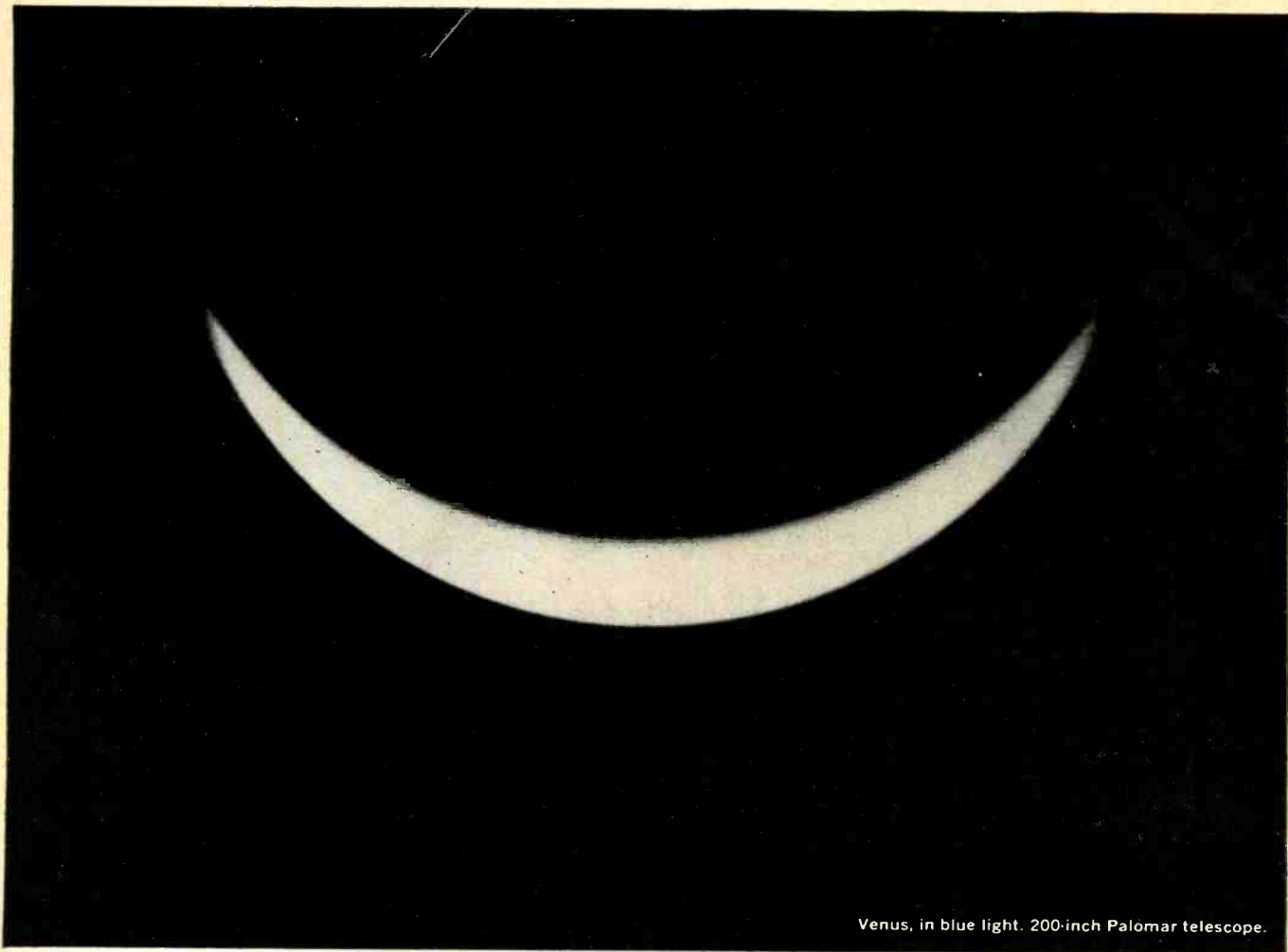

Venus, in blue light. 200-inch Palomar telescope.

## SPACE FLIGHT and NUCLEAR PROPULSION

A drastic reduction in vehicle mass ratios...substantially increased specific impulse values...a capability for achieving very high speeds...these are some of the significant advantages that will come from the application of nuclear energy to space flight.

A number of different propulsion systems have been proposed to utilize nuclear reactions. The simplest system consists of a fission reactor through which the propellant is passed, heated, and then expanded through a rocket nozzle. Fission reactors can also be employed as a source of energy to generate electric power, which in turn can be used to accelerate ions or charged particles, or to create and accelerate a plasma. And fusion reactors, when developed, can be used to generate electric power for the same purposes. In addition, in the case of the fusion reactor, there is the attractive possibility that the reaction energy can be used directly without conversion to electric power.

The fission-powered thermal propulsion system will probably constitute one of the next major advances in space technology. As an example of the gain which can be achieved, consider a vehicle with a payload weight of about 25 tons for a manned flight to one of the nearer planets, landing, and returning. Powered

by chemical rocket engines, the takeoff weight for such a vehicle would be 50,000 tons. But powered by a fission-thermal propulsion system, weight at launch would not exceed 500 tons...a 100-fold reduction in the mass ratio. Considerably greater gains are predicted for the more advanced systems.

Systems studies and advanced research in the application of nuclear energy to the requirements of space flight are in progress at Space Technology Laboratories. This work illustrates the emphasis at STL on the exploration and development of new concepts and techniques in ballistic missile and space technology.

Both in support of its over-all systems engineering responsibility for the Air Force Ballistic Missile Program, and in anticipation of future system requirements, STL is engaged in a wide variety of analytical and experimental research. Projects are in progress in electronics, aerodynamics, hypersonics, propulsion and structures.

*The scope of activity at Space Technology Laboratories requires a staff of unusual technical breadth and competence. Inquiries regarding professional opportunities on the STL Technical Staff are invited.*

## SPACE TECHNOLOGY LABORATORIES

*A Division of The Ramo-Wooldridge Corporation*

5790 ARBOR VITAE STREET • LOS ANGELES 45, CALIFORNIA

# RELIABILITY

# is the word



# El-Menco

## Dur-Micas

are

the

# CAPACITORS

with

## BUILT-IN RELIABILITY.

TWO WAYS . . .

- Highest-Grade INDIA RUBY Mica Films
- TOTAL DEBUGGING . . . Guarantee Super Dependability\*

## the finest of materials...

superior engineering know-how . . . combine to build in El-Menco Dur-Mica Capacitors the highest reliability . . . to give long, ever-ready, powerful service in electronic equipment — from lightning-fast giant brains to tiny transistor receivers.

### \* unique features in

## El-Menco Dur-Micas

● Specially-selected, highest-grade India Ruby mica films . . . pre-tested to have highest insulation resistance . . . greatest dielectric strength . . . lowest dissipation factor. Specially developed dipped coating retains the superior properties of India Ruby mica.

● Debugging — the removal of early failures by subjecting mica capacitors to short life tests at elevated voltages and temperatures . . . THE SCORE . . . DM30, 10,000 MMF, "Debugged" El-Menco Dur-Mica Capacitors . . . subjected to 257,000 hours of life at 85°C with 100% of the rated DC voltage applied . . . turned in a record computed reliability performance — APPROX. 0.6% CUMULATIVE FAILURES OR ONLY 1 FAILURE PER 43 MILLION UNIT-HOURS.

### El Menco "Dur-Micas"

have proved their tremendous power and ability under accelerated conditions of 1 1/2 times rated voltage at ambient temperatures of 125°C and 150°C, winning out over all others in longest life, most powerful performance, smallest size, greatest stability.

DM15, DM16, DM19, DM20, DM30, DM40, DM42, DM43 . . . perfect for extreme miniaturization; ideal for new miniaturized designs and printed wiring circuits. New "hairpin" parallel leads insure easy applications in radio, television, guided missiles. El-Menco Dur-Micas meet all humidity, temperature and electronic requirements, including military specs.

Avoid Costly Breakdowns . . . with Two-Way Built-In Rugged Reliability.

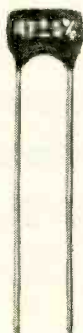

DM15



DM20



DM42

ACTUAL SIZE

Write for FREE sample and catalog on your firm's letterhead.

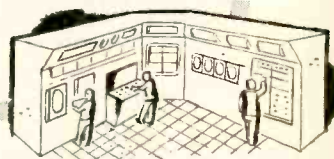

# El-Menco Capacitors

## THE ELECTRO MOTIVE MFG. CO., INC.

Manufacturers of El-Menco Capacitors

WILLIMANTIC

CONNECTICUT

- molded mica
- mica trimmer
- dipped paper
- tubular paper
- ceramic feed-thrus
- silvered mica films
- ceramic discs

Arco Electronics, Inc., 64 White St., New York 13, N. Y.  
Exclusive Supplier To Jobbers and Distributors in the U.S. and Canada

# Whichever *-hp-* oscilloscope these new, time-saving

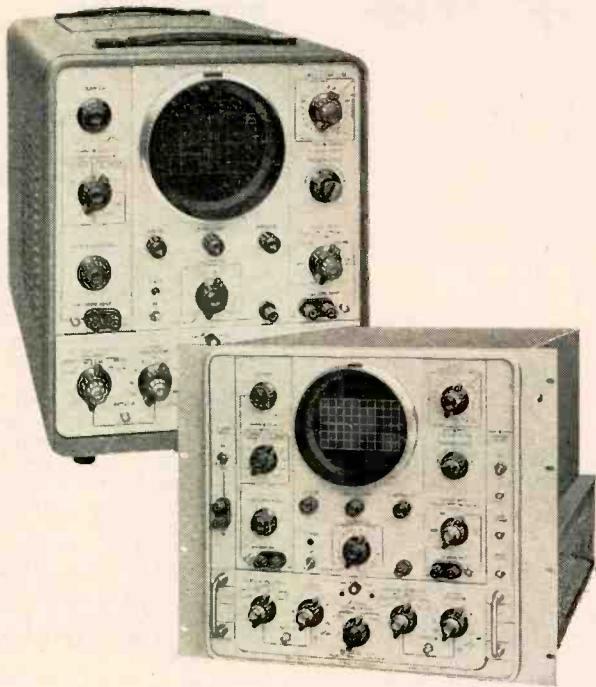

## dc to 10 MC — \$1,100.00

### *-hp-* 150A/AR High Frequency Oscilloscope.

World's premier hf oscilloscope. 24 direct-reading sweep times; sweeps 0.02  $\mu$ sec/cm to 15 sec/cm. Universal automatic triggering wherein one preset condition insures optimum triggering. Plug-in amplifiers for high gain or dual channel operation (see opposite page). Cabinet (150A) \$1,100.00. Rack (150AR) \$1,200.00.



## dc to 300 KC — \$650.00

### *-hp-* 130A/BR Low Frequency Oscilloscope.

Similar horiz. and vert. amplifiers; input circuits balanced on 6 most sensitive ranges. Single ended input dc or ac coupled; direct reading, needs no pre-amplifier with many transducers. Brilliant, high resolution trace. Universal automatic trigger. *-hp-* 130BR (rack) similar to 130A except includes x 5 magnifier for all ranges which expands fastest sweep to 0.2  $\mu$ sec/cm. 130A (cabinet) or 130BR (rack) \$650.00.



## New amplifiers and accessories



### *-hp-* 152B Dual Trace Differential Amplifier

New plug-in amplifier providing differential input and dual traces electronically switched between A and B channels at either 100 KC or on alternate sweeps. Sensitivity range 0.05 v/cm to 50 v/cm, input attenuator with 9 calibrated ranges in 1-2-5-10 sequence and vernier. \$250.00.



### *-hp-* 153A Very High Gain Amplifier

New plug-in permitting *-hp-* 150A to be used for many direct measurements from transducer without *preamplification*. Pass band dc to 500 KC, sensitivity 1 mv/cm to 125 v/cm, balanced input on the 6 most sensitive ranges. 15 calibrated ranges in 1-2-5-10 sequence, 1 mv/cm to 50 v/cm; plus vernier. \$125.00.



### *-hp-* 151A High Gain Amplifier

For either 150A or 150AR, high gain unit with 5.0 mv/cm sensitivity, frequency response dc to 10 MC. 12 calibrated ranges on 0.5, 1-2-5 sequence. 1 megohm input impedance with 27  $\mu$ f shunt. Pass band rise time 0.035  $\mu$ sec. Has 2 BNC terminals. \$200.00.



provides 6 different oscilloscopes!

**you choose, you get  
convenience features...**



**dc to 200 KC — \$435.00**

**-hp- 120A/AR Industrial Oscilloscope.**

For lab or production line work, outstanding value and performance. Automatic trigger, 15 calibrated sweeps in 1-2-5 sequence, sweep speed range 1  $\mu$ sec/cm to 0.5 sec/cm, x 5 sweep expansion all ranges, automatic synchronizing on all internal or external voltages, including line power. High sensitivity, calibrated vertical amplifiers, all power supplies regulated. 120AR rack mount instrument only 7" high. Utmost dependability; extra rugged construction. 120A (cabinet) or 120AR (rack) \$435.00.

**immediate delivery; see  
your -hp- rep now**

**direct reading, high  
accuracy**

**universal automatic  
triggering**

**color-coded controls,  
simplest to use**

**"no-pre-amp" operation from  
many transducers**

**highest performance,  
outstanding value**

## **increase convenience of your 150A**



**-hp- AC-21C 50:1 Voltage  
Divider Probe**

A 50:1 divider with high 10 megohm input impedance and low 2.5  $\mu$ f input capacitance. Convenient "pen" size for maximum handling ease. Probe has durable, attractive nylon barrel, alligator clip contactor. \$25.00.



**-hp- 115A Oscilloscope Testmobile**

Most convenient mobile oscilloscope mounting. For 150A Oscilloscopes but usable with other instruments. Rolls easily on large 4" rubber-tired wheels. Extra-sturdy construction of 7/8" tube stock, gleaming chrome throughout. Oscilloscope shelf tilts 30° in four 7-1/2° increments for better viewing. \$80.00.

*Data subject to change without notice. Prices f.o.b. factory.*

### **HEWLETT-PACKARD COMPANY**

4649A PAGE MILL ROAD • PALO ALTO, CALIFORNIA, U.S.A.  
CABLE "HEWPACK" • DAVENPORT 5-4451  
FIELD ENGINEERS IN ALL PRINCIPAL AREAS

**See your -hp- representative!**

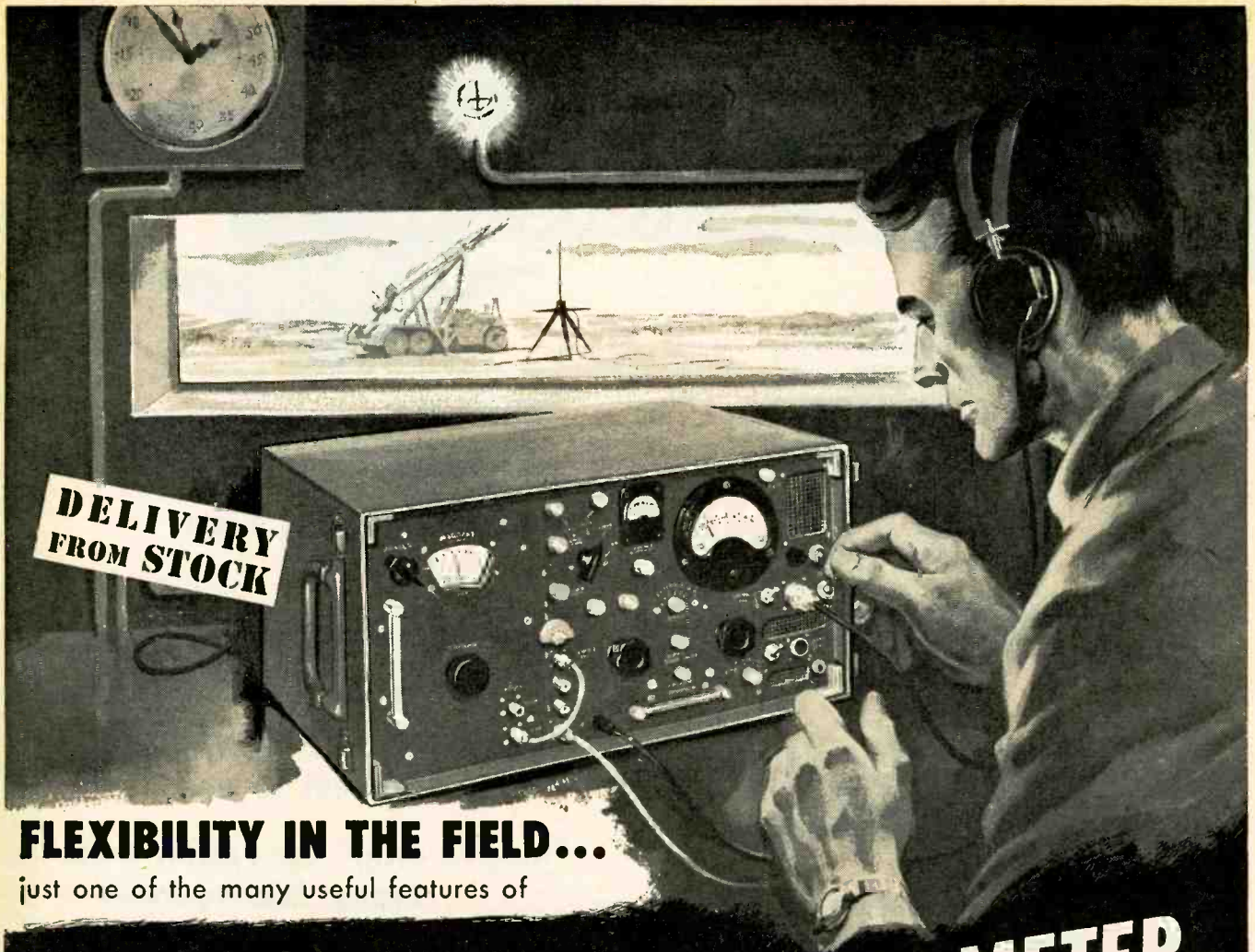

## FLEXIBILITY IN THE FIELD...

just one of the many useful features of

# EMPIRE'S NOISE & FIELD INTENSITY METER MODEL NF-105

Model NF-105 remotely located from its antenna, for personnel safety.

- Measures 150 kilocycles to 1000 megacycles accurately and quickly with only one meter.
- Approval status: MIL-I-6181B, Class 1 MIL-I-6181C, Category A; MIL-I-26600 (USAF)
- Direct substitution measurements by means of broad-band impulse calibrator, without charts, assure repeatability.
- Self-calibrating, for reliability and speed of operation.
- True peak indication by direct meter reading or aural slideback.
- Four interchangeable plug-in tuning units, for extreme flexibility.
- Economical . . . avoids duplication.
- Safeguards personnel . . . ALL antennas can be remotely located from the instrument without affecting performance.
- Compact, built-in regulated A and B power supply, for stability.
- Minimum of maintenance required, proven by years of field experience.



Only the Model NF-105 is so simple to operate that one technician can take readings over the entire frequency range in less time than required by three engineers manning any other three separate instruments.

Send for our Catalog No. N-357

**edp**

**EMPIRE DEVICES PRODUCTS CORP.**  
AMSTERDAM, NEW YORK VICTOR 2-8400

MANUFACTURERS OF:

FIELD INTENSITY METERS • DISTORTION ANALYZERS • IMPULSE GENERATORS • COAXIAL ATTENUATORS • CRYSTAL MIXERS

# HIGH

## BETA

130 at 1 amp  
30 at 5 amps

$V_{CBO}$  -40V, -60V, or -80V

# LOW

$I_{CO}$  2mA at rated voltage

$R_{CS}$  less than .05 ohms

## TI GERMANIUM POWER TRANSISTORS

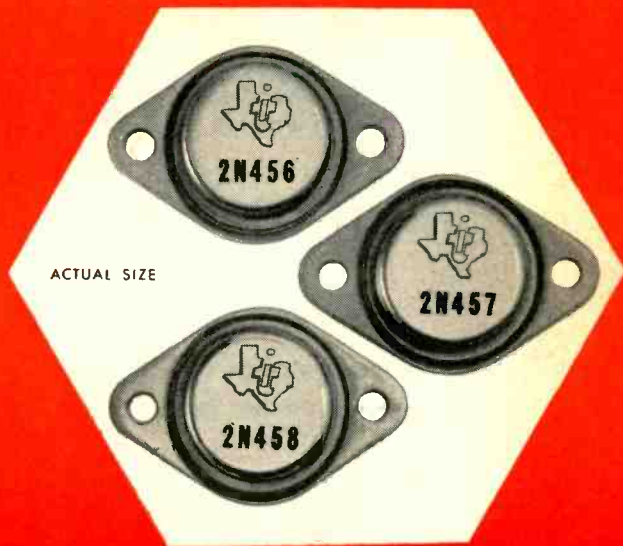

You get high current gain and power output with linear transconductance and extremely low distortion when you specify TI PNP germanium power transistors. Assurance of performance as specified results from checking  $I_{CO}$  at half as well as full rated voltage, and by checking beta again at low voltage ( $V_{CE} = 1.5V$ ) and at two current ratings (1 amp and 5 amps). Ideally suited for your audio amplifier, current switching, and power conversion applications, TI 2N456, 2N457, and 2N458 germanium power transistors dissipate 50 watts with -40, -60, and -80V<sub>CBO</sub> ratings... BV<sub>CBO</sub> ratings average 20 volts higher for each transistor.

Check the specifications below for the unit most appropriate to your particular requirements.

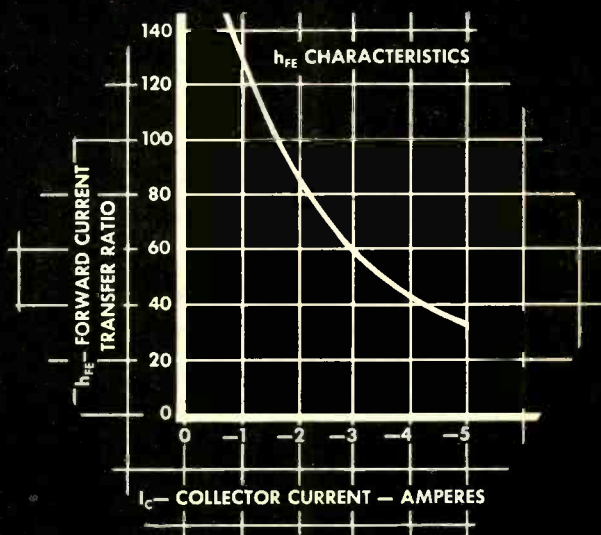

maximum ratings at 25° C*		2N456	2N457	2N458	Unit
$V_{CBO}$	Collector to Base ( $I_C = -2.0mA$ )	-40	-60	-80	V
$V_{CEX}$	Collector to Emitter ( $V_{BE} = +0.2V, I_C = -2.0mA$ )	-40	-60	-80	V
$V_{EBO}$	Emitter to Base ( $I_E = -2.0mA$ )	-20	-20	-20	V
	Total Dissipation†	50	50	50	W
$I_C$	Collector Current	5	5	5	A
$I_B$	Base Current	3	3	3	A
$T_j$	Junction Temperature	95	95	95	°C

typical characteristics at 25° C*		2N456	2N457	2N458	Unit
$BV_{CBO}$	Collector to Base Breakdown Voltage ( $I_C = -10mA, I_E = 0$ )	-60V	-80	-100	V
$h_{FE}$	Forward Current Transfer Ratio ( $I_C = -1.0A, V_{CE} = -1.5V$ ) ( $I_C = -5.0A, V_{CE} = -1.5V$ )	130 30	130 30	130 30	—
$R_{CS}$	Common-Emitter Saturation Resistance ( $I_C = -5.0A, I_B = -1.0A$ )	0.048	0.048	0.048	Ohm
	Thermal Resistance from Collector Junction to Mounting Base	1.1	1.1	1.1	°C/W

\* Temperature is measured on mounting base.

† For operation at higher temperatures refer to the Derating Curve.

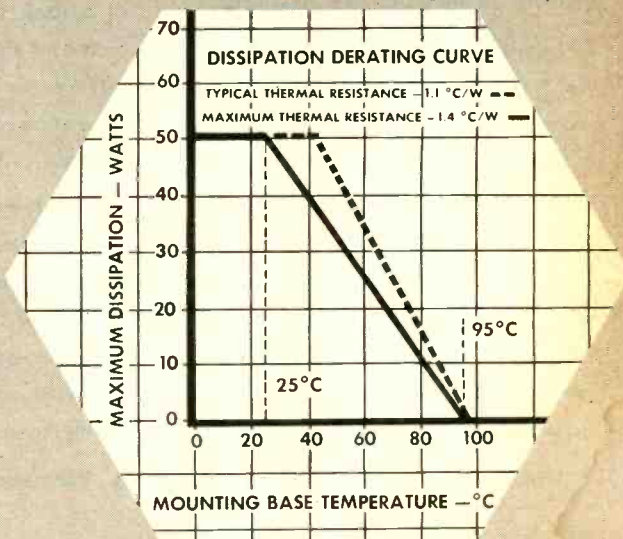

AVAILABLE NOW IN PRODUCTION QUANTITIES

NEW 310,000 sq. ft. SEMICONDUCTOR-COMPONENTS DIVISION HOME



ADVANCED FACILITIES FOR THE MOST ADVANCED COMPONENTS... TO MAKE YOUR GOOD PRODUCTS BETTER



**TEXAS INSTRUMENTS**  
INCORPORATED  
SEMICONDUCTOR - COMPONENTS DIVISION  
POST OFFICE BOX 312 • DALLAS, TEXAS

# MEETING MIL-T-19500A Military Specification For Transistors

Stringent military requirements demand that transistors do not fail in operation.

The tests described below are performed on all General Transistor types to insure continuous, high quality performance. Every production lot is sampled on a daily basis. The criterion for these tests is MIL-T-19500A, Military Specification for Transistors.

Prior to, and upon completion of each of the mechanical tests described below; collector cutoff current, emitter cutoff current, and D. C. current gain are measured and recorded. The end point values of these critical electrical parameters must not exceed the limits as set forth in the applicable military specification.

1. **Physical dimensions**—The transistor is examined to verify that all physical dimensions are as specified.
2. **Lead solder test**—The leads of the transistor are immersed for 10 seconds in molten solder, at 230°C, to a point of 1/16 of an inch from the case of the transistor.
3. **Temperature cycling test**—The transistor is subjected to five temperature cycles:—65°C minimum temperature for 15 minutes, room ambient temperature for 5 minutes, and 85°C maximum temperature for 15 minutes.
4. **Glass strain test**—The transistor

is completely immersed in water at 85°C for 15 seconds and, immediately thereafter, in water at 0°C for 15 seconds.

5. **Moisture resistance test**—The transistor is subjected to varying temperature and humidity cycles: 25°C with 50% relative humidity, 65°C with 90-95% relative humidity, and then back to 25°C with 50% relative humidity. One cycle is 8 hours in duration, and the test consists of 10 cycles.

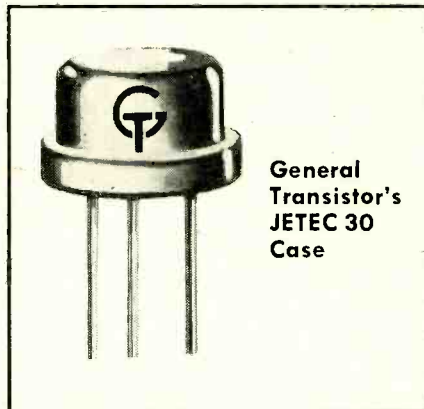

General  
Transistor's  
JETEC 30  
Case

6. **Shock test**—The transistor is subjected to five blows from each of four different orientations, each with an acceleration of 500G and a duration of 1ms.
7. **Centrifugal acceleration test**—The transistor is restrained by its case. A centrifugal acceleration of 20,000G is then applied to the transistor for one minute in each of three different orientations. The acceleration is then gradually decreased to zero.
8. **Vibration, fatigue test**—The

transistor is rigidly fastened on a vibration platform and is subjected to a simple harmonic motion at a single frequency between 40 and 100 cps, for 32 hours in each of three orientations, with a constant peak acceleration of 10G.

9. **Salt spray (corrosion) test**—After 100 hours of salt spray, the transistor is washed, brushed, air blasted, and then permitted to dry for 24 hours at 40°C. The transistor is then examined for any destructive corrosion or loss of plating which interferes with mechanical or electrical performance.

10. **Lead fatigue**—Any two consecutive leads on each transistor are selected. A pull of 16 ounces is applied to each lead, for three 90° arcs of the case. The transistor is then examined for broken leads.

11. **Storage life test**—The transistor is stored at a temperature of 85°C for a period of 1000 hours. During this test, measurements are made at intervals of 0, 250, 500 and 1000 hours.

12. **Operation life test**—For a period of 1000 hours and at a temperature of 25°C, the transistor is subjected to the operation life test. During this test, measurements are made at intervals of 0, 250, 500 and 1000 hours.

Write for transistor Application Note 3-58 "The Effects of Long Term Aging on Computer Transistors."

## GENERAL TRANSISTOR CORPORATION

91-27 138th PLACE • JAMAICA 35, NEW YORK







*In research—meet a man who gets results . . .*

**This General Mills scientist could be solving one of your major problems right now**

He's Dr. John Barkley, our director of research. Like all our people, Dr. Barkley works and lives in an atmosphere that is conducive to creative thinking.

The research department he directs is staffed with highly capable scientists—including several with national and international reputations in their special fields. Our facilities are modern, efficient and well equipped for carrying out basic studies in frontier fields of science.

Our research activities cover broad areas in physics, chemistry, mechanics, electronics and mathematics. Some of the studies representative of these activities are:

Solid state physics investigation  
 Special and ultra-pure materials  
 Ions in vacuum  
 Sputtering by bombardment  
 Electron physics  
 Surface electron microscopy  
 Surface phenomena  
 Optics  
 Particle mechanics  
 Lighter-than-air vehicle concepts  
 Meteorology

Rheology  
 Physical Chemistry  
 Applications of plastics  
 Radiation research  
 Magnetic phenomena  
 Plasma dynamics  
 Ion dynamics and propulsion  
 Geophysics  
 High altitude physics  
 Physical instrumentation  
 Information theory

We team this research with engineering and fine precision manufacturing to serve the nation's most exacting customers. We'd like to serve you.



Dr. Barkley, with 19 years experience in research and research management, directs and plans all activities listed at right—but still finds time for fishing and golfing only minutes from home. Dr. Barkley is one of the reasons our customers say, "At General Mills, we get results."

**MECHANICAL DIVISION**

1620 Central Avenue • Minneapolis 13, Minnesota



# General Electric Semiconductor News

## New controlled rectifier does all these

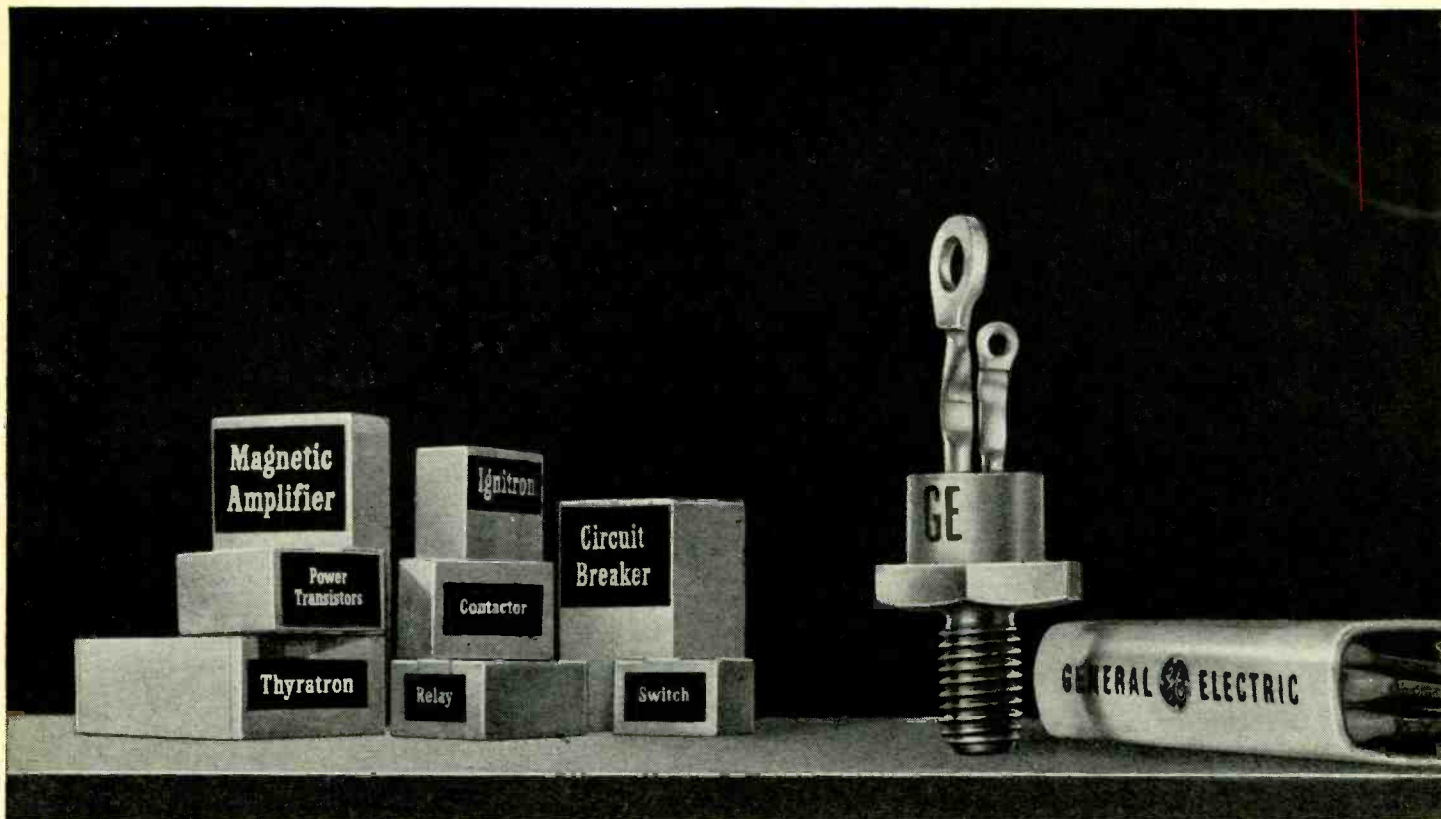

### Maximum Allowable Ratings and Characteristics

(Resistive or Inductive Load)

Continuous Peak Inverse Voltage (PIV)  
 Transient Peak Inverse Voltage (Non-recurrent > 5 millisecc)  
 RMS Voltage (V<sub>rms</sub>)  
 Average Forward Current (I<sub>F</sub>)  
 Peak One-cycle Surge Current (i surge)  
 Minimum Forward Breakover Voltage (V<sub>BO</sub>)  
 Maximum Forward Voltage (V<sub>F Ave.</sub>)  
 Maximum Reverse Current (I<sub>R</sub>)  
 Maximum Gate Current To Fire (I<sub>GF</sub>)  
 Maximum Gate Voltage To Fire (V<sub>GF</sub>)

ZJ39A 25	ZJ39A 40	ZJ39A 75	ZJ39A 100	ZJ39A 150	ZJ39A 200	ZJ39A 250	ZJ39A 300
25	40	75	100	150	200	250	300 V
35	60	100	150	225	300	350	400 V
17.5	28	53	70	105	140	175	210 V
Up to 16 amperes							
150 amperes							
25	40	75	100	150	200	250	300 V
0.75 Volts (Full Cycle Average)							
5 ma (Full Cycle Average)							
25 ma							
3 Volts							

## Finer performance of G-E low-current silicon rectifiers now within reach for all your requirements

	MAXIMUM RATINGS AND SPECIFICATIONS								
	PIV	RMS Voltage	Cont. Reverse D-C Volt	D-C Output (150°C Amb.)	D-C Output (50°C Amb.)	One-cycle Surge Current	Full-Load Forward Voltage Drop	Leakage Current	Ambient Operating Temp.
1N536-40, 1N1095-96 series	50-600	35-420	50-600	250	750	15	0.5	0.4-0.3	165
1N440B-445B series	100-600	70-420	100-600	300-500 (100°C)	300-750	15	0.5		150-165
1N1487-92 series	100-600	70-420	100-600	250 (125°C)	750 (25°C)	15	0.55	0.3	140
1N1692-95 series	100-400	70-280	100-400	250 (100°C)	600 (50°C)	20	0.6	0.5	115
	volts	volts	volts	ma	ma	amps	volts	ma	°C

The time has come to reconsider possible applications of G.E.'s outstanding low-current silicon rectifiers in the 1N536, 1N440 Series (150°C line) . . . the 1N1487 Series (125°C line) . . . and four recently added types in the 100°C area, the new 1N1692 Series. You'll find these devices more attractive to use than ever before—both in quality and price—with equally fine values in low-current silicon stacks. Stud-mounted units are also available.

General Electric low-current silicon rectifiers are designed for maximum forward conductance at high operating temperatures. High current loads are carried *without* external heat sinks. Reverse current at maxi-

# jobs, and more—prices reduced 50%

## The ZJ39A Silicon Controlled Rectifier can do the job of

- Thyratrons
- Ignitrons
- Magnetic amplifiers
- Power transistors
- Relays
- Switches
- Contactors
- Circuit breakers

### ... in these applications

- Static switching
- DC motor control
- DC power regulation
- Variable DC supplies
- DC to DC converters
- Frequency changers
- Inverters
- Dynamic braking
- Constant current supplies
- Pulse width modulation
- Ignitron firing
- Welding control
- Temperature control
- Power pulse generator

... and many others

Price reductions in some cases greater than 50% will enable hundreds of new users to become acquainted with General Electric's new silicon controlled rectifier.

Neither a transistor nor a rectifier, this remarkable device combines features of both. In the reverse direction it acts like a standard rectifier. But it also blocks forward current until either a critical breakover voltage is exceeded or a signal is applied to the third lead. Then it switches to a conducting state and performs exactly like a forward-biased silicon rectifier.

The controlled rectifier offers the circuit designer current ratings comparable to thyratrons, blocking voltages useful in industrial circuits, complete control of current turn-on without complicated circuitry, and switching speeds in microseconds.

While in many ways similar to the gas thyatron, the controlled rectifier provides faster firing and recovery times, very low forward voltage drop, higher efficiency, absence of filament with attendant warm-up delay and power consumption, and higher-temperature operation.

Check the sample ratings and suggested applications at left. Application data and specifications will be sent on request.

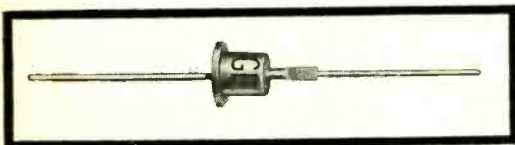
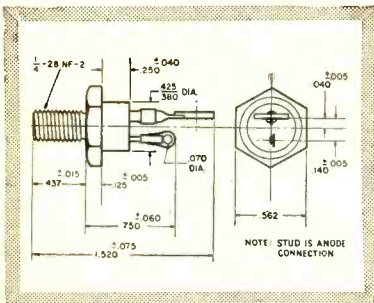

imum junction temperature is maintained at an extremely low level, making these devices ideal for low-leakage applications.

Minimum forward voltage drop and a hermetically sealed case have produced silicon rectifiers whose reliability exceeds all existing MIL specs. A comparative evaluation shows that G-E devices have the *highest* resistance to thermal runaway at maximum full load operating temperatures. Thermal shock and temperature-cycle tests show a closer match of materials for expansion and contraction, to protect against breaking the hermetic seal and shattering the silicon pellet.

Ask your G-E semiconductor representative for the "big news" on low-current silicon rectifiers. Or write for more information.

## For fast delivery, lower prices, see your local G-E distributor!

A recent check shows that General Electric transistors and rectifiers are being sold by local tube distributors for within pennies of the factory price on quantities less than one hundred—with the important difference that transportation charges are prepaid when you buy from your local G-E distributor.

Increased stocking of semiconductors by local G-E distributors means you now have *one* source for all your electronic needs. General Electric distributors can also furnish you with a wide variety of technical information, application data and spec sheets.

General Electric Company, Semiconductor Products Department, Section S25758, Electronics Park, Syracuse, N. Y.

# GENERAL ELECTRIC

Servo Motors For

# Transistorized Operations

• Meets MIL-E-5272 •  $-65^{\circ}\text{C}$  to  $+125^{\circ}\text{C}$  temperature range.

	SIZE 8	SIZE 10	SIZE 11	SIZE 15	SIZE 18
Oster Type	8-5001-00	10-5052-00	11-5101-00	15-5153-00	18-5201-00
<b>Electrical Characteristics:</b>					
Frequency (cps)	400	400	400	400	400
Torque at Stall (oz. in.)	.15	.30	.63	1.45	2.35
No Load Speed (rpm)	6500	6500	6500	5200	5200
Speed at Half Torque (rpm)	4000	4000	4000	3200	3200
Time Constant (sec.)	0.03	0.015	0.016	0.017	0.013
Reversing Time (sec.)	0.051	0.025	0.028	0.030	0.022
Theo. Acceleration at Stall (rad/sec <sup>2</sup> )	22500	45000	41500	31000	40000
Operating Temp. Range ( $^{\circ}\text{C}$ .)	$-54$ to $+125$	$-54$ to $+125$	$-54$ to $+125$	$-54$ to $+125$	$-54$ to $+125$
Slot Effect	1.6v/26v	1.0v/36v	1.0v/40v	1.0v/40v	1.0v/40v
Duty Cycle	Cont.	Cont.	Cont.	Cont.	Cont.
<b>Fixed Phase</b>					
Voltage	26	115	115	115	115
R (Stall) Ohms	196	1270	1250	490	280
X (Stall) Ohms	183	1560	1780	890	570
Z (Stall) Ohms	268	2210	2175	1030	640
P.F. (Stall)	0.73	0.57	0.58	0.49	0.45
Effective R (Stall) Ohms	366	3840	3800	2160	1460
Parallel Tuning cond. for unity P.F. (Stall) Mfd.	1.0	0.13	0.15	0.33	0.55
<b>Control Phase</b>					
Voltage	40/20	40/20	40/20	40/20	40/20
*R (Stall) Ohms	480	124	145	58	39
*X (Stall) Ohms	445	215	204	103	77
*Z (Stall) Ohms	660	248	250	118	86
*P.F. (Stall)	0.73	0.50	0.58	0.49	0.45
*Effective R (Stall) Ohms	910	495	430	240	190
*Parallel Tuning cond. for unity P.F. (Stall) Mfd.	0.4	1.4	1.3	2.9	4.1
<b>Mechanical Characteristics:</b>					
Rotor Inertia (gm. cm <sup>2</sup> )	.47	.47	1.07	3.3	4.0
Weight (oz.)	1.2	2	4.5	8	14
Mounting Type	Synchro	Synchro	Synchro	Synchro	Synchro
Motor Length	.863	.672	1.703	1.625	2.03
Type Shaft	Pinion	Pinion	Plain	Plain	Plain
Shaft Extension	.375	.218	.437	.540	.540
Outside Diameter	.750	.937	1.062	1.437	1.750
Type Connection	Leads	Terminals	Terminals	Terminals	Terminals

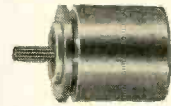

Size 8

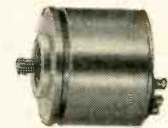

Size 10

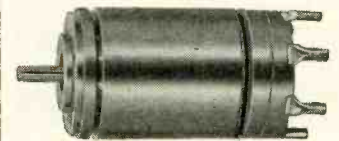

Size 11



Size 15



Size 18

\*For 40v connection

This complete line can be varied by Oster specialists to your precise requirement. Write today for further information, enclosing detailed data on your needs.

Other products include motor-gear-trains, synchros, AC drive motors, DC motors, servo mechanism assemblies, motor tachs, servo torque units, reference and tachometer generators, actuators, motor driven blower and fan assemblies and fast response resolvers.

**MANUFACTURING COMPANY**

Your Rotating Equipment Specialist

**Avionic Division**

Racine, Wisconsin

Engineers For Advanced Projects:

Interesting, varied work on designing transistor circuits and servo mechanisms. Contact Mr. Zelazo, Director of Research, in confidence.

# A **NEW** POWER FERRITE for FLYBACK TRANSFORMERS by ALLEN-BRADLEY



CLASS **W-04**

**HIGHER FLUX DENSITY**  
**LOWER CORE LOSSES**  
**HIGHER CURIE POINT**

Now, with the higher flux density of Allen-Bradley's new Class W-04 ferrite, you can design smaller flyback transformers with smaller cores. This saves space . . . saves weight . . . and saves copper, too. And the new ferrite is priced so that, with this smaller size, the actual cost of the core itself is also reduced.

Specify Allen-Bradley's new W-04 ferrite for *your* flyback transformers. The table on the following page compares the superior characteristics of the new W-04 with Allen-Bradley's "premium quality" W-03 ferrite.

**ALLEN-BRADLEY CO.**

**ELECTRONIC COMPONENTS**

QUALITY

Allen-Bradley Co.  
222 W. Greenfield Ave.  
Milwaukee 4, Wisconsin

In Canada—  
Allen-Bradley Canada Ltd.  
Galt, Ontario



Check the

superior characteristics  
of this

# NEW ALLEN-BRADLEY W-04 Power Ferrite

Class	Temp. °C	$B_{max}^*$ in Gauss at 10 Oe	Core Loss $P_h$ in $\mu$ Watts cm <sup>3</sup> cps				$\mu_{max}^*$	$\mu_0$ at Room Temp.	$B_u^{**}$	$\mu$ at $B_u$ †	Curie Temp. °C
			B = 1350 Gauss		B = 1800 Gauss						
			16 Kcps	60 Kcps	16 Kcps	60 Kcps					

**RECOMMENDED FOR FLYBACK TRANSFORMER CORES (AND OTHER POWER APPLICATIONS)**

<b>W-04</b>	25	4900 ± 10%	3.8 ± 20%	5.3 ± 20%	6.4 ± 20%	9.0 ± 20%	7000 ± 30%	2000	2700 ± 15%	6000 ± 25%	225
	115	3700 ± 10%	3.8 ± 20%	5.3 ± 20%	6.4 ± 20%	9.0 ± 20%	7000 ± 30%				
<b>W-03</b>	25	4200 ± 10%	4.1 ± 20%	5.5 ± 20%	6.9 ± 20%	9.1 ± 20%	6000 ± 30%	2000	2100 ± 15%	5600 ± 25%	180
	115	2800 ± 10%	4.2 ± 20%	6.5 ± 20%	6.9 ± 20%	10.0 ± 20%	6000 ± 30%				

**RECOMMENDED FOR TV YOKE CORES**

<b>W-01</b>	25	2850 ± 10%	5.8 ± 30%	9.5 ± 30%	9.2 ± 30%	16.0 ± 30%	5000 ± 20%	850	1200 ± 20%	5000 ± 25%	180
	115	2000 ± 10%	4.4 ± 30%	7.9 ± 30%	7.4 ± 30%	14.5 ± 30%	6000 ± 30%				

\* $B_{max}$  and  $\mu_{max}$ , Frequency—16 Kcps.

\*\*Usable flux density—flux density at which the 115°C permeability is equal to ½ of the 25°C permeability.

†Permeability of the core at 25°C at  $B_u$ .

The above table shows the superiority of the new W-04 ferrite—higher flux density, higher permeability, lower core loss . . . properties that permit significant improvement in your flyback transformer design.

Allen-Bradley has also developed new square-loop power ferrites (R-03), and ferrites with unique characteristics for transistorized medium frequency power inverters (W-07).

The experienced engineering staff at Allen-Bradley will be glad to assist you with your ferrite problems. Write, today!

Allen-Bradley Co.  
222 W. Greenfield Ave., Milwaukee 4, Wis.  
In Canada—  
Allen-Bradley Canada Ltd., Galt, Ont.



Allen-Bradley ferrites are available in a wide range of shapes and sizes for various applications. Just a few of the basic shapes and sizes are shown above.

**ALLEN-BRADLEY CO.**  
ELECTRONIC COMPONENTS  
QUALITY

Table-top operation . . . and full 42-inch width . . .



. . . combined in one  
**Whiteprinter**

**OZALID**  
**Streamliner 200**

Now all the advantages of whiteprinting are combined in a convenient TABLE MODEL—the new, low-cost Ozalid Streamliner 200.

Compact, easy to operate, the Streamliner 200 stands just 22" high, 38" deep (including feedboard). With it *anyone* can turn out sparkling whiteprints in seconds *up to 42 inches in width!*

Perfect for the small office, it's an ideal stand-by for the large printroom, too. For the full story call your local Ozalid representative or write Ozalid, Dept. L-7-8, Johnson City, N. Y.



A Division of General Aniline & Film Corporation. In Canada: Hughes Owens Company, Ltd., Montreal.

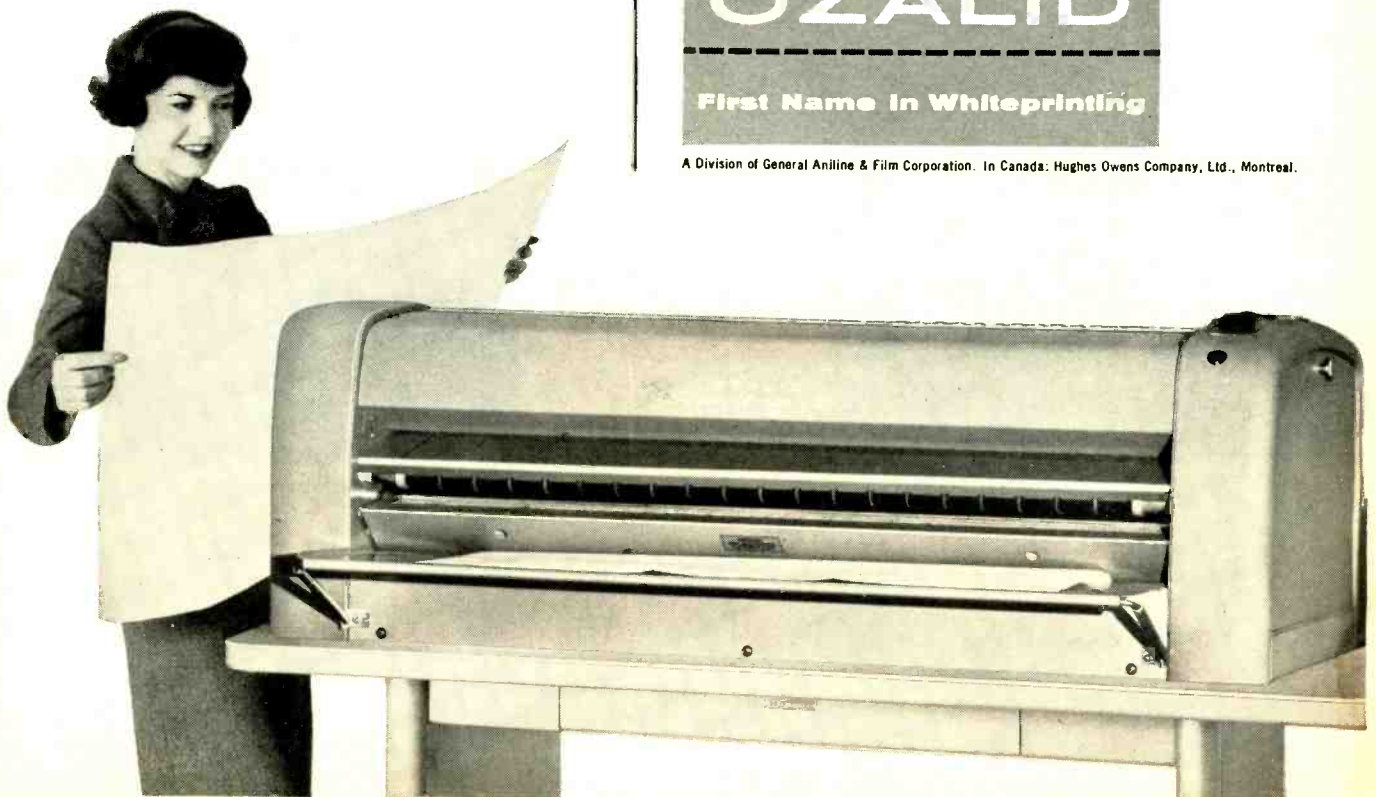

# THE SKY IS





# NO LONGER THE LIMIT

Under the water . . . on the water . . . on land . . . in the air . . . and out into space . . . in all these areas Hughes advanced technology is being applied to vital military and commercial electronics projects.

In the space satellite field, for example, Hughes is active in the preliminary design of guidance and control systems, communication and telemetry systems, and sensing devices using infrared, optical and radar techniques.

Responsible for guiding and formulating the advanced systems concepts that make this new product diversification possible is the Systems Analyst. His creative thinking has motivated such new Hughes projects as advanced ballistic missile guidance, space vehicle systems, and tactical missile systems. Other new programs initiated by Hughes Systems Analysts include advanced radar systems for all areas of military and civilian applications, including AICBM, missile

guidance, early warning, air traffic control; and integrated electronics systems for undersea warfare.

Currently the Hughes Research and Development Laboratories are engaged in the greatest expansion in their history. Professional opportunities have never been more promising, especially in the more senior areas such as Systems Analysis.

Other Hughes activities are also participating in the expansion. Hughes in Fullerton is developing and producing advanced three-dimensional radar systems. Hughes Products, the commercial activity of Hughes, is producing an electronics system which automates a complete line of machine tools.

Today Hughes offers Engineers and Physicists the opportunity of locating with an established firm and working in advanced new technical fields.

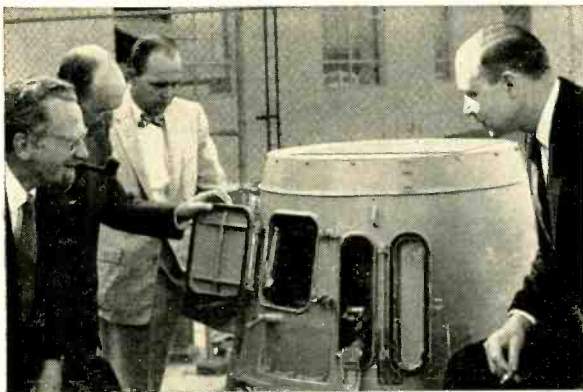

The wide range of activity at the Hughes Fullerton facility extends from basic data processing and surveillance radar research through final design and packaging.



Ferromagnetic studies conducted by the Hughes Research Laboratories include fundamental research in the physics and chemistry of ferrites, synthesis of ferrite materials and development of ferromagnetic devices.

*New commercial and military contracts have created an immediate need for engineers in the following areas:*

Circuit Design	Aerodynamics
Reliability	Vacuum Tubes
Communications	Crystal Filters
Microwaves	Systems Analysis
Nuclear Electronics	Computer Engineering

*Write in confidence to Mr. Phil N. Scheid,  
Hughes General Offices, Bldg. 6-O, Culver City, California.*

© 1958. HUGHES AIRCRAFT COMPANY

*Creating a new world with ELECTRONICS*

## HUGHES

HUGHES AIRCRAFT COMPANY  
Culver City, El Segundo,  
Fullerton and Los Angeles, California  
Tucson, Arizona

# How CDF Di-Clad<sup>†</sup> can solve your printed-circuit problems

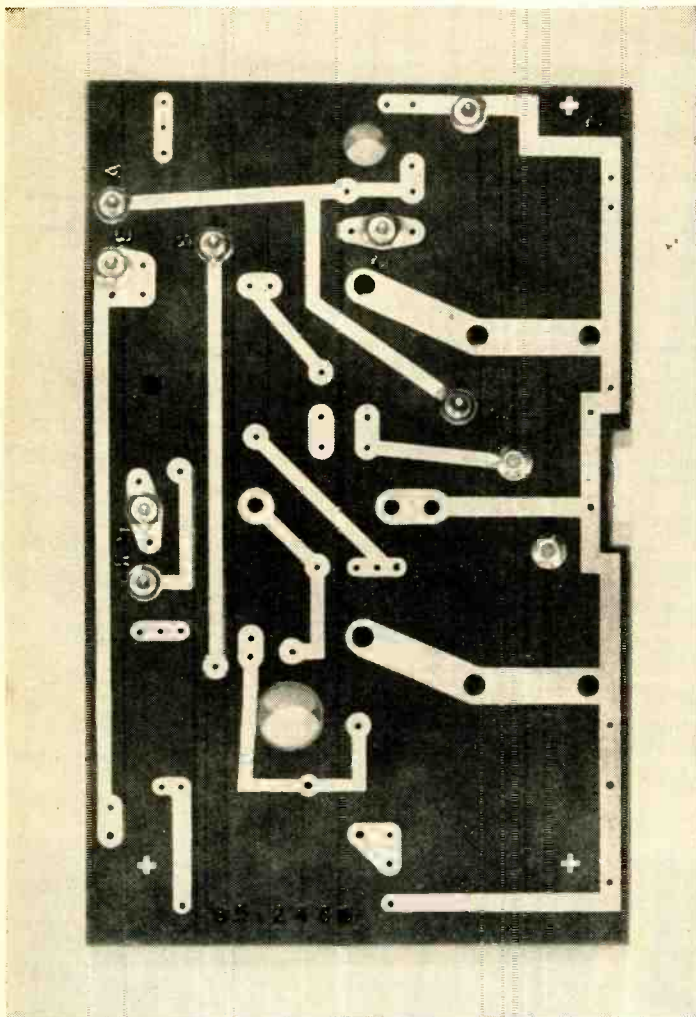

The CDF line of copper-clad laminates in all grades is now known by a new name—Di-Clad. Di-Clad grades meet the varying needs of design, production, and operation of electronic equipment. Grades other than those described are also available.

**Di-Clad 28E.** For high mechanical strength, low moisture-absorption, and good insulation resistance, CDF Di-Clad laminates of epoxy resin laminated with glass fabric offer the designer a strong, reliable combination.

**Di-Clad 112T.** A Teflon\* glass-fabric laminate offering the best dielectric properties over a wide temperature and frequency range.

Send us your requirements and let our engineers help you select the right grade for your application.

<sup>†</sup>Trademark of Continental-Diamond Fibre Corporation

\*Du Pont trademark for its tetrafluoroethylene resin.

**Di-Clad 2350.** An economy paper-base phenolic grade having good tensile, flexural, compressive, and impact strength. Adequate for most non-critical printed-circuit applications. Can be cold punched and sheared up to 5/64 of an inch in thickness.



## CONTINENTAL-DIAMOND FIBRE

A SUBSIDIARY OF THE *Buhl* COMPANY • NEWARK 16, DEL.

### TYPICAL Di-Clad PROPERTY VALUES

	Di-Clad 2350	Di-Clad 26 (NEMA XXXP)	Di-Clad 28 (NEMA XXXP)	Di-Clad 28E (NEMA G-10)	Di-Clad 112T Teflon*
BOND STRENGTH—0.0014" foil (lbs. reqd. to separate 1" width of foil from laminate)	6 to 10	6 to 10	6 to 10	8 to 12	4 to 8
MAXIMUM CONTINUOUS OPERATING TEMPERATURE (Deg. C.)	120	120	120	150	200
DIELECTRIC STRENGTH (Maximum voltage per mil for 1/16" thickness)	800	900	850	650	700
INSULATION RESISTANCE (Megohms) 96 hrs. at 35°C. & 90% RH (ASTM D257, Fig. 3)	500	150,000	600,000	100,000	75,000
DIELECTRIC CONSTANT 10 <sup>6</sup> Cycles	4.5	4.0	3.6	4.9	2.6
DISSIPATION FACTOR 10 <sup>6</sup> Cycles	0.040	0.026	0.027	0.019	0.0015
ARC-RESISTANCE (Seconds)	5	10	10	130	180
TENSILE STRENGTH (psi.)	18,000	16,000	12,000	48,000	23,000
FLEXURAL STRENGTH (psi.)	27,000	21,000	18,000	70,000	13,000
IZOD IMPACT STRENGTH edgewise (ft. lbs. per inch of notch)	0.80	0.45	0.42	12.0	6.0
COMPRESSIVE STRENGTH flatwise (psi.)	32,000	28,000	25,000	62,000	20,000
BASE MATERIAL OF LAMINATE	Paper	Paper	Paper	Medium-weave, medium-weight glass cloth	Fine-weave, medium-weight glass cloth
COLOR OF UNCLAD LAMINATE	Natural	Natural greenish	Natural	Natural	Natural

All these standard grades are available with 0.0014" and 0.0028" or thicker electrolytic or rolled copper foil on one or both surfaces. Other metal foils and other resin-and-base combinations can be supplied on special order.

\*Du Pont Trademark

# NLS Model 481

## Four-Digit Digital Voltmeter

- Measures DC Voltages from 1 Millivolt to 1,000 Volts
- Displays Measurements on Illuminated Numerical Readout
- Scale Factor and Linearity Accurate to 0.01%
- 10 Megohm Input Impedance
- Automatic Range Changing, Decimal Placement, and Polarity Indication
- New Snap-In Readout Assembly
- Furnished Complete; No Extras to Buy



Here is the greatest value ever offered in a precision instrument! Look at the features listed above . . . features that assure higher performance, reliability, and accuracy than provided by any other voltmeter. And look at the price . . . less than one-half the price of competitive instruments.

As originator of the digital voltmeter, NLS has led the way in developing new manufacturing techniques. Now, NLS is the first to mass produce digital voltmeters and make possible the unique combination of high performance and low cost in the NLS 481. See this rugged new industrial voltmeter demonstrated, and discover why electronic and servo-type digital voltmeters — as well as the most precise moving-coil voltmeters — are made obsolete by the NLS 481!

Write today for complete specifications and the name of the nearest demonstrator-equipped NLS field engineer!

### INSTRUMENTS TO MEET EVERY APPLICATION

NLS manufactures the most complete line of three, four, five, and six digit instruments for automatically measuring DC and AC voltages, voltage ratio, and resistance. Complete catalog available upon request.

# NEW LOW-COST INDUSTRIAL VOLTMETER

FULL PRICE

\$985

F.O.B. Del Mar, California



Originators of the Digital Voltmeter

**non-linear systems,  
inc.** SAN DIEGO COUNTY AIRPORT,  
DEL MAR, CALIFORNIA

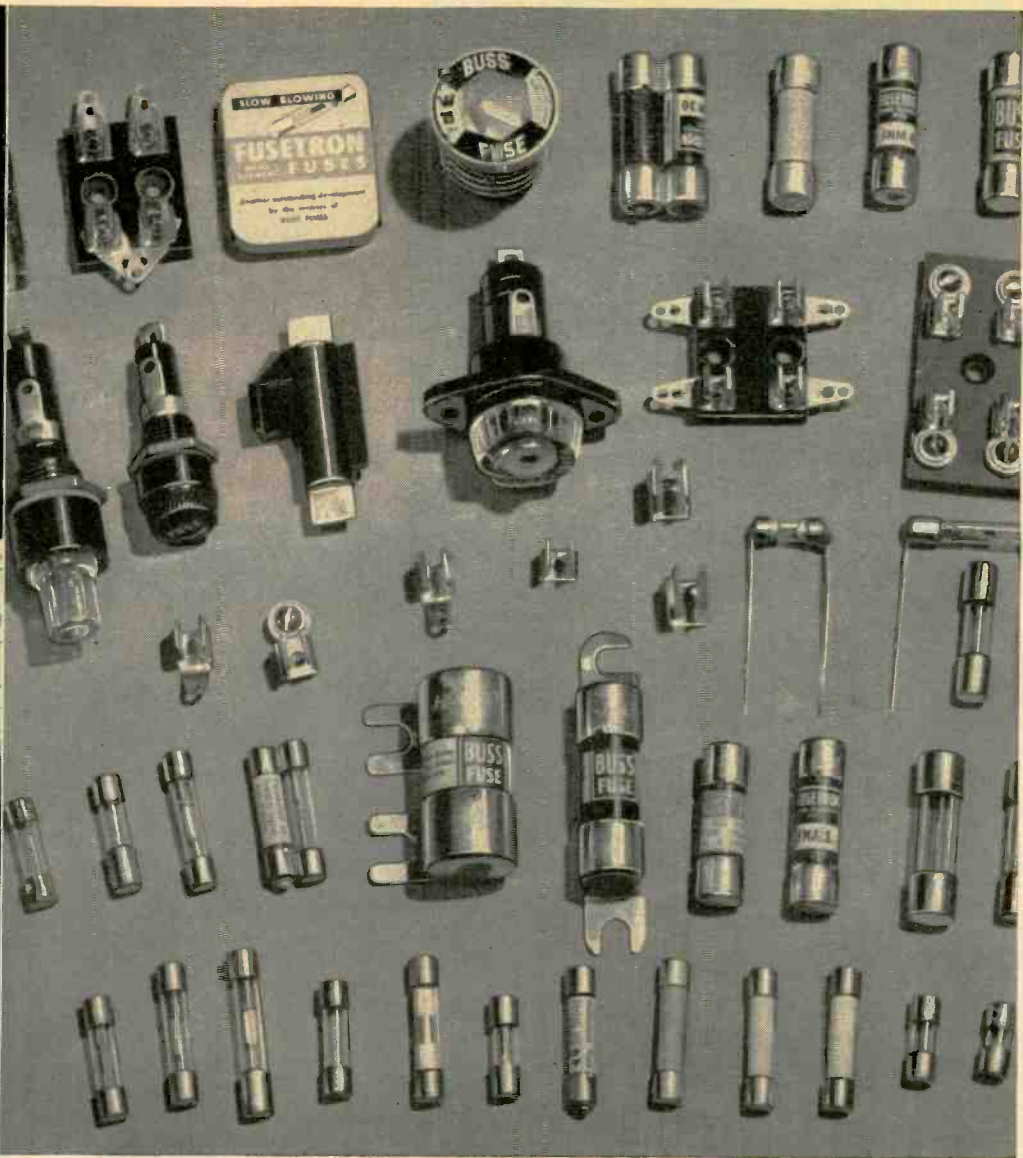

# Guard against needless trouble and shutdowns . . . by specifying dependable *BUSS* fuses!

Should a fuse fail to protect your equipment if electrical trouble occurs . . . unnecessary damage results. Or, if a fuse blows needlessly your equipment is shutdown without good cause.

Why risk faulty fuses causing trouble and reflecting on the service and reliability of your equipment? You can be sure of dependable electrical protection by specifying *BUSS* fuses.

Every *BUSS* fuse is tested in a sensitive electronic device that automatically rejects any fuse not cor-

rectly calibrated, properly constructed and right in all physical dimensions.

### One source for all your fuse needs.

To meet your needs, — the *BUSS* line of fuses is most complete . . . plus a companion line of fuse clips, blocks and holders.

### To help you on special problems in electrical protection . . .

. . . *BUSS* places at your service the facilities of the world's largest fuse research laboratory and its staff of engineers. If possible, our

engineers will help you select a fuse readily available in local wholesalers' stocks so users can easily obtain fuses for replacement.

For more information on the complete line of *BUSS* and *FUSETRON* Small Dimension Fuses and Fuse-holders, write for bulletin SFB.

Bussmann Mfg. Division  
 McGraw-Edison Co., University  
 at Jefferson, St. Louis 7, Mo.

758

*BUSS* fuses are made to protect — not to blow, needlessly



BUSS MAKES A COMPLETE LINE OF FUSES FOR HOME, FARM, COMMERCIAL, ELECTRONIC, AUTOMOTIVE AND INDUSTRIAL USE.

# NEW! two Tung-Sol Tubes for 12-volt auto radios!

Tung-Sol's latest 12v auto-radio tube developments—12EZ6 and 12FA6—provide a gain figure substantially above that of any other similar types. With these new tubes, the car-radio designer can simplify circuitry, thereby cutting out possible trouble spots. Bandwidth and frequency-drift problems are minimized . . . overall radio reliability rises.

Compare for yourself the advanced Tung-Sol types with the tubes they replace! Electrical data below!

New  
12EZ6!  
Up to  
50% more  
gain than  
12AF6 and  
12BL6 it  
replaces!



New  
12FA6!  
Up to  
20% more  
gain than  
12AD6  
it replaces!



Improved Tung-Sol types increase gain . . . widen design flexibility

## 12EZ6

7-pin, miniature, sharp cutoff pentode for use as RF or IF amplifier. Capable of 50% more gain than old Types 12AF6 and 12BL6 . . . with but a slight drop in Rp.

	NEW 12EZ6	OLD 12AF6	OLD 12BL6	
heater	12.6	12.6	12.6	volts
plate voltage	12.6	12.6	12.6	volts
grid #3 voltage <sup>b</sup>	0	0	0	volts
grid #2 voltage	12.6	12.6	12.6	volts
grid #1 voltage	-0.7 <sup>d</sup>	0	-0.65 <sup>d</sup>	volts
plate current	1.9	1.1	1.35	ma.
grid #2 current	0.7	0.45	0.5	ma.
plate resistance	0.20	0.35	0.5	megohms
transconductance	2 500	1 500	1 350	μmhos
grid #1 voltage				
for G <sub>m</sub> <sup>c</sup> =50 μmhos	-2.8	-2.7	-6.0	volts
12BL6 G <sub>m</sub> <sup>c</sup> =10 μmhos				
12AF6 G <sub>m</sub> <sup>c</sup> =40 μmhos				
grid #1 and grid #3 voltage				
for G <sub>m</sub> <sup>c</sup> =30 μmhos	-3.0	-3.5	-5.0	volts
{ 12BL6 G <sub>m</sub> <sup>c</sup> =10 μmhos				
{ 12AF6 G <sub>m</sub> <sup>c</sup> =10 μmhos				

<sup>b</sup> connected to cathode at socket

<sup>c</sup> from grid #1 to plate

<sup>d</sup> average bias developed across a 2.2 megohm grid resistor

## 12FA6

7-pin, miniature, pentagrid converter for use as oscillator-mixer. Capable of 20% more conversion gain than old Type 12AD6.

	NEW 12FA6	OLD 12AD6	
<b>Converter Service—Self Excitation**</b>			
heater voltage	12.6	12.6	volts
plate voltage	12.6	12.6	volts
grid #3 voltage	0.50 <sup>b</sup>	0	volts
grids #2 & #4 voltage	12.6	12.6	volts
grid #1 voltage (oscillator grid) rms	2.5	1.6	volts
grid #1 resistance (oscillator grid)	33 000	33 000	ohms
plate resistance (approx.)	0.8	1	megohms
grid #1 current (oscillator grid)	60	50	μa
conversion transconductance	320	260	μmhos
plate current	450	450	μa
grids #2 & #4 current	1 000	1 500	μa
cathode current	1 500	2 000	μa
grid #3 voltage for G <sub>c</sub> = 5 μmhos (approx.)	-3.5	-2.2	volts
grid #3 voltage for G <sub>c</sub> =20 μmhos (approx.)	-3.0	-1.8	volts

\*\*Screen feedback. G<sub>2-4</sub> to cathode voltage approximately 13% of G<sub>1</sub> to cathode voltage.

<sup>b</sup> Average contact potential developed across a 2.2 megohm resistor

Tung-Sol helped pioneer the 12v hybrid auto radio . . . makes a high-performance tube for virtually every other entertainment circuit need—radio, TV, hi-fi! For full data on the new 12EZ6 and 12FA6 . . . to fill any socket you have with a quality tube, write or phone us today! Commercial Engineering Dept., Tung-Sol Electric Inc., Newark 4, N. J.



# TUNG-SOL®

HERE'S NEW  
**PRECISION in CERAMICS**

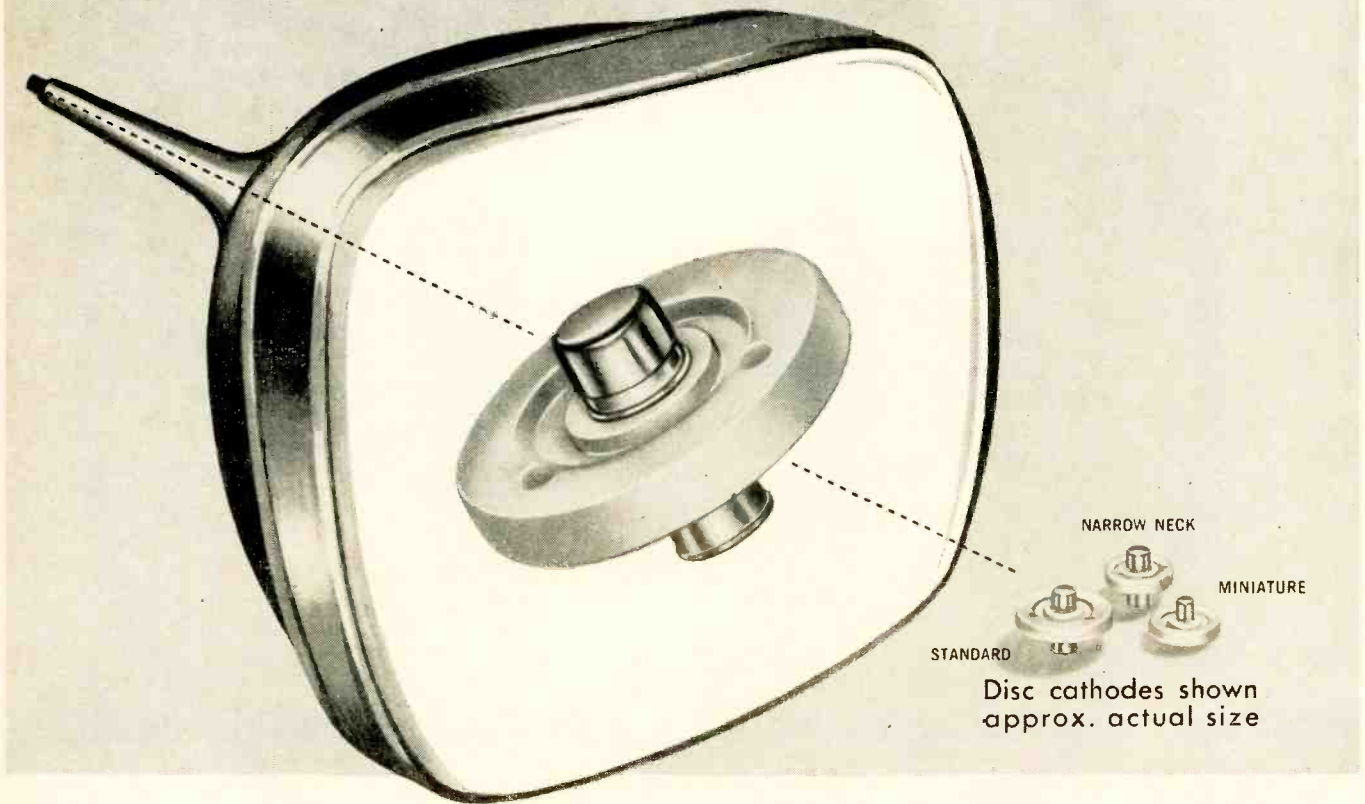

**High quality of SUPERIOR'S disc cathodes  
 made possible with G-C precision steatites**

Superior Tube Company's miniature disc cathodes save space and heater power, reduce cost to users of cathode ray tubes by utilizing slender tube necks. The application required Steatite discs with a heretofore unobtained degree of dimensional accuracy. General Ceramics' progressive manufacturing techniques have made it possible to achieve these critical tolerances and maintain absolute

uniformity in volume production runs. Since the inception of Superior's disc cathodes in 1950, engineers at General Ceramics have helped produce more compact, precision components by refining tolerances over 50% on steatite discs. New design criteria on *precision* steatites for your products is available now — write to General Ceramics Corporation, Keasbey, New Jersey, Dept. E.

**GENERAL CERAMICS**

*Industrial Ceramics for Industrial Progress... Since 1906*

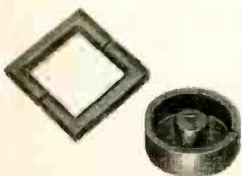

FERRAMIC CORES

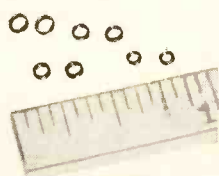

FERRAMIC  
 MAGNETIC CORES

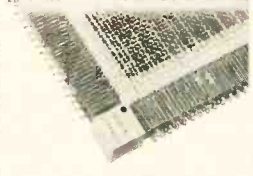

MAGNETIC  
 MEMORY PLANES

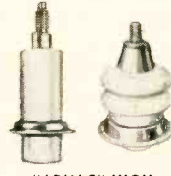

"ADVAC" HIGH  
 TEMPERATURE SEALS



SOLDERSEAL TERMINALS

**FOR THE FIRST TIME**

**a new 4PDT relay to  
meet all requirements  
of MIL-R-25018!**

Don't compromise with the Class C, Type II, Grade 3 requirements of MS 24114-9, MIL-R-25018. You don't have to any more. Now Union Switch & Signal has a 4PDT, rotary-armature relay designed to meet these specifications *completely*. It is the first of its type to do so. In fact, it *exceeds* some of the rugged requirements.

Here is the kind of performance you can expect from this new relay:

**High operating temperature.** Even at an ambient temperature of 200° C, this relay gives optimum performance. The use of ceramic material provides consistently high insulation resistance. As a result, you can install this relay closer to engines. You often can use it *without* temperature controlled boxes. Always, you will find it supremely rugged and reliable.

**High in shock resistance.** This new UNION Relay withstands shock *greater* than 55 g for 11 milliseconds—and continues to operate. In vibration tests, it shows no contact chatter up to 2,000 cycles at an acceleration of 25 g.

**New high in contact reliability.** Contact reliability of this relay is *six times* that of comparable devices because of its new 2-button, bifurcated contacts. Bifurcation also increases current carrying capacity (each button easily handles a full 2-ampere load) . . . and makes gold alloy contacts practical for both low- and high-level loads.

Contact reliability is enhanced, too, by the ceramic insulation which contains no volatile material to contaminate contacts and by separate hermetic sealing of the magnet coil.

**New torsion-type rotary-armature suspension** improves resistance to thermal shock . . . increases reliability over the entire temperature range . . . and greatly extends the operating life of this new 4PDT relay. Call or send the coupon for complete information about this and other miniature relays manufactured by Union Switch & Signal.



**GENERAL SPECIFICATIONS**

- Size ..... 1.79" long (maximum)  
1.062" in diameter (maximum)
- Weight ..... 3.2 ounces
- Nominal Operating Voltage ..... 24.5 volts
- Contact: Metal ..... gold alloy
- Contact: Bounce ..... less than 250 microseconds
- Temperature Rating ..... -65° C to + 200° C
- Shock ..... 55 g
- Vibration ..... 2,000 cps at 25 g

**COMPLETE FACTS**

Union Switch & Signal, Advertising Department  
Division of Westinghouse Air Brake Co.  
Pittsburgh 18, Pennsylvania

Please send the following:

- Complete description of your new 4PDT relay which meets every requirement of MIL-R-25018.
- Catalog of other miniature dc and ac relays which you manufacture to MIL-R-25018, MIL-R-6106C, and MIL-R-5757C requirements.
- Description of your Digital and Alpha-Numerical Indicators for data display.

Name .....

Position .....

Firm .....

Address .....

City ..... State .....

Also, put me on your technical mailing list.

*"Pioneers in Push-Button Science"*



**UNION SWITCH & SIGNAL**

DIVISION OF WESTINGHOUSE AIR BRAKE COMPANY

PITTSBURGH 18, PENNSYLVANIA

CIRCLE 37 READERS SERVICE CARD

**Forethought  
costs less than  
Afterthought**

so . . .

**Design  
These in  
When you  
Begin!**

If you need mechanical or electrical counters in any of your new products, here's a word to the cost-wise designer: *Design them in, when you begin . . . don't tack them on later.*

For if you'll give us a chance to work with you, right from the beginning, chances are we can save you time and money by adapting or modifying a *standard* Veeder-Root Counter to your needs . . . where you might get into a costly special job if you went about it alone. What's more, you save time in your engineering, purchasing and assembly departments.

Count on Veeder-Root to help you in every way . . . from design to delivery. Write:



Series 1370 High Speed Counter (1500 to 2500 rpm) built into a wide variety of equipment.

**Everyone...  
Can Count on  
Veeder-Root**

**INCORPORATED**

Hartford, Conn. • Greenville, S. C. • Chicago  
New York • Los Angeles • San Francisco • Montreal  
*Offices and Agents in Principal Cities*



Series  
1205 Reset  
Magnetic Counter with panel  
mount and lock and key.

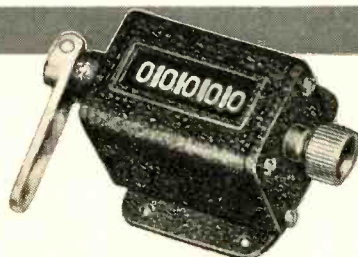

Series 1122 Small Reset Ratchet Counter.

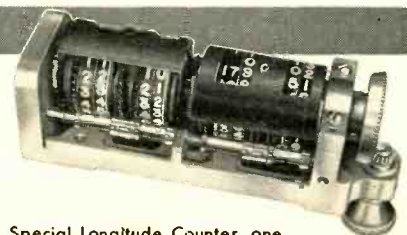

Special Longitude Counter, one  
of many made for aircraft navigational  
equipment.



# NOW... AUTOMATED PIGTAILING ... AT 75% LESS COST - with the NEW **AMP** Automachine Shielded Wire Ferrule

- machine-fed ferrules and pigtail wire
- controlled compression termination, with AMP automachine technique
- dual applicator permits termination of two leads or double-ended jumper, simultaneously
- pigtails cut to desired length, automatically!

Designed especially for television and commercial electronics applications.

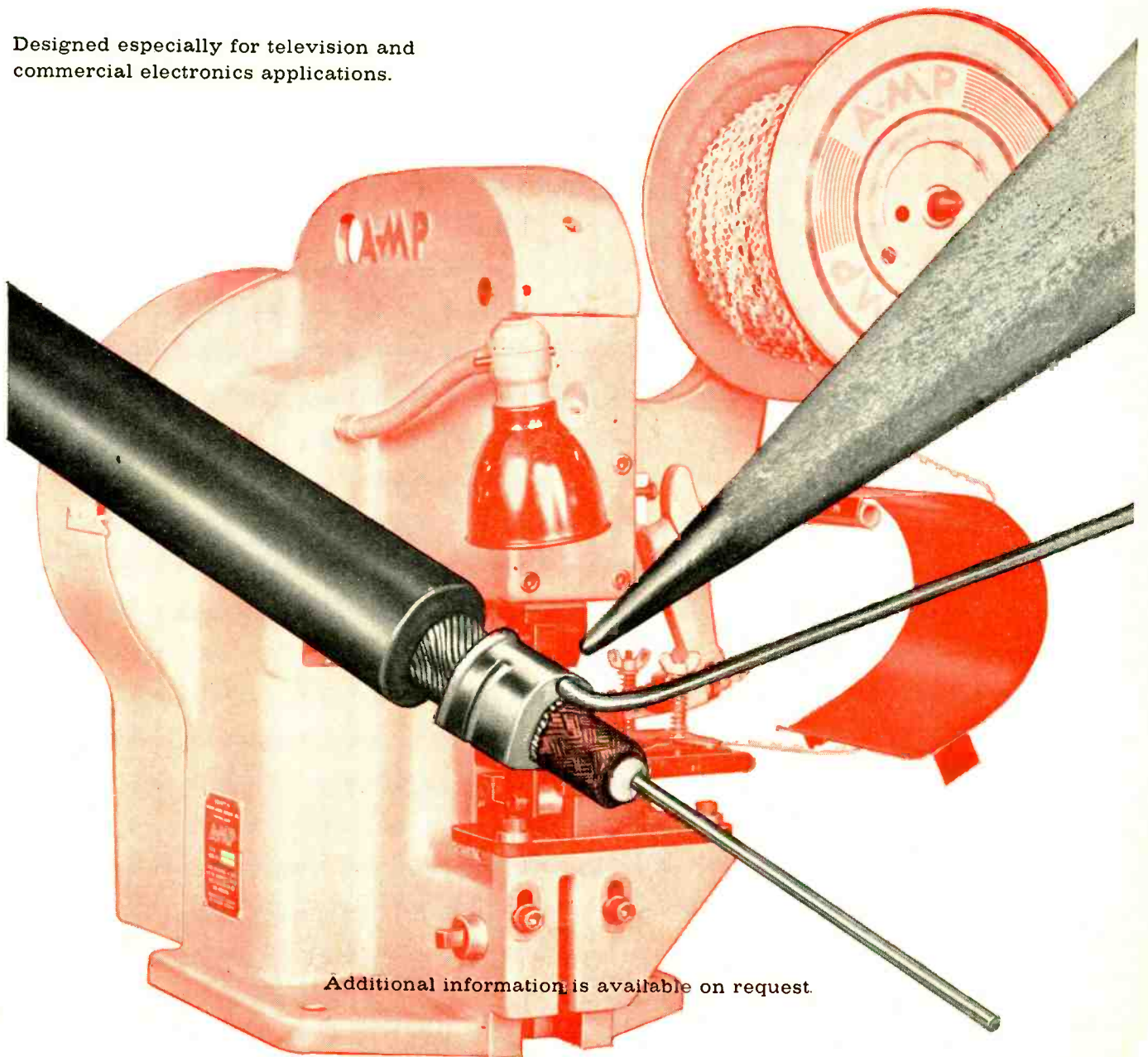

Additional information is available on request.

# AMP INCORPORATED

GENERAL OFFICES: HARRISBURG, PENNSYLVANIA

A-MP products and engineering assistance are available through wholly-owned subsidiaries in: Canada • England • France • Holland • Japan

CIRCLE 39 READERS SERVICE CARD

CIRCLE 40 READERS SERVICE CARD →

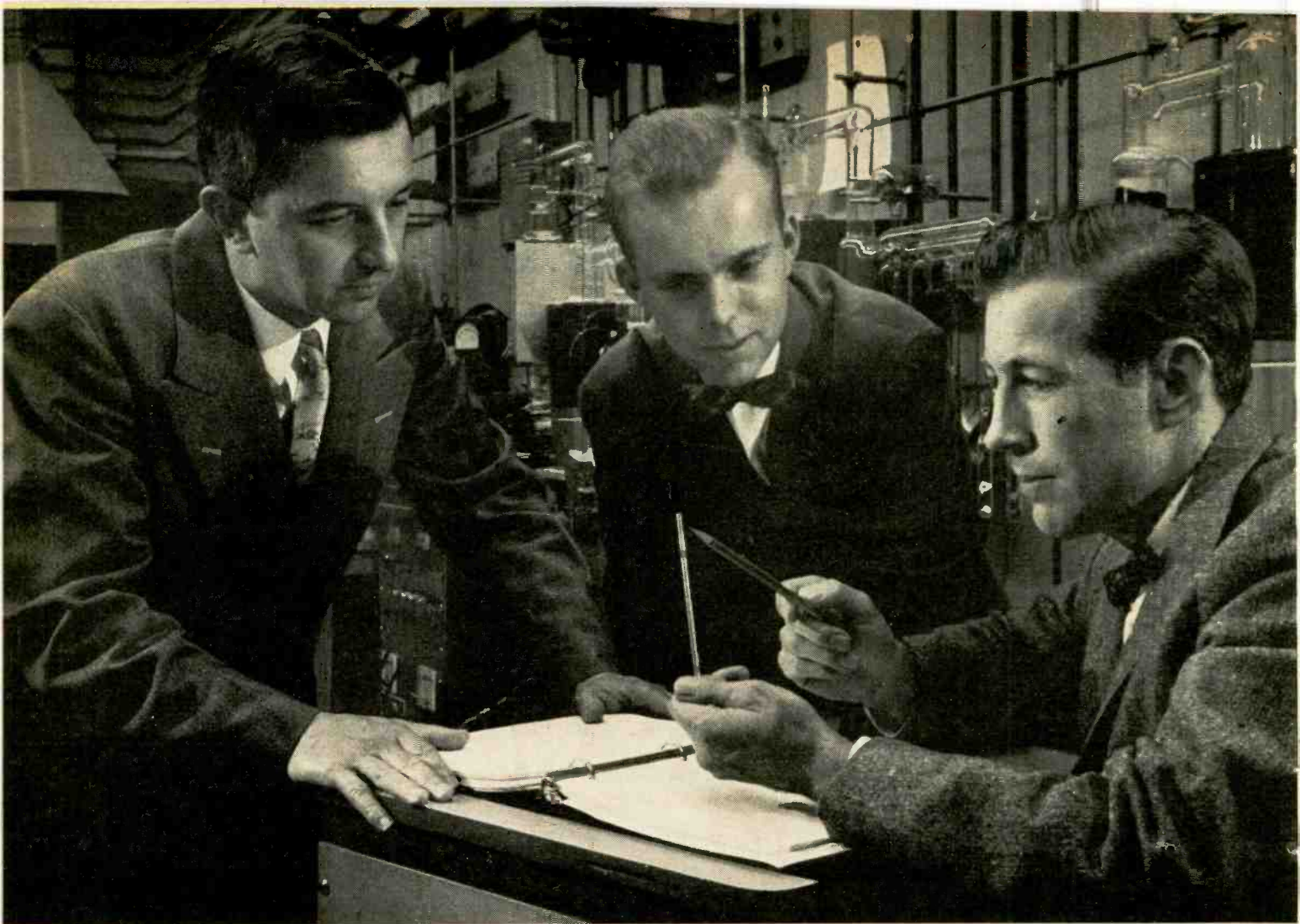

Project Engineer Fred M. Schumacher (R.) points out construction details in a newly-designed subminiature stacked ceramic gun used in an advanced design traveling-wave tube. Looking on are Engineers James F. Lynch (L.) and John P. Lindley.

## ADVANCED DESIGN OF LOW-NOISE A MAJOR EFFORT OF GENERAL ELECTRIC

**P**IONEERING in traveling-wave tube design is one of many advanced microwave activities being conducted at the General Electric Power Tube Department's Microwave Laboratory at Palo Alto, California. In the traveling-wave tube field, particular emphasis is placed on new design concepts leading to improvements in low-noise capabilities from S through K bands, extending the sensitivity and bandwidth of advanced receivers used in radars, communications, electronic countermeasures and radio astronomy.

The Laboratory's fields of activities are applied research, advanced development, and product design in microwave tubes and microwave techniques. All development work is done with an eye to practical, economical manufacture—thus minimizing the time lapse between prototype development and quantity production—and to the realistic tube needs of future microwave equipment. Technical inquiries pertaining to advanced microwave tube development invited. *Power Tube Dept., General Electric Co., Schenectady, N. Y.*

\* \* \*  
Professional opportunities available for engineering and scientific personnel. Inquiries invited.



The G-E Power Tube Microwave Laboratory is located at Stanford Industrial Park, Palo Alto, California where it was one of the Park's pioneer installations. Its staff of scientists and engineers has the advantage of consultation and technical exchange with Stanford University faculty and research staffs, as well as with General Electric's own Research and General Engineering Laboratories.

## TRAVELING-WAVE TUBES MICROWAVE LABORATORY

Vital development work in the following classes of tubes is a continuing activity of the G-E Microwave Laboratory's staff of scientists, engineers, and specialized technical personnel.

Pulse klystron power amplifiers	Super-power klystrons
CW klystron amplifiers	Voltage-tunable oscillators
High-power pulsed TWT amplifiers	High-power duplexers
Medium-power CW TWT amplifiers	Microwave filters
Low-noise, broadband TWT amplifiers	Frequency multiplier TWT amplifiers

*Progress Is Our Most Important Product*

**GENERAL**  **ELECTRIC**

9545-8481-14

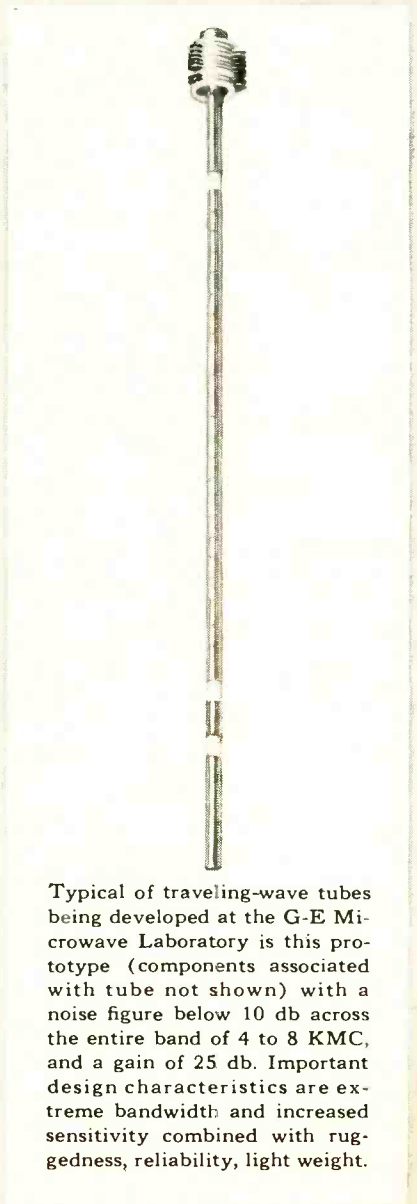

Typical of traveling-wave tubes being developed at the G-E Microwave Laboratory is this prototype (components associated with tube not shown) with a noise figure below 10 db across the entire band of 4 to 8 KMC, and a gain of 25 db. Important design characteristics are extreme bandwidth and increased sensitivity combined with ruggedness, reliability, light weight.

How the man from Tensolite cuts assembly costs

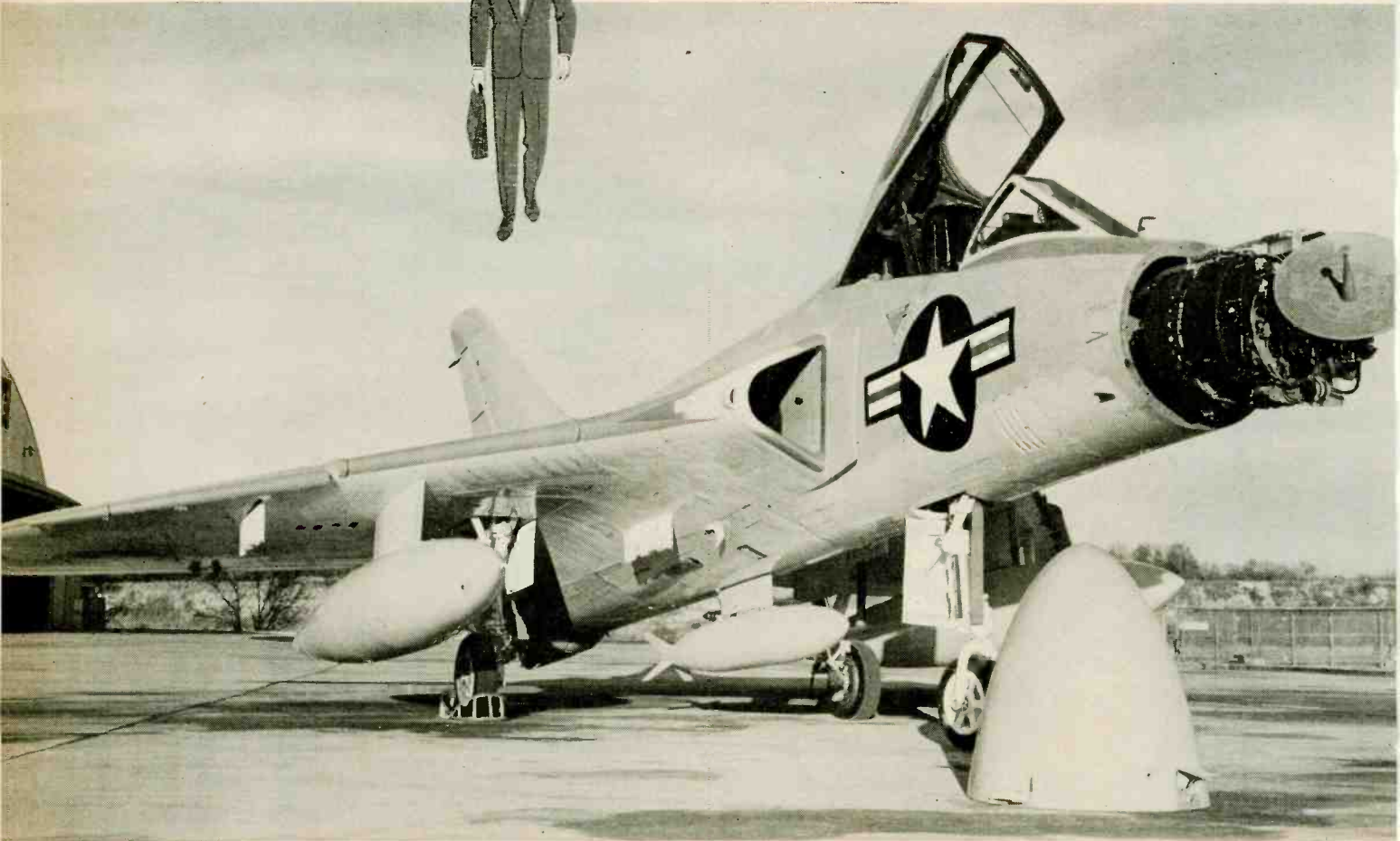

Westinghouse Aero 13 Armament Control System, mounted in nose of Navy F4D Douglas carrier-based interceptor, is typical of systems using FLEXOLON wire for faster assembly, lower production costs.

## FLEXOLON wire's greater flexibility speeds up wiring of Westinghouse control unit

Greater flexibility of new FLEXOLON high temperature hook-up wire makes an easier job of wiring intricate harnesses for Westinghouse Air Arm's armament control systems. Meeting the flexibility requirements of Westinghouse engineers, Tensolite's new wire helps reduce production time and assembly costs.

FLEXOLON wire's greater flexibility was proven in a recent series of tests on the new hook-up wire and wires of other construction. In test after test FLEXOLON wire, insulated with DuPont "Teflon,"<sup>®</sup> proved consistently more flexible than all other high temperature hook-up wires tested.

Exceeding the requirements of MIL-W-16878B . . . and providing greater dielectric strength and higher average concentricity . . . new FLEXOLON hook-up wire is another example of Tensolite's continuous leadership in miniature wire development.

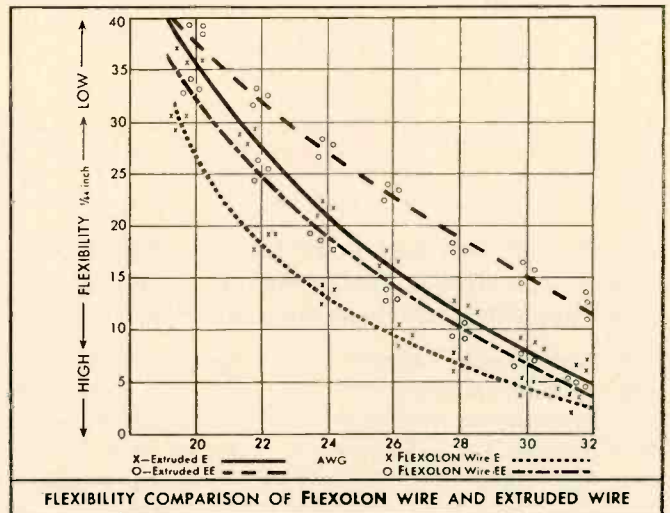

Plot of flexibility as recorded in tests proves greater flexibility of FLEXOLON wire. For complete testing data, call the man from Tensolite, or write for free FLEXOLON hook-up wire bulletin.

**Tensolite** INSULATED WIRE CO., INC.

West Main Street, Tarrytown, N. Y. • Pacific Division: 1516 N. Gardner St., Los Angeles, Calif.

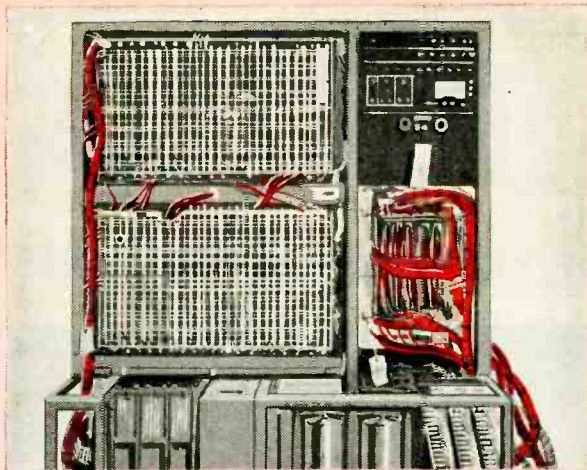

**INDUSTRIAL ELECTRONICS**—Improvement in the reliability of industrial controls, measuring equipment, business machines can be achieved with no appreciable increase in cost. TFE resins do not age—are non-flammable.

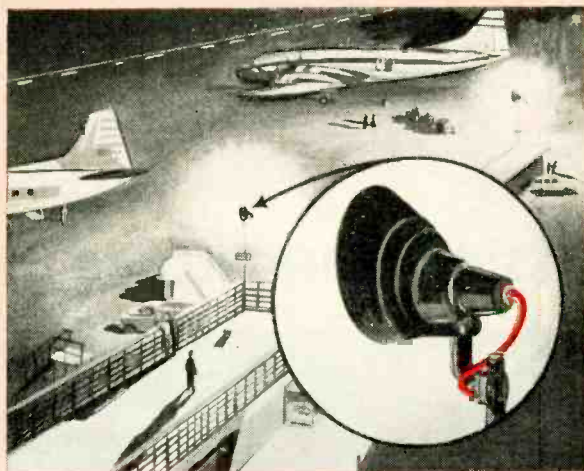

**SPECIALTY FIXTURE WIRING**—Non-flammability, resistance to heat, moisture and aging of TFE resins assure reliable performance of floodlights, heat lamps, outdoor lighting.

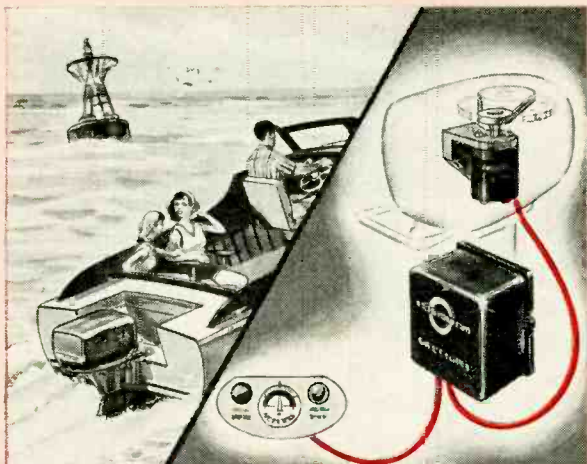

**MARINE WIRING**—TFE resins assure long, reliable performance, even in presence of fuels and lubricants, heat, moisture or corrosives. Smaller gauge wires allow miniaturization.

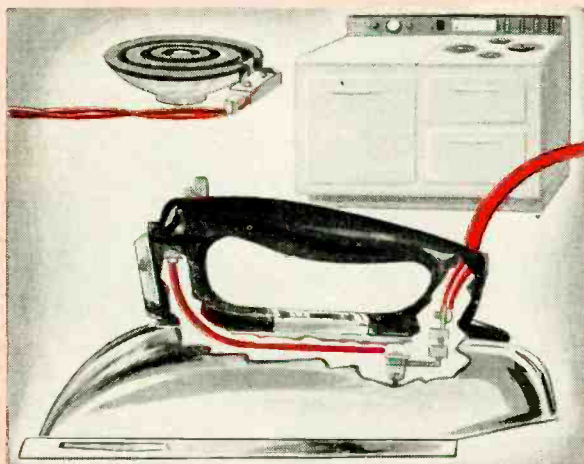

**APPLIANCE MANUFACTURING**—New designs and features are made possible by Du Pont TFE resins. Moisture and heat problems are overcome in appliances such as electric stoves, steam irons and toasters.

## For top performance in circuitry... specify wire and cable insulated with **TFE**-fluorocarbon resins

You, too, can benefit by the use of conductors insulated with TFE resins. For example, you can save weight and space with miniaturized types of wire and cable. Reduce your inspection and replacement costs. Handle unexpected power surges. Extend the operating range of your equipment to meet the toughest environmental conditions.

TFE-fluorocarbon resins improve the performance, safety and reliability of your equipment. They simplify your soldering, potting and miniaturization problems. Their electrical and structural properties do not deteriorate with age.

Best of all, you can enjoy sales and cost advantages by

**DU PONT** **TEFLON**<sup>®</sup>  
REG. U.S. PAT. OFF.  
 TFE-FLUOROCARBON RESINS

BETTER THINGS FOR BETTER LIVING . . . THROUGH CHEMISTRY

using wire protected by TFE resins. Look up your local supplier in the Yellow Pages (under "Plastics—Du Pont") . . . or for technical information write to: E. I. du Pont de Nemours & Co. (Inc.), Polychemicals Dept., Room 177, Du Pont Building, Wilmington, Delaware.

*In Canada:* Du Pont Company of Canada (1956) Limited, P.O. Box 660, Montreal, Canada.

► Write for the "HOTTEST STORY IN INSULATION." It gives you the facts that can help make your design, your product, your installation a winner.



*TEFLON is Du Pont's registered trademark for its fluorocarbon resins, including the TFE (tetrafluoroethylene) resins discussed herein.*

Design better products with

# DOW CORNING 200 FLUIDS

... ASSURE ADDED RELIABILITY AT EXTREME TEMPERATURES

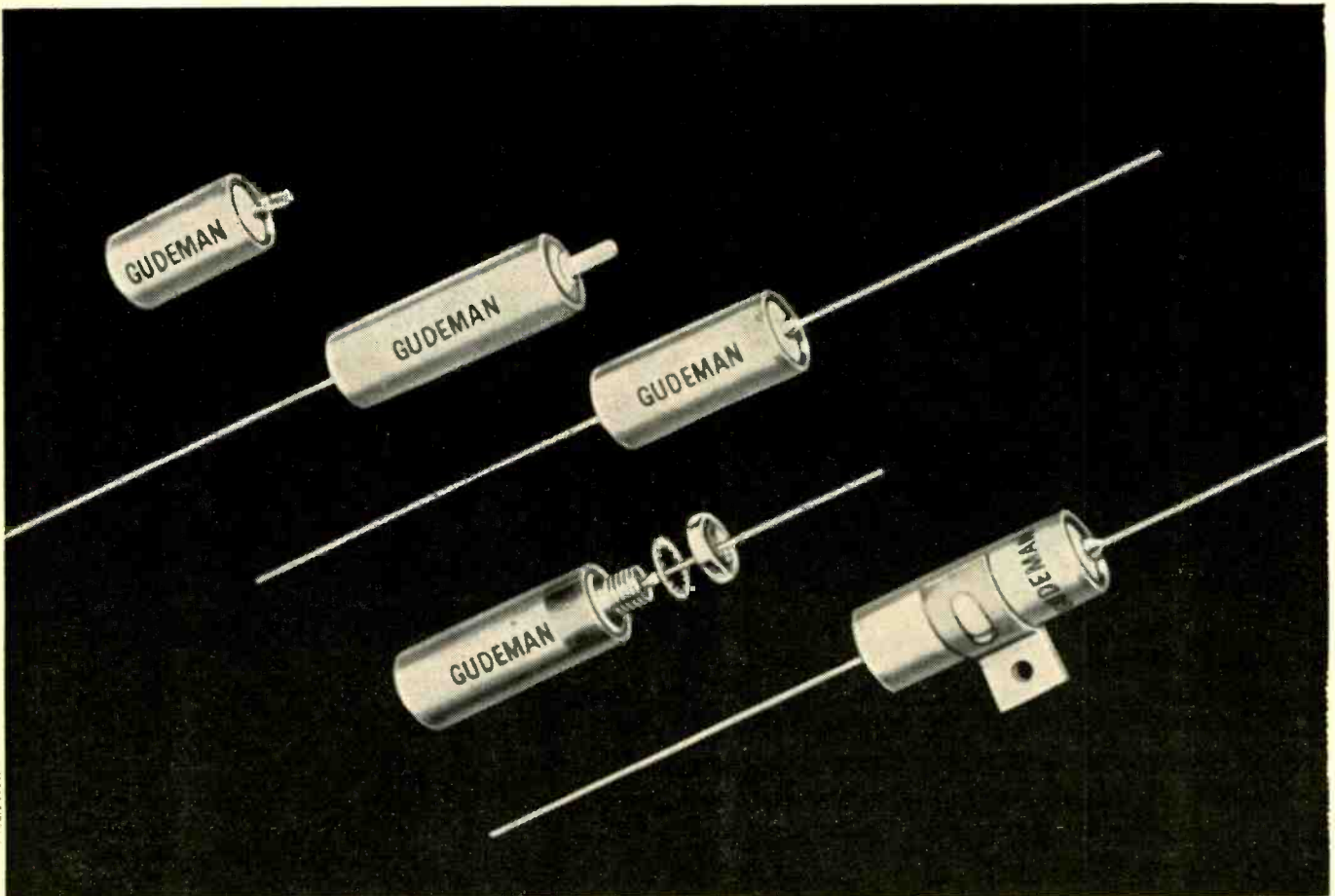

These miniature capacitors made by Gudeman Company for filter, by-pass and blocking service, are impregnated with silicone fluids to decrease electrical losses and increase permissible operating temperatures. Designed to meet all specifications of characteristic "K" MIL-C-25A, they have an operating temperature range of  $-55$  to  $125$  C.

TYPICAL DIELECTRIC PROPERTIES  
OF 200 FLUID, 100 CSTK.

Property	Temperature		
	$-55$ C	$23$ C	$200$ C
Dielectric Constant,			
1.0 kcs. -----	3.1	2.7	2.3
0.1 mcs. -----	3.1	2.7	2.3
Dissipation Factor,			
1.0 kcs. -----	0.0005	0.00004	0.001
0.1 mcs. -----	0.0002	0.00001	0.0003
Resistivity, ohm-cm. $10 \times 10^{14}$		$2.0 \times 10^{14}$	$1.0 \times 10^{13}$
Electric Strength, dc, 20 mil gap			
v/mil -----	700	650	550

As a liquid dielectric and coolant for electronic components and assemblies, Dow Corning 200 Fluid aids miniaturization and makes higher temperature operation possible. For example, paper capacitors impregnated with 200 Fluid have almost constant capacitance over an extremely wide temperature range... help assure reliable equipment performance. Heat stable electrical grade Dow Corning 200 Fluids show little change in electrical and physical properties over a wide range of frequencies and environmental conditions. Available in 20, 50, 100, 500 and 1000 centistokes viscosity grades, they are finding growing use as a means of increasing the reliability of capacitors, transformers, filter networks and other electronic devices.



**Dow Corning CORPORATION**  
MIDLAND, MICHIGAN

# Dow Corning Silicone Dielectrics

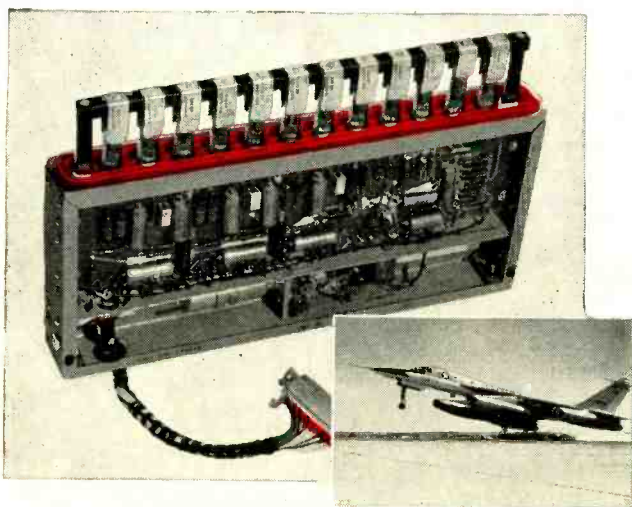

Electronic "Package" on B-58 by Emerson Electric.

## SILASTIC PROTECTS ELECTRONIC "PACKAGES"

Silastic® the Dow Corning silicone rubber, remains resilient from  $-70$  to  $250$  C, has excellent dielectric strength and offers superior resistance to moisture, ozone, corona and corrosive atmospheres. Available in many forms, including molded parts, extrusions, tapes, sheets and pastes, Silastic is ideal for insulating, sealing and cushioning delicate electrical and electronic equipment.

**SILICONE  
GLASS  
LAMINATES  
HAVE  
HIGH ARC  
RESISTANCE,  
STRENGTH**

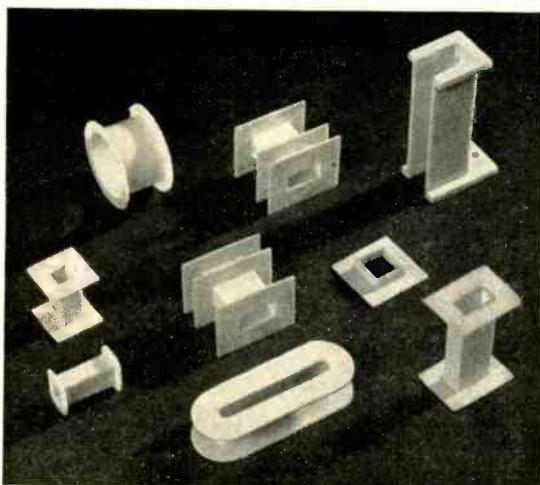

Silicone-glass laminates are easily molded into one-piece core and flange structures. Strong even at flange joints, they are lightweight and moisture-resistant, retain excellent physical and dielectric properties at  $250$  C. Finished shapes are available from leading laminators.

## SILICONE VARNISH MAKES MOTORS TOUGHER, MORE DEPENDABLE

Dipped or impregnated with Dow Corning 997 Varnish, the insulating components of motors, servos, generators, transformers and other assemblies are bonded into an integrated moisture resistant insulation system with high dielectric strength. This silicone varnish combined with other silicone components permits operating temperatures up to  $250$  C . . . protects against moisture, many chemicals and corrosive atmospheres.



AirResearch miniature motors for B-52A Bomber.

For further information on these products, write Dept. 487

# Westinghouse Roberts Test Technique Frees Reject-Strangled Production...

*Perfectly paired Hipermag\* cores  
boost magnetic amplifier output*



Mr. Cliff Horstman checks performance readings for Hipermag cores using the Roberts Dynamic Tester. This production-line test eliminates costly and complicated testing at your plant. After the Roberts test, Hipermag cores are "pegged" here according to their performance characteristics. This practice assures perfect performance-matching every time.

A very high reject ratio was strangling magnetic amplifier production at the plant of a large eastern manufacturer. Analyzed by the company's own engineers, the problem was found to be a case of inadequate core matching. A core-matching specification based on sine current dynamic testing was attempted. However, since the application was a voltage regulator using voltage reset, the problem of matching maximum permeability to the required tolerances was practically insurmountable for production-line testing.

After Westinghouse engineers analyzed the problem, it was decided that matching cores at zero control point with the Roberts tester would help obtain the desired high yields.

Production-run cores matched by this procedure were flown to the manufacturer from the Westinghouse Greenville plant. These cores resulted in an immediate improvement in production-line performance.

The Roberts core-matching technique provides the closest approach to magnetic amplifier design for commercial testing of cores that exists today. This testing technique on standard Hipermag cores provides performance tailored to your magnetic amplifier application.

Let our engineers help you with your magnetic amplifier production problems. Call your Westinghouse representative . . . or write Specialty Transformer Department, Westinghouse Electric Corporation, P.O. Box 231, Greenville, Pa.

\*Trade-Mark

J-70873

YOU CAN BE **SURE**... IF IT'S **Westinghouse** 



*Large • small • any size between—*

## **ALITE** is geared to meet your requirements for **CERAMIC-TO-METAL SEALS**

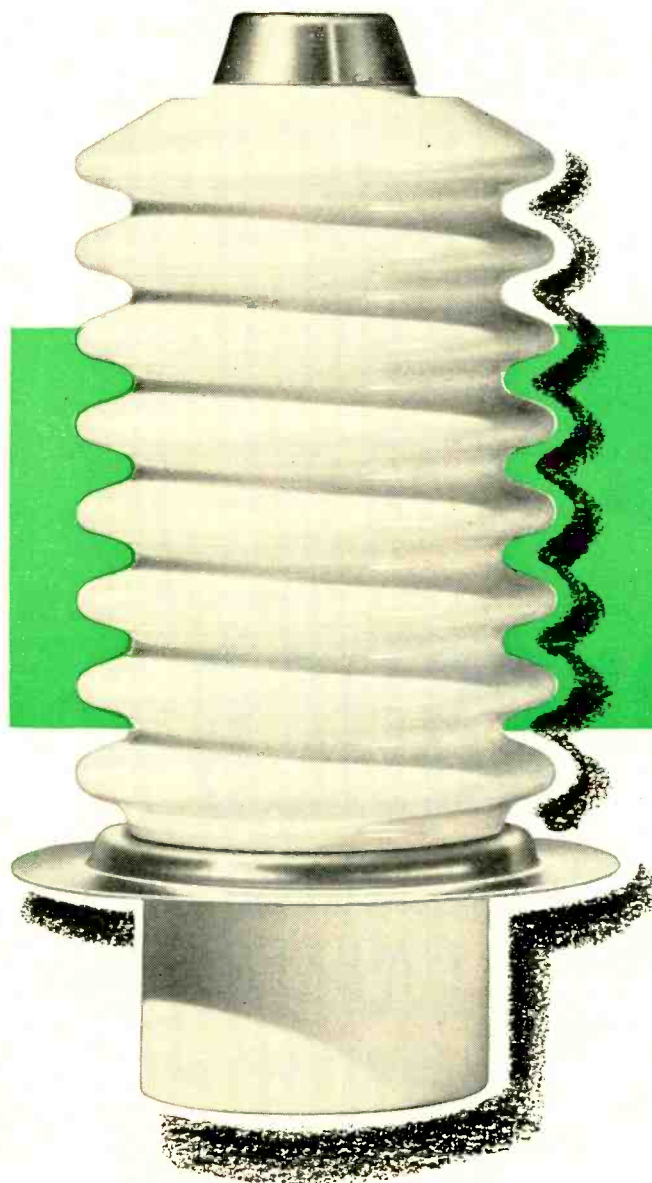

Alite offers completely integrated facilities and expert engineering assistance for producing high quality, vacuum-tight, ceramic-metal components for all your mechanical and electrical requirements.

Hermetic seals and bushings embodying Alite—the high-alumina ceramic developed by U. S. Stoneware—have the ability to withstand severe physical and thermal shock without leaks or cracking. Produced to precision tolerances, Alite units have high impact and tensile strengths for gruelling environmental conditions. They maintain excellent electrical and mechanical characteristics over a wide range of frequency and temperature. The extra-smooth, hard, high-fired glaze gives superior surface resistivity.

Every manufacturing step is closely supervised in our own plant. Positive quality control assures strict adherence to specifications, absolute uniformity and reliability of completed components.

***At no obligation to you, send us your drawings for recommendations or quotation.***

### **FREE Technical Data**



New Bulletins A-20 and A-35 describe Alite facilities and standard Alite High Voltage Bushings. Write for them now.

**ALITE DIVISION**

**U. S. STONWARE**

BOX 119 ORRVILLE, OHIO

New York Office  
60 East 42nd St.

118-F



his **unconversance**  
with certain microwave measurements  
is curable—with a D-B CATALOG

Friends, this microwave engineer lacks facts on low Qs in cavities. Not knowing where to find the facts, he's stymied. Actually, all he has to do is consult his D-B catalog. Compacted into its 180 pages are complete data on making microwave measurements. He gets clear, comprehensive theory wedded to practical help on procedure. He'll find actual drawings of test setups, plus instructions on how to operate them, using units in the peerless D-B line of precision test equipment—largest line extant today.

**FURTHER INSPECTION WILL REVEAL** a solid section on introductory concepts to microwaves—for use by purchasing personnel, inspecting individuals, and other initiates to this superlative subject.

**THERE'S A HABIT-FORMING HANDBOOK** complete with graphs and tables on microwave tube characteristics...

on conversion factors, and other daily-used data. There are dimension drawings on every AN flange in use. There's all the information needed to hook up D-B equipment to D-B equipment, or to any other equipment.

**ALL THIS DATA** is right in the lil' old D-B catalog No. C3, ready to assist in making more meritorious measurements. Please tell our engineer friend to use his D-B catalog. And if yours is on permanent "loan," let us know. We will replace it.



**DE MORNAY-BONARDI**  
780 S. Arroyo Parkway, Pasadena, California

If **FAST SWITCHING** is your need and available germanium types won't meet temperature and reliability requirements...

# SWITCH to SILICON

ACTUAL SIZE

## MILITARY TYPES

**Silicon** 1N663  
**Computer** 1N662  
**Diodes** 1N643

A definite break-through of the inherent temperature limitations of germanium is provided by these outstanding new Silicon Diffusion Computer Diodes. They switch as fast as the best germanium types...and at temperatures to 150°C!

They combine fast switching with high conductance and high break-down voltage with high temperature operation... plus PSI "Built-in-Reliability."

These three related military types can replace all germanium diodes in computers of advanced design where high reliability performance at high temperatures must be sustained without compromise.

Look at these outstanding specifications!

**HI-CONDUCTANCE** Mil-E-1/1140 (Sig C)  
**GENERAL PURPOSE** Mil-E-1/1139 (Sig C)  
**HIGH VOLTAGE** Mil-T-12679/39 (Sig C)

EIA TYPE	Minimum Saturation Voltage (volts) @ 100 $\mu$ A	Minimum Current Forward @ + 1.0v	Maximum Reverse Current ( $\mu$ A)		Reverse Recovery Characteristics	
			25°C	100°C	Reverse Resistance (ohms)	Maximum Recovery Time ( $\mu$ s)
1N663	100	10	5(75v)	50(75v)	200K	0.5
1N662	100	10	1(10v) 20(50v)	20(10v) 100(50v)	100K	0.5
1N643	200	10	.025(10v) 1(100v)	5(10v) 15(100v)	200K	0.3

Detailed specifications, ratings and curves available on request.

### Distributors:

- ALLIED RADIO  
Chicago, Illinois
- ALMO RADIO COMPANY  
Philadelphia 7, Pennsylvania
- CRAMER ELECTRONICS, INC.  
Boston 16, Massachusetts
- ELECTRONIC SUPPLY CORP.  
Pasadena, California
- ELECTRONIC INDUSTRIAL SALES  
Washington 1, D. C.
- PEERLESS RADIO DISTRIBUTORS, INC.  
Jamaica 33, New York
- PENINSULA TV AND RADIO SUPPLY  
San Jose, California
- WHOLESALE RADIO PARTS COMPANY  
Baltimore 1, Maryland

Write for full information on the entire line of PSI silicon and germanium diodes, silicon rectifiers and PSI voltage-variable capacitors (VARICAP). Production quantity delivery on all types.



## Pacific Semiconductors, Inc.

10451 West Jefferson Boulevard, Culver City, California  
 NEW YORK - 2079 Wantagh Ave., Wantagh, Long Island, N. Y.  
 CHICAGO - 6957 W. North Ave., Oak Park, Illinois  
 SEATTLE - Administration Bldg., Boeing Field, Seattle, Wash.  
 EXPORT DEPARTMENT - 431 Fifth Ave., New York 16, N. Y.

© 1958 Pacific Semiconductors, Inc.

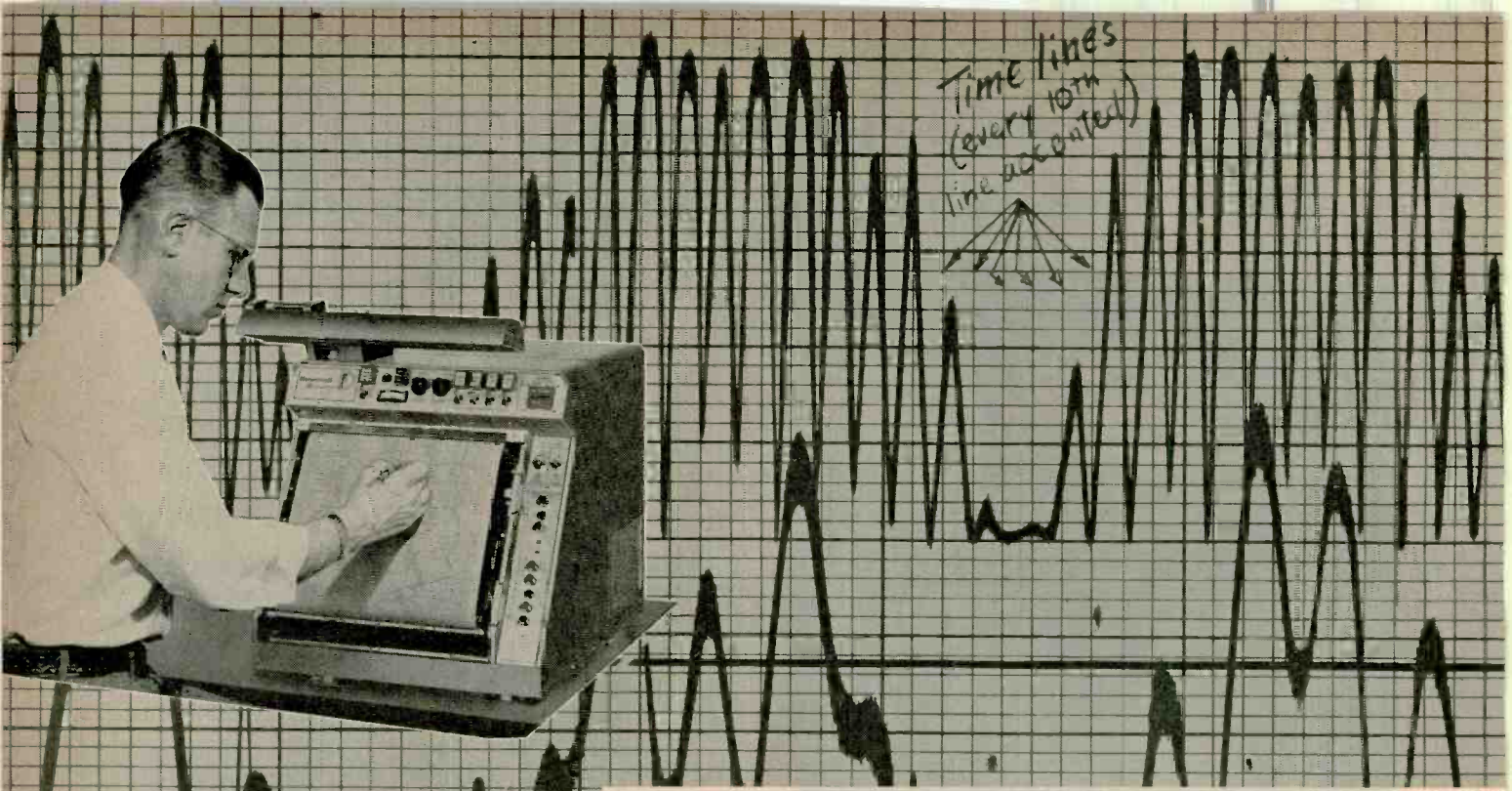

Time lines  
(every 10th  
line accented)

**this is a double**

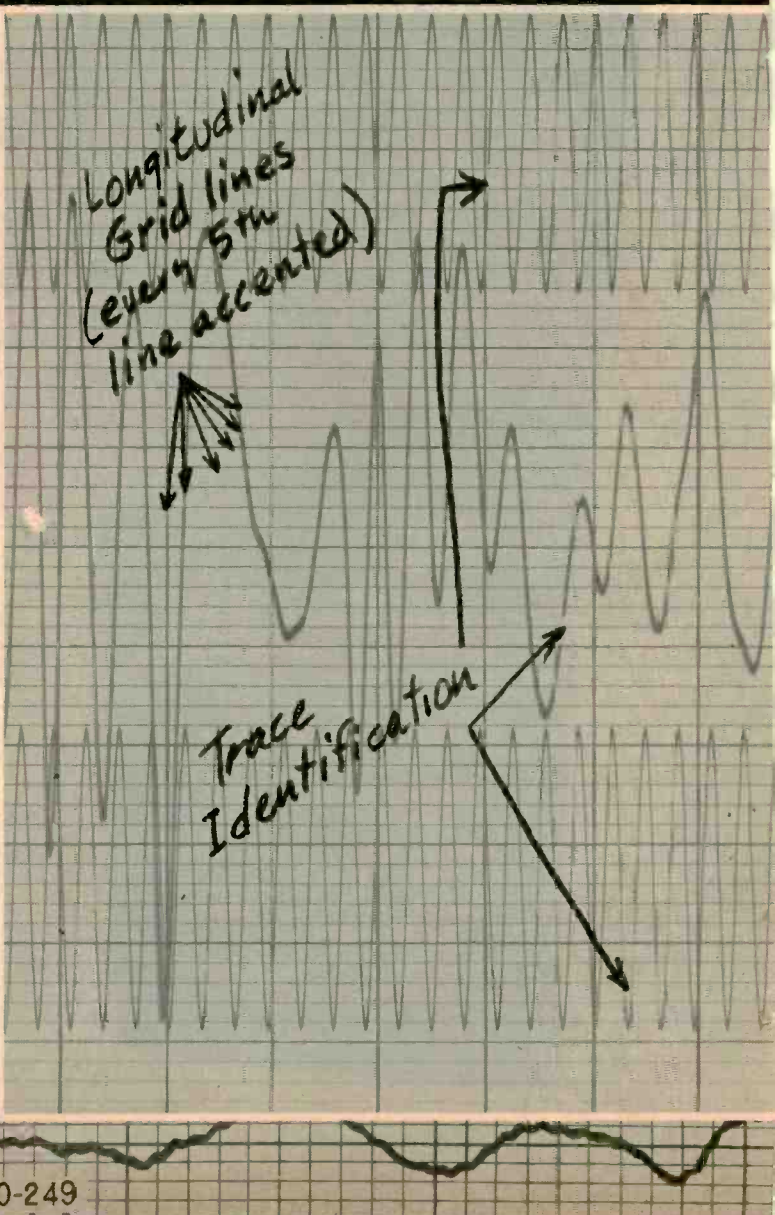
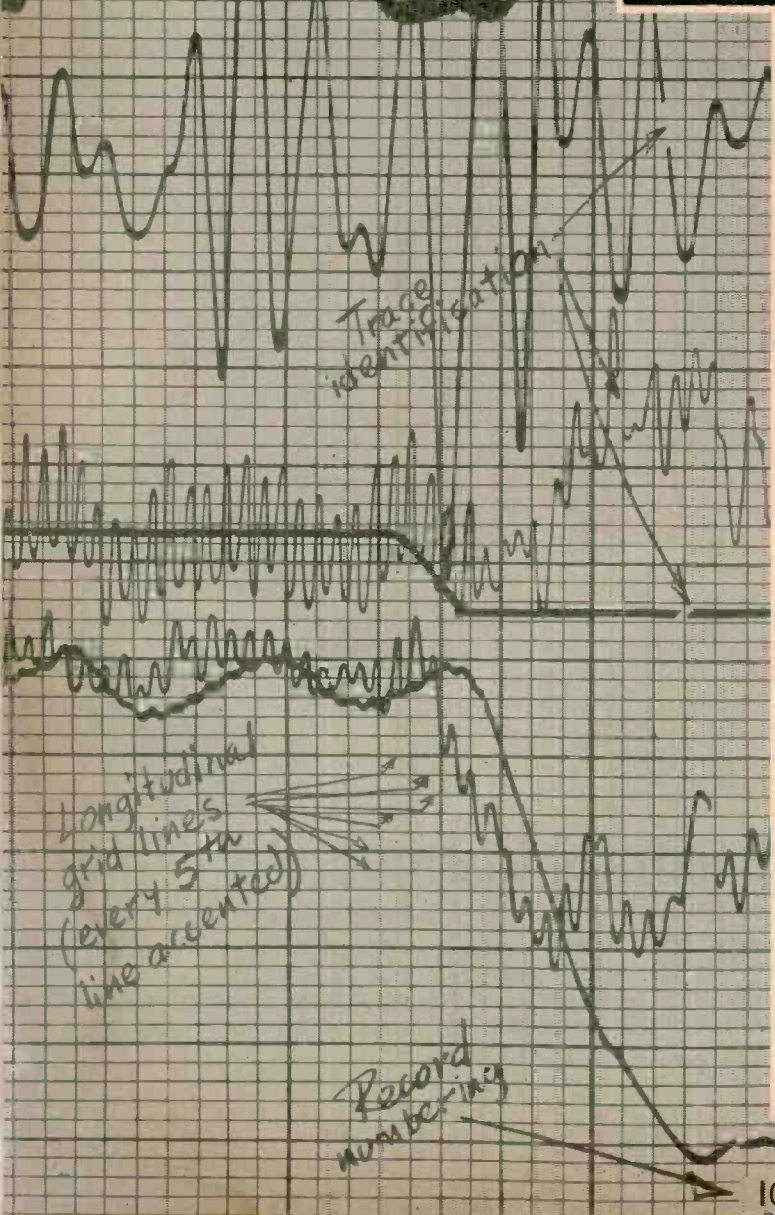



When the Honeywell Model 906 Visicorder was introduced as the first practical high-frequency direct-writing oscillograph in history, it met with instant success.

Now the new Honeywell Model 1012 Visicorder extends the range and usefulness of the exclusive Visicorder principle. It is a highly sensitive 36 channel instrument with frequencies from DC to 3000 cps. Its exclusive features are many . . . it is the most convenient, foolproof, reliable, broad-

capacity oscillograph on the market today.

And the 906 Visicorder is now available in two new models: the 906A-1 with 14 channels, and the 906A-2 with 8 channels. An accurate time-line system and a simultaneous grid-line recording system are optional in both 906A Models. Both oscillographs are producing superior, clear, reproducible, accurate, high sensitivity, high frequency direct recordings in many varied applications every day.

## record of leadership

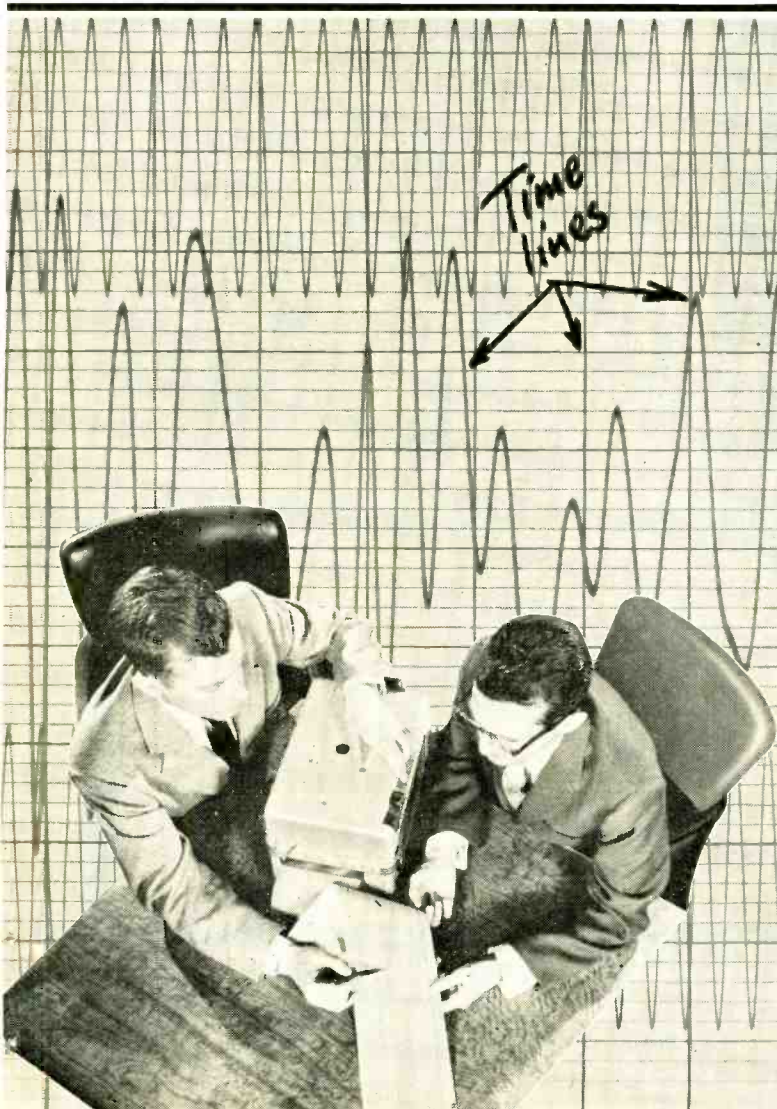

The two specimen records—one from a 906A Visicorder and one from the 1012 Visicorder—are reproduced unretouched and life size. They are an accurate indication of the excellence of Visicorder records.

For further information about these dramatic new Visicorders, call your nearest Honeywell Industrial Sales Office.

**Reference data: Write for Visicorder Bulletins 906A and 1012.**

*Minneapolis Honeywell Regulator Co.,  
Industrial Products Group, Heiland Division  
5200 E. Evans Avenue, Denver 22, Colorado*

## Honeywell



*Industrial Products Group*

# NEW DUAL-BEAM OSCILLOSCOPE

## Tektronix Type 502

- TWO-GUN CATHODE-RAY TUBE.
- 200  $\mu\text{v}/\text{cm}$  SENSITIVITY, BOTH BEAMS.
- DIFFERENTIAL INPUT, ALL SENSITIVITIES.
- 2, 5, 10, and 20 TIMES SWEEP MAGNIFICATION.
- CURVE TRACING with TWO BEAMS—(horizontal input sensitivity to 0.1  $\text{v}/\text{cm}$ ).
- SINGLE-BEAM CURVE TRACING at 200  $\mu\text{v}/\text{cm}$ , BOTH AXES.
- EXTRA FEATURE—Both amplifiers have transistor-regulated parallel heater supply.

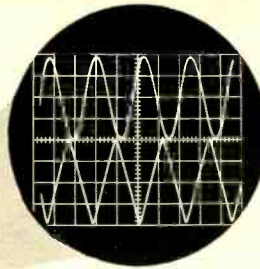

Dual display on linear time base.

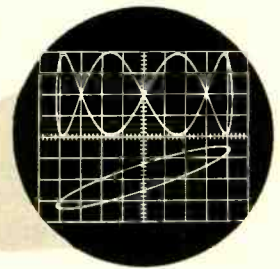

Dual display for X-Y curves.

### Here are a few uses for the Type 502:

**IN ELECTRONICS**—Use the Type 502 as a general-purpose oscilloscope and also to show simultaneously the waveforms at any two points in a circuit, e.g. input and output, opposite sides of a push-pull circuit, trigger and triggered waveform, etc.

**IN MECHANICS**—Display, compare, and measure outputs of two transducers on the same time base; plot one transducer output against another—pressure against volume or temperature for instance; measure phase angles, frequency differences, etc.

**IN MEDICINE**—Display, compare, and measure stimulus and reaction, or the outputs of two probes, on the same time base; use differential input to cancel out common-mode signals, or to eliminate the need for a common terminal; use in routine investigations, etc.

**IN ALL FIELDS**—The Type 502 can save you more than its cost in time—in as little as one application!



### TYPE 502 CHARACTERISTICS

#### HIGH-GAIN AMPLIFIERS

200-microvolts/cm deflection factors, both dc-coupled and ac-coupled. 16 calibrated steps from 200  $\mu\text{v}/\text{cm}$  to 20  $\text{v}/\text{cm}$ .

Passbands—dc-to-100 kc at 200  $\mu\text{v}/\text{cm}$ , increasing to dc-to-350 kc at 1  $\text{mv}/\text{cm}$  and dc-to-500 kc at 50  $\text{mv}/\text{cm}$  to 20  $\text{v}/\text{cm}$ .

Differential Input, Both Channels—Rejection ratios: 1000-to-1 at 1  $\text{mv}/\text{cm}$  or less, 100-to-1 at 0.2  $\text{v}/\text{cm}$ , 50-to-1 at 5 to 20  $\text{v}/\text{cm}$ .

Constant Input Impedance (1 megohm, 47  $\mu\text{f}$ ) Both Channels—from 1  $\text{mv}/\text{cm}$  to 20  $\text{v}/\text{cm}$ , for use with Tektronix P510A Probes. (2-P510A Probes furnished).

#### WIDE-RANGE SWEEP CIRCUIT (Common to both beams)

Single-knob control for selecting any of 22 accurately-calibrated sweep rates from 1  $\mu\text{sec}/\text{cm}$  to 5  $\text{sec}/\text{cm}$ .

Sweep Magnification—2, 5, 10, and 20 times, accurate within the maximum calibrated sweep rate.

Automatic Triggering—fully automatic, or preset with amplitude-level selection when desired. Sweep can also be operated free-running.

#### X-Y CURVE TRACING OPERATION

Horizontal-input amplifier permits curve-tracing with both beams simultaneously at sensitivities to 0.1  $\text{v}/\text{cm}$ . For curve tracing at higher sensitivities (to 200  $\mu\text{v}/\text{cm}$ ) with one beam, one of the vertical amplifiers can be switched to the horizontal-deflection plates.

#### OTHER FEATURES

Amplitude calibrator, 1 mv to 100  $\text{v}$  in decade steps—square wave, frequency about 1 kc.

3-kv accelerating potential on new Tektronix 5" dual-beam crt. 8-cm by 10-cm linear-display area, each beam.

Electronically-regulated power supplies.

Price . . . . . \$795

f.a.b. factory

## Tektronix, Inc.

P. O. Box 831 • Portland 7, Oregon

Phone CYPres 2-2611 • TWX-PD 311 • Cable: TEKTRONIX

**TEKTRONIX FIELD OFFICES:** Albertson, L. I., N.Y. • Albuquerque • Bronxville, N.Y. • Buffalo • Cleveland • Dallas • Dayton • Elmwood Park, Ill. • Endwell, N.Y. • Houston • Lathrup Village, Mich. • East Los Angeles • West Los Angeles • Minneapolis • Mission, Kansas • Newtonville, Mass. • Palo Alto, Calif. • Philadelphia • Phoenix • San Diego • Syracuse • Towson, Md. • Union, N. J. • Willowdale, Ont.

**TEKTRONIX ENGINEERING REPRESENTATIVES:** Arthur Lynch & Assoc., Ft. Myers, Fla.; Gainesville, Fla.; Bivins & Caldwell, Atlanta, Ga.; High Point, N. C.; Hawthorne Electronics, Portland, Ore.; Seattle, Wash.; Hytronic Measurements, Denver, Colo.

Tektronix is represented in 20 overseas countries by qualified engineering organizations.

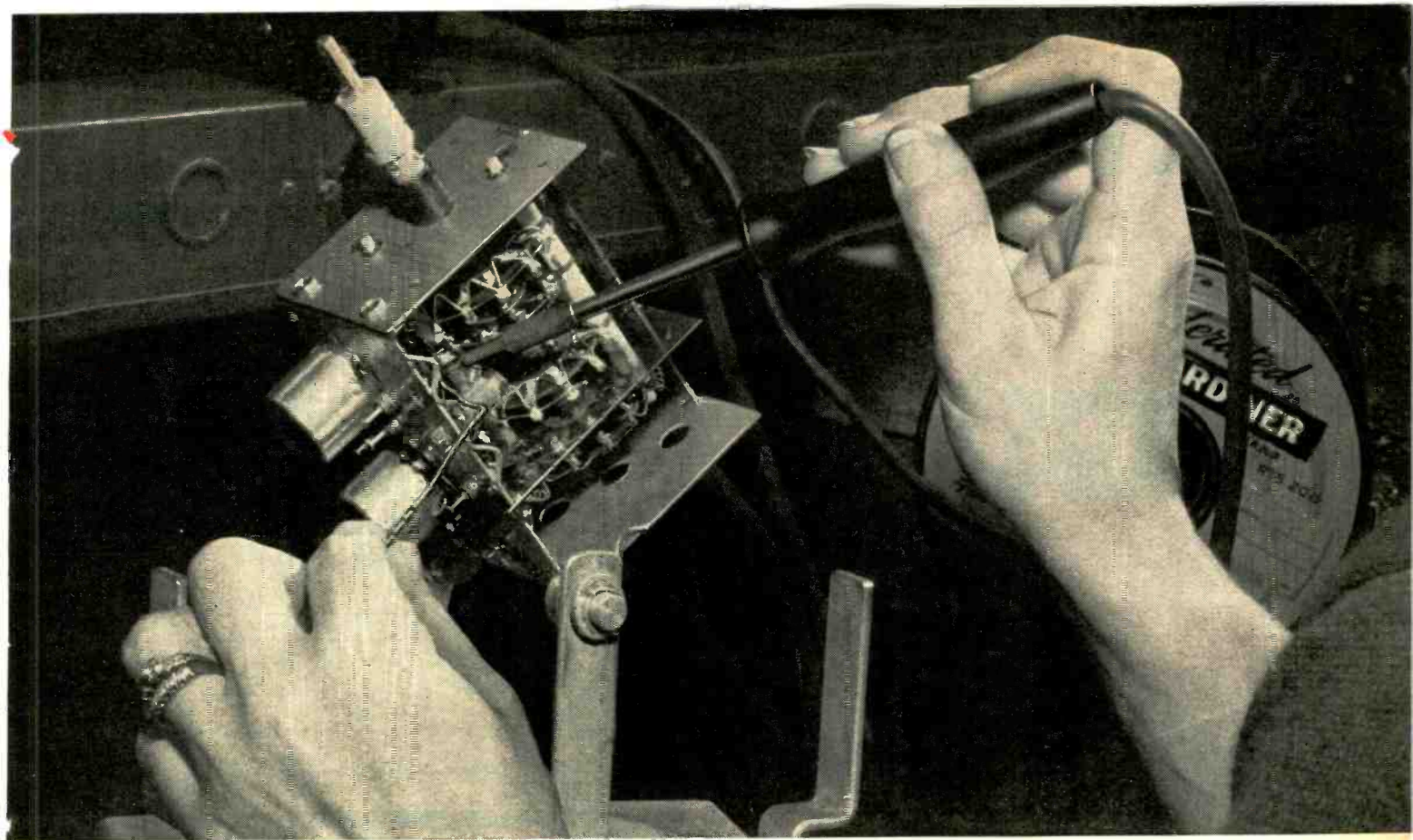

"IT'S SIMPLE ECONOMICS," says Mr. Robert R. Keller, Process Engineer at Sarkes Tarzian Inc., well known electronics components manufacturer in Bloomington, Indiana. "We have an average of 185 General Electric Midget soldering irons in operation on our television tuner assembly lines. We find the G-E Midget iron more efficient than our heavier irons on many operations. Each iron solders an average of 85,000 joints every year. Some irons solder as many as 150,000 joints

per year. Compared to maintenance and replacement costs on other soldering irons we have tested and used, we save approximately \$57.50 per year on each iron. Our present annual saving with all the G-E Midget irons is about \$10,600." Sarkes Tarzian Inc., found that the rugged ironclad copper tips on the Midget last from six to nine months, provide fast, concentrated heat with reduced risk of loosening nearby joints.

## Every Year, 185 General Electric Midget Irons Save Over \$57 Each At Sarkes Tarzian Company

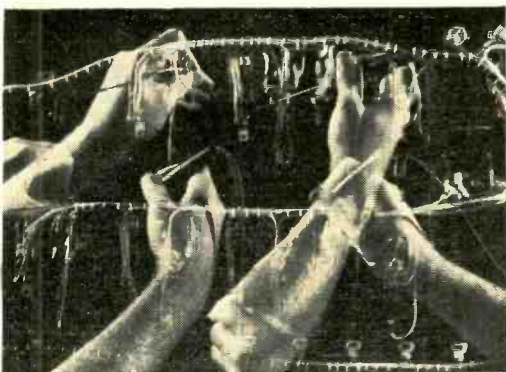

**FASTER HEAT RECOVERY** and lower maintenance of G-E soldering irons have been proved by many manufacturers under their own production conditions—along with competitive soldering irons. If you would like to compare General Electric irons with the irons you are now using, call your G-E distributor.



**DELIVERY TODAY** is now possible on popular soldering irons and other General Electric heaters and devices from a local distributor near your plant. Your replacement inventory may be reduced. For the name of your nearest stocking distributor for G-E heaters and devices, call your General Electric Apparatus Sales Office.



**SAVINGS ACHIEVED** by several users and information about the construction features of General Electric soldering irons are included in a new bulletin, "Save While You Solder," GED-3553. For a copy, call your G-E distributor or write Section 724-5, General Electric Company, Schenectady 5, New York.

**GENERAL**  **ELECTRIC**

# First From PHILCO...

# OUTSTANDING TRANSISTOR PERFORMANCE

for VHF Amplifiers  
and Oscillators

Philco MADT\* Transistors Assure Reliable Operation for Circuits With Collector Current Ratings As High As 50 ma . . . Power Dissipation Up To 100 mw . . . Collector Voltages to 35 V !

- ◆ Low  $r_b'$
- ◆ Low  $c_c$
- ◆ High  $f_{ab}$
- ◆ High  $f_{max}$

Philco's family of MADT transistors offers the designer a new dimension in very high frequency amplification and oscillation. These new transistors will provide amplification as high as 1500 megacycles. MADT transistors have been successfully operated through the entire VHF military electronics spectrum. The accompanying circuit diagrams show typical 100 mc and 200 mc amplifier layouts.

Due to their low  $r_b' c_c$  product, Philco MADT transistors will oscillate at frequencies far in excess of  $f_{ab}$ . The 2N499 produces a specified minimum of 25 mw output at 100 mc. The 2N500 will deliver 20 mw output at 200 mc.

Mass production of these very unique transistors is possible through Philco's exclusive electrochemical etching process. Due to the outstanding precision of this process, certain of these graded base transistors are manufactured with no intrinsic base region. This results in much lower power dissipation of the transistors in critical circuitry. A typical 100 mc—200 mc oscillator circuit is shown.

*Make Philco your prime source of information for high frequency transistor applications.*

Write to Lansdale Tube Company, Division of Philco Corporation, Lansdale, Pa., Dept. E758

\*Trademark Philco Corporation 187 Mic/6 Alloy Diffused-base Transistor

# PHILCO CORPORATION

LANSDALE TUBE COMPANY DIVISION  
LANSDALE, PENNSYLVANIA

## 100 MC POWER AMPLIFIER

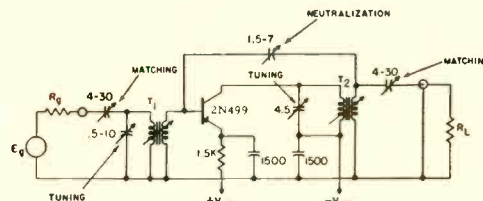

NOTE: T<sub>1</sub> - PRIMARY 6 TURNS #22 ENAMELED WIRE  
SECONDARY 2½ TURNS #22 ENAMELED WIRE  
T<sub>2</sub> - PRIMARY 5 TURNS #22 ENAMELED WIRE  
SECONDARY 2½ TURNS #22 ENAMELED WIRE

## 200 MC POWER AMPLIFIER

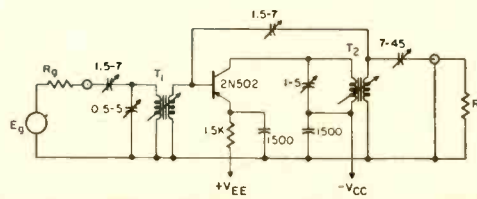

NOTE: T<sub>1</sub> - PRIMARY 3 TURNS #18 ENAMELED WIRE  
SECONDARY 1 TURN #20 ENAMELED WIRE  
T<sub>2</sub> - PRIMARY 2½ TURNS #18 ENAMELED WIRE  
SECONDARY 1 TURN #20 ENAMELED WIRE

## 100 MC—200 MC OSCILLATOR

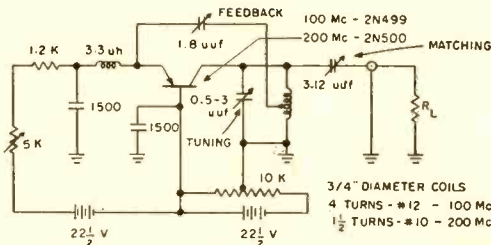

## MADT FAMILY APPLICATIONS DATA

TYPE*	$f_{max}$	Power Gain	Oscillator Efficiency	Class of Use
2N499	250 mcs (min)	10 db at 100 mcs	25% at 100 mcs (min)	oscillator and amplifier to 100 mcs
2N500			25% at 200 mcs (min)	oscillator to 400 mcs
2N501			Ultra high-speed switch typical $t_r = 12$ nsec; (18 max.); $t_c = 7$ nsec; (12 max.); $t_f = 4$ nsec; (10 max.). In circuit with current gain of 10 and voltage turnoff.	
2N502†	500 mcs	10 db at 200 mcs		amplifier to 250 mcs
2N503†		12 db at 100 mcs		amplifier to 100 mcs
2N504	50 mcs	46 db at 455 KC		high gain IF amplifier
2N588	200 mcs (min)	13 db at 50 mcs		oscillator and amplifier to 50 mcs

\*Available in voltage ratings up to 35 V and dissipation ratings to 100 mw.  
†In JETEC TO-9 Case (widely known as JETEC 30 Case).





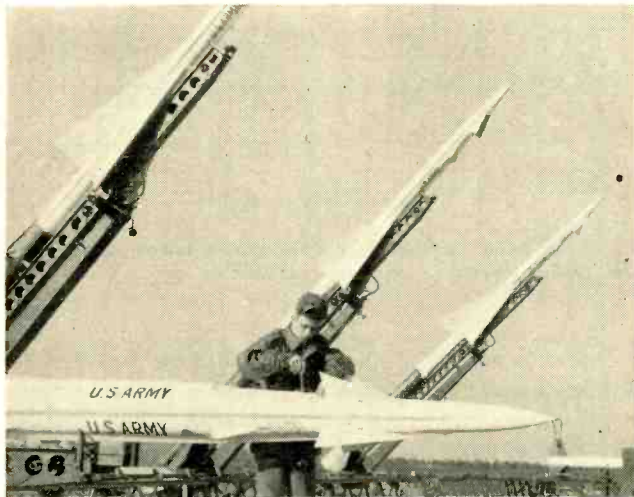

Army technician checks battery as part of routine maintenance on Nike missile installation. Reliability is strong factor in the design of modern batteries for use in missiles like these. At right, battery is removed from specially designed recess for replacement

## New Batteries for the Space Age

Electrochemical batteries have a history of reliable service older than the science of electronics as we know it today. Under the rigorous demands of missile service, battery development has taken on new impetus. In this article, the limitations and applications of some of the latest developments, including the still-secret thermal cell, are discussed. Here too, are data to aid in the selection of batteries for present and future missile applications

By DAVID LINDEN and ARTHUR F. DANIEL,

U. S. Army Signal Research and Development Laboratory, Fort Monmouth, N. J.

**A** 150 YEAR-OLD device, the battery, is gaining new popularity in the most modern equipment of the space-age. Missile designers are using these electrochemical systems with increasing frequency because of their many advantages in providing auxiliary missile power.

Missile batteries are different in

design from conventional types as they must meet many unique requirements that do not exist for the more standard battery-operated equipments. These special designs employ active electrochemical systems, thin plates, thin separation and other features emphasizing large plate area and reduced

battery resistance. In addition, missile batteries must: be lightweight; operate under unusually stringent environmental conditions of temperature, shock, acceleration and low pressure; possess extreme reliability with failure rates of less than 1 part in 100,000; give efficient performance at high current

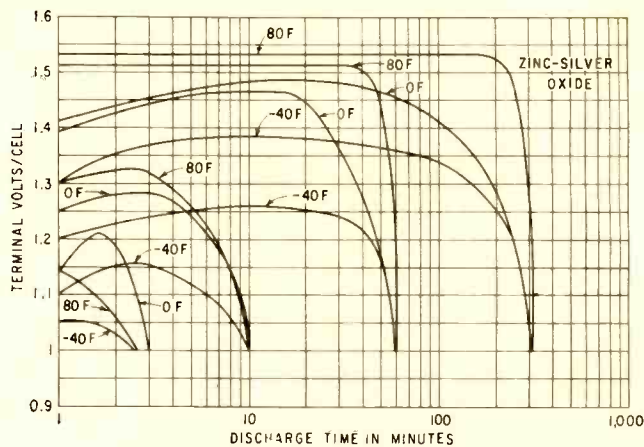
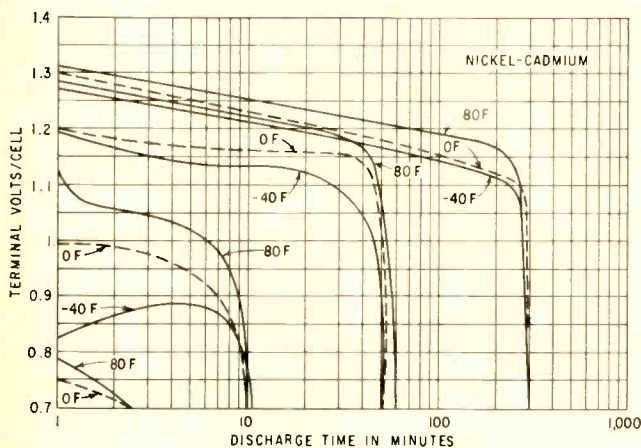

FIG. 1—Typical voltage characteristics of high-rate batteries. Curves illustrate better regulation obtained during lower current drain discharges. Design equipment to operate with the widest-voltage spread during discharge for longer service life

drains (battery must yield its capacity within a period of from 1/2 to 15 minutes); deliver moderate battery voltage, since the current trend is to use a relatively low voltage battery (up to approximately 30 v) and obtain higher voltages by motor-generators, vibrators or other electronic converters.

The ideal battery, capable of meeting all of these specifications, does not exist at the present time. However, the missile designer can select for his particular application any of several electrochemical systems, each possessing outstanding characteristics under certain conditions. At the present time, desirable batteries for high-rate applications include the rechargeable sintered-plate nickel-cadmium battery, the reserve type zinc and silver oxide battery and the thermal battery.

Typical discharge characteristic curves for nickel-cadmium and zinc-silver oxide batteries are shown in Fig. 1. Figure 2 shows typical amperes/lb as a function of discharge time for these two cells.

A fourth type, gas activated batteries, while not developed to the point permitting practical application, offers promise for meeting all of the high-rate battery requisites.

#### Nickel-Cadmium Battery

A battery system, finding early use in missile applications was the sintered-plate nickel-cadmium battery. In this design, the active materials are impregnated into a porous, sintered-nickel plaque, resulting in a battery that gives high-rate performance, superior to the common tubular or flat-pocket designs.

The outstanding characteristic

of the nickel-cadmium battery for missile applications is the high degree of reliability that can be achieved. The nickel-cadmium battery has a long life and can be frequently recharged, continuously floated, or trickle-charged to maintain it in a state of readiness. It can be on float for several years without suffering damage and overcharging has no detrimental effect on its performance. The battery can be tested periodically and, by proper maintenance and replacement of defective components, satisfactory performance during the missile flight is assured.

The battery operates under severe conditions of shock, acceleration, and pressure and retains about 50 percent of its capacity after storage of one year at normal temperatures. If longer storage is required, the battery can be kept in a wet and discharged condition without deterioration and can be recharged readily to full capacity.

#### Capacity

The capacity of the nickel-cadmium battery at high-discharge rates is not unusual when compared to other available battery types, but its voltage regulation during discharge is extremely flat. At reduced temperatures, it is necessary to heat the battery to obtain satisfactory performance. This is usually accomplished by warming the missile battery compartment with ground power until the missile is launched, as the battery will stay

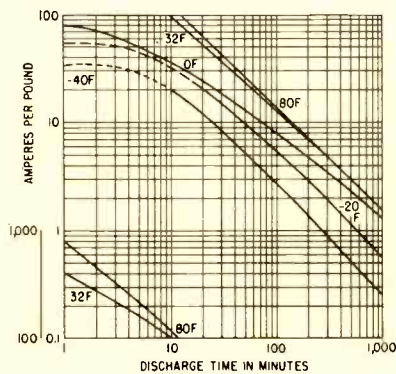
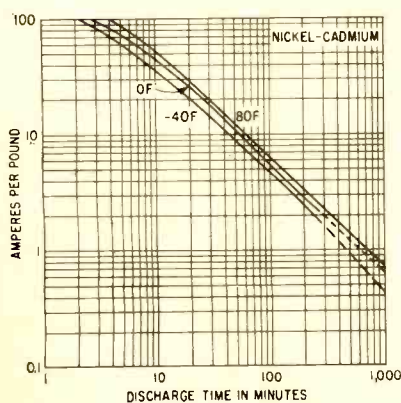
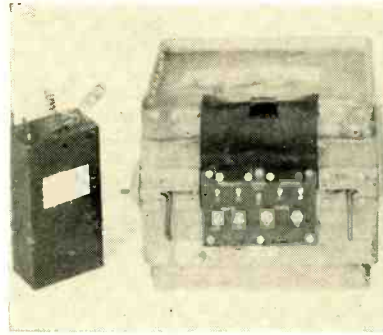
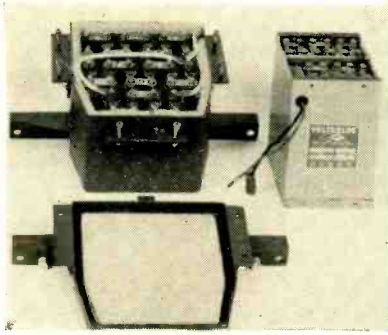
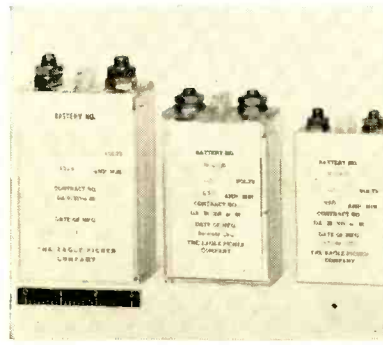
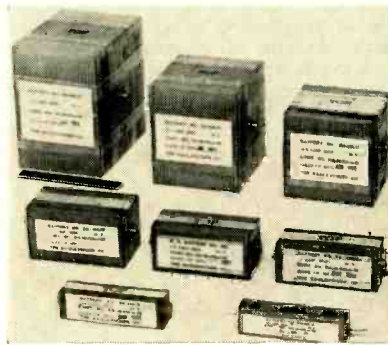

FIG. 2—Performance characteristics of common 1-lb batteries at various temperatures. Curves are based on a 20-percent voltage drop from maximum during discharge. Knowing weight or volume, service life can be estimated from these curves



At left, two types of nickel-cadmium batteries used for guided missile power supplies. At right, experimental models of automatically activated zinc-silver oxide types



Zinc-silver peroxide batteries are available in a wide variety of capacities. At left are 30-v B batteries with capacities ranging from 0.1 to 25 amp-min. A types, at right, range in capacity from 40 to 1,250 amp-min

warm during the relatively short flight.

A nickel-cadmium battery in which the battery is completely sealed so that water cannot be lost through evaporation or as a result of gassing during charge reduces maintenance, permits the use of the battery in enclosed equipment without venting and provides a structure which lends itself to miniaturization. Recommended charging voltages must not be exceeded, however, as overcharging could result in a build-up of gas which could explode the hermetically sealed battery. The electrical characteristics of the sealed cell are similar to those of the open or vented cell.

The requirement for continuous maintenance, although responsible for the high reliability of the nickel-cadmium battery, nevertheless remains a deterrent to acceptance of the battery for tactical field operation.

From a capacity standpoint, the zinc-silver oxide battery is attrac-

tive and is coming into more prominent use because of the importance of small size and weight in missile applications. The battery, in missile applications, is often used as a reserve primary type. In this design, the electrolyte is kept separated from the rest of the battery until the moment of activation, normally just prior to use. In the unactivated condition, when the battery is properly packaged and stored at normal temperatures, shelf life is unlimited.

A line of manually activated zinc-silver oxide batteries is available in 1.5- and 30-v units, ranging in capacity from 0.2 to 1,250 ampere-minutes at the one-minute rate. These cells can be grouped together to provide any desired voltage and lend themselves to varied packaging arrangements. Devices facilitating activation of these batteries are available.

The zinc-silver oxide battery is also available as an automatically activated battery containing a built-in activating mechanism.

This battery construction is most popular as the battery requires no maintenance, can be stored with the missile until required for use and activated almost instantaneously at the time of missile firing. Activation in less than 0.5 sec can be accomplished either locally or from a remote position, electrically or mechanically.

A number of different methods are used for automatic activation of the zinc-silver oxide battery. Some typical devices are shown and described in the accompanying illustrations. Both pressure and vacuum methods have been developed. The vacuum devices appear to be less reliable because the vacuum may be destroyed by gassing of the battery on standby, particularly at high temperatures. For this reason too, it is desirable that a means for venting of the battery be incorporated in missile designs.

The zinc-silver oxide battery does not perform satisfactorily at low temperatures. In automatically activated batteries this problem is eliminated by heating the electro-

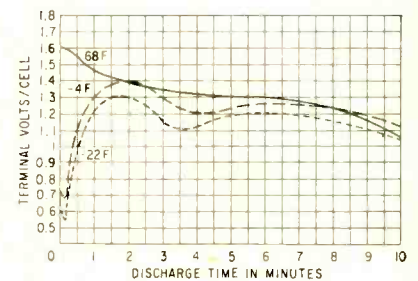

FIG. 3—Performance characteristics of 20-cell chlorine-depolarized battery at 8.5-amp discharge.

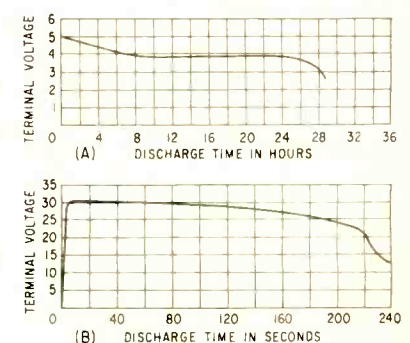

FIG. 4—Characteristics of ava batteries at room temperature—low-rate type (A) and high-rate (B)

**Table I—Battery Selection Chart For Missile Applications**

Battery Type	Dry cells Leclanche and mercury types	Lead-acid	Nickel-cadmium	Zinc-silver oxide	Zinc-silver oxide automatic activation
General characteristics	Conventional cylindrical or flat dry batteries of manganese dioxide type; non-reserve primary systems; wafer cell designs give best high-rate performance	Conventional storage type using sulfuric acid electrolyte; high-rate design employs thinner plates and greater number than automotive types	Sintered plate design in which active materials are nickel oxide and cadmium impregnated in sintered nickel plaques. Potassium hydroxide electrolyte. Rechargeable	Primary reserve type using zinc and silver oxide electrodes. Activated with potassium hydroxide electrolyte just prior to use	Same as zinc-silver oxide, except contains a device to automatically activate from a remote or local position
Chief advantages	Readily available at low cost, easily fabricated into high-voltage units, no maintenance or activation required	Low cost, rechargeable	High reliability, achieved by continuous float-charging, testing, maintenance; always ready. Rechargeable	Has highest capacity of all known practical systems for high-rate use	High capacity, no maintenance, automatic activation, excellent unactivated shelf life
Disadvantages and limitations	Poor performance at high discharge rates; not normally used in missile or high-rate applications, but in some experiments	Performance inferior to other systems available for high-rate use, cannot be recharged below 0 F	Constant maintenance required for reliable performance, heating required for operation below 30 F	Manual activation is inconvenient and undesirable for field use, low temperature performance is unsatisfactory	Reliable performance expected; still unproven. Cannot test before activation, heat in low temperatures
Capacity at 80 F, 10 min rate, 20 percent voltage drop from max during discharge: watt-hrs/lb watt-hrs/cu in.	2 0.2	7 0.45	9 0.7	28 1.8	8-15 0.7-1.1
Low-temperature performance	Poor	Fair	Fair	Poor	Poor
Unactivated shelf life	Not applicable (activated at time of manufacture)	Dry-charged battery can be stored for an unlimited period	Wet discharged battery can be stored for an unlimited period	Unlimited if properly packaged	Unlimited
Activated charge retention when stored at: 80 F..... 125 F..... 165 F..... (To 1/2 initial capacity)	1 to 2 years 2 months 1 week	1 to 2 months 1 week 1/2 day	8 to 12 months 2 weeks 3 days	1 to 7 days 1/2 day .....	1 to 7 days 1/2 day .....
Rechargeability—cycle life	Not applicable	3-6 mos life on float service; 100-300 cycles	At least 2 yrs life on float service; 300-2,000 cycles	A rechargeable model is available	Not applicable
Activation methods	Not applicable	Manual activation of dry-charged battery	Recharging required to put stored battery in service	Manual or with semi-automatic filling devices	Built-in automatic activation; heat before activation for optimum performance; activation time 0.5-1 sec
Reliability	Good; can be checked prior to use	Good; can be maintained in readiness, checked prior to use	Excellent; can be maintained in readiness and prechecked	Excellent; can be activated and partially tested before use	Reliability anticipated, but unproven; cannot pre-test
State of development	In production	In production	In production	In production	Preliminary production
Partial List of manufacturers	National Carbon Div, Cleveland, O; Ray-O-Vac Co, Madison, Wis; Burgess Battery Co, Freeport, Ill; U.S. Electric Mfg Co, New York, NY; Bright Star Battery Co, Clifton, NJ; The Magnavox Co, Fort Wayne, Ind; P. R. Mallory and Co, Inc, No. Tarrytown, N. Y.	Gould-National Batteries, Inc, Depew, NY; Electric Storage Battery Co, Philadelphia, Pa and many others	Sonotone Corp, Elmstord, NY; Gould-National Batteries, Inc, Ni-Cad Div, Easthampton, Mass; Eagle-Picher Co, Joplin, Mo; Gulton Industries, Metuchen, NJ	Eagle-Picher Co, Joplin, Mo; Yardney Electric Co, New York, NY; American Machine and Foundry Co, Raleigh, NC; Electric Storage Battery Co, Philadelphia, Pa	Eagle-Picher Co, Joplin, Mo; Yardney Electric Co, New York, NY; American Machine and Foundry Co, Raleigh, NC; F. R. Cooke Co, Denver, Col; Electric Storage Battery Co, Philadelphia, Pa

Thermal cell	Chlorine-depolarized	Ammonia vapor activated
Primary reserve type; activated by heating to a temperature sufficient to melt solid electrolyte, making it conductive	Primary reserve type; activated by introducing chlorine gas to act as the depolarizer	Primary reserve type; activated by introducing ammonia gas to form the electrolyte
Performance independent of ambient temperature, rapid activation, excellent unactivated shelf life	High capacity, good low-temperature performance, simple automatic activation	Good low-temperature performance, simple automatic activation, excellent unactivated shelf life, high reliability, pre-activation testing possible
Low capacity, cannot be tested before activation	Short shelf-life even in unactivated condition	Still in development
Not available for publication	20 1	13 0.8
Not applicable	Fair to good to -20 F	Good to -65 F
Unlimited	6 to 8 months	Unlimited
Must be used immediately after activation	1 hour ..... .....	½ week (preliminary figure) ..... .....
Not applicable	Not applicable	Not applicable
Activation device can be built in	Gas-activated; at least 1-3 secs required. Heating required for activation below -20 F	Gas-activated; at least 0.5-1 sec required. Heating required for activation below -20 F
Cannot be tested before activation	Not established; preactivation tests for defects may be feasible	Excellent reliability anticipated
In production	In development	In development
Eagle-Picher Co, Joplin, Mo; Catalyst Research Corp, Baltimore, Md; Eureka-Williams Corp, Bloomington, Ill; Wurlitzer Co, North Tonawanda, NY; Paso and Seymour, Syracuse, NY	Aerojet-General Corp, Azusa, Cal; National Carbon Div, Cleveland, O	Eastman Kodak Co, Rochester, N. Y.

lyte or battery just prior to activation. This can be done by either supplying external power to resistance-wire heaters within the battery or by employing chemical heaters in its construction. With electrical heating, the battery can be brought safely from -65 F to operating temperature in less than 15 minutes; with chemical heaters it should be possible to do this in ten seconds. The heat is retained by the battery during activation and subsequent discharge. Heating also controls the operating temperature of the battery regardless of the ambient temperature thus improving the voltage regulation over wide temperature ranges.

The automatically activated zinc-silver oxide battery is currently widely used for high-rate applications. It is also beginning to find use for moderate drain requirements when an efficient reserve type battery is desired. The battery is easy to use and requires no maintenance or charging in the field. It is smaller and lighter than other battery types of equal capacity. The battery, however, cannot be tested or checked prior to use.

Extensive manufacturing and field experience will have to be gained before the reliability of the zinc-silver oxide reserve battery can be assured. Extensive tests directed towards this goal are being conducted under the guidance of the U. S. Army Signal Research and Development Laboratory.

#### Thermal Cells

The thermal cell is useful when a reserve battery is required having indefinite shelf life and the ability to develop full voltage rapidly regardless of the ambient temperature. The thermal cell employs a salt electrolyte which is solid when the battery is inactive. In the solid state, the electrolyte is nonconducting and the battery is inert. The cell is activated by heating it to a temperature sufficiently high to melt the electrolyte, making it conductive and permitting the flow of current. This activator, which can be built into the battery, has no moving parts or components hence is smaller, simpler, and more rapid than that of the  $Zn-Ag_2O$  battery.

The life of the battery is short

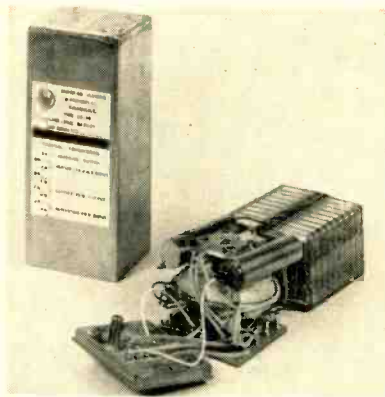

Automatic activation devices. At left, a plunger breaks seal of gas cylinder. Gas inflates bladder at end of electrolyte container forcing electrolyte through snap valve into the individual cells. At right, expanding gas inverts metal diaphragm permitting the electrolyte to enter battery compartment

and is primarily dependent on the time the electrolyte can be maintained above its melting point. The capacity of the thermal cell is low; in this characteristic, it does not compare favorably except under extremely high-rate discharges.

The thermal cell does not refer to a single electrochemical system but to an entire series of batteries using molten electrolytes. The active materials, the electrolyte, and the other battery components can be varied according to the electrical performance that is desired. Details and applications of the thermal battery are classified.

#### Gas-Activated Batteries

The gas-activated batteries are a class of reserve batteries which are activated by introducing a gas into the battery system. There are two types of gas-activated batteries; those in which the gas serves as the depolarizer or cathodic active material, and those in which the gas serves to form the electrolyte. The gas-activated batteries are attractive as their activation is much simpler and more positive than with liquid or heat activation. The gas can be distributed easily through a multiplate assembly and as it is nonconductive, there is no danger of shorting out the battery through the distribution system. Good low-temperature performance can be obtained with some gas systems without resorting to internal or external heating.

The chlorine-depolarized battery

is representative of gas depolarized systems. This battery is noted for its high energy output per unit weight and volume. The chlorine battery, containing a complete automatic activating device should, at rates ranging from 1 to 5 mins, be smaller and lighter than other battery systems having comparable electrical performance. Typical discharge curves and the effect of low-temperature activation are shown in Fig. 3. Low-temperature activation to about  $-20^{\circ}\text{F}$  is possible without requiring external heating, and sufficient heat is generated during a continuous discharge to keep the battery warm. The most efficient utilization of this battery is in discharges up to the 30-min. rate. It may be possible to perform nondestructive tests on this battery to determine its condition prior to use. This cannot be done on most reserve batteries and is an important feature for insuring maximum performance reliability.

The zinc-chlorine battery has

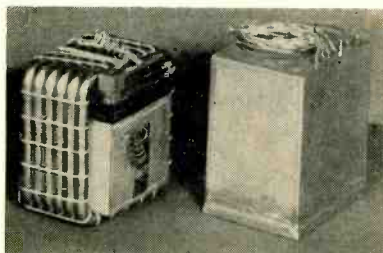

Cutaway view of automatically activated zinc-silver oxide battery. Copper tube sealed by metal foil diaphragm contains electrolyte

poor inactivated shelf-life and does not give reliable performance after 6- to 8-mos storage at normal temperature. This disadvantage has limited the field use of this battery system.

#### Ammonia-Vapor-Activated Types

The ava battery is a reserve type operating on the principle that certain solid salts such as ammonia thiocyanate, which are nonconducting when solid, will absorb ammonia with great rapidity to form electrolyte solutions of high conductivity. A typical ammonia-vapor-activated battery consists of a zinc anode, a separator impregnated with ammonium thiocyanate salt and a depolarizer such as lead dioxide. The ammonia is stored in liquid form under pressure in an ampule within the battery.

Cells are appropriately stacked to obtain the desired voltages and the entire battery encased in a pressure vessel that can withstand the pressures that develop after the battery is activated. To activate, the ammonia reservoir is opened, liberating the gas into the cells where it dissolves the salt to produce a liquid electrolyte.

#### Shelf Life

Shelf life of the ava battery in the unactivated condition is unlimited, but its activated life at present is about one week. Its capacity at normal temperatures falls between that of the silver-oxide and nickel-cadmium batteries and will probably be improved as new component materials are studied. With appropriate design, the system will perform efficiently at the 1 to 2 min rate required for missile applications and at the 24-hr rate required for radio or communications applications. Typical discharge characteristics at room temperature are shown in Fig. 4.

The most important advantage of the ava system is the expected excellent low-temperature performance. Since the natural habitat of this nonaqueous system is in the low temperature region, its discharge characteristics should be practically independent of temperature down to  $-65^{\circ}\text{F}$ , after the



A 20-cell experimental zinc-chlorine battery. At top is valve for draining and socket for activation

battery is activated. As ammonia does not volatilize readily at sub-zero temperature, it is necessary to incorporate chemical heaters in the activating device or provide external heat to activate below this temperature. Another advantage of the ava battery is that it may be possible to test it nondestructively by the introduction of ammonia vapor into the battery. After the

necessary electrical checks are made, the battery can be returned to storage in its original unactivated condition by evacuation.

It is expected that the ava system will be used widely in the not too distant future for both moderate-rate and high-rate use.

### Conventional Battery Systems

Conventional batteries are often incapable of meeting the high rate requirements of missiles as they are not designed for efficient performance at high current drain discharges. Thin plate designs using the Leclanche, mercuric oxide, or other dry cell systems were studied. However, the wet systems were found to have a lower resistance, higher capacity, and better voltage characteristics at the high-drain discharges.

One advantage of the dry cell, namely the ability to be fabricated in high-voltage stacks, is becoming somewhat less important in high-rate applications because of the trend to low-voltage battery power supplies.

A second advantage of the dry cell, the fact that the battery requires no activation, maintenance, or preparation in the field prior to or during use, has not been of sufficient importance to warrant the use of the battery for other than experimental purposes in view of its performance characteristics.

The lead-acid storage battery was used in the first high-rate applications of the late 1940's. Its high-rate and low-temperature performance was better than most of the batteries available at the time, but it was soon abandoned in favor

of new systems developed specifically for missile-type applications. Typical lead-acid battery characteristics are shown in Fig. 5. Other acid systems, such as perchloride or fluoboric acid, have been considered for high-rate use because of their excellent low-temperature characteristics brought about by the low resistivity and low freezing points of the electrolyte. These batteries have not been recommended for general use as they have a shelf life of only a few hours and relatively low capacity per unit weight and volume.

Today, the engineer has his

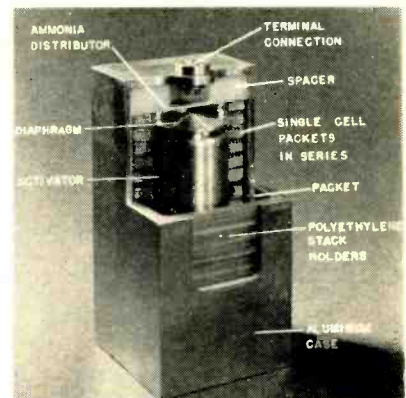

A typical ammonia vapor-activated battery. This type is built up of single cell packets, connected in series, surrounding the ammonia activator

choice of many different types of electrochemical batteries. Batteries will function capably if the most desirable system and design is selected for each application. All operational factors, electrical, physical, mechanical, and environmental, must be considered before the final choice is made.

The battery information contained in this article is intended to guide the engineer towards the selection of the best available battery, but the performance of a given battery type can be obtained most accurately by an actual test under specified use.

The authors acknowledge the assistance of the members of the Power Sources Division, U. S. Army Signal Research and Development Laboratory, and the battery industry in supplying data.

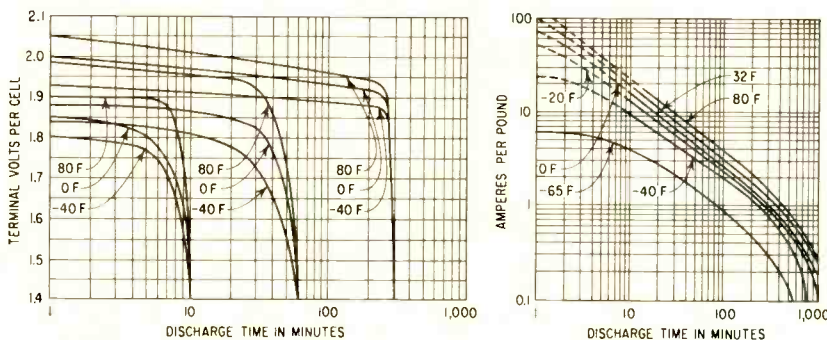
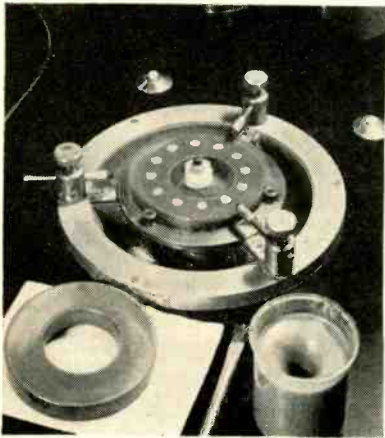

FIG. 5—Typical lead-acid battery characteristics. This type is not generally employed for missiles, except in experimental applications



Pin lap showing crystal blanks and spacers with top plate removed



Impedance matching coaxial cable is connected to alligator clip



The front cover—planetary lap with automatic cut-off

# Trigger Circuit Controls

Audio output of receiver, connected to crystals being lapped, to which the lapping machine operator ordinarily listens, triggers a circuit to automatically shut down the lapping machine. Crystal thickness is determined by an electronic circuit rather than an operator's ear. Operators can run at least twice as many machines with improved production accuracy

By J. F. BRUMACH, R. E. BENNETT, and R. P. CHALKER  
Union Thermoelectric Corp., Forest Park, Illinois

**D**ETERMINING THICKNESS of quartz crystal blanks is one of the most critical steps in the manufacture of crystals when the thickness determines the operating frequency.

A 0.000003 to 0.000008-in. tolerance is necessary for the last stock removing operation.

When a quartz crystal is subjected to a stress, a small voltage is developed across it. This voltage is directly proportional to crystal thickness and therefore to crystal frequency.

Lapping machines most commonly used for cutting crystals are controlled by an operator who listens to a noise-signal generated by the crystals being lapped. When the noise signal peaks, he turns off the machine. The automatic control

which will be described is not dependent on the operator's ear. It shuts off automatically.

## Lapping Process

Crystal blanks are placed between the top and bottom plates of the lapping machine. The blanks are moved between the plates by carriers, slightly thinner than the blanks, and made of plastic, zinc or shim steel. The plates press particles of liquid abrasive against the crystals. Voltages are developed across the crystals at a frequency which is determined by crystal thickness.

A radio receiver, connected to the top and bottom plates of the lapping machine, is tuned near the frequency of the blanks being lapped. A noise-signal can be heard from

the radio when crystal thickness produces a crystal frequency which is the same as the tuned radio frequency. The operator of the lapping machine listens to the receiver until the noise becomes loud enough to indicate a signal peak. He then turns off the lapping machine. With automatic control, the machine shuts itself off when the preset audio level is reached.

## Signal Variables

The amount of signal generated by the mechanical excitation of the crystal blanks and transmitted to the receiver depends on a number of factors which are shown in a simplified equivalent circuit, Fig. 1. Symbols  $G_1, G_2, \dots, G_n$  represent the individual crystal blanks. They can be thought of as alternating



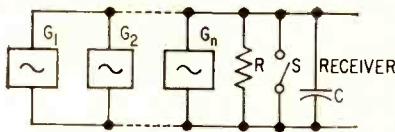
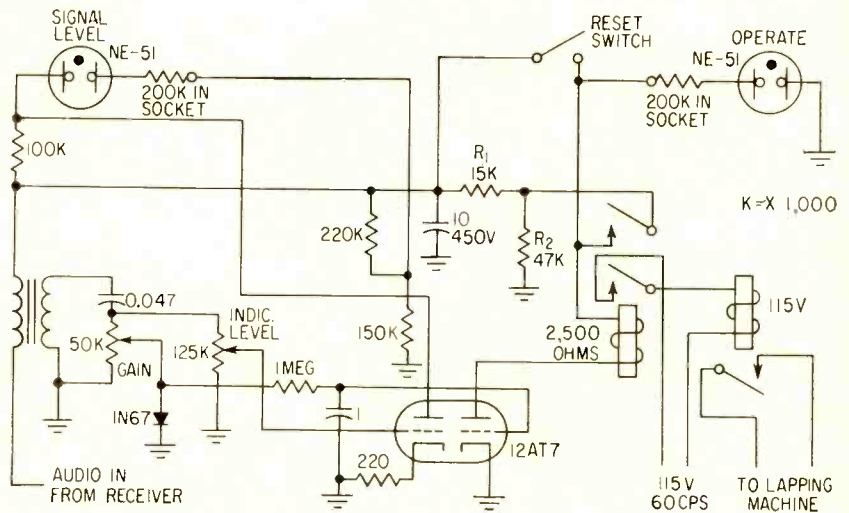

FIG. 1—Quantities  $G_1, G_2, \dots, G_n$  represent individual crystal blanks in a crystal lapping machine

FIG. 2—A 12AT7 relay control tube shuts off the crystal lapping machine at a preset signal level



# Quartz Crystal Lapping

current generators in parallel, which generate slightly different frequencies. If the frequency (thickness) variations are large, the noise peak is broad and weak. Symbol  $R$  represents the electrical resistance between the two lapping plates and depends on conductivity of the abrasive mixture, conductivity of the carriers, area of the lapping plates and the distance between them. This quantity  $R$  is smaller when thin, high-frequency blanks are lapped since the plates are closer together. Switch  $S$  represents momentary shorts that occur when metal carriers are used. Capacitor  $C$  is the capacitance between the two lap plates and depends on plate area, distance between plates, dielectric constant of the abrasive mixture and whether the carriers are conductive or nonconductive.

## Impedance Matching

A considerable improvement in the signal reception can be made by matching receiver input impedance, usually 300 ohms, to the low impedance of the lapping machine.

A short length of coaxial cable (considerably under a quarter wavelength) is used. This length exhibits inductive reactance which is resonated by a variable capacitor. Cable length is critical for accurate impedance match.

A proper impedance match is obtained only at the resonant frequency of the inductance and capacitance. When the receiver has an antenna trimmer control the external capacitor can be omitted.

Even with careful impedance matching it becomes increasingly difficult to obtain a good signal from the lapping machine at frequencies above 10 mc. Consequently, the in-going work is sorted to obtain a minimum frequency differences between blanks.

For automatic machine operation, Fig. 2, audio output of the receiver obtained by connecting the input transformer primary directly to the output tube plate is rectified and used to shut the machine at a predetermined signal level on a preset receiver frequency.

No changes are necessary in the radio receiver wiring. Audio level is rectified, and applied as bias to one grid of the 12AT7 relay tube. This bias decreases the plate current until the 2,500-ohm relay drops out. One contact of the relay opens the circuit to the 115 v relay which opens the powerline circuit to the lapping machine. A second contact opens the plate circuit of the tube and prevents the relay from closing until voltage is applied by the reset switch. Closing the reset switch starts the lapping machine.

The bias voltage is applied through a 1-sec time constant circuit consisting of a 1 megohm resistor and a 1- $\mu$ f capacitor. This circuit prevents short interference pulses from operating the relay.

There are two neon indicator lamps. One is connected in the plate circuit of the 12AT7 through the 2,500-ohm relay and glows whenever the relays are closed and the lap is in operation. Another is connected to the other plate of the tube and acts as an indicator of signal level. Adjustment is provided by a potentiometer in the grid circuit.

The 10  $\mu$ f capacitor by-passes audio frequencies at the plate voltage return points for the 12AT7. The  $R_1$  and  $R_2$  voltage divider decreases holding current in the relay tube circuit. The entire unit is mounted in a fuse box.

Operation of the automatic shut-off requires a better signal, and more freedom from noise bursts than aural monitoring. It is therefore difficult to extend its operation to high frequency. However, it is useful up to about 14 mc.

The automatic system will enable an operator to tend at least twice as many machines, since he has only to load and start the machine, and can unload at any convenient time after it has stopped.

# Computer Analyzes

Brain-wave analyzer uses Schmitt trigger and flip-flop circuits to chart behavior of irregular electrical waveforms emitted by the brain. This new approach to neurophysiological indexing of brain waves uses derivative curves of the primary eeg signals to quantitatively describe waveshape deviations in terms of time and amplitude and aids study of adaptability to space travel

By **CARL J. ZAANDER**

Physicist, Mechanics Research Department, American Machine and Foundry Co., Chicago, Ill.

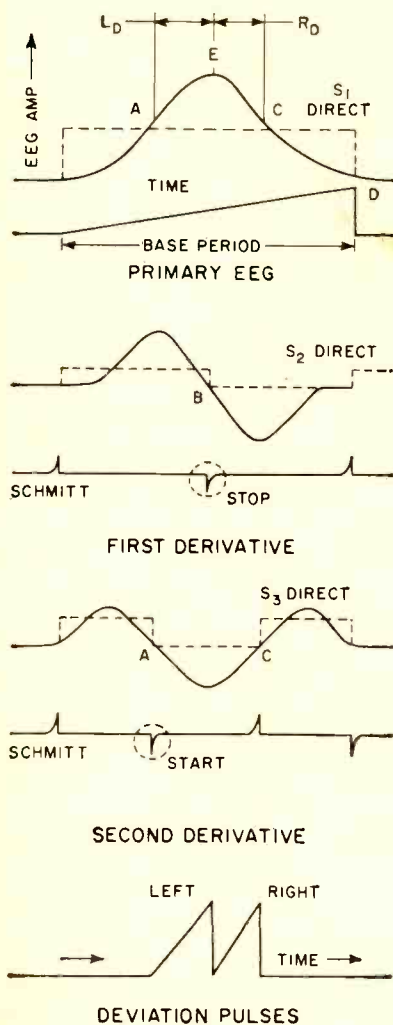

FIG. 1—Idealized representation of eeg signal shows the primary eeg the base period, right-deviation and left-deviation coefficients on three parallel charts

**E**LECTRICAL SIGNALS emitted by the brain are useful indexes of brain condition and activity. Analysis of changes in potential between separate points on the brain is a widely used means of diagnosing pathological conditions, such as epilepsy and brain tumors and of investigating changes in brain activity when a person is subject to stress, stimulation and fatigue.

## The EEG Signal

Visual examination of these brain signals shows changes in amplitude and frequency content. The earliest investigators employed direct Fourier analysis of short sections of an eeg (electroencephalogram) record; later, mechanically tuned recorders were used and today, highly selective wave analyzers determine frequencies and amplitudes of the sine-wave components in the eeg signal. While Fourier analysis can provide a good mathematical fit to a selected portion of the eeg signal, correlation of the results with the clinical conditions of the subjects has not been completely successful.

Many qualified observers believe that the inability of applying the Fourier series significantly to eeg interpretation is attributable to causes other than the practical limitations of modern frequency analyzers. Correlation existing be-

tween the frequency components of the eeg signal and the clinical state of the subject may be reduced due to insufficient discrimination against the nonsignificant components of the eeg signal.

## New Approach

In 1954, a group working at the Aero Medical Laboratory at Wright-Patterson Air Force Base devised a new theory as to neurophysiological coding of the eeg signal. Instead of assuming that the basic elements of the eeg are sine waves, they postulated that the eeg potential is expressible by a Gram-Charlier series which is composed of a superposition of the normal functions together with their derivatives. This type of series is capable of fitting irregular waveforms with relatively few terms.

An electronic period analyzer which quantitatively describes each individual brain-wave burst has been developed by the Mechanics Research Department of American Machine & Foundry. The project was sponsored by the Air Force Aero Medical Laboratory for research in airmen's reactions to oxygen deficiency, fatigue, alertness and chemical effects on brain performance. Such an instrument using relays as the decision elements had been built by the electronics group of the Aero Medical Laboratory at WADC and was de-

# Brain Waveforms

scribed April 1957 at the IRE Second National Simulation Conference, Houston, Texas. This model is based on the representation of the primary eeg signal as a mathematical combination of the terms of a Gram-Charlier series.

## Waveform Analyzer

The eeg analyzer automatically computes, records and displays clinically-significant excursions of the primary eeg signal on three parallel charts. These significant quantities are called left deviation, right deviation and base period (see Fig. 1).

The primary eeg waveform is shown as an idealized positive-going signal. The left deviation coefficient  $L_n$ , is the time between the first point of inflection and signal maximum;  $R_n$ , the right deviation coefficient, is the time between the maximum and the second inflection point; and the base period is the time between zero crossings.

The comparative magnitude of the left and the right deviation coefficients is a measure of the skewness of the curve. This physiologically significant factor is unobtainable with frequency analysis.

When a subject is asleep or not

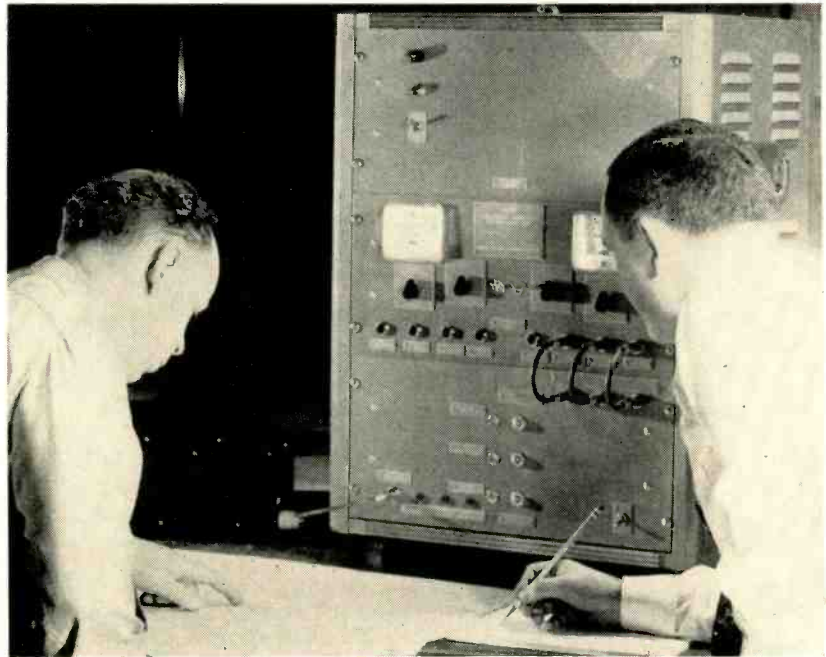

Front view of the electroencephalogram analyzer. Schmitt-circuit indicator lights are on the lower panel, the middle panel contains the computer. Power supply is at top

concentrating his brain generates isolated slow waves. Comparison of the awake and asleep base period curves shows that other signals generated by an alert brain damp the slow waves. The precise presentation of small variations in the slow waves is one of the principal rea-

sons the eeg analyzer is an excellent fatigue and alertness detector.

The equipment produces the three derived outputs of each primary eeg signal as triangular pulses whose heights are proportional to these quantities. Plotting amplitude horizontally rather than longitudinally compresses the graphs from five to six times and greatly assists inspection and analysis.

The basic units of the analyzer are a zero-crossing detector, a computer and a power supply.

The zero-crossing detector locates the position of the zeros of the primary eeg and its first and second derivatives.

The computer operates on the zero-crossing measurements to produce an analog voltage proportional to the time between adjacent primary zeros (the base period); and operates on the zeros of the first and second derivatives to produce analog voltages proportional to the values of the left and right deviation coefficients.

The power supply provides the regulated +250 v, +180 v, -150 v

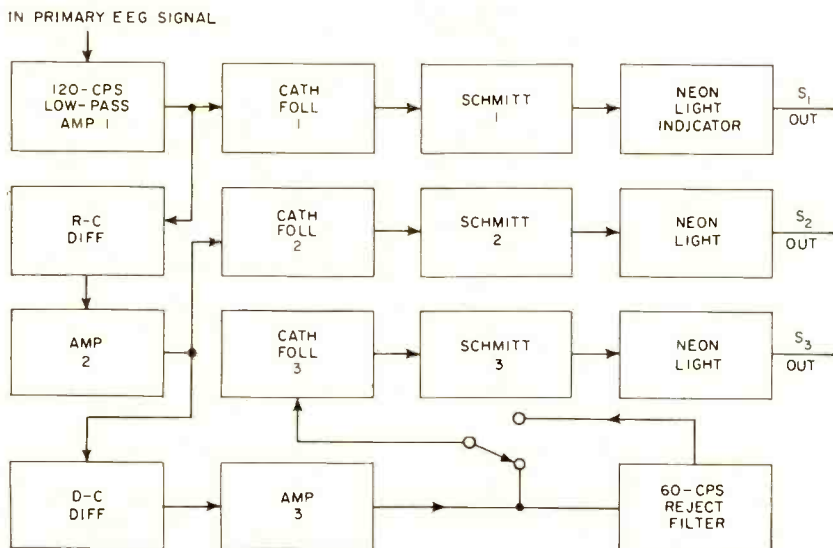

FIG. 2—Block diagram of the zero-crossing detector which locates the position of the zeros of the primary eeg and its first and second derivatives

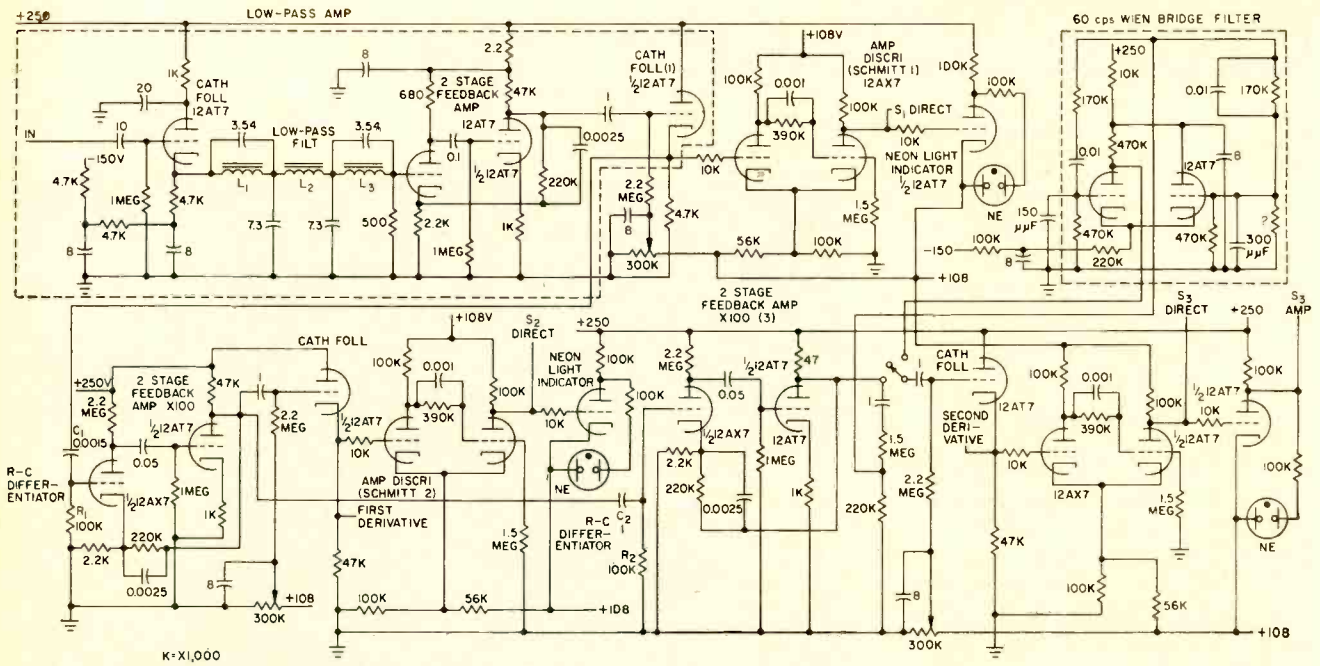

FIG. 3—Zero-detector circuitry uses Schmitt triggers to produce an output of one value whenever the input signal exceeds a particular reference and conversely generates an output of one other value whenever the input signal is less than the reference value

and 120 v d-c required to operate the entire equipment.

### Zero Detector

Figure 2 is a block diagram of the zero detector. The eeg signal is amplified and band-limited in preparation for the Schmitt-trigger circuits which are the decision elements. The Schmitt circuit produces an output of one value whenever the input signal exceeds some reference value and conversely, generates an output of one other value whenever the input signal is less than the reference value. The reference is held as near zero as possible for the detection of base-line crossings of the primary signal

and its first and second derivatives.

The Schmitt circuits operate with a high input signal to reduce the timing error associated with detecting a base-line crossing corresponding to a fixed voltage. Three Schmitt circuits handle an input signal of approximately 100-v, peak-to-peak, without overloading. The circuits have approximately equal sensitivities for both polarity signals, that is, their hysteresis is symmetrical.

The primary eeg signal is received with an amplitude of approximately 2.5-v peak-to-peak and feeds a low-pass amplifier with a gain of about 40. The amplifier output feeds a cathode-follower

whose d-c cathode potential is adjustable. Since the cathode-follower is direct-coupled to the first Schmitt, the adjustable control on the cathode-follower becomes the Schmitt's sensitivity control. The Schmitt, in turn, is coupled to an amplifier operating a neon-light indicator used in sensitivity adjustments.

### Low-Pass Amplifier

As shown in Fig. 3, the low-frequency band-pass filter is introduced to eliminate 120-cps interference and has essentially flat amplitude and linear phase characteristics. The eeg wave is passed without distortion and is delayed

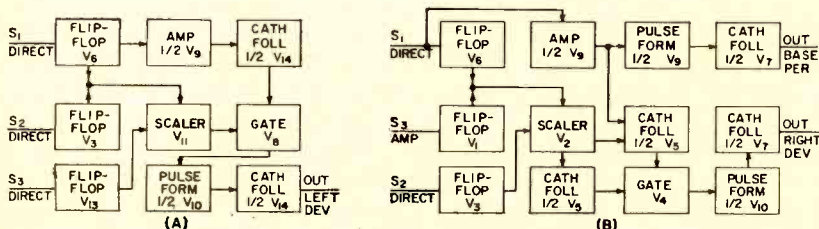
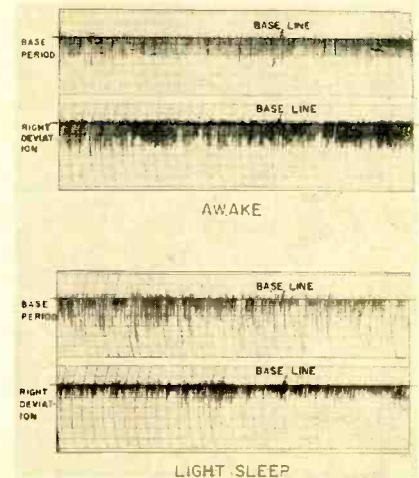

FIG. 4—Block diagrams of the left deviation pulse circuit (left) and right-deviation and base-period pulse circuit (right) used in eeg waveform analyzer



Brain-wave recording of subject awake and at rest shows that isolated slow waves generated during sleep (below) are dampened by an alert awake brain

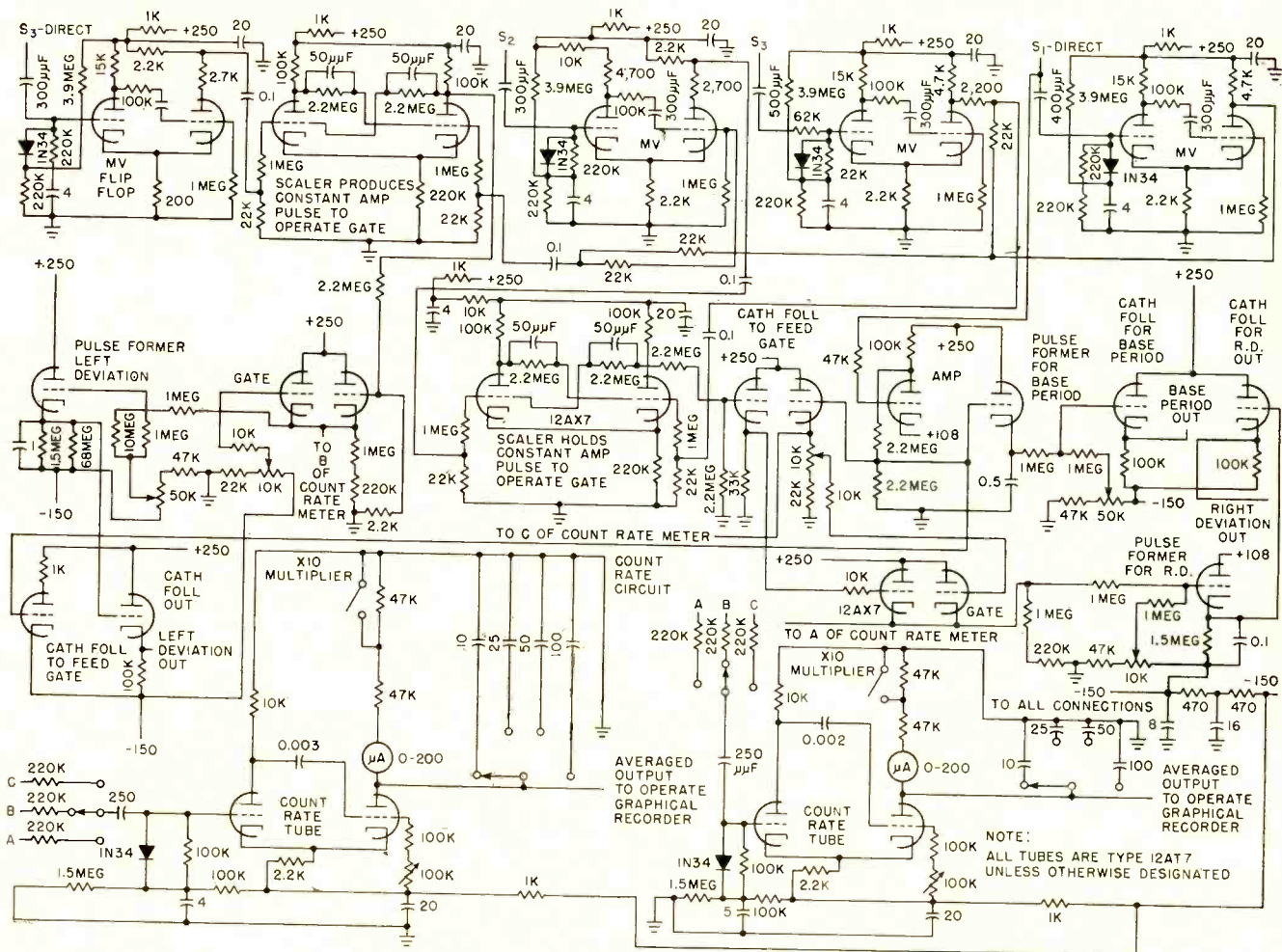

FIG. 5—Schematic of the computer which operates on the zero-crossing measurements of the detector to produce analog voltages proportional to the time between base periods and also proportional to the time values of the left and right deviation coefficients

approximately 8 millisecc. The cathode follower operates at about zero cathode potential with respect to chassis ground to keep the direct-current as small as possible and avoid core-saturation signal distortion. The two-stage feedback amplifier has a gain of about 100. Maximum undistorted signal at the amplifier output is about 100 v.

Because the unit is particularly sensitive to stray 60-cps pickup from the power transformers, the low-pass amplifier is housed in a special high-permeability case.

#### Schmitt Discriminator

Both sections of the first 12AX7 tube, Fig. 3, are the first Schmitt discriminator. The left half is normally conducting and its low plate potential holds the right half off. A sufficiently negative input signal raises the plate potential of the left side and causes the right side to conduct. Positive feedback

through the common cathode resistor starts a regenerative action which cuts off the left side and produces a negative output signal. When the negative input signal is removed the circuit reverts to its original state.

The output produced when the Schmitt input signal deviated from zero is approximately  $\pm 0.3$  v. If a common supply is used for both the adjustable reference and the plate supply, sensitivity is independent of the actual value of the supply voltage for small changes in magnitude. These circuits produce rectangular waves of approximately 5 v.

Outputs of the three Schmitt circuits are direct-coupled to three amplifiers driving the sensitivity-control indicator-light circuits. When the right half of a Schmitt is conducting, the amplifier is cut off, raising its plate potential and the neon tube glows. When the

right half of the Schmitt is non-conducting, the amplifier tube has zero bias and, consequently, low plate voltage hence the light is out.

#### Differentiators

The amplified, band-limited signal is differentiated by the combination  $R_1, C_1$  (Fig. 3). Phase shift was measured with Lissajou patterns. There is no appreciable deviation from 90 deg in the 5- to 100-cps range and differentiation is essentially perfect through the region of interest.

Differentiator combination,  $R_2, C_2$ , produces the second derivative and operates the same as the first derivative circuit.

#### Rejection Filter

The 60-cps rejection filter, shown in Fig. 3, uses a 12AT7 tube in a difference circuit in conjunction with a Wien-Bridge. This filter is optional and may be switched in or

out. It attenuates the 60-cps component before the third Schmitt which is especially sensitive to spurious 60-cps voltage because of the selective amplification of the differentiation circuits. The filter reduces this component by a factor of approximately 100 and reduces the signal bandwidth to about 30 cps.

### Computer

The left deviation coefficient is a quantity proportional to the time from a negative-going second derivative zero to the following negative-going first derivative zero in a positive excursion of the primary eeg signal. (See Fig. 1)

The computer has to generate a pulse proportional to the time between the left inflection point *A* and the signal maximum *E*. The second derivative has a zero at *A* where the signal changed from positive to negative. The dotted curve,  $S_3$  Direct, is the output of the third Schmitt (second derivative) circuit. Its derivative yields a negative spike at point *A*. All that is required, therefore, is to start a pulse at *A* and stop it at point *E* (taken in a similar manner from the  $S_2$  direct Schmitt). This constant amplitude pulse is then integrated to produce another pulse with an amplitude proportional to the left deviation coefficient. The right deviation coefficient pulse is similarly generated.

Figure 4 is a block diagram showing the elements that form the left deviation pulse. The signals  $S_1$  direct,  $S_2$  direct and  $S_3$  direct, generated by the zero detector, are differentiated to deliver negative spikes to the flip flops. These monostable multivibrators produce output pulses of approximately 200  $\mu$ sec duration when activated with negative spikes. When the scaler is activated by the  $S_3$  flip flop, point *A*, Fig. 1, it generates a constant amplitude pulse until the  $S_2$  flip flop receives a negative spike (point *B*, Fig. 1) that resets it to off. The scaler output pulse then has a duration equal to the interval between points *A* and *B*.

A pulse from the  $S_1$  flip flop (produced when the primary eeg signal passes through zero) com-

bines with the  $S_2$  flip flop output and resets the scaler to prevent noise pulses from holding the scaler on and missing the next pulse.

The scaler output is shaped into a triangular pulse by a parallel R-C pulse former. The gate is opened by the  $S_1$  pulse so that left deviation pulses are produced only during positive excursions of the primary eeg signal. The cathode follower receiving the pulse-former output provides a relatively low output impedance and permits the use of chassis ground as the output signal reference level.

### Right Deviation

The functional relationship of elements used to form the right deviation coefficient (Fig. 5) are identical with those forming the left deviation pulse except that the  $S_3$  pulse has the wrong polarity to operate the  $S_3$  flip flop. For this reason the right deviation pulse is taken from the  $S_3$  amplifier in the zero detector circuit.

The base-period output is a signal whose amplitude is proportional to the length of time the primary eeg signal is positive. It is obtained from the  $S_1$  direct output. After amplification, this pulse is fed to a pulse former and then to the output cathode follower.

Figure 5 is the computer schematic.

The scalers are bistable flip flops activated by suitable combinations of multivibrator pulses. The scaler stages have an input sensitivity of approximately 15 v and produce a rectangular output pulse of approximately 30 v.

The gate tubes are cathode followers with a common cathode connection. The cathode essentially follows the more positive grid. One cathode follower receives the scaler output while the other receives a signal derived from the  $S_1$ -direct pulse. Therefore the common cathode of the gate tube produces an output only when both grids are negative, that is, when the primary eeg signal is positive. When properly adjusted the gate output is a replica of the scaler output with about one-half the scaler pulse amplitude.

The pulse formers generate triangular-shaped deviation and base-

period pulses. The cathode cannot follow the input signal because of the large capacitance across the output. When a negative impulse is applied to the grid, the capacitor discharges exponentially until the input signal is removed. However, the voltage drop is essentially linear because the maximum discharge is limited to about 5 percent of the voltage across the capacitor. Thus, a triangular pulse whose amplitude is proportional to the pulse duration is formed.

The pulse-former cathodes operate at about ground potential because the resistor divider in the grid circuits returns to a negative voltage whose proper value is bound by adjusting three variable resistors. These adjustments give a chassis voltage reference for operating a graphical recorder.

### Count Rate Meters

The count rate meter flip-flop tubes operate so that the meter reading is proportional to the input pulse rate. The circuit has an accuracy of approximately  $\pm 5$  percent with respect to meter linearity. Deviation from linearity is principally due to the fact that at full scale the voltage drop across the R-C averaging circuits has become an appreciable portion of the supply voltage. The count-rate circuits have an input sensitivity of about 1.5 v and produce pulses of approximately 475  $\mu$ sec duration. Either count rate circuit can be initiated by base period pulses or the deviation coefficients. Averaging times from 0.1 to 10 seconds can be selected.

The author thanks Dr. N. Burch, Department of Psychiatry, Baylor University, M. A. McLennon of Wright-Patterson Air Force Base and B. Saltzberg of the Ramo-Wooldridge Corp. for their assistance during the conceptual stages of this program and C. Barr and J. Buckley of AMF for their assistance during the designing and testing of this equipment.

### REFERENCE

- (1) N. R. Burch, T. H. Greiner and E. G. Correll, Automatic Analysis Of Electroencephalogram As An Index Of Minimal Changes In Human Consciousness, *Federation of American Societies of Experimental Biology*, 14, March, 1955.

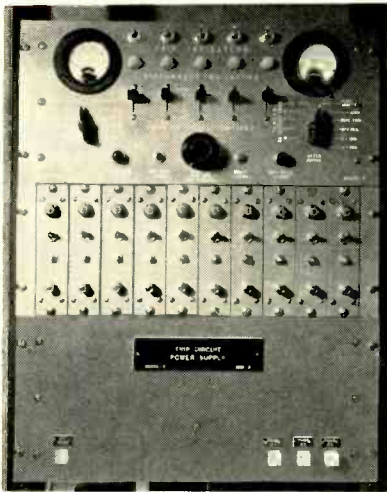

Trip system equipment will shut down the reactor if ion-chambers malfunction or component fails in the system

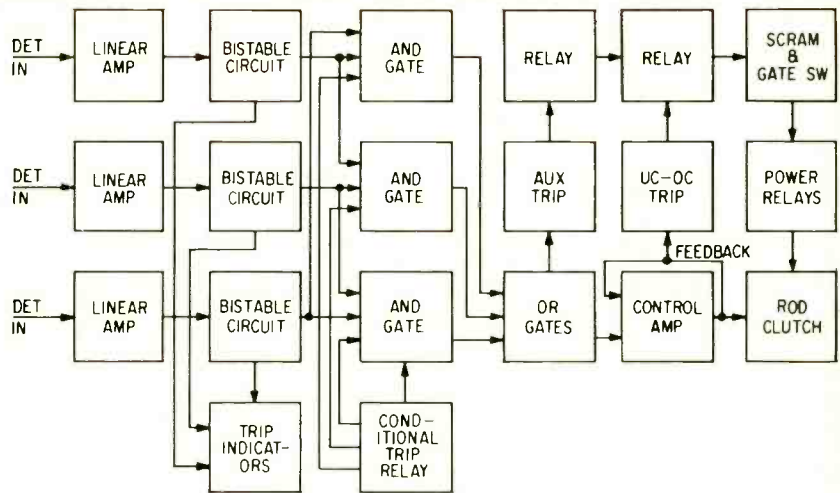

FIG. 1—Block diagram of the trip system. Trip signals are fed both to the OR gate of the control amplifier and to the OR gate of the auxiliary trip circuit, which opens the power relays and drops the control rods

# How Transistor Circuits Protect Atomic Reactors

All transistorized trip system guards against nuclear radiation hazards and provides maximum critical assembly safety even at the expense of reactor plant shutdown. Malfunction in the ion-chambers or circuit component failure generates a trip signal that drops the reactor control rods. Auxiliary trip circuits provide fail-safe operation, each made capable of shutting down or scrambling the reactor

By **E. J. WADE** and **D. S. DAVIDSON**

General Electric Co., Knolls Atomic Power Laboratory, Schenectady, N. Y.

**T**RIP circuits for experimental reactors provide maximum safety against radiation hazards, even at the expense of reactor shutdown because many built-in safety features of power reactors may not be available. To ensure reliable operation, several circuits in parallel are each capable of shutting down or scrambling the reactor if a component fails. These circuits fail

safe and have interlocks to ensure proper operation.

### Design Philosophy

Five inputs from ion-chambers are used, with provision for operating with a minimum of three. Each safety control rod in the reactor is restrained by a magnetic latch that is controlled by an output circuit. These output circuits hold constant

current until actuated by a trip signal which reduces the current to zero in a few milliseconds.

To ensure tripping, each input circuit is directly connected to all of the output circuits. There is no common bus and an open or a short either in the interconnections or at the inputs will cause a trip.

Power for all the magnetic latches is fed through two series

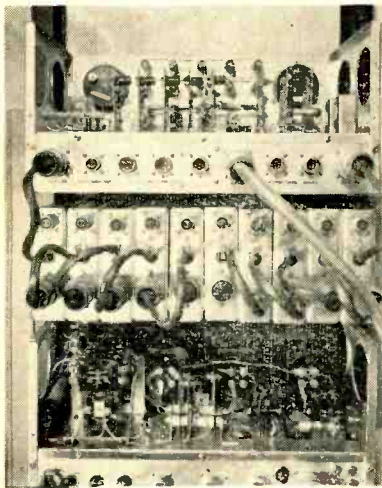

Internal view of trip system equipment. Power supply is at bottom, control amplifiers above and meter monitoring is located at the top

relays, held closed by an interlock circuit. Tripping of any output circuit opens the interlocks and trips all the rods. Most component failures also open the interlocks. If a condition arises where all but one of the input circuits and one of the output circuits are inoperative because a component fails in a manner which does not cause a trip, then a trip signal to the remaining input circuit will still trip the remaining output circuit and relays.

### Block Diagram

The block diagram, Fig. 1, shows the arrangement used in the overall system. The detectors and amplifiers, not discussed in detail, supply a signal to the input of the bistable circuits.

The outputs of the bistable circuits are connected through AND gates so that, if desired, two input signals are necessary before a trip signal is generated. In either case, the trip signals are fed in two directions, first to the OR gates of the output amplifiers and second to the OR gate of the auxiliary circuit, which opens the power relays and drops all the control rods in the reactor. Since this is a back-up circuit, the control amplifiers will reduce the rod currents to zero before the relays open.

The input bistable circuit, shown in Fig. 2, has a dual function. The portion to the right of the dotted line acts as a regulator that holds

a constant voltage on the output circuits until tripping occurs.

Considering the portion of the circuit to the right of the dotted line, a 5-v reference is obtained from the voltage divider  $R_2$ - $R_1$  and applied to the base of  $Q_2$ . Since the emitter of  $Q_2$  is at the output potential, this transistor acts as an error-signal amplifier. The amplified error signal from the collector of  $Q_2$  is applied to the base of  $Q_1$ , which acts as a series regulator holding the output at a constant value.

Transistor  $Q_3$  is nonconducting for the normal input potential of -9 v. Under this condition the base of  $Q_3$  is near ground potential and the emitter is at +2.7 v.

As the input is reduced toward the trip point of -3 v, the bias is reduced on  $Q_3$  and it starts to conduct. Current flow from the collector of  $Q_3$  into voltage divider  $R_2$ - $R_1$  reduces the reference potential at the base of  $Q_2$ . This reduces the current through  $R_2$ ,  $Q_2$ ,  $R_1$  and  $R_1$ . The resulting positive change in potential at the collector of  $Q_2$  is fed back to the base of  $Q_3$ . Also, positive feedback to the emitter of  $Q_3$  from the change in potential at the junction of  $R_1$  and  $R_2$  latches the bistable in the tripped condition.

To prevent tripping during the presence of noise, a capacitance of 0.02  $\mu$ f is connected from the junction of  $R_2$  and  $R_1$  to ground so that pulses shorter than 1 millisecond will not trip the circuit.

Once tripped, the circuit cannot be reset by restoring negative potential at the input because the di-

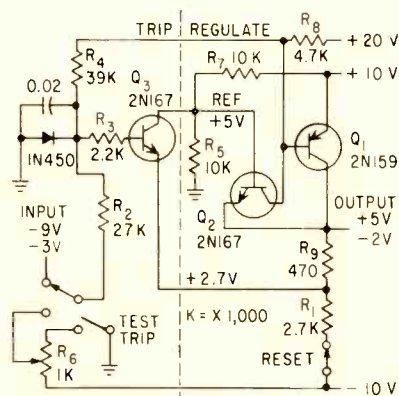

FIG. 2—Schematic of dual-function input bistable circuit. Portion of the circuit to the right of the dashed line acts as a regulator by maintaining constant voltage at the output until trip

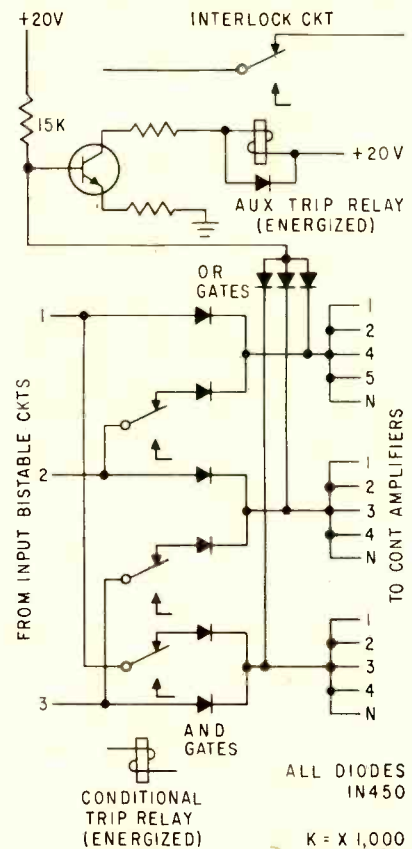

FIG. 3—Schematic of AND-OR gates and auxiliary trip circuit. The AND gates require two inputs to generate a trip. Auxiliary circuit opens interlocks

ode will prevent the base of  $Q_3$  from becoming negative while the emitter current holds  $Q_3$  in saturation. When the reset switch is opened the current in  $Q_3$  cuts off and when it closes, current flows through the regulating circuit with  $Q_3$  biased nonconducting. Since current flow is required to maintain the input at a negative potential, an open circuit or a short to ground will cause tripping. Built-in test facilities can be activated when the circuit is disconnected from the ion-chamber amplifiers.

### Accidental Trips

Although only three inputs are shown in Fig. 2, there are actually five inputs. The other two do not go through the AND gates and either one but not both may be disconnected without opening the interlocks. Indication of which input circuit has caused a scram is given by neon lamps since the bistables remain tripped until reset manually.



As shown in Fig. 3, outputs from three of the bistable circuits are connected through AND gates consisting of three pairs of diodes. The connection is arranged so that two bistable circuits must generate a tripping signal to interrupt the current to the output circuits and cause a trip. This feature is provided to reduce the possibility of accidental trips due to component failures and may be disconnected by deenergizing the conditional trip relay that opens one of each pair of diodes.

The outputs of the bistable units or the outputs of the two out of three AND gates are connected through OR gates to the auxiliary trip relay circuit that opens the interlocks. This circuit consists of a transistor with its base current supplied from +20 v through a resistor and the base potential clamped to the 5-v outputs of the bistable circuits through the OR gates. When a trip signal is generated all the base current is diverted through one of the diodes and the potential goes negative, cutting off the transistor and opening the relay.

Normally, the relay current is controlled by the emitter resistor, since the transistor is not in saturation, and an increase or decrease in relay current on the monitoring meter would indicate loss of control by the transistor.

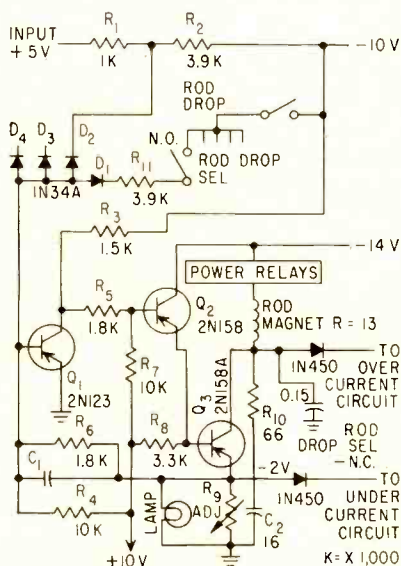

FIG. 4—Schematic of feedback type regulator control amplifier. The amplifier uses the +10-v supply as a reference to hold the output at -2 v

The control amplifiers (Fig. 4) are primarily feedback type regulators which hold the magnet currents constant. A negative 2-v potential across a shunt is combined with a positive 10-v reference to generate an error voltage at the junction of  $R_1$  and  $R_2$ . The error potential is amplified by  $Q_1$  and applied to the base of emitter follower  $Q_2$  through divider  $R_5$ - $R_7$ . The output of  $Q_2$  drives the base of the output stage  $Q_3$ .

The current through the rod magnets is set by adjusting  $R_8$  and is normally 0.6 ampere. The lamp across this resistor indicates rod magnet current and the brilliance is unaffected by the adjustment.

The inputs are normally maintained at 5 v by current supplied from the input bistable circuits. Tripping occurs whenever the potential at one of the inputs drops sufficiently to allow current flow through one of the diodes. This, in effect, changes the reference potential and causes the output current to approach zero. Amplifier  $Q_1$  becomes saturated and emitter follower  $Q_2$  then turns off the output transistor  $Q_3$ .

The variation in peak collector voltage of  $Q_3$  is limited to 50 v by damping circuit  $R_{10}$  and  $C_2$  and the reversed potential, of about five times normal, reduces the current to zero in about 10 milliseconds. A slight reversal of current reduces the residual flux. Tripping of any one output control amplifier actuates the undercurrent-overcurrent relay and opens the interlock circuit, which provides additional back-up against any control amplifier being inoperative and may also signal failure of components.

For certain tests, selected rods must be tripped. Also, rod-drop selector switches connect an additional input of the control amplifiers to a bus. When the desired rod selections have been made, the bus is connected to -10 v, which drops the desired rods.

#### Protective Circuits

The undercurrent-overcurrent circuit is shown in Fig. 5. This circuit guards against improper operation of the control amplifier. The output may be used to scram the reactor or give operator warning.

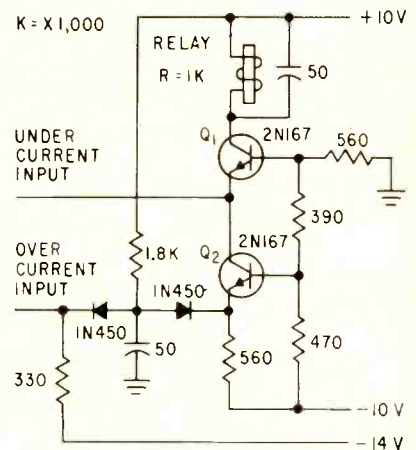

FIG. 5—Schematic of undercurrent-overcurrent back-up circuit. The circuit does not permit the rod currents to vary beyond predetermined limits without initiating a reactor scram

The circuit operates on overcurrent if the output power transistor does not have sufficient potential to regulate the current, either because of low voltage from the power supply, high coil resistance or the current being set too high.

Operation due to undercurrent may occur for many reasons such as component failures in the control amplifier, open circuit or high resistance in the magnet circuit or as a result of low supply voltage.

The circuit consists of a relay in series with two transistors either of which may open the relay-coil circuit. The bases are biased by a voltage divider at the desired potentials. The inputs from the control amplifiers are applied to the emitters of the transistors.

The undercurrent input will be at the potential which corresponds to the output of the control amplifier having the lowest current and an input less than 1.3 v will cut off  $Q_1$  and open the relay. Normally, no current will flow to the undercurrent input since all the diodes in the gate circuit will be nonconducting.

The operation for the overcurrent input is similar, except that the input has a large 180-cps component from the unfiltered 3-phase supply for the rod magnets and the peak values are rectified and filtered before being applied to  $Q_2$ .

#### REFERENCE

- (1) R. S. Stone, Recent Developments in Nuclear Instrumentation at the Knolls Atomic Power Laboratory, *AIEE Communication and Electronics*, Sept. 1957, p. 396.

# Push-Pull Amplifiers

Single-ended push-pull output of a 10-watt audio amplifier directly feeds voice coil of loudspeaker making output transformer unnecessary. First preamplifying stage has positive feedback to the point of oscillation, while the first amplifier and output stages have negative feedback. Stable circuit has low distortion, flat response and a few deg phase shift over audio range

By J. RODRIGUES DE MIRANDA

Radio Apparatus Laboratory, Philips Incandescent Lamp Factories Ltd., Eindhoven, Netherlands

**H**I-FI is taking root in Europe. Much of the interest and enthusiasm of American audio fans seems to be spreading among their European cousins. And, although the degree of hi-fi popularity still lags behind that in the United States, many European engineers and electronics' firms are doing significant work in this field.

One development is a moderately powered amplifier which works directly into the voice coil of a loudspeaker and makes the output transformer unnecessary. The direct coupling between the power stage and the loudspeaker transforms the whole system into an R-C coupled amplifier with no phase-shifting elements other than the coupling capacitors and parasitic capacitances. Therefore, feedback stability problems do not occur and interesting and unusual circuits are possible.

The complete power amplifier

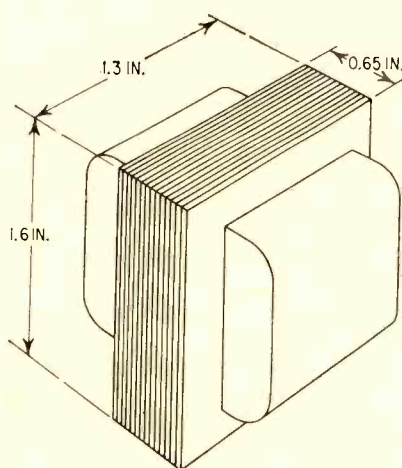

FIG. 2—Approximate dimensions of the double choke for screen-grid supplies

comprises a preamplifier, a phase inverter and a single-ended push-pull output stage to which the loudspeaker with an 800-ohm voice coil is coupled through a large electrolytic capacitor. The push-pull output stage has low-voltage high-cur-

rent tubes that require a load resistance of only 800 ohms.

## Circuit Without Feedback

A simplified amplifier circuit without feedback is shown in Fig. 1. Tube  $V_1$  is the preamplifier. The voltage developed across the plate load resistor  $R_3$  is applied through capacitor  $C_5$  and grid resistor  $R_6$  to the control grid of output tube  $V_3$ . The same voltage is also applied through  $C_2$  to the control grid of the phase inverter  $V_2$ . The voltage across the plate resistor  $R_7$  of  $V_2$  is applied through  $C_1$  and resistor  $R_5$  to the control grid of the output tube  $V_4$ .

Tubes  $V_3$  and  $V_4$  are connected in a single-ended push-pull arrangement so that they are connected in series for d-c and in parallel for a-c. The load current flows from point  $P$  through capacitor  $C_L$  and the loudspeaker load  $R_0$  to ground.

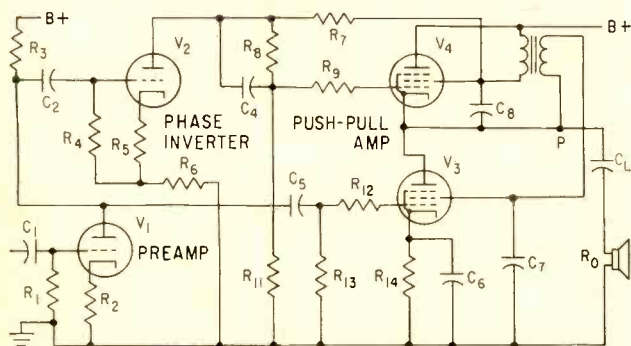

FIG. 1—Circuit without feedback couples through capacitor  $C_L$  to voice coil of speaker. Tubes  $V_3$  and  $V_4$  are in parallel for d-c

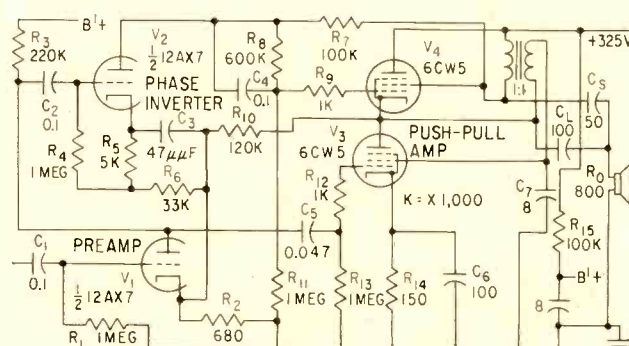

FIG. 3—Audio amplifier with feedback has 10-watt output and uses basically the same configuration as given in Fig. 1.

# Drive Speaker Directly

Special attention should be given to the screen-grid current supply of power tubes  $V_2$  and  $V_1$ . The screen grid must be at approximately plate d-c potential, but it must also have cathode voltage for a-c. The required d-c potential for tube  $V_2$  could have been obtained from  $B+$  through a voltage dropping resistor, but because the screen grid current increases with increasing output, the available screen-grid d-c voltage would be undesirably low at maximum output. On the other hand, the power-tube screen-grids should not be connected directly to their respective plates because then the tubes would operate as triodes.

In both cases a voltage reducing resistor between plate and screen grid would decrease the maximum output. If the resistor were too high, it would lower the d-c screen-grid potential considerably and especially so at maximum output. If the resistor were too low it would consume a considerable part of the output power.

A workable compromise is obtained by connecting the loudspeaker between the  $B+$  and the screen grid of tube  $V_1$  and feeding the screen grid of tube  $V_2$  through a suitable resistor and bleeder. An apparent disadvantage of this method is that the loudspeaker carries a high d-c potential.

## Choke Stepdown

Still another possibility is to insert a choke between the screen grid and plate of each tube. When the two chokes are combined on a single core, the d-c magnetizing forces counterbalance and make an air gap unnecessary. With a relatively small core, an inductance of 60 henrys can easily be realized. A dimensional diagram of the choke is shown in Fig. 2.

Choke stepdown provides a high plate efficiency for the output stage. Since each of the two halves of the choke is in parallel with the load, the output is decreased at low frequencies. With an inductance of 60

henrys the choke attenuates only frequencies below 25 cps. Stray capacitance is not important because the load impedance is only 800 ohms.

Grid-cathode a-c voltages for tubes  $V_2$  and  $V_1$  should be equal in magnitude and 180 deg out of phase. One difficulty inherent in the

circuit of Fig. 1 is that the cathode of tube  $V_1$  is at full output a-c voltage  $v_o$ . Thus, the a-c voltage applied to the signal grid of  $V_1$  with respect to ground should be  $v_s + v_o$  and therefore larger than the output signal.

The grid voltage of  $V_1$  is obtained from the plate of phase inverter



Young lady removes front piece to show amplifier within speaker enclosure

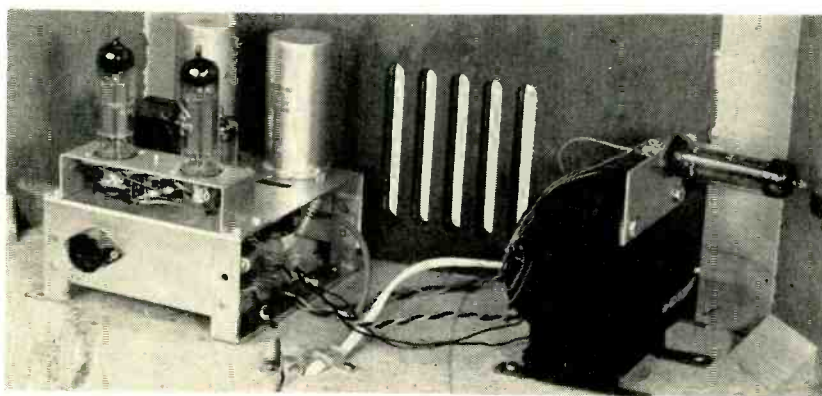

Amplifier (left) and power supply (right) within loudspeaker enclosure

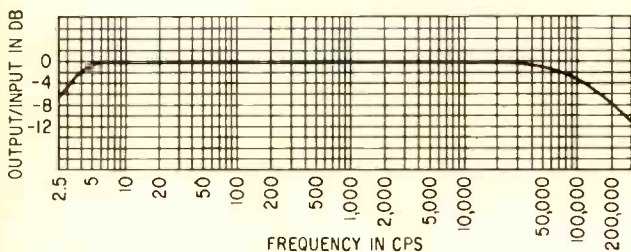

FIG. 4—Amplifier has flat response over audio range

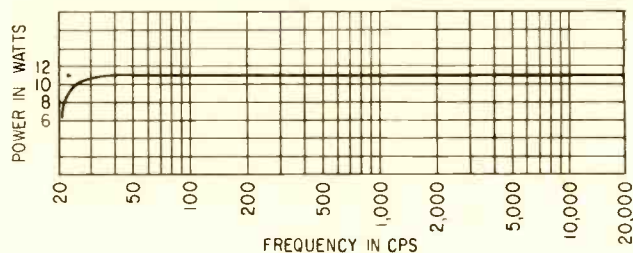

FIG. 5—Power-frequency curve for one-percent distortion

$V_2$ . High voltage for  $V_2$ , in turn, is obtained from the screen grid of  $V_1$  through plate-load resistor  $R_1$ . Screen grid of  $V_1$  has a-c output voltage through capacitor  $C_3$ . With this arrangement the plate signal current of  $V_2$  has to develop a voltage across  $R_7$  which is practically equal to  $v_o$  only.

### Circuit With Feedback

A circuit with positive feedback in the preamplifier-phase-inverter stage and overall negative feedback from output to input is shown in Fig. 3. The system has extremely low distortion without much sacrifice in sensitivity. The single-ended push-pull output stage is particularly suitable because of the negligible amount of phase shift over an extended frequency range. If the positive-feedback value is almost sufficient to cause the combination  $V_1$  and  $V_2$  to oscillate, the amplification of the combination tends to infinity. If then, because of negative feedback, the output signal of the complete amplifier has a finite value, the negative feedback resulting from the combination of positive and negative feedback must also tend to infinity. The contribution of the output stage to the distortion disappears completely, while the distortion caused by the preamplifier phase inverter with positive feedback equals the distortion without positive feedback divided by the negative feedback factor. The negative feedback

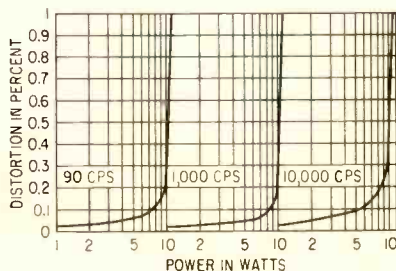

FIG. 6—Distortion characteristics at three frequencies; 90 cps, 1,000 cps and 10,000 cps in range of interest

factor is calculated for the no positive feedback conditions. The chosen amount of positive feedback is sufficient to bring the first stage near oscillation. Because of the negative feedback, the amplifier is completely stable, even if the preamplifier stage starts oscillating when negative feedback is removed.

In the circuit of Fig. 3 the positive feedback is obtained through a common resistor  $R_2$  of triodes  $V_1$  and  $V_2$ . For the required negative feedback, the hot end of  $R_2$  connects directly to the output through resistor  $R_{10}$ . There is no phase shifting element in either feedback loop. If an output transformer had been used and the negative feedback had been taken from a secondary winding, it would have been extremely difficult to keep the phase shift sufficiently low to avoid oscillation.

### Power Output Tubes

In a single-ended push-pull circuit the required load resistance is

half that of a single tube because the tubes are in parallel to a-c. Since a low load impedance is necessary for matching to the speaker, tubes which deliver a relatively high plate current at a relatively low plate and screen-grid voltage are necessary. Two 6CW5 tubes were selected for the circuit of Fig. 3; they have a load impedance of only 800 ohms.

The power tubes operate class A with a maximum output power of 11 watt with one percent distortion. The required input voltage for this output is 0.6 v. The required plate voltage is 325 v, the plate current consumption is 75 ma.

### The Loudspeaker

The loudspeaker is a standard one whose voice coil is specially wound with fine wire to provide a 400 to 800-ohm impedance. Precautions were taken to obtain an enamel insulation of uniform thickness since the insulation thickness becomes of more importance when wire of thinner copper diameter is

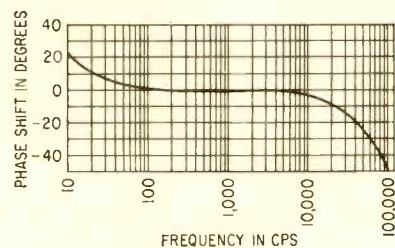

FIG. 7—Phase-shift characteristic of amplifier shows little shift over audio frequency range of interest

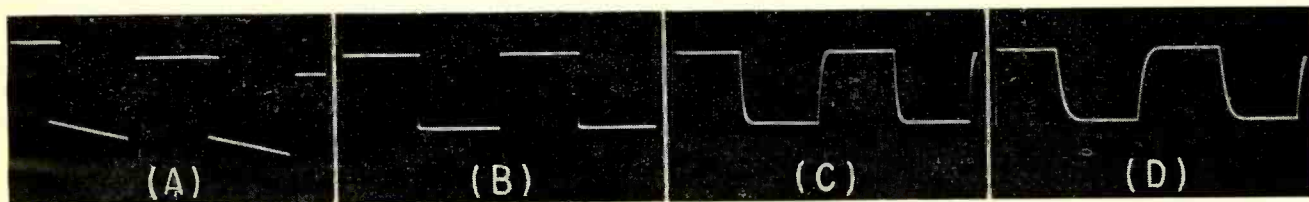
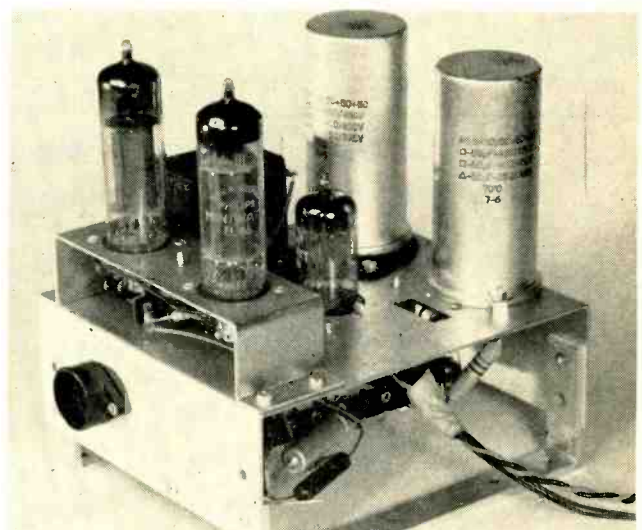
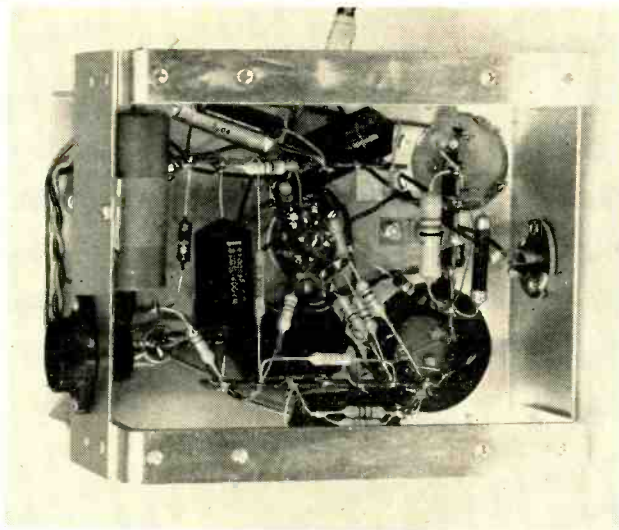

FIG. 8—Square-wave responses at 60 cps (A), 1,000 cps (B), 10,000 cps (C) and 20,000 cps (D)



Neat, compact circuitry appears under chassis of amplifier which is compact enough to be mounted in speaker enclosure

Small double choke is mounted behind power tubes. The EL 86 tubes are European equivalents of 6CW5 power output tubes

used to wind the voice coil.

A frequency response curve shown in Fig. 4 has a smooth response with a gradual roll off both at the low- and high-frequency end. The 3 db points are at 3 cps and 100 kc. The power frequency curve of Fig. 5 was measured for one-percent distortion. Full output is still available at 30 cps and output is flat to beyond 20 kc. Distortion was not measured beyond audio range.

Harmonic distortion as a function of output power at 90 cps, 1,000 cps and 10 kc is shown in Fig. 6. Although at 10 kc the distortion at 10 watt reaches 0.4 percent, the distortion at lower outputs is extremely low for all frequencies and is reflected by the low intermodulation figures. The phase relation be-

tween output and input signals is shown in Fig. 7 and confirms the results of the frequency response curve. Phase shift at 10 cps is 22 deg, at 100 kc is - 45 deg.

Square-wave responses at maximum outputs for 60 cps, 1,000 cps, 10 kc and 20 kc appear in Fig. 8. Here too, the smooth shape, without ringing or overshoot is apparent. The low frequency range is primarily limited by the input capacitor  $C_1$ , the double choke and by the loudspeaker coupling capacitor. Increasing the values of the capacitors would extend the frequency range toward the lower end. The higher frequency range is limited mainly by Miller effect and by the input capacitance of the power tubes. To compensate for this,

capacitor  $C_3$  which has a twofold influence on the performance of the amplifier is added in the circuit of Fig. 3. It extends the frequency response curve toward the higher end and it decreases distortion at higher frequencies. The optimum values of  $C_3$  for both purposes do not coincide; therefore, a compromise value has been chosen. A larger value increases the frequency range, but the distortion at the high frequency end increases too.

### Prospective Applications

If the output is too low for American hi-fi needs, it may be doubled by simply doubling the output tubes. A separate cathode resistor-capacitor assembly for each pair of output tubes is recommended, but only one double choke is required as shown in Fig. 9.

Because the physical dimensions of the amplifier are small, it is well suited for assembly within the loudspeaker enclosure. The resulting amplifier-loudspeaker unit has 0.6-v input for maximum acoustical output.

Two of these speaker units make an ideal stereo installation in combination with a stereo tape deck or, in the future, a stereo turntable together with an appropriate double preamplifier. For single-channel signals in which the inputs of the two units are in parallel, interesting pseudo stereo effects result.

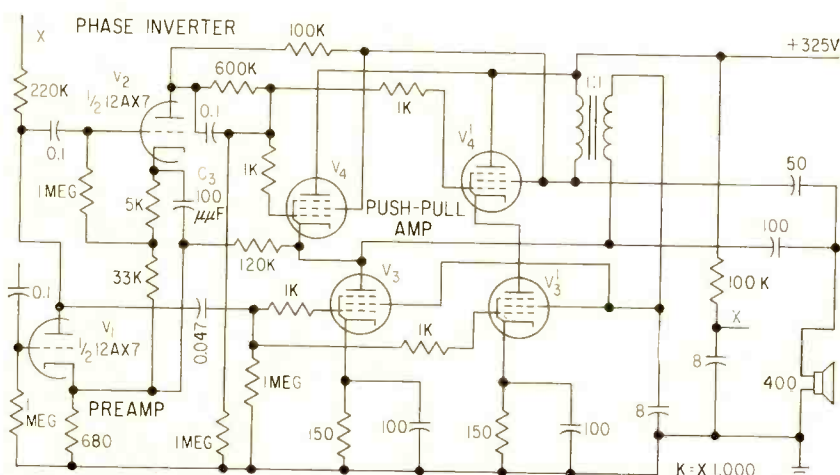

FIG. 9—Doubling the number of output power tubes doubles power output to 20-watt and halves loudspeaker impedance requirement

Unique combination of transistorized half- and full-adders, emitter followers, output amplifiers and multiplier gates provides simultaneous binary addition of digital inputs. Matrix-type switching gives high-speed full-adder operation at low voltage and power levels with only seven active logic elements. Input data is introduced by toggle switches; output is displayed by pilot lamps

By **FREDERICK B. MAYNARD**

Research Department, Semiconductor Division, Motorola, Inc, Phoenix, Arizona

# Half-Adders Drive

**C**ONVENTIONAL ASSEMBLIES of components to perform the particular arithmetic functions of binary addition generally take two forms. One, called a translator, is exemplified by the transistorized circuit in the Philco Transac<sup>1</sup>. The other, called coincidence adder, is primarily used with dual-control

grid-type electron tubes<sup>2</sup>. For both forms, the minimum number of active elements used in the logical functions for a full-adder is twelve. The transistorized computer discussed here is a novel form which requires only seven active elements in each full-adder to perform binary logic.

Basic operating principle of the binary adder revolves around the matrix-type switching used to accomplish simultaneous computation.

Switching transistors of the 2N311 type are especially useful in a matrix adder since they have large current gain, low voltage drop during conduction and exceptionally low inverse emitter saturation current. Also fast rise and fall times contribute to the speed and reliability of the logic functions. Characteristics that make this transistor useful are shown in Table I.

## Computation Method

Simultaneous computation is not as common as the serial type used in modern large scale computers. An advantage of the simultaneous method is that an entire computation can occur in essentially one pulse time whereas with the serial method, a single pulse time is required for each operation in the computation. Hence, the simultaneous method is comparatively fast even when individual components are not in themselves fast.

Since the simultaneous method requires a large number of computational components, there is, at present, no great interest in the possibilities of the method. How-

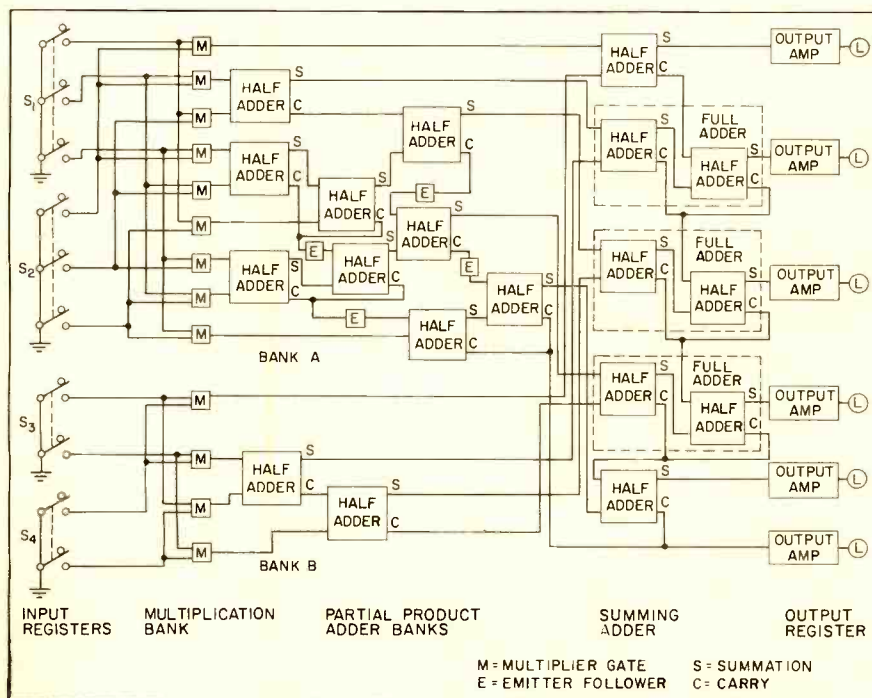
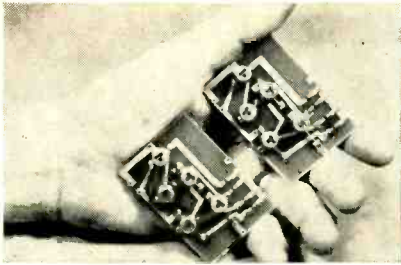

FIG. 1—Block diagram of complete computer showing functional relationships of components to provide simultaneous operation



Two half-adder components. Only three of the five transistors used in a half-adder are required to perform logical functions. All computer components are assembled on etched circuit boards and used as modular building blocks



Model computer performs simultaneous binary addition in  $7\mu\text{sec}$ . Only active circuit elements used are 178 transistors

# Simultaneous Computer

TABLE I—Switching Parameters

$\beta$ (common emitter)	Average—50
$V_{ce\ sat}$	Average—50 mv
Rise time	Average—0.5 $\mu\text{sec}$
Fall time	Average—1.8 $\mu\text{sec}$
$I_{co}$ ( $V_e = -15\text{v}$ )	60 $\mu\text{amp}$
$I_{co}$ ( $V_{c-b} = -15\text{v}$ )	60 $\mu\text{amp}$

ever, if a transistor or other device can be developed which is sufficiently reliable and cheap, the possibilities of the simultaneous method will demand more thorough exploration.

## Operation

A model computer of the type discussed here has been built to demonstrate a simultaneous computation of the general equation  $(A \times B) + (C \times D) = S$ . The complete unit, shown in block diagram form in Fig. 1, consists of two separate input registers and two associated multiplying banks. Each multiplying bank is connected to its own partial product adder bank. The partial sums are brought together in the final summing adder which terminates in the six-channel

binary indicating register.

Input register *A* has a capacity of three binary multiplicand and three binary multiplier digit channels with a multiplying capacity of 49. Register *B* has two binary multiplicand and two binary multiplier channels with a multiplying capacity of 9.

Multiplying bank *A* contains nine multiplier gates. This number is established by the multiplication requirements. Since each multiplicand digit is multiplied by each multiplier digit and since there are three of each, nine multiplications are required. It follows that bank *B* contains four binary multiplier gates.

Partial product adder bank *A* contains nine matrix-type half-adder units with associated drive inverting amplifiers. The units are interconnected to give three full-adder and three half-adder components. Adder bank *B* contains only two half-adders.

Summed partial products from both adder banks are brought together in the intermediate register and fed into a final summing adder bank containing two half and three full-added units. The resulting binary signals are amplified in the output register and displayed by pilot lamps on the readout panel.

A four-point matrix made of *pn*p junction switching transistors is shown in Fig. 2. The bases and emitters are cross-connected in matrix form. Input *A* can be switched either to the bases of  $Q_1$  or  $Q_2$ . Input *B* can be switched between two alternate sets of emitters. For any position of the input switches, only one transistor is in a conducting state.

## Half-Adder

If the switch positions indicated on Fig. 2 represent a ZERO-ZERO input,  $Q_4$  is conducting. If either  $S_1$  or  $S_2$  is actuated, conduction is established through either  $Q_2$  or  $Q_3$  respectively. If both switches are actuated,  $Q_1$  conducts.

A common output from the collectors of  $Q_2$  and  $Q_3$  will be a sum output because the input must be either ZERO plus ONE or ONE plus ZERO binary addition. Likewise, an output from  $Q_1$  indicates a carry since it represents an addition of ONE plus ONE. Transistor  $Q_4$  serves no function in binary addition because ZERO plus ZERO addition requires only a ZERO output which is, effectively, no output. Thus, three transistors make up a complete half-adder.

A full-adder, shown in Fig. 3, is made by joining two half-adder

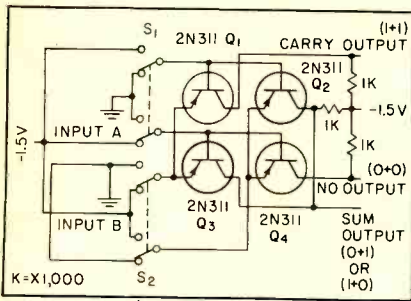

Fig. 2—Four-point transistor matrix for performing binary addition in half-adder

units together. One of the second half-adder inputs, designated input C, is exactly like input B since it switches on the emitters in the second matrix. The input inverting amplifier of the second half-adder serves as a switch between the base input of the second half-adder and sum output of the first half-adder. Carry from the full-adder can derive from either half section but never both; therefore, it is sufficient to join the two carry outputs to make a full-adder carry output.

One of the novel features of this adder is that no inhibitor signal is required to repress an unwanted sum signal. Other adders, especially some electron-tube types, use complicated designs to overcome the problem.

Clean transfer of conduction conditions, largely resulting from the properties inherent in matrix type of switching, makes the unit described here a straightforward adder. Saving in transistors is attained since the purely logical functions require seven transistors to accomplish as much as the eleven or more transistors used in other circuit configurations.

### Multiplier Gate

The multiplier gate, shown in Fig. 4A, is simply a coincidence gate giving an output at C only when both inputs A and B are activated. This design takes cognizance of the binary multiplication rule that a product of ONE is obtained only when the multiplier and multiplicand digits are ONE.

Emitter-follower noninverting amplifiers, shown in Fig. 4B, are used at some points to improve the switching characteristics of the longer carry paths. Each final binary channel is terminated in an output amplifier, shown in Fig. 4C,

which renders the binary output devisible by illuminating pilot lamps.

Toggle switches are used for manually inserting numerical inputs. When a problem is put into the computer, the response appears instantaneous to the operator. If a sufficiently fast method were available to introduce input information, about 100,000 computations per second could be made.

A total of 178 transistors is required to operate the computer. Multipliers, adders and inverters use 166; 12 are amplifiers.

### Operating Characteristics

A fast, 1.5-volt pulse of suitable polarity was applied to the full-adder stage shown in Fig. 3. The time delay measured from its lead-

delay results from accumulated delay times of carries which have to chain across the system. For this reason, the final output pulses are delayed by varying amounts depending on the type of computation. Improved computational speed can be obtained by using different circuit constants.

All transistors are operated at saturation when conducting or cut-off when nonconducting; therefore, the signal levels throughout the whole system are virtually equal to the supply voltage. Exclusive of output amplifiers, the system operates from a single 1.5-volt flashlight battery and has a maximum current drain of 120 milliamperes. Average power dissipation for each transistor is a little over one mw.

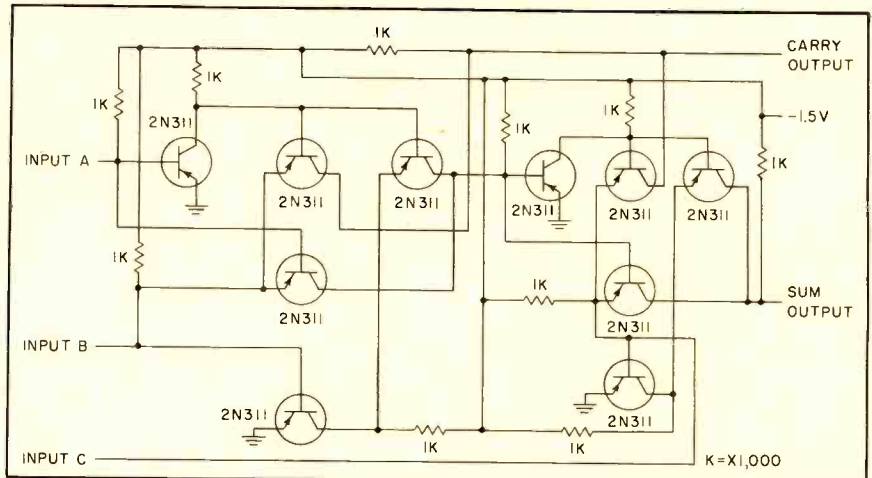

FIG. 3—Full-adder schematic. Push-pull inverting amplifiers replace switches  $S_1$  and  $S_2$  shown in Fig. 2 to provide completely automatic operation

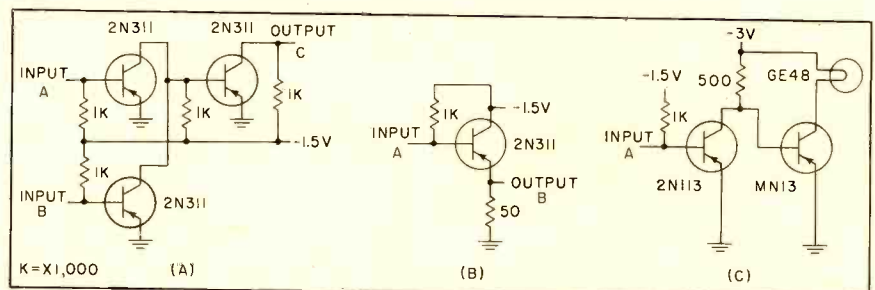

FIG. 4—Computer contains 13 multiplier gates (A), 4 emitter-follower amplifiers (B) and 6 output registers (C) all of which use the same basis transistor type

ing edge to the leading edge of the output was  $0.2 \mu\text{sec}$  on the carry and  $0.35 \mu\text{sec}$  on the sum.

Measurements made on the complete computer indicated that the average arrival time of the leading edges of the output pulses varied between 5 and  $7 \mu\text{sec}$ . Most of the

All transistors used in this computer are presently being replaced by production 2N426 transistors.

### REFERENCES

- (1) A. L. Cavaliere, What's Inside Transac, *Electronic Design*, p 22, July 1, 1956.
- (2) Engineering Research Associates, "High-Speed Computing Devices", McGraw-Hill Book Co., New York, 1950.



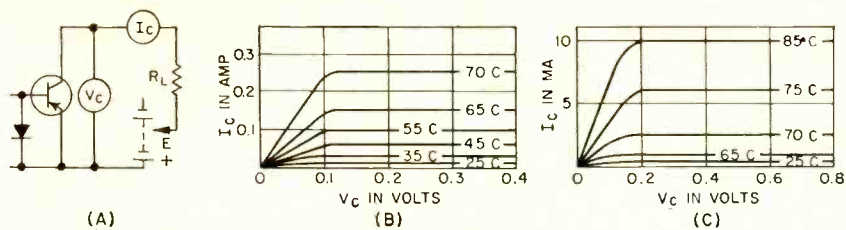

FIG. 1—Improvement in thermal drift brought about by diode compensation (A) is evidenced by drift characteristic of 2N290 transistor alone (B) and with GEX541 diode connected across emitter-base junction (C)

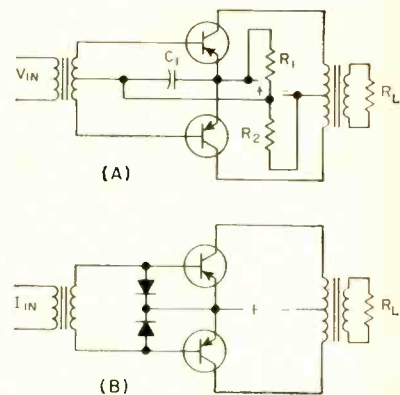

FIG. 2—Conventional (A) and compensated class-B push-pull amplifier (B)

# Diode Cuts Transistor Cutoff-Current Drift

Amplified thermal  $I_{co}$  variations in grounded-emitter amplifiers can be compensated by connecting diode, having similar collector-base junction saturation-current characteristics, across transistor's base-emitter junction

By HENRI H. HOGE Chief Engineer, Advanced Research Associates, Inc., Kensington, Md.

USE OF RESISTORS to compensate a transistor d-c amplifier's drift current simply restricts the transistor's operating range, leaving the drift current still present and uncompensated. The compensation method to be described does not include any linear elements to restrict the transistor's dynamic range. It has effected negligible drift when incorporated in 10 to 20-w amplifiers.

In the common-emitter configuration, collector-current drift is a result of the variations of the  $I_{co}$ , flowing through the emitter-base junction, being amplified by a factor of beta. Figure 1 illustrates the way in which a diode can be connected across the transistor emitter-base junction to compensate for the amplified leakage current. The diode must have a junction area whose saturation-current characteristic is similar to that of

the transistor's collector-base junction. Also the diode must be located as near to the transistor as possible so they will both be at the same operating temperature (transistors have been constructed with the diode in the same housing).

## Push-Pull Circuits

When transistors with this compensation are used in push-pull class-B amplifiers, the unbalance or drift is approximately equal to the difference between the  $I_{co}$  of the two halves of the circuit. Compensated transistors of this type should be fed from a current source, with the attendant advantage that the base-emitter potentials need only be high enough to allow the necessary current to be fed through the base-emitter diode. In this way the additional capacitance of the diodes does not greatly affect the alpha-cutoff frequency.

In the conventional class-B transformer-coupled amplifier shown in Fig. 2A divider  $R_1R_2$  reduces the overall efficiency of the stage and also necessitates the addition of  $C_1$  to reduce the effects of  $R_1$ . The transistors in this circuit are driven from a voltage source which means that the off transistor is back-biased. This back-biasing not only sweeps all the carriers from the base region but also causes  $I_{bc}$  to flow. This of course has to be made up on the next change of polarity before transistor action can occur, manifesting itself as crossover distortion.

The circuit in Fig. 2B uses the compensated transistors fed by a current source. The off transistor is back-biased only by the forward drop of the compensating diode. Crossover distortion is reduced, the resistors and capacitor can be eliminated increasing efficiency.

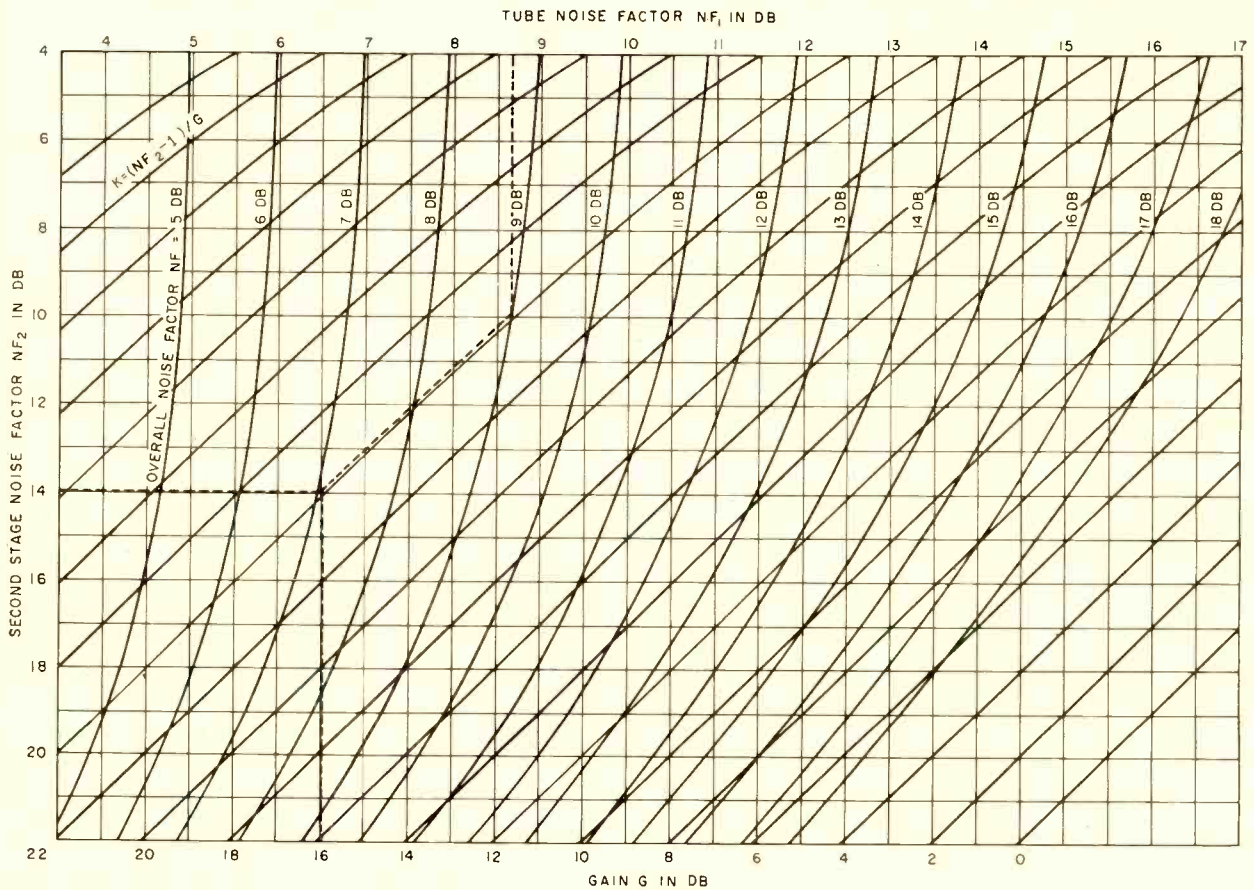

FIG. 1—Resultant is read at top of scale. Vertical curves represent various values of overall noise, while diagonals are references for  $K$ , a constant equal to the quantity  $(NF_2 - 1)/G$

# Tube Noise Factor Chart

When second-stage noise factor, first-stage gain and overall noise factor of radar and similar uhf equipment are known, the tube noise factor may be determined directly in db, without intermediate conversion to power ratios

By LUCIEN P. A. DeBACKER, Electron Tube Division, Radio Corporation of America, Harrison, N. J.

**E**XACT VALUES of tube noise factor are often required for the evaluation of radar receivers or other uhf equipment. Calculations involving conversions to and from power ratios are time consuming.

Tube noise factor  $NF_1 = NF - (NF_2 - 1)/G$ , where  $NF_1$  is the tube noise factor,  $NF_2$  is the noise factor of the second stage (such as crystal noise),  $G$  is the gain of the first stage and  $NF$  is the overall noise factor of the system corrected

for cable losses and transit time.

The known quantities are usually stated in decibels, converted to power ratios and substituted in the formula to calculate  $NF_1$ , which is then converted back into decibels. The graph of Fig. 1 allows the calculations to be performed in two steps without converting recorded decibel readings.

To use the chart locate  $NF_2$  on the left-hand scale and  $G$  across the bottom scale. The in-

tersection of perpendicular lines from these two points determines the location of a diagonal line along which the quantity  $(NF_2 - 1)/G$  is a constant  $K$ . Follow this line and locate its intersection with the curve for  $NF$ . Tube noise factor  $NF_1$  is given directly above this intersection on the top scale. An example is shown in which  $G = 16$  db,  $NF_2 = 14$  db and  $NF = 9$  db. Then  $NF_1$  is read on the top scale as 8.65 db.

D-SUB-MINIATURES:  
PRINTED CIRCUIT PIN AND  
SOCKET INSERTS (RIGHT)

DC-37P-1

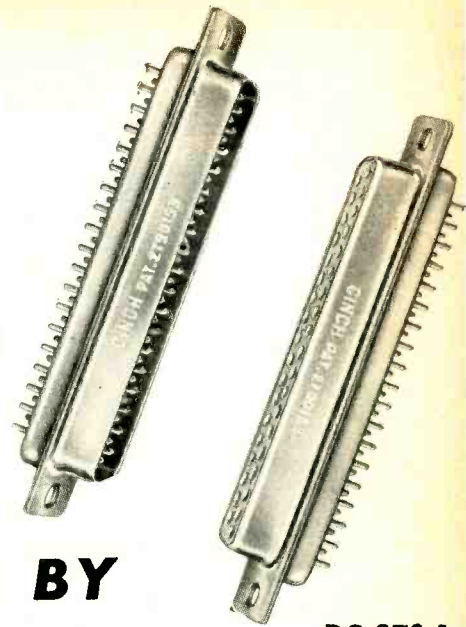

DC-37S-1

# NEW PRINTED CIRCUIT SUB-MINIATURE CONNECTORS BY

# CINCH

D Sub-Miniature plugs and sockets with printed circuit pin and socket inserts are now available as listed for immediate delivery.

More than thirty years experience in the design and manufacture of standard electronic components insure Cannon Connectors by CINCH to be of the highest quality materials, fabricated to specifications to maintain consistent quality of product; highest standards throughout all operations.

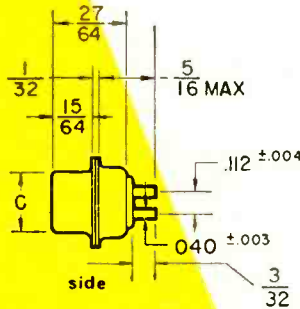
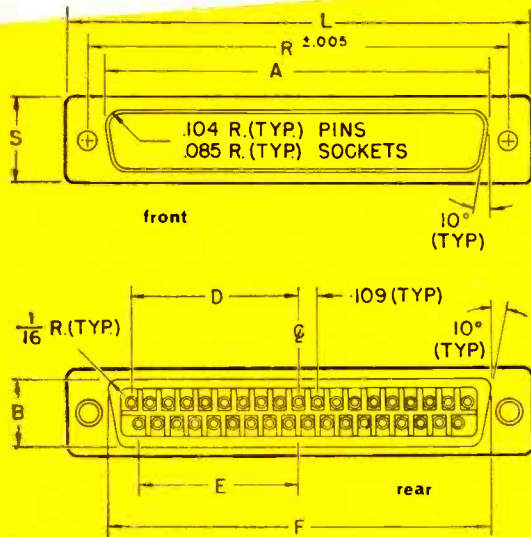

DIMENSION TAB

SIZE	A	B	C	D	E	F	L	R	S
DE-9P-1	45/64	27/64	23/64	.216	.162	49/64	1-13/64	63/64	31/64
DE-9S-1	41/64	27/64	5/16	.216	.162	49/64	1-13/64	63/64	31/64
DA-15P-1	1-1/64	27/64	23/64	.378	.324	1-3/32	1-17/32	1-5/16	31/64
DA-15S-1	31/32	27/64	5/16	.378	.324	1-3/32	1-17/32	1-5/16	31/64
DB-25P-1	1-9/16	27/64	23/64	.652	.598	1-5/8	2-5/64	1-55/64	31/64
DB-25S-1	1-33/64	27/64	5/16	.652	.598	1-5/8	2-5/64	1-55/64	31/64
DC-37P-1	2-13/64	27/64	23/64	.978	.924	2-9/32	2-23/32	2-1/2	31/64
DC-37S-1	2-11/64	27/64	5/16	.978	.924	2-9/32	2-23/32	2-1/2	31/64
DD-50P-1	2-7/64	17/32	15/32	.933	.879	2-11/64	2-5/8	2-13/32	39/64
DD-50S-1	2-5/64	17/32	27/64	.933	.870	2-11/64	2-5/8	2-13/32	39/64

Manufactured by Agreement with  
Cannon Electric Company

### CONDENSED DATA

- SHELL MATERIAL — Steel with cadmium plate finish
- CONTACT MATERIAL — Copper alloy with gold over silver plate
- INSULATION MATERIAL — nylon or Diallyl-phthalate
- POLARIZATION — keystone shell shape
- CURRENT RATING — 5 amperes
- WIRE SIZE — #20 AWG
- NUMBER OF CONTACTS — 9, 15, 25, 37, or 50
- VOLTAGE — D's will withstand a test voltage (60cps ac rms) of 1300 volts and show no evidence of breakdown. The test voltage is applied for a period of 1 minute between the contacts and between the contacts and the shell.

Centrally located plants at  
Chicago, Illinois; Shelby-  
ville, Indiana; LaPuente,  
California; St. Louis, Missouri.



**Cinch**  
ELECTRONIC  
COMPONENTS

## CINCH MANUFACTURING CORPORATION

1026 South Homan Ave., Chicago 24, Illinois

Subsidiary of United-Carr Fastener Corporation, Cambridge, Mass.

one voltage may cause extensive damage.

The most common methods of circuit protection in complex digital computers are indicator or signaling fuses, resettable indicating fuses and circuit breakers. Circuit breakers are relatively expensive and seldom rated for high d-c voltage. Fuses protect the circuits but occasionally fail as indicators. These occasional failures could result in considerable down time in a large computing system.

The Burroughs 220 medium-to-large digital computing system uses ferromagnetic core memory of up to 10,000 computer words, central processor, control console and various electronic and electro-mechanical input-output units. In all, the system requires 25 separately regulated voltages supplying 12 cabinets which enclose a total of 17 load centers. A maximum system requires 32 kw of d-c power. D-c power for each component, data processor, memory, tape unit and Cardatron, is switched on or off separately. By using this building block principle, any component may be switched off without affect-

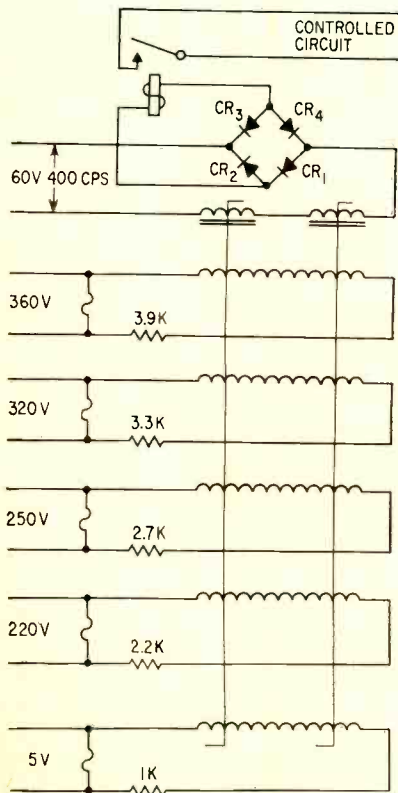

FIG. 1—Basic magnetic-amplifier circuit uses bridge unbalance to operate control relay

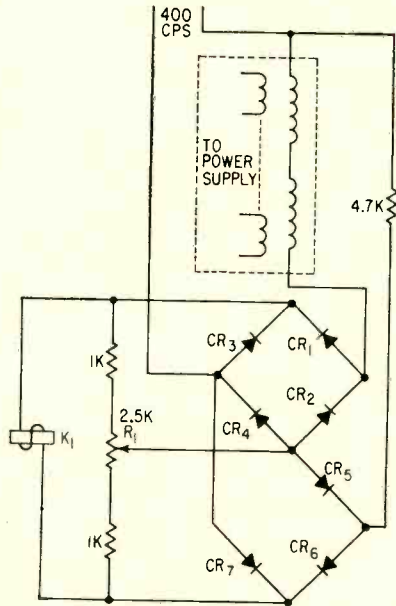

FIG. 2—Using another bridge makes protection circuit more sensitive

ing the rest of the system.

The circuit protection system required for the 220 should be capable of clearing faults on positive and negative d-c buses without causing damage to other sections of the equipment. It should operate rapidly and reliably without maintenance and at a low initial and recurring cost.

### Protection Circuit

Circuit protection at the load centers is accomplished by sensing devices that determine if any fuses are open. If any of the possibly 300 fuses are open, the d-c voltages to that equipment are turned off.

Sensing open fuses is accomplished by placing one of 15 control windings of a series-connected magnetic amplifier across each fuse with an appropriate current-limiting resistor in series with each winding. The schematic of the entire circuit is shown in Fig. 1 with only representative control windings shown for clarity.

If a fuse opens, the voltage drop across the fuse forces current through the control winding causing the magnetic amplifier to saturate. With the magnetic amplifier saturated, a voltage is applied across the bridge formed by  $CR_1$ ,  $CR_2$ ,  $CR_3$ , and  $CR_4$ . Output from the bridge operates relay  $K_1$ . When activated,  $K_1$  opens the relays and contactors that switch d-c power

to the affected piece of equipment.

Breadboard operation revealed that the sensitivity of the circuit could be increased by the modification shown in Fig. 2. Output of a second bridge formed by  $CR_5$ ,  $CR_6$ ,  $CR_7$ , and  $CR_8$  is balanced against the output of the first bridge by adjusting  $R_1$ . This makes it possible to compensate differences in magnetic amplifiers and resistors and also allows the use of more sensitive relays.

### Circuit Characteristics

Since speed and size are important, the magnetic amplifier was made to operate at the available 400 cps. Although a self-saturating

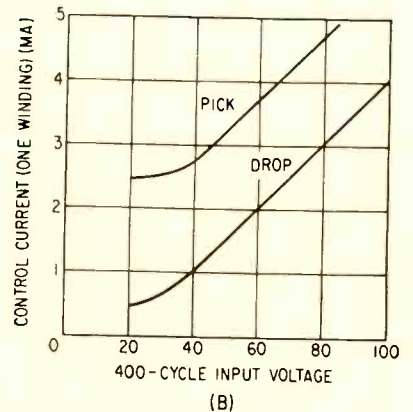
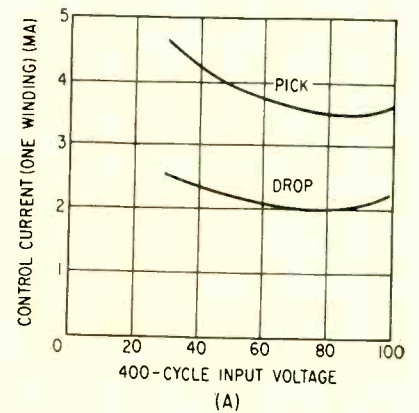
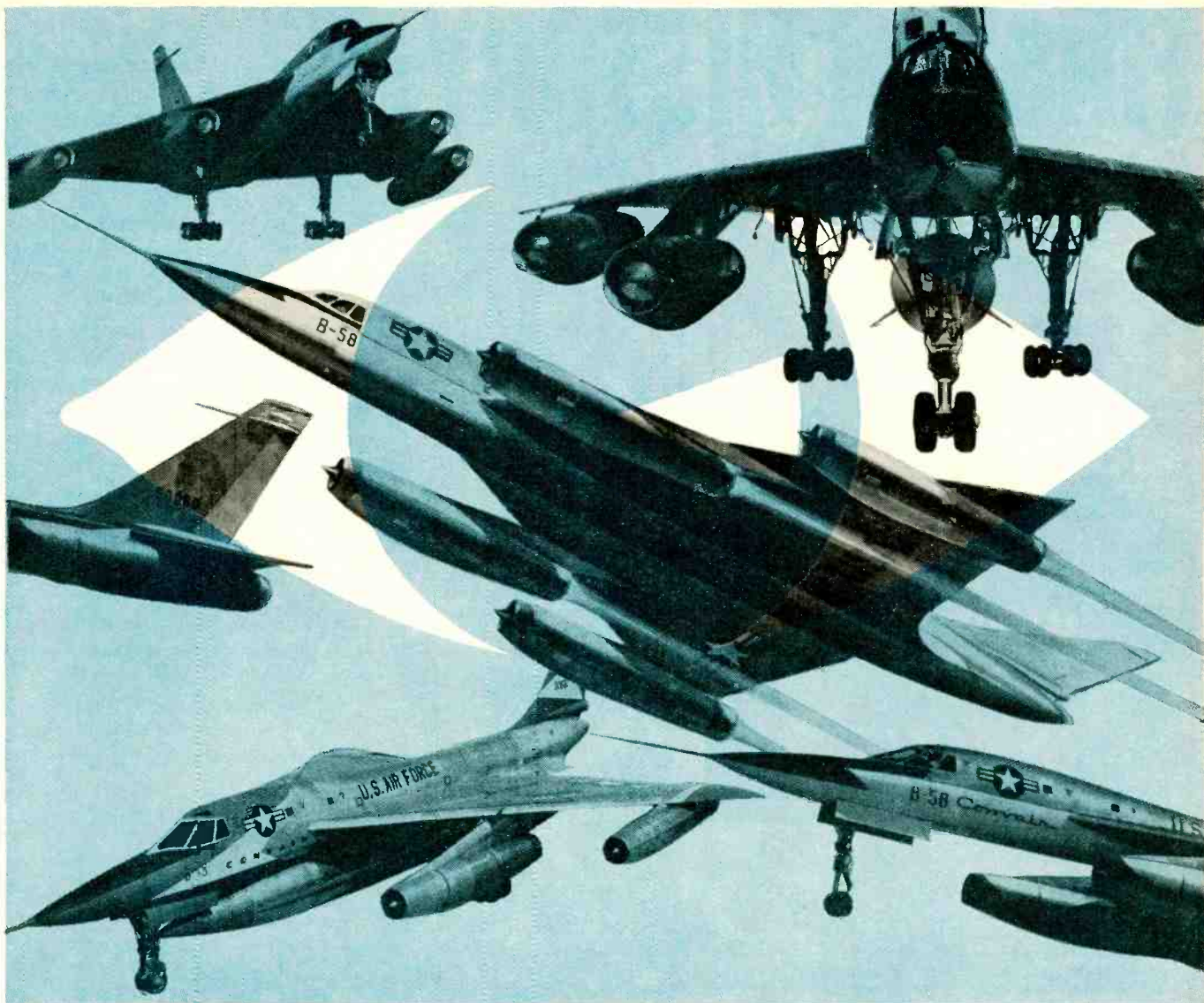

FIG. 3—Plot shows characteristics with relay current balanced to zero by  $R_1$  for different values of input voltage (A) and balanced to zero for 60-volt input (B)

type magnetic amplifier would make the unit more sensitive, it would also be sensitive to the direction of the control current, which in many cases would be unpredictable.

Circuit sensitivity is shown in



## *Any way you look at it...*

Yes, any way you look at the B-58, America's first and only bomber capable of sustained supersonic speeds, you see an aerodynamically-advanced configuration. From the tips of its conical cambered wings to the tail of its trim, area rule fuselage . . . the B-58 reflects the alert, imaginative thinking of engineers at Convair-Fort Worth.

Throughout the design stages of the B-58 . . . and in the conception of every one of the more than half-a-hundred Air Force projects now on hand . . . one major con-

sideration is *Growth Potential* . . . the weapon must fly even faster, farther, safer tomorrow than it does today!

Growth potential of a weapons system results directly from growth potential for the individual engineer. If professional growth is a condition of your career plans, send a confidential resume of your training and experience for consideration *by engineers* in the area most suited to your qualifications. For personalized handling address your inquiry to P. O. Box 748E.

# CONVAIR FORT WORTH

FORT WORTH, TEXAS

CONVAIR IS A DIVISION OF GENERAL DYNAMICS CORPORATION

# FIRST IN HISTORY

# FIRST IN POPULARITY

**ERIE BUTTON<sup>®</sup>**  
**SILVER-MICA**  
 SMALL SIZE - HIGH FREQUENCY  
*Capacitors*

ERIE Type 370 Button Silver-Mica Capacitors were introduced in 1941, the first of their type in the electronic industry. These high frequency capacitors still lead the field in popularity, due to their extremely small size, minimum circuit inductance, and stability. The compact design permits current to fan out in a 360° pattern from the center terminal.

The "370," which has an outside diameter of only .447", is available in eight standard styles with various mounting and terminal arrangements for soldered or screw attachment. Type 370 Button Micas come in capacity ranges from 15 MMF up to and including 2,400 MMF.

ERIE's Engineering Department has developed a complete line of Button Bracket Assemblies. A typical five-unit bracket occupies an area of less than one-half square inch, saving valuable chassis space.

ERIE Button Silver-Mica Capacitors are still the world's best for VHF and UHF applications and for commercial equipment, where properties of the mica dielectric and the design features exceed performance of other types of capacitors. Standard ERIE Button Micas exceed the requirements of characteristics B and D MIL C-10950-B.

Write for Bulletins 318-1 and 320.

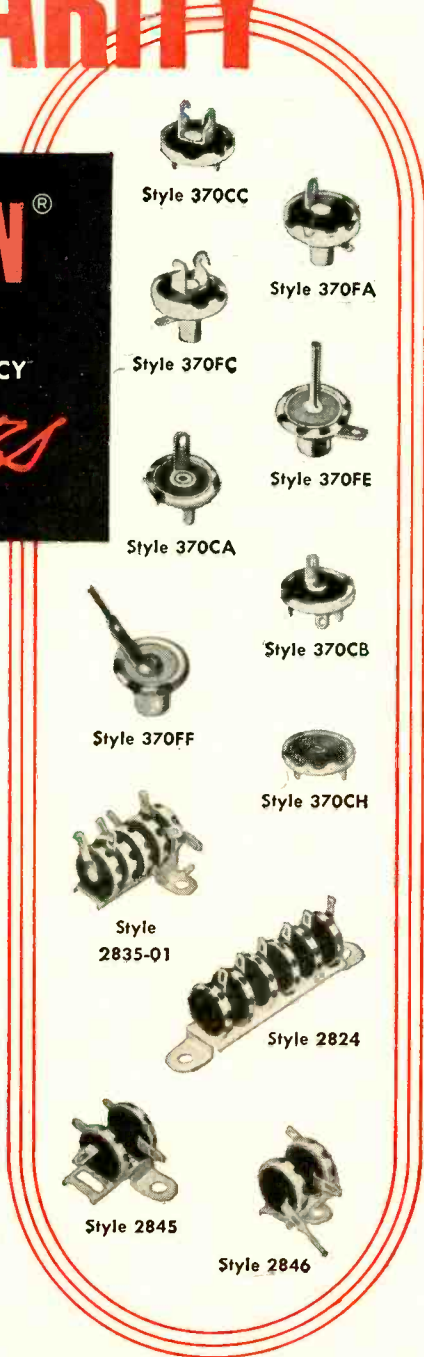

Fig. 3. In Fig. 3A, the circuit was balanced with  $R_1$  at different levels of input voltage. For this particular design, maximum sensitivity was obtained at 80 volts. This also shows that the circuit is not sensitive to the voltage which is applied.

Fig. 3B shows the circuit in balance at 60 volts. The control current required through one control winding to operate the relay is recorded for different input voltages. In this case, the sensitivity is inversely proportional to the input voltage. This was not considered a disadvantage, however, since the input voltage, once set, was regulated within one percent.

Fig. 4 shows response time of the circuit including the relay. This reaction time is very rapid compared to the time required for a fuse to blow under moderate overloads of 300 to 500 percent.

Actual operation of this detection system has disclosed several welcome features that were not

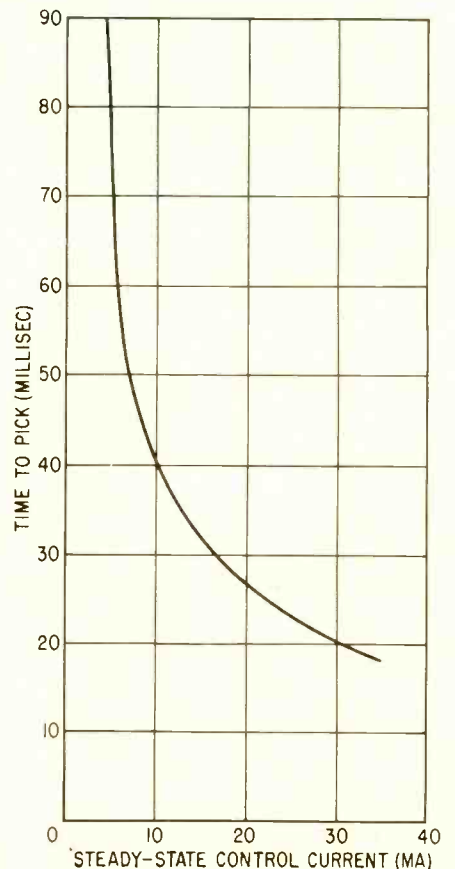
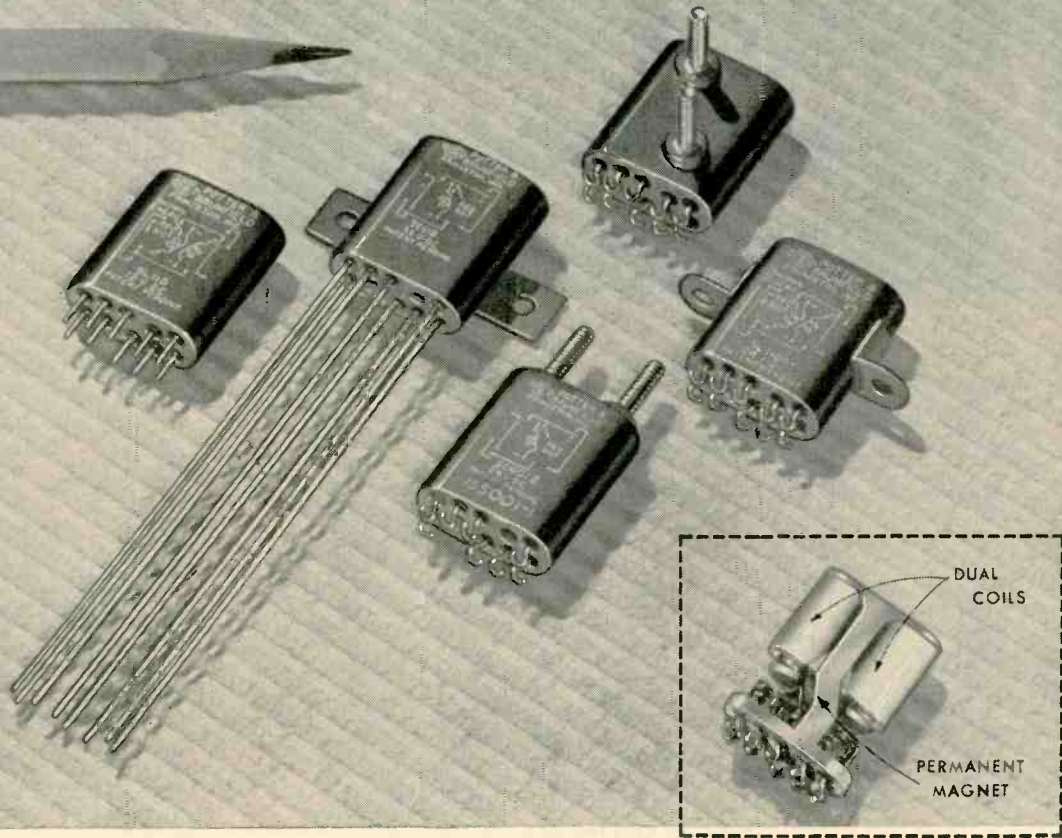

FIG. 4—Response-time data was taken with 1,000 ohms in series with control winding and 150 ohms shunting one other control winding. Results are almost identical with 3,900 ohms series resistance

**ERIE** Electronics Division  
 ERIE RESISTOR CORPORATION  
 MAIN OFFICES: ERIE, PA.  
 FACTORIES: ERIE, PA. • HOLLY SPRINGS, MISS. • TRENTON, ONTARIO, CANADA

# P&B MICRO-MINIATURE RELAYS LEAD IN performance

**SHOCK: 100g\* VIBRATION: 30g to 2000 cps\***



## \*NO CONTACT OPENING

New P&B crystal-case size relays, the SC and the SL (magnetic latching), show amazing shock and vibration capabilities. They absorb shocks of 100g and vibrations 30g to 2000 cps. without contact openings!

A highly efficient magnetic structure utilizing a permanent magnet makes possible at least twice the contact pressure found in DPDT relays of comparable size. One watt of power for three milliseconds operates either relay. Transfer time is unusually fast — 0.5 milliseconds maximum.

For more information, contact your P&B sales engineer, or write Potter & Brumfield, Princeton, Indiana.

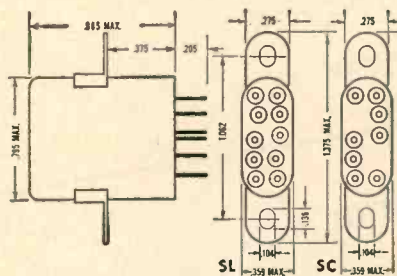

**SL**—dual coil latching relay. Operates on a 1 watt, 3 ms. pulse at nominal voltage. Permanent magnet latch lacks the armature in either position.

**SC**—nan-latching relay with series-connected dual coils. Operates on approximately 1 watt at nominal voltage. Coils must remain energized to hold the armature in the operate position.

### SC and SL Series Engineering Data

#### GENERAL:

Insulation Resistance: 10,000 megohms, min.  
Breakdown Voltage: 1,000 V. RMS.  
Shock: 100g.

Vibration: 30g 55 to 2000 cps.; 0.195" max. excursions from 10-55 cps.  
Temperature Range:  $-65^{\circ}$  C. to  $+125^{\circ}$  C.  
Weight: 15 grams without mounting bracket.  
Operate Time: 3 MS. max. with 550 ohm coil @ 24 V. DC. (SL: 630 ohm coil at 24 V. DC).  
Transfer Time: 0.5 MS max.  
Terminals: (1) Plug-in for microminiature receptacle of printed circuit board.  
(2) Hook end solder for 2 #24 AWG wires.  
(3) 3" flexible leads.  
Enclosure: Hermetically sealed.

#### CONTACTS:

Arrangement: 2 Form C.  
Material: Gold flashed palladium.  
Load: 2 amps @ 28 V. DC, resistive; 1 amp @ 115 V. 60 cycles AC, resistive.  
Pressure: SC—16 grams min.; SL—20 grams min.

#### COIL:

Power: Approx. 1.0 watt at Nominal Voltage.  
Resistance: SL—40 to 1400 ohms; SC—35 to 1250 ohms.  
Duty: Continuous.

#### MOUNTINGS:

Bracket, stud and plug-in.

P&B STANDARD RELAYS ARE AVAILABLE AT YOUR LOCAL ELECTRONIC PARTS DISTRIBUTOR



# POTTER & BRUMFIELD INC.

PRINCETON, INDIANA • SUBSIDIARY OF AMERICAN MACHINE & FOUNDRY COMPANY

CIRCLE 59 READERS SERVICE CARD

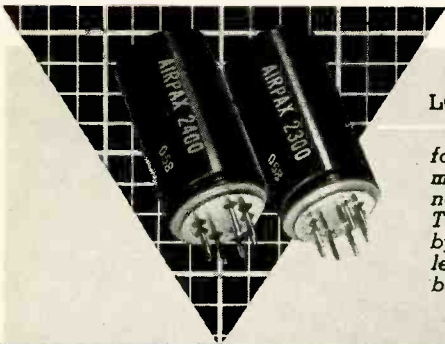

### LOW-NOISE CHOPPERS

for null-seeking servos and instrument amplifiers hold wide-band noise in the low microvolt range. This unusually low level is achieved by chopper construction. Even lower levels can be obtained in narrow-band applications by filtering.

# Low-Noise Choppers —from Airpax!

Airpax choppers Types 2400 (60-CPS) and 2300 (400-CPS) are specifically designed for use in low-level modulators. In most cases it is below the instrument background noise.

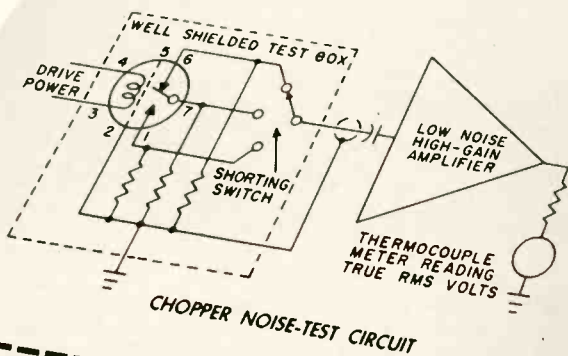

- CHOPPER CHARACTERISTICS**
- DRIVE:** 6.3 volts RMS
  - LIFE:** greater than 5,000 hours in usual applications
  - CONTACTS:** 0 to 2 milliamperes at 0 to 100 volts into resistive load
  - CASE:** hermetically sealed with 7-pin miniature base and drive coil leads out top—same size as other Airpax standard miniature choppers



Airpax Products Company, Cambridge Division, Jacktown Road, Cambridge, Maryland

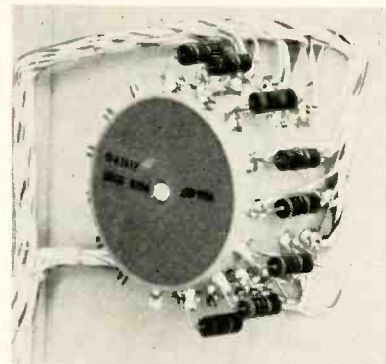

Assembled and installed in digital computer, magnetic-amplifier circuit removes d-c voltage to unit in which a fuse is open

anticipated. On several occasions, the magnetic amplifier has sensed an overload and turned the d-c voltages off before the fuse could actually clear the condition. Once the magnetic amplifier had even detected high-resistance fuses by turning the data-processor system off.

## Transistor Preamp Has Very Low Noise

By RENE N. FOSS

Electrical Engineer, Applied Physics Lab., U. of Washington, Seattle, Wash.

BROADBAND ultrasonic preamplifiers were required for use with hydrophones at locations many miles away. A gain of approximately 35 db at about 250 kc was needed with an extremely low noise figure (within 1 db of thermal).

An added requirement for the amplifier was that power to operate it (8 to 20 ma d-c) be fed down the same RG/8 coaxial cable used to transmit the signal. Thus it was not necessary to lay any additional wires or cable to the hydrophone site.

One of the difficulties encountered in designing these preamplifiers was obtaining transistors with sufficiently low noise figures. No data was available from manufacturers concerning the noise level of their transistors in this frequency region. Data for 1,000 cps was of no value.

The 2N123 transistor was found to have extremely low noise at these frequencies. Several hundred of these transistors have been used,



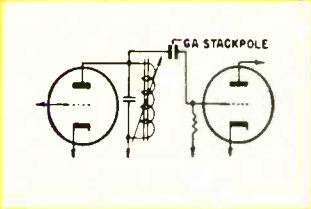
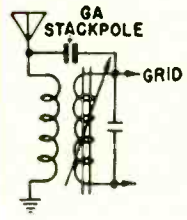
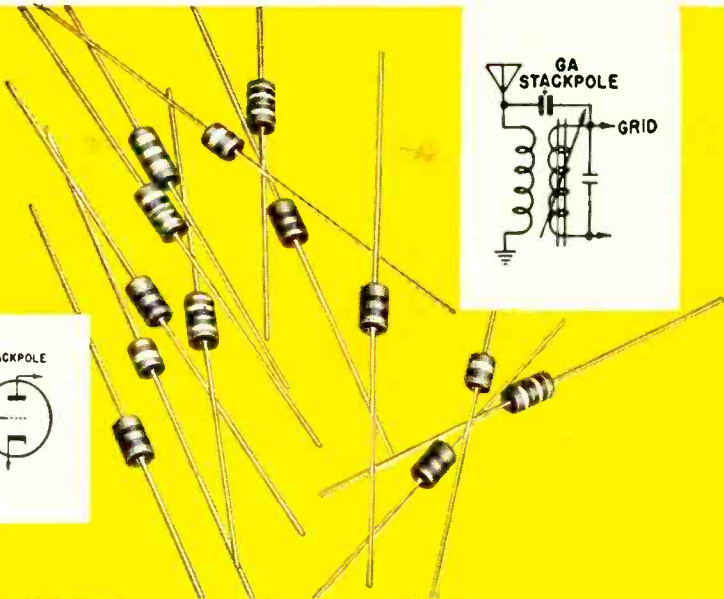

# CONVENIENT CIRCUIT COUPLING and BYPASSING... with the simplest, most inexpensive capacitor design yet produced

Pioneered by Stackpole, these sturdy little units make ideal low-cost coupling, bypass and neutralizing capacitors for TV, radio and military electronic equipment.

only 0.330" to 0.170" in length, Stackpole GA Capacitors have adequate stability and T.C. characteristics for a host of TV, radio and military electronic equipment uses.

Insulated bodies, dielectrics and electrodes are integrally molded for maximum stability and durability. Securely anchored leads are treated for easy soldering. Ranging in size from

Electronic Components Division  
**STACKPOLE CARBON COMPANY**  
St. Marys, Pennsylvania

**46 E.I.A.**  
**"preferred" values**  
0.10 TO 10.0  $\mu\text{f}$   
5%, 10% or 20% tolerances.  
Standard 3- or 4-band color code.



- Coldite 70+® fixed composition resistors
- Snap and Slide Switches
- Ceramag® ferromagnetic cores
- Variable composition resistors
- Ceramagnet® ceramic magnets
- Fixed composition capacitors
- Iron cores
- Brushes for all rotating electrical equipment
- Electrical contacts
- Hundreds of related carbon, graphite and metal powder products.

Available From Stock!

Additional New Features!

Moderately Priced!

# ERA's TRANSISTORIZED HIGH CURRENT REGULATED POWER SUPPLIES



Ratings  
up to 12 Amps!

### IDEAL FOR:

- Battery Substitution
  - Computers
- Transistor Bias
  - Motor and Relay Control
- Television
  - All High Current  
Laboratory and Industrial  
Applications

### SPECIFICATIONS

Models listed are designed for 105-125 VAC input, 60-400 cps. Continuously adjustable output. Line regulation is within  $\pm 0.5\%$ . Load regulation is within  $\pm 0.5\%$ . Frequency response of regulator extends into high audio frequencies. Ripple less than 0.05% or 5 mv. Current limiter control on front panel for full overload and circuit protection. Units are for bench or standard 19" rack mounting.

### FEATURES

- Continuously Variable Output
- Vernier Voltage Control
- Fast Transient Response
- Low Output Ripple
- Positive, Negative, Zero % Regulation Control
- Line Frequency Insensitive
- Remote Sensing
- Constant Current Overload Limit Control
- Positive or Negative Outputs Ungrounded
- Terminals On Front and Rear
- Hinged Panel For Full Accessibility
- High Efficiency
- Low Heat Dissipation
- Compact, Light Weight
- Instant Warm-up Time
- Moderately Priced

### TYPICAL STOCK MODELS

Model Number	Voltage VDC	Current Amps.	Output DC R (ohms)	Price FOB Factory
TR32-4	4-32	0-4	0.01	\$375.00
TR32-8	4-32	0-8	0.005	\$410.00
TR32-12	4-32	0-12	0.002	\$495.00

Additional stock models also available.

Special designs also made to customers specifications. Write for quotation.

### Pioneers in Semi-Conductor and Transistorized Products.

- First Miniaturized Power Packs.
- First Transistorized Power Supplies.
- First Automatic Transistor Test Equipment.
- First Dual Output Tubeless Supplies.
- First Packaged Transistor Circuits.
- First Transistor Application Power Supplies.
- First Constant Current Generators.
- First High Current Semi-Conductor Regulated Supplies.
- First "E" Core Transistorized Converters/Inverters.
- First High Power Semi-Conductor Frequency Changers.

Manufactured at ERA's New and Larger Facilities

**Electronic Research Associates, Inc.**  
67 Factory Place, Cedar Grove, N. J. CEnter 9-3000

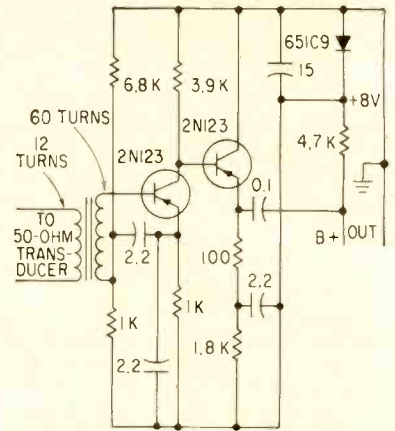

FIG. 1—Two-transistor ultrasonic pre-amplifier provides 35 db gain at 250 kc with very low noise

and well over 95 percent have been found to have excellent noise characteristics.

A schematic of the preamplifier is shown in Fig. 1. Actual maximum gain of the very broadband amplifier occurs at about 50 kc; at 250 kc, gain is about 35 db. The input transformer presents the base of the first transistor with an input impedance of 1,500 ohms, providing the transistor with a good input impedance with regard to noise. Output impedance of the amplifier is 50 ohms, so it can feed

## Tv Camera Preamp Uses Transistors



Transistors, used in the preamplifier of this new GE monochrome tv studio camera, are expected to reduce microphonics. High-pitched voices or sound waves tend to vibrate tube elements, producing annoying wavy lines on tv screen

# new **OAK** chopper needs no phase-shift circuit!



HAS 0° or 180°  
PHASE-LAG  
"DESIGNED-IN"

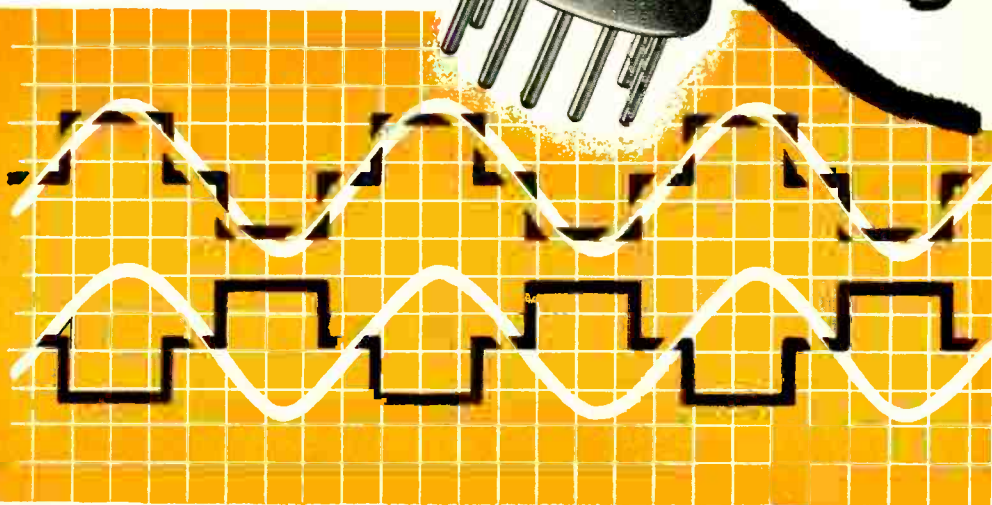

## SPECIFICATIONS

**Coil:** Current, 25 ma; impedance, 190 ohms; resistance, 160 ohms.

**Contacts:** Dwell time, 150-160°; rating, 100 V, 2 ma. Resistance, less than 200 milliohms.

**Phase Change:**  $\pm 10^\circ$  At constant 400 cps under all conditions of use and life.

**Noise:** Less than .5 millivolt RMS into 1 meg.

**Vibration:** 10-55 cps.

**Weight:** Less than 1 oz; dia. 11-16".

**Height:** Seated, 1 1/8".

Inherent in every device of the vibrating reed type are two phase-lags—an electrical phase angle resulting from the current lagging the applied voltage in the drive coil, and a mechanical angle due to the inertia of mass in the moving reed, lagging further behind flux from the driving current.

In OAK's new Type 605 Chopper, these two lags have been carefully brought to a total of 180°. Thus, the chopper can be so wired to be exactly 180° out of phase, or reversed to be 360° out (in phase). This design eliminates the R-C circuit ordinarily needed to bring this coincidence of voltage and output phase—saving circuitry, parts, and weight.



Shown at the left is the new chopper with side mount. Also available with flattened and pierced pins, solder loops, or as a vertical flange mount unit.



Dept. G, 1260 Clybourn Ave., Chicago 10, Illinois  
Phone: MOhawk 4-2222

Switches • Rotary Solenoids • Special Assemblies • Choppers • Vibrators

Use these new Beckman size 8's to design subminiature systems



Are you trying to design subminiature systems with oversize components? Here are seven dwarfs—a full line of size 8 servomotors—that do the work of 10's! Look at this storybook performance:

... torque and acceleration measure up to or surpass the best size 10's!

... seven models, three for operation at 115 volts, four at 26 volts!

... continuous operation at stall, both windings fully excited, to ambients of 130°C; total unit temperature to 200°C!

... stainless steel case, shaft and bearings; windings encapsulated for environmental protection—shock to 100G's, 30G's vibration to 2,000 cycles, exceeding MIL-E-5272A specs!

The secret? A new design, new laminations—and craftsmanship (a real secret, these days). Delivery? Thirty days or less.

We'll be happy to send you all details in Data File B 73.

BECKMAN SIZE 8  
2-PHASE AC SERVO MOTORS  
(no-load speed 6,000 rpm)

	Weight oz.	Length in.	Rotor Inertia gm. cm. <sup>2</sup>	Acceleration at Stall rad/sec <sup>2</sup>
<b>26-volt models</b> (torque at stall .25 oz. in., power input 2.3 watts)				
8 SM 420 servomotor	1.1	.840	.1	170,000
8 MG 420/410 servomotor-rate generator	1.9	1.350	.16	110,000
8 VM 420 velocity-damped servomotor	1.9	1.395	.24	73,000
8 IM 420 inertia-damped servomotor	2.0	1.355	.24	73,500
<b>115-volt models</b> (torque at stall .33 oz. in., power input 2.9 watts)				
8 SM 460 servomotor	1.6	1.165	.2	115,000
8 VM 460 velocity-damped servomotor	2.4	1.720	.34	68,000
8 IM 460 inertia-damped servomotor	2.5	1.680	.34	68,500

Helipot Corporation  
Newport Beach, California  
a division of  
Beckman Instruments, Inc.  
Canadian Factory:  
No. 3 Six Points Road  
Toronto 18, Ontario  
Sales Representative:  
R-O-R Associates, Ltd.  
1470 Don Mills Road  
Don Mills, Ontario

Beckman® Helipot

potentiometers . . . dials . . . delay lines . . . expanded scale meters . . . rotating components . . . breadboard parts

any length of 50-ohm cable.

The capacitor in the line blocks from the output stage the direct current being fed down the line for preamplifier power. The reactance of this capacitor had to be low at the operating frequency (250 kc). A Zener diode establishes operating voltage for the amplifier.

Other two-transistor broadband designs were made with 2N123 transistors (using transformer coupling between stages) having gains in excess of 60 db at 250 kc. However, they require neutralization and in general take many more parts. The circuit shown is thus appealing because of its relative simplicity.

### Noise Charts Aid Engineers

COMMUNICATIONS engineers are expected to get an assist from charts of radio noise levels from cosmic sources. The charts enable the user to determine the level of interference for a particular location at various hours of the day and for any day of the year.

The charts, developed by D. H. Menzel, director of Harvard College Observatory, include methods for conversion to other frequencies and bandwidths.

Detailed analysis of available noise surveys were the basis of the charts. They are broken into two parts—one for the northern and another for the southern hemisphere. Transparent overlays that can be rotated are used to determine actual conditions for a given time and location.

### British Tv Link To Use Twt's

THREE REPEATER stations will be placed in operation in England early in 1959. The 115-mile link will improve tv coverage by BBC in East Anglia.

The system, being installed by Marconi Wireless Telegraph, will use all travelling-wave tube techniques. It will handle 405 or 625-line signals. Color transmissions can be made without modification on either type of signal.

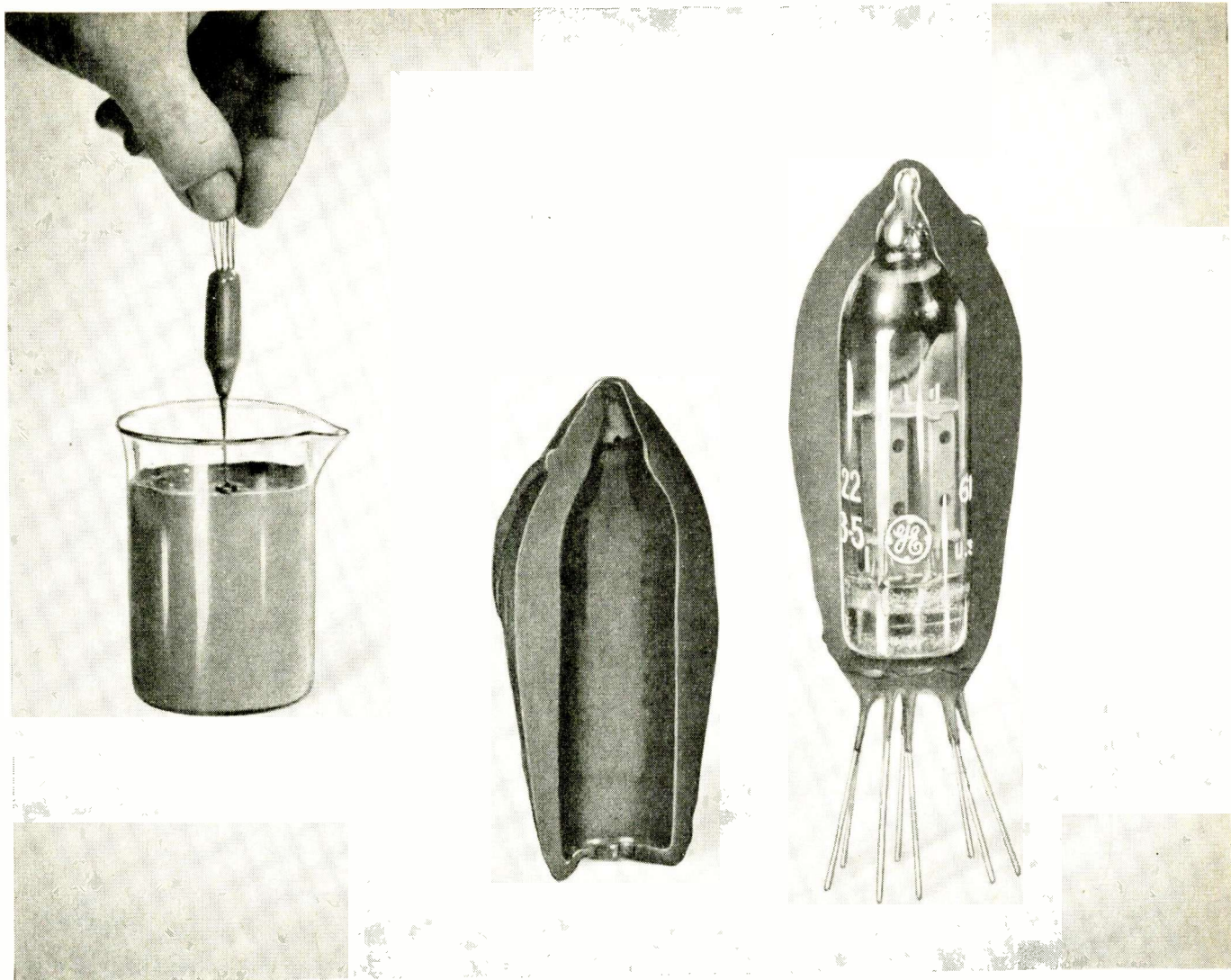

G-E RTV is an easily applied potting and encapsulating material. Tough, heat-resistant, resilient, it does not shrink or form voids during cure.

## ***New RTV silicone rubber from G.E.***

**CURES WITHOUT HEAT • LOW VISCOSITY • SOLVENT-FREE • NO VOIDS OR SHRINKAGE**

**CURES WITHOUT HEAT** G.E.'s RTV (room temperature vulcanizing) silicone rubber cures at room temperature in any time you select up to 48 hours. It comes in a wider viscosity range than any similar compound—from 250 poises (pourable) to 15,000 poises (spreadable). Easily applied by pouring, dipping, spreading or with a pressure gun.

**WON'T SHRINK, VOID-FREE** RTV compounds are 100% solids (no solvents). They cure without shrinkage; form no voids; provide resilient, shock-absorbent protection against physical damage or moist and corrosive atmospheres. Tensile and tear strength exceed those of previously available materials and are retained after prolonged heat aging.

**RESISTS HEAT ABOVE 300°C** General Electric RTV

silicone rubber keeps its high dielectric strength at temperatures above 300° C. It has the well-known properties of silicone rubber, such as ability to withstand moisture, weathering, ozone, corona, oxidation and exposure to fuels and solvents.

**IDEAL FOR POTTING AND ENCAPSULATING** General Electric RTV compounds flow easily into and around complex shapes. They are ideal for potting and encapsulating. Other uses include caulking and sealing in hard-to-reach places, performing "on-the-spot" rubber repairs, model making and molding in low-cost plastic tooling.

**For complete application data, check Reader Service Card. If you'd like a sample for evaluation, drop us a note telling us about your proposed application.**



# **GENERAL**



# **ELECTRIC**

Silicone Products Dept.

Waterford, N. Y.

*Advanced missile and space projects*

*require Engineers*

*and Scientists to work on*

# THE FRONTIERS OF SPACE

Lockheed Missile Systems Division, recently honored at the first National Missile Industry Conference as "the organization that contributed most in the past year to the development of the art of missiles and astronautics," holds such important, long-term projects as the Navy Polaris IRBM, Earth Satellite, Kingfisher (Q-5) target missile for the Army and the X-7 ramjet test vehicle for the Air Force.

To carry out such complex projects, the frontiers of technology in all areas must be expanded. High-level engineers and scientists are needed now for responsible positions in our Research and Development laboratories and in our project organizations.

If you are experienced in physics; mathematics; chemistry or one of the engineering sciences, your inquiry is invited. Please write Research and Development Staff, Sunnyvale 27, California. (For the convenience of those living in the East and Midwest, offices are maintained at Suite 745, 405 Lexington Ave., New York 17, and at Suite 300, 840 N. Michigan Avenue, Chicago 11.)

**Lockheed** / MISSILE SYSTEMS DIVISION

SUNNYVALE • PALO ALTO • VAN NUYS • SANTA CRUZ • COOKE AIR FORCE BASE, CALIF. • CAPE CANAVERAL, FLORIDA • ALAMOGORDO, NEW MEXICO

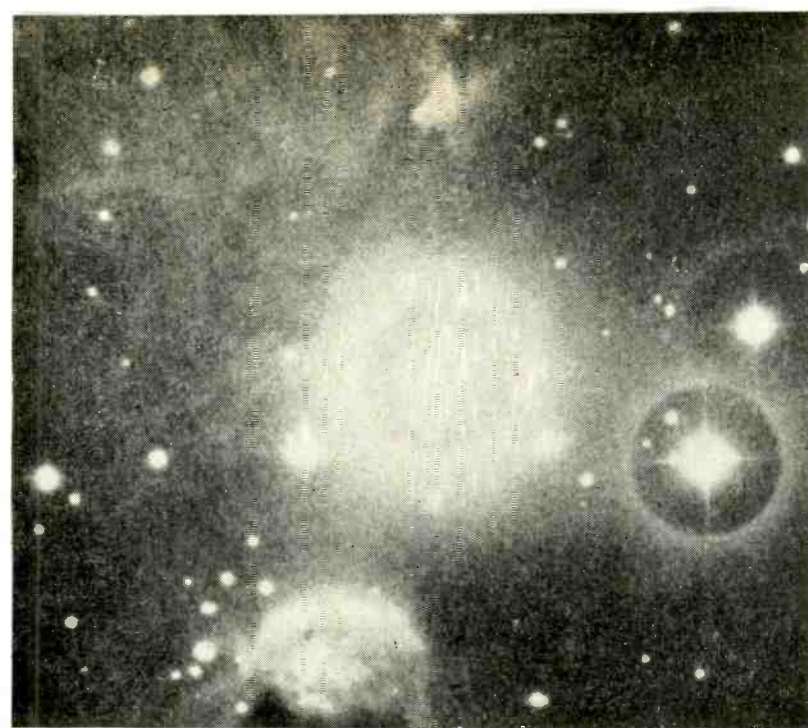

# TECHNOLOGY



## FLIGHT IN THREE MEDIUMS

Several things set the Polaris apart from other outer space weapons in the ballistic missile category, for the Polaris program involves a wholly new concept of weaponry.

1. It will be dispatched from beneath the surface of the sea.
2. It will be radically smaller than currently developed land-launched missiles, yet its payload will be as effective and its range the same as other IRBMs.
3. It will be the first operational outer space missile to employ solid fuel as a propellant.
4. It will travel through three mediums in a single flight—water, air and outer space.
5. Its launching base—a submarine—is not fixed but a mobile vehicle.

## OUTER SPACE PROGRAM

Very little can be said about the Earth Satellite program at this time except that its success will necessitate advancing the state of the art in all sciences.

The Earth Satellite Project is perhaps the most sophisticated outer space program to reach the "hardware" stage in the U.S. today.

## ENEMY SIMULATOR

The Lockheed Kingfisher Q-5 is the nation's fastest target missile, developed for the Air Force to test the accuracy of our newest supersonic weapons.

It is a ramjet target vehicle with Mach 2-plus capabilities. The Q-5 not only has speed to match the defensive missiles, but can also simulate a vast array of supersonic enemy missiles and airplanes attacking from great height. It is instrumented to score near misses and even theoretical hits without itself being destroyed.

It is recoverable from flight by parachute to be flown again, permitting weapon system evaluation to be conducted at greatly reduced cost.



# ENGINEERS . . .

*with Creative Imagination  
probe physical universe  
at Cubic Corporation*

Cubic Engineers, endowed with creative imagination, successfully developed a single system for the simultaneous tracking or guiding of five or more anti-bomber or anti-ICBM missiles.

At Cubic Corporation creative imagination is continuing to broaden the scope and realization of such versatile systems as MOPTAR, which is completely mobile and capable of operating in the most stringent missile environments.

**YOU**, who enjoy the creative challenge of scientific and technical developments which probe the very nature of the physical universe, should talk to Cubic!

Cubic Corporation **EIGHT NOW** affords Engineers and Scientists the opportunity to grow and gain added prestige in such advanced fields as:

Advanced Mathematics	Airborne Packaging
RF-UHF-MF	Digital Data Handling
Antenna Propagation	Electronic Circuitry

At Cubic Corporation in beautiful, equable-climated San Diego you will be associating with a company in which creativity is required, recognized, rewarded.

*Write or phone*

Mr. Joseph Devlin  
5575 Kearny Villa Rd.  
San Diego 11, Calif.  
BRowning 7-6780





# Nickelonic News



DEVELOPMENTS IN NICKEL AND NICKEL ALLOYS AND THEIR APPLICATIONS



## Underseas two years: Atlantic phone cable amplifier tubes retain full emission, promise 20 years continuous service

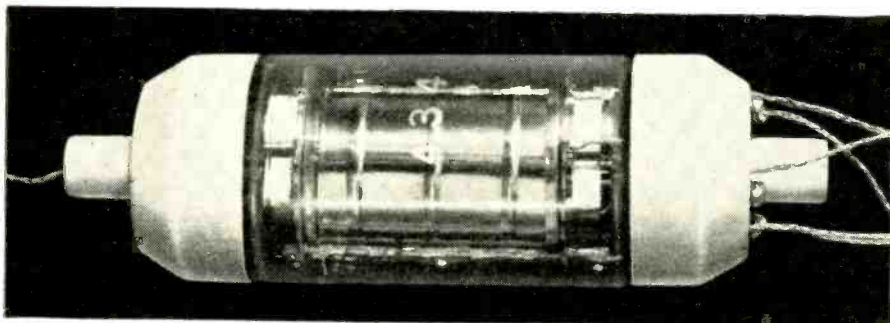

**175HQ amplifier tube** used in underseas phone cable repeaters. There are 306 tubes in the Atlantic cable. All rely on parts made of Nickel.

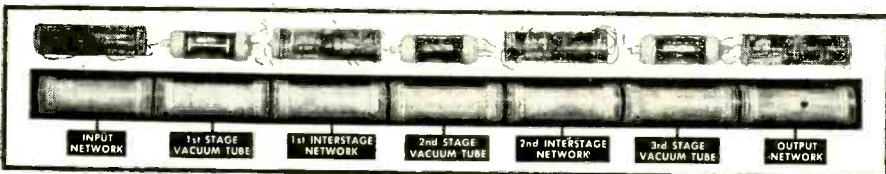

**Nickel parts are essential** in the 175HQ tubes, shown in this portion of phone cable repeater unit. Tubes designed and built at Bell Telephone Laboratories, Inc.

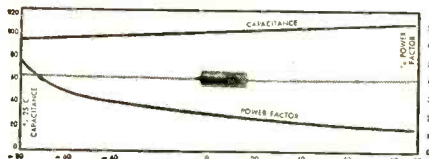

**New G-E Solid Tantalytic Capacitors.** Electronic grade "A" Nickel lead wires help make it rugged.

### Small, rugged electrolytic capacitor... Nickel leads boost its strength

HUDSON FALLS, N. Y.: The new Solid Tantalytic® capacitor is designed for low voltage circuits — its capacitance changes not more than 20% from +85°C down to -80°C. General Electric designers gave it unusual resistance to mechanical shock with Electronic grade "A" Nickel lead wires. They chose Nickel for three good reasons: (1) welds easily — high thermal coefficient of electrical resistivity aids

\*Trademark, The International Nickel Co. Inc.

quick, strong spot welding. (2) solders easily — speeds hermetic sealing, and assembly into circuits. (3) meets stringent mechanical specifications — leads (0.0201" diameter) withstand 30 second pull test of 3 pounds, four 90° alternate bends.

**Pertinent literature:** Write for "Inco Technical Bulletin T-15".

©General Electric Co.

### Non-magnetic Monel "403" alloy aids precise tuning by klystron bellows

SAN BRUNO, CAL.: The low permeability of Monel "403" non-magnetic nickel-copper alloy (1.1 max. at 27°F) in the tuning bellows of this new Eimac X-639 Klystron permits precise frequency adjustment without disturbing the tube's magnetic circuit. And... the good forming and brazing characteristics of Monel "403" alloy make for easy bellows manufacture.

Inco Nickel for the cathode assures stable emission characteristics. Electronic grade "A" Nickel for the focus electrode is readily formed, does not contaminate vacuum. Monel nickel-copper alloy for the neck provides strength at elevated temperatures... withstands oxidation and corrosion.

**Pertinent literature:** Write for Inco Technical Bulletin T-5.

Nickel and Monel alloys aid manufacture, operation of this Eimac X-639 Klystron by Eitel-McCullough, Inc. Delivers 50 watts in 7100-8500 mc range.

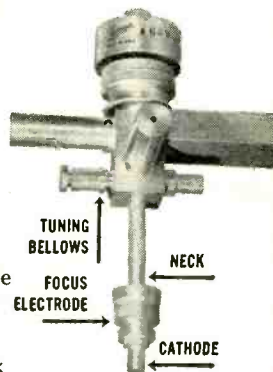

MURRAY HILL, N. J.: These Atlantic phone cable tubes *must* have long, no-failure lives — tube replacement costs run to half a million dollars each!

Designers at Bell Telephone Laboratories have left nothing to chance in developing this kind of reliability. They use Nickel in many parts of the 175HQ amplifier tubes for both cables of the Atlantic phone system. Experience backs up their use of Nickel. The very first telephone cable to use these tubes — Key West-Havana — have had no tube failures in over 8 years!

**These repeater tubes** rely on Inco Nickel and Nickel alloys in 12 parts — cathode lead, connector, tubing and sleeve; getter tapes and flag; electrostatic shield wings and Nickel-plated steel shielding; Nickel anode side rods; eyelets in mica; connecting tape; and carbonized Nickel in control grid radiator.

**The record proves** that electronic grades of Nickel and its alloys, now freely available, possess high strength at high temperatures, outstanding vacuum characteristics, good weldability and the ductility needed for intricate forming operations.

**Pertinent literature:** Electronic grades of Nickel and Nickel alloys (such as "330" Nickel for anodes, "D" Nickel for supports) with their uses, are detailed in "Inco Nickel Alloys for Electronic Uses." Write for a copy.



THE INTERNATIONAL NICKEL COMPANY, INC. • 67 Wall Street • New York 5, N. Y.



## Box-Shaped Tube Envelope

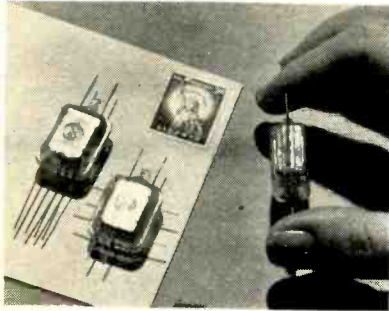

A CUBICAL ENVELOPE developed by Westinghouse has structural advantages which enhance tube reliability and provide a convenient tube shape. Tube leads are all in one plane making the lead welds to the mount structure more accessible and subject to control. The design is applicable to a complete line of receiving tubes and uses the same electrode structure as conventional receiving tubes.

### Shock and Vibration

High-dimensional accuracy of protrusions for locating the mica spacers eliminate the need for mica serrations and decrease the danger due to loose particles and gas. Since the mount structure is locked within the envelope, microphonism and resistance to severe vibration and shock are improved.

The envelope shape permits

flexibility for equipment designers. Tubes can be recessed or strapped onto printed circuit boards. If desired, the straps can serve as an effective heat sink.

Mechanized feeding to printed circuit boards and chassis is possible because of the rectangular shape. If a high-temperature envelope material is used, size of the new tubes can be reduced. The box shape is well suited to the tight space requirements of modules and subassemblies. Since the tube socket is eliminated, noise and circuit capacitance is reduced.

Larger lead spacing is possible minimizing pickup and making soldering easy. Lead arrangement can be designed to fit the circuit.

## I.O. Tube For Night Reconnaissance

A NEW CAMERA TUBE based on tv principles picks up scenes at light levels 100 to 1,000 times below those needed for conventional pickup.

Extreme sensitivity claimed for the tube is achieved by two "intensifier stages" placed between the pickup face and the signal output assembly at the rear. The tube am-

plifies light intensity many times.

In the intensifier orthicon, electrons emitted into the tube from the front face area go to an intensifier screen which emits from ten to twenty electrons for each one that strikes it. Since the tube uses two such screens, approximately 300 electrons are provided to the signal output assembly for each one that leaves the faceplate.

The new device was developed by RCA in a program sponsored by the Aeronautical Research Laboratory at Wright Air Development Center. Its potential value to astronomy has been emphasized.

The tube may enable astronomers to observe previously unseen details of plants and nebulae. It will also permit visual reconnaissance in almost complete darkness.



Two intensifier stages increase electron flow approximately 300 times

## Counting Done by Frequency Division

A STABLE AND RELIABLE binary divider has been developed by the combination of two magnetic memory cores and a transistor. The dividers can be cascaded to produce a division ratio of 2 to the  $n$  power where  $n$  is equal to dividers in the chain.

Simple feedback circuits alter the

ratio of any group of dividers and provide a means for obtaining any required division less than  $2^n$ . Each binary divider is mounted on a printed circuit board and solidly encapsulated in epoxy resin. Overall size, exclusive of connecting pins, is  $1 \times 1 \times \frac{3}{8}$  in. Connecting pins are arranged at one end with spacings

and sizes that are intended for direct mounting to larger printed circuit boards.

Fig. 1 illustrates an arrangement for obtaining a 1,000 cycle pulse output from a 100-kc sine wave frequency standard. Inductor  $L_0$  is a saturable reactor or memory core. It is required for input frequencies

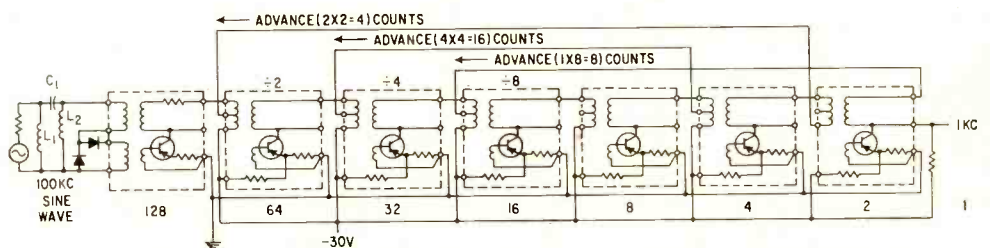
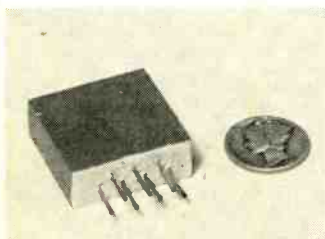

FIG. 1—Seven binary dividers in cascade produce an output pulse for every 128 input pulses. The feedback loops were selected to reduce the input from 128 to 100. The "Advance (4) Counts" circuit is fed back at a point which reduces the input count required by 4; the other two feedback circuits reduce the input count required by 16 and 8, respectively. Overall input requirement is therefore reduced by 28 allowing a 100-kc input to produce a 1-kc output

*faced with a tough design problem?*

*Rugged*  
**ALSiMAG<sup>®</sup>**  
**ALUMINA CERAMICS**  
*may be the answer!*

For exacting applications, your chances are better with ALSiMag because more special-characteristic Aluminas are available here than from any other source. You benefit from extra "know-how" . . . years of experience in producing simple and complicated Alumina parts in a broad range of shapes and sizes . . . plus equipment for rapid delivery in any quantity. Precision tolerances. Prototypes before tooling, if you like.

Advantages like these give you greater freedom: Tensile strengths up to 25,000 lbs./sq. in. Compressive strengths up to 420,000 lbs./sq. in. Flexural strengths up to 62,000 lbs./sq. in. Superior electrical characteristics. Safe operation at continuous temperatures up to 2952° F. Loss factors as low as .0074 at 10,000 MC.

Not all applications need such advanced properties. A standard ALSiMag material—from the industry's widest selection—may meet your specifications. Let us help match your requirements to the ALSiMag material that will do the job at lowest cost. Premium ALSiMag Aluminas will be suggested only where superior performance is needed. Send blueprint or sketch with details of operating conditions.

A Subsidiary of  
Minnesota Mining and  
Manufacturing Company

**AMERICAN LAVA**  
**CORPORATION**

CHATTANOOGA 5, TENN.

56TH YEAR OF CERAMIC LEADERSHIP

For service, contact American Lava representatives in Offices of Minnesota Mining & Manufacturing Co. in these cities: (see your local telephone directory): Atlanta, Ga. • Boston: Newton Center, Mass. • Buffalo, N. Y. • Chicago: Bedford Park, Ill. • Cincinnati, O. • Cleveland, O. • Dallas, Texas • Detroit, Mich. • High Point, N. C. • Los Angeles, Cal. • New York: Ridgefield, N. J. • Philadelphia, Pa. • St. Louis, Mo. • St. Paul, Minn. • So. San Francisco, Cal. • Seattle, Wash. • Canada: Minnesota Mining & Manufacturing of Canada, Ltd., P. O. Box 757, London, Ontario. All other export: Minnesota Mining & Manufacturing Co., International Division, 99 Park Ave., New York, N. Y.

RBM  
98000  
SERIES

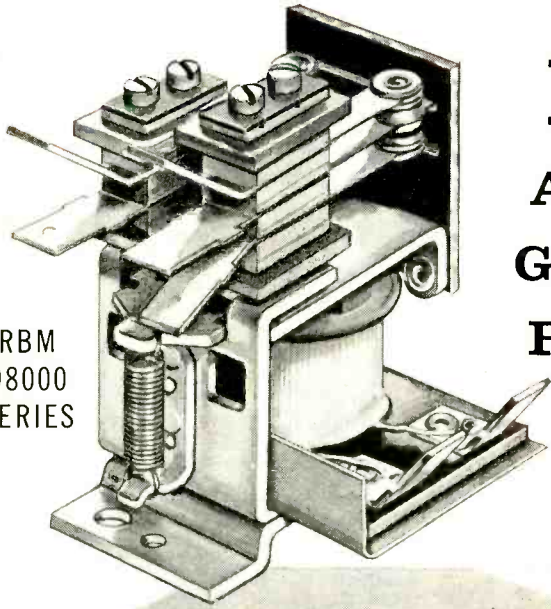

# RBM

## AC OR DC

## GENERAL

## PURPOSE

## RELAY

Since the basic relay and its many contact forms, ratings, and terminal variations are regular production items at RBM, design bottlenecks can be shattered. RBM has "CUSTOMER-ized" these relays to fulfill almost every conceivable requirement. This vast background of application engineering can serve you with design shortcuts... lower your "finished product" cost. Ask your RBM product application engineer.

*RBM'S VERSATILITY PERMITS ENGINEERING SHORT-CUTS  
THAT LOWER YOUR "FINISHED PRODUCT" COST!*

MANY ARE LISTED BY U/L  
FILE NOS. E12139 OR E22381



PRESSFIT PILE-UP  
ELIMINATES DRIFT,  
ASSURES CONTACT  
STABILITY

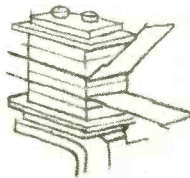

DEPENDABLE CROSS-BAR  
CONTACTS AVAILABLE  
FOR LOW VOLTAGE AND/OR  
LOW CURRENT CIRCUITS

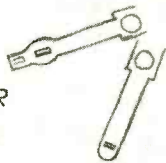

SIMPLIFIED MAGNET  
FRAME AND ARMATURE  
ASSEMBLY PROVIDES  
EFFICIENT, POSITIVE  
ACTION

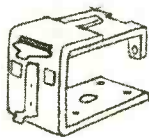

VARIETY OF  
MOUNTINGS AVAILABLE

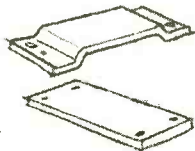

### OTHER FEATURES

	AC, 98700 TYPE	DC, 98600 TYPE
• MAX. COIL VOLTAGE	230 AC	115 DC
• MAX. COIL RES. IN OHMS	—	20000
• MAX. COIL WATTS OR VOLT AMPS.	9.0 V.A. INRUSH 6.5 V.A. SEALED	4.0 W.
• MAX. CONTACT FORM WITH RATED CURRENT AT 32 V. DC OR 115 V. AC (NON-INDUCTIVE LOAD)	2 PDT 15 AMPS. 4 PDT 6 AMPS. 6 PDT 3 AMPS	2 PDT 15 AMPS. 4 PDT 6 AMPS. 6 PDT 3 AMPS.
• APPROX. WEIGHT	4.1 OZ.	4.1 OZ.

ALSO AVAILABLE IN 97000 SERIES  
PROVIDING ADDITIONAL COIL  
POWER... GREATER SENSITIVITY

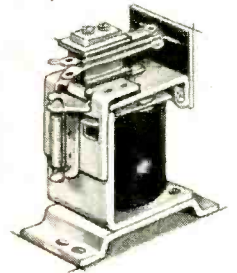

Consult Your Local RBM Product Application Engineer or Write For Bulletin 1060

# RBM Division

ESSEX WIRE CORPORATION, LOGANSPORT, INDIANA

between 0 and 50 kc. A 100 to 1 division from a 1-mc standard is also possible.

Other models of this binary divider are available for operation at input prf's of 1 and 5 mc. Higher frequency units are under development by the manufacturer Rixon

Electronics, Silver Springs, Md.

Terminal arrangement was chosen for most practical application to printed circuit boards, however, where thickness must be minimized, terminal pins can be brought out one side rather than the end as illustrated.

## Ceramic Receiving Tube Report

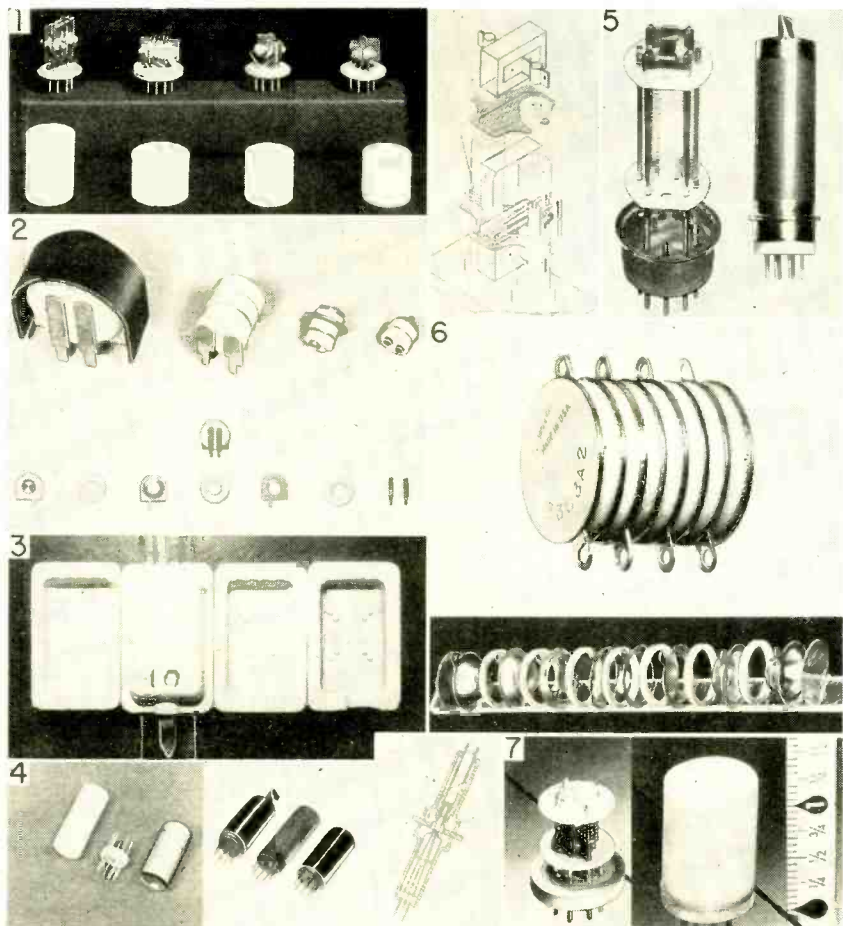

Ceramic tubes: 1. Four Sylvania tubes and structural details of stacked mount; 2. General Electric ceramic tubes and assembly of Z2354 triode; 3. Westinghouse "Pyroceram" vessel; 4. RCA ceramic tubes and cross-sectional view of "pencil" tube structural principals; 5. Bendix TE-31 power pentode; 6. Eimac double triode with separate cathodes; 7. Raytheon QM676—an r-f pentode similar to a 6AK5

THE PRESENT TECHNICAL position of various structural approaches for ceramic tubes is outlined in a report of the Advisory Group on Electron Tubes, an agency of the Assistant Secretary of Defense, Research and Engineering.\* Ceramic-seal techniques preferred on the different projects and the various tube types which might appear as a result of the development work now in progress are discussed. Present objective requirements of the

different projects are commented on also. Emphasis is placed on the technical aspects of the work.

Development of ceramic receiving tubes in this country has received the support of the military departments to the extent of several million dollars. In addition a somewhat smaller, but by no means insignificant amount, has been invested directly by industry. At present there are eight different active projects and one completed project; five of these have



They can be your design assistants on other Essex Engineered Products.

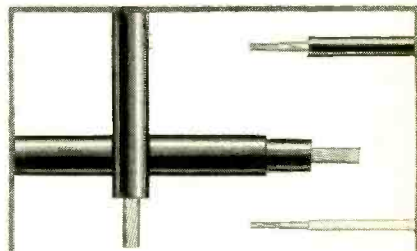

### WIRE AND CABLE

A complete line of appliance wiring material, radio, television and electronic hook-up wire, 200° C high temperature Sil-X wire, automotive wires and cables, and flexible cords.

Wire and Cable Div., Ft. Wayne, Ind.

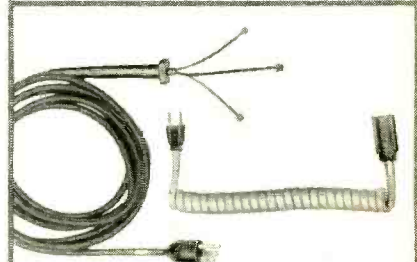

### COILED CORDS-CORD SETS

Prime source for plastic and rubber power supply cords. Terminations of all types (molded plastic and rubber) with infinite design possibilities. Complete line of Coiled Cords including HPN.

Write for Coil Cords Literature  
Cords Limited Division, DeKalb, Ill.

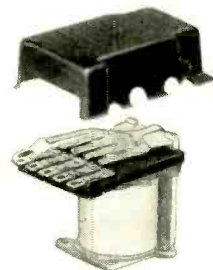

### TYPE MS RELAY

A low cost, space saving single pole or common multiple contact D.C. unit. Highly reliable. Can be built to withstand extreme environmental conditions.

Write for Bulletin MS-3  
R-B-M Control Div., Logansport, Ind.



## ESSEX

WIRE CORPORATION

CIRCLE 69 READERS SERVICE CARD

# NEW PRECISION VARIABLE RESISTOR with no sliding wiper

By

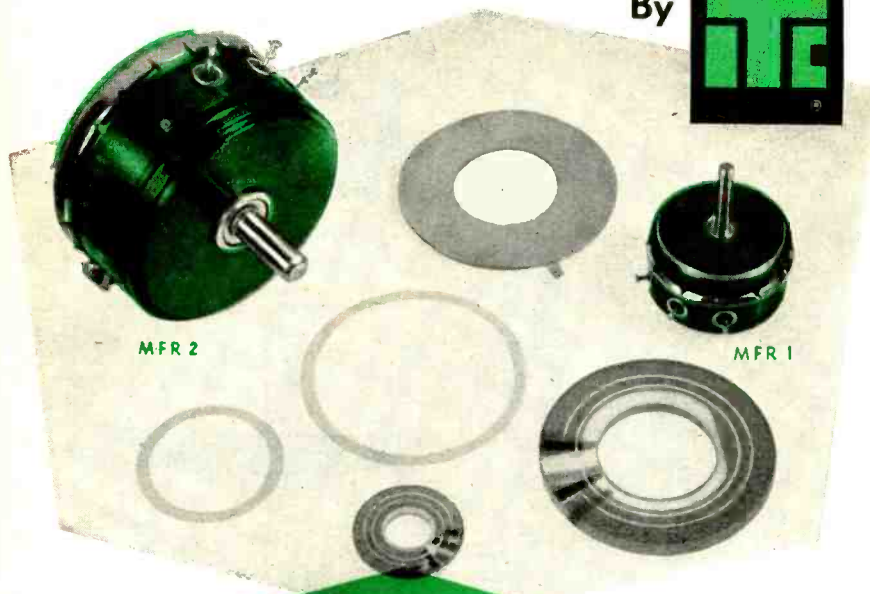

These Rotary Metallic Film Potentiometers are the perfection of years of research and development

*Super reliability is inherent through unique manufacturing techniques*

## FEATURES:

- Complete Hermetic Seal
- Infinite Resolution
- High Temperature Operation
- Long Life
- Low Torque
- Exceptionally High Accuracy
- Extremely Low Noise

A patented compression contact eliminates the wear or friction caused by usual wiper contacts. A precious metal capsule contact provides dependable long life operation. The deposited metal film resistance element is encased and hermetically sealed. The ultimate in craftsmanship is employed in the manufacture to produce a potentiometer unparalleled for performance. This new concept of design makes possible super reliability under the most severe environmental conditions such as those encountered in airborne, missile and satellite applications.

*Details will be sent upon request.*



## TECHNOLOGY INSTRUMENT CORP.

569 Main St.  
Acton, Mass.  
COlonial 3-7711

P. O. Box 3941  
No. Hollywood, Calif.  
POplar 5-8620

received military support and four have been industry supported. Of the latter four at least one is currently being negotiated.

A review of each of the projects is given. No significance is to be attached to the order in which these projects are presented.

### Military Sponsored Projects

The basic design of Sylvania tubes is illustrated in insert 1. The stem or header consists of a high-alumina body ceramic wafer through which tantalum leads, placed to fit standard sockets, are sealed by means of the active-alloy process using a nickel-titanium solder. A stacked mount with planar geometry is fabricated as a unit and spot-welded to the header. Effort has been directed toward the following types of tubes: SN-1724F (6J6); SN-2146B (6AQ5); SN-2358A (6111); SN-1809A (6AK5); SN-2360A (6206); SN-2359A (6112); SN-2361A (5977); SN-2145B (6AL5); and SN-2362A (6788). The first two types have been passed to users for trial.

The design approach in the Eitel-McCullough project is shown in insert 6. The structure is a stacked mount in which sections of the ceramic envelope become spacers for the elements. Tubes under development, or considered for development are: CD16 (6SN7); CD18 (6AK5); CD19 (6C4); CD22 (6AQ5); CD24 (6SL7); CD25 (6AL5); CD26 (2C51).

The general structure of the Bendix Aviation tubes is shown in insert 5. Life tests indicate that the tubes developed will meet a 400C ambient.

The present contract calls for the production for evaluation of 500 each of the following types, and the establishment of facilities to supply 10,000 of each type, monthly: TE-31 (6L6); TE-32 (half 6AS7); TE-33 (half 5R4); TE-34 (6AG7).

A Signal Corps study contract with Raytheon completed in 1956, produced a conventional glass envelope tube—the QM619—which was capable of withstanding severe shock and vibration environmental conditions. The electrical characteristics are very similar to those of the 6AK5,

# THE GRANT MARK II THINSLIDE HAS MET WITH IMMEDIATE APPROVAL!

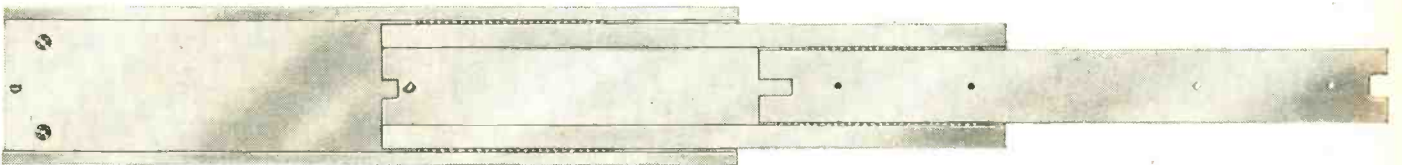

*and here's why...*

It is the lightest, most compact and smoothest operating slide available with non-binding, non-walking and non-friction action.

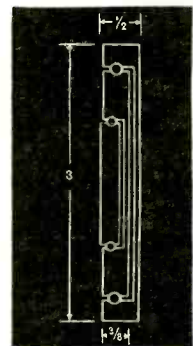

The Mark II Thinslide is available in lengths from 12" to 24".

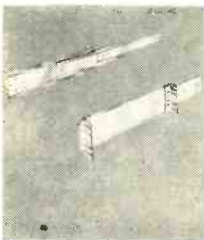

*Designed specifically for mounting to standard relay racks—needs only 3/8" side space. Requires no modification to cabinet or chassis.*



*For loads up to 100 lbs.*



*The only extruded aluminum thinslide with stainless steel ball bearing action—slide is corrosion resistant.*



*Space-saving — eliminates need for rear access doors and aisles.*



*Tested under most adverse conditions — meets military specifications.*



*Can lock and tilt in plus 45° and 90° positions.*



Write for additional data on the Mark II — you'll be happy you did!

*Grant Pulley & Hardware Corporation*

23 High Street, West Nyack, New York 944 Long Beach Avenue, Los Angeles 21, California



SEE THE GRANT EXHIBIT AT THE WESCON SHOW — BOOTH NO. 132

"Chesty" says: "Get acquainted  
with the wire that has the



**engineered  
personality!"**



# CHESTER

*plasticord-plasticote*

## WIRES and CABLES

Though most wires look alike, there is a difference. At Chester, we think of this as wire personality. Chester wires and cables reflect their background . . . ultra-modern production facilities, selected raw materials, exacting manufacturing methods supervised by engineers who are wire and cable specialists.

And every type of Chester conductor is *especially engineered for its recommended application*. The next time you need an insulated conductor, inspect a Chester sample first! Our engineers will be happy to show you how the wires with the *engineered personality* can help solve your wiring problems!



**CHESTER**

A Subsidiary of Miami Copper Company

CHESTER, NEW YORK, U.S.A.

**CABLE  
CORP.**

Pioneer Producers  
of Plastic Insulated  
Wires and Cables since 1940

CHESTER CABLE CORP., CHESTER, N. Y.

- Have a sales engineer call  
 Send data and sample on the following wires

B

Send for  
Wire Samples  
and Data Sheets

NAME..... TITLE.....  
COMPANY.....  
STREET.....  
CITY..... ZONE..... STATE.....

Fill out coupon and  
mail, today! Use the  
margin space below  
coupon for additional  
wire data requests.

except for Gm which is approximately 4000 micromhos.

Conventional mica spacers and a soft glass envelope limited the environmental temperatures in this tube to below 200 C. The possibility of operating up to ambient temperatures in the 400 C region has led to the ceramic structure of insert 7.

### Non-Military Sponsored Projects

The mount design for RCA ceramic tube is derived from the "pencil" tube structure, but specific features of the S-band tube are incorporated in the ceramic subminiature tube. Because mica insulators are not necessary with this design, the problems of mica decomposition at high temperature and mechanical failures, associated with micas, are eliminated. Insert 4 is a photograph of the ceramic stem, and the ceramic and metal bulbs.

The basic philosophy adopted at General Electric was that used in the original "light-house" tubes, where the sandwich-type planar construction gave inherently high-shock resistance, and also extremely low lead inductances.

Construction of the power triode, is shown in insert 2.

Westinghouse has seen possibilities in the use of the new Corning glass-ceramic materials—"Pyroceram," and it is working closely with Corning Glass Works to make some of the materials adaptable to tube envelopes, Insert 3. Since the softening of the new materials occurs in a range of from 1,150 to 1,350 C, tube processing temperature of 700 to 800 C appear to be feasible.

### Conclusions

As a result of the survey the ad hoc committee felt that ceramic tubes now under development offer potential advantages in: a. Improved quality through higher processing temperatures, b. Operation at higher ambient temperature, c. Increased resistance to nuclear radiation, d. Increased ruggedness, and e. Reduced microphonism.

\*Members of the ad hoc committee were: J. C. McNally, Bell Telephone Laboratories; W. H. Kohl, Stanford University; J. R. Wilson, Bell Telephone Laboratories; A. K. Wright, Tung-Sol Electric and representatives in each of the three military services.



# For the Who's Who in Microwave Engineering

## Here's the "What's New" in Microwave Equipment



# PRD New 160 Page Catalog

Covering the most complete line of microwave equipment, designed for a high ratio of signal (technical data) to noise (generalities), this book is much more than a catalog. Functionally organized, conveniently arranged, it provides an informative guide with quick readout of what you want to know. Basic engineering considerations are included as well as precise performance data.

To place yourself on PRD's "Who's Who" list to receive this 160 page reference volume, send us your name and title . . . on your company letterhead, please.

With this catalog, you can preview the newest in microwave equipment . . . even before you see it at PRD's WESCON Booths 1357-1358 . . . if you write us . . . right now.



**POLYTECHNIC RESEARCH & DEVELOPMENT Co., Inc.**

202 Tillary Street, Brooklyn, New York • UL 2-6800

CIRCLE 73 READERS SERVICE CARD

## Flame Jets Replace Slow Annealing in Oven

By W. HAROLD SMALL, Raytheon Manufacturing Co., Waltham, Mass.

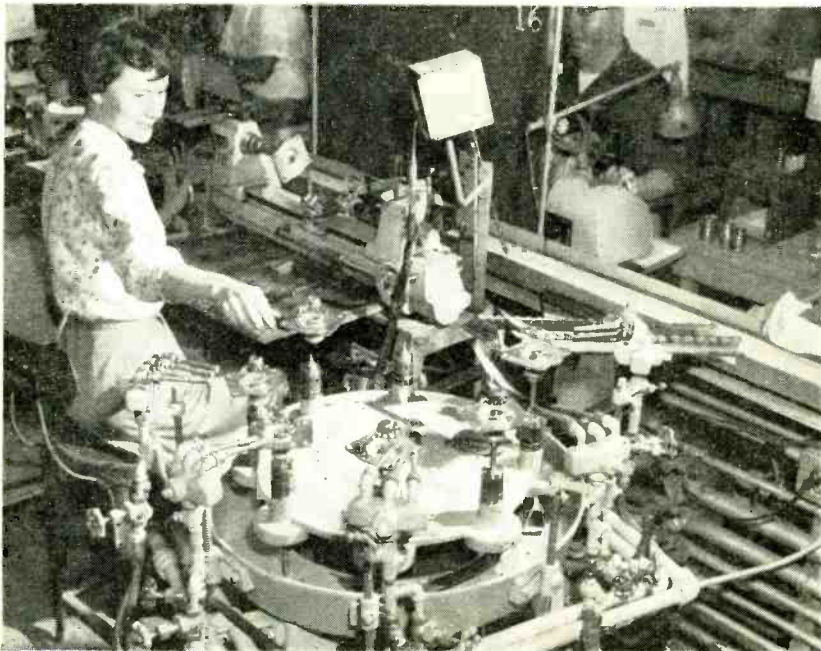

Operator loads hot magnetron assemblies on spindles of rotary annealer

AUTOMATIC MACHINERY tempers glass sub-assemblies of magnetron tubes at Raytheon's power tube plant. Annealing time is cut from hours to minutes, with savings as high as 24 cents per tube.

The annealing machine employs a rotary conveyor (converted from

a glass-stem sealing machine) with 8 radial fixtures. Each fixture is a tapered rod with a metal collar which carries the work at the proper height through the flames. Table is driven by a 110 v a-c motor.

To load the machine, the operator picks up the subassemblies with

tongs and places them on the rods. Subsequent operations are entirely automatic.

Every 14 seconds the 8 fixtures are automatically indexed 45 degrees. This brings them successively in line with a series of 5 gas jets. Flame temperature, approximately 400 C at the first jet, drops to 100 C in the cycle.

Fixtures bear on an inclined track which gradually raises them as they advance beyond the fifth position. At the final position the track ends, the fixtures drop and the work is deposited by a chute onto a belt conveyor which takes it to the in-line inspection station.

To cope with strain produced by the previous sealing operation, multiple flame heads pinpoint direction of heat to strain areas. Four jets are used at the first station, only 2 jets at the last. Flame temperatures at each station are preset and maintained by mixer valves.

Since the fixtures are much smaller in mass than the sub-assemblies, they heat up rapidly to approximately the same temperature.

The drive and indexing mechan-

## DESIGN TRENDS: Chocolate Bar Modules in Camera

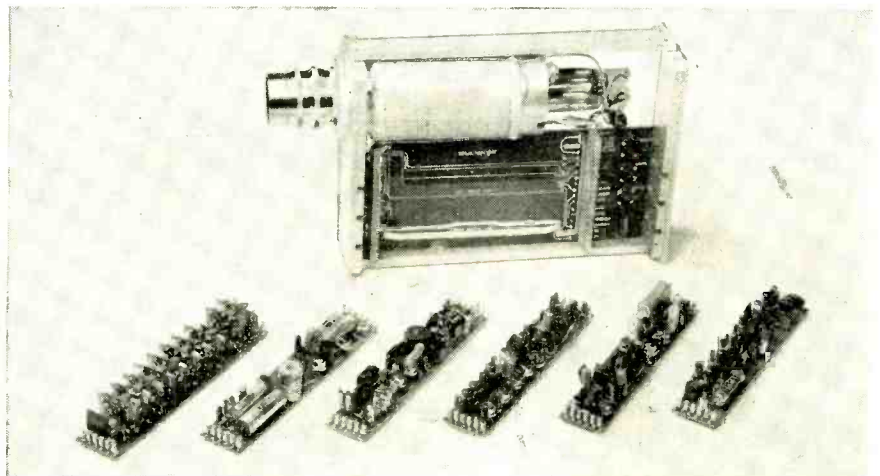
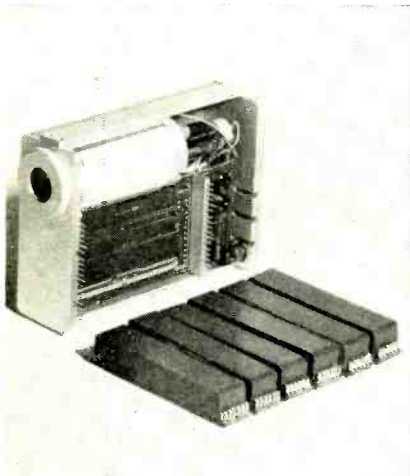

Transistorized modules, potted in bars and plugged into a central printed circuit board, are used in this tv camera designed by Dage Television Division, Thompson Products, Inc., Michigan City, Ind., for military, aviation and broadcasting use. Unit weighs 4 pounds, draws under 7 watts and measures 2 $\frac{3}{8}$  by 5 $\frac{3}{8}$  by 7 $\frac{1}{4}$  inches. Modules, shown potted and unpotted, are video and sweep amplifiers, sync generator, binary strip, oscillator and power supply. Camera contains no operating controls, uses single coaxial cable. Video signal may be carried 2,000 feet by cable, or 5,000 feet with transistorized line amplifier. Power from battery, adjacent a-c or d-c source, or remote d-c source may be used. Case is machined aluminum with sheet aluminum side panels. A 10-pound, 10-watt monitor being developed will have a volume equal to a box the size of the crt

FOR ANY KLYSTRON NEED — SEE SPERRY

SPERRY made microwave radar possible by developing the klystron 20 years ago. Since then, Sperry klystrons have become the design choice in every radar field — from missile guidance to the most accurate radar test equipment. For example:

## Low-voltage reflex klystron for testing X-band radars

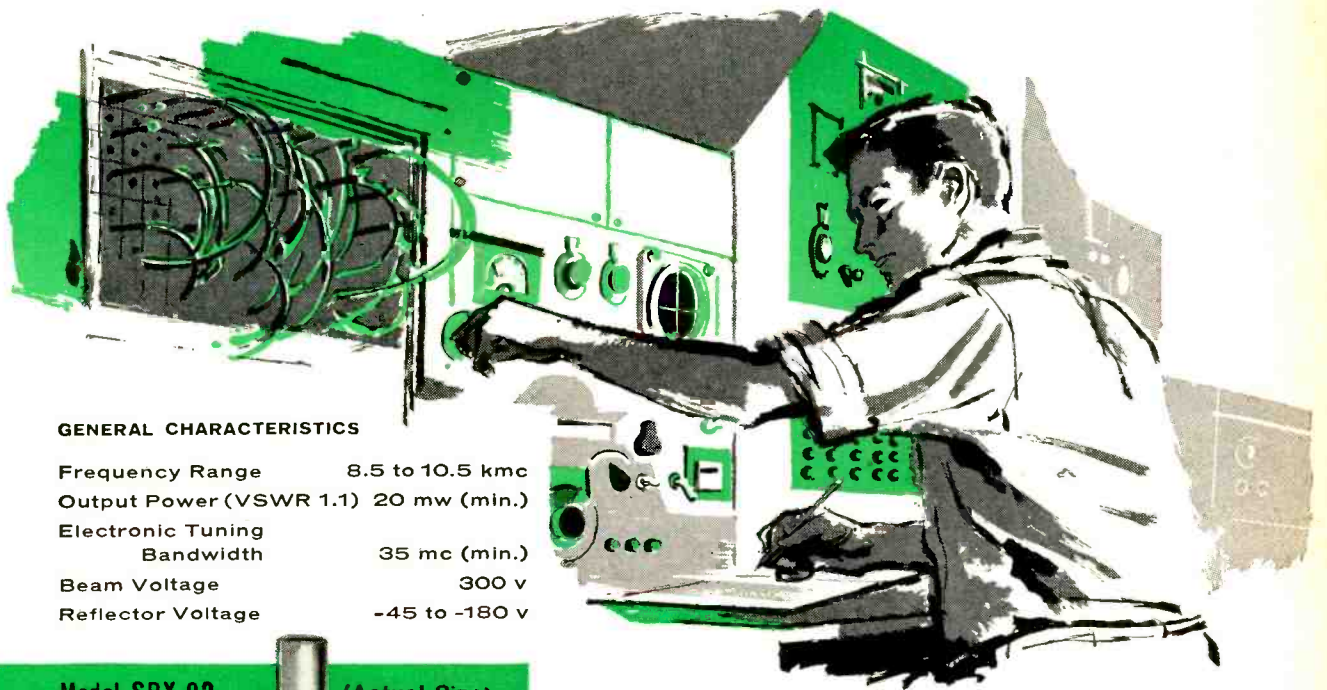

### GENERAL CHARACTERISTICS

Frequency Range	8.5 to 10.5 kmc
Output Power (VSWR 1.1)	20 mw (min.)
Electronic Tuning Bandwidth	35 mc (min.)
Beam Voltage	300 v
Reflector Voltage	-45 to -180 v

Model SRX-92 (Actual Size)

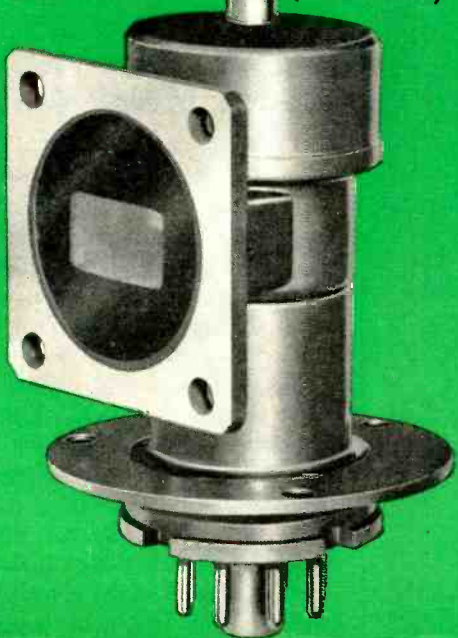

Here is the ideal signal source for radar test equipment — the SRX-92 reflex oscillator klystron. Offering complete coverage of the frequency range from 8.5 to 10.5 mc, this Sperry tube also serves as local oscillator in microwave receivers and spectrum analyzers, or as a low-voltage bench oscillator.

Spanning 21% of the center frequency, the SRX-92 also features low hysteresis, high thermal stability, and single-screw tuning—in a low-cost package that weighs only 4½ ounces. The SRX-92 meets Navy requirements. Write or phone the nearest Sperry district office for more details and shipping schedules.

**ELECTRONIC TUBE DIVISION**  
**SPERRY GYROSCOPE COMPANY**  
Great Neck, New York

DIVISION OF SPERRY RAND CORPORATION  
BROOKLYN • CLEVELAND • NEW ORLEANS • LOS ANGELES • SAN FRANCISCO • SEATTLE  
IN CANADA: SPERRY GYROSCOPE COMPANY OF CANADA, LTD., MONTREAL, QUEBEC.

# Actual Performance Results PROVE...

## FANSTEEL

# Tantalum Capacitors

give you....

- GREATER CAPACITY IN SMALLER SPACE
- LONGER OPERATING LIFE
- UNLIMITED SHELF LIFE
- UNEXCELLED STABILITY... no important characteristic changes even in long periods of operation
- WIDE TEMPERATURE OPERATING RANGE

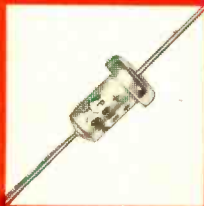

PP Type, for temperature ranges from  $-55^{\circ}\text{C}$  to  $+35^{\circ}\text{C}$

Ask for Bulletin 6.100

VP Type, for excessive vibration or shock requirements

Ask for Bulletin 6.113

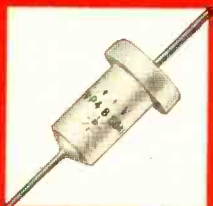

HP Type, for high ambient temperatures (to  $125^{\circ}\text{C}$ ) and for vibration resistance

Ask for Bulletin 6.111



PP, VP and HP Types are also available with insulated sleeves

## IMMEDIATE DELIVERIES

Fansteel Tantalum Capacitors of any size or rating can be shipped from stock.

**FANSTEEL METALLURGICAL CORPORATION**

North Chicago, Illinois, U.S.A.

C586A

RELIABLE TANTALUM CAPACITORS SINCE 1930

ism is located beneath the machine where it cannot endanger the operator. The rotary table supporting the 8 fixtures is readily removed as a unit for maintenance.



Assembly descends chute. Pipe section above gas and air valves has mixer preset for flame temperature control



Fixture rods rise on inclined plane until assembly is level with chute at left

Magnetron subassemblies were formerly annealed in batches in a large heated vacuum tub, which cooled them gradually—sometimes as long as 12 hours. The new method takes 2 minutes and reduces handling.

## Copper Spray, Clip-on Leads Make Varistors

By C. C. MARTINDELL

Western Electric Co., Allentown, Pa.

SPRAYED COPPER forms contact surfaces of silicon carbide varistors. Terminals shaped like a paper clip are attached to both sides of the varistor disk at once and then clipped to form two leads.

A semiautomatic machine is used to spray 0.0025 inch thick contacts on both sides of varistor disks. Pressed and fired disks are loaded into slots of a conveyor which carries them past 4 metallizing guns, 2 on each side of the conveyor. Guns are fed by spools of copper wire melted as the wire passes through

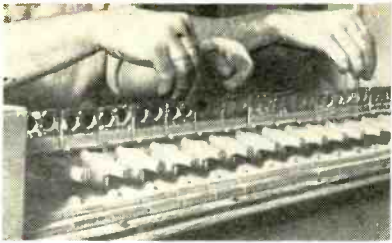

Varistor disks are hand loaded in metalizing conveyor

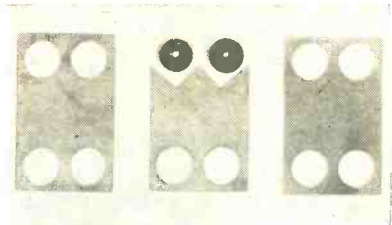

Mask, shown disassembled, is made on punch press

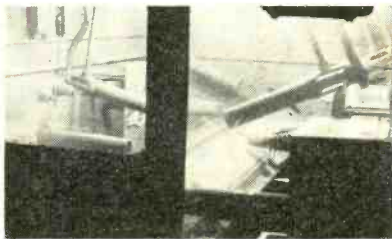

Large tubes carry cooling air to sprayed disks

oxygen-hydrogen flames.

Air pressure blows the molten copper against the disks, where the copper freezes. Low pressure air streams from large tubes cool the disks. The coated disks drop into a container as the conveyor turns over on its return to the loading station.

The commercial metallizing guns are equipped with nozzles which compress the copper spray into a flat elliptical pattern oriented parallel to the conveyor travel. This concentrates the spray on the disks.

The sides of the conveyor slots are provided with holes slightly smaller than the varistor disks, to mask the edges and prevent shorting across the disk edges. The masks are made of simple punch press parts held in place by a toggle clamp.

Spray accumulates on the conveyor. The partially solidified copper stream also abrades the masks. The design of the masks minimize these problems. Masks are disassembled and tumbled daily to remove copper buildup until pitting

**SIZE  
REDUCED  
AS MUCH AS**

**61%**

***Performance Actually Improved!***

**FANSTEEL**

## New Sub-Miniature Size S-T-A Capacitors SOLID TANTALUM

Now you can save more space and at the same time get improved performance when you design these new sub-miniature Fansteel S-T-A capacitors into your products. You get unsurpassed stability over an operating temperature range of  $-75^{\circ}\text{C}$  to  $+85^{\circ}\text{C}$ ... high resistance to vibration and shock which eliminates possibilities of any altitude or humidity problem.

**AVAILABLE  
FROM STOCK**

You get immediate delivery of the sizes listed at right.

For complete specifications and details write for bulletin 6.112.

**SPECIFICATIONS AND ORDERING REFERENCES**

	Catalog Number	Capacity In MFD*	Working Voltage	Surge Voltage
100 SERIES	STA-157	3.5	10	12
	STA-162	2.0	15	18
	STA-167	1.5	20	24
	STA-172	1.2	30	36
	STA-177	1.0	35	42
400 SERIES	STA-457	7	10	12
	STA-462	4	15	18
	STA-467	3	20	24
	STA-472	2.4	30	36
200 SERIES	STA-257	17	10	12
	STA-262	11	15	18
	STA-267	8	20	24
	STA-272	6	30	36
300 SERIES	STA-357	70	10	12
	STA-362	45	15	18
	STA-367	35	20	24
	STA-372	23	30	36
	STA-377	20	35	42

\*Standard Capacity-Tolerances are minus 15%, plus 25%.

**FANSTEEL METALLURGICAL CORPORATION**

North Chicago, Illinois, U.S.A.

C585A

RELIABLE TANTALUM CAPACITORS SINCE 1930

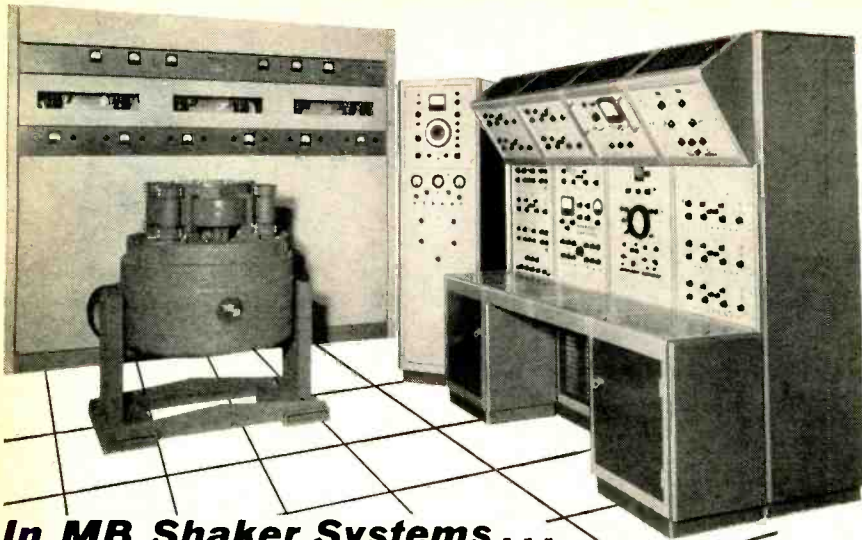

**In MB Shaker Systems...**

## response equalized for "hi-fi" random motion

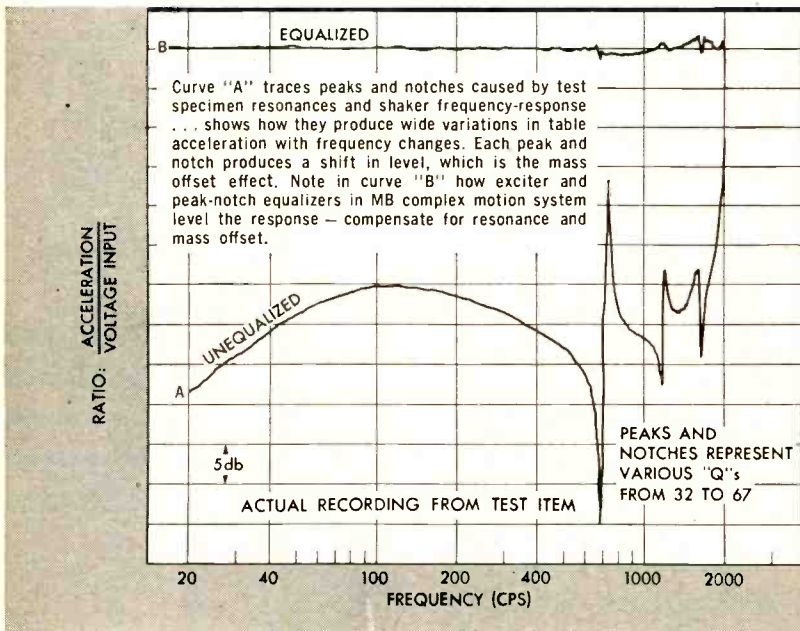

For accurate reproduction of vibration environments, the variation of shaker table acceleration with time should be identical to that of the input voltage. Flat frequency response of the system insures this result.

### ADVANTAGES OF MB SYSTEM

With electronic analogs, MB's peak-notch compensator gives the exact inverse electrical equivalence of the mechanical system resonance. Independent adjustment of the peak and notch frequencies allows peak to oc-

cur prior to notch, (or vice versa), in a single unit as required by the specimen. This automatically, precisely provides the mass offset required. Compensator also corrects for high Q resonances at low as well as high frequencies.

MB is the only manufacturer of all units comprising complete random motion test systems. Avail yourself of our experience, quality design, and technical service facilities. Send for Bulletin 420E that tells more.

**MB manufacturing company**

A DIVISION OF TEXTRON INC.

1075 State Street, New Haven 11, Connecticut

HEADQUARTERS FOR PRODUCTS TO ISOLATE... EXCITE... AND MEASURE VIBRATION



of the surface prevents copper removal.

The flat and symmetrical design permits the mask parts to be reversed and turned end for end, extending the life of each assembly. The parts are cheaply replaced when too worn or pitted for further use.

Soldering of terminals to disks is complicated by oxidation of the copper during the spraying process. After metallizing, the disks are impregnated with silicone oil.

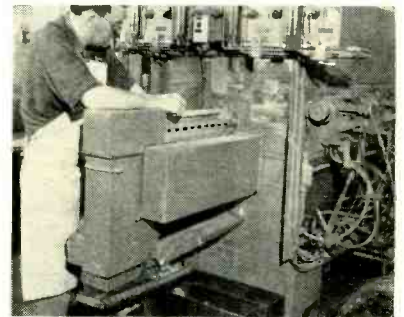

Disks fall from slots in masks as conveyor recycles

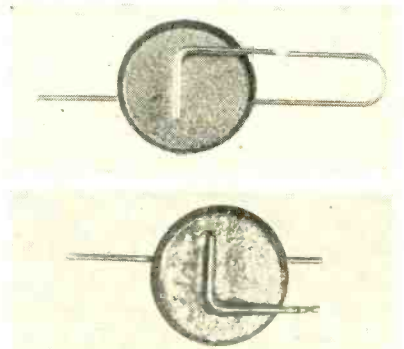

Loop of clip-on terminal is cut off after soldering

However, a dip soldering technique overcomes these problems. A layer of rosin flux is floated on top of the solder. The disks, with terminals in place, are dipped twice into the solder through the flux giving a satisfactory bond.

The terminal is similar to a paper clip. It holds the disk firmly between its legs. The soldering machine holds the assembly by the top of the clip, so machine parts do not contact the solder during dipping.

To start the operation, terminals and disks in groups of 6 are aligned in a holding fixture. The fixture goes into the soldering machine. After 2 dips in the rosin-solder pot,

# OHMITE<sup>®</sup> industry's most complete line of WIRE-WOUND RESISTORS

WRITE ON COMPANY LETTERHEAD FOR CATALOG 58

**Ohmite has exactly the resistor you need**

Ohmite offers the most complete line of high quality resistors on the market . . . fixed, adjustable, tapped, noninductive, and precision resistors in many sizes and types of terminals . . . in a wide range of wattages and resistances. All-welded construction. Ohmite application engineers will be pleased to help you in selecting the resistors for your job.



**FIXED**

Resistance wire is wound on a ceramic tube and protected by a vitreous-enamel coating. Many kinds of terminals available. May be single winding, tapped, or multisection. Watts, 3 to 1000; ohms, 0.1 to 1,700,000.

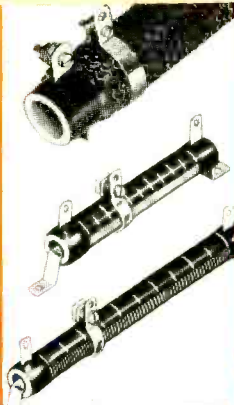

**DIVIDOHM ADJUSTABLE**

Vitreous-enamelled resistors with the wire exposed in a strip along one side for contact with adjustable lugs. Most Ohmite resistors can be ordered adjustable. Watts, 10 to 1000; ohms, 1 to 100K.



**AXIAL LEAD**

Small vitreous-enamelled resistors with wire leads axially welded to caps on ends of the units. Also TUBE OHM ceramic jacketed style. Watts, vitreous 3 to 10; Tubeohm, 5 to 25; ohms, vitreous 1 to 50K; Tubeohm 1 to 25K.

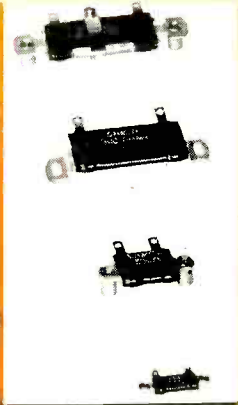

**THIN**

Resistance wire is wound on a core of flattened oval cross section and protected by vitreous enamel. Several sizes. Fixed, adjustable or tapped. Watts, 10 to 75; ohms, 0.1 to 100K.

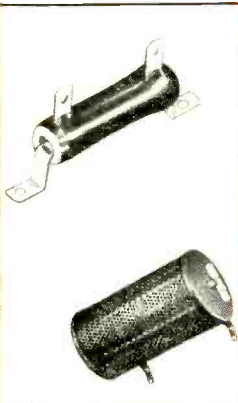

**NONINDUCTIVE**

Tubular vitreous-enamelled resistors with special winding. Dummy antennas consist of assemblies of several resistors. Watts, 5 to 1000; ohms, 1 to 5000.

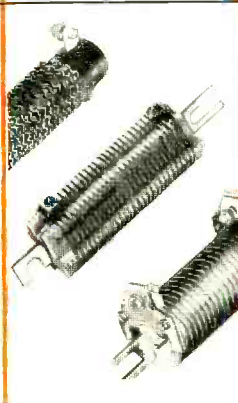

**HIGH CURRENT**

CORRIBS have exposed corrugated ribbon wound and enamelled on a tubular core. POWR-RIBS have bare coil of edgewise wound ribbon or round wire.

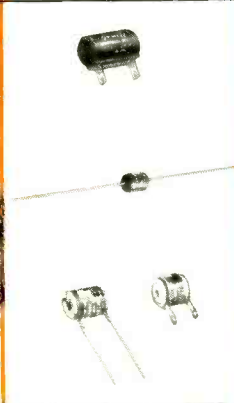

**PRECISION WIRE-WOUND**

Pie-wound resistors, encapsulated, impregnated, or hermetically sealed in glass. Also standard resistors wound to close tolerance. Watts, 1/8 to 2; ohms, 0.1 to 5 megohms.

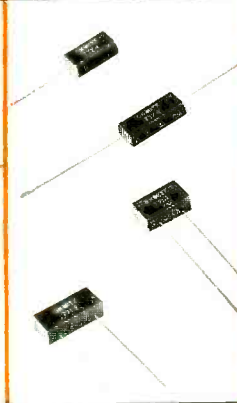

**PRECISION METAL FILM**

Consists of a unique metal film permanently bonded to a glass plate. The assembly is sealed in a high-temperature resistant plastic case. Watts, 1/4 at 150°C to 1/2 at 105°C; ohms, 25 to 350K.

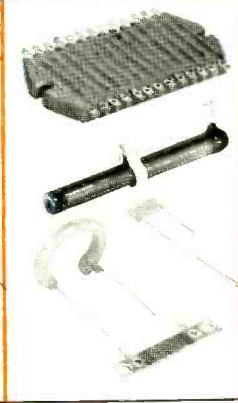

**SPECIAL VARIETIES**

Ohmite can provide toroids, flat strips, plaques, special-sized tubes, or tubes with mixed terminals, etc. Watt ratings and resistances are available as required.

RHEOSTATS    RESISTORS    RELAYS  
TAP SWITCHES    TANTALUM CAPACITORS  
R. F. CHOKES    VARIABLE TRANSFORMERS

**OHMITE MANUFACTURING COMPANY**  
3610 Howard Street, Skokie, Illinois





**WE WANT MORE  
HIGH LEVEL  
ENGINEERS  
ON OUR TEAM**

at  
**Bendix-Pacific**  
in Southern California

- MISSILE GUIDANCE
- AIRBORNE RADAR
- TELEMETERING
- SONAR

There are important positions available in these small, independent engineering groups at Bendix-Pacific for high level engineers from senior grade and up. Bendix-Pacific is particularly interested in strong, analytical engineers who have the calibre and capabilities to advance into systems engineering programs.

Please write W. C. Walker your qualifications or fill in the coupon and mail it today.

W. C. Walker, Engineering Employment Mgr.  
Pacific Division, Bendix Aviation Corp.  
11608 Sherman Way, North Hollywood, Calif.

I am interested in this engineering field \_\_\_\_\_  
I am a graduate engineer with \_\_\_\_\_ degree.  
I am not a graduate engineer but have \_\_\_\_\_ years experience.

Name \_\_\_\_\_  
Address \_\_\_\_\_  
City \_\_\_\_\_  
Zone \_\_\_\_\_ State \_\_\_\_\_

CIRCLE 79 READERS SERVICE CARD

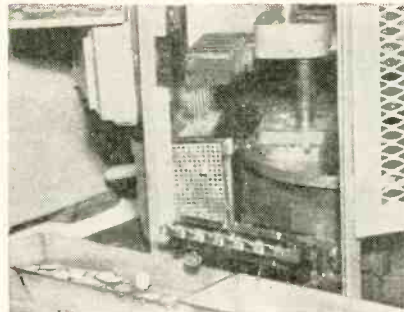

Disks hang by terminal loops during dip soldering



Disks hang in soldering machine (left) as excess wire is cut off in clipping machine



Soldering machine drops disks into clipping fixture (right) as clipper operator marks finished varistors

a third dip in solder alone completes the soldering cycle and removes excess flux.

Soldered assemblies are dropped by machine into another holding fixture. This fixture is placed in an air-operated clipping die which clips off the upper loop of the terminal. After clipping the varistors drop into a pan.

One clipping machine operator serves 2 soldering machines. The soldering machines have been constructed as a pair, indexing in opposite directions toward the clipping machine.

# JAMES

Introduces  
**a New Line  
of Low Noise  
SPDT  
Miniature  
Choppers**

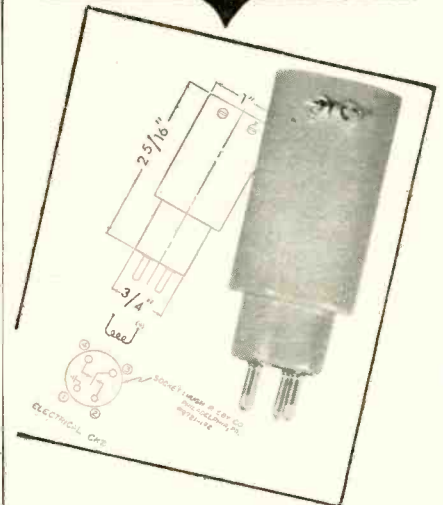

JAMES, leading manufacturer of DPDT instrument and military choppers, now introduces a new line of SPDT miniature choppers\* for low noise instrument application.

This new design is based on the JAMES patented center pivot construction and features models with both seven pin and four pin bases. All will fit standard 3/4 inch sockets and shield bases.

**A unique feature**—these JAMES models are the first offering both MBB and BBM contact closures in 3/4 inch diameter miniature designs.

Models available include both base coil and top coil connections. Frequency ranges are from 0—120 cps and 350—475 cps. The low noise driving systems reduce residual noise and thermal drift to a minimum.

Specifications on these new models are available by writing

\*Pat. No. 2,831,936

**JAMES**   
**VIBRAPOWR COMPANY**

4050 N. Rockwell St., Chicago, Ill., CO rnelia 7-6333

CIRCLE 121 READERS SERVICE CARD



# IT'S A MUST!

If you sell to the \$7 billion electronics industry, you'll want a free copy of *electronics MARKET MEDIA FILE*.

What are the prospects for:  
**MILITARY ELECTRONICS?**  
**REPLACEMENT  
ELECTRONICS?**  
**HOME ELECTRONICS?**  
**INDUSTRIAL  
ELECTRONICS?**

Who are the  
**BUYING INFLUENCES?**

Why are more than 9,000 men who make the buying decisions for 30 giant companies subscribers to *electronics*? . . . and what does that mean to your advertising dollar?

The 1958 *electronics MARKET MEDIA FILE* gives the answers in 12 fact-packed pages that you will refer to time and again throughout the year.

Send for your *free* copy today.

**ABC electronics ABP**  
**A MCGRAW-HILL PUBLICATION**  
**330 W. 42nd St., New York 36, N. Y.**

## Get Diamond's NEW microwave catalog and price list!



Diamond's handy "short-form" catalog #958 contains over 850 standard microwave items — thoroughly detailed — all on one side. Simple in format for efficiency in use.

Handsomely printed on coated card stock. Lacquered for extensive use without smudging or becoming dirty. Has tab for file folder use — is punched for 3-ring binder — lies flat when hung on wall, for ready reference.

Send for your free copy today!



**DIAMOND**  
**ANTENNA & MICROWAVE  
CORPORATION**  
7 North Avenue • Wakefield, Mass.

CIRCLE 80 READERS SERVICE CARD

## IF THIS IS YOUR PROBLEM

If you need effective, highly readable, smartly illustrated company literature (booklets, pamphlets, manuals) to display your products, inform the public of your operations, attract key personnel to your plant, train employees, and perform any of the other communicative functions that are vital to your business . . .

## THIS IS YOUR ANSWER

The McGraw-Hill TECHNICAL WRITING SERVICE has a staff of more than 150 highly-trained writers, editors, and illustration specialists whose job it is to create technical and general literature for industry. We write, illustrate, design, and print Equipment Manuals, Product Bulletins, Handbooks, Company Histories, Annual Reports, and other specialized material. Save money and time. Let our staff be your staff for Technical and Business publications.

This service is available through ad agencies.

Write • Phone

**TECHNICAL WRITING SERVICE**  
McGraw-Hill Book Co., Inc.  
330 W. 42nd St., N. Y. 36, N. Y.  
LOngacre 4-3000

# Relay Production Is High



The Bristol Co.  
high-speed relays

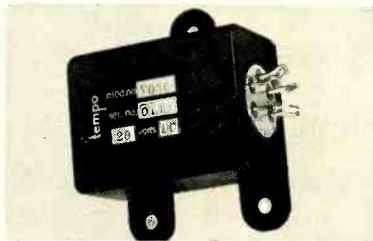

Tempo Instrument, Inc.  
time delay relay

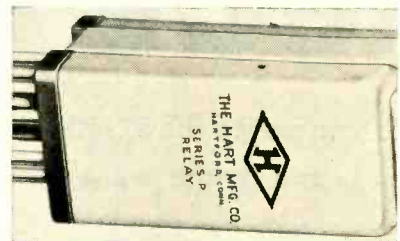

The Hart Mfg. Co.  
polarized type

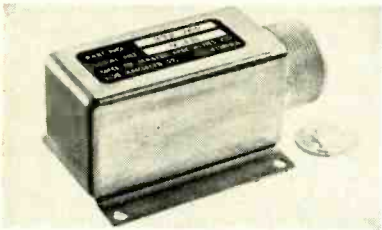

Master Specialties Co.  
fail-safe unit

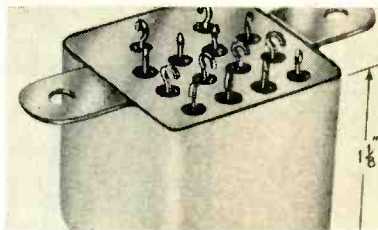

Electro-Mechanical Specialties Co., Inc.  
subminiature device

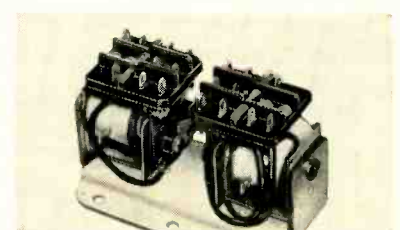

Line Electric Co.  
latch relay

MANUFACTURERS are constantly improving on relays to achieve superior performance and reliability in missile and airborne applications as well as for critical industrial uses.

The Bristol Co., Waterbury 20, Conn., (200) announces new Synconverter relays for modular type equipment. They are designed to operate reliably at speeds as high as 300  $\mu$ sec in low-power and dry circuits and at extremes of military environmental conditions.

In production at Tempo Instrument, Inc., 240 Old Country Rd., Hicksville, N. Y., (201) are a series of heavy duty transistorized time delay relays. Time delay periods are from 0.01 to 60 sec, delay occurring between application of current and relay contact pull-in. Units feature high accuracy and 10 ampere contact rating.

The Hart Mfg. Co., 110 Bartholomew Ave., Hartford, Conn., (202) has available new Diamond H series P relays. They are engineered to provide extremely fast action with freedom from bounce, together with high sensitivity and excellent stability. Under some conditions they will handle over 1,000 pps.

A new relay being offered by Master Specialties Co., 956 E. 108th St., Los Angeles 59, Calif., (203) senses the phase sequence of a three phase power supply, and operates to close a contact when the applied phase sequence is A-B-C. Unit is fail-safe because the relay contact is normally open.

Electro-Mechanical Specialties Co., Inc., 1016 N. Highland Ave., Los Angeles 38, Calif., (204) has introduced the No. 5000 relay designed to meet requirements for airborne, missile and computer applications. It combines the functions of a dry circuit relay with those of a high current relay, from 1  $\mu$ a at 5 mv to a 5 ampere resistive load.

A latch relay in production at Line Electric Co., 271 S. Sixth St., Newark 3, N. J., (205) is quality control tested for dependability and long life—one million operations minimum. Rating is 5 and 10 amperes at 115 v a-c noninductive or 26.5 v d-c.

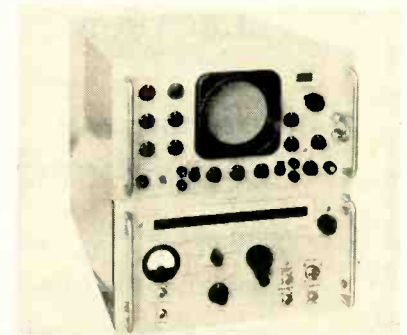

## Spectrum Analyzer for 10 mc-40,880 mc

POLARAD ELECTRONICS CORP., 43-20 34th St., Long Island City 1, N.Y. Model SA-84 spectrum analyzer covers the frequency range of 10 to 40,880 mc in a single unit. It features: simplified band selection, which automatically displays an expanded slide-rule dial of the band in use, and thus eliminates operator error; stable local oscillators; and built-in attenuators up through X band. The spectrum is displayed on a crt which has special provision for high intensification to enable viewing in brightly-lit rooms. High resolution, sensitivity and stability are available in all eight bands. Circle 206 on Reader Service Card.

(Continued on page 116)

For more information use READER SERVICE Card



# MICRO SWITCH Precision Switches

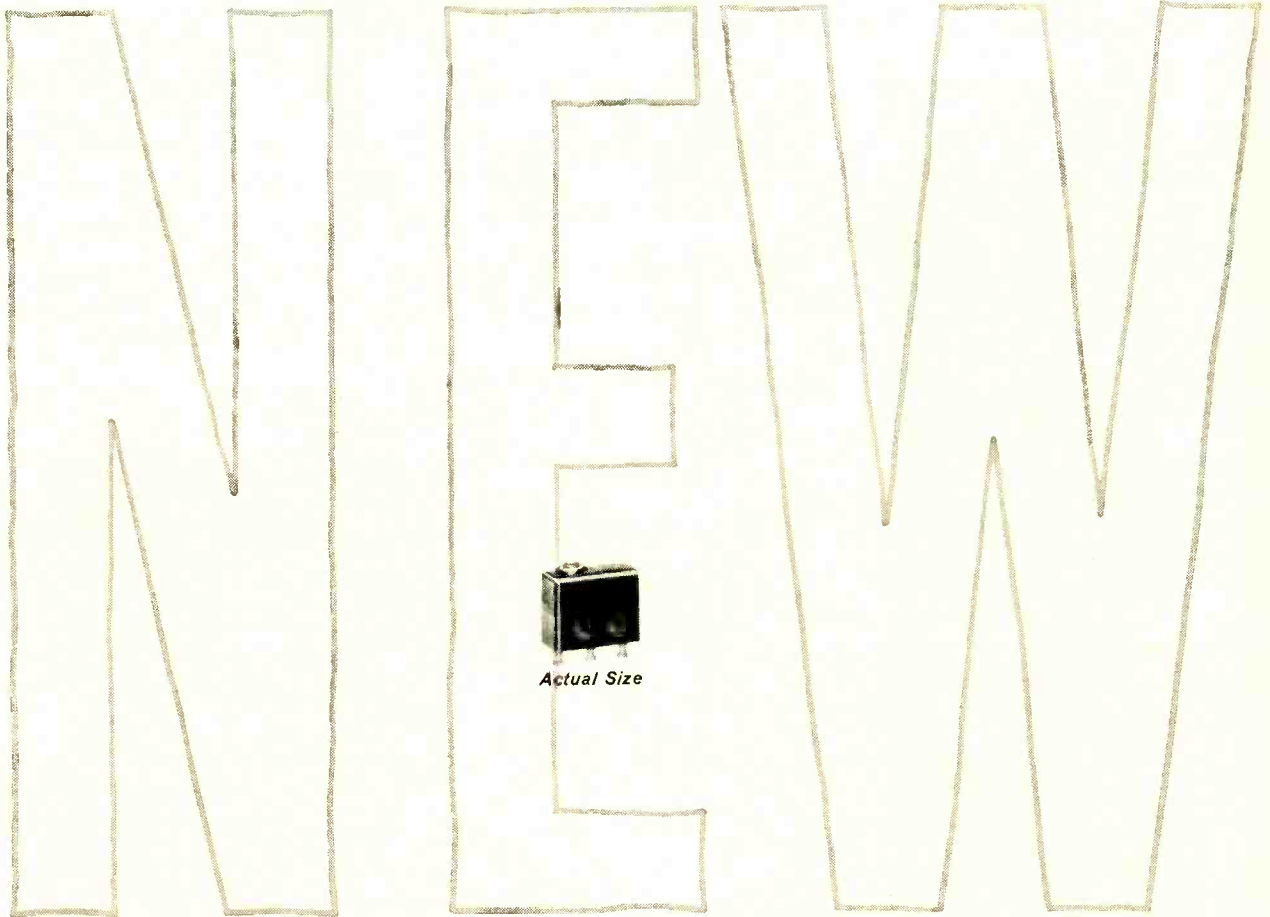

## We've Miniaturized the Subminiature!

WEIGHT: 1 gram . . . 28 switches to the ounce . . . over 430 to the pound. SIZE: .500" long, .200" wide, .350" high.  
CUBIC CONTENT: .035 cubic inches. ELECTRICAL RATING: 5 amps-250 vac, 30 vdc. SPDT.

After a long period of laboratory development, MICRO SWITCH announces this new, highly miniaturized precision snap-action switch and a complementary line of actuators.

We call it the "Sub-subminiature!"

This new "SX" basic switch represents an entirely new set of answers to the space-weight problems in dependable precision switching. It combines new small size with more than ample capacity for wide usefulness, meeting the pressing demand for miniaturization combined with reliability.

In its exacting development, many prob-

lems of design, testing and quality control presented themselves. However, 23 years of experience proved of immense value. As a result, a new standard has thus been set by which all precision switches must be measured.

This broad experience can prove of equal value to you. Send for more information about this new switch. Request Data Sheet No. 148.



MICRO SWITCH...FREEPORT, ILL.

A division of Honeywell

In Canada: Honeywell Controls, Ltd.,  
Toronto 17, Ontario

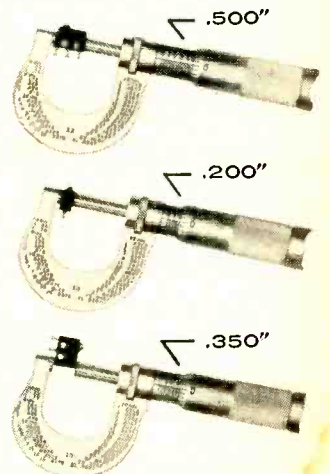

*The two-word name MICRO SWITCH is NOT a generic term. It is the name of a division of Honeywell.*



# Honeywell

## MICRO SWITCH PRECISION SWITCHES

**ANY TYPE TERMINAL  
for RADIO, TELEVISION,  
COMMUNICATIONS  
and ELECTRONIC  
APPLICATIONS**

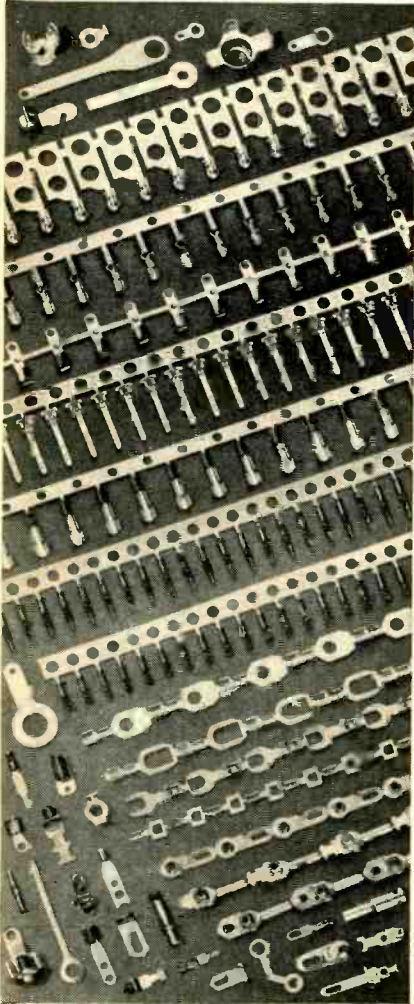

Malco supplies terminals for all standard and special requirements. Send blueprint or specifications for specific information and prompt quotation.

**REQUEST  
BULLETIN  
552**



**Malco TOOL and MANUFACTURING CO.**

4023 W. LAKE ST. • CHICAGO 24, ILL.  
CIRCLE 82 READERS SERVICE CARD

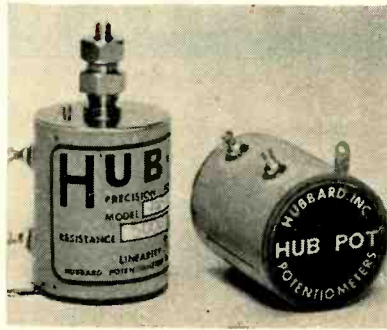

**Precision Pot  
handles up to 3 w**

HUB-POT, INC., 1242 E. Transit Ave., Pomona, Calif. Model 101 10-turn pot is only 1 in. in diameter and weighs less than 60 grams. It operates satisfactorily over a temperature range of from -85 F to +185 F and when subjected to 5 g of vibration between 20-2,000 cps and up to 30 g of shock in six directions. It is available in eight different standard resistance values between 500 and 100,000 ohms. Standard linearity tolerance is  $\pm 0.5$  percent. Circle 207 on Reader Service Card.

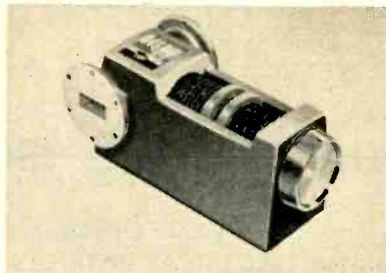

**Frequency Meters  
direct-reading**

POLYTECHNIC RESEARCH AND DEVELOPMENT CO., INC., 202 Tillary St., Brooklyn 1, N. Y. Types 532 through 538F1 are a series of direct-reading, TE11 mode frequency meters, each covering a full waveguide band in the frequency range from 3.95 to 40 kmc. Direct-reading accuracy is 0.08 percent for most ranges. This is provided by a continuous dial, 100 in. long, helically calibrated around a drum of 7 in. circumference. Reaction coupling types, tuned by a non-contacting plunger, the meters are housed in a cast aluminum case which also serves as a self-support-



**KEY ENGINEERING  
OPENINGS  
AT VOUGHT**

**ELECTRONICS**

Projects involve advanced guidance and control and fire control systems for missiles and high-performance manned aircraft. They begin with investigations and theory and progress through systemization and packaging to detailed hardware design. Key responsibilities await additional men who are qualified in these areas. Advanced degrees preferred.

**Stability and Control Engineer.** E.E., M.E., or A.E., with emphasis on flight stability and control problems or dynamics. (Special consideration given graduate study or extensive experience in transients or closed loop stability analysis.) To assist in design of autopilot and control systems for high-performance missiles and aircraft.

**Antenna Design Engineer.** E.E., or Physics Degree with demonstrated aptitude for antenna design. To join active projects involving design of flush-mounted, recessed and external antennas at all frequencies for very high-performance aircraft and missiles.

**Fire Control and Microwave Systems Engineer.** Requires E.E., or Physics Degree; at least 2 years experience in radar, data link, or fire control systems; and strong ability in this work.

**Test Equipment Engineer.** Requires E.E., or Physics Degree and at least 2 years experience in this or related field. (Desirable: broad background in electronics design with emphasis on digital computers or microwave systems.) To join in the design of complete checkout systems for missiles and associated subsystems.

**Reliability Analyst.** Requires M.E., Physics, E.E., or Math Degree; broad knowledge of electronic and mechanical systems; experience in operations research or reliability. Helpful: statistical methods experience.

**To arrange for a personal interview, or for a prompt report on these or other current openings, return coupon to:**

C. A. Besio  
Supervisor, Engineering Personnel  
CHANCE VOUGHT AIRCRAFT,  
Dallas, Texas Dept. R-4

I am a \_\_\_\_\_ Engineer,  
interested in the opening for \_\_\_\_\_  
Name \_\_\_\_\_  
Address \_\_\_\_\_  
City \_\_\_\_\_ State \_\_\_\_\_

**re·lent'less:** *a missile that pierces hostile sky  
to pinpoint its nuclear strike*

When a target's latitude and longitude are marked on this missile's brain, an appointment has been made.

To keep its rendezvous, the Chance Vought *Regulus II* performs miracles of navigation: it will launch stealthily from submarines — nuclear and conventional — from surface craft and mobile shore launchers. It will compensate automatically for wind and weather and for the earth's rotation. It will detour enemy strongpoints, outfox known counterweapons. Closing in on its quarry, it can plummet from over 60,000 feet to smokestack height to escape radar detection.

In minutes, *Regulus II* can pierce over 1,000 miles of hostile sky to score a nuclear bull's-eye.

The first of the Navy's nuclear-driven subs, designed to roam the seas as unseen *Regulus II* bases, is now in construction. The missile itself has made over 25 successful flights. Under Navy leash in key locations, it will be a relentless watchdog for peace.

**Scientists and engineers: pioneer with Vought in new missile, manned aircraft, and electronics programs. For details on select openings write to: C. A. Besio, Supervisor, Engineering Personnel, Dept. R-4.**

CHANCE **VOUGHT AIRCRAFT**  
INCORPORATED DALLAS, TEXAS



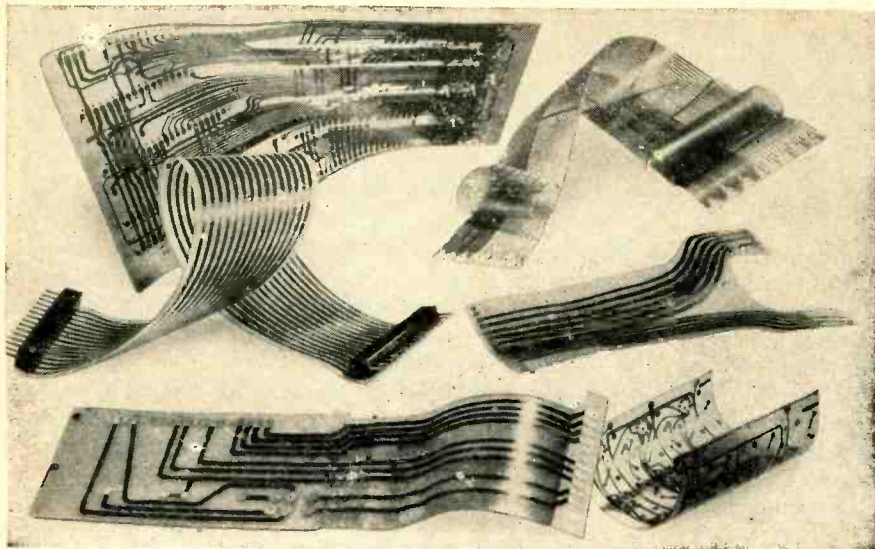

## SANDERS **FLEXPRINT** WIRING

*New, flat, flexible wiring sharply reduces weight, bulk and cost of electronic and electrical assemblies.*

Sanders Flexprint Wiring brings to commercial and military applications a combination of field-tested advantages unmatched by conventional wiring and ordinary printed circuits.

- Completely flexible . . . exactly reproducible.
- Available in all lengths and current-carrying capacities.
- Weighs less than half as much as conventional wiring . . . occupies less than one-third the space . . . conforms to any housing shape or layout.
- Designed and produced in straight cables or complex harnesses . . . in single or multiple layers or bonded to rigid materials as a replacement for printed board.
- Permanently bonded in insulating plastics to meet environmental and reliability requirements.
- Withstands effects of vibration and flexing . . . allows interconnected assemblies to move independently.
- Speeds up assembly . . . permits automatic production . . . eliminates error.
- Easily cut, stripped and connected.
- Available in vinyls, polyethylenes, polyesters, silicones, Kel-F, Teflon, or other insulations.

*Write today for complete data about capabilities, prices and deliveries.*

Ⓟ TRADEMARK — SANDERS ASSOCIATES, INC.

**SANDERS ASSOCIATES, INC.**

NASHUA, NEW HAMPSHIRE • Dayton, Ohio • Inglewood, Calif. • Washington, D.C.

ing stand. The plunger drive system is specially treated for minimum wear, and a unique spring-type nut reduces backlash to negligible proportions. Circle 208 on Reader Service Card.

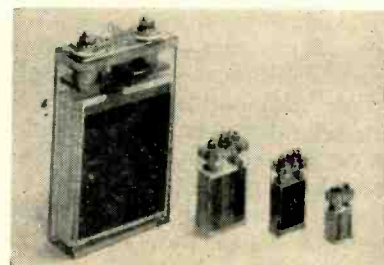

### Storage Batteries nickel cadmium

GOULD-NATIONAL BATTERIES INC., Nicad Division, Easthampton, Mass. Reliability and long life under extremes of environment are features of these sintered plate nickel cadmium storage batteries. Low internal resistance (0.001 ohm for 10 AH type cell) permits exceptionally high discharge currents. Illustrated are individual cells with capacities of 64, 5, 2 and 1 ampere hours. Battery uses include portable electronic equipment, missile auxiliary power, aircraft engine starting and data processing. Circle 209 on Reader Service Card.



### Resonators ruggedized devices

PHILAMON LABORATORIES, INC., 90 Hopper St., Westbury, L. I., N. Y. Ruggedized to take vibration and 15 G 11 millisecc shock, new MJ series miniaturized tuning fork resonators will operate with either transistors or tubes. They are available in frequencies from 400 to 2,200 cps, and in 0.01, 0.02 or 0.05 percent overall accuracy ratings over -55 C to +85 C operating temperature range. Accuracies are un-

affected while operating under rated vibration of 5.0 G's to 40 cps, 0.060 in. displacement 40 to 55 cps, 2.0 G's above 55 cps to 45 percent of fork frequency. Hermetically sealed evacuated units are 1 1/2 in. by 1 3/8 in. by 2 5/8 in. high and weigh 4.5 oz. Circle 210 on Reader Service Card.

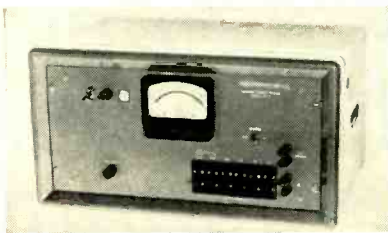

### Back Current Tester for semiconductors

TRANS ELECTRONICS, INC., 7349 Canoga Ave., Canoga Park, Calif., has available a new test unit for back current, saturation or reverse testing of germanium or silicon semiconductors. Model BT1 has four output voltages up to 0-1,000 v, each presettable within its range. Line regulation and load regulation are better than 0.1 percent; ripple is less than 0.1 percent. Price of the unit is \$575. Circle 211 on Reader Service Card.

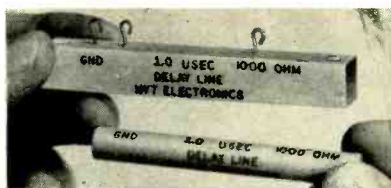

### Delay Lines subminiaturized

NYT ELECTRONICS, INC., 2979 N. Ontario St., Burbank, Calif. A standard new series of delay lines are ultra-compact in size, and meet the requirements of MIL-C-15305A, grade 1, class B. As a measure of their compactness, the 1.0  $\mu$ sec, 1,000-ohm line has a delay-bandwidth product per cu in. of over 7.5. Molded in epoxy resin, units are supplied in square and tubular configurations for mechanical versatility in p-c applica-

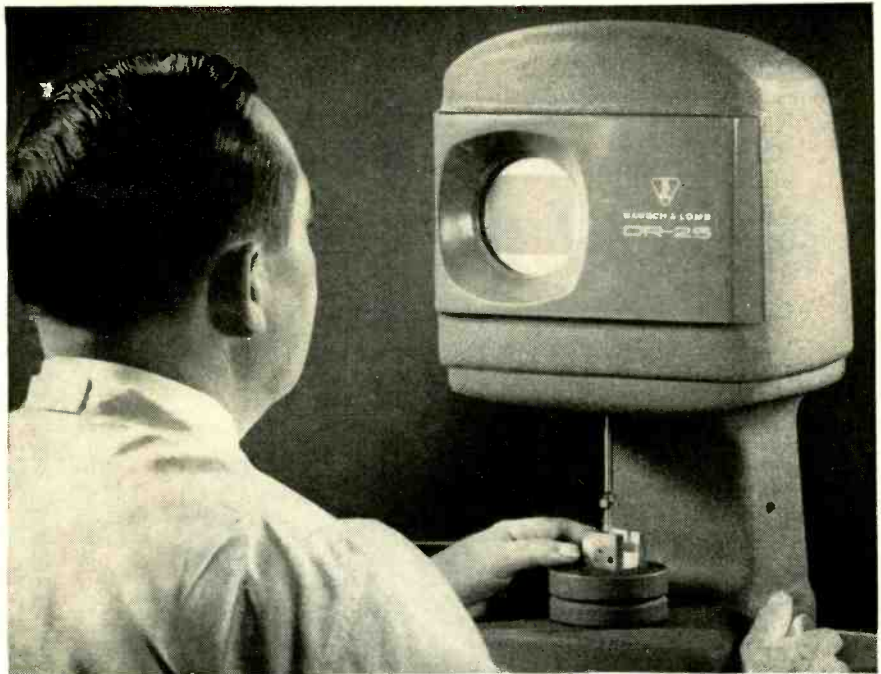

# New! BAUSCH & LOMB DR-25 OPTICAL GAGE

Direct scale reading to .0001" ...

0" to 3" range... accurate to .000025"!

## FAST, EASY AS A-B-C!

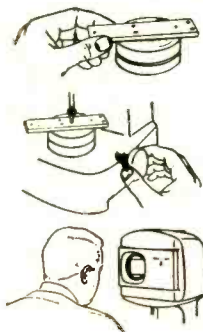

- A** Just set part to be measured on anvil . . . no masters or set gages needed. Large work table makes it easy to adapt special fixtures, accommodates widest variety of work.
- B** Turn knob to lower spindle . . . it will stop automatically on contact, with constant spindle pressure.
- C** See precise measurement at a glance . . . direct-reading scale is illuminated, magnified. No eyestrain, no conversion, no guesswork. Dependable measurement of depth, thickness, height, diameter, taper, angularity of surfaces, runout.

ONLY **\$695** COMPLETE

Distributed in the U.S.A. through the DoALL Co.

On-the-job demonstration!  
JUST MAIL  
THE COUPON TODAY!

**BAUSCH & LOMB OPTICAL CO.**  
70931 St. Paul St., Rochester 2, N. Y.

I'd like a free on-the-job demonstration of the new B&L DR-25 Optical Gage, with no obligation on my part.

Please send Catalog D-285.

Name .....

Company ..... Title .....

Address .....

City ..... Zone ..... State .....

**BAUSCH & LOMB**



# DIRECT DISPLAY OF RESPONSE UP TO 20 Mc

The Marconi 20-Mc Sweep Generator can be used in conjunction with any oscilloscope for direct display of video response characteristics up to 20 Mc. The instrument is designed for precise measurement. Frequency is indicated by crystal-controlled marker pips; and a special circuit provides for differential amplitude measurements, enabling relative response to be determined with a discrimination better than 0.01 dB.

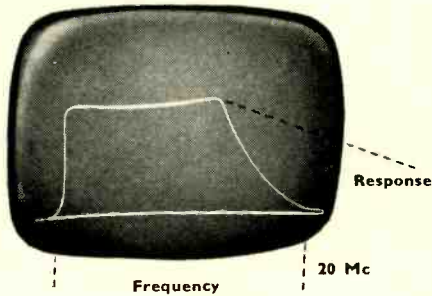

## MARCONI 20-Mc SWEEP GENERATOR TYPE 1099



### Abridged Specification

**Frequency Swept Output:** Frequency Range: Lower limit 100 kc, Upper limit 20 Mc. Output level: Continuously variable from 0.3 to 3 volts. Output Impedance: 75Ω. **Time Base:** Repetition Rate: 50 to 60 cps. Output for c.r.o. X deflection: 250 volts. **Frequency Markers:** At 1 Mc intervals; every fifth pip distinctive and crystal controlled. Tubes: 6AK5, 6BH6, 5763, 6BJ6, 6CD6G, 6BE6, 12AT7, 12AU7, 6C4, 5V4G, OA2, 5651.

Send for leaflet B124/A.

**MARCONI  
INSTRUMENTS**

111 CEDAR LANE  
ENGLEWOOD  
NEW JERSEY  
Tel: LOwell 7-0607

CANADA: CANADIAN MARCONI CO • 6035 COTE DE LIESSE • MONTREAL 9  
MARCONI INSTRUMENTS LTD • ST. ALBANS • HERTS • ENGLAND

tions, or stacking on common mounting screws. Units can be stacked in series to give higher delays, or tap-off points used to give lower delays. Circle 212 on Reader Service Card.



## Sweeping Oscillator high output

KAY ELECTRIC Co., Maple Ave., Pine Brook, N. J. The Vari-Sweep model 400 has a wide range of continuous frequency coverage from 15 to 470 mc combined with a measure of accuracy and a level of performance previously associated with limited, fixed-frequency-band oscillators only. It provides frequency sweeps that are flat, wide, and linear. Its r-f output voltage is high enough for testing lossy networks without using additional amplifiers, and throughout the range it is a fundamental frequency held constant by a fast-acting age circuit. Circle 213 on Reader Service Card.

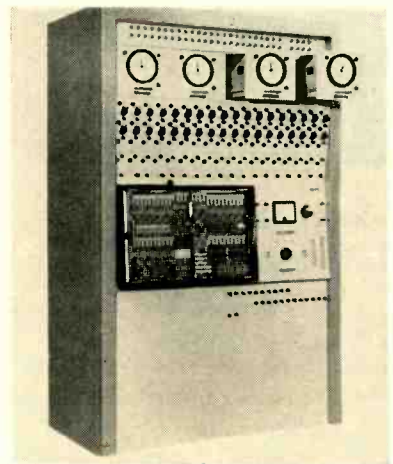

## Analog Computer expandable unit

MID-CENTURY INSTRUMATIC CORP.,  
611 Broadway, New York City,  
N. Y. Model MC-5800 precision



master analog computer comprises 48 operational amplifiers. The basic computer employs expanded unique circuit logic so that a purchased computer may be expanded in the field on a building-block basis without rewiring or mechanical modification. Expansion may be accomplished with respect to function as well as size. The computer also has a packaging feature. It may be instantly "unzipped" from the confines of its cabinet for unobstructed access during maintenance. Circle 214 on Reader Service Card.

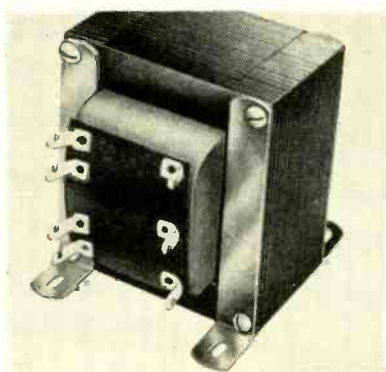

### Transformer withstands 2,000 v rms

CHICAGO STANDARD TRANSFORMER CORP., 3501 Addison St., Chicago 18, Ill. Model P-6463 filament transformer is designed especially for use with the Eimac 4CX1000A transmitting tube. It provides center-tapped secondaries of 6.0, 6.5 or 7.0 v, at 13 amperes. Primary is 117 v, 60 cps. The unit is designed to withstand 2,000 v rms. It measures only 2 1/8 in. by 3 3/8 in. by 3 3/8 in. high. It has 2 1/4 in. by 2 1/8 in. mounting centers. Circle 215 on Reader Service Card.

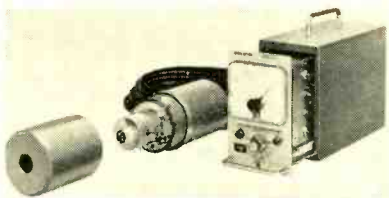

### Monitoring System detects radiation

RIGGS NUCLEONICS Co., 2390 Olive Ave., Altadena, Calif. Model GA-

look what **\$24<sup>50</sup>** buys  
in test equipment!



**HEATHKITS  
GIVE YOU  
TWICE AS MUCH  
equipment for  
every dollar  
invested**

The famous model V-7A Vacuum Tube Voltmeter is a perfect example of the high-quality instruments available from Heath at 1/2 the price you would expect to pay! Complete, only **\$24<sup>50</sup>**

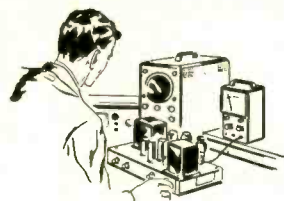

Get the most out of your test equipment budget by utilizing HEATHKIT instruments in your laboratory or on your production line. Get high quality equipment, without paying the usual premium price, by dealing directly with the manufacturer, and by letting engineers or technicians assemble Heathkits between rush periods. Comprehensive instructions insure minimum construction time. You'll get more equipment for the same investment, and be able to fill your needs by choosing from the more than 100 different electronic kits by Heath. These are the most popular "do-it-yourself" kits in the world, so why not investigate their possibilities in your particular area of activity! Write for the free Heathkit catalog now!



Contains detailed descriptions of Heathkit models available, including VTVM's, scopes, generators, testers, bridges, power supplies, etc.



Also describes Heathkit ham gear and hi-fi equipment in kit form. 100 interesting and profitable "do-it-yourself" projects!

### FREE catalog

Mail coupon below for your copy—Now!

**HEATH COMPANY**  
A SUBSIDIARY OF DAYSTROM, INC.,  
BENTON HARBOR 14, MICHIGAN

Name \_\_\_\_\_

Address \_\_\_\_\_

City & Zone \_\_\_\_\_

State \_\_\_\_\_

FC-2-XPF  
Short leads—  
0.2" grid spacing

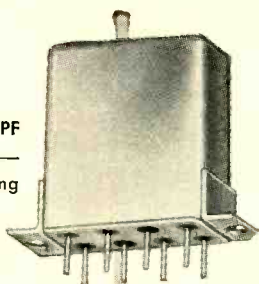

Actual size photos

✓ **125° C. Ambient...**  
✓ **Power and Low  
Level Switching**

✓ **30 G Vibration**  
AT 2000 CYCLES

FC-2-XLF  
Long leads—  
0.2" grid spacing

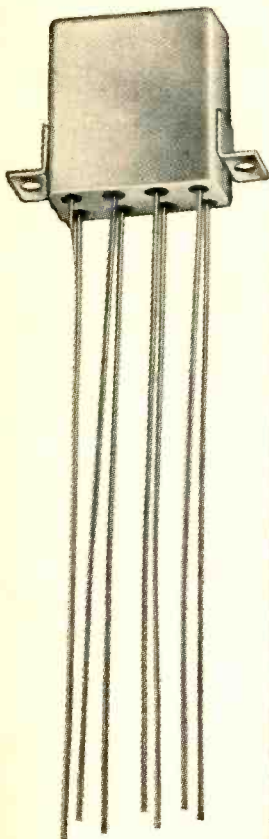

FC-2-XHF  
Hook leads—  
0.2" grid spacing



**NEW! FC-2  
DC RELAYS**

Subminiature,  
hermetically-sealed types

These new FC-2 types are the latest development in high reliability missile relays — designed and produced by Struthers-Dunn, the pioneers in miniature, hermetically-sealed relays.

30 G vibration at 2000 cycles and 50 G shock specifications are readily met, as well as other requirements of MIL-R-5757C and MIL-R-25018.

Write for Struthers-Dunn DATA BULLETIN FC-2



**STRUTHERS-DUNN, Inc.**

Pitman, N. J.

Makers of the world's largest assortment of relay types

Sales Engineering Offices in: Atlanta • Boston • Buffalo • Chicago • Cincinnati  
Cleveland • Dallas • Dayton • Detroit • Kansas City • Los Angeles • Montreal • New  
Orleans • New York • Pittsburgh • St. Louis • San Francisco • Seattle • Toronto

3B is a completely self-contained, battery-operated independent radiation monitoring system. System consists of a control unit with meter relay, manual reset, 3 or 6 decade log scale, calibration controls, electronic calibration test adjustments and 10 mv recorder output. It will measure, display, record and control alarms for gamma radiation from background 0.025 mr/hr to 100 kr/hr or higher in the energy range from 80 kv to 1.3 mev. Circle 216 on Reader Service Card.

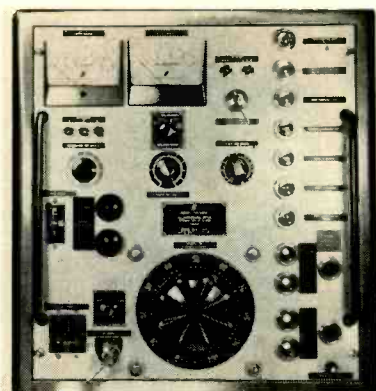

**H-V Power Supplies  
in 19 models**

BETA ELECTRIC, Division of Sorensen & Co., Inc., Richards Ave., South Norwalk, Conn. Series 7000 h-v a-c power supplies are available in 19 models, operating on 220 or 440 v, 60 cps, single-phase inputs, with output voltages ranging from 0-25 to 0-150 kv, at 5 to 100 kva. The rugged two-section units have a continuously adjustable automatic rate of rise in conformance with ASTM standards, so that they can be used for dielectric testing in accordance with ASTM specifications. Circle 217 on Reader Service Card.

**Dehydrator  
pressurized**

THE LEWYT MFG. CORP., 43-22 Queens St., Long Island City 1, N. Y., has developed a new, long-life pressurized-dehydrator for use in conjunction with electronic equipment. The machine increases the reliability of high power radar equipment as it removes moisture from the air used to pressurize the

waveguides of the equipment. Capable of operating under extreme temperature and humidity conditions, the unit first dehydrates air and then compresses it before discharging it into the electronic equipment. The unit's operation is particularly effective for ship-board use. Circle 218 on Reader Service Card.



### Logic Package for multiple uses

SPRAGUE ELECTRIC CO., 35 Marshall St., North Adams, Mass. Type 200C9 transistorized multiple logic package introduces a new concept to computer design work. One single ceramic-base printed circuit with integral resistors and capacitors can be used as a flip-flop, pulse generator, or gating, amplifying, clipping, shaping, or delaying circuit by simple external connections to the 9 leads, which have been brought out from the p-c network. Complete data is detailed in engineering bulletin 6712, available on letterhead request.

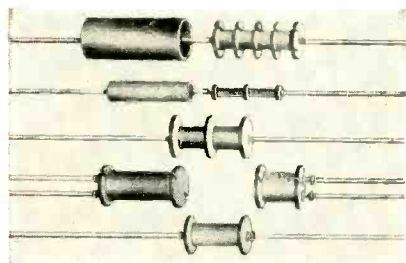

### Epoxy Bobbins with leads, shells

THOR CERAMICS, INC., 225 Belleville Ave., Bloomfield, N.J., announces a new line of epoxide resin bobbins with leads and shells for encapsulation. Outstanding adhesive qualities make these miniature forms ideal for hermetically sealing wire-wound resistors. Fabricated from thermosetting epoxide resin, it has excellent physical and

# NEW CONCEPTS IN TR TUBES...



MA338 is typical of these new tubes. It is a significant advance over the conventional 6334.

**Microwave Associates now offers guaranteed crystal protection for entire life of tube . . . even under full power and elevated temperatures.**

Out of Microwave's Switching Devices Laboratory, directed by Dr. Lawrence Gould, comes an important advance in duplexer tubes.

**NEW KEEP-ALIVE DESIGN** with new ruggedized windows and new stable gas fill maintains spike and flat leakage powers within specified limits over a wide temperature range.

Duplexer loss *plus* interaction *plus* noise generation from keep alive are controlled within tight limits as specified by the system overall noise figure requirement.

**RETROFIT IS EASY . . .** single and dual tubes are physically interchangeable with conventional tubes, or tubes can be shortened if desired.

Each half of a dual tube is tested individually to provide guaranteed performance. Tubes for applications requiring high repetition rate and short recovery time are available.

**FOR COMPLETE DATA** about these new TR tubes and other advanced tubes for switching high powers with guaranteed crystal protection at any frequency, write or phone for specific information.



**MICROWAVE ASSOCIATES, INC.**

BURLINGTON, MASSACHUSETTS • Telephone: BRowning 2-3000

ENGINEERS AND PHYSICISTS:

# WRITE US

for illustrated brochure

**TALENT GROWS AT EMERSON ELECTRIC**

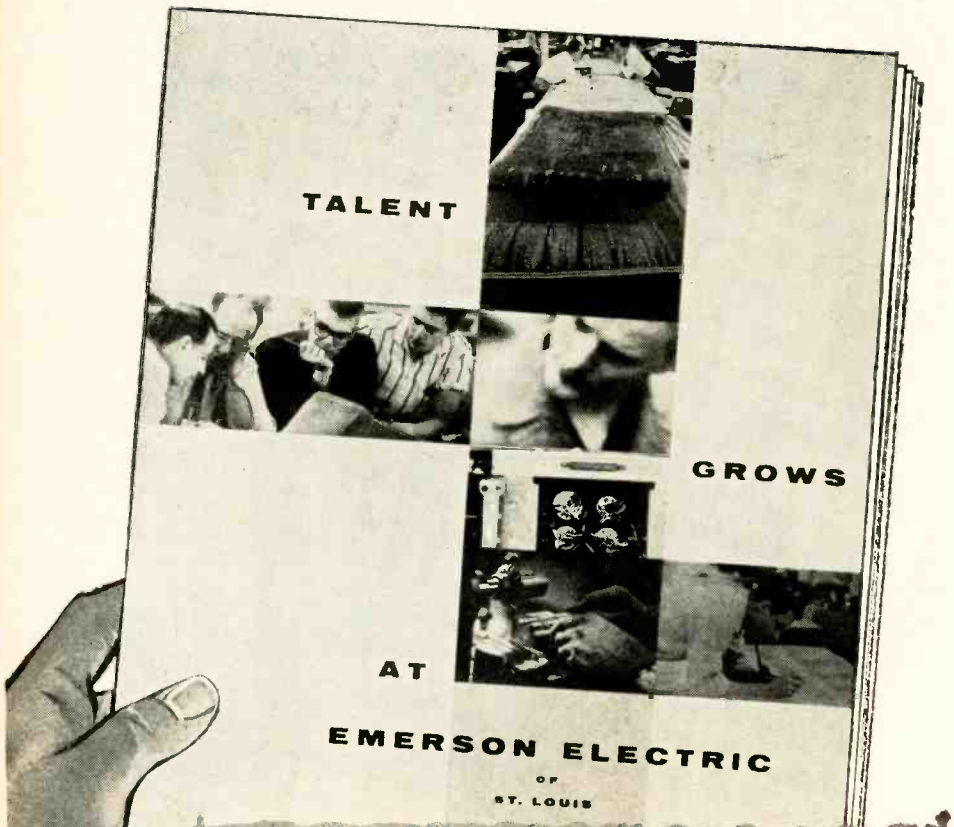

This colorful new brochure is a pictorial tour of our Electronics and Avionics Division, our operations and community. More important, we sincerely believe it will provide you with clear, logical reasons why "talent grows at Emerson Electric": ours is an expanding company, doing some of the most advanced work in avionics-electronics—a medium-size growth company in which people know each other and are quick to recognize where ideas come from.

If you desire opportunity for growth, WRITE TODAY for free brochure and include resumé of your business and education background. Simply address R. L. Middleton, Engineering Employment Manager. There is no obligation.

Electronics and Avionics Division

**EMERSON ELECTRIC**

8100 W. Florissant

St. Louis 21, Mo.

electrical characteristics, high tensile strength, low water absorption, and a dielectric constant of 3.70 at 60 cps and low loss factor of 0.009 at 60 cps. They operate to a maximum temperature of 150 C. Leads may be specified for different lengths and o-d. Circle 219 on Reader Service Card.

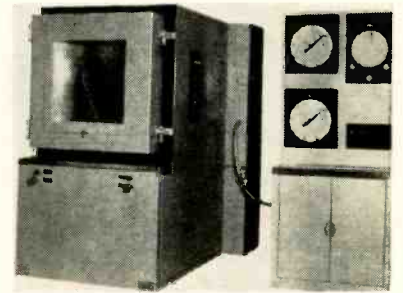

## Test Chamber 27 cu ft unit

ENVIRONMENTAL EQUIPMENT CO., 369 Linden St., Brooklyn 27, N.Y., offers a new 27-cu ft altitude, humidity, temperature test chamber with interior dimensions of 3 ft by 3 ft by 3 ft. Standard test range is -100 F to +200 F, 20 to 95 percent R.H. and 100,000 ft altitude. Greater test ranges, cabinet sizes and accessories are available. Send for descriptive literature. Circle 220 on Reader Service Card.

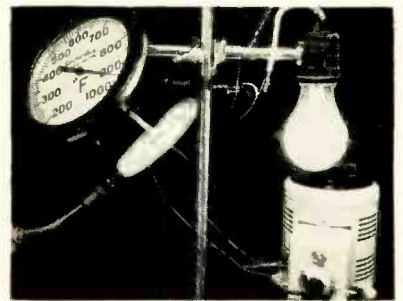

## Flexible Wire ceramic-coated

HITEMP WIRES, INC., 1200 Shames Drive, Westbury, N. Y., announces Ceramatemp flexible magnet wire with a conservative duty rating of 1,000 F for continuous operation. Its insulation exhibits excellent abrasion and cut-through resistance. Its flexibility is such that it will not crack when wrapped around a man-



# TELREX LABORATORIES

Designers and Manufacturers of

## COMMERCIAL SERVICE "BEAMED-POWER" ARRAYS

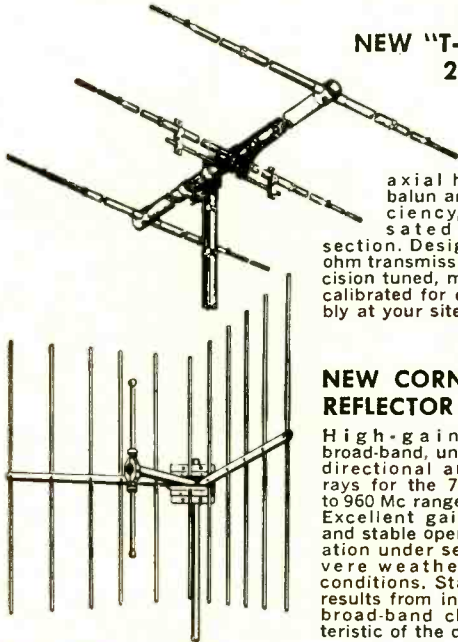

### NEW "T-MATCH" 20 METER ARRAY

Equipped with coaxial half-wave balun and high efficiency, compensated T-match section. Designed for 52 ohm transmission line. Precision tuned, matched and calibrated for easy assembly at your site.

### NEW CORNER REFLECTOR

High-gain, broad-band, unidirectional arrays for the 70 to 960 Mc range. Excellent gain and stable operation under severe weather conditions. Stability results from inherent broad-band characteristic of the design.

Telrex is equipped to design and supply to our specifications or yours, Broad-band or single frequency, fixed or rotary arrays for communications, FM, TV, scatter-propagation, etc.

Consultants and suppliers to communication firms, universities, propagation laboratories and the Armed Forces.



ASBURY PARK 25  
NEW JERSEY, U.S.A.  
Tel. PRospect 5-7252

CIRCLE 92 READERS SERVICE CARD

## NEW SYNCHRONOUS TIMERS

- 1-minute timer adjustable in 1 second intervals—0 to 60 seconds. 3-minute timer adjustable in 3 second intervals—0 to 180 seconds. 5-minute timer adjustable in 5 second intervals—0 to 300 seconds
- No guesswork . . . exact time interval set by positioning bronze pointer
- Sweep-second pointer provides visual count-down during timing operation
- Automatic reset returns pointer to start position after each cycle
- Models interchangeable without disturbing mounting base or wiring
- Rugged timing mechanism guarantees accurate, trouble-free performance

For complete information, write today for descriptive bulletin 10336.

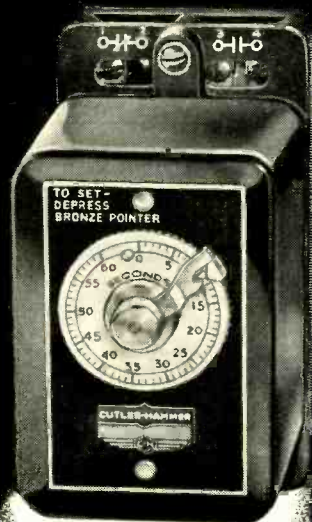

CUTLER-HAMMER Inc.  
1225 St. Paul Ave.  
Milwaukee 1, Wis.



## CUTLER-HAMMER

Cutler-Hammer Inc., Milwaukee, Wis. Division: Airborne Instruments Laboratory. Foreign: Cutler-Hammer International, C. A. Associates: Canadian Cutler-Hammer, Ltd.; Cutler-Hammer Mexicana, S. A.; Intercontinental Electronics Corporation, Inc.

CIRCLE 93 READERS SERVICE CARD

ELECTRONICS engineering edition—July 18, 1958

# STODDART

## COAXIAL ATTENUATORS AND TERMINATIONS

made with exclusive Stoddart Filmistors for highly accurate and stable resistive values from dc to 3000 mc.

2, 6 and 10-position  
TURRET ATTENUATORS  
with simple "PULL-TURN-PUSH"  
operation, small and rugged.

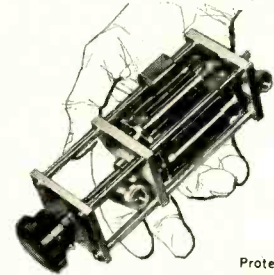

Protected under  
Stoddart Patents

## ATTENUATOR PADS

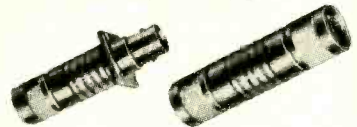

Available in any conceivable combination of male and female Type C and Type N connectors. Maximum length of 3" for any attenuation value.

GENERAL SPECIFICATIONS  
VSWR: Less than 1.2 to 3000 mc.  
Characteristic Impedance: 50 ohms.  
Attenuation Value: Any value from 0 db to 60 db including fractional values.  
Accuracy:  $\pm 0.5$  db; values above 50 db have rated accuracy of attenuation through 1000 mc only.  
Power Rating: 1.0 watt sine wave.

## COAXIAL TERMINATIONS



Small-stable-50 or 70 ohms

1/2-Watt: 50 ohms impedance, TNC or BNC connectors, dc to 1000 mc, VSWR less than 1.2.

1-Watt: 50 ohms impedance, dc to 3000 mc or dc to 7000 mc, Type N or Type C connectors, male or female; VSWR less than 1.2, 70 ohm, Type N, male or female terminations available.

Fast delivery on all items.  
Send for complete literature.

**STODDART**  
AIRCRAFT RADIO CO., INC.  
6644 Santa Monica Blvd., Hollywood 38, Calif.  
HOLLYWOOD 4-9292

CIRCLE 94 READERS SERVICE CARD

# BIRD

## "Termaline" DIRECT READING RF LOAD- WATTMETERS SERIES 6100



### MODEL 612

Models 61 and 611  
are identical in  
appearance

These popular direct reading instruments measure and absorb power in 50 ohm coaxial line systems through the range of 30 to 500 mc.

They are portable and extremely useful for field or laboratory testing . . . checking installation of transmitters . . . trouble shooting . . . routine maintenance . . . production and acceptance tests . . . transmitter tune-ups . . . measuring losses in transmission lines . . . testing coaxial line insertion devices such as, connectors, switches, relays, filters, tuning stubs, patch cords and the like . . . accurately terminating 50 ohm coaxial lines, and . . . monitoring modulation by connecting phone, amplifier or audio voltmeter to the DC meter circuit.

Power scales for Model 61 Special are made to meet your requirements.

WRITE FOR BULLETIN TW606

## SPECIFICATIONS

RF INPUT IMPEDANCE: 50 ohm nominal.

VSWR: Standard specification 1.1 to 1 maximum over operating range.

ACCURACY: 5% of full scale.

INTERNAL COOLANT: Oil.

POWER RANGE: Model 611—0-15, 0-60 watts full scale. Model 612—0-20, 0-80 watts full scale.

INPUT CONNECTOR: Female "N".

EXTERNAL COOLING METHOD: Air Convection.

OTHER BIRD PRODUCTS

RADIATOR STRUCTURE: All Aluminum.

FINISH: Bird standard gray baked enamel.

WEIGHT: 7 pounds.

OPERATING POSITION: Horizontal.



"ThruLine"  
Directional  
RF Wattmeters



"Termaline"  
RF Load Resistor

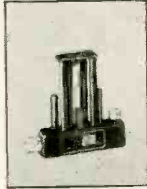

Coaxial  
RF Filters



Coaxial  
RF Switches

drel just three times its own diameter. Nickel clad copper conductors are being coated in single and heavy thicknesses, in sizes 20 to 30 Awg, with expanded size range expected in the near future. Circle 221 on Reader Service Card.

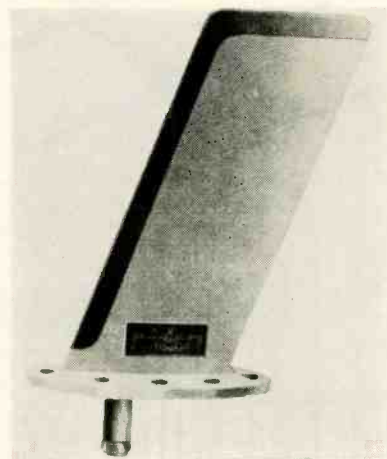

### UHF Blade Antenna meets MIL-T-5422C

DORNE & MARGOLIN, INC., 29 New York Ave., Westbury, L.I., N.Y. Type DM C7-2 antenna is a direct replacement for the AT-256/ARC antenna on high performance aircraft. Drag at Mach .9 and 25,000 ft for the AT-256 is 17.5 lb while for the DMC7-2 it is less than 3 lb. The new antenna operates in the 225 to 400 mc band for use with communication and data link equipment. It is a high strength swept-back aluminum blade that extends just  $7\frac{1}{4}$  in. from the aircraft skin. It can withstand more than 8 lb per sq in. lateral static load. Circle 222 on Reader Service Card.

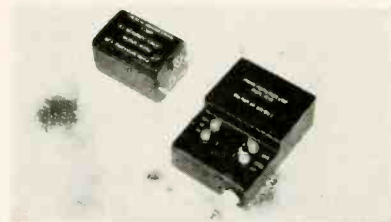

### Power Supplies for radar use

PERKIN ENGINEERING CORP., 345 Kansas St., El Segundo, Calif., announces two new airborne radar



**BIRD ELECTRONIC CORP.**  
EXpress 1-3535  
1800 E. 38 St., Cleveland 14, Ohio

Western Representatives: VAN GROOS COMPANY, Woodland Hills, Calif.

# VERSATILITY

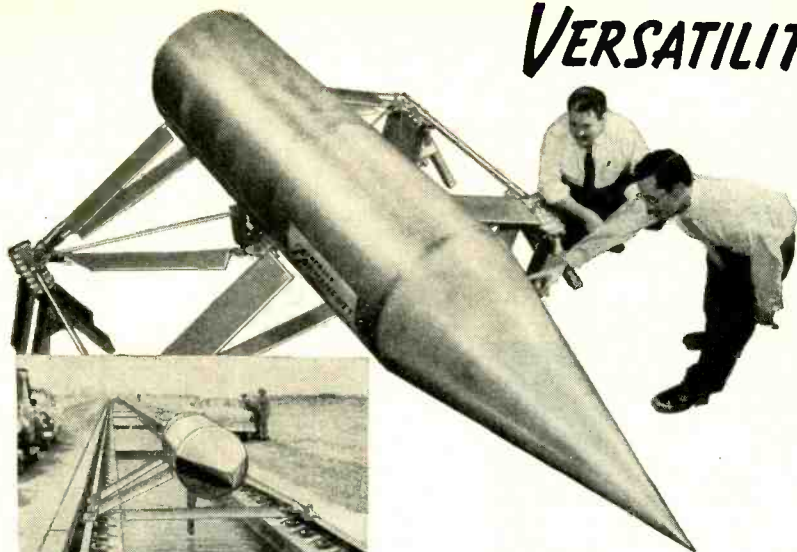

General-Purpose Test Vehicle

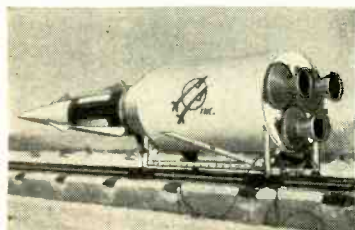

Rocket Test Sled, Nike Hercules Missile Warhead

## ROCKET PROPELLED TEST VEHICLES

- STRUCTURES
- MECHANICAL DESIGN
- AERODYNAMICS
- MANUFACTURING
- PROPULSION SYSTEMS
- FIELD TESTS

# AIRCRAFT ARMAMENTS, INC.

Cockeysville, Maryland

A SUBSIDIARY OF UNITED INDUSTRIAL CORP.

CIRCLE 96 READERS SERVICE CARD

## Eliminate Voltage Adjustment and Meter Reading with NEMS · CLARKE PM 206/PM 216 PREAMPLIFIER-MULTICOUPLER

### SPECIFICATIONS

Pass Band (PM-206)	215-245 Megacycles
Pass Band (PM-216)	225-260 Megacycles
Uniformity of response	Within 3 db
Gain	20 db in Pass Band
Impedance	Designed to operate in a 50 ohm system
Noise Figure	Better than 6 db
Isolation	37 db minimum
Tube Complement	1-6280/416B 3-5842/417A 1-5651
Size	19" x 7" x 16 1/2"
Types of connection	Type C

(Other types available on request)



Our PM206/PM216 Preamplifier-Multicouplers have self-contained power supplies. The recessed panel construction protects patching cables. Units are designed to connect six receivers with one antenna. Rugged construction assures long-life.

Visit us at the WESCON SHOW • Booth 1556

## NEMS · CLARKE COMPANY

A DIVISION OF VITRO CORPORATION OF AMERICA  
919 JESUP-BLAIR DRIVE • SILVER SPRING, MARYLAND • JUNIPER 5-1000

CIRCLE 97 READERS SERVICE CARD

ELECTRONICS engineering edition — July 18, 1958

## PRECISION DEFLECTION WITH COSSOR YOKES

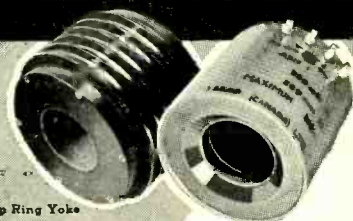

Slip Ring Yoke

Two-Axis Fixed Yoke

### Component Development Engineering at its BEST!

- ADVANCED ELECTRICAL DESIGN
- PRECISION MECHANICAL DESIGN
- ACCURATE PRODUCTION METHODS

Custom Built to the most  
Exacting Specifications  
by Cossor Engineers

In Mumetal Cores for Optimum Geometry  
In Ferrite Cores for Speed and Sensitivity  
In Non-magnetic Cores for Perfection of Response

Any of Cossor's Three Core Types can be made in single or double axis with single or push-pull windings, and encapsulated for fixed or slip ring (rotating) use.

Normal characteristics of yokes for 1-1/2 in. neck tubes are:

Positional accuracy - the spot position will conform to the yoke current co-ordinates within 0.25% of tube diameter. For deflection angles less than 25° better accuracy can easily be achieved.

Memory - 0.5% max. without over-swing;  
0.1% or less with controlled over-swing.

Complete encapsulation in epoxy (stycast) or silicone resins is standard for all Cossor deflection yokes, and is done with special moulding tools ensuring accurate alignment of the yoke axis. When slip rings are added, solid silver rings are mounted in encapsulating resin. The finished slip ring yoke is precision turned to centre bore, and can include bearing mounting surfaces with dimensional tolerances approaching those associated with high quality metal parts.

Settling Time (Micro sec.) =  $\frac{120 \sqrt{\text{Inductance in Henries}}}{\text{Accelerator Voltage - KV}}$

Sensitivity degrees/milliamperes =  $\frac{0.095 \sqrt{\text{Inductance - millihenries}}}{\text{Accelerator Voltage - KV}}$



COMPONENTS DIVISION

## COSSOR CANADA LIMITED

301 Windsor St., Halifax, N. S.  
8230 Mayrand St., Montreal, Que.  
648A Yonge St., Toronto, Ont.  
Corporation House, 160 Laurier West, Ottawa, Ont.

CIRCLE 98 READERS SERVICE CARD



• **R-F RECEIVER DESIGN**  
 • **INERTIAL NAVIGATION**

**Two of many areas in Avionics  
 in which Bell Aircraft has openings  
 for qualified electronics engineers**

Particularly good opportunities are now available for engineers with radio frequency experience in the 100 kilocycle to 35,000 megacycle range with emphasis on transistorizing of circuits... and for those with experience in inertial instrumentation design and evaluation.

**Present openings include assignments in:**

- Pulse and Digital Coding
- Identification Systems
- Electronic Counter Measures
- Landing Systems
- Digital Computers
- Precise Instrumentation Development

These assignments embrace a wide range of high level design and development problems which will afford full scope to your creative ingenuity with unusual opportunities for rapid advancement and professional recognition. Salaries commensurate with your background, good living and working conditions, and liberal benefits. Please write: Supervisor of Engineering Employment, Dept. H-33, BELL AIRCRAFT CORPORATION, P. O. Box 1, Buffalo 5, N. Y.



power supplies. Model M763 pulse generator operates from a 13.8 v 120 ma 400 cps a-c input and provides 120 v peak minimum, 320 v maximum. Model M740 is a h-v d-c power supply providing 8 kv at 100  $\mu$ a from 115 v, single phase, 400 cps a-c input line. Regulation is 5 percent no load to full load. Both units are completely encapsulated. For further information write on company letterhead.

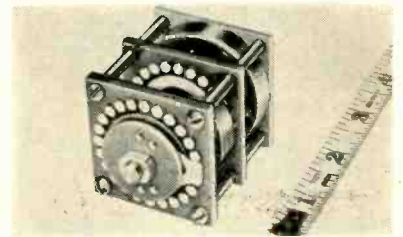

**New Rotor  
 for s-p switches**

THE DAVEN CO., Livingston, N. J., has developed a special new rotor which will break up to 5 amperes a-c resistive load at 115 v. The special rotor is now available on all the company's single pole switches. The new unit may be had in three sizes. The 1 1/4 in. size can be secured on a s-p unit with up to 32 positions, make-before-break (shorting). The 2 1/2 in. size is available with up to 48 positions, make-before-break (shorting). And the 3 in. size is available with up to 60 positions, make-before-break. Circle 223 on Reader Service Card.

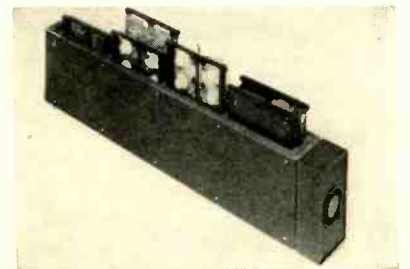

**Digital Amplifier  
 for airborne use**

EPSCO, Inc., 588 Commonwealth Ave., Boston 15, Mass., has available an airborne subminiature digital tape recording amplifier. Designed for use in airborne data acquisition systems, the Minidrive





*Customized*  
**CANS**

**FOR HIGH VOLTAGE SHIELDS, COVERS,  
HOUSING AND SPECIAL APPLICATIONS**

Easiest way to solve a customized can problem is to have OLIVE CAN COMPANY "tackle it"! OLIVE CAN has produced an endless variety of millions upon millions of customized cans for the electronic industry. This unique and specialized service has made OLIVE CAN the accepted leader in its field. 46 years of engineering and production "know how" plus complete design and tool room facilities coupled with high-speed, automatic machinery have resulted in amazing economies for leading manufacturers nation-wide. Why not let OLIVE CAN do the same for you?

*Write today for information and quotation to your requirements.  
No obligation.*

**OLIVE CAN COMPANY**

4700 North Oketo Avenue • Chicago 31, Illinois • UNderhill 7-7474  
**ORIGINATORS OF LOW COST, HIGH VOLTAGE HOUSINGS FOR THE TV INDUSTRY**

CIRCLE 100 READERS SERVICE CARD

**YOUR BEST BUY!**

*Silicone Coated*  
**RESISTORS**

5 TO 50 WATTS • FIXED AND ADJUSTABLE  
HIGH PERFORMANCE • LOW COST

Your inquiry or drawing will bring quotations  
—samples on request

**MILWAUKEE RESISTOR CO.**

702 W. Virginia Street • Milwaukee 4, Wisconsin

CIRCLE 101 READERS SERVICE CARD

• DC TO 10 KMC • 50 OHMS • 1 WATT  
**COAXIAL TERMINATIONS**

Model No.	Type Connector	Maximum VSWR in 50-ohm Systems
535-MN	"N" Male	DC-1 KMC: 1.03 1-4 KMC: 1.05
535-FN	"N" Female	4-10 KMC: 1.15

Type 535 terminations also available in type "TNC", "SC", "BNC", and "C" connectors.

**Weinschel Engineering**  
KENSINGTON, MARYLAND



CIRCLE 102 READERS SERVICE CARD

ELECTRONICS engineering edition — July 18, 1958

**Using  
Thermistors**

Edited by  
**FENWAL ELECTRONICS**

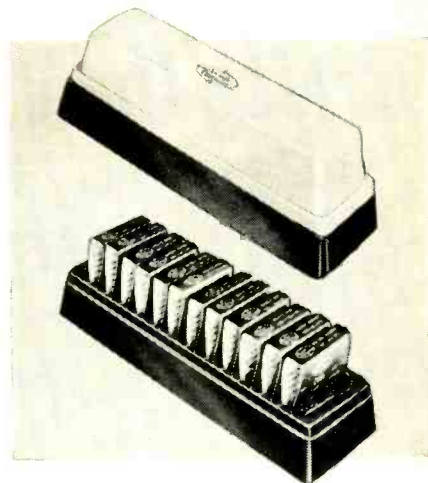

**New Experimenter's  
Thermistor Kit**

Now it's easier than ever to choose the thermistor best for your application!

**New Fenwal Thermistor Kit No. G200** can be purchased for experimental work and use in circuit design. It contains a selection of 12 thermistors — 2 glass probes, 3 beads, 2 discs, 3 rods and 2 washers. Price is only \$19.95 f.o.b. Framingham, Massachusetts.

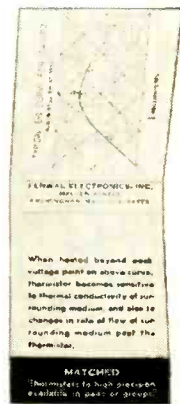

Complete technical data provided with each thermistor right on its individual package. Information includes: ratio of resistance at 0°C and 50°C; dissipation constant; time constant; typical E-I curve; typical Resistance-Temperature curve; actual resistance at 5 specific temperatures; plus current, voltage and temperature parameters.

To order Fenwal Thermistor Kit No. G200, write — FENWAL ELECTRONICS, INC., 26 Mellen St., Framingham, Mass.

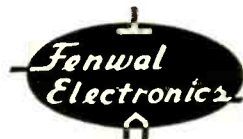

Design — Engineering — Production  
of Precision Thermistors

CIRCLE 103 READERS SERVICE CARD

# Now! A COMPLETE SHAKER SYSTEM for less than \$550.00!

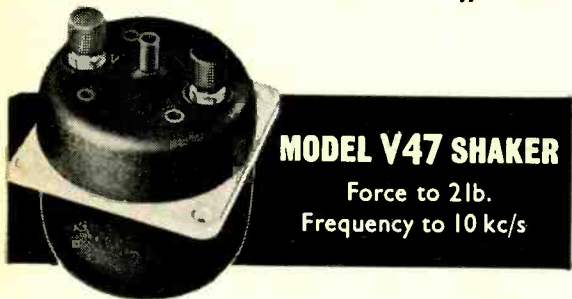

**MODEL V47 SHAKER**  
Force to 2 lb.  
Frequency to 10 kc/s



**MODEL D5 POWER OSCILLATOR**

Power output to 5W.  
Frequency 10 c/s to 10 kc/s

GOODMANS, Europe's foremost manufacturers of Shakers, have expanded their production facilities to ensure prompt delivery to all parts of the North American continent.

GOODMANS Shaker Systems play an increasingly important part in the world's missile and electronic industries. Applications include calibration of accelerometers, environmental testing of aircraft and missile components, actuation of servo valves, and testing of hair springs.

Call or write now for full details of this precision engineered equipment.

**USERS OF GOODMANS EQUIPMENT INCLUDE**

- U.S. Navy • The State University of New York • Washington University • Oxford University • The University of Maryland • Rutgers University • Massachusetts Institute of Technology • General Dynamics Corporation • Mullard Ltd. • Jaguar Cars • Rolls Royce Ltd.



• **EASTERN DIVISION**  
SOLARTRON INC.  
530/2 COOPER STREET,  
CAMDEN 2, N.J.  
Phone: Woodlawn 4-3039

• **WESTERN DIVISION**  
SOLARTRON INC.  
10761 BURBANK BOULEVARD,  
NORTH HOLLYWOOD, CALIF.  
Phone: Stanley 7-5081

**CANADIAN ENQUIRIES TO:**

GD 52 Nickam Instruments & Supply Ltd., 99 Floral Parkway, Toronto 15, Ontario. Phone: Cherry 4-4191

**THE GOODMANS RANGE**

**MODEL 390A**  
Force to 25 lb.  
Frequency to 4 kc/s

**MODEL 790**  
Force to 50 lb.  
Frequency to 500 c/s

**MODEL 8/600A**  
Force to 200 lb.  
Frequency to 1 kc/s

**MODEL 16/600**  
Force to 400 lb.  
Frequency to 400 c/s

**MODEL D 120**  
Power Output 120 W  
Frequency 10c/s to 10k/cs

provides for 14 channels of pulse data recording on magnetic tape. The completely transistorized unit will meet all specifications and will operate reliably over an ambient temperature range of -55 C to +71 C. Size is 21½ in. wide by 6 in. high by 20½ in. long; weight, approximately 14 lb including internal power supply. Circle 224 on Reader Service Card.

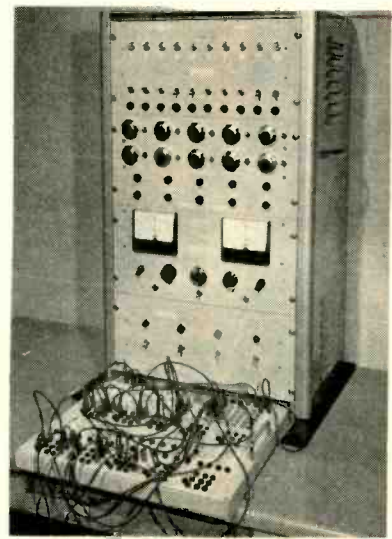

**Analog Computer desk-top type**

ENGINEERING SPECIALTY CO., P. O. Box 19, Sugarhouse Station, Salt Lake City 5, Utah. Model AC-2 analog computer unit includes components, 10-turn coefficient potentiometers with counting dials, amplifiers, initial condition volt sources, diodes, hold and initial condition provisions, two voltmeters, problem board, patch cords, and self-contained power supply—all mounted in a desk top cabinet with a fan and filter to provide proper air circulation. Circle 225 on Reader Service Card.

**Purifier for argon-helium**

LIQUID METALS, INC., Box 266, Westford, Mass., has developed an argon-helium purifier. Total impurity content is in the range of 1 part in 100 million to 1 part in 10 billion. A wide range of sizes is produced from the laboratory model (3 cu ft/hr) to the production

model (6,000 cu ft/hr). Circle 226 on Reader Service Card.

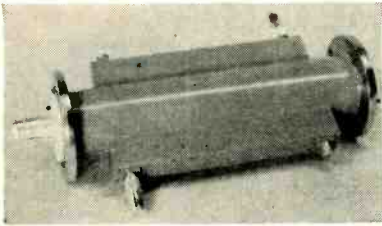

### Directional Coupler precision unit

AMTRON CORP., 17 Felton St., Waltham 54, Mass., announces the model JP 400 mc precision coaxial directional coupler. It provides a forward output which is  $50 \pm 0.3$  db down from the forward power in the  $3\frac{1}{2}$  RETMA line at center frequency, and a reflected output which is  $40 \pm 0.3$  db down from the reflected power in the  $3\frac{1}{2}$  line. Coupling varies slowly with frequency, being  $\frac{1}{2}$  db down at 0.8 and 1.2  $f_0$ , 1 db down at 0.75 and 1.25  $f_0$ , 3 db down at 0.5 and 1.5  $f_0$ . Circle 227 on Reader Service Card.

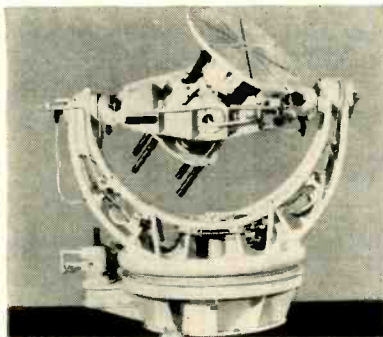

### Flight Simulator for test purposes

J. W. FECKER, INC., 6592 Hamilton Ave., Pittsburgh 6, Pa., has introduced 3-axis flight simulators for testing the mechanical and electronic inertial guidance assemblies and components of missiles and aircraft. They are ruggedly built to minimize structural resonances. Units are available for a wide range of load capacities. Speeds of up to 50 cps are possible, depending upon the variables involved. Circle 228 on Reader Service Card.

# NEW

*electronically  
controlled*

## TOROIDAL WINDER

# TW 300

*faster production at lower cost  
speeds up to 2000 turns per minute  
4-digit, 2- or 7-position predetermined  
turns counting*

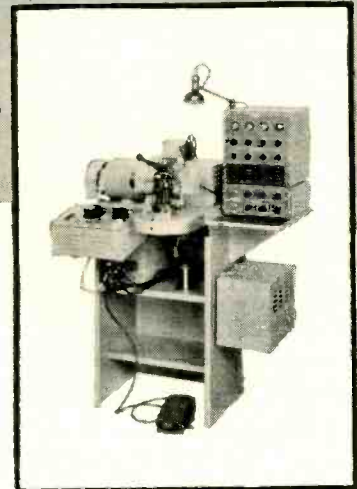

The entirely NEW electronic system of the TW 300 provides unmatched features in a toroidal winder . . . proximity pick-up for use with any size wire without physical contact . . . 100% accurate turns counting . . . controlled slow-start, slow-stop driving motor . . . automatic segmental winding with perfect repeatability . . . progressive winding of segments or continuous coils in either direction.

The TW 300, designed for easy servicing and maintenance, cuts production time and operator fatigue to the bone. Flexibility in production of new coil types with superior electrical characteristics is unlimited because of the new control system with automatic winding features. This machine is a significant advance toward complete automation of toroidal winding.

*You get the BEST from BOESCH*



**BOESCH MANUFACTURING  
COMPANY, INCORPORATED  
DANBURY, CONNECTICUT**



## 6 Taylor-Fabricated Laminated Plastic Insulators Protect Control Elements of GE Automatic Toaster

These insulators for the pop-up mechanism, color control unit, and heating element in the General Electric Automatic Toaster are made of continuous filament woven glass fabric with melamine resin bond. This Taylor Fibre Co. material was selected for its ability to withstand the temperatures encountered in the toasting operation, its excellent arc resistance and mechanical strength, and its cost, which is lower than that of the mica insulators formerly used.

Another factor in the decision was the capacity of Taylor Fibre Co. to produce the fabricated parts to specification, and in the large quantities required, at reasonable cost.

You, too, may have applications which can utilize the combination of physical, mechanical and electrical properties found only in lami-

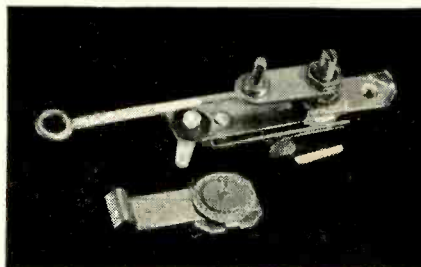

nated plastics. Our application engineers will be glad to discuss them with you, offer engineering assistance, and recommend a Taylor grade that will fit your specific requirements. Our plants at Norristown, Pa., and La Verne, Calif., are both fully equipped for fast supply of basic materials and finished parts. Write us for detailed information or to arrange for a Taylor Fibre man to call on you. TAYLOR FIBRE CO., Norristown 40, Pa.,

# Taylor

LAMINATED PLASTICS VULCANIZED FIBRE

## Literature of

### MATERIALS

**Metal Stampings.** The Staver Co., 45 N. Saxon Ave., Bay Shore, N. Y. A four-page folder details the services of the company in the fabrication and production of stampings from rare and specialized metals and includes a handy quick reference chart covering the properties and typical uses for 20 different types of rare or special metals. **Circle 300 on Reader Service Card.**

### COMPONENTS

**Microwave Tubes and Components.** Bomac Laboratories, Inc., Salem Road, Beverly, Mass. A six-page folder includes specifications on TR, ATR, Pre-TR and attenuator tubes, pressurizing windows, spark gap tubes, reference cavities, klystrons, and other microwave tubes and components. **Circle 301 on Reader Service Card.**

**Miniature Pots.** Waters Mfg., Inc., Wayland, Mass. A four-page folder contains features and specifications for the new type E line of miniature precision potentiometers. **Circle 302 on Reader Service Card.**

**Silicon Power Diodes.** International Rectifier Corp., El Segundo, Calif. Bulletin SR304 contains an illustrated description of a line of 25 to 45 ampere silicon power diodes. Types and ratings are listed, and characteristics curves included. **Circle 303 on Reader Service Card.**

**Switching Reactors.** Control, a division of Magnetics, Inc., Butler, Pa., has issued a 16-page catalog on the company's complete line of standard switching reactors for one-step, low-cost static control. **Circle 304 on Reader Service Card.**

**Waveguide Bends.** Microwave Development Laboratories, Inc., 92 Broad St., Wellesley, Mass. The 12-page catalog No. C-158 provides an up-to-date guide for the selection of precision cast bends

# the Week

and formed waveguide bends. Ordering information is included. Circle 305 on Reader Service Card.

## EQUIPMENT

**Automatic Voltage Regulators.** The Superior Electric Co., Bristol, Conn. New Stabiline bulletin S358IE describes the complete standard line of IE (Instantaneous Electronic) automatic voltage regulators. Circle 306 on Reader Service Card.

**Magnetic Tape Recorders.** Amplifier Corp. of America, 398 Broadway, New York 13, N. Y. The Magneloop series of continuous loop magnetic tape recorders-reproducers incorporating an unusual tape drive are described in a four-page folder. Circle 307 on Reader Service Card.

**Power Transistor Characteristic Plotter.** Dunn Engineering Associates, Inc., 225 O'Brien Highway, Cambridge 41, Mass., has available a new data sheet on the model 341 power transistor characteristic plotter, a compact, versatile, general purpose curve tracer for use with both point contact and junction transistors. Circle 308 on Reader Service Card.

## FACILITIES

**Facilities Brochure.** Benrus Watch Co., Inc., 30 Cherry Ave., Waterbury, Conn. A new booklet describes equipment, processes, techniques and abilities available at the company. It also describes the type of work that is being done on a sub-contract basis. The brochure can be obtained by writing on company letterhead.

**Transducer Testing.** Edcliff Instruments, 1711 So. Mountain Ave., Monrovia, Calif. A recent facilities bulletin summarizes the general environmental specifications to which the company manufactures its transducers. Circle 309 on Reader Service Card.

# CONQUEST OF SPACE



There are some who find fulfillment in boundless outer space. And more power to them!

But those of us who still have our feet on the ground also find real challenges in less expansive surroundings.

With the aid of a medium-power microscope and several years' experience with fluoro-chemical designs, we successfully pack 4 filter reactors and a 350 VA power transformer into 60 cubic inches of hermetically sealed inner space. Result is 6 pounds of streamlined reliable power for small space platforms...proved in performance in '58-model missiles and (pardon the expression) aircraft.



Have slide rule... will travel. You can reach us at:

Raytheon Manufacturing Company  
Magnetic Components Department  
Section 6120  
Waltham 54, Massachusetts



## PLANTS and PEOPLE



# N. Y. Plant to Hire 1,000

ONE THOUSAND PERSONS will be employed in a new \$2 million plant now under construction in the Bronx, New York.

Herold Radio & Electronics Corp. will occupy the 125,000 sq ft manufacturing and office facility (picture) being built on a five-acre site. Firm has a 41-year lease on the property. Aggregate rental exceeds \$4 million.

The building, scheduled for completion by year's end, will be used by Herold to integrate New York operations now scattered in nine plants and warehouses in Pelham, Mt. Vernon and the Bronx.

Company manufactures hi-fi stereophonic phonographs, transis-

tor and clock radios, and associated equipment. The new structure will increase the firm's working space by 40,000 sq ft—almost 50 percent. Building will be situated between 241st and 244th streets off the Bronx River Parkway.

Ground floor of the new plant will be devoted entirely to manufacture. The 20,000 sq ft on the second floor will accommodate executive offices and the research engineering department.

The new plant will mark the second electronics facility built in the Bronx by the Irving J. Feder Company within the last year. The firm also constructed the 86,000 sq ft Loral Electronics plant.

# Collins Sets Up Department

FORMATION of a separate Airborne Instrument Manufacturing Department to speed up production of automatic pilot, integrated flight, and magnetic compass systems, aircraft instruments and other precision electromechanical devices has been completed by Collins Radio Company, Cedar Rapids, Iowa.

The new department was formed as a result of the Company's continued expansion in the flight control instrument field. Instrument production facilities at Collins have more than doubled in the past six months, say company officials.

"The concentration of emphasis on instruments in an autonomous organization is designed for improved control over all aspects of production including design, scheduling, quality control, cost, inspection and procurement, and provides

facilities to meet an increasing demand for airborne instruments," a spokesman said.

# Mosler Safe Co. Starts Expansion

THE Mosler Safe Company's new electronic alarms and monitoring equipment plant on a 7½ acre site at Danbury, Connecticut, has begun. It will include offices, laboratories and production facilities.

Completion is scheduled for mid-November, 1958. Plans call for eventual use of the entire site with employment for several hundred persons.

Martin S. Coleman, firm president said the new plant, for which hiring has started, will increase production of the firm's line of

electronic and electrical security devices. It will also consolidate operations which are presently in four separate Danbury, Connecticut locations.

Executive offices of the Mosler Safe Company are in New York. Plants are located in Hamilton, Ohio, Covington, Kentucky and Mexico City, Mexico.



# Bradley Named V-P, G-M

WILSON BRADLEY, JR. (picture) is appointed vice-president and general manager of the Endeveco Corp., Pasadena, Calif. In addition to his duties as v-p, he will remain active in the design and development of new electronic components. He has gained prominence for the development of basic transducer designs.

Bradley formerly worked in industrial marketing for the McCarty Co., was assistant to the g-m of Beckman Instruments, Inc., a representative for the Wright Engineering Co., and for the past several years has been on the Endeveco staff.

# Wire Company Adds to Plant

INCREASED demand for recently developed new products of the Times Wire and Cable Co., Inc., has made it necessary for the company to build a \$300,000 addition to its Wallingford, Conn., plant. Times, an affiliate of the International Silver Co. of Meriden, Conn., manufactures engineered cables for the electronic, electrical and communi-

# NEW LOW PRICES!

**Increased demand for Raytheon high-quality AC and DC small parts welding equipment brings you reduced costs**

**ONLY \$360**

This complete plug-in welding system including popular 18A Weldpower DC Control and Model "J" Welding Head, designed for high speed production welding of small parts.

**Typical Metal Combinations You Can Weld With the 18A**  
.006" dia. copper wire to .032" dia. tinned copper wire  
.003" thick nickel to .010" dia. nickel rod  
.001" thick silver to .002" dia. copper wire  
.005" thick Nispan to stainless rod .032" dia.

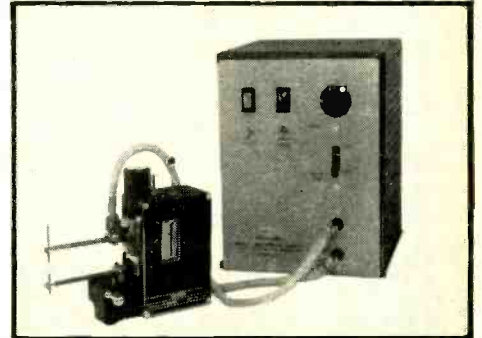

**ONLY \$614**

This welder includes the Model 60A DC Power Supply and Model "J" Welding Head. Heat control for the 60A Power Supply adjustable between 675 and 1500 volts; switch selects storage capacity of 14, 28 or 56 microfarads. Price includes all interconnecting cables.

**Typical Metal Combinations You Can Weld with the 60A**  
#30 stranded copper wire to .080" dia. tinned steel pin heads  
.010" dia. platinum wire to .040" dia. paliney pin  
#22 tinned copper wire to .003" thick copper strip  
.030" dia. tinned copper wire to stainless steel .004" thick

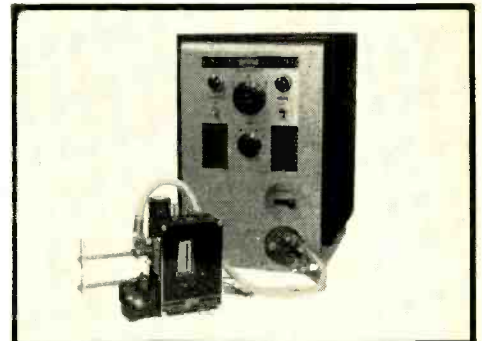

**ONLY \$553**

Precise control of welding time and heat by Raytheon Model 2-152 fully synchronous spot timer and the Raytheon Model 2-154 Thyatron Contactor assures strong, uniform welds. Ideal where a large number of welds per minute are required. The Model "J" Head and all interconnecting cables are included in this price.

**Typical Metal Combinations You Can Weld with the Synchronous Spot Timer, Model 2-152**

.010" thick stainless steel to .010" stainless steel  
.003" thick gold plated nickel to .020" dia. kovan pin  
.020" thick nickel to .010" thick stainless steel  
.005" dia. tungsten wire to .020" dia. nickel silver pin

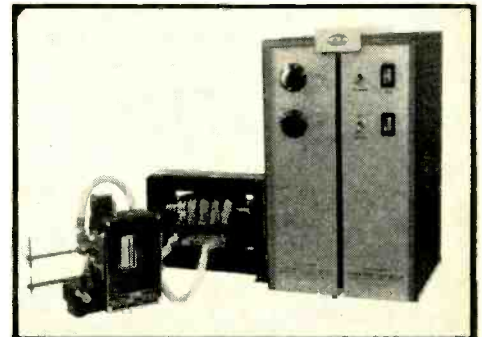

## **Check these outstanding features of Raytheon Welders**

- Uniform welds provided by uniform pulses of built-in voltage regulating circuit.
- Difficult welding problems solved by adjustable pulse time.
- No relay problems thanks to all-electronic firing circuit.
- Maximum flexibility—several heads can be used with one control.
- Compact, little bench space required.

For full information on these systems now available at new low costs plus a FREE ANALYSIS of your welding problems by a *Raytheon Welding Analyst*, write today.

**RAYTHEON MANUFACTURING COMPANY, Commercial Equipment Division,  
Industrial Products Department EL7, Waltham 54, Mass.**



*Excellence in Electronics*

## Research and Development Engineers and Physicists

-Specializing in Servos, Transistorized  
Circuitry, Logical Design, Microwaves  
and Antennas, Special Purpose and  
General Purpose Computer Engineering  
(Degree required)

### Make the most of your experience

Work on advanced projects such as airborne radar, analysis and development of circuits for advanced radar systems; electronic analog computers and general purpose digital computers; armament control; checkout and test equipment; bombing navigation systems; inertial guidance; analytical studies associated with new electro-mechanical systems.

Autonetics offers a 12-year stockpile of experience in the design, development, and quantity manufacture of flight controls, inertial navigators, armament controls, automated machine controls, computers, landing systems, radar systems, data processing equipment, and electro-mechanical servo systems—plus a complete flight test section, specialized engineering and production facilities.

If you have a formal education, and have sound experience in any of the fields related to our work, just send the coupon below. Attach resume if you wish.

Mr. C. F. Benning, Autonetics,  
9150 E. Imperial Highway, Downey, California

Dear Mr. Benning: Please consider my qualifications for the following field(s).

Inertial Guidance  Fire Control  Computers  Bombing Navigation Systems  Automatic Checkout and Test Equipment

Name \_\_\_\_\_

Home Address \_\_\_\_\_

City \_\_\_\_\_ State \_\_\_\_\_

Home Phone \_\_\_\_\_

Degree(s) \_\_\_\_\_

Experience \_\_\_\_\_

**Autonetics**

A DIVISION OF NORTH AMERICAN AVIATION, INC.  
NERVE CENTER OF THE NEW INDUSTRIAL ERA



cations industries, and is a major producer of long line coax cables used in closed circuit and wired tv transmission systems.



### Sylvane Becomes V-P, Chief Engr.

APPOINTMENT of Allen A. Sylvane (picture) as vice president and chief engineer of Continental Electronics, Brooklyn, N. Y., is announced. He will head the research and development program and production of Navy training sonobuoy devices and communication equipment. He served in a similar capacity with Continental Electronics Ltd. the past 14 years.

Prior to joining Continental Electronics Ltd., Sylvane was chief engineer of Commercial Radio-Sound Corp. of New York.

### Walker Is EIA Section Chairman

LEONARD G. Walker, marketing manager, microwave and industrial control department, Motorola Inc., has been appointed chairman of the Microwave Section, EIA Technical Products Division. He succeeds Maury G. Staton, who resigned following a change in his position with RCA.

Walker joined Motorola in 1951 after a 15-year affiliation with the Idaho Power Co., as an electrical engineer. Staton, whom he re-



places at EIA, is now with the Astro Electronic Products Division, RCA Labs, in Princeton, N. J.

## S-C Shifts Two Key Men

NEW director of manufacturing of Stromberg-Carlson's Electronics Division, Rochester, N. Y., is Clarence F. Van Epps. He will be succeeded as manager of materials engineering by Ernest W. Goral, who has been assistant manager of the department for the past 2½ years.



## Advance Riordan

IN Willimantic, Conn., William Brand & Co., Inc., promotes Charles R. Riordan (picture) to assistant general manager. He had previously been assistant sales manager of this company which manufactures Turbo wires, cables and electrical insulating tubing.

## Caffin Takes New Position

FORMERLY sales engineer at the Kearfott Co., William D. Caffin was recently named sales supervisor at Daystrom Transicoil Corp., Worcester, Pa., manufacturers of servo and synchro assemblies and components. He will be responsible for liaison between the com-

# Real Time RECORDING... WITH INSTANTANEOUS READOUT

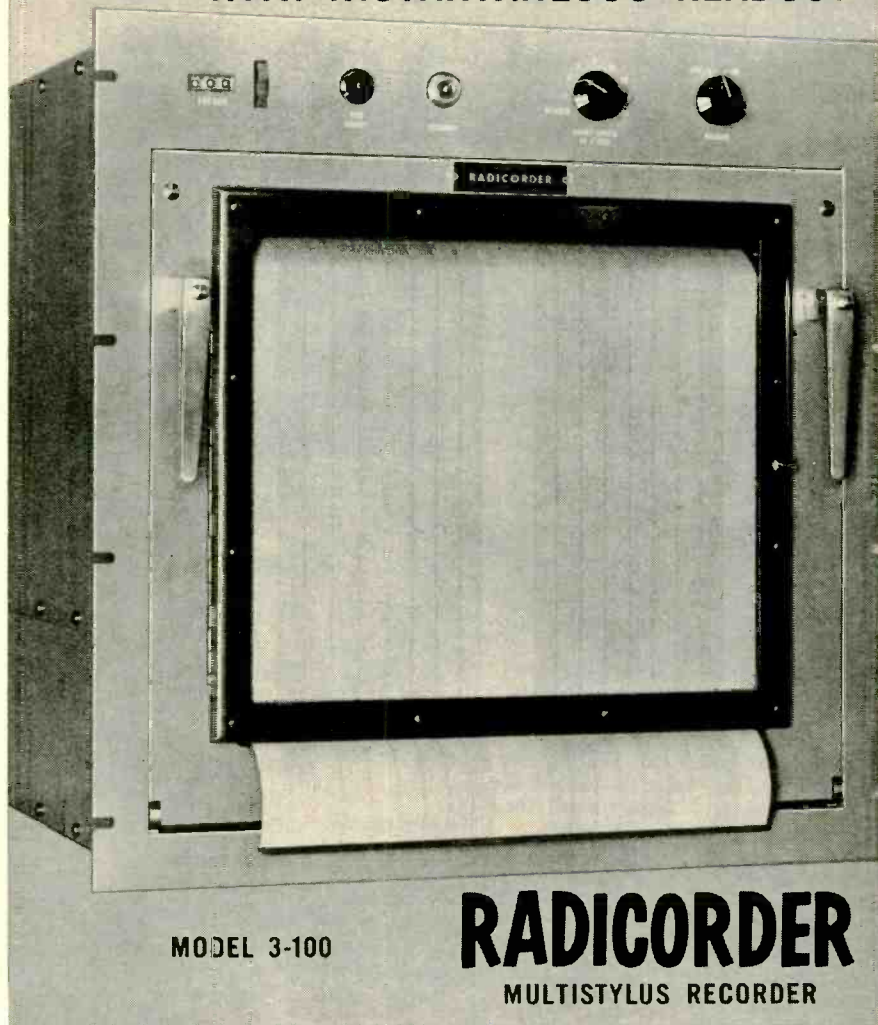

Uses fixed-styli technique to record multiple channels of pulse information or as many as 646 on-off functions.

Plots analog or digital data in decimal-digital, binary-digital, or discrete-level analog form on electrosensitive paper chart.

### Easy to read

- Finite data points
- Integral grid lines

### Accurate

- Up to  $\pm 0.08\%$  full-scale (dependent on number of styli assigned to channel) with no under- or overshoot.

### Modular recording-head construction

- Simple replacement
- Flexible arrangement

### Local and remote jump-speed control

- Up to 100 in./second

Write P. O. Box 37, Melbourne, Florida for complete data and prices.

Personnel Inquiries Invited



**RADIATION  
INC.**

MELBOURNE AND ORLANDO, FLORIDA  
AVIONICS • ASTRONICS • INSTRUMENTATION

## WHO IS BORG?

George W. Borg, who founded this corporation, is the "Mr. Clutch" who started with Borg & Beck. He then helped organize the Borg-Warner Corporation of which he became president. Later he served as chairman of the board until he resigned to devote his full attention to The George W. Borg Corporation.

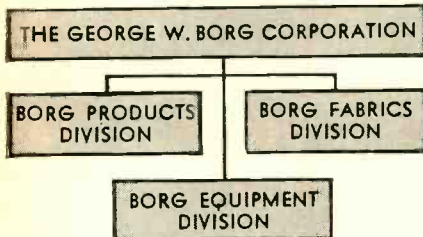

The George W. Borg Corporation is comprised of three divisions

- **Borg Products Division**  
Manufactures automotive clocks.
- **Borg Fabrics Division**  
Manufactures deep-pile fabrics best known of this line is the fashionable "Borgana" fabric.
- **Borg Equipment Division**  
Manufactures Micropots (precision potentiometers), Microdials (precision turn-counting dials), instrument motors, frequency standards, aircraft navigational instruments and components for systems.

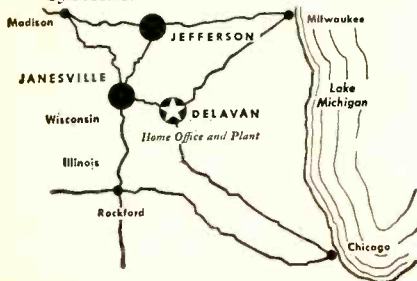

## HOW BORG EQUIPMENT DIVISION CAN HELP YOU . . .

Borg's background of experience will save you time and money by helping you solve design and production problems of electronic components. Whether you are faced with a special problem or interested in a standard component, call Borg Equipment Division for an economically sound solution. Write today for catalog BED-A90.



**BORG EQUIPMENT DIVISION**  
THE GEORGE W. BORG CORPORATION  
JANESVILLE, WISCONSIN

CIRCLE 111 READERS SERVICE CARD

pany, its representatives and customers. He will also be in charge of internal sales department operations.



## Lamme Medal to H. S. Black

RECIPIENT of the 1957 Lamme Gold Medal of the AIEE is Harold S. Black (picture) research engineer of Bell Telephone Laboratories, New York, N. Y. His more than 60 inventions have made major contributions to long distance and overseas telephone communications and to the field of electronics. The medal was presented on June 23 during the summer general meeting of AIEE in Buffalo, N. Y.

## Instron Moves

PRECISION materials testing equipment manufacturer, Instron Engineering Corp., has moved from its former quarters in Quincy, Mass., to a new, modern plant in Canton, Mass. Situated on a spacious 15-acre lot, the new single story structure includes 18,000 sq ft of manufacturing space and 7,000 sq ft for administrative and engineering staff offices.

## Name DuMont Engineer of Year

AT ITS RECENT annual convention, the New Jersey Society of Professional Engineers presented the award of "Engineer of the Year" to Allen B. DuMont, chairman of

# ACCURACIES BETTER THAN 1 PART IN 50 MILLION are free!

## WHY NOT USE THEM!

The standard time and frequency transmissions of the National Bureau of Standards radio stations WWV and WWVH provide an invaluable service to laboratories and experimenters throughout the world. Extremely precise (normal transmission stability is within 1 part in  $10^9$  at WWV and 5 parts in  $10^9$  at WWVH) audio and radio frequency standards, as well as accurate time intervals and radio frequency propagation warnings, are placed at the disposal of anyone having a receiver capable of tuning to one or more of the transmitting frequencies. Proper use of these facilities can be made to supplement the instrumentation of any laboratory.

The Model WWVC Standard Frequency Comparator is just such an instrument . . . a highly sensitive crystal-controlled radio receiver utilizing WWV and WWVH transmissions.



**MODEL WWVC  
COMPARATOR**

A 5-position dial switches *precisely* to any Standard Frequency—2.5, 5, 10, 15, or 20MC. It features built-in oscilloscope and speaker, comparator function selector, Collins plug-in filter for high selectivity, automatic gain and volume controls and adjustable threshold control which eliminates noise and other modulation in tick position.

Send for bulletin #557, "Using Standard Time and Frequency Broadcasts"

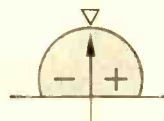

## SPECIFIC PRODUCTS

Box 425, 21051 Costanso  
Woodland Hills, Calif.

CIRCLE 112 READERS SERVICE CARD

**Celco**  
TRANSISTORIZED

# YOKES

3/8" ★ 1" ★ 1 1/8" ★ 2" ★ 2 1/2" CRT NECK DIA.

for MILITARY and COMMERCIAL PRECISION DISPLAYS

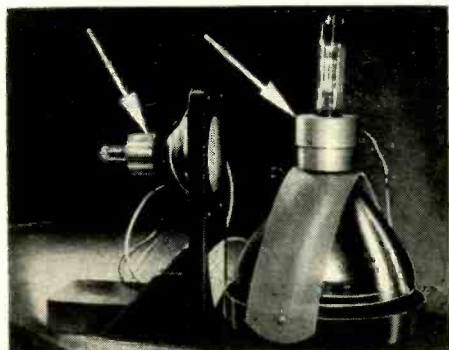

HIGH RESOLUTION  
FAST RECOVERY  
HIGH SENSITIVITY  
LOW LI<sup>2</sup>  
CONTROLLED  
MAGNETIC FIELDS

Write for CELCO DEFLECTION YOKE Catalogue & Design Sheets or for immediate engineering assistance Call your nearest CELCO Plant:

Mahwah, N. J.      Miami, Fla.      Cucamonga, Calif.  
Davis 7-1123      Plaza 1-9083      Yukon 2-2688

**Celco** Constantine Engineering Laboratories Co.

CIRCLE 113 READERS SERVICE CARD

Single  
sideband  
reception  
with the

**RACAL**  
**RA.17C**

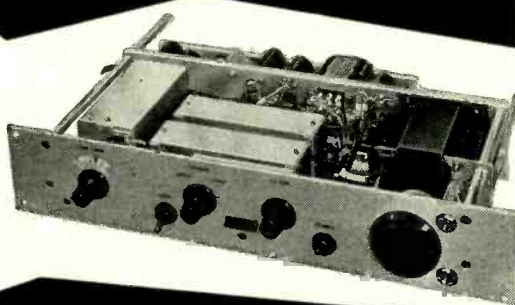

Another adaptation of the sensational new British H.F. communications receiver now available.

Suitable for both pilot carrier and suppressed carrier systems, the RA.17C plus RA.63 SSB adaptor can also be used for SSB reception of DSB transmissions, thus reducing the effects of selective fading, and by the choice of reception of either sideband, avoiding adjacent channel interference. The exceptional performance, stability and setting accuracy of the RA17C are, of course, retained.

- RA.63 SSB ADAPTOR**
- Entirely self contained.
  - Operates from 100 kc's I.F. output.
  - 50 dB unwanted sideband rejection.
  - A.F. output: 100 mW at 3 ohms, 3 outputs of 6 mW at 600 ohms.
  - Designed for separate 19" rack mounting.

**RACAL ENGINEERING LTD. BRACKNELL, BERKSHIRE, ENGLAND**

Represented in U.S.A. by  
AVCO MANUFACTURING CORPORATION,  
Research & Advanced Development Division,  
20 South Union Street, Lawrence, Mass.

Represented in Canada by:  
INSTRONICS LIMITED,  
11 Spruce Street,  
Stittsville, Ontario.

CIRCLE 114 READERS SERVICE CARD

ELECTRONICS engineering edition — July 18, 1958

# BORG 205 SERIES MICROPOTS...

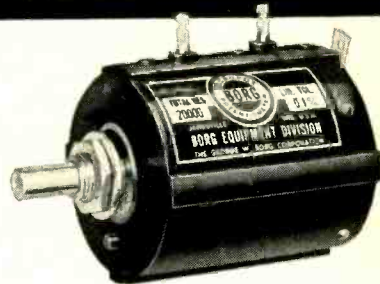

**OFFER  
DEPENDABLE, LIFETIME  
PRECISION!**

Borg 205 Series MICROPOTS have proven themselves exceptionally rugged and dependable. They have given years of service in many different mobile and stationary applications for both military and commercial uses. They're readily available, too, as Borg's modern production facilities assure prompt delivery in any quantity. Write today for the name of your nearest Borg Jobber or "Tech-Rep". It will pay you to know him.

**Check These Advantages...**

- ✓ Fine resolution because of 43 1/2" Kohlrusch winding in the helical element!
- ✓ Accurate setting and resetting due to anti-backlash spring in contact guide!
- ✓ Permanent accuracy because resistance wire is moulded integrally with housing!
- ✓ Long life because slider-contact is the only moving member that touches the resistance element.

Write for Catalog  
BED-A90



*Built by Borg*

MOTORS  
MICROPOTS  
MICRODIALS

**BORG EQUIPMENT DIVISION**  
THE GEORGE W. BORG CORPORATION  
JANESVILLE, WISCONSIN

CIRCLE 116 READERS SERVICE CARD

# SILVER PAINT AND SILVER PASTE

Take the "bugs" out of the application of conductive silver coatings. Use Drakenfeld silver paint and silver paste tailored to meet your needs. We formulate special compositions for glass and ceramic bodies and other materials. Let us know your specific requirements. Samples will be supplied to fit them. Your inquiry will receive prompt attention.

**B. F. DRAKENFELD & CO., INC.**

Box 519, Washington, Pennsylvania

*Drakenfeld*

**YOUR PARTNER IN SOLVING CONDUCTIVE COATING PROBLEMS**

CIRCLE 117 READERS SERVICE CARD

the board of Allen B. DuMont Laboratories, Inc.

DuMont was honored not only for his achievements that led to television, but for his engineering developments that led to vital electronic devices such as radar, loran, and oscilloscopes.

## Appoint Hupp R&D Manager

New manager, research and development for the Erie-Pacific Division of Erie Resistor Corp., Hawthorne, Calif., is Ross E. Hupp. He was the founder of Hupp Instrumentation Co., designers and manufacturers of digital instruments, recently purchased by Erie Resistor Corp.

## News of Reps

APPOINTMENT of H. P. Tom Collins to represent Fairchild Controls Corp. Components Division in the seven state area of Florida, Georgia, Alabama, Mississippi, Tennessee and the Carolinas is announced.

The Shepard Instrument Div. of Savage Industries, Phoenix, Ariz., has appointed Gawler-Knoop Co. as sales reps for metropolitan New York, Long Island, New Jersey, eastern Pennsylvania, Delaware, Maryland, Virginia, and D. C.

Dielectric Products Engineering Co., Inc., Raymond, Maine, manufacturer of antennas, transmission line, filters, baluns, diplexers and dehydrators, names D. S. Wilson as their rep for the northern New York area.

Standard Electromagnetics, Inc., Frederick, Md., announces the following new reps to handle its electromagnetic devices:

Cozzens and Cudahy, Inc., for the greater metropolitan Chicago area; Shephard-Winters Co. for the southern California territory; Antle-Smith Sales in southwestern U. S.; and Roger M. Minthorne Co., covering northwestern U. S., British Columbia, and Alaska.

## NEW at Monitor!

Low Frequency  
crystals to  
meet high  
vibration  
requirements

Monitor's modern  
facilities and tech-  
niques insures the  
quality of all units.

Fully tested from 2 to 2,000 CPS vibration. Acceleration of 15 to 30 G's. Frequency range 16 to 100 kc — typical tolerance  $\pm .012\%$  from  $-40^{\circ}\text{C}$  to  $+70^{\circ}\text{C}$ . Lower frequencies down to 400 cycles available in other Monitor types with less rigid requirements.



Small size  
MC-13/U

If you have a special crystal problem,  
call, wire or write.

SEND FOR NEW CATALOG!

**MONITOR PRODUCTS COMPANY**

815 Fremont Ave., South Pasadena, Calif.  
RYan 1-1174

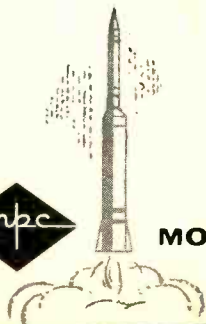



## ARNOLD / TOROIDAL COIL WINDER

*sets up quickly... easy to operate...  
takes wide range of wire sizes*

### SPECIFICATIONS:

- Min. finished hole size: .18 in.
- Max. finished toroid O.D.: 4.0 in.
- Winding speed: 1500 turns/min.
- Wire range: AWG 44 to AWG 26
- Dual, self-checking turns counting system
- Loading (wire length) counter
- Core range: 1/4" I.D. to 4" O.D. to 1 1/2" high

### LABORATORY USE

- Change wire and core size in 45 sec.

### PRODUCTION USE

- 1500 turns per minute
- Insert core and load in 20 sec.

*includes all rings, counters and accessories*

IMMEDIATE DELIVERY. Literature on request

**ARNOLD MAGNETICS CORP.**

4615 W. Jefferson Blvd., Los Angeles 16, Calif.  
REpublic 1-6344

CIRCLE 119 READERS SERVICE CARD

WE also wind  
toroidal trans-  
formers for  
military envi-  
ronment to your  
specifications.

## SOLUTION TO A PRINTED CIRCUIT DESIGN PROBLEM

Microdot printed circuit to coax connectors are available to mate any of the standard Microdot micro-miniature coaxial fittings. Designed with "long" or "short" mounting pins to fit standard .100" grid pattern on panels 1/16" to 3/16" thick. Available in 50, 70 and 93 ohm for quick, easy connect and disconnect—screw or slide-on style, in straight or right angle types. Proven in commercial and military applications. Immediate delivery.

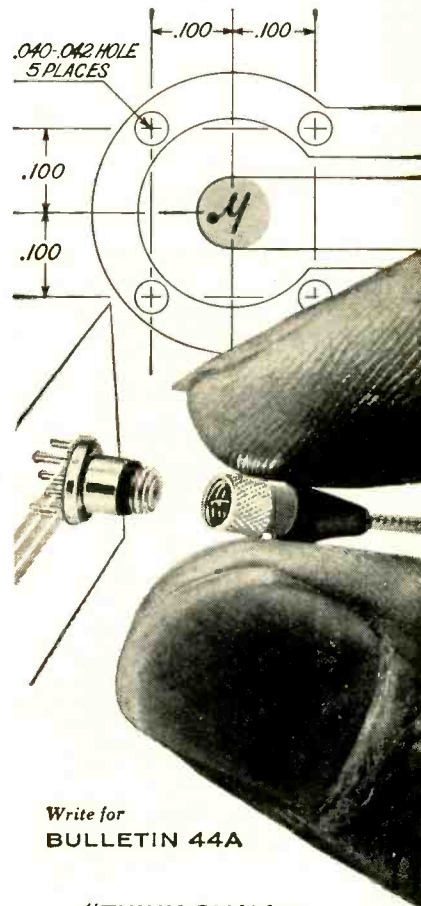

Write for  
BULLETIN 44A

**"THINK SMALL—  
THINK MICRODOT"**

*Our sales engineers are located in all major cities to readily assist you in special design and standard applications. "Think Small—Think Microdot."*

**MICRODOT, INC.**  
220 PASADENA AVENUE  
SO. PASADENA, CALIFORNIA  
CIRCLE 122 READERS SERVICE CARD

there's  
only  
**I**  
buyers'  
guide

serving the  
electronics industry

and it's the . . .

**ABC** **ABD**  
**electronics  
BUYERS' GUIDE**

A McGRAW-HILL PUBLICATION  
330 WEST 42nd ST. NEW YORK 36, N. Y.



**Precious  
Metals  
Plated**

**ON ANY PART —  
TO ALL SPECS**

**GOLD, SILVER, PLATINUM,  
RHODIUM, PALLADIUM...** the  
precious metals generally cost the  
same, no matter where you buy  
them. But you *do* get more for  
your money when you buy pre-  
cious metal plating from Harper-  
Leader. You get the full benefits  
of the engineering, metallurgical,  
and other highly specialized serv-  
ices of Harper-Leader's technical  
staff.

Send for Bulletin E-58

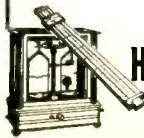

**HARPER-LEADER, INC.**

Waterbury 20, Conn.

CIRCLE 120 READERS SERVICE CARD

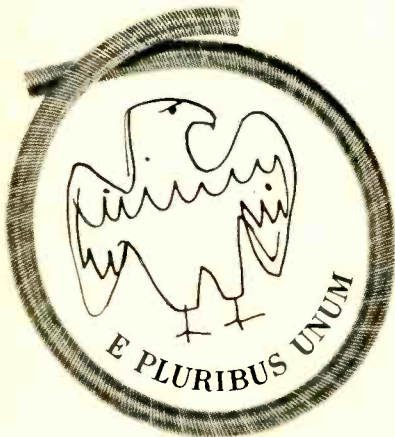
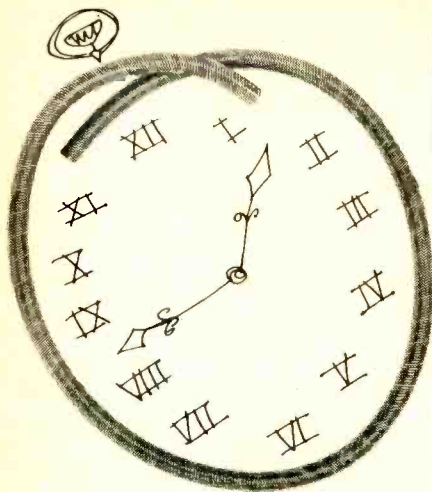

*S.S. White*

## FLEXIBLE SHAFTS save time, trouble and money

Save time by designing your remote controls and power drives with S.S. WHITE FLEXIBLE SHAFTS. Selecting an S.S. WHITE FLEXIBLE SHAFT is a simple, easy matter. You can choose the right one for any application from a wide range of Standard "off-the-shelf" units, pre-engineered units or custom-engineered units. Since a single S.S. WHITE FLEXIBLE SHAFT may replace a complicated system of gears, pulleys and belts, you'll also save considerable design and layout time, too.

Save trouble by using quality-built S.S. WHITE FLEXIBLE SHAFTS in your equipment. Our years of experience in the design, manufacture, and application of flexible shafts to hundreds of different products assures you of getting the best possible shaft for your need.

Save money by using S.S. WHITE FLEXIBLE SHAFTS to replace expensive parts needed to carry power and control around turns. You also save by simplifying assembly and by saving space.

USEFUL DATA on how to select and apply flexible shafts! Write for Bulletin 5601.

*S.S. White*

FIRST NAME

IN FLEXIBLE SHAFTS

S.S. WHITE INDUSTRIAL DIVISION

Dept. E, 10 East 40th Street  
New York 16, N. Y.

Western Office:

1839 West Pico Blvd., Los Angeles 6, Calif.

CIRCLE 123 READERS SERVICE CARD

## NEW BOOKS

### Progress in Semiconductors

BY A. F. GIBSON, P. AIGRAIN  
AND R. E. BURGESS

John Wiley & Sons, Inc., New  
York, 1957, 280 p, \$10.50.

THIS is the second volume in what is to be "an annual book, containing a number of review articles written by leading specialists in the field."

The very existence of such a book is in itself reason to recommend it. Its usefulness, independent for the moment of whether a particular review article is well done, is that the various contributors are specialists in the subject under review, have usually done an extensive literature search and present an imposing bibliography, and they in general make a critical evaluation of the pertinent ideas on the subject. These points make each article a primary reference source for one who wants to become acquainted with the problems in a new field (new to him) of semiconductor research. If in addition, the articles are intelligently organized and written in a clear, comprehensive style, as are several in this volume, the value of the volume is but enhanced.

**Highlights**—Three articles in particular, The Production of High-Quality Germanium Single Crystals by L. G. Cressell and J. A. Powell, Impurities in Germanium by W. Crawford Dunlop, Jr. and Properties of the III-V Compound Semiconductors by F. A. Cunnell and E. W. Saker should be most useful to one who desires to become conversant with the results of materials research of the past five or so years and to gain an appreciation of the problems and subtleties involved in producing materials to suit a particular need. These three articles in the above order, together with the references, would read as a well organized textbook on the subject.

**Single-Crystal Production**—The first of these papers concerns itself with the problems involved in producing single germanium crystals with a minimum number of imper-

## Pulse Notes



### Adjustable and Fixed Linear Inductors Introduced by Pulse

A new line of adjustable and fixed linear inductors is now available from Pulse Engineering. Pulse linear inductors are designed to replace toroids in wave filters, resonant circuits, impedance choke applications, and resonant transformer applications.

Pulse linear inductors provide a marked improvement over toroids in several respects. Variation of inductance is absolutely linear from  $-55^{\circ}\text{C}$  to  $+125^{\circ}\text{C}$ . Temperature coefficients of 55 parts per million to 161 parts per million are available. They are self-compensating with polystyrene foil capacitors in resonant meshes. They have a higher Q over a wider range, typically, 500 at 50 kc. Pulse linear inductors are more astatic than toroids and possess a lower external field.

Other advantages include low price, small size, Q variation of  $\pm 10\%$  from  $-30^{\circ}\text{C}$  to  $+85^{\circ}\text{C}$ , inductance range of 100  $\mu\text{h}$  to 2h. The adjustable inductor, VL Series, has a variable inductance of  $\pm 7\%$  of center value.

By using these linear inductors, Pulse has been able to improve the frequency attenuation response of their filter networks, reduce the sizes and achieve an excellent stability of attenuation. (See graph)

#### CHANGE IN INDUCTANCE VS. TEMPERATURE

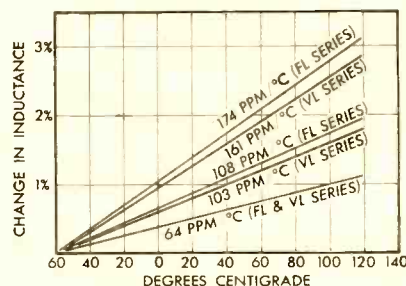

New Pulse linear inductors are available in quantity now. For complete technical information, prices, and delivery, call your nearest Pulse Engineering representative or write to Dept. E7

**Pulse  
Engineering  
Inc.**

2657 Spring Street  
REDWOOD CITY CALIFORNIA

CIRCLE 124 READERS SERVICE CARD

fections (on an atomic scale) in the geometric decay of atoms which is the crystal lattice. A critical discussion and evaluation of the various methods of growing crystals is included.

The second article describes in detail the wide range of electrical properties that one can achieve by judicious doping of germanium with minute (a few parts in 10 million) amounts of various impurities, as well as the physical principles involved.

The third paper is essentially a tabulation of the physical and electrical properties of the III-V semiconductors, typified by InSb, with a discussion of the particular use to which a specific "intermetallic" semiconductor may be put. Thus, InP or GaAs are theoretically capable of greater efficiency as solar batteries than Si; InSb is a sensitive photoconductor in the far infrared and AISb may be useful for rectifiers that operate at high temperatures. It was disappointing to note however, that at this late date, the old melting point (958 C) of Ge (p 44, Table 3) is listed, rather than the correct value of 936 C.

**Radiation Effects**—J. H. Crawford and J. W. Cleland present a fine survey of radiation effects in semiconductors. The design engineer who, for example, may shortly have to develop reliable transistor circuits which must operate near a reactor in a nuclear powered airplane may obtain an appreciation of the possible effects of radiation on transistor properties and thus on the circuit parameters he must consider.

The lead article, Semiconductor Alloys by F. Herman M. Glicksman and R. H. Parmenter, reviews the "present status of the theory of semiconducting alloys" and "illustrates the theory by typical examples". This is a highly specialized article, both from the theoretical and pragmatic point of view, in that at present the theory is at an early stage of development and unique application for semiconductor alloys (with the possible exception of thermoelectric refrigeration which is not discussed in the article, and which is being pursued



## LOW COST PARTS

- less than  
metal.

### precision molded in NYLON

Precision parts in NYLON are rapidly replacing metal parts in scores of industries.

Swenson engineers have overcome major difficulties in adapting injection moldings to precision production of gears, sleeves, collars, rings, etc. that were heretofore considered impossible to produce.

Great savings in manufacturing can be effected by the use of injection molded plastic parts. Swenson engineers can quickly tell you the extent to which your parts can be replaced by NYLON for better service to your customers and more profit to you.

Write today for new folder. Send rough sketches, drawings or samples of parts you would like to produce in plastic for engineers recommendations and quotation.

"Engineers in Plastics"



**v. h. Swenson co., inc.**  
556 Elm Street    Arlington, N. J.

CIRCLE 125 READERS SERVICE CARD

For Those Who Demand Service!

# COSMIC

ELECTROLYTIC  
& PAPER  
TUBULAR

"35 YEARS OF PROVEN  
DEPENDABILITY"

## Condensers

**COSMIC CONDENSER CO.**  
853 Whittier St., Bronx, N. Y.  
PHONE  
LUdlow 9-3360

CIRCLE 126 READERS SERVICE CARD

## .. . Electrical Coil Windings

For 40 years . . . specializing in all types of coils to customers' specifications. Design or engineering assistance available on request.

# COTO-COIL CO., INC.

SINCE 1917

65 Pavilion Avenue    Providence 5, Rhode Island

# MAGNELINE®

## NEW DIGITAL READOUT INDICATOR

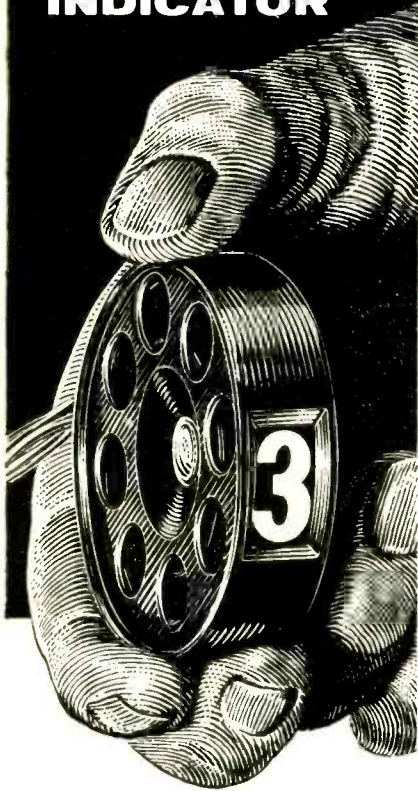

### DURABLE... COMPACT ... EASY TO READ

MAGNELINE is the ideal indicator for use in computers and electronic systems requiring accurate display. It positions rapidly—produces two-per-second responses with low power.

Simplicity assures long life. Only one integral part is in motion. Featherweight rotor is magnetically activated, rides on precision ball bearing. No mechanical detents or electrical contacts to wear or foul. The  $\frac{3}{8}$ " x  $\frac{3}{8}$ " digits are white on black background to give clear legibility at 25 feet. Even at 60° angle, figures can be quickly and accurately read.

Magneline measures only  $\frac{23}{32}$ " wide by  $2\frac{29}{64}$ " in diameter. Weighs only 3.3 ounces. Units can be stacked in series for multiple digits. Write for complete technical data.

## PATWIN

WATERBURY 20, CONNECTICUT  
A Division of The Patent Button Company

CIRCLE 128 READERS SERVICE CARD

mainly by the Russians, with very little published work in this country).

A fine review of high electric fields in semiconductors is contributed by J. B. Gunn. It is becoming more generally appreciated that many device properties, present and potential, derive from deviations from Ohm's Law that occur for large electric fields (such as occur at  $pn$  junctions). The theory is discussed first, but the organization is such that one can get a qualitative feeling for the points involved by reading the discussion. Unfortunately, the large body of information on high electric field effects at low temperatures is given but cursory mention.

Articles on lifetimes of free electrons and holes in solids by A. Rose and on theories of electroluminescence by D. Curie complete the volume. Rose presents a general approach to the problem of lifetimes, an approach designed to unify the many diverse situations and concepts encountered in both semiconductors and insulators. His is a review worth reading for one who has had sufficient experience with such problems to appreciate the value of such a point of view.

Theories of Electroluminescence is a most disjoint article which can be understood only by one who is already familiar with the contents. However, 82 references are appended.—SEYMOUR H. KOENIG, Adj. Asst. Prof. Elec. Eng., IBM Watson Laboratory, Columbia University, N. Y.

### Essentials of Television

By MORRIS SLURZBERG, WM. OSTERHELD, ELMO VOEGTLIN.

McGraw-Hill Book Co., New York, 1957, 687 p, \$8.50.

REGARDLESS of how many texts are written on some subject there will always be room for another good one. Messrs. Slurzberg and Osterheld are masters of the idiom in bringing to the novice the technical know-how of the complexities of electronic circuitry. This book is purported for those who have only a rudimentary knowledge of basic circuitry and no mathematic

# CABINETS

Precision construction to exact specifications! Complete packaged aluminum cabinet—basic structure, side panels, doors, front panels, interior chassis and frame structures for support of electronic equipment.

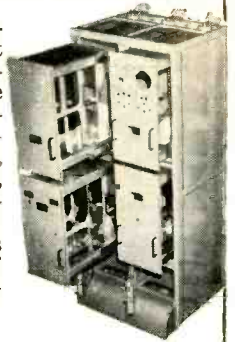

## ANTENNAS

Circular and rectangular parabolic antennas with reflector tolerances to meet the most rigid specifications fabricated to order.

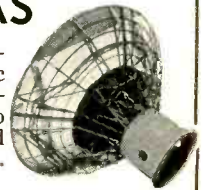

CONSULT OUR ENGINEERING STAFF in pre-designing or development stages of projects requiring precise fabrication. No Obligation.



T.M. Reg.  
Canada

WASHINGTON ALUMINUM CO. INC.  
Dept. 25-7 Baltimore 29 Md. Circle 2-1000

CIRCLE 154 READERS SERVICE CARD

## AT LAST—THE IDEAL BARRIER TERMINAL STRIP



### JONES 500 SERIES LONGER—STURDIER

Wider and higher barriers for increased creepage distances. Closed bottoms for complete insulation. Material between barriers at the base adds to the strength and maintains the same creepage distance between contact to contact and contact to ground. Can be imprinted here. No insulating or marker strip required. Three series—540, 541 and 542 having the same terminal spacing as our 140, 141 and 142 series.

Complete listing in the new Jones No. 22 catalog. Write for your copy today.



HOWARD B. JONES DIVISION  
CINCH MANUFACTURING CORPORATION  
CHICAGO 24, ILLINOIS  
SUBSIDIARY OF UNITED-CARR FASTENER CORP.

CIRCLE 129 READERS SERVICE CARD





# MEMO:

## NEW PRODUCTS RELEASES

TO: ALL MANUFACTURERS

FROM: electronics

electronics publishes all new product items of interest to makers and users of electronic and allied equipment.

The reverse side of this card provides a service to subscribers by facilitating the flow of additional information between manufacturers and our readers.

Take advantage of Reader Service--and the readership of electronics...keep the industry informed about your New Products and New Literature via their mention in the editorial pages of electronics.

FIRST CLASS  
PERMIT NO. 64  
(SEC. 34.9 P.L.&R.)  
NEW YORK, N. Y.

### BUSINESS REPLY CARD

NO POSTAGE STAMP NECESSARY IF MAILED IN THE UNITED STATES

4¢ Postage Will Be Paid By

**ELECTRONICS**  
Reader Service Dept.  
330 West 42nd Street  
New York 36, N. Y.

FIRST CLASS  
PERMIT NO. 64  
(SEC. 34.9 P.L.&R.)  
NEW YORK, N. Y.

### BUSINESS REPLY CARD

NO POSTAGE STAMP NECESSARY IF MAILED IN THE UNITED STATES

4¢ Postage Will Be Paid By

**ELECTRONICS**  
Reader Service Dept.  
330 West 42nd Street  
New York 36, N. Y.

# New CANNON XLR plugs for audio and electronic uses

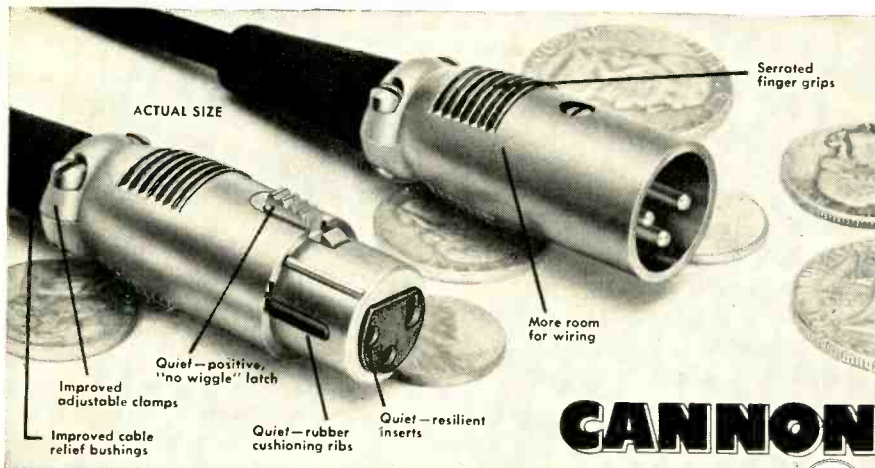

## CANNON PLUGS



### GREATER VALUE AT NO INCREASE IN PRICE

Improved features illustrated above give you more for your money than any similar plug on the market.

These deluxe audio plugs, in handsome satin nickel finish, give protection against disagreeable interference and mechanical noises. Positive latch holds firmly, yet allows for quick disconnect. Improved strain relief bushings and cable clamps accommodate full range of microphone cables. Series includes wide variety of shell types, with three and four contacts. Mates with Cannon former XL series.

Like all the plugs in the complete Cannon line the XLR series is manufactured of finest quality materials for reliable, long-lasting service. See the distributor nearest you or write for Bulletin XLR-3.

27,000 kinds to choose from! Call on Cannon for all your plug needs. If we don't have what you want, we'll make it for you. We're ready to help you at any stage—from basic design to volume production—with the largest facilities in the world for plug research, development and manufacturing. Write us today about your problem. Please refer to Dept. 120

**CANNON ELECTRIC COMPANY**  
3208 Humboldt St., L.A. 31, California

Where Reliability for Your Product  
is Our Constant Goal 346

CIRCLE 130 READERS SERVICE CARD

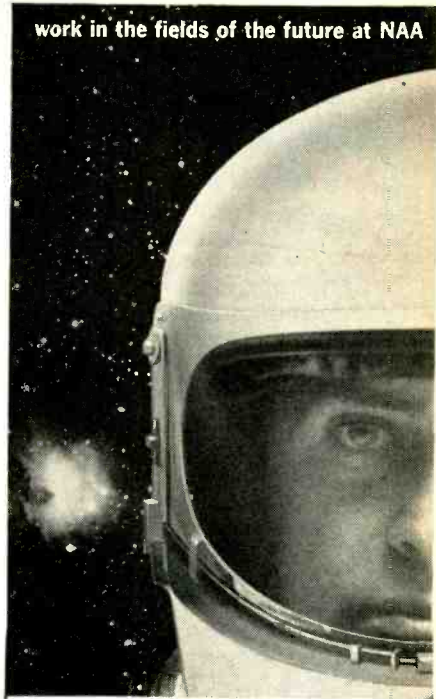

## ELECTRONICS ENGINEERS

Work on America's most  
advanced weapon systems

The WS-110A and WS-202A are typical of the top-level projects currently under way at North American. NAA's work on these far-advanced weapon systems has created outstanding career opportunities for engineers qualified in Flight Control Analysis, Reliability Analysis, Flight Simulation, and Systems Analysis.

We have immediate openings in applied research on radome development, antenna development, infrared, and acoustics.

Minimum requirements are actual experience plus B.S. and advanced degrees in E.E. and Physics.

For more information please write to: Mr. F. G. Stevenson, Engineering Personnel, North American Aviation, Inc., Los Angeles 45, California.

THE LOS ANGELES DIVISION OF  
**NORTH  
AMERICAN  
AVIATION, INC.**

**EASY-WORKING, POWERFUL**

**WHITNEY-JENSEN  
No. 241 HAND  
NOTCHER**

LENGTH OVERALL 21"

WEIGHT  
7 LBS.

CAPACITY  
16 Ga. Mild Steel

EXAMPLES OF MAXIMUM NOTCHING AND SHEARING OF NO. 241 NOTCHER

Useful for a lot of different notching operations, as shown by examples of side, corner, and flange cuts. Very efficient on corner moulding, also shallow sheet metal channels. The curved blade hooks to a point that will engage a punch prick for exact location of notch.

**WHITNEY METAL TOOL CO.**  
722 FORBES ST., ROCKFORD, ILL. Since 1910

CIRCLE 131 READERS SERVICE CARD

WHY MAKE IT DIFFICULT  
WHEN THERE'S AN EASY WAY  
WITH **SYSTRON**

IN-LINE  
READOUT  
In a  
SINGLE  
UNIT

Model 1031  
Megacycle-Microsecond  
Counter-Timer

In just one glance you have the answer — and you get the answer in just one unit. With Systron's single package IN-LINE readout digital counter, there's no transposing, no confusion, no second look. Large 1-inch IN LINE digits are clearly readable at distances up to 40 feet, overcoming fatigue and error factors. One unit eliminates auxiliary boxes; increases accuracy as well as speed.

Other Important SYSTRON Features:

- Magnetron Beam Switching Tubes
- Local or Remote Indication
- Adjustable Trigger Controls
- Drives Digital Recorder Directly

For complete specifications and prices, please write

**SYSTRON CORPORATION**

950 GALINDO STREET • CONCORD, CALIFORNIA  
REPRESENTATIVES IN PRINCIPAL CITIES

CIRCLE 132 READERS SERVICE CARD

# LOW RESISTANCE OHMMETERS

with test currents never exceeding 110 ma.

The ideal meter for checking fuses, sensitive relay contacts, transformer windings, motors, bus bars, bonding, etc. Entirely self-contained including battery supply.

- **Accuracy:** LRO  $\pm 1\%$  of full scale reading. LRO-1  $\pm 1\frac{1}{2}\%$  of full scale reading.
- **Ranges:** Full scale readings of .1 ohm, 1 ohm and 10 ohms. 100 meter scale divisions. One scale division on .1 range is .001 ohm.
- **Built-in Meter Protection:** In event that resistance is beyond meter range instrument is protected.
- **Low Test Current:** Never exceeds 110 ma., eliminating danger of damage to most sensitive circuitry or components under test.
- In two models:

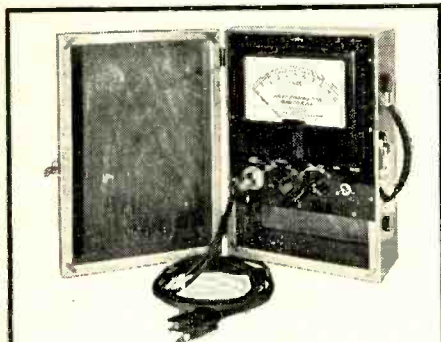

**MODEL LRO-1.** Commercial version. In polished hardwood case with carrying handle. Test leads. Price: \$175.00.

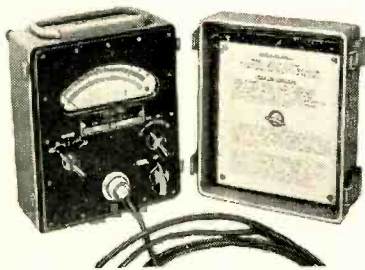

**MODEL LRO.** Same as LRO-1 but designed to meet critical requirements of military service. In aluminum gasketed case for extra-rugged field service. Price \$310.00.

Write for descriptive literature...

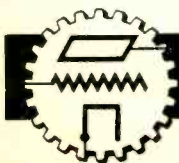

**Industrial Instruments**

89 Commerce Road,  
Cedar Grove (Essex County) N. J.

CIRCLE 134 READERS SERVICE CARD

beyond high-school level. Yet the coverage is complete and quite illuminating in its detailed analysis of the various sections of the television system. Naturally, its mathematical treatment has only limited depth but for any one who has a clinical desire to learn what makes tv tick, this book should serve the purpose admirably.

Included is a complete breakdown of three commercial black-and-white receivers and a recent RCA color receiver. The circuits of the receivers are subdivided into basic sections which are fully explained with schematic diagrams of each section. There is exceptionally good coverage of front-ends, picture tubes, types and sources of waveforms, and f-m. Color tv occupies over 100 pages and could in itself make a good text to introduce one to the subject.—MAURICE PLOTKIN, RCA Institute, New York, N. Y.

## THUMBNAIL REVIEWS

1958 Test Equipment Annual. Howard W. Sams & Co., Inc., Indianapolis, 1957, 116 p, \$1.00 (Paper). Product listing with specifications for over 350 pieces of test equipment are supplemented with articles on use, application and maintenance.

A Management Guide to Electronic Computers. By William D. Bell, McGraw-Hill Book Co., Inc., New York, 1957, 403 p, \$6.50. Using nontechnical language, this book covers fundamentals of digital type computers and their use in business. Actual case histories are cited to illustrate the experiences of various companies.

Installing Electronic Data Processing Systems. By Richard G. Canning, John Wiley & Sons, Inc., New York, 1957, 193 p, \$6.00. Initial organization of data processing programs, including selection of personnel, development of detailed procedures for system operation, physical installation of equipment, techniques for converting to electronic record keeping and methods for maintaining daily work schedules. Human considerations and second year planning are touched on in appendices. Familiarity with machine programming and coding methods is assumed throughout.

## American Blower suggests: CONSIDER COOLING EARLY!

Before your designs for electronic equipment get too far along, be sure to provide for dependable cooling. Specify an American Blower packaged air-moving unit. Numerous sizes and designs to choose from—many can be modified as needed. Or, if necessary, we can start from scratch and design a fan or blower to fit your exact needs. Individual specification bulletins are available; write, detailing your requirements. American-Standard,\* American Blower Division, Detroit 32, Michigan. In Canada: Canadian Sirocco products, Windsor, Ontario.

## COMPACT TUBE COOLER

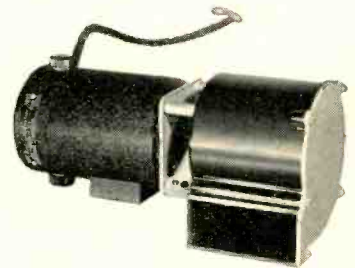

Designed for military applications. Capacity: 35 cfm @ 4" sp to 80 cfm @ 1.5" sp @ 8000 rpm approx. Write for Bulletin 312.

## FOR AIR-FLUSHING CABINETS AND RACKS

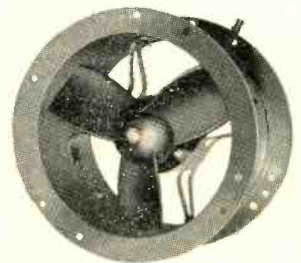

Tubeaxial fan, double-flanged for mounting at either end. Capacity: 295 cfm, free delivery @ 1550 rpm. Bulletin 5112.

\* AMERICAN-Standard and Standard® are trademarks of American Radiator & Standard Sanitary Corporation.



**AMERICAN-Standard**  
AMERICAN BLOWER DIVISION

CIRCLE 135 READERS SERVICE CARD

# NEW! RVG-8T

## 1/2" TRIMMER POT

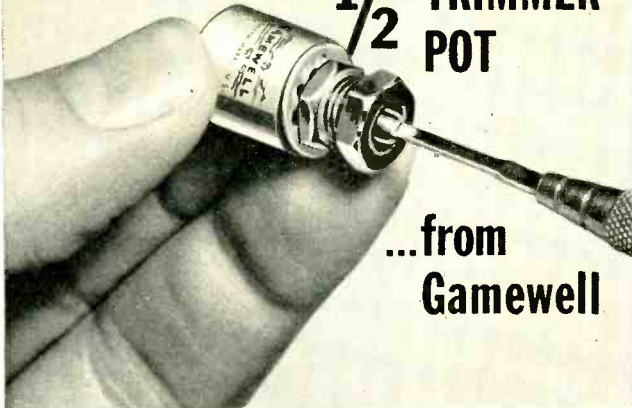

...from  
**Gamewell**

Linearity  $\pm 3\%$  and  
Power Rating 2w @  
85°C derated to 0  
at 150° standard —  
200°C intermittent  
operation available

### RVG-8T Specifications

1/2" Trimmer Pot	
Rating (watts)	2
Torque (oz.-in.) Max.	1.
special high torque available	
Weight (ounces)	1/3
Resistance Range $\pm 5\%$	20 $\Omega$ to 50K*
Electrical Function Angle	320°
Voltage, Max. (insulation)	1000 DC
Linearity, Standard (%)	$\pm 3$

\*100K available  
Notes: Shaft lock nut is supplied.

## High Performance and Low Cost

Improve performance of your electrical and electronic circuitry with this new RVG-8T 1/2" Trimmer Potentiometer.

Excellent performance characteristics for its type and size. Windings are on cards or mandrels, usually with wire temperature coefficient of 20 ppm. Body is one-piece phosphor bronze, nickel plated; terminals are gold plated; stop pins and shaft are of stainless steel; precious metal contacts are

used throughout. Insulation is designed to withstand 1000 volts DC.

Available now! RVG-8T is stocked in standard resistance ranges. 100 ohms to 50K ohms — up to 100K ohms available. Can be supplied with precision potentiometer tolerances, servo-mount, or for 200°C intermittent operation. Write for prices and catalog sheet today.

**THE GAMEWELL COMPANY**  
Newton Upper Falls 64, Mass.

**PRECISION POTENTIOMETER DIVISION**



GA8-5

CIRCLE 136 READERS SERVICE CARD

## TEFLON FOR V. H. F. REQUIREMENTS

Relatively inexpensive Teflon inserts can be molded into a Thermosetting or Thermoplastic base, accurately locating the low loss material i.e. Teflon, where needed.

Teflon inserts, premolded or fabricated, securely locked in place during molding.

An inexpensive approach to an expensive problem.

We can assist in redesigning your present product to incorporate a Teflon plastic composite.

### WHALITE MANUFACTURING COMPANY

PLASTIC MOLDING • MONTVILLE, NEW JERSEY • DEerfield 4-2432

CIRCLE 137 READERS SERVICE CARD

## NEW! 1" PANEL METERS...

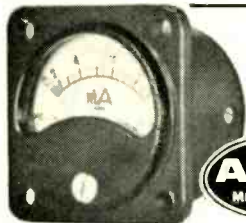

### FEATURING A SHIELDED MOVING COIL MOVEMENT

Immediate  
Delivery!

#### D.C. MICROAMMETERS

0-300	.....	4.95
0-500	.....	5.75

#### D.C. MILLIAMMETERS

0-1	.....	4.95
0-5	.....	4.95
0-10	.....	4.95
0-50	.....	4.95
0-100	.....	4.95
0-200	.....	4.95
0-300	.....	4.95
0-500	.....	4.95

#### D.C. VOLTMETERS

1000 Ohms Per Volt		
0-3	.....	4.95
0-10	.....	4.95
0-50	.....	4.95
0-150	.....	4.95
0-300	.....	4.95

#### RECTIFIER TYPE

A.C. VOLTMETERS		
1000 Ohms Per Volt		
0-15	.....	5.25
0-150	.....	5.25
0-300	.....	5.25



SAVE  
VALUABLE  
SPACE IN  
COMPACT  
EQUIPMENT

**ALCO ELECTRONICS MFG. CO.**  
3 Wolcott Ave Lawrence, Mass.

CIRCLE 138 READERS SERVICE CARD

ELECTRONICS engineering edition — July 18, 1958

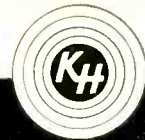

## Krohn-Hite POWER AMPLIFIER



MODEL UF-101

### FEATURING

- LESS THAN 0.005% DISTORTION AT 50 WATTS
- 110 DB DYNAMIC RANGE
- 50 WATTS OUTPUT FROM 15 CPS TO 30 KC

### SPECIFICATIONS

POWER OUTPUT.....	50 watts from 15 cps to 30 kc
FEEDBACK.....	80 db
FREQUENCY RESPONSE	$\pm 0.5$ db from 0.5 cps to 30 kc $\pm 3$ db from 0.03 cps to 70 kc
DYNAMIC RANGE.....	110 db
OUTPUT IMPEDANCE.....	2, 4, 8, 16 and 450 ohms
VOLTAGE GAIN.....	14 db or 30 db to 16 ohm output
PRICE.....	\$425.00

Typical harmonic distortion at 1,000 cps is 0.003% in voltage at 50 watts.

Available for rack mounting at \$5.00 additional.

For further information on:

- Filters
- Power Supplies
- Oscillators
- Power Amplifiers

write for our free catalog D



## Krohn-Hite CORPORATION

580 MASSACHUSETTS AVENUE  
CAMBRIDGE 39, MASS., U. S. A.

CIRCLE 139 READERS SERVICE CARD

**Now—  
NO plate too small—**

**213B**

**NO panel too big**

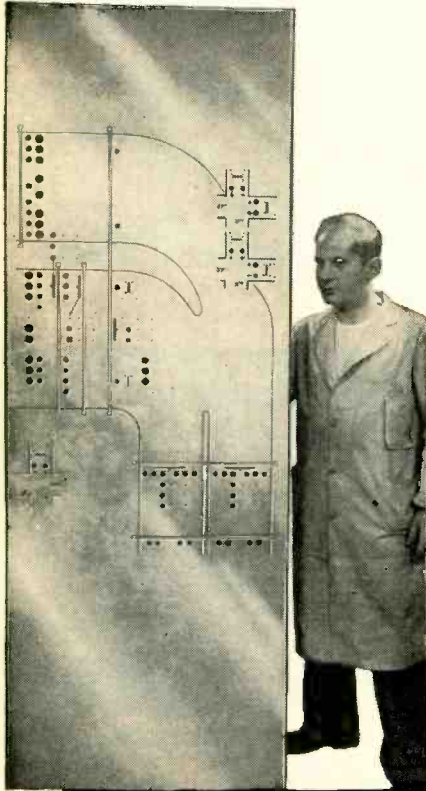

**NO  
size limits  
on engraving**

**ENGRAVES 18"x6" RECTANGLE  
IN ONE SET-UP**

- Takes up only 2 feet of bench space
- Engraving chassis can be detached from base and placed directly on workpiece of any dimension
- Self-centering workholder cuts down set-up time
- Heavy duty cutter spindle

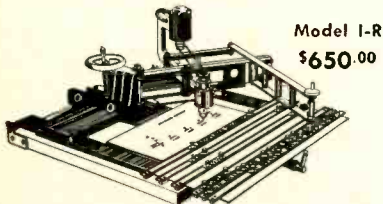

Request our 28-page illustrated catalog ZR-3 on your business letterhead.

**new hermes** ENGRAVING MACHINE CORP.  
13-19 UNIVERSITY PLACE, NEW YORK 3, N. Y.

CIRCLE 140 READERS SERVICE CARD

**COMMENT**

Security—or  
Opportunity?

Frequently we get into discussions with engineers around the country that get deeper into the meaning of professional engineering than the mere technicalities of the business. These discussions sometimes reveal some painful soul searching.

Less frequently, our friends express their thoughts in writing.

Nevertheless, the other day this note arrived from one of our readers down Philadelphia way. It seemed worthwhile printing in full. It reflects a problem that is deep-seated in this and other industries.

Yesterday I spent about three hours in what developed into a beef session among a dozen or so of my colleagues in the engineering profession.

We were talking about jobs and salaries and our respective futures. I was completely floored by the amount of conversation that went on on the subject of guaranteed security.

Engineers should be expected to know that this is a contingent universe and that nothing in it is ever really sure or certain. Indeed, in a free economy, the right to succeed of necessity implies the risk of failure.

As provident human beings we do our best to erect fences against personal damage from all reasonably probable sources. But, discounting the convict serving a life sentence, no man can expect any such thing as guaranteed security.

Furthermore—and this bothered me most—many of my colleagues seem to be interested in security above all else. It seems to me that when security becomes more important than initiative, it's time to turn in your sliderule.

I can't figure out what's happening to us. Electronics is a young industry; its leaders are still predominantly young men. But the spirit and daring that characterize young men seems dead.

Let's hope for the sake of humanity that the spirit that inspired

**NEW GENERAL ELECTRIC  
BEAD SIZE THERMISTORS**

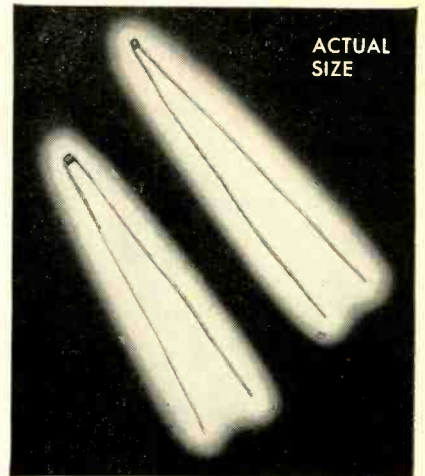

New G-E "Bead Size" Thermistors —  
D-054 (1000 ohms at 25° C) and  
D-051 (20,000 ohms at 25° C)

**BETTER TOLERANCES  
... FOR LESS COST**

G.E.'s new "bead size" D-050 series thermistors are available with resistances from 1,000-20,000 ohms at 25° C. These .05-inch diameter disc thermistors provide lower thermal time constants and are available for 250°C maximum operating temperature (standard, 150° C). You can buy them economically with resistance tolerances of only ±5% (standard, ±10%).

**NEW THERMISTOR MATERIALS**

Extensive research has added many new thermistor materials to the G-E line. These can now be used in a wide variety of design applications not previously covered by grade 1 and 2 materials.

**COMPLETE RESISTANCE RANGE**

G-E thermistors can be supplied in sizes from .05 up to 3 inches with resistance values from 1 to 10,000,000 ohms, and temperature coefficients of resistance from -1% to -5% at 25° C. For more technical information or the assistance of a G-E engineer, write: *Magnetic Materials Section, General Electric Company, 7806 N. Neff Road, Edmore, Michigan.*

*Progress Is Our Most Important Product*

**GENERAL ELECTRIC**

CIRCLE 141 READERS SERVICE CARD

## Recent Raytheon achievements in Microwave

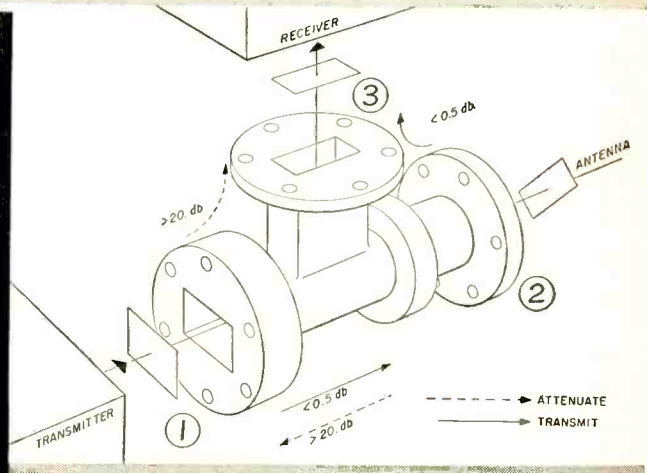
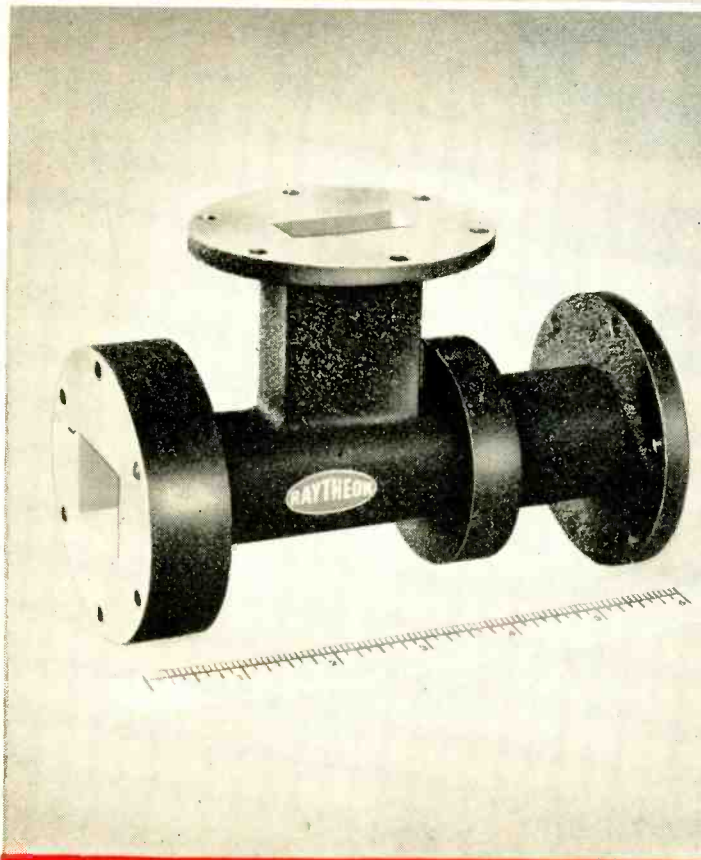

**THE MICROWAVE CIRCULATOR.** Typical of recent Raytheon developments in advanced microwave equipment and components is the microwave ferrite circulator recently developed by Raytheon's Special Microwave Device Group. **HOW IT WORKS:** in the diagram above, transmitted signals enter arm (1) vertically polarized. They are then rotated 45° from the vertical in a ferrite Faraday rotator with a longitudinal field applied by a small cylindrical permanent magnet. They flow out of the circulator at the antenna arm (2) which is set at the same 45° angle. Received signals fed into the antenna arm are rotated an additional 45° by the ferrite Faraday rotator and can only leave through the receiver arm (3).

## To the man who is looking for **FRONTIER PROJECTS IN ELECTRONICS:**

As an engineer or scientist who wants to accomplish more in 1958, you naturally want to be where new things are happening.

Whatever your specialized background and interests, chances are you'll find a current Raytheon project that offers exceptional opportunity for you to put your scientific skill and creative imagination to work.

Raytheon's constant expansion during 1958 covers advanced activities in:

**COMMUNICATIONS** (Commercial and Military) — scatter, microwave relay, multiplex, mobile transistorized equipment.

**COUNTERMEASURES**—radar countermeasures equipment, advanced study projects.

**RADAR** (Pulse and CW Systems)—search, fire control, bombing, navigation and guidance, air-traffic control, weather and marine, military and commercial.

**MARINE EQUIPMENT**—submarine, ship and airborne sonar, depth sounders, direction finders, radars.

**GUIDED MISSILES**—prime contracts:  
Navy Sparrow III (air-to-air)  
Army Hawk (ground-to-air)

**MICROWAVE TUBES**—"Amplitrons," magnetrons, klystrons, traveling wave tubes, storage tubes, backward wave devices.

**SEMICONDUCTORS**—devices, materials and techniques; silicon and germanium.

For interview and prompt helpful counsel, please write to  
E. H. Herlin, Professional Personnel Section  
P.O. Box 237, Brighton Station, Boston 35, Mass.

Excellence in Electronics



**RAYTHEON MANUFACTURING COMPANY**

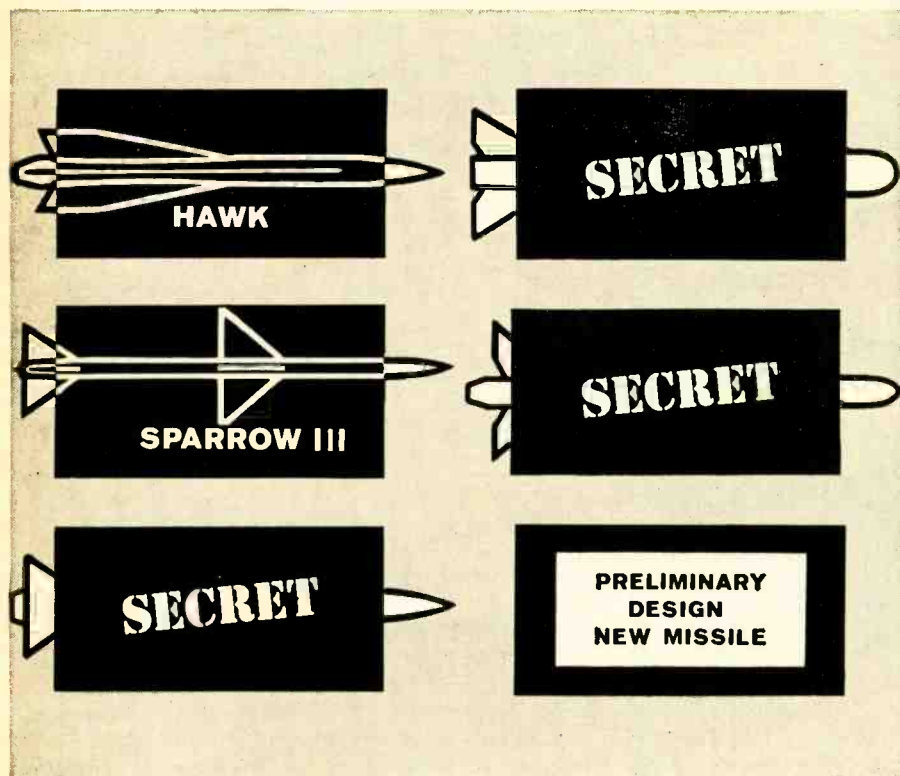

**RAYTHEON MISSILE CONTRACTS** now cover complete systems responsibility for both air-to-air and surface-to-air missiles.

## These advanced missile projects call for exceptional creativity

The need for engineering resourcefulness and creativity grows continually as Raytheon missile activities expand into new areas.

As an experienced engineer with a keen interest in working on advanced missile projects, you can begin building a rewarding future at Raytheon *today*.

There may well be an opportunity in one of the following areas that is right for you:

- |                  |                       |
|------------------|-----------------------|
| <b>SYSTEMS</b>   | <b>APPLICATIONS</b>   |
| <b>PACKAGING</b> | <b>CIRCUIT DESIGN</b> |
| <b>MICROWAVE</b> | <b>RELIABILITY</b>    |
| <b>RADAR</b>     | <b>SPECIFICATIONS</b> |

For interview at our suburban laboratory in Bedford, Mass., write, wire or telephone collect: CRestview 4-7100. Ask for R. W. McCarthy.

**RAYTHEON MANUFACTURING COMPANY**  
Bedford, Massachusetts



*Excellence in Electronics*

**MISSILE SYSTEMS  
DIVISION**



the great trailblazers of our profession will prevail.

O. G. POWERS JR.

CHESTER, PA.

We can't agree with everything reader Powers says, nor do we entirely share his bleak conclusion—being somewhat optimistic ourselves. But we found his thoughts most provocative.

### Crystal Converter

Concerning the article "Crystal Converter for Tropo-Scatter Receivers" (Apr. 11, p. 78) . . .

The caption of the photo on p 79 should read "Front panel of f-m receiver showing converter, demodulator and combiner" (not condenser). In Fig. 2, the box between the two plug-in filters on the third level should be labelled *IF Amp* (not *IF Preamp*).

The second clause of the caption of Fig. 3, p 80, should read "including 0.5 db preselector losses for both" (not 0 to 5 db). In Fig. 4 there is missing a 470  $\mu\text{f}$  coupling capacitor between the plate of the first 5842 tube and the 5842 grounded-grid tube.

Fig. 5 shows the dual-diversity combining system; the center label should read "Parallel connect to similar circuit for dual diversity" (not quadruple diversity) and the caption should point out that a dual diversity system (not a dual-diversity combining system) can be made into quadruple diversity system by connecting two dual diversity systems in parallel.

In Fig. 6, p. 81, the label "Output" should read "Parallel connect to similar circuits for diversity." The connection (just to the right of center) between the 1.2K resistor and the 1  $\mu\text{f}$  capacitor should go directly to the cathode.

In Fig. 7, a 221-ohm resistor should be added in the cathode circuit of the first 5654 tube, between the 0.01  $\mu\text{f}$  capacitor and the 22K resistor. The junction of the 221-ohm and 22K resistors should be bypassed to ground with a 0.1  $\mu\text{f}$  capacitor.

PAUL GRUBER

RADIO ENGINEERING LABORATORIES  
LONG ISLAND CITY, N. Y.



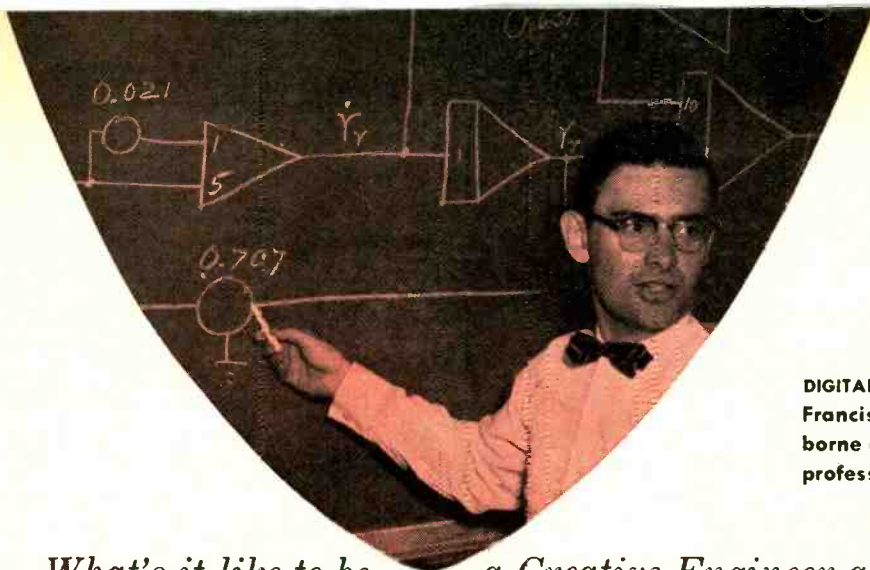

DIGITAL COMPUTER SYSTEMS ENGINEER Sherman Francisco tells why simulation studies of airborne computers offer a singularly challenging professional experience.

*What's it like to be*

*a Creative Engineer at*

# IBM

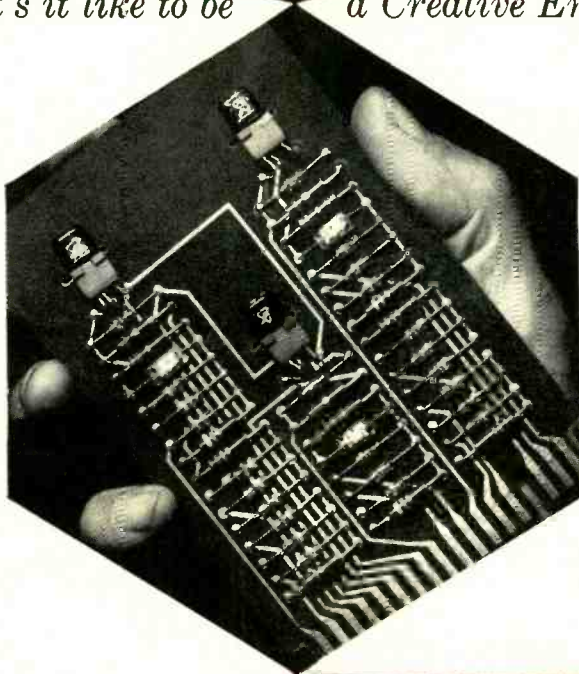

"Airborne computers present a special challenge to the creative engineer, because their systems must be planned and designed with flight situations in mind. Through simulation studies, we test computer systems right in our own labs—simulating both the dynamics of the aircraft and the environmental conditions encountered. My biggest thrill? To see my first simulated bombing mission!"

For those who can qualify, the engineering of digital computer systems at IBM Owego offers one of the most challenging assignments in electronics today. You can use your experience in: Instrumenting mathematical equations; programming operational steps; simulation studies; real time control; digital-to-analog conversion.

*Challenging assignments for well-qualified E.E.'s, M.E.'s, Physicists and Mathematicians in:*

- Digital computer systems and logic
- Radar systems
- Inertial guidance
- Test equipment development
- Electronic circuit design

FOR DETAILS, just write, outlining background and interests, to:

Mr. R. A. Whitehorne, Dept. 5545  
 Mgr. of Technical Recruitment  
 International Business Machines Corp.  
 590 Madison Ave., New York 22, N.Y.

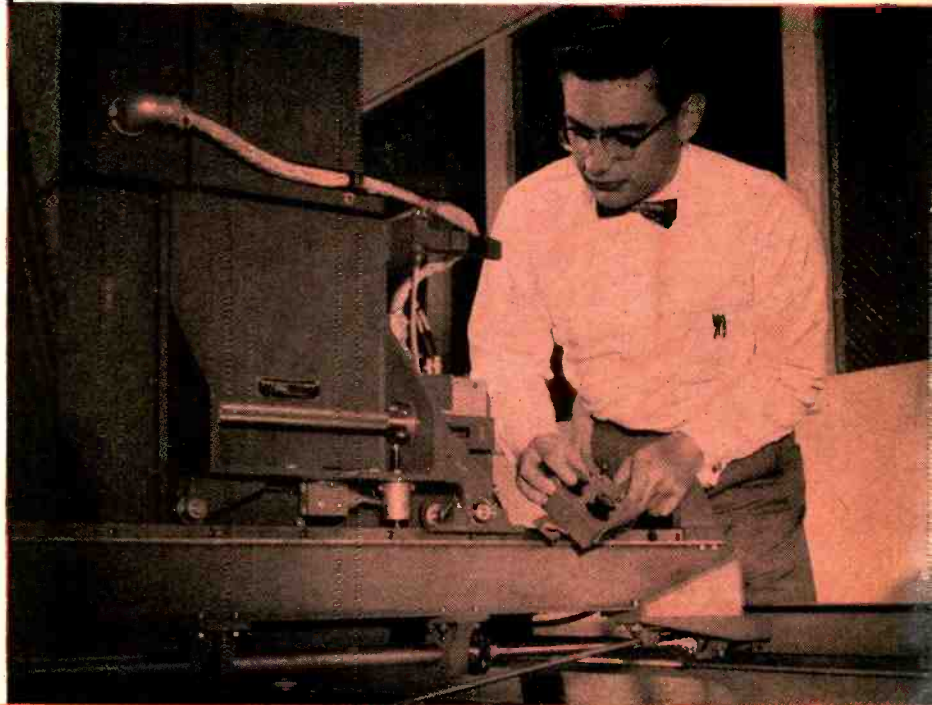

# IBM

## MILITARY PRODUCTS

DATA PROCESSING  
 ELECTRIC TYPEWRITERS  
 MILITARY PRODUCTS  
 SPECIAL ENGINEERING PRODUCTS  
 SUPPLIES  
 TIME EQUIPMENT

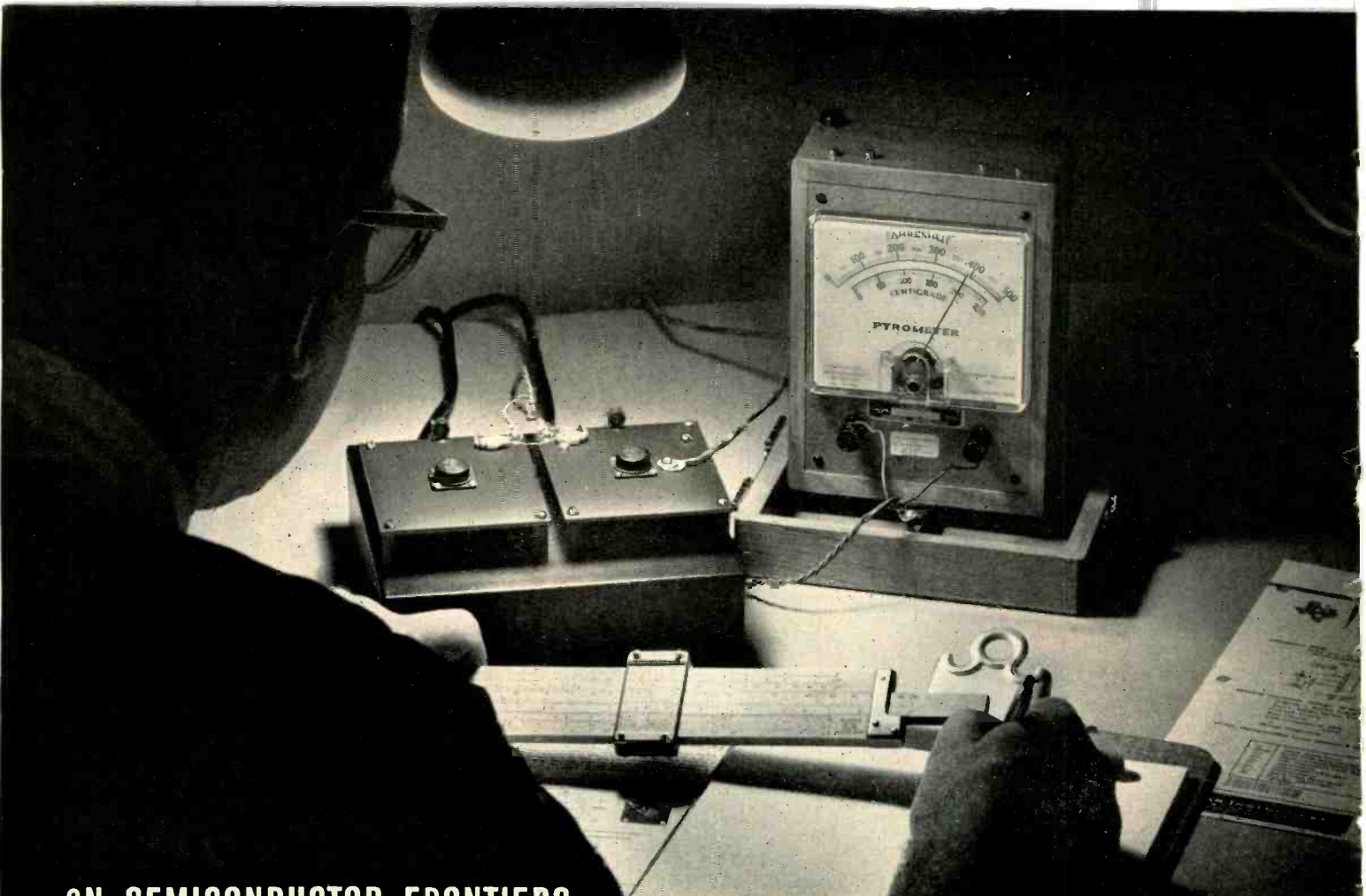

ON SEMICONDUCTOR FRONTIERS

# YOU can help 'beat the heat' at 200°C

ELECTRONIC ENGINEERS

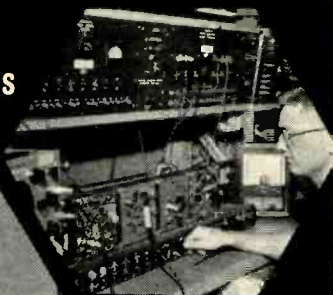

PHYSICAL CHEMISTS



SOLID STATE PHYSICISTS

ELECTRONIC ENGINEERS at TI are beating the semiconductor heat barrier with devices that will operate at 200 degrees centigrade and higher — twice the boiling point of water! Working closely with other scientists on the TI team, they continually explore new fields in electronics. Under the hot glare of infrared light which simulates extreme operating conditions, the engineer shown above is testing the newest TI silicon power transistor operating in conjunction with the totally new *Sensistor* temperature-sensing silicon resistor.

On this frontier, there is plenty of room for electronic engineers, physical chemists, solid state physicists, and others to build America's electronic future. If you are interested in joining other leading engineers and scientists at the industry's most modern research, development and production facilities — write or call for more information on 28-year-old Texas Instruments, recognized leader of the semiconductor industry. You will discover up-to-date supplemental benefits — profit sharing, insurance, retirement programs, and company-sponsored educational assistance.

**Semiconductors and Other Components** — Transistors, diodes, rectifiers, capacitors, resistors, transistor circuit applications, test equipment, mechanization. Write Harry Laur.

**Electronic and Electromechanical Apparatus** — Radar, sonar, infrared, optics, navigation, magnetics, telemetering, communications, computers, transformers. Write R. E. Houston.

**Research and Manufacturing** — PhD level for research, development and applications: solid state device technology, ferromagnetics, infrared, microwave, magnetics, digital computers, radar, sonar, telemetering, etc. Engineers for production, planning, purchasing, cost analysis, etc. Write A. E. Prescott.



**TEXAS INSTRUMENTS**  
INCORPORATED

6000 LEMMON AVENUE • DALLAS 9, TEXAS

## TV and Communications Engineers

Consider a Career in  
RADAR SYSTEMS DEVELOPMENT  
at  
SYLVANIA'S MISSILE SYSTEMS  
LABORATORY  
in Suburban Boston

There are outstanding opportunities for experienced development engineers in the following areas of ADVANCED VHF-UHF RADAR SYSTEMS DEVELOPMENT:

- Broadband & high power pulsed transmitters
- Broadband low noise receivers
- Electronic scanning techniques
- Transmission line devices
- Precision phase measurement and other RF instrumentation

Immediate openings for  
DEVELOPMENT GROUP LEADERS  
with 6-10 years experience

SENIOR ENGINEERS  
with 3-6 years experience

ENGINEERS  
with 1-3 years experience

Previous experience in radar development is helpful but not essential

Send resume in confidence to:

GRAYDON A. THAYER

Interview & relocation expenses paid by Sylvania. Inquiries answered within two weeks. Convenient Saturday interviews.

WALTHAM LABORATORIES  
Electronic Systems Division



# SYLVANIA

SYLVANIA ELECTRIC PRODUCTS INC.

100 First Ave.

Waltham 54, Massachusetts



Electronics by  
**AVCO**  
**Crosley**  
— means unerring  
accuracy!

*Engineers!* come with us and  
reach your career target!

CROSLEY offers you exciting challenges in a variety of interesting and expanding projects. We sincerely believe your professional growth will be given a chance to develop to its fullest extent when you and CROSLEY join forces as "Partners In Opportunity."

### HERE ARE FIELDS OF CURRENT ACTIVITY:

- |  |  |
|--|--|
| 1. Ground Radar  | 5. Communications<br>(Airborne Transmitters and Receivers) |
| 2. Airborne Defense Systems  | 6. Airborne Fire Control                                   |
| 3. Antenna and Micro-Wave Equipment  | 7. Servo-Mechanisms  |
| 4. Computer and Analytical Services<br>(Design and Development)<br>(Programming and Application) | 8. Transistorized Equipment                                |
|  | 9. Guided Missiles   |
|  | 10. Infra-Red Research                                     |

Write us for complete details. We'll send you literature and we'll tell you about the advantages of family living in Cincinnati—"Queen City of the West, Closest to the Heart of America". There are numerous company benefits and you will be paid generous relocation expenses.

Send your resume to:

Personnel Manager  
Dept. 22

**AVCO**  
**Crosley**

**AVCO** MANUFACTURING CORP.  
CROSLEY DIVISION  
1329 ARLINGTON STREET  
CINCINNATI 25, OHIO

# RADAR SYSTEM DESIGNERS

FOR SYLVANIA'S EXPANDING MISSILE SYSTEMS LABORATORY

in suburban Boston

Immediate openings for Radar System Designers with 4 to 10 years experience—for:

SYNTHESIS\* OF LARGE GROUND BASED SYSTEMS including phased arrays, electronic scanning, multistatic systems, pulse compression, MTI and Doppler systems.

NETWORK SYNTHESIS, applied to UHF and microwave systems analysis and engineering design of subsystems.

Positions are in the new 40,000 square foot wing of the Waltham Laboratories building.

To learn more of these opportunities at Sylvania's Missile Systems Laboratory send resume to GRAYDON A. THAYER

Interview and relocation expenses paid by Sylvania. Inquiries will be answered within two weeks. Convenient Saturday interviews arranged.

WALTHAM LABORATORIES Electronic Systems Division



SYLVANIA ELECTRIC PRODUCTS INC.

100 First Avenue—Waltham 54, Massachusetts

\*System synthesis includes system analysis, system and subsystem conceptual design, and sufficient detailed engineering analysis to insure practicability of system design.

## ENGINEERS • FEE PAID

### ENGINEERS

Analog or digital computers, pulse, printed, transistor circuitry, microwave, UHF & VHF communications, radar, reliability, environment, components, servo, antenna, infra-red, systems, gyroscopic, standards, platform, propulsion, jet engines.

**7,000 - 15,000**

### PROGRAMMERS—MATHEMATICIANS

Data processing, test trajectories, IBM 704, systems analysis, closed loop simulation tech, ballistic analysis, logic, servo-mech theory, coding & debugging systems.

**7,000 - 13,000**

## BENNETT Personnel & Associates

(Agency)

Commercial Trust Bldg.  
Philadelphia 2, Penna.  
RITTENHOUSE 6-4830

A non-profit organization  
S.E.E. GIVES

### To ENGINEERS

Service in providing contacts for choice positions available now. Send resume. Small Refundable Handling Charge. No Fee.

### To EMPLOYERS

Automatic access to a wide variety of desirable talent—now and regularly—from wide geographical locations.

### SCIENTISTS, ENGINEERS & EXECUTIVES, INC.

1026 Seventeenth St., N.W.  
Washington 6, D. C. — Metropolitan 8-2749

### ENGINEERS

If you have been looking for an Employment Agency that is skilled in the STATE OF THE ART of Technical Recruitment and RELIABILITY OF INFORMATION concerning positions, why not communicate with us at once!

ALL POSITIONS FEE PAID.

FIDELITY PERSONNEL SERVICE  
1218 Chestnut St. Phila. 7, Pa.  
Specialist in Aviation, Electronics and Nucleonics

### ELECTRONICS ENGINEER

Design and development of Gaging Instruments. Mature engineer with at least 5 years experience in electronics. Production background desirable. Write giving full resume.

STANDARD GAGE COMPANY, INC.  
Poughkeepsie, N. Y.



In Boston . . .

### PROJECT ENGINEER

### GYROS AND ACCELEROMETERS

Opportunity for an experienced instrument design engineer to plan, coordinate and supervise development projects. Intimate knowledge required of inertial components.

Plan to visit our new facilities while vacationing in New England.

Write to Bruce Buntin, Personnel Director, Minneapolis-Honeywell, Boston Division, 40 Life Street, Boston 35, Mass.

# Honeywell



Boston Division

## ELECTRICAL AND ELECTRONIC ENGINEERS

We have an exceptional opportunity for a highly creative engineer with an outstanding record of achievement and at least five years of top level experience in:

### Radio—Radar Interference Circular Wave Guide Development

This is a permanent position, in an organization with over 20 years experience in the research and development field, offering unlimited opportunity for professional growth, stimulating staff associations and an unusually pleasant working climate, in addition to excellent salary and employee benefits.

If you are interested in a challenging research assignment, please send a complete resume to:

A. J. PANERAL

### ARMOUR RESEARCH FOUNDATION

Of Illinois Institute of Technology  
10 West 35th St. Chicago 16, Illinois

# CATAPUULT:

*Weapon with a Past*

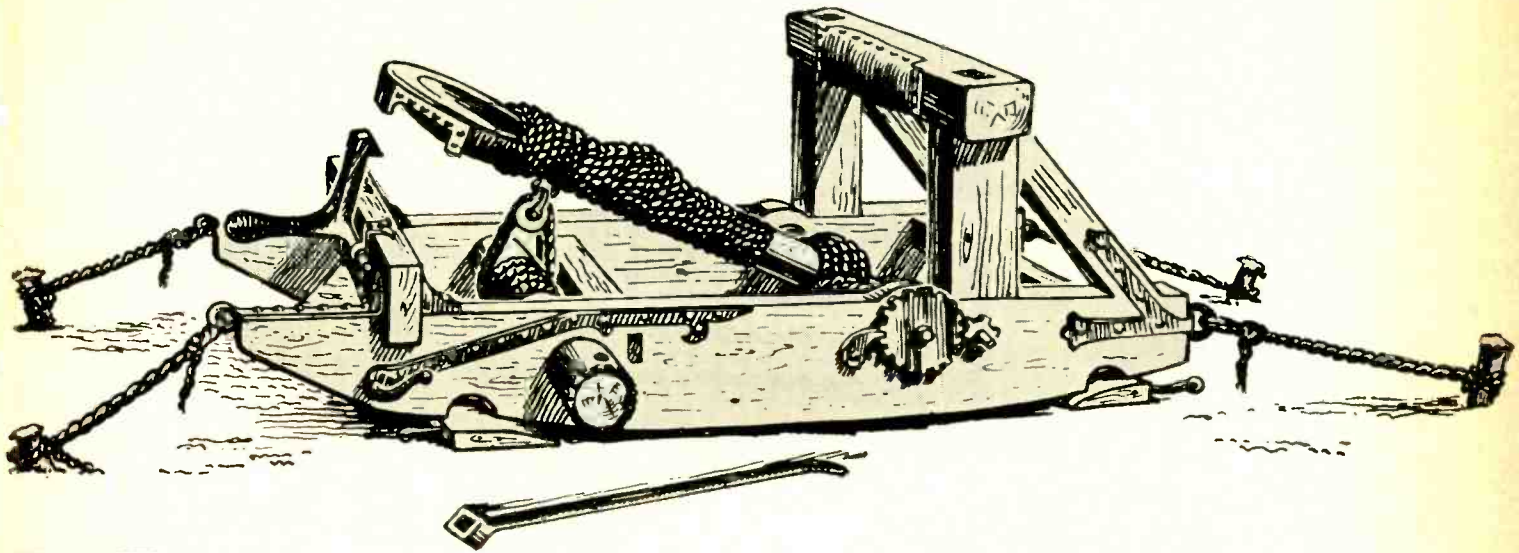

# UNIVAC<sup>®</sup>:

*Weapon with a Future*

Once a major weapon of warfare, the catapult is today all but obsolete. No less obsolete are weapons that were modern only yesterday. In our time, the concepts and instruments of warfare are changing overnight. Not knowing what lies ahead in the cold war of technology—yet realizing that defense industry offers the greatest opportunities—the engineer or scientist faces an enigma. The electronic computer, fundamentally a calculating machine, has to all intents and purposes

assumed the role of a weapon. Univac computers are integral to weapons systems such as the ICBM. In warning and interception, they are important weapons of defense. In atomic research and massive military logistics they are also instruments of warfare. Moreover, the computer will be vital to the development of all future weapons.

The computer is a weapon with a future—and Univac is a company with a future in both the military and commercial fields.

## **IMMEDIATE OPENINGS FOR:**

**Electronic Engineers**—With BS, MS and PhD degrees for Development Engineering. Experience in radar, servo-mechanisms, communications data processing desirable but not necessary.

**E E's, Mathematicians and Physicists**—With BS, MS and PhD degrees for Systems Engineering. Two or more years experience on electronic data processing systems.

**Mechanical Engineers**—With BS or MS degrees for Development Engineering involving the packaging of electronic equipment to meet military environmental specifications.

**Mathematicians and Physicists**—With BS or MS degrees for programming electronic digital computers. One or more years experience in digital programming.

**Field Maintenance Engineers**—With BS degree in Electrical Engineering or equivalent for maintenance of data processing equipment. Must be willing to relocate.

Address replies to: MR. R. K. PATTERSON, Dept. 7-2

**Remington Rand Univac**

DIVISION OF SPERRY RAND CORPORATION

Univac Park • St. Paul 16, Minnesota



**ENGINEERS, EE**



Openings now for additional creative engineers on a program that has attracted some of the best minds in electronics



The command radio-radar guidance system under development at General Electric offers an unprecedented challenge to electronic engineers highly qualified in these areas:

Systems analysis, evaluation & integration \* Systems & component reliability \* Transistorized circuits, pulse circuitry, IF-Video circuits \* RF & Microwave components & plumbing \* Communications control devices \* Doppler radar design & development \* Digital data processing techniques, data transmission involving D&D of ground-based & airborne antennae, transmitters, receivers; application of transducers, transponders, etc. \* Test operations, including planning, range instrumentation & test execution; development & application of automatic test equipment.

For additional unclassified details on this System, write for descriptive folder "A." If interested in the current long-range openings, include your resume in confidence to:

Mr. E. A. Smith, 7-E

MISSILE GUIDANCE SECTION

**GENERAL ELECTRIC**

COURT STREET, SYRACUSE, N. Y.

**ENGINEERS • SCIENTISTS**

**R & D**

**Opportunities in CALIFORNIA With SYLVANIA**

At Sylvania's Mountain View Laboratories, there are unlimited opportunities for the engineer who wants to work in an environment where individual contributors are recognized as the basic ingredient in creative engineering, and advancement is based on ability.

*There are openings now in research, development and fabrication of electronic countermeasures systems and equipment.*

**SYSTEMS ENGINEERS**

With special interest in advanced systems planning for electronic countermeasures systems, systems analysis, experimental and theoretical susceptibility studies, aerodynamics applied to problems by use of analog computer simulation, applied statistics involving decision theoretic techniques, laboratory test and integration of electronic systems, Academic work beyond bachelor degree or research experience in experimental physics, statistics or electronics is desirable.

**ANTENNA ENGINEERS**

Research, development and design of electronic countermeasures antenna systems. Requires BS in EE or Physics, plus one year of graduate study in electromagnetic theory, optics and advanced math, industrial experience, knowledge of propagation theory and capability for systems analysis. Also opportunities for recent graduates with academic background in antennas and microwaves.

**ELECTRONIC ENGINEERS**

Research and advanced development in the fields of electronic countermeasures and electronic systems; particular areas of activity are transmitters, receivers, analyzers, direction finders, data handling, RF circuits and antennas. Experience and/or advanced academic training are especially desirable.

**MECHANICAL DESIGN ENGINEERS**

Electromechanical design experience, preferably in microwave systems, equipment and packaging. Ability to originate and direct design, to follow through projects. Also engineering experience on high performance precision hydraulic drive and servo control, as in large antenna pedestals. Require proven creative ability.

Please send your resume to

Mr. J. C. Richards



**SYLVANIA**

SYLVANIA ELECTRIC PRODUCTS INC.

P.O. Box 1296

Mountain View, California

ADDRESS BOX NO. REPLIES TO: Box No. Classified Adv. Div. of this publication. Send to office nearest you. NEW YORK 36: P. O. BOX 12 CHICAGO 11: 520 N. Michigan Ave. SAN FRANCISCO 4: 68 Post St.

**SELLING OPPORTUNITY WANTED**

Can sell your electronic component parts in Southern California. B.S.M.E. with instrumentation sales background. RA-8337, Electronics.

**FOR RATES OR INFORMATION About Classified Advertising,**

Contact *The McGraw-Hill Office Nearest You.*

- ATLANTA, 3  
1301 Rhodes-Haverty Bldg.  
JACKSON 3-6951  
M. H. MILLER
- BOSTON, 16 350 Park Square  
HUBBARD 2-7160  
J. D. WARTH
- CHICAGO, 11  
520 No. Michigan Ave.  
MOHAWK 4-5800  
W. J. HIGGINS - D. C. JACKMAN
- CINCINNATI, 37  
2005 Seymour Ave.  
ELMHURST 1-4150  
F. X. ROBERTS
- CLEVELAND, 13  
1164 Illuminating Bldg.  
55 Public Square  
SUPERIOR 1-7000  
W. B. SULLIVAN
- DALLAS, 1 901 Vaughan Bldg.  
1712 Commerce St.  
RIVERSIDE 7-5117  
GORDON JONES
- DETROIT, 26 856 Penobscot Bldg.  
WOODWARD 2-1793  
J. G. GRANT
- LOS ANGELES, 17 1125 W. 6th St.  
MADISON 6-9351  
R. L. YOCOM
- NEW YORK, 36 500 Fifth Ave.  
OXFORD 5-5959  
R. W. OBENOUR D. T. COSTER R. P. LAWLESS
- PHILADELPHIA, 3  
Six Penn Center Plaza  
LOCUST 8-4330  
H. W. BOZARTH - R. J. EDSALL
- ST. LOUIS, 8 3615 Olive St.  
JEFFERSON 5-4867  
F. E. HOLLAND
- SAN FRANCISCO, 4 68 Post st.  
DOUGLAS 2-4600  
R. C. ALCORN

CLASSIFIED **SEARCHLIGHT SECTION** ADVERTISING

BUSINESS OPPORTUNITIES

EQUIPMENT - USED or RESALE

DISPLAYED RATE

The advertising rate is \$24.75 per inch for all advertising appearing on other than a contract basis. Contract rates quoted on request.

AN ADVERTISING INCH is measured 7/8 inch vertically on one column, 3 columns—30 inches—to a page.

EQUIPMENT WANTED or FOR SALE ADVERTISEMENTS acceptable only in Displayed Style.

UNDISPLAYED RATE

\$2.40 a line, minimum 3 lines. To figure advance payment count 5 average words as a line.

BOX NUMBERS count as one line additional in undisplayed ads.

DISCOUNT of 10% if full payment is made in advance for four consecutive insertions of undisplayed ads (not including proposals.)

Send NEW ADS or inquiries to Classified Adv. Div. of Electronics P. O. Box 12, N. Y. 36, N. Y.

**LARGEST STOCK OF**  
**RELAYS**  
**IN THE WORLD**  
**SOLENOIDS • STEPPERS**  
**SENSITROLS**  
**PRODUCTION QUANTITIES**  
**MOST MAKES IN STOCK**  
 Send for Latest Catalog E  
**Universal RELAY CORP.**  
*Formerly Universal General Corp.*  
 42 WHITE ST., NEW YORK 13, N. Y. • WALKER 5-9257



**V. H. F. U. H. F.**  
**RDO RECEIVER**  
 38 MC to 1000 MC precision Receiver covering complete range using 3 turning units. The RDO is a high quality Navy search receiver using the same turning units as the APR-4, but has additional features, such as input and output signal strength DB meters, audio output metering, noise limiter, greater stability, for noise measuring etc. Input 10V60CYC. Panadaptor output avail. Complete W/3 turning units.  
 Brand new, original boxes. **\$159.50**  
 Govt. acq. cost. \$1500.00  
**HEADPHONES - MIKES - CORDS**  
 Permo Flux \$45.00 HI-FI Headset—Uses annular grooved plastic fibre comes with voice coils as in speakers, and brand new rubber ear pads to obtain spacing for correct acoustical load. GIVES FINEST MUSIC REPRODUCTIONS! Imp: 300 Ohms per unit or 600 Ohms when wire series.  
**BRAND NEW \$6.95**  
 Less Head Band. **\$9.95**  
 Write for flyer.  
**R. W. ELECTRONICS**  
 Dept. L.  
 2430 S. Michigan Ave. Chicago 16, Ill.

**3" Round Elapsed Time Meter \$12.75**  
  
**WESTON PHOTRONIC CELL \$4.50**  
**PHOTO ELECTRIC Switch**  
 Darkness throws the switch—turns light on at dusk—off at dawn. Fools burglars who watch for signs of an empty house. **\$10.94**  
  
**TELECHRON Motors**  
 1 RPM \$3.95 60 RPM \$4.85  
 2 RPM 2.90 3 RPM 2.85  
 4 RPM 3.90 1 RP/2Hr. 2.80  
 3.6 RPM 3.15 1 RP/12Hr. 3.25  
 1 RPM—50 Cycles. \$1.85  
 Laboratory Special 1 of Each Motor \$25  
**GLEASON-AVERY**  
 1800 synchronous motor  
 115v 18 watt \$4.50  
 same motor 8 RPM 8.50  
**HAYDON TIMING MOTORS**  
 1 Rev 4 hours 115v \$1.70  
 1 RPM 115v 60cy. 2.60  
 1 RPM 230v 60 cy. 1.00  
 2 RPM 230v 60 cy. 1.00  
 3 RPM 115v 60 cy. 2.60  
 30 RPM 115v 60 cy. 2.60  
 150 RPM 115v 60 cy. 1.30  
 HANSEN 4RPM 115v 60cy. 4.24  
 CRAMER 4 RPM 115v 60 cy. 4.65  
 Laboratory special 1 of each motor \$16.50  
**RELAY CONTACT BURNISHERS .59—2 for \$1.00**  
**PM MOTORS**  
 Made by DELCO or DIEHL \$375  
 Removed from equipment  
 See Our Other Ad on Page 158  
**BLAN**  
 EST. 1923  
 INCLUDE POSTAGE  
 64 C Dey St.  
 New York 7,  
 N. Y.

**SCR 584 ANTENNA PEDESTALS**  
 Complete 360° azimuth & full elevation sky sweep (210°). Fully equipped with azimuth & elevation motors, potentiometers, selsyns, and amplidyne. The ideal antenna system for sky sweeping, tracking, telemetering.  
 In Excellent Condition. Delivery from Stock. An outstanding buy at our special price. Control consoles also in stock. Complete details in McGraw-Hill MIT Radiation Lab Series, Vol 1 Radar System Engineering & Vol 26 Radar Scanners & Radomes.  
**RADIO RESEARCH INSTRUMENT CO.**  
 550 FIFTH AVE. NEW YORK JUDSON 6-4691

*Buying Good Used Equipment*  
 is frequently the difference between having good needed equipment or doing without it.

Money saving prices on tubes. TV, Radio, Transmitting, and Industrial Types. New, 1st quality, guaranteed. Top name brands only. Government surplus and commercial test, lab. and communications equipment in stock. Sell us your excess tubes and equipment. Unused, clean tubes of all types wanted. Send specific details in first letter. Write for "Green Sheet" catalog 25c.  
**BARRY ELECTRONICS CORP.**  
 512 Broadway WA 5-7000 New York 12, N. Y.

**V & H RADIO-ELECTRONICS**  
  
**U.S.A. center for TUBES and ELECTRONICS**  
**SEND FOR OUR NEW FREE CATALOG**  
 How many copies do you need? We specialize in wholesale and export. Huge inventory. Inquiries solicited. Call REpublic 5-0215 for quotes on your requirements.  
**V & H RADIO-ELECTRONICS**  
 2029-2047 West Venice Blvd. Los Angeles 6, Calif.

Are you a buyer of tubes—aircraft or ground electronics?

**TECHNICAL SYSTEMS CORP.**

12-01 43rd Av., L. I. C. 1, N. Y.  
RA 9-0652-3

- AN/APR-4 38-4000 MC Receiver
- AN/ASQ-1 Magnetometer
- AN/APN-3-CPN-2 Shoran
- AN/ARC-27 200-400 MC Trans.-Rec.
- AN/ARC-33-34 200-400 MC Trans.-Rec.
- AN/ARN-14 Omni-Range
- AN/ARN-6 100-1750 KC Direction Finder
- AN/ARN-7 100-1750 KC Direction Finder
- AN/APN-22 Microwave Actineter
- AN/APN-34 DME
- AN/APN-70 Lorain
- AN/CPS-5 Airport Search Radar
- AN/TPS-10 3 CM Height Finder
- AN/APS-10 3 CM Airborne Nav. Radar
- AN/APS-33 3 CM Airborne Nav. Radar
- AN/PRC-6-8-9-10 20-55 MC F. M. Radio Sets
- AN/TRC-1-3-4 70-100 MC F. M. Radio Sets
- AN/TRC-8 230-250 MC F. M. Radio Sets
- AN/CRD-2 540 KC-30 MC Direction Finder
- AN/TXC-1-RC-120 Facsimile Transceivers
- AN/ARC-3 100-150 MC Trans.-Rec.
- SCR-399 1.5-18 MC Hi-Power Mobile Radio
- BC-312-342 1.5-18MC Communication Receivers

**RADIO—RADAR—JAMMING EQUIPMENT**

Microwave Plumbing-R.F. Sources-Etc. If you Need Electronic Equipment. Contact us. Many Late Equipments Available.

**ANTENNA PEDESTALS**

We have Antenna Rotating Pedestals with a capacity of up to 2000 lbs. Slip rings & data & take-off system is included.

WRITE FOR OUR CATALOG

**TEST EQUIPMENT**

- AN/ARM-1 ARC-3 Test Set
- AN/URM-25 10K-50MC Signal Generator
- AN/URM-49 400-1000 MC Signal Generator
- AN/URM-61 1,800-4000 MC Signal Generator
- AN/URM-19-23 Power Bridges
- AN/URM-23
- AN/URM-43 Power Meter
- AN/URM-64 900-2100 MC Signal Generator
- AN/UPM-11 X-Band Range Calibrator
- AN/UPM-12 X-Band V.S.W.R. Test Set
- AN/UPM-15 Pulse Generator
- AN/UPM-17 10-11,000 Spectrum Analyzer
- AN/UPM-23
- AN/UPM-33 X-Band Spectrum Analyzer
- AN/FSM-TSM Crystal Test Sets
- SG-1 Omni Test Set
- SG-8 Noise Generator
- SG-18 Pulse Generator
- TS-62 X-Band Echo Box
- TS-85 Voltage Divider
- TS-102 Radar Range Calibrator
- TS-118 R-F Wattmeter
- TS-125 S-Band Wattmeter
- TS-147 X-Band Signal Generator
- TS-148 X-Band Spectrum Analyzer
- TS-155 S-Band Signal Generator
- TS-186 100-10,000 MC Precision Heterodyne Freq. Meter .002% accuracy
- TS-239 Precision Pulsescope
- TS-251 Lorain Range Calibrator
- TS-270 S-Band Echo Box
- TS-432 150KC-20MC Noise Field Meter
- TS-488 X-Band Echo Box
- TS-587 15-400MC Noise Field Meter
- TS-600
- TS-606
- TS-670
- TS-857
- BC-221 125 KC-20MC Precision Freq. Meter
- LAE 520-1300 MC Signal Generator
- LAF 90-600MC Signal Generator
- LAG 1200-4000 MC Signal Generator
- LM 195KC-20MC Frequency Meter Accuracy .02% Modulated

MANY OTHER TEST EQUIPMENTS AVAILABLE

**T.V. RADIO STATIONS**

Write for list of broadcast equip.

**400 CYCLE GENERATOR-1 PHASE POWER**

**For Your Test Bench**

- Leland—2 K.W.—17.4 amps.
- 115 Volts—400 Cy.—1 PH.
- Ball Bearing Construction.
- Spark Gap Modulator—by Raytheon — Type CRP — 10249. Welded steel mounting base. 43" L. x 18" W.



**BRAND NEW  
U. S. NAVY  
SURPLUS**

- Also, Same Generator Mounted on Base with—
- 3 H.P. Motor 60 Cy. 1 Ph. \$295.
- 3 H.P. Motor 60 Cy. 3 Ph. \$289.
- 3 H.P. Motor 110 V.D.C. \$275.
- F.O.B. Chicago

SHIP WT. 400 LBS. NOW ONLY \$18950 F.O.B. CHGO.

**GROBAN SUPPLY CO.**

1139 S. Wabash Ave., Chicago 5, Ill.

**MOST POWERFUL TELECHRON**

- MOTOR MADE—6 watts—**
- 1 RPM 115 v 60 cy. . . . \$6.75
- 4 RPM 115 v 60 cy. . . . 11.50
- CRAMER 44 SP1, 45 sec.
- 6 switch Timer with clutch using 4 RPM 6 w TELECHRON Motor . . . . . \$17.50

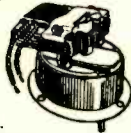

See Our Other Ad On Page 157  
**BLAN** 64 C. DEY ST.  
NEW YORK 7, N. Y.

Where  
To Buy

**OPTICS FOR INDUSTRY! OPTICS FOR THE SPACE ERA!**  
**Giant FREE CATALOG**

OVER 1,000 OPTICAL BARGAINS!  
Comparators • Microscopes • Magnifiers  
... many Cost-Cutting, Quality Control Aids  
Astronomical Telescopes • Satellite Scopes  
to See the Wonders of Space!  
REQUEST FREE 80-PAGE CATALOG "EX"  
EDMUND SCIENTIFIC CO., BARRINGTON, NEW JERSEY



**PROFESSIONAL  
SERVICES**

**TELECHROME MFG. CORP.**

*Electronic Design Specialists*  
**COLOR TELEVISION EQUIPMENT**  
Flying Spot Scanners, Color Synthesizers, Keyers, Monitors, Oscilloscopes and Related Apparatus Telemetering for Guided Missiles.  
J. R. Popkin-Curman, Pres. & Dir. of Eng.  
28 Ranick Dr. Amityville, L. I., N. Y.

**AMERICAN GEOPHYSICAL & INSTRUMENT CO.**

Oliver W. Osborne  
*Design & Development Of Electrical Instruments*  
Repairing All Types of Electronic Equipment  
1723 Market Street Gardena, Calif.  
DAvis 3-7387 DAvis 4-4858

**SEARCHLIGHT  
EQUIPMENT  
SPOTTING  
SERVICE**

This service is aimed at helping you, the reader of "SEARCHLIGHT", to locate surplus new and used electronic equipment and components not currently advertised. (This service is for USER-BUYERS only) No charge or obligation.

**How to use:** Check the dealer ads to see if what you want is not currently advertised. If not, send us the specifications of the equipment wanted on the coupon below, or on your own company letterhead to:

**SEARCHLIGHT EQUIPMENT  
SPOTTING SERVICE**

**Electronics  
Classified Advertising Division  
P.O. Box 12, N.Y. 36, N.Y.**

Your requirements will be brought promptly to the attention of the equipment dealers advertising in this section. You will receive replies directly from them.

**Searchlight Equipment Spotting Service  
c/o Classified Advertising, ELECTRONICS  
P. O. Box 12, N. Y. 36, N. Y.**

Please help us locate the following equipment:

.....

.....

.....

.....

.....

NAME ..... TITLE .....

COMPANY .....

STREET .....

CITY .....

ZONE ..... STATE ..... /7/18/58



# INDEX TO ADVERTISERS

AMP, Incorporated	43	Electronic Research Associates, Inc.	94
AD-YU Electronics Laboratories Inc.	160	Empire Devices Products Corporation	26
Aircraft Armaments, Inc.	127	Emerson Electric	121
Airfax Products Co.	92	Engelhard Industries, Inc.	19
Alco Electronics Mfg. Co.	147	Erie Electronics Division, Erie Resistor Corp.	90
Allen-Bradley Co.	32A, 32B		
American Blower Div. of American Standard	146		
American Lava Corporation	99		
Anaconda Wire & Cable Co.	16A, 16B	Fansteel Metallurgical Corp.	108, 109
Arnold Magnetics Corp.	141	Fenwal Electronics Inc.	129
Autonetics, A Div. of North American Aviation Inc.	136		
Bausch & Lomb Optical Co.	119	Genewell Co.	147
Bell Aircraft Corp.	128	General Ceramics Corp.	40
Bell Telephone Laboratories	9	General Electric Co.	
Bendix Aviation Corp., Pacific Division	4, 112	Apparatus	57
Bird Electronic Corp.	126	Power Tube Dept.	44, 45
Boesch Mfg. Co., Inc.	131	Semiconductor Prod.	30, 31
Borg Corporation, George W.	138, 139	Silicone Prod. Dept.	96A
Bussmann Mfg. Co.	38	Metallurgical Dept.	148
		General Mills, Mechanical Div.	29
		General Transistor Corp.	28
		Grant Pulley & Hardware Corp.	103
Cannon Electric Co.	145	Harper Leader, Inc.	141
Ceteo-Constantine Engineering Laboratories Co.	139	Heath Company	121
Chance Vought Aircraft Inc.	116, 117	Heiland, a Div. of Minneapolis-Honeywell	54, 55
Chester Cable Corp.	104	Helipot Corp., Div. of Beckman Instruments, Inc.	96
Cinch Mfg. Corp.	85	Hewlett-Packard Company	24, 25
Constantine Engineering Laboratories Co.	139	Hughes Products, a Div. of Hughes Aircraft Co.	15, 34, 35
Continental-Diamond Fibre Div. of the Budd Company, Inc.	36		
Convair Fort Worth	89	Industrial Instruments, Inc.	146
Cosmic Condenser Co.	143	International Nickel Co., Inc.	97
Cossor (Canada) Limited	127		
Coto-Coil Co., Inc.	143		
Cubic Corp.	96D		
Cutler-Hammer, Inc.	125		
Daven Company	3rd Cover	James Vibrapower Company	112
DeMorney-Bonardi	52	Jones, Howard B. Div. Cinch Mfg. Corp.	144
Diamond Antenna & Microwave Corp.	113		
Dow Corning Corp.	48, 49		
Drakenfeld & Co., Inc., B. F.	140	Kintel (Kay Lab)	13
du Pont de Nemours & Co. (Inc.) E. I. Polychemicals Dept.	47	Krohn-Hite Corporation	147
Edmund Scientific Co.	158	Leach Corporation	20
Eitel-McCullough, Inc.	21	Librascope, Inc.	159
Electro Motive Mfg. Co., Inc.	23	Lockheed Missile Systems Division	96B, 96C

follow your career under ideal conditions at

# LIBRASCOPE

LIBRASCOPE uses the engineering project team method.



*Computer—Controls—Components  
Design—Development—Manufacturing*

You can be assured of ideal working conditions at well located Librascope. Why? Because of the physical plant; air-conditioned, ultra-modern; the location; at the edge of the foothills; near Los Angeles, Hollywood and the pleasant residential areas of Burbank, Glendale, Pasadena.

A company with highest professional and technical standards. If you are an M.E. or E.E., mathematician or physicist, interested in Analog or Digital Computers • Logical Design • Instrumentation • Servo Mechanisms • Electro-mechanical • Systems • Transistor Applications • Controls for commercial and Military Equipment, you're invited to investigate the opportunities at Librascope which has just held its 20th Anniversary—a sound, stable organization growing with automation. Write Glen Seltzer, Employment Manager.



**LIBRASCOPE**

LIBRASCOPE, INCORPORATED  
808 Western Ave. • Glendale, Calif.

Write today for this interesting booklet about Librascope.



# PRECISION PHASE DETECTOR

TYPE 205



**Frequency Range:** 100 KC to 15 MC  
**Accuracy:** 0.1° or 1%  
**Resolution Time:**  
 The smallest measured phase angle in degrees  $8 \times 10^{-11} \times 360 \times$  frequency in cps.  
**Sensitivity:**  
 Approximately 0.01 volt full scale.  
**Price:** \$445.00

# PRECISION PHASE METER

TYPE  
405 SERIES



**Direct Reading in Degrees with No Adjustment.**

**Frequency Range:** 1 CPS. to 500 KC  
**Accuracy:** 1/2° Relative, 1° Absolute  
**Input Voltage:** 0.3 volt to 70 volts  
**Phase Range:** 0-12°, 0-36°, 0-90° and 0-180°, full scale deflection  
**Frequency Range:**  
 Type 405 — 8 cps. to 100 kc; Type 405H — 8 cps to 500 kc; Type 405L — 1 cps. to 20 kc.  
**Price:**  
 Type 405 — \$499.00; Type 405H — \$538.00; Type 405L — \$560.00.

**A-D-YU**  
**ELECTRONICS LAB., INC.**  
 formerly **ADVANCE**  
 249 TERHUNE AVE. • PASSAIC, N. J.

CIRCLE 143 READERS SERVICE CARD

M. B. Manufacturing Co., a Division of Textron, Inc. ....	110	Union Switch & Signal Div. of Westing- house Air Brake Company .....	41
Magnetics, Inc. ....	87	U. S. Stoneware .....	51
Malco Tool & Mfg. Co. ....	116	United Transformer Co. ....	2nd Cover
Mallory and Co., Inc., P. R. ....	10, 11	Veeder-Root, Inc. ....	42
Marconi Instruments, Ltd. ....	120	Washington Aluminum Co., Inc. ....	114
Microdut Inc. ....	141	Waters Manufacturing, Inc. ....	17
Micro Switch a Div. of Minneapolis- Honeywell Regulator Co. ....	116	Weinschel Engineering .....	129
Microwave Associates, Inc. ....	123	Westinghouse Electric Corp. ....	50
Milwaukee Resistor Co. ....	129	Whalite Mfg. Co. ....	117
Monitor Products Co. ....	140	White Dental Mfg. Co., S. S. ....	142
Nems-Clarke, Inc. ....	127	Whitney Metal Tool Co. ....	145
New Hermes Engraving Machine Corp. ....	148		
Non-Linear Systems, Inc. ....	37		
North American Aviation .....	145		

Oak Mfg. Co. ....	95
Ohmite Mfg. Co. ....	111
Olive Can Co. ....	129
Oster Manufacturing Co., John .....	32
Ozalid, Division of General Aniline & Film Corp. ....	33

Pacific Semiconductors, Inc. ....	53
Patwin, A Division of the Patent Button Company .....	144
Phileo Corporation .....	58
Polytechnic Research & Development Co., Inc. ....	105
Potter & Brumfield, Inc. ....	91
Pulse Engineering .....	142

RBM Division, Essex Wire Corp. ....	100, 101
Racal Engineering Ltd. ....	139
Radiation, Inc. ....	137
Radio Corporation of America .....	4th Cover
Ramo-Woolridge Corp. ....	22
Raytheon Mfg. Company .....	6, 133 135, 149, 150

Sanders Associates, Inc. ....	118
Solartron, Inc. ....	130
Sorensen & Co. ....	5
Specific Products .....	138
Sperry Gyroscope Company, Division of Sperry Rand Corp. ....	107
Sprague Electric Co. ....	3
Stackpole Carbon Co. ....	93
Stoddart Aircraft Radio Co., Inc. ....	125
Struthers-Dunn, Inc. ....	122
Swenson Co., Inc., V. H. ....	143
Syston Corporation .....	145

Taylor Fibre Co. ....	132
Technology Instrument Corp. ....	102
Tektronix, Inc. ....	56
Telrex Laboratories .....	125
Tensolite Insulated Wire Co., Inc. ....	46
Texas Instruments Incorporated .....	27
Tung-Sol Electric, Inc. ....	39

Professional Services .....	158
-----------------------------	-----

## CLASSIFIED ADVERTISING

F. J. Eberle, Business Mgr.

## EMPLOYMENT OPPORTUNITIES 151-156

## EQUIPMENT

(Used or Surplus New)

For Sale .....

157, 158

## Advertisers Index

Armour Research Foundation of Illinois Institute of Technology .....	154
Avco Manufacturing Corp., Crosley Division .....	153
Barry Electronics Co. ....	157
Bennett Personnel & Associates .....	154
Blan .....	157, 158
Fidelity Personnel Service .....	154
General Electric Company .....	156
International Business Machines Corp. ....	151
Minneapolis-Honeywell Regulator Co. ....	154
Radio Research Instrument Company .....	157
Remington Rand Univac, Div. of Sperry Rand Corp. ....	155
R. W. Electronics .....	157
Scientists, Engineers & Executives Inc. ....	154
Standard Gage Company .....	154
Sylvania Electric Products, Inc., Mountain View, California .....	156
Waltham, Mass. ....	153, 154
Technical Systems Corp. ....	158
Texas Instruments Corp. Inc. ....	152
Universal Relay Corp. (Formerly Univer- sal General Corp.) .....	157
V & H Radio Electronics .....	157

This index is published as a service. Every care is taken to make it accurate, but ELECTRONICS assumes no responsibilities for errors or omissions.

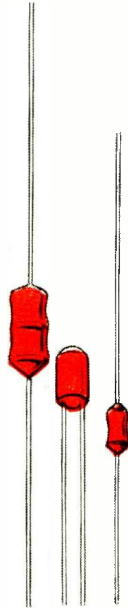

# The INCREDIBLE SHRINKING RESISTOR...

Daven has always been the leader in the miniaturization of precision wire wound resistors. Now, due to further advances in resistor manufacture, Daven is able to offer higher resistance values in smaller sizes than ever before. Typical miniature units, with their new maximum values, are tabulated here.

For guided missiles, airborne radar, telemetering, and for any application where extremely small size

and dependability are of prime importance, specify Daven miniature wire wounds.

TYPE	DIAM	LENGTH	MAX WATTS	MAX OHMS
1250	1/4	1/2	.33	1 Megohm
1274	3/16	3/8	.25	250 K
1284	1/4	27/64	.25	1 Megohm

THE **DAVEN** CO.



LIVINGSTON, NEW JERSEY

TODAY, MORE THAN EVER, THE DAVEN © STANDS FOR DEPENDABILITY!

**"SMALL"  
SIZE...  
"BIG"  
SOUND!**



**RCA-6973**...miniature beam-power tube makes practical the design of compact, low cost, high-fidelity audio amplifiers.

The "combo" takes off! Just a "small" group of musicians, but they've got the "big" sound. Jazz provides performers with a gratifying means of self-expression, allows creative talent freedom to range the gamut of emotions. Designers of amplifiers for music reproduction, too, express their talents in meeting the challenge of *compactness and power* demanded by today's devotees of high fidelity. RCA's development of the 6973 gives the design engineer the "vehicle" for modern design.

A 9-pin miniature, RCA-6973 offers a combination of features well suited to compact quantity-produced power amplifiers. It is capable of delivering up to 20 watts of power output in push-pull class AB<sub>1</sub> service with total harmonic distortion of

only 1.5%. Double-base-pin connections for the grids more effectively conduct heat and keep the grids "cool" in operation. This minimizes grid emission, permits the use of high values of grid circuit resistance, and enables practicable economies by reducing grid-driving power requirements. High power sensitivity, stability, dependability, and low heater power, too, make RCA-6973 the designer's "choice" for high-fidelity amplifier designs in the modern trend to "small" size—"big" sound!

Your RCA Field Representative has complete information. Call him today. For Technical data, write RCA Commercial Engineering, Sec G-19-Q-3, Harrison, N. J.



**RADIO CORPORATION OF AMERICA**  
Electron Tube Division

Harrison, N. J.

**RCA FIELD OFFICES**

**EAST:** 744 Broad Street  
Newark 2, N. J. • HUmboldt 5-3900

**MIDWEST:** Suite 1154, Merchandise Mart Plaza  
Chicago 54, Ill. • WHitehall 4-2900

**WEST:** 6355 E. Washington Blvd.  
Los Angeles 22, Calif. • RAymond 3-8361