

electronics

OCTOBER 1, 1957

A MCGRAW-HILL PUBLICATION • PRICE ONE DOLLAR

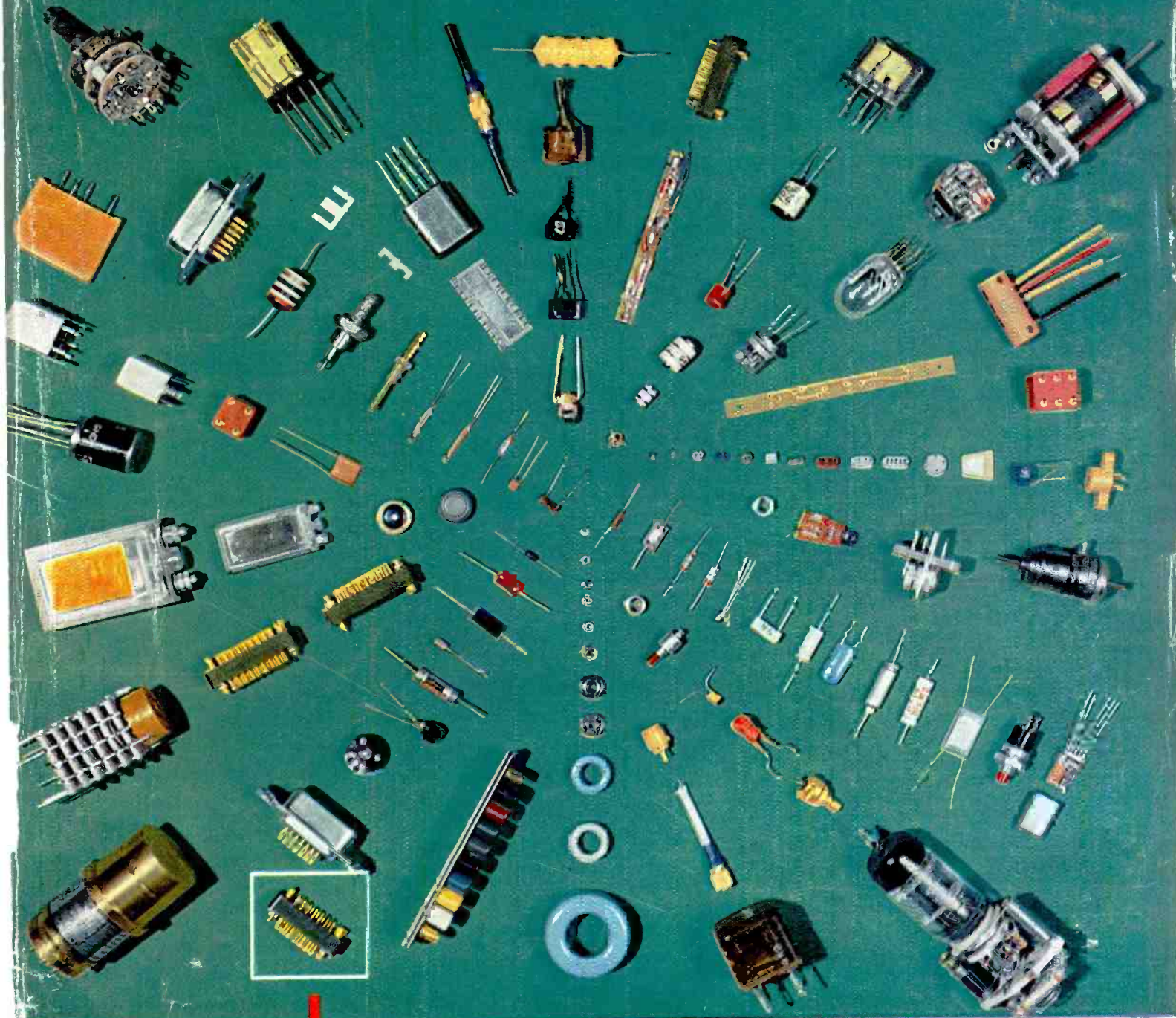

ACTUAL SIZE

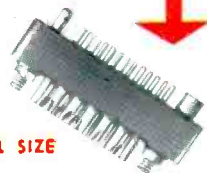

MINIATURIZATION

A 28-page Special Report

MINIATURIZED COMPONENTS... FROM STOCK



As leaders in miniaturization for over twenty years, UTC stock item units have provided smallest size with a maximum of reliability. Hermetic stock items have been proved to MIL-T-27A, eliminating costs and delays of initial MIL-T-27A testing.



HERMETIC SUB-MINIATURE AUDIO UNITS

The smallest hermetic audios made (except our DO-T's, for transistor use)

Dimensions... 1/2 x 11/16 x 29/32... Weight, 8 oz.

TYPICAL ITEMS

Type No.	Application	MIL Type	Pri. Imp. Ohms	Sec. Imp. Ohms	DC in Pri MA	Response ±2 db (Cyc.)	Max. level dbm	
H-31	Single plate to single grid, 3:1	TF1A15YY	10,000	90,000	0	300-10,000	+13	
H-32	Single plate to line	TF1A13YY	10,000****	200	3	300-10,000	+13	
H-33	Single plate to low impedance	TF1A13YY	30,000	50	1	300-10,000	+15	
H-35	Reactor	TF1A20YY	100 Henries-0 DC, 50 Henries-1 Ma. DC, 4,400 ohms.					
H-36	Transistor Interstage	TF1A15YY	25,000	1,000	.5	300-10,000	+10	
H-37A	Transistor Output	TF1A15YY 500 CT (DCR50)	500 CT (DCR50)	50 (DCR5)	3.5	300-10,000	+15	
H-40A	Transistor Output	TF4RX17YY 500 CT (DCR26)	500 CT (DCR26)	600 CT	10	300-10,000	+15	

*Can be used for higher source impedance, with some reduction in frequency range.

COMPACT HERMETIC AUDIO FILTERS

UTC standardized filters are for low pass, high pass and band pass application in both interstage and line impedance designs. Forty-five stock values, others to order. Case 1-3/16 x 1-11/16 x 1 1/8 - 2 1/2 high... Weight 6-9 oz.

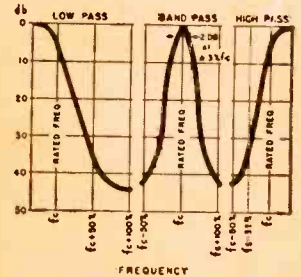

OUNCER (WIDE RANGE) AUDIO UNITS

Standard of the industry for 18 years, these units provide 30-20,000 cycle response in a case 7/8 dia. x 1-3/16 high. Weight 1 oz.

TYPICAL ITEMS

Type No.	Application	Pri. Imp.	Sec. Imp.
O-1	Mike, pickup or line to 1 grid	50, 200/250, 500/600	50,000
O-2	Mike, pickup or line to 2 grids	50, 200/250, 500/600	50,000
O-3	Dynamic mike to 1 grid	7.5/30	50,000
O-7	Single plate to 2 grids, D.C. in Pri.	15,000	95,000
O-9	Single plate to line, D.C. in Pri.	15,000	50, 200/250, 500/600
O-10	Push-pull plates to line	30,000 ohms plate to plate	50, 200/250, 500/600
O-12	Mixing and Matching	50, 200/250	50, 200/250, 500/600
O-15	10:1 single plate to 1 grid	15,000	1 megohm
O-20	Transistor to line	1,500 CT	500/125 (split)



HERMETIC VARIABLE INDUCTORS

These inductors provide high Q from 50 - 10,000 cycles with exceptional stability. Wide inductance range (10-1) in an extremely compact case 25/32 x 1-1/8 x 1-3/16... Weight 2 oz.

TYPICAL ITEMS

TYPE No.	Min. Hys.	Mean Hys.	Max. Hys.	DC Ma
HVC-1	.002	.006	.02	100
HVC-3	.011	.040	.11	40
HVC-5	.07	.25	.7	20
HVC-6	.2	.6	2	15
HVC-10	7.0	25	70	3.5
HVC-12	50	150	500	1.5

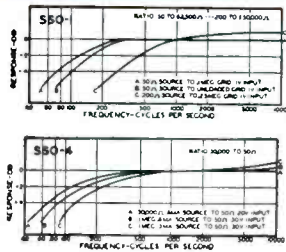
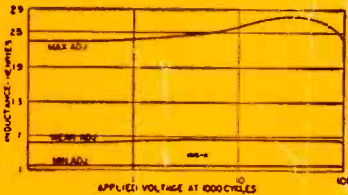
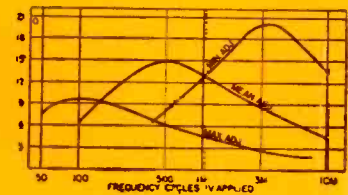

SUB-SUBOUNCER AUDIO UNITS

UTC Subouncer and sub-subouncer units provide exceptional efficiency and frequency range in miniature size. Constructional details assure maximum reliability. SSO units are 7/16 x 3/4 x 43/64... Weight 1/3 oz.

TYPICAL ITEMS

Type	Application	Level	Pri. Imp.	MA D.C. in Pri.	Sec. Imp.	Pri. Res.	Sec. Res.
*SSO-1	Input	+ 4 V.U.	200 50	0	250,000 62,500	13.5	3700
SSO-2	Interstage /3:1	+ 4 V.U.	10,900	0-.25	90,000	750	3250
*SSO-3	Plate to Line	+20 V.U.	10,000 25,000	3 1.5	200 500	2600	35
SSO-4	Output	+20 V.U.	30,000	1.0	50	2875	4.6
SSO-5	Reactor 50 HY at 1 mil.	D.C. 4400 ohms D.C. Res.					
SSO-6	Output	+20 V.U.	100,000	.5	60	4700	3.3
*SSO-7	Transistor Interstage	+10 V.U.	20,000 30,000	.5 .5	800 1,200	850	125

*Impedance ratio is fixed 1:1250 for SSO-1, 50:1 for SSO-3. Any impedance between the values shown may be employed.

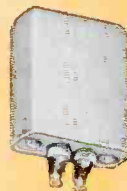

HERMETIC MINIATURE HIGH-Q TOROIDS

MQE units provide high Q, excellent stability and minimum hum pickup in a case only. 1/2 x 1-1/16 x 17/32... weight 1.5 oz. MIL type TF4RX20YY.

TYPICAL ITEMS

Type No.	Inductance	DC Max.
MQE-2	12 mhy.	100
MQE-4	30 mhy.	65
MQE-7	100 mhy.	35
MQE-9	.25 hy.	22
MQE-11	.6 hy.	14
MQE-13	1.5 hy.	9
MQE-15	2.3 hy.	7.2

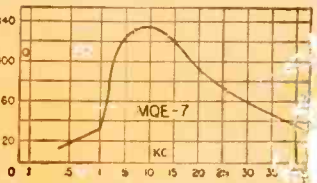

Let us miniaturize your gear.

SEND DETAILS OF YOUR NEEDS FOR SIZES AND PRICES

UNITED TRANSFORMER CORPORATION

150 Varick Street, New York 13, N. Y.

PACIFIC MFG. DIVISION: 4008 W. JEFFERSON BLVD., LOS ANGELES 16, CALIF.

EXPORT DIVISION: 13 EAST 40th STREET, NEW YORK 16, N. Y. CABLES: "ARLAB"

A McGRAW-HILL PUBLICATION

H. W. MATEER, *Publisher*

W. W. MacDONALD, *Editor*

Managing Editor
JOHN M. CARROLL

Feature Editor
JOHN MARKUS

Associate Editors
JOHN M. KINN, Jr.
FRANK LEARY
MICHAEL F. TOMAINO
HOWARD K. JANIS
SYLVESTER P. CARTER
DAVID A. FINDLAY
HAIG A. MANOOGIAN
ROLAND J. CHAREST

Assistant Editors
WILLIAM P. O'BRIEN
GEORGE SIDERIS
LAWRENCE KAMARCK
EDWARD DeJONGH
JOHN F. MASON
BARRY MILLER

Pacific Coast Editor (Los Angeles)
HAROLD C. HOOD

Midwestern Editor (Chicago)
HAROLD HARRIS

HARRY PHILLIPS, *Art Director*
ROY THOMPSEN
BARBARA ELLWOOD

JOHN C. WRIGHT, Jr., *Production Editor*
BERNICE DUFFY
JEAN L. MATIN

Editorial Assistants
GLORIA J. FILIPPONE
ARLENE SCHILP
BARBARA HEARST
NOREEN HENNESSY
PHYLIS A. CRONIN
BARBARA HABERMANN

JAMES GIRDWOOD, *Adv. Sales Mgr.*
R. S. QUINT, *Assistant Adv. Sales Mgr. and
Buyers Guide Mgr.*
FREDERIC STEWART, *Promotion Mgr.*
FRANK H. WARD, *Business Mgr.*
G. E. POMEROY, *Classified Mgr.*
JEAN W. HEIGES, *Research*
WALLACE B. BLOOD, *Market Consultant*

New York
DONALD H. MILLER
HENRY M. SHAW
MARTIN J. GALLAY

Boston
WM. S. HODGKINSON

Philadelphia
JAMES T. HAUPTLI

Chicago
BRUCE WINNER
WALTER M. LUCE

Cleveland
WARREN H. GARDNER

San Francisco
T. H. CARMODY
R. C. ALCORN

Los Angeles
CARL W. DYSINGER
RUSSELL H. ANTLES

Atlanta
M. MILLER

Dallas
GORDON L. JONES

London
HERBERT LAGLER
KEITH HENNEY, *Consultant*

MINIATURIZATION OF ELECTRONIC EQUIPMENT—The array of components from 56 manufacturers presents some of the latest developments available to the design engineer for miniaturized circuits. Identification of the units is given on p 204. Photo by Hans Basken.COVER

FIGURES OF THE MONTH. 6

INDUSTRY REPORT 7

Carrier Aircraft Land No Hands.	7	Color TV Views Living Cells.	20
Instrument Makers Convene.	8	Gases Produce Power.	22
Fast Cryogenic Memories.	8	FCC Actions.	22
Films Train Electronics Men.	10	Beacon Guides Pilot Home.	22
Business Briefs.	12	Density Gauge Hastens Analysis.	24
Bells Ring For Mobile Owners.	12	Computers Come To The Rescue.	26
Industry Exploits Diodes.	14	Germanium Unaltered.	26
Medics Test Electronics.	14	Desk-Size Computer.	26
Computers Replace Sky Dome.	16	Industry Shorts.	28
Military Electronics.	16	Meetings Ahead.	28
Old Tubes Never Die.	16	Britain Builds Synchrotron.	28
Spiral Traveling Wave Antenna.	20		

FEATURES

Computer Inventories Oil in Refinery Tanks.	143
By D. J. Gimpel and H. O. Barton	
Test Equipment for Transistor Production.	148
By Andrew B. Jacobsen and Carl G. Tinsley	
Mobile Monitor Covers TV Stations for FCC.	152
By Raymond L. Day	
Infrared Detector Aids Medical Diagnosis.	155
By W. E. Osborne	
Tape Recorder Selects Radio Announcements.	158
By D. V. R. Drenner	
Phase-Shift Oscillator Indicates Radar Range.	160
By R. Cameron Barritt	
High-Speed Computer Stores 2.5 Megabits.	162
By William N. Papian	
Ultrasonic Iron Solders Aluminum.	168
By Thomas J. Scarpa	
Strain-Gage System for Aircraft Telemetry.	170
By William O. Brooks and Dwight L. Stephenson	

CONTINUED ON NEXT PAGE

Single Sideband Links Canadian Traders 174
 By S. G. L. Horner, Murray G. Crosby and Barton C. Coffman

**MINIATURIZATION OF ELECTRONIC EQUIPMENT—
 A Special Report** 177
 By David A. Findlay

Transistors Boost Video for TV Studio Monitors 205
 By L. N. Merson

Compliance Meter Tests Phono Cartridges 206
 By Arthur R. Kopp

Probability Computer for Noise Measurement 208
 By A. W. Sullivan and J. D. Wells

Waveguide Loss Charts (Reference Sheet) 210
 By A. F. Pomeroy

ELECTRONS AT WORK 214

Two-Collector Transistor 214	Inexpensive Oven Thermostat 222
Antenna Alarm Anticipates Ice 216	By N. B. Crane
2,000-MC Scatter Link 216	Silicon Diodes Protect Meters 224
Silicon Transistor Oscillators 218	By K. D. Smith
By E. G. Homer	Cascade Auto Preamplifier 234
Cloud Detector for Satellite 218	By H. J. Wirth
TV Checks Die Positions 220	Wide Range A-C Timer 240
Switching Core Tester 242	
Annular Constructed Transistor 244	
Transistorized Reactor Control 246	
Mixer For Tape Recording 248	
By R. C. Ferrara	
Radiation of Magnetic Materials 250	

PRODUCTION TECHNIQUES 252

Plastic-Pouch Tube Pack 252	Drying Toroid Cores 264
Cutting Sponge Rubber 252	Molded Flush Printed Wiring 266
Design of the Month: Connector 254	By R. M. Bell
Expendable Crystal Wipers 256	Rubber Pad Saves Coils 274
Machine Puts Inserts in Mold 258	Harness Board Holder 278
Set Screws Center Punch 280	
Nylon Rollers on Wire-Cutter 282	
Chromized Grid Mandrels 284	

NEW PRODUCTS 286

LITERATURE 378

PLANTS AND PEOPLE 392

NEW BOOKS 422

THUMBNAIL REVIEWS 429

BACKTALK 434

INDEX TO ADVERTISERS 469

electronics

OCTOBER 1, 1957 Vol. 30, No. 10

Published three times a month with an additional issue in June, by McGraw-Hill Publishing Company, Inc., James H. McGraw (1860-1948) Founder.

Executive, Editorial, Circulation and Advertising Offices: McGraw-Hill Building, 330 W. 42 St., New York 36, N. Y.

Longacre 4-3000. Publication Office 99-129 North Broadway, Albany 1, N. Y. See panel below for directions regarding subscription on change of address. Donald C. McGraw, President; Joseph A. Gerardi, Executive Vice President; L. Keith Goodrich, Vice President and Treasurer; John J. Cooke, Secretary; Nelson Bond, Executive Vice President, Publications Division; Ralph B. Smith, Vice President and Editorial Director; Joseph H. Allen, Vice President and Director of Advertising Sales; A. R. Venezian, Vice President and Circulation Coordinator.

Single copies \$1.00 for Technical Edition and 50¢ for Business Edition in United States and possessions, and Canada; \$2.00 and \$1.00 for all other foreign countries. Buyers' Guide \$3.00. Subscription rates—United States and possessions, \$6.00 a year; \$9.00 for two years. Canada, \$10.00 a year, \$16 for two years. All other countries \$20.00 a year, \$30.00 for two years. Three year rates accepted on renewals only, are double the one-year rate. Second class mail privileges authorized at Albany, N. Y. Printed in U.S.A. Copyright 1957 by McGraw-Hill Publishing Co., Inc.—All Rights Reserved. Title registered in U. S. Patent Office. BRANCH OFFICES: 520 North Michigan Avenue, Chicago 11; 68 Post Street, San Francisco 4; McGraw-Hill House, London E. C. 4; National Press Bldg., Washington, D. C. 4; Architects Bldg. 17th & Sansom Sts., Philadelphia 3; 1111 Henry W. Oliver Bldg., Pittsburgh 22; 1510 Hanna Bldg., Cleveland 15; 856 Penobscot Bldg., Detroit 26; 3615 Olive St., St. Louis 8; 350 Park Square Bldg., Boston 16; 1321 Rhodes Haverly Bldg., Atlanta 3; 1125 West Sixth St., Los Angeles 17; 1740 Broadway, Denver. ELECTRONICS is indexed regularly in The Engineering Index.

Subscriptions: Address correspondence to Subscription Manager, Electronics, 330 W. 42nd St., New York 36, N. Y. Allow one month for change of address, stating old as well as new address. Subscriptions are solicited only from persons engaged in theory, research, design, production, maintenance and use of electronic and industrial control components, parts and products. Position and company connection must be indicated on subscription orders.

Postmaster: please send form 3579 to Electronics, 330 W. 42 St., New York 36, N. Y.



Member ABC and ABP

**in 1958
it will take**

52,000

**circulation
to adequately
cover the
electronic
market!**

electronics

A MCGRAW-HILL PUBLICATION



330 WEST 42nd STREET NEW YORK 36, NEW YORK

ELECTRONICS — October 1, 1957

This AC Regulator?

Get In Line!

Sorensen AC Line Regulators Handle 150 VA to 15 KVA;
Accurate within $\pm 0.1\%$ against Line or Load. Highly
Dependable—with Clean Wave Form and Frequency Insensitivity.



It's a sure thing you can depend on a sustained steady voltage level, in circuit or hook-up, when there's a Sorensen AC Line Voltage Regulator cut into your power source.

On applications such as communications equipment, appliance testing, instrument calibration, and color photography—and for general laboratory use, the refined Sorensen regulating circuit gives unequaled accuracy and dependability.

An exclusive factor, unique and effective, is the safety diode which produces a voltage drop, in place of a surge, when there's a filament break in any tube. Over-voltage circuit breakers are also included in units of more than one KVA rating.

The unusual reliability and acceptance of these voltage regulators is established overwhelmingly by the thousands of installations using them throughout the world, with great numbers of these Sorensen units in continuous service for ten years and more.

Check your local Sorensen representative on what these line voltage regulators can do in your operations. Or, for technical data, write directly to **SORENSEN & COMPANY, Inc.**, Richards Avenue, South Norwalk, Conn.

SPECIFICATIONS Model 1000 S* (illustrated)

Output voltage	115 VAC, single phase, adjustable 110-120 volts	Power factor range	From unity to 0.7% lagging
Input Voltage	95-130 VAC, single phase, 50/60 cycles, $\pm 10\%$	Load range	0 to full
Regulation accuracy	$\pm 0.1\%$, against line; $\pm 0.1\%$, against load	Width	17 $\frac{1}{4}$ "
Distortion produced	3% Max.	Height	8 $\frac{1}{4}$ "
Time constant	0.1 second	Depth	11"
		Rack mount height	8 $\frac{1}{4}$ "
		Net weight	75 lbs.
		Shipping weight	87 lbs.

*Ask for data on other models and capacities.

Sorensen

controlled power for research and industry

**Model
TF 995A/2**

*For both
r.f. and i.f.
testing
with c.w.,
f.m., a.m., or
simultaneous
f.m. and a.m.*

MARCONI

FM/AM SIGNAL GENERATOR

The MARCONI Signal Generator Model TF 995A/2 is an accurate and dependable instrument of broadest applicability. It covers from 1.5 to 220 Mc in five bands and there are facilities for crystal standardization from 13.5 Mc upwards. A precision slow-motion mechanism is employed for the main tuning drive and, for making bandwidth measurements, there is a separate directly-calibrated incremental control.

The open-circuit output level is variable, in 1-dB steps, from a minimum of 0.1 microvolt to a maximum of 100 millivolts at 52 ohms and 200 millivolts at 75 ohms. The output may be continuous wave, frequency modulated, amplitude modulated, or simultaneously both frequency and amplitude modulated. The modulation, obtained either from an internal 1000-cps oscillator or from an external source, is variable to maximum frequency deviations ranging from 25 to 600 kc for f.m., and to depths up to 50% for a.m.



**MARCONI
INSTRUMENTS**

Marconi for f.m. test gear

44 NEW STREET · NEW YORK 4

CANADA: CANADIAN MARCONI COMPANY,
6035 COTE DE LIESSE,
MONTREAL, 9.

MARCONI INSTRUMENTS LTD · ST. ALBANS · HERTFORDSHIRE · ENGLAND

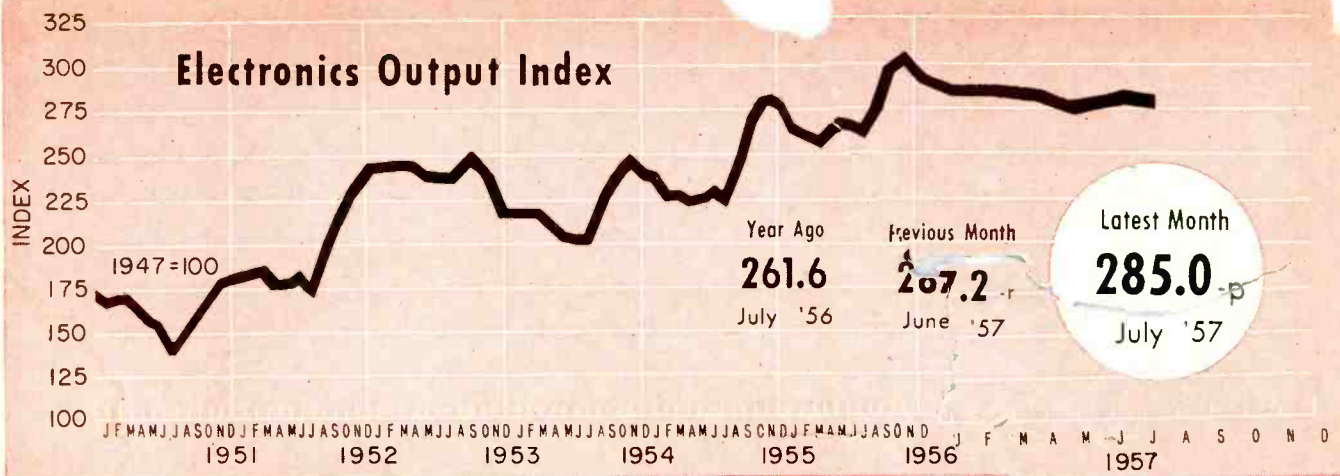

FIGURES OF THE MONTH

	Latest Month	Previous Month	Year Ago
RECEIVER PRODUCTION			
(Source: RETMA)			
Television sets, total	July '57 360,660	June '57 543,778	July '56 336,931
With UHF	55,401	72,766	41,803
Color sets	nr	nr	nr
Radio sets, total	612,588	1,088,343	566,697
Auto sets	256,279	416,058	198,565

	Latest Month	Previous Month	Year Ago
RECEIVER SALES			
(Source: RETMA)			
Television sets, units	July '57 426,294	June '57 389,770	July '56 405,310
Radio sets (except auto)	597,484	729,421	576,453

	Latest Month	Previous Month	Year Ago
RECEIVING TUBE SALES			
(Source: RETMA)			
Receiv. tubes, total units	July '57 33,077,000	June '57 35,328,000	July '56 31,400,000
Receiv. tubes, value	\$27,042,000	\$31,314,000	\$24,781,000
Picture tubes, total units	491,935	1,104,013	589,070
Picture tubes, value	\$9,835,586	\$19,981,319	\$12,043,831

	Quarterly Figures		
	Latest Quarter	Previous Quarter	Year Ago
INDUSTRIAL TUBE SALES			
(Source: NEMA)			
	2nd '57	1st '57	2nd '56
Vacuum	\$10,191,621	\$11,224,707	\$7,680,250
Gas or vapor	\$2,758,630	\$3,332,357	\$2,983,488
Magnetrons and velocity modulation tubes	\$17,177,922	\$15,359,108	\$16,254,025
Gaps and T/R boxes	\$1,589,670	\$1,409,463	\$1,238,469

	1st '57	4th '56	1st '56
MILITARY PROCUREMENT			
(Source: Defense Dept.)			
Army	\$69,381,000	\$56,185,000	\$40,490,000
Navy	\$21,426,000	\$34,210,000	\$28,700,000
Air Force	\$159,829,000	\$145,962,000	\$124,828,000
Total—Electronics	\$250,636,000	\$236,357,000	\$194,018,000

	Latest Month	Previous Month	Year Ago
BROADCAST STATIONS			
(Source: FCC)			
TV stations on air	June '57 519	May '57 519	496
TV stations CPs—not on air	132	126	113
TV stations—new requests	79	77	43
A-M stations on air	3,079	3,060	2,896
A-M stations CPs—not on air	159	167	124
A-M stations—new requests	322	311	274
F-M stations on air	530	532	530
F-M stations CPs—not on air	31	27	16
F-M stations—new requests	24	21	10

	June '57	May '57	June '56
COMMUNICATION AUTHORIZATIONS			
(Source: FCC)			
Aeronautical	49,699	53,413	48,745
Marine	63,844	63,025	56,915
Police, fire, etc.	23,270	23,103	20,718
Industrial	35,711	35,313	30,597
Land transportation	9,592	9,580	8,990
Amateur	160,000	162,533	150,549
Citizens radio	27,931	26,930	18,602
Disaster	347	352	327
Experimental	788	783	706
Common carrier	2,790	2,731	2,308

	June '57	May '57	June '56
EMPLOYMENT AND PAYROLLS			
(Source: Bur. Labor Statistics)			
Prod. workers, comm. equip.	394,200-p	384,600-r	382,200
Av. wkly. earnings, comm.	\$79.39 -p	\$79.00 -r	\$74.59
Av. wkly. earnings, radio	\$77.18 -p	\$76.21	\$72.40
Av. wkly. hours, comm.	40.3 -p	40.1	40.1
Av. wkly. hours, radio	40.2 -p	39.9	40.0

	July '57	June '57	July '56
SEMICONDUCTOR SALES ESTIMATES			
Transistors, Units	1,703,000	2,245,000	885,000

	July '57	June '57	July '56
STOCK PRICE AVERAGES			
(Source: Standard and Poor's)			
Radio-tv & electronics	51.56	51.42	58.81
Radio broadcasters	64.78	66.56	73.42
	p—provisional	r—revised	nr—not reported

FIGURES OF THE YEAR

Television set production	3,082,799	3,752,133	-17.8	7,357,029
Radio set production	7,799,822	7,225,862	+ 7.9	13,981,800
Television set sales	3,236,697	3,273,560	- 1.1	6,804,756
Radio set sales (except auto)	4,236,453	3,967,555	+ 6.8	8,332,077
Receiving tube sales	254,252,000	259,056,000	- 1.8	464,186,000
Cathode-ray tube sales	5,306,594	5,738,123	- 7.5	10,987,021

TOTALS FOR THE FIRST SEVEN MONTHS

	1957	1956	Percent Change	1956 Total
Television set production	3,082,799	3,752,133	-17.8	7,357,029
Radio set production	7,799,822	7,225,862	+ 7.9	13,981,800
Television set sales	3,236,697	3,273,560	- 1.1	6,804,756
Radio set sales (except auto)	4,236,453	3,967,555	+ 6.8	8,332,077
Receiving tube sales	254,252,000	259,056,000	- 1.8	464,186,000
Cathode-ray tube sales	5,306,594	5,738,123	- 7.5	10,987,021

INDUSTRY REPORT

electronics—October 1 • 1957

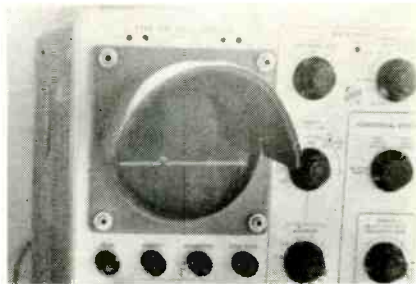
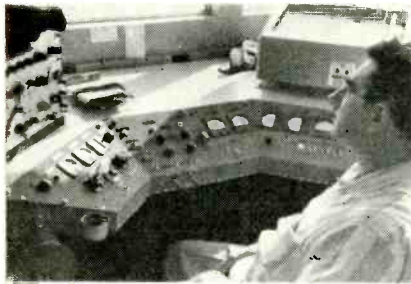

AUTOMATIC TOUCHDOWN of Navy F3D jet fighter on deck of carrier Antietam (upper left) is electronically controlled. Corner reflector on nose provides signals to tracking radar (upper right) used in conjunction with computing and monitoring equipment (lower photos) as . . .

in range, bearing and elevation to a Reeves Reac d-c analog computer where it is compared with an ideal flight path already set into the computer. Error signals resulting from the difference between actual and ideal flight path are sent by data link to the plane's autopilot to correct position.

► **Radar**—To achieve the touchdown accuracy, new radar ranging circuits were developed. However, their configuration could not be disclosed for security reasons. The radar characteristics disclosed show that the system operates in the K band to provide a small dish and minimize image effects encountered in low-angle tracking and uses a quarter-microsecond transmitted pulse. Also, by placing a small motor, with an eccentric hole drilled through its shaft, at the focus of the parabola and feeding the energy through this shaft, a half-degree conical scanning beam is formed.

The normal closing speed for the plane is about 120 knots. This means the plane travels 2 miles more in one minute. If planes are to land at a rate of one a minute, they must use two radar systems.

► **Market**—Assuming all system tests are passed, there would be approximately 50 systems that could be used on active carrier and all-weather shore stations in this country. Figures for the foreign market were not available. According to the normal development and production timetable, it would take 3 years to go into full production on the system.

(Continued on page 8)

Carrier Aircraft Land No Hands

Precision tracking radar in R and D equipment key to highly accurate landing technique

SAFELY and electronically landing carrier and land-based aircraft under all weather conditions is a step closer to fruition with the successful completion of preliminary tests on the Bell Aircraft Automatic Carrier Landing System.

► **Requirements**—The Navy required that an aircraft touch down with a maximum longitudinal dispersion of ± 30 ft and a maximum

lateral dispersion of ± 25 ft from a fixed point. During 120 test landings on an airport runway the average dispersion was less than 18 ft longitudinally and negligible laterally.

► **How It Works**—The aircraft carries a small corner reflector, a data-link receiver and modified pitch and lateral autopilots. The Bell-designed precision auto-tracking radar acquires the plane at about 3-mile range and locks into auto-track.

The Radar feeds positional data

Instrument Makers Appraise Developments

Keynote of Conference:
entire systems operated by
computer-issued instructions

INSTRUMENT MEN, attending the Twelfth Instrument-Automation Conference and Exhibit in Cleveland last month, talked mainly about three subjects: growth of their industry, systems engineering and computer-controls. They were told to watch for a steady increase in large-scale installations of computers and new instrumentation systems in business and industry.

► **Direct Control**—More attention is being paid to computer facilities, both analog and digital, used to design, study and utilize direct-control systems, according to Case Institute of Technology's Irving Lefkowitz. Two problems lie ahead: learning correctly what goes on in the process system, and developing instrumentation of sufficient power and range to handle this information.

► **Logging**—Giving impetus to the growth predictions, Daystrom announced that its Controlonics Group Systems Division has installed an entire electronic system in Louisiana. The Sterling Steam Electric Station of the Louisiana Power and Light Co. will have an information system covering measurements at 350 points. Of this group, 100 points will be logged every hour automatically. All electronics of this system are solid state and all relays are of the mercury-wetted computer type. The equipment includes the first industrial use of a transistorized digital computer and the DADIT, a transistorized analog-to-digital converter.

The system continuously scans 250 points with readouts on a separate printer when they exceed set limits and has provision for automatic alarm. This is the closest step to date to closing the loop for complete automatic control of an entire plant according to Chalmer Jones, Controlonics' General Manager. No human control is necessary, other than programming the computer

for optimum operation.

► **Monitoring**—A display of equipment for electronic monitoring and control of a petroleum refinery was presented by Beckman Instruments. The system records the complex pulses of the operation that reforms the crude oil after the cracking process. Controls will alert plant operators the instant physical variables, such as temperatures, pressures or flows, shift outside predetermined limits.

► **Computer Controls**—Cuthbert C. Hurd, IBM's Director of Automation Research, said that computers can, in principle, be used to control

automatic factories in the steel, petroleum and the utilities industries.

Two research methods for confirming these statements are simulation and perturbation. Simulation methods have been used by IBM to demonstrate the feasibility of controlling 1,000 aircraft between airports with safe operation achieved under computer-issued instructions. Perturbation methods will be employed in the forthcoming Vanguard satellite program. Orbit calculations will be refined.

Effective automatic controls will be applied to chemical-processing only after the kinetics of processing streams are understood fully.

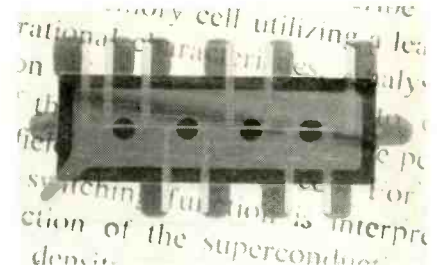
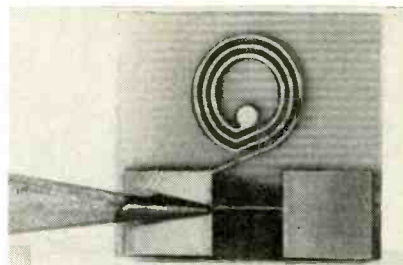

PERSISTOR (left), Ramo-Wooldridge's a new fast cryogenic memory device shown about four times production size, along with the IBM array of four memories (right) give further impetus to low temperature computer work as . . .

Fast Cryogenic Memories Bow

Speed of new units increased one-hundred fold using printed circuit technique

INDEPENDENT research by two organizations separated the full breadth of the United States has produced superconducting memories operating under similar principles. Both cells were disclosed at a recent conference on Low Temperature and Physics. The conference was held at the University of Wisconsin.

► **West Coast**—The Persistor is the result of research conducted at the Ramo-Wooldridge Aeronautical Research Laboratory. The unit is

a miniature Bi-metallic, printed circuit which operates at a temperature within a few degrees of absolute zero, requires little power and has been designed with switching times as short as 10 millimicroseconds. Dr. Milton U. Clauser, director of the laboratory estimates that Persistors, manufactured by printed circuit techniques, will cost a fraction of a cent per unit.

► **Use**—Maintaining the low temperatures required for Persistor operation offers no obstacle to their immediate use in computers since recent advances in helium liquefiers make it feasible to maintain

(Continued on page 10)

plant
Burnell moves a step further
 in toroid, filter and
 related network leadership



our new
 Pelham
 Manor
 plant

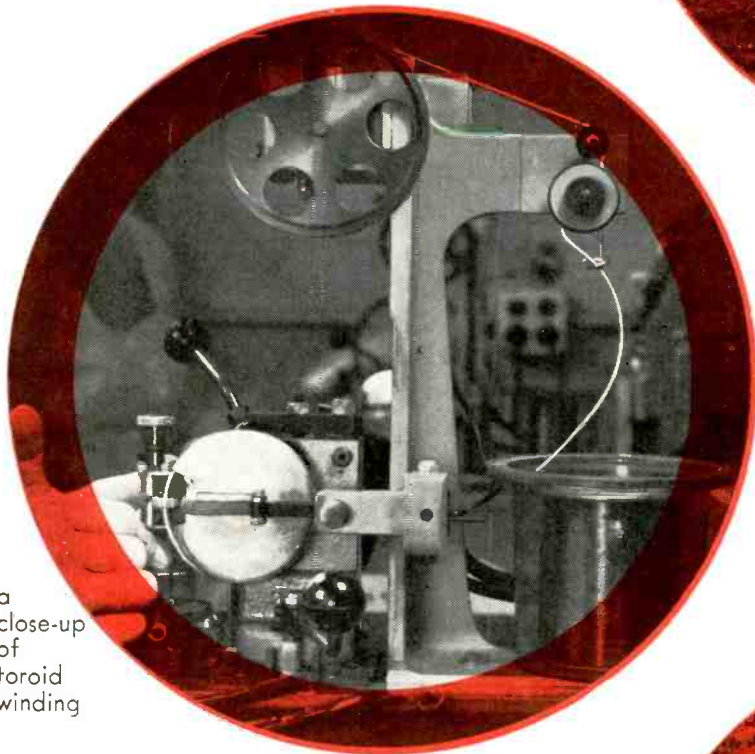

a
 close-up
 of
 toroid
 winding

Burnell & Co. is now producing toroids, filters, and related networks in its new Pelham Manor plant — largest and best equipped of its kind in the country. For customers, this means fast attention to samples, quicker delivery of orders, more solutions to network problems.

- look to Burnell to remain first in . . .**
- advanced research**
 - product development**
 - new design ideas**
 - new circuit components**
 - new production methods**
 - economy**

Burnell & Co., Inc.

first . . . in toroids, filters, and related networks

EASTERN DIVISION
 10 PELHAM PARKWAY
 PELHAM MANOR
 NEW YORK



Dept. E107

PACIFIC DIVISION
 720 MISSION STREET
 SOUTH PASADENA
 CALIFORNIA

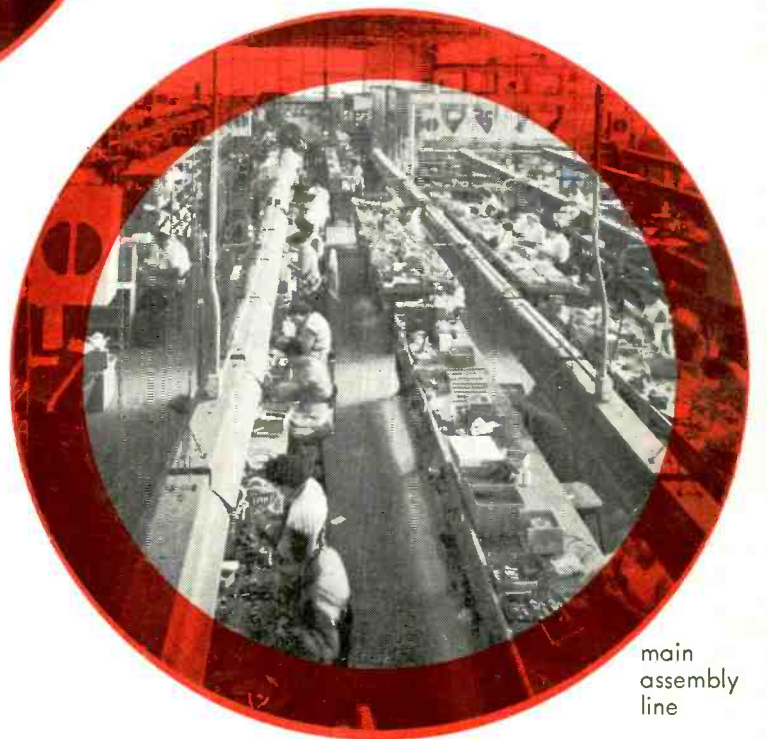

main
 assembly
 line

low temperatures at a cost which can be considered a negligible part of the cost of operation of a computer.

► **How it Works**—The Persistor is a loop composed of segments of two metals, lead and tin, both of which are maintained in a superconductive state. One segment of the loop is metal operating at its critical superconducting temperature, the point at which a change in current changes it from its superconductive state to its state of normal resistance.

Current is induced in this loop and circulates continuously and indefinitely. Current direction represents the information being stored and is determined at any time by impressing a current pulse on the loop sufficient to exceed the critical superconducting value. The direction of circulation of current in the loop is reversed if the interrogating pulse is added to the current in the loop, and remains in the same direction if it is subtracted.

► **Output**—A voltage pulse is obtained whenever the current in the loop reverses. Thus, the direction of the current in the Persistor is indicated by the presence or absence of a voltage pulse upon interrogation.

The currents and voltages involved are well within the range of computer circuits. Current pulses of 100 milliamps may be used to energize or interrogate the Persistor, an output pulse of 0.1 volts may be obtained.

At the Low Temperature Conference, E. C. Crittenden and F. W. Schmidlin reported that Persistors, for use in computer memories, could be assembled in a density of a half million per cubic foot. This is about twice the number of elements presently employed in major computers.

► **East Coast**—A device similar in operation to the Persistor was also reported by IBM. Characteristics given indicate an operating speed of 10 milli microseconds, and a drive-current requirement of less than 150 ma.

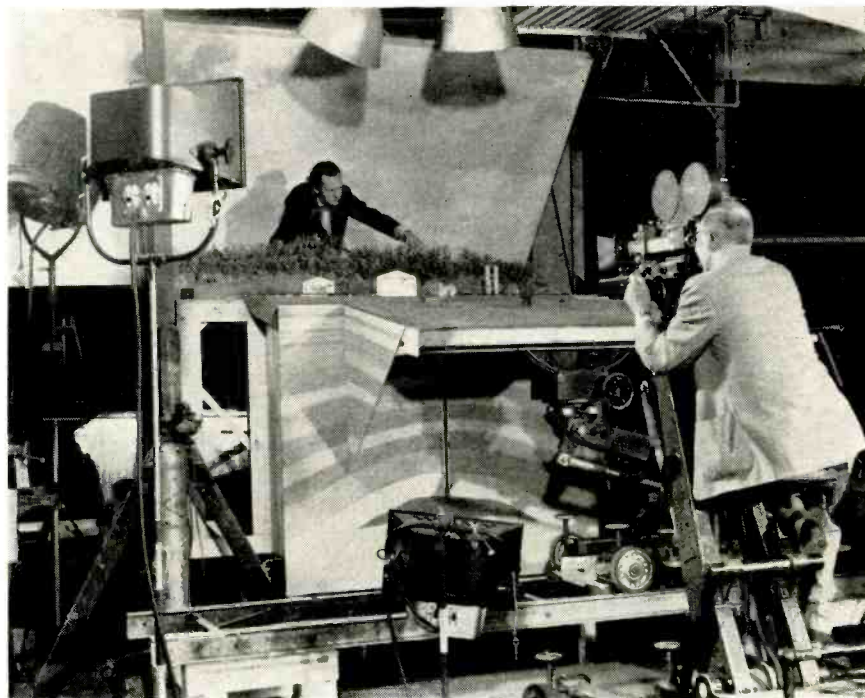

ELECTRONICS AIDS to the petroleum geologist are depicted in the shooting of a miniature set on the Jam Handy stage in Detroit as . . .

Films Train Electronics Men

Documentary films play increasingly important role in electronics industry

IT WAS the year 1894 when the first business film was made on behalf of a then (and now) popular brand of Scotch whiskey. With such a rousing sendoff it was perhaps inevitable that the fledgling industrial film should continue to grow and prosper.

Motion pictures are employed today by the electronics industry not only in advertising, sales promotion and public relations, but also in employee recruiting and training, research and development, and report presentation.

► **Public Relations**—One of the pioneers in the use of the film for all of these applications is AT&T, which currently is offering to any organized group such title as "The Transistor" and "Telephone Cable for Cuba." Dumont Laboratories have "The Dumont Story", Remington Rand tells about "Univac" and RCA Victor has filmed "The Sound and the Story", which covers the recording and manufacture of a

record album from original conception to final package.

► **Education**—For more specialized audiences, one major tube manufacturer is putting the finishing touches on a film illustrating the making of tv receiving and picture tubes, and aimed particularly at television servicemen. Technical films made by Bell Labs, on such subjects as solid-state theory or submarine cable technology, are often supplied to engineering schools and colleges. The American Management Association offers "Integrating the Office for Electronics", a non-technical orientation film for office managers.

► **Employee Training**—A growing use of the industrial film involves the permanent recording of trial-and-error procedures "to avoid making the same mistake twice". When one large western telephone company had a near-chaotic condition due to equipment failure, as soon as matters were righted the entire sequence of breakdown and correct repair procedure was re-enacted before the movie camera.

(Continued on page 12)

TYPICAL CAPACITANCE vs TEMPERATURE CHARACTERISTICS at 1000~

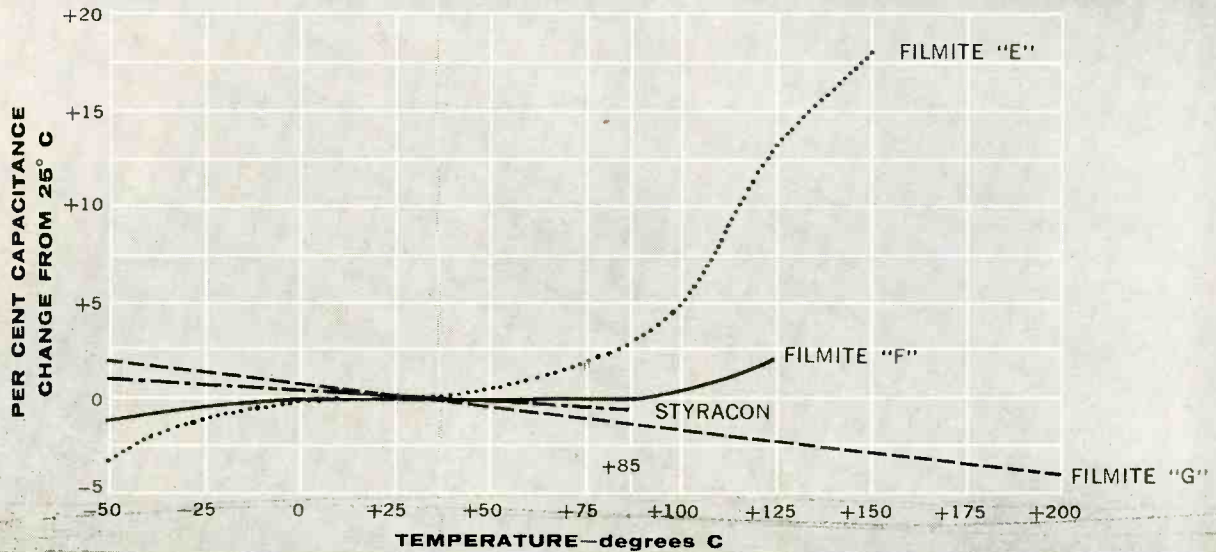

	STYRACON (85°C)	FILMITE "E" (150°C)	FILMITE "F" (125°C)	FILMITE "G" (200°C)
RATINGS	.001 to 1.00 μ F 50 to 600 WVDC	.001 to 1.00 μ F 200 to 2500 WVDC	.001 to 1.00 μ F 200 to 600 WVDC	.001 to 1.00 μ F 200 to 600 WVDC
STYLES	tubular metal cases screw-neck cases drawn metal cases	tubular metal cases screw-neck cases	tubular metal cases screw-neck cases "bathtub" cases	tubular metal cases screw-neck cases drawn oval cases
WRITE FOR TECHNICAL DATA	Engineering Bulletin No. 2510	Engineering Bulletin No. 2410	Engineering Bulletin No. 2560	Engineering Bulletin No. 2610

4 kinds of film dielectric capacitors

for specialized applications

Here are four plastic-film dielectric capacitors now in regular production at Sprague:

STYRACON CAPACITORS find wide application in laboratory equipment and in industrial controls where their low dielectric hysteresis (low "soak"), high insulation resistance, high "Q", low and linear temperature coefficient of capacitance are of great value.

FILMITE "E" CAPACITORS are general-purpose capacitors for use up to 150°C where capacitance stability with temperature is of secondary importance. They are also used at lower temperatures where very high insulation resistance is a prime requirement.

FILMITE "F" CAPACITORS are intended for use in circuits where

the absolute minimum in capacitance change with temperature is a must and relatively large capacitance values are used. These capacitors typically will be within .05% of their 25°C value from -10°C to +85°C. They may be used up to 125°C where greater capacitance excursion is tolerable.

FILMITE "G" CAPACITORS have the highest temperature rating of any organic dielectric. They may be used up to 200°C! All units are nickel-plated to withstand high temperature corrosion. They also have the highest insulation resistance, the lowest dielectric hysteresis, and the lowest dissipation factor of any capacitor made so that they are often used at lower temperatures which are above the 85°C limit of the lower-cost Styracon Capacitors.

CAPACITANCE VS. TEMPERATURE CHARACTERISTICS of all four types of film capacitors are compared in the chart above for the benefit of the circuit designer.

ALL SPRAGUE FILM CAPACITORS are designed to have positive electrical contact between leads and electrodes, even at low operating voltages.

WRITE FOR ENGINEERING BULLETINS on the Sprague plastic-film capacitors in which you're interested. Address your letter to Sprague Electric Co., Technical Literature Section, 35 Marshall Street, North Adams, Mass.

SPRAGUE[®]
the mark of reliability

SPRAGUE COMPONENTS:

CAPACITORS • RESISTORS • MAGNETIC COMPONENTS • TRANSISTORS • INTERFERENCE FILTERS • PULSE NETWORKS • HIGH TEMPERATURE MAGNET WIRE • PRINTED CIRCUITS

The resulting film is now used as part of a periodic refresher course for all operating personnel.

► **Permanent Records**—AT&T discovered that in their cable-laying procedures, where projects are often separated by hiatuses of many years, the same mistakes were being made repeatedly and crews were constantly having to learn all over again. To circumvent this a cable-laying mockup has been constructed and experience-proved procedures have been permanently recorded on film.

► **Reports**—The motion picture is also an ideal medium for dramatic and accurate presentation of progress reports. A firm which is now developing a new fire-control system presents a film report to its sponsoring government agency every 60 days. For several years Audio Productions, an independent film studio in New York, has been photographing similar periodic progress reports on the DEW line. And Bell Labs uses films to round out R&D reports when presenting them to Western Electric prior to manufacturing.

► **Recruiting**—When a manufacturer recently obtained a large contract and needed many more experienced engineers in a hurry, conventional recruiting of college seniors had to be ruled out. Instead a film was prepared showing the plant, its equipment and working conditions, as well as answering the many questions the prospect's wife might have concerning the move. Although the film was often shown only to individuals or groups of two or three at a time, it snared the desired manpower at a very low cost per head.

► **R&D**—Ultra-high-speed photography, resulting in exceedingly slow motion, is often employed in research and development. With the camera operating at 3,000 or 4,000 frames per minute as against the conventional 16 or 24 fps, the implosion-explosion pattern of the television picture was studied. New safety precautions and handling techniques were devised as a direct result.

Business Briefs

► **Business** this fall looks good to most of the 205 industrial concerns reporting in the National Industrial Conference Board's survey on the business outlook. Manufacturers of electrical industrial equipment, general industrial machinery, instruments and controls and apparatus are particularly cheerful

► **Common stock** issues by two small electronic firms, brought out in the midst of the big August drop in security prices, were completely sold out. Narda Microwave of Mineola issued 90,000 shares and Electronic Research Associates of Nutley, N. J. issued 100,000, both at \$3 per share. Milton D. Blauner & Co. and Michael G. Kletz & Co. underwrote the Narda issue while Singer, Bean & Mackie, Inc. underwrote the ERA issue

► **Private** placement of 100,000 shares of common stock made by Audio Devices of New York City through Carl M. Loeb, Rhoades & Co. Three year warrants to purchase another 20,000 shares were included. Further financial details were not divulged. Proceeds will be used for plant facilities and working capital for a new manufacturing division to produce electronic components

► **Sales** of General Transistor Corp., Jamaica, N. Y., more than tripled in the first six months of 1957 over the same period of 1956. Sales for the first six months of 1957 were \$1,228,589 compared with \$364,143 in the same period last year



RADIOTELEPHONE owner pushes buttons as . . .

Bells Ring For Mobile Owners

RECENTLY designed radio telephone system with push button dialing has undergone successful field tests through 25 miles of mountainous

terrain. The Motorola-developed equipment permits connection of telephone company's automatic base station which receives subscriber calls directly with unattended exchanges through ten-party line.

► **Operation**—Removal of handset and depression of the push-to-talk button connects subscribers with base station and local exchange. Buttons pushed in proper sequence contact desired exchange and party.

A lock-out circuit located in the control head of the radio unit assures complete privacy by excluding all radiotelephones other than the one dialed. When subscriber replaces headset upon cradle, two sequential tone bursts signal exchange to turn off base station transmitter.

Specific tone sequence for dialing avoids wrong number difficulties.

(Continued on page 14)

Component Specification: ARNOLD

- ✓ SILECTRON CORES
Types C, E and O
- ✓ TOROIDAL CORES
Nylon and Aluminum cased
- ✓ BOBBIN CORES

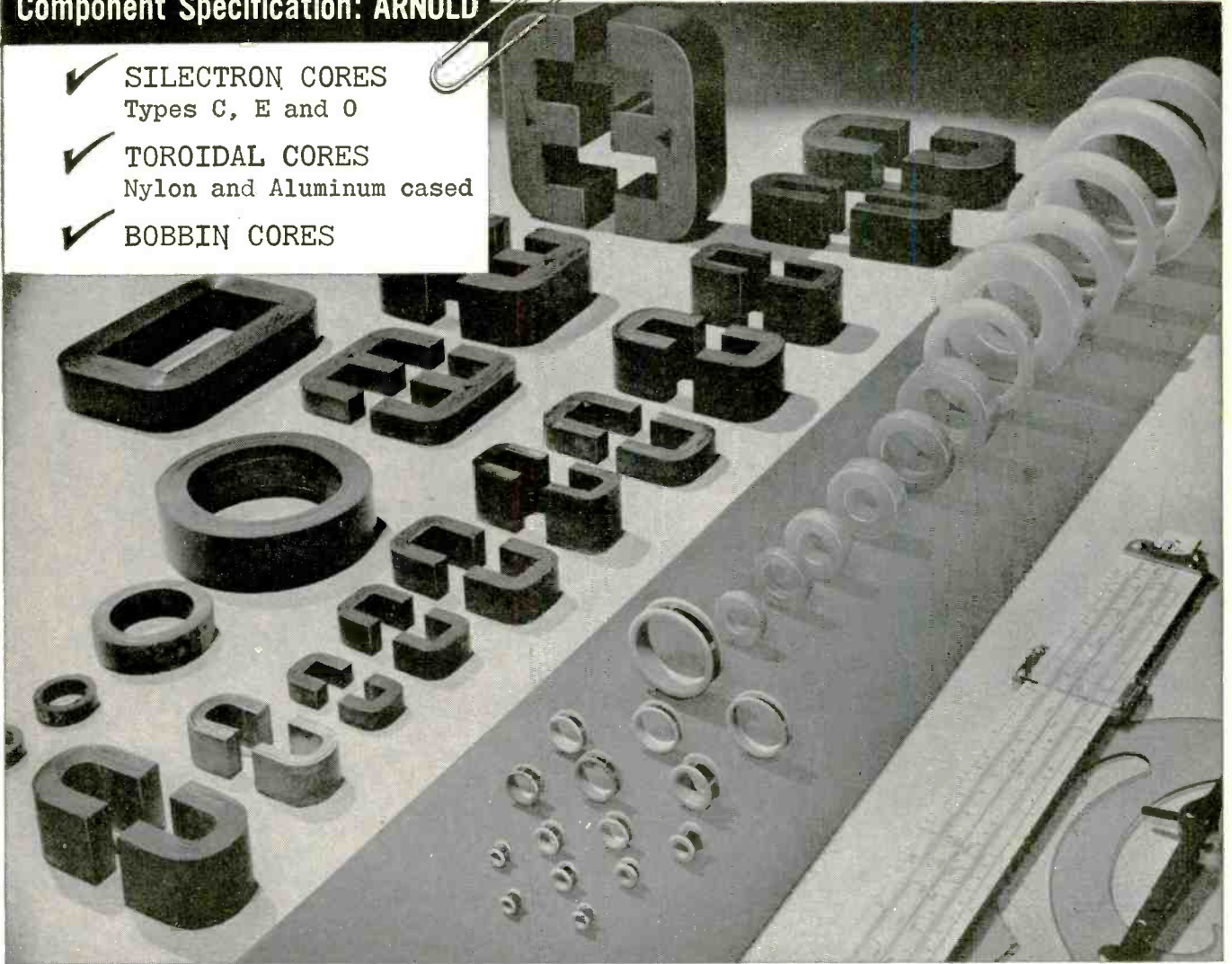

The ARNOLD LINE-UP includes the TAPE CORES you need

APPLICATIONS

We'll welcome your inquiries on your Tape Wound Core requirements for Pulse and Power Transformers, 3-Phase Transformers, Magnetic Amplifiers, Current Transformers, Wide-Band Transformers, Non-Linear Retard Coils, Reactors, Coincident Current Matrix Systems, Static Magnetic Memory Elements, Harmonic Generators, etc.

ENGINEERING DATA

For data on the various types of Arnold Tape Cores, write for these Bulletins:

- SC-107—Silectron Cores, Types C, E and O
- TC-101A—Toroidal Cores, nylon and aluminum cased
- TC-108—Bobbin Cores

ADDRESS DEPT. E-710

How to be *sure* of tape core performance and uniformity? Just specify and use *Arnold Cores* in your transformer, magnetic amplifier, reactor and computer assemblies, etc.

Here's why!

To begin with, Arnold is a fully integrated company, controlling every manufacturing step from the raw material to the finished core. Then, modern testing equipment permits 100% inspection of cores before shipment. Finally, you're matching your requirements against the most experienced and complete line of tape cores in the industry. Arnold produces Types C, E and O Silectron cores,

nylon and aluminum cased toroidal cores, and bobbin cores to meet whatever your designs may require in tape thickness, material, core size or weight. Wide selections of cores are carried in stock as standard items for quick delivery: both for engineering prototypes to reduce the need for special designs, and for production-quantity shipments to meet your immediate requirements.

Let us help you solve your tape core problems. Check Arnold, too, for your needs in Mo-Permalloy or iron powder cores, and for cast or sintered permanent magnets made from Alnico or other materials.

WSW6447

THE ARNOLD ENGINEERING COMPANY



Main Office & Plant: Marengo, Illinois
Repath Pacific Division Plant: 641 East 61st Street, Los Angeles, Calif.

District Sales Offices:

Boston: 200 Berkeley St. Los Angeles: 3450 Washire Blvd.
New York: 350 Fifth Ave. Washington, D.C.: 1001-15th St., N.W.

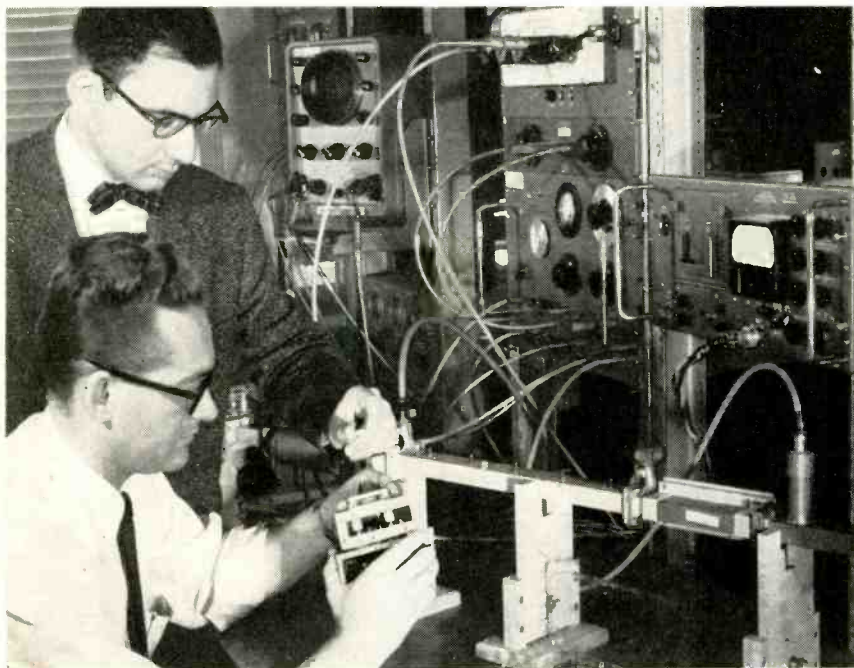

SPECIAL gold-bonded diode held by A. Uhlir, Jr. is used in TH microwave radio relay system diode modulator examined by P. I. Sandmark as . . .

Industry Exploits Diodes

Diodes provide gain in frequency converters and have transistor characteristics

WORKING with gold-bonded germanium diodes and diffused pn junction silicon diodes, significant gain in frequency converter stages have been achieved by scientists at Bell Telephone Laboratories.

Possessing characteristics of both a transistor and a diode, the Westinghouse-developed Dynistor, with these attributes, offers potential application in the field of industrial control.

► **Frequency converter**—The most promising results have been obtained with gold-bonded germanium diodes in converting low frequencies to the higher frequency range. For example, gains as high as 6 db with adequate bandwidth for most applications have been achieved when converting from 75 mc to 6,000 mc. Possessing unilateral characteristics, a converter amplifier stage of this type has proven to be very stable as a transmitter modulator in the TH microwave radio relay system recently

announced by Bell Laboratories.

► **Applications**—Further practical applications of diode converters have indicated no loss of signal in the converter stage. Also exhibiting conversion gain, diffused silicon *pn* diodes have been made usable at higher temperatures than germanium diodes. Conversion gains as high as 45 db have been achieved in converting high frequencies to the lower frequency range.

Experiments conducted on a negative-resistance diode amplifier operating at 6,000 mc have proven that the regenerative problem of such amplifiers has limited the usefulness of diffused silicon *pn* diodes. It is expected that non-reciprocal ferrite devices may improve the feasibility of regenerative operation of diode amplifiers and frequency converting stages.

► **Dynistor**—The characteristics of the Dynistor indicate its potential as a switching device in power control circuits. Actual power ratings for the Dynistor have not been established, but it has been operated with continuous currents up

to 4 amperes and in special applications up to 11 amperes. Under pulsed conditions the device has passed 500 amperes in 5- μ sec pulses. The Dynistor has a forward and reverse characteristic similar to a conventional diode. However, in the reverse or blocking direction, in which the Dynistor is normally operated, two distinctly different regions exist. The characteristics permit switching uses.

Medical Research Tests Electronics

Area plan for cooperation among engineers and medical men is paying off

A REGIONAL plan for cooperation between electronics engineers and medical researchers is "working very well" in the Buffalo-Niagara area of New York, says Lee B. Lusted, chairman of the IRE's Professional Group on Medical Electronics.

Dr. Lusted told *ELECTRONICS* the plan was developed by Wilson Greatbatch of Taber Instrument Corp., Dr. Robert Cohn of the Chronic Disease Research Institute and Godfrey Buranich of Bell Aircraft Corp. Noye Laboratories and the University of Buffalo Medical School and Children's Hospital are also participating.

► **Tryout**—Companies develop new prototype instruments at their own expense. Medical research institutions try out the instruments in their laboratories and test them gratis. If the medical researchers find that the instrument is useful to them, the company builds a final model of the tested prototype which the research institution may purchase at a nominal price.

A medical researcher has a chance to find out what instrument he needs by actually trying out a company's ideas in his own laboratory. Similarly, a firm benefits from unbiased tests which might otherwise be too expensive.

(Continued on page 16)

KAHLE machines

for

every phase of

semiconductor production

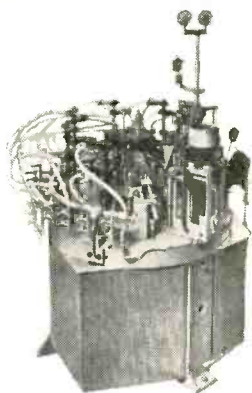

AUTOMATIC DIODE BEADER #2719



AUTOMATIC
MICRO-MINATURE
GLASS BODY MAKER
#2461

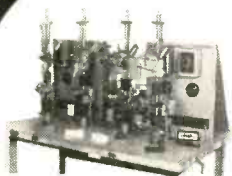

AUTOMATIC GLASS DIODE
SEALER #2948

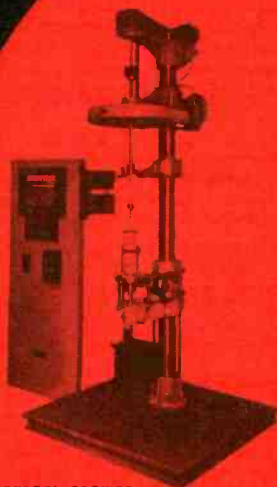

CRYSTAL GROWER
#2901B

Kahle has the answer for semiconductor manufacturers looking to increase manufacturing profits by cutting production costs.

Kahle is now offering semiconductor manufacturers a complete line of automatic and semi-automatic machinery for every phase of production including:

- GLASS CUTTING
- LEAD BEADING
- ENCAPSULATING
- CRYSTAL GROWING (GERMANIUM OR SILICON)
- CRYSTAL SLICING AND DICING
- MOUNTING AND ETCHING
- CAT WHISKER PRODUCTION
- FINAL SEALING
- TESTING

Twenty-five years of design and manufacture of automatic electronic production machinery are concrete proof of Kahle's experience. All machines are tested before your representative — your assurance of immediate, quality semiconductor production as soon as these machines reach your plant.

When writing for data sheets on all Kahle Semiconductor Production Machinery, please specify your problem or applications.

KAHLE
ENGINEERING
COMPANY

GENERAL OFFICES
1310 SEVENTH STREET, NORTH BERGEN, N. J.
PLANTS:
SEVENTH STREET, NORTH BERGEN, N. J.
HUDSON AVE., UNION CITY, N. J.

DESIGNERS AND BUILDERS OF SPECIAL AUTOMATIC AND SEMI-AUTOMATIC EQUIPMENT FOR ALL INDUSTRIAL OPERATIONS

Computers Replace Celestial Dome

Metal arm, activated by analog computers, simulates sky at fraction of cost of skydome

NEW CELESTIAL navigation trainer is now being developed that simulates, by means of three computers, the expensive and complicated revolving dome that to date has been used to simulate the sky in present celestial navigation trainers.

The trainer, devised by Naval Training Device Center engineers and contracted to Reflectone for development and production, needs no special building, no air conditioning for delicate gear, and can be fitted into a standard size classroom. Maintenance is simple, a special operator is not required, and the total cost of equipment is a fraction of what a revolving dome-type trainer costs.

► **Arm**—To replace the dome, a spherical reflector is placed at the end of a metal arm. The arm is positioned by three analog computers to simulate, one at a time, the stars required for a three-star fix. Relative motions of the stars, earth and airplane are simulated by computers and controls which drive the celestial sphere and recorder simultaneously. The student takes readings on the reflector with an operational periscopic sextant. Accuracies are expected to be comparable to those attained in operational flights.

Besides celestial navigation, which is rarely used alone, the 1A19 offers simultaneous training in DR, pressure pattern, loran and drift meter navigation.

Flight conditions accommodated: flights at all latitudes including polar, 100,000-foot altitude, 1,500-knot air speed, 300-knot winds, and vertical speeds up to 10,000 fpm.

► **Use**—It is anticipated that the Navy and Marine Corps will buy approximately 25 complete units. USAF, who will be invited to evaluate equipment after completion, offers another potential market of considerable magnitude.

Military Electronics

► **Production contracts** for guidance systems for Navy's Talos total more than \$47 million to date. Prime production contracts for Terrier's guidance radars amount to more than \$51½ million. Sperry produces both systems

► **Black background screen** for radar and other visual electronic indicators is announced by Du Mont Laboratories. The new screening technique creates the same high contrast characteristics that might be attained with a black phosphor, according to Du Mont's Stanley J. Koch. Usable without hoods and in high ambient light levels, the screen is suitable for airborne cockpit radar equipment and other cathode-ray tube presentations used in open areas

► **Westinghouse gets Navy contracts** totaling \$19 million for radar and armament systems. Tail-turret defense system, Aero 21-B, that automatically detects enemy aircraft, aims and fires, will go to BuAer for installation on Navy's carrier-based bomber, A3D. Advanced air-search, ship-borne radar sets to be installed aboard Navy ships after mid-1958 will go to BuShips

► **Ultra-high-speed electronic data-processing system** will be developed for BuShips by RCA under \$1½ million contract. System will incorporate random access memory and high-density tape recording features

► **Functional and environmental tests** on electro-mechanical components for guidance and control systems designed and developed by Autonetics have been carried out at altitudes of 90,000 feet. Components were mounted in a metal-framed gondola carried aloft by a helium-filled balloon

Old Tubes Never Die

Reliable discontinued types continue to satisfy varied industrial and consumer needs

SOURCES and supplies of discontinued tubes appear to be diminishing more rapidly than the demand for them. Few major tube companies find it worthwhile to produce these types and negligible inventories of discontinued types in current demand cause large users to scurry for replacements.

► **Demand**—Over 500,000 discon-

tinued tubes were sold last year in the United States. Most were earmarked for domestic distributors, the foreign market or military use. Tubes in heavy demand include pre-war reliables like the 45 power triode, the 75 twin diode and the 80 rectifier. Distributors in rural areas, particularly the southern states and northern New England, do a brisk trade in such tubes.

► **Replacement**—Industrial and elevator control circuits, ticker-tape

(Continued on page 20)

a Standard for Reliability



PHOTOGRAPH COURTESY
THE MARTIN COMPANY

Large-scale electronic manufacturers require fast and reliable tube-testing methods. To meet this need, The Martin Company of Baltimore has developed a high-speed precision tube tester which complies with all the test requirements of MIL-E-13 specifications.

The General Radio Vacuum-Tube Bridge has been incorporated in the tester to allow the operator to make periodic comparison measurements and thus maintain tester accuracy. The Vacuum-Tube Bridge is ideally suited to act as watch dog. It not only measures amplification factor, dynamic plate resistance, and transconductance directly, but performs each measurement independently of the other. Cross checks can be made at any time using known mathematical relationships. Interelectrode and stray capacities can be easily balanced out — thus eliminating awkward and cumbersome correction factors. Negative coefficients can be measured as readily as positive values. For these many reasons, Martin uses the General Radio Vacuum-Tube Bridge as their standard for measuring tube reliability.

Write for complete information

GENERAL RADIO Company

275 Massachusetts Avenue, Cambridge 39, Mass., U.S.A.

Broad Avenue at Linden, Ridgefield, N. J. NEW YORK AREA 1000 N. Seward St. LOS ANGELES 38

8055 13th St. Silver Spring, Md. WASHINGTON, D. C.

1150 York Road, Abington, Pa. PHILADELPHIA

1182 Los Altos Ave., Los Altos, Calif. SAN FRANCISCO

6605 W. North Ave., Oak Park, Ill. CHICAGO

In CANADA: 99 Floral Parkway, TORONTO 15

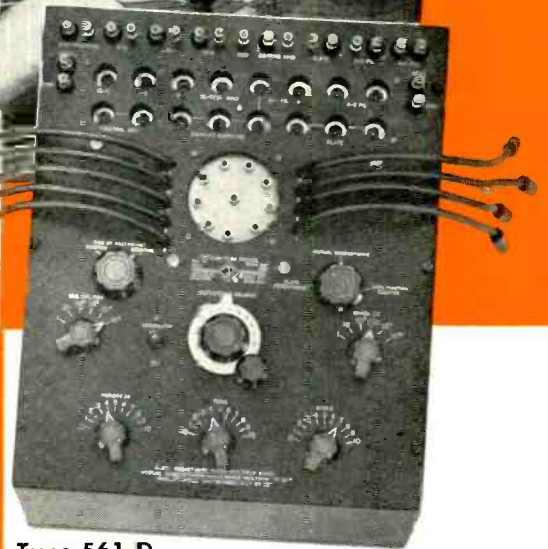

Type 561-D Vacuum-Tube Bridge . . . \$850

Range: Amplification factor (μ): 0.001 to 10,000
Dynamic plate resistance (r_p): 50 ohms to 20 megohms
Transconductance (g_{m1}): 0.02 to 50,000 micromhos

Accuracy: $\pm 2\%$ when r_p is somewhere between 1 kilohm and 1 megohm; at lower and higher values of r_p the error increases slightly.

Tube Mounting: Ten different adaptor plates are furnished for mounting all commonly used tubes. An additional "universal" adaptor is supplied for use with unmounted or nonstandard tubes. Extra sockets are also provided for transistors and subminiature tubes.

Current and Voltage Ratings: Maximum allowable plate current and voltage is 150 ma and 1500 volts, respectively. An external power supply is required.

Transistor parameters — both forward and reverse voltage amplification factor, resistance, and transconductance can be measured quickly and easily. From these measurements, two of the more common parameters (h_{11} and h_{12}) are given directly; the other two (h_{21} or α and h_{22}) are readily calculated.

All G-R Products
are now covered by a

2-Year Warranty



Approved and Accepted in TOUGH Applications



CK6832 RELIABLE SUBMINIATURE TWIN TRIODE for D.C. AMPLIFIER and COMPUTER SERVICE

with *all* the reliability specified, including *heater cycling life test; 100 hour survival rate life test; 500 hour intermittent high temperature life test;* — and with the desirable performance characteristics of its prototype, the miniature CK5755.



*Developed for Bell Telephone Laboratories
under Army Ordnance Contract.*

Featuring:

UNIQUE ELECTRICAL STABILITY...12 mVdc, max.

The grid to grid unbalance voltage resulting from a reduction of heater voltage from 6.3 to 5.9 volts

UNIQUE MECHANICAL STABILITY...20 mVac, max.

The grid to grid unbalance voltage resulting from six repeated shocks having an acceleration of several hundred G

**CLOSE BALANCE
BETWEEN SECTIONS.....24 mVdc, max.**

The grid to grid unbalance voltage resulting from six operating cycles of fifteen minutes "on" and five minutes "off"

LOW GRID CURRENT..... 3×10^{-8} A, max.

Each section

LOW MICROPHONICS.....10 mVac, max.

Output of each section resulting from vibration at 40 cps, 15 G

CK6832

μ 26
Gm 1050 μ mhos
 I_b 0.8 mAdc



SPECIAL TUBE DIVISION

RELIABLE MINIATURE AND SUBMINIATURE TUBES • VOLTAGE REFERENCE TUBES
VOLTAGE REGULATOR TUBES • PENCIL TUBES • NUCLEONIC TUBES

NEWTON, MASS.: 55 Chapel St. • Bigelow 4-7500
NEW YORK: 589 Fifth Ave. • PLaza 9-3900
CHICAGO: 9501 Grand Ave., Franklin Park • TUxedo 9-5400
LOS ANGELES: 5236 Santa Monica Blvd. • NOrmandy 5-4221

Designed for Computers
Made for Computers
Tested for Computers
Dependable in Computers



RELIABLE

COMPUTER TRANSISTORS

in the JEDEC 30 package



Actual Size

Reliability must be designed and built into computer transistors. It cannot be obtained by selection.

Raytheon Computer Transistors were developed under Signal Corps contract and are manufactured especially for computer service, on a separate production line. They are backed by five years of experience in the mass production and quality control of Raytheon Fusion-Alloy Transistors.

Maximum stability is guaranteed by rigid test procedures including *strict process control*, *100°C baking* of every transistor, *100% steam cycling* to assure positive hermetic sealing.

When you specify Raytheon Computer Transistors you are also assured of:

- HIGH VOLTAGE RATINGS • HIGH CURRENT GAIN
- FAST SWITCHING SPEED
- LOW SATURATION RESISTANCE

Here are the electrical specifications for Raytheon PNP Computer Transistors

Parameter	Conditions (25°C)	Units	2N425			2N426			2N427			2N428		
			Min.	Avg.	Max.	Min.	Avg.	Max.	Min.	Avg.	Max.	Min.	Avg.	Max.
BVPT		volts	-30	-50	—	-25	-45	—	-20	-30	—	-15	-25	—
V _{BE1}	I _B = -1mA V _{CE} = -0.25v	volts	—	-0.35	-0.45	—	-0.35	-0.45	—	-0.35	-0.45	—	-0.35	-0.45
h _{FE1}	I _B = -1mA V _{CE} = -0.25v		20	30	40	30	40	60	40	55	80	60	80	—
h _{FE2}	I _B = -10mA V _{CE} = -0.35v		10	15	—	10	18	—	15	20	—	20	30	—
R _{Sat.}	I _B = -10mA	ohms	—	2.2 for I _C = -100mA	3.2	—	2.2 for I _C = -100mA	3.2	—	1.4 for I _C = -150mA	2.1	—	1.1 for I _C = -200mA	1.6
f _{αb}	V _{CB} = -5v I _E = 1mA	Mc	2.5	4.0	—	3.0	6.0	—	5.0	11.0	—	10.0	17.0	—
C _{ob}	V _{CB} = -5v I _E = 1mA	μμf	—	14	20	—	14	20	—	14	20	—	14	20
Switching Speeds														
t _d + t _r	I _C = -50mA R _L = 200 ohms	μsec	—	0.53	1.0	—	0.53	1.0	—	0.43	0.85	—	0.43	0.85
t _s	Values of i _B "on" and i _B "off" are	μsec	—	0.3	0.6	—	0.3	0.6	—	0.3	0.6	—	0.3	0.6
t _f	5.0mA for 2N425 3.3mA for 2N426 2.5mA for 2N427 1.6mA for 2N428	μsec	—	0.45	0.65	—	0.35	0.55	—	0.35	0.55	—	0.30	0.50

For all types I_C (max.) = -400mAdc average
I_C (max.) = -1000 mA peak

Dissipation coefficient in free air = 0.4°C/mw
Dissipation coefficient with radiator = 0.28°C/mw
Dissipation coefficient with infinite sink = 0.18°C/mw



SEMICONDUCTOR DIVISION

Silicon and Germanium Diodes and Transistors • Silicon Rectifiers

NEWTON, MASS.: 55 Chapel St. • Bigelow 4-7500
NEW YORK: 589 Fifth Ave. • PLaza 9-3900
CHICAGO: 9501 Grand Ave., Franklin Park • TUxedo 9-5400
LOS ANGELES: 5236 Santa Monica Blvd. • NOrmandy 5-4221

machines, railroad telephone equipment and hi-fidelity amplifiers are a few of the sources of replacement demand for discontinued types.

A prominent theatre-service company estimates that 20 percent of American movie exhibitors use pre-war sound equipment for which there is a continuous replacement demand. Although some sound equipment is modified to handle new tube types by altering filament voltages or socket connections this company alone replaced 1,000 type 45 triodes last year. Replaced tubes may run to \$35 each.

► **Present Applications**—High-per-

formance characteristics qualify some discontinued tubes for use in new equipment. For example, the manufacturer of a diathermy machine employs a triode amplifier originally designed for amateur use while the maker of an automobile ignition tester finds an 80 rectifier essential.

Because adequate substitutes do not exist, Boonton Radio of New Jersey is compelled to use a specially-processed 2A6 high-mu triode priced at \$31.50. In this application, the high input impedance of the 2A6, registered in 1933, makes it well suited as the voltmeter tube in a Q meter.

Spiral Traveling Wave Antenna



THE TRAVELING wave antenna has become of considerable interest in recent years for such applications as ultra high frequency point-to-point communications and fringe area television reception. A familiar example of such antenna is the array of parallel rods, or Yagi antenna, often used for tv reception. This antenna is of simple and inexpensive construction, and for certain applications can be built at a small fraction of the cost of a parabolic reflector antenna of comparable performance.

The power gain of the long Yagi antenna is a function of the overall length; doubling the length doubles the gain. There has, however, been a maximum practical length for these

antennas in the past, determined by increasing difficulty in exciting the antenna when it becomes very long. This limitation can be removed by twisting the rods of the antenna gradually along the supporting axis, as shown in the photograph. With this technique, much longer antennas, with consequently higher gains, can be designed. Experimental work in the Engineering Division at SRI, sponsored by Air Force Cambridge Research Center, has verified the expected behavior of the twisted Yagi antenna.

The model shown in the photograph has a total length of 10 feet, and is a small scale replica of the final antenna. A full scale model might have a length, depending on the frequency of operation, of 100 feet or more.

Color Tv Views Living Cells

Ultraviolet-sensitive system shows chemical make-up of transparent cells and tissue

MEDICAL ELECTRONICS gets another boost with a television color translating microscope at the Rockefeller Institute for Medical Research. It makes possible a closer look at organic cells and tissue.

Examination of such cells by conventional means involves staining them. The distinctive colors of the normally transparent cells indicate the presence of certain chemical constituents. Unfortunately, this method means death to the cells.

► **Color Technique**—It has been known that cells transparent to visible light often have characteristic absorptions in the presence of ultraviolet. This knowledge led to a system of photographing the specimens at three different wavelengths of ultraviolet and making separation negatives to prepare a color print.

Color-television techniques have eliminated the delay of making pictures and permitted continuous observation of the specimen. An ultraviolet-sensitive television camera, a color tv receiver, sources of ultraviolet and a microscope comprise the RCA system.

► **Light Sources**—Three pulsed sources of light are used with the wavelengths of each controllable from the front panel. A focusing system, including a rotating mirror, directs the light into the microscope. The synchronizing generator is used to time the whole system. Amplified pulses from the generator are fed through slip rings on the rotating mirror to thyratrons. These, in turn, feed the light sources in succession. The mirror reflects the light to the specimen in the microscope.

► **Camera Window**—The image orthicon of the tv camera is equipped with a window that passes ultraviolet.

(Continued on page 22)

Barry's New "Lo" Mount Meets MIL-C-172B at low cost

— with this extra vibration isolation that adds reliability to your design.

We designed for lower cost — and developed a better mount for MIL-C-172B. Even at 10° inclination, the new Model L44 Mount performs effectively. And its other characteristics, too, far exceed requirements of MIL-C-172B.

The basically simple and versatile construction of this new isolator lets us match characteristics to your specification. Your design now gains added reliability with a mount that more than satisfies MIL-C-172B — and at low cost.

Extra-low transmissibility and low natural frequency

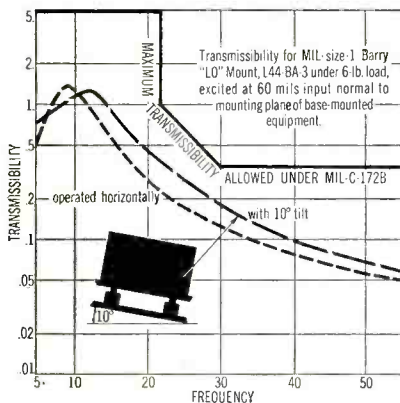

This low transmissibility — below 2 at resonance in all load ranges — is a major advantage of the Model L44 isolator. It accommodates high-amplitude inputs, even at resonance, without snubbing. Typical isolation at 10° inclination is also shown above.

Very low rocking modes

In base-mounted systems, transmissibility of rocking modes under horizontal vibration is reduced to the point where they are indiscernible. This is due to the combination

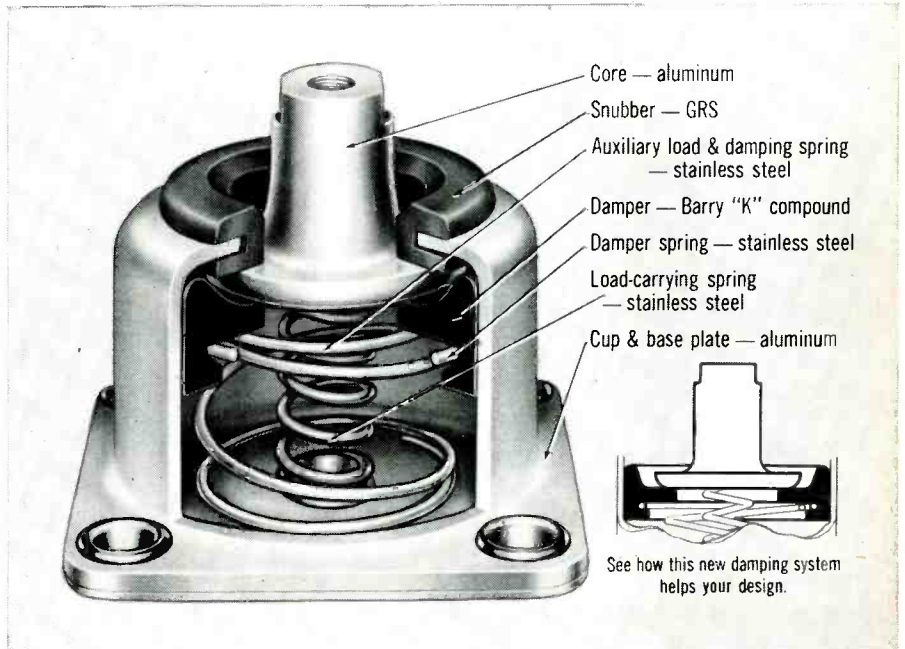

MIL-size 1 "Lo" Mount shown 1½ times actual size

of inherently low ratio of horizontal-to-vertical stiffness plus horizontal self-centering friction damping.

For center-of-gravity designs

Independent horizontal damping makes the "Lo" mount especially suited for installation in the plane

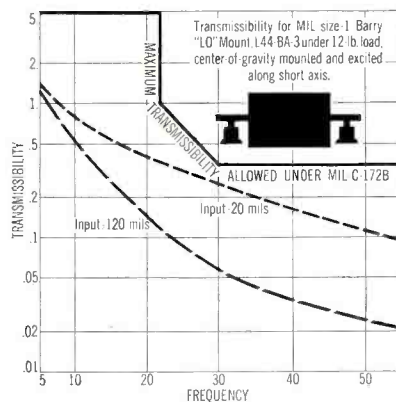

of center-of-gravity of the equipment. The natural frequency of the system shown above is below 5 cps.

Controllable characteristics

These exceptional characteristics result from the unique Barry spring and friction-damping design pictured above. And these characteristics can be controlled to give high performance with a wide variety of equipment. Horizontal and vertical damping can be controlled independently. Special versions of the "Lo" mount will control transmissibility at resonance for a given input . . . or handle very high-amplitude inputs at resonance without snubbing.

Physical characteristics

The L44 Mount is dimensionally interchangeable with MIL size 1 isolators. It is available in 7 load ranges from 0.25 to 10 pounds per mount in long- and short-core models. It meets all environmental as well as vibration requirements of Procedure I, MIL-E-5272A. Temperature range is -85F to 250F. Weight is 1½ ounces per mount.

Write today for data sheet 57-05 Barry's new Western Division, in Burbank, California, offers fast, on-the-spot design and prototype service, and production of special systems.

BARRY
CONTROLS
INCORPORATED

WESTERN DIV. BURBANK, CAL.

BARRY B MOUNT

SALES REPRESENTATIVES
IN ALL PRINCIPAL CITIES

707 PLEASANT STREET, WATERTOWN 72, MASSACHUSETTS

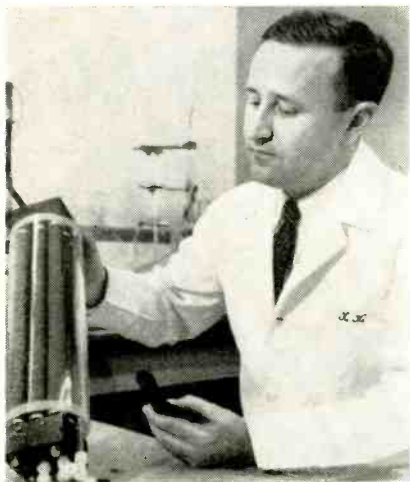

GASES go in and electricity comes out as . . .

Gases Produce Power By The Kilowatt

New power cell uses gaseous hydrogen and oxygen

A NEW CELL which differs completely from conventional dry cells and storage batteries, has been developed into a practical form at the National Carbon Co. The cell produces electricity by electrochemical action, using hydrogen and oxygen gases as fuels.

► **Reaction**—Each gas is fed into a hollow porous catalyzed-carbon rod which is surrounded by potassium hydroxide electrolyte. The reaction develops a potential of about one volt across the electrodes with high currents available.

Problems associated with the gas flow are not overwhelming since the cell operates at approximately atmospheric pressure and uses air instead of pure oxygen. Theoretically, the fuel cell has an infinite life since there is no deterioration with use. The only by-product of the reaction is water which is disposed of by evaporation.

► **Capacity**—Operating efficiency is in the range from 65 to 80 percent. The ultimate design is expected to produce one kilowatt of power for each cubic foot of volume. The cell will use either solar or nuclear energy to decompose water.

FCC Actions

- **Amends** Industrial, Scientific and Medical Service rules to permit operation of ultrasonic measurement equipment over a continuous band of frequencies
- **Extends** the time in which interested parties can furnish data and information on the Commission's inquiry into the allocation of frequencies of the non-government services in spectrum between 25 and 890 mc. New deadline is November 1
- **Increases** to Dec. 15 effective date of amendments to rules that will make available additional Maritime Mobile Service frequencies in the range 157.3 to 162.0 mc
- **Studies** possibility of amending rules to authorize f-m broadcast stations to employ antenna systems utilizing either horizontal or vertical polarization
- **Amends** its television table of assignments. Commission shifts channel 8 from Muskogee to Tulsa, Okla.

Beacon Tells Pilot Airport Heading

Talking beacon broadcasts compass heading heard on airborne vhf receiver

LIGHT PLANES may be guided to small airports by a talking beacon developed for the Army Signal Corps. The beacon broadcasts compass headings and can be heard on any airborne vhf receiver.

Air Associates, Teterboro, N. J., developed the beacon and operated one last month as a trial for private flyers. The Signal Corps, which already operates a beacon at Army Electronics Proving Ground, Fort Huachuca, Ariz., gets demonstration model.

Small quantity production in lots of five is anticipated now. Units would cost \$15-18,000.

► **Potential** customers are corporations and private operators who maintain airports not easily accessible. On a coordinated civilian basis, says the company, 150 talking beacons would blanket the

U. S. Units abroad would aid bush pilots, particularly corporation pilots in Central and South America.

► **Effective** reception is more than 50 miles, depending upon altitude and terrain. Frequency is 118-135 mc. Demonstration unit has space for uhf equipment ranging from 236-272 and from 354-400 mc.

► **Two 5-watt** transmitters energize unidirectional narrow pattern antennas mounted back to back on 18-foot mast, and broadcast recorded voice bearing. A 50-watt transmitter sends continuous masking tone and Morse code station identification. It also energizes bidirectional antenna which radiates broad figure-eight pattern. All three operate on same frequency through use of common crystal-controlled exciter.

► **Two bearings** are broadcast simultaneously 180 degrees apart, permitting pilot to hear his bearing every 15 seconds.

(Continued on page 24)

PLAIN FACTS ABOUT VIBRATION AND SHOCK MOUNTINGS

FOR AIRBORNE ELECTRONIC EQUIPMENT

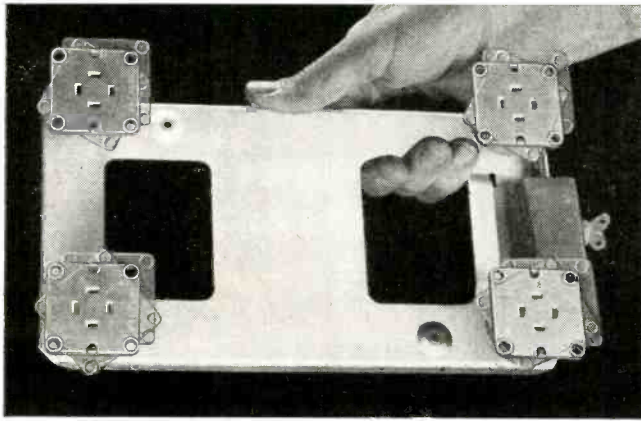

OUT-DATED UNIT MOUNT BASE

16 mounting holes and 16 bolts required.

Unit mountings may be improperly attached to the rack, and are very likely to be seriously misaligned during attachment to aircraft or missile structure.

Even minor discrepancies in spacing and attachment of unit mounts can defeat the whole purpose of the mounting base, and result in poor performance and deterioration of equipment.

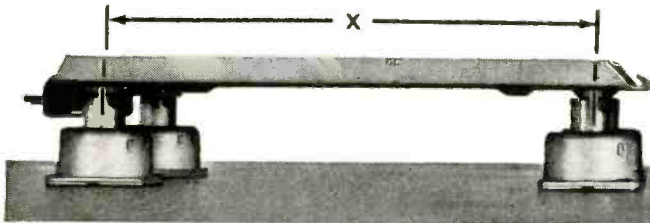

Excessive height required. Unit mount bulk imposes reduced spacing (X) between support centers, resulting in impaired stability (critical in lateral direction). Greater sway space required.

Well Designed Electronic Equipment, If Poorly Mounted, Too Often Operates Inefficiently and Unreliably

Failure also can result from use of inadequate mountings which are not engineered for the particular equipment and purpose. Conventional shock mounts or so called "isolators", reasonably effective when installed under ideal laboratory conditions, become dangerous trouble makers when installed by usual production line methods.

Attachment of a base plate to unit mounts to achieve spacing control is a makeshift arrangement resulting in excessive weight with no height reduction.

Failure also can result from obsolescent unit mounts employing internal rubber, organic or synthetic materials which deteriorate rapidly and are susceptible to temperature and environmental changes.

The importance of today's electronic equipment surely justifies the use of integrated mounting systems designed to meet specific problems rather than the unreliable application of assembled "catalogue" mounts.

USE OF ROBINSON ENGINEERED MOUNTING SYSTEMS results in:

- Reliable and uniform performance in every installation under all types of environmental conditions.
- Reduced cost through "de"ruggedization of equipment — substantial reduction of size and weight is possible by simplified and compact design.
- Simplified installation — only four attachment holes required—pre-spaced to save time and assure accuracy.

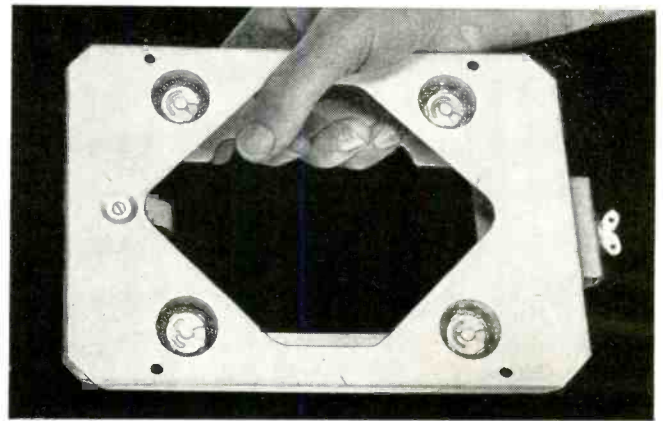

TODAY'S ENGINEERED MOUNTING SYSTEM

Only 4 mounting holes required.

Prespaced holes in a one piece base plate assure quick, accurate attachment. Relationship of all 4 holes is definitely fixed (holes spaced for interchangeability with unit mounts).

No installation errors or misalignment can occur to disturb the precise performance of the mounting system as checked and approved on acceptance tests.

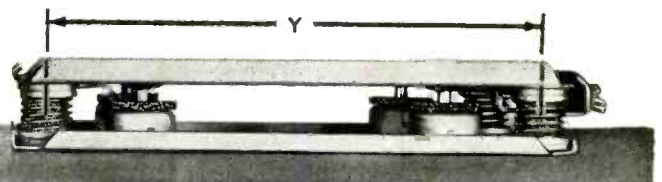

Note reduction in mounting height. Important space saved. Maximum spacing (Y) of resilient elements at extreme corners provides stability. Less sway space required.

Robinson All-Metal Engineered Mounting Systems Assure Outstanding Performance and Reliability of Equipment

The Robinson concept of vibration and shock control is the design and application of 100% all-metal mounting systems. Engineered with careful understanding of the equipment to be protected and performance expected, Robinson mounting systems come to you completely manufactured, ready to receive the electronic equipment or instrument.

The integration of these mounting systems into the electronic equipment of aircraft and missiles results in reduction of elapsed design time and basic development cost.

Robinson Mountings utilize, as main resilient elements, metal wire cushions (MET-L-FLEX), exclusive with Robinson. This construction has been thoroughly proven by years of use in nearly all military and commercial aircraft.

Some other important characteristics of Robinson Mountings: inherent high damping, non-linear spring rate, performance unaffected by grease, oil, water, dust, extreme temperatures or environmental changes.

For full information about this new concept of vibration and shock control, write or wire today.



West Coast Engineering Office:
604 Colorado Avenue, Santa Monica, California



TWO MINUTES AFTER he lowers a probe through a protective shield (left) to a desired depth in the earth, the



operator has accurately determined (right) the moisture content or density of the subsoil when radioactivity in . . .

Ultrasonic Uses Cited in Britain

Treatment of pasteurized milk, mass metal inspection and mine detection stir interest

MILK, metal and minefield ultrasonic uses are arousing interest in Britain.

► **Milk preservation**—A method of preparing pasteurized milk for storage by treating it with ultrasonic waves, pouring it into polyethylene bags and quick-freezing it in a brine bath has been developed by Britain's National Institute for Research in Dairying, with financial backing from National Research Development Corp.

Commercial possibilities include provision of fresh milk for long sea voyages, storage during time of over-production and shipment to countries where milk is scarce or unobtainable. National Research Corp. holds patent rights to process.

► **Metal inspection**—A new system for automatic inspection of metal and other solid parts has been developed by Kelvin & Hughes Ltd., London. It combines a new automatic electronic system with conventional sound beam detection of defects. Firm says new system maintains constant vigilance, operates alarm when defect is found. Technique, called "Autosonics," is said to make possible large volume inspection based on predetermined standard.

► **Mine detection**—An echo-sounding device for detecting mines, salvage or fish that can be whipped along or below water surface by a helicopter at 50 knots may be placed on the market soon by Pye Marine Ltd. Firm has completed two months of tests.

Helicopter-borne device is attached by cable to transducer housed in specially designed bomb-shaped submarine body. Use of "fishfinder" for mine detection, says company, would eliminate need for surface vessel entering suspected waters.

(Continued on page 26)

Density Gauge Hastens Analysis

Detector determines effects of environment on organic and inorganic materials

OPERATIONAL PRINCIPLE of the d/M-Gauge, developed by Nuclear-Chicago Corp., is based on the varying degree that radioactivity is scattered when placed in contact with masses of different moisture content or density. Application of this principle is made through the use of either a moisture probe containing a radioactive radium-beryllium source of fast neutrons, or a density probe containing a cesium-137 gamma ray source. The probes are used interchangeably with a radioactivity counting instrument (scaler).

► **Direct readout**—Measurements are obtained by inserting the desired probe into the material being tested and reading the scaler for a visual scatter count which varies with moisture or density variations. This count is located on a calibration chart and the moisture content or density of the material is read directly from the chart itself. The probes normally measure a spherical volume of material with an average diameter of 14 inches. Moisture or density measurements can be made at any depth within a material, ranging from the top 12

inches to 60 feet below the surface.

Accuracy of the system is within 2 lbs per cu ft for density determinations over the range from 50 to 150 lbs per cu ft. Moisture determinations are accurate to within $\frac{1}{4}$ lb per cu ft over the range from 0 to 100 percent moisture content.

► **Time-Saver**—In soil compaction control tests, required during highway construction projects, for example, an operator can obtain moisture or density data at a rate that formerly required the efforts of 5 to 10 technically trained personnel.

Continuous studies of the same volume of material over an extended period of time is accomplished by an access tube driven into the material and left in place for future measurements. Since the sample of material is chemically and physically unchanged by the testing process, such measurements provide an accurate basis for determining the effects of purely environmental changes on a particular volume of material.

The savings in time and labor make the new approach well suited to moisture-density determinations in many industrial processes, such as the manufacture of raw materials, chemicals, and fertilizers. The gage is equally adaptable to all sub-soil moisture measurements.

PERKIN

MISSILE AND RADAR STANDARD DC POWER SUPPLIES

MISSILE—GROUND

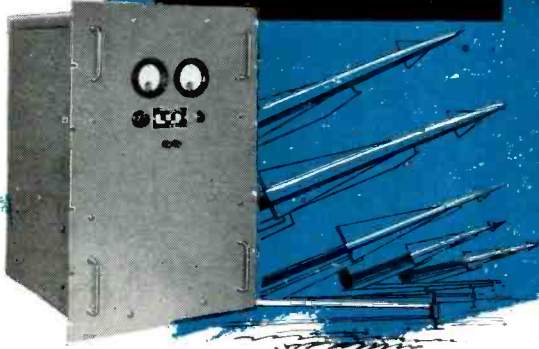

Perkin has developed Magnetic Amplifier Regulated DC Power Supplies for missile launching and check-out, with ratings of 30, 50, 100, 200, 300, 400, 500 amperes and above. The unit shown here is a 24-32V, DC @ 100 amp. unit, 19" rack panel mount, with a regulation of $\pm \frac{1}{2}\%$ over the range of 24-32 volts. There are provisions for remote operation and sensing. Perkin ground power supplies are now being used in the Thor, Atlas, Bomarc, Vanguard and other missile programs.

MISSILE—AIRBORNE



Perkin airborne power supplies more than meet both military specifications MIL-E-5272A and MIL-C-7115. The use of silicon rectifiers provide a much more compact package with higher efficiency ratings and longer life expectancy. The unit illustrated provides 27.5 volts DC (26 to 30 volt range), 20 amperes continuous duty. The input is 115/200V AC, 3 phase; frequency range 400 CPS ± 6 CPS. The regulation is less than ± 0.5 volts.

6 KV



RADAR—AIRBORNE

Perkin has designed and manufactured over 6,000 units operating in Military and Commercial Radar Systems. 6, 7, 8, 9, 10 KV and other ratings can be designed for your specific mechanical and space configurations. Typical 6KV specifications are: AC Input—100-120V, 380-420 CPS, single phase; DC Output—6KV, $\pm 5\%$ @ 100 microamperes; Temperature Range— -55°C to $+125^{\circ}\text{C}$ @ 50,000 feet altitudes and above. Weight—2 1/4 lbs.; no tubes or moving parts.

RADAR—GROUND

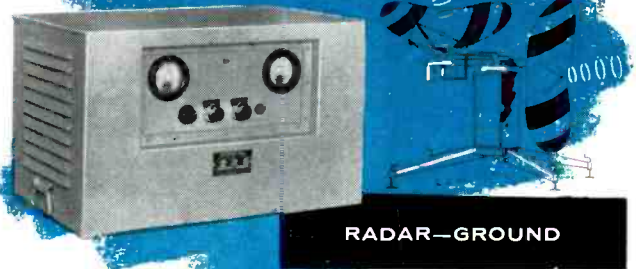

Hundreds of Perkin Ground Radar Systems are in operation throughout the country. Built to specifications MIL-E-4158, this unit was conservatively designed and will operate at 150% load continuously without damage to the unit. Specifications are: AC Input—120/208V $\pm 10\%$, 3 phase, 60 cycle ± 2 CPS, 4 wire system; DC Output—24-32V @ 100 amps; Regulation— $\pm \frac{1}{2}\%$ (for any combination of line and load changes); Ripple—1% RMS or less.



Other Standard Perkin Products Include:

- Laboratory DC Power Supplies and AC Line Regulators
- Pulse Generators
- DC-DC and DC-AC Static Inverters
- Servo Controls
- Magnetic Amplifiers
- Transistorized B+ and Heavy Duty Power Supplies

PERKIN ENGINEERING CORPORATION

345 KANSAS STREET, EL SEGUNDO, CALIFORNIA • OREGON 8-7215

Immediate delivery on standard models available from factory and:

New York Area Office: Sales and Warehousing: 1060 Broad Street
Newark 2, New Jersey • Market 3-1454

New England Area Office: 46 Amesbury, Lawrence, Massachusetts • MURdock 3-3252

Chicago Area: 5218 W. Diversey Ave. • Chicago, Illinois • PALisade 5-6824

Sales offices in principal cities throughout the country.

For a prompt reply on your application, write or wire FACTORY on your letterhead... or check (✓) coupon below, specifying information desired.

PERKIN ENGINEERING CORPORATION

345 Kansas St., El Segundo, California

Please send further data on power supplies for:

- MISSILE—GROUND RADAR—GROUND
MISSILE—AIRBORNE RADAR—AIRBORNE

Other Power Supplies rated at _____ Volts, _____ Amps.

Name _____

Title _____

Company _____

Address _____

City _____ State _____

Phone _____ Ext. _____

PERKIN

For further data return above coupon.



RESEARCH for the Air Force and AEC at the Rand Co. in California, (above) and calculations for businesses throughout the country are expedited as . . .

Computers Come To The Rescue

Large installations point-up the importance of computers in business and research

GROWTH of computer centers in the U. S. has more than doubled in the past three years. Much of this growth may be attributed to the increasing awareness by industry of the savings involved in the use of such centers.

► **Fallout**—Nuclear fallout and Air Force problems are studied at the Rand Corp. with the first IBM 704 that makes use of transistorized switching circuits. The research organization's giant data-processing system at Santa Monica, Calif., has been equipped with a Model 738 auxiliary storage unit which quintuples the 704's memory capacity.

The 738 is a high-speed magnetic-core storage unit that holds 32,768 six-character words. It uses 432 transistors mounted on 72 printed-circuit boards in the preamplifier stages of the output switchgear. The unit makes stored data accessible to the computer in 12 microseconds.

► **Roads**—The effects of the nation's \$50-billion road building program on the national economy were forecast by a computer. At the recent opening of the Computer Services Division of the Council for Economic and Industry Research,

Inc., an IBM 704 predicted that in the thirteen years covered by the national road building program an average of some 880,000 jobs across 190 industries would be generated. The 1947 Bureau of Labor Statistics Inter-industry study was used as the base for the classification system.

► **Double-duty**—The new \$1-million computer system being installed at the Pacific Power & Light Co. in Portland, Ore., by the Electrodata division of Burroughs will serve both the accounting and engineering departments. Between making out bills for the company's 300,500 customers, the system, built around a Datatron high-speed computer, will calculate optimum operating curves based on 30-year records of rainfall and stream-gage data for the firm's hydroelectric generating stations.

Germanium Unaltered by Some Impurities



GROWING germanium crystals containing high concentrations of tin was recently investigated by F. A. Trumbore of Bell Telephone Laboratories. Also studied were the electrical properties of the compound. Although semiconductor materials in general are extremely sensitive to impurities, experimentation showed that the electrical characteristics of germanium were not affected significantly by the presence of tin. This verified a long-held theory in which an impurity having the same number of valence electrons possessed by germanium was thought to be neutral. Virtually the same room-temperature resistivities of 30 to 50 ohm-centimeters were recorded for both the impure and ultrapure germanium



BUILT to undercut current market, this . . .

Desk-Size Computer is New Research Tool

DESK-SIZE analog computer is now being marketed by Donner Scientific, Concord, Calif., for \$15,035. The computer, Model 3100, is said to be capable of solving problems as accurately as equipment priced at thirty or forty thousand dollars.

► **Characteristics**—The 3100 is a linear computer with built-in provisions for working with nonlinear input gear. It contains 30 stabilized d-c amplifiers and 40 coefficient potentiometers. Reference power supply is chopper stabilized. All equipment is housed in a single desk-type console with controls and the removable problem board within easy reach.

► **Buildup**—The computer is designed to let a purchaser start small and build up. Minimum starting equipment is 10 amplifiers and 20 potentiometers. Several full consoles can be interconnected through their problem boards to work as a single system.

Characteristics of the 10-amplifier rack, the basic module, shows d-c gain in excess of 30 million with less than 0.2 degree phase shift at 1,000 cps. Grid current is eliminated in the amplifier by capacitive coupling between stages.

Peak-to-peak output is 200 volts, 20 ma. Drift referred to summing junction is under 250 microvolts per day.

(Continued on page 28)

Ge and Si from Sylvania now cut to size to cut growing pains —and costs

Crucible-size pieces
 of Sylvania germanium or
 silicon cut waste and
 handling time.

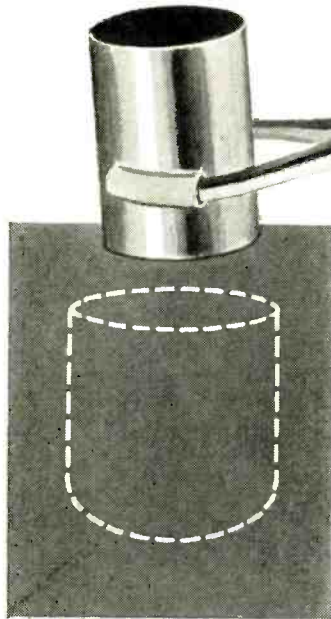

Here's Another Contribution to efficiency in your single-crystal growing operation from Sylvania, your dependable source of *both* germanium and silicon:

When you order either semiconductor material in charge size, you eliminate the delays and waste that go with further cutting and etching. Pieces are ready for your crucible as they are delivered.

In addition to this important service, Sylvania can meet your semiconductor requirements in practically any form you specify.

Sylvania n-type germanium—with a resistivity greater than 40 ohm cm—is available as either undoped single crystals or polycrystalline as-reduced or purified ingots. Sylvania can supply special cut pieces for practically every size and shape of crucible for vertical or horizontal crystal growth. Transistor and diode manufacturers report unusually high uniformity and yield from these Sylvania materials.

Sylvania silicon can be supplied as polycrystalline stalagmatic rod in three standard grades based on resistivity—from solar grade to over 100 ohm cm p-type, or 40 ohm cm n-type. Standard diameter is 1½ inches. All grades are available in cut pieces to your specification.

Write today for information on Sylvania's semiconductor materials—for specifications on crucible-sized pieces.



TUNGSTEN • MOLYBDENUM • CHEMICALS • PHOSPHORS • SEMICONDUCTORS

SYLVANIA ELECTRIC PRODUCTS INC.
 Tungsten and Chemical Division
 Towanda, Pennsylvania

 **SYLVANIA**

LIGHTING • RADIO • ELECTRONICS • TELEVISION • METALS & CHEMICALS

Industry Shorts

► **Radios** — One-quarter million more radios were shipped to dealers by manufacturers during last June than had been shipped the previous month. Cumulative radio shipments during the first half of the year totaled 3,436,428 radios, compared to 3,270,809 radios sent to dealers during the like months of 1956.

► **Television**—An increase in the number of tv sets shipped to dealers by manufacturers in June compared with May was also reported.

However cumulative shipments of tv sets to dealers during the first half of this year, 2,503,966, declined from the 2,775,022 sets shipped during the like 1956 period.

► **Soviet**—U. S. electronics engineers who recently visited Russia were shown through a television laboratory and plant. They report color and tube development making big strides. Optimistic Russian production goal this year is 2.5 million sets, with stations now totaling 22 to be increased to 75 by 1960.

► **Czechoslovakia**—will import some 73,000 Soviet television sets in 1957. She began to make tv sets in 1953, the year Stalin died. According to official Czech statistics, 84,676 units were turned out up to last year. Import's brought the total sold in the period to 93,265.

► **Poland**—In May the Polish government demanded that the electrical industry produce 16,000 tv sets this year, or 617 percent above the 1956 level. More recently, the Poles agreed to buy \$14 million worth of tv sets from Britain's Pye Ltd.

Poland is spending almost \$6 million on tv stations and relay links scheduled for operation in December, including equipment from Marconi of Britain.

That British firms see a further market for tv gear in Poland is pointed up by the fact that Marconi shipped 88 tons of tv studio and associated equipment to the Poznan trade fair. The tv exhibit required the largest stand.

Meetings Ahead

Oct. 7-9: National Electronics Conference, IRE, AIEE, RETMA, SMPTE, Hotel Sherman, Chicago.

Oct. 7-11: American Institute of Electrical Engineers, Fall general meeting, Chicago, Ill.

Oct. 8-12: Ninth Annual Convention, Audio Engineering Society, New York Trade Show Building, NYC.

Oct. 9-11: Fourth Annual Symposium on High Vacuum Technology, Committee On Vacuum Techniques, Hotel Somerset, Boston, Mass.

Oct. 9-12: Audio Engineering Society, 1957 Convention, N. Y. Trade Show Building, N. Y. C.

Oct. 16-18: American Institute of Electrical Engineers, Conference on Computers in Control, Chelfonte-Haddon Hall Hotels, Atlantic City, N. J.

Oct. 16-18: IRE Canadian convention Automotive Building, Exhibition Park, Toronto, Canada.

Oct. 21-22: First National Symposium on Engineering Writing And Speech, IRE, PGEWS, Sheraton-McAlpin Hotel, N. Y. C.

Oct. 21-26: Institution of Radio Engineers Australia, annual convention, IRE, Hotel Australia, Sydney, Australia.

Oct. 21-26: International Conference on Ultra High Frequency Circuits and Antennas, Societe Des Radioelectriciens, Paris, France.

Oct. 24-25: Computer Applications Symposium, Armour Research Foundation, Hotel Sherman, Chicago.

Oct. 28-30: Fourth Annual East Coast Conference on Aeronautical and Navigation Electronics, IRE, Lord Baltimore Hotel & 7th Reg. Armory, Baltimore, Md.

Oct. 31-Nov. 1: Professional Group on Nuclear Science, fourth annual meeting, Henry Hudson Hotel, N. Y. C.

Oct. 31-Nov. 1: 1957 Electron Devices Meeting, PGED, Shoreham Hotel, Washington, D. C.

Nov. 2-10: 1957 International Congress of Measuring Instrumentation and Automation, Interkama Dusseldorf, Germany.

Nov. 4-6: Third Annual Symposium on Aeronautical Communications, PGCS, Hotel Utica, Utica, N. Y.

Nov. 6-9: Tenth Annual Conference on Electronic Techniques in Medicine and Biology, ISA, AIEE, Boston, Mass.

Nov. 11-13: Third Instrument Conference, IRE, PGI, Biltmore Hotel, Atlanta, Ga.

Dec. 9-13: Eastern Joint Computer Conference, IRE, ACM, AIEE, Sheraton Park Hotel, Washington, D. C.

Jan. 6-8: Fourth National Symposium on Reliability and Quality Control, Hotel Statler, Washington, D. C.

Britain Builds Proton Synchrotron

Work underway on 7-billion volt accelerator for atomic energy research program at Harwell

BRITISH Prime Minister Harold Macmillan has announced that Britain is building a seven-billion electron volt proton synchrotron for its nuclear research program.

He said the National Institute for Research Into Nuclear Science had agreed on a design and that work is already underway. The

particle accelerator will cost about \$21 million.

The machine is designed to produce a beam of atomic particles more dense than that from any other accelerator in the world. It will have a 6,000-ton magnet in the form of a ring 120 ft in diameter.

Scheduled for completion in two years, the machine will be constructed on a site adjacent to the Atomic Energy Authority's research establishment at Harwell.

KAY ELECTRIC Noise Figure Measure Equipment Now Augmented with Improved Versions of *NEW LONDON* Random Noise Sources

The New London Random Noise Sources added to the Kay Electric line have been refined and improved by Kay engineers. The most important change is the increased stability obtained from a regulated power supply.

Kay Electric Company now offers the most complete and versatile line of Random Noise Sources. These units feature non-tunable outputs matched over their respective frequency bands.



RANDOM NOISE SOURCE for VHF-UHF

MODEL 175-A (formerly New London Model 175)

- **Balanced Output—No Balun**
- **Broadband—No Tuning, 50 to 900 mc**
- **Long Life Diodes**

This noise source, consisting of two 5722 noise diodes operating in an inherently balanced arrangement, makes full use of the distributed parameters of each diode to achieve a wide band noise output characteristic. Thus, this instrument gives noise figure readings of balanced 300 ohm receivers over the entire 50 to 900 mc frequency range without tuning.

SPECIFICATIONS

Frequency Range: 50 mc to 900 mc
Noise Figure: 0 to 19 db
Accuracy: ± 0.5 db below 400 mc; ± 1 db maximum at 900 mc when using 300 ohm equipment
Output Impedance: Designed for 300 ohm balanced inputs
Tube Life: 200 hours of continuous operation at maximum output

PRICE: \$325.00

RANDOM NOISE SOURCE

MODEL #403-A
 (formerly New London Model 403)

This noise source instrument measures noise figure, bandwidth, and gain of receivers, and calibrates signal sources . . . all with very high accuracy. It features a VSWR of less than 1.3 over the entire frequency range of 3 to 500 mc. Long-life, inexpensive noise diodes are used, and no tuning is required.

SPECIFICATIONS

Frequency Range: 3 mc to 500 mc
Noise Figure: 0 to 19 db direct reading
Accuracy: ± 0.5 db over entire frequency range
Output Impedance: 50 ohms unbalanced
PRICE: \$325.00

ALSO AVAILABLE

UHF NOISE SOURCE MODEL #191-A

(formerly New London Model 191)
Frequency Range: 10-3000 mc **PRICE:** \$790.00

ALL PRICES F.O.B. FACTORY

PLUS THE REGULAR LINE OF KAY ELECTRIC NOISE SOURCES AND NOISE FIGURE MEASURING SETS

Mega-Node (Cat. No. 240-A)—Frequency Range: 5 to 220 mc. Noise Figure Range: 0 to 16 db at nom. 50 ohms; 0 to 23.8 db at 300 ohms. Output Impedance: Unbalanced—50, 75, 150, 300 ohms. Infinity: Balanced—100, 150, 300, 600 ohms. Infinity: **Price:** \$295.00

Mega-Node Sr. (Cat. No. 250-B)—Frequency Range: 10 to 3,000 mc. Noise Figure Range: 0 to 20 db. Output Impedance: Nom. 50 ohms into type N connector. **Price:** \$790.00

Rada-Node (Cat. No. 600-A)—Frequency Range: 5 to 26,500 mc. Noise Figure Range: 0 to 23.8 db depending on output impedance; accurate to ± 0.25 db. **Price:** \$1,395.00 (For frequencies to 400 mc. Other standard noise sources may be used with Rada-Node at prices shown).

Microwave Mega-Nodes—Frequencies Ranges: 1,200 to 26,500 mc. Noise Output: Fluorescent—15.8 db ± 0.25 db; Argon—15.28 db ± 0.1 db. **Prices:** \$295.00 to \$595.00 with power supply.

For Literature on Complete Line of Kay Instruments, Write:

KAY ELECTRIC COMPANY

Dept. E-10

14 Maple Avenue, Pine Brook, N. J.

Caldwell 6-4000

Another Application for FERRAMICS®

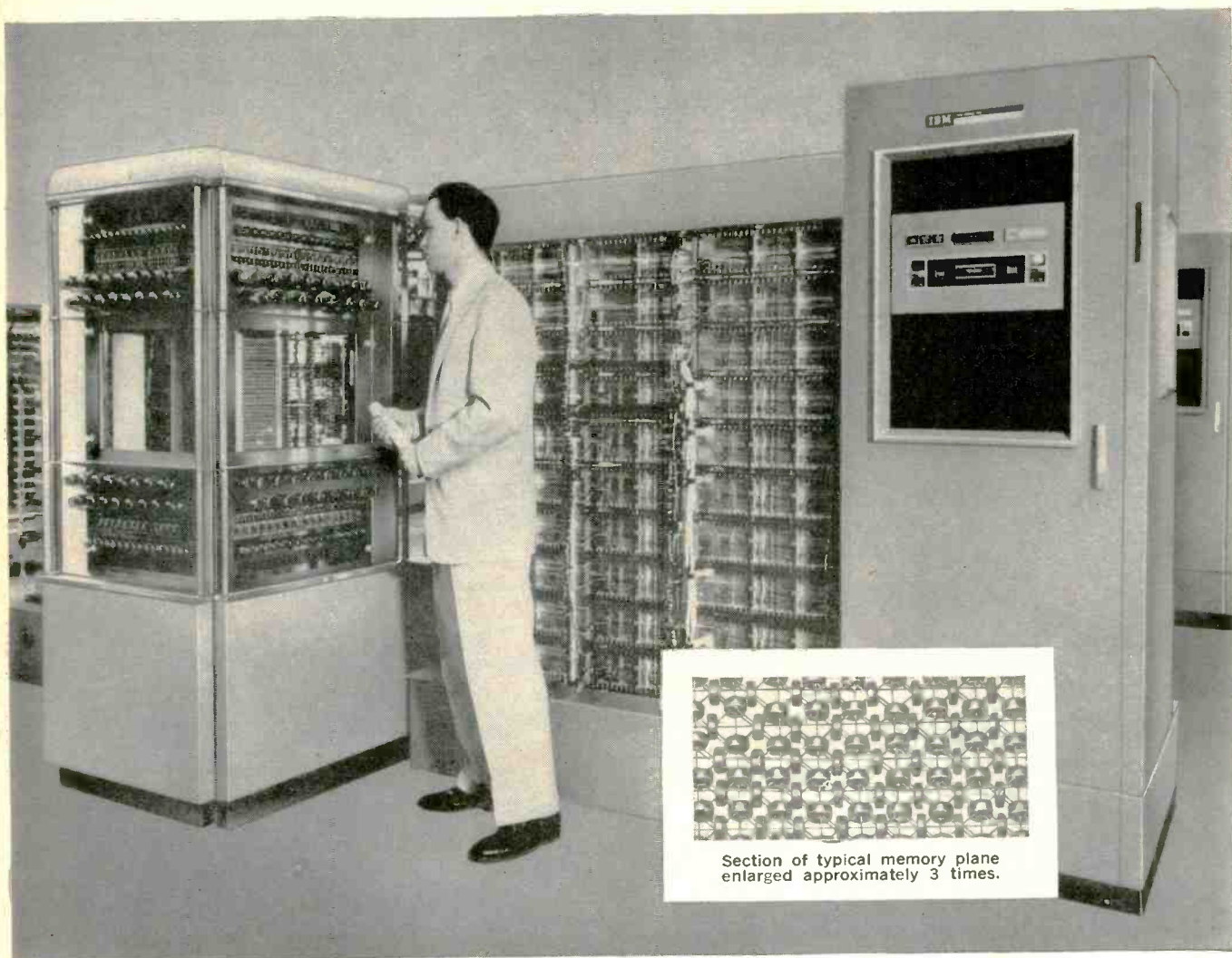

Section of typical memory plane enlarged approximately 3 times.

Ferramic® Cores help IBM Sage Computer Perform Amazing Feats of Memory

General Ceramics Magnetic Memory Cores play an important role in the reliable functioning of the Sage Computer. G-C engineers developed rectangular hysteresis loop ferrites and worked closely with Lincoln Laboratories at MIT and IBM to perfect toroids with the required magnetic properties for this vital defense system.

These dependable components provide increased speed and accuracy for computers and automatic controls. General Ceramics cores and completely assembled memory planes are available for automation systems. For complete information write today to General Ceramics Corporation, Kearsbey, New Jersey—Dept. E.

GENERAL CERAMICS

Industrial Ceramics for Industrial Progress... Since 1906

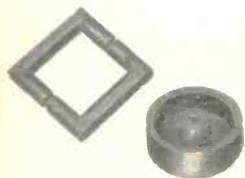

FERRAMIC CORES



MAGNETIC MEMORY CORES AND PLANES

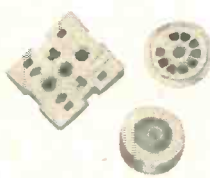

PRECISION STEATITES

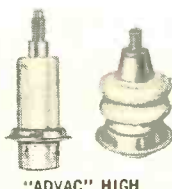

"ADVAC" HIGH TEMPERATURE SEALS

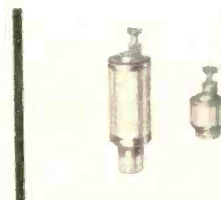

SOLDERSEAL TERMINALS

Now Available!

PHILCO Silicon Transistors

With These Outstanding Advantages:

- Excellent performance at Temperatures from -60°C to $+140^{\circ}\text{C}$
- Collector Saturation Voltage of 0.1 Volt or Under
- Maximum Frequency of Oscillation in the 15 Megacycle Range.

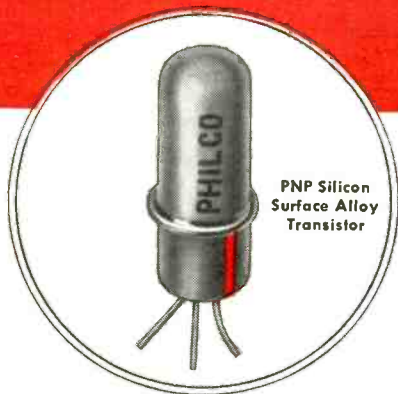

PNP Silicon
Surface Alloy
Transistor

Unmatched performance and reliability! Characteristics assured by extensive life tests under typical operating conditions. Philco PNP Silicon Transistors make practical complete transistorization of military and commercial circuits—where high ambient temperatures are encountered.

Philco Silicon Transistors are in production and immediately available. Specify Type 2N354 for amplifier, oscillator and low level general purpose applications and Type 2N355 for high speed switching.

FEATURES

- HIGH TEMPERATURE PERFORMANCE • VERY LOW LEAKAGE CURRENT • HIGH SPEED • SUITABLE FOR DIRECT COUPLING
- LOW SATURATION VOLTAGE • ABSOLUTE HERMETIC SEAL

Make Philco your prime source of information on Silicon Transistor Applications.

Write to Dept. E, Lansdale Tube Company Division, Lansdale, Penna.

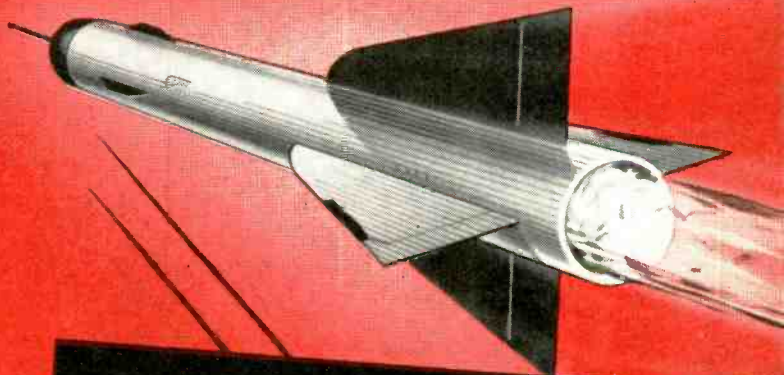

Characteristics of Types 2N354 and 2N355
($T_c = 25^{\circ}\text{C}$)

Characteristic	Condition	Typical Value
Current Amplification Factor, h_{fe}	$V_{CE} = -6\text{ v}$ $I_E = 1\text{ ma}$	18
Output Capacitance, C_{ob}	$V_{CB} = -6\text{ v}$ $I_E = 1\text{ ma}$	$7\text{ }\mu\text{f}$
Maximum Oscillation Frequency, f_{max}	$V_C = -6\text{ v}$ $I_E = 1\text{ ma}$	15 mc
Cutoff Current, I_{CBO} or I_{EBO}	V_{CB} or $V_{EB} = -10\text{ v}$.001 μa

Maximum Power Dissipation—150 mw
Maximum Collector Voltage—2N354-25 v
2N355-10 v

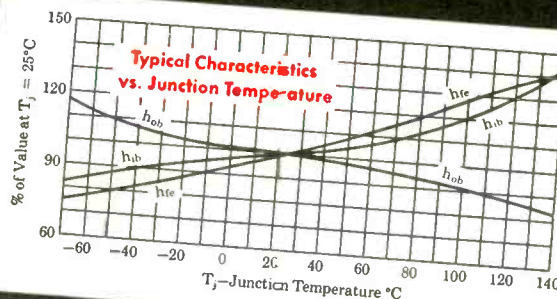
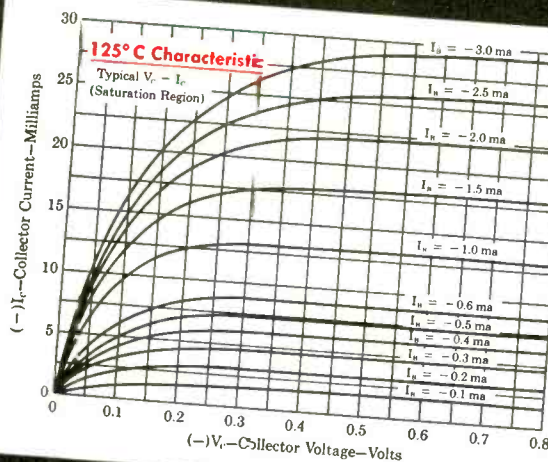

PHILCO CORPORATION
LANSDALE TUBE COMPANY DIVISION
LANSDALE, PENNSYLVANIA



2800 HOURS / 130° C

BH VINYL-SIL

VINYL-GLASS SLEEVING

FOR MAXIMUM FLEX-LIFE

320 HOURS / 150° C

115 HOURS / 180° C

4 HOURS / 232° C

When flexibility in an insulation is a must — so is BH Vinyl-Sil. Formulated especially for high processing temperatures, hotter operation, and compatibility with wire enamel, BH Vinyl-Sil's flexibility lasts — check these figures.

BH Vinyl-Sil is a superior insulation for standard applications, too — the regular 8,000 volt grade, or the Underwriters' recognized Vinyl-Sil 105. Because "flex-life" temperatures are important as a guide to ultimate life expectancy, maximum retention of this property is your best assurance of product quality.

The dependability of all BH electrical insulations is the result of 35 years of pioneering in the production of flexible, high-temperature resistant sleeveings.

We'll be glad to help you with your insulation problems and send appropriate samples — just give us the facts.

BENTLEY, HARRIS MANUFACTURING CO.
1000 Barclay Street Telephone: TAYlor 8-0634
CONSHOHOCKEN 4, PA.

Specifications MIL-I-3190B; MIL-I-18057A and NEMA VS 1 — 1957 have recently been issued. We'll be glad to supply you with free copies.

BENTLEY, HARRIS

Flexible
SLEEVINGS

BH Non-Fraying glass fiber sleeveings are made by exclusive Bentley, Harris process (U.S. Pat. Nos.: 2393530; 2647296 and 2647299).

Get out your pencil and . . .

Help yourself to

electronics' READER SERVICE

it's free—it's easy—it's for your convenience

NOW!

All Advertisements
New Products, and
New Literature are
numbered for your
convenience.

Each Advertisement, New Product, and New Literature item is numbered.
For more information simply . . .

- (1) Circle number on postpaid card below that corresponds to number at the bottom of Advertisement, or New Product item. Follow the same procedure if you desire New Literature.
- (2) Print your name, title, address, and firm name carefully. It is impossible to process cards that are not readable.

Correct additional postage **MUST** be added to cards for all **FOREIGN MAILINGS**

OCT
1-57
CARD
EXPIRES
JAN • 1ST

• **electronics** • READER SERVICE CARD

Please Print Carefully

NAME _____ POSITION _____

COMPANY _____

ADDRESS _____

1	2	3	4	5	6	7	8	9	10	11	12	13	14	15	16	17	18	19	20
21	22	23	24	25	26	27	28	29	30	31	32	33	34	35	36	37	38	39	40
41	42	43	44	45	46	47	48	49	50	51	52	53	54	55	56	57	58	59	60
61	62	63	64	65	66	67	68	69	70	71	72	73	74	75	76	77	78	79	80
81	82	83	84	85	86	87	88	89	90	91	92	93	94	95	96	97	98	99	100
101	102	103	104	105	106	107	108	109	110	111	112	113	114	115	116	117	118	119	120
121	122	123	124	125	126	127	128	129	130	131	132	133	134	135	136	137	138	139	140
141	142	143	144	145	146	147	148	149	150	151	152	153	154	155	156	157	158	159	160
161	162	163	164	165	166	167	168	169	170	171	172	173	174	175	176	177	178	179	180
181	182	183	184	185	186	187	188	189	190	191	192	193	194	195	196	197	198	199	200
201	202	203	204	205	206	207	208	209	210	211	212	213	214	215	216	217	218	219	220
221	222	223	224	225	226	227	228	229	230	231	232	233	234	235	236	237	238	239	240
241	242	243	244	245	246	247	248	249	250	251	252	253	254	255	256	257	258	259	260
261	262	263	264	265	266	267	268	269	270	271	272	273	274	275	276	277	278	279	280
281	282	283	284	285	286	287	288	289	290	291	292	293	294	295	296	297	298	299	300
301	302	303	304	305	306	307	308	309	310	311	312	313	314	315	316	317	318	319	320
321	322	323	324	325	326	327	328	329	330	331	332	333	334	335	336	337	338	339	340
341	342	343	344	345	346	347	348	349	350	351	352	353	354	355	356	357	358	359	360
361	362	363	364	365	366	367	368	369	370	371	372	373	374	375	376	377	378	379	380
381	382	383	384	385	386	387	388	389	390	391	392	393	394	395	396	397	398	399	400
401	402	403	404	405	406	407	408	409	410	411	412	413	414	415	416	417	418	419	420
421	422	423	424	425	426	427	428	429	430	431	432	433	434	435	436	437	438	439	440
441	442	443	444	445	446	447	448	449	450	451	452	453	454	455	456	457	458	459	460
461	462	463	464	465	466	467	468	469	470	471	472	473	474	475	476	477	478	479	480
481	482	483	484	485	486	487	488	489	490	491	492	493	494	495	496	497	498	499	500
501	502	503	504	505	506	507	508	509	510	511	512	513	514	515	516	517	518	519	520
521	522	523	524	525	526	527	528	529	530	531	532	533	534	535	536	537	538	539	540
541	542	543	544	545	546	547	548	549	550	551	552	553	554	555	556	557	558	559	560
561	562	563	564	565	566	567	568	569	570	571	572	573	574	575	576	577	578	579	580
581	582	583	584	585	586	587	588	589	590	591	592	593	594	595	596	597	598	599	600

INSIDE FRONT COVER

INSIDE BACK COVER

BACK COVER

Some Advertisements which cannot be numbered for the READER SERVICE CARD due to lack of space, must be indicated by writing the Advertiser's name in the space provided at the bottom of the card . . .

NOW IN YOUR HANDS . . .

THE ALL NEW 1957 electronics BUYERS' GUIDE!

USE IT THROUGHOUT THE YEAR AS YOUR STANDARD REFERENCE SOURCE

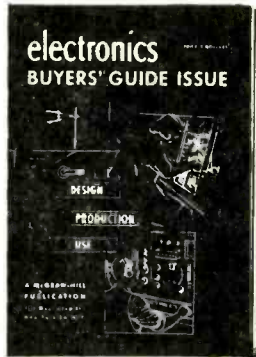

For 17 years . . .

THE BUYING GUIDE

For the electronics industry

As easy to use as the telephone book, your all new 1957 electronics BUYERS' GUIDE features:

COMPLETENESS: 1070 pages of products, manufacturers, trade names, manufacturers' representatives, and professional services.

ACCURACY: The entire electronic industry is questioned from scratch each year. For the 1957 GUIDE, there were 181 changes, 586 deletions (of the deletions, many were due to mergers and name changes), and 872 additions. Total

number of manufacturers increased to 4013 from 3727 in 1956. 87 new products were added in 1957 for a total of 1773.

USE: Whether you are concerned with the design, production, or use of electronic circuitry, turn to the listings of the electronics BUYERS' GUIDE. Here you will find the page numbers that refer you to catalog-type advertising, specially prepared to supplement the listings and give you the technical information you must have to specify and purchase electronic and allied products.



A McGraw-Hill Publication, 330 West 42nd Street, New York 36, N. Y.



FIRST CLASS
PERMIT NO. 64
(Sec. 34.9 P.L.&R.)
NEW YORK, N. Y.

BUSINESS REPLY CARD
NO POSTAGE STAMP NECESSARY IF MAILED IN THE UNITED STATE

4¢ Postage Will Be Paid By

ELECTRONICS

Reader Service Dept.
330 West 42nd Street
New York 36, N. Y.

tools for digital techniques in the laboratory

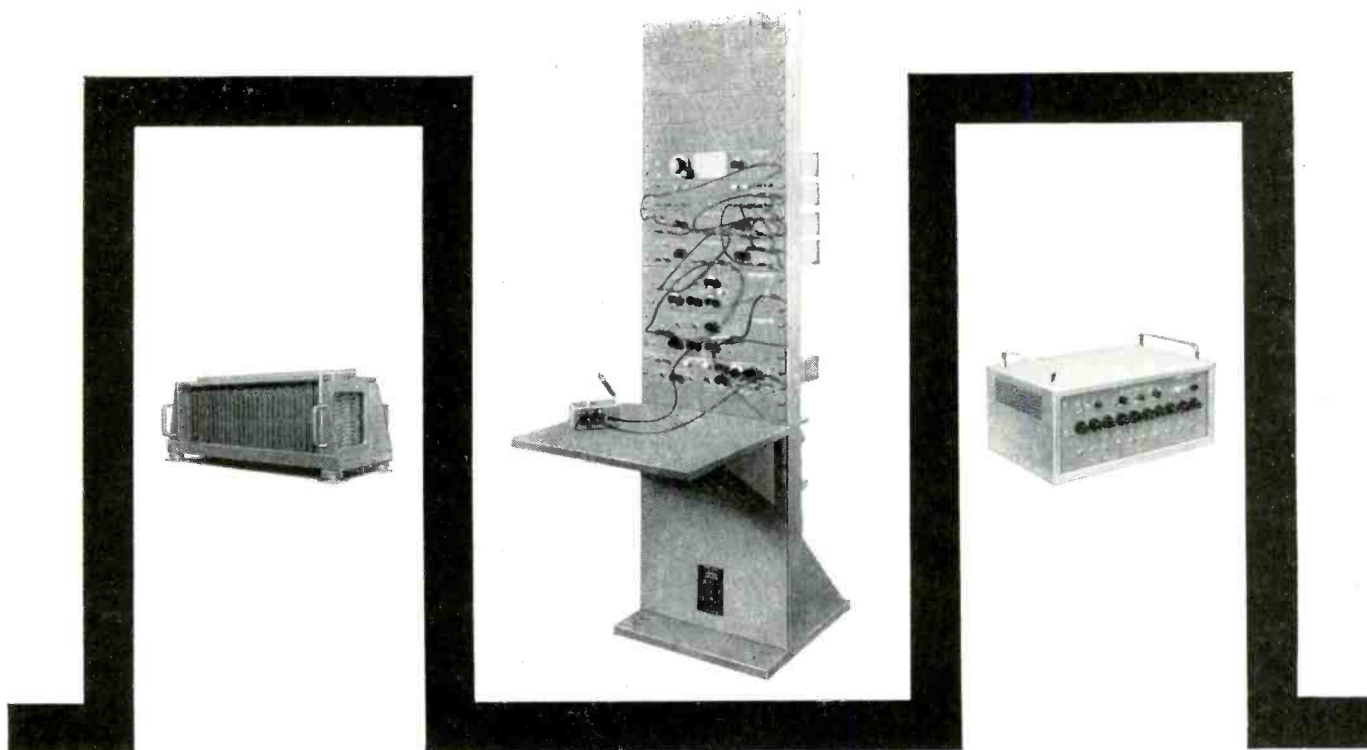

tools for engineers



It wasn't long ago that the average digital specialist was spending more time breadboarding than he was solving problems. Long on ideas, he was woefully short on tools. That's why Burroughs organized the Electronic Instruments Division—to supply the digital specialist with the laboratory test equipment his technology demands. And it has!

Today E.I.D. offers the laboratory working in digital techniques specialized equipment and services in these three major areas:

- (1) *Logical Building blocks.* Unitized Pulse Control Equipment that brings block diagrams to life in minutes for the solution of logical problems . . . permits fast test set-ups for testing components, circuits, systems. Plus the BCT-301, a complete system for putting magnetic cores in a simulated system and observing their performance.
- (2) *Special purpose laboratory test equipment.* A group of instruments implementing the use of precision digital methods in comparison, measurement, and counting. Typical units are a precision delay generator . . . high frequency pulse generator . . . a device for displaying up to ten separate inputs on a scope face simultaneously . . . and a calibrator especially designed for measuring peak amplitude in millivolts.
- (3) *Complete systems design.* When design and test requirements are extremely complex, E.I.D. will design, develop, and install a complete system . . . such as complete core memories, memory plane testers, digital computer subsections.

If you'd like to learn more about any particular area of E.I.D. service, we'll be happy to send you all the information available. You need only request it. But if you have a particular problem, why not send it along to us now. We'll gladly work with you in developing a solution. There's no obligation.

BURROUGHS CORP. • ELECTRONIC INSTRUMENTS DIVISION • Department C • 1209 Vine Street • Philadelphia 7, Penna.



FOR RESTAURANTS, NIGHT CLUBS

Neat, trim, unobtrusive, the MLC is a superb little performer too. Delivers clean, sweet music and voice reinforcement that overcomes noise and dead spots.



SOUND AND AMUSEMENT TRUCKS

The versatile, dependable MLC efficiently handles all types of program material without harsh, annoying blare prohibited by many town ordinances.



PATIOS, SWIMMING POOLS, LAWNS

Here's weatherproof high fidelity that is also low in price. With the MLC, you can economically extend a music system outdoors and retain hi-fi quality.



TO ADD HI-FI TO P.A. SYSTEMS

In paging applications, the MLC penetrates high noise levels... its wide frequency range adds deep richness to music reproduction. Here's double duty, double value!

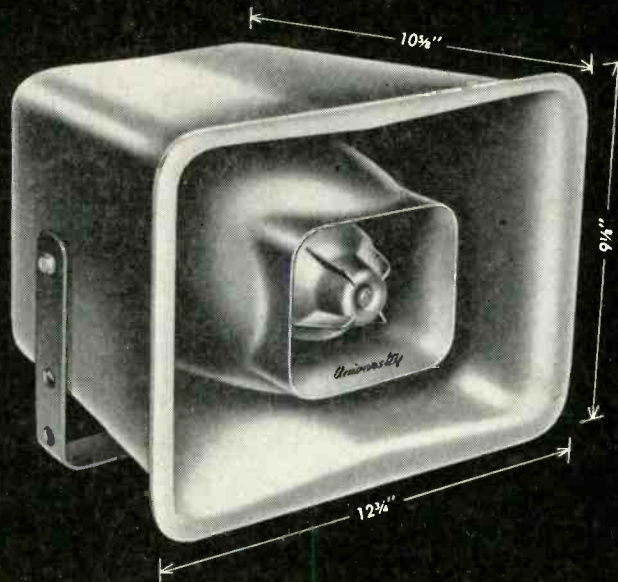

NEW...UNIVERSITY DUAL-RANGE MLC

Weatherproof Super-Compact Speaker System for Voice and Music

MODEL

Now...real high fidelity never before available in a rugged, small size, weatherproof speaker system. Unique wide-angle, dual folded horn design with separate low and high frequency drivers. Dependable, easy to install, low in cost, the MLC offers these outstanding features:

BETTER LOWS: Balanced "compression" folded horn, starting with 6" throat and energized by top quality woofer driver provides *more* lows than other designs.

BETTER HIGHS: Driver unit tweeter with wide angle horn transmits more highs with greater uniformity... high frequency response that you can hear!

BETTER EFFICIENCY: Dual range theater type system permits uncompromising design of the woofer and tweeter sections for greatest efficiency. Penetrates noise with remarkable fidelity and intelligibility.

LESS DISTORTION: *Separate* low and high frequency driver systems reduce intermodulation and acoustic phase distortion found in other systems which use two different horns on a single diaphragm.

MORE DEPENDABLE: Experienced mechanical engineering and careful electrical design meet the challenge of diversified application and environmental hazards. Rugged and conservatively rated—you can *rely* on the MLC.

SPECIFICATIONS: Power Capacity, 15 watts; Frequency Response, 150-15,000 cps; Impedance, 8 ohms; Dispersion, 120°; Sound Pressure Level, 117 db taken at 4 ft., 750-1250 cps with 1 cps sweep; Dimensions, Bell Mouth 12 3/4" W x 9 1/4" H, Overall Depth 10 3/4"; Shipping Weight, 10 lbs.; **\$54.50 List.**

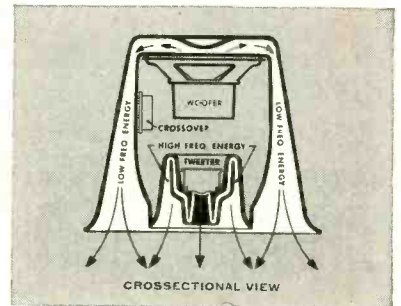

FOR HEAVY DUTY APPLICATION...

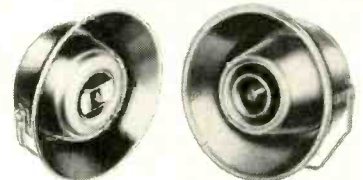

MODEL BLC

MODEL WLC

MODEL BLC employs same design principles as the MLC except for heavy duty 8" woofer with uniform response from 70 cps, exclusive "reciproating flare" wide-angle tweeter and has 25 watt power capacity. Exceptionally shallow depth, only 9", ideal for close quarters. **\$86.00 List.**

MODEL WLC, largest of the series, has 30 watt power capacity, 12" super-efficient woofer with response from 50 cycles, heavy duty radial tweeter... and a decade of successful performance in concert halls, rinks, auditoriums, stadiums and outdoor theaters throughout the world. **\$250.00 List.**

LISTEN

University sounds better



UNIVERSITY LOUDSPEAKERS, INC., 80 SOUTH KENSICO AVENUE, WHITE PLAINS, N. Y.

Relay Sales

Telephone Relays

Midget Relays

Keying Relays

Rotary Relays

Sealed Relays

Sensitive Relays

Latching Relays

Stepping Relays

Delay Relays

Timers

Contactors

Motor Starting Relays

Differential Relays

Polarized Relays

AN Approved Relays

Write for Catalog
1957-C8

Relay Sales

why wait for RELAYS

**LEADING MAKES-
LATEST TYPES
IN STOCK!**

C. P. CLARE
Mercury Wetted
Contact



We maintain complete distributor stocks of the following makes:

Advance Relays Phillips Controls
Automatic Electric Struthers-Dunn
Clare Leach Relays
Neomite-Elgin Terado and Others

Potter & Brumfield

We Anticipate Your Relay Needs

Relay Sales cannot get better delivery from manufacturers than you. Relays now in stock were ordered as long as 10 months ago and selected by men who have specialized in supplying relays to the industry for many years. The items illustrated are typical of hundreds of thousands in stock. They are available in all popular coil ratings and contact arrangements. Why wait for relays? Call us today!

Write or Phone for Same Day Shipment
Phone: West Chicago 1100

RELAY SALES, INC.

P.O. BOX 186-A

West Chicago, Ill.

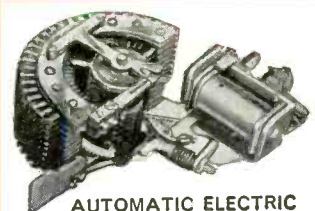

AUTOMATIC ELECTRIC
Type 45 Stepper
Wide Selection

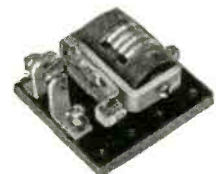

STRUTHERS DUNN
Keying Relay
Many Types in Stock

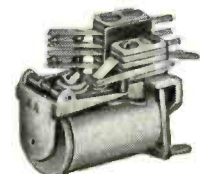

PHILLIPS CONTROL
9QA Midget for Sub Chassis
Mounting. Many Others
in Stock



(Actual Size)
NEOMITE-ELGIN
Sub Miniature Hermetically Sealed
Relay. All Advance Types in Stock

It's a tough life

but the sensitive

Fenwal THERMOSWITCH® unit takes it in its stride

Fenwal THERMOSWITCH Temperature Controls are enclosed in a tamper-proof assembly that's built to take grueling punishment — and stay highly accurate, uniformly sensitive throughout the operating range — *and its range is three to five times that of an ordinary thermostat!*

That means you can run your machine at greater speeds . . . your machine will require less maintenance! It means greater flexibility for your machine — greater sales for you — *and all at a low first cost.*

Even the assembly of a Fenwal THERMOSWITCH unit is easier and cheaper! The application of Fenwal THERMOSWITCH units are limitless — they're being used in planes . . . factories . . . ships . . . hospitals . . . homes . . . laboratories — *used almost any place where temperature is a factor and accuracy is a must!*

Drop us a line at Fenwal Incorporated, 2010 Pleasant Street, Ashland, Mass. and we'll send you our catalog MC-135 or our sales engineer, whichever you want.

This is our 17000 series (we've got 25,000 other variations with the operating ranges from -100°F to 600°F) in use in Master Jet Frymaster. The Fenwal control gives the machine rapid, precise response; greater reliability — even makes it more economical by conserving cooking fat and gas!

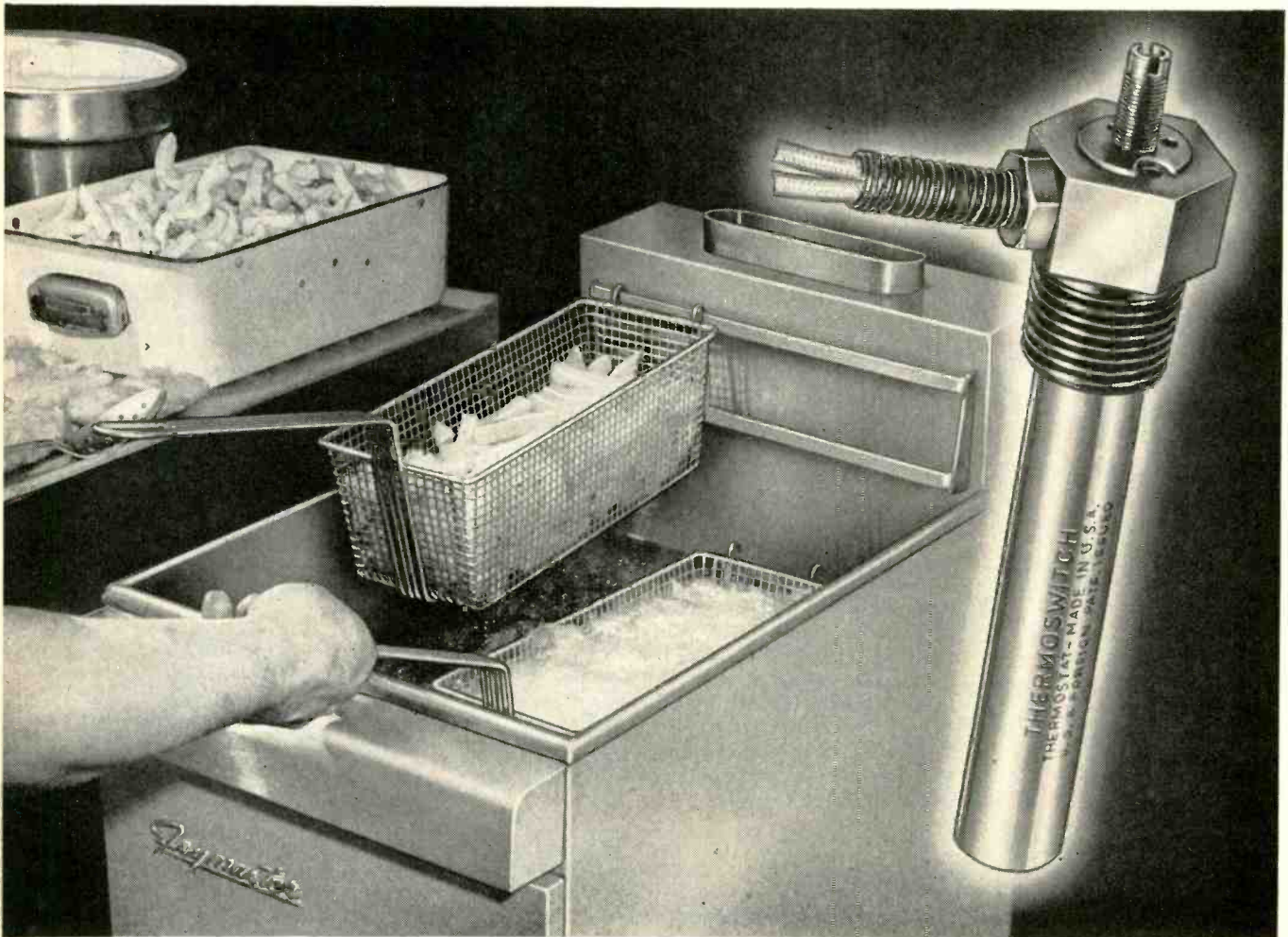

CONTROLS TEMPERATURE... PRECISELY

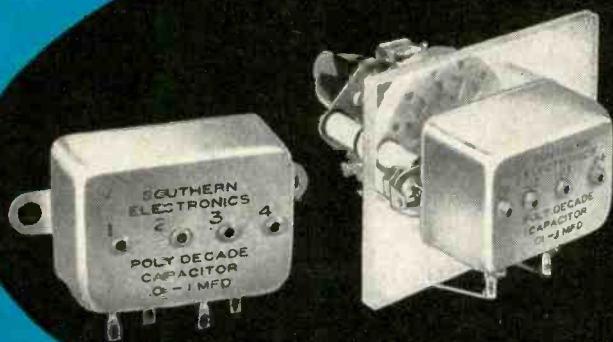
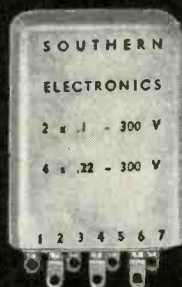

CONDENSE AND SAVE!



Plastic condenser block capacitors save you space, labor, money!

Multiple capacitors in one block! Now you can install one capacitor case and use 125% less space than before — at a saving in labor costs of up to 300%.

Let us solve your condenser block problems. Send us your requirements. Many case sizes and configurations are available with polystyrene or MYLAR* dielectric to tolerances as close as 1%.

now after years of intense research and development of military requirements



offers you **RC NETWORKS**

PITCH FILTERS INTEGRATOR NETWORKS

RC NETWORK as low as ½% capacitors and ½% resistors for reliable RC value of 1%.

- Hermetically sealed and potted
- Meets exacting military specifications
- SAVES SPACE & LABOR



PRECISION DECADE CAPACITORS with attached rotary switch or completely boxed!

Now on special order! Decade capacitors with higher voltage ratings, closer tolerances and capacitance from .001 to 10 M.F.D with polystyrene or MYLAR* dielectric to tolerances as low as 1%.

CHECK THESE OUTSTANDING FEATURES:

- Standard voltage rating . . . 200 V.D.C.
- Very high insulation resistance
- Low dissipation factor
- Low dielectric absorption
- Small sizes

*DuPont T.M.

**SOUTHERN
ELECTRONICS**
Corporation



For your most exacting requirements—
always specify S.E.C.

Wire, write or phone for a complete catalog today!

150 West Cypress Ave., Burbank, California

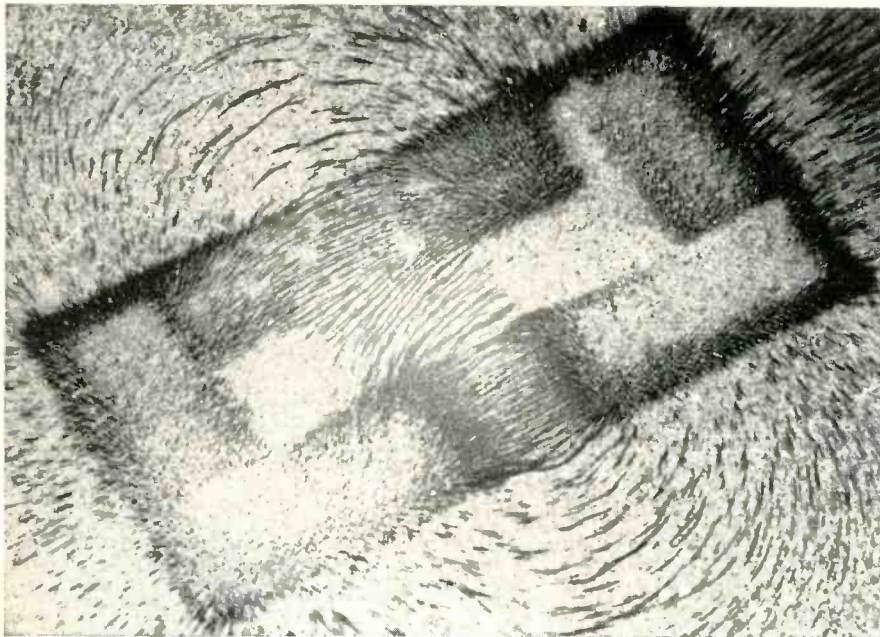

Flux pattern of experimental magnetic circuits

How location of magnets affects magnetic circuits

Adapted from an article by Charles A. Maynard, vice president, Research and Engineering, The Indiana Steel Products Company

The LOCATION of permanent magnets in a magnetic circuit is a definite factor in design. To determine the extent to which this is true, involved calculations are necessary.

A comparatively simple experiment, however, which shows the nature of the changes that take place when permanent magnets are placed in different positions in a magnetic circuit, was devised by Mr. Maynard. The material on which the following questions and answers are based was taken from a report, "An Experiment in Magnet Location," published in Vol. 3, No. 5, of Applied Magnetism. A copy of this issue is available on request to The Indiana Steel Products Co., Dept. A-10, Valparaiso, Ind.

Question: What effect does the location of permanent magnets have on a magnetic circuit?

Answer: It has a marked influence on the flux density in the various portions of the magnetic circuit.

Question: Is there a preferred location for magnets?

Answer: Yes, it is important to place the magnets as close to the air gap as possible.

Question: What is the benefit of their location?

Answer: The leakage flux is reduced, and the useful flux in the air gap is increased.

Question: How is this an important factor in design?

Answer: It minimizes the amount of magnet material required to produce a given flux in the air gap.

Question: Does this mean lower magnet costs?

Answer: Generally, this is true. However, structural considerations may prevent the placement of permanent magnets at preferred positions.

Question: Are there available quantitative data which indicate the degree to which magnet position influences the efficiency of a circuit?

Answer: A brief experiment was conducted on the nature and magnitude of the changes that occur when magnets are placed in various positions in a simple magnetic circuit. The results are discussed in *Applied Magnetism*, Vol. 3, No. 5.

World's largest permanent magnet separates electron particles

The largest and most powerful permanent magnet ever designed is an important part of a new Mass Spectrometer to be used for high molecular weight hydrocarbon



Indiana's C. A. Maynard inspects air gap of giant Alnico V magnet assembly

analysis at the Whiting, Indiana, research and development laboratories of a large Midwestern oil company. Function of the spectrometer is to establish a strong magnetic field that separates electron particles.

The Alnico V permanent magnet used in the assembly has a maximum field strength of 6,000 gauss . . . equal to 10 tons of magnetic holding force . . . and weighs 1,300 pounds. The complete assembly, which weighs approximately 4,700 pounds, was designed and fabricated by The Indiana Steel Products Company, Valparaiso, Indiana.

THE INDIANA STEEL PRODUCTS COMPANY
VALPARAISO, INDIANA

THE WORLD'S LARGEST MANUFACTURER
OF PERMANENT MAGNETS

INDIANA
PERMANENT
MAGNETS

In Canada . . . The Indiana Steel Products Company of Canada Limited, Kitchener, Ontario

DESCRIPTIVE DATA

- **SIZE:** 1 inch diameter x 2¼ inches long
- **WEIGHT:** 3.8 ozs.
- **FULL SCALE RANGE:** 40 to 400 degrees/second
- **LINEARITY:** 0.1% of full scale to ½ range, within 2% to full range
- **RESOLUTION:** 0.01% full scale
- **DAMPING:** Fluid damped, temperature compensated
- **PICKOFF:** Variable Reluctance type, 400 - 6,000 cps
- **MOTOR EXCITATION:** 6.3 volts - 400 cps, 26 volts - 400 cps, 9 volts - 1,000 cps

Putting the sting exactly where it belongs

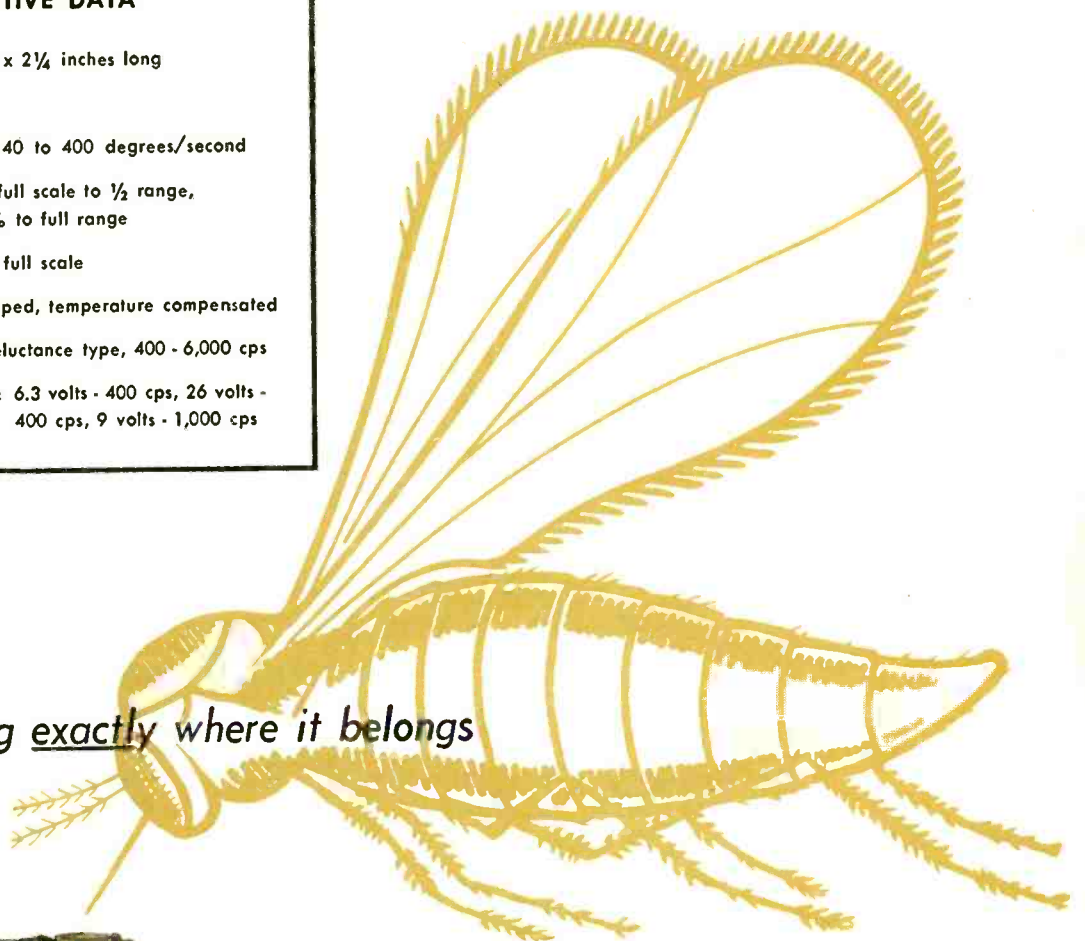

GOLDEN GNAT

Miniature Rate Gyros for Missiles and Aircraft

Here is a precision, miniature rate gyro. It's tiny . . . measures only 1 inch in diameter and 2¼ inches in length. It's rugged . . . withstands 100G shock and 10G vibration to 2,000 cps. It has a record of proven performance.

Even under the most severe environmental conditions the Golden Gnat will perform as required. To make this possible many unique design details have been incorporated. One such detail is the Gnat's *gold plated* steel housing for improved corrosion resistance and positive hermetic sealing.

Wherever the need exists for high performance miniature rate gyros such as for autopilot stabilization in missiles and aircraft, antenna stabilization and fire control applications, the Golden Gnat is ideally suited. Write for Bulletin GN . . . Minneapolis-Honeywell, Boston Division, Dept. 7, 1400 Soldiers Field Road, Boston 35, Mass.



Gnat Rate Gyro
Shown actual size

MINNEAPOLIS
Honeywell 
B O S T O N D I V I S I O N



MINIATURE SELENIUM RECTIFIERS BY WESTINGHOUSE

longest expected...

...life rate in the industry.....

From 60,000 to 100,000 operating hours . . . that's the rated life you can expect from highly-reliable miniature selenium rectifiers by Westinghouse.

Made by superior vacuum evaporation deposit process, Westinghouse selenium rectifiers are ideally suited for high gain magnetic amplifier circuits, sensing devices, computers, high voltage, low-current power supplies . . . and many other applications requiring rectifiers with exceptionally low reverse current, minimum unforming and long life.

No matter what your needs . . . 6 to 100,000 volts . . . from a few micro-amps to 50 milliamps . . . stacks, cans, or cartridges in a variety of configurations . . . Westinghouse has the miniature rectifier to meet your specific requirements.

Just call your Westinghouse sales engineer.

J-22065

YOU CAN BE SURE...IF IT'S

Westinghouse



*"These transistors
are unusually
high quality"*

*"Yes, sir. We're buying
Bendix now"*

For better transistors at low cost . . .

TRY BENDIX HIGH GAIN POWER TRANSISTORS

If you are in design, project, or research and development, Bendix Transistors can mean much to you and your job. The enthusiastic endorsements of other engineers show that Bendix Transistors help in these six ways: (1) High power and current gain; (2) Low leakage; (3) Life stability; (4) High break-down voltage; (5) Low thermal resistance; (6) Linear temperature variation.

The extra quality at no extra cost stems from our transistor program. Here, the simplified design *increases dependability* and also *cuts costs*. The component parts and materials—all exceeding specification requirements by a sizeable margin—*provide extra performance capability*. Our close quality control uses Bendix-developed methods and instruments to assure uniformly dependable quality. And improved manufacturing techniques at high-volume level make for *better transistors at low cost*.

Write us now for complete details or for help with your circuitry problems. SEMICONDUCTOR PRODUCTS, BENDIX AVIATION CORPORATION, LONG BRANCH, NEW JERSEY.

LARGE SELECTION OF POWER TRANSISTORS FOR MANY DIFFERENT APPLICATIONS

Type Number	Primary Application	Max. Collector Voltage	Max. Collector Current	Thermal Resistance	Collector Dissipation	Current Gain B at Ic	Power Gain at Max. Power Out	Max. Undistorted Power Out
		Vdc	Adc	°C/W	W ^a at °C ^b	— Adc	db	W
2N234 2N234A	Audio Amp.	30 Vce	3	1.5	7.5 75	25 0.5	30	2
2N235 2N235A	Audio Amp.	40 Vce	3	1.5	7.5 75	50 0.5	36	2
2N236 2N236A	Audio Amp.	40 Vce	3	1.5	10 80	40 0.75	35	4
2N285 2N285A	Audio Amp.	40 Vce	3	1.5	5 85	150 0.5	39	2
2N399 ^d	Push Pull Amp.	40 Vce	3	1.5	7.5 75	40 0.75	33	8 ^c
2N400	Audio Amp.	40 Vce	3	1.5	18 60	80 1.3	35	6
2N401 ^d	Push Pull Amp.	40 Vce	3	1.5	7.5 75	40 0.5	30	5 ^c
2N420 2N421 ^e	High Current Switch	40 Vce	5	1.5	10 80	50 4.0	—	—

^a—Each transistor
^b—Mounting-base temperature
^c—Output power using two transistors in push-pull
^d—Supplied in matched pairs
^e—Missile transistor with collector solder lug

VOLUME PRODUCTION ASSURES IMMEDIATE DELIVERY

Red Bank Division



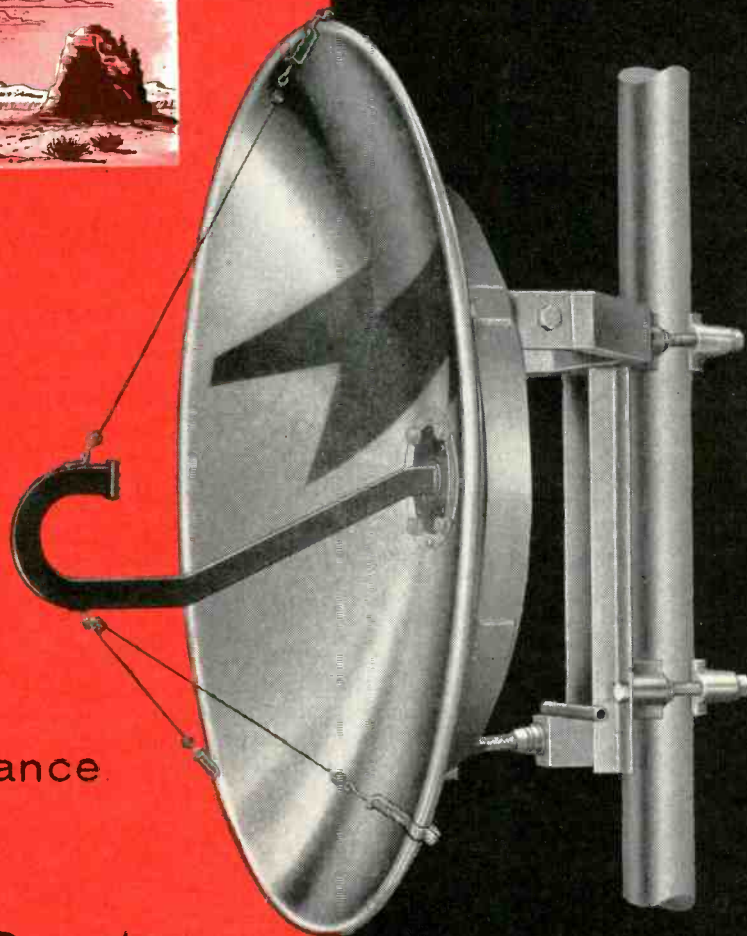
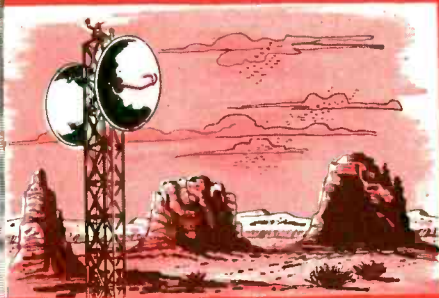
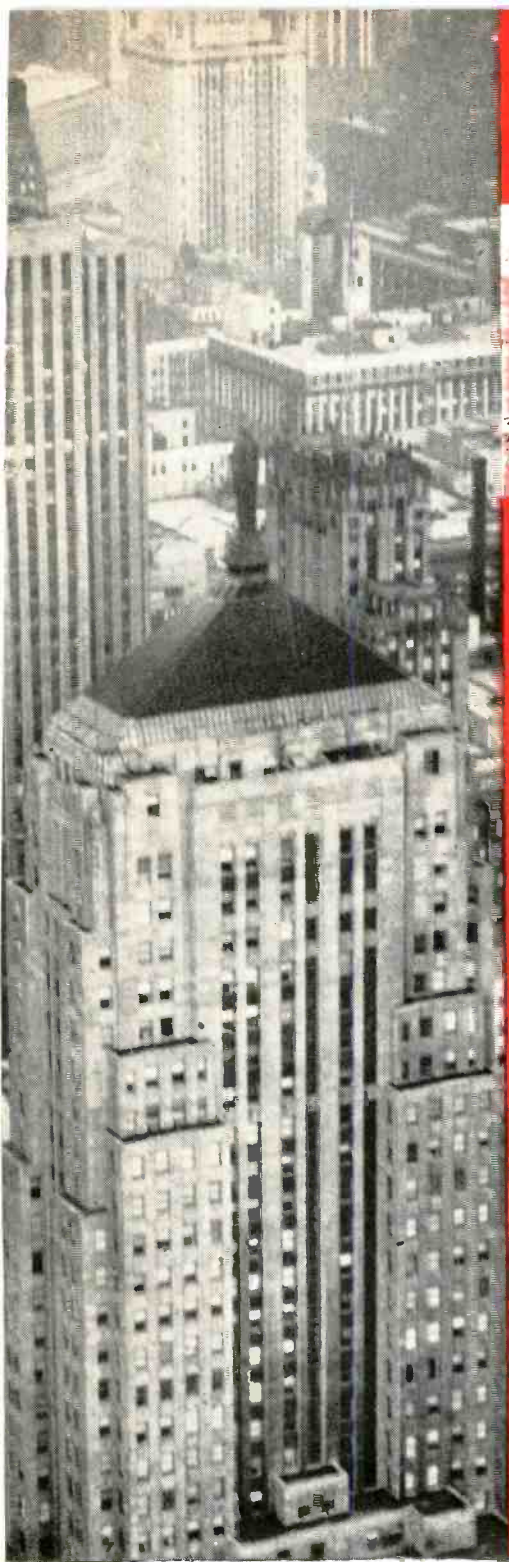

Proved
Performance
for
Cross Country
Microwave



PARABOLIC
ANTENNAS

This busy metropolitan area is the termination of over 1000 miles of microwave systems, providing reliable communications across town and country for the Western Union Telegraph Company. ANDREW's experience in research, development and manufacturing is the reason why the dependable performance of an ANDREW PS8-37, eight-foot Parabolic antenna was selected for this installation.

All ANDREW parabolic antennas conform to the newly proposed RETMA-FCC standards governing radiation patterns and side lobes, and they are *guaranteed* to give specified pattern and VSWR in your microwave system.

From a selection of over thirty stocked parabolic antennas, you can choose the type and size that will give optimum system performance with

absolute mechanical and electrical reliability.

Microwave engineers have found ANDREW a valuable partner in planning their communication systems. A parabolic antenna computer for calculating system performance is available to you upon request. Write today for information and expert advice relative to your microwave antenna system requirements.

Andrew

CORPORATION 363 EAST 75TH STREET • CHICAGO 19

ANTENNAS • ANTENNA SYSTEMS
TRANSMISSION LINES

OFFICES: NEW YORK • BOSTON • LOS ANGELES • TORONTO

www.americanradiohistory.com

R-B-M Miniature Multipole Relays of Proven Reliability

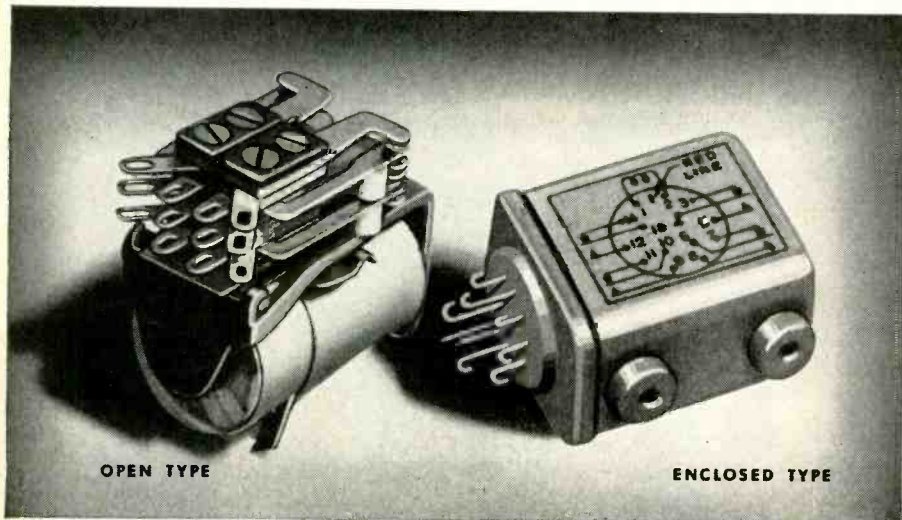

OPEN TYPE

ENCLOSED TYPE

Light weight, Small Size Open and Hermetically Sealed Types for Electronic and Communication Application

APPLICATION: R-B-M Miniature Multipole Relays are used where the prime factors in switching electronic circuits are small size, light weight and reliability. These proven designs are produced for switching low power circuits, low capacitance circuits and power circuits. 125° C insulation now available on some versions. Coils can also be designed for plate circuit.

CONSTRUCTION:

Magnet Frame—Four sizes available on open type relays and three sizes on hermetically sealed type.

Contacts—Cross-bar palladium welded to nickel silver springs or button contacts on Beryllium copper springs.

Terminals and Mountings—Glass headers provided with either solder or plug-in type terminals with many various types of mountings available. Octal type plug-in headers can be provided on the HL enclosure. Plug-in terminals to fit either 9 or 14 pin standard sockets. Maximum of 14 pins for solder connections.

TYPICAL SPECIFICATIONS *

Open	Maximum Coil Resistance (OHMS)	Minimum Power Requirements Per pole at 25° C (WATTS)	Maximum Contact Form With rated current at 32 V.D.C. or 115 V.A.C. (non-inductive load)	Maximum Coil Watts	Enclosed
SM	9,000	.2	4 PDT 5 Amps. or 3 Amps. 6 PST 3 Amps.	3.75	HSM
SMD-2	9,000	1.0	SPNO Parallel Contacts Make 80 Amps. Break 20 Amps. at 32 V.D.C.	3.75	HSMD-2
SC	18,500	.16	4 PDT 5 Amps. or 3 Amps. 6 PST 3 Amps.	4.5	HPSC
SA	18,500	.14	4 PDT 5 Amps. or 3 Amps. 6 PST 3 Amps.	4.5	HLSA
SM-RF	9,000	.2	SPNO, SPDT, DPNC, SPNC, DPNO	3.75	HSM-RF HLSM-RF
SAD-2	18,500	1.0	SPNO Parallel Contacts Make 80 Amps. Break 20 Amps. at 32 V.D.C.	4.5	HLSAD-2

*Other ratings and specifications available.

For additional information write for Bulletin No. 1050



RBM DIVISION

Manufacturers of Magnetic Controls and Devices / LOGANSPORT, INDIANA

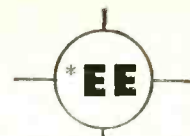

other outstanding
*ESSEX ENGINEERED
production proven products

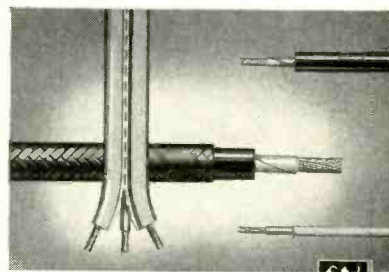

WIRE AND CABLE

A full "Extra Test" line of lead, appliance, automotive and refrigeration wires, plus submersible pump cable and 200° C. Sil-X insulations are examples of the versatility of "Essex Engineering".

Wire and Cable Division
Fort Wayne, Ind.

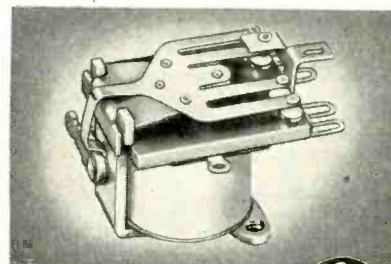

MINIATURE RELAYS

The Type MS Miniature Sensitive Relay is ideal for any application requiring a compact, highly reliable single pole D. C. device, where a low cost solution is required because of volume usage and competitive problems. Request Bulletin No. MS-1.

R-B-M "Control" Division
Logansport, Ind.

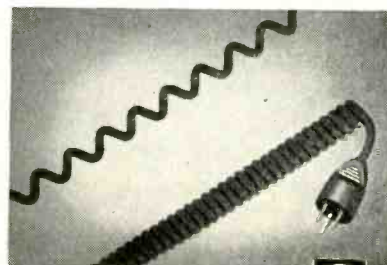

COILED CORDS

The "spring" in Coiled Cords automatically synchronizes with moving components that are electrically powered. There are no looping, tangling cords in the way... because Coiled Cords extend and retract as needed. Write for new literature.

Cords Limited Division
DeKalb, Ill.





MODEL 372 SLIDING COAXIAL TERMINATIONS

This equipment, available only from Narda, provides the most convenient means for evaluating the residual VSWR of coaxial slotted lines. VSWR of the element is 1.05 or less; covers range from 2000 to 12,400 mc.

N Connector, male or female \$110 C Connector, male or female \$116



MODEL 371 FIXED COAXIAL TERMINATION

This Narda coaxial termination is the first and only to cover the entire frequency range from S to X band. Same range and element VSWR as above.

N Connector, male or female \$55 C Connector, male or female \$58

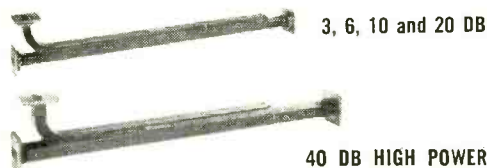

3, 6, 10 and 20 DB

40 DB HIGH POWER

HIGH DIRECTIVITY COUPLERS

The 40 db High Power Coupler is another exclusive Narda product. Similar to standard types, except that coupling irises are in the narrow wall, it may be used at full rated power of the waveguide size. Nominal coupling value is 40 db; directivity 40 db. Directivity for 3, 6, 10 and 20 db couplers is also 40 db. Standard cover flanges on primary line; low VSWR termination and standard cover flange on secondary. All bands covering frequencies from 2600 to 18,000 mc.



STANDARD REFLECTIONS

Narda offers five values of reflections for each of six different waveguide sizes... the most complete choice we know of! Provides calibrated reflections or VSWR's for use in standardizing reflectometers or calibrating slotted line impedance meters.

SPECIFICATIONS

Reflection Coefficient	0.00	0.05	0.10	0.15	0.20
Accuracy	0.002	0.0025	0.0035	0.0045	0.007
VSWR Equivalent	1.00	1.105	1.222	1.353	1.50

Models for 2.60 to 18.0 kmc, from \$125 to \$300

Microwave engineers—

Where can you use these exclusive features offered by narda?

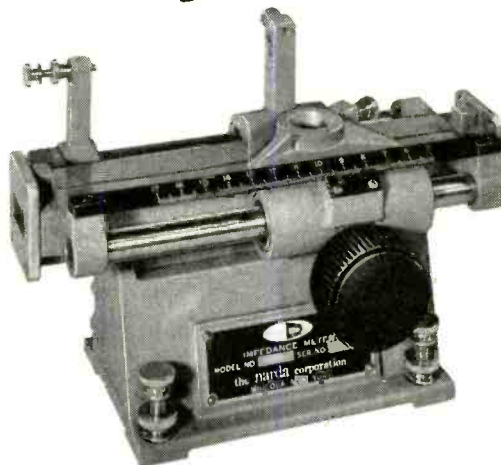

Waveguide and Coaxial IMPEDANCE METERS

Exclusively in Narda Waveguide and Coaxial Impedance Meters, the carriage mounting and drive mechanism are integral with the precisely machined transmission line casting. This insures permanent accuracy and freedom from slope errors—no more tedious adjustment or possibility of misalignment.

Other features include angle-mounted scale and vernier for optimum visibility; readily removable supporting pedestal; and smooth carriage travel action. Waveguide models, accurate for VSWR's of 1.01, are available for complete coverage from 2600 to 18,000 mc; N or C Connector coaxial models, from 1500 to 12,400 mc.

WAVEGUIDE IMPEDANCE METERS

Frequency (kmc)	Narda Model	Residual VSWR	Price
2.6 — 3.95	224	1.01	\$425
3.95 — 5.85	223		350
5.3 — 8.2	222		325
7.05 — 10.0	221		270
8.2 — 12.4	220		250
12.4 — 18.0	219		270

COAXIAL IMPEDANCE METERS

Frequency (kmc)	Connectors (One Male, One Female)	Narda Model	Price
1.5 to 12.4	Series N	231	\$360
1.5 to 12.4	Series C	232	390

Complete Coaxial and Waveguide Instrumentation for Microwaves and UHF—including:

DIRECTIONAL COUPLERS
TERMINATIONS
FREQUENCY METERS
HORNS

TUNERS
ECHO BOXES
SLOTTED LINES
BENDS

ATTENUATORS
STANDARD REFLECTIONS
BOLOMETERS
THERMISTORS

MAIL COUPON TODAY FOR
FREE CATALOG AND NAME OF
NEAREST REPRESENTATIVE

The Narda Microwave Corporation
160 Herricks Road
Mineola, N. Y.
Dept. E-1



NAME _____

COMPANY _____

ADDRESS _____

CITY _____ ZONE _____ STATE _____

 the narda
microwave corporation

160 HERRICKS ROAD, MINEOLA, N. Y. • PIONEER 6-4650

New, revolutionary Wedge Action

MARK II RELAY

Specifications:

- Operating Vibration ... 5 to 2000 cps, 30 G's
- Contact Rating ... Dry Circuit to 2 amps
- Contact Arrangement ... 6 pole double throw
- Ambient Temperature ... -65°C. to $+200^{\circ}\text{C.}$
- Contact Bounce ... None
- Operating Shock ... 100 G's

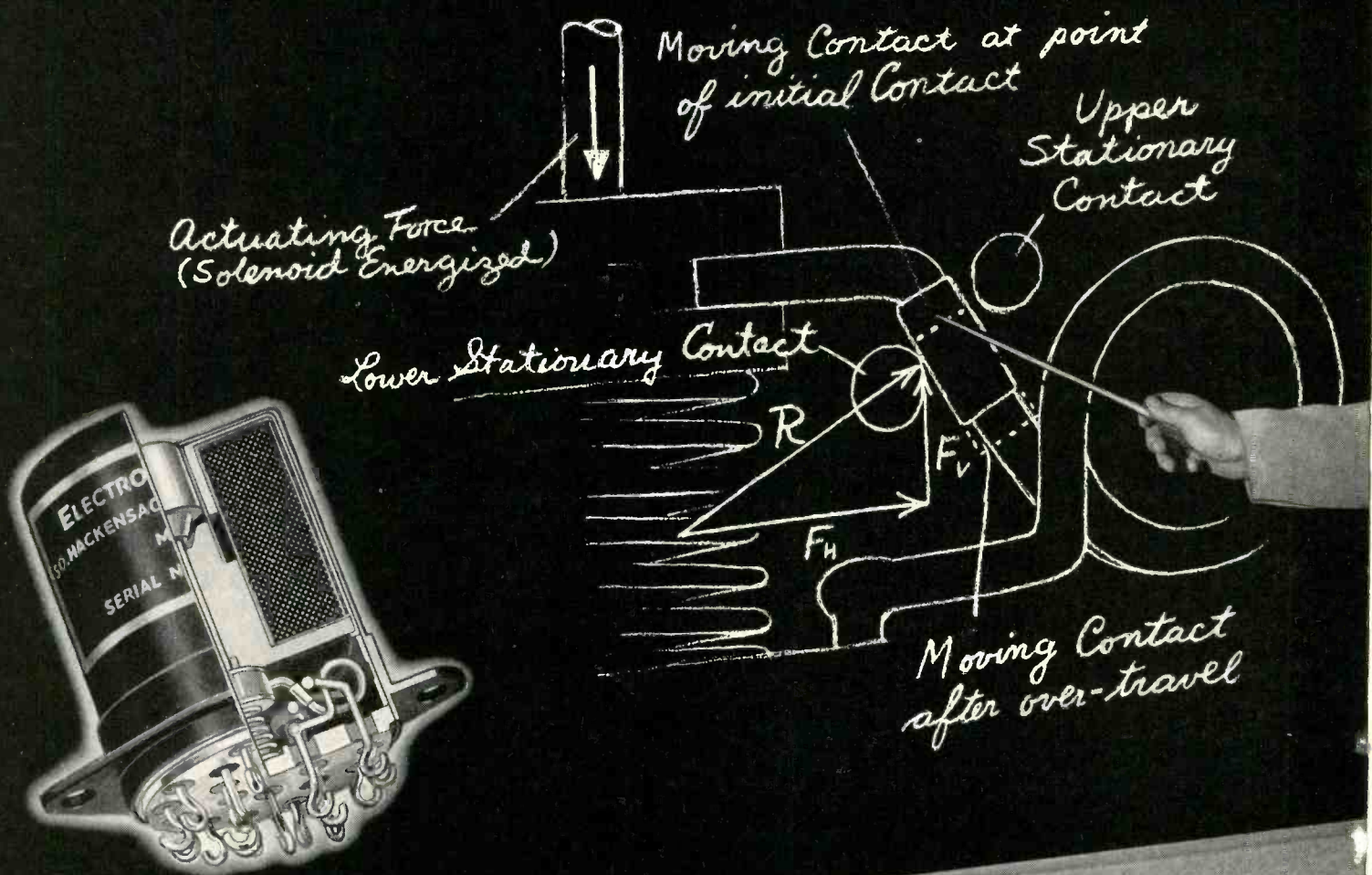

Relay announced by **ELECTRO TEC!**



Now In Production!

NEW MARK II RELAY

AIDS ULTRA-RELIABILITY

under most extreme environmental and operating conditions.

(See specifications, left)

NOVEL WEDGE ACTION SWITCHING

provides positive contact in both energized and de-energized conditions.

Contact pressure constantly *increases* during over-travel.

Wedge Action now supersedes "Wiping Action".

- Removes contaminants from contact surfaces.
- Reduces resistance to micro-level currents.
- Renders relay extremely resistant to shock and vibration.

BRIEF DESCRIPTION: Six pole. Double-throw Miniature unit. Hermetically sealed. Meets and exceeds specifications MIL-R-5757C and MIL-R-25018.

Designers of critical modern electronic equipment, where ultra-reliability is vital, are invited to write—or *wire collect*—for further details on this entirely new and original high-performance relay concept.

Mark II Relay performance is based on an outstanding combination of extremely careful selection of precious metals and other component materials; novel—and exhaustively *proven*—structural design; unique precision production processes, exclusive to Electro Tec.

Mark II Relay Folder, or Engineering Departmental Services, available on request.

ELECTRO TEC CORP.

South Hackensack, N. J.



Products of Precision Craftsmanship

PATENTS PENDING

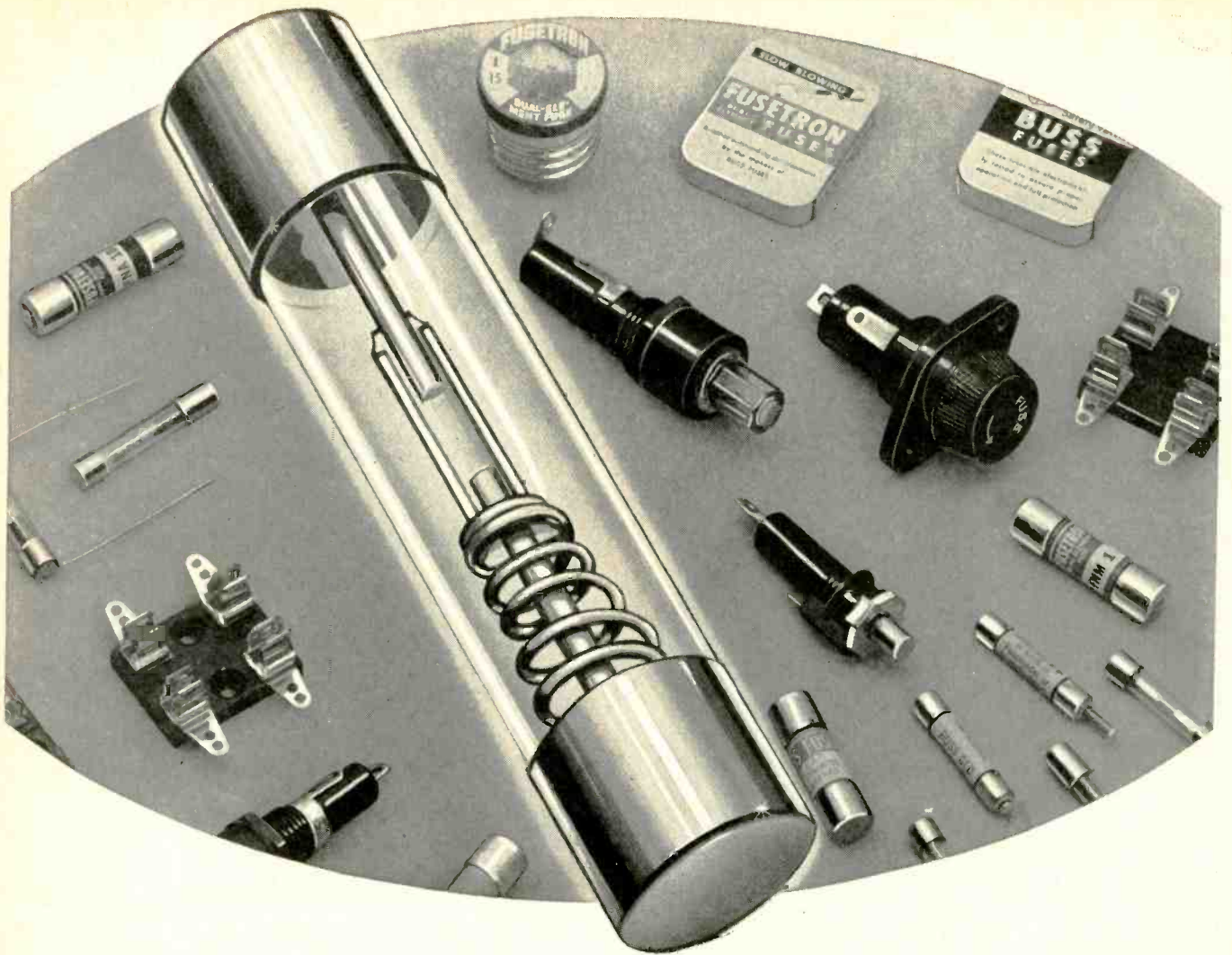

Save Time and Trouble by Standardizing on BUSS Fuses

YOU'LL FIND THE RIGHT FUSE EVERYTIME... IN THE COMPLETE BUSS LINE

By using BUSS as your source for fuses, you can quickly and easily find the type and size fuse you need. The complete BUSS line of fuses includes: dual-element (slow blowing), renewable and one-time types . . . in sizes from 1/500 amp. up — plus a companion line of fuse clips, blocks and holders.

**BUSS TRADEMARK
IS YOUR ASSURANCE OF FUSES OF
UNQUESTIONED HIGH QUALITY**

Over the past 43 years, millions upon millions of BUSS fuses have operated properly under all service conditions.

Thus, BUSS fuses have earned a reputation for accurate and dependable electrical protection.

To make sure this high standard of dependability is maintained . . . BUSS fuses are tested in a sensitive electronic device. Any fuse not correctly calibrated, properly constructed and right in all physical dimensions is automatically rejected.

SHOULD YOU HAVE A SPECIAL PROBLEM IN ELECTRICAL PROTECTION . . .
The BUSS fuse engineers are at your service—and in many cases can save

you engineering time by helping you choose the right fuse for the job. Whenever possible, the fuse selected will be available in local wholesalers' stocks, so that your device can be serviced easily.

Before your final design is crystallized, be sure to get the latest information on BUSS and FUSETRON Small Dimension fuses and fuseholders . . . Write for bulletin SFB. Bussmann Mfg. Division McGraw-Edison Co., University at Jefferson, St. Louis 7, Mo.

BUSS fuses are made to protect — not to blow, needlessly



MAKERS OF A COMPLETE LINE OF FUSES FOR HOME, FARM, COMMERCIAL, ELECTRONIC, AUTOMOTIVE AND INDUSTRIAL USE.

How magnetic tape converts blueprints to parts

From numbers to metal without templates or models

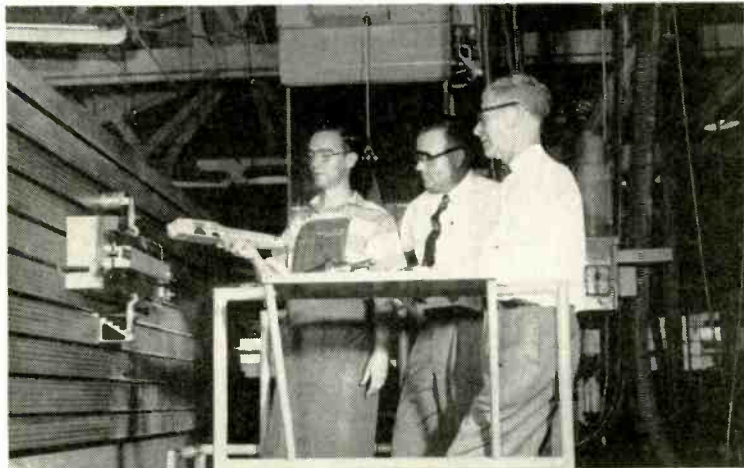

Photo Courtesy of Lockheed Aircraft Corporation

This part was made with "production tooling" that cost less than conventional machining on a single sample. The "tooling" was a reel of magnetic tape programmed from blueprints by computer and electronic director. In a kind of machine-shop black magic, the part sprang into being on a Giddings and Lewis Numerically Controlled Milling Machine. Much larger parts are also similarly made on this same mill.

NOW AT WORK IN ACTUAL PRODUCTION

This is not just a futuristic experiment. A commercial version has been delivered to a number of manufacturers. The first, at Lockheed Aircraft Corporation, produced 96 different complex parts in its second month of operation. Lockheed is using the tape-controlled mill to improve tolerances, eliminate human error and cut machining costs — often by over 50% (\$21.32 versus \$69.50 per part on one item). It is used for cams, templates and other intricate tooling — also for production parts on Lockheed's supersonic F-104 "Starfighter."

From initial experience at Lockheed, tape-controlled machining shows promise of reducing lead time from drawing board to production of parts by 60 to 70 percent. Since the "complete sets of tooling" are reels of tape, they can be stored as neatly as a row of books. Additional production runs can be made with a minimum of setup.

Earlier, at the Giddings and Lewis factory, tape-controlled milling was used to make one-of-

a-kind cams and templates for tracer-controlled machines. Cost on a competitive bid basis was less than 50% of that for same work by conventional means. Ironically, this intricate tooling is what numerical control will eliminate wherever it supplants tracer-controlled machines.

A SIMPLE WAY TO HANDLE A MILLION COMMANDS

For the numerically controlled mill, magnetic tape provides 200 commands per second, each defining exact tool positions in three linear coordinates (angular coordinates too, on some).

A minimum signal commands only 0.000125 inch of tool motion. One reel of tape programs up to 1½ hours of machine time.

These closely spaced commands are ideal for a self-correcting system of servo controls. Also they eliminate need for expensive computing and interpolating equipment at the individual machine. Centralized programming can make tapes for many machines and is not tied to the time-consuming repetitions of actual production.

With its fourteen tracks, a one-inch magnetic tape has ample reserve for extra functions. Six are used for tool-position coordinates. The others control start, stop, coolant, and even voice instructions for impending tool change. Tracks can even be shared by several functions, allowing still further expansion.



Control tape on an Ampex FR-100 can hold over 1 million commands for each axis of tool movement

We will be glad to furnish more facts on magnetic tape recording and its use in machine tool control. Write Dept. E-8.

MAGNETIC
TAPE
APPLICATIONS
BY AMPEX

ONE OF A SERIES
8



Series FR-100



Series 800 Mobile
and Airborne



Model FR-200
Digital



Series FL-100
Loop Recorders



Series FR-1100

INSTRUMENTATION
DIVISION

AMPEX
CORPORATION

FIRST IN MAGNETIC TAPE INSTRUMENTATION

934 CHARTER STREET · REDWOOD CITY, CALIFORNIA

District offices serving all areas of the United States and Canada; Foreign Representatives in countries around the world.

new

BACK-MOUNTING TEST JACKS
permit bench soldering to wiring
harness before mounting.

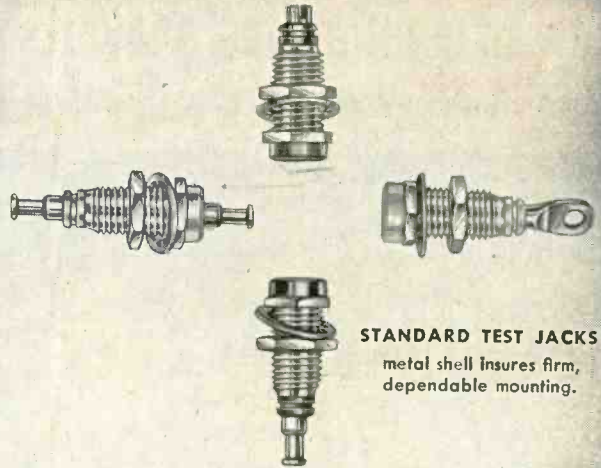
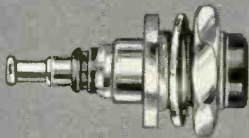
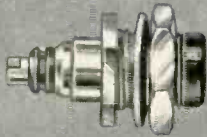
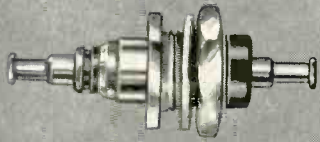

STANDARD TEST JACKS
metal shell insures firm,
dependable mounting.

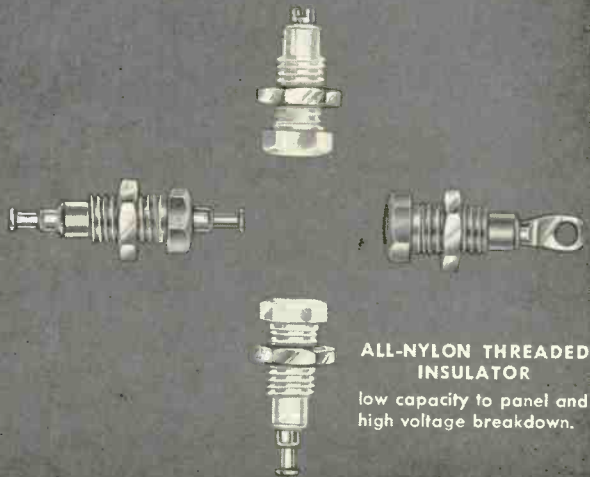

**ALL-NYLON THREADED
INSULATOR**
low capacity to panel and
high voltage breakdown.

Test Jacks by Ucinite

The introduction of Ucinite's back-mounting jacks makes available for the first time a *complete* line of *high quality* test jacks suitable for use in equipment where long life and dependability are essential.

Ucinite Test Jacks, designed for standard .080 phone tips, are available in a variety of colors ideally suited to coded application. Silver-plated, heat treated beryllium copper contact is made in one piece with large terminal ends for easy solder-

ing. The feed through type is provided with a one-piece brass terminal stud, tin-plated.

The specialized abilities and experience of Ucinite's own staff of design engineers are available for work on new and unusual problems. Volume production facilities ensure fulfillment of the largest requirements.

For full information, call your nearest Ucinite or United-Carr representative or write directly to us.



**The
UCINITE CO.**

Newtonville 60, Mass.

Division of United-Carr Fastener Corp.

**Specialists in Electrical Assemblies,
Radio and Automotive**



THREAD CUTTING FASTENER HOLDS TIGHT TO CURVED SURFACES

- Low Cost
- Re-Usable
- Self-Locking
- Vibration-Proof
- Spring Take-Up

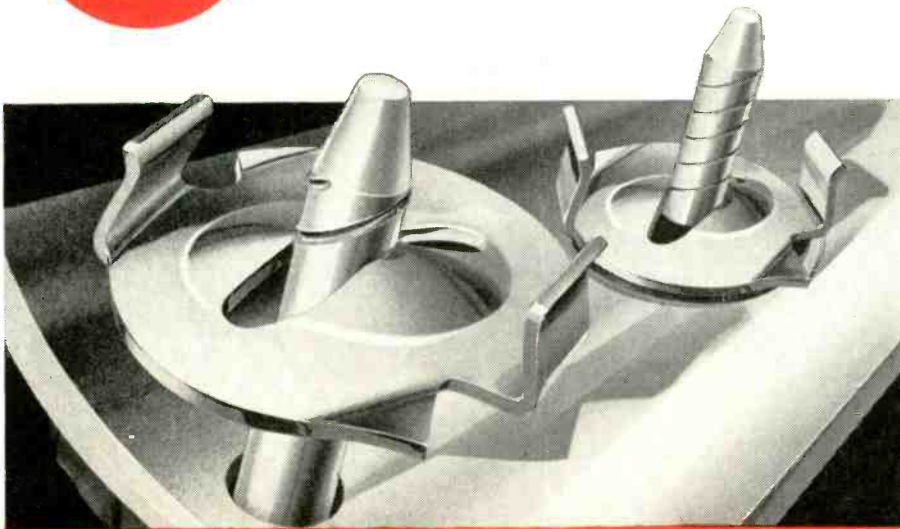

Specially designed to hold die-cast or cold-forged name plates, emblems and trim against sheet metal surfaces . . . DOT'S unique T.C.F. can be used in many other applications which require a spring take-up fastener that pulls up tight without backup on flat or contoured surfaces.

It cuts clean, deep threads on unthreaded studs, even those that are chrome plated. When used with its preassembled plastic sealer, T.C.F. makes a water-tight seal. The sealer precedes the fastener onto the stud so that it is not damaged by the thread-cutting process.

Available in quantity, with or without sealer, to fit 1/8" and 3/16" studs. Drawings available on request for magnetic tool or simple hand tool.

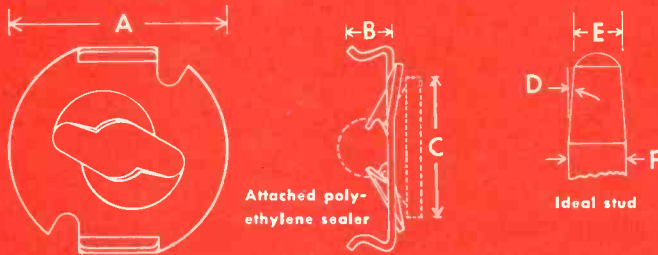
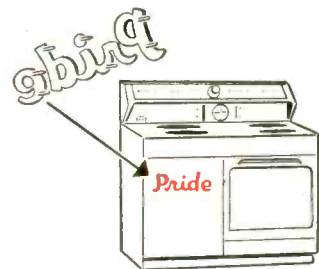
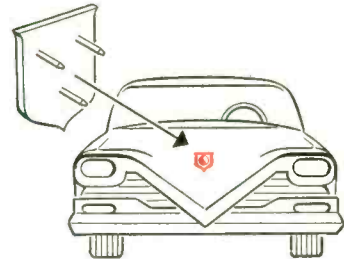
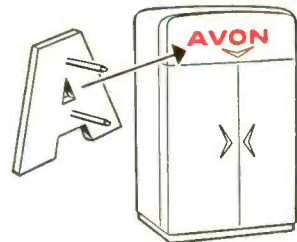

Nominal Sizes	A	B	C	D	E	F	Driving Torque	Ultimate Strength
1/8"	.560	.170	.450	6°/4°	.095 .085	.130 .125	7-10 Inch lbs.	200 lbs.
3/16"	.705	.200	.450	6°/3°	.160 .150	.192 .184	20-30 Inch lbs.	400 lbs.
1/4"	.875	.260	.625	6°/4°	.190 .180	.255 .245	25-30 Inch lbs.	500 lbs.

Manufactured by
MONADNOCK MILLS SUBSIDIARY
San Leandro, Cal.



Manufactured by
CARR FASTENER CO. DIVISION
Cambridge, Mass.

UNITED - CARR FASTENER CORPORATION

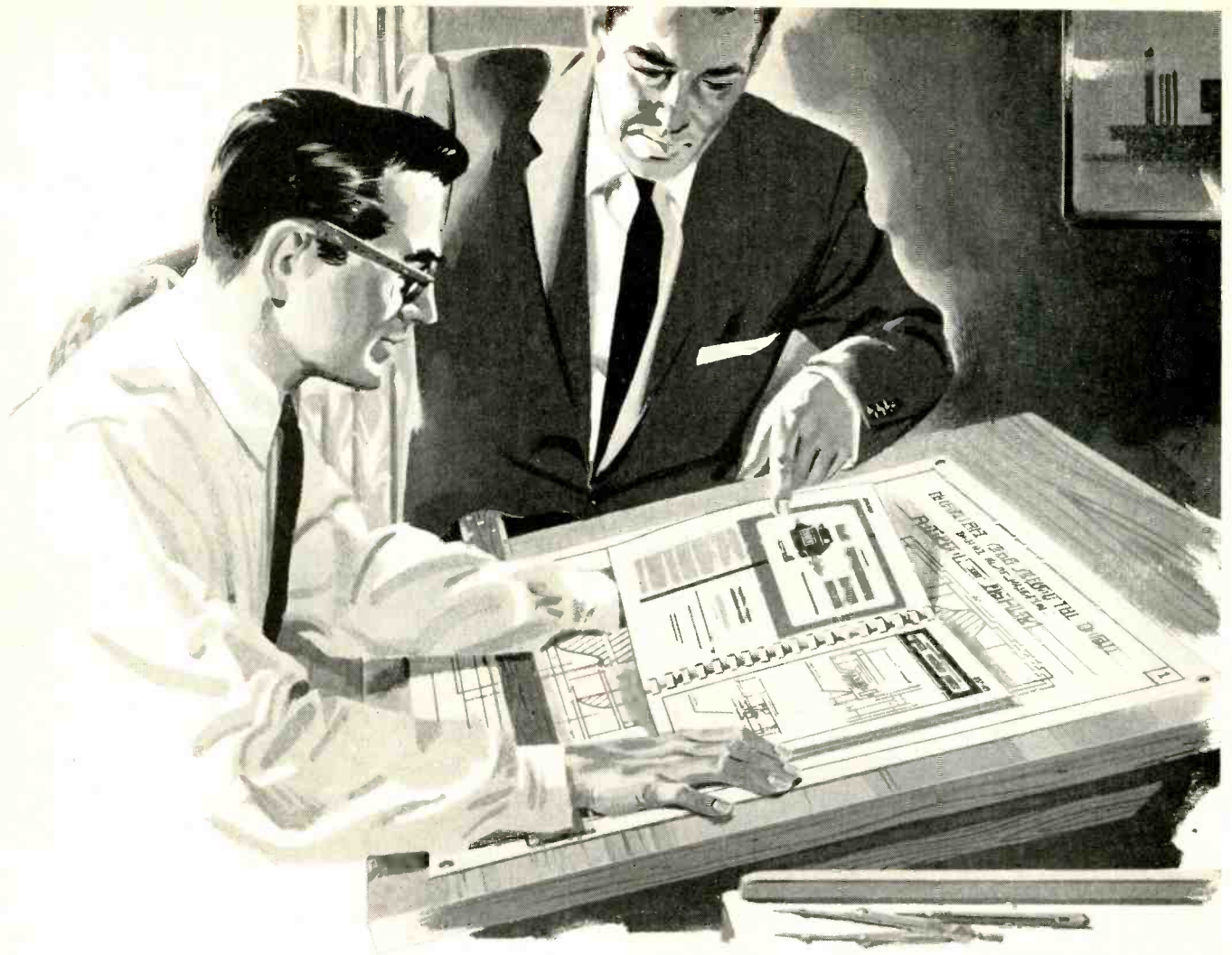

Here's why it pays to CALL FOR HELP
... first thing instead of last

If you want to do anything "by the numbers," first thing to do is call the No. 1 man . . . your Veeder-Root District Engineer. Because he's an *original thinker* like yourself when it comes to designing or building *Control* into any type of product or process.

He knows his book on the most complete line of standard electrical, mechanical and manual counters made anywhere in the world. And from this line he can very likely adapt or modify a standard counter to your special needs. This saves cost and time in engineering, purchasing, assembly.

And you get a lot of new user-benefits to merchandise . . . direct readings, rather than dials and scales . . . remote indication from plant to office if needed . . . production figures that serve as a fair base for wage and incentive payments, production and stock *Control*, tax computation . . . and as proof of your own performance guarantee. So call the V-R man in, *when you begin* . . . look him up in your local phone book, or write direct to:

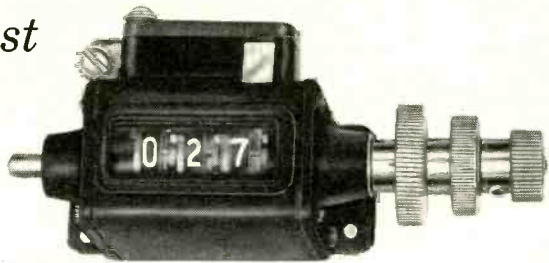

VEEDER-ROOT INC., Hartford 2, Connecticut

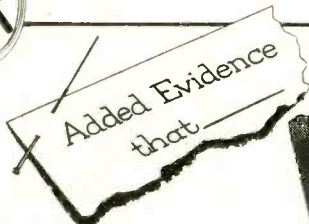

Everyone Can Count on
VEEDER-ROOT

Hartford, Conn. • Greenville, S. C. • Chicago • New York • Los Angeles • San Francisco • Montreal • Offices and Agents in Principal Cities

GIANT SIZE POWER IN PINT-SIZE PACKAGES

Power Supplies in modern airborne radar systems must be as small and light as possible . . . because every pound of weight is reckoned in thousands of dollars. AMP engineers utilized AMPLI-FILM® (the dielectric with the strength of a giant) to develop the miniaturized power supplies shown below.

KEEP ALIVE POWER SUPPLY Part No. 851069

Input.....115 V.—400 CPS
Output.....900 V. D.C.
Ripple.....4 V.
Regulation.....40% (zero to full load)

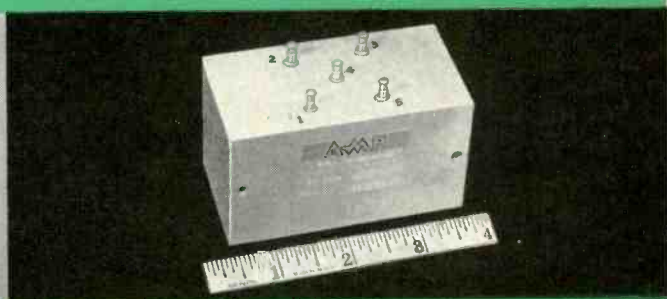

INDICATOR POWER SUPPLY Part No. 851066

Input.....115 V.—400 CPS
Output.....Multiple regulated outputs
to suit #6866 cathode ray
memory tube.



MODULATOR POWER SUPPLY Part No. 851070

Input.....115 V.—400 CPS
Output.....3.5 KV. D.C.
Ripple.....39 V.
Regulation.....25% (zero to full load)

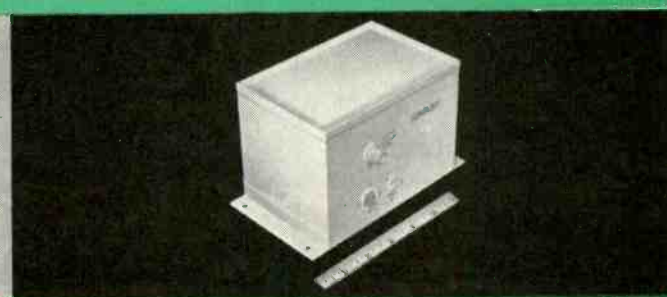

Write for information on standard power supplies
or special designs for your unusual requirements.

AMP INCORPORATED



CHEMICALS AND DIELECTRICS DIVISION
155 Park Street, Elizabethtown, Pennsylvania

Wholly Owned Subsidiaries: Aircraft-Marine Products of Canada Ltd., Toronto, Canada • Aircraft-Marine Products (Great Britain) Ltd., London, England • Societe AMP de France, Le Pre St. Gervais, Seine, France • AMP-Holland N.V.'s-Hertogenbosch, Holland. Distributor in Japan: Oriental Terminal Products Co., Ltd., Tokyo, Japan.

THE ONE UNIVERSAL METER

MICROVOLTS TO KILOVOLTS



The KIN TEL Model 203 is a combination DC microvolt-ammeter and amplifier. It provides an exceptionally wide range of measurements. Fifteen voltage ranges cover from 100 microvolts full scale to 1000 volts full scale, with 100 megohms input impedance. Ten current ranges cover from 100 micro-microamperes full scale to 100 milliamperes full scale. As little as 10 microvolts or 10 micro-microamperes may be measured with accuracy. The uncluttered zero-center meter face instantly indicates polarity on a mirrored scale. When used as a DC amplifier, the instrument features exceptionally low drift with high gain, very high input impedance and low output impedance. Gains up to 80 db with less than 10 microvolts drift may be obtained. The Model 203 utilizes KIN TEL'S unique chopper stabilized circuit to provide high sensitivity with previously unobtainable drift-free stability and high input impedance.

APPLICATIONS: Electronic, medical, geophysical, chemical, metallurgical research and development... transistor production and circuit design... thermocouple calibration... null detector... recorder driver amplifier... and as a general purpose laboratory instrument wherever dc voltage and currents are measured or amplified.

SPECIFICATIONS

Voltage Range (full scale).....	100 μ v to 1000v	Accuracy on All Ranges.....	\pm 3% of full scale
Current Range (full scale).....	100 μ ma to 100 ma	Maximum Gain as Amplifier.....	80 db \pm 1.5%
Input Impedance.....	10 megohms below 10 mv, 30 megohms at 30mv, 100 megohms above 30mv	Output Rating.....	1v across 1000 Ω
Impedance Accuracy.....	\pm 1.5%	Output Impedance.....	less than 5 Ω
		Drift (after 15 min. warmup)....	10 μ v equivalent input
		Price.....	\$550.00

Rack Mounting available as Model 203R



[KAY LAB]

STABILITY  *Locked in!*
WITH CHOPPER AMPLIFIERS

5725 KEARNY VILLA ROAD • SAN DIEGO 11, CALIFORNIA • BROWNING 7-6700

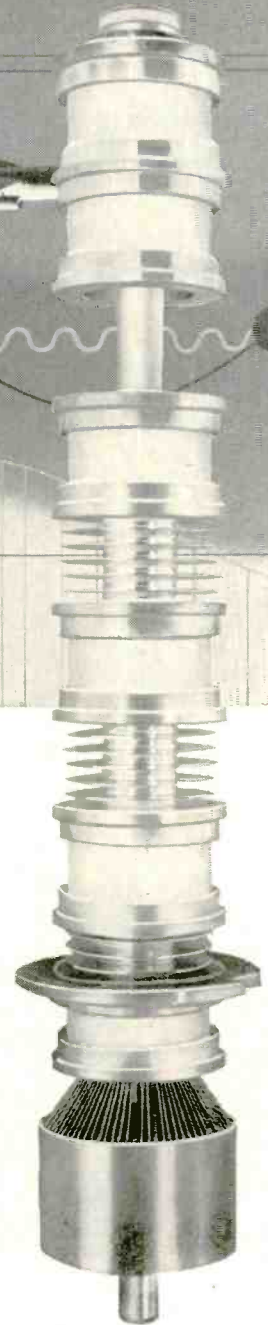
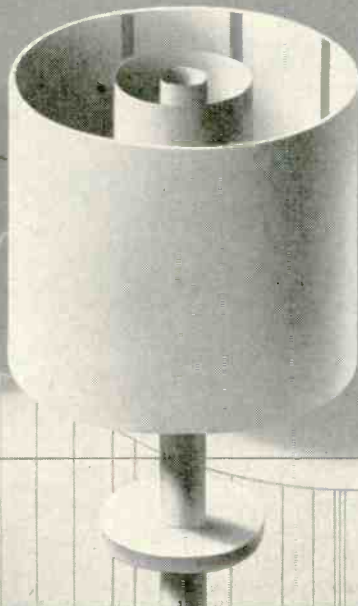

Eimac
3KM2500LT
Modulating
Anode
Klystron

Eimac 3KM2500LT Klystron Meets CAA Civil Tacan Requirements

Shaped RF Pulse, 30kw Peak Power Output for 955-1220 mc Air-Navigational Systems

Now available as a standard Eimac product is the 3KM2500LT (formerly the developmental X676) air cooled, three cavity modulating anode amplifier klystron. The 3KM2500LT delivers 30 kw peak power output in the 955-1220 mc range with a power gain of 35 db and efficiency of 40%.

A typical air navigation systems requirement is a shaped RF pulse output to eliminate spectrum interference in adjacent channels. The Eimac 3KM2500LT meets the 60 db requirement of the CAA's air navigational system without using critically tuned, expensive filters in the RF output transmission line. The modulating anode permits pulsing the beam current while keeping the accelerating voltage constant. Also, the modulator circuit for this application is quite simple. The RF cavities are external to the vacuum system and detachable from the klystron. The user may purchase spare tubes without buying additional tuning and focusing assemblies.

For the design engineer, the features of the 3KM2500LT simplify circuitry — for the equipment operators the 3KM2500LT provides reliable, long-lived performance at moderate cost.

Another addition to the incomparable Eimac amplifier klystron line is the new 3K2500LX which delivers 1000w/cw 980-1200 mc.

EITEL-McCULLOUGH, INC.
SAN BRUNO CALIFORNIA

Eimac First in high power amplifier klystrons



Typical Pulse Operation 3KM2500LT

DC Beam Voltage	24 KV	Power Output	32 KW	Power Gain	35 db
DC Beam Current	3.3 Amps	Driving Power	10 watts	Average Power	1 KW
Power Input	80 KW	Efficiency	40%		

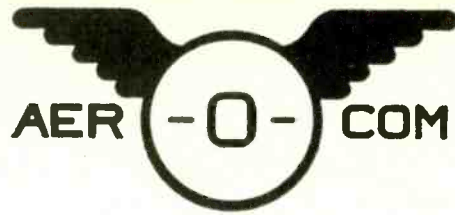

DEFINITELY DEPENDABLE!

Aerocom's Dual Automatic Radio Beacon

Reliability is built into every part of this dual 1000-watt aerophare unit. Ruggedly constructed and conservatively rated, it provides trouble-free unattended service, and at truly low operating and maintenance cost. It operates in the frequency range 200-415 kcs, using plug-in crystal for desired frequency.

Uses single phase power supply, nominal 220 volts, 50 or 60 cycles. Consists of two 1 kw transmitters with keyer (2 keyers if desired), automatic transfer unit and weatherproof antenna tuner. Each transmitter housed in separate standard rack cabinet, with controls in rack cabinet between the transmitters.

Nominal carrier power is 1000 watts. High level plate modulation of final amplifier is used, giving 30%-35% tone modulation. P-T switch interrupts tone, permitting voice operation. Operates in ambient temperatures from -35°C to 50°C, humidity up to 95%.

Standby transmitter is placed in operation when main transmitter suffers loss (or low level) of carrier power or modulation, or continuous (30 sec.) tone. Audible indication in monitoring receiver tells when standby transmitter is in operation.

Antenna may be either vertical tower or symmetrical T type.

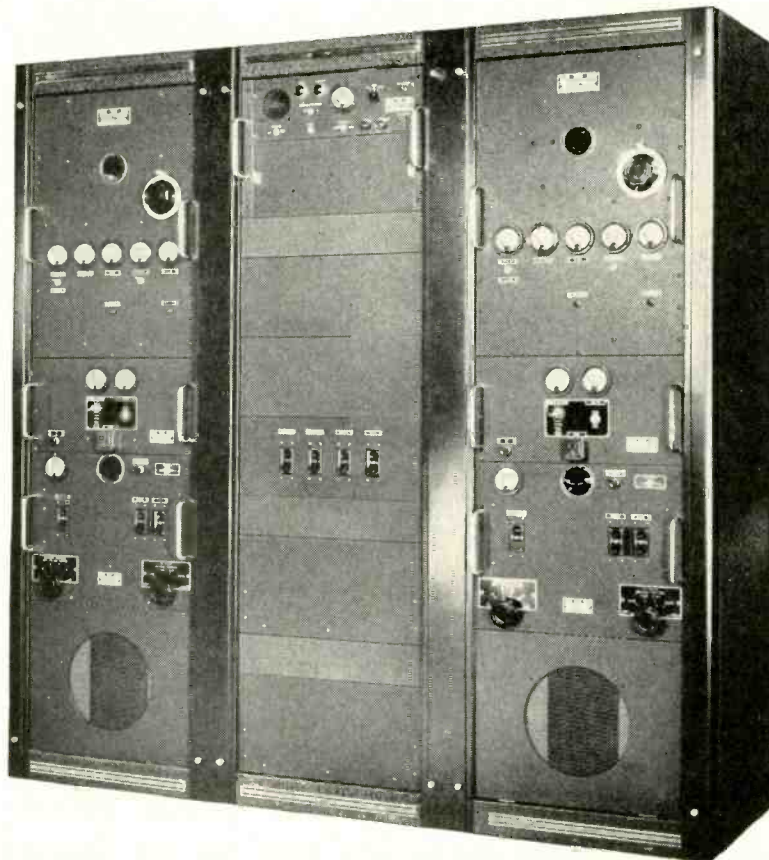

Also available in
50 WATT
100 WATT
and
4 KILOWATT
models

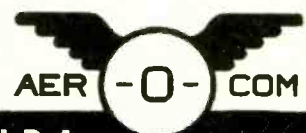
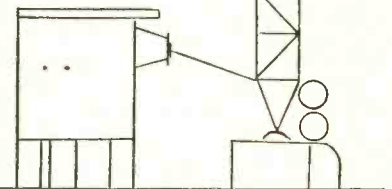

A-101

3090 S. W. 37th AVENUE, MIAMI, FLORIDA

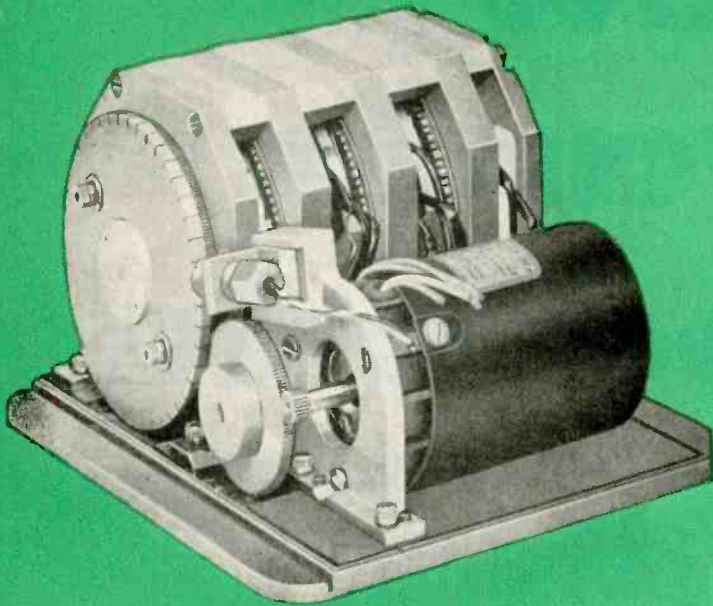

MYCALEX TM Commutation Switch for Telemetry, Using Precision-molded SUPRAMICA* 555 ceramoplastic Commutator Plates.
MYCALEX ELECTRONICS CORPORATION
Under Exclusive License of MYCALEX CORPORATION OF AMERICA



Precision-molded SUPRAMICA* 555 ceramoplastic Commutator Plate, CP-346, with 360 Contacts and 2 Slip Rings.
Other Standard Plates are Available.

RELIABILITY DOES NOT COST EXTRA

MYCALEX* TM commutation switches set new standards of reliability for aircraft and missile telemetry

\$25,000 a minute is costly time — but that is the estimated value of the final "count-down" for a major missile test.

Telemetered information will record the vital history of the flight and point the way to new developments and advancements. To achieve complete control, absolute dependability and long life, precision equipment is essential, both during flight and during the "count-down" when a complete check-out is demanded. Cleaning and adjusting commutators during the final hours or minutes of "count-down" is expensive — and wasteful.

MYCALEX* TM commutation switches with precision molded commutator plates of SUPRAMICA 555 ceramoplastic introduce new standards of reliability to this important operation. Hundreds of hours of completely unserviced life with dependable, low-noise-level signals is definitely attainable. Customer

evaluation tests have shown satisfactory operation of MYCALEX TM switches for over 1000 hours at 1200 RPM with only brush cleaning and routine maintenance.

These exceptional performance standards are possible because of painstaking precision assembly and testing, and the use of SUPRAMICA ceramoplastic commutator plates, which have total, permanent dimensional stability and will withstand temperatures as high as 500 degrees C. without distortion or contact loosening.

MYCALEX TM commutation switches and SUPRAMICA ceramoplastics are making significant contributions to the reliability and durability of electronic equipment for military and civilian applications.

Write for detailed information.

*MYCALEX and SUPRAMICA are registered trade-marks of Mycalex Corporation of America. 555 is a trade-mark of Mycalex Corporation of America.

MYCALEX
CORPORATION OF AMERICA



EXECUTIVE OFFICES:
30 ROCKEFELLER PLAZA
NEW YORK 20, NEW YORK

GENERAL OFFICES AND PLANT:
CLIFTON, NEW JERSEY

CHICAGO — LOS ANGELES — DAYTON
WASHINGTON — MIAMI

WORLD'S LARGEST MANUFACTURER OF GLASS-BONDED MICA AND CERAMOPLASTIC PRODUCTS

New Sylvania Photodiode

Type 1N77B

... puts tinier beams

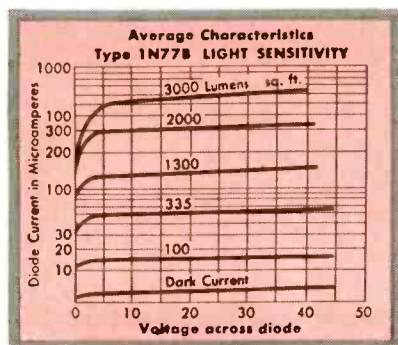

Light sensitivity of the new Sylvania photodiode, type 1N77B

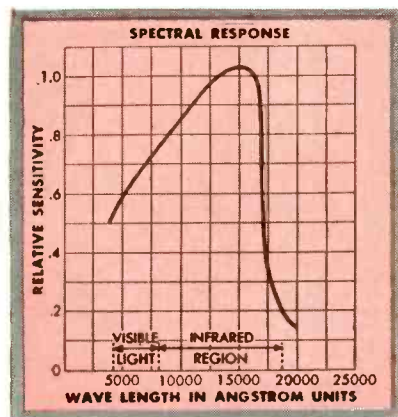

Spectral Response of Sylvania's new 1N77B

Sylvania designs a smaller photodiode with improved capabilities to handle applications where space is limited

Sylvania, leader in diode development, introduces the 1N77B, a new smaller junction photodiode with superior power dissipation and higher temperature capabilities. The improved unit, with a diameter of .077 inch, is ideal for highly compact assemblies and other applications where space is at a premium. The new 1N77B, which replaces type 1N77A, is now available at substantially lower prices in volume quantities.

The compact construction and fast response of the Sylvania 1N77B make it ideal for rapid, highly sensitive scanning and reading applications, such as in computer tape or punched cards readout. The new unit is also readily

“Sylvania—synonymous

with  Semiconductors”

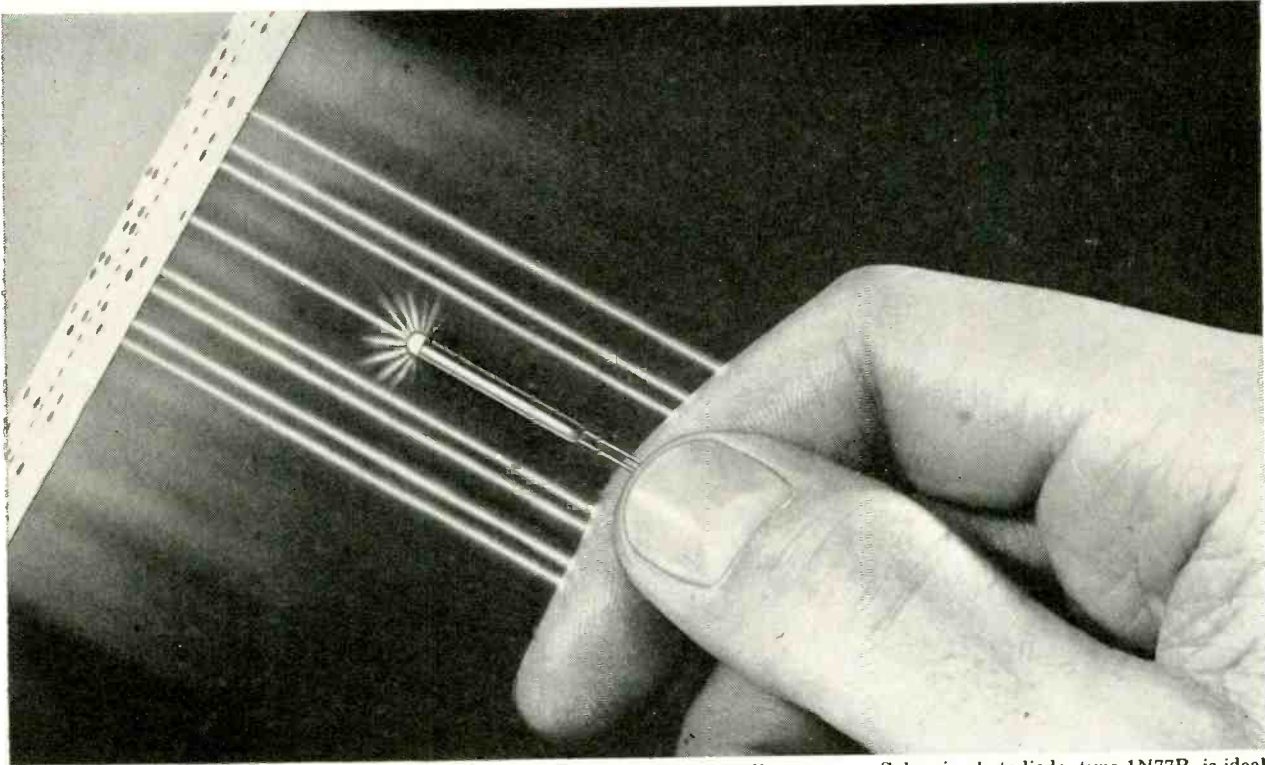

A fraction of an inch in diameter, new Sylvania photodiode, type 1N77B, is ideal for computer tape readout. It operates in the visible and infrared regions

of light to work

adaptable to infrared detection and heat-seeking devices because it is sensitive to light wave lengths extending from near ultraviolet into infrared. Other applications for the new 1N77B include liquid level control, headlight and street light dimmers, intensity controls, photoelectric controls and motion picture sound pickup.

Sylvania's improved photodiode has a higher lumen intensity than other types and a high output impedance. This is especially advantageous when coupling into vacuum tube or grounded collector transistor circuits. The new units are hermetically sealed in glass with a built-in lens that focuses light on the sensitive portion of the junction. The light interruption frequency response of the 1N77B photodiode is flat from 300 cycles to 15 kc at 100 percent with 260 lumens/sq. ft.; $R_L = 110,000$ ohms, -45 v.

Contact your Sylvania representative for further information on the new 1N77B.

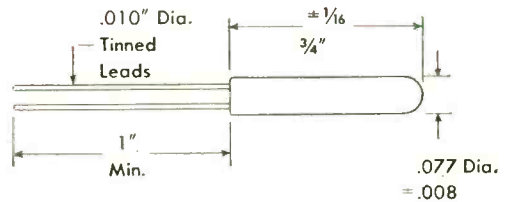

Sylvania's new photodiode, type 1N77B, is nearly 20 percent smaller in diameter than type 1N77A which it replaces

TABLE OF RATINGS & CHARACTERISTICS

Absolute Maximum Ratings (at 25°C):	
Operating Voltage	50 volts dc
Ambient Temperature (Maximum)	75°C
Power Dissipation	40 Milliwatts
Forward Current	10 Ma dc

CHARACTERISTICS

Reverse Current—Dark ($E_R = -10$ volts)	15 μ a max.
Reverse Current—Dark ($E_R = -50$ volts)	100 μ a max.
Noise Voltage—Dark ($E_R = -45$ volts)	15 Millivolts max.
	$R_L = 100,000$ ohms)
Light Sensitivity	18.7 peak-to-peak volts—min.
Light Sensitivity	37.5 peak-to-peak volts—max.
Typical Minimum Frequency Response	15.0 KC



SYLVANIA

SYLVANIA ELECTRIC PRODUCTS INC.
1740 Broadway, New York 19, N. Y.
In Canada: Sylvania Electric (Canada) Ltd.
Shell Tower Bldg., Montreal

LIGHTING • RADIO • TELEVISION • ELECTRONICS



MICRO SWITCH Precision

... FIRST IN PRECISION SWITCHING

MICRO SWITCH offers over 10,000 TYPES of Precision Switches—

Many are fully described with electrical ratings and mechanical characteristics in these nine catalogs

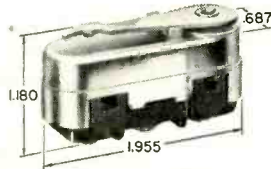

• Many types of MICRO SWITCH basic switches are specially designed to meet rigid aircraft requirements. Type HS Hermetically Sealed Switch is one of these. The precision snap-action unit is hermetically sealed within a metal chamber. Conductors to terminals are sealed in glass. Shown is a Type HS which has a lever-type actuator. Also available with leaf and roller actuators.

Catalog 78—Basic switches for airborne equipment

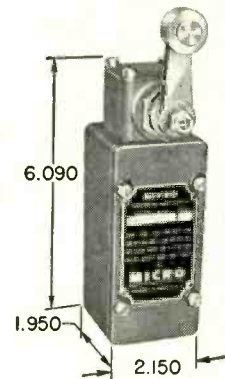
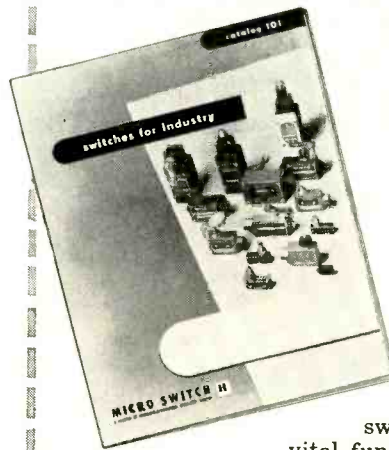

• MICRO SWITCH precision switches are used to perform vital functions in every type of industrial equipment. A most versatile heavy duty limit switch is the Type ML Series. This is available in sealed, two-circuit and explosion-proof models. Shown is the ML model with adjustable roller-arm actuator. Also available with plunger and roller-plunger actuators.

Catalog 101—Switches for Industry

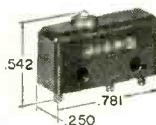
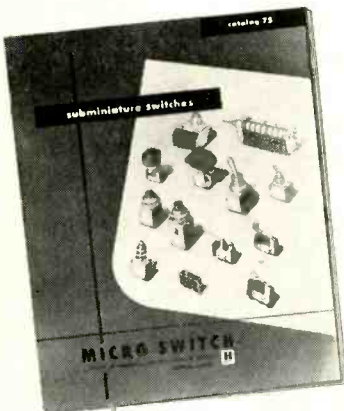

• MICRO SWITCH subminiature switches combine the features of extremely small size and light weight with high electrical capacity, precise operation and long life. Shown is Type 1SM1, the basic subminiature switch. This switch is assembled into auxiliary actuator brackets, pushbutton assemblies and rotary actuators. It is ideal for applications where space limitations are critical.

Catalog 75—Subminiature Switches

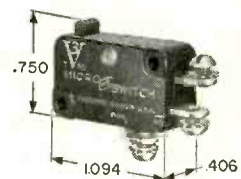
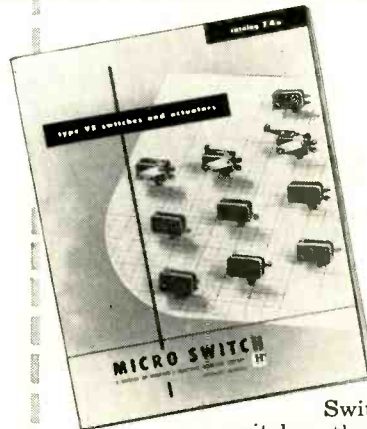

• MICRO SWITCH Type v3 Switches are ultra-small precision switches that have the highest electrical rating for their size of any switches available. The v3-1 model shown meets the exacting requirements of designers for an extremely small switch without sacrifice of quality. These switches are available in a wide variety of terminal designs, contact arrangements and operating characteristics.

Catalog 74—Type V3 switches and actuators

Switches have uses unlimited

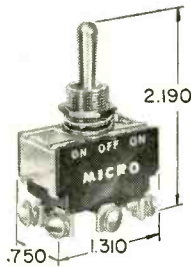
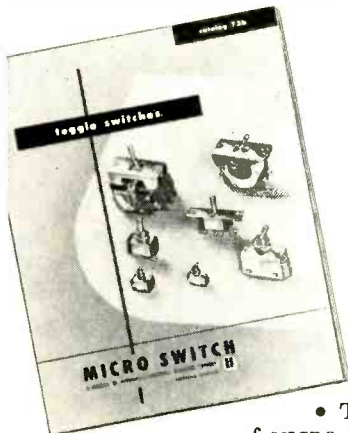

• Typical of the broad line of MICRO SWITCH Toggle Switches is Type 12TS1. Five features give it superior service and life characteristics: (1) greater over-surface creepage (2) sealed toggle lever (3) no return springs in momentary versions (4) solid silver contacts and (5) copper moving contact carrier.

Catalog 73—Toggle Switches

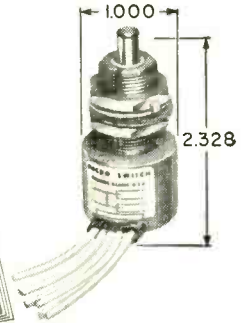
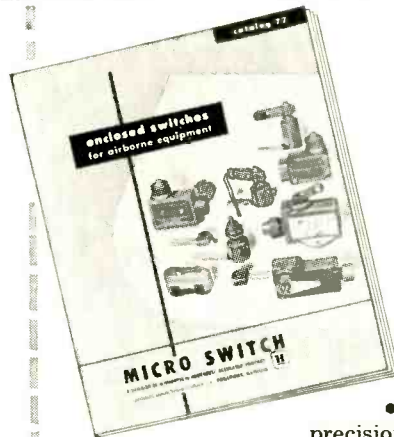

• Many of the MICRO SWITCH precision switches shown in this catalog are also widely used in commercial applications other than aircraft. One such switch is the versatile Type EN. This switch is completely sealed and easily mounted in cramped space. The 1EN1-6 model shown contains two SPDT precision switching units giving a DPDT contact arrangement. Also available with linkage type actuators.

Catalog 77—Enclosed switches for airborne equipment

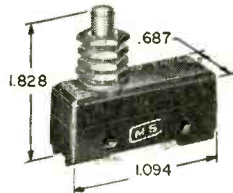
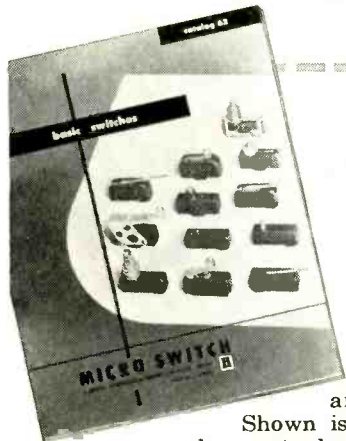

• This catalog covers a wide variety of MICRO SWITCH basic switches, auxiliary actuators and terminal enclosures. Shown is the Type BZ-2RQ1 with panel mount plunger. This switch can be used as a manual or mechanical pushbutton or for in-line operation where considerable over-travel is desired. Panel mounting permits adjustment of operating point with respect to the actuating device.

Catalog 62—Basic Switches for industrial and commercial applications



• An enclosed switch is a switch enclosed in a durable metal housing to protect the switching element from physical damage. An excellent example is the small, versatile 2-circuit enclosed limit switch of the Type 1LS1. It is completely sealed and has high electrical capacity. Adjustability features suit it to all types of industrial applications where space limitation is a prime factor in switch selection.

Catalog 83—Industrial enclosed switches

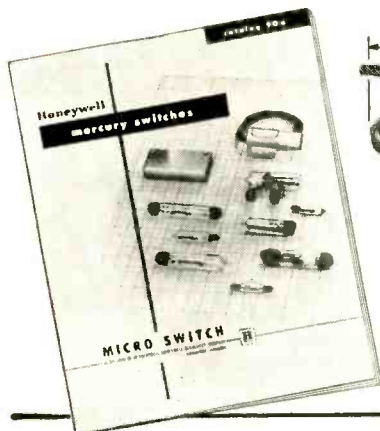

• The mercury switches shown in this catalog are standard designs for use in a-c or d-c applications. They provide reliable, trouble-free service in clean atmosphere as well as in locations affected by dust, fumes, spray or splash. Shown is the ultra-small Type AS408 which has been widely used by manufacturers of animated displays, home freezer units, alarms and other control and indicating devices.

Catalog 90—Honeywell Mercury Switches

There is—or can be—a MICRO SWITCH Precision Switch to meet every switch requirement. Why not consult MICRO SWITCH Engineering Service today on YOUR switch problem. It's as close as your nearby branch office.

MICRO SWITCH

A DIVISION OF MINNEAPOLIS-HONEYWELL REGULATOR COMPANY

In Canada, Leaside, Toronto 17, Ontario • FREEPORT, ILLINOIS





S.S. White
 Flexible Shafts
 Eliminate
 Unnecessary
 Parts

One manufacturer used flexible shafts to replace 35 parts in a Hydraulic Power System . . . cut costs by 90%. Four flexible shafts replaced a 35-part remote-control system . . . simplified design . . . made assembly easier . . . eliminated alignment problems . . . improved performance!

This is only one of hundreds of remote control and power drive problems these quality

flexible shafts are solving in every industry today. Can S.S. White flexible shafts help improve *your* product? Perhaps make it lighter in weight . . . cut production costs . . . eliminate unnecessary parts?

If you'd like to know more about flexible shafts, the advice of our engineers costs you nothing. Just write to

S. S. White Industrial Division, Dept. E, 10 East 40th Street, New York 16, N. Y.
 Western Office: 1839 West Pico Blvd., Los Angeles 6, Calif.

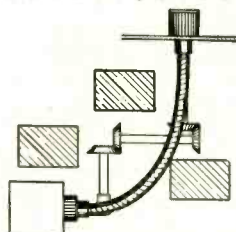

S.S. White

FIRST NAME

IN FLEXIBLE SHAFTS



Useful data on how to select and apply flexible shafts! Write for Bulletin 5601.

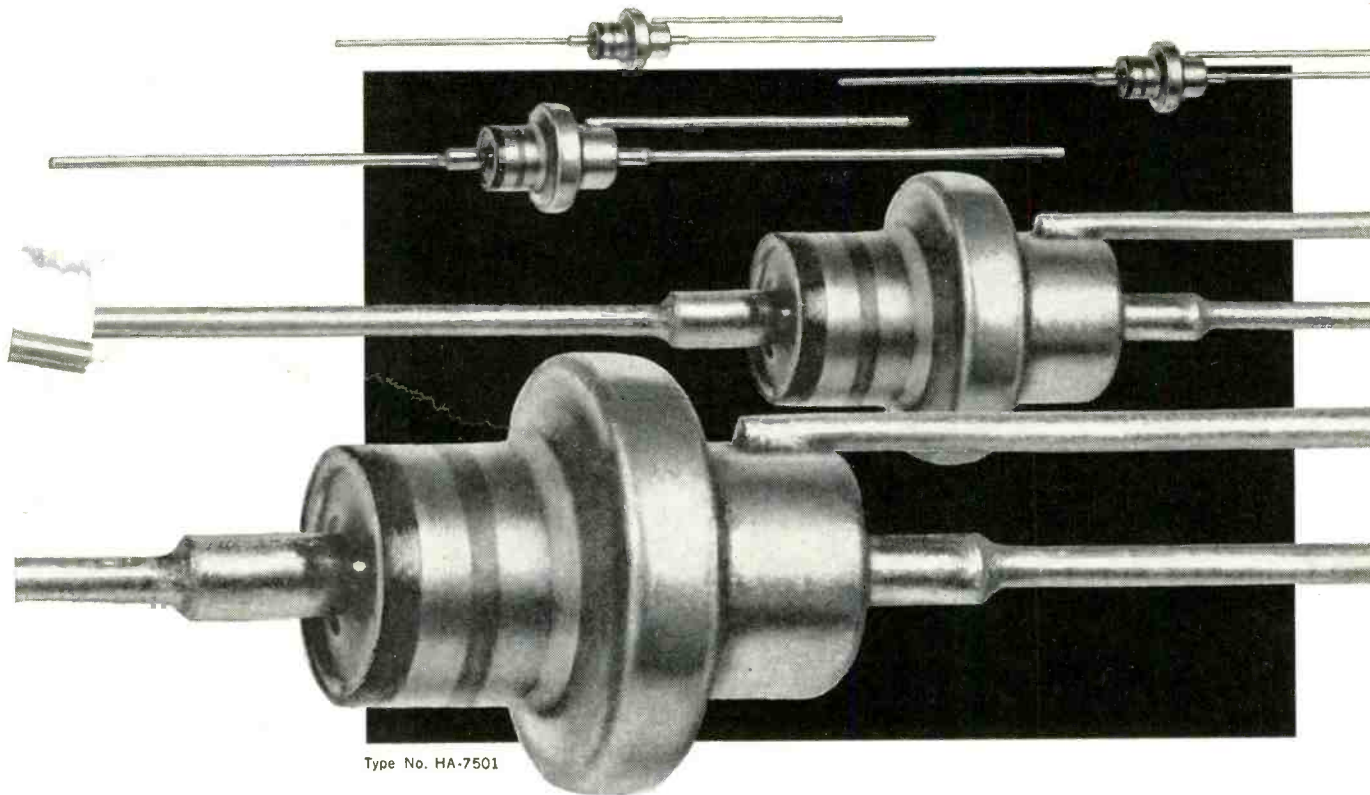

Type No. HA-7501

here today!

SILICON TRANSISTORS by HUGHES
now in production quantities

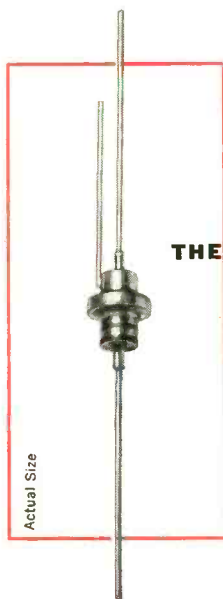

THE HUGHES PACKAGE

Hughes offers a "high temperature" transistor, an alloy-junction PNP device for audio, switching, and control circuitry at medium power levels—and at junction temperatures as high as 150°C. Outstanding characteristics: power dissipation in

Here Hughes departs from the conventional to offer a transistor with coaxial leads. In contrast to the single-ended configuration, this unique design permits the maximum flow of heat from the crystal through the package while providing an extremely sturdy internal structure. Also, it permits rigid mounting (particularly on printed circuit boards), thereby increasing the ability of the equipment to withstand

free air at 25°C, 500mW...saturation resistance at 100mA collector current, 10 ohms...voltage for the common emitter connection, 50V maximum...and, in addition, high current capabilities coupled with low reverse saturation currents.

physical shock or vibration. Abetted by small size and a hermetic seal, this kind of ruggedness results in a package which is just about as practical as a package can be. Maximum dimensions: body length, .396 inch; body diameter, .343 inch.

Perhaps you saw our new transistor at the WESCON show and discussed it there. If not, and you wish additional information now, please write:

**SEMICONDUCTOR DIVISION
 HUGHES PRODUCTS**

*International Airport Station
 Los Angeles 45, California*

Creating a new world with ELECTRONICS

HUGHES PRODUCTS

HUGHES



SEMICONDUCTORS

© 1957, Hughes Aircraft Company

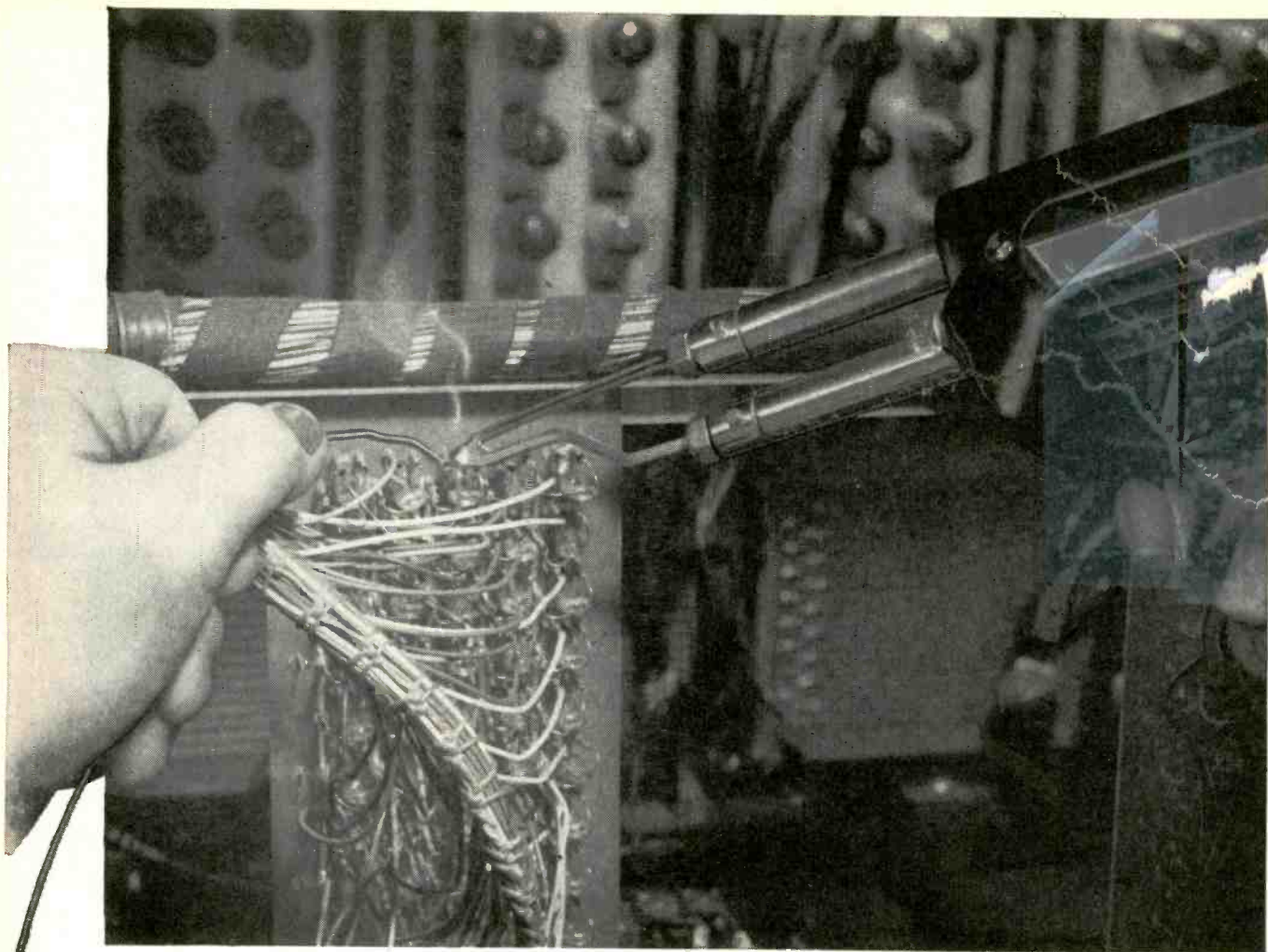

“Dutch Boy” Solder specialists help keep electronic brains sane

*...develop solder-flux
combinations that
give practically
perfect performance*

Who wants a psychopathic computer?

Not the electronic-brain makers... or their customers. That's why they demand... and get... practically never-miss reliability in soldering the thousands of joints and connections in even a small computer. A single open could put the circuitry out of commission.

“Dutch Boy” Solder specialists have done much to improve reliability of metal joining... helping to improve soldering methods, advising on (and sometimes devising) new equipment, and, most of all, developing improved solders and fluxes.

As new electronic devices are developed, as new service requirements unfold, National Lead solder specialists meet the challenge — a new test to insure flux continuity and integrity in cored solders... new formulations for ultra-cold service... fluxes that are truly non-conductive and non-corrosive — these are a few of the things National Lead people have done to solve customers' solder problems... produce solders worthy of the “Dutch Boy” name.

Maybe your “Dutch Boy” Solder specialist can help you improve your production soldering. It's easy to find out. Just write National Lead Company, 111 Broadway, New York 6, N. Y. Offices in Principal Cities.

Dutch Boy® Solders and Fluxes





offers still more simple, fast, time saving oscilloscopes

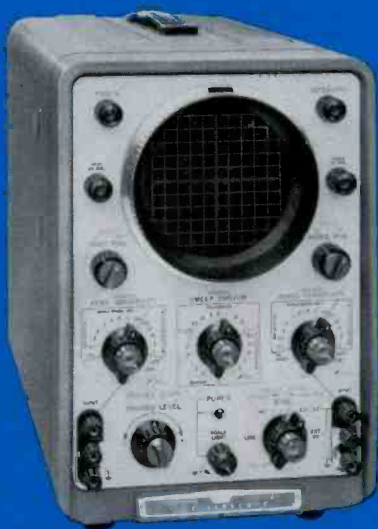

-hp- 130A

Low Frequency Cabinet Oscilloscope, Model 130A. Covers dc to 300 KC. Similar horizontal and vertical amplifiers. Input circuits balanced on 5 most sensitive ranges. Single ended input may be dc or ac coupled. Direct reading, linear sweep times. With most transducers, needs no preamplification to produce brilliant, high resolution trace. Universal automatic triggering; one preset condition provides optimum triggering for almost all inputs. \$650.00.



-hp- 150AR

High Frequency Rack Mount Oscilloscope, Model 150AR.

Same as -hp- 150A except for mounting in standard relay rack. Fitted with "pull-out" slides for maximum servicing accessibility. \$1,200.00.



-hp- 130BR

Low Frequency Rack Mount Oscilloscope,

Model 130BR. Similar to -hp- 130A except for rack mount and includes x5 magnifier usable on all ranges and expanding fastest sweep to 0.2 μ sec/cm. Parallel input terminals front and rear. \$650.00.

**ON YOUR OWN BENCH, ON YOUR OWN PROBLEMS, SEE, FEEL,
OPERATE THESE NEW -hp- OSCILLOSCOPES**

Call your -hp- representative.

Ask him to bring an -hp- oscilloscope to your lab or shop. Try it, side by side with old-style scopes you may have been using.

Let the instrument itself show you how much time, work, mathematics and do-over it can save.



HEWLETT-PACKARD COMPANY

4443 Page Mill Road • Palo Alto, Calif., U.S.A.
CABLE "HEWPACK" • DAVENPORT 5-4451

Field engineers in all principal areas

Data subject to change without notice.

Prices f.o.b. factory.



150A HIGH FREQUENCY OSCILLOSCOPE

"OPERATE" this new -hp- oscilloscope—Fast, Easy!

see yourself the unique features that make this oscilloscope

world's easiest to use • quickly learned by anyone • instant, direct reading

most widely versatile • world's best scope value

Instantly adjust horizontal sensitivity between steps on external input attenuator.

Eliminate errors Light indicates when fastest calibrated internal sweep is exceeded.

Easy to examine leading edge, any part of signal with x 5 to x 100 magnifier.

Twist of wrist for perfect focus; no bloom, no ghosts, high writing rate without CRT post-accelerator.

Instantly position any part of normal or **30-foot long expanded trace** center screen for clear, detailed study.

Quick change Exclusive -hp- twist-lock bezel means instant access to filters, front change of CRT tubes; convenient, fast camera mounting.

Save time Direct reading sweeps; no calculation or multiplying factors; instantly select exact sweep desired.

Eliminate error lamp warns when sweep is magnified on CRT.

Amplifiers have Gaussian frequency response; no overshoot or ringing.

Bright, clear trace mono-accelerator CRT.

No syno adjusting Universal automatic PRESET condition

VERNIER SWEEP TIME / CM (MILLISECONDS) 10 5 2 1 .5 .2 20 50 100 200 500 1000 2000 5000 10000

TRIGGER SLOPE SWEEP MAGNIFIED

TRIGGER LEVEL 0 1 2 5 10 20 50 100

SWEEP MODE TRIGGER CHASE FREE RUN

INTENSITY

SCALE LIGHT

FOCUS

HORIZ. POSITION

VERNIER MAGNIFIER UNCALIBRATED

HORIZ. SENSITIVITY EXT. INPUT VOLTS/CM (MAGNIFICATION) X1 X5 X10 X50 X100

INT. SWEEP CAL.

INTENSITY

SCALE LIGHT

FOCUS

HORIZ. POSITION

CALIBRATOR MILLIVOLTS VOLTS 20 50 1 2 5 10

SWEEP MODE TRIGGER CHASE FREE RUN

INT. EXT. AC

LINE EXT. DC

POWER

Select calibrated

input sensitivity; read voltage directly within 3%; or adjust pattern to any sensitivity with vernier knob. Voltage presentation most linear of any oscilloscope made today.

Widely versatile

plug-in amplifiers. -hp-151A for highest sensitivity, maximum dc gain of 5 mv/cm, dc to 10 MC. -hp-152A for perfect dual trace presentation without complexity and expense of dual beam scope.

-hp-150A Oscilloscope

SWEEP
Range: 0.02 μ sec/cm to 15 sec/cm.
Calibrated: 24 calibrated sweeps in 1, 2, 5 and 10 sequence, 0.1 μ sec/cm to 5 sec/cm. Accuracy within 3%.
Vernier: Permits continuous adjustment of sweep time.
Triggering: Internally, line voltage; externally with 0.5 v or more.
Trigger Point: Any positive or negative level on positive or negative slope of signal triggering sweep \pm 30 v to \pm 30 v range for external trigger.
Preset Triggering: Switch position on sweep mode control automatically selects optimum setting for stable triggering for majority of conditions.
Single Sweep: Sweep circuits may be set for triggered single sweep operation. After being triggered, sweep remains locked out until reset. Indicator light glows when sweep is armed.
HORIZONTAL AMPLIFIER
Sweep Magnification: Sweep may be expanded 5, 10, 50 or 100 times. Multiturn horizontal

positioning control provides a fine degree of adjustment, permits viewing any 10 cm portion of expanded sweep.
Indicators: "Reminder" lights glow when sweep magnifier is used, or when expanded sweep time exceeds fastest calibrated sweep time.
External Input: Pass band dc to over 500 KC. Sensitivity range 200 mv/cm to 15 v/cm. Five calibrated ranges plus vernier.

VERTICAL AMPLIFIER

Main Vertical Amplifier: Pass band dc to more than 10 MC. Optimum transient response and rise time less than 0.035 μ sec.
Signal Delay: 0.25 μ sec. delay permits viewing leading edge of signal triggering sweep.
Input: Through plug-in preamplifier.

GENERAL

Amplitude Calibrator: 18 Calibrating voltages in 2, 5, 10 sequence, 0.2 mv to 100 v peak-to-peak, are available at a binding post to provide maximum flexibility. Accuracy within 3%. Approximately 1 KC square wave with rise and decay times less than 1 μ sec.

Sawtooth Output: \pm 20 to \pm 20 v sawtooth waveform of sweep.
Gate Output: \pm 20 v signal for duration of sweep.

CRT Bezel: CRT Bezel readily removable by a 15° twist, providing rapid means of changing filters and replacing CRT if different phosphors are required. Bezel locks to provide firm mount for standard oscilloscope camera equipment.
CRT Plates: Direct connection to deflecting plates via terminals in access compartment.
Intensity Modulation: Terminals provided; 20 v positive signal blanks CRT at normal intensity.
Price: \$1100.00.

-hp-151A High Gain Amplifier

Sensitivity Range: 5 mv/cm to 50 v/cm.
Input Attenuator: 12 calibrated ranges, in 0.5, 1, 2 and 5 sequence, from 5 mv/cm to 20 v/cm. Vernier permits continuous adjustment between ranges.
Input Impedance: 1 megohm shunted with 27 μ f.

Pass Band: dc to 10 MC, 0.035 μ sec rise time.
Coupling: ac or dc.
Dual Inputs: Two signal inputs with Type BNC. Selection of either input by panel switch.
Price: \$200.00.

-hp-152A Dual Channel Amplifier

Sensitivity Range: 0.05 v/cm to 50 v/cm.
Input Attenuator: 9 calibrated ranges, in 1, 2, 5 and 10 sequence, from 0.05 v/cm to 20 v/cm. Vernier permits continuous adjustment between ranges.
Input Impedance: 1 megohm shunted with 27 μ f.
Pass Band: dc to 10 MC, 0.035 μ sec rise time.
Coupling: ac or dc.
Electronic Switching: By alternate sweeps or chopped at approximately 100 KC.
Vertical Positioning: Individually adjustable.
Polarity of Presentation: Input signal as applied or inverted.
Input Connectors: Type BNC both channels.
Price: \$250.00.

Data subject to change without notice.

SPECIFICATIONS

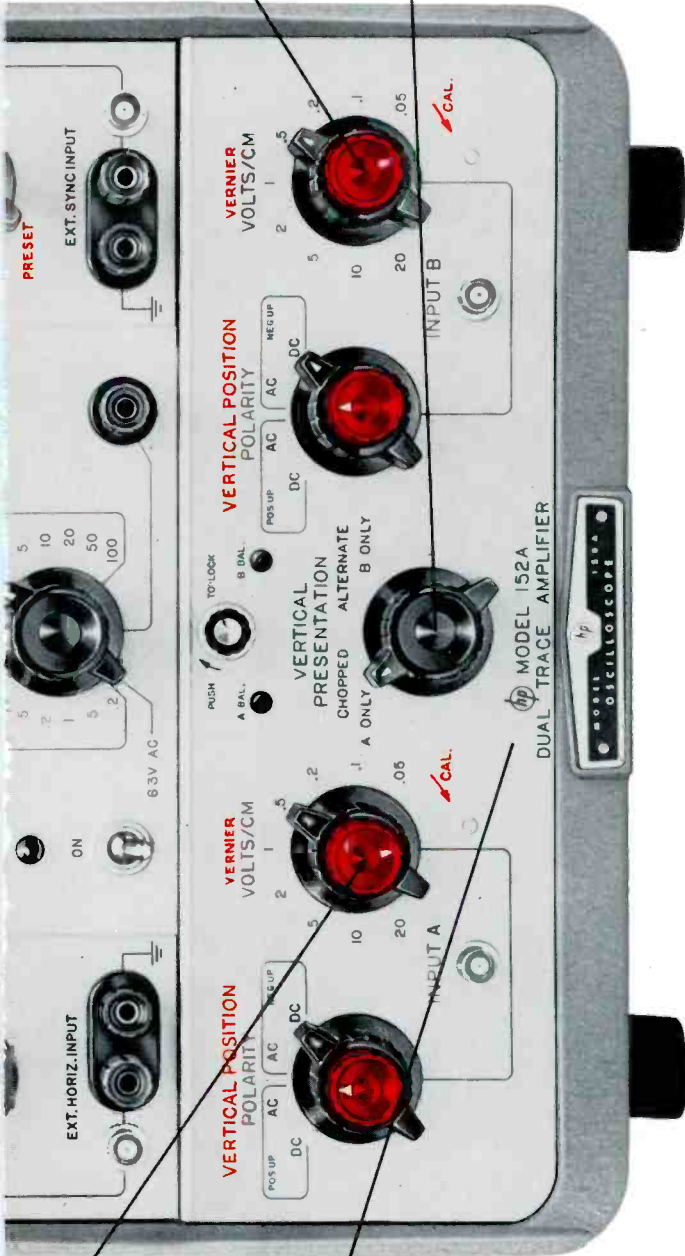

Easy to learn
concentric, color-coded controls, human-engineered for fast learning, easiest use without training!

Instantly examine
"A" or "B" inputs singly, alternately or "CHOPPED." Complete blanking of switching transients on "CHOPPED" presentation. Independent trace positioning.

PRESENTING

one completely new instrument that
can be worth more to you than any similar equipment
you have ever owned because it does more things better
and faster, eliminates errors, ends tedious computation
—saves hour upon hour of precious engineering time.

THE WORLD'S PREMIER

**HIGH
FREQUENCY
OSCILLOSCOPE**

simplest to use
direct reading
most widely useful
fastest operating



specialized services help you
in the preparation of your technical manuals

Over 80 leading manufacturers and government agencies (list on request) avail themselves of our services regularly.

We apply our own specially developed techniques (with resulting economies) to all phases of manual preparation and production: Engineering analysis, technical illustration, layout, copy preparation—right down to final printed production, if you wish. Our experience as the world's largest electronics data publishing firm—producers of the famous PHOTOFACT Service Data—qualifies us to produce the most competent publications relating to the theory, operation, maintenance or repair of electronic devices.

Any one or all of our services can help solve your technical publication problems efficiently, speedily, economically. Let us show you how our unique facilities can be of service to your company.

which of these services can you use?

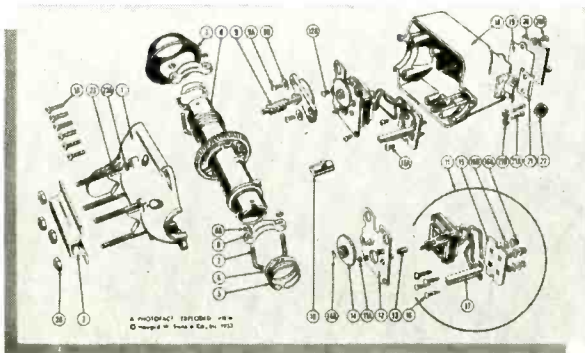

EXPLODED VIEWS: Our skilled drawings in proper perspective simplify replacement parts ordering—make reassembly and maintenance easier and more positive.

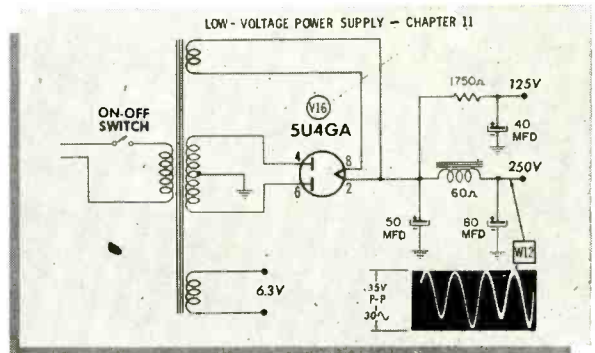

SCHEMATICS: Our famous Standard Notation Schematics are the industry's standard for legibility, easy use and clear understanding.

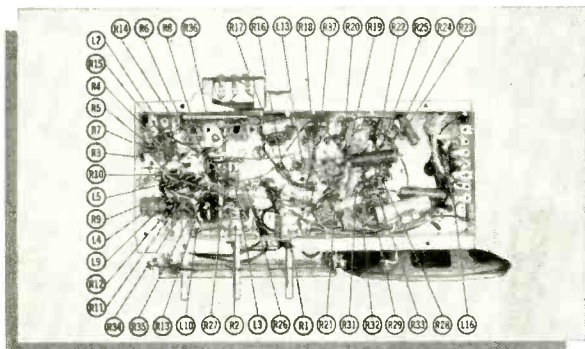

KEYED PHOTOS: There's no confusion when your parts lists, schematics and copy are "keyed" to an actual photo of your product (one of our specialties).

HOWARD W. SAMS & CO., INC.

Industrial Service Division, Dept. 1A
2201 East 46th Street, Indianapolis 5, Indiana
Phone: CLifford 1-4531



Write or phone for this 24-page brochure showing the services we perform for the Electronic industry

Please send informative brochure to:

Name _____
Company _____
Address _____
City _____ Zone _____ State _____

SOLA CONSTANT VOLTAGE DC POWER SUPPLY

is shown here with its three major components indicated. This assembly is a typical standard design rated at 125 volts, 2 amperes, and is mounted on a standard, 19" relay rack chassis only 5 1/4" high.

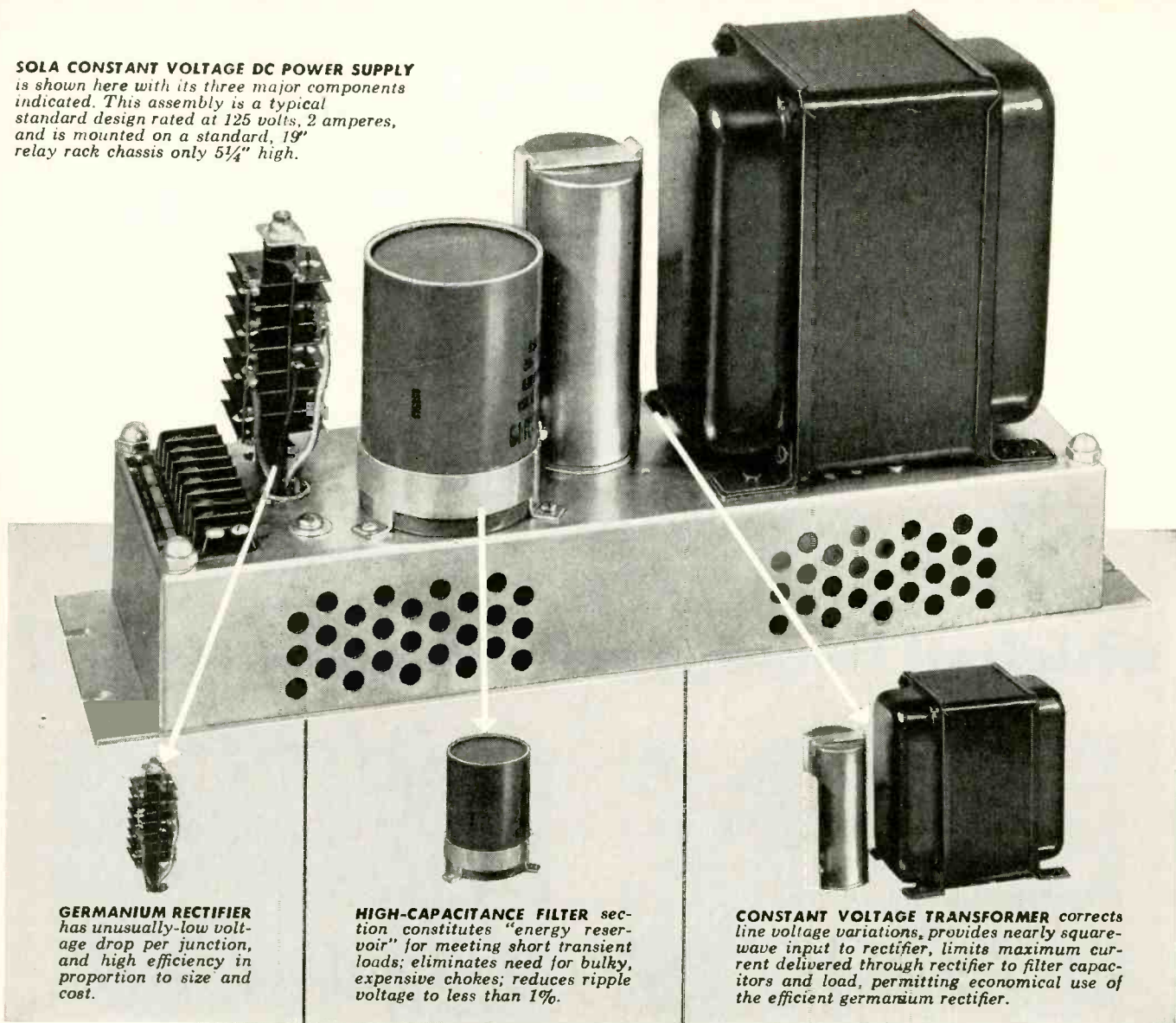

GERMANIUM RECTIFIER has unusually-low voltage drop per junction, and high efficiency in proportion to size and cost.

HIGH-CAPACITANCE FILTER section constitutes "energy reservoir" for meeting short transient loads; eliminates need for bulky, expensive chokes; reduces ripple voltage to less than 1%.

CONSTANT VOLTAGE TRANSFORMER corrects line voltage variations, provides nearly square-wave input to rectifier, limits maximum current delivered through rectifier to filter capacitors and load, permitting economical use of the efficient germanium rectifier.

2 amps of 125v regulated dc power in only 5 1/4" of relay-rack height

Exceptional performance under intermittent, variable, pulse, or high-amperage loads is a prime advantage of the new static-magnetic, Sola Constant Voltage DC Power Supply. Its design simplicity — possible because of the mutual support and protection provided by the combination of its three basic components — provides compact size, low weight, and moderate price in proportion to power output and performance.

Output of these power supplies is regulated within $\pm 1\%$ for line voltage variations of up to $\pm 10\%$. They

are available in six stock models, in ratings ranging from 24 volts at six amperes to 250 volts at one ampere. Also, design-and-assembly service for special ratings is offered to meet the specific requirements of equipment manufacturers.

Your area representative, listed below, is part of a nationwide organization maintained to provide you with prompt service. He'll be happy to supply further information on stock or special Sola Constant Voltage DC Power Supplies.

SOLA *Constant Voltage* **DC POWER SUPPLIES**



Write for Bulletin 7J-CV-235
SOLA ELECTRIC CO.
4633 W. 16th Street
Chicago 50, Illinois

CONSTANT VOLTAGE TRANSFORMERS • LIGHTING TRANSFORMERS • CONSTANT VOLTAGE DC POWER SUPPLIES
SOLA ELECTRIC CO., 4633 West 16th Street, Chicago 50, Illinois, Blshop 2-1414 • BRANCH OFFICES: Boston, Mass.; Cleveland, Ohio; Kansas City, Mo.; Los Angeles, Calif.; New York, N. Y.; Philadelphia, Pa.; San Francisco, Calif.; Wallingford, Conn. • Representatives in Other Principal Cities
Sola Electric (Canada) Ltd., Toronto 17, Ontario: 102 Laird Drive, Mayfair 4554

OAK rotary solenoids*

*Mfd. under license from G. H. LELAND, INC.

built for you separately
or in remote-controlled
subassemblies

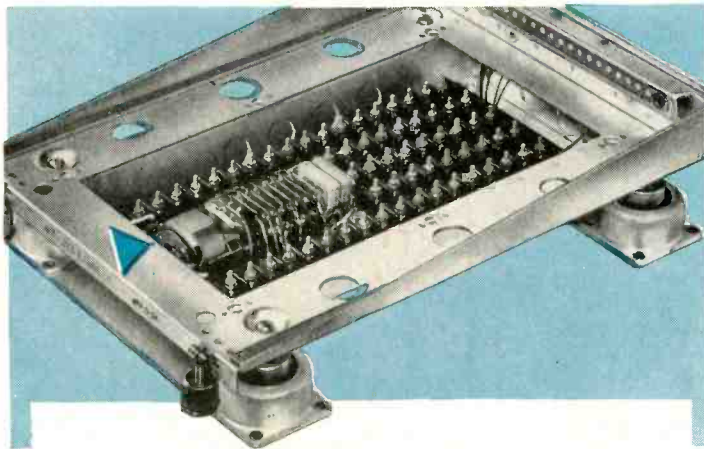
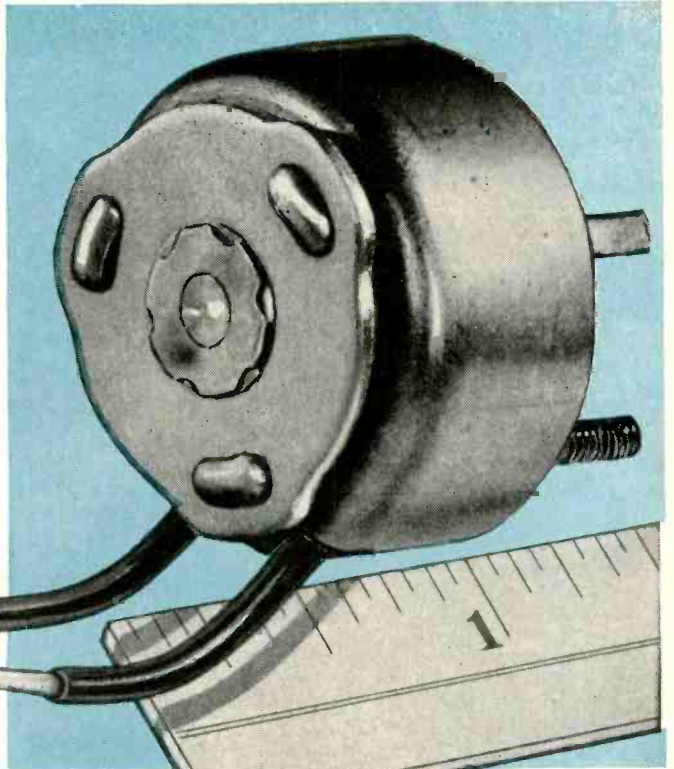

TYPICAL OAK SUBASSEMBLY WITH ROTARY SOLENOID (MT273E BASE BUILT FOR BENDIX RADIO DIV.)

Oak stamps, draws, welds, and etches the aluminum chassis . . . builds the rotary solenoid switch . . . manufactures the screw machine parts . . . makes the complicated cable harness . . . assembles all the parts . . . then runs life tests, heat and cold checks, and humidity chamber trials.

Oak can offer you complete engineering and manufacturing facilities for electro-mechanical subassemblies, plus a knack for making complicated devices producible. Time and again, Oak engineers have suggested changes that resulted in lower costs and better operation.

meet the most severe MIL specifications

In converting a straight pull to rotary motion, Oak rotary solenoids give a high-torque, positive action, even under severe mechanical operating conditions. Oak rotary solenoids are compact, also, and help economize in wiring and mechanical linkage on remote-control devices. Three standard sizes in many variations cover a wide range of switching and light mechanical tasks. Oak also can supply *any component* needed to accompany rotary solenoids. Because Oak engineers know the application possibilities of rotary solenoids inside and out, consult them early in the design stage. They can save you valuable time. Write for a copy of Oak's rotary solenoid bulletin that includes time-saving lay-out sheets.

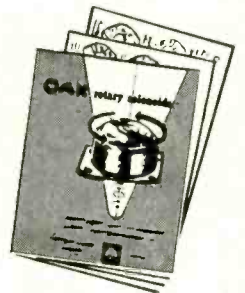

OAK MFG. CO., Dept. G, 1260 Clybourn Ave., Chicago 10, Ill.
Phone: MOhawk 4-2222

OAK MFG. CO. 



Chicago, Ill.

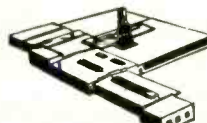

Crystal Lake, Ill.



Chicago, Ill.



Elkhorn, Wis.

SWITCHES • CHOPPERS • SPECIAL ASSEMBLIES • VIBRATORS • TUNERS

A NEW Amperex FRAME GRID TUBE

It's the
frame grid construction

that makes the difference...

- Higher transconductance
- Tighter G_m tolerance
 (all tubes — $G_m = 12,500 \begin{matrix} +2500 \\ -2000 \end{matrix}$)
- Low transit time
- Low capacitances
- Better grid and plate current division

ADDITIONAL FEATURES

- Passive cathode for long life
- Ruggedized construction
- New 'dimple' anode

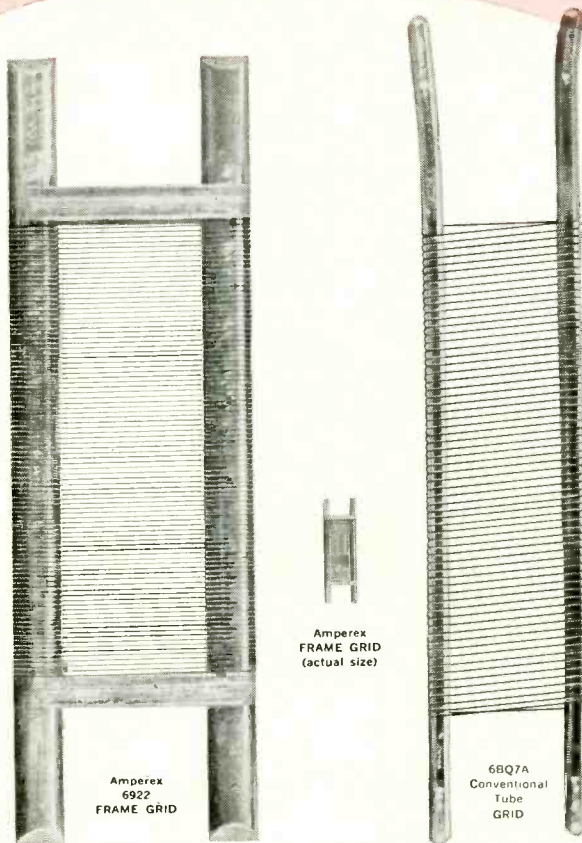

In the Amperex 6922 Frame Grid, note the fine wires under tension with the tight tolerances of the grid-to-cathode spacing determined by the carefully controlled diameter of the centerless ground grid-support rods and the frame cross-braces between these rods.

In conventional tubes, the grid dimensions are obtained by stretching on a mandrel. The tolerance of grid-to-cathode spacing is therefore dependent upon this operation as well as the tolerances of the holes in the top and bottom mica rod supports.

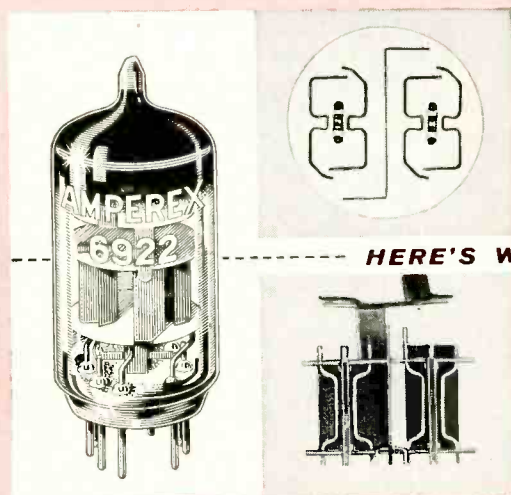

Amperex 6922
 PREMIUM QUALITY

ruggedized, low-noise, broad-band twin triode

HERE'S WHAT THIS MEANS TO THE DESIGN ENGINEER...

- Reliable radar cascode stages
- Higher speed computer operation
- Lower noise, higher gain RF amplifiers
- Minimum guaranteed 10,000 hour life

TYPICAL OPERATION	
Plate Supply Voltage	100 volts
Grid Supply Voltage	+9 volts
Cathode Bias Resistor	680 ohms
Plate Current	15 ma
Transconductance (min. 10,500; max. 15,000) 12,500 umhos	
Amplification Factor	33
Equivalent Noise Resistance	300 ohms
Grid Voltage (rms)	0.75 volts



ask Amperex

about "premium quality" frame grid tubes for communication, instrumentation and industrial applications.

Amperex ELECTRONIC CORPORATION, 230 Duffy Avenue, Hicksville, L. I., N. Y.

In Canada: Rogers Electronic Tubes & Components, 11-19 Brentcliffe Road, Leaside, Toronto 17



SIZE 23

Norden-Ketay presents
a superior new
synchro . . .

3SYN

THE 3 FUNCTION, 3 MINUTE QUADRATURE BAR SYNCHRO

3-IN-1 VERSATILITY: TORQUE TRANSMITTER TORQUE RECEIVER • CONTROL TRANSMITTER

FUNCTION	UNITS	3SYN	STANDARD MIL SYNCHROS
NKC TYPE DESIGNATION		113CF2A	113F2B/113C2A
Number of Phases } STATOR } ROTOR		3 1	3 1
EXCITATION PHASE		Rotor	Rotor
FREQUENCY	cps	400*	400
VOLTAGE RATING	volts	115/90	115/90
Maximum Input } CURRENT } POWER	amps watts	0.92 7.5	1.21 9.4
INPUT IMPEDANCE	ohms	138/86.4°	105/86.6°
Maximum Null Volts } TOTAL } FUND.	mv mv	100 50	100 75
DC Resistance at 20°C } STATOR } ROTOR	ohms ohms	3.93 3.04	5.86 2.59
MOMENT OF INERTIA	oz-in ²	0.45	0.43
FRICTION TORQUE AT 20°C MAXIMUM	oz-in	0.1	0.1
ELECTRICAL ERROR, MAXIMUM	minutes	±3'	±8'
RECEIVER ERROR, MAXIMUM	degrees	0.5	1
TORQUE GRADIENT, MINIMUM	oz-in/deg	0.25	0.13
DAMPING TIME, MAXIMUM	sec.	1	2
OPERATING TEMP. RANGE	°C	-55 to +55 †	-55 to +55
WEIGHT	oz.	21	21
MILITARY DESIGNATION			23TR4a/23TX4a

* Although this synchro is rated at 400 cps, 3SYNs are available to your order to operate at any frequency from 400 cycles to 10,000 cycles.
† The normal temperature range of -55°C to +55°C can be extended to 110°C on special order.

3SYN as a TORQUE TRANSMITTER

- Twice the torque gradient (0.25 oz-in) of standard mil synchros (0.13) drives a bigger load, or the same load more accurately.
- More than twice the electrical accuracy (3') of mil synchros (8').

3SYN as a CONTROL TRANSMITTER

- Better regulation with less input current improves efficiency, drives more transformers.
- 3-minute accuracy surpasses mil synchro performance (8').

3SYN as a TORQUE RECEIVER

- Twice the receiver accuracy ($\pm 1/2^\circ$ error) compared with standard mil synchro ($\pm 1^\circ$ error).
- One-half the damping time (1 sec) compared with mil synchro (2 secs).

PLUS

3SYN minimizes problem of 'spares', since it is interchangeable with mil torque transmitters, control transmitters, and torque receivers. Moreover, 3SYN does not merely equal, but *excels* the critical ratings of standard mil synchros in each of those three functions.



For full data and application engineering on the 3SYN synchro, write to:
Norden-Ketay Corporation, Western Division, 13210 Crenshaw Blvd., Gardena, Calif.

Sales Offices: Stamford Conn. | Chicago
Washington, D.C. | Dayton, Ohio | Los Angeles

MIL-AC Custom Air Conditioning



Condition: Unusual Configuration

Air conditioning today's electronic systems often calls for specialized equipment that saves space, fits into unusual configurations and still meets the most difficult environmental conditions (MIL-E-5272*).

Custom air-conditioning is our business at Ellis and Watts. For example, our MIL-AC air conditioning units can be square, oblong, L-shaped, T-shaped, curved, pyramid—virtually any shape your conditions require. They can be designed for integral mounting in electronic consoles or computer racks; or for use as adjacent or remote equipment to air condition entire systems.

MIL-AC units are self-contained, compact, lightweight, readily air-transportable. They can be designed to cool, heat, humidify, dehumidify, filter, and can incorporate air-cooled or water-cooled condensers. Units are manually or automatically controlled. We are staffed with specialists who will analyze your requirements, submit a proposal, complete your installation promptly and to your complete satisfaction.

Write for helpful load calculating Nomograph and other technical data for use in making time-saving preliminary calculations.

*Military specification dealing with the following climatic and environmental conditions: Temperature, humidity, altitude, salt spray, vibration, fungus, sunshine, rain, sand and dust, explosive atmosphere, acceleration and shock



Typical MIL-AC Unit. MIL-AC configurations, features and functions to suit your specific requirements.

ELLIS AND WATTS PRODUCTS, INC.



P.O. Box 33, Cincinnati 36, Ohio.

Ellis and Watts also design and build custom air conditioners, liquid coolers and heaters, dehumidifiers, wave guide dehumidifiers, laboratory temperature and humidity control units.



NOW

a transistorized

DATRAC

important addition to
the **FIRST Family** of
voltage-digital converters



MODEL B DATRAC — for ground facilities



TRANSICON DATRAC — for industrial applications

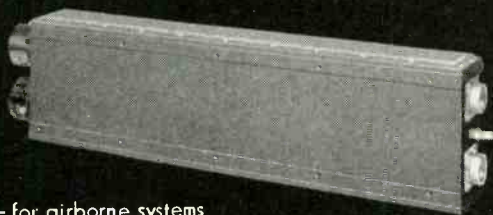

MINIDATRAC — for airborne systems

An instrument unexcelled for ground facilities, the Model B DATRAC features field-proven reliability; .05%* accuracy; conversion time of 2 μ sec./bit; bi-polar input of $\pm 1, 10, 100$ volts full scale; straight binary models up to 17 bits or 3-place binary coded decimal; fully reversible.

A tool designed specifically for industry, the TRANSICON DATRAC, utilizing the latest proven semiconductor and magnetic circuit techniques (it employs no vacuum tubes), features:

- provision for scaling, linearization, and limit comparisons
- conversion rate: any from 5 μ sec./bit to ∞
- absolute accuracy: .05%*
- bi-polar input with ± 10 volts full scale
- in-line visual readout optional
- 3-4 decimal digit and 12-16 bit straight binary models
- absolute value output indication
- fully reversible

An equipment of proven accuracy and reliability for airborne systems, the MINIDATRAC, qualifying under the applicable portions of MIL-E-5272 and MIL-E-5400, features .1%* accuracy with a conversion rate of 2 μ sec./bit, capable of inflight digital recording or pulse code modulated telemetry.

* $\pm 1/2$ least significant digit.

Write for engineering data sheets on each of the DATRAC converters

The Epsco logo consists of the word "Epsco" in a bold, red, sans-serif font. To the left of the text is a solid red square. To the right of the text are three stylized, grey, arrow-like shapes pointing upwards and to the right, each with a thin line extending from its base.

First in data control

Epsco, Incorporated, 588 Commonwealth Ave., Boston 15, Mass., 108-03 Queens Blvd., Forest Hills 75, N. Y.
For service in the West: Epsco Service Corp. of California, 1722 Westwood Blvd., Los Angeles 24, California



SOUND-LEVEL METERS
Types 1400 & 1408



STROBOSCOPES
Types 1200, 1201, 1202, 1206, 1207 & 1210



THICKNESS GAUGES
Types 1101, 1101/1, 1107 & 1108

NOW AVAILABLE!

A new series of leaflets featuring the application of

DAWE

ELECTRONIC INSTRUMENTS

to the following industries:

TEXTILE · OIL · AUTOMOBILE
AIRCRAFT · CHEMICAL · BUILDING
POWER GENERATION · PRINTING
COMMUNICATIONS · WORKSHOPS
TRANSPORT · SHIPPING
IRON & STEEL

Write for your copy now stating the industry in which you are interested.

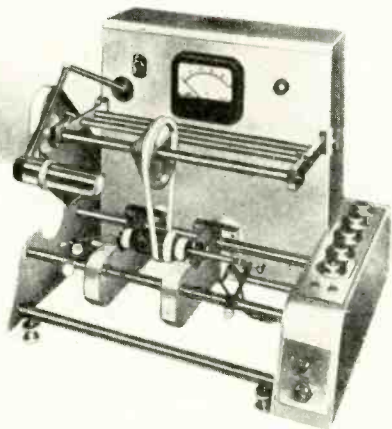

DYNAMIC BALANCING MACHINES
Types 1250, 1251, 1252 & 1253



VISIGAUGE
Type 1108



VIBRATION INDICATOR
Type 1414



Full Technical Data From:
THE HICKOK ELECTRICAL INSTRUMENT CO.

10514 Dupont Avenue • Cleveland 8, Ohio
In Canada: Dawe Instruments Ltd.
1654 Bank St., Ottawa 1, Ontario

Single New Rectifier Outperforms

12 full size conventional stacks!

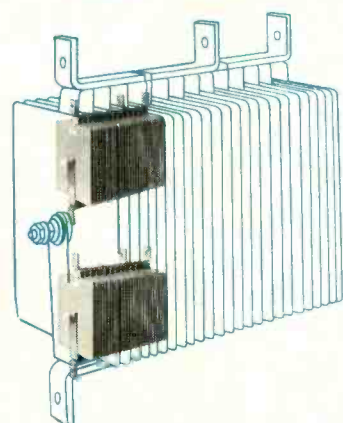
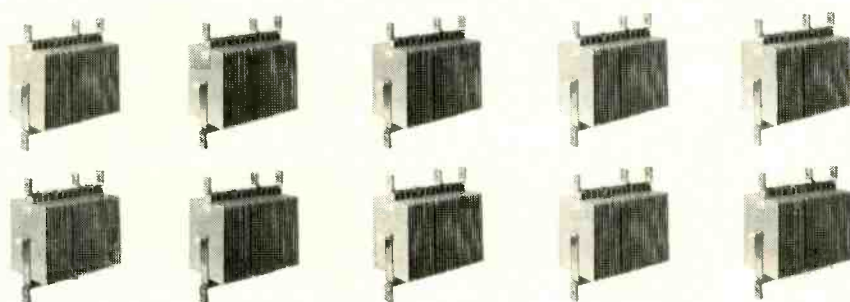
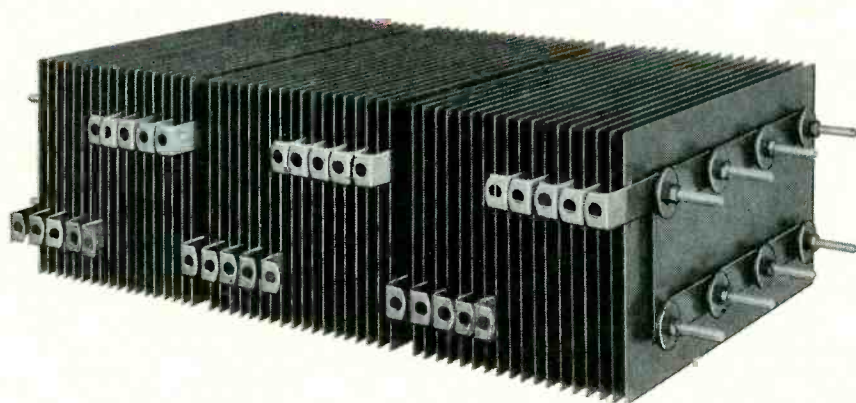

Radio Receptor **HCD^{*} Petti-Sel** *High current density **Industrial Type Selenium Rectifiers**

Produced by the improved new vacuum process developed by Siemens of West Germany and now manufactured exclusively by Radio Receptor in the U.S.

- Smaller cell sizes**
- Lower voltage drop**
- No artificial barrier**
- Negligible aging with an estimated life of 100,000 hours!**

Because the exclusive Siemens vacuum process eliminates the need of an artificial barrier layer, it is possible for Radio Receptor to offer smaller cell sizes operating at high current density, yet with lower voltage drop. In actual dimensions this means that just *one* RRco. HCD rectifier measuring 8" x 16" x 25", rated at 26V AC, 4500 amps DC, replaces *twelve* usual stacks 6" x 7¼" x 10".

RRco. Petti-Sel rectifiers do far more than save space. They reduce assembly time, require fewer connections and cost less per ampere. Their dependability has been proved for years in European circuits and the outstanding electrical characteristics are not even approached by other standard cells available today. For further information please write today to Section E-10R.

Radio and
Electronic Products
Since 1922



Semiconductor Division

RADIO RECEPTOR COMPANY, INC.

A Subsidiary of General Instrument Corporation
240 WYTHE AVENUE, BROOKLYN 11, N. Y. • EVergreen 8-6000

Radio Receptor products for Industry and Government:
Germanium and Silicon Diodes, Selenium Rectifiers, Thermanon Dielectric Heating Generators and Presses, Communications, Radar and Navigation Equipment

DRIVER-HARRIS ALLOYS AT WORK IN PRODUCT ADVANCEMENT

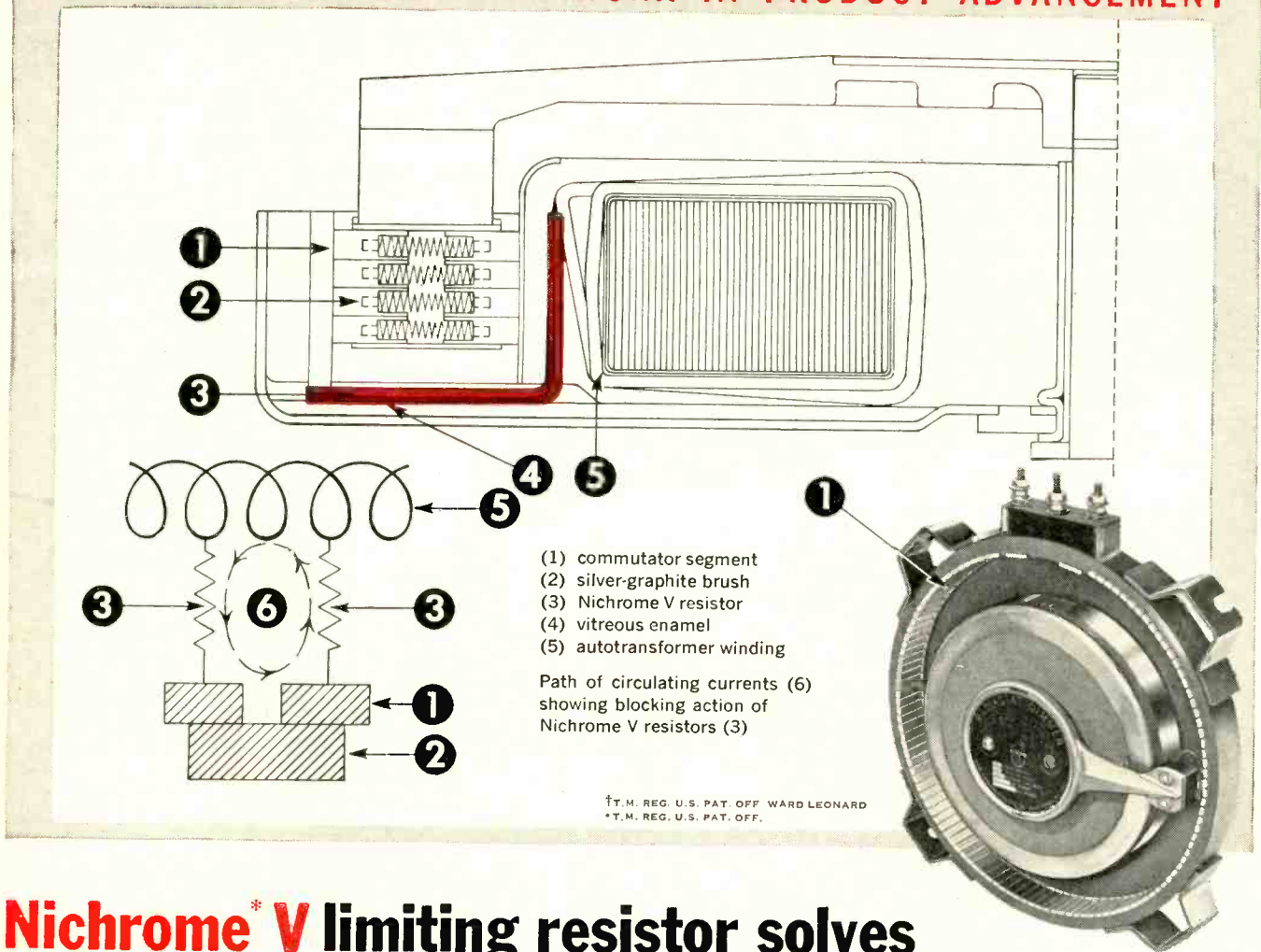

- (1) commutator segment
- (2) silver-graphite brush
- (3) Nichrome V resistor
- (4) vitreous enamel
- (5) autotransformer winding

Path of circulating currents (6) showing blocking action of Nichrome V resistors (3)

†T.M. REG. U.S. PAT. OFF. WARD LEONARD
*T.M. REG. U.S. PAT. OFF.

Nichrome[®] V limiting resistor solves age old brush problem in Ward Leonard Dimmers

This Ward Leonard 6.6 KW Radiastat[†] Dimmer is essentially a specially designed core type autotransformer whose output voltage is linear, furnishing smooth, stepless control from maximum to zero. Other notable features are: Highest rating in smallest size and longer, maintenance-free life.

Nearly all adjustable autotransformers depend upon carbon brushes to limit the short-circuiting current which occurs whenever the brush straddles two segments. However, in the Radiastat Dimmer, circulating currents are kept to a minimum in a unique way, permitting use of self-cleaning, self-lubricating, low resistance silver-graphite brushes.

In the Radiastat, each segment is electrically connected to its respective turn of the winding through a Nichrome V current limiting resistor. During commutation, the main winding is protected against burnout from high short-circuiting currents, thereby eliminating external resistors or high resistance brushes.

These all important resistors (one for each segment) connect to the segments beneath the vitreous enamel and run out and up to connect with the winding. They protect every step of the Radiastat, regardless of the contact arm position—drop a penny or a nail across adjacent segments—there's no puff! no burnout! The Nichrome V circulating current resistors completely safeguard the unit.

Nichrome V is used because it supplies a specified ohmage in a #10 wire 3³/₁₆" long; bonds well with the vitreous enamel; is highly resistant to heat and corrosion, and easily withstands severe current surges.

Driver-Harris now produces 132 different high nickel alloys in many different forms and in hundreds of sizes for almost every kind of industrial application. Do you need help with a special alloy? Tell us about it and if we haven't got it, we'll develop it for you.



Driver-Harris[®] Company

HARRISON, NEW JERSEY • BRANCHES: Chicago, Detroit, Cleveland, Louisville

Distributor: ANGUS-CAMPBELL, INC., Los Angeles, San Francisco

In Canada: The B. GREENING WIRE COMPANY, Ltd., Hamilton, Ontario

MAKERS OF THE MOST COMPLETE LINE OF ALLOYS FOR THE ELECTRICAL, ELECTRONIC, AND HEAT-TREATING INDUSTRIES



MINIATURIZED SEALED RELAYS



VIBRATION...yet normal operation

No—we don't use paint mixers to measure the vibration resistance of General Electric miniaturized sealed relays. But, it is a dramatic illustration of the punishment G-E hermetically sealed relays can—and do—withstand.

The best of laboratory equipment is used to measure this vibration resistance, and the results prove—General Electric voltage-calibrated Micro-miniature relays withstand vibration of 20 G's acceleration from 55 to 2000 cycles (.125 inch excursion from 10 to 55 cycles).

Excellent vibration resistance is just one of the many "plus" features—such as high- and low-temperature operation, high shock resistance, and rugged construction—you get with *all* Miniature, Sub-miniature, and Micro-miniature G-E sealed relays. Today, General Electric relays are proving their reliability on a variety of military and industrial electronics applications.

What's more, you get all of General Electric's complete line of standard-listed relays on *only 3-week shipment from*

receipt of order—plus—immediate service on samples and prototypes.

For further information, contact your G-E Apparatus Sales Office—or—write to General Electric Co., Sect. 792-7, Schenectady 5, N. Y., for complete relay data. *Specialty Control Dept., Waynesboro, Va.*

Progress Is Our Most Important Product

GENERAL  ELECTRIC

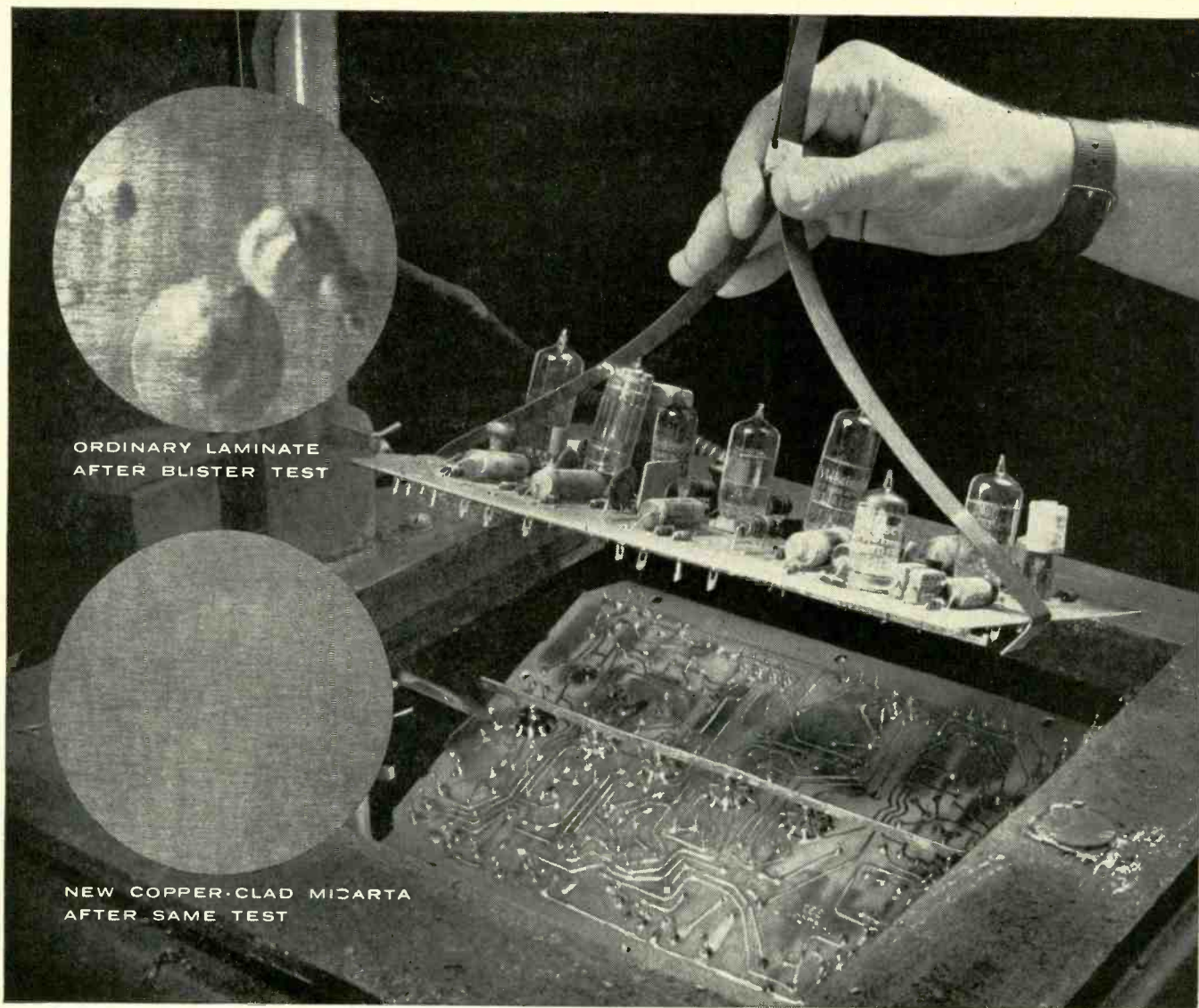

ORDINARY LAMINATE
AFTER BLISTER TEST

NEW COPPER-CLAD MICARTA
AFTER SAME TEST

New copper-clad **MICARTA**[®] takes dip solder bath without blistering!

New H-3032 copper-clad MICARTA[®] cuts costs and production time of printed circuits. Copper-clad MICARTA speeds up soldering, without the normal accompaniment of an increase in rejects and missed connections. It can be cold punched without cracking or chipping.

The laminate won't blister even when dip soldered for 10 seconds at 500°F! Examine the two close-up photographs. One shows an ordinary laminate after a laboratory test. Note the blistering, then look at the MICARTA dip soldered for the same length of time—and there is no blistering!

A special adhesive is used which has the same

high electrical properties, solvent resistance and low moisture absorption as the MICARTA laminate itself. Actually, adhesive strength is increased during soldering.

Because of a new adhesive process, copper-clad MICARTA keeps its high bond strength—from 10 to 13 pounds versus an industry standard of six pounds—even after heating and cooling is repeated many times. This is especially valuable for electronic circuits.

Copper-clad MICARTA may be the answer to your circuit assembly problem. Write for further information and technical data to Westinghouse Electric Corp., MICARTA Div., Hampton, S. C.,

J-06624-X

YOU CAN BE SURE...IF IT'S Westinghouse

Tuning Fork Controlled

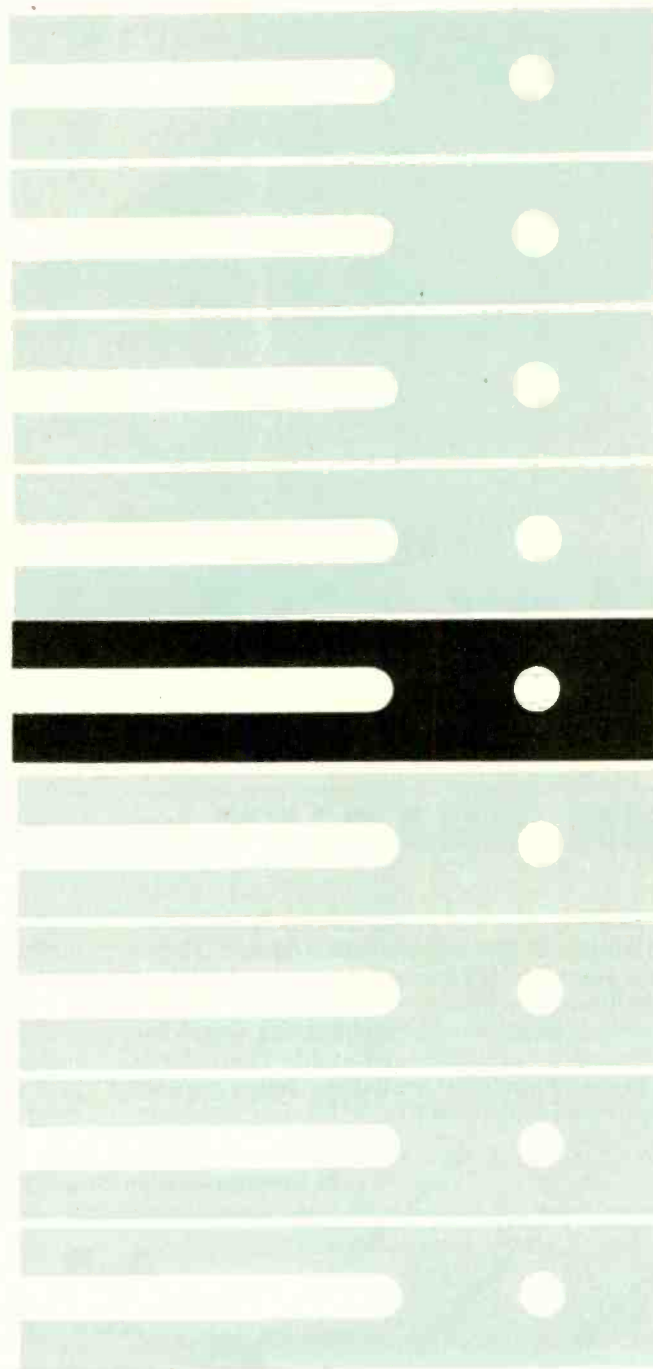

Tuning Fork Resonators, the ultimate in precision audio frequency control.

PHONE OR WRITE

for complete information regarding component type Tuning Fork Resonators, and variously packaged Frequency Standards, Oscillators, Drivers, and Frequency Dividers.

PHILAMON LABORATORIES INC.



90 Hopper Street, Westbury, Long Island, N. Y. EDgewood 3-1700

Circle 49 Readers Service Card

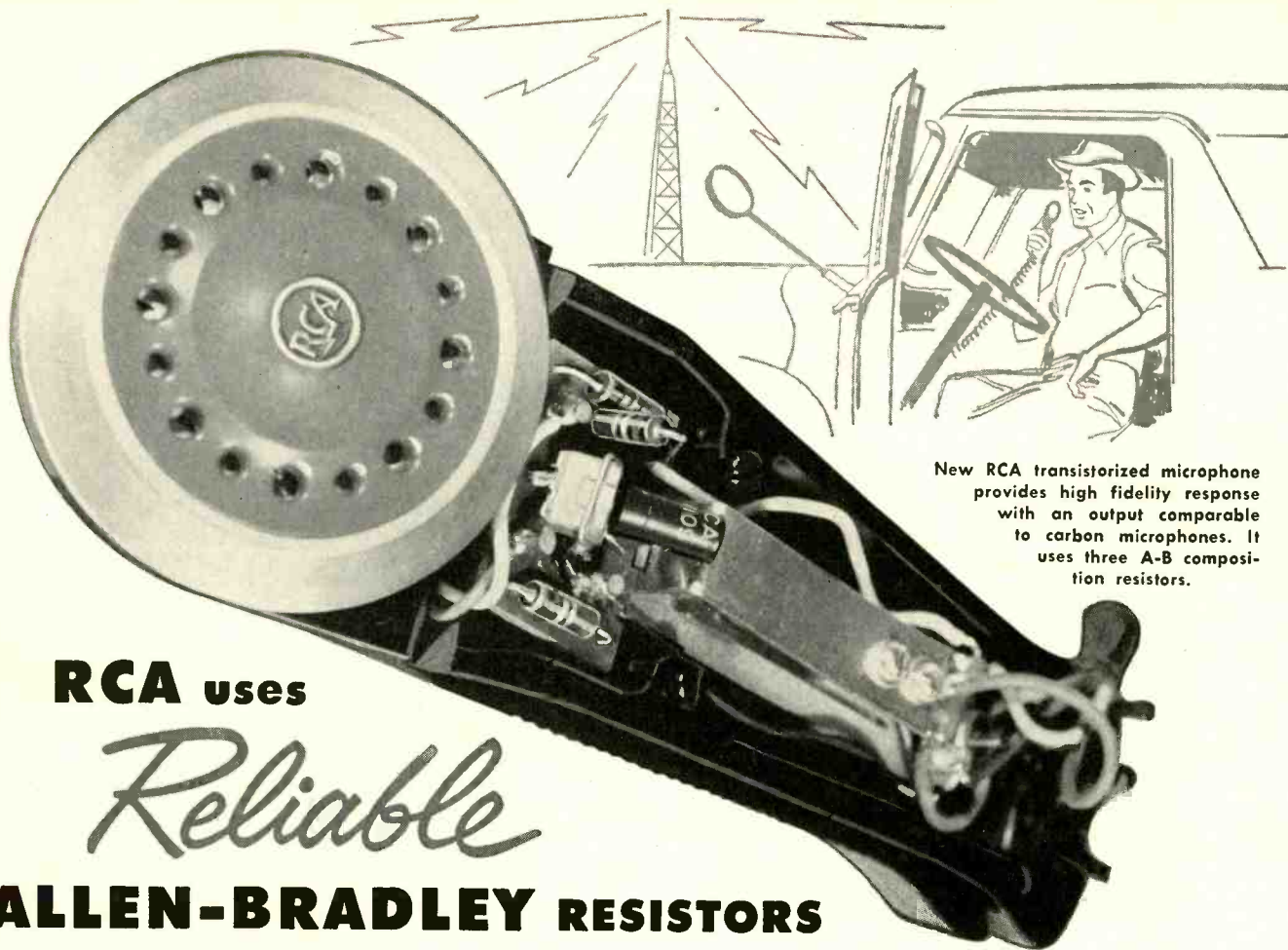

New RCA transistORIZED microphone provides high fidelity response with an output comparable to carbon microphones. It uses three A-B composition resistors.

RCA uses

Reliable

ALLEN-BRADLEY RESISTORS

The reliability of your product is no better than the reliability of the components you use. That's why it is sound design procedure to specify Allen-Bradley hot molded resistors. They are recognized by electronic engineers throughout the world for their conservative ratings and stable characteristics. The solid molded insulating jacket assures superior humidity resistance after subjection to

high humidity for long periods of time . . . as normally encountered in actual practice. These resistors *cannot* "open circuit."

You cannot go wrong with Allen-Bradley *quality* components—composition resistors; ceramic capacitors, and ferrite parts. Write for technical information, today.

Allen-Bradley Co., 110 W. Greenfield Ave., Milwaukee 4, Wis.
In Canada—Allen-Bradley Canada Ltd., Galt, Ont.



**A-B
HOT MOLDED
COMPOSITION
RESISTORS**

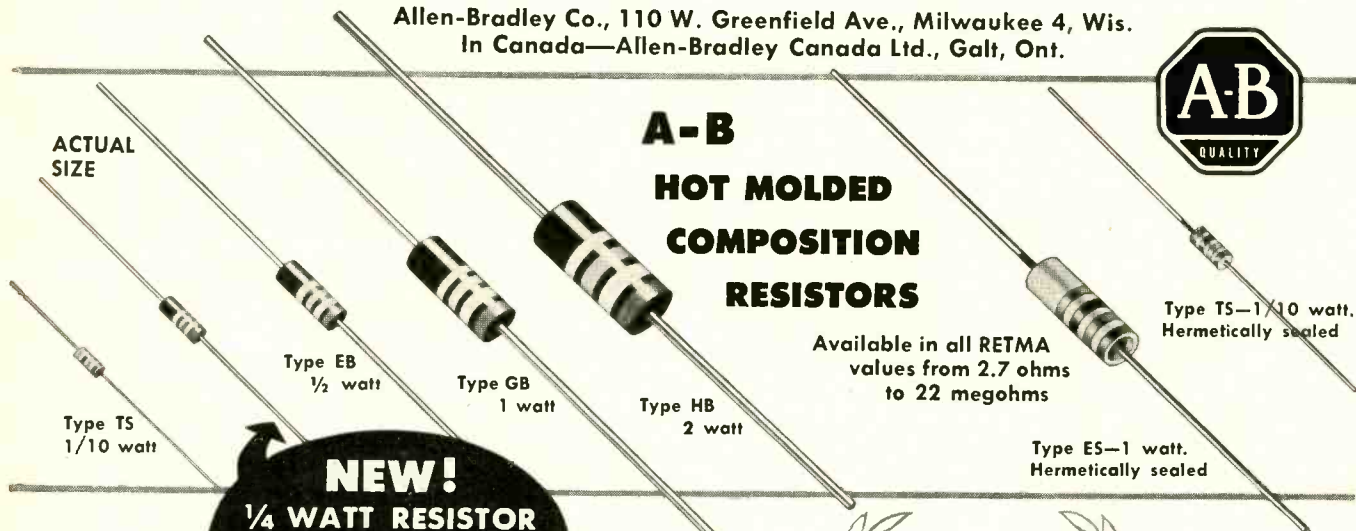

ACTUAL SIZE

Type TS
1/10 watt

Type EB
1/2 watt

Type GB
1 watt

Type HB
2 watt

Type TS—1/10 watt.
Hermetically sealed

Type ES—1 watt.
Hermetically sealed

Available in all RETMA values from 2.7 ohms to 22 megohms

NEW!
1/4 WATT RESISTOR
Type CB—only 1/4 inch long.
Hot molded insulating jacket. Rated at 70°C.

**ALLEN-BRADLEY
HOT MOLDED COMPOSITION RESISTORS**

QUALITY











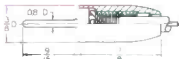

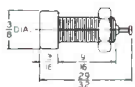
NOW AT YOUR FINGERTIPS!

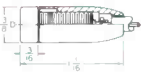
a complete line of nylon jacks, binding posts, and solderless plugs!

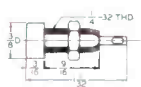
more for your connector dollar!

- Shock-proof nylon construction—won't chip or crack with the hardest usage.
- Provides high voltage insulation—voltage breakdowns up to 12,500 volts DC.
- Highly resistant to extremes of heat, cold, and moisture.
- Plugs designed for simplified, solderless connection of up to 16 gauge stranded wire.
- Available in 13 bright colors for coded applications. (See chart below.)
- Economical—simple, functional engineering design gives you top quality at low cost.

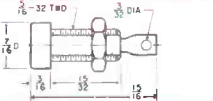
UNITS SHOWN ACTUAL SIZE

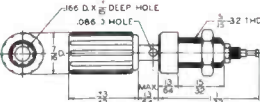
CONNECTOR TYPE	DIMENSIONS	DESCRIPTION
 105-301 to -313		NYLON TIP PLUG (Patent Pending) Completely insulated, sleeve is molded of tough nylon and will not chip or crack even when subjected to extreme temperature changes. Recessed metal head prevents exposure of metal surfaces when engaged in any standard tip jack. Current rating: 10 amps. Metal parts are nickel-plated brass. Designed for solderless connection of up to 16 gauge stranded wire.
 105-601 to -613		NYLON TIP JACK (U.S. Pat. No. 2,704,357) Completely insulated nylon body with machined beryllium copper contact. Current rating: 10 amps. Voltage breakdown: 11,000 volts DC. Capacity to 1/16" panel: 2.0 mmf. Contact is silver-plated—recessed in head. Solder terminal is hot tin dipcoated. Single 1/4"-32 nut furnished for mounting—no auxiliary mounting hardware needed. Mounts in 7/64" dia. hole.
 105-701 to -713		NYLON JACK AND SLEEVE (Jack—U.S. Pat. No. 2,704,357) Complete assembly includes a standard nylon tip jack less mounting nut with an inside threaded, molded nylon insulating sleeve. Ideal for patch cards, this assembly is also excellent for panel mounting where an insulated rear connection of a panel mounted tip jack is desired.
 105-801 to -813		NYLON TIP JACK New low cost insulated tip jack. Body molded of tough, low-loss nylon. Forms silver-plated phosphor bronze contact. Current rating: 10 amps. Voltage breakdown: 9,000 volts DC. Capacity to 1/16" panel: 2.0 mmf. Single 1/4"-32 nut furnished for mounting—no auxiliary mounting hardware needed. Mounts in 17/64" dia. hole or double flat hole.
 108-301 to -313		NYLON BANANA PLUG (Patent Pending) Compact high voltage insulated plug for a wide variety of applications. Current rating: 10 amps. Easy solderless connection of up to 16 gauge stranded wire. Nylon insulating sleeve retains strength and low-loss characteristics over a wide range of temperatures. Body and pin are of one-piece nickel-plated brass with high grade nickel-silver springs.
 108-901 to -913		NYLON BANANA JACK Completely insulated, molded nylon body. Current rating: 10 amps. Voltage breakdown: 12,500 volts DC. Capacity to 1/16" panel: 1.5 mmf. Contact is cadmium-plated. Accommodates banana plugs of a nominal diameter of .175". Single 5/16"-32 nut furnished for mounting—no auxiliary mounting hardware needed. Mounts in 21/64" dia. hole.
 111-101 to -113		NYLON BINDING POST (Patent Pending) Compact, completely insulated, pre-assembled 6-way binding post. Molded nylon body. Shank is silver-plated brass—thumb nut is self-captivated and cannot be removed. Insulation resistance greater than 200 meg. after MIL-T-5422B humidity test. Voltage breakdown: 8,000 volts DC. Current carrying capacity: 15 amps. Capacity to 1/8" panel: 3.3 mmf. Single 5/16"-32 nut furnished for mounting—no auxiliary mounting hardware needed. Mounts in 21/64" dia. hole, "D" hole, or double-flat hole.

COLOR CODING BY CATALOG NUMBER All nylon connectors are available in the colors indicated at right. Catalog numbers ending in 1 (for example 105-301) indicate white; 2—red; 3—black; 4—dark green; 5—light blue; 6—orange; 7—yellow; 8—brown; 9—light green; 10—dark blue; 11—ivory; 12—violet; 13—grey.

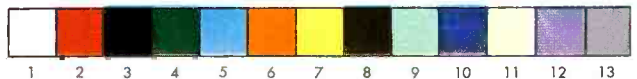

Other connectors: Johnson also manufactures a complete line of standard connectors in addition to the nylon line illustrated above. For complete information on these as well as other quality Johnson electronic components write for your free copy of our current component catalog.



E. F. Johnson Company

116 SECOND AVENUE SOUTHWEST • WASECA, MINNESOTA

DEMODULATORS FOR POSITIONING SERVOS

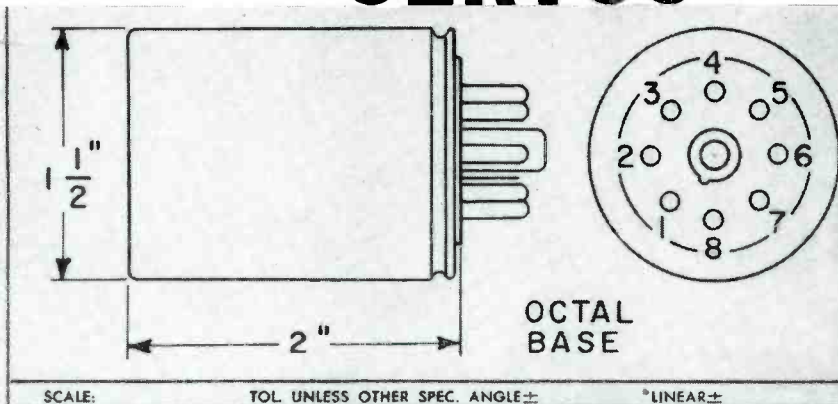

AIRPAX PRODUCTS	
BALTIMORE, MD.	FORT LAUDERDALE, FLA.
SYNCHRONOUS DEMODULATOR	
DATE	15, AUG. 57
	PART NO. T

SYNCHRONOUS RING DEMODULATORS HAVE HIGH ACCURACY

Accuracies as high as 9 minutes can be obtained with Airpax demodulator Type D-5170. The internal parameters of this unit are optimized for maximum accuracy. Under rated extremes of temperature, reference voltage, and reference frequency, null error will not exceed 15 minutes.

Here, indeed, is the component you are looking for to use in your high performance positioning servo. It is complete and compact. Type D-5170 is especially recommended for null seeking systems; it has a highly accurate null. Type D-5171 has a wider linear range and is suggested for use in proportional control systems.

You probably have an application coming up in which one of these precision-made components can replace considerable circuitry. We have engineering data ready for you; just write to



DEMODULATOR CHARACTERISTICS

Synchronous demodulators Types D-5170 and D-5171 are transformer coupled ring rectifiers.

Input: Modulated 400 CPS not to exceed 40 RMS volts.

Output: Unfiltered polarity reversible DC into 125-ohm load. With 1 RMS Volt Input the output is:

Type Number	Output Current in Microamperes
D-5170	240
D-5171	180

These outputs are within $\pm 10\%$ of specified values, and are linear within 3% for inputs below 1 volt for Type D-5170 and below 3 volts for Type D-5171.

Reference: 26 ± 2.6 RMS volts at 400 ± 40 CPS at about 3.2 ma.

Stability: 5% or better.

Zero Error: Less than ± 5 microamperes output into 125-ohm load.

Temperature: -55 C to $+85$ C.

Shock and Vibration: 30 G shock for 11 milliseconds and vibrations of 10 G from 10 to 2000 CPS in all directions.

Enclosure: Hermetically sealed with octal-pin base, weight about 7 oz., seated height 2 inches, diameter $1\frac{1}{2}$ inches.

AIRPAX PRODUCTS CO., CENTRAL ENGINEERING DIV., CITY OF PLANTATION, FORT LAUDERDALE, FLORIDA



Microwave cooking shaves hours from food preparation time. This is a home-type electronic oven developed by Raytheon for production by appliance manufacturers.

Meals in minutes by electronics— in permanent magnet equipped range,

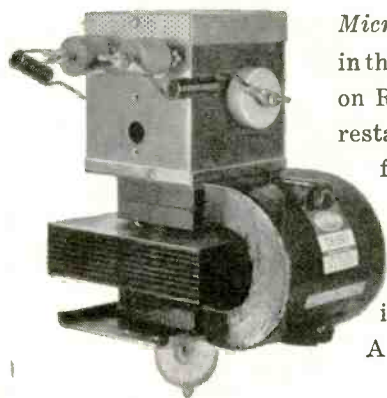

Permanent magnet is C-shaped casting at right of magnetron; box on top is filter assembly.

Microwave energy does the cooking in this domestic electronic oven based on Raytheon's "Radarange" for the restaurant industry. Microwaves are far higher in frequency than broadcast waves—fact, the magnetron tube (at left) steps up the vibrations to an incredible 2,450,000,000 times a second! A vital part of the magnetron is

the Crucible Alnico permanent magnet shown in the inset.

This is one of many practical applications for Crucible Alnico permanent magnets. Crucible has been a leading producer of permanent magnets, known for their *consistently higher* energy product, ever since Alnico alloys were developed. You can now order them sand cast, shell molded, or investment cast to every size, shape, or tolerance needed.

It's why an increasing number of manufacturers find the answer to their magnet problem at Crucible. *Crucible Steel Company of America, The Oliver Building, Mellon Square, Pittsburgh 22, Pa.*

CRUCIBLE

first name in special purpose steels

Crucible Steel Company of America

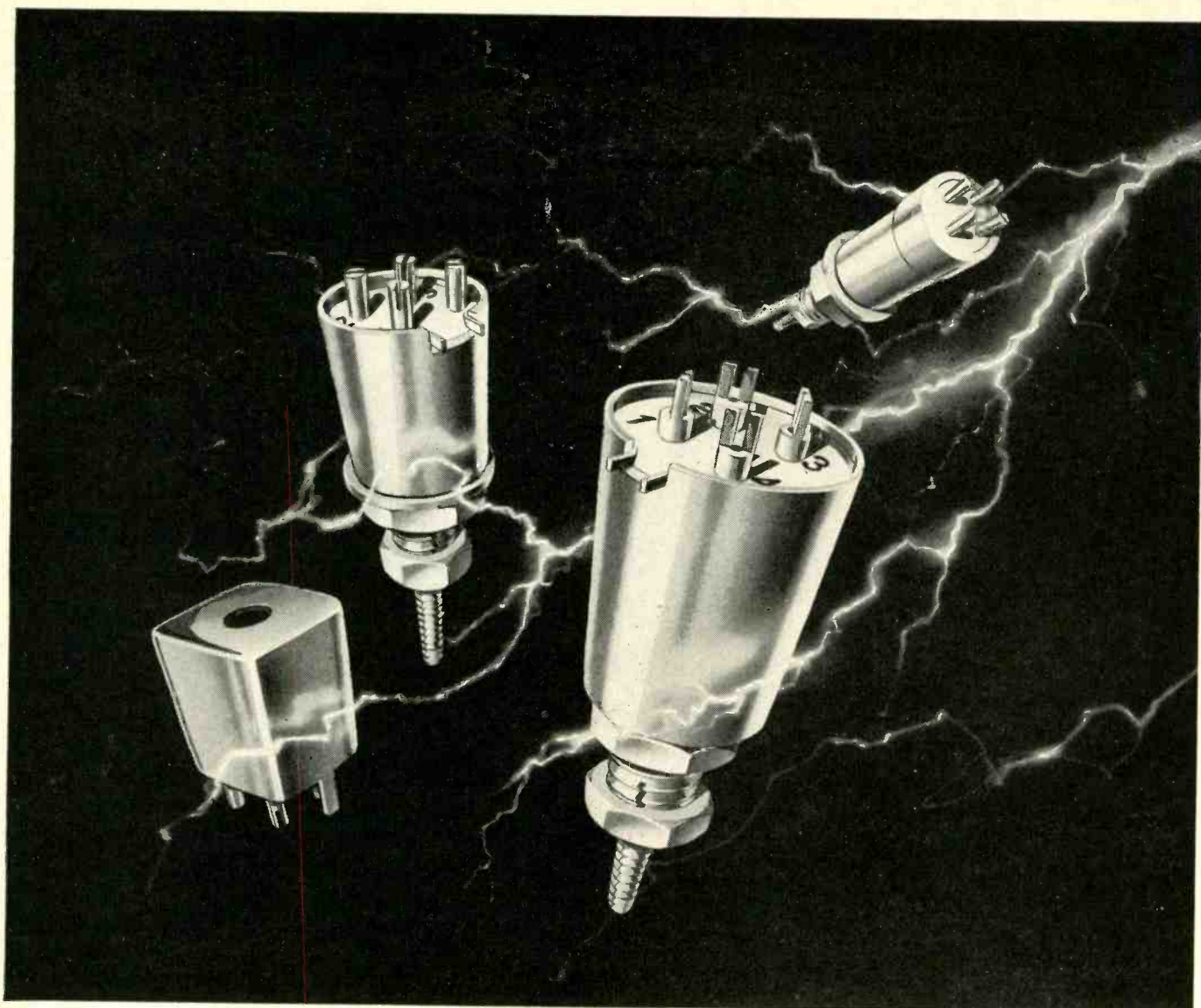

These shielded coil forms offer the utmost in reliability due to their unique design and construction. Dimensions when mounted, including terminals, are: LS-9, $\frac{1}{16}$ " diameter x $\frac{1}{2}$ " high; LS-10, $\frac{5}{8}$ " x $1\frac{1}{16}$ "; LS-11, $1\frac{1}{16}$ " x $1\frac{1}{32}$ ". Each form mounts by a single stud. The LS-12 is a square type for printed circuits and measures $\frac{1}{2}$ " x $\frac{1}{2}$ " x $\frac{1}{2}$ ". Single layer or pie-type windings to your specifications.

Reliability – under any condition!

CTC miniaturized shielded coil forms are highly shock resistant. With mechanically enclosed, completely shielded coil windings, they bring all the ruggedness and dependable performance you require for your "tight spot" applications — IF strips, RF coils, oscillator coils, etc.

CTC combines *quality control* with *quantity production* to supply exactly the components you need, in any amount. CTC *quality control* includes material certification, checking each step of production, and each finished product. And CTC *quantity production* means CTC can fill your orders for any volume, from smallest to largest.

For samples, specifications and prices, write to Sales Engineering Dept., Cambridge Thermionic Corporation, 437 Concord Ave., Cambridge 38, Mass. On the West Coast contact E. V.

Roberts and Associates, Inc., 5068 West Washington Blvd., Los Angeles 16, and 61 Renato Court, Redwood City, Cal.

TYPE SPC phenolic and ceramic printed circuit coil forms can be soldered after mounting. Phenolic forms: $\frac{3}{4}$ " high when mounted, in diameters of .219" and .285". Ceramic forms: $\frac{1}{4}$ " diameter, in mounted heights of $\frac{3}{8}$ " and $1\frac{1}{16}$ "; with $1\frac{1}{32}$ " powdered iron core, and collars of silicone fibre-glass. Forms come with threaded slug and terminal collar. Units mount through two to four holes, as required. Available as forms alone or wound as specified.

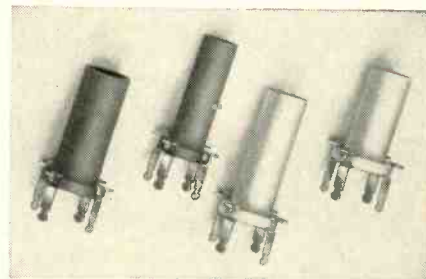

CTC

CAMBRIDGE THERMIONIC CORPORATION

*makers of guaranteed electronic components
custom or standard*

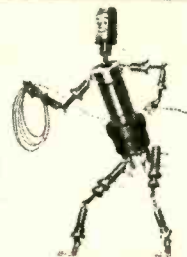

THE Elin DK-102 PRECISION POWER OSCILLATOR!



© Reg. U.S. Pat. Off. Pat. Pending.

For top precision performance in the oscillator field it's Elin oscillators that can speed your results, save dollars! Ideal for pre-flight missile system checkouts, power source for all "bridge type" transducers, precision 400 cycle gyro testing, special power sources, time correlations, etc.—*wherever* you need "tuning fork" Frequency Stability, Absolute Voltage values, extremely low Output Impedance, Ultra-low Distortion and High Power Capacity!

The Elin Precision Power Oscillator gives you all this through an exclusive High-Q LC tuned circuit and special voltage-sensitive bridge combined in a circuit employing a large amount of negative feedback.

Standard model—2 watts power output (6 watt model, DK-106) at fixed audio frequencies between 250 to 15,000 cps. Special models available in higher power capacities and at other frequencies or to customer specifications. Write for literature TODAY!

SPECIFICATIONS:

FREQUENCY

250 CPS. to 15,000 CPS.

POWER

2 Watts (DK-102, DK-102R).
6 Watts (DK-106, DK-106R).

VOLTAGE

10, 30 & 100 volts RMS.
All with floating, center tapped output.

DISTORTION

0.1% maximum harmonic content
0.05% maximum AC hum
0.01% maximum noise

FREQUENCY STABILITY

±0.5% maximum, under usual
lab ambient conditions.
±0.02% maximum, per ±10 volts
variation in line voltage.
±0.05% maximum, zero to full load.

AMPLITUDE STABILITY

±0.1% maximum, under usual
ambient conditions.
±0.02% maximum, per ±10 volts
variation in line voltage.
±0.2% maximum, zero to full load.

PRICE: from \$295.00

Model DK-102R

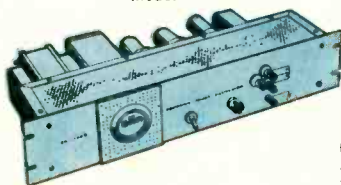

ELIN LEADS A "DOUBLE LIFE" of quick-change versatility providing fast modification from a DK-102 (cabinet model) to a DK-102R for rack mounting! All models are smartly styled, compact (5¾" H x 9"D x 16¾"W) and built to give reliable, trouble-free service. 115V AC plug-in power is made to either lugs or AN adapter at rear of chassis!

elin / **ELECTRONICS INTERNATIONAL CO.**

145 West Magnolia Boulevard, Burbank, California

Special Products Division of International Electronic Research Corporation, Burbank, California



... YOU SHOULD KNOW THERE IS A MORE ACCURATE V O M

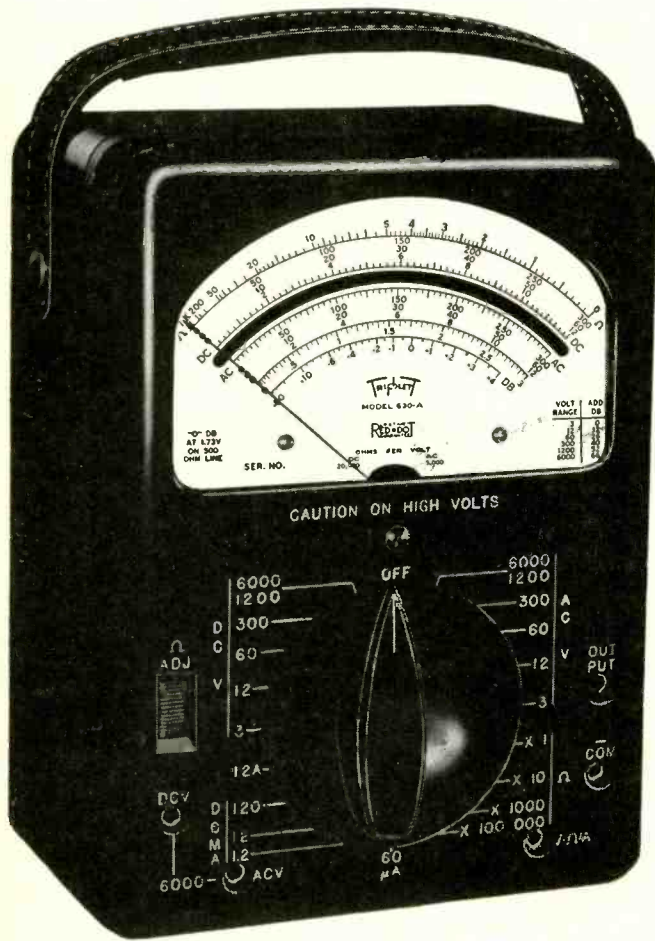

1½% accuracy . . .

mirror scale

to eliminate any possible parallax and give you readings with the same laboratory accuracy that is built into the instrument.

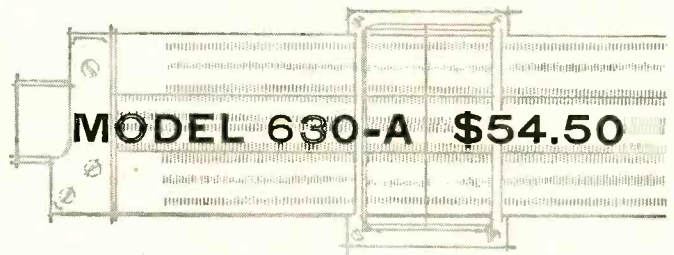

MODEL 630-A \$54.50

This VOM is truly what laboratories buy when they must have the best.

Model 630-A is prized in 782 industrial laboratories

115 research laboratories

237 development laboratories

and is owned by over 300 engineering consultants and used for critical production line testing and in the maintenance of automation equipment by over 1100 manufacturers of all types of products.

TRIPLETT FEATURES:

½% resistors—molded mounting for resistors and shunts allows direct connections without cabling. (No chance for shorts—longer life and easy-to-replace resistors in their marked positions.) King sized recessed knob for the single selector switch for both circuit and range—just turn and make reading.

Resistance ranges are compensated for greatest accuracy over wide battery voltage variation.









33 RANGES:

12 D.C.-A.C. Volts (20,000 ohms per volt DC, 5000 ohms per volt AC.); 5 Current Ranges; Resistance from .1 Ohms to 100 Megohms; Decibel and Output readings.

TRIPLETT

**TRIPLETT
ELECTRICAL
INSTRUMENT
COMPANY
Bluffton, Ohio**

Burton browne advertising

								
631 Combination V-O-M—VTVM	630-NA For Best Testing Around the Lab, Production Line or Bench	630 The Popular All-Purpose V-O-M	630-A A Good Lab and Production Line V-O-M	310 The Smallest Complete V-O-M with Switch	630-T For Telephone Service	666-HH Medium Size for Field Testing	625-NA The First V-O-M with 10,000 Ohms/Volt AC	666-R Medium Size with 630 Features

VARIAN ANNOUNCES...

Overseas Microwave Tube Representatives

BELGIUM

REGULATION-MESURE
Brussels;
22, Rue St. Hubert

DENMARK

TAGE OLSEN A/S
Copenhagen 5;
Centrumgarden, Room 133
6D, Vesterbrogade

ENGLAND

LIVINGSTON LABORATORIES, LTD.
London N. 19;
Refcar Street

FRANCE

JIVECO ELECTRONICS
Paris 16e;
21, Avenue Victor Hugo

GERMANY

SCHNEIDER-HENLEY & CO.
Munich 59;
Gross Nabas-Str. 11

HOLLAND

I.R.C.A.
Voorburg;
92 Paradysstraat

ITALY

HENRY C. MILANO
Torino;
Via Cesare Battisti, 2

JAPAN

MARUBUN CO., LTD.
Chuo-Ku, Tokyo;
No. 1, 2-Chome
Odenmachi, Nihonbashi

NORWAY

MORGENSTIERNE & CO.
Oslo;
Colleis Gate 10

SWEDEN

INGENIORSFIRMAN MAGNETIC AB
Stockholm C;
Stora Nygatan 39

SWITZERLAND

MAX PAUL FREY
Koniz-Bern; Hangweg 27

*These companies, representing
Varian Associates — world's largest manufacturers
of klystrons — are ready to provide complete
sales and engineering service for your
microwave tube requirements and to supply
you with dependable*

Varian KLYSTRONS
Varian TRAVELING WAVE TUBES
Varian BACKWARD WAVE OSCILLATORS

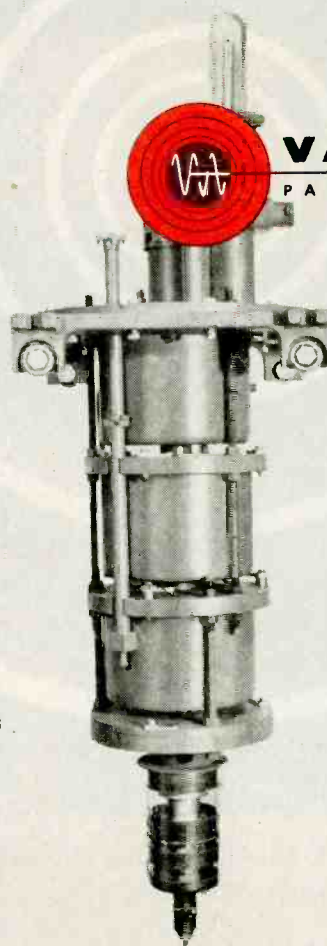

VARIAN associates
TUBE DIVISION

PALO ALTO 1, CALIFORNIA

Representatives in all principal U.S. cities



KLYSTRONS, TRAVELING WAVE TUBES, BACKWARD WAVE OSCILLATORS, LINEAR ACCELERATORS, MICROWAVE SYSTEM COMPONENTS,
R. F. SPECTROMETERS, MAGNETS, MAGNETOMETERS, STALOS, POWER AMPLIFIERS, GRAPHIC RECORDERS, RESEARCH AND DEVELOPMENT SERVICES

WESTINGHOUSE MAGAMP

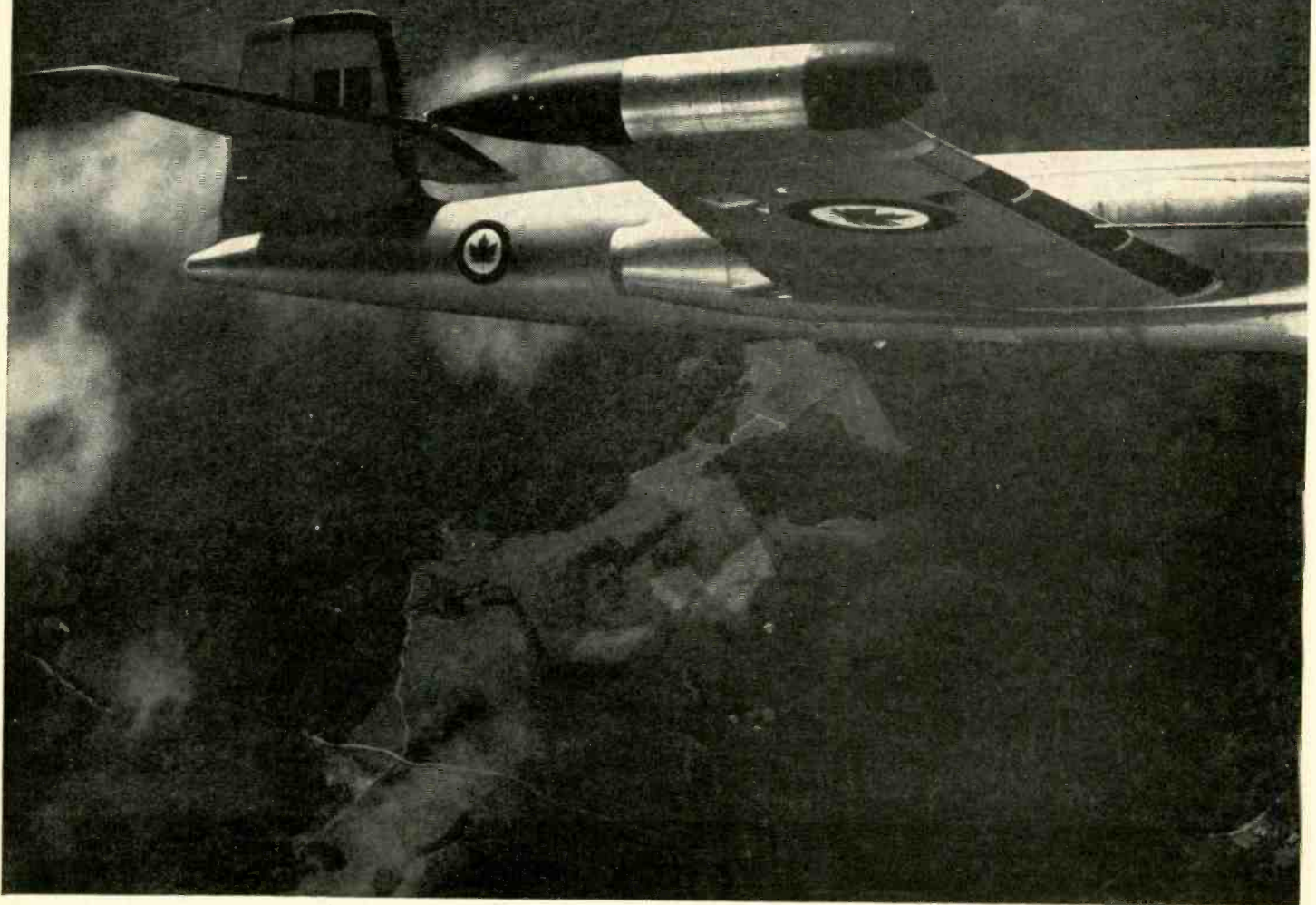

Another Example of CREATIVE MAGAMP ENGINEERING By Westinghouse

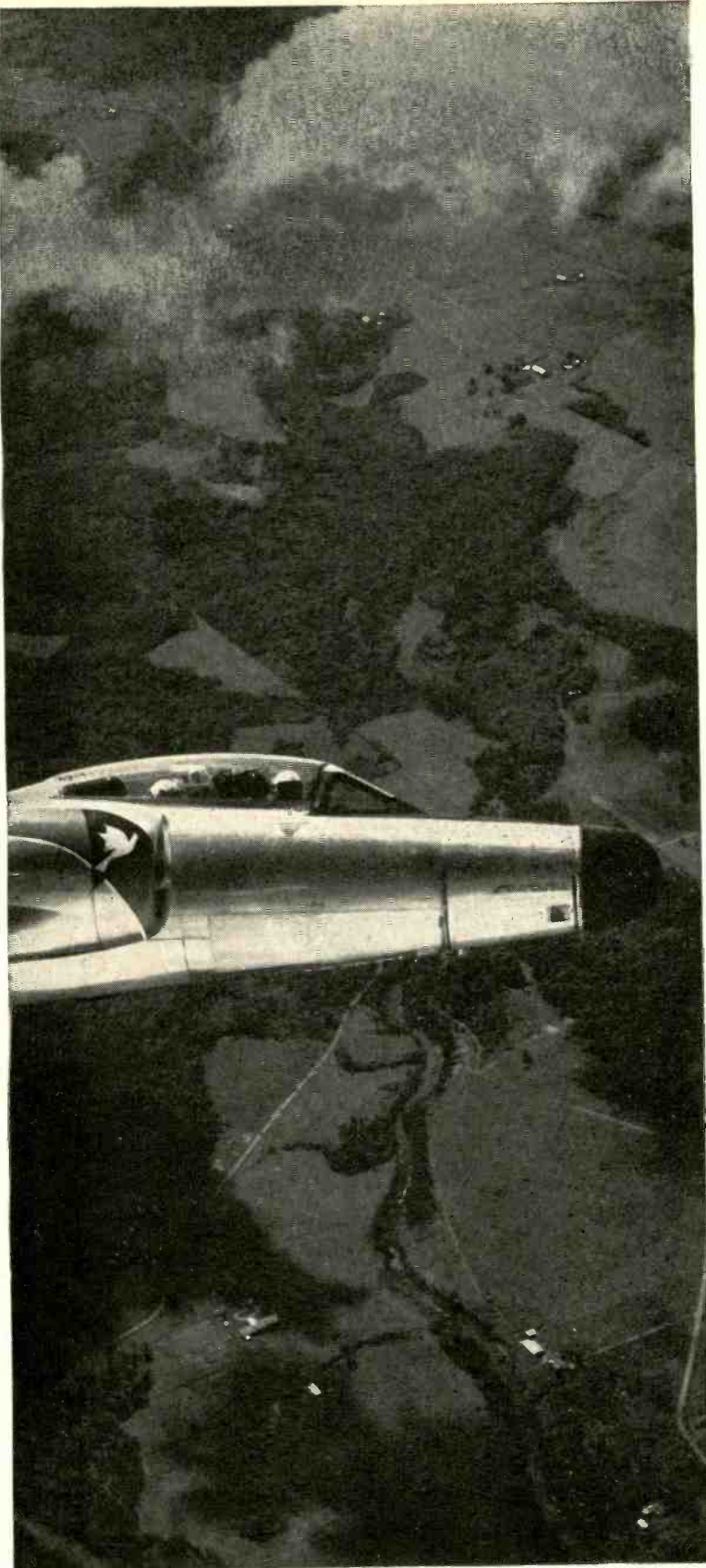

World's Lightest Magnetic Amplifier Regulator Unit . . . Capable of Voltage Regulation Plus or Minus 1 Volt up to 120°C.

The high altitude missile-carrying CF-100 Mark VI, designed and developed by Avro Aircraft Ltd., of Canada, is undergoing advanced flight testing. Complete dependability and fast response are critical in control and power supply components for these all-weather aircraft. That's why Westinghouse transformer-rectifier unit with MAGAMP* static control was specified — it assures electrical system reliability over a wide range of temperatures and altitudes on aircraft and guided missiles.

Using a 12-phase amplifier and silicon rectifiers, Westinghouse can obtain an output of 5.6 kw . . . yet the unit occupies less than one cubic foot and weighs only 62 pounds. By designing reactors that will operate at 200°C internal temperatures, Westinghouse engineers are able to provide the only magnetic amplifier voltage regulator on the market that will operate at a sea-level temperature of -55°C to +120°C.

This is an example of Westinghouse creative MAGAMP engineering to solve today's problems and tomorrow's applications. For information or engineering assistance on your specific control problems, call your Westinghouse sales engineer, or write Westinghouse Electric Corporation, P.O. Box 868, 3 Gateway Center, Pittsburgh 30, Pennsylvania.

*TRADE-MARK

J-22030

MAGAMP STATIC REGULATOR CHARACTERISTICS

INPUT
190 to 210 volts rm-3 phase

OUTPUT
28 volts at 200 amperes

FREQUENCY RANGE
380 to 420 cps

RIPPLE
1.5-volt peak ripple

TRANSIENT RESPONSE
0.2-second maximum

EFFICIENCY
Minimum of 80% at full load

PERFORMANCE
As specified in MIL-E 5272 A

LIFE
1,000 hours minimum with no
maintenance or adjustments.

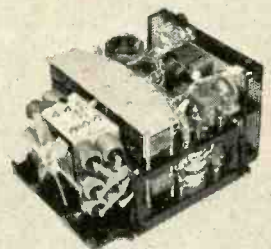

YOU CAN BE SURE...IF IT'S **Westinghouse**





This is a typical *Truflex*[®] formed part

Illustrated is one of many parts being produced by General Plate's Truflex Thermostat Metal Department. Today, hundreds of manufacturers rely on General Plate's years of processing experience for thermostat metal parts that control, compensate and indicate temperature.

Here are other typical Truflex formed parts and sub-assemblies.

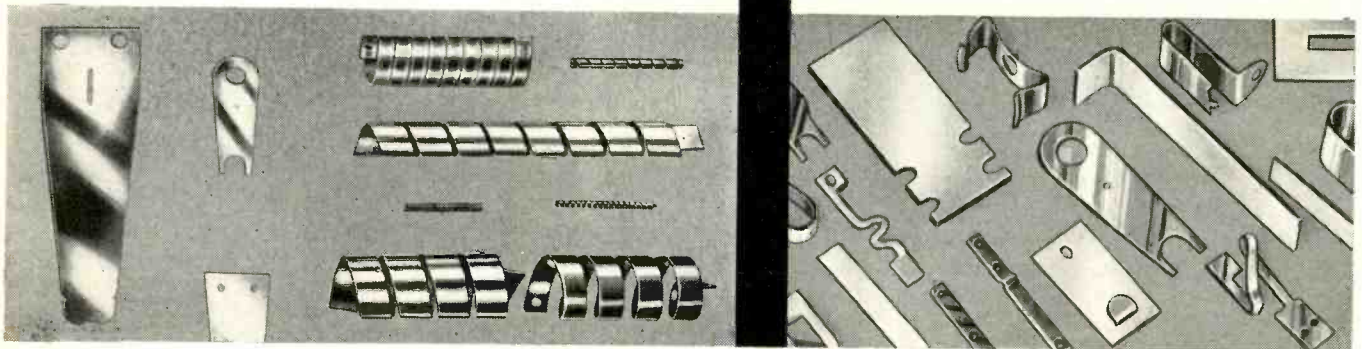

You can profit by using General Plate clad metals.

METALS & CONTROLS CORPORATION

General Plate Division



1310 Forest Street, Attleboro, Mass.

FIELD OFFICES: NEW YORK, CHICAGO, DETROIT, MILWAUKEE, LOS ANGELES

You can depend on Truflex parts!

- Truflex parts and sub-assemblies are engineered to your specifications, ready for installation.
- Every piece — in lots of 10 or 10,000 — is a duplicate of the original . . . eliminating rejects and costly assembly adjustments.
- Production problems, special equipment, and prolonged experimental work are all eliminated when you use Truflex parts.
- If you prefer to make your own parts, Truflex Thermostat Metals are available in extra long coils or flat strips manufactured to your exact specifications.

Send us a drawing of your thermostat metal parts and let us show you what Truflex Thermostat Metal can do for you.

PERFORMANCE PROVEN

... FOR OVER 25 YEARS

H-H RESISTORS and RHEOSTATS



H-H Long-Life Resistors

Blue Ribbon Resistors

Fugged blue ribbon resistors provide higher wattage ratings per unit, save space and weight. Construction features high temperature, vitreous enamel, crazeless coating for maximum moisture resistance. Aluminum thru-bar distributes heat uniformly. Corrosion resistant and vibration-proof.

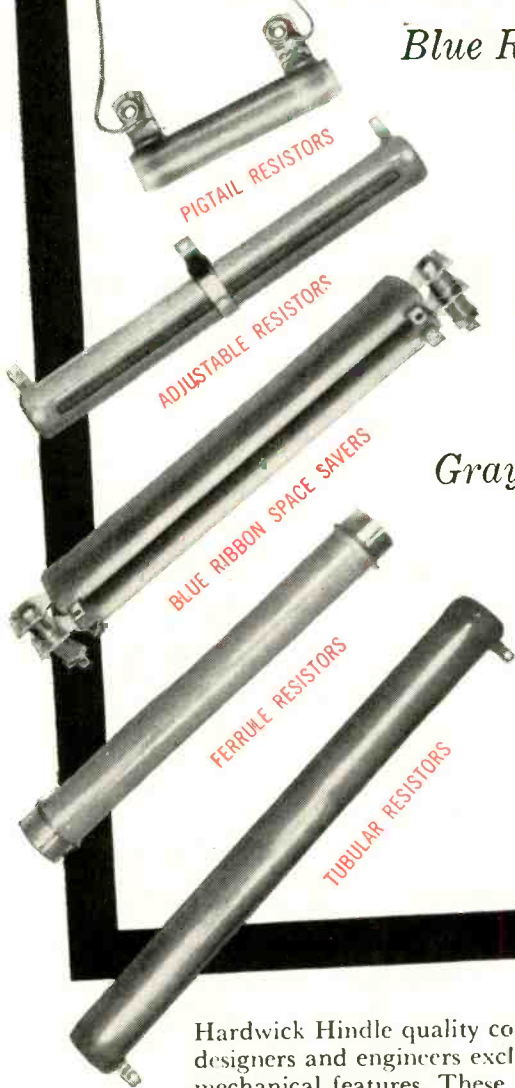

Gray Line Resistors

These dependable resistors feature high temperature gray enamel coating and stronger core for extra dependability under the most extreme operating conditions. All wire connections on H-H Long Life Resistors feature all welded construction. The fixed, ferrule and adjustable types meet MIL-R-26 specifications.

Hardwick Hindle quality components offer circuit designers and engineers exclusive electrical and mechanical features. These design "plus" factors provide complete dependability where severe operating environments are encountered in commercial or military service. Complete data on H-H Rheostats and Resistors is available on request. Call or write for illustrated resistor and rheostat catalogs today! Standard stock items available for immediate delivery from authorized local electronic parts distributors.

TYPE A RHEOSTATS (25 Watts)



Functions smoothly under the most adverse conditions. Terminals of strong, corrosion resistant alloy, are permanently welded to winding form. Wound ring is made an integral part of the refractory base by vitreous enamel. Shafts are insulated. Three terminals permit use as potentiometer or rheostat.

TYPE AM RHEOSTATS (25 Watts)



Featuring porcelain-vitreous enamel construction, Type AM rheostats are exceptionally rugged, compact and possess excellent heat dissipating characteristics. Resistive element is wound on a flat, pure mica form, placed within a refractory base and completely embedded in vitreous enamel.

TYPE AMS RHEOSTATS (25 Watts)



This type Hardwick Hindle Rheostat includes all the electrical and mechanical advantages featured in the Type AM with lug terminals. However, Type AMS Rheostats incorporate screw type terminals.

TYPE H RHEOSTATS (50 to 1000 W.)

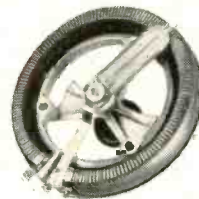

High temperature enamel affords maximum safety under overloading. H-H bus-bar construction provides ample resistance, ample safety under maximum current requirements. Constant pressure contact arm provides trouble-free operation.

The Mark of Quality Since 1924



**HARDWICK
HINDLE · INC**

40 HERMON ST., NEWARK 5, N.J., U.S.A.

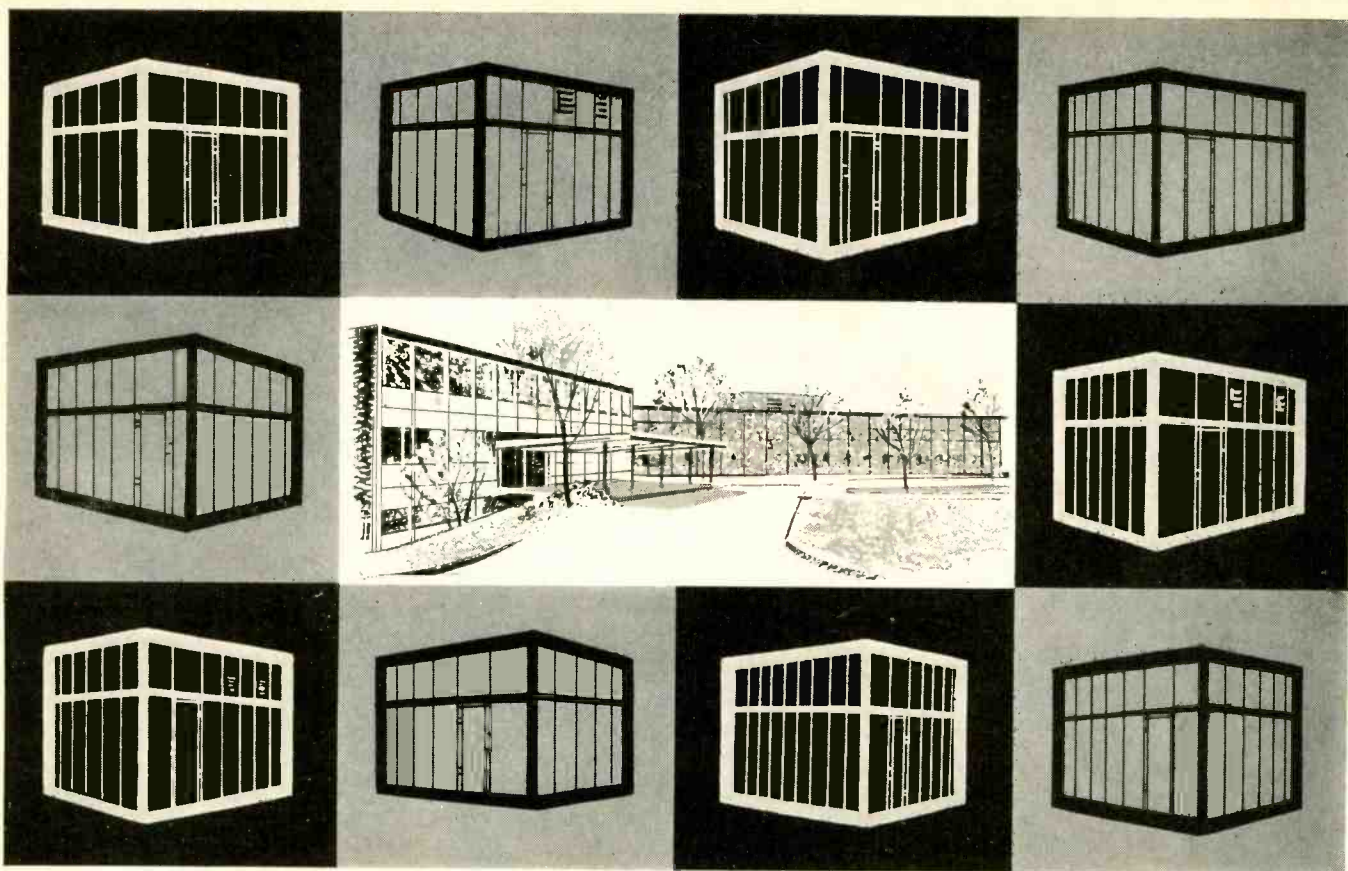

RCA Cherry Hill center studies TV interference in **35** ACE shielded enclosures

FCC regulations governing receiver radiation specifically state that r-f interference in the frequency range of 450 kc to 25 mc cannot exceed 100 microvolts as measured on the power line connected to the TV receiver. RCA thoroughly tests the prototype of every TV set it manufactures, both color and black and white, against these FCC regulations. And it's all done with great accuracy in one of the thirty-five Ace enclosures at RCA's modern Television Engineering Laboratories at the Cherry Hill Center, Camden, N. J. Actually the largest number of shielded enclosures ever installed at one site, these represent an important part of one of the best equipped engineering laboratories in the world.

Here, thorough shielding is a must, for numerous engineering tests involving interference are often under way at the same time. Other receiver studies carried out in these rooms include tests for gain, selectivity, sensitivity, and general circuit design.

Each of the Ace RFI-Design* rooms is constructed of prefabricated galvanized steel panels and frames with special r-f leak-proof doors of the same material. They provide over 100 db attenuation at all frequencies from 14 kc to 1000 mc. All are ventilated from a central air conditioning source.

An interesting collateral function of these enclosures is their use as

*Lindsay Structure

partitions to section off areas of the engineering department. Should the occasion arise, two adjacent rooms may be combined into a large one merely by removing adjoining walls and bolting the remaining structure together. Similarly, dimensions can be easily changed by adding or removing interchangeable panels.

The Cherry Hill installation is a stimulating illustration of the way standard Ace enclosures are solving today's shielding needs. They can be equally effective in your own plant. An Ace Sales Engineer would be glad to discuss it with you. Or, write for further information—a free catalog on standard Ace enclosures is yours for the asking.



First and Finest In Shielded Enclosures

ACE ENGINEERING & MACHINE CO., INC. • 3644 N. Lawrence St., Phila. 40, Pa.

**MORE COMPACT CIRCUITRY
NOW POSSIBLE WITH**

Collins
**MINIATURIZED
MECHANICAL FILTERS**

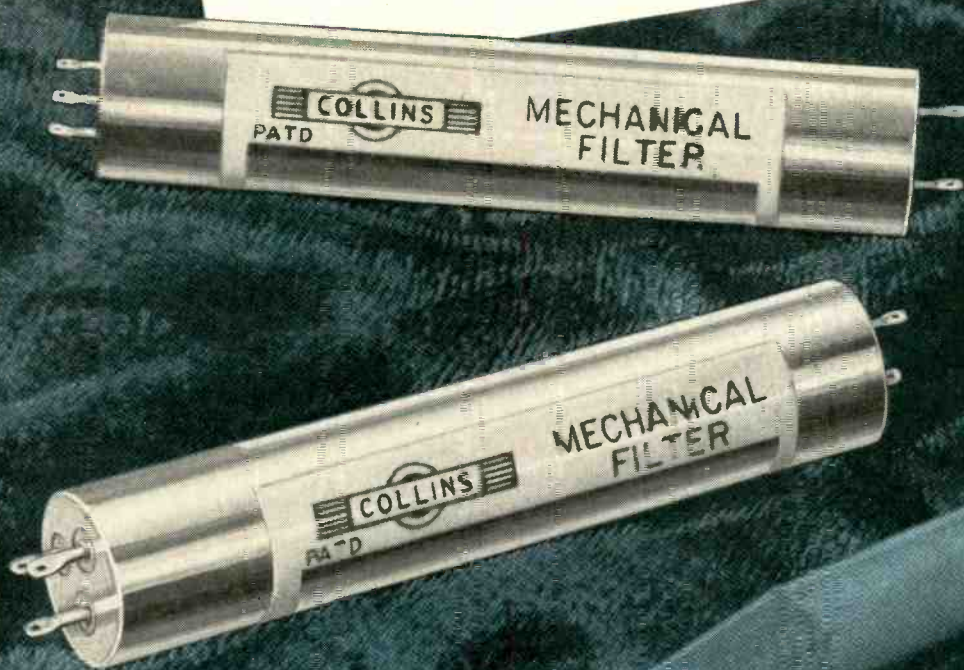

I. F. circuitry problems are minimized through use of the new Collins "Y" Series mechanical filters. Response characteristics of this lipstick case sized component are identical to other model Collins mechanical filters which, of course, are still available.

Additionally, this series is offered at the lowest prices yet! The "Y" Series mechanical filters meet all requirements of Specification MIL-STD-202 for vibration, shock and moisture — operating temperature range: minus 40° C. to 85° C.

The hermetically sealed cartridge brass case measuring 2-3/16" long by 7/16" in diameter is nickel plated.

Available from stock: Center frequencies of 455kc and 6db bandwidths of 2.1kc (F455Y-21), 3.1kc (F455Y-31), 4.0kc (F455Y-40), 6.0kc (F455Y-60), 8.0kc (F455Y-80), 12.0kc (F455Y-120), 16.0kc (F455Y-160), and 35.0kc (F455Y-350). Other bandwidths available soon.

Write for four page Technical Bulletin

World's Largest Exclusive Producer of Toroidal Windings

COMMUNICATION ACCESSORIES COMPANY

Lee's Summit, Missouri • Phone Kansas City BRoadway 1-1700

A Subsidiary of Collins Radio Company



How to make a Magnetic Core that's really SMALL?

use **AL**

PERMENDUR

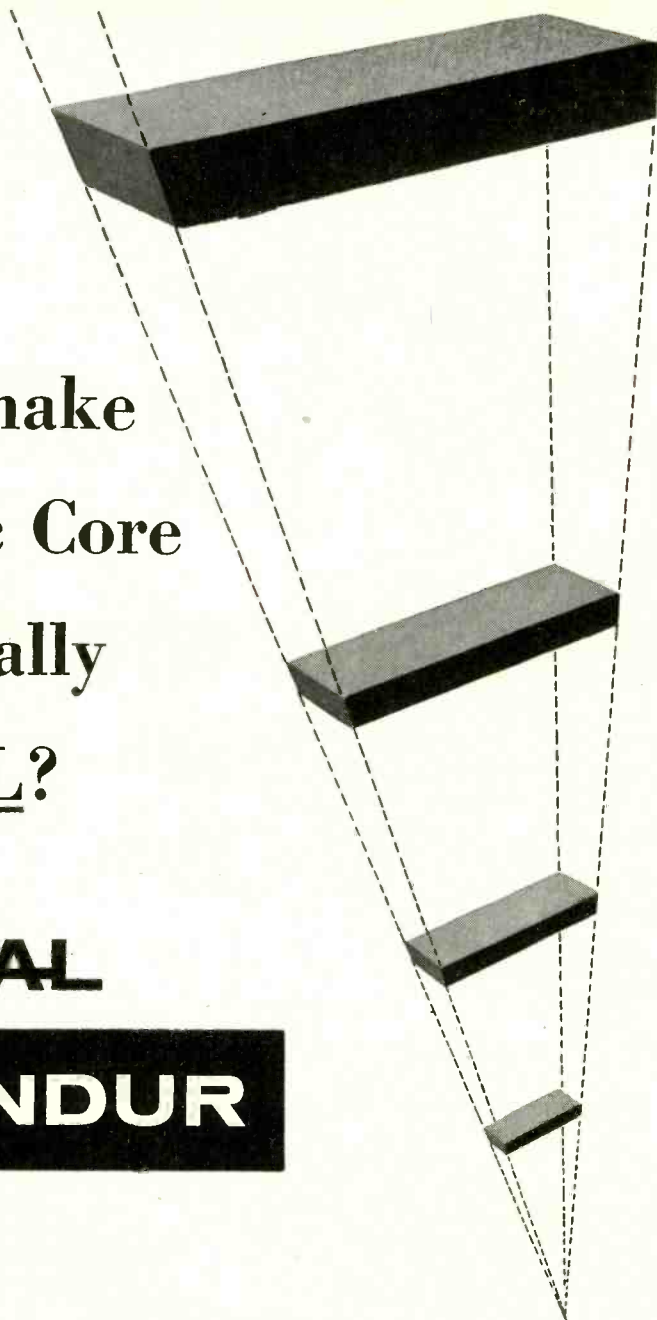

Write for
your copy

"MAGNETIC MATERIALS"

This 32-page book contains valuable data on all Allegheny Ludlum magnetic materials, silicon steels and special electrical alloys. Illustrated in full color, includes essential information on properties, characteristics, applications, etc. Your copy gladly sent free on request.

ADDRESS DEPT. E-94

When the conditions of service make it imperative for you to hold the size and weight of magnetic cores at an absolute minimum, that's the place to use Permendur. With it you can push the flux density up to 20 kilogausses, and practically eliminate weight as a consideration.

Along with its suitability for cores wherever the premium is laid on compactness, Permendur is just the thing for sonar magnetostriction applications, too. We maintain proper annealing facilities for this

alloy. Write for technical data on it, and let our engineers help you to cash in on its possibilities.

In addition to Permendur, we offer a range of high-permeability alloys, oriented silicon steels and other electrical alloys that is unmatched in its completeness. Our services also include the most modern facilities for lamination fabrication and heat treatment.

Let us supply your requirements. *Allegheny Ludlum Steel Corporation, Oliver Building, Pittsburgh 22, Pa.*

STEELMAKERS to the Electrical Industry

Allegheny Ludlum



WSW 6119

NOW...

Ruggedized

PANEL METERS

with

LONG
250°
SCALES

First with a comprehensive line of ruggedized d-c and a-c panel meters, Weston now provides these instruments in the popular 3½" size with *long readable scales*, *higher accuracy*, *improved sensitivities* and *superior ballistic characteristics*. Designed to meet, and surpass in scale length and accuracy, all requirements of MIL-M-10304A. They incorporate all Weston ruggedized design features including integrally molded and bonded shock mounting plates; shock-absorbing spring-backed jewels; screw driver type zero correctors, front sealed; anti-static treated plastic sealed windows; self shielding etc. For all the facts, consult your nearest Weston representative, or write—Weston Electrical Instrument Corporation, Newark 12, New Jersey.

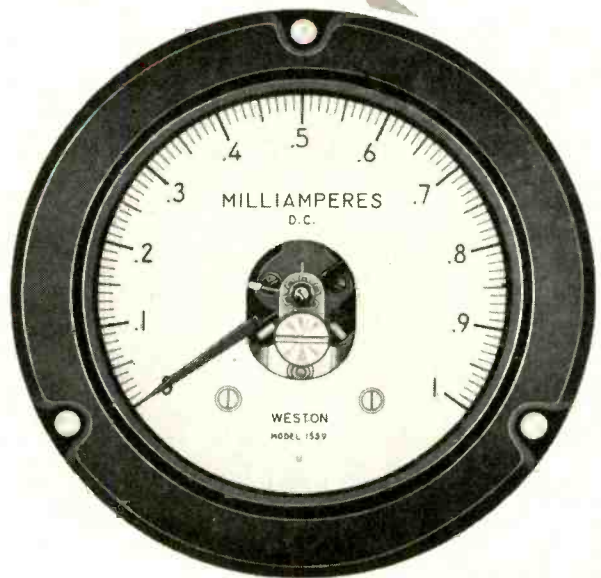

WESTON

Instruments





model VC20G



model VC9G

NEW FROM JFD



model VC16G



model VC10GW

Trimmer Capacitors for Miniaturization and Subminiaturization



model VC10GW
actual size



WHERE DESIGNS CALL FOR MAXIMUM RANGE IN MINIMUM PHYSICAL SIZE

VC9G Trimmer series (lug & lead type for printed circuits)

Model	Capacitance Range (MMF)	
	Min.	Max.
VC9G	0.8	8.5
VC10G	0.8	4.5
VC31G	0.8	12
VC32G	0.8	18
VC42G	1	21
VC43G	0.8	30

VC9GW Trimmer series (4 wire type for printed wiring boards)

Model	Capacitance Range (MMF)	
	Min.	Max.
VC9GW	0.8	8.5
VC10GW	0.8	4.5
VC31GW	0.8	12
VC32GW	0.8	18
VC42GW	1	21
VC43GW	0.8	30

VC20G Trimmer series (panel type)

Model	Capacitance Range (MMF)	
	Min.	Max.
VC20G	0.8	8.5
VC21G	0.8	4.5
VC22G	0.7	12
VC23G	0.8	18
VC24G	1	30

These new miniature types incorporate the exclusive new JFD telescoping tuning assembly. Both the telescoping piston and self-contained adjustment shaft function as a low inductance coaxial assembly within the dielectric cylinder. This innovation makes possible a highly compact variable trimmer piston capacitor of minimum size for the given capacitance range—up to 50% reduction in overall length compared to previous similar types.

VC16G Split stator series (panel type)

Model	Capacitance Range (MMF) Plate to Plate	
	Min.	Max.
VC16G	0.8	2.5
VC17G	1.1	4.5
VC18G	1.8	7.5
VC80	0.4	1.0
VC81	0.6	1.6
VC82	0.85	2.8
VC83	3.0	6.0

The new JFD Split Stator trimmer series was expressly engineered for critical push pull radio frequency circuits and similar sensitive networks. The extreme stability and low temperature coefficient of the quartz dielectric types recommend these trimmers for applications requiring extreme low-loss operation with maximum tuning resolution. Where maximum range for physical size is needed, you have your choice of the JFD glass dielectric split stator type.

JFD keeps pace with new trimmer capacitors ready to meet new challenges. The result is today's JFD line of 42 Precision trimmers (the industry's largest) to meet your most critical network design and production needs.

Write for Bulletins 201A, 202A, 203A and 204A, for comprehensive electrical data on above JFD trimmers.

PHONE: DEWEY 1-1000



JFD ELECTRONICS, INC.

PIONEERS IN ELECTRONICS SINCE 1929

1462 62nd Street, Brooklyn 19, New York

NEW

new prices, new services, new capacity



make **ANTI-CORROSIVE** first choice for stainless fastenings

NEW PRICES make Anti-Corrosive the *lowest cost* source of supply for most of the tens of thousands of items which we manufacture and stock.

NEW SERVICES through our regional product managers and warehousing provide *immediate* quotations and delivery scheduling, *fastest shipment* of your orders. **NEW WAREHOUSES** IN FORT LEE, N. J., AND LOS ANGELES, CALIF., ASSURE QUICK SERVICE.

NEW CAPACITY in the form of cold-heading and hot-forging equipment, plus a doubling of manufacturing area, mean lower costs and faster deliveries for our customers.

NEW CATALOGS and in-stock product lists give the most complete, easy-to-find information in the field, eliminate figuring by showing prices in quantity groups *plus* delivery times. Write for your **FREE** copies today.



PIONEERS SINCE 1927



ANTI-CORROSIVE
METAL PRODUCTS CO., INC.
CASTLETON-ON-HUDSON, NEW YORK

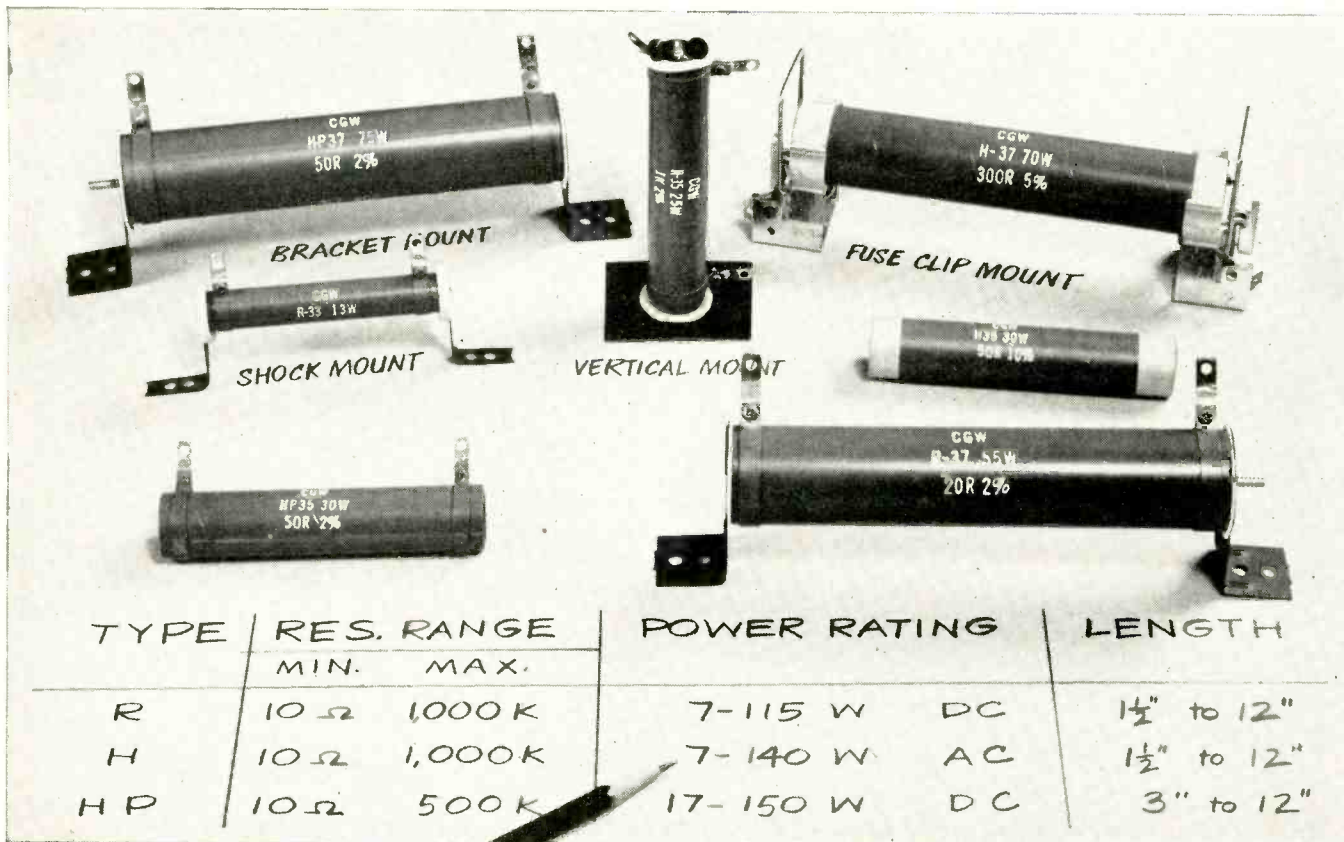

Why Corning High-Power, High-Frequency Resistors meet your most exacting circuit requirements

You'll find Corning High-Power and High-Frequency Resistors designed for stable, long-life service—even under the most difficult operating conditions.

With Corning Resistors you get the highest resistance range for a given physical size compared to wire-wound resistors.

Their thin-film construction makes them inherently non-inductive. The noise level of these resistors is so low it's difficult to measure. The resistive film is a metallic oxide, fused to the PYREX® glass core at red heat to form a permanent bond. This special glass insures highest core resistivity even at elevated temperatures, great resistance to chemical attack and to mechanical and thermal shock.

These Corning Resistors are remarkably stable regardless of mois-

ture and humidity.

They meet all characteristics of MIL-R11804B.

The chart in the next column gives you a quick idea of their exceptional frequency characteristics.

The ranges and ratings shown in the illustration are for our standard lines, but we can design and build resistors to match your own requirements for all usable frequencies. We have made specials with ratings up to 150 kw. and we can go higher.

Within the standard range of these resistors, we can give you wide variations in mounting hardware. You can get hardware for vertical or horizontal mountings and mountings to absorb mechanical shock and severe vibration. Ferrule-type terminals are available for use with standard fuse clips.

For more complete details, write for catalog sheets.

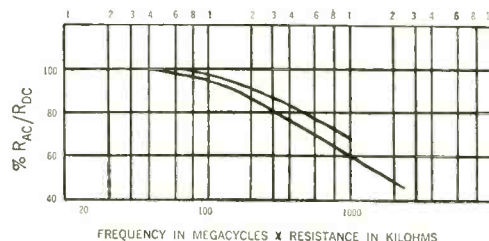

Keep your file up-to-date with data on these other electronic components made by Corning in addition to the Types R*, H, and HP Resistors: Low Power, Types N, S*, and WC-5; Capacitors: Fixed Glass*, Transmitting, Canned High-Capacitance, Subminiature Tab-Lead, Special Combination. Direct Traverse* and Midget-Rotary* Trimmers. Metallized: Glass Inductances; Attenuator Plates; Fotoform Glass; Electrolytic Level Switches.

*Distributed by Erie Resistor Corporation

Corning means research in Glass



CORNING GLASS WORKS, 94-10 Crystal Street, Corning, N. Y.
Electronic Components Sales Department

NOW... AUTOMATED TESTING OF GENERAL ELECTRIC THYRATRONS!

Uniform Performance of tubes is fully proved in advance

Automated testing of G-E thyratrons means proved-in-advance performance. Uniformity of product characteristics and quality is assured by unvarying machine precision—free from the possibility of human error. This General Electric “first” is one more reason why you can specify G-E thyratrons for your equipments with confidence. 27 types give full coverage of your design requirements. Check the listing of essential characteristics on the back of this page; then call your nearest G-E Regional Power Tube Office for expert application advice. *Power Tube Department, Electronic Components Division, General Electric Co., Schenectady 5, New York*

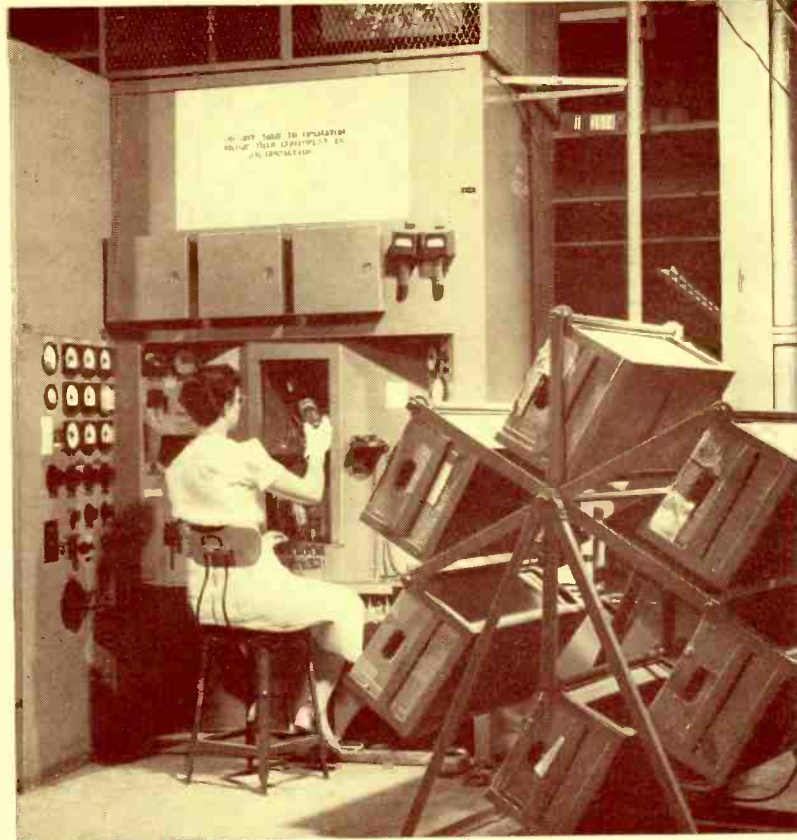

● Operator inserts a GL-6807 thyatron in rotating mechanism that carries all tubes automatically through an extensive series of performance checks. Racked tubes ready for testing are at operator's right. G.E.'s automated test equipment—the only one of its kind—tests thyratrons for heater current; for peak anode voltage; peak cathode current; grid emission; and tube control characteristics. These and many other tests, automatically applied, mean proved-in-advance performance for all General Electric thyratrons.

General Electric tube-design plusses for better thyatron performance, longer life:

- Closely controlled mercury content in G-E mercury-filled thyratrons means (1) initial mercury distribution time is cut down, (2) greater freedom in choosing mounting position.
- A new, chemically stable epoxy-resin compound for bases and anode caps adds greatly to General Electric thyatron life. Bases and anode caps stay firmly in place.
- General Electric's unique method of cathode processing gives superior adherence to coating of cathode; helps prevent flaking off. Tubes last longer, perform better.
- New types—new improvements—constantly are being added. First to develop and build thyratrons, General Electric continues to maintain design leadership.

➔ ➔ ➔ ➔ TURN THE PAGE FOR LISTING OF G-E THYRATRONS ➔ ➔

A G-E THYRATRON FOR EVERY APPLICATION

Consult This List of G-E Recommended Types

TYPE	ANODE			VOLTAGE, PEAK INVERSE	CATHODE		AVERAGE CONTROL CHARACTERISTICS			TEMPERATURE RANGE C ▲	INERT GAS OR MERCURY
	AVERAGE	PEAK	FAULT		VOLT-AGE	CURRENT, AMPERES	AT 100 VOLTS	AT 1000 VOLTS	OTHER		
GL-5557	0.5	2	40	5000	2.5	5.0	-1.0	-7.0		+40 to +80	Mercury
GL-5948○	1.0	1000	—	25000	6.3	30.0				-50 to +75	Hydrogen
GL-4832	1.25	5	50	10000	5.0	7.5				-55 to +70	Inert
GL-872-A	1.25	5	50	10000	5.0	7.5		(Rectifier)		+20 to +60	Mer.-Vapor
GL-8008	1.25	5	50	10000	5.0	7.5		(Rectifier)		+20 to +60	Mer.-Vapor
GL-3C23	1.5	6	120	1250	2.5	7.0	-2.5	-5.0		-40 to +80	Inert & Mer.
GL-393-A	1.5	6	55	1250	2.5	7.0	-2.5	-5.5		-40 to +80	Inert & Mer.
GL-575-A	1.5	6	60	15000	5.0	10.0		(Rectifier)		+20 to +50	Mer.-Vapor
GL-673	1.5	6	60	15000	5.0	10.0		(Rectifier)		+20 to +50	Mer.-Vapor
GL-869-B	2.5	10	100	20000	5.0	19.0		(Rectifier)		+30 to +40	Mer.-Vapor
GL-5558	2.5	15	200	5000	5.0	4.5		(Rectifier)		+30 to +60	Mer.-Vapor
GL-5559	2.5	15	200	1000	5.0	4.5	-1.6	-6.5		+40 to +80	Mercury
GL-5560	2.5	15	200	1000	5.0	4.5	+1.0	-9.0		+40 to +80	Mercury
	†0.5	30	200	1000	5.5	4.5	+1.0	-9.0		+40 to +80	Mercury
GL-6011/710	2.5	30	250	1500	2.5	9.0	-1.0	-5.0		-40 to +80	Inert & Mer.
GL-5544(x)	3.2	40	560	1500	2.5	12.0	0	-8.0		-55 to +70	Inert
GL-5C21/C6J	6.4	77	770	1250	2.5	21.0	+1.0		-2.0@ 750 V. 0@ 200 V.	-55 to +75	Inert
FG-105	6.4	40	400	2500	5.0	10.0	+1.0	-9.0		+40 to +80	Mercury
	*4.0	16	160	10000	5.0	10.0	+1.0	-9.0		+25 to +50	Mercury
	*2.5	77	400	750	5.5	11.0	+1.0			+30 to +95	Mercury
FG-172	6.4	40	400	2000	5.0	10.0	+2.0	-9.0		+40 to +80	Mercury
	*2.5	77	400	750	5.5	11.0	+1.0		-14.0@2000 V.	+30 to +95	Mercury
GL-5561	6.4	40	400	3000	5.0	10.0		(Rectifier)		+40 to +80	Mer.-Vapor
	*4.0	16	160	10000	5.0	10.0		(Rectifier)		+25 to +50	Mer.-Vapor
GL-6807(x) □	6.4	80	1120	1500	2.5	21.0	0	-6.0		-55 to +70	Inert
GL-6808(x) □	6.4	80	1120	1500	2.5	21.0	0	-6.0		-55 to +70	Inert
GL-6909(x) □	6.4	80	1120	1500	2.5	21.0	0	-6.0		-55 to +70	Inert
GL-857-B	10.0	40	400	22000	5.0	30.0		(Rectifier)		+30 to +40	Mer.-Vapor
GL-414	12.5	100	1500	2000	5.0	19.0	-10.0	0@ 200 V.		+40 to +80	Mercury
	5.0	100	1500	3000	5.0	19.0	-10.0	0@ 200 V.		+40 to +80	Mercury
GL-5830	12.5	75	1500	10000	5.0	20.0	+1.0	-6.0@8000 V.		+40 to +65	Mercury
GL-5855(x)	18.0	160	2000	1500	2.5	34.0	-3.0	0@ 300 V.		-55 to +70	Inert
GL-870-A	75.0	450	4500	16000	5.0	65.0		(Rectifier)		+35 to +40	Mer.-Vapor

(x) High commutation-factor tube.

† These ratings apply only when the tube is used for ignitor-firing.

* These ratings apply only when the tube is used in thyatron welding-control service.

○ Pulsing service.

□ These types are identical except for base. GL-6807 has conventional four-pin base; GL-6808 has bracket-type base with flexible leads; GL-6809 has spade lug terminal base.

▲ Temperature range of mercury tubes is expressed in terms of condensed mercury temperature; temperature range of inert gas and inert-gas-and-mercury tubes is expressed in terms of ambient temperature.

For further information on the types shown, or any G-E Power Tubes, contact your Regional G-E Office:

EASTERN REGION

Power Tube Department
200 Main Avenue
Clifton, New Jersey
Phone: (Clifton, N. J.)
GRegory 6-6387

CENTRAL REGION

Power Tube Department
3800 North Milwaukee Avenue
Chicago 41, Illinois
Phone: SPring 7-1600

WESTERN REGION

Power Tube Department
11840 West Olympic Boulevard
Los Angeles 64, California
Phones: GRanite 9-7765
BRadshaw 2-8566

GOVERNMENT SALES

Power Tube Department
Bldg. 267—1 River Road
Schenectady, New York
Phone: FRanklin 4-2211
Extension 6181

NOTE: Calls to Clifton from New York City can be made direct by dialing WIsconsin 7-4065-6-7-8

Progress Is Our Most Important Product

GENERAL  ELECTRIC

9545-8481-3

NOW... AUTOMATED TESTING OF GENERAL ELECTRIC THYRATRONS!

Uniform Performance of tubes is fully proved in advance

Automated testing of G-E thyratrons means proved-in-advance performance. Uniformity of product characteristics and quality is assured by unvarying machine precision—free from the possibility of human error. This General Electric “first” is one more reason why you can specify G-E thyratrons for your equipments with confidence. 27 types give full coverage of your design requirements. Check the listing of essential characteristics on the back of this page; then call your nearest G-E Regional Power Tube Office for expert application advice. *Power Tube Department, Electronic Components Division, General Electric Co., Schenectady 5, New York*

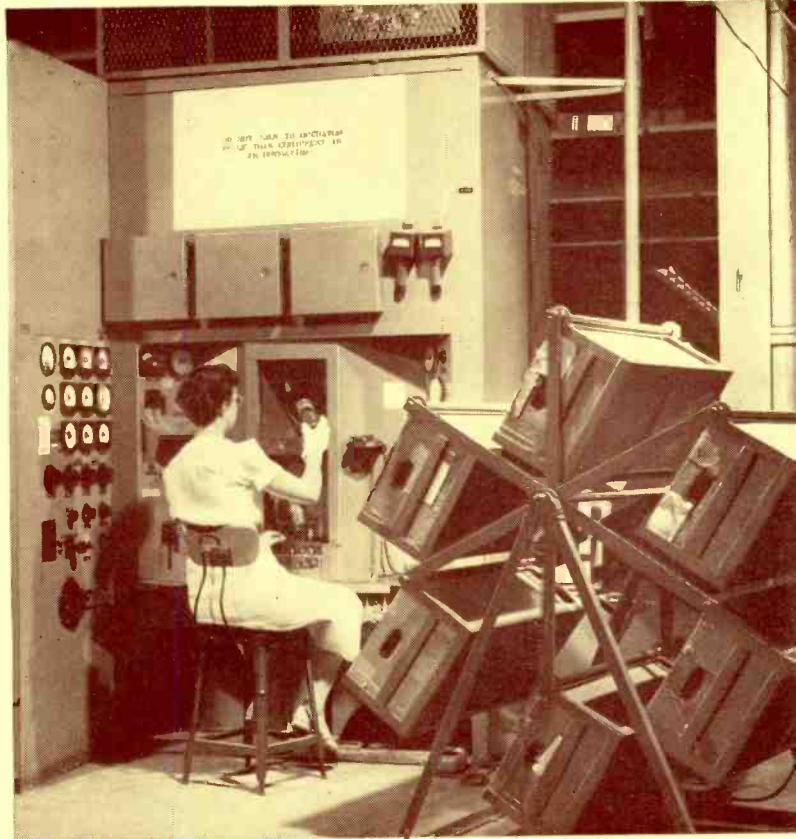

● Operator inserts a GL-6807 thyatron in rotating mechanism that carries all tubes automatically through an extensive series of performance checks. Racked tubes ready for testing are at operator's right. G.E.'s automated test equipment—the only one of its kind—tests thyratrons for heater current; for peak anode voltage; peak cathode current; grid emission; and tube control characteristics. These and many other tests, automatically applied, mean proved-in-advance performance for all General Electric thyratrons.

General Electric tube-design plusses for better thyatron performance, longer life:

- Closely controlled mercury content in G-E mercury-filled thyratrons means (1) initial mercury distribution time is cut down, (2) greater freedom in choosing mounting position.
- A new, chemically stable epoxy-resin compound for bases and anode caps adds greatly to General Electric thyatron life. Bases and anode caps stay firmly in place.
- General Electric's unique method of cathode processing gives superior adherence to coating of cathode; helps prevent flaking off. Tubes last longer, perform better.
- New types—new improvements—constantly are being added. First to develop and build thyratrons, General Electric continues to maintain design leadership.

➔ ➔ ➔ ➔ **TURN THE PAGE FOR LISTING OF G-E THYRATRONS** ➔ ➔

A G-E THYRATRON FOR EVERY APPLICATION

Consult This List of G-E Recommended Types

TYPE	ANODE			VOLTAGE, PEAK INVERSE	CATHODE		AVERAGE CONTROL CHARACTERISTICS			TEMPERATURE RANGE C ▲	INERT GAS OR MERCURY
	CURRENT AMPERES AVERAGE	PEAK	FAULT		VOLT-AGE	CURRENT, AMPERES	AT 100 VOLTS	AT 1000 VOLTS	OTHER		
GL-5557	0.5	2	40	5000	2.5	5.0	-1.0	-7.0		+40 to +80	Mercury
GL-5948○	1.0	1000	—	25000	6.3	30.0				-50 to +75	Hydrogen
GL-4832	1.25	5	50	10000	5.0	7.5				-55 to +70	Inert
GL-872-A	1.25	5	50	10000	5.0	7.5			(Rectifier)	+20 to +60	Mer.-Vapor
GL-8008	1.25	5	50	10000	5.0	7.5			(Rectifier)	+20 to +60	Mer.-Vapor
GL-3C23	1.5	6	120	1250	2.5	7.0	-2.5	-5.0		-40 to +80	Inert & Mer.
GL-393-A	1.5	6	55	1250	2.5	7.0	-2.5	-5.5		-40 to +80	Inert & Mer.
GL-575-A	1.5	6	60	15000	5.0	10.0			(Rectifier)	+20 to +50	Mer.-Vapor
GL-673	1.5	6	60	15000	5.0	10.0			(Rectifier)	+20 to +50	Mer.-Vapor
GL-869-B	2.5	10	100	20000	5.0	19.0			(Rectifier)	+30 to +40	Mer.-Vapor
GL-5558	2.5	15	200	5000	5.0	4.5			(Rectifier)	+30 to +60	Mer.-Vapor
GL-5559	2.5	15	200	1000	5.0	4.5	-1.6	-6.5		+40 to +80	Mercury
GL-5560	2.5	15	200	1000	5.0	4.5	+1.0	-9.0		+40 to +80	Mercury
	†0.5	30	200	1000	5.5	4.5	+1.0	-9.0		+40 to +80	Mercury
GL-6011/710	2.5	30	250	1500	2.5	9.0	-1.0	-5.0		-40 to +80	Inert & Mer.
GL-5544(x)	3.2	40	560	1500	2.5	12.0	0	-8.0		-55 to +70	Inert
GL-5C21/C6J	6.4	77	770	1250	2.5	21.0	+1.0		-2.0@ 750 V. 0@ 200 V.	-55 to +75	Inert
FG-105	6.4	40	400	2500	5.0	10.0	+1.0	-9.0		+40 to +80	Mercury
	*4.0	16	160	10000	5.0	10.0	+1.0	-9.0		+25 to +50	Mercury
	*2.5	77	400	750	5.5	11.0	+1.0			+30 to +95	Mercury
FG-172	6.4	40	400	2000	5.0	10.0	+2.0	-9.0		+40 to +80	Mercury
	*2.5	77	400	750	5.5	11.0	+1.0			+30 to +95	Mercury
GL-5561	6.4	40	400	3000	5.0	10.0			(Rectifier)	+40 to +80	Mer.-Vapor
	*4.0	16	160	10000	5.0	10.0			(Rectifier)	+25 to +50	Mer.-Vapor
GL-6807(x) □	6.4	80	1120	1500	2.5	21.0	0	-6.0		-55 to +70	Inert
GL-6808(x) □	6.4	80	1120	1500	2.5	21.0	0	-6.0		-55 to +70	Inert
GL-6909(x) □	6.4	80	1120	1500	2.5	21.0	0	-6.0		-55 to +70	Inert
GL-857-B	10.0	40	400	22000	5.0	30.0			(Rectifier)	+30 to +40	Mer.-Vapor
GL-414	12.5	100	1500	2000	5.0	19.0	-10.0	0@ 200 V.		+40 to +80	Mercury
	5.0	100	1500	3000	5.0	19.0	-10.0	0@ 200 V.		+40 to +80	Mercury
GL-5830	12.5	75	1500	10000	5.0	20.0	+1.0	-6.0@8000 V.		+40 to +65	Mercury
GL-5855(x)	18.0	160	2000	1500	2.5	34.0	-3.0	0@ 300 V.		-55 to +70	Inert
GL-870-A	75.0	450	4500	16000	5.0	65.0			(Rectifier)	+35 to +40	Mer.-Vapor

(x) High commutation-factor tube.

† These ratings apply only when the tube is used for ignitor-firing.

* These ratings apply only when the tube is used in thyatron welding-control service.

○ Pulsing service.

□ These types are identical except for base. GL-6807 has conventional four-pin base; GL-6808 has bracket-type base with flexible leads; GL-6809 has spade lug terminal base.

▲ Temperature range of mercury tubes is expressed in terms of condensed mercury temperature; temperature range of inert gas and inert-gas-and-mercury tubes is expressed in terms of ambient temperature.

For further information on the types shown, or any G-E Power Tubes, contact your Regional G-E Office:

EASTERN REGION

Power Tube Department
200 Main Avenue
Clifton, New Jersey
Phone: (Clifton, N. J.)
GRegory 6-6387

CENTRAL REGION

Power Tube Department
3800 North Milwaukee Avenue
Chicago 41, Illinois
Phone: SPring 7-1600

WESTERN REGION

Power Tube Department
11840 West Olympic Boulevard
Los Angeles 64, California
Phones: GRanite 9-7765
BRadshaw 2-8566

GOVERNMENT SALES

Power Tube Department
Bldg. 267—1 River Road
Schenectady, New York
Phone: FRanklin 4-2211
Extension 6181

NOTE: Calls to Clifton from New York City can be made direct by dialing WIsconsin 7-4065-6-7-8

Progress Is Our Most Important Product

GENERAL  ELECTRIC

9545-8481-3

New!
**DPS Connectors for
 High Altitudes-Vibration**

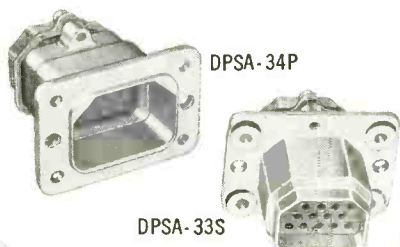

These rack/panel pressurized connectors are designed for high altitude and vibration applications. When the DPS connector is mated, it is sealed about the insert faces by means of a specially designed rubber seal, that allows an axial tolerance of up to 1/8" while still effecting a seal. This seal is encased in the #34 shell so that the step down design of the mating #33 shell seats into and against it. In addition, the #34 or pin insert shell encloses a monobloc silicone insert designed so that the tightening of the junction shell effects a compression seal around the wires that have been inserted. The #33 or socket insert shell has a plastic front insulator, to insure alignment of contacts, and is backed up by a silicone rear insulator that is also tapered to permit the corresponding taper of the junction shell to compress it around the wires as the junction shell is tightened. Contacts for DPS connectors must be ordered separately, and installed at time of wiring. Co-axial contacts, and thermocouple contacts are available. Also, air lines. DPS connectors are available in 4 different sizes with several insert arrangements for each size.
Write for Bulletin DP-101 TODAY!

WHAT'S NEW FOR YOU

New!
**Coaxial Connector
 Screw Type Coupling**



TNC Coaxial
 Receptacle SA-445

Latest RF Connector Series — The TNC. The TNC is a screw type coupling version of the improved BNC series for small coaxial connectors. This TNC series, made by the Eastern Division of Cannon Electric, is available in two types: low voltage and high voltage. Both types are ideal where minimum noise is desired. They are lightweight, waterproof, sealed connectors which will operate at any altitude.

The high voltage TNC is recommended for AC rating up to 5,000 volts. Low voltage rating is to 500 volts. The TNC series is also available with collet cable clamp.

Write for RF Coaxial Bulletin DC-1 TODAY!

IN CANNON PLUGS

New!
**Quick-Disconnect
 Accessories for AN-Plugs**

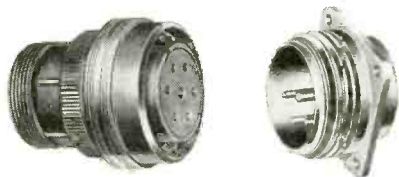

CA06BQ Plug

CA02AQ Receptacle

An accessory that consists of coupler and an adapter has been recently perfected by Cannon to provide quick connect and quick disconnect characteristics to AN connectors.

The adapter is designed to screw over the coupling threads of a standard AN receptacle, and contains an external locking groove which receives the formed ends of the coupler latch when fully engaged. The entry of the coupler latch into this groove permits a compression spring to move the coupler sleeve forward, locking the parts securely. A simple straight pull back on the sleeve releases the latch and permits disconnection.

The coupler consists of a special spring latch assembly, and is designed to replace the coupling nuts on Cannon AN3106A and AN3106B plugs.

**Write for Bulletin
 PR-QD TODAY!**

**CANNON
 PLUGS**

WHERE RELIABILITY
 IS THE 5TH DIMENSION



Please refer to Dept. 120

CANNON ELECTRIC CO., 3208 Humboldt St., Los Angeles 31, California. Factories in Los Angeles, Salem, Mass., Toronto, London, Melbourne. Manufacturing licensees in Paris, Tokyo. Representatives and distributors in all principal cities.

TRANSFORMER

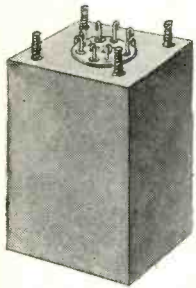

Voltage Ratio Accuracies
TO 5 PARTS PER
MILLION

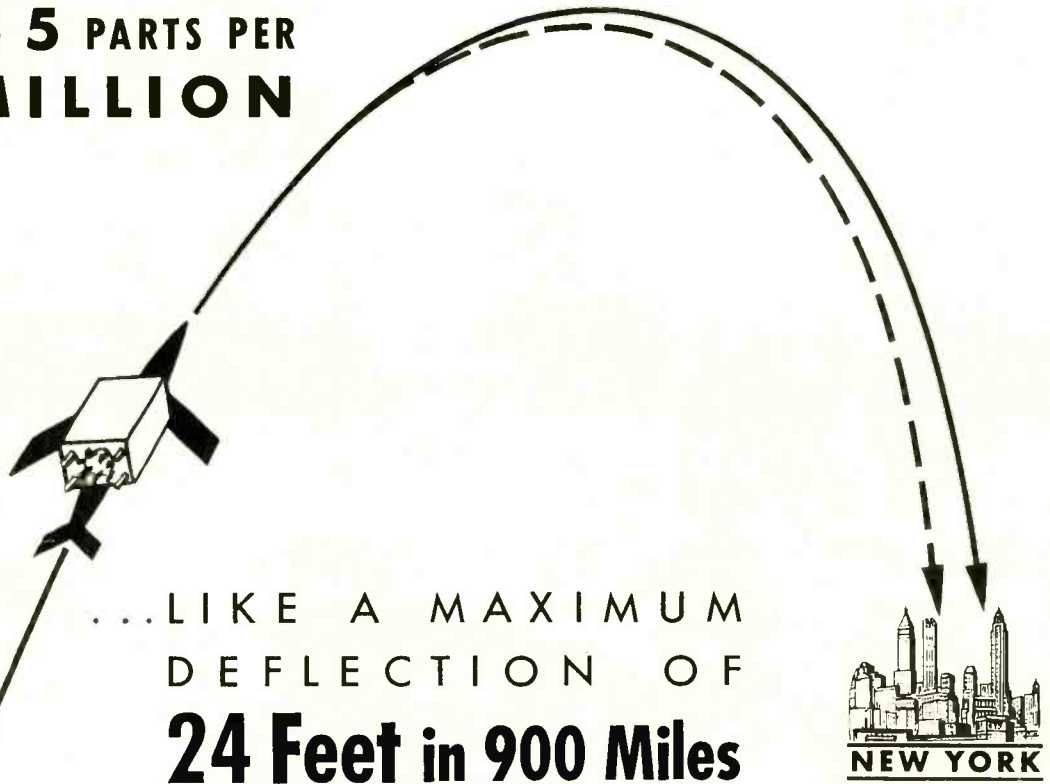

... LIKE A MAXIMUM
DEFLECTION OF
24 Feet in 900 Miles

This degree of voltage ratio accuracy has been built into special purpose transformers designed and manufactured by TRANSFORMERS, INC. These transformers have a measured voltage ratio accuracy of 0.0005% at room temperatures and under no load conditions, with comparable accuracy at other temperatures and loads.

TRANSFORMERS, INC.—first to specialize in the design and production of extremely precise transformers—is staffed, equipped, and has the experience to produce special purpose or standard transformers



- ▶ in PRODUCTION quantities
- ▶ to your SPECIFICATIONS
- ▶ with Lab-Tested PRECISION

A typical example of TRANSFORMERS, INC. capability is a transformer mass produced with a voltage ratio accuracy of 0.01%, with a phase shift of 0.1 milliradian maintained through an ambient temperature range of -65° to $+105^{\circ}$ C with load variations of $\pm 20\%$.

If you require precision, special purpose transformers for voltage reference, computer excitation, or any other electronic application,

**BE PRECISE!
SPECIFY . . .**

TTRANSFORMERS, INCORPORATED

200 Stage Road, Vestal, N.Y.

IMPROVED SENSITIVITY for 110-degree tubes...

There's more than meets the eye in this Stackpole Ceramag 110° yoke core. Molded as a solid piece, it is then cracked into halves so perfectly that the cracks defy detection. Thanks to this almost zero air gap, flux loss is at a minimum . . . sensitivity greatly increased.

And . . . to save weight and material costs, the neck is flared rather than molded into the cylindrical shape of conventional yoke cores.



BRIGHTEN the TV PICTURE with

STACKPOLE
Ceramag
**FERROMAGNETIC
CORES**

HIGHER VOLTAGES at lower cost

Boosting flyback voltages while shrinking transformer size and cost have been Ceramag specialties since Stackpole pioneered the use of ferrite-cored flybacks in 1946. Now, higher efficiency Ceramag grades in shapes and sizes to meet your requirements, set the pace in terms of greater electrical and mechanical uniformity.



ELECTRONIC COMPONENTS DIVISION

STACKPOLE CARBON COMPANY • St. Marys, Pa.

Taylor's New

Copper-Clad Laminate

Cu-246

for volume users of printed circuits

Now available for volume production of printed circuits, the new Taylor Grade **Cu-246** copper-clad laminate is the result of two years of research and field testing.

The base material is a translucent paper base grade with a special phenolic type resin formulated to be well balanced in electrical and mechanical properties to meet the varied solvent resistance and process requirements encountered in printed wiring production.

High purity rolled copper is again used in this new printed circuit material assuring you of the consistently dependable performance found in the other printed circuit laminates being produced by Taylor. Rolled copper has no lead inclusions and is free of pits, pinholes and other imperfections.

The rolled copper surface is adaptable for silk screening, offset printing or photoengraving processing . . . also for semi-precious and precious metal plating, with a minimum of preparation. **Cu-246** is available in all standard sheet sizes . . . special sizes supplied on request . . . in thicknesses from .020" to .250" . . . with copper on one or both sides.

You'll get the same dependable performance from Taylor **Cu-246** as you have from other laminates in the list of Taylor materials. For more detailed information on Taylor **Cu-246** . . . for a discussion on how this new copper-clad laminate can help you make better printed circuits at lower cost . . . contact your nearest Taylor sales office.

**HERE'S WHY
TAYLOR Cu-246
COPPER-CLAD
LAMINATE
CAN GIVE YOU
BETTER
PRINTED CIRCUITS**

- good mechanical and electrical stability over wide humidity range
- ready punchability . . . can be cold punched and cold sheared up to 1/16" thickness
- resists all commonly used solvents
- good insulation resistance . . . has excellent surface resistivity after etching

TAYLOR FIBRE CO., PLANTS IN NORRISTOWN, PA. AND LA VERNE, CALIFORNIA

INTEGRATED MANUFACTURER & FABRICATOR OF
Phenolic—Melamine—Silicone—Epoxy—Copper-Clad and
Combination Laminates • Vulcanized Fibre

TAYLOR
Laminated Plastics
Vulcanized Fibre

A Complete Line

**TUNG-SOL GERMANIUM
PNP TRANSISTORS
NOW IN JETEC 30
PACKAGE**

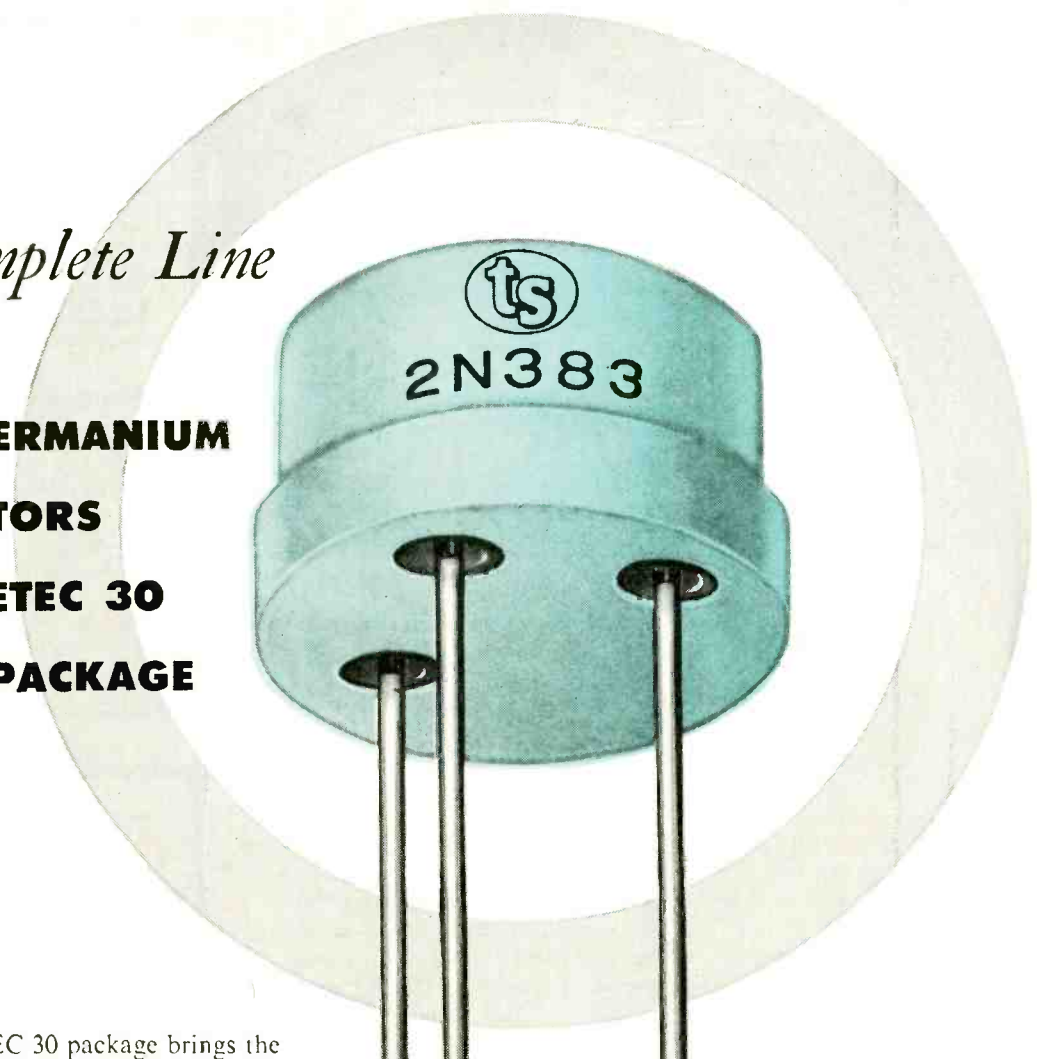

The proposed JETEC 30 package brings the convenience and economy of standardization to the users of germanium PNP transistors. All the desirable electrical characteristics, without the confusion over mechanical and electrical interchangeability, can now be obtained in one standard package.

The new JETEC 30 package features a highly reliable welded hermetic seal, an extremely durable metal housing and a lead-basing design which facilitates use with printed circuitry.

For additional information about this complete line of Germanium PNP Transistors please contact Semiconductor Division, Tung-Sol Electric Inc., Newark 4, N. J.

TUNG-SOL[®]
ELECTRON TUBES • SEMICONDUCTOR PRODUCTS

SALES OFFICES:

ATLANTA, GA.; COLUMBUS, OHIO;
CULVER CITY, CALIF.; DALLAS, TEXAS;
DENVER, COLO.; DETROIT, MICH.; IRVINGTON, N. J.;
MELROSE PARK, ILL.; NEWARK, N.J.; SEATTLE, WASH.



STANDARD EIA (RETMA) MEDIUM POWER TRANSISTORS						
Power Output	RATINGS (25°C)		TYPICAL CLASS B OPERATION (25°C)			
	V _c	P _c	E _{cc}	Power Output	Distortion Max.	Power Gain (Po-100MW)
2N381	25v	200 MW	-12v	500 MW	5%	31 db
2N382	25v	200 MW	-12v	500 MW	5%	33 db
2N383	25v	200 MW	-12v	500 MW	5%	35 db

Premium Quality General Purpose	RATINGS (25°C)			TYPICAL CHARACTERISTICS (25°C)		
	V _c	P _c	T _j	Max I _{cb0} At -45v	Frequency Cutoff	Forward Current Ratio
2N460	-45v	200 MW	+100°C	15 μa	1.25 MC	.96
2N461	-45v	200 MW	+100°C	15 μa	1.25 MC	.98

STANDARD EIA (RETMA) HIGH FREQUENCY TRANSISTORS								
Computer	RATINGS (25°C)		TYPICAL CHARACTERISTICS (25°C)					
	V _c	I _c	I _{aco}	hFE ₁ I _b = -1ma.	hFE ₂ I _b = -10ma.	Rise Time	Storage Time	Fall Time
2N425	-20v	-400 Ma	4 mc	30	18	0.5 μs	0.25 μs	0.3 μs
2N426	-18v	-400 Ma	6 mc	40	24	0.5 μs	0.25 μs	0.3 μs
2N427	-15v	-400 Ma	11 mc	55	30	0.4 μs	0.25 μs	0.3 μs

Portable Radio	Application	Max. V _c	I _{aco}	C _c	Power Gain 455 Kc	Conversion Gain
2N413A	IF Ampl.	-15v	3 Mc	12 ± 2 μμf	32 db	—
2N414	Converter	-15v	5 Mc	12 μμf	—	26 db
2N414A	IF Ampl.	-15v	5 Mc	12 ± 2 μμf	35 db	—

STANDARD EIA (RETMA) HIGH POWER TRANSISTORS						
Power Switch	RATINGS (25°C)		TYPICAL SWITCHING APPLICATION (25°C)			
	V _c	P _c	E _{cc}	Switching Power	Load Current	Switching Power Gain
2N378	-40v	15 W	-14v	26 W	2 amps	24 db
2N379	-80v	15 W	-28v	52 W	2 amps	23 db
2N380	-60v	15 W	-28v	54 W	2 amps	29 db

Also Available: New! 2N459 rated for 100 volt peak operation; 2N242, AUDIO POWER AMPLIFIER and 2N307, GENERAL PURPOSE.

glass-base laminates?

C-D-F DILECTO® is the answer!

Teflon*, silicone, epoxy, melamine, and phenolic glass-fabric laminates. Polyester glass-mat laminates.

You can improve design, speed production, and save money by specifying one of the many C-D-F Dilecto grades. Whatever your application for these laminates — with fine- or medium-weave glass-cloth base — you'll find a better answer to your problem at C-D-F. (Melamine can also be made with glass-mat base.) And C-D-F offers modern machining and fabrication facilities to deliver production quantities of finished Dilecto parts to your specifications.

See our catalog in Sweet's Product Design File, where the phone number of your nearby C-D-F sales engineer is listed. For free trial samples of glass-base Dilecto, or of any other C-D-F plastics, mica, or fibre product, send us your print or your problem! Write for your free copy of C-D-F Technical Bulletin 64.

*DUPONT TRADEMARK FOR TETRAFLUOROETHYLENE RESIN

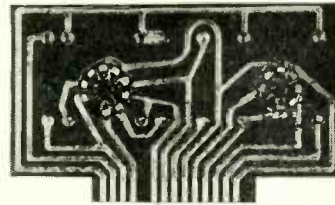

SPEED AUTOMATIC PRODUCTION of printed circuits with warp-resistant C-D-F metal-clad Teflon* and epoxy laminates. Other advantages: high bond strength of copper to laminate, superior blister-resistance in solder immersion.

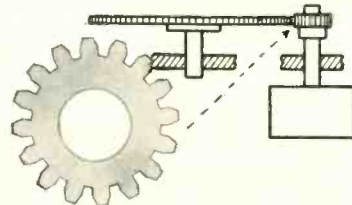

HIGH-VOLTAGE (1800v.) RF ISOLATION is achieved by miniature C-D-F Dilecto gears in an aircraft receiver-transmitter switch. They also had to exhibit dimensional stability through a wide temperature range, resistance to fungus growth and thermal shock.

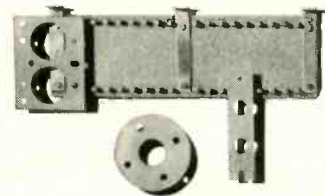

PRECISE MACHINING AND FABRICATION are standard benefits of Dilecto laminated plastics. These silicone glass-base parts (coil mountings, aircraft terminal board) were sawed, drilled, punched, and milled in production quantities by C-D-F and customer.

PROPERTIES OF SOME TYPICAL C-D-F DILECTO GLASS-BASE GRADES

Grade	Equivalent NEMA or ASTM grade	Flexural Strength Lengthwise (PSI)	Dissipation Factor at 10 ⁶ Hz Cond. A	Dielectric Strength Parallel Step x step	Insulation Resistance Cond. C96/35/90	Arc Resistance (seconds)	Maximum Operating Temp. (°C.)
GB-112T (Teflon*)	None	14,000	0.0015	65	100,000	180 +	250
GB-12S (Silicone)	G-7	28,000	0.002	60	100,000	180+	200
GB-28E (Epoxy)	G-10	70,000	0.019	65	75,000	130	150
GB-28EFR (Flame-Retardant Epoxy)	G-10	68,000	0.010	65	100,000	180	150
GB-28M (Melamine)	G-5	50,000	0.014	50	100	185	135
GB-261D (Phenolic)	G-1 and G-2	22,000	0.020	55	10,000	5	150
GM-PE (Polyester)	GPO-1	35,000	0.020	70	200	130	150

These are typical grades for typical applications. To meet special requirements, C-D-F makes many other Dilecto grades, one of which may serve your purpose better than any of these listed here. Consult the C-D-F Technical Department for expert assistance with your design problem involving laminated plastics products.



CONTINENTAL-DIAMOND FIBRE

A SUBSIDIARY OF THE *Built* COMPANY • NEWARK 16, DELAWARE

PUSH-PUSH

PULL-PUSH

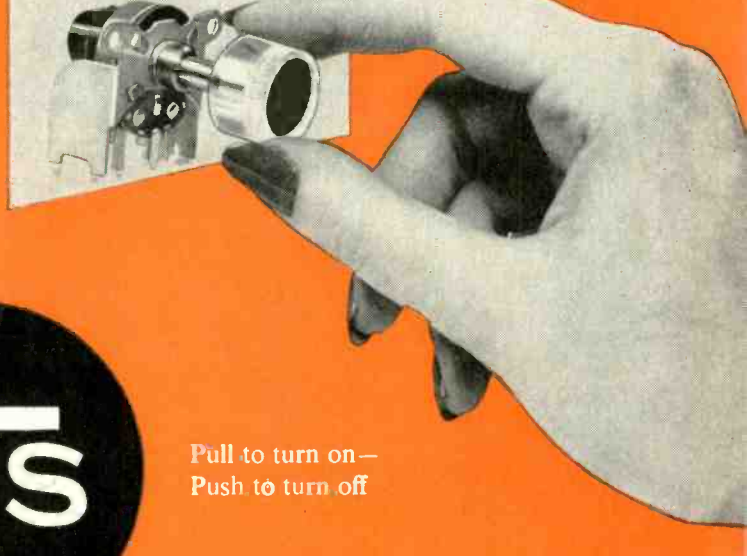

One push on—
One push off

Pull to turn on—
Push to turn off

Two new switch- controls Volume setting unaltered by ON-OFF operation

Just switch on and walk away. No coming back or waiting for further adjustment after warm-up.

Volume can be changed instantly as desired by rotating shaft . . . or can remain indefinitely at any selected setting regardless of on-off switch operations.

Push-push switch available with either 3 amp 125V rating (Type J) or 6 amp 125V rating (Type TJ).

Pull-push switch available with 3 amp 125V rating (Type K). Both switches available in many special terminal and control combinations.

Write today for Data Sheets containing dimensional drawings and complete technical details.

WEST COAST SUBSIDIARY
Chicago Telephone of
California, Inc.
105 Pasadena Avenue
South Pasadena, California
L. A. Phone: CLinton 5-7186
TWX LA 1105

EAST COAST OFFICE
5 Haddon Avenue
Haddonfield, New Jersey
Phone: Haddonfield 9-5512
TWX No. Haddonfield 529
Phila. Phone: Market 7-3129

SOUTHWESTERN U.S.A.
John A. Green Company
137 Parkhouse
Dallas 7, Texas
Phone: Riverside 3266

CANADIAN SUBSIDIARY
C. C. Meredith & Co., Ltd.
Streetsville, Ontario
Phone 310

SOUTH AMERICA
Jose Luis Pontet
Buenos Aires, Argentina
Montevideo, Uruguay
Rio de Janeiro, Brazil
Sao Paulo, Brazil

OTHER EXPORT
Sylvan Ginsbury
8 West 40th Street
New York 18, New York
Phone: Pennsylvania 6-8239

The most complete line of variable resistors and associated switches available is manufactured by CTS. Consult CTS Specialists on all your control problems.



WEST COAST MANUFACTURERS:

Many types of variable resistors now in production at our South Pasadena plant. Your coil, transformer and compression molding business also invited. Prompt delivery. Modern versatile equipment. L. A. phone CLinton 5-7186.

Burton Browne Advertising

CHICAGO TELEPHONE SUPPLY Corporation

ELKHART • INDIANA

The Exclusive Specialists in Precision Mass Production of Variable Resistors

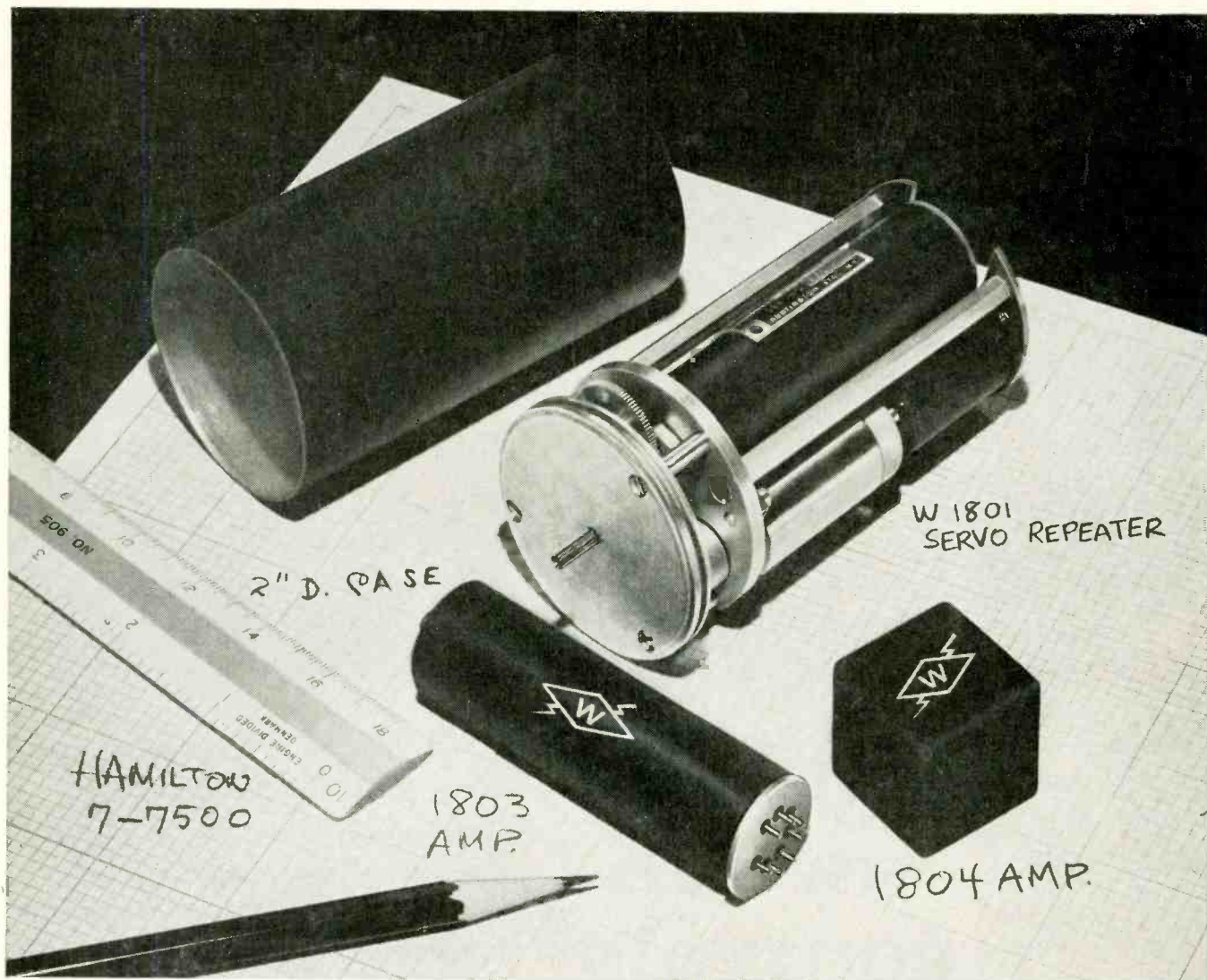

Waldorf announces an important new design concept... MICROMATION

MICROMATION—the logical result of Waldorf's unique talent for compressing more performance and reliability into less space.

MICROMATION—making use of Waldorf's credo of less space, less weight, less heat, less power, to provide just the first of a series of related components and assemblies for servo and computer applications.

MICROMATION now makes available—

Model W1801—Transistorized Servo Repeater System; size 2" Dia. x 4" long, weight 13 oz. including amplifier and power supply.

Model W1803—Transistorized Servo Amplifier; size 13/16" Dia. x 2 3/4" long, weight 2 oz.

Model W1804—Transistorized Servo Amplifier; size 1" x 1" x 1".

In the housing of the W1801 Servo Repeater System illustrated are all the electronic and electromechanical components to develop shaft position output with torque exceeding 20 oz.-in. Static accuracy is within 0.1° of input from synchro or transducer. Velocity constant is 60 sec.⁻¹. Requires only 115V, 400 cps supply. Other configurations are available to suit your requirements. Uses include control of positioning devices, valves or computer elements.

May also be used as aircraft indicators. Meets military specifications.

Model W1803 Amplifier as used in the W1801 Servo Repeater is designed for minimum mounting surface—13/16" Dia.

Model W1804 Amplifier is identical electrically but packaged for minimum volume—1" x 1" x 1".

Both accept synchro, potentiometer, or other transducer data. Both drive size 8 or size 10 motors.

Interested?

If these product improvements—or the coming innovations in **MICROMATION**—integrators, differentiators, coordinate-converters, vector solvers and power supplies challenge your imagination, why not ask for further data?

Waldorf

INSTRUMENT COMPANY

Division of F. C. Huyck & Sons

DEPARTMENT EA-40 • ELECTRONICS DIVISION • WALDORF INSTRUMENT COMPANY • HUNTINGTON, LONG ISLAND, NEW YORK

Transitron

Silicon Transistors

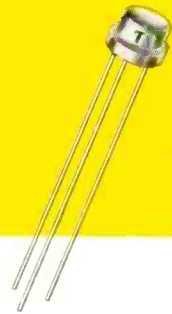

ACTUAL SIZE

Features . . .

- Low I_{co} , typically under .02 μ a
- Operation to 175°C
- 200 mw Power Rating
- High Frequency Operation
- High Temperature Tested
- Excellent Stability
- Welded Hermetic Seal

... for high temperature operation

Transitron's NPN silicon transistors are designed for a wide range of small signal applications in the power range up to 200 mw. They will provide dependable operation up to 175°C in circuits such as RF and IF amplifiers, video and audio amplifiers, servo control, switching, and many others.

Manufactured by diffusion in the liquid phase during crystal growth, these transistors are essentially free of parameter drift and instability common in conventional grown junction transistors. Through close process control, these units have exceptionally low I_{co} up to their maximum voltage and temperature ratings. As a result, performance reliability can be achieved even at higher voltage levels.

For environmental stability, extensive temperature cycling and storage as well as mechanical and hermetic seal tests are included as a regular part of the manufacturing process.

Type	Minimum Common Emitter Current Gain, B	Maximum Collector Voltage V_{ce} Peak (volts)	Typical Cut-off Frequency (mc)	Maximum Collector Cut-Off Current at 25°C at V_{ce} Max. (μ a)
ST42	40	45	11	.5
ST32	40	30	11	.5
ST12	40	15	11	.5
ST33	30	30	17	.5
ST13	30	15	17	.5
ST41	20	45	10	.5
ST31	20	30	10	.5
ST11	20	15	10	.5
2N332	9	45	7	50
2N333	18	45	9	50
2N334	18	45	11	50
2N335	37	45	10	50

Send for
Bulletin TE-1353

Transitron

electronic corporation • wakefield, massachusetts



Transistors



Diodes



Regulators



Rectifiers



Precision instruments for automatically measuring DC, AC-DC, Ohms and DC-AC ratios constructed from basic modules.

For example:



Combine the Universal Power Module

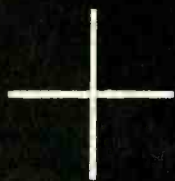

with the DC Switch Module

to get an 0.01% Digital Voltmeter



a completely new idea in digital instrumentation!

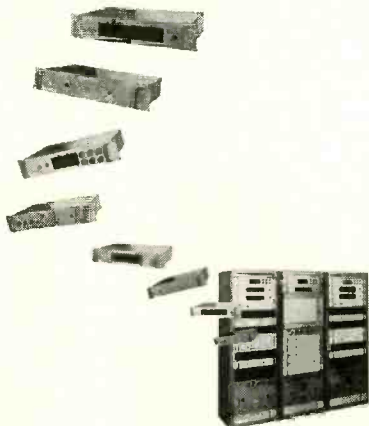

Now from five basic E-I modules, almost any combination of instruments can be assembled for precision, digital measurement of DC, AC-DC, Ohms and AC-DC Ratios. The basic E-I modules never become obsolete. As needs change, simply regroup or add new modules. This new modular concept provides maximum versatility and enables equipment to be kept current at minimum cost and engineering.

New engineering specification and other features have been incorporated into the basic modules from the experience of over 2,500 digital instruments in the field. Where applicable, all circuits have been fully transistorized to provide increased reliability, low power consumption, low heat dissipation and to eliminate radio noise and line transients.

New catalog sheets give the complete story of this newest advance in digital instrumentation and complete specifications on all modules. Write for your set today.

**ELECTRO
INSTRUMENTS**
INC. 3794 Rosecrans, San Diego, California

2
NEW
**LEAD
TYPES**

Silicon Rectifiers



150ma TYPE
(400ma at 25°C)



250ma TYPE
(750ma at 25°C)

RATINGS TO 600V. PIV IN BOTH TYPES

Features . . .

- Operation to 175°C
- High power handling ability
- Convenient mounting
- Small size
- Hermetically sealed

Two new lead types have now been included in Transitron's expanding family of silicon rectifiers. The subminiature glass units combine high current-voltage ratings with the smallest possible size to provide greater design versatility. For applications requiring ratings in the region of 250 ma per cell, the new standard series is recommended.

The same high degree of reliability which has been characteristic of Transitron's silicon diodes and stud type rectifiers has been "built into" these new lead types. Extensive environmental testing insures dependability under the most severe operating conditions.

Type	Peak Recurrent Inverse Operating Voltage (volts)	Maximum Average Forward Current @ 150°C (ma)	Maximum Average Forward Current @ 25°C (ma)	Maximum Inverse Current @ 150°C Full Load (ma)
SUBMINIATURE TYPES				
TG62	600	150	400	.2
TG42	400	150	400	.2
TG22	200	150	400	.2
STANDARD TYPES				
1N547	600	250	750	.3
1N540	400	250	750	.3
1N538	200	250	750	.3
1N537	100	250	750	.4

Send for
Bulletin TE- 1351

Transitron

electronic corporation • wakefield, massachusetts



Transistors



Diodes



Regulators



Rectifiers



NEWS ABOUT SILICON DEVICES

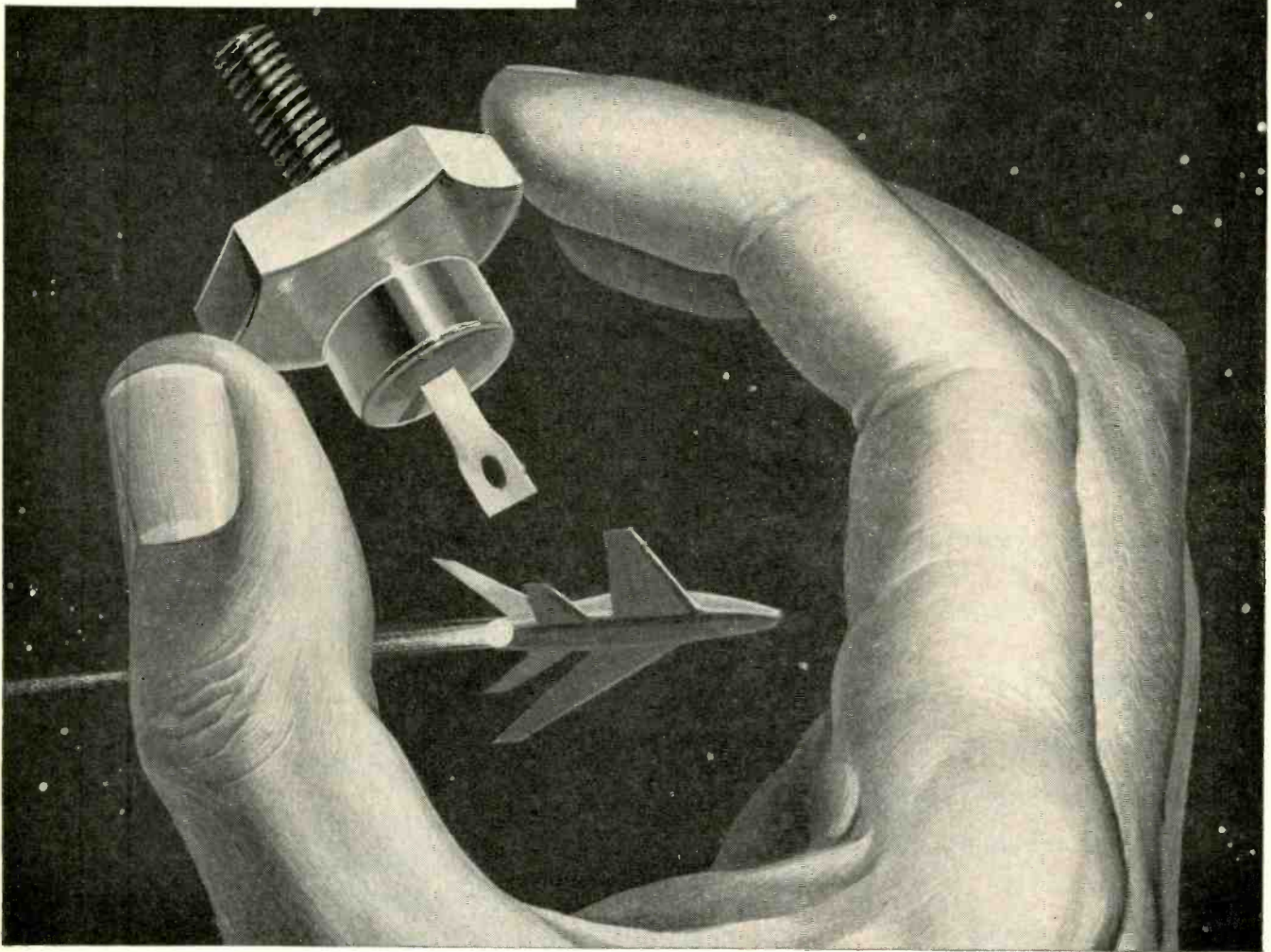

SILICON RECTIFIERS are finding increasing use at elevated temperatures in aircraft and missile applications by providing more power per pound.

Now...design improvements made possible with components of Du Pont Hyperpure Silicon

Today silicon rectifiers make possible a vast improvement in jet-age aircraft generators—the use of engine oil as a coolant instead of less-efficient ram air. Silicon rectifiers take the place of oil-sensitive brushes, commutator and slip rings... are completely unaffected by 150°C. engine oil. Result: a *brushless* generator of less weight and size than ordinary generators.

Silicon devices can similarly help you miniaturize—improve design and performance. Silicon rectifiers have excellent stability... can operate continuously at -65 to 200°C. They're up to 99% efficient—reverse leakages are only a fraction of those of other semiconductors. Both transistors and rectifiers of silicon can pack *more* capacity into *less* of your equipment space.

Note to device manufacturers:

You can produce high-quality silicon transistors and rectifiers with Du Pont Hyperpure Silicon now available in three grades for maximum efficiency and ease of use... purity range of 3 to 11 atoms of boron per billion... available in 3 forms, needles, densified, cut-rod. Technical information is available on crystal growing from Du Pont... pioneer producer of semiconductor-grade silicon.



NEW BOOKLET ON DU PONT HYPERPURE SILICON

You'll find our new, illustrated booklet about Hyperpure Silicon helpful and interesting—it describes the manufacture, properties and uses of Du Pont Hyperpure Silicon. Just drop us a card for your copy. E. I. du Pont de Nemours & Co. (Inc.), Pigments Department, Silicon Development Group, Wilmington 98, Delaware.

PIGMENTS DEPARTMENT



REG. U. S. PAT. OFF.

BETTER THINGS FOR BETTER LIVING
...THROUGH CHEMISTRY

Beckman/Berkeley

UNIVERSAL EPUT
AND TIMER
MODEL 7370

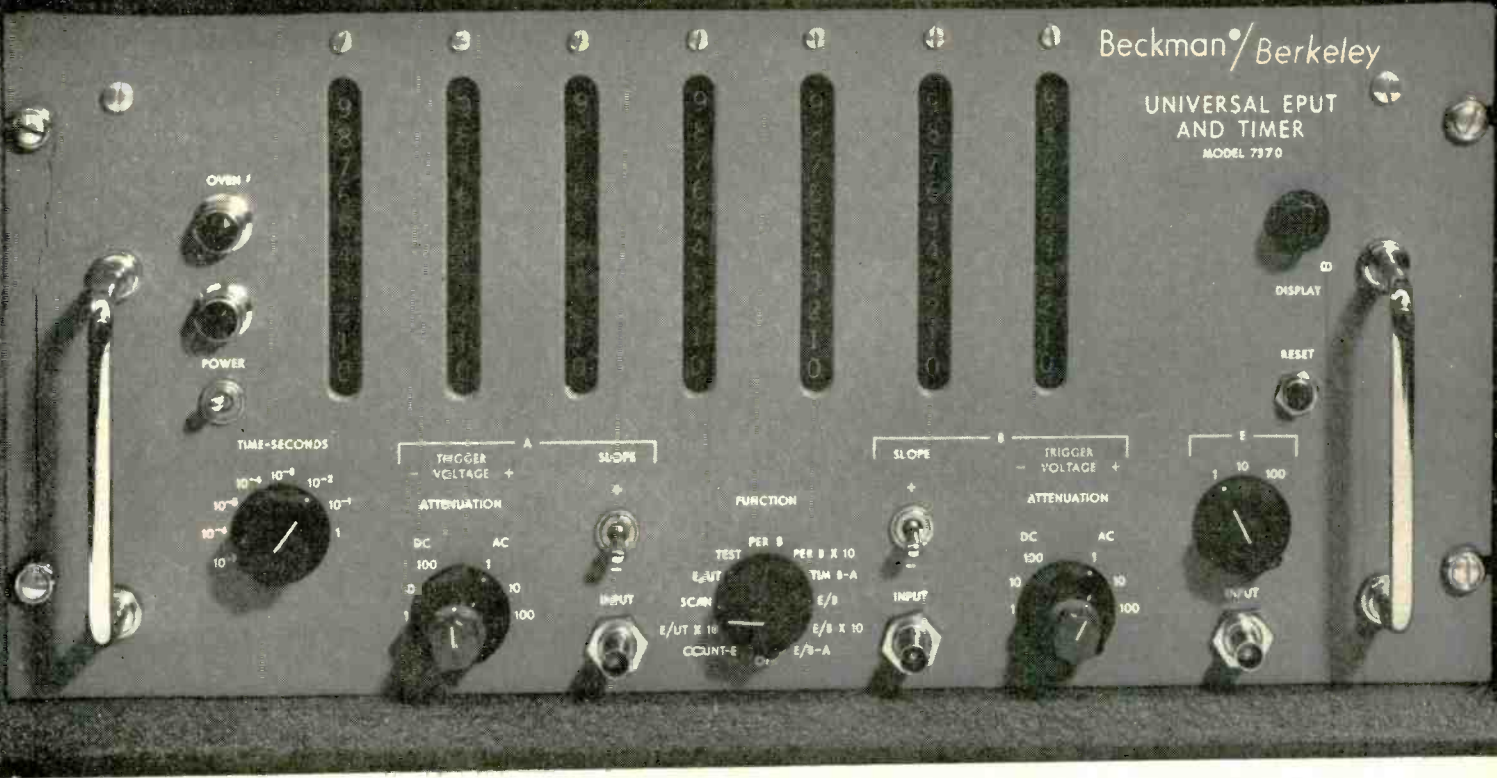

NOW 10 MC!

*New Beckman/Berkeley Universal EPUT® and Timer...
a completely self-contained unit!*

KEY FEATURES

- No meter indicators—7-place direct digital readout
- Frequency measurements at 0.1 v. rms
- Three input channels for greater flexibility, more logical operation
- 10 operating functions without plug-ins
- Small, compact, moderately priced
- 0.1 microsecond resolution

Capable of direct measurements up to 10 mc—without heterodyning or requiring plug-ins—Model 7370 meets growing test instrumentation needs with the design and performance superiority characteristic of Beckman/Berkeley timer-counters, acknowledged standards of the field.

Providing three input channels, selectable time base and 7 Decimal Counting Units, Model 7370 handles every phase of counting and timing, including frequency ratio measurements. A simple switch permits the operator to select any of the following functions: "Events/Unit Time", "Period", "Time Interval Measurement", "Events/Time A-B", "Count Events", "Gate", "Events/Unit Time $\times 10$ ", "Period $\times 10$ ", "Events/Time A-B $\times 10$ ", "Scan", and "Test".

The EPUT function permits accurate measurement of frequencies up to 10 mc by direct counting for a precise period of time. The versatile Model 7370 also serves as a reliable secondary frequency standard. Other applications include phase measurement, telemetry, stability check, calibration of frequency or pulse generators, events timing, and ballistics, viscosity, and elasticity measurement.

For further description, design specifications, and prices of Beckman/Berkeley 7000 series EPUT meters, timers, and accessories—see following pages.

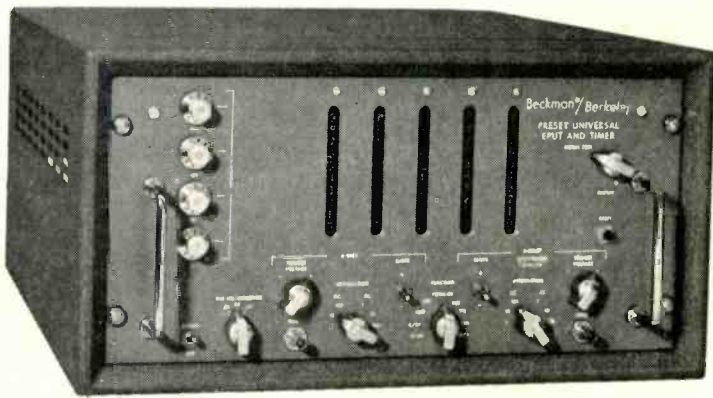

Preset Universal EPUT and Timers Models 7351 (100 kc) and 7361 (1 mc)

With their variable preset "count down" time bases, Models 7351 and 7361 Preset Universal EPUT Meters are unique multipurpose instruments. Regardless of transducer conversion factors, results may be read in direct digital form by merely selecting the proper time base. These instruments make fast, accurate measurements of time intervals of any preset number of periods from 1 to 10,000 over the frequency range 0 to 10 kc. They totalize a selectable sequence of events, divide frequency, function as single preset counters, generate pulses of varying frequency. Applications include precise measurement of velocity, pressure, flow, viscosity, low and high frequency, frequency ratio and period, and tachometry.

10 MC EPUT TIMER Model 7170

The 10 mc Model 7170 EPUT Timer automatically counts and displays the number of events that occur during a precise time interval. This new instrument has been developed for applications requiring the measurement of frequencies above the range of conventional EPUT meters. Its range is from 10 cps to 10 mc. Seven Decimal Counting Units are employed to give direct readout up to 9,999,999. The time base consists of a 1 mc, oven-stabilized, crystal-controlled oscillator and a series of frequency dividers. Connections are provided for driving Berkeley digital recording and readout units.

0.1 μSEC. TIME INTERVAL METER Model 7270

The Beckman/Berkeley Model 7270 Time Interval Meter will measure elapsed time between two events to an accuracy of ±0.1 microsecond. Time intervals of 0.1 or 1 microsecond may be selected, and time intervals of 1 or 10 seconds may be displayed. Accurate timing signals are provided by a 1 mc, oven-stabilized, crystal-controlled oscillator and frequency multiplier. Externally generated timing signals up to 10 mc may also be used. The Model 7270 makes Period and Time Interval Measurements to a minimum of 0.3 microseconds and, with two independent input channels and an X10 function, performs exceedingly accurate frequency ratio measurements. The timing signals are available for external use, and four-line binary-coded information from the Decimcl Counting Units is also provided.

STANDARD FEATURES All 7000 Series Models

- 1 0.1 v rms sensitivity
- 2 AC or DC coupling of input circuits
- 3 Step attenuators—trigger-adjusted noise discriminators
- 4 Binary-coded output with direct connection to digital printers, data converters, in-line readouts, etc.
- 5 Stable frequency dividers
- 6 Electronic reset—not relay type
- 7 External frequency standard input connection
- 8 Multivoltage accessory socket to power photocells, etc.
- 9 Crystal-controlled time marker output
- 10 Unitized modular design
- 11 Large, bright, direct digital readout
- 12 Modern all-aluminum cabinets



Portable Universal EPUT and Timer Model 5230 (100 kc)

Combines many features of the popular Beckman/Berkeley 7000 series in a new, lightweight, portable instrument to perform the functions of a counter, timer, time interval meter, EPUT meter, frequency ratio or period meter. Printed circuitry contributes to compact design, increased reliability, and low cost.



DIGITAL PRINTER Model 1452

Automatically and permanently records information from any 7000 series instrument or the 5200 portable series. Prints data in digital form on standard adding machine tape, with printer and scanner in one compact unit. May be modified to print "Time" or "Code" information simultaneously with data. Rack or bench mounted... available in up to eight digits... one printout every 0.85 seconds. Price (8-digit unit) \$950.00.

Standard Universal EPUT and Timers Models 7350 (100 kc) and 7360 (1 mc)

These Beckman/Berkeley universal instruments are standard in the 7000 series. They combine high-speed electronic counting with a precision time base in multipurpose circuitry. They function as counters, timers, time interval meters, EPUT meters, frequency, frequency ratio or period meters, or as secondary frequency standards. All 7000 series universal models have provisions for standardization against WWV and may be coupled to external frequency standards. Connections are provided for driving Berkeley digital printers, data converters, or in-line remote readout indicators.



SPECIFICATIONS & PRICES

BRIEF SPECIFICATIONS	Model 5230	Model 7170	Model 7270	Model 7350	Model 7351	Model 7360	Model 7361	Model 7370
RANGES-FREQUENCY	0 cps to 100 kc	10 cps to 10 mc		0 cps to 100 kc	0 cps to 100 kc	0 cps to 1 mc	0 cps to 1 mc	10 cps to 10 mc
TIME INTERVAL	100 μ sec to 10 ⁴ sec		0.3 μ sec to 10 ⁷ sec	10 μ sec to 10 ⁶ sec	10 μ sec to 10 ² sec	1 μ sec to 10 ⁷ sec	10 μ sec to 10 ³ sec	0.3 μ sec to 10 ⁷ sec
PERIOD	0 cps to 10 kc		0 to 3 mc	0 cps to 100 kc	0 cps to 10 kc	0 cps to 1 mc	0 cps to 10 kc	0 to 3 mc
TIME BASES	0.1 and 1 sec	0.1 μ sec to 10 sec	0.1 μ sec and 1 μ sec	10 μ sec to 10 sec	Time Interval* Generator	1 μ sec to 10 sec	Time Interval* Generator	0.1 μ sec to 10 sec
CODED OUTPUT FOR DRIVING DIGITAL RECORDER, ETC.	\$30.00 extra	Yes	Yes	Yes	Yes	Yes	Yes	Yes
COUNT CAPACITY (READOUT)	4 digit	7 digit	7 digit	6 digit	5 digit	7 digit	6 digit	7 digit
ACCURACY	± 1 count, ± oscillator stability							
OSCILLATOR STABILITY	1 part in 10 ⁴ per day	3 parts in 10 ⁷ per week	3 parts in 10 ⁷ per week	3 parts in 10 ⁶ per week	1 part in 10 ⁶ per day	3 parts in 10 ⁶ per week	1 part in 10 ⁶ per day	3 parts in 10 ⁷ per week
INPUT SENSITIVITY	0.25 v. rms	0.1 v. rms	0.2 v. rms	0.1 volt rms**			A & B—0.2 v. rms E—0.1 v. rms	
INPUT IMPEDANCE	1 megohm, direct	1 megohm, ac coupled	1 megohm, ac or direct coupled	10 megohm, ac or direct coupled			A & B—1 megohm, ac or direct coupled E—1 megohm, ac coupled	
TRIGGER SLOPES	Positive or Negative	Positive or negative						
CABINET DIMENSIONS	12" H x 8" W x 14" D	10 1/4" H x 20 3/4" W x 16 1/2" D (Rack Panel—8 3/4" x 19")						
APPROX. SHIPPING WT., LB.	30	60	60	60	50	60	50	70
PRICE: (F.O.B. FACTORY)	\$575.00	\$1675.00	\$1675.00	\$945.00	\$1295.00	\$1245.00	\$1445.00	\$1975.00

*Variable from 0.1 millise to 0.9999 sec in 0.1 millise increments and from 1 millise to 9.999 sec in 1 millise increments
**Modification for 5 millivolt sens. @ 5 cps available, \$50.00 extra



IN-LINE READOUT Model 5916

Large, illuminated, in-line *in-plane* figures reduce fatigue and error. Ideal for remote observation of data. It can connect directly to any 7000 series instrument or 5200 series portable. Presentation rate up to 15 per second; accepts binary voltages. Price (6-digit unit) \$775.00.

TRANSDUCERS—A large number of transducers especially designed for use with Berkeley counting, timing, and frequency measuring equipment is available. These include tachometer pickups, photo-cells, and light sources. Specifications and technical description on request.

See us at **NEC...**

For a close look at these advanced counting and timing instruments, be sure to visit Booths 241-244 at the NEC show in Chicago, October 7-9. Technical data and specifications are available from Beckman/Berkeley representatives or at the factory. Please address Dept.G10.

Beckman[®] / Berkeley Division

2200 Wright Avenue • Richmond 3, California
a division of Beckman Instruments, Inc.

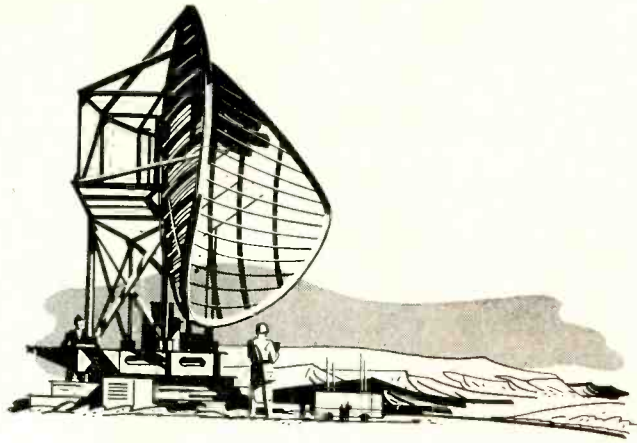

JOIN WITH HANDY & HARMAN SILVER BRAZING FOR PERMANENT PROFIT

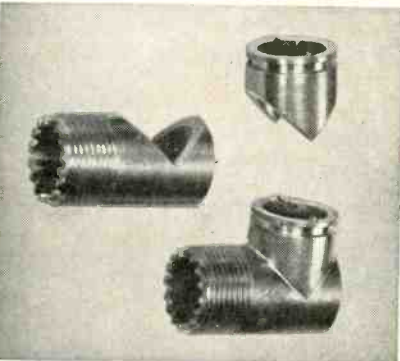

EASY-FLO Brazing Simplifies Multiple Joint Design and Production

Silver brazing with EASY-FLO makes possible simplicity of design and assembly, often abolishing machining operations like stamping, riveting, staking and threading. You see here some of a large variety of brass connectors for radar equipment, manufactured by the King Electronics Company, Incorporated, Tuckahoe, New York. All must meet rigid performance requirements which in turn, establish equally exacting production specifications.

Many different types of joints are involved. Prime performance requirement of these connectors is unimpaired electrical conductivity, for they must in no way impede the current flow of the wires they house. All must be 100% moistureproof and gasproof, have high mechanical strength and take uniform plating without prior finishing. Joined connectors must be perfectly aligned and undistorted.

Each of these requirements is fully met by Handy & Harman silver alloy brazing with EASY-FLO 45 and HANDY FLUX at considerable savings in money and time. Savings that warrant your attention, whatever your product or production methods. Our experience proves that savings through silver alloy brazing can be enjoyed by many manufacturers of many different products in a host of industries. This "King Connector" story is but one example of how silver alloy brazing meets the needs of one product from *start to finish*.

It is worth thinking about—worth getting in touch with Handy & Harman to find out. We will work with you all the way.

TAKE TWENTY

BULLETIN 20 tells you why high strength, speed and economy are inherent in EASY-FLO brazing. Also gives Handy information about joint design and fast brazing methods. We'll be pleased to send you a copy.



Your NO. **1** Source of Supply and Authority on Silver Brazing Alloys



HANDY & HARMAN

General Offices: 82 Fulton St., New York 38, N. Y.
DISTRIBUTORS IN PRINCIPAL CITIES

OFFICES and PLANTS
BRIDGEPORT, CONN.
PROVIDENCE, R. I.
CHICAGO, ILL.
CLEVELAND, OHIO
DETROIT, MICH.
LOS ANGELES, CALIF.
TORONTO, CANADA
MONTREAL, CANADA

50 ohm Coax Terminations dc to 4 KMC!



8 new instruments! 1 to 500 watts coverage!

New Sierra 160 series Coaxial Terminations are ideal for use with directional couplers, or in other applications requiring wide frequency range and low VSWR. They provide extremely high stability, and will dissipate full rated power continuously up to an ambient temperature of 40°C. Derating permits operating at still greater ambient temperatures. Terminations are completely shielded, and may be used to adjust transmitters without radiation. They are also useful for converting Sierra Bi-Directional Power Monitors to a termination type wattmeter.

SPECIFICATIONS

Model	Power*	Connectors	VSWR
160-1F	1 watt	Type N fem.	} Less than 1.06, dc to 2 KMC; } } less than 1.08, dc to 4 KMC. }
160-1M	1 watt	Type N male	
160-5F	5 watts	Type N fem.	Less than 1.08, dc to 4 KMC.
160-5M	5 watts	Type N male	
160-20F	20 watts	Type N fem.	} Less than 1.08, dc to 1 KMC; } } less than 1.15, dc to 4 KMC. }
160-20M	20 watts	Type N male	
160-100F	100 watts	Type N fem.	Less than 1.2, dc to 3300 MC.
160-500F	500 watts	Type N fem.	

*Up to 40° C ambient.

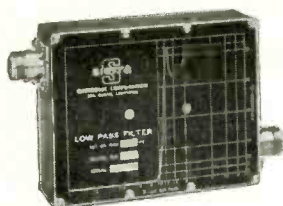

New LOW PASS FILTERS

Sierra 184 series Low Pass Filters have an insertion loss not more than 0.4 db in pass band, sharp cut-off, 1.5 VSWR or less, and rejection greater than 60 db from 1.25 to 10 times cut-off frequency. Five models: for cut-off frequencies of 44, 76, 135, 230, 400 MC. Power range 250 watts in pass band, 25 watts in rejection band.

Write for Bulletin!

Sierra Electronic Corporation

A Subsidiary of Philco Corporation

3885 Bohannon Dr., Davenport 6-2060, Menlo Park, Cal., U.S.A.

Sales Representatives in major cities

CANADA: Atlas Radio Corp., Ltd., Toronto, Montreal, Vancouver, Winnipeg

EXPORT: Frazar & Hansen, Ltd., San Francisco, New York, Los Angeles



WIDEBAND DIRECTIONAL COUPLERS

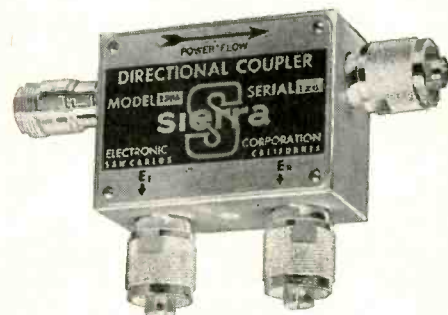

Versatile, accurate Sierra couplers are offered in 6 models for frequencies 10 kc to 2000 mc. Couplers provide transmission line measurements including reflection coefficient, VSWR, power. Also permit matching of loads to lines dynamically by indicating conditions providing minimization of reflected voltages. Request Bulletins 101, 104.

Coupling Factor: (in db ± 1 db)

Model	10 kc	3 mc	10 mc	30 mc	100 mc	300 mc	1000 mc	2000 mc
137, 137A				73	63	53	43	37
138, 138A				59	49	39	29	
145		52	42	32	22	12		
150				53	43	33	23	
139	50	50						

Directivity: 12 db ± 3 db greater than coupling factor at each frequency.

Impedance: Models 137 and 138 are 51.5 ohms. Models 137A, 138A, 145 and 150 are 50.0 ohms. Model 139 may be matched to most impedances.

Power: Usable to 1000 watts throughout frequency range.



SIERRA 148 CRYSTAL DETECTOR

Insures sensitive readout for Sierra Directional Couplers. Low VSWR, high sensitivity to 1200 MC. 50 ohm input impedance, filtered output. Type N input, BNC output connectors.

Data subject to change without notice

You can now get...

Hipermag* cores that slash magnetic amplifier rejects up to 75%

The greatest single advance in giving you reactor cores of such proved reliability is the new Roberts Dynamic Test—an exclusive Westinghouse development. Using the constant-current flux-reset method, this test literally measures magnetic properties of the core under simulated operating conditions in half-wave, saturable reactors. The Roberts Test is the only method that offers practical performance-matched cores required for high-precision magnetic amplifiers.

You get data on (1) peak flux density, (2) peak differential permeability, (3) loop squareness and (4) d-c control magnetizing force at four points on the dynamic B-H curve. Test values can be used directly as constants in amplifier design.

The Roberts Test actually eliminates core testing and matching in your plant—performance is now predictable. Westinghouse cores assure you, as never before, of the performance you design into your product.

Also available is a full line of Hipersil® and Hiperthin cores for electronic applications.

Call your Westinghouse representative or write, Specialty Transformer Department, Westinghouse Electric Corporation, P. O. Box 231, Greenville, Pa.

*Trade-Mark
J-70796

YOU CAN BE SURE...IF IT'S

Westinghouse



Production line Roberts Test and performance matching at Westinghouse eliminate costly and complicated testing at your plant.

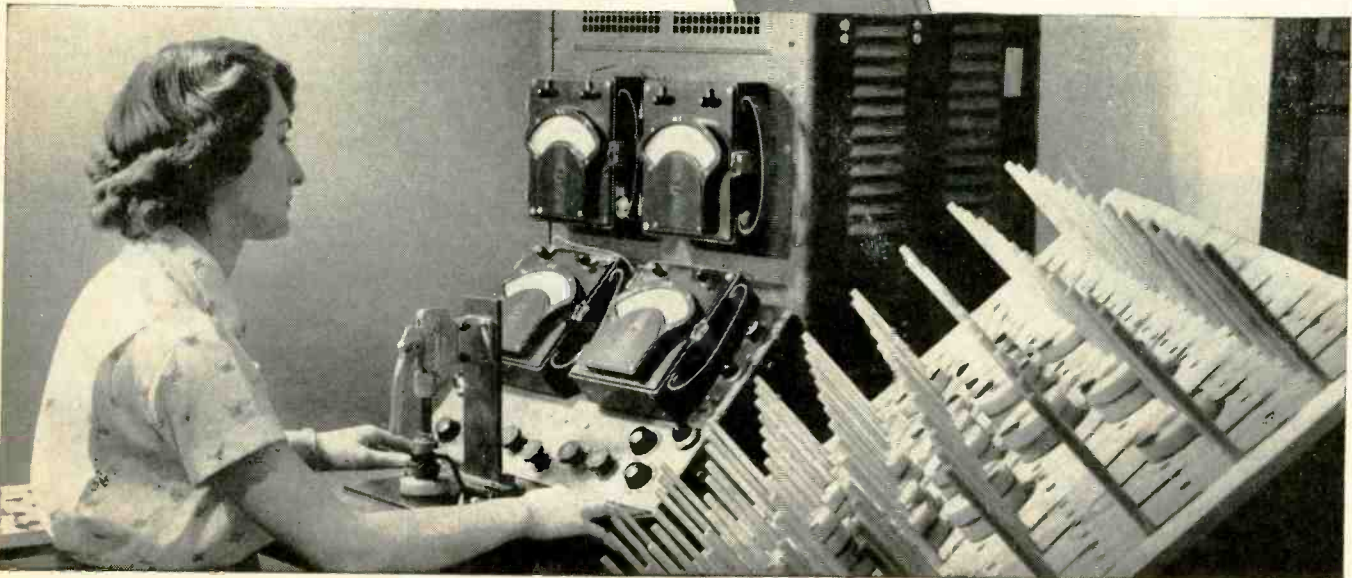

ANNOUNCING

VARIABLE VACUUM CAPACITORS

Actual size illustrations



**IN HIGH ALUMINA CERAMIC ENVELOPES
FOR LOW LOSS AND HIGH TEMPERATURE OPERATION**

The three capacitors illustrated are product of a design and development project which has established a *break through* into higher practicality for variable vacuum capacitors. They have great appeal in applications where technical, physical and cost factors have heretofore been prohibitive. There are at present three *size groups*, each of which contains several types differing in capacitance range and voltage ratings.

The art of adjusting the position of elements within vacuum sealed electronic devices by use of a bellows arrangement substantially predates World War II. In this new range of capacitors UNITED ELECTRONICS has advanced this custom through associating it with the newer techniques of ceramic bodies as employed in modern miniaturized and ruggedized electron tubes. Ceramic to metal closures are doubly important in variable vacuum capacitors since moving internal parts are involved. Extremely close tolerance assemblies are made possible under conditions of high production mechanization.

Modern miniaturized circuitry, whether in air, liquid or in rigid encapsulation, will invite advantageous opportunities for these new ceramic VariVacs available in voltage ratings of from 1,000 to 25,000, and with maximum engaged capacitance values up to 500 uuf.

A large, stylized 'VAR-VAC' logo is centered on a yellow rectangular background. The logo features the word 'VAR' on the left, a bellows symbol in the middle, and the word 'VAC' on the right, all in a bold, blocky font.

The above Trade Mark symbolizes
Variable Vacuum Capacitors by
UNITED ELECTRONICS

Write for technical bulletin CDB-4

UNITED  ELECTRONICS, 42 Spring Street, Newark 4, N. J.

Why they come to

UNITED ELECTRONICS



***TYPE 3B24WA**

Ruggedized version of JAN 3B24W rectifier.

Height 4.8125 Diam 1.5625

MAX ELECTRICAL RATINGS

Ef 5 volts epx 20 kv
 If 3 amps ib 300 ma
 Ib 60 mAdc

SHOCK RATING 450 G

employs bonded thoria tungsten core filament



TYPE 582, Half-Wave

High vacuum rectifier for use in airborne equipment where gas tubes give short life on 400 cps or higher source.

Height 5.75 Diam 1.57

MAX ELECTRICAL RATINGS

Ef 2.5 volts If 5 amps
 55,000 ft. epx 9 kv
 Ib 1 amp Ib 200 mAdc
 i surge 5 amps tk 40 (min.) sec.

SHOCK RATING 300 G



**TYPE 583
 Clipper Diode-Rectifier**

Designed under latest concepts of rugged and reliable objectives, UNITED type 583 has the industry's esteem for good performance.

Height 4.875 Diam 1.445

MAX ELECTRICAL RATINGS

epx 17 kv Ib 8 amps
 Ib 65 mAdc

SHOCK RATING 375 G



**TYPE 596
 Full Wave Rectifier**

Reliable, high altitude (60,000 ft.) version of JAN 1641

MAX DIMENSIONS

Height 5.75 Diam 2.250
 Ef 5 volts If 3 amps

TYPICAL RATINGS

cond input	choke input
epx 2300 v	2750 v
Ib 825 mAdc	360 ma
Ib 275 mAdc	275 mAdc



**TYPE 589 Rectifier-Clipper
 External Anode Type**

Designed for oil or air operation weights only 3/4 oz. and has SHOCK RATING of 300 G, Ef 6.3 V; If 1.65 Aac length less leads 1.875

MAX ELECTRICAL RATINGS

Clipper	Rectifier
epx 10 kv	16 kv
Ib 8 amps	.250 amp
Ib .020 Adc	.065 Adc

These reliable tubes were all originated and developed by UNITED ELECTRONICS COMPANY. Types indicated by (*) embody "bonded thoria tungsten core filament" developed by UNITED and available only in tubes made by this company. This filament is essentially non-fracturable. Its emissivity life is far superior to that provided by ordinary thoriated tungsten.

Write for new 40-page booklet.

UNITED ELECTRONICS, 42 Spring Street,

Originators and Manufacturers

with

LEADERSHIP IN

extreme test

CRITERION TUBES

Manufacturers of modern electronic equipment have encountered instrumentation problems, demanding unprecedented performance of electron tubes.

They have come to UNITED ELECTRONICS, where they find unique engineering initiative, and an ever growing *success experience* in their quest for better tubes. They find here a refreshing atmosphere of knowledge, practicality and friendliness. They find here, minds that are not too inhibited by precedent and outmoded concepts of design approach.

RESULT: New EXTREME-TEST CRITERION TUBES which, understandably, other tube manufacturers are trying hard to copy.



TYPE 554 Rectifier-Clipper
External Anode Type

Designed for oil or air operation has max length (minus leads) of 2 1/4 inches. **SHOCK RATING** 300 G
Ef 6.3 volts; If 3.5 Aac

MAX ELECTRICAL RATINGS

Clipper	Rectifier
epx 16 kv	18 kv
ib 12 amps	.470 amp
lb 60 mAdc	150 mAdc



TYPE 576-A
Rectifier-Clipper

Ruggedized and up-rated version of our type 576 good for 500 ma lb without forced air.

MAX ELECTRICAL RATINGS

Clipper	Rectifier
epx 25 kv	25 kv
ib 14 amps	2.5 amps
lb .030 Adc	.500 Adc
Ef 5.4 volts	5 volts
If 15 amps	14 amps

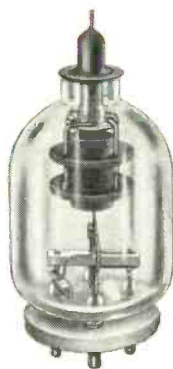

***TYPE 705WA**
Half Wave Rectifier

Here again UNITED engineers came up with a much needed improvement over JAN type 705A. This tube has a **SHOCK RATING** of 300 G and high dependability due to bonded thoriated filament and graphite anode in enormously rugged assembly.



***TYPE 561**
Rectifier-Clipper

This is a low impedance companion to our famous X-80. Has same filament characteristics as X-80 but rated for epx of 30 kv.

MAX ELECTRICAL RATINGS

Clipper	Rectifier
epx 30 kv	30 kv
ib 80 amps	2.7 amp
lb .075 amp	.860 amp



***TYPE X-80**
Rectifier-Clipper

Employs exclusive UNITED bonded thoriated filament and powerful rugged graphite anode.
Height 9.75

Clipper	Rectifier
epx 40 kv	40 kv
ib 80 amps	2.5 amps
lb .075 amp	.800 amp
Ef 11.5 volts	If 15.5 amps

Diam 3.63

Newark 4, N. J.

New components made from technical ceramics cut costs

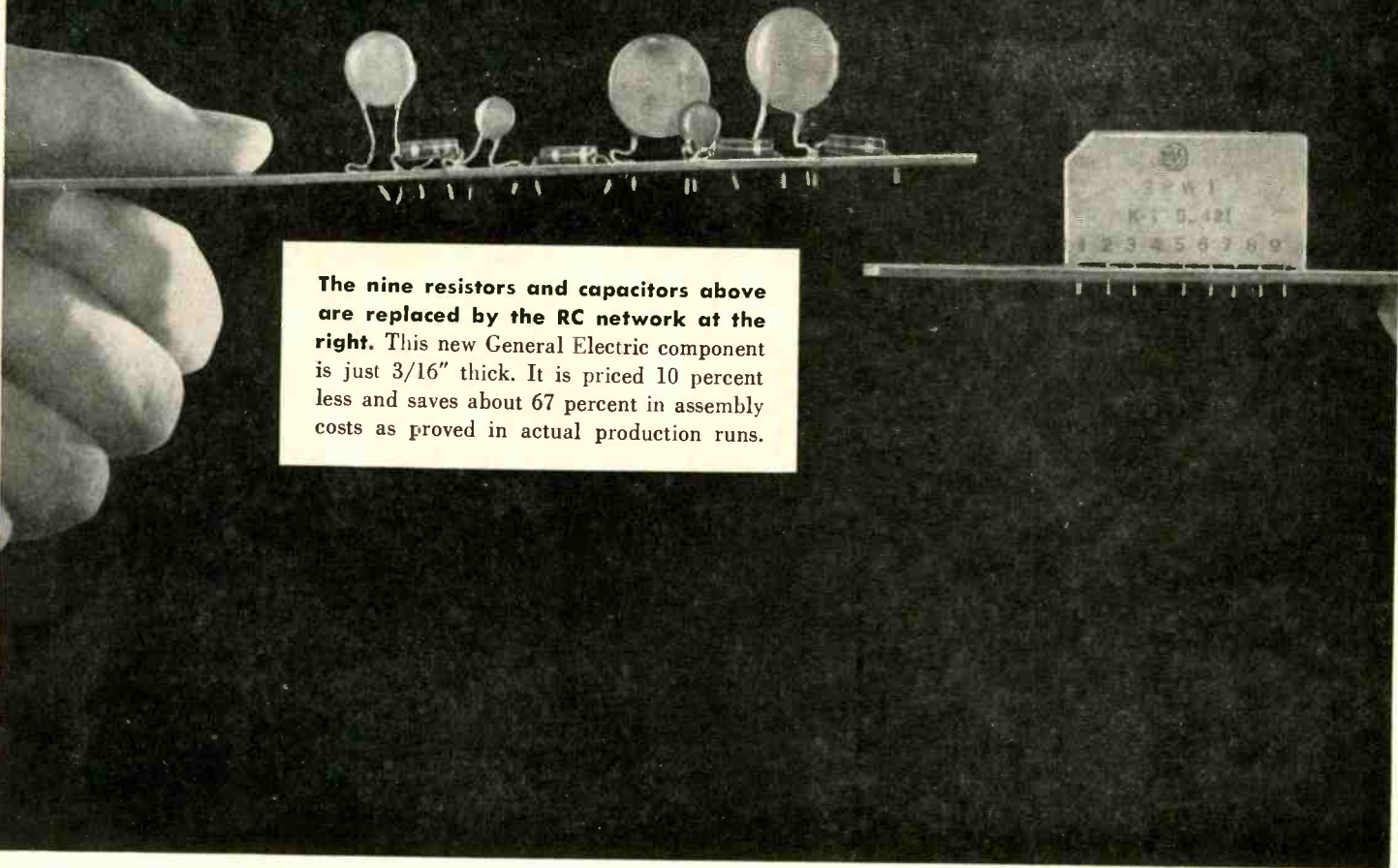

The nine resistors and capacitors above are replaced by the RC network at the right. This new General Electric component is just 3/16" thick. It is priced 10 percent less and saves about 67 percent in assembly costs as proved in actual production runs.



Lead Metaniobate

A piezoelectric material recently developed by General Electric, Lead Metaniobate remains remarkably stable over the temperature range from -54°C to 265°C , an important fact in high-temperature instrumentation devices. It displays superior aging characteristics compared with other ceramic piezoelectric bodies. The high Curie temperature (570°C) allows repeated heat cycling with no effect on electrical output.



Thru-Con print wire board

Now you can design a compact wiring pattern on both sides of the board *without* the cost of further processing to connect them. The "Thru-Con[®]" board additive technique plates *through* the holes at the same time it plates the wiring pattern. This permits high-speed dip soldering remarkably free from rejects. No special eyelets or pre-cleaning are required. Assembly weight is reduced, and inventory is simplified.

of electronic assemblies

Basic Improvements in RC Networks and Capacitors Developed by General Electric Research

Technical ceramics have remarkable electrical and mechanical properties that lead to the utmost simplification in component parts—as superior to present components as the auto was to the horse.

The new RC network shown at the left replaces a host of individual resistors and capacitors. The price saving can be ten percent or better. The assembly saving in print wire boards—inserting one unit instead of five or ten—averages about 67 percent. Furthermore, this small RC network results in a smaller overall assembly, at proportionate savings in board costs. Yet you are not restricted to the usual limitations due to environmental temperatures, for the new network operates at 95°C, ten degrees over the normal requirement.

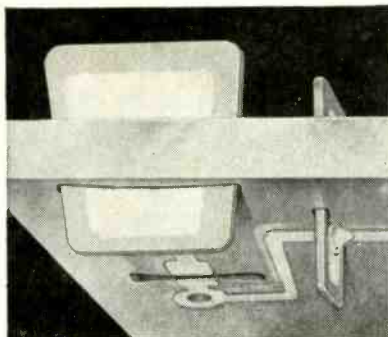

Wejcap capacitors are small, flat capacitors that have no leads at all. They are merely wedged into print wire boards. Leads are an encumbrance. They get bent and broken. They are tough to align. They have to be crimped. Wejcap capacitors eliminate these problems and cost 25 percent less. Tests on

Wejcap capacitors also show that four of them can be inserted in the time it takes to put in three ordinary capacitors. If only three Wejcap capacitors are applied in your volume-production chassis, you can expect to cut as much as 20 percent from your capacitor costs.

Both Wejcap capacitors and RC networks are available in a range that makes of medium and high volume assemblies can capitalize on. For further information fill out the coupon.

**Manager of Sales, Specialty Electronic Components Department,
General Electric Company, Auburn, New York**

Please send me complete technical information on

<input type="checkbox"/>	RC Networks	<input type="checkbox"/>	Lead Metaniobate
<input type="checkbox"/>	Ferrites	<input type="checkbox"/>	Wejcap capacitors
<input type="checkbox"/>	Thru-Con® Print Wire Boards		

Name _____ Position _____

Company _____

Address _____

City _____ Zone _____ State _____

Progress Is Our Most Important Product

GENERAL  ELECTRIC

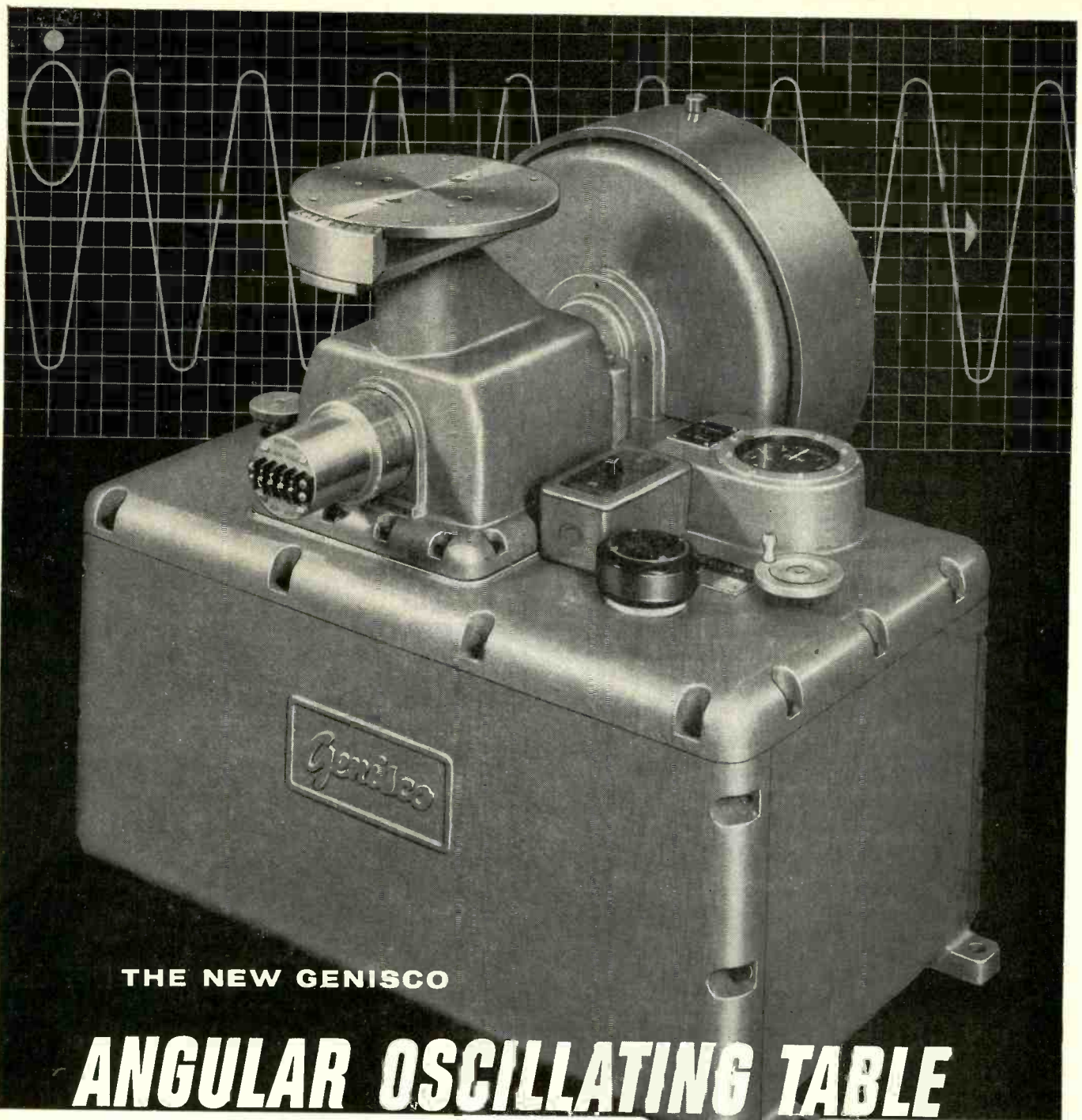

THE NEW GENISCO

ANGULAR OSCILLATING TABLE

Generates a precise sinusoidal function accurate to within 0.1% at excursions up to $\pm 2^\circ$, 0.5% up to $\pm 10^\circ$, and 1% up to $\pm 15^\circ$.

This newest Genisco machine utilizes a unique conical crank mechanism to generate an angular oscillation which closely corresponds to a theoretical sinusoidal waveform. A precision sine-cosine resolver coupled to the crankshaft can be used to bring a test instrument output signal and the oscillating table output signal into coincidence for direct reading of phase lag angle.

The extreme accuracy of the Model B386 Oscillating Table makes it particularly suited for evaluating the damping and response characteristics of angular accelerometers and rate gyros. The Model B386 can also be used for calibrating peak angular velocities and peak accelerations to the accuracy of the known angular excursion and frequency. Within its range, the machine can double as an environmental angular shake table.

For complete information and performance specifications, write to—



Brief specifications:

Angular Excursion: Infinitely adjustable from zero to $\pm 15^\circ$.

Frequency Range: Continuously variable from 0.02 to 3 cps in the low range; 0.2 to 30 cps in the high range.

Accuracy:

Angular Excursion—within 10 minutes of arc.
Frequency Indication—within 1% with tachometer; within 0.1% with stroboscope

Fayload Capacity: 100 lb. deadweight; 750 lb.-in. under dynamic conditions. Protected against dynamic overload by replaceable shear pins.

Vibration Isolation:

Vertical Displacement—0.003" max. at any frequency.
Lateral Displacement—0.001" max. at any frequency.

Platform Diameter: 8"
Approx. Weight: 400 lb.

2233 FEDERAL AVE., LOS ANGELES 64, CALIFORNIA



**At Boeing,
Seattle, Washington**

MIL-W-5086 low tension airframe wire is used in low voltage circuits throughout the B-52 Intercontinental Jet Bomber.

**At Douglas,
El Segundo, California**

MIL-W-5274A hook-up wire is used in the electrical, radio and radar components of the A4D Skyhawk and F4D Skyray.



**At Western Electric,
Burlington, N. Carolina**

MIL-W-76A is used extensively in the Nike Ajax guided missile system.



**At Raytheon,
Waltham, Massachusetts**

MIL-W-16878B high-temperature hook-up wire is used in *classified* airborne navigation and bombing radars.

CLASSIFIED

**At Chance-Vought,
Dallas, Texas**

MIL-C-7078A shielded air frame wire is used near radio and radar apparatus to assure distortion-free operation of electronic equipment on the F7U-3 fighters.



**At Burgess Battery,
Freeport, Illinois**

JAN-C-76 general purpose hook-up wire is used to interconnect cells of dry batteries for portable military equipment.



**At North American
Aviation, L. A., Calif.**

MIL-C-17B coaxial cable is used in high frequency radio and radar circuits on the F100 Super Sabre fighters.



**FOR
MILITARY
SPEC WIRE
AND CABLE**

**leading manufacturers
choose Brand quality,
Brand service**

Turbo-Brand wires are manufactured under a program of scientific quality control to exceed the rigid requirements of these and other manufacturers the world over. Available as single conductors or as custom-designed multi-conductor cables, Turbo-Brand cable may be specified to incorporate any number of conductors, any combination of wire types, and any predetermined lay-up pattern. Your inquiry is invited.

**WILLIAM BRAND
& COMPANY, INC.**

WILLIMANTIC 3.  CONNECTICUT

Electrical and Electronic Wires and Cables • Harnesses and Cable Assemblies • Plastic and Coated Insulating Tubings • Identification Markers

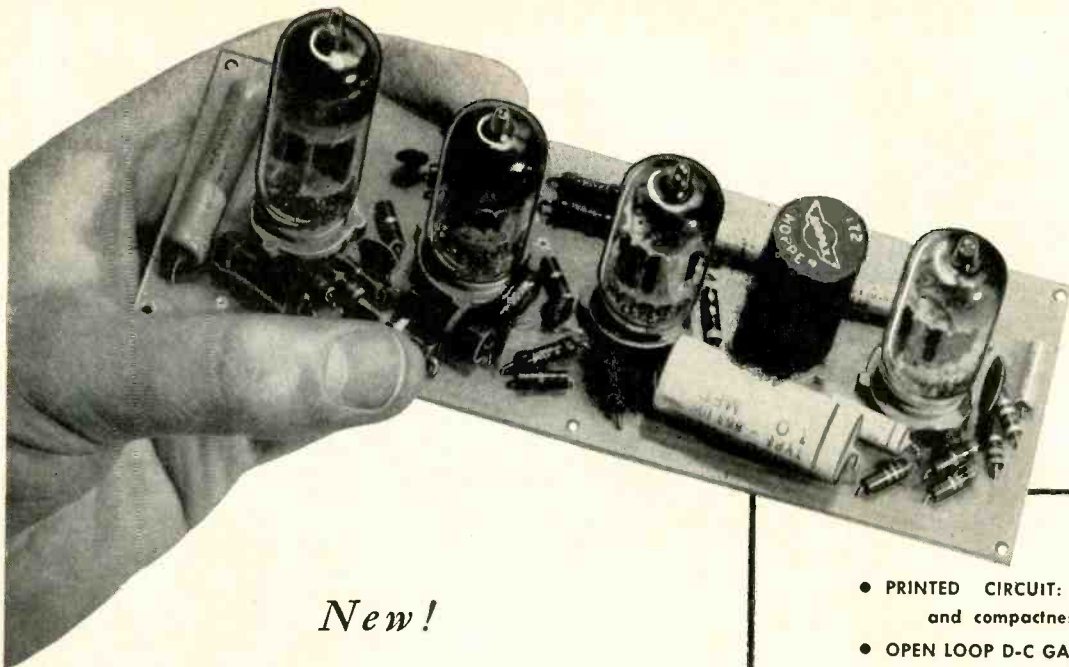

New!

*Greater System Accuracy
and Reliability with the*

- PRINTED CIRCUIT: Economy, reliability and compactness.
- OPEN LOOP D-C GAIN: 10 million.
- LONG TERM DRIFT, NOISE and OFFSET: under 100 microvolts.
- OUTPUT VOLTAGE RANGE: ± 115 volts.
- SIZE: 7" x 2 1/2" board.
- MOUNTING: Any convenient method.
- PRICE: \$95.00.

PHILBRICK PRINTED CIRCUIT AMPLIFIER

Model USA-3

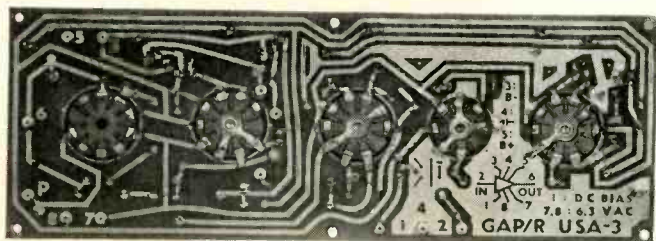

Underside of Model USA-3 showing printed circuit, amplifier connection scheme, and connecting terminals.

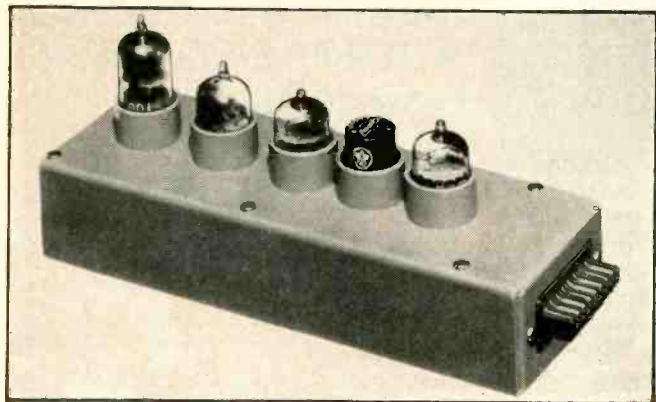

Model USA-3 showing one of the several types of modular packaging available at extra cost.

High performance combined with the reliability and compactness of a printed circuit design are featured in the new Philbrick Universal Stabilized Amplifier, Model USA-3. It is ideally suited for applications to instrumentation, control and analog computation. Extremely high open-loop d-c gain, wide bandwidth, low noise and wide output range are important performance characteristics of this new chopper stabilized amplifier. An interesting design feature makes this instrument safe against self-destruction, even under prolonged overload conditions or direct grounding of its output. At a price of only \$95.00, it offers more performance per dollar than any other amplifier on the market today. Write to George A. Philbrick Researches, Inc., Dept. 14, for Bulletin USA-3.

GEORGE A.
PHILBRICK
RESEARCHES, INC.

230 Congress Street, Boston 10, Massachusetts

cooling avionic systems

During World War II, Eastern Industries pioneered cooling systems for aircraft electronic systems. Now, thousands of installations later, and as the leader in this challenging field, Eastern is still pioneering.

Experience has been a springboard to new developments . . . compactness, simplification, refrigeration cycles. Research and development continue to play their vital parts in perfecting systems to overcome the new problems as expanded aircraft performance produces fantastic rises in temperatures.

If you have a challenging problem, come to the leader in the field for complete and creative engineering help.

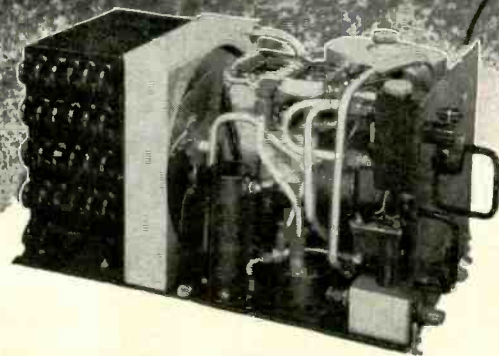

COOLING UNIT

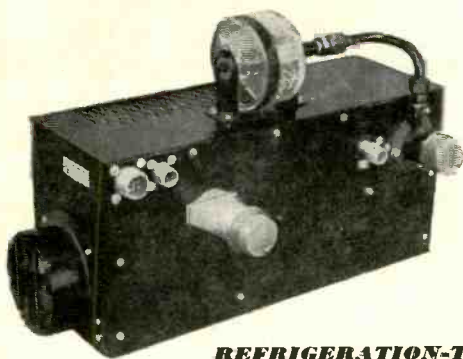

REFRIGERATION-TYPE

ELECTRONIC TUBE COOLING UNITS

Custom-made units, with or without refrigeration cycles, provide a method of maintaining safe operating temperature limits in electronic equipment. Standard sub-assemblies and components normally are used to create a custom-made design to fit your exact needs. Costs are minimized for these completely self-contained units by combining heat exchangers, fans or blowers, liquid pumps, reservoirs, flow switch, thermostat, and other common components.

Write for Eastern AVIONICS BULLETIN 340

PIONEER OF THE THERMAL FRONTIER

INDUSTRIES, INC.

100 Skiff St., Hamden 14, Conn.

West Coast Office: 1608 Centinela Avenue • Inglewood 3, California



Eastern

**AT PHELPS DODGE, MAGNET WIRE "SERVICE"
MEANS FAR MORE THAN JUST DELIVERY!**

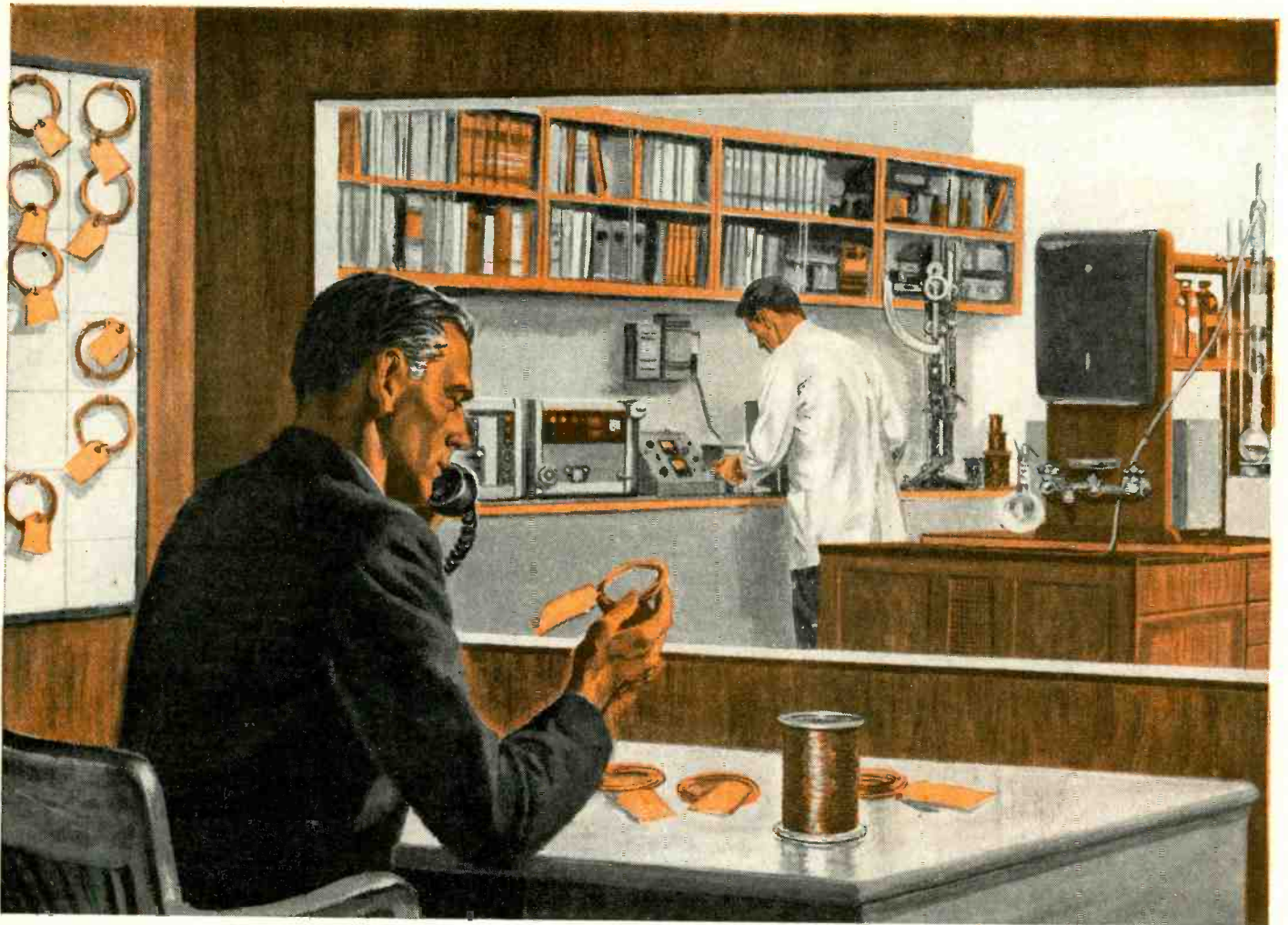

FIRST FOR LASTING QUALITY—FROM MINE TO MARKET

- A complete line of uniformly high-quality products—backed by the finest research and manufacturing facilities.
- Modern, up-to-date packaging designed specifically for easy handling and convenient use.
- Prompt customer service on deliveries and all inquiries.
- Application of vast engineering experience in helping select correct wire and insulation to meet requirements.
- Dependable warehouse system in close proximity to major markets.

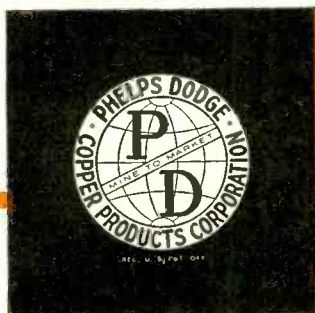
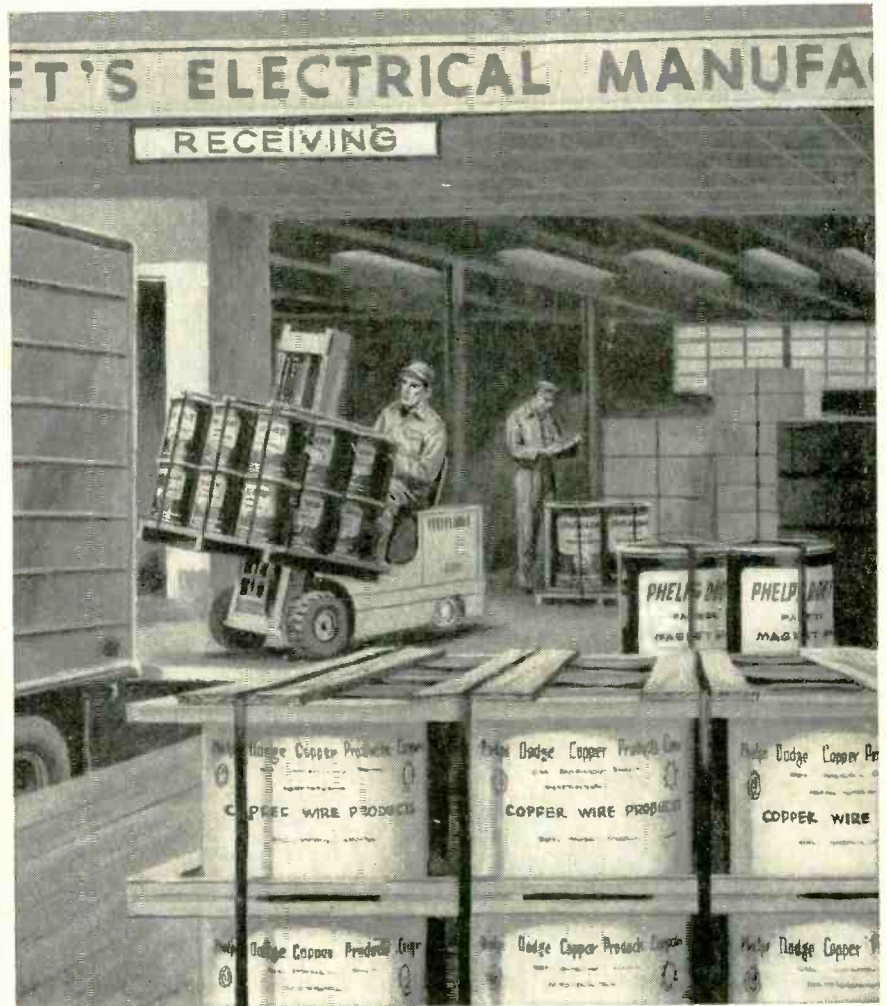
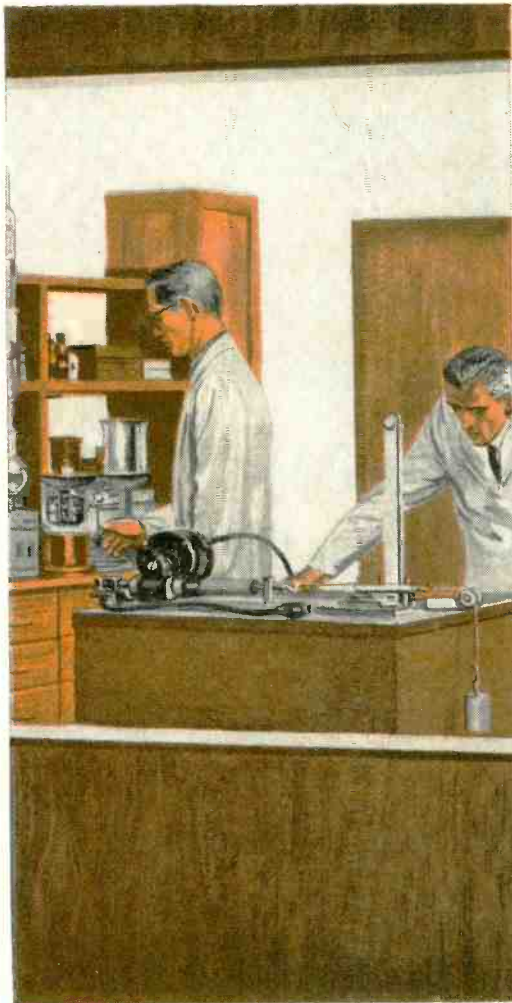

PHELPS DODGE COPPER PRODUCTS
CORPORATION

INCA MANUFACTURING DIVISION
FORT WAYNE, INDIANA

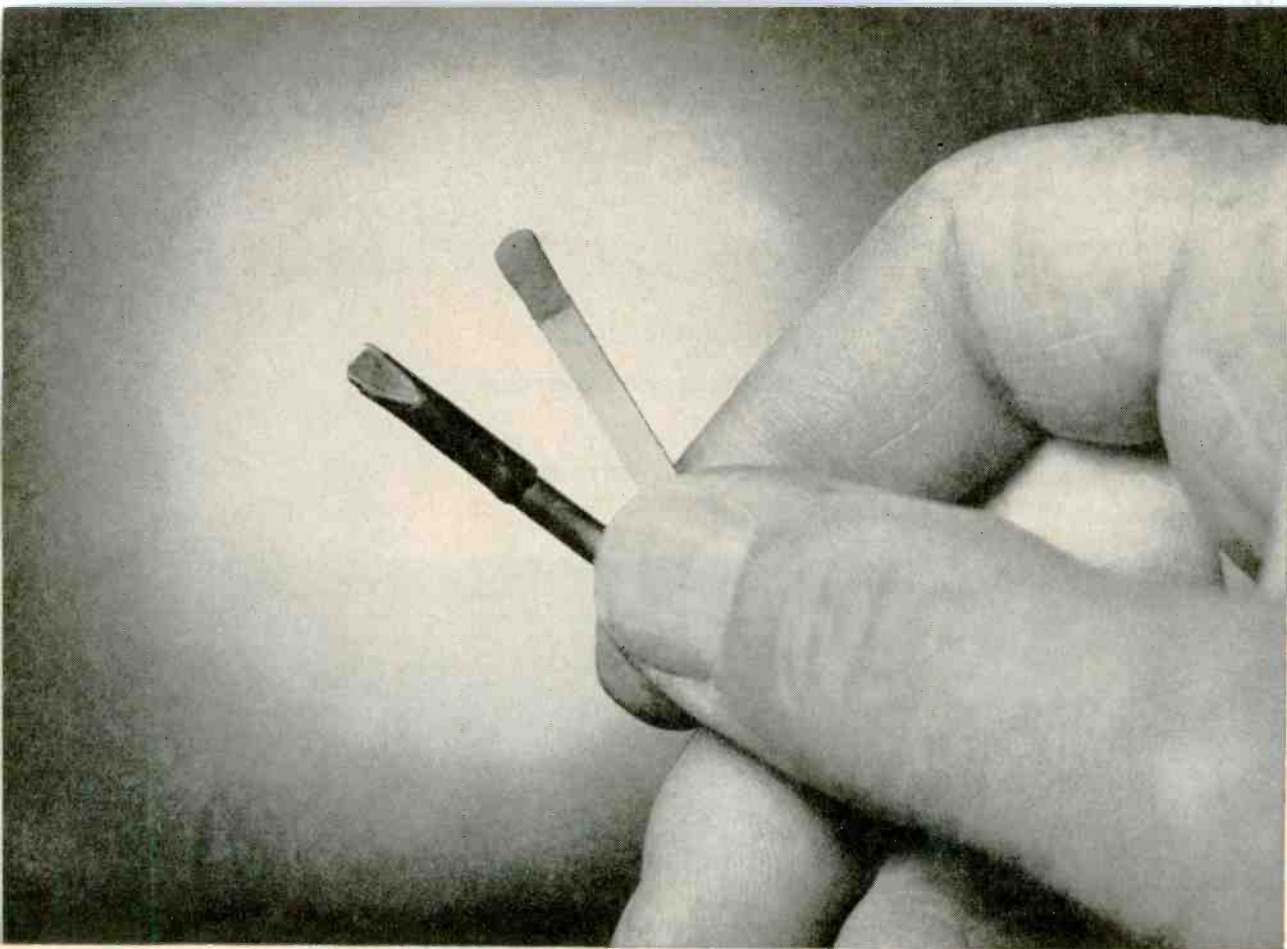

ACTUAL
SIZE



Tip and Shank of New G-E Soldering Iron No Bigger Than a Paper Match: Gives Quick Heat Recovery for Production Use

General Electric's new Miniature soldering iron is designed especially for continuous production-line work on sub-miniature components. It can help increase your production by delivering fast, more dependable heat recovery from joint-to-joint. This is made possible by an efficient tubular heater built into its $\frac{1}{8}$ " diameter, long-life tip. As a result, heat is concentrated right at the work, minimizing heat loss.

What's more, the maneuverable Miniature iron gives you tip-touch control for rapid soldering of critical joints. Its tiny $\frac{1}{8}$ " shank reaches into almost inaccessible areas, with reduced risk of damage to adjacent parts.

Here are just a few of the other big reasons why the new Miniature is the answer to your needs for a small, efficient, production soldering iron:

EASY TO MAINTAIN—Tip and heater assembly can be replaced quickly and easily.

IMPROVES OPERATOR EFFICIENCY—Weighs less than $1\frac{1}{4}$ ounces, reduces fatigue.

TIP LASTS LONGER—Vacuum processed iron tip resists harmful effects of tin and high temperatures.

PORTABLE—Transformer plugs into any standard 115-volt outlet.

For more information contact your local G-E Apparatus Distributor, or write for Publication GEC-1318, Section 724-8, General Electric Company, Schenectady, N. Y.

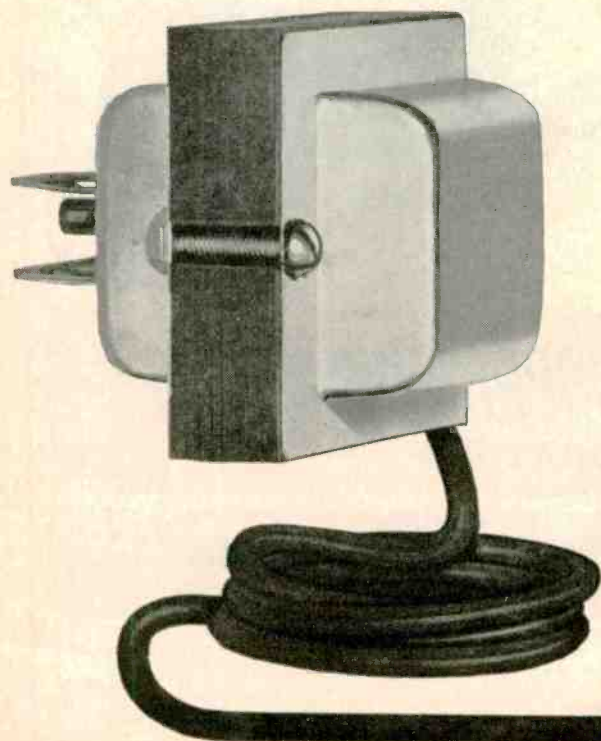

GENERAL  ELECTRIC

exceptional
 temperature
 range
 R M C
 type

JL

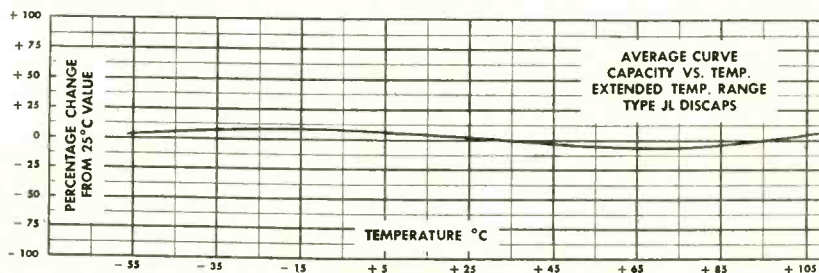
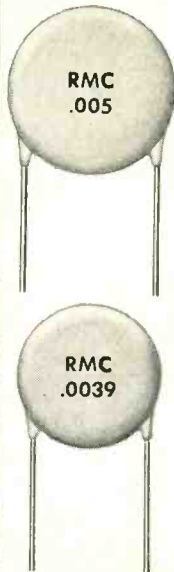

SPECIFICATIONS

LIFE-TEST: As per RETMA REC-107-A
 POWER FACTOR: 1.5% Max. @ 1 KC (initial)
 POWER FACTOR: 2.5% Max. @ 1 KC (after humidity)
 WORKING VOLTAGE: 1000 V.D.C.
 TEST VOLTAGE (FLASH): 2000 V.D.C.
 LEADS: No. 22 tinned copper (.026 dia.)
 INSULATION: Durez phenolic—vacuum waxed
 INITIAL LEAKAGE RESISTANCE: Guaranteed higher than 7500 megohms
 AFTER HUMIDITY LEAKAGE RESISTANCE: Guaranteed higher than 1000 megohms
 CAPACITY TOLERANCE: $\pm 10\% \pm 20\%$ at 25° C

Where application requires ceramic capacitors with slight capacity variation over an extended temperature range, RMC Type JL DISCAPS will meet the specifications. Maximum capacity change between -60° and +110° C is only $\pm 7.5\%$ of value at 25° C. Rated at 1000 V.D.C. Type JL DISCAPS are available in capacities between 150 MMF and 5000 MMF. Write today for samples and complete information.

DISCAP
 CERAMIC
 CAPACITORS

RADIO MATERIALS CORPORATION
 GENERAL OFFICE: 3325 N. California Ave., Chicago 18, Ill.
 Two RMC Plants Devoted Exclusively to Ceramic Capacitors
 FACTORIES AT CHICAGO, ILL. AND ATTICA, IND.

TIMERS...SPECIAL DELIVERY

Standard or special—
Industrial Timer makes rapid deliveries on all models

Sometimes you need a standard model timer . . . other times you need a special. Either way we can give you the extra rapid service you may need because of the efficient way we design, manufacture and stock timers for industrial applications.

To meet *all* of the widely varying needs of our customers we manufacture a complete line of timers in the four broad classifications illustrated here:

1. TIME DELAY TIMERS
2. INTERVAL TIMERS
3. RE-CYCLING TIMERS
4. RUNNING TIME METERS

From these we have already developed 20 basic types which can be combined in endless number of ways . . . to date, our engineers have combined them into over 1000 different models. So what might seem to be a special timer requirement to you, will very often be a standard timer in our large stock, and that is the reason we have the ability to fill special orders so quickly. And as far as standard timers are concerned we can give overnight service if necessary.

So, for the utmost in all-round service depend on us for this outstanding combination: deliveries "Immediate on Standards . . . First on Specials".

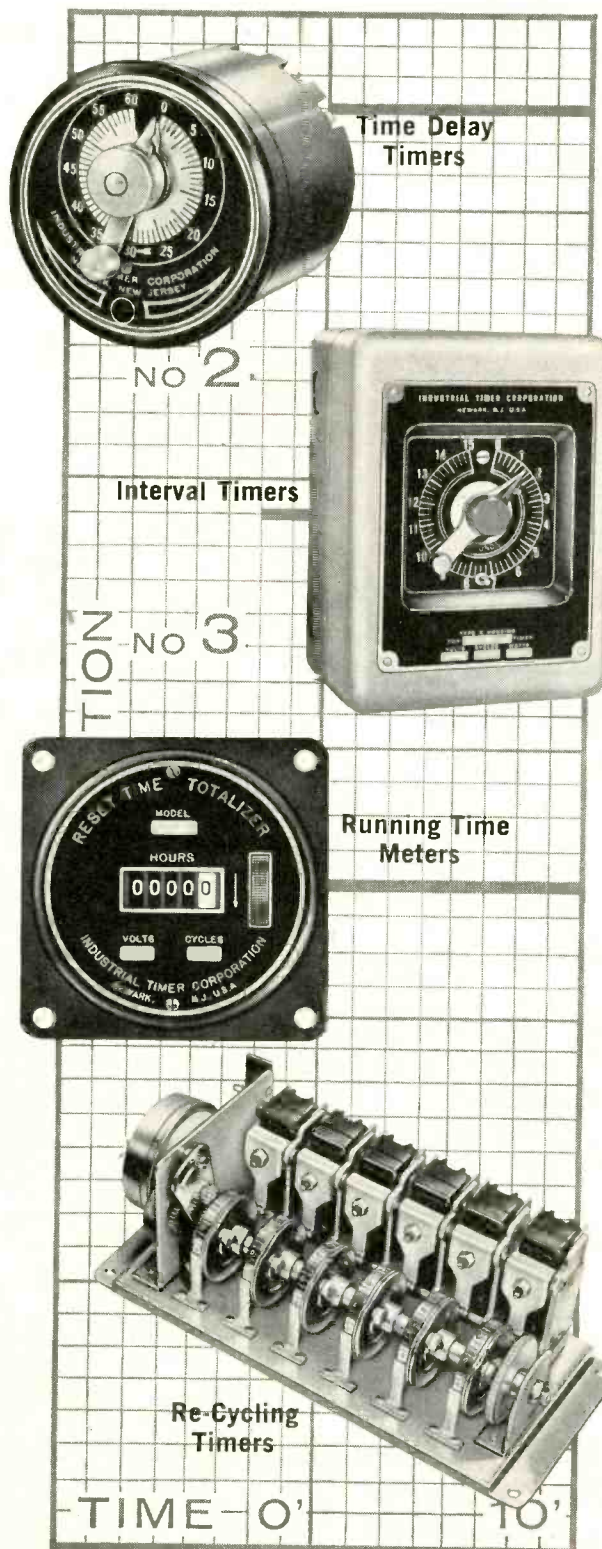

Speed up your automatic control projects—profit by our timing application experience

No need to let timing problems delay you in your automatic control projects when you can place them with us and get faster solutions. Even though no two automatic control jobs are ever exactly alike, and even though the timer requirements of each are very different we have established an excellent record in helping out in these situations.

20 years of experience in analyzing complex timer applications has provided us with the special knowledge required to give our customers the right answer in near-record time.

Our large stock of standard and combination timers enables us very often to fill orders for these requirements without any time loss because we have already developed so many new combinations specifically for automatic control functions.

Extra special automatic control timer—this calls for original designing. Our engineers will go right to work and get the job done. That's the way we grow and we like it.

Whatever your control problem, you have everything to gain by submitting it to our timer specialists. They'll come up with the answer—almost with the speed of automatic control itself.

*Timers that Control
the Pulse Beat of Industry*



INDUSTRIAL TIMER CORPORATION

1409 McCARTER HIGHWAY, NEWARK 4, N. J.

'SCOPE for VISUAL MICROWAVE ANALYSIS

Saves Engineering Manhours

Polarad Model TSA Spectrum Analyzer enables new visual techniques for checking and testing of microwave equipment with the same ease as standard oscilloscopes used in lower frequency work.

This instrument displays on a frequency base: pulse modulation components, frequency differences, attenuation and band width characteristics, leakage detection, radiation and interference signals, and VSWR information, with high sensitivity on a bright easily defined CRT.

Frequencies are read directly on the linear dial with 1% accuracy as the set is tuned. Maximum reliability and long life is assured through special, non-contacting oscillator choke sections. A stable frequency marker with both frequency and amplitude adjustment is provided.



Model TSA

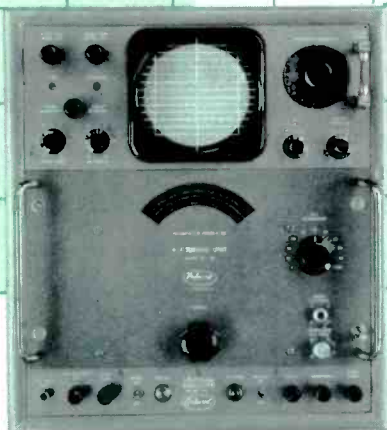

Write for your copy of the Polarad "Handbook of Spectrum Analyzer Techniques". It includes discussion of operation, applications and formulae for analysis techniques.

POLARAD ELECTRONICS CORPORATION

43-20 34th Street, Long Island City 1, New York

REPRESENTATIVES: Abington, Albany, Atlanta, Baltimore, Boeing Field, Chicago, Cleveland, Dayton, Denver, Detroit, Englewood, Fort Worth, Kansas City, Los Angeles, Portland, Rochester, St. Louis, Stamford, Sunnyvale, Syracuse, Washington, D. C., Westbury, Westwood, Wichita, Winston-Salem, Canada: Annprior, Ontario. Resident Representatives in Principal Foreign Cities.

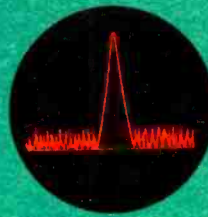

LEAKAGE AND INTERFERENCE MEASUREMENT

A simple, quick method of determining component leakage in microwave equipment is to watch the Spectrum Analyzer CRT while probing with a microwave test antenna. Because of high sensitivity of the TSA, CW signals will appear on the scope when the area of leakage has been found.

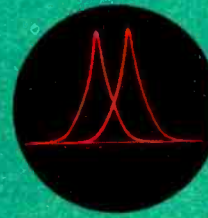

VISUAL FREQUENCY CALIBRATION

The Model TSA Spectrum Analyzer calibrates frequency by comparing the signal from a frequency standard as a reference with that of an unknown. When signal coincidence occurs on the CRT, the unknown frequency is precisely shown. With a resolution of 25 kc, two 10 mc signals can be compared with an error of less than 0.00025 percent.

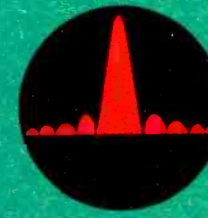

MEASUREMENT OF PULSE MODULATION

The output of a pulse modulated microwave system can be received and displayed, as shown, on the CRT of the Polarad Model TSA Spectrum Analyzer. The presentation is a measure of the quality of modulation and points up undesirable modulation components which can then be corrected by adjusting the modulator and observing the correction visually.

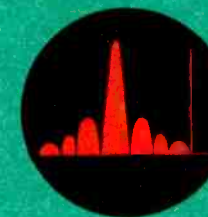

CHECKING AFC OF RADAR SYSTEMS

AFC can be checked readily by observing the manner in which the radar local oscillator signal tracks the transmitter spectrum on the spectrum analyzer.

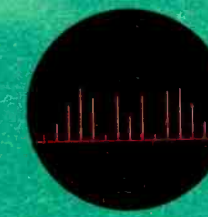

CHECKING OUTPUT OF FM GENERATORS

Modulation index of frequency modulated signals can be checked.



IN ACTION

A microwave receiver with large dynamic range; excellent gain stability for these applications:

- General communications.
- Field intensity meter.
- Frequency meter.
- Measurement of radiation and leakage of microwave devices.
- Measurement of bandwidth of microwave cavities.
- Measurement of relative power of fundamental and harmonic signal frequencies.
- Measurement of noise figure.
- Antenna field patterns.



AM, FM, CW, MCW and PULSE RECEPTION



High video output — low impedance
Trigger output
Special recorder output

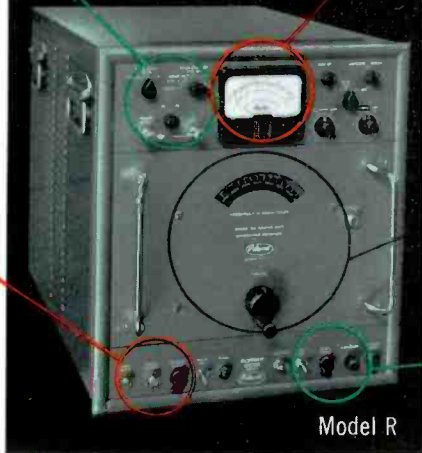

Model R



Output level reading directly in db
High sensitivity



Direct reading UNI-DIAL control,
Broadband coverage

Seven interchangeable plug-in r-f tuning units cover the entire frequency range:

- *†RR-T 400-1,000 mc
 - *†RL-T 950-2,040 mc
 - *†RS-T 1,900-4,340 mc
 - *†RM-T 4,200-7,740 mc
 - *†RX-T 7,300-11,260 mc
 - †RKS-T 9,500-15,600 mc
 - †RKU-T 14,700-22,000 mc
- *Microwave preselection, tracked and double-tuned
†U.S. Patent No. 2,774,243



Audio output,
Audio output control
AFC switch

MULTI-PURPOSE BROADBAND MICROWAVE RECEIVER 400-22,000 mc

Four distinct receivers in one:

- an AM-FM receiver
- a field intensity receiver
- a pulse, pulse time or pulse position demodulator
- a sensitive microwave power meter

This receiver is designed for quantitative analysis of microwave signals and is ideal for the reception and monitoring of all types of radio and radar communications within the broad band 400 to 22,000 mc. It permits comparative power and frequency measurements, by means of its panel-mounted meter, of virtually every type of signal encountered in microwave work.

It is compact and functional, featuring 7 integrally designed plug-in, interchangeable RF microwave tuning units to cover 400 to 22,000 mc; non-contacting chokes in pre-selector and microwave oscillator to assure long life and reliability, and large scale indicating meter for ease of measurement.

Look at the front panel controls and see the versatility of this instrument — in every-day laboratory, production and field testing.

Call any Polarad representative or the factory for detailed specifications:

POLARAD ELECTRONICS CORPORATION

43-20 34th Street, Long Island City 1, New York

REPRESENTATIVES: Abington, Albany, Atlanta, Baltimore, Boeing Field, Chicago, Cleveland, Dayton, Denver, Detroit, Englewood, Fort Worth, Kansas City, Los Angeles, Portland, Rochester, St. Louis, Stamford, Sunnyvale, Syracuse, Washington, D. C., Westbury, Westwood, Wichita, Winston-Salem, Canada: Annapolis, Ontario. Resident Representatives in Principal Foreign Cities.

SPECIFICATIONS:

Sensitivity:

- (a) For Model RR-T: Minus 85 dbm
- (b) For Models RL-T; RS-T, RM-T and RX-T: Minus 80 dbm
- (c) For Models RKS-T and RKU-T: Minus 65 dbm

Frequency Accuracy ±1%

IF Bandwidth: 3 mc

Image Rejection:

- (a) For frequency ranges 400-11,260 mc: Greater than 60 db
- (b) For frequency ranges 9,500-22,000 mc: (RKS-T and RKU-T tuning heads) Spurious response rejection obtained through the use of a bandpass filter

Gain Stability with AFC: ±2 db

Automatic Frequency Control: Pull-out range 10 mc off center

Recorder Output: 1 ma full scale (1,500 ohms)

Trigger Output: Positive 10-volt pulse across 100 ohms

Audio Output: 5 volts undistorted, across 500 ohms

FM Discriminator: Deviation Sensitivity: .7 v./mc

Skirt Selectivity: 60 db — 6 db bandwidth ratio less than 5:1

IF Rejection: 60 db

Maximum Acceptable Input Signal Amplitude: 0.1 volts rms, without external attenuation

Video Response: 30 cps. to 2 mc

SUPERIOR TUBE ADDS 5 NEW GLASS SEALING ALLOYS TO STANDARD LINE



Now Superior offers glass sealing alloy tubing with expansion characteristics to meet practically any glass sealing requirement. These five new analyses are in addition to six already in the line. Superior also offers titanium tubing for ceramic-to-metal seals. All are

available in quantities as small as 50 ft. and are cold drawn to close tolerances. Size limits in most cases from .012 to 1 1/8 in. OD. Write or send coupon for new Data Memorandum 15 giving technical information on all these alloys and the known applications for them.

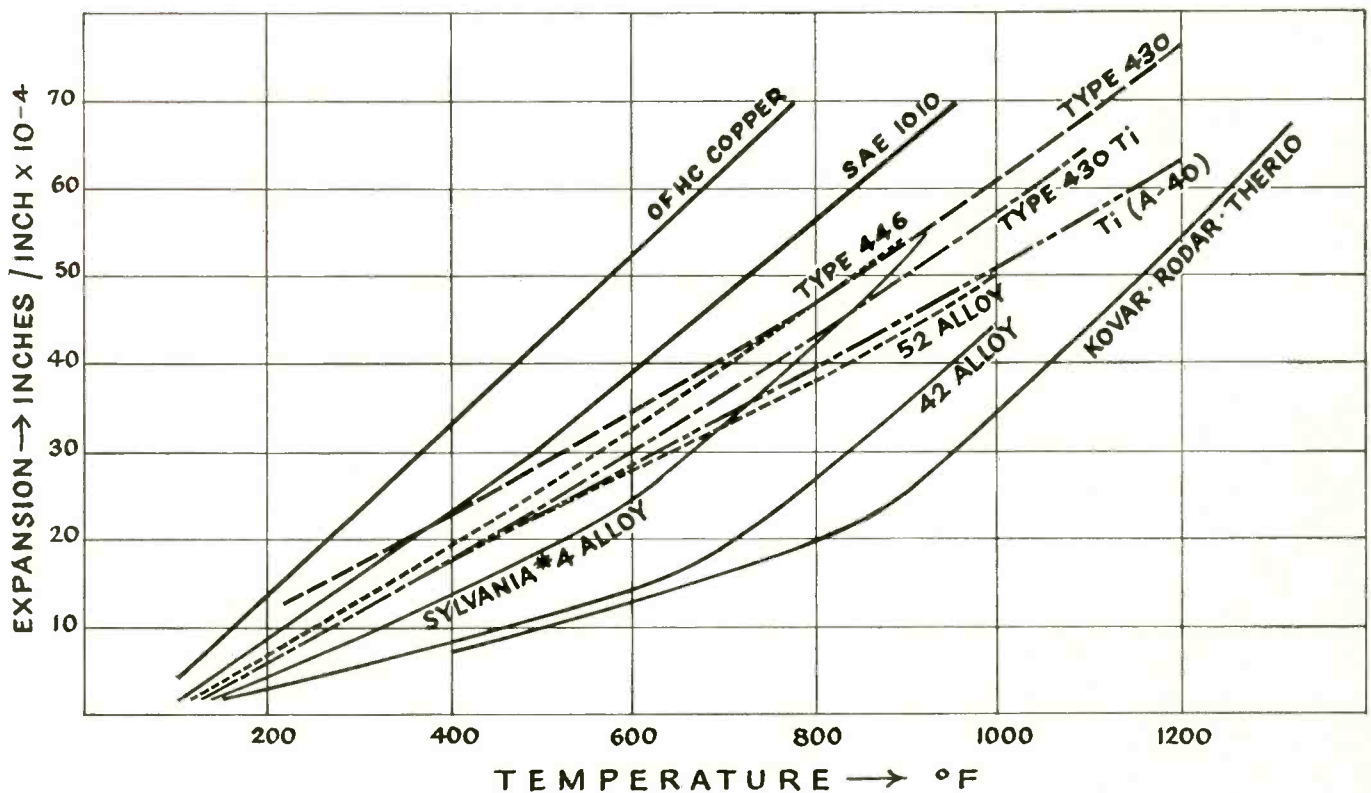

APPROXIMATE EXPANSION CURVES OF VARIOUS METALS

Superior Tube

The big name in small tubing
NORRISTOWN, PA.

Johnson & Hoffman Mfg. Corp., Mineola, N.Y.—an affiliated company making precision metal stampings and deep-drawn parts.

*Stocked and sold by the Stupakoff Division of the Carborundum Co., Latrobe, Pa. T.M. Reg. U.S. Pat. Off., Westinghouse Electric Corp.

†T.M. Reg. U.S. Pat. Off., Wilbur B. Driver Co.

‡T.M. Reg. U.S. Pat. Off., Driver-Harris Co.



SUPERIOR TUBE CO.
2500 Germantown Ave., Norristown, Pa.

Send me a copy of new Data Memorandum 15, on glass sealing alloys.

Name _____

Company _____

Street _____

City _____ Zone _____ State _____

TAPES YOU CAN TRUST!



109—INTERNATIONAL STANDARD—For moderate speeds, tensions, pressures. 1.5 mil cellulose acetate backing. Uniformly accurate because of carefully milled resinous components, rigidly controlled oxide manufacturing process. .55 mil coating of standard output oxide.



108—GENERAL PURPOSE—Uses the same reddish-brown oxide as offered in No. 109 Instrumentation Tape. Because of its dimensional stability, this tape is recommended for multi-track applications. "Weather-balanced", it's ideal in extremes of temperature and humidity.



128 — HIGH OUTPUT — 100% more output (+6db) at 15 mil wave length. This tape is specifically designed for uses where high output at long wave length is required. 1.5 mil polyester base achieves high dimensional stability. .65 mil coating of "High Output" oxide.



159—EXTRA PLAY—50% more recording time on the reel! Made with 1 mil polyester backing, .35 mil coating of high potency oxide. Offers improved high frequency response, improved short wave length output, and better head conformity eliminates signal loss.



148—LONG WEAR—Rugged newcomer! This premium tape gives you 3.5 db greater output at short wave lengths, yet withstands heat-wear in temperatures up to 200°F. and eliminates head build-up. Has 1.5 mil polyester backing, .35 mil coating of "High Output" long wear oxide.



149—LONG WEAR, EXTRA PLAY—Matches 148 for heat-wear resistance and magnetic properties but records 50% longer because of its thinner 1 mil polyester backing. Selection for use of this tape should be based on strength versus playing time as the determining factor.

Choose from a complete line of "Scotch" Brand Instrumentation Tapes for industry and defense

Whatever your recording requirements, "SCOTCH" Brand has the right magnetic tape for you. Here's the world's fullest line of tapes for exacting instrumentation use — and the most reliable. Every "SCOTCH" Brand Instrumentation Tape meets critical dropout specifications. In pulse recording these tapes average less than 1 error per roll.* In direct recording, these tapes conform to proposed Navy specifications defining dropouts as variations

of 22% or more in signal magnitude, lasting 300 or more microseconds.** All tapes shown are available in standard widths of 1/4", 1/2", 5/8", 3/4" and 1".

FREE BOOKLET gives you specific engineering data on dropouts plus complete physical and magnetic specifications of these famous "SCOTCH" Brand products. Write: Minnesota Mining and Mfg. Co., Dept. PL-107, St. Paul 6, Minnesota.

*Measured by recording 200 non-return pulses per inch on a 0.035" track. A reduction to less than 50% normal signal amplitude constitutes a signal error. Zero errors are measured by saturating the tape unidirectionally. Each spurious signal greater than 10% of normal signal amplitude constitutes a zero error. Errors per roll based on recording 7 tracks on rolls 1/2" x 2500'.

**Based on a 8750 cps signal played at 7.5 ips.



WHICH MAGNETIC TAPES ARE BEST FOR YOUR INSTRUMENTATION NEEDS?

Tape Number and Description	Stability	Strength	High Temperature Performance	High Speed Performance	Long Wave Length Output	Short Wave Length Output	Recording Time
108 General Purpose	Best	Best	Good	Good	Good	Good	Normal
109 General Purpose	Good	Good	Good	Good	Good	Good	Normal
128 High Output	Best	Best	Very Good	Very Good	Best	Good	Normal
148 Long Wear	Best	Best	Best	Best	Good	Best	Normal
149 Long Wear Extra Play	Best	Good	Best	Best	Good	Best	Extended
159 Extra Play	Best	Good	Good	Good	Good	Best	Extended

All quantities expressed are relative to No. 109

The term "SCOTCH" and the plaid design are registered trademarks for Magnetic Tape made in U.S.A. by MINNESOTA MINING AND MFG. CO., St. Paul 6, Minn. Export Sales Office: 99 Park Avenue, New York 16, New York. © 3M Co., 1957

Quick-Opening Fasteners

Selecting Small Fastenings for Metal Closures

*"Use captive fasteners wherever feasible . . . Avoid the use of loose washers and loose nuts . . . Fasteners on equipment covers should be operable either with no tools or with standard hand tools"**

(John D. Folley, Jr. & James W. Altman, Research Scientists, American Institute for Research)

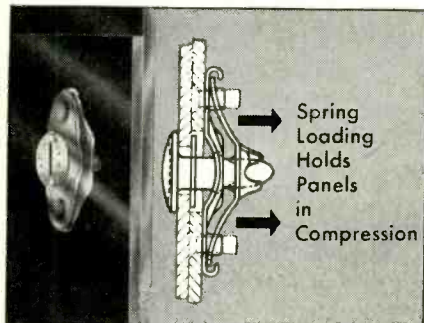

Quarter-Turn Fastener

Lion Fasteners open and close with a $\frac{1}{4}$ turn, hold sheets tightly under the compression of a rugged spring. Quickly operated and fully retained in the outer panel, they are approved under U. S. Government military specifications. Stud and receptacle float for easy alignment and simplified hole preparation. Flush, oval, wing, knurled, ring, and key head styles available. Sizes—No. 2, No. 5, and High Strength for extra heavy duty.

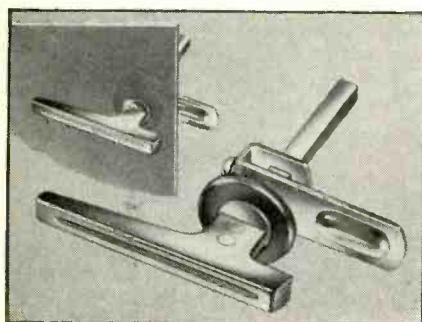

Cabinet Latch

Just drill a hole, push the fastener stem through, and slide the special push-on

clip into place. No welds, screws, bolts or rivets: the fastener is permanently installed in seconds!

Adjustable to any grip length or panel thickness, the pawl is fixed in place by a single set screw. The fastener's brightly finished knob is set off by a plated washer. Also furnished with screwdriver operated flush head.

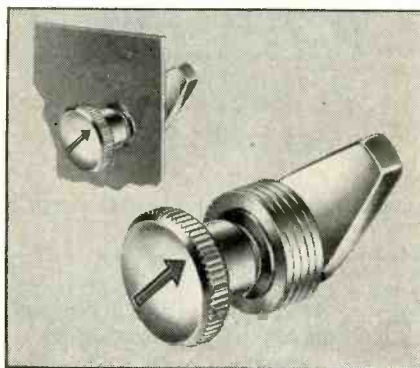

Spring Tension Latch

For fastening slide-out drawers and hinged panels the Southco Arrowhead Latch is recommended. It locks or opens with a quarter turn yet occupies less than $\frac{1}{2}$ " inside space.

Doors are held under spring tension—a push against the arrowhead knob relaxes this tension, allows operation with fingertip ease. Drill a single hole for installation—no fastening to the door is necessary. No striker plate is needed.

Pawl stop is eliminated—arrowhead shows at a glance exact position of pawl.

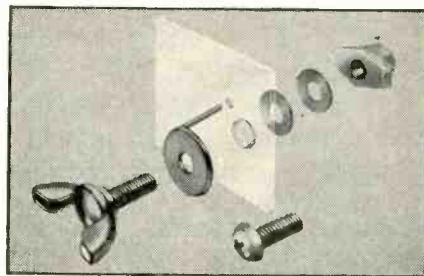

Adjustable Panel Latch

Small doors and panels can be fastened with greatest speed and lowest cost with the Southco Adjustable Latch.

The entire fastener is quickly installed through two holes punched in the door; no bolts or rivets are needed.

It operates with a quarter turn, requires no striker plate. An extra twist after the nylon pawl is engaged pulls up the door to form a seal and eliminate vibration.

Available with wing, knurled, or Phillips head.

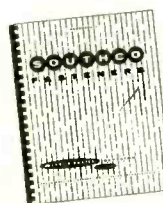

Free Fastener Handbook

Send for your free copy of Fastener Handbook No. 7, just released. Gives complete engineering data on these and many other special fasteners. Fifty-two pages, in two colors.

Write on your letterhead to Southco Division, South Chester Corporation, 233 Industrial Highway, Lester, Pa.

SOUTHCO FASTENERS

© 1956

LION

* Quotation from "Designing Electronic Equipment for Maintainability"; Machine Design, July 12, 1956.

U N I Q U E

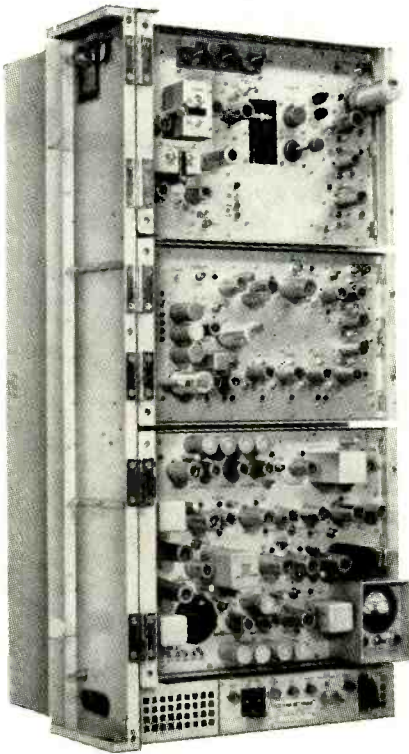

Full utilization of the superior characteristics of tropo scatter communication is achieved by REL combining diversity receiver equipment. These notable advantages are unique with REL diversity receivers:

- 1) Positive improvement in signal-to-noise ratios over single receiver operation, when received signals in each receiver are approximately equal in quality:
 - 3 db for dual diversity
 - 4.75 db for triple diversity
 - 6 db for quadruple diversity
- 2) Signal-to-noise ratios at least equal to that of best receiver in the diversity combination.
- 3) Circuit reliability enhanced by combining all signal paths.
- 4) Response time of the combining action optimized for both voice and teletype reception to an attack time of 0.2 milliseconds.
- 5) Combiner dynamic response increased to 40 db.
- 6) The adaptability and versatility of all receivers further augmented by a 1500 ohm output for standard graphic recording equipment.

The same imagination and skills which devised this apparatus are available for solving your specialized radio problems.

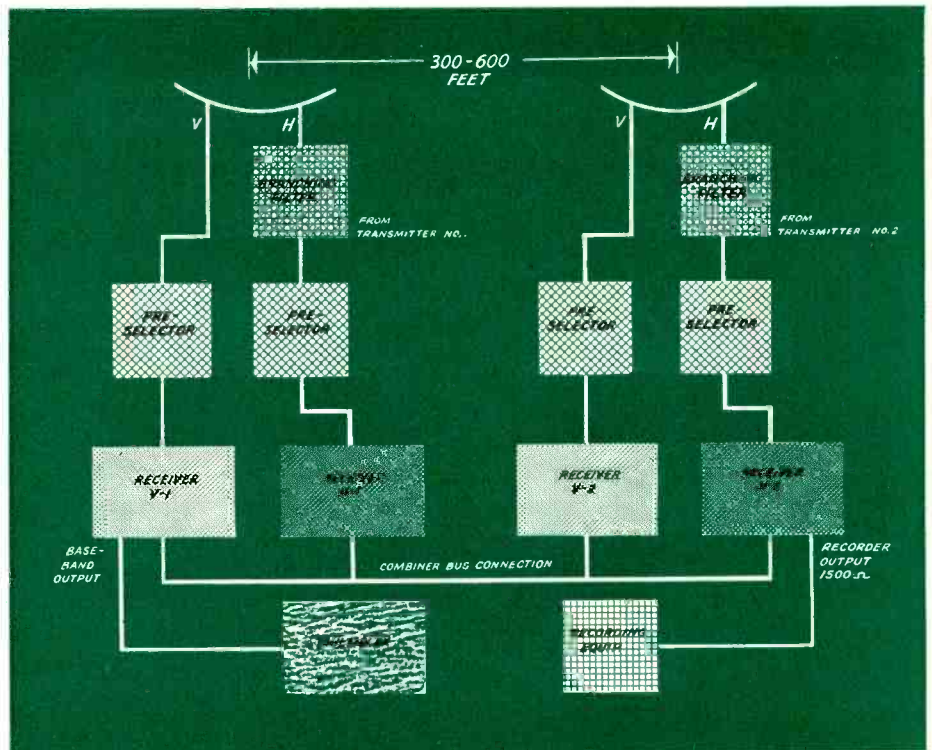

Typical quadruple diversity operation of REL combining receiver. Output to multiplex available from all receivers. V = vertical polarization, H = horizontal.



**Radio Engineering
Laboratories · Inc.**

29-01 Borden Ave · Long Island City 1, N. Y.

Stillwell 6-2100 · Teletype: NY 4-2816

Canadian Representative:

Ahearn & Soper Co · 384 Bank St · Ottawa

NEW



MINIATURIZED MICROWAVE ISOLATORS such as this new Raytheon X band unit weigh as little as 6 ozs.

MICROWAVE FERRITE ISOLATORS

—New designs now available for several bands

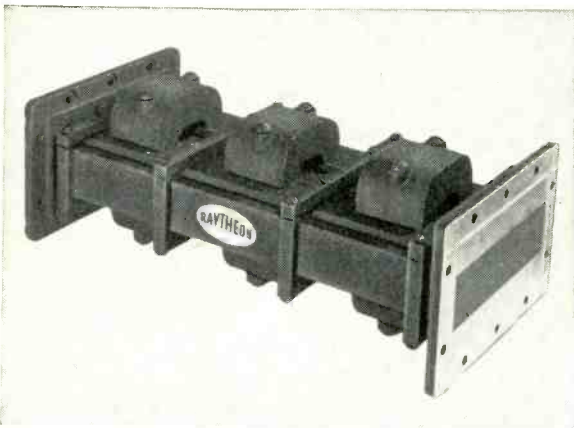

NEW HIGH POWER L-BAND ISOLATOR, first of its kind, typifies Raytheon leadership in microwave ferrite materials and devices.

You'll want to learn more about Raytheon's new full line of microwave ferrite load isolators as well as other devices now available commercially for the first time. Included in the line is a completely new L-band isolator, the first of its kind ever built. There are also units for S, C, X, K_v, and K_u bands.

RAYTHEON'S TYPE R-151 FERRITE MATERIAL is available for Faraday rotation devices in X and K band frequencies and for resonant-type isolators in S through K bands. Other compositions are available for various applications.

WRITE TODAY for technical data sheets on standard Raytheon microwave ferrite devices and material. Please state your specific requirements for more complete data. Write to W. C. Plouffe at address below.

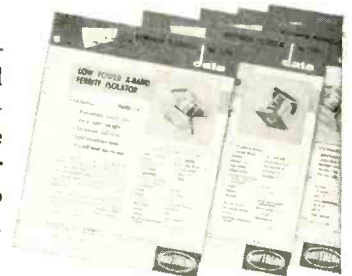

Excellence in Electronics

RAYTHEON MANUFACTURING COMPANY

**SPECIAL MICROWAVE DEVICE GROUP
28 SEYON STREET, WALTHAM 54, MASS.**

Waldes Truarc Rings cut assembly costs, improve performance of precision photo-optics equipment

Charles Beseler Co., E. Orange, N. J. uses Waldes Truarc Retaining Rings in 3 applications shown.

REFLECTING MIRROR ASSEMBLY IN OPAQUE PROJECTOR

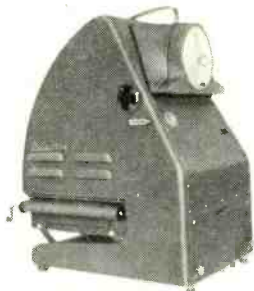

VU-LYTE II PROJECTOR

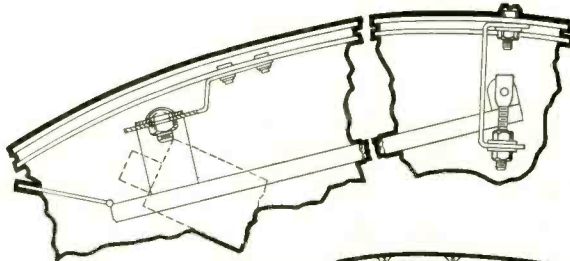

BEFORE

"The front surface mirror is the most precise optical element in a properly-functioning opaque projector," Beseler writes. "Previously we used this extremely cumbersome means of holding the mirror in position. As mirror adjustments are always required and the mirror is extremely delicate, our spoilage was terrific."

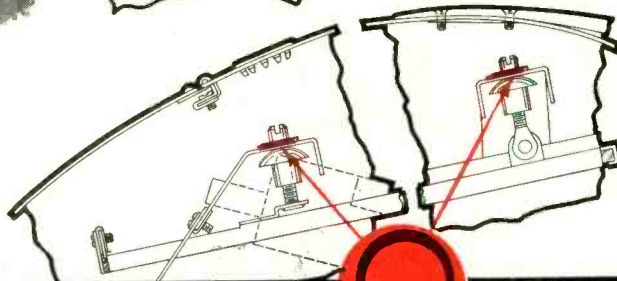

AFTER

"Two Truarc Series 5100 Rings made possible complete redesign of the mirror assembly. Now mirrors can be adjusted from outside the projector. Rejects now are practically nil. More precise adjustment of the mirror is possible. And because of the greater ease in adjustment, we have cut labor costs \$2.00 per unit."

HEAT ASSEMBLY IN PRINT DRIER

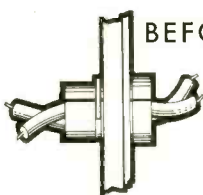

BEFORE

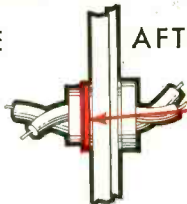

AFTER

Here a Waldes Truarc crescent ring, Series 5103, replaced a split collar and clamping ring. Results: labor costs cut 50¢ per unit because of greater ease of assembly. Drier provides more uniform heating.

35 MM MICRO-FILM NEGATIVE CARRIER IN ENLARGER

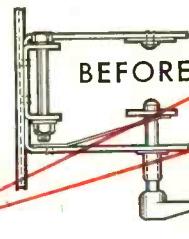

BEFORE

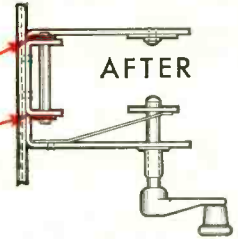

AFTER

2 Waldes Truarc Series 5133 E-Rings replaced 2 cap nuts—at a saving of 20¢ per unit in labor costs.

Whatever you make, there's a Waldes Truarc Ring designed to save you material, machining and labor costs, and to improve the functioning of your product.

In Truarc, you get

Complete Selection: 36 functionally different types. As many as 97 standard sizes within a ring type. 5 metal specifications and 14 different finishes. All types available quickly from leading OEM distributors in 90 stocking points throughout the U. S. and Canada.

Controlled Quality from engineering and raw materials through to the finished product. Every step in manufacture watched and checked in Waldes' own modern plant.

Field Engineering Service: More than 30 engineering-minded factory representatives and 700 field men are at your call.

Design and Engineering Service not only helps you select the proper type of ring for your purpose, but also helps you use it most efficiently. Send us your blueprints today...let our Truarc engineers help you solve design, assembly and production problems...without obligation.

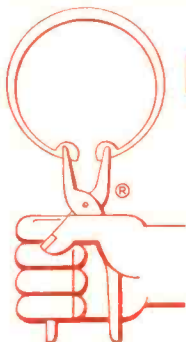

WALDES TRUARC
RETAINING RINGS

WALDES KOHINOOR, INC.
47-16 AUSTEL PLACE, L. I. C. 1, N. Y.

Waldes Kohinoor, Inc., 47-16 Austel Place, L. I. C. 1, N. Y.
Please send new, descriptive catalog showing all types of Truarc rings and representative case history applications. (Please print)

Name.....
Title.....
Company.....
Business Address.....
City..... Zone..... State.....

E109

WALDES TRUARC Retaining Rings, Grooving Tools, Pliers, Applicators and Dispensers are protected by one or more of the following U. S. Patents: 2,382,948; 2,411,426; 2,411,761; 2,416,852; 2,420,921; 2,428,341; 2,439,785; 2,441,846; 2,455,165; 2,483,379; 2,483,380; 2,483,383; 2,487,802; 2,487,803; 2,491,306; 2,491,310; 2,509,081; 2,544,631; 2,546,616; 2,547,263; 2,558,704; 2,574,034; 2,577,319; 2,595,787, and other U. S. Patents pending. Equal patent protection established in foreign countries.

AMP-lok

The new concept in

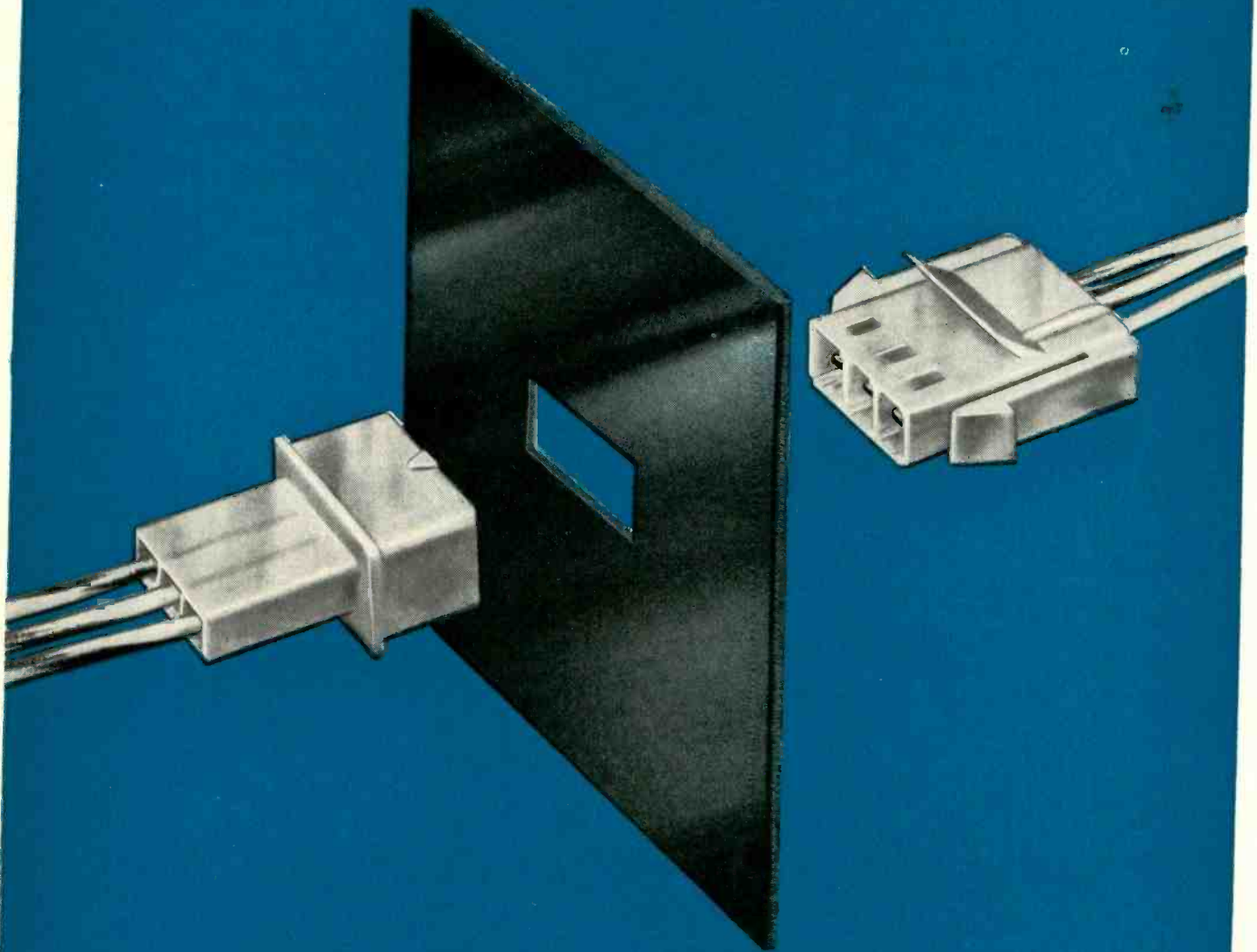

AMP-lok eliminates the necessity for supplementary mounting devices in through panel multiple connector applications.

multiple connector design

... IT'S SELF-ANCHORING

AMP-lok obsoletes all it replaces because of the following design features:

- contacts are identical . . . self-cleaning . . . recessed for safety
- finger grip engagement and disengagement
- polarized to eliminate circuit error
- wide panel thickness accommodation — one simple mounting hole required
- color-coding available

AMP-lok can be used as a safe, free-hanging multiple connector, also.

Additional literature and samples available on request.

AMP INCORPORATED

GENERAL OFFICES:

3339 Eisenhower Blvd., Harrisburg, Pa.

Wholly Owned Subsidiaries: Aircraft-Marine Products of Canada, Ltd., Toronto, Canada • Aircraft-Marine Products (Great Britain) Ltd., London, England • Societe AMP de France, Le Pre St. Gervais, Seine, France • AMP — Holland N. V. 's-Hertogenbosch, Holland
Distributor in Japan: Oriental Terminal Products Co., Ltd., Tokyo, Japan



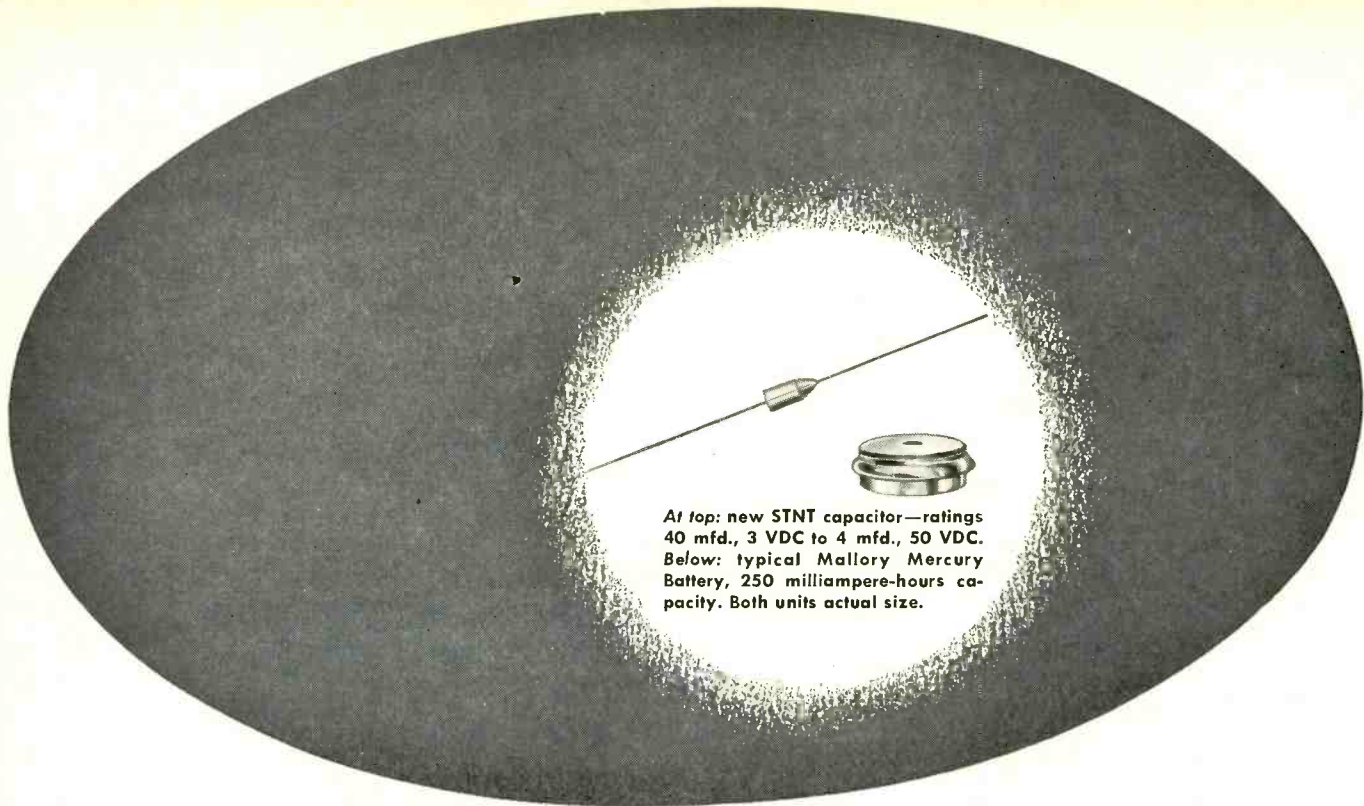

At top: new STNT capacitor—ratings 40 mfd., 3 VDC to 4 mfd., 50 VDC. Below: typical Mallory Mercury Battery, 250 milliampere-hours capacity. Both units actual size.

Big Performance in Subminiature Size —for your Transistor Circuits

The new transistorized products that you are designing can be engineered to even smaller size, and to even higher standards of performance, by using Mallory subminiature batteries and capacitors.

Mercury Batteries, pioneered and developed by Mallory are outstanding for high milliampere-hour capacity in extremely compact size. The unique combination of the electrochemical cell system and structure used in Mallory Mercury Batteries gives a constant energy discharge that offers the ideal power source for transistors. They last for several years on the shelf, and need no recuperative periods between use. They withstand extremes of temperature and humidity far beyond conventional batteries.

Mallory Subminiature Capacitors cover a complete

range of sizes and characteristics to match your applications. Newest and smallest is the STNT—only 0.145" in diameter and 0.250" long; available in ratings from 40 mfd., 3 VDC to 4 mfd., 50 VDC. Other models include: ultra-miniature TAW tantalum capacitors in 1 to 6 mfd. ratings; TAP tantalum capacitors for -55 to $+80^{\circ}$ C, rated 2 mfd./90 VDC to 30 mfd./6 VDC; TNT tantalum capacitors with double the capacity of STNT, in slightly larger case size; and type TT miniature aluminum electrolytics.

Mallory application engineers can give you valuable assistance not only in selecting the subminiature components for your application, but also in coordinating circuit designs for peak over-all performance. Write today for technical data and for a consultation.

Expect more . . . get more from

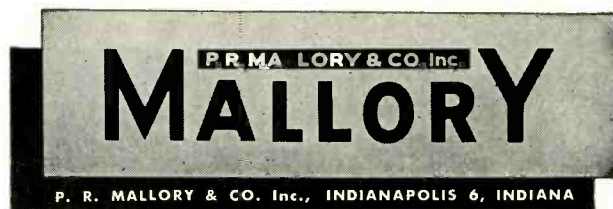

Serving Industry with These Products:

Electromechanical—Resistors • Switches • Tuning Devices • Vibrators
Electrochemical—Capacitors • Mercury and Zinc-Carbon Batteries
Metallurgical—Contacts • Special Metals • Welding Materials

Parts distributors in all major cities stock Mallory standard components for your convenience.

See us at Wescon . . . The Mallory Booth is 1312

Computer Inventories Oil in Refinery Tanks

SUMMARY — System automatically measures height and temperature of liquids stored in 88-tank “farm” of new Tidewater refinery at Delaware City. Measurements on tanks ranging from about 2,000 to 200,000 barrels in capacity and 11 to 15 ft in height determine actual liquid volume for production and inventory control. Computing elements account for geometric oddities of individual tanks using data stored on magnetic tape. Error detector accounts for tape defects and recognizes only certain bit combinations

By **D. J. GIMPEL** and **H. O. BARTON**

*Panellit, Inc.
Skokie, Illinois*

OBJECT of the data reduction system to be described is to automatically register the corrected volume of liquid in a given tank. This is the volume that the particular liquid would occupy if it were at a temperature of 60 F.

Measurement Technique

An automatic system must measure height and temperature, pick out data from two sets of tables and multiply the results. Measuring height is done remotely by level transducers consisting of ten-turn foot potentiometers and vernier inch potentiometers driven by a float mechanism. Their output resistance is proportional to height. Temperature is obtained from four resistance thermometers suspended in the liquid. These variables are converted to digital values by a null-balance servo coupled to a rotational digital converter.

A series of multilevel stepping switches connect the signal inputs from a given tank to the digital conversion mechanism as shown in Fig. 1. Before measurement a series of identifying information is printed out on typewriter.

The operator sets the material identification in accordance with the refinery's code. The material in a given tank has been classified in one of thirteen groups in accordance with American Petroleum Institute group classification. The operator chooses one of the thirteen temperature correction factor curves which closely approximate the correction factor curves of all the types of liquids handled in the refinery.

The temperature transducer is then used for an analog conversion from temperature to correction factor. The thirteen nonlinear curves of temperature against cor-

rection factor are generated by a resistor network used in conjunction with a ten-tap balancing slide-wire in the digital converter mechanism. This correction factor is stored in the computer.

Tape Storage

Storing the information for 88 strapping tables is handled digitally by a magnetic tape storage system because of the large data capacity requirement. Each table lists volume against height in 0.01-ft increments over an average range of 50 feet. Each volume requires five significant digits or 25 bits including check bits for an overall total of approximately 11-million bits. By careful use of tape space this information can be stored on one 11-in. reel of $\frac{3}{8}$ -in. tape. Figure 2 shows a typical section of the seven channel tape.

The first step in the computation

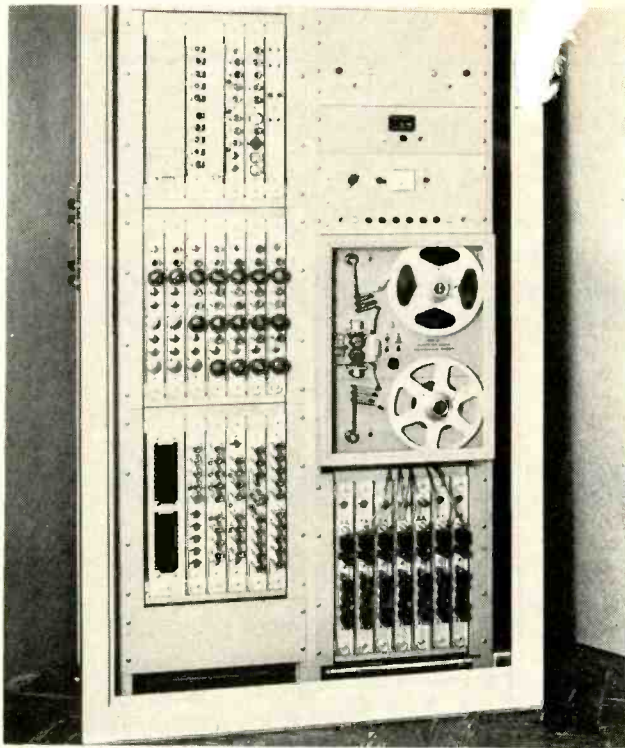

Overall view of computer shows subchassis construction and tape transport mechanism containing tabular data

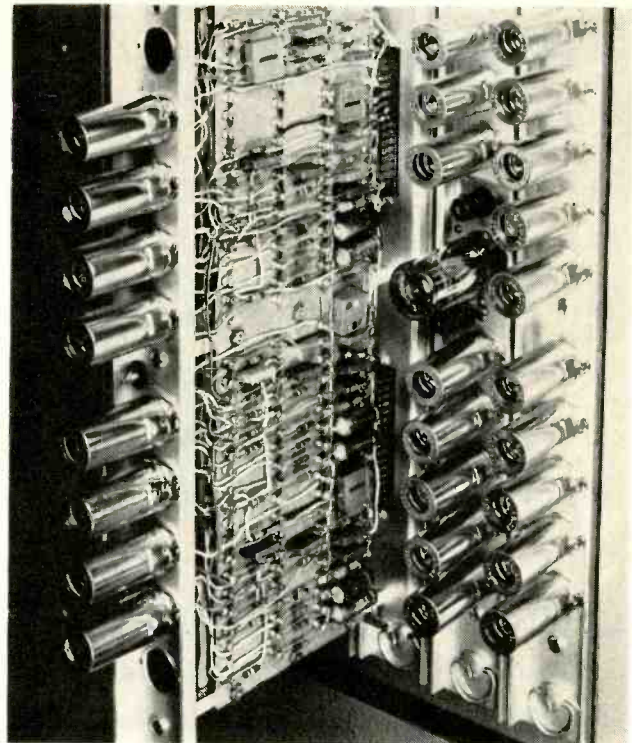

Typical subchassis shows wiring and parts layout used throughout computer. Modular construction facilitates interchange

is to find the section of tape containing the height against volume information for the tank being measured. The stepping switches set up the tank identification number. The tape mechanism is started in the forward direction. A pulse on channel 7 activates bistable multivibrator B_1 to open and gate E shown in Fig. 3. Data on channels 3 or 4 passes through the gate and triggers the first significant figure comparison network shown in Fig. 4. According to the code chosen, channels 3 or 4 will always have a pulse for any usable number. This provides a convenient timing reference for the com-

parison, making the system relatively insensitive to small variations in tape speed and pulse spacing.

Tape Transport

The section called tape transport control serves to reverse, stop and start the tape transport. If no equality is found in comparison, this circuit determines whether to continue forward or to reverse direction depending upon whether the tank number searched for is greater or less than the one read on the tape. The tank number is recorded on both sides of a block pulse for this comparison.

If the comparison of the first significant-figure shows equality, a pulse activates bistable multivibrator B_2 , opening and gate F . A channel 3 or 4 pulse derived from the second significant figure is allowed to pass through F to activate the second significant figure comparison network.

A second equality operates bistable multivibrator B_3 which opens and gate D and allows signals on channel 6 to enter the height register. Tape space is not given to word identification or height, instead a pulse in channel 6 indicates the presence of a new word or volume. Thus to reach the desired

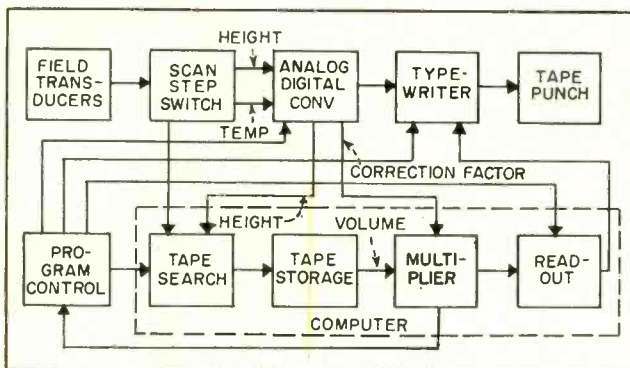

FIG. 1—Tank farm data reduction system feeds information from field transducers through scan step switch to be digitalized. Pulses from switch, converter and program control activate tape search to find previously stored tank volume figure

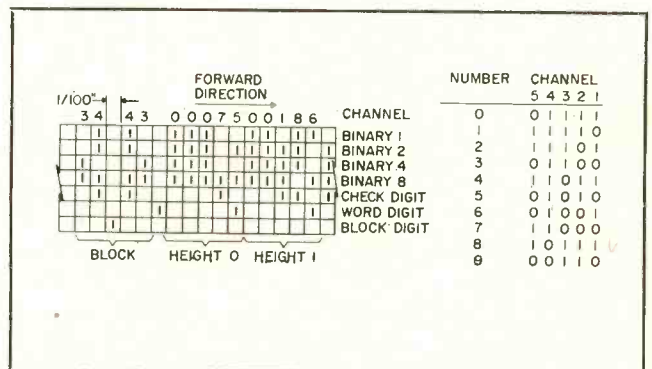

FIG. 2—Typical section of seven-channel magnetic tape used to store information from 88 strapping tables that account for geometric oddities of tank and gives actual volume when height of liquid in tank is known

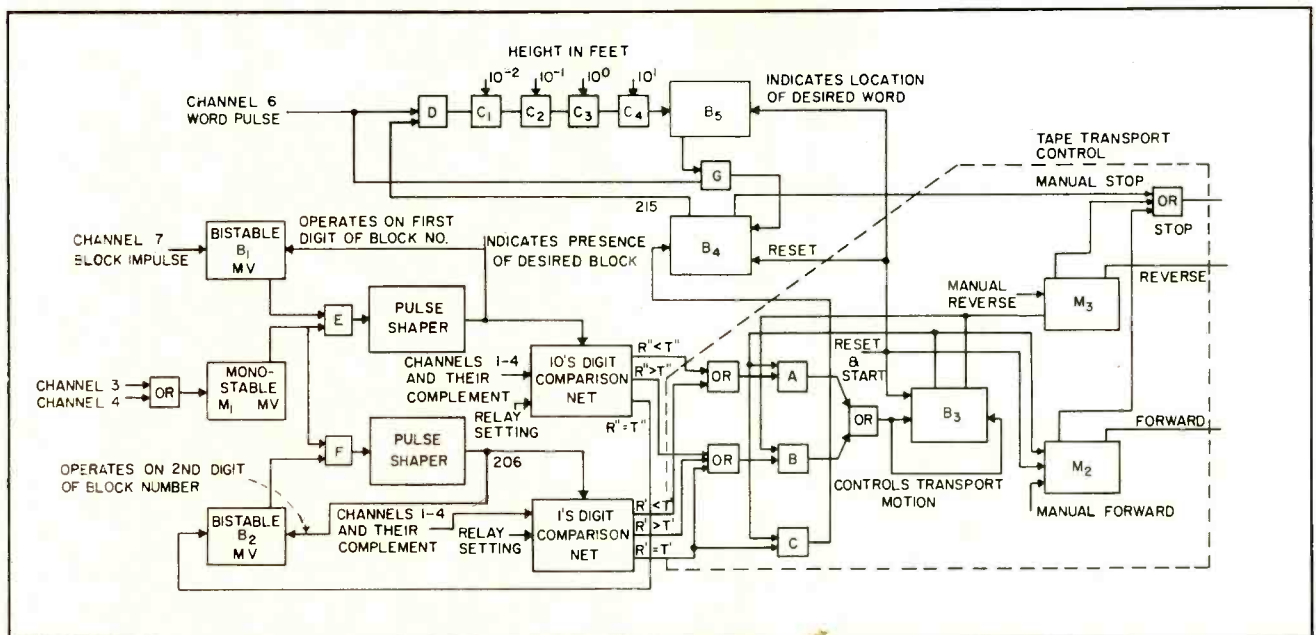

FIG. 3—Tape search control system finds tape section containing height-against-volume information for the tank being measured. It provides signals to reverse, stop and start the transport mechanism

volume, the number of pulses on channel 6 are counted in decade channels C_1 through C_4 .

A volume corresponding to a height of 21.67 ft will be located after the 2,167th pulse on channel 6. The height has been registered on counters C_1 through C_4 during the height printout. When the desired block is found, B_4 allows channel 6 pulses to enter the height register which is connected to count backwards. At zero a pulse out of C_4 resets B_4 . Resetting B_4 stops the transport. When B_4 originally opened a gate to the height register, it also opened gates from channels 1 through 4 to the shift register buffer storage.

Buffer Storage

The tape transport operates at 60 ips and has an information density of 100 bits/in/channel. Thus, data appears at a rate of 6,000 bits/sec/channel, at a greater rate than can be accepted by the multiplier. Buffer storage is required to match the high-speed tape transport with the multiplier. The shift register is a magnetic core memory device that stores the volume as read from the tape. Information enters the shift register immediately following location of the desired block, but only the volume corresponding to the measured height is left in the register when

the countdown is completed and B_4 resets.

Error Detection

The presence of defects, oxide occlusions and foreign matter on the tape may result in errors in the read data. Thus an error-detector network for decimal digits is incorporated in parallel with the shift register as shown in Fig. 5. Since only 10 of the 32 words possible with five channels of binary code are used (with the fifth channel specifically for error detection to give every coded digit an even number of bits), a circuit was designed to recognize only the bit combinations corresponding to the decimal digits.

The error circuit detects all single-bit errors and 34 percent of double-bit errors. The probability of a double-bit error is much less than that for a single bit. The circuit continually monitors the information entered into the shift register. Determination of a single error causes the system to recycle. A second error stops the machine and causes an alarm. With the correction factor registered in counters C_5 through C_6 and the volume in the shift register, the computer is ready to multiply.

Multiplication is based upon parallel, successive additions. The accumulator, consisting of C_{10} through

C_{18} shown in Fig. 6, performs the successive additions. The correction factor stored in C_5 through C_6 is the multiplicand, or the number to be successively added into the accumulator. The volume in the shift register is the multiplier controlling the number of times the correction factor is added. The diode switching matrix moves the decimal point as the multiplier digits are used.

Results

In this system both correction factor and volume are five-digit numbers. Thus the product would be ten digits of which only the largest five are significant because of the accuracy of the correction factor and volume units. If the last three digits or stages of accumulation are dropped, an error always less than that of the uncertainties in the measurement section results. Therefore the accumulator consists of seven decade stages of which only the first five most significant are read out.

To control and time the multiplication process a 12-cathode gas counter tube is driven by an astable multivibrator. Two pulses are used for synchronizing and control. A train of ten pulses is used for cycling and a train of nine pulses is used for accumulation.

After search and countdown are



Operator uses parametrical test equipment to measure I_{c0} , I_{e0} and current gain of power transistors

TEST EQUIPMENT for

By **ANDREW B. JACOBSEN**

Senior Staff Engineer

and **CARL G. TINSLEY**

*Electrical Engineer
Motorola Inc.
Phoenix, Arizona*

SUMMARY — Separate parametric and application test equipments are used for production-line testing of several-thousand power transistors a day. Parameter measurement results are indicated by go-no go indicator and also by conventional meter. Application test measures power gain and distortion. Use of semiconductor components in circuitry assures dependable operation

MASS PRODUCTION of power transistors requires rapid and efficient testing procedures and instruments. The equipment to be described uses transistors to test several thousand Motorola 2N176 power transistors per day.

Test Specifications

There are two types of transistor test specifications. The parametric test determines the magnitude of a particular transistor parameter, for example the small-signal current gain β .

The other, an application test, determines the performance of the transistor in a circuit having cer-

tain fixed operating conditions, for example the power gain for a given circuit.

Parametric Tests

The parametric test circuits provide the necessary d-c and a-c electrical conditions for measuring collector and emitter diode saturation currents I_{c0} and I_{e0} , small signal current gain β , input impedance h_{ie} , and collector saturation voltage V_{ce} .

The manual switching arrangement shown in Fig. 1 connects the transistor to the test circuits. All test circuits ground the collector of the power transistor to reduce electric shock hazard, provide adequate

heat transfer and allow for automatic transistor feed, if desired.

The test circuits and d-c regulated power supply are completely independent plug in units.

Each test circuit is simultaneously connected to the test transistor, the indicating meter and the go-no go lamp.

Prime power source is 117-v, 60-cps through a line-voltage regulator. The 35-v d-c power supply in Fig. 2 incorporates a bridge rectifier and open-ended regulator with a Zener diode for reference. The output voltage drops about 0.5 v when the current varies from no load to full load of 3 amp. Ripple

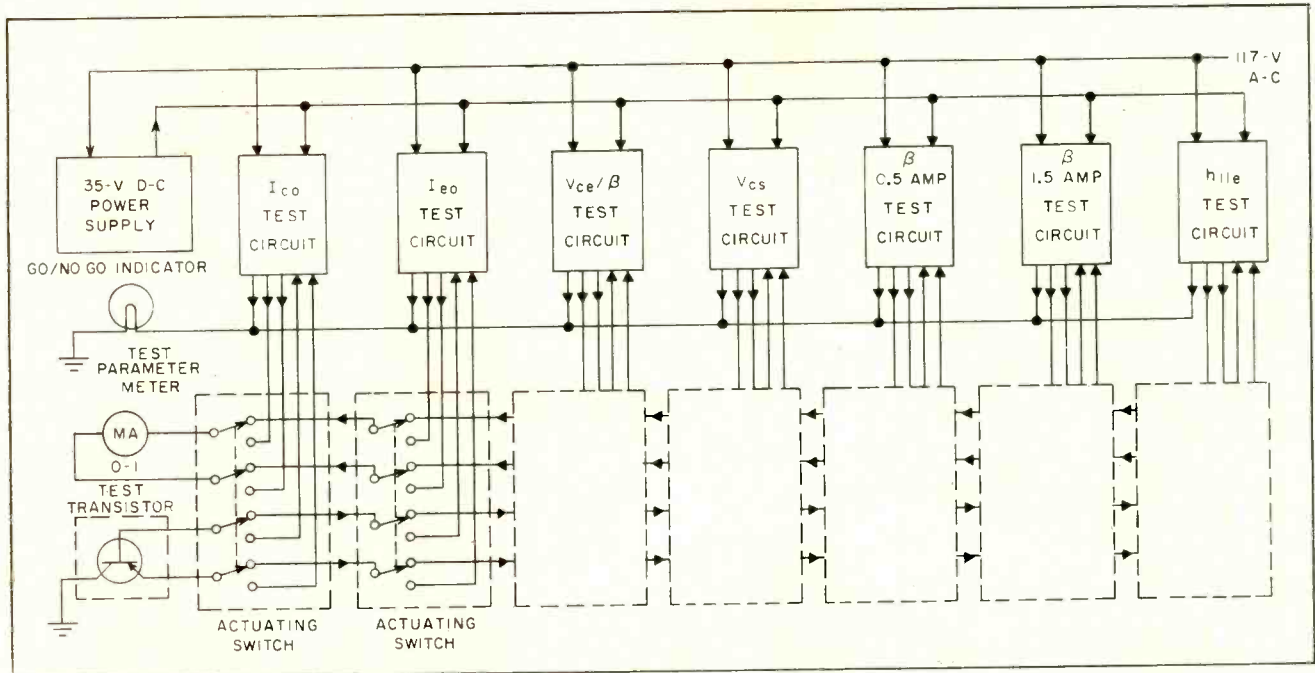

FIG. 1—Circuit-selecting switching and indicator system for parametric test equipment. Individual test circuits are plug-in type

Transistor Production

voltage is less than 0.1 percent at full-load current.

Collector Back-Current Test

Collector back current I_{co} , is measured with a base-to-collector voltage of 35 v and the emitter open. Figure 3 shows the details of this circuit.

The meter which indicates I_{co} is in series with the test transistor and is calibrated to read 10 ma at full scale. Transistor Q_2 is on and Q_1 is off for all transistors with I_{co} less than 3 ma. For this condition the relay K_1 is energized and the indicator light is off. If I_{co} exceeds 3 ma, Q_1 is turned on and Q_2 is turned off dropping out the relay

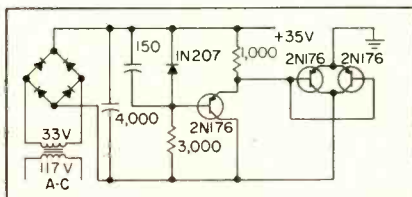

FIG. 2—Thirty-five-volt power supply for parametric test equipment

and turning on the indicator light.

The resistor in the collector of Q_1 limits its collector dissipation to a safe value for shorted transistors or those with high I_{co} values. This protective circuit causes a voltage error for I_{co} values above 3 ma (maximum allowable for the 2N176).

Emitter Back-Current Test

Emitter back-current I_{eo} is measured with a base-to-emitter voltage of 12 v and the collector open using the circuit of Fig. 4. A separate floating 12-v power supply keeps the collector at chassis ground.

The meter circuit is the same as for the I_{co} test and is calibrated for a full-scale value of 10 ma.

The Zener diode gives a constant voltage source for test transistors with I_{eo} less than 3.5 ma. With a short circuit in the test socket, for example, the Zener diode drops out and the circuit is current limited to about 6 ma.

Transistor Q_1 is biased to ener-

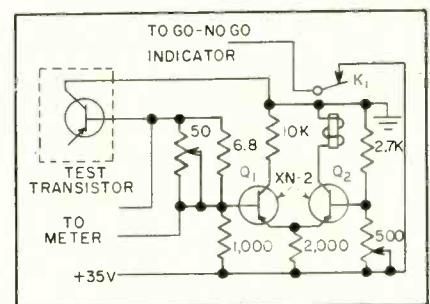

FIG. 3—Plug-in circuit for collector back current test

gize K_1 , lighting the indicator lamp, if I_{co} exceeds 2 ma. This circuit provides accurate measurements up to the rated value at 2 ma.

Current-Gain Test

The complete schematic circuit for measurement of current gain is shown in Fig. 5. For this test, the transistor is operated with 12-v d-c collector-to-emitter voltage and 500-ma d-c collector current. The d-c conditions are established with transistor Q_1 and resistor R_1 . A Zener diode provides a voltage

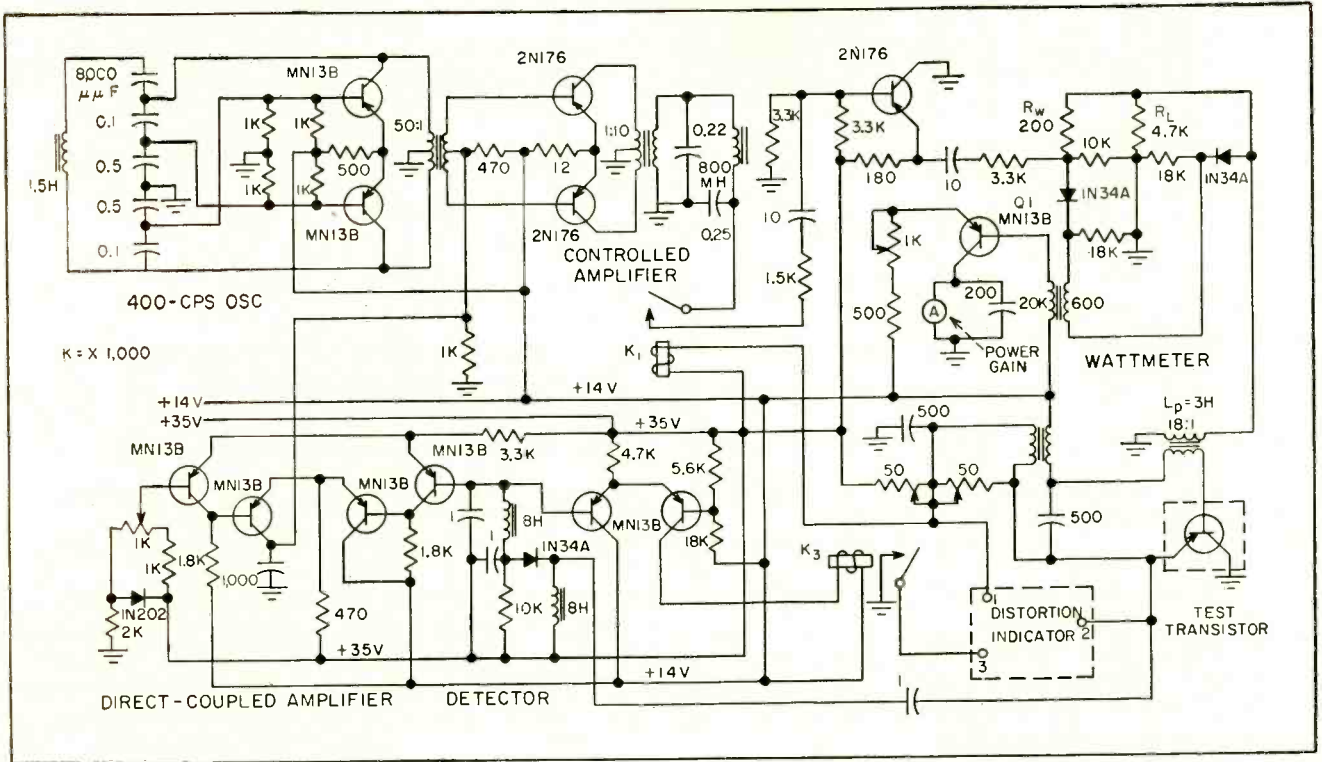

FIG. 7—Circuit for measuring power gain and distortion of transistors with input impedance of 10 to 15 ohms and power gains of 30 db

sistor: 14-v collector-to-emitter voltage, 500-ma collector current and an audio output of 2 w. This circuit gives a direct meter reading of power gain in db and a light indication for amplifier distortion in excess of 9 percent.

The transistor power gain for these conditions is obtained from a calibrated input power meter with the output automatically held constant at 2 w.

Two regulated power supplies, 35 v and 14 v, similar in design to that in Fig. 2, accommodate the test transistor, an oscillator, various amplifiers, a metering circuit and a distortion indicator.

Operation of the automatic power gain test and distortion indicating circuit may be followed by

referring to the Fig. 7.

The 400-cps oscillator runs continuously and the gain of the control amplifier is set by an amplified error signal to provide the necessary input signal for 2-w output signal power.

The test transistor output is rectified by the detector circuit and is compared with the Zener reference voltage to provide an error signal to the differential direct-coupled amplifier. This amplifier provides enough gain so the output for test transistors having a power gain of 26 to 36 db is 2 w \pm 0.3 db.

Relay K_1 removes the input signal to the wattmeter when no transistor is in the test socket.

Input Wattmeter

Signal power input to the test transistor is a measure of the transistor power gain in this circuit because the signal power output is held constant. Input power to the test transistor is measured by the wattmeter circuit in Fig. 7, which, when calibrated is accurate within ± 0.1 db for transistors with input impedances between 8 and 22 ohms. Outside this range the error increases to ± 1 db for 4 to 40-ohm input impedances. Nearly all the transistors of the type to be tested

are within the 8 to 22-ohm range of input impedances giving the power gain tester an overall accuracy of ± 0.3 db for power gains of 26 to 36 db.

The input to the transistor under test has less than 1-percent harmonic distortion. This low value is obtained by using a 400-cps filter which attenuates the second and higher harmonics.

Distortion Indicator

The distortion indication circuit is shown in Fig. 8. The output of the test transistor is passed through a high-pass filter that attenuates the 400-cps fundamental 36 db compared with the second and third harmonics.

The output of the filter is amplified by transistor Q_1 , rectified by Q_2 , and the resulting d-c is applied to the base of Q_3 .

The emitter of Q_3 is biased to a potential equivalent to 9-percent distortion. When the distortion exceeds 9-percent, Q_3 energizes relay K_2 , lighting the distortion indicator lamp.

A negative feedback circuit stabilizes the gain of Q_1 . The relay turns on distortion indicator lamp when power output cannot be maintained at 2 w.

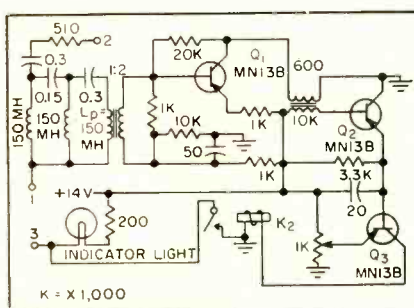

FIG. 8—Distortion indicator circuit plugs into circuit shown in Fig. 7

Mobile Monitor Covers

By **RAYMOND L. DAY**

*Engineer In Charge
Mobile Television Monitoring Unit
Federal Communications Commission
Laurel, Maryland*

SUMMARY — Station compliance with FCC rules and regulations is checked by personnel in air-conditioned truck, completely equipped with tv signal-measuring instruments. Mobile facilities fill reception-range gaps not covered by regular monitoring stations. Receiving system covers all channels. Unit features special i-f amplifier, pulse generator and color phase meter

ALTHOUGH 18 FCC monitoring stations are equipped with measuring and analyzing instruments required to evaluate technical performance of licensed stations, these monitoring stations are able to satisfactorily receive only a small proportion of the more than 500 tv stations in operation. If the 31 FCC field offices could, with appropriate instruments, provide additional tv-monitoring coverage, there would still be many tv stations outside the reliable reception range and it would be expensive to provide each office with

adequate instruments for comprehensive tv enforcement measurements.

Roving Monitors

Mobile facilities are the obvious answer to nation-wide tv monitoring and measuring enforcement. The first mobile tv monitor, in operation since September of 1955, travels wherever television stations are operating and wherever sufficient signal strengths are available for observations. The FCC unit is equipped primarily to observe television emissions, and the

engineer-in-charge generally confines himself to monitoring and inspecting television stations.

The enforcement program is a cooperative effort between industry and government. Observed discrepancies are called to the attention of the station personnel with admonition that an unnoticed shortcoming at the station may lead to later equipment failure. Gathered information is useful to the commission in the promulgation of rules and regulations which might improve the television service.

The monitoring vehicle, shown in photo, is a 1½-ton truck chassis with a package-delivery body. The original chassis has been supplemented by overload springs, dual rear wheels and power braking. The six-volt generator has been replaced with a heavy-duty alternator-rectifier system for powering some of the equipment from the six-volt battery or from the alternator itself. At present, however, all equipment is powered from 110-volt, 60-cycle sources.

Six equipment racks contain most of the equipment. The racks are bolted together to form a single unit, shock-mounted at the top and bottom. The base for the equipment racks consists of four steel channel irons bolted to the truck frame. In 22,000 miles of travel, no equipment failure can be attributed to mechanical shock or vibration.

Other instruments carried, but not rack-mounted, are: two signal

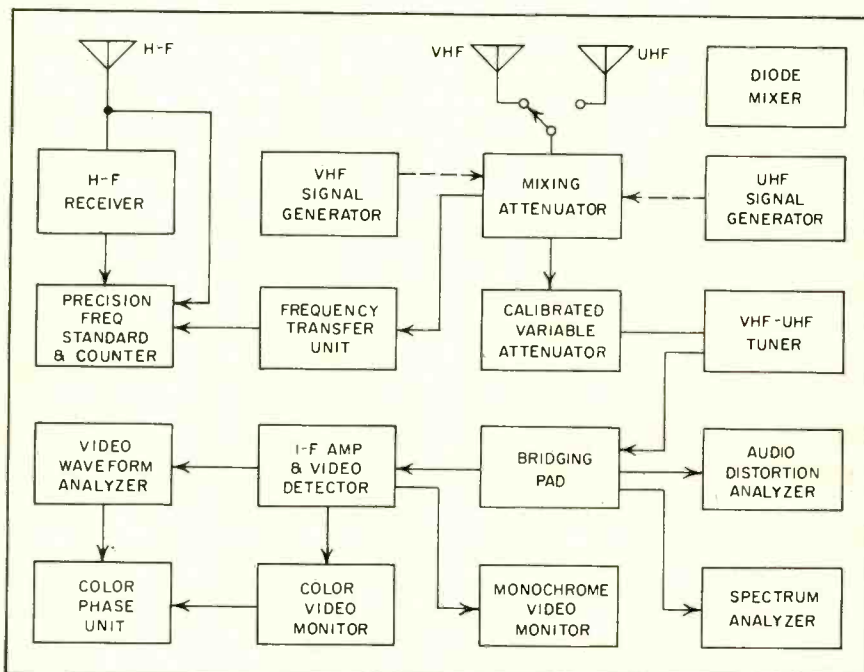
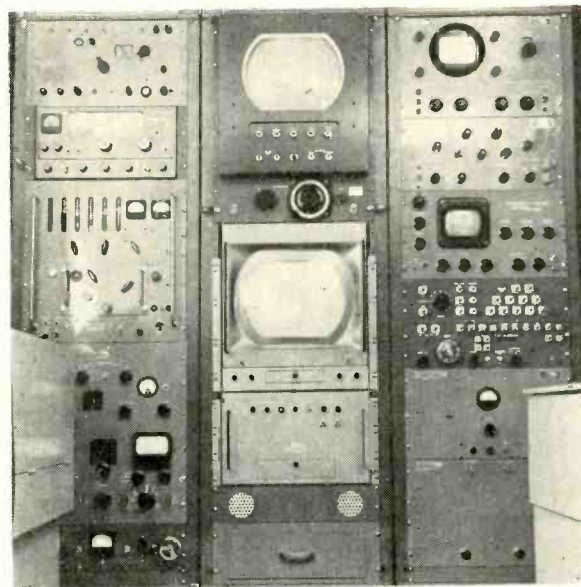

FIG. 1—Block diagram of mobile monitor. Actual installation permits a variety of connections, dictated by the job

TV Stations for FCC



Exterior of mobile monitor shows corner reflector used for uhf reception. Interior, (right), shows rack-mounted instruments

generators, an oscilloscope, recording camera, tube tester, and vacuum-tube voltmeter. A half-ton air conditioner is also installed.

Instruments

Block diagram, Fig. 1, shows the instruments connected for monitoring. Patch-cord connections between the instruments permits a variety of arrangements dictated by the job. For instance, the vhf antenna might be connected to the counter for a direct measurement of a carrier frequency.

With few exceptions, the equipment is used as manufactured. The input frequency of the panoramic receiver was changed to cover the i-f pass band used in the receiving system. Both monochrome and color monitors are provided with video inputs on the front panels. These monitors also have horizontal and vertical synchronizing voltages at the front panels. The color monitor has a panel jack for a 3.58 mc subcarrier, available for frequency measurement or for color-phase measurements. No changes of circuitry were made in either of the monitors.

The f-m measuring set was originally intended to tune 88 to 108 mc f-m broadcast band. The tuning range has been changed to

cover the i-f pass band of the receiving system and the receiver is used as the audio detector of the receiving system. The distortion analyzer, incorporated with the f-m measuring set, is available for audio proof-of-performance measurement.

Special I-F Unit

The receiving system consists of a modified tuner, which covers all tv channels, and an i-f amplifier built specially for the monitoring unit. The tuner was changed so that the r-f input and the mixer output have impedances of 50 ohms and the bandwidth of the tuner has been broadened considerably. The FCC Laboratory staff built the i-f amplifier, which has two selectable band-pass characteristics. A flat response as well as the sloped response used for tv reception. Incorporated in the amplifier is a pulse generator which acts as an electrical chopper to give a zero reference for the measurement of video levels. The i-f circuit diagram is given in Fig. 2.

The bridging pad and the color phase meter were also built at laboratory. The phase meter circuit is shown in Fig. 3. Both delay lines are variable from the front panel, one calibrated from 0 to 360 deg.

The vhf antenna is a simple dipole adjusted for each channel so that the impedance matches the 50-ohm feed lines. The dipole is mounted on an aluminum mast approximately 15 feet above the vehicle. A corner reflector is used for uhf reception.

With the monitoring instruments, the following features of television signals can be measured in the monitoring unit: carrier frequencies, vertical and horizontal scanning rates, video modulation levels, pulse durations, aural bandwidth, color subcarrier frequency, color phase, sideband attenuation and ratios between visual and aural carriers. In addition, observations are made of pulse shapes, shading, smearing or streaking and ringing.

Electronic Counter

All frequency measurements involve the use of the electronic counter, capable of counting frequencies as high as 100 mc. Several methods of determining carrier frequencies are used, often to check one against the other. The first and most convenient method is possible on carrier frequencies below 100 mc. The antenna is connected directly to the counter's input terminals and the aural carrier is counted. The counter does not dis-

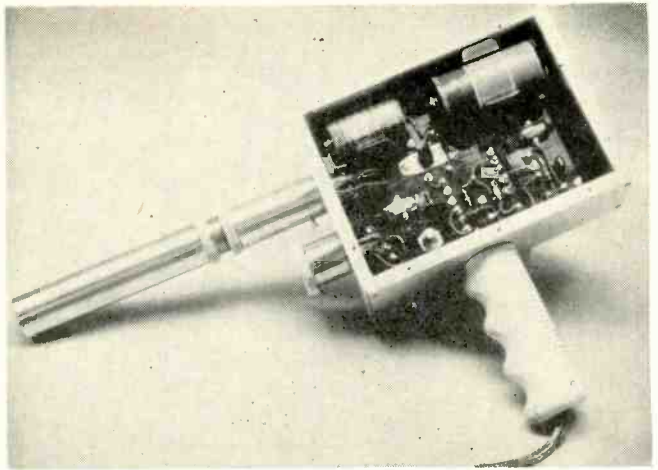
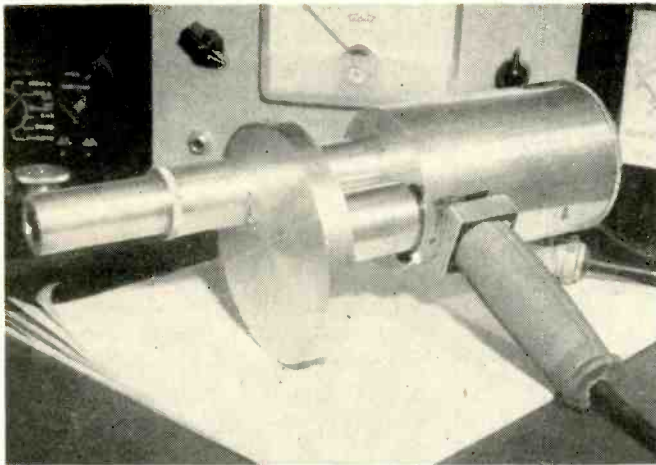

Mechanically chopped infrared detector (left) has motor mounted in separate cylinder to prevent heating of photocell. More compact unit (right) uses electronic chopping to eliminate heating problem

INFRARED DETECTOR Aids Medical Diagnosis

By W. E. OSBORNE

Chief, Guided Missile Division
Nevada Air Products Co.
Reno, Nevada

SUMMARY — Sensitive infrared detector circuits respond to minute temperature changes in head or body produced by emotion or deep thought. Technique has been applied to electroencephalography for study of the brain and as diagnostic detector for local inflammations in body. Similar equipment with positioning circuits is being developed for aircraft collision warning

INFRARED detectors of the photoconductive type can record emotions or concentrated thought when the detector is placed within a few inches of a person's head. Two theories advanced for this phenomenon are that the observed signal is the result of extremely high-frequency emanations from the brain, possibly mixing and beating, or that the waveform appearing is caused by minute temperature changes in the scalp, created by blood movements in the skin when the subject is emotionally disturbed or even when thinking.

The first theory would account for the very fast triggers and time constants which activate thoughts, and which are supposedly created

by a rapid polarization and depolarization of the nerve cells. However, as the amplitude of such pulses must be extremely small, a detector of the PbS, PbTe or other presently-used types is far from efficient as a pickup device.

With the second theory, a detector with a peak response near the threshold of the far infrared spectrum (> 8 microns) should be the most efficient, as blood temperature is equivalent to a wavelength of over 9 microns and this wavelength is increased by hair or grease. This suggests infrared detectors of germanium or related types, with added impurities of zinc, gold or arsenic. However, while these doped germanium or

silicon detectors perform efficiently, practical considerations limit their application in the present case, as cooling of the cell with liquid helium and/or nitrogen is necessary.

Photocells

Although the energy distribution curve of human blood peaks at around 9.3 microns, a small but measurable percentage of the total radiated energy falls on either side of this maximum, including the intermediate spectrum between 1 and 5 microns. Emissivity factors change each individual case.

Response of lead sulphide cells approaches zero at 3.5 microns but a small tail persists out to beyond 10 microns. Although the ampli-

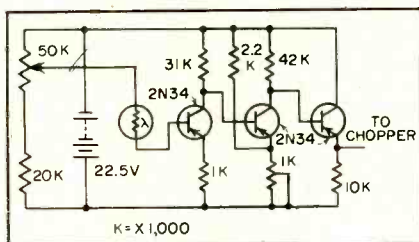

FIG. 4—Transistor preamplifier is more compact than tube circuit but has lower signal-to-noise ratio

operation for an hour is possible with little trouble from motor heating.

Electronic Chopping

While a motor-driven chopper is practical in the single-channel gun, the use of six or eight of these around a patient's head is neither desirable nor practical. For the electroencephalograph, therefore, the motors are eliminated and electronic chopping is used. A block diagram of this system appears in Fig. 2.

A PbS cell is mounted in a collimator at the input to each of the channels, to detect and feed the signal through a d-c preamplifier. The output of this is electronically chopped at 1,000 cps or lower and fed to the main amplifier of Fig. 1.

Chopping after the cell by such methods as commutating the cell bias voltage, or at the preamp output, introduces a large noise signal. In this circuit an opposing signal is introduced from a phase-shift oscillator to reduce residual noise from around 50 millivolts to the

present 30 microvolts. However, the 0.5-mm cell used, together with its input circuit, produces a noise level of only $3 \mu\text{V}$, so that at the present time mechanical chopping is still about 10 times as sensitive as the electronic chopper. The PbS cell swing ratio, or resistance change from no-signal to signal conditions, is occasionally as high as 20 to 1.

An improved chopper now being used is shown in Fig. 3. Two small-value capacitors remove the remains of unwanted noise spikes and permit a lower residual noise factor.

A transistorized preamplifier is shown in Fig. 4. A single PbS cell, with a cooled resistance of 0.5 to 2 megohms, feeds a transistor stage at a current gain of approximately 35. This input circuit is distinguished by the fact that no appreciable voltage change occurs across the cell. A 50 K helical potentiometer is used for balancing. Direct coupling is used, and the circuit is perfectly stable when temperature-compensated. Second-stage current is limited to about 2.5 ma, and the output impedance is about 750 ohms looking back. It is shunted by 10,000 ohms. Second stage gain is around 38 db.

Performance

The performance of the transistorized preamplifier is in some respects superior to that of the vacuum-tube type. A high-gain version of the latter is shown in Fig. 5. Two matched PbS cells operate

into a bridge type of compensated d-c amplifier, with cathode-follower output. Overall voltage gain is 300. The transconductance of the 5672 tubes holds the output impedance at about 2,000 ohms, but lower values can be obtained with different tubes. Stability is not as perfect as with the transistorized version, but signal-to noise ratio is slightly better. There is, however, the disadvantage of isolating several batteries, and greater current consumption, as well as size and weight.

The square-wave phase-shift oscillator is a conventional type.

Ultimate sensitivity among the various combinations described is that of a mechanical chopper with a pair of balanced PbS cells as the detector. However, for the electroencephalograph the problem arises of obtaining subminiature motors of high torque, plus shielding from commutation interference. Electronic choppers of small physical size are therefore employed. If the transistorized preamplifier is used, a higher quality transistor should be incorporated.

A gun which contains a preamplifier complete with electronic chopper is shown with case open in one photograph. A miniaturized multi-channel version of this same unit, mounted in a frame around the patient's head, is being built for the electroencephalograph.

The basic principle described here for therapeutic use is also being developed, with addition of circuits to provide positioning data, for preventing aircraft collisions. With the mechanically chopped device, airplanes can be detected at long ranges. The electronically chopped unit presently possesses a lesser but still practical range when used for this purpose.

The extreme sensitivity of this type of detector, used in conjunction with a specially designed amplifier and optical system, may be assessed by the fact that a target temperature change of less than 0.1 deg F may be detected at a range of several miles in clear weather. Infrared radiation from clouds and sun may be cancelled by special circuit arrangements.

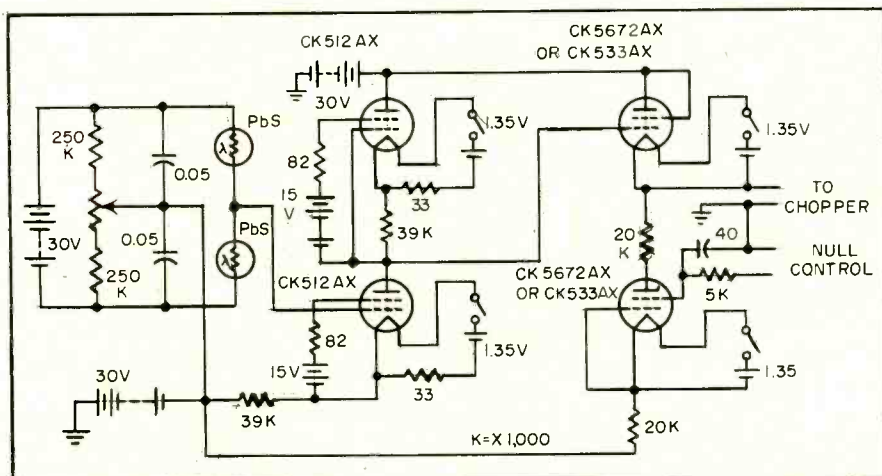

FIG. 5—Miniature-tube preamplifier is fed from a pair of matched detectors

Tape Recorder Selects

By D. V. R. DRENNER

Engineer, Station KGGF,
Coffeyville, Kansas

SUMMARY — Up to 45 one-minute spots are prerecorded on magnetic tape, each preceded by two tone bursts. When operator dials code of desired spot, control system increases playback speed to 45 ips for search and stops at correct point on tape. Message is then ready to go on air when operator depresses play button

ECONOMICS of present-day radio broadcasting has led to use of many automatic devices.

The system shown in Fig. 1 has been devised to allow the use of a typical magnetic tape recorder for automatic selection and playback of one-minute spot announcements. The use of relatively costly acetate disks is reduced, and the audio fidelity vastly improved. Although this machine was studio built, commercial recorders can be converted.

Any one of 45 prerecorded an-

nouncements may be selected by a telephone dial. In the search mode the machine runs forward or reverse at a speed of 45 ips until reaching the dialed spot. The machine stops and restores the dialing system. Provision is made for automatic insertion into the station's audio facilities and return to the normal playback speed of 7.5 ips at the end of the search run.

Cost of construction, reliability, and ease of operation by nontechnical personnel led to the adoption of

a single-track, tone-on-tape system. A stable and reliable tone-operated switch, based on an established design¹ was chosen. It employs a selective amplifier utilizing parallel-T networks in a feedback path as shown in the complete schematic diagram of Fig. 2.

Tone Switch Control

Sequential tone bursts of 0.5 sec operate the tone switches, which control the various functions of the system. The tone bursts are recorded on the tape at 45 ips immediately preceding each one-minute spot announcement with a 5-sec interval between the tone bursts and the announcement. Frequencies in the band from 100 to 3,000 cps are used, with a playback level of -10 vu. Since two tone bursts are required for each spot, and a total of only ten parallel-T networks are used, the maximum number of announcements is 45. Although this number could be extended, prohibitive cost of more elaborate stepping switches and parallel-T networks dictated some compromise between the overall cost of the system and

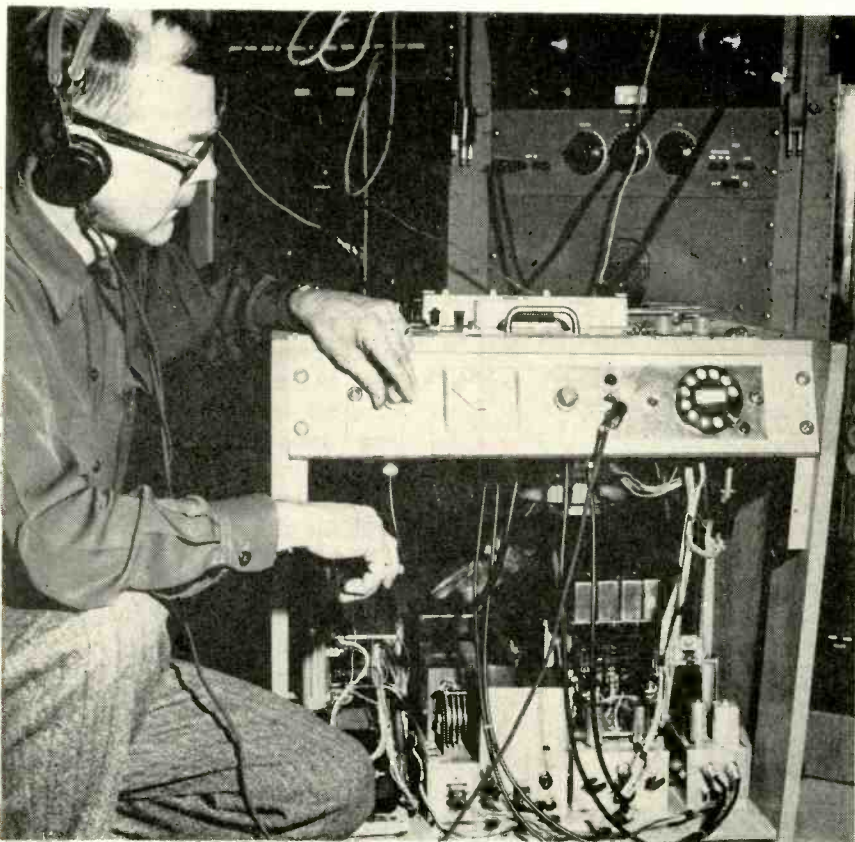

Author Drenner makes adjustments on KGGF's automatic tape recorder. Visible components at bottom of opened chassis are, from left to right, the dual power supplies, dual amplifiers and recording amplifier

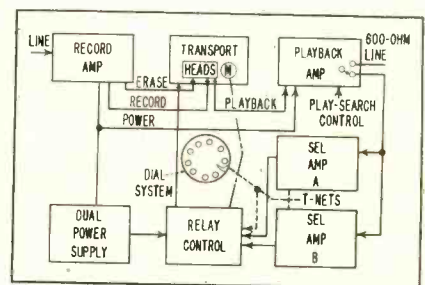
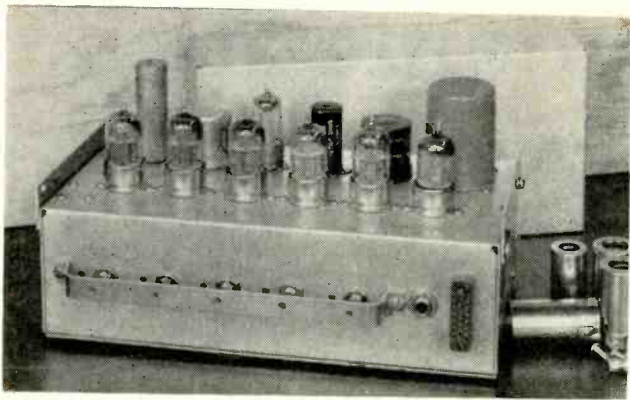
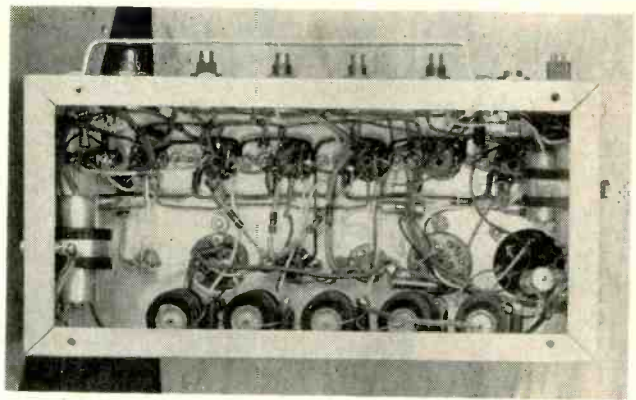

FIG. 1—Playback amplifier feeds the station's audio lines for transmission or the dual selective amplifiers for searching



Aural radar-range indicator contains seven tubes, three relays and a transformer



Wiring connections of audio indicator. No attempt was made to minimize components used

SUMMARY — Valuable accessory for airborne radar fire controls presents radar-range information as audio signals, relieving radar-attack pilot's overcrowded visual field. Variable-frequency phase shift oscillator beats out two different tones which indicate the impending firing range as plane flies the final mile to the target

By **R. CAMERON BARRITT**

*Engineer
Westinghouse Air Arm
Baltimore, Maryland*

Phase-Shift Oscillator

DURING the crucial radar-attack period, the pilot has his hands and feet on the controls, an index finger in readiness on the trigger button and his eyes on a crt indication of the target, simultaneously keeping track of range, range rate and aircraft attitude while remaining aware of the other aircraft instruments.

Since the pilot's visual sense is occupied fully, it was reasoned that radar range and phase information might be presented to the aural sense to alleviate the overload.

Aural Tracking

The system developed uses two audio tones, fixed and variable, during the final mile to the target. A clicking sound indicates in-range. The variable frequency approaches the fixed frequency as the range is shortened and beats and difference tones indicate the firing range. The variable frequency is a rising tone

signal since psychological data was obtained only on this type of signal. No sound is made available during search.

Upon lock-up, a fixed tone of approximately 1,020 cps is heard. Great range distances represented by voltages up to 250 v have no effect upon this signal. When the radar range shortens to 2,000 yards, represented by 10 volts, a tone of approximately 350 cps is heard. This signal is just above one-third of the fixed-tone frequency and avoids a beat.

At about one-half mile from the target, 5.3 volts, the variable frequency increases to about half the frequency of the fixed tone and produces a minor beat. At this point the major beat starts as a rattle, turns to a rasping sound and then to a readily recognized descending tone. Finally a pounding beat is heard. Thus, through part of the alert, a tone rises and a tone falls.

The beat lapses into prolonged cancellations at 2.5 volts or 500 yards. A further slight decrease in range causes a continuous stacatto clicking. Finally the break signal from the radar computer activates an attention-getting buzzer. The levels and times of occurrence of all signals are adjustable over a moderate range.

Oscillators

As shown in Fig. 1, the unit contains seven tubes, three relays and a transformer. Lock-up 28 volts operates a relay, K_1 , that completes the output transformer circuit of the power amplifier. The fixed oscillator, fed into this at all times, consists of a triode and a toroidal inductance. The variable-frequency oscillator is unusual.

The range voltage is clamped with a Hughes silicon diode. The characteristic is not ideal and curvature causes non-linearity in the

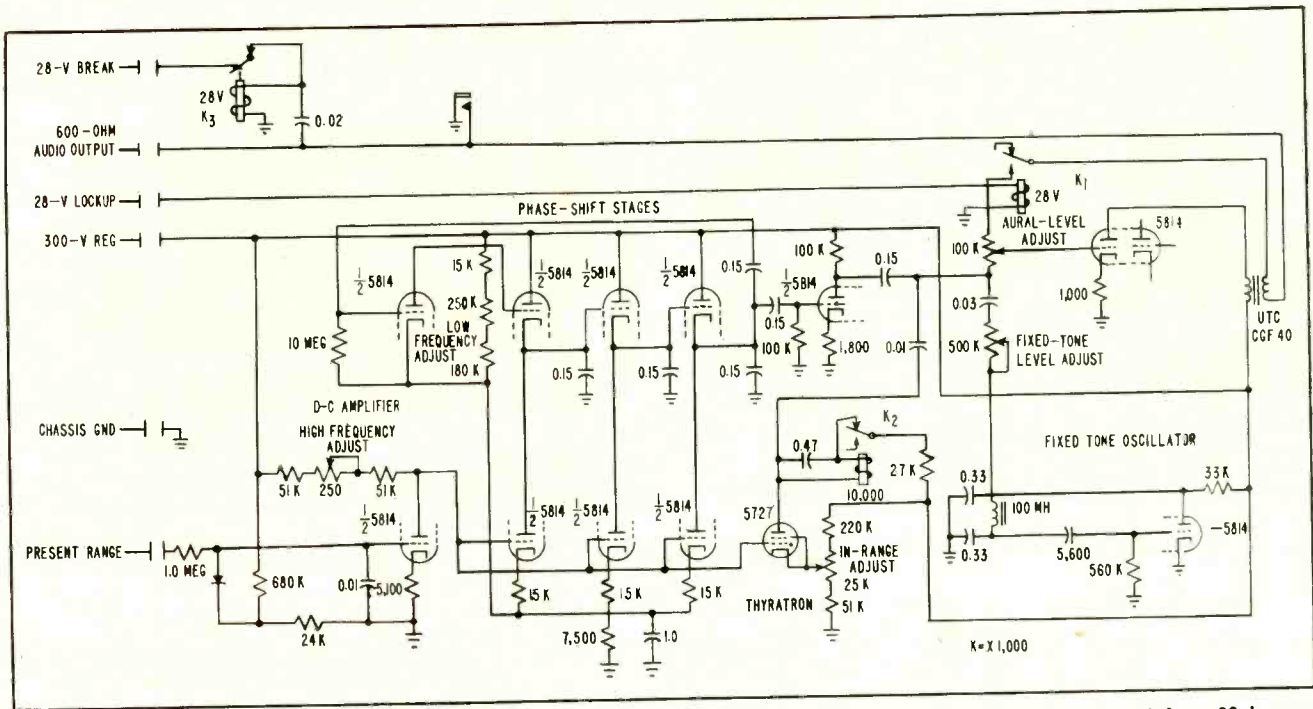

FIG. 1—Two-tone generator employs a variable-frequency oscillator with 180-degree phase-shift network consisting of three 60-degree sections. Of each triode pair, one triode is a cathode follower and the other functions as a cathode resistor

Indicates Radar Range

initial part of the run of the variable oscillator.

The range voltage polarity is inverted with a d-c amplifier and feeds into the variable-frequency oscillator, floating above ground. The oscillator consists of an oscillator tube and three phase-shifters of variable resistance tubes. Variable-oscillator output passes through an amplifier and feeds into the output amplifier.

The in-range signal is handled by a thyatron set to fire below 2.5 volts. Current is interrupted by a 10,000-ohm relay K_2 with a time constant to furnish the clicking. Break is handled by a 28-v relay, K_3 , hooked up as a buzzer and fed by the break line from the computer. No attempt was made to miniaturize the unit.

Phase Shift

The model uses a phase-shift oscillator with a 180-degree phase-

shift network broken into three 60-degree sections, each consisting of a tube and a capacitor. The tubes are triode pairs, each a cathode follower with its sister as the cathode resistor, furnishing the ultimate in control. Operation at lower frequencies but difficult to obtain¹ being determined by the g_m of the tube just before cut-off. The equivalent resistance of the cathode follower is the reciprocal of this value and its limit determines the oscillation range.

When an attempt is made to lower the lowest frequency attainable by using larger values of capacitance, the low Q results in a departure from the required 180-degree phase shift. This limitation at low frequencies affects the frequency range of the vfo. It is easier to get a higher range ratio at a higher frequency.

With this type of oscillator, range is sacrificed for a lower limit

frequency and vice versa. The present circuit at the chosen lower limit is capable of a frequency ratio of 10 to 1. Employment of four phase-shift sections instead of three will increase the ratio to as much as 100 to 1.

Lack of an ideal amplitude-vs-frequency characteristic is desirable, since amplitude rises with frequency exalting the beat at fire time. The present circuit is complicated by the need to invert the range voltage and use of d-c coupling.

If the computer were to supply an in-range 28 volts for rockets and guns as well as missiles, the thyatron in the aural tie-in could be eliminated, however, placement of the circuit is arbitrary since the aural-range unit could be on the A frame instead of being a cockpit unit.

REFERENCE

(1) M. E. Ames, Wide Range Deviable Oscillator, *ELECTRONICS* p 96, May 1949.

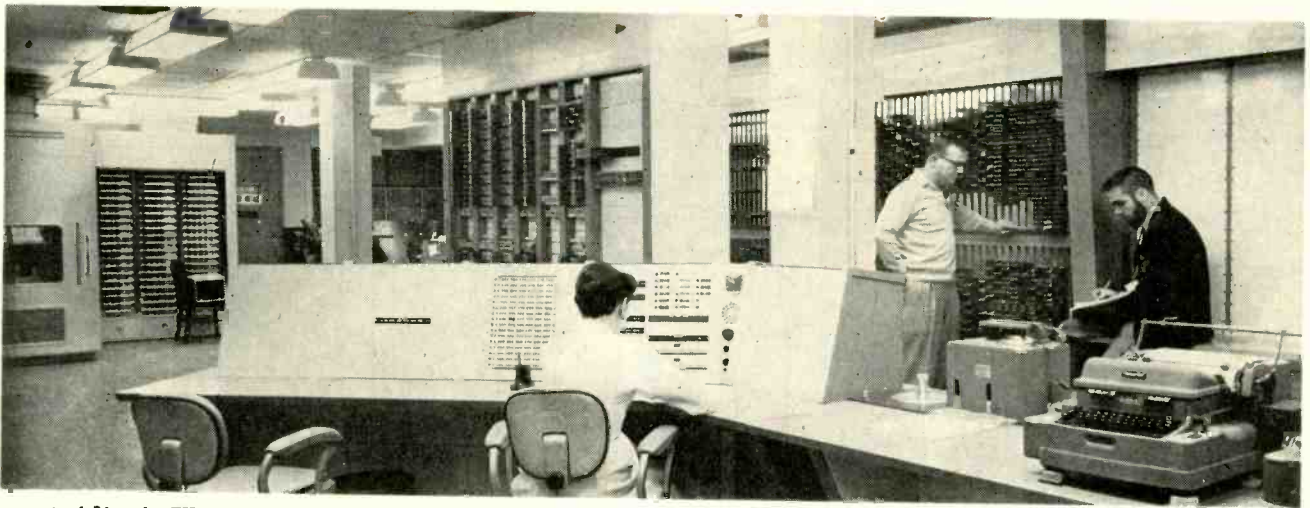

Layout of Lincoln TX-2 computer system. The 2.5-megabit memory is at left and the manipulative elements are behind the console. Engineers at right check out part of the TX-2 manipulative elements

High-Speed Computer

By WILLIAM N. PAPIAN

Staff Member
Lincoln Laboratory
Massachusetts Institute of Technology
Cambridge, Massachusetts

SUMMARY — Development of a transistorized arithmetic and control unit operating at a 5-megapulse-a-second clock rate, a 2.5-million-bit, 6-microsecond internal memory and a 64-register storage unit of index registers and program counters provides the basic units that make up the largest-memory computer built to date. Discussion of characteristics of Lincoln TX-2 computer reveals design details

DISTINGUISHING FEATURES of the Lincoln TX-2 computer that answer the clamor for greater capability in today's digital-computer applications, a clamor usually accompanied by reservations on size, cost, and complexity, are a transistor arithmetic and control unit operating at a 5-megapulse/sec. clock rate, a 2.5-million bit, six-microsecond internal memory unit and a 64-register storage unit of index registers and program counters.

Logic

Two developments in the logic or organization structure of digital machines complement these equipment innovations. They are: an arithmetic element which can be fractured (under program control) from a single 36-bit unit into com-

binations of 9-bit units and an input-output system which provides for the concurrent programmed operation of a variety of devices on a priority basis.

A control console and terminal equipments coupled with the features outlined above, combine to

make the Lincoln TX-2 an extremely capable and flexible digital computer.

Characteristics

The TX-2 is a general-purpose large-scale digital computer that uses the binary code, is a parallel machine using a single-address word structure. The memory word length is 36 bits, factorable into sub-words that are multiples of 9 bits. A number of 18-bit indexing registers are available.

Coincident-current magnetic-core arrays are used as primary storage and have a 6-microsecond cycle time. Bank one contains 65,536 37-bit words; bank two, 4,096 37-bit words and further banks can be accommodated up to a total of 262,144 words (approximately ten million bits). The storage banks

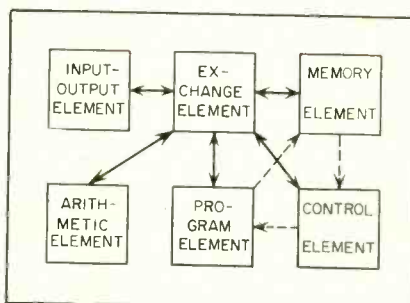
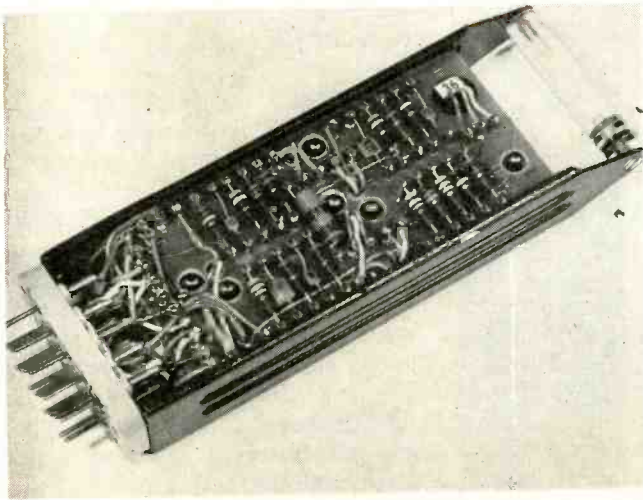
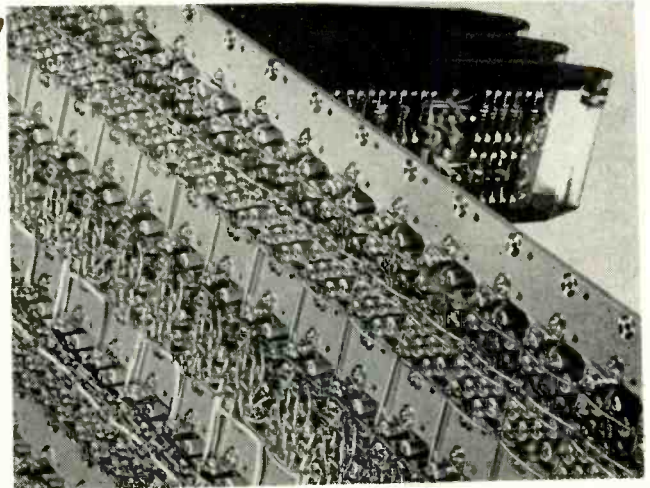

FIG. 1—Block diagram shows major elements of the computer and how information flows between them. Dashed lines indicate internal loop



Plug-in package contains complete flip-flop network plus two gate circuits and two additional buffer amplifiers



Receiving sockets for flip-flops used in memory are mounted in frames and their interconnecting wiring soldered by hand

Stores 2.5 Megabits

can be operated simultaneously and independently.

Peak operating rates for typical instructions are: 150,000 additions per second and 80,000 multiplications per second for 36-bit words, to 600,000 additions or multiplications per second for 9-bit words.

Transistors numbering about 22,000 and several hundred diodes are used. There are 625 vacuum tubes of which 608 are dual triodes used in the large memory.

Input-Output

The TX-2 communicates with the outside world through its input-output element. Whenever an incoming word (binary-coded number representing data or in-

structions) is to be received it passes from the input-output element through an exchange element, into the memory. Output words travel the other way.

Figure 1 shows how words travel through the exchange element on their way to and from the major elements of the machine. The dashed lines at the left indicate an important loop used in the computer's basic internal cycle.

Typically, an address is supplied to the memory element from the program element. The word from the addressed memory register is sent to the control element which retains and acts out the command portion of the word, and sends the address portion back to the pro-

gram element where it may be modified. The address, which may or may not have been modified, then brings an information word out of the memory element, through the exchange element and into the arithmetic element for an arithmetic operation.

Not shown are the control lines from the control to the other elements to determine and synchronize the internal operations and transfers of information in and between the elements.

Transistor Elements

Manipulations consisting of transfers, shifts, additions, multiplications and so forth, are performed by surface-barrier tran-

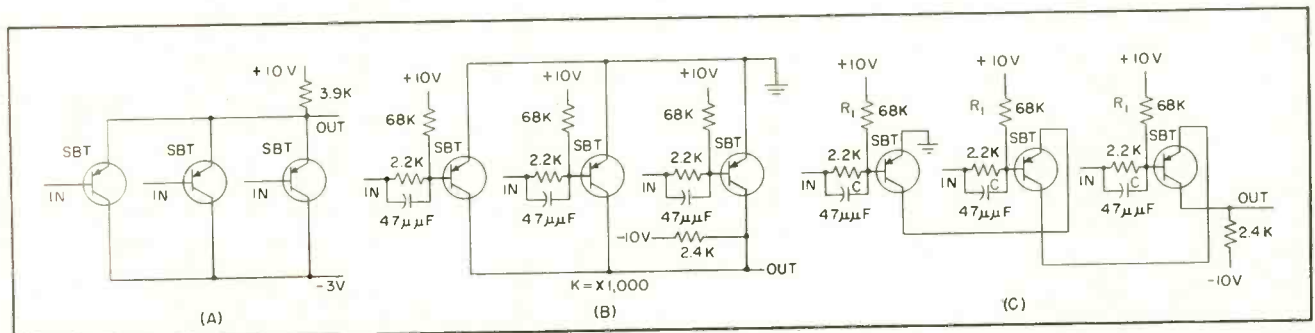
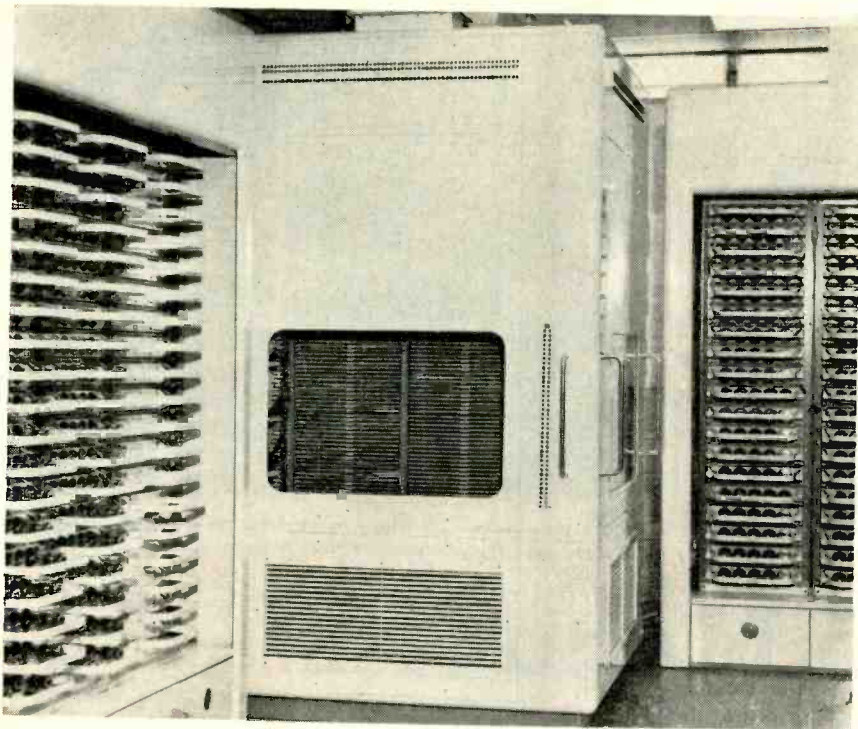

FIG. 2—Typical basic transistor circuits used in the computer are: three emitter-follower stages in parallel (A); three grounded-emitter stages in parallel (B) and three grounded-emitter stages in series (C)



External view of memory shows digit-plane drivers and sensing circuits at left, memory stall with memory-core matrix switches and memory planes in the center and the matrix switching drive circuits at right

sistor circuits operating at rates up to five megapulses a second. Two basic transistor circuits predominate: a saturating grounded-emitter stage and a saturating emitter-follower stage.

Three emitter-follower stages are shown in Fig. 2A combined in parallel to form an *or* network for negative input signals. One or more negative input signals will clamp the output terminal to -3 volts. Ground-level on all of the inputs will raise the output terminal to ground level, thus the same configuration is used as a three-input *and* network.

Three grounded-emitter stages connected in parallel also make an *and* network for positive inputs or an *or* network for negative inputs as indicated in Fig. 2B. In a grounded-emitter stage, the polarity of the signal is inverted. Connecting them in series, as in Fig. 2C results in an *or* network for positive inputs.

The value of resistor R is chosen so under the worst expected component and power-supply variations, the drop across the conducting transistor is less than 200 millivolts. The +10 volt supply and R_1 bias the transistor deeply into the off condition to provide in-

creased tolerance to noise. For the on condition, the input drives the transistor into saturation to provide a solid output level that is independent of variations in input peak amplitudes. Capacitance C shortens turnoff time by speeding the removal of minority carriers from the base, as shown in the experimental circuit of Fig. 3.

Ten of these basic circuits are combined into the standard TX-2 flip-flop detailed in Fig. 4. The flip-flop is basically an Eccles-Jordan trigger circuit with a three-transistor amplifier on each output and a single-transistor amplifier on each input. This flip-flop offers an unusual degree of freedom since its input trigger requirements are independent of clock rate and its output waveforms are not affected by normal loading variations.

Figure 5 indicates the high performance and stability of this well-buffered network.

The circuits are built on dip-soldered etched boards, mounted in steel shells, and connected to plugs. The receiving sockets are mounted in frames and interconnected and soldered by hand.

The resulting five-megapulse system of manipulative elements occupies less than 400 sq ft of floor

space and dissipates less than 800 watts of power.

The Big Memory

The TX-2 six-microsecond, random access, 2.5 megabit memory is a coincident-current unit using two-to-one selection-current ratios for two-coordinate read and three-coordinate write operations. The core array is 256-by-256 with each register holding 36 bits plus a parity checking bit and a spare bit. Vacuum tubes are required only in the high-level driving circuits. The low-level circuits use transistors. Magnetic-core matrix switches supply current pulses to the 512 selection lines.

The 2.5-million cores were made and tested at Lincoln Laboratory. Each ring-shaped core is 80 mils in outside diameter, 50 mils inside, and 22 mils high. A core is switched in one microsecond by a total current of 820 ma and pro-

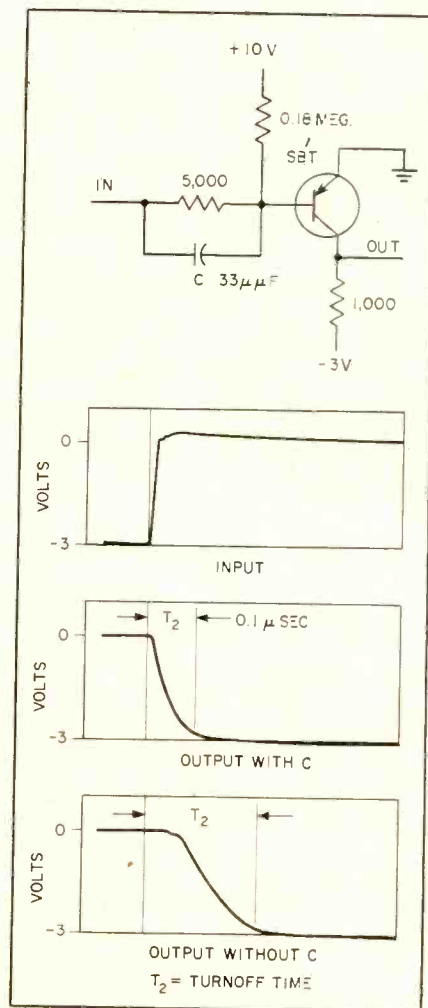

FIG. 3—Improvement in grounded-emitter stage turnoff time by adding C is shown in curves

duces a peak output of 100 mv. A total of 4,096 of these cores is wired into a 64-by-64 plane module; sixteen of these modules are tested and then assembled to form a full 256 by 256 digit plane; 38 digit planes are stacked and interconnected to form the completed array.

The sense, or output, windings of four subassemblies are connected in series-parallel. Each large digit plane has, therefore, four output terminal pairs as shown typically in Fig. 6. Sense amplifier circuits such as shown in Fig. 7 incorporate a balanced amplifier, full-wave rectifier using two emitter followers, pulse amplifier, and line driver. These sense amplifiers feed the memory buffer register in which the signal is sampled at the proper time by an 80-milli-microsecond strobe pulse.

Digit-plane windings are also interconnected in four sections, each of which is driven by the circuit shown in Fig. 8A. Here transistors bring the 3-volt signal levels up to about 9 volts to drive vacuum tubes which provide for further amplification and delivery of a 410-ma pulse to the digit windings. Similar circuits are used to drive the two core-matrix switches on the selection lines.

Each core-matrix switch is made up of 256 tape-wound molybdenum-permalloy cores which are essentially saturable-core pulse transformers with four separate windings arranged and interconnected to form a 16 x 16 two-coordinate switch. These switches operate such that the interval between read and write may be extended several microseconds under computer program control so the memory address register need not hold the given address after the read half of the cycle.

Fast-Access Memory

A small, economical and fast storage unit makes available a reasonable number of intermediate-speed registers to aid in the manipulation of program element words.

This small memory contains sixty-four 19-bit registers and requires a total of 434 transistors, 8 diodes, and 1 vacuum tube. Only 0.6 microsecond is required for ac-

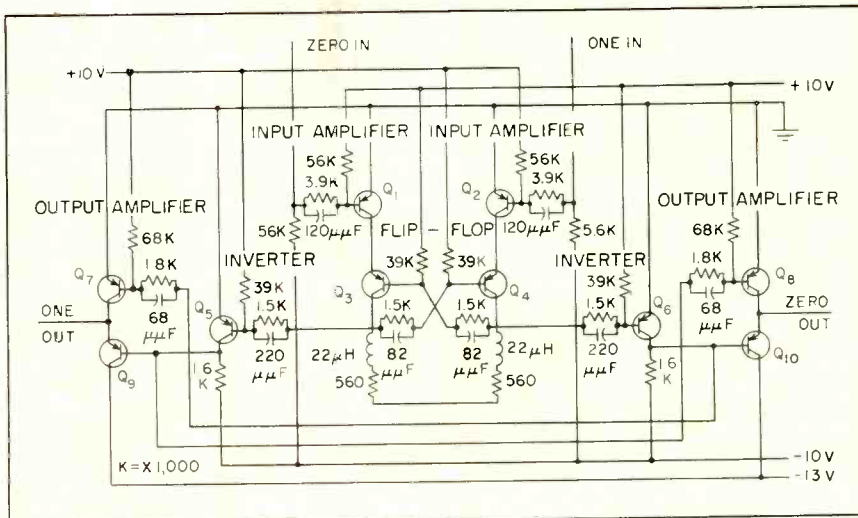

FIG. 4—Basic surface-barrier transistor flip-flop with input and output buffers as used in computer to perform arithmetic operations

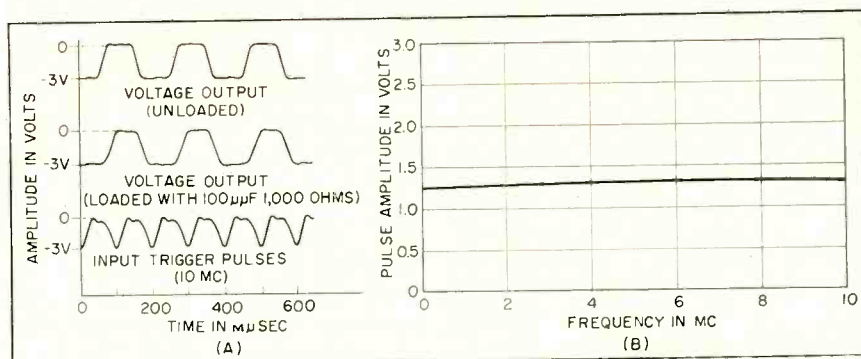

FIG. 5—Curves show output waveforms of flip-flop (A) and trigger sensitivity of flip-flop (B) in dictating high performance and stability of circuit

cess to this memory which completes a full cycle in 4 microseconds.

Each information digit of each register is represented by a pair of ferrite cores. A write operation always leaves the pair with like magnetization in magnitude and direction. A memory register line is selected on a single-coordinate basis using a relatively large cur-

rent pulse for the read operation. This register line passes through each one of the pair of digit cores in opposite directions. Consequently, only one core of each pair switches; its partner merely takes a reversible excursion into saturation.

The switched core develops an emf considerably larger than its partner's and of opposite polarity. The digit winding passes through each member of the pair in the same direction so that it picks up the algebraic sum of a large voltage of one polarity and a small voltage of opposite polarity. The polarity of the resultant signal is, therefore, a function of the polarity of the net current during the previous write operation. Since the register is the only line receiving any significant drive current during read, it may be driven as heavily as is required for fast access time.

The write cycle is a two-coordi-

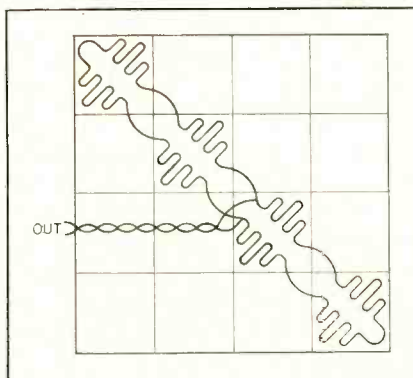
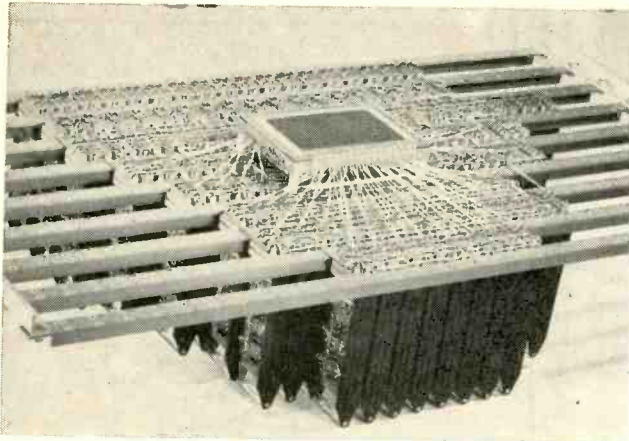
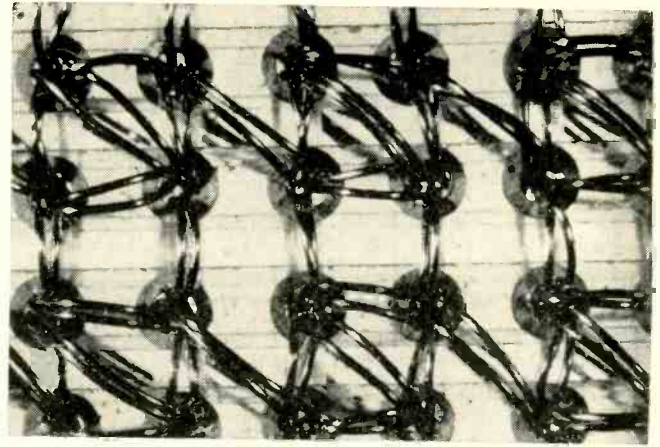

FIG. 6—Connection schematic for one sense winding of a 256-by-256 memory plane in the big memory



The 64-by-19 memory plane is shown connected to the sensing and drive circuit modules



Close-up of 64-by-19 array showing winding details and ferrite cores used in memory plane at left

nate operation and the net switching current is constrained to be no more than three times as large as the maximum current which will not switch a core. Write currents are applied to the digit windings, the same windings on which the output signals appear during read. These digit currents are one-third the amplitude required for switching and of polarities determined by the digit flip-flops.

No influence is exerted by the small digit current except during the write operation when a two-thirds amplitude current is applied to the selected register line in a direction opposite to read current. This register current adds to the digit current through one and subtracts from the digit current through the other member of each pair of cores on the selected register.

The polarity of the digit current determines at which core, of each pair, the two currents will add and thus, whether the stored

information is a one or a zero.

The cores are 47 mils in outside diameter, 27 mils inside and 12 mils high. They switch at relatively low current with a somewhat longer switching time than the cores used in the big memory. The low switching currents make transistor drive easier and access time is kept short by the large read current which single-coordinate register selection makes possible.

Digit currents are 8 ma, register current pulses are 18 ma for write and 117 ma for read. The open-circuit signal induced on a digit winding by a switching core during read is ± 0.5 volt and lasts for about 0.3 microsecond. Surface barrier and 2N123 transistors are used for signal amplification and for all the current drives except the 117-ma read pulse which is supplied from a 6197 pentode.

Figure 8B shows the way in which three surface-barrier transistors are arranged in series to deliver a large, 15-volt pulse to

the 6197 without exceeding their rated 6-volt limits.

Logic Features

The intermediate-speed registers made available by the described memory are to be used to store index registers and program counters. The availability of a relatively large number of program counters makes possible and economical, a multiple-sequence program technique whereby a number of input-output sequences and the internal computer sequences may operate concurrently.

The input-output devices may include paper tapes, magnetic tapes, cathode-ray displays, analog-digital converters, other computers and the like. A multiple-sequence computer is much like a number of logically separate computers which time-share the same memory, arithmetic, and program elements.

When an input-output device needs attention, its program counter is selected and enough computer instructions from its sequence are performed to meet its needs. Control then reverts to some other sequence. The main computational sequence is treated as just another user of the machine and is given attention when the more pressing needs of lightly buffered input-output devices have been met.

Efficient operation and a minimum of programming restrictions result when a priority system is used to rank the program sequences. In TX-2, high-speed free-running devices rank high and get attention first. Electric typewriters have a low priority since they can

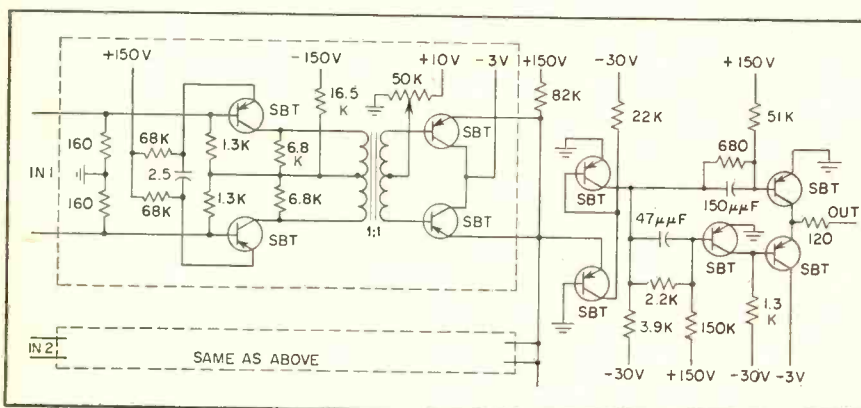

FIG. 7—Sense amplifier circuits drive the memory buffer register where output signal is sampled at proper time

wait indefinitely. The lowest priorities are assigned to main computational sequences.

The final feature is the flexible structure of the arithmetic element which can be altered under program control. In effect, each computer instruction specifies a particular form of machine, ranging from a full 36-bit computer to various combinations of 27-bit, 18-bit, and 9-bit configurations. Figure 9A graphically illustrates four of the possible machine configurations, including two in which parts of the memory are cross-coupled to different parts of the arithmetic element.

Not only does this scheme make more efficient use of the memory for storing data of various word lengths, but it also results in greater over-all machine speed because of the increased parallelism of operation. For example, two 18-bit multiplications may go on simultaneously. This feature is particularly valuable in control and equipment design applications, where incoming data is seldom available to a precision greater than 18 bits, and often only to 9 bits.

The ability to fracture the arithmetic element on an instruction-by-instruction basis requires switching of some of the interconnecting paths between digit stages. For example, parts (5) and (6) of Fig. 9B show the respective basic paths followed by information in the A and B registers of the arithmetic element during a shift right operation in the cases of 36-bit and 18-bit configurations. Part (7) of the figure shows the switching required to instrument just those two configurations for the simple operation.

Experience

The TX-2 computer embodies significant experience gained from components and systems investigations. An eight-stage double-rank shift register containing 99 surface barrier transistors has been on life test since April 1955. It circulated a fixed pattern for 10,789 hours with no errors and no transistor failures.

An eight-bit error-detecting multiplier using 600 SBT's was de-

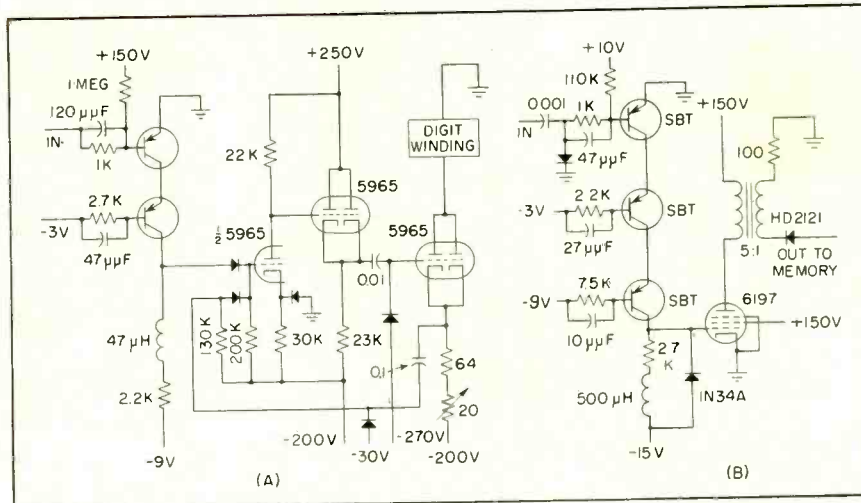

FIG. 8—Digit plane driver circuit (A) delivers a 410-ma pulse to the digit windings. Driver circuit for read windings (B) delivers a 117-ma read pulse

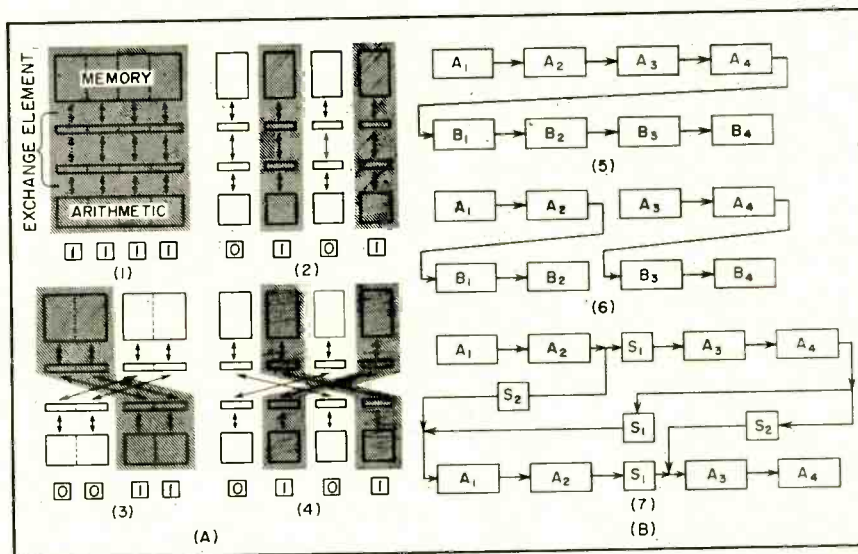

FIG. 9—Four possible configurations that can be used with the TX-2 (A) are the 36-bit configuration (1), four 9-bit, (2), two 18-bit (3) and four 9-bit cross-coupled (4) configurations. Possible paths between digit stages in arithmetic element are also shown (B). Blocks show shift-right operation for 36 bits (5), two 18-bit segments (6) and an 18-bit breakup (7). Switch positions for the 36-bit shift are S₁ closed and S₂ open. Switch positions reverse for the 18-bit shift

signed and completed in August 1955 and has been in nearly continuous operation since. Operating margins are periodically checked, and in steady state operation the multiplier's error rate has been about one every two months, or one error per 5×10^{11} multiplications at 10^5 multiplications per second. Most of these errors appear to have been caused by defects in the wiring. Of the eight transistor failures, seven were caused by accidental application of overvoltage or overload, and one was a defective transistor. A ten-percent sample of the multiplier's transistors are now undergoing extensive tests.

The research reported herein

was supported jointly by the Army, Navy and Air Force under contract with the Massachusetts Institute of Technology.

BIBLIOGRAPHY

- W. A. Clark, The Lincoln TX-2 Computer Development, Proc Western Joint Computer Conference, Feb. 1957.
- K. H. Olsen, TX-2 Circuitry, Proc Western Joint Computer Conference, Feb. 1957.
- J. L. Mitchell and K. H. Olsen, TX-0, A Transistor Computer with A 256 x 256 Memory, Proc Eastern Joint Computer Conference, Dec. 1956.
- R. L. Best, Memory Units In The Lincoln TX-2, Proc Western Joint Computer Conference, Feb. 1957.
- J. W. Forgie, The Lincoln TX-2 Input-Output System, Proc Western Joint Computer Conference, Feb. 1957.
- J. M. Frankovich, A Functional Description of the Lincoln TX-2 Computer, Proc Western Joint Computer Conference, Feb. 1957.

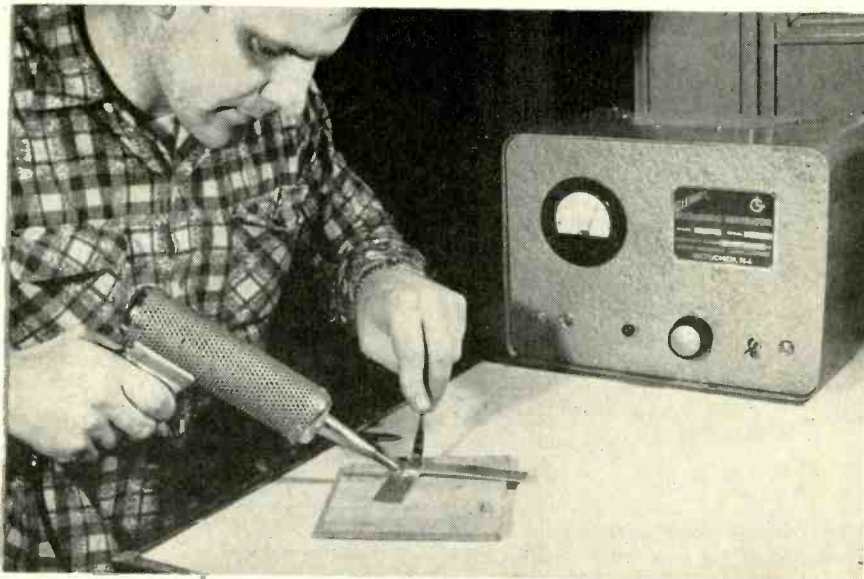

Ultrasonic soldering gun, used here to solder two pieces of aluminum, obtains an oxide-free alloy bond between the solder and the aluminum. The gun is used also to solder aluminum foil for capacitors and aluminum wire for electrical connections

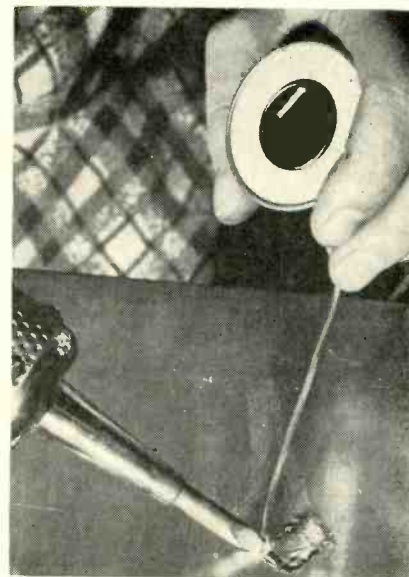

Photograph shows the ultrasonic gun in action. The tip is driven at an ultrasonic frequency by a transducer

ULTRASONIC IRON

METALS THAT OXIDIZE instantaneously, such as aluminum, magnesium and their alloys, can be soldered as readily as copper by using a soldering gun that employs an ultrasonically-driven, gas- or electrically-heated tip.

Ultrasonic soldering is essentially an abrasion of the oxide layer of a metal that occurs beneath a pool of molten solder, permitting the solder to flow directly onto the abraded metal surface before further oxidation can take place. Two pieces of any light metal may be soldered by first ultrasonically tinning each surface and then soldering the tinned surfaces in the conventional manner.

The process is shown in Fig. 1. The electrically-heated tip is driven at an ultrasonic frequency by a suitable transducer. The sonic field, set up at the interface between the tip and the metal, abrades the surface of the metal while the molten solder forms a firm alloy bond to the microscopically-pitted surface of the metal.

The ultrasonic soldering iron is equipped with the generator whose circuit is shown in Fig. 2. It consists of a Hartley oscillator, and an amplifier that drives the tuned grid of the output tube which in turn drives an output transformer of special design to match the impedance of the ceramic transducer. The grid of the output tube is normally heavily biased to nearly com-

plete cut-off by the 33,000-ohm resistor in its cathode circuit. Keying of the generator is accomplished by SW_1 which shorts the cathode resistor, leaving only the fixed bias on the grid furnished by the power supply and permitting the tube to conduct.

Two versions of the generator are commonly used. One version employs a gas-heated soldering tip and the generator is not required to furnish heating power to the tip. The second version has an extra power transformer for furnishing current to an electrically heated soldering tip. The gas-heated soldering gun is mounted on a self-contained propane fuel tank with the burner so positioned that both the work and the tip may be heated to the correct temperature for proper alloying.

The piezo-electric transducer element is designed for a resonant frequency of 20 kc operating on its longitudinal mode. Mechanical energy is coupled from the transducer to the soldering tip by a velocity

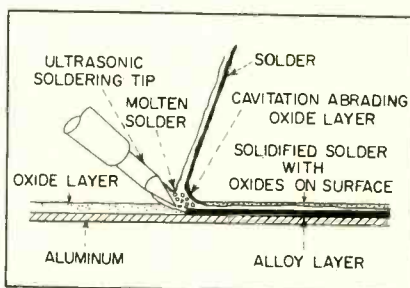

FIG. 1—Diagrammatic views shows how the ultrasonically-driven tip removes the oxide layer from the metal and the molten solder forms an alloy layer on the surface of the aluminum. Excess solder, solidifying with oxide products on its surface, is removed and fresh solder is added if needed to provide a perfect bond

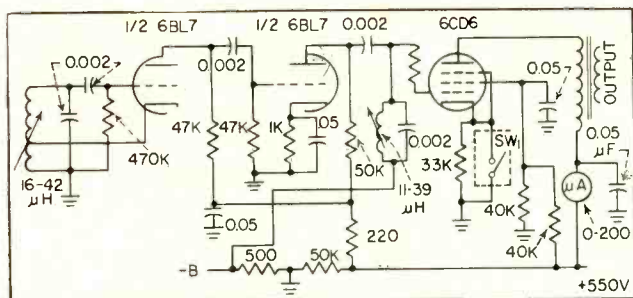

FIG. 2—Generator circuit consists of a Hartley oscillator, tuned to the resonant frequency of the ceramic transducer. The generator is keyed by switch SW₁.

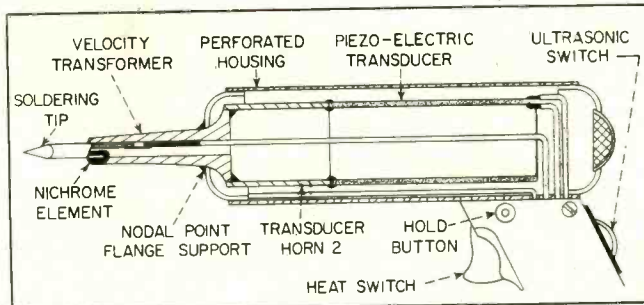

FIG. 3—Essential features of the ultrasonic soldering gun. Mechanical energy is coupled from the transducer to the tip by a velocity transformer, electrically analogous to a voltage step-up

SUMMARY — Oxide layer on metal is removed by ultrasonic iron tip, driven at 20 kc by piezoelectric transducer energized by Hartley oscillator and two stages of amplification. The sonic field abrades the surface of the metal while molten solder forms an alloy bond before further oxidation can take place. Work surface is heated by an electric tip or gas torch

By **THOMAS J. SCARPA**

*Vibro Ceramics Division
Gulton Industries, Inc.
Metuchen, N. J.*

SOLDERS ALUMINUM

transformer which is electrically analogous to a voltage step-up transformer. The amplitude of motion at the soldering tip is increased over the amplitude of the motion of the transducer directly as the ratio of the large to small diameters of the horn. The horn is made of low thermal conductivity high-chrome stainless steel to help thermally isolate the transducer from the heated tip. In addition, the flange support at the nodal point of the horn is made of high thermal conductivity material so that the perforated metal housing acts in effect as a heat sink or low thermal impedance to shunt the heat around the transducer element. The transducer is attached to the velocity transformer with a high-strength thermo-setting plastic adhesive having a very low compliance and an acoustic impedance matching that of the ceramic transducer. The long cylindrical section of the horn provides sufficient radial compliance so that any radial vibration of the transducer

will not affect the bond at the junction of the horn and the cylinder.

Operation

To operate the unit, the generator is turned on and the frequency is trimmed to that of the transducer, indicated by the meter in the plate circuit of the output stage. The work surface is heated, either by the electrical tip, gas torch, or if essentially flat, by placing on a heating plate. The work surface is then coated with solder which, although melting, will not adhere due to the intervening oxide film. When the work surface is thoroughly heated so as to readily melt the solder into a flowing pool, the ultrasonic energy is turned on by means of a convenient finger switch. A distinct low-intensity singing sound will ensue from the tip which is then worked back and forth over the aluminum surface beneath the molten solder. The solder immediately adheres and the surface becomes tinned. Excess solder is removed immedi-

ately as it contains oxide products removed by cavitation, and fresh solder is then added if needed. Any metal may now be soldered to this tinned surface in the conventional manner. No further ultrasonic energy is needed. Two pieces of aluminum may be soldered together quite readily by first pretinning each surface. Aluminum wire or foil may be ultrasonically tinned and then stored for further soldering at a future date with conventional soldering methods. The utilization of aluminum foil for capacitors, aluminum wire for electrical connections and direct soldering to aluminum chassis is now immediately feasible.

In vhf antenna work, a problem arose recently of making good electrical connection to an aluminum antenna operating in the 200-400 mc region. All mechanical methods of bonding gave spotty and noisy action. A soldered connection made with an ultrasonic soldering iron immediately solved the problem and gave noiseless operation.

Strain Gage System for

By **WILLIAM O. BROOKS**

*Ramo-Wooldridge Corp.
Los Angeles, California*

and

DWIGHT L. STEPHENSON

*Los Alamos Laboratories
Los Alamos, New Mexico*

SUMMARY — High-accuracy transistorized strain-gage system for aircraft and missile applications has one-percent linearity and provides 0 to 5-volt d-c output suitable for subcarrier oscillator modulation in f-m telemetering systems. Bridge excitation supply powers three paralleled gages having total resistance of 40 ohms

HIGH-PERFORMANCE AIRCRAFT and missiles have made the need for high-accuracy telemetered strain-gage systems more critical.

This article describes the design of a prototype strain-gage instrumentation system having a 0 to 5-v d-c output suitable for telemetering. In addition to the strain-gage, the system as shown in Fig. 1 includes a standardized bridge-excitation supply capable of supplying 1 to 3 strain-gage bridges and amplifiers and a strain-gage amplifier-converter to provide a d-c signal from the a-c strain-gage output.

Bridge Excitation Supply

The regulated a-c power supply is shown in block form in Fig. 2. The

design approach used was to standardize the input voltage and then amplify it to the required power level with a stable amplifier. The requirement of ± 1 -percent regulation meant that a stable a-c voltage standard had to be developed first.

The a-c voltage standard was developed around the use of Zener diodes to clip the incoming variable a-c into a fixed amplitude square wave and then filtering out the harmonics to a sine wave by use of a low-pass filter. The 1N429 diodes chosen are of the double-anode type and clip both sides of the waveform symmetrically. When operated at an a-c peak-current rating of 7.5 ma, they have a low temperature co-efficient.

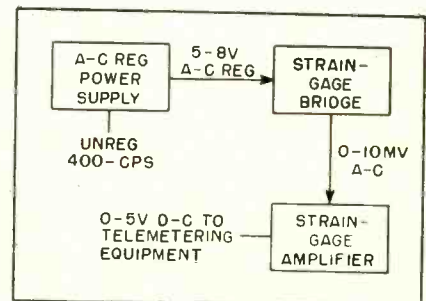

FIG. 1—Strain-gage instrumentation system

With an input line variation of as much as ± 10 -percent it is necessary to use two clipping stages to limit the output variation to the required minimum.

The output of the clipper circuit goes to a low-pass filter with a flat response from 380 to 420 cps and a rejection of 40 db at the second harmonic of 760 cps to obtain the lowest possible distortion. The best filter obtainable was flat within ± 0.5 -percent at room temperature over this frequency range.

Variations in output from the filter due to copper losses and so on amounted to as much as 3 percent total over the temperature range concerned. Two deposited-carbon resistors were used for compensation, each having a negative temperature coefficient of approximately 300 parts per million in series-circuit legs.

Transistor Amplifier

Silicon transistors were required in the amplifier shown in Fig. 3 to

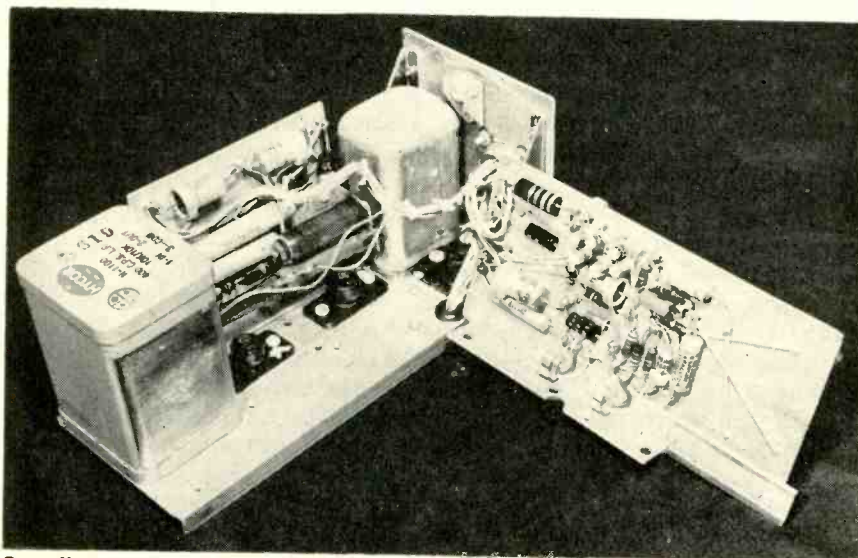

Overall view of prototype version of complete strain-gage instrumentation

Aircraft Telemetry

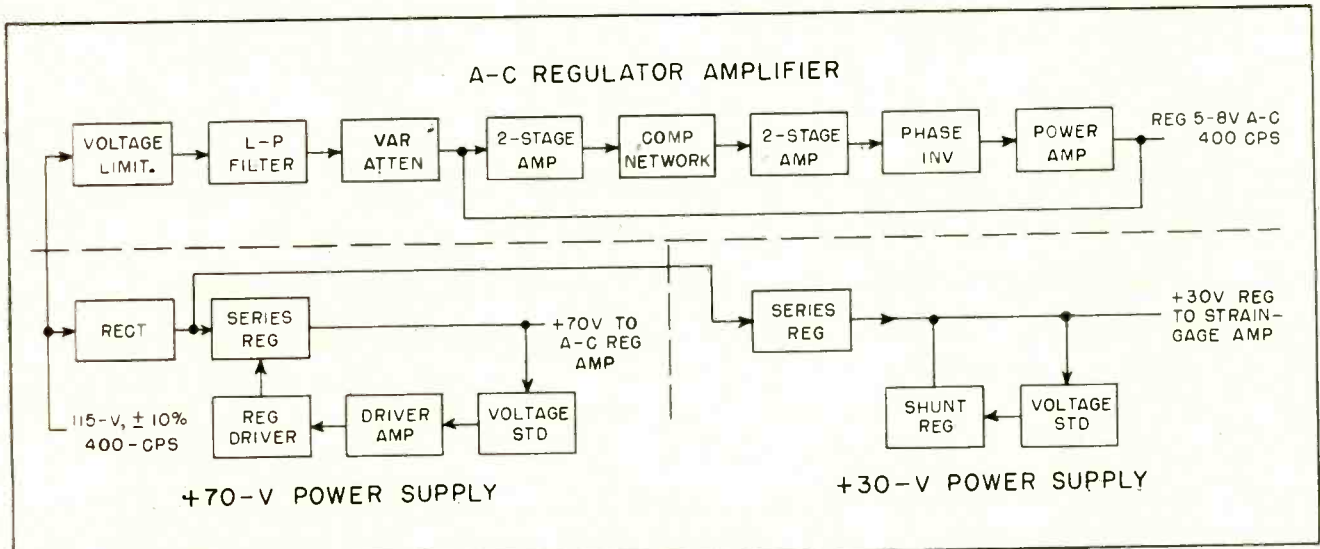

FIG. 2—Block diagram of bridge excitation and strain gage amplifier power supply

cover the wide temperature range. The available high-power transistors of the silicon variety were type 970's having a dissipation rating of 8.5 at 25 C or 3.5 at 100 C. at +100 C, their class B sine-wave output is approximately 2.5 w. Considering 80-percent output transformer efficiency, this permits an output of approximately 2 w.

Since these transistors do not have a military specification, variations in leakage current, current gain and power output are great. For use in class B, with a minimum of distortion, matched pairs must be used.

The emitters of the 970's tie directly to ground. Elimination of the emitter resistances is necessary to obtain the required output power.

Base bias is set at a point giving approximately 2 ma of total no-signal collector current to overcome the switching step of class-B operation. A thermistor network in each 970 base keeps this 2 ma constant by continuously lowering the base bias voltage with increasing temperature, thereby compensating for the increase of collector current brought about by increased leakage current within the transistor.

Driver

Experiments proved that the driver requirements could be met

with a standard phase inverter resistance coupled to the output transistors. The output impedance of the pushpull 970's is 2,000 ohms collector to collector and the input impedance is 140 ohms base to base or approximately 35 ohms each.

The output stage operates best with an impedance mismatch by the driver; a high driving impedance is required to obtain the smallest step in the output waveform. Sufficient power output with good wave form is obtained from the type 953 driver transistor with an 820-ohm load resistor in the collector and emitter circuits respectively.

Large values of coupling capacitors prevent loss at low frequencies when working into the low input base resistances of the type 970 output transistors.

The 40 db of negative feedback in a single loop requires special compensation to prevent instability and oscillation. This compensation becomes more critical with variable loading. A value of 35 db feedback at 40-ohms load increased to 45 db with 120 ohms load and to 55 db with open-circuit loading as shown in Fig. 4. To insure stability, a 10-db safety margin is required making a total of 65 db, an exceptional amount in one loop around a five-stage amplifier, when the

output transformer is included.

This quantity of feedback was made possible by special shaping networks. The networks are combined and added in one low-level stage prior to the driver permitting the other stages prior to the driver to be direct coupled, thus giving the full range response with little frequency attenuation.

D-C Power Supplies

The 100-ma, 70-v supply is of the series regulator type and uses a type 970 transistor as an emitter follower. A type 953 transistor, connected as an emitter follower, provides necessary current gain to control the 970 power transistor.

Resistor R_1 is a current limiting protective resistor that prevents burnout of transistor Q_2 if the circuit malfunctions. Transistor Q_1 , connected as a grounded emitter, provides the necessary gain and phase reversal for the correct voltage control.

The voltage standard is a series-string of 15 4.9-v Zener diodes in series with the base of Q_1 . These low-voltage Zener diodes were used instead of one 70-v diode to increase dissipation limits and to give a low temperature coefficient when used over the required wide temperature range.

Resistor R_2 causes approximately

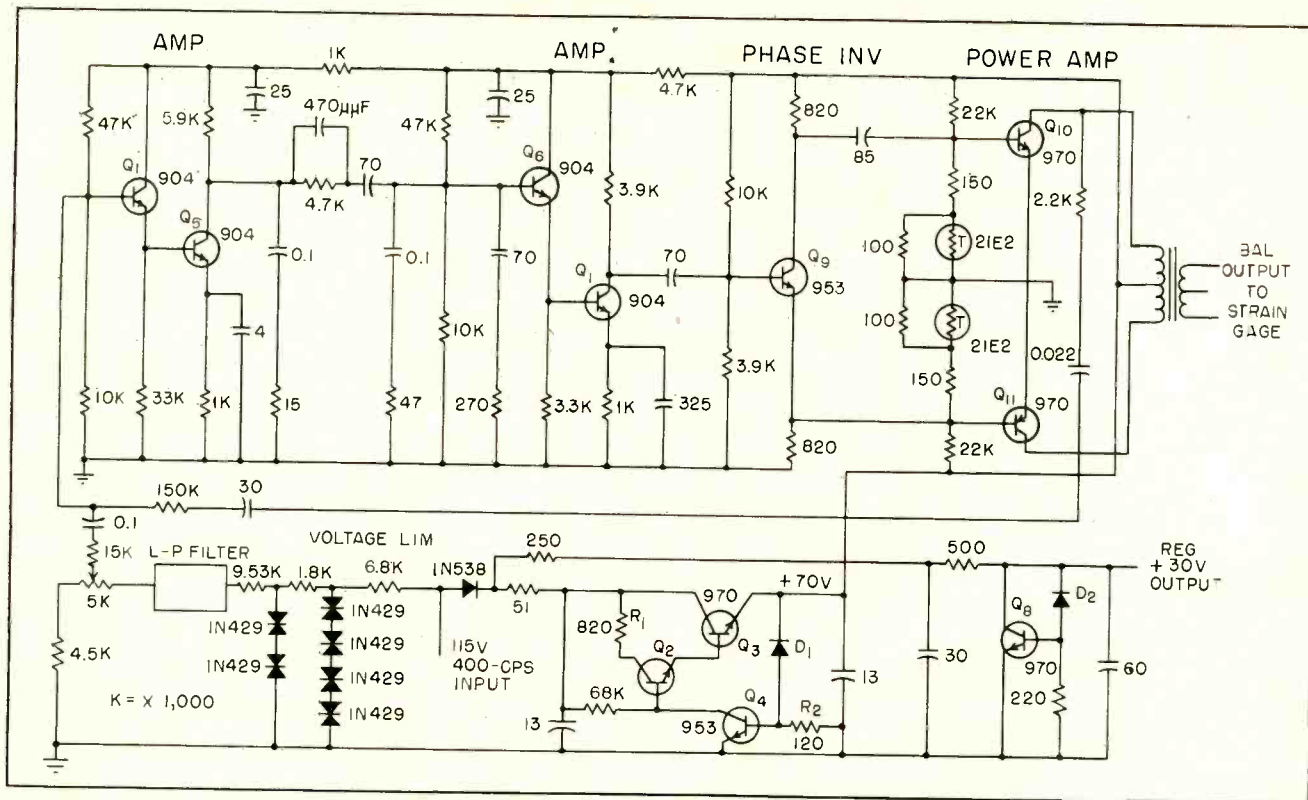

FIG. 3—Complete circuit diagram of excitation and power supply. Diode D_1 represents 15 651C4 diodes connected in series; D_2 is six 651C5 diodes in series

5 ma of continuous current drain through the Zener diodes to place them in the most stable operating part of their temperature characteristic.

The 30-v d-c supply is of the shunt-regulator type and uses the same type of Zener diode voltage

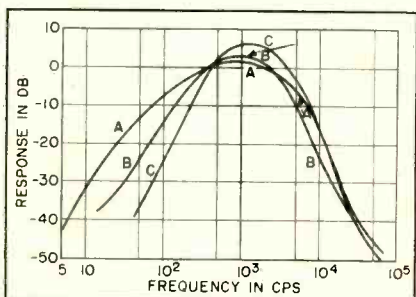

FIG. 4—Response curves for a-c regulated power supply with 40-ohm (A), 120-ohm (B) and open-circuit (C) output loads

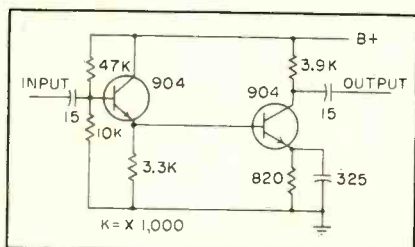

FIG. 5—Two-stage amplifier has 45-db gain

standard; however, additional amplifier stages are not needed because only ± 5 -percent regulation is required.

It can be seen from the photographs the excitation-supply unit is a preprototype unit and would need repackaging to take vibration tests. It was developed to determine if it would need a complete potted assembly to distribute heat well enough to stay within the ± 1 -percent amplitude-variation specifications over the specified temperature range. The unit passed the test at $+0.6$ -percent and -0.4 -percent variation with a maximum of 2-percent distortion indicative that the unit could be repackaged in the unpotted form.

Strain-Gage Amplifier

The strain-gage amplifier receives its signal input from an a-c excited strain-gage bridge. This input signal is balanced to ground, and is at approximately 0 to 10 mv.

The amplifier output is used to feed a telemetering input and is 0 to 5v d-c into a 1-meg load from a 10,000-ohm output impedance.

Frequency response is 0 to 10 cps and the requirement for overall

linearity an stability of 1 percent from the a-c input to the d-c output dictates a feedback loop encompassing both amplifier and rectifiers so as to eliminate rectifier non-linearity and instability with temperature changes.

Design Approach

Rough calculations using estimated variations in transistor and diode parameters, both production variations and those induced by temperature variations, indicated that approximately 40 db of feedback would be required to achieve the desired linearity and gain stability. The a-c input to d-c output voltage gain required was 54 db; therefore total open-loop amplifier gain was determined to be 94 db. Shaping networks produce an additional loss of 20 db, making the total gain requirement 120 db.

Due to the extreme temperature variations encountered, silicon diodes and transistors are used throughout, transistor bias networks are designed to provide good stability factors.

Figure 5 illustrates a typical two-stage grounded-collector to ground-emitter amplifier and the associated

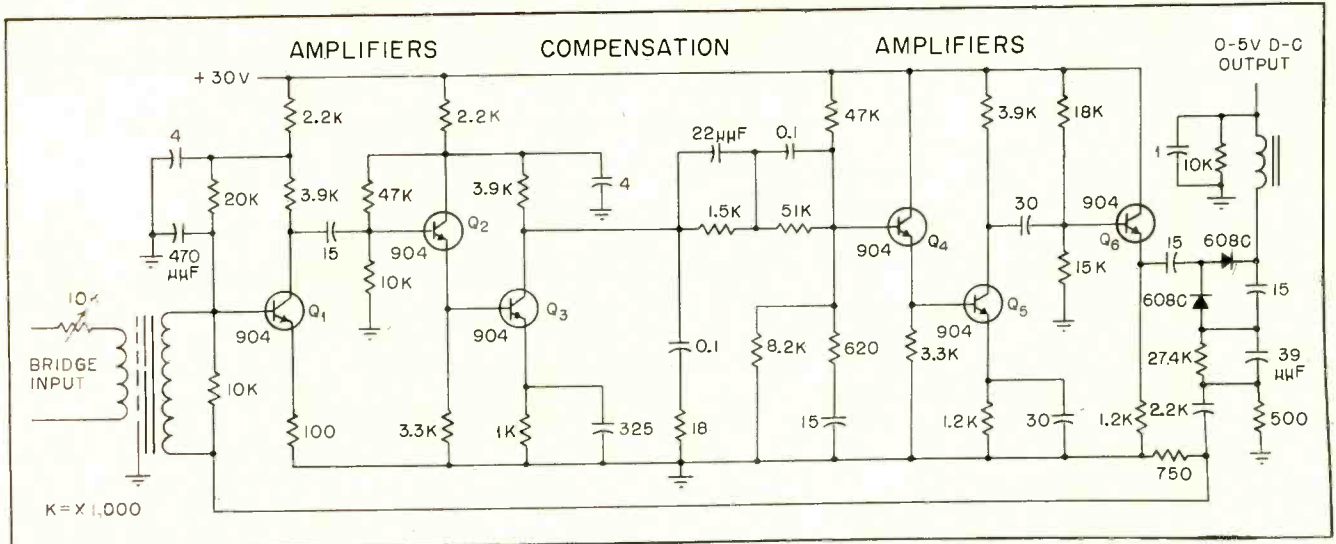

FIG. 6—Transistorized strain-gage signal amplifier converts a-c input into d-c output through voltage doubler and low-pass filter

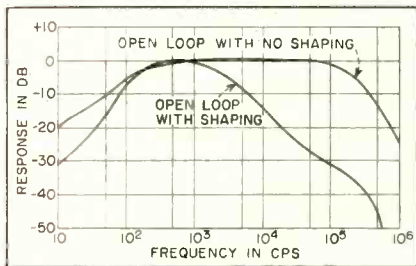

FIG. 7—Strain gage amplifier response

bias stabilization network. This amplifier has no apparent shift of operating point over the required temperature range; typical gain is 45 db and output voltage capability is 3.5v rms. Direct coupling serves the multiple purpose of reducing phase shift and the number of components required while also providing excellent stability.

The stability factor of the grounded-collector stage is calculated to be $S = 3.3$. Stability of the second stage is also excellent.

A-C Amplifier

Two of these basic amplifiers plus a phase-inverting grounded-emitter stage and an emitter-follower output stage make up the a-c amplifier portion (Fig. 6) of the strain gage amplifier.

A silicon-diode voltage-doubler and an L-C filter provide the a-c to d-c conversion. The 500-ohm wire-wound resistor, R_{fb} provides the rectifier current feedback impedance. The feedback loop therefore includes the diodes and the input transformers. Considerable amplifier frequency-response shaping

was required by use of lead-lag networks to achieve a satisfactory phase and gain stability margin.

Amplifier Performance

Figure 7 illustrates the frequency response both open loop and closed loop including the shaping networks. Due to the 120-db open-loop gain, it was necessary to make the plots by holding the output constant at an arbitrary 0 db while varying the input voltage.

Figure 8 illustrates the a-c output waveform as seen at the input to the voltage-doubler circuit. The steep sides indicate essentially zero feedback and extremely high amplifier gain during zero diode current, while the rounded tops repre-

sent the amplified sine wave with heavy feedback.

Figure 9 shows the feedback voltage; the niches indicate diode cut-off points, and therefore, no feedback.

Environmental tests indicated excellent linearity and stability from approximately -10°F to $+185^{\circ}\text{F}$. Linearity remained good below this point; however, gain stability dropped off somewhat. For this reason the final packaged unit contains a miniature thermostat and two parallel internal heaters.

The metal container is lined with sheets of plastic foam for heat insulation. The entire package is capable of maintaining an 80°F temperature differential and therefore keeps the internal temperature well above the low temperature limitations. The entire amplified assembly is potted with a standard potting compound and a 20-percent (by weight) filler is used to enhance the thermal conductivity and thereby minimize hot spots.

Measurements over the entire temperature range indicate that stability and linearity are within 1 percent from 0.1v to 5v d-c. Ripple on the d-c output is less than 50mv under all conditions.

The complete system provides 1-percent linearity and stability over the following environmental conditions: temperature, -55 to 185°F ; vibration, 20 to 2,000 cps at 10 gs; altitude, 70,000 ft; shock, 15 gs; input voltage variations, 105 to 125v rms; input frequency variations, 380 to 420 cps.

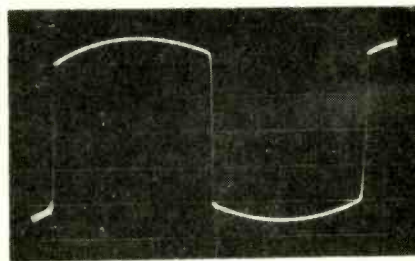

FIG. 8—Waveform at input to voltage-doubler circuit in Fig. 6

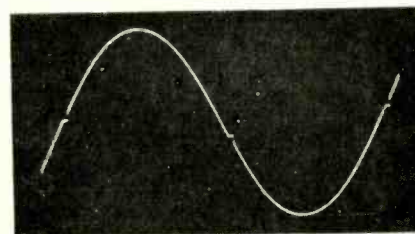

FIG. 9—Niches in feedback voltage waveform indicate diode cutoff points

Canadian Traders

By **S. G. L. HORNER,**

*Radio Division, Fur Trade Dept.
Hudson's Bay Company
Winnipeg, Manitoba, Canada*

MURRAY G. CROSBY

and

BARTON C. COFFMAN

*Crosby Laboratories Inc.
Hicksville, New York
U. S. A.*

Inverters change the 32 v d-c to 115-v a-c and place a total limit of approximately 200 watts for both transmitter and receiver. Separate inverters for transmitter and receiver improve the voltage regulation.

The transmitter requires 150 watts and the receiver requires 100 watts, or a total of 250 watts. A push-to-talk system disables part of the transmitter during reception and part of the receiver during transmission to fit the 200-watt limit.

In the transmitter, supply voltage for the final amplifier tubes is limited to hold the power drain within 150 watts. This results in a peak-envelope-power output of 30 watts. If power drain is not critical, the final amplifier output can be boosted to approximately 60-watts peak envelope power by raising the supply voltage to the final tubes.

Beam power amplifiers, type 6146 in push-pull, were chosen as the final amplifiers. They operate close to their class-C efficiency yet still in their linear condition. Overall efficiency with respect to power drain is therefore relatively high.

Circuit

The transmitter uses filter-type sideband separation with mechanical filters. A triple-triode balanced modulator, shown in Fig. 2', is used because of its simplicity. Output of the balanced modulator is fed to the sideband filter for single-sideband operation, or combined with



Typical radio station at Holman Island, 400 miles north of the Arctic Circle, is one of the sixty-one stations in the ssb network

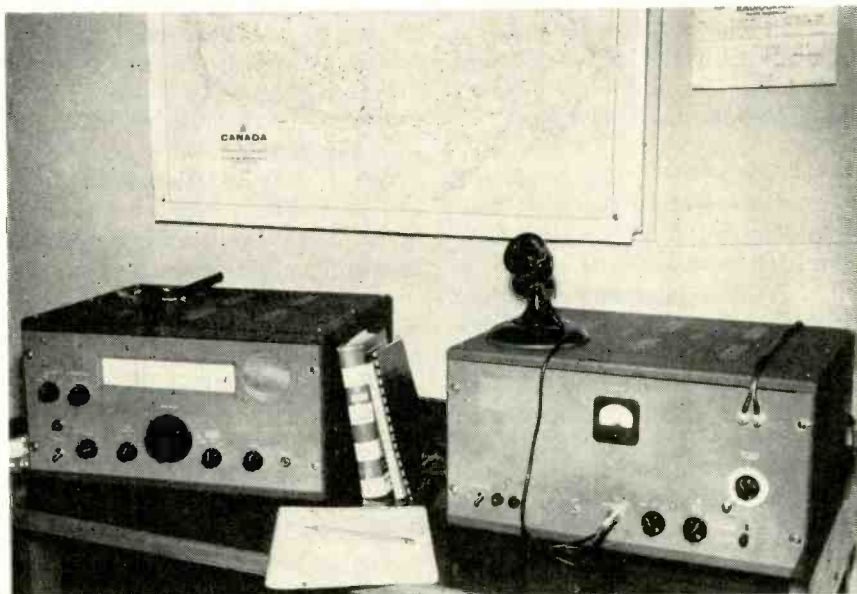

Receiver and transmitter installation used for low-power ssb operation. Black dots on map mark trading posts

the carrier to give a-m output. For c-w operation, the unmodulated carrier is switched to the amplifier stages.

After proper amplification, the 455-kc sideband output is fed to a balanced converter to produce the operating frequency. This converter feeds the final driver amplifier and the final linear stage. Antenna is matched by tapping on a link-coupled tuned circuit.

Although requirements called for a single fixed transmitter frequency, by changing coils the

transmitter is adapted to three different frequency ranges, 1.5 to 2.6, 2.5 to 4.4, and 4.3 to 7.6 mc. Since the operational frequency does not go higher than 7.6 mc, only a single conversion is required from 455 kc to the operating frequency.

The transmitter produces 30-watts peak envelope power in single-sideband operation, 15 watts rms c-w and 6 watts rms a-m carrier. Single-sideband rejection is better than 35 db and cross modulation is better than 40 db. Harmonic distortion is less than 2 per-

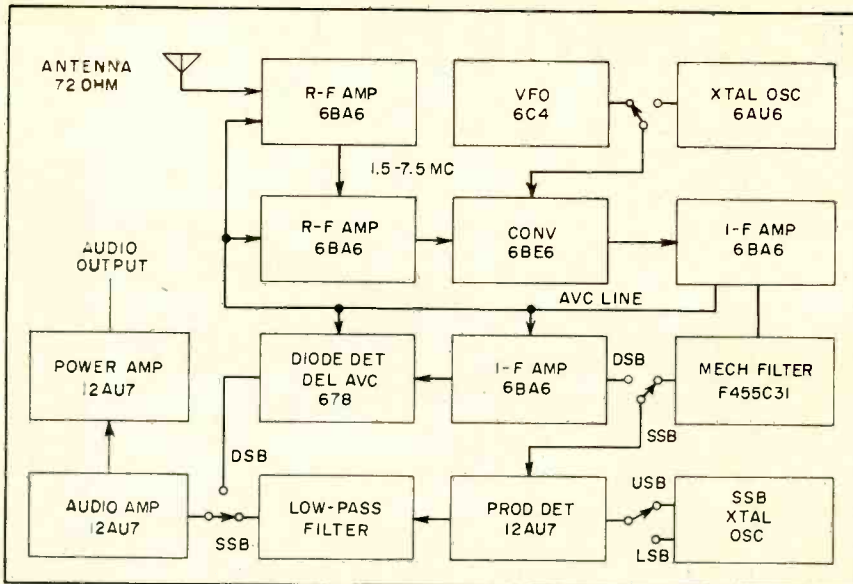

FIG. 3—Receiver tuning range, 1.5 to 7.5 mc, is covered in three bands. A switch selects upper or lower sideband or a-m with diode detection. Continuous wave is received on the upper or lower sideband position

cent with audio response from 300 to 3,200 cycles \pm 3 db. The antenna output is arranged for a balanced 75-ohm line feeding a doublet cut to the operational frequency.

Receiver

The receiver uses the same 455-kc mechanical filter for sideband separation connected as shown in Fig. 3. Crystal-carrier oscillators are located on the skirts of the mechanical filters as shown in Fig. 4. This arrangement calls for retuning the receiver when reception is changed from one sideband to the other. However, a quick switch from one sideband to the other is not usually required.

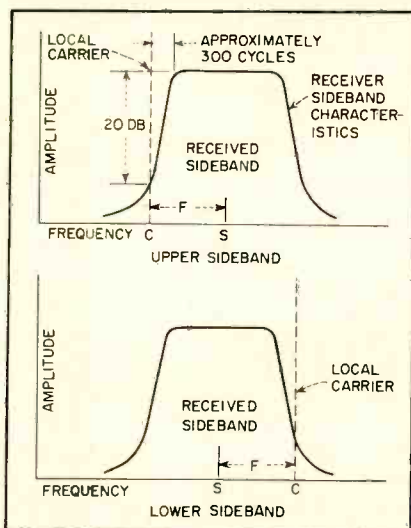

FIG. 4—Sideband filter and local-carrier placement

The tuning range, 1.5 to 7.5 megacycles, is covered in three bands. A switch selects the upper sideband, the lower sideband, or a-m with diode detection. Continuous wave is received on either the upper or lower sideband position.

The receiver input is balanced at 75 ohms for connection to the transmitter antenna.

One stage of frequency conversion converts the operational frequency to the 455-kc i-f system. The mechanical filter provides all of the i-f selectivity with the exception of one transformer. The local oscillator can be either variable tuned or fixed-tuned by any of three crystals.

The crystal carrier oscillators and the sideband filter feed a triple-triode product detector², Fig. 5, for ssb or c-w reception. For avc and a-m diode reception the mechanical filter feeds a diode detecting system. The audio system provides two watts output to a built-in loudspeaker.

Audio response of the receiver is 300 to 3,200 cycles \pm 3 db. Sideband rejection of approximately 30 db is obtained with distortion of less than 3 percent. Cross modulation is better than 40 db.

Performance

This ssb northern radio network, comprising sixty-one stations, has been operating for eighteen months. Reliability of communica-

tion by radiotelephone in the h-f band between stations using low power at ranges of 200 to 500 miles has increased remarkably through ssb. This installation shows that 30 to 50-watt peak-envelope-power ssb stations out-perform 150 to 350-watt a-m stations, especially when radio conditions are poor and qrm is at its worst. During the early hours of darkness when tropical broadcasting and radioteletype make traffic handling practically impossible from 150 to 350-watt a-m stations, these 50-watt ssb stations continue to pass traffic.

With sideband suppression of 40 to 50 db, it is practical to operate one section of the radio network on the upper sideband and another section on the lower with no appreciable interference between the two sections, even though many of the stations on the opposite sidebands are separated by distances ranging from 200 to 250 miles. This indicates the practical appeal of ssb transmission for government agencies and private firms as it

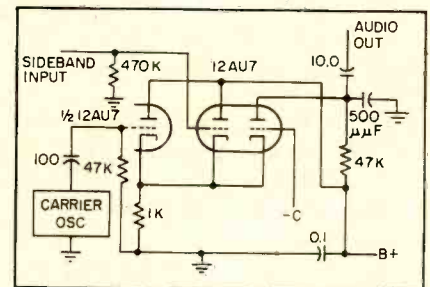

FIG. 5—Triple-diode product detector in receiver is used for ssb and c-w detection

gives two frequencies for any one frequency assigned in the very congested h-f radio spectrum.

Reliability is increased due to the complete use of receiver-type tubes other than the AB₂ linear amplifier, both in the transmitter and receiver the absence of high-wattage primary power and the use of mechanical filters in the generation of the sideband. Good reliability is of great importance to any communication system operated in extremely isolated areas by nontechnical personnel.

REFERENCES

- (1) M. G. Crosby, Transformerless Single-Sideband Balanced Modulator, *Proc IRE* p2A, Dec. 1956.
- (2) M. G. Crosby, Reception with Product Detectors, *QST* p 20, May 1956.

MINIATURIZATION of Electronic Equipment

By **DAVID A. FINDLAY**
Associate Editor

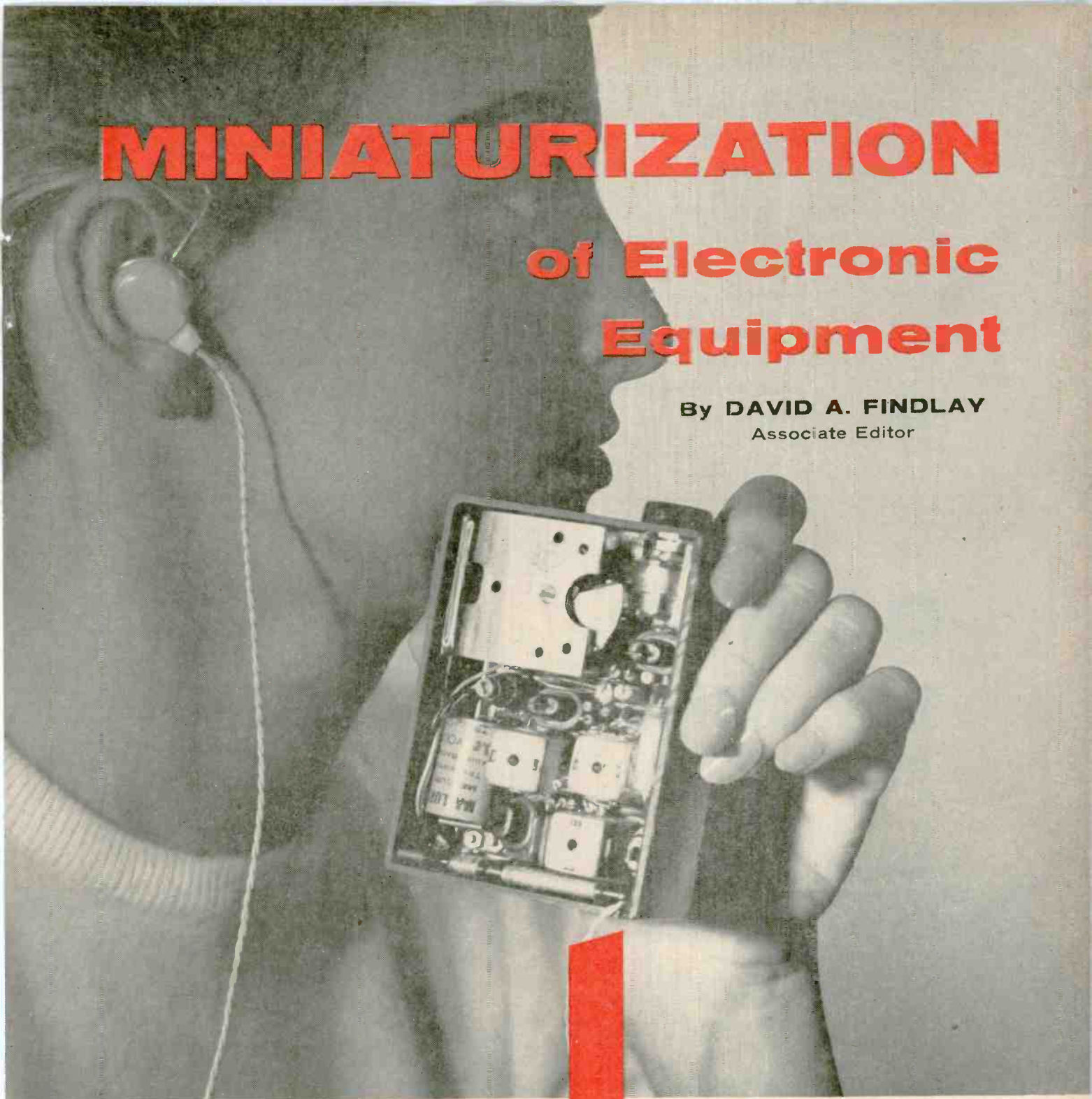

Superheterodyne Receiver by Westbury Electronics

DESIGN	page 178
MATERIALS	185
CABLES AND CONNECTORS	186
CIRCUIT COMPONENTS	188
MAGNETIC COMPONENTS	191
ELECTROMECHANICAL COMPONENTS	193
PANEL COMPONENTS	195
POWER SUPPLIES	196
RELAYS	199
TUBES AND TRANSISTORS	200
PRODUCTION	202

An
electronics
Special Report
OCTOBER 1, 1957

MINIATURIZING *electronic equipment is not just a matter of making the system smaller. As a device is made smaller accessibility goes down and rejection rate, operating temperature and cost generally go up.*

The increasing amount of equipment carried on military aircraft and ships has made it necessary for the design engineer to cram more equipment into less space. In civilian equipment, such as computers, the number of components alone makes miniaturization essential if the computer is to be housed in a reasonable-sized building.

With signal circuits miniaturized, there still remains a problem of power handling equipment. To achieve maximum usefulness from miniaturization, all elements of the system must be reduced to the same order of size. New design techniques, components and production methods have been developed to aid the designer in reaching this goal.

DESIGN for Miniaturization

Techniques for putting more equipment in less space

DESIGN In design of miniaturized equipment many other factors must be considered before the final arrangement of the miniaturized unit can be decided. For military equipment, the Signal Corps Engineering Laboratories consider reliability, performance, repairability and size in that order of importance.

To obtain reliability in miniaturized design, components must be of high quality. As components are miniaturized, it is more difficult to manufacture them with a low rejection rate.

In a typical computer printed-circuit board the rejection rate may be one out of nine. By reducing the size of this board to one quarter its present size the reject rate will go up to one out of three.

The temperature extremes that the components will be exposed to are an important factor in reliability. In miniaturized circuits these temperatures are likely to be higher than in a conventional assembly.

Accessibility for repair must also be considered. If cost is not a factor or if the unit is too complex for repair by a relatively unskilled technician, it may be desirable to design it as a throw-away unit.

However, if the unit is to be repaired, means must be provided for reaching the components. This can be done by using subassemblies, either separate printed-circuit boards mounted on the main board or by the use of throw-away plug-in package components containing resistors, capacitors and various other networks that can be easily removed and replaced.

In an airborne computer designed by Epsco, accessibility to electron tubes is obtained by using a removable slide-on cover over the tube section. The cover provides a double service of heat dissipation and physical protection. Once the cover is removed the subminiature tubes are accessible in specially designed tube bases. The subminiature leads are clipped to fit. The metal housing insures that the tubes will remain firm in their sockets.

In this same computer, surface area of the printed-circuit board is conserved by mounting resistors on end as shown in one of the photographs. The upper lead of the resistor is folded back to the surface of the board. This method saves circuit board area and does not increase the height of the package,

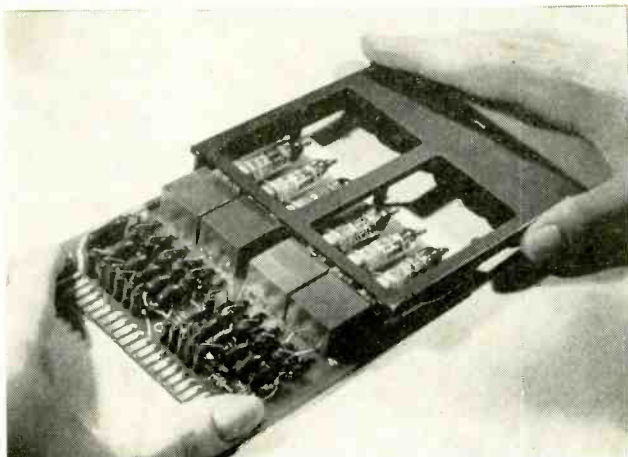

Printed circuit section for Epsco airborne computer uses metal housing to provide support for printed circuit and serve as heat sink for vacuum tubes

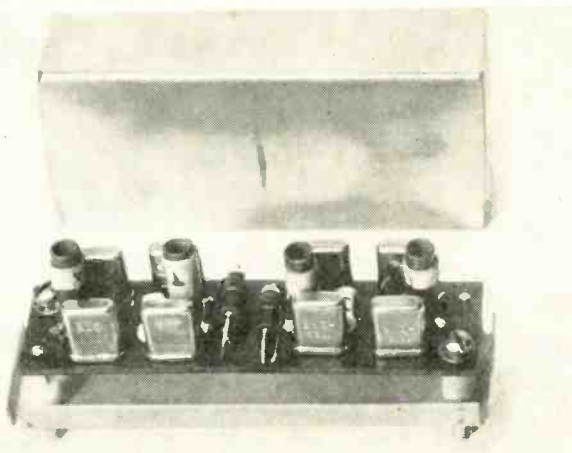

Crystal filter developed by Hycon permits elimination of double conversion stages in receiver to give smaller package by using less components

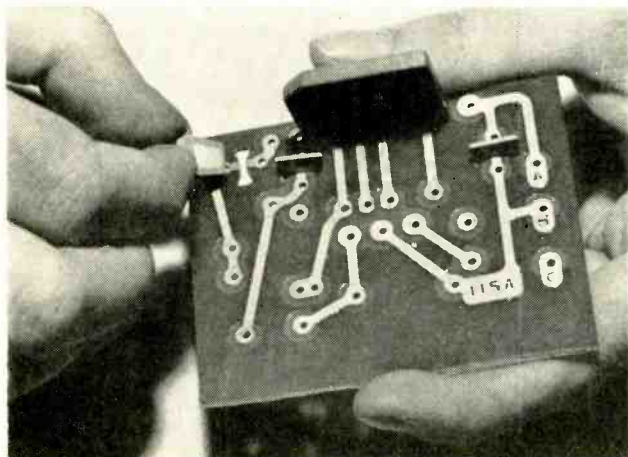

Capacitor insertion technique developed by GE uses wedge-shaped capacitors that can be dropped into printed-circuit board slots by automatic machinery

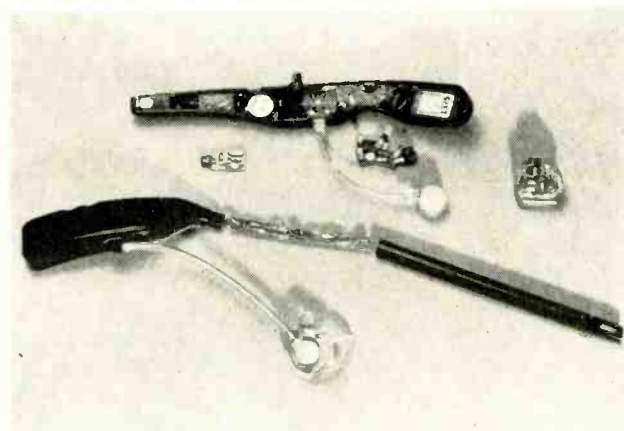

Three ways to package hearing aids are Acousticon earpiece construction (top), Beltone printed circuit (bottom) and Sonotone unit on small chassis at right

since the encapsulated transformers mounted on the same board occupy as great a height.

PRINTED CIRCUITS—The printed-circuit board has become an important adjunct of miniaturization. Providing a chassis as well as wiring interconnecting components, printed-circuit boards can be designed to fit into similarly shaped packages. The relative closeness of these individual packages is determined by the height of the components above the circuit board. This height is determined by the largest component on the board. There is little use in using one or more miniaturized components on a board if one large unit destroys space saving.

A technique for using printed-circuit subassemblies is illustrated in one of the photographs. These potted metal-cased subassemblies made by MF Electronics can be used in electronic printed circuits to provide a complete amplifier, flip-flop or multivibrator in a minimum of space. Only four or five leads need be connected into the printed-circuit board.

The Erie Resistor Co. has developed a system of

package assembly using clip boards and printed circuits to build up a component package. Resistors and capacitors are inserted in clips and the entire unit is encapsulated. Vertical mounting of the components provides more components per unit surface area on printed circuit boards. The flexibility of the packaging system permits a wide choice of circuit designs.

For development work a kit supplied by the company permits the engineers to construct an actual size package for testing and experimentation.

The packaged assembly circuit provides a component density of 15 units per sq. in. of chassis area.

A three-dimensional modular construction system developed by the Ainsley uses two interlocking printed circuits in a cross shape as shown in the illustration. The board is arranged to accept a subminiature vacuum-tube socket on the top of the crossed circuits. The lower end of the board is connected to a socket for plugging into a conventional metal chassis. In assembly, the printed-circuit boards can be mounted with components and dipped in the usual manner. The boards are then interlocked and

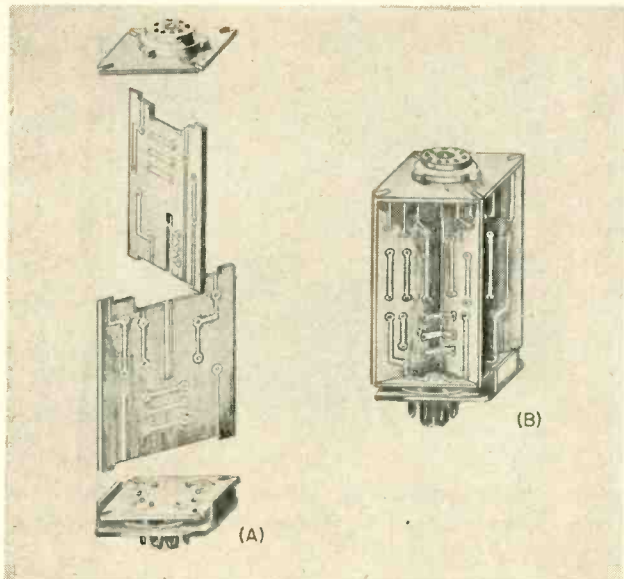

Crossed printed-circuit boards provide a three-dimensional circuit mounting arrangement in Ansley design

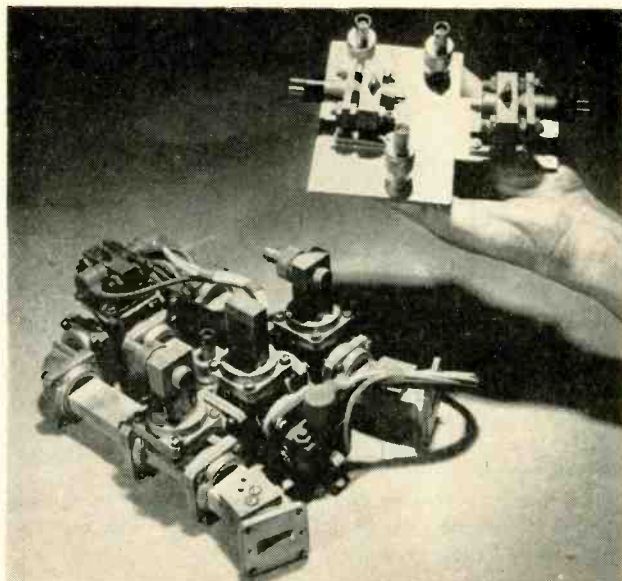

Printed-circuit microwave front-end assembly by Sanders weighs 12 oz as compared to 14 lb for waveguide construction

any cross-over connection from one board to the other is made. This includes connections from the tube socket board and the base plug.

In a molded printed-circuit system developed by Westinghouse for use in airborne electronics, a standardized panel has been developed using a 1/10 in. grid system. Conductor paths are etched on the laminate and holes for connecting leads for components are punched from a universal template. The standardized spacing permits prebending of component leads in jigs and insures proper fit when inserted.

MICROWAVE—Miniaturization of microwave circuits has been achieved by the use of printed strip circuits. In the system shown in one of the photographs a photo-etched microwave unit occupies roughly 1/75th the space required for the waveguide counterpart. This flat strip unit weighs 12 oz. as compared to 14 lb for its conventional counterpart.

This radar front-end assembly consists of two klystrons and three connectors, has a volume of 24 cu in. as compared to the waveguide unit's volume of 1,800 cu in.

Where various assemblies are located in widely separated points, accessibility for testing and repair can be obtained by the use of flexible flat cable conductors. The Tape Cable system shown in one of the photographs uses a 50-conductor cable as the main supply to three 9-contact plugs and a 14-contact plug. A 9-contact printed-circuit board with a strain relief is used for making wire connections. The plugs used in the system are made by Elco and Tape Cable. Use of this type of cable permits installations where cabling space is severely limited. It also makes possible the removal of the units with cables attached for testing and inspection.

The conductor pattern has been set up with a standard 0.1-in. center spacing. Nine sizes of cable have been established, including 9, 14, 17, 30, 40 and 50 conductors.

The standard size conductor is 0.0015 in. by 0.03 in. This gives a conductor density of 1,160 conductors per sq in. cross section. A 100-ft roll of 50-conductor cable weighs 2½ lb. Interconductor capacitance is less than 5- μmf per ft. Grounding alternate conductors will reduce the capacitance to less than 1 μmf per ft. The tensile strength of the tape cable is 80 lb per inch of width.

Advantages claimed for flat cabling are that all conductors may be dip soldered simultaneously to a printed-wiring chassis or plug and that there is less danger of cabled wiring being interchanged at the connections since the flat construction makes it difficult for wires to be crossed. The tape is available in lengths up to 1,000 ft on a roll.

In a Stromberg-Carlson project, printed-circuit boards are mounted in a book arrangement using flat cable at the hinge to supply connections between boards. This technique permits movement of the boards for inspection and testing while connected to the circuit.

A modified form of the NBS Tinkertoy system developed at Sanders Associates, Inc. uses ceramic wafer construction with Mylar capacitors and pre-cured encapsulated tape resistors. These components can be mounted directly on the ceramic sections of the module. Unlike the original tape resistors used in the Bureau of Standards module, wire leads are used on the Sanders resistors and capacitors. The Mylar capacitors, approximately ½ in. square and 1/16 in. thick, are available in values ranging from 0.0056 μf 0.022 μf . The resistors have the same thin flat form as the prototype tape resistors and are rated at ¼-watt dissipation at 150 C. They are encap-

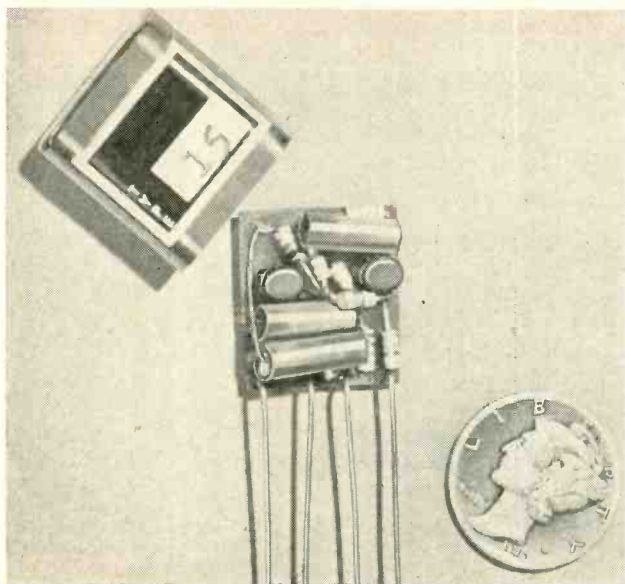

Printed-circuit subassembly by MF Electronics provides complete flip-flop, multivibrator or amplifier stage

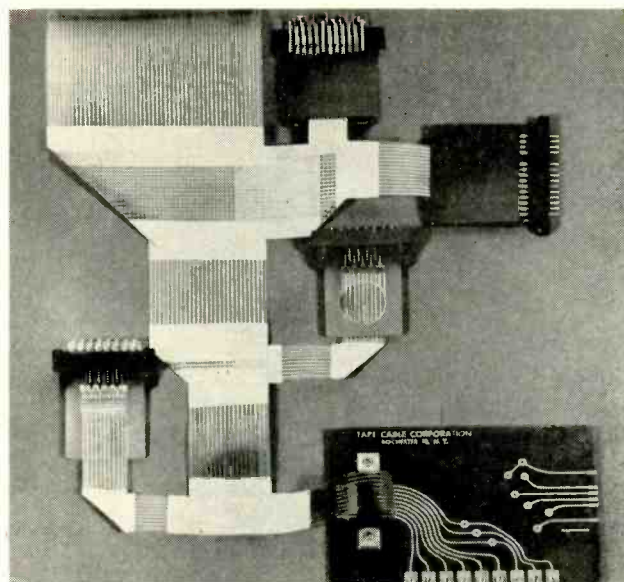

Harness by Tape Cable provides flexible flat 50-conductor interconnection system. Panels on plugs are strain-reliefs

sulated in a plastic sheath for environmental protection.

In the design of packaged building blocks for computing applications, Hoover Electronics Company has standardized the shape and size of the building blocks to permit compact assemblies. The units available are phase-sensitive modulators, operational mixers, subcarrier oscillators, flip-flops, shift register elements, counter elements and other devices required in computing systems. The units are housed in packages $\frac{1}{8}$ in. x $\frac{1}{8}$ in. x $2\frac{1}{4}$ in. The housing acts as an electrostatic shield and protects the components physically. The building block is plugged into a 9-pin miniature socket. The standardized size of the units permits close packing.

Another means of miniaturization is by the reduction of the number of stages necessary to perform an operation. In conventional mobile radio, it is necessary to use two or three frequency conversions before reaching the frequency at which adequate selectivity can be achieved. By the use of crystal filters and crystal discriminators such as those made by Hycon, single-conversion receivers are possible. This technique offers savings in size and power requirements. In a typical application three vacuum tubes and an oscillator crystal are eliminated by the installation of a crystal filter system. As the crystal filter is approximately one-quarter the size of a conventional L-C filter it replaces, there is an additional saving at this point also.

SIX DESIGN TRICKS—The antenna loading coil shown in the photograph is a variable inductance wound with plated copper wire from a grounded drum to an active dielectric cylinder. The two cylinders are driven by a common spring-loaded gear drive. Over a frequency range from 25 to 52 mc,

inductance is changed from 3.0 mh to 0.1 mh. The Q is greater than 50 at 52 mc and greater than 225 at 24 mc. The 2 in. x 2 in. x 3 in. unit can handle 25 watts. The unit was designed by Alto Scientific Company.

The four miniature chassis shown in the next photograph illustrate the techniques used by hearing-aid manufacturers to fit amplifiers into eyeglass frames or other types of compact units that fit the ear.

The Sonotone ear unit at the top of the picture is constructed on a $\frac{1}{2}$ in. x $\frac{3}{4}$ in. printed-circuit chassis. Component leads are used to hold 3 transistors and 11 miniature resistors and capacitors in place. A 1.5-v mercury battery is mounted at the upper end of the chassis.

The two irregularly shaped chassis in the center are separate stages of the amplifier used in the Acousticon eyeglass-frame hearing aid. Another photograph shows how these units mount in the earpiece. Both sections use a laminate base for component mounting but without a printed circuit. Component leads are used to provide interconnection on the bottom side of the board.

The 3-stage transistor amplifier for the Beltone hearing aid fits into a tubular eyeglass frame. The three transistors, five resistors and three capacitors are mounted on a flexible $\frac{1}{4}$ in. by $2\frac{1}{4}$ in. printed-circuit board made by Photocircuits for this application.

In preparing subminiature transformers for potting, strip-foil can be used to eliminate magnetic hum. A length of foil is cut as shown in a photograph and the transformer is placed at the junction of the two sections. To eliminate gaps that might permit hum the same strip is used to wrap the transformer. The same technique, developed by Magnetic Shield, can be used for shielding vacuum

SIX DESIGN TRICKS

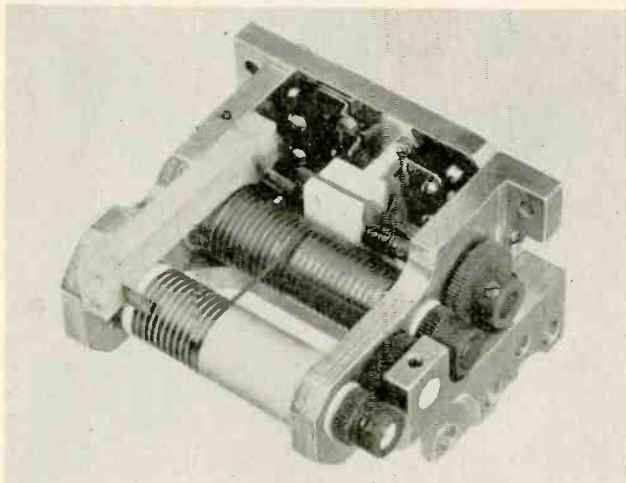

VARIABLE INDUCTOR in compact package is varied by transporting winding from shorted drum to dielectric cylinder. Inductance range is from 0.1 to 3 mh in this Alto design

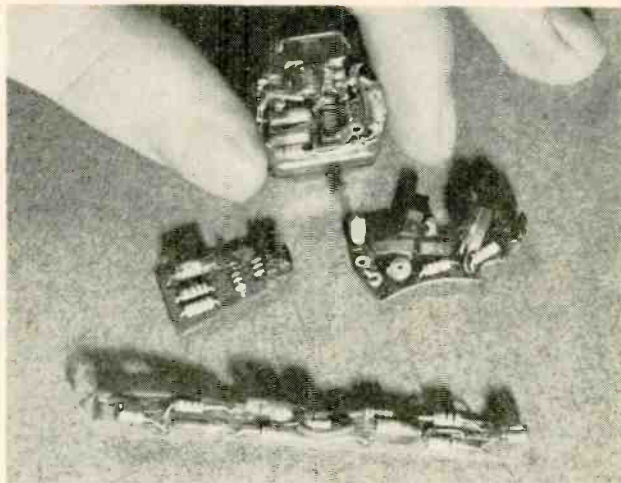

SHAPED CHASSIS for Sonotone, Acousticon and Beltone hearing aids mount components to make best use of available space. Board at right center carries specially designed switch

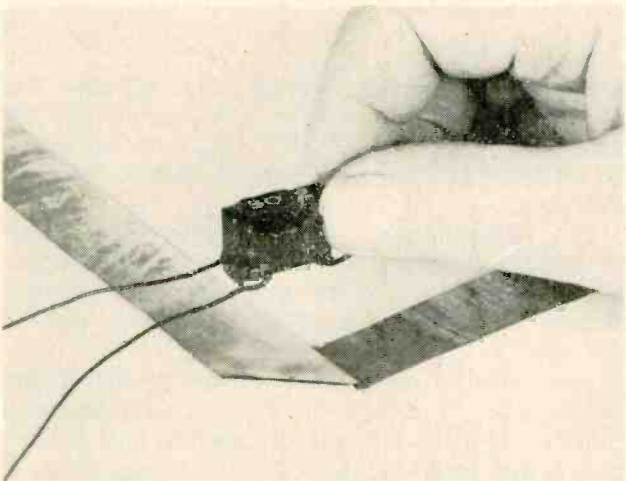

SHIELDING MATERIAL in thin strip made by Magnetic Shield is wrapped around transformer in two directions to make compact package. Folding strip at center eliminates possible air gap

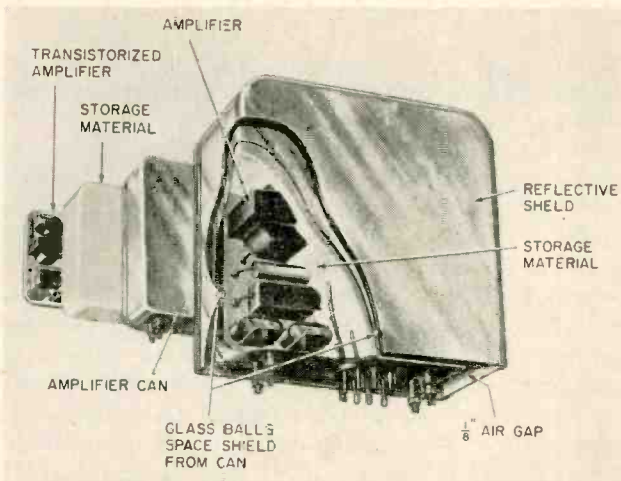

HEAT STORAGE materials around transistor amplifier in Minneapolis-Honeywell design maintains constant temperature for long periods by high heat absorption at melting point

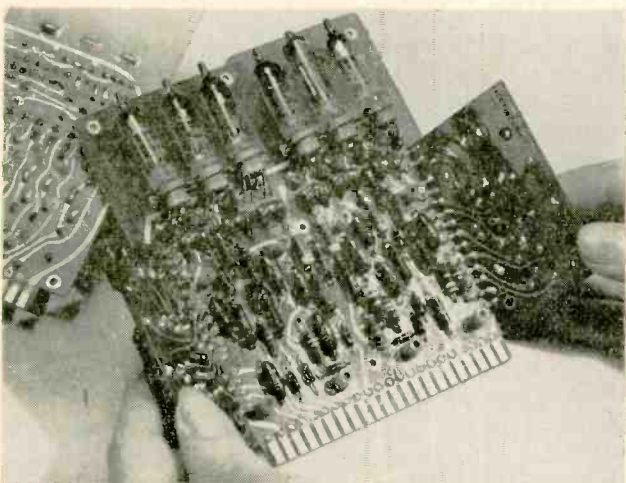

SUBASSEMBLIES mounted above main board in Epsco computer are hinged on spring wire connectors that serve double purpose of hinge and electrical connector between boards

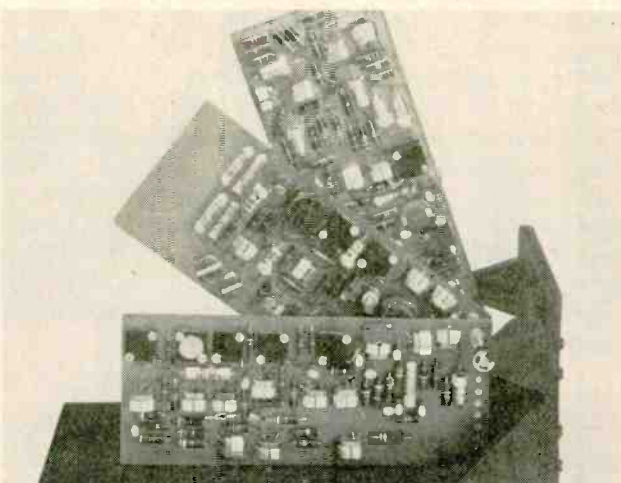

ACCESSIBILITY of printed-circuit boards in Texas Instrument airborne telemetering system is obtained by mounting the boards on a bar to permit rotation to a vertical position

tubes, choppers, relays and similar equipment.

High-temperature protection of electronic components can be obtained by using a heat storage material surrounding the device. This material should be selected to have a melting point near the maximum operating temperature of the device. The material acts as a reservoir during high-temperature conditions and returns heat to the device when the ambient temperature is lower.

A transistor amplifier using this technique has been designed by Minneapolis Honeywell. The unit is designed for application in an autopilot. As shown in the illustration, the heat storage material forms a layer around the entire amplifier. Melting point of the material is 215 F. The outer can of the unit is chrome plated and highly polished to act as a radiation shield.

In tests at 350 and 500 F, operating temperature was maintained practically constant for periods of 19 and 9 minutes respectively.

Subassemblies are hinged above the main circuit board in a computer designed by Epsco. At the outer edge of each subassembly a series of springs connect the circuits of the lower board to the circuits of the upper board. These spring conductors also serve as a hinge on which the upper board can be swung back to expose all the components on the lower board plus the lower side of the upper circuit board.

Packaging of a transistorized missile telemetering system under development at Texas Instruments uses a bar as the rotating point for three etched-circuit boards containing a low-level amplifier, two phase-error detectors and the modulator. This packaging arrangement permits ease of maintenance and testing of the structure.

SIX WAYS TO SAVE SPACE—In a subminiaturized transistor position servo amplifier shown in the photograph, General Precision Laboratories has used a circular wrap-around design to save space. The flexible printed circuit wrapped around a Kearfott servo motor allows cooling air to pass through the annular space between the amplifier and servo motor to obtain greater cooling efficiency.

The three-deck Texas Instrument binary storage unit is an example of space saving by the use of high-component-density packaging. Resistors and capacitors used occupy no more vertical height than the transistors. Area on the printed-circuit boards is saved by vertical mounting of these components. This method gives considerable saving in printed-circuit size with no increase in the height required for the complete unit.

In the diode cartridge and conductor matrix shown in one of the photographs a plug-in diode cartridge assembly is used. This system was developed by the Methode Manufacturing Corp. for use in an automatic credit-checking device. The cartridge housing a diode is inserted into the two-sided etched wiring matrix to connect the vertical bus bar on the bottom side of the panel through the diode to a

horizontal bus bar on the top side of the matrix. The cartridge which is attached or removed by a 90-deg twist after insertion into keyed holes, provides a triggering device which can be inserted at any desired intersection coordinate in the matrix to provide yes or no answers. The cartridges are approximately 3/16 in. in diameter and 1/4 in. long. Matrix spacings can be as little as 1/4 in. A matrix employing up to 10,000 individual positions in 100 x 100 configuration can thus be made in an area of approximately 26 x 26 in.

In a miniaturized transistor servo amplifier designed by M. Ten Bosch a terminal board is used with components mounted through the board to save space and increase rigidity of construction. The power transistors are overlapped on an L-shaped bracket mounting to obtain rigidity, optimum weight distribution, efficient heat conduction to the heat sink and use of minimum space. Temperature compensation permits a wide range of operation from -55 C to + 125 C. Metallized paper and tantalum capacitors are used as well as tuned 60-cps or 400-cps transformers for minimum size. Up to 9 watts controlled power is available in a plug-in package 1 1/8 in. x 1 1/8 in. x 3 1/8 in. Weight of the total package is 7 oz.

An example of miniaturization by redesign using miniature components in place of conventional size units is shown in the photograph of two miniature bridge balance and calibrating units. Both devices are identical in operation. The only difference in these two units made by B & F Instruments is that the smaller unit uses components selected for their miniature size. Further size reduction could have been effected but would have required the use of under-rated components and elimination of some operational features. The volume of the new unit is 20 percent of that of the previous design. Wattage ratings are the same.

In the voltage regulator system shown in one of the photographs an H-shaped frame is used, with the servo motor and similar components placed in the center section. This section includes an in-line motor, damper, gear train, and induction potentiometer. These are located in the upper section. In the lower section an insulated compartment contains the reference, generation, sampling and comparison circuits.

The remaining area available in the lower section contains a 60-watt power supply. Two transistor chassis are supported on either side of the H-frame with one package serving as a servo amplifier and the other as the summing amplifier. The transistors are mounted on an insulated channel at the top of the package. The system designed by the Emerson-Electric Company of St. Louis maintains a 115-volt, 400-cps reference signal for an airborne electronic computer within 0.25 percent of the nominal signal value.

The unit weighs less than 5 1/2 lb and occupies a space of 4 1/2 in. x 5 1/2 in. by 9 in. The two separate sub-chassis for the transistor amplifiers simplify maintenance of the equipment.

SIX WAYS TO SAVE SPACE

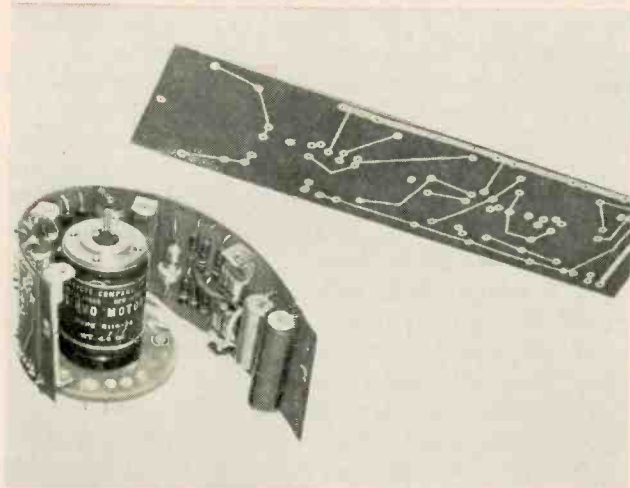

WRAP-AROUND printed-circuit amplifier by GPL surrounds the associated servo motor. Design also provides air passage between motor and components for cooling air

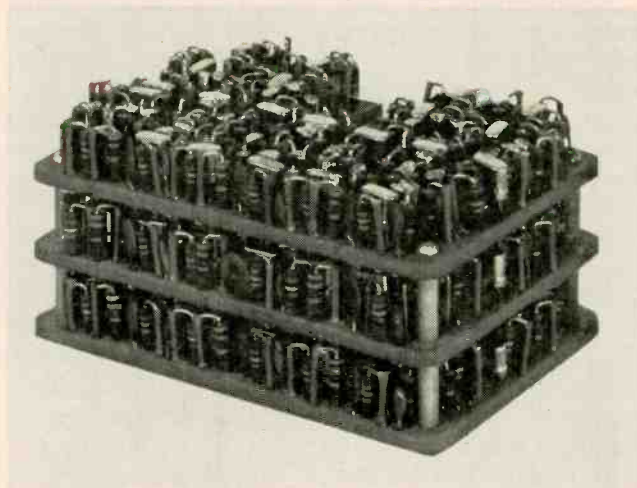

HIGH-DENSITY packaging of Texas Instrument binary storage unit uses on-end mounting of resistors and capacitors to get maximum use of volume without increase in stacking height

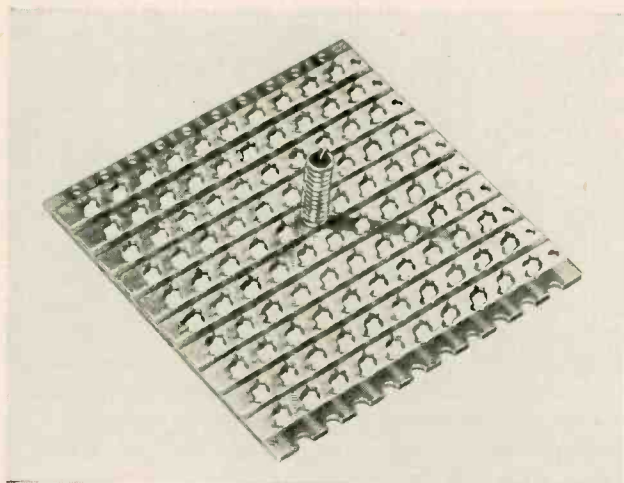

DIODE MATRIX developed by Methode using two-side printed-circuit board has high packing density by use of plug-in diode cartridge that connects diode between circuits on either surface

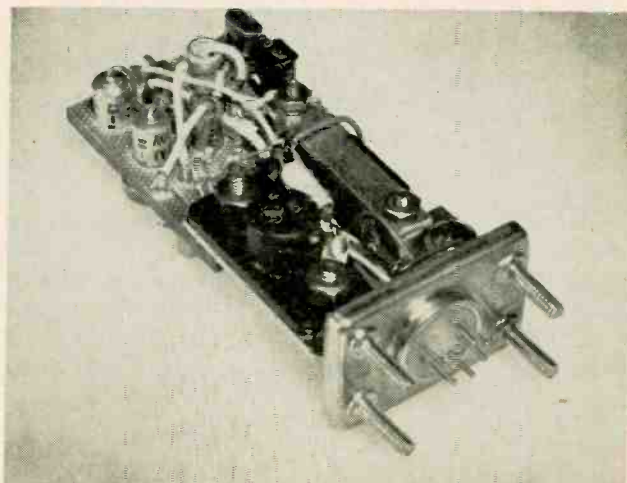

TERMINAL-BOARD construction by M. Ten Bosch mounts large capacitors through holes in board to make maximum use of available volume in modular construction

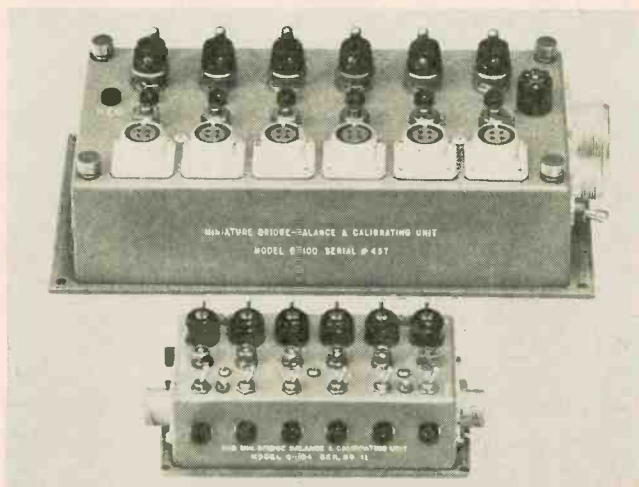

COMPONENT DEVELOPMENTS permit miniaturization of B&F bridge balance and calibrating unit. This instrument has been miniaturized by selection of components.

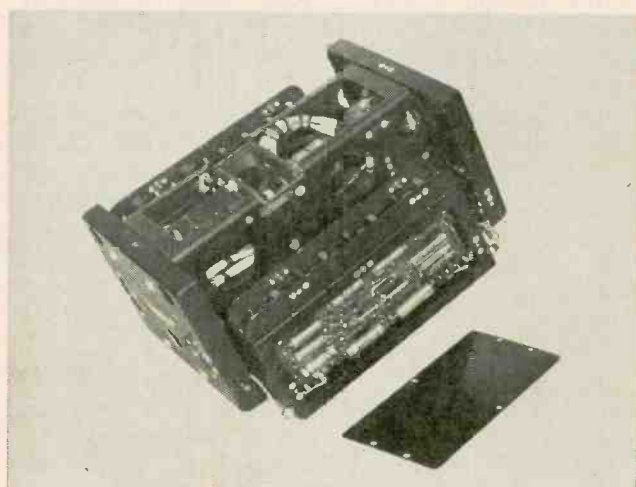

CHASSIS DESIGN by Emerson-Electric with servo motors and power supply mounted in center of H-shaped unit has transistor amplifiers on subchassis that fit into either side

MATERIALS for Miniaturization

Chemistry, metallurgy and other arts
are keys to smaller size

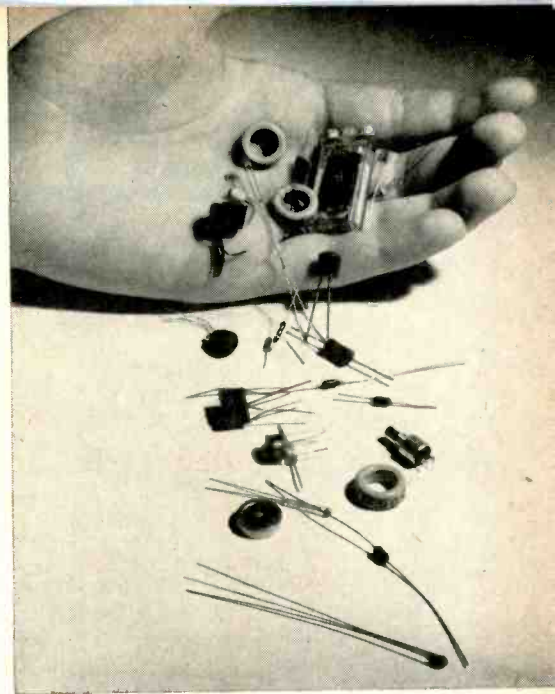

VOLUME—New ceramic and plastic materials and techniques for producing smaller parts from these materials has been essential to miniaturization of components. Typical volume requirements for some miniaturized components are given in the table.

CIRCUIT COMPONENTS—With the development of new and better dielectric materials, capacitors are packing more capacitance into a smaller volume. In transformers, wire insulation is a critical factor in the number of turns that can be placed on a miniature core. With thinner insulation, the problem of voids in the insulating material becomes more critical and closer quality control is necessary to produce a uniform product.

In power supply equipment, development of the power transistor has aided greatly in reducing the bulk of power supplies and converters. Silicon diodes have reduced the size of power-handling rectifiers, and the new ceramic tubes are approaching a size comparable to transistors.

TRANSDUCERS—Miniaturized amplifiers for control circuits require input and output devices that

will match them in size. Manufacturers of transducers, pickups, sensing devices, servos and similar units have matched the electronics designer in the development of smaller components. With cables and connectors, efforts have been made to bring the size of the cable down to a size comparable to that of the equipment it feeds.

The shrinking size of panels has reduced the space available for potentiometers, switches, plugs and jacks. The volume of these components has been reduced to fit the diminishing area.

Flexible cable developed from printed-wiring techniques provides a flat cable that can be used in very small spaces. One particular application for this type of cable is as an umbilical cord for missiles.

MATERIALS—New machining techniques have made it possible to achieve 0.0005-in. tolerance on parts made from Teflon and Kel-F. Some insulators, made using a technique developed by Tripoint Plastics, have a wall thickness of less than 0.008 in., an outside diameter of 0.062 in. and an inside diameter of 0.012 in. Complex tapers, undercuts and shoulders can also be incorporated to enable the insulator to function as a structural member or further reduce mass and weight of final assembly.

In molded nylon bobbins a technique developed by American Molded Products permits the accurate molding of parts to close tolerances in miniature sizes. Nylon forms with thin wall sections having strength and toughness can be molded into intricate shapes, including spots and holes for wiring lead entries.

In vitrified ALSiMag ceramic, cylinders for miniaturized resistors capacitors and similar units can be obtained as small as 0.109-in. outside diameter by 0.075-in. inside diameter and 0.3-in. in length. Both inside and outside can be metallized in volume production. Using glass as a base, Corning Glass produces metallized glass inductances that have negligible drift in high-frequency tuning circuits under extreme temperature changes. Miniaturization of

Parts Densities for Transistor Equipments

Item	Approx Number of Parts Per Cu Ft
Transistors (2N96)	50,000
Resistors	3,000,000
Ceramic Capacitors (less than 100 $\mu\mu\text{f}$)	2,000,000
Ceramic Capacitors (greater than 100 $\mu\mu\text{f}$)	450,000
Diodes	600,000
Capacitors (15 μf , tantalum)	75,000
Glass Capacitors (greater than 510 $\mu\mu\text{f}$)	350,000
Transformers	30,000
Single Tuned I-F Transformers	60,000

CABLES

and CONNECTORS

Flat cable and new miniaturized connectors give circuit packaging flexibility

COAXIAL CABLE—Miniaturization of electronic equipment has required miniaturization of r-f coaxial cables and connectors as well. Subminiature cables of 50, 75 and 95-ohms impedance with dielectrics of polyfluoron, polyethylene and Teflon are now available.

With the reduction in size of these cables, a reduction in power rating has also been necessary. In an investigation of 6 subminiature coaxial cables, Amphenol has determined maximum ratings based on safe operating temperature of the particular cable dielectric material. Table I shows the dielectrics and dimensions of the cables. Power handling capacities are shown in the graph.

PRINTED CABLE—Flexible printed cables have been developed by Sanders Associates, Tape Cable Corp., Methode Co. and J. Frank Motson Co. These cables use a flexible base with copper conductors printed or imbedded in the material.

In the Sanders cable, Kel-F plastic is used in thin sheets to provide a flexible base. Glass cloth can be used in the lamination of this material to increase strength and high temperature stability. By laminating layers of the base material, additional conductor layers can be built up. Depending on flexibility required, the stacked cables can be fabricated up to 5 layers high. In these stacked cable circuits the insulating layer between circuits should be a minimum of 5 mils thick when using 2-oz copper foil as conductors.

CABLE CONNECTORS—A new miniature printed-circuit connector designed by Elco is made for a line spacing of 1/10 in. on the printed circuit. Two rows of contacts are spaced 0.2 in. apart and the shifted 0.1 in. in relation to each other. The connector is available in sizes from 5 to 47 contacts.

Subminiature connectors with a flashover voltage level of 1,800 v are designed by Cannon. This is the voltage at which flashover may occur between two contacts, or between a set of contacts and the shell of the connector. These hermetically-sealed connectors have a maximum leakage rate of 1 micron cu ft per hr at a pressure differential of 1 atmosphere.

In a miniature connector designed by DeJur-Amsco Corp., an 11-contact unit has an overall length of approximately $\frac{3}{4}$ in. and a width of $\frac{1}{4}$ in.

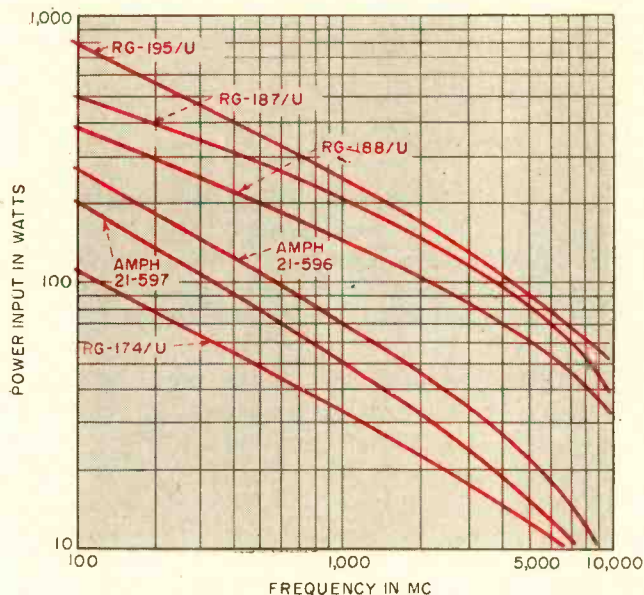

Power handling capabilities of subminiature Amphenol Teflon dielectric cables at various frequencies

SUBMINIATURE R-F CONNECTORS—Subminiature connectors for r-f cables are available that are from $\frac{1}{2}$ to $\frac{1}{3}$ the size of conventional units. In the Subminax connectors made by Amphenol, Teflon or glass-Teflon is used as the dielectric material.

The Glennite model C-21 coaxial-cable connectors are 0.565 in. in diameter and 1 in. long. They occupy only $\frac{1}{4}$ the volume of a comparable conventional size unit. Weight of a total connector is 6 grams. These units. Weight of a total connector is 6 grams.

The Dage Series DM miniature coaxial cable connectors are designed to provide weatherproof operation. Silver plating on metal parts of 0.002 in. thickness provides firm contact. Miniature and subminiature connectors made by Kings Electronic Co. are designed for operating temperatures as high as 350 to 450 F. The units mount in a $\frac{1}{2}$ in. panel hole.

A miniature high-temperature electrical connector designed for operation at high altitudes is supplied by the Glendale Division of Consolidated Electro-dynamics. Construction used in these connectors provides a long creepage path between pins despite small connector dimensions. Each pin and mating con-



Printed-circuit cable connector by Elco attaches 17-conductor cable to circuit board. Flat cable passes through strain-relieving grip on plug

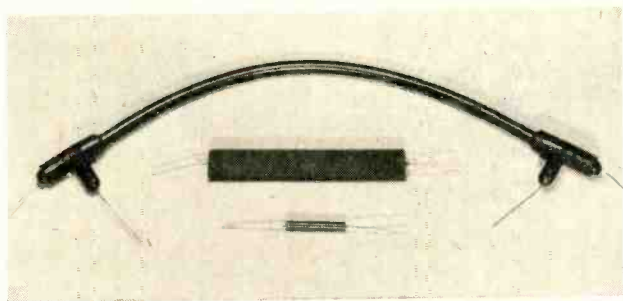

Three Columbia delay lines having equal delay time of 0.1 μ sec. Lengths for this delay are 17 in. (top), 5½ in. (center) and 15/8 in. (bottom)

connector is surrounded by Teflon. Three separate seals are provided on these units. One is around the entering wire, another around each pin connection, and the third is at the interlocking faces. This assures an insulation resistance of 10^9 megohms.

A miniature coaxial connector made by Microdot is available in 50, 70 and 93-ohm sizes. The connector weighs 0.08 oz. and is less than ½ the size of NC connectors. Cable diameters as small as 0.06 in. can be used with these push-on type connectors.

Standoff and feed-through type terminals have also been miniaturized. Overall length of a standoff designed by Seaelectro is only 0.45 in. The feed-through type units are 0.515 in. in length. Terminals are rated at 750 volts at sea level with a 3,000-volt flash-over point. Teflon body material is used.

For hermetic-seal terminals, physical size is not the only requirement. Electrical performance must be equal to or superior to that of large terminals. To make a good sealing material, a material must be

heat-resistant, sealable with high-dielectric strength, insulation resistance and corona resistant.

Hermetic seal terminals made by the Sphere Company use a sintered Teflon glaze on a steatite ceramic. This provides a moisture absorption factor approaching zero and almost complete elimination of electrical surface leakage during polarization tests. Coating the steatite with Teflon reduces the cost of the complete unit to less than that for steatite glaze.

DELAY LINES—Miniaturization in delay lines has made great advances in recent years. A delay cable of the RG-65/U type has an impedance of 950 ohms with a delay of 0.04 μ sec. A length of 2.5 ft of cable with an outside diameter of 0.4 in. is required for a delay of 0.1 μ sec.

Using a magnetic core to increase the unit inductance, a line with an impedance of 4,500 ohms and a delay of 0.08 μ sec per ft can be made. A length of 1½ ft is required for a delay of 0.01 μ sec. A new delay line developed by Columbia consists of a resin encapsulated round stick with a diameter of 0.25 in. and a length varying from 1 in. to several inches depending on delay time. The units have a fast rise time, small ripple ratio, linear phase shift and are rated for operation from -55 C to +125 C.

Three delay lines, having similar properties, are shown in the photograph. Delay of all three units is 0.1 μ sec. Length of the larger unit is 17 in. The center unit is 5½ in. in length and the smaller unit is 1½ in. long.

A high-impedance miniature delay line manufactured by Advance Electronics has a physical size ¼ in. in diameter and from 1.5 to 6.5 in. in length depending on delay time. Characteristic impedance from 1,500 to 4,000 ohms are available with useful bandwidths of over 8 mc. Delay times of over 0.6 μ sec are available. Weight is less than 6 oz.

The Valor Electronics Co. delay line is a metal tube 1½-in. long \times ⅜ in. diameter. This houses a 0.25 μ sec delay line having a rise time of 0.07 μ sec.

The delay line uses subminiature toroids for the inductive elements and temperature compensating disk capacitors for the capacitive elements. The size of each delay section in a typical delay line is 0.35 in. in diameter by 0.12 in. in thickness.

Characteristics of Miniature Cables

Cable	Dielectric	Inner Cond Dia	Core Dia	Outer Cond Dia	Cable Dia	Z ₀
Amphenol						
21-596	Polyfluoron	0.019	0.060	0.085	0.100	50
RG-174/U	Polyethylene	0.019	0.060	0.085	0.100	50
Amphenol						
21-597	Polyethylene	0.017	0.100	0.125	0.150	75
RG-187/U	Teflon	0.012	0.063	0.080	0.110	75
RG-188/U	Teflon	0.020	0.060	0.080	0.110	50
RG-195/U	Teflon	0.012	0.102	0.124	0.155	95



Miniature Ace trimmer potentiometer mounts on three plug-in terminals for printed-circuit insertion

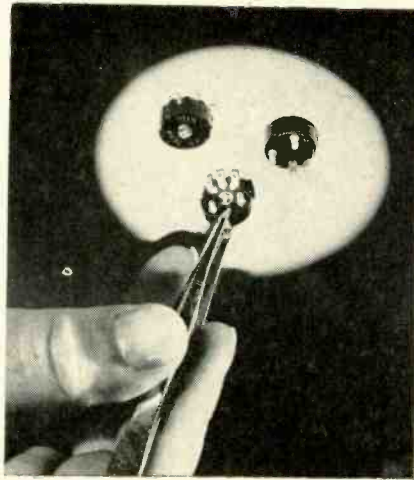

Control potentiometers by Centralab for hearing aids and miniature radios require less than 5/16 in. behind panel

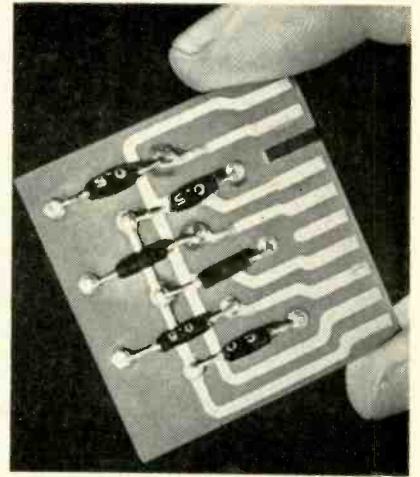

Miniature 2-in. square panel board mounts 5/16 in. long General Resistance resistors for aircraft instrumentation

CIRCUIT COMPONENTS

Resistors, capacitors and inductors take higher temperatures and less space

CAPACITORS—Size reduction in capacitors has been obtained by use of new materials and configurations. Materials that are being used include ceramics, Teflon, tantalum, glass and Mylar. Precision ceramic capacitors such as the flat Miniplate units made by Glenco can be used in applications where high capacitance is required in small volume. These units are used in applications in temperature-compensation circuits.

In the Vitramon capacitors a porcelain or vitreous enamel dielectric is used with silver electrodes and leads. The dielectric and vitreous material are fused into a monolithic block. A controlled process of applying the enamel leaves a dielectric of a few mils thickness. The silver electrodes are on the order of 0.0001-in. thick. Available with either axial or radial leads these capacitors can be brazed using high temperature lead within $\frac{1}{8}$ in. of the capacitor body.

The rectangular shaped body makes it possible to obtain close mounting on a printed-circuit board without danger of electrical interference. Component

density of these units is such that 1,000 pieces can be stacked in a 2½-in. cube.

In the Aerovox Cerafil capacitor, ceramic materials are used to provide capacitors for transistor circuits ranging from 0.001 to 0.1 μf . With sizes of 0.09 in. by 0.32 in. and 0.31 in. by 0.75 in. respectively, these units are rated at 100 volts.

Ceramic-cased electrolytic capacitors manufactured by Aerovox provide capacitances as high as 500 μf at 3 volts in a $\frac{3}{8}$ -in. tubular case. The dense steatite case provides high protection against effects of humidity.

Mylar has been used in capacitors as a dielectric and as an encasing material. Mylar-coated capacitors produced by Good-All use a thin coating of Mylar to provide abrasion resistance while adding less than $\frac{1}{16}$ in. to the body diameter. Mylar is also used as the dielectric material.

In the three capacitors shown in the photograph the capacitance and voltage rating are equal. The larger unit has a paper dielectric with a plastic case.

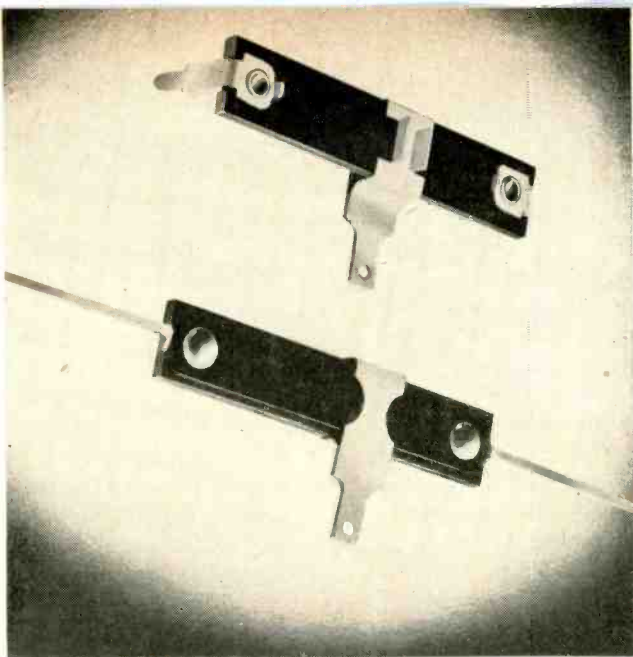

Printed-circuit resistors can be obtained with values as low as 5 ohms by use of a carbon-silver resistance element developed in Britain by Egan

The center unit uses a polyester dielectric with a plastic-treated thin-wall paper case. The smaller unit uses a polyester dielectric with the case formed by dipping in epoxy resin. All three of these capacitors are manufactured by Good-All Electric Co.

Mylar dielectric capacitors encapsulated in epoxy are supplied by the Texas Capacitor Co. in values up to 0.025 μf with a $\frac{1}{4}$ in. diameter and $\frac{1}{8}$ in. length at 400 volts. Diameters vary with capacitors and voltage rating from $\frac{1}{8}$ in. to 1 in.

The tantalum capacitors which have made possible a great reduction in size at low voltages are ideally suitable for transistor circuits. Mallory TAP capacitors suitable for operation in a temperature range from -55 to $+85$ C uses a sintered pellet anode. Dimensions on these units are $\frac{1}{2}$ in. in length and 0.225 in. in diameter. The type TNT subminiature tantalum capacitor provides a large μf -volt rating per unit volume. The table shows typical values of capacitance per unit volume on these units at various voltages.

In glass capacitors, Corning Glass has units made completely of glass with the exception of the metal foil plates. Volume of the type CY10 is only 0.005 cu in. Where wire terminals are not required further reductions can be obtained to as little as 1/10 of the volume of wire-lead types.

The Aerovox plastic-coated dipped mica capacitors use an epoxy coating to obtain high operating temperature in a small size.

POTENTIOMETERS—A miniature potentiometer developed by the General Scientific weighs only 10 grams and measures $\frac{1}{2}$ in. in diameter and $\frac{1}{2}$ in. in length. The hermetically sealed unit can be solder-mounted. Resistance values of up to 75,000 ohms are available.

A potentiometer less than $\frac{5}{16}$ in. in diameter and $\frac{7}{8}$ in. long is available for application at up to 125 C from Carter.

A precision potentiometer that is $\frac{7}{8}$ in. in diameter and requires about $\frac{3}{8}$ in. behind the panel for mounting is also available from the Carter Co. Normal tolerance is ± 5 percent.

A subminiature wirewound precision potentiometer is designed by Ace Electronics for plug-in mounting on printed circuits. The $\frac{1}{2}$ in. diameter potentiometer is available in resistances from 10 ohms to 250,000 ohms with ± 0.3 linearity. Weight is $\frac{1}{4}$ oz. The design of these potentiometers permits stacking. Six potentiometers can be ganged on one shaft.

A miniature variable resistor has been designed by Centralab for use in transistor hearing aids, miniature radios, telephone equipment and military applications. The unit is $\frac{1}{2}$ in. in diameter. Depth required behind panel is less than $\frac{3}{8}$ in. for a unit including an on-off switch. Without the on-off switch, depth behind panel is less than $\frac{1}{8}$ in. The units can handle $\frac{1}{2}$ of a watt and are of carbon composition construction.

A potentiometer developed by Fairchild Controls uses a continuous film construction with evaporated alloy as the resistance element. The unit, $\frac{3}{4}$ in. in diameter, is stable over a temperature range from -55 to $+225$ C. A similar resistance element is used in the Filmpot trimmer manufactured by the same company. The rectangular construction of these units permits easy stacking.

A miniature potentiometer manufactured by Minelco is a wirewound unit dissipating $\frac{1}{4}$ watt in a unit $\frac{1}{2}$ in. in diameter and $\frac{1}{8}$ in. high. The complete potentiometer is contained in the control knob. Units are available in linear and audio tapers from 500 to 10,000 ohms.

A high-precision miniature potentiometer manufactured by Technology Instrument has a linearity of less than 0.5 percent of the total resistance with an accuracy of total resistance of ± 5 percent. The entire potentiometer is $\frac{1}{2}$ in. in diameter and has a 2-watt power rating.

A miniature potentiometer for low values of resistance is available from Circuit Instruments. Values from 400 to 5,000 ohms are available with tolerances as low as ± 3 percent. These units can dissipate $\frac{1}{2}$ watt.

FIXED RESISTORS—For applications where space is at a minimum in one particular direction, resistors

Volume Requirements of Tantalum Capacitors

Rating in μf	Voltage	Minimum μf per Cu In.
80	3	12,000
50	6	7,500
25	15	4,000
15	30	2,300
8	50	1,200



Three Good-All capacitors of same voltage and capacitance rating differ only in dielectric material and external housing

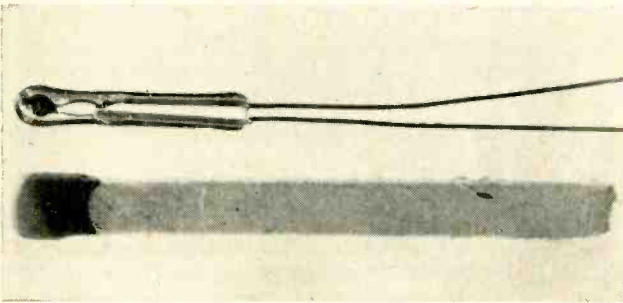

Bead type thermistor made by Fenwal compared to match. Where space is limited or close contact is desirable sensing unit can be obtained without glass casing

as thin as $\frac{1}{8}$ in. in diameter are available from Daven. Values up to 200,000 ohms are made in a 2 in. length. These units will dissipate $\frac{1}{2}$ watt. Values up to 100,000 ohms are available in a 1 in. length. All units are noninductive.

Precision resistors with an accuracy of 0.01 percent and a voltage divider providing two or more resistance sections are available in an epoxy resin housing from Consolidated Resistance. For a two-section unit with a 10-to-1 division, the size is $\frac{5}{16}$ in. in diameter and $\frac{3}{8}$ in. long.

A subminiature encapsulated resistor produced by Daven is $\frac{1}{4}$ in. in diameter and $\frac{5}{16}$ -in. long and can be supplied in values up to 400,000-ohms maximum. This resistor is available with axial or radial lead arrangement.

Another resistor manufactured by Daven is $\frac{3}{8}$ in. in diameter by $\frac{7}{8}$ in. in length. Maximum resistance of 180,000 ohms can be wound on these resistors

rated at $\frac{1}{4}$ watt and 125 C. Tolerances as close as ± 0.02 percent can be obtained.

An encapsulated wafer-thin card type resistor is also available when limited space prohibits the use of the usual cylindrical bobbin-type wire-wound resistors. This unit is adaptable to circuits using transistors in guided missiles and airborne applications. Although originally designed for Tinkertoy type construction, the design is also suitable for multisection card type units.

In the type GM miniature resistor developed by Workman TV, carbon composition is used. The size of the resistor proper is $\frac{1}{4}$ in. in length and $\frac{1}{8}$ in. diameter. They are rated at $\frac{1}{4}$ watt from 1 to 180 ohms. From 220 ohms to 4.7 megohms the rating is $\frac{1}{2}$ watt.

A coaxial tape resistor developed by Hansen is designed for applications in high-frequency circuits. Suitable uses for tape resistors are as terminating resistors in waveguides and as a dissipating material in waveguides, strip-lines or other microwave gear. These tape resistors are capable of withstanding temperatures up to 200 C. In the high-frequency coaxial tape resistors, use of three external leads provides better grounding and also contributes to cooling by dissipating more heat to the outer coaxial conductor.

A circuit board shown in one of the photographs consists of six epoxy-coated resistors made by General Resistance. The entire circuit is mounted on a 2 x 2-inch board for installation in a flight test instrumentation system for Republic Aviation. These precision wirewound resistors are made to a tolerance of 0.1 percent and are available in a resistance range from 0.1 to 25,000 ohms. The resistors are $\frac{5}{16}$ in. long and have a rating of $\frac{1}{10}$ w at 85 C.

INDUCTORS—Miniaturized r-f inductors are available having dimensions of less than $\frac{1}{4}$ in. in length and $\frac{1}{8}$ in. in diameter from Essex Electronics. In this size unit, inductance goes as high as 15 millihenries.

These units will withstand temperature variations from -55 to $+135$ C and will operate under 95-percent relative humidity at 85 C for 5,000 hours without noticeable degradation in Q or insulation resistance.

DIODES—In crystal diodes, size of the unit has been reduced to little more than the thickness of the connecting leads. Typical dimensions are $\frac{1}{16}$ in. in diameter and about $\frac{1}{4}$ in. in length. Using a soldering iron, connections may be soldered as close as $\frac{1}{4}$ in. to the glass envelope. Even closer joints can be made using discharge welding equipment.

A miniature selenium diode for pulse and digital application has been designed by Electronic Devices, Inc. The leads are formed for insertion in printed-circuit boards. Presently in use in card-to-tape converter handling 600 milliamper pulse, the unit is designed for computer applications. Average forward current is 10 milliamperes. Blocking voltage is 125-v pulse.

MAGNETIC COMPONENTS

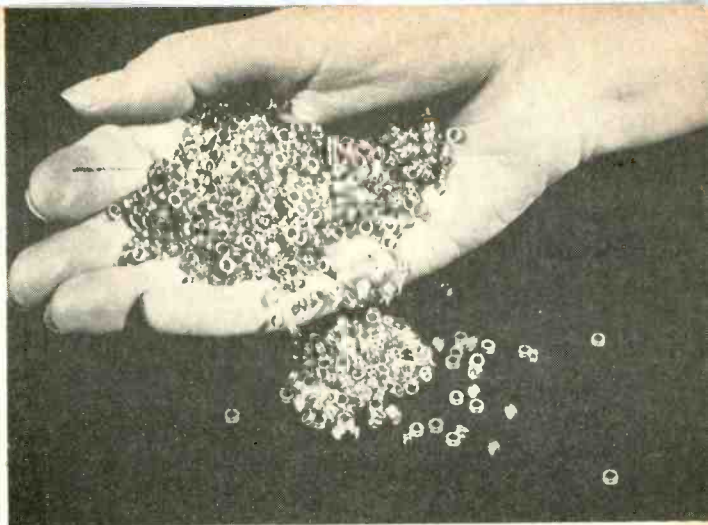

New wires, cores and insulations cut size of magnetic units

MATERIALS—New insulating material, finer drawn wires and more efficient steels for cores have enabled transformer designers to reduce the space requirements of these units. New insulating materials have helped reduce size by permitting transformers to operate at higher temperatures. Although this is true, transformers are still among the larger components to be mounted on electronic circuit boards.

INSULATION—As shown in one of the photographs, a Westinghouse airborne high-temperature transformer has been reduced in size by the use of silicone resin for impregnation and silicone rubber for encapsulation.

Reduction in weight from 20 lb to 14 lb on a 42,000-v transformer by use of Teflon tape has been reported by Goslin Corp. A smaller transformer made by the same company was reduced from 11 to 2 lb. Tape thicknesses of 0.002 in., 0.005 in. and 0.010 in. have been used in these transformers. This tape has dielectric strength of 400 to 500 volts per mil, and a dielectric constant of 2. Dissipation factor is 0.0002. High-temperature operation has little effect on these values. The tape is used for interlayer insulation, wrapping of the core and lead wires, as pads and as case lining to house the transformers.

A thermosetting glass fiber wrapping is used over the Teflon to permit liquid resin impregnation of the units. This impregnation prevents internal movement as well as eliminating moisture and dirt penetration.

In development work done by American Machine & Foundry, under an Air Force contract, wafer coils of aluminum or copper have been used for the windings of transformers. The space factor of the aluminum foil has been found to be superior to copper magnet wire. The coil technique uses a strip of aluminum or copper foil wrapped around the center form of the transformer lamination. A number of

these coils of foil can be placed along the core with the inner and outer layers interconnected.

The miniaturization technique developed by Raytheon uses fluorochemical liquids as a cooling agent in a sealed container. These transformers can operate in the region of 200 C and are constructed of inorganic materials throughout. The high-dielectric fluorochemical liquid vaporizes in contact with the hot windings and then condenses on the inner surface of the transformer case. The condensation takes place in a space normally provided for expansion of insulating liquids or gases. Active boiling in the vicinity of hot spots greatly increases the circulation of the fluid and results in a reduction of the temperature gradient from the winding to case. Woven glass insulating material is interleaved with the windings to serve as a wick to carry liquid directly to the hot spots which are then cooled by evaporation of the liquid.

CORES—Grain-oriented steel cores for blocking

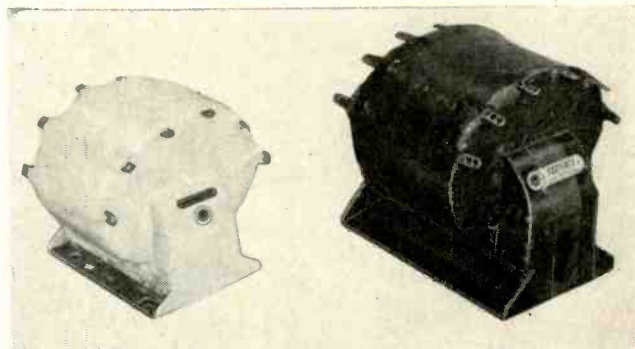

Size of equal power-handling capacity Westinghouse transformers is greatly reduced by the use of silicone resin for impregnation and silicone rubber for encapsulation

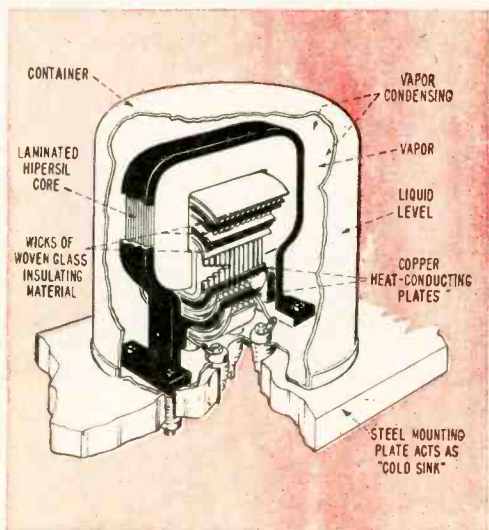

Cut-away view of liquid-cooled transformer

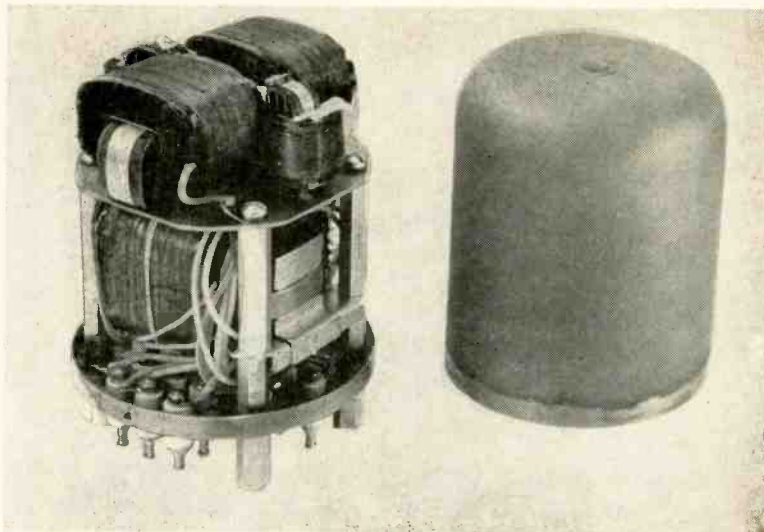

Fluorochemical-cooled Raytheon power transformer with cover removed

oscillators interstage and low-level modulator transformer permit the design of extremely small units. In the photograph, the smallest unit shown provides a pulse width of $0.05 \mu\text{sec}$ and weighs 1 gram. The largest of the three units is designed for a $25\text{-}\mu\text{sec}$ pulse and weighs $6\frac{1}{2}$ grams. The center unit weighs $4\frac{1}{2}$ grams and for a typical $3\text{-}\mu\text{sec}$ pulse width has a $0.05 \mu\text{sec}$ rise time. These UTC transformers are vacuum molded for environmental protection in military applications.

In transistor transformers low current, voltage and impedance have permitted the design of extremely small units. In the DO-T structure used by UTC, the unit weighs $1/10$ oz. and will handle 500 mw.

Miniature molybdenum permalloy powder cores are available from Arnold Engineering Co., and from Magnetics, Inc. Cores are used for miniature magnetic amplifier, pulse transformer, audio transformers and similar applications. Laminated cores for transistor and electron-tube audio transformers can

be obtained in core sizes of $\frac{1}{2} \times \frac{1}{8}$ in. from Magnetics, Inc.

PULSE TRANSFORMERS — Pulse transformers with greater than 2 megohms insulation resistance are now available in miniaturized form. These units are in a box $1 \times \frac{3}{8} \times \frac{1}{2}$ in. Use of inert gas eliminates the weight of transformer fluids. A 50 percent increase in life is obtained with resistance to shock of better than 60 g at 0 to 2,000 cps. Miniature pulse transformers with a rise time of $0.2 \mu\text{sec}$ are available from Aladdin Electronics and Polyphase Instrument Co. The Aladdin units can be obtained in cases as small as $\frac{1}{16}$ in. high and less than $\frac{1}{16}$ in. in diameter. Maximum working voltage rating is 50 volts. These units all use ferrite core materials to obtain the smaller size. A new pulse transformer introduced by Pulse Engineering Co. utilizes a flat-bed ferrite core with high permeability.

Using a cup core of ferrite material which will cover a wide range of pulse widths and powers, yet be small enough to be commensurate with the size of transistors, Technical Engineering has developed a line of pulse transformers. Axial leads units have a maximum diameter of $\frac{1}{8}$ in. and a height of $\frac{1}{16}$ in. A plug-in unit is also available for printed-circuit insertion. Pulse widths may be from 2 to $0.05 \mu\text{sec}$ with pulse repetition rates up to 1 megacycle. The total pulse energy is 4-watt-microseconds, and weight is 5 grams.

Pulse transformers manufactured by Du Mont are available with repetition rates of 5 to 6 megacycles and duty cycles of 40 percent without backswing. Transformers are molded in an epoxy resin, wound in a ferrite pot core, or encased in an aluminum can.

For miniature transformers made by Chicago Transformer, Gramer Halldorsen, Triad and Microtran, dimensions are dependent on type of housing. In the open frame type, dimensions can be as small as a $\frac{3}{8}$ in. cube.

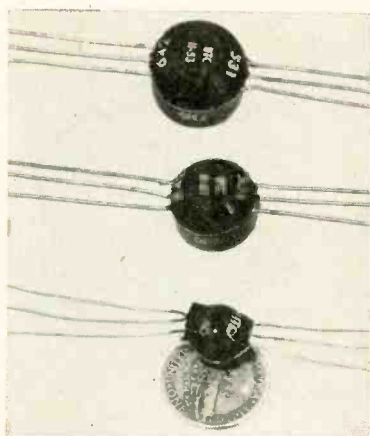

Vacuum-molded UTC transformers for military equipment

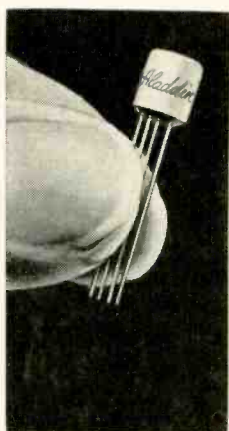

Ferrite-core pulse transformer

ELECTROMECHANICAL COMPONENTS

Input and output devices approach circuit components in size

MOTORS AND GYROS—Miniature motors for applications in cooling, blowers, recording devices and actuators are available in sizes as small as $\frac{3}{4}$ in. in diameter from Small Motors, Inc. A miniature permanent magnet motor with governor attached is less than 2 in. long. The unit can be operated from 6 to 28 v d-c and provides fast-starting action at temperatures as low as -55 C. Output is a maximum of $\frac{1}{400}$ hp. and speed varies from 5,000 to 20,000 rpm. Torque is 0.20 in. ounces and current drain is 0.2 ampere. Size of the entire unit is $\frac{3}{4}$ in. x $\frac{7}{8}$ in. x 2 in. including governor.

A tiny induction motor that can provide 5,000 rpm at temperatures up to 200 C is manufactured by Chase Electronics. The unit is suitable for guided missiles and airborne applications where high temperatures are encountered.

An extremely small permanent magnet d-c motor made by Hamilton Watch Co. was originally designed for use in an electric wrist-watch. Mounted in a plastic case, the complete motor is less than $\frac{1}{8}$ in. in diameter and less than $\frac{1}{2}$ in. long. Speeds up to 6,000 rpm are possible when the motor is running free. The motor can be operated from 1.5 volts.

A line of $\frac{1}{2}$ in. diameter clutches and brakes has been developed for subminiature components by Autotronics. High torque carrying ability makes it possible for these clutches and brakes to be used at the output end of a servo system as well as on the input.

In a rate gyro made by Raytheon for Minneapolis-Honeywell, size has been reduced to 1 in. in diameter by $2\frac{1}{2}$ in. long. Weighing 3.8 oz, the unit is designed for autopilot damping, radar antenna stabilization and fire-control applications.

A miniature rate gyro made by United States Time Corp. is available in a single axis telemetering package which includes d-c output circuits. The entire system occupies a space of 12 cu.in. Weight is $1\frac{1}{2}$ lb. The gyro itself is less than 1 in. in diameter, $2\frac{1}{8}$ in. long and $3\frac{1}{2}$ oz in weight.

As components for motors, resolvers and gyroscopes, precision slip-ring assemblies and commutators are required. In units designed by Electro-Tec, a plastic material is molded around wire leads. The plastic is then machined to proper shape and slip-rings are deposited in machined grooves to make the conducting rings an integral part of the unit.



Magnetic clutch and brake assembly $\frac{1}{2}$ inch in diameter by Autotronics can handle a maximum torque of 4 oz.-in. in servo applications

Final machining insures concentricity and dimensional accuracy. Diameters are available from 0.035 to 36 in. in cylindrical or flat assemblies.

A subminiature switch assembly for telemetering, programming and commutation applications is available from Electro-Miniatures Corp. With rotor molded in Kel-F, the unit has been tested at speeds as high as 5,000 rpm. Accuracy of registration is maintained by the use of a small rotor diameter and a simple indexing system. A symmetrical 5-cone, 2-cycle rotor at 5,000 rpm. will yield discrete switching times at the rate of 166 cps. Housing is 0.937 in. in diameter and a little over $1\frac{1}{4}$ in. in length. These dimensions are for a six-circuit unit.

SOLENOIDS—Subminiature d-c solenoids are available for use in aircraft equipment to operate miniature valves, drift computers, navigational instruments and fire-control system accessories. Using solenoids manufactured by Precision Scientific Products up to $6\frac{1}{2}$ -lb pull can be developed in a unit $\frac{3}{4}$ in. in diameter and $1\frac{1}{2}$ -in. long. Stroke of this unit

is 0.02 in. Units are available that can operate at ambient temperatures up to 600 F.

A special solenoid developed by Naybor Laboratories is designed for operation from transistors. Full travel of 0.04 in. is obtained in less than 0.003 sec. This solenoid was originally designed as part of a microwave-cavity tuning system.

TRANSDUCERS—Input and output equipment for electronic devices should be miniaturized to take full advantage of the miniaturized electronic components. A pressure-to-frequency transducer which is basically a combination of a variable-inductance pressure transducer and a stabilized transistor oscillator is manufactured by Ultradyn. The unit, occupying a volume of 7 cu in., provides an output frequency signal linearly proportional to pressure at a level of 0.5 volt into a 1,000-ohm load. It uses flexible printed circuit construction and has an accuracy of ± 1 percent of full range pressure.

Impulse-generator pickups designed by Electro Products can be used to provide speed information from moving ferrous metal parts. Applications include jet and rocket engine speed indicating systems. The pick-up unit is $\frac{1}{4}$ in. in diameter and 1 in. long. Using a 30-tooth gear for speed measurements, output voltages vary from 0 to 9 volts in surface speed range of 0 to 1,000 in. per sec. Temperature range of this magnetic pick-up is from -400 to $+500$ F.

A subminiature variable reluctance accelerometer made by Gulton Industries is designed for measuring low-frequency vibrations and accelerations of structures too small in size to accommodate conventional pick-ups. They are suitable for use on wind-tunnel models where space and weight are prime considerations. Dimensions are $\frac{1}{8} \times \frac{1}{2}$ in. and the unit is $\frac{3}{16}$ in. thick. Standard carrier systems from 1,500 to 5,000 cps can be used. Units are available

with ranges from 1 to 100 g. Weight of the unit is 2.5 grams.

MICROPHONES—Miniature magnetic microphones and receivers are available in sizes as small as $\frac{1}{2}$ sq in. with a thickness of $\frac{1}{8}$ in. Frequency response of these compact units made by Knowles Electronics has not been degraded by reduction in size.

In miniature motors, instruments, sensitive relays and potentiometers, ball bearings have become important as low-friction mounting devices. Diameters as small as $\frac{1}{10}$ in. outside diameter are available from companies such as New Hampshire Ball Bearing, New Departure, Fafnir, and Miniature Precision Bearings. These bearings are available in design shapes for various operating conditions such as radial, angular contact, high-speed, and thrust bearings with grooved raceways.

A mechanical differential with an overall diameter of $\frac{1}{2}$ in. can transmit 2 oz-in. of torque at 1,000 rpm. The unit, weighing $\frac{1}{2}$ oz, is made by Pitman. Ball bearings are used in the planetary gear arrangement.

BLOWERS—Cooling devices for miniature equipment require blowers capable of removing a large amount of air, yet the package must be in keeping with the size of the electronic equipment. Driven by a hysteresis motor operating at 22,000 rpm, a 3 cu ft per min subminiature blower is produced by Sanders. The package is a 1 in. cube and weighs only 1 oz.

A 4-oz, 2-in. diameter blower made by Rotron is capable of moving 60 cu ft per minute at 20,000 rpm. The unit is $1\frac{1}{2}$ in. in length. A 3-phase drive motor is used to operate the blower. This type of motor will not lose efficiency at high altitudes other than the slight effect of lower cooling efficiency by the less dense air.

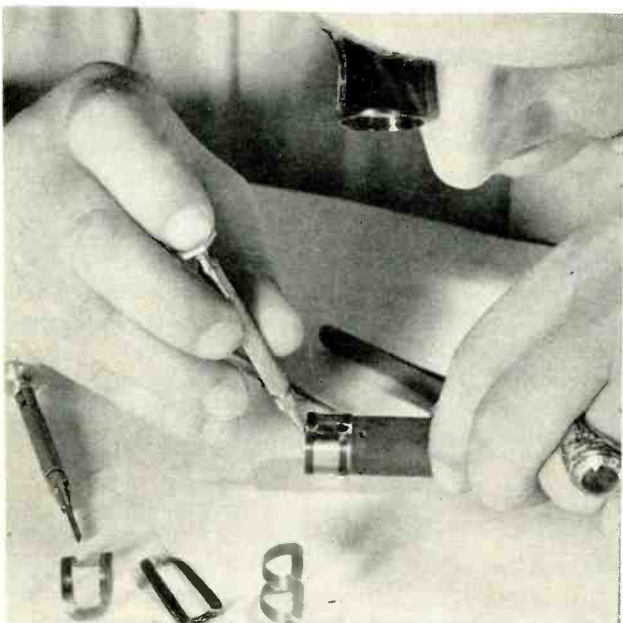

Winding coils for miniature gyro in Westinghouse fire control system requires skill and precise workmanship

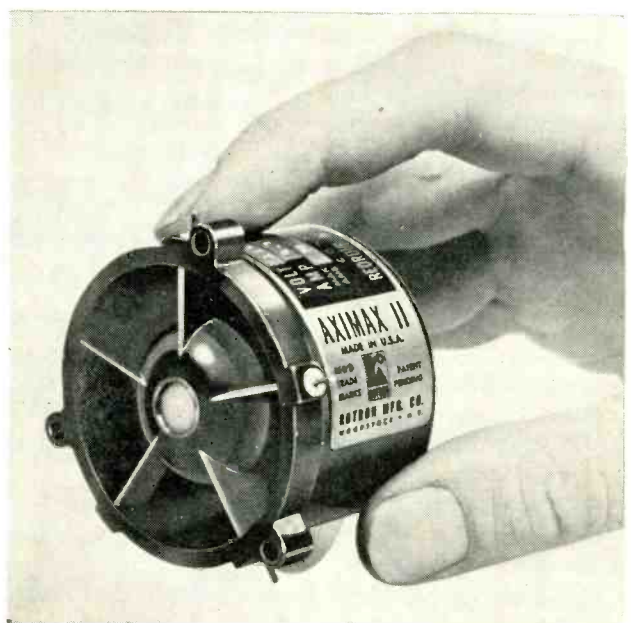

Blower by Rotron capable of moving 60 cu ft of air per minute is less than 2 in. in diameter

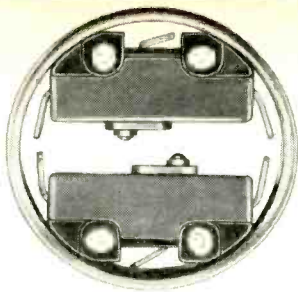

Design of Haydon switch permits arrangement of two switches in 1-in. circle

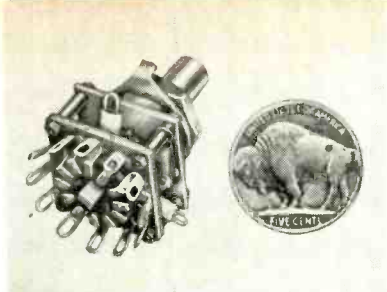

Miniature 12-position R-F Electronics rotary switch requires only $\frac{3}{4}$ inch of panel space

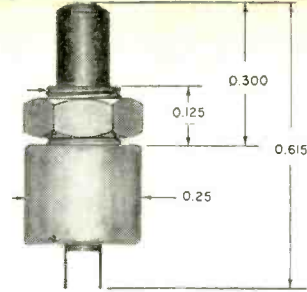

Momentary-contact switch by Grayhill has less than $\frac{5}{8}$ -in. overall length



Plug and jack for 500-volt breakdown is available from Carter Parts

PANEL COMPONENTS

Shrinking panel space requires more compact controls

SPACE—In miniaturized equipment, panel space for mounting switches, indicators, jacks, potentiometers and controls is limited. Space allowances behind the panel is also limited. Controls must be selected to permit mounting close together without the danger of mechanical or electrical interaction.

SWITCHES—A 12-position rotary switch manufactured by RF Electronics requires a space behind the panel of only $\frac{3}{4}$ in. square. Up to six decks can be combined for single-knob operation. Another 12-position rotary switch manufactured by Clarostat has a circular body $\frac{3}{4}$ in. in diameter. All moving parts and contact mechanisms are enclosed and the switch is sealed to protect it from dust and atmospheric conditions. It can handle 15 ma at 300 v.

In a miniature ceramic switch requiring $1\frac{1}{2}$ sq. in. of panel space, Daven provides 18 positions. Ceramic parts are silicone impregnated to function under high humidity conditions.

Using an enclosure 2 in. in diameter by $2\frac{1}{2}$ in. long, General Hermetic Seal Corp. has developed a 24-contact rotary switch sealed in inert gas. The gas acts as an insulator and arc suppressor, eliminating need for heavier insulating fluids or for larger spacing between contacts.

Another selector switch manufactured by the Oak Company provides up to 18 contacts per section and fits into a circle $1\frac{3}{8}$ in. in diameter. Only $\frac{5}{8}$ in. is required behind panel for a single-section switch.

In miniaturized momentary contact and on-off switches, new shapes have been developed to take advantage of space-saving arrangements. In a precision snap-action switch manufactured by Haydon, the case is laid out so that two switches can be fitted into a one-inch circle with an actuating arm between. Nine of the subminiature switches ganged together will take less than 1 cu.in. of space.

A pushbutton switch manufactured by Grayhill has a body diameter of $\frac{1}{4}$ in. Total length from face of button to contacts at rear is 0.615 in. The switch

rated at 100 ma at 110 volts has been operated in tests with currents as high as 1 ampere for well over 100,000 cycles. Life at nominal rating will easily exceed a million operations.

A magnetically-held toggle switch manufactured by Lear weighs less than 4 oz. and occupies a volume of less than 2.5 cu. in. The switch incorporates a solenoid unit that holds the switch in position. A fail-safe arrangement prevents the solenoid from pulling the switch closed.

PLUGS AND JACKS—A test plug and jack manufactured by Seaelectro uses beryllium-copper to extend its life. A solid beryllium-copper rod is machined into the one-piece metal insert with a four-leaf contact at one end and terminal lug at the other. The Teflon housing is shatter-proof, immune to moisture and can withstand elevated temperatures.

A 2-conductor plug and jack set available from Carter Parts Co. is made of molded nylon in open and closed circuit types. The unit weighs less than 1 gram and can withstand over 500 volts rms before breakdown. Colored nylon nuts for mounting are available for use as color coding devices.

Plugs and jacks for panel test equipment made by Switchcraft are about half the size of conventional plug and jack assemblies. The plug is $1\frac{1}{8}$ in. overall. The handle is 1 in. long.

A subminiature jack and plug combination made by Telex is about $\frac{1}{3}$ of the size of the previous units. The miniature plug is $\frac{1}{4}$ in. in diameter at its widest point. Length is $1\frac{1}{8}$ in. including tip.

Panel meters designed for use in miniaturized equipment by Marion Electrical Instruments Co. provide a scale arc of more than $1\frac{1}{2}$ in. in a panel hole $1\frac{1}{8}$ in. in diameter. The mechanism is self-shielding and permits mounting on magnetic or nonmagnetic panels without affecting calibration. The case design provides sufficient space to permit self-contained ranges of up to 300 volts with the inclusion of necessary rectifiers and resistors.

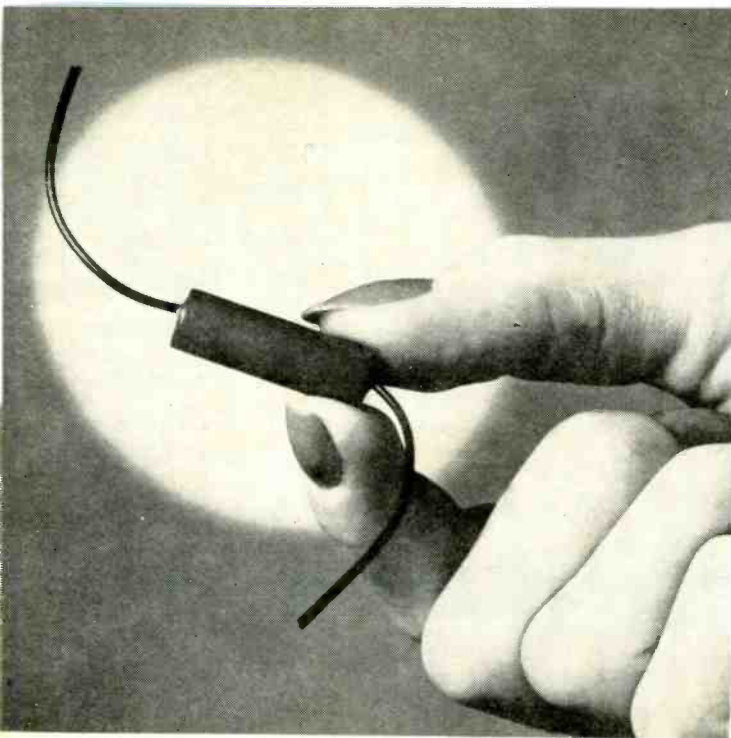

Solid electrolyte National Carbon battery supplies 95 volts with current drain of $10 \mu\text{a}$. Battery uses silver, silver-iodide and vanadium pentoxide

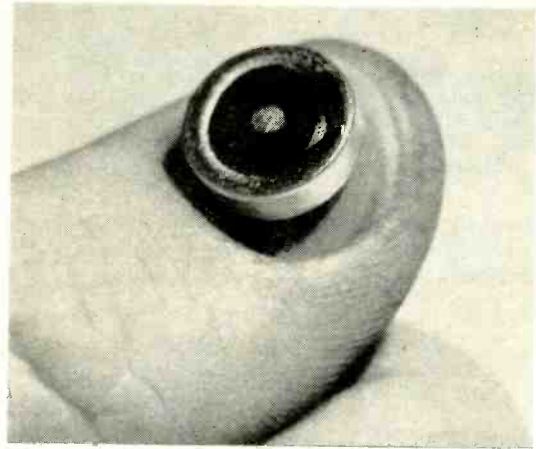

Battery for hearing aids and other low-drain applications made by National Carbon provides a total of 60 ma-hour in 0.31 cu cm package

BATTERIES—Miniaturization of tube equipment and the development of transistor equipment for applications in missiles and similar devices has increased the use of batteries. It has also required batteries able to pack more power into less space, and batteries capable of high outputs over a short period of time. Normally, batteries of the same voltage are available in several different physical sizes. Most economical service will usually be obtained by selecting the largest battery that can be tolerated by the miniaturized design.

A miniaturized battery developed by National Carbon Company is less than $\frac{1}{2}$ in. in diameter and $\frac{1}{8}$ in. thick. The weight is $\frac{1}{20}$ th of an ounce. It is made exclusively of nonmagnetic materials and occupies a volume of 0.31 cu cm. The nominal voltage rating is $1\frac{1}{2}$ and it provides a total of 60 milliamper-hours to a cut-off voltage of 1.3 v. Recommended average current drain is $60 \mu\text{a}$ or less. The battery was originally designed for use in an electric wrist watch made by the Hamilton Watch Company.

Another National Carbon battery uses a solid electrolyte for low-current applications. Battery weighs less than an ounce and is made of silver, silver iodide and vanadium pentoxide. Life of this battery is estimated at over 20 years of continuous service. It is $\frac{1}{4}$ in. in diameter and 1 in. long. Weight is $\frac{1}{4}$ oz. A 95-volt unit consists of 200 paper-thin cells. A continuous current drain of $10 \mu\text{a}$ can be maintained with flash currents in the μa range. Temperature range is from -70 to $+170$ F. Shelf should be clear of sharp projections that might puncture the battery or ground it to the metal battery case.

POWER

New batteries and

HIGH VOLTAGE BATTERIES—A solid electrolyte battery developed by General Electric Co. uses a silver bromide electrolyte with a cupric bromide plus carbon cathode. The anode is made of silver.

A typical 94-volt battery consists of 127 individual cells. Applications given for this battery include: one-shot devices in which the required energy is stored in the capacitor; intermittent devices using repeated storage in the capacitor, bias supplies requiring only a potential with currents that are of leakage levels, and very low drain supplies wherein long periods of disuse require a source having long storage life.

The battery can be used as a voltage source for the first four or possibly all ten dynodes of multiplier phototubes. Another application is to power portable ionization devices such as Geiger tubes.

The Mallory Solidion high-voltage battery is another of the solid electrolyte family of batteries providing low current drains at high voltage levels over a long period of time. A 50-volt stack of batteries occupies a space of 0.2 cu in. and weighs less than 0.3 oz. The 500-volt unit shown in one of the photographs is compared in size with a 500-volt unit using conventional electrolytes. The 500-volt solid electrolyte unit is made up of stacks of individual batteries encased in plastic tubing. These batteries have a shelf life estimated at 5 to 10 years, high resistance to impact and acceleration, and freedom from corrosive qualities. The use of stacks allows flexibility in the arrangement of the battery package. In geometric cell arrangements, the configuration can be estimated at 200 volts per cu in. of space.

In high-energy short-life batteries, a typical unit

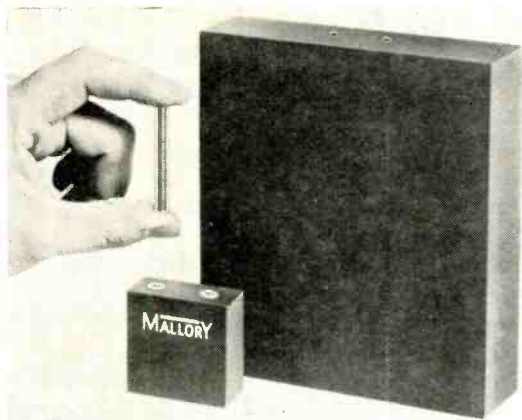

Reduction in size of 500-volt battery is illustrated by comparison with wet electrolyte unit. Hand holds stack of wafers used to assemble Mallory battery



Silver-zinc liquid electrolyte Yardney battery only slightly larger than a postage stamp has nominal capacity of 0.5 ampere hour

SUPPLIES

transistor units increase power source efficiency

is made by Frank R. Cook Co. using a liquid electrolyte. The low internal resistance of this type of battery permits energy to be removed at a high rate. A typical cell, a little over 1 in. in width, $1\frac{3}{4}$ in. in height and less than $\frac{1}{2}$ in. deep can supply a maximum output of 10 amperes with an 0.5 ampere-hour capacity. Its no-load voltage is 1.86 v and up to 2 amperes can be drawn from the battery while maintaining a terminal voltage of 1.4 v.

An automatically activated silver-zinc battery package using cells similar to the one just described can supply 360 v at 125 ma, 200 at 350 ma, 6.8 v at 20 a and -135 v at 100 ma. These outputs are furnished simultaneously within a 0.8 sec after activation signal is applied and for a minimum duration of 45 sec. Weight of the unit is 10.8 lb.

In operation, the high-discharge battery uses an electrical impulse to fire two gas cartridges. The resultant gas pressure is conducted through a container holding the electrolyte. The gas powers a piston which forces the electrolyte fluid through a disk into the battery cell. Time required for activation is 0.5 sec.

Another liquid electrolyte battery that can supply power for long periods of time in a package 80 percent smaller and 85 percent lighter than comparable lead-acid units is the silver-zinc battery manufactured by Yardney Electric Corp. The smallest single-cell unit weighs less than $\frac{1}{7}$ th of an oz. and is packaged in a case $1\frac{1}{8}$ in. high by $\frac{3}{8}$ in. wide and $\frac{3}{8}$ in. deep. Nominal capacity is 0.5 ampere hour with a 38 watt-hour output per pound.

Because of low internal resistance these silver cells can be discharged at rates 20 times the

numerical ampere-hour capacity. This provides power reserve for emergency use or for a compact high-drain source. The construction is spill proof and practically gas free. Operation at shock loads as high as 1,000 g's under severe acceleration and vibration are possible.

Nickel-cadmium alkaline storage batteries are finding increasing applications in electronic devices. These units have a flat discharge voltage curve and momentary discharges as high as 25 times the rated ampere-hour capacity can be obtained. A 19-cell, 24-volt, $\frac{1}{2}$ ampere hour capacity battery is manufactured by Nickel Cadmium Battery Corp. This battery occupies a cube about $3\frac{1}{2}$ in. on a side. A 3.6-ampere hour capacity nickel cadmium battery manufactured by Sonotone is packaged in a unit $9 \times 4\frac{1}{2} \times 3\frac{1}{2}$ in.

RECTIFIERS—Practically all semiconductor rectifiers are considerably smaller than vacuum tube rectifiers used in powering electronic equipment. But even among these rectifiers there is a trend toward miniaturization. In the Transitron silicon rectifiers shown in comparison with a match in one of the photographs, a prototype unit put into production three years ago has been superseded by the smaller axial lead subminiature version shown. The miniaturized unit has superior ratings due to more efficient design. The prototype unit was rated at 150 milliwatts maximum dissipation. The new subminiature version is rated at 250 mw. Operating temperature range has been extended from 150 C in the prototype to 200 C in the subminiature version.

Other rectifiers not much larger than a book of matches are capable of handling heavy currents. The

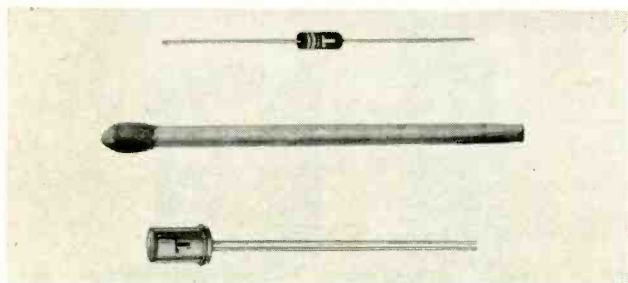

Miniaturized Transistron silicon rectifier (top) has greater capacity and temperature range than larger unit at bottom

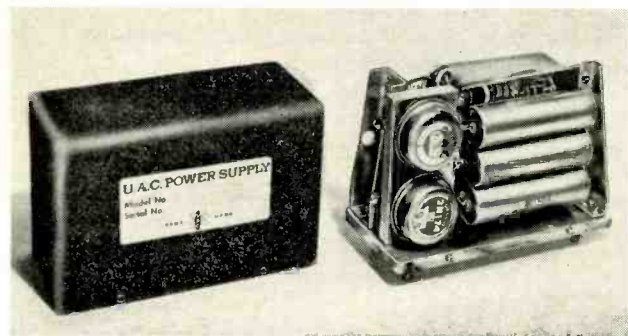

Transistor power supply by Universal Atomics operating from flashlight battery provides high voltage for Geiger counters, and multiplier phototubes

Federal Telecommunication Laboratories has produced two high current units. The larger one is rated at 50 amperes and the other at $7\frac{1}{2}$ amperes for continuous operation.

A direct replacement silicon rectifier designed by International Rectifier Corporation is packaged as a direct replacement for a 6X4 vacuum tube rectifier. The physical dimensions of the package designed to plug into this 6X4 socket are approximately the same as those of the tube with the exception of height. The rectifier unit, labeled S6X4, is $1\frac{1}{4}$ in. high as compared to $2\frac{1}{2}$ in. for the 6X4.

Silicon-diode rectifiers are adaptable to series connection for high voltage requirements, since no special matching of inverse characteristics is required. This design is used in the silicon rectifier cartridge that can be snapped into a conventional 30-amp fuse clip. Outputs are available from 45 to 100 ma with voltage ratings of 1,200 to 8,000 peak inverse volts. A larger housing permits operation to 16,000 volts.

A series of stud-mounted hermetically sealed silicon diodes capable of operation at 375 C has been developed by the United States Dynamics. The units cover a current range from 100 ma to 1 amp. When mounted these units are about $\frac{7}{8}$ in. above chassis level, including stud. Weight is less than 1 oz.

A silicon power rectifier designed for magnetic amplifier and d-c blocking applications is manufactured by the Automatic Manufacturing Division of General Instrument Corp. Handling $\frac{1}{2}$ watt, the unit is an axial-lead type $\frac{5}{16}$ -in. long and $\frac{3}{8}$ -in. in diameter at its widest point.

SUPPLY PACKAGES—Transistor inverters, converters and magnetically regulated power supply units have become popular for miniature applications. A 28 v d-c to 250 v d-c converter for aircraft transmitters and receivers manufactured by Aircraft Radio can be used as a direct replacement for their dynamotor. The d-c input applied to two heavy-duty transistors connected in a self-excited multivibrator switching circuit is supplied to the primary of a transformer as a series of square-wave pulses. The square wave a-c output voltage is rectified and filtered to produce a d-c output at the desired voltage level.

Losses in the transistors and rectifiers are quite small and the unit shows voltage and current ratios quite similar to those of an a-c transformer. The unit is 50 percent lighter than and has less than $\frac{1}{3}$ the losses of the equivalent dynamotor. Efficiency is approximately 85 percent as compared to 55 percent for the dynamotor unit. Regulation is excellent and since there are no moving parts the maintenance is held to a minimum.

An additional advantage is that the unit is self-protecting. A short circuit across the output terminals stop oscillation and reduce the output to zero without placing an overload on any of the components in the circuit. The transistors are used at less than one-quarter of their rated current with a load of 150 milliamperes. There are no altitude limitations. The unit has been designed to be electrically interchangeable with the dynamotor that had been standard equipment on the company's navigation and communication equipment.

A transistorized power supply that operates from $1\frac{1}{2}$ -v flashlight batteries and delivers simultaneous outputs that supply tube-plate voltages and high voltage for Geiger counters and multiplier phototube system is available from UAC Electronics, a division of Universal Transistor Products Corp. With an input of $1\frac{1}{2}$ to 6 v d-c, outputs are available in a range from 67.5 v d-c to 1,500 v d-c, and in a current range from 200 μ a to 5 μ a. The output is regulated to ± 2 percent with a ripple of less than 20 mv at 900 v. The package size is approximately $1\frac{1}{2}$ x $1\frac{1}{2}$ x $3\frac{1}{2}$ in.

Another unit is made by the same manufacturer for applications such as radiation counters, multiplier phototubes, electrostatic precipitators, battery-operated oscilloscopes and other applications requiring high voltages. This system can supply up to 20,000 v from a 1.5-v input at a current of 1 μ a. With a higher input voltage, output current can be as high as 200 μ a. These units provide an efficiency of over 90 percent and require $\frac{1}{2}$ cu in. per watt. A typical unit is shown in a photograph.

A miniaturized high voltage d-c power supply for electrostatic applications is manufactured by Sky-sweeper, Inc. The unit, consisting of a transformer, three rectifiers and three capacitors is encapsulated in a metal can $2\frac{5}{8}$ x $2\frac{3}{8}$ x $6\frac{1}{2}$ in. long. Input is from a 117 v, a-c line. Output currents at 10,000 volts are limited to several hundred μ a rising to a maximum of 2 ma under short-circuit conditions. The supply may remain short-circuited indefinitely without impairment.

RELAYS

**Sensitivity and ruggedness increase
as size is diminished**

LIGHT WEIGHT—In miniature relays, Elgin Watch has produced a unit $\frac{1}{2}$ -inch in height and $\frac{3}{8}$ in. in diameter. Width of the case is 0.196 in. It is available with d-c coil resistances from 50 to 2,000 ohms and can switch $\frac{1}{4}$ amp at 28 volts d-c resistive. Weighing less than $\frac{1}{16}$ oz. the relay is suitable for high vibration applications with as much as 10 g at 500 cps. Life is estimated at one million operations at rated load.

A 1 x 1 x $\frac{1}{4}$ in. relay weighing 0.44 oz also made by Elgin can handle 2 amperes at 28 volts d-c, or 115 volts a-c. This unit is a rotary action double-pole, double-throw relay.

A miniaturized relay with low capacitance values is manufactured by Brubaker. This unit, suitable for radar and control circuits has three μmf capacitance. The hermetically-sealed case is 0.79 x 0.87 x 0.35 inch. The unit is available with plug-in base for printed circuits or hook-type for soldering.

A miniature relay with a 9-pin base designed for plug-in in printed-circuit applications is made by the Sigma Instrument, Inc. The unit is 1 in. square and 2 in. high. Sensitivity to d-c signals is 20 to 100 mv.

Another relay designed for installation on printed circuits comes with mounting brackets that provide electrical connections as well as secure positioning. The sections of the terminals that insert into the board are an integral part of the coil terminals and contact springs. This prevents internal loss in conductivity and continuity. The number of relay contacts connected to the printed-circuit board is usually large enough to support the relay with only the solder of the terminals. The unit is $1\frac{3}{4}$ in. x 1 in. Height is from $1\frac{1}{8}$ in. to $1\frac{1}{2}$ in. depending on the number of contacts used. This switch is manufactured by Automatic Electric.

A relay designed for high shock and vibration conditions is made by the Hi-G Company, Inc. The one-ounce relay can withstand greater than 1,000 g shock and 30 g's, 2,000-cps vibration without contact breakage. The $1\frac{1}{4}$ -in. high unit has relay contacts rated at 2 amperes at 30 volts or 115 volts a-c.

A subminiature relay weighing less than $\frac{3}{8}$ oz is made by the Ace Relay Associates. Case dimensions are 0.87 x 0.79 in. The diameter is 0.35 in. Vibration



Relay by Elgin capable of handling $\frac{1}{4}$ ampere at 28 volts has a life estimated at 1 million operations

specifications are from 5 to 2,000 cps. at 20 g with shock tolerance of 50 g. Life is a minimum of 500,000 operations. The relay contacts can handle 3 amperes at 28 volts d-c, or 1 ampere at 115 volts a-c. The coil assembly is hermetically sealed independent of contact assembly eliminating possibility of contact contamination.

TIME DELAY—A time-delay relay capable of operating without contact chatter to 1,500 cps at 10 g is permanently calibrated and hermetically sealed at the factory by Thomas A. Edison. Compensation for changes in ambient temperature between -65 and $+100$ C is achieved by a matching expansion member. The relay operates on the principle of differential expansion. This expansion is multiplied by a linkage system producing a high-rate of contact closure. As the heater causes the expansion member to elongate, the lever pivots on a hinge, compressing the bow spring in the direction of contact closure. Height of the unit is 2 in. and the diameter is $\frac{3}{4}$ in.

A miniature mercury plunger relay has been developed by Ebert Electronics Corp., in a double-pole, single-throw version. Each contactor of this relay is rated at 20 amperes at 115 volts, 10 amperes at 230 volts, and 5.2 amperes at 440 volts. Overall size of the unit is $4\frac{1}{4}$ x $2\frac{3}{8}$ x $1\frac{1}{4}$.

METER RELAY—In the redesign of a sensitive meter relay made by Assembly Products, Inc. the size of the unit has been reduced by 20 percent. Range of operation was extended to 10 amperes and temperature range -50 deg. to 150 deg. This relay uses a D'Arsonval-type movement to provide a sensitive relay actuated by signals as small as $0.2 \mu\text{a}$ or 0.1 mv. The 1 x $1\frac{1}{4}$ x $1\frac{1}{8}$ in. relay will withstand shock and vibration up to 20 g.

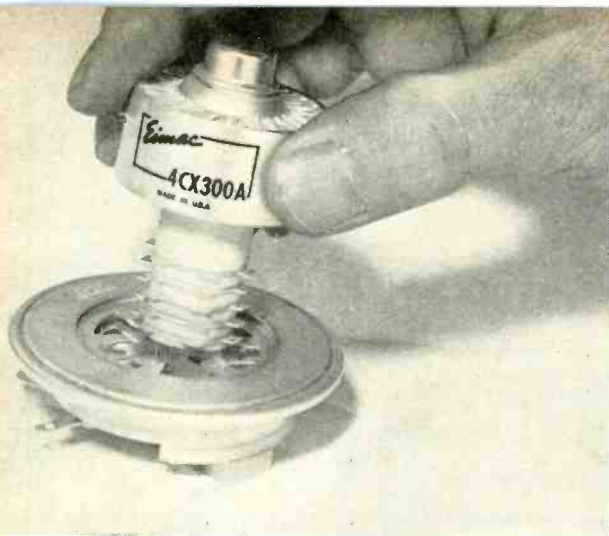

High-power Eitel-McCullough miniature transmitter tube using ceramic ring construction

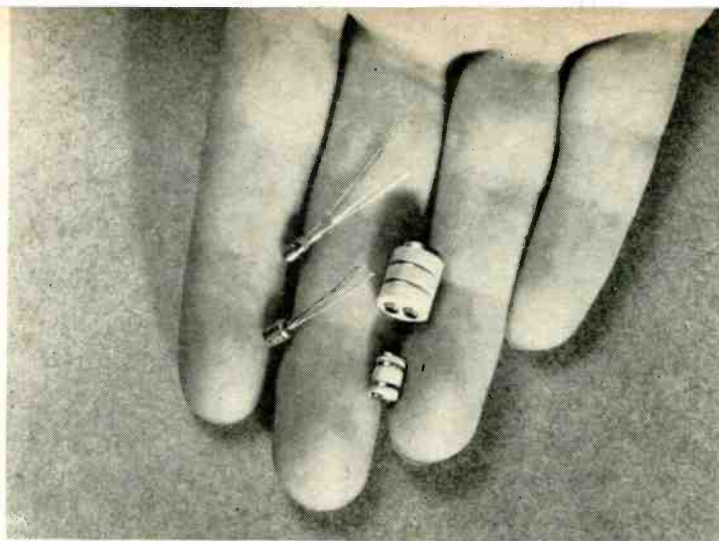

Two of the smallest available transistors for hearing aids compared in size with GE ceramic tubes

TUBES AND

Ceramic tubes compete with

CERAMICS—One trend in miniaturization of tubes has been the development of the ceramic cases. Tubes of this construction developed by Eitel-McCullough, Sylvania and General Electric are smaller in size than their glass-encased contemporaries and can withstand higher ambient temperature and shock conditions.

Eitel-McCullough receiving design was developed from a design originated for transmitting tubes of the type shown in one of the photographs. This construction has been applied to a tube equivalent to the 6SN7 double triode. Construction is a series of ceramic rings with elements as shown in the cross-sectional diagram. Tabs around the outer edge of the ring's of the ceramic tube connect the elements to the circuit.

In the approach to ceramic tubes adopted by Sylvania, the tube elements are mounted on ceramic shafts with spacers to hold the elements in proper position. In the beam-power pentode design the metal outer case acts as the anode. In the r-f type tube, the plate is mounted on the ceramic rods with the other elements, and the housing is of a ceramic material.

These tubes fit a standard 9-pin base, but height of the tube is reduced to less than $\frac{1}{2}$ that of the glass-envelope equivalent. There are no mechanical resonances in these tubes below 2,000 cps. Vibration fatigue is 15 g at 60 cps for 100 hours. In thermal shock tests these tubes passed 10 immersion cycles from liquid nitrogen to a tin solder bath without damage.

In the General Electric concept of miniature ceramic tubes, a triode r-f amplifier, 6BY4, has been developed for use in uhf television receivers. The

tube is about $\frac{3}{8}$ in. long and $\frac{1}{8}$ in. in diameter. The 6BY4 form is constructed as shown in the illustration. An even smaller version, using the same type of construction, is compared in one of the photographs.

The dimensions of this tube are $\frac{1}{8}$ in. in diameter and $\frac{1}{2}$ in. high. A photograph also shows these two tubes in comparison to transistors.

In high-frequency tubes, a backward wave oscillator made by Varian Associates and a miniaturized travel-wave tube by the Geisler Laboratories are two developments that place these tubes in smaller packages.

The Varian tube which measures $4\frac{1}{2}$ x $5\frac{1}{8}$ x $6\frac{1}{16}$, is a voltage-tunable oscillator for the frequency range from 8.2 to 12.4 kmc. Applications include use as a local-oscillator in tunable radar and wide-range receivers, as a master oscillator for wide-band radar transmitters and as a signal source for signal generators and test sets. Average output is 30 to 120 milliwatts in the operating range from 8.2 to 12.5 kmc.

RECTIFIERS—A miniature external anode rectifier clipper diode is manufactured by United Electronics. The size of these units is 1.87 in. high, not including leads, and a little over 0.875 in. at the widest point of the tube.

These tubes can handle up to 150 ma at 17,000 volts with liquid cooling when used as a rectifier. With air cooling, 70 ma is the top current that can be handled.

An indicator tube manufactured by the Electronic Tube Division of Burroughs is a miniaturized version of the Type 6844 indicator tube. The unit is $\frac{3}{4}$ in.

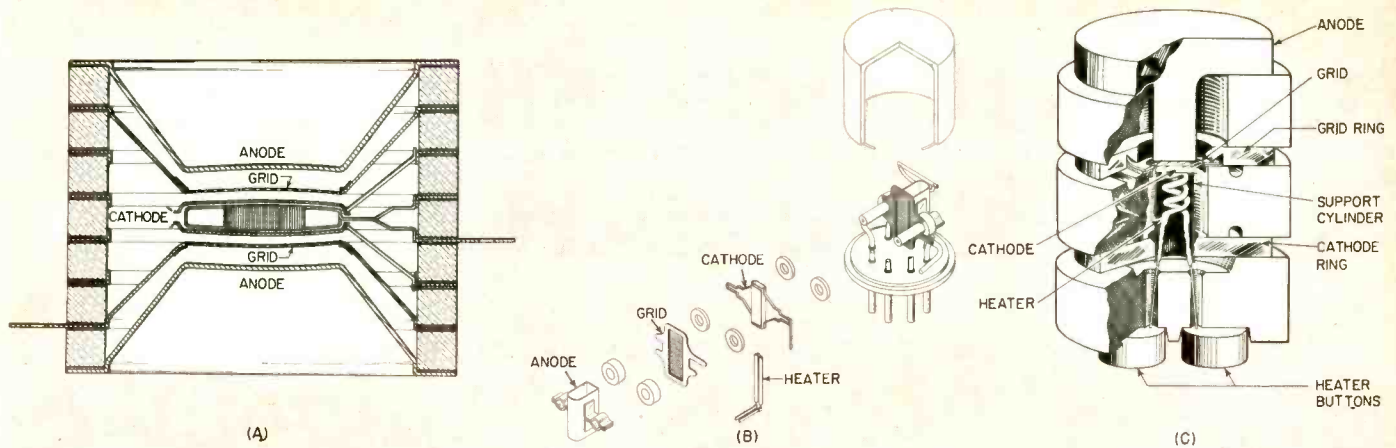

Internal views of Eitel-McCullough (A), Sylvania (B), and General Electric (C) ceramic tubes shows three approaches to design and construction of rugged high-temperature tubes for missile and similar applications

TRANSISTORS

some transistors in size

high and a little over $\frac{1}{2}$ in. in dia. It occupies $\frac{1}{4}$ the volume of the previous tube and requires $\frac{1}{8}$ watt. The two units are compared in the lower left photograph.

A miniature camera tube for television equipment is manufactured by Resistron Laboratories. The tube is $\frac{1}{2}$ in. in dia. and $3\frac{1}{2}$ in. long. It is capable of 400 line resolution and is primarily designed for installation where weight and size considerations are important.

TRANSISTORS—Diminutive transistor housings are reducing the size of transistors to little more

than that required for the active elements. The Philco 2N207 audio transistor has case dimensions of less than $\frac{1}{8}$ in. high and $\frac{1}{8}$ in. diameter at its widest point.

This transistor has been designed for use in low-level miniature amplifiers such as hearing aids. The unit is also suitable for use in direct coupled amplifiers and switching circuits in the audio-frequency range. Characteristics of the transistor will be unchanged by acceleration rates as high as 20,000 g.

This package provides a complete stage of amplification that can be soldered into a circuit with the connection of only four leads.

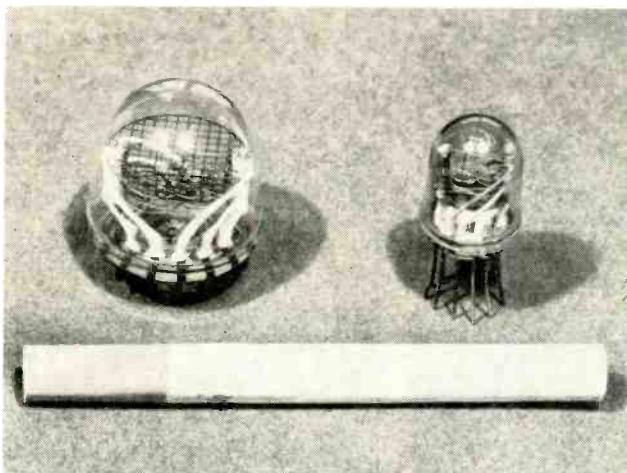

Comparison of miniaturized version of Burroughs numerical indicating tube with the older type. The unit is a little over $\frac{1}{2}$ in. in diameter

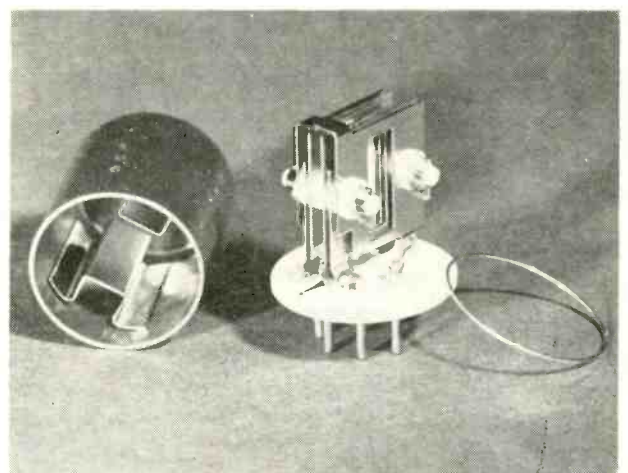

Ceramic encased Sylvania receiving tube with cover removed. This design fits a standard 9-pin miniature socket but height is considerably less than that of conventional tube

PRODUCTION for Miniaturization

Special tools and techniques speed assembly work

EQUIPMENT—In mass production of printed wiring assemblies automatic assembly machines can turn out large quantities of units with little chance for errors. In many miniaturized assemblies, however, the production quantity is small or the size restrictions are such that hand assembly is necessary. Because of the closeness of wiring and component placement it is essential that assembly be made as automatic a process as possible.

TECHNIQUE—In the design of a flip-flop shown in a photograph for an airborne data and control system, the Dynalysis Development Laboratories developed techniques for assembly manufacture. Sub-assemblies are made wherever possible and these circuits are tested before being incorporated into the next assembly. Component leads are bent before assembly and placed in an appropriate slot in an aluminum jig with the leads left exposed.

An aluminum jig is used for the dual advantage of excellent heat conduction during soldering, and elimination of the possibility of it being soldered to the components. Fine component leads are wrapped around heavier ones and the latter are used as tie points. Soldering is done with the aid of small clip-type heat sinks. The complete subassemblies are then tested and varnish-type insulation is painted on those leads or components which might short to each other or to the case. No other insulation is used.

Subassemblies are joined together until the product is completed and installed in the case with an epoxy-

type potting and sealing compound. A miniature soldering iron with a single bevelled surface on a $\frac{3}{8}$ in. diameter clip is used in all assembly steps.

SOLDERING—In soldering operations involving the assembly of miniature circuits a small soldering iron with a fine tip is essential to prevent damage to other components and permit the operator to see the work during soldering. The pistol-grip type of soldering iron manufactured by Hexacon has a $\frac{1}{8}$ dia. tip, and a light in the pistol grip illuminates the soldering area.

The American Beauty transformer type soldering iron designed for precision soldering has a split collet receptacle in the handle to permit quick change of tip elements. The transformer unit has prongs for a wall plug as the integral part of the housing permitting easy mounting to the receptacle outlet. Use of a low-voltage output transformer permits installing the heating element in a small tip.

For work on very fine subassemblies and components, a resistance heat soldering tool may be useful. In the Thermo-tip and Thermo-grip units made by Ideal Industries, improved joint quality, lower production costs and increased operator safety can be obtained. X-ray examination of resistance-soldered joints show a low degree of voids enclosed in the soldered terminal. In resistance heat soldering the work itself serves as the heating element, providing a resistance path. The solder cannot melt until the work is hot enough to cause solder flow.

SIX WAYS TO SPEED PRODUCTION

PRINTED-CIRCUIT relay by Automatic Electric designed for plug-in installation eliminates possibility of wiring error. All connections are dip soldered

ASSEMBLY JIG for cementing Sonotone phonograph pickups uses rotating fixture. As jig is rotated it passes through oven at rear. Revolution speed is timed to bake cement

HYPODERMIC NEEDLE is used at Micro-switch to place controlled amount of cement in proper position on switch. Clamp is modified hair curler

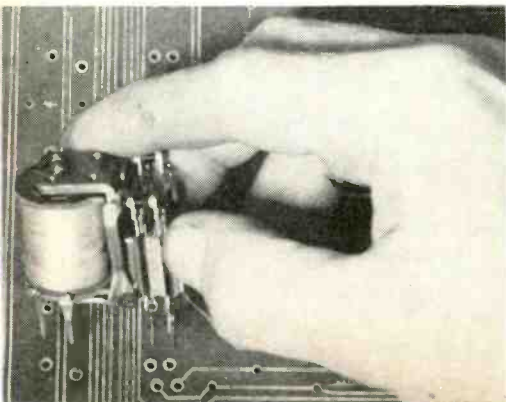

For the soldering of miniature connectors, Amphenol suggests that an automatic timing device such as the Zephyr Microbrazer be used to control the amount of heat applied to the terminals of the connector. This prevents over-heating, damage to the connector, and cold-solder joints.

In handling very thin material soldering is often impractical because of heat sensitivity. Welding techniques reduce the heat concentration to an area of about 0.002 sq in. Duration of heat is determined by a pulse of about 2 milliseconds. A miniature spot-welder produced by Ewald is capable of welding potentiometer caps and wire terminations to a single turn of wire of 0.0004 in. diameter.

SIX WAYS TO SPEED PRODUCTION —Operations that can perform more than one step of assembly at once are desirable. Some examples of these techniques are shown in photographs. A relay assembly designed for plug-in to printed-circuit boards eliminates the danger of interchanging the lead connections. With one particular relay, simply inserting it in the board makes 12 connections which can be dip-sorted simultaneously. This relay is designed by Automatic Electric.

A technique developed by Sonotone for the manufacture of ceramic phonograph cartridges using a rotating assembly plate is shown in the photograph. The operator places the unit in its mounting and cements it in place. As the fixture is revolved for assembly on the next unit, the cemented assemblies are carried around to the rear under a housing which encloses an oven. The revolution speed of the unit is timed to bake the cement until it reaches its specified hardness.

Another technique that can be used for cementing small parts is that used in the manufacture of Micro-Switches. The assembler uses a hand vise to pick up the unit to prevent contamination. A conventional medical hypodermic needle is used to inject the proper amount of the cement into the assembly. A modified hair curler is then used to hold the cemented parts together until dry.

Assembly of miniaturized equipment often involves the development and design of special tools. Use of

the wire-wrapped terminals such as those made by Malco can be adapted to automatic assembly operations on printed circuit boards. With this technique, fully automatic assembly of 20 wire-wrapped terminals can be inserted into printed-circuit boards at rates up to 20 boards per minute. The wrapped terminals are easily visible for inspection.

In the modular assembly method of Sanders Associates, the riser wires between wafers are made in an S form. These S-shaped pieces are placed in a formed jig, and the entire side of the modular assembly is soldered in one operation. After assembly a special device shown in the photograph is used to trim the leads to the proper size.

CIRCUIT PACKAGES —One means of reducing the amount of intricate assembly work required in a product is by the use of plug-in and prepackaged subassemblies. Interstage networks have been used in radio sets for many years, and are now finding application in printed circuits. These interstage networks are available from companies such as Centralab and Onondaga Pottery Co. They can be obtained with solder leads or with plug-in connection tabs for printed circuit boards.

Another type of packaged circuit made by Centralab and MF Electronics provides a complete transistor stage in one unit. In the Centralab single-stage amplifier four leads serve to connect the complete stage into the circuit. The stage consists of a transistor, 3 resistors, and an input capacitor in a package $\frac{1}{4}$ in. in diameter and $\frac{2}{10}$ in. high.

The MF transistor subassemblies supplied as flip-flops, multivibrators and amplifiers are designed for application in computers, missiles and telemetering systems. The volume of each of these units is less than $\frac{1}{8}$ cu. in. and they weigh about $\frac{1}{8}$ oz. They are sealed with epoxy resin in a drawn nickel-silver case.

A four-stage transistor amplifier supplied by Centralab provides a complete amplifier with only seven leads to be soldered. A two-lead resistor-capacitor parallel combination made by Centralab provides a bypassed resistor for many applications. It is also available with crimped leads for printed wiring boards insertion.

SOLDERLESS TERMINALS by Malco for printed circuit boards can be rapidly inserted from strip. Wire connections are made using special wire-wrap tool

SIMULTANEOUS WIRING of 15 connections on module are made in one operation at Sanders using an S-shaped lead. After dip-soldering, the ends of the shaped wire are clipped

MULTIPLE COMPONENT assemblies, such as the Centralab resistor-capacitor combination, can save wiring time and errors by reducing number of leads

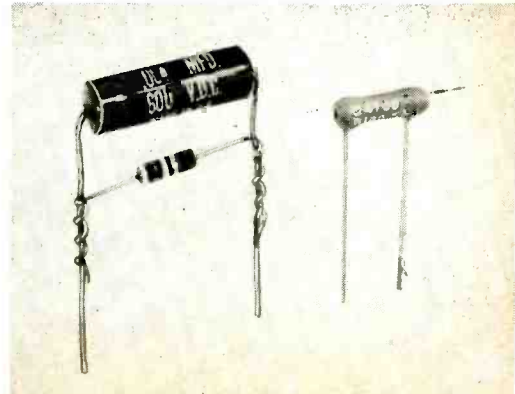
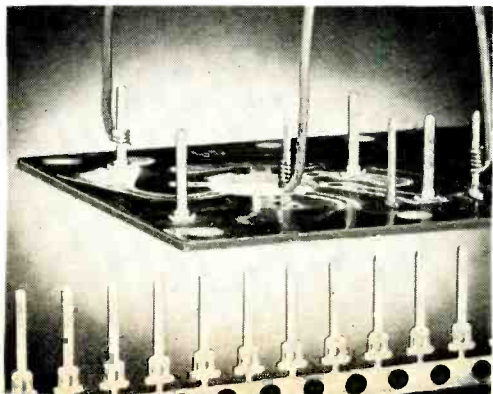

THE FRONT COVER

(1) rotary switch—Oak Mfg., (2) transformer—Stromberg-Carlson, (3) coaxial connector—Amphenol, (4) resistor—General Resistance, (5) transformer—Triad, (6) connector—DeJur-Amsco, (7) transformer before potting—Microtran, (8) i-f transformer—Aircraft Radio, (9) R-C network—General Electric, (10) connector—Amphenol, (11) transformer laminations—Magnetics, Inc., (12) transistor flip-flop—MF Electronics, (13) transformer—Chicago Transformer, (14) three-stage hearing-aid amplifier—Beltone, (15) precision resistor—Consolidated Resistance, (16) hearing-aid chassis—Sonotone, (17) r-f inductor—Fugle-Miller, (18) silicon rectifier—Automatic Mfg., (19) printed circuit—Bureau of Engraving, Inc., (20) transformer—Gramer-Halldorson, (21) resistor—Daven, (22) indicator tube—Burroughs, (23) resistor bridge—International Resistance, (24) i-f transformers—Automatic Mfg., (25) transformer—Triad, (26) slip-ring assembly—Electro-Tec, (27) thermistor—Gulton, (28) pulse transformer before potting—DuMont, (29) ceramic triodes—General Electric, (30) photo-transistor—General Transistor, (31) flexible printed circuit—Photocircuits, (32) transformer—Triad, (33) capacitor—Gulton, (34) silicon diode—Automatic Mfg., (35) capacitor—Gulton, (36) resistor—Workman, (37) transistor—Centralab, (38) transistor bases—Mansol Ceramics, (39) capacitor—General Electric, (40) transistor amplifier—Centralab, (41) transistor socket—Grayhill, (42) batteries—Yardney, (43) battery—National Carbon for Hamilton Watch

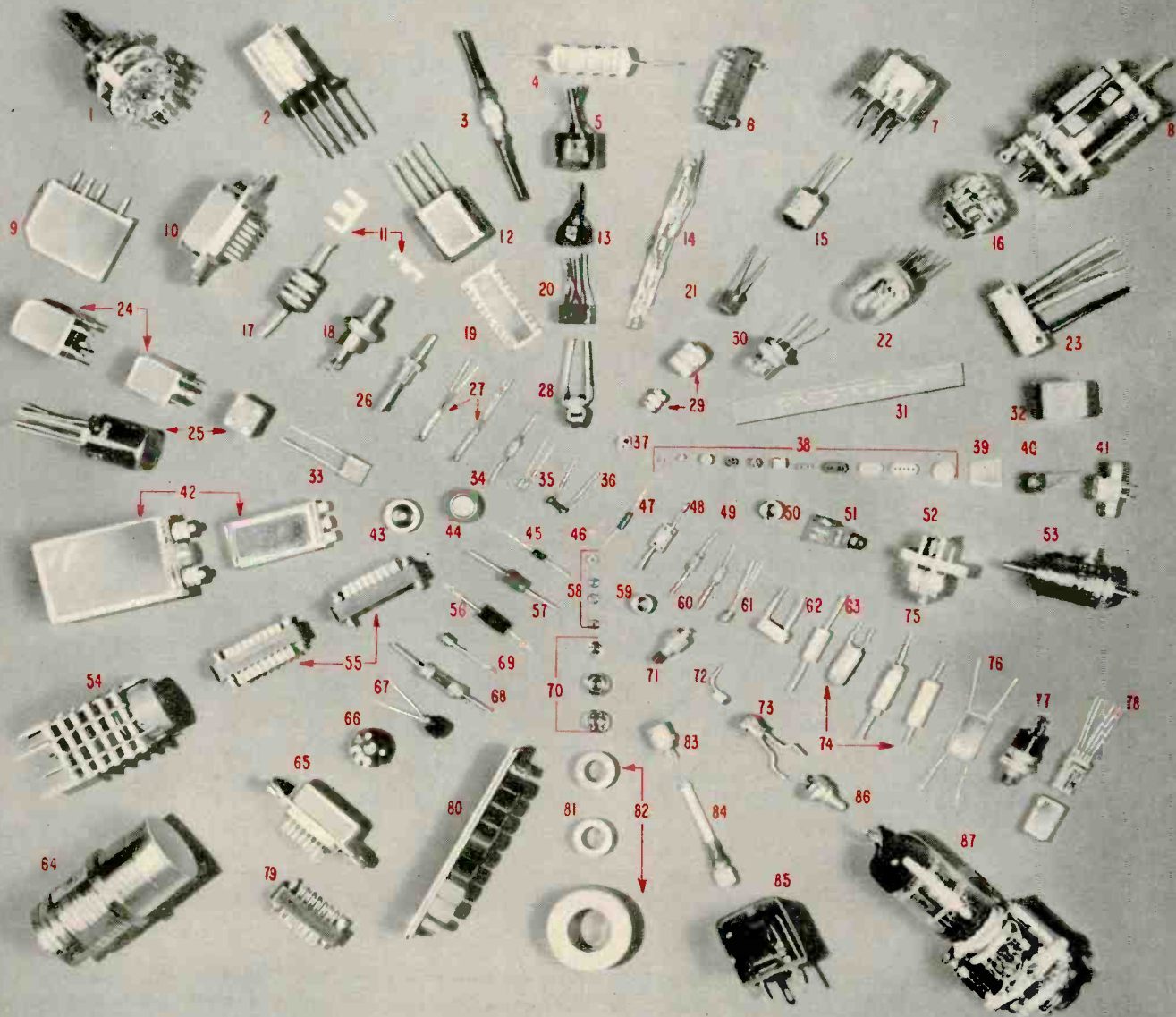

(44) battery—Mallory, (45) resistor—General Resistance, (46) bearing—New Hampshire Ball Bearing, (47) capacitor—Aerovox, (48) capacitor—Corning Glass, (49) diode—Radio Receptor, (50) bobbin core—Magnetics, Inc., (51) hearing-aid amplifier subassembly—Acousticon, (52) ceramic-tube socket—Jetron, (53) magnetic clutch and brake—Autotronics, (54) module—Sanders, (55) connector—DeJur-Amsco, (56) tape resistor—Sanders, (57) resistor—Daven, (58) ball bearing—Miniature Precision Bearings, (59) bobbin core—Magnetics, Inc., (60) diode—Clevite, (61) transistor—Philco, (62) capacitor—Vitramon, (63) capacitor—Aerovox, (64) rate gyro—Raytheon for Minneapolis-Honeywell, (65) connector—Amphenol, (66) variable resistor—Centralab, (67) potentiometer—Minelco, (68) wire-wound resistor—Daven, (69) transistor—Raytheon, (70) ball bearings—Fafnir, (71) switch—Grayhill, (72) selenium diode—International Rectifier, (73) selenium diode—Electronic Devices, Inc., (74) capacitor—Good-All, (75) capacitor—Aerovox, (76) capacitor—Sanders, (77) switch—Grayhill, (78) relay—Elgin, (79) connector—DeJur-Amsco, (80) jack board—Grayhill, (81) core—Magnetics, Inc., (82) core—Arnold, (83) diode socket—Grayhill, (84) connector—Amphenol, (85) blocking oscillator—DuMont, (86) coaxial connector—Amphenol, (87) 110-mc oscillator—Aircraft Radio

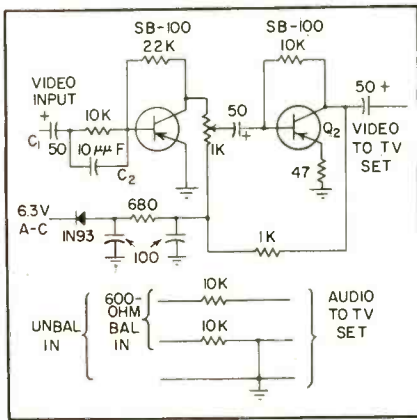

FIG. 1—Jeep kit incorporates video pre-amplifier and audio isolation network

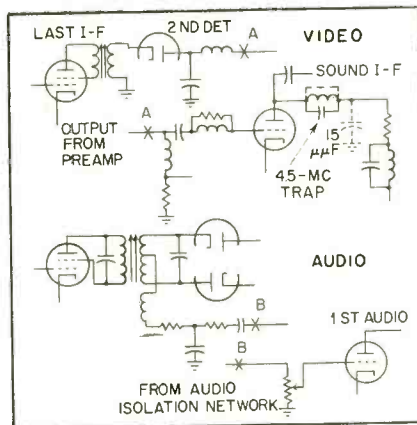
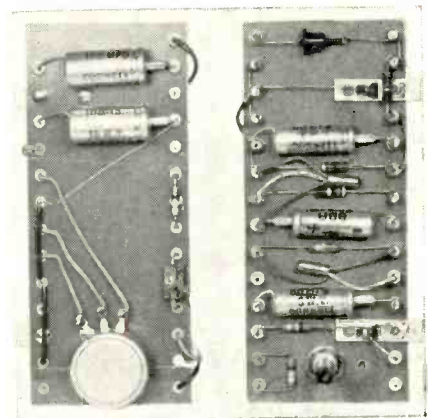

FIG. 2—Typical tv receiver circuits show where modifications are made



Jeep kit installation (lower right) on tv receiver

Transistors Boost Video for TV Studio Monitors

By L. N. MERSON

Engineer
Philco Corporation
Philadelphia, Pa.

SUMMARY — Compact transistor preamplifier unit boosts video line level to permit use of standard black-and-white or color receiver as studio line monitor. Unit may also be used as video line boost or distribution-line isolation amplifier

WHERE a television studio monitor or jeep is needed temporarily, a conventional tv receiver may be used by employing a jeep kit to boost the video line level to that required by the receiver. Figure 1 shows the necessary conversion circuitry. Fifty such kits and receivers were used at the 1956 presidential-nomination convention in Chicago.

Levels

The preamplifier provides a maximum output level of 3.5 v p-p from the normal video line level of 1.4 v p-p of video and sync from a 75-ohm line. This output level is sufficient to operate the receiver through its full dynamic range.

Bandwidth is flat to almost 8 mc. The small amount of degeneration introduced in the emitter cir-

cuit of Q_2 modifies the inherent transistor clamping action and prevents clipping on sudden surges of video. Capacitor C_1 provides d-c isolation enabling the input transistor to be properly biased, the 10,000-ohm input resistor prevents

loading of the video line and C_2 provides high-frequency peaking.

Audio line levels are normally 0 to 4 vu across 600 ohms. These levels are usually adequate for the receiver audio circuits.

Receiver Modifications

A typical receiver modification is shown in Fig. 2. The video-detector load is opened at A and the jeep-kit output fed in. The 4.5-mc trap is shorted out and a 15- μf shunt capacitor is added to flatten the video bandwidth.

The audio circuit is broken at B and the audio fed in.

These jeep kits can also be used as line boost amplifiers or as distribution-line isolation amplifiers. Their wide bandwidth permits them to be cascaded without bandwidth restriction.

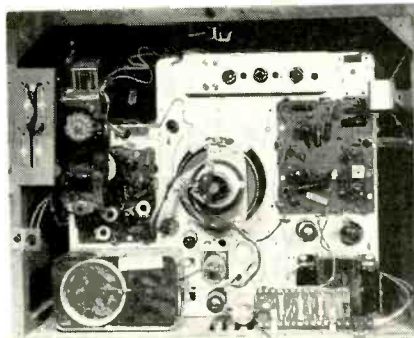

Top and bottom views of jeep kit illustrate compactness of unit

COMPLIANCE METER

By ARTHUR R. KOPP

Cartridge Dept.
Electro-Voice, Inc.
Buchanan, Mich.

SUMMARY — Simple system for production line or laboratory testing measures compliance of phonograph cartridge by using a mass and the cartridge as the frequency-determining components of an oscillator circuit. Meter gives compliance readings directly over range from 0.5×10^6 to 6×10^6 cm per dyne

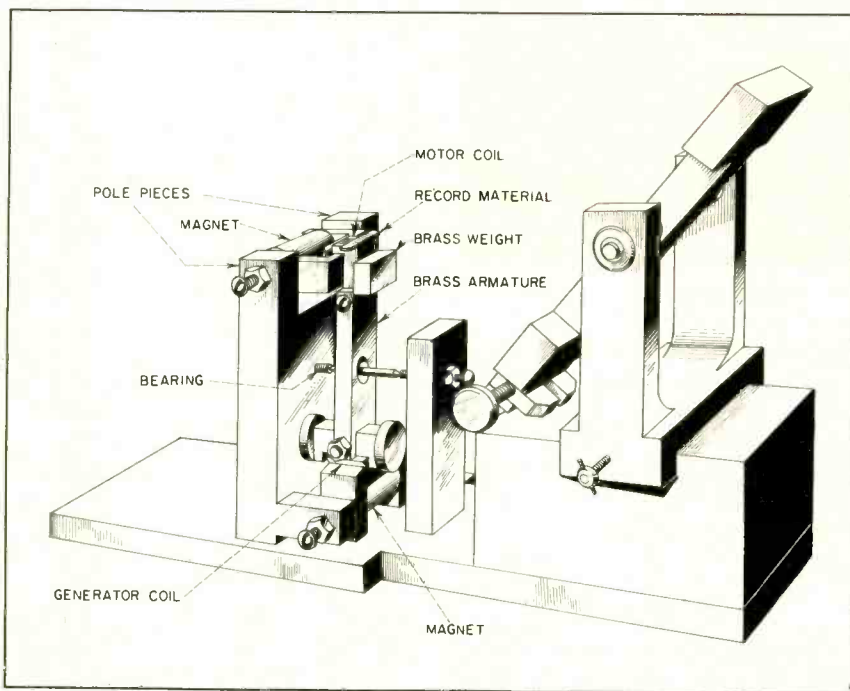

FIG. 1—Mechanical setup for compliance meter. Cartridge under test is held in screw clamp at right center

STYLI of phonograph cartridges must track large and complex groove excursions with a minimum of record wear. The measure of a cartridge's ability to do this is a function of its mechanical compliance at the stylus. Compliance, which is the reciprocal of stiffness, is the mechanical analog of electrical capacitance and is measured in centimeters per dyne.

A static measurement of compliance may be made by applying a known force to the stylus and measuring the resultant displacement. This, however, involves the use of either a microscope or a shadowgraph machine and much care to obtain accurate results.

Construction

An instrument is required which will measure dynamic cartridge compliance with accuracy and yet be simple and quick to use. The meter to be described was designed with these requirements in mind and features laboratory accuracy along with quick readings and versatility.

Essentially, it contains a dynamically-balanced mass which is free to rotate for a few degrees on low-friction bearings, as shown in Fig. 1. Attached to either end of this brass armature are coil forms which contain a number of turns which contain a number of turns of No. 30 wire.

Adjacent to each coil is a stationary magnet assembly making the unit a generator and motor electromechanical transducer. The leads from each coil are made long and are coiled so that the compli-

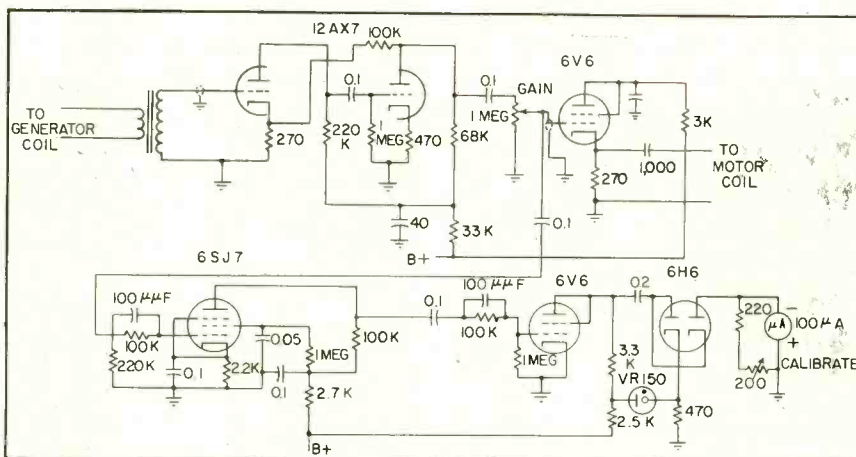
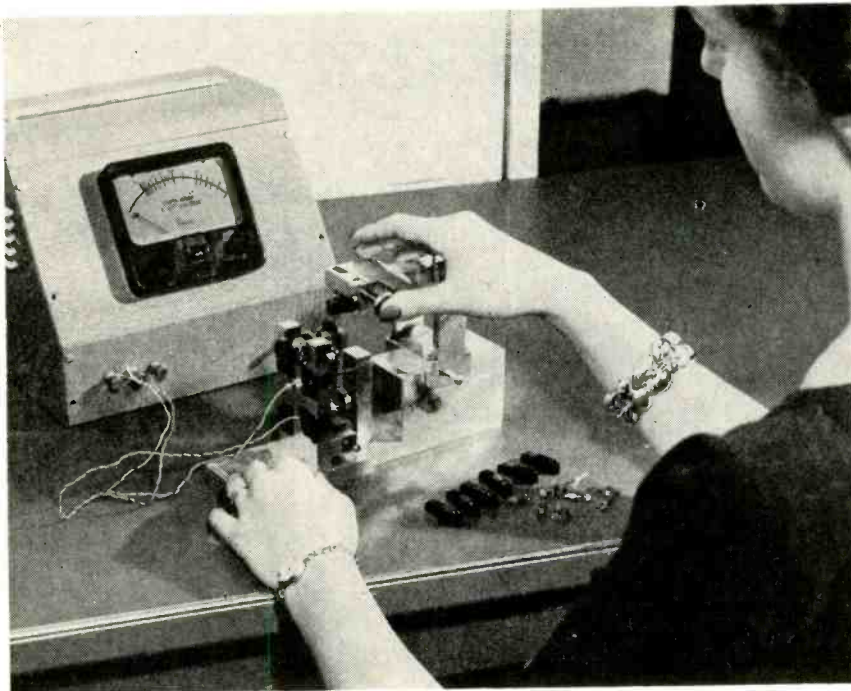

FIG. 2—High-gain amplifier provides feedback of generator output to compliance meter drive motor to make unit self-resonating

Tests Phono Cartridges



Compliance meter set up for production-line testing of phonograph cartridges

ance coupled to the brass armature is extremely high. The electrical equivalent circuit then would be represented by pure inductance with negligible series resistance and infinite capacitance.

On the upper coil is cemented a small piece of record material which is used to facilitate the application of the stylus. The application of a cartridge then makes the assembly a mechanical series resonant circuit at a frequency determined by a known mass and the unknown compliance of the cartridge.

To make the basic instrument an instantaneous reading device, it is necessary to make the effective mass and unknown compliance the frequency determining components of an oscillator with frequency, as a function of the unknown compliance, indicated on a meter scale.

A high-gain stable class-A voltage amplifier shown in Fig. 2, is used with its input and output connected to the generator and motor coils respectively of the instrument. The output of the second stage is fed to a conventional frequency-meter circuit.

The sine wave is clipped to feed

square waves into a differentiating and rectifying circuit and the resultant unidirectional pulses are fed into a self-integrating micro-with frequency and hence reads ameter. The meter reads linearly compliance $\times 10^{-6}$ cm per dyne in an inverse logarithmic fashion.

Calibration

The frequency meter has a range from 0 to 50 cps. Thus with an effective mass of 18.0 grams, the instrument covers the convenient range of from 0.5×10^{-6} cm per dyne to 5 or 6×10^{-6} cm per dyne. Controls provide for frequency adjustment for calibration and gain adjustment to prevent the system from oscillating too violently when a high-Q compliance is applied.

When used as a manual laboratory instrument, the motor coil is connected to a variable-frequency audio oscillator. The generator coil is connected to an a-c vtvm. When the unknown compliance is applied, the mechanical system is tuned to resonance as indicated by voltage maximum on the vtvm. The compliance then is a function of frequency as $C_M \propto \frac{1}{F^2}$.

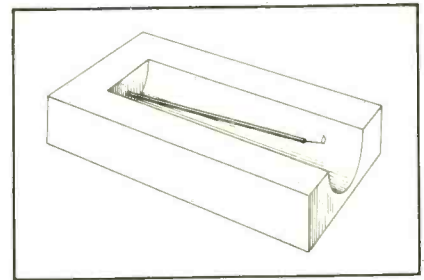

FIG. 3—Compliance standard used in calibrating meter

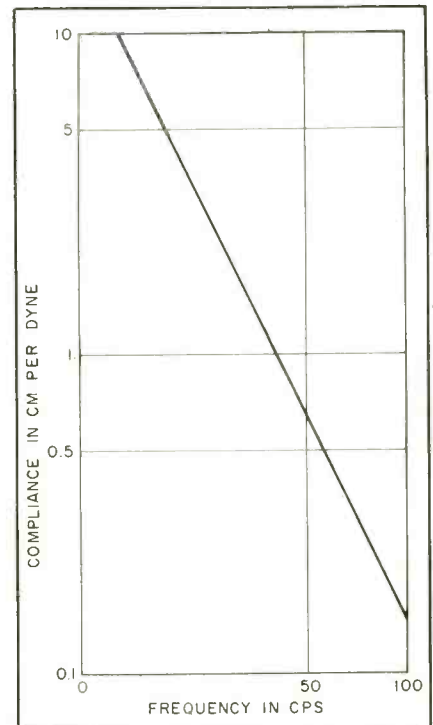

FIG. 4—Typical plot of compliance as compared to resonant frequency

The meter can be calibrated by use of compliance standards, one of which is shown in Fig. 3. A few such standards can be made up by use of the formula for the compliance of a cantilever beam.

$C_M = (4L^3/EWT^3) \times 10^{-3}$ cm per dyne, where L = length, W = width, T = thickness and E = Young's modulus in newtons per sq meter. A chart can be made on logarithmic paper with compliance as the ordinate and frequency as the abscissa yielding a straight line as shown in Fig. 4. From this calibration, the effective mass of the moving mechanism may be ascertained.

Probability Computer For

By **A. W. SULLIVAN** and **J. D. WELLS**

*Engineering and Industrial Experiment Station
University of Florida
Gainesville, Florida*

*Physics Department
Research Laboratories
Westinghouse Electric Corp.
East Pittsburgh, Pa.*

SUMMARY — Designed to study the amplitude distribution of atmospheric noise and its effect on radiotelegraph, frequency-shift radioteletype and a-m speech, computer takes the noise signal from receiver i-f and feeds it to a half-wave detector coupled to an overdriven d-c amplifier that produces a constant-amplitude pulse each time a reference threshold is exceeded by the noise input

PROPER DESIGN of communication systems requires quantitative assessment of the magnitude of the noise contributing, to interference. Since noise is characterized by a rather complicated waveform of a nonrepetitive nature it is generally desirable to resort to statistical methods for evaluating and describing the noise signal. A useful function which describes the amplitude of the noise is the first amplitude distribution function.

Principles

The first order amplitude-probability distribution is given by

$$P(E \geq E_0) = \int_{E_0}^{\infty} p(E) dE \quad (1)$$

where $P(E \geq E_0)$ is the probability that the input noise voltage E exceeds an arbitrary threshold E_0 and $p(E)dE$ is the probability that voltage E lies in the range, $E, E + dE$.

An equivalent time function which expresses the relation in terms of the length of time that the reference is exceeded is given as

$$P(E \geq E_0) = \frac{\sum_1^n \frac{\Delta t_n}{T}}{\Delta t_1 + \Delta t_2 + \Delta t_3 + \dots} \quad (2)$$

where Δt_n represents time increments when the noise voltage exceeds the reference threshold and

T is the total time over which the elements Δt_n are measured.

Equation 2 and therefore Eq. 1 may be solved electrically by generating a signal that is a function of the time that the threshold is

exceeded and averaging these signals over a selected period of time. A simple method of accomplishing the first part of the instrumentation consists of generating a constant-amplitude pulse whose width is equal to the time the threshold is exceeded. If the pulse amplitudes are normalized to unity, the average value of the output pulse train gives the probability.

A finite change of input voltage, $E_0 + \Delta E$, corresponds to a change of output indication from zero to one and this change of voltage is termed the increment of the unit. Ideally, this increment would approach zero but since this is not a realizable condition, an increment that is very small compared to the maximum voltage E is required. The actual requirement for the size of the increment is that its rise-time be essentially independent of the slope of the noise signal as E passes through the increment.

Circuit

A circuit diagram of the probability computer is shown in Fig. 1. The unit operates directly from any receiver having an i-f within the tuning range of the input amplifier's i-f transformer. This i-f amplifier provides isolation for the computer circuits and a convenient means of adjusting the gain when operation of several units with equal channel gains is desired.

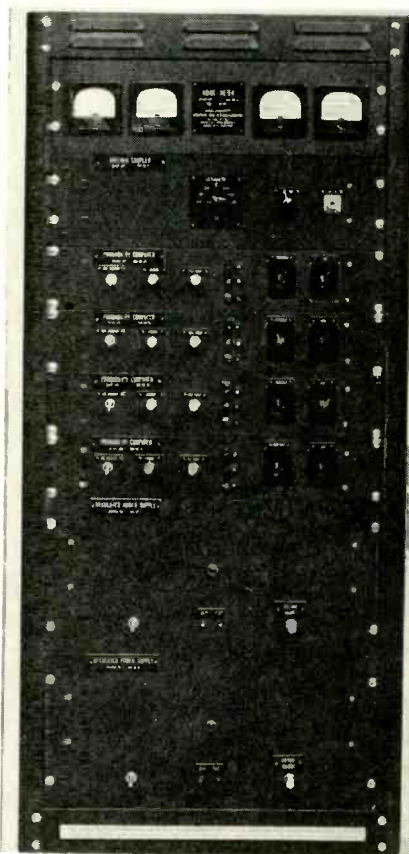

Complete noise measuring equipment. Simultaneous measurement of four points on the distribution curve is possible. Meters provide visual observation of noise at these points if graphic recording is not required for permanent record

NOISE MEASUREMENT

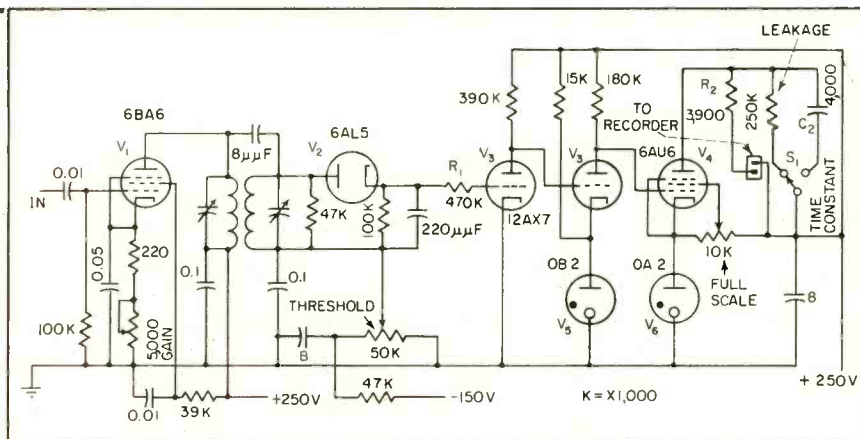

FIG. 1—Probability computer circuit. Input is from receiver i-f circuit. Output drives pen motor of strip recorder to give permanent data

A conventional half-wave detector feeds an overdriven d-c amplifier which produces a constant-amplitude pulse each time the reference threshold is exceeded by the noise input. The pulse duration corresponds to the time the threshold is exceeded.

As measured at the detector load, the voltage increment of this unit is approximately 50 millivolts and pulses are produced whose rise-time equals the time required for the noise voltage to cross the increment. The output pulses are integrated over a period of approximately 16 seconds by R-C network R_2 and C_1 , and the averaged plate current of the output stage may be recorded to give the probability record. Accuracy, determined by the graphic recorder, is usually on the order of one percent.

Operation is achieved with good accuracy at frequencies up to 5 kc at the detector load, and the frequency response is determined primarily by the series grid resistor R_1 and the input capacitance of V_3 . The computer circuit proper operates satisfactorily at frequencies up to approximately 35 kc.

Operation

The arrangement of component units is shown in the functional diagram in Fig. 2.¹ The antenna coupler consists of a cathode-follower unit which includes the vari-

able attenuator used in the measurement procedure. A standard signal generator normally serves as the calibrating source since sine-wave calibration is used.

For accurate results with this system, it is important that the receiver i-f signal be a symmetrical damped sinusoid when the input circuit is shock-excited by a pulse and when the amplitude of the waveform exceeds the linear range of the receiver, the response in the linear range is not affected.

The first requirement is generally met by careful alignment of the receiver tuned circuits since any variations in the waveform within the receiver linear range are usually the result of mistuning which alters the shape of the envelope. The second requirement is sometimes more difficult to satisfy due to blocking and long recovery times after overload. Distortion of the portion of the pulse within the linear range results and introduces errors in the measurement.

It is essential that the portion of the pulse which lies within the receiver linear range be undistorted by receiver overload if accurate measurements are to be made. The linear dynamic range of the receiver should be as great as possible. Some receivers have a linear range of approximately 40 db, although 25 db is the usual range.

Threshold adjustments on the

probability computers are referred to the input of the antenna coupler. If an input signal of 50 microvolts is required for an output indication on a unit, the threshold is said to be 50 microvolts. The system linear range is first determined from the antenna input to the detector load in the probability computer. Then an input signal equal to the desired threshold level is applied from the signal generator and the threshold adjustment on the probability computer is set so the output meter indicates half-scale. This reading shows that the input signal is in the increment. This procedure completes the threshold setting adjustment and need be repeated only once for each computer unit.

Input signals must be set within the linear range of the equipment for each threshold adjustment and any one set of adjustments will

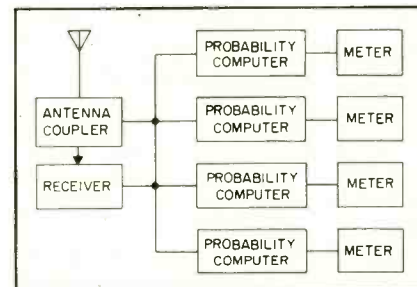

FIG. 2—Block diagram of complete noise measuring system. Calibrating source (not shown) is used to initially set up probability computers

cover a dynamic range of 40 db or less. It is possible however, to shift the effective thresholds by an attenuator so a range of 100 db or more may be covered in several steps.

For example, if a 100-microvolt threshold is set with 0-db attenuation, then with 20-db attenuation introduced in the system the new threshold would be 1,000 microvolts.

This work was supported by the Air Force Cambridge Research Center through Contract No. AF 19(604)-876.

REFERENCE

(1) J. D. Wells, Logarithmic Amplifier Measures Noise, *ELECTRONICS*, 30, p. 169. Apr. 1957.

Waveguide Loss Charts

By A. F. POMEROY

Bell Telephone Laboratories
Murray Hill, N. J.

SUMMARY — Graphical presentation of attenuation values provides data for typical commercial microwave equipment. When effective resistivity is known or estimated, attenuation in db/ft can be determined at 1 to 75 kmc. Internal rectangular dimensions are also given

ATENUATION PER FOOT of a particular commercial rectangular waveguide at a given frequency may be computed from published information, but for rapid extrapolation or comparison the accompanying charts offer a ready solution.

One must know or be able to estimate the effective resistivity of the conducting surface. This is the product of d-c resistivity and a surface roughness factor

K_r , which is unity for an ideal polished surface. Materials having low d-c resistivities require smooth surfaces for low effective resistivity and low loss. In materials having high d-c resistivities the current penetrates deeper into the material and K_r is near unity even for moderately rough surfaces. Thus surface roughness has almost no effect on high-resistivity materials.

Another factor is the size of the hollow waveguide cross section. Lowest losses are obtained by use of the largest possible waveguide. The chart shows the penalty resulting from use of a smaller size.

Measured attenuation of two sizes of rectangular copper waveguides shows that the effective resistivity is about 2.2×10^{-6} ohm-cm from 4 to 6 kmc. This is about 28 percent above the d-c resistivity of 1.72×10^{-6} ohm-cm. Measurements on WR-229 drawn of 90-10 brass show an effective resistivity of 4.3×10^{-6} ohm-cm at 4 kmc, which is about 7.5 percent above the d-c resistivity of 4×10^{-6} ohm-cm.

Plotting points on the graph were determined from the equation

$$\alpha = \frac{5.963 (R K_r / \lambda)^2 (1/b + \lambda^2/2a^2)}{\sqrt{1 - \lambda^2/4a^2}}$$

wherein

α = attenuation in db/ft in rectangular waveguide

R = d-c resistivity of conducting surface in ohm-cm

a = wide dimension of waveguide in in.

b = narrow dimension of waveguide in in.

λ = free-space wavelength in in.

K_r = surface roughness factor

RK_r = effective resistivity of conducting surface in ohm-cm

Example

Suppose it is necessary to find the attenuation of WR51 made of high-conductivity copper at frequencies from 16.4 to 20.6 kmc. Using 2.5×10^{-6} ohm-cm as an effective resistivity, we read on the chart 0.092 db/ft at 16.4 kmc and 0.078 db/ft at 20.6 kmc. The attenuation of other sizes can be found in a similar manner.

Representative frequencies in the recommended ranges were chosen for each size shown in the charts. Interpolation between the characteristics to find the loss for other frequencies is straightforward.

The effective resistivity should be nearly constant over a small frequency interval, which leads to another use of these characteristics. To find an average ef-

Table I—Nominal Internal Dimensions for Standard Hollow Rectangular Waveguides

WR No.	Wide	Narrow
10	0.100	0.050
12	0.122	0.061
15	0.148	0.074
19	0.188	0.094
22	0.224	0.112
28	0.280	0.140
34	0.340	0.170
42	0.420	0.170
51	0.510	0.255
62	0.622	0.311
75	0.750	0.375
90	0.900	0.400
112	1.122	0.497
137	1.372	0.622
159	1.590	0.795
187	1.872	0.872
229	2.290	1.145
284	2.840	1.340
340	3.400	1.700
430	4.300	2.150
510	5.100	2.550
650	6.500	3.250
770	7.700	3.850
975	9.750	4.875

(continued on page 212)

★ NEW - MOLDED RIGID TAIL PRINTED CIRCUIT CINCH SOCKETS :



24260
7 PIN
with telescopic
shield (Shown
enlarged)

Quantity production of low loss mica components, finest molding machines and equipment operated under most experienced guidance and engineering supervision with adequate and unequalled facilities has advanced CINCH to the foremost in production of low loss Mica components in quantity.

★ Snap in type contact. Can be stacked for automatic assembly. Can be furnished with integral twist lock telescopic shield. General purpose Mica or Alkyd insulation.

24261



7 PIN
with center post
Mica

24264

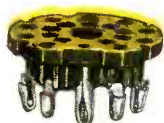

9 PIN
with center post
Mica

24262



7 PIN
with ground strap and
center post Alkyd

24265



9 PIN
with ground strap and
center post Alkyd

24263
9 PIN
with telescopic shield

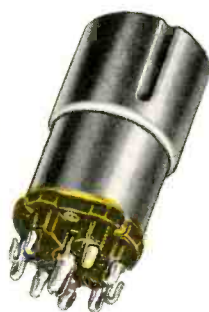

24260
7 PIN
with telescopic shield



CINCH will design, or re-design, components to fit specific needs, and will assist in the assembly of components through proven automation technique.



Cinch
ELECTRONIC
COMPONENTS

Centrally located plants at Chicago, Illinois; Shelbyville, Indiana; LaPuente, California; St. Louis, Missouri.

CINCH MANUFACTURING CORPORATION

1026 South Homan Ave., Chicago 24, Illinois

Subsidiary of United-Carr Fastener Corporation, Cambridge, Mass.

Waveguide Loss Charts (continued from page 210)

fective resistivity over a band of frequencies, measured values of db/ft may be plotted on the characteristics and an ordinate drawn through the average value of effective resistivity. This result is probably more accurate

than any one of the individual determinations.

Thanks are due Miss J. D. Goeltz and Mrs. Dolores G. Hill for their work in computing the attenuations used in plotting the characteristics.

BIBLIOGRAPHY

A. F. Pomeroy and E. M. Suarez, Determining Attenuation of Waveguide from Electrical Measurements on Short Samples, *IRE Trans RGM-TT*, p 122, Apr. 1956.

F. A. Benson, Waveguide Attenuation and Its Correlation with Surface Roughness, *Proc IEE*, 100, Part III, p 85, Mar. 1953.

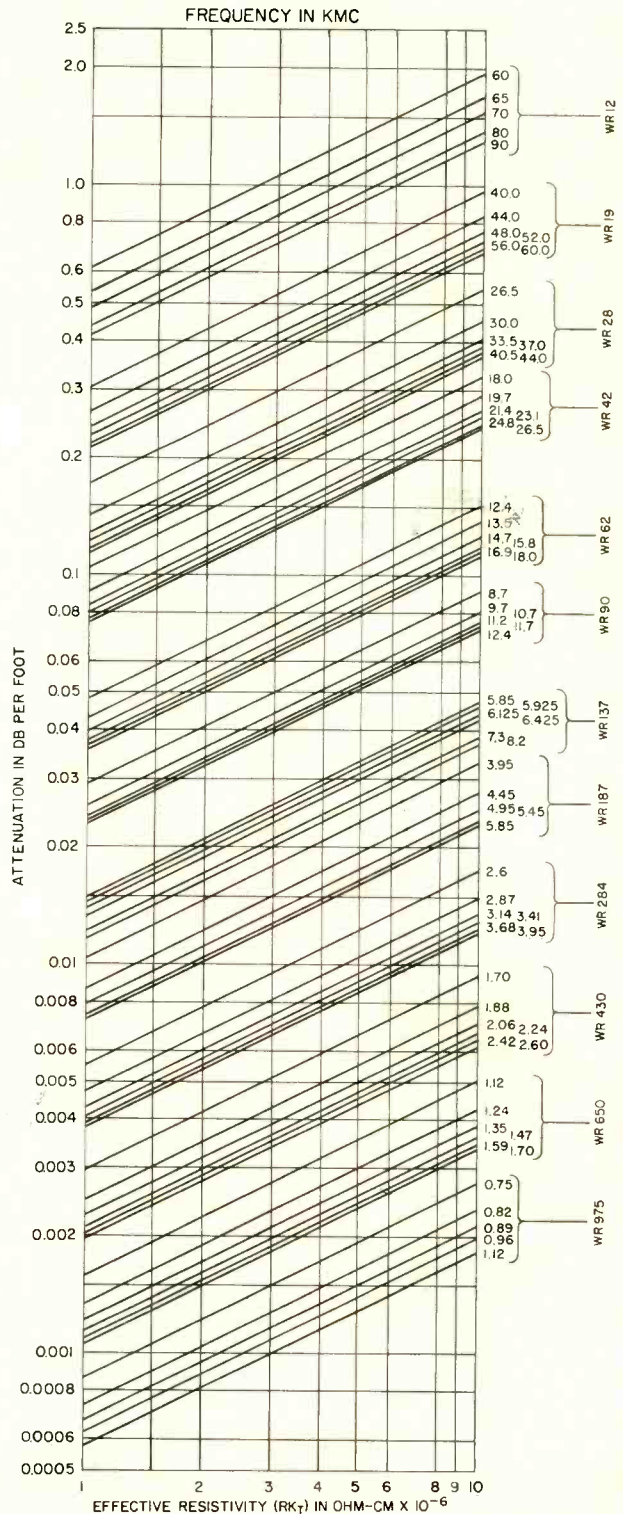
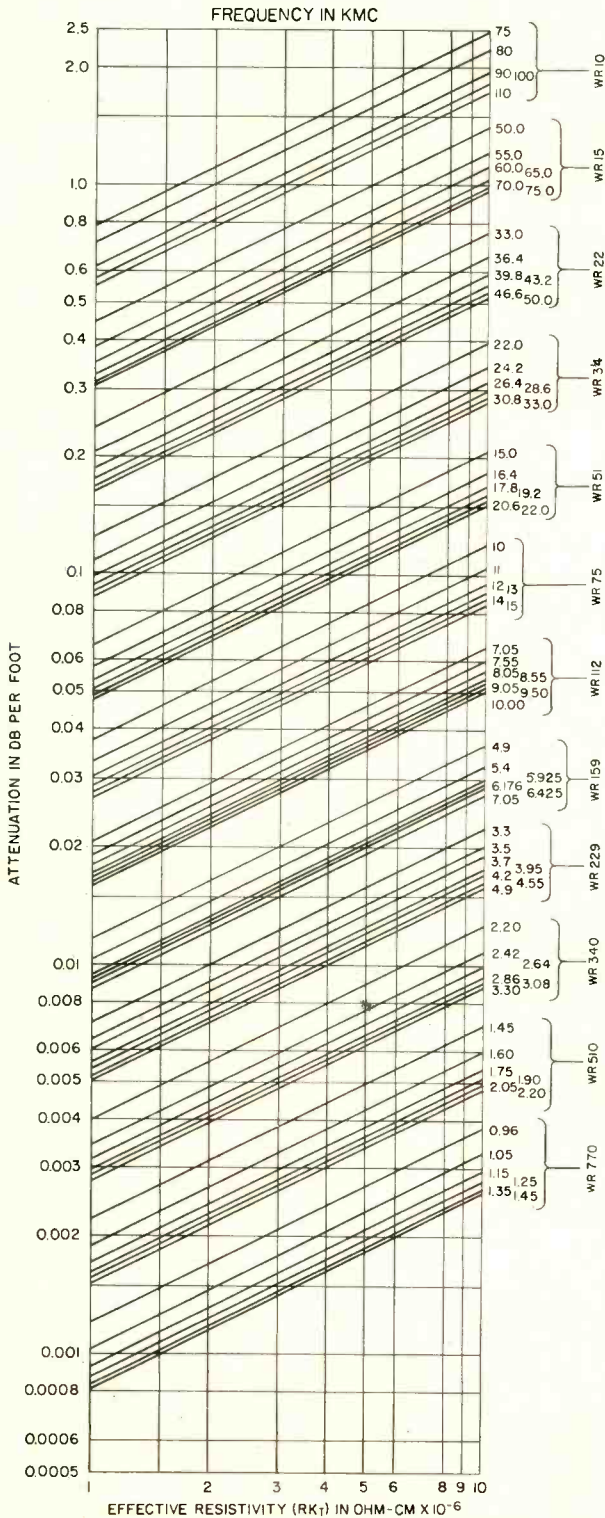

When Equipment "Goes Mobile"...



Get dependable power from

Mallory Vibrators

Designing mobile electronic equipment? Portable or vehicular two-way radios, test apparatus, PA amplifiers, headlight dimmers, ultra-violet portable test lamps for geologists... there's practically no end to new kinds of battery-powered products that may be on your drawing boards tomorrow. And when you come to the vital power supply design, call on Mallory vibrators and Mallory engineering help.

New Mallory vibrator models, embodying a unique concept of contact engineering that comes from Mallory's 25 years of vibrator pioneering, offer even better performance than ever before. They last up to 100% longer, run quieter, and give more constant output throughout their life. A complete range of interrupter and self-rectifying types, suitable for light to heavy duty, covers any application you may have.

Profit by Mallory Assistance in engineering your vibrator power supply. We can help you not only in selection and application of the Mallory vibrator model that best fits your needs, but also in design of power supply circuitry and use of related components to get top overall performance. Write today for a consultation by a Mallory vibrator specialist.

Parts distributors in all major cities stock Mallory standard components for your convenience.

Serving Industry with These Products:

Electromechanical — Resistors • Switches • Tuning Devices • Vibrators
Electrochemical — Capacitors • Mercury and Zinc-Carbon Batteries
Metallurgical — Contacts • Special Metals • Welding Materials

Expect more...get more from

P. R. MALLORY & CO. Inc.
MALLORY

P. R. MALLORY & CO. Inc., INDIANAPOLIS 6, INDIANA

Two-Collector Transistor for Binary Full Addition

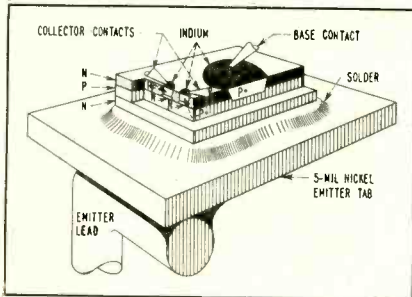

FIG. 1—Cross section of experimental two-collector full-adder transistor using point contacts

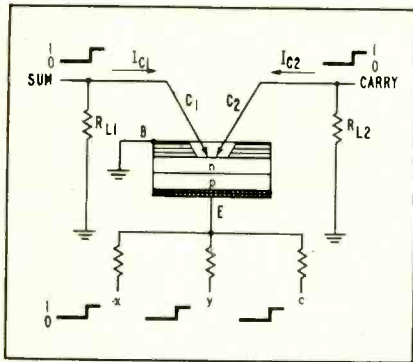

FIG. 2—Full adder circuit

MULTIELECTRODE transistors can be used to perform complex logical operations and provide amplification in computer circuits. The advantage of performing these operations in a single transistor is economy of component parts. For high-speed operation, where the capacitance and inductance of sockets and leads become speed limiting factors, there is an inherent advantage of having logical operations performed within the semiconductor body of the transistor itself.

Figure 1 shows a schematic cross section of an experimental two collector, full-adder transistor which utilizes point contacts as the collector electrodes.

► **Full Adder**—A full-adder circuit using this type of transistor is illustrated in Fig. 2. The input signals at terminals X, Y, and C represent the binary numbers to be

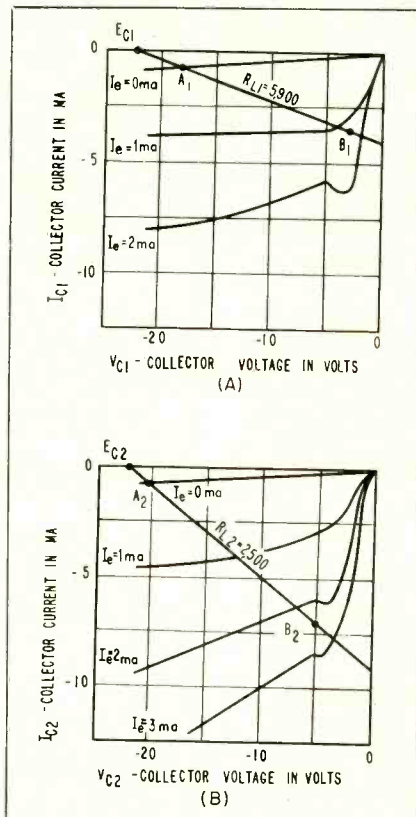

FIG. 3—Characteristic curves

added. The currents I_x , I_y , and I_c corresponding to those numbers are mixed at the emitter. The output signals are the two collector voltages representing the sum and carry. Load lines corresponding to the unequal load resistors R_{L1} and R_{L2} are shown superimposed upon the individual collector V-I characteristics in Fig. 3.

With zero emitter current, the operating points at each collector will be those labeled A_1 and A_2 . As the emitter current is increased from a zero value collector 1, C_1 is favored for low emitter currents, because either it is physically closer to the emitter, or its effective intrinsic alpha initially exceeds that of C_2 .

When the emitter current is increased until the C_1 operating point is at B_1 , C_1 is saturated and subsequent emitter hole current may now

go to C_2 . As the emitter current is increased over the value needed to saturate C_1 , the current in C_2 increases. As the emitter current is further increased, the electric field near C_2 becomes strong enough to begin to divert some of the current originally going to C_1 . With continued emitter current increases, this diverting action becomes stronger, and finally C_2 collects essentially all of the injected hole current and is driven to saturation, as indicated by operating point B_2 in Fig. 3. Now C_1 is collecting current and is in the off condition indicated by operating point A_1 . The load resistor for C_2 must be roughly half the value of that for C_1 plus that which was necessary to build up the strong electric fields in the base region to accomplish the robbing action.

After the second collector is in saturation, any additional emitter current will not be accepted at C_2 , but instead will be collected at C_1 until it, too, is again saturated. If C_1 is considered as the sum collector and C_2 the carry collector, the operation of full addition is accomplished.

The transistor, in view of its multiple electrodes and properties of collector interaction, can be used in other circuits. For example, if the full-adder circuit of Fig. 2 has a lower value of load resistor for C_2 the binary logical connective neither-nor is obtained. The full added circuit with different value of input current can perform the logical operation not-both.

► **Junction Type**—Recent advances in the techniques of transistor fabrication have made it practicable to construct all-junction designs of the full adder transistor. In these designs, the formed point-contact collectors, which are difficult to produce to preassigned specifications are replaced by $p-n$ hook collectors which are made by alloying and

it's

first in
Performance
Reliability
and Quality

Kepeco

FOR VOLTAGE REGULATED POWER SUPPLIES

KR SERIES



1.5 Amp.

KR
SERIES

MODEL
KR-16MC

OUTPUT VOLTS DC	6.3V AC	Model	Rack Mount			Price
			W	H	D	
0-150	Each supply	KR16	19"	12 1/4"	17"	\$625
100-200	has two	KR17	19"	12 1/4"	17"	\$625
195-325	15 Amp.	KR18	19"	12 1/4"	17"	\$695
295-450	outputs	KR19	19"	12 1/4"	17"	\$695

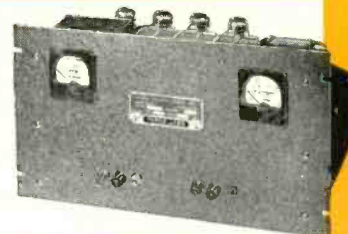

600 ma.

KR
SERIES

MODEL KR-8M

OUTPUT VOLTS DC	6.3V AC	Model	Rack Mount			Price
			W	H	D	
0-150	Each supply	KR 8	19"	10 1/2"	13"	\$330
100-200	has two	KR 5	19"	10 1/2"	13"	\$240
195-325	10 Amp.	KR 6	19"	10 1/2"	13"	\$240
295-450	outputs	KR 7	19"	10 1/2"	13"	\$250

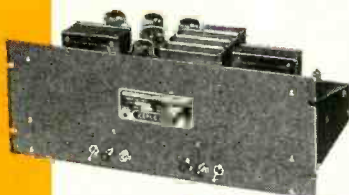

300 ma.

KR
SERIES

MODEL KR-4

OUTPUT VOLTS DC	6.3V AC	Model	Rack Mount			Price
			W	H	D	
0-150	Each supply	KR 12	19"	7"	11"	\$270
100-200	has two	KR 3	19"	7"	11"	\$180
195-325	5 Amp.	KR 4	19"	7"	11"	\$180
295-450	outputs	KR 10	19"	7"	11"	\$190



125 ma.

KR
SERIES

MODEL KR-1C

OUTPUT VOLTS DC	6.3V AC	Model	Rack Mount			Price
			W	H	D	
0-150	Each supply	KR 11	19"	7"	11"	\$180
100-200	has one	KR 1	19"	7"	7 1/2"	\$ 90
195-325	3 Amp.	KR 2	19"	7"	7 1/2"	\$ 90
295-450	output	KR 9	19"	7"	7 1/2"	\$ 97

To Include 3" Current and Voltage Meters, Add M to Model number (e.g. KR 16-M) and Add \$30.00 to the Price.
To Include Dust Cover and Handles for Table Mounting, Add C to Model number (e.g. KR16-C) and Add \$10.00 to the Price.
To Include Meters, Dust Cover and Handles, Add MC to Model number (e.g. KR-16 MC) and Add \$40.00 to the Price.

PRICES F.O.B. Flushing

★ **FAST** RECOVERY TIME ★ **GOOD** STABILITY ★ **LOW** OUTPUT IMPEDANCE

Kepeco **KR** Voltage Regulated Power Supplies are conservatively rated and are designed for continuous duty at 50°C ambient.

REGULATION: Less than 0.2 volts for line fluctuation from 105-125 volts and less than 0.2 volts for load variation from 0 to maximum current.

RIPPLE: Less than 3 mv. rms.

STABILITY: The output voltage variation is less than the regulation specification for a period of 8 hours.

RECOVERY TIME: Less than 50 microseconds. The excursion in the output voltage during the recovery period is less than the regulation specification.

OUTPUT IMPEDANCE: Less than 0.1 ohms from 20 cycles to 100KC. Less than 0.5 ohms from DC to 20 cycles. Many units have very much lower output impedance.

featuring

All models available
for 400 cycle operation
on special order.

- Fast recovery time, suitable for square wave pulsed loading.
- Voltage range continuously variable without switching.
- Either positive or negative may be grounded.
- Advanced vacuum tube regulator circuitry.
- Power requirements 105-125 volts, 50-65 cycles.
- Locking type voltage control AC, DC switches, fuses, and pilot lights.
- Terminations on rear of unit.
- Oil filled condensers.
- Color Grey Hammertone.
- Guarantee one year.

SEND FOR BROCHURE B-576 — SPECIFICATIONS ON NEW MAGNETIC, TRANSISTOR AND TUBE VOLTAGE REGULATED POWER SUPPLIES AND SEMI-CONDUCTOR DC TO DC CONVERTERS



KEPCO LABORATORIES, INC.

131-38 SANFORD AVENUE • FLUSHING 55, N.Y. • INDEPENDENCE 1-7000

VISIT BOOTHS #126-127 • N.E.C. SHOW • OCTOBER 7-8-9 • CHICAGO

diffusion processes. Figure 4 shows a cutaway view of an experimental structure of this type which is currently being investigated. The details of the various processes involved in the assemblies of such a unit are indicated in the illustration.

The experimental hook collector transistors differ in some respects from those with point-contact collectors. The intrinsic alphas of hook collectors can be made much higher than those normally achieved in formed point-contact collectors. Values as high as 40 have been found to be reasonably easy to obtain.

Since both collectors are equidistant from the emitter plane, the stronger collector, 1, is initially favored, for the full adder operation. The turn-on point for collector

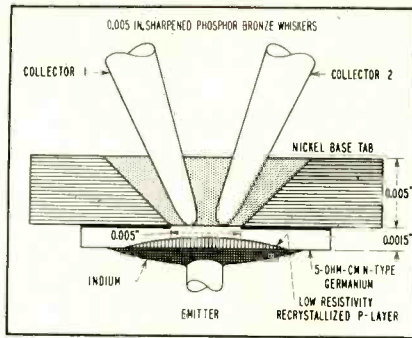

FIG. 4—Cutaway of full adder

2 as emitter current is increased does not in general coincide with the turn-off point as emitter current is decreased, in contrast to the case for point-contact transistor.

► **Application**—Binary logical connectives not-both and neither-nor can also be achieved in a fashion

which allows more tolerance on input amplitudes than was the case for the point-contact collector transistor. The speed of operation of the transistor is, however, much lower than that of the point-contact collector model.

An advantage of a transistor as a logical element is its amplifying action. While the current gains of the point-contact transistors described here are typically between 3 and 4, ten times these values can be achieved by replacing the formed point-contact collectors with *p-n* hook collectors made by an alloying and diffusion process. Transistors of the latter variety show the most promise of lending themselves to controlled production.

This material has been abstracted from the IBM Journal, July, 1957.

Antenna Alarm Anticipates Ice On DEWline

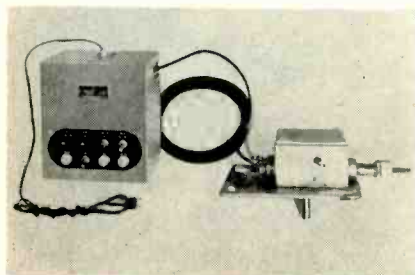

Ice alarm control box (left) and detector housing (right). Temperature-sensitive switch extends from the bottom of the housing and the precipitation sensor protrudes to the extreme right

A SLEET-AND-ICE alarm system to detect incipient icing conditions has been developed for protecting antenna towers. Approximately 100 of these systems have been furnished by the American Instrument Co., Inc. for radar towers on DEW line and Project Alice.

This system responds when atmospheric conditions favor ice formation, before the ice actually forms. Advance warning reduces the power consumption of antenna heaters since the heaters seldom have to cope with deposited ice.

The ice alarm consists of a detection unit, installed on the antenna or other outdoor location, and a control box with associated alarm devices, installed indoors. The sys-

tem anticipates icing by sensing the two ice-forming conditions, low temperature and precipitation. The two sensing elements are connected in series so that the alarm system remains inoperative unless both conditions exist concurrently. The alarm can turn on the antenna heaters if desired. As soon as the icing conditions pass, the system clears itself automatically.

► **Detection Unit**—The sensing elements consist of a developed precipitation monitor and a Fenwal snap-action temperature-sensitive switch. The thermostat, can withstand wide climatic variations since it can be exposed indefinitely to -100 F and to well above 125 F and still operate precisely at its setpoint temperature. There is a direct and constant relationship between angular rotation of the temperature setting screw and the amount of adjustment in setpoint temperature. This allows the thermostat to be equipped with a direct-reading temperature dial and pointer so that the unit can be set in the field. The thermostat usually is set to actuate at 35 F dry bulb, since icing can occur outdoors a few degrees above freezing because of evaporative cooling.

The precipitation detector consists of two parallel coils of resistance wire wound around the outside of a plastic coil form. A drop of water on the detector provides sufficient conductivity to short out the windings and complete the circuit to ground (provided the contacts of

2,000-MC Scatter Link



Scatter transmission system between Cedar Grove, N. J. and Somers, Conn. uses 18-ft parabolic reflector. The Du Mont system operates at 2,180 mc carrying 72 voice channels. Transmitter output is 1-kw. Receiver is dual diversity type operating reliably on an 8 microvolt signal

PROBLEM:

How to incorporate fast programming and maintenance into a circuit analyzer.

SOLUTION:

Adaption of Grant Slides to major operating sections.

Dit-mco, Inc., recently developed a new, large capacity mobile Circuit Analyzer built expressly for field use. Subject to generally adverse field conditions, it was necessary for the equipment to stand up under wear, be easily maintained, yet have operating parts quickly accessible. To achieve this, Dit-mco had the switching sections, power supply, detector unit and relay control section mounted on Grant Slides. Grant Slides solved the maintenance problem by permitting extremely fast inspection of the internal components of the equipment.

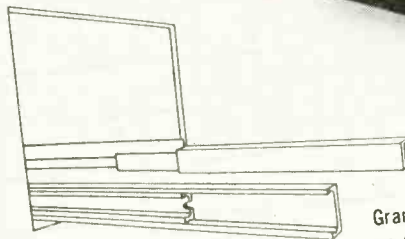
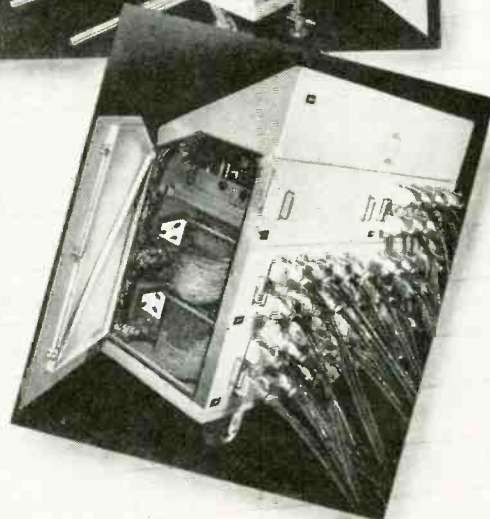

Grant No. 380 Slide recommended for loads up to 500 lb./pair.
Write for complete technical data on the wide range of Grant Slides.

Courtesy Dit-mco, Inc. Kansas City, Mo.

GRANT INDUSTRIAL SLIDES

Grant Pulley & Hardware Corp.
23 High Street, West Nyack, New York
944 Long Beach Ave., Los Angeles, California



the thermostat are closed). The inside of the tubular coil form contains a potted 2.8-watt 6-volt heater which operates continuously while the system is in use. This heater changes any snow or sleet falling on the detector to water, so that the element is responsive to all types of precipitation and by keeping the detector warm, it accelerates drying allowing the system to clear itself quickly when the precipitation stops.

The control unit, shown in Fig. 1, contains a cathode-follower amplifier and an associated alarm circuit. The amplifier and detection units are powered through a 1-to-1 isolation transformer, the 2.8-w heater being supplied from the 6-volt tap of the transformer through the cable shield.

The combination of closed ther-

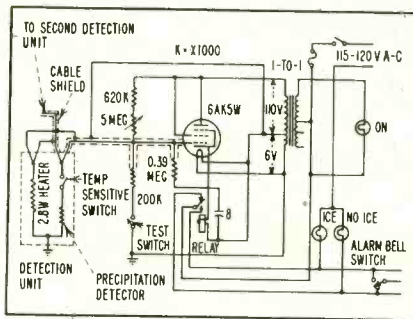

FIG. 1—Alarm circuit is basically a cathode-follower

mostat contacts and shorted precipitation-element windings develops a small voltage (on the order of a few volts) between the grid and ground. This produces sufficient current change through the cathode follower and its biasing resistor to actuate the 1-amp d-c relay of the alarm circuit. The amplifier circuit

contains a 5-megohm variable resistor allowing adjustment of the threshold sensitivity to compensate for resistance changes of the precipitation-element windings. A test switch is provided to test the amplifier and alarm circuits.

Each control box may be connected to one or two detection units wired in parallel. The detection units may be placed up to 1,000 feet away from the control box using RG-69/U cable, and 2,000 feet away using RG-62/U cable. Ground connections for the detection unit are usually made by mounting the cast aluminum housing directly on the metal antenna tower. The housing of the detection unit is fully moisture-proofed by a gasket in the cover and gasketing in the bushings where the sensing elements are threaded into the housing.

Silicon Transistor Crystal Oscillators Have High Temperature Stability

By E. G. HOMER

Canoga Park, Calif.

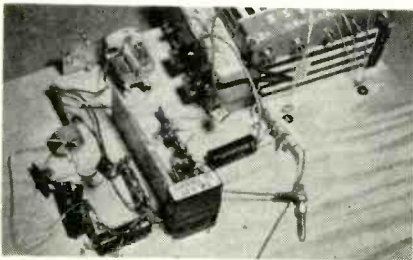

Experimental breadboard setup for testing transistor oscillator circuit

USE of silicon transistors for crystal oscillators suggests itself because of their low I_{co} and desirable temperature characteristics. However, silicon requires more initial voltage to start conduction. This characteristic requires circuits of a special nature as shown below.

Additional difficulty has occurred in using low-frequency crystals. Such crystals with little temperature variation at these frequencies are not particularly active. The losses in the low-frequency crystal from internal friction, the elastic restoring forces and the mass are such as to make it difficult to start oscillation.

The Q of a quartz crystal is very

high, which makes it an ideal band-pass filter. This principle was first used as series resonant filtering between an oscillator of somewhat different design and an emitter follower.

Despite the high-frequency cutoff of Texas 904 transistors used, they did not oscillate in circuits used with germanium transistors. A dormant silicon transistor in typical oscillator circuits will have almost no current flowing since I_{co} is small. A first step is to overcome the lack of current flow by the addition of

a bias circuit that will allow current to flow in the collector.

In the circuit of Fig. 1, current flowing in the tank circuit comprising choke and capacitor would allow one oscillation during the build up of current. However, the Llewellyn criteria for stability are now satisfied and the circuit continues to oscillate.

This oscillator is sensitive to load changes. Therefore an emitter follower must be used as the next stage. In addition, this next stage will furnish power and help achieve

Cloud Detector for Earth Satellite

Measurements to determine area of earth covered by clouds from earth satellite will be made by Perkin-Elmer detector and telemetered back to earth. A mirror 3 in. in diameter x 3/16 in. in thickness directs cloud reflections through holes in the satellite shell to an infrared detector 1/25 in. long and 1/25 in. wide.

Silicon solar batteries mounted adjacent to the detector will distinguish between day and night to turn off equipment when satellite is on the dark side of the earth. Data measured by this means will be telemetered back to earth.



for circuits requiring utmost voltage economy

GOLD BONDED

Radio Receptor Germanium Diodes

**10MA forward current
with a maximum loss
of only .37 volts!**

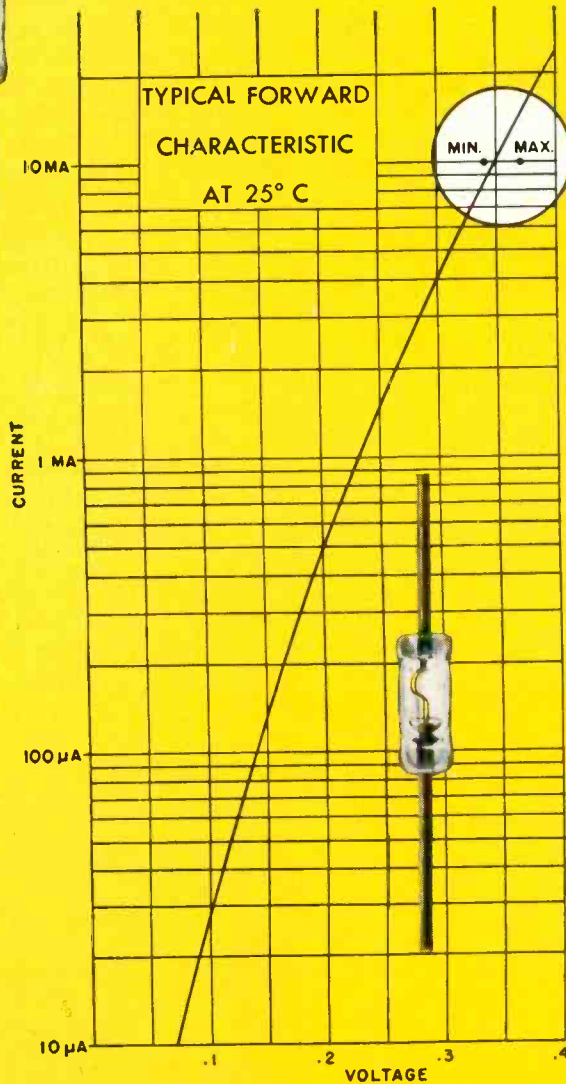

DR 385

DR 434

DR 435

This extremely low controlled forward voltage drop combined with fast transient response makes these diodes ideal for transistorized circuits, computers and other applications where conservation of power is of prime importance.

Characteristics at 25° C

	DR 385	DR 434	DR 435
Forward voltage drop @ 10MA			
Minimum	0.34V	0.34V	0.34V
Maximum	0.37V	0.37V	0.37V
Maximum reverse current at -10V	10UA	10UA	10UA
Peak inverse voltage	60V	40V	30V

Maximum ratings at 25° C

Maximum inverse operating voltage	50V	30V	20V
Continuous DC forward current	100MA	100MA	100MA
Surge current for 1 second	500MA	500MA	500MA
Average power dissipation	80MW	80MW	80MW
Derating above 25° C	10MW/10°C	10MW/10°C	10MW/10°C

Available now in production quantities for immediate delivery

For further information on these, or any other RRco. diode type, write today to Section

Semiconductor Division

RADIO RECEPTOR COMPANY, INC.

Subsidiary of General Instrument Corporation

240 Wythe Avenue, Brooklyn 11, N. Y. • EVERgreen 8-6000

Radio Receptor Products for Industry and Government: Selenium Rectifiers • Germanium Diodes
Thermatron Dielectric Heating Generators & Presses • Communications, Radar & Navigation Equipment

RADIO & ELECTRONIC



PRODUCTS SINCE 1922

TRANSISTOR INVERTER

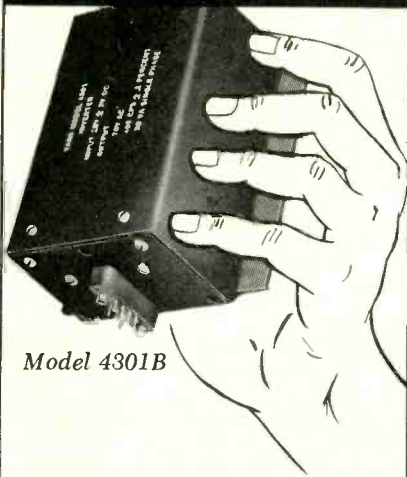

Model 4301B

• 30 VA OUTPUT

MISSILES AND AIRCRAFT

The Model 4301B is a typical Varo transistor inverter. Other models with higher power output, higher frequency output, and ac input are available for systems engineering. Custom designs can be produced for special applications.

SPECIFICATIONS

Output: 30 V.A. 1 ϕ
 Frequency: 400 cps \pm 0.1%
 Voltage: 115 V \pm 10%
 Harmonics: 10% max.
 Input: 26 to 29 VDC
 Temperature: -55 $^{\circ}$ F to +160 $^{\circ}$ F
 Vibration: 10g to 1000 cps
 Size: 29 cu. in.
 Weight: 2 lb.

Varo transistor inverters are designed to operate gyros in guidance systems. They are frequency regulated by a Varo bimetal tuning fork, voltage regulated by a zener diode reference, and produce a sine wave output through Class B amplification.

Attractive Research Positions Available

VARO Mfg. Co., Inc.

2201 Walnut St., Garland, Texas

PHONE DALLAS, TEXAS — BRoadway 6-6141

FACTORY REPRESENTATIVES

LOS ANGELES, CALIFORNIA — REpublic 4-0154
 POUGHKEEPSIE, N.Y. — GLobe 4-7611
 DAYTON, OHIO — CLearwater 4-5281

Circle 125 Readers Service Card

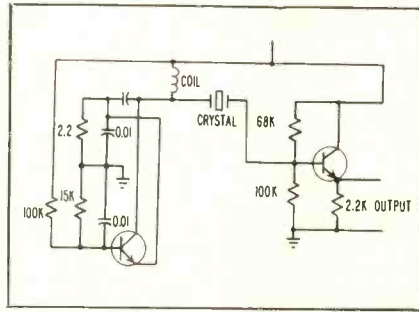

FIG. 1—Initial experimental circuit showing output stage

an impedance match for the following circuit.

The next step is to replace the coupling capacitor with a crystal and resonate the circuit. This oscillator has the advantage that only ordinary parts are required. Any toroid of satisfactory capacitance between turns and of proper core material for the frequency desired can be used. An ordinary i-f transformer or oscillator coil can also be used.

The toroid used for this application was shielded. The coil tested at 0.7 mh. The Q is 45. When this coil was substituted for one of poorer characteristics, the output voltage became 14 volts peak to peak. The oscillator was stable and measured 500,140 cycles.

Additional experiments were carried out to test the function of some of the oscillator components. When the 0.01- μ f capacitor across the 2.2 kilohm resistor was removed, the output of the oscillator dropped to 4 volts. When the 0.01- μ f capacitor across the 15 kilohm was removed, the oscillator ceased to operate.

Using an ordinary coupling 0.1- μ f capacitor instead of a crystal the oscillator was varied from 500 to 50 ke by the addition of series chokes and parallel capacitors.

Another oscillator employs a type of transformer common in transistor i-f and oscillator circuits that use a center-tapped primary of high impedance and a low-impedance secondary. This oscillator, shown in Fig. 2, combines the previously recommended use of proper bias for current flow in the transistor when the transistor possesses a low I_{co} . In addition, it presents a definite voltage across the crystal. This is necessary as previously explained

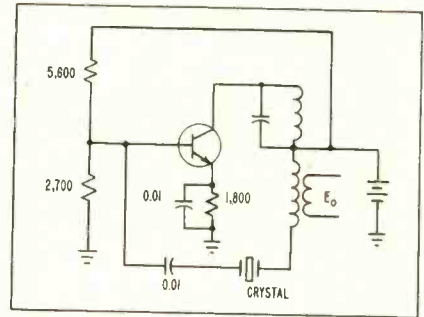

FIG. 2—Feedback oscillator using center-tapped coil

for lower frequency crystals. It can be further substantiated by checking the relative activity in a Pierce-type electron tube oscillator.

This circuit presents the additional advantage in that oscillator frequency is controlled by the crystal and acts as more than a filter. This effect is substantiated by data taken with variation in temperature. The previous circuit tends to decrease in amplitude with small frequency drifts and would soon cut off altogether if the drift were large. In addition, precautions are taken to avoid stray capacitive coupling from bypassing the crystal and allowing false frequencies to be amplified. None of these difficulties were found in the circuit of Fig. 2.

The method of operating this oscillator is similar to the series-resonant filter. The slug or variable capacitor is adjusted until the

TV Checks Die Positions

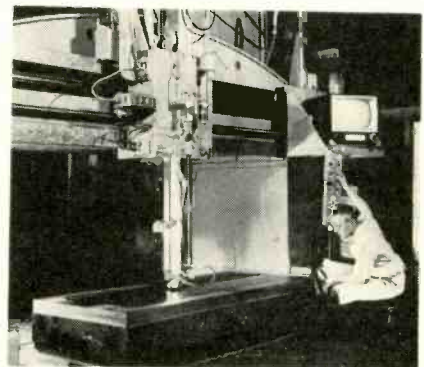

Three industrial television cameras trained on calibrated scales of a new die layout machine permits the operator to observe settings. 10 times actual size on a 17-in. tv screen. The equipment is installed in the Cleveland Works of Aluminum Co. of America for scribing the surface of a die block that can be as large as 10 ft x 22 ft and more than 3 ft in thickness

from **AMPHENOL**
Research and
Development

★
Two years in design and testing, AMPHENOL's proven Poke-Home contacts are ready! Six major new connector lines (in standard, rack & panel and miniature types) incorporating Poke-Home contacts are now being tooled. Watch for further announcements!

POKE-HOME CONTACTS

- ★ Wired outside the connector — "poked home" for assembly
- ★ Increased reliability
- ★ Individual wire maintenance
- ★ Ease of inspection
- ★ Adaptable to automation
- ★ Substantial reduction in wiring costs

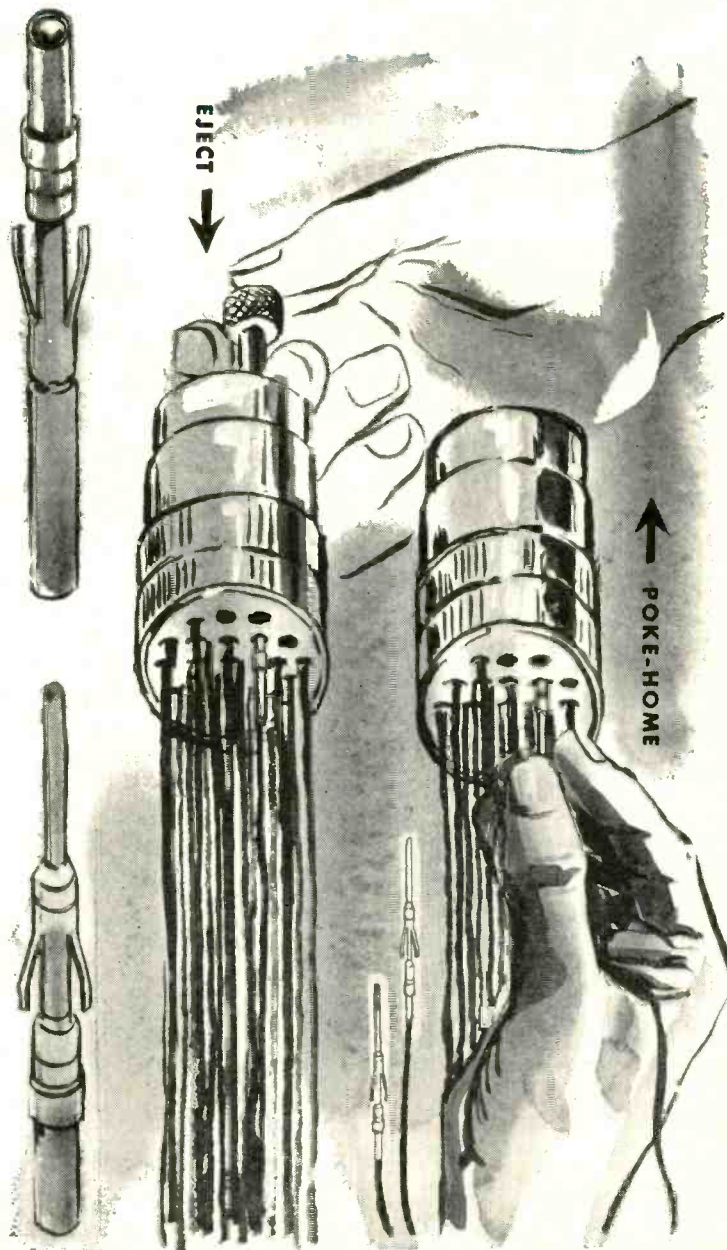

AMPHENOL ELECTRONICS CORPORATION
chicago 50, illinois



**WE WANT MORE
HIGH LEVEL
ENGINEERS
ON OUR TEAM**

at

Bendix-Pacific
in Southern California

● MISSILE GUIDANCE
● AIRBORNE RADAR
● TELEMETERING
● SONAR

There are important positions available in these small, independent engineering groups at Bendix-Pacific for high level engineers from senior grade and up. Bendix-Pacific is particularly interested in strong, analytical engineers who have the calibre and capabilities to advance into systems engineering programs.

Please write W. C. Walker your qualifications or fill in the coupon and mail it today.

W. C. Walker, Engineering Employment Mgr.
Pacific Division, Bendix Aviation Corp.
11608 Sherman Way, North Hollywood, Calif.

I am interested in this engineering field _____
I am a graduate engineer with _____ degree.
I am not a graduate engineer but have _____
years experience.

Name _____

Address _____

City _____

Zone _____ State _____

proper frequency is generated for passage through the crystal. In this case, it is more practical to short out the crystal until the oscillator is tuned to nearly the correct frequency.

Then with the crystal in the circuit, slight variations in the tank circuit are enough to allow the crystal to pass the frequency. This circuit thus still maintains the theory that a definite voltage must be present across the crystal, although in this case the voltage would only be instantaneous if the tank were improperly tuned.

The circuit, with proper bias for current flow and feedback through the crystal, assures good starting. In addition to being used with various Miller i-f transformers and oscillator coils and a GE oscillator coil, it was also extended to utilize a medium-power TI 953 transistor.

The data shown in Table I were taken in an effort to discover the effects of temperature on the oscillator. The first readings were taken with the crystal in the cir-

Table I—Oscillator Behavior

Temp	Freq in kc	Output, peak-to-peak	
		V	Current
80	521,945	1.08	5.5 ma
90	521,955	1.08	5.5 ma
100	521,975	1.08	5.6 ma
110	521,968	1.08	5.6 ma
120	521,964	1.08	5.7 ma
130	521,959	1.08	5.8 ma
Without crystal			
Temp	Freq in kc	Output, peak-to-peak	
		V	Current
80	521,994	1.22	5.6 ma
90	522,220	1.20	5.6 ma
100	522,823	1.20	5.8 ma
110	523,516	1.20	6 ma
120	524,040	1.18	6 ma
130	525,051	1.16	6 ma

cuit, the second with it out. An additional fact was revealed, although not thoroughly substantiated, that the drift in frequency was not caused by the components as much by the variation in parameters of the transistors themselves. This was only checked in one way by changing the capacitor in the tank circuit.

Inexpensive Oven Thermostat

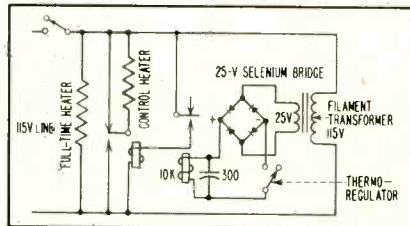

Circuit diagram of inexpensive oven-temperature control

BY N. B. CRANE

Reliability Engineering Division
Battelle Memorial Institute
Columbus, Ohio

IN CERTAIN reliability and component life studies, electronic components are stressed at elevated temperatures for long periods of time. The environmental equipment temperature control directly affects the accuracy of the experiment. The circuit to be described here is an inexpensive and accurate oven temperature control system.

One heater element is left turned on all the time. Its dissipation is adjusted to maintain the oven tem-

perature just below the desired operating temperature. A second smaller heater is controlled by a Central Scientific Co. DeKhotinsky thermoregulator that cycles the oven about the desired temperature.

The thermoregulator is sensitive to temperature change and normally to vibration and shock. If vibration from a blower motor or a power relay is transmitted to the thermoregulator the contacts will bounce severely. This problem is eliminated by a hold circuit utilizing a small filament transformer, selenium rectifier bridge, capacitor and sensitive relay. The hold time can be adjusted, by changing the size of the capacitor, to accommodate a particular installation.

One disadvantage of this control is that it is not calibrated directly in temperature. To use it with an oven it is therefore necessary to make a trial run using a temperature recorder to adjust the thermoregulator dial. The manufacturer



Want a standard power reactor from 50 to 2000 watts? Put your finger on CONTROL

No need to put up with extra costs for special design of saturable reactors. No reason for waiting for special units to be designed to meet your individual requirements. CONTROL offers two complete lines of power reactors. You pick them from our catalog. We take sub-assemblies from our shelves, add control windings to your specifications, and deliver complete units—fast.

CONTROL reactors are ready in eleven sizes in both 120 and 240 volt ranges. Our unique catalog R-10 gives you complete physical and operating characteristics. It tells you, for instance, that six ampere-turns control nearly 2,000 watts in the largest size, and that only two ampere-turns are needed for the 50-watt smallest size, illustrating the extremely high gain of these units.

Want to know about cut-off ratios? CONTROL reactors run at least 40 to 1. Want to know about construction? Cutaway shows you the tough, rugged design that insures "forever" operation with no servicing or maintenance, if operation is normal.

Yes, there's a real improvement here for harassed engineering departments. Standardization means reliability and quality at a competitive price. Write for Catalog R-10 today and read all about it. CONTROL, Dept. E-12, Butler, Pennsylvania.

Reliability begins with **CONTROL**



A DIVISION OF MAGNETICS, INC.

Designed for
Application



90901

The No. 90901
One Inch
Instrumentation Oscilloscope

Miniaturized, packaged panel mounting cathode ray oscilloscope designed for use in instrumentation in place of the conventional "pointer type" moving coil meters uses the 1" 1CP1 tube. Panel bezel matches in size and type the standard 2" square meters. Magnitude, phase displacement, wave shape, etc. are constantly visible on scope screen.

JAMES MILLEN
MFG. CO., INC.

MAIN OFFICE AND FACTORY
MALDEN
MASSACHUSETTS



lists the range of the thermoregulator from -45 to 260 C. In our laboratory they have been successfully used for oven control from room temperature through 150 C and probably can be operated at higher temperatures.

One laboratory-made oven of 3.5

cubic feet operates at 150 C with less than $\pm \frac{1}{2}$ C variation, using this control. It has also been used to improve the performance of commercial laboratory ovens whose controls lack the sensitivity and accuracy desired for component testing.

Silicon Diodes Protect Meters

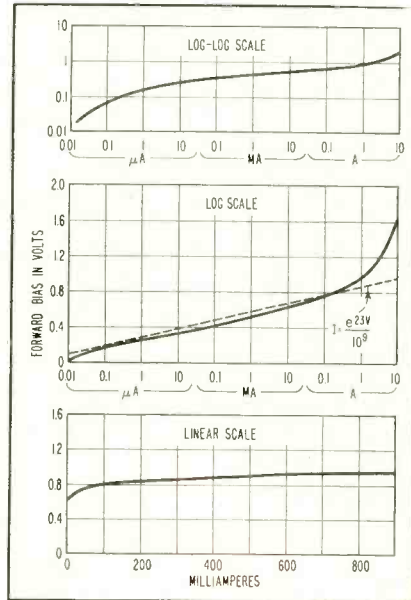

FIG. 1—Forward current in representative diode, plotted on three separate scales to facilitate proper choice

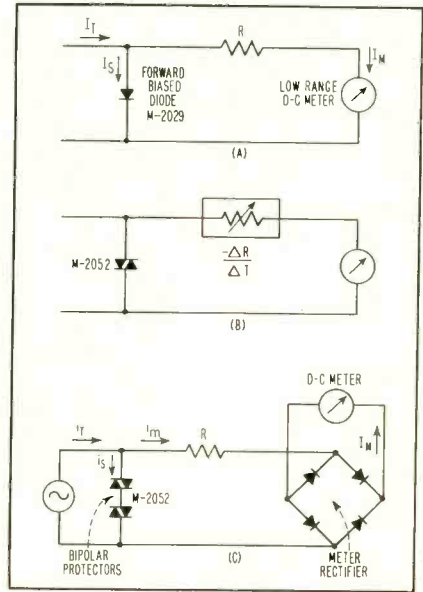

FIG. 2—Meter protection circuits, basic (A) bipolar with temperature compensation (B) and a-c type (C)

By K. D. SMITH

Bell Telephone Laboratories
Murray Hill, N. J.

SENSITIVE d-c meters of the D'Arsonval type are fairly delicate and will be severely damaged if subjected to currents one or two orders of magnitude larger than full-scale deflection. Fuses provide some protection, but it is sometimes undesirable to interrupt the circuit even if an overload exists.

The logarithmic characteristic of silicon diodes makes them suitable for providing instantaneous meter protection. Furthermore, they will reset automatically when the overload condition is removed.

► Protection—A typical $V-I$ curve for a forward-biased M-2029 experimental diffused-junction silicon diode at room temperature is shown

in Fig. 1, on linear, log-linear and log-log scales. Forward voltage drop is in the order of 0.25 V at one μ a, and six decades of current increase are required to raise this drop to one volt.

If, for a $100\text{-}\mu$ a meter in a test circuit, it is desired to provide built in protection that will limit the meter current to twice full scale, such can be supplied even though the trouble condition results in a current of one ampere in the circuit. One diode and one resistor will give this protection, together with a metering potential drop of 0.5 v at full-scale deflection and some nonlinearity of indication in the upper portion of the scale. If this nonlinearity is objectionable, an overload meter current of about three times full-scale for a circuit overload of $10,000$ times full-scale

Constantin

GLASS - TO - METAL SEALS

ENGINEERED FOR LONG-LIFE AND GREATER ECONOMY

Constantin's staff of manufacturing engineers have spent many years in researching and designing reliability and economy into thousands of different glass-to-metal seals. Each is built to rigid custom specifications. Each requires extensive testing. Only by this meticulous care and treatment has Constantin been able to continually satisfy their customers with precision, quality components.

These customers manufacture a wide, diversified range of components which require many different styles of Constantin glass-to-metal seals including all-in-one assemblies, capacitor end seals, transistor mounts, crystal holders, connectors, single terminals and multi-headers — manufactured to the closest engineering specifications.

The latest production techniques and the finest materials in hermetic sealing are incorporated directly into your product. The handling and supervision of production is entrusted to experienced design engineers and technicians from the moment your order enters the Constantin plant to final shipment.

Write today for complete information.
Please mention your application.

"Quality With Confidence"

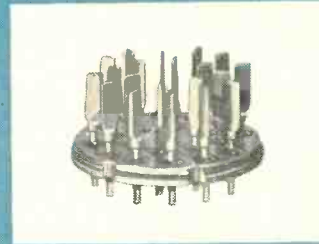

L. L. Constantin & Co.

GENERAL OFFICES: ROUTE 46, LODI, N. J.

PLANTS: 187 SARGEANT AVE.
CLIFTON, N. J.
ROUTE 46, LODI, N. J.

MANUFACTURING ENGINEERS

6TH AND CAPITAL STS.
SADDLE BROOK, N. J.

EN

now! 400 mA
600 volts PIV

in a glass package

immediately available in production quantities

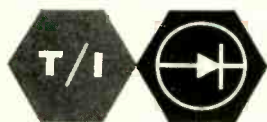
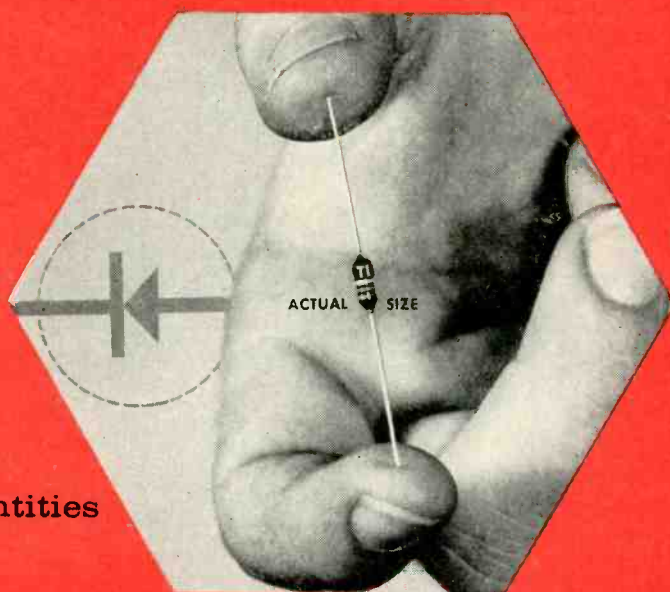

a new solution to your
inventory and spare parts problems:

You can now get *big* voltage operation (to 600 V) plus a new high in forward conductance (400 mA) along with a 2 million-to-1 forward-to-reverse current ratio... from new TI diffused silicon glass diode/rectifiers! This means you can eliminate scores of diodes and rectifiers from your inventories... and stock only five TI diode/rectifiers for virtually *all* your requirements. For your magnetic amplifiers, modulators, demodulators, networks or subminiature power supplies, this new TI diode/rectifier series – with its extremely wide 225 to 600 voltage range – will meet your exacting circuitry needs.

To see why, check these significant parameters:

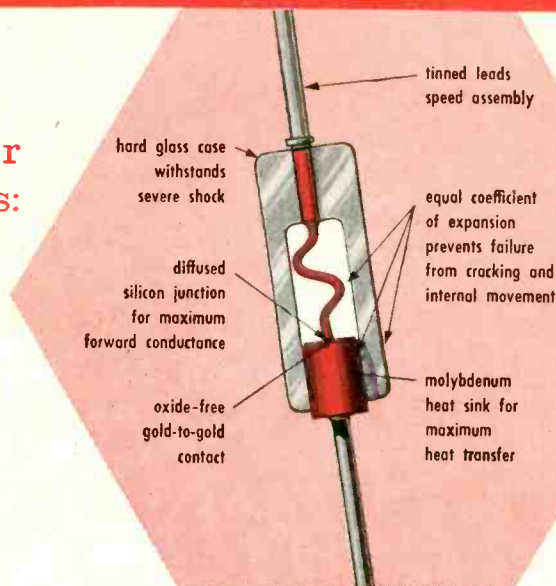

maximum ratings

	1N645	1N646	1N647	1N648	1N649	
Peak Inverse Voltage at -65 to +150°C	225	300	400	500	600	V
Average Rectified Forward Current at +25°C	400	400	400	400	400	mA
Average Rectified Forward Current at +150°C	150	150	150	150	150	mA
Recurrent Peak Forward Current at +25°C	1.25	1.25	1.25	1.25	1.25	amp
Surge Current, 1 Second DC at +25 to +150°C	3	3	3	3	3	Amp
Power Dissipation at +25°C	600	600	600	600	600	mW

specifications

	275	360	480	600	720	V
Minimum Breakdown Voltage at +100°C	0.2	0.2	0.2	0.2	0.2	μA
Maximum Reverse Current at PIV at +25°C	15	15	20	20	25	μA
Maximum Reverse Current at PIV at +100°C	1.0	1.0	1.0	1.0	1.0	V
Maximum Voltage Drop at I _O = 400 mA; at +25°C						

Put TI diode/rectifiers to work for you now!
Write today for Bulletin No. DLS-770



TEXAS INSTRUMENTS
INCORPORATED
POST OFFICE BOX 312 • DALLAS, TEXAS

TI silicon high power transistors

15 watts at 100°C



immediately available in production quantities from TI



absolute maximum ratings	2N424	2N389
Power Dissipation at 100°C . . .	15	15 Watts
25°C . . .	37.5	37.5 Watts
Collector to Emitter Voltage . . .	+60	+60 Volts
Base to Emitter Voltage	-2	-2 Volts
Collector Current	2	2 Amps
Saturation Resistance	10	6 Ohms
Base Current	0.5	0.5 Amp
Storage Temperature	-65 to +150°C	

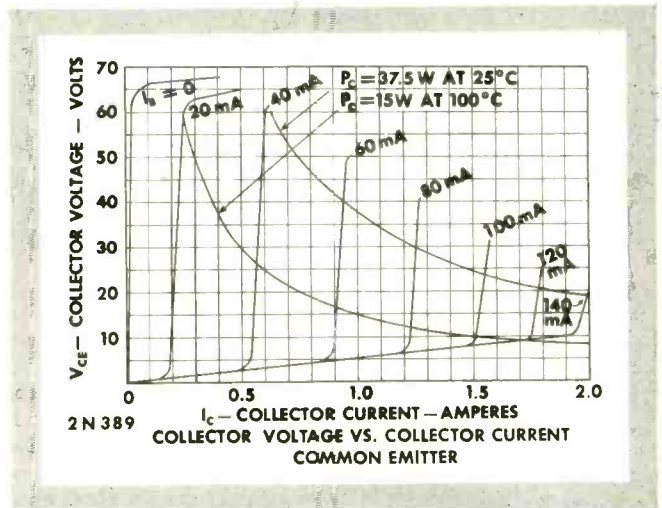

New! 39 TI silicon transistor types—your widest choice



TEXAS INSTRUMENTS
INCORPORATED
POST OFFICE BOX 312 · DALLAS · TEXAS

Circle 257 Readers Service Card

P&B PROGRESS/

NEW! INGENIOUS IMPULSE LATCHING RELAY

**NOW! TWO-COIL PERFORMANCE
AT SINGLE COIL COST!**

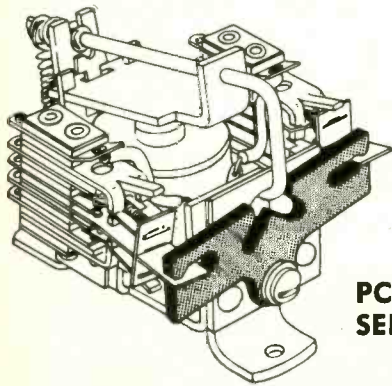

**PC
SERIES**

This new series, the PC, is an ingenious impulse latching relay which employs a single coil and armature to activate an insulated rocker arm. Switching is positive, fast (30 milliseconds).

Its low cost, dependability and versatility make it ideal for a wide range of uses. For example, two leading TV set manufacturers use the PC in their remote control circuits as an "off-on" switch. It is also used by a maker of automatic garage doors. Conveying systems, automatic processing equipment, flow controls—the PC is right for these applications and many more.

Contact arrangements are available up to 4 Form C (4PDT), and the snap-action contacts are rated 5 amps. at 115 V. AC resistive. The relay may be ordered open, as shown, or in a metal dust cover.

Write or wire today for complete information.

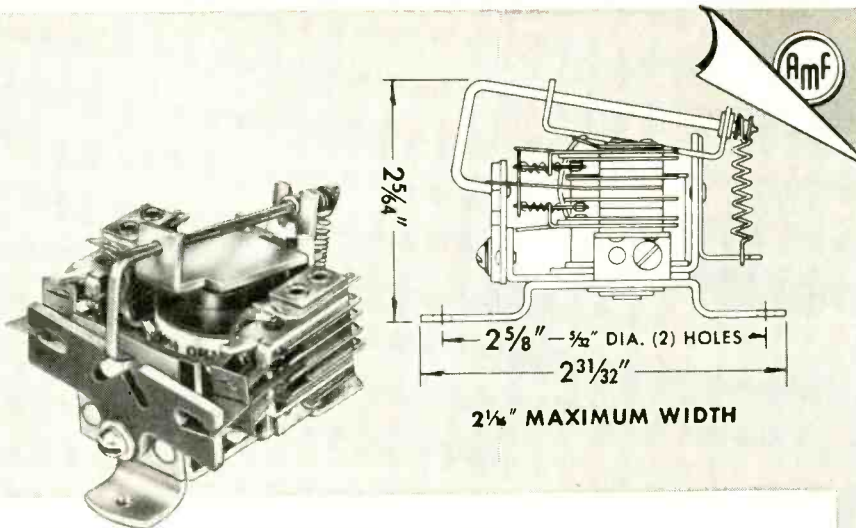

PC SERIES ENGINEERING DATA

GENERAL: Description: Single coil, impulse latching relay.

Insulating Material: Laminated Phenolic.

Insulation Resistance: 1500 megs. min.

Breakdown Voltage: 500 V. RMS.

Ambient Temperature: $-55^{\circ}\text{C. to } +85^{\circ}\text{C.}$

Weight: 5 ozs. (open)

Pull-In: DC, 75% } for nominal voltage.
AC, 78% }

Operate: 30 MS.

Terminals: Pierced Solder Lugs

Coil: Two #20 AWG Wires

Contacts: One #20 AWG Wire

Enclosures: "A" Can.

CONTACTS: Arrangements: 4 Form C. max. (4PDT)

Material: $1/8$ " dia. Silver Cadmium oxide gold flashed.

Load: 5 amp. @ 115 V. AC resistive.

Pressure: 20 grms. min.

COIL: Resistance: .016 to 34,500 max.

Power: DC, 9 watts.

AC, 18.4 Volt Amps. } at nominal voltage.

Duty: Intermittant.

Insulation: Cellulose acetate wrap; varnish impregnated (open).

MOUNTINGS: Two $1/2$ " dia. holes on $2 5/8$ " center.

P&B STANDARD RELAYS ARE AVAILABLE AT YOUR LOCAL ELECTRONIC,
ELECTRICAL AND REFRIGERATION DISTRIBUTORS

Potter & Brumfield, inc.

PRINCETON, INDIANA

SUBSIDIARY OF AMERICAN MACHINE & FOUNDRY COMPANY

Manufacturing Divisions also in Franklin, Ky. and Laconia, N.H.

Mail the coupon below for further engineering data on P&B's new PC Series relays plus new compact catalog of standard type relays. If you need answers to a specific application problem, write in detail.

Potter & Brumfield, Inc., Princeton, Indiana
Attn: T. B. White, Brig. Gen. USMC (Ret.)
Special Projects Engineer

Please send me complete data on the new PC Series relays,
plus the new compact catalog of P&B standard relays.

Name _____

Company _____

Address _____

City _____ Zone _____ State _____

See our catalog in Sweet's Product Design File



Though total current is 10,000 times that required for full-scale deflection of microammeter at left, current is limited to $100\ \mu\text{a}$, yet lamp load is fully illuminated—a current of 1 ampere

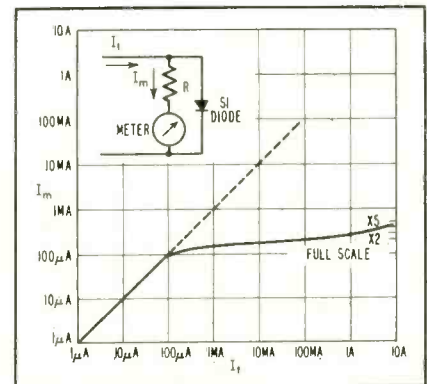

FIG. 3—Overload protection for model 301 $100\text{-}\mu\text{a}$ d-c meter

current must be accepted.

Figure 2A shows a suggested protection circuit and Fig. 3 shows the overload characteristic obtained in a laboratory setup. If trouble currents larger than one ampere d-c are anticipated, a larger diode would be necessary. This would result in some increase in shunt current at low voltages and greater error in on-scale deflection.

The value of resistance R is chosen to make the potential drop across the meter and resistor about one volt under the condition of maximum safe meter current. If a moderately rugged panel-type meter is used and if the maximum meter current is assumed to be four times full scale, then the non-linearity resulting from the diode shunt can be held within the accuracy of meter calibration for all scale readings at room temperature.

► **Temperature**—The forward voltage drop across a semiconductor $p\text{-}n$ junction is temperature dependent. For the diffused silicon junc-

For Small Spaces, High Temperatures

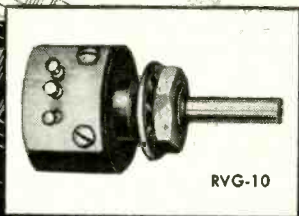
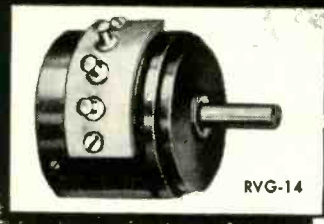

GAMEWELL RVG SERIES Miniature **PRECISION** **POTENTIOMETERS**

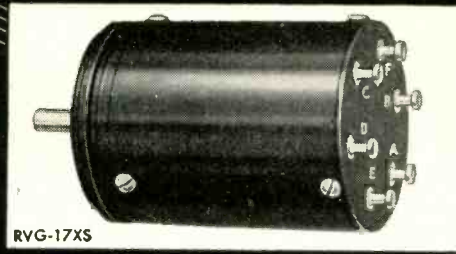

These Gamewell pots — $\frac{5}{8}$ " , $\frac{7}{8}$ " and $1\frac{1}{16}$ " — provide superior characteristics in miniature size . . . ideal for high temperatures and other environmental extremes. All have anodized aluminum bodies, stainless steel shafts, excellent linearity and meet MIL-E-5272A specs as they apply. RVG-17XS has a specialized arrangement which produces sine-cosine functions with unique precision and smoothness.

For dependable performance under rugged environmental conditions and severe space restrictions, specify one of these RVG Precision Potentiometers. Many special features and modifications are also available to meet your specific need. Write or call for details.

THE GAMEWELL COMPANY
NEWTON UPPER FALLS 64, MASS.

GAMEWELL

PRECISION POTENTIOMETERS

GA6-18

Check these dimensions
for reducing
"package" size

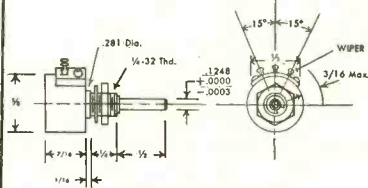

RVG-10

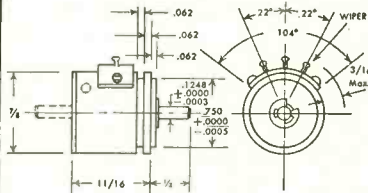

RVG-14

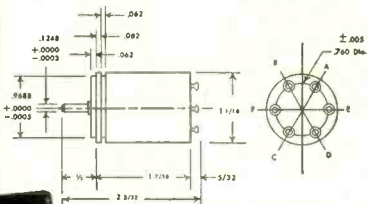

RVG-17XS

SPECIAL!
Send for New catalog
with data on complete
line.

tions considered here the voltage at a particular current will vary approximately as

$$V = V_0 - 0.0025 \Delta T$$

where V_0 is the forward voltage at a reference temperature.

Thus at high temperatures greater protection will be given the meter, but the error of on-scale deflection will also increase. A possible corrective measure would be the use of a negative-temperature-coefficient thermistor for all or part of the resistance R , as indicated in Fig. 2B. In laboratory circuits it should be feasible to choose R in terms of the expected ambient at the location of the diode.

A linear low-current with logarithmic high-current meter indi-

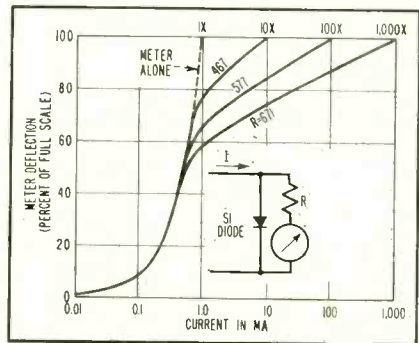

FIG. 4—Deflection vs current for linear-log presentation of model 301 1-ma d-c meter

cation may readily be provided by increasing the meter series resistance so overload currents result in on-scale meter deflections. Calibration of the logarithmic region will be temperature dependent, as noted above.

For special applications R might be adjustable and set for different ambient conditions. Figure 4 shows experimental response curves for a 1-ma meter arranged for linear-log presentation. Values of the series resistance R were arbitrarily chosen to give the indicated full-scale current values. For the 1,000-times compression, the transition between linear and log presentation occupies only a small portion of the scale, near the midscale deflection.

► **A-C Protection** — Low-range a-c milliammeters may be protected by using two single diodes in parallel-opposed connection as a shunt or



Better Things for Better Living
... through Chemistry

ELECTRONIC DESIGN

LATEST PROPERTY AND APPLICATION DATA ON

TEFLON[®]

tetrafluoroethylene
resins

NEWS

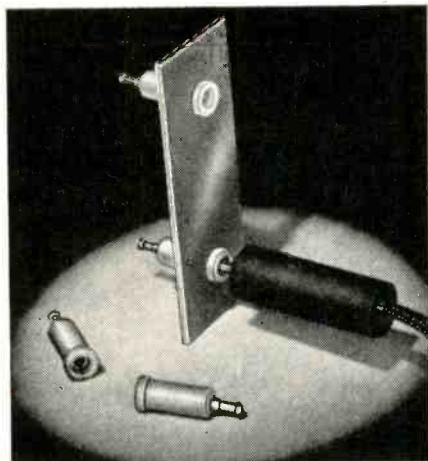

Test-point jacks employ toughness, dielectric strength of TEFLON[®] resins

Both insulating and mechanical properties of TEFLON tetrafluoroethylene resins are important in "Press-Fit"[™] test-point jacks developed by the Sealectro Corporation of Mamaroneck, N. Y. The high dielectric strength of TEFLON resins permits insertion into standard metallic panel boards. Mounting hardware and special seals are eliminated. The terminals are press-fitted into drilled or punched holes. Yield and recovery characteristics of the tough material assure a tight, permanent fit in the board and snug mounting of the beryllium-copper contacts. Since TEFLON resins have an extremely low coefficient of friction, the terminals may be inserted easily. For color-coding purposes, the jacks are made with colored TEFLON resins in the standard eight RETMA colors. Companion plugs are also available.

*Registered trademark, Sealectro Corporation



TEFLON[®] is a registered trademark . . .

TEFLON is Du Pont's registered trademark for its fluorocarbon resins, including the tetrafluoroethylene resins discussed herein. This registered trademark should not be used as an adjective to describe any product, nor should it be used in whole, or in part, as a trademark for a product of another concern.

Hook-up wire of TEFLON[®] specified for environmental test equipment

tetrafluoroethylene resins

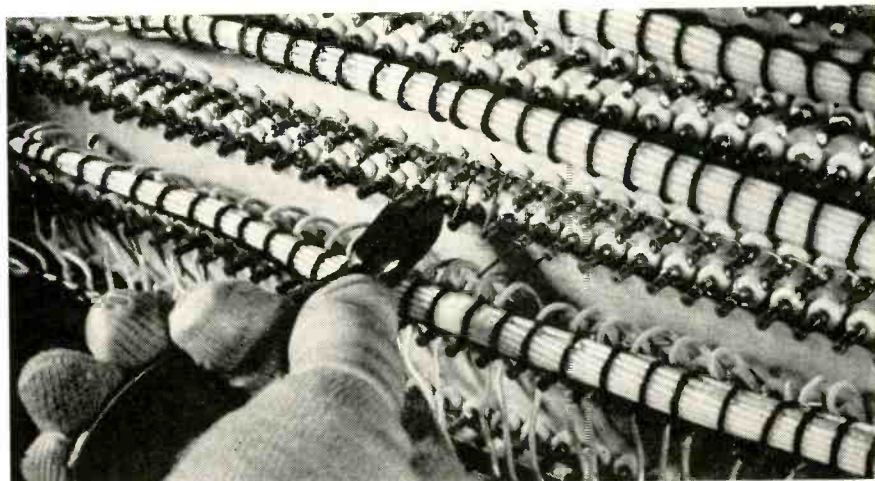

REVERSE SIDE of component testing board. Hook-up wire insulated with TEFLON resins withstands all test conditions . . . is rated for continuous operation from -90°C. to +210°C.

(Test equipment by Inland Testing Laboratories, Cook Technological Center, Morton Grove, Illinois; "Permacode" wire supplied by Revere Corporation of America, Wallingford, Conn.)

Over 70,000 resistors, diodes and transistors are being simultaneously life-tested by a major national laboratory to determine their reliability. Environmental chambers specially designed for the project use TEFLON tetrafluoroethylene resins exclusively for wire and terminal insulation. TEFLON resins are unaffected by the stringent life-test conditions and have no influence on the components being tested.

Thin-walled insulation of TEFLON tetrafluoroethylene resins on wire will not burn, melt or decompose when nearby connections are soldered. It does not undergo shrinkage during soldering. Protected by TEFLON resins, thin conductors can operate hotter, at higher current ratings. Wire insulated with TEFLON resins has favorable attenuation characteristics even at super-high frequencies.

Du Pont TEFLON resins can do jobs no other insulating material can do. To investigate the scope of their electronic use more fully, send the coupon.

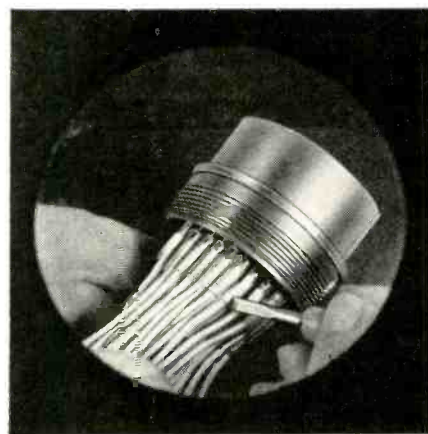

FIFTY-ONE WIRES are connected to a test equipment receptacle. Miniaturization is often made possible by TEFLON resins.

SEND FOR INFORMATION

For additional property and application data on Du Pont TEFLON tetrafluoroethylene resins, mail this coupon.

E. I. du Pont de Nemours & Co. (Inc.), Polychemicals Dept.
Room 1710, Du Pont Building, Wilmington 98, Delaware

Please send me more information on Du Pont TEFLON tetrafluoroethylene resins. I am interested in evaluating TEFLON for _____

Name _____

Company _____ Position _____

Street _____

City _____ State _____

Type of Business _____

In Canada: Du Pont Company of Canada (1956) Limited, P.O. Box 660, Montreal, Quebec

MINIATURIZATION IN EVERY PRODUCT LINE



RF CONNECTORS

Subminax® RF connectors to set the highest standards of reliability for miniature components



RG CABLES

Subminax cables—polyethylene or Teflon—mate with Subminax connectors—complete the reliability circuit



RACK & PANEL CONNECTORS

Amazing Micro-Ribbon connectors use flexible "ribbon" contacts, "wedge" principle for quality performance

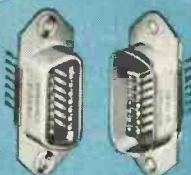

A-N CONNECTORS

Miniature AN-type 165 series connectors are widely used in military and commercial equipment



MICROPHONE CONNECTORS

New Miniature Microphone Connectors represent AMPHENOL's latest contribution to the art of miniaturization



AMPHENOL Industrial Distributors carry stocks of standard AMPHENOL components in order to provide immediate service

AMPHENOL ELECTRONICS CORPORATION
chicago 50, illinois



AMPHENOL CANADA LIMITED
toronto 9, ontario

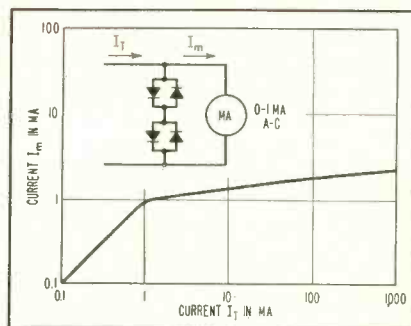

FIG. 5—Overload protection for 1 ma a-c meter

with the M-2052 experimental bipolar forward-bias limiter. An interesting situation occurs when the meter being protected is itself a rectifier type, using a copper-oxide or germanium-rectifier bridge.

The overall circuit may then be as shown as in Fig. 2C. Operation of this circuit is feasible because of the difference in energy gap of the semiconductors. Two protector diodes are required, however. Performance of a low range rectifier-type a-c meter, when protected by a silicon diode pair, is shown in Fig. 5.

The range in which silicon diode meter protection can be useful is limited on the low end by the finite resistance of the $p-n$ junction at low voltages; this shunts the meter and results in inaccuracy of current indication. The better diodes have currents of 1 or $2\mu\text{a}$ at 0.3 v. and would be reasonably satisfactory for meters with $10\mu\text{a}$ or higher full-scale reading. The high-current limitation is set by the current capability of the diode. Since diodes such as rectifiers may be designed for continuous forward currents of many amperes this limitation requires only the selection of a suitable diode design. However, special high-current diodes should be unnecessary in most applications.

One limitation that may be of importance is the possible damage if the overload is a complete short circuit of a high-energy capacitor. Although any of the diodes under consideration may be expected to withstand instantaneous forward current surges of several amperes, they may be burned out by heavier

High Purity

Baker ELECTRONIC CHEMICALS

For your electronic tubes and screens—

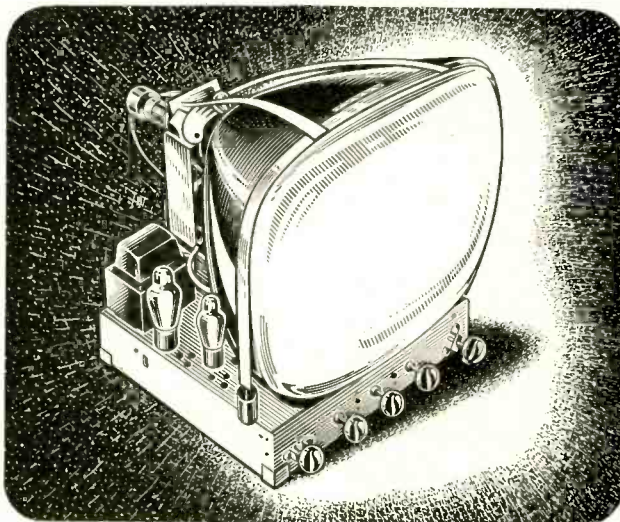

- Acetic Acid
- Acetone
- Aluminum Nitrate
- Aluminum Sulfate
- Ammonium Carbonate
- Ammonium Chloride
- Ammonium Hydroxide
- Ammonium Phosphate
- Antimony Trioxide
- Barium Acetate
- Barium Carbonate
- Barium Fluoride
- Barium Nitrate
- Benzene
- Boric Acid
- Cadmium Chloride
- Cadmium Nitrate
- Cadmium Sulfate
- Calcium Carbonate
- Calcium Chloride
- Calcium Fluoride
- Calcium Nitrate
- Calcium Phosphate
- Carbon Tetrachloride
- Cobalt Carbonate
- Ether, Anhydrous
- Ether, Petroleum
- Hydrochloric Acid
- Hydrofluoric Acid
- Hydrogen Peroxide
- Lithium Carbonate
- Lithium Chloride
- Lithium Nitrate
- Lithium Sulfate
- Magnesium Carbonate
- Magnesium Chloride
- Magnesium Oxide
- Manganese Dioxide
- Manganous Carbonate
- Methanol
- Nickelous Chloride
- Nickelous Nitrate
- Nickelous Sulfate
- Nitric Acid
- Potassium Dichromate
- Potassium Hydroxide
- iso-Propyl Alcohol
- Radio Mixtures
- Silicic Acid
- Sodium Carbonate
- Sodium Chloride
- Sodium Hydroxide
- Sodium Phosphate Dibasic
- Strontium Nitrate
- Sulfuric Acid
- Toluene
- Triple Carbonate
- Xylene
- Zinc Chloride
- Zinc Nitrate
- Zinc Oxide

BARIUM NITRATE, REAGENT for Electronics

One of many high purity Baker production chemicals for the electronic industry. You may use Barium Nitrate as a screen-settling compound, or your use may be in emission coatings. Baker Barium Nitrate, Reagent for Electronics, is produced to high purity standards that make it ideal for either of these important applications.

In the specifications reproduced below, note the low limit of Calcium and Strontium Salts. For your additional protection, Iron, Copper and Nickel are controlled to rigid specifications because these are known to be critical in electronic applications. The assay of 99% minimum is further assurance of highest purity. Thorough blending insures that purity is uniform within each lot.

For maximum plant efficiency, Baker Barium Nitrate, Reagent for Electronics, is produced in a fine crystalline form which goes into solution more rapidly.

Today, the increasing demands of the electronic industry for closer tolerances present ever-new challenges for higher chemical purity. Baker works closely with chemists and electronic engineers to aid in meeting these challenges. Look over the list of Baker electronic chemicals on this page—write for prices and samples of those which interest you.

BARIUM NITRATE, "Baker Analyzed" Reagent for Electronics, Crystal, A.C.S.
Ba(NO₃)₂

Meets A.C.S. Specifications

Assay (Ba(NO ₃) ₂)	99.0	%
Insoluble Matter	0.010	%
pH of 5% Solution at 25°C	5.0-6.5	
Chloride (Cl)	0.0005	%
Substances not Precip. by H ₂ SO ₄ (as SO ₄)	0.050	%
Calcium and Strontium Salts (as SO ₃)	0.10	%
Heavy Metals (as Pb)	0.0005	%
Iron (Fe)	0.0002	%
Copper (Cu)	0.00005%	
Nickel (Ni)	0.00005%	
Water (H ₂ O)	0.10	%

J. T. Baker Chemical Co.

REAGENT • FINE • INDUSTRIAL

Phillipsburg, New Jersey

PURITY BY THE TON
—for production use

BRANCH OFFICES

NEW YORK
122 E. 42nd St.

CHICAGO
435 N. Michigan Ave.

PHILADELPHIA
6908 Market St., Upper Darby, Pa.

LOS ANGELES
170 E. California St., Pasadena 5, Cal.

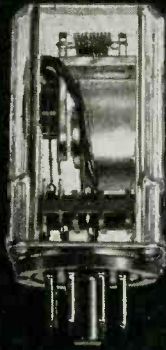
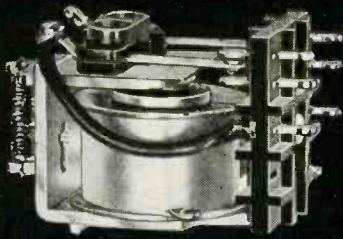

ELGIN
announces the

NEW ADVANCE

GH
SERIES

Low Cost

Midget Relays

... open or plastic enclosed

Elgin's new GH series combines the high efficiency required of general purpose relays with low cost. Their midget size suits them for installations where space is a problem (see specifications below). Open relays in 5 and 10 ampere ratings and clear plastic dust-tight enclosed 5 ampere relays are immediately available from stock. Specify dependable ELGIN performance ... specify GH from your electronic parts distributor!

SPECIFICATIONS

NOMINAL POWER REQ.—DC relays, 1 to 2 watts; AC relays, 2 to 3 volt amperes.

NOMINAL VOLTAGE—DC relays, 6 to 120 volts; AC relays, 6 to 220 volts. (On specification, DC voltage coil up to 220 volts or AC voltage coil up to 440 volts can be supplied.)

RESISTANCE—DC relays, 25 to 8,000 ohms; AC relays, 4 to 5,000 ohms.

PULL-IN CURRENT VALUES—7.2 Milliamps max. at 2,500 ohms; 5.0 milliamps max. at 5,000 ohms.

DUTY CYCLE—continuous.

TEMPERATURE RANGE— -55° to $+85^{\circ}$ C when specified.

INSULATION RESISTANCE—100 meg-ohms min.

DIELECTRIC STRENGTH—standard: 500 volts RMS. (When specified, 1,000 volts RMS can be met.)

MAXIMUM WEIGHT—2 ounces.

GHA SERIES, 5 amp. open relay

Contact rating, 5 amps. resistive, 2 amps. inductive at 115 volts AC or 26.5 volts DC. Contact material is fine silver, 1C, 2C, 3C arrangements only. Relay is 1.1" high, 1.732" long and .937" wide. Contact terminals can be used as solder lugs or for printed circuitry.

(Also available: GHB series, 10 amp. open relay.)

GHP SERIES, 5 amp. clear plastic enclosed relay.

Dust-tight plug-in. Contact rating, 5 amps. resistive, 2 amps. inductive at 115 volts AC or 26.5 volts DC. Contact material is fine silver, available in 1C or 2C arrangements only. Enclosure is $2\frac{1}{8}$ " x $1\frac{13}{32}$ " overall. $2\frac{1}{8}$ " overall length above chassis.



ELECTRONICS DIVISION

ELGIN NATIONAL WATCH COMPANY

2435 N. Naomi Street, Burbank, California

current surges in the circuit.

Therefore, where it appears probable that peak currents in excess of 5 will be encountered, some form of current-limiting element should be incorporated, or a heavy duty diode used as the protector.

Although the circuits described here were tested with experimental Bell Laboratories diodes, the same basic principles may be employed with commercially available diodes having similar characteristics.

Cascode Auto Preamplifier

BY H. J. WIRTH

*Electronics Scientist
U. S. Navy Electronics Lab.
San Diego, Calif.*

THE CASCODE circuit has proved itself an excellent amplifier for low-level r-f applications. Recently this circuit has been used in preamplifiers for microphones, magnetic-tape recorders, magnetic pickups and other low-level audio applications. The design of such an amplifier can be carried out in eight simple steps.

A typical cascode circuit is shown in Fig. 1. This circuit consists of a two-stage amplifier with a grounded-cathode stage feeding a grounded-grid stage. The eight steps in the design procedure may be best illustrated by a descriptive example.

First, select the d-c potential E_a . This potential must be lower than



Microphone preamplifier in NEL plug-in unit

New

Du MONT TYPE 405 VTVM

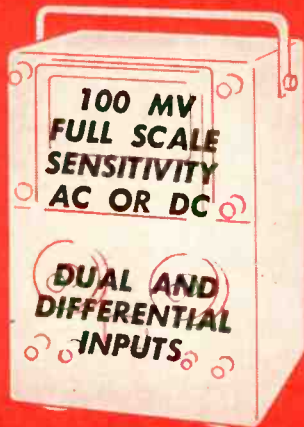

Now there's no need to weigh feature against feature when it comes to vacuum tube voltmeters — the new Du Mont 405 has everything!

The 405 is the first VTVM to combine 100 millivolt full scale sensitivity, either AC or DC, with dual and differential inputs. Besides, it features DC performance from 2 millivolts to 1000 volts with 120 megohm input. It doesn't stop there, for it also offers highly accurate AC performance from below 50 cps up into the UHF range. As an ohmmeter, the Type 405 is calibrated from 0 to 500 megohms, in eight ranges.

Another in the outstanding Du Mont 400 Series, the 405 is "human engineered" for ease and convenience of operation, reliability, and precision. Its rugged construction is backed by the exclusive Du Mont 5-year guarantee offered with all instruments of the 400 Series.

Price **\$265⁰⁰**
Slightly higher in 50-cycle areas.

Write for complete details

FEATURING

- **ACCURACY:** 2%.
- **SCALE:** Illuminated 4" mirror-backed scale for accurate readings.
- **STABILITY:** Very low drift. Less than ± 3 millivolts on any range.
- **VERSATILITY:** Designed for safe off-ground operation up to 1000 volts DC.
- **REGULATED:** Regulated DC and filament supply.
- **AMPLIFIER OUTPUT:** Amplifier output available with power gain over 60 db.
- **SIZE:** Compact, weighs only 12 pounds.
- **PROBE STORAGE:** Built-in probe storage compartment.

DU MONT[®]

One of the  Series

Technical Sales Department, ALLEN B. DU MONT LABORATORIES, INC., Clifton, N. J.

LEACH

SOLVES RELAY ENVIRONMENTAL PROBLEMS

Unique Balanced-Armature Relays meet all requirements of the most exacting operating environments — shock, acceleration, vibration and high temperatures.

In the Leach Balanced-Armature Relay, shock and vibration forces cannot move the relay armature. This eliminates faulty operation of contacts during extreme vibration and acceleration.

These Leach Relays meet or exceed requirements of MIL-R-5757, MIL-R-6106, MIL-E-5272. Typical ratings include: vibration, 20 G's to 500 cps (higher ratings available); shock and acceleration, more than 50 G's; temperature, -50° to $+125^{\circ}\text{C}$; life, 50,000 continuous operations minimum at rated load; available 28 vac, 115 vac, 400 cps operation. At right is Leach 9226, 1.49x1.49x1.68 inches.

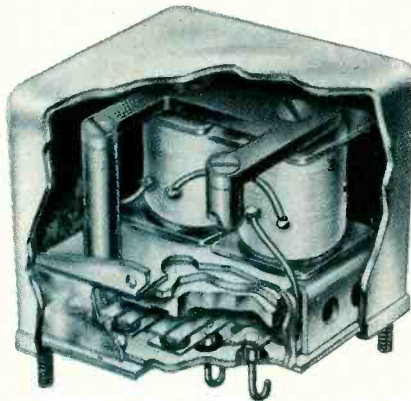

Leach has gained a unique reputation for creating reliable relays, *custom-tailored* to solve specific circuitry problems. Write for your copy of the Leach Balanced-Armature Relay Catalog.

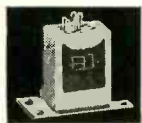

LEACH CORPORATION

LEACH RELAY DIVISION

5915 Avalon Blvd., Los Angeles 3, California

District Offices and Representatives in Principal Cities of U. S. and Canada

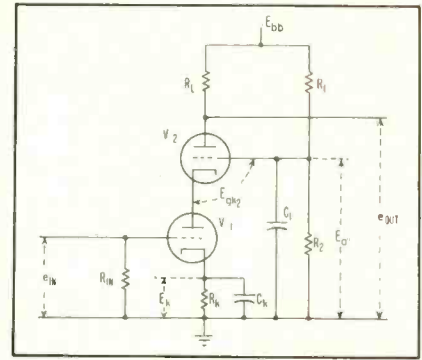

FIG. 1—Basic cascode amplifier circuit

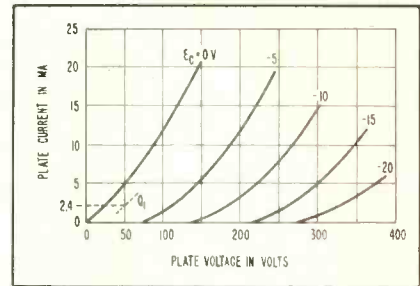

FIG. 2—Selecting operating point of V_2

the cathode-to-heater rating for the tube. An optimum point can best be selected through a trial-and-error process after the remaining steps in the design are carried out, but a value between $\frac{1}{3}$ to $\frac{1}{2}$ of the $B +$ voltage should prove adequate. Utilizing a 12AU7 tube and a $B +$ voltage of 250 volts, let the voltage at E_a be 78 volts, which can be readily obtained with a voltage divider composed of a 220,000-ohm resistor and a 100,000-ohm resistor.

Second, select the operating point of V_2 . Figure 2 shows the selection of the operating point of V_2 at Q_1 . The cathode voltage of V_2 (with respect to ground) is given by

$$E_{k2} = E_a + E_{gk2}$$

For the example

$$E_{k2} = 78 + 2 = 80 \text{ volts}$$

The tube parameters of V_2 at Q_1 can then be calculated.

$$r_{p2} = \frac{\Delta e_b}{\Delta i_b} = 13,000 \text{ ohms}$$

$$\mu_2 = \frac{\Delta e_b}{\mu e_c} = 19$$

Third, determine the operating point Q_2 of tube V_1 . The plate voltage of V_1 is equal to the cathode voltage of V_2 . The currents through both tube sections are equal. Figure 3 shows the selection of the operating point of V_1 at Q_2 . The para-



WESTINGHOUSE SILICON RECTIFIER WN-5082, with maximum peak inverse voltage ratings of 50-400 v. (300 to 5000 amperes in bridge assemblies.)

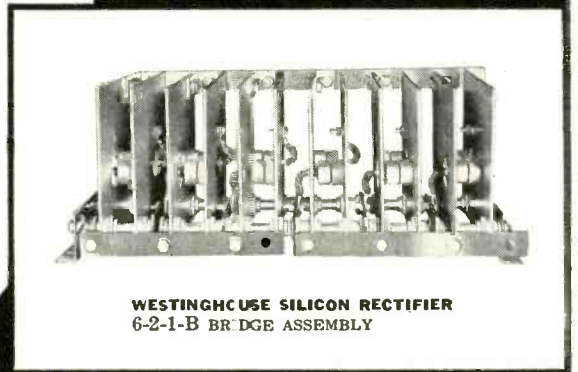
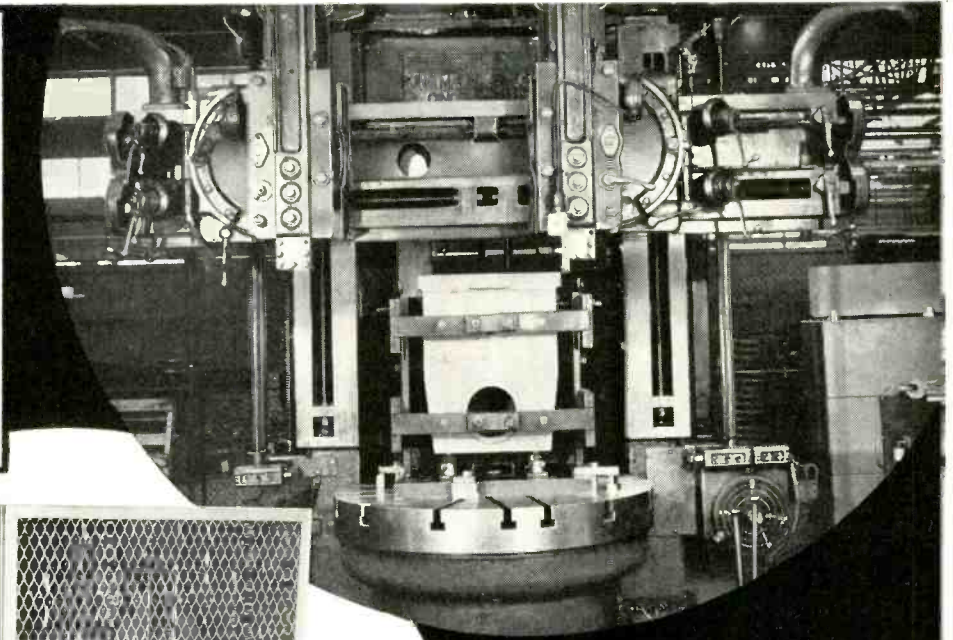

WESTINGHOUSE SILICON RECTIFIER 6-2-1-B BRIDGE ASSEMBLY

Westinghouse SILICON^(Si) RECTIFIERS put more muscle in DC power converter!

Successfully proven in rigorous welding, aircraft and guided missile applications, Westinghouse Silicon Power Rectifiers offer many advantages for power supplies.

Used in the Westinghouse 50KW Power Converter to drive the boring mill above, the WN-5082 bridge assembly supplies greater power and higher efficiency in less space. The 3-phase 60-cycle 440 v. power supply operates with a full load efficiency of 90% and an even higher half load efficiency. Regulation is approximately 8% from no load to full load with a Power Factor of 96 to 97.

Especially rugged for varying duty cycles, the WN-5082 withstands heavy loads of constant on-off operation, high-voltage transients, alternate heating and cooling.

Westinghouse can supply single diodes or complete bridge assemblies built to your specifications. For full information on how Westinghouse Silicon Rectifiers can bring new efficiency and economy to your applications, mail the coupon today.

YOU CAN BE SURE...IF IT'S

Westinghouse

WESTINGHOUSE ELECTRIC CORPORATION
P. O. Box 868, Pittsburgh 30, Pa.

Please send me data on the new Westinghouse WN-5082 Silicon Rectifier.

Please send me data on other Westinghouse Silicon Rectifiers. (Describe types or applications) _____

NAME _____
TITLE _____ FIRM _____
ADDRESS _____
CITY _____ ZONE _____ STATE _____

new!... protective shells for miniature and subminiature Continental Connectors

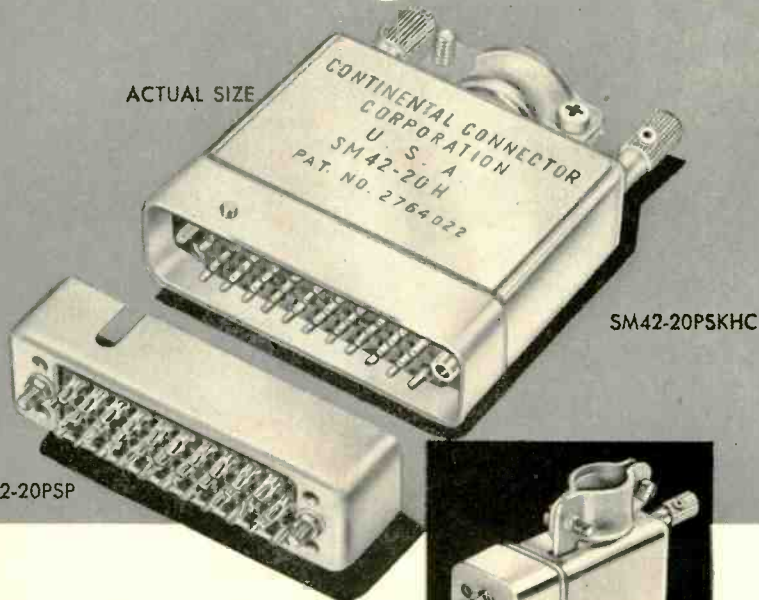

"COMPLETE PROTECTION" FOR ALL APPLICATIONS

Aluminum shells now give complete protection on Continental Miniature Series 20 and Subminiature Series SM 20. The shells are available with or without polarizing screwlocks*.

Complete enclosures make these protective shells and connectors ideal for either internal or external applications.

Series 20 is available in 5, 7, 9, 11, 14, 20, 26, 34, 50, 55, 75, and 104 contacts. Series SM 20 Subminiature in 5, 7, 11, 14, 20, 26, 34, and 50 contacts.

Connectors can be used without hoods and with protective shells only. Write for outline drawings showing shell and hood arrangements. Electronic Sales Division, DeJUR-Amsco Corporation, 45-01 Northern Boulevard, Long Island City 1, N. Y.

EXCEEDS MIL-C-8384 SPECIFICATIONS

*PAT. NO. 2,746,002

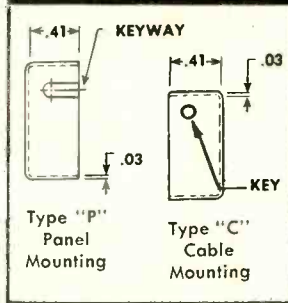
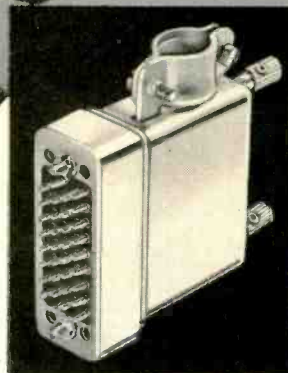

New Subminiature Connector Catalog. Write for free copy on your company letterhead.



you're
always
sure
with

DeJUR

electronic
components

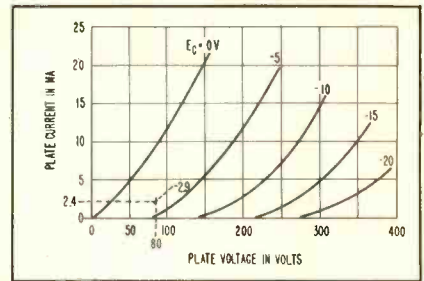

FIG. 3—Choice of operating point for V_1

meters of V_1 at Q_2 can then be calculated.

$$r_{p1} = 11,000 \text{ ohms}$$

$$\mu_1 = 19$$

Fourth, determine the value of the cathode resistor, R_k .

$$R_k = E_k / i_p = 1,200 \text{ ohms}$$

The value of both E_k and i_p can be obtained from Fig. 3.

Fifth, determine the effective load resistance for V_1 . This can be readily computed from:

$$R_{Leff} = \frac{r_{p2} + R_L}{\mu_2 + 1} = \frac{13,000 + 47,000}{19 + 1} = 3,000 \text{ ohms}$$

Sixth, determine the gain of tube V_1 . This can be obtained from

$$A_1 = \frac{\mu_1}{1 + \frac{\mu_{p1}}{R_{Leff}}} = \frac{19}{1 + \frac{13,000}{3,000}} = 3.6$$

Seventh, determine the gain of tube V_2 from

$$A_2 = \frac{\mu_2 + 1}{1 + \frac{\mu_{p2}}{R_L}} = \frac{10}{1 + \frac{13,000}{47,000}} = 15$$

Eighth, determine the total gain from

$$A_t = A_1 A_2 = 3.6(15) = 54$$

If a low-impedance source is employed, a transformer is required to raise this impedance so the noise level is determined by the source rather than the preamplifier tube. The input transformer should have a turns ratio given by

$$N_2 / N_1 = \sqrt{R_{eq} / R_{source}}$$

where N_1 = turns on primary transformer winding

N_2 = turns on secondary transformer winding

R_{source} = signal source impedance

R_{eq} = equivalent grid resistance that would produce the same noise level as the preamplifier tube

In the normal audio spectrum this equivalent resistance is given by

$$R_{eq} \approx 2.5 / g_m$$

The amplifier construction should

FINE WIRE OF DUCTILE AND NON-DUCTILE MATERIALS MEETS EVERY APPLICATION REQUIREMENT

BAKER's vast experience and research in metallurgy have made possible the development and production of fine wires of ductile and non-ductile materials to meet the expanding needs of industry. This know-how in metals has enabled BAKER to develop processes for bare drawing wire as fine as .0004". Where smaller fine wire is required, BAKER meets the need by employing the Wollaston process, when working with ductile metals, and the Taylor and Extrusion methods for non-ductile materials.

Extruded Wire of low fusing alloys can be supplied by BAKER in sizes down to .001". These have found application as protective fuses for instruments and can be supplied to fuse at any desired current. **BAKER Wollaston Wire** is produced with a length of bare drawn wire inserted into a close fitting tube of another metal, which is removed and dissolved by acid or other solvents before application. Both are drawn down to the desired size. **BAKER Taylor Process Wire** can be supplied in ductile and non-ductile materials. The metal or alloy is contained in an insulating material and both are drawn to the desired size. In this way, the metals or alloy core are not contaminated and are of exceptionally high purity. Sizes from .040" to .00004" are available. The chemical properties of BAKER precious metal **Potentiometer Wire** render it immune to corrosion and provide the high quality wire necessary for the delicate, precision potentiometer. Sizes as small as .0005" diameter, and enamelled to .001" diameter, can be supplied.

Write for complete catalog material and details.

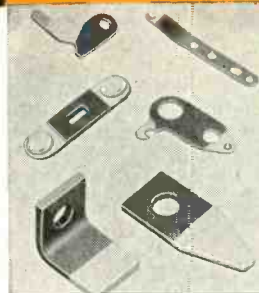
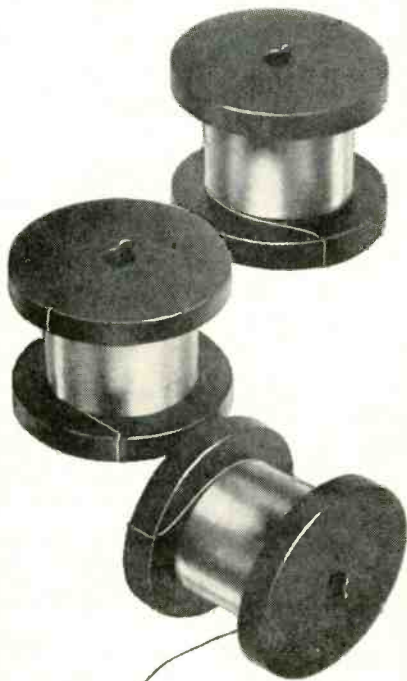

PRECIOUS METAL CONTACTS resist chemical attack and effects of the electrical arc to provide long life, unvarying performance.

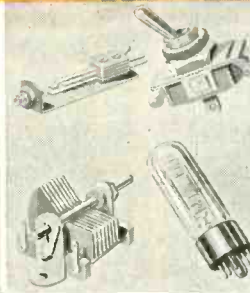

RHODIUM PLATING provides a hard, brilliant white, non-tarnishable surface extremely resistant to corrosive conditions.



NITRONEAL® GAS GENERATOR economically and safely provides forming gas atmosphere for bright annealing of tube parts.

BAKER PRECIOUS METALS

BAKER & CO., INC.

113 ASTOR STREET, NEWARK 2, NEW JERSEY
NEW YORK • SAN FRANCISCO • LOS ANGELES • CHICAGO

ENGELHARD INDUSTRIES

RESEARCH MAINTAINS BAKER'S LEADERSHIP IN PRECIOUS METALS

The **LARGEST** Selection of the **SMALLEST** **ELECTROLYTICS**

is available from AEROVOX!

...and only from Aerovox can you choose from the widest selection of case styles and constructions in a complete range of low-voltage values. For small space applications... for transistorized assemblies... **ALL** your requirements for miniature electrolytic capacitors are available from Aerovox.

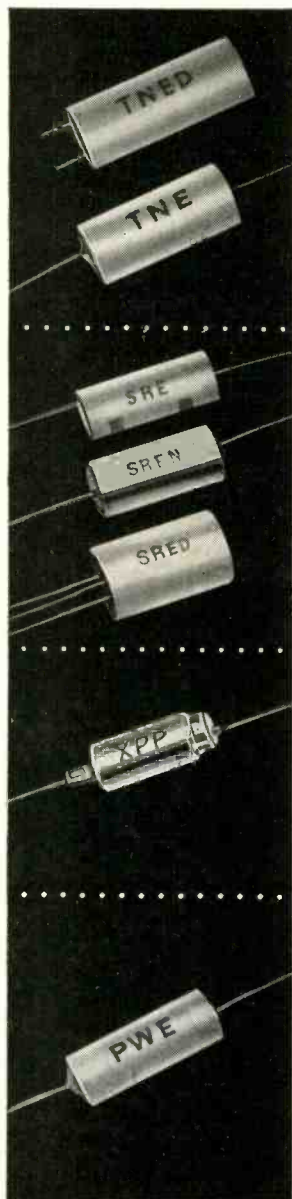

TYPES TNE & TNE

Preferred type subminiature electrolytics where cost, small size and long operating life are of prime importance in transistor assemblies. These tiny, low-impedance, low power factor units are furnished in film-lined glossy tubes with plastic end seals. Available in standard voltage ratings of 3 to 50 vdc with operating temperature range of -30°C to $+65^{\circ}\text{C}$. Leads are firmly imbedded in plastic end seal and will not pull out or work loose under the most severe operating conditions. Color coded end-fill and case marking denotes positive terminal.

TYPES SRE, SREN, AND SRED

Improved electrolytics especially suitable for cathode bypass applications, screen circuit filters and transistorized assemblies. Units tightly sealed in tubular aluminum cases available with external wax-impregnated cardboard insulating tube. Exclusive end-seal provides greater creepage distance and assures positive electrical and mechanical contact. Standard dc voltage ratings from 3 to 150 volts. Operating temperatures from 0°C to 85°C .

TYPE XPP

Miniature, hermetically-sealed, metal-cased tubular aluminum units designed specifically for maximum life where size and weight must be kept to a minimum. Exceptional shelf-life characteristics. Standard voltage ratings of 1 to 5 vdc and standard temperature range from -20°C to $+65^{\circ}\text{C}$. Available with axial leads only.

TYPE PWE

Miniature electrolytics encased in dense steatite tubes with special plastic end fill. Offering high capacitance at low voltages, these units are capable of handling full-size loads in industrial applications. Standard voltages from 1 to 50 vdc and standard operating temperatures from -20°C to $+50^{\circ}\text{C}$.

For detailed technical information write...

AEROVOX CORPORATION

NEW BEDFORD, MASS.

In Canada: AEROVOX CANADA LTD., Hamilton, Ont.
Export: Ad. Auriema, Inc., 89 Broad St., New York, N. Y. • Cable: Auriema, N. Y.

follow standard practice for low-level audio applications. The use of high quality components and isolation from magnetic and electric fields cannot be overemphasized.

Figure 4 shows a complete sche-

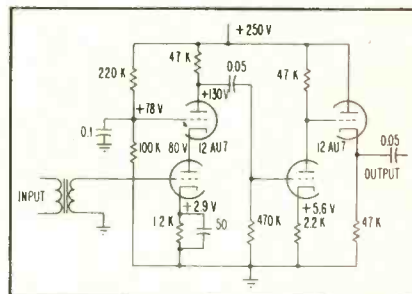

FIG. 4—Cascode microphone preamplifier

matic of the amplifier with the addition of a standard triode amplifier that is direct-coupled to a cathode follower. This circuit is used as a preamplifier for a dynamic microphone having a gain of 51 db exclusive of the input transformer.

Wide Range A-C Timer

By H. J. FRASER

School of Electronics and Communications
Department of Technical Education
N.S.W., Australia

IN the a-c timing circuit described here, a high-vacuum rectifier generates bias for the thyatron. High leakage resistance of the rectifier permits use of high resistance in timing network to obtain a time delay of 450 seconds per microfarad.

► **Operation**—Circuit shown in Fig. 1 is a simple thyatron timer with the addition of a 1B3 rectifier. With switch S_1 in position 1, capacitor C_1 is charged through the rectifier to a voltage E dependent upon the setting of potentiometer R_1 which serves as a time control. This voltage is divided across R_1 , R_2 , R_3 and R_4 , which form the discharge resistance, and a voltage of approximately $\frac{ER_4}{R_3}$ appears at the thyatron grid to bias it below cutoff. With S_1 switched to position 2, the charging source is removed, and C_1 will discharge through R_1 , R_2 , R_3 and R_4 . Assuming R_1 , R_2 and R_4 are much less than R_3 , the dis-



CLARE RELAYS and AUTOMATION

Cutaway view of CLARE Mercury - Wetted - Contact Relay, two of which are used by AccuRay to control cigarette making process.

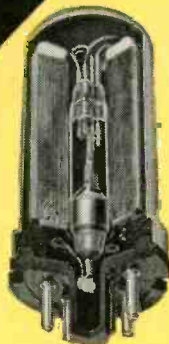

Drawings (left) from high-speed photographs show the cycle. (a) Filament of mercury forms between the contacts as they separate. (b) This becomes narrower in cross section and (c) finally parts at two points, allowing globule of mercury to fall out. Mercury flows up the capillary path, replaces amount lost, restores the equilibrium. (d) The momentary bridging of the parting contacts—and the extremely fast break that ends it—minimizes the arc and adds greatly to contact load capacity. Contact closure between the two liquid surfaces bridges mechanical bounce and prevents any crater from appearing in the electrical circuit.

How *AccuRay*® uses long-life CLARE Mercury-Wetted-Contact Relays to provide accurate, continuous and automatic control of a manufacturing process

Actuated by variations in the electric current set up by a constant intensity beam of radiation through a cigarette "rod," two CLARE Mercury-Wetted-Contact Relays help the AccuRay Cigarette-Gauge controller to proportion the weight of cigarettes as they are being produced.

In this way AccuRay, a revolutionary precision process control system, uses electronics to provide automatic control of cigarette and other manufacturing production processes.

Engineers of Industrial Nucleonics Corporation, makers of this new process control, picked CLARE Relays to perform these important functions because only these relays gave the long life and low maintenance required. These machines wrap and cut 20 cigarettes a second, day and night, day after day.

With a service life of billions of operations* it is no wonder this relay has become the first choice of hundreds of leading designers of computing, data-processing and control equipment. For complete information write for Bulletins 120 and 122 to C. P. Clare & Company, 3101 Pratt Blvd., Chicago 45, Illinois. In Canada: 659 Bayview Avenue, Toronto 17. Cable address: CLARELAY.

* More than two years ago a life test started on a group of these relays carrying a full contact load of 5 amperes at 50 volts d-c with suitable spark suppression. They have been operating continuously ever since at 5,184,000 operations a day. They have now passed the 4 billion mark—and the end is not yet in sight.

CLARE RELAYS

FIRST in the industrial field

© Industrial Nucleonics Corporation, Columbus, Ohio

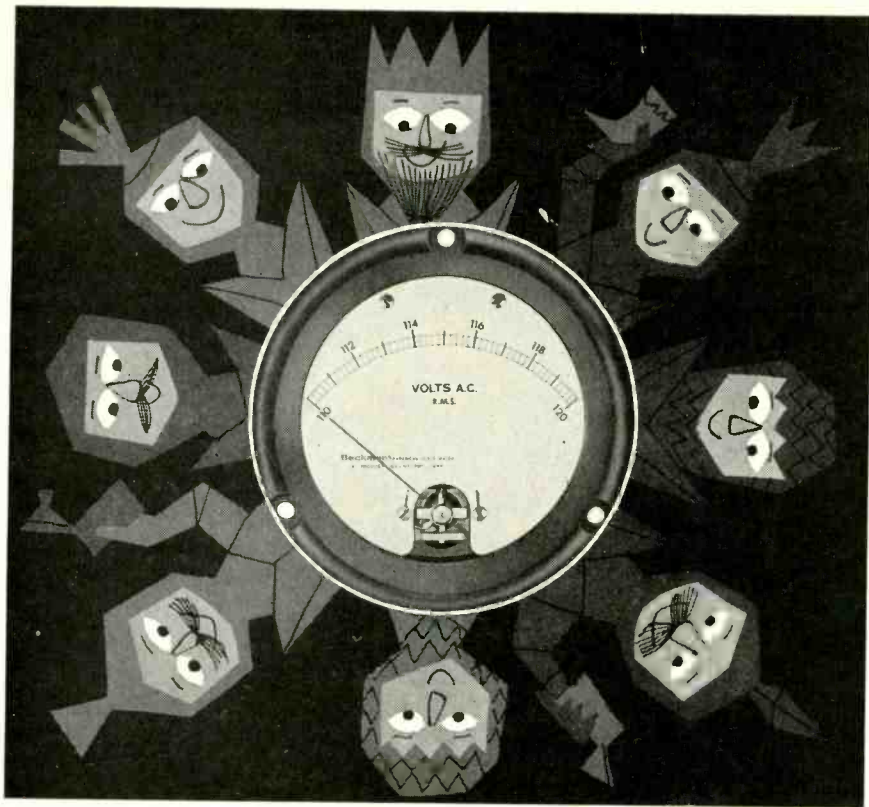

Even when set at an illogical, illegible angle, Beckman Expanded Scale Voltmeters read

RIGHT at a glance

BECKMAN EXPANDED SCALE VOLTMETERS always read billboard-clear, even when the installation's angular, tangular, bothersome or bewildering. Needle position tells all—you don't have to read the fine type.

HOW COME? The meter's selective: non-essential parts of the scale have been eliminated, and the useful portion expanded. And so we bid farewell to crowded divisions at one end of the scale. Instead, meet real easy reading.

AC OR DC? Either. Also, they're as small as 2½" dia., as accurate as 0.3% of center-scale voltage. Resolution's as high as 0.1 volt.

HOW MANY MODELS? The 126 standard models—available in commercial and military versions—are for panel installations in ground power facilities, test equipment and aircraft. On special order, meters can be adapted for non-standard voltage ranges, scales, accuracies, shapes and sizes.

WANT MORE? Write for data file 104A.

Beckman
Helipot
Corporation

Newport Beach, California
A division of
Beckman Instruments, Inc.
Engineering representatives
in principal cities

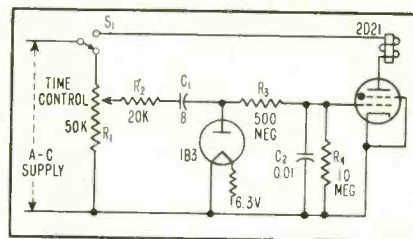
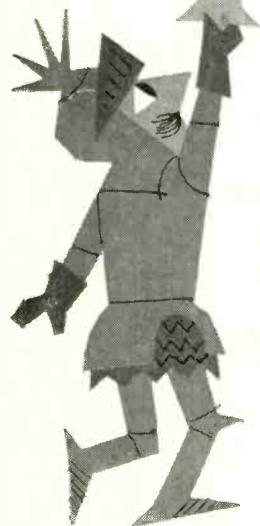

FIG. 1—Wide range a-c timer circuit provides time delay of 450 seconds per microfarad

charge time constant will be approximately R_3C_1 .

After a time, t_d , the grid voltage rises above cutoff, and the thyatron fires to operate a relay in its anode circuit. Switching S_1 back to position 1 will reset the timer for the next timing operation.

Because the anode of the 1B3 is supported only by the lead sealed into the dome of the bulb, it has an extremely high leakage resistance to cathode. This allows the use of a large resistance in the discharge circuit. As grid-circuit resistance R_3 is fixed by the tube manufacturer's rating, the maximum value of R_3 is limited to ensure that the thyatron can be biased beyond cutoff. For maximum time delay

$$R_3 = \left(\frac{E_{max} \cdot R_4}{e_c \cdot \epsilon} \right)$$

where

e_c = critical grid bias

E_{max} = maximum voltage to which C_1 is charged.

Switching Core Tester

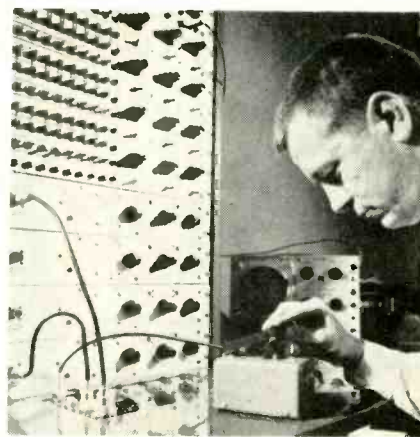

Production tester for computer memory cores installed at Westinghouse plant, has four-channel output that can duplicate actual computer operating sequences. Outputs can be paralleled or operated individually

POCO TIEMPO IS SPECIAL!



Special group! With its own coil-winding, machining and assembly facilities.

Its own sales, engineering, purchasing, inspection and shipping activities. Its own everything but red tape. **Special orders!** Potentiometers, in prototype quantities, with these special modifications: resistance values, tolerances, linearities, taps, shafts, lids, bushings, ganged assemblies, torque, bearings and rotation. Take your pick. **Special Delivery!** In 10 days or less. **Special price?** No! Not one cent extra! *For your non-standard prototype pots, go fast, go first-class, go Poco Tiempo! Ask for it by name.*

Beckman[®] / Helipot

Helipot Corporation, Newport Beach, California
a division of Beckman Instruments, Inc.
Engineering representatives in principal cities

Multi-Scope for
more accurate,
efficient re-
search, test and
control!



"WORKHORSE" OF 2-CHANNEL OSCILLOGRAPHY

.. at the lowest price on the
market today!

May be used as
either a single- or
2-channel 'scope.

Range: DC to 250
KC.

Individual or com-
montime bases with
sweep ranges from
below 2 seconds to
50,000 cps.

Now, get all the advantages of true 2-channel oscillography at a really rock-bottom price!

Made by the originators of multi-beam 'scopes and tubes, ETC Model K-26 is the most widely used 2-channel 'scope in its field today. Its 5" flat-face dual-gun tube, its control features, sensitivity, bandwidth, frequency response and gain handle over 90% of all modern applications for either single- or dual-channel oscilloscopes. Only the costly special features needed in larger ETC models for ultra-critical work have been omitted. **PRICE \$975**
Write for ETC Bulletin K-26 giving full details. **ONLY**

HEADQUARTERS FOR MULTI-BEAM 'SCOPES



AND MULTI-GUN CR TUBES Other ETC 2-channel 'scopes are available with vertical amplifier frequency range from DC to 15MC. Standard and special types available with up to 8 separate channels on a single tube face. Cathode ray tubes supplied in a full line from 2- to 10-gun types. Write for catalog.



electronic tube
CORPORATION

1200 E. Mermaid Lane

Philadelphia 18, Pa.

Capacitor C_2 is used to limit unwanted a-c voltages on the thyatron grid.

The experimental circuit with a timing capacitor of $8 \mu\text{f}$ and resistor R_2 of 500 megohms gave a maximum time of 60 minutes for an a-c supply voltage of 240 v. For a supply voltage of 115 v a time delay of 40 minutes was obtained with $C_1 = 8 \mu\text{f}$ and $R_1 = 300$ megohms.

► **Supply voltage**—Calculations indicate 10-percent change in timing for 10-percent change in supply voltage. With a low leakage timing capacitor and high-stability resistors timing accuracy obtained is comparable to conventional a-c timing circuits.

Transistor Uses Annular Construction

A TRANSISTOR capable of switching currents up to 40 amperes has been developed at the Australian Commonwealth Scientific and Industrial Research Organization. This tran-

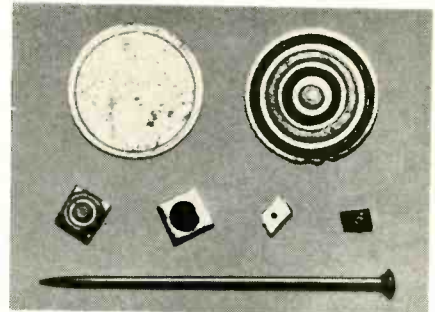

Active element of switching transistor shown with conventional transistor elements and pin for size comparison

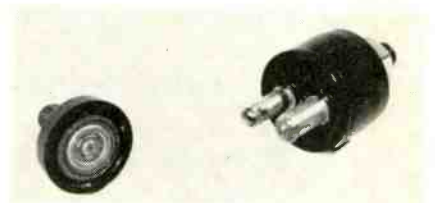

Internal and external construction of 40-ampere switching transistor

sistor, still an experimental type, is designed to produce a 1-kw pulse of a few microseconds duration for use in radar modulators. Since the pulse repetition rate is low and circuit efficiency is high, a mean dis-

Having your ups
and downs?



... if they involve WIRE WOUND RESISTORS

DALOHM has the answer!

All Dalohm components are carefully designed and skillfully made to assure you of supreme quality and dependability, plus the widest versatility of application.

Outstanding examples of the Dalohm line are the following miniature, silicone coated, wire wound resistors.

You Can Depend On



FOR CRITICAL ELECTRONIC DESIGN WHERE SPACE IS A PROBLEM



TYPE RS

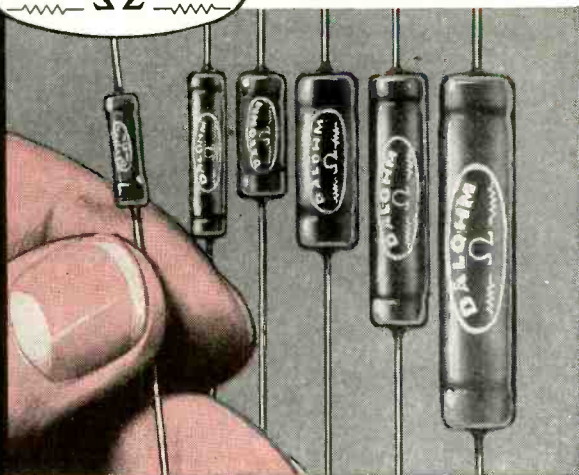

Smallest in size, Dalohm Type RS resistors are silicone sealed, offer high di-electric strength, maximum heat dissipation, and resistance to abrasion, plus every other desirable characteristic:

- 100% impervious to moisture and salt spray
- Complete welded construction from terminal to terminal
- Temperature coefficient 0.00002/Deg. C
- Resistance ranges from 0.05 ohm to 175K ohm, depending on type
- Tolerances 0.05% to 3%, depending on type
- Five wattages—2, 3, 5, 7, and 10; six physical sizes

Write for Bulletin R-23D

DALE PRODUCTS, Inc.

1300 28th Avenue
Columbus, Nebraska, U.S.A.

TYPE RLS

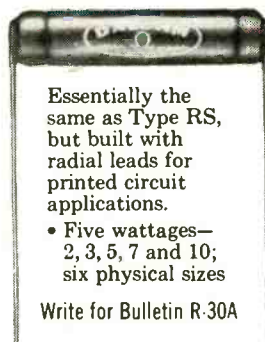

Essentially the same as Type RS, but built with radial leads for printed circuit applications.

- Five wattages—2, 3, 5, 7 and 10; six physical sizes

Write for Bulletin R-30A

TYPE RSE

"RUGGEDIZED"

A modified RS Type, with tremendous shock resistance obtained by encasing them in a metal housing, yet maintaining miniature size.

- Five wattages—2, 3, 5, 7, and 10; seven physical sizes.

Write for Bulletin R-25B



JUST ASK US!

You are invited to write for the complete catalog of Dalohm precision resistors, potentiometers and collet-fitting knobs.

If none of our standard line fills your need, our able engineers and skilled craftsmen, equipped with the most modern equipment, are ready to help solve your problem in the realm of development, engineering, design and production. Just outline your specific situation.

• Export Dept:

Pan-Mar Corp.,
1270 Broadway, New York 1, N.Y.

A New Concept of TIME . . .



INDUCTOR MOTOR

REVERSIBLE MOTOR

CLUTCH MOTOR

HYSTERESIS MOTOR

DIRECT CURRENT MOTOR

400 CPS MOTOR

... this Complete
NEW Line of
HAYDON*

TIMING MOTORS

Here is a complete line of timing motors that includes the right choice for every APPLICATION . . . entirely re-designed for finer performance. Features include: slower basic rotor speed (450 rpm), controlled lubrication, total enclosure, smaller size, superior accuracy, quieter operation and longer life.

HYSTERESIS . . . the ideal general-purpose motor.

INDUCTOR . . . extra torque (30 ounce inches) for display and other heavy-duty jobs.

CLUTCH . . . allows automatic re-setting without external clutches.

REVERSIBLE . . . a hysteresis type with 2 coils, each producing opposite rotation.

DIRECT CURRENT . . . a permanent magnet type for 6 to 32 volts.

400 CPS . . . miniature and heavy-duty models for airborne instrumentation.

FOR COMPLETE INFORMATION, write today for new catalog . . . or contact the HAYDON Field Engineer nearest you.

*Trademark Reg. U.S. Patent Office

HAYDON
AT TORRINGTON

HEADQUARTERS FOR
TIMING

A SUBSIDIARY OF GENERAL TIME CORPORATION

HAYDON Manufacturing Company, Inc.
2434 ELM STREET, TORRINGTON, CONN.

sipation of only a few watts is involved.

The alloyed junction germanium *pn*p transistor is shown in the photograph. The indium-gallium alloy emitter is arranged in an annular position with relation to the base. In the photograph the emitter can be seen as a gray ring and the base as black rings. The collector covers almost all of the back surface.

Table I—Specifications of Switching Transistor

Maximum collector current	40 amp
Maximum collector-base voltage	-30 v
Current gain (I_c/I_b) at 40 amps	10-15
Rise time (grounded base)	$\sim 1 \mu\text{sec.}$
Extrinsic base resistance	$\sim 1 \text{ ohm}$
Maximum total average dissipation	$\sim 5 \text{ watts}$
Peak pulse output power	1 kw

A partly assembled and complete pulse transistor is shown in the other photograph. Specifications are as given in the table. This information has been supplied by McGraw-Hill World News.

Transistorized Reactor Control

A SYSTEM using a neutron-sensitive thermopile, a magnetic modulator, an excitation source for the modulator and a transistor amplifier is used to measure neutron flux density in a pile control system. The thermopile is made of individual thermocouple disks consisting of a sequence of three $\frac{3}{8}$ -in. diameter disks, the outer disks being bismuth and lead and the inner disk being the neutron flux-to-heat converting material of boron impregnated powdered copper disk 0.006 in. in thickness. These disks are stacked in 100 thermocouple sections to form a thermopile.

The thermopile has a resistance of $\frac{3}{4}$ milliohm and produces an output signal of 21 microwatts into a matched load when placed in a neutron flux density of 3.8×10^{12} neutron per sq cm per sec. A magnetic modulator designed to match the

FLASH!

Engineers... here's the answer to your Fine Magnet Wire problems!

*Hudson is the only
American firm producing
insulated copper wires as
fine as .0006 inch diameters.*

Hudson's .0006" diameter round magnet wire is available with film insulations of Polyurethane or Formvar. This is the finest quality wire on the market and Hudson provides the finest service in meeting your requirements, in fact, quality and service are guaranteed. Phone or write Hudson now!

Hudson's Film Insulated Magnet Wire Line

- Single & Heavy Plain Enamel
- Single & Heavy EZ-Sol (nylon)
- Single & Heavy Hud-Sol (polyurethane)
- Single & Heavy Formvar
- Single & Heavy Siliclad (silicone)

- Hudson's Bare Wires available in 15 metals.
- Hudson's Specialty Wires available in silver plated and electro tinned copper and copper alloys; single end, stranded & bunched, or flat wire ribbons.
- Hudson's Thermoplastic and Teflon (Du Pont) extruded wires available in a wide range of sizes.

Hudson's Fabric Insulated Magnet Wire Line

- Single & Double Celanese covered
- Single & Double Nylon covered (20 or 40 denier)
- Single & Double Silk covered
- Single & Double Cotton covered
- Single & Double Orlon covered
- All combinations of Film & Fabric insulations

makers of quality fine wire for over 50 years

HUDSON WIRE COMPANY

Ossining, New York
Bare, Specialty & Thermoplastic Wire Plant

Winsted, Conn. & Cassopolis, Mich.
Magnet Wire Plants

thermopile uses Mo Permalloy cores.

The transistor amplifier uses common emitter degenerative stages. Frequency selective L-C tuned circuits between emitter and ground are tuned to a frequency near the second harmonic. The fourth stage of the amplifier is un-

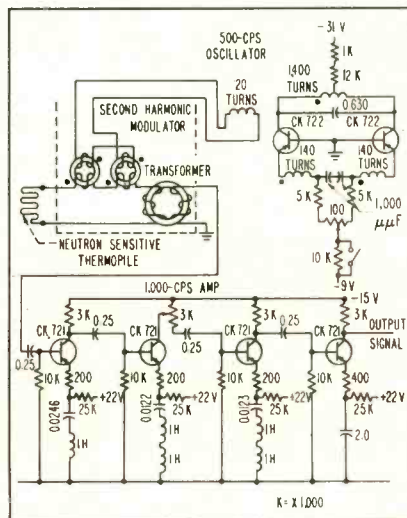

tuned. The output of the amplifier is adequate to excite electronic drivers for control-rod actuation. The system using transistors increases reliability of reactor control equipment.

This material was abstracted from "Solid State Neutron Flux Measuring System", *Elec Eng*, p 678,, Aug, 1957.

Two-Channel Mixer For Tape Recording

By R. C. FERRARA
General Electric Co.
Syracuse, N. Y.

A TRANSISTORIZED two-channel audio mixer described here can be used as an input control device for tape recorders or audio systems.

► **Circuit** — The mixer circuit shown uses two 2N107 *mnp* transistors. Each channel contains an input jack, gain control, transistor and filter network. The mixer input is fed to the base of the transistor through a 250,000-ohm gain control. Emitter voltage is



a new measure



in Celco



precision

TOROIDAL COMPONENTS





Whether it's a complex 10 winding magnetic amplifier or a simple choke . . . at Celco each toroid is precision-made. New core materials are used in Toroidal magnetic amplifiers, reactors and transformers to achieve maximum performance.

At Celco, the proper matching of cores, winding, handling, impregnation, encapsulation and electrical history of the final assembly is carefully controlled to maintain the original design characteristics.

Our years of design, development, and production know-how are available for application to your specific **TOROIDAL** problems.



Celco

Constantine Engineering Laboratories Co.
MAHWAH, NEW JERSEY

* For immediate attention,
call DAVIS 7-1123
— or write today.



NEW MOTOROLA SWITCHING TRANSISTOR

*provides extreme reliability
at a highly competitive price*

TECHNICAL DATA MOTOROLA MN19					
Maximum Ratings			Typical Values		
	V_{CB}	V_{CE}	$f_{\alpha b}$	h_{FE}	V_{CS}
Test Condition	Emitter Open	Base Open	$I_C = 3 \text{ ma}$ $V_{CB} = 5V$	$I_C = 10 \text{ ma}$ $V_{CE} = 1V$	$I_C = 10 \text{ ma}$ $I_B = 1 \text{ ma}$
Value	40V.	20V.	8 MC	40	.05V.

PULSE RESPONSE in typical test circuit

Rise Time	t_r	0.1 μ sec
Storage Time	t_s	0.05 μ sec
Fall Time	t_f	0.11 μ sec

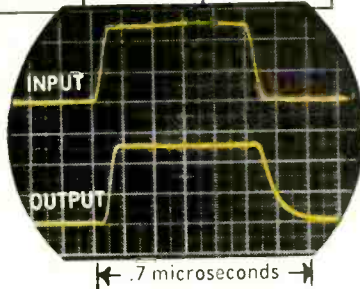

- Very high voltage breakdown
- Very low saturation resistance
- JETEC size group 30 case
- Performance proven in stringent military applications
- Continuous life-testing and quality assurance program guarantees military reliability level
- "Productioneered"—the MN19 is engineered for extreme quality . . . in quantity. You are assured a dependable volume supply at highly competitive prices.

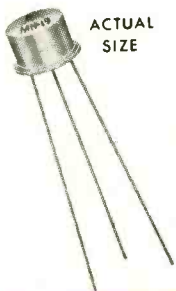

SAMPLE ORDER—4 FOR \$24.00

For complete technical information concerning the MN19 or other performance-proven Motorola Semiconductors—write, wire or phone Motorola, Inc., 5005 East McDowell Road, Phoenix, Arizona. BRidge 5-4411

"DEPENDABLE QUALITY—IN QUANTITY"

MOTOROLA SEMICONDUCTORS

MOTOROLA, INC.
5005 E. McDOWELL
PHOENIX, ARIZONA

Other Motorola Quality Products Include:



High-Power
Audio Transistors



High-Voltage
Power Transistors



Silicon Power
Rectifiers



Medium-Power
Transistors

ULTRA SPEED SWITCHING TRANSISTOR TO BE ANNOUNCED SOON—Motorola's development team has many exciting new types ready for release including a switching transistor operating in the millimicrosecond range.



you can depend upon
Automatic
coaxial
SWITCHES and RELAYS



Custom engineered to your specifications

Unsurpassed accuracy and dependability, based on over 15 years experience in producing precision parts for the Army, Navy, Air Force, and Atomic Energy Commission.

AUTOMATIC'S Coaxial Switches and Relays are available in the following types:

SPDT, DPDT, Crossover, Resistor Terminated, Multiple Position, and Rotary—both continuous and index type.

All switches available for both manual and relay operation, and may be ordered with all standard and sub-miniature fittings.

AUTOMATIC'S Switches and Relays are small in size...light in weight...low in cost...and have excellent electrical characteristics.

Our engineers are always ready to discuss your special requirements.

WRITE, WIRE, OR PHONE FOR FREE TECHNICAL INFORMATION

Automatic
METAL PRODUCTS CORP.

317 Berry Street, Brooklyn 11, N. Y. • Evergreen 8-0364

Circle 148 Readers Service Card

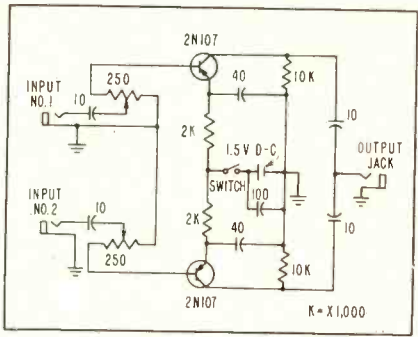

Circuit for the two-channel audio mixer. Microphones, phone pickups and speaker voice coils in any combination can be used for mixing. The number of audio channels can be expanded to include more than two

filtered by a network consisting of a 2,000-ohm resistor and a 40- μ f capacitor.

The collector current feeds into a 10,000-ohm load resistor. The output of each channel, taken across the load resistors through 10- μ f blocking capacitor, is combined and fed to the output jack. A 100- μ f capacitor is used across the battery as a filter and as an aid in maintaining battery life. The power required for the mixer circuit is derived from a 1.5-v battery, with little current drain. In general, the circuit is well filtered against noise.

Radiation Effects on Magnetic Materials

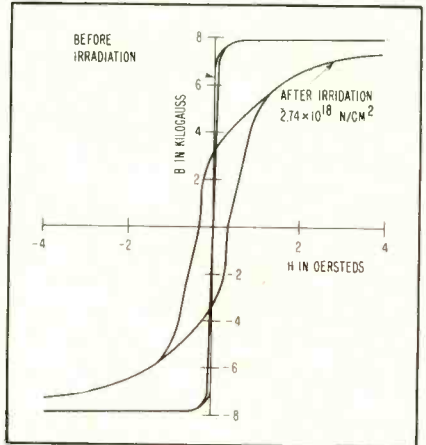

FIG. 1—Effects on 60-cps hysteresis loop irradiation

Table I—Percentage Change in D-C Magnetic Properties

	μ_{max}	H_c	B_r	B_m
3.5% Silicon Iron	-1	5.7	0.8	0
Orthonol	15	-28	-24	-4
5-79 Mo Permalloy	-93	815	-38	-3.2
2 Vanadium Permendur	1.7	-2	-0.6	-0.7
16 Alfenol	15	-8	7.5	-5
50-50 Nickel Ferrite	1.4	-4.6	-4	-1.7
2-81 Mo Permalloy (powder)	-3.7			0.2

IRRADIATION tests were made at the Brookhaven National Laboratory on samples of seven magnetic core materials, 5-percent silicon iron, Orthonol, 5-79 Permalloy, 2 V Permendur, 16-Alfenol, 50-50 nickel ferrite and 2-81 Mo Permalloy.

The materials were irradiated for approximately 17 days at a neutron flux density of 1.8×10^{12} neutrons per sq cm per sec. Magnetic measurements were made before, during and after irradiation.

The 2-V Permendur, 16-Alfenol and 3.5-percent silicon iron cores showed only slight changes in magnetic properties and showed practically complete recovery after removal from the pile. The 2-Vanadium Permendur has also been shown to be suitable for magnetic amplifier cores at temperatures up to 500 C. Orthonol and 5-79 Mo

Permalloy cores both showed major changes in magnetic properties. The 5-79 Mo Permalloy deteriorated to such an extent that any circuit requiring optimum properties of this material would fail. The 2-81 Mo Permalloy powder core and the 50-50 nickel-ferrite core showed no appreciable changes at d-c, 60 or 400 cps. Tests in the 5 to 50 kc region showed core loss characteristics changed appreciably from before to after radiation.

The effect of radiation on the 60-cps hysteresis loop of 5-79 Mo Permalloy is shown in Fig. 1. The percentage change in d-c magnetic properties as a result of radiation is shown in Table I.

This material was abstracted from Naval Ordnance Laboratory Report 4381 by R. S. Sery, R. E. Fischell and D. I. Gordon.



E-I has everything in glass-to-metal seals*

- STANDARD TERMINALS
- CUSTOM TERMINALS
- CUSTOM SEALING
- ON-THE-SPOT
ENGINEERING ASSISTANCE
- NEW PLANT TO SPEED PRODUCTION
- ENGINEER-DESIGNER
HANDBOOK AND CATALOG



Almost two decades of progressive engineering are your assurance E-I can serve you better

Hermetic sealing problems of the most difficult kind are nothing new at E-I... for we have been solving them constantly for almost 20 years. Today, the complete E-I line offers designers a choice of over 500 standard preferred types, each available with optional features and modifications. If required, custom types can be produced to specifications, or E-I will seal components of your manufacture. Standard terminals and typical custom seals are included in latest E-I catalog-handbook available on request. Call or write for your copy, today!

*Canadian Pat. 523,390; British Pat. 734,583; U.S. Patent Pending - All Rights Reserved



ELECTRICAL INDUSTRIES

A Division of Philips Electronics, Inc. - MURRAY HILL, NEW JERSEY

New Shipping Pack Swings Vacuum Tubes in Plastic Pouches

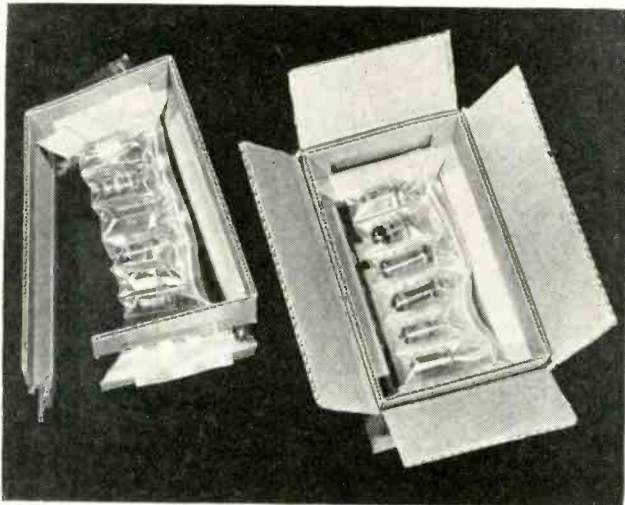

Polyethylene Swing-Pack pouches help ease shocks of shipping, thereby protecting delicate radio tubes in shipment

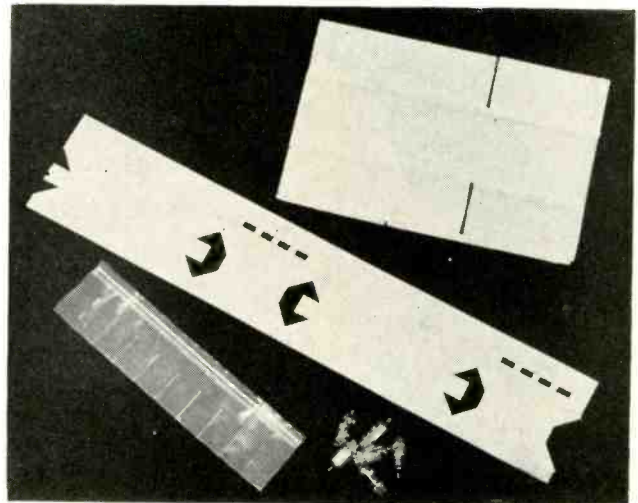

Plastic pouch and cardboard shipping container before assembly. Tubes are placed in compartments of pouch first

A NEW PACKAGING DEVELOPMENT for radio tubes and other fragile or delicate components utilizes the flexibility, resilience and softness of a polyethylene pouch, suspended in air, for its success as a shock-resistant shipping container. The pouch is attached at each end of a corrugated cardboard box, so that at no time do the contents of the pouch rattle against the sides.

Film extruded from Bakelite polyethylene is used in making the pouches, which are heat-sealed into compartments each big enough to hold one unit of the item to be packed. This allows many units to be shipped in a single box without their rubbing or banging together, thus preventing breakage. Other advantages of this package are its light weight and easy assembly.

The manufacturer is Polyfab Co., 3511 Eagle Rock Blvd., Los Angeles.

The pack uses a Flexigrip closure consisting of extruded ridges that can be pressed together to form a seal which is dust-tight yet can easily be opened to remove a tube. Also of Bakelite polyethylene, this seal is made by Flexigrip, Inc., 504 E. 74th St., New York, N. Y.

Cutting Sponge Rubber into Long Strips with Pinking Machine

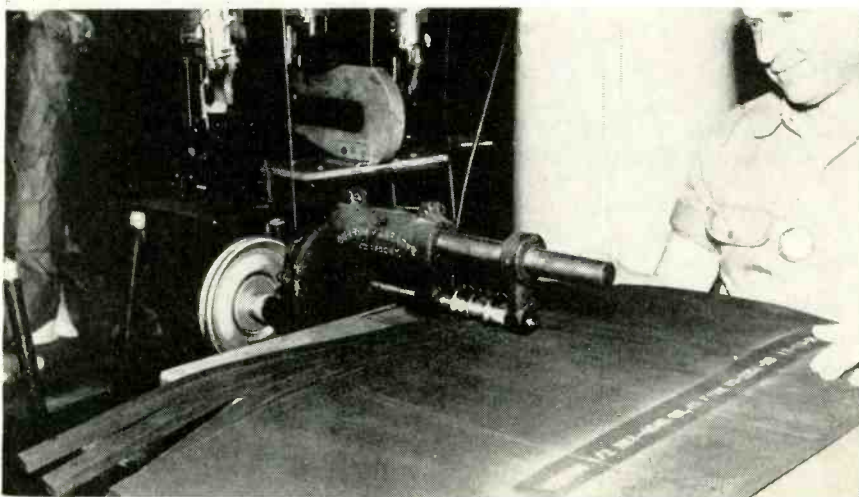

With new method, operator simply guides sheets of sponge rubber along pre-set guide bar behind cutters of pinking machine

SHEETS OF SPONGE RUBBER are being stripped down to size at The Martin Co. by a cutting method similar to that employed by shoemakers. This cutting operation, which has increased production output by 87 percent, utilizes a machine which pinks, or cuts, the sheet material into straight-edged strips of uniform thickness and size. When performed by hand and without the aid of the pinking machine, this same operation requires a longer period for setting up and actual cutting.

The tools used in the former method for cutting the strips of rubber consisted of a razor blade, a metal cutting-edge, clamps and a measuring instrument. The sheet

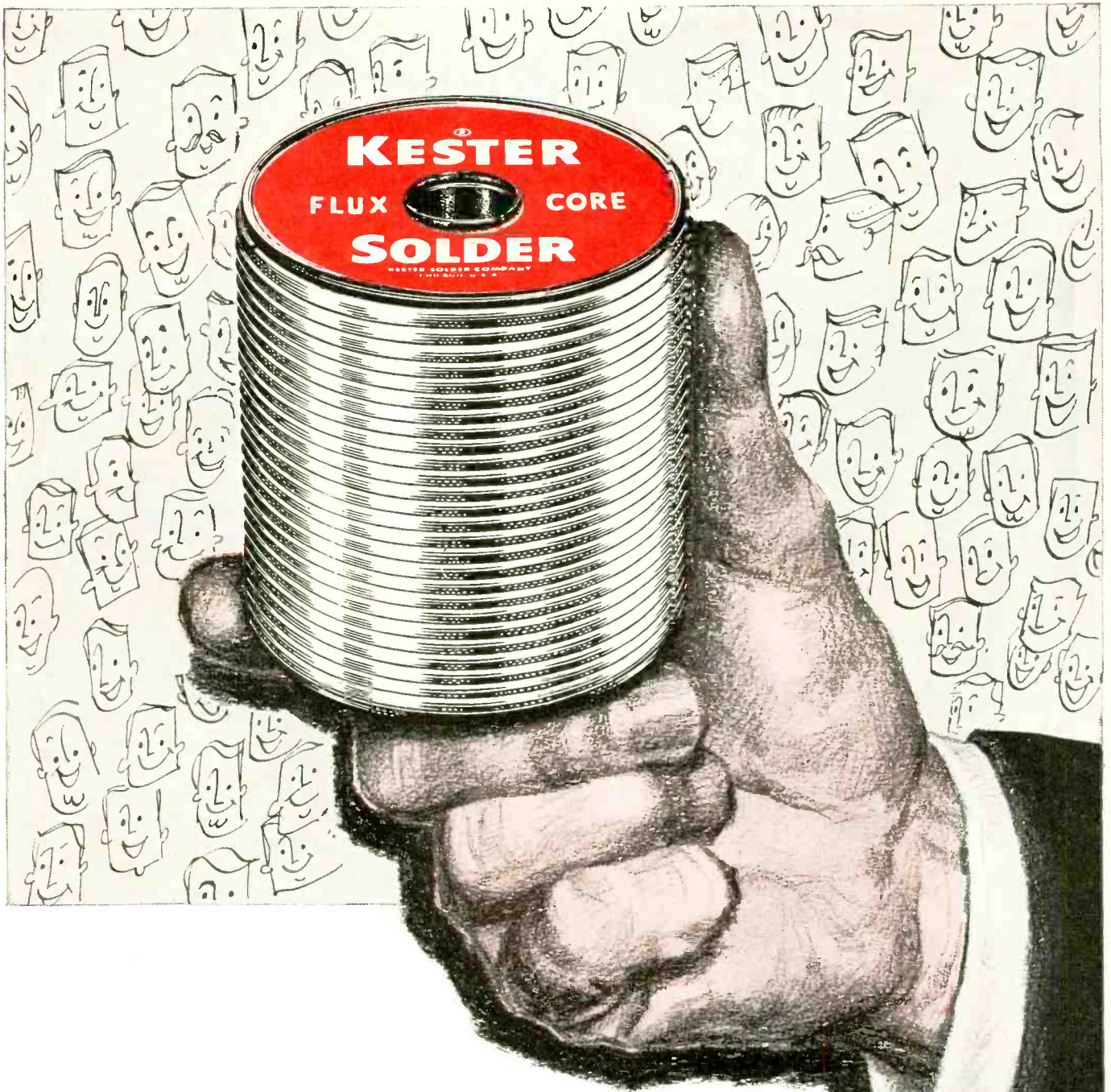

YOU'VE GOT TO HAND IT TO ENGINEERING!

You've got to hand it to the engineering profession. The "slide-rule" boys know quality when they see it . . . and they won't be satisfied with anything less. Take solder, for example. Engineers depend on KESTER FLUX-CORE SOLDER in their work because they know Kester's reputation

for quality and precision manufacturing . . . a reputation built up over more than 50 years. That's why Kester's the preferred choice of a great majority of electronic manufacturers. *Engineers know that a few pennies saved on a "second-line" solder product can waste dollars!*

KESTER SOLDER

4204 Wrightwood Avenue, Chicago 39, Illinois
Newark 5, New Jersey, Brantford, Canada

SEND TODAY for your copy of the 78 page Kester Text-book, "Solder . . . Its Fundamentals and Usage." It's Free.

Company

rubber was clamped under the metal cutting-edge, measured according to the thickness and length desired, then tediously cut with the razor blade.

In order to improve the method for turning out the strips, Martin adapted the pinking machine to the cutting operation. The lengthy set-up time, the ragged edges and the

irregular-cut sizes were virtually eliminated. As an added advantage, gang cutting was made possible, thus allowing several strips of rubber to be cut simultaneously.

Ultrasonic Machining of Ceramic Spacers for Vacuum Tubes

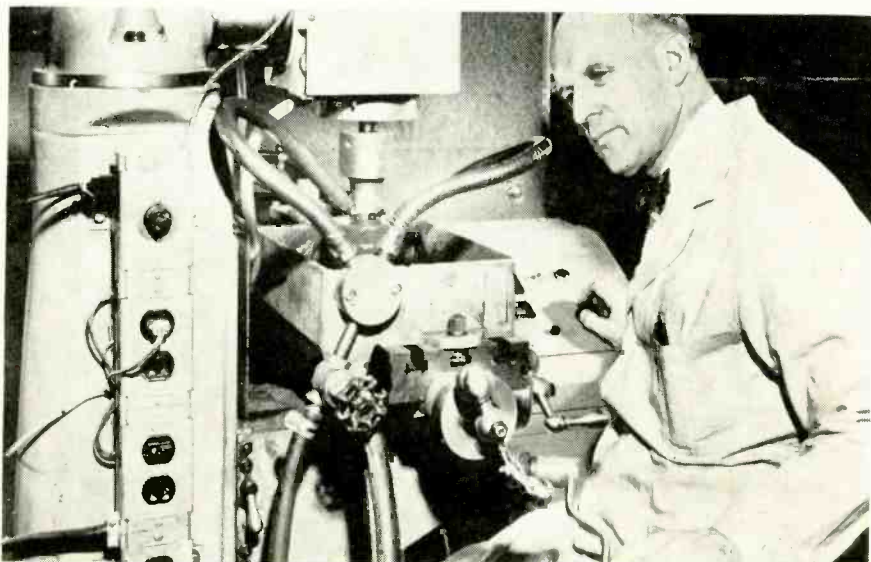

Machining alundum spacer disks for tubes. Right hand of operator tunes generator



Withdrawing tool after cutting holes

AN ULTRASONIC TECHNIQUE for drilling ceramic tube spacers, developed by C-Mar Corp. of Manasquan, N. J., makes possible volume production of close-tolerance ceramic parts with intricate configurations. An electromechanical transducer vibrates the impact tool

at 25,000 cps. Particles of abrasive, introduced as a slurry between work and tool face, are driven with tremendous impact into the work to produce intricate orifices, multiple arrangements of holes and slots, and other complex configurations in a single operation. Be-

cause the work is not chipped, spun, stressed or distorted, parts can be shaped to close tolerances with high piece-to-piece reproducibility.

By using ultrasonically machined alundum spacers, one manufacturer of ruggedized tubes has reduced tube noise and tripled the life of

Design of the Month: SELF-LOCKING CONNECTOR

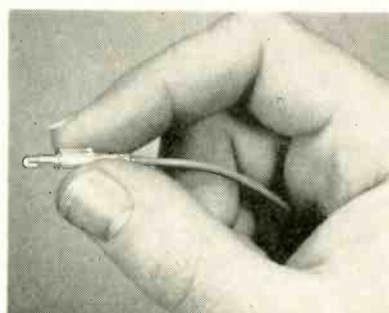
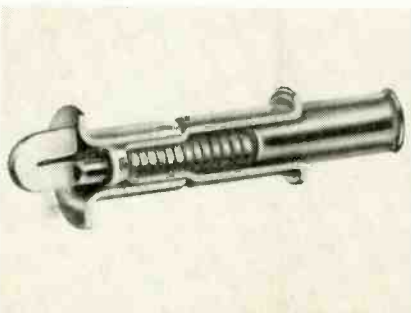
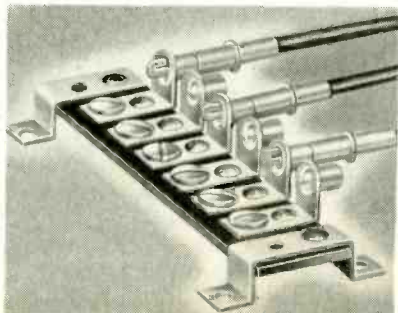

Plug locks automatically when inserted in simple tubular rivet serving as jack. Contact members themselves form locking mechanism, giving vibration-proof and impact-proof grip that can be released only by pulling flanged outer sleeve away from jack as at right. Design withstands pull on cord up to mechanical fracture limits of materials; this static pull-out limit ranges up to 230 lb and even higher, depending on connector size and current rating in Hubbell Interlock line, distributed by

Avnet Interlock Sales Corp., 36 N. Moore St., New York City. Jacks are available integral with screw terminals for panel boards or for strips as at left, with soldering lugs for panel mounting, with axial-lead terminations for wire disconnects, or as rivets alone for crimping directly into printed wiring boards. Internal spring, shown in cutaway view, provides hammerblow action of contact head for breaking through oxide and dirt film and then maintaining true pressure contact

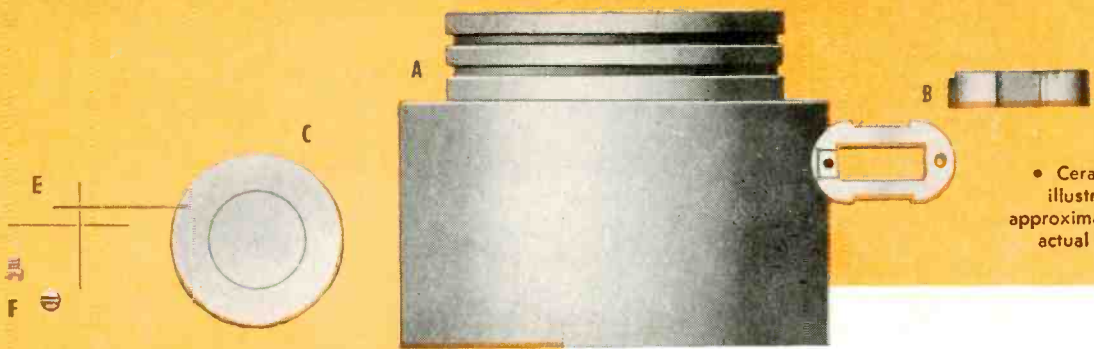

• Ceramics illustrated approximately actual size.

ALSiMAG[®]

PRECISION CERAMICS

produced to precision tolerances

New equipment and techniques are constantly added to improve precision. Few people—few engineers—are aware of the close tolerances which are now possible. There are 3 main reasons for this progress:

COMPOSITIONS. Widest range in the industry. Some AlSiMag materials are hard as sapphire—more wear resistant than tool steel—and are non-magnetic and chemically inert. New Alumina "super ceramics" perform unbelievable feats of strength, thermal and mechanical shock resistance plus excellent electrical characteristics at ultra high frequencies and temperatures. Improved characteristics promote ruggedization, permit miniaturization.

CONTROLS. In preparation of raw materials, designing and building dies, calculating shrinkages . . . at every manufacturing step—forming, firing, inspecting. Over 55 years of experience—where precision in ceramics was pioneered!

FINISHING. Equipment plus skill. Every machine for precision finalizing. Thoroughly trained personnel who consider difficult specifications a personal challenge.



Tell us about your component problems. AlSiMag Precision Ceramics may do a better job for you. Send us a blueprint or sketch with an outline of the operating procedure for complete details.

Do you know.....

that ceramics can be supplied, in quantity: To tolerances generally associated with precision metal work.

- A. Pistons and cylinders with maximum clearance of as little as .0015".
- B. With faces parallel within .0005".
- C. In flatnesses within light bands.
- D. In thicknesses from .007" up.
- E. In tubular form as small as .015" OD, .008" ID.
- F. Threaded screws as small as 2-56 thread.
- G. With drilled holes as small as .010".

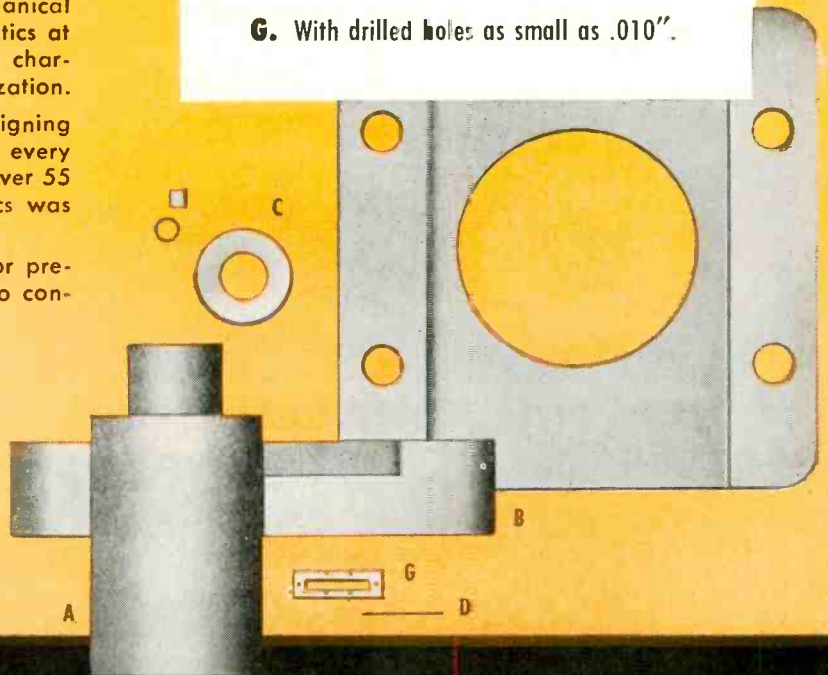

A Subsidiary of
Minnesota Mining and
Manufacturing Company

AMERICAN LAVA CORPORATION

CHATTANOOGA 5, TENN.
58TH YEAR OF CERAMIC LEADERSHIP

For service, contact Minnesota Mining & Manufacturing Co. Offices in these cities (see your local telephone directory): Atlanta, Ga. • Boston: Newton Center, Mass. • Buffalo, N. Y. • Chicago, Ill. • Cincinnati, O. • Cleveland, O. • Dallas, Texas • Detroit, Mich. • High Point, N. C. • Los Angeles, Calif. • New York: Ridgefield, N. J. • Philadelphia, Pa. • Pittsburgh, Pa. • St. Louis, Mo. • St. Paul, Minn. • So. San Francisco, Calif. • Seattle, Wash. Canada: Minnesota Mining & Manufacturing of Canada, Ltd., P. O. Box 757, London, Ont. All other export: Minnesota Mining & Manufacturing Co., International Division, 99 Park Ave., New York, N. Y.

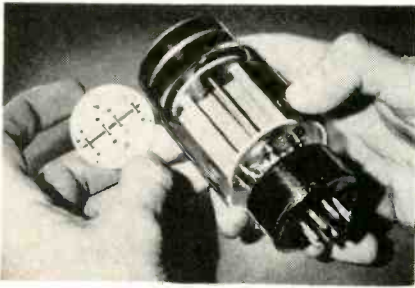

Finished spacer and example of use in ruggedized tube

its tubes. With a melting point more than twice as high as the 1,757 F melting point of the mica formerly used, the ceramic spacers allow higher internal tube temperatures, more complete degassing and quieter, longer life. Although the alundum spacers cost more than the old mica spacers, this higher initial cost was offset by improved performance and greater durability.

Expendable Wipers Clean Crystal Machines

VACUUM PULLING FURNACES for growing high-purity silicon crystals at the Westinghouse Electric Corp. plant in Youngwood, Pa. are efficiently cleaned before each run with industrial paper wipers de-

veloped by Scott Paper Co., Chester, Pa.

Since the growing process is slow, extreme care must be taken to clean the furnaces properly. Even the presence of lint cannot be

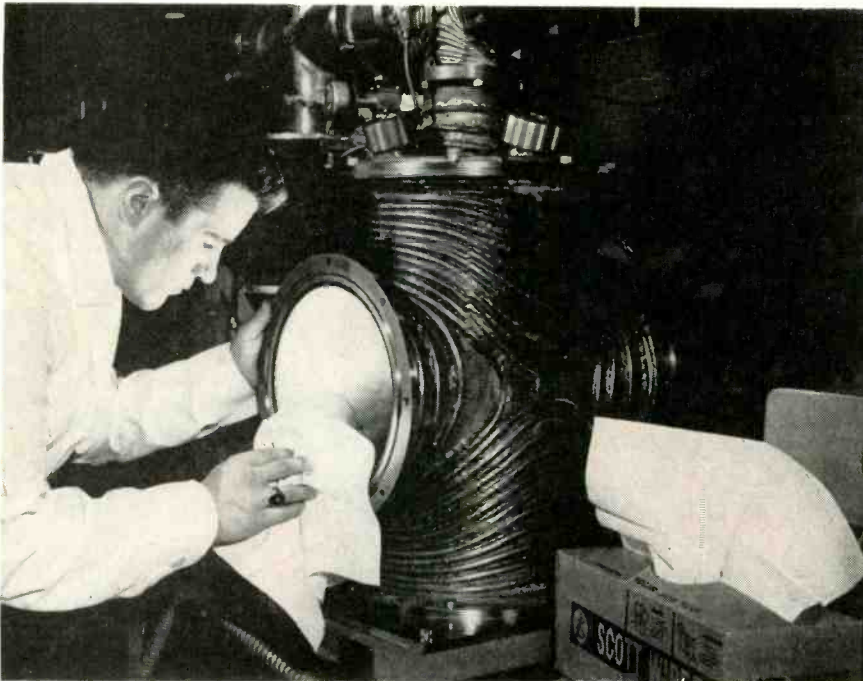

Cleaning vacuum pulling furnace with lint-free expendable paper wipers



Hundreds of tiny embossed spaces on wipers are highly effective for absorbing liquids and coolants from individual crystal blanks after slicing operations. Wipers also serve as cushions for slices

ENGINEERS

... cross new frontiers in system electronics at THE GARRETT CORPORATION

Increased activity in the design and production of system electronics has created openings for engineers in the following areas:

ELECTRONIC AND AIR DATA

SYSTEMS Required are men of project engineering capabilities. Also required are development and design engineers with specialized experience in servo-mechanisms, circuit and analog computer design utilizing vacuum tubes, transistors, and magnetic amplifiers.

SERVO-MECHANISMS

AND ELECTRO-MAGNETICS Complete working knowledge of electro-magnetic theory and familiarity with materials and methods employed in the design of magnetic amplifiers is required.

FLIGHT INSTRUMENTS AND TRANSDUCER DEVELOPMENT

Requires engineers capable of analyzing performance during preliminary design and able to prepare proposals and reports.

FLIGHT INSTRUMENTS

DESIGN Requires engineers skilled with the drafting and design of light mechanisms for production in which low friction, freedom from vibration effects and compensation of thermo expansion are important.

HIGH FREQUENCY MOTORS, GENERATORS, CONTROLS

Requires electrical design engineers with BSEE or equivalent interested in high frequency motors, generators and associated controls.

Send resume of education and experience today to:

Mr. G. D. Bradley

THE GARRETT CORPORATION

9851 S. Sepulveda Blvd.
Los Angeles 45, Calif.

DIVISIONS:

AiResearch Manufacturing
Los Angeles
AiResearch Manufacturing
Phoenix
AiResearch Industrial
Rex—Aero Engineering
Airsupply—Air Cruisers
AiResearch Aviation
Service

Electronic Cooling Package...by AiResearch

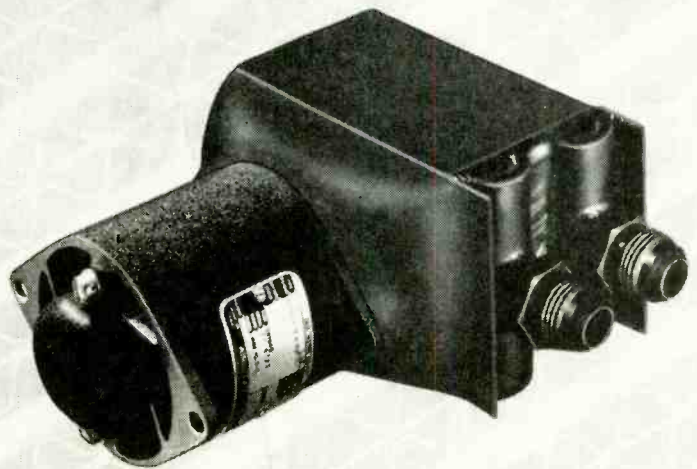

SPECIFICATIONS OF TYPICAL AIRESEARCH COOLING PACKAGE

Air Flow	60 CFM
Fan Air Inlet Pressure	18 PSIA
Fan Pressure Rise	1.2 inches water
Heat Exchanger Pressure Drop	1.0 inches water
Liquid	Water
	Methanol
	(70% Methanol)
Liquid Flow	0.4 GPM
Heat Rejection*	300 Watts
Fan Power	30 Watts, 110 V., single phase, 400 cycle
Package envelope dimensions	7 x 6 x 3 inches
Package wet weight	2.5 lbs.

*Assumes Class A (85°C.) electronic components, liquid inlet temperature to heat exchanger, 55°C. Includes heat from fan motor.

This high performance AiResearch package cools sealed and pressurized electronic equipment. The fan circulates air through the liquid cooled heat exchanger and over electronic components in a hermetically sealed module. Air cooled units are also available. Fan and heat exchanger are designed, built and packaged by AiResearch for matched performance. Package size is tailored to your individual cooling requirements.

The Garrett Corporation, through its AiResearch Manufacturing divisions, is an industry leader in components and cooling systems for aircraft, missiles and nuclear applications. This wide experience is now being offered to the electronics industry to provide a cooling package to meet any cooling requirement. Send us details of your problem or contact the nearest Airsupply or Aero Engineering office for further information.

THE GARRETT CORPORATION

AiResearch Manufacturing Divisions

Los Angeles 45, California • Phoenix, Arizona

AERO ENGINEERING OFFICES:

MINEOLA • ATLANTA • BALTIMORE • BOSTON • CHICAGO • CINCINNATI • COLUMBUS
DETROIT • INDIANAPOLIS • PHILADELPHIA • ST. LOUIS • SYRACUSE • WINTER PARK

AIRSUPPLY OFFICES:

BEVERLY HILLS • DENVER • FT. WORTH • KANSAS CITY • SAN DIEGO • SAN FRANCISCO
SEATTLE • TULSA • WICHITA

THE ONLY COMPLETE SOURCE FOR EVERY PRECISION CONNECTOR

ENGINEERED COMPONENTS and ASSEMBLIES

U. S. COMPONENTS, INC.

454 E. 148th St., N. Y. 55, N. Y.

TEL. CY 2-6525

U. S. Components are headquarters for all precision connectors for use in Avionics, Automation, Communication, Controls, Instrumentation, Missiles, Portable Equipment, Printed Circuits, Test Apparatus. Name it . . . we have it!

FREE SHORT FORM CATALOG FOR ALL PRECISION CONNECTORS



U. S. Components, Inc.
associated with U. S. Tool & Mfg. Co., Inc.
454 E. 148th St.
New York 55, N. Y.
CYpress 2-6525

U. S. Components, Inc.
454 E. 148 St., N. Y. 55, N. Y.

Gentlemen:
Please rush your free short form catalog . . . the only complete source of precision connectors.

Name _____
Company _____
Address _____
City _____ State _____

Circle 152 Readers Service Card

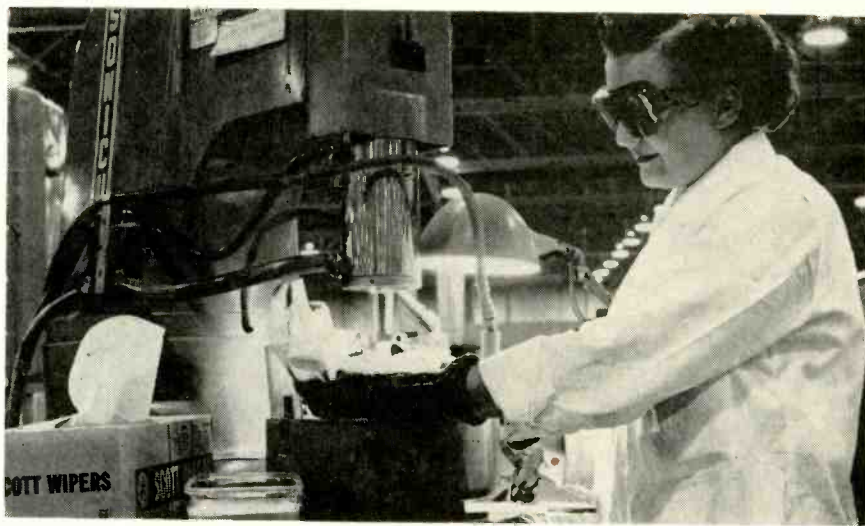

Wipers absorb excess fluid used in crystal dicing operations on Sheffield Cavatron ultrasonic machine tool. Fluid contains abrasive which when removed reduces friction and increases life of cutting tool

tolerated on interior surfaces of a furnace because it would carbonize at high temperatures and imperil the purity of the silicon crystal in growth.

Wipers are used to clean all crevices and interior surfaces, the section of the furnace in which the seed is placed during the growing operation, and the glass panels which house the heating elements. The wipers can be dipped in solvent to remove stubborn and sticky deposits.

► **Wiper Details**—Each wiper con-

sists of two paper plies welded together for extra strength and embossed to produce hundreds of tiny spaces for trapping dust and dirt particles and absorbing solvents.

Low unit cost of the wipers permits several of them to be used during the furnace cleaning chore, eliminating recontamination. The wipers are also used in the crystal slicing area in connection with slicing, lapping, ultrasonic dicing and grinding operations. Being highly absorbent, the wipers readily soak up the liquids and coolants employed in these operations.

Blow-Loading Machine Puts Inserts in Molds

LOADING OF METAL INSERTS for molding of standoff terminals is speeded up by the new Freeloader fully automatic blow-loading machine developed by Whitso, Inc., Schiller Park, Ill. The technique permits loading parts in batches of any size by a shotgun technique, in contrast to hopper feed mechanisms which feed parts successfully like a machine-gun.

► **How It Works**—In principle, blow-loading makes use of a stream of air passing through a loading orifice. The resulting air turbulence takes the form of a vortex spiralling down and through the orifice itself. If a part is brought close to the orifice, it will be pulled

into it by the vortex. Once the part is seated, it seals the orifice and remains in place until the air pres-

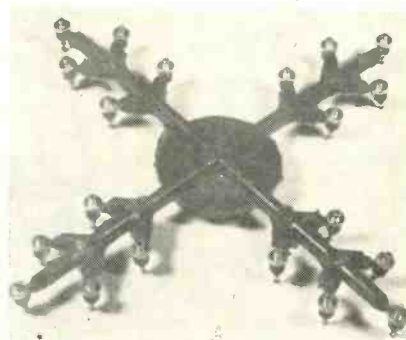

Example of application for blow-loading, in which 20 terminals and 20 mounting rivets are dropped into mold for application of melamine plastic insulating bodies

now...

Clevite announces

a new diode

GERMANIUM

ALLOYED WITH

SILICON!

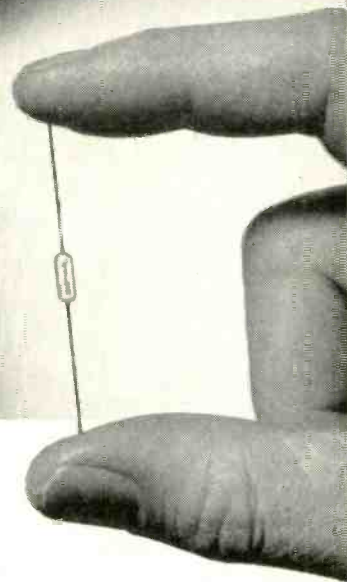

New Clevite Germanium-Silicon Alloy Gold Bonded Glass Diodes, now available for immediate delivery.

- ▶ Better high temperature performance than germanium.
- ▶ Higher forward conductance at lower voltages than silicon.

All germanium RETMA specifications can now be met at higher temperatures with these new Germanium-Silicon alloy diodes... plus increased reliability at all temperatures.

For complete information write or phone for Engineering Bulletin B-215.



Brush Electronics Co.



Cleveland Graphite Bronze Co.



Clevite Harris Products Inc.



Clevite Ltd.



Clevite Research Center

CLEVITE

TRANSISTOR PRODUCTS

241 Crescent St., Waltham 54, Mass. TWinbrook 4-9330



A Division of Clevite Corporation

Vital to Semiconductors!



Alpha UHP* ultra high purity metals—

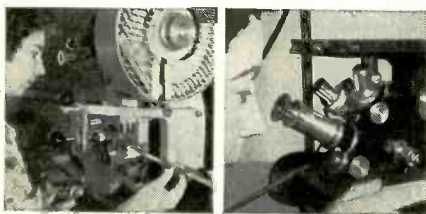

Modern precision equipment is used for rolling, extruding and punching.

Precision devices for accurate inspection are part of our standard equipment.

what are they—and what do they mean to

SEMICONDUCTORS?

The performance of semiconductors are vitally effected by *small bits of rare metals* such as INDIUM, GALLIUM, ANTIMONY, ARSENIC and others, which must possess the highest degree of purity... be critically close in tolerance... and offer complete alloy uniformity.

Alpha, a pioneer in high purity metals, offers all of the metals and their alloys, commonly used in semiconductor manufacture, in a complete range of uniform sizes and shapes. All pellets, discs, washers and spheres are processed from metals approaching 99,999 in purity.

Whether you are interested in Alpha's semiconductor UHP products for experiment or production, they are available to you in minimum quantities and any shape or alloy that suits your needs.

For further information, write Dept. CS today.



IN CHICAGO, ILLINOIS
ALPHA-LOY CORP. (Division of Alpha Metals)
Other ALPHA Products . . . Cored & Solid Wire Solder
Wide Range of Fluxes . . . Soft Solder Preforms
★Trade Mark

Circle 154 Readers Service Card

PRODUCTION TECHNIQUES

(continued)

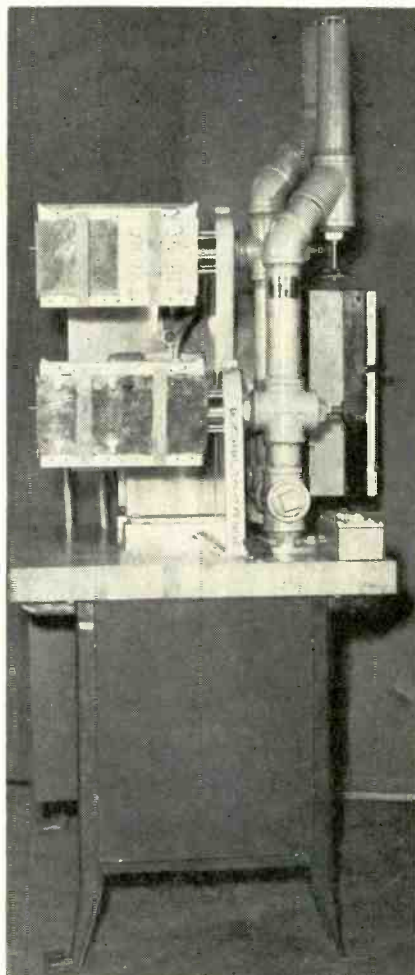

Two-drum Freeloader machine. Each drum has two sections, one for loading rivets and other for loading terminals into collector plates. Pipes go to compressed-air supply

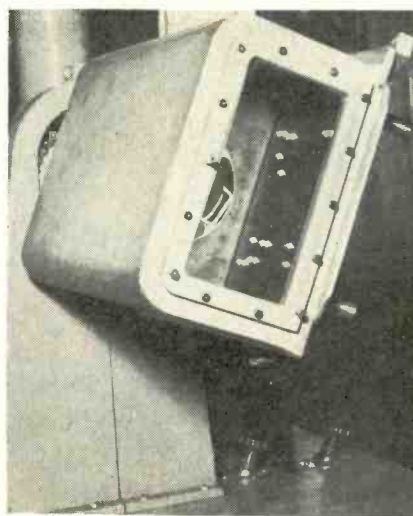

Rivets drop into holes in collector plate as drum rotates

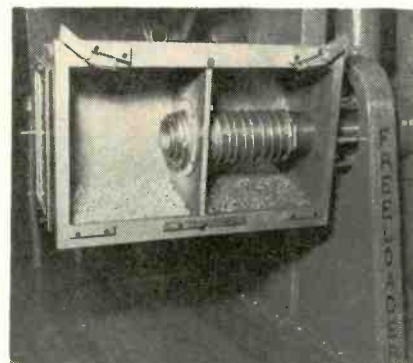

Drum with collector plates removed, showing terminals in right-hand section. Compressed air emerges from pipe into left-hand section, then feeds back into terminal section through screens

sure is released.

The new machine makes use of a covered oscillating loading drum which slides the pieces back and forth over the orifices of a collecting pattern. In this way, random movement brings the parts into contact with the air vortices. Air is introduced to the drum by means of a centrifugal blower.

A collecting plate with the required number and arrangement of orifices is first placed on one face of the drum. The operator charges the loading drum with a sufficient quantity of small parts, then covers it with the collector pattern plate and starts the electric motor which powers the oscillating mechanism. The parts are simply poured into the drum in bulk form. No preliminary placing or arranging is required.

Inside the oscillating drum, the

parts begin to slide back and forth over the pattern. The operator opens an air valve, introducing pressure into the drum through a nozzle. Blow-loading starts to work.

As air pressure increases, each orifice in the collector plate becomes equipped with its own miniature whirlwind. Pieces sliding over the individual orifices are quickly caught and drawn into place by the air currents. Those which attempt to load the wrong way cannot enter and are scoured aside by the mass of parts in the drum. Oscillation and pressure is continued until all orifices are loaded. The completely loaded pattern is then removed from the drum and transferred to the mold by means of collets, loading trays or other suitable fixtures.

► **Performance**—Within reasonable limits, part size alone does

**WHERE
RELIABILITY
COUNTS...**



Aladdin[®] **ELECTRONICS**
**MICRO-MINIATURE
COMPONENTS ARE BEING
USED TO MINIMIZE
MASS and VOLUME
IN MODERN EQUIPMENT**

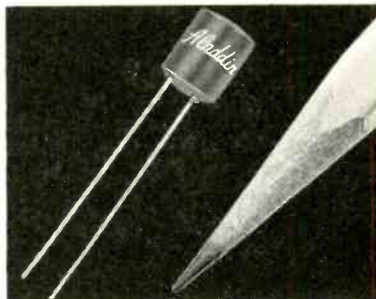

Aladdin
INDUCTORS

Standard increments of inductance up to ONE HENRY... Operating temperatures up to 125°C.
Size: .285" dia.
.300 to 350" long
Weight: .73 gram
Write for Bulletin 54.

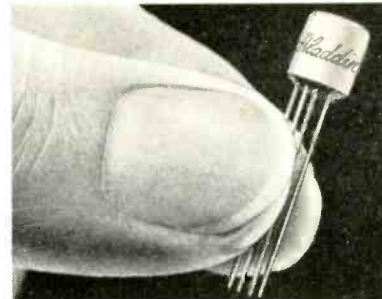

Aladdin
PULSE TRANSFORMERS

Described in a new supplement to the Aladdin Pulse Transformer Encyclopedia.
189 standard catalog units, ideal for transistor circuit applications.
Write for the complete encyclopedia (Bulletin 55).

Aladdin[®] **ELECTRONICS**

A Division of Aladdin Industries, Inc.
716 Murfreesboro Road
Nashville, Tennessee
Tarrytown, N.Y.; Pasadena, Calif.

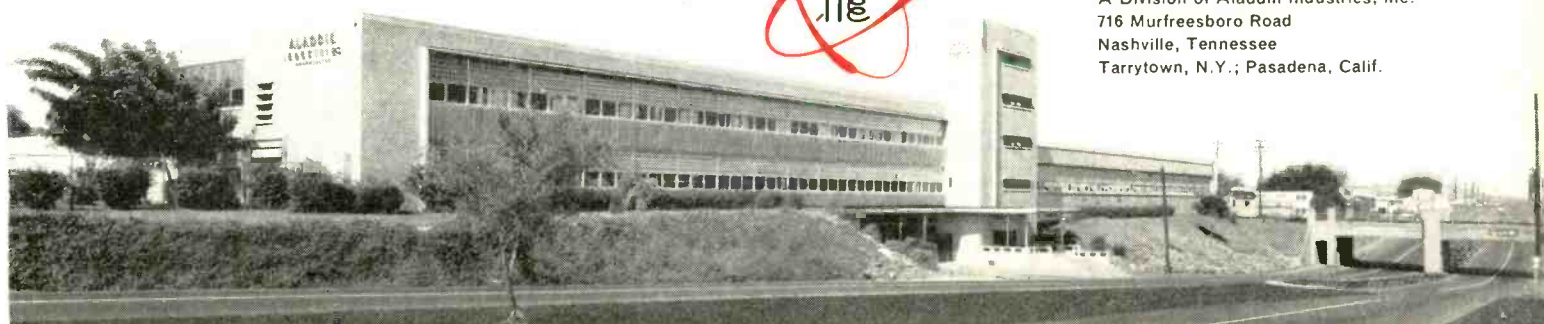



DATA from a DUMMY



with an FM TELEMETRY Transmitter

Sensitized for human reactions, this dummy helps collect human factor data for development of ejection seats for supersonic jet aircraft. The full-scale rocket sled tests are one phase of the industry-wide program to develop a safe standardized pilot escape system for the Air Force.

The Model 3021 Transmitter used in these tests is a rugged subminiaturized unit designed for high shock impact and extreme environments.

- Frequency - 215-235 mc
- Power Output - 2 watts
- Weight - 1.7 pounds

Write for complete data and prices to P. O. Box 37, Melbourne, Florida

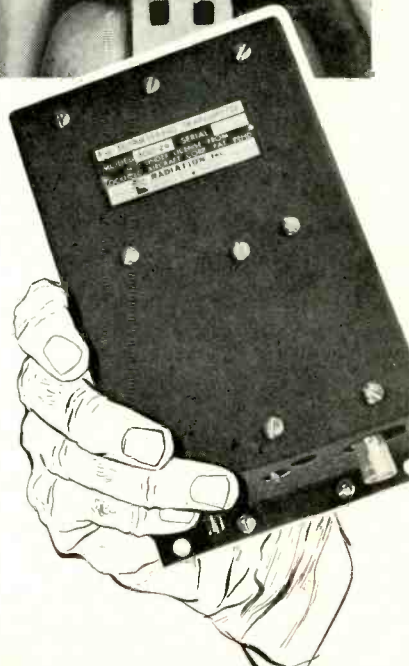
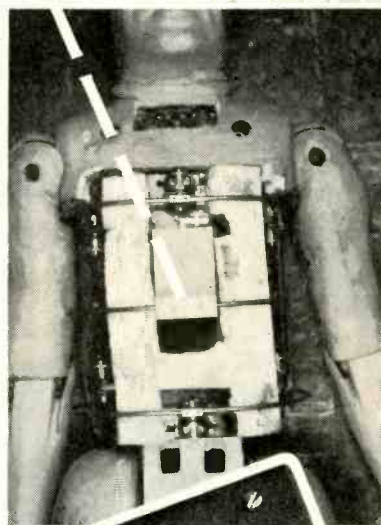

Personnel Inquiries Invited.



RADIATION INC.

MELBOURNE AND ORLANDO, FLORIDA
ELECTRONICS • AVIONICS • INSTRUMENTATION

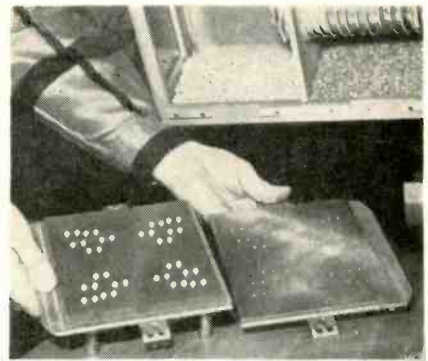

Loaded collector plates are removed from drum. Plates have double patterns, slightly offset from each other, so that each provides two sets of 20 components to cut loading time in half



Transfer plate is placed over terminal collector plate and plates are inverted so terminals drop into transfer plate. In same way, mounting rivets are dropped into another transfer plate

not affect the loading operations. A 1-inch No. 10 screw loads as easily as a subminiature electronic terminal. The machine will handle almost any number of parts with equal efficiency. Loading is generally accomplished in periods from 30 seconds to 3 minutes, regardless of part size or quantity.

Mold cavities are not limited in number because of insert handling time, since the machine can position 1,000 parts as quickly as 100. Versatility is inherent in the process; exchanging collector plates is all that's required to change from one job to another.

► **Case History**—In one application, molding standoff terminals were being processed. As part of his molding cycle, the operator was loading a 20-cavity mold with two inserts per cavity. The terminals were small enough to require the use of tweezers.

When the machine was used to

2

new components from OHMITE®

subminiature wire-type
tantalum capacitors and
variable transformer

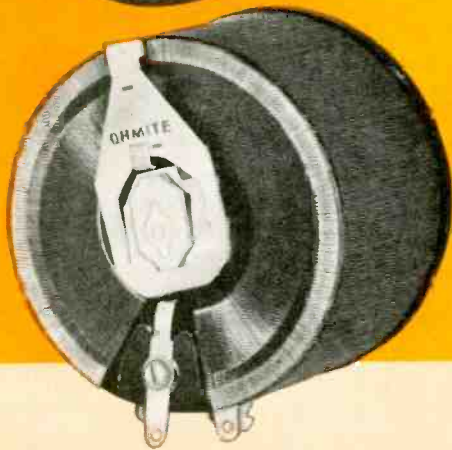
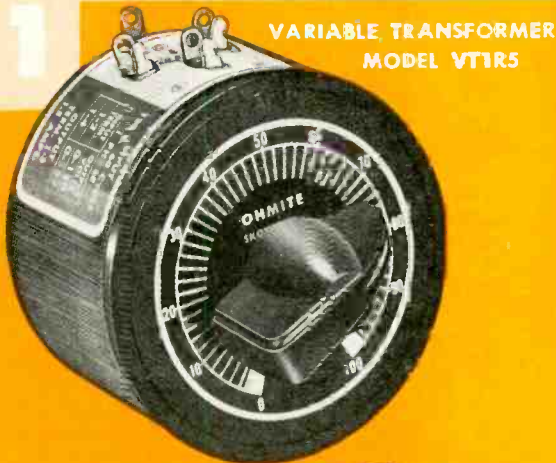

MORE CAPACITY FOR EQUAL SIZE

The rating of 1½ amperes represents a continuous rating at any brush setting. This "bonus" in current capacity is the result of a unique core design by Ohmite. The new Ohmite VARIABLE TRANSFORMER model VT1R5 features: Long-wearing, nonoxidizing, rhodium-plated coil contact surface, a ceramic hub that mounts the contact arm, and provides 3000 VAC insulation between parts at line potential and shaft assembly; positive brush to center-lead connection because brush pigtail shunt is bonded into solid copper-graphite slip ring. Input voltage is 120 V, 60 cycle; output voltage is 0-120 V—0-132 V. Mounted by 3/8"-32" bushing and nut. Write for Bulletin 151.

2

TANTALUM CAPACITORS SERIES TW

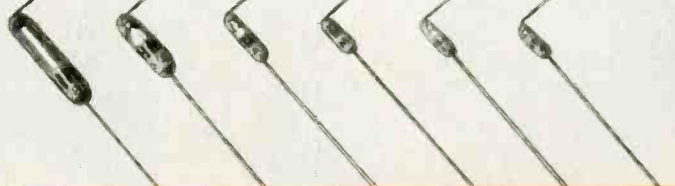

GREATER CAPACITANCE PER UNIT VOLUME

The new Series TW Ohmite subminiature Tan-O-Mite® TANTALUM CAPACITORS are wire-type units that feature greater capacitance per unit volume, lower leakage current and power factor, and small capacitance drop at extremely low temperatures as compared to other types of electrolytics. Ultrasmall for low-voltage DC transistorized electronic equipment, these new tantalum capacitors have *high stability, high capacitance, long shelf life, and excellent performance under temperature extremes of -55° C to +85° C.* They are available in six subminiature sizes: 0.1 to 60 mfd. over-all capacitance range.

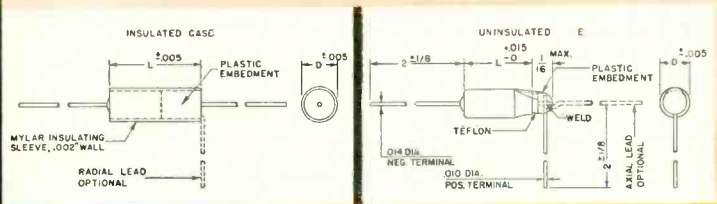

SIZE	UNINSULATED		INSULATED	
	D (inches)	L (inches)	D	L
T	.075 (5/64)	.156 (5/32)	.082	.203
S	.075 (5/64)	.187 (3/16)	.082	.234
M	.095 (3/32)	.172 (11/64)	.100	.218
A	.095 (3/32)	.250 (1/4)	.100	.312
B	.125 (1/8)	.312 (5/16)	.134	.375
C	.125 (1/8)	.500 (1/2)	.134	.562

Smallest size is .075 (5/64) x .156 (5/32) inches; the largest is .125 (1/8) x .500 (1/2) inches. Five stock sizes are available in a wide range of capacitances, voltages. Units insulated with a tough Mylar® plastic sleeve can be furnished. Write on company letterhead for Bulletin 148B.

BE RIGHT WITH

OHMITE®

RHEOSTATS • RESISTORS • RELAYS • TAP SWITCHES
TANTALUM CAPACITORS • VARIABLE TRANSFORMERS

OHMITE MANUFACTURING COMPANY
3610 Howard Street, Skokie, Illinois

Hermetically sealed

edcor **POLYSTYRENE CAPACITORS**

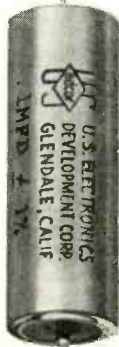

HIGH
insulation resistance!

LOW
capacitance drift!

LOW *dielectric absorption!*

For precision, high-stability applications—complete variety of standard tubular types—all sizes, ratings and mountings!

Precision-engineered bathtub-type custom capacitors in Standard, Trim-adjustable and Decade models are also available to your specifications—delivered promptly!

For complete Edcor literature or an Engineering Representative to assist you, write: Sales-Engineering Dept., U. S. Electronics Development Corp., 1323 Airway, Glendale 1, California.



u s e d c o r U. S. Electronics Development Corporation
1323 Airway, Glendale 1, California

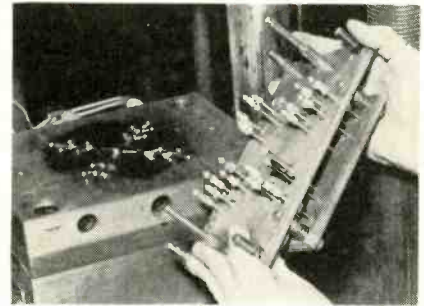

Preparing to drop rivets into mold in press

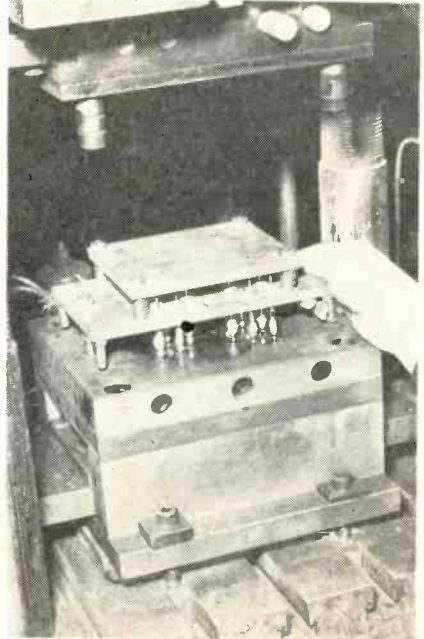

Rivet-loading plate is inverted over mold in press and spring-loaded top plate is pressed down to open all collets simultaneously so that 20 rivets drop into recesses of mold

replace manual loading, production-per-hour for the whole work cycle made an impressive jump. Analyzed on the basis of a 7½-hour shift, it was found that in one day's work the operator is now able to load 10,000 inserts.

Cumulative insert handling time (molder's time spent loading inserts) amounted to about 2 hours. Using manual handling methods the same production previously required 9½ man-hours for the insert handling operations alone.

Drying Toroid Cores

CORE DIP OPERATOR Mary Murphy was responsible for saving some 760 work hours a year at Lenkurt Electric Co., San Carlos, Calif., because she brought attention to an

available
soon...

HYFEN

a big step
toward
automation
of wiring
harnesses

**Crimped
pins and
sockets
snap-locked
in plug
or receptacle.
Individual circuit
removal or
gang disconnect.**

Hyfen ends the need for time consuming solder operations — and the high rejection rate inherent with solder. Pins and sockets are speedily crimped on wire ends by automatic installation tooling — or where more convenient, by bench or hand tools. Dies control and provide a uniform depth of indent which can be inspected by depth micrometer assuring absolute unvarying reliability. Crimping may be done before or after harness is in place.

Hyfen meets or exceeds MIL specifications for voltage drop, dielectric strength, contact engaging force, and contact retention force. It provides high corrosion resistance since there are no fluxes or dissimilar metals involved. Floating contacts in both plug and receptacle make for uniform mating and disconnecting force by the alignment flexibility provided.

Hyfen principle is not limited as to size, shape of plug and receptacle nor to number or size of connections. Wire for bulletin.

Burndy, Norwalk, Connect.—Scarboro, Canada



UNION

Here's the "HOTTEST" AC Relay on the market—

125°C



New High-Temperature UNION AC Relay rated from -65°C . to 125°C ., 115 Volt, 60 to 400 cycles. Suitable for airborne circuits, including jet planes and missiles.

Miniature relay applications are getting hotter all the time—and many of them call for self-contained AC relays.

To meet these needs, UNION has developed AC relays incorporating silicon rectifier assemblies. They'll withstand temperatures from -65°C . to 125°C .. The size is the same as the 85°C . UNION AC Relay.

New Hi-Lo Contacts, too! These contacts permit switching loads of two amperes or dry-circuitry level in the one relay. Or, you can get gold alloy contacts for dry-circuitry use.

OTHER ADVANTAGES

Vibration resistance. up to 1,000 cycles at 15 G's and shock in excess of 50 G's.

Life expectancy. Tested through 1,000,000 operations.

Coil resistance. 2,400 ohms.

Small size, lightweight. Measures only $\frac{1}{4}$ " higher than our DC relays and weighs about 5 oz. All other construction features are the same as the DC relay.

Types and Mountings. Available in 6 PDT or 4 PDT models, plug-in or solder-lug connections and all the usual mountings. Meets or exceeds all requirements of MIL-R-5757-C, MIL-R-25018, and MIL-R-6105B. Write for complete information. Ask for Bulletin 1012.

UNION SWITCH & SIGNAL

DIVISION OF WESTINGHOUSE AIR BRAKE COMPANY

PITTSBURGH 18, PENNSYLVANIA



New method of drying impregnated cores in basket. Loaded rack in oven illustrates method formerly used

unnecessary step in her job. After toroid cores had been dipped for sealing, they were formerly hung individually on racks to go into the oven. The operator noticed that impregnated cores did not adhere to each other, even if they'd been in close contact while drying. Individual handling of impregnated cores was therefore eliminated, and they now go into the oven all in a basket. Lacquered cores still have to be separated.

Molded Flush Wiring For Printed Circuits

By R. M. BELL
Manager, Plastics Laboratory
International Business Machine Corp.
Poughkeepsie, N. Y.

TINY METAL SPHERES fused to the bottom of copper foil provide mechanical interlock between conductor and insulating base material of printed wiring boards to give

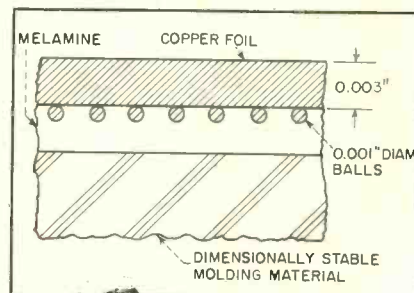

FIG. 1—Cross-section of finished board, in which spheres anchor copper foil to melamine coating on phenolic molding material

★ *New*

CRYSTAL CONTROLLED FM SIGNAL GENERATOR 400 to 550 mc

The New Type 242-A Crystal Controlled FM Signal Generator provides crystal controlled frequencies at integral 1 MC points throughout the entire frequency range. In addition, a variable frequency oscillator, which may be standardized against the internal temperature-controlled crystal oscillator, provides continuous coverage between integral megacycle points.

Two RF output voltage levels are provided. Either a fixed high-level output or a continuously adjustable output, through a calibrated piston-type attenuator, is available.

FM modulation may be obtained from either an internal audio oscillator or an external source. The deviation metering circuit is designed to indicate true deviation when either single or multiple-tone modulating signals are applied and an internal compressor circuit may be switched in to maintain constant peak deviation against variations of external modulating signals.

FEATURES

- RF Center frequency shifts less than 0.0001% under FM from 0 to 300 KC deviation.
- Internal compressor circuit maintains constant peak deviation with external modulating signals varying between 0.8 and 6.0 volts.
- Internal Heaters operate on standby to minimize warmup time.

SPECIFICATIONS

R.F. RANGE: 400 - 550 MC; single range. Internal crystal control at integral MC points accurate to $\pm .002\%$; continuous coverage between integral MC points through internal VFO accurate to $\pm .01\%$.

RF OUTPUT VOLTAGE: (a) 1.0 to 100,000 microvolts continuously variable (b) 1.5 volts minimum (fixed high level).

RF OUTPUT IMPEDANCE: 50 ohms resistive V.S.W.R. $\pm 2\text{db}$

FM MODULATION: 0-300 KC continuously variable

AMPLITUDE DISTORTION: less than 3% at 300 KC deviation

PHASE DISTORTION: linear with modulating frequency within $\pm 1^\circ$ from 1000 to 100,000 cps.

INTERNAL MODULATING OSCILLATOR: 400 and 1000 cps $\pm 2\%$

EXTERNAL MODULATION REQUIREMENTS: 0.8 to 6.0 volts RMS, 300 to 100,000 cps, into either 560 or 20,000 ohms for ± 300 KC deviation.

SPURIOUS RF OUTPUT: At least 40 db below signal

INCIDENTAL FM: Spurious modulating frequencies up to 100 KC at least 25 db below 300 KC

INCIDENTAL AM: Less than 10% at 300 KC deviation

POWER REQUIREMENTS: 105-125 volts, 50-400 cps.

PRICE: \$3,475.00 F.O.B. Boonton, N. J.

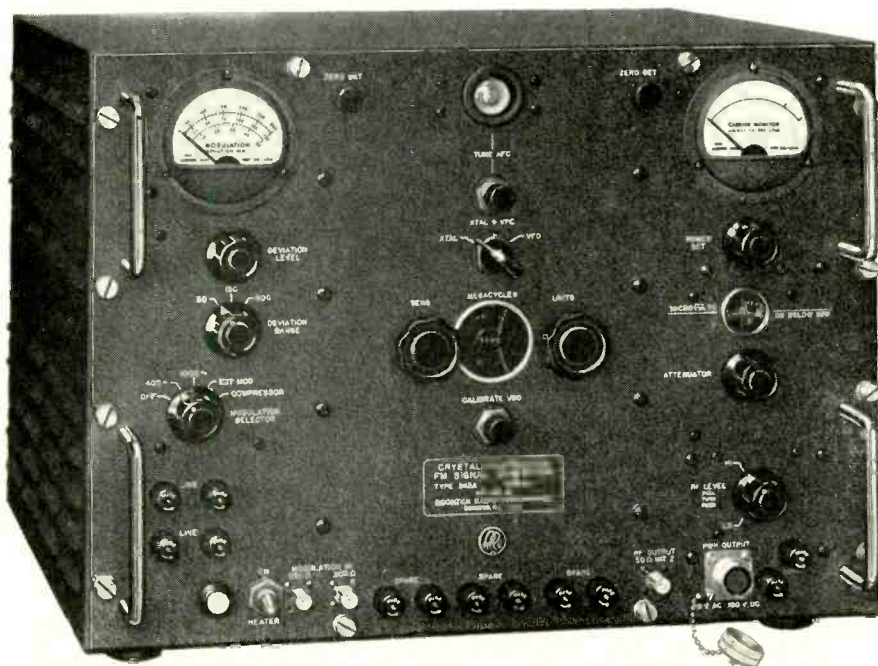

★ TYPE 242-A

**BOONTON
BRC
RADIO
CORPORATION**

Boonton, New Jersey



in
tape
wound
cores...



Only

G-L

can offer you...

► **consistent uniformity...**

The engineering staff of G-L Electronics completely re-engineered the tape wound core and its manufacturing process to assure the production of consistently uniform, high quality cores. Now, through new, exclusive, G-L production and advanced test procedures, you can be sure of getting "Precision Made" tape wound cores with the greatest uniformity ever achieved in commercial quantities. Proof comes not only from our own exhaustive tests but also from customers who report unbelievable uniformity with every core.

► **prompt deliveries...**

Production line techniques have been worked out to make sure that every order is completed in time to meet delivery dates. You can depend upon a delivery date quoted by G-L Electronics so that you can schedule your own operations with confidence.

Proof of our claims will come when your order for G-L cores is filled. Write, wire, call or teletype us about your requirements.

G-L ELECTRONICS

DEPT. E-10, 2921 ADMIRAL WILSON BOULEVARD
CAMDEN 5, NEW JERSEY
WOodlawn 6-2780 TWX Camden, N.J.

greatly improved peel strength, in a new flush molding process that is adaptable to concave and convex shapes as well as flat boards. The nature of the bond is shown in Fig. 1. Patterns can be produced on both sides if desired, with an accuracy of positioning that depends only on the dies and molding

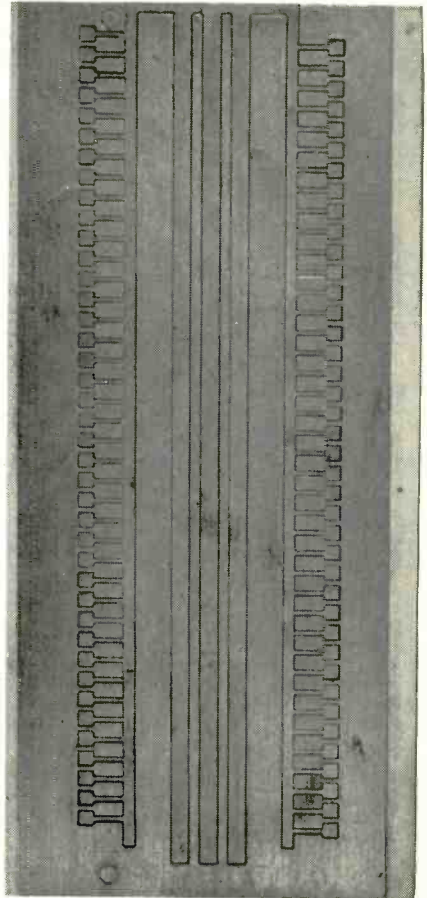

Example of emitter as molded, with all desired wiring recessed

materials used. The process has already been used for large-quantity production.

The mechanical bond, achieved entirely without adhesives, has a strength of 9 to 14 lb per inch of width and is exceptionally resistant to mechanical, chemical, electrical and thermal effects. The bond is unaffected by the normal chemical and heat requirements involved in manufacturing a flush circuit, and makes it possible for the first time to use milling and turning operations if desired.

► **Fusing Spheres to Foil**—Processing of the foil in preparation for

**THEY'RE
CHECKING VIDEO EVERYWHERE**

WITH THE
FAMOUS



Model 1003-B

**PORTABLE VIDEO TRANSMISSION
TEST SIGNAL GENERATOR**

- ★ Completely self contained
- ★ Portable
- ★ Multi-frequency burst
- ★ Stairstep
- ★ Modulated stairstep
- ★ White window
- ★ Composite sync
- ★ Regulated power supply.

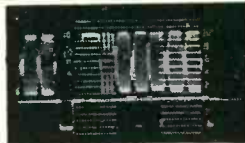

MULTI-FREQUENCY BURST AMPLITUDE vs FREQUENCY. Check wide band coaxial cables, microwave links, individual units and complete TV systems for frequency response characteristics without point to point checking or sweep generator.



WHITE WINDOW
LOW & HIGH FREQUENCY CHARACTERISTICS. Determine ringing, smears, steps, low frequency tilt, phase shift, mismatched terminations, etc. in TV signals or systems.



STAIRSTEP SIGNAL modulated by crystal controlled 3.579 mc for differential amplitude and differential phase measurement. Checks amplitude linearity, differential amplitude linearity and differential phase of any unit or system. Model 1003-C includes variable duty cycle stairstep (10-90% average picture level).

Model 608-A HI-LO CROSS FILTER for Signal analysis.



MODULATED STAIRSTEP signal thru high pass filter. Checks differential amplitude.



MODULATED STAIRSTEP signal thru low pass filter. Checks linearity.



1004-A VIDEO TRANSMISSION TEST SIGNAL RECEIVER for precise differential phase and gain measurements. Companion for use with 1003-B.



1521-A OSCILLOSCOPE CAMERA—Polaroid type for instantaneous 1 to 1 ratio photo-recording from any 5" oscilloscope.

DELIVERY 30 DAYS



Literature on the above and more than 100 additional instruments for monochrome and color TV by TELECHROME are available on request.

The Nation's Leading Supplier of Color TV Equipment
28 Ranick Drive Amityville, N. Y.
Lincoln 1-3160

for precision that assures
brilliant performance



choose

Electra

DEPOSITED CARBON RESISTORS

In Deposited Carbon Resistors, Electra leads the field. The users of these resistors . . . users who order time after time after time . . . reads like a Who's Who of the electronics industry. These users know that they can depend on Electra Deposited Carbon Resistors for outstanding performance on extra close tolerance applications that require extra precision. They know, too, that Electra service is the kind of service that keeps production on schedule, makes their jobs easier all around.

STANDARD

Optimum combination of high capacity, small physical size and economy. Now available in Electra's improved, exclusive insulation for greater accuracy and stability. Nine sizes, 1/8 to 2 watt, 2 ohms to 50 megohms.



MOLDED

Encased in tough plastic to give you extra mechanical protection, longer load life, better insulation against electrical shock and humidity. Five sizes, 1/8 to 2 watt, 10 ohms to 40 megohms.



HERMETICALLY SEALED

Sealed in impervious ceramic sleeve with special silver alloy to meet your toughest, most rigid requirements. Eleven sizes, 1/8 to 3 watt, 10 ohms to 50 megohms.



ELECTRA MANUFACTURING CO.

4051 Broadway

Kansas City, Mo.

WEstport 1-6864



molding involves five steps:

(1) The rough side of 0.0012 to 0.0036-inch electrodeposited copper foil is lightly coated with a light turbine oil to produce a tacky surface for preliminary temporary bonding of metal powders to foil.

(2) An approximate single particle thickness of copper or bronze powder is applied over the oil-

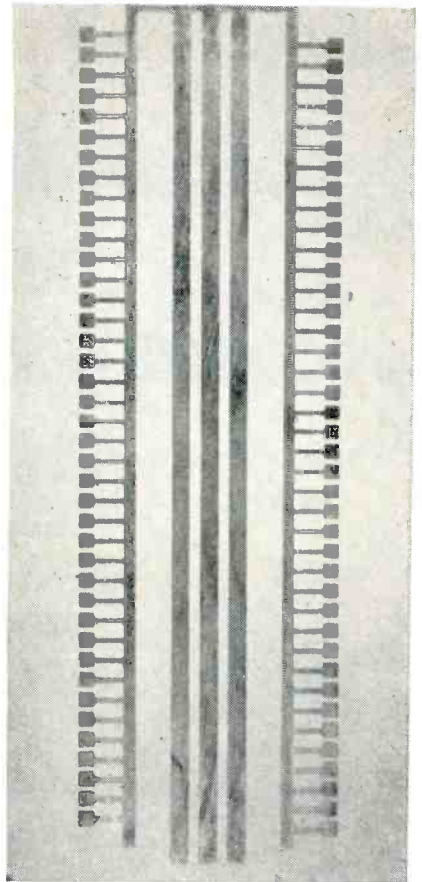

Emitter board after sanding to remove unwanted surface copper foil. Common connection is used for electroplating purposes and is removed later by milling at top

coated surface. From 15,000 to 20,000 particles per square inch of foil surface will result in maximum bond strengths. The particles, roughly spherical in shape, are first screened to have a maximum diameter of 0.0015 inch.

(3) The foil is placed in a controlled-atmosphere furnace at 1,600 F to 1,900 F for the sintering operation. This bonds the foil and powder by an alloying or diffusing process. Since only a portion of the mass melts at the temperatures used, the particle shape is not changed appreciably.

(4) After sintering, the foil is



**IMMEDIATE
DELIVERY**
STOCKED
FOR

"Stocked for Immediate Delivery"—can be music to the ears of your production design engineers or purchasing agent.

Out of thousands of styles and sizes of fine-silver headed rivets as specified in customer orders came a list of 70 standard size contacts most frequently used. All 70 standards are "Stocked for Immediate Delivery" at Mallory.

For your new designs . . . check the Mallory "preferred list" for a size to fit your job. A Mallory standard can save engineering time . . . assure economical cost and prompt

delivery when you go into production.

For your existing production lines . . . check the Mallory "preferred list" for a size closely matching the contacts you may now be purchasing on special order. A change to a Mallory standard may enable an appreciable cost savings on current and future production runs.

Write . . . or ask the Mallory representative for your copy of the Mallory Contact Division brochure 3-15A. It contains a complete stock list, dimensions, and pricing information.

Serving Industry with These Products:

Electromechanical — Resistors • Switches • Tuning Devices • Vibrators
 Electrochemical — Capacitors • Mercury and Zinc-Carbon Batteries
 Metallurgical — Contacts • Special Metals • Welding Materials

P. R. MALLORY & CO. Inc.
MALLORY

P. R. MALLORY & CO. Inc., INDIANAPOLIS 6, INDIANA

**True Hermetic Sealing
assures Maximum Stability**

in **AMPERITE** **RELAYS and REGULATORS**

Simplest • Most Compact • Most Economical



STANDARD



MINIATURE

Thermostatic **DELAY RELAYS** 2 to 180 Seconds

- Actuated by a heater, they operate on A.C., D.C., or Pulsating Current.
- Hermetically sealed. Not affected by altitude, moisture, or other climate changes.
- SPST only — normally open or normally closed.

Amperite Thermostatic Delay Relays are compensated for ambient temperature changes from -55° to $+70^{\circ}$ C. Heaters consume approximately 2 W. and may be operated continuously. The units are most compact, rugged, explosion-proof, long-lived, and — inexpensive!

TYPES: Standard Radio Octal, and 9-Pin Miniature

**PROBLEM? Send for
Bulletin No. TR-81**

Also — Amperite Differential Relays: Used for automatic overload, under-voltage or under-current protection.

BALLAST REGULATORS

Amperite Regulators are designed to keep the current in a circuit automatically regulated at a definite value (for example, 0.5 amp.) ... For currents of 60 ma. to 5 amps. Operate on A.C., D.C., Pulsating Current.

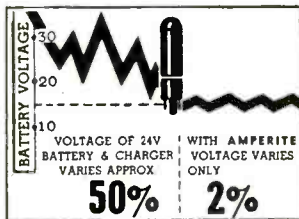
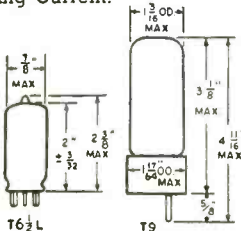

Hermetically sealed, they are not affected by changes in altitude, ambient temperature (-55° to $+90^{\circ}$ C.), or humidity... Rugged, light, compact, most inexpensive.

Write for 4-page Technical Bulletin No. AB-51

AMPERITE CO., Inc.

561 Broadway, New York 12, N. Y.

Telephone: CAnal 6-1446

In Canada: Atlas Radio Corp., Ltd.
50 Wingold Ave., Toronto 10, Ontario.

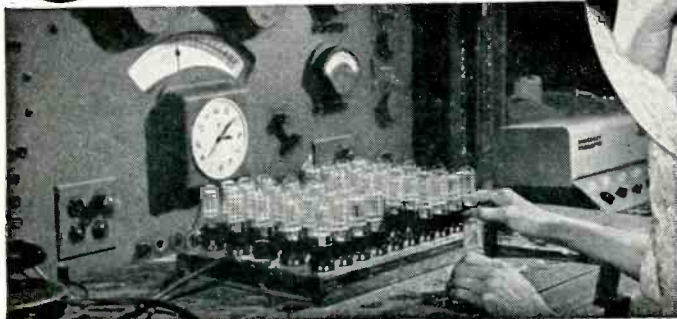

Individual inspection and double-checking assures top quality of Amperite products.

cooled in atmosphere to room temperature.

(5) The foil is rolled between parallel rolls to uniform thickness, in preparation for the molding operation.

► **Molding Foil to Base**—A mold is provided with raised areas in it corresponding to the pattern desired. The height of such raised portions is 0.002 inch more than the thickness of the foil.

The mold operation is the same as used in conventional molding practice. The foil can be molded to any thermosetting or thermoplastic material. If adhesive-type

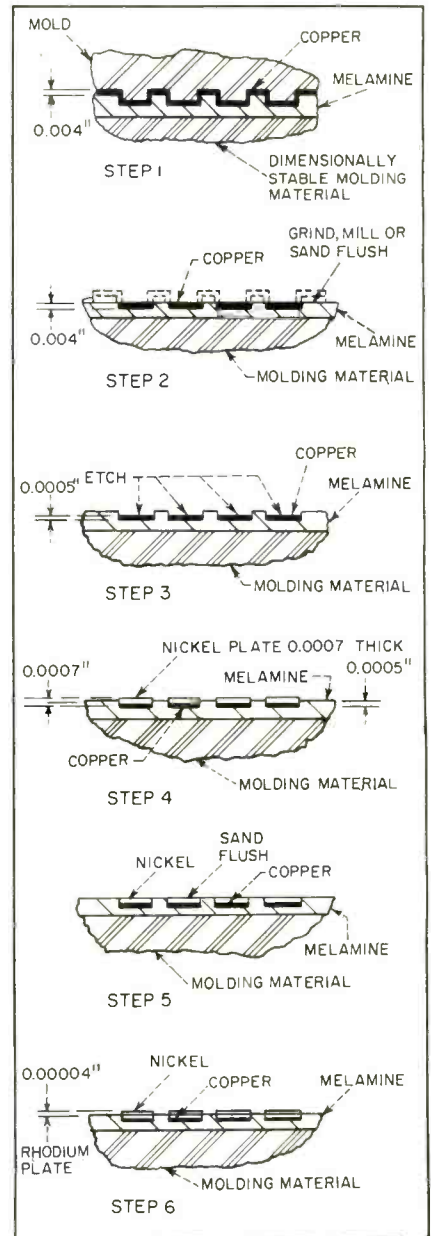

FIG. 2—Steps in molding flush circuit

SOLID-ELECTROLYTE
TANTALEX[®]
CAPACITORS

new dimensions in miniaturization and reliability



This solid-electrolyte Tantalex Capacitor (shown 1½ times actual size) is rated at 4.7 μ F, 10 volts d-c, and is only 1/8" in diameter by 1/4" long.

Now, circuit designers in computers and military electronics have an electrolytic capacitor that offers greater miniaturization than ever before . . . with no sacrifice in reliability. Sprague's recently announced solid-electrolyte Tantalex Capacitors find ideal application in the transistor circuits of these critical fields.

The tiny sintered tantalum anode of Type 150D Tantalex Capacitor is impregnated with a solid, non-corrosive, semi-conductor material which cannot leak under any circumstance. It combines true miniaturization with electrical stability previously unobtainable in an electrolytic capacitor of any type.

Thermal coefficient of these capacitors is sufficiently low and linear so that for the first time a circuit designer can think of an electrolytic in terms of parts per million capacitance change. Nominal value is +500 ppm/°C. The

capacitor may be used without derating over a range from +85°C to as low as -80°C, a temperature at which no other electrolytic has proved useful.

Solid construction permits the Type 150D to withstand the severe shock and vibration encountered in missile and ballistic applications. Hermetic sealing makes it completely immune to humid atmospheric conditions.

Complete performance data covering the wide range of sizes and ratings are in Engineering Bulletin 3520A, available on letterhead request to the Technical Literature Section, Sprague Electric Company, 35 Marshall Street, North Adams, Mass.

★ ★ ★

Sprague, on request, will provide you with complete application engineering service in the use of Tantalex Capacitors.

SPRAGUE[®]
the trademark of reliability

SPRAGUE COMPONENTS:

CAPACITORS • RESISTORS • MAGNETIC COMPONENTS • TRANSISTORS • INTERFERENCE FILTERS • HIGH TEMPERATURE MAGNET WIRE • PULSE NETWORKS • PRINTED CIRCUITS

target bearing 095°
...range 1,500...

speed—
270,000
m.p.h.!

Guided missiles of the future are *on our scopes today*—thanks to the agile brain of an amazing new ECM Simulator developed for the Air Force by Hallicrafters RDA.*

Designed for advanced study of jamming, deception and countermeasures techniques, the device furnishes to the PPI scope exact simulations of moving targets, and jamming, *in infinite variation*.

Programming may be generated according to predetermined plan, or targets may be controlled manually. *Speeds as fantastic as 270,000 m.p.h.*, as well as radical directional changes, now can be simulated for planning tomorrow's countermeasures.

ECM Simulator is another example of electronic design leadership that has made Hallicrafters a prime mover of key military projects for over 22 years.

The tough jobs get off the ground in a hurry at

hallicrafters

4401 W. Fifth Ave. • Chicago, Ill.

*Rapid Development Assistance

bonds are employed in this process, the fluid flow of the plastic material will cause a washing of the adhesive in the molding operation. Use of electrodeposited copper foil and sintered particles has eliminated this problem.

A typical application of a molded flush circuit is an emitter. Wire brushes are pulled over the surface of the emitter and electrical timing impulses are emitted. The process of preparing an emitter, illustrated in Fig. 2, involves six steps:

(1) A semicured melamine is employed when a good wear-resistant plastic surface is required. Below the liner stock, phenolic material in powder or pill preform, usually of a dimensionally stable type, is molded. In this operation the top and lower cavity of the mold should be held at the uniform temperature of 300 F. A slightly higher heat will cause blistering.

(2) After ejection from the mold, the raised section of the emitter is removed, giving a totally flush emitter with a surface of melamine and copper. This operation is done by grinding, sanding or milling. If the surface is circular it can be turned. Without the bond strength acquired by the sintered copper operation this type of machining could not be used.

(3) The emitter with the copper is etched to a maximum depth of 0.0005 inch.

(4) The emitter is now plated with approximately 0.0007 inch of hard nickel.

(5) The hard nickel is polished to a highly smooth flush surface.

(6) In the final operation, 0.00003 to 0.00004 inch of rhodium is plated on the emitter for wear resistance.

Rubber Pad Saves Transformer Coils

A SIMPLE RUBBER mat for cushioning the impact of a hydraulic press on transformer coils has resulted in fewer rejected coils and in dollars saved at Lenkurt's San Carlos, Calif. plant. The mat allows a little give when the coil is being com-

Up A Custom Cable Tree, Engineer ?

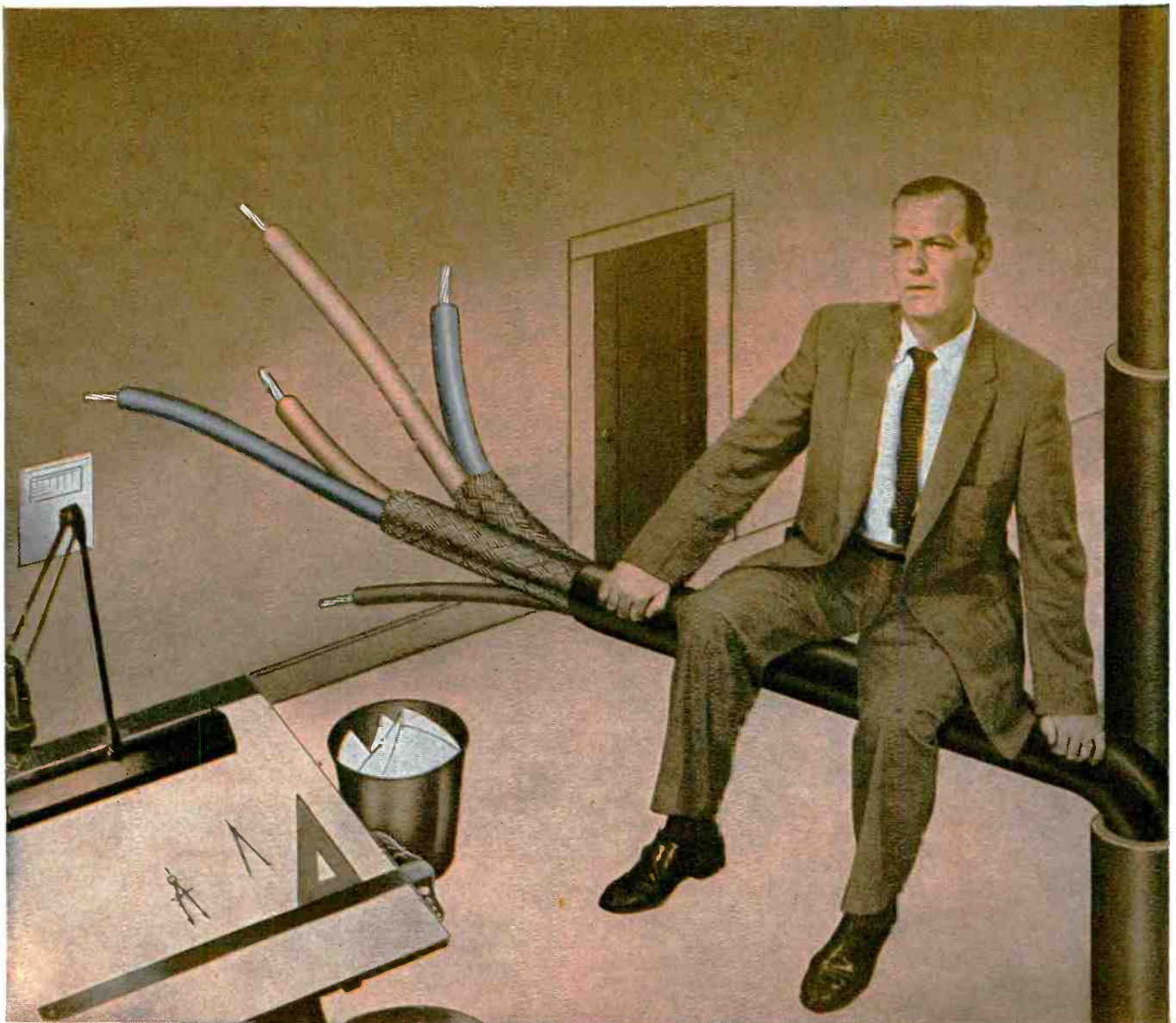

PHALO Will Bring You Down!

You're an engineer . . . darn good one too — yet this custom cable problem has you way up in a tree!

But are you discouraged? Well, yes, honestly you are . . . then you have a flash PHALO — Call PHALO.

So you do and like so many other engineers

who found themselves hanging by a cable problem . . . you're suddenly off the hook!

*Your First Step —
Get This Catalog!*



PHALO — **PLASTICS CORPORATION**
Corner of Commercial Street
WORCESTER, MASSACHUSETTS

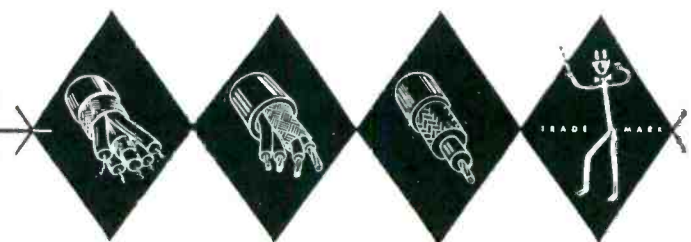

**Another
EECO
FIRST!**

**TIMING, SEARCH,
AND CONTROL SYSTEM FOR
TAPE RECORDERS**



Operator lifts up rubber pad which cushions impact of press on coil assembly

pressed to the required size. Previously, pressure on the coil, which rested on two steel plates, often caused wires in the coil to break.

Harness Board Holder

USE OF AN adjustable harness board upheld production of business machine assemblies 10 percent at Friden Calculating Machine Co., San Leandro, Calif. The work is now less tiring because the operator can be seated and can tilt the board for easier access to the top of the wiring. Less space is needed than the work bench used formerly,



Adjustable-height harness board holder is bolted to floor. Single locking clamp permits adjusting board to most convenient angle for each phase of assembly work in business machine plant



- Automatically locates information on tape recording in a matter of seconds.
- Provides second-by-second identification, during recording and playback, re-cycling every 24 hours.
- Incorporates easy-to-read decimal indicators for hours, minutes, and seconds.

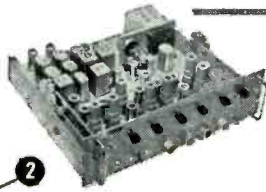

1 TIME DISPLAY—accepts timing signal from tape recorder and displays time code during playback.

2 TIME SELECTOR—compares playback code with preset code and controls tape recorder during search operation.

3 CODE GENERATOR—generates and displays timing code and prepares it in form for recording.

4 POWER SUPPLIES—furnish +200 volts and filament voltage. Two power supplies required.

5 COMPLETE SYSTEM (less tape recorder) mounted in standard cabinet (panels 19 inches wide, chassis 16 inches deep).

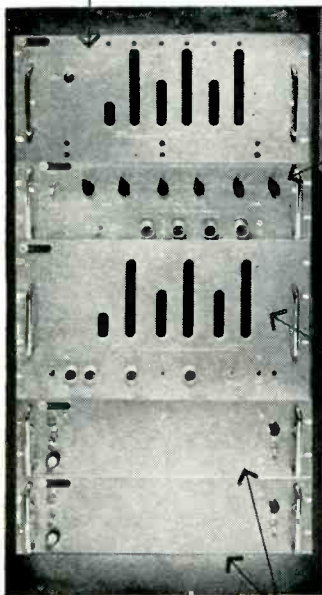
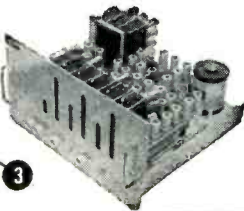

This EECO system provides a means of identifying information as it is recorded on magnetic tape, and of making a rapid search of the recording afterwards for purposes of selective playback, editing, dubbing, erasure, or other treatment. A full two-hour tape recording may be searched from end to end in approximately 57 seconds. Because a one-per-second signal and continuous signal (carrier) on the tape are used to synchronize decoding operation, variations in tape speed during search do not cause errors. During recording operation, time signal can be shifted to nearest 1/100th second to synchronize with standard time transmissions. After initial synchronization, drift is less than one second in 30 days.

The system consists of five basic units: A Code Generator and Power Supply used in the recording operation; a Time Display, Time Selector, and second Power Supply used in the playback operation. The configuration of equipment is entirely flexible, depending upon the desired application. The entire system may be assembled at one location, as illustrated, or the recording and playback functions may be separated for use with different tape machines.

Operates with any tape recorder meeting these primary requirements:

1. Two or more tracks, one for the time code.
2. Provision for remote control.
3. Capability of playback at fast forward and rewind speed.
4. Bandpass adequate to reproduce the time code faithfully at any tape speed encountered during search operation.

For complete description and specifications, ask for Bulletin S-2856-E.

**ELECTRONIC ENGINEERS
AND PHYSICISTS**

Interesting and challenging work in systems and related projects offers unusual employment opportunity at EECO. Send a resume of your qualifications to the attention of R. F. Lander.



Electronic Engineering Company of California

1601 EAST CHESTNUT AVE. • SANTA ANA, CALIFORNIA

For high-speed switching

CBS HIGH-FREQUENCY TRANSISTORS

2N438

2N439

2N440

These transistors are designed for high-speed switching, control, analog and digital computer applications. All three are available in symmetrical versions, and they feature:

1. *JETEC Case* . . . employs a standard metal case (with .200 inch pin spacing) welded to achieve reliability never before approached with NPN transistors.
2. *Alloy-Junction* . . . for greater uniformity, higher voltage and current, flatter gain, and lower saturation resistance.

Note the many desirable features. Write for Bulletin E-268 giving complete data and helpful application notes.

CHECK THESE FEATURES

1. High frequency response:
2N438 2.5 to 5 mc.
2N439 5 to 10 mc.
2N440 10 to 20 mc.
2. High operating voltage . . . up to 30 volts.
3. High switching speed . . . below 0.2 μ sec.
4. High current amp. factor . . . up to 100.
5. High dissipation rating . . . up to 100 mw.
6. Low leakage current 3 μ amps av.
7. Low base resistance 150 ohms av.
8. Low collector capacitance 10 μ mf.

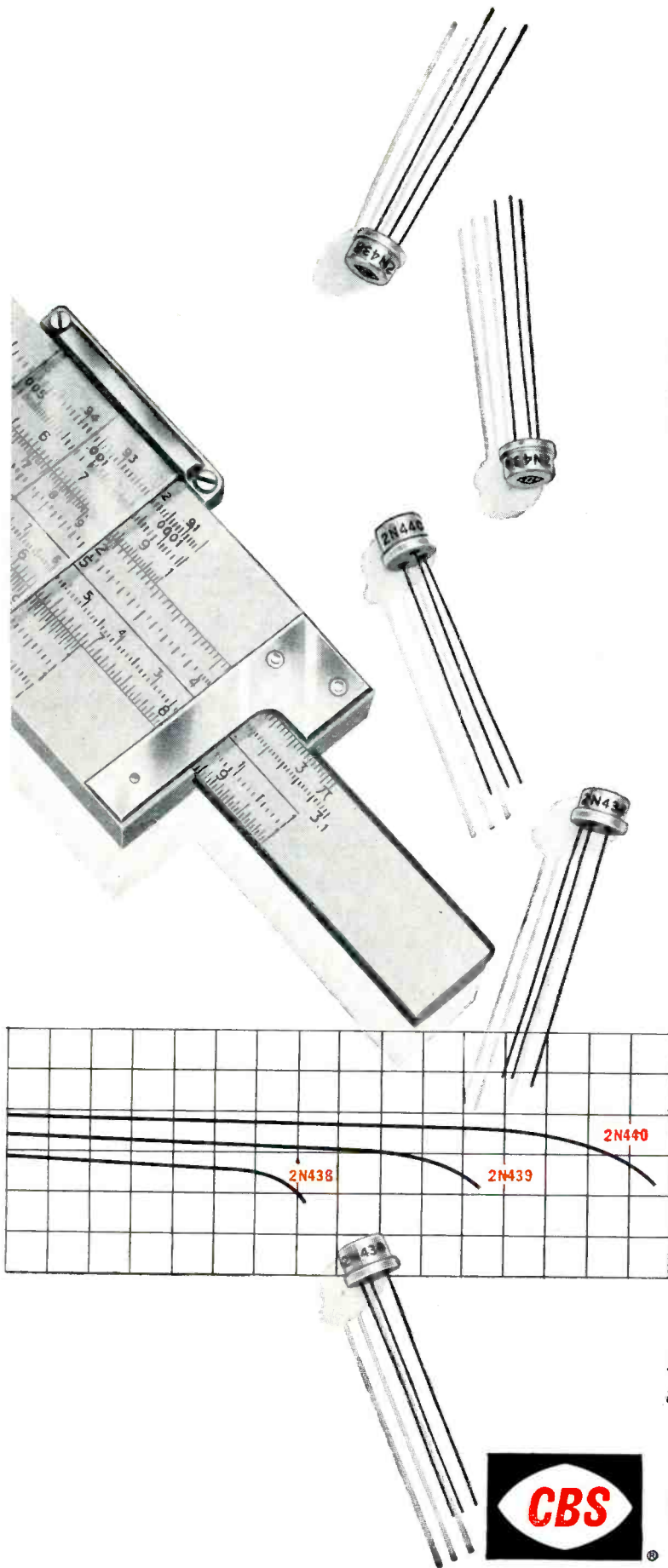

*Reliable products
through Advanced-Engineering.*



semiconductors

CBS-HYTRON

Semiconductor Operations, Lowell, Mass.

A DIVISION OF COLUMBIA BROADCASTING SYSTEM, INC.

A New Broad Band **Kearfott**



Model
W177-2C-1

FERRITE ISOLATOR for Laboratory Test Bench Use

Use this Ferrite Isolator in your microwave setup for maximum frequency stability.

Typical Performance Curves

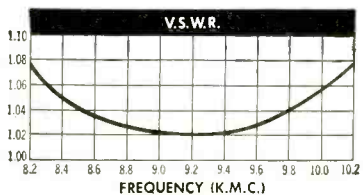
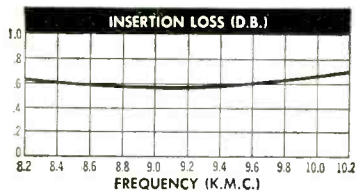
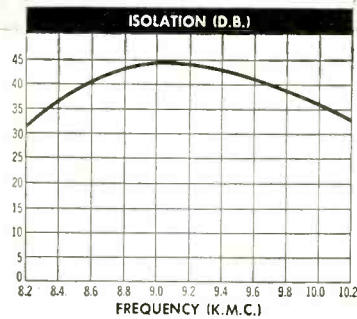

CHECK THESE FEATURES:

Broad Band—Usable from 8.2 to 10.2 KMC

High Isolation—A minimum of 25 db over the band

Insertion Loss—Less than 1 db

Small & Compact—Only 2½ inches long—weighs only 1½ lbs.

Flanges—Cover type. Mates with UG39/U flanges. Will absorb up to 10 watts reflected power

Price—\$135.00 each f.o.b., Van Nuys, Calif.

Delivery—From stock

Order—Model W177-2C-1

For custom-made isolators for specific radar & microwave application, you can depend on the skill of the Kearfott organization.

Kearfott, Western Division, has complete facilities for waveguide production, with qualified experts to assist in solving your problems. Let us help you.

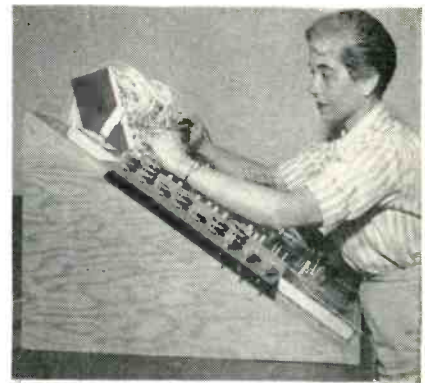

Workbench setup formerly used took up too much room and was tiring because worker had to stand up. Shift to new system saved 200 man-hours on 21 programming units for automatic writing-calculating machine

permitting installation of three extra boards in the same area.

The new board holder uses a Powrarm fixture made by Wilton Tool Mfg. Co., 925-41 Wrightwood Ave., Chicago. This is mounted on an adjustable-height metal stand bolted to the floor.

Production Titles

THE FOLLOWING definitions of engineering titles are taken from ASME Standard No. 106—Industrial Engineering Terminology, published by the American Society of Mechanical Engineers.

► **Industrial Engineer**—One who has the necessary education, training, experience and personal attributes to perform the work included in the field of industrial engineering, which is the art and science of utilizing and coordinating men, equipment and materials to attain a desired quantity and quality of output at a specified time and at an optimum cost. This may include gathering, analyzing and acting upon facts pertaining to building and facilities layouts, personnel organization, operating procedures, methods processes, schedules, time standards, wage rates, wage payment plans, costs and systems for controlling the quality and quantity of goods and services.

► **Management Engineer** — One who has the necessary education, training and experience to perform



For detailed information, ask for bulletins on new Ferrite Isolators and Radar Test sets.

Kearfott COMPANY, INC.
LITTLE FALLS, NEW JERSEY
WESTERN DIVISION
MICROWAVE DEPARTMENT
14844 OXNARD ST. • VAN NUYS, CALIF.

SALES OFFICES

Eastern Office: 1378 Main Ave. Clifton, N.J.	Midwest Office: 188 W. Randolph St. Chicago, Ill.	South Central Office: 6115 Denton Drive Dallas, Texas	Western Area Office: 253 Vinedo Ave. Pasadena, Calif.
---	--	--	--

HIGH QUALITY DIODES AND TRANSISTORS MUST HAVE CONSISTENTLY HIGH QUALITY WELDS

Raytheon subminiature precision welding systems provide extremely uniform production—from the 1st to the 1,000,000th unit.

The four difficult welds shown here are being performed with Raytheon precision welding equipment at the rate of 25,000 units a day by the diode division of a major electronics manufacturer.* In addition to joining the components of these diodes, the welding also seals them hermetically. Statistical sampling of production runs consistently meets JETEC specifications for high quality welds.

Raytheon AC and DC power supplies, controls, welding heads and transformers have been proved in applications where high speed, low cost, precision welding is required. Millions of tubes, transistors, diodes, relays, instruments, capacitors and resistors have been produced with Raytheon welders—designed and produced by *electronic* engineers for use in electronic manufacture.

Learn how Raytheon can help you solve your production problems; have your own samples processed in our Welding Application Laboratory. Write Dept. 6120ED.

*Name on request

TYPICAL DIODE ASSEMBLY —
four welds performed with Raytheon precision welding equipment

.010" diam. soft annealed nickel wire to tungsten spike

Pinch-off weld joining .010" diam. annealed nickel wire, .032" diam. tinned copper wire and hermetically sealing both in Kovar tube

Kovar disk hermetically sealed to plated mild steel case

.032" diam. tinned copper butt weld to Kovar disk

RAYTHEON MANUFACTURING COMPANY

Commercial Equipment Division

Waltham 54, Mass.

Excellence in Electronics



Raytheon production equipment for the electronic industry — AC and DC welding equipment • Automatic welding systems • Magnetizers • Ultrasonic Impact Grinders

Better solders, fluxes and alloys for better electronic components

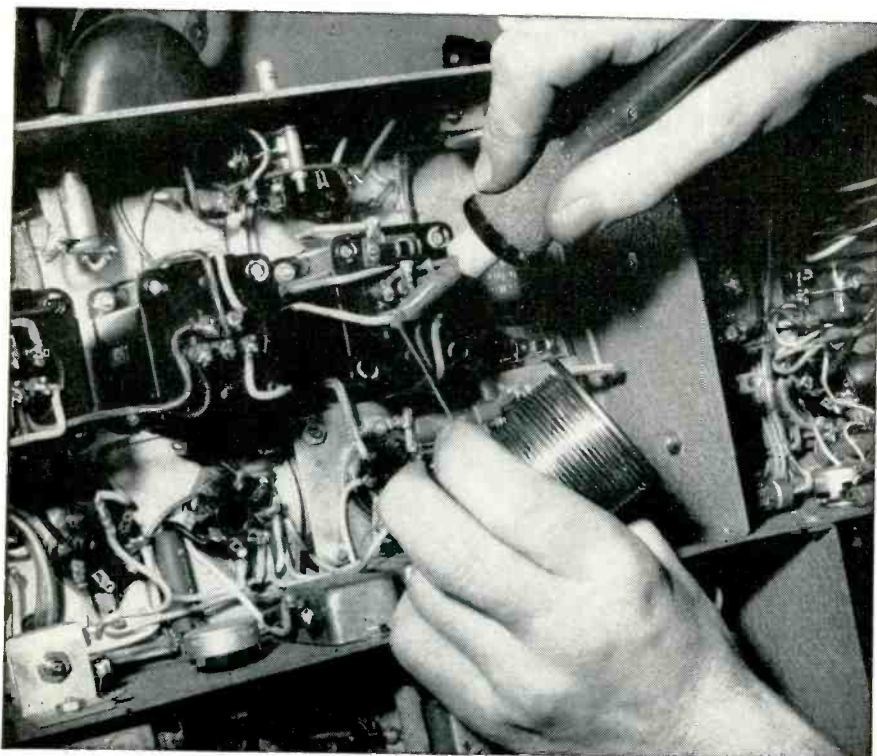

For volume production components, Federated supplies these quality-controlled alloys and non-ferrous supplies:

1. Counter-electrode alloys that are spectrographically or quantometrically tested. Samples from each heat meet exacting specifications to assure proper performance.
2. Rosin Core and Activated Rosin Core Solders of uniform quality for high-speed production, competitively tested to assure maximum efficiency and non-corrosive characteristics.
3. Liquid fluxes that surpass government corrosion-free requirements.
4. High-fluidity Castomatic® Solder for printed circuits, automatically cast under pressure in air-tight machines to minimize dross formation, gives better results in the dipping pans.

All Federated products are produced under the strictest quality-control procedures, developed by ASARCO's Central Research Laboratory, where spectrographically pure metals are refined for electronic experimentation.

No other producer of non-ferrous materials gives you such assurance of constant quality. Try Federated products. It will pay you well.

Federated Metals

Division of

AMERICAN SMELTING AND REFINING COMPANY

120 Broadway • New York 5, N. Y.

In Canada: Federated Metals Canada, Ltd., Toronto and Montreal

the functions of management engineering, which involves the application of engineering principles to all phases of planning, organizing and controlling a project or enterprise.

► **Methods Engineer**—The title given a member of that subclassification of industrial engineering comprised of individuals qualified by training, education or experience to establish methods and the means by which they can be made most effective. Methods engineering is the technique that subjects each operation of a given piece of work to close analysis in order to eliminate every unnecessary element or operation and in order to approach the quickest and best method of performing each necessary element or operation. It includes the improvement and standardization of methods, equipment and working conditions; operator training; determination of standard times; and occasionally devising and administering various incentive plans.

► **Process Engineer**—An individual qualified by education, training and/or experience to prescribe efficient production processes to produce a product as designed and who specializes in this work. This work includes specifying all the equipment, tools, fixtures and the like that are to be used, and often, the estimated cost of producing the product by the prescribed process.

► **Production Engineer**—An individual qualified by education, training and/or experience to perform production engineering functions and who specializes in this work.

Set Screws Speed Centering of Punch

CENTERING THE PUNCH instead of the table has greatly speeded lineup of punch presses at Lenkurt's San Carlos plant. To line up the punch with the die, formerly the operator or setup man had to move the table by knocking it around with a hammer. This was the method provided by the press manufacturer.

In the adaptation devised by

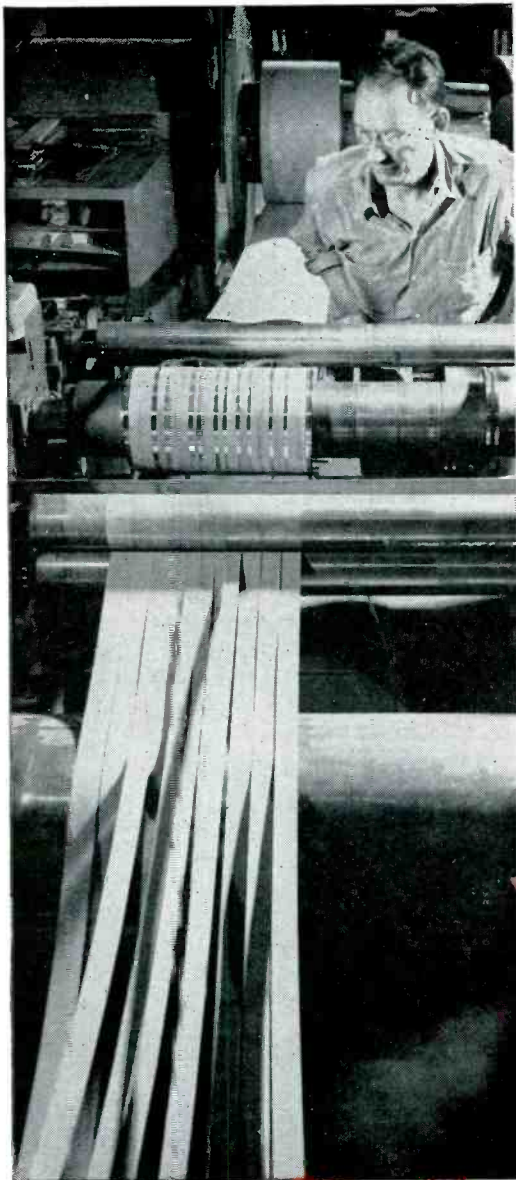

MOLONEY HyperCores

Start out Better, Wind up Best

Better electrical qualities in cores just don't happen . . . they are built in. Moloney HyperCores start out right and stay that way. The finest cold rolled oriented silicon steel is fed through machines which accurately slit it into ribbons of a width to fit your specifications. These are carefully wound into cores of superior quality on Moloney patented mandrels. These machines maintain proper tension, stop when cores are wound to exact dimensions.

The result is a core with the famous Moloney "extra" . . . a core with better performance that weighs less, takes up less space. Moloney HyperCores offer you lower losses and greater flux carrying capacities. And their standards are assured by rigid quality control all along the production line.

Moloney can ship HyperCores quickly in any quantity you need in any of 300 standard sizes . . . or build them to your specifications. So if your product demands better performance, smaller size and less weight . . . specify the best electronic core, specify Moloney.

ME87-20



Write today, for Bulletin SR-208 containing specifications, performance data and prices on 300 stock sizes.

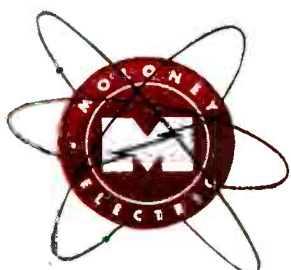
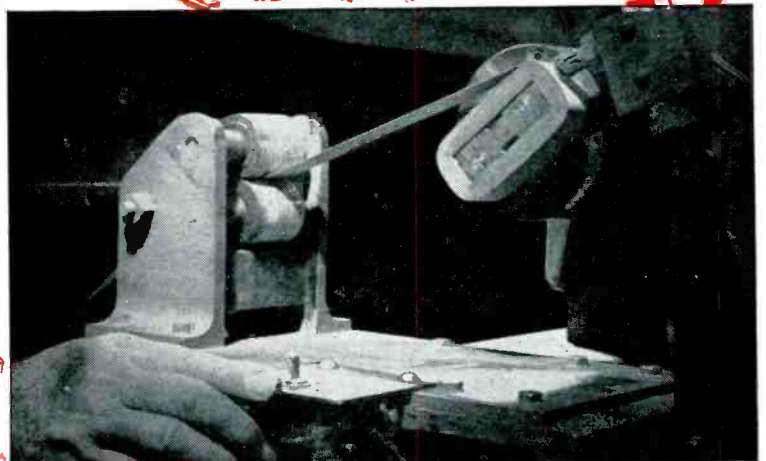

MOLONEY ELECTRIC COMPANY

*Plate and Filament Transformers • Chokes • Unit Rectifiers • Modulation Transformers
and Reactors • Pulse Transformers and Charging Chokes • HyperCores for Magnetic Components
Developmental Magnetic Components • Power and Distribution Transformers*

**SALES OFFICES IN ALL PRINCIPAL CITIES
FACTORIES AT ST. LOUIS 20, MISSOURI AND TORONTO, ONT., CANADA**



I Get Shortest Etching Time with **HUNT ETCHANTS**

HUNT R.C.E.
(Rapid Circuit Etch)

FOR PRINTED CIRCUIT BOARDS

Hunt R. C. E. is a proprietary etchant, formulated to etch printed circuits fast and to speed up production. It offers these 6 big advantages:

- | | |
|------------------------------------|-------------------------------------|
| 1. 15% increase in etching speed | 4. Easily removed by washing |
| 2. Fast action over entire circuit | 5. Substantial increase in capacity |
| 3. Uniformly smooth etching | 6. Freedom from fumes |

HUNT S.C.E. (Solder Circuit Etch) FOR SOLDER-PLATED CIRCUIT BOARDS

This ready-prepared product is designed to etch solder-plated circuit boards more easily, more effectively than it has ever been done before. You'll find that Hunt S. C. E..

- | | |
|--|---|
| 1. Etches rapidly at room temperatures | 4. Has guaranteed uniformity, and is of the highest quality because of rigid laboratory control |
| 2. Has a high capacity for copper | |
| 3. Never attacks the circuit | |

Hunt S. C. E. is essentially an oxidizing solution with the capacity to keep the oxidized copper permanently in solution. Although many acids will etch copper, S. C. E. solution has the peculiar property of not attacking the solder . . . but giving fast, odorless etching of the copper.

Write to nearest Hunt Branch for:

Technical Bulletin No. 1.—
"The Etching of Copper by Hunt R. C. E. Solution"

Technical Bulletin No. 3—"the Etching of Solder Plated Circuit Boards by Hunt S. C. E. Solution"

HUNT R.C.E. SOLUTION
145 lb. rubber drums
600 lb. poly drums

HUNT S.C.E. SOLUTION
125 lb. carboys
530 lb. poly drums



Manufacturing Chemists

Established 1909

PHILIP A. HUNT COMPANY
PALISADES PARK, N. J.

Chicago • Cleveland • Cambridge • Brooklyn • Atlanta • Dallas • Los Angeles • San Francisco

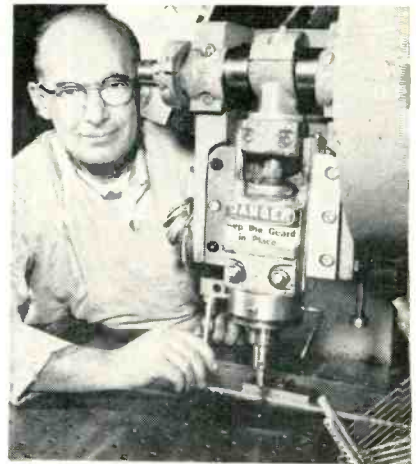

Method of adjusting set screws to line up punch with die in bed of press

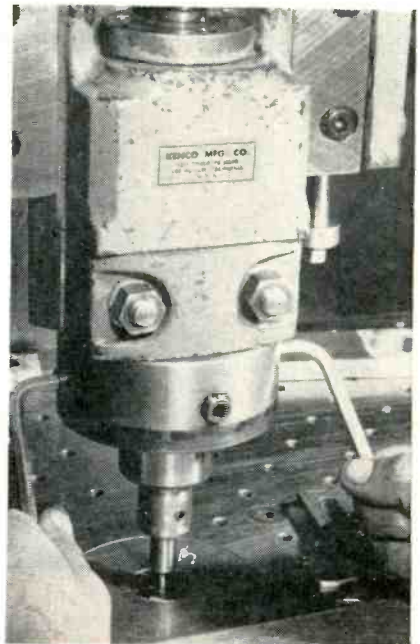

Wrenches are used two at a time to speed alignment of punch

Mark Giron of their Tool and Die department, the punch-holder is centered by four set screws. The screws are adjusted by Allen wrenches to move the punch. The table remains fixed. It is estimated that the idea saves at least four minutes on each set-up.

Nylon Rollers Added to Wire-Cutting Machine

REPLACEMENT OF metal wire-gripping rollers with nylon rollers brought a \$15 suggestion award for Louis Tavis of Friden Calculating Machine Co. With some types

How to judge a new brand of magnetic tape

"Ampex Instrumentation Tape" bcws in with facts and figures

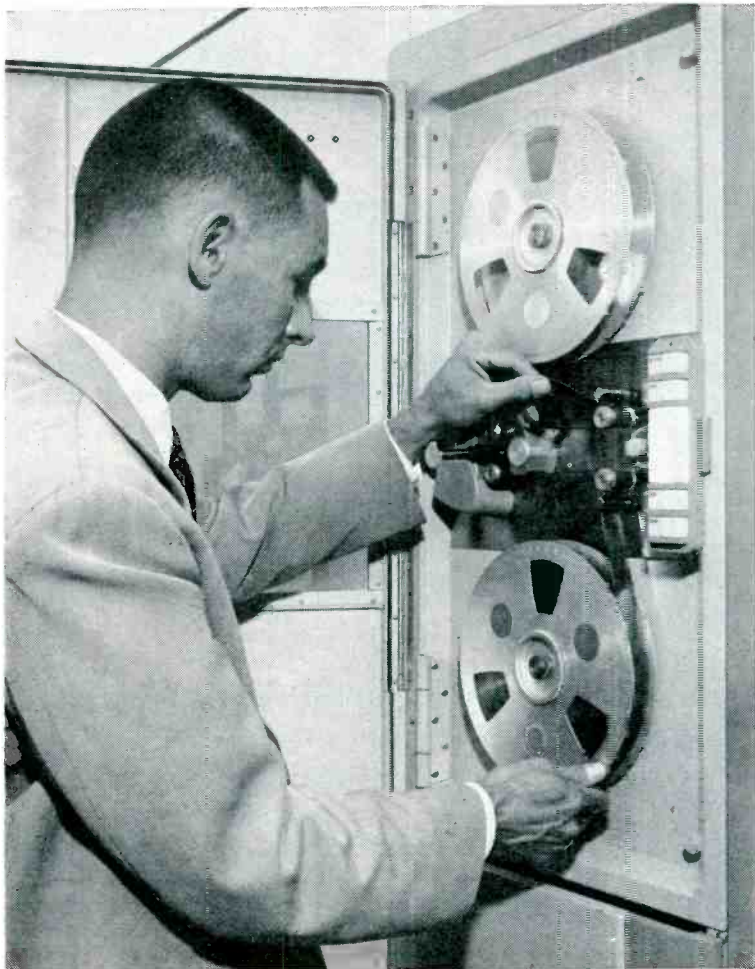

Whether you are a believer in heredity or environment, here is a mighty offspring to watch. Ampex Instrumentation Tape shares a distinguished family name with Ampex's Tape Recorders. It inherits a wealth of experience. It is growing in a fertile environment of research, testing, and process improvement.

For many years each new Ampex Tape recorder has been a significant advancement in the state of the art. But in making these forward steps, Ampex's engineers repeatedly have come face to face with need for improvements in tape as well. Ampex is now sharing research and knowledge with Orradio Industries to set new standard in tape excellence. Orradio is originator of the Ferro-Sheen process — also is the largest manufacturer dedicated exclusively to magnetic tapes.

signal strength. Also, Ampex tape is made with a binder of exceptional adhesive strength. Try to strip the oxide off a sample of Ampex tape. Then compare it with others.



The completeness and accuracy of specifications that have always distinguished Ampex recorders are extended to magnetic tape too. The new Ampex magnetic-tape brochure clearly differentiates the kinds of tapes we offer and gives relevant specifications, features and tape-testing techniques. May we send you a copy?

PREMIUM QUALITY FOR SLIGHT EXTRA COST

Ampex Instrumentation Tape is a superior quality sold at slightly higher price than regular instrumentation grades. For this difference it offers a number of special advantages. Each individual reel is tested for freedom from dropouts. Uniformity from reel to reel is maintained to ± 0.5 db. Within the reel, it is ± 0.25 db. All the types we offer are compatible to each other and require no special bias settings. These are specifications we invite you to test for yourself.

Ampex tape can soon be ordered with precision reels. These greatly improve tape guidance and provide uniform, distortion-free tape wrap. A center plastic strip grips the tape to start.

TWO QUALITIES YOU CAN EASILY TEST

An oxide surface of exceptional smoothness distinguishes Ampex Instrumentation Tape from others. It is achieved by the Ferro-Sheen process. There are no small surface projections to rub off and accumulate oxide on heads and guides. The microscopic flatness also achieves better tape-to-head contact eliminating "noisy" variations in signal

MAGNETIC TAPE APPLICATIONS BY AMPEX

ONE OF A SERIES



Series FR-100



Series 800 Mobile and Airborne



Model FR-200 Digital



Series FL-100 Loop Recorders



Series FR-1100

INSTRUMENTATION DIVISION

AMPEX CORPORATION

FIRST IN MAGNETIC TAPE INSTRUMENTATION

934 CHARTER STREET · REDWOOD CITY, CALIFORNIA

District offices serving all areas of the United States and Canada; Foreign Representatives in countries around the world.

a New Concept in

ELECTRONIC COUNTING EQUIPMENT

- Printed Wiring & Modular Construction
- Simplified Circuitry, Low Maintenance
- Self-testing, Self-indication
- Low Power Requirement
- Counter Tube Life: 10,000 hours
- Competitively Priced

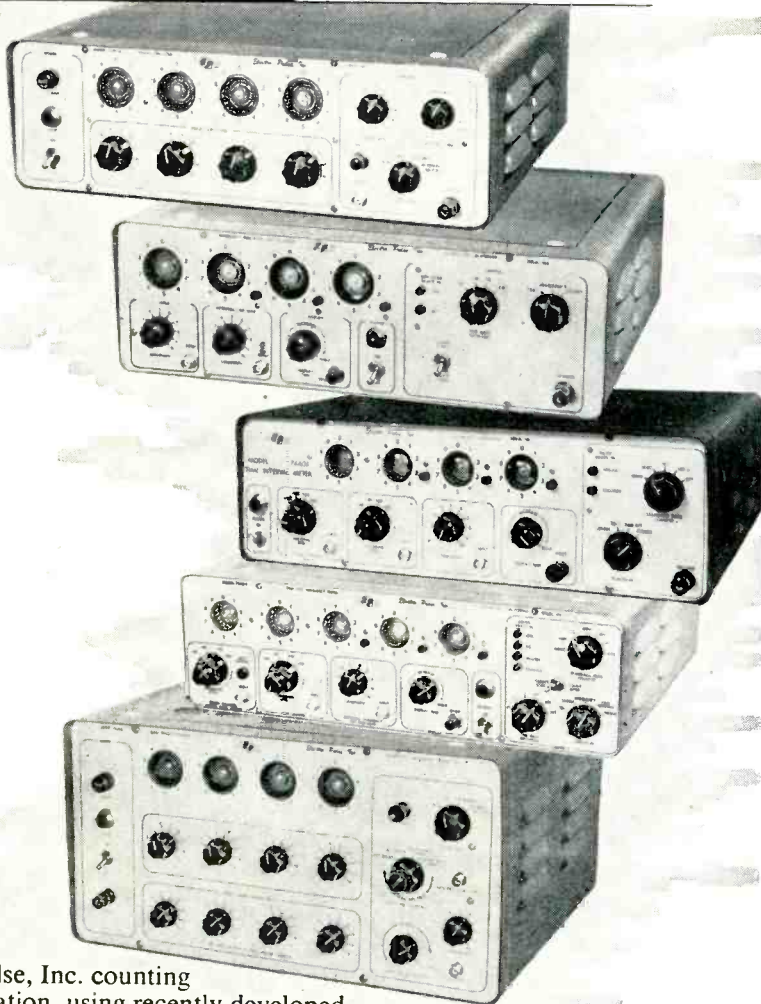

Electro-Pulse, Inc. counting instrumentation, using recently developed self-indicating glow transfer tube counters, offers significant advantages in a wide range of measurement and control applications. Simplified circuitry and advanced design provide laboratory accuracy and industrial reliability.

Packaging features include snap-off top and bottom cabinet plates—for easy maintenance access and conversion to bench or relay rack mounting. Standard printed circuit modules utilized in this equipment may also readily be combined for OEM and other special test and control requirements.

Instruments available include single and dual preset counters, frequency indicators with and without print-out, time interval meters, totalizers, combination frequency and time interval indicators.

Contact local Representative for further information—or...
Write for Complete Data: Catalog IC-57/E

Electro-Pulse, Inc. also offers a broad line of precision pulse instrumentation:

Pulse Generators, Time Delay Generators, Magnetic Core Testing Equipment, Pulse Code Generators, etc.

Write for Catalog 1-57/E

EP Electro-Pulse, Inc.

11861 TEALE ST., CULVER CITY, CALIF. • Phone: EXmont 8-6764 or TEXas 0-8006

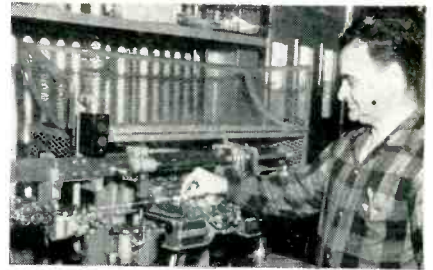

Location of new wire-gripping nylon rollers on Artos machine



Wire now passes between nylon rollers

of wire, the old-type metal grippers on the Artos automatic wire cutter occasionally damaged the insulation. The two rollers serve to hold the wire taut for cutting.

Chromized Grid Mandrels Resist Brazing

A NEW CHROMIZING process for vacuum tube grid mandrels permits easy removal of grid assemblies after brazing. The grids are produced by brazing copper-plated tungsten washers to gold-plated tungsten wire wound around a flat thin tungsten mandrel.

► **Process Details**—The mandrel is first given a surface alloying with chromium by the Chromalloy process (Chromalloy Corp., 450 Tarrytown Road, White Plains, N. Y.). The mandrel is then fired in a mildly oxidizing atmosphere so that an oxide layer forms over the entire surface. The result is a surface which molten metal will not wet during brazing.

► **Brazing**—The grids to be brazed are first fired in a hydrogen atmosphere at 1,140 F for 6 minutes, then soaked in a solution of 85 percent HNO₃ and 15 percent water. The grids are removed and the edges of the mandrel rubbed smooth with a metallic cloth so that it can be re-used. During service the mandrel must not exhibit dimensional changes, embrittlement or warpage.

PYLE *star-line* CONNECTORS

Assure long-lasting protection of vital connections under a wide range of extreme environmental conditions

Currently establishing itself as a performance leader in the missile systems field, Pyle-Star-Line connectors offer engineers an entirely new line of electrical connectors for universal military and industrial use.

With characteristics of construction and performance never before combined in compact, rugged, lightweight standardized connectors, they exceed NEC requirements and classes A, B, C and E of military specifications MIL C-5015C.

FEATURES

Tough, lightweight shell: Strength comparable to mild steel, yet weighs only $\frac{1}{3}$ as much.

Anodic coating: Gives shell toughness of case-hardened steel. Takes up to 1800 volts to penetrate coating.

"Sandwich" insulation: Silicone laminate floats between two rigid discs. Silicone disc absorbs shock, lets contacts align themselves freely; rigid discs impart just the right amount of restraint. Gives all advantages of both flexible and rigid mountings.

Chamber sealing: Silicone insulation disc positively and completely prevents water, gas, moisture or dust from passing into shell.

Wide range of pin and socket configurations: Configurations from 2 to 100 poles available. Within each form size all inserts are interchangeable and reversible.



Environmental Limits of Pyle-Star-Line connectors	
Temperature	-80 F. to 225 F.
Pressure	300 PSI External, 200 PSI Internal
Chemical Resistance	Most acids, most alkalis, oil
Corrosion Resistance	Salt Spray: 300 days without failure
Dust Resistance	Exceed requirements of MIL C-5015C
Shock Resistance	50G Minimum
Vibration	Exceed 20G to Method II of Mil C-5015C
Humidity & Moisture Resistance	Exceed Class E. Spec. of Mil C-5015C
Air Leakage	Meet Class E Spec. of Mil C-5015C

Write today for complete specifications.

the **PYLE-NATIONAL** company



Where Quality is Traditional

1330 North Kostner Avenue, Chicago 51, Illinois

District Offices and Representatives in Principal Cities of the United States
CONDUIT FITTINGS • CIRCUIT CONTROLS • LIGHTING EQUIPMENT



New Products

Edited by WILLIAM P. O'BRIEN

81 New Products and 53 Manufacturers' Bulletins Are Reviewed
. . . Control, Testing and Measuring Equipment Described and
Illustrated . . . Recent Tubes and Components Are Covered

AMPLIFIER SYSTEM

a wide band instrument

DYNAMICS INSTRUMENTATION CO., Division of Alberhill Corp., 1118 Mission St., So. Pasadena, Calif. Model 1054 a-c voltage amplifier system is a seven-channel, wide-band instrument exceptionally linear in phase and amplitude characteristics.

One important application of the system is in the amplification of transducer signals prior to recording on standard types of seven-channel magnetic tape equipment.

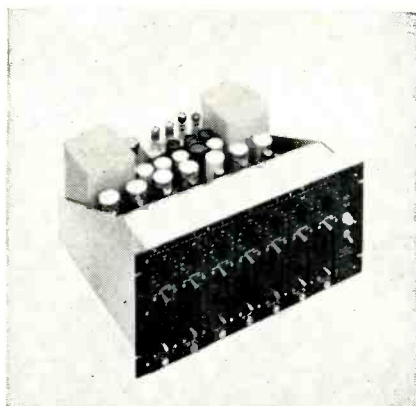

Uniformity of performance from 2 cps to 100,000 cps is maintained on all 11 settings of voltage gain from 1 to 100. Use of direct-coupling permits each amplifier to have a good l-f transient characteristic free from excessive multiple overshoots.

Signal-to-noise ratio is optimized on all settings of voltage gain because changes in gain are accomplished by variation of feedback networks rather than merely by attenuating the input signal. Complete specifications are available on request. Circle 401 on Reader Service Card.

COAX TERMINATIONS

only 9/16 in. in diameter



STODDART AIRCRAFT RADIO, INC., 6644 Santa Monica Blvd., Hollywood 38, Calif., has available a low-cost coaxial termination only 9/16 in. in diameter. Precise resistance values from d-c to 1,000 mc are maintained in these units by exclusive filmistors—thin plat-

inum films in ceramic forms which are assembled in coaxial sections. Vswr is less than 1.20 to 1,000 mc, characteristic impedance 50 ohms, peak voltage 100 v. Type BNC or type TNC male or female connectors are available. Units also feature gold-plated electrical contacts and durable chrome satin exterior finish. Circle 402 on Reader Service Card.

SLOTTED LINE

covers 1,120 to 1,700 mc

OMEGA LABORATORIES, INC., P. O. Box 264 Rowley, Mass., presents a new slotted line, model OXZ-L, which covers the entire L band frequency range of 1,120 mc to 1,700 mc.

Highly accurate probe travel along the length of the slot is assured by employing four hardened and precision ground ways on both sides of the waveguide body.

Radiation from the slot and car-

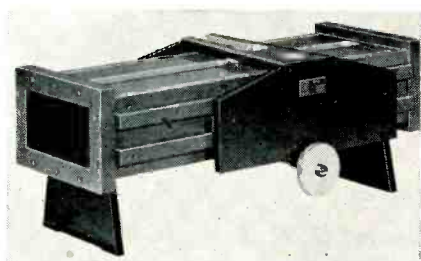

riage assembly is held to a low level by a unique design of both the slot and the carriage.

The model OXZ-L slotted line

is designed to accommodate many of the presently available probe assemblies as well as those of the company's manufacture. Circle 403 on Reader Service Card.

DELAY LINES

distributed-constant type

INTERNATIONAL RESISTANCE CO., 401 North Broad St., Philadelphia 8, Pa., is now producing distributed-constant delay lines. Housed in an impregnated waxed rigid cylin-



our leadership protects yours...

When you specify Cornell-Dubilier capacitors, you can be sure that nothing is left to chance. Production procedures, test and inspection operations and quality control are in full compliance with Cornell-Dubilier high-quality standards and *your* specifications. Quality and Reliability are talents we have cultivated since 1910. That's why you can count on the consistently dependable facilities of C-D's 16 plants!

Typical C-D paper tubulars:

TIGER CUB*: Cardboard-cased paper tubular with Polykane⁽¹⁾ end-fill. Vikane-impregnated for excellent capacitance stability. High moisture resistance. Operating temperature range: -55°C to +100°C.

TINY CHIEF*: Small, all-purpose paper tubular, molded in extra-hard thermosetting plastic for long-lasting all-around satisfaction. Available with high temperature wax impreg-

nant for operating temperature range -40°C to +90°C and Vikane or Polykane* impregnant for -55°C to +100°C operation.

ROYAL CUB*: Cardboard-cased paper tubular with Polykane* end-fill. Tough, durable, withstands rough handling, vibration, shock, soldering iron heat. Operating temperature range: -55°C to +100°C.

BUDROC*: Steatite-cased paper tubular. Polykane* end-fill for extra protection against heat and humidity. High temperature wax impregnant for operating temp. range -40°C to +90°C and Vikane impregnant for -55°C to +100°C.

⁽¹⁾ Polykane: A development of the C-D laboratories. A solid thermosetting compound will not crack, soften or flow.

Write for catalog to Cornell-Dubilier Electric Corporation, South Plainfield, New Jersey.



CONSISTENT HI-DEPENDABILITY CORNELL-DUBILIER CAPACITORS

• ®  SOUTH PLAINFIELD, N. J.; NEW BEDFORD, WORCESTER & CAMBRIDGE, MASS.; PROVIDENCE & HOPE VALLEY, R. I.; INDIANAPOLIS, IND.; SANFORD, FUGUAY SPRINGS & VARINA, N. C.; VENICE, CALIF.; A SUB.: THE RADIART CORP., CLEVELAND, OHIO; CORNELL-DUBILIER ELECTRIC INTERNATIONAL, N. Y.

der with tinned solid axial leads, these delay lines have a time delay of 0.2 to 1.0 μ sec. They are of a geometry that is well suited to requirements for point-to-point wiring and printed board applications. Principal applications are in color tv receivers, computers, test equip-

ment and telemetering equipment. A few of the desirable features which they incorporate are inherent uniformity and economy, elimination of variations in tension during winding, and reduction to a minimum of hand operations and human judgment. Simplicity of

design permits close control of electrical characteristics. Specific functions are pulse forming or shaping, phase matching, timing adjustments and temporary storage. Units for special requirements can be supplied. **Circle 404 on Reader Service Card.**

KILOVOLT METER

measures voltages, waveforms

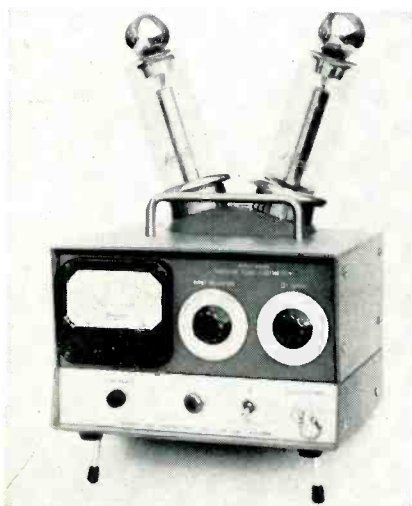

JENNINGS RADIO MFG. CORP., Box 1278, San Jose, Calif. The J-1003 h-v vtvm was designed for measurement of voltages of various waveforms including pulses at frequencies from 10 cps to 20 mc with an accuracy of ± 3 percent. Higher frequencies can be measured with slight loss in accuracy. The linear meter scale provides full-scale readings of 2.5, 5, 10, 25, 50 and 100 kv.

A vacuum capacitor voltage divider is used at each of the two inputs. The range may be doubled by installation of accessory vacuum capacitors on the h-v probes.

The probe assembly may be removed from the main instrument assembly so that the probes may be installed close to the h-v circuits to be measured but with the meter itself at a safe distance. Measurements may be made across balanced or unbalanced circuits with either or neither side grounded.

A novel electronic circuit is used in the vtvm portion of the instrument which provides excellent stability and obviates the need for frequency readjustment of zero settings. A jack is provided on the front panel to permit use of an oscilloscope for visual observation of waveforms. **Circle 405 on Reader Service Card.**

RANGE MARKER

for miniature applications

MICROSONICS, INC., Hingham Industrial Center, Hingham, Mass., has added to its line of ultrasonic solid delay lines, a new precision range and timing marker of miniature size. The unit utilizes ultrasonic propagation in fused quartz and is expected to give exceptionally stable time delays from 0.5 to 10 μ sec. A single input pulse results in multiple output pulses



accurately calibrated in μ sec or yards.

Cases housing the new miniature devices are hermetically sealed and warranted shock and vibration proof. Maximum length is 1 1/2 in. and maximum diameter is 3/8 in. Mounting is through a BNC type flange.

The company's other lines contain units ranging up to a 4,500 μ sec delay with a frequency range of from 10 to 200 megohms. **Circle 406 on Reader Service Card.**

WIRE STRIPPER

simple, readily adjustable

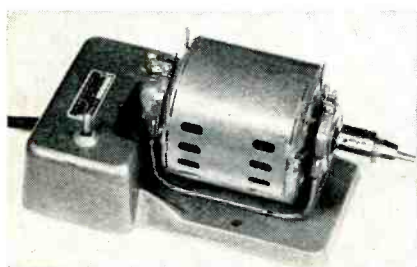

CARPENTER MFG. CO. INC., P. O. Box 217, Highbridge Road, DeWitt 14, N. Y. A new nose-type wire stripper features simple construction, adjustable and easy-to-use wire stripper for removing film-type insulations from wire leads of spring-wound coils and electrical components within wire

gage sizes from Awg No. 10 to Awg No. 25.

Model 22 wire stripper has these features: (1) The stripping insert is a four-bladed, spring collet type cutter, precision made of tool steel; the cutter arms are flexible enough to permit cutting through and removing the film insulation without cutting into or damaging the copper conductor. (2) The insert is held in a precision-



for
analog computer
readout:

modern, compact, mobile

SANBORN CONSOLE RECORDING SYSTEMS

Up to eight problem variables can be recorded in inkless, permanent, rectangular coordinate tracings — with Sanborn's improved six- and eight-channel 156-, 158-5490 Console Systems. Less than four feet high and about two feet in width and depth, these Systems are completely mobile and designed for maximum operating convenience. Controls and indicators on the sloping top panel include individual-channel attenuation, position, balance, sensitivity and stylus heat adjustments; switch for turning off B+ of output amplifiers; chart drive motor switch (can also be remotely controlled); code marker and/or one-second interval timer stylus switch. The Recorder unit, either six or eight channels, features paper loading from the top, and nine precisely controlled speeds from 0.25 to 100 mm/sec. Four dual-channel DC Driver Amplifiers of current feedback design are housed below the Recorder, and are mounted on a chassis which may be withdrawn for inspection.

Electrical specifications of the Console Recording Systems include a basic sensitivity of either .01 volt/chart division (5490 types) or 0.1 volt/chart division (5495 types); linearity of 1%; drift less than 1/2 chart division/hour (5490), less than 1/20 chart division/hour (5495); flat frequency response to 20 cps, down 3 db at 60 cps for all amplitudes to 5 cm peak; either single-ended or push-pull input signals of 5 meg. impedance (each input lead to ground).

A useful companion instrument is the new Sanborn Model 183 Programmer, designed to provide a connecting link between an analog computer and the Console Recording System. Shown mounted at the top rear of the Console, the Programmer operates the Console in the following automatic sequence: turns recorder drive on — feeds calibration signals to all channels — reads initial DC levels of computer — closes contacts to start computer problem — records computer output for a preset chart length — turns off recorder drive and resets itself for another cycle.

Further technical data, prices and delivery information — on the 5490, 5495 Console Recording Systems and two- to eight-channel 5475/5480 Systems are available on request from your Sanborn Sales-Engineering Representative or the Industrial Division in Waltham.



SANBORN COMPANY
INDUSTRIAL DIVISION

175 Wyman Street, Waltham 54, Massachusetts
Visit Sanborn Booths 115-116, National Electronics Conference, Chicago, Ill., October 7-9

ACEPOT*
ACETRIM*

Sub-Miniature Potentiometers and Trimmers

$\frac{1}{2}$ " size, precision wire-wound,
up to 250K, $\pm 0.3\%$ linearity

setting new standards
for dependability
in sub-miniaturization

Let the facts speak for themselves! ACE Sub-Miniature Precision Wire-Wound Potentiometers and Potentiometer Trimmers are the result of 4 years development and over a year of successful use by leading electronic equipment manufacturers. Users have conclusively proved that ACEPOTS and ACETRIMS meet requirements for space and weight saving compactness, while at the same time meeting MIL specs' most stringent qualifications for performance and dependability. Why invite trouble with untested components when you can protect your reputation with ACEPOT and ACETRIM . . . the subminiature potentiometers and trimmers proved in actual use.

Condensed Engineering Data

	ACEPOT (potentiometer)	ACETRIM (trimmer)
Resistance Range	10 \sim to 250K $\pm 2\%$	10 \sim to 150K $\pm 3\%$
Linearity	$\pm 0.3\%$	$\pm 0.3\%$
Resolution	extremely high	excellent
Ambient Temperature	-55°C to 125°C *	-55°C to 125°C
Torque	low or high	low or high

The above specifications are standard — other values on special order.

Available in threaded bushing, servo, flush tapped hole or flange mounting, and ganged units. All units sealed, moistureproofed, and anti-fungus treated. Meet applicable portions of JAN specs and MIL-E-5272A standards.

*New X-500 ACEPOT operates to a new high of 150°C .

*Expedited delivery on prototypes; prompt servicing of production orders.
Send for Fact File and application data sheets.*

*trademarks applied for

ACEPOT*
ACETRIM*

ACE ELECTRONICS ASSOCIATES

Dept. E, 101 Dover St. • Somerville 44, Massachusetts

machined collet holder designed for maximum concentricity and ease of adjustment to the various wire gages. (3) A single setting of this stripping insert will strip a range of wire sizes. Circle 407 on Reader Service Card.

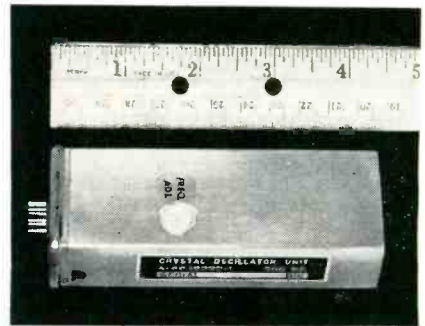

CRYSTAL OSCILLATORS subminiature, ruggedized

BULOVA WATCH CO., Electronics Division, Woodside 77, N. Y., has introduced a complete line of sub-miniature packaged crystal oscillators. Ruggedized for missile and other airborne applications, the following specifications are designed to provide optimum frequency control:

Dimensions, 1 in. by $1\frac{1}{2}$ in. by 4 in.; frequency stability, up to ± 1 part in 10^6 ; frequency range, 180 kc to 50 mc; harmonic content, less than 5 percent; available output voltage up to 50 v peak to peak; input voltages, 75, 150 and 250 v for tube circuits, and 6 to 24 v for transistorized circuits.

For custom applications these oscillators are available in the standard 7-pin plug-in type and other mountings. Circle 408 on Reader Service Card.

CARBON RESISTORS feature high stability

ERIE RESISTOR CORP., Erie, Pa., is producing a line of deposited carbon high stability resistors, to which it has given the trade name "Hi-Stab." The resistors are available in molded, non-insulated, and hermetically sealed ceramic encased types. They are extremely stable under severe environmental conditions and are designed to

1=4/VOCA^{model 101}

IN ONE INSTRUMENT!

DEMOLAB introduces the VOCA, a precision differential null type potentiometric voltmeter and search VTVM for AC and DC, including a precision calibrator delivering square wave and DC output reference voltages. Plus accessories.

.1V to 500 Volts in a 5 digit readout.
4 Digits .01V to .1V—3 Digits .001V to .01V. 2 Digits .001V to .01V—Usable readouts down to 50 uv.

to .05% from 0 to 500 Volts DC
to .1% from .5 to 50 Volts RMS AC

1 part in 10,000 at low end of each range.
1 part in 100,000 at high end of each range.

Amplitude referenced against a Standard Cell. Super regulated power supply for stability.

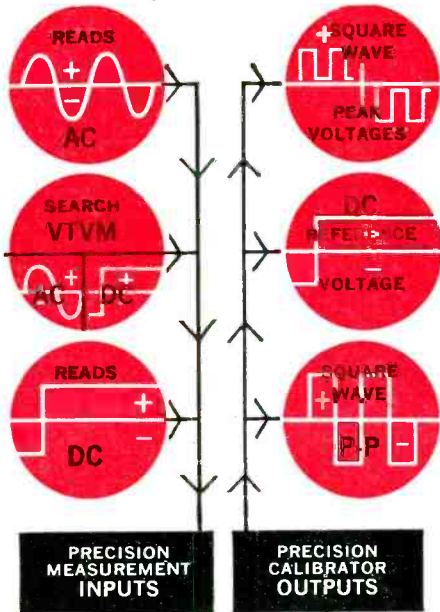

BUILT-IN FEATURES

RANGE:

ACCURACY:

READOUT RESOLUTION:



Rack Mounting with Bench Brackets

ACCESSORY FEATURES:

A family of input probes, shunts, and output units extending the AC range and the basic accurate reference standards of the instrument to an infinite variety of functional uses is available.

DEMOLAB CORPORATION
Instrument Division

1550 North Highland Avenue
Hollywood, California
Representatives in all major areas

ACCESSORIES

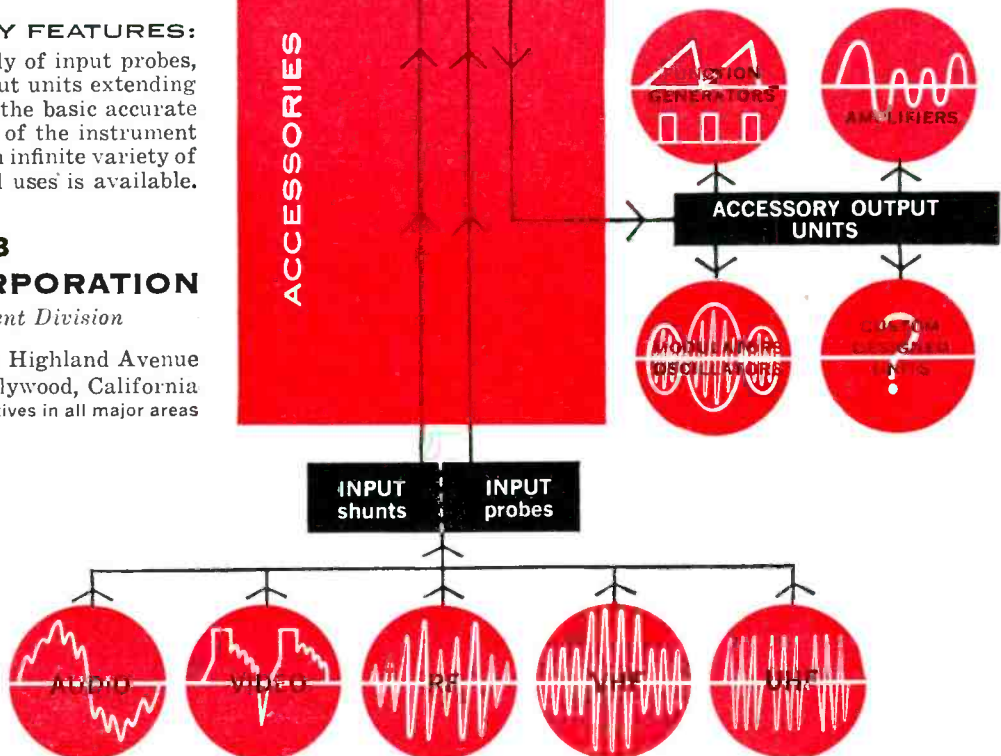

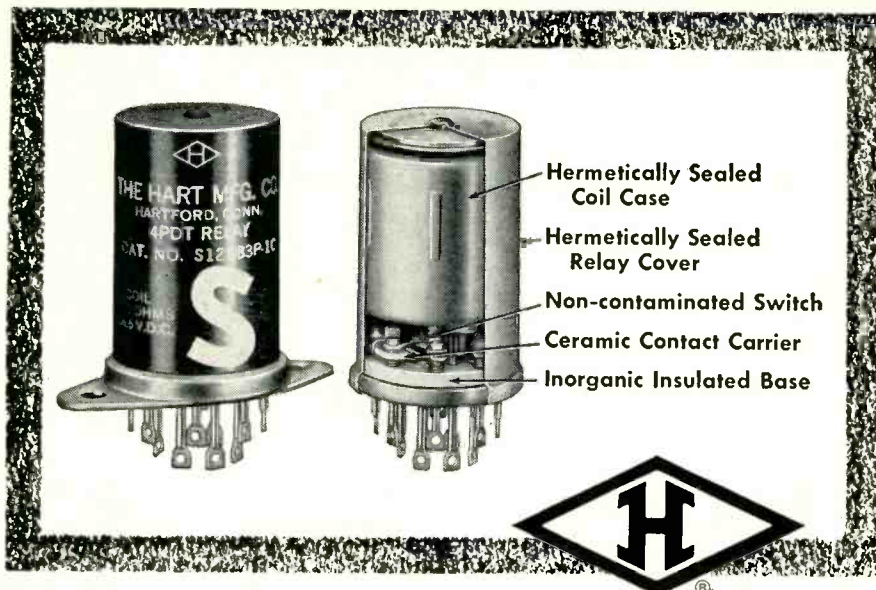

Double sealing . . . inorganic construction make

New 'Diamond H' Series S Relays Doubly Dependable

in dry circuits

Separately sealed coils isolated from completely inorganic switches within their hermetically sealed cases make these new "Diamond H" Series S aircraft type 4PDT relays supremely reliable in dry circuits.

Physically and electrically interchangeable with "Diamond H" Series R relays, widely used in guided missiles, computers, jet engine controls, automation control systems and similar critical applications because of their broad range of performance characteristics, Series S relays will permit intermixing of dry and wet circuits safely.

Contacts are specially processed and cleaned before assembly; subsequent contamination from gases off the coil insulation is prevented by the coil seal. The switch mechanism has been simplified and is completely inorganic to eliminate other possible causes of malfunctioning.

Standard contact ratings include 30 V., D. C.; 115 V., A. C.;

2, 5, 7-1/2 and 10 A., resistive; 2 and 5 A., inductive, with special ratings available to 350 V., D. C., 400 MA, or other combinations including very low voltages and amperages, or amperages up to 20 for short life requirements. Coils are available with resistances of 1 ohm to 50,000 ohms. Operating time of 24 V. models is 10 ms. or less; dropout less than 3 ms.

Vibration resistances range from 10-55 cycles at 1/16" double amplitude to 55-2,000 cycles at 20 "G"; operational shock resistances to 50 "G" plus, and mechanical shock resistance up to 1,000 "G". Nine standard mounting arrangements, plus a ceramic plug-in socket, are available. The unit displaces only 1.6 cubic inches, excluding terminals.

"Diamond H" engineers will be happy to work out a variation to meet your specific requirements. Tell us your needs . . . or write for bulletin on new "Diamond H" Series S relays.

THE HART MANUFACTURING COMPANY

202 Bartholomew Avenue, Hartford, Conn.

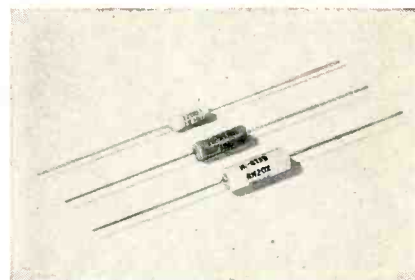

exceed MIL-R-10509B specifications.

Hi-Stab resistors have been tested by exposure to a humid underground atmosphere for three years, during which the average resistance change was only 0.3 percent. In another test these same resistors were immersed in tap water for 4,500 hours with negligible average resistance change.

The Hi-Stab resistors are more economical than wire-wound resistors and are ideally suited for low noise applications and installations in which high stability with low inductance is essential. Recommended are use for military radar and guided missiles, and for commercial computer circuits, communications, instrumentation, and quality radio, tv and hi-fi sets. **Circle 409 on Reader Service Card.**

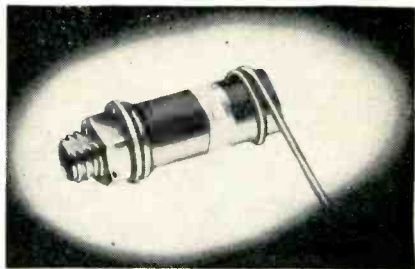

TRIMMER CAPACITOR with reduced overall length

JFD ELECTRONICS, INC., 6101-16th Ave., Brooklyn 4, N. Y., has developed a new miniature trimmer model VC20G piston capacitor ranging in capacitance from 0.8 to 8.5 μf . Key feature is a telescopic tuning assembly which cuts down overall length by nearly 50 percent reducing length when panel mounted to $\frac{3}{16}$ in. Anti-backlash design assures unsurpassed tuning resolution.

Another improvement is a special alloy undercoat that protects all metal parts from corrosion and

no head bobbing—no board flopping



Translucent **Formica**[®] copper clad cuts assembly costs...

Assembly and inspection are easier, quicker and cheaper with translucent Formica copper clad boards. Hewlett-Packard Co., Palo Alto, California, reports substantial savings over opaque boards.

Translucency is an important property of many Formica copper clad laminates. Equally essential to top circuit performance are these other outstanding Formica properties: high in-

sulation resistance up to 1,000,000 megohms, cold punching to and including $\frac{1}{16}$ " , 450°F solder temperature, 6 lbs. and higher bond strength. For complete information on how Formica can help you achieve better, low cost circuitry, write today for Copper Clad Technical Data bulletin 688. Formica Corporation, a subsidiary of American Cyanamid, 4530-7 Spring Grove Ave., Cincinnati 32, Ohio.

Save your engineers— use our engineering staff
... it's part of the complete laminated plastics service

subsidiary of 



- (1) Application Engineering
- (2) Research
- (3) Fabricating
- (4) Customer stock service

FI-1425

MARS outstanding design SERIES

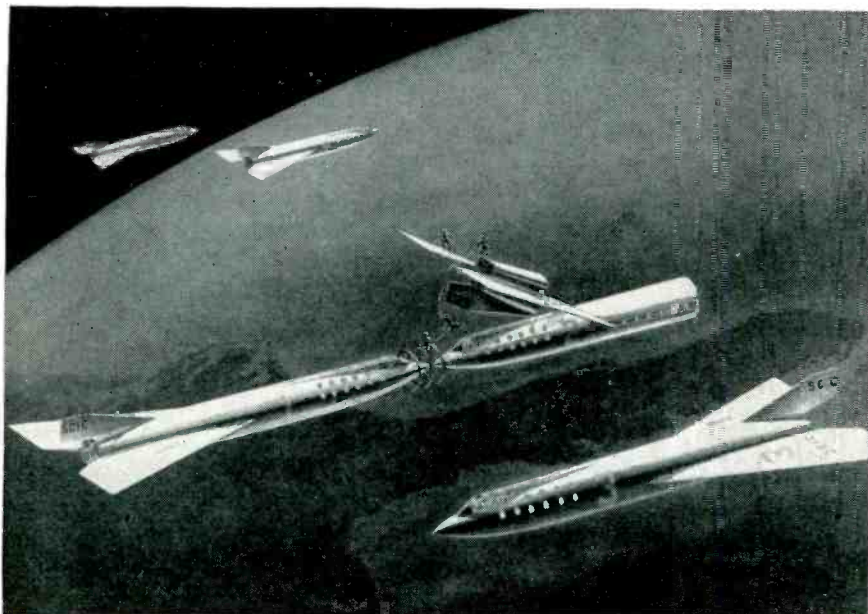

birth of a satellite

Most new ideas, like this inhabited satellite, start out as drawings on a sheet of paper. Here artist Russell Lehmann shows the first step in building the space station proposed by Darrell C. Romick, aerophysicist engineer at Goodyear Aircraft.

Two ferry ships, one stripped of rocket units, are joined end to end. As others are added, this long tube forms temporary living quarters for crews. Eventually, outer shell will be built around core, making completed station 3,000 feet long, 1,500 feet in diameter.

No one can be sure which of today's bright ideas will become reality tomorrow. But it is certain that in the future, as today, it will be important to use the best of tools when pencil and paper translate a dream into a project. And then, as now, there will be no finer tool than Mars—from sketch to working drawing.

Mars has long been the standard of professionals. To the famous line of Mars-Technico push-button holders and leads, Mars-Lumograph pencils, and Tradition-Aquarell painting pencils, have recently been added these new products: the Mars Pocket-Technico for field use; the efficient Mars lead sharpener and "Draftsman's" Pencil Sharpener with the adjustable point-length feature; and—last but not least—the Mars-Lumochrom, the new colored drafting pencil which offers revolutionary drafting advantages. The fact that it blueprints perfectly is just one of its many important features.

The 2886 Mars-Lumograph drawing pencil, 19 degrees, EXEXB to 9H. The 1001 Mars-Technico push-button lead holder. 1904 Mars-Lumograph imported leads, 18 degrees, EXB to 9H. Mars-Lumochrom colored drafting pencil, 24 colors.



J.S. STAEDTLER, INC.
HACKENSACK, NEW JERSEY

at all good engineering and drawing material suppliers

permits use under extreme environmental conditions. Noise free tuning is assured by the use of 24 caret gold plate. Mechanical end stops are provided at each end of the capacitance range.

Micro-vernier adjustment of approximately 0.7 μmf per turn with no tuning reversals is also provided. The new VC20G uses glass dielectric cylinders specially processed to provide excellent electrical properties with no derating ± 125 C. This renders the trimmer more stable in temperature and extended life. Circle 410 on Reader Service Card.

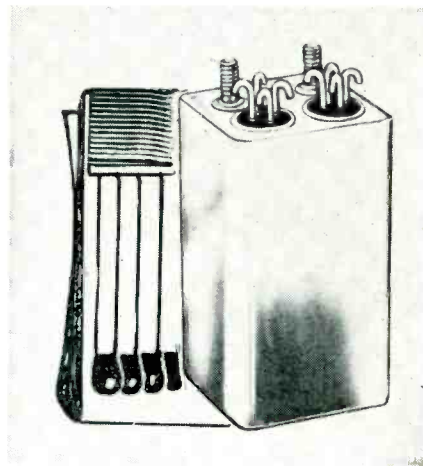

SENSITIVE RELAYS for commercial and military

WHELOCK SIGNALS, INC., 273 Branchport Ave., Long Branch, N. J., is offering a new line of miniature sensitive relays which are ideally suited to both commercial and military applications where single-pole or double-pole sensitive relays must meet the rigid requirements of space, shock, temperature and vibration.

These tiny relays are highly sensitive to low input. They are hermetically sealed with headers for solder connections and have high shock immunity. The series is available either spdt or dpdt. Other features include: standard operating power 400 mw for dpdt with other contact arrangement and conditions permitting lower operating power; 10 g vibration immunity in accordance with MIL-R-5757B; silver contacts—rated 2 amperes 28 v d-c resistive; life—over 100,000 operations at rated

Now—

from the makers
of precision
aircraft switches . . .



- **LONGER LIFE**
(150,000 operations, elec. and mech.)
- **DIRECT INTERCHANGEABILITY**
(Meets AN 3234 Specifications)
- **ACCURATE REPEATABILITY**
- **LOW COST**

The new Electro-Snap F2 Series snap action switches are extra-compact with extremely high electrical capacity for their size. Mechanical and electrical life at 1/32" overtravel is 150,000 operations, minimum, with accurate repeatability and constant stability of tolerances. Self-aligning springs provide contact wiping action rare in a switch of this size.

Write for Data Sheet FN-9

ELECTRO-SNAP

SWITCH AND MFG. CO.

4236 West Lake Street, Chicago 24, Illinois



SERIES F2 BASIC SWITCH
F2-3: Single Pole, Double Throw
F2-2: Single Pole, Normally Open
F2-1: Single Pole, Normally Closed

Durable case of special plastic gives the switch an ambient temperature rating of -100° to $+275^{\circ}$ F.* Available, at low cost, in three basic models with a wide selection of actuators.

*Available with -100° $+350^{\circ}$ rating

OPERATING CHARACTERISTICS

Electrical Rating:

10 AMPS; IND. + RES.
30 V.D.C. 110/250 V.A.C.
(RATING FOR AIRBORNE APPLICATION;
6 AMP 30 V.D.C. INDUC.)

Operating Force 7 to 12 oz.
Reset Force 4 oz. Min.
Pretravel 3/64 Max.
Movement Differential $.011 \pm .005$
Overtravel 1/32 Min.

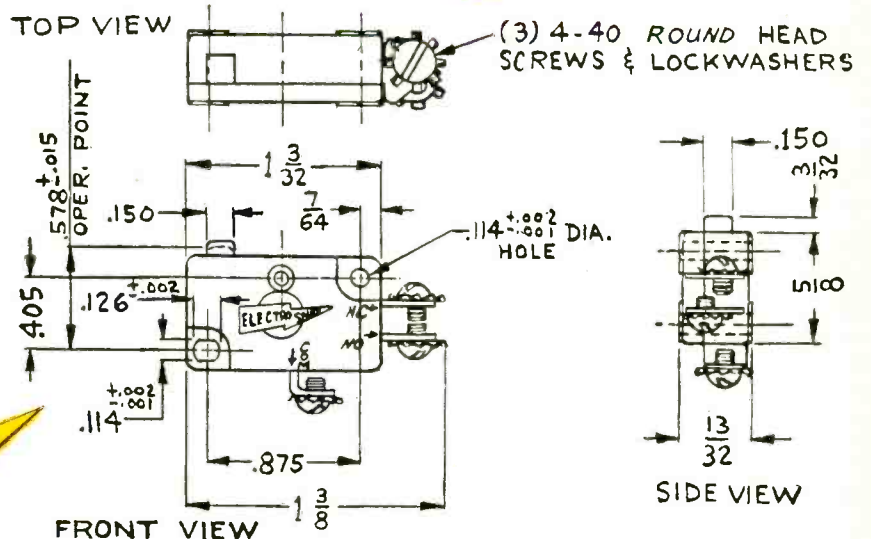

MODERN DESIGN
IN A COMPLETE LINE
OF SWITCHES



SUB-MINIATURE SWITCH

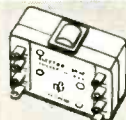

MULTI-POLE SWITCHES

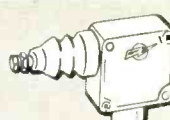

ONE-WAY LIMIT SWITCH



BASIC SWITCH

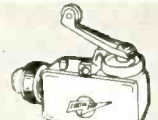

HERMETICALLY-SEALED LIMIT SWITCHES



14,000 G-E GLOW LAMPS KEEP 2,000,000 PEOPLE PER YEAR ON TIME!

Cleveland, Ohio—The flight information board at Hopkins Airport contains more than 14,000 G-E Glow Lamps that are turned on and off from a master control panel to form letters and numbers in lights. And although glow lamps are not primarily designed for lumen output, this board is easily readable from any spot in the spacious terminal. But—functional as this application might be . . . and dramatic as it is . . . General Electric Glow Lamps have many electrical characteristics that are stirring real enthusiasm in the electronic design field. So, consider G-E Glow Lamps for every live circuit in your design plans. General Electric Co., Miniature Lamp Dept., Nela Park, Cleveland 12, Ohio.

A Single G-E Glow Lamp May Serve As A:

*RELAXATION OSCILLATOR • LEAKAGE INDICATOR
SWITCH • VOLTAGE REGULATOR • VOLTAGE INDICATOR*

Progress Is Our Most Important Product

GENERAL  ELECTRIC

resistive load; double-coil magnetic circuit of high efficiency type with windings up to 8,000 ohms and 1 w maximum dissipation. **Circle 411 on Reader Service Card.**

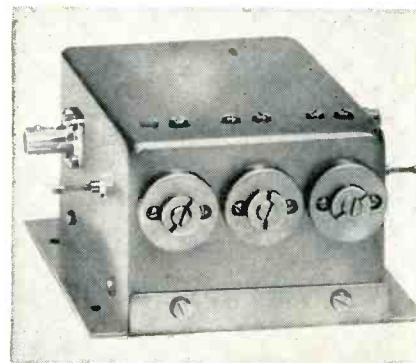

BANDPASS FILTERS use triple-tuned network

APPLIED RESEARCH, INC., 76 S. Bayles Ave., Port Washington, N. Y., has developed a line of bandpass filters with center frequencies from 30 to 2000 mc. The filters, whose actual performance closely approaches theoretical expectations, use triple-tuned distributed constant networks.

A typical model, the HFF-T-3, has a center frequency of 425 mc and a bandwidth of 50 mc. Insertion loss is 0.15 db with an input-output vswr of 1.03 in the passband. The filter also has a peak-to-valley ratio of 0.25 db or less, an impedance level of 50 ohms and a power rating of 100 watts. **Circle 412 on Reader Service Card.**

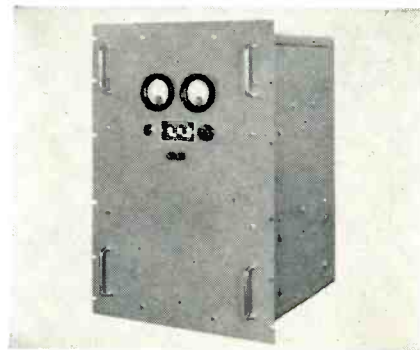

D-C POWER SUPPLIES for missile test, checkout

PERKIN ENGINEERING CORP., 345 Kansas St., El Segundo, Calif., has available model numbers M-675, M-676, M-677 and M-678 semi-

*precise
voltage
regulation!*

actual
size

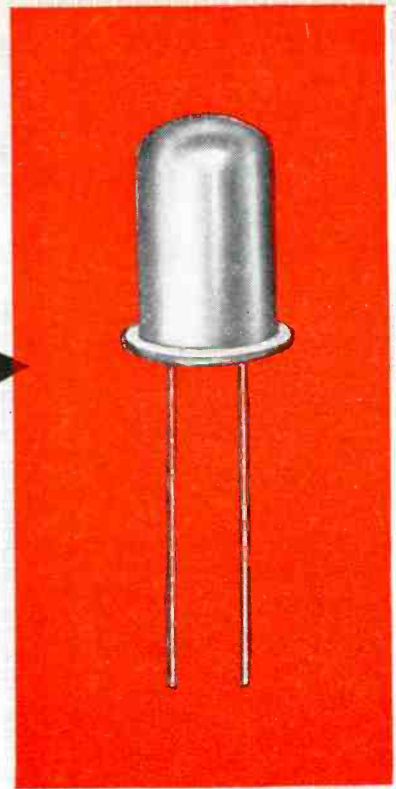

U.S. SEMCOR

SILICON ZENER DIODES

for immediate delivery in singles, pairs, matched sets . . .



Now in atmospheric conditioned high volume production, U. S. Semcor's silicon ZENER DIODES provide low backward current with abrupt breakdown . . . give precise voltage reference at high temperatures for Voltage Regulation Circuits . . . may be combined to match any given parameters. Nominal Ratings from 3.9 to 560 Volts . . . 10% Tolerance. Singles, Pairs, Quads . . . *Close Tolerance Sets and Special Packages to Order.*

U. S. Semiconductor Products Inc. is managed by the originators of the first production silicon ZENER DIODES, and is augmented by an engineering and research staff with 42 years of pinpointed experience.

Our field Engineering Representatives welcome the opportunity to consult with you on standard or special ZENER DIODE requirements. For address of office nearest you—or for complete technical data—WRITE TODAY to Sales Engineering Dept., U. S. Semiconductor Products, Inc., 3536 West Osborn Road, Phoenix, Arizona.

ORDER SAMPLE UNITS NOW!

We invite your evaluation of our
precision manufactured units

U.S. SEMCOR

U. S. SEMICONDUCTOR PRODUCTS, INC.

3536 WEST OSBORN ROAD • PHOENIX, ARIZ. • Appelgate 8-5591

Cut Tooling Costs, Stamping Costs, Delivery Time.

"RAPID TOOLING"

The "Rapid-Tooling" process is a newly developed method to produce small, medium or large runs of stamped parts at a fraction of normal costs. Aluminum and magnesium up to 1/4" thick, and steel up to 3/16" thick can be stamped.

With a large range of shapes, forms and sizes . . . with complete uniformity of production and tolerances to .003" possible . . . "Rapid-Tooling" maintains your quality specifications and in many cases saves up to 80% of conventional tooling costs.

Circle 189 Readers Service Card

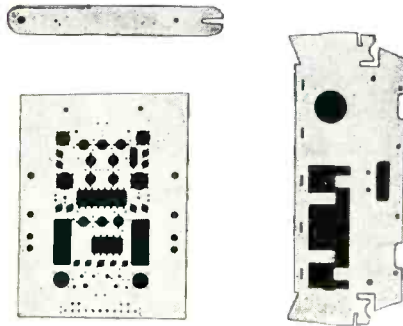

Send blueprints for quotes

insuline
CORPORATION OF AMERICA
Division of Van Norman Industries
186 Granite St., Manchester, N. H.

Revolutionary, New



Epoxy Resin Potted
PERMANENTIZED TRANSFORMERS

custom built to your specifications

GOOD OVERLOAD FACTORS

EXTREMELY RUGGED

GOOD LOOKING

INEXPENSIVE

LOW LOSSES

HIGHLY RELIABLE

LOW TEMPERATURE RISE

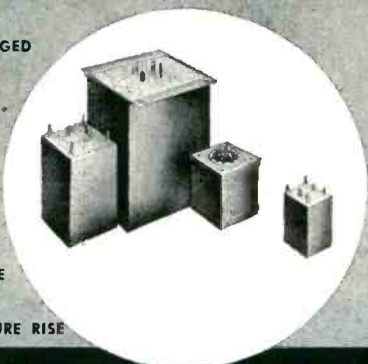

New formula developed by Electro makes possible reduced size and more rugged construction in resin-potted transformers. New potting material welds core, coil, case, and terminals, with permanent bonding to case. Built to withstand 170° C. May be qualified under MIL-T-27A, grades 1, 2, 4, or 5 in class R, S, or T, as well as commercial specifications.

ELECTRO ENGINEERING WORKS, INC.

401 Preda St., San Leandro, Calif. • In Metropolitan Oakland area

militarized d-c power supply units especially designed for use in missile test and checkout. The units are 28 v d-c nominal output, with voltage outputs ranging from 24 to 40 v at load capacities from 30 to 500 amperes.

Special design features include MIL type components such as MIL-T-27A Grade 3 magnetic components, ruggedized construction for mounting in missile vans, as well as various MIL approved components. Especially popular for this application is model No. M-675-1, a most compact 28-v 100-ampere d-c output unit, in a standard 19-in. rack mounting type construction.

Rating is 24 to 32 v d-c at 100 amperes. Regulation is ± 0.5 percent over the voltage range. Ripple is 1 percent rms. Circle 413 on Reader Service Card.



SWEEPING OSCILLATOR
low cost r-c type

HEWLETT-PACKARD Co., 395 Page Mill Road, Palo Alto, Calif. A unique feature of the model 207A audio sweep oscillator is the 20 cps to 20 kc range in a single dial sweep. The instrument employs a new variation of the time tested r-c oscillator circuit and achieves its extreme frequency range without bandswitching and with greater stability than other audio sweeping types. The accuracy of the model 207A is ± 4 percent including warmup drift and aging of tubes and components.

The oscillator has been designed for motor drive to speed the testing of audio circuits and

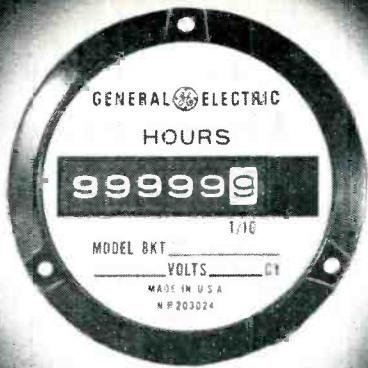

Round model for panel mounting.

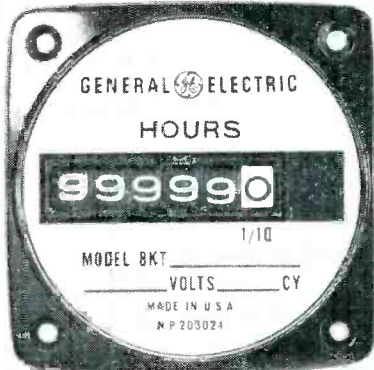

Square model for panel mounting.

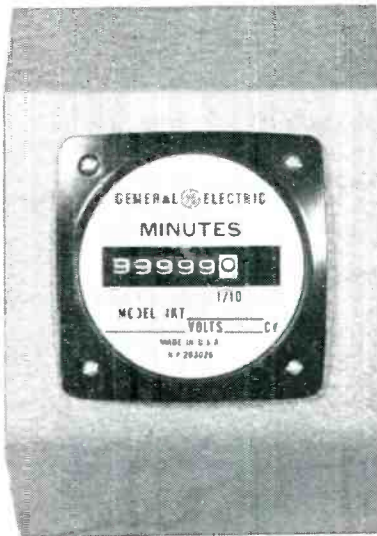

Portable model for laboratories.

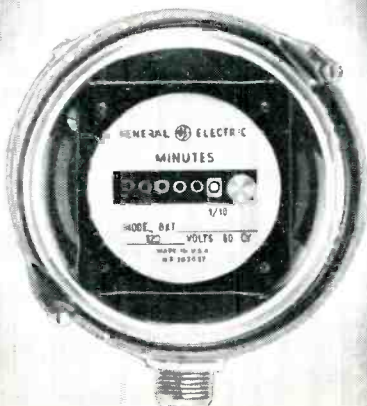

Conduit case for easy installation.

NEW General Electric Time Meters cost less, read easier, give wider range of measurement

ALL DIGITS 2½ TIMES LARGER—NEW, EXTRA DIGIT GIVES WIDER RANGE FROM 0 TO 99999.9 HOURS OR MINUTES



OLD
(Life Size)



NEW
(Life Size)

At a new, low cost, General Electric now offers you a complete line of time meters for measuring operating time of every type of electrical equipment.

Available in 2½ and 3½ inch sizes these new General Electric Time Meters offer you these important benefits:

- **DUST-PROOF PROTECTION** . . . due to totally enclosed construction. Sealed models also available to military specifications.
- **RESET MODEL** . . . conveniently located reset knob available (optional) on all General Electric Time Meters except sealed models.
- **INCREASED OPERATING TEMPERATURE RANGE FROM -67F to 150F** . . . means more flexible application and longer meter life.

3 WAYS YOU BENEFIT WITH GENERAL ELECTRIC TIME METERS:

LOWER COST, BETTER PLANNED MAINTENANCE . . . because you can

measure the operating time of your equipment, thus allowing you to apply pre-planned productive maintenance.

LESS DOWNTIME, FEWER PRODUCTION LOSSES . . . because you can measure the total operating life of your equipment, and thus replace it on a scheduled basis before it breaks down unexpectedly.

BETTER UTILIZATION OF MANPOWER AND MACHINES . . . because General Electric Time Meters measure the shut-down time of your equipment, allowing efficient scheduling of employee and machine work assignments.

FOR AN ACTUAL DEMONSTRATION of how these new General Electric Time Meters can help you save money and improve operating performance, call your nearest General Electric Apparatus Sales Office. And write today for descriptive bulletin GEA-6710, General Electric Company, Section 584-12, Schenectady, N. Y.

Progress Is Our Most Important Product

GENERAL  ELECTRIC

EAGLE MULTIFLEX (multiple circuit) reset timer

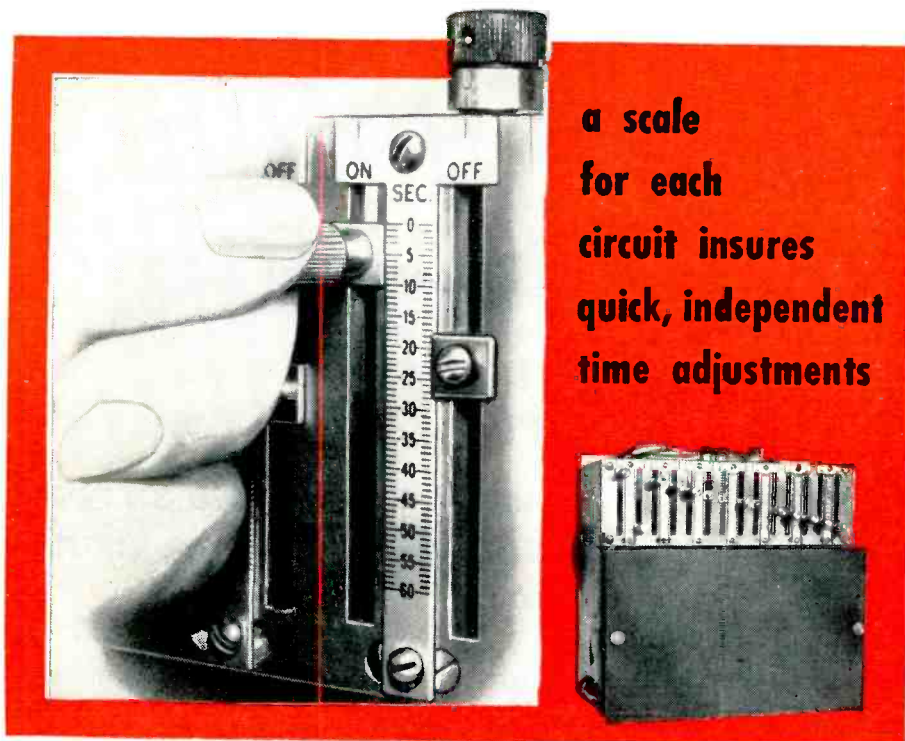

a scale
for each
circuit insures
quick, independent
time adjustments

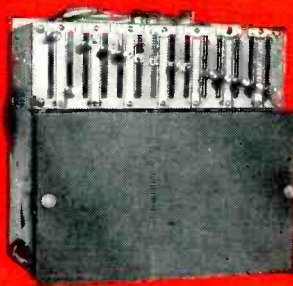

For controlling operation phases of electrically energized devices in processing work. The Multiflex Reset Timer closes and opens one to six circuits during a time interval started by push button, limit switch or other means. It's the only multiple circuit timer that provides a calibrated scale for quick, independent adjustment of each circuit. Time changes are made rapidly by moving a simple slide adjustment. Settings are possible to 1% of full scale. Vernier knobs are provided for use where more accurate settings are required. Multiflex Timers are available with time scales from 30 seconds to 5 hours. Send for free bulletin.

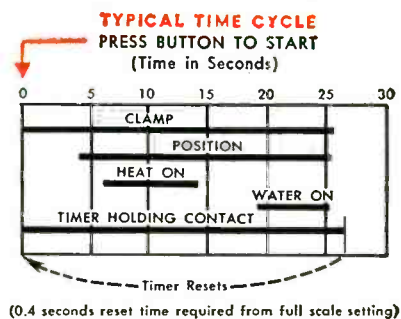

MAIL COUPON TODAY

EAGLE SIGNAL CORPORATION
Industrial Timers Division, Dept. E-1057
MOLINE, ILLINOIS

Please send Bulletin 130 containing full data on Multiflex Reset Timer.

NAME AND TITLE _____
COMPANY _____
ADDRESS _____
CITY _____ ZONE _____ STATE _____



SIGNAL CORPORATION
Industrial Timers Division
MOLINE, ILLINOIS

Eagle timers save time . . . save money

NEW PRODUCTS

(continued)

devices of many kinds. Model 207A audio sweep oscillator is priced at \$275. Circle 414 on Reader Service Card.

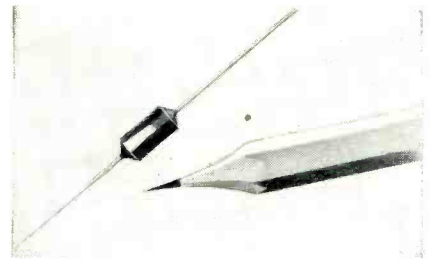

WIRE WOUND RESISTOR for microminiaturization

THE DAVEN CO., Livingston, N. J., announces a new wire wound resistor type developed for the Armed Services microminiaturization program. Type 1274, a completely encapsulated unit, measures $\frac{3}{16}$ in. in diameter by $\frac{3}{8}$ in. in length. It is rated at 0.25 w. Maximum resistance is 250,000 ohms. All requirements of MIL-R-93-A, except physical size, can be met by this resistor. Its size is such that it can be substituted in many circuits for deposited carbon resistors where greater accuracy, increased stability, or lower noise is necessary. Circle 415 on Reader Service Card.



V-T ELECTROMETER

measures d-c from
 10^{-3} to 10^{-11} amps

TULLAMORE ELECTRONICS LABORATORY, 6055 South Ashland Ave., Chicago 36, Ill. Model VTE-1 vacuum-tube electrometer measures direct currents of either polarity from 10^{-3} to 10^{-11} amperes. Built-in bucking current source, with range from 10^{-3} to 10^{-9} amperes provides means for scale

Get out your pencil and . . .

Help yourself to electronics' **READER SERVICE**

it's free—it's easy—it's for your convenience

NOW!

All Advertisements
New Products, and
New Literature are
numbered for your
convenience.

Each Advertisement, New Product, and New Literature item is numbered.
For more information simply . . .

- (1) Circle number on postpaid card below that corresponds to number at the bottom of Advertisement, or New Product item. Follow the same procedure if you desire New Literature.
- (2) Print your name, title, address, and firm name carefully. It is impossible to process cards that are not readable.

Correct additional postage **MUST** be added to cards for all **FOREIGN MAILINGS**

OCT
1-57
CARD
EXPIRES
JAN • 1ST

• **electronics** • **READER SERVICE CARD**

Please Print Carefully

NAME _____ POSITION _____

COMPANY _____

ADDRESS _____

1	2	3	4	5	6	7	8	9	10	11	12	13	14	15	16	17	18	19	20
21	22	23	24	25	26	27	28	29	30	31	32	33	34	35	36	37	38	39	40
41	42	43	44	45	46	47	48	49	50	51	52	53	54	55	56	57	58	59	60
61	62	63	64	65	66	67	68	69	70	71	72	73	74	75	76	77	78	79	80
81	82	83	84	85	86	87	88	89	90	91	92	93	94	95	96	97	98	99	100
101	102	103	104	105	106	107	108	109	110	111	112	113	114	115	116	117	118	119	120
121	122	123	124	125	126	127	128	129	130	131	132	133	134	135	136	137	138	139	140
141	142	143	144	145	146	147	148	149	150	151	152	153	154	155	156	157	158	159	160
161	162	163	164	165	166	167	168	169	170	171	172	173	174	175	176	177	178	179	180
181	182	183	184	185	186	187	188	189	190	191	192	193	194	195	196	197	198	199	200
201	202	203	204	205	206	207	208	209	210	211	212	213	214	215	216	217	218	219	220
221	222	223	224	225	226	227	228	229	230	231	232	233	234	235	236	237	238	239	240
241	242	243	244	245	246	247	248	249	250	251	252	253	254	255	256	257	258	259	260
261	262	263	264	265	266	267	268	269	270	271	272	273	274	275	276	277	278	279	280
281	282	283	284	285	286	287	288	289	290	291	292	293	294	295	296	297	298	299	300
301	302	303	304	305	306	307	308	309	310	311	312	313	314	315	316	317	318	319	320
321	322	323	324	325	326	327	328	329	330	331	332	333	334	335	336	337	338	339	340
341	342	343	344	345	346	347	348	349	350	351	352	353	354	355	356	357	358	359	360
361	362	363	364	365	366	367	368	369	370	371	372	373	374	375	376	377	378	379	380
381	382	383	384	385	386	387	388	389	390	391	392	393	394	395	396	397	398	399	400
401	402	403	404	405	406	407	408	409	410	411	412	413	414	415	416	417	418	419	420
421	422	423	424	425	426	427	428	429	430	431	432	433	434	435	436	437	438	439	440
441	442	443	444	445	446	447	448	449	450	451	452	453	454	455	456	457	458	459	460
461	462	463	464	465	466	467	468	469	470	471	472	473	474	475	476	477	478	479	480
481	482	483	484	485	486	487	488	489	490	491	492	493	494	495	496	497	498	499	500
501	502	503	504	505	506	507	508	509	510	511	512	513	514	515	516	517	518	519	520
521	522	523	524	525	526	527	528	529	530	531	532	533	534	535	536	537	538	539	540
541	542	543	544	545	546	547	548	549	550	551	552	553	554	555	556	557	558	559	560
561	562	563	564	565	566	567	568	569	570	571	572	573	574	575	576	577	578	579	580
581	582	583	584	585	586	587	588	589	590	591	592	593	594	595	596	597	598	599	600

INSIDE FRONT COVER

INSIDE BACK COVER

BACK COVER

card . . .



Some Advertisements which cannot be numbered for the **READER SERVICE CARD** due to lack of space, must be indicated by writing the Advertiser's name in the space provided at the bottom of the



NOW IN YOUR HANDS . . .

THE ALL NEW 1957 electronics BUYERS' GUIDE!

USE IT THROUGHOUT THE YEAR AS YOUR STANDARD REFERENCE SOURCE

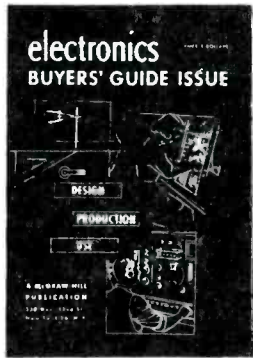

For 17 years . . .

THE BUYING GUIDE

For the electronics industry

As easy to use as the telephone book, your all new 1957 electronics BUYERS' GUIDE features: **COMPLETENESS:** 1070 pages of products, manufacturers, trade names, manufacturers' representatives, and professional services.

ACCURACY: The entire electronic industry is questioned from scratch each year. For the 1957 GUIDE, there were 181 changes, 586 deletions (of the deletions, many were due to mergers and name changes), and 872 additions. Total

number of manufacturers increased to 4013 from 3727 in 1956. 87 new products were added in 1957 for a total of 1773.

USE: Whether you are concerned with the design, production, or use of electronic circuitry, turn to the listings of the **electronics BUYERS' GUIDE**. Here you will find the page numbers that refer you to catalog-type advertising, specially prepared to supplement the listings and give you the technical information you must have to specify and purchase electronic and allied products.



A McGraw-Hill Publication, 330 West 42nd Street, New York 36, N. Y.



FIRST CLASS
PERMIT NO. 64
(Sec. 34.9 P.L.&R.)
NEW YORK, N. Y.

BUSINESS REPLY CARD
NO POSTAGE STAMP NECESSARY IF MAILED IN THE UNITED STATE

4¢ Postage Will Be Paid By

ELECTRONICS

Reader Service Dept.

330 West 42nd Street

New York 36, N. Y.

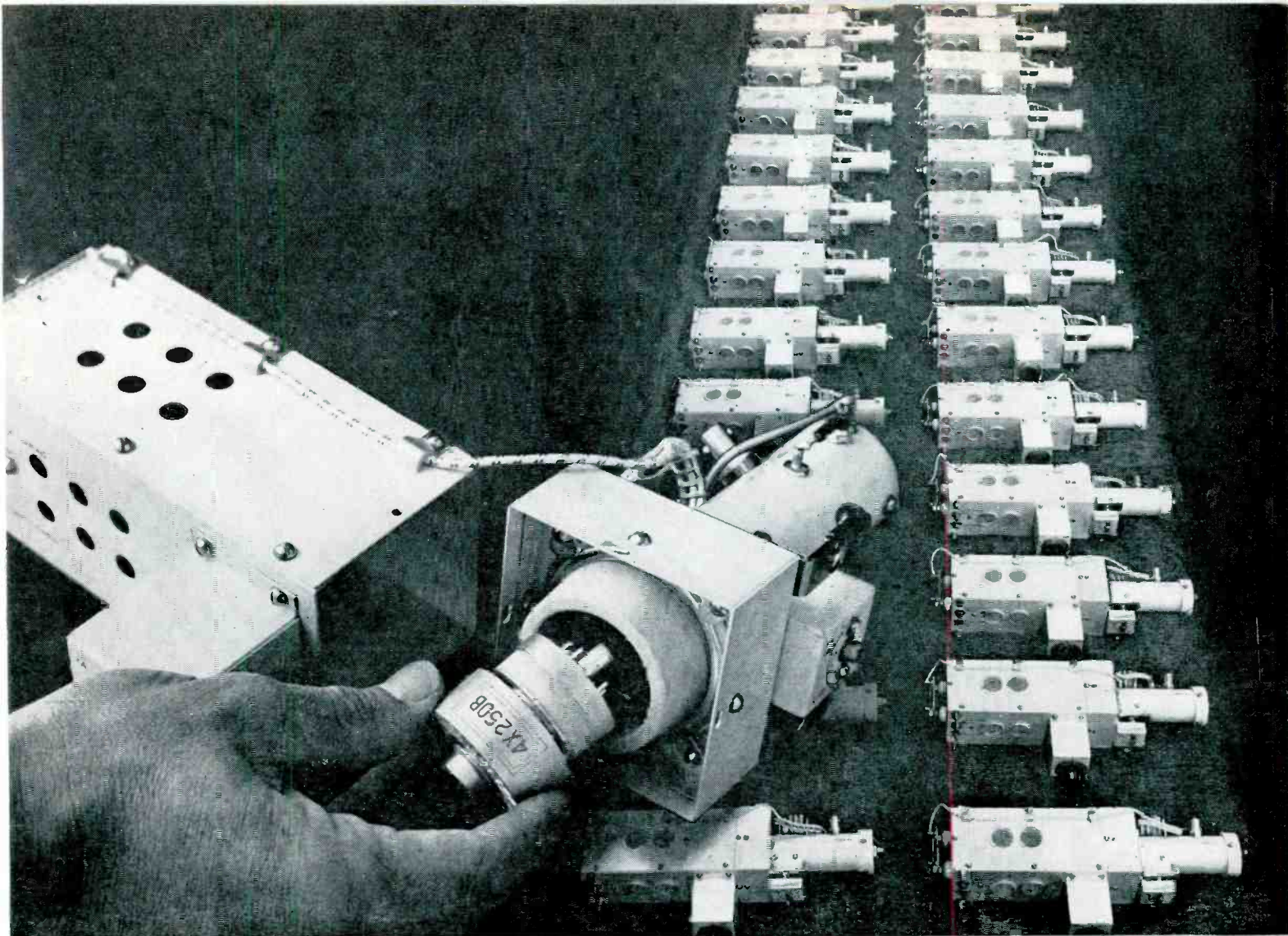

Final Amplifier Sections of Kaar Type TV-3 CAA Transmitters

EIMAC 4X250B Replaces 4X150A in CAA Ground Station VHF Transmitter

Kaar Engineering uses the Eimac 4X250B in the final amplifier of its TV-3 CAA transmitter, for several outstanding reasons:

1. The Eimac developed 4X250B meets the CAA efficiency requirements.
2. In the TV-3 as in most other equipment, the 4X250B is unilaterally interchangeable with the 4X150A.
3. Kaar finds that uniform tubes are assured by Eimac's exclusive long-pulse cathode evaluation testing.

4. Eimac ceramic construction makes this tube highly immune to damage by heat or shock.

In addition, ceramic permits optimum processing techniques that lead to tube reliability and longevity.

As one engineer put it, "We plugged in an Eimac 4X250B and immediately saw the difference."

For further information on Eimac tubes that can take it, consult our Application Engineering Department.

EITEL-McCULLOUGH, INC.
SAN BRUNO, CALIFORNIA

Eimac First with Ceramic Tubes that can take it



EIMAC CERAMIC 4X250B OPERATES AT FULL RATINGS THROUGH 500MC MAXIMUM RATINGS

	FM	AM	SSB		FM	AM	SSB
D-C Plate Voltage	2000	1500	2000	Screen Dissipation, watts	12	8	12
D-C Screen Voltage	300	300	400	Grid Dissipation, watts	2	2	2
D-C Grid Voltage	-250	-250	—	Plate Dissipation, watts	250	165	250
D-C Plate Current, ma	250	200	250				

PANELSCOPE

by

Waterman

**AUTOMATIC
OR MULTI-PURPOSE
PORTRAYAL**

SEE US AT N.E.C.
BOOTH No. 70



ANOTHER EXAMPLE OF **Waterman** PIONEERING...

The Waterman **PANELSCOPE** is a new concept in miniaturized built-in cathode ray tube oscilloscope gaining wide use as an integral part of electronic equipment. A unique design has permitted its use in commercial products, factory test stands, field trouble shooting kits, system monitors and many other applications.

The **PANELSCOPE** compactness (5¼" x 5-3/16" and 10" depth at 5 lbs.) is coupled with the following features:

- **SIMPLICITY OF OPERATION** — Can be supplied so that a twist of a single rotary switch provides a synchronized pattern of desired incoming signal (up to 9 circuits) against proper linear time base. This is ideal for monitoring and trouble shooting, as it removes the need of fiddling with knobs as is done now on general purpose oscilloscopes. The static controls, such as beam, focus, positioning, and graticule brightness, are located in tube escutcheon.
- **AVAILABLE CIRCUITS** — A wide variety of — signal amplifiers with response from dc to megacycles and sensitivities from 5 millivolts — synchronized or triggered linear time base generators from ½-cycle (and lower if need be) to 2 microseconds — can be specified by you to fit your needs for any particular equipment.
- **FLEXIBLE DESIGN** — The basic **PANELSCOPE** consists of the cathode ray tube and high voltage supply packaged in the standard case without the panel mounted controls. The **PANELSCOPE** can also be supplied fully wired and tested with chosen signal amplifier, linear time base generator and attendant sync. amplifier.
- **POWER REQUIREMENT** — Less than 10 watts of line power for built-in high voltage supply — The required B+ and heater current is determined by your requirements. For those cases where B+ and heater power is not available, auxiliary **PANELPACK** can be supplied.

There is a place in your equipment for Waterman **PANELSCOPE**, a custom built oscilloscope at production prices, although your needs may be for but one or many. A Waterman representative will help you fit a **Panelscope** to your requirements.

WATERMAN PRODUCTS CO., INC.

PHILADELPHIA 25, PA.
CABLE ADDRESS: POKETSCOPE

MANUFACTURERS OF

POKETSCOPE*

PULSESCOPE*

RAKSCOPE*

RAYONIC* Cathode Ray Tubes
and Other Associated Equipment

*T.M. REG.

MEMO...
Write for details today!

WATERMAN PRODUCTS

expansion. Time constants of 0.1 sec to 30 sec are available on a single rotary selector switch. Zero drift is 0.1 percent per day after initial warmup period. The unit is available with high and low level relay trips for process or nuclear control applications. Circle 416 on Reader Service Card.

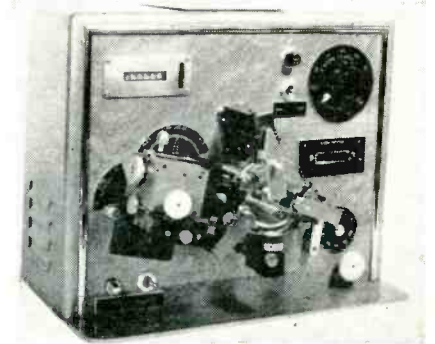

TOROIDAL WINDER

for wire sizes 26 through 40

ELECTRO DEVICES, INC., 580 Main St., Wilmington, Mass. Model D Midjet toroid coil winder has been specifically designed and developed to wind miniature and sub-miniature toroids.

This semiautomatic machine will wind 300 turns of No. 29 H.F. wire on a cherrio core producing a finished o.d. of 0.622 and i.d. of 0.125. This is accomplished on the company's principle of drawing the wire from the inside of a patented shuttle, which allows winding coils that have an inside diameter of as small as ⅜ in. Wire sizes from No. 26 through No. 40 may be used finishing off to a maximum o.d. of 1.125 and i.d. of 0.093.

Model D is a complete unit, automatic, fast, compact and easily carried for relocation. Circle 417 on Reader Service Card.

RECTANGULAR-WAVE GENERATOR

weighs only 3 lb and 2 oz

ELCOR INC., P. O. Box 354, McLean, Va. Model RWG-8A rectangular-wave generator is the first of a line of modular instruments with self-contained power supplies for operation directly from 117 v 60 cps a-c. Featuring output rise and fall

**When tapes
must hold at
high heat...**

you need
REG. U. S. PAT. OFF.
SCOTCH
Brand!

"SCOTCH" Brand Electrical Tapes with Thermosetting Adhesives do everything ordinary pressure-sensitive tapes do... with these important extras:

Increased initial adhesion—up to 80% more quick-stick on contact... gives you faster, neater application and more holding power.

Improved thermosetting properties—during cure at 250° to 300° F., a positive chemical change takes place which increases the bond strength of the Thermosetting Adhesive. After cure, this tape holds tight at any temperature.

Longer shelf life—you can stock in quantity to handle all your needs... know your

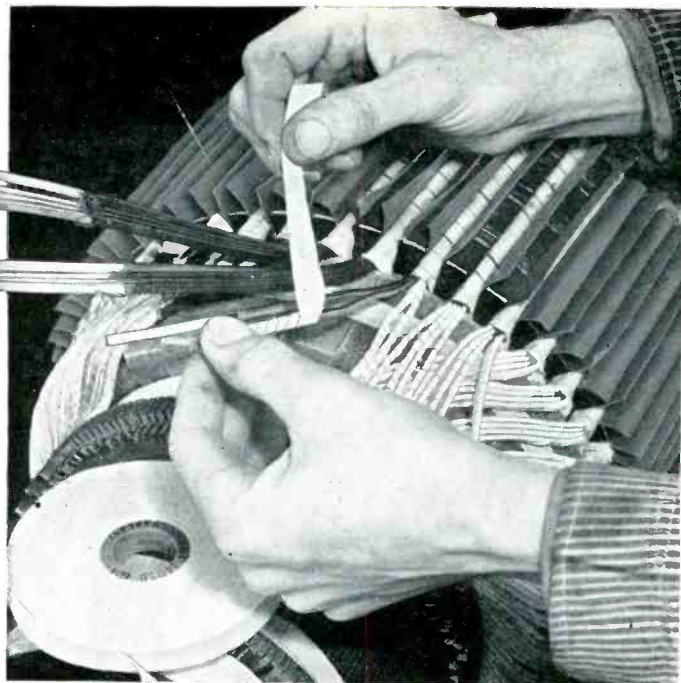

tape will be fresh and tacky when you need it.

Once cured, Thermosetting Tape holds under extreme operating heat without softening, preventing throw-out... has high bond strength for anchoring leads... resists solvent action of waxes and varnishes. The *only* electrical tapes combining *all* of these advantages are "SCOTCH" Brand Electrical Tapes with Thermosetting Adhesives.

Send for free booklet: *illustrates applications, describes properties of "SCOTCH" Brand Thermosetting Electrical Tapes. Just write on your letterhead to 3M Co., St. Paul 6, Minnesota, Dept. CA-107.*

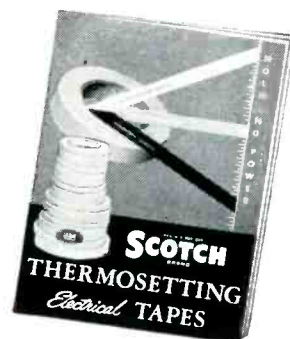

The first true thermosetting adhesive... still the industry standard...

REG. U. S. PAT. OFF.
SCOTCH Electrical Products
BRAND

The term "SCOTCH" is a registered trademark of Minnesota Mining and Mfg. Co., St. Paul 6, Minn. Export Sales Office: 99 Park Ave., New York 16, N. Y. In Canada: P. O. Box 757, London, Ontario.



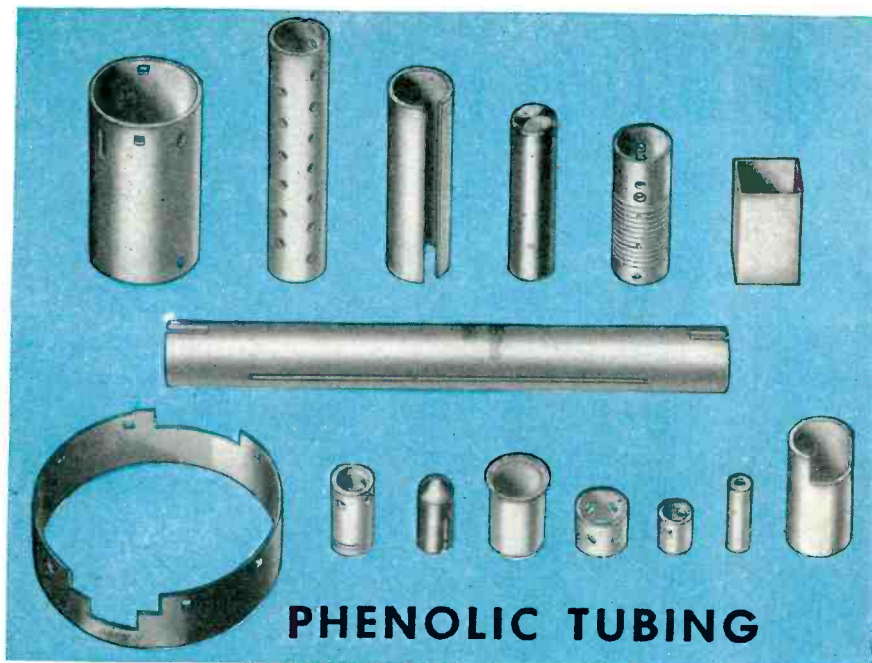

PHENOLIC TUBING

CLEVELITE*

IS YOUR BEST BUY BECAUSE

It is made of the highest quality acid-free kraft paper and the finest electrical-grade resins obtainable.

The processing cycles allow ample time for proper curing, ensuring uniformity and good machinability.

It is available in the diameters, wall thicknesses and lengths you may require.

It is subjected to a thorough and rigid inspection.

This know-how and careful workmanship are the result of many years' experience.

You can depend upon prompt, reliable service at all times.

CLEVELITE HAS THE COMBINED QUALITIES TO MAKE YOUR PRODUCT BETTER . . . AT LOWER COSTS!

Write for copy of our latest Clevelite brochure.

Why pay more? For quality products . . . call CLEVELAND!

*Reg U.S. Pat. Off.

THE CLEVELAND CONTAINER COMPANY

6201 BARBERTON AVE. CLEVELAND 2, OHIO

PLANTS AND SALES OFFICES:

CHICAGO • DETROIT • MEMPHIS • PLYMOUTH, WIS. • OGDENSBURG, N.Y. • JAMESBURG, N.J. • LOS ANGELES

ABRASIVE DIVISION of CLEVELAND, OHIO

Cleveland Container Canada, Ltd., Prescott and Toronto, Ont.

Representatives:

NEW YORK AREA: R. T. MURRAY, 604 CENTRAL AVE., EAST ORANGE, N. J.
 NEW ENGLAND: R. S. PETTIGREW & CO., 62 LA SALLE RD., WEST HARTFORD, CONN.
 CHICAGO AREA: PLASTIC TUBING SALES, 5215 N. RAVENSWOOD AVE., CHICAGO
 WEST COAST: IRV. M. COCHRANE CO., 408 S. ALVARADO ST., LOS ANGELES

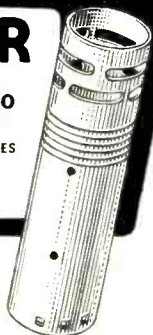

times of 0.25 μ sec, this instrument converts a sine wave or any other periodic waveform into a rectangular wave of the same frequency. Alternatively upon the flick of a front-panel switch, a rectangular wave at the power-line frequency is generated. Two model A105-15A Isoplys are employed in a unique direct-coupled discriminator circuit that provides an 8-v zero-based negative-going output signal at low impedance.

Optional features include an amplitude control and variable output bias. Case dimensions are 1 $\frac{3}{4}$ in. by 8 $\frac{1}{2}$ in., with a 1 $\frac{1}{2}$ in. by 9 $\frac{1}{2}$ in. front panel for mounting in a standard half-width relay rack. Other modular units with the same size and general appearance as the unit shown include a wide-band decade d-c amplifier, flip-flop, binary scaler, gated oscillator and pulse generator. The self-contained power supply feature provides a maximum of convenience and a minimum of interaction when various modular units are interconnected, to make a complete system. The complete instrument weighs only 3 lb and 2 oz. **Circle 418 on Reader Service Card.**



SILICON TRANSISTOR

features high power rating

GENERAL ELECTRIC Co., Syracuse, N. Y., has announced a new 85-



If you want to draft a more
successful **engineering** career...

**MANY DOUGLAS ASSIGNMENTS LET YOU
FOLLOW THROUGH FROM DESIGN TO DELIVERY**

Frequently, it's important that you have the chance to apply theories you've helped to develop. Douglas is anxious that engineers expand their knowledge of a problem in practical ways. This is accomplished by keeping your assignments varied... by often letting you follow the job through to completion. There are many exceptional opportunities to start your career at Douglas, including...

**CAREER OPPORTUNITIES FOR STATIC AND
DYNAMIC TEST ENGINEERS!**

Aeronautical and Mechanical Engineers conduct ground, wind tunnel and flight tests to insure the design integrity of the aircraft.

For important career opportunities
in your field, write:

C. C. LaVENE
DOUGLAS AIRCRAFT COMPANY
BOX F-620
SANTA MONICA, CALIFORNIA

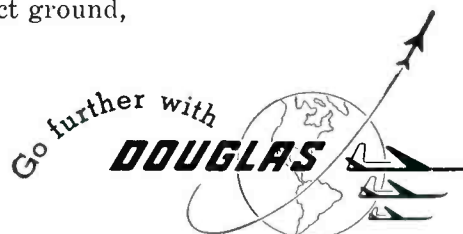

FIRST IN AVIATION

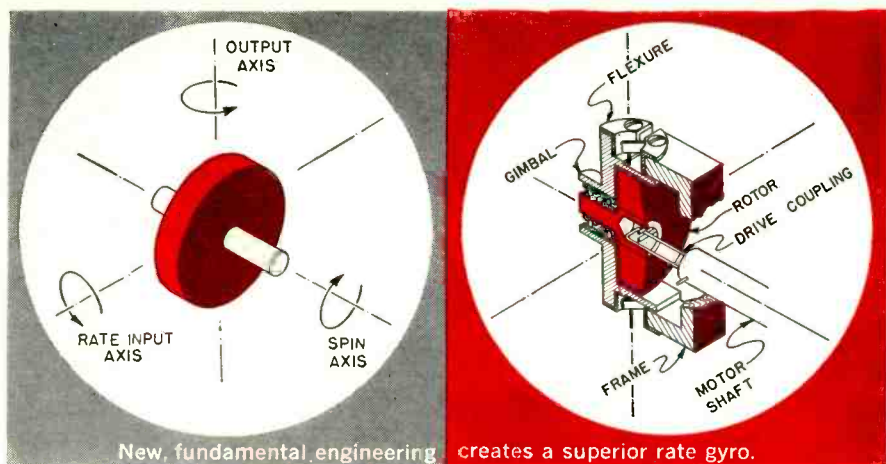

New, fundamental engineering creates a superior rate gyro.

New 'SW' Rate Gyro

*Simplicity
delivers
superior
performance*

Fundamental engineering and precision manufacturing team up to enable new Humphrey SW Rate Gyros to deliver superior performance. More rugged ... more dependable ... greater precision for the most demanding applications in advanced missile and aircraft systems.

Simplicity of design eliminates unnecessary parts. Heart of the SW Rate Gyro is the solid rotor inertial element mounted on precision radial thrust bearings in the exclusive bridge-like gimbal. Two unitized steel flexures give pivot and spring-restraint functions attaching gimbal to frame.

Using compatible materials and high-G centrifuge balancing adds to superior performance qualities. No deterioration of the SW's performance even under the most severe environmental conditions. Operates in temperatures from -65°F to $\pm 185^{\circ}\text{F}$; vibration at 10G from 20 to 2,000 cps; and shock to 100G.

Four basic sizes provide choice of drive motors and pick-offs to avoid any compromise in your system design.

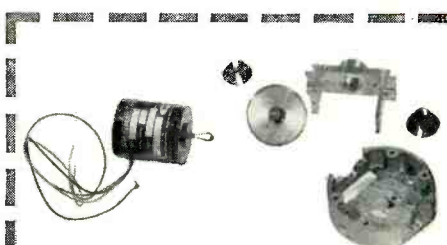

Minimum number precision parts: solid rotor; exclusive coupling, flexures.



Simple sub-assembly: one compact unit; motor separate from sensing element.

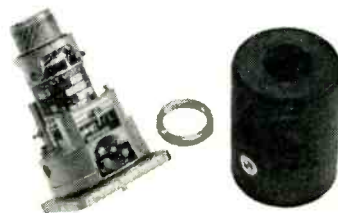

Floating-piston constant-action dry-air damper; effective pressure-sealed case.

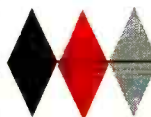

Humphrey Inc.

ELECTRO-MECHANICAL INSTRUMENTS

Dept. E-10

2805 CARON ST. • SAN DIEGO 6, CALIF.
Send full information.

NAME _____
COMPANY _____
ADDRESS _____
CITY _____ STATE _____

FOR COMPLETE SYSTEMS, SPECIFY HUMPHREY GYROSCOPES, ACCELEROMETERS, POTENTIOMETERS

watt silicon power transistor. JETEC type-designated 2N451, the new 65-volt transistor is expected to find application in d-c to d-c or d-c to a-c converters; servo amplifiers in autopilots and engine controls and for driving amplidyne fields; power supplies as series regulators, and replacement of mechanical contactors and switches.

Capable of dissipating 85 w at 25 C mounting base temperature, the new 2N451 has a nominal collector saturation resistance of two ohms.

Beta for the new silicon power transistor is specified as a minimum of 10, while beta cutoff is 400 kc. Input impedance at a collector current of 1 ampere is 25 ohms with a mounting base temperature of 25 C. Maximum collector current rating is 5 amperes.

The 2N451 is hermetically sealed in an all-welded case designed for mounting on an external heat sink by means of a single-threaded stud. It is designed to meet the requirements of MIL-T-19500A. Circle 419 on Reader Service Card.

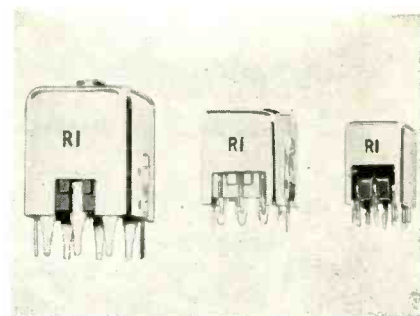

I-F TRANSFORMERS in three frequencies

RADIO INDUSTRIES, INC., 5225 N. Ravenswood Ave., Chicago 40, Ill. New intermediate frequency transformers in three sizes— $\frac{1}{2}$ in., $\frac{1}{4}$ in. and $\frac{3}{8}$ in.—are manufactured for transistorized circuits. The $\frac{3}{8}$ in. is the latest development resulting from several years of work with semiconductive components in perfecting miniaturized i-f and oscillator applications.

All three sizes are engineered and mass-produced to meet any specific requirements of unloaded "Q", ranging from 40 to 200 for

Never before... Duplexing and Break-In Without Relays
NEW! Northern Radio
DUPLEX TELEGRAPH SYSTEM

For Multi-Channel Tone Equipment

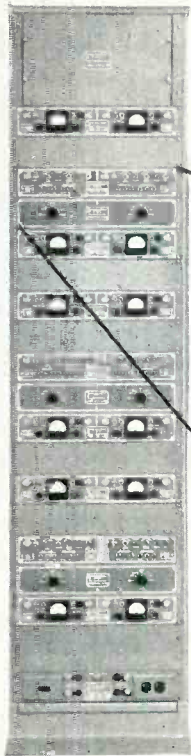

Dual Duplex Selector Panel,
Type 200 Model 1

Dual Loop Switch Panel, Type 200A Model 1

*The use of this unit with the Dual Duplex Selector Panel is optional. The Dual Switch Panel is particularly recommended when rapid switching of various duplex modes of operation is required.

NEW!

Simple 4 position switch selects from 12 possible duplex combinations.

NEW!

Duplex operation between stations connected via carrier telegraph channels.

NEW!

All-electronic, without relays or moving parts to wear.

NEW!

Polar or neutral for either half duplex or full duplex.

NEW!

Break-in now also possible for all half-duplex circuits.

NEW!

Provided with positive feature to prevent space signal lock-out.

NEW!

Includes individual line battery for each channel.

The Northern Radio Duplex Telegraph System consists of one each Dual Frequency Shift Tone Keyer, Type 153 Model 3; Dual Duplex Selector Panel, Type 200 Model 1; Dual Loop Switch Panel, Type 200A Model 1; and Dual Frequency Shift Tone Converter, Type 152 Model 3. The Frequency Shift Tone Keyer and Converter are our latest improved Model 3's, specifically designed for use with this system.

The Dual Duplex Selector Panel and Dual Loop Switch Panel make possible complete duplexing and break-in operation of a Northern Radio or similar multi-channel Frequency Shift tone telegraph system. Such a system meets the requirements of any standard telegraph line or terminal apparatus for either full duplex or half-duplex operation. Because this system is all-electronic, it meets all speed requirements and yet has the flexibility and isolation heretofore possible only with relays.

The Dual Loop Switch Panel rapidly selects half-duplex and/or full duplex mode of operation for any of the 4 standard loop options by front panel switching available from the 12 loop options in the Dual Duplex Selector Panel.

The Dual Duplex Selector Panel provides 12 loop options, patching facilities for monitoring purposes and channel routing, including the possibility of patching-in another teleprinter loop circuit (T-junction). Any of the 12 loop options are available and may be selected for the Dual Loop Switch Panel by simple strapping arrangement. It has an individual line battery for each channel for greatest circuit flexibility. Battery and line fuses are also provided for maximum protection.

The Dual Duplex Selector Panel is provided with positive non-lockout features. An accidental "spacing" of the line, even over prolonged periods of time, such as caused by patching errors, will not lock the system into a permanent space (no loop current) condition. The system will instantly be ready to operate as soon as the fault is removed. This is due to a novel arrangement of the internal batteries which at all times can provide power to the telegraph loops.



Pace-Setters in Quality Communication Equipment

NORTHERN RADIO COMPANY, inc.

147 WEST 22nd ST., NEW YORK 11, NEW YORK

In Canada: Northern Radio Mfg. Co., Ltd., 1950 Bank St., Billings Bridge, Ottawa, Ontario



NEW SERVO AMPLIFIERS DEVELOPED AT DAYSTROM INSTRUMENT

Typical items developed by Daystrom Instrument in conjunction with its systems work are these miniature servo components. Additionally, Daystrom offers custom designed units and servo sub-systems for data processing, automation systems, fire control systems, simulators and other applications.

3 WATT,

all transistorized designed to operate 400 cycle motors with 35 volt center tapped control windings. Overall Dimensions—1.30 inches x 1.30 inches square; Length 5.50 inches... Weight 6.5 ounces, Input Impedance 10K ohms, Gain 350, Power Supply 28 VDC. Amplifier package is plug-in type using a Winchester Type SMRE7P-G plug.

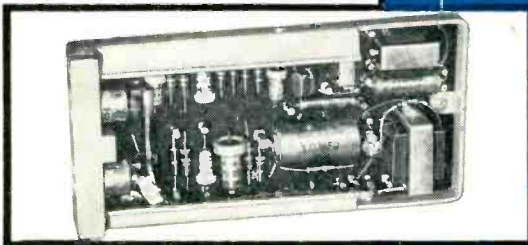
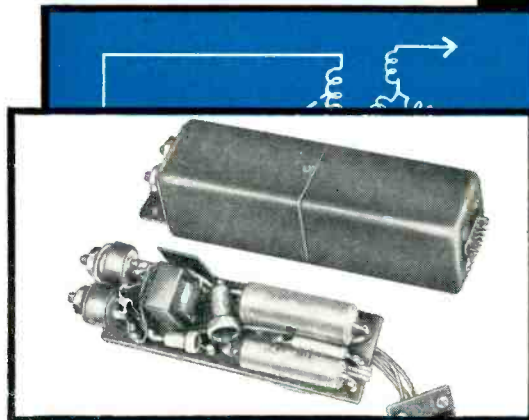

4 WATT,

all transistorized designed to operate 400 cycle servo motors with 26 volt control windings. Width—1.06 inches; Height 2.68 inches; Length—5.43 inches... Weight 7.1 ounces, Input Impedance 20K ohms, Gain 1000, Power Supply 28 VDC.

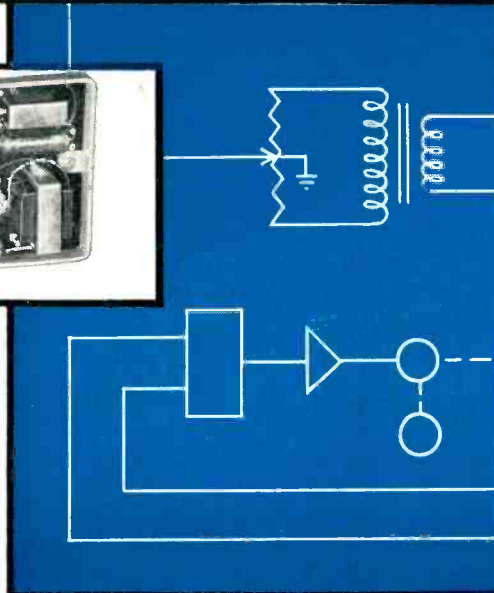

Our servo engineers are ready to help you. Let us have your requirements.

DAYSTROM INSTRUMENT

Division of Daystrom Inc.
Archbald, Pennsylvania



the $\frac{1}{4}$ in. and $\frac{1}{2}$ in. and as high as 140 for the new, smaller $\frac{3}{8}$ in. Built-in shunt capacitors provide capacities ranging from 65 to 470. Circle 420 on Reader Service Card.

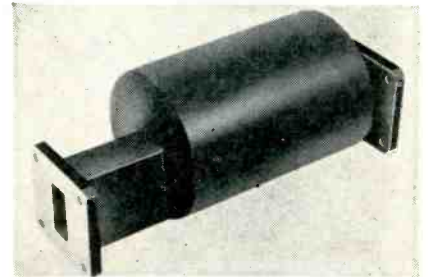

AIRTRON, INC., 1101 W. Elizabeth Ave., Linden, N. J. Now available are a series of test equipment ferrite isolators, designed to meet the high performance characteristics required for test equipment applications.

Several broad frequency ranges are covered by WR-90, WR-112, WR-137 and WR-187 waveguide sizes and may be obtained with a variety of flange combinations. Other sizes are presently being developed for use as test equipment and should be available shortly.

The WR-90 ferrite isolator, for example, covers the entire frequency range of 8,200 to 12,400 mc with an isolation of 30 db minimum and a maximum insertion loss of 1.0 db. The input vswr is 1.15 maximum with a matched load and the power handling capacity of 10 w average and 25 kw peak with a 2-1 load mismatch. Circle 421 on Reader Service Card.

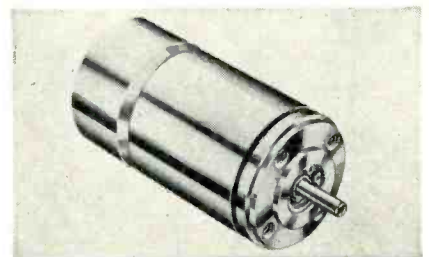

SERVOMOTOR
is velocity-damped

BECKMAN/HELIPOT CORP., Newport Beach, Calif., announces produc-

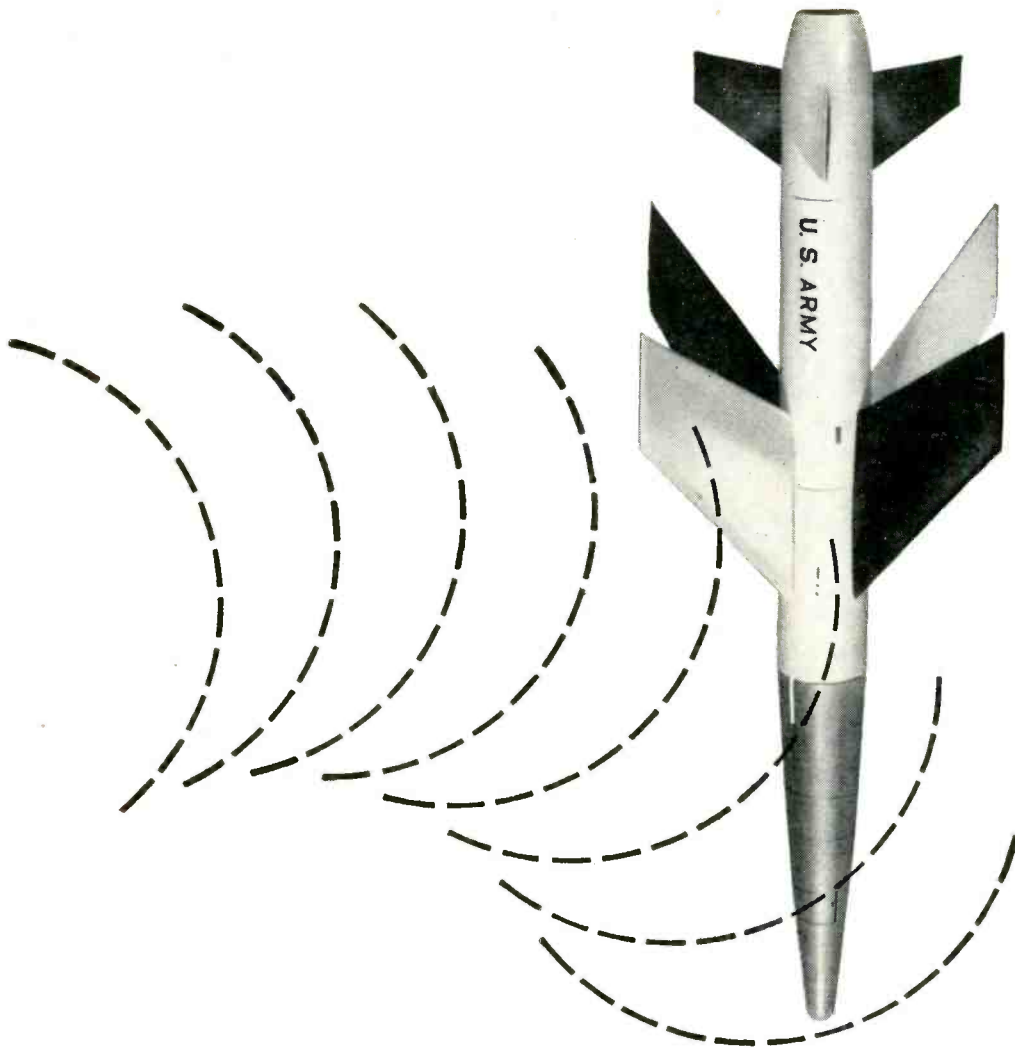

NEW WEAPON, NEW CONCEPT

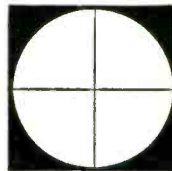

An important new weapon for a new U. S. Army concept is now being delivered in quantity by Martin-Orlando. This is LACROSSE, a field artillery guided missile, developed to implement the combat concept of the Pentomic Army... a "fighting" Army consisting of self-sufficient highly mobile battle groups. LACROSSE will provide these battle groups with the shockpower of extraordinary speed, mobility and accuracy in heavy armament support of their operations. LACROSSE is the first generation of an entirely new kind of general purpose weapon. All of its components, consisting of the missile mounted on a standard Army truck and a guidance system, can be airlifted to advance areas. The missile is fired in the general direction of the target—without target data at the launching site. Its pinpoint accuracy is controlled by a forward observer. The Martin Company, with more than 10 years of design, production and operational experience in guided missiles, today stands as a leader in this important field.

MARTIN
BALTIMORE DENVER ORLANDO

FIGHT VIBRATION WITH VIBRATION

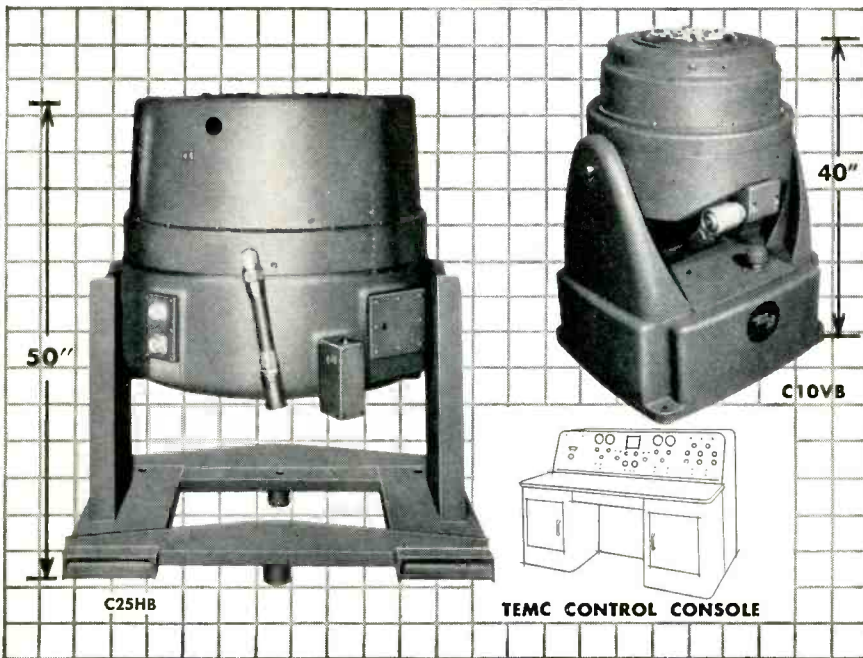

Vibration Testing cuts product development time

Testing components and structures with electrodynamic vibration exciter systems cuts research and development time in aircraft and missile systems. Often within hours, or minutes, the effect of service vibration can be pinpointed.

MB has perfected shaker systems that permit testing to all required specifications, enable engineers to speed product development from blueprint to prototype to production.

COMPLEX MOTION TESTING

Several MB Exciter Systems reproduce complex and random motions. They can subject products to the actual service vibration. The Model C10VB Shaker shown offers the widest frequency range for its force. Model C25HB provides higher forces for higher "g."

ENVIRONMENTAL TESTING

Both the above shaker systems can be used with environmental chambers . . . for "high altitude" and high or low temperature vibration testing. Oil cooled, they don't affect chamber vacuum.

SPECIFICATIONS

MB C10VB System provides . . .
 10 "g" on table loads to 145 lbs.
 20 "g" on table loads to 57.5 lbs.

Force output:	Band width:
1750 lbs. Sine	5-5000 cps
1050 lbs. RMS	15-2000 cps
3150 lbs. Peak	15-2000 cps

MB C25HB System provides . . .
 10 "g" on table loads to 422 lbs.
 20 "g" on table loads to 172 lbs.

Force output:	Band width:
5000 lbs. Sine	5-2000 cps
3500 lbs. RMS	15-2000 cps
10,500 lbs. Peak	15-2000 cps

In meeting your requirements, MB offers you advanced designs . . . plus quality construction of shaker, amplifier and control system . . . plus an experienced field service organization.

tion of the model 11VM460 velocity-damped servomotor. This size 11 unit provides electromagnetic viscous-damping, readily adjustable from 5 to 90 dyne-cm-sec per radian.

High acceleration at stall provides fast, precise response to error signals at unit operating temperatures up to 200 C with no degradation of performance. Temperature range is -55 to +160 C ambient.

Fixed windings operate from a 115-v, 400-cycle source, and can be wound for any standard carrier voltage supply. Control windings are wound for transistorized amplifier input, and may be custom wound for other inputs as required. Power requirements are 1.75 w per phase.

Weighing 6 oz, the servo-mount unit is 2.033 in. in length and 1.062 in. in diameter. Leads are color-coded, Teflon-insulated wire. Circle 422 on Reader Service Card.



SERVO AMPLIFIER

miniature, transistorized KEARFOTT Co., INC., 1378 Main Ave., Clifton, N. J. Designed for maximum flexibility in system design, the type T3103 miniature transistorized servo amplifier is capable of delivering a maximum power of 6 w. The unit is highly shock and vibration resistant, features which make it particularly suitable for missile and high-speed aircraft applications. A plug-in type component, the amplifier is completely potted in a special Kearfott-developed compound having high strength, high stability and lightweight characteristics. Captive screws, available in varying lengths to suit

MB manufacturing company

A DIVISION OF TEXTRON INC.

1075 State Street, New Haven 11, Connecticut

HEADQUARTERS FOR PRODUCTS TO ISOLATE . . . EXCITE . . . AND MEASURE VIBRATION



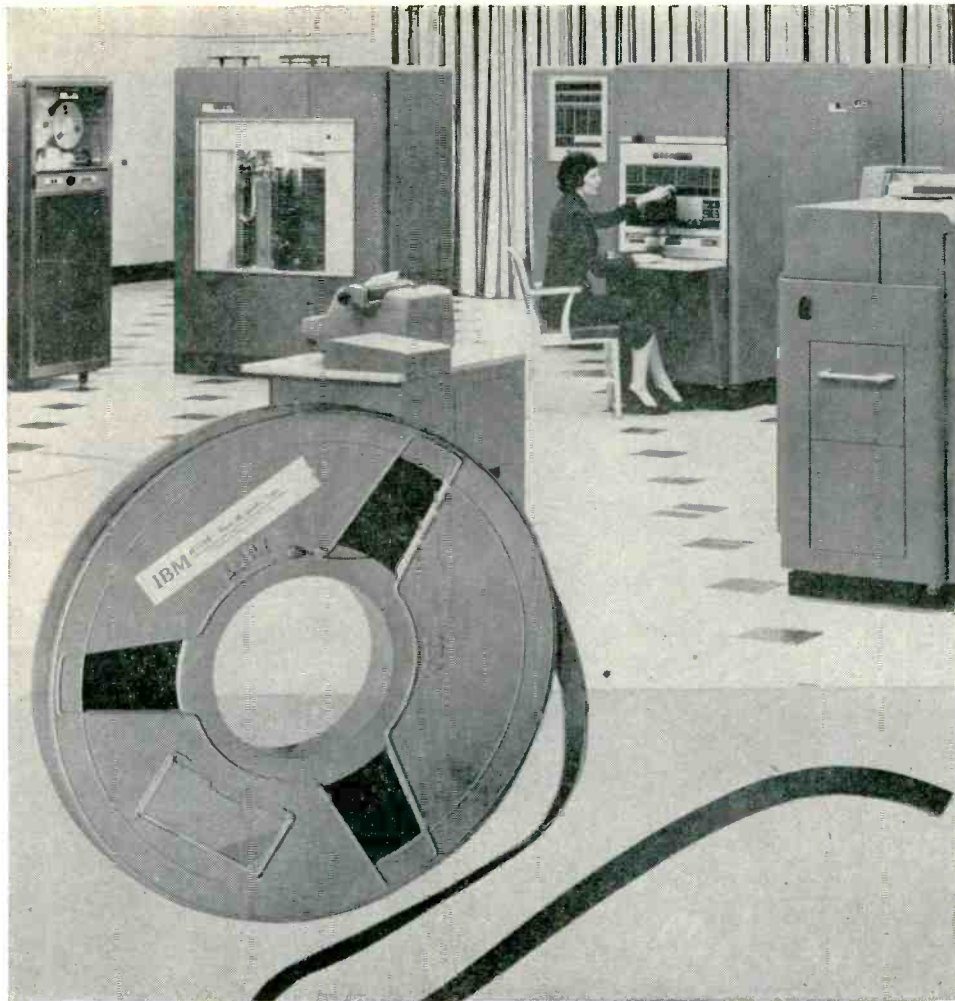

"MYLAR" offers a unique combination of properties valuable for electrical design

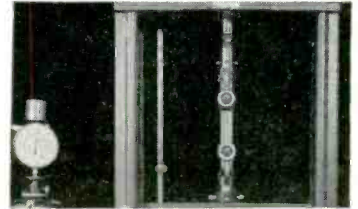

HIGH TENSILE STRENGTH. "Mylar" is the strongest plastic film. Instron tester shows an average strength of 20,000 lbs. psi.



HIGH DIELECTRIC STRENGTH. Average of 4,000 volts per mil . . . average power factor of 0.003 at 60 cycles . . . dielectric constant above 3.0 at 72°F., 1,000 cycles.

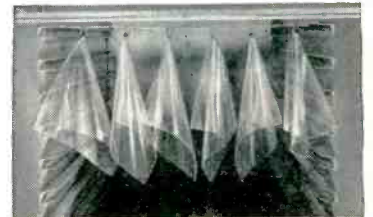

THERMAL STABILITY. Tests prove "Mylar" has an effective operating range, -80°F. to 300°F. . . won't brittle with age.

Here's why IBM introduced magnetic tape made with MYLAR for its data processing equipment

PROBLEM: International Business Machines Corporation wanted to increase the humidity and temperature range of magnetic tape used in its data-processing equipment. IBM was looking for a magnetic tape that maintained a relatively stable dimension through a wider range of atmospheric conditions.

SOLUTION: After conducting field tests over a period of 14 months, in conjunction with its own environmental test program on data-processing machines, IBM introduced magnetic tape using Du Pont "Mylar"* polyester film as the base.

RESULTS: Magnetic tape made with "Mylar", reports IBM, has good dimensional stability. This stability reduces the need for critically controlling temperature and humidity

in recording or storage areas.

HOW CAN "MYLAR" HELP YOU? No matter what product you make, it will pay you to investigate the unique opportunities offered by "Mylar" . . . opportunities to speed up production, improve performance or cut costs. For dramatic proof through successful applications of "Mylar", send today for a copy of our new booklet.



BETTER THINGS FOR BETTER LIVING
... THROUGH CHEMISTRY



*"MYLAR" is Du Pont's registered trademark for its brand of polyester film.

E. I. du Pont de Nemours & Co. (Inc.)
Film Dept., Room E-9, Wilmington 98, Del.

Please send your booklet outlining advantages of magnetic recording tape made with "Mylar".

Please send your booklet listing properties, applications and types of "Mylar" available. (MB-11)

Application _____
Name _____ Title _____
Company _____
Address _____
City _____ State _____



ANNOUNCING



A MINIATURIZATION MIRACLE *by Tensolite*

Here, literally is the world's smallest 300 Volt, High Temperature, stranded hook-up wire! So tiny it can be threaded through the eye of a needle! Expressly designed to give you top performance where SPACE LIMITATION is an important factor! TEFLON® insulated and stranded for super flexibility . . . REDUCE space requirements . . . REDUCE assembly time . . . REDUCE rejects!

TENSOLITE is proud to announce this giant step forward in the endless search for greater miniaturization. Our Factory and Field Engineers will assist you with unusual or specific applications where miniaturization is a must. Write today for complete descriptive literature and samples.

**BOOTH #108
CHICAGO N.E.C.**

HERE ARE SOME OUTSTANDING FEATURES AND CHARACTERISTICS

VOLTAGE RATING: 300 Volts	O. D. CONDUCTOR: .006
TEMPERATURE RANGE: -90°C to +250°C	INSULATION: Teflon
AWG SIZE: #36	WALL THICKNESS: .0045"
STRANDING: 7/44 (4% SPC)	SPARK TEST: 1000 Volts RMS
O. D. FINISHED WIRE: .015	



© DUPONT

Tensolite

INSULATED WIRE COMPANY, INC.
198 MAIN STREET, TARRYTOWN, N. Y.
PACIFIC DIV.: 1516 N. GARDNER ST., LOS ANGELES, CALIF.



particular specifications, provide a mounting means of maximum ease.

Gain of the amplifier may be easily established at various values between 100 and 1,000 merely by inserting one external resistor to achieve the gain desired.

Should it be necessary to interchange one unit for another, gain tolerance between interchanged units will not exceed ± 10 percent. This unit measures $1\frac{3}{8}$ in. wide by $1\frac{3}{8}$ in. deep by $1\frac{3}{4}$ in. high. **Circle 423 on Reader Service Card.**

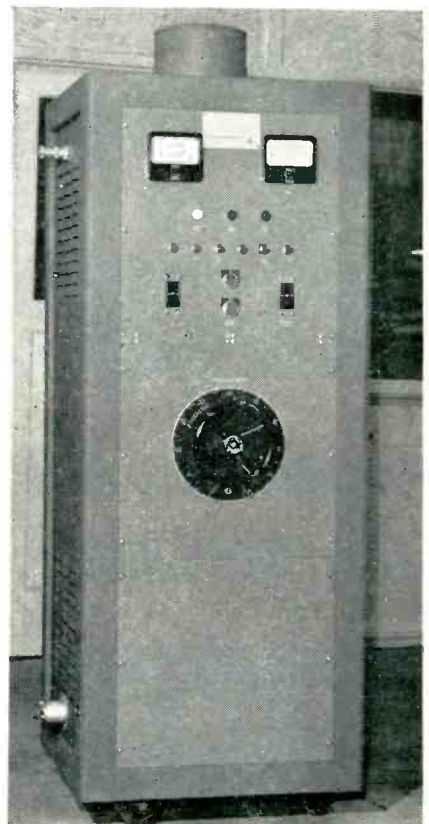

D-C POWER SUPPLY

0 to 10 kv at 0 to 1 ampere

LEVINTHAL ELECTRONICS PRODUCTS, INC., 760 Stanford Industrial Park, Palo Alto, Calif. Model PC-58 power supply produces 0 to 10 kv at 0 to 1 ampere d-c with 1-percent rms ripple. Either positive or negative polarity can be obtained with the opposite side grounded. It utilizes a three-phase full-wave bridge circuit with metering for both voltage and current. The unit is completely monitored and protected and cap-

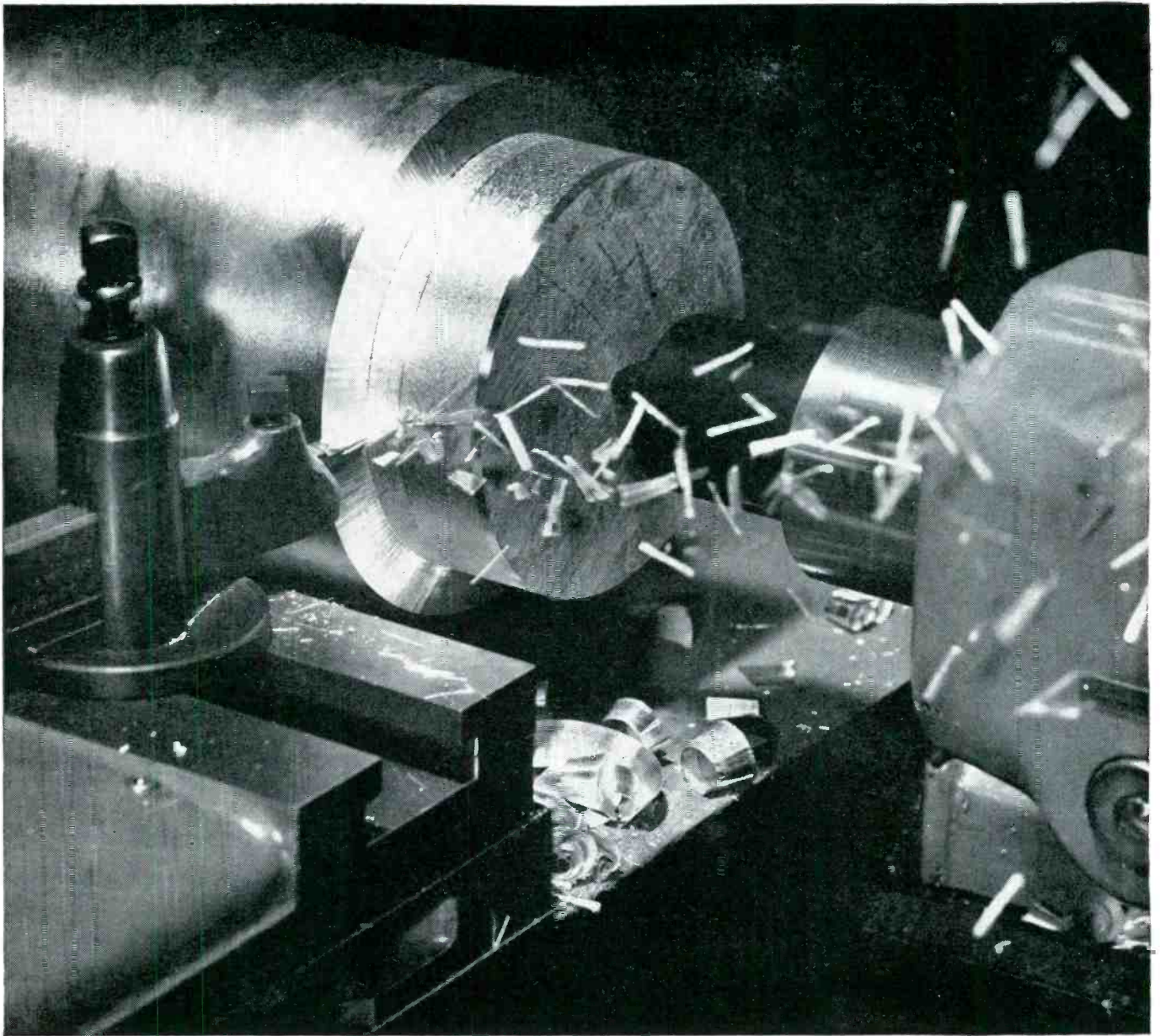

Speed! Of all structural metals, Magnesium costs less to machine

In the picture above, a lathe is making a roughing cut of 0.800" in an eight inch magnesium billet. The feed is 0.030 inches per revolution at a speed of 630 feet per minute. In finishing operations, cuts of 0.500" can be made with a feed of 0.003 ipr and a speed of 5,000 fpm.

That's real speed and efficiency—the kind you can always expect when you machine magnesium. This remarkable metal can be milled, drilled, sawed, reamed, bored, planed, tapped and threaded faster than any other structural metal!

Faster machining means easier machining and lower cost machining. It means more production per hour and per dollar, and longer tool life.

The following table shows how well magnesium compares to the others:

METAL	RELATIVE MACHINABILITY
magnesium	1.0
cast aluminum	1.8
brass	2.3
cast iron	3.5
rolled aluminum	5.0
mild steel	6.5

Let us give you more information about the machinability of magnesium. Contact the nearest Dow sales office or write to THE DOW CHEMICAL COMPANY, Magnesium Department, Midland, Michigan, Dept. MA 1404M.

YOU CAN DEPEND ON

DOW

PRICE - Competitive...
 QUALITY - Unexcelled...
 DELIVERY - Timely...
 PERFORMANCE -
 Faultless!

FOUR REASONS WHY YOU SHOULD

SPECIFY

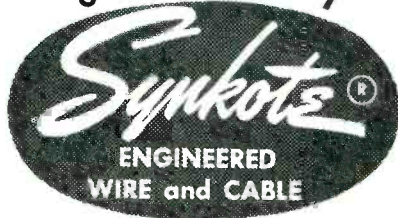

When your responsibility is to procure insulated wire and cable for your product you want the best available at a cost consistent with quality and performance.

The combination of superior components, consistently competitive low costs and engineering skills makes Synkote a symbol of high quality, trouble free wire or cable conforming to your most exacting specifications.



SPECIFY  FOR SURE PERFORMANCE.

PLASTOID
 Corporation

Plant: HAMBURG, N. J.
 Offices: 42-61 24th Street,
 Long Island City 1, New York

able of being interlocked with other equipment.

Equipment requires about 15 kva of power from a 230-v three-phase 60-cps source. Circle 424 on Reader Service Card.



PATENT PENDING

ALL-NYLON FILTERS

withstand rust, corrosion

DANIELSON MFG. Co., Danielson, Conn. New, complete all-nylon filters designed to withstand rust and corrosion in a wide range of applications have been announced. The Danco filters are custom-molded in types, sizes and shapes to meet specific filtering requirements. One-piece nylon moldings with nylon mesh and supporting structural frame injection-welded together in a permanent bond offer greater savings in original cost as well as in production assembly. Circle 425 on Reader Service Card.

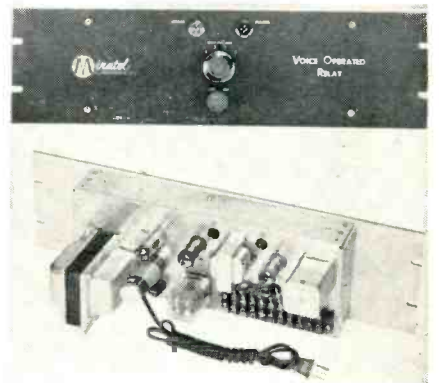

VOICE OPERATED RELAY

has varied applications

MIRATEL INC., 1080 Dionne St., St. Paul, Minn. Among the many uses of this voice-operated relay are the controlling of recorders, trans-

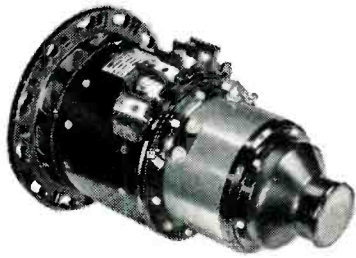

**High-temperature
AC GENERATORS**

**AC Voltage Regulators
(Magnetic Amplifier Type)
and
SYSTEM COMPONENTS**

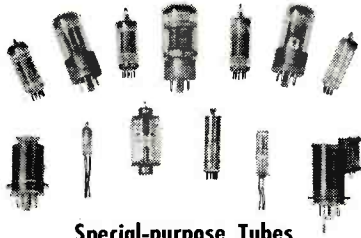
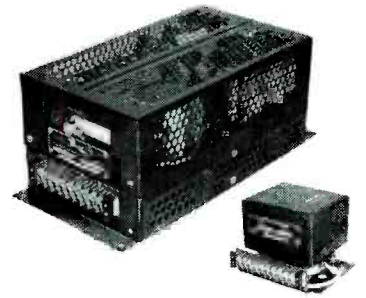

**Special-purpose Tubes
featuring
HARD GLASS TYPES**

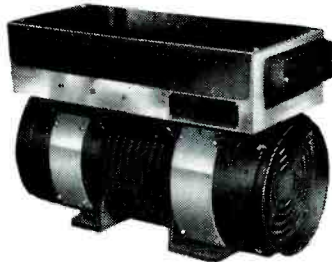

High-altitude and Missile INVERTERS

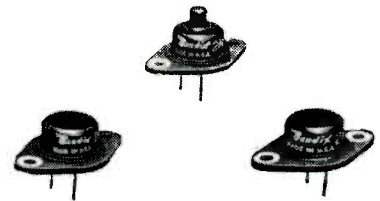

**High Gain
POWER TRANSISTORS**

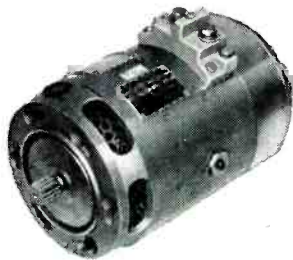

**High-temperature
DC GENERATORS**

**DC VOLTAGE REGULATORS
and
CONTROL PANELS**

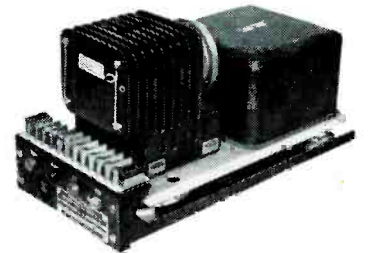

BENDIX RED BANK—UNEXCELLED PERFORMANCE

AROUND THE



AROUND THE



There's no questioning the quality of special-purpose electron tubes, electrical power equipment or high gain power transistors when they're made by Bendix Red Bank. The proof is in acceptance—almost universal acceptance. Twenty-four hours a day, in countries around the world, equipment like that shown above is proving that skillful design and expert engineering (plus an almost unmatched quality control system) can build an international reputa-

tion for dependable performance. If you can use quality like this, call on us for recommendations. Write today for brochure detailing our engineering, production, and service facilities. RED BANK DIVISION, BENDIX AVIATION CORPORATION, EATONTOWN, NEW JERSEY.

West Coast Sales and Service: 117 E. Providencia Ave., Burbank, Calif.
Canadian Affiliate: Aviation Electric, Ltd., P. O. Box 6102, Montreal, P. Q.
Export Sales and Service: Bendix International Division, 205 E. 42nd St.,
New York 17, N. Y.

Red Bank Division



A Radical New Approach!

TO DIFFICULT SWITCHING REQUIREMENTS

CERAMIC VACUUM RELAYS

by *Jennings*

Vacuum Enclosure

Insures Clean Contacts that stay clean at dry circuit levels.

Reduces Contact Arcing and Pitting at high currents.

Stacked Ceramic Construction

Permits Small, Compact Design that insures reliable performance under extremes of vibration, temperature, and shock.

Three Sets of Parallel Contacts

Increase Reliability because three relays in parallel are more reliable than one.

Decrease Bounce Time to less than 100 μ sec.

Increase Make Current to 100 amperes inrush because contacts are not bouncing and arcing.

Increase Contact Life when interrupting currents up to 15 amperes at 28 vdc or 2 crp at 300 vdc.

(Heavy duty contacts will interrupt up to 60 amps at 28 vdc)

This revolutionary new vacuum relay has been fully tested and is available in production quantities.

Send for catalog literature on SPD™ and 4PDT Type RA relay.

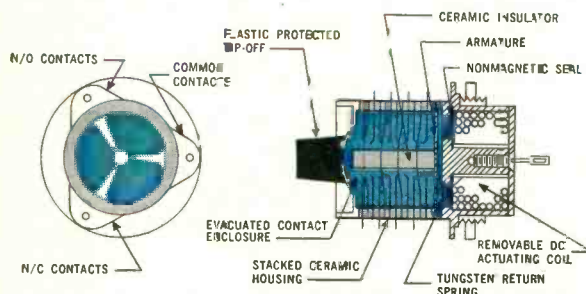

mitters, automatic programming, Conelrad cluster operations, and subcarrier keying.

The relay in two models may be used bridging a 600 ohm line with signal input levels of 0 db at 1 mw reference or 0 db at 6 mw reference and a threshold level of -15 db at either reference. The drop out times are independent of input level and adjustable from 1 to 5 sec. Longer drop out times are available if desired. Critical circuits are voltage regulated and the relay contacts for external control are dpdt rated at 2 amperes 115 v a-c. The unit is standard rack mounting with 5 1/4 in. panel and 5 1/2 in. deep. The relay specifications have been approved by the FCC Engineering department. Circle 426 on Reader Service Card.



HOT SYNCHROS

450 F temperature resistant

CLIFTON PRECISION PRODUCTS Co., Inc., 9014 West Chester Pike, Upper Darby, Pa., announces 450 F temperature resistant size 10 synchros. The transmitter was developed for direct turbo jet engine mounting and has passed tests at 450 F for 100 hours and 350 F for 1,000 hours. High accuracies are maintained.

Available as transmitters, transformers, differentials, and resolvers.

JENNINGS RADIO MANUFACTURING CORPORATION - 970 McLAUGHLIN AVE. P.O. BOX 1278 - SAN JOSE 8, CALIFORNIA



Shown at Bell Laboratories, Murray Hill, N. J., are, left to right, F. J. Herr, S. T. Brewer, L. R. Snoke, E. E. Zajac and F. W. Kinsman.

They're wiring the seas for sound

These five Bell Labs scientists and engineers may never "go down to the sea in ships." Yet, they're part of one of the most exciting sea adventures of modern times. Along with many other specialists, they are developing the deep-sea telephone cable systems of the future.

Here's how they join many phases of communications science and engineering—to bring people who are oceans apart within speaking distance.

F. J. Herr, M.S., Stevens Institute, is concerned with systems design and analysis. He studies the feasibility of new approaches and carries out analysis programs to select optimum parameters for a proposed system design.

S. T. Brewer, M.S. in E.E., Purdue, communications and electronics engineer, explores new designs for sea-bottom amplifiers needed to step up power of hundreds of simultaneous telephone conversations.

L. R. Snoke, B.S. in Forestry, Penn State, is the team biologist. He investigates the resistance of materials to chemical and microbiological attack in sea water. Materials are evaluated both in the laboratory and in the ocean.

E. E. Zajac, Ph.D. in Engineering Mechanics, Stanford, is a mathematician. He studies the kinematics of cable laying and recovery. Cable's dynamic characteristics, ship's motion, the mountains and valleys in the ocean bottom—all must be taken into account.

F. W. Kinsman, Ph.D. in Engineering, Cornell, solves the shipboard problems of storage, handling and "overboarding" of cable. New machinery for laying cable is being developed.

Deep-sea cables once were limited to transmitting telegraph signals. Bell Labs research gave the long underseas cable a voice. New research and development at the Labs will make this voice even more useful.



BELL TELEPHONE LABORATORIES

WORLD CENTER OF COMMUNICATIONS RESEARCH AND DEVELOPMENT

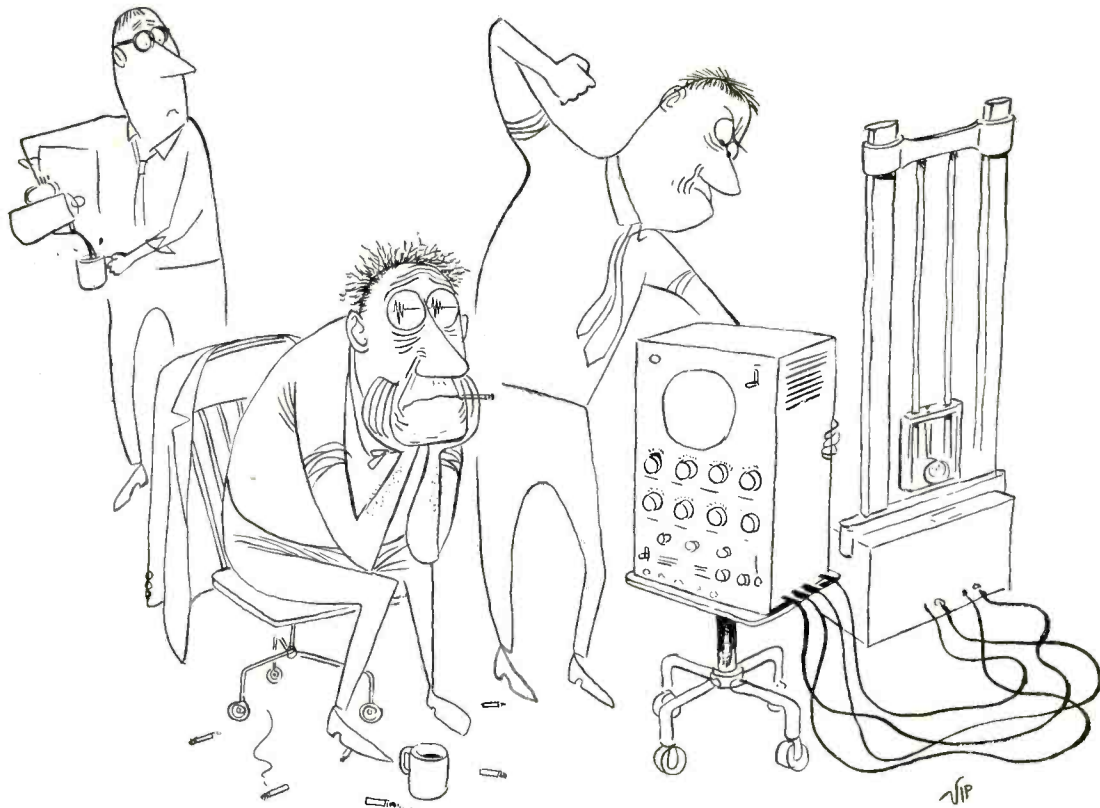

PROBLEM: Transients—Capture and Study

© 1957, Hughes Aircraft Company

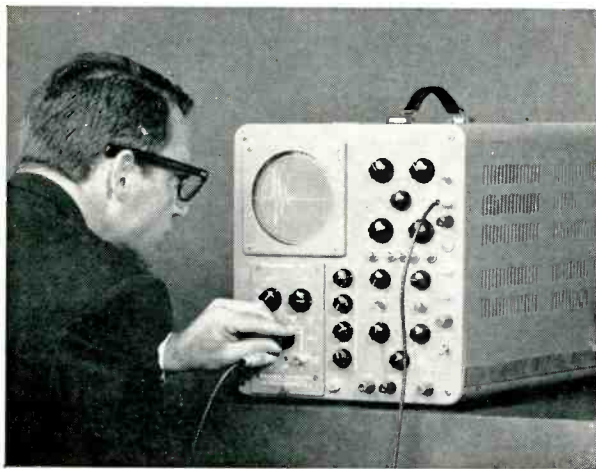

Ask to see the MEMO-SCOPE Oscilloscope in action. A Hughes representative will arrange an on-the-job demonstration—at your convenience. Make your request to:

HUGHES PRODUCTS, MEMO-SCOPE Oscilloscope
International Airport Station, Los Angeles 45, California

If you're engaged in watching transients, the profit-watchers may be watching you. Because transient study on conventional scopes can waste time, effort and research dollars. Inability to "capture" traces need never happen to you.

SOLUTION: The happy answer is the new Hughes MEMO-SCOPE® Storage Type Oscilloscope: A transient recorder with a *memory*, it can capture and retain single or successive writings for an *infinite length of time or until intentionally erased*. Any number of elusive wave forms may be instantly "frozen" in brilliant display for study or photography *at leisure*. The savings to you are self-evident.

HUGHES MEMO-SCOPE OSCILLOSCOPE

STORAGE TUBE

5-inch diameter Memotron® Direct Display Cathode Ray Storage Tube. Writing speed for storage: 125,000 inches per second. The optional Speed Enhancement Feature multiplies writing speed approximately four times.

MAIN VERTICAL DEFLECTION AMPLIFIER

Frequency Response: DC to 700 KC down 3 db at 700 KC.

MAIN HORIZONTAL DEFLECTION AMPLIFIER

Frequency Response: DC to 250 KC down 3 db within that range.

Sensitivity: 0.5 volts to 50 volts per division continuously adjustable.

Input Impedance: 1 megohm shunted by 50 μ f.

Creating a new world with **ELECTRONICS**

HUGHES PRODUCTS

® Trademark Hughes Aircraft Company

ers, these units are stainless steel.

Transmitter characteristics, rotary as primary: 26 v input, 0.145 ampere input, 0.61 w input, 11.8 v output, sensitivity 206 mv per deg, phase shift 8 deg, d-c resistance—22.5 ohms rotor, 9 ohms stator. Complete specifications are available. Circle 427 on Reader Service Card.

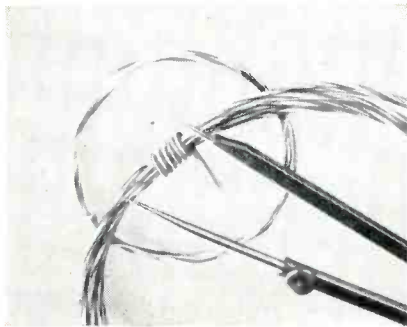

HOOK-UP WIRE for airborne instrumentation

HITEMP WIRES, INC., 1200 Shames Drive, Westbury, Long Island, N. Y., now makes available an entirely new type of miniature, extruded Teflon insulated, hook-up wire, to meet the increased need in the airborne instrumentation field.

This new product is a 300-v wire, and has a wall thickness of extruded insulation of 0.003 in. to 0.006 in. Sizes available are 32 Awg to 22 Awg inclusive. Each of these sizes can be obtained in any of the ten standard solid colors or spiral striped codings. Circle 428 on Reader Service Card.

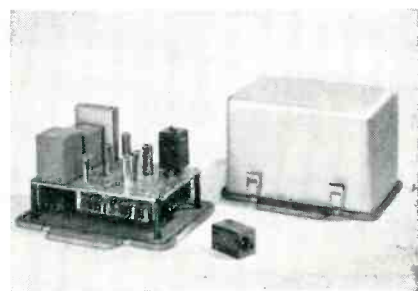

TELEMETERING UNITS give two channels

MOORE ASSOCIATES, 2628 Spring St., Redwood City, Calif., offers a receiver-transmitter telemetering set for use with telephone lines or cables with less than 20 db at-

NEW and

SPECIAL!

VOLTAGE and CURRENT REGULATION WITH LIMITING! (IN A SINGLE UNIT)

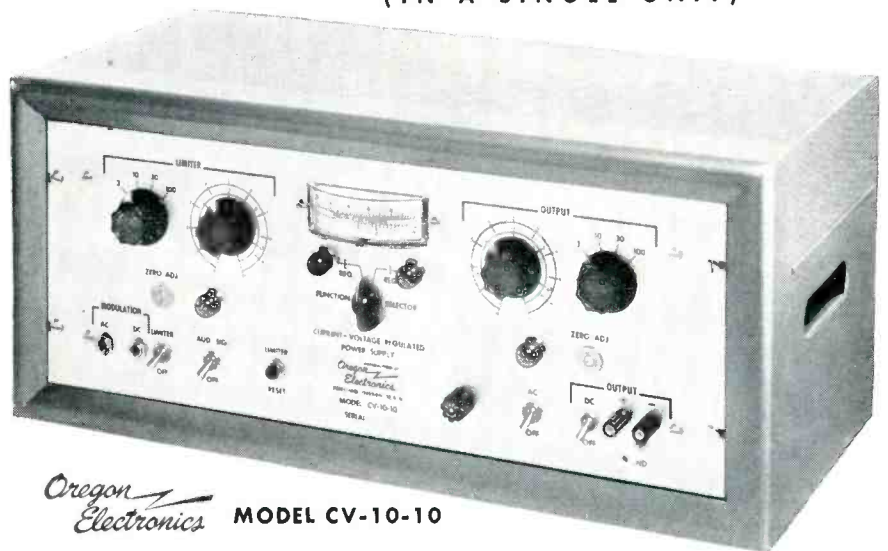

Oregon Electronics MODEL CV-10-10

for TRANSISTOR ENGINEERING

For the first time you can have a power supply that will protect transistors from overload . . . both voltage and current! Set for maximum voltage on the limiter control and the output power will be interrupted **before** the limit is exceeded. (An audible or visual alarm can also be used). When used for regulated voltage supply, the system becomes a current limiting circuit.

SPECIFICATIONS

INPUT: Nominal 117V, 50-60 cycles.

OUTPUT: Voltage or current regulated ranges—0-3; 0-10; 0-30; 0-100 volts or milliamperes. Output floating or either positive or negative grounded.

REGULATION: Voltage—better than 0.05%. Current—better than 0.1%.

RIPPLE: Voltage—Less than 2mv peak-peak. Current—Less than 2mv peak-peak across 100 ohm load.

LIMITER: Provides visual and audible alarm or visual and cutout as selected. Same ranges as output. Adjustable by means of panel control.

MODULATION & EXTENDED CONTROL: Plugging jacks provide for external modulation or adjustment of current regulated output and extended or remote adjustment of voltage output.

METER: Dual range 3-10 and multipliers.

PANEL: Anodized aluminum—natural or satin black. Standard rack width, 7" high.

CABINET: Heavy gauge steel finished in silver grey smooth baked enamel.

Oregon Electronics

Write for
complete information

2105 S.E. SIXTH AVE.
PORTLAND 14, OREGON
BELmont 6-9292

MANUFACTURERS OF SPECIAL ELECTRONIC EQUIPMENT

1460
series**MOTOR OPERATED**

Available SP2T thru SP6T—also DPDT and DP transfer. Frequencies thru 11,000 MC. AC or DC operation.

M1460
series**MANUALLY OPERATED**

—same contact arrangement and R F head as the 1460 Series. For chassis or panel mounting.

TRANSCO

COAXIAL SWITCHES

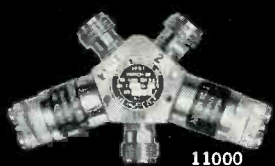
11000
series**SOLENOID OPERATED**
Miniature - SPDT

HN or Type N connectors. Frequencies thru 11,000 MC. AC or DC operation. Weight 6 oz.

14000
series**SOLENOID OPERATED**
Miniature - SP4T

Weight only 12 oz. Frequencies thru 11,000 MC. Designed for wide application flexibility.

**PROJECT ENGINEER OPENING
FOR R. & D. ELECTRONICS**

Engineer on Microwave Antenna Systems with Southern California leader in Avionics. Excellent company benefits. Address inquiries to Personnel Director.

*—they simplify
design of
R F systems*

With TRANSCO switches, you can cut down the number of components in a system—one switch handles up to 6 circuits. TRANSCO switches are small, and light in weight. Each is supplied in a choice of configurations to simplify installation.

Adds versatility to a system. All channels on a TRANSCO can be operated independently, and there's a wide variety of make-and-break arrangements available. TRANSCO switches operate through 11,000 MC—a standardization which cuts your stocking requirements to only one switch for this entire R F band width

High-efficiency switching is due to minimum insertion loss, low VSWR, and high isolation between channels. TRANSCO units are qualified to applicable military specifications. Performance has been fully confirmed in the field, where thousands of units are giving dependable service.

Technical data on any unit or the complete line sent on request. Send us your coaxial switching problems.

tenuation. The Model 55 transmitter generates two independent signaling tones in the 2.8 to 100-kc. range. The precise frequency is controlled by interchangeable plug-in networks for each channel.

The receiver has two independent outputs up to 20 and 50 ma for recording and, by use of plug-in hermetically sealed relays, up to 20 amp at 250 v for control of other apparatus.

Each channel utilizes a very narrow bandwidth, so that close spacing between channels is possible. With the plug-in networks used, channels may be closer than 1.5 percent of the frequency. Between 3 and 100 kc, this makes over 200 separate channels available on a telephone line, without interfering with the normal voice channel.

These units are designed for reliable, continuous unattended service. Cases are waterproof and dust-tight, and conservatively rated components are used throughout. The units mount by their cast-aluminum bases, with stainless-steel spring catches holding the cover firmly against a rubber gasket. **Circle 429 on Reader Service Card.**

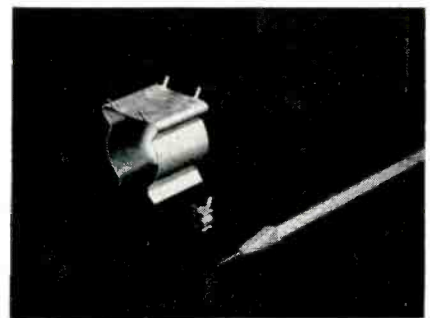

COMPONENT CLIPS for printed boards

ATLAS E-E CORP., 47 Prospect St., Woburn, Mass., has announced a line of component clips for mounting on printed circuit boards. Mounting tabs spaced for 0.1 in. grids are used instead of riveting. The tabs, capable of taking five 90 deg bends without fracturing, are inserted either manually, or by automatic machine into $\frac{3}{8}$ in. diameter holes in a printed board and bent over underneath clinching the clip in place. Clips and

TRANSCO PRODUCTS, INC.

The Finest in R F System Components

12210 NEBRASKA AVENUE, LOS ANGELES 25, CALIFORNIA

REPRESENTATIVES IN MAJOR AREAS

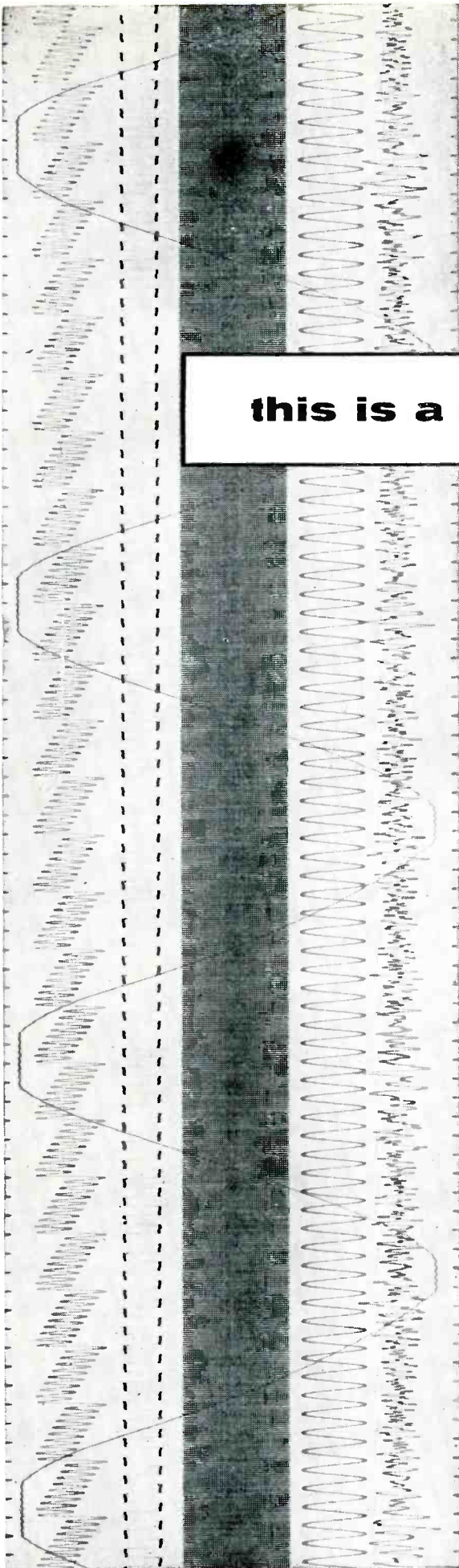

this is a record of leadership

This Visicorder Oscillograph record* is a symbol of the leadership that is typical of Honeywell engineering. In laboratories all over the world the Visicorder's instantly-readable direct records are showing the way to new advances in rocketry, control, computing, product design and component test, and in nuclear research.

The Model 906 Visicorder is years ahead of the trend. It is the first recording oscillograph that combines the convenience of direct recording with the high frequencies and sensitivities of photographic-type instruments. The Visicorder alone among oscillographs makes it possible for you to monitor high-speed variables as they go on the record.

To record directly the high frequency variables you need to study, use the Visicorder Oscillograph. Call your nearest Minneapolis-Honeywell Industrial Sales Office for demonstration.

*reproduced half size

Minneapolis-Honeywell Regulator Co., Heiland Division, 5200 East Evans Avenue, Denver 22, Colorado.

Reference Data: Write for Visicorder Bulletin

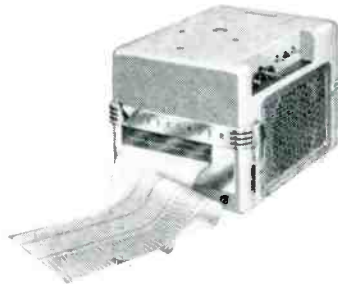

MINNEAPOLIS
Honeywell



Heiland Division

New!



Miniature Precision Rotary Selector Switch

Here's the exceptionally positive action only a multi-leaf wiper, button-contact switch can offer—now in the smallest sizes consistent with the quality and dependability required for today's compact, precision equipment:

- Features solid silver alloy button-type contacts, collector rings, and spring suspension leaf-type wiper arms for low contact resistance—0.002 ohms.
- Integral lugs and contacts staked in glass-fibre Silicone-laminate stators. Lugs cannot turn or loosen. Stator material will not carbonize even if severely overheated. Terminations can be made mechanically secure *before* soldering.
- Molded Melamine rotor covering entire contact circle provides high voltage breakdown between decks.
- Outstanding moisture, humidity, and salt-spray resistance through use of passivated stainless steel, nickel-plated brass, Steatite, Nylon, molded Melamine, and Silicone-base glass-fibre laminate parts.
- Adjustable stainless steel stops—easily positioned.
- Uniformly high quality—cost-reducing mechanized production and assembly.
- Small size—only 1 3/4" square. 1" deep for first deck, only 5/8" deep for additional decks.

CONDENSED SPECIFICATIONS

Shallcross "Miniature Series"

POLES PER DECK—1 to 4.
 INDEXING (detent)—1 1/4°, 15°, 22 1/2°, 30°.
 MOUNTING—Single or 2-hole, with non-turn tang.
 OPERATING VOLTAGE—to 1500 volts.
 BREAKDOWN VOLTAGE—to 4000 volts.
 BREAKING CURRENT—5 amp @ 125 V. ac.
 CARRYING CURRENT—15 amp.

Shallcross

SHALLCROSS MANUFACTURING COMPANY, 522 Pusey Avenue, Collingdale, Pa.

tabs are of one-piece construction made of beryllium copper and finished by electroplating over copper flash. Clips maintain a tight grip on components over a wide variation range loaded from 5 to 50 g's.

They are available in the following component diameters: 0.170, 0.235, 0.312, 0.400, 0.500, 0.625, 0.750, 0.875 and 1.00 in. Bulletin 32 may be had on request. Circle 430 on Reader Service Card.

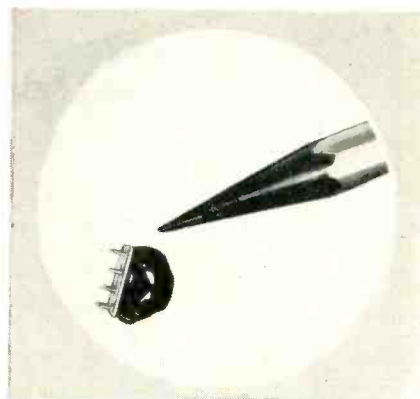

PLUG-IN TRANSFORMER for printed circuits

CELCO CONSTANTINE ENGINEERING LABORATORIES Co., Island Ave., Mahwah 1, N. J., has in production high precision plug-in transformers for the latest printed circuit application. In keeping with today's avionic equipment where space and weight conditions are a dominant factor, these epoxy encapsulated units are designed for maximum moisture resistance and insulated for high operating temperatures. Plug-in terminals are spaced on multiples of 0.1 in. for standard grids.

The part shown incorporates the use of thin gage alloys for improved performance and the latest winding techniques. Circle 431 on Reader Service Card.

HIGH GAIN ANTENNA with suppressor-type feed

ANDREW CORP., 363 E. 75th St., Chicago 19, Ill., has announced fiberglass radome high gain antennas for the 450-470 mc band. Type 212 omnidirectional antennas have a gain of 10 db across this

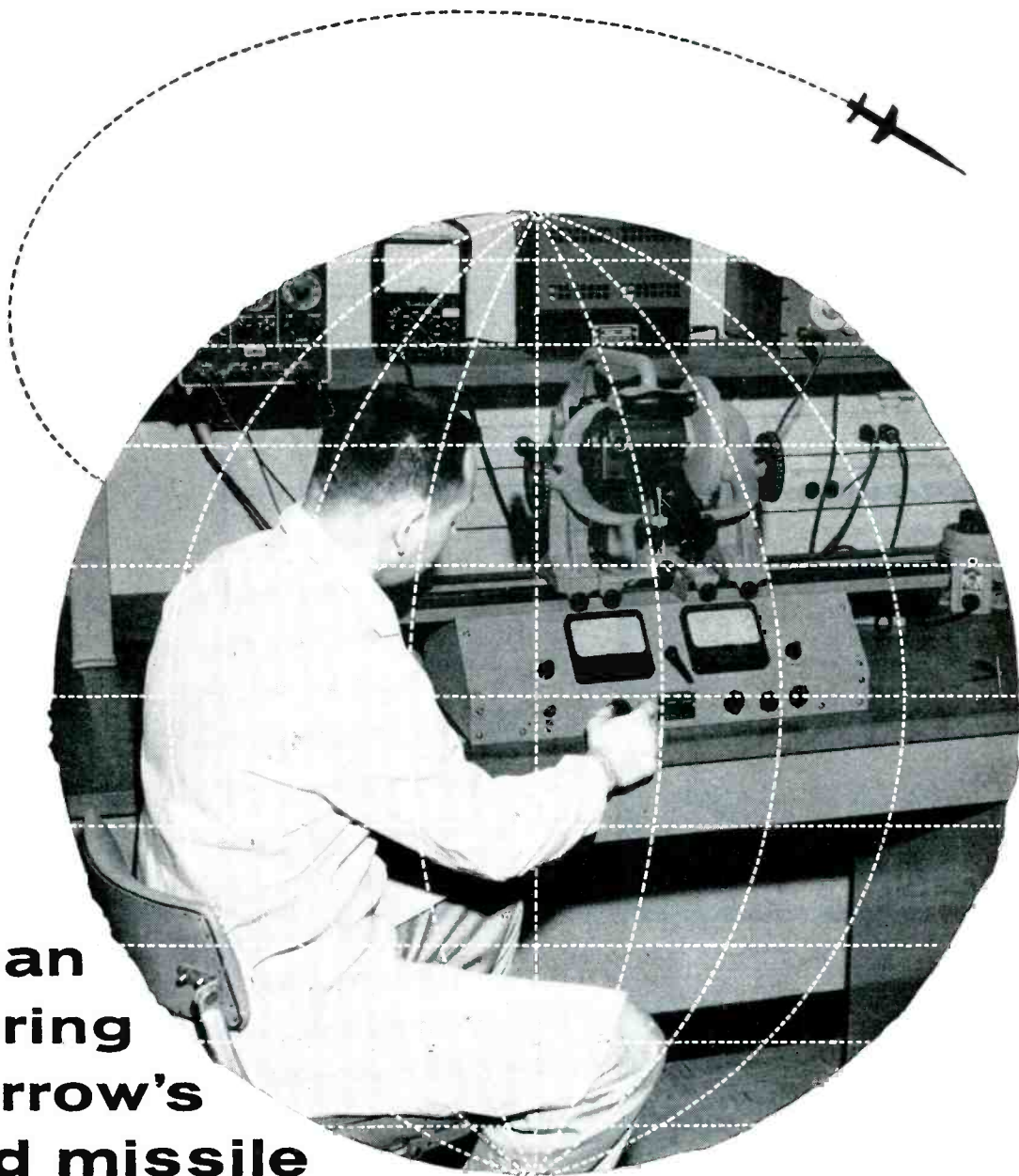

This man is steering tomorrow's guided missile

His uniform is a laboratory coat, his cockpit a dust-free room with carefully controlled temperature and humidity. He's a skilled General Mills gyro technician—as much a part of the defense of his country as the jet pilot. Results from his work, and from work in other R & D labs, assure us that tomorrow's guided missiles will be even more accurate than today's. ¶ At the Mechanical Division of General Mills, the gyro lab is part of a

talented, well equipped guidance and navigation systems development group. The group also includes top men and facilities in infrared, microwaves, electronic and mechanical design, and overall systems engineering. We team these men and facilities with a complete precision production plant to handle systems, sub-systems and major assembly problems for the world's most exacting customers. Possibly you too can benefit from our capabilities.

WE'D LIKE TO TELL YOU MORE

Send for facts about our unusual skills and how other companies use them in defense weapons production. Write to Mechanical Div., General Mills, Dept. EL10, 1620 Central Ave. N.E., Minneapolis 13, Minn.

MECHANICAL DIVISION

Creative Research and Development • Precision Engineering and Production



PROTOTYPE PROBLEMS?

Magnetic Metals Company can make sample tape wound cores to specification... with one week delivery!

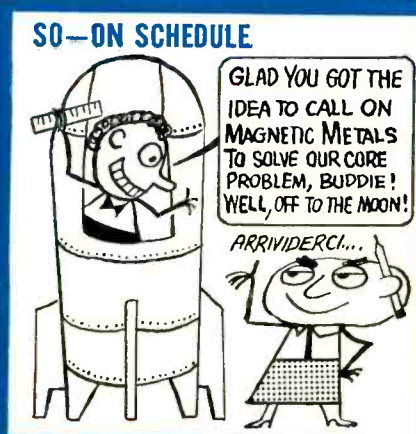

Specify Centricores having uniform magnetic properties.

Processed from thin gauge materials including Hymu, Squaremu "49", Microsil and "49" Alloy.



Wide variety of standard sizes available for quick delivery in either metallic or phenolic cases!

USE 'EM IN FLYING SAUCERS OR ANY TYPE PROTO...



"Buddie" was thinking ahead when he called for Centricores; when the prototype is approved and production gets underway, Centricores can be depended on for uniform characteristics. Magnetic Metals Company through closely controlled production methods can assure uniformity—to the most exacting physical and electrical specifications. You may have complete dimensional and test data; write for bulletin C4.

MAGNETIC METALS COMPANY

ELECTROMAGNETIC CORES and SHIELDS

HAYES AVENUE AT 21st STREET • CAMDEN 1, N. J.



NEW PRODUCTS

(continued)

entire band and can be used at any frequency in the band with no troublesome tuning adjustments.

The newly developed suppressor-type feed incorporates the desirable feature of a single-point feed, while maintaining high aperture efficiency, eliminating wasted radiation and producing superior mast isolation.

To facilitate handling and installation, the antenna is supplied in three sections, the longest of which is 12 ft. Overall length is 23 ft, with the lower 3 ft for mounting.

This lightweight antenna is enclosed in a fiberglass radome which assures dependable systems performance under unfavorable weather conditions. Windload rating is 30 lb per sq in., with $\frac{1}{2}$ in. of radial ice. Circle 432 on Reader Service Card.

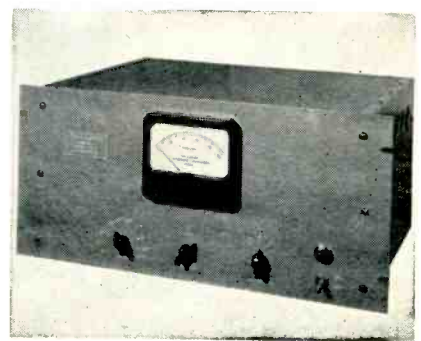

ELECTROMETER is highly accurate

TULLAMORE ELECTRONICS LABORATORY, 6055 South Ashland Ave., Chicago 36, Ill. Model VTE-2 electrometer measures currents from 10^{-9} to 2×10^{-18} amperes with an accuracy of 1 percent from 10^{-9} to 2×10^{-11} amperes, and 2 percent from 10^{-11} to 2×10^{-18} amperes. Zero drift is less than 0.5 percent per day on all ranges except the 10^{-18} ampere range where it becomes a maximum of 5 percent per day. Each decade is covered by three current ranges: 10, 5, and 2.

These versatile instruments have many applications, among which are the measurement of: high resistances, leakage currents of insulators, and currents from ionization chambers and phototubes. A model is available with

New Silicon Diode Simplifies Microwave Power Measurements



Much past emphasis in microwave silicon diode research has been directed toward its improvement as a superhetrodyne or video detector of microwave signals. For many years microwave diodes have also been used by instrument designers and others as a low cost replacement for baretters or thermistors in the measurement of microwave power or voltage. Such users, relatively neglected by the diode designer, have been plagued with the random variation of the absolute sensitivity and in the law of detection of microwave diodes. This variation discouraged many potential users.

By carefully controlling the silicon resistivity, whisker pressure and other parameters, Microwave Associates, Inc., has now produced the type MA-424 diode which provides a reproducible law of detection, standardized voltage and power sensitivity and at a very low cost compared to the baretter.

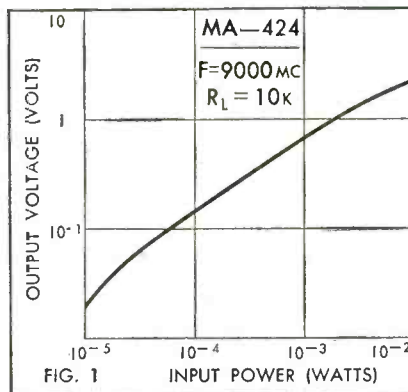

This diode should be immediately useful in a host of applications, where simplicity and low cost are factors. Applications include instruments for measuring microwave power, voltage, impedance, power ratios, etc., and in systems for microwave AGC and other types of control which rely on quantitative relationships between input microwave power and resulting rectified dc

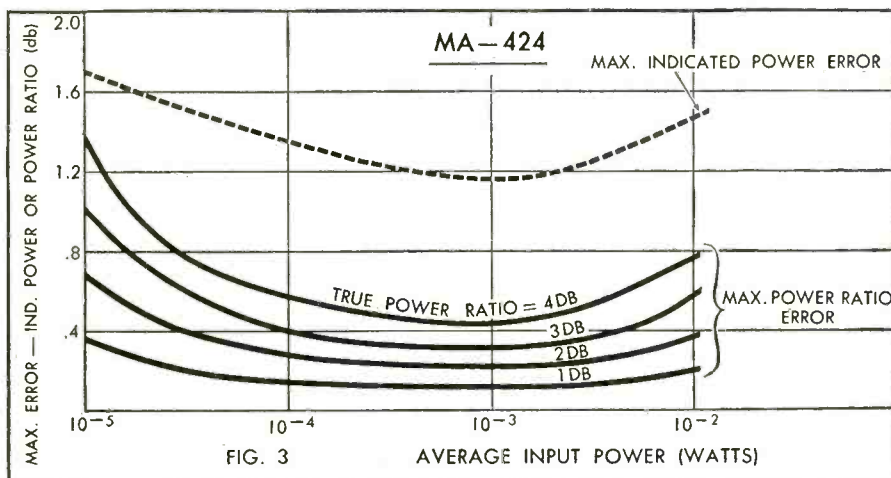

The MA-424 is stable, relatively broadband and requires very simple read out circuitry.

Figure 1. indicates the nominal output voltage versus input power of the MA-424. The curve applies at signal frequency of 9000 mc., and a load resistance of 10K with the diode operating in a fixed tuned waveguide holder. All diodes are tested at 10 μ w, 50 μ w; 1 mw and 10 mw, as shown in the main illustration. Figure 3. shows the maximum possible power error through the diode's range.

The law of detection exponent of the MA-424 is shown in Figure 2. for

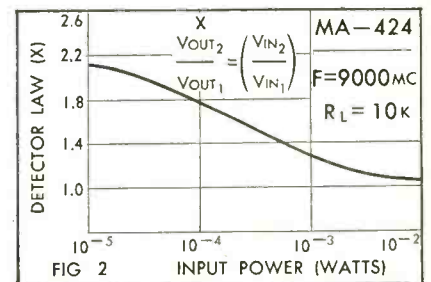

four power levels. Selection of the proper operating level allows the MA-424 to measure ratios such as VSWR.

INVESTIGATE FURTHER:

Early action will make you one of the first to take advantage of the quantitative use of output voltages now made possible at low cost by MA-424 microwave diodes. Send for detail specifications and prices.

Microwave Associates, Inc.
Burlington, Massachusetts
BUrlington 7-2711

MICROWAVE ASSOCIATES  INC.

BALLANTINE

SENSITIVE WIDE BAND ELECTRONIC VOLTMETER

measures 1 millivolt to 1000 volts
from 15 cycles to 6 megacycles

Accuracy 3% to 3 mc; 5% above
Input impedance 7.5 mmfds shunted by 11 megs

When used without probe, sensitivity
is increased to 100 MICROVOLTS but
impedance is reduced to 25 mmfds
and 1 megohm

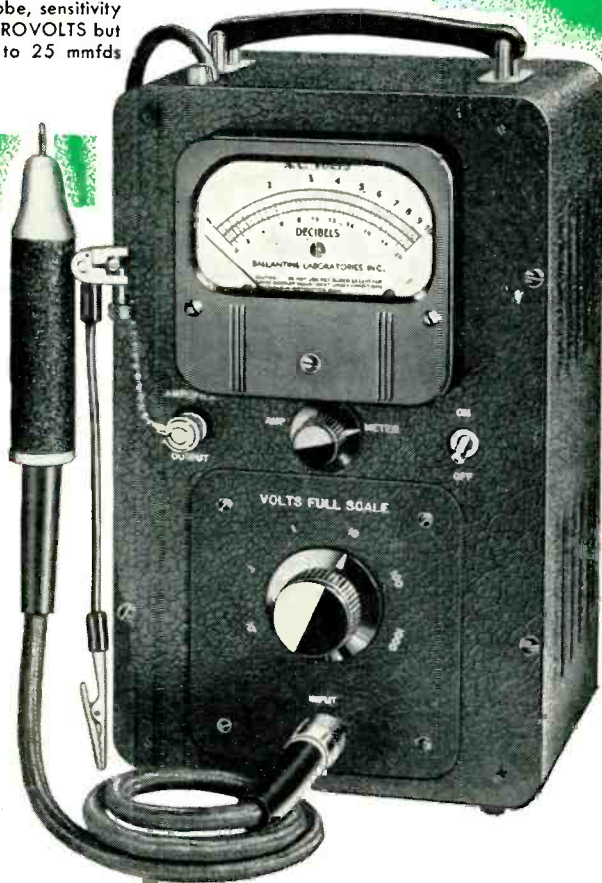

MODEL 314
Price \$285

- Same accuracy at *ALL* points on a logarithmic voltage scale and a uniform DB scale.
- Only *ONE* voltage scale to read with decade range switching.
- No "turnover" discrepancy on unsymmetrical waves.
- Easy-to-use probe with self-holding connector tip and unique supporting clamp.
- Low impedance ground return provided by supporting clamp.
- Stabilized by generous use of negative feedback.
- Can be used as 60 DB high fidelity video pre-amplifier.

All Ballantine instruments are SENSITIVE - ACCURATE - DEPENDABLE

Write for catalog for complete information.

BALLANTINE LABORATORIES, INC.

100 FANNY ROAD, BOONTON, NEW JERSEY



NEW PRODUCTS

(continued)

high and low level trip circuits
for reactor control applications.
Circle 433 on Reader Service Card.

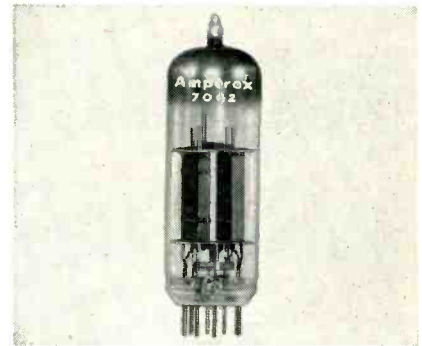

TWIN TRIODE improved miniature type

AMPEREX ELECTRONIC CORP., 230
Duffy Ave., Hicksville, L. I., N. Y.,
has announced a new miniature
twin-triode with separate cath-
odes, designated as type 7062, and
designed as an improved plug-in
replacement for the older type
5965 in most computer applica-
tions.

The 7062 is manufactured to
extremely close tolerances and op-
erates at a reduced heater current
of 400 ma as compared with 450
ma for the 5965. A longer glass
envelope reduces tube operating
temperature and assures more re-
liable operation. Life tests have
proven the ability of the new type
7062 to maintain its characteris-
tics over long periods of opera-
tion.

Detailed data and application
engineering information are avail-
able. Circle 434 on Reader Service
Card.

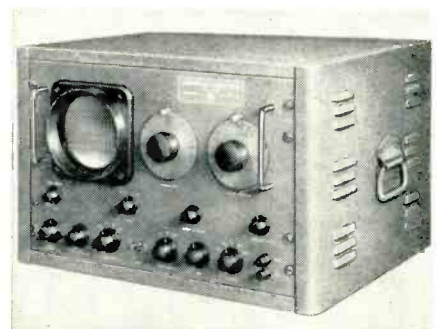

SPECTRUM ANALYZER covers 75 cps to 600 kc

PROBESCOPE CO., INC., 44-05 30th
Ave., Long Island City 3, N. Y.,

**DOW CORNING
CORPORATION**

Silicone Dielectrics

ELECTRICAL AND ELECTRONIC NEWS No. 14



Silastic Withstands Heat and High Voltage on Spark Plug Lead

Selecting a rubbery insulating material that would withstand up to 15,000 volts at 400 F in aircraft spark plug lead assemblies posed no problem for design engineers at Scintilla Division, Bendix Aviation Corporation, Sidney, New York. Already familiar with Silastic*, the Dow Corning silicone rubber, they knew it has excellent resistance to moisture and retains good mechanical and dielectric properties even after prolonged exposure to heat and high voltages.

Actually, Scintilla uses Silastic in four different areas on the new Bendix lead: for the inner and outer layers of the cable; for the molded terminal insulators; and as an interlayer to separate the three courses of

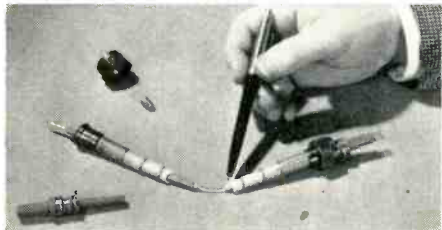

braided metal sheathing. Interlaying the braided sheathing with Silastic not only keeps moisture out, but protects the sheathing against vibration to give it longer life.

The new Silastic insulated lead is now standard for the Wright turbo compound 18 cylinder, 3350 hp engine that powers the DC 7, the Super Constellation and various military aircraft. No. 54

*T. M. REG. U. S. PAT. OFF.

Dow Corning Silicone Lubricants, including oils and greases, are described in a new, illustrated 8-page brochure that gives their properties, lists their applications, and cites factors which contribute to obtaining longer life. No. 55

NEW SILICONE INSULATING RESINS FLOW FREELY WITHOUT SOLVENTS

Two new free-flowing, solventless silicone electrical resins are now available from Dow Corning in commercial quantities. Identified as R-7501 and R-7521, these 100% silicone resins are ideal for impregnating or encapsulating miniature and subminiature motors, transformers and other electrical and electronic assemblies.

Since both new resins pour freely, they quickly saturate and fill all voids in even the most complex assemblies, thus eliminating the problem of insulation punctures caused by escaping solvent gases. As shown in the photo, Dow Corning R-7521 is more fluid at room temperature and penetrates much deeper into 20-40 mesh sand than a conventional epoxy resin.

Both of the new resins cure to a strong, bubble-free mass having excellent dielectric properties, good thermal conductivity and high moisture resistance. When cured, they readily withstand continuous service at 400 F ambients and intermittent exposure to temperatures up to 500 F.

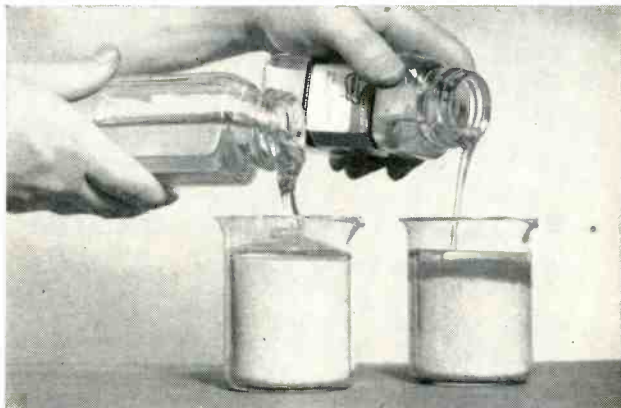

At room temperature the viscosity of R-7501 is 2500 centistokes and the viscosity of R-7521 is 100 centistokes. Either resin may be thinned by warming to 175 F. If desired, the resins can be blended together to obtain any intermediate viscosity.

The resins are cured by adding a peroxide catalyst and heating at temperatures up to 390 F. Shelf life of the uncatalyzed resins is well over a year; pot life of the catalyzed resins at room temperature is over six months. Dow Corning R-7501 and R-7521 can be used as received or combined with a wide range of inorganic fillers. No. 53

Silicone Insulated Motor Still on Test after 66,080 Hours at 240C

At 10 A. M., June 3, 1946, a silicone insulated 5 hp motor was generator loaded to operate at its test temperature of 240 C in Dow Corning's motor test labs. Every 500 hours since the test began, the motor has been shut down and exposed to 100% relative humidity for 24 hours. As of 11 A. M. August 1, 1957, this motor was still on test after 66,080 hours at an average copper temperature of 240 C! That's equivalent to 404 years operation at the Class H temperature of 180 C. No. 56

Silicone Materials in Appliance Design, a recent article in ELECTRICAL MANUFACTURING, lists a variety of applications for several different silicones in appliances; describes how silicones have made possible design changes heretofore impractical, and how they extend service life and dependability. To receive your copy, circle No. 57

Parts and components made with Dow Corning Silicone Molding Compounds are lightweight, show excellent resistance to heat, and have good structural and electrical properties. Used as brush holders, collector rings, terminal boards, multiple lead connectors, heat dams for turbine driven alternator bearings, and aircraft brake shoe backing. No. 58

Send Coupon for More Information

DOW CORNING CORPORATION - Dept. 4822
Midland, Michigan

Please send me 53 54 55 56 57 58

NAME _____

TITLE _____

COMPANY _____

STREET _____

CITY _____ ZONE _____ STATE _____

ATLANTA • BOSTON • CHICAGO • CLEVELAND • DALLAS • DETROIT • LOS ANGELES • NEW YORK • WASHINGTON, D. C.
Canada: Dow Corning Silicones Ltd., Toronto; Great Britain: Midland Silicones Ltd., London; France: St. Gobain, Paris

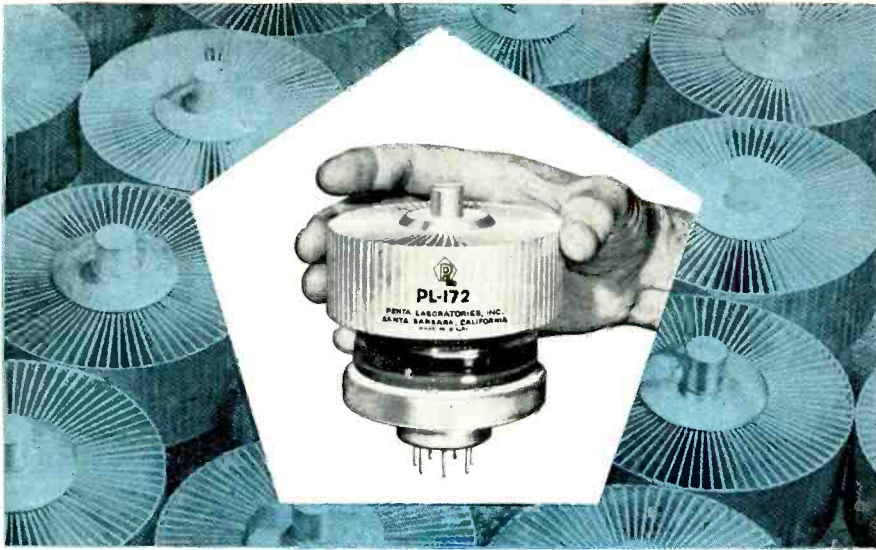

EXCLUSIVE "VANE" DESIGN IMPROVES
LINEARITY, EFFICIENCY IN THE
PENTA PL-172
1-KW BEAM PENTODE

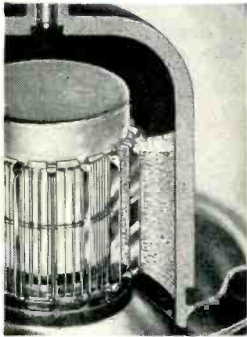

Vertical vanes in this unique Penta-designed suppressor grid channel the electron flow, providing true beam-tube performance... give extra high power at low plate voltages. Ring-type screen and suppressor grid contact surfaces and low-inductance leads make the tube extra stable. Low input capacitance for superior wide-band performance.

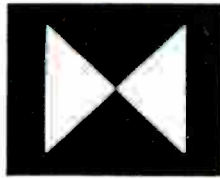

IT'S TRIED AND TRUE!

The PL-172, which has already logged over a year of nationwide service in a variety of r-f and a-f applications, is a *proved* performer—one you can depend upon. Versatile, too—delivers over 1000 watts of Class AB₁ *actual useful output* per tube at only 2000 plate volts... over 1500 watts per tube at maximum Class AB₁ ratings... over 2 KW in Class C. For critical Class AB₁ linear amplifier applications, for high power audio service, or for low-drive Class C use, the PL-172 is the logical choice.

CONVENIENT SOCKET AVAILABLE

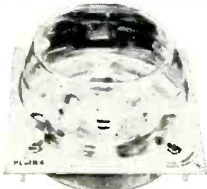

Especially made for the tube above, the PL-184 socket provides connections for all tube terminals, including suppressor grid and screen grid rings. Also provides means of directing air flow for cooling anode and seals. Built-in capacitors provide low-inductance r-f by-passing for suppressor and screen grids.

FREE SIX-PAGE DATA SHEET—gives full ratings of the PL-172, characteristic curves and information on Class AB₁ and Class C operation... a complete engineering data sheet, giving results of actual tests.

ASK FOR A FREE COPY of "Transmitting Tubes for Linear Amplifier Service" This nine-page bulletin discusses linear amplifier tube requirements in detail... shows with graphs, characteristic curves and data why and how Penta's exclusive beam-pentode designs outperform four-element tubes.

PENTA LABORATORIES, INC.

312 North Nopal Street, Santa Barbara, California

TRADE MARK REG. U.S. PAT. OFF.



announces model SS-500 spectrum analyzer covering the 75 cps to 600 kc frequency range. It will give an instantaneous fourier analysis of high speed vibration, noise, pulse and harmonics.

Model SS-500 will be found a valuable tool in the design of jet engines, telemetering, microphonic studies, crystal characteristics and wind turbulence test.

Features include automatic optimum resolution, continuously variable sweep width and center frequency, input overload protection, tube failure indicators, internal frequency calibration, flat face crt with camera mount bezel.

Center frequency is 0 to 500 kc; sweep width, 2 kc to 200 kc; resolution, 150 cps to 2 kc; full scale sensitivity, 250 μ v to 250 v. It has a linear and two decade log voltage scale, and a 60 db dynamic range. Circle 435 on Reader Service Card.

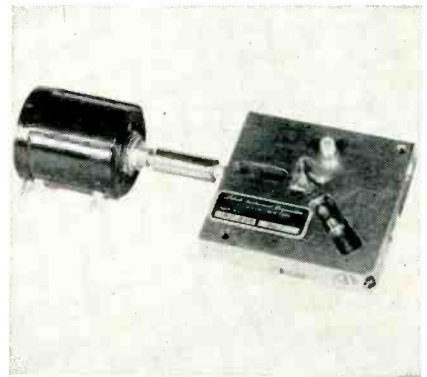

SQUARING MECHANISM
real miniature type

BELOCK INSTRUMENT CORP., 111-01 14th Ave., College Point, N. Y., has designed and developed a tiny squaring mechanism. It is a bidirectional mechanical device for squaring and extracting square roots and it is being manufactured for use in all types of mechanical and electromechanical analog computers. Constructed with an aluminum casing it weighs 10 oz; with a steel casing it weighs 20 oz.

The mechanism offers a high degree of accuracy and has a durability formerly obtained only in devices many times its size. The lightweight feature of its construction is especially significant

TIME: 1967

PLACE: *Your bed, late at night*

SUBJECT: *A question you wish you had asked yourself 10 years ago:*

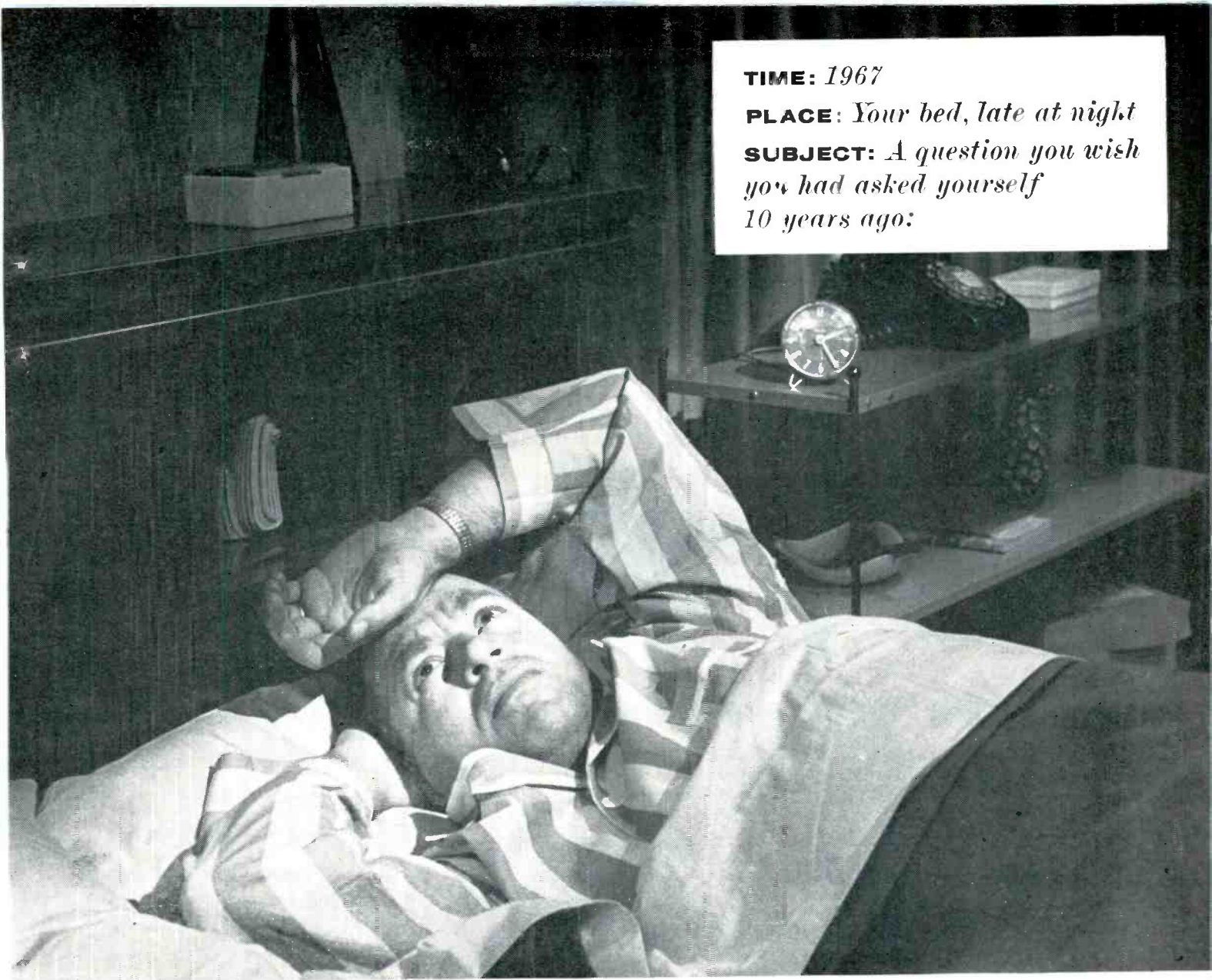

Is my career moving ahead with electronics ...or am I specializing too much?

■ It comes as a shock to realize that the broad field of electronics has left you behind while you have been specializing in a narrow area. This is the age of unprecedented electronic advances. It's difficult enough to keep abreast of new developments, much less catch up.

It's a problem engineers at Lockheed never worry about. Their assignments cover virtually the entire spectrum of electronic activities. In the Electronic and Armament Systems Laboratory assignments include:

Radar, data link, communication systems, navigation, computers, IFF, IR systems, optical systems, instrumentation, telemetering, data reduction equipment, video, measurement techniques, component evaluation, circuit analysis and other related areas of development endeavor.

In the field of electronics technical management, systems openings include areas such as:

Fire control, countermeasures, inertial systems, weapons, communications, infrared, optics, sonics, magnetics, antennas and microwaves.

If you've been specializing and wish to broaden your scope, we invite you to consider our program. Please write E. D. Des Lauriers at 1708 Empire Avenue in Burbank, California.

LOCKHEED

THE CALIFORNIA DIVISION OF LOCKHEED AIRCRAFT CORPORATION • BURBANK, CALIFORNIA

now

a full line of Chicago Standard TRANSISTOR TRANSFORMERS

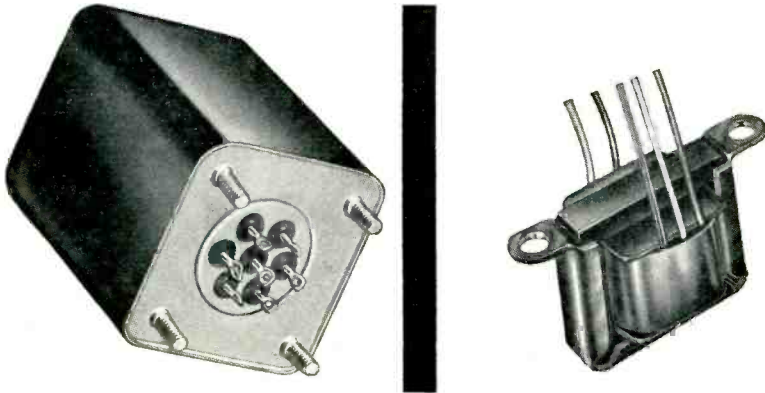

hermetically sealed or open mounting

Twenty-seven new up-to-date transistor transformers have been added to the Chicago Standard stock line, available for immediate delivery. They match the most frequently used transistors, and have applications in many existing transistor circuits. Included are inputs, outputs, interstages and drivers.

These units are available hermetically sealed in military standard cases (type TAMS), built in accordance with MIL-T-27A, Grade 4 Class R operating temperature, life expectancy X (10,000 hours minimum). Also available with open mountings (type TA) for non-military applications. For detailed information, write for Chicago Catalog CT3-57 and Stancor Bulletin 535.

TRANSISTOR AUDIO TRANSFORMERS

MS Type Chicago No.	Applica-tion	Imp. in Ohms Pri.	Imp. in Ohms Sec.	Max. Pri. D.C. Ma.	DC Res. Pri.	in Ohms Sec.	Power in Watts	Open Type Stancor No.
TAMS-1	Input	600 C.T.	10	20	42	.8	.05	TA-1
TAMS-2	Interstage	100 C.T.	10 C.T.	100	4.3	.8	.25	TA-2
TAMS-3	Interstage	100	1000 C.T.	100	5.8	45	.25	TA-3
TAMS-4	Interstage	500 C.T.	5000 C.T.	12	37	250	.03	TA-4
TAMS-5	Driver	1000	200 C.T.	10	400	115	.05	TA-5
TAMS-6	Driver	2000	200 C.T.	5	720	115	.05	TA-6
TAMS-7	Driver	100	100 C.T.	100	12	12	.5	TA-7
TAMS-8	Output	9800	15	2	640	2	.05	TA-8
TAMS-9	Output	1000	4/8/16	10	180	3.5	.2	TA-9
TAMS-10	Output	2000 C.T.	4/8/16	—	250	4	.2	TA-10
TAMS-11	Output	48 C.T.	8/16	275	5	1.5	5	TA-11
TAMS-12	Output	20 C.T.	8	500	.55	.35	10	TA-12
	Driver	200 C.T.	400 C.T.	10	—	—	.6	TA-13
	Output	24 C.T.	16/4 C.T.†	200	—	—	10	TA-14

†2 secondaries 16 ohm series, 4 ohms parallel

TRANSISTOR POWER TRANSFORMER—Primary 117 V, 60 cycle

Application	Plate Supply No. 1		Plate Supply No. 2		Stancor Part No.
	AC Volts	DC Ma	AC Volts	DC Ma	
For bridge rec-tifier systems	13 or 18	900	13 or 18	900	TP-1

CHICAGO STANDARD TRANSFORMER CORPORATION

3502 ADDISON STREET

CHICAGO 18, ILLINOIS

Export Sales: Roburn Agencies, Inc., 431 Greenwich St., New York 13

NEW PRODUCTS

(continued)

for computers used in air navigation and by the armed forces in gun fire control systems. Circle 436 on Reader Service Card.



D-C POWER SUPPLIES rugged, compact, portable

NUTRON MFG. Co., INC., 67 Monroe Ave., Staten Island 1, N. Y. The new portable power series offers a general purpose instrument for laboratory, field or industrial use combining features of ruggedness, compactness and extreme portability consistent with engineering design accuracy desired in a precision instrument.

Special features are: continuously variable output; h-v vernier adjustment; regulated output; easy to read 2½ in. meters; rated for full load over entire voltage range; convenient line cord storage in rear panel; sloping front panel for wide angle vision; and easily dismounted rear panel for access to tubes.

Complete technical specifications are available on request. Circle 437 on Reader Service Card.

ELECTRONIC TIMER small and lightweight

RADEX CORP., 2076 Elston Ave., Chicago 14, Ill. A new electronic timer has been designed which can be used for a large variety of purposes, such as industrial control, life test cycling, interval photography and the like. The unit is small, lightweight, and accurate.

The timing cycle is adjustable from 45 seconds to 15 minutes, with other time ranges available

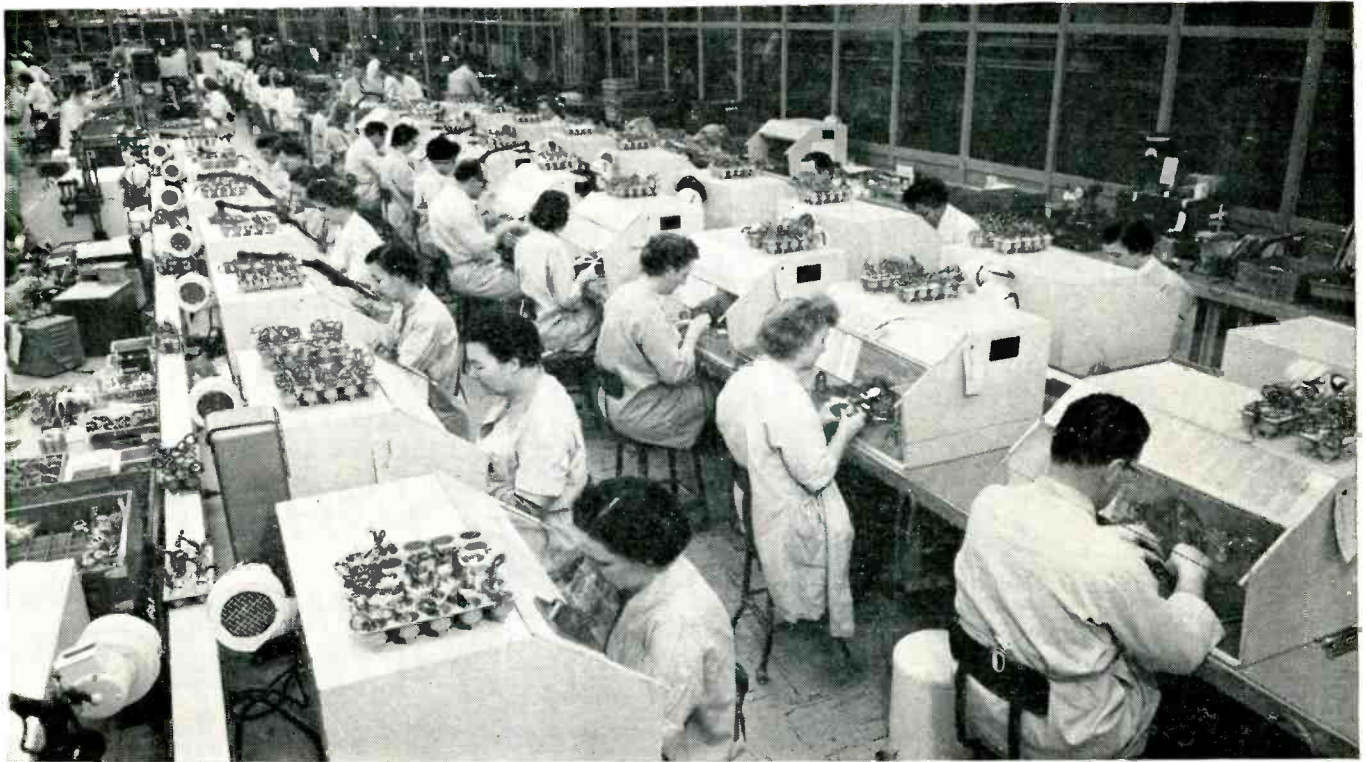

Portion of Eclipse-Pioneer's synchro calibration and test facility.

WHY IT PAYS TO SHOP AT THE BENDIX "SUPERMARKET"

— NATION'S LARGEST PRODUCER OF SYNCHROS

SHAFT POSITION-TO-DIGITAL CONVERTERS



Eclipse-Pioneer Coded Commutator type shaft position-to-digital converters are miniature devices for converting Analog information to Binary Digital form. Designed for Digital control systems, data processing equipment, telemetering applications, or computers. Especially suited to air-borne use.

Specifications:

	Model GS-1-A1	Model GS-2-A1
Type output	8 digit gray (Reflected Binary Code)	7 digit Natural Binary Code (double brush)
Shaft resolution	1 part in 256	1 part in 128
Current rating	.015 amps. (max.) per digit with non-inductive loading	.015 amps. (max.) per digit with non-inductive loading
Shaft speed	Max. continuous input of 150 revs. per minute	Max. continuous input of 150 revs. per minute
Input torque	0.2 ounce-inch (max.)	0.4 ounce-inch (max.)
Diameter of unit	15/16 inch	15/16 inch

In buying precision synchros, doesn't it make a lot of sense to insist on getting exactly what you want, when you want it—and at minimum cost?

Best way to be *sure* you get all three is to depend on the Bendix "Supermarket".

Our mass synchro production facilities . . . the nation's largest . . . are constantly turning out just about all types of synchros imaginable. This means we can offer you immediate delivery of most synchro types—and minimum cost on all synchro types, even for small quantity orders.

You can depend on the quality of Bendix synchros, too. They will equal . . . or exceed . . . the accuracy of any other synchros made today. Sound reasons why you'll be ahead to rely on the experience and mass-production facilities of *Bendix*.

District Offices: Burbank, Calif., Dayton, Ohio, Seattle, Wash.
Export Sales and Service: Bendix International Division, 205 E. 42nd St., New York 17, N. Y.



Eclipse-Pioneer Division

Teterboro, N. J.



LAPP INSULATION

FOR WATER-COOLED SYSTEMS

For carrying cooling water which must undergo a change in potential, use of Lapp porcelain eliminates trouble arising from water contamination and conductivity, sludging and electrolytic attack of fittings. Permanent cleanness and high resistance of cooling water is assured with the completely vitrified, non-absorbent Lapp porcelain.

PORCELAIN WATER COILS

Twin hole or single hole models to provide flow of cooling water from 2 to 90 gallons per minute. Each assembly includes ceramic coil, aluminum mounting base, nickel plated brass attachment fittings... and is proof-tested to 100 lbs. per square inch water pressure.

PORCELAIN PIPE

Practically any piping layout can be made with these pieces... swivel flanges provide automatic alignment. Straight pipe up to 60" lengths, 90° and 180° elbows, fittings for easy attachment to metal pipe; matching support insulators. Inside diameters 3/4" to 3".

WRITE for Bulletin 301 containing complete description and specification data. Lapp Insulator Co., Inc., 135 Sumner Street, Le Roy, New York.

Lapp

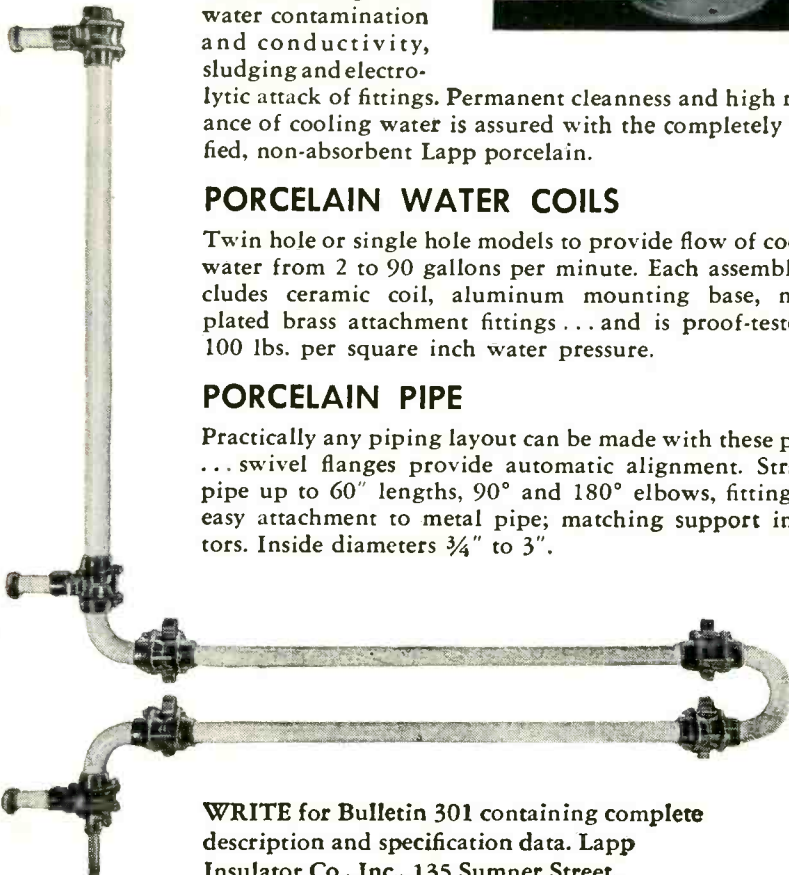
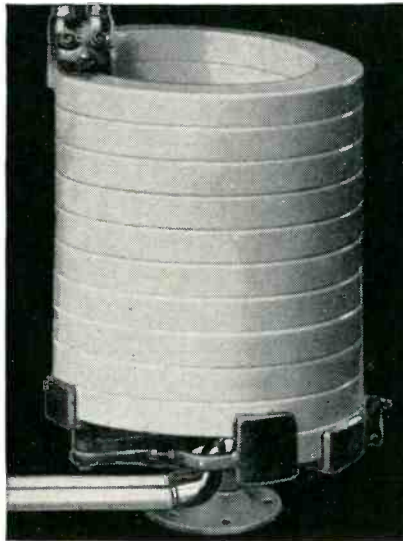

NEW PRODUCTS

(continued)

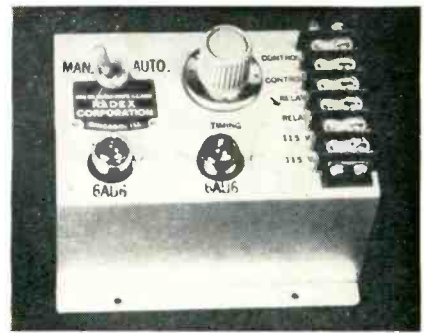

on special order. The timer may be reset at any time during the cycle. Repeat cycle accuracy is 3 per cent. Operation may be either manual or automatic. Contacts are rated at 5 amperes, 115 v, and can be furnished either single pole normally open or single pole normally closed.

Overall dimensions are 6 1/2 in. long, 4 5/8 in. wide, 3 3/8 in. high. Circle 438 on Reader Service Card.

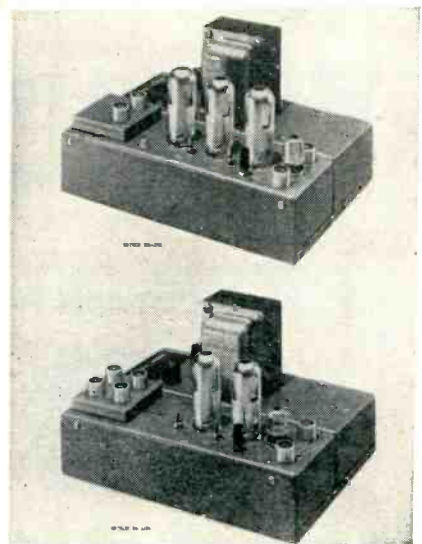

BRIDGING AMPLIFIERS two new models added

ENTRON, INC., P. O. Box 287, Bladensburg, Md., has completed the first production run of two new units in its series of vhf tv bridging amplifiers. Now available from stock are the unity gain, four output model BA-4; the new, 10 db gain, four output model BA-400 and the new, 25 db gain, two output model BA-250. All models are for 75 ohm systems and will handle up to 0.2 v per channel, maximum output. The new amplifiers feature single control adjustable equalization and adjustable gain. Plug-in attenuators insure less

Only **NLS** Digital Voltmeters give you
consistent speed and accuracy in...



PRODUCTION LINE TESTING

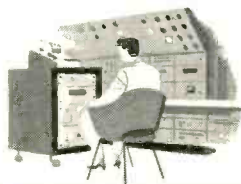

RECEIVING INSPECTION



LABORATORY INSTRUMENT CALIBRATION



AUTOMATIC DATA LOGGING



HERE is a fully automatic digital voltmeter that embodies all the time-proved features of reliability, accuracy, and read-out speed of the NLS model 451 DC meter PLUS automatic calibration and an AC-DC converter. Unskilled personnel can easily read and understand the illuminated 4-digit numerical display of voltages in ranges from 0.001 to 999.9 AC or DC.

Reliability and long life are assured by NLS exclusive oil bath immersed stepping switches. Accuracies are guaranteed to a resolution of one-digit; linearity of .01%; voltage standardization to .02%. The Model 4512 will make precise voltage measurements considerably faster than any other type of measuring equipment—automatically shows DC polarity and automatically changes voltage ranges. Interconnection may be made with other NLS equipment such as input scanners, serial converters and print controls—to fit individual automation system requirements. Automatic data logging systems utilizing Clary printers, Flexowriters, Electric Typewriters, Paper Tape Punches and IBM card punches can be inexpensively adapted to model 4512.

NLS is the originator and foremost producer of digital voltmeters with full scale ranges from 10 millivolts to 1000 volts; sensitivity from 1 microvolt up; reading speeds of up to 20 per second; accuracies approaching .01%; up to 6 digit, 1" high illuminated readouts.

NLS Digital Voltmeters and Ohmmeters, Ratiometers, Scanners, and Converters are in volume production and prompt deliveries are assured. Write or wire for complete data.

NLS provides engineering and service facilities in principal cities—coast to coast.

Originators of
the Digital
Voltmeter



**non-linear systems,
inc.**

San Diego County Airport,
Del Mar, California
Sales Engineering Offices
in Los Angeles,
San Francisco,
Phoenix, Cleveland
and Orlando, Fla.

WHY

TIC TRIMMERS?

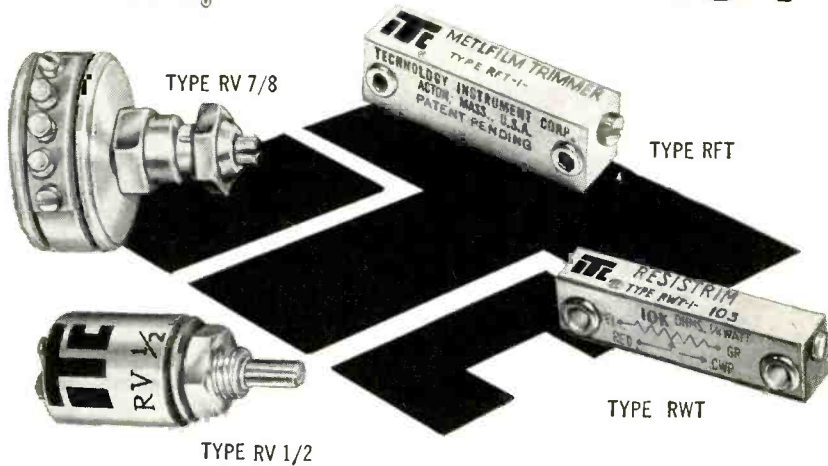

TIC, originator of trimmer pots, combines advanced design techniques and craftsmanship in its miniature and subminiature precision trimmer potentiometers. Pot size ranges from 1/8 inch to 3/8 inch . . . power ranges up to 4 watts.

TIC pots provide the ultimate in:

- Long Term Reliability by use of precious metal contacts, low temperature coefficient of resistance
- Sealing Design Techniques provide protection against moisture and salt spray
- Rugged Construction for resistance to shock and vibration
- Flexibility of Design Applications, a variety of shapes for optimum space use
- High Resolution

TYPE	TURNS	RESIST. RANGE	TEMP. RANGE
RFT*	25 metallic film	50 — 25K ohms	-55° to +125°C
RWT	1 wire wound	50 — 15K ohms	-55° to +95°C
RV 1/2	1 wire wound	50 — 100K ohms	-55° to +145°C
RV 7/8	1 wire wound	100 — 100K ohms	-55° to +145°C

*Optimum spacing — as many as 7 in area of 1 sq. in.

All designed for the most stringent aircraft and rocket applications.

All units are available from stock in production quantities.

Complete information on request.

These advanced design features provide for wide applications:

- Threshold voltage adjustment
- Fixed gain adjustment
- Parameter compensation
- Critical magnetic and electric bias
- Establishing circuit values
- Padding
- Balancing adjustments
- Adjusting scale factors

NEW PRODUCTS

(continued)

than 0.5 db through-line loss. Silicon power rectifiers contribute to low power consumption and very long life. These three units afford the system engineer the equipment flexibility which permits distribution line and bridging point layout to be made independently of the trunk line amplifier placement. Model BA-250 is designed for limited cascading and is available on special order with regulated power supply as the model BA-250R. Circle 439 on Reader Service Card.



D-C CONVERTERS

use transistors

RHO ENGINEERING Co., 2242 Sepulveda Blvd., Los Angeles, Calif., has started manufacture of transistorized d-c converters with outputs up to 300 watts. Using special high temperature transistors, the units have an operating range of -55 C to +85 C.

Metal construction is confined to the cadmium-plated base plate. The 75-watt unit measures 4 1/4 by 1 1/4 by 2 3/4 in. and weighs 11 ounces. Units with higher outputs are slightly larger.

A commercial version of the same design with an operating temperature range of -30 C to +71 C is available for use in mobile radios and other battery-operated equipment. Circle 440 on Reader Service Card.

CRYSTAL HOLDERS

cover up to 12,000 mc

AMERICAN ELECTRONIC LABORATORIES, INC., 641 Arch St., Philadelphia 6, Pa. announces the completion of its 1000-Series Blue Line crystal detector mounts with the advent of



569 Main Street, Acton, Mass. COLonial 3-7711

NEW

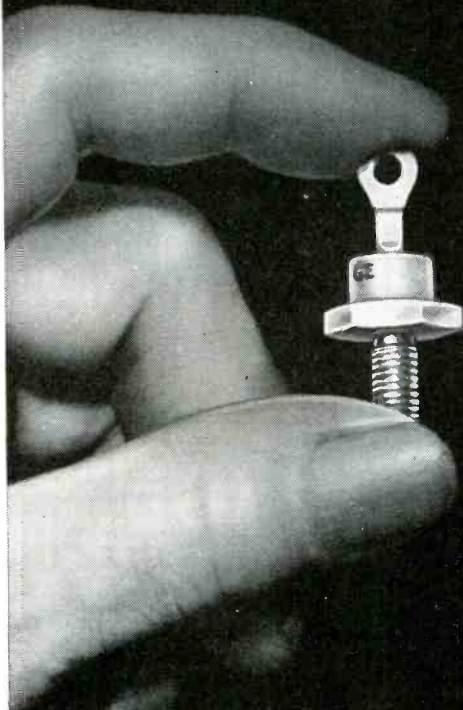

JETEC TYPES
 1N1301
 1N1302
 1N1304
 1N1306

MAXIMUM ALLOWABLE STUD TEMPERATURE AS A FUNCTION OF FORWARD CURRENT 1N1301 SERIES RECTIFIER

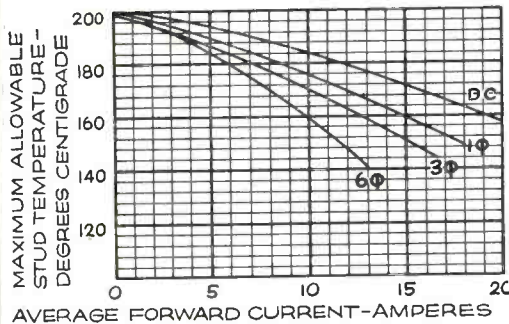

Medium-Current Silicon Rectifier

In low-current applications:
BETTER PERFORMANCE AT EQUAL COST!

In high-current applications:
EQUAL PERFORMANCE AT LOWER COST!

This new stud-mounted silicon rectifier has been conservatively rated, as are all General Electric rectifiers. Yet in applications where you would normally apply a low-current (2 to 10 amperes) rectifier, the new Series 1N1301 will give you superior electrical characteristics at a comparable price. It is interchangeable with most lower rated units.

In applications where you would apply a high current rectifier (up to 20 amperes) the new Series 1N1301 will give you equal performance at less cost.

The most compact size available

Series 1N1301 gives you the maximum power possible per cubic inch of space. It is available in a range of voltage ratings, and meets rigid military specifications.

For complete technical data on Series 1N1301—and on the full line of G-E high and low current silicon rectifiers, consult your General Electric representative. Or write, General Electric Company, Semiconductor Products Dept., Section S25107, Electronics Park, Syracuse, New York.

Check these conservatively rated features

- Operating voltage**
 - 1N1301 50 PIV
 - 1N1302 100 "
 - 1N1304 200 "
 - 1N1306 300 "
- Operating current** —up to 20 amperes
- Operating temperature** —up to 200°C
- Peak one cycle surge current** —300 amperes
- Maximum full load voltage drop** —0.5 volts $\frac{9}{16}$ HEX
(full cycle average —10 amps, 200°C junction temperature)
- Maximum leakage current** —5 ma $\frac{1}{4}$ -28 STUD
(full-cycle average, 200°C junction temperature)

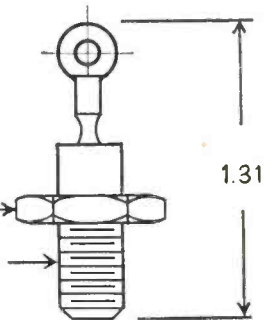

Progress Is Our Most Important Product

GENERAL  ELECTRIC

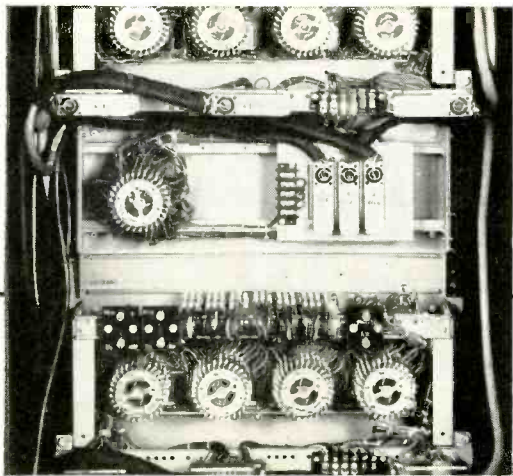

OWENS-CORNING FIBERGLAS CORPORATION

DEPENDS ON

NORTH RVF SWITCHES NORTH RELAYS

**TO CONTROL
PRODUCT FLOW
AND PROVIDE
COMMUNICATIONS
AND
AUTOMATIC TALLY**

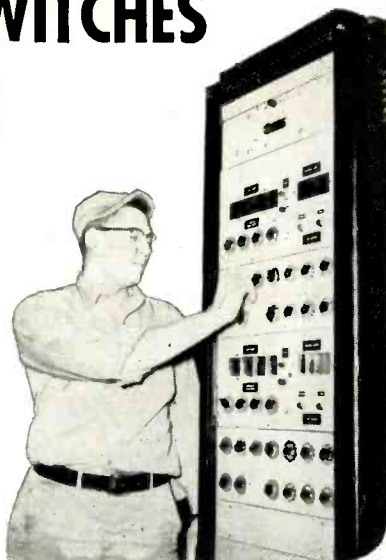

North RVF Switches, North Relays and North Connectors assure reliable low-cost production control of finished goods in the new Barrington, New Jersey, plant of the Owens-Corning Fiberglas Corporation.

From the central North-built control station the following functions are controlled:

1. **Product Flow** — through gate control of a complex conveyor system.
2. **Communications** — to all key production areas.
3. **Automatic Tally** — provides recorded product count per production order with facilities for direct input to the accounting system.

For any industrial application calling for relays, switches, or other switching components, you can rely on

INDUSTRIAL DIVISION

NORTH ELECTRIC COMPANY

7710 SOUTH MARKET STREET • GALION, OHIO

Available in Canada through Ericsson Telephone Sales of Canada, Ltd., Montreal 8, P. Q.



NEW PRODUCTS

(continued)

the model C 1300 (4,000–8,500 mc) and the model C 1400 (8,000–12,000 mc). The entire line of lightweight, high sensitivity crystal holders now cover the range of 500 to 12,000 mc. Circle 441 on Reader Service Card.

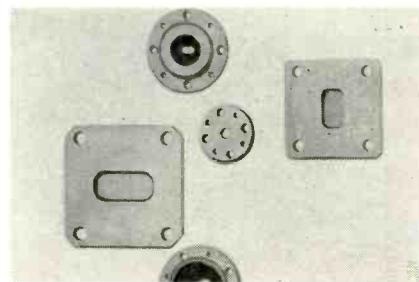

WINDOW SEALS
in 7 sizes to 90 kmc

DE MORNAY-BONARDI, Pasadena, Calif., introduces a new line of hermetic waveguide window seals covering the microwave and ultra-microwave range from 8.2 to 90 kmc in 7 sizes.

When soldered directly to the waveguide flange, the seal maintains a constant pressure and constant dielectric inside, sealing out moisture and dust. Temperature range is -55°C to 100°C and the seal will withstand degassing by baking. The units will also endure shock and vibration and hold a hard vacuum.

The seal passes microwave energy with minimum reflection loss, the vswr averaging 1.19 over the entire range. Optically clear metal-glass-mica windows are featured in the design. Circle 442 on Reader Service Card.

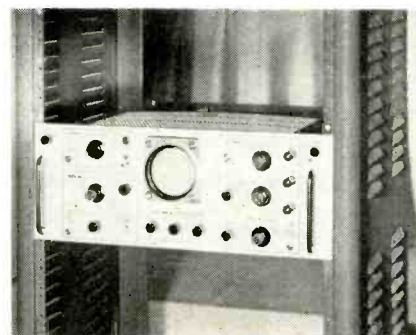

RACK-MOUNTING SCOPE
d-c to 10-mc range

TEKTRONIX, INC., P. O. Box 831,
Portland 7, Oregon, Type RM16



This shows how

YOU AS A SENIOR ENGINEER CAN PROFIT FROM MY EXPERIENCE

My name is John H. Whitmore, and I am a 1953 graduate of the University of Kansas where I majored in Engineering Physics. Being intensely interested in securing a future in my chosen field, I decided to explore job opportunities thoroughly. This decision resulted in more than 14,000 travel miles for personal interviews at 30 of the 103 companies and laboratories which were interested in my qualifications and abilities.

I chose the Research and Development Laboratory of Link Aviation because my primary concern was the application of my educational training and technical background to challenging research and development problems in areas allowing for professional growth and advancement. Currently I am a member of a development team working on a high precision measuring device for commercial and military customers.

In addition to my job satisfaction, there are many Link extras including:

1. An equitable and liberal salary structure.
2. A profit sharing retirement fund.
3. Opportunity for graduate study.
4. Group life and health insurance.

At present, Link has openings for Senior Engineers in Research and Development who have:

1. A minimum of a B.S. degree.
2. A strong technical background in Electronics, Physics, Applied Mechanics or related fields.

3. A desire to grow professionally.

Link Aviation is a medium sized company, situated in a community with excellent schools and housing, pleasant climate and friendly atmosphere. It is also convenient to such metropolitan centers as New York, Philadelphia, Rochester and Syracuse.

INTERESTED? Write or call collect to:

Laurence E. Fogarty
Manager, Engineering Division

or

Harold S. Hemstreet
Technical Director, Binghamton Laboratory
Link Aviation, Inc.—2
Binghamton, New York
Telephone: Binghamton 3-6311

If you prefer that we contact you, please mail the following coupon to Dr. Fogarty or Mr. Hemstreet:

I am interested in learning more about your openings for Senior Engineers. Please contact me by:

PHONE NO. _____ AT _____

MAIL _____

NAME _____

ADDRESS _____

CITY _____ STATE _____



AVIATION, INC.

A SUBSIDIARY OF GENERAL PRECISION EQUIPMENT CORPORATION

BINGHAMTON, NEW YORK



HOMELITE

will meet your specs for
LIGHTWEIGHT GENERATORS

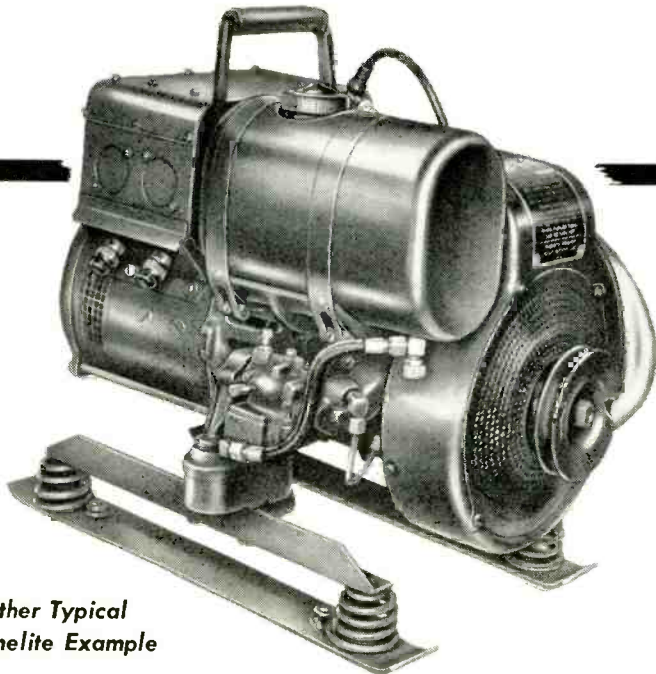

Another Typical
Homelite Example

To meet the requirements for lighter, smaller and more powerful auxiliary gasoline-engine-driven generators for both rotary and fixed wing aircraft, Homelite has designed and built several special units.

Typical of these new Homelite generators is the Model 34D28 shown above.

Weighing only 67 pounds . . . almost half the weight of previous auxiliaries with comparable power . . . this Homelite develops 70 amperes at 28.5 volts DC and is capable of starting 700 h.p. aircraft engines either directly or with a small battery floated on the line.

Requiring less than 3 cubic feet of storage space, this unit is equipped for push button or manual starting and starts without preheating in temperatures as low as minus 40 degrees Fahrenheit.

Meeting specifications for light-weight, powerful generators . . . for both military and commercial applications . . . is the specialty of the house with Homelite. We've been doing it for close to half a century.

No matter how new, how different or how tough your requirements . . .

turn them over to Homelite. The chances are you'll get the most satisfactory answer . . . faster.

Write and our engineers will get in touch with you.

Homelite builds generators in sizes from .15KW up to 5KW in all voltages and frequencies . . . with either gasoline engine or electric motor drive.

Manufacturers of Homelite
Carryable Pumps
Generators • Blowers
Chain Saws

Canadian Distributors: Terry Machinery Co., Ltd., Toronto, Montreal, Vancouver, Ottawa

PERFORMANCE • DEPENDABILITY
SERVICE

HOMELITE

A DIVISION OF TEXTRON INC.
6810 RIVERDALE AVENUE
PORT CHESTER, N. Y.

NEW PRODUCTS

(continued)

is a 3 in. rack-mounting oscilloscope with a dc-to-10 mc pass-band and 0.035 μ sec risetime. Vertical deflection is calibrated from 0.1 to 50 v/div in nine steps. Three additional a-c coupled steps have sensitivities from 0.01 to 0.1 v/div with 2 cps to 9 mc pass-band and 0.04 μ sec risetime. Signal delay is 0.25 μ sec with an input capacitance of 38 μ f direct and 13 μ f with probe.

Twenty-two calibrated sweep rates from 0.2 μ sec/div to 2 sec/div may be selected by a single knob. Full sweep range is from 0.04 μ sec/div to 6 sec/div. Four modes of sweep triggering are provided: amplitude level selection with either preset or manual stability control, fully automatic triggering and high-frequency sync.

Built-in 1-kc square-wave calibrator has 11 fixed outputs from 0.05 to 100 v peak-to-peak. Power consumption is 260 watts. The RM16 is \$795 while the RM-16-S1, which operates on 50 to 800 cps powers, is \$830. Circle 443 on Reader Service Card.

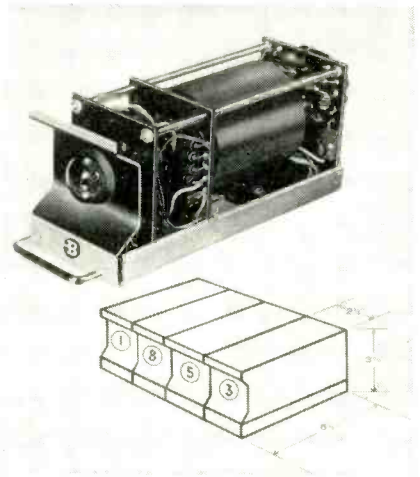

DECADE COUNTER with electronic readout

BURROUGHS CORPORATION, Electronic Tube Division, Plainfield, N. J., is now producing a new decade counter with an all-electronic numerical readout. Each plug-in module contains a type 6700 beam switching tube and a type 6844 NIXIE indicator tube.

Figures displayed are in-line and visible 30 to 40 ft. A potential counter-tube life of 50,000 hours is

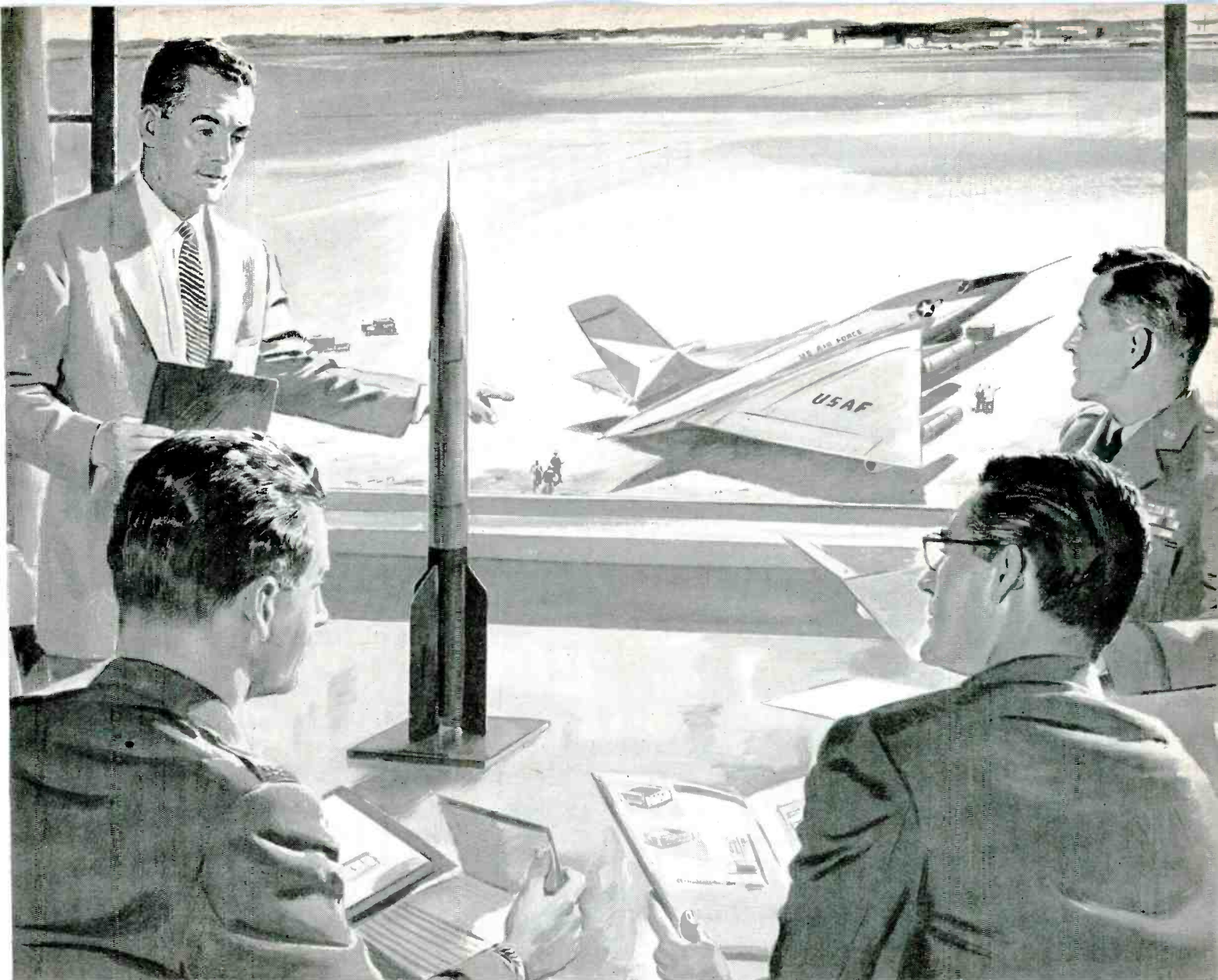

3-minute check-out for jets

Our system for testing guided missiles before launching can be applied with equal practicality to checking the standby readiness of jets.

With an adaptation of test equipment we have already produced, *one man* will be able to check out a jet in *three minutes*. This application to jets is now only a matter of cooperative development.

The system will be compact and mobile and will utilize the latest digital and analog control system techniques. Test sequence and acceptance limits will

all be programmed in advance. An "umbilical" cord will be used for plug-in connection to an associated output jack on the aircraft.

The system will automatically perform the tests, evaluate the responses, and—in three minutes—either check out the plane for flight, or call for replacement equipment.

We would welcome the opportunity to discuss application of these techniques to any similar testing problem.



STROMBERG-CARLSON

A DIVISION OF GENERAL DYNAMICS CORPORATION

General Offices and Factories at Rochester, N. Y.—West Coast plants at San Diego and Los Angeles, Calif.



LOOK TO TOBE FOR PROGRESS

electronic RF filters

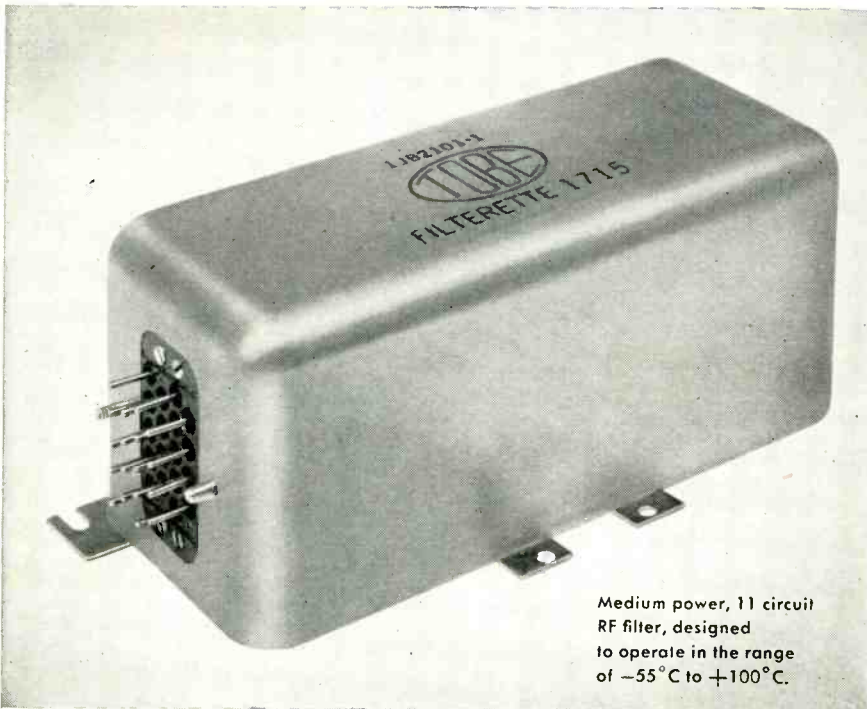

Medium power, 11 circuit
RF filter, designed
to operate in the range
of -55°C to $+100^{\circ}\text{C}$.

As specialists in the design and manufacture of RF filters since 1922, TOBE has accumulated a vast wealth of data covering filtering techniques. When it comes to filtering problems, TOBE can solve them.

TOBE Filterettes in both single and multiple circuits, are available in several hundred standard designs to meet any conceivable application. All types are engineered to operate under the most severe environmental conditions.

For further data or engineering aid, write TOBE DEUTSCHMANN Corporation, Norwood, Mass.

- *Tobe Exclusives:*
- Miniaturization with maximum quality.
- Guaranteed attenuation characteristics under full-load operating conditions.
- Current ratings up to 350 amps., AC and DC voltage ratings up to 5000 volts.
- Maximum insertion loss at all frequencies from 14 kc to 15,000 mc.
- Each type available in a variety of mounting styles.

specify
TOBE
PRODUCTS

TOBE DEUTSCHMANN • CAPACITOR PIONEERS SINCE 1922

NEW PRODUCTS

(continued)

claimed. Units require $3\frac{1}{8}$ in. panel space and may be cascaded for any desired count capacity. Manual or electronic zero setting may be provided.

Three models cover to 10 kc, 100 kc, and 1 mc respectively. Circle 444 on Reader Service Card.

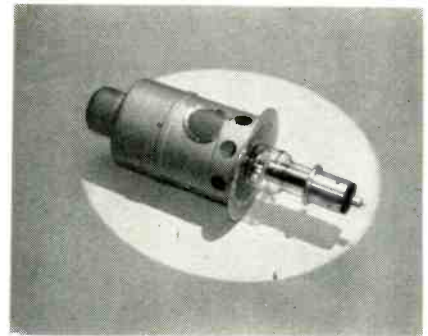

X-RAY TUBES forced-air cooled

MACHLETT LABORATORIES, INC., Springdale, Conn., announces the EG-180R x-ray tube for continuous high-power applications. The end-grounded tubes are completely cooled by forced-air; no hose lines or heat exchangers are required. Full power may be used in ambient temperatures up to 135°F .

The tubes require two minutes or less for morning warm-up. Individual exposures require less than 0.5 minute.

Two versions of the EG-180R are available: a beryllium window tube, the EG-180RB, which has a 40 deg cone of radiation, and the EG-180RX, a nickel window tube with a 360 deg band of radiation. Circle 445 on Reader Service Card.

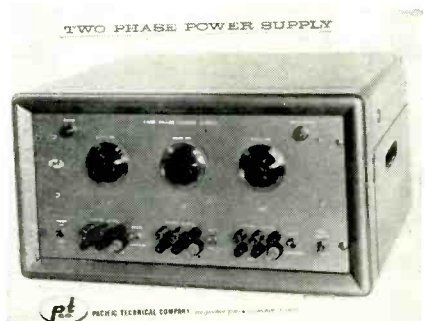

TWO PHASE SUPPLY continuously variable

PACIFIC TECHNICAL COMPANY, 2047
Sawtelle Blvd., Los Angeles 25,

NEW POWERSTAT® Variable Transformer

TYPE LW136

New Flexibility with Isolated Secondary Winding on Single Core

... a source of adjustable low voltage output
... a limited range line correction
... a limited range of "buck boost" voltage



TYPE LW136



TYPE LW136-3

Be sure to see
SUPERIOR ELECTRIC'S
Mobile Display
when it is in your area

Offices: Los Angeles, California • San Francisco, California • Toronto, Ontario, Canada • Miami, Florida • Chicago, Illinois • Baltimore, Maryland • Detroit, Michigan • New York, New York • Cleveland, Ohio • Dallas, Texas • Seattle, Washington

SINGLE PHASE

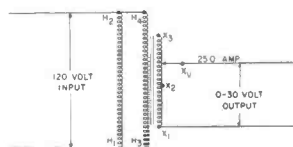

INPUT 120 Volt, 50/60 Cycle, 1 Phase
OUTPUT 0-30 Volt, 25 Amp., 0.75 KVA

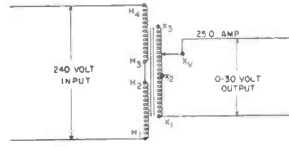

INPUT 240 Volt, 50/60 Cycle, 1 Phase
OUTPUT 0-30 Volt, 25 Amp., 0.75 KVA

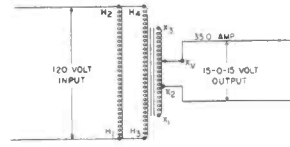

INPUT 120 Volt, 50/60 Cycle, 1 Phase
OUTPUT 15-0-15 Volt, 35 Amp., 0.53 KVA

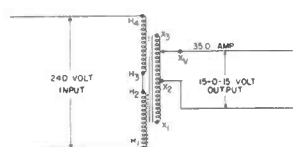

INPUT 240 Volt, 50/60 Cycle, 1 Phase
OUTPUT 15-0-15 Volt, 35 Amp., 0.53 KVA

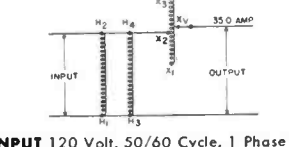

INPUT 120 Volt, 50/60 Cycle, 1 Phase
OUTPUT 105-135 Volt, 35 Amp., 4.7 KVA

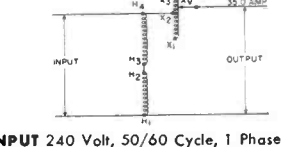

INPUT 240 Volt, 50/60 Cycle, 1 Phase
OUTPUT 225-255 Volt, 35 Amp., 8.9 KVA

INPUT 107-137 Volt, 50/60 Cycle, 1 Phase
OUTPUT 120 Volt, 35 Amp., 4.2 KVA

INPUT 226-256 Volt, 50/60 Cycle, 1 Phase
OUTPUT 240 Volt, 35 Amp., 8.4 KVA

THREE PHASE

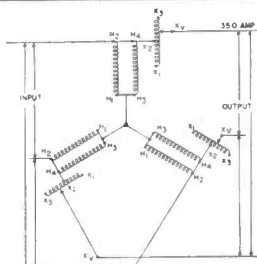

INPUT 240 Volt, 60 Cycle, 3 Phase
OUTPUT 210-270 Volt, 35 Ampere, 16.4 KVA

INPUT 214-274 Volt, 60 Cycle, 3 Phase
OUTPUT 240 Volt, 35 Ampere, 14.6 KVA

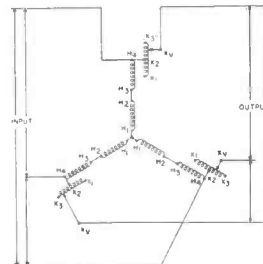

INPUT 480 Volt, 60 Cycle, 3 Phase
OUTPUT 450-510 Volt, 35 Ampere, 31.0 KVA

INPUT 452-512 Volt, 60 Cycle, 3 Phase
OUTPUT 480 Volt, 35 Ampere, 29.1 KVA



a precision product of
THE SUPERIOR ELECTRIC COMPANY

210 BRADLEY AVENUE, BRISTOL, CONNECTICUT

Send for Bulletin SE-L5571

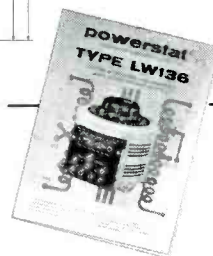

Name
Company
Street
City Zone State

1000 HOURS (OR MORE)

NEW PRODUCTS

(continued)

of trouble-free performance

**WITH
NEW** 
**HIGH-SPEED
ROTARY
SWITCHES
FOR AIRBORNE
APPLICATIONS**

Watchmaker's precision is combined with proved principles of electrical design to give you superior performance in high-speed multi-circuit commutation. Inherent ruggedness and strength of construction assure long, service-free life. All IDL switches are hermetically sealed. Current production assures delivery in quantity.

TELEMETERING SWITCH

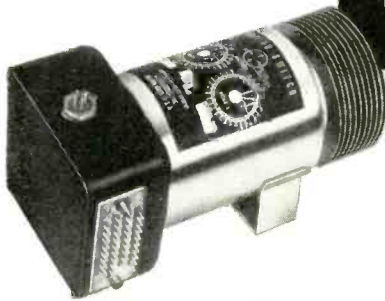

One of IDL's growing family of high-speed rotary switches for missile and aircraft applications.

3 Poles
30 Contacts per pole, BBM
10, 15 or 30 RPS

Power 7W or 15W Weight 2 lbs.
115V, 400C, single phase Overall Length 5 1/4"

Other specifications and units for other switching applications are also available.

Can your circuits use switching performance like this . . . ?

For 1000 or more service-free hours
At 900 samples per second
At -67° F to $+200^{\circ}$ F
After being subjected to 2000 cps vibrations 12 "g"

Under 75 g continuous acceleration
Into loads varying from 25 ohms to megohms
With input signals from 1 mv to 200 volts dc
With up to 50 ma current
With high production rates

To learn more about IDL's family of switches, send us your specifications or write for our complete brochure.

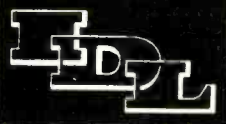
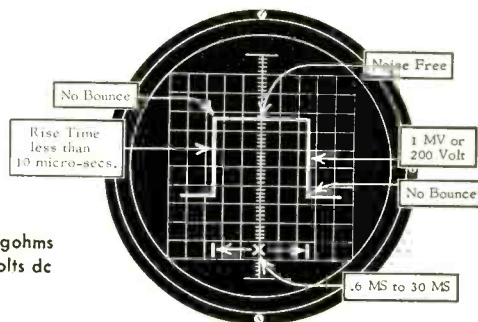

INSTRUMENT DEVELOPMENT LABORATORIES, INC.

An Affiliate of Royal McBee Corporation

66 Mechanic Street, Attleboro, Massachusetts, U. S. A.

In Canada: Measurement Engineering, Ltd., Arnprior, Ontario

Calif., introduces its new two-phase power supply for use in the development and testing of 400-cps servos, servo motors, two-phase gyro motors and other components. The unit features three continuously variable outputs, two at zero degrees and the other at ± 90 deg.

All outputs are individually fused with blown fuse indicator on the front panel. The total output of 580 volt-amps is distributed in the following way: the first two outputs, 0 to 225 volts, 1 amp, zero phase; the third output, 0 to 130 volts, 1 amp, ± 90 deg phase.

A system of five terminals per output allows the insertion of wattmeters or ammeters and includes an ammeter shunt switch. Input is either 115 or 200-volt line-to-line, 3 phase, 400-cps. Panel light indicates the correct input phasing. The unit weighs 51 lb, measures 22 by 15 by 11-in., and is either cabinet or rack mounted. Price is \$265. Circle 446 on Reader Service Card.



BEAM POWER TUBE of the glass-octal type

RADIO CORP. OF AMERICA, Harrison, N. J. The 6DQ5 is a new high-perveance beam power tube of the glass-octal type designed especially for use as a horizontal-deflection amplifier tube in color tv receivers.

Featuring a large reserve of power capability and having a high operating efficiency attributable to improved beam formation which results from advanced design of the electrode structure, a single 6DQ5 can provide full deflection for the RCA 21 in. type color picture tube.

Design features include a sturdy

IMPROVED

HIGH-PERFORMANCE OSCILLOSCOPE

DC-to-15 MC Vertical Response
0.05 v/cm Vertical-Deflection Factor
0.04 μ sec/cm Calibrated Sweep

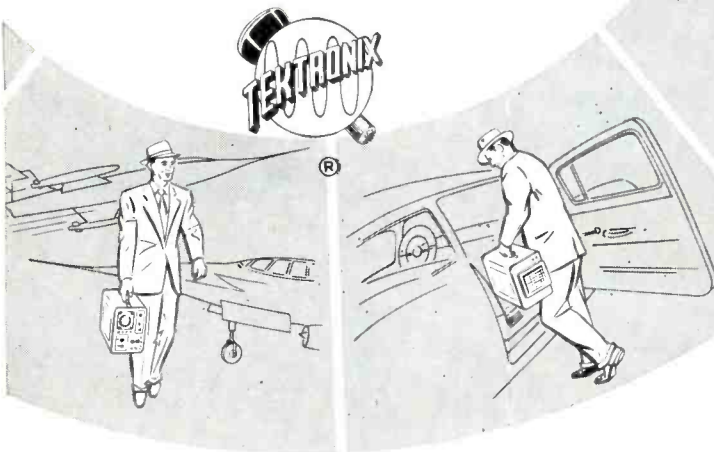

TYPE 515A SPECIFICATIONS

VERTICAL RESPONSE

Passband—dc to 15 mc.
Risettime—0.023 μ sec.
Signal Delay—0.25 μ sec.

VERTICAL SENSITIVITY

0.05 v/cm to 50 v/cm, continuously variable.
9 calibrated steps from 0.05 v/cm to 20 v/cm.

SWEEP RANGE

0.04 μ sec/cm to 6 sec/cm, continuously variable.
Single control selects any of 22 calibrated steps from
0.2 μ sec/cm to 2 sec/cm.
5 x magnifier, accurate on all ranges.

FOUR-WAY TRIGGERING

- 1. Amplitude-Level Selection**—adjustable amplitude-level and stability controls for triggering at a selected level on either the positive or negative slope of external, internal, and line signals, ac or dc-coupled.
- 2. Preset Stability**—same as above, except stability control is preset at the optimum triggering point and requires no readjustment.
- 3. Automatic Triggering**—automatic level-seeking trigger circuit provides dependable triggering for most applications. One simple setting assures positive sweep-triggering by signals of widely differing amplitudes, shapes, and repetition rates. No trigger controls need be touched until a different type of operation is desired. Provides a reference trace on the screen when no trigger signal is present.
- 4. High-Frequency Sync**—assures a steady display of sine-wave signals up to approximately 20 mc.

OTHER FEATURES

4-KV Accelerating Potential
DC-Coupled Unblinking
Square-Wave Amplitude Calibrator
Electronically-Regulated Power Supplies
Dimensions—9 $\frac{3}{4}$ " wide, 13 $\frac{1}{2}$ " high, 21 $\frac{1}{2}$ " deep.
Weight—40 pounds.

TYPE 515A \$750

Prices f.o.b. Portland, Oregon

The Tektronix Type 515A is high in performance, quality and value. It offers two important improvements over its very popular predecessor, the Type 515 . . . doubled sensitivity, and preset stability control. Yet it costs no more.

Although a higher-performance instrument, the Type 515A is smaller and weighs less than many other five-inch laboratory oscilloscopes. Therefore it is more easily moved from place to place in the laboratory, and to remote locations for applications requiring precise measurements. Take a look at the specifications and see if you don't think the Type 515A has interesting possibilities in your work.

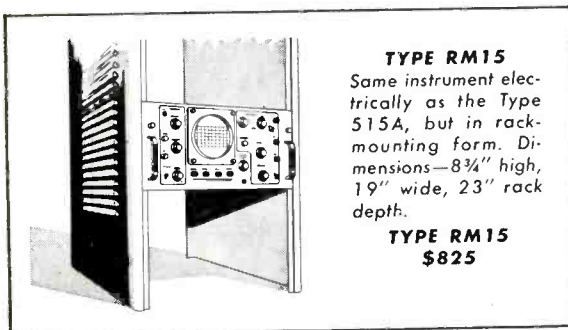

TYPE RM15
Same instrument electrically as the Type 515A, but in rack-mounting form. Dimensions—8 $\frac{3}{4}$ " high, 19" wide, 23" rack depth.

TYPE RM15
\$825

Tektronix, Inc.

P. O. Box 831 • Portland 7, Oregon
Phone Cypress 2-2611 • TWX-PD 311 • Cable: TEKTRONIX

SEE THE TYPE 515A AND OTHER NEW
TEKTRONIX INSTRUMENTS AT N. E. C.
BOOTHS 192-193.

See how big 3-D views speed assembly, measurement and inspection of tiny parts.

FREE 15-DAY, ON-THE-JOB TRIAL!



**Bausch & Lomb
STEREOMICROSCOPES**

These essential production tools make small-parts manufacture faster and easier, make precision surer. Views are vivid, magnified in natural 3-dimensional detail. Complete line to fit exact model to your specific industrial needs. Dustproof, shockproof, built for rugged production-line use—you can mount them right on machines!

See for yourself! Use a B&L Stereomicroscope on your own job for 15 days—absolutely free, no obligation. All we ask is the opportunity to let our Stereomicroscopes prove themselves to you. Just call your regular B&L dealer, or mail the coupon today.

BAUSCH & LOMB

SINCE  1853

BAUSCH & LOMB OPTICAL CO.
61422 ST. PAUL ST., ROCHESTER 2, N. Y.

- Yes, I'd like to borrow a B&L Stereomicroscope for a 15-day trial without cost or obligation.
 Send me B&L 3-D Micro-Vision Book, containing valuable data, showing actual stereo views.

NAME.....
TITLE.....
COMPANY.....
ADDRESS.....
CITY..... ZONE..... STATE.....

NEW PRODUCTS

(continued)

mount structure utilizing stem leads having high heat conductivity to provide cool operation of grids No. 1 and No. 2 with the result that emission from them is minimized, and radiating fins on grid No. 2 to increase its dissipation capabilities. In addition, specially designed micas together with beam-confining electrodes having rounded contours to reduce voltage gradients, insure against high-voltage breakdown.

The 6DQ5 has the following maximum ratings: d-c plate voltage of 900 v (including boost), peak positive-pulse plate voltage of 7,000 v, peak cathode current of 1 ampere, plate dissipation of 24 w, and grid-No. 2 input of 3.2 w. Circle 447 on Reader Service Card.

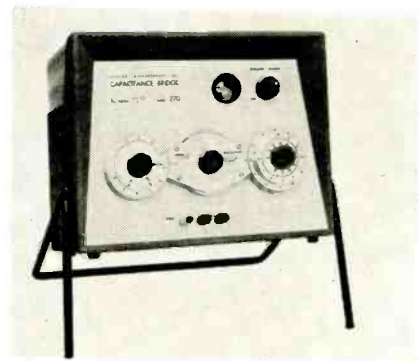

CAPACITANCE BRIDGE new package styling

ELECTRO-MEASUREMENTS, INC., 7524 S. W. Macadam Ave., Portland, Oregon, offers a new capacitance bridge, Model 270, for laboratories, production lines, and inspection stations where critical measurements are required. The instrument's seven ranges provide an accuracy of 0.20 percent from zero to 120 μf . On the lowest range, measurements can be made to within 0.01 μf . Dissipation factors at 1 kc can be measured from 0 to 1.05 in three ranges.

The three main sets of dials, on which all measurements are made, are arranged in line for ease of readout. The capacitance dial has 12,000 effective graduations, spaced about 1 mm apart.

The all-metal cabinet is supported by an adjustable wrought-iron stand. The stand folds out of the way for storage and serves as a carrying handle. In use, the

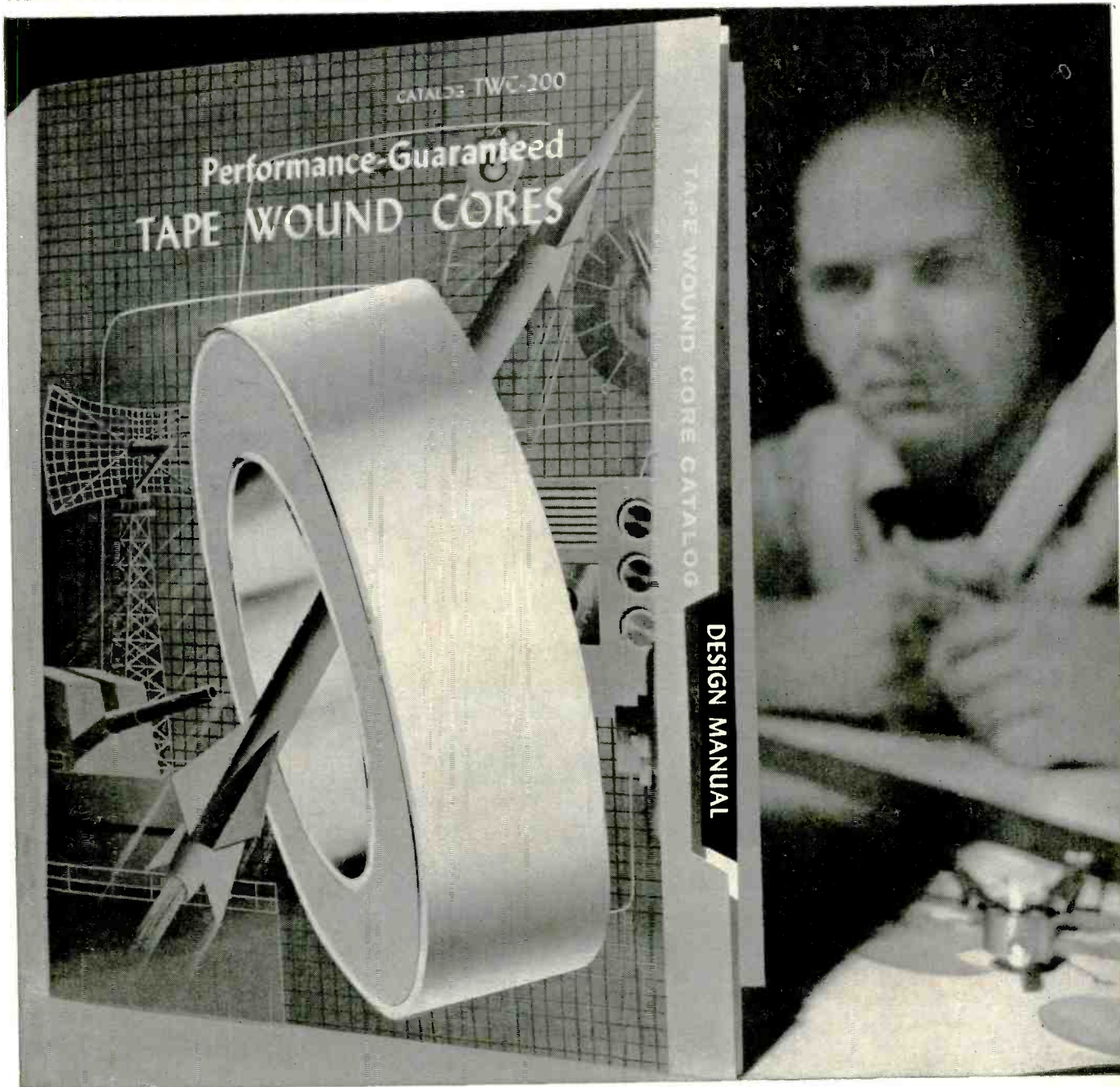

Here's the first design manual for your work with tape wound cores

Because engineers have expanded high permeability magnetics into a host of new uses, Magnetics, Inc. has combined its new tape wound core catalog with the industry's first design manual. If you and your staff need a working familiarity with magnetic equations, characteristics and terminology, this 28-page book will be of unusual value.

This design manual has been compiled under the direction of our laboratories. It contains basic units and conversion factors, methods of testing (dynamic, EI loop and d-c), properties and magnetic values of nickel-iron alloys, and many pages of curves showing the variation of magnetic properties with temperature and of core loss with frequency.

This fact-packed catalog and design manual also describes in detail the tape wound cores and bobbin cores which we manufacture. It will enable you to design around and specify the industry's only Performance-Guaranteed Tape Wound Cores. Should your engineering departments feel that more than one copy would be of value, please write for TWC-200 on company letterhead, giving full names and titles. *Magnetics, Inc., Dept. E-10, Butler, Pa.*

MAGNETICS inc.



two special services on
DIAMONITE high alumina parts

to speed up your production or development work

- **PROMPT, 24 HOUR OFF-THE-SHELF SERVICE** from large, comprehensive carefully-controlled inventories of hundreds of precision DIAMONITE parts in different shapes and sizes . . . rings, cylinders, tubes and rods. You can adapt these standard parts to your specific projects . . . and get your ideas into production in a matter of days or weeks, instead of months. You will also be in a position to enjoy better deliveries and better costs, as well as better quality, when you are ready to go into production.
- **SPEEDY SERVICE ON SPECIAL SHAPES** in small lots from DIAMONITE'S complete, modern pilot plant. The shapes will be engineered to your submitted drawings. Delivery of parts will be made in a matter of days. This saves you three ways: (1) In time required to get your projects through the preliminary stages; (2) In saving on costly dies until you have tested your ideas and worked out the "bugs"; and (3) In time needed to get the project into production. Air mail your prints and specifications for prices and deliveries.
- **ALL DIAMONITE PARTS** — from inventory or from pilot plant — have all the properties for which DIAMONITE is famous. These include extremely low dielectric loss factors, high thermal shock resistance, high strength, high hardness, absolute zero water absorption, and many other desirable characteristics.

Start saving time and money now in developing your ideas. Send for a copy of the DIAMONITE OFF-THE-SHELF Inventory and Price List #357, or pick up your copy at

DIAMONITE
 products manufacturing company

pioneers in
 the development of high
 alumina ceramics

Canton 3, Ohio
 Phone: GLEndale 6-8195

terminals, near the cabinet bottom, are five inches above the work area. Circle 448 on Reader Service Card.

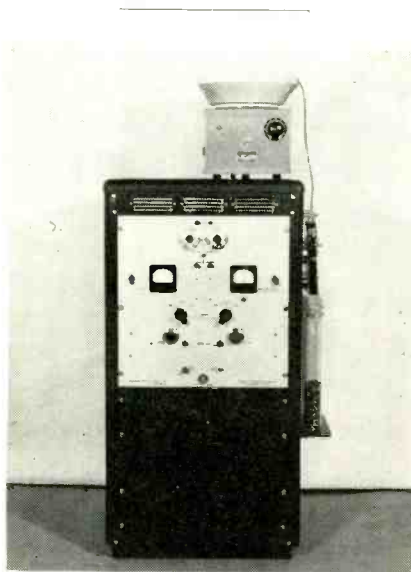

RESISTANCE SORTER
 operates automatically

STREMPER INSTRUMENT CORP., R. D. 1, Lake George, N. Y. Demand for reliable, unattended resistance sorters for component and equipment production has brought about standardization on two new models of automatic sorters, type R-1A for axial lead resistors and type R-1B (shown) for capped or no-lead resistors.

Parts are sorted at 4,000 pieces per hour into "acceptable", "high", and "low" groups. The standard machine has d-c bridge measurement with 2 v across the part, independent setting of high and low tolerance limits from 0.5 percent to 20 percent with accuracy of sorting at the limits of ± 0.2 percent. Special voltages, higher accuracies can be supplied; reel pack and strip pack fixtures are available. Circle 449 on Reader Service Card.

D-C STANDARD
 and null meter

KIN TEL (Kay Lab), 5725 Kearny Villa Road, Box 623, San Diego 12, Calif. Model 301 is an extremely compact variable d-c standard and null meter. Direct reading calibrated dials provide instant voltage selection with standard cell

high voltage



- Upper Left: HP-1 unregulated hi-pot tester, 0-2.5 KV, 0-2 MA DC . . . \$175.00
- Center: H-50 industrial HV supply 0-30KV, 0-5 MA DC, basic 20 safety and performance features . . . \$630.00
- Right: CS-46H59 super-regulated custom HV supply, 0-70 KV, 0-10 MA DC, regulated to 35 ppm! Ripple less than 70 ppm . . . \$15,600.00

From The Simplest Standard To The Most Sophisticated Custom Design, NJE Leads The High Voltage Power Supply Field.

27 STANDARD MODELS, HUNDREDS OF CUSTOM DESIGNS AVAILABLE ON SHORT, DEPENDABLE DELIVERY CYCLES.

WRITE FOR CATALOG AND CUSTOM DESIGN FILE.

NJE CORPORATION
ELECTRONIC DEVELOPMENT & MANUFACTURING

345 Carnegie Avenue, Kenilworth, New Jersey
COMPETENT ENGINEERING REPRESENTATION EVERYWHERE

TELEPHONE: Chestnut 1-1500
TELEFAX: FFP, TWX: Roselle 51

NJE LEADS THE POWER SUPPLY FIELD

BULOVA

FAMED FOR PRECISION SINCE 1875

CRYSTAL FILTERS

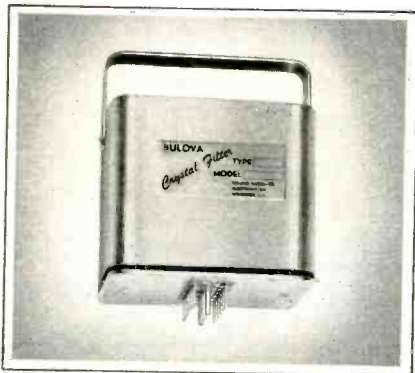

Precision engineered multiple-crystal filters are now available as packaged units from one of the world's foremost manufacturers of quality crystals.

By being able to maintain exacting control of individual crystal characteristics, during manufacture, Bulova can quickly and economically produce precision crystal filters on a custom design or production basis.

TELEMETRY: Many telemetry centers are now relying on Bulova filters to preserve the accuracy of multiplexed data during processing. Wide band and narrow band filters are available.

SINGLE SIDE BAND: For voice and other ssb applications Bulova filters provide excellent suppression of unwanted side band in both transmitting and receiving equipment.

Center frequencies from 10 KC to 20 MC, with bandwidths of .01%-8% of center frequency can be provided in either symmetrical or asymmetrical filters using Bulova high precision crystals.

Send for literature on Bulova's standard and custom design filters today, or let our engineering staff study your filter problem and recommend a suitable package for your particular application.



BULOVA

watch company

Electronics Division
Woodside 77, N. Y.

Write Dept. A-848 For
Full Information and
Prices on Crystal Filters

NEW PRODUCTS

(continued)



accuracy. A chopper stabilized circuit constantly compares the output with an internal standard cell to provide stability, accuracy and excellent dynamic characteristics. Power supply output voltage is 1 to 501 v at up to 20 ma. As a null voltmeter, the unit measures voltage from 1 to 501 v with excellent accuracy. It has four decades null meter ranges from 50 v to 501 mv full scale. The meter can also be used to read input voltage or the output voltage of the supply.

Model 301 features 0.01 percent stability, 0.02 percent accuracy, 0.002 percent line and load regulation, less than 100 μ v ripple, 0.2 millisecc response time, and less than 0.01 ohm output impedance.

Applications include production calibration of precision measuring instruments and power supplies, design of d-c amplifiers and complex electronic circuitry, transducer supply, transistor testing and computer reference. **Circle 450 on Reader Service Card.**

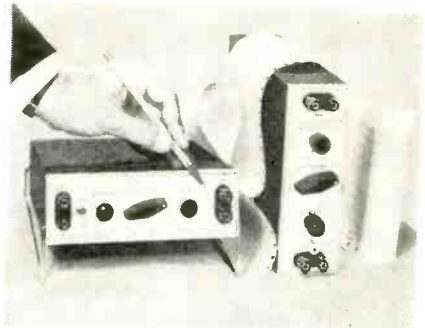

D-C AMPLIFIER
completely transistorized

TEXAS INSTRUMENTS INC., 3609
Buffalo Speedway, Houston 6,

FREQUENCY STANDARDS



PRECISION FORK UNIT TYPE 50

Size 1" dia. x 3 3/4" H. Wght., 4 oz.*
 Frequencies: 240 to 1000 cycles
 Accuracies:—
 Type 50 ($\pm 0.02\%$ at -65° to 85°C)
 Type R50 ($\pm 0.002\%$ at 15° to 35°C)
 Double triode and 5 pigtail parts required
 Input, Tube heater voltage and B voltage
 Output, approx. 5V into 200,000 ohms

*3 1/8" high
 400 - 1000 cy.

FREQUENCY STANDARD TYPE 50L

*Size 3 3/4" x 4 1/2" x 5 1/2" High
 Weight, 2 lbs.*

Frequencies: 50, 60, 75 or 100 cycles
 Accuracies:—
 Type 50L ($\pm 0.02\%$ at -65° to 85°C)
 Type R50L ($\pm 0.002\%$ at 15° to 35°C)
 Output, 3V into 200,000 ohms
 Input, 150 to 300V, B (6V at .6 amps.)

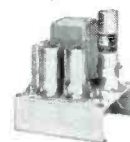

PRECISION FORK UNIT TYPE 2003

Size 1 1/2" dia. x 4 1/2" H. Wght. 8 oz.*
 Frequencies: 200 to 4000 cycles
 Accuracies:—
 Type 2003 ($\pm 0.02\%$ at -65° to 85°C)
 Type R2003 ($\pm 0.002\%$ at 15° to 35°C)
 Type W2003 ($\pm 0.005\%$ at -65° to 85°C)
 Double triode and 5 pigtail parts required
 Input and output same as Type 50, above

*3 1/2" high
 400 to 500 cy.
 optional



FREQUENCY STANDARD TYPE 2005

*Size, 8" x 8" x 7 1/4" High
 Weight, 14 lbs.*

Frequencies: 50 to 400 cycles
 (Specify)
 Accuracy: $\pm 0.001\%$ from 20° to 30°C
 Output, 10 Watts at 115 Volts
 Input, 115V. (50 to 400 cycles)



FREQUENCY STANDARD TYPE 2007T TRANSISTORIZED

Size 1 1/2" dia. x 4 1/2" H. Wght. 7 ozs.*
 Frequencies: 240 to 1000 cycles
 Accuracies:—Same as 2003, above
 Type 2007S—Silicon type
 Input, 28V.
 Output, Multitap, 75 to 100,000 ohms

*3 1/2" in 2007S, 400 to 800 cycles.



FREQUENCY STANDARD TYPE 2121A

*Size
 8 3/4" x 19" panel
 Weight, 25 lbs.*
 Output: 115V
 60 cycles, 10 Watt
 Accuracy:
 $\pm 0.001\%$ from 20° to 30°C
 Input, 115V (50 to 400 cycles)

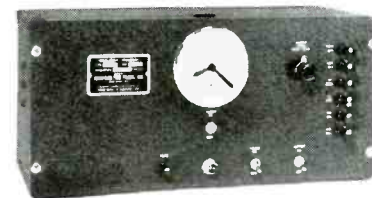

FREQUENCY STANDARD TYPE 2001-2

Size 3 3/4" x 4 1/2" x 6" H., Wght. 26 oz.
 Frequencies: 200 to 3000 cycles
 Accuracy: $\pm 0.001\%$ at 20° to 30°C
 Output: 5V. at 250,000 ohms
 Input: Heater voltage, 6.3 - 12 - 28
 B voltage, 100 to 300 V., at 5 to 10 ma.



FREQUENCY STANDARD TYPE 2111C

*Size, with cover
 10" x 17" x 9" H.
 Panel model
 10" x 19" x 8 3/4" H.
 Weight, 25 lbs.*

Frequencies: 50 to 1000 cycles
 Accuracy: ($\pm 0.002\%$ at 15° to 35°C)
 Output: 115V, 75W. Input: 115V, 50 to 75 cycles.



ACCESSORY UNITS for TYPE 2001-2

- L—For low frequencies multi-vibrator type, 40-200 cy.
- D—For low frequencies counter type, 40-200 cy.
- H—For high freqs, up to 20 KC.
- M—Power Amplifier, 2W output.
- P—Power supply.



This organization makes frequency standards within a range of 30 to 30,000 cycles. They are used extensively by aviation, industry, government departments, armed forces—where maximum accuracy and durability are required.

WHEN REQUESTING INFORMATION
 PLEASE SPECIFY TYPE NUMBER

American Time Products, Inc.

580 FIFTH AVENUE, NEW YORK 36, N. Y.

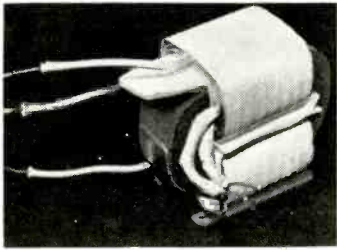

Aircraft high voltage pulse transformer uses POLYPENCO Teflon Tape insulation for interlayer case lining and terminal wrapper.

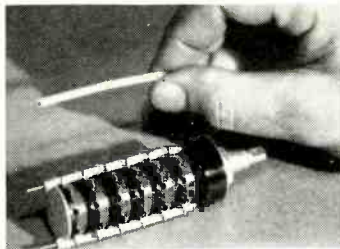

POLYPENCO Teflon Spaghetti Tubing used in miniature rotary tap switch combines high dielectric strength in thin sections with resistance to soldering heats.

FOR **MINIATURE** ELECTRONIC PARTS POLYPENCO TEFLON* Assures Superior Performance

With increased emphasis on the miniaturization of electronic systems, Teflon tape and spaghetti tubing are being subjected to more severe requirements than ever before. Uniform density and controlled properties in thin-walled sections are of major importance. That's why POLYPENCO Teflon is being used so widely in the electronics field today. Polymer's rigid in-process testing assures you unvarying quality . . . the quality necessary to design and fabricate more minute parts and components for top performance.

Teflon's Outstanding Properties

- Dielectric Constant. 2.0
- Power Factor. 0.0005
- Dissipation Factor. 0.0002
- Dielectric Strength, Volts/mil. . 400-500
- Volume Resistivity. 10^{15} ohm-cm
- Surface Resistivity
100% R.H. 10^{13} ohm
- Water absorption. Zero
- Fungus Resistance. Excellent
- Services entire frequency range
- Arc Resistance—Good, leaves no carbon path regardless of time of exposure

Stock Shapes Readily Available

POLYPENCO Teflon rod, tubing and

sheets are available in a wide range of sizes. POLYPENCO Teflon Tape and Spaghetti Tubing are made in 10 fade-proof colors for coding. Spaghetti Tubing is available in 26 AWG sizes from No. 30 to 0. Nationwide stocking and service points assure prompt delivery. The name of your nearest representative is immediately available on request.

Fabricating Service

Custom fabricated parts are available from The Polymer Corporation of Penna., engineered for the best in design, quality and tolerance.

Write for latest data and bulletins.

THE POLYMER CORPORATION OF PENNA.

Reading, Pa.

Export: Polypenco, Inc., Reading, Pa., U.S.A.

*DU PONT TRADEMARK

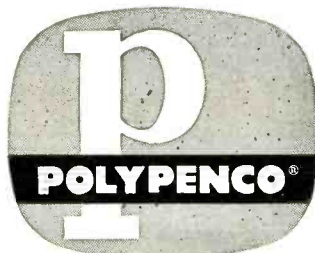

POLYPENCO nylon, POLYPENCO Teflon*, FERROTRON® and NYLATRON® GS

Texas. Model 301 amplifier is an electronically modulated d-c amplifier for use with milliammeter recorders. Instrument sensitivity is from 10 mv to 100 v d-c. Frequency response extends to 50 cps.

The amplifier is powered by either line voltage or a self-contained battery. Battery life is approximately 300 hours.

Input impedance is 2.5 megohms per volt; output impedance is 39 ohms, to provide proper damping for the recording instrument. Accuracy is 2 percent of full scale.

The unit weighs 4½ lb and measures 7½ by 10 by 2½ in. **Circle 451 on Reader Service Card.**



TV MONITOR for closed circuit use

KIN TEL (Kay Lab) 5725 Kearny Villa Road, San Diego 11, Calif. Model ARM-14 is a new 14-in. video monitor designed to provide remote viewing of video information from the company's industrial or broadcast tv camera chains. The monitor contains a precision deflection system and a broadband video amplifier that provide exceptional over-all picture quality. Video bandwidth is in excess of 8 mc and horizontal resolution is better than 600 lines. Only one coaxial cable is necessary between the camera control unit and the monitor. Sync is provided by blanking pulses on the video waveform. The monitor may be positioned up to 1,000 ft from the camera control unit, and farther if line amplifiers are used.

The unit is available in a cabinet or a 19-in. rack mountable

PYRAMID CQM

1. High reliability, ideally suited for computer requirements.
2. Highest purity aluminum used.
3. Molded terminals for tight permanent seal.
4. Low leakage current.
5. Long shelf life.
6. Low equivalent series resistance.

Computer circuits require electrolytic capacitors of the highest reliability. Pyramid type CQM capacitors fill this requirement. They are made with electrodes of the highest purity aluminum obtainable (99.99%) and specially formulated electrolytes. Carefully inspected materials, coupled with controlled manufacturing methods, produce a capacitor capable of meeting the most exacting computer specification.

The capacitors are made in high purity aluminum containers hermetically sealed with molded tops held in place by rolling the can rim securely over a buna rubber gasket. The terminals are molded into the top. These terminals and the buna rubber gasketing insure a tight, permanent seal.

Two types of terminals are available: (1) a screw type terminal with tapped inserts, (CQM); (2) a lug type terminal, with anti-rotational locks, swaged to solid aluminum inserts, (CQML).

Internal connections to the aluminum inserts are made with straps of the same high purity aluminum as the electrodes. This feature contributes to low leakage and long shelf life.

Pyramid type CQM capacitors may be ordered in various capacitance and voltage combinations ranging from 45,000 mfd at 5 WVDC to 850 mfd at 400 WVDC. Container diameters are 1 $\frac{3}{8}$ ", 2", 2 $\frac{1}{2}$ " and 3". The height for all units is 4 $\frac{1}{8}$ ". Other sizes, or units for special applications may be obtained by inquiring of Pyramid's Engineering Department.



NEW FROM PYRAMID

PYRAMID TQ

1. Designed for high reliability electronic equipment, telephone networks, and industrial control systems.
2. Wide temperature range: -20°C. to +85°C.
3. Hermetically sealed aluminum can.
4. Low leakage current.
5. Long life, trouble free operation.
6. Manufactured under quality controlled conditions.

Present day electronic equipment, telephone network systems, and industrial control systems, where a high degree of reliability is essential, require capacitors having a long life.

Pyramid Electric Company introduces type TQ, a high quality electrolytic capacitor which will meet the requirements of design engineers today and for some time to come.

From raw material to finished product, the Pyramid type TQ is manufactured under controlled conditions and constant supervision.

Type TQ Capacitors are available in single, dual and triple capacitances. They vary in voltage range from 6 to 450 working volts DC. Can sizes are available in 1" diameter x 2 $\frac{1}{2}$ " length, 1" x 3", 1" x 3 $\frac{1}{2}$ ", 1" x 4", 1 $\frac{3}{8}$ " x 2 $\frac{1}{2}$ ", 1 $\frac{3}{8}$ " x 3 $\frac{1}{2}$ " and 1 $\frac{3}{8}$ " x 4".



For complete specifications write for technical bulletin.



PYRAMID ELECTRIC CO.

NORTH BERGEN, NEW JERSEY

from Instrument Calibration HEADQUARTERS



MODEL
829

a
modern
method of
maintaining
ACCURACY

Superior and sustained quality control, through frequent calibration of test instruments, can be achieved by semi-skilled personnel using these self-contained standards.

Portable Model 829 calibrates both AC and DC meters over ranges from 0.25 millivolt to 2000 volts and 2 microamperes to 20 amperes. Direct reading accuracy of 1% (0.5% using charts supplied). Output frequency from 50 to 400 cps depending on line frequency used.

Net price \$2,650.



MODEL 261B

Console Model 261B calibrates all types of AC meters to direct reading accuracies of 0.5% (0.25% using calibration charts) over frequency range of 50 to 1600 cps. Current range from 1.5 milliamperes to 200 amperes; voltage range from 75 millivolts to 1500 volts. Output of electronic power oscillator has less than 5% total harmonic content at 60 cycles.

Net price \$9,250.

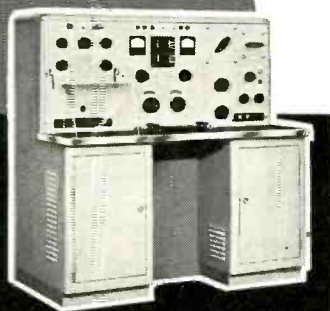

MODEL 262B

Model 262B Dual Potentiometer Standard calibrates DC electrical measuring instruments to direct reading accuracies of 0.1% (0.05% using calibration charts) through voltages ranging from 1 millivolt to 1500 volts and currents ranging from 1 microampere to 150 amperes. Employs Weston instruments and standard cells.

Net price \$15,600.

Prices are f.o.b. Boonton, N.J. & subject to change without notice.



Radio Frequency
LABORATORIES, INC.
Boonton, New Jersey, U. S. A.



WE CAN
HELP
YOU

Technical and application data for our six basic models are fully described in a new 24-page catalog. Send for it today.

chassis. The rack mount model will accept any three remote control panels for remotely controlled pan-tilt, iris-focus, 3-lens turret, and camera control accessories. Circle 452 on Reader Service Card.



THREE-TURN POTS miniaturized units

SPECTROL ELECTRONICS, 1704 S. Del Mar Ave., San Gabriel, Calif., announces their model 550 series of three turn potentiometers. The miniaturized units have a diameter of $\frac{3}{8}$ in.

Linearities as low as ± 0.15 percent are available. Ranges are in standard values from 10 to 36,000 ohms at 1 watt. Up to three units may be mounted on a common shaft and units may have a maximum of twelve taps per section.

The entire series meets military environmental specifications, operating from -55 C to $+85$ C and withstanding vibrations from 55 to 500 cps at 15g and 500 to 2,000 cps at 10g. A life of over 2,000,000 cycles is predicted.

Units are available in either standard bushing or ball-bearing servo mounts. Front and rear lids are made of machined aluminum for stability and rigidity. Shaft radial play is limited to less than 0.0002 in., since the shaft is supported at both ends.

Special electrical rotation, high temperature coils (150 C), special length shafts, slotted shafts and other special features are available on request. Circle 453 inside back cover.

VHF LINE AMPLIFIER with automatic-level-control

ENTRON INC., P. O. Box 287, Bladensburg, Md., Model LRA-40 trunk

Ask yourself why do you hesitate?

Take any One

OF THESE BOOKS

FREE

with membership in

McGraw-Hill's Book Club for
Electronics and Control Engineers



COUNTLESS Electronics and Control Engineers find these important technical books indispensable to a field so dynamic that even specialists can hardly keep up!

How many of the books shown here do you wish you had immediately at hand? We invite you to take one AS A GIFT and one as your first selection... your introduction to a technical reading program that cannot fail to be of value to you.

The McGraw-Hill Electronics and Control Engineers' Book Club was organized for engineers like yourself to bring to your attention outstanding books in your field that you might otherwise miss. The twelve books shown above suggest the quality of the volumes that will be made available to you. And you may obtain any or all selections at substantial savings.

How the Club operates. The Club will describe all forthcoming selections to you. Every second month you will receive the *Electronics and Control Engineers' Book Club Bulletin*. This gives complete advance notice of the next main selection as well as a

number of alternate selections. All books are chosen by editors of the McGraw-Hill Book Company whose thoroughgoing understanding of the standards and values of technical literature will be your guarantee of the authoritativeness of the selections.

From this point on, the choice is yours. If you want the main selection you do nothing; the book will be mailed to you. If you want an alternate selection or if you want no book at all for that two-month period, you notify the Club by returning the form and postage-paid envelope enclosed with your *Bulletin*.

We ask you to agree only to the purchase of three books a year. Certainly out of the large number of books in your field offered you in any twelve months there will be at least three you would buy in any case. By joining the Club you will save, in cost, about 15 percent from the publishers' prices.

It's up to you. Reach for your pen right now and fill out the coupon. You need send no money now. Remember, by taking advantage of this special introductory offer you will receive absolutely FREE any one of these books, together with your first selection—at the special club price.

So while this offer is in effect, put your application form in the mail today!

Mail Entire Coupon to:

The McGraw-Hill Electronics and Control Engineers' Book Club
330 West 42nd Street, New York 36, N. Y. P. O. Box 97

Please enroll me as a new member of the Electronics and Control Engineers' Book Club. I am to receive FREE the book I have indicated along with my first selection checked below. You will bill me for my first selection only at the special club price, plus a few additional cents for postage and handling. (The Club assumes this charge on prepaid orders.) Forthcoming selections will be described to me in advance and I may decline any book. I need take only 3 selections or alternates in 12 months of membership.

- Pulse and Digital Circuits** by Jacob Millman, Professor of Electrical Engineering, Columbia University and Herbert Taub, Associate Professor of Electrical Engineering, The City College of New York. Publisher's Price, \$12.50. Club Price, \$10.60.
- Modern Physics for the Engineer** edited by Louis N. Ridenour, Vice President, International Telemeter Corporation. Publisher's Price, \$8.00. Club Price, \$6.80.
- Electronic Analog Computers**, 2nd Ed., by Granino H. Korn and Theresa M. Korn, Industrial Consultants. Publisher's Price, \$7.50. Club Price, \$6.40.
- Mechanical Design for Electronics Production** by John M. Carroll, Associate Editor, *Electronics*. Publisher's Price, \$6.50. Club Price, \$5.50.
- Contracts, Specifications and Engineering Relations**, 3rd Ed., by Daniel W. Mead, written by the Staff of Mead and Hunt, Inc., and Joseph R. Akerman, Revisions Editor and Principal Author. Publisher's Price, \$7.00. Club Price, \$5.95.
- Random Processes in Automatic Control** by J. Halcombe Laming, Jr., Deputy Associate Director and Richard H. Bartin, Assistant Director, Instrumentation Laboratory, Massachusetts Institute of Technology. Publisher's Price, \$10.00. Club Price, \$8.50.
- Transistors in Radio and Television** by Milton S. River, Author of *Color Television Fundamentals*. Publisher's Price, \$6.50. Club Price, \$5.50.
- Servomechanism Practice** by W. H. Ahrendt, President, The Ahrendt Instrument Company. Publisher's Price, \$7.50. Club Price, \$6.55.
- Automatic Feedback Control System Synthesis** by John G. Truxal, Professor and Head, Dept. of Electrical Engineering, Polytechnic Institute of Brooklyn. Publisher's Price, \$12.50. Club Price, \$10.00.
- Electronic and Radio Engineering**, 4th Ed. by Frederick E. Terman, Dean, School of Engineering, Stanford University. Publisher's Price, \$13.50. Club Price, \$11.50.
- Analog Computer Techniques** by Clarence L. Johnson, Captain, U. S. Air Force; Assistant Professor of Mathematics, U. S. Air Force Institute of Technology. Publisher's Price, \$6.00. Club Price, \$5.10.
- Introduction to Numerical Analysis** by F. D. Hildebrand, Associate Professor of Mathematics, Massachusetts Institute of Technology. Publisher's Price, \$8.50. Club Price, \$7.25.

No-risk guarantee. If not completely satisfied, I may return my first shipment within 10 days and my membership will be canceled.

Name (Please Print)

Address

City Zone State

This offer is available only in the United States and its possessions. In Canada write McGraw-Hill Canada, 253 Spadina Road, Toronto 4.

stoddart coaxial attenuators and terminators

*made with exclusive
Stoddart Filmistors
for highly accurate
and stable resistive values*

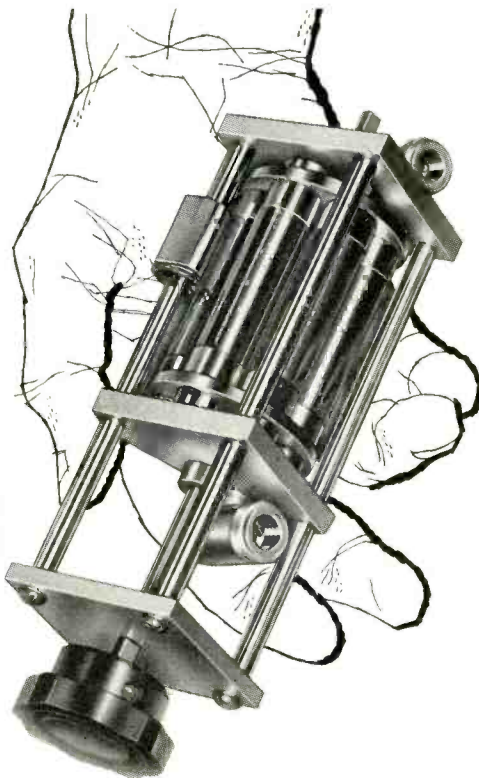

NEW PRODUCTS

(continued)

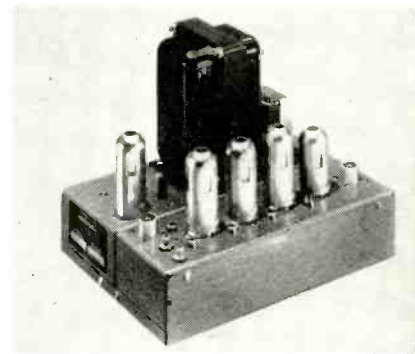

line amplifier is a broadband vhf amplifier equalized to compensate for cable slope between 53 mc and 89 mc to ± 0.25 db. It will provide up to 0.2 volt output across a 75 ohm load and has a maximum gain of 45 db on channel 6.

Stable, drift-free automatic-level-control holds the output level within 1 db for 10 db increases of input level.

An 8.5 db noise figure is attained through the use of the new 6922 low noise dual triode in the input stage. The power supply utilizes a constant voltage transformer and silicon diodes. It maintains output stability ± 0.2 db for ± 20 percent line voltage variations. **Circle 454 on Reader Service Card.**

6 position TURRET ATTENUATORS with simple "pull-turn-push" operation

Extremely precise resistance values from dc to 3000 mc are maintained by Stoddart-developed Filmistors—thin metallic films in ceramic forms which are assembled in properly designed coaxial sections. Turret units are small, and built for long service.

VSWR: Better than 1.2 to 3000 mc.
Characteristic Impedance: 50 ohms
Attenuation Value: Any value from 0 db to 60 db
Accuracy: ± 0.5 db
Power Rating: 1.0 watt sine wave
Connectors: Type N, female

ATTENUATOR PADS

Uniform size, many combinations



You can specify these small "in-the-line" pads in any conceivable combination of male and female Type C and Type N connectors. Single pads with female connectors can be provided with flange for panel mounting. Convenient to use... pads have maximum length of only 3" for any attenuation value. Electrically, pads are the same as those in turret model above.

COAXIAL TERMINATIONS

small, stable—50 or 70 ohm



$\frac{1}{2}$ -watt terminations—50 ohms impedance, TNC or BNC connectors, to 3000 mc. Low cost. VSWR less than 1.20.
1-watt terminations—50 ohms, DC to 3000 mc or DC to 7000 mc. VSWR less than 1.20. Type N or Type C connectors, male or female. 70-ohm, Type N, male or female terminations available.
Platinum film resistors, gold-plated electrical contacts, durable satin chrome exterior finish. Wattages are continuous sine wave ratings.



RELAYS

with wedge action contacts

ELECTRO TEC CORP., South Hackensack, N. J., announces their Mark II relay with wedge action contacts for reliable action under extreme environmental conditions. The wedge action insures positive contact, increases contact pressure after the initial engagement and effectively removes contaminants from the contact surfaces.

The Mark II is a miniature six-hole, double-throw, hermetically

All items immediately available from stock

Send for Attenuator Catalog A-2

stoddart aircraft radio co., inc.

6644 Santa Monica Blvd., Hollywood 38, Calif. • HOLLYWOOD 4-9294



any time now...

**one of our clients
is going to ask
for the moon**

...and, following our
usual policy, we'll have to produce it!

EFCON
CLOSE-TOLERANCE CAPACITORS

ELECTRONIC FABRICATORS, INC.

DEPT. E4, 682 BROADWAY, N. Y. 12, N. Y.

TELEPHONE: SPRING 7-4900 CABLE: ELFACAP



Announcing...

WALTHAM

FLOATED RATE GYRO

Type WG-4

The WG-4 Floated Rate Gyro is of miniature size for aircraft and missile use and is intended to supply a large output signal from each of two potentiometer pickoffs under severe conditions of temperature, vibration and shock. The basic design incorporates a single phase spin motor with high precision governor to render overall performance independent of line voltage and frequency. Gimbal fluid damping is provided with internal compensation for temperature, hence the unit does not require temperature control. A high degree of null and scale factor stability is achieved through a low stress torsion bar design. The gimbal system is supported on bearings independently of the torsion bar. A generous provision for differential expansion eliminates fluid leakage and hermetic seal problems.



SPECIFICATIONS FOR BASIC UNIT

INSTALLATION

DIMENSIONS: 2¼" dia., 3¾" long
EXTERNAL ELECTRICAL connections via Viking VR9/2AG1 connector. Weight 1.0 lb.

SPIN MOTOR

EXCITATION: 115 volts, 400 c.p.s., single phase
POWER: 5.5 watts
STALL CURRENT: 105 ma.
RUNNING CURRENT: 60 ma.

POTENTIOMETERS

TOTAL RESISTANCE: 10,000 ohms
MAX. RECOMMENDED EXCITATION: 50 volts

PERFORMANCE

MAX. INPUT: $\pm 75^\circ/\text{sec}$.
MAX. NULL OUTPUT: $\pm 1^\circ/\text{sec}$.
DAMPING FACTOR: 0.8 ± 0.2
NATURAL FREQUENCY: 19 c.p.s.
WARM-UP TIME: Less than 1 minute
AMBIENT TEMPERATURE RANGE:
 -55°C to $+71^\circ\text{C}$
LIFE: 1000 hours minimum
ENVIRONMENTAL: MILE-5272A

NOTE: Units can be supplied to this basic design with other motor inputs, pickoffs, etc., to suit particular applications. This information is for reference ONLY. Engineering Specifications and Drawings will be supplied upon request.

GYROS... FREE, RATE AND INTEGRATING, TACHOMETERS, ELAPSED TIMERS, AIRCRAFT CLOCKS, ELECTRONIC AND ELECTRO MECHANICAL ASSEMBLIES.

WALTHAM PRECISION INSTRUMENT COMPANY
FORMERLY WALTHAM WATCH COMPANY

WALTHAM 54, MASSACHUSETTS

PRECISION HAS BEEN OUR BUSINESS SINCE 1850

sealed unit which meets military specifications. It has operating vibration resistance from 5 to 2,000 cps at 30 g, shock resistance to 100 g and a temperature range from -65°C to $+200^\circ\text{C}$.

Currents up to 2 amps may be switched reliably. A 26.5 v d-c coil is standard, but other values can be provided. Circle 455 on Reader Service Card.

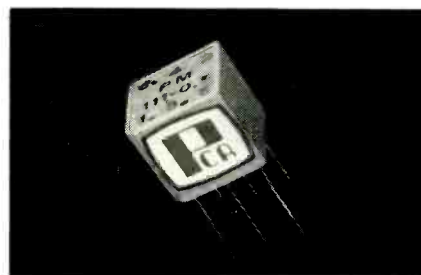

TRANSFORMER

for etched circuitry

PCA ELECTRONICS INC., 16799 Schoenborn St., Sepulveda, Calif. Keyed for automation, this encapsulated pulse transformer has many applications; such as, blocking oscillators, triggering and counting circuits, impedance matching, and phase inversion, pulse shaping, d-c isolation, as wide band input and output transformers, and many other uses.

The leads are spaced on a tenth of an in. grid. The mounting surface is provided with four legs to eliminate moisture trap between the unit and etched board. It is available in two and three windings with pulse widths from 0.1 to 16 μsec . Circle 456 on Reader Service Card.

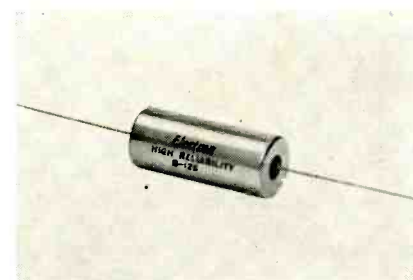

CAPACITORS

high-reliability type

ELECTRON PRODUCTS Co., 430 N. Halstead Ave., Pasadena, Calif., has announced a line of high-



All business is specialized

...and nothing specializes
on your business like your
business paper

This profit-wise peddler looks for the wettest crowds. His business is specialized. Like yours.

And like your business, this business paper of yours specializes, too. It packs into one place the current facts you want. It scouts out, sorts out, reports and interprets the specific news and information you need to keep posted and keep ahead in your field. Cover to cover, editorials and ads, it concentrates on bringing you specialized help you can't get anywhere else. Read it thoroughly... and put it to work.

This business paper in your hand has a plus for you, because it's a member of the Associated Business Publications. It's a paid circulation paper that must earn its readership by its quality... And it's one of a leadership group of business papers that work together to add new values, new usefulness, new ways to make the time you give to your business paper still more profitable time.

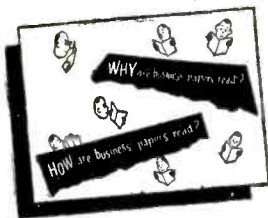

A copy of this quick-reading, 8-page booklet is yours for the asking. It contains many facts on the benefits derived from your business paper and tips on how to read more profitably. Write for the "WHY and HOW booklet," Room 2710.

McGraw-Hill Publishing Company
330 W. 42nd St., New York 36, N. Y.

One of a series of ads prepared by
THE ASSOCIATED BUSINESS PUBLICATIONS



IMMEDIATE DELIVERY

(Small Quantity)

Precision Carbon Deposited Resistors

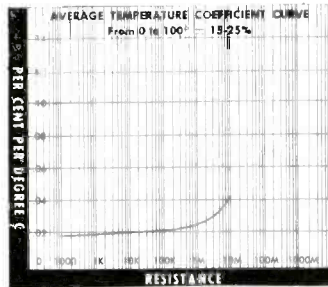

Temperature coefficient characteristics for ALPT-1 watt resistor

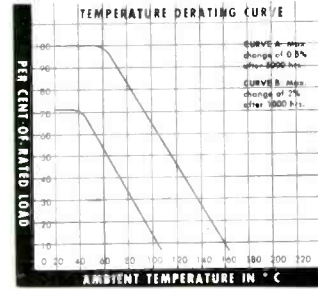

Derating curve for ALPT-1 watt resistor

STANDARD RESISTORS $\pm 1\%$ TOLERANCE IN 10% RMA
VALUES FROM 10 OHMS TO 2.7 MEGOHMS

APST-1/2 WATT, APXT-1/2 WATT AND APCT-1 WATT
SALES OFFICES AND DISTRIBUTORS

Factory Delivery, other than stock values:
1/10, 1/5, 1/4, 1/2, 1, 2 and 5 Watt

ALLIES' PRODUCTS CORPORATION
P. O. Box 188, Kendall Branch, Miami, Florida

BROCHURE SUPPLIED UPON REQUEST.

Circle 382 Readers Service Card

MEASUREMENTS' NEW SQUARE WAVE GENERATOR



Model 72

FEATURES:

- Fast rise time
- No overshoot
- Control of square wave symmetry
- Wide Frequency range
- Two output impedances may be terminated in any load resistance value
- Accommodates synchronizing signals of either polarity

CONDENSED SPECIFICATIONS:

Frequency Range-Steps: 5 cps to 5 Mc in 18 steps. Vernier control for frequency adjustments over a 2:1 range.
Rise Time: 0.02 Microseconds, all ranges, 75 ohms. 0.05 Microseconds, all ranges, 500 ohms.
Output Voltage and Impedance: 2 to 12v. maximum.
Power Requirements: 115 volts, 50/60 cycles, 75 watts.
Dimensions: 10" H x 14" W x 7 1/4" D.
Weight: 18 lbs.

Measurements' new Square Wave Generator produces square waves with a rise time of 20 millimicroseconds—over the range of 5 cps to 5 Mc. A symmetry control permits exact Square-Wave Balance. The Model 72 generates ideal square waves for checking performance of audio and video systems, components and cathode ray oscilloscopes.

Send for Model 72 Brochure

Laboratory Standards



MEASUREMENTS CORPORATION
BOONTON, NEW JERSEY

BIG-POT PERFORMANCE in Miniature-pot size

Waters PRECISION MINIATURE POTENTIOMETERS

are built, tested, and certified* to such rigid specifications as AIA, RETMA, JAN-R-19, MIL-E-5272A, and other applicable military specifications. *This new line* of single-turn pots packs Waters traditional performance into tight spots.

NOW! A complete single-turn-pot line from Waters

*Complete test data on request.

CHECK THESE SPECIFICATIONS

Model	Resistance Range (ohms)	Standard Linearity†	Case Dia. (inches)	Standard Shaft Dia. (inches)
WP 1/2	1/2 to 250K	1.0%	1/2	1/8
WP 7/8	1/2 to 250K	0.5%	7/8	1/8 or 1/4
WP 1 1/16	1/2 to 350K	0.5%	1 1/16	1/8
WP 1 1/8	1/2 to 350K	0.5%	1 1/8	1/4
WP 1 1/2	1/2 to 500K	0.5%	1 1/2	1/4

† For best possible linearity submit detailed specifications. Servo mount standard, three hole and bushing mounting available.

A micro-miniature potentiometer that meets the requirements of today and tomorrow for high performance, while retaining the rugged dependability of the approved Waters design.

TYPE WP 1/2

Proved reliable in thousands of military and commercial installations. Available in dual unit with Waters new concentric shaft construction.

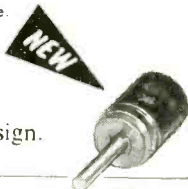

TYPE WP 7/8

Offers Waters reliability in the AIA nominal one-inch diameter. Available as servo or bushing-mounted unit, it gives high precision in a miniature size.



TYPE WP 1-1/16

Provides higher resistance values with better resolution and linearity, yet is a miniature unit in every sense. Available as dual unit with concentric shafts.



TYPE WP 1-1/8

Reliability and precision equal to many 2-inch or larger potentiometers results from Waters proved miniature design and assembly techniques.

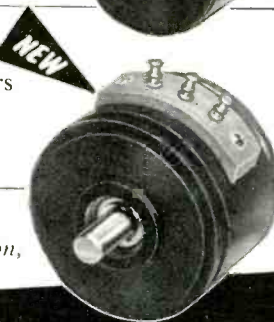

TYPE WP 1-5/8

Write for catalog of the Waters complete single-turn-pot line; precision, trimmer, low torque, miniature.

reliability capacitors designed to withstand mechanical, electrical and thermal abuse. Units are manufactured with Mylar film for low leakage, and Kraft tissue for exceptional durability. Extended foil construction permits an average current up to 2 amperes per μf at all power frequencies, and much higher instantaneous values in pulse networks. Units meet all requirements of proposed high-reliability specification MIL-C-14157A as set forth by Army Signal Corps for guided missile capacitors.

Capacity drift with temperature throughout a range of -55 C to $+125\text{ C}$ is less than ± 5 percent. Insulation resistance exceeds $30,000\text{ meg} \times \mu\text{f}$ at 25 C . Physical size of these capacitors is held to very small dimensions.

Designated as B-125, the line is available in 200-v, 400-v and 600-v ratings, and in all case styles. Literature will be sent on request. Circle 457 on Reader Service Card.



SHAFT ANGLE CONVERTER lightweight, reliable

INSTRUMENT DEVELOPMENT LABORATORIES, INC., 67 Mechanic Street, Attleboro, Mass., announces a new, lightweight shaft angle converter which converts rotary motion into an accurate coded system of numbers. A binary-decimal read-out of 1 in 3,600 counts at 40 codes per revolution of the input shaft is provided by the converter.

Intermittent gearing and precision bearings result in very low driving torque. The input shaft will rotate up to 300 rpm in either direction supplying digital output coding.

The code drum cylinder, an

Waters
MANUFACTURING, inc.

APPLICATION ENGINEERING OFFICES
IN PRINCIPAL CITIES
Wayland, Massachusetts



COOLING A KLYSTRON ?

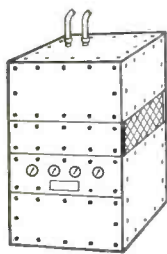
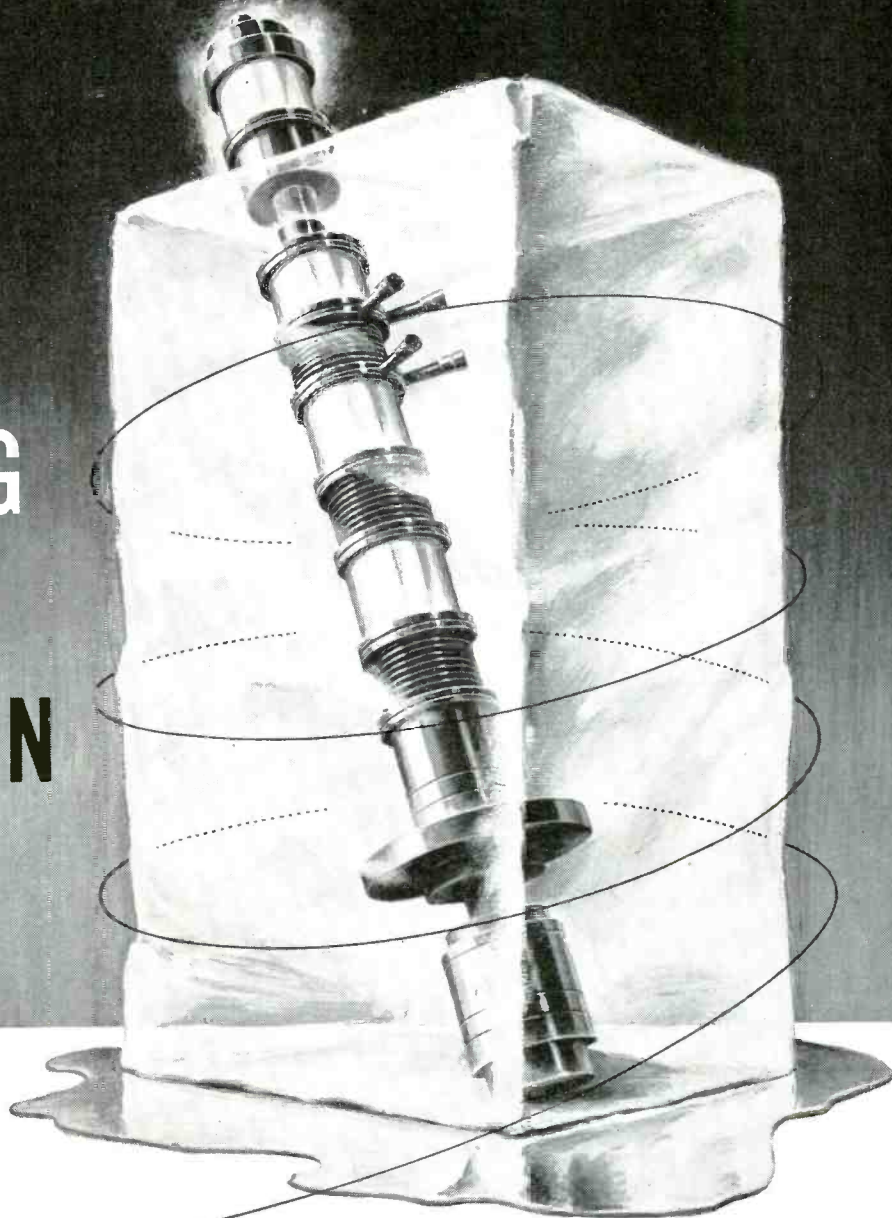

... or any liquid cooled tube

One to one hundred KW dissipation, liquid to air or liquid to liquid, John Wood Company designs and produces all types of liquid cooling systems for all types of power tubes.

With unequalled engineering and production facilities, and backed by more than 90 years experience in heat exchange and associated fields, John Wood offers extensive knowledge of the use of liquid coolants in-

cluding water, water-glycol, hydraulic oil, transformer oil and fluorochemicals. This company has experience in design to MIL electronic specifications, with accurate control of coolant temperatures, pressures and flow.

John Wood Company can help you, whatever your requirements. Factory representatives will be pleased to discuss, and answer your problems.

John Wood also manufactures special combustion heaters for vans and shelters housing electronic equipment.

- Hot air heaters 60,000; 90,000 and 120,000 BTU/hr. output
- Hot water heaters 80,000 BTU/hr. output

JOHN WOOD COMPANY

Heater and Tank Division — Conshohocken, Pennsylvania • Chicago, Illinois • Red Oak, Iowa



electronic counter

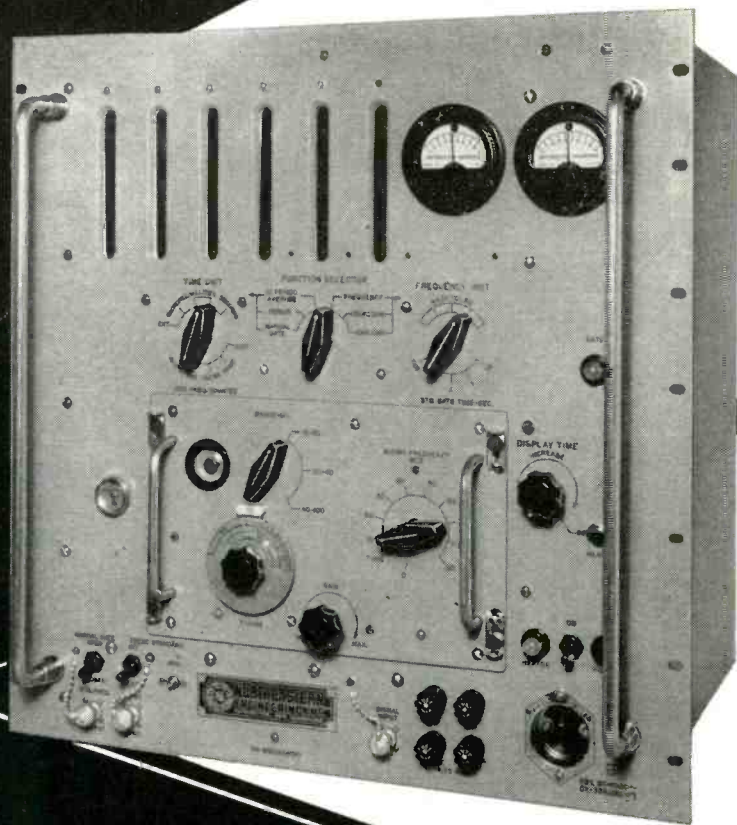

CAT. NO. — NE — 14-20 FM

ACCURATE • SIMPLE
DIRECT READING
INSTANTANEOUS
RELIABLE

FREQUENCY MEASUREMENTS
10 CPS to 220 MC; TIME
INTERVAL 1 MS to 100 DAYS;
PULSE LENGTH, REP, RATES,
FREQUENCY DRIFT

northeastern

Manchester



engineering

New Hampshire

epoxy fiber glass tube with a 0.005 in. copper wall, is 0.65 in. in diameter and approximately 1½ in. long.

The brushes, rated at 40 v d-c at 20 ma, can operate directly in most circuits. Brush bounce is negligible.

The entire unit weighs slightly more than three ounces, is 1.87 in. in diameter and 2.37 in. long. Expected total life is in excess of 1,000 hours. **Circle 458 on Reader Service Card.**



MICROVOLT-AMMETER and amplifier

KIN TEL, 5725 Kearny Villa Road, San Diego 11, Calif. Model 203AR is a compact, 19-in. rack-mountable combination d-c microvoltmeter, microammeter, and low-level d-c amplifier. Partially transistorized, it uses chopper circuitry to provide high sensitivity with previously unobtainable drift-free stability and high input impedance.

Fifteen voltage ranges cover from 100 μ v full scale to 1,000 v full scale and 19 current ranges cover from 1 milli-microampere full scale to 1 ampere full scale. The uncluttered zero-center meter face instantly indicates polarity on two mirrored scales which cover all ranges. The instrument is capable of measuring as little as 10 μ v or 100 μ ma with accuracy. Input impedance is 10 megohms on the 30 mv range or below and 100 megohms on the 100 mv to 1,000 v ranges. Impedance accuracy is ± 1.5 percent.

Output terminals on the front panel are provided for its use as a low-drift d-c amplifier with high gain, high input impedance and

**LOW HUMIDITY DRY BOXES
DUST CONTROL HOODS**

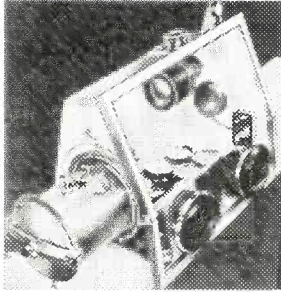

LOW HUMIDITY DRY BOX
• low cost
• transparent plastic or stainless steel



write for information on **LINT-FREE** gloves



25 DUST CONTROL HOOD • transparent plastic
• pressurized

write for literature

P. M. LENNARD CO., INC.

1 HANSON PLACE, BROOKLYN 17, NEW YORK, STerling 9-2420
Circle 386 Readers Service Card

another wonderful
GRC idea
for designers

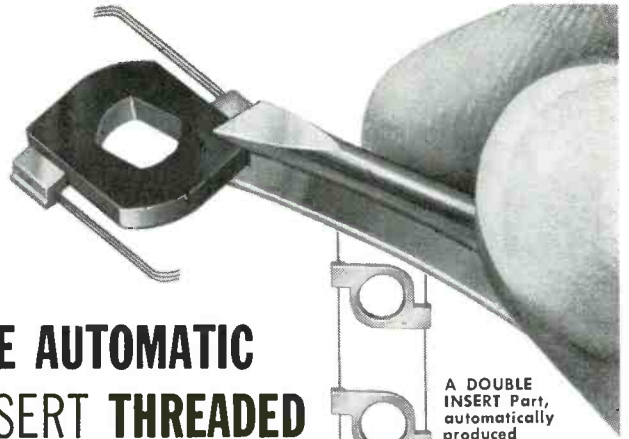

GRC's UNIQUE AUTOMATIC METHODS INSERT THREADED PIECES, WIRES, even CONTINUOUS ELEMENTS, RIGHT IN THE MOLDING OR CASTING CYCLE

Fast . . . economical, GRC's exclusive automatic machines insert elements in zinc alloy die castings . . . in thermoplastic moldings, assure uniformity, eliminate assembly . . . make possible entirely new designs . . . cut labor and costs.

Write for bulletins, send prints for quotation.

No size is too small! Maximums: Zinc Alloy 1 1/2", 1/2 oz.
Plastic 1 1/4", .03 oz.

A DOUBLE INSERT Part, automatically produced

For this IBM Brush Assembly, the core is die cast automatically and continuously onto 6 strands of music wire 3 on each side.

In the second cycle the nylon insulating jacket is molded automatically and continuously . . . right onto the die cast core and wire inserts.



GRIES

GRIES REPRODUCER CORP.

World's Foremost Producer of Small Die Castings

151 Beechwood Avenue, New Rochelle, N. Y. • New Rochelle 3-8600
Circle 384 Readers Service Card



FOR PUBLIC ADDRESS, RADIO, and kindred fields, JONES 400 SERIES PLUGS & SOCKETS

of proven quality!



P-406-CCT

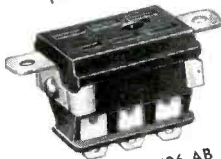

S-406-AB

Socket contacts phosphor bronze cadmium plated. Plug contacts hard brass cadmium plated. Insulation molded bakelite. Plugs and sockets polarized. 2, 4, 6, 8, 10, 12 contacts. Steel caps with baked black crackle enamel. Catalog No. 21 gives full information on complete line of Jones Electrical Connecting Devices — Plugs, Sockets and Terminal strips. Write

Jones

HOWARD B. JONES DIVISION
CINCH MANUFACTURING CORPORATION
CHICAGO 24, ILLINOIS
SUBSIDIARY OF UNITED CARB FASTENER CORP.

Circle 387 Readers Service Card

Electromagnetic Clutches and Brakes

for the Electronics

Industry in 6 models

shown x 4 sizes

x 3 shaft alternates =

72 configuration

selections

Manufactured by

AUTOTRONICS INC.

Florissant, Missouri

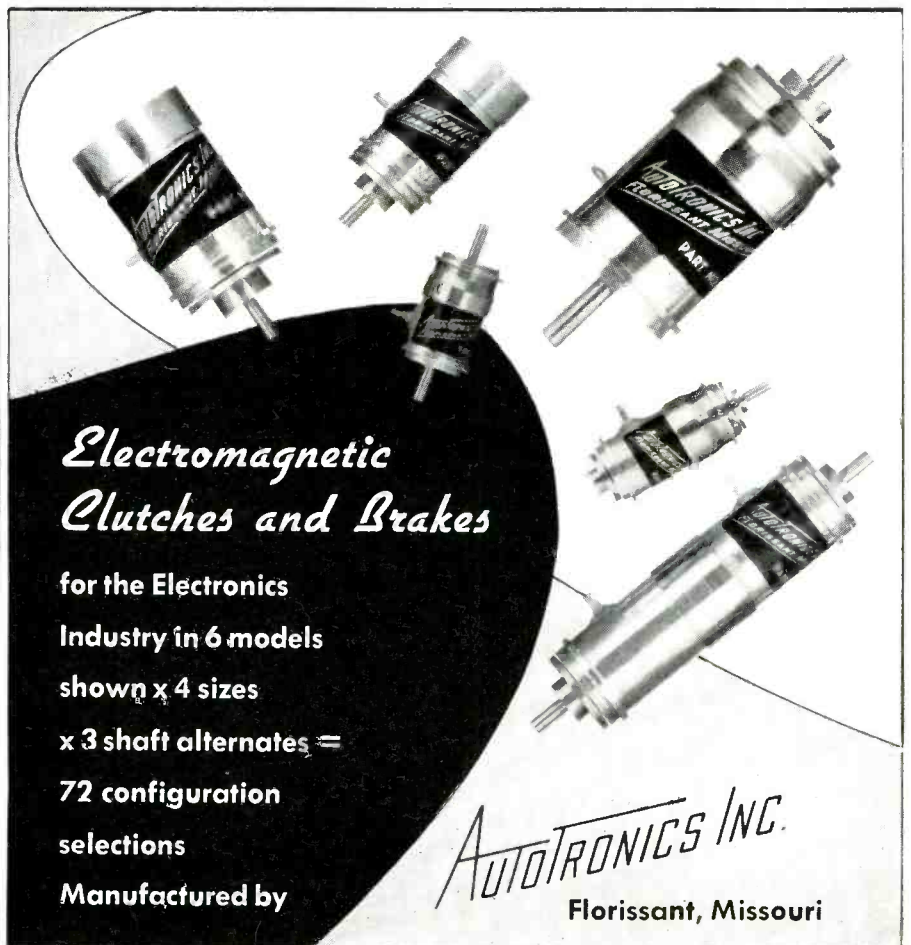

Circle 385 Readers Service Card

361

MISSILE Performance Data



RECORDED ON-BOARD

CENTURY MODEL 409D RECORDING OSCILLOGRAPH

Numerous agencies engaged in the manufacture and evaluation of missiles have turned to the Century Model 409D Recording Oscillograph as a reliable means of collecting missile performance and control data.

On-board mounting eliminates the necessity for the costly and often not reliable RF link.

The ruggedness and reliability of this 12-channel oscillograph have been demonstrated many times. One agency reports having recovered 42 satisfactory record rolls out of 43 firings. Another, using special mounting configuration, reports recording at 60 G's without damage.

This 13 lb. instrument is compact enough to be installed in most missiles and all electrical connections including remote control are accomplished through a single multi-pin AN connector.

Wire, Write or Phone

CENTURY ELECTRONICS & INSTRUMENTS, INC.
1333 North Utica, Tulsa, Oklahoma

NEW PRODUCTS

(continued)

low output impedance. Maximum gain as an amplifier is 80 db, and maximum output is ± 1 v across 500 ohms or greater. Output impedance is less than 2 ohms and drift is less than 10 μ v equivalent input. **Circle 459 on Reader Service Card.**

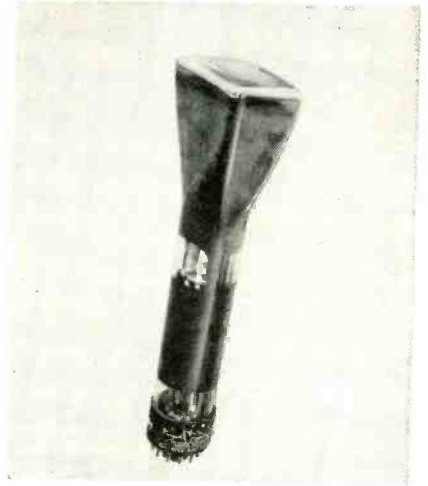

CATHODE-RAY TUBE rectangular 3-in. type

WATERMAN PRODUCTS CO., INC., 2445 Emerald St., Philadelphia 25, Pa. Type 3AHP is the latest addition to the Rayonic line of cathode-ray tubes. It was designed to give maximum emphasis to brightness and definition for those applications where these characteristics are paramount.

A vertical sensitivity of 26 to 35 v d-c per in. is achieved with a second anode voltage of 1,000. When an extremely well defined spot is required for high resolution and optimum brightness the tube can be operated with 2,000 volts at the second anode. Under these conditions the vertical sensitivity is 52 to 70 volts per in.

The tube is available in P1, P2, P7 and P11 phosphors. **Circle 460 on Reader Service Card.**

COAX R-F CABLES with irradiated polythene

BRITISH INSULATED CALLENDER'S CABLES LTD., 21 Bloomsbury St., London WC 1, England, announces the manufacture of a selected number of types of small coaxial r-f cables insulated with irradi-

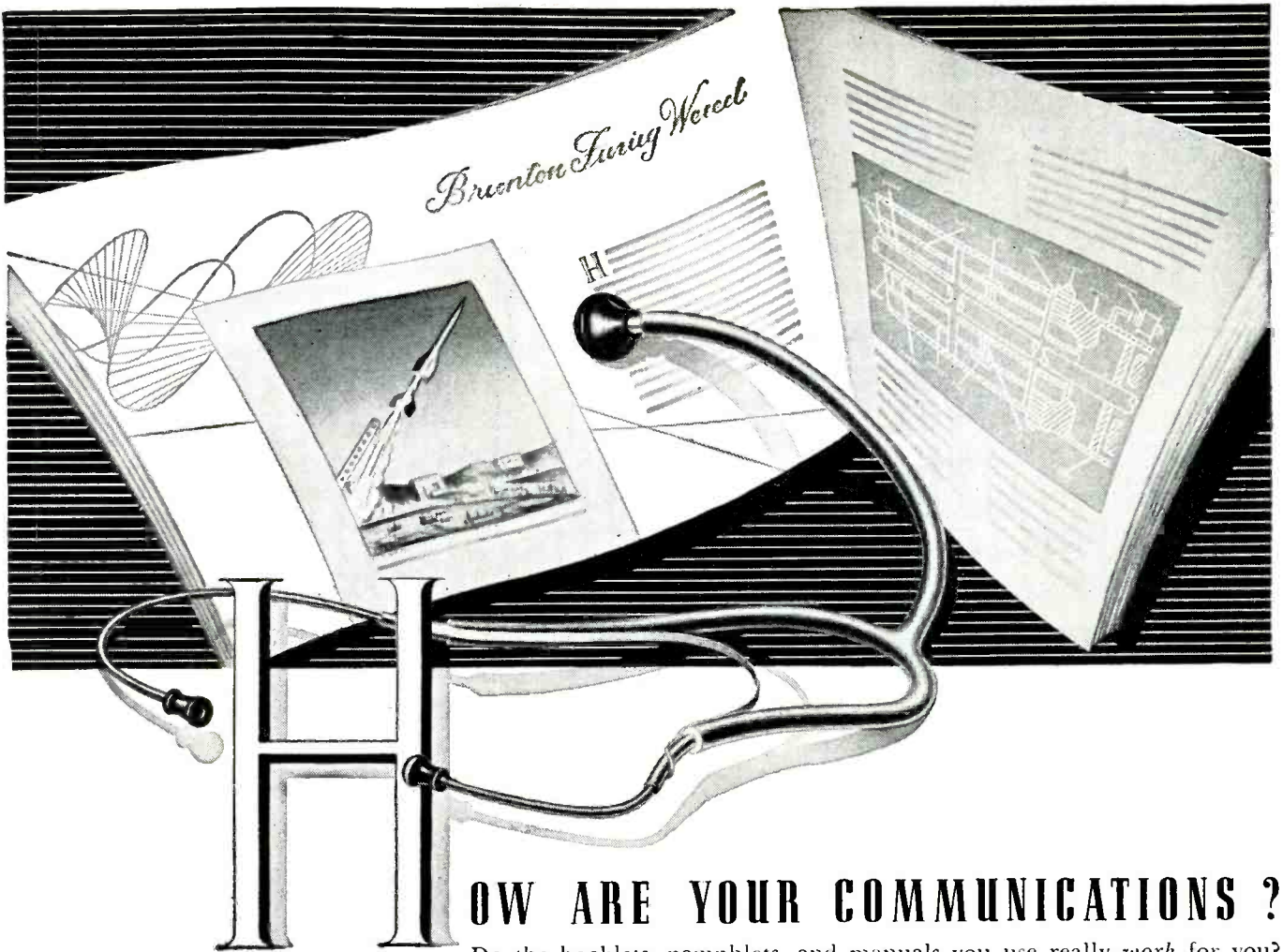

HOW ARE YOUR COMMUNICATIONS ?

Do the booklets, pamphlets, and manuals you use really *work* for you? Are these vital publications, that tell the story of your products and your company, as effective, readable, well designed and illustrated as they can be? Today more than ever, your entire operation is judged by each annual report, employee manual, and public relations piece that you produce. Have you examined your communications lately? If you have any doubt as to the impact of your instructional and promotional literature, remember . . .

COMMUNICATION IS OUR BUSINESS

For a good many decades McGraw-Hill has stood for complete coverage in the business literature field. Now the McGraw-Hill TECHNICAL WRITING SERVICE offers a new approach to your publication problems — an *integrated* writing, editing, illustrating, and printing service for the *custom* production of: INSTRUCTION MANUALS, PRODUCT BULLETINS, TRAINING AIDS, INDUSTRIAL RELATIONS LITERATURE, ANNUAL REPORTS, COMPANY HISTORIES, PROCEDURAL GUIDES and other collateral literature. More than 150 editorial and graphic experts are at your disposal, ready to prepare high-quality material to your own or government specifications. Save time, save money . . . and make your communications work! Let *our* staff be your staff for technical and business publications.

McGraw-Hill Book Co. TECHNICAL WRITING SERVICE

Write or phone Technical Writing Service, McGraw-Hill Book Co., Inc.
330 West 42nd Street, New York 36, N. Y. • LOnacre 4-3000

This service is available through ad agencies.

look what **\$24⁵⁰** buys
in test equipment!

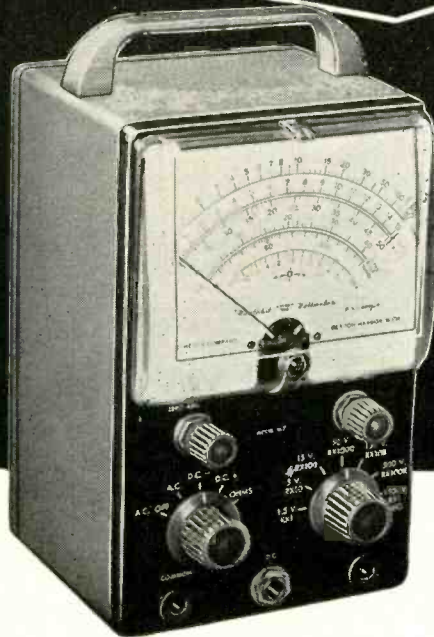

**HEATHKITS
GIVE YOU
TWICE AS MUCH
equipment for
every dollar
invested**

The famous model V-7A Vacuum-Tube-Voltmeter is a perfect example of the high-quality instruments available from Heath at 1/2 the price you would expect to pay! Complete, only **\$24⁵⁰**

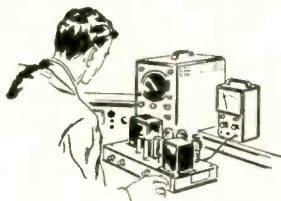

Get the most out of your test equipment budget by utilizing HEATHKIT instruments in your laboratory or on your production line. Get high quality equipment, without paying the usual premium price, by dealing directly with the manufacturer, and by letting engineers or technicians assemble Heathkits between rush periods. Comprehensive instructions insure minimum construction time. You'll get more equipment for the same investment, and be able to fill your needs by choosing from the more than 100 different electronic kits by Heath. These are the most popular "do-it-yourself" kits in the world, so why not investigate their possibilities in your particular area of activity! Write for the free Heathkit catalog now!



Contains detailed descriptions of Heathkit models available, including VTVM's, scopes, generators, testers, bridges, power supplies, etc.



Also describes Heathkit ham gear and hi-fi equipment in kit form. 100 interesting and profitable "do-it-yourself" projects!

FREE catalog

Mail coupon below for
your copy—Now!

HEATH COMPANY
A SUBSIDIARY OF DAYSTROM, INC.,
BENTON HARBOR 14, MICHIGAN

Name _____

Address _____

City & Zone _____

State _____

TRANSISTOR INVERTER
for missile and aircraft

VARO MFG. CO., INC., 2201 Walnut St., Garland, Texas, has added to its line of transistorized equipment the models 4301, 4301B and 4301C transistor power supply d-c to a-c inverters. The 4301 series is designed to operate gyros, hysteresis motors, strain gages, and other airborne equipment where precision 400 cps power is necessary. Mechanical provisions are made for attaching a phase adaptor where 3 phase output is desired.

Frequency is synchronized in the light efficient unit by a tuning fork oscillator. Regulation is ach-

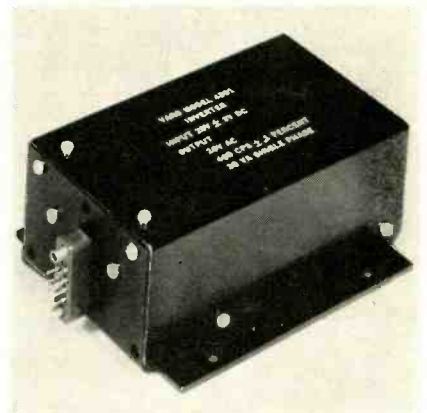

**RAWSON
THERMOCOUPLE METERS**



R.M.S. Readings

No Wave Form Errors

SINGLE RANGES from 1 ma full scale to 10 amperes full scale. Good from DC to 2 megacycles and higher.

MULTIPLE RANGE INSTRUMENTS
RAWSON THERMAL MULTIMETERS
Write for Bulletin 502

Other Rawson Instruments
DC METERS AND MULTIMETERS
FLUXMETERS
ELECTROSTATIC VOLTMETERS
WATTMETERS
ELECTRODYNAMOMETER TYPES
SINE COSINE POTENTIOMETERS
ROTATING COIL GAUSSMETERS

**RAWSON ELECTRICAL
INSTRUMENT COMPANY**

111 Potter Street Cambridge, Mass.

Circle 264 Readers Service Card

**ELECTRONIC
ENGINEERS**

a FUTURE



IFI—a young, rapidly expanding organization that has doubled its size the past year, offers unusual, interesting and challenging

opportunities on all levels to Electronic Engineers with circuitry and equipment design background or applicable experience to work on UHF and VHF systems. Wide band knowledge particularly desired.

As a member of an IFI project, you'll have opportunity to improve your technical knowledge, enjoy freedom and a team spirit found only in a young organization of our size.

Positions carry salaries commensurate with experience. Excellent benefits, including profit-sharing retirement trust plan.

Please address inquiries to:

MR. JOHN V. HICKS

Instruments For Industry, Inc.

162 Glen Cove Road, Mineola, New York
Pioneer 2-5300

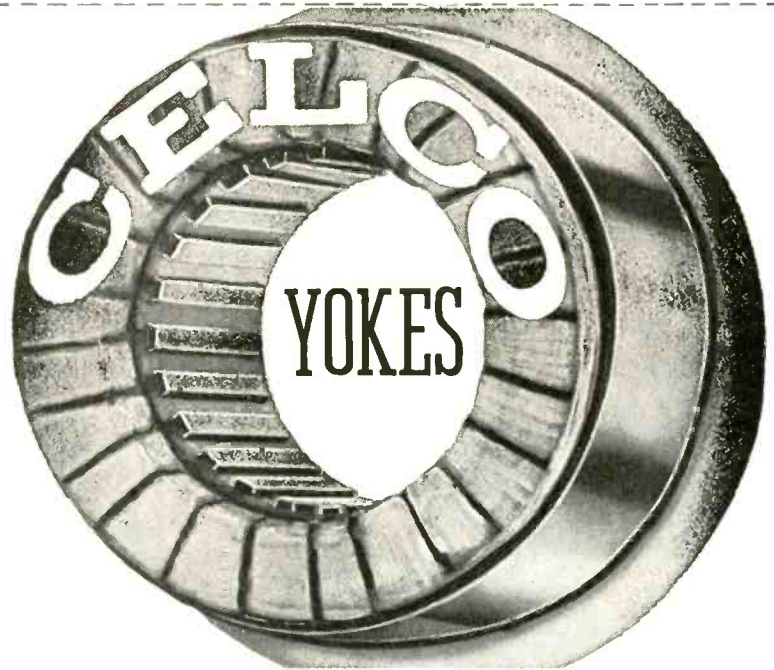

FOR HIGH ACCURACY DISPLAY SYSTEMS

We specialize in the design and manufacture of precision deflection Yokes for military and commercial applications. Phone or write for immediate engineering evaluation of your critical display problems—Phone DAVIS 7-1123. MAHWAH, N. J.



Celco Constantine Engineering Laboratories Co.
MAHWAH, NEW JERSEY

Circle 265 Readers Service Card

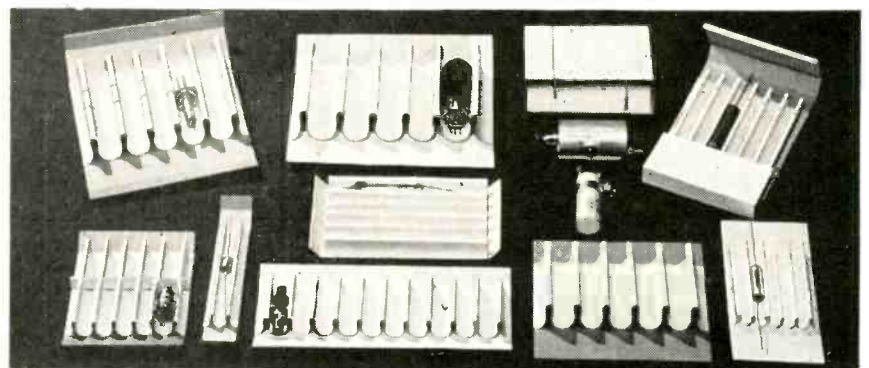

**PROTECT Delicate ELECTRONIC COMPONENTS
While Handling in Production and Shipment
with RONDO**

RONDO, a cardboard device, holds and protects inserted objects by the spring-clip action of its fluted partitions. Easy to load and handle. Various sizes and styles have been developed for many parts, such as tubes, resistors, capacitors, diodes, fuses, etc., with diameters from 8 to 26mm and up.

Maximum efficiency and economy are accomplished when the same RONDO device is used throughout production, storage, shipping and display. RONDO is a paper product, sold at paper prices.

Send for leaflet and suggestions regarding your specific packing need.

RONDO PROCESS AND DESIGNS ARE COVERED BY
PATENTS IN ALL MAJOR COUNTRIES



RECOGNIZED ALL OVER THE WORLD

AMERICAN RONDO CORP., 100A SANFORD ST., HAMDEN 14, CONN.

Representatives: C. S. Shotwell, 527 S. Alexandria Ave., Los Angeles, Cal. • Brown & Scratch, 664 N. Michigan Ave., Chicago, Ill.

UP TO 350°C...



when the **HEAT'S** on...

Let **ERIE Custom Build your**

**HIGH TEMPERATURE BUTTON®
CAPACITORS FOR CONTINUOUS
OPERATION UP TO 350°C**

ERIE Button Silvered-Micas...
Still the World's Best
High Frequency Capacitors

- ... have the lowest insertion loss of any known capacitor
- ... have the lowest inductance of any known capacitor
- ... have excellent High Frequency characteristics—High "Q" Factor

Applications

- Standard ERIE Button mica capacitors are used in military and commercial equipments and for VHF and UHF applications where high stability and low loss are essential.
- High Temperature ERIE Button mica capacitors are used where Intense Heat Challenges High Performance... High Altitude Missiles and Aircraft are typical applications for units required to operate without failure in the 350°C range.
- Typical test results over the range of -50°C to +350°C show average change in ERIE Button micas of less than 4% in capacitance and power factor.
- Because of the exacting requirements of capacitors operating at these temperatures, ERIE Button micas are usually custom-designed for such applications. We welcome inquiries for further design and application study.



ieved by comparing a sample of output with stable d-c reference voltage. The difference is used to control the amplitude of a diode modulator. Low distortion and output impedance are achieved by means of class B power amplifiers employing voltage feedback. All cases of power transistors are grounded to a thermoconductive plate for low thermal resistance and heat removal.

The unit, measuring 5 in. by 3 in. by 2 in., weighs only 2 lb in the 4301 and 4301B models and 3.5 lb in the 4301C. It is frequency synchronized at 400 cps ± 0.1 percent under all conditions. Circle 462 on Reader Service Card.

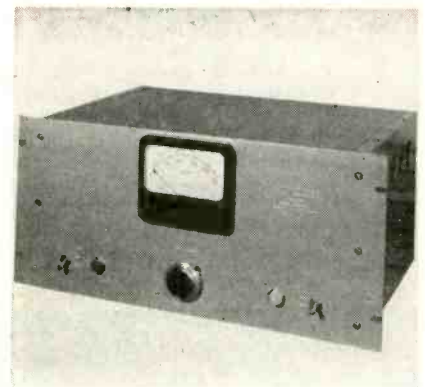

H-V SUPPLIES highly stable

TULLAMORE ELECTRONICS LABORATORY, 6055 South Ashland Ave., Chicago 36, Ill. The HVCST series h-v supplies have a stability comparable to that of a standard cell. This is accomplished through the use of temperature-regulated primary and secondary voltage standards and chopper stabilization of the regulating amplifier. Both the chopper stabilization and temperature regulation are accomplished by means of plug-in units which may be added at any time to the standard HV series.

Available in two ranges, 800 to 2,500 v and 500 to 1,500 v with reversible polarities, these supplies can deliver an output current of 8 ma. The output impedance is less than 1 ohm.

Regulation for line voltage changes from 100 to 125 v is better than 0.001 percent. Long term stability is 0.005 percent. These

supplies are very well suited for precision spectroscopy and fast coincidence applications where the new 14-stage multiplier phototubes are used. Circle 463 on Reader Service Card.

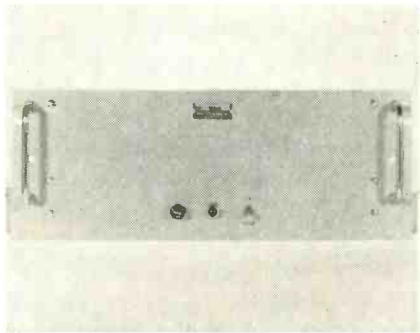

MULTICOUPLER for telemetering

NEMS-CLARKE, INC., 919 Jesup-Blair Drive, Silver Spring, Md, announces a new receiver multicoupler for use with their line of telemetering receivers. The MC-206 couples six receivers to one antenna and is used over the frequency range of 215 to 245 mc. Isolation between receiver outputs has received considerable attention in the design of this instrument. Complete specifications are available. Circle 464 on Reader Service Card.

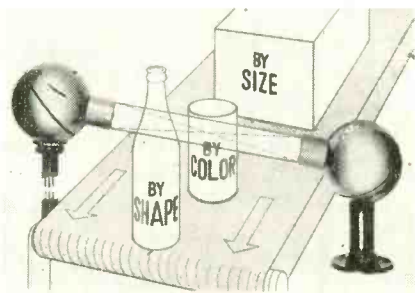

ELECTRONIC EYE tool for automation

BASIC CONTROLS Co., 1714 Westwood Blvd., Los Angeles 24, Calif. The series S5 electronic-eye system consists of two units: a projector (light source) and a receiver (light sensitive control). The operating components of both units are housed in spheres, 5 in. in diameter. This system is completely self contained. The re-

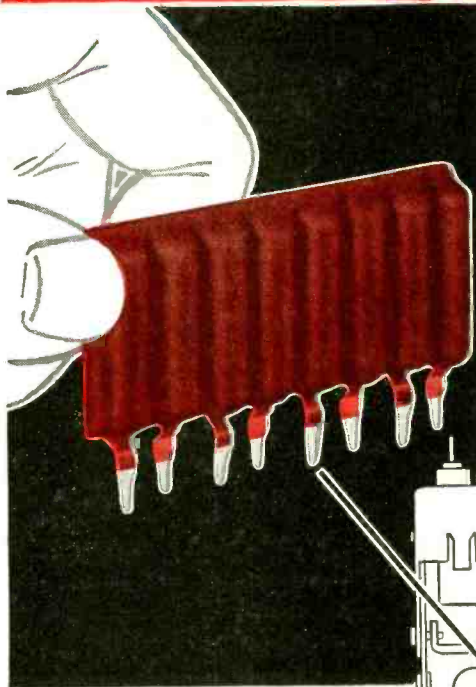

Uses
ERIE
"PAC"*
in
AUTOMOBILE
RADIOS

* WHAT IS "PAC"?

"PAC" stands for "Pre-Assembled Components". In "PAC" interconnected capacitors and resistors are automatically assembled by ERIE into a unitized module for quick, easy installation by the set manufacturer.

WHAT DOES "PAC" DO?

- Speeds Assembly
- Reduces Inventory
- Eliminates Assembly Equipment
- Simplifies Inspection
- Cuts Down Chassis Area
- Reduces Number of Punched Holes
- Reduces Number of Insertions
- Resists Vibration
- Withstands Extreme Temperatures

"PAC" is used by many other manufacturers of radios, TV sets, and a wide variety of other electronic equipment. Labor is saved. Design is simplified. Our engineers will be glad to consult with you about incorporating "PAC" in your equipment.

ERIE *Electronics Division*
ERIE RESISTOR CORPORATION
MAIN OFFICES: ERIE, PA., U.S.A.
FACTORIES: ERIE, PA. • HOLLY SPRINGS, MISS. • TRENTON, ONTARIO, CANADA

0 CPS to 1 MC!
DIRECT READING



new
Computer-Measurements Model 226A

UNIVERSAL COUNTER-TIMER

OUTSTANDING FEATURES:

- ★ Three independent, adjustable trigger level controls permitting full rated sensitivity at any voltage level between -300 and +300 volts.
- ★ Small voltage increments ordinarily masked by attenuators are easily selected.
- ★ Simplified color-coded controls and direct read-out in kc, mc, sec, or millisecc, with automatic decimal point indication.
- ★ Oscilloscope marker signals facilitate start and stop trigger level adjustment for time interval measurement of complex waveforms.

A brand new, multi-purpose instrument provides precision measurement of frequency, frequency ratio, period (1/frequency) and time interval. Pressure, velocity, acceleration displacement, flow, RPS, RPM, etc., may also be measured with suitable transducers. The 226A may be used as a secondary frequency standard.

price: **\$1,100.00**

Long Term: 3 parts per million per week
 Display Time: Automatic: Continuously variable 0.1 to 10 seconds
 Manual: Until reset
 Input Impedance: 1 megohm and 50 mmf
 Trigger Level: Continuously adjustable from -300 to +300 volts
 Accuracy: ± 1 count \pm stability
 Secondary Frequency Standard: 1 mc; 100, 10, 1 kc; 100, 10, and 1 cps
 Dimensions: 17" W x 8 $\frac{3}{4}$ " H x 13 $\frac{1}{2}$ " D approx.
 Weight: 50 lbs. approx.

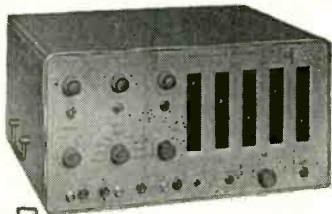

MODEL 225A 0 cps-100 kc UNIVERSAL COUNTER-TIMER

Similar to the 226A in design. Featuring Oscilloscope Trigger Level Marker Signals; Three Direct-Coupled Inputs of 70 mv sensitivity; Direct Reading, Automatic Illuminated Decimal Point. Easily portable. Price: \$840.00

Data Subject to Change Without Notice - Prices F.O.B. Factory

Write for complete specifications on the new 226A and the 225A models and the complete CMC line of electronic counting and controlling equipment.

Computer-Measurements Corporation
5528 Vineland Avenue, North Hollywood, Calif. 78K

FREQUENCY

SPECIFICATIONS:

FREQUENCY MEASUREMENT

Frequency Range:
0-1,000,000 cycles per second
 Input Sensitivity:
0.2 volt rms.
 Direct-coupled input
 Time Bases:
0.00001, 0.0001, 0.001, 0.01, 0.1, 1 and 10 seconds. Also can use external 0-1 mc standard

PERIOD MEASUREMENT

Period Range:
10 microseconds to 1,000,000 seconds
 Frequency Range:
0.000001 cps to 100 kc
 Input Sensitivity:
0.2 volts rms.
 Direct-coupled input

Gate Times:

1 and 10 cycles of unknown frequency
 Standard Frequency Counted:
1 mc; 100, 10, 1 kc; 100, 10, 1 cps; external 0-1 mc.

TIME INTERVAL MEASUREMENT

Range:
3 microseconds to 1,000,000 seconds
 Start and Stop:
Two independent or common channels
Positive or negative slope
 Input Sensitivity:
0.2 volts rms.
 Direct-coupled input
 Standard Frequency Counted:
1 mc; 100, 10, 1 kc; 100, 10, 1 cps; external 0-1 mc.

GENERAL

Stability:
Short Term: 1 part in 1,000,000 (temperature-regulated crystal)

PERIOD • TIME INTERVAL • FREQUENCY • PERIOD • TIME INTERVAL • FREQUENCY

ceiver sphere houses the light sensitive eye, an amplifier, and a relay. The projector sphere contains a lamp and transformer. Qualities such as size, shape, color, quantity, texture and position can be watched and controlled without being touched.

All operating components in the receiver sphere are assembled in its top half, which is removable and plugs in to facilitate servicing and maintaining the system. The only wires from the system are leads to the power line and to the device being controlled. If desired, the spheres can mount directly on the conduit which carries the electrical leads. No other mounting devices, brackets, or external equipment are necessary.

Instruction sheet and price list are available. Circle 465 on Reader Service Card.

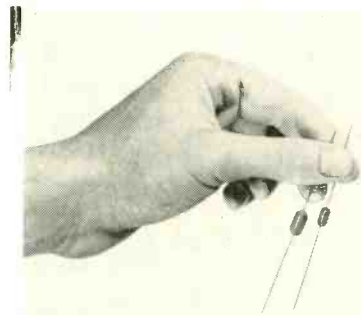

PRECISION RESISTORS encapsulated, wire-wound

KELVIN ELECTRIC Co., 5907 Noble Ave., Van Nuys, Calif., has announced a new epoxy-encapsulated wire-wound precision resistor which is vacuum impregnated and vacuum cast to eliminate hot spots caused by voids in windings.

Designated series EP, the new line utilizes tension-free winding techniques which reduce resistance drift with age, and shorts or opens due to thermal shock. They meet MIL-R-93A and MIL-R-9444. The resistors are heat cycled before encapsulation and postcured before final inspection, thus resulting in long term stability of resistance under rigid environmental temperature conditions. The EP series has an operating range from -65 to +125 C

FREQUENCY • TIME INTERVAL • PERIOD • FREQUENCY • TIME INTERVAL • PERIOD • FREQUENCY

CMC

and a temperature coefficient of ± 0.000020 C.

The series also includes two miniature types, one measuring $\frac{1}{8}$ in. in diameter by $\frac{3}{8}$ in. long, and the other $\frac{1}{4}$ in. by $\frac{1}{2}$ in. long. These feature a high-gloss surface finish which prevents the penetration of moisture. Other types are capable of handling up to two watts dissipation. Circle 466 on Reader Service Card.

MINIATURE POT
molded composition type

OHMITE MFG. Co., 3630 Howard St., Skokie, Ill. Type AS miniature potentiometers constitute the smallest molded composition pot available. Only $\frac{1}{2}$ in. in diameter, it is rated at 0.5 w continuous duty.

The relatively thick, solid, molded resistance elements offer a large factor of safety in contrast to the film-type elements incorporating troublesome rivets and soldered connections. Type AS units are furnished in linear taper with locking type, screw-driver-slotted shafts.

The units are dusttight, splash-proof and fungus-resistant. Terminals are gold plated to speed soldering. Available in 15 resistance values from 100 ohms to 5.0 megohms, these units meet stringent military specifications.

Bulletin 149 is available from the company. Circle 467 on Reader Service Card.

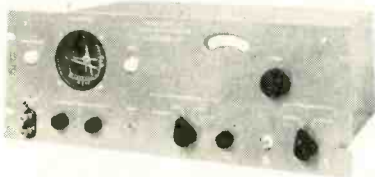

NULL INDICATOR
tunes from 50 to 2,000 cps

GERTSCH PRODUCTS, INC., 3211 South La Cienega Blvd., Los Angeles 16, Calif., announces development of the model 510 R phase sensitive tuned null indi-

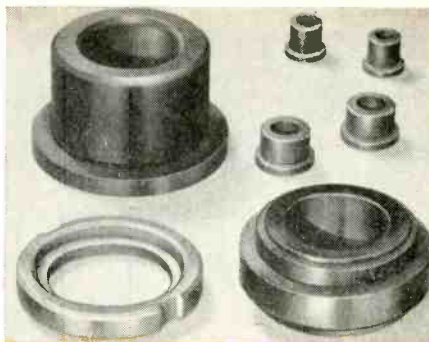

FOR:
Guide Bushings, Vanes and Wear Rings

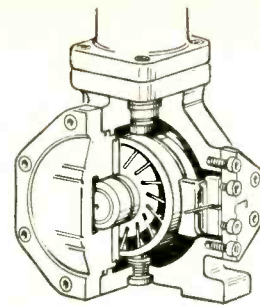

HAVE YOU CONSIDERED THE IMPORTANT ADVANTAGES OF FILLED TEFLON*?

Electronic Bushings, Insulators and Tuning Slugs

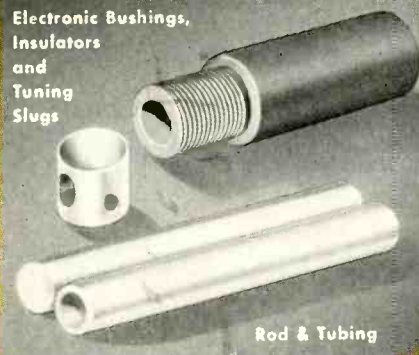

Rod & Tubing



Formed Gaskets

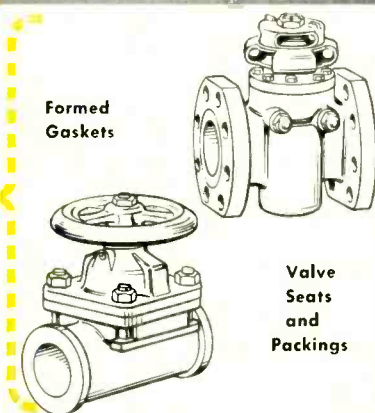

Valve Seats and Packings

It has been definitely established that the value of Teflon can be considerably enhanced by the use of fillers in certain applications. Laboratory and field experience has demonstrated that the use of fillers permit Teflon to be more readily tailored to a wide variety of chemical, electrical and mechanical applications. Also, some mechanical properties can be improved. These include:

- 1) resistance to deformation under load
- 2) resistance to wear
- 3) thermal conductivity
- 4) compressive strength
- 5) hardness

By thus improving its properties, Teflon now offers even greater industrial potential. This is the reason filled Teflon has become an important item in the "John Crane" Chemlon® line of better Teflon products.

Chemlon is available with such fillers as glass fiber, carbon, graphite, copper and bronze, talc, calcium fluoride and other inorganic materials.

Tell us about your requirements. We'll tell you the advantages you can get from filled Chemlon. Request Bulletin T-104.

Crane Packing Company, 6402 Oakton Street, Morton Grove, Illinois, (Chicago Suburb). In Canada: Crane Packing Co., Ltd., Hamilton, Ont

*DuPont Trademark



FM Deviation Check
4.3 kc modulation at
first carrier null.

Deviation = ± 10.32 kc.
Panoramic display shows
actual sideband spread
including those beyond
deviation.

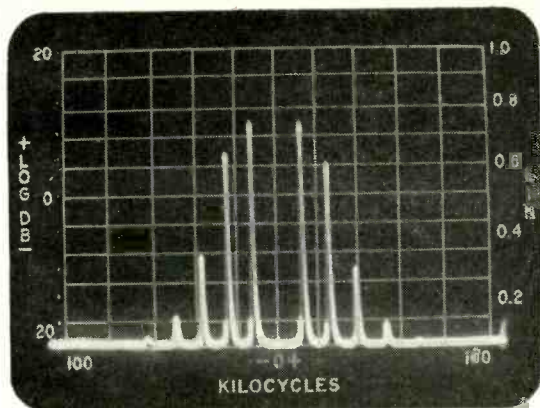

Two photos showing
FM signals of equal deviations (± 55.2 kc) but
different energy distributions. FM deviation
monitor would read
identically in both tests.

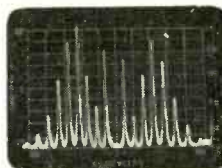

10 kc modulation at second
carrier null

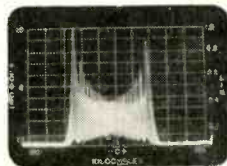

Same modulation level—frequency 1 kc

FM problems?

pictures like these
give the answers
you need for FM
operating and
equipment
testing



with a PANORAMIC PANALYZOR

you can

- Determine sideband spillover . . . assure conformance with statutory bandwidth restrictions of sideband energy
- See RAPIDLY the frequency vs amplitude contents of FM signals . . . compare relative magnitudes of FM frequency components
- Measure deviation precisely through carrier and sideband nulls
- Observe clearly sideband structure under complex forms of modulation
- Analyze carrier shifts, incidental AM, hum, RF harmonics non-linearities . . . detect carrier pulling or instability in both magnitude and direction
- Adjust operating parameters at optimum

Major regions of FM system sideband energy due to speech modulation clearly illustrated on Panalyzer. Slow scans aid in visual appreciation of average envelope. Extended exposure photographs also are valuable for complex wave analysis.

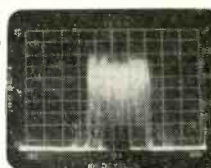

Two photos showing FM due to clipped sine waves

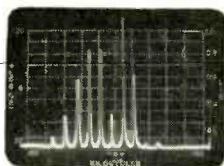

Relative lack of sidebands to left of carrier (centered on Panalyzer screen) indicate limited deviation on clipped end of oscillator swing

Here the other side is clipped. Note mirror image effect and slight carrier shift.

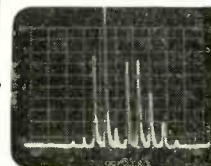

3 models . . . 9 types meet almost every need . . . present a full graphic picture of incomparable value . . . provide a measuring tool of utmost simplicity, complete reliability, tremendous flexibility



Send for our new CATALOG DIGEST and ask to be put on the mailing list for THE PANORAMIC ANALYZER, our regular bulletin featuring application data.



the pioneer
is the leader

Write, wire, phone for more information TODAY. A Panoramic Application Engineer is always available to discuss specific problems

Panoramic Radio Products, Inc., 530 So. Fulton Ave., Mount Vernon, N. Y.
Phone: OWens 9-4600 • Cables: Panoramic, Mount Vernon, N. Y. State

ator. The instrument combines high gain, high selectivity tuned amplifiers with precise phase detectors and a combined display indication of both in phase and quadrature voltage components. Tuning from 50 to 2,000 cps, continuous, the instrument provides at least 60 db rejection of noise and harmonics.

When used with the Gertsch precision a-c voltage dividers (Ratio Tran) and bridge isolation transformers, the model 510R provides a complete package for high accuracy a-c bridge measurements.

The instrument is available in either the rack model or for bench mounting. Circle 468 on Reader Service Card.



MAGNETIC CLUTCH and brake

DYNAMIC INSTRUMENT CORP., 59 New York Ave., Westbury, L. I., N. Y., announces a new addition to its line of miniature magnetic clutches for application to low-power servomechanisms. Model D104, a single end magnetic clutch-brake has been designed to meet the most stringent military, environmental and performance specifications.

Standard models are designed to operate on 24 v d-c but can be

wound for 1.5 to 300 v on request. The unit delivers a minimum of 8 oz-in. of clutching torque and braking torque. Response is extremely rapid, as low as 3 millise. Angular displacement error upon engagement is held to a minimum. Power consumption is 3 w.

Mounting of this unit is identical to the Mark 14 servo motor, with an o-d of $\frac{1}{8}$ in. Special mechanical designs are readily available. Circle 469 on Reader Service Card.

SILICON RECTIFIERS feature h-v ratings

PACIFIC SEMICONDUCTORS, INC., 10451 West Jefferson Blvd., Culver City, Calif., announces 16 new silicon rectifiers characterized by high voltage ratings and excellent efficiency at high temperatures.

The new product line is divided into two groups. Eight miniature silicon rectifiers, designated as the PS100 series, are rated at 200 ma maximum average forward current; maximum rms voltage input from 35 v to 280 v, and temperature rating 150 C.

The eight subminiature silicon rectifiers, designated as the PS005 series, are rated at 125 ma, maximum rms voltage input from 35 v to 280 v and 100 C temperature. Circle 470 on Reader Service Card.

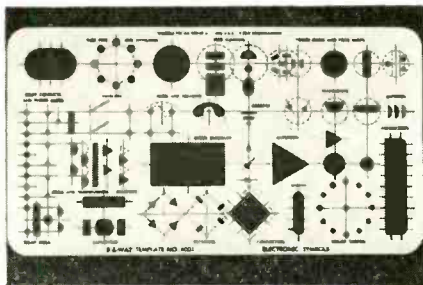

DRAFTING TEMPLATE includes many new symbols

E-Z-WAY TEMPLATES, P. O. Box 535, Reseda, Calif. Schematic diagrams can now be drawn to meet the new revised MIL-STD-15A specifications as well as the ASA specification Y32.2 with the new 6001 electronic symbols template. The new template is designed to

Now —

NO plate too small — 213B

NO panel too big

NO size limits on engraving

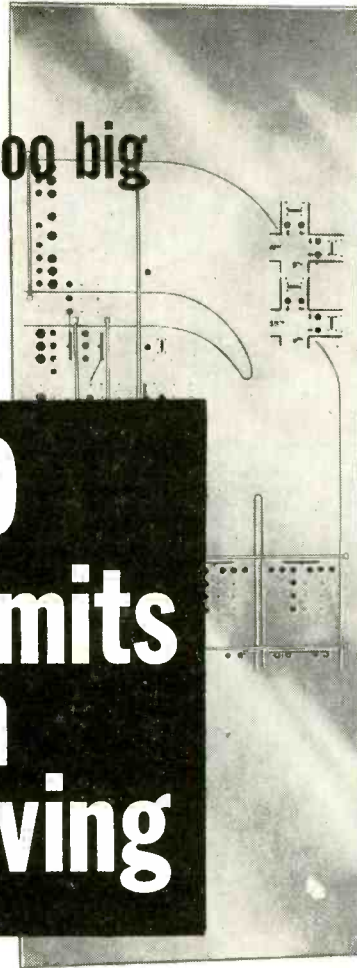

The new ENGRAVOGRAPH Model I-R takes up only 2 feet of bench space and engraves anything from tiny nameplates to giant panels. Engraving chassis can be detached from base and placed directly on workpiece of any dimension. Smaller plates can be easily clamped in a self-centering workholder which is standard equipment.

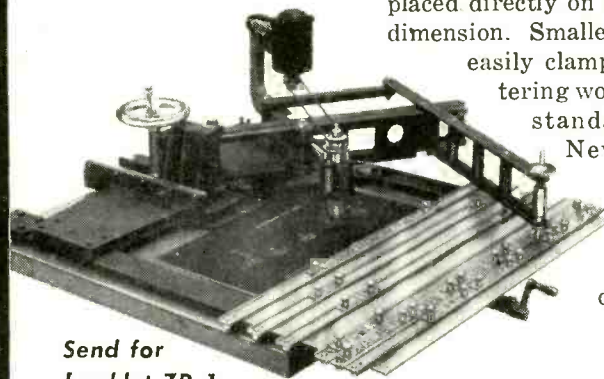

Send for
booklet ZR-1

New sturdy pantograph construction; heavy duty cutter spindle; two-way depth regulator.

new hermes ENGRAVING MACHINE CORP.

13-19 University Place, New York 3, N.Y.

Four Bulletins on FANSTEEL TANTALUM CAPACITORS

Fansteel TANTALUM CAPACITORS
Bulletin 6.100-1
Supersedes Bulletin 6.100

WRITE FOR BULLETINS INDICATED

- Bulletin 6.100 "PP" Series—For General Use
- Bulletin 6.111 "HP" Series—High Temperature
- Bulletin 6.112 "STA" Series—Solid Tantalum
- Bulletin 6.113 "VP" Series—Vibration Resistant

FANSTEEL METALLURGICAL CORPORATION
NORTH CHICAGO, ILLINOIS, U.S.A.
RECTIFIER-CAPACITOR DIVISION



FANSTEEL METALLURGICAL CORPORATION
North Chicago, Illinois, U.S.A.

C577A

enable the user to quickly and accurately draw circuit symbols.

The many symbols that can be drawn with this template include *pnp* and *nnp* transistors, diodes, electronic tubes, power plugs, pilot lamps, relays, phone jacks, connectors, rotary switches, resistors, capacitors, inductors, transformers, amplifiers and block diagram symbols.

The template is fabricated from dimensionally stable rigid vinyl plastic that will not burn, warp or discolor and features a special non-slip, low glare surface. Circle 471 on Reader Service Card.

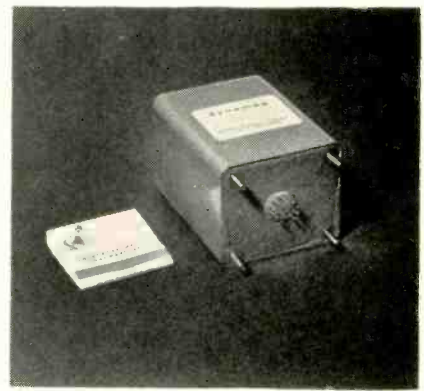

MAGNETIC AMPLIFIER with plug-in terminals

DYNAMICS RESEARCH ASSOCIATES, P. O. Box 5841, Ferguson 21, Mo. Type MA-61 operational magnetic amplifier is a highly stable d-c amplifier operating from a 60-cycle 115-v rms line. Featuring a linear reversible output, the amplifier is suitable for amplifying signals from thermocouples, strain gages, photoelectric cells, demodulators and instrument pickoffs. Having an infinite internal gain, the amplifier is stabilized by current or voltage negative feedback external to the amplifier. The feedback parameters determine the overall gain of the amplifier which may be varied over a wide range. The feedback may be arranged to make either the load current or load voltage independent of changes in the load value.

Zero drift is less than 0.2 percent of full scale output for temperature range of 0 to 170 F. Fluctuations in supply power voltage and frequency of 10 per-

cent gives a zero error of less than 1 percent of full scale output. These low drift features make the amplifier valuable for direct current instrumentation of industrial plants.

Power gains up to 3×10^6 are obtainable. The linearity of the output, in terms of input signal, is less than $2 \mu\text{a}$ or 0.3 mv over $\frac{1}{10}$ the maximum output, and less than $10 \mu\text{a}$ or 1.4 mv over full output. The amplifier has a maximum power rating of 25 mw and is made for driving meter movements, electro-hydraulic valves, and power amplifiers. It is especially useful for mixing two or more input signals and for providing a buffer between a high impedance signal source and a low impedance load.

The unit is $2\frac{1}{2} \times 2\frac{1}{2} \times 3\frac{1}{2}$ in. high with plug-in terminals and four tie-down studs. Circle 472 on Reader Service Card.

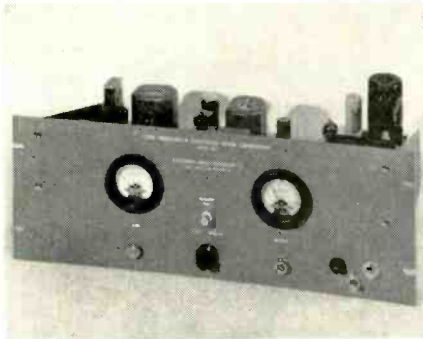

NOISE GENERATOR

used with analog computers

ELECTRONIC NOISE GENERATOR Co., P. O. Box 45344, Airport Station, Los Angeles 45, Calif. Model 301 low frequency Gaussian noise generator makes available a random voltage source with a spectral density which is automatically controlled to ± 0.1 db from 0 to 35 cps and a Gaussian amplitude distribution with an accuracy of better than 1 percent. Maximum output voltage is 15 v rms.

This precision noise generator design has been extensively used with analog computers to study the effects of random disturbances on fire control systems, guided missile systems and airframe structures. It has also proved its

New Bulletin

FANSTEEL SILICON RECTIFIERS

- Write today
for your
FREE Copy

FANSTEEL METALLURGICAL CORPORATION
North Chicago, Illinois, U. S. A.



E 578A

PROBLEM:
find the "pot"

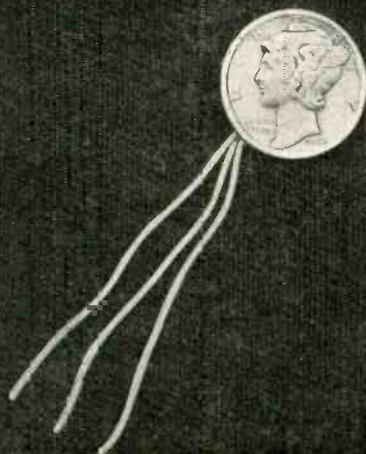

This is the "Tail" of **A DAYSTROM "POT"**

The Model 300-00—smallest, most ruggedly-accurate wire-wound potentiometer on the market!

If you are having trouble finding the right "pot," a "pot" that will fit into the tiniest space, weigh less than an overstuffed feather, and still provide unexcelled accuracy and resolution characteristics, you will want to know about the Model 300-00 sub-miniature, wire-wound potentiometer produced by DAYSTROM POTENTIOMETER, and now improved even over the high-performance original.

So **SMALL** and **COMPACT** it can easily be covered by a dime (3/16 inch thick). One half as large as its nearest competitor.

So **RUGGEDLY ACCURATE** it can be used for the most exacting applications.

- High Power Rating
- Extremely Fine Resolution
- Operable Over Extreme Temperature Ranges
- Designed to stack (21 per cubic inch)

The Model 300-00 is just one of the many production or custom-made potentiometers available from DAYSTROM POTENTIOMETER. The Model 300-00 and its big brother—the 303-00 (higher resistance values)—are available out of stock.

Openings exist for highly qualified engineers.



DAYSTROM PACIFIC

A Division of DAYSTROM, INC.

POTENTIOMETER DIVISION

9320 Lincoln Boulevard Los Angeles 45, California

usefulness in statistical computer studies of problems in the fields of biology, meteorology and oceanography. **Circle 473 on Reader Service Card.**

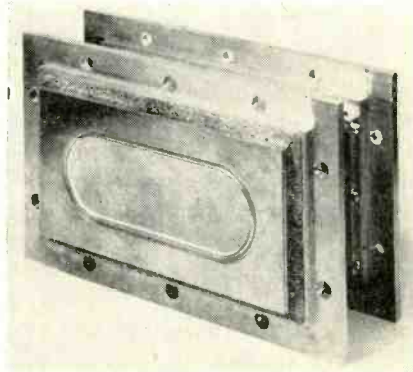

PRE-TR TUBE
for high power applications

BOMAC LABORATORIES, Beverly, Mass., announces the BL-612, an L-band pre-TR tube designed with ceramic windows for use in high power applications. Preliminary tests indicate that successful operation at 6 mw (peak) and 12 kw (average) is possible and the bandpass is from 1,250 to 1,350 mc. Two gaskets are supplied with the BL-612 to allow mounting in a standard 10-hole L-band mounting seat.

The tube weighs approximately 5½ lb and is 3½ in. long, 5⅞ in. wide and 3.600 in. (maximum) in height. **Circle 474 on Reader Service Card.**



A-C VOLTMETER
has all-transistor design

ALECTRA DIVISION, Consolidated Electrodynamics Corp., 325 North Altadena Drive, Pasadena, Calif., has announced a new, battery-operated a-c electronic voltmeter,

featuring a space-saving, all-transistor design and printed wiring. Known as the type 10A, it is a compact, portable instrument which can be carried in one hand.

Normal warm-up period required by vacuum-tube equipment is eliminated, since inherent characteristics of transistors permit instant operation. The absence of drift caused by vacuum tube warm-up assures stable readings as soon as the instrument is turned on.

The voltmeter is capable of measuring voltages from 1 mv full-scale to 300 v full-scale, within the frequency range of 20 cps to 500 kc. The instrument's large meter swing enables voltage differences as small as 0.5 percent to be detected. Measurements are 6 by 8 by 6 in. and weight is 5 lb. Further information appears in CEC bulletin 7001. Circle 475 on Reader Service Card.



D-C POWER SUPPLIES are transistorized

PERKIN ENGINEERING CORP., 345 Kansas St., El Segundo, Calif., has available transistorized regulated d-c power supplies with voltage from 3 to 350 v and current ratings from 50 ma to 20 amperes. The tubeless units are based on a combination of magnetic amplifier pre-regulators and unique transistor circuitry as the final element of regulation, resulting in a performance equalling or excelling vacuum tube type, or straight magnetic amplifier type power supplies. They are used in applications which may require power levels up to 1 kw, and where precise, transient-free power is required. Fixed as well as wide

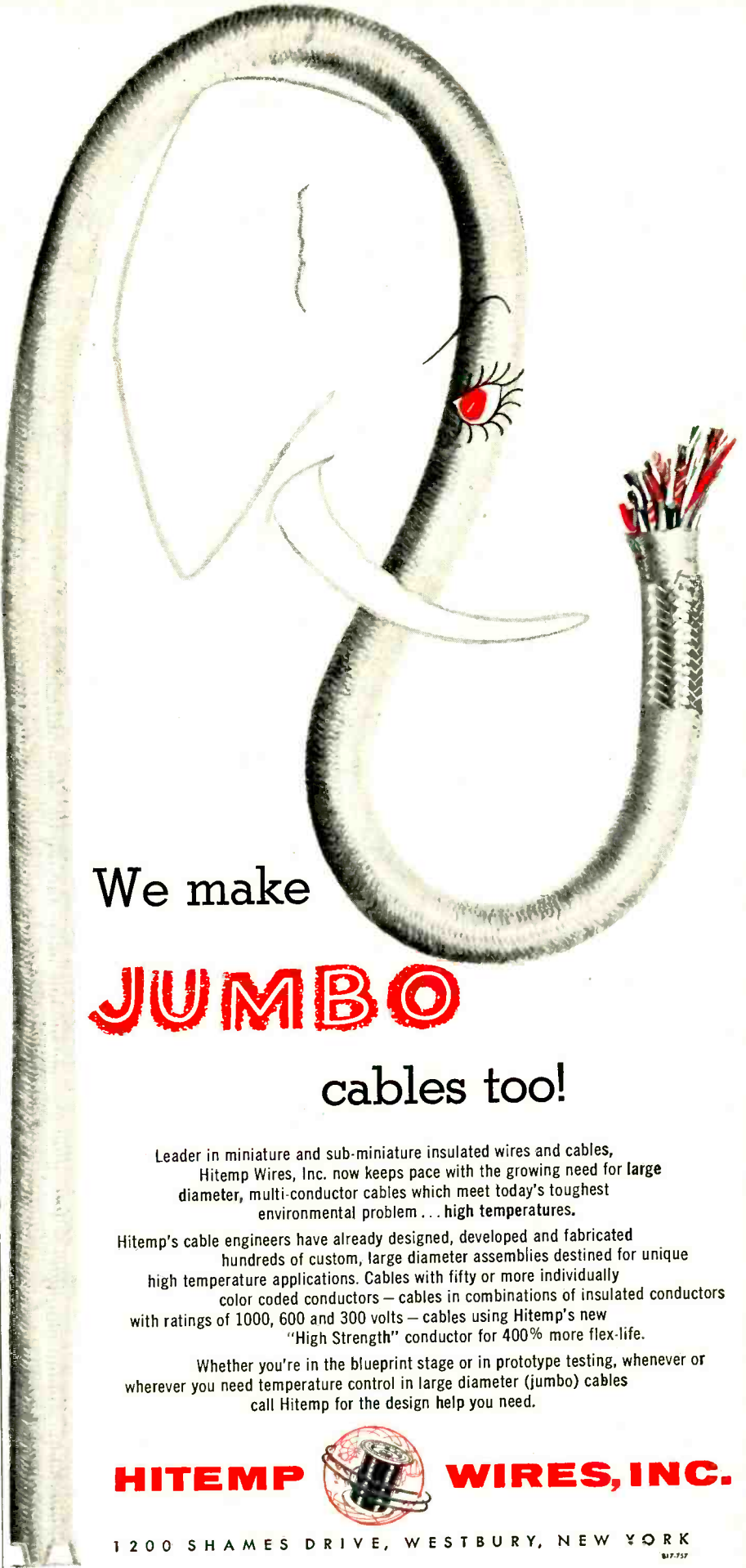

We make

JUMBO

cables too!

Leader in miniature and sub-miniature insulated wires and cables, Hitemp Wires, Inc. now keeps pace with the growing need for large diameter, multi-conductor cables which meet today's toughest environmental problem... high temperatures.

Hitemp's cable engineers have already designed, developed and fabricated hundreds of custom, large diameter assemblies destined for unique high temperature applications. Cables with fifty or more individually color coded conductors — cables in combinations of insulated conductors with ratings of 1000, 600 and 300 volts — cables using Hitemp's new "High Strength" conductor for 400% more flex-life.

Whether you're in the blueprint stage or in prototype testing, whenever or wherever you need temperature control in large diameter (jumbo) cables call Hitemp for the design help you need.

HITEMP

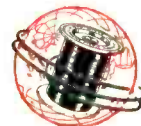

WIRES, INC.

1200 SHAMES DRIVE, WESTBURY, NEW YORK

BU 7-757

variable voltage range units can be supplied.

Typical performance characteristics are: ± 0.5 v at 300 v, 0-1 ampere, or ± 50 mv at 30 v, 0-10 amperes; low internal impedance of 0.5 ohm maximum at 300 v, 0-1 ampere, or 0.1 ohm maximum at 30 v, 0-10 amperes; and low ripple and noise of 10 mv rms maximum at 300 v, 0-1 ampere, or 2 mv rms maximum at 30 v, 0-10 amperes. **Circle 476 on Reader Service Card.**

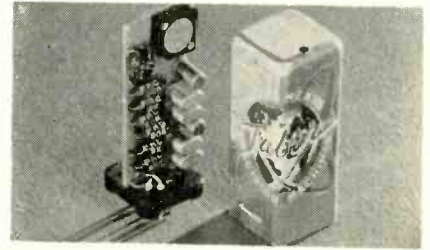

TRANSISTOR AMPLIFIER high-gain, plug-in type

TABER INSTRUMENT CORP., North Tonawanda, N. Y. Model 198 transistor amplifier has a 1 percent closed-loop gain stability from -60 C to $+125$ C. It is a high-gain, low-power plug-in amplifier designed for servo and audio applications. It has an open-loop gain of 90 db and a closed-loop gain variable from $\times 2$ to $\times 1,000$. It will operate at 40 g's at 60 cps without significant increase in background noise. It weighs less than 2 oz and has a bandwidth of 5 cps to 50 kc. **Circle 477 on Reader Service Card.**

METAL FILM RESISTORS with low ohmic values

THE DAVEN CO., Livingston, N. J., announces the availability, in large quantities, of the Davohm series 850 hermetically sealed metal film resistors, featuring extremely low ohmic values.

These metal film resistors have ohmic values as low as two ohms in $\frac{1}{2}$ w size, three ohms in 1 w size, and four ohms in 2 w size. These low values are within ± 1 percent accuracy and stable. They have the same characteristics as all other resistance values. The posi-

Business

Merck Plans to Produce Electronic Silicon at New Chemicals Division

By a WALL STREET JOURNAL Staff Reporter

NEW YORK—Merck & Co., maker of drugs and fine chemicals, has entered a new field. Dr. William H. McLean, president of the chemical division, announced the company has set up a new electronic chemicals division for production of electronic silicon and related products. The division will make the highest grade of silicon in the world.

Wanted: Sales & Marketing Executive

Brilliant Future With New Division

Merck & Co., Inc., needs a Sales and Marketing executive with a technical background to organize and direct the Sales and Marketing Department of the Electronic Chemicals Division. This is an outstanding opportunity for an individual interested in building a new department. He will supervise all sales, marketing, and promotional activities.

To qualify for this position, the applicant must have exceptional technical know-how and experience in electronic engineering and physics plus commercial sense and knowledge of markets.

The job will grow in direct proportion to the man's ability. Potential growth is as unlimited as that of the electronic chemicals industry.

Address résumés to: Dept. E-10

G. A. Ducca

MERCK & CO., Inc., Rahway, New Jersey



tive temperature coefficient of these resistors is the same within ± 20 ppm per deg C for any resistance value from two ohms to four megohms.

In addition, the series 850 metal film resistors offer the lowest noise level available, excellent high frequency characteristics, a wide temperature range and complete hermetic sealing in smallest size. Due to the fact that there are no organic compounds in this resistor, it will never short out or burn up. **Circle 478 on Reader Service Card.**

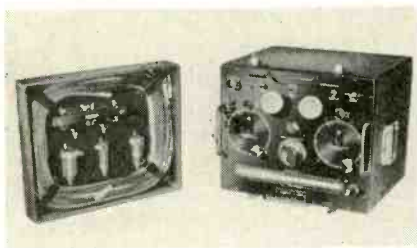

FIELD TEST SET
rugged and accurate

NORDEN-KETAY CORP., Commerce Road, Stamford, Conn., offers a new accurate test set for flight line testing of aircraft pressure instruments and systems. This test set simulates two types of temperature probes and generates selected pilot and static pressures facilitating flight line checking of altimeters, Mach meters, air-speed indicators and true air-speed computers.

The completely self-contained test set weighs only 85 lb. It is fully automatic, and can be operated by unskilled personnel.

Range is from 100 to 1,000 knots and $-1,000$ ft to $+80,000$ ft. Accuracy is ± 1 percent air-speed; ± 1 percent or ± 35 ft altitude. Power is 115 v, 60 cps. **Circle 479 on Reader Service Card.**

INDUSTRIAL SOLVENT
used with ultrasonic cleaners

LONDON CHEMICAL Co., INC., 1535 North 31st Ave., Melrose Park, Ill. Sonic-Solve No. 113 has the power to remove contaminants without affecting plastics, decals,

numbers, magnet wire or insulating varnishes. The non-ionic, non-hydroscopic liquid is completely stable and safe for use with electronic cleaning equipment.

After 10 seconds in an ultrasonic cleaner using this solvent, completely assembled open relays are devoid of rosin fluxes, oils, greases and dirt. Another five minutes in an ultrasonic dryer and the parts are ready for packing. Sonic-Solve also dries rapidly in open air. No rinsing or neutralizing is necessary. The solvent is nonflammable and has a minimum toxicity of 500 ppm in air in an eight-hour working day.

Where variations in selective solvency are desirable, the manufacturer will test-clean, offer recommendations and develop a specific formulation for thorough cleaning. All that is required is a description of the basic contamination and sample parts or units. **Circle 480 on Reader Service Card.**

FERRITE CORE
for electronic computers

RADIO CORP. OF AMERICA, Camden, N. J., has announced an improved low-drive ferrite core for use as an information-storing device in electronic digital computers. It is comparable to the high-drive core in ability to withstand large disturbing current impulses without reversing its flux state.

Type 222M2 has faster turnover time, higher output signal and a driving current in the 300-500 ma range. A minute ring-shaped device processed by ceramic techniques, the core possesses magnetic properties. Directed current will cause the core to change its positive or negative state—thus either storing or releasing coded information within millionths of a second.

For example, operating in a coincident-current type matrix, the 222M2 receiving a full driving current of 400 ma will produce an undisturbed "One" output signal of 72 mv peak, and a 2.4 μ sec turnover time. **Circle 481 on Reader Service Card.**

the specs are the proof . . .
the BEST BUYS are EICO
for COLOR & Monochrome TV servicing

NEW COLOR and Monochrome DC to 5 MC LAB & TV 5" OSCILLOSCOPE

#460
Factory-wired and tested **\$129⁹⁵**
Also available as kit **\$79⁹⁵**

• Features DC Amplifiers!

Flat from DC-4.5 mc, usable to 10 mc. VERT. AMPL.: sens. 25 rms mv/in.; input Z 3 megs; direct-coupled & push-pull thruout; K-follower coupling bet. stages; 4-step freq-compensated attenuator up to 1000:1. SWEEP: perfectly linear 10 cps-100 kc (ext. cap. for range to 1 cps); pre-set TV V & H positions auto, sync. ampl. & lim. PLUS: direct or cap. coupling; bal. or unbal. inputs; edge-lit engraved lucite graph screen; dimmer; filter; bezel fits std. photo equip. High intensity trace CRT. 0.06 usec rise time. Push-pull hor. ampl., flat to 400 kc, sens. 0.6 rms mv/in. Built-in volt. calib. Z-axis mod. Sawtooth & 60 cps outputs. Astig. control. Retrace blanking. Phasing control.

NEW TV-FM SWEEP GENERATOR & MARKER

#368
Factory-wired and tested **\$119⁹⁵**
Also available as kit **\$69⁹⁵**

Entirely electronic sweep circuit (no mechanical devices) with accurately-biased inductor for excellent linearity. Extremely flat RF output; new AGC circuit automatically adjusts osc. for max. output on each band with min. ampl. variations. Exceptional tuning accuracy; edge-lit hairlines eliminate parallax. Swept Osc. Range 3-216 mc in 5 fund. bands. Variable Marker Range 2-75 mc in 3 fund. bands; 60-225 mc on harmonic band. 4.5 mc Xtal Marker Osc., xtal supplied. Ext. Marker provision. Sweep Width 0-3 mc lowest max. deviation to 0-30 mc highest max. dev. 2-way blanking. Narrow range phasing. Attenuators: Marker Size, RF Fine, RF Coarse (4-step decade). Cables: output, scope horiz., scope vertical.

NEW DYNAMIC CONDUCTANCE Tube & Transistor Tester

#666
Factory-wired and tested **\$109⁹⁵**
Also available as kit **\$69⁹⁵**

COMPLETE with steel cover and handle.

SPEED, ease, unexcelled accuracy & thoroughness. Tests all receiving tubes (and picture tubes with adapter). Composite indication of Gm, Gp & peak emission. Simultaneous sel of any 1 of 4 combinations of 3 plate voltages, 3 screen voltages, 3 ranges of continuously variable grid voltage (with 5% accurate pot). New series-string voltages: for 600, 450, 300 ma types. Sensitive 200 ua meter. 5 ranges meter sensitivity (1% shunts & 5% pot.) 10 SIX-position lever switches: free point connection of each tube pin. 10 push-buttons rapid insert of any tube element in leakage test circuit & speedy sel. of individual sections of multi-section tubes in merit tests. Direct-reading of inter-element leakage in ohms. New gear-driven roller chart. Checks n-p-n & p-n-p transistors; separate meter readings of collector leakage current & Beta using internal dc power supply. CRA Adapter \$4.50

See the 50 EICO models IN STOCK at your neighborhood distributor. Write for FREE Catalog E-10

Prices 5% higher on West Coast

EICO 33-00 NORTHERN BLVD., LONG ISLAND CITY 1, N. Y.

Circle 276 Readers Service Card

WHO IS BORG?

Borg is a highly respected name in its field . . . the manufacture of components for systems. Borg has gained wide recognition as a supplier of electronic components for military and commercial uses.

BORG PLANTS

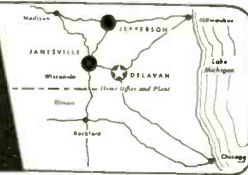

Borg manufacturing plants are centrally located about 90 miles from Chicago. Easily accessible by highway, rail and air.

WHAT BORG MAKES

Precision Is Our Business. For many years Borg has been prominent in the design and manufacture of precision components for systems.

• AIRCRAFT INSTRUMENTS

Aircraft components, instruments and electronic sub-assemblies.

• FREQUENCY STANDARDS

Crystal controlled oscillator type frequency standards.

• POTENTIOMETERS

Quantity production of Borg MICROPOTS (precision potentiometers) to meet your specifications.

• MICRODIALS

Precision MICRODIALS for single and multi-turn devices. Indexed accuracy of up to one part in 1,000.

• INSTRUMENT MOTORS

Precision motors, synchronous and induction types. Gear trains.

BORG CAN HELP YOU

Borg can assist you in the design and construction of prototypes. Complete facilities for pilot runs and quantity production. Write for Bulletin BED-A50 or call us today.



BORG EQUIPMENT DIVISION
THE GEORGE W. BORG CORPORATION
JANESVILLE, WISCONSIN

Circle 277 Readers Service Card

New Literature

Double Stub Tuners. Weinschel Engineering, 10503 Metropolitan Ave., Kensington, Md. Models DS-109, 109L and 109LL double stub tuners are completely described in the loose-leaf catalog sheet, bulletin No. 19. Complete technical specifications are included. **Circle 501 on Reader Service Card.**

Thermistors. Global Division, The Carborundum Co., Niagara Falls, N. Y. Technical bulletin GR-3 contains physical and electrical characteristics for the types B, F, and H thermistors—nonlinear (negative temperature coefficient) resistors which offer a wide range of temperature coefficient characteristics. Typical applications are included. **Circle 502 on Reader Service Card.**

Random Noise Amplifier. The Calidyne Co., Winchester, Mass. Bulletin No. 190-57 illustrates and describes the model 190 random noise amplifier which was designed as a matched power supply for the model 177 shaker for random vibration testing of components. Installation details are included. **Circle 503 on Reader Service Card.**

Impregnating Resins. Emerson & Cuming, Inc., 869 Washington St., Canton, Mass. A new 10-page brochure describes Eccoseal, a line of impregnating resins. Included are materials for transformers, coils, capacitors and electronic circuits. Several of the impregnants are epoxides; one can be used to temperatures as high as 600 F. One resin is extremely low loss; others feature low viscosity, long room temperature pot life and moderate curing temperatures. Ordering information is also in the brochure. **Circle 504 on Reader Service Card.**

Frequency Counter. Hewlett-Packard Co., 275 Page Mill Road, Palo Alto, Calif. Volume 8, No. 11 of the *Journal* illustrates and describes the model 521C frequency counter which measures to 120 kc with good accuracy, and is small

and convenient for general purpose use. Also included are some handy uses for the model 650A test oscillator. **Circle 505 on Reader Service Card.**

Connector Brochure. DeJur-Amsco Corp., 45-01 Northern Blvd., Long Island City 1, N. Y., has issued a completely revised and new 12-page brochure on Continental Connector's subminiature series connectors. It contains specifications, outline drawings, illustrations and general information. **Circle 506 on Reader Service Card.**

Electrical Insulating Materials. Electro Technical Products, a Division of Sun Chemical Corp., 113 East Centre St., Nutley 10, N. J., has available an electrical insulation selector chart. It contains a description, salient features and suggested uses for 25 different materials. **Circle 507 on Reader Service Card.**

Flexible Shafts. S. S. White Industrial Division, 10 E. 40th St., New York 16, N. Y. Design features and specifications for a new line of standard flexible shafts for solving a wide variety of power transmission and remote control problems are described and illustrated in a four-page two-color bulletin now offered. Shafts discussed were designed primarily to provide ready-to-install units for design and prototype work. **Circle 508 on Reader Service Card.**

Film Capacitor Data. Sprague Electric Co., 35 Marshall St., North Adams, Mass. Three new engineering bulletins covering new standard types of plastic film-dielectric capacitors have recently been issued.

Engineering Bulletin 2410 covers Filmite "E" capacitors in tubular metal cases for operation at temperatures up to 150 C where high insulation resistance is required but moderate shifts in capacitance are not objectionable.

Engineering Bulletin 2560 describes Filmite "F" capacitors, both in tubular metal cases and in

bathtub cases. These capacitors have a special film dielectric which gives an extremely stable capacitance vs temperature curve, approaching a zero temperature coefficient from 0 deg to +85 C and which will shift approximately only 2 percent up to 125 C.

Engineering Bulletin 2610 describes 200 C Filmite "G" capacitors in both tubular metal cases and in drawn oval cases. The capacitors discussed can also be used at lower temperatures for applications requiring maximum insulation resistance or minimum dielectric absorption or dissipation factor. Typical uses are in jet aircraft, missiles, and oilwell logging.

Other literature is available. Circle 509 on Reader Service Card.

Relay Bulletin. Phillips Control Corp., 59 W. Washington St., Joliet, Ill. The latest in a series of engineering bulletins provides a comprehensive report on the type 4 relay. It is available along with other relay studies in a three-ring, loose-leaf binder.

The new bulletin deals with specific applications involving coils and contact arrangement of the type 4, showing four basic groups in actual size drawings. Photographs, features and other technical data on coil characteristics, contact forms are included for both enclosed and hermetically-sealed relays. Circle 510 on Reader Service Card.

Transistor Equipment Catalog. Electronic Research Associates, Inc., 67 East Centre St., Nutley 10, N. J., has available a new, 10-page, multicolor folder-type catalog. The new catalog covers a complete line of products, including transistorized inverters and converters, transistorized high current power supplies, transistorized Transpac power packs, transistor test equipment, Transpac miniaturized power packs, transistor regulated d-c power supplies, Transamp packaged circuits, transistor application power supplies, and price sheet.

The catalog includes technical descriptions, specifications, application notes, model numbers and

Eliminate Costly Reading Errors!

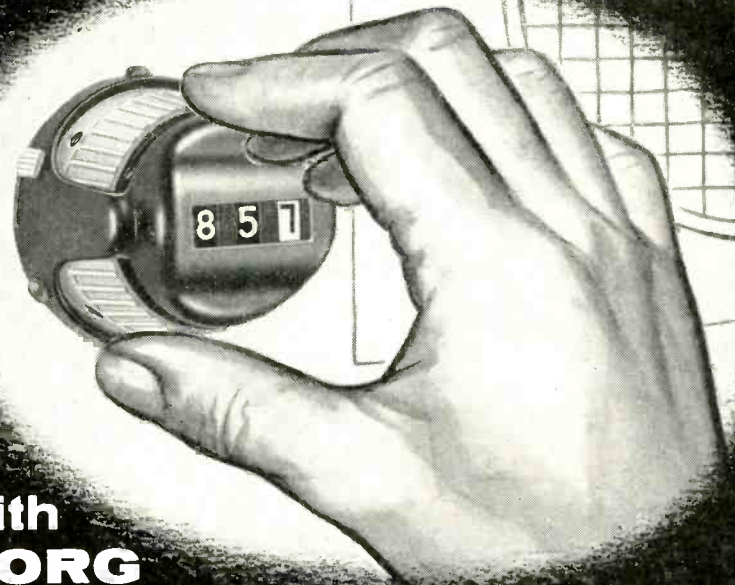

with
**BORG
DIRECT-READING
MICRODIALS...**

Large, clear numbers are easily and accurately viewed through the curved, one-piece window of Borg Direct-Reading Microdials. The in-line digital presentation practically eliminates reading and setting errors . . . especially under the difficult conditions of forced fast reading and setting. Human engineering studies have determined that the greatest accuracy of perception of precise numerical values is provided by an in-line digital presentation. Borg Microdials are designed to take maximum advantage of this fact. Available in 3, 4 and 5 digit models.

CONCENTRIC SCALE MICRODIALS

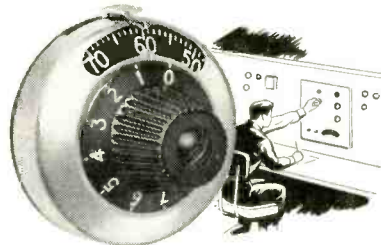

Borg Concentric Scale MICRODIALS indicate the position of any multi-turn device of 10 turns or less.

Borg Concentric Scale MICRODIALS are precision dials with an indexed accuracy of one part in 1,000. They indicate the position of any multi-turn device of 10 turns or less. Concentric scales indicate full turns and increments. Fingertip brake retains any setting. Knob fastens directly to shaft . . . no backlash. Accurate . . . easy to install.

**Write For Complete Data On All Borg Microdials
Ask For Catalog BED-A56**

BORG EQUIPMENT DIVISION
THE GEORGE W. BORG CORPORATION
JANESVILLE, WISCONSIN



Build by Borg
**MOTORS
MICROPOTS
MICRODIALS**

Don't Worry about a thing!

The New 'Sensitive Research' CONTACT METER

will control it AUTOMATICALLY to an accuracy of .25%.



CONTACT MAKING PANEL INSTRUMENTS for the Automatic Inspection or Control between Electrical Minimum and Maximum Limits

Sensitive Research Contact Making Edgewise Panel Instruments provide the means for the electrical sensing of preset values of Voltage, Current, Watts, Micromhos and any other quantity that can be indicated electrically. They are Reference Standards, modified with adjustable contacts and furnished with electronic relay systems. Their proven Stabili-

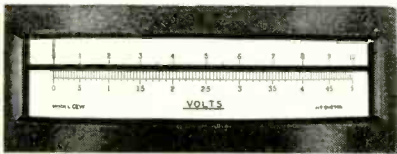

ty, Long Life and Traditional Dependability means you

'DON'T HAVE TO WORRY ABOUT A THING.'

- Accuracies to .25% • 7" or 5" hand-drawn mirrored scale
- Automatic or manual reset • A.C., D.C. or both
- Contacts variable over 90% of the instrument's scale

Rep. in E. Pennsylvania and So. New Jersey — I. E. Robinson Co.
Offices — Upper Darby, Pa., Camp Hill, Pa. and Asbury Park, N. J.

Rep. in New England — Yewell Associates, Inc.
Offices — Burlington, Mass. and Bridgeport, Conn.

SENSITIVE RESEARCH INSTRUMENT CORPORATION

NEW ROCHELLE, N. Y.

ELECTRICAL INSTRUMENTS OF PRECISION SINCE 1927



prices. Circle 511 on Reader Service Card.

Rotary Electrical and Electronic Equipment. Western Gear Corp., P. O. Box 182, Lynwood, Calif. Bulletin No. 5721 illustrates the more than 70 different types of miniature motors, gear motors, motor generator sets, fans and blowers designed and manufactured by the company. Engineering drawings, performance curves and other detailed information is provided for the engineer. A section of the catalog also details specified electronic equipment such as voltage regulator power supplies, transistorized voltage regulators and stroboscopes.

To obtain a copy of this catalog address the company, indicating your name, title and company affiliation.

Research and Development. Gulton Industries, Inc., 212 Durham Ave., Metuchen, N. J. "From Raw Materials to Complete Systems" is the title of a new facilities brochure. Detailed and descriptive, the new brochure was designed to acquaint industrialists with the extensive research and development program for industry conducted by the company.

The eight-page illustrated brochure highlights the company's activities in the areas of materials research, component development, data instrumentation, ultrasonic and acoustic research, medical instrumentation, underwater sound, ordnance development and nuclear research. Circle 512 on Reader Service Card.

Bolometer Preamplifier. Weinschel Engineering, 10503 Metropolitan Ave., Kensington, Md. A loose-leaf perforated catalog sheet covers the model BA-1A bolometer preamplifier. Included are description, uses, features, specifications, price, block diagram for typical insertion loss measurement, and recommended accessories. Circle 513 on Reader Service Card.

Closed Circuit TV Systems. Kin Tel, A Division of Cohu Electronics, Inc., 5725 Kearny Villa

Road, Box 623, San Diego 12, Calif. Catalog No. 6-42 describes the company's basic wired, closed circuit industrial tv system, consisting of camera, camera control and monitor. It contains data on remotely controlled pan-tilt, iris-focus, and other camera accessories; special ruggedized equipment for operation under adverse environmental conditions of noise, heat, shock and extremes of temperature or humidity; and lists and describes a number of potential and actual installations where industrial tv is saving time, money, and providing more efficient use of equipment and personnel in plants throughout the world. **Circle 514 on Reader Service Card.**

Potentiometer Bulletin. Norden-Ketay Corp., Commerce Road, Stamford, Conn. A loose-leaf perforated single-sheet bulletin gives specifications and outline drawings for sector potentiometers. The units discussed in bulletin No. 415 are designed to operate in damping fluids, and in temperatures in excess of 150 C.

The potentiometers described have a life in excess of 1,000,000 cycles, and resolutions as fine as 0.0006 in. **Circle 515 on Reader Service Card.**

Transistorized Power Supply. General Electric Co., Communication Products Dept., Syracuse, N. Y. Bulletin ECR-490A covers the new transistorized power supply for two-way radio units, which provides advantages of transistor power without obsoleting the user's existing radio equipment. The transistorized power supply described makes possible system modernization without expensive maintenance. The cost of installing the device discussed is written off in savings from lowered maintenance expenses resulting from fewer vibrator replacements and service calls. **Circle 516 on Reader Service Card.**

Transistor Test Equipment. Electronic Research Associates, Inc., 67 E. Centre St., Nutley 10, N. J., has available a new two-color sheet describing its line of tran-

NOW QUICK SERVICE ON PRINTED CIRCUIT PROTOTYPES



Now Photocircuits Corporation offers you
the services of its newly formed

PROTO DIVISION

for faster delivery of Printed Circuit Prototypes

- No need to wait weeks for a few engineering samples! We'll deliver FULLY FABRICATED parts within days from receipt of your art work or negatives and specifications.
- This separate division is completely streamlined in its methods and systems to guarantee you the fastest possible service.
- To accomplish this result a special set of "ground rules" has been formulated. Your local factory Sales-Engineer will give you all the details.
- He can figure costs *on the spot!* You will not be delayed by having to write the factory for formal quotation.

The PROTO DIVISION combines speed with the three vital attributes that have made Photocircuits the leader in the industry . . . EXPERIENCE, EQUIPMENT and CONTROL!

NOW you'll meet that deadline and still benefit from all the cost and quality advantages of printed wiring.



Phones:
Glen Cove 4-8000
Flushing 7-8100
Cable: PHOCIRCO

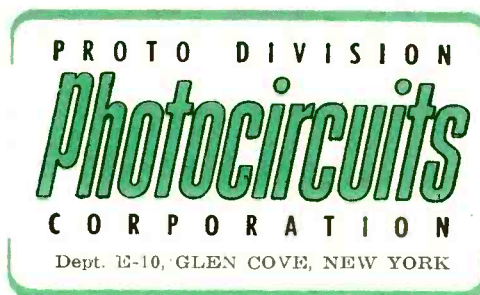

Sales- Engineering Offices:
HOUSTON, TEX. • LOS ANGELES, CAL. • ATHERTON, CAL. • ROCHESTER, N. Y. • KANSAS CITY, MO.
CHARLOTTE, N. C. • DENVER, COLO. • SPOKANE, WASH. • CHICAGO, ILL. • PHILADELPHIA, PA.



**NEW
FREQUENCY DOUBLERS**

- Double the sampling rate
- Double the band width
- Eliminate zero offsets

**DC-AC
CHOPPERS**

Twenty-two types,
both single and
double pole.

Long life.

Low noise level.

Extreme reliability.

Write for Catalog.

**STEVENS
INCORPORATED
ARNOLD**

7 ELKINS STREET
SOUTH BOSTON 27, MASS.



S/A-10C

Circle 283 Readers Service Card

**MICROWAVE
POWER
ATTENUATOR
Model AT-70**

50 WATTS CONTINUOUS
DC TO 4000 MC

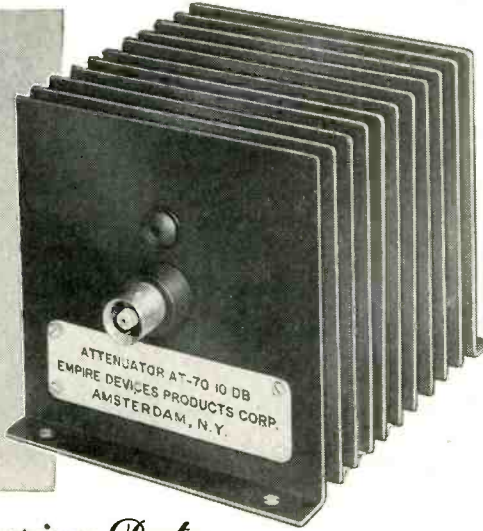

Engineering Data

APPLICATIONS:

Isolates power sources producing up to 50 watts of continuous power from low-power measuring devices, such as bolometers; decreases the effective power output of a transmitter when reduced radiation is desired; dummy load for a transmitter, permitting simultaneous monitoring of transmitter output; broad-band power attenuation over a wide range of frequencies.

Send for our complete catalog.

DESCRIPTION: Empire Model AT-70 uses a T-network of concentric line construction employing precision resistors of the deposited carbon type. The series elements consist of rod resistors, while the shunt elements are discs. For increased power dissipation, the attenuator is oil filled and equipped with cooling fins. The maximum attenuation is 20DB. For attenuation values in excess of 20DB, Attenuator Model AT-50 may be series connected with a Model AT-70, 20DB Attenuator.

edp EMPIRE DEVICES PRODUCTS CORPORATION
AMSTERDAM • NEW YORK

manufacturers of

FIELD INTENSITY METERS • DISTORTION ANALYZERS • IMPULSE GENERATORS • COAXIAL ATTENUATORS • CRYSTAL MIXERS

sistor test equipment. The catalog discusses test instrumentation suitable for both laboratory and production testing of transistors and transistorized equipment.

Listed in the catalog sheet are a full description and technical specifications covering the company's transistor comparison tester, transistor alpha-beta tester, automatic transistor noise figure meter, and transistor noise figure calibrator. **Circle 517 on Reader Service Card.**

Radar Developments. Sperry Gyroscope Co., Division of Sperry Rand Corp., Great Neck, N. Y. The Company's new "True Tracking" and "Off-Center" radar developments are described in a 6-page illustrated brochure.

True tracking radar shows immediate differentiation between moving vessels and stationary objects. Off-center radar gives greater, more important scanning area information while retaining close-in definition. Mark III technical data are included. Adaptability to existing Mark III radars is explained. **Circle 518 on Reader Service Card.**

Antenna Pattern Instrumentation. Polytechnic Research & Development Co., Inc., 202 Tillary St., Brooklyn 1, N. Y. Volume 5 No. 2 of *PRD Reports* features an illustrated technical paper titled "Antenna Pattern Instrumentation." It describes a complete microwave test equipment system for antenna pattern measurements in the frequency band from 1,000 mc to 10,500 mc. Discussed in detail are the various components of the system, including transmitter, heterodyne frequency meter and recording receiver.

After describing the use of the equipment in antenna pattern measurement, the paper also discusses other applications, including calibration of attenuators, impedance measurement and field strength measurement. **Circle 519 on Reader Service Card.**

Transistorized Instruments. Cubic Corp., 5575 Kearny Villa Road, San Diego 11, Calif., has available a 2-page brochure describing

Temper,
Temper!



can
control it

If the temper of thinstrip used in your present production is getting your temper up, Somers will be glad to show you how closely it can be controlled.

Whatever your problems with thin gauge brass, nickel, copper and alloys, from .0001" to .010", Somers has the modern equipment, complete laboratory facilities and nearly 50 years of experience ready to help you solve them without cost or obligation.

Write for Confidential Data Blank.



Somers Brass Company, Inc.
112 BALDWIN AVE. WATERBURY, CONN.

Circle 281 Readers Service Card
ELECTRONICS — October 1, 1957

NEW LITERATURE

(continued)

10 completely transistorized instruments. The leaflet lists five test instruments in a self-powered series, including waveform generator, pulse generator, frequency meter, transistor curve tracer, 30-mc generator.

Two power-measuring devices are listed, a calorimetric wattmeter and peakpower test set. In microwave instrumentation, the brochure describes a klystron power supply, standing-wave amplifier, and microwave test set. **Circle 520 on Reader Service Card.**

Silicone Molding Compounds. Dow Corning Corp., Midland, Mich., has published a new brochure exclusively devoted to silicone molding compounds. The low thermal conductivity, superior electrical properties, and high temperature strength-to-weight ratio of these materials are discussed, along with chart, graphs and field examples.

Physical and electrical properties of MIL-M-14E, which these materials are designed to meet, are also listed, both for types MSI-30 and MSG.

Code No. 7-603 is a four-page, three-color brochure. **Circle 521 on Reader Service Card.**

Phasemeter. Statham Development Corp., 12411 West Olympic Blvd., Los Angeles 64, Calif., has available a new bulletin on the recently developed model PM-1B Phasemaster. The bulletin describes in detail the specifications and applications of the Phasemeter as well as significant features. In addition, it contains illustrations and a diagram of the new unit. **Circle 522 on Reader Service Card.**

Computer Quality Electrolytics. Pyramid Electric Co., North Bergen, N. J., has available a new engineering bulletin for the type CQM computer quality electrolytic capacitors.

The four-page well illustrated bulletin indicates that CQM capacitors may be ordered in various capacitance and voltage combinations ranging from 45,000 μ f at 5 v to 850 μ f at 400 v. Container diameters are 1 $\frac{3}{8}$ in., 2 in., 2 $\frac{1}{2}$ in. and 3 in. Heights of all units are

...IF YOU NEED POWER SUPPLIES TRANSVAL

Call
Vermont 9-2301, Culver City, California
For Data on TRANSISTORIZED Power Supplies that gives you these advantages:

- ★ PROTECTED from overload and short-circuit
- ★ DESIGNED to meet YOUR exact specifications
- ★ PRODUCED to meet YOUR schedule

HIGH VOLTAGE POWER SUPPLY

Output voltage to 1050 volts (± 5 V). Regulation 0.5% with nominal load and input from 109 to 121 volts. Size: 5" x 4" x 4 $\frac{1}{2}$ "; 3 $\frac{1}{2}$ lbs.

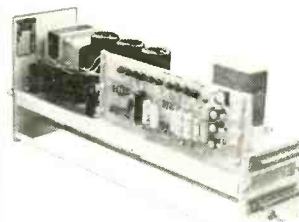

ULTRA STABLE POWER SUPPLY

Stability of one millivolt over entire output range of 0 to 4 amps at 10 volts. Other voltages with the same stability may also be obtained.

MULTIPLE HIGH VOLTAGE POWER SUPPLY

Designed for multiple voltage control ranging from -150 volts at 600 ma. to +300 volts at 250 ma. Up to 6 different voltages per drawer. Can be made to ANY specification.

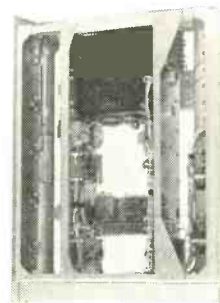

TRANSVAL engineers have set new standards for high stability, light weight power supplies based on advanced techniques of applying transistors. The units shown above are only a few of the many developed by Transval that meet specifications never before considered practical for transistorized power supplies. Among the leading builders of missiles, rockets, and piloted aircraft using Transval transistorized power supplies are Douglas, North American, Northrop, Hughes, Beckman, Norden Ketay, and Canadian Applied Research Ltd.

Find out today how TRANSVAL can help you. Phone, wire, write

TRANSVAL Engineering Corporation

10401 West Jefferson Boulevard
Culver City, California

Specialists in Transistorized Power Supplies

Circle 282 Readers Service Card

FAST

PRODUCTION OF NEW PRODUCT

Fabrications

FOR QUICK DELIVERY OF

Spinformings



GUIDED MISSILES, TURBO JETS,

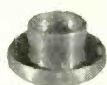

COMMERCIAL PLANES, PARTS,

Hydroformings



INDUSTRIAL PRODUCTS AND A



GROWING LIST OF NEW, UN-

Fabrications



PUBLISHED DEVELOPMENTS USE



THIS CREATIVE SHOP.

High speed facilities, unexcelled workmanship and consistent research keep this shop available to designer, engineer and purchasing agent working with advanced concepts. Send drawings for quotations and literature.

ROLAND TEINER

Company, Inc.

Dept. 61 — 134 Tremont Street
Everett 49, Massachusetts Tel. EV 7-7800

ENGINEERING REPRESENTATIVES IN MANY CITIES

Circle 285 Readers Service Card

NEW LITERATURE

(continued)

4½ in. Circle 523 on Reader Service Card.

Direct-Reading Loran. Sperry Gyroscope Co., Division of Sperry Rand Corp., Great Neck, N. Y. An up-to-date 16-page illustrated booklet describing the specifications, operation and application of Sperry's direct-reading Loran is available for the writing. Circle 524 on Reader Service Card.

Transistor Bulletin. General Transistor Corp., 91-27 138th Place, Jamaica 135, N. Y. Availability of bulletin G-120, which describes GT's line of *mpn* and *npm* transistors for radio, r-f and i-f applications, has been announced. The bulletin also contains valuable information on 4-, 6-, and 7-transistor radio kits together with accompanying circuit diagrams. Circle 525 on Reader Service Card.

Linear Amplifier. The Victoreen Instrument Co., 5806 Hough Ave., Cleveland 3, Ohio. A new bulletin descriptive of the company's model 672A linear amplifier built to ORNL Specification Q1326 has been announced.

The illustrated 2-page bulletin (Form 3001-7) gives complete electrical and mechanical specifications, performance data, and lists potential uses and applications for the equipment. Circle 526 on Reader Service Card.

Ceramic Magnets. Stackpole Carbon Co., St. Marys, Pa. The 12-page bulletin RC-11A on Ceramagnet, the high coercive force permanent magnets that are molded from low-cost ceramic powders, is now available. The revised bulletin includes many helpful diagrams and illustrations of specific Ceramagnet uses and their advantages for various mechanical, electrical and electronic applications. Also included are ten graphs plotting every magnetic characteristic of importance to design engineers. Circle 527 on Reader Service Card.

Small Size Electronic Instruments. The Bristol Co., Waterbury 20, Conn., has released a new bulletin describing and illustrating their new line of small-size self-balanc-



This Man Has

E.Q.

DO

YOU?

H. E. Ellerman, Jr. has the E.Q. (Exceptional Qualifications) that make him a valued member of the Westinghouse-Baltimore Organization. His background includes a B.S.E.E., graduate courses toward an M.S.E.E., and a Business Administration Certificate, six patents on various control mechanism, plus experience as a Design Engineer and Supervisory Engineer.

Today as Manager of Ordnance Engineering, Harry Ellerman is characteristic of the group of brilliant engineers whose outstanding achievements have materially contributed to the reputation Westinghouse-Baltimore enjoys as a leader in the electronics field.

PERHAPS YOU HAVE THE E.Q. to fill one of the specialized openings at Westinghouse-Baltimore. Why not drop us a letter about yourself? **WRITE TO:** Dr. J. A. Medwin, Westinghouse Electric Corporation, Dept. 711, P. O. Box 746, Baltimore 3, Md.

Westinghouse

BALTIMORE



Advanced Electronics Systems, Ordnance, X-Ray, Carrier Microwave, and Induction Heating Equipment for Military, Industrial, and Commercial Purposes

An Engineer's Company

October 1, 1957 — ELECTRONICS

ing electronic potentiometers and bridges.

The instruments described match the appearance of the company's pneumatic Metagraphic instruments for graphic panel and console use. They are made in both recording and indicating versions, and the two types of chassis are interchangeable through plug-in construction features. The recorder uses a 3-in. strip chart. Face dimensions are only 5 by 5½ in.

Bulletin P1271 tells how the instruments are available in three basic circuit types: a-c bridge, d-c potentiometer, and differential transformer balance types. **Circle 528 on Reader Service Card.**

Magnetic Tape Recorder. Ampex Corp., 934 Charter St., Redwood City, Calif., has available a bulletin containing complete specifications on the newest addition to the standard Ampex product line of magnetic tape recorders. It describes the 601-2 portable two-track stereophonic recorder, using precision in-line heads for recording and reproducing.

The unit discussed in the literature also features interchannel crosstalk below the inherent noise level; separate microphone and line inputs and level controls on each channel permit stereophonic mixing. The device described records both stereo and single-channel tapes and plays back stereo, full or half track tapes. Convenient plug-in transformers are available for low impedance microphone operation. **Circle 529 on Reader Service Card.**

Pushbutton Switches. Micro Switch, A Division of Minneapolis-Honeywell Regulator Co., Freeport, Ill. Data sheet 128 illustrates and describes magnetic hold-in lighted pushbutton switches. It shows contact arrangement, characteristics, electrical data and prices. **Circle 530 on Reader Service Card.**

Rod and Sheet Plastics. Emerson & Cuming, Inc., 869 Washington St., Canton, Mass. Rod and sheet plastics for electronics is the subject of a new 17-page brochure.

The brochure contains a tech-

TRACER-GUIDED DRILLING 100 HOLES P. M. WITH NEW HERMES Engravo

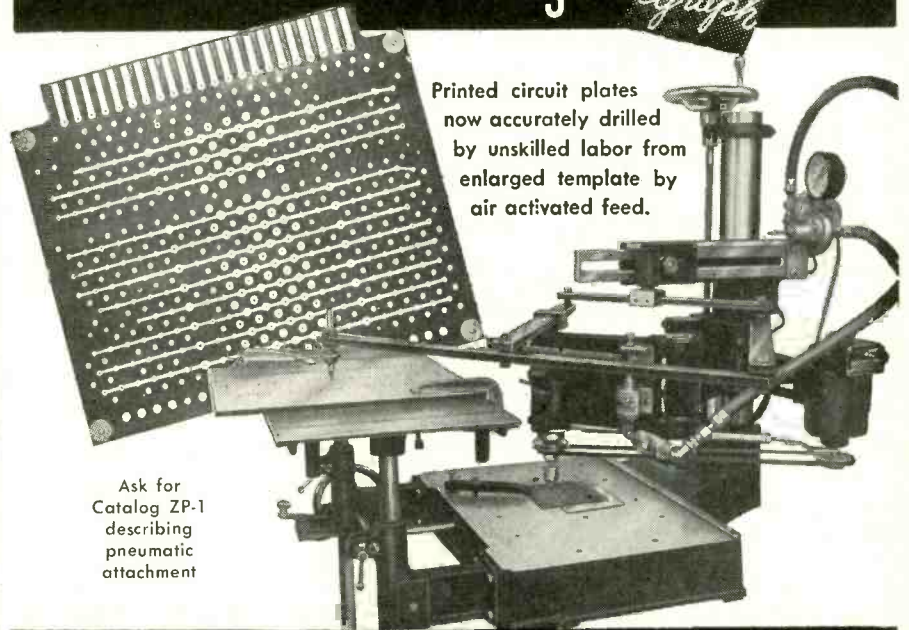

Printed circuit plates
now accurately drilled
by unskilled labor from
enlarged template by
air activated feed.

Ask for
Catalog ZP-1
describing
pneumatic
attachment

new hermes ENGRAVING MACHINE CORP.
13-19 University Place, New York 3, N.Y.

Circle 286 Readers Service Card



GOES DIELECTRIC STRENGTH

(Up to 2,500 VRMS* as required by
MIL Specs—even up to 3,000 VRMS*)

GOES INTERNAL TEMP. RISE

(25% cooler internal hot spot)

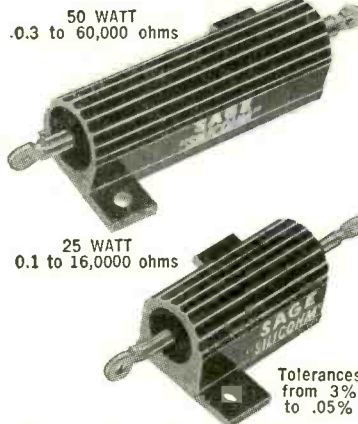

NEW SAGE Type "M" (Metal-clad) "Silicohm" Resistors Give You BOTH!

If you have been stumped because miniature, chassis-mounted resistors in the past offered only 1,000 VRMS dielectric, then here's good news. Thanks to a superior, new type of filling material and new production techniques, SAGE now offers this new, improved, precision wire-wound resistor with a *standard* rating of 1,500 VRMS dielectric strength—and up to 3,000 VRMS on special order. And the cooler hot-spot means longer life, improved stability and greater all-around reliability.

Complete data available on request

Meet all requirements of applicable military specifications in existence or in prospect.

*GUARANTEED (AT SLIGHT PREMIUMS)

Tolerances
from 3%
to .05%

SAGE

ELECTRONICS CORPORATION

302 North Goodman St., Rochester 7, N.Y.

BIRD Termaline 50 Ohm Coaxial Line Load Resistor

SERIES 88

As a reflection-free termination for rigid or flexible 50 ohm transmission line, the rugged and lightweight Series 88 "Termaline" Load Resistor is recommended for use during adjustment, testing and alignment of transmitters operating in frequency range up to 3300 mc.

It may also be used to terminate a line when power is being measured by a Bird "ThruLine" Directional Wattmeter. Standard VSWR specification is 1.1 to 1 maximum, controlled by tests from 0 to 1000 mc.

Phone or write on other VSWR requirements.

Series 88 "Termaline" Load Resistor data sheet # R-886 and "ThruLine" Directional Wattmeter data sheet # 406 also available for immediate delivery.



"ThruLine"
Directional
RF Wattmeters



"Termaline"
RF Absorption
Wattmeters



Coaxial
RF Filters



Coaxial
RF Switches



1200
Watts
Continuous
Duty
1500 Watts
Intermittent Duty
2 to 3 KW
Continuous Duty with
forced air cooling
Input connections are
available to terminate
most coaxial lines.



BIRD ELECTRONIC CORP.
Express 1-3535
1800 E. 38 St., Cleveland 14, Ohio

Western Representative: VAN GROSS COMPANY • Sherman Oaks, California
Circle 288 Readers Service Card

Perma-Power

TRANSISTOR POWER SUPPLY

MODEL A-400

Especially designed to operate, service
and test transistor portable radios
and low power transistor circuits.

Highest quality components combined with
careful engineering make this instrument
extremely reliable and useful for labora-
tory and service applications.

\$6450 from
Electronic Parts
NET Distributors only

SPECIFICATIONS

Input: 115 Volts 50/60 cycles
Output Voltage: 0-30 Volts
Output Current: 0-15 MA and 0-60 MA
Accuracy: 2% on both voltage and current
Ripple: Less than 500 microvolts (.002%
at full output)
Regulation: 1.2 Volts Maximum; Zero to
full load current
Internal Impedance: Less than 20 ohms
DC to Radio Frequencies (including 7.0
ohm Meter Fuse, optionally removable)
Terminals: 5-Way Binding Post
Size: 10" x 6 1/2" x 5 3/4"
Weight: 16 pounds

"TRULY A
VARIABLE BATTERY"

FEATURES

- Continuously adjustable output using variable autotransformer control, setting of all transistor battery voltages.
- Two output current ranges monitor current for single transistor or entire set.
- Extremely low ripple for testing lowest level transistor circuits.
- Very low internal impedance providing excellent regulation.
- Precision D'Arsonval meters provide laboratory accuracy.
- Milliammeter protected by front panel fuse; additional internal line fuse.
- Output isolated from line and case.
- Attractive Slope - Front, Maroon Hammerloid Cabinet - Rubber feet.

Perma-Power

Manufactured by

COMPANY 3100 N. ELSTON AVENUE CHICAGO 18, ILL

There's always something new being developed by Perma-Power

nical data sheet and ordering information for each product. Included are Stycast HiK, adjusted dielectric constant plastic for the range from 3 through 20; Stycast LoK, low loss and low dielectric constant stock; Eccostock, specialty epoxide materials. There is also information on a series of foams and absorbers both in rod and sheet form. Circle 531 on Reader Service Card.

D-C Power Rectifiers. The Christie Electric Corp., 3410 W. 67th St., Los Angeles 43, Calif. Bulletin AC-57-A contains a complete cataloging of the Stavolt automatically regulated power rectifiers of either selenium or silicon. The units discussed, available in 72 standard models with up to 15,000 amperes continuous capacity, are proving particularly useful as d-c sources for ground support equipment and missile testing. Models are available for uses requiring outputs from 1.5 kw to 45 kw. Circle 532 on Reader Service Card.

Stabilized D-C Indicating Amplifiers. Leeds & Northrup Co., 4934 Stenton Ave., Philadelphia 44, Pa., has available a new two-page data sheet ED7 (1) describing the company's stabilized d-c voltage and current indicating amplifiers.

The data sheet gives examples of applications such as output measurement of strain gages, thermocouples, phototubes and the like. It describes the amplifiers' use (1) as a recorded preamplifier including accuracies when combined with Speedomax G or H recorders; (2) as a direct reading indicator and (3) as a null detector. Complete specifications are listed for both types of amplifiers and the operation of the amplifiers is explained with the aid of schematic diagrams. Ordering instructions are given and illustrations of the meters and connections are shown. Circle 533 on Reader Service Card.

Electronic Instruments. Kin Tel, A Division of Cohu Electronics, Inc., 5725 Kearny Villa Road, Box 623, San Diego 12, Calif. Short Form Instrument Catalog No. 17-1 illustrates and describes a wide

Look into This
Industrial
Package Deal

AVAILABLE IN
Jacksonville
FLORIDA

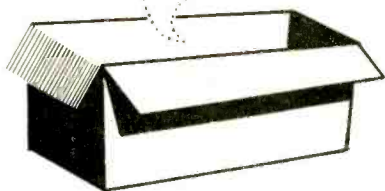

Jacksonville offers you a package deal for the establishment of a unit of your operation in this area

This deal consists of helping you locate in the most suitable spot, arranging for construction of a building to your specifications on a purchase or lease basis and helping you find private financing if you need it.

A wide variety of sites are available... ranging from adjacency to deep water terminals to railroad, highway and airport locations.

Jacksonville is an ideal spot for many types of industry. Living conditions are pleasant year-round. Schools are excellent. Skilled and unskilled labor is available, cooperative. Industrial water reserves are virtually inexhaustible. Jacksonville is a major distribution point for the Southeast and Latin America.

Write today for details of Jacksonville's industrial package deal. Also for "The Jacksonville Story", a factual compact outline of Jacksonville's industrial and commercial advantages. **JOIN THE MODERN TREND — TO JACKSONVILLE.**

Ideal Every Day for Work and Play

The CITY OF JACKSONVILLE, Florida
Electric and Water Utilities

THE COMMITTEE OF ONE HUNDRED,
Jacksonville Area Chamber of Commerce
604-E Hogan Street Phone: Elgin 3-6161

Circle 290 Readers Service Card

ELECTRONICS — October 1, 1957

NEW LITERATURE

(continued)

line of electronic instrument. Included are: the 111 series wide-band d-c amplifiers; microvoltmeters; model 204A electronic galvanometer; d-c power supplies; d-c meter calibrators; and the model 301 d-c standard and null meter. Prices are given. Circle 534 on Reader Service Card.

Dielectric Material. Monsanto Chemical Co., Plastics Div., Springfield 2, Mass., has available a data sheet giving property and performance information on polyethylene formulation 12253 which will meet the requirements of MIL-C-17B specifications for coaxial cable manufacturers. The formulation discussed conforms to MIL-D-3054A, which specifies the requirements for polyethylene dielectric material used in the manufacture of radio-frequency cable. Circle 535 on Reader Service Card.

Servosystem Laboratory Manual. Servi Corp. of America, 2020 Jericho Turnpike, New Hyde Park, N. Y. The "Servosystems Laboratory Manual" is the first step in a long range program of service to engineering education.

Designed to be useful to both industries and schools, the manual furnishes the framework for an introductory laboratory course in servomechanisms, feedback control systems and the like.

Seven integrated, class-tested experiments are included in the manual and each of them builds on what the student has learned in the earlier experiments. The experiments call for the breadboarding of a basic servosystem which is used throughout the course. Practical applications of principles are stressed and theoretical material is kept to a minimum since the manual is intended for use in conjunction with any of the standard texts in the field.

The manual contains 32 pages including numerous diagrams and photographs. Price is \$2.00. Circle 536 on Reader Service Card.

Current Drivers. Burroughs Corp., Electronic Instruments Division, 1209 Vine St., Philadelphia 7, Pa. Two new current drivers, the types 3003 and 3004, are now fully

Pulse Notes



USING PULSE TRANSFORMERS IN TRANSISTOR CIRCUITS

The circuit diagram below illustrates the use of the new STAT-TRAN* Pulse Transformer in transistor blocking oscillator circuits.

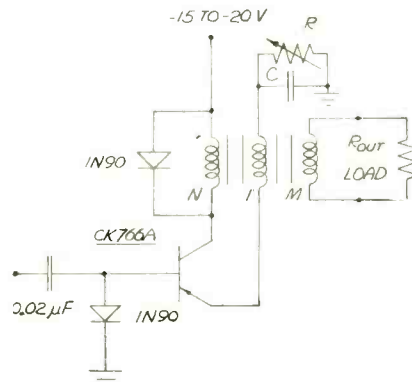

STAT-TRANS* used in the above circuit are identified on the basis of primary inductance measured at 1kc @ 0.04 v rms. The STAT-TRAN* has 4:1 pulse forming windings where the 4N winding is in the collector and the 1N winding is in the emitter. The circuit above was chosen because it requires a low level trigger of less than 0.5 v from a high impedance input and produces a low impedance output pulse essentially equal to the supply voltage.

The STAT-TRAN* transformer excels in this circuit because:

1. The coil is wound on a flat bed which gives better control of leakage and distributed capacity.
2. The core material is of extremely high permeability (2400 μ) which provides for the highest flux density and lowest core losses.

Write today for your free copy of our new 12 page catalog giving complete specifications on pulse transformers and filters as well as outlining typical circuitry and applications.

*REG. TRADE NAME

3

Pulse Engineering



2657 Spring Street
REDWOOD CITY
CALIFORNIA

Circle 291 Readers Service Card

387

over
50
types of
ENCAPSULATED
WIRE-WOUND
RESISTORS

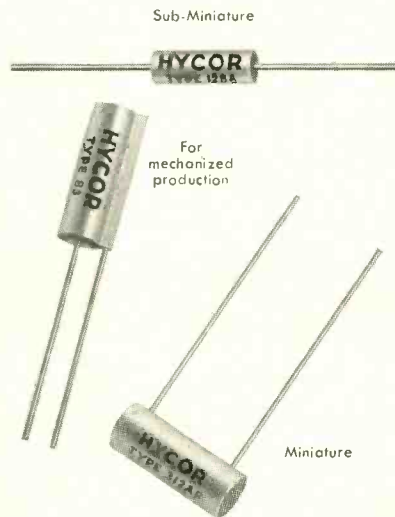

precisioneered
SERIES "PH"

HYCOR makes anything you want in precision wire-wound resistors—from sub-miniature 1/10th watt to 4 watt units—axial and radial leads, lug types, and for use in printed wiring circuits. Highly resistant to extreme humidity, temperatures and shock. Meet government and industry specifications. Uniform high quality and reliability assured by the most modern encapsulating and precision winding facilities in the country.

Write for Bulletin PH



INTERNATIONAL RESISTANCE CO.
HYCOR DIVISION
12970 Bradley Ave., Sylmar, California

Circle 292 Readers Service Card

described and illustrated in a four-page brochure. As explained in the brochure, the current drivers were designed specifically for the testing of square loop, tape wound, bobbin cores. The type 3003 produces a negative current pulse and the type 3004 a positive current pulse. All specifications including rise time, duration and amplitude of the rectangular output current pulse are included in the brochure. Circle 537 on Reader Service Card.

Printed Circuit Capacitor. Pyramid Electric Co., North Bergen, N. J., has available a new engineering bulletin for the type BTS, a plastic tubular capacitor for printed circuits. The capacitors discussed are keyed for automation assembly and are available in capacitance ranges from 0.001 μ f to 0.47 μ f, and voltage ranges from 200 to 600 v. Sizes of the units outlined vary from $\frac{3}{8}$ in. by $1\frac{1}{8}$ in. to $\frac{1}{2}$ in. by $1\frac{1}{8}$ in. Requests for copies of the bulletin should be directed to the Sales Department of the company.

Transistor Servo Amplifier. M. Ten Bosch, Inc., Pleasantville, N. Y. A four-page brochure covers the performance characteristics of production models of the 60 and 400-cps transistor servo amplifiers (TRAMPS). Miniaturized units capable of providing up to 9 w controlled power at a weight factor of less than 7 oz per w are described in detail. An engineering application questionnaire is included to assist in the selection of the TRAMP and control system companions which were designed to military specifications. Circle 538 on Reader Service Card.

Direct Impulse Counter. Post Machinery Co., Beverly, Mass. Model F-2 direct impulse counter for accurate, reliable industrial counting—up to 10 units per sec with direct readout totalizer—is described in a single-sheet bulletin. Features and specifications are included. Circle 539 on Reader Service Card.

Miniature Selenium Rectifier. General Electric Co., Schenectady 5, N. Y. Bulletin GEA-6538B, two

**Tough
Heyco Nylon
STRAIN
RELIEF
BUSHINGS**

Insulate and anchor the power supply cord to your housing . . .

no need for grommets,
wire knots or costly
labor.

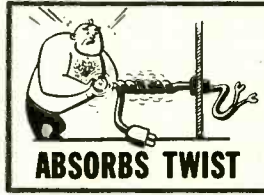
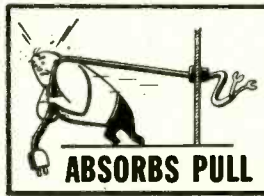

Send for samples to fit your wire, today!

**HEYMAN
MANUFACTURING COMPANY**
KENILWORTH 2, NEW JERSEY

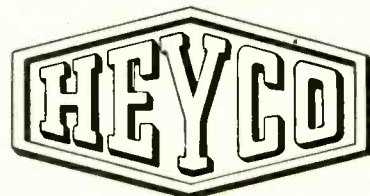

**HEY MAN!
... SAY HEYMAN**

Circle 293 Readers Service Card

October 1, 1957 — ELECTRONICS

pages, describes the new miniature double-diode Vac-u-sel selenium rectifier for TV horizontal-phase-detector diode. With minor modifications in the basic circuit, it may also replace the 6AL5 tube now used. Applications, models, mechanical and environmental specifications, and ratings are discussed. **Circle 540 on Reader Service Card.**

Tantalum Foil Capacitors. Ohmite Mfg. Co., 3655 Howard St., Skokie, Ill. Bulletin 152 discusses the distinguishing and unique characteristics of tantalum foil capacitors; their exceptional stability, shelf life, greater capacitance per unit volume and other characteristics. Applications and limitations of the polar and non-polar types of tantalum foil electrolytics are covered. Detailed physical and operational specifications are provided as well as a handy table of many standard capacitance and voltage values. **Circle 541 on Reader Service Card.**

Facilities Brochure. Farnsworth Electronics Co., A Division of International Telephone and Telegraph Corp., Fort Wayne 1, Ind. A 20-page illustrated brochure contains a short history of the company and outlines its varied capabilities and accomplishments in guided missile electronics, test and support equipment and other electronic equipment. One page is devoted to the company's environmental testing facilities. **Circle 542 on Reader Service Card.**

Airborne Components Catalog. G. M. Giannini & Co., Inc., 918 East Green St., Pasadena 1, Calif., has released a new airborne components catalog. The 56-page book contains complete information on their full line of high performance transducers. Instrument sections included are: accelerometers, pressure transducers, gyros, temperature probes and vane transducers. Also included is a technical data section containing valuable and previously unpublished data. **Circle 543 on Reader Service Card.**

Frequency Measurements. Beckman/Berkeley, 2200 Wright Ave.,



FOR
SEMICONDUCTOR
APPLICATIONS



DOPED GOLD PLATING PROCESSES

Co-deposits 24K Bright Gold and closely controlled percentages of Antimony, or other Group 3 or 5 elements,—developed specifically for Germanium and Silicon semiconductors. Bath operates at room temperatures and produces dense, fine grained, uniformly thick "Doped" Gold Plate precisely to your specifications. Write for technical data.

Precious Metals Division
SEL-REX CORPORATION

Nutley 10, New Jersey

(Offices: Detroit, Chicago, Los Angeles)

Manufacturers of Exclusive Precious Metals Processes, Metallic Power Rectifiers, Airborne Power Equipment, Liquid Clarification Filters, Metal Finishing Equipment and Supplies.

Circle 294 Readers Service Card



FREE!

send for the
most widely used

ELECTRONIC SUPPLY GUIDE

**ALLIED'S
COMPLETE 404-PAGE
1958 CATALOG**

your best buying guide to
the world's largest stocks of
ELECTRONIC SUPPLIES FOR INDUSTRY

FOR FAST SERVICE IN
THE CHICAGO AREA
CALL

**HAymarket
1-6800**

Use our speedy
"Will Call" or
Delivery Service

our 37th year

- Receiving Tubes
- Test Instruments
- AN Connectors
- Power & Gas Tubes
- Meters & Supplies
- Metal Chassis Bases
- Diodes & Transistors
- Relays & Switches
- KNIGHT P.A. Equip.

Simplify and speed your purchasing of electronic supplies and equipment at ALLIED. We make fast, expert shipment from the world's largest stocks of *everything* in Electronics. We save you time, effort and money. Manufacturers' prices available on quantity discounts. Send today for your **FREE 1958 ALLIED Catalog**—the complete Buying Guide to Electronic supplies for Industrial and Communications use.

ALLIED RADIO
100 N. Western Ave., Dept. 11-K7
Chicago 80, Illinois



Circle 295 Readers Service Card

Frankly...

our Model #814 has the widest tuning range of any stabilized oscillator on the market; it's so stable you can't even jar it out and reliability is proved by 3,000 hours of continuous laboratory use. In two words: it's tops.

Want to know more about it?
Write for our Bulletin #814 today.

SPECIAL PRODUCTS DIVISION
LABORATORY FOR ELECTRONICS, INC.
75 PITTS STREET BOSTON 14, MASS.



Circle 296 Readers Service Card

Brew Delay Lines

Brew will meet your requirements for . . .

- performance
- price
- delivery

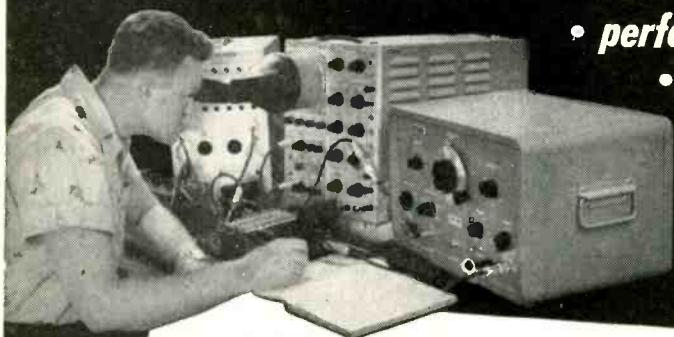

distributed constant, lumped constant, ultrasonic

Advanced engineering and production techniques, most modern laboratory and test equipment, and large scale manufacturing facilities enable Brew to meet your most exacting delay line requirements. Here at Brew you have the *one source* for Distributed Constant, Lumped Constant, and Ultrasonic Delay Lines, and here you benefit from the expert knowledge, experience, and *complete cooperation* of one of the pioneer delay line manufacturers.

Available covering an extremely wide range of characteristics. Meet MIL Specs. *Send us specifications on your requirements.*



Richard D. BREW and Company, Incorporated

Concord, New Hampshire
design

development

telephone: CApitol 5-6606
manufacture

Circle 297 Readers Service Card

Richmond 3, Calif. Data File 111, describing the many ways EPUT and frequency meters can be used is ready for distribution. The 17 page booklet covers such things as measurement of low to uhf frequencies, rotational velocity, flow, pressure, temperature and strain. It also covers telemetry and setting up a secondary standard of frequency. Loaded with graphs and charts, data file 111 is a definitive discussion of this topic. **Circle 544 on Reader Service Card.**

Doped Gold Processes. Sel-Rex Corp., 75 River Road, Nutley, N. J., has available descriptive literature and technical data on the new doped gold processes, utilizing Group 3 and 5 elements, for use in germanium and silicon semiconductor applications. The processes described eliminate major shortcomings of conventional materials by operating at room temperatures, and producing bright, uniformly distributed gold deposits in required thicknesses, directly from the bath. **Circle 545 on Reader Service Card.**

Precision Delay Generator. Burroughs Corp., Electronic Instruments Division, 1209 Vine St., Philadelphia 7, Pa., has published a four-page brochure, illustrating and describing the operations of the type 6010 precision delay generator, designed as a piece of laboratory test equipment for applications which require accurate, variable, time interval pulses.

In this brochure, the precision delay is divided into its three operating units—the trigger generator, the delay generator, and the regulated power supply, and the operation of each unit is described. All output waveforms from the delay generator are illustrated along with the particular specifications for each waveform such as rise time, pulse width and amplitude. All other operating specifications, both electrical and physical, are included in the brochure. **Circle 546 on Reader Service Card.**

Long Scale Panel Meters. Weston Electrical Instrument Corp., Newark 12, N. J., has issued a bulletin



**LIBRASCOPE
SHAFT POSITION-TO-DIGITAL
CONVERTERS**

Equipped with ANTI-AMBIGUITY
DOUBLE BRUSH PICKOFFS

Useful in a wide variety of applications, including digital aircraft and missile controls, machine tool controls, digital readout from strip chart recorders, and as the modulator and de-modulator in pulse-code modulated radio links.

GRAY CODE MODEL — Capacity of 8 binary digits (single brush pickoff).

BINARY MODEL — Capacity of 7 to 19 binary digits.

BINARY CODED DECIMAL MODEL
Capacity range from 0-1999 to 0-35,999.

Units for special codes or capacities are built to meet specific requirements.

SHOCK ENDURANCE 20g
TEMPERATURE RANGE..... -50° to 83°C min.
CODE DISCS..... Rhodium plated phenolic
PICKOFFS..... Multiple wire brush.
Two pickoffs/channel
ROTATION..... Continuous, either direction.

**RUGGED—NON-MAGNETIC—LONG LIFE
MAY BE READ WHILE IN MOTION**

**SPECIAL CONVERTERS DESIGNED TO MEET
YOUR INDIVIDUAL PROBLEMS**



Send for illustrated brochure
LIBRASCOPE

A SUBSIDIARY OF GENERAL PRECISION EQUIPMENT CORPORATION

808 Western Avenue • Glendale, California
Circle 298 Readers Service Card
ELECTRONICS — October 1, 1957

NEW LITERATURE

(continued)

covering the group of long scale Western panel meters for specialty applications. The bulletin discusses instruments available in sizes from 2½ in. to 5½ in. for a wide range of current and voltage indications as well as tachometry and temperature applications. In addition to long, readable 250-deg scales, the instruments described have excellent ballistic characteristics and provide higher accuracy and improved sensitivity. Circle 547 on Reader Service Card.

Laminate for Printed Circuit Applications. International Resistance Co., 401 North Broad St., Philadelphia 8, Pa. The 4-page bulletin LT-2 covers Fluorply-F laminate for printed circuit applications. Included are comprehensive data on size and thickness, properties, current-carrying capacities, foil, copper finish, post-etching suggestions, handling recommendations, and ordering information. Circle 548 on Reader Service Card.

Miniature Pulse Transformers. James S. Spivey, Inc., 4908 Hampden Lane, Washington 14, D. C. A single-sheet bulletin covers the type 30A miniature pulse transformers. Specifications, applications and performance data are included. Circle 549 on Reader Service Card.

High-Accuracy Resolver. Norden-Ketay Corp., Commerce Road, Stamford, Conn., has achieved a higher accuracy and impedance than has previously been obtainable in a size 15 resolver.

The 105D2V resolver has been designated by the Bureau of Ordnance as Mark 4, Mod 1. A loose-leaf perforated bulletin contains advantages, characteristics and dimensional drawings. Circle 550 on Reader Service Card.

Lineal Footage Counter. Post Machinery Co., Beverly, Mass. Connected to any Post Decitron electronic counter, the new lineal footage device discussed in a recent single-sheet bulletin, permits accurate length measurement for continuous production items. Specifications are included. Circle 551 on Reader Service Card.

SILICONE RUBBER

and allied products

TEMP-R-TAPE®

Pressure Sensitive
TEFLON® TAPE

FROM STOCK Easy-to-apply Class H insulation or non-stick facing. —100° F to 400° F (—70° C to 200° C) temp. range. ¼" to 2" rolls. Special widths to 12", .006" and .013" thickness. 1500 vpm dielectric strength, volume resistivity 2x10¹⁴, dielectric constant 2.3 (60 cycles) 2.2 (1 meg.); power factor .0040 (60 cycles), .0033 (1 meg.) white and NEMA colors.

SILICONE SPONGE RUBBER

FROM STOCK COHRlastic® R-10470 sheets ⅛" thru ½" thick, closed cell for soft gasketing, vibration dampening, pads or cushions. —100° F to 400° F temp. range. Meets specifications: Sperry P. .691, 746 (type HTM); Scintilla 9-3143; MCI 4546; BMS 1-23, others. Extruded rod and special shapes.

SILICONE RUBBER SHEETS

FROM STOCK COHRlastic® 500 (AMS 3302B, MIL-R-5847A) 50 durometer ⅜" thru ¾" sheets with good tensile, abrasion resistance and tear strength. —85° F to 500° F flexibility. COHRlastic® 700 (AMS 3304B) 70 durometer ⅜" thru ¾" sheets for high temperature, low compression set, —70° F to 500° F flexibility. Wide range of other stocks available.

COATED FABRICS

FROM STOCK Silicone rubber coated glass, Dacron and nylon fabrics for high temperature mechanical and electrical applications. .004" thru .042" gauge, —120° F to 500° F temp. range. By the yard or as cut gaskets and assemblies.

CONDUCTIVE GASKETING

FROM STOCK flexible aluminum wire impregnated with neoprene rubber provides air seal, yet conducts high frequency currents. 24 and 30 mesh, .016" and .020" thick, 8" wide, length to 36 yds. or as cut gaskets.

OTHER CHR PRODUCTS include silicone rubber and sponge rubber extrusions and moldings, COHRform® (silicone foam rubber), aircraft fabric and Teflon covered seals; aircraft anti-icing, de-icing and heater assemblies; capacitor bushings, conductive silicone rubber.

CHR

Samples and Data
on Request

THE **CONNECTICUT
HARD RUBBER** CO.

500 EAST STREET • NEW HAVEN 9 • CONN.
Circle 299 Readers Service Card

Plants and People

Edited by WILLIAM P. O'BRIEN

Electronics manufacturers expand plants and facilities by acquisition, leases or new construction. Top engineers and executives in the industry are promoted and move to new responsibilities. RETMA becomes Electronic Industries Association

New West Coast Plant Occupied by Gertsch

GERTSCH PRODUCTS, INC., has completed a move from its former West Los Angeles location to new facilities at 3211 So. La Cienega Blvd., Los Angeles, Calif.

The new building, a modern two story front brick structure, contains some 30,000 sq ft of production, office, and engineering space. The new plant, representing a four-fold increase in space, has been necessitated by sales and shipments which have increased by 70 percent over the like period last year.

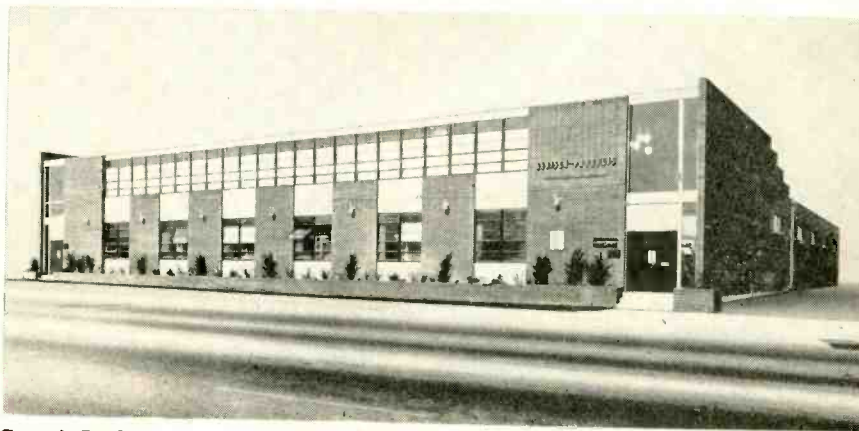

Gertsch Products new plant in Los Angeles, Calif.

Andersen Laboratories Expands in New Connecticut Quarters



Andersen Laboratories' new expanded quarters

ANDERSEN LABORATORIES, INC., suppliers of highly critical radar components and pioneer developers of solid ultrasonic delay lines, has more than doubled its floor space and added considerably to its facilities

and staff in a move to new quarters at 501 New Park Ave., West Hartford, Conn.

Curtis H. Alvord, president, in announcing the move, states that the company's major product is

needed in the new radar and guided missile control systems such as the DEW Line and others being installed as part of our national defense system.

Formed in 1951 by Walter M. A. Andersen and Curtis H. Alvord, the company devoted its formative period primarily to research. The present firm has grown out of this early work in which only a few people were employed. Today the company requires over 50 people in its research, development and production departments.

Assembly Products Selects Quality Control Manager

APPOINTMENT of Frank L. Ross as manager of quality control at Assembly Products, Inc., Chesterland, Ohio, was recently announced. He will have responsibility and authority for raising product quality

New 3/4" Sensitive Relay

APPLICABLE TO PRINTED CIRCUITS

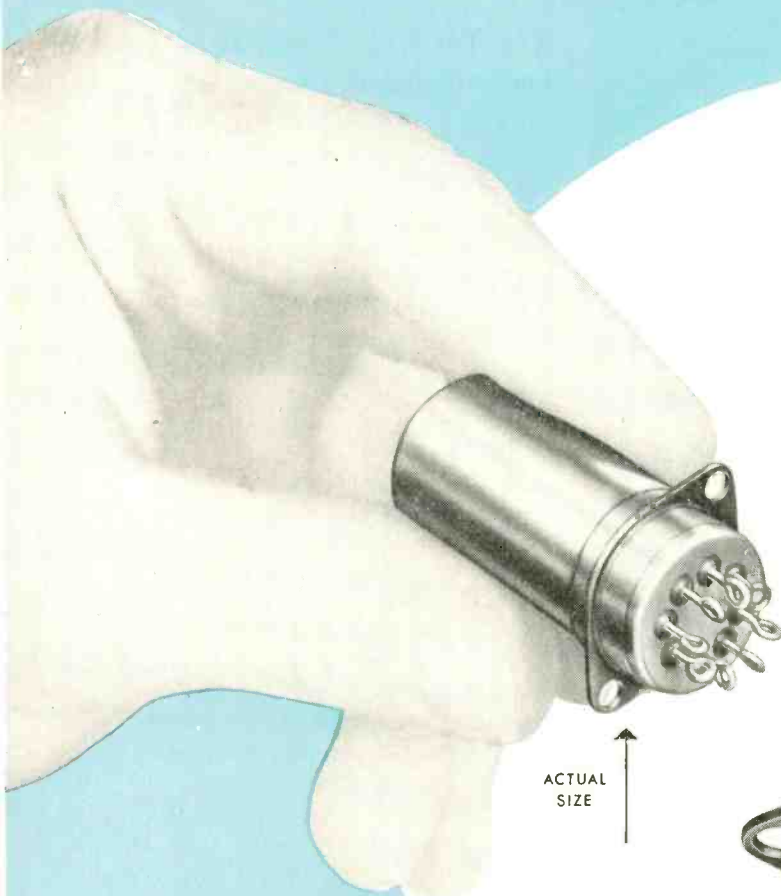

↑
ACTUAL
SIZE



ALLIED TYPE RSH
has sensitivity of
40 milliwatts in D.P.D.T.
and 22 milliwatts in
S.P.D.T.

ELECTRICAL SPECIFICATIONS

CONTACTS: Up to D.P.D.T. rated at 2 amperes
at 26.5 volts DC or 115 volts AC resistive load

COIL: Sensitivity—40 milliwatts D.P.D.T.
22 milliwatts S.P.D.T.

Resistance—up to 14,000 ohms

TEMPERATURE: Minus 60° C to plus 125° C

VIBRATION: 10G up to 500 cycles

SHOCK: 50G plus (operating)

ALTITUDE: 70,000 feet or 1.3 inches of mercury

TERMINAL TYPE: Solder, plug-in, and printed
circuit.

WEIGHT: 2 ounces

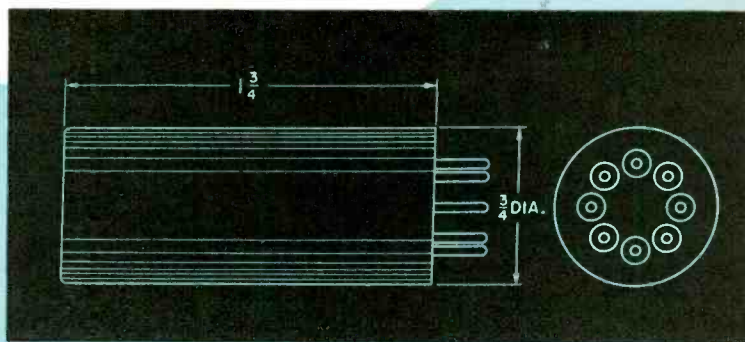

Write for catalog sheet giving complete information



ALLIED CONTROL



ALLIED CONTROL COMPANY, INC., 2 EAST END AVENUE, NEW YORK 21, N. Y.

AL 186

wherever possible at Assembly Products. He will concentrate on procurement of better materials, improved production methods, and more efficient inspection.

Formerly a quality control and product design engineer at the Brush Electronics Co., Cleveland, Ross has had 15 years' experience in electronics and communications engineering. Before going to Brush in 1955, he was manager of quality engineering at the Hickok Instrument Co., Cleveland. Previously, he taught electronics at the Penn Technical Institute, Pittsburgh, Pa., and served in Saudi Arabia as a communications engineer with RCA International.



Frank L. Ross

greatly increased activities in the microwave and uhf test equipment field, such as the recent acquisition of Kama Instrument Corp., and a general expansion of the company's research and production facilities.

Kin Tel Gets New Chief Development Engineer

JOHN P. DAY has been named chief development engineer of the Kin Tel Division of Cohu Electronics Inc., San Diego, Calif. He will direct research and development in the fields of industrial and broadcast tv and electronic instrumentation. Day was formerly associated with U. S. Naval Electronics Laboratory in San Diego where he headed the instrumentation section of the research division. He was responsible for designing microwave communication systems, high speed photo-recording equipment and subminiature radar equipment.

He has also been consultant to the missiles systems division of Lockheed in Burbank, and engineering staff specialist in the design and development of missile and interceptor aircraft electronics systems at Convair.

Magnetic Controls Expands Facilities

COMPLETION of new engineering and production facilities has been announced by Magnetic Controls Co., Minneapolis, Minn.

The new addition of 7,500 sq ft brings the total floor space of the firm's modern plant facilities in St. Louis Park, a Minneapolis suburb, to 20,000 sq ft. Both floor space and company personnel have quadrupled in the past 18 months.

Present employment of 125 is expected to be increased to 150 people in the near future.

Magnetic Controls Co. is a major supplier of magnetic temperature controls, used extensively in airborne and shipboard fire control systems and in inertial guidance systems. The firm also produces magnetically regulated power supplies for computers and other mili-

IT&T Launches New Plant in California



IT&T's western electronic components manufacturing facility at Palo Alto

BURRELL A. PARKHURST, president of the Components Division of International Telephone and Telegraph Corp., Clifton, N. J., has announced the launching of a new manufacturing operation in Palo Alto, Calif.

The plant, a supplement to the American manufacturing facilities of the parent corporation, which has factories throughout the world, will initially produce hermetic seals, and selenium and other semiconductor type rectifiers for use in radio, tv, industrial and aircraft applications. These will be followed by numerous new components which are being developed by IT&T. The Division will continue to manu-

facture semiconductor products in Clifton.

The new Components Division plant is housed in a modern single span building at 815 South San Antonio Road, Palo Alto, and contains approximately 8,000 sq ft of manufacturing space with a two-story office structure attached.

Narda Changes Company Name

THE Narda Corp., Mineola, N. Y., has changed its name to The Narda Microwave Corp. The new name was chosen to better reflect Narda's



BURTON BROWNE/New York

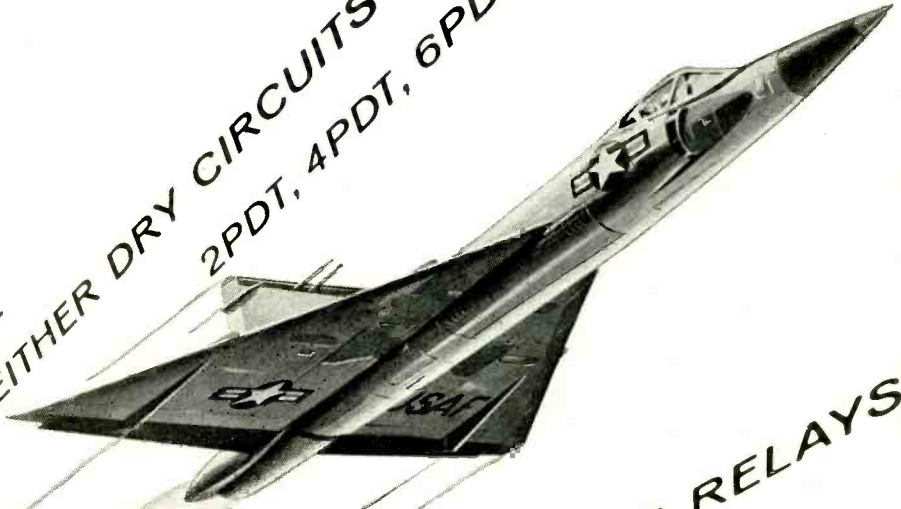

NEW! ANOTHER FILTERS EXCLUSIVE
 THE SAME SUB-MINIATURE RELAY FOR EITHER DRY CIRCUITS OR POWER
 HERMETICALLY SEALED
 2PDT, 4PDT, 6PDT

LATCHING OR GENERAL PURPOSE
 ALL MADE TO MIL-R-25018 (USAF) AND MIL-R-5757C

LEADING MANUFACTURERS OF HERMETICALLY SEALED SUB-MINIATURE RELAYS

WRITE FOR COMPLETE CATALOG
FILTERS, INC.
 PORT WASHINGTON, LONG ISLAND, N. Y.
 PORT WASHINGTON 7-3850

Precision



Deflection **YOKES** and Systems

We now supply yokes to the largest laboratories and defence projects in the U. S. A. Available to customers specs. in Nickel Iron, Ferrite, Class A or H insulation. Moulded-in slip rings can be supplied.

Linearity - standard $\pm 1\%$, custom build to $\pm .1\%$.

Orthogonality $\pm \frac{1}{4}^\circ$.

Half-axis colinearity $\pm \frac{1}{2}^\circ$.

Mutual interaxis coupling .0025 or as specified by customer.

Differential capacity unbalance - 3.5 uuf max.

High Altitude Performance is limited only by flashover point of the terminals, which can be specified by customer.

Temperature Range -

Standard deflection yokes will operate as specified from -10°C to $+60^\circ\text{C}$.

Class H insulated deflection yokes will operate from -50°C to $+160^\circ\text{C}$.

Humidity: The yoke is unaffected by humidity.

Meet JAN and MIL Specs.

For further information write:

COSSOR

(CANADA) LIMITED
301 Windsor Street
Halifax, Nova Scotia
Phone 4-6487

Circle 301 Readers Service Card

tary applications; magnetic motor amplifiers for both commercial and military use, particularly in servo systems; and specialized plastic components.

New Factory Opened by Potter Instrument

THE Potter Instrument Co., Inc., producer of electronic equipment for use with computers and control of industrial machinery, has opened a new factory and office building on Sunnyside Blvd. in Plainview, Long Island, N. Y. The move represents the fourth time in the company's 14-year history that it has doubled its capacity to keep pace with the demand for the counting, timing and data handling equipment it manufactures.

More than 50,000 ft of floor space are available. Engineering manufacturing and administrative facilities have been greatly expanded, and central location of all departments under one roof provides an efficient operation.

Bristol Promotes Two Application Engineers



W. E. Rufleth

ACCORDING to a recent announcement by The Bristol Co., Waterbury, Conn., Walter E. Rufleth has been named manager of telemetering systems applications, and Ken-

AN INVITATION TO JOIN ORO

Pioneer In Operations Research

Operations Research is a young science, earning recognition rapidly as a significant aid to decision-making. It employs the services of mathematicians, physicists, economists, engineers, political scientists, psychologists, and others working on teams to synthesize all phases of a problem.

At ORO, a civilian and non-governmental organization, you will become one of a team assigned to vital military problems in the area of tactics, strategy, logistics, weapons systems analysis and communications.

No other Operations Research organization has the broad experience of ORO. Founded in 1948 by Dr. Ellis A. Johnson, pioneer of U. S. Opsearch, ORO's research findings have influenced decision-making on the highest military levels.

Our computer laboratory is equipped with the 1103-A Univac, the "Cadillac" of computers. Encompassing 1200 sq. ft., it is leased at a cost of \$40,000 per month. ORO's professional atmosphere encourages those with initiative and imagination to broaden their scientific capabilities. For example, staff members are taught to "program" their own material for the Univac computer so that they can use its services at any time they so desire.

ORO starting salaries are competitive with those of industry and other private research organizations. Promotions are based solely on merit. The "fringe" benefits offered are ahead of those given by many companies.

The cultural and historical features which attract visitors to Washington, D. C. are but a short drive from the pleasant Chevy Chase suburb in which ORO is located. Attractive homes and apartments are within walking distance and readily available in all price ranges. Schools are excellent.

For further information write:
Professional Appointments

OPERATIONS RESEARCH OFFICE **ORO**

The Johns Hopkins University
7100 CONNECTICUT AVENUE
CHEVY CHASE, MARYLAND



K. R. Neale

neth R. Neale has been appointed manager of electronic products applications.

Rufleth has had wide experience in the application of the company's Metameter telemetering systems for remote measurement and control, and in the public utility field in general. He and his group will be responsible for the application of telemetering systems for water, gas, oil, and power, and for special instrument applications in these public and private utility areas.

Neal and his group will be responsible for the application of recording and controlling electronic potentiometers and bridge instruments, pH and conductivity equipment, electronic pressure and temperature controllers, and millivoltmeters.

Higdon To Direct Topp's Long-Range Planning

ROBERT V. HIGDON, vice president and special assistant to the president of Topp Industries, Inc., Beverly Hills, Calif., has been named to direct the firm's long-range planning program.

He will now make his headquarters at the company's executive office in Beverly Hills. He formerly was president of Haller, Raymond and Brown, Inc., a division of Topp Industries, in State College, Pa.

Higdon has been associated with the Naval Research Laboratory,

COLOR TV SHADOW MASKS

—A development of BUCKBEE MEARS through close cooperation with TV industry engineers. Containing 400,000 close tolerance holes (.010" ± .0005").

Now produced in quantity on our especially designed continuous etching machines.

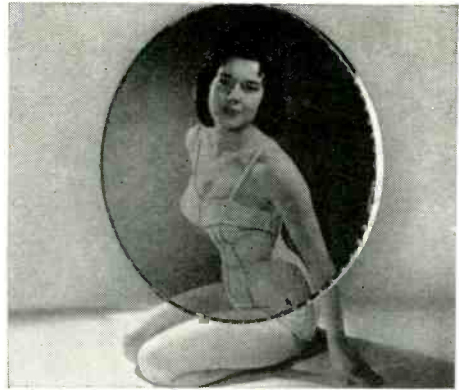

TONI BUILDING
SAINT PAUL 1, MINN.

ETCHED AND ELECTRO-FORMED PRECISION PARTS

—Electric shaver combs, metal reticles for optical instruments, fine tube mesh and code discs.

These are but a few of the variety of parts that can be quickly produced to precise tolerances by our process. Send your specific problem and specifications to our engineers.

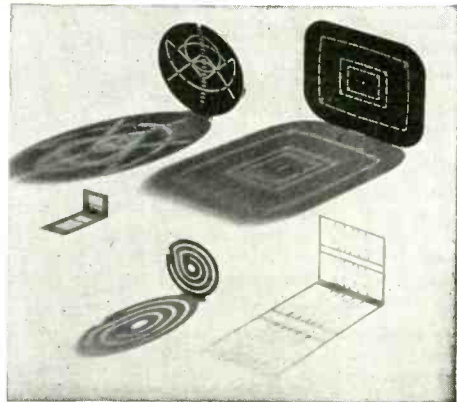

Circle 302 Readers Service Card

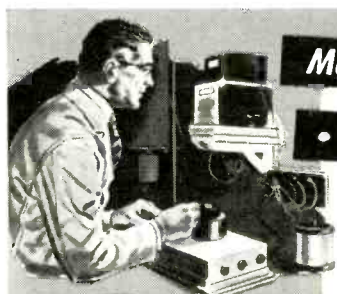

Metallurgists & Specialists in Small Wire

• Serving Industry—for Over 56 Years

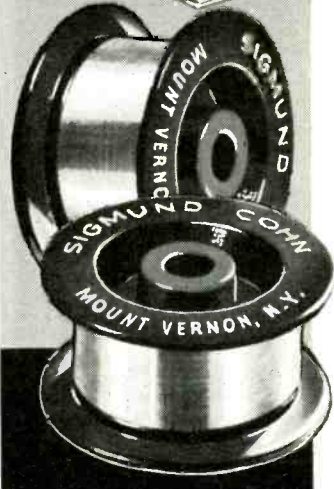

BASE METAL WIRES . . . Very small diameter — for filaments, thermocouples, resistance units.

PRECIOUS METAL WIRES . . . Produced in Platinum, Gold, alloys and pure metals — small diameter . . . Platinum alloy resistance wires.

COATED WIRES . . . Comprising an extensive range of electroplated grid wires . . . Enamel insulated wires for precision resistors and potentiometers.

ANODIZED ALUMINUM WIRE . . . Insulation at 800°F . . . Precision drawn to close resistance in the smaller sizes

Write for List of Products



Specialists in the Unusual

SIGMUND COHN CORP.

121 SOUTH COLUMBUS AVE., MOUNT VERNON, N. Y.

Norden Laboratories Corp., and was assistant professor of electrical engineering at Pennsylvania State University. Since joining HRB, Inc., eight years ago, he has worked on radar relay and mapping, and missile guidance analysis, as well as acting as chief executive of HRB, Inc., from 1950.

Avion Div. of ACF Unites N. J. Facilities

AVION Division of ACF Industries, Inc., recently completed consolidation of its N. J. headquarters facilities with the occupancy of a third building in the Paramus Industrial Park, on Park Place just off Route 17.

The move brings together in the new building the following elements: the coil-winding and assembly groups; the component test group; the maintenance shop; the environmental test group and the components engineering group. A covered areaway joining the new building and others of the group provides an additional 1,100 ft of working area. All of Avion's New Jersey operations are now centered in the new facility except for a small portion situated in the original 20,000 sq ft building about one mile east on Route 17.

Avion is engaged in development and production of magnetic components; industrial controls; situation display and infrared devices; computer and data processing equipment; engine controls, regulators and converters both for industry and for the military. The division is also conducting research, development and production on classified projects for the military.

Pearl Joins ESC Corp.

ESC CORP., Palisades Park, N. J., specialist in the design, development and manufacture of standard and custom-built lumped and distributed constant delay lines, announces the appointment of Stanley L. Pearl as project engineer.

Pearl's responsibilities will in-



Specialists IN STAMPING AND DRAWING

- KOVAR • RODAR
- THERLO • FERNICO
- Other IRON-NICKEL-COBALT Alloys

CUT TOOLING COSTS!
Over 3,000 high precision tools and dies available to reduce your initial tooling time and costs.

COMPLETE FACILITIES FOR PRECISION PRODUCTION OF ELECTRONIC COMPONENTS

Our facilities are geared to meet your production and engineering needs for components of any description. Unusually Complete Tool Room • Press Shop • Hydrogen Annealing, Machining and Polishing Operations • Glass-to-Metal Hermetic Sealing. Production of completed parts ready for assembly in your own plant.

A complete service in our plant means prompt service to your plant.

Call on us for free consultation and quotations.

ZELL PRODUCTS CORP.
279 Main Street, Norwalk, Conn.

Circle 304 Readers Service Card

A NEW CASE

for a **BEEDE** ELECTRIC METER

MODERN
•
EASY TO READ
•
REASONABLY PRICED

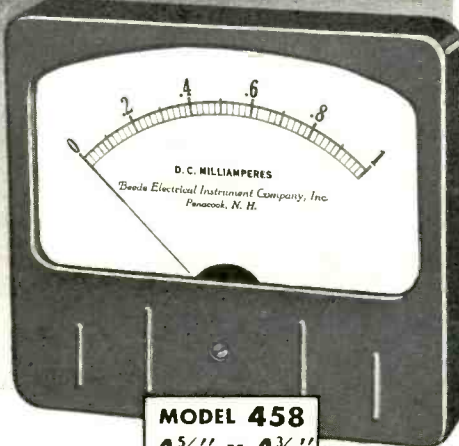

MODEL 458
4 5/8" x 4 3/16"

FOR SMALL POWER-UNIT PANELS - INDUSTRIAL TEST UNITS—COMMUNICATION EQUIPMENT, ETC.
LONG LASTING AND ACCURATE TO THE DOT

BEEDE ELECTRICAL INSTRUMENT CO., INC.
PENACOOK, N. H.



Stanley L. Pearl

clude supervision of design, development, and new processing of delay lines, pulse forming networks, and related pulse equipment.

Prior to his joining ESC, Stanley Pearl worked on delay line design, semiconductor applications and component reliability studies.

Bradley Labs Hires Siek

RICHARD A. SIEK, formerly senior engineer in semiconductor development at Raytheon Mfg. Co., Newton, Mass., has joined Bradley Laboratories, Inc., New Haven, Conn., manufacturer of metallic rectifiers.

Andrew Corp. Selects Holtum as Chief Engr.

A. G. HOLTUM, JR. was recently appointed chief engineer with the Andrew California Corp. of Claremont, Calif., an affiliate of Andrew Corp., Chicago, Ill., designers and manufacturers of antennas, antenna systems and transmission lines.

Holtum had previously been with the Army Electronic Proving Ground, Ft. Huachuca, Ariz., where he held the position of Chief, Radio Communications Division, Signal Communications Dept., engaged in scientific testing and evaluation of communication systems and concepts.

From 1946 to 1954, he was employed by the Signal Corps Engi-

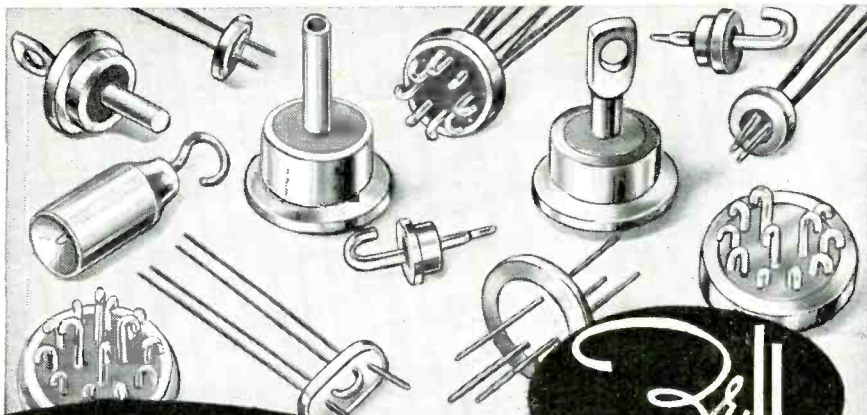

Compression and Kovar Type HERMETIC SEALS

"The Seal of Excellence"

Meeting the ever-increasing standards of perfection established by the electronics industry is a challenge admirably met by Zell's highly skilled engineers. They are able to exercise unusually rigid quality controls because all production operations are carried out in Zell's own completely equipped, ultra modern plant.

SPECIALISTS IN STAMPING AND DRAWING KOVAR — RODAR — THERLO — FERNICO AND OTHER ALLOYS

Write us for FREE Technical Consultation and Information.



The completeness of our facilities assures the completeness of your satisfaction!

Circle 306 Readers Service Card

ZELL Hermetic Seals Enjoy These Desirable Characteristics:

- ★ A stable finish that protects seals against corrosive atmospheres. ZELL'S GOLD PLATE WITHSTANDS THE MOST STRINGENT TRANSISTOR ETCH TESTS DEvised.
- ★ High resistance to mechanical and thermal shock.
- ★ Excellent electrical properties.
- ★ Tight dimensional tolerances.
- ★ Easy weldability and solderability.

ALL FACILITIES UNDER ONE ROOF

- Complete tool room facilities.
- 65 Power Presses (to 50 tons).
- Double stage annealing-fusing furnaces.
- Advanced plating facilities for Nickel, Gold, Tin, Cadmium, Copper, Silver, etc.
- Complete glass facilities.
- Mass Spectrometer leak testing.

ZELL engineers control every process every step of the way, assuring uniform quality and performance.

REPRESENTATIVES: Your Inquiries invited!

ZELL PRODUCTS CORP.
279 Main Street, Norwalk, Conn.

Make springs yourself . . . fast, exact! WITHOUT USE OF ARBORS

For a replacement or experimental spring, any shape, diameter or pitch from flat or round wire sizes .005" to .125", you can produce it in a matter of seconds with Perkins Precision Spring Coiler. You eliminate arbors, yet turn out precision springs — torsion, compression, extension, tapered, or special springs, coiled either

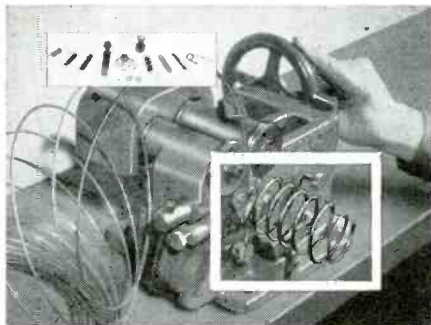

left or right hand, in any desired length, any diameter from 3/32" to 12" and larger, with or without initial tension, and with open or closed ends. Eliminate expensive special orders and costly production delays! Make your own springs to exact specifications as replacements or experimental work. Make them fast, right in your own shop!

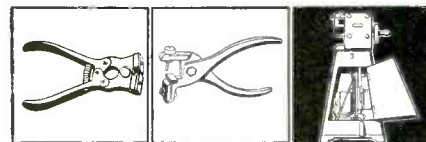

Starret adjustable jaw cut nippers (left) and Gardener Hook-Kon spring looping tool (center) — handy, precision, time-saving accessories for spring coiling. Perkins Spring Coiler available as bench model or power model shown here, (right) for tool shop or continuous runs.



Perkins Machine and Gear Co.
Special Machinery Division, Dept. C3
W. Springfield, Mass.
Please send information and prices on Perkins Spring Coiler.
Hand Model Power Model

Name Title
Company
Address
City State

INDIUM may be important to your future...

Commercial Quantities Available:
 Indium metal (specially refined 99.999% pure)
 Indium metal (99.97% pure)
 Indium wire Indium foil and ribbon
 Intermediate "Indalloy" solders
 Indium pellets Indium spheres
 Indium powders Other high-purity metals

Write Dept. E-10 for new Indium bulletin:
 "INDALLOY 'Intermediate' SOLDERS"

**QUALITY
SERVICE
RESEARCH**

THE INDIUM CORPORATION OF AMERICA
 1676 Lincoln Avenue • Utica, New York
 Since 1934 . . . Pioneers in the Development
 and Applications of Indium for Industry
 Circle 308 Readers Service Card

PHILLIPS HERMETIC SEALS

The Man from Phillips is the man to see for glass-to-metal seals — any type, any size, any quantity, standard or custom-engineered. Exceptionally fast delivery. Write for catalog.

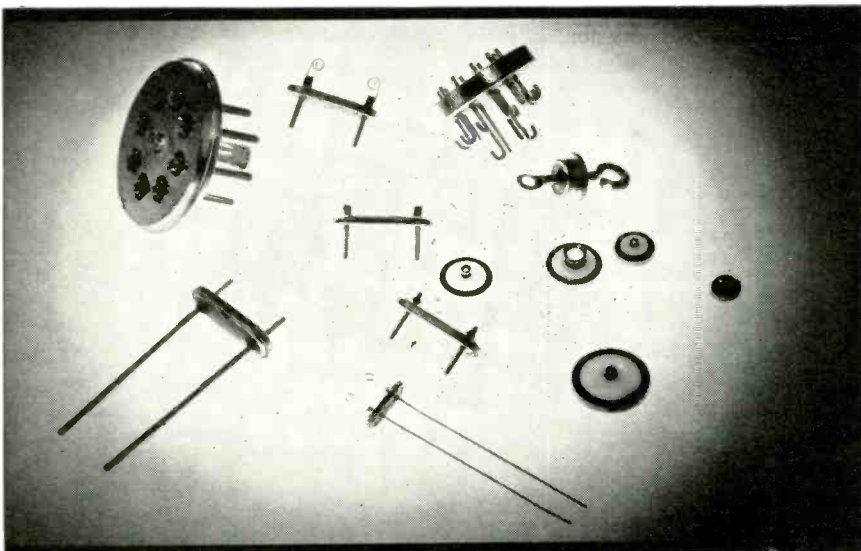

Phillips Control Corporation, Joliet, Illinois — AN ALLIED PAPER CORPORATION
 SUBSIDIARY — SALES OFFICES: NEW YORK - PHILADELPHIA - BOSTON - SAN FRANCISCO - DENVER - SANTA
 MONICA - WASHINGTON - WINSTON SALEM - CLEVELAND - DALLAS - SEATTLE - KANSAS CITY - ST. LOUIS - DETROIT

Circle 309 Readers Service Card



A. G. Holtum, Jr.

neering Laboratories, Ft. Monmouth, N. J., where he served as an engineering specialist in the antenna field.

This appointment is part of the expansion of Andrew western facilities to permit closer cooperation with customers in development of antenna systems for telemetry, airborne communications and similar applications.

Expanded Facilities Announced by Sargent

SARGENT ENGINEERING CORP., designers and producers of hydraulic, pneumatic, electronic and mechanical components for the marine, aviation and missile industries, announces the expansion of its plant facilities in Huntington Park, L. A., Calif.

With more than 300,000 sq ft under roof, the new expansion is similar to the present buildings, modern air-conditioned construction, and will add substantially to the production facilities.

Ferrucci Joins Bradley Labs

APPOINTMENT of William Ferrucci to its application engineering staff has been announced by Bradley Laboratories, Inc., New Haven,

Conn., manufacturer of metallic rectifiers. Ferrucci was previously employed in electronics work at Pratt & Whitney Aircraft, Southington, Conn.

Farnsworth Builds Another Indiana Plant

A \$2,500,000 plant on a 71-acre plot in Fort Wayne, Ind., will be completed in April 1958 by Farnsworth Electronics Division of International Telephone and Telegraph Corp.

The new plant will be the division's third in Fort Wayne and its fourth in Indiana, increasing total floor space from 420,000 to 580,000 sq ft, with room for further expansion.

Dedication ceremonies were attended by persons prominent in government, education and industry, including U. S. Senator Homer Capehart; Farnsworth Electronics' founder and technical director, Dr. Philo T. Farnsworth; and IT&T president Edmond H. Leavey.

Joint Computer Conference Scheduled

THE 1957 Eastern Joint Computer Conference and Exhibit will be held at the Sheraton Park Hotel, Washington, D. C., Dec. 9-13.

This year's conference theme, "Computers With Deadlines to Meet", has produced a wealth of material for presentation and discussion. Nine full technical sessions, ranging from industrial control computers and instrumentation to on-line business systems, are planned.

It will be the seventh Eastern Joint Computer Conference sponsored by the AIEE, the IRE and the Association for Computing Machinery. A co-sponsor this year is the National Simulation Council.

Basic purpose of the conferences is to promote and exchange information on electronic computing equipment between designers, producers, users and other interested groups. In addition to the technical

Reliable Electrical Connections

by R. George Roesch

Automatic Wire Processing with Standard Equipment

When standard equipment can be incorporated into a system for automatically stripping, fluxing and tinning coil leads, the cost of such equipment is invariably much less than that of special equipment.

The benefits of mechanizing any operation are (1) uniform quality, (2) fewer rejects and (3) lower inspection costs.

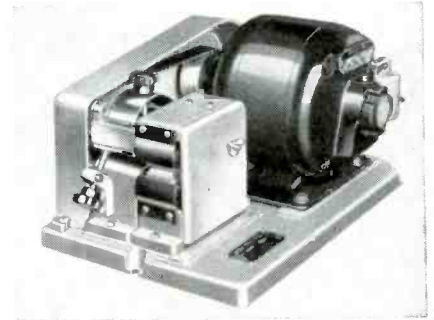

For example, using a standard wire stripper such as illustrated, we have made automatic coil lead straightening, trimming and stripping equipment for Electric Auto-Lite, Ford Motor, General Electric, Westinghouse and others. (Note: Each system was designed and built to meet the individual requirements of the user.)

A COMPLETE PROGRAM generally works out like this:

1. Your Products and Your Present Methods are studied by our engineers, without obligation to you.
2. When we are certain we completely understand your needs and wishes, a Program of Engineering and Experimental Work will be submitted. (NOTE: Nothing will be undertaken until Proven Methods have been experimentally developed.)
3. This Program will tell you (a) How Much Time will be required and (b) The Maximum Cost of Engineering and Experimental Work.
4. If you accept this program, the results must meet your own specifications. Otherwise there will be no charge made by us.
5. Assuming the experiments made prove the job can be done, we will then submit Schematic Drawings and a Quotation for your consideration on all the equipment needed to perform the desired operations.

If you are making Coils in large numbers, we'd like to hear from you.

THE ERASER COMPANY, INC. 1068 S. Clinton St., Syracuse 4, N. Y.

It is said by Tin Research Institute that soldering of silver-plated contacts can be facilitated if the surfaces are first immersed in a cold solution of 8% thiourea in 5% hydrochloric acid.

Circle 311 Readers Service Card

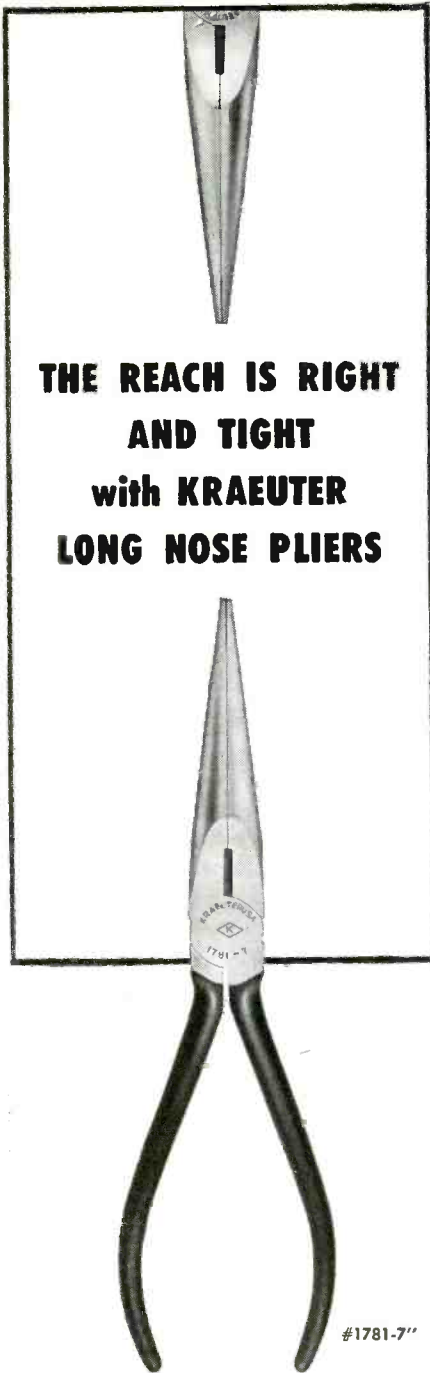

**THE REACH IS RIGHT
AND TIGHT
with KRAUTER
LONG NOSE PLIERS**

#1781-7"

You can depend on reachability and cutting power with Krauter's #1781 Long Chain Nose Pliers. And your reach will be tight and sure for those hard-to-get-at jobs with the extra long milled jaws of these pliers.

Buy the right line. It's the Krauter line for electronic and electrical work. Krauter tools are unreservedly guaranteed.

Send for catalog #25 illustrating complete Krauter line.

**BUY THE FINEST
BUY KRAUTER
BUY AMERICAN**

AS MODERN AS TOMORROW

krauter & co., inc.

FOR 100 YEARS THE FINEST IN HAND TOOLS 1860-1960 NEWARK, N. J.

Circle 310 Readers Service Card

ELECTRONICS — October 1, 1957



Unitize—Miniaturize

WITH *Vector* STRUCTURES FOR CIRCUITRY

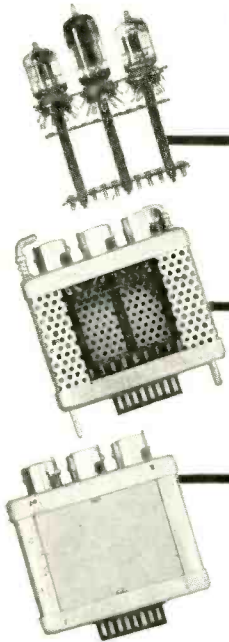

TAKE ONE
STRIP
TURRET

ASSEMBLE
IN
LIP-LOC
CASE

Result
PLUG IN
UNIT

Choice of Deck, or Wall type strips in many sizes offer miniaturization, accessibility, ease of assembly and adaptation to semi-automatic machinery.

A sectionalized case with a choice of plugs quarter turn locks, ventilated or solid wall; with two piece center section or snap-open side ports.

For circuit unitization, faster final assembly, stock reduction and ease of maintenance.



VECTOR ELECTRONIC COMPANY, 3352 San Fernando Road, Los Angeles 65, Calif. • Tel. CLevland 7-8237
Circle 312 Readers Service Card

RECORDERS WORK... WHILE YOU
ARE BUSY ELSEWHERE

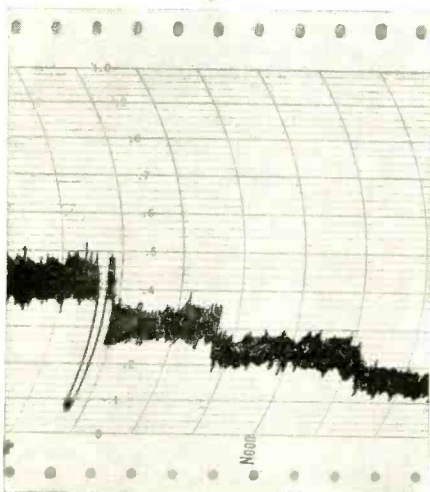

Courtesy Nuclear Measurements Corp., Indianapolis, Indiana

This record was made by a DC Milliammeter in a monitoring unit, measuring fall-out over Indianapolis after the explosion of an experimental bomb.

The recorder was on the job continuously for 1½ days before fall-out began to increase as shown here. Meanwhile the technicians and engineers were busy at other tasks.

Make recording instruments help you multiply your effectiveness. Ask for Catalog 657.

Product Representatives in
Most Principal Cities

The ESTERLINE-ANGUS Company, Inc.

Pioneers in the Manufacture of Graphic Instruments

Dept. E6, P. O. Box 596, INDIANAPOLIS 6, INDIANA

sessions, there will be a large exhibit area devoted to the display of complete data processing and computing systems, as well as computer components and sub-assemblies.

RETMA Becomes EIA

MEMBERS of the Radio-Electronics-Television Manufacturers Association recently voted to change the name of the 33-year old industry organization to the Electronic Industries Association. Changes in the names of two of its five divisions were also voted. The Set Division now becomes the Consumer Products Division, while the Tube Division expands to the Tube and Semiconductor Division.

The change of name reflects the view of the members that the term "electronic" is generally understood as descriptive of the growing variety of electronic products including older radio and tv equipment and components.

First quarterly meeting of the Association under its new name was held Sept. 10-12 at the Ambassador Hotel in Los Angeles. The meetings coincided with the all-industry celebration of National Television Week, Sept. 8-14.

Brush Electronics Hires Engineering Manager

REGINALD G. SCHULER has been named general engineering manager of Brush Electronics Co.,



Reginald G. Schuler

When to specify
**VULCAN ELECTRIC
 TUBULAR HEATERS**

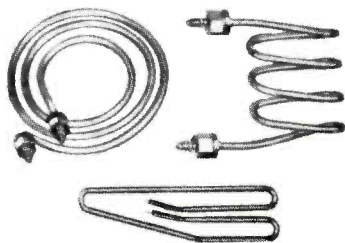

1. When application is for: Considerable heat — confined space. Straight or formed in variety of shapes for liquid, gas or metal heating applications. For casting into iron or aluminum. With threaded fittings for liquid immersion heating (water, oil, etc.).

2. When specifications call for: Length — 10" to 148"; diameter — .250", .280", .333", .450"; wattage — 10 to 10,000 (or higher); voltage — standard 115 or 230, special 6 to 440; sheaths — copper, steel, high temperature alloys.

3. When you have "hot" problems: Vulcan Engineers are ready to provide special heating units — engineered to your needs.

**NEW FINNED
 TUBULAR HEATERS**



Vulcan's new Finned Tubular Heaters provide six times as much radiating surface as standard tubular heaters. Fin is spirally edge wound from continuous strip of steel, then silver brazed to surface of sheath. Heaters can be formed at factory into one or a series of hairpin bends.

Write for free catalog.



ELECTRIC COMPANY
 DANVERS 10, MASS.

Cartridge • Strip • Tubular • Immersion Electric Heaters • Soldering and Branding Irons Solder and Glue Pots

PLANTS AND PEOPLE

(continued)

Cleveland, Ohio. For the past two years he has served as director of engineering of the Badger Meter Mfg. Co., Milwaukee, Wis. Previously, he was for seven years, research director of the Victor Adding Machine Co., Chicago, and before that, was chief of the research department of the Teletype Corp., also of Chicago.

Schuler holds a number of patents, including key patents on electronic communication and data processing systems. In his new post he will be fully responsible for the direction of the product engineering program at Brush, a division of Clevite Corp.

**Kin Tel Completes \$1
 Million Expansion**

A QUARTER of a million dollars expansion of San Diego plant facilities has been completed by Kin Tel Division of Cohu Electronics, Inc., manufacturers of electronic instruments for communication, measurement and control.

New facilities include an office and engineering building which will house general headquarters and the complete engineering staff, opening up additional space in the main factory for an expanded production line.

**Methode Takes Over
 New Location**

METHODE Mfg. Corp. has moved a portion of operations to 7447 Wilson Ave., Harwood Heights, Chicago 31, Ill., occupying a new one-story plant especially designed for its manufacturing requirements. Methode produces electronic components including plastic and metal sockets, electrical connectors and printed electronic circuits.

The new plant contains 40,000 sq ft of floor space located on 95,000 sq ft of land and more than doubles the concern's available factory footage. Substantial space is devoted to housing a highly mechanized printed circuit production facility capable of turning out 25,000 sq ft of etched wiring panels per month.

The older (Churchill St.) loca-

**PRECISION
 ENGINEERED
 Sub-Miniature
 Pilot Lights**

... facilitate the solution of
 miniaturization problems.

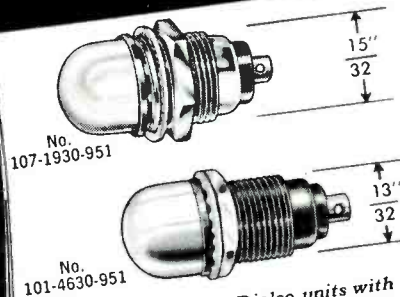

Example: Here are 2 Dialco units with but a tiny difference in o.d. of bushing: A refinement that helps to save space and weight where every fraction counts.



On your next miniaturization project, consult DIALCO for the Pilot Lights. You will quickly find the proper unit for use with either tiny Incandescent bulbs (T-1 3/4); or with sub-miniature Neon bulbs (NE-2D).

TWO-TERMINAL units are fully insulated. SINGLE-TERMINAL units are for use on grounded circuits. Also DIMMING or NON-DIMMING sub-miniatures for every requirement. Meet all applicable Military Specifications.

Samples for design purposes on request at once — no charge.

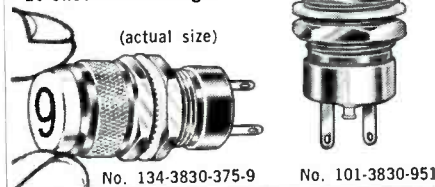

Foremost Manufacturer of Pilot Lights

**DIALIGHT
 CORPORATION**

58 STEWART AVE. BROOKLYN 37, N. Y.
 HYacinth 7-7600

Dialight Corp., 58 Stewart Ave., Brooklyn 37, N. Y.

- Send brochures on Sub-Min. Pilot Lights
- Brochures on other Dialco Pilot Lights

Name _____

Position _____

Company _____

Address _____

Circle 315 Readers Service Card

EISLER VERTICAL SPOT WELDERS

MADE IN SIZES 1/2—1—2—3—5 KVA

WITH OR WITHOUT TRANSFORMER OR TIMER

Sent to Any Radio Tube Manufacturer in U.S.A. on a 30 Day Free Trial Basis.

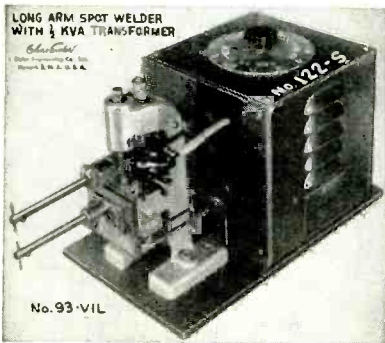
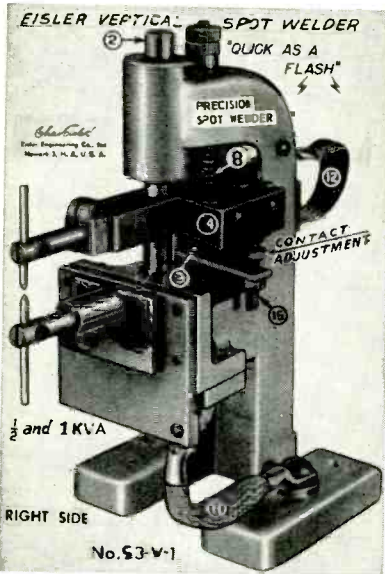

TRANSISTOR MAKING EQUIPMENT

DIODE MACHINERY AUTOMATIC OR SEMI-AUTOMATIC

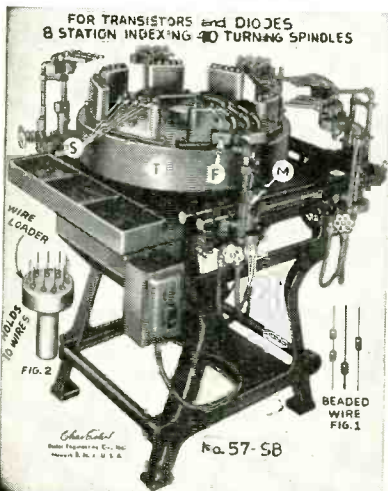

Send for Catalog Dr. Chas. Eisler, M. E. Founder
CHAS. EISLER, JR., PRES.

EISLER ENGINEERING CO., INC.

751 So. 13th St. NEWARK 3, N. J.
Circle 316 Readers Service Card

PLANTS AND PEOPLE

(continued)

tion is now devoted entirely to assembly of sockets and connectors. Approximately one-third of the company's employees are employed in the new plant.

EIA Chooses 1958 Conference Site

THE Electronic Industries Association, formerly RETMA, has chosen San Diego, Calif., as the site of its 1958 Industrial Relations Conference. The Conference is scheduled for Feb. 20-24 at the Town and Country Hotel, San Diego, Calif.

Tentative decisions as to the subjects for panel discussions include: (1) Collective Bargaining in the Electronics Industry; (2) Technical Manpower Development and Utilization; (3) What To Do When the Union Knocks On the Door; and (4) Justifying and Staffing an Industrial Relations Organization in a Growing Company.

Browder Named Sales Manager



James W. Browder

JAMES W. BROWDER of San Diego, Calif., has been named sales manager of Western Design & Mfg. Corp. of Santa Barbara, Calif., designers, engineers and manufacturers of electromechanical and electronic equipment for the air-

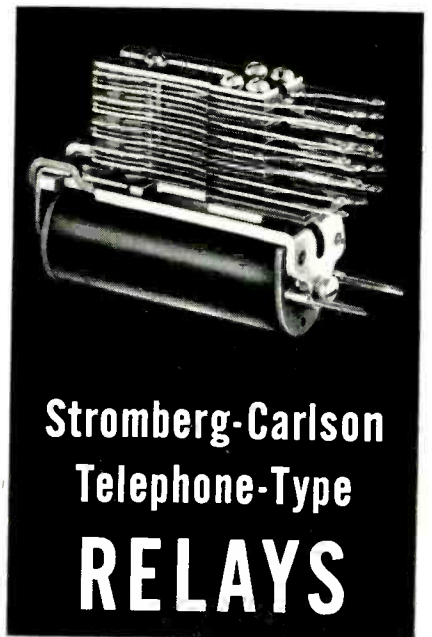

Stromberg-Carlson Telephone-Type RELAYS

for industrial applications
PROMPT SHIPMENTS

For any part of your operation that depends on electromechanical switching, these "telephone-quality" relays by Stromberg-Carlson will provide unsurpassed reliability.

Proven by many years of meeting the exacting demands of the telephone industry, Stromberg-Carlson twin-contact relays are now available for industrial application.

These "telephone-quality" relays are available in many types, of which the following are representative:

Type A: a general-purpose relay especially adapted to the control of switching operations. Approximate size: 2³/₃₂" high, 7/8" wide with 20 Form "A" springs (maximum).

Type B: a gang-type relay—2³/₃₂" high, 2⁷/₈" wide—which can be equipped with 60 Form "A" spring combinations (maximum). The Type BB relay accommodates up to 100 Form "A" spring combinations. Size: 2⁵/₃₂" high, 4⁷/₈" wide.

Type C: two relays on the same frame; mounts in the same space as the A type. It is especially effective where space is at a premium.

Type E: interchangeable with many other makes. It combines the time-proven characteristics of the A relay with a new universal mounting arrangement common to many other brands.

Complete specifications of all Stromberg-Carlson relays are contained in Bulletin T-5000R, available on request.



STROMBERG-CARLSON

A DIVISION OF GENERAL DYNAMICS CORPORATION
TELECOMMUNICATION INDUSTRIAL SALES
114 CARLSON ROAD • ROCHESTER 3, N. Y.

Circle 317 Readers Service Card

October 1, 1957 — ELECTRONICS

craft and missile industry.

The new sales manager's background includes 13 years as an electronics engineer and scientist for the U. S. Navy. He served at the Naval Radio-Radar Laboratory at Norfolk, the Navy Electronics Laboratory at San Diego, and in radar design with the Bureau of Ships, Washington, D. C.

After leaving the Navy, Browder held the position of design specialist with Ryan Aeronautical and was also technical advisor to the vice-president of the Electronics Division at National Aircraft Corp.

Mammoth TV Tower Planned for Tokyo

CONSTRUCTION in Tokyo of a 322-meter-high tv tower, said to be the highest tv tower and the second highest structure in the world, was recently begun. The tower will be four meters higher than the Eiffel tower in Paris and second in height to the 509-meter-high Empire State Building in New York.

The structure, being built by Nippon Television City Corp., will be able to accommodate facilities for six tv stations. It was designed by Dr. Tachu Naito, professor of architecture at Waseda University.

New Entry in Transistor Field Announced

INDUSTRO TRANSISTOR CORP. has completed its initial transistor manufacturing facilities located at 87-31 Britton Ave., Elmhurst, N. Y.

The firm is now manufacturing germanium alloy-junction (*npn*, *pnp*) transistors for use in computers, audio equipment, as well as portable transistor radios.

Stromberg-Carlson Advances Morris

APPOINTMENT of Frank A. Morris as director of the newly-established Stromberg-Carlson Telecommunication Research has been announced. In his new position he will be directly concerned with the coordination of research with prac-



Model 3055

Smallest size yet in a variable reluctance transducer— $\frac{1}{4}$ -in. diameter x 1-inch long. Weighs approximately $4\frac{1}{2}$ grams.

NEW subminiature high temperature pickup

- Translates mechanical motion into AC voltage for telemetering and control
- Operates from near absolute zero to plus 500° F. ambient temperatures
- Moisture and oil resistant

Write for voltage curves, specifications, price today



7580

ELECTRO PRODUCTS LABORATORIES

4501-K North Ravenswood, Chicago 40, Ill.

Canada: Atlas Radio Ltd., Toronto

Circle 318 Readers Service Card

SMALL SCREW THREADS ARE NO PROBLEM

WHEN YOU SPECIFY
J. I. MORRIS COMPANY
Specialists in Miniature



Don't let small threads and turned parts be a problem in your miniaturization program! Call on us for the finest quality parts with threads from 56 to 160 TPI or metric and the proposed National Miniature Standard to 140NM.

Stock includes 000-120, 00-96, 00-90, 0-80, 1-72, and 2-56 screws, burr-free nuts, and washers in brass. Also matching taps, dies, and drills. Specials from one dozen to large runs in any material *delivered on time*. Latest machinery and inspection equipment and complete second operation facilities insure finest quality and service.

Call on us. We appreciate the opportunity to help and will gladly furnish information or quotations without obligation.



Send for free catalog with dimensional data and prices

J. I. MORRIS COMPANY
Southbridge, Mass.

Using Thermistors

Edited by
FENWAL ELECTRONICS

This is the third in a series of news columns devoted to thermistors — a device that is super-sensitive to temperature change.

The example in point: power measurement and voltage control.

A bead thermistor can be used to balance a bridge circuit, allowing the thermistor current to be measured and its DC power calculated. This is done with a 2000 Ω bead thermistor in a 200 Ω bridge circuit with a variable resistor in series with the bridge. This will heat the thermistor enough to lower the resistance to 200 Ω and balance the circuit to determine the H.F. power. By applying a source of high frequency power to the thermistor through capacitors this will further heat the thermistor and the bridge will be unbalanced. Then reduce the DC power until the bridge balances again. Calculate the new DC power, and the difference between the two calculations is the H.F. power.

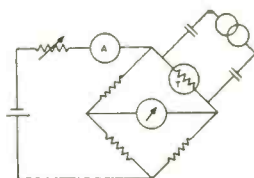

To maintain constant voltage a thermistor with a suitable series resistor "A" can be placed in parallel with a load in a circuit. As the load resistance increases there is a reduced drop across resistor "B." This tends to raise the voltage across the load. The thermistor heats up, reduces its resistance, and more current passes through it and through resistor "B." This brings the voltage across the load back to its original state. Controls like this can maintain as close as 1% voltage regulation over a broad range of load resistance, or any voltage from 1/2 volt to 100 volts can be regulated in this way with suitable circuitry.

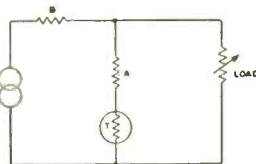

Engineers: these and other thermistor applications are discussed in 12-page catalog EMC-1. Write for your copy to FENWAL ELECTRONICS, INC., 29 Mellen St., Framingham, Massachusetts.



Makers of Precision Thermistors

Circle 320 Readers Service Card

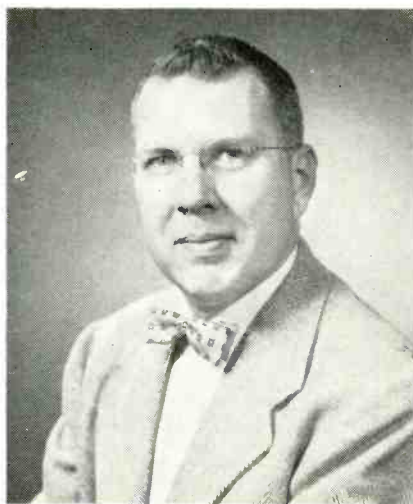

Frank A. Morris

tical application and development of products in the field of telecommunications.

As project engineer, Morris was a pioneer in the development of the company's complete electronic switching systems. Since 1945 he has directed research in wire communication, including Toll Ticketing, which is the automatic recording and computation of toll call billing information. This involved data processing, and the development of code recognizing devices designed for the telephone industry, but suitable for many other applications as well.

Kahn Research Labs Hires Washton

ARTHUR A. WASHTON, formerly chief engineer of Radalite Corp., has joined Kahn Research Laboratories, Freeport, N. Y., as a research engineer.

He was also associated with the Dictograph Products Inc.; David Bogen, Inc.; and Emerson Radio.

Washton, in his new post, will be concerned with the research and development of compatible single-sideband equipment, as well as other communications products.

Technicraft Buys L.A. Site

PURCHASE by Technicraft Laboratories Inc. of a ten acre industrial site in the Los Angeles area was recently announced. Construction has begun, and it is planned that first Technicraft Pacific Coast ship-



METERS

**The Ultimate
in Precision and
Ruggedness**

- 1% OR BETTER ACCURACY
- MACHINE TURNED PARTS
- FOR EXTRA RUGGEDNESS: Spring Mounted Bearings—Infinite Point Suspension System
- PERFECT TRACKING OVER ENTIRE SCALE
- HIGHEST DEGREE OF LINEARITY

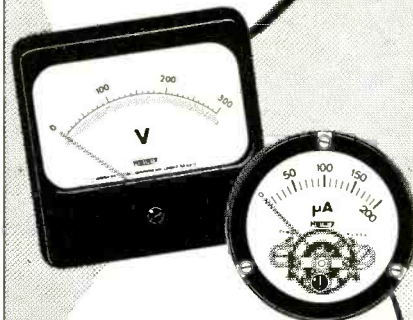

**A COMPLETE RANGE
OF METERS TO MEET
COMMERCIAL
AND MILITARY
REQUIREMENTS**

*Write for Catalog
& Specifications*



AMERICAN METRIX CORPORATION

**40 HADDON AVE.
CAMDEN 3, NEW JERSEY**

Circle 321 Readers Service Card
October 1, 1957 — ELECTRONICS

NEW!

1/10th and 1/8th watt sizes
for transistorized circuits

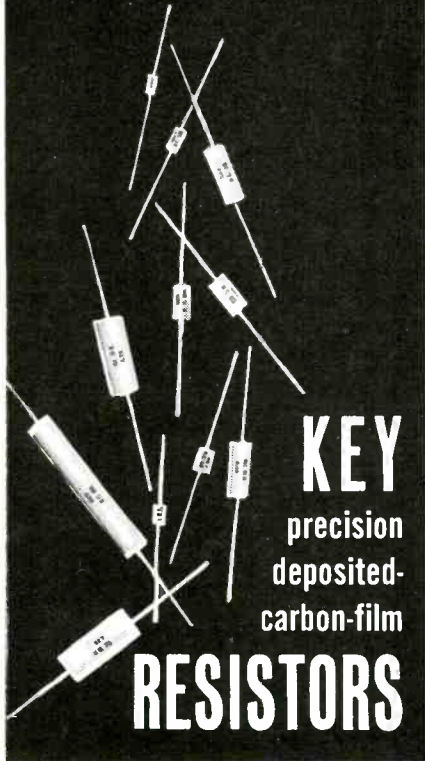

KEY
precision
deposited-
carbon-film
RESISTORS

MAXIMUM RELIABILITY: each unit checked by X-Ray for 100% perfection *plus* quality control through each step to final inspection. Each unit given individual leak test.

SEVEN SIZES from 1/10th to 2 watt. **HERMETICALLY SEALED** to equal or exceed MilSpec MIL-R-10509B, Characteristic B. Manufactured to 1% tolerance or to your special order.

Write for technical information

KEY



RESISTOR CORPORATION

321 West Redondo Beach Blvd.

Gardena, California

FAculty 1-2149 • DAvis 3-5000

PLANTS AND PEOPLE

(continued)

ments will be made from the new plant during January 1958.

Designers and manufacturers of radar components and electronic devices, Technicraft already has under construction a new plant in Thomaston, Conn., duplicating facilities now in operation there.

Bambara Gets V-P Post at CBS Labs

APPOINTMENT of Joseph Bambara as vice-president of Electronics Systems of CBS Laboratories was recently announced. In his new position, he will assume responsibility for the laboratory section dealing with electronic systems and data handling.

Bambara has been associated with CBS Laboratories for seven years. During that time he has been responsible for the successful design and development of a variety of complex electronic systems and components. In recent years he has been largely concerned with research and development on military projects and will continue to spearhead the activity in this area.

Prior to joining CBS Laboratories in 1950 as a project engineer, Bambara was experienced in radar, tv and allied electronic fields.

Rhodes Joins Torotel

DALE SIZEMORE, president, announces the appointment of Melvin Rhodes as vice-president and chief engineer of Torotel, Inc. of Hickman Mills, Mo., manufacturers of toroids for electronic applications.

Rhodes has had wide experience in the electronics industry and is original holder of several circuit patents. Previously he has been connected with Collins Radio, serving as project engineer on FD105 integrated flight systems, and also with the Wilmar Mfg. Co. and with Midwest Engineering & Development Co.

Narma Upped By Fairchild

FAIRCHILD RECORDING EQUIPMENT Co., of Long Island, N. Y., has ap-

Mini Lines

The new
miniaturized
encapsulated
delay lines.

MAGNETIC-CORE DELAY LINES

Excellent transmission
fidelity.

DELAY-LINE FLATS

New elliptical core de-
sign offers wide range
of characteristics.

Our Delay Lines are being used by leading manufacturers of commercial and military electronic equipment.

COLUMBIA TECHNICAL CORP.

61-02 Thirty-First Ave. — Woodside 77, N. Y.

Circle 322 Readers Service Card

ELECTRONICS — October 1, 1957

Circle 323 Readers Service Card

407

USERS SAY:

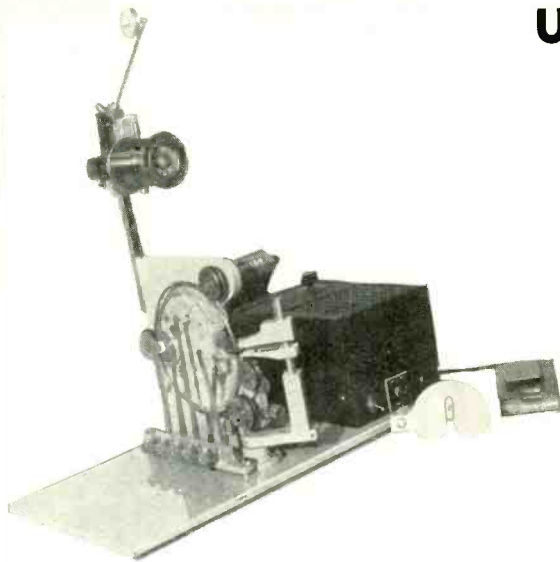

HARDER TOROIDAL COIL WINDING MACHINES
Model L-2 shown

"essential to our re-
search program . . ."

"most versatile!"

"we wind at 2500
rpm . . ."

" . . . winding coils
readily that were next
to impossible before
receiving the L-2"

Standard ring size is
7" diameter. Special
models in 10," 14" and
24". Also 3" subminiature.

WRITE FOR FURTHER INFORMATION

DONALD C. HARDER CO.

3710 MIDWAY DRIVE • SAN DIEGO 10, CALIFORNIA • PHONE: ACademy 2-5240

Circle 324 Readers Service Card

Little Mag Says:



**MAGNATRAN MEANS
RELIABILITY IN MAGNETIC
COMPONENTS. THAT'S WHY
IT IS USED IN WHITE ALICE
UHF SYSTEM**

reliability (rill'abil'iti), quality of being reliable;
trustworthiness; dependability. n. 12.
reliable (rill'ial), worthy of trust; that can be
depended on. Send for the book.

**WHITE ALICE EQUIPMENT
MUST BE RELIABLE →**

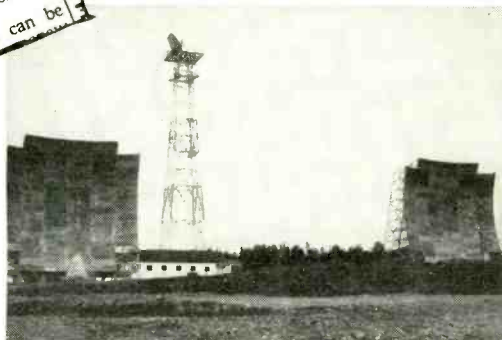

- Unitized Rectifiers® • Modulation Transformers •
- Reactors • Filter Reactors • Filament Transformers
- Amplifiers • Rectifiers • Rectifier Plate Transformers.



MAGNATRAN incorporated

P.O. Box 211 KEARNY, NEW JERSEY, U.S.A.

pointed Rein Narma as manager of the production and engineering division of the company. Narma is currently serving as chief engineer and will continue carrying out these duties.

In his new position he will be responsible for the activities of the entire production and engineering division and will direct and coordinate engineering, manufacturing, quality control, and associated functions.

Narma was formerly vice-president of Gotham Audio Development Corp., and is known for his design work in the recording field. He has also served with Rangertone as a development engineer.

Narda Names Project Engineer



Robert E. Othmer

THE appointment of Robert E. Othmer as project engineer for the Narda Microwave Corp., has been announced by Stuart Casper, vice-president for engineering. Othmer's primary responsibility will be the development of transistorized electronic instruments. He will work directly under Leonard Kent, chief microwave engineer, at Narda's headquarters in Mineola, N. Y.

Before joining Narda, Othmer was a project engineer at Frankfort Arsenal and at Emerson Radio and Phonograph Corp. Most recently he was associated with the



SPADE BOLTS

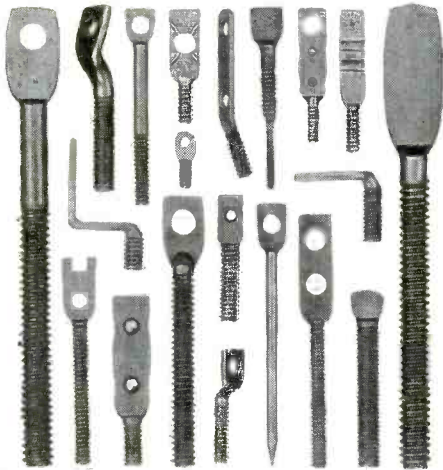

Specialists in designing and manufacturing of all-purpose fasteners and wire forms. Tooled to produce over 1000 styles in any screw size, material, finish, quantity, to your specifications.

Serving Industry for Thirty-Five Years
— OTHER PRODUCTS —

Simplex

WIRE STRIPPERS & CUTTERS

• TOOLS • DIES • STAMPINGS

Bulletins on complete line on request

WENCO MANUFACTURING CO
1133 W. Hubbard St., Chicago 22, Ill., U.S.A.

Circle 326 Readers Service Card

For consistently high purity...

"LINDE" M.S.C. RARE GASES
Trade-Mark
(Mass Spectrometer Controlled)

- Helium
- Neon
- Argon
- Krypton
- Xenon

In radar electronic equipment, nuclear radiation counters, cosmic ray cloud chambers, and thyratrons, where the purest rare gases are demanded, LINDE M.S.C. Grade gases meet the specifications. They are produced under continuous mass spectrometer control to assure you of gases of *known* purity and consistently high quality. LINDE, the world's largest producer of gases from the atmosphere, can meet your individual needs of volume, mixture, and container.

For information on the physical, chemical, and electrical properties of these gases, send for the booklet, "LINDE Rare Gases."



LINDE COMPANY

Division of
Union Carbide Corporation
30 E. 42nd Street New York 17, N.Y.

In Canada:
LINDE COMPANY, Division of Union Carbide
Canada Limited, Toronto

The term "Linde" is a registered trade-mark of Union Carbide Corporation.

Circle 328 Readers Service Card

VARIABLE ELECTRONIC FILTERS

Frequency 0.02 to 20,000 cps



Models 330-A and 330-M

These KROHN-HITE Continuously Variable Electronic Band-Pass FILTERS feature a frequency range of 100,000 to 1. Gain is unity in the pass band and drops at a rate of 24 db per octave outside the band. There is no attenuation in the center of the pass band with a band width as narrow as one octave. Use is made of RC filter circuits which do not ring and are not disturbed by external magnetic fields. A wide dynamic range is obtained with internal hum and noise less than 0.1 millivolts. Direct reading dial calibration is used on both the high and low cut-off sections which are independently adjustable from 0.02 to 2,000 cps in the 330-A, and from 0.2 to 20,000 cps in the 330-M. Calibration Accuracy is $\pm 5\%$. Price \$475.00 f.o.b. factory.

For further details write

KROHN-HITE Corporation

DEPT. E 580 MASSACHUSETTS AVENUE

CAMBRIDGE 39, MASS.

Circle 327 Readers Service Card

**ONE FLICK RESETS THIS
HIGH SPEED Electric COUNTER**

Model "YE" by
DURANT

(Test count-life over 70 million)

- Offered in TWO STYLES:
1. Quick PUSH-BUTTON RESET
 2. Electric REMOTE RESET

First high-speed electrically actuated counters with added advantage of electric reset. Clean-cut, legible 3/16" figures, white on black. Ideal for all high-speed electric counting applications — accurate at high, low or intermediate speeds.

DURANT MANUFACTURING CO.
1912 N. Buffum St. 12 Thurbers Ave.
Milwaukee 1, Wis. Providence 5, R. I.
Representatives in Principal Cities

ALASKA GRAY
AND SEAL BROWN



Compact, with great rigidity — entirely enclosed against dust and moisture. Base or panel mount. Speeds to 1500 C.P.M.



PRODUCTIMETERS
SINCE 1879
Count Everything

Circle 329 Readers Service Card

409

Wire Forms

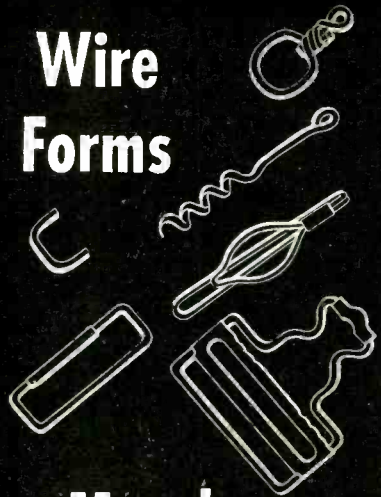

Metal Stampings



Deep Drawings..

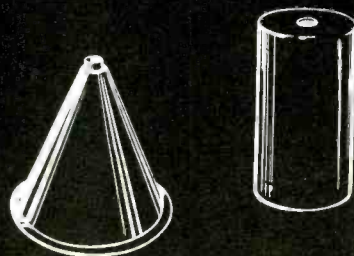

Largest Metal Specialties manufacturer in the country. Tool making, assembling, plating and finishing—all under one roof. Completely equipped.

Send us your prints or sample for our quote. Write for catalog No. 100.

Phones:
New York City: Rector 2-7875
Belleville: Plymouth 9-7100

**EASTERN TOOL
& MFG. CO.**
Belleville 9, N. J.

Circle 330 Readers Service Card

Aeroflex Corp., where he directed the development of one of the first successful applications of printed electronic circuits to frequencies above 200 mc, for a subminiature portable transreceiver. He also participated in the development of a gyro-stabilized tv camera mount for NBC.

Westinghouse Gets Big Government Contract

A \$1,400,000 government contract for the production of 3,600 magnetron tubes has been awarded to the Westinghouse Electric Corporation's electronic tube division, Elmira, N. Y. The order was announced by R. N. Stoddard, manager of government sales for the division.

The (WL-6249A) magnetrons will generate the powerful radar pulses for airborne radar sets.

Received under public bid, the contract was awarded to Westinghouse by the Dayton Air Force Depot. Deliveries of the magnetrons were scheduled to begin in August 1957 and to continue for about one year.

Leeds & Northrup Co. Promotes Beggs

THE appointment of George E. Beggs to the new post of assistant to the president in charge of long-range planning, is announced by I. Melville Stein, president of Leeds



George E. Beggs

% STILL OPERATING

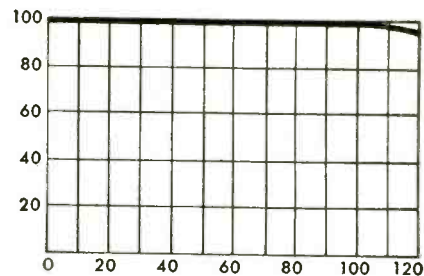

% RATED LIFE

If you want reliable transformers

..don't overlook this old solution

Right now, you demand more from transformers than ever before. You must have high reliability, even at extreme altitudes, and you need smaller lighter units.

Used, and *proved*, for decades, oil-encased transformers should not be forgotten in a search for new methods.

Everyone knows the advantages: effective convection of heat, excellent insulating properties, complete insurance against hidden leaks. Oil-sealed types (with a nitrogen bubble) are good, light, high-altitude transformers. Gas-free oil-filled types (with a bellows to allow for heat expansion) withstand very high voltage stresses. Except in the smallest sizes, they save space, too.

You can place several high voltage units close together in a single oil-filled case, and save case weight. Those connections moved inside the case no longer need large insulators. Even the units themselves can be smaller. This all adds up—particularly in high altitude service—to interesting savings in space and weight.

We make all sorts of transformers and special assemblies for the communication industry: encapsulated, cast in epoxy or foam, and just potted in pitch. But oil transformers still have an important place.

Whatever type you need, we'll be glad to hear from you. Our facilities in design, production, and quality control are at your service. Our experience, too.

CALEDONIA

ELECTRONICS AND TRANSFORMER CORPORATION

Dept. E-10, Caledonia, N. Y.

In Canada: Hackbusch Electronics, Ltd.
23 Primrose Ave., Toronto 4, Ontario

Circle 331 Readers Service Card

October 1, 1957 — ELECTRONICS

& Northrup Co., Philadelphia.

Beggs was formerly manager, Development Division, Research & Development Dept., and joined L&N in 1940. He holds a Presidential Certificate of Merit for his work in 1942-45 as a technical aide, National Defense Research Committee, OSRD. He has contributed papers on communications and amplifier equipment.

Waters Names Houghton Chief Engineer

APPOINTMENT of Richard Houghton as chief engineer of Waters Mfg., Inc., was recently announced by Robert A. Waters, President.

Formerly in charge of the Missile Instrumentation Group at Sanders Associates, Houghton will be responsible for all engineering activities in the development and manufacture of Waters potentiometers, panel meters, electronic components and instruments, and in the expansion of the Waters line of electrical and electronic products.

Hillman Gets Top Post at Automation Dynamics

LEON HILLMAN has been appointed president and director of engineering of Automation Dynamics Corp.,



Leon Hillman



ELECTRO-MAGNETIC CLUTCHES and BRAKES

by **MAGTROL, INC.**

240 SENECA ST.

BUFFALO 4, N. Y.

Circle 332 Readers Service Card

SOMETHING TO CROW ABOUT

TWO RELAYS ABOUT TO HATCH!

a NEW	•	a NEW
Sensitive Relay with	•	Crystal Case
High Vibration Resistance	•	Relay

Wheelock SIGNALS
INC.
RELAYS LONG BRANCH, N. J.

FREE

ENGINEER'S FACT FILE

A Complete Reference Manual on MERCURY PLUNGER RELAYS

For all loads up to 60 AMPS or 5 HP.



Send for
**FREE
FACT FILE**
and 30 day
test details

- ★ 35 Millisecond Fast Action! ★ Hermetically Sealed!
- ★ Installs in one minute! ★ No maintenance required!
- ★ No pitting! No sticking! No corrosion! ★ No Sparks!

Solves your relay problems once and for all



EBERT ELECTRONICS CORP.

212-02 JAMAICA AVE., QUEENS VILLAGE 28, N. Y.

Circle 334 Readers Service Card

Tenafly, N. J. The company specializes in automation controls for aircraft and industry involving electronic measurement, communication, computing and control. The newly organized firm is currently developing a transistorized telemetering system for the International Geophysical Year project.

Hillman was formerly vice-president and chief engineer of Production Research Corp. He will continue as special lecturer with the Electrical Engineering Dept. of Newark College of Engineering.

RCA Division Adds Field Engineers

N. N. WHITE AND H. J. CORNYN have been added to the field engineering group of RCA Semiconductor Division, Somerville, N. J.

White has been associated with the engineering staffs of several companies including Link Aviation, Inc., and the Avion Division of ACF Industries.

Cornyn was associated with the technical staff of the Bell Telephone Laboratories for two years before joining RCA in 1954 as a field engineer in the Tube Division. While in military service, beginning in 1955, he was assigned to the Army Security Agency as an engineer. Most of his career has been directed to the field of semiconductors.

M-H Rents Fall River Plant

MINNEAPOLIS-HONEYWELL REGULATOR Co. recently announced the leasing of a new \$300,000 plant in Fall River, Mass., for production of a new line of electronic industrial controls.

Employment in the 37,400 sq ft, one-story plant is expected to total 200. The new plant is to be a manufacturing unit of the Industrial Division.

The Fall River plant is the third for Honeywell in Massachusetts. Its Datamatic Corp. plant at Newton Highlands produces large-scale business computers in the \$2½ million category and its Boston di-

TELREX LABORATORIES

Designers and Manufacturers of

COMMERCIAL SERVICE "BEAMED-POWER" ARRAYS

Calibrated
for the commercial
13 to 14
mc. band.
Other
frequencies
available.

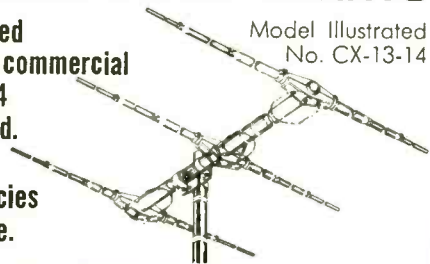

Model Illustrated
No. CX-13-14

Precision Tuned, Matched and Calibrated for easy assembly and repetition of our Specifications at your site, providing optimum gain per element and hi-signal-to-noise, hi-signal-to-interference "Balanced Pattern."

Electrical Specifications: Gain 8 db, F/B ratio 28 db, V/S/W/R 1.2/1 or better! Impedance, 52 ohm thru coaxial halfwave "Balun" (supplied). Power capacity 5 KW - Higher power models available at extra cost.

Mechanical Specifications: Wt. 60 lbs., 3" OD x 26 ft. boom, taper swaged elements, tapering from 1 3/8" OD to 1/2" OD, incorporating stainless steel hardware, "Borg-Warner" Cyclocac moldings, 1/4-20 S.S. junction terminals and heavily cadmium plated mounting plate. Wind surface area: 7 sq. ft. Wind load at 100 mph: 210 lbs.

Price \$338.00 f.o.b. Asbury Park, New Jersey
Available three (3) days after receipt of order.
Descriptive literature on request.

Telrex is equipped to design and supply to our specifications or yours, Broad-band or single frequency, fixed or rotary arrays for communications, FM, TV, scatter-propagation, etc.

Consultants and suppliers to communication firms, universities, propagation laboratories and the Armed Forces.



telrex LABS.
COMMUNICATION & TV
ANTENNAS SINCE 1921

**ASBURY PARK 25
NEW JERSEY, U.S.A.**

Tel. PRospect 5-7252

**PRECISE
CURRENT**
for your
**TESTING
NEEDS!**

**VARIABLE FREQUENCY
FULLY AUTOMATIC MOTOR
GENERATOR SETS ADJUST
360 TO 400 CPS.**

Generator mounted controls include reset buttons, limit switch. Motor and generator remain stationary. Vari-drive pulley adjustment controlled by small motor. Remote control panels available.



Units can be equipped with synchronous motor starter and magnetic amplifier, automatic voltage regulator.

**MANUAL ADJUSTMENT
MOTOR GENERATOR SET
GIVES 45 TO 60 CPS OUTPUT**

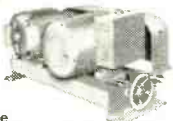

Easily adjusted by simple hand wheel controlling variable pitch pulley V-belt arrangement. Unit holds speed accurately. Frequency meter indicates output. Single phase generator speed varies from 1350 to 1950 rpm.

WRITE FOR NEW FOLDER!

Builders of Fine Electrical Machinery Since 1928
KATO Engineering Company

105 MAXFIELD AVENUE, MANKATO, MINN.
Circle 336 Readers Service Card

TELEPHONE AND TELEGRAPH EQUIPMENT

Radio Engineering Products is currently producing a number of types of equipment, electrically and mechanically interchangeable with standard Bell System apparatus.

CARRIER-TELEPHONE EQUIPMENT

C5 Carrier-Telephone Terminal (J68756). A kit for adding a fourth toll-grade channel to existing C systems is available. • C1 Carrier-Telephone Repeater (J68757) • 121A C Carrier Line Filter • H Carrier Line Filter (X66217C).

CARRIER-TELEGRAPH EQUIPMENT

40C1 Carrier-Telegraph Channel Terminal (J70047C) • 140A1 Carrier Supply (J70036A1, etc.) • 40AC1 Carrier-Telegraph Terminal.

VOICE-FREQUENCY EQUIPMENT

V1 Telephone Repeater (J68368F) • Power Supply (J68638A1) • V1 Amplifiers (J68635E2 and J68635A2) • V3 Amplifier (J68649A) • V-F Ringers (J68602, etc.) • Four Wire Terminating Set (J68625G1) • 1C Volume Limiter (J68736C).

D-C TELEGRAPH EQUIPMENT

16B1 Telegraph Repeater (J70037B) • 10E1 Telegraph Repeater (J70021A) • 128B2 Teletypewriter Subscriber Set (J70027A).

TEST EQUIPMENT

2A Toll Test Unit (X63699A) • 12B, 13A, 30A (J64030A) and 32A (J64032A) Transmission Measuring Sets • 111A2 Relay Test Panel (J66118E) • 118C2 Telegraph Transmission Measuring Set (J70069K) • 163A2 Test Unit (J70045B) • 163C1 Test Unit (J70045D).

COMPONENTS AND ACCESSORIES

255A and 209FG Polar Relays • Repeating and Retard Coils, several types • 184, 185, 230A and 230B Jack Mountings.

RADIO ENGINEERING PRODUCTS

1080 UNIVERSITY ST., MONTREAL 3, CANADA

TELEPHONE
University 6-6887

CABLES
RADENPRO, MONTREAL

Circle 337 Readers Service Card

quality...
uniformity...
service...

GLASS for
HERMETIC SEALING
• EPOXY PREFORMS
• PRESSED CERAMICS

mansol
CERAMICS CO.

134 SUTLE ST. • THORNTON HEATH
RELEVILLE, NEW JERSEY | SURREY, ENGLAND

Circle 338 Readers Service Card

ELECTRONICS — October 1, 1957

Electrical Coil Windings

For 40 years . . . specializing in all types of coils to customers' specifications. Design or engineering assistance available on request.

COTO-COIL CO., INC.

SINCE 1917

65 Pavilion Avenue Providence 5, Rhode Island

Circle 339 Readers Service Card

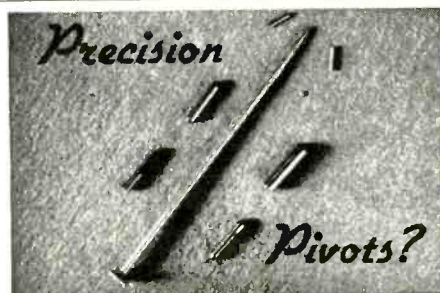

The "spike" in the center is a common pin.
The others are VK precision pivots.

Call VK

Steel, chromium plated, or carbide precision pivots to .013" diameter. 1 RMS or finer surface finish. Diameter tolerance to .000010". Chamfers, radii, lapped ends, etc.
Also volume production lapping of flat or round production parts.

Send us your specifications.

The VAN KEUREN COMPANY
176-D WALTHAM ST. WATERTOWN, MASS.

Circle 340 Readers Service Card

**CRITICAL
POT SPECS*
are met at CIC**

**INFINITE
RESOLUTION**

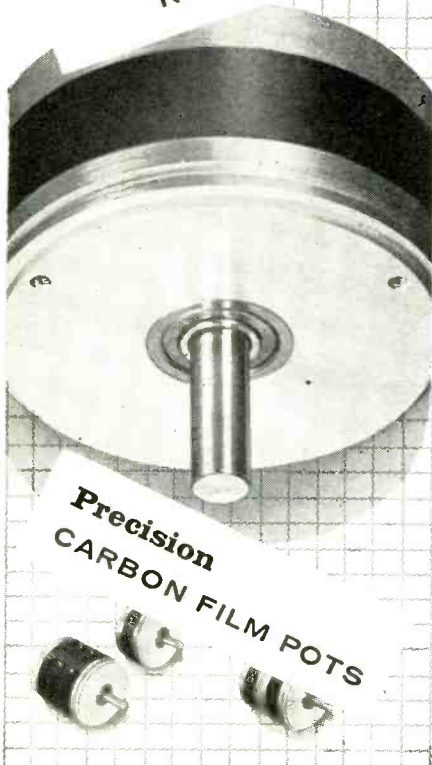

**Precision
CARBON FILM POTS**

Equipment designers who demand more than "shelf item" specifications, rely on CIC for dependable delivery of ultra-precise potentiometers.

The result of CIC research, carbon film potentiometers are setting new standards of accuracy, life at higher speeds and performance reliability.

CIC has assisted many firms in a wide variety of industrial instrumentation, military fire control and flight guidance equipment.

Why not discuss your specific requirements with us?

*New carbon film techniques assure virtually infinite resolution; linearity to .01%, sine-cosine to .025%; compact ganging; precision ball bearing servo construction.

"For Precision Performance...specify CIC"

Detailed Technical Data
Sheets available on request.

cic

**COMPUTER
INSTRUMENTS
CORPORATION**

92 Madison Ave. • Hempstead, Long Island, N. Y.

Circle 341 Readers Service Card

PLANTS AND PEOPLE

(continued)

vision plant manufactures gyroscopes, synchro motors, accelerometers and other precision servo components.

Royson Engineering Elects Wiegmann V-P



Edwin C. Wiegmann

EDWIN C. WIEGMANN was recently elected vice-president of Royson Engineering, a 10 year old company in Hatboro, Pa., that is expanding to specialize in the research, development and manufacture of instruments, recorders and special printing devices. Wiegmann, who was formerly with Brown Instrument Division of Minneapolis Honeywell, is chief engineer at Royson.

Sylvania Reassigns Cowden

APPOINTMENT of David G. Cowden as manager of special-purpose tube operations for the Television Picture Tube Division of Sylvania Electric Products Inc. has been announced.

In his new assignment, he will be responsible for the manufacture of special purpose cathode-ray tubes, such as flying spot scanners, and those used in radar and closed circuit television.

Cowden joined Sylvania in 1952 at Seneca Falls as an engineer in the hydrogen thyratron tube department. In 1955 he was named manager of the hydrogen thyratron operations, and, the following year, chief of mask operations in the

FUNDAMENTALS OF ELECTRONIC DEVICES

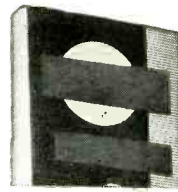

JUST PUBLISHED!

Gives a working knowledge of electron devices that will help you in applying them efficiently in today's circuits and systems. Explains inner workings of each major component as well as its best circuit applications.

Devices covered include transistors, vacuum tubes, amplifiers, photoconductive and photovoltage cells, oscillators. By K. R. Spangenberg, Stanford U. 505 pp., 442 illus., \$10.00

MATHEMATICS FOR SCIENCE AND ENGINEERING

JUST PUBLISHED! A reference book planned especially to help engineers and technicians find, understand, and apply the mathematical procedures best adapted to solve a particular problem simply and quickly. Covers mathematics all the way from arithmetic to such things as complex numbers, infinite series, and methods of approximation. By Philip L. Alger, Cons. Eng., GE. 360 pp., 117 figures, \$6.95

PULSE AND DIGITAL CIRCUITS

Tested methods of working with all types of pulse and digital circuits. Expert guidance helps you analyze every circuit—shows how each is designed—how it functions—how it is best applied in modern electronic fields. By Jacob Millman, Columbia Univ., and Herbert Taub, C. C. N. Y. 687 pp., 872 illus., \$12.50

EPOXY RESINS

JUST PUBLISHED! Covers the whole range of information needed to make effective industrial use of epoxy resins. Applications, covered against a background of chemistry and technology of the resins and their reactions in curing, include complete plotting of electric coils used in solenoids, torroid coils, etc. By Henry Lee and Kris Neville, The Epoxylite Corp. 305 pp., 176 illus., \$8.00

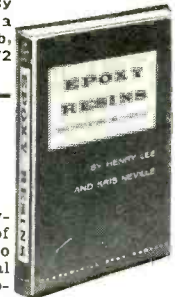

SEE THESE BOOKS 10 DAYS FREE

McGRAW-HILL BOOK CO., INC., Dept. L-10
327 W. 41st St., N.Y.C. 36

Send me book(s) checked below for 10 days' examination on approval. In 10 days I will remit for book(s) I keep, plus few cents for delivery costs, and return unwanted book(s) postpaid. (We pay delivery costs if you remit with this coupon—same return privilege.)

- Spangenberg—Fund. of Elect. Devices, \$10.00
 Alger—Math. for Science & Engrg., \$6.95
 Millman & Taub—Pulse & Digital Circ., \$12.50
 Lee & Neville—Epoxy Resins, \$8.00
 (PRINT)

Name

Address

City Zone.....State.....

Company

Position

For price and terms outside U. S.
write McGraw-Hill Int'l., N.Y.C. L-10

Circle 342 Readers Service Card

October 1, 1957 — ELECTRONICS

company's color tv tube department.

Before joining Sylvania, Cowden was with General Electric Co. in Syracuse, N. Y. and Kuthe Laboratories Inc. in Newark, N. J.

Ramo-Wooldridge Hires Two More Engineers

EDWARD J. ROBB and ALBERT A. SORENSEN recently joined the Guided Missile Research Division, The Ramo-Wooldridge Corp., Los Angeles, Calif.

Dr. Robb's experience includes instrumentation in connection with high energy accelerators, power system analysis, analog computer design, and network synthesis techniques. He was an assistant professor at the University of Connecticut.

Sorensen, former research engineer on digital computers for Minneapolis-Honeywell and Remington Rand Univac, was a teaching assistant at the University of Minnesota.

Micromag Establishes New Division

MICROMAG INSTRUMENT Co., Boston, Mass., manufacturers of magnetic amplifiers and toroidal inductors, has established a new division to custom design and manufacture wave filters.

Specialty of the division will be audio to 1 mc high, low, band pass and band stop filters, constructed of temperature stabilized toroidal inductors and temperature compensated capacitors. Filters meeting extreme specifications of shock, environment or vibration will also be produced.

The division is equipped to deliver sample units, within a few days and production quantities to meet manufacturers' schedules.

Appointments Announced At Convair-Astronautics

WILLARD D. WALKER has been named chief electronics engineer at

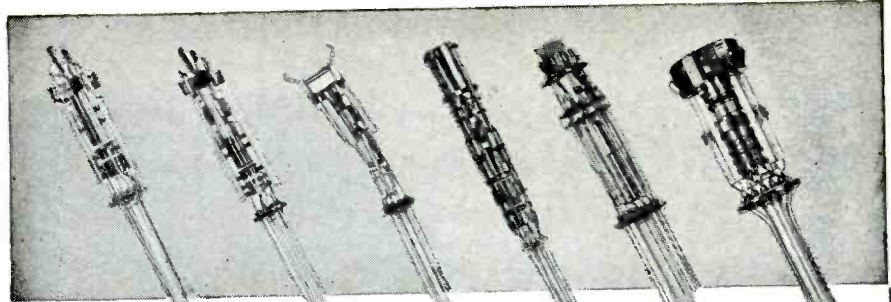

Superior manufactures superior ELECTRONIC GUN MOUNTS!

For the CRT industry, SUPERIOR offers a full range of magnetic, electrostatic and color gun mounts including mounts for the 110° narrow neck tubes . . . all precision engineered. SUPERIOR makes a complete line of electrostatic focus and deflection guns for radar and industrial purposes including character and Vidicon-type mounts. You may order standard types or we will design and build to your specifications.

Whether your order be large or small, you will enjoy all the benefits of our rigid inspection, testing and control. For complete satisfaction based on dependable service, call or write to

SUPERIOR  ELECTRONICS

CORPORATION

208-212 Piaget Ave. • GREGory 2-2500 • Clifton, N. J.

Circle 343 Readers Service Card

Pilot Runs at **LOW COST** to your specifications

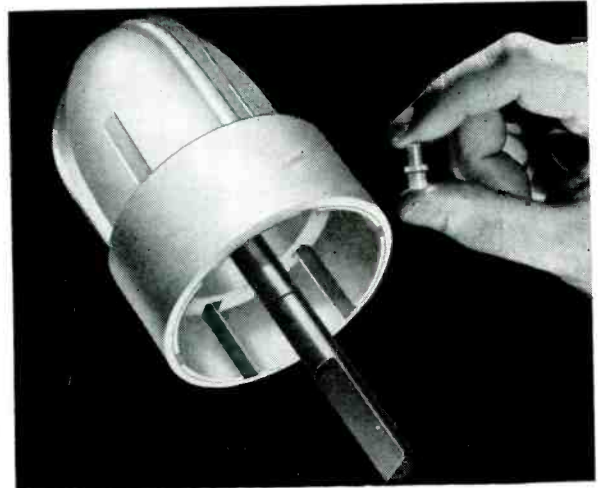

market trials are important

If you're planning a pilot run before starting full production, let us do it for you at *very low cost* . . . regardless of product size, shape or quantity. Special facilities also available to work out your production problems. Write us today! All inquiries receive our prompt and interested attention.

Custom
molders
of the
unusual

STANDARD PLASTICS CO., Inc.

62 WATER ST., ATTLEBORO, MASS., Tel. AT. 1-1940
N. Y. OFFICE: 303 FIFTH AVE., Tel. MU. 9-1910

ATTRACT AND HOLD TECHNICAL PERSONNEL

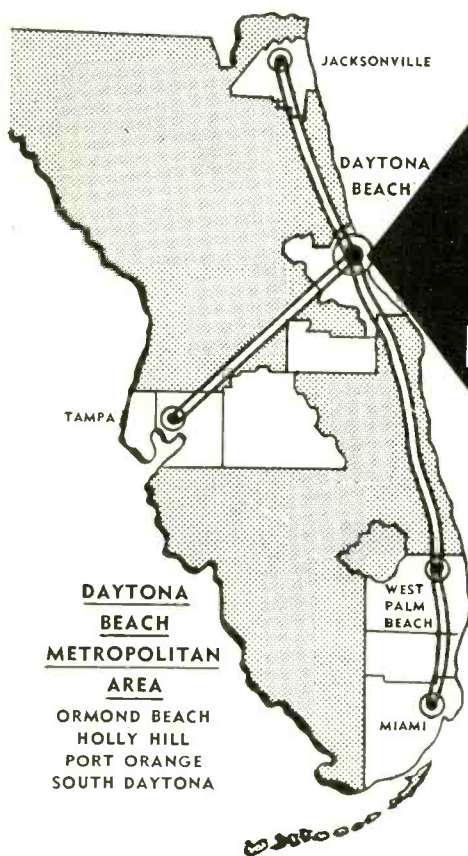

**SERVE
FLORIDA'S
METROPOLITAN AREAS
FROM A
DAYTONA BEACH
INDUSTRIAL SITE**

Daytona Beach, the east-to-west terminal on the north-to-south route of the projected Federal Limited Access Highway System, gives industry a plus for the future.

WRITE FOR NEW 86 PAGE
INDUSTRIAL BROCHURE

**INDUSTRIAL DEPARTMENT
CHAMBER OF COMMERCE
DAYTONA BEACH, FLORIDA**

Circle 345 Readers Service Card

Convair-Astronautics, San Diego, Calif. For the last two years he had been assistant chief engineer at Kin Tel.

Convair-Astronautics, pilot producer of Atlas intercontinental ballistic missile for the Air Force, is a division of the Convair Division, General Dynamics Corp.

Walker formerly was chief electronics design engineer on the Terrier missile program at the Pomona, Calif., division of Convair.

In two other appointments at the division, C. J. Dunn and E. T. Clare were named senior project engineers under chief project engineer Charles S. Ames. Dunn formerly was a staff specialist for chief engineer Mortimer Rosenbaum, and Clare was assistant chief electronics engineer.

New Manager Named for CEC Division



A. P. Stuhrman

APPOINTMENT of A. P. Stuhrman as manager of the Central Manufacturing Division, of Consolidated Electrodynamics Corp., has been announced. Stuhrman succeeds William D. Nesbit, who resigned.

In his new post, Stuhrman will direct all activities of the division, which operates principal manufacturing facilities at the company's main Pasadena plant and subsidiary facilities in El Monte, Calif. He will also be responsible for

dependable and consistent SWITCHBOARD OPERATION

SWITCHCRAFT INC.

T-SWITCHES

Quality Switchboard Components

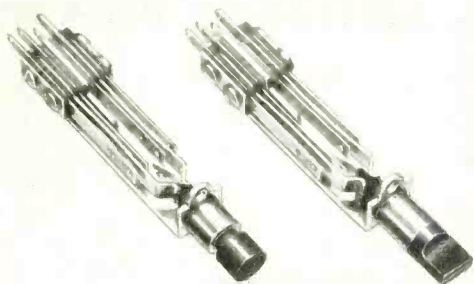

A long frame switch designed especially for high quality communication and switchboard equipment and to meet the exacting requirements of the Armed Services.

Long life springs—requires minimum of panel space—2 frame designs.

Series 11000—Push Button Switch.

Series 11200—Two Position Turn Button Switch.

Write for Catalog S-57A.

SWITCHCRAFT INC.

1336 N. Halsted St.,
Chicago 22, Ill.

Canadian Representative: Atlas Radio Corp., Ltd.,
50 Wingold Ave., Toronto.

NOW we can meet the demand for

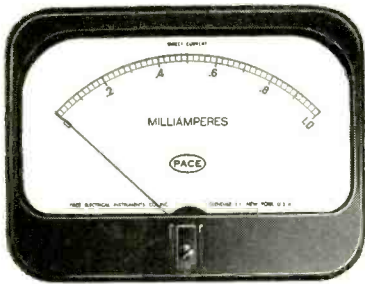

PACE
THE METER OF PRECISION

METERS!
2" TO 7" SIZES

Expanded plant . . . increased staff . . . New, improved automation techniques . . . to meet the demand of electronic equipment manufacturers for custom produced panel meters, in production quantities.

PACE meters are manufactured under rigidly controlled climatic conditions to meet critical specifications as to sensitivity, resistance, damping, response time, illumination, scaleplate design, etc.

Send for latest illustrated catalog, available upon request.
Write, wire or phone for applications engineering, consultation and assistance!

PACE ELECTRICAL INSTRUMENTS CO., INC.

a Division of Precision Apparatus Co., Inc.
70-31 84th Street, Glendale 27, L.I., N.Y.
Export: Morhan Exporting Corp., 458 Broadway, N.Y. 13, N.Y.

Circle 347 Readers Service Card

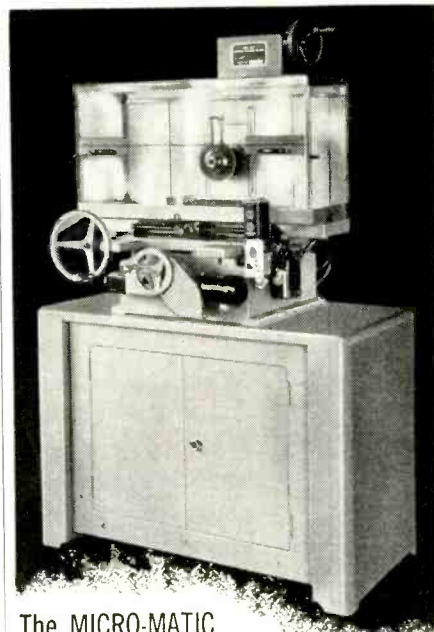

The MICRO-MATIC precision wafering machine—fully automatic model-WMA

SLICES

to extremely close tolerances

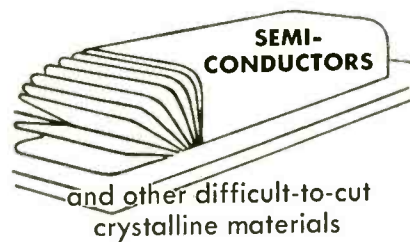

AUTOMATIC INDEXING ON FULLY AUTOMATIC PRODUCTION MODELS

Write for descriptive literature

**MICROMECH
MANUFACTURING CO.**

1020 Commerce Ave. • Union, N. J.

Circle 350 Readers Service Card

**PRECISION
PLASTIC
CAPACITORS
AT
COMPETITIVE
PRICES!**

POLYSTYRENE and MYLAR*
Capacitance From .001 mfd to any value
Voltage From 50 V.D.C. to 30 KV
Tolerance Polystyrene From $\pm 0.1\%$ to $\pm 5\%$
Mylar* From $\pm 1\%$ to $\pm 10\%$

**SMALLEST CASE SIZES
TUBULAR—BATHTUB—RECTANGULAR**

Very Good Deliveries *DuPont T.M.

PRECISION CAPACITORS, INC.
150 W. Cypress Ave. Burbank, Calif.

Circle 348 Readers Service Card



DE MORNAY-BONARDI

**first in
ultramicrowave
equipment**



A complete line of research instruments covering frequencies up to 90,000 mc . . . proved in laboratories the country over.

DE MORNAY BONARDI

DE MORNAY-BONARDI • 780 SOUTH ARROYO PARKWAY • PASADENA, CALIFORNIA

Circle 349 Readers Service Card

SILVER PAINT AND SILVER PASTE

Take the "bugs" out of the application of conductive silver coatings. Use Drakenfeld silver paint and silver paste tailored to meet your needs. We formulate special compositions for glass and ceramic bodies and other materials. Let us know your specific requirements. Samples will be supplied to fit them. Your inquiry will receive prompt attention.

B. F. DRAKENFELD & CO., INC.

Box 519, Washington, Pennsylvania

Drakenfeld

YOUR PARTNER IN SOLVING CONDUCTIVE COATING PROBLEMS

Circle 351 Readers Service Card

designed for continuous duty...

360-440 CPS BENCH TYPE

Variable Frequency Power Supply

Operating from standard 115v 60 cps power, the Model 1460 provides 400 cps 100-130 volt supply at any bench position. Utilization of units of this type allows testing at 400 cps - 10% at any individual position without interference with any other test position. The unit can be easily operated by unskilled personnel.

Catalog "M" describing this unit as well as other CML generators in the power range of from 50 VA to 80 KVA in single and three phase units and frequency range of 20 cps to 60 KC with all specifications listed, is yours on request.

Our design engineering department is at your service to design and custom-build a power supply unit for your specific need.



**WHERE
DEPENDABILITY
IS OF
PRIME
CONCERN**

**OUTPUT - 100 V. A.
DISTORTION - 2%
STABILITY - 1 CPS
REGULATION - 1%**



COMMUNICATION MEASUREMENTS LABORATORY, INC.

350 LELAND AVENUE, PLAINFIELD, NEW JERSEY

maintenance of CEC buildings and plant equipment at these locations.

Stuhrman joined Consolidated one year ago as director of quality control. Previously, he was manager of quality control, Convair-Pomona; director of engineering, Electrotech Corp., Azusa, Calif., and vice president and chief engineer, Wilcox Electric Co., Kansas City, Kansas.

Phillips Control Changes Division Corporate Name

CHANGE in the corporate name of the hermetic seal division of the Phillips Control Corp., Joliet, Ill., has been announced by John W. Ayers, president.

The new name is Philtrol Seals, Inc., changed from Superior Hermetic Seals Co.

Philtrol Seals, Inc., produces a variety of hermetic seals—transistor mounts, crystal bases, single and multiterminals in Kovar as well as compression types, and condenser end seals. It manufactures a variety of customized hermetic seals for special requirements.

Phillips Control Corp. is a subsidiary of Allied Paper Corp.

Video Instruments Elects Pohl V-P and G-M

THE DIRECTORS of Video Instruments Co., Inc., Los Angeles electronics firm, have announced the



Peter Pohl

Lepel

HIGH FREQUENCY Induction HEATING UNITS

**BRAZING
ANNEALING
HARDENING
SOLDERING
MELTING**

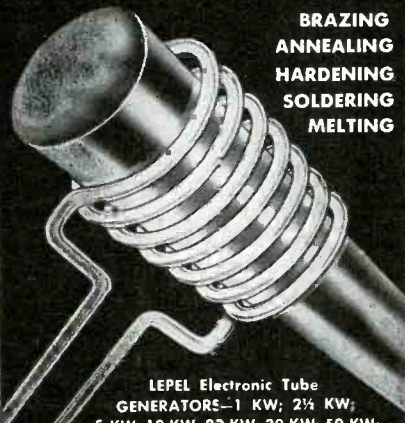

LEPEL Electronic Tube
GENERATORS—1 KW; 2½ KW;
5 KW; 10 KW; 25 KW; 30 KW; 50 KW;
75 KW; 100 KW.

LEPEL Spark Gap Converters
2 KW; 4 KW; 7½ KW; 15 KW; 30 KW.

WRITE FOR THE NEW LEPEL CATALOG... 36 illustrated pages
packed with valuable information.

All Lepel equipment is certified to comply with the
requirements of the Federal Communications Commission.

**LEPEL HIGH FREQUENCY
LABORATORIES, INC.**
55th STREET and 37th AVENUE, WOODSIDE 77,
NEW YORK CITY, N. Y.

Circle 353 Readers Service Card

election of Peter Pohl, electronics engineer, to the post of vice president and general manager of the company.

Pohl recently left a position with Hughes Aircraft Co., Products Div., to accept the executive job with Video Instruments. He was in charge of sales of storage tubes and memory oscilloscopes in the Western United States for Hughes. He rose to prominence in the electronics engineering field when he originally introduced the large screen oscilloscope to the industry.

Pohl announced that Video Instruments will manufacture a line of solid state, differential d-c amplifiers and other transistorized instrumentation equipment for industrial and military applications.

Victoreen Elects Johnston A Vice-President



Joseph M. Johnston

ELECTION of Joseph M. Johnston as vice-president-manufacturing, of the Victoreen Instrument Co., Cleveland, Ohio, has been announced. He previously served the company as operations superintendent of both instruments and components divisions. Prior to this he was associated with El-Tronics, Inc., Philadelphia, Pa., as both chief engineer and operations manager. Johnston was formerly a member of the scientific staff of

*Save Money
and Time with*

Malco

**SOLDERING LUGS
• TERMINALS •
PRINTED CIRCUIT
HARDWARE**

Tell us about your application and production requirements. We'll supply your needs from our complete line—or adapt to your specifications—and show you how to cut costs and speed up production!

- Miniature Tubular Terminals, Wire Wrap Terminals and Contacts for Automated Printed Circuit Applications
- Solderless Crimp-on Terminals
- Line Cord Interlock Terminals
- Automatic terminal inserting, crimping and staking machines

Contact us today. Send blue print or specifications for specific information. Request bulletins for general information.

Malco TOOL and MANUFACTURING CO.

4023 W. LAKE ST. • CHICAGO 24, ILL.

Circle 354 Readers Service Card

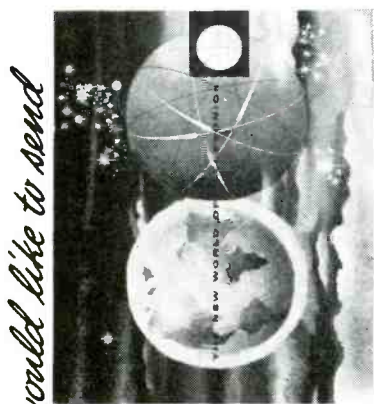

we would like to send

this book to you

OF INTEREST TO ANYONE
IN ELECTRONICS

AMPHENOL ELECTRONICS CORP.
1830 S. 54th Ave., Chicago 50, Ill.

NAME _____

COMPANY _____

TITLE _____

ADDRESS _____

CITY _____ ZONE _____ STATE _____



***CUSTOM BUILDERS AND DESIGNERS OF:**

CAVITIES

**MIXERS • DETECTOR MOUNTS
 DUPLEXERS • MULTIPLIERS
 ROTARY JOINTS • BENDS
 TWISTS • OTHER COMPLEX
 COMPONENTS & ASSEMBLIES**

Application-engineered microwave parts and complex assemblies are our specialized field. We'll manufacture components to your prints ... or we will design and integrate them into your application.

You can depend on J-V-M for close coordination, guaranteed electrical performance and "know how" that is attested by innumerable assemblies ranging from dc. to 40,000 mc. now in industrial and military use.

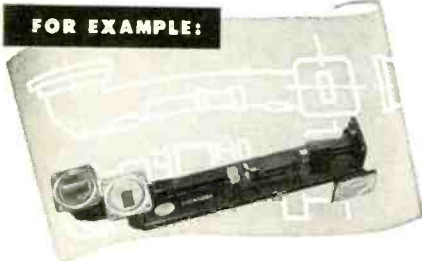

1. Variable vane directional coupler . . . sliding vane type . . . high directivity—low VSWR.

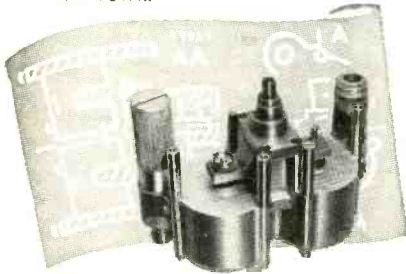

2. Pre-selector-mixer . . . S band . . . 50 ohm input impedance . . . high Q double-tuned ganged cavities . . . detector output . . . frequency stable from -55° to +85° C.

**CUSTOM-ENGINEERED
 MICROWAVE
 PARTS**

Get full information on J-V-M standard or custom-engineered microwave parts and components, also complex mechanical assemblies. Request catalog today.



J-V-M ENGINEERING COMPANY

4631 Lawndale Avenue, Lyons, Ill. (Chicago Suburb)

Circle 355 Readers Service Card

Columbia University, N.Y.C., and was chief of the radiation instruments department of Evans Signal Laboratory, Belmar, N. J.

Tobe Deutschmann Ups R. L. Stone



Robert L. Stone

THE APPOINTMENT of Robert L. Stone as assistant manager of the Engineering Division was recently announced by Tobe Deutschmann Corp.

Stone was formerly employed by Cornell-Dubilier Electric Corp., New Bedford, Mass., in the Engineering Test Laboratory, and has been with Tobe Deutschmann Corp. for the past six years as both a field and project engineer.

Farr Takes New Post at Westinghouse Division

ERIC M. FARR has been named manager of manufacturing services for the Westinghouse television-radio division in Metuchen, N. J. In his new post he will be responsible for all industrial and production engineering, tools and equipment and plant maintenance activities for the division.

Since 1953 Farr has been engineering section manager in charge of tv final assembly and cabinet design engineering. He first joined Westinghouse in 1951 as a section engineer at the Sunbury, Pa., works of the tv-radio division and later served as supervising engineering and engineering section manager.

You Get Things Done With Boardmaster Visual Control

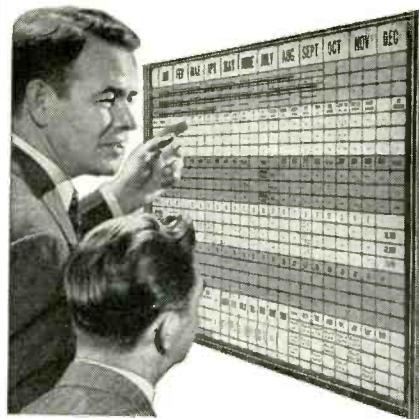

- ☆ Gives Graphic Picture of Your Operations —Spotlighted by Color
- ☆ Facts at a glance — Saves Time, Saves Money, Prevents Errors
- ☆ Simple to operate — Type or Write on Cards, Snap in Grooves
- ☆ Ideal for Production, Traffic, Inventory, Scheduling, Sales, Etc.
- ☆ Made of Metal. Compact and Attractive. Over 200,000 in Use

Complete price **\$4950** including cards

FREE 24-PAGE BOOKLET NO. C-30 Without Obligation

Write for Your Copy Today
GRAPHIC SYSTEMS

55 West 42nd Street • New York 36, N. Y.
 Circle 357 Readers Service Card

AUTOMATIC Coil Company

An excellent source for all your coil needs. Coils and electronic assemblies of any design and requirement are manufactured to meet your specific demands. Quality materials and precision workmanship assure you of maximum performance and reliability.

MEETS AND EXCEEDS MIL/JAN SPECS

THE ANSWER TO YOUR COIL PROBLEMS.

- Made to withstand rigid temperature and humidity specs.
- Coils molded in plastic.
- Close tolerances held.

Our facilities are at your service **WRITE, WIRE, or PHONE**

AUTOMATIC COIL COMPANY INC.
 415 BEDFORD AVE., BKLYN., 11, N. Y.

Circle 356 Readers Service Card

October 1, 1957 — ELECTRONICS

NEW CHRISTIE
SILICON
POWER RECTIFIERS

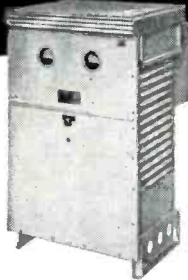

For Top Reliability

- A standard line from 30 to 1000 amps
- Closely regulated by magnetic control
- Voltages : 8-16-32-36
- Stationary or Mobile Types
- For Missile, Aircraft, Lab & Factory

Write for Latest Bulletins on
Silicon & Selenium Power Rectifiers

CHRISTIE ELECTRIC CORP.

Dept. EL, 3410 W. 67th St., Los Angeles 43

Over a Quarter Century of
Rectifier Manufacturing

Circle 358 Readers Service Card

**ARE YOUR
COMPONENTS
TEMPERATURE-
CRITICAL?**

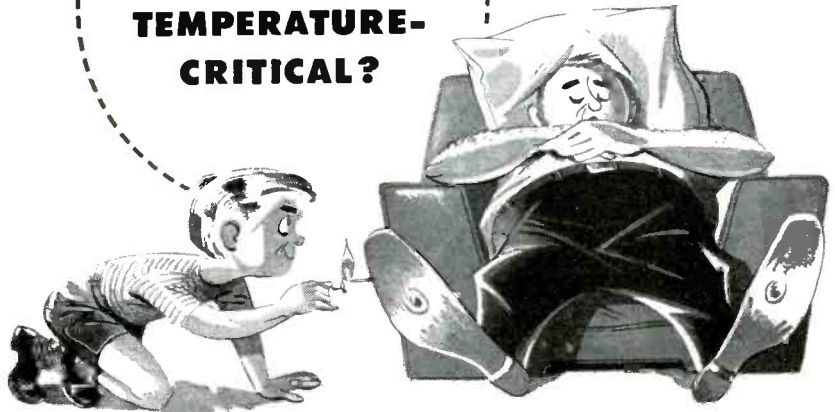

**SOLVE YOUR PROBLEMS
WITH MONITOR
COMPONENT
OVENS**

Quality ovens in ranges of temperature stability from $\pm 5^{\circ}\text{C}$ to $\pm .01^{\circ}\text{C}$. For use in ground or airborne equipment. Can be used to house thermocouples, transistors, standard cells, crystals, potentiometers and other critical components.

Write, wire or phone us, today!

MONITOR  PRODUCTS COMPANY

SOUTH PASADENA, CALIFORNIA • RYan 1-1174
Circle 359 Readers Service Card

**Earn Extra Income
in MOBILE-RADIO
MAINTENANCE!**



It's now a big business (650,000 installations) . . . fast-growing (70% increase just last year) . . . specialized . . . and high-paying!

Learn how to turn this opportunity into cash—write today for free booklet "HOW TO MAKE MONEY IN MOBILE-RADIO MAINTENANCE!" It's published as a service to radio engineers by Lampkin Laboratories, Inc., manufacturers of the well-known 105-B Micrometer Frequency Meter and 205-A FM Modulation Meter.

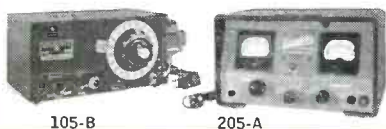

105-B

205-A

LAMPKIN LABORATORIES, INC.
Instruments Div., Bradenton, Fla.

At no obligation to me please send "HOW TO MAKE MONEY IN MOBILE-RADIO MAINTENANCE."

Name _____
Address _____
City _____ State _____

Circle 361 Readers Service Card

for complete
selection of Basic Requirements
for your Coil Winding needs it's . . .

Coil Winding Equipment Co.

write for complete
technical literature

COIL WINDING EQUIPMENT CO., Oyster Bay, New York

Circle 360 Readers Service Card

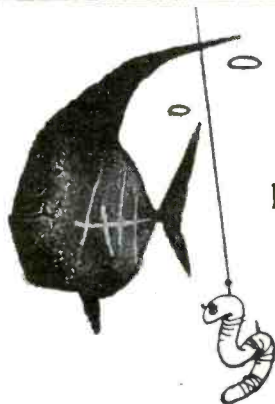

experience pays

let TWS* prepare
your industrial literature

***TECHNICAL WRITING SERVICE**
McGraw-Hill Book Co.
330 W. 42nd St., N.Y.C.

send for information

PRECISION
PAPER
PART
PROBLEMS?

— NIEMAND BROS.
have the ANSWERS!

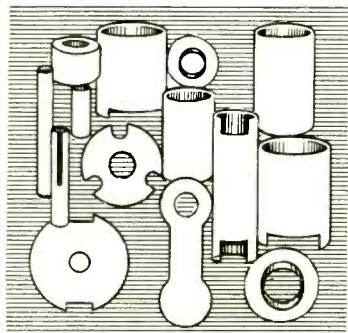

Many manufacturers have found the answers to problems of reducing unit costs and speeding up production by using Niemand Bros. Paper Tubular Products.

They're practical—buy them in the quantities you need in the materials you want—high dielectric kraft, fish paper, foils, special protective coated and laminated papers and Mylar*. Printed or plain, they're made in diameters from .093" to 2" and up.

And, also available from Niemand Bros. are precision drawn paper or Mylar* caps in diameters from .141" to 2", as well as die cut washers and custom parts.

*DuPont's reg. trade mark for its polyester film.

Send for
complete details.

**NIEMAND
BROS., INC.**

37-03 THIRTY-FIFTH AVENUE
LONG ISLAND CITY 1, N. Y.

*Specialists in Paper Tubes
Products for Electrical Applications*

RAvenswood 8-0909

Circle 371 Readers Service Card

New Books

An Introduction To Semiconductors

BY W. CRAWFORD DUNLAP JR.
John Wiley & Sons, New York 1957,
417 p, \$11.75.

THIS is a good book for those for whom it is intended; according to the author the book was "written for two sorts of people . . . the main group includes those engineers, technicians and research workers who are entering upon active work with semiconductors and wish a source of general information about the subject that will bring them up to date on all phases without overwhelming masses of detail . . . the second type is the student . . . interested in supplementing his course work in solid state theory with material on both the scientific and the technical aspects of semiconductors. . . ."

► **Introductory Level**—The book achieves this goal extremely well; it gives a very good and complete survey of the whole field for newcomers, be they technicians, students or scientists. It only follows then, that the book does not offer anything to those who have been in the field for some time and who are already on an advanced level. But the book was not intended for these anyhow. Correspondingly, this book does not replace the more advanced books such as Shockley's or Spence's. However, it is an excellent preparation for those who will eventually read the more advanced texts.

The completeness of the book is also very good. It is quite obvious that it has been written, not as a manuscript for a series of lectures, but by a man who is actively engaged in industrial semiconductor research. Not only does it contain those matters that are of importance in today's transistors but also things that, although being completely academic today, will probably be the bread and butter of tomorrow's semiconductor devices, such as the many-valley model of the band structures of germanium, silicon, etc.

► **Applications**—The only part this

reader was not quite happy about was the section on applications. Here, the level of presentation is definitely below that of the rest; some of the curves and diagrams contain too many purely accidental details that are not essential to the device and that may vary tremendously if one picks a different unit made by another process. In the transistor section, this reader would have been happier if such transistors had been replaced with more modern structures which are altogether missing. But, perhaps all this is not too important, because the applications are something one has to learn by doing.

In conclusion, this book could appeal to everybody who wants a source of general information about the field of semiconductor physics. It certainly should be present in every laboratory to be put into the hands of advanced technicians and trainees. It would be unfortunate if the rather high price of the book should turn out to be a deterrent, because the book really does fill a need.—HERBERT KROEMER, *RCA Laboratories, Princeton, N. J.*

System Engineering

BY HARRY H. GOODE and ROBERT E. MACHOL

McGraw-Hill Book Company, New York, 1957, 551 p, \$10.00.

THE role of complex man-made systems of equipment is constantly becoming of increasing importance. These systems include such things as computers, interceptor aircraft, automatic factories, air defense systems, guided missiles, and the nation-wide telephone network.

► **System Approach** — To create such complexes as these a broad system approach has evolved—an approach that considers the overall functioning of a total system rather than the individual parts separately. This concept of not breaking a system into pieces and letting

them go their own ways through development, but rather maintaining the integrity of the system throughout, has paid large dividends. For example, in the design of military aircraft, years can be cut from the total development time in this way.

Goode and Machol are to be congratulated for putting between hard covers a large quantity of material of use to the designer of a large-scale system. Here is an unquestionably important book—a first book on a subject in which interest is growing at a prodigious rate; a valuable book including a large volume of material useful to a system designer.

It should be pointed out that there is a difference of opinion as to the limits of activity of the System Engineer. There are organizations in which this activity exceeds the design of large-scale systems to meet predetermined specifications and includes the more comprehensive task of finding answers to basic problems and specifying systems embodying these answers. The scope of the activity as interpreted by this book, the somewhat limited design aspect, agrees closely with, for example, the ideas of many of the more progressive aircraft companies.

The present book is essentially a set of tools for the implementation of the system approach by the system designer.

Contents—The first chapter introduces the concept of comprehensive system design as a necessary facet of the increasing complexity of man's existence. The important concept of the team approach is introduced. The second chapter is a brief resume of a number of typical large-scale systems already in existence. In the third chapter a short general approach to system design is outlined.

The next ten chapters consist of a thorough coverage of the essentials of the methods of probability and statistics and end with an extensive illustration of the application of these methods to system design.

The seven chapters following, 14 through 20, cover the theory and application of computers, both digital and analog, with a comparison

FOR DATA PROCESSING COMPONENTS AND SYSTEMS

SPECIFY POTTER

Potter instruments and systems are unexcelled in reliability, accuracy and flexibility.

The equipment shown is typical of many more available as individual components or in integrated systems to meet specific requirements.

Write for brochure describing these and other Potter units, including special products. For detailed technical specifications on any of the Potter Products listed above, contact your Potter Representative or the factory.

DATA-HANDLING EQUIPMENT



Digital Magnetic Tape Handlers



Perforated Tape Readers



"Quick Look" Recorders

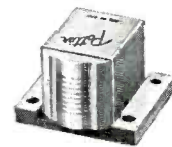

Record-Playback Head Assemblies



Record-Playback Amplifiers

PRESET INTERVAL GENERATORS



Preset Interval and Delay Generators

HIGH SPEED ACCESS REGISTERS



Ten-Bit Parallel Output (Serial Input) Using Magnistors



Ten-Bit Serial Output (Parallel Input) Using Magnistors



Six-Bit Digital Comparator Using Magnistors



POTTER INSTRUMENT COMPANY, INC.
SUNNYSIDE BOULEVARD
PLAINVIEW, N. Y.

3-D CHASSIS KIT SIMPLIFIES BREADBOARDING!

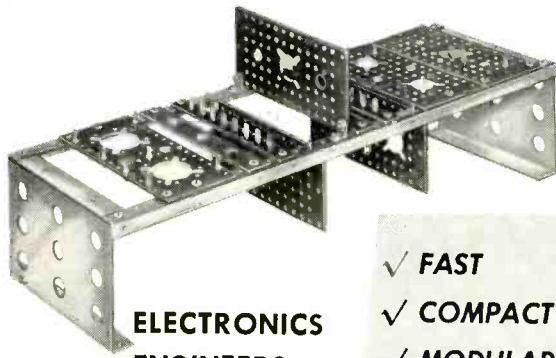

**ELECTRONICS
ENGINEERS . . .**

use the 3-D Chassis Kit in building block form in endless combinations. Receives many different type tubes . . . condensers, controls, components. Two or more may be joined. Easily wired, reusable. Simplicity, quality, low-cost! Made by specialists!

- ✓ FAST
- ✓ COMPACT
- ✓ MODULAR
- ✓ VERSATILE
- ✓ ECONOMICAL

**SEND FOR
FREE DETAILED
FOLDER**



42 Elm Street, Stoneham, Massachusetts

Circle 373 Readers Service Card

The Technitrol Variable Pulser



- * Wide pulse repetition frequency range from 20 cps. to 2.0 mcs.
- * Pulse rise and fall times are symmetrical at 0.05 μ s.
- * Duration of pulse variable from 0.2 μ s to 5.0 μ s in steps of 0.1 μ s.
- * Stable pulse duration controlled by electric delay lines.
- * Low impedance output, amplitude continuously variable from 0 to 40 volts without distortion.
- * Trigger pulse precedes output pulse.

This reliable and versatile instrument, developed for our own use, has wide possibilities for application in many laboratories.

Write for Bulletin 186ED



"MANUFACTURERS OF PULSE TRANSFORMERS,
DELAY LINES, AND ELECTRONIC TEST EQUIPMENT"

Circle 374 Readers Service Card

NEW BOOKS

(continued)

of the application of these two techniques.

Chapter 21 briefly presents some of the philosophy of the steps and tools of problem solving. Chapter 22 presents the single thread approach to the design of a system. This is a step-by-step elaboration of the functions required of the system and the relations between them. An interesting and engrossing detailed example is given in the single thread analysis of a machine to play and win the simple game NIM.

► **Design Tools** — The following chapters outline tools for use in the design of systems. The subjects covered by chapters, are in order: queueing theory, game theory, guides to system design, (linear programming, group dynamics and cybernetics), computer simulation, system components, information theory, servomechanism theory and human engineering. Most of these are covered in a brief manner, in particular the chapter on servomechanisms.

A possible criticism of these chapters is that they are all presented without distinguishing between their relative values. Thus the chapter on game theory which finds very little practical application in system design at present is introduced in essentially the same way as the chapter on servomechanism theory, the application of which, in system design is enormous.

An epilogue deals with economics, test and evaluation, and the management of system development. There is a comprehensive bibliography. A small number of problems on selected topics is included.

The book may be thought of almost as a handbook of useful reference material for the large-scale system designer. Very little space is devoted to the basic philosophy of what is unique to the system approach and how to go about applying it. The author's feelings along those lines is to be found in a discussion in the chapter on servomechanism theory: ". . . the sophistication of any field is indicated by the extent of its ability to synthesize solutions of stated problems. It will be recognized that large-

Let's face it!

HAVE YOU A DISASTER PLAN FOR YOUR PLANT?

**BOMBS...OR FIRE...OR FLOOD...OR TORNADO
... you can handle them if you act now.**

Let's face it . . . the threat of war and the atomic bomb has become a real part of our life—and will be with us for years. Fires, tornadoes and other disasters, too, can strike without warning.

Whatever the emergency is, everybody's going to want help at the same time. It may be hours before outside help reaches you. The best chance of survival for you and your workers—and the fastest way to get back into production—is to know what to do and be ready to do it. Disaster may happen TOMORROW. Take these simple precautions TODAY:

- Call your local Civil Defense Director.** He'll help you set up a plan for your offices and plant—a plan that's safer, because it's integrated with community Civil Defense action.
- Check contents** and locations of first-aid kits. Be sure they're adequate and up to date. Here, again, your

CD Director can help. He'll advise you on supplies needed for injuries due to blast, radiation, etc.

- Encourage personnel** to attend Red Cross First-Aid Training Courses. They may save your life.
- Encourage your staff** and your community to have their homes prepared. Run ads in your plant paper, in local newspapers, over TV and radio, on bulletin boards. Your CD Director can show you ads and official CD films or literature that you can sponsor locally. Set the standard of preparedness in your plant city. There's no better way of building prestige and good community relations—and no greater way of helping America.

Act now . . . check off these four simple points . . . before it's too late.



Acme 2002 POTTING COMPOUND

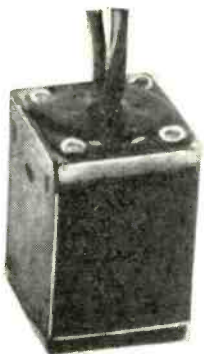

**Recommended
For All
MINIATURIZED
UNITS**

ACME 2002 POTTING COMPOUND is unaffected by climatic changes and assures 100% protection against extremes of temperature ranging from -100° F. to $+185^{\circ}$ F.

Developed to withstand elevated and subzero conditions, ACME 2002 forms a hard, moisture-proof seal that will not crack or become brittle when subjected even to sudden changes in temperature. Exterior casings are not necessary.

There are many Acme Compounds for various applications. Let us help you.

**Integrated Electrical Products
of Highest Quality for
Over Fifty Years**

ACME WIRE CO.
NEW HAVEN, CONN.

MAGNET WIRE • COILS
VARNISHED INSULATIONS
INSULATING VARNISHES
AND COMPOUNDS



Circle 375 Readers Service Card

NEW BOOKS

(continued)

scale system design is as yet so new that analysis is our only tool." No doubt as time goes on more will be learned about applicable synthesis techniques. For example, some of the present work in the stimulation of creativity may develop into a useful synthesis tool for the system designer.

One omission in the tool list provided by the authors is engineering economic theory, which is probably of much more importance to the practicing system designer than such abstruse subjects as game theory. In 520 pages of text only seven pages of the epilogue are devoted to a quick discussion of certain aspects of economic theory.

In conclusion, this is a valuable book which for many years will have an important place in the libraries of system designers and those who work with them.—W. G. BENDER, *Bell Telephone Lab.*, 463 West St., New York, N. Y.

Transistor Circuit Engineering

EDITED BY RICHARD F. SHEA
John Wiley & Sons, Inc., New York,
1957, 468 p, \$12.00.

It should be stated immediately that this book is not, as is too frequently the case, merely a rehash of the previous volume by most of the same authors. It is a new text, with the emphasis on techniques of circuit design and engineering as indicated by the changed title. While it is true that some of the material has appeared previously in articles, this material has been organized into the text in a valid and coherent fashion.

Combined with the new material, the result is a useful and generally commendable work. As such, it may be recommended, to both beginners and experienced practitioners in transistor circuit design and engineering, as a worthwhile addition to the slowly expanding library of transistor texts.

► **Contents**—The book consists of twelve chapters, one appendix, a bibliography and index.

The first two chapters are intro-



“Acton Laboratories
550A RECORDER
has
**SIX TIMES
MORE
resolving
power
than”**

- 8 CHANNEL
- DIRECT WRITING
- DC — 800 CPS



for the facts
behind this statement
ask for ALI
Laboratory Report
Vol. I #7



ACTON LABORATORIES, INC.
ACTON, MASS.
Circle 376 Readers Service Card

COSMIC

ELECTROLYTIC & PAPER
TUBULAR

Condensers

35 YEARS OF
“PROVEN
DEPENDABILITY”

COSMIC CONDENSER CO.
853 Whittier St., Bronx, N. Y.
PHONE
LUDlow 9-3360

Circle 377 Readers Service Card
October 1, 1957 — ELECTRONICS

ductory and discuss such topics as characteristics and equivalent circuits. The treatment is essentially in terms of *h* parameters and both frequency and temperature effects are included.

Chapter three is concerned with bias and stabilization and is quite properly introduced this early in the book, since a knowledge of stabilization and bias circuits is a necessary preliminary to any circuit design and engineering.

Chapters four through seven cover the various aspects of amplifier design, and range from d-c through r-f and video. Included here, as well as in chapter three are design procedures and illustrative examples which should be of great utility to circuit designers.

Chapter eight is devoted to a fairly comprehensive presentation of oscillator types and design procedures for the most common of these.

Chapter nine contains some interesting material on modulation, mixing and detection, but falls short of the other chapters as a design aid.

Chapter ten, Transient Response and Pulse Circuits, is second only to chapter four on audio amplifiers in length and includes a treatment of both small and large signal response, as well as a number of pulse and logic circuits applicable to digital computers.

Chapter eleven on systems contains general information and representative circuits illustrating the application of transistors to a-m/f-m and television receivers, but is of restricted utility as a design guide.

Finally, chapter twelve, Special Circuits, contains a conglomeration of items varying from limiters through active filters to regulated dc supplies.

► **General Comments**—As can be seen from this summary, the book covers most of the significant aspects of circuit design, and as such can be useful in the majority of cases one might encounter. The engineering approach has been retained with good uniformity in most of the chapters and the combination of design equations and illustrative examples makes for



because our research developed the prototype

WE are seeking people capable of working on advanced research with our outstanding staff which has developed many widely publicized systems and components including SINS (Ship Inertial Navigation System) and HIG GYROS.

OUR staff currently is extending the boundaries of human knowledge in INERTIAL NAVIGATION — FIRE CONTROL — MISSILE CONTROL & FLIGHT CONTROL.

The MIT INSTRUMENTATION LABORATORY with its 750 employees is famous for OUTSTANDING CONTRIBUTIONS and LEADERSHIP in the development of high performance control systems — using an ultimate combination of gyroscopic devices, servo-mechanisms and electronic components.

WORK with our nucleus of accomplished Engineers and Scientists in Advanced Research and Development of
INERTIAL GUIDANCE SYSTEMS,
GYROSCOPIC DEVICES,
SERVO-MECHANISMS,
ANALOGUE AND
DIGITAL COMPUTERS,
TRANSISTOR CIRCUITRY,
OPTICAL INSTRUMENTATION . . .

SALARY & BENEFITS —

Liberal starting salary, reviews with merit adjustments and promotional increases. Excellent pension plan, free life insurance, Blue Cross Blue Shield, 10 paid holidays and many others.

ENGINEERS —

*Electrical
Mechanical
Aeronautical*

PHYSICISTS • MATHEMATICIANS

Write: IVAN R. SAMUELS, Director of Personnel



M.I.T.
**INSTRUMENTATION
LABORATORY**

68 Albany Street • Cambridge 39, Mass.

GRADUATE COURSES may be taken for credit while earning full pay . . .

NEW! PORTABLE SUBMINIATURE OSCILLOSCOPE
MINI-SCOPE

Less than 6" square

A rugged general purpose oscilloscope, ideally suited for field servicing and laboratory use.

MODEL 311
ONLY **79⁰⁰** F.O.B.
BROOKLYN N. Y.

FEATURES:

- TIME BASE — .5 μ to 30KC
- Less than 5 lbs.
- Self focusing — 1" C.R.T.
- Self contained power supply

SPECIFICATIONS:

MODEL 311
Vert. and 1V R.M.S./inch;
Hor. Amp. — DC to 150 KC; 3 db down.

MODEL 312
Vert. Amp. — 20 MV/inch R.M.S.
Hor. Amp. — 1V/inch R.M.S.;
DC-150 KC; 3 db down.
115 Volts — 60 cycle A.C. input.

EPR SPECIAL PRODUCTS CORP.
675 BARBEY ST. • BROOKLYN 7, N. Y. • HYacinth 5-0133

Circle 378 Readers Service Card

ADEL LINE SUPPORTS
designed for every application

CLAMPS • BLOCKS • HARNESS STRAPS
for military & industrial systems & equipments

They cut maintenance and replacement costs... performance and reliability far beyond specifications of any other Line Support.

CLAMPS provide cushioned, vibration absorbing support for cables, tubing and piping.

BLOCKS provide resilient support for multiple grouping of lines to eliminate failures.

HARNESS STRAPS embody heat and cold resistant material for temperatures far above +550°F to well below -90°F.

For safety, flexibility, durability and economy SPECIFY ADEL and be certain of getting the best possible service from products that are the result of advanced engineering design and the most modern production techniques.

A COMPLETE LINE... SERVICE-FITTED, TESTED AND APPROVED. SPECIFICATIONS ARE AVAILABLE TO AIRCRAFT, MISSILE AND ORIGINAL EQUIPMENT MANUFACTURERS... WHAT ARE YOUR REQUIREMENTS?

Reliability
ADEL PRECISION PRODUCTS
A DIVISION OF GENERAL METALS CORPORATION

DIRECT INQUIRIES TO
Huntington Division
1444 Washington Ave.,
Huntington 4,
West Virginia

DISTRICT OFFICES: Burbank • Mineola • Dayton • Wichita • Dallas • Toronto

Circle 379 Readers Service Card

easy comprehension and application of the material. In this respect the book is superior to any other transistor text this reviewer is familiar with, and does to a certain extent fill a gap in the transistor literature.

The writers have generally adhered to the *h* representation and symbols as contained in the applicable IRE Standards. This approach has simplified the presentation to a great extent.

The book generally avoids elaborate theoretical analysis and is almost completely lacking in discussion of the physics of transistors. In addition the chapters on systems, and modulation, detection and mixing, fall far short of the others as design aids and might well have been sacrificed if a considerable expansion was not considered warranted. While one can not argue about the inclusion of some of the special circuits, it seems that a more complete treatment of low-noise stages and power supply design, as well as d-c amplifiers might have been more useful. The lack of illustrative design examples in these cases will be found a handicap by those individuals who are not familiar with some of the referenced material.

Another quite serious lack, is the complete absence of any material information on feed-back amplifier design.

► **Conclusions**—The book adopts what this writer considers an excellent approach to the problems inherent in the title and will be found generally useful as a guide and aid to circuit designers. It does not contain significantly new or advanced treatments but the subjects are covered in a generally coherent and reasonable fashion. The chapters on amplifiers, oscillators, and transient response and pulse circuits are especially successful from this point of view and should be most useful to the circuit design engineer.

To someone looking for more than an engineering design approach, the lack of physical treatment and the step by step presentation of design procedures may seem somewhat elementary. However, speaking as a practicing engineer, this reviewer found it a welcome

change from elaborate and complicated texts and a useful addition to these perhaps otherwise quite commendable works.—S. SHERR, *Section Head, General Precision Lab., Inc., Pleasantville, N. Y.*

Thumbnail Reviews

Automatic Coding. Franklin Institute, Philadelphia 3, Pa., 1957, 118 p, \$3.00. Collection of eight papers presented at the Automatic Coding Symposium recently held at the Franklin Institute.

Semiconductor Electronics. Edited by Geoffrey Knight, Jr. Semiconductor Information Service, Box 407, Cambridge 39, Mass., \$8.00 per year. Monthly survey of published literature on transistors and their applications.

Proceedings of the RETMA Symposium on Applied Reliability. Engineering Publishers, GPO Box 1151, New York 1, N. Y., 1957, 151 p, \$5.00. Papers delivered at RETMA symposium in Dec. 1956 at Los Angeles including a supplement entitled "A General Guide for Technical Reporting of Electronic Systems Reliability Measurements".

Industrial Rectifying Tubes. Phillips Technical Library, Eindhoven, Holland, 1957, 126 p, \$2.15. Operation, construction and application of hot-cathode, gas-filled rectifiers in battery chargers, power rectifiers, d-c arc welders and motion-picture arc lamps. Design equations and typical examples are given for the various applications.

Marine Radiotelephone Permit Q & A Manual (3rd Class Operator). By Milton Kaufman, John F. Rider Pub., Inc., New York, 1957, 48 p, \$1.35. Questions and answers likely to arise on FCC examination for 3rd class permit. Appendices include list of radiotelephone equipment which meet FCC requirements for shipboard use.

Automatic Record Changer and Tape Recorder Service Manual—Vol. 9. Howard W. Sams, Inc., Indianapolis, 1957, 256 p, \$3.95. Service information on 14 tape recorders and four record changers produced in 1956.

Handbook of Sound Reproduction. By Edgar V. Villchur, Radio Magazines Inc., Mineola, N. Y., 1957, 217 p, \$6.50. Intended as a popular reference for the growing number of audio enthusiasts who may wish to gain a more

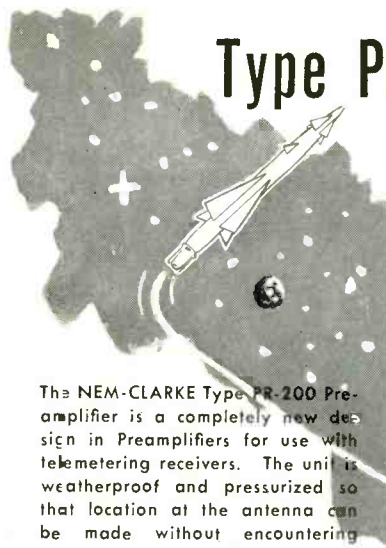

Type PR-200 Preamplifier

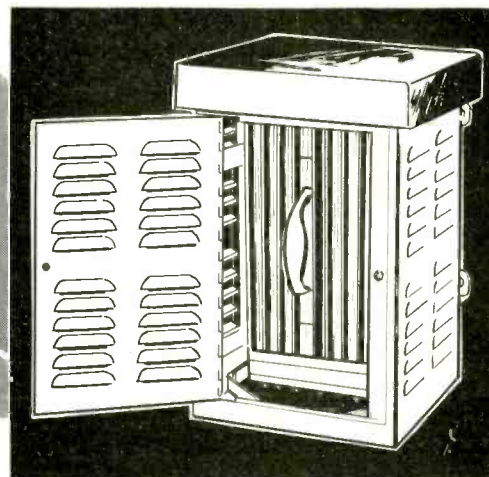

The NEM-CLARKE Type PR-200 Preamplifier is a completely new design in Preamplifiers for use with telemetering receivers. The unit is weatherproof and pressurized so that location at the antenna can be made without encountering moisture problems. Line losses as high as 6 db will not decrease the sensitivity of the receiving system by more than a few tenths of a db when this preamplifier is used.

NEMS CLARKE



A DIVISION OF VITRO CORPORATION OF AMERICA

919 JESUP-BLAIR DRIVE
SILVER SPRING, MARYLAND

For further information
write department A-1

SPECIFICATIONS

Pass band.....215-245 megacycles
Uniformity of response.....within 2 db
Gain.....20 db minimum in pass band
Impedance.....Designed to operate in 50 ohm system
Noise figure.....6 db maximum
Type PR-210 also available with pass band 225-260 megacycles

Circle 364 Readers Service Card

MODERN COIL EQUIPMENT

Plus

MODERN COIL HANDLING

Insure perfection in

all DANO COILS

- Specially Treated Coils
- Vacuum Impregnated Coils
- High Temperature Coils
- Encapsulated Coils
- Form Wound Coils
- Paper Interleave Coils
- Bobbin Coils

Also Transformers Made To Order



Circle 365 Readers Service Card

NETWORKS FILTERS



Fast Delivery
at Competitive Prices

- Toroidal Wave filters: high-, low-, band-pass
- Active feedback filters
- Twin-T and other RC nets
- Ask for bulletins LC and RC

Complete engineering service for prompt quotations on special problems



INSTRUMENT LABORATORIES
BOX 9006 • AUSTIN 17, TEXAS

Circle 366 Readers Service Card



TO THE **ONE MAN IN THREE**

OFFICIAL U. S. ARMY PHOTOGRAPH

ARMY'S HAWK MISSILE, recently revealed, destroys attackers flying at even the lowest altitudes and in the blind zone of conventional radars. Raytheon is prime contractor with complete systems responsibility for HAWK—and for the Navy's new air-to-air Sparrow III.

To the one man in three who will qualify as a Raytheon engineer:

our small, versatile project groups are staffed with extremely capable engineers. This policy pays off exceedingly well for energetic, imaginative men who are looking for individual recognition with the challenge of responsibility and ready opportunity for advancement.

Which of these interesting Situations with a Future is right for you?

As one of the world's fastest growing electronics companies with a record for history-making achievements, Raytheon is continually expanding. Interesting, rewarding openings for all types of engineers now exist in:

COMMUNICATIONS (Commercial and Military) — scatter, microwave relay, multiplex, mobile transistorized equipment.

COUNTERMEASURES — radar countermeasures equipment, advanced study projects.

RADAR (Pulse and CW Systems) — search, fire control, bombing, navigation, air traffic control, weather and commercial marine.

MARINE EQUIPMENT — submarine, ship, and airborne sonar, depth sounders, direction finders.

GUIDED MISSILES — prime contracts: Navy Sparrow III (air-to-air), Army Hawk (ground-to-air).

MICROWAVE TUBES — amplitrons, magnetrons, klystrons, traveling wave tubes, storage tubes.

ELECTRON TUBES, SEMICONDUCTOR DEVICES, MAGNETIC COMPONENTS • MICROWAVE COOKING OVENS, ELECTRONIC INDUSTRIAL EQUIPMENT, ELECTRONIC MEDICAL EQUIPMENT

Raytheon plants are ideally situated for delightful suburban living in New England, California and Tennessee.

For the details you want, please write to Leonard B. Landall, Raytheon Manufacturing Company, Waltham 54, Mass. There's no obligation and your inquiry is completely confidential.

RAYTHEON MANUFACTURING COMPANY
WALTHAM 54, MASSACHUSETTS

Are you the
ONE MAN IN THREE?

Excellence
in Electronics



MICROWAVE & POWER TUBE engineers check operation of Raytheon microwave tubes in Air Force jet.

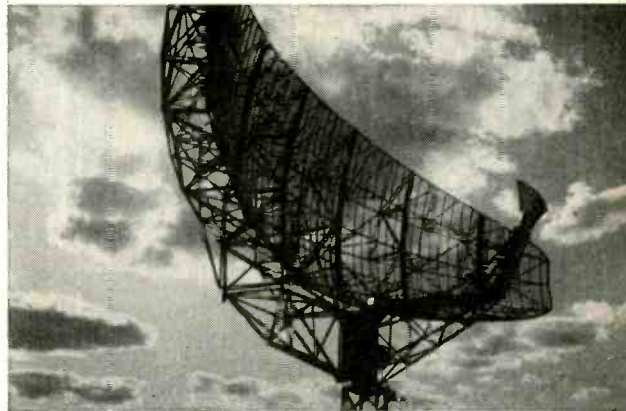

WAYLAND LABORATORY engineers developed this 40-foot L-band antenna to extend the range of radar.



MAYNARD LABORATORY engineers design and flight test airborne navigation and guidance systems.



MISSILE SYSTEMS DIVISION facilities include observation tower with radar tracking equipment.

YOKE

SPECIALISTS

COMPLETE LINE for every Military and Special purpose.

- Yokes for 7/8", 1-1/8", 1-1/2", 2-1/8" neck diameter CR tubes.
- Rotating and fixed coil designs.
- Core material to suit your requirements.

Special test instruments can establish your yoke deflection parameters to an accuracy of $\pm 0.1\%$.



Series aiding field and parallel (bucking) field designs.

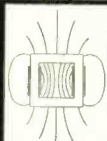

Consult Dr. Henry Marcy on your new applications today.

syntronic

INSTRUMENTS, INC.

170 Industrial Road • Addison, Ill. • Phone: Terrace 4-6103

Circle 368 Readers Service Card

fundamental background, the first third of this book deals with the fundamental aspects of sound while remaining chapters discuss separately each system component required for faithful sound reproduction.

Modern Applied Photography. By G. A. Jones, Philosophical Library, New York 1957, 162 p, \$4.75. Survey of photography in science and industry emphasizes its value in research, production investigation and recording. Practical applications are included.

Learning Electricity Fundamentals. By Leonard R. Crow, Howard W. Sams & Co., Inc., Indianapolis, 1957, 408 p, \$5.95. Fine elementary introduction to electricity and its common household applications. Treatment covers brief history of electricity, theory of generators and motors, practical electrical wiring, etc.

Proceedings of the Second Retma Symposium on Applied Reliability. Engineering Publishers, GPO Box 1151, New York, 1957, 93 p, \$5.00 (paper). Fourteen papers presented at Syracuse meeting in June include application evaluation of electronic parts, achievement of reliability in military equipment and failure prediction techniques for radar design.

Radio Operators License Q & A Manual. By Milton Kaufman, John F. Rider Publisher, Inc., New York, N. Y., 720 p, \$6.60. Sixth Edition contains questions from most recent FCC Study Guide and their answers.

Digital Calculating Machines. By G. A. Montgomerie, D. Van Nostrand Co., Inc., 1957, 262 p, \$6.75. General introduction to digital calculating machines for scientific users. Desk-type calculating machines are emphasized with little material on large automatic computers.

Vector Analysis. By Louis Brand, John Wiley & Sons, Inc., New York, 1957, 282 p, \$6.00. This basic introduction to vector algebra and calculus covers such topics as analytical and graphical line vectors, differential line invariants and integral theorems, abstract vector spaces, Green's identities and a logical development of electrodynamics based on Maxwell's equations.

Training Manual on Antennas, Vol. I. TechRep Div., Philco Corp., 18th and Courtland Streets, Philadelphia, Pa., 1957, 221 p, \$2.00. In addition to covering propagation and antenna and transmission line theory, this manual describes antennas for scatter-propagation communications systems and radio astronomy. A lecture outline and examination are included.

PREFERRED
by **TECHNICIANS**
and **ENGINEERS**

New!
TEFLON
HIGH TEMPERATURE
HOOK-UP WIRE • CABLE
TUBING & SLEEVING
MORE COLORS • MORE SIZES
THE "IN-STOCK" LINE
JAN-C-76, MIL-W-76A, MIL-W-16878B, MIL-W-5086, MIL-C-7078, MIL-W-12349, MIL-I-631C, MIL-I-3190, JAN-T-713.
FREE CATALOGS ON REQUEST.

BIRNBACH RADIO CO. INC.
145 HUDSON ST., NEW YORK 13, N. Y.

WIRE • CABLE • JACKS and PLUGS

Circle 367 Readers Service Card

for Results

Mc GRAW-HILL
DIRECT MAIL LIST SERVICE

McGraw-Hill Mailing Lists Will Help You

- Merchandise your advertising
- Conduct surveys
- Get inquiries and leads for your salesmen
- Pin-point geographical or functional groups
- Sell direct
- Build up weak territories
- Aid dealer relations

Direct Mail is a necessary supplement to a well rounded Business Paper advertising program.

Most progressive companies allocate a portion of their ad budgets to this second medium at the same time as they concentrate on the best business publications.

600,000 of the top buying influences in the fields covered by the McGraw-Hill publications make up our 150 mailing lists. Pick YOUR prospects out of our Industrial Direct Mail catalogue.

Write for your free copy.
It contains complete information.



All business is specialized

... and nothing specializes on your business like your business paper

Here's a smart business man. He spends his time where every sitzmark parks a prospect at his feet. It's simple sense: He *specializes* . . . and it pays!

Your business is specialized, too . . . and so is your business paper. The time you spend with it pays . . . for its editors are experts in your specialty. They scout the field . . . report what's good that's new . . . find ideas that worked . . . suggest methods to keep you a leap ahead of competition.

The ad pages are as specialized as the editing. They, too, tend strictly to business . . . your business. They bring you data on new products, new materials . . . gather in one place a raft of ideas on where-to-buy-what, or how to make (or save) a dollar.

That's help you can't find concentrated into such quick reading time *anywhere* else! It's help that puts many a man out front in his field, as a specialist who knows what's what today . . . sees what's coming tomorrow. It's simple sense to read every page, every issue.

This business paper in your hand has a plus for you, because it's a member of the Associated Business Publications. It's a paid circulation paper that must earn its readership by its quality . . . And it's one of a leadership group of business papers that work together to add new values, new usefulness, new ways to make the time you give to your business paper still more profitable time.

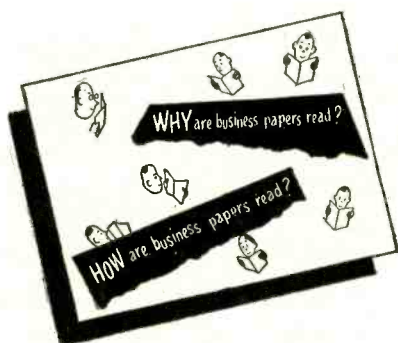

A copy of this quick-reading, 8-page booklet is yours for the asking. It contains many facts on the benefits derived from your business paper and tips on how to read more profitably. Write for the "WHY and HOW booklet." Room 2710.

McGRAW-HILL PUBLISHING COMPANY
330 West 42nd St., New York 36, N. Y.



One of a series of advertisements prepared by THE ASSOCIATED BUSINESS PUBLICATIONS

VIBRATION

HOPKINS HY-THERM CAPACITORS

ARE RIGOROUSLY TESTED IN
OUR LABORATORIES FOR THE
ABILITY TO SERVE BEYOND SPECIFIED REQUIREMENTS

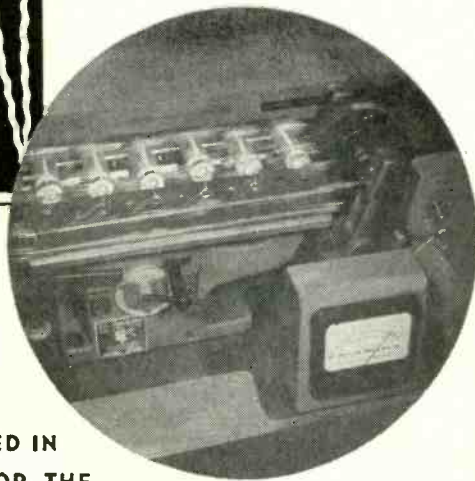

*For Applicable Military Specifications
Meeting or Exceeding Requirements of
MIL-C-25A.*

*Demanding Exceptional Stability and
High Insulation Resistance.*

WRITE OR WIRE FOR CATALOG
TO-DAY

HOPKINS *Engineering* COMPANY

12900 FOOTHILL BOULEVARD P. O. Box 191
SAN FERNANDO, CALIFORNIA
EMPIRE 1-8691

Circle 363 Readers Service Card

RIBBONS • STRIPS

of
★ PURE TUNGSTEN ★ THORIATED TUNGSTEN
★ MOLYBDENUM ★ SPECIAL ALLOYS
and OTHER METALS

IN
ULTRA THIN SIZES

to
TOLERANCES CLOSER THAN COMMERCIAL STANDARDS
by

OUR SPECIAL ROLLING TECHNIQUE

Note: for highly engineered applications—strips of TUNGSTEN
and some other metals can be supplied

ROLLED DOWN TO .0003 THICKNESS

- Finish: Roll Finish—Black or Cleaned
- Ribbons may be supplied in Mg. weights if required

For HIGHLY ENGINEERED APPLICATIONS

DEVELOPED AND MANUFACTURED BY

H. CROSS CO.

15 BEEKMAN ST., N. Y. 38, N. Y.
TELEPHONE: WOrth 2-2044
COrtlandt 7-0470

Backtalk

More Gravity

DEAR SIRS:

RESPONDING somewhat late to your invitation to hypothesizers' comments on gravity, I must confess to abysmal ignorance of the subject. My only qualification is intense interest.

I have been greatly intrigued by the various ingenious hypotheses offered, particularly that of Mr. Heintze and his "appulsion". To me, the most interesting part of his article was the statement that "No logical explanation of this something, and of its mode of action has been published so far and nothing could be found representing a satisfying answer in regard to "attraction", despite search throughout many years."

Consider two pieces of paper held parallel and a short distance apart. Blow a stream of air between them. They will be forced together due to the pressure—velocity relationship of the air stream. It is this same phenomenon that keeps the ball aloft in the well-known vacuum cleaner demonstration where the jet of air from the exhaust of the cleaner is directed upward and a large ball is "balanced" on the jet.

Now consider the known universe, the matter therein and the "ether". It has been well demonstrated that all the various stars and their attendant systems, and the enormous galaxies such as the Milky Way are moving at tremendous speeds relative to each other and therefore relative to the ether.

Is it not possible that these great velocities through the ether could create just such forces as those that, in air, draw the papers together and thus draw all matter together? If this "ether" is, as postulated, an all pervading "something" these forces might account for some of the binding attractions within the atom.

Now if someone with an "arithmetic head" will get busy and explain to me why this is impossible, I will appreciate it very much.

KONRAD B. ZOLL
Resident Engineer
D/A Radio Receiving Station
La Plata, Maryland

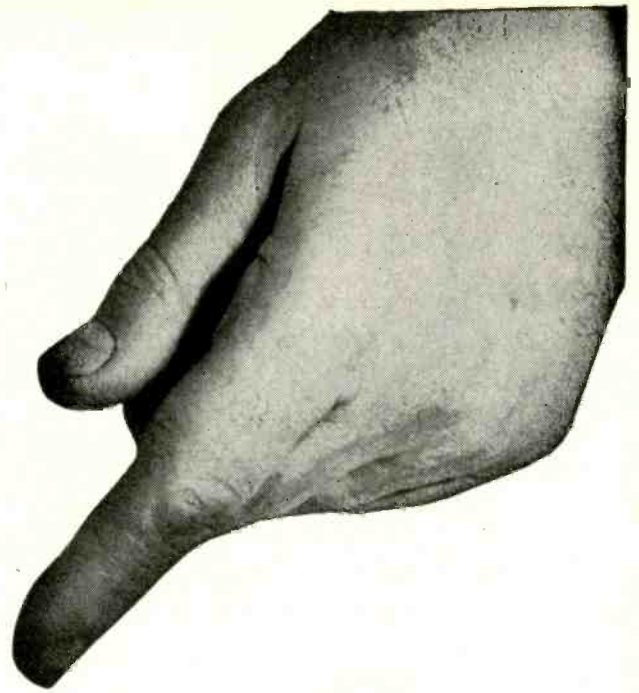

How to keep informed on the “with what” part of your business

AT YOUR FINGER TIPS, issue after issue, is one of your richest veins of job information – advertising. You might call it the “with what” type – which dovetails the “how” of the editorial pages. Easy to read, talking your language, geared specifically to the betterment of your business, this is the kind of practical data which may well help you do a job quicker, better – save your company money.

Each advertiser is obviously doing his level best to give you helpful information. By showing, through the advertising pages, how his product or service can benefit *you* and *your* company, he is taking his most efficient way toward a sale.

Add up all the advertisers and you've got a gold mine of current, on-the-job information. Yours for the reading are a wealth of data and facts on the very latest in products, services, tools . . . product developments, materials, processes, methods.

You, too, have a big stake in the advertising pages. Read them regularly, carefully to keep job-informed on the “with what” part of your business.



McGRAW-HILL PUBLICATIONS

The BOSTICK LABORATORY, INC.

Pulse Transformers—Inductors
Complete Service—Consulting,
Design, Development;
Also Production Orders
Main Plant Tyngsboro, Mass.
Business Office P. O. Box 167
Chester, N. J.

BRIGGS ASSOCIATES, INC.

Engineering Services
ELECTRONICS MECHANICAL
Development — Manufacturing — Consulting
Special Machines — Instrumentation — Automation
Electron Tube Design, Materials, Reliability
10 DeKalb St. Broadway 9-2120 Norristown, Pa.

CROSBY LABORATORIES, INC.

Murray G. Crosby & Staff
Radio - Electronics
Research Development & Manufacturing
Communications, FM & TV
Robbins Lane, Hicksville, N. Y.
WEHs 1-3191

DUNLAP ELECTRONICS, INC.

MANUFACTURING FACILITIES
RESEARCH & DEVELOPMENT
Specializing in Printed & Etched Circuits
Transistors—Pulse Techniques—Environmental
Test Facilities
3 Day Service on Printed Circuit Samples
764 Ninth Street Des Moines, Iowa
AT 8-0801

ELECTRONIC RESEARCH ASSOCIATES, INC.

"TRANSISTORIZE" YOUR PRODUCT!
Complete Service in consulting, research, development,
and production on Transistor circuitry,
products and instrumentation.
87 East Centre Street Nutley, N. J.
NUTley 2-5410

PROFESSIONAL SERVICES

Eugene Mittelman, E. E., Ph. D.

Consulting Engineer, Physicist
INDUSTRIAL ELECTRONICS
RESEARCH DEVELOPMENT
Mathematical Analysis, Instrumentation & Control
High Frequency Heating
549 W. Washington Blvd., Chicago 6, Illinois
Phone: STate 2-3171

NIAGARA ELECTRON LABORATORIES

CONSULTATION - DESIGN - CONSTRUCTION
MFG. THE THERMOCAP RELAY
Specializing in solution of problems of electronic
and electro-physical instrumentation for the re-
search or analytical laboratory. Industrial plant
problems also invited
Andover, New York Cable Address: NITRONLAB

ERCO RADIO LABORATORIES, INC.

Radio Communications Equipment
Engineering - Design - Development - Production
Our 27th Year in Air to Ground
Communications and Radio Beacons
Garden City • Long Island • New York

ALBERT PREISMAN

Consulting Engineer
Television, Pulse Techniques, Video
Amplifiers, Patent technical consultation.
616 St. Andrews Lane, Silver Spring, Maryland

McCann Engineering Company

Consulting Mechanical Engineer
Design and Development of Test Equipment
for Synchros, Potentiometers, Gyros, Etc.
Redesign of Products—Trouble Shooting
Production—Automatic Machinery
Special Machines with Sequence, Form
Recognition, Dimension Decision and
Special Environment Features.
9210 So. Vermont Los Angeles 44, Calif.

TELECHROME MFG. CORP.

Electronic Design Specialists
COLOR TELEVISION EQUIPMENT
Flying Spot Scanners, Color Synthesizers, Keyers,
Monitors, Oscilloscopes and Related Apparatus,
Telemetering for Guided Missiles.
J. R. Popkin-Curman, Pres. & Dir. of Eng.
28 Ranick Dr. Amityville, L. I., N. Y.

MEASUREMENTS CORPORATION

Research & Manufacturing Engineers
Harry W. Houck
Specialist in the Design and
Development of Electronic Test Instruments
Boonton, New Jersey

WHEELER LABORATORIES, INC.

Consultation—Research—Development
Microwaves—UHF—VHF—VLF
Antennas and Components
Harold A. Wheeler and Engineering Staff
HUnter 2-7876 Great Neck, N. Y.
Antenna Laboratory — Smithtown, N. Y.

**MANUFACTURERS' REPRESENTATIVES
IN THE ELECTRONIC INDUSTRY**



As a service to readers, ELECTRONICS presents the advertisements for some of the leading manufacturers' representatives in the electronic industry. These firms are qualified to help the Manufacturer with his distribution problems; the Buyer with his product needs.

YARDNEY LABORATORIES

Research-Design-Development
Electro-Chemical Generators of Energy
40-48 Leonard Street Worth 6-3100
New York 13, N. Y.

HORMAN ASSOCIATES, INC.
2017 "S" STREET, N.W.
WASHINGTON 9, D. C.
DECATUR 2-5705

SERVING
DELAWARE, MARYLAND
DISTRICT OF COLUMBIA
AND
NORTHERN COUNTIES
IN VIRGINIA AND WEST
VIRGINIA
TELETYPE NO. WA-559

REPRESENTING —

HEWETT-PACKARD CO.
SORENSEN & COMPANY INC.
VARIAN ASSOCIATES
BETA ELECTRIC CORP.
ELECTRO-MEASUREMENTS INC.
GERTSCH PRODUCTS INC.

SENSITIVE RESEARCH INST. CORP.
SANBORN COMPANY
KINTEL (formerly KAY LAB)
JOHN FLUKE MANUFACTURING CO.
BUDD STANLEY COMPANY, INC.
WEINSCHEL ENGINEERING CO.

Complete Recalibration Laboratory

SAMUEL K. MACDONALD, INC.

manufacturers representatives over 25 years
1531 SPRUCE STREET, PHILA. 2, PA.

Territory: Pennsylvania • New Jersey
Delaware • Maryland
Virginia • West Virginia
District of Columbia
Other Offices:
Pittsburgh
Baltimore
Washington, D. C.

160,000 prospects!

In *Electronics* magazine the advertiser talks to 46,000 paid subscribers, plus 3 or 4 interested potential customers receiving each copy for pass-along reading . . . approximately 160,000 prospects

**• CONTACTS •
FOR THE FIELD OF
ELECTRONICS**

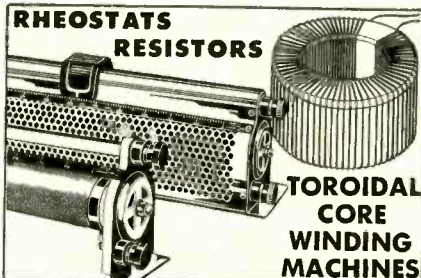

REX RHEOSTAT CO.
BALDWIN, N. Y.

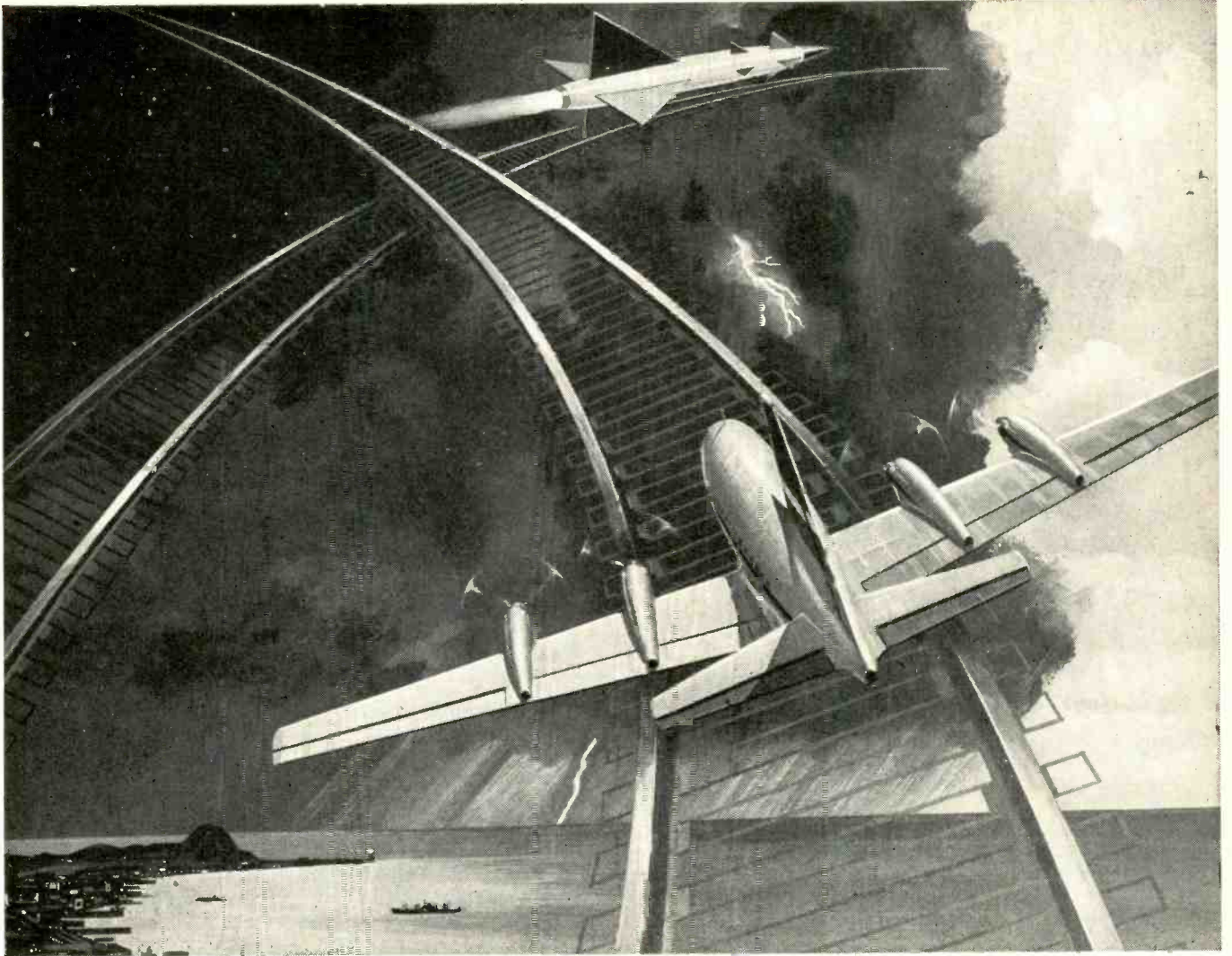

Pathfinders of the airy blue

ATRAN is an uncanny navigating device developed by Goodyear Aircraft engineers. It is so vital to our national security, the facts about it are still top-secret.

TO MASTER the mystic forces of the sky — that is the purpose and the plan of all Goodyear Aircraft engineers.

How well they succeed is evidenced by such miracle developments as ATRAN. This is the amazing all-weather navigator which unerringly pilots planes and missiles to targets thousands of miles away.

ATRAN is a good example of the challenge — and the opportunity—available at Goodyear Aircraft. Here are myriad outlets for your skill and imagination in airship design, electronics, radomes, fire control, cockpit canopies, radar structures, metals engineering — to name just a few.

At your disposal are the most modern engineering and research laboratories, including one of the largest computer laboratories in the world.

If you have faith in your ideas and confidence in your ability to make them work, a rewarding career can be yours at Goodyear Aircraft. Our continued growth

and diversification have required expansion of our engineering staffs in all specialties at both Akron, Ohio, and Litchfield Park, Arizona.

Salaries and benefits are, of course, liberal. And if you wish to continue your academic studies, company-paid tuition courses leading to advanced degrees are available at nearby colleges.

For further information on your career opportunities at Goodyear Aircraft, write: Mr. C. G. Jones, Personnel Dept., Goodyear Aircraft Corporation, Akron 15, Ohio.

They're doing big things at
GOOD YEAR
AIRCRAFT



ATRAN—T. M. Goodyear Aircraft Corporation, Akron 15, Ohio

EMPLOYMENT OPPORTUNITIES

**ENGINEERS
PHYSICISTS MATHEMATICIANS
Designers**

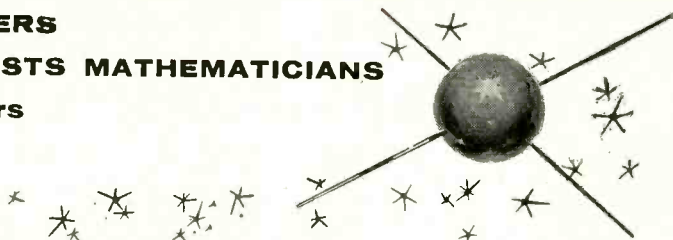

**Important NEW Developments
create Advanced
Positions
AT MELPAR**



Leading Research Laboratory in Suburban
Washington, D. C.

Several long range systems development programs have recently been awarded to Melpar, the execution of which require our engineers and scientists to pioneer into the no-man's-land of science. Of a highly advanced nature, these programs are vital to the Nation's defense and include *weapons systems evaluation* in a variety of fields and over 90 diversified projects in *electronic R & D*.

These long term assignments have created challenging openings which you are invited to consider. As a Melpar staff member you will become a member of a small project team charged with responsibility for *entire* projects, from initial conception to completion of prototype. Your advancement will be rapid, thanks to our policy of individual recognition, which promotes you on the basis of your performance, rather than age or tenure.

**Wire or phone collect, or write to:
Technical Personnel Representative**

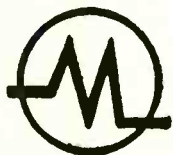
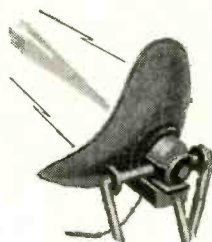

MELPAR Incorporated

A Subsidiary of Westinghouse Air Brake Company
3331 Arlington Boulevard, Falls Church, Va.
10 miles from Washington, D. C.

Openings Also Available at Our
Laboratories in Boston and Watertown, Massachusetts.

ENGINEERS

**CHANGING JOBS IS EASY . . .
MAKING THE RIGHT
CHANGE IS NOT**

It takes skill and experience . . . and Abbott's offers both. For 33 years we've been placing professional men where they have the best chance for success.

- CHIEF ENGINEER**—Missile development
- CHIEF ENGINEER**—Weapons systems
- SUPERVISOR PRODUCT ENGINEER**—Electro-mechanical
- SECTION MANAGER**—Fire control system
- ASSISTANT PROJECT ENGINEERS**—Radar
- PROJECT ENGINEER**—Servos, structures, mechanics
- DEVELOPMENT ENGINEER**—Control servos
- EXECUTIVE TRAFFIC MANAGER**—Major manufacturing background.

SALARIES—\$10,000 to \$20,000

Of course, your reply will be held strictly confidential, and our client companies will assume all expenses and our service charges. Please send 3 copies of your resume to Mr. George R. Sandel, Director.



EMPLOYMENT SPECIALISTS
333 Washington Street, Boston 8, Mass.

RATES

"Employment Opportunities"

Displayed—The advertising inch is \$25.25 per inch for all advertising appearing on other than a contract basis. Contract rates quoted on request.

An advertising inch is measured 7/8" vertically on a column—3 columns—30 inches to a page.

Subject to Agency Commission.

Undisplayed—\$2.40 per line, minimum 3 lines. To figure advance payment count 5 average words as a line.

Discount of 10% if full payment is made in advance for 4 consecutive insertions.

Not subject to Agency Commission.

Send **NEW ADS** to **ELECTRONICS**, Class. Adv. Div., P. O. Box 12, New York 36, N. Y., for November 1st Issue Closing October 3rd.

ENGINEERS AND SCIENTISTS, EE's, ME's, Physicists

anyone can
make claims,
but here's
proof

number 6 in a series of six

GENERAL ELECTRIC'S HEAVY MILITARY ELECTRONIC EQUIPMENT DEPARTMENT

*offers a finer
family environment*

Engineers with HMEE have a high JSQ (Job Satisfaction Quotient). And why not. Here is the excitement of working with the leader in the field; the tremendous variety of assignment; unsurpassed stability; 3-way professional development (including 100% graduate tuition refund); peace of mind of outstanding life, accident, and medical insurance programs; plus the satisfaction of knowing their families have a finer family environment in which to grow.

The HMEE engineer knows Syracuse (pop. 225,000) is:

1 A community with 31 elementary, 8 junior high, 7 senior high schools, 21 parochial schools; LeMoyné College and Syracuse University.

2 A community that by 1960 will have spent over \$1,000,000 a year for 10 consecutive years on new and improved school facilities. (And this does not include the multi-million dollar suburban school programs.)

3 A community whose 12 hospitals are to be augmented by a multi-million dollar medical research center.

4 A community with a diverse recreational establishment: (e.g. city sponsored summer ice skating, swimming and skiing instruction; AA baseball, major league basketball, championship collegiate football.)

5 A community close to the year-round hunting, fishing, swimming, boating, skiing, and picnicking facilities of the Great Lakes, the Thousand Islands, Adirondack Mountains, the Finger Lakes, and Niagara Falls.

We realize most discerning engineers don't consider recreational facilities to be *the* most important factor when considering a

new position. Yet, this thing called Family Environment does exist. We think it exists to an unusual degree in Syracuse, the home of HMEE.

*If you agree, consider our present
openings. We have more than
75 unfilled assignments in:*

MARINE AND ORDNANCE RADAR • GROUND
RADAR • SONAR • COMMUNICATIONS AND DATA
HANDLING • MISSILE GUIDANCE AND CONTROLS
AIRBORNE EQUIPMENTS

Here is one of them:

An engineer with creative and analytical abilities to work in development of low frequency (1-5 kc) transducers; lightweight, hi-power, reliable. Specific duties:

- Study and select means of energy conversion.
- Analytical design of transducer element and experimental verification of design.
- Combine elements in an array to give desired beam patterns, acoustic loading, etc.
- Follow construction through naval tests and shipboard mounting.
- Consult with systems engineers on tie-in problems with sonar systems.

Interested? Take a few moments to write us about your background, education, experience, and, most important, your *interests*. We'll respond promptly.

Write in complete confidence to: Mr. George B. Callender, Dept. 27J
HEAVY MILITARY ELECTRONIC EQUIPMENT DEPT.

GENERAL  ELECTRIC

Court Street, Syracuse, New York

ENGINEERS & PHYSICISTS *Electronics*

Information manual
about APL and its
current programs
now available

The Applied Physics Laboratory (APL) of The Johns Hopkins University is unique in that we are neither an industrial nor an academic organization, but rather a composite, having drawn freely from the methodologies of each.

For thirteen years APL has pioneered in guided missiles. Today we are engaged in a broad program of R & D for the Navy; in addition, we are responsible for technical direction of industrial and academic contractors in developing the Terrier, Talos and other major weapons and weapons systems. Our staff members enjoy not only the stimulus of association with their immediate colleagues at APL, but also with those in other organizations of considerable stature.

NEW 30-PAGE PUBLICATION

A few positions for senior engineers and scientists are now open. Information on our accomplishments and goals is available in a new 30-page publication, just off the press.

In it staff leaders representing each of the various disciplines and fields outline the nature of their programs. Information on our new laboratory in Howard County, Md. (equidistant between Baltimore and Washington) is also included, together with facts on the outstanding communities in which our staff members live.

Quantity is somewhat limited. May we suggest you send now to:
Professional Staff Appointments,

The Johns Hopkins University
Applied Physics Laboratory

8609 Georgia Avenue

Silver Spring, Md.

Engineers do better at
BENDIX PRODUCTS DIVISION

You can complete your
graduate study at

The **UNIVERSITY** of
NOTRE DAME



and work at one of these
stimulating assignments

- SYSTEMS ANALYSIS
- HYDRAULIC CONTROLS
- SERVOMECHANISMS
- ROCKET CIRCUITRY • HEAT TRANSFER
- MAGNETIC AMPLIFIERS
- COMPUTER APPLICATIONS
- NUCLEAR ENGINE CONTROLS
- TRANSISTORIZATION
- TESTING • VIBRATIONS
- STRUCTURES & STRESS
- ELECTROMECHANICAL DESIGN
- AIRCRAFT

If you are interested in a good starting salary and a successful engineering career, send a summary of your educational and practical background to:

Administrative Engineering
Bendix Products Division
203 Bendix Drive, South Bend, Ind.



*The broader the base
the brighter the future*

It just makes good sense—the range of job opportunities is far wider and advancement opportunities greater with a company operating on the sound basis of diversified engineering and manufacturing.



Electronics Engineers—

Is Leadership your target?

Your opportunities for personal and professional growth at Stromberg-Carlson are as big as your own initiative.

First, you'll get the recognition you deserve as a professional engineer. You'll *advance* fast because the company is *growing* fast (5-fold expansion since 1942).

You'll like the work, too—interesting, challenging assignments in many varied fields of engineering.

Living conditions in Rochester match the high calibre of the job assignments at Stromberg-Carlson. This is a beauti-

ful medium-sized city of fine homes, excellent schools, and vast facilities for culture and recreation—in an invigorating *four-season* climate.

Openings are now available for Electrical Engineers, from junior to senior engineering levels, in the fields listed at the right. Specialized experience desirable in transistorization, sub-miniaturization, and advanced circuitry.

To decide which field of work offers you the greatest opportunity for leadership, check the list, then send a letter or resumé to:

ARTHUR N. PAUL, Director of Technical Personnel



STROMBERG-CARLSON

A DIVISION OF GENERAL DYNAMICS CORPORATION

1405 N. GOODMAN STREET • ROCHESTER 3, N. Y.



Electronic Communication Systems

Telecommunications
Switching Circuits
Carrier Circuits

Data Processing

Solid State Digital Computer Systems

Electromechanical Design

Radar and Countermeasures

Missile Guidance Systems

Production Engineering

Navigation Systems

Systems Test Equipment

Industrial Engineers

Electromagnetic Wave Propagation

Antenna Design

Search Receiver Design

▶ OPPORTUNITIES at **Admiral**®

▶ Opportunity for Study

Pursue graduate and undergraduate studies at Chicago's great technological centers with Admiral's college tuition refund plan



University of Chicago



Northwestern University



Illinois Institute of Technology

▶ Opportunity for Relaxed Living

in Chicago's beautiful suburbs convenient to Admiral's main research center as well as Chicago's big-city attractions.

▶ Opportunity for Stimulating Work

Admiral's commanding lead in certain broad areas of military and civilian electronics has created a number of challenging opportunities. Match your special interests and past experience against the following check list.

COMMUNICATIONS—Design of airborne, automatic tuned communication systems.

COUNTERMEASURES—Design work in systems and equipment in a wide range of techniques.

RADAR—X band fire control. L band identification.

MILITARY TELEVISION—Receiver and transmitter design. Camera design. Transistor applications.

PALO ALTO RESEARCH—Development of new technologies opens door on a program of advanced research in aeronautical electronics. Experienced and intermediate level engineers send resume and salary requirements to R. M. Jones, Admiral Corporation, 901 California Ave., Palo Alto, Cal. . . . for California openings only.

Current openings offer excellent income and opportunity for rapid advancement. Complete employee benefit program includes retirement plan, paid group insurance, college tuition refund plan and ideal working conditions. On-the-job training for junior and intermediate engineers. Write, summarizing your education and experience to John Harlan, Personnel Division.

Admiral Corporation

3801 W. ARMITAGE AVE., CHICAGO 47, ILL.

P
H
O
P
H
O
E
N
I
X
N
I
X

At the crossroads of opportunity
for men with vision in
Electronic Engineering

GOODYEAR AIRCRAFT CORPORATION

ELECTRONIC LABORATORY

Arizona Division
Litchfield Park, Arizona

A Subsidiary of the
GOODYEAR TIRE & RUBBER CO

**WE HAVE OPENINGS
IN OUR MODERN
LABORATORIES FOR
ADVANCED ENGINEERS
IN ELECTRONIC RESEARCH**

Long range research and
development projects

University of Arizona graduate
studies available under company
financed evening courses.

*Leisure Living At Its Best
"In the Valley of the Sun"*

Modern Inexpensive Housing

Send resume to: A. E. Manning

Engineering and Scientific Personnel

GOODYEAR AIRCRAFT

LITCHFIELD PARK
PHOENIX, ARIZONA

Similar opportunities available in
our
Akron, Ohio Laboratory

BURROUGHS ALWAYS NEEDS *Good* ENGINEERS

MAN plus a Computer equals a GIANT!

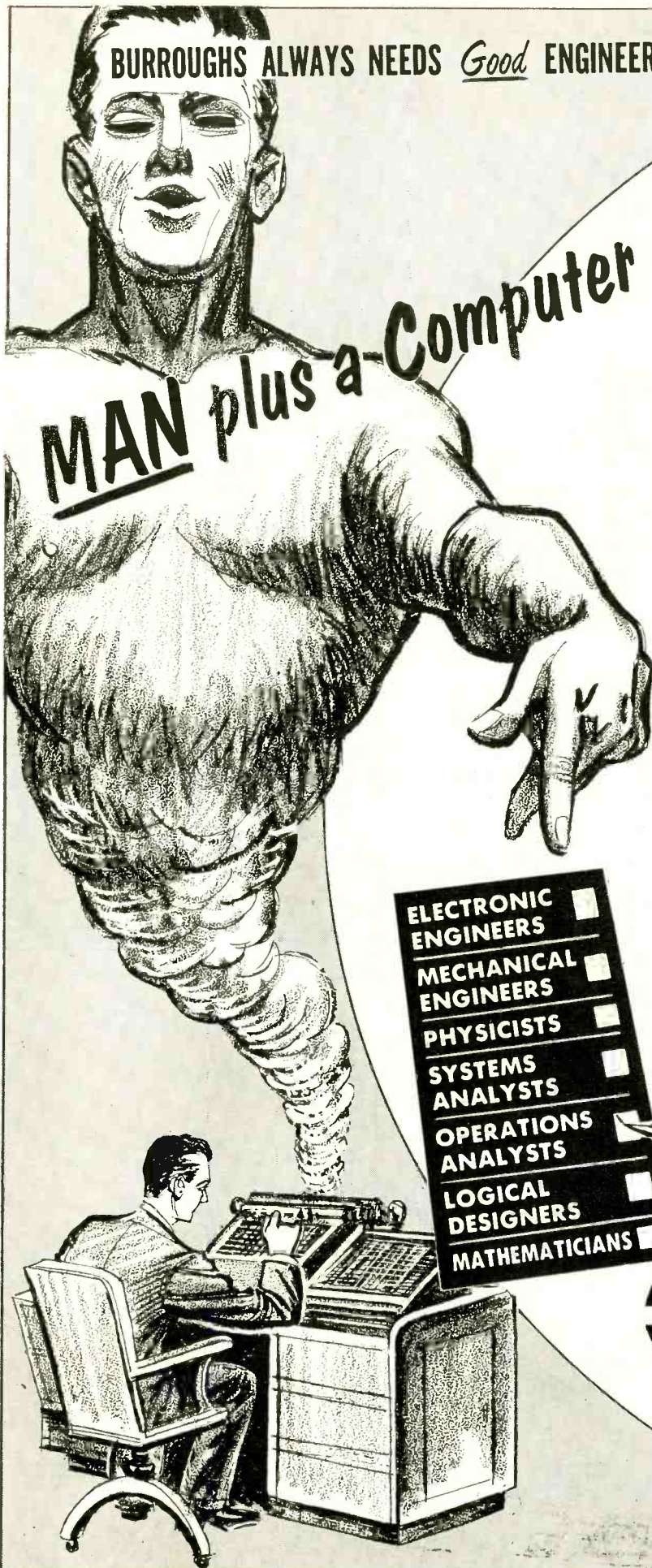

Teamwork is an essential ingredient of all successful activity, be it between man and man, man and beast or man and the machinery which his mind creates. The man-computer team is the latest of modern industry's unbeatable combinations. Separately, each is restricted in scope of activity and accomplishment. Together, as a working team, they add up to nothing less than a giant. Keeping the varied abilities of himself and the computer in balance, is scientific man's control over this potent new force that is rapidly shaping much of today's industrial philosophy. By harnessing the computer's fantastic speed and accuracy, he is solving heretofore impossible problems and opening roads to virgin fields of advanced thought.

Engineering and improving upon these new electronic devices is the special job of our creative teams at the Research Center. You, too, can be a part of this program of planned progress that has made Burroughs the foremost name in computation.

Our present needs are for people experienced in Electronic Digital Computers, Guided Missiles, Radar, Fire Control Systems and allied areas of electronics, with specific emphasis on men who by education or experience can qualify for the openings listed herein.

- ELECTRONIC ENGINEERS
- MECHANICAL ENGINEERS
- PHYSICISTS
- SYSTEMS ANALYSTS
- OPERATIONS ANALYSTS
- LOGICAL DESIGNERS
- MATHEMATICIANS



Write or Telephone
M. E. JENKINS
 Placement Manager
PAOLI 4700

For Interview at Your Convenience

BURROUGHS CORPORATION

Research Center

PAOLI, PA.

*On Philadelphia's Main Line,
 Near Historic Valley Forge*

ENGINEERS • PHYSICISTS

*Big things
are happening*

in

MOTOROLA's

**Chicago Civilian Research
and Development Laboratories**

- Industrial Communications Equipment
- Consumer Products

Here is opportunity *unlimited* for men who like challenges and the rewards that go with accomplishment in non-military engineering assignments. This is your opportunity to advance your career while working in well instrumented laboratories and enjoying the benefits from association with men of the highest technical competence. There are many liberal employee benefits, including an attractive profit sharing plan.

You'll like living in one of the beautiful suburbs of the playground of the midwest, where there are endless social, cultural, and educational activities to choose from the year-round. Exciting life or quiet life—Chicago offers either.

Salary levels are open and commensurate with ability. Directly related engineering experience is *not needed*.

POSITIONS AVAILABLE IN:

- Two-way communications • Portable communications • Radio & TV (color)
- Component engineering • Transistor research and application • Microwave systems • Servo-mechanisms • Field engineering • Communications Sales Engineering • Field service engineering

For full discussion of these opportunities — Write:

**Mr. L. B. Wrenn, Dept. A
MOTOROLA, INC.
4501 Augusta Blvd., Chicago 51, Ill.**



MOTOROLA

ENGINEERS

**DOES YOUR CAREER
NEED A CATALYST?**

Catalysis is one way to describe Abbott's service for professional men. We supply the ingredients—placement skill and experience—needed to set off the reaction that will take you to a better job. For 33 years professional men have relied on Abbott's detailed knowledge of the employment market for placement with America's leading companies.

CHIEF DEVELOPMENT ENGINEER
—Electronic tubes

ADVANCED DEVELOPMENT ENGINEER—Microwave tube

CHIEF ENGINEER — Product research and development

ENGINEERING DEPT HEAD—Elec instrument

DEVELOPMENT ENGINEERS—Communications systems

SENIOR PROGRAMMERS — Computers

SALES ENGINEERS—Microwave tubes

SALARIES—\$8,000 to \$18,000

Thirty-three years of confidential service, nationally recognized by leading companies as the personnel representative for engineering, scientific and administrative people.

OUR CLIENT COMPANIES WILL ASSUME OUR SERVICE CHARGES. Please send 3 copies of your resume to Mr. George S. Sandel, Director.



EMPLOYMENT SPECIALISTS
333 Washington Street, Boston 8, Mass.

**ELECTROMECHANICAL
ENGINEER**

This industrial research organization has an opening on its staff for a man skilled in the design of electromechanical devices and the construction of prototypes for specific industrial applications. Degree in engineering or mechanical engineering required. Some industrial experience in electrical engineering helpful.

Send resume to John A. Stowe

Arthur D. Little, Inc.

30 Memorial Drive
Cambridge 42, Massachusetts

MOUNTAIN VIEW, CALIFORNIA

- ▶ **Reconnaissance Systems Laboratory**
Newest of Sylvania's Mountain View facilities offers opportunities for research, development and fabrication of military electronic reconnaissance systems for detection and surveillance of electromagnetic radiation in and around the earth.
- ▶ **Electronic Defense Laboratory**
Research, development and fabrication of electronic countermeasures systems and equipment.
- ▶ **Microwave Physics Laboratory**
Research and advanced development in guided microwave control devices utilizing ferrites, gaseous electronics, ferroelectrics and paramagnetic resonance.
- ▶ **Microwave Tube Laboratory**
Research, design, development and production of Klystron, Traveling Wave tubes and Backward Wave oscillators.

Openings in the following fields:

- Operations Research
- Guided Microwave Devices
Research & advanced development
- Systems Analysis
- Systems Development
- Design & Development
Transmitters, receivers, components, antennas
- Data Handling
- Electronic Packaging
- Field Engineering
- Mechanical Engineering
- Microwave Tubes
Research, design & development

For further information on these West Coast opportunities, send your resume to

J. C. Richards
P.O. Box 1296
Mountain View, Calif.

ENGINEERS and SCIENTISTS

**Sylvania
Now
Selecting
Men
for Advanced
Electronic
Research and
Development
in East
and West
Coast
Locations**

East or West, Sylvania Laboratories are in the forefront of advanced electronic research and development, offering positions to men capable of important scientific contributions...and interested in the rewards this growing company offers for creative work.

Salaries are entirely commensurate with background and ability. Benefits are broad, and include ample provision for graduate study. Opportunities for growth are genuine.



SYLVANIA
SYLVANIA ELECTRIC PRODUCTS INC.

WALTHAM, MASSACHUSETTS▶ **Missile Systems Laboratory**

Openings for senior men in weapons systems analyses, design, development & management.

- High Power Radars
- Electrically Scanned Antennas
- Missiles & Guidance
- Operations Research
- Information Theory
- Data Processing
- Electronic Physics

▶ **Avionics Laboratory**

- Electronic Systems Design & Development
- Microwave & Antenna Research & Development
- Electronic Packaging & Test Design
- Computer Systems Engineering & Logical Design
- Technical Coordination & Liaison

▶ **Applied Research Laboratory**

- Operations Research
- Communications Theory
- Automatic Controls
- Airborne Interceptor Radar
- Radar Simulators
- Missile Electronics

For further information on these East Coast opportunities, send your resume to

Graydon A. Thayer
100 First Ave.,
Waltham, Mass.

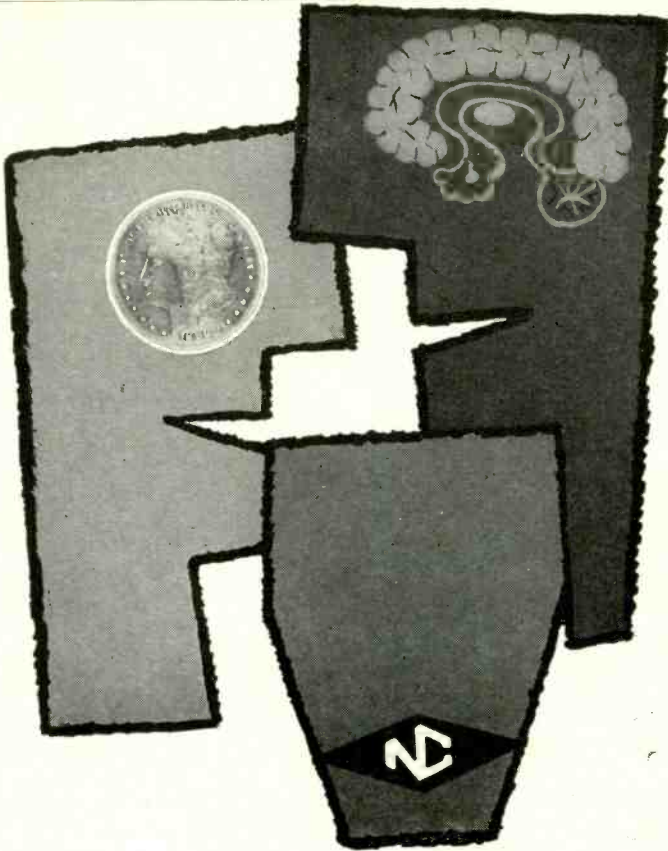

ENGINEERS & SCIENTISTS

**WE CAN OFFER YOU
THREE THINGS:**

HARD WORK

GOOD PAY

NATIONAL'S REPUTATION

That the work is hard, the record shows. It's difficult enough to develop a workable concept of harnessing atomic resonance for frequency control, but it's harder still to engineer the concept into a practical, reliable apparatus like the Atomichron—a unit with a stability of 1 in 10^{10} .

That the pay is good, the record shows, too. For one doesn't keep some of the best minds in electronics with promises. Men who develop high information density receivers of the sort that are used in astrophysics and geodesy find very tangible rewards at National.

As for reputation, National has maintained one for good engineering and fine craftsmanship in electronics since 1914. And anyone familiar with scatter systems and signal processing equipment knows that National isn't content simply to rest on laurels.

If you're one of the rare ones, to whom such things are sufficient reward—if you're interested more in the solidity of good work than in a parklike atmosphere or walnut desks—and if you have the courage and the ability to tackle some of the most difficult and intriguing problems in modern physics and electronics, then you owe it to yourself to contact National.

Send your resume today to F. M. Swope. It will be read by engineers and you will get a reply from an engineer.



NATIONAL COMPANY, INC.

61 Sherman Street • Malden, Mass.

**FOR RATES
OR INFORMATION**

About Classified
Advertising,

Contact

*The McGraw-Hill
Office Nearest You.*

ATLANTA, 3
1301 Rhodes-Haverty Bldg.
JACKSON 3-6951
R. POWELL

BOSTON, 16
350 Park Square
HUBBARD 2-7160
J. WARTH

CHICAGO, 11
520 No. Michigan Ave.
MOHAWK 4-5800
W. HIGGINS
J. BRENNAN

CINCINNATI, 37
2005 Seymour Ave.
ELMHURST 1-4150
F. ROBERTS

CLEVELAND, 15
1510 Hanna Bldg.
SUPERIOR 1-7000
W. SULLIVAN

DALLAS, 2
901 Vaughan Bldg.
RIVERSIDE 7-5117
G. MILLER

DETROIT, 26
856 Penobscot Bldg.
WOODWARD 2-1793
W. STONE

LOS ANGELES, 17
1125 W. 6 St.
MADISON 6-9351
C. DYSINGER
D. McMILLAN

NEW YORK, 36
500 Fifth Ave.
OXFORD 5-5959
S. HENRY
D. COSTER
R. LAWLESS

PHILADELPHIA, 3
17th & Sansom St.
RITTENHOUSE 6-0670
H. BOZARTH
R. EDSALL

ST. LOUIS, 8
3615 Olive St.
JEFFERSON 5-4867
F. HOLLAND

SAN FRANCISCO, 4
68 Post St.
DOUGLAS 2-4600
R. ALCORN

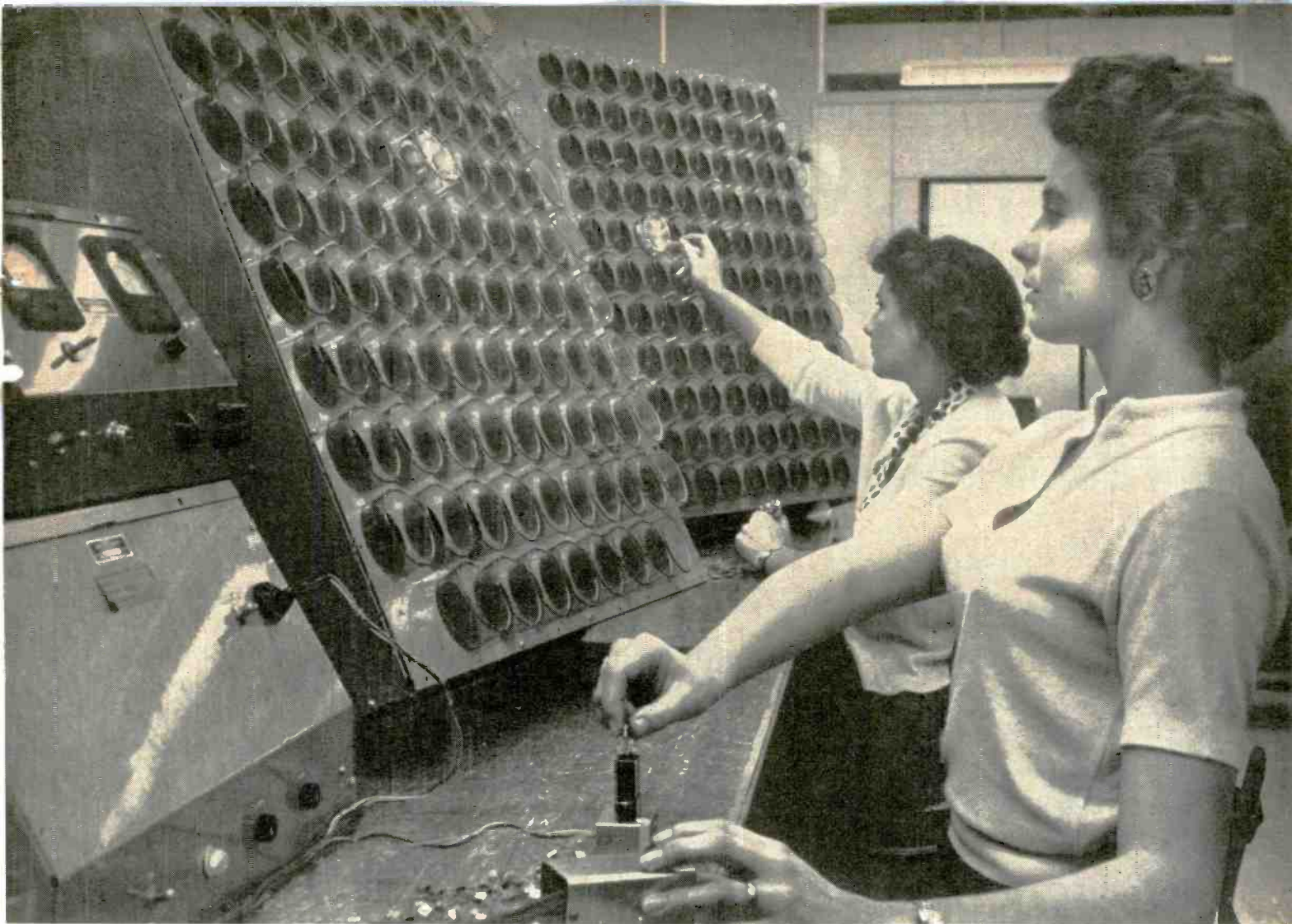

lighting a transistor's way home . . . automatically!

Homely articles like water glasses and light bulbs are used in this automated selector built by TI mechanization engineers. Now, non-technical TI-ers close a circuit with a transistor just off the production line; wait a second for the circuit to evaluate it; then pop the unit into the glass that lights up. This "matching" operation is another advance toward automation of semiconductor manufacture . . . to free technical personnel for other important duties . . . to help Texas Instruments produce more electronic components and apparatus at lower cost.

This special application is typical of the many special engineering opportunities now open at Texas Instruments . . . openings for industrial engineers, machine designers, automation engineers, and other specialists to fill a continuing need to develop the mechanics for making things that have never been made before. Eighty per cent of today's TI products are new to its production lines within the last 3 years.

You are invited to join one of the many expanding programs at 27-year-old Texas Instruments . . . where recognition of individual achievement has contributed to TI's twentyfold growth in the last ten years — to a current

\$70 million volume. Advanced personnel policies include company-sponsored educational assistance, profit sharing, insurance, and retirement programs.

Texas Instruments plants are within Dallas, yet away from downtown traffic . . . within 5 minutes of fine residential areas, churches, and public and private schools. Your home will be within 15 minutes of year-around recreational, amusement and cultural activities.

SEMICONDUCTORS AND OTHER COMPONENTS — Design engineering, industrial engineering, production coordination, product evaluation, mechanization for making transistors, diodes, rectifiers, resistors, panel instruments. Write W. C. Spaller.

ELECTRONICS AND ELECTROMECHANICAL APPARATUS — Radar, sonar, infrared, navigation, magnetics, telemetering, communications, computers, transformers. Write R. E. Houston.

RESEARCH — Ph.D. level for research: semiconductor materials and devices, ferromagnetics, infrared, high speed data reduction, etc. **ADMINISTRATION** — Engineers for: production, planning, purchasing, cost analysis, etc. Write W. D. Coursey.

keep an eye on TI



TEXAS INSTRUMENTS
INCORPORATED
6000 LEMMON AVENUE DALLAS 9, TEXAS

Microwave Tube Design Engineers

Investigate the unusual opportunities now being offered in our expanding engineering program at . . .

Westinghouse

ELECTRONIC TUBE DIVISION

ELMIRA, N. Y.

- MAGNETRON TUBE DESIGNERS
- TRAVELING WAVE TUBE DESIGNERS
- DESIGNERS of other
MICROWAVE TUBES and DEVICES

Immediate opportunities also available for design engineers on electronic tubes such as CATHODE RAY, CAMERA, POWER and RECEIVING TUBES.

Previous experience in RESEARCH, DESIGN, or DEVELOPMENT desirable.

Write or send resume to Mr. W. Kacala, Supervisor of Industrial Relations, Box 284, Dept. M-3U, Elmira, N. Y., or phone collect Elmira 9-3611. Evenings or weekends, phone 2-2139.

Westinghouse
ELECTRONIC TUBE DIVISION ELMIRA, NEW YORK



To *EMPLOYERS* *who advertise* *for MEN:*

When there are many applicants for a single position it frequently happens that the only letters acknowledged are those of the most promising candidates. Others may not receive any indication that their letters have even been received by a prospective employer much less given consideration. These men often become discouraged, will not respond to future advertisements, and sometimes question their bona fide character.

Every advertisement printed in the Employment Opportunities Section is duly authorized.

It will help to keep our readers interested in this advertising if you will acknowledge every application received, even if you merely return the letters of unsuccessful applicants with, "Position filled, thank you" written or stamped on them.

We suggest this in a spirit of cooperation between employers and the men replying to employment advertisements.

Classified Advertising Division
McGraw-Hill Publishing Co., Inc.

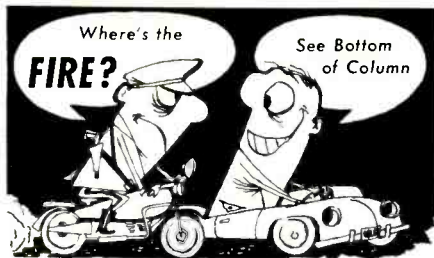

Electronic Engineers
 Mechanical Engineers
Advancement... Security
...Responsibility

Professional personnel needed at all levels to fill responsible openings at this steadily expanding Division of Bendix Aviation Corporation. It's your chance to get specific assignments at the peak of the art in ELECTRONICS and MICRO-WAVE DEVELOPMENT and DESIGN. Good salaries, all employee benefits, ideal suburban living conditions. Whether you be a Department Chief or a Junior Engineer with less than one year's experience, we have the opening and the shoes for you to fill.

Address: Chief Engineer Dept. H



York, Penna. York 47-2611

Fire up your income and your opportunities at ASCOP where you will find red hot opportunities in the fields listed below. Call or write, Technical Personnel Manager.

- ELECTRONIC ENGINEERS**
 Skilled In
 Data Acquisition
 Data Handling
 RF Techniques
 Circuit Design
 Transistor Applications



16 Wallace Road, Princeton, N. J.
 Phone PLainsboro 3-4141
 Dept. H, 15551 Cabrito Road
 Van Nuys, Calif.
 Phone State 2-7030

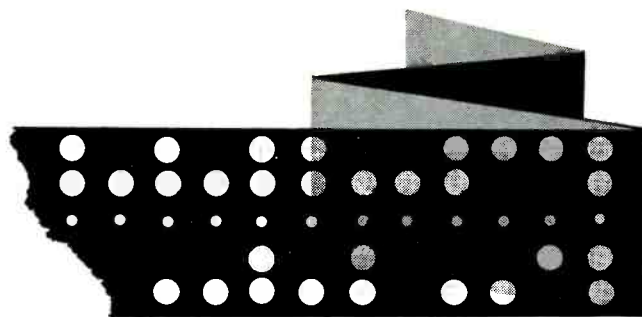

computers

Northrop needs computing analysts, qualified either by experience or education, to work in their ever-expanding Computer Center at Hawthorne, in Southern California. If you are qualified, there is an interesting position as well as a bright future for you at Northrop.

Applied mathematicians and engineers are needed as computing analysts for assignment to Northrop's analogue computing facility, as well as their enlarged digital electronic computer department which provides unparalleled service in the practical solution of complex engineering problems.

Your assignments will be fresh and stimulating, and you will have frequent opportunities to advance in your field. Besides an excellent salary, you will receive company-paid benefits that are unexcelled in the entire aircraft industry. Your colleagues will be the brilliant engineers who developed the USAF-Snark SM-62 intercontinental guided missile and the new USAF-Northrop T-38 supersonic twin-jet trainer. These men are congenial and helpful, and will respect your ability and individuality just as Northrop expects them to do. And you and your family will fully enjoy Southern California's many attractions and its delightful all-year climate.

If you qualify for any phase of computer research, design, or application, we invite you to contact the Manager of Engineering Industrial Relations, Northrop Division, Northrop Aircraft, Inc., OREGON 8-9111, Ext. 1893, or write to: 1041 East Broadway, Dept. 4600 L, Hawthorne, Calif.



NORTHROP

Northrop Division of Northrop Aircraft, Inc.
 BUILDERS OF THE FIRST INTERCONTINENTAL GUIDED MISSILE

5-A-143

**PRODUCT
ENGINEERS**

1. For design of production test equipment for electromechanical systems.
2. To supervise test equipment assembly and repair groups.

**PROJECT and
FIELD ENGINEERS**

*Mechanical,
Electrical,
Physicist*

For engineering and development of advanced airborne navigation systems and related test equipment.

Excellent opportunities with Kollsman, designers of America's finest aircraft instruments—a firm small enough to provide quick recognition, large enough to assure stability.

Please send resumes to
T. A. DeLuca



kollsman INSTRUMENT CORPORATION

60-08 45th AVENUE, ELMHURST, NEW YORK • SUBSIDIARY OF *Standard* COIL PRODUCTS CO. INC.

EMPLOYMENT PROBLEM?

When you are in need of specialized men for specialized jobs, contact them through an employment ad in a McGraw-Hill Publication.

Management, Engineering, Production, Maintenance, Selling . . . these represent broadly the principal functions in business and industry. And it is principally to the men and executives who fill key jobs in these important divisions that McGraw-Hill publications are directed.

McGraw-Hill Domestic Publications

- AMERICAN MACHINIST
- AVIATION WEEK
- BUSINESS WEEK
- CHEMICAL ENGINEERING
- CHEMICAL WEEK
- COAL AGE
- CONTROL ENGINEERING
- CONSTRUCTION METHODS AND EQUIPMENT
- ELECTRICAL CONSTRUCTION AND MAINTENANCE
- ELECTRICAL MERCHANDISING
- ELECTRICAL WHOLESALING
- ELECTRICAL WORLD
- ELECTRONICS
- ENGINEERING AND MINING JOURNAL
- ENGINEERING NEWS-RECORD
- FACTORY MANAGEMENT AND MAINTENANCE
- FLEET OWNER
- FOOD ENGINEERING
- NATIONAL PETROLEUM NEWS
- NUCLEONICS
- PETROLEUM WEEK
- POWER
- PRODUCT ENGINEERING
- TEXTILE WORLD

THE MEN YOU NEED ARE
THE MEN WHO READ THE

McGraw-Hill PUBLICATIONS

330 West 42nd St.,
New York 36, N. Y.



ENGINEERS & SCIENTISTS

*If Your Goal Is
Professional Maturity & Technical Excellence—
Consider **Magnavox***

When uncompromising excellence is required in the design and development of radar, communications and navigation systems, computers, and electro-mechanical devices, you'll hear the name of Magnavox . . . because Magnavox has built its reputation on quality, integrity, originality, for forty-six years. Engineers who share this devotion are now offered important opportunities at all levels in the following areas:

- COMMUNICATIONS & NAVIGATION**—airborne, shipboard and ground equipments.
- RADAR**—airborne equipments and fire-control systems.
- COMPUTERS**—analog and digital techniques.
- ELECTRO-MECHANICS**—synchros, speakers, and components.

Choice of three locations: home office and headquarters R & D Laboratory in Fort Wayne, Indiana, described by Look Magazine as the happiest city in the United States; our brand-new electronics laboratory in Urbana, home of the University of Illinois; or our laboratory in Los Angeles, California.

Please send resume to:
Mr. Robert B. Wright, Technical Personnel Director

THE MAGNAVOX CO.
FORT WAYNE 4, INDIANA

S.E.E. GIVES**To ENGINEERS**

Free Service in providing contacts for choice positions available now. Send resume.

To EMPLOYERS

Automatic access to a wide variety of desirable talent—now and regularly—from wide geographical locations.

Let us demonstrate immediate effectiveness.

**SCIENTISTS, ENGINEERS
& EXECUTIVES, Inc.**

1026 Seventeenth St., N.W.
Washington 6, D. C. — METropolitan 8-2749

ENGINEERS

If you have been looking for an Employment Agency that is skilled in the STATE OF THE ART of Technical Recruitment and RELIABILITY OF INFORMATION concerning positions, why not communicate with us at once! ALL POSITIONS FEE PAID.

FIDELITY PERSONNEL SERVICE
1218 Chestnut St. Phila. 7, Pa.
Specialist in Aviation, Electronics and Nuclear

**NEW DIVISION
ELECTRONIC TUBE COMPANY**

SALARIES TO \$16,500
Our client with a 500 PCT. growth during last 5 years will hire 20 capable engineers and are urgently in need of now (5) electrical or mechanical engineers or physicists, on the M.S. or PHD level having wide scientific perspective in the field of chemistry, metallurgy and ceramics. Company assumes all expenses.

MONARCH PERSONNEL Chicago 4, Illinois
28 E. Jackson Blvd.

**ELECTRONICS ENGINEER
\$10-\$14,000.00 Yr.**

Well known company seeks Supervisory Engineers with experience in Computer & Analytical devices. Should have Executive ability & Technical background.

For Confidential & Prompt Service
Send resume to:
J. COOPER
202 S. State—Suite 1100 Phone: Harrison 7-6337
Chicago, Illinois

QUICK SOLUTION to MAN POWER PROBLEMS

through the EMPLOYMENT OPPORTUNITIES SECTION of this publication. The market place for those offering or wanting the services of men on engineering, technical and executive level.

This section offers a quick, effective solution to your man power problems. Because its readership is confined to just the type of men you need, waste circulation is avoided . . . You reach only the men you want.

**CLASSIFIED ADVERTISING
DIVISION****ELECTRONICS**

330 WEST 42ND ST.
NEW YORK 36, N. Y.

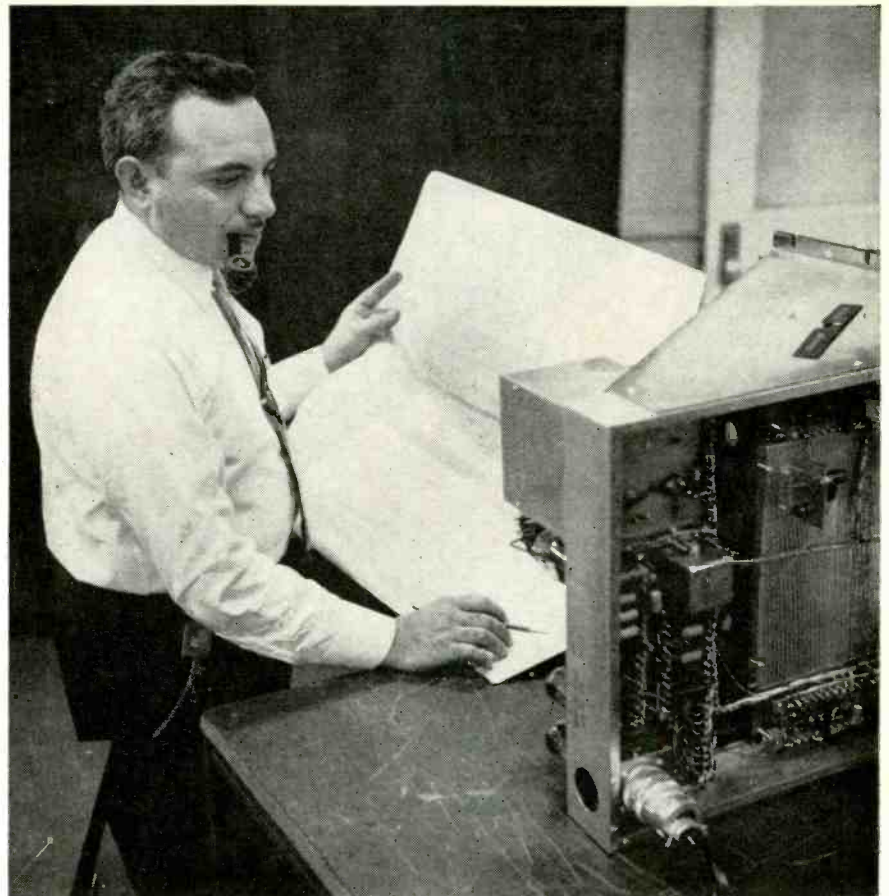

One engineer does not make a company but he and his fellows are our most important asset. Whether he is engaged in design, development or applications engineering, he is a working engineer striving to produce or help create a better product in the field of electronics and telephony.

This is our principal concern, this business of producing better products for the great system of electronics and communications which is the International Telephone & Telegraph Corporation. To do our share requires the constant strengthening of our engineering staff. This means the most effective utilization of the skills, talents and leadership of our engineers. It means a constant search for good engineers. It means that we must daily try to convince you, the engineer choosing a company in which to fashion a career, that Federal offers career opportunities that will challenge your capacities, tax your professional skills and provide you satisfaction, reward and compensation for your efforts.

We earnestly invite you to inquire about careers at Federal. All you need do is write to Mr. Joseph L. Connington, Technical Placement Director.

Federal Telephone and Radio Co.

A Division of International Telephone & Telegraph Corp.
100 KINGSLAND ROAD, CLIFTON, N. J.

ENGINEERS for GUIDANCE and NAVIGATION SYSTEMS

ADVANCED ENGINEERING

**FOR
CONTEMPORARY
ENGINEERS**

...the ability to think
ahead of textbook engineering
is a prime qualification
at Sanders Associates.

Please address inquiries to D. H. Johnson.

SANDERS ASSOCIATES, INC.
NASHUA NEW HAMPSHIRE



**DO YOU NEED
ENGINEERS
WITH EXPERIENCE IN:**

- Research
- Development
- Design
- Instrumentation
- Servomechanisms
- Missiles
- Audio Systems
- Control Systems
- Radar
- Computers
- Transistors
- Other Fields

Place an "ENGINEERS WANTED" advertisement in this EMPLOYMENT OPPORTUNITIES SECTION of ELECTRONICS. It's an inexpensive, time saving method of selecting competent personnel for every engineering job in the electronics industry. The selective circulation of ELECTRONICS offers you an opportunity to choose the best qualified men available throughout the industry.

*For Rates and Information
Write:*

**CLASSIFIED ADVERTISING DIVISION
MCGRAW-HILL PUBLICATIONS
P. O. Box 12
New York 36, N. Y.**

CAREER OPPORTUNITIES



- Navigation Systems
- Communication Systems
- Servos
- Transistors
- Transmitters
- Receivers
- Antennas

With a company making premium grade electronic equipment for aircraft for almost 30 years. Located in the beautiful lake region of Northern New Jersey, less than 35 miles from New York City.

- **TRANSISTOR CIRCUIT PROJECT ENGINEER**
- **METHODS ENGINEERS**
- **GYRO DESIGN ENGINEER**
- **TECHNICAL WRITERS**
- **TRANSMITTER DESIGN ENGINEERS**
- **CHIEF ENGINEER TO HEAD SERVO AND INSTRUMENT DEPARTMENT**
- **ENGINEERING CONTROL DEPARTMENT HEAD**

Enjoy the pleasure of working in a new laboratory in a company whose products are known as the highest quality in the industry.

Write or call collect: Personnel Manager
AIRCRAFT RADIO CORPORATION
Boonton, N. J. DE 4-1800 — Ext. 238

**SUPERVISOR MARKET and
NEW PRODUCT RESEARCH
INSULATING MATERIALS**

The Position: To develop and lead market research, technical service, and other commercial programs to establish new products in the insulating materials industry. You will supervise our technical service activities on new industrial laminates and other new products.

Qualifications: An electrical engineering background (chemical knowledge helpful) with a strong and varied experience in electrical insulation or electronics. You are creative and possess business experience translating new product ideas into successful commercial sales.

Opportunities: Our planned growth programs and flexible salary structure provide unexcelled opportunities in the years ahead.

Mr. Robert E. Dunham
Department #13
The Richardson Company
27th Avenue & Lake Street
Melrose Park, Illinois

REPLIES (Box No.): Address to office nearest you
c/o This publication Classified Adv. Div.
NEW YORK: P. O. Box 12 (36)
CHICAGO: 520 N. Michigan Ave. (11)
SAN FRANCISCO: 68 Post St. (4)

SELLING OPPORTUNITY WANTED

Upstate New York. Seeking additional major line. Calling on all electrical industries. RA-6066, Electronics.

electronic engineers

- DESIGN ● DEVELOPMENT
- FIELD ENGINEERING

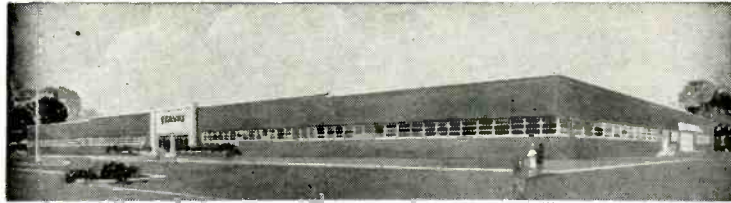

STAVID is engaged in design, development, modification, installation, testing and evaluation of military electronic and electro-mechanical equipment.

STAVID ENGINEERS possess an enviable reputation and are noted for their competence and diversification. You can fulfill your professional ambitions at STAVID.

(New Plant now under construction — 65,000 square feet)

STAVID offers challenging permanent field assignments in New Jersey, the Boston, Mass. area, and other desirable locations throughout the U. S.

Call for interview arrangement or send complete resume to: Personnel Dept.

Opportunities available in the following fields for those persons with BE or MS degree with minimum of 3 years' experience or equivalent:

- Fire Control Radar
- Missile Electronics
- Coils, Transformers
- Transistors
- Filter Networks
- Instrumentation
- Microwave
- Servos
- Antennas
- Computers
- Simulators
- Telemetry
- Navigation Systems



**STAVID
ENGINEERING, INC.**

Route 22, Plainfield, N. J. Plainfield 7-1600

ENGINEERS

*Find out
the
full scope
of
opportunities
in
Electronics
at.....*

Practically any professional interest an electronics engineer may have will find a creative outlet at General Electric's Electronics Park, as you will see by the fields in the coupon on the right. But no mere listing can give you a complete picture of the scope of work at our operation here.

Electronics Park is a birthplace of new concepts and ideas in electronics. Engineers here are continually working on new problems... creating new components, systems, equipment... from which whole new product lines are developed. And as new lines are created, new independent G-E departments are formed. The nucleus of such new departments are often drawn from the development staff at Electronics Park... and the engineer may either follow his "brain-child" or begin anew on the spark of another idea.

Why not check your special professional interest on the coupon and send it to us at Electronics Park. A bachelor's or advanced degree in Electrical or Mechanical Engineering or Physics, and/or experience in electronics is necessary to qualify for current openings here.

GENERAL  ELECTRIC

TO GENERAL ELECTRIC

Electronics Park
Syracuse, N. Y.
ATT.: Technical Personnel Dept.

I AM INTERESTED IN

- ... Advanced Development
- ... Design
- ... Field Service
- ... Technical Writing
- ... Sales

IN THE FIELD OF...

- ... Military Radio & Radar
- ... Multiplex Microwave
- ... Mobile Communications
- ... Semiconductors
- ... Electronic Components
- ... Computers
- ... Tubes
- ... Television Receivers
- ... Industrial Television
- ... Antennae

FROM:

NAME _____

ADDRESS _____

DEGREE _____

Communications Engineer

Graduate Electrical Engineer capable of assuming responsibility in the solution of various technical problems related to communications systems in the electric utility field. Applicant preferably should have experience in layout, design, selection and application of communication and related equipment.

Please send complete confidential resume to Personnel Relations Dept.

E B A S C O
Services Incorporated
2 Rector St.—New York

NEEDED:

A SALES MANAGER

to organize and direct the activities of an expanding staff of sales engineers. This opportunity is with a 16-year-old manufacturer of electronic components in New England. It calls for an able administrator and it will afford him plenty of scope to make intelligent use of his personal drive and initiative. Starting salary between \$12,000 and \$15,000 with excellent earnings potential. Candidates should have a degree in electronic engineering or its equivalent in practical experience. Address your letter of application to:

P-6089, Electronics
Class. Adv. Div., P. O. Box 12, N. Y. 36, N. Y.

YOUR ORGANIZATION

Is it complete?
Are you expanding it?
Making Replacements?

Naturally, you are anxious to secure the most suitable man or men available. You want men with the special training that will make them an asset to your organization. You can contact such men through an advertisement in this Employment Opportunities Section of ELECTRONICS.

Classified Advertising Division

ELECTRONICS

P. O. BOX 12
New York 36, N. Y.

Inventors and Inventions
Helps engineers and technicians make money inventing. Shows many ways profitable inventions originated. Pointers on protecting, patenting, marketing inventions. By C. D. Tuska, RCA Patent Expert. 173 pp., illus., \$3.75

Patent Notes for Engineers
Manual for inventors, especially engineers, technicians, in industry. Shows what makes an invention patentable. Covers relations with employer, patent attorney; infringement, etc. By C. D. Tuska. 7th Ed., 198 pp., illus. \$4.00

American Institute of Physics Handbook

DWIGHT E. GRAY, Coordinating Editor
Compiled by more than 90 Experts. 8 Big Sections. Over 1500 pages, 6 x 9, illustrated, \$15.00

With the help of this Handbook you can now save yourself hours of searching through scattered references for the fact or formula you need. Here, instantly available, are the basic physical data so frequently needed in scientific, engineering, and research endeavors. Sections cover mechanics, acoustics, heat, electricity and magnetism, optics, atomic and molecular physics, and nuclear physics.

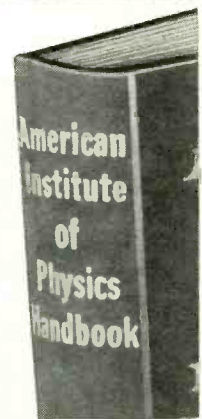

McGraw-Hill Book Co., Dept. FL-327 W. 41st St., New York 36, N. Y.

Send me book(s) checked below for 10 days' examination on approval. In 10 days I will remit for book(s) I keep, plus few cents for delivery costs, and return unwanted book(s) postpaid. (We pay delivery costs if you remit with this coupon—same return privilege.)

AIP—Amer. Inst. of Physics Hdbk., \$15.00
 Fink—Television Engg. Hdbk., \$18.00
 Tuska—Inventors and Inventions, \$3.75
 Tuska—Patent Notes for Engrs., \$4.00 (Print)

Name

Address

City Zone State

Company

Position

For price and terms outside U. S. write McGraw-Hill Int'l., N.Y.C. FL-

TELEVISION ENGINEERING HANDBOOK

Covers the entire subject of television technology, including fundamentals as well as practical design data for transmitters, receivers, and networks. The entire field of color television has been treated right up to date. There is new material on colorimetry,

video waveforms and spectra, the design of wideband amplifiers, and of deflection systems. Prepared by 33 specialists. Edited by Donald G. Fink, Director of Research, Philco Corporation. 1483 pages, 6 x 9, 1159 illustrations, \$18.00

SEARCHLIGHT SECTION

(Classified Advertising)

BUSINESS OPPORTUNITIES
EQUIPMENT - USED or RESALE

DISPLAYED RATE

The advertising rate is \$21.75 per inch for all advertising appearing on other than a contract basis. Contract rates quoted on request. AN ADVERTISING INCH is measured 7/8 inch vertically on one column, 3 columns—30 inches—to a page.

EQUIPMENT WANTED or FOR SALE ADVERTISEMENTS acceptable only in Displayed Style.

UNDISPLAYED RATE

\$2.40 a line, minimum 3 lines. To figure advance payment count 5 average words as a line.

PROPOSALS, \$2.40 a line an insertion. BOX NUMBERS count as one line additional in undisplayed ads.

DISCOUNT of 10% if full payment is made in advance for four consecutive insertions of undisplayed ads (not including proposals).



ENGINEERING DEGREES IN E.E.

Under & Postgraduate Major Electronics May be earned by HOME STUDY or residence work
5719-G Santa Monica Blvd.
Hollywood 38, California

WANTED

Capacitor Winding Machine

Used, to wind 12" wide paper, 12 spindles, mandrel 1" to 3".

Write W-6019, Electronics
Class. Adv. Div., P.O. Box 12, N.Y. 36, N.Y.

CASH PAID!

Sell your surplus electronic tubes. Want unused, clean transmitting, special purpose, receiving, TV types, magnetrons, Klystrons, Broadcast, etc. Also want military & commercial lab test and communications gear. We swap too, for tubes or choice equipment. Send specific details in first letter. For a fair deal write, wire or telephone: WALKER 5-7000
Barry, 512 Broadway, New York 12, N. Y.

NEW ADVERTISEMENTS

received by October 3rd will appear in the November 1st issue, subject to space limitations.

Address copy to the
Classified Advertising Division

Electronics

P. O. Box 12

New York 36, N. Y.

SPECIAL PURPOSE TUBES

OA2	.75	4-65A	13.50	FG-32	4.50	719A	10.00	5678	.75
OA2WA	2.50	4-125A	20.00	FG-33	15.00	721A	.50	5684	10.00
OA3/VR-75	.90	4-250A	32.50	VX-33A	3.50	721B	6.85	5685	10.00
OA4G	.75	4-400A	42.50	35T	3.00	723A/B	6.50	5686	1.75
OA5	3.50	4-1000A	125.00	35TG	2.0	725A	2.25	5687	2.00
OB2	.50	4B31	20.00	VX-41	5.00	726A	4.00	5687WA	4.00
OB2WA	2.50	4B32	7.50	FP-54	75.00	726B	9.50	5691	4.50
OB3/VR-90	.80	4C33	100.00	HK-54	2.00	802	2.00	5692	4.75
OC3/VR-105	.50	4C35	15.00	VX-55	3.50	804	7.00	5693	3.00
OC3W	2.00	4D32	23.00	FG-57	7.50	805	3.00	5702	1.25
OD3/VR-150	.50	4E27	8.00	RK-61	2.25	807	1.20	5703	.75
OD3W	2.00	4J45	35.00	RK-65/SD23	6.50	807W	1.25	5704	1.15
EL-C1A	6.00	4J46	35.00	FG-67	6.75	810	10.00	5719	1.30
EL-1C	1.50	4J52	50.00	HY-69	2.50	811	3.00	5720	15.00
1AD4	.90	4J61	125.00	FG-81A	8.50	812	2.50	5725	2.00
1AE4	1.00	4PR60A	25.00	FG-95	13.50	813	9.50	5726	1.00
1AF4	2.50	4X150A	17.50	100TH	5.75	814	1.75	5727	1.25
1AG5	2.00	4X500F	40.00	102L	2.50	815	1.50	5728	7.50
1B24	5.00	5A6	2.00	121A	2.50	816	1.35	5734	13.25
1B35	3.25	5A1P	5.00	122A	2.50	826	.75	5740	75.00
1B35A	6.50	EL-5B	4.00	123A	2.50	828	8.00	5749	1.15
1B37	6.00	5B1P	2.50	124A	2.50	829B	8.50	5750	2.00
1B63A	15.00	5B1A	7.50	FG-172	15.00	832A	6.00	5751	1.85
1B83	7.50	5B2A	3.00	FG-190	10.00	834	5.00	5755	6.50
1P21	35.00	5C22	25.00	CE-200	5.00	835	2.50	5763	.85
1P22	5.00	5CP1	2.50	203A	2.50	836	1.20	5771	350.00
1P25A	15.00	5CP1A	7.50	207	50.00	837	1.25	5783	3.00
1P28	7.50	5CP7A	8.00	CE-235A	5.00	845	2.00	5784	4.00
1Z2	2.50	5CP12	9.00	FG-235A	55.00	850	5.00	5796	10.00
2AP1	2.00	5FP14	5.00	242C	10.00	866A	1.25	5798	12.50
2AP1A	3.50	5HP1	1.75	QK-243	40.00	866 JR	1.25	5801	3.50
2BP1	3.50	5J1P	7.50	244A	3.50	868/PJ-23	1.50	5803	3.50
2C36	35.00	5J2A	5.00	245A	5.00	869B	50.00	5814	.65
2C39	4.00	5J4	3.50	249B	3.00	GL-872A	2.00	5814A	1.50
2C39A	10.00	5J5A	7.50	249C	2.50	872A	1.00	5814WA	3.00
2C40	6.50	5JP11A	7.50	250R	3.50	874	.75	5819	25.00
2C42	8.00	5LP1	12.50	251A	40.00	884	.95	5820	400.00
2C43	8.00	5LP2A	7.50	252A	6.50	885	.65	5827	3.50
2C46	5.00	5R4GY	1.20	253A	2.00	913	17.50	5828	6.00
2C50	5.00	5R4WGY	2.50	254A	2.00	917	1.40	5829	.80
2C51	3.00	5RP1A	15.00	257A	10.00	918	1.50	5830	85.00
2C52	2.75	5RP11A	75.00	FG-258A	75.00	920	2.00	5839	7.50
2D21	.75	5SP1	30.00	259A	10.00	922	1.75	5840	2.85
2D21W	.85	5SP7	30.00	262B	4.75	923	1.25	5842	12.00
2E22	2.00	5UP7	12.50	FP-265	12.50	927	1.00	5847	12.00
2E24	2.00	5X3	2.00	267B	3.50	929	1.00	5854	.85
2E26	3.25	5XP1	50.00	268A	5.00	931A	3.75	5881	3.00
2J33	17.50	5YX1	50.00	271A	5.00	959	1.15	5886	2.00
2J47	50.00	5Y3WGT	1.00	272A	4.50	CK-1006	2.25	5894	16.50
2J51	175.00	EL-C6J	10.00	274A	2.50	1237	4.50	5899	3.25
2J52	50.00	EL-C6L	5.00	274B	.50	HY-1269	3.00	5902	3.75
2J54	28.00	6AC7W	.50	275A	3.50	1274	2.50	5902A	5.00
2J59	50.00	6AD4	2.50	276A	10.00	1614	1.50	5910	.50
2J61	8.50	WE-6AK5	1.25	279A	150.00	1620	3.50	5915	.50
2J62	3.00	6AK5W	1.00	282A	2.00	1624	1.10	5932	3.25
2J64	75.00	6AN5	2.15	285A	4.50	2050	50.00	5933	1.25
2K25	10.00	6AN5WA	4.50	286A	3.25	2050W	1.00	5948/1754	100.00
2K26	32.50	6AQ5W	1.75	287A	2.00	5528	2.50	5949/1907	75.00
2K28	27.50	6AR6	1.25	293A	8.00	5550	5.00	5962	4.00
2K29	35.00	6AR6WA	1.00	300B	8.00	5550	30.00	5963	1.25
2K30	75.00	6AS6	1.25	304TH	7.00	5552	55.00	5964	.85
2K33A	75.00	6AS6	1.25	304TH	17.50	5553	75.00	5975	3.00
2K34	85.00	6AS7G	2.25	310A	17.50	5556	10.00	5977	2.50
2K35	150.00	6AU6WA	1.85	311A	3.50	5557	4.50	5979	6.00
2K41	95.00	6BA5	3.00	313C	3.50	5558	4.50	5980	5.50
2K42	100.00	6BA5	3.00	313C	2.00	5559	6.75	5981/5650	50.00
2K45	25.00	6BA6W	1.75	323A	7.50	5560	13.50	5993	8.00
2K47	75.00	6BE6W	2.00	323B	3.50	5584	3.00	5998	4.00
2K48	50.00	6BL6	20.00	328A	3.50	5591	2.75	6005	1.75
2X2A	.75	6BM6	25.00	336A	3.50	5610	1.00	6012	3.50
3ABP1	50.00	6C4W	4.00	338A	3.50	5632	8.50	6021A	4.00
3AP1	1.50	6C21	15.00	339A	8.50	5633	4.00	6037	40.00
3AP11A	5.00	6F4	2.25	347A	2.50	5634	5.00	6038	7.50
3B24	.75	6J4	1.25	350A	2.50	5635	4.00	6073	1.25
3B24W	4.25	6J4WA	2.00	350B	2.00	5636	2.25	6080	3.50
3B25	4.50	6J6W	.85	354A	7.50	5636A	3.00	6087	4.00
3B26	2.75	6K4	2.00	355A	7.50	5737	2.75	6098	6.00
3B28	3.75	6K4A	2.50	388A	1.00	5638	3.00	6100	2.00
3B29	4.50	6L4	2.00	393A	3.50	5639	5.00	6130	4.25
3BP1	2.00	6L6WGA	3.25	394A	2.50	5639A	5.50	6134	3.50
EL-C3J	8.50	6L6WHB	3.00	403A	1.25	5640	5.00	6136	2.25
EL-C3J/A	10.00	6Q5G	2.00	403B	2.50	5641	3.75	6137	2.00
EL-3C	3.50	6S7WGT	2.00	404A	12.00	5642	1.10	6146	4.35
3C23	3.00	6SK7W	.75	407A	2.25	5643	3.00	6189	2.50
3C24	2.00	6SK7WA	2.00	408A	1.75	5644	5.00	6201	2.85
3C30	3.00	6SL7WGT	1.25	409A	4.25	5645	4.50	6263	9.00
3C33	5.00	6SN7WGT	.75	417A	12.00	5646	3.00	6264	9.00
3C45	4.25	6SU7GT	2.00	418A	17.50	5647	3.50	6328	4.85
3D22	9.50	6X4WA	2.00	420A	6.50	5650	50.00	6463	1.50
3E22	4.00	7MP7	15.00	421A	4.00	5651	1.25	6626	2.50
3E29	8.50	7YP2	50.00	429A	7.50	5651WA	3.00	6627	2.50
3GP1	2.00	X-10	4.00	GL-434A	7.50	5654	1.25	6655	35.00
3J21	30.00	12AT7WA	2.75	450TH	38.50	5656	3.75	8005	4.00
3J31	30.00	12AU7WA	2.50	450TL	38.50	5663	.75	8012A	3.50
3JP1	7.50	FG-17	4.50	464A	1.75	5667	100.00	8013A	4.50
3JP2	2.50	HK-24	2.00	GL-575A	10.00	5670	2.00	8020	1.25
3JP7	7.50	HK-24G	2.00	631-P1	5.00	5670WA	4.00	9001	.75
3JP12	7.50	26C6	.75	701A	1.50	5672	1.00	9002	.50
3KP1	7.50	26Z5W	3.00	707B	2.00	5675	8.00	9003	1.00
3X2500A3	135.00	FG-27A	8.50	715C	10.00	5676	.75	9005	2.00

ALL TUBES ARE NEW, INDIVIDUALLY CARTONED, FULLY GUARANTEED

western engineers

ELK GROVE, CALIFORNIA

SUPPLIERS OF TUBES SINCE 1932

Prices are FOB
shipping point

Orders for less than
\$10 cannot be
processed



TUBES

★ NEW ★ NAME BRANDS ★ IMMEDIATE DELIVERY
★ LOW PRICES ★ UNCONDITIONAL GUARANTEE

1108 Venice Boulevard • Los Angeles 15, California
Richmond 9-7644

Cable Address: JASHELEC

Telegraph: FAX

OA2	50.60	2K43	100.00	6K4	2.00
OA5	3.50	2K44	110.00	6L6WGA	3.25
OB2	.60	2K45	30.00	6L6WGB	3.25
OB2WA	2.50	2K46	175.00	6SK7W	.85
OC3/VR105	5.00	2K47	100.00	6SU7GT	2.00
OD3	.50	2K48	50.00	6V6GT	1.00
1A4D	1.00	2K50	125.00	6X4W	1.00
ELC1B	1.00	2K54	5.00	6X5W	1.00
1B22	1.10	2K56	50.00	6X5WGT	1.25
1B23	2.00	2X2A	.75	7UP7	20.00
1B24	5.00	3AP1	2.00	7YP2	75.00
1B24A	12.50	3B22	1.45	SR-512	150.00
1B25	1.25	3B24	.75	12AT7WA	2.75
1B26	1.25	3B24W	4.50	12AU7WA	2.50
1B27	10.00	3B24WA	7.50	12AY7	1.75
1B29	2.50	3B26	2.75	12DP7	15.00
1B32	1.00	3C22	55.00	12GP7	2.00
1B35	3.25	3C23	3.00	12SPTB	25.00
1B36	3.75	3C31	1.00	X-13	150.00
1B37	6.00	3C33	6.00	BL-15	Q
1B40	3.00	3DP1-S2	5.00	BL-16	Q
1B42	12.00	3DP11A	6.00	PJ22	6.00
1B44	15.00	3DP21A	3.00	HK-24	2.00
1B45	22.50	3E29	9.00	26A7GT	3.00
1B47	4.00	3FP7A	2.50	26D6	.50
1B51	6.75	3JP1	7.50	26E6WG	2.50
1B58	60.00	3J30	25.00	28D7W	5.00
1B62	4.00	3J31	35.00	RK29D	Q
1B63A	15.00	4PR60A	27.50	VR33	30.00
1N23BM	2.50	3K23	150.00	VR34	40.00
1N25	2.00	3K30	95.00	RK47	3.00
1N26	3.50	3W5000A3	95.00	V-50	150.00
1N28	6.00	4-65A	13.50	V-50XR	150.00
1N31	1.75	4-125A	19.50	HK-54	2.00
1N32	9.00	4-250A	30.00	FG-57	7.00
1N38A	.60	4-400A	34.00	QK-57	Q
1N40	4.75	4-1000A	110.00	QK-59	20.00
1N42	8.00	4A1	2.00	QK-60	20.00
1N46	.40	4B23	4.00	RK-60/1641	1.25
1N52	.60	4B26	7.00	QK-61	20.00
1N63	1.40	4D21	19.50	RK-61	2.25
1N69	.40	4E27	7.00	QK-62	20.00
1P21	29.50	4J22	35.00	HY-65	1.00
1P22	5.00	4J26 30	29.50	HY-69	2.00
1P24	1.50	4J32	45.00	RKR-72	.50
1P25	1.50	4J34	25.00	QK-63	2.00
1P28	7.50	4J42	25.00	FG-95	14.00
1P30	1.35	4J50	95.00	WE101D	3.00
1Q22	40.00	4J52	50.00	WE101F	3.00
1W5	.75	4J63	40.00	FG-105	11.00
1Z2	2.50	4J64	40.00	F-123A	2.50
2AP1	15.50	4PR60A	27.50	F-128A	2.50
2A515	5.00	4X150G	37.50	FG-154	10.00
2BP1	3.00	4X150D	25.00	VT158	9.75
2B24	.80	4X250M	35.00	FG-166	6.75
2C33	.75	5ABP1	20.00	FG-172	15.00
2C36 846B	25.00	5ADP1	20.00	QK172	495.00
2C37	25.00	5A50A	1.00	FG178	10.00
2C39A	10.00	5BP2A	2.95	QK-181	12.50
2C40	6.50	5BDP7	25.00	HF-200	10.00
2C42	8.00	5CP1	1.95	WL-200	50.00
2C43	7.50	5CP1A	7.50	QK202	165.00
2C46	5.00	5CP7	6.00	203A	2.50
2C50	6.00	5CP1A	8.00	204A	2.50
2C51	3.25	5CP11A	9.50	205F	6.00
2C52	2.75	5C22	20.00	207	75.00
2C53	9.75	5JP1	7.50	211/VT4C	.40
2D21W	1.00	5JPIA	22.50	212E	15.00
2D29	.80	5JP2	6.50	WL-218	15.00
2E22	2.00	5JF4	3.50	CEP220	4.00
2E24	2.50	5JPS	6.50	227A	2.75
2E25	3.75	5JPIA	7.50	RX233A	.75
2E27	.60	5LPIA	20.00	QK-243	40.00
2E32	1.00	5MP1	2.95	WE245A	200.00
2E41	1.50	5NP1	2.50	QK246	150.00
2M21	99.50	5R4G	1.25	QK429	150.00
2J31	12.25	5RAWGA	4.00	249B	2.50
2J32	10.00	5RAWGB	6.00	249C	2.50
2J34	10.00	5SP1	37.50	250-R	4.00
2J36	29.50	5SP1A	45.00	250TH	21.00
2J39	25.00	5SP7	37.50	250-TL	12.50
2J48	35.00	5Y3WGT	1.40	250R	3.50
2J49	35.00	5Y3WGT A	3.75	WE-251A	42.50
2J50	35.00	5ZP16	60.00	WE-252A	7.50
2J51	150.00	6AC7A	.75	QK253	150.00
2J54	25.00	6AC7W	.75	WE-254A	2.25
2J55	50.00	6AK5W	1.00	FG-258A	75.00
2J56	40.00	6AN5	2.25	WE-258B	5.00
2J61	8.50	6ANSWA	4.75	259A	10.00
2J61A	40.00	6AR6	1.35	V-262	175.00
2J62	3.00	6AS6W/5725	2.70	FP265	15.00
2J62A	40.00	6AS7G	2.50	WE-269A	6.00
2K22	1.50	6AUGWA	1.60	FG-271	22.00
2K23	12.50	6BM6A	29.00	WE-271A	5.00
2K25	12.50	6C21	15.00	WE-274B	.50
2K26	32.50	6D4	1.50	WE-282A	2.00
2K33A	50.00	6J4	1.50	WE-282B	3.75
2K34	85.00	6JAWA	2.00	QK283A	150.00
2K41	100.00	6J5WGT	3.50		
2K42	110.00	6J6W	.85		

QK284A	150.00	KU-627	7.50	927	.75	5829	.85
FP285	Q	KU-628	7.50	935	4.00	5829WA	3.75
WE-285A	4.50	WL-652	20.00	957	.35	5837	50.00
WE-286A	3.25	HK-654	17.50	958A	.35	5840	3.00
WE-287A	2.00	GL-672	20.00	959	1.15	5840A	4.50
WE-290A	7.00	WE-701A	1.50	991	.35	5841	4.25
WE-290A	8.00	WE-703A	1.25	CK-1005	.35	5842/417A	12.00
WE-293A	5.00	WE-704A	1.60	CK-1007	.45	5844	1.50
GB-302	2.50	WE-705A	.75	K1253P7	29.50	5847/404A	11.00
		706AY-GY	10.00	HY1269	3.00	5851	3.50
		707B	2.00	1274	2.45	5852/TE5	6.00
		WE-708A	.75	1603	3.50	5853	60.00
		WE-709A	1.50	1614	1.50	5855	35.00
		714A	1.00	1619	.30	5876	5.00
		715A	1.75	1620	3.75	5877	1.25
		715B	2.50	1622	2.00	5893	9.00
		717A	.50	1623	1.25	5896	3.00
		720AY-EY	35.00	1624	1.00	5896A	3.25
		721A	1.50	1625	.30	5899	3.50
		721B	7.00	1626	.25	5902	4.00
		722A	.75	1631	1.00	5902A	5.50
		723A/B	6.00	1636	.75	5902A(CL)	2.50
		725A	2.25	1641	1.35	5903	12.50
		726A	4.25	1850A	Q	5906	8.50
		726B	9.50	ZB3200	75.00	5907	12.50
		730A	7.50	2000T	150.00	5908	12.50
		750TL	30.00	2050	1.00	5910	.60
		803	2.00	2051	.65	5915	.50
		804	7.00	HK3054	100.00	5916	8.50
		807W	1.25	807	75.00	5917	3.25
		811	2.90	R-4330	9.00	5933/807W	1.25
				R-4340	9.00	5945/1754	150.00
				5517	1.00	5956	35.00
				5531	200.00	5962/BS101	4.00
				5544	25.00	5964	.80
				5551/FG271	22.00	5965	10.00
				5553/FG258A	75.00	5967	3.00
				5559/FG57	7.00	5977A	3.00
				5560/FG95	16.00	5981	50.00
				5588	75.00	5982	149.50
				5606	125.00	5987	9.50
				5618	40.00	5992	9.00
				5618	2.75	5993/TE-10	9.00
				5634	2.00	6005/6AQ5W	2.00
				5636	2.50	6019	300.00
				5639A	5.00	6021	3.00
				5641	6.00	6021-A	4.50
				5643	4.50	6029/408A	2.50
				5644	5.00	6037/QK243	49.00
				5645	5.75	6038	7.50
				5646	5.00	6046	.75
				5647	3.00	CK-6050	2.00
				5647A	4.00	6072	3.00
				5650/5981	5.00	6073	1.25
				5651	50.00	6074	2.50
				5654/6AK5W/	1.25	6080	3.50
				6096	3.00	6080WA	7.00
				6096	4.00	6081/ATR407	22.50
				6096	100.00	6082	3.00
				6096	95	6088	1.50
				6097	35.00	6095	2.00
				6099	100.00	6096	1.30
				6100/6C4WA	2.00	6097	1.50
				6101/6J6WA	2.25	6099	1.40
				6110	4.00	6100	2.00
				6111	1.00	6101/6J6WA	2.25
				6112	4.50	6110	5.50
				6116	5.75	6111	4.00
				6182	1.75	6112	4.50
				6187	2.25	6116	60.00
				6188	4.00	6130	5.00
				6189	5.00	6136	2.50
				6192	3.50	6147	3.00
				6193	1.25	6159	3.00
				6194	1.40	6161	42.00
				6195	4.25	6162	Q
				6196	.85	6184	9.00
				6197	4.00	6186/6AG5WA	2.25
				6198	1.15	6189/12AU7WA	2.50
				6199	1.75	6197	1.25
				6200	2.00	6199	27.50
				6201/12AT7WA	2.75	6201	2.75
				6203	4.00	6205	4.50
				6205	1.00	6211	1.00
				6206	3.00	6263	10.00
				6207	1.25	6264	10.00
				6208	1.00	6278/CSF14	19.50
				6209	4.50	6339	20.00
				6210	1.15	6363	75.00
				6211	2.00	6406/QK428	200.00
				6212	2.00	6533	10.00
				6213	3.50	6611	12.00
				6214	1.00	6612	14.00
				6			

NEED METERS?

STANDARD or SPECIALS

ANY QUANTITY—NEW—MILITARY

FOR ELECTRONIC—MILITARY
AIRCRAFT—HAMS

ALL MAKES—MODELS
RANGES—SIZES

METERS REPAIRED
RESCALED
RECALIBRATED

WRITE - PHONE - WIRE

INSTRUMENT SERVICE

76-14 Woodside Ave.

Elmhurst 73, N. Y.

CAA No. 4264 Ltd. HA 9-2925

NEON Bulbs #NE 47 12000 pcs 10 to box lot price or major part 6¢ ea.

2 x 35—350v FP plug in 40,000 pcs 18¢ ea.

2 1/2" PM 1 oz. slug speakers 80¢ ea.

Ceramic condensers all sizes \$15.00 M

American Resistors 1/2W \$10.00 per M

1W \$15.00 per M

2W \$25.00 per M

Min. of 100 of #

Micro switches normally closed 10,000 pcs low price for lot

Tubes JAN large quantities low prices 6SH7, OD3, 395A, 12SF7, 6SG7GT, 872A, 315A, 215A, 7193

BELEVISION, INC.

254 Greenwich St., N. Y. 7, N. Y.

Barclay 7-6063

(364 — Pieces Available)
TANTALUM (Type "XT") CAPACITORS

Special \$24.95 each
8. MFD — 480 VDC — 125° C
(Dim.: 2 3/8 x 1 1/8 Dia.)

A. MUGILL CO.

17 Warren St., NYC. WO 4-0865

Teletype Equipment

80 Perforators, Morse Tape Wheatstone 3/ISS.
50 Keyboards Model 15 unused.
40 Rectifiers No. 11 unused.
10 Rectifiers RA-30 unused.
Teletypes Models 15, 19, 14 etc.

SUPLEX LAMPS LIMITED

239, High Holborn London W.C.1, England
Cables: Suplexlamp London.

IF THERE IS
Anything you want

that other readers of this
paper can supply

OR—

*Something you
don't want*

that other readers can use, advertise it in the

SEARCHLIGHT SECTION

NEW YORK'S RADIO TUBE EXCHANGE

100
1,000
100,000
1,000,000
DECEIVING, TRANSMITTING &
SPECIAL ELECTRONIC TUBES
& TRANSISTORS

Type	Price	Type	Price	Type	Price
OA2	.65	3P17A	2.00	715C	3.00
OA3	.95	3R30	25.00	715C	11.00
OB2	.60	3R31	45.00	717A	.35
OB3/VR90	.85	3R32	150.00	718A	10.00
OC3/VR105	.50	3K23	150.00	720A/EY	50.00
OD3/VR150	.45	3K30	95.00	721A	.75
1B22	1.00	4B1A	5.50	724B	7.50
1B23	2.75	4B24	5.00	725A	4.00
1B24	5.50	4B24	4.50	725A/B	7.50
1B25	1.25	4B31	20.00	725A	3.00
1B27	10.00	4C2/CV92	9.00	726A	5.00
1B29	2.50	4E27	8.00	726C	14.00
1B35	3.35	4E27	8.00	726C	14.00
1B36	2.75	4J30	40.00	730A	5.00
1B37	8.00	4J30A	25.00	801A	6.50
1B42	4.50	4J32	45.00	801A	1.75
1B44	15.00	4J34	35.00	804	8.00
1B45	22.50	4J36	15.75	805	4.50
1B47	7.50	4J50	95.00	805	1.10
1B51	6.75	4J52	50.00	807 W/5933	1.50
1B58	60	5A150A	20.00	808	1.00
1B62	5.00	5A150A	20.00	808	2.70
1B63A	19.00	5A150A	20.00	810	10.00
1N21	8.00	5B1P1	2.50	811A	3.50
1N21B	.95	5B1P4	2.50	811A	2.25
1N23	.50	5C1P1	1.75	814	1.50
1N23B	.90	5C1P1A	2.50	815	1.50
1N25	2.00	5C1P7	5.00	820A	6.50
1N26	3.50	5C1P7A	7.50	828	8.00
1N32	9.50	5C1P11A	9.50	829	5.00
1N38A	.50	5C1P12	17.00	830B	.45
1P21	30.00	6C22	17.00	830B	.45
1P25	45.00	6D11	5.00	832	4.00
1P28	8.25	6P1	5.00	832B	6.00
1P29	1.50	6P2	5.00	833A	33.00
1P30	1.25	6P4	5.00	834	5.00
2B1	5.00	6P5	9.00	837	1.25
2C34/RK34	.25	5P11A	9.50	837	1.25
2C35	2.00	5J30	4.00	838	.70
2C36	5.50	5J30	4.00	845	1.25
2C39A	10.00	5J33	4.00	845	.35
2C43	8.50	5M1	2.50	845	3.00
2C44	.50	5M1G	1.30	851	20.00
2C45	.50	5M1G	1.30	851	20.00
2C50	6.00	6A150A	85.00	852	4.00
2C51	3.00	6C1	13.50	861	10.00
2C52	2.50	6A150A	1.00	865	.40
2D21W	1.50	6A150A	1.00	868A	18.00
2J21	4.00	6A150W	70	872A	1.00
2J22	4.00	6C1	25.00	874	1.00
2J27	4.00	6C21	25.00	874	.70
2J31	12.25	6J8W	.75	878	.50
2J32	12.00	6J8W	.75	878	.50
2J33	29.50	6SU7GT	2.00	917	1.30
2J34	12.50	7BP	4.50	919	1.70
2J35	20.00	7A17WA	2.50	924	1.00
2J39	25.00	12A17WA	2.50	954	.35
2J41	125.00	12A17Y	1.50	958A	.35
2J42	60.00	12D17A	20.00	957A	.35
2J48	10.00	12GP7	15.00	958A	.35
2J49	27.50	15E	1.20	959	1.25
2J50	35.00	15E	1.20	959	1.25
2J51	200.00	RK-21	1.00	9N1E16	.35
2J56	35.00	2A7GT	3.00	1280	.95
2J61	12.00	2A7GT	3.00	1280	.95
2J61A	30.00	35TG	2.25	1000	5.00
2J62	5.00	HR-54	3.50	1612	1.50
2J63	12.50	HR-57	4.50	1613	1.25
2K22	13.50	RK-60/1641	1.25	1618	1.25
2K23	10.00	QR-61	20.00	1619	.45
2K24	12.00	QR-61	20.00	1622	1.50
2K26	35.00	QR-62	20.00	1624	1.50
2K28	37.00	HY-65	1.00	1625	.35
2K29	25.00	HY-65	1.00	1626	.25
2K33	100.00	HY-69	2.25	1626	1.50
2K38A	50.00	RK-72	.35	2050	1.50
2K38B	50.00	RK-73	.35	2051	1.00
2K39	100.00	FG95	16.50		
2K41	90.00	HF100	4.00		
2K44	125.00	13D17A	6.50		
2K45	32.50	211/VT4C	.50		
2K48	195.50	250TH	21.00		
2K47	100.00	30ATL	18.00		
2K48	50.00	30ATL	18.00		
2K50	140.00	30T4/RK75	60	5820	475.00
2K54	15.00	VT327A	3.50	8015	450.00
2K55	14.00	250B	2.00	8015	450.00
2K56	50.00	294A	2.50	8012A	2.50
2Y30	2.00	WE-416A	1.00	8013	3.00
2X2	.30	WL-417A	3.50	8013A	3.50
2X2A	1.00	WE-417A	12.50	8019	1.75
3A4	3.95	44B	4.00	8025	3.80
3B1	1.50	GL-502A	1.25	8025	3.75
3B22	1.35	559	16.00	PD8365	96.00
3B24	3.95	559	16.00	904	1.52
3C22	59.50	HY-616	45	9002	.90
3C23	3.95	WE-701A	1.85	9003	1.25
3C24/24G	2.00	WE-703A	1.00	9004	.35
3C27	1.95	WE-704A	60	9005	2.75
3C31/C1B	1.00	WE-705A	75	9006	.25
3C35	6.50	706A-Y-GY	35.00		
3C45	2.00	707A	2.00		
3D11A	7.00	707B	2.50		
3D21A	3.00	716A	1.50		

VARIOUS 5000
AND 6000
SERIES OF
NEW PRO-
DUCTION

OTHER TEST EQUIPMENT USED CHECKED OUT, SURPLUS

- TSK1/SE K Band Spectrum Analyzer
- TS3A/AP Frequency and power meter
- S Band
- RF1A/AP Phantom Target S Band
- TS12/AP VSWR Test Set for X Band
- TS13/AP X Band Signal Generator
- TS14/AP Signal Generator

MINIMUM ORDER, \$25.00

SPECIAL
Thousands of tubes available at special prices

PARTIAL LIST			
2AP1	6H6	307A	5691
4C27	6K8G	274A	5692
4C28	6AR6	274B	5693
5A6	5RAWGY	262B	5639
58P4	5W4GT	328A	5814
4J52	0Z4	587A	9001
2A4G	6AC7	450TH	9002
6C21	28D7	450T1	9003
6J5GT	85	— ANY OTHER TYPES	

NEW UNUSED SURPLUS STANDARD LABORATORY RECEIVERS

AN/APR4 complete with five tuning units
38 to 4000 m.c.



AN/APR5A,
3000-6000 m.c.
AN/APR10,
2000-4400 m.c.

NEW TS-147 X TEST SET HARD-TO-GET X-BAND SIGNAL GENERATOR

Now Available
Test Set TS 147 UP is a portable Microwave Signal Generator designed for testing and adjusting beacon equipment and radar systems which operate within the frequency range of 8500 MC to 9600 MC.

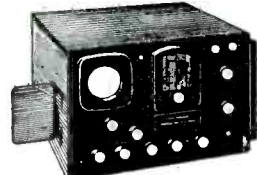

NEW
Microwave
Test Equipment
TS148/UP
SPECTRUM
ANALYZER

Field type X Band Spectrum Analyzer, Band 8430-9580 Megacycles.
Will Check Frequency and Operation of various X Band equipment such as Radar Magnetrons, Klystrons, TR Boxes. It will also measure pulse width, c-w spectrum width and Q or resonant cavities. Will also check frequency of signal generators in the X band. Can also be used as frequency modulated Signal Generator etc. Available new complete with all accessories, in carrying case.

New Unused Surplus TS 259 K Band 23400-24500 Megacycles Signal Generator

SPECIAL! 5,000 V. POWER SUPPLY
For IP25 Infrared Converter from
3 V. Battery Source. NEW, Com-
plete with RCA 1654 Tube. **\$9.90**

OTHER TEST EQUIPMENT USED CHECKED OUT, SURPLUS

- TS33/AP X Band Power and Frequency Meter
 - TS34/AP Western Electric Synchroscope
 - TS35/AP X Band Signal Generator
 - TS36/AP X Band Power Meter
 - L-96A Signal Generator
 - TS45 X Band Signal Generator
 - TS47/APR 400-400 MC Signal Generator
 - TS69/AP Frequency Meter 400-1000MC
 - TS100 Scope
 - TS102A/AP Range Calibrator
 - TS108 Power Load
 - TS110/AP S Band Echo Box
 - TS125/AP S Band Power Meter
 - TS126/AP Synchroscope
 - TS147 X Band Signal Generator
 - TS174/U Signal Generator
 - TS175/U Signal Generator
 - TS182
 - TS226 Power Meter
 - TS239A-TS239C Synchroscope
 - TS251
 - TS258
 - TS270 S Band Echo Box
 - TF890/I X Band Spectrum Analyzer
 - 834 General Radio Frequency Meter
- SURPLUS EQUIPMENT**
- S04 Radar, Complete
 - APA10 Oscilloscope and panoramic receiver
 - APA38 Panoramic Receiver
 - APS 3 and APS 4 Radar
 - APR4 Receiver and Tuning Units
 - APR5A Microwave Receiver
 - APT2-APT5 Radar Jamming Transmitter



Phone: ORegon 4-7070

LIBERTY ELECTRONICS, INC.

119 PRINCE ST.
NEW YORK 12, N. Y.
Cables: TELSERUP

TUBES

- JAN and Commercial
- Advertised Brands Only!
- Special Prices to Quantity Buyers
- Guaranteed • Look & Compare
- From 10%-95% Below Manufacturers Prices

RECEIVING TYPES

Write for Special Prices,
Quantity Buyers

1A3	6SK7
2A3/G	6W4/GT
6A87	6W6/GT
6AC7	6Y6/G
6AC7W	7A6
6AK6	7C4
6AT6	12AV7
6B4/G	12AX7
6BZ7	12C8
6C4	12SC7
6F5	12SH7
6J4	12SL7/GT
6J4WA	14N7
6J6W	25AV5/GT
6SG7/GT	25RQ6/GT
6SH7	VR-105
	VR-150

5,000 AND 6,000 SERIES

5379	\$1.15	5750	2.00
5591	2.75	5751	2.15
5632	7.50	5760	2.95
5636	2.55	5763	1.05
5651	1.29	5796	7.50
5654	1.35	5814	1.05
5656	3.25	5814A	1.50
5670	2.00	5814WA	3.00
5678	1.75	5831	3.20
5686	1.75	5915	.50
5687	2.05	5933	1.50
5687WA	4.00	5963	1.49
5688	1.25	5964	7.74
5703	1.00	5977	3.00
5725	1.99	6005	1.70
5726	1.00	6046	.75
5727	1.45	6096	1.30
5744	1.00	6186	1.05
5749	1.25	6189	1.75

CATHODE RAY TUBES

2AP1	\$1.95	5HP4	2.49
2AP1A	5.44	5JP1	8.75
2BP11	7.99	5JP4	3.99
3AP1	2.50	5LP1	13.99
3AP11A	4.95	5JP5	5.95
3EP1	1.50	5RP2	12.95
3FP7	2.50	5NP1	1.99
3GP1	2.00	9LP7	9.00
3HP7	2.95	10KP7	12.95
5AP1	2.75	12DP7/A	
5BP1	2.45		
5BP4	2.75		18.95
5CP1	2.25	12GP7	12.95
5CP2	12.49		
5CP11A	9.50	902P1	2.89
5FP7	2.50	902A	2.89

THYRATRONS

2D21	\$ 7.79	3C23	3.75
2D21W	1.29	3C45	5.50
CSB	.99		
FG-105	11.99	5C22	22.50
FG-154	9.95	269A	8.50
FG-172	13.45	394A	2.99
FG-190	12.90		
KU610	2.45	884	1.00
2C33/RX233A	.69	885	1.10

KLYSTRON

2K22	\$14.50	2K54	12.95
2K23	14.50	707A	2.55
2K25	14.75	707B	3.75
2K28	29.50	723/AB	7.99
2K33A	49.00	726A	4.50
2K35	99.50	726B	15.00
2K45	34.95	726C	12.50

TR AND ATR TUBES

1B24	5.99	709A	1.69
1B26	1.00	721A	1.49
1B29	2.39	721B	7.00
1B32		724A	1.15
		724B	.89
532A	.99	1960	1.89
471A	1.25		

SPECIAL PURPOSE & TRANSMITTING TUBES

CEP-120	5.49	4E27	6.95	800	1.29
CK-507AX	1.10	5D21	6.99	801A	.42
CK-521AX	1.10	5D23	9.50	803	2.00
EF-50	.59	7C22	49.95	805	3.75
EM-3GA	39.50	10	.39	807	1.10
FP-62	2.95	10Y	.29	807W/5933	1.50
HF-100	7.49	15E	1.20	814	2.49
HY-65	1.40	35TG	3.25	815	1.99
HY-114B	.59	100TH	6.95	826	.75
f123A	4.75	100TL	10.95	828	8.00
2C34/RK34	.29	203A	2.50	829B	8.50
RK-59	1.88	204A	17.50	830B	1.05
		205B	1.99	832A	6.75
RK-65/		207	39.95	836	1.20
5D23	9.50	211/VT4C	.49	837	3.50
VR-78	.59	250TL	12.95	841	.59
WE215A/VT-5		262B	5.00	843	.49
		271A	12.99	845	3.49
10Spec/VT-25A		276A	7.50	852	15.00
		279A	7.50	860	3.49
45Spec/VT-52	.26	282A	3.49	861	14.00
		286A	7.50	864	.69
30Spec/VT-67		294A	8.00	877	3.50
		294A	8.00	877	3.50
VT-127A	.26	304TH	9.95	918	1.49
VT-158	2.75	304TL	22.50	927	1.25
ZB-120	.49	304TL	22.50	927	1.25
1N40	4.50	307A	.85	954	.19
1P30	1.35	310A	3.45	955	.29
2R22	.49	316A	.95	956	.25
2C22	.29	328A	3.50	957	.35
2C26	.29	350B	2.95	958A	.35
2C39	4.00	HK354C	14.35	1608	2.99
2C39A	10.50	388A	1.49	1611	.79
2C40	7.95	403B/5591	2.75	1613	.95
2C42	8.49	434A	6.66	1619	.92
2C43	8.00	446A	.49	1625	1.00
2C44	1.35	446B	.99	1625	1.00
2C46	5.25	468	8.99	1626	.29
2C51	2.75	464A	1.75	1629	.29
2C53	9.90	483	8.95	1630	.79
2E24	2.19	485	6.95	1632	.59
2E27	.95	559	.95	1642	.59
2E36	1.65	HY-615	.49	8002R	18.50
2E41	1.35	701A	4.99	8005	4.50
2E42	2.29	703A	1.75	8012	1.85
3C28	5.95	708A	2.99	8025	2.00
3C33	5.99	713A	.96	8025A	2.25
3D23	4.99	715A	6.00	9001	.70
3E29	8.00	715B	2.99	9002	.50
4C27	8.95	715C	14.50	9004	.19
4D21	19.50	717A	.49	9006	.19

RECTIFIERS & REGULATORS

OB2	5.69	4B27	1.75	253A	3.39
OC3	.69	4B36	4.69	274B	.79
OD3	.69	5R4/WGY	3.19	346B	4.49
RK60	1.99	5Y3/GT	5.4	705A	1.65
RRR-72	.49	5Y4/GT	.49	836	1.29
RRR-73	.49	6-4	1.00	872A	1.05
VU-111	.19	7H-4B	1.00	GL-872A	2.49
2X2-879	.39	12X3	1.59	874	1.25
2X2	.89	15R	.39	876	.99
2V3/G	1.39	120A	1.45	878	.90
3B23	3.25	217A	2.99	9-1	.69
3B24	1.89	221A	3.99	1646	.59
3B27	3.48	231D	1.45	1641	1.99
3B28	3.89	233A	1.99	8013	2.50
4A-11	.49	249C	3.00	8013A	3.45
4B22	3.99	250R	6.95	8020	1.49

MAGNETRONS

QK-59	24.50	2J61	8.40	718AY	29.75
QK-62	24.00	2462	3.00	718BY	29.75
		312A	49.94	718CY	29.75
QK-185	80.00	4J22	32.50	718DY	29.75
2J21	2.99	4J23	32.50	718EY	29.75
2J21A	3.95	4J26	32.50	720Y	29.75
2J22	3.75	4J28	32.50		
2J26	2.50	4J31	99.50	720DY	29.75
2J27	4.99	4J43	70.00	720EY	29.75
2J30	14.50	5J23	99.50	725A	2.45
2J31	12.50	5J30	15.00	728AY	35.00
2J32	9.50	5J32	65.00	728BY	35.00
2J34	13.50	5J33	17.99	728CY	35.00
2J36	25.00	700A	10.99	728DY	35.00
2J38	14.00	706AY	8.75	728EY	35.00
2J39	11.00	706B	12.50	730A	7.95
2J40	25.00	706C	14.50		
2J49	31.50	706DY	14.50	6177	69.95

COAX CONNECTORS

- SO239
- 24¢
- 831R



- M359A
- 15¢
- 831AD



ONE OF THE LARGEST SURPLUS DEALERS IN THE COUNTRY

All boxed and fully guaranteed. Special quantity discount—10% on 100 or more of same type. Minimum order \$10.00. Thousands of other types in stock. Send us your requirements. F. O. B. New York 25% deposit with order or if paid in advance save C.O.D. charges. Rated firms net 10 days. Prices subject to change without notice. For fast service ask for Sy.

FAY-BILL DISTRIBUTING CO. DEPT. E1

418 Broome St., N. Y. 13, N. Y.
Telephone CAnal 6-8404

- CAPACITORS -

16 mfd.—600 V. . . . \$1.89

Dual 8 mfd oil filled cond. hermetically sealed and packed. Tube type PT-SC-11 measuring 3 1/2"x2 1/2"x2 1/2". Stud mnt. centers 2". Plugs into standard four prong socket.

Mfd	Volts	Price	Mfd	Volts	Price	Mfd	Volts	Price	
.001	10KV	5.25	5	1500	.59	4	7500	59.50	
.001	50KV	24.95	5	2000	1.19	4	10KV	74.50	
.0025	10KV	5.95	5	2500	1.29	4	15KV	PUR	
.005	25KV	29.95	5	3000	2.98	5	330	1.19	
.01	1500	.55	5	4000	3.25	5	600	.95	
.01-01	3000	.40	5	5000	3.05	5	1000	1.69	
.012	25KV	12.95	5	7500	5.75	5	5000	27.50	
.015	16KV	14.50	5	25KV	38.50				
.02	80KV	4.75	5-5	600	.49	2x5	400	.89	
.02	10KV	2.25	5-5	9000	8.95	2x5	600	1.19	
.02	20KV	9.95	5-1	2000	.32	6	330	1.29	
.025	50KV	32.95	5-1	115VAC	.32	6	1000	1.95	
.03	7500	4.25	5-1	2500	.75	6	1500	2.95	
.04	17KV	7.95	1	600V	.44	6	600	1.35	
.05	2500	.75	1	1000V	.69	7	800	1.55	
.05	7500	4.25	1	1500V	.99	7	300VAC	1.50	
.05	16KV	7.95	1	2000V	1.75	8	600VAC	2.40	
.05	100KV	89.50	1	3000V	2.95	8	1000	2.15	
.05-05	12KV	8.95	1	3600V	2.45	8	1500	3.65	
.05-05	50KV	60.00	1	4000V	4.75	8	2000	6.95	
.08	12.5KV	7.95	1	5000	6.25	8	2500	9.95	
.1	1500V	.45	1	6000	8.95	8	3000	12.50	
.1	2000V	.65	1	7500	7.50	2x8	600	1.89	
.1	2500V	.69	1	10KV	25.95	4x8	800	3.85	
.1	3000	.65	1	15KV	33.50	9	10KV	PUR	
.1	4000	1.19	1	25KV	75.00	10	400	.65	
.1	5000	1.49	1	30KV	PUR	10	600	.98	
.1	5000	3.25	2x1.25	7500	20.00	10	600	1.19	
.1	6000	2.25	1.25	330VAC	.49	10	600	1.49	
.1	7500	.89	2	15KV	49.50	10	1000	3.75	
.1	7500	4.25	2	200	.25	10	1400	2.25	
.1	12KV	6.95	2	600	.55	10	1500	4.25	
.1	15KV	8.95	2	1000	.79	10	2000	6.75	
.1	20KV	9.95	2	1000V	1.29	10	2500	10.95	
.1	25KV	24.95	2	1000V	1.75	10	2500*	6.25	
.1	27.5KV	27.50	2	1500	2.15	10	4500	45.00	
.1	125	27.5KV	27.50	2	2000	2.75	10	5000	PUR

ELECTRONIC

WAR TERMINATION INVENTORIES

WRITE OR WIRE FOR INFORMATION ON OUR COMPLETE LINE OF SURPLUS ELECTRONIC COMPONENTS. ALL PRICES NET F.O.B. PASADENA, CALIFORNIA

C&H SALES CO.

2176-E East Colorado St.
Pasadena 8, California
RYan 1-7393



DIFFERENTIAL

Size 2-11/16" long 1-11/16" dia. 1-1 reverse ratio. 1/4" shaft on each end; one shaft 25/32" long, one shaft 15/32" long. Input and output gear 1-23/32" dia. 53 teeth.

Stock No. 150

\$3.50 ea.

INVERTERS

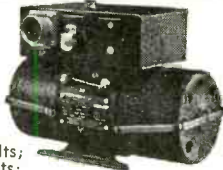

- 10042-1-A Bendix
DC Input 14 volts; output: 115 volts; 400 cycles. 1-phase; 50 watt **\$35.00**
- 12116-2-A Bendix
Output: 115 VAC; 400 cyc; single phase; .45 amp. Input: 24 VDC, 5 amps. **\$35.00**
- 12117 Bendix
Output: 6 volts; 400 cycles, 6 volt amperes, 1 phase. Input: 24 VDC; 1 amp. **\$15.00**
- 12121 Bendix
Input: 24 volt D.C. 18 amp. 12000 r.p.m. Output: 115 volts, 400 cycle, 3-phase. 250 volt amp, 7 pf. **\$49.50**
- 12123 Bendix
Output: 115 V; 3 phase; 400 cycle; amps. .5; Input: 24 VDC; 12 amp. **\$49.50**
- 12126-2-A Bendix
Output: 26 volts; 3 phase; 400 cycle; 10 VA; 6 PF. Input: 27.5 volts DC; 1.25 amps. **\$24.50**
- 12130-3-B Bendix
Output: 125.5 VAC; 1.5 amps. 400 cycles single phase, 141 VA. Input: 20-30 VDC. 18-12 amps. Voltage and frequency regulated. **\$49.50**
- 12137 Bendix
Output 250 VA, 115 volts, 3 phase, 400 cycle, 1.25 amp., 0.8 pf. Input 27.5 volt DC, 20 amp. **\$59.50**
- 12142-1-A Bendix
Output: 115 volts, 3 phase, 400 cycle, 250 VA. Input: 27.5 VDC, 22 amps. Voltage and frequency regulated. **\$99.50**
- 12147-1 Pioneer
Output: 115 VAC, 400 cycles; single phase. Input: 24-30 VDC; 8 amps. **Price \$39.50 each**
- 778 Bendix
Output: 115 volt, 400 cycle; 190 VA; single phase and 26 volt, 400 cycle, 60 VA, single phase. Input: 24 VDC. **\$37.50**
- 10285 Leland
Output: 115 volts AC; 750 VA, 3 phase, 400 cycle, .90 pf and 26 volts. 50 VA single phase, 400 cycle, .40 pf. Input: 27.5 VDC 60 amps. cont. duty, 6000 rpm. Voltage and frequency regulated. **\$59.50**
- 10339 Leland
Output: 115 volts; 190 VA; single phase; 400 cycle, .90 pf and 26 volts; 60 VA; 400 cycle, .40 pf. Input: 27.5 volts DC, 18 amps. cont. duty, voltage and freq. regulated. **\$49.50**
- 10486 Leland
Output: 115 VAC; 400 cycles; 3-phase; 175 VA; .80 pf. Input: 27.5 DC; 12.5 amps.; cont. duty. **\$70.00**
- 10563 Leland
Output: 115 VAC; 400 cycle; 3-phase; 115 VA; 75 pf. Input: 28.5 VAC; 12 amps. **\$35.00**
- F16 Jack & Helntz
Output: 115 volts, 400 cycle, 1 or 3 phase, 250 VA pf. 9. Input: 27.5 volts, 20 amp. Electronic frequency and voltage regulated. **\$99.50 each**
- PE109 Leland
Output: 115 VAC, 400 cyc.; single phase; 1.53 amp.; 8000 rpm. Input: 13.5 VDC; 29 amp. **\$50.00**
- PE218 Leland
Output: 115 VAC; single phase pf. 90; 380/500 cycle; 1500 VA. Input: 25-28 VDC; 92 amps.; 8000 rmps.; Exc. Volts **\$30.00**
- BRAND NEW
MG149F Holtzer-Cabot
Output: 26 VAC @ 250 VA; 115 V. @ 500 VA; single phase; 400 cycle. Input: 24 VDC @ 36 amps. **\$40.00**
- MG153 Holtzer-Cabot
Input: 24 VDC; 52 amps. Output: 115 volts —400 cycles, 3-phase, 750 VA. Voltage and frequency regulated. **\$95.00**
- AN 3499 Eicor, Class "A"
Input: 27.5 volts at 9.2 amps. AC. Output: 115 volts, 400 cycles; 3 phase, 100 voltamp; continuous duty. **Price \$39.50 each**

POTTER & BRUMFIELD RELAY

SP5M5LS. SPDT 8,000 ohm 11/16" dia. x 1 11/16" long. Approx. weight 1 oz. Hermetically sealed. Standard 7-pin miniature base.

Price **\$3.00** each

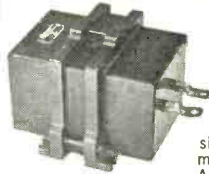

\$14940 TRANSFORMERS

Mfgd. by Kenyon. Output: 5 volts, 115 amps. Input: 105/125 volts, 60 cycle, single phase. Overall dimensions: 10" x 7" x 6". Approx. weight: 30 lbs. **\$15.00**

SELSYNS-SYNCHROS



- 1CT cont. Trans. 90/55V 60 cy. **\$37.50**
- 1DG Diff. Gen. 90/90V 60 cy. **37.50**
- 1F Syn. Mtr. 115/90V 60 cy. **37.50**
- 1G Gen. 115V 60 cy. **12.50**
- 1SF Syn. Mtr. 115/90V 400 cy. **7.50**
- 2J1F1 Gen. 115/57.5V 400 cy. **10.00**
- 2J1F3 Gen. 115/57.5V 400 cy. **7.50**
- 2J1FA1 Gen. 115/57.5V 400 cy. **5.00**
- 2J1G1 57.5/57.5V 400 cy. **7.50**
- 2J1H Diff. Gen. 57.5V 400 cy. **17.50**
- 2J5D4 Cont. Trans. 105/55V 60 cy. **17.50**
- 2J5F1 Cont. Trans. 105/55V 60 cy. **17.50**
- 2J5H1 Gen. 115/105V 60 cy. **17.50**
- 2J15M1 Gen. 115/57.5V 400 cy. **34.50**
- 5CT cont. Trans. 90/55V 60 cy. **34.50**
- 5D Dff. Mtr. 90/90V 60 cy. **34.50**
- 5DDG Diff. Gen. 90/90V 60 cy. **34.50**
- 5F S'n. Mtr. 115/90VAC 60 cy. **34.50**
- 5G S'n. Gen. 115/90VAC 60 cy. **42.50**
- 5HCT Cont. Trans. 90/55V 60 cy. **12.50**
- 5SDG Diff. Gen. 90/90V 400 cy. **25.00**
- 6G Syn. Gen. 115/90VAC 60 cy. **34.50**
- 7G Syn. Gen. 115/90VAC 60 cy. **42.50**
- R110-2A Kearfott Cont. Mtr. 115V 400 cy. **17.50**
- R200-A Kearfott Cont. Trans. 26, 11.8V 400 cy. **15.00**
- R210-1-A Kearfott Trans. 26, 11.8V 400 cy. **20.00**
- R220-A Kearfott Receiver 26, 11.8V 400 cy. **20.00**
- R235-A Kearfott Resolver 26, 11.8V 400 cy. **22.50**
- C567C1 Type 11-4 Rep. 115V 60 cy. **20.00**
- C694C5-2 Type 1-1 Transm. 115V 60 cy. **20.00**
- C694C5 Syn. Transm. 115V 60 cy. **20.00**
- C694C5-1 Type 11-2 Rep. 115V 60 cy. **10.00**
- C76165 Volt. Rec. 115V 60 cy. **12.50**
- C78243 Syn. Transm. 115V 60 cy. **5.00**
- C78249 Syn. Diff. 115V 60 cy. **7.50**
- C78863 Repeater 115V 60 cy. **20.00**
- C79331 Transm. Type 1-4 115V 60 cy. **7.50**
- 851 Bendix Autosyn Mtr. 22V 60 cy. **7.50**
- 403 Kollsman Autosyn. Mtr. 32V 60 cy. **7.50**
- FPE-2E-11 Diehl Servo Mfr. 75/ 15V 60 cy. **19.50**
- FPE-4S-1 Resolver 400 cy. **25.00**
- FJE-43-9 Resolver 115V 400 cy. **15.00**
- 999-0411 Kollsman 26V 400 cy. **10.00**
- 13770-10 Kollsman 26V 400 cy. **20.00**
- 1515B-0410 Kollsman 26V 400 cy. **12.50**
- 10047-2A Bendix 26V 400 cy. **15.00**
- 2900 Transicoil 115V 400 cy. **15.00**
- 15CX4e Synchro Transmitter MK 22 MOD 1 **15.00 ea.**

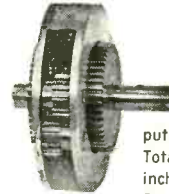

SIMPLE DIFFERENTIAL

1 to 1 reverse ratio; 48 teeth on input and output gear, 1-1/32 inch diameter. Total outside diameter 1-25/32 inches. Shaft size is 1/4 Inch. One shaft is 9/16" long; other shaft is 3/16" long. **\$5.00**

Stock No. 151

400 CYCLE MOTOR GENERATOR

Output: 115 volts, 400 cycle, single phase, 2 kva. Input: 115 volts D.C., 4 h.p., 3450 r.p.m. Motor and generator in separate frames. Dimensions mounted: 48" long; 17 1/2" wide. **\$100.00 each**

3800 CYCLE INVERTER

Mfgd. by Eclipse-Pioneer #12144-1-A. Input: 24-30 volts DC, 10 amps AC. Output: 115 volts, .95 amps, 3800 cycle, single phase. Approx. weight 2 1/2 lbs. **Priced at \$39.95**

Forward & Reverse 2 1/4-0-2 1/4. Input shaft spline gear 12 teeth 9/32" dia. 3/8" long. Output shaft 15/64" dia. x 15/32" long. Control shaft 11/32" x 3/8" long. Cast aluminum construction. Approx. size 3" x 3" x 2 3/4". **No. 145 \$17.50 ea.**



(All Shafts on Both Ball Bearing Supported)

SMALL DC MOTORS



- (approx. size overall 3 3/4" x 1 1/4" dia.):
- 5067126 Delco PM, 27 VDC, 125 RPM, Governor Controlled **\$15.00 ea.**
- 5069600 Delco PM 27.5 VDC 250 rpm **15.00**
- 5069230 Delco PM 27.5 VDC 145 rpm **15.00**
- 5068750 Delco 27.5 VDC 160 rpm w. brake **6.50**
- 5068571 Delco PM 27.5 VDC 10,000 rpm 1x1x2") **5.00**
- 5069790 Delco PM, 27 VDC, 100 RPM, Governor Controlled **15.00 ea.**
- 5BA10A118 GE 24 VDC 110 rpm **10.00**
- 5BA10AJ37 GE 27 VDC 250 rpm reversible **10.00**
- 5BA10AJ52 27 VDC 145 rpm reversible **12.50**
- 5BA10AJ50, G.E., 12 VDC, 140 R.P.M. **15.00**
- 206-1001 PM Planetary Gear Reduced Motor with Magnetic Brake. Mfgd. by Air Equipment 26 volts 600 ma 145 rpm **17.50**
- 5BA10FJ33, G.E., 12 VDC, 56 R.P.M., reversible **15.00**
- 806069 Oster series reversible 1/50 h.p. 10,000 rpm. 27.5 VDC 1 5/8" x 3 1/2" **5.00**
- C-28P-1A 27 VDC 1/100 h.p. 7,000 rpm **3.00**
- 7100-B-PM Hansen 24 VDC 160 rpm **7.50**
- SSF6-6-1 Diehl PM 27.5 VDC 10,000 rpm **4.00**
- 6-volt PM motor mfgd. by Hansen 5,000 rpm 1 1/4" in dia., 2" long overall **4.00**

COMMUNICATIONS EQUIPMENT CO.

PULSE TRANSFORMERS

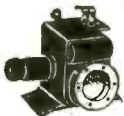

352-7150. Primary 50 ohms. Secondary 1000 ohms, 12,000 Ω , 12.0 Amp. Pulse: 1 or 2 usec. at .001 duty ratio. Fitted with magnetron well and bifilar winding for filament supply. \$22.50
MAGNETRON PULSE TRANS. #964: Prim. imp. 30 ohms, 1600 v. pulse. Secondary imp. is 1250 ohms, 12 KV pulse. Turns ratio sec:pri. is 7.5:1. Duty ratio is 0.001 at 1.2 usec. Bifilar winding 1.2A. \$8.50
RAYTHEON WX-4293E: Primary 4KV, 1.0 PPS. SEC. 16K-16 AMP DUTY RATIO: .001 400 CYCLE FIL. TRANS. "BUILT-IN". \$17.50
GE =K-2499A: Primary: 9.33 KV, 50 ohms imp. Secondary: 28 KV, 450 ohms. Pulse length: 1.05/5 usec. @ 635/120 PPS. Pk Power Out: 1.740 KW Bifilar: 1.5 amps. \$62.50
GE =K-2748-A: 0.5 usec @ 2000 Pps. Pk. Pwr. out is 32 KV impedance 40-100 ohm output. Pri. volts 2.3 KV Pk Sec. volts 11.5 KV Pk Bifilar rated at 1.3 Amp Fitted with magnetron well. \$24.50
K-2745: Primary: 3 $\frac{1}{2}$ KV. 50 ohms Z Secondary: 117/2.6 KV 1025 ohms Z. Pulse length: 0.25/1.0 usec @ 600/800 PPS. Pk. Power 200/150 KW, Bifilar: 1-3 Amp. Has "built-in" magnetron well. \$32.50

PULSE NETWORKS

H-616 10KV, 2.2 usec., 375 PPS, 50 ohms imp. \$22.50
 H-615 10KV, 0.85 usec., 750 PPS, 50 ohms imp. \$22.50
 H-605: 25 KV. "E" CKT. 1.5 usec. 400 PPS, 50 Ohms Impedance, 5 sections. \$62.50
 7-5E3-1-1200-67P, 7.5 KV "E" Circuit, 1 microsec, 200 PPS, 67 ohms impedance 3 sections. \$7.50
 7-5E3-3-200-67P, 7.5 KV. "E" Circuit, 3 microsec, 200 PPS, ohms imp. 3 sections. \$12.50
G.E. #3E (3-84-810) 8-2.24-405 50P4T; 3KV "E" /2000 PPS/50 ohms/2 sections. \$6.00
G.E. #3E (3-84-810) 8-2.24-405 50P4T; 3KV "E" CKT Dual Unit; Unit 1, 3 sections, 0.84 Microsec, 810 PPS, 50 ohms imp.; Unit 2, 3 Sections 2.24 microsec, 405 PPS, 50 ohms imp. \$6.50
 #632: "E" Network, 1600v., .6 usec/2 usec. 2000 PPS/350 PPS. 30 Ohms Imp. \$7.50

PULSE MODULATOR

MIT. MOD. 3 HARD TUBE PULSER: Output Pulse Power 144 KW (12 KV at 12 Amp). Duty Ratio: .001 max. Pulse duration: 0.5, 1.0, 2.0 microsec. input voltage: 115 v., 400 to 2400 cps. Uses: 1-715B, 1-829B, 3-722. 1-73. New. Complete with pressurized housing. \$135

MICROWAVE PLUMBING

X-BAND—RG, 52/U WAVE GUIDE

PARABOLOID DISH, 18" diam. Spun Aluminum 5" Focus. For AN/APS-6. \$4.50
3 CM. DIPOLE and Feed Assembly (May be used with above dish) 8-inches long. \$5.00
FLEXIBLE SECTION 9 in. long, Cover-to-Cover. \$5.50
ROTARY JOINT (APS-6) Sperry PT #55275, 180 deg. rotation, choke to choke. Has "Built-in" Di-Coupler. 20 DB, with "N" Takeoff. \$17.50
3 CM. DIPOLE FEED, 15" L. for APS-15. \$14.50
**MITERED ELBOW, Cast aluminum, 1 $\frac{1}{4}$ " x $\frac{3}{8}$ " V.G. W. E. Flanges. "E" Plane. \$3.50
3 CM. ANTENNA ASSEMBLY: Uses 17" paraboloid dish, operating from 24 vdc motor. Beam pattern: 5 deg. in both Azimuth and elevation. Sector Scan: over 160 deg. at 85 scans per minute, Elevation Scan: over 2 deg. Tilt. Over 24 deg. \$35.00
Cross-Guide Directional Coupler, UG-40 output flange. Main Guide is 6" Long, with 90 Deg. "E" Plane bend at one end, and is fitted with Std. UG 30/10G 40 flanges. Coupling figures: 20 db Nominal. \$22.50
Bulkhead Feed-thru Assembly. \$12.00
Pressure Gauge Section with 15 lb. gauge. \$10.00
Directional Coupler, UG 40/U take off 20db. \$15.00
MAGNET AND STABILIZER CAVITY For 2141 Magnetron and "E" Plane 2 $\frac{1}{2}$ radius. \$8.50
90 degree elbows, "E" Plane 2 $\frac{1}{2}$ radius. \$8.50
Beacon/receiver unit. Complete with dual klystron mount, TR/ATR section, duplexer, and 30 mc IF/Mixer unit. Originally designed for 9000 mc receiving using 723A/B. New, less tubes. \$22.50
Klystron mount for 732A/B. Front end of microwave receiver (50-3), with balanced mixer crystal mt. and iris coupling for AFC, less tube. \$15.00**

10 CM.—RG48/U Waveguide

Waveguide-to-Coax. adapter. Matches RG48/U waveguide to RG 44/U rigid coax. Complete with flanges. "T" match. \$15.00
10CM ECHO BOX: Tunable from 3200-3333 Mc. For checking out radar transmitters, for spectrum analysis, etc. Complete with pickup antenna and coupling devices \$17.50
POWER SPLITTER for use with type 726 or any 10 CM Shepherd Klystron. Energy is fed from Klystron antenna through dual pick-up system to 2 type N connectors. \$12.50
LHTR. LIGHTHOUSE ASSEMBLY. Parts of RT39 APG 5 & APG 15, Receiver and Trans. Cavities w/ assoc. Tr. Cavity and Type N CPLG. To Recvr. Uses 2C10, 2C43, 1B27. Tunable APX 2400-2700 MGS. Silver Plated. \$15.00
McNally Klystron cavity for 2K28 or 707B, tunes 2700-2900 mc. Complete with tuning vanes. \$5.00

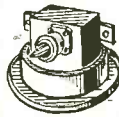

3000 MC WAVEMETER

Mfd. by G.E. for Armed Services 3000-3700 MC. Comes furnished with variable attenuator, coax. adapter cord. Cal. chart and pickup antenna. Has output jack for external meter or other monitor device. Resonance indicator is 3 $\frac{1}{2}$ " 20 microamp meter. Brand new, in portable wooden carrying case. \$75.00



DYNAMOTORS

TYPE	INPUT		OUTPUT		Price
	VOLTS	AMPS	VOLTS	AMPS	
BDAR83	14	2.8	375	.150	\$6.50
POSX-15	14	2.8	220	.08	8.95
DM33A	28	7	540	.250	3.95
B-19	12	9.4	275	.110	5.50
DA-3A*	28	10	500	.050	3.95
			300	.260	
			150	.010	
			14.5	5	
PE 73 CM	28	19	1000	.350	10.50
DAG-33A	18	3.2	450	.06	2.50
BDAR 93	28	3.25	375	.150	6.95
			† Less Filter	* Replacement for PE 94.	
PE 94. Brand New					5.95

INVERTERS

800-1B Input 24 vdc, 62A, Output: 115 V, 800 cy. 7A, 1 phase. Used excellent. \$18.75
 PE-218H: Input: 25/38 vdc, 92 amp. Output 115V 300/500 cy. 1500 Volt-ampere. NEW. \$32.50
 PE206: Input: 28 vdc, 36 amps. Output: 80 V 800 cy. 500 volt-amp. Dim. 13 x 5 $\frac{1}{2}$ x 10 $\frac{1}{2}$. New. \$22.50
 EICOR—ML 3011-5, Input: 13.75 V; 18.4A, Output: 115V/400~, 3 ϕ . 0.95 PF. Input: 100 VA. New. \$37.50
 LELAND #10553, Input: 28 vdc/12A, Output: 115 vac/400 cycle/3 phase, 115 va. Slightly used, ex cond. \$32.00

BROADBAND VIDEO AMPLIFIER

Navy type AM-518/SSA: input data: 2 channel, 70 ohms impedance each channel; output data: 2 channels, 50 ohms each channel; 1 to 4 volts overall gain; 100 cycle to 10 MC frequency range. Power required 115 volts, 1 phase, 60 cycle, 13 $\frac{1}{2}$ " wide x 17 $\frac{1}{4}$ " high x 28 $\frac{1}{2}$ " deep, overall. Mfr. Bendix Aviation Corp. Used, excellent. \$112

343 Canal St., New York 13, N.Y. Dept. E-10 Chas. Rosen Phone: Canal 6-4882

COMMUNICATIONS EQUIPMENT & TEST EQUIPMENT

SEND US YOUR LIST OF REQUIREMENTS
 ALL THE BEST & FINEST AT LOW PRICES
 MAIL, WIRE OR TELEPHONE FOR QUOTE.
MONTGOMERY EQUIPMENT CO.

14315 BESSEMER ST. TEL: 5tate 6-4657 VAN NUYS, CALIFORNIA
 HANDBOOK MAINTENANCE INSTRUCTIONS RADIO SET AN/ARC-27—
 Late Revision, new printing \$20.00 each

BEARINGS —

Miniatures; Precision; Stainless Steel;
 Special Sizes, Tolerance & Construction.

RAWAY BEARING CO.
 4-8 Forsythe St. Walker 5-8150 N. Y. C. 2, N. Y.

APR-4 RECEIVERS

Tuning units covering 38 to 4,000 MC.

ALLTRONICS-HOWARD CO.
 Box 19, Boston 1, Mass. Richmond 2-0048

Your inquiry will have Special value . . .

If you mention this magazine, when writing advertisers. Naturally, the publisher will appreciate it . . . but, more important, it will identify you as one of the men the advertisers wants to reach with this message . . . and help to make possible enlarged future service to you as a reader.

AN CONNECTORS

FAST DELIVERY

FROM STOCK
 Let us quote on your requirements.

LOW PRICES

All comply with government specifications

Wilgreen Industries
 99 MURRAY ST., NEW YORK 7, N. Y.
 Worth 4-2490-1-2

Cadmium or olive drab finish.



WE BUY
 ARC-3
 ARN-6
 ART-13
 AS-313
 LOOPS
 BC-788C
TEST EQUIPMENT
 Top Prices Paid
 Write today!

NEW FREE SALES CATALOG 116

It is loaded with bargains in ALL departments:

- | | |
|--------------|-------------------|
| Tubes | Test Equip. |
| Meters | Mikes |
| Headsets | Transmitters |
| Receivers | Capacitors |
| Transformers | Etc., etc., etc., |

SEND FOR CATALOG 116 TODAY!
 You'll be glad you did!

ARROW SALES, INC. Dept. E.
 7460 Varna Ave., No. Hollywood, Cal.

this Searchlight Section of **ELECTRONICS**

is an index of reliable sources for Used and Surplus Equipment now available. Consult the Searchlight Section in regular monthly issues for later offerings.

If you don't see what you want—ask for it. Ask the advertisers. They are constantly adding to their stocks and may have acquired just what you need. And, when you have special items to dispose of, use the Searchlight Section of Electronics to help you locate buyers . . . Send a list of your equipment and we will gladly give full information as to space and rates.

Classified Advertising Division

ELECTRONICS

P. O. Box 12 • New York 36, N. Y.

TUBES

★ Brand New! Fresh! Guaranteed!
 ★ Nationally known brands!
 ★ Prices reduced from 5 to 30%!

BROADCAST TUBES

2H21	\$25.00	356B	\$3.25
3C23	5.00	359A	1.10
3E29	8.00	371A	1.00
4E27	7.00	372A	2.10
4-400A	38.50	373A	2.75
4-1000A	125.00	374A	2.75
5D23/RK65	7.00	381A	5.00
6C21	13.50	387A	4.00
15E	1.20	403A	1.25
24G	3.00	403B	2.50
HK 24	2.50	404A	12.00
53A	5.00	407A	2.25
HY65	1.00	408A	1.75
100TH	6.00	416B	25.00
C100A	10.00	417A	12.00
101D	2.75	421A	4.50
101F	2.75	427A	10.00
104D	2.75	429A	7.50
121A	1.50	441A	5.00
VT127	1.00	450TH	40.00
VT-127A	2.50	471A	4.00
F-128A	7.00	575A	12.00
VT-158	9.50	HK 654	15.00
211	4.00	750TL	30.00
227A	3.75	801A	55.05
250TH	21.00	813	8.50
250TL	12.00	815	1.25
251A	40.00	828	8.00
252A	7.00	829	3.50
253A	3.00	829B	8.00
254A	2.00	830B	4.5
261A	7.00	838	.70
262B	5.00	838W	2.50
272A	5.00	843	.35
274B	.50	845	3.00
282A	2.00	852	4.00
282B	3.75	864	.25
300B	5.00	1619	.30
304TH	10.00	1620	3.50
305A	2.50	1625	.30
310A	3.50	3X2500A3	150.00
310A	3.50	4X150A	15.50
311B	4.00	4X150D	20.00
313C	2.25	4X250B	38.00
327A	3.40	5680	130.00
328A	3.50	5736	110.00
331A	6.00	F129B	145.00
337A	5.00	220B	55.00
348A	4.00	508	190.00
349A	4.50	858	140.00
354A	8.00	880	200.00

5,000 SERIES & UP

5517	\$1.00	5719	\$1.40	5995	\$9.75
5588	45.00	5719A	2.75	6000	2.00
5610	1.00	5725/GAS6W	2.75	6005	1.70
5633	4.00	5744	1.00	6021	3.00
5635	4.00	5750	2.20	6045	2.00
5636	2.40	5751	2.00	6073	1.50
5637	3.00	5751WA	3.50	6080	3.50
5641	5.75	5763	.90	6080WA	6.00
5643	4.00	5783	3.75	6110	1.30
5644	3.85	5784	4.00	6088CT	1.90
5644	5.00	5784WA	6.00	6099	1.40
5645	4.75	5787	3.75	6100	2.00
5646	3.75	5787WA	4.75	6101	2.00
5647	3.75	5814	.50	6106	8.00
5651	1.25	581A	1.50	6110	4.75
5651WA	3.25	5814WA	3.00	6111	3.75
5654/6AK5W	1.25	5829WA	3.50	6112	4.00
5654/6AK5W	1.25	5840	3.00	6116	45.00
6096	2.75	5840A	4.25	6130	4.50
5663	.95	5844	1.40	6147	3.00
5670WA	4.00	5854	2.50	6159	3.00
5672	1.00	5854	1.30	6161	37.50
5677	1.00	5886	1.75	6201	
5677	5.00	5896	3.00	12AT7WA	3.00
5678	1.00	5898	7.50	6211	1.00
5687	2.00	5899	3.25	6263	9.50
5687WA	4.00	5899A	5.75	6279/SC22	27.00
5691	4.75	5902	4.00	6280/416B	35.00
5692	5.00	5932	3.00	6386	5.00
5696	.75	5933	1.50	7193	.20
5702	1.30	5967	9.50	8012	1.00
5702WA	3.85	5969	9.50	9002	.65
5703WA	3.85	5977	2.50	9003	.90
5704	1.20	5977A	3.00	9004	.50
5718	1.25	5992	6.75	9006	.20
5718A	4.00	5992	6.75	9006	.20

RECTIFIERS & REGULATORS

OB2	\$5.50	3B26	\$2.50	250R	\$3.95
OB2WA	2.25	3B28	4.00	267B	4.95
OB3	.90	3529	4.75	314A	80.00
OC3	.50	5R4GY	1.25	371A	1.00
OC3	2.25	5R4WGY	2.50	371B	2.50
OD3	.50	5Y3WGT	1.30	575A	10.00
OD3W	2.25	5X3	2.20	705A	.65
SB	2.00	6-4	.50	836	1.20
SC	1.95	6-7	.50	869B	32.50
1V	.90	6-11	.50	872A	1.00
2C53	9.00	7H4B	.50	876	.75
2X2	.25	15R	.25	878	.50
2X2A	.75	RX21	5.00	878	.50
3B24	.65	100R/8020	2.75	VXR2700	6.00
3B24W	4.25	249B	2.50	5931/5U4WG	4.00
3B24WA	7.00	249C	2.50	8013	3.00

SCOPE TUBES

2AP1	\$2.00	5BP1A	\$8.50	5JP1A	\$25.00
3AP1	1.25	5BP4	2.25	5NP1	2.00
3CP1	1.75	5CP1	1.75	7BP1A	15.00
3DP1S2	4.75	5CP1A	7.00	7CP1	4.99
3FP7	1.00	5CP11	7.00	19P7	10.00
3GP1	2.00	5CP11A	8.50	12DP7	12.00
3JP1	7.00	5FP7A	2.50	51UCP11	25.00
3WP1	50.00	5FP7A	2.50	51UCP11	25.00
3EP1	1.25	5JP1	8.75	902P1	2.25

KLYSTRONS

1K015XA/X481	2K55	\$14.00	QK404	\$48.00
B, C, D	3K30	\$40.00	723A/B	6.50
5R16	6B1L6	24.00	726A	4.75
2K25	6B1M6	27.50	726C	9.50
2K28	6B1M6A	28.50	9611	40.00
2K43	V45	P.O.R.	5721	135.00
2K45	V50	P.O.R.	5721	135.00
2K48	V50	P.O.R.	5981/5650	45.00
2K54	V82	P.O.R.	6116	45.00

LIGHTHOUSE TUBES

2C39A	\$10.00	2C46	\$5.00	464A	\$1.90
2C40	6.00	3C22	56.00	8011	1.00
2C42	8.00	446A	.50	8014A	60.00
2C43	7.75	446B	.75		

TR. AND ATR. TUBES

1B24	\$5.50	1B47	\$3.50	532A	\$2.25
1B24A	12.50	1B58	50.00	709A	.50
1B35	3.00	1Q22	40.00	724B	.65
1B35A	6.50	GA4	4.00	6232	17.00
1B40	2.00				

THYRATRONS

C1K	\$7.00	FG-32	\$4.00	715C	\$10.00
1C	1.00	FG105	11.00	885	.75
2D21	.70	FG154	9.00	2050W	3.50
2D21W	.80	VT-158	9.00	2051	.65
3C45	4.50	FG-172	15.00	5559/FG57	8.00
4B25	5.00	FG-271	22.00	5796	7.00
C5B	5.00	393A	3.35	5948/1754	100.00
EL5B	5.00	KU-627	7.00	5966/E36	33.50
5C22	20.00	677	30.00	6130	4.50
C6M/5528	5.00				

All items F.O.B. Los Angeles, subject to prior sale and change of price without notice. This is only PARTIAL LISTING. Thousands of other tubes in stock. Minimum order \$10.00. Write for unlisted items of call REPUBLIC 5-0215. Cable VHRADLECT. Bell Teletype: TWX LA 1460

V & H RADIO and ELECTRONICS

2029-2047 W. VENICE BLVD. LOS ANGELES 6, CALIF.

SAVE UP TO 70% OF WHOLESALE COST

ALL COMPONENTS 1ST QUALITY AND 100% GUARANTEED

WE INVITE YOUR INQUIRIES FOR ALL YOUR ELECTRONIC NEEDS

FROM ONE OF THE LARGEST INVENTORIES IN THE U.S.A.

SYNCHROS

COMPLETE LINE OF COMMERCIAL ARMY AND NAVY TYPES

1CT	\$37.50	5N	\$22.50
1DG	37.50	5SDG	12.50
1HCT	42.50	5SP	29.50
1F	37.50	5SG	29.50
1G	37.50	5G	34.50
3D	62.50	6DG	27.50
3HCT	62.50	6HG	42.50
5B	22.50	7G	42.50
5CP	34.50	7DG	42.50
5HCT	42.50	23CX6	45.00
5F	34.50	2J1F1	4.95
5G	34.50	2J1G1	3.95

MANY OTHER TYPES IN STOCK QUOTATIONS ON REQUEST

POLYSTYRENE CAPACITORS
1% Tolerance

Hermetically Sealed 200VDCW-500VDC
0.5 MFD \$7.50 Ea.
1 MFD \$12.10 Ea.
MFD by Western Electric... Brand New

IMMEDIATE DELIVERY

MICROWAVE RECEIVERS

AN/APR-4 RECEIVER 115v 60 cy with plug in TUNING UNITS to cover 38 to 4000 mc.
AN/APR-1 RECEIVER 115v 60 cy with plug in TUNING UNITS to cover 38 to 3000 mc.
AN/APR-5 RECEIVER 115v 60 cy 1000 to 6200 mc.
LN STOCK—IMMEDIATE DELIVERY

TYPE "J" POTENTIOMETERS
2 Watt Carbon

Full range of Values Available From Stock for Immediate Delivery
Single Type J Units... \$.95 Ea.
Dual Type JJ Units... \$2.95 Ea.
Triple Type JJJ Units... \$3.95 Ea.
SEND FOR COMPLETE LISTING

FREQUENCY METER

125KC to 20 MC—Heterodyne Freq. Meter—Crystal Calibrated—Accur. .02% to 2MC; .01% from 2-20 MC—Modulated—Battery Oper.—w/Calibration Books—Exc. Cond.—checked out—Gtd. Ea. \$79.50

MEGGER

Winslow 5G-1000—Insulation Resistance Test Set—Range 0-1000 Megohms at 500 VDC—complete with Leads & Carrying Case—Brand New \$129.50

HEWLETT-PACKARD

WAVE GUIDE TEST EQUIP'T
G-370B Fixed Attenuator 1" x 2" 6DB \$45.00
G-370D Fixed Attenuator—1" x 2" —20DB 45.00
J-370C Fixed Attenuator 3/4 x 1 1/2" —10DB 45.00
J-370D Fixed Attenuator 3/4 x 1 1/2" —20DB 45.00
S-370D Fixed Attenuator 1 1/2 x 3" —6DB 52.50
S-370D Fixed Attenuator 1 1/2 x 3" —20DB 52.50
G-870A Slide Screw Tuner 1 x 2" 3.95 to 5.85 KMC. 95.00
J-870A Slide Screw Tuner 3/4 x 1 1/2" 5.85 to 8.20 KMC. 95.00
AC-24 WAVE GUIDE STAND. 2.50
S-25 Wave Guide Clamp 3" x 1 1/2" 1.25
G-25 Wave Guide Clamp 2" x 1 1/2" 1.25

KOLLSMAN SERVO MOTORS WITH TACH GENERATOR

TYPE 890-0160640-MOTOR-115V-60 Cy. 2Ph. 3350 RPM-5 Watts Output GEN. 6.5/1000 RPM. \$59.50 Ea.
TYPE 1623B - 0410120 - Motor 26V-400 Cy.-2Ph. 6500 RPM 4.5 Watts Output GEN. 0.34V/1000 RPM. \$42.50 Ea.

Terms: 20% cash with order, bal. C.O.D. unless noted. All prices net F.O.B. our warehouse Phila., Pa., subject to change without notice

Special Discounts on Quantity Purchases

TEST EQUIPMENT

GENERAL RADIO

GR 106M-1 Hy. Std. Inductance	\$52.00
GR 107N-Variable Inductor	\$50.00
GR 219K Decade Condenser	\$110.00
GR 419A Wavemeter 20-300 Mc	\$75.00
GR 434B Audio Freq. Meter	\$95.00
GR 475-B52 Frequency Monitor AND GR 681-A52 Frequency Dev. Meter	\$300.00
GR 572B 1KC Hummer	7.50
GR 629A Int. Freq. Meter	\$7.50
GR 700P1 Voltage Divider	\$25.00
GR 713B Beat Freq. Osc.	\$225.00
GR 715AE DC Amplifier	250.00
GR 720A Int. Freq. Meter	\$75.00
GR 723C VT Fork 1 KC	\$89.50
GR 724B Precision Wavemeter	160.00
GR 727A VTVM (Battery Oper)	\$85.00
GR 727A VTVM (Battery Oper)	\$105.00
GR 814-P2 Filter	\$15.00
GR 830A Low Pass Filter	\$20.00
GR 1110A Freq. Standard with GR 1110P1 Multivibrator	\$475.00
GR 1176A Freq. Meter 25-60,000 cy	\$170.00
GR 1535B Contactor	\$75.00
GR 1861A Megohmmeter	\$75.00
Boonton 152A FM Signal Gen. 20-28 MC 4-1-5 MC w/150R Pwr Supply	\$185.00
Dumont 185 Electronic Switch	\$7.50
Lavoie LA-269A Oscilloscope	\$9.50
Dumont 248 Oscilloscope	\$375.00
Estertine Angus-20 Pen Operation Recorder Portable type	\$320.00
Hewlett-Packard 325B Distortion Analyzer	\$220.00
Hewlett-Packard 337B FM Monitor 25-175 mc	\$465.00
Kay Megawave 50 KC-1000 MC.	\$200.00
Lavoie LA-269A Oscilloscope	\$950.00
Measurements 62 VTVM	99.50
Measurements 78E Std. Signal Gen.	115.00
Measurements 79B Pulse Gen.	165.00
Rubicon 1168 Resis. Std. .001 ohms	\$5.00
Rubicon 1169 Resis. Std. .001 ohm. 500 amp.	150.00
Rubicon 1171 Resis. Std. .0001 ohms	150.00
Sperdy Meraloid Model 291A Cavity Freq. Meter 2575-3780 MC—Accur. 0.1% MC.	\$395.00

Victoreen 247 AY Radiation Survey Meter 0-2.5/25/250/2500 milliroentgen/hr	\$115.00
Weston Model 1 Direct Reading Ohmmeter 0-2.5/25/50 ohms 3/4 W.	120.00
Weston 45 DC Voltmeter 0-15V-1/4 W. Accuracy	\$35.00
Weston 695 Power Level Meter	30.00
Weston 785 Industrial Circuit Tester	95.00
Weston 796 Megohmmeter 0-20/200 megohms 500V. Battery Operated.	\$42.00
AN/UPM-2 Wavemeter 80-1220 MC Accur. 1 MC	\$97.50
AT-48/UP-3 CM Pickup Horn Antenna	9.95
AT-105/AP-K Band Pickup Horn Ant. BC-921 Frequency Meter 125 KC-20,000 KC—Accur. 0.1%	12.95
I-128 Signal Generator 15-25 MC & 195-225 MC—Int. Mod.	\$115.00
I-138A 10CM Signal Generator 2700-2900 MC.	\$125.00
LAE-1 UHF Signal Generator 510-1300 MC Accur. 1%	\$225.00
LAF VHF Signal Generator 90-800 MC. Accur. 1%	\$325.00
LAG Microwave Signal Generator 1200-4000 MC Accuracy 1%	\$375.00
LP Std. Signal Generator 9.5 KC-50 MC-2V. Output.	\$375.00
ME-11A/U. R.F. Wattmeter	\$80.00
TS-33/AP 3 CM Frequency Meter 8700-9500 MC Accur. .03%	\$145.00
TS-34/AP Oscilloscope 30cps-1 Mc Portable	\$195.00
TS-46/AP Wave Meter 3000 MC	49.50
TS-100/AP Oscilloscope A, J, P & X Indication. Freq. video to 3 MC.	89.00
TS-174/U Freq. Meter 20-230 MC Accur. .05%	385.00
TS-211A/U Precision Echo Box 3730 to 8910 MC—Measures frequency, power, an etrum analysis. Incl. Crystal mixer tester	\$225.00
STODDART TS-537/U Noise and Field Intensity Meter 15-400 MC.	1200.00
TS-588A/U Std. Signal Generator 5 KC-50MC 2V. output.	390.00

Note—All items new except where noted * Excellent Used—Checked out & Guaranteed

WRITE FOR A COMPLETE LIST OF SURPLUS EQUIPMENT

LECTRONIC RESEARCH LABORATORIES
715-19 Arch St., Phila. 6, Pa. • Market 7-6771
Cable Address: LECTRONIC, Philadelphia

Universal RELAY CORP.

THE LARGEST STOCK OF RELAYS IN THE WORLD

TIME DELAY RELAYS

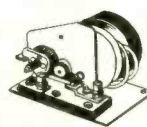

KURMAN R300 MOTOR DRIVEN
110V, 60 cye, Continuously adjustable delay 10 to 60 sec; SPST (1A) 15-amp contacts; Normally off, turns on at end of time period and remains on until power is turned off.
#R671 7.95*

CRAMER 340 MOTOR DRIVEN

110V, 60 cye, Contains two switch units actuated by pawls which ride on synchronous motor driven cams. Contacts 15 amp at 110VAC. Knob, pointer and dial can be mounted so that time interval may be preset to open 1st circuit from a few minutes to approx. 60 min. and 2nd circuit from approx. 70 min. to 120 min. Cams inside can be adjusted to change time sequence as desired. Motor 1/2 RPH. Contacts may be arranged to open relay circuit at end of time cycle. Supplied less knob and dial. Knob shaft: 1/4" d x 3/4" L. Unit: 3"W x 4"H.
#R933 4.00*

HEINEMAN FA533XB SILIC-O-NETIC PNEUMATIC



48VDC; DPDT (2C); 45 sec delay in make, instantaneous break, Electrically actuated, pneumatically timed; Sealed in solder dipped brass can; Octal plug base; 1/2 x 1/2 x 3/8 over-all; #R1317 9.50*

ALL MERCHANDISE IS GUARANTEED AND MAY BE RETURNED FOR FULL CREDIT

Prices listed with asterisk (*) are subject to QUANTITY DISCOUNTS

1-9	as quoted	50-99	15%
10-49	10%	over 100	20%

WHELOCK CHRONOMETRIC DELAY

Signal Engineering RX-9038-1:

(W.E. KS10163): Sig Corp Stk # 227705-22; 0.75 to 2.0 sec (adjustable); Accurately timed by means of an escapement mechanism. Delay in make, instantaneous break. 28VDC. DPST (2A); 10 amp contacts; 150 ohm. #R1318 6.00*

SANGAMO TIMER 3S-61S3K8

115V 60 cye; Sign flasher type; Individual cams open and close 3 sets of 20-amp contacts to deliver pulses: 4 per sec; 2 per sec and 1 long & 1 short per sec; Motor revolves at 600 RPM and drives a 2 1/2" d gear at 1 RPS. Two motors built in tandem give extra torque. #R1320 6.00*

AMPERITE THERMOSTATIC



Amperite Thermostatic Delay Relays are actuated by a heater and therefore be used on AC, DC, or pulsating current. Being hermetically sealed, Amperite Relays are not affected by altitude, moisture, or other atmospheric conditions. SPST is available—normally open or normally closed. Available in voltage ratings of 2.5, 5, 6.3, 12, 26 and 115 volts. Delays in seconds are available as follows: 2, 3, 5, 10, 15, 20, 30, 45, 60, 75, 90 and 120 seconds. Most types from stock. When ordering specify: Voltage—Delay in Seconds—Open or Closed. Net each \$2.35

Send for latest Circular.

Universal RELAY CORP.
Formerly Universal General Corp.
42 WHITE ST., NEW YORK 13, N. Y. • WALKER 5-9642

DUMONT HIGH VOLTAGE POWER SUPPLIES

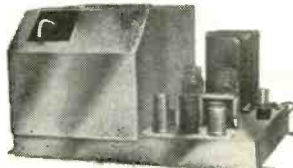

Delivers 23 kv. fully regulated and adjustable

RADAR • SNOOPERSCOPIES
COLOR AND PROJECTION TV
HIGH VOLTAGE TESTING, ETC.

Made by Dumont for RA119, 30 inch TV. Pulse Type H.V. generator and voltage-doubler with 3 tube voltage-regulator. Contains sweep protection circuits to disable the H.V. upon sweep failure. Low voltage also regulated by use of Sola Power Transformer with matching capacitor (cost over \$30). Contains 13 tubes and 3 relays. Input 117 V. AC 60 cycles. Schematic diagram included. Original cost over \$150.

NEW \$49.95 ea. F.O.B. BROOKLYN

ELECTRON TUBES HIGH QUALITY TOP MFR.

2AF4A	\$0.79	5840	2.25
6J7	.95	5899	3.00
6J4WA	1.50	5902	3.50
6J6WA	1.50	5977	2.00
5639	3.50	6021	3.50
5718	1.25	6101	1.50
5719	1.25	6111	3.50
		6112	4.00

SEG ELECTRONICS CO., INC.
1778 Flatbush Avenue, Brooklyn 10, N. Y.
CL 2-6333

Terms: Check with order. Well-rated firms net ten days. Minimum order ten dollars



"For hard-to-find items
try easy-to-find
ALVARADIO!"

INDUSTRIAL CONDENSERS

- A) 80 mfd. 4,000 volts. General Electric. Cat. 14P204 \$39.95
- B) 100 mfd. 4,000 volts (Sprague Vit. Q) Cat. P15902 \$49.95

COMPLETE INSTALLATIONS

- 1) AN/GRC-32B GROUND RADIO INSTALLATION.
- 2) AN/CRD-6 DIRECTION FINDER INSTALLATION.
- 3) MAR UHF COMMUNICATION EQUIPMENT.

Write for prices and data.

1-222 SIGNAL GENERATOR-MICROVOLTER

Freq. range 8-15 MC. & 150-230 MC. Complete with all tubes and 5 MC. Calibrating Crystals. Self-contained 110 V. and 60 cycle power supply. With Schematic. Cost the Govt. approx. \$700.00 Brand New **\$39.95**

Test Equipment

- AN/UPM-1, -7, -8, -10, -11
- AN/GPM-14
- LAE-1, -4
- TS-32, -33, -34, -35
- TS-36, -39, -45
- TS-47, -56, -59
- TS-62, -67, -74
- TS-89, -92
- TS-110, -111
- UHF Micro-Volter Model 10
- TS-125, -143
- TS-182, -184
- TS-204, -218, -277
- TS-268, -294C
- TS-488
- I-56
- IE-19
- IE-35, -36

Radar Equipment

- APA, -6, -10, -11
- APS-4, -6, -15
- SCR-717, -720
- SL APQ-13
- APT-5A ART-26

GROUND ELECTRONICS

- ARB BC-342
- ART-13 BC-344
- BC-191 BC-348
- BC-222 BC-375
- BC-224 CRT-3
- BC-312 TCS-12
- BC-314

AIRCRAFT ELECTRONICS

- ARC-1 ARC-27
- ARC-3 MN-62
- ARC-4 MN-55
- ARC-5 LP-21
- ARC-12 LP-31
- ARM-6 AS313-B
- APN-9 RTA1B

SCR 718C

1,000's of other items
Tell us your needs!

ALVARADIO INDUSTRIES

Established 1947. All items guaranteed.

Mailing Address:

P.O. Box 151-E, No. Hollywood, Calif.

Office-Warehouse:

5523 Satsuma Ave., No. Hollywood, Calif.

Cable Address: ALVARADIO

**SCR 584
RADAR TRAILER**

IN STOCK AS NEW—COMPLETE
FULLY EQUIPPED. 10 CM.
SEARCH AND TRACK. PPI.

A Rare Opportunity. Call Us

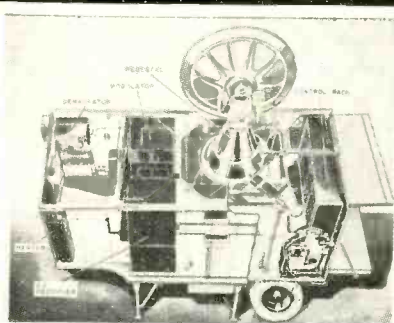

RADIO-RESEARCH INSTRUMENT Co.
550 - 5 Ave., N. Y. 36, N. Y. Tel: JU 6-4691
PAUL J. PLISHNER

ELECTRON TUBES

CONSISTENTLY HIGH QUALITY — AT SENSIBLE PRICES!

SPECIALISTS IN JAN, W.E., SUBMINIATURE, 5000/6000 SERIES AND RECEIVING TYPES

GUARANTEED • UNUSED • BOXED • 1st QUALITY • WRITE FOR COMPLETE LIST

0A2.....75	3J30.....25.00	35TG(surp).....2.00	422A.....7.00	5687.....2.70
0A3/VR75.....75	3K200000LK.....Write	VC50/32(cap).....8.00	GL434A.....5.00	5693.....4.50
0B2.....70	4-65A(surp).....15.00	56.....20	GL502.....1.50	5721.....125.00
0C3.....75	4-125A.....30.25	QK60.....20.00	UE578.....7.00	5725.....1.50
0D3.....75	4-250A.....35.00	QK61.....21.50	KU-610.....3.50	5726/6ALS......65
1AD4.....1.10	4-1000A.....95.00	FG81A.....3.10	Z666/5J30.....5.00	WL5736.....110.00
1B24.....5.00	4B24/EL3C.....4.50	100R/451.....1.75	X673.....12.50	5744.....1.00
1B24A.....15.00	4C35.....15.00	100TH(surp).....6.25	724B......60	5787WA.....5.00
1B26.....1.00	4J21.....70.00	FG-105.....11.00	726A.....5.00	5794.....5.00
1B32/532A......25	4J36.....70.00	120.....15.00	726C.....14.00	5844......50
1B35.....3.35	4J78.....70.00	F-128A.....10.00	750TL(surp).....30.00	5802.....4.50
1B40.....2.00	4PR60A.....30.00	R161.....1.00	803.....1.50	5812.....1.00
1B63A.....19.00	4X150A(surp).....19.00	806.....7.50	805.....4.00	5814.....1.00
1N21......10	4X500A(surp).....45.00	807W/5933.....1.50	807W/5933.....1.50	5819.....23.95
1N23......10	4X500A(surp).....45.00	807W/5933.....1.50	807W/5933.....1.50	5829WA.....3.00
1N48......40	4X500F.....40.00	807W/5933.....1.50	807W/5933.....1.50	5840A.....4.50
1N52......65	4X500F.....40.00	807W/5933.....1.50	807W/5933.....1.50	5840A.....4.50
1N65......85	4X500F.....40.00	807W/5933.....1.50	807W/5933.....1.50	5840A.....4.50
1N70......65	4X500F.....40.00	807W/5933.....1.50	807W/5933.....1.50	5840A.....4.50
1P23.....1.75	5CP1A.....6.50	807W/5933.....1.50	807W/5933.....1.50	5840A.....4.50
1P24.....1.35	5D21.....6.50	807W/5933.....1.50	807W/5933.....1.50	5840A.....4.50
1P25A.....20.00	5D23/RK65.....7.50	807W/5933.....1.50	807W/5933.....1.50	5840A.....4.50
1P30.....1.25	5HP1.....2.25	807W/5933.....1.50	807W/5933.....1.50	5840A.....4.50
1P37.....3.50	5J23.....Write	807W/5933.....1.50	807W/5933.....1.50	5840A.....4.50
1P41.....2.50	5FP7.....7.75	807W/5933.....1.50	807W/5933.....1.50	5840A.....4.50
1U4......38	5J23.....Write	807W/5933.....1.50	807W/5933.....1.50	5840A.....4.50
1Z2.....1.25	5J23.....Write	807W/5933.....1.50	807W/5933.....1.50	5840A.....4.50
CE2C.....2.00	5J23.....Write	807W/5933.....1.50	807W/5933.....1.50	5840A.....4.50
CL-2.....10.00	5J23.....Write	807W/5933.....1.50	807W/5933.....1.50	5840A.....4.50
2B21.....3.95	5J23.....Write	807W/5933.....1.50	807W/5933.....1.50	5840A.....4.50
2C39A.....10.00	5J23.....Write	807W/5933.....1.50	807W/5933.....1.50	5840A.....4.50
2C39AM.....10.00	5J23.....Write	807W/5933.....1.50	807W/5933.....1.50	5840A.....4.50
2C43.....2.75	5J23.....Write	807W/5933.....1.50	807W/5933.....1.50	5840A.....4.50
2C51/396A.....7.50	5J23.....Write	807W/5933.....1.50	807W/5933.....1.50	5840A.....4.50
2C53.....9.75	5J23.....Write	807W/5933.....1.50	807W/5933.....1.50	5840A.....4.50
2D21W......95	5J23.....Write	807W/5933.....1.50	807W/5933.....1.50	5840A.....4.50
2E24.....2.25	5J23.....Write	807W/5933.....1.50	807W/5933.....1.50	5840A.....4.50
2E25.....3.50	5J23.....Write	807W/5933.....1.50	807W/5933.....1.50	5840A.....4.50
2E26.....2.95	5J23.....Write	807W/5933.....1.50	807W/5933.....1.50	5840A.....4.50
2E35.....1.80	5J23.....Write	807W/5933.....1.50	807W/5933.....1.50	5840A.....4.50
2J21A.....3.50	5J23.....Write	807W/5933.....1.50	807W/5933.....1.50	5840A.....4.50
2J22.....3.50	5J23.....Write	807W/5933.....1.50	807W/5933.....1.50	5840A.....4.50
2J23.....9.00	5J23.....Write	807W/5933.....1.50	807W/5933.....1.50	5840A.....4.50
2J54.....25.00	5J23.....Write	807W/5933.....1.50	807W/5933.....1.50	5840A.....4.50
2K25.....13.50	5J23.....Write	807W/5933.....1.50	807W/5933.....1.50	5840A.....4.50
2K30/410.....115.00	5J23.....Write	807W/5933.....1.50	807W/5933.....1.50	5840A.....4.50
2K45.....35.00	5J23.....Write	807W/5933.....1.50	807W/5933.....1.50	5840A.....4.50
12N155(CBS).....3.75	5J23.....Write	807W/5933.....1.50	807W/5933.....1.50	5840A.....4.50
12N255(CBS).....2.90	5J23.....Write	807W/5933.....1.50	807W/5933.....1.50	5840A.....4.50
2V3G......65	5J23.....Write	807W/5933.....1.50	807W/5933.....1.50	5840A.....4.50
3A5.....1.50	5J23.....Write	807W/5933.....1.50	807W/5933.....1.50	5840A.....4.50
3B24.....10.50	5J23.....Write	807W/5933.....1.50	807W/5933.....1.50	5840A.....4.50
3B25.....5.00	5J23.....Write	807W/5933.....1.50	807W/5933.....1.50	5840A.....4.50
3B26.....3.95	5J23.....Write	807W/5933.....1.50	807W/5933.....1.50	5840A.....4.50
3B28.....3.75	5J23.....Write	807W/5933.....1.50	807W/5933.....1.50	5840A.....4.50
3B29.....4.75	5J23.....Write	807W/5933.....1.50	807W/5933.....1.50	5840A.....4.50
3C22.....59.50	5J23.....Write	807W/5933.....1.50	807W/5933.....1.50	5840A.....4.50
3C23.....3.95	5J23.....Write	807W/5933.....1.50	807W/5933.....1.50	5840A.....4.50
3C24/24G.....1.70	5J23.....Write	807W/5933.....1.50	807W/5933.....1.50	5840A.....4.50
3C33.....6.00	5J23.....Write	807W/5933.....1.50	807W/5933.....1.50	5840A.....4.50
3C45.....6.75	5J23.....Write	807W/5933.....1.50	807W/5933.....1.50	5840A.....4.50
3D23.....4.00	5J23.....Write	807W/5933.....1.50	807W/5933.....1.50	5840A.....4.50
3E29.....8.00	5J23.....Write	807W/5933.....1.50	807W/5933.....1.50	5840A.....4.50

TERMS: 25% Deposit with Order. Balance C.O.D.—or Send Full Remittance with Order. Well Rated (D&B) Firms. Net 10. All Items Subject to Stock Depletion and Price Variation Without Prior Notice. All Merchandise Fully Guaranteed for Cost of Merchandise Only. Minimum Order \$10.00.

Walker
5-7000

Cable:
Baryleet,
NY

Telegrams:
Barry, Fax,
NYC

Twx:
NY1-3731
(Unattended)

WRITE FOR "BARRY'S GREEN SHEET" OF EQUIPMENT BARGAINS.
LATEST SEPT. 1, 1957 ISSUE OFF PRESS

BARRY ELECTRONICS CORP.
512 BROADWAY N.Y. 12, N.Y.

**SAVE ON BRAND NEW U. S. NAVY SURPLUS
MOTOR-GENERATORS**

400 CYCLE—1 PHASE POWER
FOR YOUR TEST BENCH

MOTOR: General Electric—3
H.P.—115/230 volts—60 Cy.
—1 PH. 3425 R.P.M. Frame
224.—Type KC. Ball Bearing
Construction.
GENERATOR: Leland — 2
K.W.—17.4 amps. 115 Volts—
400 Cy.—1 PH.—Ball Bearing
Construction.
Spark Gap Modulator
—by Raytheon—Type
CRP—10249. Welded steel
mounting base. 43" L. x 18" W.

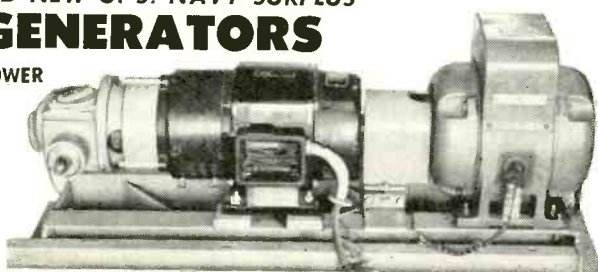

TODAY'S VALUE \$1200.00
SHIP. WT. 400 LBS. NOW ONLY **\$295.00**
F.O.B. CHGO.

GROBAN SUPPLY CO. Dept. EL-10 1139 S. Wabash Ave., Chicago 5, Ill.

TRANSMITTERS • RECEIVERS • RADAR

FREQUENCY SHIFT KEYING and PHOTO TRANSMISSION

Model TEG transmitter—frequency range: 200 to 18,000 kcs, crystal controlled; emission A₁A₂A₃; 10 preset channels; frequency shift keying up to 600 wpm; power output 100 watts; input voltage is 115 v, 1 ϕ, 50-60 cps set consists of transmitter, 2 antenna tuners, terminal, 2 transmitters controls, and 2 power transformers.—Mfr: RCA.

• TEST EQUIPMENT •

Hundreds of different types of test equipment, military as well as commercial types. Write for new catalog on your letterhead.

- TS-3A/AP—"S" Band Power Meter and Signal Generator.....\$97.50
- TS-10/AP—Aldimeter Test Set.....\$27.50
- TS-12/AP—Standing Wave Indicator.....Write
- TS-13/AP-X BAND RADAR TEST SET—Measures power, freq. signal-to-noise ratio, I.F. Band-pass, etc. Input—115/1/60—800.....\$149.00
- TS-15/AP—Fluxmeter, Direct Reading.....\$69.50
- TS-34/AP—Oscilloscope, Portable, with 5, 50 and 250 Micro-second Start-Stop.....Special \$149.00
- TS-35A/AP—X Band Signal Generator and Power Meter. Input—110/1/50—1200 cps. Can generate and measure RF power. New.....\$175.00

- TS-36/AP—Power Meter 8700 to 9500 mcs. 0.1 mw to 1 Watt in Input.....\$125.00
- TS-56/AP—Slotted Line, 500-675 mcs.....Write
- TS-69/AP—Freq. Meter, 400 to 1000 mcs.....\$69.50
- TS-70/AP—R. F. Wattmeter, 200-500 mcs.....Write
- TS-74/UPM—Dummy Load, "S" Band, 50 & 72 ohm input.....\$95.00
- TS-89/AP—Voltage Divider, Capacitive.....\$49.50
- TS-98/AP—Voltage Divider, Resistive 800 ohms imp. Ratio 22:1 (app.).....\$27.50
- TS-100/AP—TEST SCOPE, type A, R, J & X indications, gated & ungated sweep, Int. or Ext. trigger.....Write
- TS-110/AP—Hand Tuned Echo Box, 2400-2700 mcs; cw, mew, or Pulsed; 50 ohms Impedance; Ring-time 2.5 miles; Accuracy ±3.5 mcs. With Accessories. New.....\$75.00
- TS-155/AP—Signal Generator, 2700-2900 mcs. Variable Pulse Width, Rate and Delay, 50 ohms imp.....Write
- TS-170/ARN-5—Test Set for ARN-5.....Write

• MOTOR GENERATORS • CONVERTERS •

- 28dc to 110/1/800 @ 1kva.....\$49.50 (Overall length 12 inches)
- 110dc to 110/1/800 @ 350va.....150.00
- 110 ac to 110/1/800 @ 350va.....235.00
- 110dc to 110/1/400.....295.00
- 110/1/60 to 110/1/400 @ 2kva.....395.00
- 110dc to 28dc @ 250va.....49.50
- 110/1/60 to 28dc @ 250va.....97.50
- 220/1, 3/60 to 28dc @ 250va.....97.50
- 110dc to 110/1/60 @ 1.25kva.....117.50
- 220dc to 110/1/60 @ 1.25kva.....130.00
- 110dc to 110/1/60 @ 350va.....85.00
- 110dc to 110/1/60 @ 500va.....95.00
- 110dc to 110/1/60 @ 5kva.....285.00

SYNCHROS & SELSYNS

- | | |
|----------------|--------------------|
| 1F.....\$55.00 | 8DG.....\$34.50 |
| 1SF.....55.00 | 8G.....49.50 |
| 1G.....55.00 | 7G.....49.50 |
| 1DG.....42.50 | 2J1F.....10.00 |
| 5F.....39.50 | 2J1G.....10.00 |
| 5G.....39.50 | 2J1H.....10.00 |
| 5T.....45.00 | AY-43 autotyn..... |
| 5SDG.....27.50 | |

• SOME SPECIAL ITEMS •

- DUAL OUTPUT GENERATOR: 115/1/400 @ 39 Amps and 28 V DC @ 17.9 Amps, NEW, MOUNTED OR UNMOUNTED. Write
- WESTINGHOUSE ELECTRIC GENERATOR—10 KVA—AC. Output 115/1/60 @ 105.5 amps; 80 pf, 50°C; cont. duty 1800 rpm, sep. excited; 125 dc. DC generator Output 125 volts dc @ 8 amps. This generator is mounted on bed plate with room for motor mounting. It can be driven by any mechanically coupled motor, dc or ac or other drive.....\$459.00
- MOTOR GENERATOR 800-1D — Input 24-28 volts dc. Output 115 v. 800 cycles at 10.5 amps. Small and compact.....\$29.50
- M-209—Holtzer-Cabot—Filtered. Input 115/1/60. Output 115 volts, 3ϕ, 233 cycles; at 0.4 amps and 24 volts dc at 6.5 amps, 3500 rpm.....\$125.00
- POWER UNIT TYPE 23—Rotary transformer, filtered. Input 24 vdc Output 0.3 volts at 2 amps and 200 volts at 30 ma.....\$19.00

• Design, Modification, Production and Testing of Communications and Radar Equipment



COMPASS ELECTRONICS SUPPLY

A DIVISION OF COMPASS COMMUNICATIONS CORP.
75 VARICK STREET CANAL 6-7455 NEW YORK 13, N. Y.
CABLE ADDRESS: COMPRADIO, N. Y.

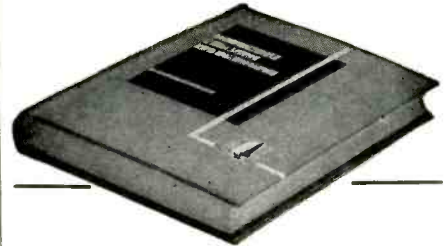

RELIABILITY FACTORS FOR GROUND ELECTRONIC EQUIPMENT

Methods and working data to help designers build greater reliability into military electronic equipment. Pinpoints causes of poor reliability. Discusses electrical and mechanical factors, human engineering, and components. Gives results of failed-parts studies. Edited by Keith Henney. 200 pp., 196 illus., \$8.50

ELECTRONIC ENGINEERING

Techniques of circuit analysis for radar, television, electronic control, instrumentation, and computers. Gives alternate methods for many circuits, and provides means for combining circuits of different types. Examples relate techniques to practice. Discusses solid state theory, and transistors as circuit elements. By Samuel Seely, Prof. & Chrmn., Dept. of Elec. Engrg., Syracuse U. 525 pp., 782 illus., \$8.00

RANDOM PROCESSES IN AUTOMATIC CONTROL

Presents theory and practical techniques for analyzing linear control systems subjected to random inputs. Treats concepts of probability and random time functions in detail. Develops techniques for designing systems containing constant and time-varying components. Provides computational methods for use on computers. By J. H. Laming, Jr., and R. H. Battin, Instrument. Lab., Mass. Inst. of Tech. 429 pp., illus., \$10.00

THE MIGHTY FORCE OF RESEARCH

FORTUNE Magazine editors tell how 4 billion dollars for research is opening new business opportunities. Reveals who does research, who pays, how it is carried out, what is accomplished, and what it means for you. By Editors of FORTUNE. 308 pp., 21 illus., \$1.00

10 DAYS' FREE TRIAL

McGraw-Hill Book Co., Inc., Dept. FL-327 West 41st St., N. Y. 36, N. Y.

Send me book(s) checked below for 10 days' examination on approval. In 10 days I will remit for book(s) I keep, plus few cents for delivery costs, and return unwanted book(s) postpaid. (We pay delivery cost if you remit with this coupon—same return privilege.)

- Henney—Reliability Factors for Ground Electronic Equipment—\$8.50
- Seely—Electronic Engineering—\$8.00
- Laming & Battin—Random Processes in Automatic Control—\$10.00
- FORTUNE—The Mighty Force of Research—\$4.00

(PRINT)

Name.....
Address.....
City.....Zone.....State.....
Company.....
Position.....
For price and terms outside U.S., write McGraw-Hill Int'l., N.Y.C. FL



KOILED CORDS 3 wires \$1.26
22 inches long stretches to 9 ft.

Only a few more left
GONIOMETER
TYPE CFT-47372 — 250 to 1500 K.C.

nightlighter — Automatic lightswitch. Darkness throws the switch—turns lights on at dusk... off at dawn. Fools burglars who watch for signs of an empty house. Same as your city buys for \$45 on top of street lamp posts. \$15.95



TELECHRON Motors

1 RPM.....\$3.95	3.6 RPM.....\$3.15
2 RPM.....2.90	6.0 RPM.....4.85
3 RPM.....3.90	3 RPH.....2.35
4 RPM.....3.90	1 RP 2Hz.....2.80
	1 RP 12Hz.....3.25

1 RPM—50 Cycles, \$1.85
Laboratory Special 1 of Each Motor \$25

PLEASE INCLUDE POSTAGE

BLAN
EST. 1923

64 T Dey St.
New York 7,
N. Y.

D-E-L-A-Y-E-D A-C-T-I-O-N

LIGHT SWITCH

Shuts light off automatically almost a minute later. Keeps porch or garage light on after you shut it off. \$3.50
DEALERS WRITE FOR PRICES

HAND WOUND 10 Sec. to 24 Min. TIMER SWITCH \$1.35

6 Watt Most POWERFUL TELECHRON MOTOR
110 V. 60 Cy
1 RPM.....6.50



HAYDON TIMING MOTORS

110v 60 Cycle 30 RPM.....\$2.60
110v 60 cycle 1RPM.....\$2.60
230v f2 RPM.....\$1.00
60 cy 1 RPM.....\$1.00
HANSEN Synchron 4 rpm \$4.24
CRAMER 4 rpm.....\$4.65

DIEHL-DELCO

P. M. motors.
Made for 24 volts.
Will work at lower speed at 12v. or 6v Battery \$375
or Rectifier. Size 1" x 1" x 2"



RESISTORS, CONTROLS & POTENTIOMETERS

Sub-miniature types in all values,

LEGRI S CO.

391 Riverdale Ave., Yonkers, N. Y. YOnkers 9-6000

"KING OF THE RESISTORS"

"Sorry, cannot specify the names of manufacturers—but they are what you think they are!"

SPECIAL SALE • REGULATED POWER SUPPLIES

NEW CONDITION

A SPECIAL PURCHASE OF A LARGE QUANTITY OF DRESSEN-BARNES REGULATED POWER SUPPLIES OFFERED AT A REAL SAVINGS IN \$ \$ \$ \$.

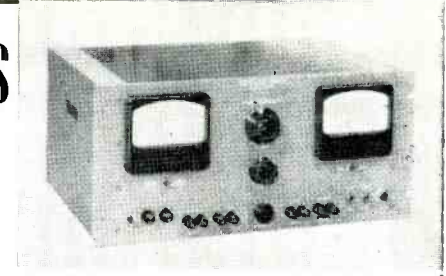

Model D3-500B Dual Reg. Supply
 2—0-300 VDC. 0-500 MA.
 2—Bias Voltage 300 VDC Fixed
 2—6.3 VAC. at 10 Amps Unreg. . \$390.00

Model 3-1.5 MB Reg. Supply
 1—0-300 VDC @ 0-1500 MA.
 1—0-150 VDC @ 5 MA.
 1—6.3 VAC. @ 10 Amps Unreg. . \$390.00

Model D5-200C Dual Reg. Supply
 2—30-500 VDC. @ 0-200 MA.
 2—6.3 VAC. @ 10 Amps Unreg. . \$375.00

Model 1.5-150X Sub Chassis Mtg. Supply
 1—150 VDC. @ 0-150 MA.
 1—6.3 VAC. @ 6 Amps Unreg. . . \$50.00

Model D5-300B Dual Reg. Supply
 2—0-500 VDC. 0-300 MA.
 2—Bias Voltage 300 VDC Fixed
 2—6.3 VAC @ 10 Amps Unreg. . \$390.00

Model D50-.05B Dual Reg. Supply
 2—0-50 VDC. @ 0-50 MA. . . . \$160.00

Model D1-100B Dual Reg. Supply
 2—0-100 VDC. @ 0-100 MA. . . \$270.00

Model 4-200X Sub Chassis Mtg. Supply
 1—400 VDC. 0-200 MA.
 1—6.3 VAC. @ 6 Amps Unreg. . . \$80.00

Model 28-5MX Sub Chassis Mtg. Supply
 1—28 VDC. @ 0-5 Amps Unreg. . \$300.00

Model DF-300F Reg. Supply
 1—0-500 VDC. @ 0-300 MA.
 1—0-300 VDC. @ 0-150 MA.
 1—6.3 VAC. @ 10 Amps Unreg. . \$240.00

Model 3-150B Regulated Supply
 1—0-300 VDC. @ 0-150 MA.
 1—0-150 Neg. VDC. @ 5 MA.
 1—6.3 VAC. @ 6 Amps Unreg. . . \$120.00

Model 3-150L Reg. Power Supply
 1—0-300 VDC. @ 0-150 MA.
 1—6.3 VAC. @ 6 Amps Unreg. . . \$75.00

Several other models in limited quantities.

APN4B Loran—New with Mounts, Plugs, and New PE-206 Inverter. . . . \$119.50 Each
 Kay Mega—Sweep Video Generator, Calibration Model—Excellent. . . . 150.00 Each
 Ferris Noise & Field Strength Meter, Model 32B—Excellent. . . . 200.00 Each
 Hewlett—Packard Test Oscillator Model 650A—Excellent. . . . 150.00 Each
 Hewlett—Packard Audio Oscillator Model 205A—Excellent. . . . 250.00 Each
 Hewlett—Packard Volt Meter DB Model 400C—Excellent. . . . 100.00 Each
 TS-175/U Frequency Meter 85-1000 MC.—Excellent. . . . 400.00 Each
 Dumont Type 324R Cathode-Ray Oscillograph 50-400 Cy.—Excellent. . . 450.00 Each
 Teletronic Lab. Model 101 Oscillograph—Excellent. . . . 150.00 Each

F.O.B. Pasadena, California

PHOTOFLASH SPECIALS
 G.E. FT-524 Quartz Photoflash
 Tubes 3000 W.S.—New. \$20.00 Ea.
 G.E. 80 MFD. @ 4000 V.
 Photoflash Capacitors
 640 W.S.—New. . . . 49.50 Ea.
 Sprague 100 MFD. @ 4000 V.
 Photoflash Capacitors
 800 W.S.—New. . . . 62.50 Ea.

Sycamore 2-4131

PHOTOCON SALES

RYan 1-6751

421 NORTH ALTADENA DRIVE
 PASADENA, CALIFORNIA

RADAR

P.P.I. REMOTE REPEATERS

- VD 7" Upright
 - VE-7" Table Type
 - VF-5" "B" Scope "5" P.P.I.
 - VG-24" Plotting Table
 - VJ-12" Upright
 - VK-12" Upright
 - VL-12" Upright R.H.I. IND.
- All indicators are 110v 60 cyc.

Radalab INC.

87-17 124th St., Richmond Hill 18, N. Y.
 Phone Virginia 9-8181-2-3

OVERSEAS CUSTOMERS CALL US DIRECTLY BY
 TELEX OVERSEAS TELETYPE TWX N. Y. 4-4361

EE-94-95

CODE PRACTICE EQUIPMENT

This is 20 and 40 man code practice set. This equipment is a complete setup for a school to teach Morse Code up to 400 WPM. The set consists of a recorder, turntable, switchboard, 6TG-3Y keys, code keys, headsets, clock, timer, wire record set, oscillator, etc. We can supply this set from a current production contract. Write.

RDO & APR-4

SEARCH RECEIVERS

The RDO is a very elaborate radar search receiver greatly improved over the APR-4. The set uses APR-4 tuning units, but is much more versatile, having input metering, D.B. output meter, automatic noise limiter and greater selectivity and sensitivity. The RDO is recommended when only the very best will do. Input 110/60 cys.



COUNTER MEASURES EQUIPMENT

SEARCH DETECTION

- AN/APR-4 38-4000 MC RDO 38-4000 MC
- AN/APR-2 300-1000 MC SCR-616 115-600 MC
- AN/APR-5 1000-3100 MC
- AN/APR-6 1,000-10,000 MC

DIRECTION FINDING

- AN/APA-17 300-10,000 MC
- AN/APA-24 100-750 MC
- AN/APA-48 140-300 MC

PANORAMIC AND PULSE ANALYZING

- AN/APA-6 Pulse Analyzing
- AN/APA-11 Pulse Analyzing
- AN/APA-10 Panadaptor
- AN/APA-38 Panadaptor
- AN/ARQ-5 18-80 MC Receiver Indicator
- AN/ARQ-8 25-105 MC Barrage Rec-Trans Indicator
- AN/ARQ-10 1.5 MC-50 MC Receiver-Trans. Jammer Indicator
- AN/ARQ-1 Thru 12 also avail.
- AN/APA-23 Signal and Time Recorder

NOISE GENERATORS

- AN/URA-T1 AN/URA-2T MD-4/URA
- Shot-Noise, Banpipes, Tone, Random Keying, Output.
- These units will key any transmitter.

JAMMER TRANSMITTERS

- AN/APT-1 thru 10 25-3,000 MC AN/APQ-15
 - AN/APQ-1 thru 20
 - AN/SPT-Series
 - SCR-596 1.5-30 MC Barrage Ground Jammer
 - TDY, MRQ, SPT, SPQ, TPQ-1AN/UPT-T1-T3, T4
- Many other countermeasures equipments avail. both hi and low power. These equipments can be used in test new radar and computer systems for susceptibility to jamming and other countermeasures. We can supply complete setups covering any freq. from 100 KC 10,000 MC. with power supplies for mobile operation.

MAR POINT TO POINT RADIO SET

Portable 225-398 mc point to point 10 chan. crystal controlled voice and new radio set. This is a very late radio set used for point to point and ground to air communication. The transmitter output is 8 watts on 10 pre-set crystal controlled channels instantly selected by a band switch. The REC is also crys. controlled on the trans. freq. The set is inclosed in 3 water proof shock proof cabinets that may be set up in a few minutes on location. This equipment is ideal where a reliable radio link easily transported is needed. Power input is either 24 VDC 115/230V AC or DC. Complete sets avail. Write

GROUND INSTRUMENT LANDING SYSTEM

This set consists of an AN/CRN-10 localizer and a AN/CRN-2 glide path ground station. This equipment can be set up at an airport to provide a complete I.L.S. that will operate with the AN/ARN-5 and RC-103 airborne I.L.S. system to provide blind approach facilities. This system can be installed permanently or transported. Each station has complete monitoring fac'l. Input power is 110V 60 cyc.

AN/TRC-1-3-4

100 MC RADIO-RELAY EQUIPMENT

The AN/TRC series is a mobile portable set for duplex or simplex radio telephone point to point communication. This set will operate with the CF series carrier systems to provide multi channel operation. The set operates on 100 MC with an output of 10-50 watts. The set is crystal controlled. Complete sets avail. Input 110v 60 cyc.

SCR-399-499

Mobile and fixed station high power radio sets: the SCR-399 is mounted in a HO-17 shelter. The SCR-499 is transported in carrying cases to be set up for field operation. Freq. of the sets is 2-18 mc. pwr output is 350w. Phone and C.W. 2 communication receivers are provided. Input is 110v 60 cys.

AN/ASQ-1 AIRBORNE MAGNETOMETER

This is an airborne chart recording magnetometer. The equipment has a sensitivity of 2 gamma. The AN/ASQ-1 records on an Esterline angus recorder disturbance in the earth's magnetic field. Input is 28v DC. Weight about 130 lbs.

SHORAN

AN/APN-3-AN/CPN-2

The AN/APN-3 and AN-CPN-2 are Precision distance measuring installations. This equipment operates on 225 mc. The range is 250 miles with an accuracy of 25 feet. This equipment is widely used by geological companies for prospecting and mapping. Power input is 110v 400 cyc and 28v DC.

• RADALAB • RADALAB • RADALAB • RADALAB • RADALAB • RADALAB • RADALAB • RADALAB •

Now! 100 + CUSTOM METERS from only these 6

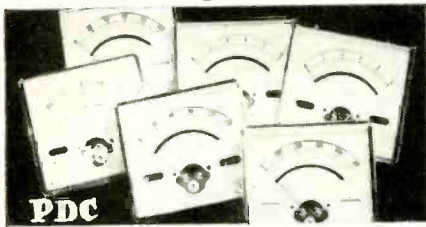

PDC CUSTOM METERS

A completely new idea in custom meter design... PDC Custom Meters are now available for general meter use, engineers, experimenters, hobbyists, pilot runs, spot applications, and in-the-field measurements.

Six basic meters, with slip-on interchangeable scale faces, and companion snap-in multipliers and shunts, permit coverage of more than 100 AC and DC voltage and current ranges.

Each meter features D'Arsonval moving coil design, polished jewels and pivots, fatigue tested springs, knife-edged pointer, mirror scale, lithographed scale face, high-quality shunt or multiplier, optional shadow mask and illumination. Plastic case in sizes 2 1/2", 3 1/2" or 4 1/2".

Here's How It Works! You need a 2.5 volt, 20,000 ohms/volt meter. You refer to the PDC master chart to determine which basic meter, scale face and shunt or multiplier is required. You then take the basic meter, slip on the interchangeable scale face, which fits snugly into place, and then snap in the required shunt into the lock-type holes in the rear of the meter...

A Custom Meter in Less Than a Minute!

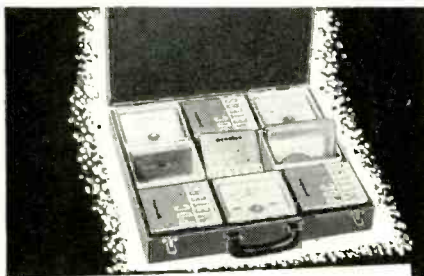

Special Industrial Package \$129⁹⁵

- Six Meters... 4 1/2"
- Slip-on scale faces
- Snap-in resistors
- Beautiful Attache case
- Illumination packet

Special scales (such as VU, db, etc.) as well as zero center galvanometer is optional in package.

Special Industrial Package, and replacements of basic meters, scale faces, shunts and multipliers, are available through your local electronics distributors, or write to:

PRECISE DEVELOPMENT CORP.

Oceanside, N. Y.

Circle 390 Readers Service Card

Electro Engineering Works, Inc.	298
Electro Instruments Inc.	106
Electro Products Laboratories	405
Electro-Pulse, Inc.	284
Electro-Snap Switch & Mfg. Co.	295
Electro Tec Corporation	46, 47
Electronics	3
Electronic Batteries, Inc.	475
Electronic Engineering Company of California	276
Electronic Fabricators, Inc.	355
Electronic Instrument Co., Inc. (EICO)	377
Electronic Tube Corp.	244
Electronics Division, Elgin National Watch Co.	234
Electronics International Co.	83
Ellis & Watts Products, Inc.	71
Empire Devices Products Corp.	382
Epsco Incorporated	72, 73
Eraser Co., Inc.	401
Erie Electronics Division, Erie Resistor Corp.	366, 367
Esterline-Angus Co., Inc.	402

G-L Electronics	268
G-M Laboratories, Inc.	474
Ganewell Company	230
Garrett Corporation	256, 257
General Ceramics Corp.	30
General Electric Co.	
Apparatus Dept.	77, 126, 299
Miniature Lamp Dept.	296
Semiconductor Products Dept.	335
Specialty Electronic Components Dept.	118, 119
Tube Dept.	96A, 96B, 136, 137
General Mills	323
General Radio Co.	17
Genisco Incorporated	120
Good-All Electric Mfg. Co.	139
Grant Pulley & Hardware Corp.	217
Graphic Systems	420
Gries Reproducer Corp.	361

Fansteel Metallurgical Corp.	372, 373
Federated Metals Div. of American Smelting & Refining Co.	280
Fenwal, Inc.	36
Fenwal Electronics, Inc.	406
Filtors, Inc.	395
Ford Radio & Mica Corp.	472
Formica Corp.	293
Freed Transformer Co., Inc.	476

Hallcrafters Company, The	274
Handy & Harmon	112
Harder Co., Donald C.	408
Hardwick Hindle Inc.	89
Hart Manufacturing Co.	292
Haydon Mfg. Co., Inc.	246
Heath Company	364
Heiland, a Div. of Minneapolis-Honeywell	321
Helipot Corp., Beckman Div.	242, 243
Heller Roberts Mfg. Corp.	475
Hewlett-Packard Company	64A, 64B, 64C, 64D
Heyman Mfg. Co.	388
Hickok Electrical Inst. Co.	74

microminiaturized

TRANSISTOR ASSEMBLIES SEALED AND POTTED

- Amplifiers, flip-flops, sawtooth generators, multivibrator, oscillators
- Any existing circuit can be assembled into these units or units can be added to an existing circuit now used
- Truly subminiature — less than one-fifth of a cubic inch
- Special circuits made to specifications

M F ELECTRONICS CO.
122 East 25th St., New York 10, N.Y.
GRamercy 3-5899

Circle 391 Readers Service Card

SUBMINIATURE TRANSFORMER

Hermetic Sealed or Epoxy Imbedded

Field Tested — used with transistors by leading manufacturers in large quantities.

NEW!

400 cps Servo transformer-Sub-Miniature Size
Spec. Pri. 10,000ct
Sec. 500
ac power: 12.5 watt 3/4"x1"x1" # 427
ac power: 6.25 watt 3/4"x1"x3/4" # 414
Pri. unbalance dc: ± 4ma
60 cps Isolation transformer-Sec. ct
Spec. Output 115 v. 3.0 mw 3/4"x1"x1" # 608
Enclosed: any manner
Special requisition will be constructed within two weeks.

Flea type in stock

Sizes

- # F-2010 = .263 x .410 x .325
- # O-T560 = .245 x .376 x .325
- # M-340 = Still Smaller

Frank Kessler Co. Inc., 41-45 47th St., L.I.C. 4, New York Tel: Stillwell 4-0263

Circle 392 Readers Service Card

Hitemp Wires, Inc.	375
Homelite a Div. of Textron Inc.	338
Hopkins Engineering Co.	434
Horman Associates, Inc.	436
Hudson Wire Co.	247
Hughes Products, a Div. of Hughes Aircraft Co.	63, 318
Humphrey, Inc.	306
Hunt Company, Philip A.	282
Hycor Div. of International Resistance Co.	388

Indiana Steel Products Co.	38
Indium Corp. of America	400
Industrial Timer Corporation	128
Instrument Development Laboratories Inc.	342
Instruments for Industry, Inc.	365
Insuline Corp. of America	298

JED Electronics Inc.	94
JVM Engineering Co.	420
Jacksonville Area Chamber of Commerce	387
Jennings Radio Mfg. Corp.	316
Johnson Company, E. F.	80A
Jones Div., Howard B. Cinch Mfg. Co.	361

Kahle Engineering Co.	15
Kato Engineering Co.	413
Kay Electric Co.	29
Kearfott Co., Inc.	278
Kepec Laboratories, Inc.	215
Kessler Co., Inc., Frank	470
Kester Solder Co.	253
Key Resistor Corp.	407
Kintel (Kay Lab)	54
Kraeuter & Co., Inc.	401
Krohn-Hite Corporation	109

Laboratory for Electronics, Inc.	390
Lampkin Laboratories, Inc.	421
Lapp Insulator Co., Inc.	332
Leach Corporation	236
Lennard Co., Inc., P. M.	361
Lepel High Frequency Laboratories, Inc.	419
Librascope, a Subsidiary of General Precision Equipment	391
Linde Company, Div. of Union Carbide Corp.	409
Link Aviation, Inc.	337
Lockheed Aircraft Corp., California Div.	329

McCoy quartz crystals

meet
5
important
requirements

SIZE ... Less than 1/2" wide; please note dimensions below.

WEIGHT ... One twenty-fifth (1/25) of an ounce.

VIBRATION ... Withstands from 10 to 2000 c.p.s.

SHOCK ... Withstands from 0 to 30 g.

STABILITY ... Frequency stabilities of ±.0025% over -55° C to ±90° C possible.

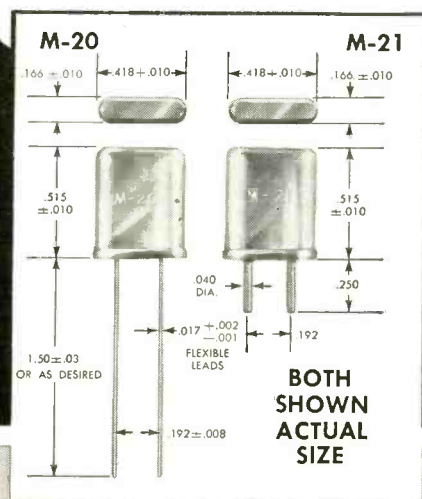

McCoy McMite lightweight quartz crystals extend the limits of electronic design. These little, hermetically sealed units are built rugged to pack regular size performance into minimum space ... with no sacrifice of stability or dependability! Produced in frequencies from 3 mc to 125 mc to meet government specifications or made to your own specifications.

FREE ILLUSTRATED CATALOG.
Send for your copy today.

ELECTRONICS COMPANY
MT. HOLLY SPRINGS, PENNA.
DEPT. E-10
PHONE 376-377

McCoy

New TYPE 202 VECTORLYZER

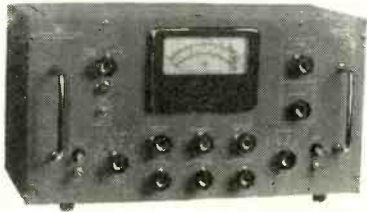

Accuracy—0.05° or 2%
Full Scale Sensitivity—1° or 0.04 Volt Rms
Frequency Range—15 CPS to 500 Mega-
cycles

Use It To Measure

1. Precision measurement with error less than 0.05°, sensitivity can be 1° full scale.
2. Vector sum or vector difference of two voltages.
3. Imaginary and real components of an unknown voltage in terms of a reference voltage.
4. Ratio of two voltages.
5. Voltage across two points which are both a.c. ground potential.
6. Magnitude and phase angle of an unknown impedance.

Specifications

Phase Angle Range:
0-1, 0-2, 0-4, 0-10, 0-20, 0-60 up
to 360 degrees full scale.

Frequency Range:
Binding Post—15 cps to 200 kc.
Probe—100 kc to 500 megacycles.

Voltage Range:
Binding Post—0.4, 0.04, 0.1, 0.2,
0.4, 1, 2, 4, 10, 20, 40, and 100
volts rms full scale.
Probe—0.4, 2 and 4 volts rms full
scale.

Price: \$485.00

ADVANCE
Electronics Lab., Inc.
249-259 Terhune Ave.,
Passaic, N. J.



Circle 394 Readers Service Card

M B Manufacturing Company, A Division of Textron Inc.	310
M F Electronics	470
M. I. T. Instrumentation Laboratory	427
MacDonald, Inc., Samuel K.	436
Magnatran, Inc.	408
Magnetic Metals Co.	324
Magnetics, Inc.	223, 345
Magtrol, Inc.	411
Maleo Tool & Mfg. Co.	419
Mallory and Co., Inc., P. R.	142, 213, 271
Mansol Ceramics Co.	413
Marconi Instruments Ltd.	5
Martin Company	309
McCoy Electronics Company	471
McGraw-Hill Book Co.	353, 414
Measurements Corp.	357
Merck & Co., Inc.	376
Metals & Controls Corp., General Plate Div.	88
Micromech Mfg. Co.	417
Micro Switch a Div. of Minneapolis-Honeywell Regulator Co.	60, 61
Microwave Associates, Inc.	325
Millen Mfg. Co., Inc., James	224
Minneapolis-Honeywell Regulator Co. Boston Div.	39
Minnesota Mining and Manufacturing	130
	131, 303
Moloney Electric Co.	281
Monitor Products Co.	421
Morris Company, J. I.	405
Motorola, Inc.	249
Mullard Overseas Ltd.	363
Myalex Corp. of America	57

N J E Corporation	347
Narda Microwave Corp.	45
National Lead Company	64
Nems-Clarke, Inc.	429
New Departure Div. of General Motors	68
New Hermes Engraving Machine Corp.	371, 385
Niemand Bros., Inc.	422
Non Linear Systems Inc.	333
Norden-Ketay Corp.	70
North Electric Co.	336
Northeastern Engineering	360
Northern Radio Company	307

Oak Mfg. Co.	67
Ohmite Mfg. Co.	263
Operations Research Office	396
Oregon Electronics	319

Pace Electrical Instruments Co., Inc.	417
Panoramic Radio Products, Inc.	370
Penta Laboratories, Inc.	328
Perkin Engineering Corp.	25
Perkins Machine & Gear Co.	399
Perma-Power Co.	386
Phalo Plastics Corp.	275

Want **HIGH**
INSULATION AND
MECHANICAL STRENGTH?

get **BOTH**
IN NATURAL
MICA

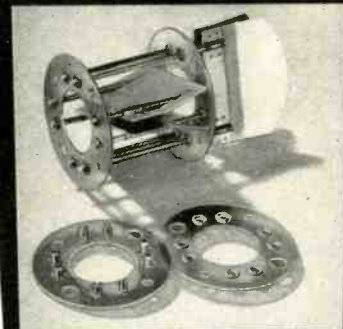

"Gun" assembly for oscillographic tube depends on .020" thick natural mica for insulation and structural rigidity.

Natural MICA's 6.2 Kv/mil dielectric strength and low thermal expansion answer a critical electronics need. High heat resistance and 32,000 psi *minimum* compressive strength are added values. *And*, mica can be readily fabricated to extremely close tolerances.

You get *all* of MICA insulation's advantages when FORD shapes and fabricates it into the precise forms you need. Write for MICA BULLETIN and details.

YOUR PROBLEM ?

... Discuss it with FORD MICA engineers, backed by 40-year-plus leadership in mica insulation precision-stamping and fabrication.

Since
1917

FORD RADIO
& MICA CORP.

536-540 63rd Street
Brooklyn, N.Y. GEdney 9-8300

Circle 395 Readers Service Card

October 1, 1957 — ELECTRONICS

Phelps-Dodge Copper Products Corp. Inca Mfg. Div.	124, 125
Philamon Laboratories, Inc.	79
Philbrick Researches, Inc., George A.	122
Phitec Corporation	31
Phillips Control Corp.	400
Photocircuits Corporation	381
Plastoid Corp.	314
Polorad Electronics Corporation	128A, 128B
Potter & Brumfield, Inc.	228, 229
Potter Instrument Co.	423
Polymer Corp. of Penna.	350
Precise Development Corp.	470
Precision Capacitors, Inc.	417
Precision Metal Products	424
Pulse Engineering	387
Pyle-National Co.	285
Pyramid Electric Co.	351

RBM Division Essex Wire Corp.	44
RCA Electron Tube Division	4th Cover
Radiation Inc.	262
Radio Engineering Laboratories, Inc.	133
Radio Frequency Laboratories, Inc.	352
Radio Engineering Products	413
Radio Materials Corp.	127
Radiometer	473
Radio Receptor Co., Inc.	75, 219
Rawson Electrical Instrument Co.	365
Raytheon Mfg. Company	18, 19 134, 279, 430, 431
Relay Sales Inc.	35
Rex Rheostat Co.	436
Rhinson Aviation, Inc.	23
Roland Teiner Co., Inc.	384

Sage Electronics Corp.	385
Sams & Co., Howard W.	65
Sanborn Company	289
Schweber Electronics	469
Sel-Rex Corporation	389
Sensitive Research Instrument Corp.	380
Shalleross Mfg. Co.	322
Sierra Electronic Corp.	113
Sola Electric Co.	66
Somers Brass Company, Inc.	383
Sorensen & Co., Inc.	4
South Chester Corporation	132
Southern Electronics Corp.	37
Sprague Electric Co.	11, 273
Stackpole Carbon Co.	99
Staedtler, Inc., J. S.	294
Standard Plastics Co., Inc.	415
Stevens Arnold, Inc.	382
Stoddart Aircraft Radio Co., Inc.	354
Stronberg-Carlson Company	339, 404
Superior Electric Company	341
Superior Electronics Corp.	415
Superior Tube Co.	129
Sylvania Electric Products, Inc.	27, 58, 59
Syntronic Instruments, Inc.	432

Taylor Fibre Co.	100
Technitrol Engineering Co.	424
Technology Instrument Corp.	334
Tektronix, Inc.	343
Telechrome, Inc.	269

AM STANDARD SIGNAL GENERATOR

Type MS111

FREQUENCY:
10 kc/s to 108 Mc/s on
fundamentals. 12 ranges

AM:
0-90%

DISTORTION:
Less than 5% at 90% AM

OUTPUT VOLTAGE:
0.2 μ V to 0.2 V open circuit
0-2 V from separate jack

OUTPUT IMPEDANCE:
10 and 75 ohms
(or 50 ohms on request)



Low incidental FM • Constant output on all ranges to 20 Mc/s • Electronically stabilized power supply • Extremely wide frequency range and low distortion AM make the instrument invaluable for lab. work.

RADIOMETER

72 Emdrupvej, Copenhagen NV-1, Denmark

Represented in Canada by

BACH-SIMPSON • London/Ontario

Represented in the United States by

WELWYN INT. INC. • 3355 Edgecliff Terrace, Cleveland 11, Ohio

Circle 396 Readers Service Card

new from trio... high temperature build-in miniature AC VTVMs

ruggedized
reliable
light: 1.3 lbs.
small: std 3 1/2"
meter space

for building into equipment meeting MIL-E-5400 and MIL-T-945A; uses meter meeting MIL-M-10304A. Series 121 single-range AC VTVMs withstand as high as 85° C, maintain $\pm 2\%$ full-scale accuracy to as high as 71° C. Input Z 1 meg, frequency range 20-50,000 cps — available in any range from 30 MV to 300 VAC. Power required is 6.3 V and 125-200 VDC (Trio Model CP auxiliary power supply available). Highly flexible automatic scale selection. Adding extra terminals makes separately available both the 200 μ A DC meter & stable, linear, current-feedback amplifier. Special scaleplates, ranges, Z's on request.



For free 36-page Engineering Guide, write to Dept. E-10
Trio Laboratories Inc.
Seaford, N. Y.

Booth 151-152,
National
Electronic
Conference
Chicago, Oct. 7-9

trio

when ordinary instruments are
too big or inadequate...

Make a **GM** PORTABLE D'ARSONVAL

GALVANOMETER

*the Heart
of Your
Instrument*

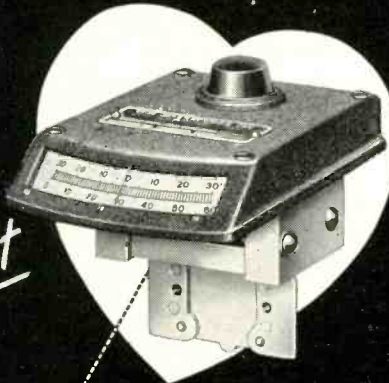

FOR MEASURING LIGHT reflectance and color, the Photovolt Corporation of New York uses a Model 600 G-M Galvanometer for its popular Reflection Meter (left). Whatever your own particular instrument field, you can achieve this same self-contained portability, ruggedness and high sensitivity with G-M Galvanometers. Complete catalog on request.

GM LABORATORIES, INC.

4336 NORTH KNOX AVE., CHICAGO 41, ILL.
Circle 398 Readers Service Card

Good News Travels Fast . . .

WINCHESTER CONNECTORS

OFF THE SHELF DELIVERY!

Types SA — A — SM — S — M
— MRE — QRE — HMRE — All
Hoods and clamps now stocked by
CORONET ELECTRONICS, INC.
INDUSTRIAL
DISTRIBUTORS.

Write, wire or call for
**WINCHESTER
INDUSTRIAL
BULLETIN
W-1000**



Coronet
Electronics inc.

120 LIBERTY ST., N. Y. 6 • CO 7-3760

Telrex Laboratories	412
Tensolite Insulated Wire Co.	312
Texas Instruments Incorporated	226, 227
Tobe Deutschmann Corp.	340
Tranco Products, Inc.	320
Transformers, Incorporated	98
Transistron Electronic Corp.	105, 107
Transval Engineering Corp.	383
Trio Laboratories, Inc.	473
Triplett Electrical Instrument Co.	84
Tung-Sol Electric, Inc.	101

U. S. Components, Inc.	358
U. S. Electronics Development Corp.	264
U. S. Semiconductor Products, Inc.	297
Ucinite Co.	50
Union Switch & Signal Div. of Westinghouse Air Brake Company	266
United-Carr Fastener Corp.	51
United Electronics	115, 116, 117
United Transformer Co.	2nd Cover
University Loudspeakers, Inc.	34

Van Keuren Co., The	413
Varian Associates	85
Varo Mfg. Co., Inc.	220
Vector Electronic Co.	402
Veeder-Root, Inc.	52
Vulcan Electric Co.	403

Waldes Kohinor, Inc.	135
Waldorf Instrument Co., Div. of F. E. Huyek & Sons	104
Waltham Precision Instrument Co.	356
Waterman Products Co., Inc.	302
Waters Mfg., Inc.	358
Wenco Manufacturing Co.	409
Westinghouse Electric Corp.	40, 41 78, 86, 87, 114, 237, 384
Weston Electrical Instrument Corp., a Subsidiary of Daystrom, Inc.	93
Wheelock Signals, Inc.	411
White Dental Mfg. Co., S. S.	62
White Instrument Laboratories	429
Wood Co., John	359

Zell Products Corp.	398, 399
---------------------	----------

MANUFACTURERS REPRESENTATIVES	436
----------------------------------	-----

PROFESSIONAL SERVICES	436
-----------------------	-----

EMPLOYMENT OPPORTUNITIES...437-456

EDUCATIONAL 457

EQUIPMENT
(Used or Surplus New)
For Sale457-468

WANTED
Employment 457

EMPLOYMENT OPPORTUNITIES
ADVERTISERS INDEX

Abbott's Employment Specialists.....440, 446
Admiral Corp. 444
Aircraft Radio Corp..... 454
Applied Science Corp. of Princeton..... 451

Bendix Aviation Corp.
Products Division 442
Products Division—Missiles 438
York Division 451
Burroughs Corp., Research Center..... 445

Chemstrand Corporation 559
Cooper, J. J..... 453

Ebasco Services Inc..... 456

Federal Telephone & Radio Co..... 453
Fidelity Personnel Service..... 453

General Electric Co.....441, 455
Goodyear Aircraft Corp.
Akron, Ohio 437
Litchfield Park Arizona..... 444

International Business Machines Corp.... 439

Johns Hopkins University, The Applied
Physics Laboratory 442

Kollsman Instrument Corp..... 452

Little Inc., Arthur D..... 446

Magnavox Co. 452
Melpar Inc. 440
Monarch Personnel 453
Motorola Inc.
Chicago, Illinois 446
Phoenix, Arizona 438

National Co., The..... 448
Northrop Aircraft Inc..... 451

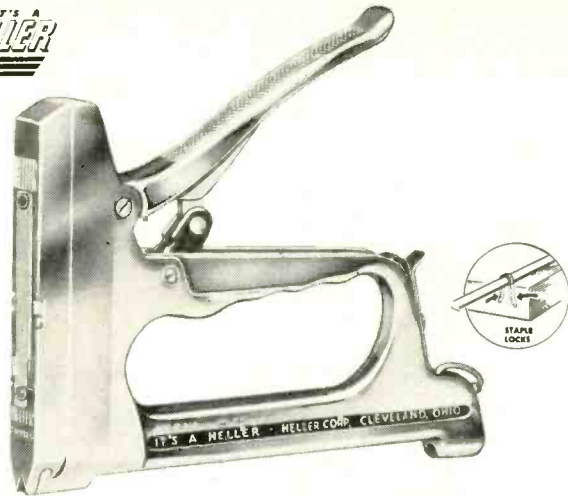

WORLD'S FINEST STAPLING GUN
for fastening wire and tubing

The fast easy way to fasten wiring or small tubing is to use the new Heller WT-1 automatic stapling gun that operates with one hand. Staples cannot pinch the wire, and they lock securely in hard or soft wood, plaster, etc. Gun is loaded in seconds with a continuous strip of staples in 3/8 or 1/8 in. leg length. A leader in the industrial fastening field for 30 years, Heller makes a complete line of over 300 staplers, tackers, stitchers and nailers for manual, foot, pneumatic and electric operation. Write for literature.

HELLER ROBERTS

Manufacturing Corporation
HELLER INDUSTRIAL FASTENER DIVISION
2135 Superior Ave., Cleveland 14, Ohio

Circle 400 Readers Service Card

STURGES BATTERIES

Superior Power with Unlimited Uses

Used successfully in many industries, e.g. Electronics . . . Aviation . . . Sound Recording . . . Electrical Instruments . . . Television Lighting etc. Sturges Batteries supply superior power, dependable performance and economy of operation. Available in many different voltages . . . in sizes and shapes to meet restricted space limitations.

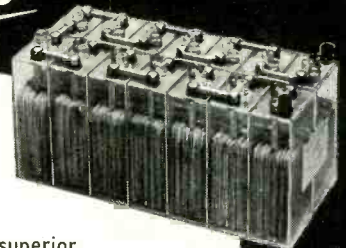

Type "H" Storage Battery
Amp. Hrs.—15
Voltages from 2 to 28 or as specified
Weight from 1 7/8 lbs. to 26 1/2 lbs.



Type "S" Storage Battery
Amp. Hrs.—6; Voltages from 2 to 28 or as specified;
Weight from 12 oz. to 12 lbs.

FREE

Write for literature on six different sizes of type "S" and type "H" Batteries; including performance curves, size specifications, etc.

CONSULT US ON ALL YOUR SPECIAL BATTERY APPLICATION PROBLEMS

STURGES BATTERIES

- ★ Lightweight—Non-Spill (in any position)
- ★ Transparent Molded Plastic Case
- ★ High Output of Watt Hours Per Pound of Battery
- ★ Continuous High Voltage Uniformity While Discharging
- ★ Conforms to Any Amount of Space

manufactured by **ELECTRONIC BATTERIES, INC.**

Bush Terminal Building Number 4 • 28-34 35th Street • Brooklyn 32, New York

Circle 599 Readers Service Card

FREED TELEMETERING COMPONENTS

FOR IMMEDIATE DELIVERY
FROM STOCK

BAND PASS FILTERS				DISCRIMINATORS					
Center Frequency F ₀ (KHz)	Per cent Deviation of F ₀	Per cent Linearity	Catalog No.	Center Frequency F ₀ (KHz)	Per cent Deviation of F ₀	Per cent Linearity	Catalog No.		
4	8 1/2	15	0.5	1.0	4	8 1/2	15	0.5	1.0
5.6	8 1/2	15	0.5	1.0	5.6	8 1/2	15	0.5	1.0
7.3	8 1/2	15	0.5	1.0	7.3	8 1/2	15	0.5	1.0
9.6	8 1/2	15	0.5	1.0	9.6	8 1/2	15	0.5	1.0
1.3	8 1/2	15	0.5	1.0	1.3	8 1/2	15	0.5	1.0
1.7	8 1/2	15	0.5	1.0	1.7	8 1/2	15	0.5	1.0
2.3	8 1/2	15	0.5	1.0	2.3	8 1/2	15	0.5	1.0
3.0	8 1/2	15	0.5	1.0	3.0	8 1/2	15	0.5	1.0
3.9	8 1/2	15	0.5	1.0	3.9	8 1/2	15	0.5	1.0
5.4	8 1/2	15	0.5	1.0	5.4	8 1/2	15	0.5	1.0
7.35	8 1/2	15	0.5	1.0	7.35	8 1/2	15	0.5	1.0
10.5	8 1/2	15	0.5	1.0	10.5	8 1/2	15	0.5	1.0
12.3	8 1/2	15	0.5	1.0	12.3	8 1/2	15	0.5	1.0
14.5	8 1/2	15	0.5	1.0	14.5	8 1/2	15	0.5	1.0
22.0	8 1/2	15	0.5	1.0	22.0	8 1/2	15	0.5	1.0
30.0	8 1/2	15	0.5	1.0	30.0	8 1/2	15	0.5	1.0
30.0	8 1/2	15	0.5	1.0	30.0	8 1/2	15	0.5	1.0
40.0	8 1/2	15	0.5	1.0	40.0	8 1/2	15	0.5	1.0
40.0	8 1/2	15	0.5	1.0	40.0	8 1/2	15	0.5	1.0
52.5	8 1/2	15	0.5	1.0	52.5	8 1/2	15	0.5	1.0
52.5	8 1/2	15	0.5	1.0	52.5	8 1/2	15	0.5	1.0
70.0	8 1/2	15	0.5	1.0	70.0	8 1/2	15	0.5	1.0
70.0	8 1/2	15	0.5	1.0	70.0	8 1/2	15	0.5	1.0

DISCRIMINATOR LOW PASS FILTERS					
Center Frequency F ₀ (cps)	Attenuation	Center Frequency F ₀ (cps)	Attenuation	Center Frequency F ₀ (cps)	Attenuation
6	790	81	790	208	10,000
8	900	110	900	208	10,000
11	1,050	160	1,050	208	10,000
14	1,200	185	1,200	208	10,000
20	1,600	220	1,600	208	10,000
25	2,100	330	2,100	208	10,000
35	2,700	450	2,700	208	10,000
45	3,600	600	3,600	208	10,000
60	4,800	800	4,800	208	10,000

Characteristic impedance of all—330!!

INPUT					
Center Frequency F ₀ (cps)	Attenuation	Center Frequency F ₀ (cps)	Attenuation	Center Frequency F ₀ (cps)	Attenuation
400	14,500	3,000	14,500	23	30,000!!
560	22,000	3,900	22,000	23	30,000!!
730	30,000	5,400	30,000	23	30,000!!
960	40,000	7,350	40,000	23	30,000!!
1,300	52,500	10,500	52,500	23	30,000!!
1,700	70,000	12,300	70,000	23	30,000!!
2,300				23	30,000!!

Characteristic impedance of LPI-10 thru 23—30,000!!
of LPI-24 thru 28—5,100!!

Write for detailed information on these and other components for military and commercial applications. Send for NEW 48 page TRANSFORMER CATALOG. Also ask for complete LABORATORY TEST INSTRUMENT CATALOG.

FREED
TRANSFORMER CO., INC.
1722 WEIRFIELD STREET
BROOKLYN (RIDGWOOD) 27, N. Y.
Circle 600 Readers Service Card

Richardson Co., The.....	455	Instrument Service Corp.....	459
Sanders Associates, Inc.....	454	JSH Sales Co.....	458
Scientists Engineers & Executives.....	453	Legri-S Co.....	466
Stavid Engineering.....	455	Liberty Electronics Inc.....	459
Stromberg-Carlson Co., Div. of General Dynamics Corp.....	443		
Sylvania Electric Products Inc.....	447		

Lectronic Research Laboratories.....	464
Texas Instruments Inc.....	449
Mogull Co., A.....	459
Monmouth Radio Labs.....	460
Montgomery Equipment Co.....	462
Westinghouse Electronic Tube Div.....	450

Pacific International University.....	457
Photocon Sales.....	467
Radalab Inc.....	467
Radio-Research Instrument Co.....	465
Raway Bearing Co.....	462

SEARCHLIGHT SECTION ADVERTISERS' INDEX

Seg Electronics Inc.....	464
Suplex Lamps Ltd.....	459
Alltronics-Howard Co.....	462
Alvaradio Industries, Inc.....	465
Arrow Sales Inc.....	463
Barry Electronics Corp.....	457, 465
Belvision.....	459
Blan.....	466
Universal Relay Corp. (Formerly Universal General Corp.).....	464
C & H Sales Co.....	461
Communications Equipment Co.....	462
Compass Electronics Supply Co.....	466
V & H Radio & Electronics.....	463
Engineering Associates.....	463
Western Engineers.....	457
Wilgreen Industries.....	462

Fay-Bill Distributing Co..... 460

Groban Supply Co..... 465

This index is published as a service. Every care is taken to make it accurate, but ELECTRONICS assumes no responsibility for errors or omissions.

Size has nothing to do with accomplishment

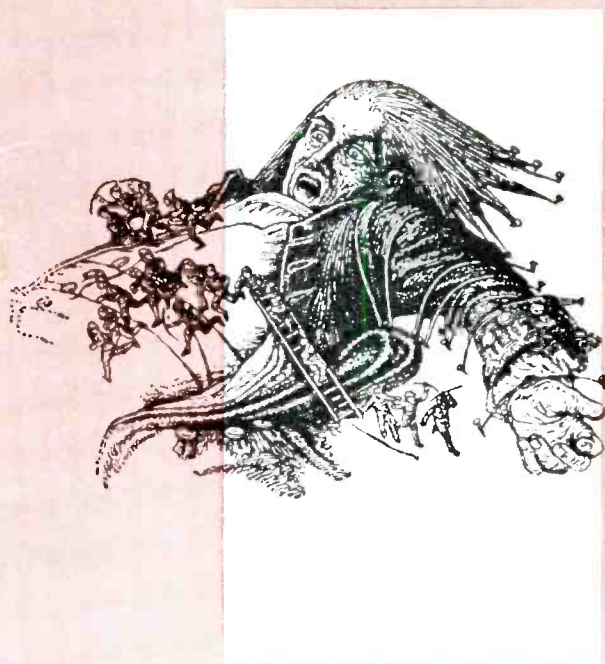

Inside these fully encapsulated miniature precision wire wound resistors, Daven furnishes the solution to problems presented by space limitations. A new winding technique permits the use of extremely fine sizes of resistance wire to obtain two or three times the resistance value previously supplied on a miniature bobbin. This new development more firmly establishes DAVEN's leadership in the field of miniature and standard size precision wire wound resistors.

Types and Specifications

Type	Dia.	Length	Max. Res.	Wattage Rating	Terminals
1273	1/4	5/16	400K	.1	One End #22 Gauge
1283	1/4	5/16	400K	.1	Axial #22 Gauge
1274	3/16	3/8	100K	.1	Axial #22 Gauge
1284	1/4	27/64	.5 Meg.	.25	One end #20 Gauge
1192	1/4	1	1.0 Meg.	.75	Axial #22 Gauge

- Fully encapsulated.
 - Meet and exceed all humidity, salt water immersion and cycling tests as specified in MIL-R-93A, Amendment 3.
 - Operate at 125°C continuous power without de-rating.
 - Can be obtained in tolerances as close as $\pm 0.05\%$.
 - Standard temperature coefficient is $\pm 20\text{PPM}/^\circ\text{C}$.
- Special coefficients can be supplied on request.

For maximum resistance in minimum space:

Daven's new winding technique cuts giants down to size

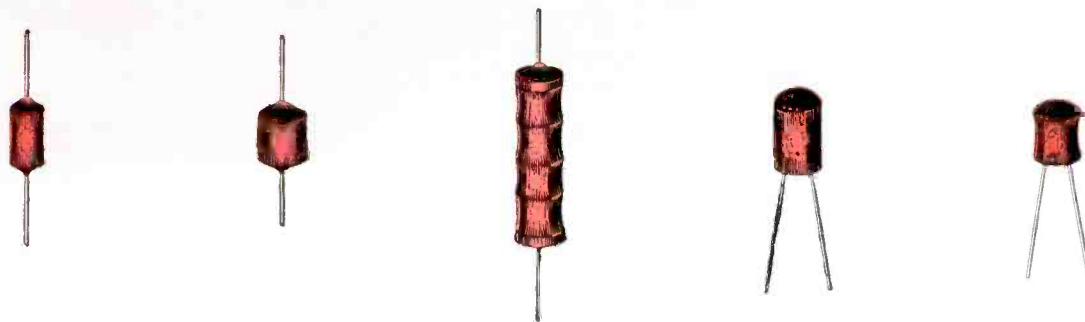

THE **DAVEN** co.

®

Livingston, N. J.



Write for complete resistor catalog.

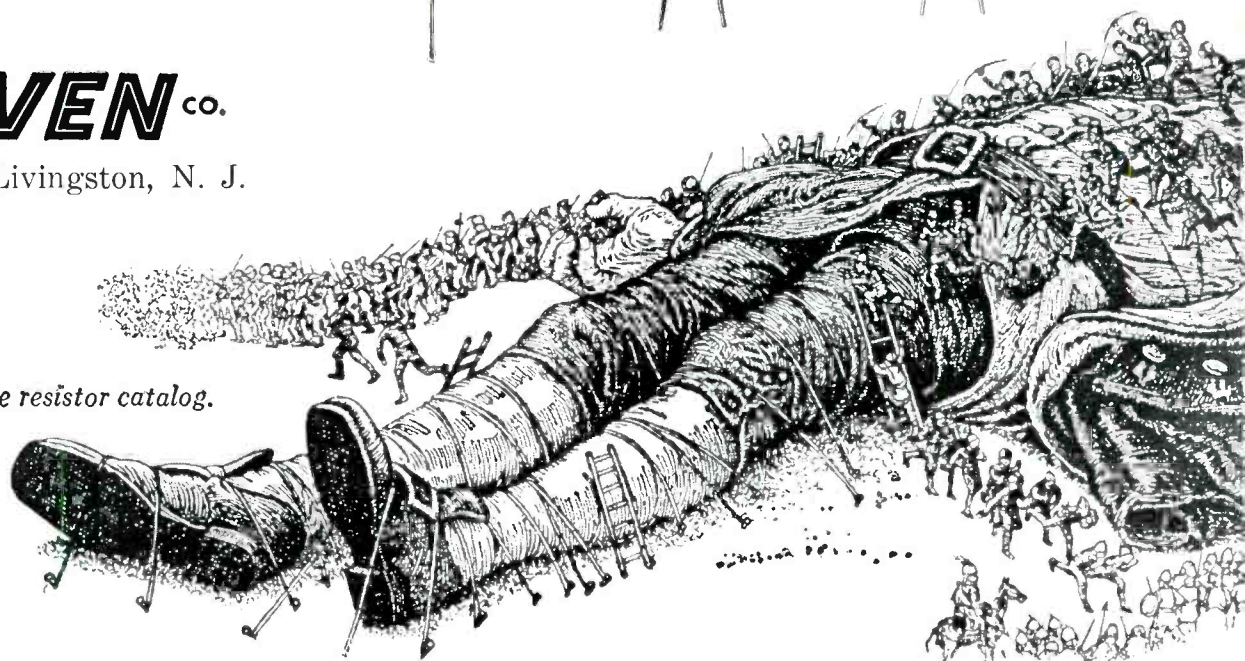

WORLD'S LARGEST MANUFACTURER OF ATTENUATORS

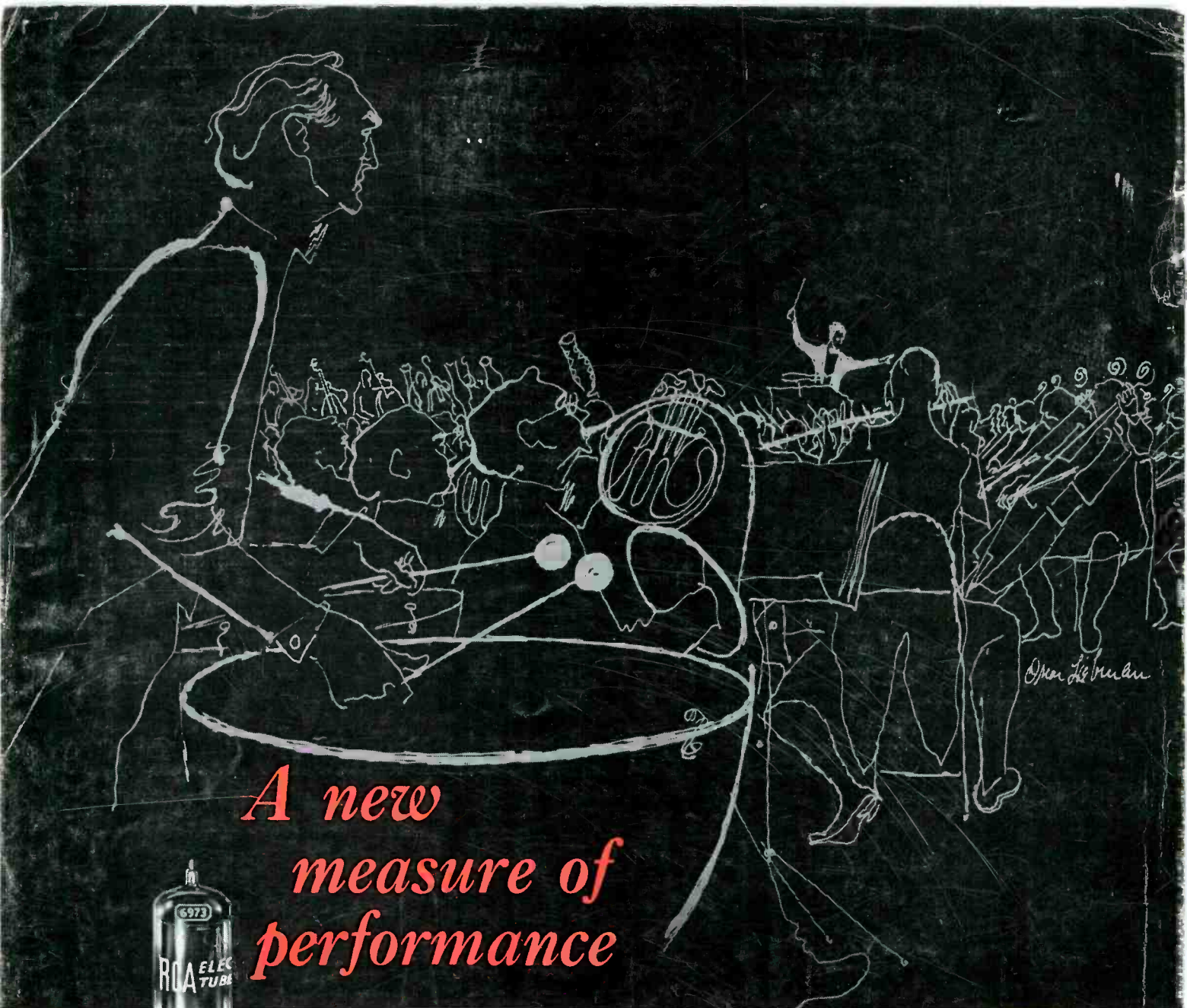

*A new
measure of
performance*



miniature RCA-6973...for your compact high-fidelity designs

To help you endow your popular-priced high-fidelity amplifier designs with a noteworthy measure of concert-hall presence, RCA proudly presents its latest audio-tube development—the RCA-6973. Featuring linear operation over a wide range of power, a pair of these beam-power, 9-pin miniatures can deliver 20 watts of audio power with only 1.5% distortion. Here, too, is a tube that offers the advantages of low heater wattage (6.3v at only 450 ma)!

And, for a new measure of performance in medium-priced high-fidelity FM receivers, RCA presents two new tubes—the 6DT8 and the 12DT8. These new RF amplifier and mixer-oscillator tube types can make valuable contributions to your FM-tuner designs. Both types have inter-unit shielding enabling you to achieve substantial reductions in antenna radiation.

For data sheets on any of these new types, or for information on other well-known RCA "audio" tubes, such as the 12AX7 and 6L6-GB, write to RCA Commercial Engineering, Section J-19-Q-1, Harrison, N. J.

Your RCA representative is ready to discuss your high-fidelity tube requirements. Why not call him today at the field office nearest you?



TUBES for HIGH FIDELITY

RADIO CORPORATION OF AMERICA
Electron Tube Division Harrison, N. J.

RCA District Offices:

East:

744 Broad Street, Newark, N. J.
HUmboldt 5-3900

Midwest:

Suite 1181, Merchandise Mart Plaza
Chicago, Ill.
WHitehall 4-2900

West:

6355 E. Washington Blvd.
Los Angeles, Calif.
RAYmond 3-8361