

electronics

MAY • 1955

PRICE 75 CENTS

A MCGRAW-HILL PUBLICATION

STRAIN-TESTING NEW PLANE

Hydraulic cylinders apply calculated forces to tail structure while 200-channel automatic recorder prints readings of strain gages on individual cards. Portable servo motor zeroes each circuit automatically.



OUR 10 MILLIONTH MILITARY UNIT SHIPPED THIS YEAR

Military Components FOR EVERY APPLICATION

A HUNDRED STOCK UNITS in our catalog B... 30,000 special designs

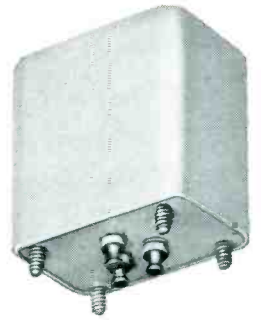

FILTERS

UTC filters, equalizers and discriminators are produced in designs from .1 cycles to 400 mc. Carrier, aircraft and telemetering types available in standard designs.

POWER COMPONENTS

The scope of military power components produced at UTC ranges from 500 lb. plate transformers to miniaturized 2 oz. units... hermetically sealed and encapsulated... molded types.

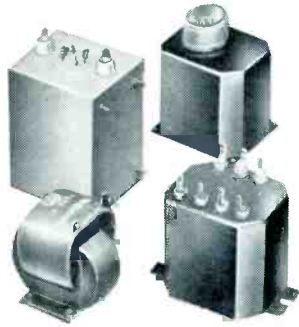

ENCAPSULATED UNITS

8 years of encapsulation experience assure maximum reliability in this class of UTC material.

MOLDED UNITS

UTC molded units range from 1/4 oz. miniatures to the 100 lb. 3 phase unit illustrated.

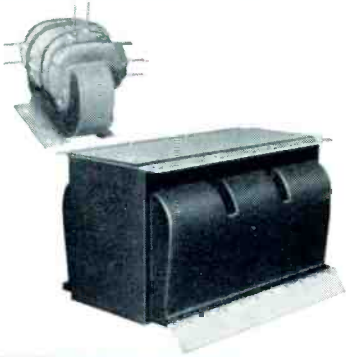

PULSE TRANSFORMERS

UTC pulse transformers cover the range from molded structures weighing a fraction of an ounce to high power modulator applications.



MINIATURIZED COMPONENTS

UTC H-30 series audios are the smallest hermetic types made. Class A, B, and H power components of maximum miniaturization are regular production at UTC.



AUDIO COMPONENTS

UTC military audio units range from 1 ounce subminiatures to high power modulation transformers. Standard, high fidelity, sub-audio, and super-sonic types.



HIGH Q COILS

Unequalled stability is effected in UTC high Q coils thru special processes and materials. Toroid, mu-core, and variable inductors are available to military standards.



MAGNETIC AMPLIFIERS

In addition to a stock line of servo motor magnetic amplifiers, UTC manufactures a wide variety to customer specifications. Saturable reactors are supplied for frequencies from 1 cycle to 40 mc.



WRITE FOR UTC CATALOG B

...includes complete line of hermetic audios, reactors, magnetic amplifiers, filters, high Q coils, pulse transformers, etc.

UNITED TRANSFORMER CO.

150 Varick Street, New York 13, N. Y. EXPORT DIVISION: 13 E. 40th St., New York 16, N. Y. CABLES: "ARLAB"

electronics

MAY • 1955

A McGRAW-HILL PUBLICATION

H. W. MATEER, *Publisher*

W. W. MacDONALD, *Editor*

VIN ZELUFF, *Managing Editor*

JOHN MARKUS, *Associate Editor*

ALEXANDER A. MCKENZIE, *Associate Editor*

JOHN M. CARROLL, *Associate Editor*

WILLIAM P. O'BRIEN, *Assistant Editor*

WILLIAM G. ARNOLD, *Assistant Editor*

DAVID A. FINDLAY, *Assistant Editor*

HAIG A. MANOOGIAN, *Assistant Editor*

EDMUND B. PALMQUIST, *Assistant Editor*

JANE CHRISTIE, *Editorial Assistant*

GLORIA J. FILIPPONE, *Editorial Assistant*

ARLENE SCHILP, *Editorial Assistant*

GLADYS T. MONTGOMERY, *Washington Editor*

HARRY PHILLIPS, *Art Director*

ELEANORE LUKE, *Art Assistant*

WALLACE B. BLOOD, *Manager*

R. S. QUINT, *Buyers' Guide Manager*

FRANK H. WARD, *Business Manager*

H. E. HILTY, *Classified Manager*

DONALD H. MILLER, *New York*

JAMES GIRDWOOD, *New York*

WM. S. HODGKINSON, *New England*

JAMES T. HAUPTLI, *Philadelphia*

CHARLES WARDNER, *Chicago*

BRUCE WINNER, *Chicago*

J. L. PHILLIPS, *Cleveland*

HENRY M. SHAW, *Cleveland*

T. H. CARMODY, *San Francisco*

R. C. ALCORN, *San Francisco*

CARL W. DYSINGER, *Los Angeles*

WM. D. LANIER, *Atlanta*

JAMES H. CASH, *Dallas*

KEITH HENNEY, *Consultant*

STRAIN-TESTING NEW PLANE—Use of Beckman recorder enables Convair to obtain readings of 200 strain gages in five minutes while stressing plane for final airframe check. Details on p 186.COVER

SHOPTALK 2

FIGURES OF THE MONTH 6

INDUSTRY REPORT 7

Transistor Computer To Hit Market 7	Cheaper Color Pickups Promised 16
Push For Color Tube Output 7	Private Planes Boost Sales 20
Profits Gain As Taxes Slide 8	Tubes Infiltrate Metal Trades 20
Wiring Boards Hypo Plastic Sales 10	Electronics Booms In The West 22
Magnistors Hold Promise 10	Microwave Ovens To Enter Homes 22
U. S. May Up Surplus Disposal 12	Financial Roundup 24
Tubes Show Tubes On TV 12	What It Takes To Be An Executive 24
Future Holds \$20 Billion 12	U. S. Cues Electronics At Fair 24
Robot Assemblers Coming Soon 14	Robot Op Takes Code At 600 WPM 24
Magnetic Amplifier Sales Rise 14	Military To Give Navajids Business 26
Glass Makers Push Parts Invasion 14	Future Meetings 26
Renewal Market Gains Prominence 16	Industry Shorts 26

CROSSTALK 125

FEATURES

Data Reduction System for Missile Telemetry 126
By E. M. McCormick

UHF Rebroadcasting Cuts Costs 131
By Henry G. Root

Photoelectric Reader Feeds Business Machines 134
By David H. Shepard and Clyde C. Heasley, Jr.

Microwave Modulator Uses Ferrite Gyrotator 139
By J. N. Barry and W. W. H. Clarke

Fan-Pencil Antenna for Search Radars 142
By Vernon E. Trinter

Single-Tone Calling Simplifies Mobile Radio 144
By Elmer W. Hassel

Meter Shows Color-Burst Deviation 149
By M. Joffe

Band-Pass Filters Using Strip-Line Techniques 152
By E. H. Bradley and D. R. J. White

Automatic Micrometer Sorts Insulating Wafers 156
By E. T. Fearon

CONTINUED ON NEXT PAGE

contents

continued

Audio Oscillator Has Low Distortion.....	158
By Peter G. Sulzer	
Cathode-Ray Display of Seismic Recordings.....	160
By G. M. Groenendyke and G. B. Loper	
Local Oscillator for C-W Radars.....	166
By Harold B. Goldberg	
Short-Interval Timer.....	168
By N. A. Moerman	
Airborne Interrogator Spots Location.....	170
By A. R. Applegarth	
Feedback-Stabilized Transistor Amplifier.....	174
By Dean W. Slaughter	
Standard Symbols for Electronics (Reference Sheet).....	176
ELECTRONS AT WORK.....	182
Extend Transmission Range Sevenfold.....	182
Tube Prints Letters.....	182
Producing Colpitts Oscillations.....	184
DEW Line Radar.....	184
The Front Cover.....	186
Designing 2,000-Mc Components.....	186
Observing Whistlers.....	198
TV Previews New Tube.....	200
Insect Control by Irradiation.....	202
Autopilot Magnetic Servo.....	208
Computers Simulate Engines.....	214
Mobile Power Supply.....	216
Tradic Computer.....	222
Magnetic Frequency Multiplier.....	224
PRODUCTION TECHNIQUES.....	232
Unitized Production Benches.....	232
Soldering Staples Save Panel Space.....	232
Rubber Band Protects Panel Finish.....	234
Pictorial Inspection Records.....	234
Formica Bench-Tops Reduce Rejects.....	240
Holding Jig for Terminal Boards.....	242
Ultrasonic Soldering Tools.....	246
Embedding Technique.....	250
Cable Plug Wrench.....	264
Specifications for Printed Wiring.....	266
Grids for UHF Pencil Tubes.....	270
Induction Soldering of Tuned Stubs.....	278
NEW PRODUCTS.....	280
LITERATURE.....	347
PLANTS AND PEOPLE.....	360
NEW BOOKS.....	401
THUMBNAIL REVIEWS.....	406
BACKTALK.....	408
INDEX TO ADVERTISERS.....	455

SHOP

IN THIS ISSUE—The new symbols for electronics diagrams that have been approved by the American Standards Association appear on pages 176, 178, 180. We are adopting the new symbols for all diagrams as of now, although the change may not be readily apparent since there is little change in those most often used.

OFFICIAL—In the normal course of business we receive mail from all parts of the world. But it was with a bit of surprise that we signed for a letter delivered to us by diplomatic pouch from Europe. The subject? Sorry, classified for reasons of commercial security.

MUSIC FOR ENGINEERS—The special attraction that music holds for many ELECTRONICS readers showed up in the response to a recent article in Industry Report. A short description of a build-it-yourself electronic organ was sufficient to bring in a flood of letters, including one from Brazil, a lot of phone calls and two visitors to the office in quest of more information.

The interest of the inquirers seemed to be more personal than business, since their job titles indicated fields far removed from electronic music. The reason behind it may have been summed up by one of the visitors who explained, "I like music but I can't play any instrument well. With an organ, I can hold down one key and still get music while I'm hunting for the next."

electronics

MAY, 1955

Vol. 28, No. 5



Member ABC and ABP

TALK

OUR COVERS . . . A History of Electronic Automatic Production Techniques

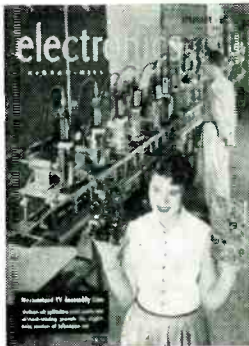

Mechanized TV Assembly Line Feb. '55

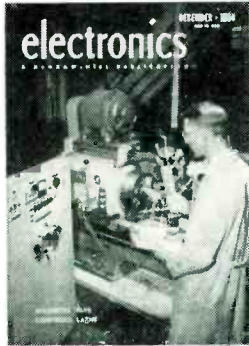

Magnetic Tape Controls Lathe Dec. '54

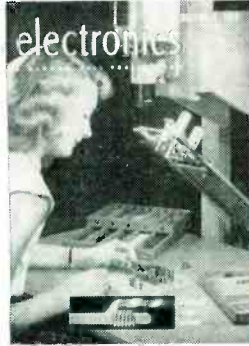

Solderless Circuit Assembly Nov. '53



Components For Printed Circuits Aug. '53

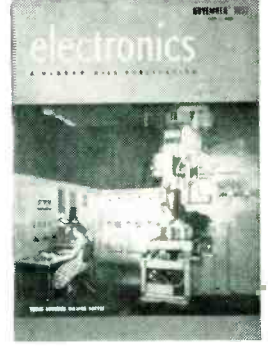

Tubes Control Milling Cutter Nov. '52

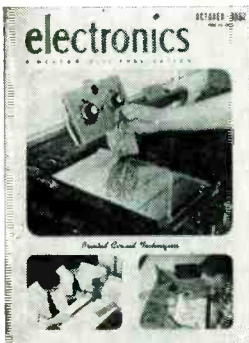

Printed Circuit Techniques Oct. '52

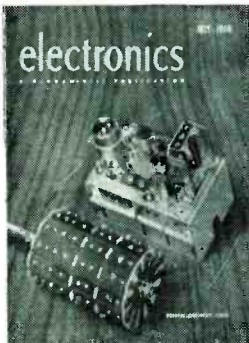

Printed-Circuit TV Tuner July '50

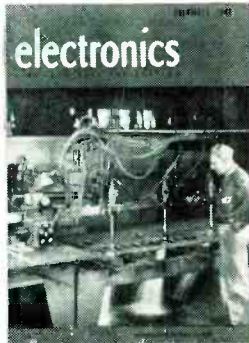

Photoelectric Cutting Machine Dec. '48

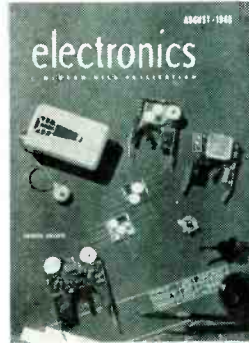

Printed Circuits Aug. '48

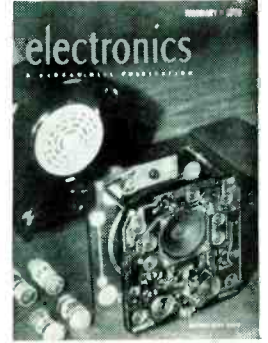

Machine-Made Radio Feb. '48

EXPENSIVE SURPLUS — ELEC-TRONICS reprints are made by the photo-offset process, by photographing pages cut from an issue.

Usually, they are ordered within a few weeks of publication, but one recent order called for an article that appeared in 1951. We could find no loose pages of the article in our files, nor a single copy. Even a surreptitious search of editors' desk drawers drew a blank. We do have

bound volumes, but these do not permit the pages to lie flat as required by the reproduction process.

A search of second-hand book stores finally turned up the issue needed. But we had to pay \$1.20 for it, just 140 percent more than the one-year subscriber pays.

SHADES OF GUTENBERG—Most typographical errors are merely routine, the misspelled word doesn't

make sense. But occasionally one does. In January, in the article on recording the radio-tv audience, we caught one that did, a mirror sends light to a group of six apertures, each *mashing* a 931A phototube.

This month we chuckled over a cute one, a phase angel. But a draftsman stopped us cold with a chart, lettered Magnetron Sales Club. We didn't join. It was meant to be Climb.

Published monthly with an additional issue in June by McGraw-Hill Publishing Company, Inc., James H. McGraw (1860-1948), Founder, Executive, Editorial and Advertising Offices: McGraw-Hill Building, 330 W. 42 St., New York 36, N. Y., Longacre 4-3000. Publication Office, 99-129 North Broadway, Albany 1, N. Y. Donald C. McGraw, President; Paul Montgomery, Executive Vice-President; Joseph A. Gerardi, Vice-President and Treasurer; John J. Cooke, Secretary; Nelson Bond, Executive Vice-President, Publications Division; Ralph B. Smith, Vice-President and Editorial Director; Joseph H. Allen, Vice-President and Director of Advertising; J. E. Blackburn, Jr., Vice-President and Circulation Director.

Subscriptions: Address correspondence to Electronics—Subscription Service, 330 W. 42nd St., New York 36, N. Y. Allow one month for change of address. Subscriptions are solicited only from persons engaged in theory, research, design, production, maintenance and use of electronic and industrial control components, parts and end products. Position and company connection must be indicated on subscription orders.

Single copies 75¢ for United States and possessions, and Canada; \$1.50 for Latin America; \$2.00 for all other foreign countries. Buyers' Guide \$3.00. Subscription rates—United States and possessions, \$6.00 a year; \$9.00 for two years. Canada, \$10.00 a year; \$16.00 for two years. Other western hemisphere countries and the Philippines, \$15.00 a year; \$25.00 for two years. All other countries \$20.00 a year; \$30.00 for two years. Three-year rates, accepted on renewals only, are double the one-year rate. Entered as second-class matter August 29, 1936, at the Post Office at Albany, N. Y., under act of Mar. 3, 1879. Printed in U.S.A. Copyright 1955 by McGraw-Hill Publishing Co. Inc.—All Rights Reserved.

BRANCH OFFICES: 520 North Michigan Avenue, Chicago 11, Ill.; 68 Post Street, San Francisco 4; McGraw-Hill House, London, E. C. 4; Washington, D. C. 4; Philadelphia 3; Cleveland 15; Detroit 26; St. Louis 8; Boston 16; 1321 Rhodes-Haverty Bldg.; Atlanta 3, Ga.; 1111 Wilshire Blvd., Los Angeles 17; 738-9 Oliver Building, Pittsburgh 22. ELECTRONICS is indexed regularly in The Engineering Index.

c o n c e r n i n g

ELECTRONIC FREQUENCY REGULATION



MODEL FCD250

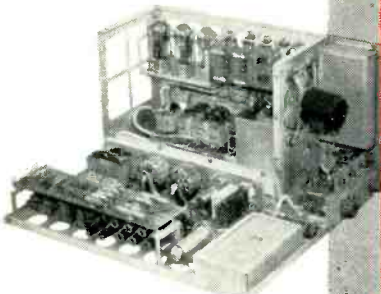

MODEL DFCD250-2AR.
Typical 3 ϕ in, 3 ϕ out air-
borne frequency changer,
built to military specifica-
tions. Input 360-440cps, out-
put 400cps \pm 0.1% over
wide ambient range.

More than 3 years widespread use in laboratory and industry have proved the reliability, economy, and convenience of SORENSEN electronic FREQUENCY CHANGERS

- 45-65cps and 360-440cps output
- 250VA and 1000VA capacity
- 1% and 0.01% frequency regulation

Sorensen electronic frequency changers are now in widespread use as sources of precision 60cps or 400cps for timing applications, for use with servo and gyro motors in design work, and for testing components or complete instruments that must operate over variable frequency conditions. They are used in checking equipment designed for 50cps (foreign) operation; the same instrument converts 50cps line to 60cps source. Many Sorensen frequency changers are also being used with field equipment in connection with motor generator sets, where frequency control is often inadequate.

Portability is an important feature of Sorensen frequency changers. The units can be located right beside the load, making costly wiring and distribution systems unnecessary. Temporary requirements can be taken care of by moving the changer from production line to lab and back, as needs arise.

SPECIFICATIONS

Model	FCD250	FCD1000	FC1000
Input voltage	95-130VAC, 1 ϕ , 50-60cps	208 or 230 VAC, 1 ϕ , 50-60 cps	
Output voltage	115VAC, 1 ϕ , adjustable between 110-120 volts		
Output frequency	400 cycles, adjustable \pm 10%		45-65 cycles, adjustable \pm 1.0%
Output voltage regulation	\pm 1.0%	\pm 1.0%	\pm 1.0%
Output frequency regulation	\pm 1.0% in standard models; \pm 0.01% with auxiliary frequency standard. Frequency fixed at 400cps, 50 or 60cps with standard.		
Capacity	250VA	1000VA	1000VA
Load range	0-250VA	0-1000VA	0-1000VA
Distortion	5% maximum	5% maximum	5% maximum
P.F. range	Unity to 0.5 lagging		
Time constant	0.25 seconds	0.5 seconds	0.5 seconds
Envelope modulation	2% maximum	2% maximum	2% maximum

AIRBORNE FREQUENCY CHANGERS

Sorensen has designed and built a wide variety of frequency changers and inverters for incorporation in military aircraft. These instruments have various specifications and are not standard. For the most part, the changers convert variable (320-1000 cps) input to precision (\pm 0.05%) output frequency, with minimum distortion (5-10%).

Sorensen airborne inverters are built to convert 28VDC input to 400-cycle, 3-phase output, with output frequency accurate to 0.05% over wide ambients.

Sorensen's heavy experience with commercial and military frequency changers is available for application to your precision frequency problems. Your inquiries are invited. Sorensen & Company, Inc., 375 Fairfield Avenue, Stamford, Connecticut.

SORENSEN

● SORENSEN & CO., 375 FAIRFIELD AVE., STAMFORD, CONNECTICUT

THIS INTERESTING QUARTERLY WILL BE MAILED FREE TO ANY PART OF THE WORLD

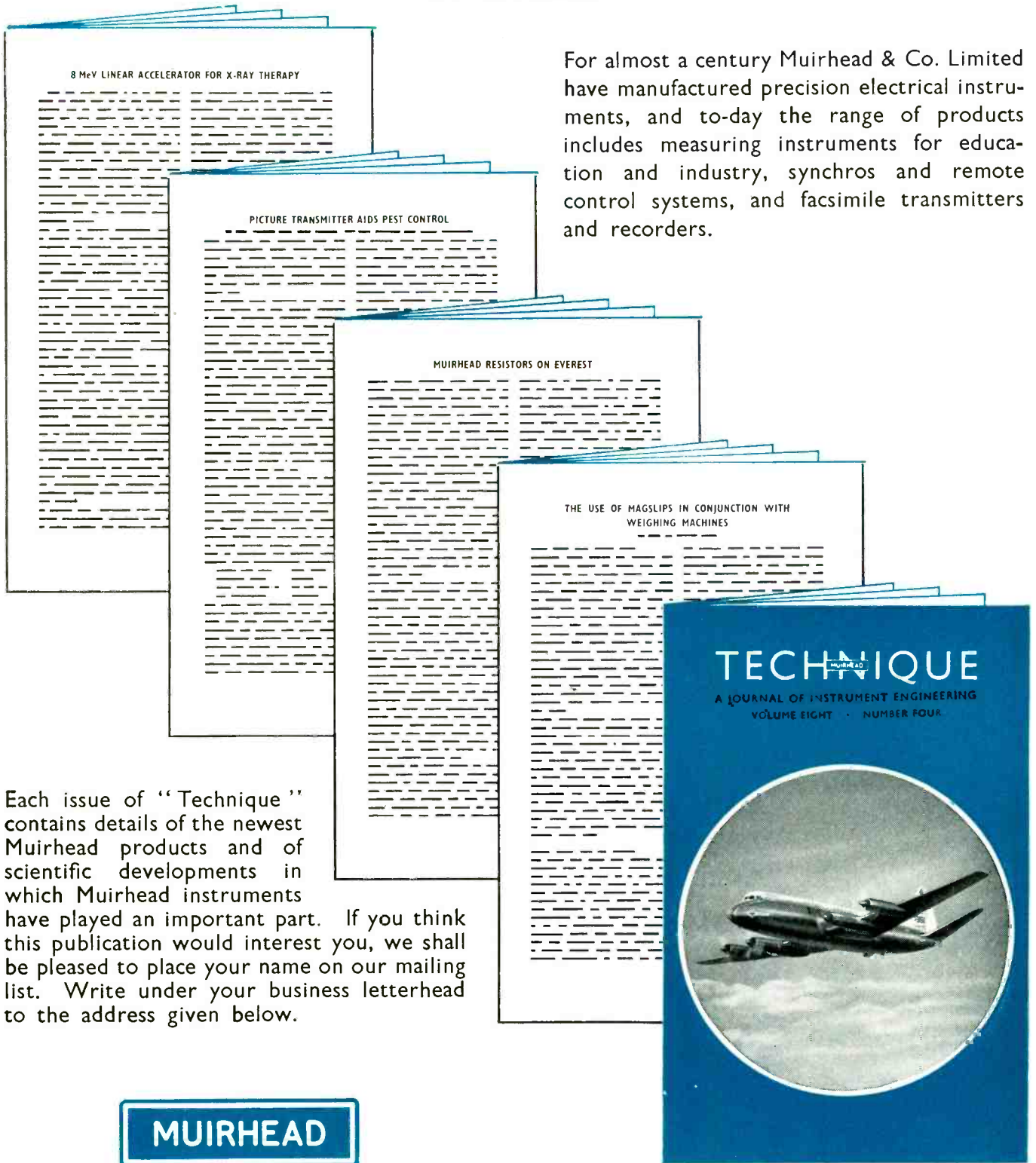

For almost a century Muirhead & Co. Limited have manufactured precision electrical instruments, and to-day the range of products includes measuring instruments for education and industry, synchros and remote control systems, and facsimile transmitters and recorders.

Each issue of "Technique" contains details of the newest Muirhead products and of scientific developments in which Muirhead instruments have played an important part. If you think this publication would interest you, we shall be pleased to place your name on our mailing list. Write under your business letterhead to the address given below.

MUIRHEAD

PRECISION ELECTRICAL INSTRUMENTS

MUIRHEAD & CO. LIMITED · BECKENHAM · KENT · ENGLAND

Sales & Service U.S.A.

MUIRHEAD INSTRUMENTS INC · 677 FIFTH AVENUE · NEW YORK 22 · N.Y.

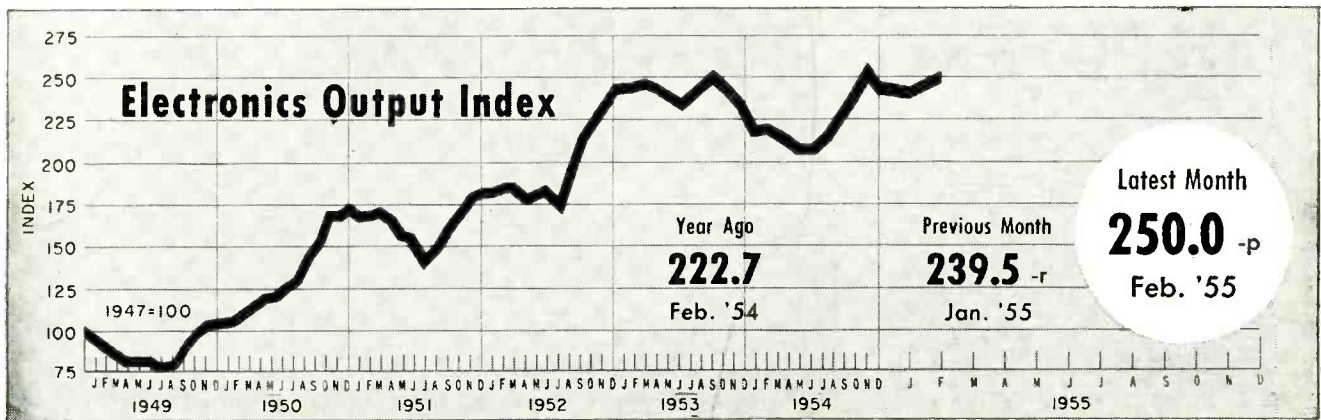

FIGURES OF THE MONTH

	Latest Month	Previous Month	Year Ago
RECEIVER PRODUCTION (Source: RETMA)	Feb. '55	Jan. '55	Feb. '54
Television sets, total . . .	702,514	654,582	426,933
With UHF	101,217	117,095	92,275
Color sets	nr	nr
Radio sets, total	1,089,724	1,068,146	769,232
With F-M	17,751	16,568	12,298
Home sets	232,831	280,121	233,063
Clock radios	150,031	166,885	105,933
Portable sets	109,120	47,303	98,275
Auto sets	597,742	573,837	331,961

	Latest Month	Previous Month	Year Ago
RECEIVER SALES (Source: RETMA)	Feb. '55	Jan. '55	Feb. '54
Television sets, units . . .	626,613	647,585	536,017
Radio sets (except auto)	320,042	474,947	262,679

	Latest Month	Previous Month	Year Ago
RECEIVING TUBE SALES (Source: RETMA)	Feb. '55	Jan. '55	Feb. '54
Receiv. tubes, total units	38,526,796	37,949,762-r	25,189,147
Receiv. tubes, value . . .	\$28,107,186	\$26,877,457	\$18,319,819
Picture tubes, total units	859,529	866,956	645,715
Picture tubes, value . . .	\$17,119,568	\$17,661,018	\$13,916,478

	Jan. '55	Dec. '54	Jan. '54
SEMICONDUCTOR SALES			
Germanium diodes, units	1,403,940	1,464,559	740,445
Silicon diodes, units			

	Quarterly Figures		
	Latest Quarter	Previous Quarter	Year Ago
INDUSTRIAL TUBE SALES (Source: NEMA)	4th '54	3rd '54	4th '53
Vacuum (non-receiving)	\$9,338,181	\$8,803,740	\$9,467,331
Gas or vapor	\$3,498,123	\$3,570,586	\$4,854,222
Phototubes	nr	nr	\$405,000
Magnetrons and velocity modulation tubes . . .	\$15,249,651	\$13,112,244	\$13,073,095
Gaps and T/R boxes . .	\$1,788,780	\$1,476,407	\$1,707,730

	Latest Month	Previous Month	Year Ago
TV SETS INSTALLED (Source: NBC Research Dept.)	Feb. '55	Jan. '55	Feb. '54
Total sets	34,364,000	33,816,000	28,289,000

	Mar. '55	Feb. '55	Mar. '54
BROADCAST STATIONS (Source: FCC)			
TV stations on air	451	448	385
TV stations CPs—not on air	122	130	190
TV stations—new requests	20	17	72
A-M stations on air	2,703	2,692	2,539
A-M stations CPs—not on air	103	101	129
A-M stations—new requests	194	186	163
F-M stations on air	538	542	555
F-M stations CPs—not on air	10	11	15
F-M stations—new requests	6	5	3

	Feb. '55	Jan. '55	Feb. '54
COMMUNICATION AUTHORIZATIONS (Source: FCC)			
Aeronautical	42,048	41,868	43,682
Marine	48,977	48,751	44,140
Police, fire, etc.	17,289	17,148	15,003
Industrial	23,405	23,223	20,280
Land transportation	7,318	7,289	6,600
Amateur	130,642	129,258	117,427
Citizens radio	9,916	9,579	5,550
Disaster	312	310	257
Experimental	597	649	532
Common carrier	1,822	1,810	1,490

	Mar. '55	Feb. '55	Mar. '54
EMPLOYMENT AND PAYROLLS (Source: Bur. Labor Statistics)			
Prod. workers, comm. equip.	369,700-p	370,100-r	361,900
Av. wkly. earnings, comm. . .	\$70.53 -p	\$70.58 -r	\$67.55
Av. wkly. earnings, radio . . .	\$69.32 -p	\$68.28 -r	\$66.59
Av. wkly. hours, comm.	40.3 -p	40.1 -r	39.5
Av. wkly. hours, radio	40.3 -p	39.7 -r	39.4

	Mar. '55	Feb. '55	Mar. '54
STOCK PRICE AVERAGES (Source: Standard and Poor's)			
Radio-tv & electronics	438.0	437.0	301.9
Radio broadcasters	502.9	496.8	302.1

p—provisional; r—revised
nr—not reported

FIGURES OF THE YEAR

Television set production	1,357,096	847,504	+ 60.1
Radio set production	2,157,870	1,641,213	+ 31.5
Television set sales	1,274,198	1,267,934	+ .5
Radio set sales (except auto)	794,989	573,302	+ 38.7
Receiving tube sales	76,476,558	47,322,147	+ 61.6
Cathode-ray tube sales	1,726,485	1,203,396	+ 43.5

TOTALS FOR THE FIRST TWO MONTHS

	1955	1954	Percent Change
Television set production	1,357,096	847,504	+ 60.1
Radio set production	2,157,870	1,641,213	+ 31.5
Television set sales	1,274,198	1,267,934	+ .5
Radio set sales (except auto)	794,989	573,302	+ 38.7
Receiving tube sales	76,476,558	47,322,147	+ 61.6
Cathode-ray tube sales	1,726,485	1,203,396	+ 43.5

INDUSTRY REPORT

electronics—May • 1955

Transistor Computer Will Hit Market Soon

Saves 50 percent in size, 90 percent in power. Unit uses 3,000 transistors

AT LEAST one transistorized electronic computer will be available for delivery early in 1956. Designated as the IBM 608, the machine is similar to electron-tube models 604 and 607. However, it performs 4,500 additions a second, $2\frac{1}{2}$ times faster than the 607.

The machine stems from a developmental machine demonstrated last fall (ELECTRONICS, p 6, Nov. 1954). It achieves a 50-percent saving in space and a 90-percent saving in power required.

More than 3,000 transistors are used—some of them 150-X4 power transistors developed by IBM. The machine uses matrices of ferrite cores as its internal memory. The components are mounted on about 700 plug-in printed wiring boards. This format is adapted to the company's mechanized assembly techniques (ELECTRONICS, p 8, March 1955).

► **More Cores**—Use of ferrite cores is now an accepted thing in large computers. The Remington Rand Univac II, advanced model of the Univac, now contains a high-speed memory capable of retaining 24,000 characters and able to execute 8,000 instructions a minute. The memory is based upon use of ferrite cores. Additional cores can be employed to provide a memory capable of storing 120,000 characters. Univac joins the IBM 705, Raytheon Raycom and RCA Bizmac in using a high-speed ferrite core memory.

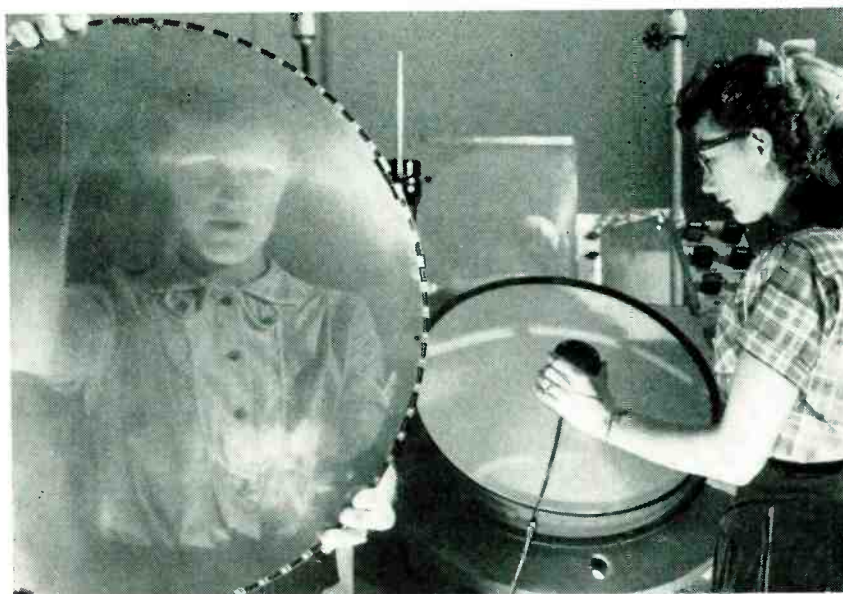

CONTINUED REDUCTION of rejects in shadow-mask color tv tubes being inspected with ultraviolet light (right) is a big factor in . . .

Push For Color Tube Output

Standardizing color tube, pushing setmaking and stepping up programming planned

WITH \$50 million reputedly already invested in development of color television, RCA has decided to throw in an undisclosed further amount to obtain broad adoption and mass production. The push will be multipronged, involving standardization of the mask type, round metal, 21-inch color kinescope, a less expensive receiver based upon designs released last September and a healthy increase in color broadcast programming.

Admitting at the start that it can't do the job alone, RCA expects that after the ball starts rolling it will recoup its initial heavy financial losses.

► **Mask Tube**—First phase of the campaign is the decision to concen-

trate manufacturing effort on the 21-inch round tube. Facilities at the Lancaster, Pa. plant presently occupy about 50,000 square feet of floor space. By August, new construction and relocation of offices will up the area to 132,000 square feet. Output is about 2,000 color tubes a month at present. Many of the operations are manual.

More efficient handling methods, including conveyor lines, now being installed, will make possible an output of some 30,000 tubes a month. RCA is confident that its projected cost of \$100 (reduced from an initial \$175) is realistic. As an example, shrinkage (rejects) of black and white picture tubes run between 10 and 20 percent. Recently the Lancaster plant reduced its spoilage on color tubes to 16.2 percent.

► **Color Set Design**—Crux of general color acceptance is reasonable



Completed color tv picture tubes undergoing final inspection at RCA plant in Lancaster, Pa.



Three-gun assembly gets careful scrutiny before being sealed into color kinescope tv tube

set cost. W. W. Watts, executive vice president for electronic products, says that a new simplified set will be announced soon. There is not yet any indication as to its price.

Consensus of those who have observed the pattern is that RCA will probably reveal a design to serve as bellwether, much as the famous model 630 did for mass production of black and white sets. With smaller manufacturers competing against the increasing production

lines of the bigger outfits, set prices can be expected to fall eventually below the \$500 level that marketing experts feel is the magic borderline for general public acceptance. RCA officials agree with the prediction that color sets at \$300 may well be possible when production reaches 5 million annually.

► **Color Programming**—Through its NBC broadcasting affiliate, RCA can help beef up sales by providing interesting color programs. There

will definitely be more color on the air, including a daily strip that can be used for demonstrations and adjustments.

Spreading interest in color will take more than network broadcasts. Local color pickups will undoubtedly lag color film programming owing to high studio costs for the former. Although all major broadcast equipment suppliers have color film equipment designs, only about 65 units have been placed on firm order or delivered to date.

Electronics Profits Gain As Taxes Slide

Net profits after taxes hit new high for many firms in 1954 when excess profits tax died

MANY firms in the electronics field showed greater net profits last year than for any year in the industry's history. This was due in part to tax savings as a result of the expiration of the excess profits tax and to the changes in the new tax law.

However, manufacturers may have to amend returns and repay for some deductions taken in 1954. The government is in the process of changing the provision in new tax law that allowed manufacturers to deduct estimated future expenses such as product warranties in the year that the products are sold. Under the old law such expenses were

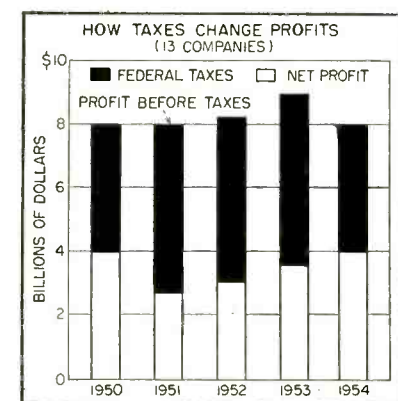

not deductible until they were actually spent.

Another provision in the new tax law which has aided net profits permits more of the cost of a new plant facility to be deductible in its first years with lower deductions in its later life. This part of the law ap-

plies only to facility additions made in 1954. Other equipment continues under the longer depreciation method.

► **Effect**—Expiration of the excess profits tax was the main factor responsible for tax gains in 1954. The other provisions mentioned were much less effective. GE in 1953 provided \$308.5 million for federal taxes on income and renegotiation while in 1954 the amount provided was \$178 million for a decrease of \$130.5 million or 42 percent.

Sylvania's federal taxes on income in 1953 amounted to \$14.9 million including \$2.3 million in excess profits tax. In 1954 total taxes were \$8.9 million representing a drop of \$6 million or over 40 percent. As a result of the new tax law, the company's federal tax provision for

(Continued on page 10)

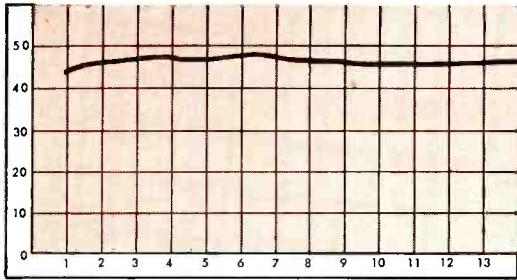

Tangential Sensitivity of IN358

The input signal level, expressed in db below 1mw required to produce an output pulse of amplitude tangential to the noise level.

Transition—matches the crystal to N-Type connector over a broad frequency range.

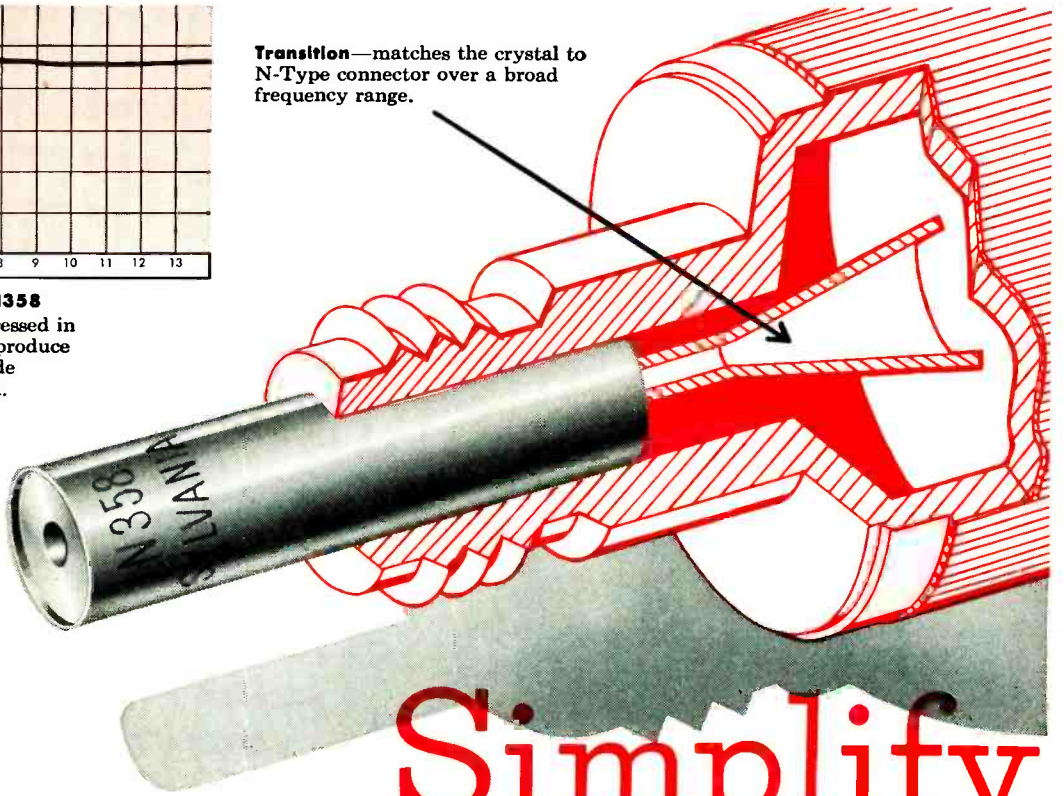
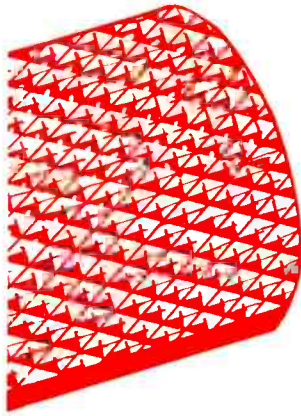

Simplify front-end design over a BROADBAND microwave frequency range

NEW TRIPOLAR CRYSTAL DIODE
offers these five advantages

- Simpler, broadband crystal mount
- Signal goes in one end—is taken off the other
- No extra plumbing is required
- Built-in rf bypass capacitor
- Available with or without built-in dc return



By matching the inherent broadband characteristics of coaxial cable, the Tripolar crystal diode introduces an entirely new concept in broadband microwave circuitry and opens a fresh, simplified approach to front-end design.

The IN358 video detector is the first of these new broadband crystal diodes. In a simple holder, it covers the frequency range from 1 to over 12 kmc. The IN358 is connected in series with standard coaxial cable between the signal source and amplifier.

Other broadband video types are available now and broadband mixer types will be ready soon.

SPECIFICATIONS

Frequency Range:.....1,000—12,400 Mc

Figure of Merit: (1).....10 min. at 6750 ± 10 Mc

Tangential Sensitivity:—40 DBM over frequency range @ 25°C

Video Resistance:.....450 ohms—18000 ohms @ 25°C

Ambient Temperature:.....—40—70°C

Note 1. Measured in untuned broadband holder

ANOTHER REASON WHY IT PAYS TO SPECIFY SYLVANIA



SYLVANIA ELECTRIC PRODUCTS INC.
1740 Broadway, New York 19, N. Y.
In Canada: Sylvania Electric (Canada) Ltd.,
University Tower Bldg., Montreal, P. Q.

LIGHTING • RADIO • ELECTRONICS • TELEVISION • ATOMIC ENERGY

1954 was reduced by \$800,000.

For Westinghouse the changes in the tax code and a change in computing current federal income tax costs had the effect of increasing the firm's 1954 net income by about \$4.5 million. The company paid a total of \$78.6 million for federal income taxes compared to \$75.9 million in 1953.

► **Future**—Not all companies had lower taxes in 1954 as a result of tax law changes. However, many that did pay higher taxes did so as a result of higher net sales which in some cases moved them to a higher income bracket. Despite tax relief in 1954 total taxes for many firms still amounted to over 50 cents on each pretax profit dollar.

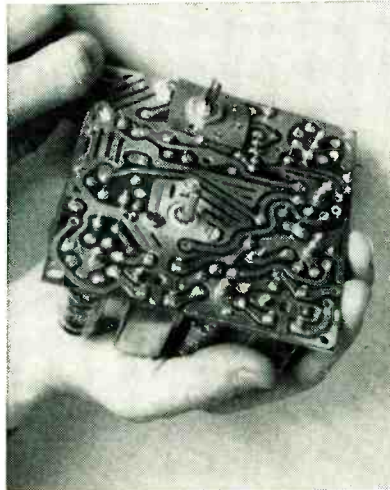

PRODUCTION of "Thru-Con" boards for table model radios is stepped up at GE as . . .

of mechanized assembly. The company will curtail production of etched board types and will step up production of "Thru-Con" boards to replace them. These have the copper wiring pattern plated not only on the board, but through its holes to make the front-to-back circuit connections.

They do not require staking pins since the holes have eyelets plated as integral parts of the wiring. GE expects that about one million radios will be produced this year using printed circuit boards.

Magnistors Promise to Supplement Transistors

New circuit element acts as amplifier or bistable storage device

MAGNISTORS are small saturable reactors having unique shapes and flux paths. They are divided into two general classes described as transient and permanent. The transient type has no memory while the permanent or two-state class will remember its set or reset condition indefinitely even if all power is removed.

Magnistors are used to gate, switch, amplify, count and record. They also form logical arrays for adding, subtracting, shifting and other computing functions.

Such a circuit element has an indefinite shelf life according to Potter Instrument Company who developed the magnistor. They are undisturbed at temperature ranges attained in commercial and military equipment. (See p 280, this issue).

The simplest form contains two windings wound on special ferro-ceramic material. One winding, the signal coil, is used to carry a sine-wave signal in the range from 100 kc to 15 mc or pulses having a repetition rate from 0 to 10 mc. By varying the d-c current applied to the second winding (control coil), the impedance of the signal winding to the carrier frequency or pulses can be varied over a

(Continued on page 12)

Wiring Boards Hypo Plastic Sales

Laminate manufacturers see their business volume tripled this year by printed wiring

GROWING use of printed wiring in electronic equipment means rising business volume for laminated sheet manufacturers. There are about two dozen firms in the laminate field although not all sell printed wiring boards. Last year these companies sold close to \$1 million worth of boards for printed wiring use. This year total printed wiring board sales may be somewhere between \$3 and \$5 million.

One major set manufacturer recently placed a \$54,000 order for one month's supply of copper-clad laminates and may spend a total of over \$500,000 this year on the material. One board manufacturer estimates that 10 percent of total laminate production is accounted for by printed circuit boards.

Big computer manufacturers such as IBM and Remington Rand are volume users of printed circuits. One of the firms has already ordered over 200,000 boards.

► **Cost**—A 3 by 4-foot sheet can cost about seven or eight dollars.

The copper foil thickness used in almost all present day applications is one to two ounces per square foot, and the increasing use of the boards has caused a tightness in electrolytic copper supply.

At present, there is only one source for the copper but one laminate maker indicates this may change soon.

► **Thru-Con**—GE, which manufactures its own laminates, recently announced that it will concentrate its production of printed wiring circuit boards on a through-connecting type which will eliminate production steps and reduce the cost

A **SNAP** FOR WIRING BOARD ASSEMBLIES

NEW Sprague Type 28D Push-Lok* Electrolytic Capacitors Give Fast, Fool-Proof Mounting

HERE'S THE BEST APPROACH yet to electrolytic capacitors for printed wiring board assemblies.

It's Sprague's new Type 28D Push-Lok Electrolytic. Just insert the connecting lugs through the slots in the wiring board, and the capacitor is held securely in place until the chassis is ready for dip soldering . . . so securely that solder gaps are eliminated. Spring action of the Push-Lok lugs is strong enough to hold relatively heavy capacitors in place, even when the board is carried sideways, or upside-down on a conveyor. Tab connections are always in close contact with the printed conductors. Yet, unlike other designs, no secondary operations are required for this fast and secure mounting.

Other advantages include:

Fool-Proof Positioning—A Push-Lok can only be inserted the right way. A wide index terminal is provided in the mounting ring to index the assembly on the chassis or other surface if desired.

The Ability to Print Wiring Boards on Both Sides—Shoulders on the Push-Lok lugs plus additional prongs keep the capacitors clear of the chassis.

Safety—Circular shield conforms with suggestions of Underwriters' Laboratories, Inc. Tools cannot be inserted easily between the bottom of the capacitor and the chassis.

FOR COMPLETE INFORMATION on these new Type 28D Push-Lok electrolytic capacitors, write for Engineering Bulletin to Sprague Electric Co., 35 Marshall Street, North Adams, Massachusetts.

**Push-Lok is a Trademark of the Sprague Electric Company*

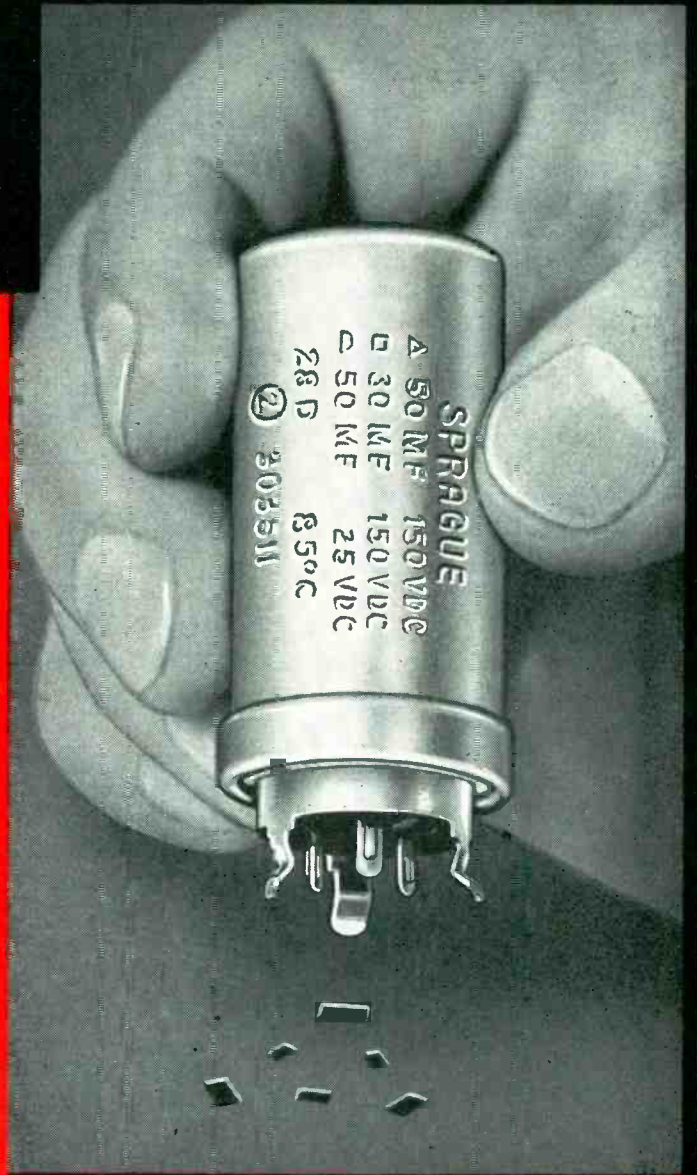

Sprague, on request, will provide you with complete application engineering service for optimum results in the use of electrolytic capacitors.

SPRAGUE

WORLD'S LARGEST CAPACITOR MANUFACTURER

Export for the Americas: Sprague Electric International Ltd., North Adams, Mass. CABLE SPREXINT

ratio as high as 500 to 1 if desired.

Power levels in the range of microwatts to tens of watts can be controlled.

U.S. Urged To Increase Surplus Disposal

THE Hoover Commission, in its report to Congress on surplus property, recommends that the Armed Forces get rid of obsolete stock or stock that is rapidly becoming unsuited to military needs. From \$10 billion to \$25 billion of supplies now in government warehouses could be eliminated with proper inventory control and more realistic stock levels.

The government would have to dump surplus stock at an annual rate of \$2 billion, original cost, for the next several years.

► **Return**—The average return from surplus sales is now running around 6 percent of original cost. Returns from electronic surplus equipment are as low as 3 percent. This is due to many factors including high obsolescence of some equipment.

Tubes Show Tubes On Closed-Circuit TV

ENGINEERS attending the IRE convention in New York were introduced to a new GE tube, the GL-6442, via a closed-circuit telecast originating at the company's tube plant in Schenectady, N. Y. The new tube promises to raise the power-handling capability of low-power radar, beacons and navigation aides at frequencies up to 4,000 mc.

The hour-long program was produced by Box Office Television. The cameras picked up live sequences demonstrating the manufacture and use of new tubes. A two-way audio system was used so that the audience could ask on-the-spot questions of design and production officials at the plant.

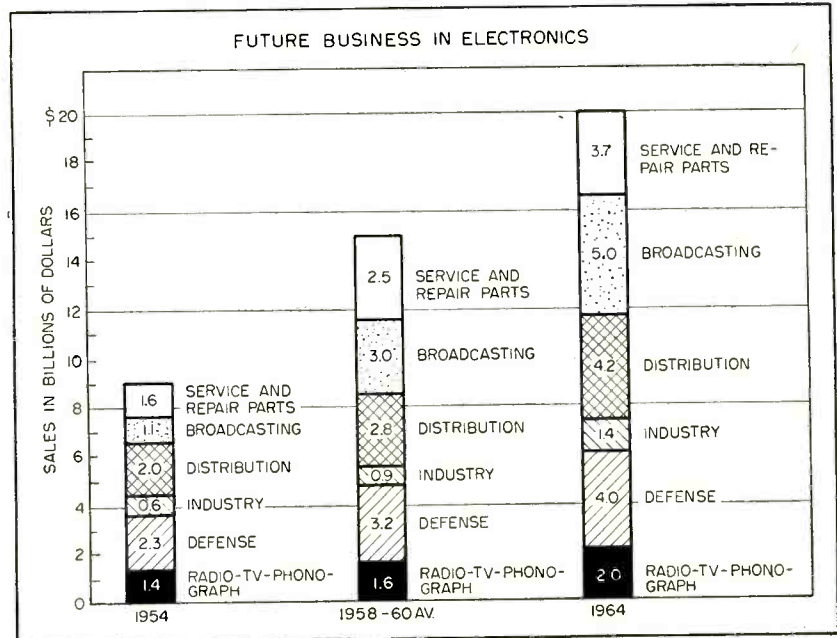

Industry Future Holds \$20 Billion

Realistic appraisal of the field's future potentials yields increasing volume figures

THE NEXT ten years in the electronics industry will see the present annual volume of \$9 billion rising to \$20 billion in the year 1964 according to an appraisal of the industry's business prospects by Sylvania Electric.

► **TV**—The report indicates that the long-term potential for tv will range between 6 million to 7.5 million sets per year throughout the next decade. In 1955 unit sales of tv sets will probably fall off to 6.4 million with a total factory value of around \$1 billion. During the three year period, 1958-60 combined unit sales of black-and-white and color sets are expected to average 6.9 million, with dollar volume averaging around \$1.2 billion a year. At the end of the decade, about 7.4 million sets will be sold at a factory price level of \$1.5 billion.

It is expected that no more than about 150,000 color tv sets will be produced this year with only 100,000 of these being sold to the public. About 34 percent of all sets produced in 1958-60 period how-

ever will be color sets and by 1964 color is seen accounting for 61 percent of total set production.

► **Radio**—The study estimates that 7 million home radio sets grossing around \$147 million will be sold in 1955 and that by 1964 8.5 million home radio units will be sold at a dollar total of near \$162 million. Annual auto set sales are expected to reach 5.6 million by 1964 with a dollar volume of \$140 million.

Records and phonographs were seen maintaining a fairly level volume of sales of between \$120 million and \$140 million over the next decade.

► **Defense**—Government purchases of electronics equipment might reach \$2.5 billion in 1955 according to the report. A volume of \$3.2 billion a year was seen for the 1958-60 period reaching \$4 billion a year by 1964.

► **Industry**—Sales of equipment for industry and commerce were estimated at \$570 million for 1954 and were expected to increase to around \$640 million this year. By 1958-60 annual sales of industrial-commercial equipment are expected to reach \$900 million going to between \$1.3 billion and \$1.4 billion

(Continued on page 14)

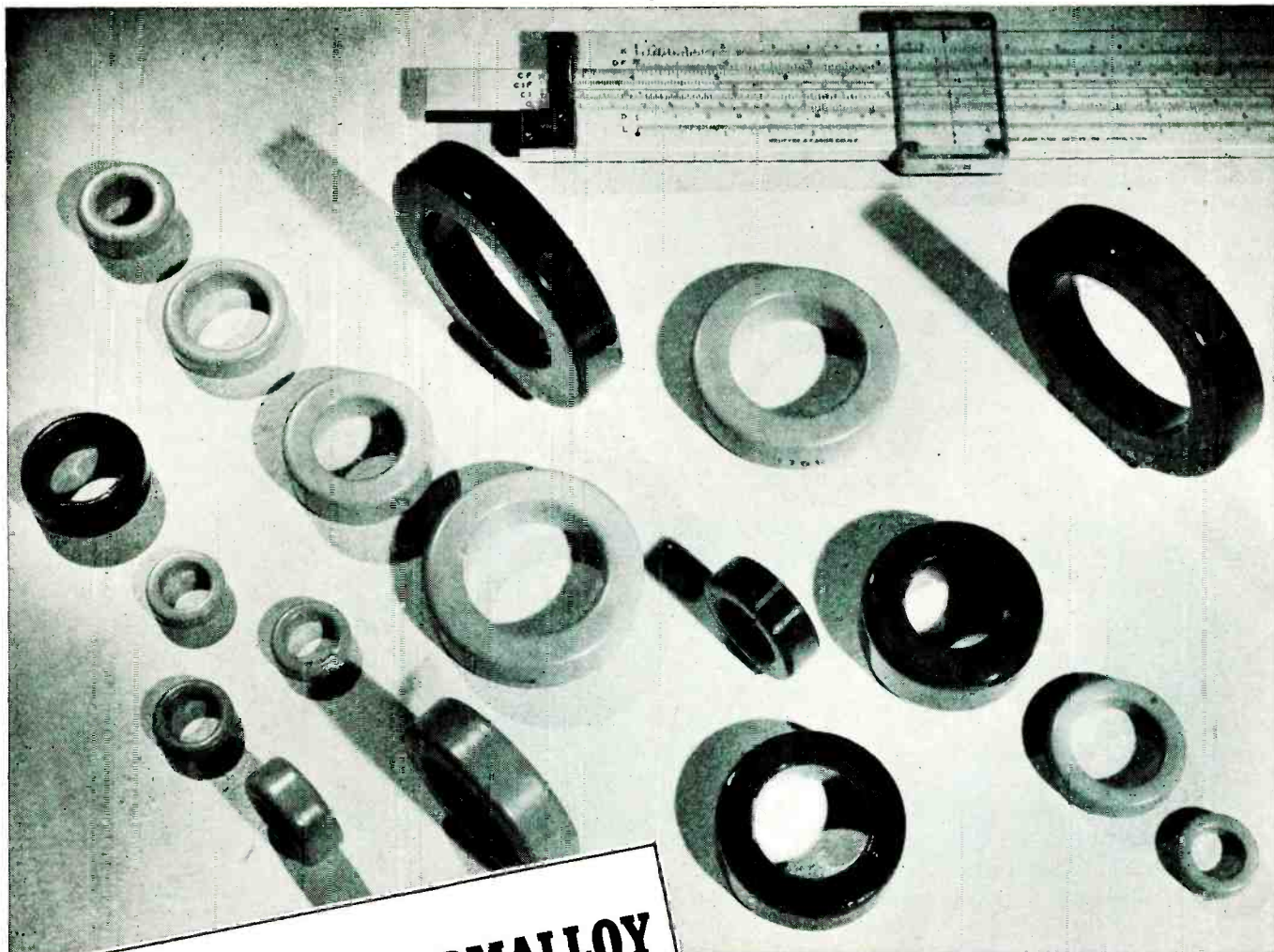

**MOLYBDENUM PERMALLOY
POWDER CORES***
(New technical data now available)
Write for Bulletin PC-104A, dated March 15, 1955

HIGH Q TOROIDS for use in
**Loading Coils, Filters, Broadband
Carrier Systems and Networks—**
for frequencies up to 200 K C

**COMPLETE LINE OF CORES
TO MEET YOUR NEEDS**

- ★ Furnished in four standard permeabilities—125, 60, 26 and 14.
- ★ Available in a wide range of sizes to obtain nominal inductances as high as 281 mh/1000 turns.
- ★ These toroidal cores are given various types of enamel and varnish finishes, some of which permit winding with heavy Formex insulated wire without supplementary insulation over the core.

For high Q in a small volume, characterized by low eddy current and hysteresis losses, ARNOLD Moly Permalloy Powder Toroidal Cores are commercially available to meet high standards of physical and electrical requirements. They provide constant permeability over a wide range of flux density. The 125 Mu cores are recommended for use up to 15 kc, 60 Mu at 10 to 50 kc, 26 Mu at 30 to 75 kc, and 14 Mu at 50 to 200 kc. Many of these cores may be furnished stabilized to provide constant permeability ($\pm 0.1\%$) over a specific temperature range.

*Manufactured under license arrangements with Western Electric Company

W&D 4744

THE ARNOLD ENGINEERING COMPANY
SUBSIDIARY OF ALLEGHENY LUDLUM STEEL CORPORATION
General Office & Plant: Marengo, Illinois
DISTRICT SALES OFFICES . . . New York: 350 Fifth Ave.
Los Angeles: 3450 Wilshire Blvd. Boston: 200 Berkeley St.

by the decade's end in 1964.

► **Tubes**—Sales of radio receiving tubes, tv picture tubes, special electronic tubes and other components for repair purposes will be near \$800 million in 1955, according to the study. In 1958-60, the total is expected to reach \$1.2 billion and by 1964 is expected to aggregate \$2.3 billion for a 250-percent gain in a decade.

► **Markup**—Added to the factory

prices of the foregoing estimates are the revenues of distribution which exceeded \$2 billion in 1954 and will be on the same level this year. By 1958-60, markup is expected to pass \$2.8 billion and rise to about \$4.2 billion in 1964.

Repairmen's service charges are expected to show a gradual increase from \$925 million this year to \$14 billion ten years hence.

Broadcasting revenues are expected to rise to \$5 billion for 1964.



TUBE sockets and other components are automatically inserted by . . .

Robot Assemblers Coming Soon

Machinery maker begins production and schedules delivery of assembler

LIMITED production has been started by United Shoe Machinery on its conveyor type machines for automatic assembly of electronic equipment. (ELECTRONICS, Sept., 1954, p 6 and 232) Delivery will begin in early summer.

The machines are already in daily operation in major radio and tv factories such as Emerson, GE and RCA. The machines have already been used to insert components in well over 500,000 printed wiring boards which have been put into commercial sets, mainly radio and tv receivers.

The equipment has a capacity of over 9,000 boards a day. Parts of the sets that utilize mechanized assembly vary from subassemblies for tv receivers to virtually complete chassis for table radios. Reliability of more than 99.5 percent for equipment under actual produc-

tion conditions has been reported by users.

► **Development**—The company is continuing development and production evaluation of a complete line of inserting units designed to handle components such as one and two-watt resistors; mica, tubular and disk capacitors; jumper wires; tube sockets; and i-f transformers. Included in this system is an advanced method of automatic dip soldering.

Magnetic Amplifier Sales Increase

WITH total sales in 1952 represented as one index point, volume increased for one manufacturer of magnetic amplifiers to 6.5 points in 1953, and to 113 points last year. The firm, which entered the field on the assumption of industry wide sales of at least 600,000 units a year, estimates that their sales index this year will be 114.

Glass Makers Push Parts Field Invasion

Glass components for mass radio-tv market debut as tube consumption grows

VALUE of glass envelopes used by the electron tube industry is in the neighborhood of \$75 million annually. Billings have increased as tv picture tubes have grown in size and number.

So far use of glass in components has been limited. However, increasing activity in the low-cost radio and tv components field is planned.

Corning Glass recently concluded an agreement for the marketing some of its electronic components through the distributors of Erie Resistor Corp. It also reduced prices in certain lines and introduced a number of low-cost components especially designed for commercial radio and tv applications.

► **Military**—Glass makers are continuing research and manufacturing of electronic devices for the military services. Recent developments include fused silica delay lines, and precision glass screens for c-r tubes which contain 200,000 accurately formed holes per square inch. In addition glass makers are working on the design of glass ra-

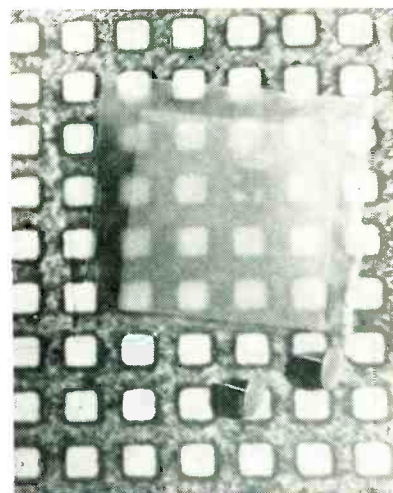

Newly developed screen of glass, shown against an enlargement of itself, contains 200,000 holes so small they cannot be threaded with a human hair

(Continued on page 16)

for modern,
profitable
automatic production...

call on **KAHLE**

**...world's leading
exclusive manufacturer
of production machinery
for the electronics field**

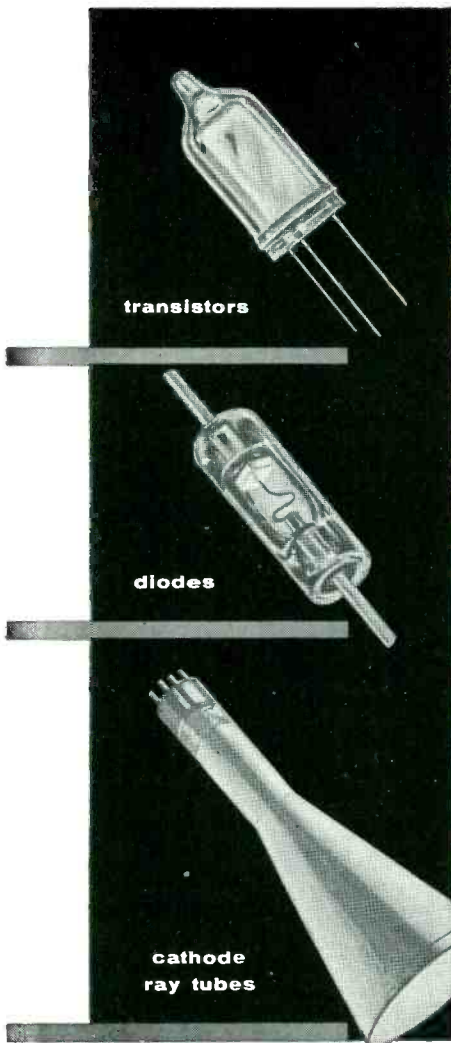

If you're making (or plan to make) *diodes, transistors, sub-miniature, miniature, cathode ray tubes, or other electronic tubes or component parts*, take full advantage of Kahle's invaluable experience.

With Kahle methods and "know-how" you're sure of getting exactly the right machinery to produce exactly what you want... accurately, dependably, profitably.

For more than a quarter of a century the leaders in the electronics field have relied on Kahle for production machinery. Typical production steps automatically performed by Kahle equipment include sealing, bulb making, stem making, exhausting, grid winding, filament coil winding, lead wire welding.

Write today for additional details, equipment specifications, production data, and quotations.

*Write for information
on special experimental
and research services
offered by Kahle.*

Get first hand information at our conveniently located plant—
15 minutes from Times Square, 5 minutes south of Lincoln Tunnel

***Kahle* ENGINEERING COMPANY**

1307 SEVENTH STREET • NORTH BERGEN, N.J.

domes for aircraft and guided missiles.

► **Tubes**—A 22-inch rectangular glass blank for color tv picture tubes is now being shipped in limited quantities by Corning Glass. The new tube is approximately the same length and height as a 19-inch round bulb and is designed to fit into the same size cabinet.

It is designed for a shadow mask tube and is constructed so the mask can be mounted by either of the two methods now in use, the flat land or the pin method. The bulb is adaptable to either the three-gun or single-gun system. Sampling of the tube began last fall. The company is also making small shipments of 21-inch round glass bulbs.

of 810,000 out of the 1.8 million sold last year were in this size. The 17-inch tube was next largest in renewal sales accounting for about 785,000 of total renewal unit volume. The 12 through 15-inch c-r tubes accounted for 148,651 units of total volume. All other sizes has unit sales below 35,000.

► **Future**—Raytheon, in appraising the future of replacement sales of receiving tubes, tv picture tubes and industrial tubes expects that by 1965 there will be a twofold or even greater increase in sales. This would bring total annual renewal sales for these tube types close to \$150 million in 1965.

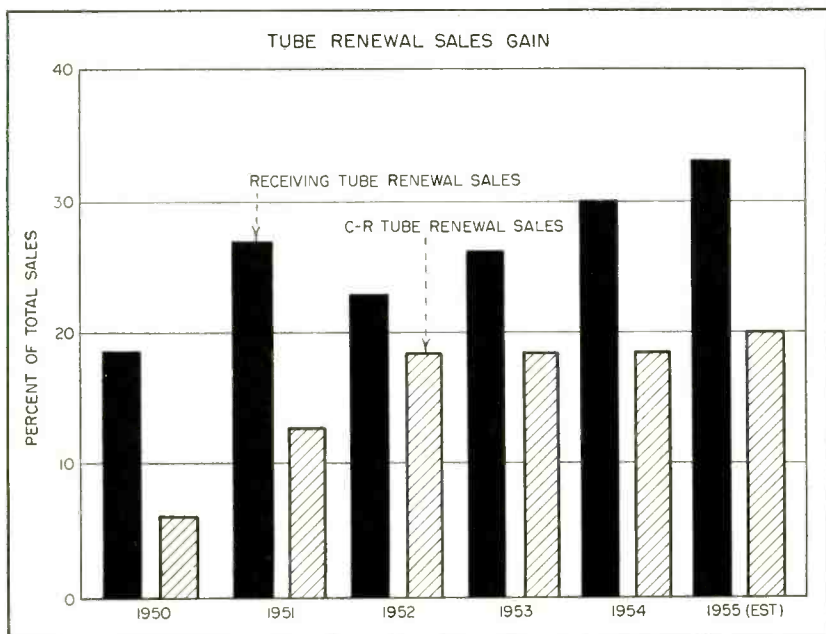

Renewal Market Gains Prominence

One-third of receiving and cathode-ray tube sales are accounted for by renewals

REPLACEMENT market for electron tubes is steadily edging into greater prominence. Last year over 30 percent of total receiving tube sales were for renewal representing a dollar volume of \$89.6 million out of total sales of \$275.9 million. This year total receiving tube renewals are running at 33.1 percent. In 1950 receiving tube replacement accounted for only 18 percent of total production.

► **Types**—The bulk of receiving tubes for replacement in the past few years have been entertainment types for home receivers. Receiving types for uses other than home entertainment sets have increased but accounted for less than 1.5 mil-

lion units of total renewal sales last year.

Most of the \$89.6 million in receiving tube renewal factory sales last year were made to parts distributors who annually do approximately \$100 million in tube sales including crts. Tube sales account for about 25 percent of total parts distributors' sales.

► **C-R Tubes**—Although unit volume of renewal sales of cathode-ray tubes is far below that for receiving tubes, dollar volume represented by the tubes is significant. Last year renewal sales of 1.8 million c-r tubes amounted to \$43.7 million equal to over half the renewal dollar volume for receiving tubes. This represented an increase of 6,000 units over 1953 sales. The big volume in cathode-ray tube replacement sales was done in the 19 through 21-inch sizes. A total

► **Color Strips**—Heart of the tube is a color-sensitive target evaporated onto the tube face. The target comprises 900 vertical strips of alternating red, green and blue color filters covered by three sets of semi-transparent signal strips. All the strips of the same color are electrically connected.

As the target is scanned by a single electron beam, the filters permit

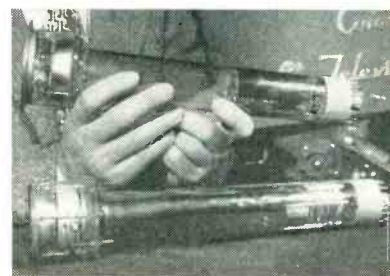

Developmental color Vidicon would replace three of the image orthicon type shown below to save expense and bulk

(Continued on page 20)

NEW!



Type 874-MD Sweep Drive . . . for G-R Slotted Line

This device represents an important advance in the field of automatic instrumentation. In conjunction with the Slotted Line, it makes possible accurate, truly *rapid* measurements of VSWR, complex reflection coefficient or impedance of antennas, termination filters, pads, cables and other network elements.

The Drive can be attached easily to one end of any of the new improved Type 874-LBA Slotted Lines. Sweep speed and length of line swept are completely adjustable, even while the carriage is traveling. Optimum settings for various measurements may thus be made.

For CRO horizontal deflection a sawtooth voltage is provided, the magnitude of which is accurately proportional to carriage position. This feature permits easy calibration of the horizontal scope axis. If the driving oscillator is square-wave modulated, a base line is made available for the scope and VSWR can be measured directly on the scope face. Positions of voltage minima can also be determined in this manner. Where preferable, a standing-wave meter can be used in place of the scope at slow speeds.

This Drive has no backlash problems whatever, because the Sweep is determined by the *position* of the carriage. Consequently, both forward and backward sweeps are used.

SWEEP SPEED — continuously adjustable from one full sweep (46 cm) in more than 10 seconds, to one full sweep in less than one second.

SWEEP RANGE — continuously adjustable from 1 cm to 46 cm.

SIGNAL FOR CRO HORIZONTAL PLATES — voltage divider with sliding contact on carriage provides d-c output.

TYPE 874-LBA SLOTTED LINE . . . with Adjustable Stub for tuning crystal rectifier. \$231.00

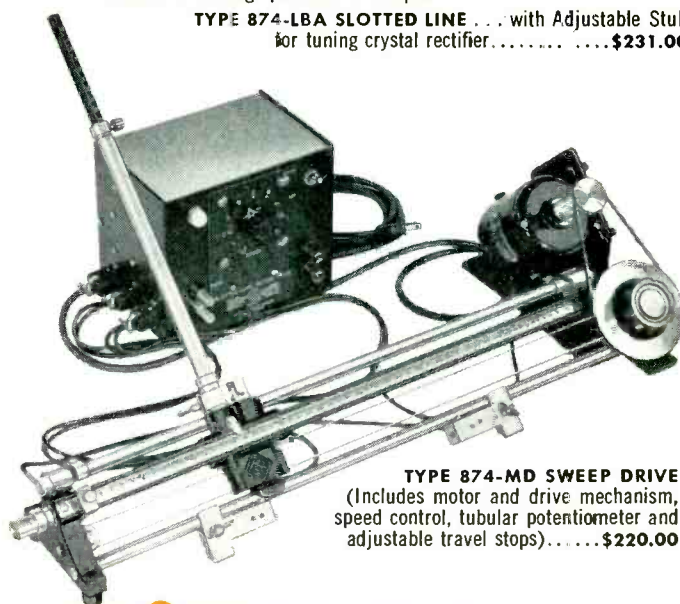

TYPE 874-MD SWEEP DRIVE
(Includes motor and drive mechanism, speed control, tubular potentiometer and adjustable travel stops). \$220.00

GENERAL RADIO Company

275 Massachusetts Avenue, Cambridge 39, Massachusetts, U.S.A.

90 West Street NEW YORK 6
8055 13th St., Silver Spring, Md. WASHINGTON, D. C.
920 S. Michigan Avenue CHICAGO 5
1000 N. Seward Street LOS ANGELES 38



1915-1955

40 Years of Pioneering

in Electronics

another **RAYTHEON** first!

GENUINE

RF TRANSISTORS

that make possible this

ALL-TRANSISTOR 455 kc I. F. PORTABLE

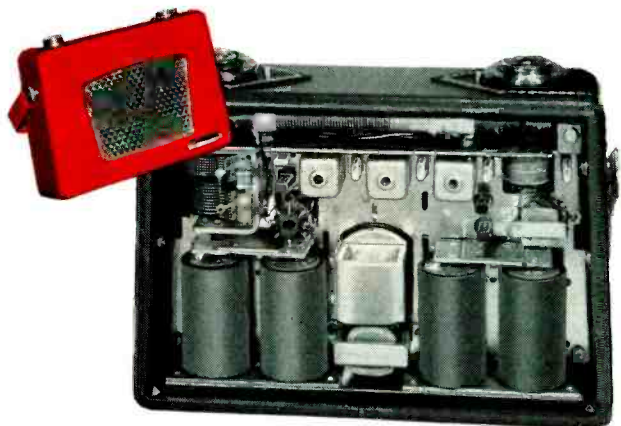
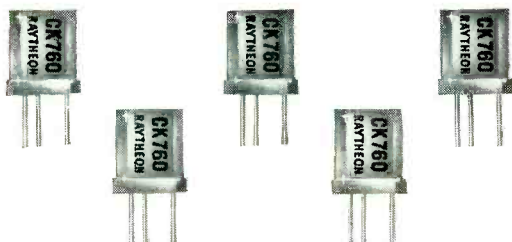

- completely interchangeable, without selection of components
- successfully field tested for an entire year
- available in production quantities
- hermetically sealed
- equipped with standard military lead spacing
- made by the Raytheon-perfected *fusion alloy* process that has already produced nearly *two million* transistors

- 455 kc performance matching highest industry standards for portable radios
- operates for 500 hours from 4 standard flashlight batteries
- delivers 120 milliwatts UPO
- ENSI (equivalent noise sideband input) comparable to vacuum tube portables

HIGH FREQUENCY TRANSISTORS — HERMETICALLY SEALED CASE									
TYPE	Collector		Emitter MA	Extrin. Base Resis. ohms	Base Current Ampl. Factor	Alpha Freq. Cutoff mc.	Max. Junc. Temp. °C	Temp. Rise °C/mW	Coll. Capac. μμf
	Volts	Cutoff μA							
CK760	-6	1	-1.0	75	40	5	85	0.62	14
CK761	-6	1	-1.0	75	45	10	85	0.62	14
CK762	-6	1	-1.0	75	65	20	85	0.62	14

Note: above characteristics are average except where noted

RAYTHEON TRANSISTORS
- more in use than all other makes combined



SILICON POWER RECTIFIERS

to 175°C

to 15 amps.

to 200 volts

REVERSE
REFORWARD > 100,000

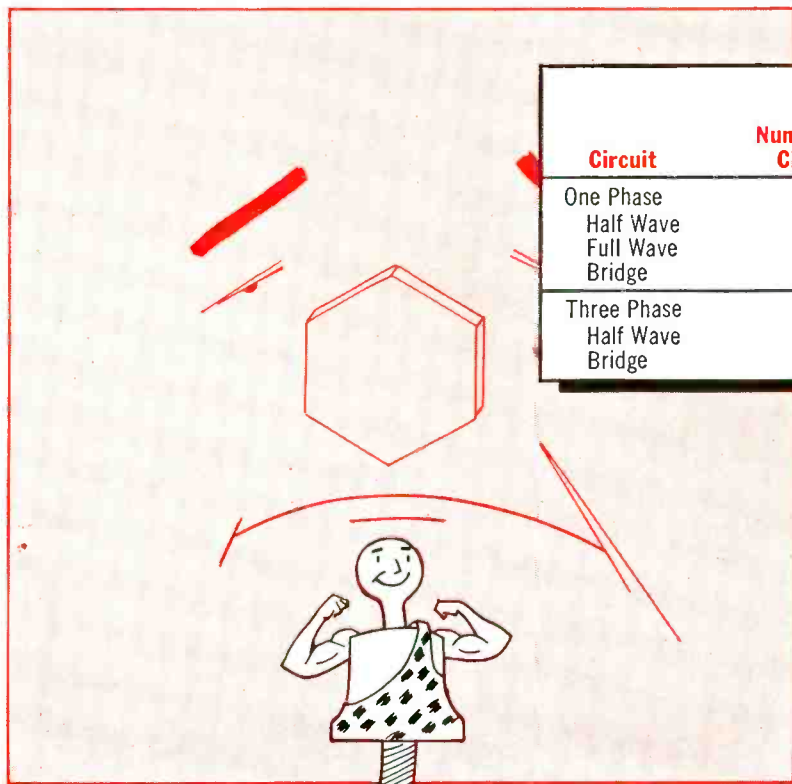

Circuit	Number of CK776	Watts Output at Case Temperature † of		
		30°C	70°C	170°C
One Phase				
Half Wave	1	700	530	265
Full Wave	2	1600	1070	530
Bridge	4	3050	2040	1020
Three Phase				
Half Wave	3	3200	2150	1070
Bridge	6	6800	4550	2270

† Maintained with heat radiator

At maximum power handling capability of CK776, an equivalent selenium rectifier could occupy as much as 100 times the volume.

RAYTHEON SILICON POWER RECTIFIER CHARACTERISTICS					
TYPE CK775	MAXIMUM VOLTAGE		MAXIMUM CURRENT		TYPICAL DISSIPATION WATTS
	RMS VOLTS	PEAK VOLTS	PEAK AMPERES	AVERAGE AMPERES	
CASE TEMP. 30°C*	40	60	50	15	40
CASE TEMP. 170°C*	40	60	15	5	10
NO HEAT RADIATOR					
AMBIENT TEMP. 25°C	40	60	6	2.0	3.0
AMBIENT TEMP. 170°C	40	60	2.0	0.5	2.0
TYPE CK776					
CASE TEMP. 30°C*	125	200	50	15	40
CASE TEMP. 170°C*	125	200	15	5	10
NO HEAT RADIATOR					
AMBIENT TEMP. 25°C	125	200	6	2.0	3.0
AMBIENT TEMP. 170°C	125	200	2.0	0.5	2.0

*maintained by external heat radiator

At 25°C both CK775 and CK776 have maximum drop at 5 amperes of 1.5 volts.

Maximum reverse current is 25mA for CK775 at -60 volts, CK776 at -200 volts.



ACTUAL SIZE



Excellence in Electronics.

RAYTHEON MANUFACTURING CO.

RELIABLE SUBMINIATURE AND MINIATURE TUBES
SEMICONDUCTOR DIODES AND TRANSISTORS
NUCLEONIC TUBES • MICROWAVE TUBES
RECEIVING AND PICTURE TUBES

Semiconductor Division — Home Office: 55 Chapel St., Newton 58, Mass., Bigelow 4-750

For application information write or call the Home Office or: 9501 Grand Avenue, Franklin Park (Chicago), Illinois, TUXedo 9-5400
589 Fifth Avenue, New York 17, New York, PLaza 9-3900 • 622 South La Brea Ave., Los Angeles 36, California, WEBster 8-2851

the signal strips to produce appropriate electrical signals. Since the beam moves in a fashion similar to the scanning of ordinary camera tubes, the tube generates directly and simultaneously the three primary color signals required for the composite broadcast signal.

Private-Plane Market Boosts Airborne Sales

Multiengined craft require much electronic gear and out-number airliners

MANUFACTURERS of airborne electronic equipment are looking to the private-plane field as a rapidly growing market for instruments. There are 70,000 active privately owned aircraft of which 40,000 carry some kind of electronic equipment. About 25,000 firms use one or more aircraft in their business—usually for chauffeuring executives.

There are 1,500 multiengined private aircraft as against 1,000 planes operated by the airlines.

► **Market**—Electronic equipment currently installed in light planes is valued at nearly \$500 million. Value of electronic equipment installed aboard airliners is about \$50 million (considering each plane's equipment worth about \$50,000).

Annual business supplying airborne electronic equipment to the airlines amounts to about \$5 million against an estimated \$1 billion for military aircraft. Yearly expenditure by light-plane owners is about \$30 million.

► **Requirements**—Minimum requirement for a private plane is a vhf receiver with broadcast and navigation-band reception and a two-watt transmitter. This can be bought for \$437.

Electronic equipment for a light twin-engined executive plane may cost \$20,550.

This includes:

2 automatic direction finders.....	\$4,000
1 vhf omnirange receiver.....	700
1 36-channel vhf receiver.....	2,000
1 marker-beacon receiver.....	600
1 3-axis autopilot with ILS.....	6,000
1 distance-measuring equipment	7,000
1 isolation amplifier.....	250
	<hr/>
	\$20,550

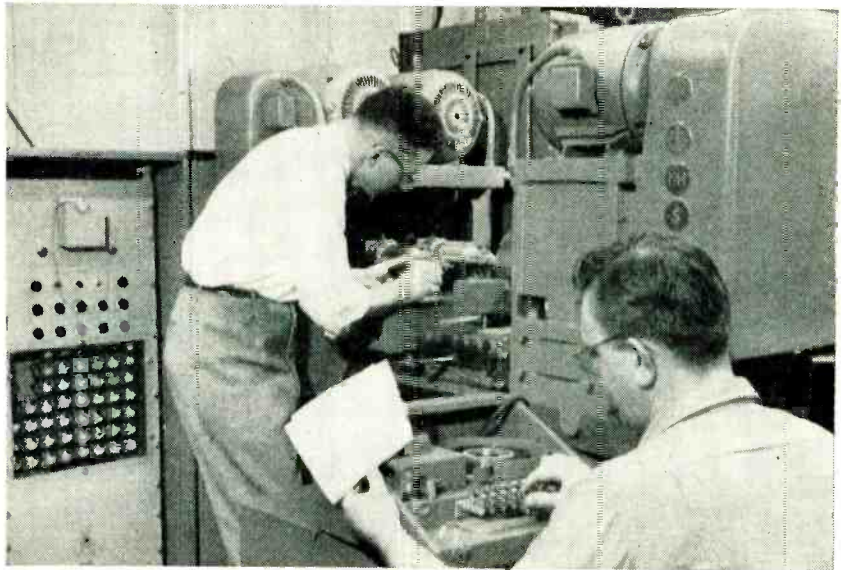

BORING work is guided by electronics at Minneapolis-Honeywell as . . .

Tubes Infiltrate Metal Trades

Companies apply electronics to milling and drilling machines for more efficient production

ELECTRONICALLY controlled milling machine capable of producing aircraft dies or parts of any shape will be developed by Convair under a \$1.1 million Air Force contract. The 200-ton milling machine and the electronic system that directs it will be completed in about 18 months.

Minneapolis-Honeywell has developed a punched paper tape controlled automatic boring machine for producing instrument gear trains.

► **Milling**—The control system for the Convair milling machine will include an input system, computer, director and control console. Signals will guide the milling machine's four cutting heads, its bed and turntable. Control system design will be based upon work done at MIT under Air Force auspices.

► **How It Works**—Punched cards of a keyboard may be used to write in the dimensions of the part. The computer prepares numerical commands for the machine and transcribes them on punched paper tape.

The commands are fed to the

electronic director and transferred to magnetic tape. The director can either control the milling machine directly or the magnetic tape can be fed to a control console designed solely for controlling machine operation.

In this way the computer-director is freed for other problems. It can support many different machines such as rolling mills, stretch presses and special-purpose profilers.

► **Savings**—The numerical or digital control concept eliminates the human error that may be introduced in analog control schemes where a machinist makes the first part with a control unit recording his movements.

On some parts, savings of as much as 85 percent of the present lead time are expected with the new method. On parts having greater complexity, the lead time savings may not exceed 15 percent over present methods. Savings of \$50,000 or more will be possible in the elimination of some toolings for just one part.

► **Drilling**—The system worked out by Minneapolis-Honeywell includes a standard four-spindle Ex-

(Continued on page 22)

NEW

ALL-ANGL BARRY MOUNT

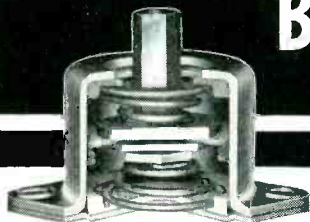

ALL-ANGL BARRY MOUNT
Cup diameter 1 inch
Maximum load 3 pounds
Weight less than 1 ounce

Works at any angle

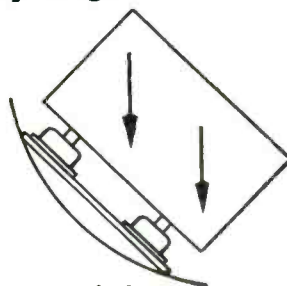
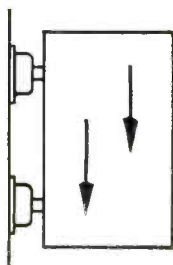
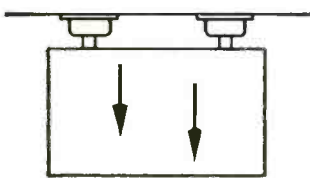

...in maneuvers through every position

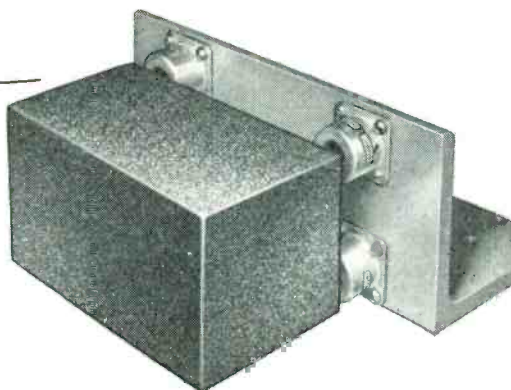

...with HIGH DAMPING in all directions

Now you can forget all limitations on mounting positions for delicate apparatus. You can design for easiest installation and best space utilization, because the new Barry ALL-ANGL vibration isolator works in any position. Upside down, on a bulkhead, at any slant — position means nothing to this new BARRYMOUNT.[®] Damping is exceptionally high in all directions; transmissibility at resonance is less than 3. The ALL-ANGL mount is interchangeable with other miniature BARRYMOUNT isolators.

This isolator is the answer to your toughest vibration-protection problems. Let us show you what it will do for you; or write for Bulletin.

BARRY CONTROLS

INCORPORATED

Formerly The Barry Corporation

707 PLEASANT STREET WATERTOWN 72, MASS.

SALES REPRESENTATIVES IN ALL PRINCIPAL CITIES

cello precision boring machine modified with built-in electronic controls and circuitry and a tape reader housed in a control cabinet.

Hole coordinates and feed instructions are punched on the tape by a perforating machine similar to a typewriter. Electronic signals from the tape regulate the linear travel of the boring machine's hydraulic cross slide and the rotary motion of a holding fixture mounted on the cross slide. Tape preparation requires approximately five minutes per hole and complete changeover from one part

to another can be accomplished in about 30 minutes.

► **Future**—Use of electronic control in metalworking operations will be much in the news next fall when nearly every large machine tool builder introduces an electronically controlled machine.

Tool builders have been busy under wraps for some time. Some of the development work has been done by electronics companies under contract while other tool builders have established their own electronics departments.

Some tape used is 35 mm wide and has sprocket holes like film.

Guided missile expenditures are expected to increase 35 percent this year and comprise a big chunk of the \$650 million super-weapons budget. One company specializing in field support equipment which includes go-no-go control system testers expects to do a \$60 million business this year.

► **Future**—Eight-year time table for tv development includes the following: automatic production of monochrome sets resulting in a 10-percent saving in direct labor together with increased quality and product uniformity; production of color sets selling for under \$500; manufacture of transistorized sets using picture-on-the-wall tubes. Immediate objective of set manufacturers is a second or third monochrome set in every home.

Electronics Booms In The West

Industry leaders anticipate increasing level of military, radio-tv and industrial sales

UNQUALIFIED optimism is the outstanding characteristic of the electronics industry in the Los Angeles area.

With 15 firms in 1943, the industry now encompasses 440 firms operating 506 plants with a total area of 9,750,281 sq ft and employing 69,637 persons. Gross billing for 1956 is expected to top \$1 billion (ELECTRONICS, April, 1955, p 20) and may reach \$1.1 billion in 1960.

► **Patterns**—The industry is made up largely of small firms (less than 500 employes) some of which started when handfuls of engineers left the electronics departments of large aircraft plants and founded organizations to exploit their individual talents.

More than half the firms are engaged in engineering and design. Products are characterized by short production runs and a high creative content per dollar.

Items manufactured include military electronic equipment, industrial and scientific instruments, test gear, computers, radio and tv sets and audio equipment.

► **Trends**—Aircraft firms entered the electronics business by way of the weapons-system method of

procuring military aircraft and guided missiles. However, the aircraft industry has been noted for subcontracting much of its specialized work in the past and even the firms best staffed electronically continue to buy off-the-shelf items from electronics manufacturers.

Precision wire-wound resistors are important to guided missiles and for specialized instruments. Units cost from 64 cents to \$64 dollars depending upon the accuracy required.

Magnetic tape is playing an increasingly important part in the film industry. Sound for the movies is recorded first on magnetic tape then put on optical sound track. Vocals, accompaniment, dialog and special effects are often recorded separately.

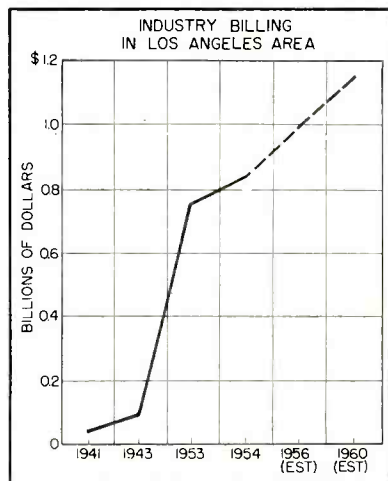

Microwave Ovens To Enter Home Kitchens

Units for home use that brown as they cook may be available late next year

ORDERS will be taken by GE next year for household electronic ovens that use magnetron-produced high-frequency radio waves to cook foods. The new ovens probably will not be available before the end of 1956. Built-in models will be displayed during the coming year, according to the company.

No price has been set for the units but they are expected to cost more than conventional built-in ovens. While it will cook faster than today's standard ovens, the current cost for electronic oven cooking will be about the same as for conventional methods.

► **Features**—Electronic ovens have been used experimentally for many years and have been produced for use in commercial establishments. Feature of the GE unit is that it browns food as it cooks.

(Continued on page 24)



this is not something new!

Leading members of the aviation industry have long known about this means of measuring aircraft and missile antenna radiation patterns. In the course of various engineering projects, they have come repeatedly to Airborne Instruments Laboratory with antenna test problems. As always, Airborne's scientists sought to create equipment, singularly perfect in performance yet flexible enough to meet many specific needs. Their efforts resulted in the Type 105 Model Range System, which automatically records polar plots of the relative field strength of aircraft radiation patterns.

The Type 105 System, however, is not only important within itself. Out of its totality have emerged several significant devices, designed for many recording purposes. Among these are the 116R Polar Pattern Recorder, the Type 20 SWR Indicator, and the Type 373 Rectangular Coordinate Recorder.

Here again is an example of creative initiative, by ALL engineers, providing a continuous succession of advanced instruments for America's industrial progress.

Send for information about the 105 Model Range System and literature on other recording devices.



Type 116R Polar
Pattern Recorder

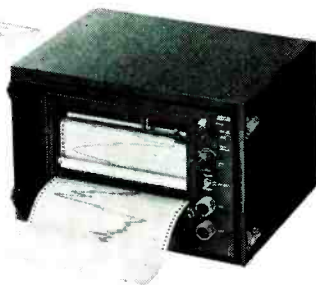

Type 373 Rectangular
Coordinate Recorder



Type 20
SWR Indicator



**AIRBORNE
INSTRUMENTS
LABORATORY**
I N C.

160 OLD COUNTRY ROAD • MINEOLA, NEW YORK

Heretofore, electronically cooked food has lacked the appetizing browned surface achieved in a regular oven.

Test data on a developmental sample of the new range shows that it cooks meats in from one-sixth to one-eighth the time required by conventional methods.

Financial Roundup

Over two-thirds of the firm's reporting show gains in 1954 net profit over 1953

YEAR 1954 was one of the best on record profitwise for the industry. Following are the net profits for 26 firms for the 12 months of 1954 or the fiscal period indicated, compared to 1953:

Company	Net Profit	
	1954	1953
Admiral	\$6,547,974	\$8,213,165
Aircraft Radio ..	576,127	390,611
Am. Cable & Radio	1,890,072	1,656,659
ACF Industries 9m	4,305,949	5,742,949
Burroughs	7,796,065	7,206,655
Electronic Assoc.	244,557	130,685
Electronic Corp.		
Of Am.	162,106	
Gen. Dry Batteries	529,301	403,358
Gen. Prec. Equip.	5,488,090	3,436,349
Globe Union	569,280	1,682,276
Hallcrafters 6m.	275,241	*949,337
Hoffman		
Electronics ...	1,485,513	1,199,655
Indiana Steel ...	587,854	335,925
Minnesota Mining	24,624,225	17,977,771
Motorola	7,572,000	7,076,000
National Union...	1,289,264*	166,458
Norden-Ketay ...	1,002,922	
Oxford Electric...	93,983	99,886
Raytheon 9m.....	3,592,000	2,703,000
Robertshaw-		
Fulton	3,677,709	2,649,181
Sprague Electric.	3,333,408	2,888,281
Standard Coil...	2,871,290	2,972,481
Texas Instruments	1,200,000	1,270,000
Traveler Radio...	241,000	
Triad Transformer	52,111	
Zenith	5,676,264	5,631,701

* Loss.

► **Securities**—American Electronics of Los Angeles filed with SEC covering \$1,250,000 of 5-percent convertible debentures due 1967 to be offered at 100-percent of their principal amount. Net proceeds are to be used to retire loans and debts and for general corporate purposes.

Collins Radio registered with SEC covering 122,500 shares of \$50 par convertible preferred stock. Proceeds will be used to redeem outstanding preferred and for working capital.

Norden-Ketay registered with SEC covering stock purchase warrants and/or 22,500 shares of common stock issuable pursuant to stock warrants. Net proceeds will be used for corporate purposes.

What It Takes To Be An Executive

Varying views are held on technical management qualifications

WHAT it takes to be a successful technical manager was one of the main discussion points in the engineering management sessions at the 1955 convention of the Institute of Radio Engineers.

► **Job**—An effective technical manager, as described in one paper, is able to organize and direct the activities of others for greater productivity. He is also effective in representing to higher management the ideas, points of view and needs of his own people in such a way that they can have a bearing upon company plans.

A technical manager is badly handicapped if he attempts to manage scientific and engineering people without a thorough understanding of their tasks. Thus it is necessary to convert some technical people into administrators and executives.

► **Qualities**—However, the very qualities that make a man outstanding as a creative engineer are likely to be disqualifying for managerial responsibility. Five important qualities in which the typical engineer differed from the typical executive are:

- The *engineer* is primarily proud of his intellectuality while the *executive* is primarily proud of his practicality.
- The *engineer* is spontaneously interested in physical things and physical processes while the *executive* is spontaneously interested in people.
- The *engineer* is more thoughtful than active, introverted, while the *executive* is more active than thoughtful, extroverted.
- The *engineer* is less able to use his own emotions as drives. He finds it hard to accept emotion in himself or others. The *executive* can accept his own emotions and use them as drives to accomplish results with himself and others.
- The *engineer* may be limited in

both fluency and clarity of verbal expression while the *executive* must be superior at both points and must be effective in verbal communications.

U.S. Cues Electronics At German Trade Fair

Thirty firms send equipment abroad for U. S. exhibit in Hanover

AMERICAN electronics will play a major role in the U. S. Department of Commerce's exhibit at the German Industries Fair, April 24 to May 3, at Hanover, Germany. At least 30 U. S. manufacturers of electronic equipment will display their products at the Fair as part of the U. S. Government exhibit. The Hanover Trade Fair is one of a series of international exhibits in which the U. S. is officially to participate as a means of acquainting Europeans with U. S. products and facilities.

Robot Op Takes Code At 600 WPM



All-electronic Morse code converter developed at C.G.S. Laboratories is viewed by company and military officials. It automatically translates Morse signals at any speed from 10 to 600 words per minute to finished form as a printed message on a standard teletype printer

(Continued on page 26)

To help you meet
the Tolerance Squeeze

QUALITY CAPACITORS BUILT BY HAMMARLUND

Performance requirements for electronic products—commercial, industrial and military—are becoming more difficult to meet. Specifications call for the finest quality components available to fulfill exacting equipment tolerances.

Hammarlund variable capacitors have been designed and built for more than 25 years to meet the most demanding of requirements. Check the general characteristics of these outstanding variables:

- Rotor and stator plates of brass stock soldered, *not staked*, to their supports to permanently insure perfect contact and prevent loosening of plates.
- Stator supports soldered into eyelets assembled to steatite insulators.
- Terminals hot-tinned for ease in soldering.
- Insulators of low-loss steatite, impregnated with DC 200 silicone fluid to prevent absorption of moisture.
- Rotor and stator assemblies nickel or silver-plated.
- Rotor contact springs of beryllium copper or phosphor bronze, and nickel or silver-plated.
- Precision soldering fixtures and assembly jigs used in fabricating to assure absolute uniformity of plate spacing.

These are basic reasons why Hammarlund capacitors should be used where highest dependability is required. Convince yourself in your engineering models and you will specify them for production.

For detailed information on Hammarlund variable capacitors write for this latest catalog. It includes complete drawings and specifications on all standard units. Ask for bulletin E-5.



 **HAMMARLUND**

THE HAMMARLUND MANUFACTURING COMPANY, INC.
Main Plant and Offices: 460 W. 34th ST., N. Y. 1, N. Y.
Midwest Sales Office: 605 N. Michigan, Chicago 11, Ill. • Export Sales Office: 33 E. 40th St., N. Y.

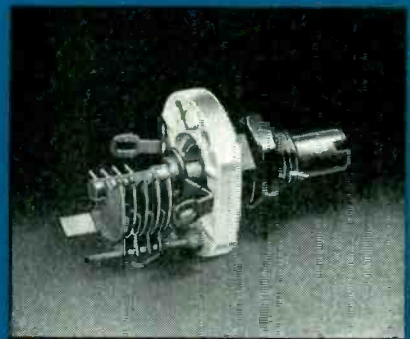

**Miniature "MAC"
Variable Capacitor**

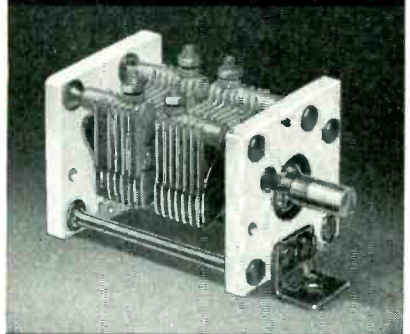

**"VU" Capacitor
For Up to 500 Mc**

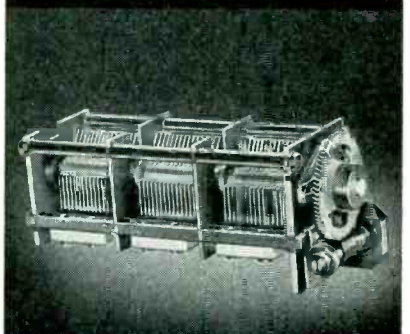

**Special 3-Gang
Precision Capacitor**

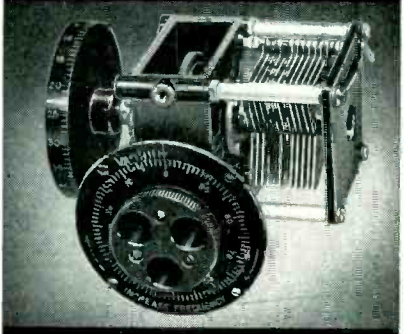

**Precision Frequency
Meter Capacitor**

Military To Give Nav aids Business

SOME TWO YEARS after the end of the war, systems of electronic aids to air navigation were generally agreed upon. Loran, the long-range aid developed for Navy ships, was agreed to be the best compromise until something better came along. For short ranges, VOR/DME was chosen to guide aircraft across the continent.

At present, the North Atlantic, the Gulf of Mexico and the area off the Pacific Coast are blanketed with an invisible network of hyperbolic lines generated by transmitters that are, mostly, run by the Coast Guard. The Civil Aeronautics Administration is pushing forward a program that will total 436 vhf omnirange and 241 distance-measuring stations across the country by the end of fiscal 1955.

► **Speedup**—Korean hostilities and the development of fast aircraft have caused some big changes in nav aids thinking. To counter loran's lack of overland coverage during daylight and extend its nighttime service, Navarho has been proposed. Operating on a low radio frequency, it is expected to extend a usable beam out to 2,500 or 3,000 miles. An experimental Air Force installation will go in soon at Camden, N. Y., using three 15-kw transmitters precisely phased.

In doubt is the future of VOR/DME. Despite a large CAA investment in ground equipment as well as a healthy amount in private aircraft, the military are pushing for adoption of another system known as Tacan. Basically, Tacan is said to do more things better than VOR/DME but the system is still under security wraps. It is known to require some of VOR/DME frequencies.

Policies mapped by the Air Navigation Development Board will be carefully scrutinized by House and Senate committees before final acceptance of the Tacan system.

FUTURE MEETINGS

- MAY 2-5: Third Annual Semiconductor Symposium of the Electrochemical Society, Cincinnati, Ohio.
- MAY 2-5: Joint Meeting URSI, IRE, National Bureau of Standards, Washington, D. C.
- MAY 3-5: First National Flight Test Instrumentation Symposium, ISA, Wichita, Kansas.
- MAY 10-12: Eleventh Annual Meeting and 1955 Metal Powder Show, Bellevue-Stratford Hotel, Philadelphia, Pa.
- MAY 13: Automation, Engineering For Tomorrow, Symposium, Engineering School, Michigan State College, East Lansing, Mich.
- MAY 16-19: Electronic Parts Distributors Show, Conrad Hilton Hotel, Chicago.
- MAY 17-19: Communications Section, AARR, St. Francis Hotel, San Francisco, Calif.
- MAY 18-20: Annual National Telemetry Conference and Exhibit sponsored by IRE, AIEE, IAS, ISA; Hotel Morrison, Chicago, Ill.
- MAY 19-21: Global Communications Conference, sponsored by AFCA; Hotel Commodore, New York, N. Y.
- MAY 23-25: Ninth Annual Convention of the American Society for Quality Control, Hotels Statler and New Yorker, New York, N. Y.
- MAY 24-26: Ninth Annual NARTB Broadcast Engineering Conference, Washington, D. C.
- MAY 25-27: Ninth Annual Frequency Control Symposium, Signal Corps, Hotel Berkeley Carteret, Asbury Park, N. J.
- MAY 26-27: Electronic Components Conference, Los Angeles, Calif.
- JUNE 2-3: IRE Materials Symposium, U. of Penn. Physics Bldg., Philadelphia, Pa.
- JUNE 3-5: ARRL Hudson Division Convention and Amateur Radio Equipment Show, Hotel Adelon, Long Beach, N. Y.
- JUNE 6-8: Fourth Annual Convention and Trade Show, National Community Television Association, Park Sheraton Hotel, New York, N. Y.
- JUNE 14-16: First Magnetics Conference and Exhibit, AIEE, APS, AIMME, William Penn Hotel, Pittsburgh, Pa.
- JUNE 20-25: Symposium on Electromagnetic Wave Theory sponsored by URSI and the University of Michigan, Ann Arbor, Mich.
- JUNE 27-29: Radome Symposium, Ohio State University and Wright Air Center, Columbus, Ohio.
- AUG. 22-23: Symposium on Electronics and Automatic Production sponsored by Stanford Research Institute and NICB, San Francisco, Calif.
- AUG. 24-26: 1955 WESCON, Civic Auditorium and Fairmount Hotel, San Francisco, Calif.
- AUG. 26-SEPT. 4: Great German Radio, Gramophone and TV Exhibition, Dusseldorf, Germany.
- SEPT. 12-16: Tenth Annual Instrument Conference & Exhibit, ISA, Shrine Exposition Hall and Auditorium, Los Angeles, Calif.
- SEPT. 19-20: RETMA Symposium "Electronics For Automation and Automation For Electronics, Philadelphia, Pa.
- SEPT. 28-29: Industrial Electronics Conference, AIEE, Rackham Memorial Auditorium, Detroit, Mich.
- OCT. 3-5: National Electronics Conference, Hotel Sherman, Chicago, Ill.
- OCT. 24-25: First Annual Technical Meeting, IRE Professional Group On Electron Devices, Shoreham Hotel, Washington, D. C.

Industry Shorts

- **Juke Box** type of storage system using magnetic disks instead of tape or drum provides fast high-capacity random-access memory for a soon-to-be-announced business computer.
- **Number** of fused junction transistors for low frequencies manufactured by Raytheon that are now in use totals nearly two million.

- **Experimental** auto radio that uses nine transistors has been developed by RCA. It requires no vibrator, power transformer or rectifier and uses about one-tenth the power needed by conventional sets.
- **Net** recovery to the U. S. Treasury under the Renegotiation Act of 1951 for the period between 1951 and 1954 was \$39 million.
- **Total** attendance at the 1955 IRE National Convention was 40,093.

WIDE RANGE
WIDE SWEEP-
Sweeping
OSCILLATOR

The
KAY
CALIBRATED
Mega-Sweep



SG-92/U

- Continuously Tunable Thru Video VHF and UHF Frequencies, 50KC-950MC Range
- Sweep Widths to 40 MC
- Single Dial Tuning

Used with a standard cathode ray oscilloscope, the Kay Calibrated *Mega-Sweep* will display the response characteristic of wide band circuits over the frequency range of approximately 50 kc to 950 mc. It features a calibrated dial indication of the approximate output frequency. The center frequency of the sweeping output voltage may thus be set to an accuracy of about 10%. The calibrated *Mega-Sweep* is the ideal instrument for use in alignment of amplifiers and filters... also as an FM source of wide range for instructional and lab purposes.

SPECIFICATIONS

- Freq. Range:** 50 kc to 1000 mc.
- Freq. Sweep:** Sawtooth, adjustable to 40 mc. Repetition rate, 50 to 100 c/s.
- RF Output:** High, approx. 100 mv max. into open circuit. Low, 5 mv into open circuit.
- RF Output Control:** Microwave attenuator continuously variable to 26 db.
- Output Waveform:** Less than 5% harmonic distortion at max. output.
- Meter:** Provides crystal detector current for peak output.
- Regulated Power Supply:** 105-125 v., 50 to 60 cps. Power Input, 100 watts.

Send for Catalog 110-A

\$495 f.o.b. factory

KAY
SWEEPING OSCILLATORS
for every application



KAY
Mega-Sweep

Widest range of the Kay line of sweeping oscillators. Provides continuous frequency coverage up through UHF-TV bands - 50 kc to 1000 mc. Widely used in radar system development and in alignment and testing of TV and FM systems and components, as well as wide band IF and RF amplifiers and filters. Freq. range, 10 mc to 950 mc. Write for Catalog 100-A. Price, \$465 f.o.b. factory.



KAY
111-A CALIBRATED
Mega-Sweep

Higher output model calibrated *Mega-Sweep*, with zero level baseline. Higher output facilitates frequency response testing of UHF converters or tuners. Wider sweep width permits multi-channel response viewing. Zero level baseline is convenient means of measuring gain of test circuit.

SPECIFICATIONS

Frequency Range	Output Impedance	Output Voltage (Into Load)
1. 10 mc-950 mc	70 ohms unbalanced	0.15 Volts
2. 450 mc-900 mc	300 ohms balanced	0.3 Volts

Sweep Width: Continuously variable to approx. 40 mc max.

Write for Catalog 111-A

Price, \$575 f.o.b. factory

KAY 112-A CALIBRATED *Mega-Sweep*

Same as 111-A, except total frequency range is 800 mc to 1200 mc. Catalog 112-A. Price, \$575 f.o.b. factory.

Dept. E-5
KAY ELECTRIC COMPANY
14 MAPLE AVENUE PINE BROOK, N. J.

Now...

WITH

A.C.

RUGGEDIZED INSTRUMENTS,

ROLLER-SMITH

Provides One Source
for All Your Instruments

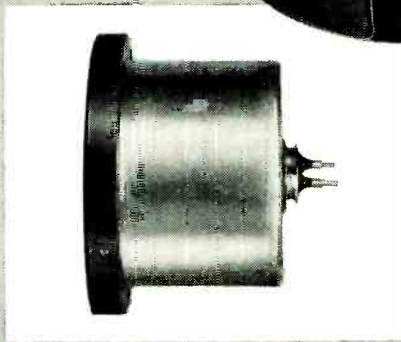
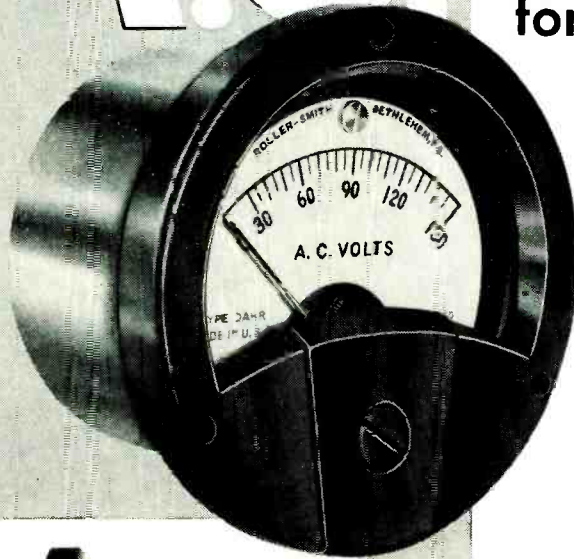

An extra feature—new "wrap around" shroud with gasket seal makes these meters as modern in appearance as they are dependable in performance. Precisely built, their neat functional form expresses the forward thinking of our engineers.

With the introduction of A.C. Ruggedized panel instruments, Roller-Smith has made their famous precision instrument line one of the most complete ever offered . . . one which provides you with a single source of supply for *all* your instrument needs.

Styled by leading industrial designers and featuring an eye-appealing "New Look," the A.C. Ruggedized line matches other Roller-Smith panel instruments and provides maximum readability, accuracy, and maintenance simplicity. Available in 2½" and 3½" hermetically sealed cases, these instruments conform to specification MIL-M-10304 (Sig. C). These A.C. Ruggedized instruments, like all other Roller-Smith products, are produced by master craftsmen with nearly 50 years of precision engineering and manufacturing experience. Whatever your instrument problem, consult us for a practical, economical solution.

Instrument Division
CORPORATION

1825 WEST MARKET STREET  BETHLEHEM, PENNSYLVANIA

Precision Products Since 1908

CONTROLLED WELDING
is an important part of
QUALITY CONTROL
in the manufacture of all



RELIABLE SUBMINIATURE TUBES

Employee Training Program in welding techniques, welder maintenance and defect detection greatly reduces the incidence of operator-caused weld defects.

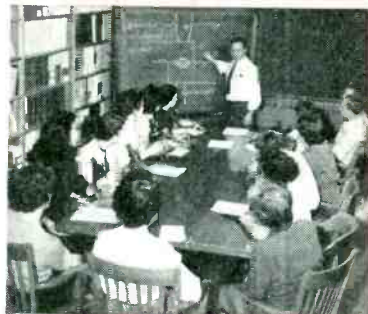

Standardized Work Place Setups for each material combination and geometric configuration to be welded, including specification of welder head, electrode material and design, welding current, time and pressure insures optimum welding conditions at all times.

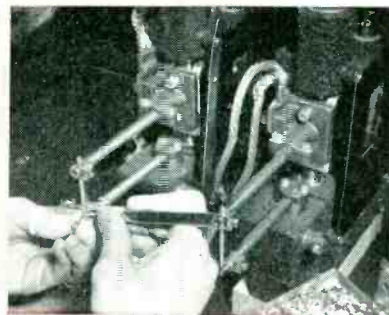

Specially Designed Precision Produced Electrodes eliminate need for hand dressing of welder points thus providing uniform contact with material to be welded.

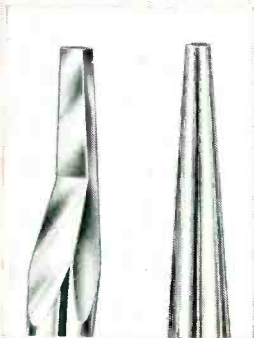

New Electronic Heat Program Controls developed by RAYTHEON permit splash free welding of coated and oxidized materials.

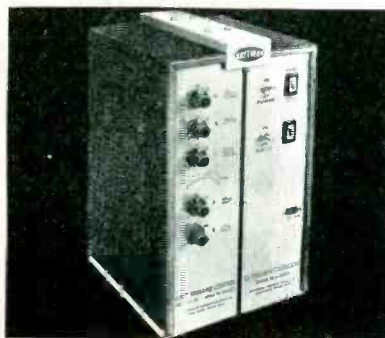

New Raytheon Designed Welding Heads have many unique features including precision controlled forging pressure insuring high weld strength, simplified design for easier maintenance, and small size which permits use of multiple welder heads by one operator.

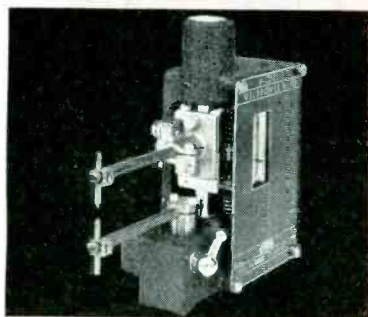

Radiographic Inspection of Welds permits precise Quality Control through non-destructive inspection techniques.

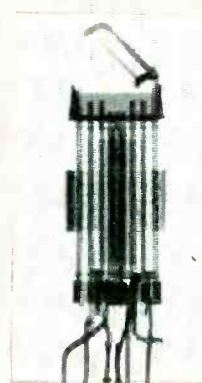

These production and testing techniques and equipments have been developed by RAYTHEON under Bureau of Ships sponsorship to improve the weld quality of guided missile tubes.



RELIABLE SUBMINIATURE AND MINIATURE TUBES
SEMICONDUCTOR DIODES AND TRANSISTORS
NUCLEONIC TUBES • MICROWAVE TUBES
RECEIVING AND PICTURE TUBES



Excellence in Electronics

RAYTHEON MANUFACTURING CO.

Receiving Tube Division — Home Office: 55 Chapel St., Newton 58, Mass., Elgelow 4-7500

For application information write or call the Home Office or: 9501 Grand Avenue, Franklin Park (Chicago), Illinois, TUxedo 9-5400
589 Fifth Avenue, New York 17, New York, PLaza 9-3900 • 622 South La Brea Ave., Los Angeles 36, California, WEbster 8-2851



AVAILABLE ON EQUIPMENT LEASE PLAN
FIELD MAINTENANCE SERVICE AVAILABLE THROUGHOUT THE COUNTRY

REPRESENTATIVES: • Albuquerque • Atlanta • Baltimore • Bayonne • Bridgeport • Buffalo • Chicago • Dayton • Fort Worth • Los Angeles • New York

MICROWAVE FIELD INTENSITY RECEIVER **BROAD BAND** 950—11,260 mcs

- Four interchangeable RF Tuning Heads
- Uni-Dial Tuning
- Double Tuned RF Pre-Selection
- Signal-Lock Automatic Frequency Control
- All purpose AM, FM, Pulse

The new Polarad Model R Receiver is a fully integrated unit which combines reliability, ruggedness and simplicity of operation. Characterized by high sensitivity, low noise figure and excellent gain stability, this versatile instrument is ideal for communications, laboratory measurements, field intensity measurements, production testing, and automatic monitoring.

Range 950 to 11,260 mc with four (4) interchangeable, plug-in RF tuning units featuring direct reading UNI-DIAL control.

Low noise figure.

Excellent gain stability.

Automatic frequency control.

Direct reading output in db with provision for external metering and recording.

Separate audio and video channels.

Connectors for external IF attenuators.

High sensitivity and broadband tuning achieved with double tuned cavity preselector which tracks automatically with the local oscillator.

External type cavity klystron with non-contacting chokes. Klystron voltages regulated and automatically tracked with the oscillator.

SPECIFICATIONS:

Basic Receiver: Model R-B

Tuning Unit Frequency Ranges:

Model RL-T: 950 to 2,040 mc
Model RS-T: 1,890 to 4,320 mc
Model RM-T: 4,190 to 7,720 mc
Model RX-T: 7,260 to 11,260 mc

Signal Capabilities:
CW, AM, FM, Pulse

Sensitivity:
—80 dbm or better throughout
range on all models

Frequency Accuracy:
1%

IF Bandwidth:
3 mc

Image Rejection:
Greater than 60 db

Gain Stability with AFC:
2 db for 24 hour period

Automatic Frequency Control:
Pull-out range 10 mc off center

Recorder output:
1 ma full scale

Trigger output:
10 v. pulse across 100 ohms

Audio output:
5 v. undistorted across 500 ohms

FM Discriminator
Deviation Sensitivity:
.7 volts/mc

Skirt Selectivity:
60 db to 6 db bandwidth
ratio less than 5:1

IF Rejection:
50 db

Input AC Power:
105 to 125 v., 60 cps., 460 watts

Input Impedance: (ANT)
50 ohms



ELECTRONICS CORPORATION
43-20 34th STREET, LONG ISLAND CITY 1, N. Y.

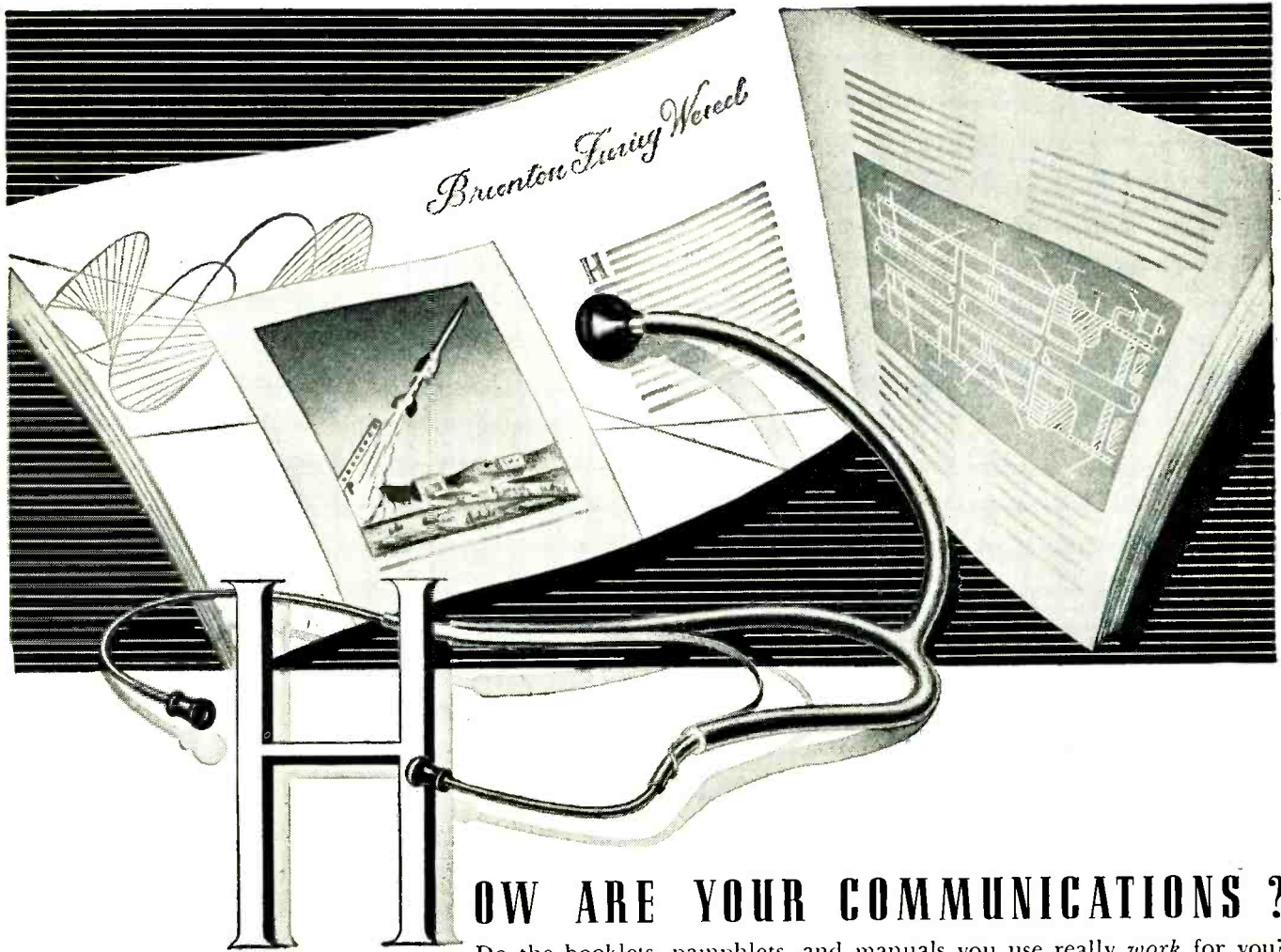

HOW ARE YOUR COMMUNICATIONS ?

Do the booklets, pamphlets, and manuals you use really *work* for you? Are these vital publications, that tell the story of your products and your company, as effective, readable, well designed and illustrated as they can be? Today more than ever, your entire operation is judged by each annual report, employee manual, and public relations piece that you produce. Have you examined your communications lately? If you have any doubt as to the impact of your instructional and promotional literature, remember . . .

COMMUNICATION IS OUR BUSINESS

For a good many decades McGraw-Hill has stood for complete coverage in the business literature field. Now the McGraw-Hill TECHNICAL WRITING SERVICE offers a new approach to your publication problems — an *integrated* writing, editing, illustrating, and printing service for the *custom* production of: INSTRUCTION MANUALS, PRODUCT BULLETINS, TRAINING AIDS, INDUSTRIAL RELATIONS LITERATURE, ANNUAL REPORTS, COMPANY HISTORIES, PROCEDURAL GUIDES and other collateral literature. More than 150 editorial and graphic experts are at your disposal, ready to prepare high-quality material to your own or government specifications. Save time, save money . . . and make your communications work! Let *our* staff be your staff for technical and business publications.

McGraw-Hill Book Co. TECHNICAL WRITING SERVICE

Write or phone Technical Writing Service, McGraw-Hill Book Co., Inc.
330 West 42nd Street, New York 36, N. Y. • LOngrave 4-3000

This service is available through ad agencies.



OHMITE[®] axial-lead vitreous-enameled resistors

18 SIZES—1 to 15 WATTS*
3/16", 1/4" and 5/16" diameters—1/2" to 1-3/4" lengths

If you want a compact, wire-wound resistor for your tough jobs, specify Ohmite axial-lead resistors. These power-type units are designed to stand up under high temperatures. All parts—core, resistance wire, vitreous-enamel coating, and terminal bands—are "thermally balanced" to expand and contract as a unit. Terminals remain firmly anchored, cracking is eliminated, and moisture cannot enter the resistor.



*The rating for any one size is determined by the maximum operating temperature as specified by Underwriters' Laboratories, RETMA, or MIL-R-26B.

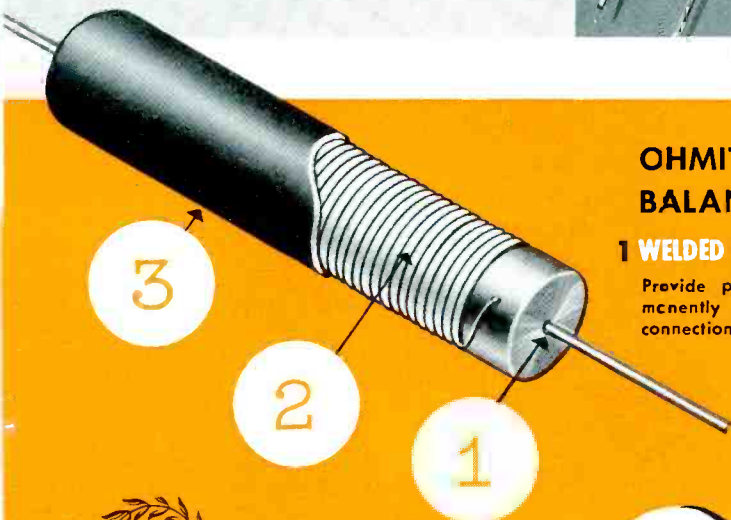

OHMITE RESISTORS HAVE BALANCED THERMAL EXPANSION

1 WELDED TERMINALS—

Provide perfect and permanently stable electrical connections.

2 STEATITE CORE—

Its thermal expansion closely matches all other materials in the resistor.

3 VITREOUS ENAMEL—

Exclusive Ohmite formula thermally matches core, terminals, and wire.

Write for Bulletin 147

OHMITE MANUFACTURING COMPANY

3610 Howard St., Skokie, Illinois (Suburb of Chicago)

30th Anniversary

1925-1955

OHMITE[®]

RHEOSTATS • RESISTORS • RELAYS • TAP SWITCHES

FOR HIGH CURRENT

LOW RESISTANCE APPLICATIONS . . .

OHMITE® *Power Type* RESISTORS

CORRIB®

Vitreous-Enameled,
Corrugated-Ribbon Type

Special Ohmite vitreous enamel locks the edge-wound ribbon alloy to a sturdy ceramic core. Fixed, tapped, and adjustable types. Available in 22 sizes from 90 to 1500 watts. Resistance values range from .04 to 70 ohms.

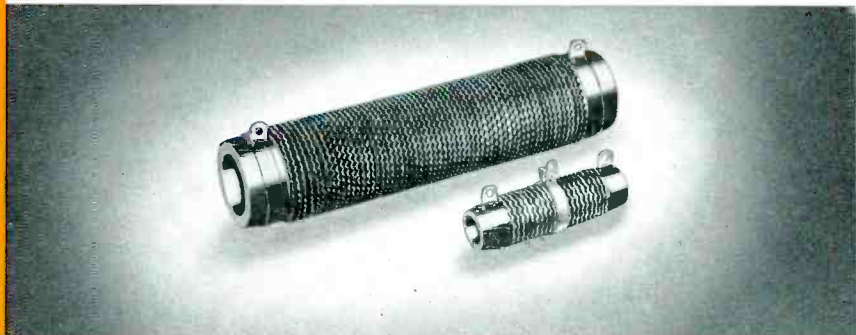

POWR-RIB

Edgewound-Ribbon Type

Has a heavy ribbon of resistance alloy, edge-wound on a ceramic core. Core is sectionalized for flexibility and shock resistance. Terminals and brackets are plated to prevent oxidation. Four sizes in resistances from .043 to 1.6 ohms; and from 24 to 95 amperes.

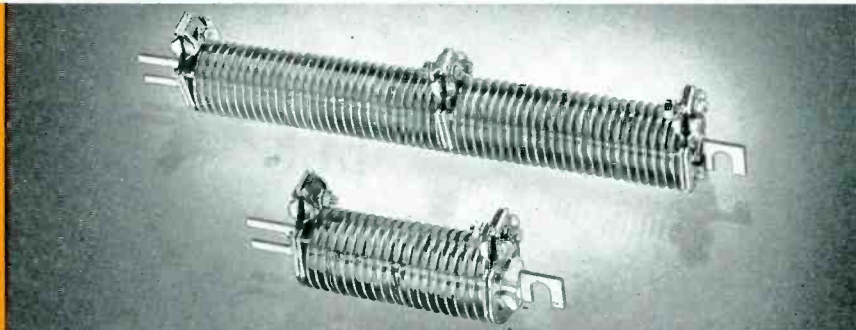

POWR-RIB

Round-Wire Type

Similar in construction to Ribbon-Wire type shown above, but with round resistance wire. Sturdy ceramic core is made in two to five sections. Available in four sizes. Resistance values from .69 to 25 ohms. Current ratings from 5.1 to 18.4 amperes.

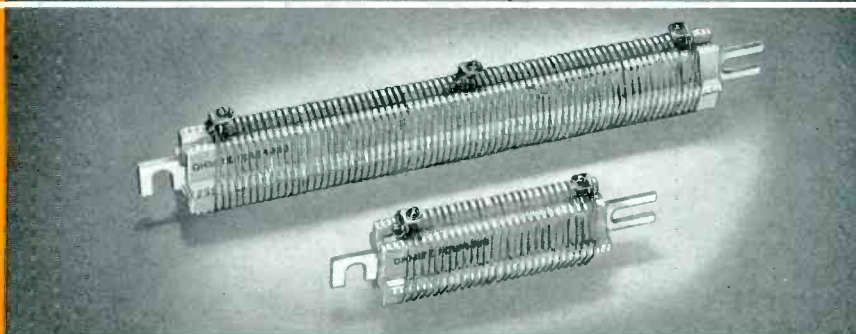

Write for Bulletin 144

Available in fixed or adjustable
"DIVIDOHM®" Types.

Be Right with **OHMITE®**

RHEOSTATS • RESISTORS • RELAYS • TAP SWITCHES



OHMITE MANUFACTURING COMPANY, 3610 Howard St.

• SKOKIE, ILLINOIS
(Suburb of Chicago)

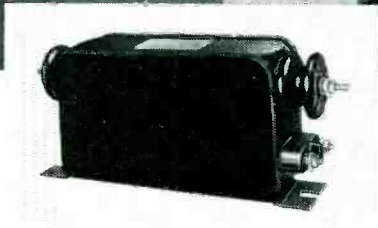

Battery Of Leesona No. 108 Coil Winders installed in the plant of Acme Electric Corporation, Cuba, N. Y. The most advanced hand-feed coil winders ever designed, Leesona No. 108's wind 4 to 30 paper insulated coils in stick form simultaneously. Note how conveniently the controls are located for quickly changing to a new coil spec — one of many advantages for speeding production on long or short runs. Inset shows an Acme Electric precision-wound luminous tube transformer which features coils that provide 18 MA 12000 volt secondary.

At ACME ELECTRIC...Leesona coil winders provide new production advantages

Manager credits No. 108 machines with vital share in increasing output

Transformers made by Acme Electric Corporation are used in a wide range of equipment, including radio, TV and other electronic apparatus, rectifiers, neon signs and fluorescent lighting. To meet increased demands for its products, Acme Electric recently replaced old hand-feed coil

winding equipment with new Leesona No. 108 Hand-Feed Coil Winders. Plant Manager W. F. Koubek of Acme Electric sends the following report:

"Leesona No. 108 Winders are doing a great job of expanding our production. For short runs on a wide variety of coil types, the quick-change features of these machines are unequalled. We're getting excellent results in both quality and quantity from the accuracy, easy operation and fast winding speed of our new 108's."

Many similar reports prove how Leesona No. 108 Coil Winders — the most accurate, flexible and economical hand-feed winders ever developed — are bringing important benefits that can save you time and money, too.

Get the Whole Story

The coupon below will bring you complete facts on Leesona No. 108 Coil Winders, together with other helpful coil winding information. Why not check and mail it today?

23B.4.6

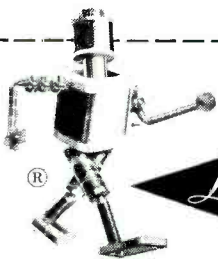

FOR WINDING COILS
IN QUANTITY...
ACCURATELY... USE
LEESONA WINDING MACHINES

UNIVERSAL WINDING COMPANY

P. O. BOX 1605, PROVIDENCE 1, RHODE ISLAND, Dept. 15

Please send me

- Bulletin on the Leesona No. 108 Hand-Feed Coil Winder.
- Condensed catalog of Leesona Winders.
- Bulletin on the new Leesona Pay-As-You-Profit Plans for purchasing or leasing modern coil winding machinery.

Name..... Title.....

Company.....

City..... Zone..... State.....

marion

**advancement
in instrument
design**

**new marion
MEDALIST*
meters**

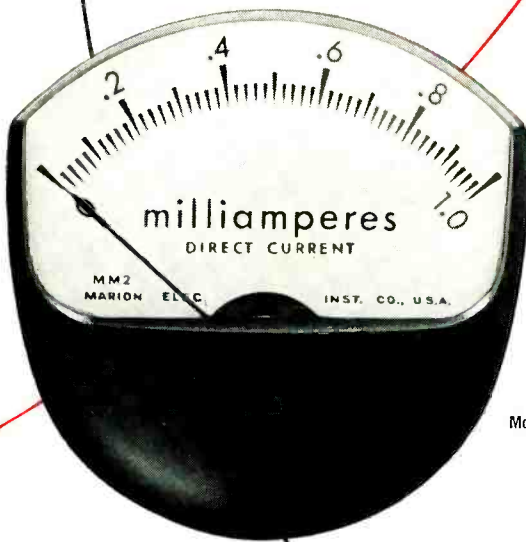

Model MM2 MEDALIST
Actual Size

Greater readability and modern styling in minimum space. Interchangeable with ASA/JAN 2½ and 3½ inch sizes. Up to 50% longer scale in same space as ordinary type. Available in various colors.

Comparison of Medalist and Standard Style

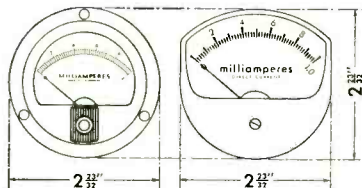

marion electrical instrument company

401 CANAL STREET, MANCHESTER, N. H., U. S. A.

Manufacturers of Ruggedized and "Regular" Panel Instruments & Related Products

copyright 1966 M.E.I. Co.

*Trademark Patents Pending.

marion meters



**"MECHANISMS
ENGINEERED IN THE AIR"**



ANNOUNCING



... the Eimac 4X5000A Ceramic Radial-Beam Power Tetrode

The Eimac 4X5000A ceramic radial-beam power tetrode, with a 5kw plate dissipation rating and 16kw power output in typical Class-C telegraphy operation fills a power gap in the tetrode field. Rugged ceramic replaces glass, increasing immunity to damage by thermal and physical shock, and stack type production techniques assure uniform quality characteristics. Straightforward coaxial structure allows the advantages of low lead inductance. An integral finned anode permits improved cooling with low air pressure. Especially suitable for Single Sideband operation, the versatile 4X5000A handles high inputs without going into the positive grid region and delivers 10kw peak envelope power output with zero driving power in typical Class-AB₁ operation. High power gain, low inter-electrode capacitances, simple circuit needs and non-emitting grid wire, inherent Eimac tetrode features resulting from over 20 years of transmitting tube specialization are, of course, maintained.

TYPICAL OPERATING CONDITIONS

Frequencies up to 30 Mc

	Class-C Telegraphy	Class-C Plate Mod.	Class-AB ₁
D-C Plate Voltage	7500	5000	7500 volts
D-C Screen Voltage	500	500	1250 volts
D-C Plate Current	2.8	1.3	1.9 amps
D-C Screen Current	.500	.170	.200 amps
D-C Grid Current	.250	.045	0 amps
D-C Grid Voltage	-350	-400	-300* volts
Peak R-F Grid Voltage	590	520	300 volts
Driving Power	150	25	0 watts
Screen Dissipation	250	85	250 watts
Plate Power Input	21	6.5	14.2 kilowatts
Plate Power Output	16	5.5	10 kilowatts

*In the Class-AB₁ operating conditions listed, adjust grid bias to obtain 500 ma d-c plate current with zero driving voltage.

The above operating conditions show approximate grid driving power and plate power output. Allowance must be made for i-f losses in practical circuits.

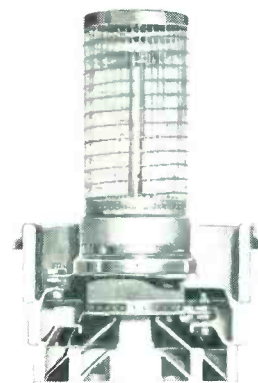

For further information, contact our Technical Services department.

EITEL-McCULLOUGH, INC.

SAN BRUNO, CALIFORNIA

The World's Largest Manufacturer of Transmitting Tubes

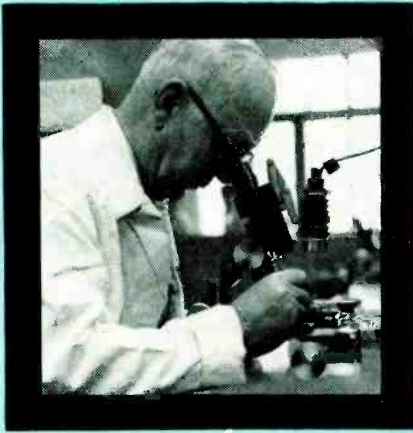

Byron Jackson Co. and The Rollin Co.

combine

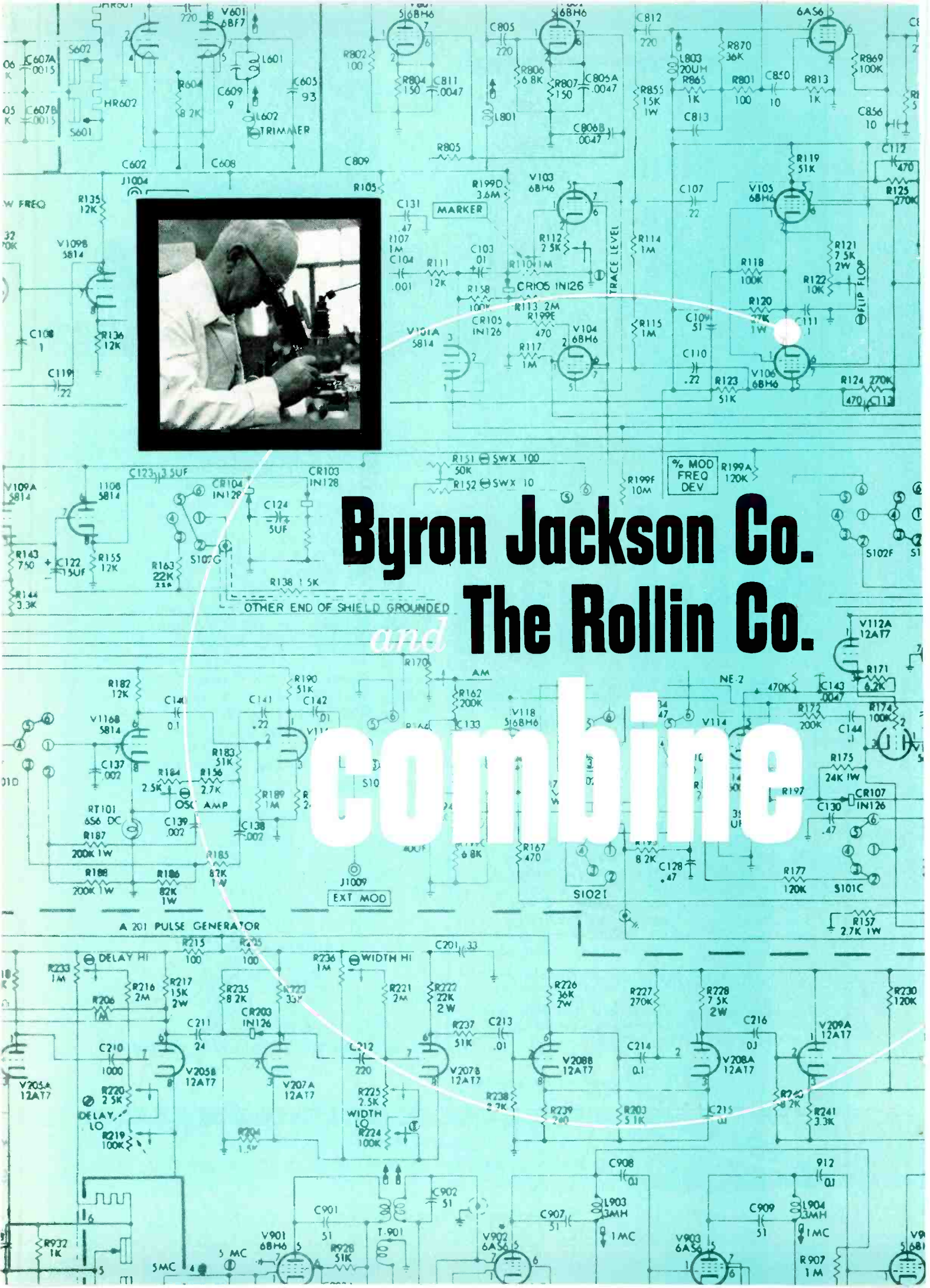



Now **electronic ingenuity** combined
with **heavy industrial facilities**

Experienced electronic engineering... backed by diversified heavy industrial facilities... gives the Byron Jackson Co. Electronic Division an unusual ability to pioneer precision electronics in practical form.

The engineering nucleus of this Electronic Division has, since 1944, been engaged in the development and manufacture of high power signal generators, precision slotted lines, miniature digital type transducers, and other precision electronic equipment. Now these electronic skills are teamed with the metallurgical, hydraulic, mechanical, chemical, nuclear, electrical and petroleum specialists and scientists of Byron Jackson Co. In addition, a multi-million dollar investment in plants and production equipment supports our specialized electronic manufacturing and testing facilities.

This unique combination of engineering talent and production abilities is ready to work for you in the field of measuring and testing instruments, complete systems, or an entire development production project.

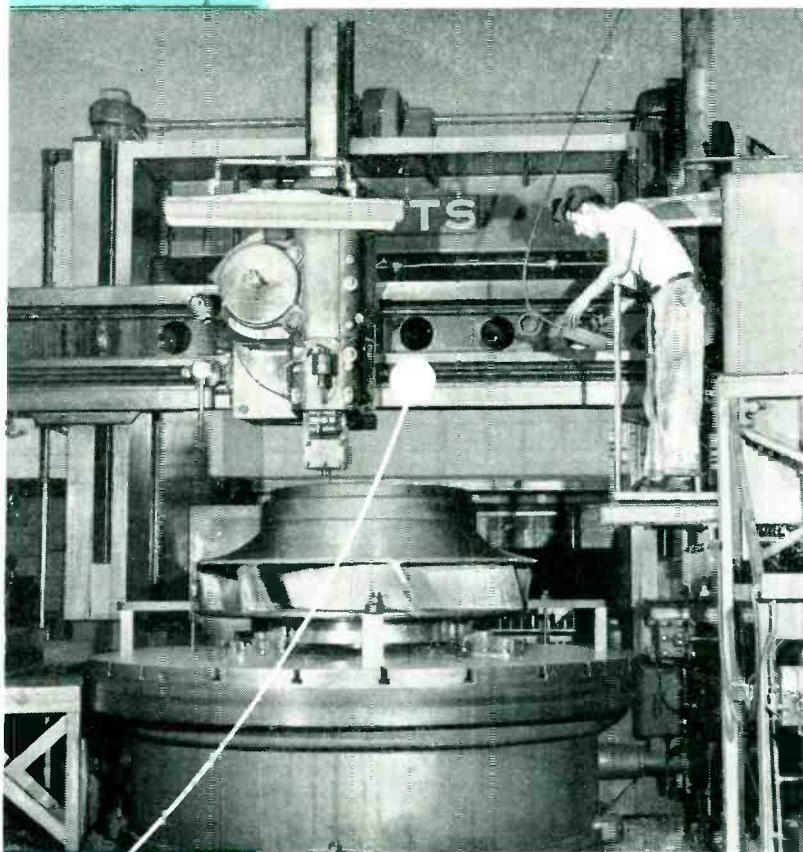

Byron Jackson Co.

ELECTRONIC DIVISION

2010 LINCOLN AVENUE, PASADENA 3, CALIFORNIA • TELEPHONE: RYAN 1-7134



MAGNETIC TAPE RECORDING

helps **Road-Test** Timken Truck Axles

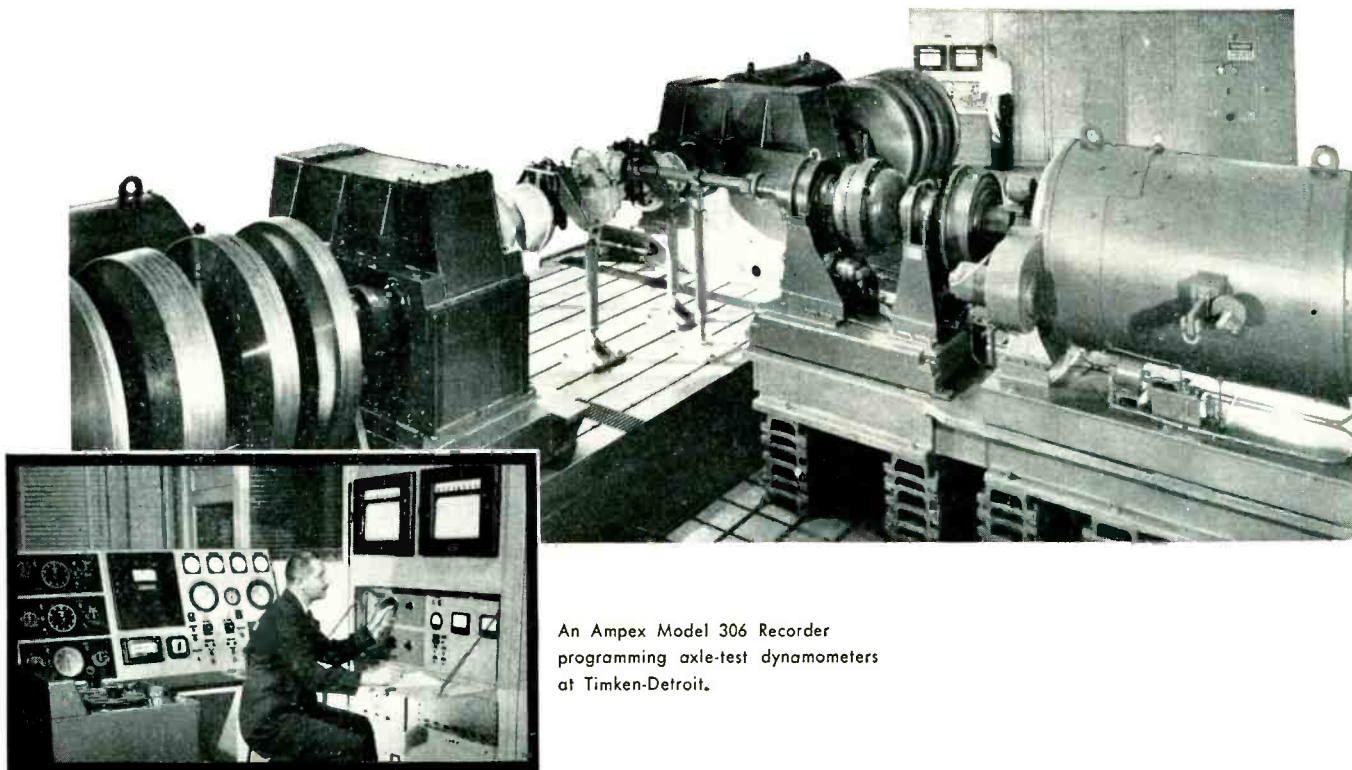

An Ampex Model 306 Recorder programming axle-test dynamometers at Timken-Detroit.

Magnetic tape recordings are now being used to duplicate rugged road-tests at the Timken-Detroit Axle Division of the Rockwell Spring and Axle Company, Detroit, Michigan. A four hour tape cycle is made of actual road surface and driving conditions . . . then played back through torque and speed dynamometers — repeatedly — until a test axle breaks down. Result: more realistic and efficient testing — better axles for today's trucks, buses and trailers.

WHY TIMKEN CHOSE AMPEX

Timken engineers required a recording and playback medium that could give near-perfect reproduction of the original road test phenomena . . . and would playback indefinitely without introducing errors through wear and speed irregularities. They found that the Ampex F-M recorder best met these exacting requirements. Its extreme stability of tape motion, precise timing and consistent accuracy produced laboratory "road-test" results within 1% of actual conditions.

LET AMPEX STUDY YOUR REQUIREMENTS

Ampex manufactures the most complete line of magnetic recorders for complex and sensitive automation, communication and data-handling systems. Why not let Ampex application engineers determine what magnetic tape recording can do for you?

For further information, send for our 16-page illustrated bulletin, "Data Recording, Machine Control and Process Regulation." Contact your nearest Ampex representative or write to Dept. E-1897



AMPEX
CORPORATION

ANOTHER APPLICATION BY THE INSTRUMENTATION DIVISION OF
AMPEX CORPORATION • 934 CHARTER STREET, REDWOOD CITY, CALIFORNIA

Branch Offices: New York; Chicago; Atlanta; San Francisco; College Park, Maryland (Washington D.C. area).
Distributors: Radio Shack, Boston; Bing Crosby Enterprises, Los Angeles; Southwestern Engineering & Equipment, Dallas and Houston; Canadian General Electric Company, Canada.

TELEMETERING

- BAND PASS
- LOW PASS

FILTERS

in Standard
Miniature
Subminiature
sizes

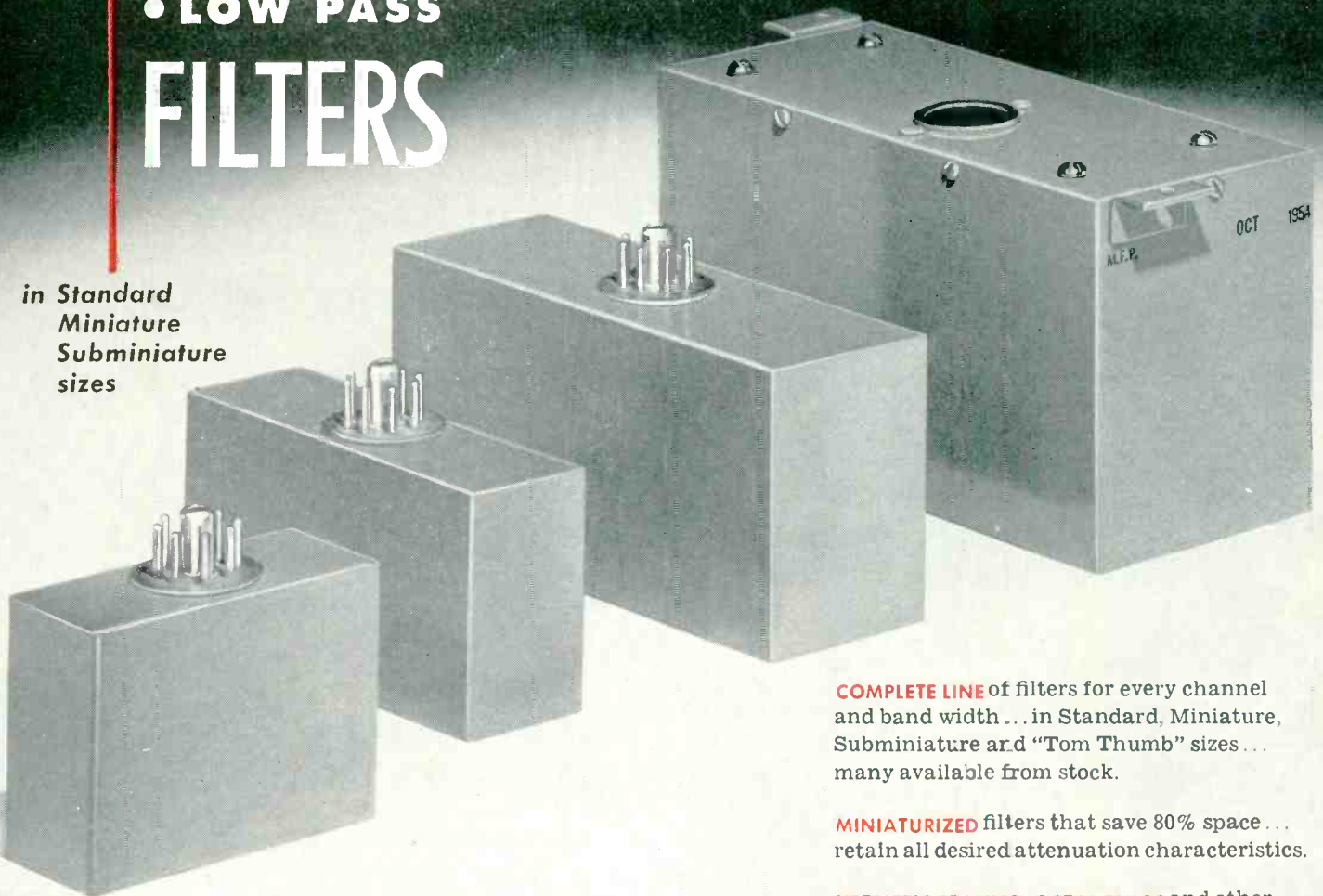

COMPLETE LINE of filters for every channel and band width . . . in Standard, Miniature, Subminiature and "Tom Thumb" sizes . . . many available from stock.

MINIATURIZED filters that save 80% space . . . retain all desired attenuation characteristics.

HERMETIC SEALING, OCTAL PLUGS and other new features.

only Burnell offers you . . .

SPECIAL PHASE LINEARITY characteristics to conform to new concepts of high accuracy telemetering practice.

SPECIFICALLY DESIGNED for telemetering, these filters have found great utility in a wide variety of communications and control applications.

APPLICATION ENGINEERING service plus complete technical literature. Write Dept. C, for Catalog 102A.



Teletype: Yonkers, N. Y. 3633

BURNELL & CO., INC.
YONKERS 2, NEW YORK

Pacific Division: 720 Mission St., S. Pasadena, Calif.

*First in Toroids
and Related
Networks*

PARTIAL LISTING OF MINIATURE TELEMETERING BAND PASS FILTERS

Channel Freq.	15% Band Width		30% Band Width		Case Size	Approx. Weight	Attenuation	
	Type No.	Type No.	W-	L- H-			15% B. W.	30% B. W.
400 CPS.	S-15456	S-15477	2 x 6 x 2 3/4	3 lbs.	3.5DB - 15%	4DB - 30%	20DB - 23%	40DB - 27%
560 "	S-15457	S-15478						
730 "	S-15458							
960 "	S-15459							
1300 "	S-15460		1 3/8 x 4 1/2 x 2 1/4	1 lb. 7 oz	3.5DB - 15%	4DB - 30%	20DB - 23%	40DB - 27%
1700 "	S-15461							
2300 "	S-15462							
2570 "	S-15463	S-15479	1 3/4 x 3 x 2 1/4	9 3/4 oz.	3DB - 15%	3DB - 30%	20DB - 23%	40DB - 26%
3000 "	S-15464							
3900 "	S-15465							
4500 "	S-15466							
5400 "	S-15467							
7350 "	S-15468							
10500 "	S-15469							
12300 "	S-15470							
14500 "	S-15471							
22000 "	S-15472							
27000 "	S-15483							
30000 "	S-15484							
40000 "	S-15485							
52500 "	S-15486							
70000 "	S-15487							
	S-15476	S-15488						

OPTIMUM OPERATING IMPEDANCES		SOCKET TERMINAL CONNECTIONS	
INPUT		OUTPUT	
Terminals 1 & 2	500 ohms	Terminals 1 & 6	500 ohms
Terminals 1 & 3	10000 ohms	Terminals 1 & 7	50000 ohms

Direct, automatic power readings



SPECIFICATIONS

Power Range: 5 ranges, front panel selector. Full scale readings of .1, .3, 1, 3 and 10 mw. Also continuous readings from -20 to $+10$ dbm. (0 dbm = .001 watt). Power range may be extended with attenuators or directional couplers in microwave system.

External Bolometer: Frequency range depends on bolometer mount. Bolometers can operate at resistance levels of 100 or 200 ohms and can have positive or negative temperature coefficients. Any dc bias current up to 16 ma is available for biasing positive or negative temperature coefficient bolometers. Dc bias current is continuously adjustable and independent of bolometer resistance and power level range.

Suitable bolometers are:

Instrument fuses: *-hp-* G-28A 1/100 amp fuse:

Barretters: Sperry 821, Narda N821B or N610B, PRD 610A, 614, 617 or 631C.

Thermistors: W. E. D166382 and 32A3, V. E. Co. 32A3, 32A5, Narda 333, 334.

Accuracy: $\pm 5\%$ of full scale reading.

Power: 115/230 v $\pm 10\%$, 50/1,000 cps, 75 watts.

Dimensions: Cabinet Mount: $7\frac{3}{8}$ " wide, $11\frac{1}{2}$ " high, $12\frac{1}{4}$ " deep.
Rack Mount: 19" wide, 7" high, $12\frac{1}{2}$ " deep.

Weight: Net 20 lbs. Shipping 32 lbs. (cabinet mount).

Price: \$250.00.

Data subject to change without notice.

CW or pulsed power
Wide frequency range
No calculations
Assured accuracy
**Operates with wide
variety of bolometers**

New! *-hp-* 430C Microwave Power Meter

Here is the newest, finest, most dependable source of instantaneous microwave power readings available today. The new *-hp-* 430C gives you power readings direct in db or mw and completely eliminates tedious computations or troublesome adjustment during operation. The instrument measures either pulsed or CW power on either waveguide or coaxial systems. Operation is entirely automatic, stability is extremely high, and the meter may be used with a wide variety of bolometer mounts having either positive or negative temperature coefficients. The broad nominal measuring range can be extended to higher powers by means of directional couplers and attenuators.

For measurements of CW or pulsed power, *-hp-* 430C uses either an instrument fuse, barretter or thermistor as a bolometer element. Operation may be at either 100 or 200 ohms. Power is read direct in milliwatts from 0.02 to 10 mw, or in dbm from -20 to $+10$ dbm.



ELECTRONIC TEST INSTRUMENTS for

**Use these precision -hp- instruments with
-hp- 430C for greater coverage, convenience**

-hp- 752 Multi-Hole Couplers—For measuring average power 1 watt to 1 kw (with attenuator) in waveguide systems. Models cover all frequencies 2.6 to 18.0 KMC. Coupling factors of 3, 10 and 20 db available most bands. Directivity better than 40 db full range; accuracy within $\pm 0.4\%$ full range. Primary guide SWR less than 1.05. \$260.00 to \$100.00.

-hp- 750 Cross-Guide Couplers—For measuring powers up to 1 kw (with attenuator), where precision accuracy of -hp- 752 not required. Comprises two waveguide sections joined on broad faces, providing 4-terminal network. Models cover frequencies 2.6 to 12.4 KMC; coupling factors 20 or 30 db, coupling accuracy better than ± 1.7 db, directivity 20 db or more. \$100.00 to \$50.00.

-hp- 382A Precision Attenuators—For measurements up to 5 and 10 watts, this revolutionary new broad band instrument may be employed. -hp- 382A attenuates from 0 to

ups, save time and insure maximum accuracy in waveguide power measurements. Models cover frequencies 3.95 to 12.4 KMC with full range SWR of less than 1.5. Permanently installed 200 ohm negative temperature coefficient thermistors. No tuning, large overload factor makes burnout virtually impossible. Maximum power level 3 mw. \$95.00 to \$75.00.

-hp- 477A Coaxial Mount — Thermistor mount providing full frequency coverage 10 MC to 10 KMC with SWR less than 1.5. Requires no tuning, uses long time constant elements for accuracy even on low duty cycle pulses. For use with 430C or other bolometer bridges providing negative temperature coefficient operation at 200 ohms. Requires 13 ma bias. Power range 0.02 to 10 mw. Uses Type N rf connector. \$75.00.

-hp- 485 Detector Mounts—Single tuning control accurately matches waveguide section to bolometer element; instrument also de-



-hp- 485 Detector Mounts



-hp- 382A Precision Attenuators

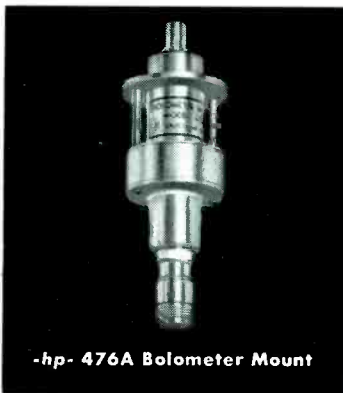

-hp- 476A Bolometer Mount



-hp- 752 Multi-Hole Couplers



-hp- 487A Thermistor Mounts



-hp- 477A Coaxial Mount

50 db, full range, independent of frequency. Phase shift constant with attenuation. Accuracy within $\pm 2\%$ of db reading. Models cover frequencies 3.95 to 18.0 KMC, maximum dissipation 5 to 10 watts. SWR less than 1.15. \$450.00 to \$250.00.

-hp- 370 Waveguide Attenuators — Waveguide sections providing fixed amounts of attenuation. Used to extend power range of -hp- 430C. Models calibrated for frequencies 3.0 to 15.0 KMC, power dissipation 1.0 watts (1 kw peak), SWR 1.15, 6, 10 or 20 db attenuation. \$75.00 to \$55.00.

-hp- 487A Thermistor Mounts—Simplify set-

ects rf energy with crystal substituted for bolometer element. Models for frequencies 2.6 to 18.0 KMC, SWR 1.25 to 1.5. All models employ crystal or barretter except P485 (12.4 to 18.0 KMC), which uses permanently installed thermistor. \$125.00 to \$75.00.

-hp- 476A Bolometer Mount—Universal bolometer mount requiring no tuning, no adjustment. Frequencies 10 to 1,000 MC, instantaneous, automatic power readings 0.02 to 10 mw. SWR less than 1.15, 20 to 500 MC; less than 1.25, 10 to 1,000 MC. Uses four 1/100 amp fuses. Uses Type N rf connectors. \$85.00.



-hp- 750 Cross-Guide Couplers

Prices f.o.b. factory. Data subject to change without notice.

HEWLETT-PACKARD COMPANY

3330A PAGE MILL ROAD • PALO ALTO, CALIFORNIA, U. S. A.

Cable "HEWPACK"

FIELD REPRESENTATIVES IN ALL PRINCIPAL AREAS



COMPLETE COVERAGE, HIGHEST QUALITY

for
**HEARING
AIDS**



OR
**RECORDING
HEADS**

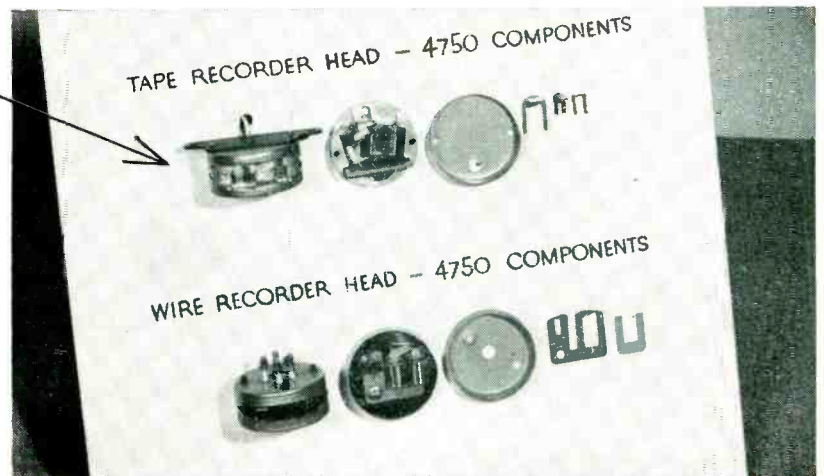

OR ANY MAGNETIC MATERIALS JOB ...

Write for
your Copy

**"MAGNETIC
MATERIALS"**



This 32-page book contains valuable data on all Allegheny Ludlum magnetic materials, silicon steels and special electrical alloys. Illustrated in full color, includes essential information on properties, characteristics, applications, etc. Your copy gladly sent free.

ADDRESS DEPT. E-65

You can rely on core materials like the Allegheny 4750 components illustrated above, in your receivers, recording heads or microphone assemblies.

In fact, whether your equipment is small or large, the extra-broad line of A-L magnetic materials will solve your magnetic core problems. It includes all grades of silicon steel sheets or coil strip, as well as Allegheny Silectron (grain-oriented silicon steel), and a wide selection of high-permea-

bility alloys such as 4750, Mumetal, Permendur, etc.

Our service on these materials also includes complete facilities for the fabrication and heat treatment of laminations. (For users of electrical sheets and strip, our lamination know-how is a real bonus value!) Either way, we'll welcome the chance to serve you. *Allegheny Ludlum Steel Corporation, Oliver Building, Pittsburgh 22, Pa.*

STEELMAKERS to the Electrical Industry

Allegheny Ludlum

W&D 5335



VITAL SPOTS IN NATIONAL SECURITY

THESE **FREED** COMPONENTS CONTRIBUTE EFFICIENT, RELIABLE PERFORMANCE IN RADAR, LORAN AND SONAR DEVICES.

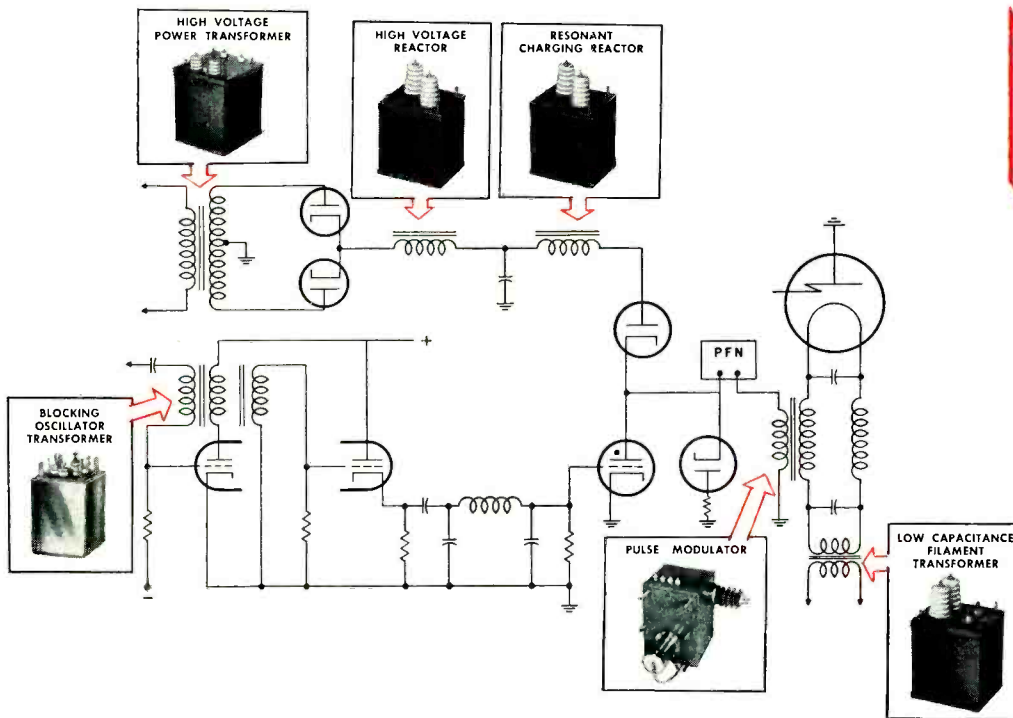

TYPICAL PULSE MODULATOR CIRCUIT SHOWS APPLICATIONS OF FREED COMPONENTS

OTHER FREED PRODUCTS TRANSFORMERS

- High Fidelity
- High Level Pulse Power
- High Q Toroids
- Slug-Tuned
- Hermetically Sealed
- Step-down
- Magnetic Amplifiers
- Miniature Transistor
- High Q Reactors
- High Temperature
- Miniature Audio
- Charging Reactors
- Sub-Miniature
- Precision Reactors
- Precision Filters

INSTRUMENTS

- Comparison and Limit Bridges
- Low Frequency "Q" Indicators
- Incremental Inductance Bridges
- Universal Bridges
- Null Detectors and V.T. Voltmeters
- Power Supplies
- A.C. Bridges and Accessories
- Differential Voltmeters
- Harmonic Distortion Meters
- Wide Band Amplifiers
- Decade Amplifiers
- Decade Inductors
- Decade Capacitors
- Megohmmeters
- Filters
- Magnetic Voltage Regulators

How well our detection and warning services will function in time of emergency will depend upon the performance of each individual component. Imaginative engineering, selected materials, careful inspection and constant quality control make Freed products the ultimate in the industry.

Send for further information and catalog

FREED TRANSFORMER CO., INC.

1722 Weirfield St., Brooklyn (Ridgewood) 27, N. Y.

G. E. MECHANIZED PRODUCTION AT LOWER COST...ASSURES

Both types offer high reliability at temperatures

Take a close look at the transistor values G.E. now offers. Because production lines are now mechanized, these transistors are made in *less time* at *reduced cost*. Machine methods today assure strictest adherence to the top quality standards demanded of all General Electric Germanium Products.

Mechanization results in CONTROLLED CHARACTERISTICS, removing any inaccuracy on the part of the operator. Narrow limits are built into production transistors giving

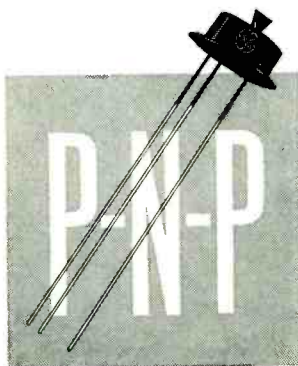

TYPE 2N43A

a more uniform product.

In military and commercial applications these G-E transistors offer precision quality, topmost reliability at mass-volume prices!

General Electric's P-N-P junction transistor, 2N43A, is the first to be written into Air

Force specifications! MIL-T-25096 (USAF) was actually written around this G-E product which was developed for the military. Now it serves an ever-increasing number of commercial as well as military applications.

APPLICATIONS AND SPECIFICATIONS

TYPICAL USES: Audio and Intercom Amplifiers, Servo Amplifiers, Carrier Current Amplifiers, Test Equipment, Fuel Gauges.

SPECIFICATIONS OF THE 2N43A and USAF 2N43A

Absolute Maximum Ratings:

Collector Voltage (Referred to base)	-45 volts
Collector Current	-50 ma
Collector Dissipation	150 mw
Storage Temperature	100° C
Collector Cutoff Current (-45 volts)	-10 microamps

DESIGN FEATURES:

- STURDY CONSTRUCTION...meets critical military tests for shock, vibration, humidity, life.
- SEALED JUNCTION...contamination gases permanently eliminated!
- HIGH POWER OUTPUT...case design makes possible a collector dissipation of 150 mw.
- HERMETIC SEAL...unaffected by moisture.
- LONG LIFE...no change in characteristics during life of equipment.

MAKES TRANSISTORS AVAILABLE CONTROLLED CHARACTERISTICS

up to 100°C...are now available in production lots!

HIGH FREQUENCY TRANSISTOR

A new, revolutionary manufacturing technique, the exclusive G-E rate-growing process, coupled with the all-welded hermetic seal, now makes possible extra long life, and noticeably-reduced manufacturing costs by—



TYPE 2N78

- Making 2000 or more transistors from one rate-grown crystal.
- Achieving uniform characteristics in all 2000 transistors—eliminating wasteful rejects.

APPLICATIONS

For pulse and switching circuits, RF and IF amplifiers; high-frequency test equipment; telephone repeaters.

SPECIFICATIONS

Collector Voltage (Referred to Base)	15 V
Collector Current	20 ma
Emitter Current	-20 ma
Storage Temperature	100° C.
High Frequency Gain at 2 mc	13 db

- For further details on specifications and prices, write *General Electric Co., Section X455, Germanium Products, Electronics Park, Syracuse, N. Y.*

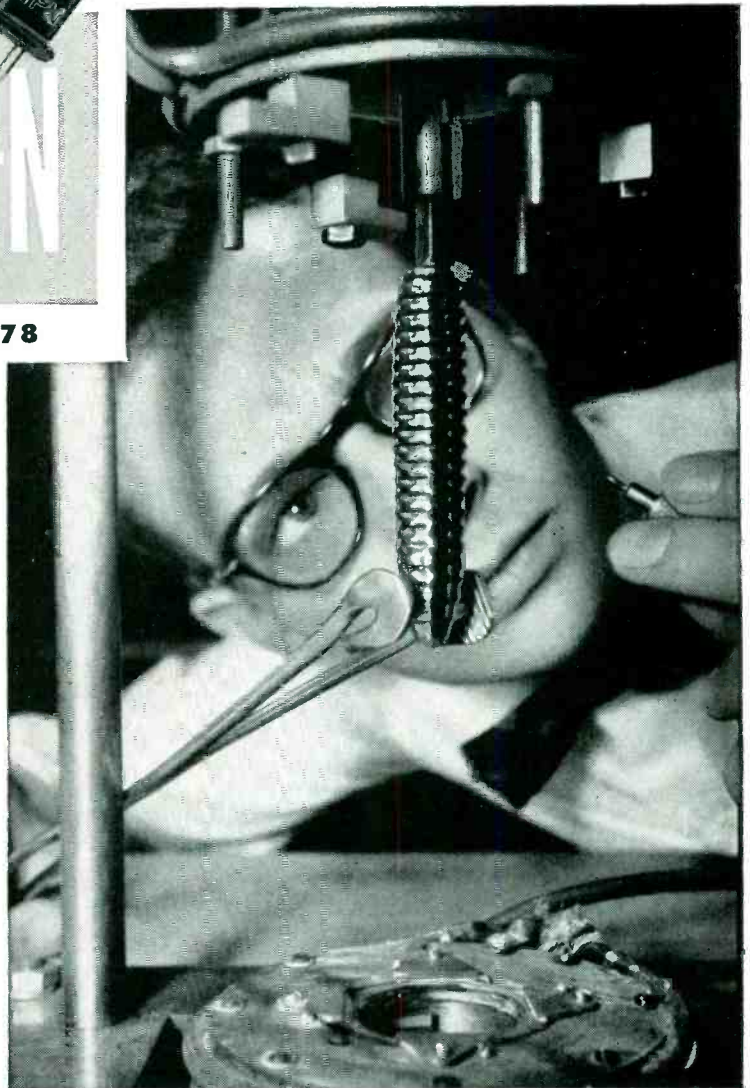

Billet of germanium is removed from furnace, prior to cutting into enough tiny pellets for 2000 transistors.

Progress Is Our Most Important Product

GENERAL  **ELECTRIC**



INTERNATIONAL

Selenium Rectifiers

the **WIDEST RANGE** in the **INDUSTRY**



INTERNATIONAL
industrial power rectifiers

Ratings to 250 KW, 50 ma to 2,300 amperes and up.
From 6 volts to 30,000 volts and up. Efficiency to 87%. Power factor to 95%. Cell sizes from 1 sq. in. to 42 sq. in. Ambient temperature range to 125°C without derating. Write for Bulletin C-349.



INTERNATIONAL
tv and radio miniature rectifiers

Input ratings from 25 to 195 volts AC and up.
DC output current from 10 to 1,000 ma. Available in half wave and voltage multiplier units. Bridge units available to 1200 ma. Write for Bulletin ER-178A



INTERNATIONAL
high voltage cartridge rectifiers

DC output voltages from 20 volts to 20,000 volts and up. DC output current, half wave, from .2 to 195 ma. Cell diameters: 1/16" to 1". Overall length: 1/2" to 12". Available with pigtail, stud, or ferrule terminals. Hermetically-sealed types also available. Write for Bulletin H-2



INTERNATIONAL

RECTIFIER CORPORATION

EL SEGUNDO, CALIFORNIA • ORegon 8-6281
NEW YORK: 501 MADISON AVENUE • PLaza 3-4942
CHICAGO: 205 W. WACKER DR. • FRanklin 2-3889

World's Largest Supplier of Quality Industrial Rectifiers

3-D

How **REMINGTON RAND** uses Micro-Vision to maintain peak shaver production

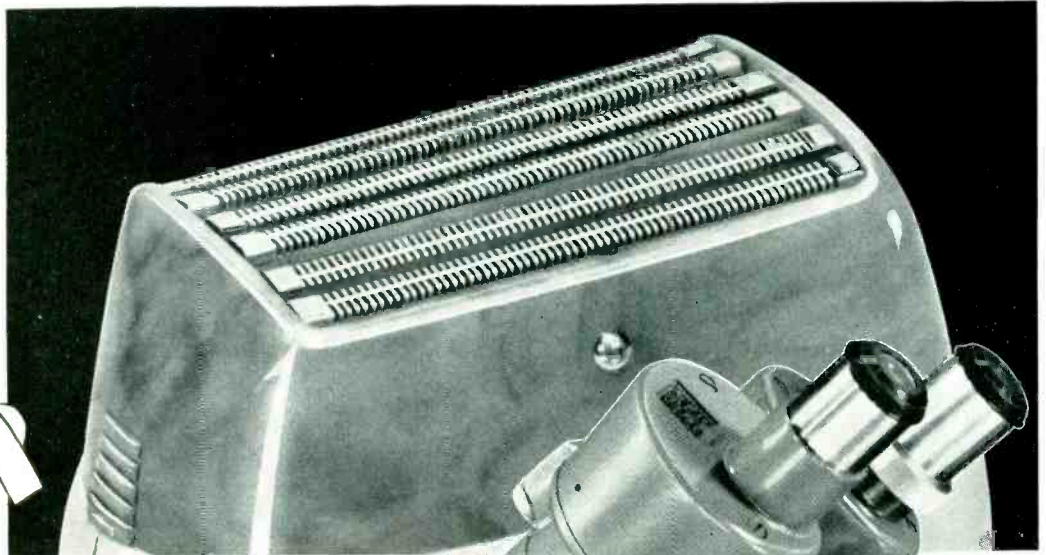
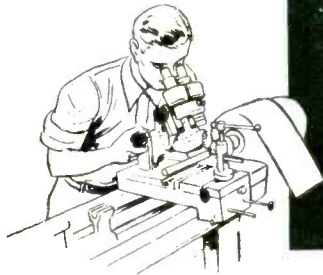

Remington Rand has solved the problem of critical inspection with Bausch & Lomb Stereomicroscopes. And it's done with an increase in production.

Clear, sharp, magnified views of shaver head—with natural depth perception—quickly reveal flaws such as tiny cracks, bent blades, burrs, contact between cutter and head. Increased operator comfort, higher efficiency, keep peak production rolling.

Write for **NEW! EXCLUSIVE 3-D
MICRO-VISION BOOK**

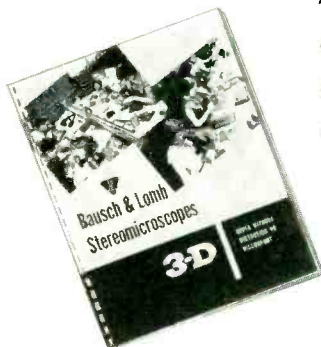

- See actual stereo views!
- Know how and where to use Stereomicroscopes!
- Fit exact model to job needs with Selector-Chart!

WRITE FOR FREE COPY. Ask for Manual D-15. Bausch & Lomb Optical Co., 61441 St. Paul Street, Rochester 2, New York.

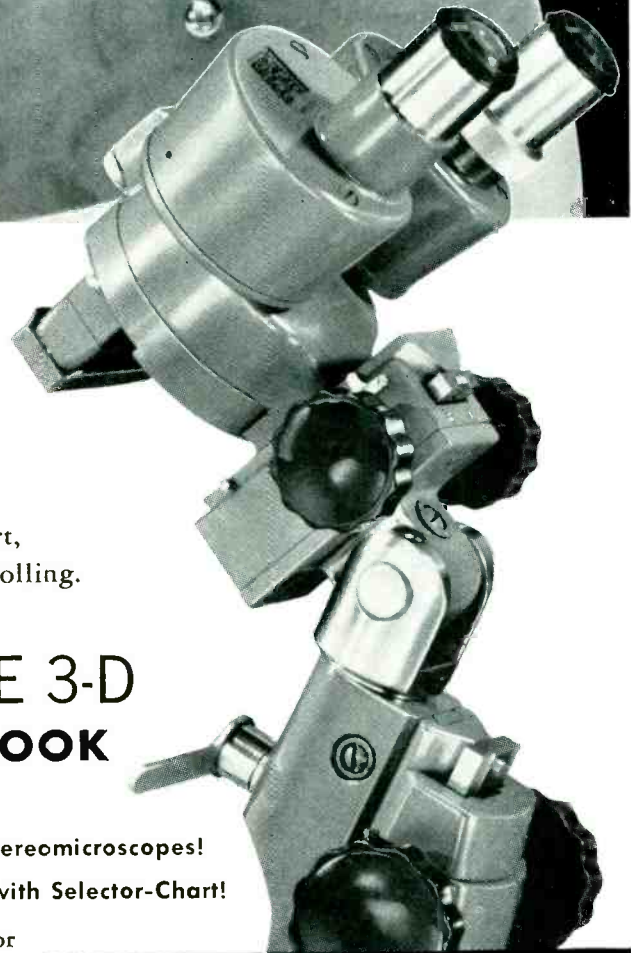

BAUSCH & LOMB

SINCE  1853

STEREOMICROSCOPES

America's only complete optical source... from glass to finished product.

New

MARCONI EQUIPMENT

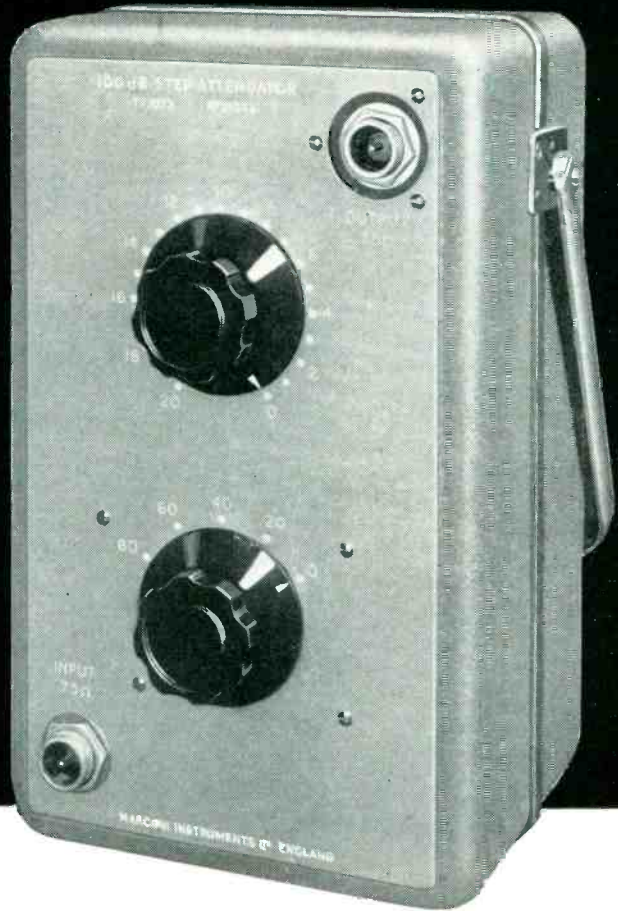

Marconi are specialists in the design of instruments to aid electrical engineers in making accurate observations of the more intricate electrical functions.

Their instruments—more than seventy specific designs—are widely used throughout industry and civil telecommunications. Full details are freely available if you will write, stating your requirements.

OUTPUT POWER METER Type TF 893

Ideal for accurate audio frequency power measurements, ideal for optimum load matching, the TF 893 has an input impedance variable in 48 steps from 2.5 ohms to 20,000 ohms, and a power measurement range extending from

20 μ W to 10 watts. The input circuit is centre-tapped for push-pull working. The frequency range extends from 20 cps to 35 kc; at 50 cps the response relative to 1 kc is 0.5 dB down, at 20 kc 1 dB down.

100-DB STEP ATTENUATOR Type TF 1073

Variable in 1-dB steps over its 0- to 100-dB range, the Marconi TF 1073 Attenuator is a particularly useful and versatile instrument. It has a characteristic impedance of 75 ohms and a fre-

quency response flat from d.c. to 100 mc. Using the full 100 dB at 100 mc the maximum error does not exceed 0.6 dB; even at 150 mc the TF 1073 has a most acceptable performance.

MARCONI INSTRUMENTS

VACUUM TUBE VOLTMETERS · FREQUENCY STANDARDS · OUTPUT METERS · FM & AM SIGNAL GENERATORS
DEVIATION METERS · WAVEMETERS · WAVE ANALYSERS · Q METERS · BEAT FREQUENCY OSCILLATORS

23-25 BEAVER STREET · NEW YORK 4 · HANOVER 2-0198

ENGLAND: HEAD OFFICE: MARCONI INSTRUMENTS LIMITED, ST. ALBANS, HERTFORDSHIRE

CANADA: CANADIAN MARCONI COMPANY, MARCONI BUILDING, 2442 TRENTON AVENUE, MONTREAL

Managing Agents in Export: MARCONI'S WIRELESS TELEGRAPH COMPANY LIMITED, MARCONI HOUSE, STRAND, LONDON, W.C.2
TC 65

Here's an exciting new development in metallized ceramics!

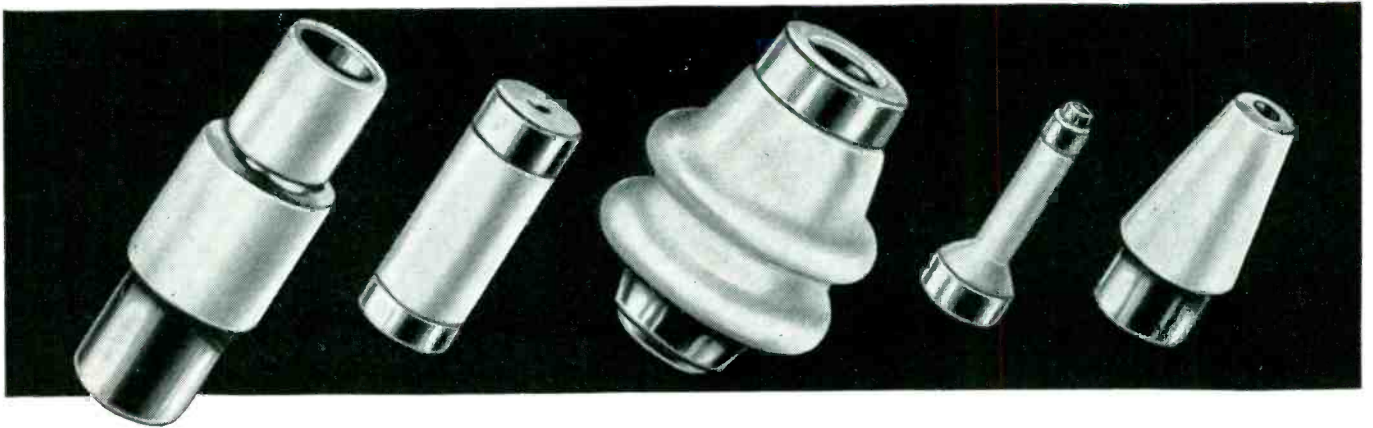

NICOTE METALLIZED CERAMIC COATING *for use with both hard and soft solders!*

Here is Frenchtown's revolutionary answer to a problem that has baffled industry for years . . . a satisfactory *single* metallic coating for refractory ceramic bodies which provides a surface for applying solders with melting points between 275° and 1600°.

NICOTE, applied to refractory ceramic bodies by high temperature firing, in most applications requires no expensive preliminary processing such as buffing, electroplating, or tinning to form a strong, firmly-adhering bond with either *hard* or *soft* solders.

Whether the problem requires the fastening of a metal part or other metallized ceramic parts to its surface, NICOTE offers distinct

advantages over ordinary silver soft receptive coatings as well as molybdenum and tungsten hard solder coatings. It will withstand molten soft soldering *indefinitely* . . . it's less costly to produce . . . requires no expensive processing.

NICOTE'S mechanical bond to the refractory ceramic body approximates ceramic strength, making it ideal for hermetic seals, high strength mechanical seals, and vacuum type applications.

Like to know more about the amazing possibilities of NICOTE Metallized Ceramic Coating for your product? Bulletin 155 contains complete engineering details. Write for a free copy today. There's no obligation, of course.

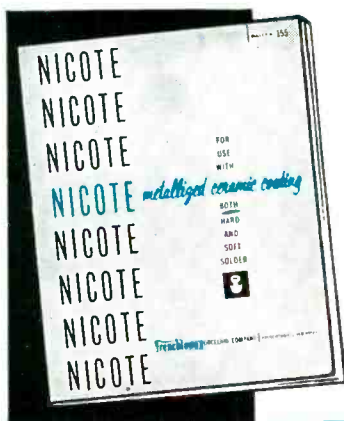

This idea starter is free for the asking . . . contains complete facts and details about NICOTE . . . Frenchtown's new single metallic coating for use with both hard and soft solders. Ask for Bulletin 155.

frenchtown

 PORCELAIN COMPANY

86 MUIRHEAD AVENUE | TRENTON 9, NEW JERSEY

OUR GOOD NEIGHBOR

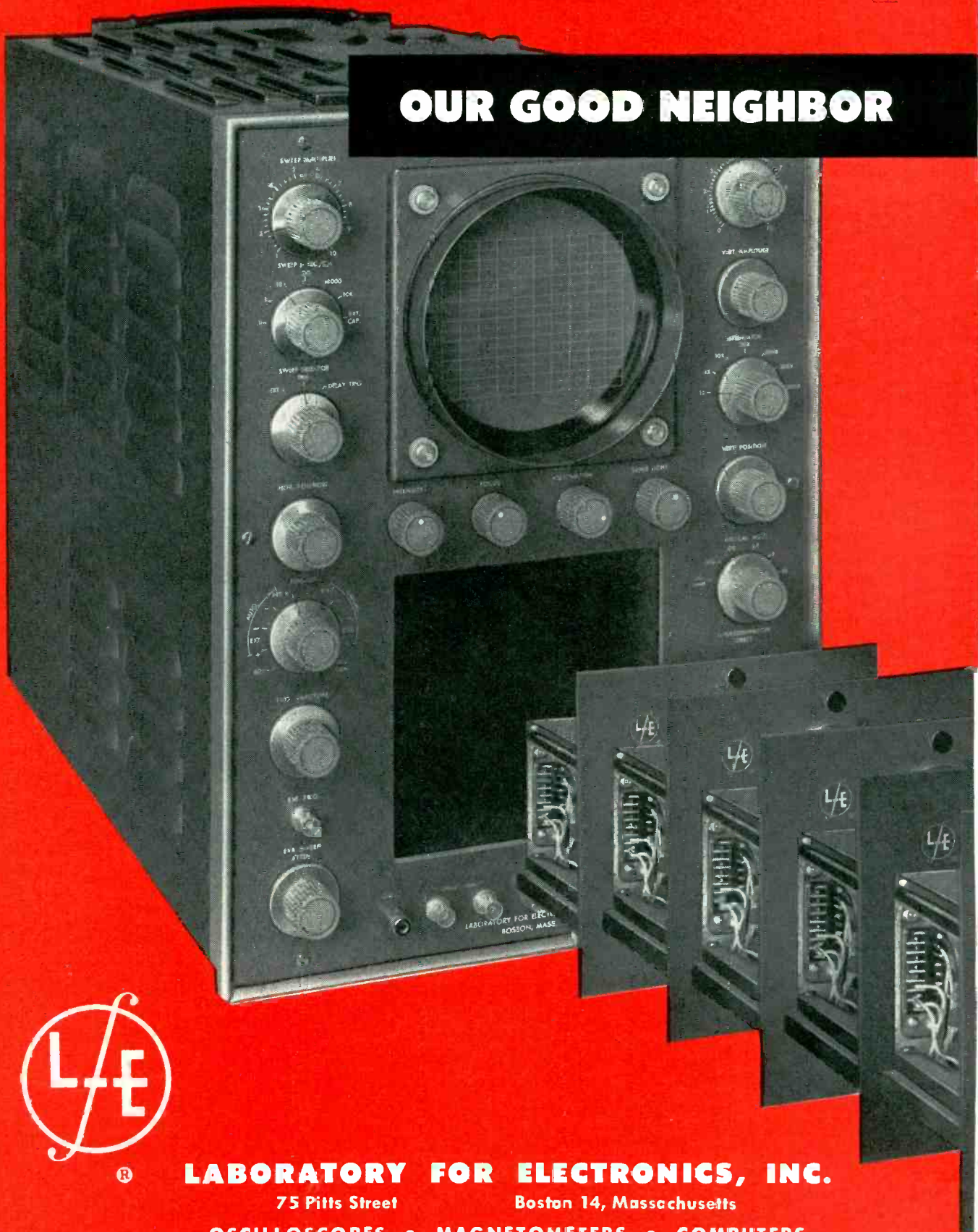

®

LABORATORY FOR ELECTRONICS, INC.

75 Pitts Street

Boston 14, Massachusetts

OSCILLOSCOPES • MAGNETOMETERS • COMPUTERS

SOLID DELAY LINES • SPAR • SPAR-5

ALSO KNOWS HIS OSCILLOSCOPES

**Government of
Canada among
many purchasers
of the new
ultra-versatile
LFE 411**

The 411 is a specialized Oscilloscope made versatile by 6 X-axis plug-in units. Great flexibility is now yours at quite reasonable cost. Check every feature — compare against competitive makes. And whatever your research problem, before you buy a new scope, call the nearest LFE Engineering Representative or write LFE direct about the matchless 411.



Specifications:

X-AXIS PLUG-IN UNITS

- Model (s) 1400, BASIC, with 0.5 to 5000 cps trigger generator
- 1401, SWEEP DELAY, continuously variable from 1. μ sec. to .1 sec.
- 1402, VIDEO SWITCH, time sharing circuit, BW 5 cps to 8mc.
- 1403, GATED MARKER GENERATOR, 0.1 to 10,000 μ sec. timing markers
- 1404, TV TRIGGER SHAPER, triggers on composite video signal
- 1405, LONG SWEEPS, from .1 sec./cm. to 5 sec./cm.

BASIC SCOPE

● Y-Axis Amplifier

- Deflection Sensitivity — 15 mv./cm. p-p for both d-c and a-c (max.)
- Max. Signal Voltage — 500 volts, peak
- Frequency Response — d-c to 10 mc. (3 db. point)
- Transient Response — Rise time (10%-90%) — 0.035 μ sec.
- Linearity of Deflection — Max. deflection, 5". At 2" unipolar deflection, maximum compression is 10%
- Signal Delay — 0.25 μ sec.
- Input Termination — 52, 72, or 93 ohms
- Input Impedance — 1 megohm, 30 μ f.

● X-Axis

- Sweep Time Range, calibrated — 0.1 μ sec./cm. to .1 sec./cm.
- External Sweep Sensitivity — 2 volts/cm., p-p.
- Frequency Response — DC to 1 mc. (3 db. point)
- Triggers — Internal \pm ; External \pm ; 60 cps; Internal Trigger Generator 5000 cps
- External Trigger Sensitivity — 1.0-100 volts for Triggers having a slope of greater than 40 volts per second.

OTHER FEATURES

- Flat-face CRT Type 5ABP-1 (P7 or P11 optional) — Accelerating Potential 3000-4000 volts
- Deflection Plates Accessible
- Power Requirements: 105 — 125 V., or 210-250 V., 50-60 cycles, 385 watts
- Dimensions: 13" w, 17 $\frac{3}{4}$ " h, 21" d.

HEAVY DUTY, PRECISION REGULATED POWER SUPPLIES

FOR LESS THAN THE COST OF BUILDING THEM YOURSELF

Bench Model 50
0-500 VDC @ 0-500 MA \$415.00



**LAMBDA'S TWO WIDEST RANGE,
MOST VERSATILE POWER SUPPLIES**



Rack Model 50-R
0-500 VDC @ 500 MA \$395.00

These general purpose, heavy duty power supplies save you time, money and experimentation. They are tested, fully guaranteed, now in use in many leading research and industrial laboratories and manufacturing plants. You get quick delivery, dependable equipment ready for immediate installation.

SPECIAL FEATURES

- ▶ Hermetically sealed oil filled condensers
- ▶ Stable 5651 reference tubes
- ▶ Easy-to-read 4" meters.
- ▶ Overload circuit breakers (magnetic type)
- ▶ Vernier high-voltage control
- ▶ Time-delay tube protection

SPECIFICATIONS

INPUT 105-125 VAC, 50-60 C, 800 W (max)

DC OUTPUT NO. 1: (regulated for line and load)

Voltage 0-500 VDC (continuously variable)
Current 0-500 MA (over entire voltage range)
Regulation (line) Better than 0.15% or 0.1 V
Regulation (load) Better than 0.5% or 0.3 V
Internal Impedance Less than 2 ohms
Ripple and Noise Less than 8 millivolts rms
Polarity Either positive or negative may be grounded

DC OUTPUT NO. 2: (regulated for line only)

Voltage Ranges Internal Impedances:
a) 0-50 VDC (no load) 3,300 ohms (max)
b) 0-200 VDC (no load) 17,500 ohms (max)

Regulation (line) Better than 0.1%
Ripple and Noise Less than 5 millivolts rms
Polarity: Positive terminal connected internally to negative terminal of DC output No. 1

AC OUTPUTS (unregulated):

Two outputs, isolated and ungrounded. Each is 6.5 VAC at 5A (at 115 VAC input). Allows for drop in connecting leads. May be connected in series for 12.6 V (nominal) at 5A, or in parallel for 6.3 V (nominal) at 10A.

SIZES AND WEIGHTS:

Bench Model 50 Size: 12½" H x 22" W x 15" D
Weight: 110 lb. net; 175 lb. shipping
Rack Model 50-R Size: 10½" H x 19" W x 14¼" D
Weight: 89 lb. net; 143 lb. shipping

LAMBDA



ELECTRONICS CORP.

103-02 NORTHERN BLVD.

CORONA 68, NEW YORK

KOCH ... World's largest fabricator of moulded Fiberglas products
PRONOUNCED "KOKÉ"



How to insure valuable equipment against damage

In the test illustrated above, a Koch Fiberglas carrying case was loaded with three times its weight and dropped 250 feet into the sea. The case was undamaged.

This remarkable case, made only by Koch, is revolutionizing the whole concept of protecting valuable equipment of all kinds in shipping, handling and long term storage.

The case will not dent. It will not corrode, so painting is unnecessary. It safeguards against shock, vibration, fungus, mildew. No outer crating or other protection is required for shipment or storage. The Koch Fiberglas case is absolutely airtight, and under severe tests has maintained a vapor and moisture transmission rate of zero.

Cushioning material inside the case is moulded to fit perfectly the contours of the equipment, giving maximum protection against vibration and shock.

Sixty thousand Koch Fiberglas cases are now in service with the U. S. Air Force and BuAer all over the world. To date there has not been a single unsatisfactory report, or casualty to a case or the valuable equipment it contains.

If you manufacture equipment that needs this kind of protection, we will be glad to confer with you about your problem. Address Dept. EK.

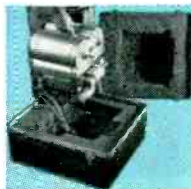

KOCH FIBERGLAS
Pioneer in reusable Fiberglas containers

CORTE MADERA, CALIFORNIA

BUDD•STANLEY specialists in microwave transmission components

announce

A REVOLUTIONARY NEW METHOD OF PRODUCING WAVE-GUIDE ASSEMBLIES

Exclusive method developed and
perfected by our research engineers



Quality
Economy
Dependability

produces waveguide assemblies
of a quality higher than your
specifications at *about half the cost.*

waveguides requiring complex
bends and tolerances never before
possible can now be produced to
meet your most exacting
precision requirements.

We shall be glad to send you complete details.
Write, wire or phone

BUDD•STANLEY CO. INC.

43-01 22nd St., Long Island City 1, N. Y.

Phone STillwell 6-1706

Cable Address "BUDDSTAN"

THE VERY SMALLEST YET



AIRPAX
A175
MIDGET
 60 cycle chopper

Phase Angle at 6.3v, 60 cycles is $21^\circ \pm 5^\circ$, at 30 cycles is nominally 20° , at 100 cycles 26° .

Contacts are SPDT, break-before-make, and are rated up to 100 volts maximum, 1 ma maximum.

Dwell Time is approx. 170° . The nominal value of dwell time changes only slightly from 30 cycles to 100 cycles.

Coil demand at 6.3 volts, 60 cycles, is approximately 37 milliamperes, coil resistance approximately 165 ohms D.C.

Noise with all 3 contacts at one megohm impedance, and with wide band amplifiers, will have an effective value of 50 microvolts or less. The offset of narrow band amplifiers will be very much less. The specification of noise requires careful definition, users should refer to the detail specifications and bulletin 103.

Temperature may be any value from -65°C to 85°C . The nominal phase angle will vary from about 17 degrees at -65°C to 25 degrees at 85°C .

Vibration from 10 to 55 cycles will not damage the chopper up to as high as 30 G. At these higher G values there will be some modulation of the phase angle.

Frequency of operation may be any value from 25 to 110 cycles, to maintain full performance, balance, etc.

Humidity may be any value, except of course for external condensation on the header.

Shock values as high as 50G will not damage the chopper.

Altitude may be any value, as the unit is hermetically sealed.

wide temperature range

broad frequency range

hermetically sealed

very low noise

long proven life

vibration proof

chatter free

shock proof

reliable

rugged

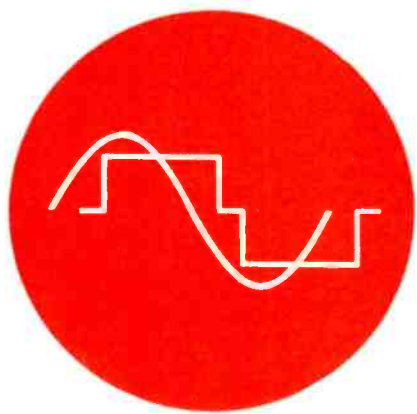



DESIGNERS **AIRPAX** **ENGINEERS**
PRODUCTS
COMPANY
MIDDLE RIVER **BALTIMORE, MD.**

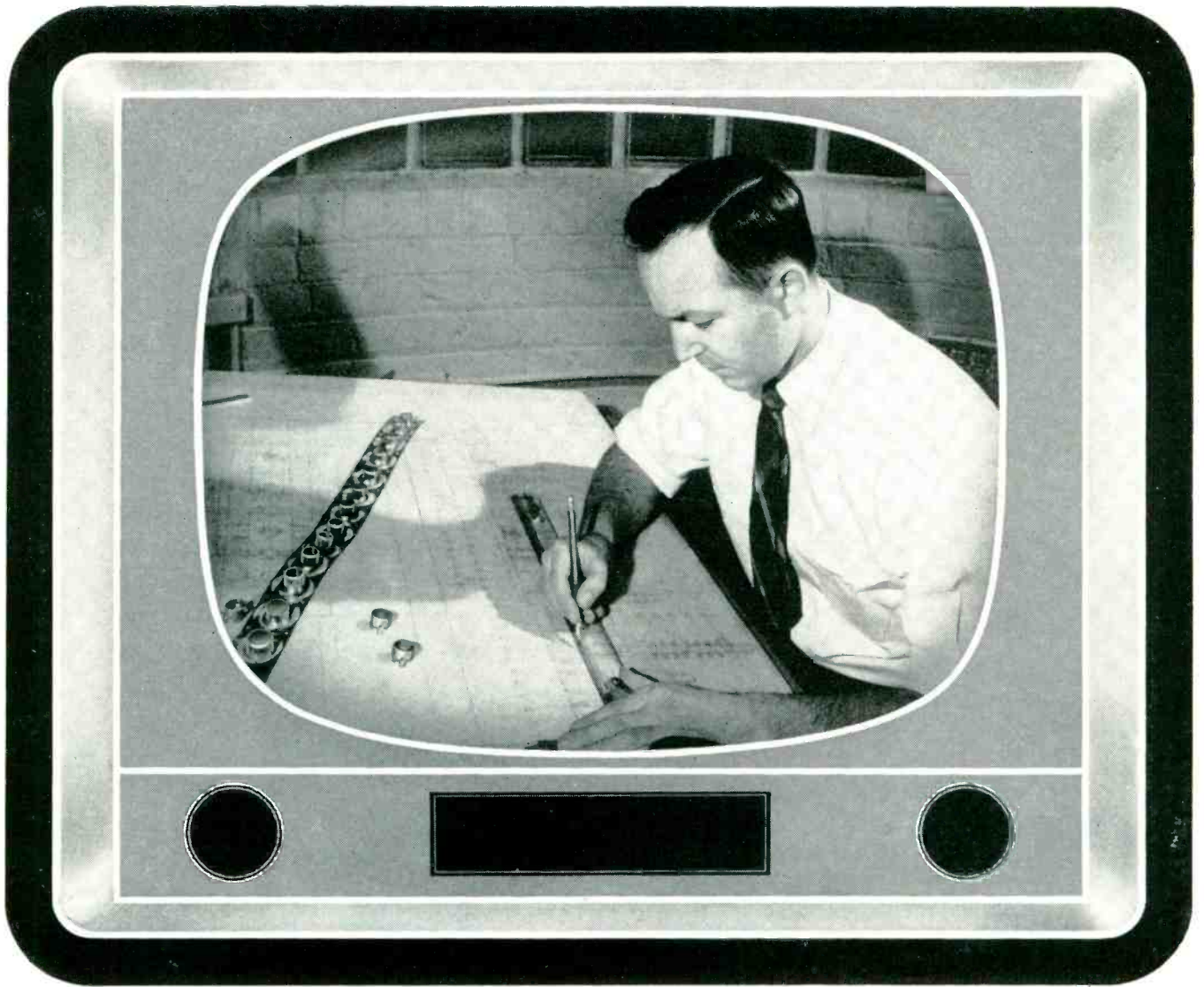

Picture of Your Set Being Improved by Volkert Stampings Research

At Volkert, as in your TV set manufacturing operations, research is an unending process.

Whether it's electron-gun parts for black-and-white or color, receiving-tube components, or shadow masks for color TV, Volkert research sees to it that the stampings you require are more economical in assembly...more efficient in performance.

Volkert serves as engineering consultant and confidential experimental laboratory for the electronics industry, as well as its No. 1 source for precision stampings. A consultation with Volkert at the *development* stage assures you dependable stampings at the *production* stage.

Here are two easy ways to learn more about precision stampings

The Volkert View quarterly keeps you up-to-date on electronic stamping developments. Just drop us a line and you'll be put on the mailing list.

Stampings for Electronics, our color film, tells how Volkert daily produces 2,000,000 precision parts. Arrange for a group showing in your plant.

VOLKERT STAMPINGS, INC.
222-34 96th Avenue, Queens Village 29, L. I., N. Y.

for design...tooling...and production of precision stampings

Volkert

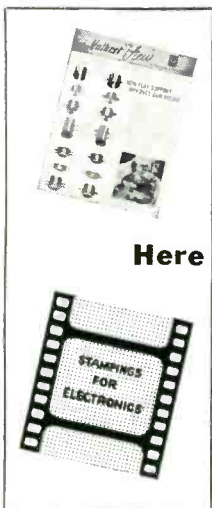

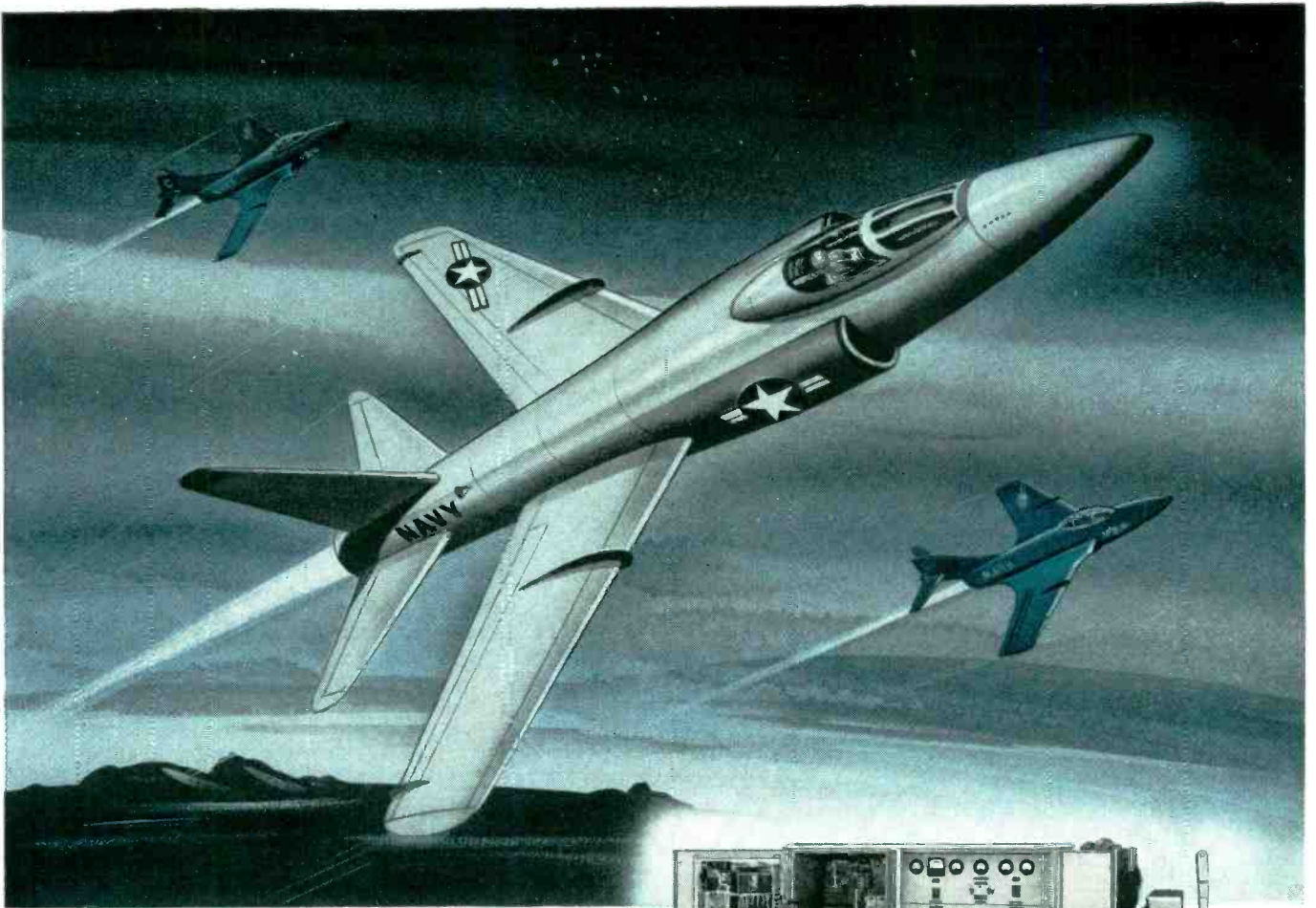

relies on Bogue Precision Power

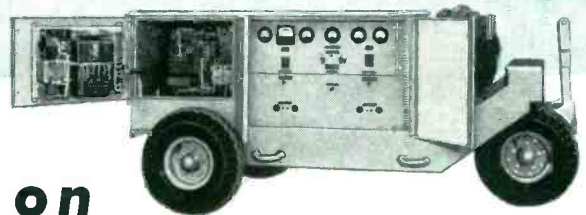

Grumman Aircraft Engineering Corporation, designers and builders of quality Naval aircraft from the FF-1 of the thirties, the famed World War II Hellcats, to the present day swept-wing Cougar and Supersonic Tiger Jets, has selected Bogue Electric power supplies for laboratory, production and flight-line testing.

Since 1892, Bogue has manufactured precision electrical equipment. The Bogue name plate on ground support apparatus, airborne

equipment, systems testers or electronic power, is your seal of time tested approval.

There is a Bogue Engineering Representative in your area to discuss your power applications and assist you in the selection and design of power apparatus to meet with your exacting specifications. A telephone call or letter will have him at your service.

Write for Descriptive Bulletin 440

**Bogue Electric Manufacturing Company
Paterson 3, New Jersey**

BOGUE

The Authority on High Cycle Precision Power

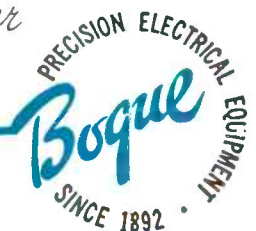
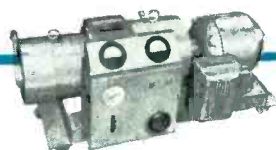
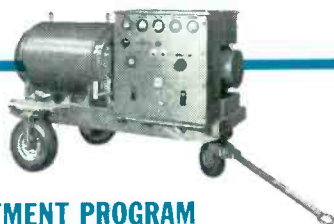

SUPPORT YOUR AIR FORCE RECRUITMENT PROGRAM



**Vital link between thought and action
paces all military and industrial activity**

RADIO COMMUNICATION, oldest of the electronic sciences, has long played an important role in the thought-action process; yet today it is being called upon for capabilities and performance characteristics far beyond those afforded by the present state of the art.

Such demands stem from the basic importance of advanced communication systems in maintaining American military superiority.

Recognizing this, The Ramo-Wooldridge Corporation is today engaged in research and development activities leading to the production of radio communications systems capable of providing the *information capacity, versatility, range, and reliability* necessary to insure maximum performance of our weapons systems.

And yet the challenge is not all military. It is inevitable that the application at Ramo-Wooldridge of these advanced modern theories and new techniques will lead to significant accomplishments in the field of commercial communications as well.

Engineers and physicists qualified to undertake advanced work in systems analysis and engineering, circuit development, transmitter and receiver engineering, modulator development, and propagation studies are invited to investigate the opportunities existing in HF and microwave communications, data transmission, facsimile, and allied fields, awaiting them at Ramo-Wooldridge.

The Ramo-Wooldridge Corporation

DEPT. E, 8820 BELLARCA AVENUE; LOS ANGELES 45, CALIFORNIA



for versatile **PRESSED** Ceramics



for uniform **EXTRUDED** Ceramics

Custom-made Technical Ceramics

**FOR WIDEST CHOICE OF MATERIALS
FOR VOLUME PRODUCTION
FOR DELIVERY AS PROMISED**

Send your blueprint with outline of operating conditions and let our engineers show you what ALSiMag can do for you!

ALSiMAG[®]

54TH YEAR OF CERAMIC LEADERSHIP

AMERICAN LAVA CORPORATION

A Subsidiary of

American Mining and Manufacturing Company
CHATTANOOGA 5, TENNESSEE

BRANCH OFFICES (see your local telephone directory): Cambridge, Mass. • Chicago, Ill. • Cleveland, Ohio • Dallas-Houston, Tex. • Indianapolis, Ind. • Los Angeles, Calif. • Newark, N. J. • Philadelphia-Pittsburgh, Pa. • St. Louis, Mo. • San Francisco, Calif. • Syracuse, N. Y. • Tulsa, Okla. • Canada: Livingston Varnish & Insulator Division, Minnesota Mining & Manufacturing of Canada Limited, 1390 Burlington Street, East, Hamilton, Ontario. Telephone Liberty 4-5735



for reliable **METAL-CERAMIC COMBINATIONS**

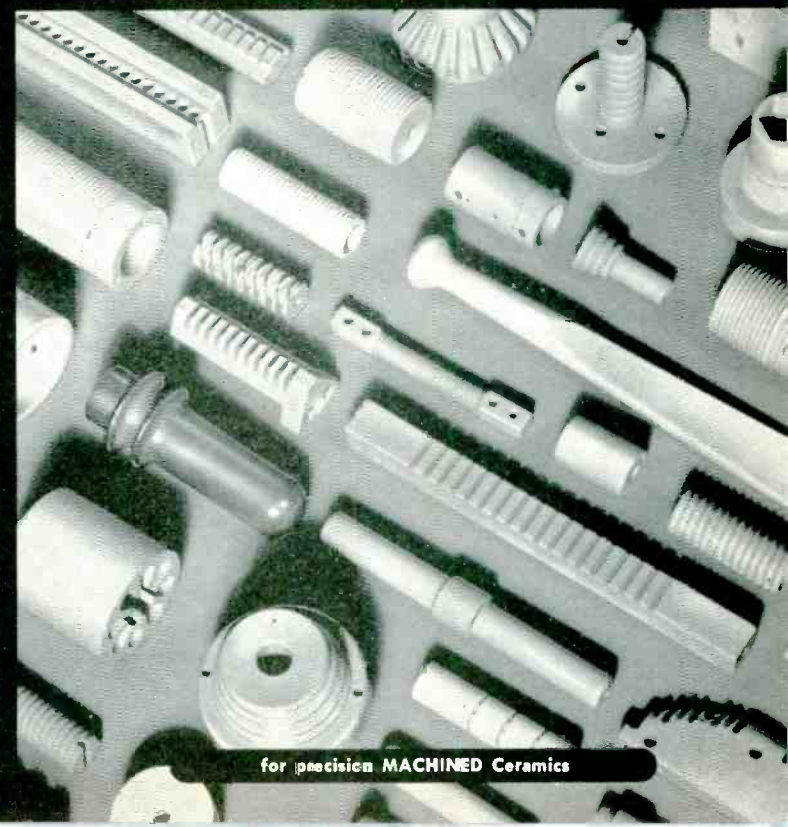

for precision **MACHINED** Ceramics

These hands can mold the future of your product . . .



U. S. Rubber engineers achieve new standards in precision moldings and extrusions

Here are the facts about "U. S." molded rubber as a basic material:

- 1) Molded rubber, in the hands of "U. S." engineers, is molded to tolerances never before obtainable.
- 2) "U. S." molds compounds to meet extreme flexing requirements.
- 3) "U. S." molds rubber that has achieved new standards in resistance to oil, water, cold, heat.
- 4) "U. S." compounds from natural and synthetic polymers.

The makers of general appliances, air conditioning, farm equipment, petroleum equipment, transportation equipment, plumbing fixtures, textile machinery, products for public utilities, chemicals and pharmaceuticals—to name just a few—are using "U. S." molded rubber to increase the performance efficiency and saleability of their products. They have obtained advantages no other material can provide.

Learn more about what United States Rubber Company can do with molded rubber for your products. Get in touch with United States Rubber Company's Molding and Extrusions Department through address below.



"U. S." Research perfects it... "U. S." Production builds it... U. S. Industry depends on it.

UNITED STATES RUBBER COMPANY
MECHANICAL GOODS DIVISION • ROCKEFELLER CENTER, NEW YORK 20, N. Y.

Hose • Belting • Expansion Joints • Rubber-to-metal Products • Oil Field Specialties • Plastic Pipe and Fittings • Grinding Wheels • Packings • Tapes
Molded and Extruded Rubber and Plastic Products • Protective Linings and Coatings • Conductive Rubber • Adhesives • Roll Coverings • Mats and Matting

**Highest Microwave Power
Absorption .. Smallest Size
.. Lowest Weight ..**

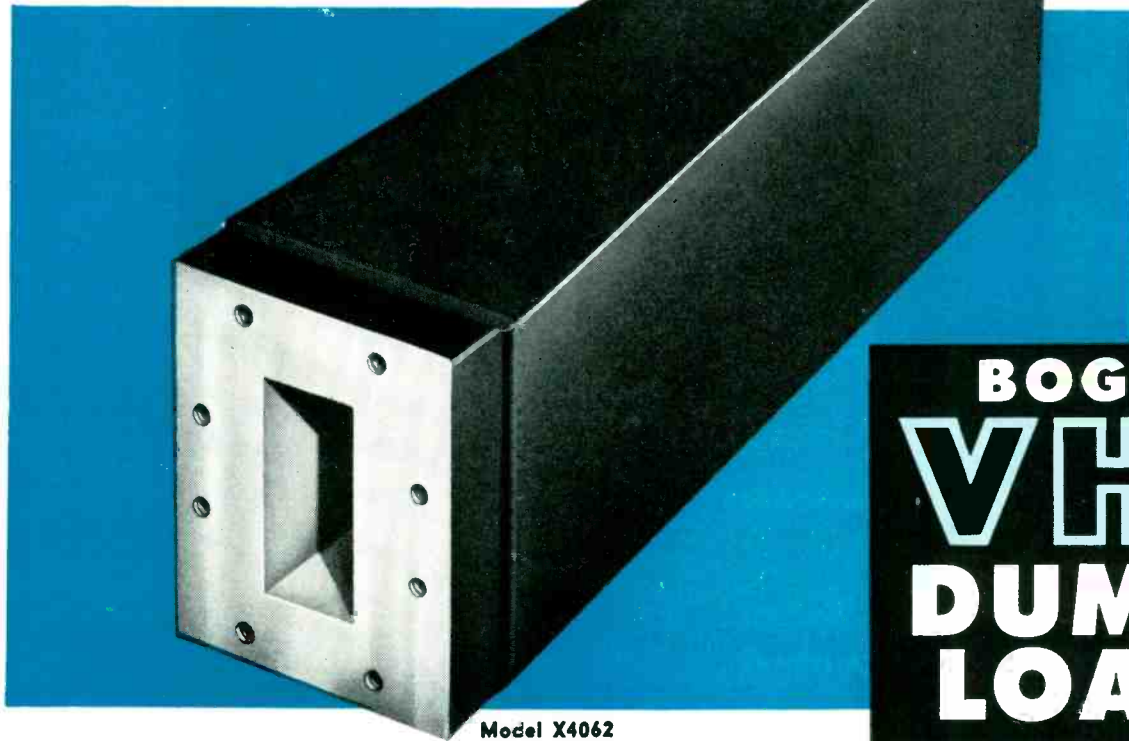

Model X4062

**BOGART
VHP*
DUMMY
LOADS**

No Cooling Fins Required

In laboratory, in field testing, in production — wherever extremely high microwave power is used—Bogart VHP* Dummy Loads do the job of much larger and heavier units. Even at the full peak power rating of rigid waveguides, no cooling fins are required.

Negligible Moisture Absorption

The lossy material is uniquely designed to present a minimum reflection coefficient, while permitting only negligible absorption of moisture.

Lightweight, Heat Resistant

All-Aluminum construction and black enamel finish help reduce weight and resist heat. All models are available with either choke or cover flanges.

Special Applications

We invite your engineers to consult with our own staff. We will be pleased to discuss your particular problems with you, without any obligation on your part. Write today.

*Very High Power!

MODEL NO.	FREQUENCY RANGE (KMC/S)	MAX. PEAK POWER (MEGA-WATTS)	MAX. AVERAGE POWER (WATTS)	MAXIMUM VSWR	LENGTH (INCHES)	WIDTH (INCHES)	HEIGHT (INCHES)	APPROX. WEIGHT (LBS.)	WAVEGUIDE AN TYPE
X4062	8.20-12.4	0.29	750	1.10	4¾	1¼	1½	¾	RG-52/U
B4062	7.05-10.0	0.46	850	1.10	5¾	1¼	1¾	1	RG-51/U
C4062	5.85-8.20	0.71	1000	1.10	6¾	1½	2¼	1¾	RG-50/U
H4062	3.95-5.85	2.0	2000	1.10	9½	1¾	2¾	3	RG-49/U
S4062	2.60-3.95	3.2	2500	1.10	13¾	2¼	3¾	6½	RG-48/U
L4062	1.12-1.70	17.2	4000	1.10	30	4¾	8	48	RG-69/U

Above data subject to change without notice.



BOGART MANUFACTURING CORPORATION
315 Selgel Street

Brooklyn 6, New York

serving the electronics industry since 1942

design • development • production



ENCAPSULATED COILS...

manufactured by the R-B-M Division of Essex Wire Corporation meet U.L. standards. One of the *new* "SCOTCHCAST" Resins is used! R-B-M tests show 6 times the dielectric strength of previous materials, and "SCOTCHCAST" gives *twice* the dielectric strength after 30 days at 90°C.

THINK WHAT "SCOTCHCAST" CAN DO FOR YOU! You can quickly and easily tailor special resins that will fit your most exacting requirements. By mixing different "SCOTCHCAST" Resins, you can control viscosity, cure-time and flexibility to withstand heat and cold cycling. You get the *right* resin for

your particular purpose! A 3M Sales Engineer will be glad to help you.

PERFECT TEAMMATES! "SCOTCH" Brand Electrical Tapes can save you time and money on dozens of different coil applications, too!

FREE! A graphic chart illustrating and describing the performance properties of the complete line of "SCOTCHCAST" encapsulating, dipping and impregnating resins will be sent on request. Write Minnesota Mining and Manufacturing Co., Dept. EE-55, St. Paul 6, Minnesota.

QUICK FACTS on "SCOTCHCAST" RESINS

- Flexible, semi-flexible and rigid varieties.
- Filled and unfilled types.
- Available for dipping, impregnating or encapsulating.
- Pot viscosities from 50 to more than 20,000 centipoise.
- Cure temperatures range from room temperature to 325°F. Cure time: 5-10 minutes and up.

Reg. U. S. Pat. Off.

SCOTCHCAST RESINS

BRAND

The term "SCOTCH" and the plaid design are registered trademarks for the more than 300 pressure-sensitive adhesive tapes made in U.S.A. by Minnesota Mining and Mfg. Co., St. Paul 6, Minn. Export Sales Offices: 99 Park Avenue, New York 16, N.Y. In Canada: P.O. Box 757, London, Ontario.



need

"muscles"

for your "brain"?

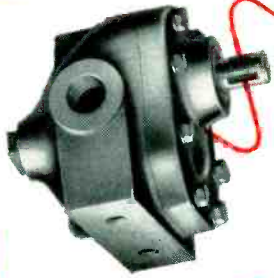
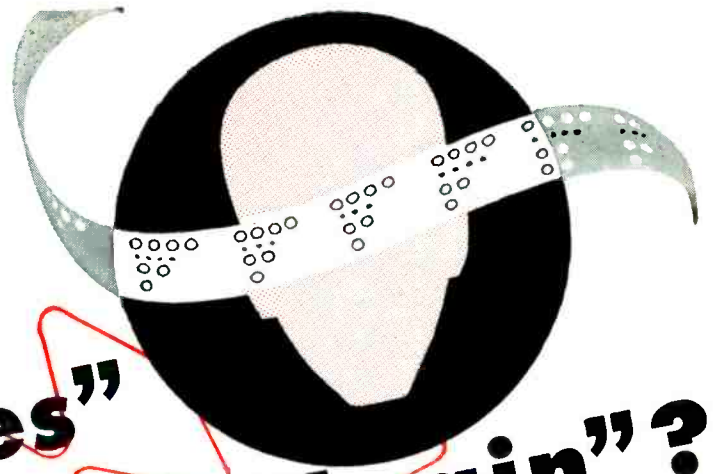

PESCO HYDRAULIC PUMPS

Gear-type Hydraulic Pumps are built with single or multiple elements in wide range of capacities for pressures up to 3000 psi. "Pressure Loaded" bearings for higher efficiency and longer service life. Can be furnished with Pesco Electric Motor as a Motor-Driven Hydraulic Pump; or with motor, reservoir and controls as a complete Pesco Power Package.



PESCO ELECTRIC MOTORS

Precision-built Pesco motors provide maximum power for minimum size and weight. Many types available for special needs; models with rigidly exact performance for servo applications. Both DC and high frequency AC motors built in 5 coordinated frame sizes from 1/100 to 11 hp permitting use of standard parts to expedite design. Many superior features to meet any requirement on humidity, temperature, vibration, duty cycle or altitude.

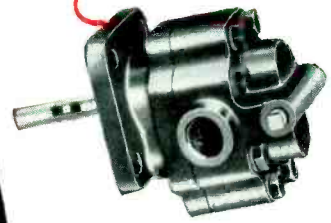

PESCO HYDRAULIC MOTORS

Gear-type, positive displacement fluid motors to provide highly efficient, rotary, variable speed hydraulic power. Lightweight and compact, motors operate in either direction without mechanical adjustment. Starting torque efficiency is over 90%. Models available for operation at pressures to 1500 psi.

Does your electronic "brain" require hydraulic or electrical "muscles"?

To assure precise functioning of automatic devices, servo mechanisms, control equipment and instruments, equip them with *power by Pesco*—Hydraulic Pumps, Hydraulic Motors and Electric Motors. These aircraft-quality units operate with unmatched precision and absolute dependability over a long service life. They are extremely compact, lightweight and ruggedly built for severe environmental conditions.

For information on how these Pesco products can be applied to your particular problem, contact: PESCO, 24700 North Miles Rd., Bedford, Ohio.



PRODUCTS DIVISION

BORG-WARNER CORPORATION
24700 NORTH MILES ROAD • BEDFORD, OHIO

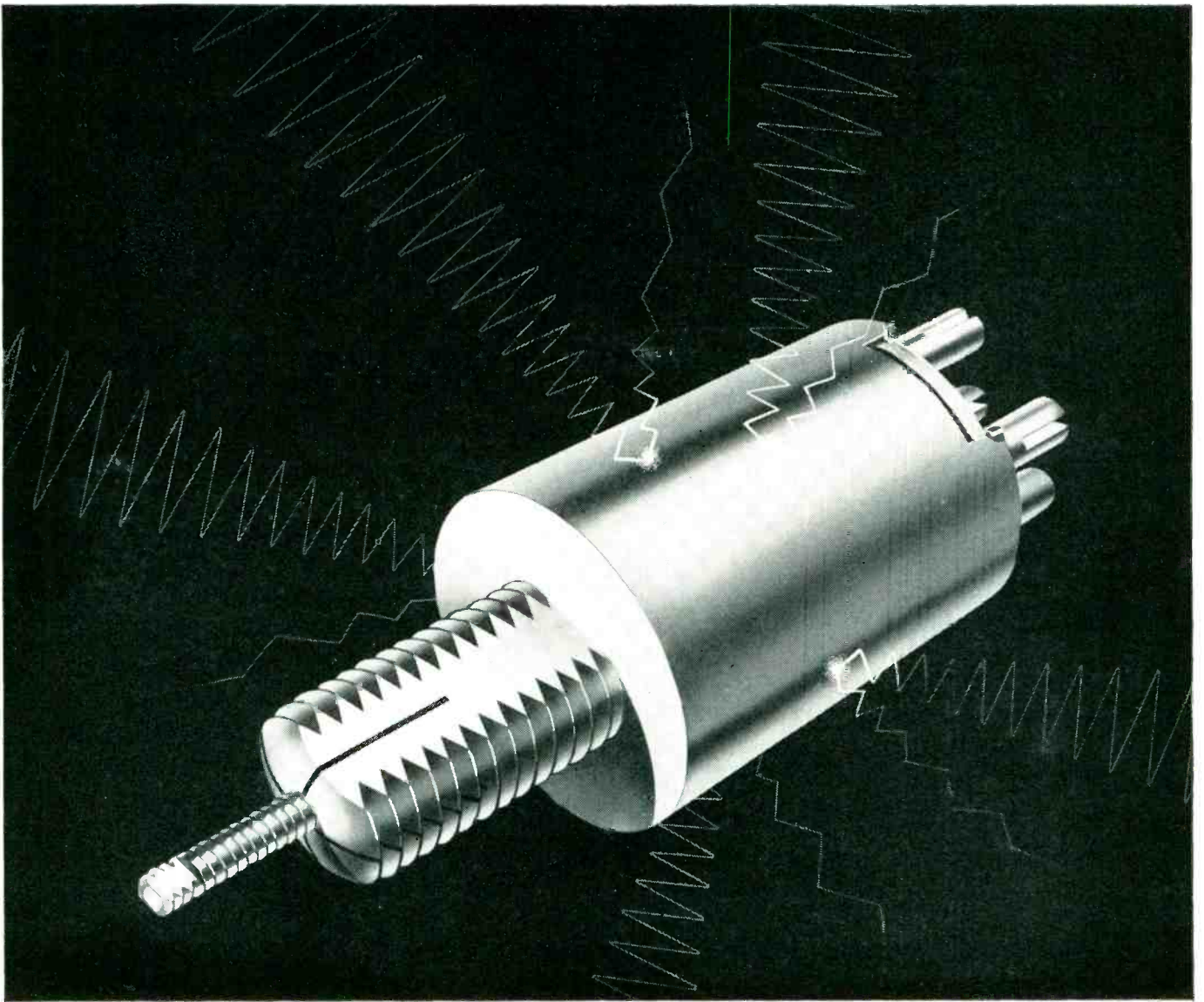

Built for close "combat" in tight spots

Into the construction of this coil form goes C.T.C.'s rigid *quality control* to highest production standards.

The result is another C.T.C. *first* — a miniaturized coil form ($\frac{1}{16}$ " diameter by $\frac{1}{2}$ " high when mounted) that is shock-resistant and exceptionally rugged — shielded against radiation, electrically, and therefore ideal for "close quarter" use in I.F. strips and numerous designs where adjacent mounting is necessary.

C.T.C.'s policy of continuous step-by-step quality control in the manufacture of every component means guaranteed performance. Already certified materials are doubly checked before manufacture.

Whatever your component need — let C.T.C. solve your problem — with either custom or standard designs of *quality-controlled, guaranteed* components — including insulated terminals, coil forms, coils, swagers, terminal boards, diode clips, capacitors and a wide variety of hardware items.

Put your component problem up to

C.T.C. now. For samples, specifications and prices — write today to Sales Engineering Dept., Cambridge Thermionic Corporation, 437 Concord Ave., Cambridge, Mass. On West Coast, contact E. V. Roberts, 5068 West Washington Blvd., Los Angeles 16 or 988 Market St., San Francisco, California.

Coil Form Data: C.T.C.'s LS-9 coil form has a brass shell enclosing a powdered-iron cup-core, tuning slug, phenolic coil form and silicone fibreglas terminal board. Three terminal boards are available with choice of two, three or four terminal layout. Forms, unassembled, may be had *without windings . . . or wound and assembled to your specifications.*

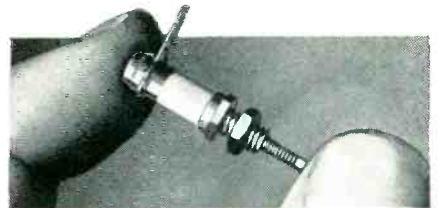

Capacitor: New CST-50 variable ceramic capacitor surpasses range of capacitors many times its size. Stands only $\frac{1}{32}$ " high when mounted, is less than $\frac{1}{4}$ " in diameter and has an 8-32 thread mounting stud. A tunable element of unusual design practically eliminates losses due to air dielectric giving large minimum to maximum capacity range (1.5 to 12MMFD).

CTC

CAMBRIDGE THERMIONIC CORPORATION

*makers of guaranteed electronic components,
custom or standard*





Precision Turning and Boring

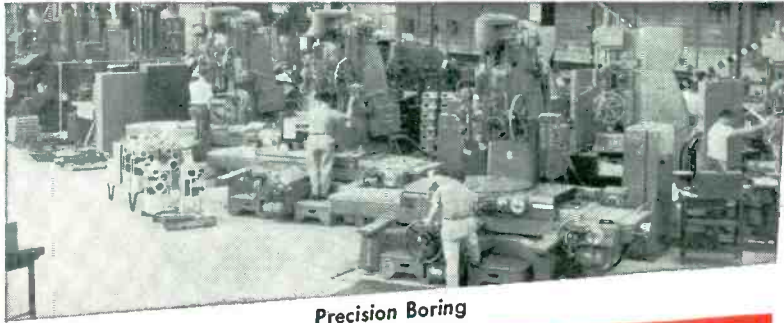

Precision Boring



Precision Welding



Instrument Plating



Hobbing 56" Ring Gear



...from drawing board

- TO FINISHED PRODUCT, DAYSTROM DOES THE COMPLETE JOB

A modern plant of 350,000 square feet ... the finest machinery and equipment for the manufacture, assembly and test of precision electronic, electro-mechanical, mechanical and nuclear instruments ... add to these a highly skilled staff of research, development, engineering and manufacturing specialists and an experienced management ... means Daystrom can do the complete job, from drawing board to finished product ... **ALL UNDER ONE ROOF!**

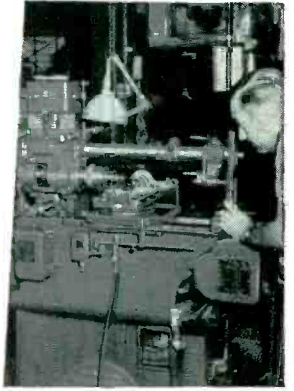

Precision Gear Cutting

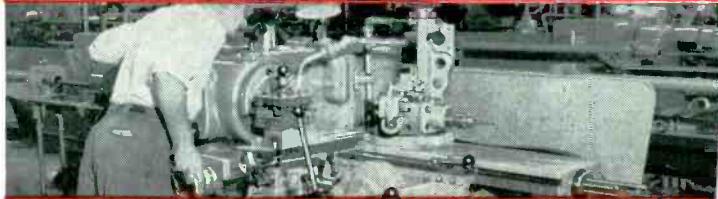

Precision Turret Lathe

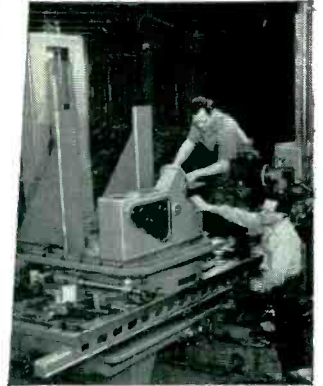

Precision Boring, Turning and Threading

Daystrom **I**nstrument

Archbald, Penna.

Division of Daystrom, Inc.

Daystrom Affiliates:
American Gyro; Heath Company;
Daystrom Electric Corp.;
American Type Founders, Inc.;
Daystrom Furniture Div.

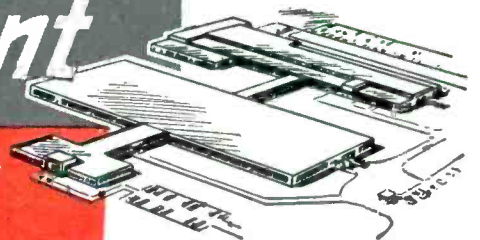

Write For Our Brochure

from VACUUM MELTING—
improved alloys with exceptional properties

WHAT ARE VACUUM-MELTED METALS?

Vacuum-melted metals are a familiar family of alloys with new, improved characteristics. For during high-vacuum melting, gaseous impurities are literally sucked from the molten metal. The result is cleaner, purer metals with desirable properties not previously attainable . . . in, for example, superalloys, bearing steels, high-strength steels, electronic metals, or magnetic alloys.

WHAT ARE THEIR ADVANTAGES?

Many characteristics of a specific alloy can be improved by vacuum melting and casting . . . for impurities that limit an alloy's potential are removed. Tensile and impact strength, stress rupture strength at elevated temperatures, and fatigue life can all be substantially improved . . . and creep and brittleness minimized by vacuum melting.

HOW CAN I BEST USE THESE IMPROVED ALLOYS?

Frankly, vacuum-melted metals are so new that many applications for them have not yet been explored. But where they have been used, they've *proved* their effectiveness in improved performance. Superalloy jet engine turbine blades, for example, have given more than *twice* the performance life of blades made of conventional air-melted alloys. And ball bearing rejects dropped from 50% to 3% when vacuum melted steels were used.

WHERE CAN I GET VACUUM-MELTED METALS?

Now, Vacuum Metals Corporation, pioneer in the development and production of vacuum-melted and cast alloys, is producing tool, high-speed, stainless and alloy steels — in most sizes and grades — as well as special ferrous and nonferrous alloys. If you have a metals problem that vacuum-melted alloys might solve, please describe it in as much detail as possible. Write *Vacuum Metals Corporation, P. O. Box 977, Syracuse 1, N. Y.*



VACUUM METALS CORPORATION

Jointly owned by Crucible Steel Company of America and National Research Corporation

STANDARD *flexlab*

**IN INDUSTRY and RESEARCH
IN GOVERNMENT
IN VOCATIONAL and
TECHNICAL SCHOOLS
and UNIVERSITIES**

Why not send for Flexlab Catalog #187—"Laboratory Equipment for Industry and Government"... or for Flexlab Catalog #216—"Laboratory Equipment for Vocational and Technical Schools."

"Custom Designed and Built"

IN GOVERNMENT

Naval Research Laboratory Los Alamos Physics Laboratory McClellan Air Force Base

Aberdeen Proving Grounds Naval Air Development Station Frankford Arsenal

Pensacola Naval Air Station White Sands Proving Grounds Naval Research Laboratory

IN SCHOOLS and UNIVERSITIES

Bell Vocational School Bell Vocational School Iowa State College

Princeton University Bergen County Vocational School

Technical School Bell Vocational School

IN INDUSTRY and RESEARCH

Westinghouse Electric Co. Monsanto Chemical Co. Ford Motor Co.

Radio Corp. of America Glenn L. Martin Co.

Commonwealth Edison Packard Motor Co. General Electric

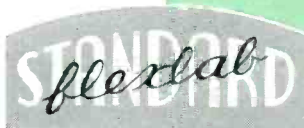

Since 1884

THE STANDARD ELECTRIC TIME COMPANY

97 Logan Street • Springfield 2, Massachusetts

**ELECTRIC CLOCK AND PROGRAM SYSTEMS • FIRE ALARM SYSTEMS • HOSPITAL SIGNAL SYSTEMS
PRECISION TIMERS • CHRONO-TACHOMETERS • PIPELINE NETWORK ANALYZERS**

Instrument Mechanisms

from the World's foremost builder

Model 9934—Miniature, self-shielded core magnet mechanism designed for operation of warning flags where space requirements are critical. Capable of 90° total deflection.

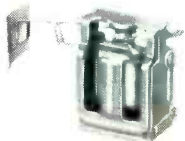

Model 9889—Small self-shielded core magnet mechanism featuring spring-backed jewels for ruggedness and the requirements of vibration and shock; suppressed characteristics if desired; optional location of mounting. Capable of 90° total deflection and can be used for both warning flags and indicator.



Whether the instrument system requires mechanisms combining miniature size with high torque, or great deflection with high sensitivity, or 'most any other combination of specific instrument characteristics... more than likely there's a WESTON mechanism already available which meets the requirements *exactly*. But for new or unusual needs, Weston engineers are available to assist at the drawing board stage. In either case, Weston's long leadership in instrument design... *since 1888*... offers best assurance of getting mechanisms *specifically designed for*, rather than merely adapted to, the system. WESTON Electrical Instrument Corporation, 614 Frel-inghuysen Avenue, Newark 5, New Jersey.

Model 9897—Long scale, 250° self-shielded movement, linear motion for operation of pointers where great deflection is a requirement. Capable of sensitivities in the order of 1½ microamperes per degree deflection.



Model 9891*—Unique "Y-Cor" magnet construction giving very high flux density with very high torque. Designed for operating extremely long pointers. Small size makes it ideal for multi-mechanism instrument use. Capable of 45° (22.5-0-22.5°) total deflection, essentially linear up to 40° (20-0-20°).

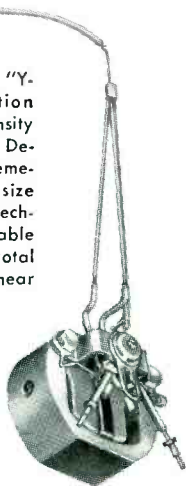

Model 9890*—Unique "Y-Cor" magnet construction, slightly larger than Model 9891, giving extremely high flux density. The extremely high torque makes it ideal for operation of the larger and heavier type pointers.

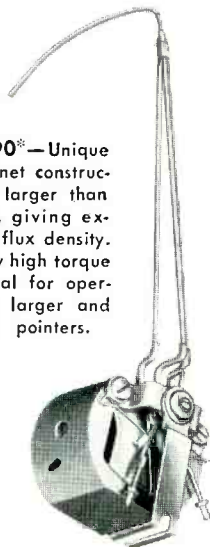

Model 9929—Self-shielded core magnet mechanism of high flux density. Designed for operating pointers with high moments of inertia. Total deflection up to 120 degrees available. Also available in miniature size (Model 9892).

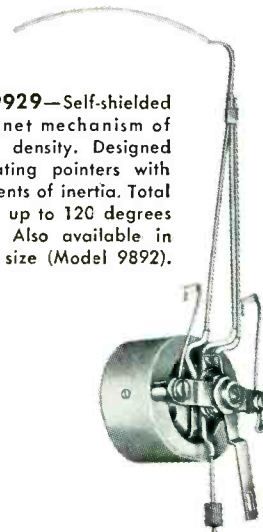

*These Models useful as sensitive, self-shielded galvanometers.

WESTON Instruments

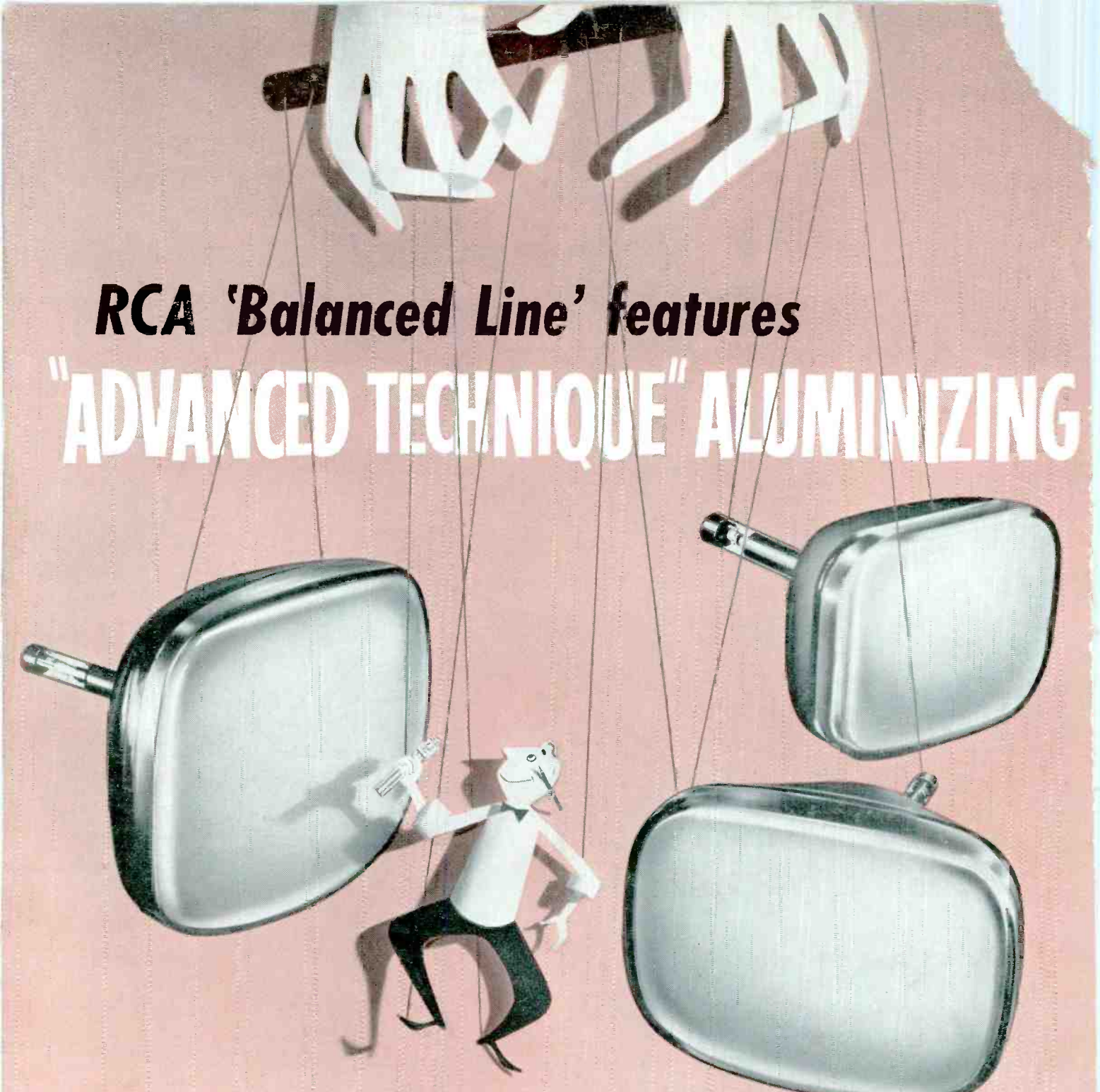

RCA 'Balanced Line' features "ADVANCED TECHNIQUE" ALUMINIZING

NEW 24-INCH Aluminized Picture Tubes—RCA-24CP4-A, RCA-24DP4-A, and RCA-24YP4—round out the RCA 'Balanced Line' for the new look in *your* receiver line.

These new tubes bring you the advantages of RCA "Advanced Technique" Aluminizing—an example of the forward thinking, planning, and engineering that make RCA Tubes famous for quality.

See for yourself how RCA top-quality aluminized picture tubes emphasize clarity and sharp detail in your new set designs. See your RCA Field Representative for your needs.

For technical data, write RCA, Commercial Engineering, Section E19Q Harrison, N. J.

RCA "Advanced Technique" Aluminized Picture Tubes		
type	diagonal deflection angle	focus
21ALP4-A	90	E
21AMP4-A	90	M
21ATP4	90	E
21AVP4-A/21AUP4-A	72	E
21AWP4	72	M
21YP4-A	70	E
21ZP4-B	70	M
24CP4-A	90	M
24DP4-A	90	E
24YP4	90	E

E = low-voltage electrostatic M = magnetic



RADIO CORPORATION of AMERICA
ELECTRON TUBES
HARRISON, N. J.



Try this for size

**For guided missiles, airborne equipment,
portable and mobile ground equipment**

In these and related fields, where lack of space is the problem, manufacturers have turned to miniaturization. Daven's **new ceramic switch** occupies a panel area of less than 1½ square inches—incorporates features that ensure long life and trouble-free operation.

Despite its small size, this switch is extremely rugged and has been designed to withstand all types of field service. Coin silver contacts, rotors and slip rings are provided for low and uniform contact resistance and excellent electrical characteristics. Ceramic parts are silicone impregnated to function under extreme humidity. Sturdy solder terminals are supplied for wiring.

Single pole style has 18 shorting type contact positions available. 2 or 3 pole types may also be obtained. Several sections may be "ganged" by adding supplementary wafers. Flash-over voltage at 60 cycles is 1000 volts peak . . . current carrying capacity is 2 amperes.

This sturdy, high-quality switch is precision produced . . . will give years of service in fine commercial and military equipment. DAVEN's expert engineering staff is at your service for help with special problems or orders to your specifications. Write today for further information.



**Miniature Ceramic
Switch... Series M**



THE **DAVEN** co.

191 Central Avenue, Newark 4, N. J.

WORLD'S LARGEST MANUFACTURER OF ATTENUATORS

NOW...

Bomac

**dual TR
MICROWAVE tubes
covering
the frequencies
from 1215 to 17,000 mc.**

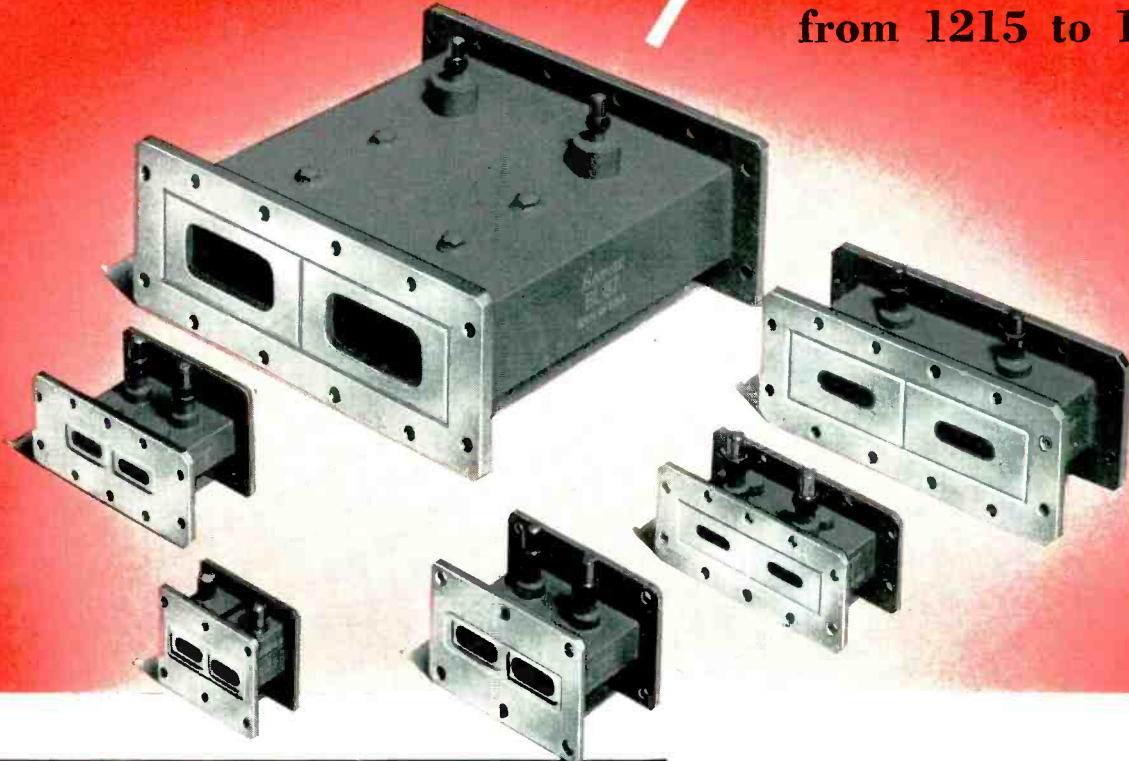

PAT. APPLIED FOR

DUAL TR AND ATR TUBES

Band	Frequency	Center Frequency	Power Level KW Max.	Type	Description	Tube Designation
L	1215-1355	1285	2000	TR	Dual, Band Pass	6634/BL90
S	2600-3000	2800	750	TR	Dual, Band Pass	6636/BL87
S	2650-2950	2800	750	ATR	Dual	BL92
C	5400-5900	5650	700	TR	Dual 5865	6640/BL60
C	5400-5900	5650	3000	TR	Dual 6568, Band Pass	BL613
C	5400-5900	5640	300	ATR	Dual, Fixed-Tuned, Contact Mount	BL63
X	8490-9578	9000	200	TR	Dual IB63A	6334/BL27
X	8490-9578	9000	200	TR	6334 tapped Flanges Both Ends	BL78
X	8490-9578	9000	200	TR	6334 plus Separate Channel IB63A	BL81
X	8490-9578	9000	200	TR	6334 with Recovery Time 1 μ sec at 1 db	6643/BL84
X	8490-9578	9000	200	TR	BL84 with Heater	BL84H
X	8490-9578	9000	200	TR	6334 with Large X Flange Input and Small X Flange Output	6642/BL600
X	8490-9578	9000	200	TR	Dual IB63A, 2 μ sec Recovery Time	6646/BL604
X	8490-9578	9000	200	TR	BL604 with Heater	6647/BL604H
X	8490-9578	9000	200	TR	6334 with Special Hole Dimensions for Aluminum Flanges	BL607
X	8490-9578	9000	200	TR	6334 with Special Saddle Type Flange	6648/BL615
X	8500-9600	9050	250	TR	Large X Guide	6501
X	8500-9600	9050	250	TR	Four-Element Tube for Large X Guide	6564/BL71
X	8490-9578	9000	250	—	Integral 6334 Hybrid Duplexer	BL507
Ku	15000-17000	16000	100	TR	Dual, Band Pass	6560/BL35

Unlimited design possibilities are now afforded the systems engineers with Bomac's complete line of dual TR tubes.

Bomac dual tubes are designed for use with suitable short-slot hybrid junctions to provide balanced duplexers of utmost simplicity.

In operation, the balanced duplexer is similar to magic-T or rat race duplexers. The very low coupling between the transmitter and antenna eliminates the necessity of employing one or more ATR tubes and reduces the losses introduced in radar systems by these tubes. The features of compactness, weight and excellent performance with respect to both transmission and reception characteristics offered by these dual tubes hold many advantages for microwave systems designers and engineers.

Bomac offers a complete line of hybrids to be used in conjunction with these dual tubes — the tubes can be supplied with integral shutters, offering continuous crystal protection.

We invite your inquiries regarding

- ENGINEERING
- DEVELOPMENT
- PRODUCTION

Bomac Laboratories, Inc.

BEVERLY, MASSACHUSETTS

GAS SWITCHING TUBES · DIODES · HYDROGEN THRATRONS · DUPLEXERS · MAGNETRONS
· MODULATORS · CAVITIES

Catalog on request.
Write (on your company letterhead)
Dept. E-6 BOMAC
Laboratories, Inc.
Beverly, Mass.



NEW Tektronix Portable Oscilloscope

gives you Laboratory Performance
...in the FIELD!



The Tektronix Type 310 is fully capable of performing much of your laboratory work, yet has the physical characteristics desirable for work away from your bench. It handles easily and fits into tight spots, simplifying field maintenance of complex electronic equipment. The high performance of the Type 310 can help you speed up your field work...its low weight and small size can ease your equipment handling problem.

Complete accessibility to tubes and components is maintained by a unique step-chassis construction, hinged at the rear. Accurate calibration and excellent linearity permit reliable quantitative measurements—you read time and amplitude directly from the screen. Functional panel design and versatile control system contribute to operator convenience, making this new oscilloscope an easy-to-use field and lab instrument.

TYPE 310 CHARACTERISTICS

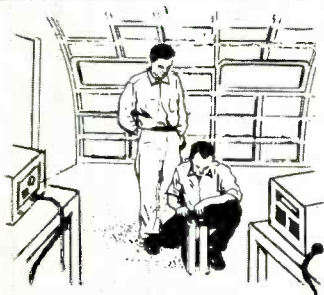

IN THE FIELD



IN THE LAB

Portability

Overall dimensions—6 $\frac{3}{4}$ " wide,
10" high, 17" deep.
Weight—only 23 $\frac{1}{2}$ " pounds.

Transient Response

Risetime—0.09 μ sec.

Sensitivity

DC to 4 mc—0.1 v/div to 50 v/div in 9 calibrated steps, 0.1 v/div to 150 v/div continuously variable. AC-Coupled—3 db down at 2 cycles. AC-Coupled only, 2 cycles to 3.5 mc—0.01 v/div to 0.1 v/div in 3 calibrated steps.

Versatile Triggering

Internal, external, line... ac- or dc-coupled, and AUTOMATIC TRIGGERING.

Flat-faced CRT

3WP with 1.8-kv accelerating potential.
Edge-lighted graticule with $\frac{1}{4}$ " divisions.

Wide Sweep Range

0.5 μ sec/div to 0.6 sec/div, continuously variable.
18 calibrated sweeps from 0.5 μ sec/div to 0.2 sec/div. Accurate 5-x magnifier extends calibrated sweep range to 0.1 μ sec/div.

Horizontal Input

Sensitivity—1.2 v/div.

Voltage Calibrator

Square wave, approximately 1 kc—
0.05 v to 100 v in 11 steps.

Jewel Warning Light

Indicates when controls are at non-calibrated settings.

Power Requirements

105 to 125 v, 60 to 800 cycles, 175 watts.

DC-Coupled Unblinking

All DC Voltages Electronically Regulated

Type 310 Cathode-Ray Oscilloscope — \$595

f.o.b. Portland (Beaverton), Oregon

Please call your Tektronix Field Engineer or Representative for complete specifications, or write to:

Tektronix, Inc.

P. O. BOX 831A • PORTLAND 7, OREGON
CYpress 2-2611 • CABLE: TEKTRONIX

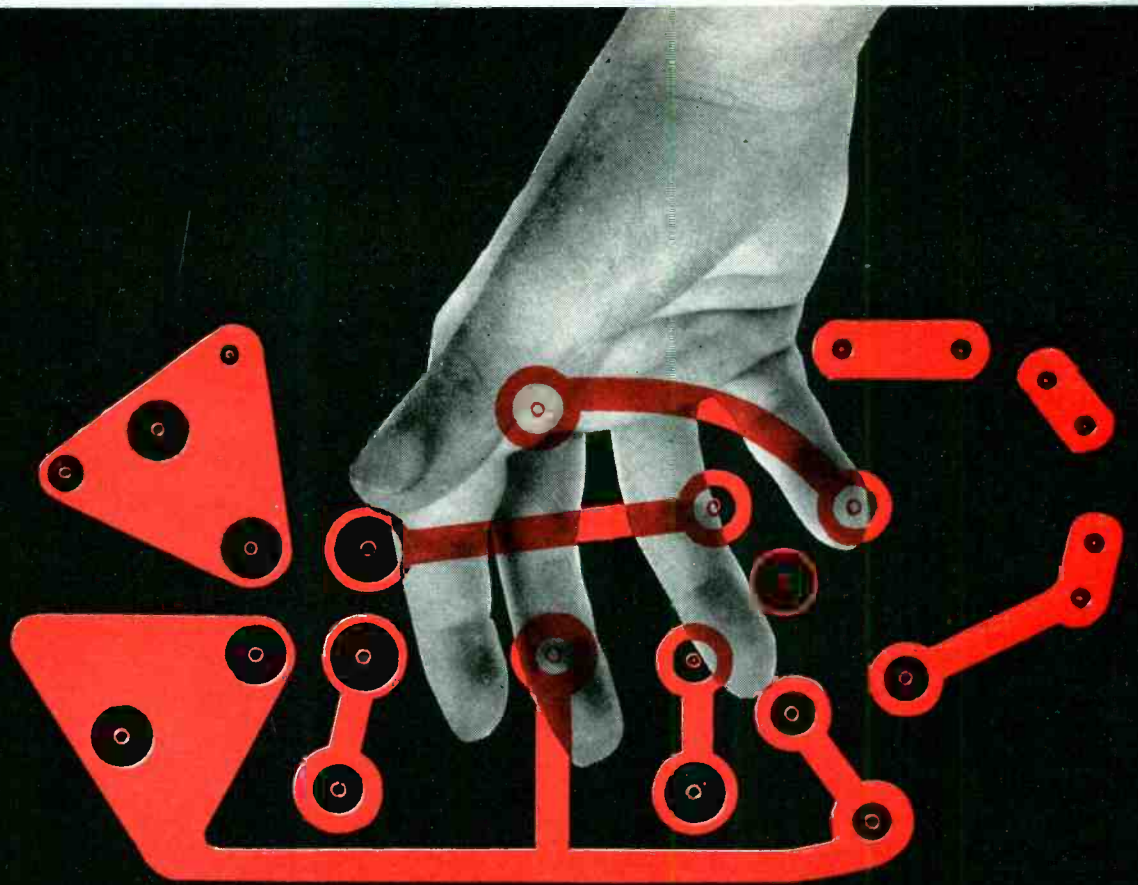

THE POWER OF THE PRESS

Printed Circuitry is the development
that's revolutionizing the electronics industry...
and we at C-D are proud of the
part we're playing in this "giant step" of progress.

Whatever your product... from television
and tape recorders to hearing aids, radar or rockets...
C-D's Printed Wiring Division
offers printed circuitry designed specifically for you.
Write for Brochure PRT 255 to
Cornell-Dubilier Electric Corp., South Plainfield, New Jersey.

consistently dependable



CORNELL-DUBILIER CAPACITORS

Plants in South Plainfield, N. J.; New Bedford, Worcester and Cambridge, Mass.;
Providence and Hope Valley, R. I.; Indianapolis, Ind.; Sanford and Fuquay Springs, N. C.; Venice, Calif.;
Subsidiaries: The Radiart Corporation, Cleveland, O.
and Cornell-Dubilier Electric International Corp.

THERE ARE MORE C-D CAPACITORS IN USE TODAY THAN ANY OTHER MAKE

GENERAL ELECTRIC ANNOUNCES

Vac-u-Sel RECTIFIERS

New Line of G-E Component Rectifiers Achieves 3 Performance Highs

- 63 VOLT PEAK INVERSE
- 130 C AMBIENT OPERATION
- 60,000 HOUR LIFE EXPECTANCY

General Electric's new line of Vac-u-Sel Component rectifiers offer greater application flexibility than any other rectifiers in history. You can now obtain a rectifier cell with a peak inverse rating of 63 volts, or a rectifier which will operate up to 130 C ambient temperature, or a rectifier which has a life expectancy of 60,000 hours.

New G-E Vac-u-Sel rectifiers now make it possible to match performance requirements for life expectancy, ambient operating temperature, and atmospheric protection, as well as electrical characteristics.

THREE NEW RECTIFIER CELLS make up the new line of Vac-u-Sel rectifiers; a 26-volt low temperature cell, a 26-volt high temperature cell, and a 45-volt high temperature cell. All three are produced by the vacuum evaporation process described at the right, but special variations in the manufacturing give them distinctly different electrical characteristics.

26-VOLT LOW TEMPERATURE CELL is the standard industrial cell, used on applications where ambient operating temperature will not exceed 55 C. Rectifiers using this cell have a life expectancy of 60,000 hours at normal current rating.

26-VOLT HIGH TEMPERATURE CELL can meet operating requirements up to 130 C at full voltage. Current need not be derated where shorter life is acceptable. Life expectancy at 130 C is 1000 hours.

45-VOLT HIGH TEMPERATURE CELL has a 63-volt peak inverse voltage. Unlike most 45-volt rectifiers, this is a true, long-life industrial cell. Frequently this rectifier may be substituted for ones employing 26-volt cells. Since fewer cells are required, savings of up to 30% in cost, and up to 35% in the size of the stacks are possible. Life expectancy of this 45-volt cell is 40,000 hours, and the cells can be used at ambient temperatures up to 110 C.

ALL VAC-U-SEL RECTIFIERS operate with exceptionally low forward voltage drop and low reverse leakage, and their margin of superiority in these characteristics increases in service. All Vac-u-Sel rectifiers undergo extensive testing and grading, and matched cells are used in assembling stacks. A variety of finishes and mounting arrangements are available to meet virtually any requirements.

MORE INFORMATION on these new Vac-u-Sel rectifiers is available from your nearest General Electric Apparatus Sales Office, or by writing Section 461-36, General Electric Co., Schenectady 5, N. Y.

Progress Is Our Most Important Product

GENERAL ELECTRIC

RECTIFIER DEPARTMENT

METALLIC RECTIFIER COMPONENTS FOR PRACTICALLY EVERY DC REQUIREMENT

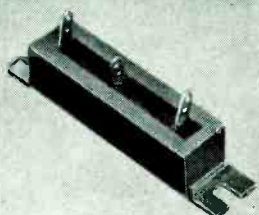

VAC-U-SEL



SELENIUM



COPPER-OXIDE

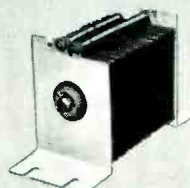

GERMANIUM



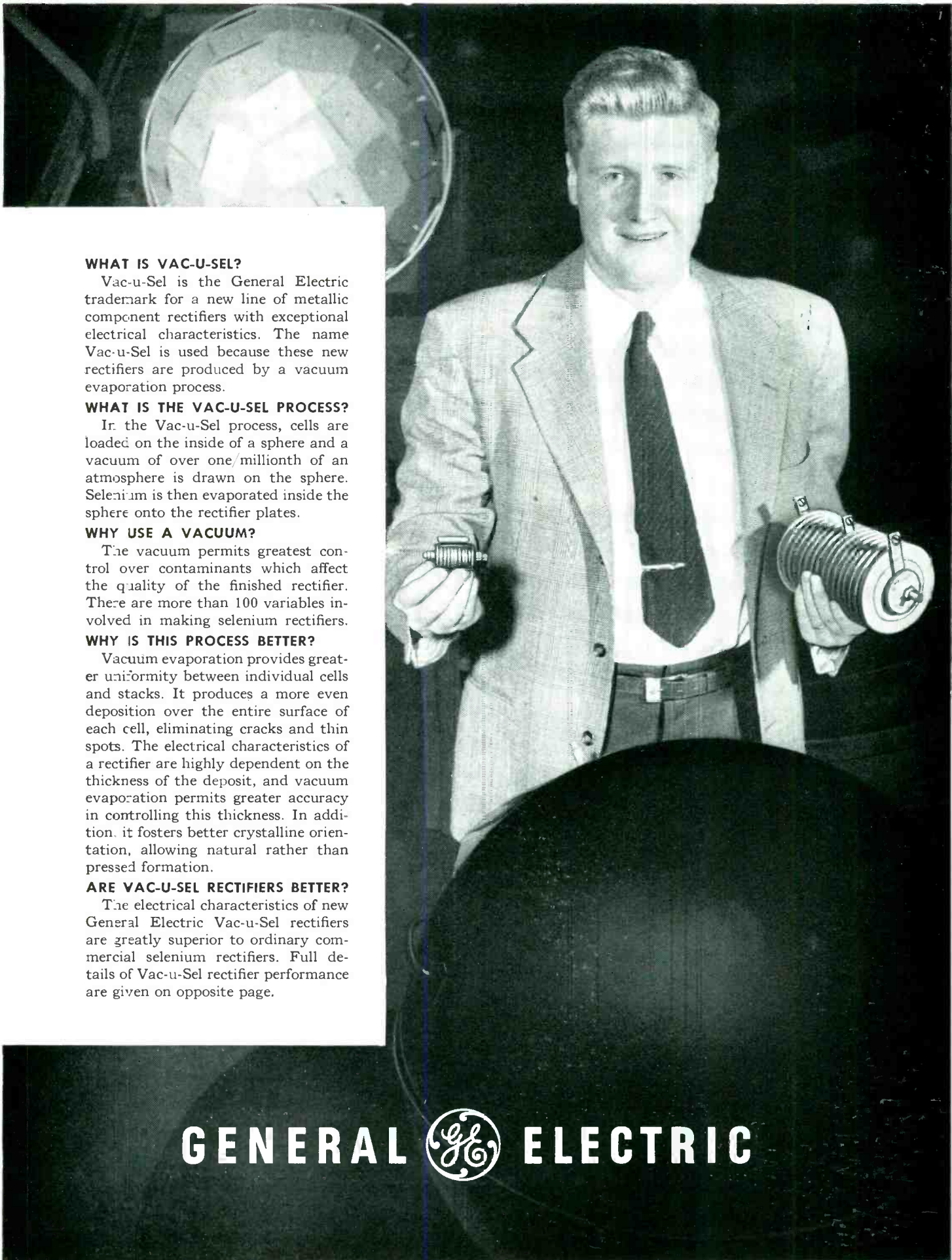

WHAT IS VAC-U-SEL?

Vac-u-Sel is the General Electric trademark for a new line of metallic component rectifiers with exceptional electrical characteristics. The name Vac-u-Sel is used because these new rectifiers are produced by a vacuum evaporation process.

WHAT IS THE VAC-U-SEL PROCESS?

In the Vac-u-Sel process, cells are loaded on the inside of a sphere and a vacuum of over one-millionth of an atmosphere is drawn on the sphere. Selenium is then evaporated inside the sphere onto the rectifier plates.

WHY USE A VACUUM?

The vacuum permits greatest control over contaminants which affect the quality of the finished rectifier. There are more than 100 variables involved in making selenium rectifiers.

WHY IS THIS PROCESS BETTER?

Vacuum evaporation provides greater uniformity between individual cells and stacks. It produces a more even deposition over the entire surface of each cell, eliminating cracks and thin spots. The electrical characteristics of a rectifier are highly dependent on the thickness of the deposit, and vacuum evaporation permits greater accuracy in controlling this thickness. In addition, it fosters better crystalline orientation, allowing natural rather than pressed formation.

ARE VAC-U-SEL RECTIFIERS BETTER?

The electrical characteristics of new General Electric Vac-u-Sel rectifiers are greatly superior to ordinary commercial selenium rectifiers. Full details of Vac-u-Sel rectifier performance are given on opposite page.

GENERAL  ELECTRIC

YOU CAN RELY ON BUSS . .

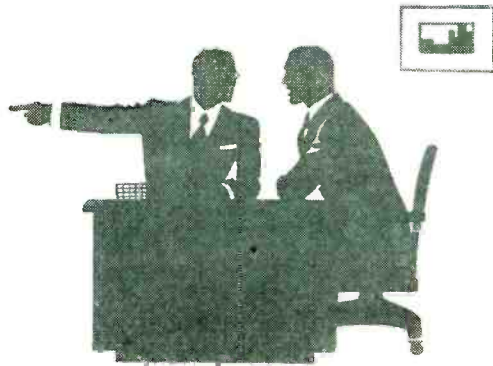

for Fuses of Unquestioned High Quality

Here's why—Millions upon millions of BUSS fuses have given dependable electrical protection in homes, on farms and in industries over the past 40 years, thus establishing the unquestioned high quality of BUSS fuses.

With a reputation like this, BUSS can't afford to take a chance with faulty fuses that could injure its business and yours.

That's why every BUSS fuse, normally used by the Electronic Industries, is tested in a sensitive electronic device that automatically rejects any fuse not correctly calibrated, properly constructed and right in all physical dimensions.

Fuses that give you double protection against loss of user goodwill are the result. Not only are users guarded against damaged equipment when there is trouble on the circuit, but they are also protected against irritating shut-downs caused by needless blows.

Then why not be sure your buying and stock records specify BUSS and FUSETRON fuses . . . you'll save time and trouble by using BUSS as the one source for all your fuse needs.

Makers of a complete line of fuses for home, farm, commercial, electronic and industrial use.

BUSSMANN MFG. CO.



University at Jefferson,
St. Louis 7, Mo.

STAND PAT WITH CLAROSTAT

Wire Wound POWER RESISTORS

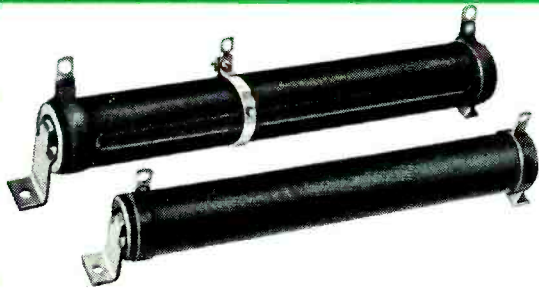

Fixed or adjustable "Greenohm" power resistors. 5 to 200 watts.

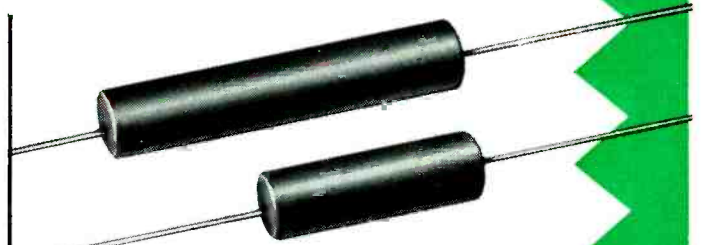

Greenohm Jr.* cement-cased tubular power resistors for point-to-point wiring. 5, 10, 14, 15 and 20 watts.

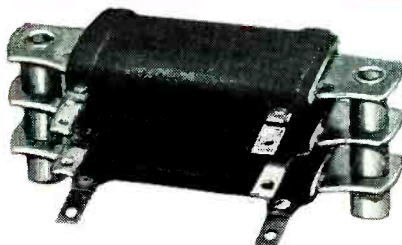

Series ZT Stack Mounting resistors, 30 to 75 watts. Approved for RW-20 through RW-24 characteristics G and J of MIL-R-26A specifications.

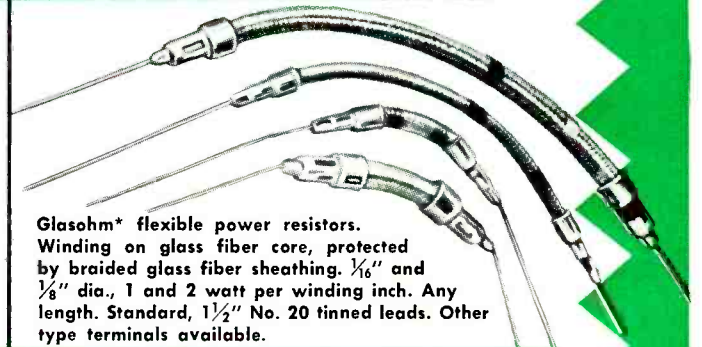

Glasohm* flexible power resistors. Winding on glass fiber core, protected by braided glass fiber sheathing. $\frac{1}{16}$ " and $\frac{1}{8}$ " dia., 1 and 2 watt per winding inch. Any length. Standard, $1\frac{1}{2}$ " No. 20 tinned leads. Other type terminals available.



Standee* power resistors. 10, 15, 20, 25 and 30 watts.



Power Resistor Decade Box.

Consider these three good reasons why your power resistor requirements are best met by specifying CLAROSTAT...

1. Adequate choice of types, wattages, resistance values, terminals, mountings. No need to improvise. No wasted time and effort trying to make the wrong thing do. Rather, you can get the correct Greenohm*, Glasohm*, Standee* or Series ZT Stack Mounting resistors for your exact needs.
2. And you can make sure of the exact resistance value and wattage rating by using the Clarostat Power Resistance Decade Box. It inserts in the actual working circuit and under actual working

conditions, any resistance value from 1 ohm to 999,999 ohms, at the mere flip of knobs. When best operating conditions are attained, you read the inserted resistance value right off the six dials. No guessing. No calculating. Rather, the correct resistance value.

3. Install the "Greenohm" or "Glasohm" or other Clarostat power resistor. You can now "Stand Pat with Clarostat." For the millions of Clarostat resistors in daily use, month after month, year after year, in all kinds of radio-electronic and electrical assemblies, are proof sufficient that no tougher power resistors are available today.

WRITE for Engineering Bulletins. Let us collaborate on your resistor problems and needs, whether standard or special.



*Reg. U. S. Pat. Off.

Controls and Resistors

CLAROSTAT MFG. CO. INC., DOVER, NEW HAMPSHIRE

In Canada: Canadian Marconi Co., Ltd., Toronto 17, Ont.

Manufactured under license in Great Britain by A. B. Metal Products Ltd., 17 Stratton St., London W. 1, Concessionaires for British Commonwealth except Canada.



ALLEN-BRADLEY COPPER CLAD MOLDED RESISTORS

rated at 3 and 4 watts at 70C Ambient Temperature

A new and important addition to the Allen-Bradley line of radio, electronic, and television components are these Types GM and HM copper clad Bradleyunits, each fitted with a heavily tinned copper clamp. These new resistors are designed to be attached to a metal panel or chassis with rivets, bolts, or self-tapping screws. If attached to a metal panel four inches square and 0.050 in. thick at an ambient temperature of 70 C, the maximum continuous wattage rating of the Type GM Bradleyunit is 3 watts; the Type HM Bradleyunit is 4 watts. At

40C ambient temperature, the ratings are 4 and 5 watts, respectively. However, if these copper clad Bradleyunits are suspended by their leads without being bolted to a metal panel, their respective ratings are 1 and 2 watts.

The copper clamp does not completely encircle the Bradleyunit, thus leaving a slot through which the color-code bands are plainly visible. Type GM Bradleyunits are available in all RETMA values from 2.7 to 22 megohms and Type HM Bradleyunits from 10 ohms to 22 megohms.

Allen-Bradley Co., 110 W. Greenfield Ave., Milwaukee 4, Wis. • In Canada—Allen-Bradley Canada Limited, Galt, Ont.

OTHER QUALITY COMPONENTS FOR RADIO, TV & ELECTRONIC APPLICATIONS

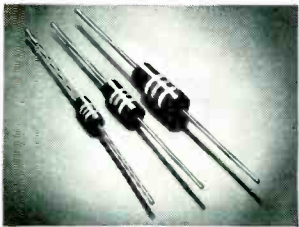

BRADLEYUNITS
1/2, 1, 2, 3 & 4 WATT

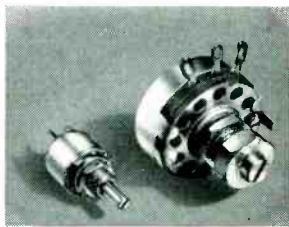

BRADLEYOMETERS
1/2 & 2 WATT

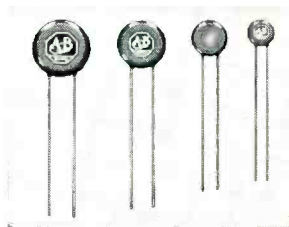

CERAMIC CAPACITORS
0.00001 to 0.022 MFD

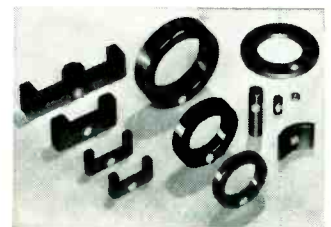

FERRITE COMPONENTS
HIGH EFFICIENCY

ALLEN-BRADLEY

RADIO, ELECTRONIC AND TELEVISION COMPONENTS

FIRST V-O-M with ALL in ONE!

TRIPLETT

MODEL 630-NA
 Volt-Ohm-Mil-Ammeter
 DEALER Net Price . . . \$69.50

MODEL 630 Famous
 Volt-Ohm-Mil-Ammeter \$39.50
 33 ranges and many other
 features making this the
 favorite in a popular V-O-M line

MODEL 630-A Laboratory Type
 Volt-Ohm-Mil-Ammeter with
 mirror scales, 1-1/2% DC
 accuracy and special 1/2%
 resistors for greater accuracy.
 Found in the best laboratories
 and production lines. \$49.50

MODEL 631 Combination
 V-O-M and VTVM \$59.50
 This sensational 2-in-1 battery
 operated combination saves
 you money — will do all your
 work easier at half the price.

MODEL 666-R Pocket size
 V-O-M. Practically a portable
 laboratory with self contained
 snap-in type batteries. \$26.50

The above are examples of
 the complete Triplett V-O-M
 line in which 10,000 ohms per
 volt AC sensitivity has been
 featured for 10 years.

TRIPLETT HAS THE MOST COMPLETE V-O-M LINE

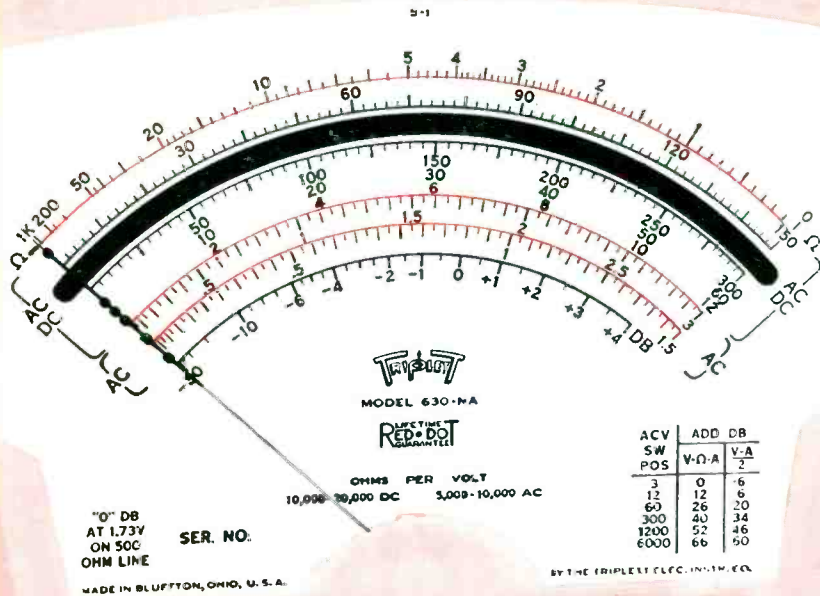

70 RANGES . . . nearly double those of conventional testers
FREQUENCY COMPENSATED . . .
 for accurate readings over entire audio range
HIGH AC-DC ACCURACY ON SAME SCALE
ACCURACY: 1-1/2% DC to 1200 Volts, 3% AC to 1200 Volts
METER PROTECTION AGAINST OVERLOADS
TEMPERATURE COMPENSATED . . .
 Accurate within a wide range of ambient temperatures
SIX RESISTANCE RANGES Including 100 Megohms
COMPLETELY INSULATED Black Molded Case
MIRROR SCALE And Knife-Edge Pointer

actual size

**ALL TRIPPLET
 TESTERS APPROVED FOR COLOR
 see them at your distributors**

TRIPPLET

TRIPPLET ELECTRICAL
 INSTRUMENT CO.
 Bluffton, Ohio

TAYLOR

Laminated Plastics
Vulcanized Fibre

Shop Talk

TAYLOR FIBRE CO.

Plants in Norristown, Pa. and La Verne, Calif.

PHENOL—MELAMINE—SILICONE—EPOXY LAMINATES • COMBINATION LAMINATES • VULCANIZED FIBRE • POLYESTER GLASS ROD

Tips for designers

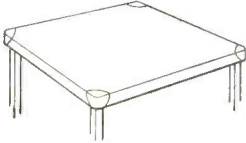

Furniture can make good use of the mar-resistant, tough surface afforded by Taylor Vulcanized Fibre plywood combination table tops.

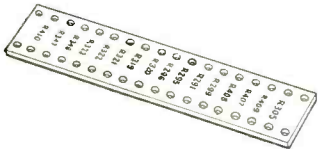

Terminal strips for high-precision electronic instruments benefit by the excellent insulating properties of Taylor XXXP-301 hot-punch phenol laminate.

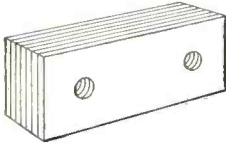

Heavy bumper blocks for steel mill use, made of Taylor Built-Up Fibre several inches thick, give long service under severe shock and abrasion.

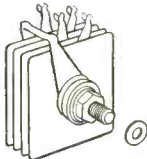

Selenium rectifier plates are insulated by washers made of Taylor Grade 353 phenol laminate . . . chosen for its dimensional stability and mechanical strength.

TAYLOR FABRICATING FACILITIES

Your production can be simplified . . . schedules safeguarded . . . inventory headaches cured . . . and overall costs reduced by having Taylor fabricate finished parts to your specifications. Efficient, modern facilities are ready to serve you. Get in touch with Taylor about your specific requirements.

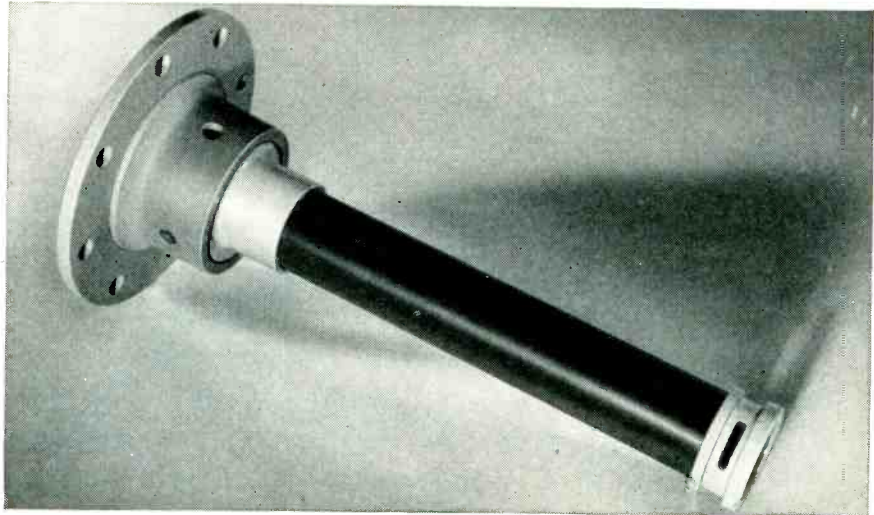

High strength, light weight, excellent insulating and corrosion-resistant qualities make Taylor Epoxy Glass Base Laminate the ideal material for tubing in an aircraft fuel gage tank unit made by Avien, Inc.

When service conditions are tough—use Taylor special-purpose laminates

Designing for severe service? Then take a look at what Taylor special-purpose laminates can do. Taylor's resin chemists have developed special formulations of melamine, silicone and epoxy resins . . . for combination with a variety of base materials. The result is a line of laminates which offer the plus performance that your new designs may require.

Taylor epoxy laminates. Retain superior mechanical properties after exposure to high temperatures (above 430 F) . . . have outstanding electrical characteristics, moisture resistance and resistance to corrosive chemicals . . . setting these laminates apart as a means of solving difficult design problems.

Taylor melamine laminates. Excellent resistance to arcing, electrical co-

rona, flame and chemical attack characterizes these materials . . . useful in many electrical applications.

Taylor silicone laminates. These withstand temperatures up to 500 F . . . provide insulation where other laminates thus far cannot be used. They also possess high mechanical strength, low power factor and low moisture absorption.

Sheets, tubes and rods of these materials are available in a range of sizes that will give you maximum economy of material in your manufacturing processes.

To help you in the application of these specialized materials to your specific product, Taylor offers the service of its experienced engineering staff. Call on Taylor for a consultation on your individual requirements.

Here's the New

PHILCO

SB

(Surface Barrier)

TRANSISTOR



**Industry's First
High Frequency Transistor**

...Available Now!

See Next Page For Details ▶

For the First Time...

High Frequency Circuits Can Be COMPLETELY TRANSISTORIZED

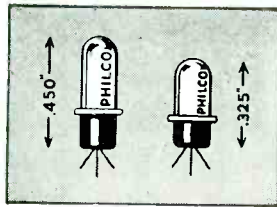

Philco SB Transistors are available in the sizes shown here—standard and miniature.

Today, Philco's new SB Transistor opens up a completely new field of commercial, industrial and military applications for the electronics design engineer. With vastly superior performance assured to 50mc and above, many basic circuits can now be *completely transistorized*. Video bandpass amplifiers, wide band low-pass amplifiers, high frequency oscillators and high speed switching are only a few of the innumerable circuits which the design engineer can produce quickly, easily, efficiently with the revolutionary new SB Transistor.

UP TO 10 TIMES BATTERY LIFE

The Philco Surface Barrier Transistor operates efficiently with power consumption of less than *one* milliwatt! This extremely low power drain results in up to *ten* times the battery life obtainable with junction transistors, vastly reducing operating costs. Hermetically sealed, the SB Transistor has greater inherent characteristics of stability, longer life and higher efficiency than any other type of transistor.

HIGHEST UNIFORMITY YET ATTAINED

Due to Philco's unique design and precision production methods, the SB Transistor reaches a degree of uniformity and unvarying quality never before achieved with transistors. This remarkable quality permits design engineers to specify the Philco SB Transistor with full assurance of superior performance.

Now being produced in quantity this new Philco SB Transistor is available for your current projects and immediate shipment can be made to you.

**For complete technical information on the PHILCO SB Transistor
write Dept. E**

PHILCO CORPORATION
GOVERNMENT AND PHILADELPHIA 44,
INDUSTRIAL DIVISION • PENNSYLVANIA

In Canada: Philco Corporation of Canada Limited, Don Mills, Ontario

V.V.T.*

the "Phantom Saboteur" of Automation
 can cause 101 production troubles...
 rejects... without your knowing it!

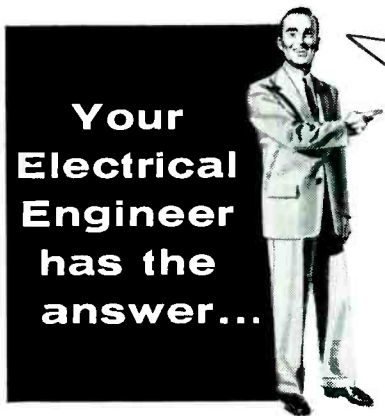

Your
 Electrical
 Engineer
 has the
 answer...

*
 "Varying Voltage Trouble
 plays hob with timers, sole-
 noids, and electronic gear in
 production and inspection
 departments. A Stabiline
 Automatic Voltage Regu-
 lator prevents this 'sabo-
 tage'."

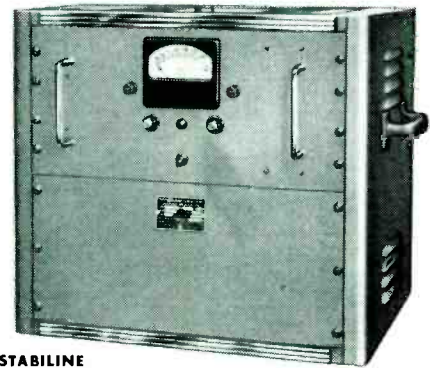

**STABILINE
 Type EM 4115**
 Superior Electric offers a complete line of automatic
 voltage regulators. Send for Bulletin S351.

● Automatic machines and processes
 . . . inspection department equipment
 can go "haywire" every time your volt-
 age varies — even within so-called
 "allowable limits". Given the oppor-
 tunity your plant Elec-
 trical Engineer

can spot V.V.T. and help you cure many
 production headaches you now con-
 sider to be "routine trouble" that you
 have to live with. When he recommends
 a Stabiline automatic voltage regulator
 you can be sure *these* troubles are under
 control.

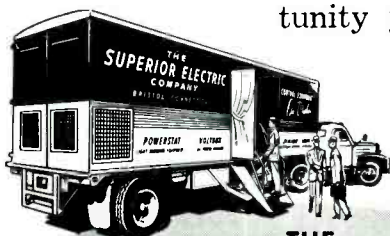

See Superior Electric's
 Mobile Display when
 it visits your area.

THE
 SUPERIOR ELECTRIC
 COMPANY

BRISTOL, CONNECTICUT

Manufacturers of: POWERSTAT Variable Transformers • STABILINE
 Automatic Voltage Regulators • VOLTBOX A-C Power Supplies
 LUXTROL Light Control Equipment • VARICELL D-C Power Supplies
 Superior 5-WAY Binding Posts

THE SUPERIOR ELECTRIC COMPANY, 205 Reynolds Ave., Bristol, Conn.

Please send me a copy of your STABILINE Bulletin S351.

Name.....

Company Name.....

Company Address.....

City.....Zone.....State.....

Simplify Your Access Panel and Door Assemblies...

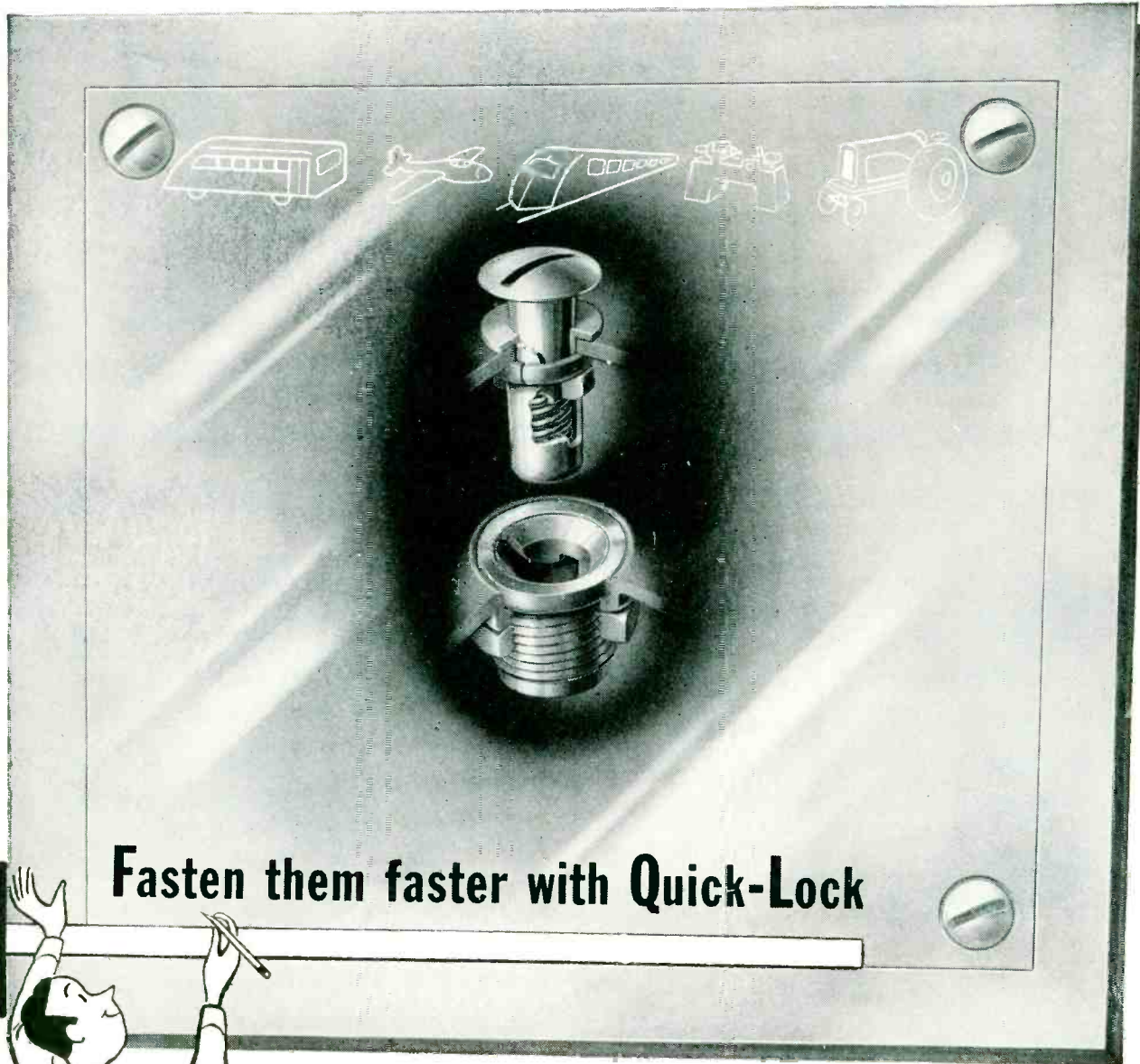

Fasten them faster with Quick-Lock

Fastening removable access doors and panels need not be a laborious and costly production or assembly operation—not if they're fastened with QUICK-LOCK.

Designed for simple installation, QUICK-LOCK requires no special tools. It speeds up mounting and demounting detachable panels with only a 90° turn required to lock and unlock it *in a jiffy*.

The flexible mounting and tapered stud makes QUICK-LOCK ideal for assembling curved sheets and insures a tight fit when locked. Stud is self-ejecting when unlocked. Minimum deflection is assured—only initial loads are carried by the helical spring. Solid supports take up increased loads.

Industrial and agricultural equipment manufacturers would do well to analyze the cost-saving features of QUICK-LOCK's simple design. A good way would be to call in a Simmons Engineer and discuss the economy of a QUICK-LOCK installation as compared to your present fastening method. Why not send for him today?

SIMMONS FASTENERS

SIMMONS FASTENER CORPORATION • 1750 NORTH BROADWAY, ALBANY 1, N. Y.

HIGH POWER SILICON RECTIFIERS

UP TO 10 AMPERES AT 125°C



ACTUAL SIZE

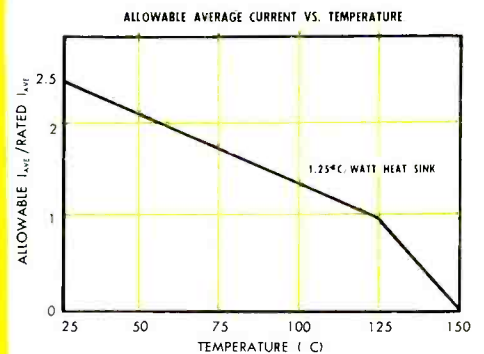
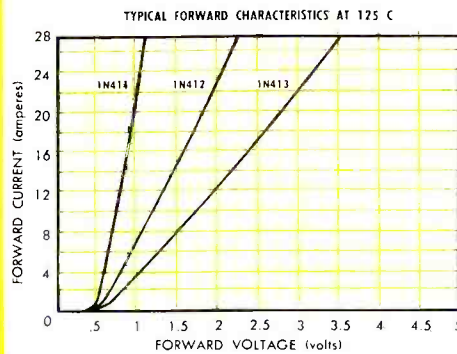
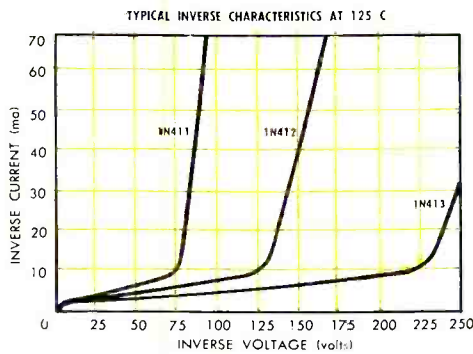

- ✚ Reliability at High Temperatures
- ✚ High Power Handling Ability
- ✚ Negligible Leakage Current
- ✚ No Forward Aging
- ✚ High Conductance
- ✚ Miniature Size
- ✚ Hermetic Sealing

Transitron's high power silicon rectifiers are designed for reliable high temperature operation in power supply and magnetic amplifier applications. Types 1N411 and 1N412 are particularly useful for 28 Volt DC supplies, while type 1N413 is designed for 130 Volt AC bridge rectifier service.

Overcoming the basic limitations of selenium, germanium and the gas-filled tube, these rugged rectifiers also offer major savings in both size and weight. Bulletin TE1321C contains detailed information.

In addition to high power types, Transitron manufactures a complete line of medium power silicon rectifiers and diodes. Write for Bulletins TE1321 and TE1322.

TYPE	RATINGS AT 125°C			
	PEAK RECURRENT INVERSE VOLTAGE (VOLTS)	MAXIMUM RMS VOLTAGE (VOLTS)	MAXIMUM AVERAGE FORWARD CURRENT (AMPERES)	
			25°C*	125°C*
1N411	50	35	25	10
1N412	100	70	18	7
1N413	200	140	12	5

*Rectifier mounted in a 1.25°C/Watt heat sink.

Transitron
electronic corporation
melrose 76, massachusetts



Glass Diodes



Silicon Diodes



Germanium Diodes



Transistors



Silicon Rectifiers



Never before!

NOT 2: motor + gear train
BUT ONE homogeneous unit
New Power Motor-Gear-Train

1. Unique: *Not 2* separate units but a single entity. An entirely new principle—another OSTER "first."

2. More Versatile: Any output speed from 10,000 to .3 RPM.

3. Extremely High Torque Capacity: e.g., 100 #-in. at 523:1 and 1600 #-in. at 10,500:1.

4. Lighter-Smaller: e.g., 10-1/2 oz., 1-1/2" dia., 3-1/2" long at 523:1 ratio.

5. Available in 28 V and 115 V DC or in 28 V and 115 V 400 cycle AC

6. 1.50" dia. (Type 3094) illustrated. Variations include 1.25" dia. (Type 3101), 1.062"* dia. (Type 3200) and 1.75"* dia. (Type 2487).

*Available soon.

For a precision speed reducer with low backlash and low composite error at a moderate price specify an OSTER Power Motor-Gear-Train adapted to your individual application. Write for further information TODAY.



Actual Size
1.50" dia. (Type 3094)

Oster[®]

JOHN OSTER MANUFACTURING CO.
AVIONIC DIVISION
RACINE, WISCONSIN

Your Rotating Equipment Specialist

Other products include Actuators, AC Drive Motors, DC Motors for Special Applications, Fast Response Resolvers, Servo Torque Units, Low Inertia Servo Motors, Synchro Differentials, Two-Phase Reference Generators, Tachometer Generators and Motor Driven Blower and Fan Assemblies.

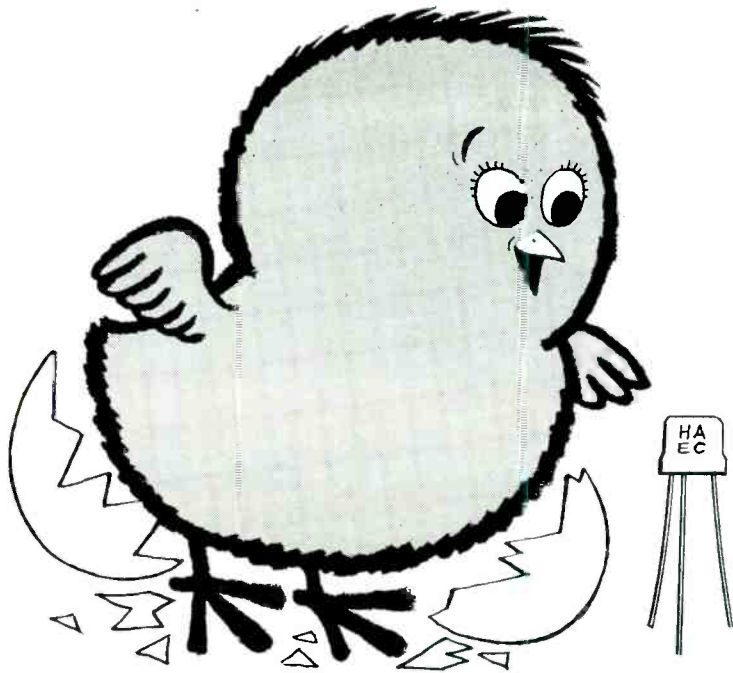

**hatched
by
HYDRO-AIRE**

a low cost **H-F TRANSISTOR** you can count on!

THE BONDED BARRIER TRANSISTOR

First dependable H-F Transistor for quantity production

ABSOLUTE MAXIMUM SPECIFICATIONS	Collector Voltage	-12 volts
	Collector Current	-3 ma
	Collector Dissipation	30 mw
	Ambient Temperature	55°C.

AVERAGE CHARACTERISTICS AT TEMP. 20° C., FREQ. 1 kc, COMMON BASE

Collector Voltage	-4.5 volts
Emitter Current	0.5 ma
H 11, input impedance, output short circuit.	350 ohms
H 12, voltage feedback ratio, input open circuit.	3.5×10^{-4}
H 21, current amplification, output short circuit.	-0.75
H 22, output admittance, input open circuit.	10 mu ohms
Ico, Collector Cutoff Current	-5 mu a.
Max. Power Gain, Gnd. Emitter.	25 db
Freq. Cutoff.	5 mc

- OTHER
HYDRO-AIRE
FIRSTS**
- Hermetic Sealing
 - Transistor Socket Strips
 - Packaged line of Transistorized Audio Pre-amplifiers



**NOW READY FOR QUANTITY
PRODUCTION AT LOW COST**

We held off counting this chicken until it was well and truly hatched! And now that time has come. The Bonded Barrier Transistor has been exhaustively tested, and found dependable in service throughout the frequency range shown at left. Not only that: the Bonded Barrier process is ideally suited for large-scale production. Hydro-Aire's Electronics Division is now completing new mass production facilities to meet the widespread demand for a transistor that offers such great potential in electronic design. Sample quantities are already being shipped to certain users. You will appreciate that we shall have to hold to certain priorities on such a much-needed item; but we shall deal as fairly as possible with all legitimate inquiries. We can only advise you to contact us right away, so that you may be high on the list, both for test quantities now and production quantities later. Please write on your company letterhead.

ELECTRONICS **HYDRO-AIRE**
 Division of 3000 VINONA AVENUE, BURBANK Inc.

The Aviation
Subsidiary of

CRANE Co.

This Magnetic Counter

Adds and Subtracts

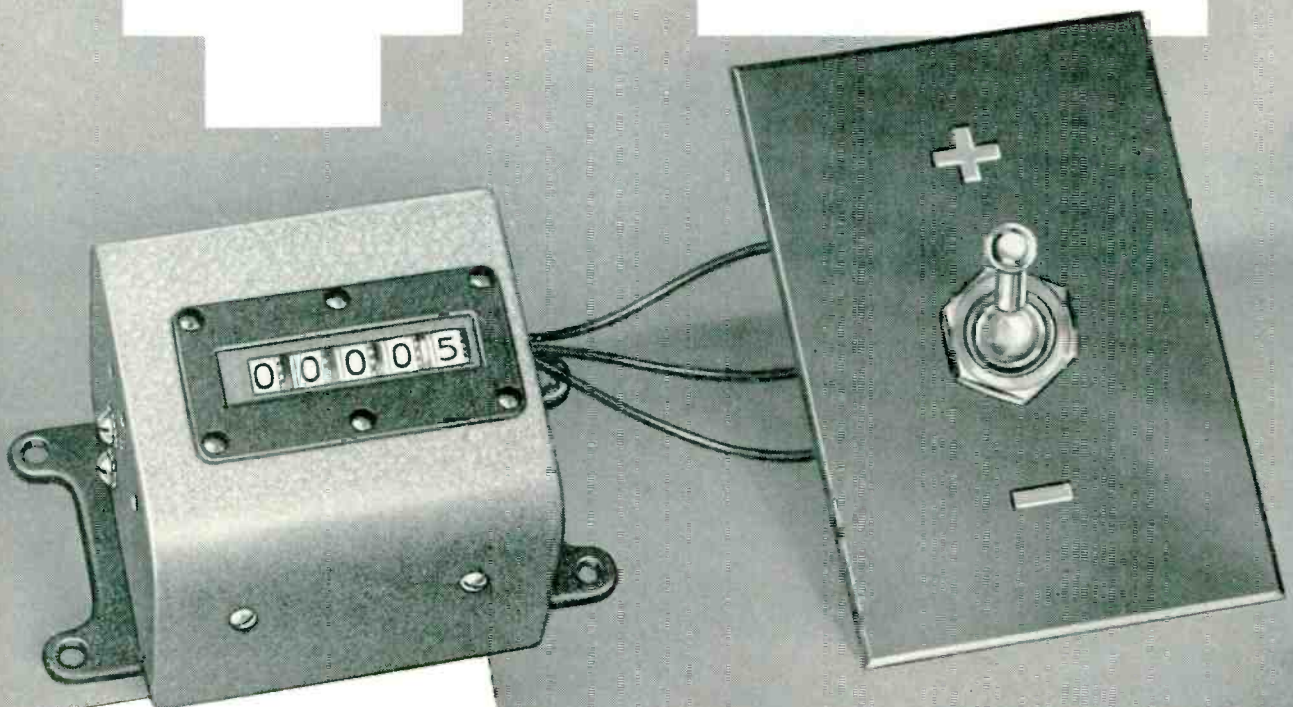

*Added Evidence
that —*

**Everyone Can Count on
VEEDER-ROOT**

Flip the switch up . . . the counter adds. Flip it down . . . it *subtracts*. And this 2-way countability makes this new counter a distinct asset to modern systems of automation, control engineering and stock control. Readily adaptable, easily installed and connected to existing circuits, the Veeder-Root "plus or minus" counter is a reliable double-

check on the operation of machines, processes, systems. And it's just one of scores of standard and special Veeder-Root Counters for every field of reckoning from atomics to electronics to automation. What is *your* counting problem? Let's put a mathematical eye on it . . . write:

VEEDER-ROOT INCORPORATED
HARTFORD 2, CONNECTICUT



Chicago 6, Ill. • New York 19, N. Y. • Greenville, S. C.
Montreal 2, Canada • Dundee, Scotland
Offices and Agents in Principal Cities

"The Name that Counts"

Speaking of resistor quality

... it is worthy of note that Stackpole Fixed Resistors are one of the most widely used brands in meeting today's exacting specifications.



Speaking of resistor supplier co-operation

... the Stackpole record of personal attention to detail in matching resistor requirements and of following through with "on time" deliveries of dependable, fully quality-controlled units, speaks for itself.

Electronic Components Division
STACKPOLE CARBON COMPANY, St. Marys, Pa.

STACKPOLE

FIXED COMPOSITION
R E S I S T O R S

*Backed by the keen personal interest
and full co-operation of the specialists who produce them*

Flexibility in Application
Versatility in design...
packaged
analog-digital
converters

Shaft Position to Digital Converters features reliability, long life, non-ambiguity and speed makes these converters ideal for computers or data handling systems where serial read-out is preferred. Librascope converters transmit information at almost any rate desired up to 1 mc and in some cases above, and may be multiple time-shared, holding extra circuitry to a minimum. All units quickly adjustable, synchro-mounted. Available in Binary, Gray code or Binary decimal code as shown in chart below. Special units may be designed to your order.

Write for catalog information.

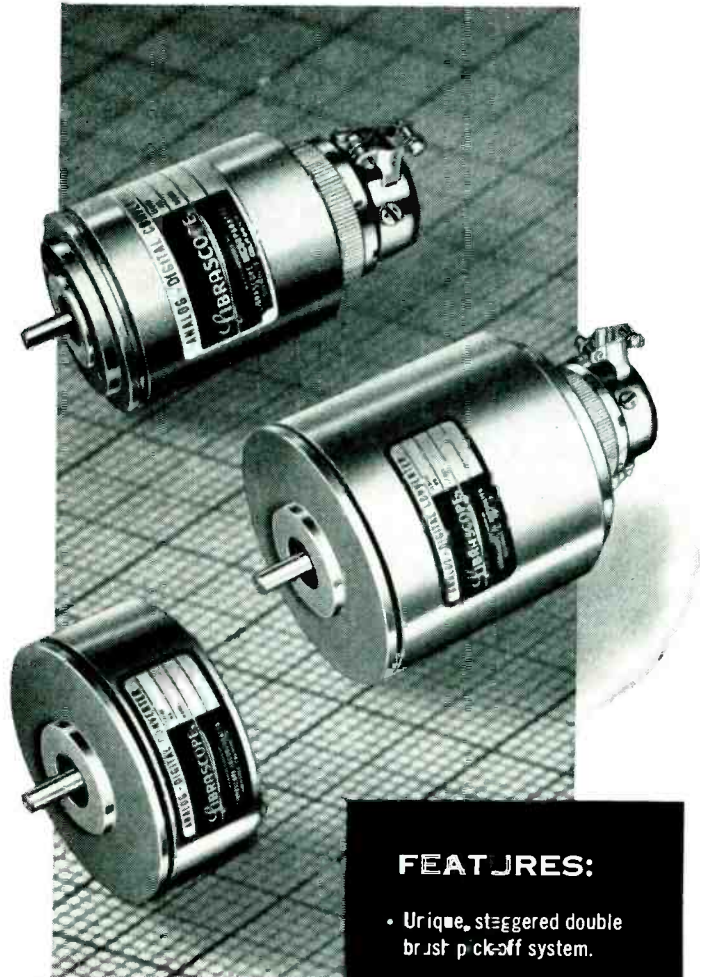

FEATURES:

- Unique, staggered double brush pick-off system.
- Reads out serially into relays or single or multiple scan matrices.
- Analog-digital or digital-analog operation.
- May be time-shared.
- Synchro-mounted.
- Associated circuitry can be designed to fit your data-handling problems.

CODE	MODEL*	RESOLUTION PER INPUT SHAFT REV.	RESOLUTION OVER FULL RANGE	DIMENSIONS DIAMETER X LENGTH
BINARY	7 digit	128	1 part in 123	2" x 2 ¹ / ₆₄ "
	13 digit	128	1 part in 8192	2" x 3 ¹ / ₃₂ "
	17 digit	128	1 part in 131,072	2" x 4 ¹ / ₁₆ "
	19 digit	128	1 part in 524,288	2" x 4 ¹ / ₁₆ "
BINARY CODED DECIMAL	0-2000	200	1 part in 2000	3 ¹ / ₁₆ " x 4 ⁷ / ₃₂ "
	0-3600	200	1 part in 3600	3 ¹ / ₁₆ " x 4 ⁷ / ₃₂ "
	0-20,000	200	1 part in 20,000	3 ¹ / ₁₆ " x 4 ⁷ / ₃₂ "
	0-36,000	200	1 part in 36,000	3 ¹ / ₁₆ " x 6 ⁷ / ₈ "
GRAY	8	256	1 part in 256	3 ¹ / ₁₆ " x 1 ¹ / ₁₆ "
* SPECIAL UNITS AVAILABLE	Precision gearing Shaft Speed: 120 rpm continuous Operating temp: -55° C to +75° C Shock and Vibration: up to 15 G, 5 to 500 cps.		Life Expectancy: Function of lead current. For 13 digit unit @ 2 ma. per brush, life approx. 5x10 ⁴ breaks or makes at approx. 120 rpm.	

Engineers, physicists and mathematicians interested in challenging California careers, contact Mac McKeague, Personnel Director.



A SUBSIDIARY OF GENERAL PRECISION EQUIPMENT CORPORATION

LIBRASCOPE, INC. • 808 WESTERN AVENUE • GLENDALE, CALIFORNIA

Don't take gaskets for granted!

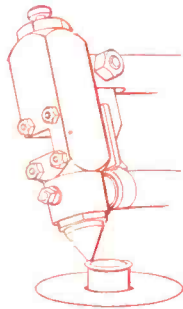

Flowed-in
gaskets are cutting costs, improving results for many users!

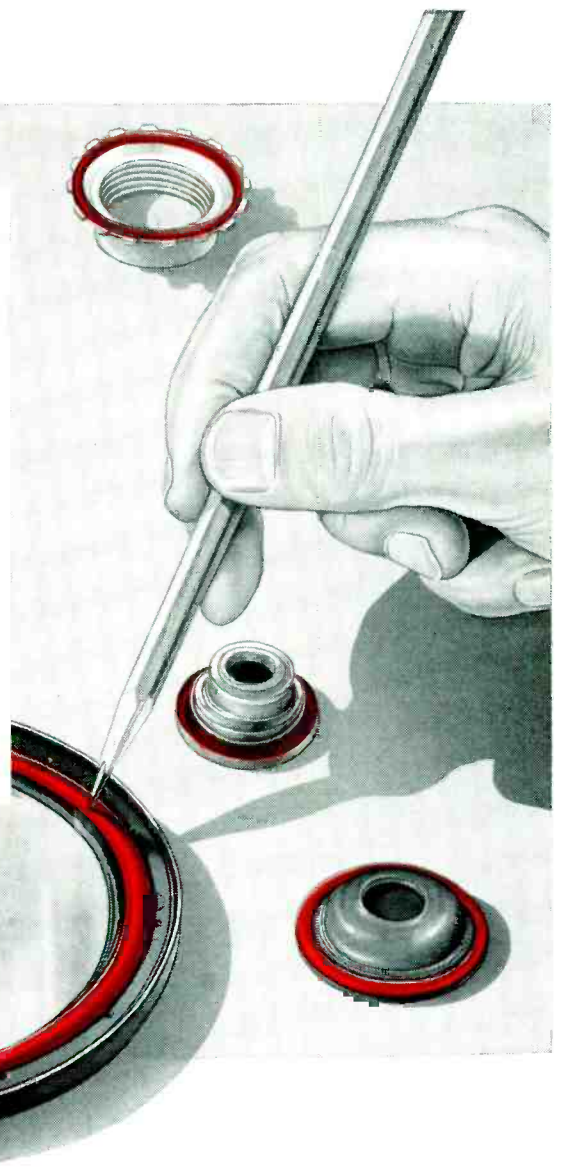

Now electronic parts manufacturers are *flowing* gaskets into place at speeds up to 300 per minute. And they end up with a gasket that is integral with the part and custom-formulated to meet a wide range of problem conditions.

Simple Application. A uniform circular track of "Flowed-in" gasket material is deposited onto a rotating part. Baking or drying transforms the fluid into a solid rubbery gasket.

Important Economies. Gaskets are flowed in place automatically or semi-automatically, replacing costly hand operations. Minimum gasket material is needed for full sealing efficiency. Scrap material problems disappear. Inventories are reduced and simplified.

Resistance Properties. Dewey and Almy "Flowed-in" gaskets are formulated with resistance properties to meet the needs of each particular job. They are now being used to create

effective seals against weather, gases, solvents, moisture, oils, hydraulic fluids, pressure . . . and to form shock-resistant cushions between component parts.

Fully Proven. The equipment which Dewey and Almy designs and builds for the "Flowed-in" gasket process is based on more than 35 years of field experience. The gasketing compounds are a result of Dewey and Almy industrial research in the chemistry of small particle dispersions . . . a continuing research program that has brought benefits to almost every industry, through such varied products as: Battery Separators • Shoe Materials • Sealing Compounds for Food Cans • Resin Adhesives • CRYOVAC Bags for Food Packaging • Soda Lime • Flowed-in Gaskets for Industry • Chemical Products for the Construction Industry • Meteorological Balloons • Print Blankets and other specialized Belting • Organic Chemicals.



DEWEY and ALMY
Chemical Company

DIVISION OF W. R. GRACE & CO.
Cambridge 40, Massachusetts

CUT

Wire forming costs with CHASE® WIRE in new *Payoffpaks!*

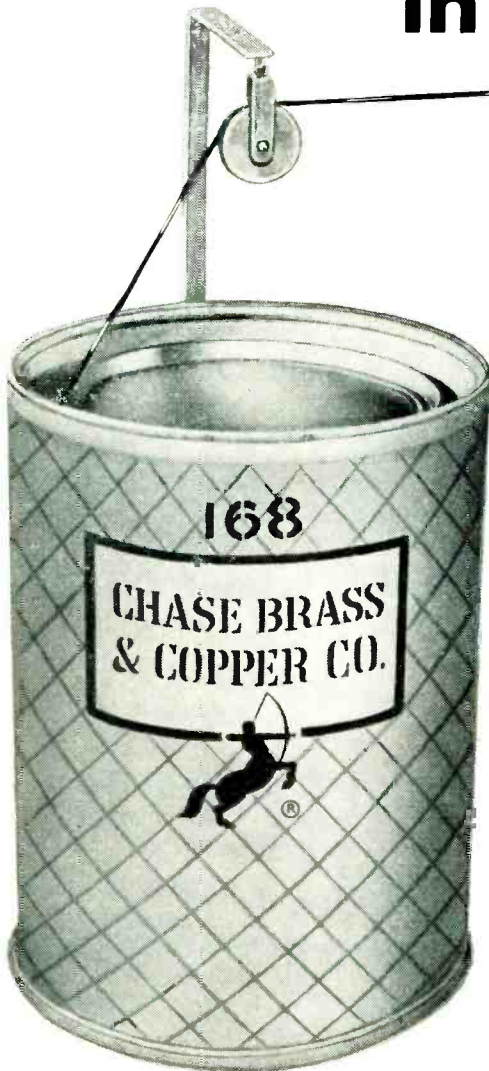

Now, in this compact, easy-to-handle PAYOFFPAK you can get a continuous length of Chase copper alloy wire weighing 400 to 500 pounds!

This new Payoffpak puts an end to frequent set-up of wire-forming machines... means *more* continuous, economical operation, *less* costly down time!

You'll like the easy way this Payoffpak handles, the space-saving way it stores... and the way it protects the shining surface of Chase copper alloy wire from rough handling in transit and storage.

Ask your Chase Wholesaler or nearest Chase Warehouse about the new Payoffpak the next time you order copper alloy wire.

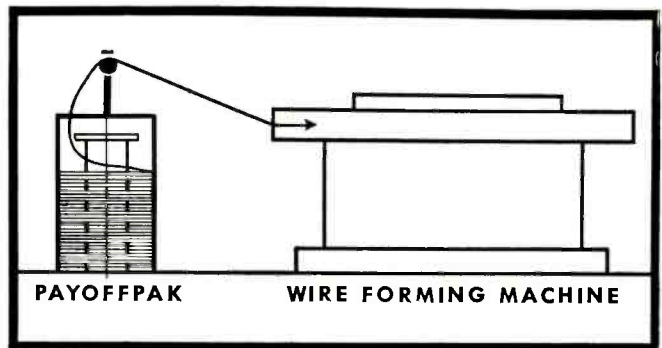

Chase

BRASS & COPPER CO.

WATERBURY 20, CONNECTICUT • SUBSIDIARY OF KENNECOTT COPPER CORPORATION

The Nation's Headquarters for Brass & Copper

- | | | | | | |
|------------|------------|------------------|-------------|--------------|---------------------|
| Albany† | Chicago | Detroit | Los Angeles | New York | St. Louis |
| Atlanta | Cincinnati | Grand Rapids† | Milwaukee | Philadelphia | San Francisco |
| Baltimore | Cleveland | Houston | Minneapolis | Pittsburgh | Seattle |
| Boston | Dallas | Indianapolis | Newark | Providence | Waterbury |
| Charlotte† | Denver | Kansas City, Mo. | New Orleans | Rochester† | (sales office only) |

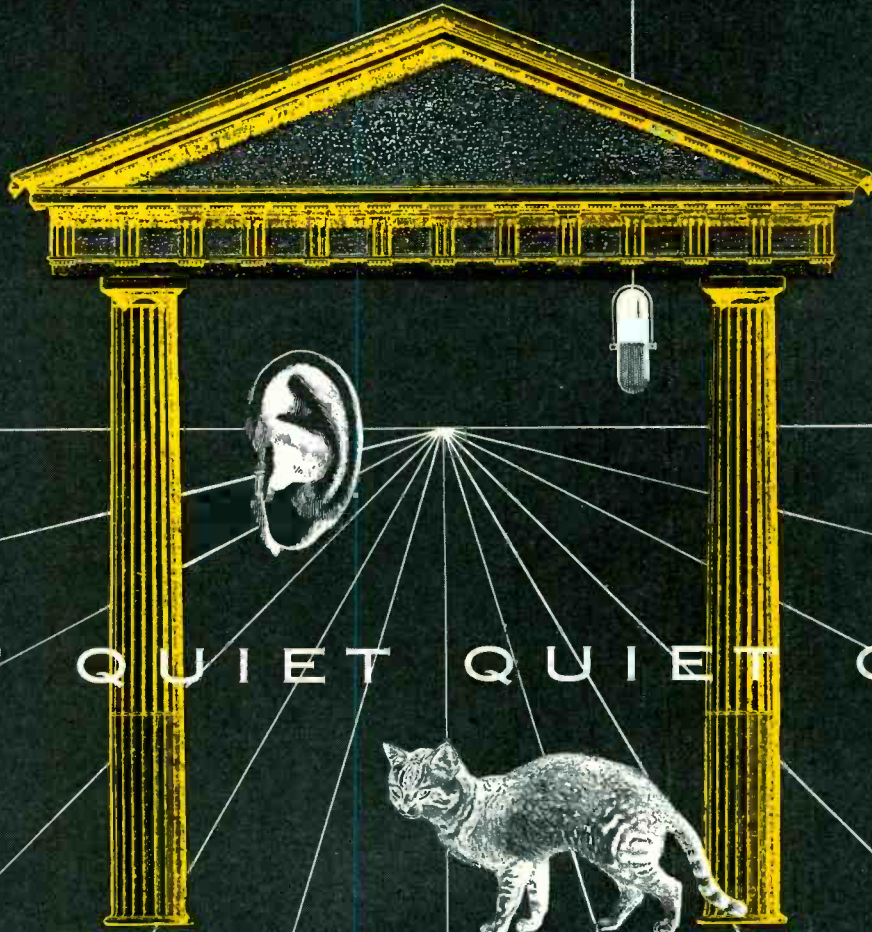

QUIET QUIET QUIET QUIET

XLR is the designation of Cannon's all new audio cord connector . . . the most modern addition to the long line of distinguished Cannon Connectors featured on all top-quality microphones. It's really quiet, too!

New resilient insulator and specialized construction of socket contact assembly protects against disagreeable mechanical interference . . . noise problems encountered with many other type connectors when their cables are moved, pulled or subjected to shock.

Features streamline design, bright nickel finish, integral cable clamp, neoprene cable relief, and the time-tested Latch-Lock that Cannon pioneered on the first audio connectors. Available with three 15-amp. or four 10-amp. contacts. Available in panel receptacle type, providing same continuous characteristics.

Available from distributors everywhere, or from the factory in production quantities.

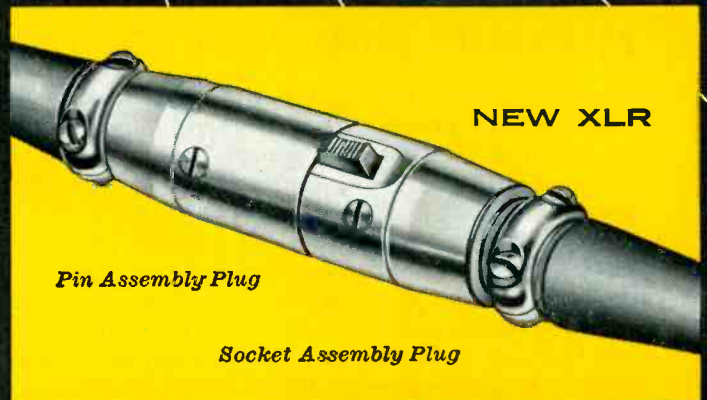

Pin Assembly Plug

Socket Assembly Plug

NEW XLR

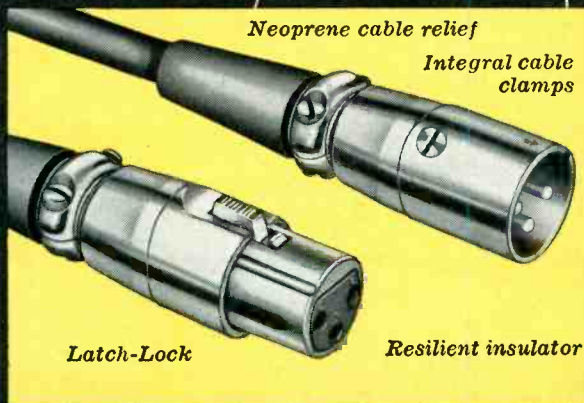

Neoprene cable relief

Integral cable clamps

Latch-Lock

Resilient insulator

first in connectors



CANNON PLUGS

CANNON ELECTRIC COMPANY
3209 Humboldt St.,
Los Angeles 31, California

Please refer to Dept. 120

Factories in Los Angeles; East Haven; Toronto, Canada; London, England. Representatives in all principal cities. Distributors everywhere.

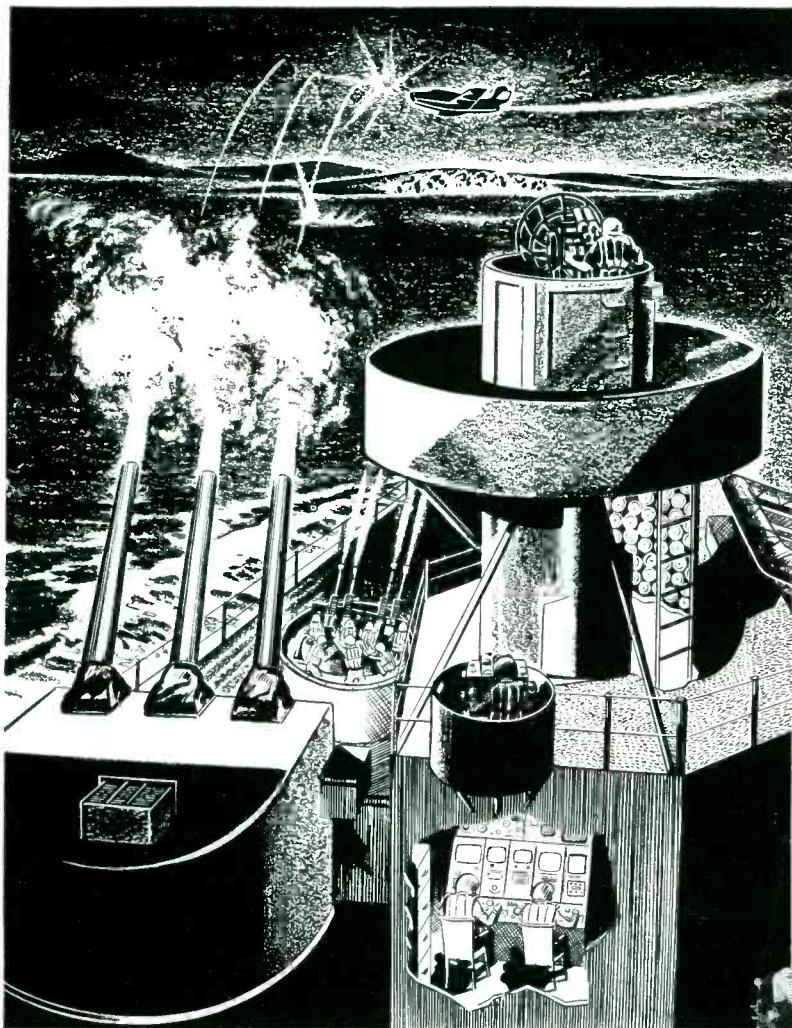

**Atlas Built
Parallax Corrector
Helps Keep Guns**

**ON
TARGET
IN ANY
SEA**

**PRECISIONEERS OF ELECTRO-MECHANICAL
ASSEMBLIES FROM PILOT STAGE...ON**

Computers, correctors, radar and sonar systems Atlas develops and "precisioners" assemblies and components for all types of electro-mechanical devices. Furnishes the practical engineering step between the idea and the production line.

Atlas design, production and methods engineers, tool-makers and skilled mechanics are ready to work on your project on a *job basis* . . . as many men, machines and hours of work it requires and no more. Every up-to-the-minute cost cutting tool and technique is utilized. Atlas metallurgical and electronic technicians thoroughly test your product.

From pilot stage to production efficiency of electro-mechanical equipment the leaders rely on Atlas "creative engineering." Atlas Precision Products Co., Philadelphia 24, Pa. (Division of Prudential Industries).

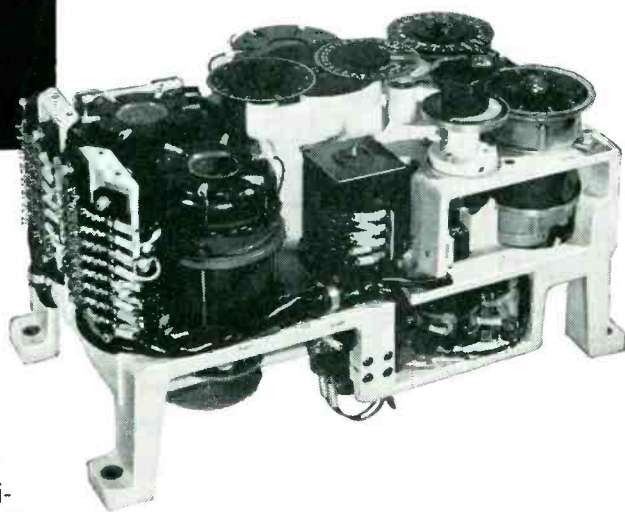

*Write for booklet "Precisionering
Electro-Mechanical Equipment."*

"From Drawing Board . . . to Production Line"



ATLAS
Precision Products



AMP Taper Tab
receptacles for wire
sizes 26 to 18

AMP Taper Pins
for wire sizes
26 to 16

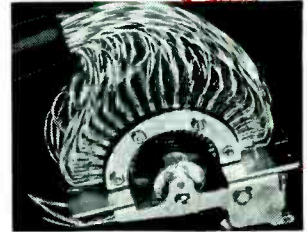
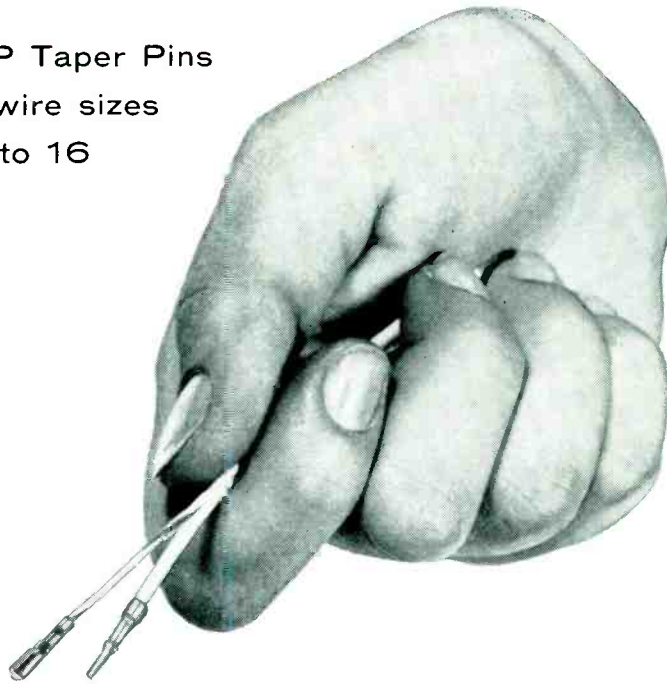

STEPPING SWITCH

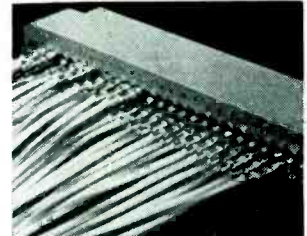

PRINTED CIRCUIT CONNECTOR

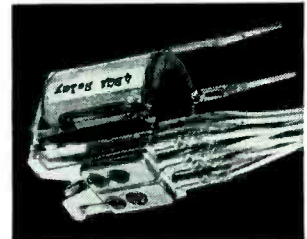

TAPER TAB RELAYS

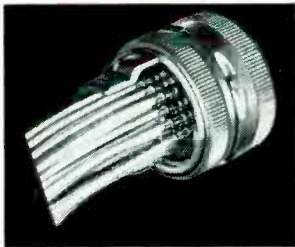

AN CONNECTOR

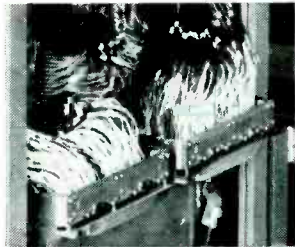

CONNECTOR BLOCK—2000 CONNECTIONS

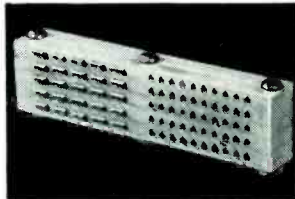

A-M-P TAPER BLOK

less cube and cost

WITH ADDED RELIABILITY

Cubic restrictions have brought about a whole new concept of wire termination. The AMP Taper Technique with AMP taper pins, tab receptacles, blocks and modified miniature components will help you take full advantage of small wire, small insulation and small space for your wire terminations.

AMP Trade-Mark Reg. U. S. Pat. Off. © AMP



*Another example of AMP's
Creative Approach to Better Wiring*



Send today for your copy of our brochure, AMP's Creative Approach to Better Wiring.

AIRCRAFT-MARINE PRODUCTS, INC., 2100 Paxton Street, Harrisburg, Pa.
In Canada: AIRCRAFT-MARINE PRODUCTS OF CANADA, LTD., 1764 Avenue Road, Toronto 12, Ontario, Canada

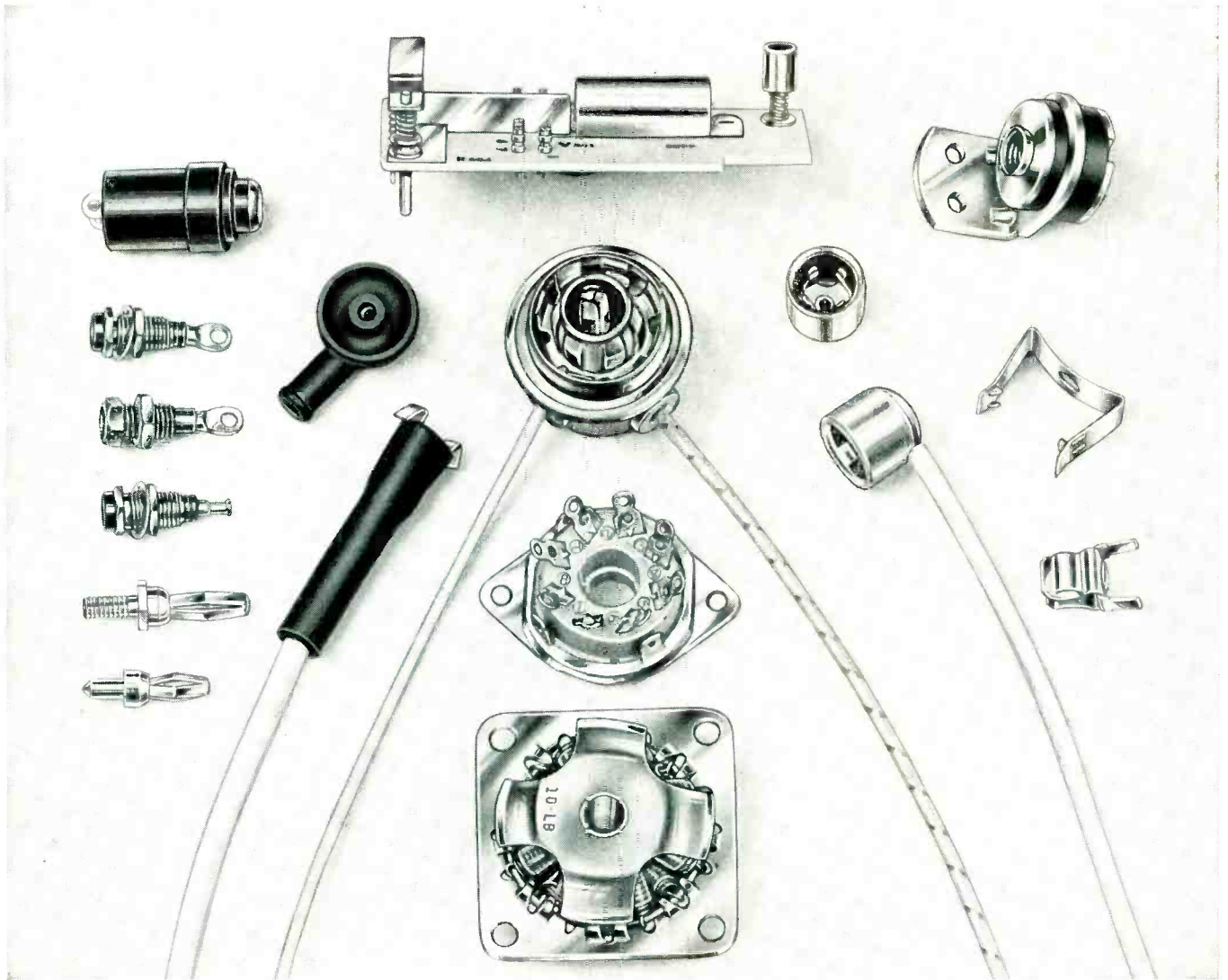

Designed to your specifications ... manufactured in volume

Switches, connectors (including new clip-on type anode connectors), tube caps, shock mounts, individual stampings and moldings... these and hundreds of other specialized components and assemblies are designed and manufactured by Ucinite for use in electronic equipment of all kinds.

With an experienced staff of design

engineers... plus complete facilities for volume production of metal parts and the assembly of metal to plastic and ceramic parts, Ucinite is capable of supplying practically any need for small electrical components. Call your nearest Ucinite or United-Carr representative for full information or write direct.



The
UCINITE CO.
Newtonville 60, Mass.
Division of United-Carr Fastener Corp.

Specialists in
ELECTRICAL ASSEMBLIES,
RADIO AND AUTOMOTIVE

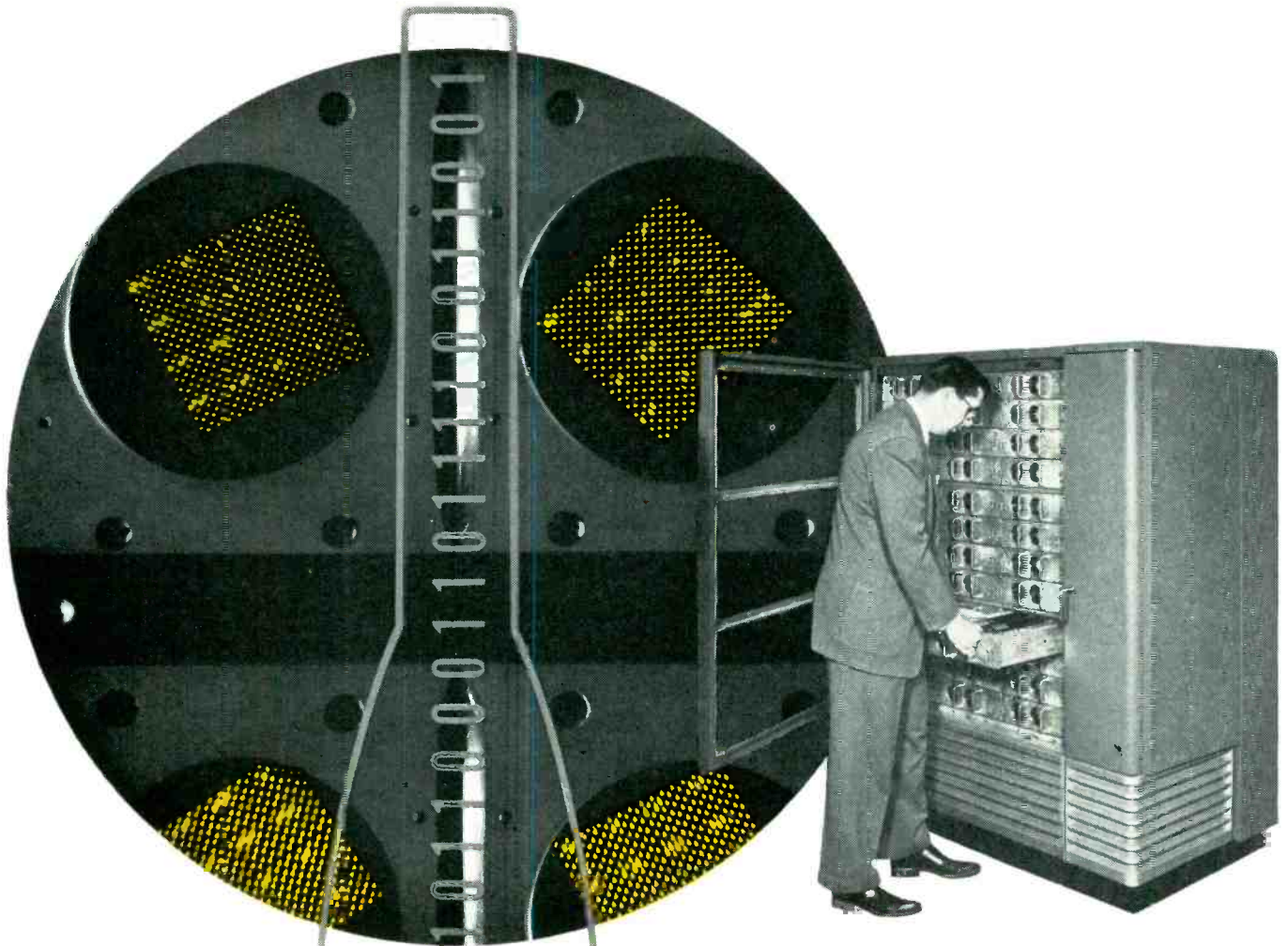

*you can't risk wiring
trouble in an electronic*
brain

Out goes your favorite reading lamp, leaving you mumbling in annoyance—even so, it's hardly a calamity. But in the International Business Machines Corporation's incredible electronic calculator, the "701," wiring trouble is simply out of the question. It cannot be allowed to happen.

One of the "701's" three "memory" devices is the Electrostatic Storage Unit. All information to and from other components of this powerful electronic "brain" passes through the Electrostatic Storage Unit which stores data or releases it in 12/1,000,000 of a second.

Obviously, this kind of performance demands consistently dependable performance from *all* machine elements.

For users of hook-up wire there is, then, significance in the fact that Rome Synthinol® Hook-up Wire is used in wiring the power supply for this electrostatic storage unit. Rome Synthinol's characteristics of high resistance to heat, flame, acids, oils, plus consistent quality control during production, are what make it dependable.

It will pay *you* to investigate the advantages of this quality Hook-up Wire, Rome Synthinol.

The banks of cathode ray tubes in the IBM Electronic Data Processing Machines are known as Electrostatic Storage Units, one of three "memory" devices.



Rome Synthinol Hook-up Wire is used in wiring the power supply for the IBM Electrostatic Storage Unit. The unit shown here is part of the deflection gate and supplies the necessary voltage to it.

It Costs Less to Buy the Best



ROME CABLE
Corporation
ROME • NEW YORK
and
TORRANCE • CALIFORNIA



**MAXIMUM EFFECTIVENESS
AT LOWEST COST...**

RMC Type JL DISCAPS

RMC Type JL DISCAPS provide ideal performance over an extended temperature range. The maximum capacity change between -60° and $+110^{\circ}$ C is only $\pm 7.5\%$ of capacity at 25° C. Lower initial cost, smaller size, and greater mechanical strength combine to effect worthwhile economies in production line operations.

In addition to standard leads, Type JL DISCAPS, as well as temperature compensating and by-pass types, are available with RMC's exclusive "Wedg-Loc" leads or plug in leads for printed circuit applications.

If you have a capacitor problem RMC engineers are prepared to work with you. Your inquiry is invited.

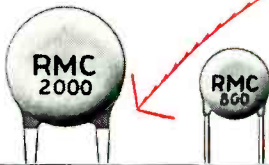

Wedg-Loc Leads



Plug-in Leads

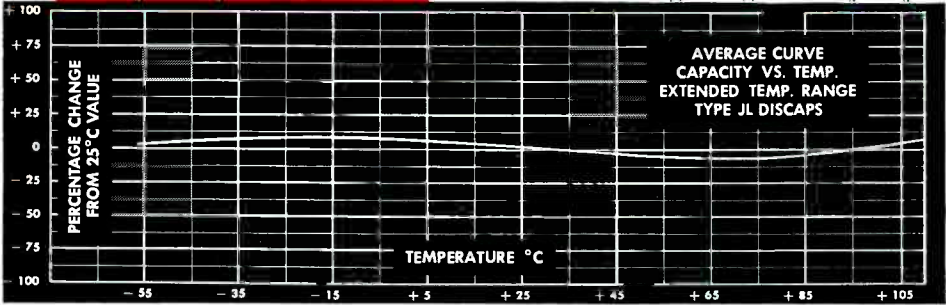

POWER FACTOR: 1% max. @ 1 K C (initial)
POWER FACTOR: 2.5% max. @ 1 K C, after humidity
WORKING VOLTAGE: 1000 V.D.C.
TEST VOLTAGE (FLASH): 2000 V.D.C.
LEADS: No. 22 tinned copper (.026 dia.)

INSULATION: Durez phenolic—vacuum waxed
INITIAL LEAKAGE RESISTANCE: Guaranteed higher than 7500 megohms
AFTER HUMIDITY LEAKAGE RESISTANCE: Guaranteed higher than 1000 megohms
CAPACITY TOLERANCE: $\pm 10\%$ $\pm 20\%$ at 25° C

DISCAP
CERAMIC
CAPACITORS



RADIO MATERIALS CORPORATION
GENERAL OFFICE: 3325 N. California Ave., Chicago 18, Ill.

FACTORIES AT CHICAGO, ILL. AND ATTICA, IND.

Two RMC Plants Devoted Exclusively to Ceramic Capacitors

**Include these
in your design**

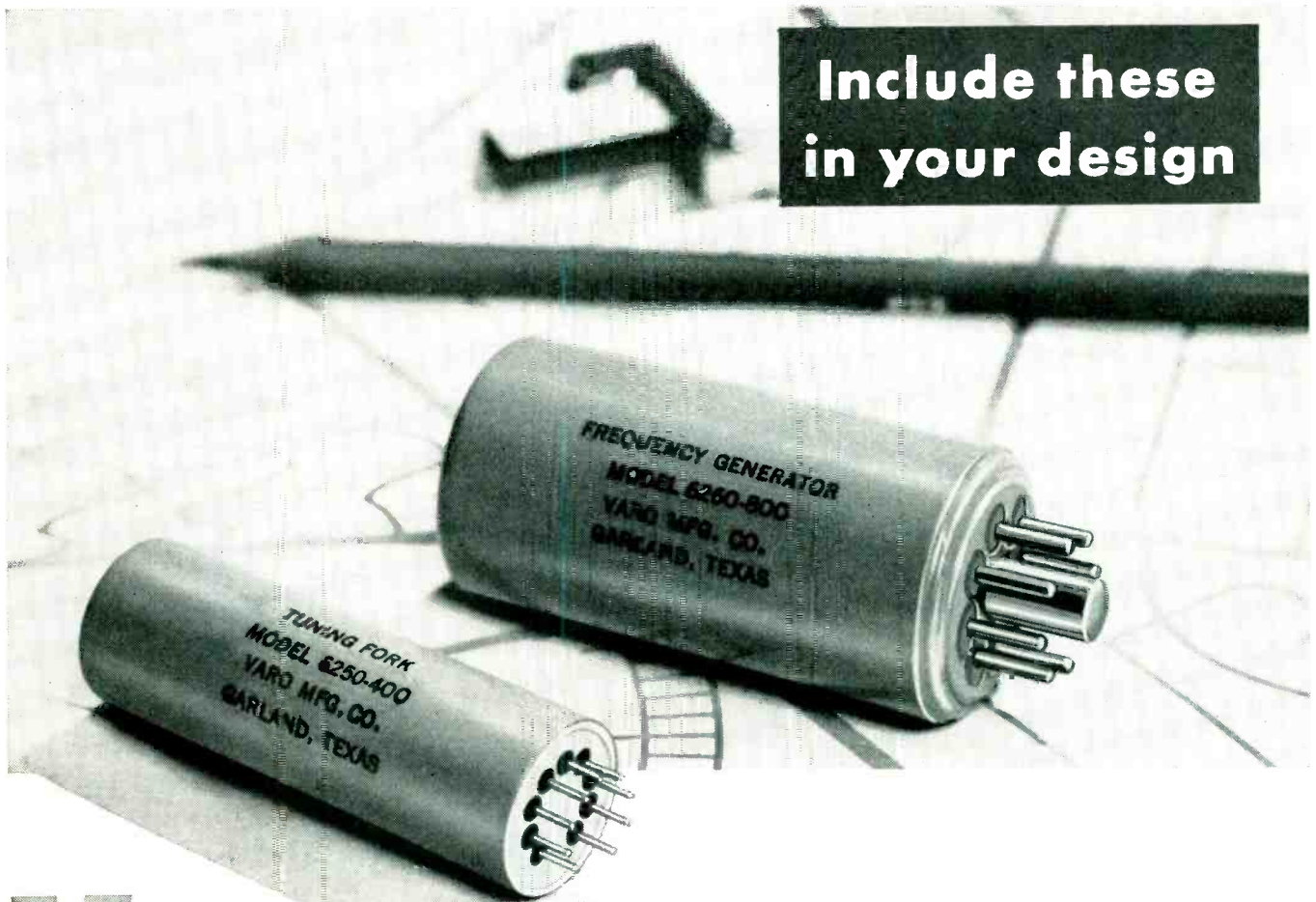

Varo Tuning Fork and Frequency Generator

The **VARO Tuning Fork** is designed for use as a high accuracy frequency or timing reference in ranges from 300 to 4000 cycles. Highly miniaturized and ruggedly constructed, the VARO Tuning Fork is designed to meet all applicable military environments including temperature extremes and vibration. When used as a signal filter, its high Q provides sharp and consistent characteristics. The VARO Tuning Fork is made to plug in a standard nine pin miniature tube socket.

The **VARO Frequency Generator's** accuracy is independent of input voltage variations and external loads. No oven or thermostat is required for its accurate operation in any environmental condition. The oscillator circuit of the VARO Frequency Generator uses silicon transistors in place of vacuum tubes. It is designed to plug into a standard octal socket. Special circuit and physical designs may be adapted to any application requirement.

SPECIFICATIONS

TUNING FORK

Accuracy: 0.1% over entire range of military environments. Higher orders of accuracy available on special request.
 Frequency: Available at any frequency within range of 300 to 4000 cps.
 Size: 0.875 in. diam.; 2.750 in. high; Standard nine pin tube socket.
 Weight: 2.502 oz. (Max.)

FREQUENCY GENERATOR

Input: 28v \pm 10%
 Output: 2.5v nominal
 Accuracy: 0.1% under all military environmental conditions
 Size: 1.375 in. diam.; 2.750 in. high; Standard octal socket.
 Weight: 4 oz.

VARO

Other VARO products made for Military Aircraft Fire Control and Navigational Equipment

FREQUENCY STANDARDS	ELECTRONIC INVERTERS
FREQUENCY CHANGERS	REGULATED SUPPLIES
VOLTAGE REGULATORS	SPEED CONTROLS
VOLTAGE AND FREQUENCY SENSITIVE RELAYS	

For further information please write:

MANUFACTURING CO., INC.

2201 WALNUT STREET, GARLAND, TEXAS

Pacific Coast Rep.: Pacific Scientific Co., 1430 Grande Vista Avenue, Los Angeles 23, California. Dayton Office: Box 553, Far Hills Branch, Dayton, Ohio

FOR YOUR AUTOMATION PROGRAM

VARIABLE RESISTORS FOR PRINTED CIRCUITS

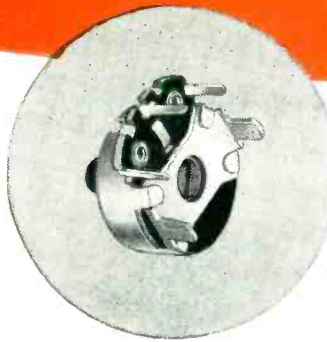

Type UPM-45

For TV preset control applications. Control mounts directly on printed circuit panel with no shaft extension through panel. Recessed screwdriver slot in front of control and 3/8" knurled shaft extension out back of control for finger adjustment. Terminals extend perpendicularly 7/32" from control's mounting surface.

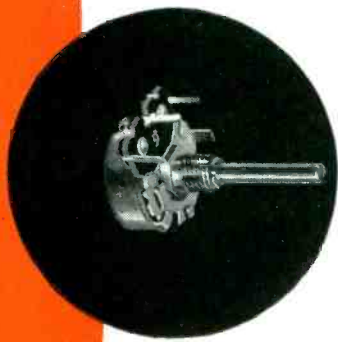

Type U70 (Miniaturized)

Threaded bushing mounting. Terminals extend perpendicularly 5/32" from control's mounting surface.

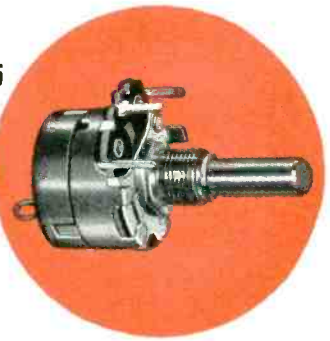

Type GC-U45

Threaded bushing mounting. Terminals extend perpendicularly 7/32" from control's mounting surface. Available with or without associated switches.

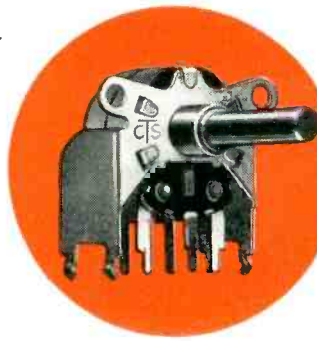

Type YGC-B45

Self-supporting snap-on bracket mounted control. Shaft center spaced 29/32" above printed circuit panel. Terminals extend 1-1/32" from control center.

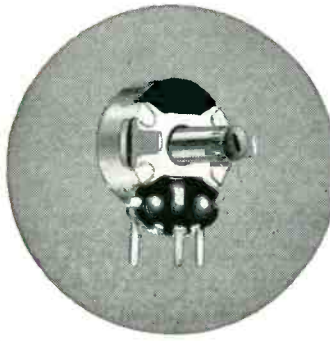

Type XP-45

For TV preset control applications. Control mounts on chassis or supporting bracket by twisting two ears. Available in numerous shaft lengths and types.

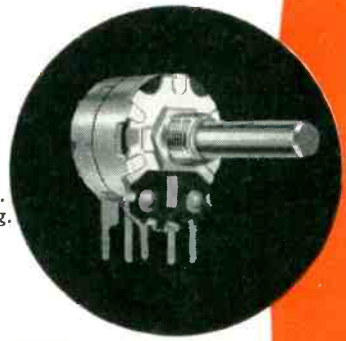

Type XGC-45

For applications using a mounting chassis to support printed circuit panel. Threaded bushing mounting.

VARIABLE RESISTORS FOR SOLDERLESS "WIRE-WRAP" CONNECTIONS

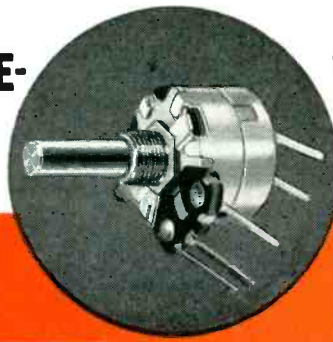

Type WGC-45

Designed for solderless wire-wrapped connections with the use of present wire-wrapping tools. Available with or without switch and in single or dual construction.

The controls illustrated are typical constructions. CTS' years of engineering and technical experience makes available many other types for your automation needs.



CHICAGO TELEPHONE SUPPLY
Corporation

ELKHART • INDIANA
FOUNDED 1896

EAST COAST OFFICE
Henry E. Sanders
130 North Broadway
Camden 2, New Jersey
Phone: Woodlawn 6-1668
TWX No. Camden NJ 380
Phila. Phone: Market 7-3129

SOUTHWESTERN U.S.A.
John A. Green Company
6815 Oriole Drive
P.O. Box 7224
Dallas 9, Texas
Phone: Dixon 9918

SOUTH AMERICA
Jose Luis Pontet
Buenos Aires, Argentina
Montevideo, Uruguay
Rio de Janeiro, Brazil
Sao Paulo, Brazil

WEST COAST OFFICE
Robert A. Stackhouse
928 S. Robertson Blvd.,
Los Angeles 35, Calif.
Phone: Crestview 4-5931
TWX No. BEV H 7666

CANADIAN DIVISION
C. C. Meredith & Co., Ltd.
Streetsville, Ontario
Phone: 310

OTHER EXPORT
Sylvan Ginsbury
8 West 40th Street
New York 18, New York
Phone: Pennsylvania 6-8239

The Exclusive Specialists in Precision Mass Production of Variable Resistors

ONE DAY SERVICE

QUARTZ CRYSTALS

ONE DAY SERVICE

ONE-DAY PROCESSING

International Crystals F-6 Series

1000 KC to 60 MC

Wire mounted, plated crystals, for use in commercial equipment where close tolerances must be observed. All units are calibrated for the specific load presented by equipment.

Holders: Metal, hermetically sealed.

Calibration Tolerance: $\pm .0025\%$ of nominal at 30° C.

Tolerance over Temp. $\pm .005\%$ from -55° to +90° C.

Range: $\pm .002\%$ from -30° C to +60° C.

Circuit: As specified by customer. Crystals are available for all major two-way equipments. In most cases the necessary correlation data is on file.)

Drive level: Maximum—10 milliwatts for fundamental, 5 milliwatts for overtone.

Prices: Available on request.



F-605

Pin dia. .050
Pin lngth. .238

USES:

1. For fast replacement in existing equipment. Replacement crystals are available for all major two-way equipment.

2. To eliminate large inventories of crystals for new equipment. In most cases you can have crystals for a set the day after the customer specifies his channel. This leads to rapid sales of your equipment, and satisfied customers.

3. For development work. Rapid delivery to insure the elimination of bottlenecks in procurement for research and development.

Send for **FREE** Catalog covering International's complete line. Crystals available from 100 KC to 100 MC.



F-609

Pin dia. .095
Pin lngth. .445

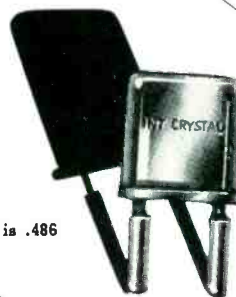

F-612

Pin dia. .125
Pin lngth. .620

Pin spacing on each of above is .486

Delivery: ONE DAY PROCESSING. All orders of less than five units of any one frequency in the range 1000 KC to 60 MC will be mailed within 24 hours from the time received.

WHEN ORDERING SPECIFY:

- (1) Frequency (2) Holder Type*
- (3) Circuit Data (32 mmf load, series resonance, etc.)
For standard commercial 2-way equipment specify model number and drawing number where available.
- (4) End Use (Equipment type & manufacturer, development, etc.)

*Adaptors can be supplied for 3/4" pin spacing.



International **CRYSTAL Mfg. Co., Inc.** 18 N. Lee Phone FO 5-1165
OKLAHOMA CITY, OKLA.

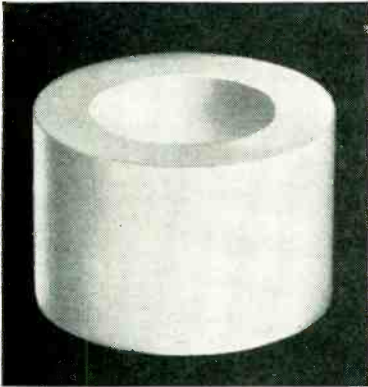
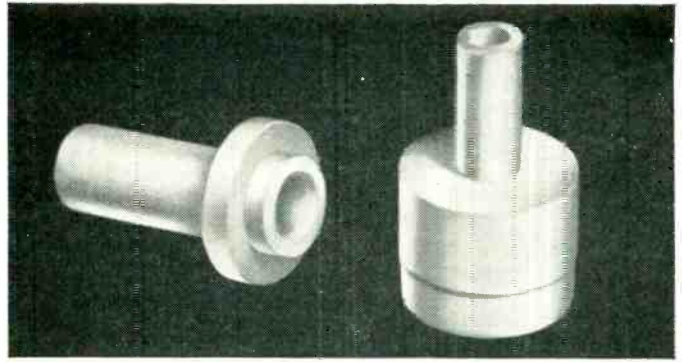
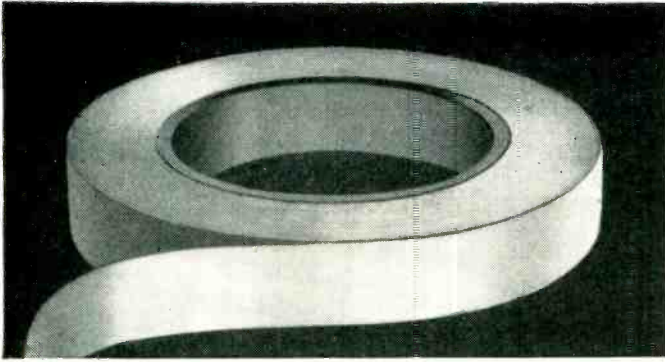

**TRY SOLVING YOUR
TOUGHEST PROBLEMS**

WITH

R/M Teflon*

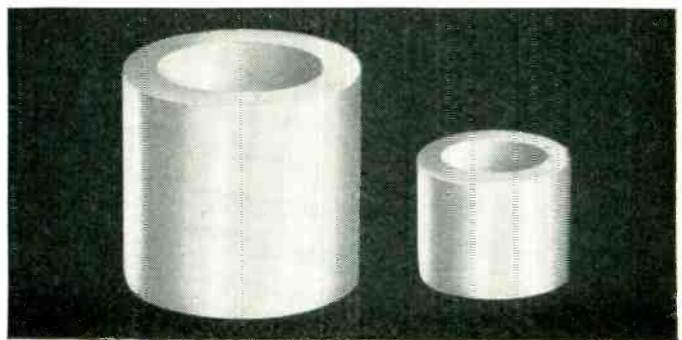
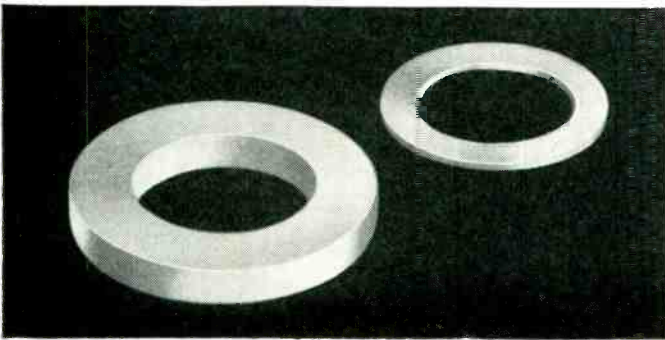
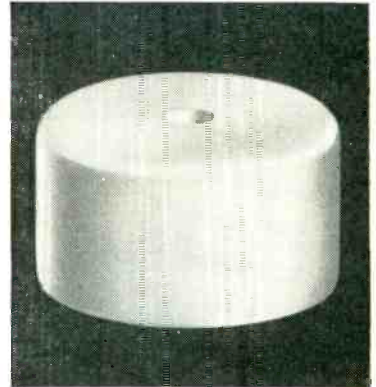

Thousands of engineers have found that "TEFLON" has what it takes to solve some really tough problems in the electronics and electrical manufacturing fields. They have also found R/M, with its unmatched skill, experience and facilities, a tremendous help in solving those problems. For R/M has been working with this plastic ever since it first was produced. If you have a problem the chances are good that R/M has encountered it and already worked out a solution.

The several different products pictured above indicate R/M's versatility in "TEFLON" manu-

facture. We can fabricate parts to your own specifications or supply you with "TEFLON" in the form of rods, sheets, tubes or tape. For further information, write today.

PROPERTIES OF "TEFLON"

High dielectric strength • Moisture absorption zero • Unaffected by weather • Excellent heat stability up to 500°F. in continuous operation • As tape leaves no carbon residue along discharge path • High impact resistance • Nonadhesive • Stretches easily • Tensile strength 1500-2500 psi.

**Du Pont's trade-mark for its tetrafluoroethylene resin*



**RAYBESTOS-MANHATTAN, INC.
ASBESTOS TEXTILE DIVISION, MANHEIM, PA.**

FACTORIES: Manheim, Pa. • Bridgeport, Conn. • No. Charleston, S.C. • Passaic, N.J.
Neenah, Wis. • Crawfordsville, Ind. • Peterborough, Ontario, Canada
RAYBESTOS-MANHATTAN, INC., Asbestos Textiles • Packings • Brake Linings • Brake Blacks • Clutch Facings • Fan Belts • Radiator Hose • Rubber Covered Equipment • Industrial Rubber, Engineered Plastic, and Sintered Metal Products • Abrasive and Diamond Wheels • Bowling Balls

El-Menco

provides
*Positive Proof
of Performance*
of the powerful new...



Dur-Mica DM 15

world's smallest mica capacitor

... First Miniature Dipped Mica Capacitors with Parallel Leads.

El Menco's Dur-Mica DM15 provides assurance of peak performance in a variety of transistor circuits and other miniature electronic equipment in military and civilian applications.

A new, tougher phenolic casing provides assurance of long-life and stability through wide ranges in temperature.

Parallel Leads provide greater versatility—allow efficient, safe use of the El Menco Dur-Mica DM15 in applications heretofore impractical.

Saves Money—El Menco's Dur-Mica DM15 costs even less than the famous El Menco CM15. Provides economy of size.

CAPACITIES AVAILABLE:

DM15—Up to 510 mmf at 300vDCw

Up to 400 mmf at 500vDCw

DM20—Up to 5100 mmf at 300vDCw

Up to 3900 mmf at 500vDCw

Available in 125°C operating temperature. Minimum capacity tolerance available—± ½% or 0.5 mmf (whichever is greater).

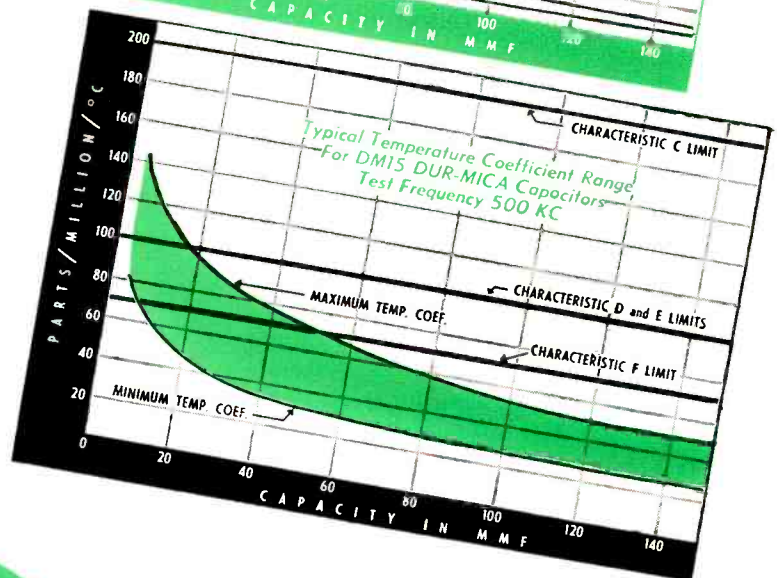

Test El Menco "Dur-Micas"
For Yourself!

For your special requirements—we are pleased to offer information and assistance. Write for free samples and catalog on your firm's letterhead.

El-Menco

Capacitors

THE ELECTRO MOTIVE MFG. CO., INC.

WILLIMANTIC CONNECTICUT

- molded mica • mica trimmer
- tubular paper • ceramic

Jobbers and distributors write to Arco Electronics, Inc., 103 Lafayette St., New York, N. Y.

NOW

MINIATURIZATION

plus

PERFORMANCE

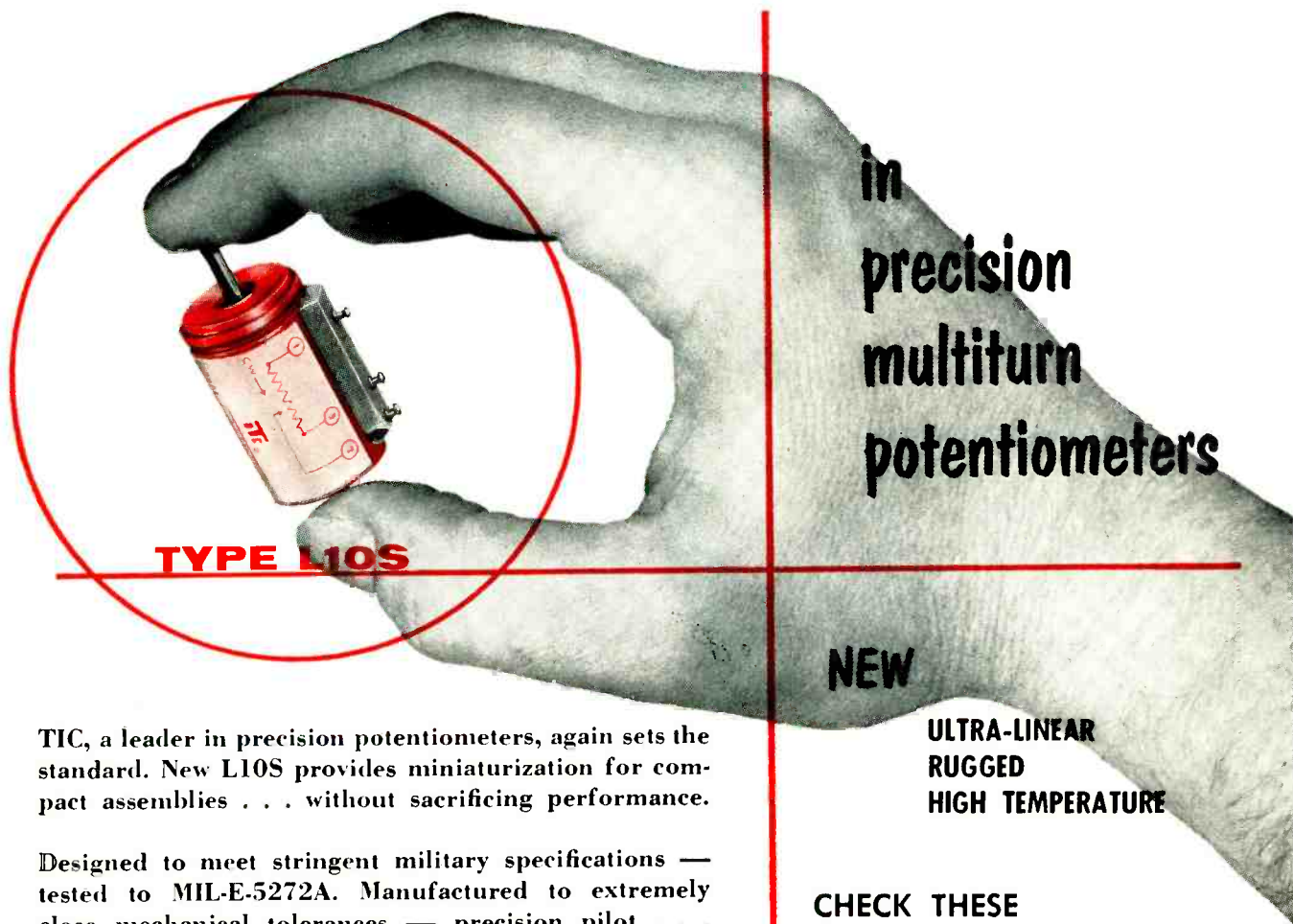

TYPE L10S

in
precision
multiturn
potentiometers

NEW

**ULTRA-LINEAR
RUGGED
HIGH TEMPERATURE**

TIC, a leader in precision potentiometers, again sets the standard. New L10S provides miniaturization for compact assemblies . . . without sacrificing performance.

Designed to meet stringent military specifications — tested to MIL-E-5272A. Manufactured to extremely close mechanical tolerances — precision pilot . . . centerless ground shaft . . . precision ball bearings. Made for high electrical accuracy. Type L10S provides rugged construction . . . light weight . . . low torque . . . inherent stability . . . and high resolution.

Wide temperature and resistance ranges of miniature L10S provide greater versatility. Extend its application in servo systems . . . computers . . . control . . . telemetering . . . and measurement systems. Check the L10S features. Then write for free brochure.

CHECK THESE FEATURES

LINEARITY:

$\pm 0.05\%$ standard; $\pm 0.025\%$, special.

TEMPERATURE RANGE:

$-55^{\circ}\text{C. to } +130^{\circ}\text{C.}$

RESISTANCE RANGE:

1000 ohms to 100,000 ohms.

WEIGHT:

1 ounce.

TORQUE:

Starting .75 in. oz., Running .60 in. oz.

TECHNOLOGY INSTRUMENT CORP.

533 MAIN ST., ACTON, MASS. COLonial 3-7711
West Coast Mail Address P.O. Box 3941 North Hollywood, Calif. POplar 5-8620

**Monsanto
PROFIT
TALK**

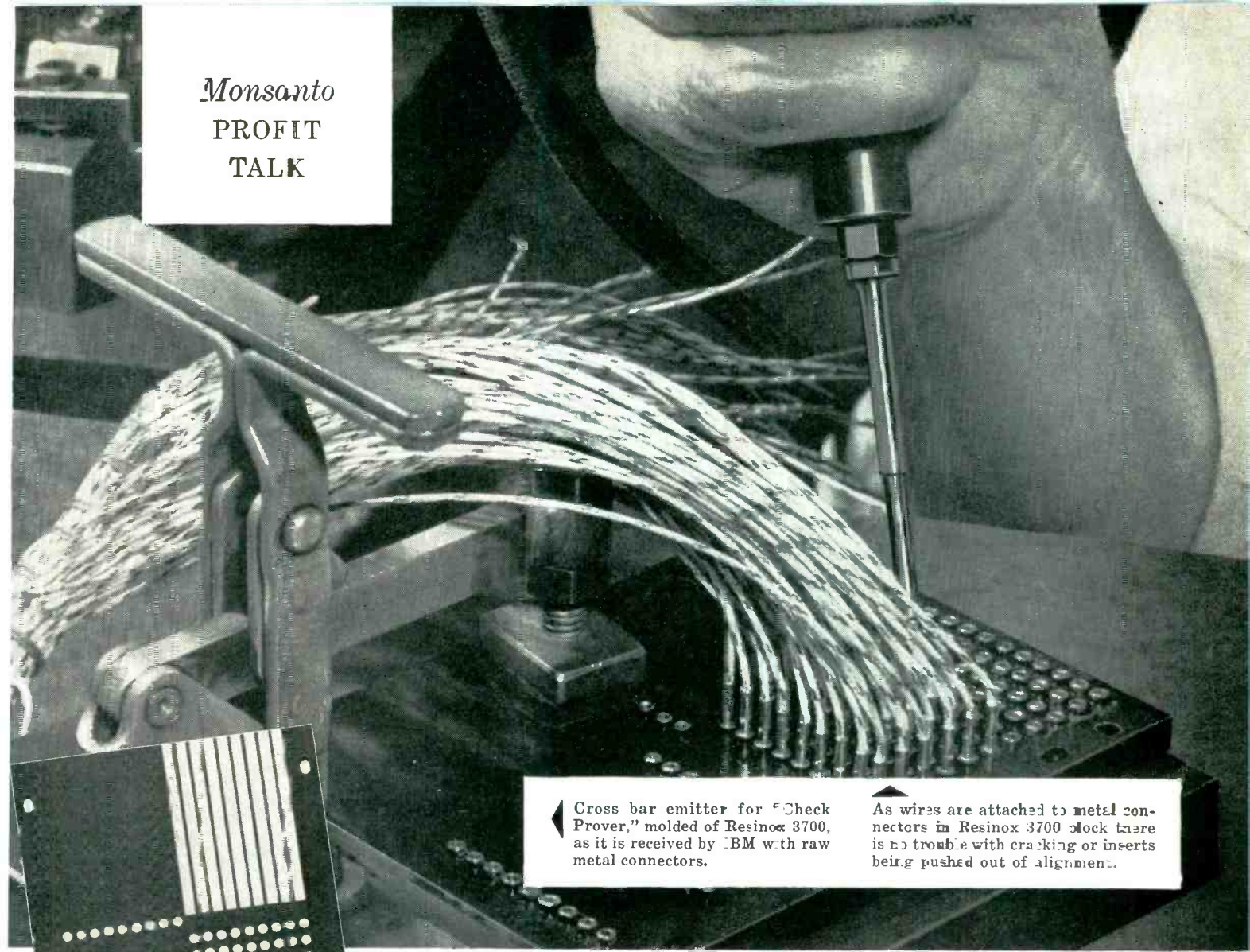

◀ Cross bar emitter for "Check Prover," molded of Resinox 3700, as it is received by IBM with raw metal connectors.

▲ As wires are attached to metal connectors in Resinox 3700 block there is no trouble with cracking or inserts being pushed out of alignment.



IBM SPECIFIES RESINOX* 3700

for cross bar emitter—cuts costs in half!

Monsanto's thermosetting molding powder ends scrapping problem...cuts machining time...speeds production of "Check Prover" part!

An integral part of IBM's famous "Check Prover" is a 4" x 5 $\frac{1}{4}$ " cross bar emitter which brings together the intricate wiring system of the machine. The block contains over 50 tiny metal inserts through which the various electrical leads pass.

The Plastics Engineers at the IBM plant in Poughkeepsie, N. Y., where the machines are manufactured, say Monsanto's Resinox 3700 has been specified for the molding of these blocks for over two years.

Resinox 3700 has completely eliminated wasteful scrapping and other serious production problems, such

as blocks cracking during wire assembly operation, and metal inserts breaking off or pushing out of alignment.

Furthermore, there are no shorting problems. Machining time on the flatter, smoother blocks has been cut 25%. The cross bar emitter is an expensive part and Resinox 3700 has reduced its production cost over \$30,000 a year.

Other qualities of Resinox 3700 of special interest to manufacturers of electrical parts are its outstanding arc resistance, its dielectric strength, its excellent dimensional stability, and its moldability.

Perhaps Resinox 3700 is exactly what *you* need to solve an electrical equipment problem. Write today for full information. Monsanto Chemical Company, Plastics Division, Dept. E-5, Springfield 2, Mass.

For outstanding heat resistance and durability, specify

RESINOX 3700

*Resinox: Reg. U.S. Pat. Off.



MONSANTO

Phelps Dodge modern fits new



First for Lasting Quality—from Mine to Market!

enamel wire

exacting coil designs !

*New processes and controls
assure uniform quality:*

1

Uniform over-all size — for uniform windings.

2

**Uniform softness with high tensile strength
for tighter windings, reduced breakage.**

3

**Uniform spooling, larger packages for lower-
cost windings.**

4

**Uniform property balance for good flexibility,
solvent resistance and dielectric strength.**

*Any time magnet wire is your problem,
consult Phelps Dodge for the quickest, easiest answer!*

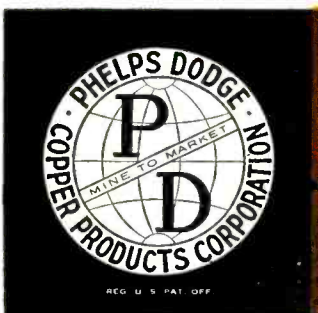

PHELPS DODGE COPPER PRODUCTS
CORPORATION

INCA MANUFACTURING DIVISION
FORT WAYNE, INDIANA

FIRST TRANSISTOR RADIO MADE POSSIBLE

... by *INSUROK*[®] copper-clad
printed circuits!



Here's a remarkable example of miniaturization . . . made possible mainly through the use of printed circuits and transistors. This diminutive radio weighs a scant 12 ounces, complete with battery. Yet, it has good tone, is selective, and delivers plenty of volume.

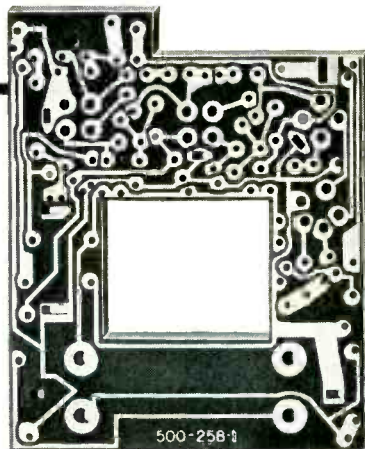

Here's the printed-circuit board used in the Regency . . . made with Richardson T-725 copper-clad INSUROK. Engineers of I.D.E.A., Inc. of which Regency is a division, laid out the circuit. Croname, Inc.* Chicago, took it from there . . . printed the complex circuit on Richardson T-725 copper-clad INSUROK, then etched it. Results: a lightweight, compact, efficient circuit . . . tedious, time-consuming wiring eliminated . . . faster assembly.

Many grades of Richardson laminate INSUROK are available copper-clad on one or both surfaces. We invite your inquiry.

**Here's what Croname has to say about T-725 copper-clad INSUROK, "Quality is superior . . . service good. And Richardson gives us helpful engineering assistance."*



Ask for descriptive bulletin,
"INSUROK Copper-Clad Laminates."

RICHARDSON
*Laminated and
Molded Plastics*

The **RICHARDSON COMPANY**

FOUNDED 1858

2797 Lake St., Melrose Park, Ill. (Chicago District)

SIX PLANTS: Melrose Park, Ill. • Indianapolis, Ind.
New Brunswick, N. J. • Newnan, Ga. • Tyler, Tex. • Ogden, Utah

SALES OFFICES IN PRINCIPAL CITIES



**Power Meter Model P-2
DC to 11,000 mc**

MICRO POWER METER DC to 11,000 mc

*measures microwave power
with only one probe*

Over the entire frequency range DC to 11,000 MC, Polarad's new Micro Power Meter utilizes only one power probe, supplied as an integral part of the instrument. This unique power probe will sustain severe overloads without burnout since it does not contain hot wire barreters or other delicate components.

This new rugged and stable instrument reduces microwave power readings to the simplicity of everyday low frequency measurements. It is a true rms milliwatt indicating meter accurately measuring CW and pulse power, in milliwatts and dbm. Insensitive to line voltage changes.

Because of its wide band coverage, the Polarad Model P-2 is outstanding as a general lab and field instrument, available for power measurements at all commonly used frequencies. The P-2 can be completely calibrated from its own self-contained DC source.

Features and Specifications:

- Single power probe for all frequencies.
- 150% overload without burnout.
- Direct reading.
- Broadband CoverageDC to 11,000 mc continuous in single mount.
- Multi-Power Range0-1 mw, 0-10 mw, 0-100 mw, 0 dbm, + 10 dbm, + 20 dbm.
- Impedance50 ohms coaxial.
- VSWRLess than 1.4:1 from 0 to 5000 mc. Less than 2:1 from 5000 to 11,000 mc.
- Accuracy± 1.0 db.
- ConnectorType N plug.
- Input Power Required115v ± 10%, 60 cps.
- Dimensions10" x 8" x 8".
- Weight14 lbs.

KLYSTRON TUBE TESTER

tests all klystron tubes



**Model K-100
Klystron Tube Tester**

Now, for the first time, you can test all commercially available klystron tubes, built-in cavity types as well as those requiring external cavities, just as easily as you make tests on vacuum tubes.

Polarad's new Model K-100 Klystron Tube Tester provides complete metering facilities and control adjustments with a tube data chart to determine settings. Safety features protect personnel at all times when testing tubes requiring high voltages.

AVAILABLE ON EQUIPMENT LEASE PLAN

**FIELD MAINTENANCE SERVICE AVAILABLE
THROUGHOUT THE COUNTRY**

Features:

Performs the following basic tests:

- a. Filament continuity.
 - b. Short circuit tests between all elements.
 - c. Static d-c tests—measurement of rated d-c currents and voltages.
 - d. Life test—relation of cathode current versus reduced filament voltages.
 - e. Dynamic test—provision is made for external modulation so that klystron tubes may be dynamically tested with external r-f measuring equipment.
- Special adapter mount for all commercial types of klystrons.
 - Safety features protect personnel during tests.
 - Protective devices prevent misadjustment and save tubes from accidental burnout.
 - Built-in heavy duty blower provides forced air cooling of the klystron tubes.
 - Tester designed to be adapted for future tubes.
 - Built-in Universal Power Supply may be used for klystron testing purposes outside the instrument.

POLARAD
PROVEN RELIABILITY

ELECTRONICS CORPORATION

43-20 34th STREET
LONG ISLAND CITY 1, N. Y. • EXeter 2-4500

REPRESENTATIVES

Albuquerque
Atlanta
Baltimore
Bayonne
Bridgeport
Buffalo
Chicago

Dayton
Fort Worth
Los Angeles
New York
Newton
Philadelphia
San Francisco
Syracuse

Washington, D.C.
Westbury
Winston-Salem
Canada: Arnprior,
Toronto
Export: Roche
International

Engineering

THE RECORD-SETTING G-12A

This is the JK Glasline unit providing stability of 1 part in 10^9 over a 24 hour period, stability that requires the most accurate methods of measurement available.



TO COMPLETE
THE ENVIRONMENTAL
PICTURE:
THE NEW JK O9 OVEN

To the protection JK Glasline design provides against moisture, contamination, vibration and barometric pressure, the JK O9 oven adds control of temperature. It is production tooled for economy and uniformity, is small and light (1.28" x 1.70" x 1.5 oz.), and is capable of maintaining a temperature constant to within $\pm 1^\circ\text{C}$ over a range of -55° to $+100^\circ\text{C}$. Here is an oven that matches the performance of many, massive multi-stage heaters — an example of JK's ultra-stable miniaturization program.

JK-G9: Precision "Glasline" quartz crystals, sealed in evacuated glass for cleanliness and protection, over a complete range of 800 cycles to 5 mc.



THE
JAMES
KNIGHTS
COMPANY

Crystals for the Critical - Sandwich, Illinois

Facilities That Measure to 1 part in 10^9

Back JK Research, Production and Certification.

Just a short time ago a crystal offering the extreme stability of the JK G-12A was viewed as a scientific curio. Even its measurement was a scientific effort; its first use limited to laboratory equipment.

But today JK Glasline crystal units in these exacting stability ranges are meeting the demand for ultra stable frequency control in many field applications. They are being production engineered, manufactured, tested, and performance certified in commercial production quantities for use as precision time base units, as long range navigational aids, and for spectrum conserving communications systems. They provide unprecedented stability and reliability, with the compactness and environmental protection that today's field equipment requires.

These advanced research, production and testing facilities are important to everyone concerned with frequency management problems because they are the keys that can unlock tomorrow's door for you. The control of the quartz crystal, so long an art, has become a science.



JK-G4: "Glasline" Crystal Filter Resonator. For broad filter applications such as power line carrier communications and telemetering. Frequency range 50 to 200 kc.



(ACTUAL SIZE)

JK-G3: 10 mc to 150 mc. Miniature size, minimum aging drift, high Q for maximum performance. JK miniaturized "Glasline" crystals meet the growing need for minimum size with maximum stability.



JK "THERMYSTAL"

AN ADVANCED FREQUENCY CONTROL DESIGN



Ultra-Precision frequency control requires that crystal oven, power supply and oscillator circuitry be compatible in design and construction for optimum precision and reliability. The James Knights Company will combine their precision crystals and ovens with tried and proven circuitry in packages that will meet your mechanical layout requirements, at a saving of valuable customer engineering time. Precision frequency signal sources covering the wide frequency range of 60 cycles to 150 mcs can be made available to meet your specific application.

- 1. Higher Merit Factor:** Vacuum enclosure increases Q of crystal.
- 2. Calibration Accuracy:** $\pm (1 \text{ cycle} + .0001\%)$
- 3. Temperature Stability:** 30 to 900 kc $\pm .0001\%$, 1000 kc to 150 mc $\pm .00005\%$. Oven temperature varies less than $\pm 1^\circ\text{C}$ over ambient range of -55°C to $+85^\circ\text{C}$.
- 4. Secular Stability:** Less than .001% per year. Crystal is specially processed and sealed in glass enclosed vacuum.
- 5. Low Oven Power:** 6.3 v @ 1.5 amp maximum. Thermostat cycles less than 3 times per minute at room temperature.

that unlocks tomorrow's door

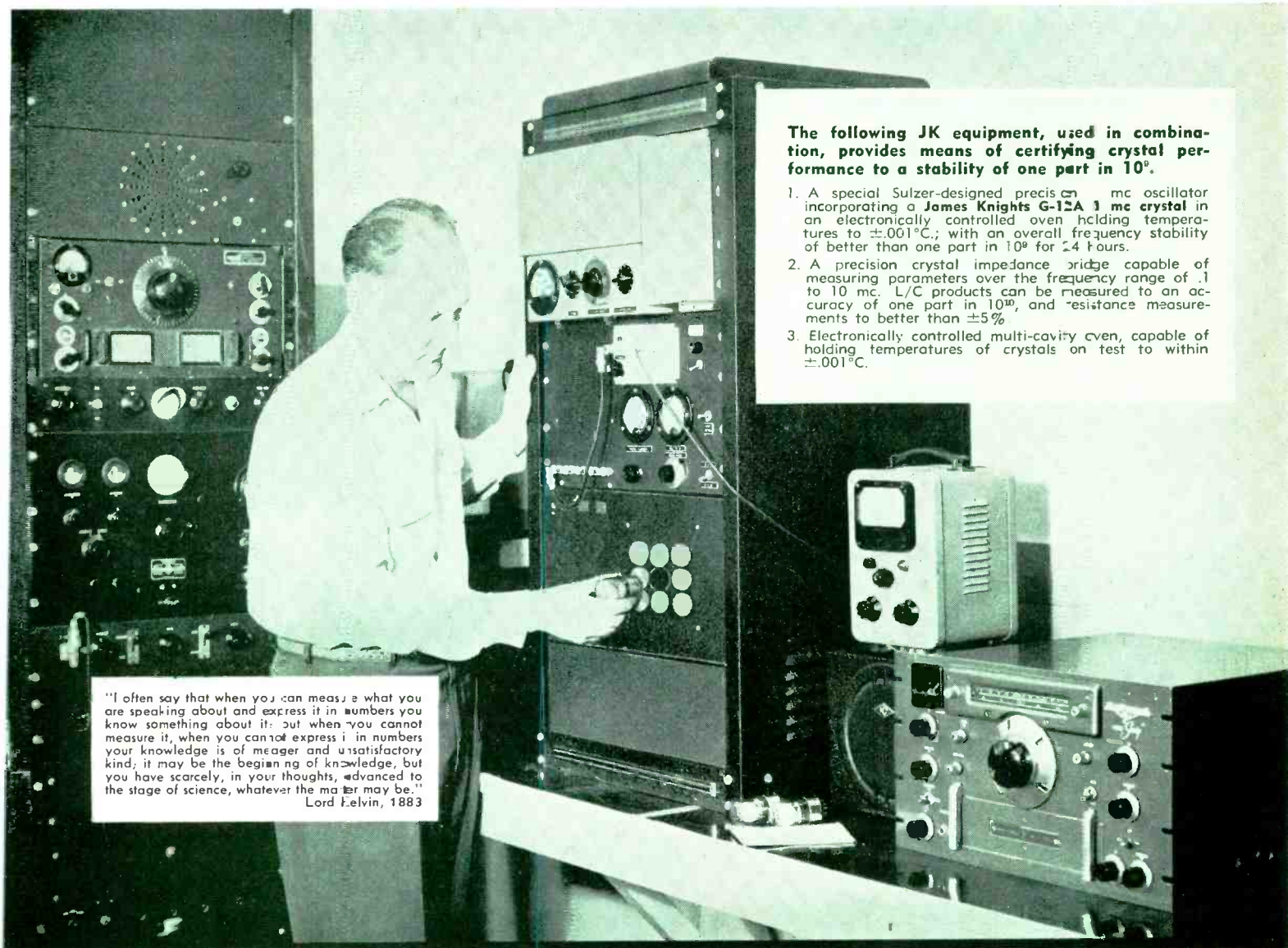

The following JK equipment, used in combination, provides means of certifying crystal performance to a stability of one part in 10^9 .

1. A special Sulzer-designed precision mc oscillator incorporating a James Knights G-12A 1 mc crystal in an electronically controlled oven holding temperatures to $\pm 0.01^\circ\text{C}$.; with an overall frequency stability of better than one part in 10^9 for 24 hours.
2. A precision crystal impedance bridge capable of measuring parameters over the frequency range of .1 to 10 mc. L/C products can be measured to an accuracy of one part in 10^{10} , and resistance measurements to better than $\pm 5\%$.
3. Electronically controlled multi-cavity oven, capable of holding temperatures of crystals on test to within $\pm 0.01^\circ\text{C}$.

"I often say that when you can measure what you are speaking about and express it in numbers you know something about it; but when you cannot measure it, when you cannot express it in numbers your knowledge is of meager and unsatisfactory kind; it may be the beginning of knowledge, but you have scarcely, in your thoughts, advanced to the stage of science, whatever the matter may be."
Lord Kelvin, 1883

JK STANDARD MILITARY AND COMMERCIAL TYPE CRYSTALS



TEMPERATURE CONTROL OVENS: Available for a wide range of applications.

Quality and service are James Knights traditions that apply to the simplest JK crystals as well as to the most complex, and apply to our smallest customer as well as our largest. So whatever your requirements — look to James Knights as a dependable, cooperative source for quality, price and delivery.



ULTRA-SONIC TRANSDUCERS: Carefully oriented and processed to your specifications, in a variety of shapes with holes, dimples, soldered-on leads, and backing plates. Can be plated with a variety of metals.

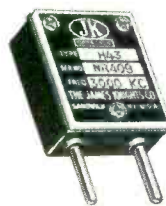

PRESSURE MOUNT-ED: A complete line of commercial and military types.



MILITARY TYPES: Hermetic sealed, metal cased, in frequency ranges from 16 kc to 100 mc.

AEROCOM'S 1046 H. F. TRANSMITTER

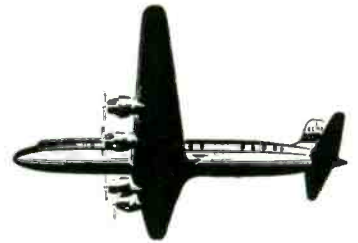

POWER + STABILITY

1000 WATTS

WITH

.003% STABILITY

Rugged, versatile general purpose H. F. transmitter—Aerocom's 1046 packs 1000 watts of power and high .003% stability under normal operating conditions (0° to +50°C.). Excellent for point-to-point or ground-to-air communications.

Multi-channel operation on telegraph A1, or telephone A3 with GM-8A modulator... new Aerocom 1046 can be *remotely controlled* with TMC-R at control position and uses only one pair of telephone lines. In A3 operation, the local dial control panel is located in modulator cabinet.

Transmitter cabinet has 8 $\frac{3}{4}$ inch panel space available for either local dial control panel or frequency shift keyer.

Model 1046 operates on 4 crystal-controlled frequencies (plus 2 closely spaced frequencies) in the band 2.0—24 Mcs. Operates on one frequency at a time; channeling time 2 seconds. Operates into either balanced or unbalanced loads. Operates in ambient -35° to +50° C. Power supply: nominal 220 volts, 50-60 cycles, single phase.

Complete technical data on request

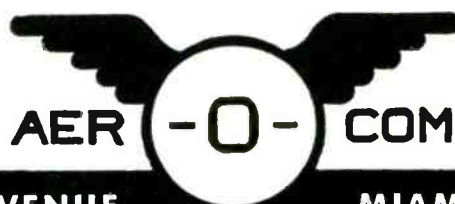
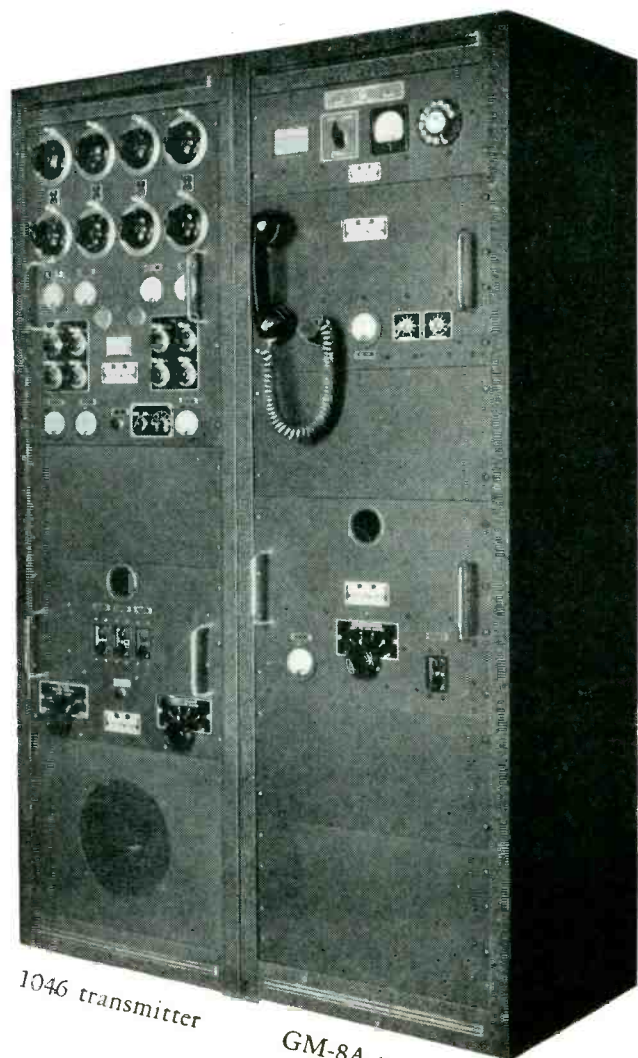

3090 S. W. 37th AVENUE

MIAMI 33, FLORIDA

POPULATION - 0

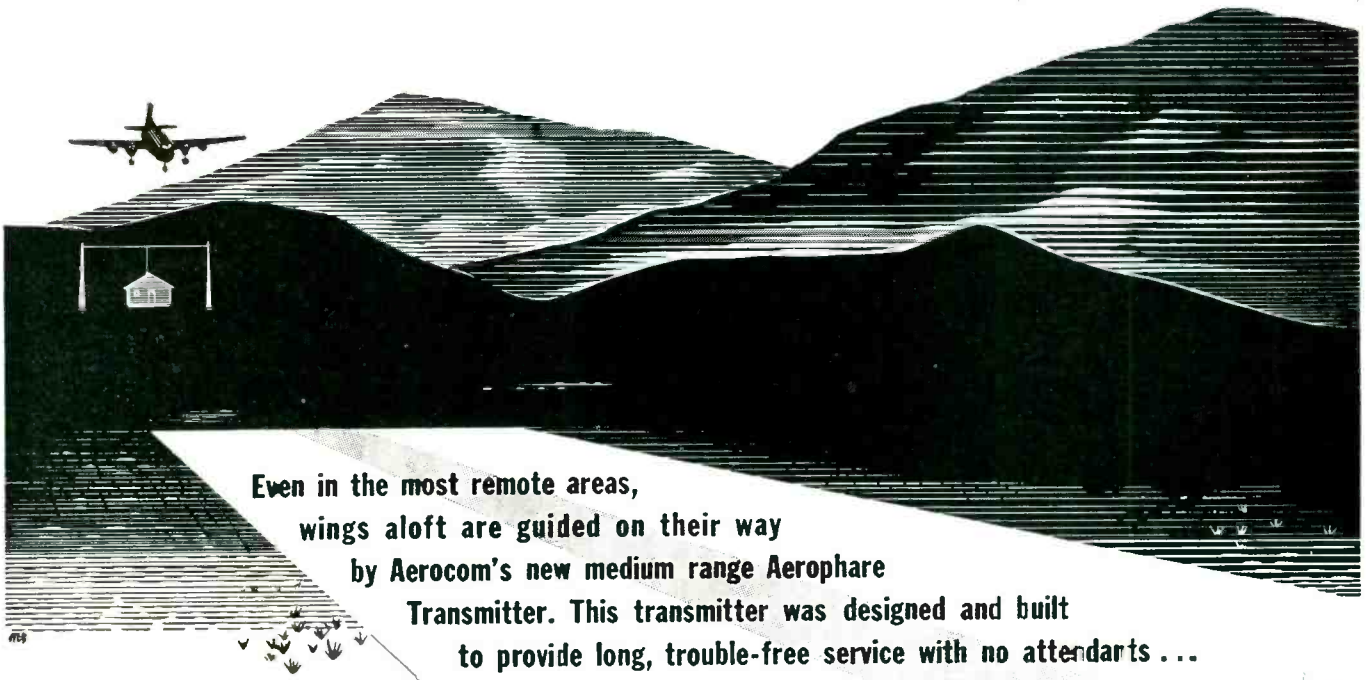

AEROCOM'S Dual Automatic Package-Type Radio Beacon

for completely unattended service. This aerophare (illustrated) consists of two 100 watt (or 50 watt) transmitters with keyer, automatic transfer and antenna tuner. (Power needed 110 or 220 volt — 50/60 cycles, 520 V.A. for 50 watt, 630 V.A. for 100 watt.)

Frequency range 200 — 415 kcs.: self-contained P.A. coil and "plug-in" crystal oscillator coil cover entire range. (Self-excited oscillator coils covering 200-290 and 290-415 kcs. are available.) High level plate modulation of final amplifier is used, giving 40% tone modulation in 100 watt transmitter and 60% in 50 watt model. Microphone P-T switch interrupts tone, permitting voice operation.

This unit can be operated in air temperature range 0°C to + 45°C using 866A rectifiers, or from — 35°C to + 45°C using 3B25 rectifiers; humidity up to 95%.

The "stand-by" transmitter is selected when main transmitter suffers loss (or low level) of carrier power or modulation. Audible indication in monitoring receiver tells which transmitter is in operation.

Unit is ruggedly constructed and conservatively rated, providing low operating and maintenance costs.

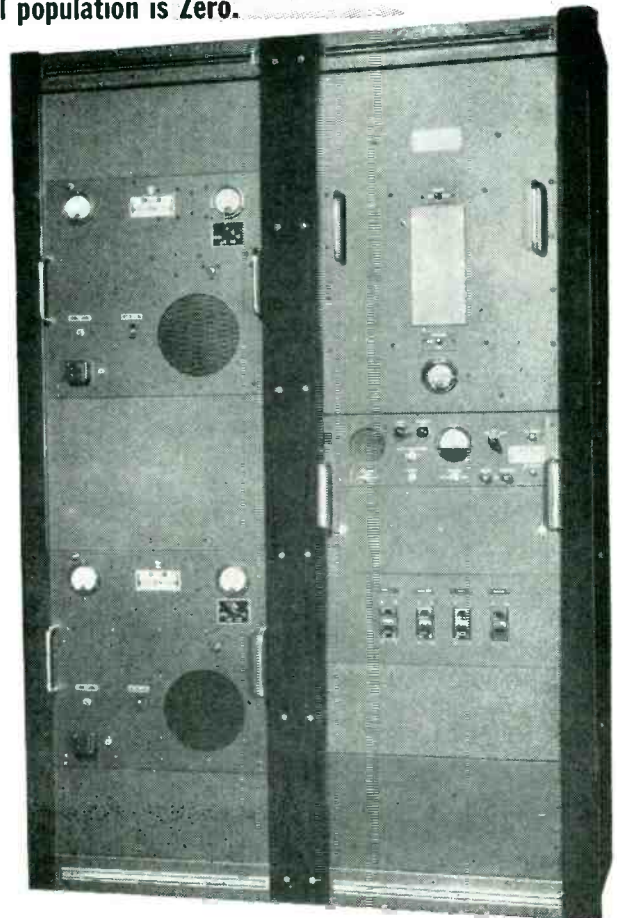

3090 S.W. 37th AVENUE

MIAMI 33, FLA.

For high heat applications C-D-F Melamine Dilecto cleanly machined by C-D-F

As operating temperatures rise, melamine laminated plastics can satisfy many requirements for component parts. Glass base melamine grades of Dilecto resist elevated temperatures—up to 300° F. continuously, 350° F. intermittently. They have extremely high impact strength; excellent arc resistance and self-extinguishing properties. C-D-F melamine Dilecto grades are usually specified for many electrical applications requiring high arc resistance, mechanical strength, flame and heat resistance.

C-D-F can supply melamine Dilecto in sheets, tubes and rods in the following grades:

GB-28M—Medium weight glass base laminate with melamine resin. Highest mechanical strength; excellent arc resistance, high heat and flame resistance; self-extinguishing. Dimensionally stable—little affected by temperature and humidity.

GB-112M—Lightweight glass fabric with melamine resin. Substantially same characteristics as GB-28M. Usually produced in thickness less than $\frac{1}{32}$ ".

GM-1—Glass mat base melamine resin bonded laminate. A lower cost product suitable for many applications requiring arc resistance along with good mechanical strength and flame resistance.

USE COMPLETE MANUFACTURING FACILITIES OF C-D-F. Make us responsible for your complete job . . . from laminates to finish machining of components. C-D-F has the know-how to cleanly machine melamine Dilecto to close tolerances. C-D-F can save you time, money and waste of material. And when you make C-D-F responsible for the complete job, you know what you're getting: components machined to exact specifications; strict adherence to quoted prices; and prompt delivery.

Write for samples and technical bulletins on melamine Dilecto components. Call in a C-D-F sales engineer, tell him your problem. He'll help you.

See our general catalog in Sweet's Design File for more data, the address and telephone number of your nearest C-D-F sales engineer. Also write for technical bulletin and specific catalog, free test samples, or send us your print for quotation.



Continental-Diamond Fibre

CONTINENTAL-DIAMOND FIBRE COMPANY • NEWARK 28, DELAWARE

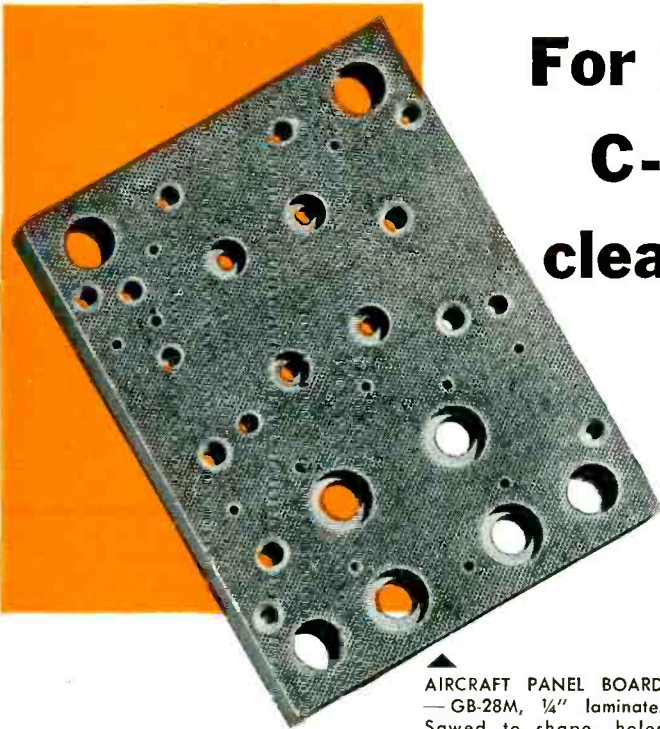

AIRCRAFT PANEL BOARD — GB-28M, $\frac{1}{4}$ " laminate. Sawed to shape, holes drilled, counterbored and countersunk. Machined by C-D-F.

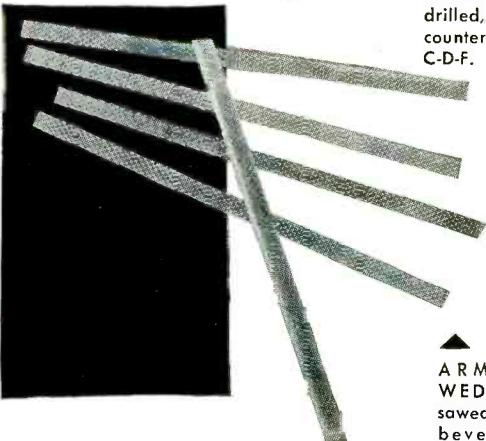

ARMATURE SLOT WEDGES — GB-28M, sawed into strips, then beveled edges were broached to angle of 21° 23', and strips were cut to exact length. Machined by C-D-F.



RF COIL FORM — Natural GB-112M Dilecto rolled tubing, smooth edged. Sawed to length; drilled and burred by C-D-F.

TERMINAL BLOCK—GB-28M. Sawed to shape, grooves milled, corners sanded round. Holes were drilled, counterbored, characters stamped. Machined by C-D-F.

INSULATOR — ML rod. Turned on automatic screw machine by C-D-F. Grade ML is a fine weave cotton fabric base laminate bonded with a melamine resin. Easy to machine.

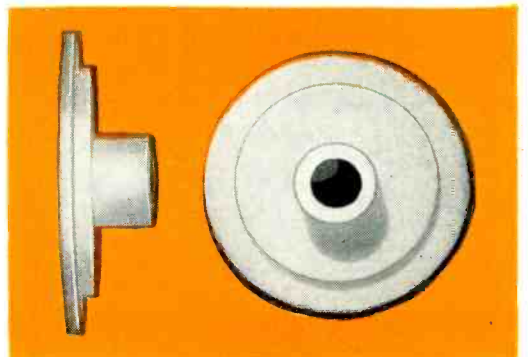
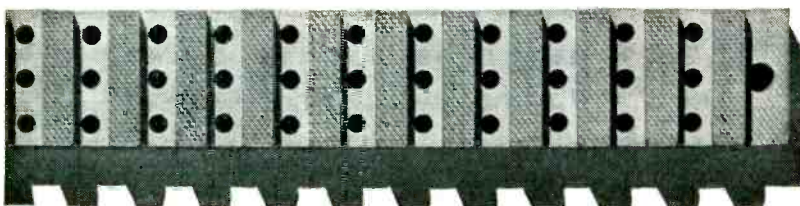

UNREGULATED LINE VOLTAGE



TYPICAL RECORDING FROM A LINE VOLTAGE VARIATION SURVEY:
 The chart at the top is representative of the average line voltage condition found in a comprehensive survey of commercial and industrial establishments. A tracing at the same point made at another time might show entirely different conditions, since periods

of stable voltage are often followed by periods of violent transient fluctuations and/or large, gradual swings. The bottom chart, recorded at the same time, shows the output voltage of a Sola Constant Voltage Transformer fed from this line.

SOLA REGULATED LINE VOLTAGE



End Fluctuating Line Voltage Handicap to Reliable Product Performance

Where line voltage fluctuations impair the performance of voltage-sensitive electronic equipment, Sola Constant Voltage Power Transformers often provide a simple, economical solution. Stock or custom designed units are available.

The Sola regulator has no moving parts and requires no manual adjustment or maintenance. Operation is automatic with response time 1.5 cycles or less. Regulates as close as $\pm 1\%$ with line voltage variations as great as 30%.

To meet special load requirements or service conditions, units can be custom-designed for production quantity orders. Variations available for special-order work include:

- Capacity ranges from a fraction of a va to 30kva
- Wide variety of voltage inputs and outputs
- Frequencies other than 60 cycles
- Provisions for wide ambient temperature ranges
- Structural features for installation as a component
- Premium mechanical features for military service and other special duty

The cost of Sola voltage regulation may be far less than you anticipate for two reasons: 1) installation of a Sola unit eliminates the need for the conventional non-regulating power supply transformer and any regulating components which you may currently use . . . 2) your requirements may be satisfied by a stock unit or custom design already on file. A Sola sales engineer is always available to discuss your voltage regulation requirements with you.

TYPICAL CUSTOM-DESIGNED SOLA POWER TRANSFORMERS

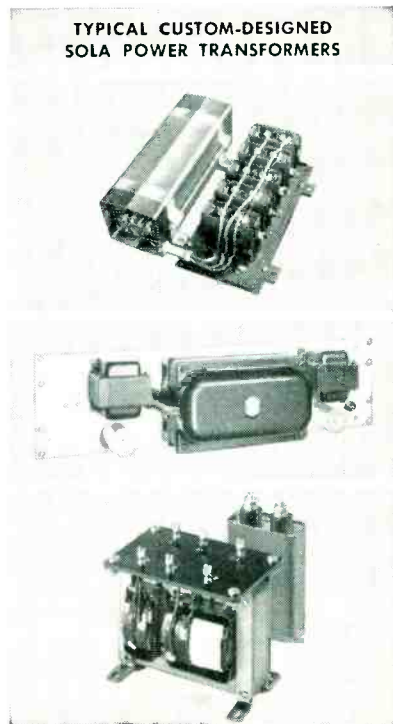

SOLA *Constant Voltage*
TRANSFORMERS

Write for Bulletin 7-CVES for facts on the complete line of Sola Constant Voltage Power Transformers.

CONSTANT VOLTAGE TRANSFORMERS for Regulation of Electronic and Electrical Equipment • **LIGHTING TRANSFORMERS** for All Types of Fluorescent and Mercury Vapor Lamps. • **SOLA ELECTRIC CO., 4633 West 16th Street, Chicago 50, Illinois, Bishop 2-1414** • **BOSTON:** 272 Centre Street, Newton 58, Massachusetts • **NEW YORK 35:** 103 East 125th Street • **LOS ANGELES 26:** 2025 Sunset Boulevard • **PHILADELPHIA:** Commercial Trust Building • **CLEVELAND 15:** 1836 Euclid Avenue • **KANSAS CITY 2, MISSOURI:** 406 West 34th Street • **TORONTO 9, ONTARIO:** 617 Runnymede Road
 Representatives in Other Principal Cities

Tests show two CATHALOYS most versatile cathode materials

New alloys from Superior Tube simplify selection, prolong tube life

Now the engineer's job of selecting the right cathode alloy for practically any electron tube can be a simple choice between two new CATHALOYS from Superior Tube.

CATHALOID A-32* is an active alloy characterized by rapid activation, high emission level throughout life, very low interface impedance, and absence of sublimation. These remarkable advantages are the result of using aluminum in place of silicon or magnesium as the reducing agent. The addition of a small percentage of tungsten also makes A-32 approximately 50% more shock resistant than cathodes without tungsten. Thus A-32 is suitable for virtually any active alloy application, including ruggedized tubes.

CATHALOID P-50 is a passive alloy of carefully controlled analysis that is commercially available in WELDRAWN† cathodes as well as Lockseam‡. It can be made in WELDRAWN form because of its capacity to take much more severe reductions in cold drawing without rupture than other grades of passive alloys. P-50 is identical in composition with the well-known ASTM Grade 21. The important difference is in the method of melting which improves the uniformity and completeness with which deoxidation is accomplished. All heats are tested in Superior Tube's laboratory before being approved for production.

Ask for complete technical reports on both these new CATHALOYS. Write Superior Tube Co., 2500 Germantown Ave., Norristown, Pa.

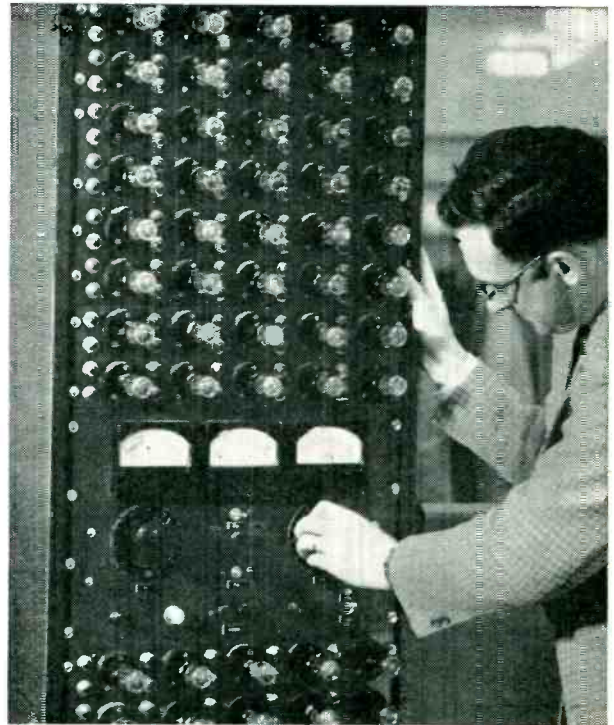

ON TEST. Laboratory photo of test diodes used in Superior Tube's electronic laboratory. Under exhaustive tests, the new Cathaloids display performance characteristics not present in other alloys.

*Patent applied for

†TM Reg. U.S. Pat. Off., Superior Tube

‡Manufactured under U.S. patents

NOTE: Cathaloid is a trademark of Superior Tube Co., Reg. U.S. Pat. Off.

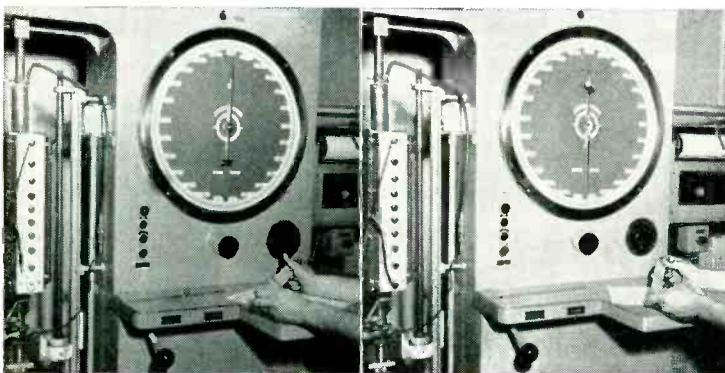

CATHALOID A-32—3750 psi
50% STRONGER. High temperature tensile testing machine proves Cathaloid A-32 approximately half again stronger than tungsten-free cathode alloys.

Tungsten-free cathode alloy—2500 psi

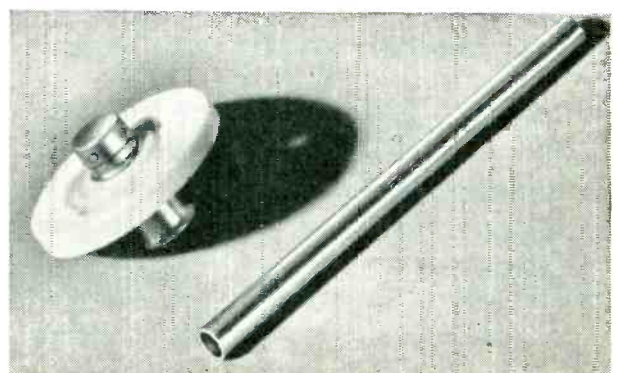

WELDRAWN PASSIVE ALLOY. Typical uses for Cathaloid P-50 are in Weldrawn cathode sleeve shown at right and in disc cathode shank at left. Heretofore, passive alloys have not been commercially available for these applications.

Superior Tube

The big name in small tubing

All analyses .010" to 5/8" OD. Certain analyses in light walls up to 2 1/2" OD.

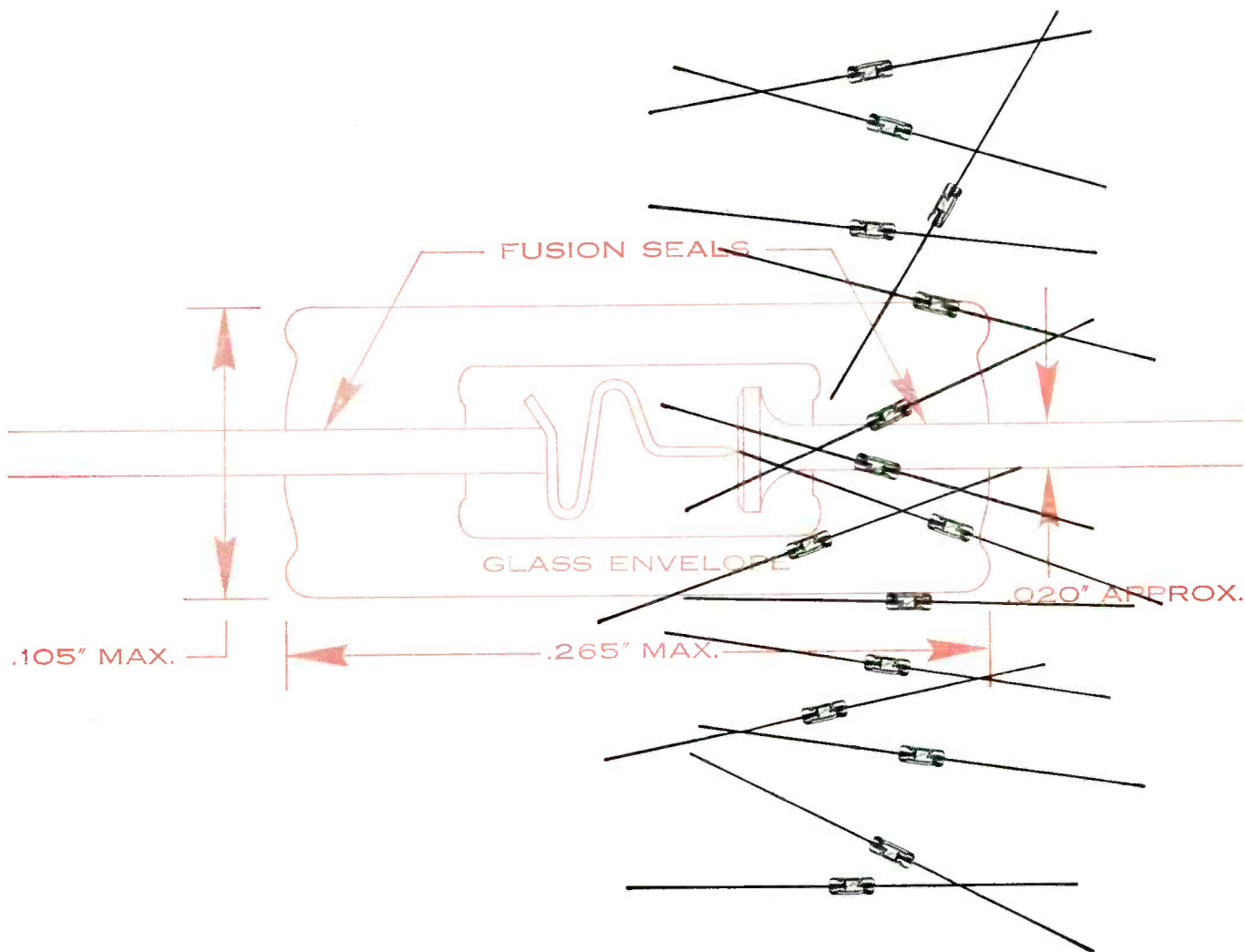

FIRST OF ALL FOR **RELIABILITY**

HUGHES SEMICONDUCTOR PRODUCTS

Why should YOU use Hughes semiconductors? First of all—for reliability. You can depend on these devices to stay within published ratings and specifications under varied and severe operating conditions.

All diodes made by Hughes are:

MOISTURE-PROOF—Fusion-sealed in a one-piece glass envelope. This construction eliminates a major cause of diode failure.

RUGGED—Small volume and mass enable them to withstand physical shock and vibration.

STABLE—Internal elements are isolated from damage or contamination. Mechanical and electrical characteristics remain stable throughout a long operating life.

THOROUGHLY TESTED—All diodes are tested for electrical and mechanical characteristics. They operate faithfully over wide ambient temperature ranges.

SUBMINIATURE*—In miniaturized circuitry, the high component density possible with these diodes promotes greater volumetric efficiency.

For instance, Hughes subminiature diodes have now been used by many major manufacturers of electronic equipment. Without exception, available performance reports indicate that, in military and commercial installations alike, the Hughes components have maintained an extraordinary record of failure-free service. Today, these same diodes are continuing to add to the reputation for superior reliability synonymous with Hughes Semiconductor Products.

The Hughes line of semiconductor devices is being steadily expanded. It now comprises a wide selection of Germanium Point-Contact and Silicon Junction Diodes, and Photocells. New products, now under development, are being readied for commercial production. Watch for their release. They, too, will embody the same Hughes quality in design and manufacture that spell out unsurpassed stability and reliability. Specify Hughes—with confidence.

HUGHES	SEMICONDUCTOR SALES DEPARTMENT	
<i>Aircraft Company, Culver City, California</i>	 	<i>New York Syracuse Philadelphia Chicago</i>

**Maximum dimensions, standard germanium diode glass envelope: 0.265 inch by 0.105 inch.*

General Plate

COMPOSITE CONTACTS

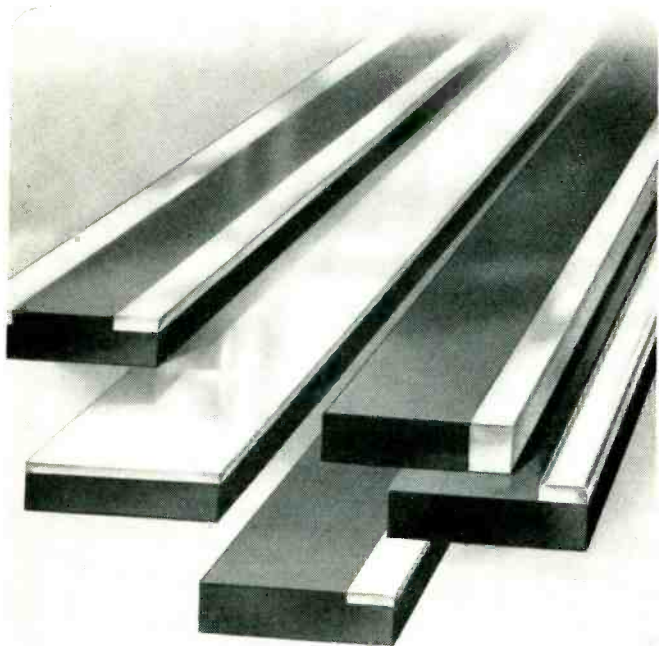

COMPOSITE STOCK

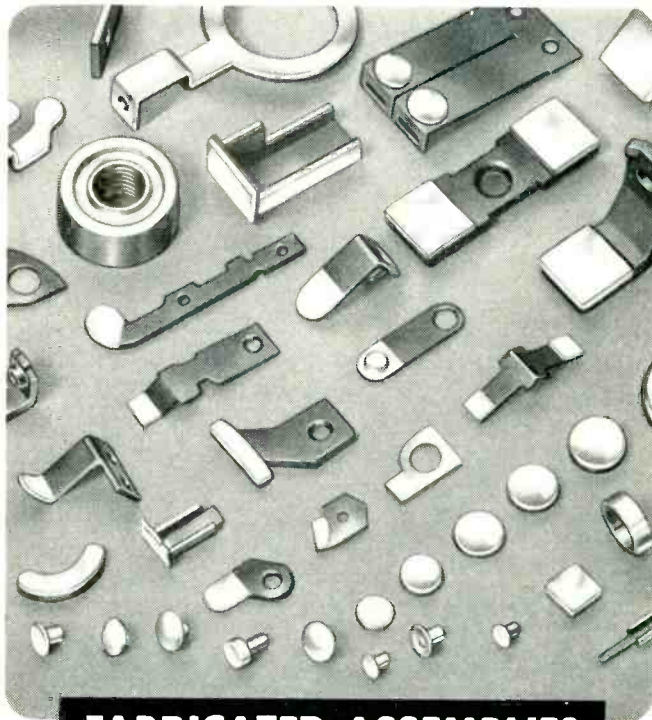

FABRICATED ASSEMBLIES

Composite Contact Material that meets your requirements Composite Contact Assemblies that cut your costs!

There are many advantages for using General Plate composite contact materials, processes and facilities. Among the more important are better performance, longer operating life and lower fabricating costs.

But that's not all — here at General Plate you have a single source that can supply your contact requirements be it composite raw stock, contacts or complete assemblies. General Plate stock and contacts are available in a wide range of alloys designed to meet your specific requirements.

General Plate Composite Contact Materials make it possible to manufacture complete contact assemblies to close tolerances by single blanking

and forming operations. Compare this to other methods whereby the contacts and supporting members are fabricated separately and then assembled by brazing, welding or staking methods.

By letting General Plate fabricate your complete contact assemblies, you will save money, time and trouble . . . needless equipment cost and problems of scrap disposal are eliminated . . . contacts and/or contact assemblies made to your exact specifications are shipped to you ready for installation.

Write for complete information and Catalog PR700.

**You can profit by using
General Plate Composite Metals!**

**METALS & CONTROLS CORPORATION
GENERAL PLATE DIVISION
35 FOREST STREET, ATTLEBORO, MASS.**

what are
your
diode
requirements?

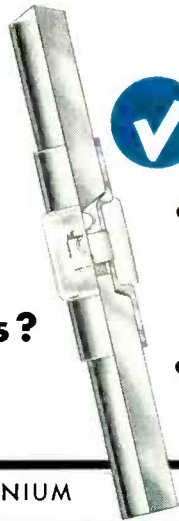

Check these
PSI features...

- Versatile lead configurations
- Glass-to-metal fusion seal
- Welded construction

Below, we've listed typical types from PSI's broad standard diode line. We also make many special diodes... and if your needs cannot be met by standard types, PSI engineers will be glad to investigate your specific problem promptly. Write us for complete product information.

GERMANIUM

GOLD BONDED DIODE SPECIFICATIONS (@ 25°C)

RETMA TYPE	PSI TYPE	OUTLINE 1	MAXIMUM INVERSE WORKING VOLTAGE (v)	MINIMUM FORWARD CURRENT @ +1v (ma)	MAXIMUM INVERSE CURRENT @ SPECIFIED VOLTAGE (ma)
HIGH VOLTAGE TYPES					
	PS200	A/B/C	200	20	0.05 (-50v) 0.2 (-200v)
1N39A		B	200	3	0.2 (-100v) 0.8 (-200v)
1N55B		A	150	5	0.5 (-150v)
HIGH CONDUCTANCE TYPES					
	PS201	A/B/C	90	150	0.02 (-10v) 0.18 (-90v)
After switching from 5 ma 1μsec forward pulse to -40v, back resistance must equal or exceed 25K in 0.3μsec. Loop resistance = 2000 ohms min.					
	PS202	A/B/C	30	100	0.02 (-20v)
	PS203	A/B/C	30	100	0.1 (-20v)
0.35 (-20v) @55°C					
GENERAL PURPOSE—MEDIUM CONDUCTANCE					
	PS205	A/B/C	80	75	0.05 (-50v)
	PS206	A/B/C	60	75	0.1 (-50v)
1N143		B	100	40	0.1 (-100v)
	PS207	A/B/C	80	40	0.05 (-50v)
	PS208	A/B/C	60	(Note 2)	0.02 (-10v) 0.12 (-60v)
After switching from 5 ma 1μsec forward pulse to -40v, back resistance must equal or exceed 80K in 0.3μsec. Loop resistance = 2000 ohms min.					
GENERAL PURPOSE					
	PS210	A/B/C	100	15	0.02 (-20v) 0.1 (-100v)
0.15 (-20v) 0.3 (-100v) @55°C					
	PS211	A/B/C	60	30	0.05 (-50v)
0.2 (-50v) @55°C					
1N63		B	100	4	0.05 (-50v)
1N67A		A	80	4	0.005 (-5v) 0.05 (-50v)

SILICON JUNCTION DIODE SPECIFICATIONS (@ 25°C) ⁶

PSI TYPE ³	OUTLINE	MINIMUM SATURATION VOLTAGE ⁴ -E _s (v)	TRANSITION VOLTAGE RATIO ⁵ E _t /E _s (%)	MINIMUM FORWARD CURRENT @ +1v (ma)	MAXIMUM INVERSE CURRENT @ SPECIFIED VOLTAGE (μa) @ 25°C (μa) @ 150°C
(D) PS500	A/B/C	500	90	3	0.01 (-150v) 5.0 (-150v)
(D) PS501	A/B/C	150	90	10	0.01 (-75v) 5.0 (-75v)
(D) PS502	A/B/C	55	95	30	0.01 (-30v) 5.0 (-30v)
(D) PS503	A/B/C	30	95	60	0.01 (-15v) 5.0 (-15v)

1. Diodes may be obtained with other configurations to meet special needs.
2. During 0.1μsec 50 ma peak half-sine forward pulse (Maximum PRF = 100 KC), forward voltage ≤ 3v.
3. (D) denotes Developmental Specification.
4. Saturation Voltage (E_s) is measured at 500μa.
5. Transition Voltage (E_t) is measured at 50μa.

6. Recovery time: After switching from 5 ma forward current to two-thirds of the minimum E_s, typically each of the diode types reaches a back resistance of 50K in less than 1μsec.

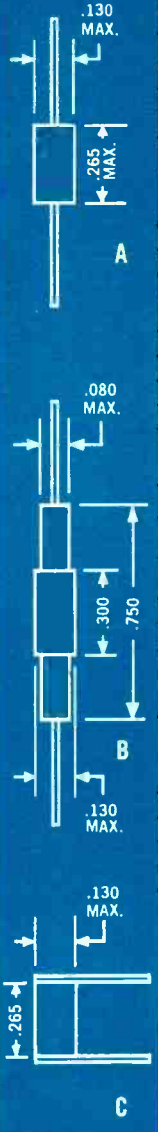

PACIFIC

THREE SALES OFFICES:



SEMICONDUCTORS, INC.

10451 West Jefferson Boulevard
Culver City, California
3959 Lincoln Avenue
Chicago, Illinois
2079 Wantagh Avenue,
Wantagh, Long Island, New York

3 SENIOR ENGINEERING JOBS

WELL WORTH LOOKING INTO . . .

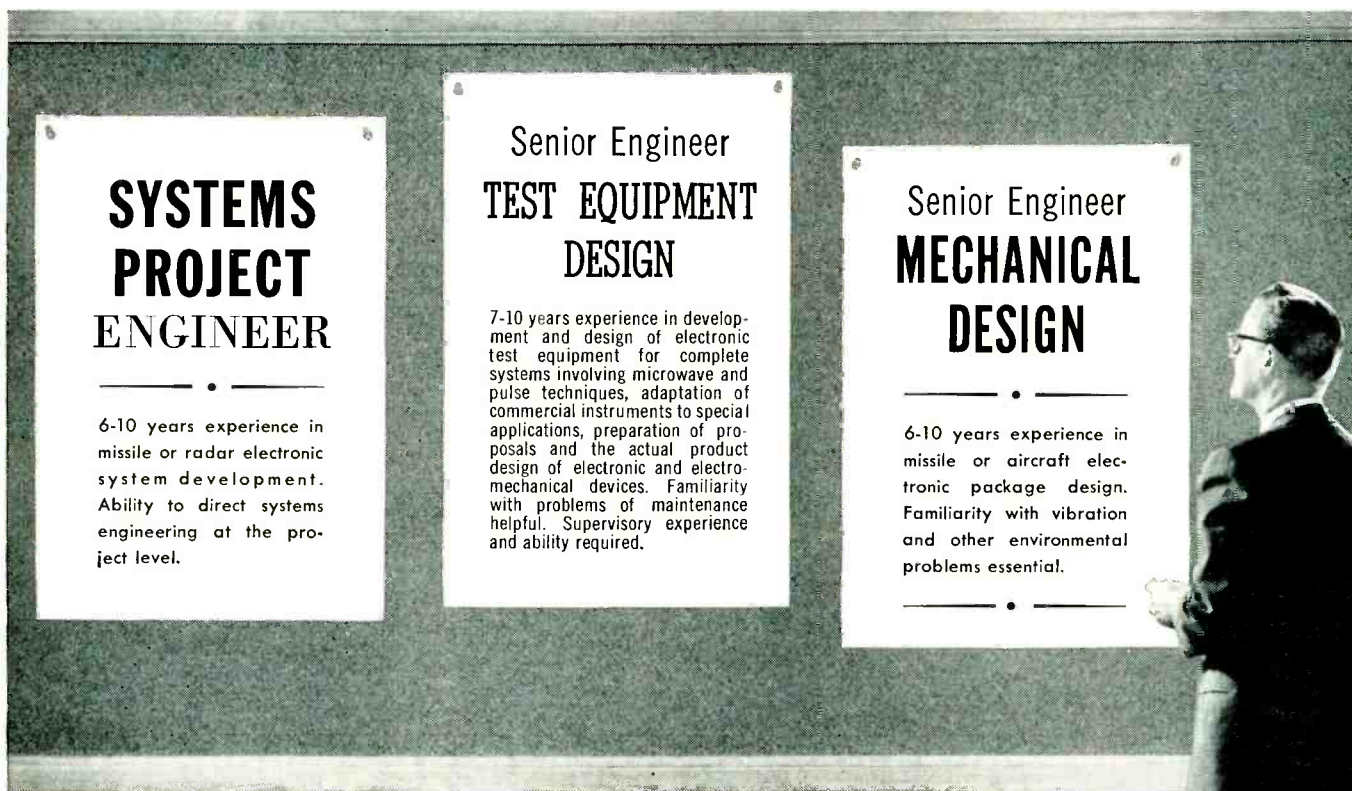

SYSTEMS PROJECT ENGINEER

6-10 years experience in missile or radar electronic system development. Ability to direct systems engineering at the project level.

Senior Engineer TEST EQUIPMENT DESIGN

7-10 years experience in development and design of electronic test equipment for complete systems involving microwave and pulse techniques, adaptation of commercial instruments to special applications, preparation of proposals and the actual product design of electronic and electro-mechanical devices. Familiarity with problems of maintenance helpful. Supervisory experience and ability required.

Senior Engineer MECHANICAL DESIGN

6-10 years experience in missile or aircraft electronic package design. Familiarity with vibration and other environmental problems essential.

Here are three especially attractive job opportunities for engineers who want to get on the ground floor in the important, interesting, and challenging phase of a new industry—guided missiles.

Qualified men are given real job responsibilities with Bendix and grow with the development of what is not only the nation's most important weapon system, but a project that will undoubtedly lead to new and im-

portant long-range commercial application.

At Bendix you will be associated with top missile authorities and have at your command unexcelled engineering and manufacturing facilities. Salaries for these top jobs and other opportunities are open for discussion. Write today to: Mr. W. L. Webb, General Manager, Missile Section, Bendix Products Division, Bendix Aviation Corporation, 401 North Bendix Drive, South Bend, Ind.

23 OTHER ENGINEERING POSITIONS!

Bendix also offers unusual job opportunities for assistant engineers, junior engineers, and technicians, as well as a score of other assignments. A 30-page book describing in

detail every phase of our guided missile operation will be sent to you on request. If you are interested in guided missiles, this book is bound to interest you. Write for it today.



problem: Electronic Assemblies

solution:

MAKEPEACE



Long experience in this highly specialized field enables Makepeace to supply efficiently and promptly electronic assemblies which meet the most unusual and exacting specifications.

Even Tighter Tolerances Than MIL-T-85-B Are Readily Met

When Makepeace supplies such components as rotary joints, antenna feeds, crystal mixers or highly specialized assemblies, manufacturers can be confident that each one will not only exactly meet but often surpass the most rigid specifications. Our engineering staff is always available for consultation on the

design and manufacture of prototypes and for projection of production runs . . . and our unusually complete testing facilities are at your disposal. We invite your inquiries.

Makepeace Can Meet Your Requirements In Collector Rings and Brushes

Complete self-contained assemblies are available either MAKEPEACE standard 2 to 24 circuit stock ring and brush assembly or units made to meet special requirements for miniature large electro-mechanical rotating devices and systems. New materials and techniques developed in our laboratory and tried in the field provide hitherto unobtainable performance at very high speeds and extremely low noise levels as well as economy of space and weight. Slip rings from .050" O.D. to 48" O.D. in solid or laminated precious metals are available in a great variety of alloys. Our unique facilities for designing, testing and engineering are at your disposal.



D. E. MAKEPEACE COMPANY

Division of Union Plate and Wire Co.

ATTLEBORO, MASS.

Sales Offices: New York • Chicago • Los Angeles • Columbus

Precision Rectangular Waveguide Tubing • Microwave Components • Microwave Transmission Assemblies • Electrical Contact Material • Formed Electrical Contacts • Crossbar Welded Contacts • Slip Ring and Slip Ring Assemblies • Brush Assemblies • Precious Metals Clad To Base Metals • Sheet — Tubing — Wire and Assemblies • Sendzmir Precision Rolling

Creative..Imaginative

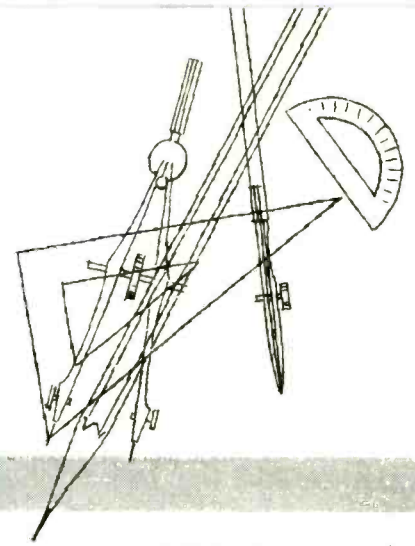

TELEPHONE PAY STATION

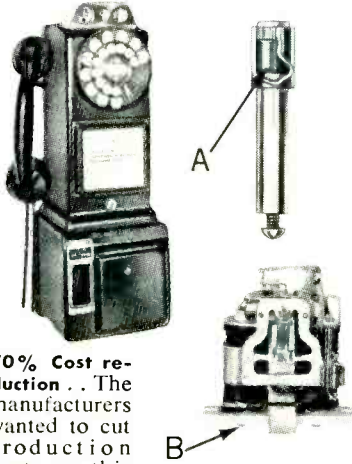

70% Cost reduction . . The manufacturers wanted to cut production costs on this pay station. They wanted more positive mechanical action built into the unit . . to minimize service calls. So their engineers, cooperating with Indiana Permanent Magnet engineers, designed a new magnet assembly using specially designed Indiana Permanent Magnet (A), replacing a conventional type steel magnet. Assembly functioned as a part of coin return assembly (B). Results were (1) flux increase 27% . . from 2750 Maxwells with steel magnet to 3500 with Indiana Permanent Magnet using Alnico III, (2) magnet cost reduced 70%, (3) weight saving, (4) simpler design, (5) fewer service calls required.

TACHOMETER

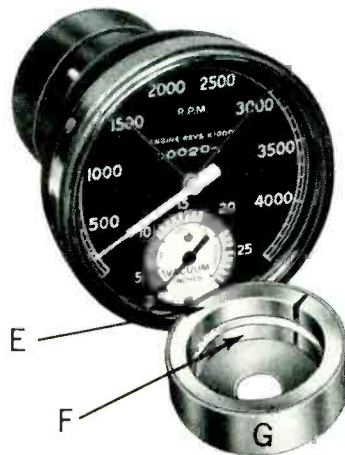

Improved stability . . This company wanted a permanent magnet assembly that would produce sufficient torque and give added stability to this tachometer. By varying the analysis and heat treatment of the magnet material, Indiana Permanent Magnet engineers developed special Cunife permanent ring-magnets (E) and (F) which, as component parts of permanent magnet assembly (G), provided the necessary torque and improved stability. Results were: (1) the desired torque and improved stability; and (2) the redesigned magnet lent itself better to the limited space resulting from the new design.

ELECTRONIC DATA PROCESSING MACHINE

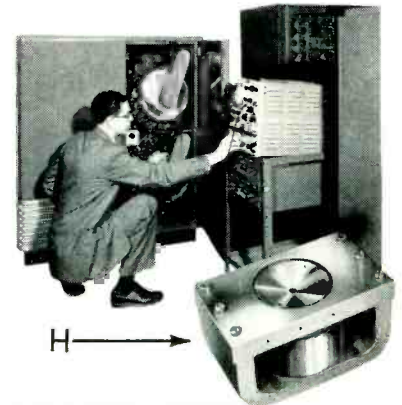

Immediate signal pickup . . This computer manufacturer required a permanent magnet to build up a magnetic surface of the drum used in Magnetic Reader and Recorder . . a unit of its Electronic Data Processing Machine. Indiana Cunife Permanent Magnets were selected. Results: Strong, dependable signals because of the high coercivity and permanence of Indiana Permanent Magnets. Another permanent magnet (Indiana Alnico) was used for the housing (H) in the magnetic tape Reader and Recorder unit of the processing machine. Results: Immediate signal pickup . . sensitivity high because of magnet's high efficiency.

Here are six thumbnail case histories of permanent magnet applications. You'll notice they all have one thing in common. *Special engineering and design service* by Indiana Permanent Magnet engineers . . design service that reflects original thinking, creative thinking, imaginative thinking . . was an important part of each story!

This specialized service is available to you without obligation. Indiana Permanent Magnet engineers, with more than 45 years experience in designing permanent magnets

for some 40,000 applications, will welcome the opportunity to assist you in the development of *your* permanent magnet designs.

Indiana maintains the *world's largest engineering staff devoted solely to the design and application of permanent magnets . .* and the world's largest and most complete permanent magnet research and production facilities.

For additional details and a copy of Engineering Design Manual 4-A-5, write The Indiana Steel Products Co., Valparaiso, Ind.

World's largest Manufacturer of Permanent Magnets

Permanent Magnet Design

*helped these original equipment manufacturers
reduce costs . . improve performance . . simplify design*

GENERATOR

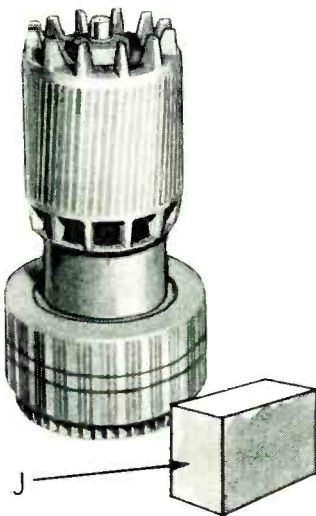

Permits uninterrupted service . . This permanent magnet generator uses 28 Hyflux Alnico V, bar-shaped Indiana Permanent Magnets. Minimum maintenance and long service are two "musts" in generators . . and Indiana Permanent Magnets help insure these qualities. These magnets (J) eliminate necessity for slip rings and commutators, which in turn eliminate sparking and resulting radio or TV interference. And there's no heat from the field coils . . nor is excitation power needed.

WATT-HOUR METER

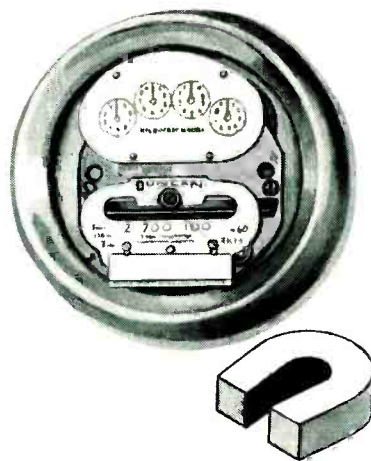

Insures field stability . . This watt-hour meter is typical of hundreds of different types of instruments and meters using permanent magnets. A single phase, 15-amp, 240-volt unit, it uses an Alnico I Indiana Permanent Magnet weighing only 0.2 lb. Uniformity and stability of field, so necessary for maintaining the initial accuracy of this meter over a long period of years, is provided by magnets of the type shown above. Similar magnets are widely used in mass spectrometers, vibration pickups, galvanometers, medical instruments, speedometers, fluxmeters, etc.

SOUND-POWERED TELEPHONE



Compactness . . was an important consideration in the design of this electric self-powered telephone. It is powered not by batteries nor other outside power sources . . but rather by sound waves which initiate a series of electrically activated impulses. Working with Indiana Permanent Magnet engineers, the manufacturer, by selecting Indiana Sintered Alnico II, was able to use extremely small magnets while maintaining high performance requirements. "Indiana Sintered Alnico II," reported this company's sales manager, "made possible small magnets of high coercive force, the greatest single factor in size reduction of transducers compared to that possible with other alloys."

Free Subscription: Write for your subscription to "Applied Magnetics" . . a bi-monthly publication carrying helpful and practical information about permanent magnets and their application to industrial and consumer products. Please write on your company letterhead.



**INDIANA
PERMANENT
MAGNETS**

THE INDIANA STEEL PRODUCTS COMPANY, VALPARAISO, INDIANA

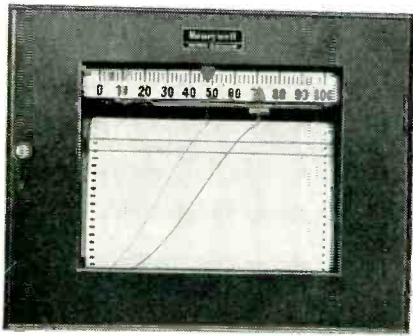

DUPLEX RECORDER

Simultaneously plots two continuous data curves vs. time. Has two independent measuring systems, each with any desired range.

See Data Sheet 10.0-6.

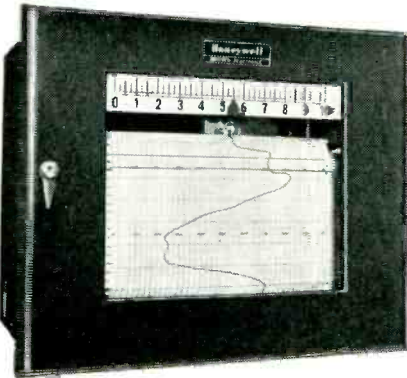

1/2 SECOND PEN SPEED RECORDER

Pen traverses full 11-inch calibrated width of chart in only 1/2 second. Precise recording of variable changes without overshoot or hunting. Full accuracy, even on spans as narrow as 3 millivolts.

Request Data Sheet 10.0-13.



BROWN-RUBICON PRECISION INDICATOR

Combination of high-precision potentiometer and automatic *ElectroniK* indicator, for highly accurate small voltage measurements and for calibrating meters, bridges and similar equipment . . . with minimum operator fatigue.

See Data Sheet 10.0-2.

Research men everywhere are finding that specialized *ElectroniK* instruments can save them many precious hours of lab time, by automatically taking over much of the routine burden of gathering, recording and plotting data.

In addition to the models pictured here, Brown instruments for research include *ElectroniK* Function Plotters, in single pen and double pen types . . . *ElectroniK* Extended Range Recorder and Adjustable Span Recorder . . . the *ElectroniK* Null Indicator, modern successor to the galvanometer . . . and a family of precision-made servo components. For a discussion of how these can help in your own research program, call your nearby Honeywell sales engineer.

MINNEAPOLIS-HONEYWELL REGULATOR Co., *Industrial Division*, Wayne and Windrim Avenues, Philadelphia 44, Pa.—in Canada, Toronto 17, Ontario.



MINNEAPOLIS
Honeywell

BROWN INSTRUMENTS

First in Controls

Get better

test data

quicker — with

ElectroniK

research

instruments

One Waldes Truarc Ring Saves a Pound in Weight Replaces Cast Retainer Plate and Four Screws

Denison Vane Type Pump/Motor



The Denison Engineering Company of Columbus, Ohio uses a Waldes Truarc Beveled Retaining Ring (Series 5002) in their pump/motor to achieve a simpler, lighter, more easily assembled unit and to cut both material costs and production time.

This vane-type power package operates as either a fluid pump or motor without alterations of any kind. Built for 2000 psi continuous duty, rugged construction was essential.

Shaft Seal Subassembly

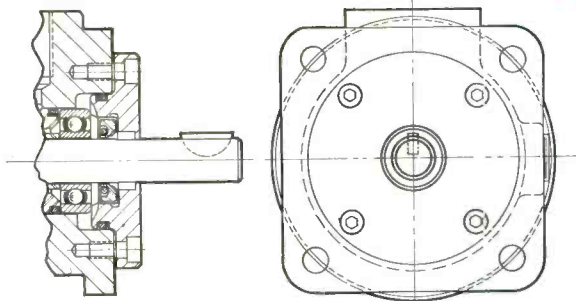

Experimental Way: One cast retainer plate plus four socket head cap screws hold unit together. Assembly requires skilled labor, machinery, time-consuming careful adjustment.

Shaft Seal Subassembly

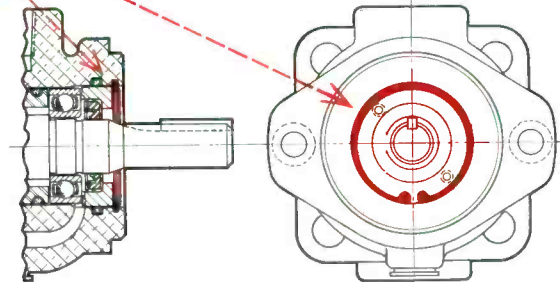

Truarc Way: Waldes Truarc beveled retaining ring (internal 5002) retains shaft and bearings, takes up accumulated tolerances rigidly, prevents leakage around shaft. Unit is one pound lighter. Assembly is quick and easy, more economical.

Wherever you now use machined shoulders, bolts, snap rings, or cotter pins, there's a Waldes Truarc Retaining Ring designed to do a better, more economical job. Truarc Rings are precision engineered, quick and easy to assemble and disassemble.

More than 5,000 stock-sizes of the different Truarc

ring types available. Ninety stocking points throughout U. S. A. and Canada.

Find out what Waldes Truarc Retaining Rings can do for you toward reducing costs and improving your product. Send your blueprints to Waldes Truarc Engineers for individual attention without obligation.

For precision internal grooving and undercutting . . . Waldes Truarc Grooving Tool!

Send for new catalog supplement

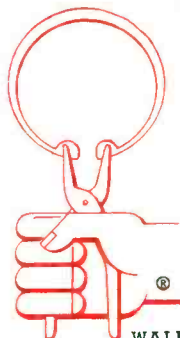

WALDES
TRUARC®
RETAINING RINGS

WALDES KCHINOOR, INC., LONG ISLAND CITY 1, NEW YORK

WALDES TRUARC Retaining Rings, Grooving Tools, Pliers, Applicators and Dispensers are protected by one or more of the following U. S. Patents: 2,382,948; 2,411,426; 2,411,761; 2,416,852; 2,420,921; 2,428,341; 2,439,785; 2,441,846; 2,455,165; 2,483,379; 2,483,380; 2,483,383; 2,487,802; 2,487,803; 2,491,306; 2,491,310; 2,509,081; 2,544,631; 2,546,616; 2,547,263; 2,558,704; 2,574,034; 2,577,319; 2,595,787, and other U. S. Patents pending. Equal patent protection established in foreign countries.

Waldes Kohinoor, Inc., 47-16 Austel Place, L. I. C. 1, N. Y.
Please send the new supplement No. 1 which brings Truarc Catalog RR 9-52 up to date.
(Please print)

Name.....
Title.....
Company.....
Business Address.....
City..... Zone..... State.....

E057

The fast way to get good components . . .



call your local
MALLORY
distributor

THE next time you need electronic components for experimental use, for short production runs, for repair work or for dozens of other purposes . . . here's a time-saving suggestion.

Pick up the phone and call your local Mallory distributor. He can give you prompt delivery . . . often in a matter of hours . . . of any of the variety of Mallory components which he carries. His stocks include an extensive selection of precision-made Mallory capacitors, resistors, controls, rheostats, mercury batteries, vibrators and rectifiers. The exact sizes and ratings you want are probably right on his shelves, ready to send to you whenever you need them.

Your nearby Mallory distributor is a good man to know. The quick service he gives can save you many valuable hours. And your "rush orders" will never sacrifice quality for convenience . . . for you will be getting the high standards of performance which have made Mallory components the choice of leading manufacturers everywhere.

We'll be glad to send you our complete new 1955 catalog listing all Mallory products carried by our distributors, and to tell you the name and address of the Mallory distributor nearest to you. Just call our local District Office, or write to us in Indianapolis.

Depend on MALLORY for Service!

P. R. MALLORY & CO. INC.
Distributor Division, Dept. A
P.O. Box 1558, Indianapolis 6, Indiana



CROSS TALK

► **TOUGH TRANSITION . . .** One of the major differences between government and commercial business is that in the first case equipment is designed primarily to meet specifications while in the second it is more often designed to meet competition.

This (plus other things widely realized in the industry) further explains why manufacturers who have run across something really exciting while fulfilling a military contract cannot always immediately convert it into civilian dollars.

► **ANOTHER BARRIER? . . .** One of the problems faced by a large and active group studying reliability is the fact that design parameters of such things as guided missiles must embrace not only the requirements of missiles as we know them today but also those likely to be devised tomorrow.

A lively and uninhibited imagination is called for, as well as intimate knowledge of current art. For who, regardless of stature, can be sure how fast or how far or how high a missile can go.

► **CRYSTALLIZING . . .** Gains in transistor production are in large part due to perfection of automatic instrumentation and control for devices that "grow" german-

ium and silicon crystals.

When making semiconductors a curveless Dior look is one goal of production men. To keep diameter constant, temperature in the crucible must be held constant within, say, 0.1 degree C at the 940-degree melting point of germanium. For silicon, which melts around 1,400 degrees, the control job is still more difficult, particularly when the level of the melt drops continuously.

To do the job, instrument men joined forces with r-f heating engineers. Automatic temperature controllers were modified to provide greater accuracy. The electronic heaters were modified to

permit practically instantaneous throttling of power output to the work coil. New circuits were devised, among them one that avoids system time lags by chopping the heating power around a dozen times per second.

► **FUNNY FIRE . . .** Back in February we noted that a remotely operated California tv station burned to the ground before the studio knew there was a fire because there was no telemetering alarm system.

Since then, in the same area, another station has had a serious fire because—of all things—the doorbell shortcircuited.

LOOKING AHEAD . . .

Mergers will continue at high level for some time. Among reasons: Desire of big non-electronic companies to diversify, need of expanding small companies for capital, current activity of investment houses

Watch for important but not necessarily last-word improvements in color-tv picture tubes by at least two manufacturers in midsummer or early fall

Business will be good but more highly competitive in period immediately ahead, new products with real advantages moving well, older products or those merely face-lifted not so well

Mechanized assembly trend, rolling up in size like a snowball, will bring some headaches, among them difficulty educating assemblers to specify wanted overall characteristics of packaged parts combinations rather than individual component requirements

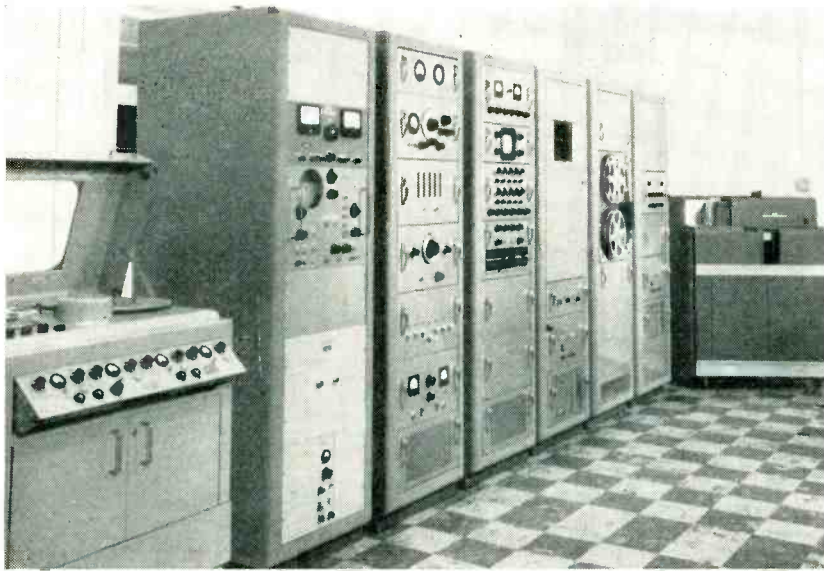

Data reduction system including tape recorder, test equipment, f-m data converter and linearizer, data processor and summary punch

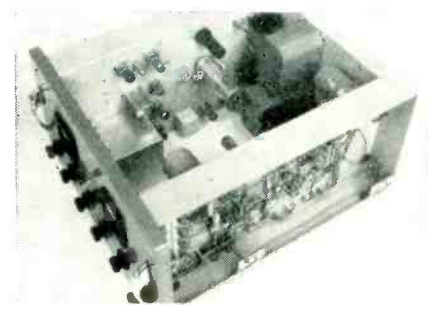

Discriminator of f-m data converter

By **E. M. McCORMICK**
Riverside, California

Data Reduction System

AN AUTOMATIC telemeter data reduction system has been developed and constructed to fulfill some of the data reduction requirements of the Missile Evaluation Department at the Naval Ordnance Laboratory, Corona, California. The input to the equipment is standard f-m/f-m telemeter signals recorded on a $\frac{1}{2}$ -inch magnetic tape and played back on an Ampex 500 tape recorder. The output consists of samples of the telemetered function to three decimal digits punched in IBM cards. These samples can occur up to 400 times per second. The system will be used also for other forms of analog-to-digital conversion including pulse-width telemetry and quantizing outputs from analog computers.

The equipment consists of the f-m data converter and linearizer designed and made in the Missile Instrumentation Section of the National Bureau of Standards (now Naval Ordnance Laboratory) Corona, California, and the Millisadic data processing system designed and made by Consolidated Engineering Corp., Pasadena, California. The author is merely reporting on

the equipment made jointly by these groups.

General Operation

The f-m data converter and linearizer demodulates any one of the f-m subcarriers and produces a pulse train, at each sampling time, whose count is proportional to the original telemetered function. The discriminator is extremely stable. Nonlinearity in the system from missile function to output can be corrected in a built-in inverse function generator. A total of 88 tubes is used.

The data processing system counts the pulses in the pulse trains from the f-m data converter and linearizer and causes the count to be punched into cards by an IBM 523 summary punch. Time count is provided by accumulating in a six-decimal-digit counter the pulses which occur at a rate of 100 per second. Each card contains six decimal digits of time; 5, 10 or 20 samples of three decimal digits each; and 14 arbitrary digits making a total of 80 columns. Since the information can be punched, in interlocking operation, at a rate of only

one card per second by using a speeded-up IBM 523, intermediate storage is used. This is provided by an Ampex digital tape recorder (DTR) in which the time-serial digital information is recorded at 20, 10 or 5 inches per second. This results in an effective card rate of 20, 10, 5 or 1 per second. The sampling rates are, therefore, from 400 to 5 per second. About 512 tubes are used in this section.

Card Record

The first six columns of a card indicate time to 0.01 second. This time is that of the first sample (columns 7, 8 and 9) whose sign is punched in column 10. The next sample is punched in columns 13, 14 and 15 with its sign in 16. The time associated with each sample is computed by linear interpolation between values on successive cards. Where no signs need be punched, 20 samples can be stored on a card, the first in columns 7, 8 and 9, the next in 10, 11 and 12 etc.

The last 14 columns of the card represent information not on the digital tape but entered directly by manually operated switches on the

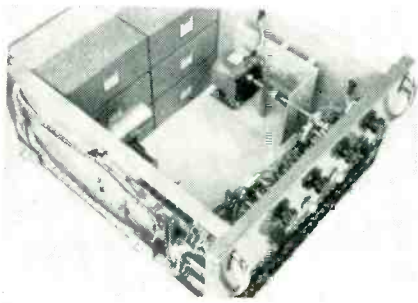

Control chassis of f-m data converter

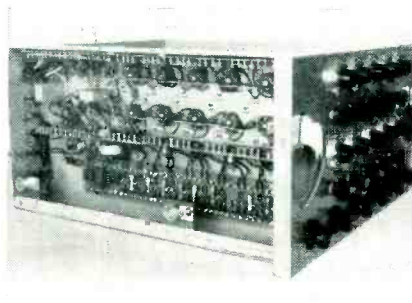

Linearizer chassis of f-m data converter

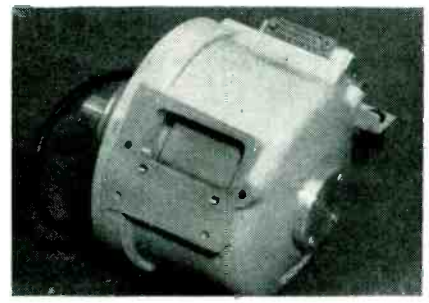

Two-card drum storage unit

SUMMARY — Flight data telemetered from experimental missiles is decommutated and recorded on punch cards for further study by f-m data converter and data processing equipment. Designed for f-m/f-m telemetering, the system also handles pulse-width signals

for Missile Telemetering

IBM punch control circuitry of the data processing equipment. Generally, these are used only for identification of records.

Telemeter Data Reduction

Reduction of f-m telemeter data involves converting the instantaneous value of subcarrier oscillator frequency to the function which it represents. A hypothetical example is given in Fig. 1. Curve *A* represents a case where the function varies linearly with frequency *s*. That is, $f = ms + b$ where *s* refers to the deviation of subcarrier frequency itself. The operation corresponding to *m* is referred to as the scale factor and *b* is the offset.

In this example, scale factor is 0.15 degrees per cycle and the offset is -2.5 degrees. When the function-versus-frequency curve is nonlinear as shown in curve *B*, it is convenient to consider the difference between it and a straight line as *A* as the nonlinear correction. Hence, in general, a system for reducing telemetered data must include scale factor, offset and nonlinear corrections. In the system described these corrections can be

made by either analog or digital means.

The f-m data converter front end is illustrated in Fig. 2. The signal obtained on playback of the telemeter tape contains all subcarriers and the one to be reduced is separated by a band-pass filter. A d-c voltage proportional to the telemetered signal is obtained from the f-m discriminator and converted to a 0 to 400-microsecond signal. This pulse-width signal is initiated each time a sample trigger occurs and is used to gate a train of pulses from the clock pulse generator. The number of output pulses indicates the absolute value of the function at that time. A zero-set arrangement is provided that permits setting the zero function indication to any frequency in the band. This, with a negative function value marker punched into the card permits offset correction. Where nonlinearity correction is required it is accomplished by making the width of the 0 to 400-microsecond gate vary nonlinearly with the input voltage. This is done by a linearizer function generator which produces the nonlinear difference function

needed to correct a type *B* curve to an *A* type.

The f-m to d-c converter is of the pulse-averaging type. As shown in Fig. 3, the subcarrier frequency is amplified, limited and differentiated to produce a series of pulses, one for each positive-going zero crossing. These pulses trigger constant-amplitude, constant-duration pulses. Normally, their duration is half the period of the subcarrier band center frequency. As the subcarrier frequency increases, the proportion of on time increases. By filtering the pulse waveform, a d-c signal proportional to deviation from center frequency can be obtained.

The discriminator has three provisions to reduce d-c drift below that of other pulse-averaging discriminators. The amplitude of the pulse in both the on and off states is accurately limited in amplitude. A highly stable and repeatable pulse-width signal is used. This is obtained by a phantastron precision delay and dual-triode coupling circuit. Finally, d-c drift is held to a minimum by a chopper-stabilized system. A high-gain operational

amplifier with considerable negative feedback is used. The filtering action is obtained by an R-C network as a part of the feedback path of this amplifier permitting 60-db-per-decade roll-off in the low-pass filter. The nominal cutoff frequency can be set to 35, 100 or 200 cps.

Pulse Train Conversion

The amplitude comparators and the precision saw-tooth sweep generator provide an output pulse accurately delayed from the input sample pulse in proportion to the input voltage. A 0 to 4-v input signal from the d-c discriminator will cause the pulse delay to vary 0 to 400 microseconds corresponding to a maximum count of 999. This is shown in Fig. 4A.

The precision sweep and the signal output from the discriminator are applied to two terminals of the crystal diode bridge null detector. A switching signal of 30 mc is ap-

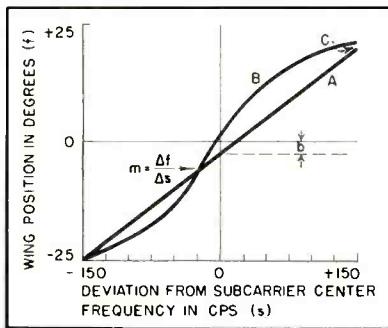

FIG. 1—Reduction of linear (A) and nonlinear (B) f-m telemeter signals

plied to two other terminals. As long as the signal-voltage amplitude differs from the saw-tooth output, there is an output from the null detectors. However, when the amplitudes match, the bridge is in balance resulting in no output. The output is amplified by a 30-mc i-f strip with a gain of 4,000. The change in amplitude at balance produces the desired output from the amplitude comparator.

Zero-Set

One of the amplitude comparators is a part of the zero-set circuit. The input is a presettable d-c voltage which causes the output pulse to occur at a corresponding time in the 400-microsecond range (Fig. 4B). In making offset corrections,

it produces a pulse corresponding to the zero value of the telemetered function. When the function value is negative, the signal pulse occurs before the zero-set pulse; if positive, after the zero-set pulse. The electronic switch basically causes the first in time of these pulses to turn the gate on, the second to turn it off. The result will be, for positive values of function, a gate (Fig. 4C), whose leading edge is fixed as it is triggered by the zero-set pulse and whose trailing edge varies in time with the amplitude of the function. When the function goes negative, trailing edge remains fixed, leading edge varies (Fig. 4D).

Total pulse width excursion is limited to 400 microseconds. By adjusting the zero-set d-c input, this pulse can be set to any desired place in the band and can accommodate an all-positive or all-negative function. An automatic servo system is provided which will reduce the pulse width to zero when a frequency corresponding to zero function value is fed into the discriminator.

The output gate duration controls the number of pulses in the train at each sampling time. This is done by switching the clock pulse generator which operates at 2.5 mc or lower depending on the scale factor required.

The zero-set pulse defines the positive and negative portions of the function excursion. Through the electronic switch and the coincidence gate circuits a negative func-

tion marker pulse can be obtained (Fig. 4E). However, when the signal pulse follows the zero-set pulse the negative marker pulse causes an X punch in the card. Since the X can not be recorded simultaneously with the sample itself, an additional circuit not shown causes one sample trigger to produce a pulse train. The next results in a recorded sign indication. Similarly, a positive marker may be obtained when desired.

Function Generator

The zero set will provide the offset corrections and the continuously variable clock pulse generator the scale factor corrections. The non-linearity correction is made by a linearizer function generator. The linear curve would require a linear saw-tooth voltage. The linearizer function generator, however, produces a sweep voltage which, when added as shown to curve A, produces a comparison voltage to the null detectors corresponding to curve B in Fig. 1. The sample trigger causes this nonlinear sweep, 400 microseconds in duration, to be generated at the same time as the saw-tooth sweep. This is done by starting a 25-kc oscillator which produces 40-microsecond pulses that are counted in a ring-of-ten counter. The amplitude of each of the output pulses (Fig. 5) can be varied by a precision ten-turn potentiometer and the polarity controlled by a switch. It is possible to approximate

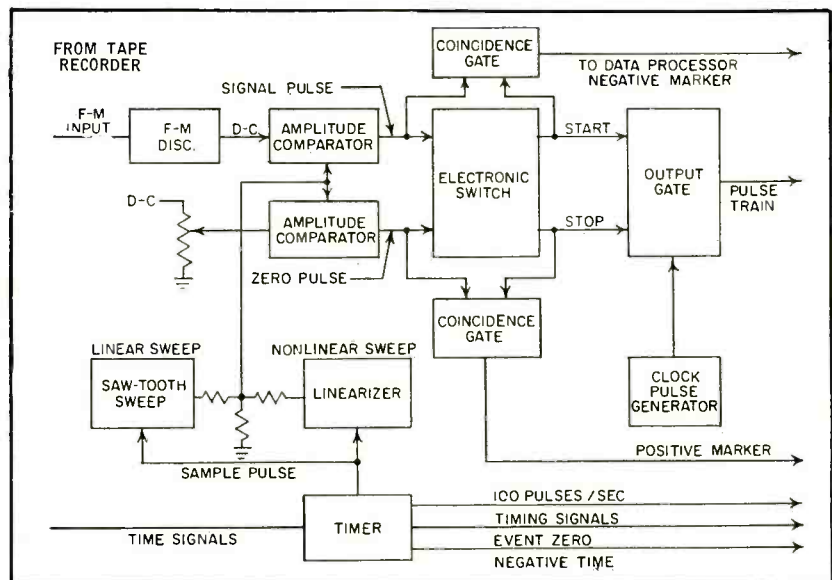

FIG. 2—Frequency-modulation data converter and linearizer

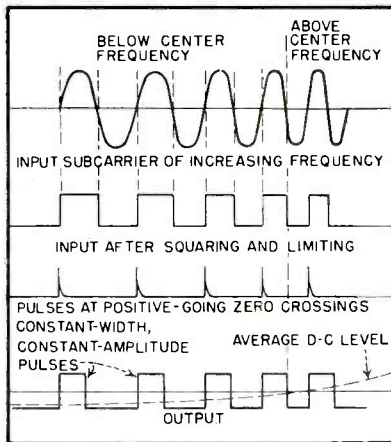

FIG. 3—Operation of pulse-averaging f-m discriminator

most nonmonotonic continuous correction curves by adjusting the pulse amplitudes and polarities. A low-pass R-C filter provides smoothing.

Setup Procedure

For a linear function a plot of the function versus subcarrier frequency would indicate the frequency for which zero function value is desired. After setting the input oscillator to this frequency, the servo on the zero set will automatically make this adjustment. The operator then adjusts the clock pulse generator so that the pulse train count for a point such as *C* (Fig. 1) will correspond to the function value.

When the curve is nonlinear as in *B*, line *A* need not be the best-fitting straight line. It is necessary only that it cross the desired curve *B* at a subcarrier frequency corresponding to the beginning of the sweep from the function generator. Then the range of the function, maximum to minimum, is divided into ten equal parts. The value for the subcarrier oscillator frequency for each is noted. Setting the input subcarrier frequency to the lowest of these frequencies, the potentiometer and switch for the first pulse is varied until the desired count is noted in the data processor counter. Then the subcarrier oscillator is set to the next higher frequency of the ten and the controls varied until the second function value is indicated.

The range time signals are applied to the sync-lock channel of the Ampex 500. The timer circuit

(Fig. 2) separates the timing signal from the sync-lock and, when it occurs as a time burst, demodulates it. The exact nature of the timing signals varies from one test range to another. However, for the systems it accommodates, the timer produces 100-pps signals. In addition, the zero-event time signal is extracted and applied separately to the data processor. It resets the time counters at that time.

The timer also produces sampling pulses at the rate of 400, 200, 100, 80, 50, 40, 25, 20, 10 and 5 per second synchronously with the timing signals. This simplifies the problem of associating a time value with every sample.

General Operation

The general data processing operation is shown in Fig. 6. The input data samples would normally be the pulse train from the f-m data converter. However, it can be a pulse-width signal which gates an internal 2.5-mc oscillator to give a 999 count for 399.6 microseconds pulse width.

Digital operations are performed on a binary-coded decimal digit basis in 1-2-4-8 form. Each decimal digit is actually four binary digits. Since decimal digits are handled sequentially, the operation is time series. However, because these serial operations involve parallel transfers of four binary digits, it is actually series-parallel.

After the sample has been counted, the three-decimal-digit number which has been totalized in the counters is transferred in time-parallel to three register decades for temporary storage. Immediately after this, the counters are cleared and are free to count another sample. The count now stored in the registers is transferred in time-series directly, channel *A* Fig. 6, to the magnetic drum memory if the sampling rate is 20 per second or less. Otherwise channel *B* Fig. 6, it is transferred to the magnetic tape (DTR) for playback later at this lower rate, Fig. 6 channel *C*.

This information occurs time-serially corresponding generally to the way it is to be stored longitudinally on a punch card. However, cards are punched or read while being pulled sideways through the

punching or reading stations. That is, all the 9's to be punched in each of the 80 columns are punched at the same time, the 8-row next and the 7-row next through to the last row which is the negative indicator row. Hence, a column-to-row transformation must be made. This is done by storing the information temporarily on a magnetic drum

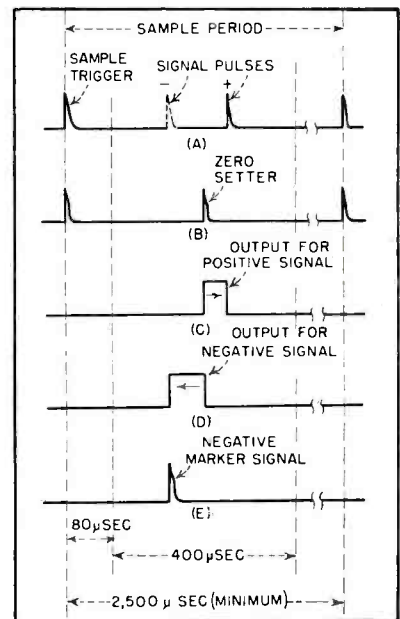

FIG. 4—Time relationships in f-m data converter

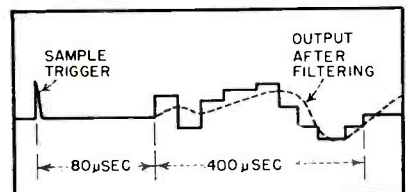

FIG. 5—Correction of nonlinear data

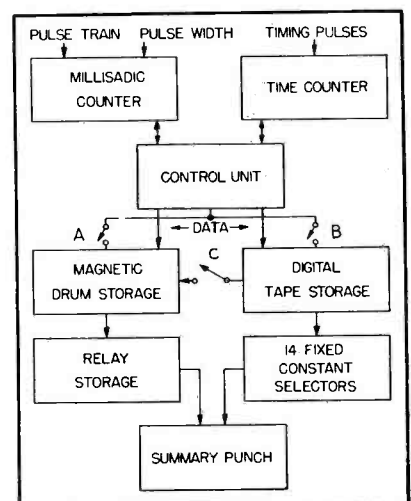

FIG. 6—Data processing system

which holds two cards of information. This is a four-inch drum rotating at 12,000 rpm. While one card is being written on the drum time-serially (column-wise) as it occurs, the preceding card is reading into the summary punch row-wise. The contact closures for the IBM punches are provided by 66 mercury relays, each operated by a thyatron.

Digits are stored in time-series on the drum until 5, 10 or 20 samples have been stored. At this time a summary punch cycle is initiated and the card is indexed through the punch row-by-row. After a row has been punched, the drum is interrogated for numbers equal to the following row number. Coincidence detection circuits set up proper column contact closures while the card is between rows. At the time the card is indexed at the next row, contacts are all set up so that the proper holes will be punched in that row. This is done simultaneously for 66 columns of the punch card.

Range time pulses at 100 per second are accumulated continuously in a six-decade counter. At the beginning of each group of 5, 10 or 20 samples of data, range time information is transferred with the data to the magnetic drum or tape. Provision has been made to indicate negative time by applying a pulse which will cause an excess count in the most significant digit of time. This produces an X punch in the card, leaving five digits to indicate time.

Tape Data Pattern

The magnetic tape data pattern is shown in Fig. 7. This indicates the manner in which the information is handled in combination time-parallel modes. The data pattern shown is for five samples per card. The pattern contains seven parallel tracks. The center track contains the sprocket pulses which indicate where the data is present on the other tracks. The left track contains the card pulse. Its occurrence on read-out causes the drum storage to switch so that the card of information just recorded will now start reading into the relay storage and the part just read-out is switched to recording. Furthermore

it causes the summary punch to start its card cycle.

A computer pulse is recorded on the next track. This has no application in the present system but it is intended to facilitate direct transfer of digital information on magnetic tape into the ElectroData 30-203 magnetic-drum computer. This would eliminate the necessity for punching cards and subsequent reading of them. This pulse occurs

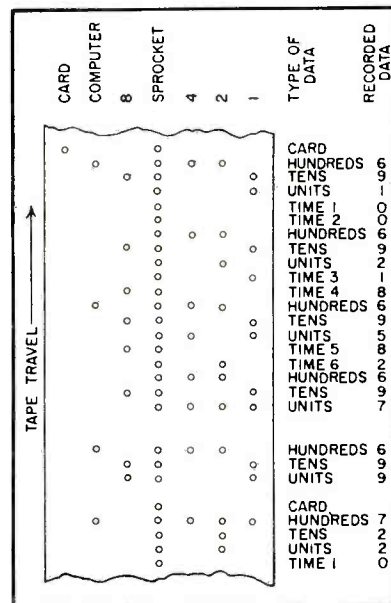

FIG. 7—Magnetic tape data pattern

once every two samples. The last four tracks contain the decimal digit in four-binary-digit form.

The first three sprockets indicate the hundreds, tens and units value of the first sample. This is followed in order by the first two digits of the six digits of time. Next are the three digits of the second sample and the next two digits of time. The third sample is followed by the least significant digits of time. Hence, transferring a sample is a five-step procedure. The fourth and all following samples will be followed by two blanks where no sprockets exist.

A 20-sample card would require 100 equivalent sprocket times. Since the read-back rate is 1 inch per second, the pulse density is 100 per inch. The 2,400-foot roll of 1-inch tape normally used on the DTR will hold over 28,000 cards of information. This, incidentally, would require 8 hours to punch out.

The magnetic tape unit has a skew-corrector circuit. This assures the simultaneity of pulses which should occur in time parallel even though they may not be read at the same time by the seven reading heads. Basically, it causes the pulses on all tracks to be lengthened so that the existence of pulses can be determined by interrogation at a later time after all pulses have had an opportunity to occur.

For independent operation, the data processor has an internal oscillator for control and will provide triggering pulses to an external device. A third mode of operation permits the data processor to function in synchronism with time signals applied to it. This operates only at a one-card-per-second rate. Both the f-m data converter and the data processor have provision for producing a single sample for test purposes.

Evaluation

The linearizing, offset and scale-factor adjustments in the equipment have certain limitations. If the function varied from 1,300 to 1,500 units, these values could not be punched out as this is beyond the range of the counter. Even a function whose count varied from 300 to 500 units could not be accommodated as the zero set cannot be zeroed outside the 0 to 400-microsecond range and, in addition, the counters cannot be preset. Providing for punching signs reduces the sampling rate by one-half. However, these limitations may not be particularly serious in many cases.

Telemetered data is punched into cards to permit subsequent operations while in digital form. If a digital computer is to be used for these operations it can be programmed to do the linearizing, offset and scale-factor adjustments.

The f-m data converter and linearizer was designed by a group at the National Bureau of Standards under the direction of M. G. Pawley. Much of the circuit design is due to E. D. Heberling. The diode bridge comparator was designed by M. L. Kuder of NBS in Washington. The data processing system was designed by a group at Consolidated Engineering Corp. under the direction of H. E. Burke.

UHF Rebroadcasting Cuts Costs

SUMMARY — Exchange of programs between two stations in Maine reduces production costs and gives greater coverage. Parabolic-dish antenna at Lewiston-Auburn end of link picks up Portland channel 53 with 48-db signal-to-noise ratio on video and 50-db ratio on sound. Picture resolution is 350 lines

By **HENRY G. ROOT**

*Chief Engineer
Radio Station WLAM
Lewiston, Maine*

OFF-THE-AIR pickup of uhf tv programs for rebroadcasting is being used by two stations to obtain increased coverage without increasing costs. Community-television type equipment and modified home receivers are used to provide reliable high-quality video and audio on an around-the-clock basis.

Station WPMT channel 53 (704 mc) in Portland Maine is 30.5 miles to the south of the twin cities of Lewiston and Auburn where WLAM-TV channel 17 (488 mc) is located. Station WPMT has an erp of 10.8 kw with an 0.9-deg beam tilt and WLAM-TV radiates 15.8 kw with a tilt of 0.5 deg. As shown in the contour sketch, Fig. 1, the Lewiston-Auburn pickup point at a 420-ft ground level is considerably above the main transmitting lobe of the Portland antenna located at a height of 336 ft. As a result of this, rebroadcasting Portland's signal from an off-the-air pickup is more difficult than the converse.

Attenuation between dipoles in free space is

$$\text{db} = 10 \log \frac{183.5 \times 10^6 R^2}{\lambda^2}$$

where R is the distance in miles and

λ is wavelength in meters.

At 704 mc. λ is 0.425 meter. Since distance R , between Portland and Auburn, is 30.5 miles the attenuation over this distance will be 119.64 db.

The 10.8-kw output of WPMT dissipated across 72 ohms (the Z of a dipole in free space) would give a developed voltage of 880 volts. Across a 72-ohm load connected and matched to a half-wave dipole at the 30.5-mile distance, 880 μ v volts would exist.

This is too low a signal strength to contend with mixer loss, lead-in loss and accompanying noise and still provide a good noise figure, especially in the immediate presence of a 1-kw ch-17 transmitter. This is the theoretical situation and of course the practical approach has some shortcomings by direct comparison. The results obtained above however are relative.

To overcome much of the pickup

Dish antenna picks up signal from Portland, 30.5 miles to the south, for rebroadcasting. Station's 488-mc transmitting antenna is at the top of the 250-ft tower



noise of the ch-53 signal from WPMT a parabolic dish shown in Fig. 2A is used. At 704 mc this is of a practical size. With a mouth diameter of 6.85 wavelengths, or 9.6 ft, a gain of 20.68 db is achieved. This type of antenna offers practically a complete null at its rear. This is a useful feature because 0.6 of a mile in this direction lies a 13-kw f-m transmitter and in Bangor 80 miles to the north in the same direction a ch-2 outlet is allocated. The rear null provides more protection than a parasitic array.

The parabola has the focus in the plane of the mouth and thus will not materially affect the impedance of the dipole placed there. A folded dipole is used so that it may be rigidly soldered to the stand-off element without insulators. The impedance is transformed to 72 ohms by a balun. The focal point

of the dish bears the relation $F = D/4$. Beam width is given by $137.5 (D/\lambda)$ in the vertical plane. In the horizontal plane it is approximately 1.25 times this figure, providing a beam spread 20 deg vertically and 25 deg horizontally. Power gain is 20.7 db.

The output of the antenna is fed to a converter and a 30-db ch-2 amplifier as shown in the block diagram Fig. 2B. The connecting lines ahead of the high-gain amplifier are cut to odd multiples of $\frac{1}{4}$ wavelength at 488 mc. This includes lengths of coaxial cable within the panels of the units. No interaction of the station carrier on the pickup is experienced.

Community television pickup equipment is used. This consists of the ch-2 converter head and a 30-db amplifier.

The following results were ob-

tained in day-to-day operation picking up ch-53 for rebroadcast: There is approximately 200 μv pickup on the 72-ohm take-off from the dipole. Antenna gain is 66.5 db going into the converter. An estimated 11-db mixing loss reduces this to 55.5 db on ch-2 coming out of converter. A 30-db low-noise amplifier raises this level to 85.5 db before entering the coaxial downlead. Approximately 6-db loss is experienced on this down lead. The signal level is 79.5-db above 1 μv or 9 $\frac{1}{2}$ mv across 72 ohms as it enters the transmitter house. The pickup system contributes approximately 20-db of noise. Signal-to-noise ratio under these conditions is excellent. A 48-db signal-to-noise ratio is obtained at the output of the receiver.

In effect this ch-2 signal is far better than a class-A contour would

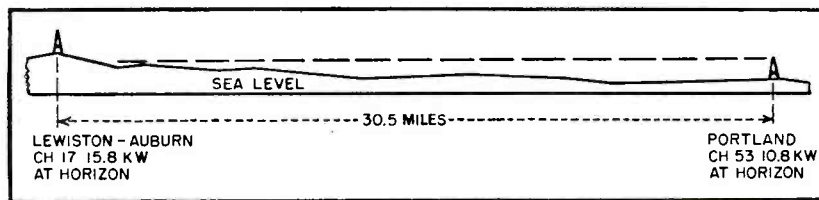

FIG. 1—Pickup antenna at Lewiston-Auburn station is above the main lobe of the Portland radiation pattern

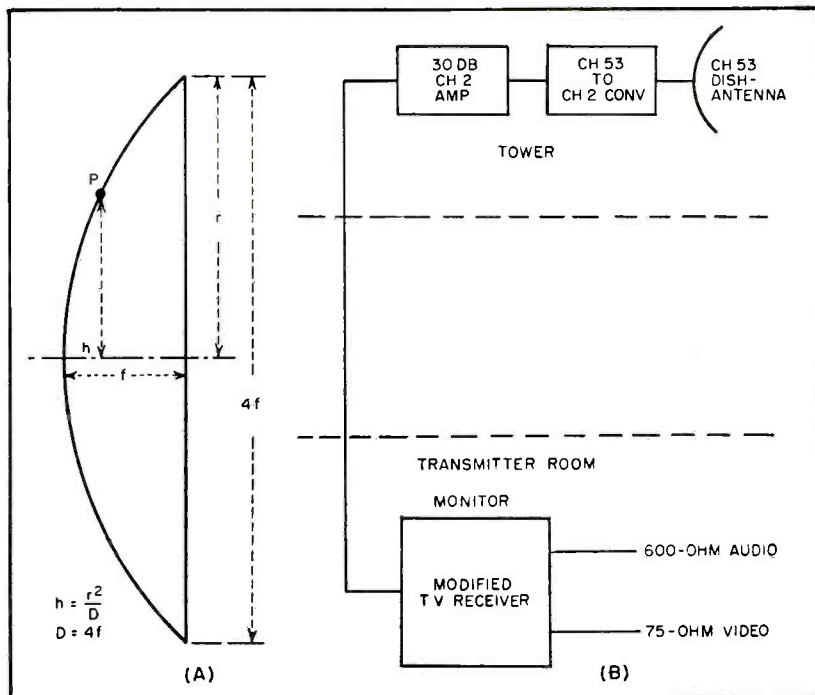

FIG. 2—Design parameters for 704-mc ch-53 dish antenna (A) used in rebroadcast pick up system (B)

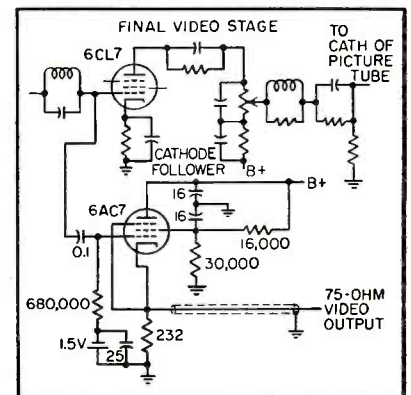

FIG. 3—Modification of commercial tv receiver for rebroadcast monitor

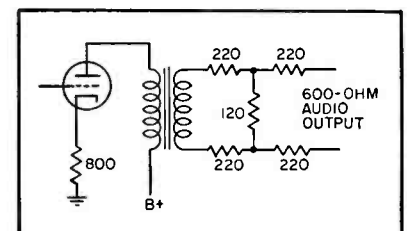

FIG. 4—Receiver audio is modified to match 600-ohm line

offer. In some receivers used as monitors, it might be necessary to disable the cascode front end to accept such a strong signal. This is done by opening up the cathode of the first tube in the tuner leaving the filament on as normal. Conversion will go on as usual within the receiver.

When WPMT picks up a signal from WLAM, two stacked yagi antennas are used. Because WLAM-TV is at a higher elevation and has higher power, less of an antenna is required at Portland. The pickup antenna is well within the main lobe of the WLAM-TV 15.8-kw carrier and does not require much antenna gain prior to conversion. Equipment similar to that at the Lewiston-Auburn end is employed in the system except that the conversion is from ch-17 to ch-2.

Cathode-follower circuits were placed in pickup monitor receivers to feed composite video from receiver output, and the last audio stage was modified to feed low-distortion audio to a 600-ohm load.

An RCA receiver, model 16-S-349U, was selected since the input could accommodate coaxial line. This receiver is built on one chassis with only the picture tube as a separate unit. This simplifies maintenance.

Receiver Modifications

The last video stage, a 6CL6, modulates the cathode of the picture tube. This means that the control grid of this stage has a negative sync signal. This is the proper polarity for feeding to the program switching buttons on the control console. The contrast control in this receiver is in the plate circuit of this last video stage and so does not affect the picture taken off the grid. The picture tube and its brightness and contrast controls still function as normal.

Another advantage is that a power transformer is used in this receiver, making the chassis cold with respect to other racks permitting a heavy copper ground strap to be run to station ground. This is a necessity because of the presence of the tv transmitter in the same room.

Modifications made in the re-

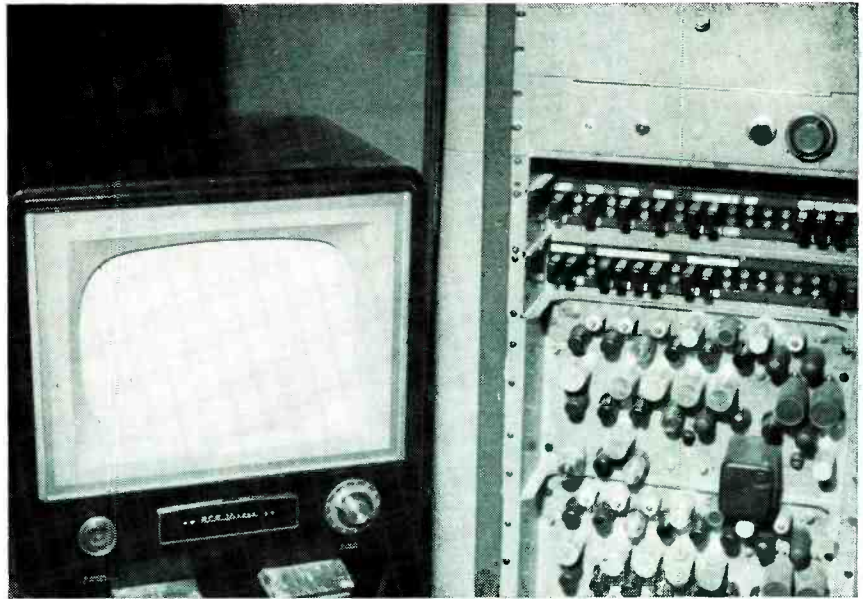

Video and audio outputs of modified commercial receiver are fed to patch panel for distribution

ceiver are shown in Fig. 3 and Fig. 4. A cathode follower is coupled to the grid of the last video stage. The bias for the 6CL6 should not pass to the grid of the cathode follower. The choice of coupling capacitor was such as to still have a low value of reactance at 20 cycles. A 0.1- μ f capacitor has 80,000 ohms reactance at this frequency. This is adequate provided at least a 680,000-ohm resistor is used in the grid circuit of the follower. Cathode source impedance using a 6AC7 is 111 ohms. Since this is higher than the desired 75-ohm line impedance a parallel 232-ohm resistor is used for matching.

Plate and screen current flowing through the cathode impedance constitute approximately 0.9-v drop and this is added to the fixed bias of 1½ volts already on the control grid. Gain of this cathode follower is 0.4.

Input capacitance of a 6AC7 is normally about 11 μ f. In a cathode follower it is reduced by the factor $[1 - (E_c/E_s)]$ or 0.6. This leaves an input capacitance of 6 μ f which is too low to cause trouble in the 6CL6 grid. The cathode follower is mounted on a small utility box on the top rear of the chassis.

The last audio stage of the receiver is a 6V6. This provides too much power and distortion for

broadcast use. The pin connections are identical to those of a 6J5 triode so that by replacing the tube and changing the cathode-bias resistor from 560 ohms to 800 ohms and cutting out the cathode bypass capacitor, distortion and output drop markedly.

600-Ohm Output

The output transformer matched approximately 6,000 ohms when feeding from a 6V6. However, to obtain low-distortion, the plate load for a 6J5 should be approximately 15,000 ohms. A UTC-A25 transformer with a 600-ohm line secondary was used. The power output can easily reach 100 mw with this tube and so a 20-db line pad also was added to attenuate the output.

Using the system described the following results were achieved: 48-db signal-to-noise ratios on video; better than 50-db signal-to-noise ratio on voice and frequency response within 3-db from 50 to 12,000 cps.

Video bandpass on the receiver is 3.5 mc. On a regular RTMA test chart, horizontal definition is 350 lines giving a completely acceptable picture. It is planned to expand this response band at a later date.

Photoelectric Reader

By DAVID H. SHEPARD and GLYDE C. HEASLY, Jr.

*Intelligent Machines Research Corp.
Arlington, Virginia*



Model of analyzing reader first developed for Farrington Mfg. Co. reads a ten-digit account number from a Charge-Card sales invoice and punches the number into the same card, using a standard IBM card punch.

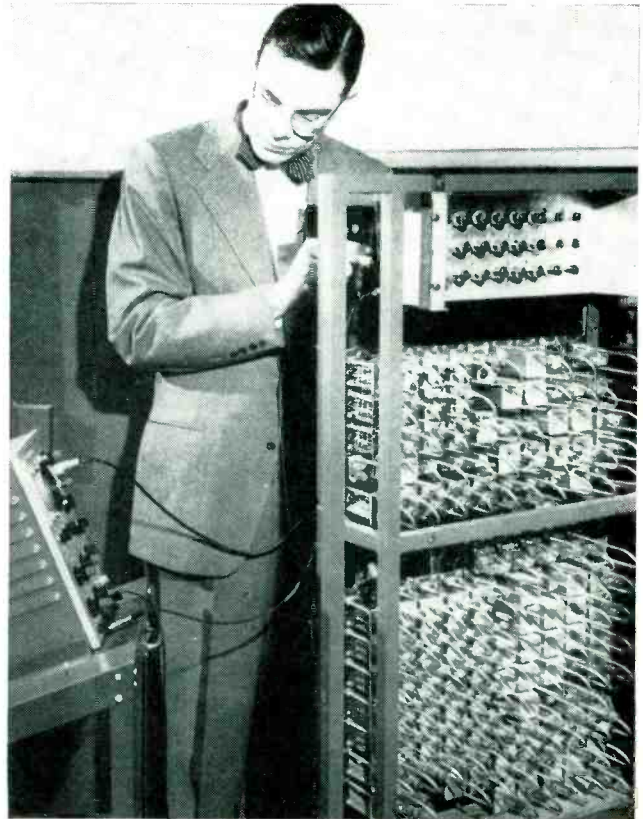

Output pulses of the photoelectric scanner are analyzed by this small special-purpose digital computer which recognizes strokes by their unique pulse patterns and recognizes characters by their unique combinations of strokes.

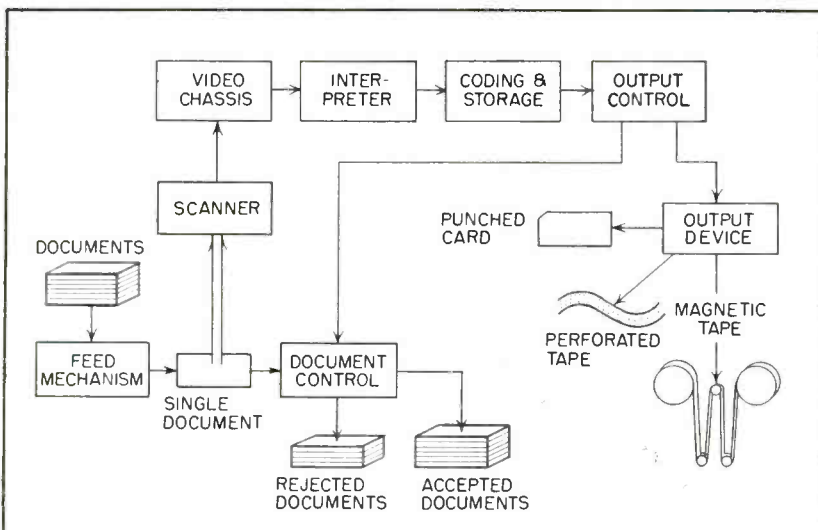

FIG. 1—Complete electronic reading system. Model now under construction will handle over 450 documents per minute, reading printed data on each in turn and transferring it to desired output medium at speeds over 300 digits per second

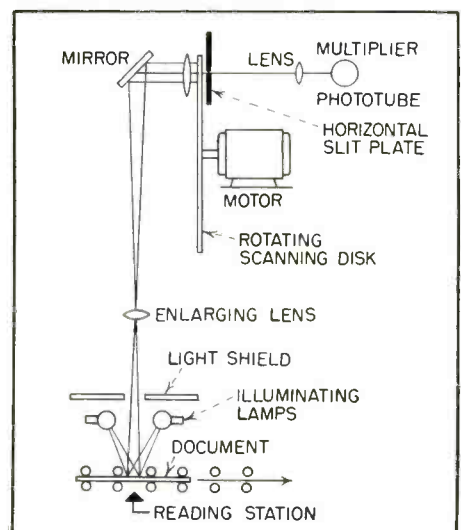

FIG. 2—Optical system for scanning one line of text on document as it moves past reading station

Feeds Business Machines

SUMMARY — Ordinary printed characters are scanned vertically at rate of 3,600 words per minute, and resulting signals from phototube are fed into a character-recognizing memory for transfer to punched cards, perforated tape or magnetic tape as required for feeding the inputs of electronic business machines

WHILE processing machines for business data are by no means new, their use has largely been limited by the slow speed, high cost and low accuracy of keyboard operations. This is so because the transfer of information from business document to machine record medium has always required the services of an operator to read the information and to manipulate a keyboard of one sort or another.

The analyzing reader eliminates this human limitation on the speed of electronic business machines by reading ordinary typed or printed characters and recording the information on machine mediums such as punched cards, perforated tape or magnetic tape. It is also possible to use information sensed to control sorting, editing and table-lookup operations.

The operation of the reading system is shown in Fig. 1. A feed mechanism passes a single document in front of a photoelectric scanner which scans the characters on the document. Electrical pulses from the scanner are amplified and shaped by the video chassis and then analyzed by the interpreter. The interpreter identifies each character and sends identifying pulses to coding and storage. The storage serves as a buffer to meet the timing requirements of the output device. Information is withdrawn from storage and used to control the output device.

Storage also contains information as to whether or not the document has been successfully read. This decision is sometimes made by

the interpreter, which can recognize errors caused by malformation of characters, or can be made by the several self-checking features built into the equipment. If a document has been correctly read, it is placed in the accepted pocket; if not, it goes into the reject pocket.

Operation of Scanner

A simplified diagram of the arrangement of the scanner is shown in Fig. 2. The document is fed at uniform rate past the reading station where it is brightly illuminated. The reflected image of the document is projected through a scanning disk onto a multiplier phototube through a series of lenses and a mirror.

The scanning disk, shown in Fig. 3, contains a number of radial slits which pass one at a time in front

of a fixed slit. At the intersection of these slits, a point of light from the image passes through and is projected onto the phototube. As the disk rotates, the intersection of the slits moves to give horizontal scanning across the image.

Because the document is moving, the image is also in constant motion, so successive scans fall on successive portions of the image. Since the scan rate is much faster than the document motion, 25 or 30 scans will occur as one character passes the reading station.

As the image of a character is scanned, the output of the phototube will vary. Thus, during a single scan the output will contain positive pulses representing dark portions of the character, with the voltage between these pulses representing the background light in-

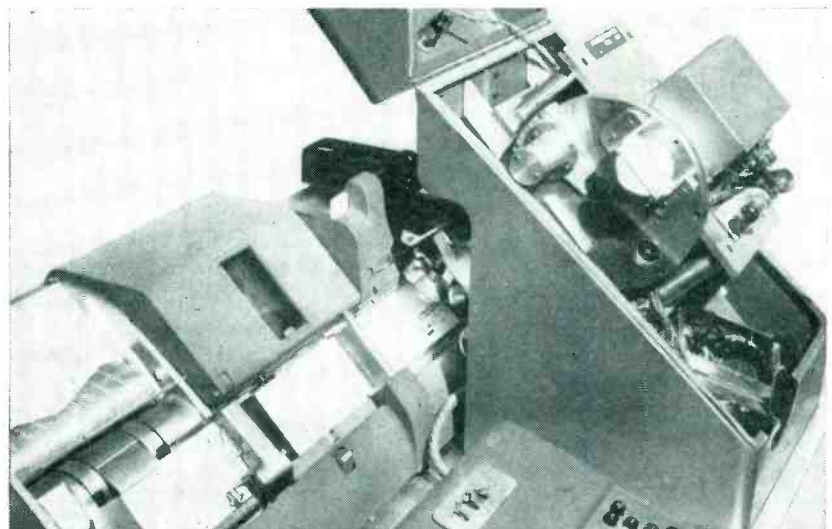

Document cards taken from stack move under scanner at right first for reading, then travel to punching position at center and finally to position at left for restacking

tensity reflected from the paper.

The means for producing constant pulse amplitudes in spite of wide variations in ink-paper contrast and light intensity is shown in Fig. 4. The gain of the multiplier phototube is controlled by changing the voltage applied to dynode 9. The output of the phototube is coupled to cathode follower V_2 , which drives the cable connecting the scanner to the video chassis. The signal is amplified by a conventional two-stage voltage amplifier V_3 - V_4 and fed to cathode follower V_5 which drives contrast control tube V_8 and the first stage, V_6 , of the clipping amplifier.

Automatic Contrast Control

The waveform of the amplified video signal fed to V_8 to adjust the contrast control voltage is shown in Fig. 5 for two successive scans. The distance between radial slits is greater than the length of the

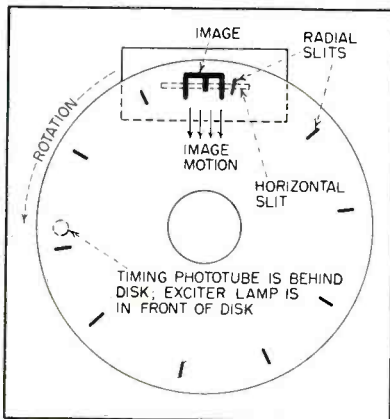

FIG. 3—Details of scanning disk used to obtain 25 to 30 vertical scans per character

fixed horizontal slit, so that no light reaches the phototube for about 10 percent of each scan cycle. During this portion of the scan the output reaches its most positive value because the phototube sees true black, or no light. This pulse is, therefore, called the black pulse. The signal pulses which occur during any scan will not be as high as the black pulse since the dark portion of any character will reflect some light. The negative or background portion of this signal, represented by the voltage between the pulses, is clamped through the 2U1

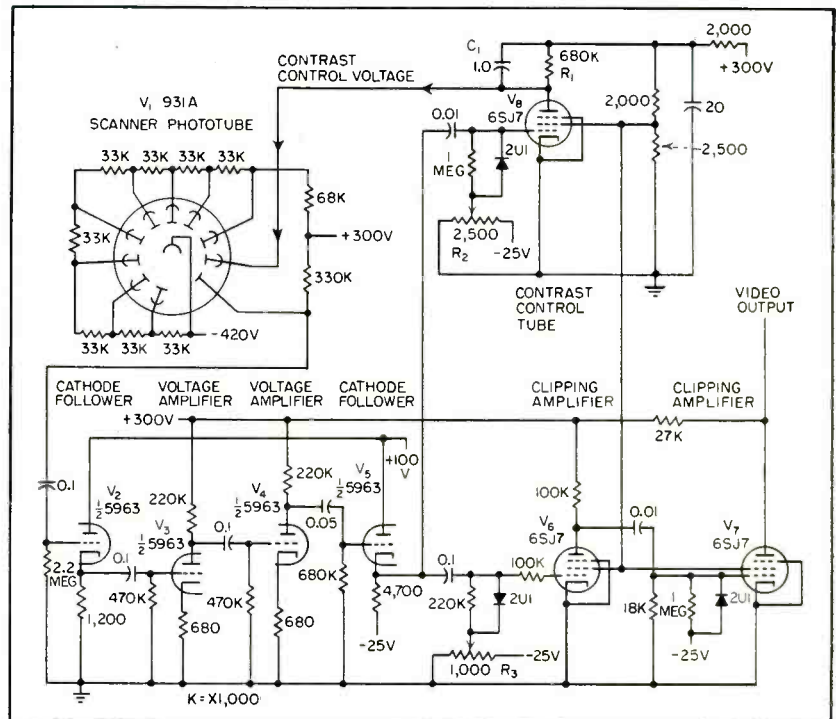

FIG. 4—Contrast control circuit used to compensate for varying degrees of contrast between document paper and characters printed on it

diode to the negative voltage set by potentiometer R_2 . The voltage difference between cutoff of V_8 and the setting of R_2 is the pulse amplitude which the contrast control system will seek to maintain.

When the voltage difference between black pulse and background is greater than the voltage between R_2 and cutoff, the black pulse will rise above cutoff and cause V_8 to conduct. During the black pulse, C_1 will charge through V_8 . The higher the black pulse rises above cutoff, the larger the charging current and therefore the greater the voltage change on C_1 .

During the interval between black pulses V_8 is cut off and C_1 tends to discharge through R_1 . The time constant is the product of C_1 and R_1 . This value is such that C_1 will discharge a small amount between black pulses. The charging of C_1 lowers the voltage applied to dynode 9, reducing the phototube sensitivity and thereby reducing the voltage difference between black pulse and background.

Because the second black pulse amplitude is reduced, it does not rise as high above cutoff and so the charging current is decreased and the voltage change on C_1 during

conduction is not as great. During each scan the net voltage change on C_1 , charging during black pulse and discharging during the balance of the scan, is a net decrease in the voltage applied to dynode 9. But the amount of this decrease gets smaller each scan until finally the black pulse only slightly exceeds cutoff and the discharge and charge during one scan are equal. When the charge and discharge have reached equilibrium, the peak-to-peak voltage between black pulse and background will very slightly exceed the voltage between R_2 and cutoff.

If light intensity or document background changes cause an increase in peak-to-peak voltage, the contrast control tube will conduct more heavily during black time and

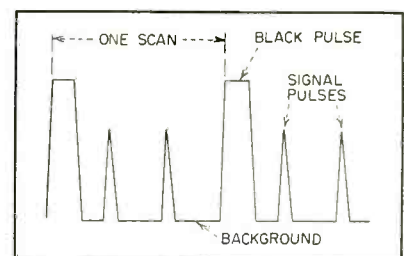

FIG. 5—Idealized scanner output waveform

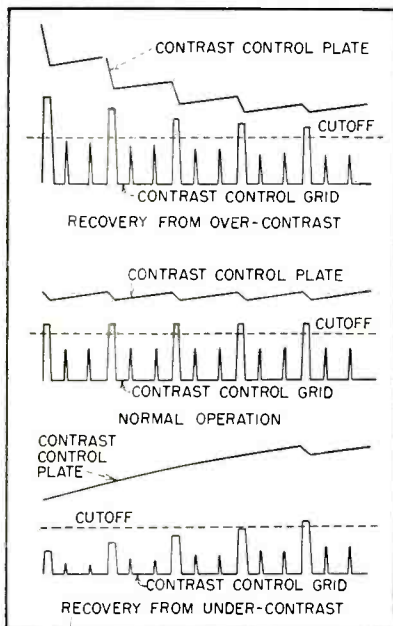

FIG. 6—Plate and grid waveforms of contrast control tube

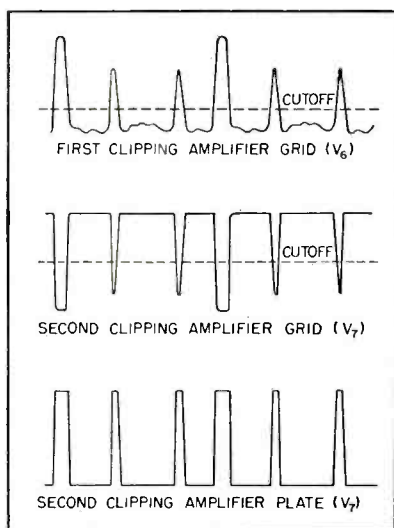

FIG. 7—Clipping amplifier waveforms

further decrease the dynode-9 voltage, thereby decreasing the peak-to-peak photomultiplier signal. After a number of scans a new equilibrium will be reached.

In the event of a decrease in signal, the black pulse will not reach cutoff and C_1 will continue to discharge through R_1 . This will increase dynode-9 potential and increase the phototube sensitivity. As the sensitivity increases, the peak-to-peak voltage will increase until the black pulse again just exceeds cutoff and equilibrium is again established. Thus, the contrast control maintains a constant

amplitude between black and the background. The grid and plate waveforms during recovery from over-contrast, normal operation and recovery from under-contrast are shown in Fig. 6.

Clipping Action

The regulated signal is fed to the grid of clipping amplifier V_6 , where the positive peaks are clamped by the 2U1 to the voltage set by potentiometer R_3 . Adjustment of this clamping voltage determines what portion of the signal will fall below cutoff and thereby be clipped. Correct adjustment of R_3 removes background noise caused by paper specks. Figure 7 shows the wave shapes at the grid and plate of V_6 .

The clipping is repeated at V_7 where the negative portion of the signal is clamped at -25 volts. Since the signal is inverted at this point one result of the clipping action of the sharp-cutoff pentode is to reduce signal and black pulses (Fig. 7) to the same amplitude.

The video output signal at this point has been compensated for variations in contrast, is free of background noise and is of constant amplitude. It gives a yes-no indication as to the instantaneous presence or absence of the character.

Identifying End of Scan

To utilize the information in the signal pulses, it is necessary to remove the black pulse from the signal and to identify the end of each scan. This is accomplished by the timing phototube and lamp. The 1P42 phototube is located behind the scanning disk several frames away from the fixed slit. An exciter lamp is located in front of the disk. The exact location is such that the phototube sees a pulse of light just before each radial slit passes off the end of the horizontal slit. This causes a pulse to occur just before the end of the scan. This pulse is called the end-of-frame pulse.

As shown in Fig. 8, timing

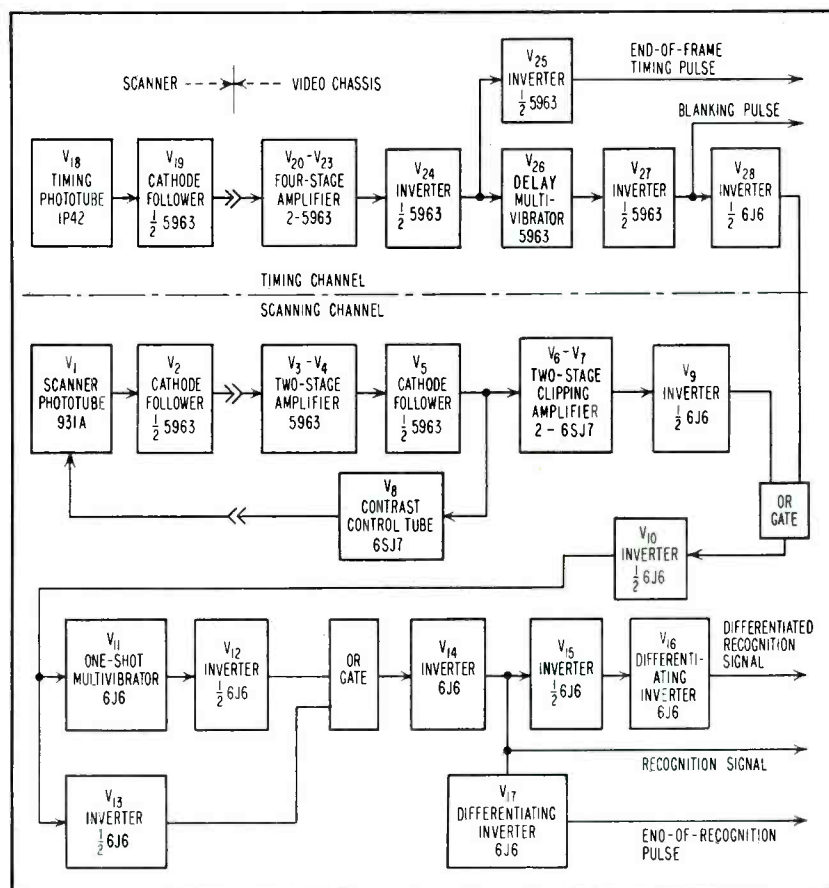

FIG. 8—Arrangement of stages on video chassis which feeds character-recognizing memory

phototube V_{18} feeds cathode follower V_{19} . The resulting negative output pulse is amplified by V_{20} - V_{23} , inverted by V_{24} and applied to the grid of single-shot multivibrator V_{25} . The output of V_{25} is a blanking voltage. It begins just before the end of one scan and lasts until after the beginning of the next scan. The length of the blanking pulse is adjustable and can be lengthened to blank out a portion of the scan where undesired information is being scanned.

The blanking signal is inverted twice in order to get standard voltage levels. This signal is fed into one half of an or gate. The video signal from V_7 is also inverted and fed to the other or gate. This or gate will cut off V_{10} only when both of its inputs are negative. Since the blanking signal is positive, the negative black pulse and any signal pulses which occur during the blank pulse have no effect on V_{10} . After the end of the blank pulse the voltage goes to a negative value and any negative signal pulses occurring in the video signal will cause positive pulses in the output of V_{10} . These pulses are fed to single-shot multivibrator V_{11} and to inverter V_{12} .

Gate Action

The single-shot multivibrator produces a short fixed-duration pulse which is inverted by V_{12} and fed into one input of an or gate. The output of inverter V_{13} is fed to the other or gate input. The function of this group of circuits is to insure that any video signal will have at least a fixed minimum duration. If a short signal occurs, V_{11} will be triggered and its inverted output will appear at the or gate output. If a longer signal occurs, V_{11} will still cycle, but the output of the or gate will remain down until the signal stops. Thus, short signals are increased to an arbitrary value where as longer signals are unaffected.

The negative pulses from the or gate are inverted and fed to the interpreter and also to inverters V_{15} and V_{17} . The direct signal from V_{14} is called the recognition signal. Inverter V_{17} has a differentiated input and is biased so that it is nor-

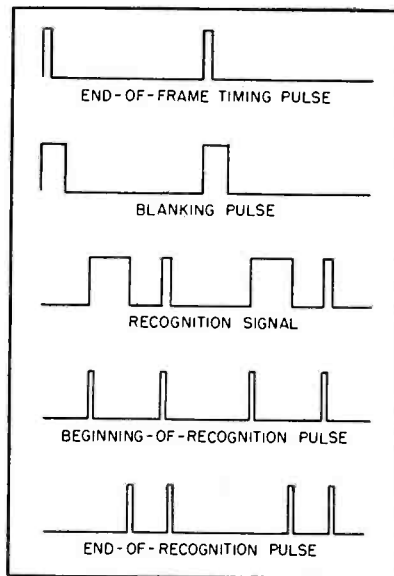

FIG. 9—Video chassis output waveforms

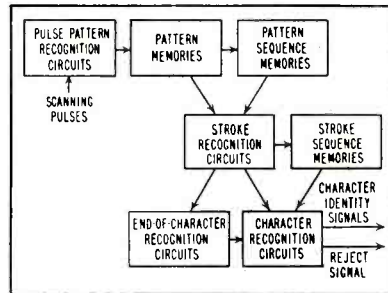

FIG. 10—Functional groups in interpreter

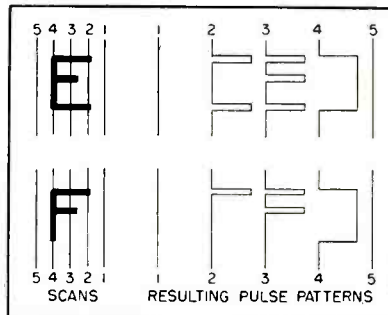

FIG. 11—Characteristic pulse patterns resulting from scanning of capital letters E and F

mally conducting. The differentiated positive pulse does not affect the output, but the differentiated negative pulse at the end of the recognition signal cuts off the tube momentarily and causes a positive pulse. Since this pulse occurs at the end of each recognition pulse, it is called the end-of-recognition pulse and is fed to the interpreter. The recognition signal is inverted by V_{15} and fed to differenti-

ating inverter V_{16} . This inverter operates like V_{17} and is sensitive to negative changes only. Since the negative change in the inverted recognition signal occurs at the beginning of each recognition pulse, the output pulse from V_{16} will also occur at the beginning of each recognition pulse. This beginning-of-recognition pulse is also brought to the interpreter.

Recognition of Characters

In addition to the three recognition signals, the end-of-frame timing pulse and the blanking pulse are also sent to the interpreter. The timing relation of these pulses is shown in Fig. 9.

The interpreter which receives pulses from the video chassis is a special-purpose small-scale digital computer (Fig. 10) that examines the pulses and looks for various pulse patterns which are significant in isolating the identity of characters. These patterns and the sequence in which they occur reveal the identity of the characters.

With the letter E as in Fig. 11, the horizontal lines produce identical three short pulse patterns for many scans. The long vertical line on the left side produces a single long pulse during at least one scan. Thus the input signals to the circuit which identified E would be: long-vertical-line-left-side, three-horizontal-lines and nothing-to-the-right-of-three-horizontal-lines.

A similar logical description is set up in the form of signals to circuits representing each of the characters which must be recognized. The outputs of these circuits can be used in any way which is desired. If an impossible combination of strokes occurs, the interpreter recognizes this as an error and sends out a reject signal which can be used to separate the document in question into a reject stack.

If printed characters are well formed and free of interference, the accuracy is equal to the accuracy of punched card reading.

BIBLIOGRAPHY

- C. C. Heasley, Jr., The Analyzing Reader Character Sensing Technique, NMAA Convention, Cleveland, Ohio, June 16, 1954.
- D. H. Shepard, Apparatus for Reading, U.S. Patent No. 2,663,758.

By J. N. BARRY
and W. W. H. CLARKE

Telecommunications Establishment
Department of National Defence
Ottawa, Canada

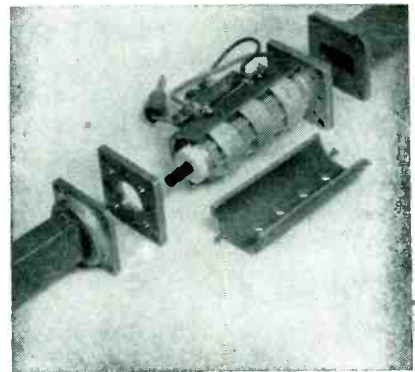
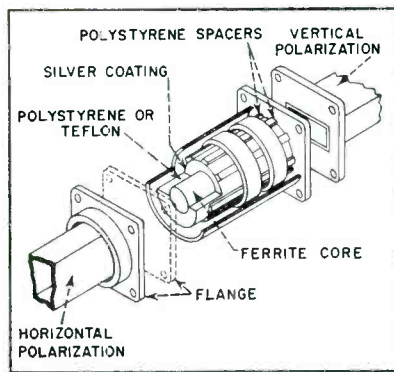

FIG. 1—Exploded view of ferrite gyrator designed to function as high-speed microwave switch

Microwave Modulator Uses Ferrite Gyrator

SUMMARY — Coaxially mounted ferrite slug in a circular waveguide section modulates microwave energy without disturbing power source. Modulating frequencies up to 1 mc or pulses involving 0.6-microsecond transients can be handled

RAPID SWITCHING or square-wave modulation of microwave power without modulation of the power source may be achieved by use of ferrite components to produce rotation of polarization as a switching function. However, failure of these ferrite components to behave rationally or consistently has made it difficult to predict the behavior of such microwave switching systems.

The ferrite circuit component to be described was designed to modulate microwave power to the greatest possible depth in response to a 100-kc square wave having rise and fall times in the order of 0.5 μ sec. It was required that the modulator circuits operate with the least possible power dissipation.

Performance indicates that such a microwave switching system is capable of modulating at frequencies of 1 mc or perhaps higher or with pulse waveforms involving transients as short as 0.6 micro-

second. This has been achieved by careful design of a current-driving circuit and a magnetizing field coil wound around a section of circular waveguide containing a ferrite core and by cut-and-try experiments with the walls of the circular waveguide and the ferrite core.

Switching Process

Figure 1 shows a cutaway view of the circular section of waveguide in which polarization rotation occurs. A ferrite slug is mounted coaxially inside a cylindrical waveguide section. A rectangular waveguide feeds microwave power into the circular section and this section feeds power to another rectangular section arranged so that the polarization of accepted power is perpendicular to that leaving the input section. The unrotated component is reflected.

Thus the switch is closed when there is no rotation (complete reflection) and opened fully when

there is exactly 90-deg rotation. Rotation varies with magnetization of the ferrite and this is controlled by a coil wound around the circular section of guide. Switching speed depends on the quality of the current pulse passed through the coil and the response of the ferrite to the magnetizing pulse in terms of Faraday rotation. Inconsistent behavior in switches is related to hysteresis of the ferrite and to changes of ferrite properties with time and presumably with temperature.

Switch Development

The circuit in Fig. 2 was employed to generate 100-kc square waves which were passed as current pulses through the switch coil by V_4 .

At first, attention was given to obtaining square current pulses by making the driving voltage waveform as sharp as possible. The voltage waveform as shown in Fig. 3

is necessary for obtaining square waves of fast current rise in an inductance. The potentials are required only to change the current and must be applied during the rise and fall times. After development of the coil and choice of ferrite, the waveforms in Fig. 4 were achieved in the switching circuit. Figure 4A shows the grid waveform applied to the driving stage; Fig. 4B shows the anode voltage waveform and Fig. 4C shows the current waveform taken across *R*.

The effects retarding the flux rise in the ferrite slug were found to be the capacitance of the coil and its capacitance to ground, the short-circuited-turn effect and the inductance of the coil, which increases with number of turns while the current required for 90-deg rotation decreases.

The brass fittings of the rectangular waveguides (Fig. 1) contribute to the short-circuited-turn effect and the conductor of the cylindrical waveguide is much more closely coupled to the coil. The

coupling of the rectangular waveguides must be accepted unless elaborate modifications are undertaken. The effect of the cylindrical conductor may be reduced by slitting it longitudinally or by reducing its thickness or otherwise increasing its resistance to the high-frequency components of the switching waveform. Both precautions were found desirable in producing an optimum switch. The required inductance of the coil was substantially set by the limitation on current magnitude to permit use of a single driving tube. The ferrite is mounted in a Teflon jacket and the cylindrical waveguide section formed by coating the jacket with conducting paint.

The high capacitance to ground, in this case the conductive coating, and the capacitance of the coil itself were reduced by spacing the winding away from the guide on low-loss polystyrene ribs and winding the coil in three pies. These procedures raised the self-resonant frequency of the coil from 100

kc to more than 1.0 mc with the ferrite slugs in place. Wave-wound pies are an advantage where the number of turns cannot be contained in a single layer coil of the required wire size. Subsequent measurements have failed to indicate advantages in multiple wave-wound coils for a 300-turn coil. The ferrite slugs introduce considerable damping and the value of damping resistor to prevent ringing must be found experimentally. Ringing was not a problem before the self-resonant frequency was increased. The short-circuited-turn effect was removed by putting a lengthwise slit with a 90-deg twist in the conductive coating. Later experiments using a paint of slightly higher resistance also proved to be satisfactory without the slit. At present, rotators are being constructed in this manner.

Material for the slug is important and it has been found that Ferramic MF 1331 offers the best performance of ferrites tried. Two paints were tried and applied by

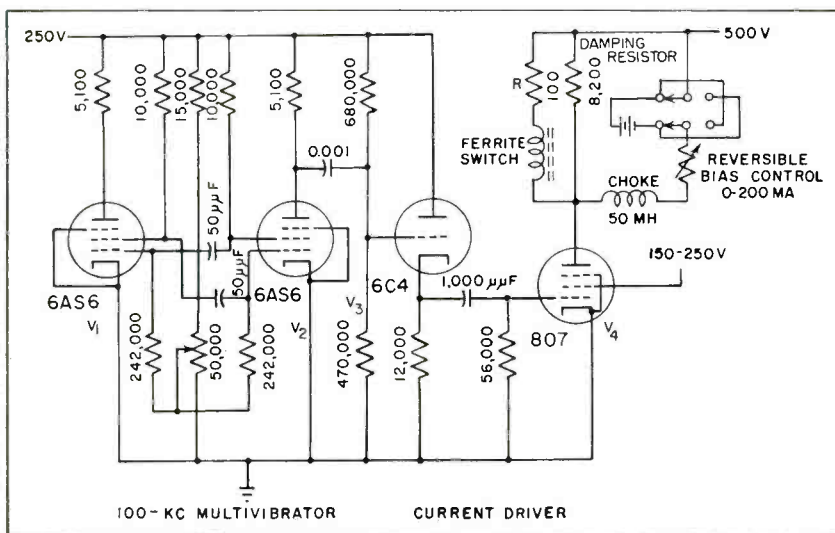

FIG. 2—Multivibrator, pulse shaping and current driving circuits used to produce square current pulses in coil

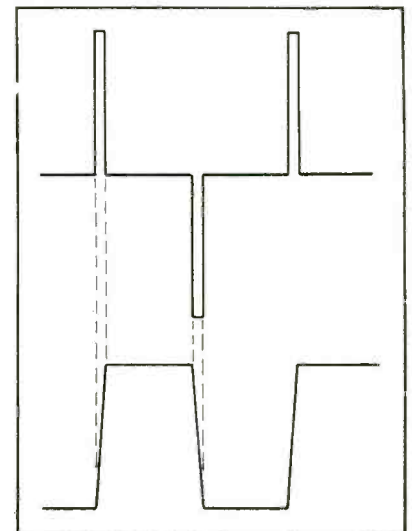

FIG. 3—Applied voltage, top, and resulting current pulse in coil, bottom

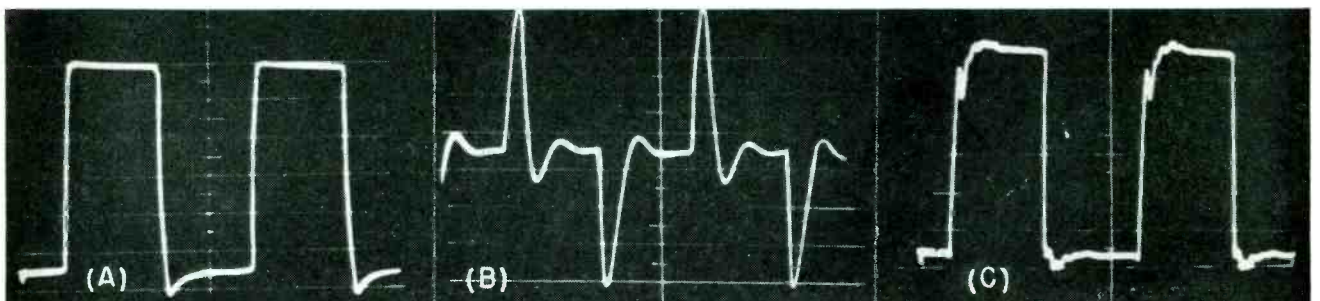

FIG. 4—Driving circuit waveforms illustrating grid voltage (A), anode voltage (B) and switch current (C)

brush. Du Pont Silver 4929, not baked although it is designed for baking on to glass, performed well with a 90-deg twisted slit to reduce the short-circuited-turn effect scribed in the paint when partially dry. Du Pont Silver 4817 had a lower conductivity and it was possible to obtain as high a switching speed with an unbroken film of this paint as with the slit scribed in film of Silver 4929. Since 4817 is not designed for baking and provides a low minimum attenuation through the switch, it is clearly the more desirable material.

Performance

The switches were tested in the waveguide circuit shown in Fig. 5, and the design produced the output waveforms shown in Fig. 6.

The waveforms are for different values of bias current. It may be seen that the bias is quite critical, particularly when very high through attenuation is required in the off switching condition. By critical adjustment this attenuation can be as high as 40 db, but in general operation a much lower figure must be accepted. The waveform even when adjusted carefully, changes to some extent with time. Figure 7 shows the through attenuation of the switch as a function of coil current. The switching requirement may be better understood from examination of this curve, since it is necessary to apply the switching current pulses to work between a maximum and adjacent minimum of attenuation. The hysteresis effect is clearly shown and the separation of the increasing and decreasing current curves is seen to be a function of the size of the closed cycle. To find the maximum of attenuation is a criti-

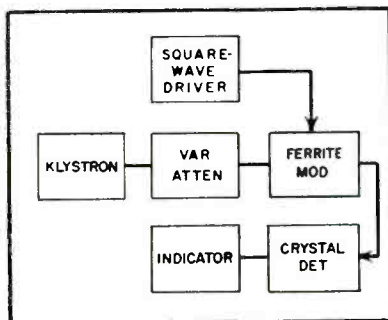

FIG. 5—Test circuit for ferrite switches

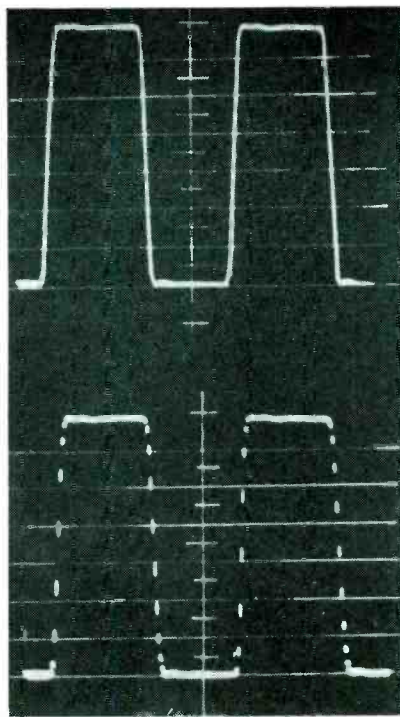

FIG. 6—Switch transmission pulses taken at crystal detector. Bottom trace includes 0.1- μ sec brightening pulses

cal requirement for switching, but for modulation there is a good steep slope which proves stable. For consistent switching, saturation of the ferrite core at 90-deg rotation might provide improvement if the shut condition were made to correspond with 90-deg rotation. However, change of saturation rotation with temperature could lead to poor stability.

Conclusions

The best waveforms show rise times of 0.7 μ sec, fall times of 0.8 μ sec and open and shut attenuations of 0.5 db and 40 db respectively. An average performance of 0.7- μ sec rise time, 0.8- μ sec fall time with open and shut attenuations of less than 1.0 db and 30 db, respectively, can be achieved and the adjustments are not too critical.

The input vswr of the open switch is of the order of 1.2 but when the switch is closed there is a vswr at the input of more than 10. This is a simple reflection of power which may be prevented from reaching the power source by duplexing techniques if such isolation is found necessary.

Faster switching speeds and higher frequencies may be achieved

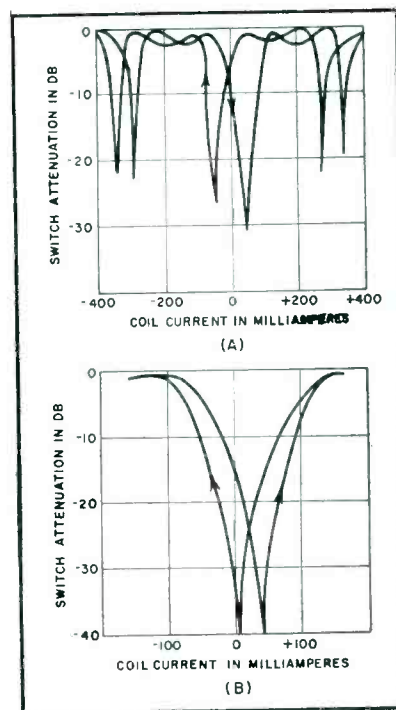

FIG. 7—Effects of ferrite hysteresis for 800-ma (A) and 300-ma (B) closed-cycle switch attenuation

with sacrifice of percentage modulation or with additions to the power in the driving circuits although the latter procedure introduces cooling problems. Slight additional improvement in speed may also be expected from further improvements to the coil design and the dielectric separating it from the conductive film.

The authors thank the Defence Research Board of Canada for permission to publish this paper and B. A. Walker for his interest in the work. The assistance of F. Vail in making the measurements is gratefully acknowledged. The work described was part of a program of modification of ferrite components designed and provided by C. H. Luhrs and Co.

BIBLIOGRAPHY

- Yager and Bozorth, Ferromagnetic Resonance at Microwave Frequencies, *Phys Rev*, 80, p 72, 1947.
- Suhl and Walker, Faraday Rotation of Guided Wave *Phys Rev*, 86, No. 1, p 122, Apr. 1952.
- C. L. Hogan, The Ferromagnetic Faraday Effect at Microwave Frequencies and its Application—The Microwave Gyrator. *BSTJ*, 31, No. 1, p 1, Jan. 1952.
- Sakiotis, Simmons and Chait, Microwave-Antenna Ferrite Applications, *ELECTRONICS*, p 156, June 1952.
- Miller, Magnetically Controlled Waveguide Attenuations, *Journ Appl Phys*, 20, p 878, Sept. 1949.
- Sakiotis and Chait, Ferrites at Microwaves, *Proc IRE*, p 87, Jan. 1953.
- E. Albers-Schoenberg, Ferrites for Microwave Circuits and Digital Computers, *Journ Phys*, 25, No. 2, p 152, Feb. 1954.

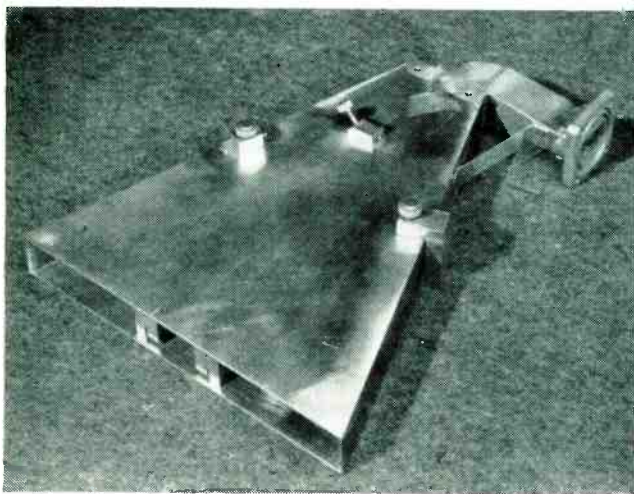

H-plane horn has 100-kw peak output. Choke arrangement and movable side walls are visible in photo at right

SUMMARY — Primary radar feed, used in conjunction with single reflector, gives choice of fan beam for searching or pencil beam for closer examination of target with throw of switch. Antenna consists of flared H-plane horn with movable side walls

Fan-Pencil Antenna

By **VERNON E. TRINTER**

*Senior Electronics Engineer
The Glenn L. Martin Company
Baltimore, Maryland*

ANTENNAS providing a choice of a fan beam or a pencil beam of radiation are desirable in many applications. Such antennas permit radar searching with the vertical-fan beam and closer inspection of target objects with the pencil beam.

A primary radar feed has been developed, which in conjunction with a single reflector provides these beam capabilities by simply throwing a switch. The antenna consists of an H-plane flared horn with side walls, which are moved between two fixed positions in selecting the beam.

Design Choices

When an antenna is required to provide a choice of fan beam or pencil beam radiations, one of three designs may be employed: the two feeds may be mounted on separate support arms, one of which is swung out of the way when not in

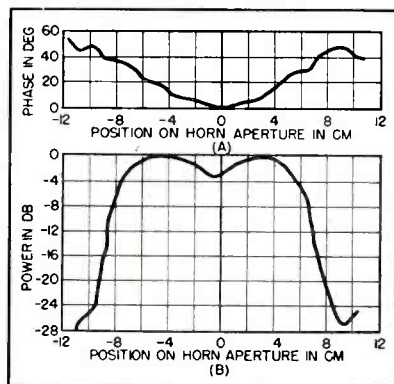

FIG. 1—Phase (A) and power distribution (B) of H-plane horn

use; the pencil beam may be distorted by displacement of a part of the reflector surface to obtain the fan beam; the two feeds may be mounted adjacently and in the same focal plane, with a resulting angular displacement between beams.

A combined feed, mounted in a fixed position in front of the re-

lector, eliminates these awkward operations. In this combined feed, the effective centers of both the fan-beam and the pencil-beam apertures coincide.

Selection of either of the two beam types is accomplished electrically by a solenoid or by a drive motor. This construction provides greater mechanical stability to the feed and reduces the number of mechanical components required for beam selection.

The reflector employed is a paraboloid of revolution, 60 inches in diameter, with a 19.5-inch focal length. It was desired to obtain a pencil beam 1.5 deg × 1.5 deg and a fan beam approximately 12 deg × 1.5 deg in the vertical plane. These fan-beam dimensions are obtained with a primary-feed aperture of approximately 1 × 7 inches. Polarization of the fan beam is horizontal and a choice of horizontal or circu-

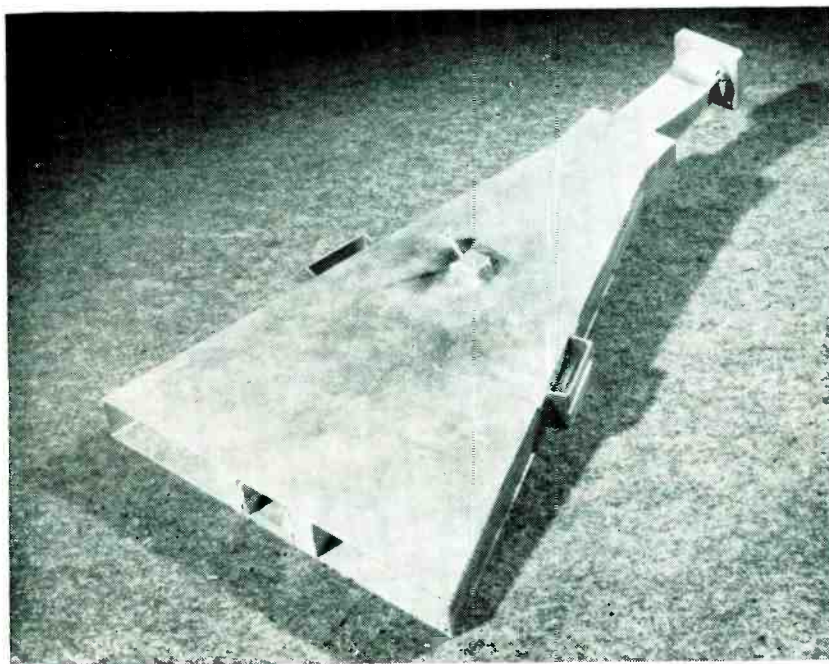

H-plane flared horn has movable walls which give a 7-inch aperture when moved outward and a 1-inch square aperture when inward as shown

shorter construction was desired, a second horn was designed as shown in the photographs. This horn is $11\frac{1}{2}$ inches in length, 5 inches less than the first horn. An improved choke design for the movable sides was incorporated, extending back to the centerline of the hinge.

Breakdown tests show that this horn can handle 100-kw peak power at a duty cycle of 0.0015. Although secondary patterns using this combined feed have not yet been measured, the similarity of the phase and amplitude distributions to those of the previous horn indicates similar secondary patterns.

Choice of either linear or circular polarization of the pencil beam is obtained with an adjustable probe, which can be inserted diagonally across the approximately square section of the horn in the pencil-beam position. The proper insertion of the probe, combined with the correct separation of movable walls, changes the linear to circular polarization.

While the movable side walls are held in position by clamps across the two broad faces of the horn, they could be positioned to advantage with solenoids or flexible cable drives, which would move them against fixed stops. Equipment to be mounted in front of the reflector would thereby be kept to a minimum. Pressurization of the feed could be accomplished by a flat window cemented in the aperture or by a rounded radome attached to the sides of the feed horn.

for Search Radar

lar polarization of the pencil beam is achieved mechanically.

First attempts to design a feed antenna providing these patterns failed because of phase and amplitude discontinuities in the aperture distributions. These discontinuities were eliminated in the final design of the combination feed by using the H-plane flared horn having movable side walls, illustrated in one of the photographs.

Side-Wall Positioning

The side walls are hinged at the throat of the horn. They may be moved either to the outside, to produce a 7-inch aperture for the fan-beam primary feed, or toward the center to provide a 1-inch square aperture for the pencil-beam primary feed.

Phase and amplitude distribution across the aperture of this feed are shown in Fig. 1. The pencil-beam and fan-beam secondary patterns are shown in Fig. 2. The latter show that the $1.5\text{-deg} \times 1.5\text{-deg}$ beamwidth requirements for the

pencil beam and the $12\text{-deg} \times 1.5\text{-deg}$ beamwidth requirements for the fan beam are very closely approximated and that the side-lobe levels are low.

Since the power-handling capacity of the first horn was only about 80-kw peak power and because a

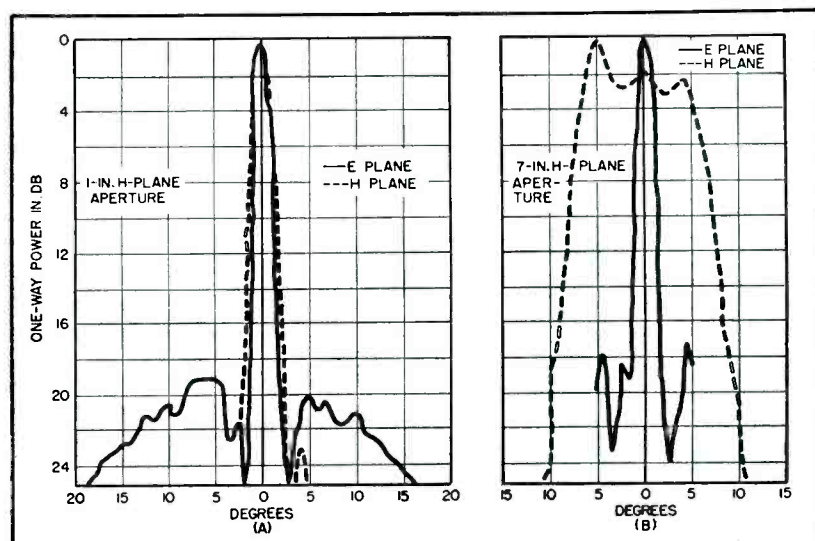
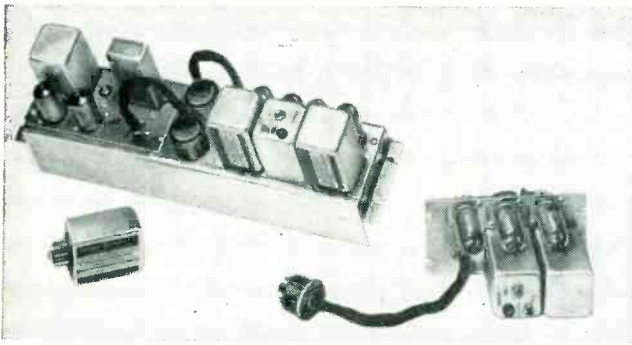
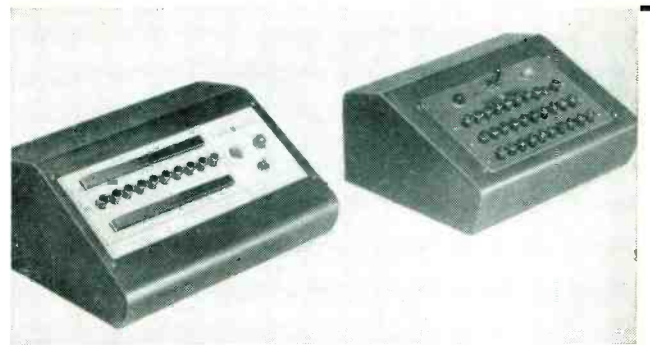

FIG. 2—Pencil beam (A) and fan beam (B) secondary patterns for H-plane flared horn with movable sides and 5-ft paraboloidal reflector with 19.5-in focal distance



Tone transmitter, tone receiver or alternate two-tone receiver can be mounted on chassis for mobile service



Typical control consoles for selective calling. Pushbutton selection of call numbers and transmitter control

Single-Tone Calling

NEED often arises for calling a single vehicle or group of vehicles to the exclusion of all others in a common vhf radio communication system. It becomes increasingly important from the viewpoint of efficient use of personnel and equipment as the system expands and as greater use is made of this medium.

Desirable features to be included are provision for base station selection and dispatching; mobile selection and indication; and mobile dispatching.

Function of Tone

Single-tone systems are generally employed where initial cost is an important consideration and up to ten different calls are required. A momentary burst of tone is used to activate the tone receiver, which may perform a variety of operations. The tone device may unmute the speaker, turn on a call lamp, or operate a beacon or horn on the vehicle.

Multiple tones are employed on systems requiring a large number of different calls. A two-tone system, for example, employs two tone bursts in rapid succession to activate the tone receivers. Combinations possible are equal to the number of tones raised to the second power. Single-tone systems are generally employed in mobile units since a relatively few base stations or repeaters are involved

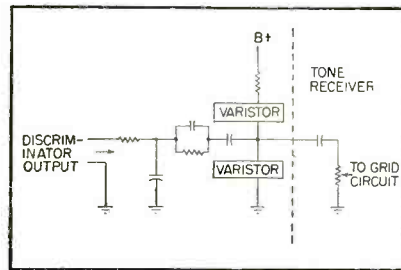

FIG. 1—Type of circuit used to tap tone signal from vhf f-m receiver and apply it to tone device

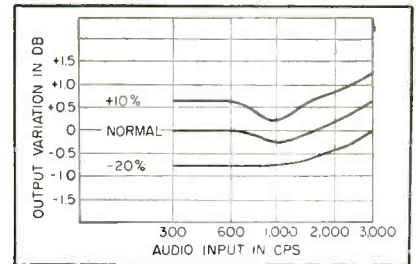

FIG. 2—Variation in tone level with changes in battery voltage at various audio frequencies

in most practical applications.

The operational requirements for a selective-calling system are exceedingly simple, consisting of an on indication when called and no indication or off at all other times. This extreme simplicity accounts for most of the design difficulties arising from effects of noise, voice and other tone signals. There are two general requirements to be met before a signal operates the tone receivers—tone frequency and tone amplitude. These two factors combine to yield a figure of merit for comparing the quality of signaling equipment.

Input Characteristic

Range of permissible amplitude excursion for operation of the tone receiver must equal or exceed the range of tone amplitude supplied by the vhf receiver under all conditions of operation including the full range of variation of supply voltage and signal strength. Design

of the tone receiver must start with the vhf receiver characteristic at the point from which the tone is taken.

The audio volume control and squelch control are usually made available to the mobile operator. Reliable calling service must be provided regardless of the setting of these controls, making it necessary in most receivers to take the tone directly from the discriminator. Disadvantages of using this point include background noise feeding into the tone receiver during absence of carrier—since this point precedes the squelch—and a drooping frequency response characteristic for constant deviation.

The objective in any tone system is to have a maximum signal-to-noise ratio. It is essential from the operational viewpoint to establish a system alignment procedure that permits independent adjustments of the transmitting and each re-

SUMMARY — Increased usage of mobile radio communications has stepped up requirement for selective-calling devices. A new approach in equipment provides plug-in bridged-T selective networks in transmitters and receivers for single or multitone calling applicable to fixed-station or mobile use

By **ELMER W. HASSEL**

*General Electric Co.
Electronics Park
Syracuse, N. Y.*

Simplifies Mobile Radio

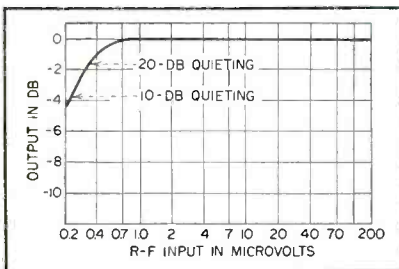

FIG. 3—Typical discriminator output for constant-deviation signal with changes in r-f signal

ceiving equipment. By modulating the transmitter to a fixed degree of deviation for each tone, the vhf receiver requirement is to provide a flat frequency-response characteristic for constant deviation. This yields a one-to-one signal-to-noise ratio for other than the desired tone.

Best Deviation

By selecting a suitable degree of deviation for the transmitter with tone, a workable signal-to-noise ratio can result for voice and noise signals. Although the tone level should be made as high as possible it must be below a level that would cause distortion and noise resulting from the high-selectivity characteristic of the modern vhf receiver. This figure is below 15 kc on wide-band equipment and below 6 kc on narrow-band equipment, particularly on fringe-area operation.

Figure 1 shows a method of

coupling the tone signal from the discriminator. Included are an i-f filter, equalizer and tone output level stabilizers. The stabilizers are varistors whose characteristics are selected to help provide a constant output level with variations in the d-c supply voltage. The effectiveness of such a network is shown in Fig. 2. A maximum change in audio frequency, such as will occur in multitone systems, or in supply voltage results in a +1.25-db or a -0.75-db variation for the worst extremes.

Although an f-m system provides

an essentially constant output for changes in input signal-strength some variations will occur, particularly when the input level drops below limiting. Most users of selective calling equipment expect it to function at the extreme fringe of voice communication. It will be seen that this is possible depending upon how the system is set with respect to levels and the condition of battery and generating equipment.

Figure 3 shows the variation in vhf-receiver output with r-f input for 10-ke deviation. Combining

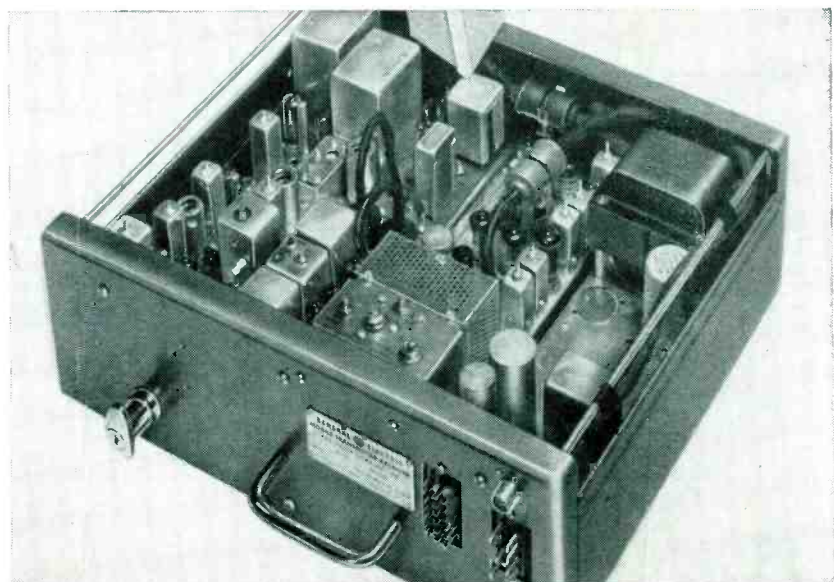

Mobile communications chassis comprises transmitter, receiver, power supply and tone equipment for selective calling

Fig. 2 and 3 gives the tone level available to the tone receiver. For example at the -20-percent extreme in supply voltage and at a 20-db quieting level, a 2.35-db drop in tone level can be expected. Applying this information to the tone receiver operating characteristic enables the limits of the selective-calling equipment to be computed.

Single-Tone Receiver

A burst of tone that meets the requirements of the circuit results in the operation of relay K_1 in Fig. 4. The circuit functions around the operation of the selective amplifier, a feedback-type employing a bridged-T selective network¹ as shown in Fig. 5. Signals fed to the input are amplified by V_{1A} and V_{2A} giving a gain of 60 db. The output of V_{2A} is fed back through the selective network to cathode follower V_{1B} , which is cathode coupled to V_{1A} .

Signals fed through the null-type selective network back to V_{1B} have the effect of canceling the input signal, resulting in low output at V_{1B} . Signals of the null frequency are reduced by 100 db, providing little negative feedback and giving full amplifier gain to this frequency. A circuit Q of 150 is obtained with this arrangement.

The selectivity and sensitivity available with the circuit described above can be used as the basis for

a selective-calling tone receiver. An added degree of selectivity can be included by the addition of a selective differential amplifier. The signal voltage at the cathode of V_1 will be a minimum at the null frequency and rise for all other frequencies above and below the null. Tubes V_{3A} and V_{2B} insert a gain of 54 db to this cathode voltage. The output of V_{2B} represents the equivalent effect of a notch filter with the desired tone frequency removed. If special care is taken regarding noise, Q's exceeding 1,000 can easily be obtained at this point.

Figure 6 displays the results of rectifying the outputs of both the selective and differential amplifiers. Connecting the rectified output of each amplifier in subtractive series yields the composite characteristic. This connection increases the Q of the circuit to 250. The relay tube grid voltage (Fig. 4) is given by the composite characteristic.

One further factor has been designed into the single-tone receiver. The selective amplifier will limit on signal amplitude before the differential amplifier. A very strong signal on the desired frequency will not operate the relay owing to the subtractive series connection. It requires a tone signal of the correct frequency, of a minimum time duration and of the correct amplitude to operate this tone receiver.

Figure 7 displays the resultant characteristic. In general terms the

operating range can be expressed as within a closed area ± 3 -percent of the center frequency and with ± 7 db of the nominal input level. A minimum of 200 milliseconds of tone is required. Plug-in type selective networks permit flexible operation over the audio passband down to 3-percent spacing. The operating range in temperature is from -20 to +100 C.

The closed response curve is obtained through the limiting action of the selective amplifier. Fluctuation in supply voltage will affect the limiting point. Figure 8A indicates the changes over the full range of voltage with which this equipment will operate, ± 25 -percent of nominal.

Since the selective differential amplifier functions to prevent relay operation on all signals but the correct tone, operation of the tone receiver through noise must be considered. Noise will have the effect of canceling part of the tone signal. The extent of this reaction is small. Change in operation for a one-to-one signal-to-noise ratio at the nominal plate voltage of 200 volts is shown in Fig. 8B.

Continuing the example started above, Fig. 8A shows that a permissible drop of 5.5 db can be tolerated at the -20-percent voltage level. Compared to the loss in audio from the receiver of 2.35 db, satisfactory operation would prevail. At 20-db quieting the noise level is

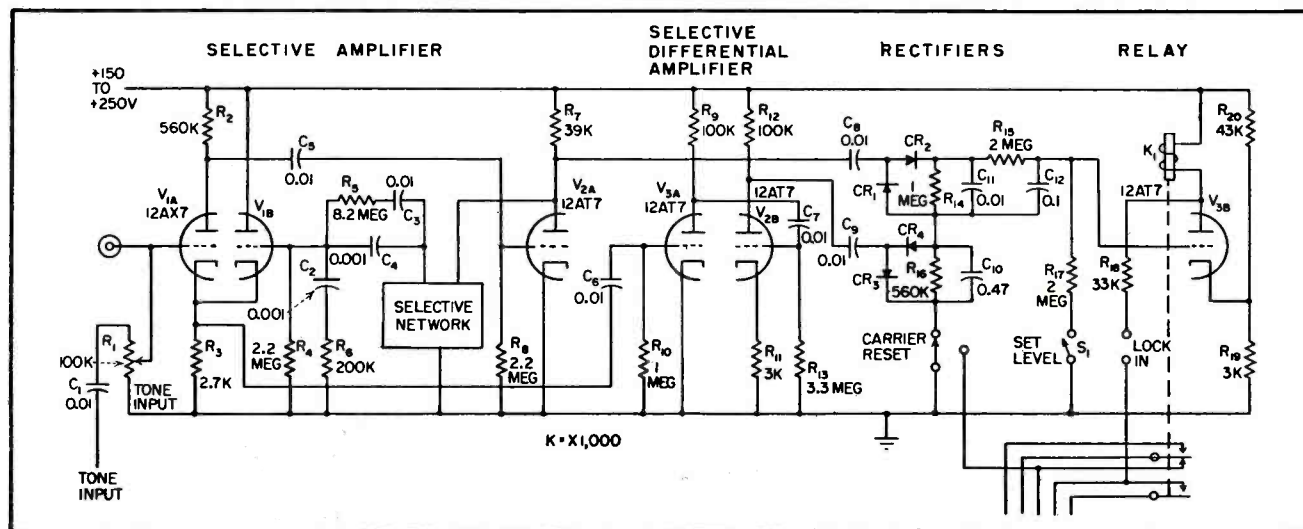

FIG. 4—Receiver for single-tone signaling uses bridged-T selective circuit operating within 0.5 percent of audio tone, reducing voice triggering to bare minimum. Plug-in selective network units are chosen for the desired audio frequency

low thus eliminating the effective loss of signal from the differential amplifier. At -20-percent supply voltage with a signal-to-noise ratio of one-to-one, the tone receiver will tolerate a tone input loss of 4 db.

If operation under extreme conditions of low signal strength, low battery voltage and high noise levels is necessary, greatly improved characteristics can be realized by setting the tone level to the tone receiver under nominal conditions to a level higher than the midrange value used throughout this description.

The input level is set by operating the set level pushbutton (S_1 in Fig. 4) and adjusting the tone input potentiometer R_1 until the threshold of operation is reached. Releasing the pushbutton automatically sets the operating level to the correct value.

A review of the tone-transmitter amplifier circuit in Fig. 9 shows a similarity to that in the tone receiver. Voltage dividers consisting of R_1 , R_2 and R_3 form the voltage-feedback loop making the basic selective amplifier a stable low-distortion oscillator. Varistor CR_1 acting on the transfer characteristic of V_{2A} forms the agc circuit. Frequency stabilities of 0.2-percent, amplitude stabilities of 0.3 db and distortion levels of 0.15-percent can be achieved over the range of 150 to 250 volts d-c supply.

The oscillator output is fed to cathode follower V_{2B} providing a 600-ohm output continuously variable up to +5 dbm. For levels up to 0 dbm less than 5-percent total distortion can be obtained. The output level is held within 1.6 db over the full voltage range of 150 to 250 volts.

Three forms of tone output can be furnished: continuous, keyed or pulsed. Continuous tone results in sine-wave output of an indefinite duration. The output may be keyed under the control of a switch or relay contacts by grounding the key-tone lead for no tone and opening the circuit around R_3 for tone.

Pulsed tone provides a tone signal of approximately one-second duration. If B+ is applied to the lead to C_1 , CR_2 will momentarily give an open circuit resulting in normal oscillator operation. When

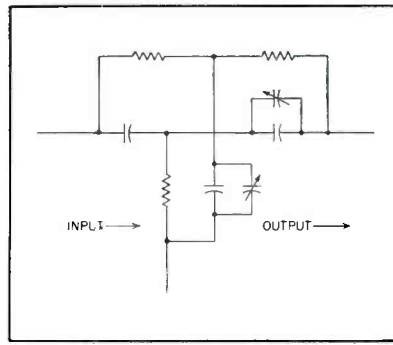

FIG. 5—Bridged-T RC network has satisfactory frequency stability from -20 to +100 C

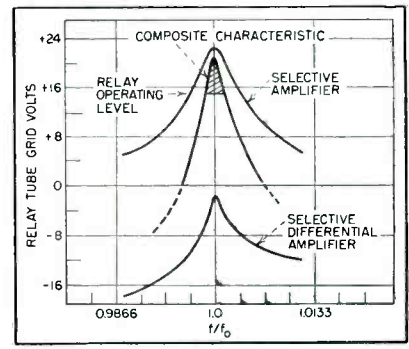

FIG. 6—Differential action of Q-multiplying amplifiers gives resultant Q of 250

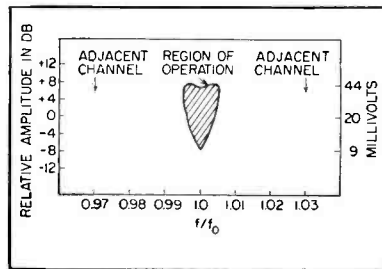

FIG. 7—Selectivity and input level characteristic of tone receiver. Relay operates only if signal falls within shaded area

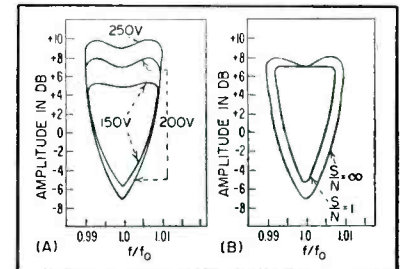

FIG. 8—Effect of plate supply variation without noise (A) and noise superimposed on tone (B) with 1-to-1 signal-noise ratio

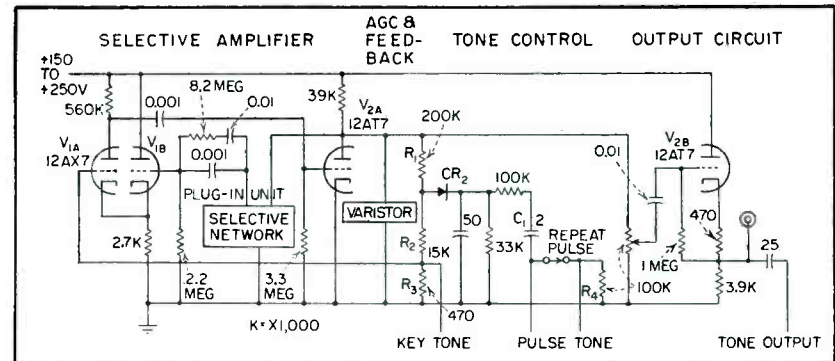

FIG. 9—Tone transmitter uses same plug-in frequency-selective network as receiver. Continuous, keyed or pulsed tone output is available

C_1 becomes charged, CR_2 again conducts, shorting out the feedback path and thus forming the tone pulse.

The pulsed-tone leads can be automatically controlled by switching contacts in the control head. Tone on each transmission or on the first transmission only may be used by including or eliminating R_4 , respectively. Rectifier CR_2 and its related components for pulsed tone are not used for continuous or keyed applications.

Each type of selective calling equipment requires its own send-

ing apparatus to perform the following desired functions:

- (1) Select the tone frequency (or frequencies, in multiple-tone systems) under the control of the dispatcher.
- (2) Turn on the vhf transmitter and put carrier on the air.
- (3) Code and time the calling signal. The length of each tone and the time interval between tones in a multitone system is related to the tone-receiving apparatus and must be designed to unlock it.
- (4) Provide for a means of keying the transmitter with or without

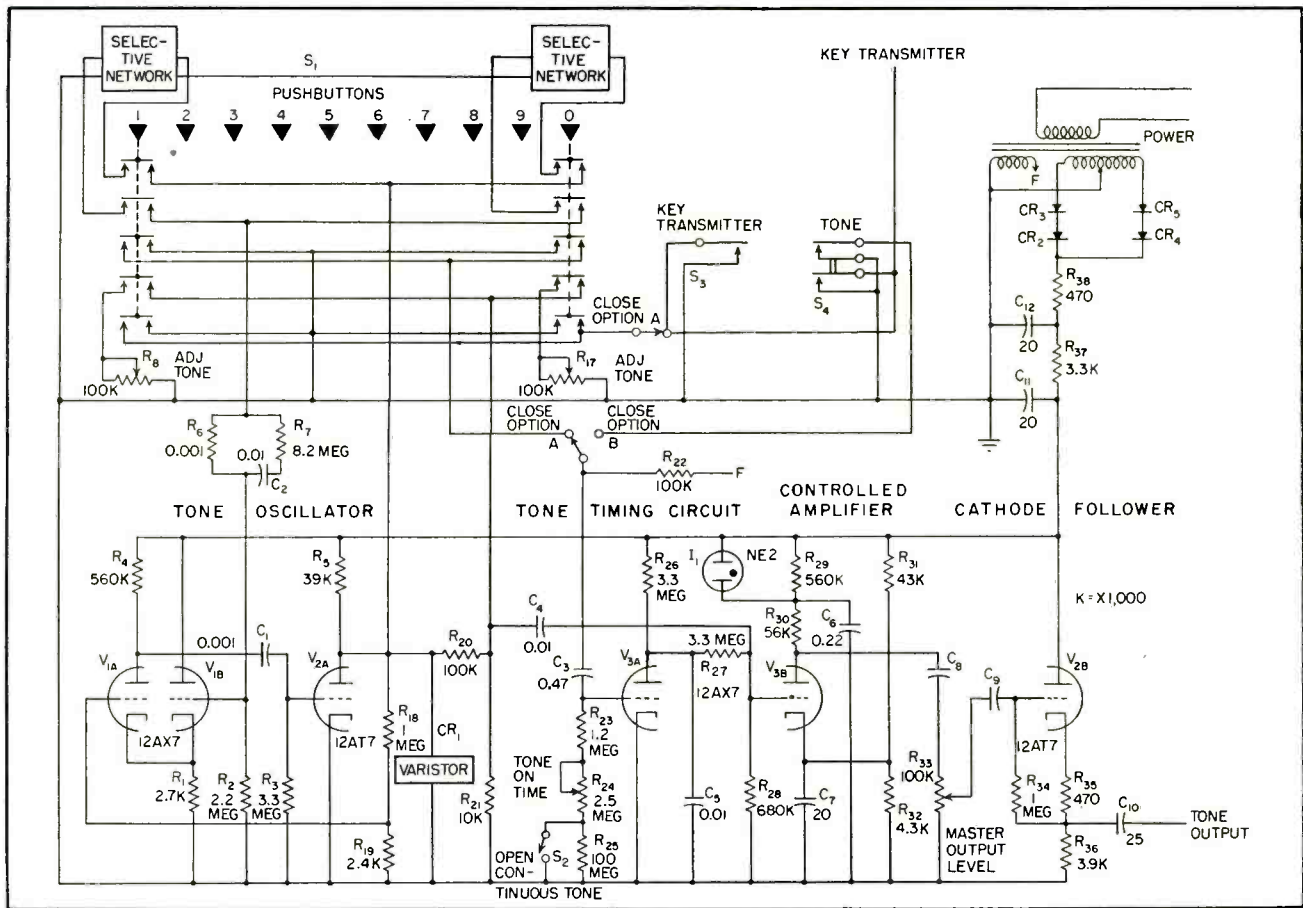

FIG. 10—Dispatching console supplies up to ten different tones for mobile calling. Electronic timing eliminates relays. Tone options A and B are described in text. Gang pushbutton detail is shown for numbers 1 and 0

tone codes, on each transmission or on the first transmission only.

(5) Provide for operation with local or remote control of the vhf transmitter carrier emission.

Tone Dispatcher

Two bar keys and ten pushbuttons form the controls giving two possible types of operation. Spring-loaded pushbuttons can be used to key the transmitter (option A in Fig. 10) pulse the tone automatically and hold the transmitter on the air. Both bars key the transmitter without tone. Rapid dispatching techniques with generally different mobile units or fleets are possible. Indicator I_1 (Fig. 10) shows when tone is transmitted.

Alternatively, equipment can be provided with interlatching pushbuttons (option B) that lock down when depressed. The lower bar keys the transmitter only, the upper bar keys the transmitter with tone, automatically sending the tone pulse. A more convenient but less rapid dispatching arrangement is provided for use on systems

that contact a given mobile or fleet successively before changing calls.

Resistors R_8 through R_{17} permit individual adjustment of the level for each tone. This is particularly advantageous on remote-control applications when the wire line connecting to the transmitter does not have a flat frequency response characteristic. Resistor R_{33} is a master output level control for changing the level of all tones simultaneously.

Tone Interval

The tone-burst interval is easily adjustable from one-half to two seconds by the setting of potentiometer R_{24} . Adjustment of the tone interval is essential to obtain optimum performance for any system to compensate for delays in the control equipment and repeaters, if used. Switch S_2 permits continuous tone to be sent when making system level adjustments and for special applications such as sounding sirens by tone.

The circuit operation is similar to the tone transmitter previously

described, with pushbuttons (S_1) connecting the selective networks to the oscillator circuit. The oscillator output connects through C_4 to amplifier V_{3A} , which normally is biased beyond cutoff giving no output. The timing takes place as follows: the grid-cathode of V_{3A} acts as a diode, rectifying a portion of the heater voltage causing a plate current limited by R_{26} ; C_8 develops a d-c voltage of 8 volts.

When S_1 or S_2 grounds one side of C_8 , V_{3A} is cut off resulting in a sharp rise in plate voltage controlled by the time constant of $C_8 R_{23} R_{24}$. During the period V_{3A} is cut off, V_{3B} becomes a class A amplifier and passes the tone pulse on to the cathode follower. The change in bias of V_{3B} ignites I_1 causing it to glow when tone is transmitted. The output circuit can supply up to 10 dbm; the source impedance is 600 ohms.

REFERENCE

- (1) L. Stanton, Theory and Application of Parallel-T Resistance-Capacitance Frequency-Selective Networks, *Proc IRE*, p 447, July 1946.

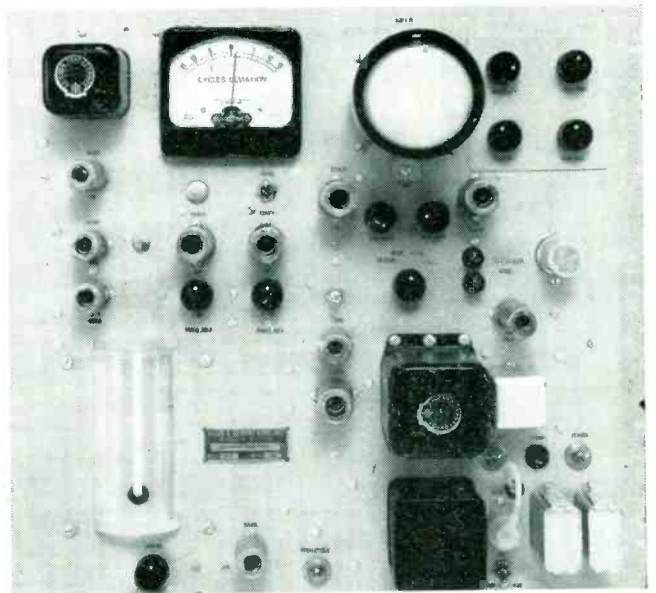
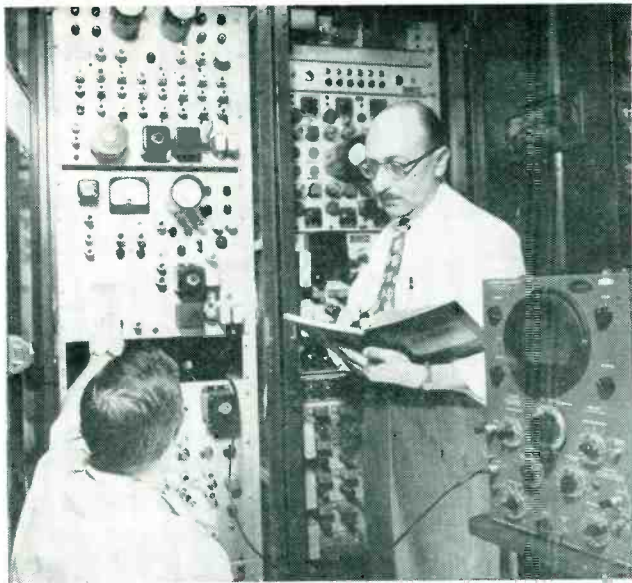

Color frequency standard undergoing tests in development laboratory. Close-up photo shows direct-reading frequency meter with monitoring-oscilloscope screen alongside. Unit is built on standard rack mounting chassis

Meter Shows Color-Burst Deviation

SUMMARY — Frequency deviation from 3.58-mc color subcarrier is indicated by direct-reading meter in cycles per second. Simple, yet accurate device, is necessary for tv transmitters in addition to usual visual and aural-carrier frequency monitors

TELEVISION STATIONS that contemplate switching from monochrome to color transmission are faced with the initial determination and subsequent monitoring of the color-subcarrier frequency of 3.579545 mc in addition to the visual and aural-carrier frequencies. The tolerance as set forth by the NTSC is ± 0.003 percent. Simply using a crystal-controlled oscillator to generate the color subcarrier does not assure that the frequency is within the tolerance specified. It is essential that a monitor or frequency standard be added to check the subcarrier frequency. A relatively simple, yet accurate standard will be described.

The subcarrier frequency stand-

By M. JOFFE

*Allen E. Du Mont Laboratories, Inc.
Circuit Research Laboratories
Passaic, New Jersey*

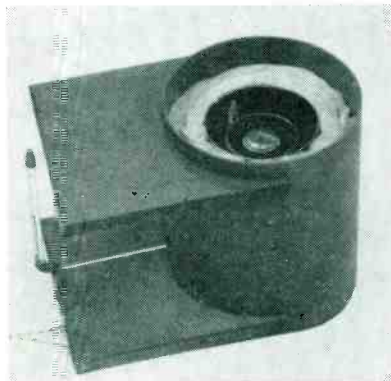

Crystal oven consists of Synthane outer cover, Fibreglas insulation layer, heater and heat-distribution shield

ard shown in the block diagram, Fig. 1, consists of a highly stable temperature-controlled 100-kc crystal oscillator and a buffer amplifier followed by a 10-kc multivibrator, which drives a 1-kc multivibrator. A tuned amplifier preceding the mixer reinforces the 3.58-mc harmonic from the 10-kc multivibrator.

After mixing, the beat difference, 455 cps, is filtered, amplified and impressed across a direct-reading frequency-deviation meter. A switch in conjunction with the oscilloscope and its amplifiers selects the following functions: 1-kc multivibrator frequency check; 10-kc multivibrator frequency check; subcarrier versus

standard-frequency beat check with an external interpolation oscillator; interpolation-oscillator calibration check.

Circuits

In the circuit of Fig. 2 a 6AK6 tube operates as the oscillator, with the crystal connected between the grid and screen. Since there are no tuned elements in the plate or cathode circuits, the frequency is that generated by the oscillating crystal. Two variable air capacitors in shunt with the crystal set the frequency and compensate for aging of the quartz plate. One of the capacitors has a range of $2 \mu\text{mf}$ and is capable of correcting a drift of approximately ± 15 cycles at 3.58 mc.

The oscillator is followed by a 12AT7 buffer-amplifier stage. One tube section feeds a synchronizing voltage to the 10-kc multivibrator. The WWV receiver is also connected to the same point. The other section of the buffer amplifier furnishes a reference frequency for checking the 10-kc multivibrator.

A second multivibrator operating at 1 kc receives its synchronizing signal from the 10-kc stage. To eliminate crosstalk difficulties switch S_1 , in series with the plate-supply voltage of the 1-kc multivibrator, cuts off the stage while

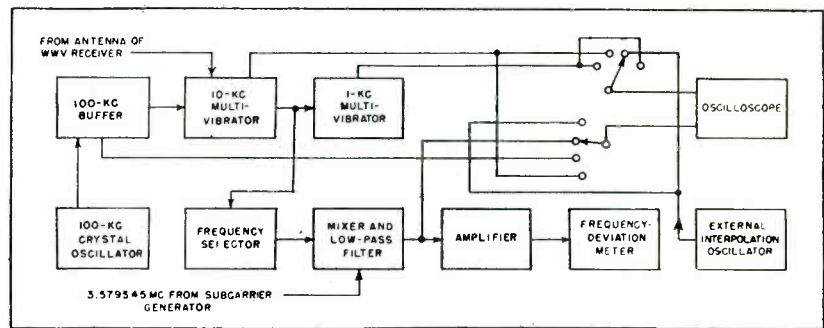

FIG. 1—Tuned-amplifier stage preceding mixer stage reinforces 3.58-mc harmonic from 10-kc multivibrator for comparison with color-burst frequency

the beat difference is being measured or the frequency of the 10-kc multivibrator is being checked.

The harmonic amplifier that receives the voltage from the 10-kc multivibrator has an L-C circuit in the plate circuit tuned to 3.58 mc. This increases the level of the 3.58-mc harmonic above all others existing in the multivibrator to reduce the possibility of selecting the wrong beat when checking the sub-carrier frequency.

The 6BE6 mixer combines the 3.58-mc harmonic and the 3.579545-mc signal from the subcarrier-frequency generator. The resultant audio beat appears in the plate circuit. A low-pass filter rejects all frequencies above 2 kc thus reducing multiple response due to the mixing action.

The voltage amplifier following the mixer feeds the power amplifier, increasing the 455-cycle output of the mixer to a level of approximately 2 watts, which is sufficient to operate the frequency meter. The impedance-coupling choke is tuned to approximately 455 cycles and aids in the rejection of harmonics that cause erratic meter operation.

Deviation Meter

The meter on the panel directly indicates subcarrier-generator frequency deviation in cycles per second. It is a dynamometer-type audio-frequency meter and indicates frequency in accordance with the audio used to energize the instrument.

The meter's center frequency is calibrated at 455 cycles and indicates zero deviation, since when a 3.579545-mc signal beats with a 3.580000-mc signal the difference frequency is 455 cycles. A deviation of 5 cycles from 3.579545 mc is shown as a 5-cycle deviation on the frequency-deviation meter.

For example:

3,580,000	
3,579,540	

460	
-455	

5	cycles low
3,580,000	
3,579,545	

455	
-455	

0	cycle
3,580,000	
3,579,549	

451	
-455	

4	cycles high

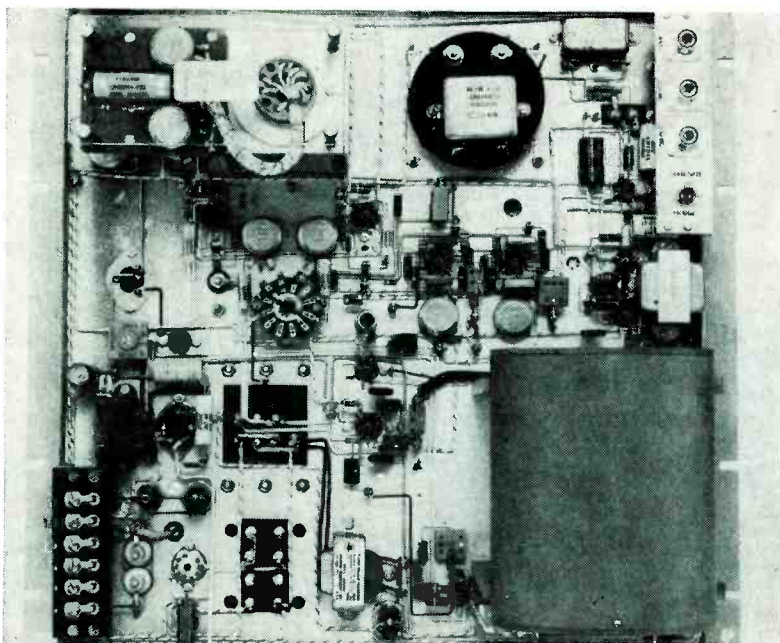

Rear view of frequency standard shows component locations. Crystal oven is at lower right and oscilloscope monitor at upper left

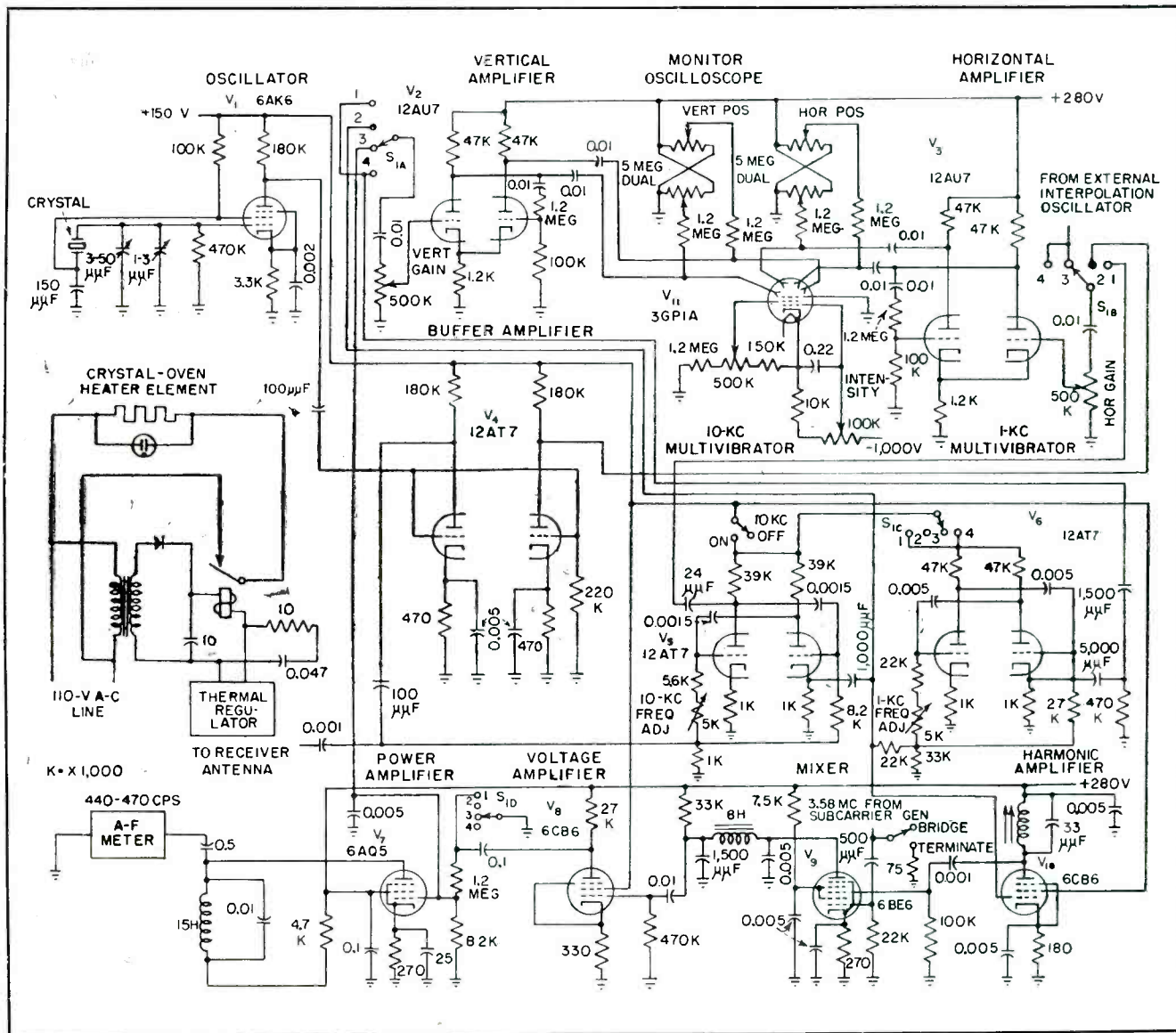

FIG. 2—Crystal oscillator V_1 is followed by multivibrator V_5 through buffer V_1 . Harmonic from V_5 is amplified by V_{10} and mixed with subcarrier signal in V_6 . Beat output is amplified and applied to frequency meter which indicates frequency difference directly as frequency deviation. The L-C network in the plate circuit of V_7 rejects harmonics preventing erratic meter operation

The 3GP1A tube is the indicator. With its amplifiers and a multiple-deck wafer switch, it allows the operator to use the built-in oscilloscope for checking the functions outlined.

An OA2 regulator tube holds the plate voltage applied to the oscillator and multivibrators at a constant value.

Crystal

The crystal is a parallel-resonant G-cut 100-kc bar. It is contained, as shown in the photograph, in a crystal oven consisting of a Synthane outer cover, a layer of Fibreglas insulation, a heater and a heat-distribution shield. The crystal

plugs into a socket fixed to the inner shield.

The heater element is wound directly on the heater tube, then cemented in place. A mercury-type thermostat sits in a well soldered to the inner surface of the heater tube and holds the temperature to $60\text{ C} \pm 0.05\text{ deg}$. The air spaces between the heater and crystal shield and between the shield and crystal reduce this variation still further, so that any temperature change at the crystal is negligible.

The contacts of the mercury-column thermostat cannot carry the current required by the heater in the crystal oven. A sensitive relay operates from the thermostat

contacts and in turn applies or disconnects the crystal-heater voltage as required to maintain a constant crystal temperature.

A selenium rectifier furnishes d-c to operate the sensitive relay; the transformer that supplies the voltage for the relay is also used to energize the heater of the oscillator tube and must be left on 24 hours a day.

A receiver capable of being tuned to any of the WWV standard-frequency transmissions must be provided.

Use of an interpolation oscillator is not mandatory, but it may be added if more accurate checks are desired.

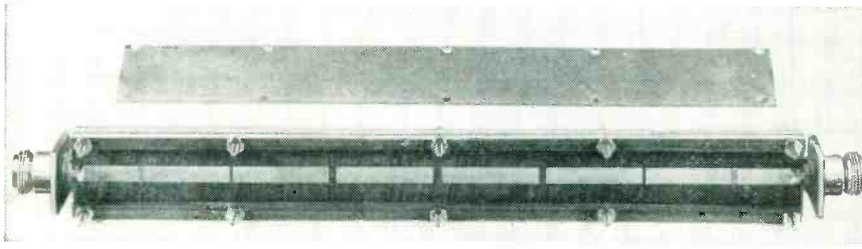

Six-stage band-pass filter using air dielectric has a center frequency of 3,350 mc. Note use of dove-tail gap at each end

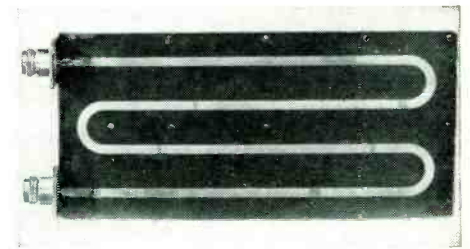

Solid dielectric band-pass filter designed for operation at 715 mc

Band-Pass Filters Using

SUMMARY — Design and construction data on filters for insertion in coaxial lines to obtain band-pass filter performance with large savings in space and weight. Use of etched wiring and sandwich construction simplifies fabrication

USING design techniques developed for direct-coupled cavity-type waveguide and coaxial filters, experimental strip-line filters having 10-percent bandwidths in the uhf spectrum have been developed. These units have less than 1-db mid-band insertion loss and provide a rejection of greater than 40 db at frequencies 12 percent from center frequency.

The design techniques discussed in this paper are general and are not restricted to the realization of these filter characteristics. Some limitations pertaining to the realizability of the cavity parameters in different dielectric media and the existence of spurious responses are discussed.

Design Formula

The design procedure for direct-coupled cavity-type strip-line filters can be evolved from synthesis procedures applied in the design of lumped-parameter circuits.

Bandpass filters can be designed from low-pass prototypes through a low-pass to band-pass transformation. The type and complexity of the low-pass prototype is dependent upon the desired frequency-response characteristics (skirt selectivity and ripple tolerances in

the pass-band). For example, the maximally flat response function is widely used in filter and i-f amplifier designs because of its mathematical simplicity and monotonic characteristic in the pass-band. Other response functions, such as

the Tchebycheff function, also have special applications.

A typical band-pass filter resulting from low-pass to band-pass transformation is shown in Fig. 1A. This configuration is not as easily realized in strip lines as is the circuit shown in Fig. 1B. The transfer function of the former network has an equal zero distribution at zero and infinite frequencies in the complex-frequency plane, whereas the filter shown in Fig. 1B has an unequal distribution with $2n-1$ zeros at zero frequency and one at infinite frequency (n is defined as the number of resonant elements).

For this reason, there exists no one-to-one relationship between the response characteristics of these two circuits. However, if the driving-point impedances of the two networks are equated and if the circuit components of one network are expressed in terms of the other, the pole distributions of each network will be identical. Although the zero distributions of the filters differ, the response characteristics are essentially identical in the neighborhood of the pass-band for small filter bandwidths. For large bandwidths, the response of the filter having an unequal zero distribution will be asymmetrical.

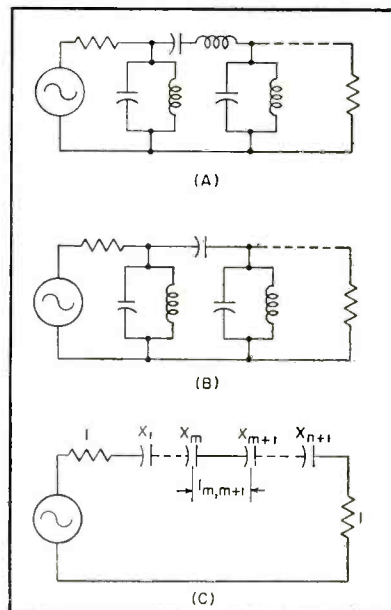

FIG. 1—Conventional band-pass circuit (A) is not as easy to duplicate in strip line as is the capacitive-coupled type (B). Direct-coupled cavity-type filter (C) can be expressed in terms of the lumped parameters of the capacitive-coupled type

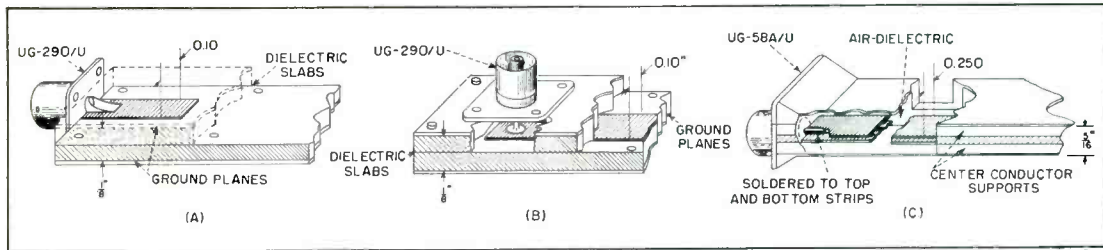

FIG. 2—Coaxial-to-strip-line transition techniques. End transition (A) and normally mounted transition (B) are used with solid dielectric. For air-dielectric strip-line, end transition (C) is used

Strip-Line Techniques

By E. H. BRADLEY AND D. R. J. WHITE

Project Engineer

Senior Engineer

Melpar, Inc.
Alexandria, Va.

Using transmission-line theory, the normalized coupling reactances, X_m , and cavity lengths, $l_{m, m+1}$, of a direct-coupled cavity-type filter having a configuration shown in Fig. 1 C, can be expressed in terms of the lumped parameters of the capacitive-coupled filter. The general design equations for an n -stage maximally-flat band-pass filter are tabulated below.

The normalized reactance of the end discontinuities is

$$X_1 = X_{n+1} \cong \sqrt{\frac{4}{\pi} \frac{f_o}{\Delta f} \sin \frac{\pi}{2n}} \quad (1)$$

and the normalized reactances of all other discontinuities are

$$X_m \cong \frac{2\sqrt{2}}{\pi} \frac{f_o}{\Delta f} \sqrt{\cos \frac{\pi}{n} - \cos \frac{2(m-1)\pi}{n}} \quad (2)$$

where f_o = center frequency of filter
 Δf = filter bandwidth
 m = serial number of discontinuity
 $= 2, 3, \dots$

The separation of the reactance elements is

$$l_{m, m+1} = \frac{\lambda_a}{2\pi\sqrt{\epsilon}} \left[K\pi + \frac{1}{2} \left(\tan^{-1} \frac{2}{X_m} + \tan^{-1} \frac{2}{X_{m+1}} \right) \right] \quad (3)$$

where λ_a = electrical wavelength in air
 K = a positive integer

Table I—Normalized Reactance Data for Six-Stage Bandpass Filter

Discontinuity m	Normalized Reactance X_m	Gap	Dimensions (d or a) in inches
1	-1.82	Dove-tail	0.070
2	-5.45	Simple	0.039
3	-10.52	Simple	0.097
4	-12.3	Simple	0.116
5	-10.52	Simple	0.097
6	-5.45	Simple	0.039
7	-1.82	Dove-tail	0.070

ϵ = dielectric constant of transmission medium

Physical Construction

The most difficult problem in the development of strip-line filters is their physical realization in the proposed type of transmission line. Prior to fabrication, it is necessary to choose a suitable dielectric medium, develop a broadband coaxial-to-strip-line transition and compile a reference library of normalized reactances versus capacitance-gap spacings for strip line.

For filters requiring high loaded Q-factors and a small insertion loss in the microwave spectrum, the use of an air-dielectric line is recommended. Where physical size is an important consideration at lower frequencies and loaded Q-factors

are not large, a high dielectric low-loss material is desired.

A study is being made to establish the availability of dielectric materials having a high dielectric constant, low loss-tangent, a satisfactory degree of homogeneity, properties suitable for copper-cladding and good environmental characteristics. Although not complete, this evaluation program indicates the existence of very few high-dielectric materials available in a suitable copper-clad laminate form.

Since space reduction is of particular importance in many applications, longer filters resulting from the use of materials having lower dielectric constants can be physically accommodated in a relatively small space by forming the transmission line into a spiral configuration. By using a low-loss dielectric such as cementable teflon, a further reduction in size can be obtained over a similar air-dielectric filter.

Having chosen a dielectric medium, a suitable strip-line-to-coax transition is required. To preserve a given filter response, the transition should have a low vswr over the entire operational frequency spectrum. In Fig. 2A, a transition, employing a UG-290/U

BNC connector mounted axially to a strip line having a ground-plane conductor spacing of $\frac{1}{8}$ inch, had a vswr of less than 2-to-1 from 2 to 3 kmc. A normal type transition, similar to those used with most strip transmission lines shown in Fig. 2B, had a narrow frequency response. It should be noted that objects near the edge of this strip line affect the performance of the transition. Asymmetrically located elements in the transverse plane of the sandwich-type strip lines, such as the extended center conductor of the coaxial connector in the transition of Fig. 2B, cause a perturbation of the electromagnetic field resulting in a tendency to radiate.

The first satisfactory design of a broad-band, coax-to-strip-line transition in an air-dielectric structure is shown in Fig. 2C. Similarly, a second broadband transition was designed for a strip line using a teflon-impregnated fibre-glass dielectric medium. Using a cascaded pair of either of these transitions, the maximum vswr over a frequency range from 1 to 5 kmc was less than 1.30, as shown in Fig. 3. It should be noted that the terminating load in these tests had a vswr equal to or less than 1.15 over this spectrum.

The final preparatory step in the realization of a capacitive-coupled strip-line filter is the compilation of normalized reactance data. A series capacitance is easily realized in a strip transmission line by making a gap in the center conductor as shown in Fig. 4A. However, except for very close spacings, it is difficult to calculate the equivalent

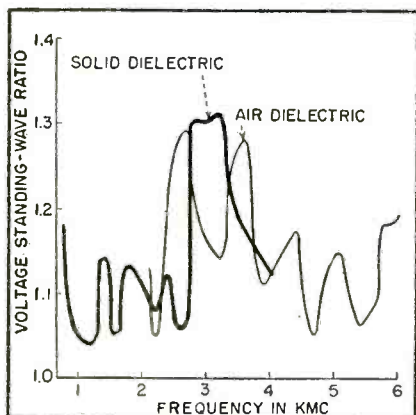

FIG. 3—Impedance match of coaxial-to-strip transitions

capacitance of a gap because of the configuration of the fringing field. A reference library of normalized capacitive reactance as a function of gap spacings can be compiled experimentally by making simple tests on one-stage strip-line filters having different gap spacings at a specified frequency. For example, having measured the loaded-Q of a one-stage filter, the capacitive reactance of the gap spacing can be computed from Eq. 1.

In order to realize the required higher capacitances at the lower frequencies without making the gap spacings unrealistically small (<0.010 in.), a dove-tailed gap designed as shown in Fig. 4B was employed.

Typical reference libraries of standard and dove-tailed gaps compiled at 3,000 mc in an air-filled line are shown in Fig. 5. As an interesting by-product of these measurements, the dielectric constant of the medium, for other than very small values of Q, can be computed very accurately using Eq. 3.

Experimental Results

Using the formulas and reference library data discussed above, a six-stage maximally-flat filter having a 10-percent bandwidth centered at 3,350 mc and 40-db rejection at 12 percent from the center frequency can be designed. Given the filter bandwidth, Δf , center frequency, f_0 , and the number of resonant elements, n , required for the desired skirt selectivity, the normalized reactances of the end discontinuities, X_1 and X_{n+1} and of the other discontinuities can be com-

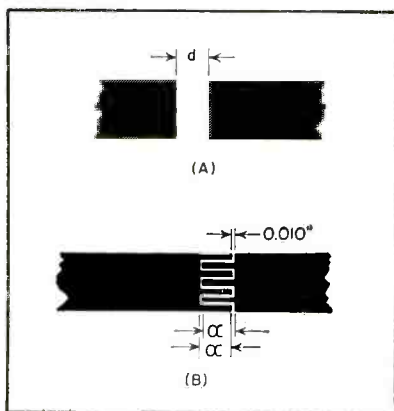

FIG. 4—Simple gap (A) and dove-tail gap (B) used in compiling table I

puted from Eq. 1 and 2, respectively, and tabulated as shown in Table I. It should be noted that the normalized reactance for a capacitive discontinuity is negative.

Referring to the design data in Fig. 5, all normalized reactances greater than 3 should be realized using simple gaps, whereas smaller values are more conveniently realized with a dove-tailed configuration. The physical dimensions of both the simple and dove-tailed gaps can be read from Fig. 5 and are included in Table I. Dove-tailed gaps are used in the outermost cavities to give the required reactance values. Considering the equivalent dielectric constant, ϵ , of

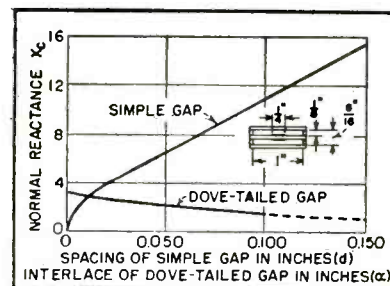

FIG. 5—Normalized reactance plot for simple and dove-tail gaps at a frequency of 3,350 mc

the transmission medium, the separation of the reactive elements can be computed from Eq. 3 to be $l_{1,2} = 1.31$ inches, $l_{2,3} = 1.47$ inches, $l_{3,4} = 1.51$ inches, $l_{4,5} = 1.51$ inches, $l_{5,6} = 1.47$ inches and $l_{6,7} = 1.31$ inches.

For an air-dielectric structure of the type shown in the photograph, the equivalent ϵ will be slightly greater than unity because of the presence of the dielectric supporting sheet for the center conductor. Using a $\frac{1}{16}$ in. supporting sheet of teflon impregnated fibre-glass, the equivalent dielectric constant of the medium is approximately 1.2 at 3,350 mc. The theoretical and experimental response characteristics of this six-stage filter are shown in Fig. 6.

Filters designed at higher frequencies or having higher loaded-Q factors require smaller coupling capacitors, thus eliminating the need for dove-tailed gaps. At lower frequencies the filters become unrealistically long. To shorten these

units, the strip line was photo-etched in a snake-like configuration with the reactance gaps located in a linear portion of the line. A filter designed at 715 mc using a teflon-impregnated fiber-glass dielectric is shown in the photograph. The effect of reflections coming from the impedance discontinuities at the bends is negligible. Theoretical and experimental response characteristics of this unit are shown in Fig. 7.

In many applications, filters must have a large insertion loss over a wide frequency spectrum outside of their fundamental passbands. To examine spurious responses in strip-line filters, response characteristics of a typical unit centered at 3,000 mc were measured from 2,500 to 10,000 mc. The spurious responses, shown in Fig. 8A, were centered at approximately integer multiples of the fundamental, had about the same Q-factor and became less discrete as the frequency increased.

Spurious responses of this type

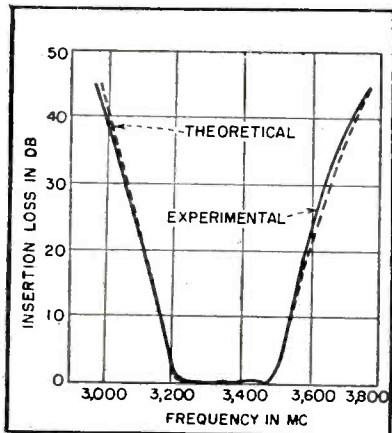

FIG. 6—Response characteristic of six-stage strip-line filter using air as the dielectric

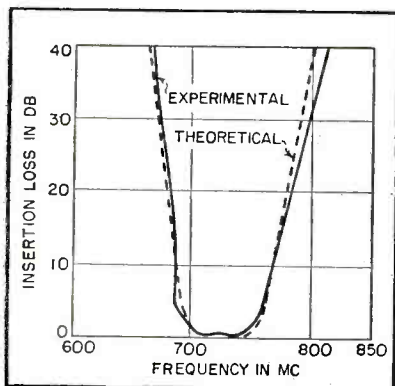

FIG. 7—Characteristic of six-stage strip-line filter in a solid dielectric

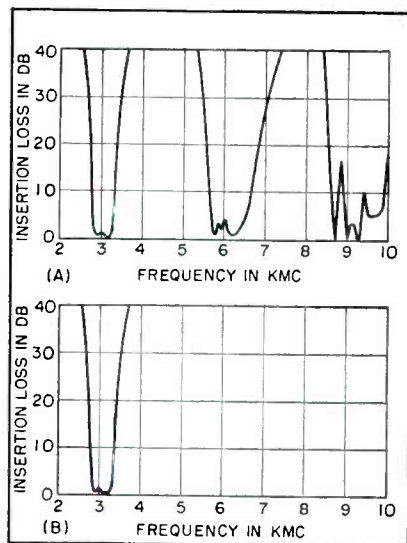

FIG. 8—Suppression of spurious response (A) in band-pass filter by cascaded band-pass low-pass filter (B)

can be removed with a low-pass filter having a cutoff frequency somewhat less than that of the first spurious response. For example, a low-pass strip-line filter was built with a cutoff frequency of 4,000 mc; when cascaded with the above band-pass filter, the composite response characteristics of both filters had no spurious responses up to 10 kmc, as seen in Fig. 8B. Above 10 kmc, it is possible that TE or TM modes of propagation may exist; this region has not yet been investigated.

Limitations

In designing and building direct-coupled strip-line filters using the above techniques, certain limitations exist. The accuracy of the design formulae is a function of the filter requirements. For filters having a loaded Q-factor of ten, it has been empirically observed that the resulting center frequency and loaded Q lie within a ± 1 percent and ± 4 percent scatter, respectively. This deviation also includes such errors as those introduced by inaccuracies in the capacitive-reactance reference library and the photo-etching facilities. It has been estimated that photo-etching tolerances of ± 0.002 inch should be adequate except where exacting requirements dictate a center frequency location of less than ± 0.5 percent. It is virtually impossible to determine the tolerance require-

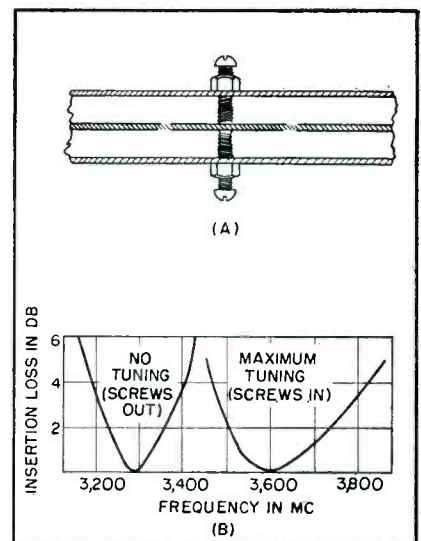

FIG. 9—Effect of capacitive tuning screws constructed as shown in (A) on response characteristic (B)

ments since there exist many inseparable variables, each of which is dependent upon the design techniques used and the filter requirements.

Where some tolerances cannot be maintained, an alternate way of realizing filters having exact center-frequency requirements is to make some provision for tuning. Figure 9A shows a longitudinal view of a one-stage strip-line filter with capacitive-tuning screws located in both ground-planes. The symmetrical location of these screws is required to minimize radiation that might otherwise exist. In a one-stage filter, a 10-percent shift in the center frequency was realized with tuning screws located approximately 0.010 in. from the center conductor. However, since the loaded Q of the filter was appreciably changed in tuning, as shown in Fig. 9B, the allowable tuning range is, therefore, restricted in certain applications. To align a multi-stage filter, all stages are completely detuned (capacitive tuning screws touching the center conductor of the strip line); the quarter-wave shift in the standing-wave pattern at the input circuit is monitored as each stage is progressively tuned.

The authors wish to acknowledge the helpful assistance of D. J. Alstadter and C. P. Andrikan in the compilation of the data presented in this paper.

Automatic Micrometer

SUMMARY — Sensing jaw is linked to mirror that sweeps beam of light across bank of 12 phototubes, each controlling one trapdoor in chute passing over twelve bins, to give precision sorting of punched phenolic resin spacers into thickness groups differing by $\frac{1}{2}$ thousandth inch

SPACINGS between contact levels on two-motion telephone selector banks have to be fixed during the assembly of the banks with an accuracy of $1\frac{1}{2}$ thousandths of an inch, but the makers of the phenolic-resin insulating sheet from which the spacing insulators are stamped can only supply sheet accurate in thickness to 3 thousandths. Moreover, this variation does not only apply sheet to sheet; it may occur to a smaller degree from place to place on one sheet.

Former practice was to measure by hand micrometer the centers of the spacing insulators as they were stamped out of the sheet, then segregate them into batches differing by half a thousandth of an inch in mean thickness. These were then used, together with metallic spacers of known thickness, to build up selector banks having the required spacing between contact levels.

When production was found to be

By **E. T. FEARON**

*Automatic Telephone & Electric Co. Ltd.
Strowger Works, Liverpool, England*

flagging because of the laboriously slow manual measurement, an automatic tester-batcher was designed. This machine has a magazine which is filled with 600 insulators every quarter of an hour. Apart from normal maintenance, such as accuracy-testing, this is the only attention it receives; all the machine operator has to do is collect the bins of correctly graded insulators as they become full.

Power for the mechanical operation of the machine comes from a $\frac{1}{8}$ -hp electric motor, which operates a feed arm to push the insulators one at a time between the measuring jaws of the micrometer. As each fresh insulator is pushed forward it displaces the last one measured. The movable lower jaw of the micrometer closes the gap and then opens to accommodate the

center section of the insulator. Measurement at the center only has been found to be adequate because variations in any sheet are negligible over the area covered by one insulator.

The movement of the lower jaw is transmitted by a second lever under the top deck of the machine, arranged as in Fig. 1, to a small mirror which reflects a narrow beam of light from a slotted light-source onto an arc array of twelve phototubes. The more the jaw of the micrometer moves to adjust itself to the insulator, the further the reflected light-ray travels over the arc. When the beam finally comes to rest it can illuminate only one phototube.

Photoelectric Circuit

A typical circuit element is shown in Fig. 2. The two rotating cams complete one revolution for each test cycle. When the lower cam in the diagram connects ground to the

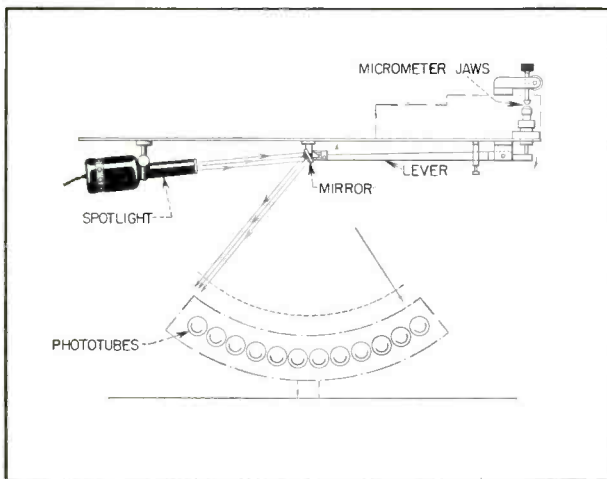

FIG. 1—Movable lower jaw of micrometer pushes down one end of mirror-bearing lever to give optical magnification of thousandth-inch movements

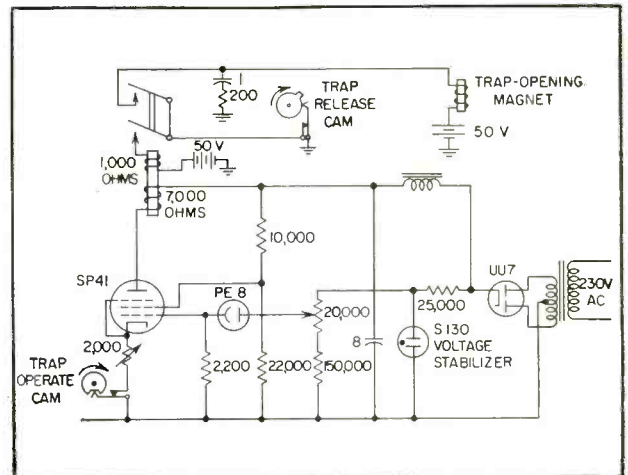
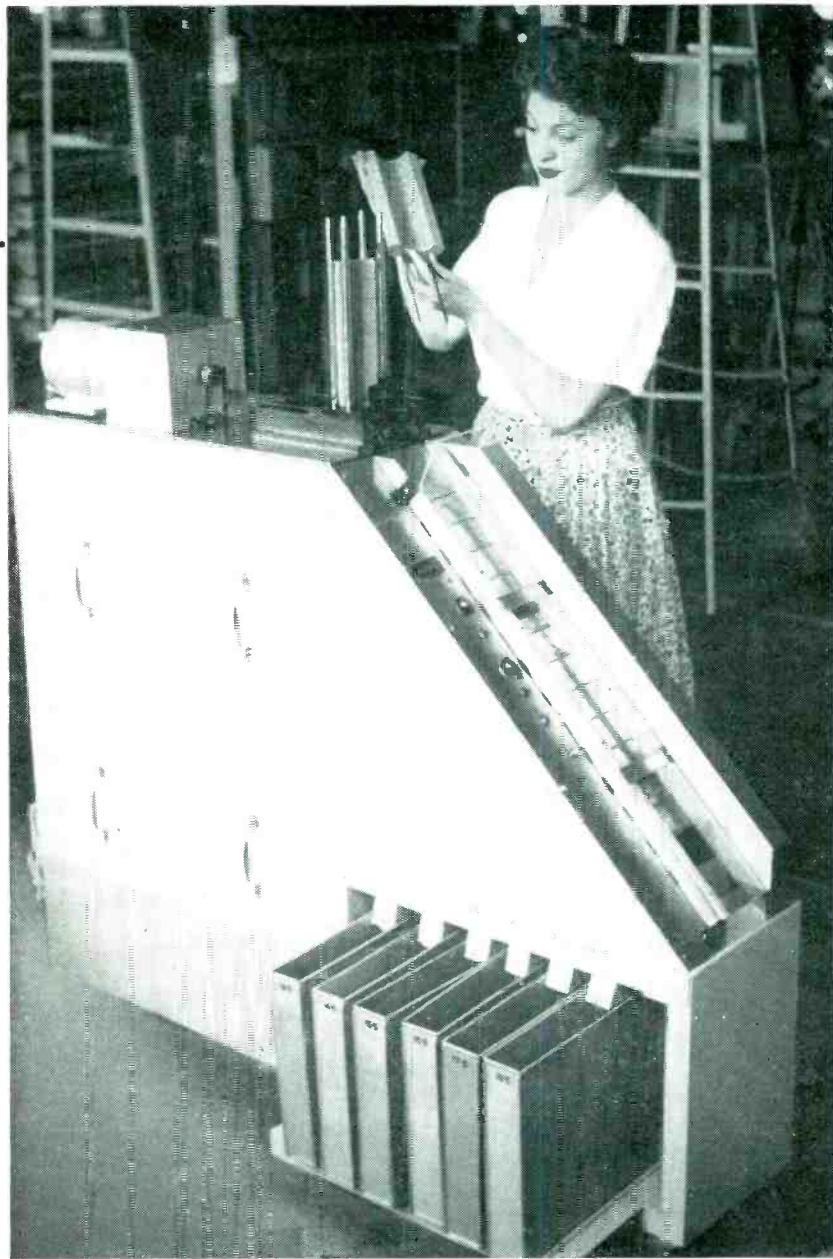

FIG. 2—Circuit used for each phototube. Motor-driven cams make one revolution for each test cycle. Power supplies are common to all twelve phototube stages

Sorts Insulating Wafers



Loading spacing wafers into sorting machine. After gaging, wafers slide down chute to open trap and drop into correct bin. Six bins are on each side of machine

cathode of the type SP41 pentode, the relay operates, assuming that the type PE8 phototube is at that moment illuminated. This relay holds operated through its own contacts and also operates the trap-opening magnet. The trap will be open ready to receive the measured insulator when it is pushed from the micrometer jaws by the next selected insulator from the maga-

zine. The trap lids form a chute down which the insulators slide as they are pushed forward.

After sufficient time has elapsed for the insulator to slide down and disappear into the furthest trap the upper cam disconnects the ground and thereby releases the relay and the trap magnet.

Each trap has its own individual chute leading to a storage bin,

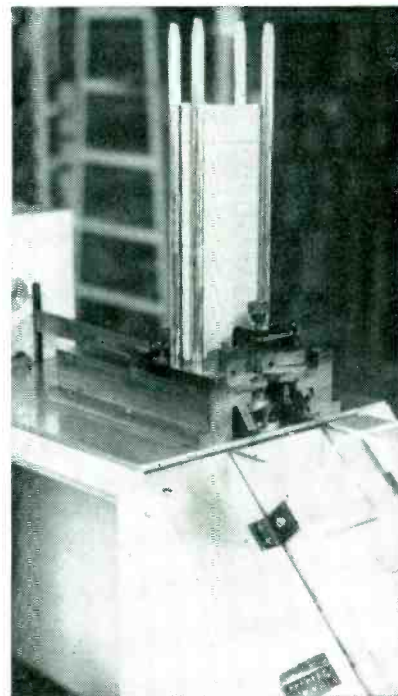

Micrometer gaging head. Lever behind stack pushes out each wafer in turn

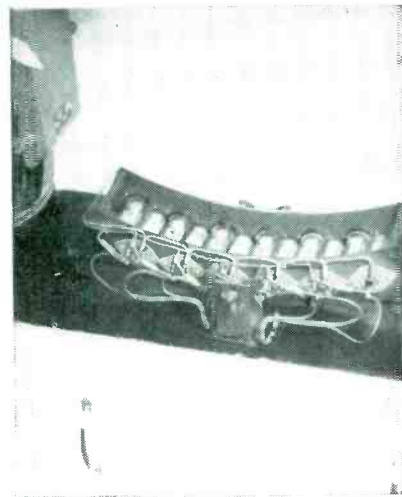

Method of arranging phototubes in arc. Covers of machine give light-tight seal

which is labeled with the mean thickness in thousandths of an inch of the insulators it holds. The leverage on the optical system is so arranged that there is a tolerance in measurement of plus or minus $\frac{1}{4}$ thousandth. There are twelve bins, labeled in steps of half a thousandth and covering the range from 13 to $18\frac{1}{2}$ thousandths arranged six on each side of the machine.

Audio Oscillator

By **PETER G. SULZER**

*Consulting Engineer
Kensington, Maryland*

RECENT publication of a paper describing a low-distortion transistor audio oscillator¹ has resulted in inquiries concerning the possibility of constructing its vacuum-tube equivalent. This oscillator, covers the frequency range from 10 cycles to 100 kilocycles, with a maximum output of 3 volts to a high-impedance load. Total rms distortion, hum and noise is less than 0.02 percent from 20 cycles to 20 kilocycles.

The desirability of substituting tubes for transistors may appear to be progress in reverse. However, in this application, where small size and low power requirements are not of great importance, tubes are able to supply more output at lower dis-

tortion over a wider frequency range than transistors.

Basic Circuit

The oscillator² shown in Fig 1A contains a voltage amplifier V_1 and a cathode follower V_2 . Regenerative feedback is provided to the cathode of V_1 , through a tungsten filament lamp, while degenerative feedback occurs through the bridged-T network³. Oscillation takes place at the frequency of minimum degeneration and zero phase shift, $f = 1/2\pi RC$, where $C = \sqrt{C_1 C_2}$. Amplitude control required for linear operation is provided by the tungsten lamp, whose resistance increases with voltage until the attenuation of the circuit containing the lamp and R_k is but slightly less than that through the bridged-T network.

The basic circuit is satisfactory as a general-purpose oscillator; however, the distortion is about 1/2 percent at an output of 5 or 10 volts. Tests of the amplifier alone have shown that most of the harmonic generation occurs in the single-ended cathode follower V_2 . This is principally because of the fact that the comparatively low lamp resistance decreases the effective feedback factor of the cathode follower.

If the output is decreased to 1

or 2 volts a distortion of 0.1 percent may be obtained, but only at the expense of serious hunting during the amplitude-stabilization process. This will occur after every adjustment of frequency and the resulting amplitude fluctuations may persist for many seconds, making the oscillator useless except as a fixed-frequency device.

Modifications

A substantial reduction in distortion can be obtained by using the two-stage cathode follower⁴ shown in Fig. 1B. Here the control grid of V_3 is driven by the plate of V_2 . The tubes are effectively in push-pull, because the plate current of V_3 decreases as the plate current of V_2 increases and therefore a reduction in even-harmonic distortion can be obtained. There is an additional advantage in that the signal currents of both tubes are available for driving the lamp and load. The two-tube cathode follower behaves as a low-impedance source because of its built-in amplified negative feedback.

The oscillator shown in Fig. 1B can be adjusted to produce a distortion of 0.005 percent at 3 volts, but the hunting problem remains. Evidently the lamp temperature and resistance should increase during

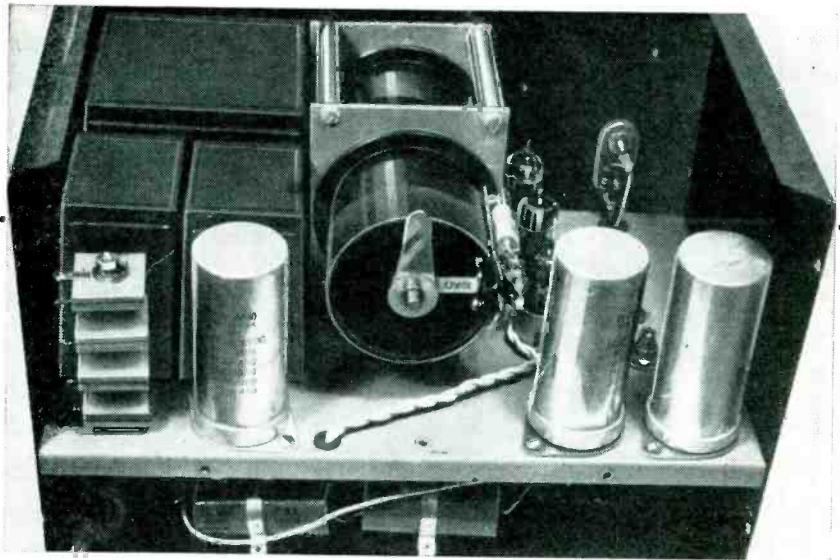

Rear view of low-distortion audio oscillator showing the two 10,000-ohm square-law potentiometers used for frequency control

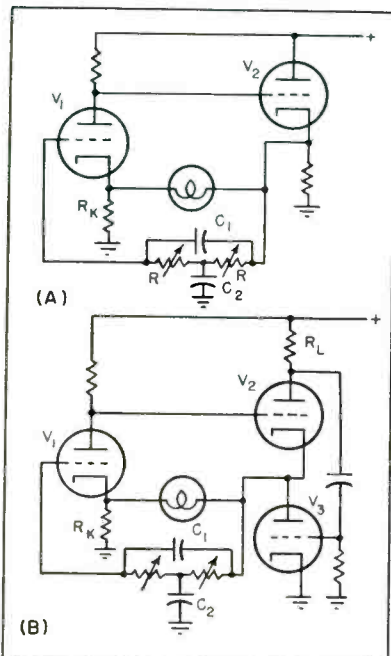

FIG. 1—Basic bridged-T oscillator uses tungsten lamp as amplitude control for linear operation (A); low-distortion bridged-T oscillator employs push-pull arrangement (B)

Has Low Distortion

SUMMARY — Production testing of high-quality amplifiers simplified by oscillator covering a frequency range from 10 cps to 100 kc in four steps by changing capacitors. Biased diodes eliminate hunting when changing frequency by clipping initial overshoot

build-up until an equilibrium condition is reached in which the amplifier gain is exactly offset by the attenuation through the bridge⁵ containing the lamp R_k and the bridged-T network. During the build-up period the lamp temperature will overshoot the equilibrium value, requiring a cooling cycle.

The resulting damped oscillation can be eliminated by any means that will do away with the initial overshoot. Two biased diodes, adjusted to clip both positive and negative half-cycles at slightly over the normal amplitude will accomplish this result. If fixed bias is used, the output-voltage variations caused by circuit changes such as the imperfect tracking of the two sections of the dual potentiometer, will produce excessive clipping and high distortion at some frequencies and insufficient clipping at others.

Fortunately excellent results can be obtained by permitting the diodes to bias themselves, with a long time constant in each diode load. The diode bias will then follow normal, slow output variations, but will permit heavy clipping when the oscillator is first turned on or when transients caused by range switching occur.

Rectification required to maintain the diode bias will produce some distortion even under steady-state conditions. However, this is minimized by the low source impedance of the output stage,

Practical Oscillator

The complete circuit of a practical oscillator is shown in Fig. 2. The frequency range from 10 cycles to 100 kilocycles is covered in four decades by switching C_1 and C_2 , whose values are shown on the

schematic diagram. Each of the two resistors consists of a 10,000-ohm square-law potentiometer in series with a 1,000-ohm carbon resistor. The two potentiometers are ganged so that the high-frequency end of the tuning range corresponds to the narrow part of the resistance card, producing a nearly logarithmic frequency scale.

A pentode voltage amplifier is used to obtain sufficient voltage gain to permit a large amount of negative feedback at harmonic frequencies. Low- μ triodes are used in the output stage to obtain sufficient plate current with the low effective supply (150 volts) per tube.

is little advantage in connecting these tubes as tetrodes, probably because of the small signal voltages involved. Several extra components would also be required.

Although a buffer amplifier would be desirable to obtain isolation and increased output power, it is difficult to produce an untuned amplifier with sufficiently low distortion. The attenuator is useful for gain measurements and other tests. Output voltage is constant within ± 3 percent at all frequencies and therefore an output voltmeter is not required.

Adjustment

The frequency controls should be adjusted to 1,000 cycles on the 1-kc to 10-kc range, and R_k should be increased until an output of 3 volts is obtained. The frequency can then be increased to 10 kc on the same range. If the output voltage is not the same for all settings of the frequency-control potentiometer, the two sections are not tracking properly and one of the 1,000-ohm series resistors should be changed so that the output at the two ends of the frequency range are equal.

With the values given for R_L and R_B a distortion of less than 0.02 percent was obtained with several different sets of tubes.

The work reported in this article was performed for McIntosh Laboratory, Inc., Binghamton, N. Y.

REFERENCES

- (1) P. G. Sulzer, Low-Distortion Transistor Audio Oscillator, *ELECTRONICS*, p 171, Sept. 1953.
- (2) P. G. Sulzer, Wide-Range RC Oscillator, *ELECTRONICS*, p 88, Sept. 1950.
- (3) P. G. Sulzer, A Note on a Bridged-T Network, *Proc IRE*, p 819, July 1951.
- (4) C. T. Hammack, Cathode Follower, *ELECTRONICS*, p 206, Nov. 1950.
- (5) P. G. Sulzer, A Selective RC Bridge, *Proc IRE*, p 333, Mar. 1952.

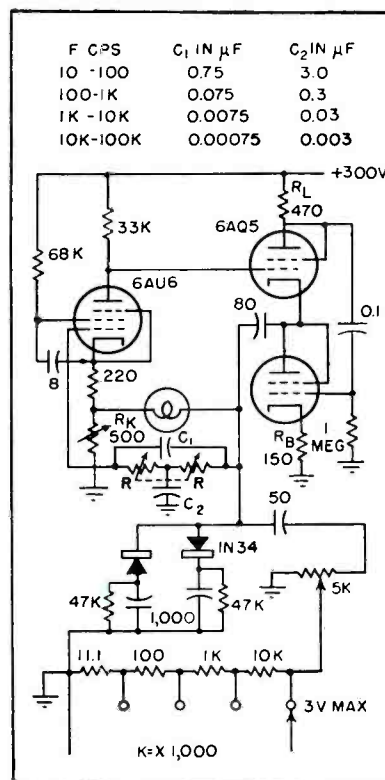
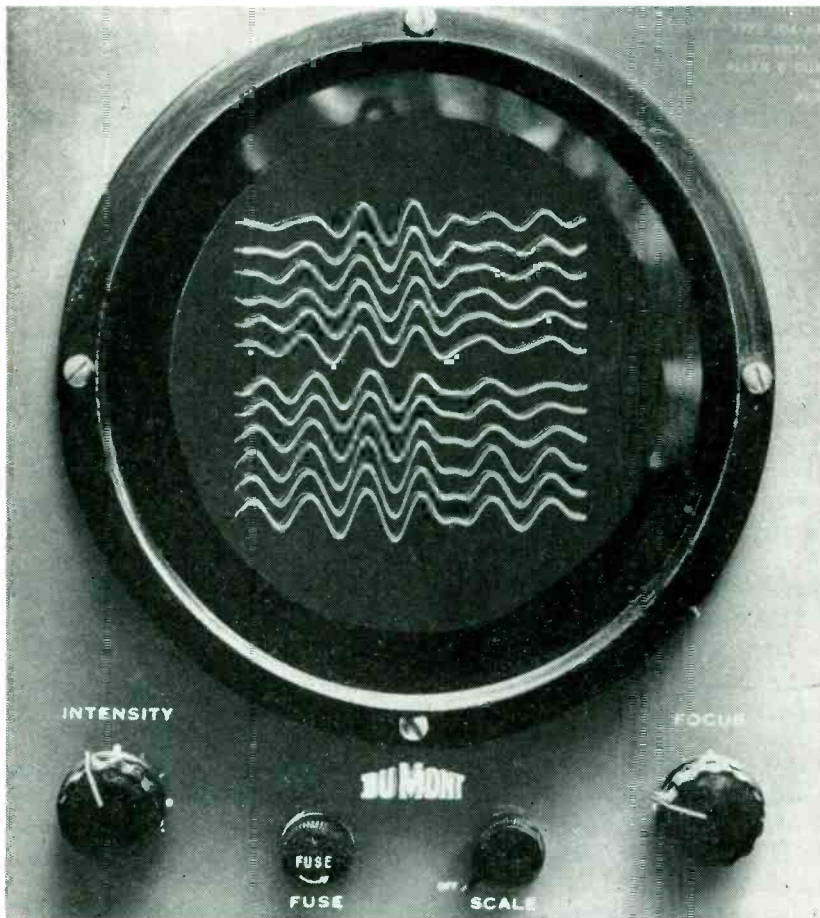
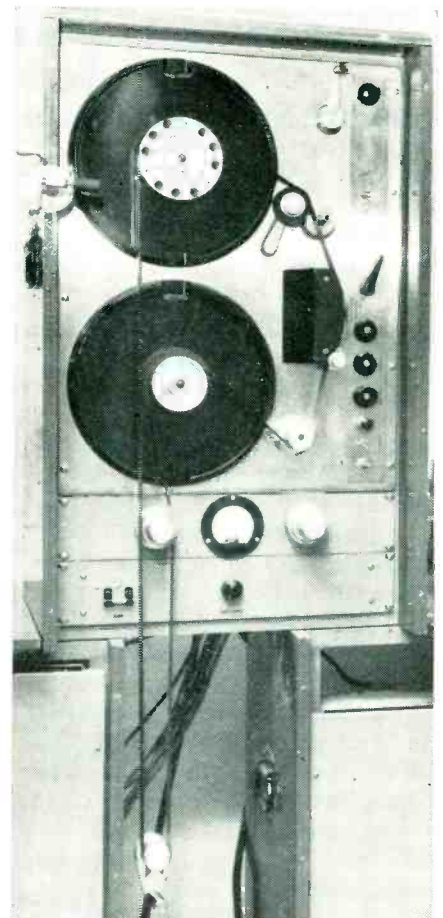

FIG. 2—Complete circuit of a practical oscillator that covers the range from 10 cycles to 100 kc in four decades



Portion of 12-trace seismogram as seen on 5-inch single-beam oscilloscope using electronic switch to sample all twelve channels from magnetic tape



Tape playback unit, with endless loop of magnetic tape in position

Cathode-Ray Display of

By G. M. GROENENDYKE and G. B. LOPER

*Field Research Laboratories
Magnolia Petroleum Co.
Dallas, Texas*

IN THEIR SEARCH for new petroleum deposits in the earth, the major oil companies use practically all known measurements that can be made of the physical nature of the earth. Of the many measuring techniques involved in geophysical prospecting, the one which commands the greatest amount of attention today is the reflection seismograph. This is an acoustic sounding technique wherein the

elastic waves generated by the detonation of a small charge of dynamite in a shallow borehole penetrate deep into the earth. These waves reflect from successive interfaces between layers of contrasting materials, as where abrupt changes of acoustic impedance occur.

The depths to the various reflecting layers are computed from the reflection times, after which contour maps are plotted depicting the

subsurface structural conditions. This survey is made in the hope of revealing structural conditions favorable for the accumulation of oil.

Because of the extreme inhomogeneity of the earth the significant reflections of acoustic energy from depth are often obscured by noise waves, or the waveforms are frequently so variable that accurate time determinations are impossible. These signals are normally recorded on photographic paper with a conventional oscillograph. In an effort to glean significant information from such recordings a number of the major oil companies and geo-

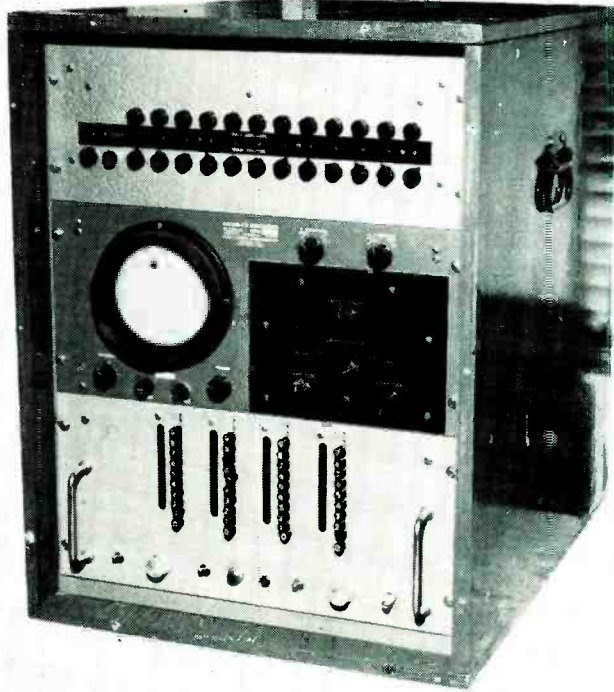

Modified DuMont 304AR oscilloscope (center) is fed through 12-channel electronic switch (top) and synchronized with magnetic-tape loop by Berkeley 5424 preset counter (bottom) controlled by time-track pulses on 13th recorded track

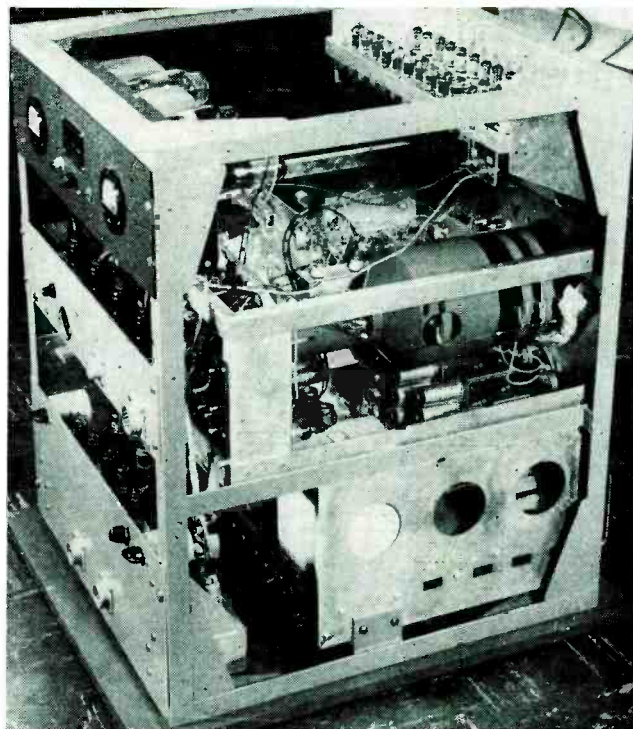

Rear of cathode-ray display unit, with power supply at top rear and auxiliary control circuits at bottom rear. Each channel of electronic switch has a trace-position control and a sensitivity control for eliminating overlapping of the 12 traces on the screen

SUMMARY — Magnetic recordings of seismic reflections in petroleum prospecting are viewed on c-r oscilloscope to study effects of filters. Electronic switch and pulse counter present twelve traces simultaneously for any desired portion of endless-loop tape

Seismic Recordings

physical contractors have begun recently to record the seismic vibrations on magnetic tape. This technique affords the means of subjecting the records to a variety of procedures intended to improve signal-to-noise ratio and to clarify correlations based on similarity of waveforms.

The equipment described here was developed to serve as a rapid means of monitoring the played-back seismic records either before or after analytical treatment without requiring the making of a conventional seismogram.

In Fig. 1 is shown a typical re-

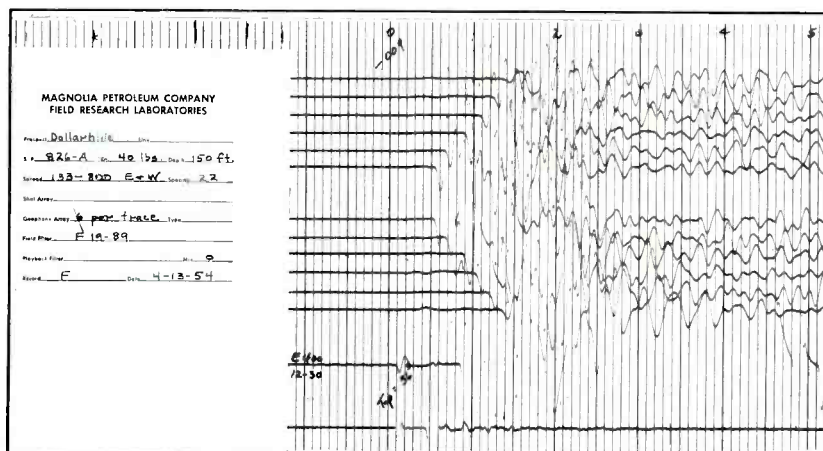

FIG. 1—Portion of typical reflection seismogram, showing signals as conventionally recorded on paper by ink-writing oscillograph. Numbers at top are tenths seconds

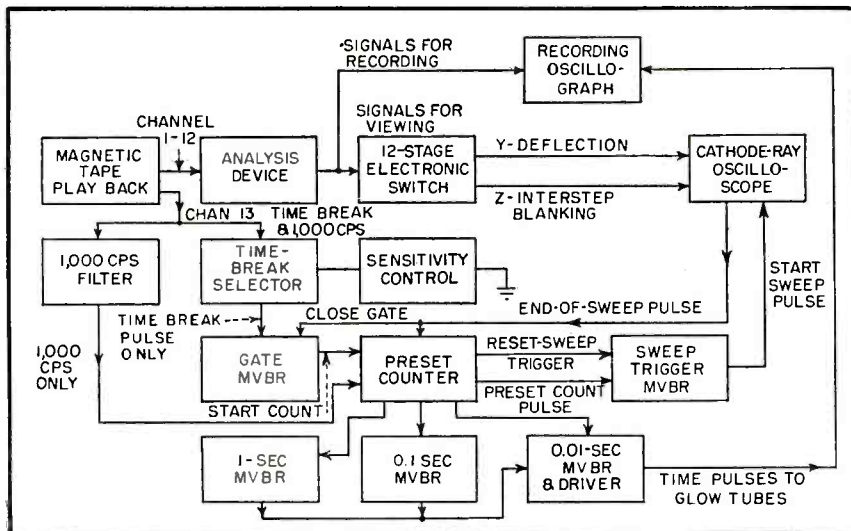

FIG. 2—Block diagram of complete cathode-ray display system used for studying selected portion of all 12 traces

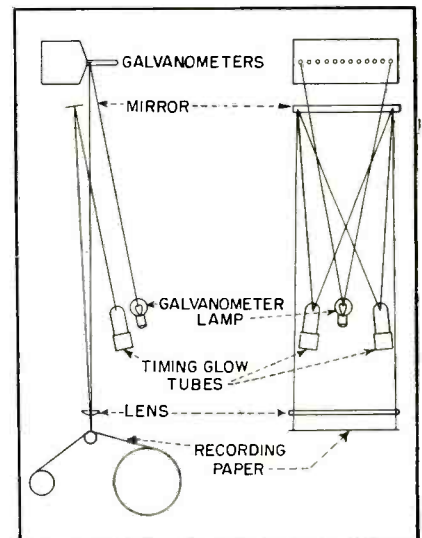

FIG. 3—Optical system used with glow tubes to give accurate time lines

flection seismogram. Time progresses from left to right, with the closest vertical lines separated by 0.01 second. Each of the first 12 traces is a recording of the motion at a point on the earth's surface as picked up by a vibration detector or geophone of the moving-coil, permanent-magnet type. Traces 6 and 7 are signals from detectors nearest the dynamite charge, other traces corresponding to successively greater distances in either direction. The frequencies involved in this record range from 20 to 90 cps. Variable electric filters in the recording amplifier have been preset to pass only this range. Frequencies from 5 cps to 200 cps are sometimes encountered and a pass band anywhere in this range may be selected if the basic channel response is broad enough.

Reflections on the record are distinguished by an increased burst of amplitude common to all traces, a common phase relationship, and similar waveform among all or most of the traces.

The bottom trace shows a sharp break near the zero time line which gives the instant the charge detonated. This is the time break.

To record these signals on magnetic tape, a 13-track recorder is employed. The 12 reflection traces are recorded with a frequency-modulated carrier. The maximum available bandwidth of the overall system is 5 to 300 cps. Time data are recorded in the form of a steady

1,000-cps note on the 13th track with direct recording (no carrier). The 0.01-second timing lines are derived from this signal. The time break is a pulse of less than 1 millisecond duration which is superimposed upon the 1,000-cps tone and exceeds it in amplitude by a factor of 2 or 3. Each magnetic tape record, representing one seismogram of about 5 seconds duration, is spliced in an endless loop and threaded onto the playback machine with fixed pulleys and a weighted, floating pulley to keep it taut. The full record thus repeats endlessly about 12 times per minute.

Block Layout

A block diagram of the cathode-ray display system is given in Fig. 2. The 12 information channels are applied to an instrument referred to as an analysis device. In the simplest form, this may involve only level adjustment or simple selective filtering to vary the frequency responses of the 12 channels. It may also include phase shifting and partial interchannel mixing. Whatever the treatment used, the modified signals then go to a 12-stage electronic switch which drives a cathode-ray oscilloscope for simultaneous viewing of the 12 traces, and to a recording oscillograph for making a permanent paper record. The c-r screen serves as a monitor to show instantly the effects of changes introduced in the analysis circuits and

thus reduces the making of paper records to those which are desired for computation and permanent file. The rest of the circuitry of the block layout is required for synchronizing the c-r sweep with the repeating of the tape loop, and for generating the timing lines in the oscillograph.

As it is not practical to use a screen large enough to display the entire seismic record in its proper proportions, the conventional seismogram being 3 to 6 feet in length, it is necessary to preselect a short portion which is to be viewed and to trigger the sweep each time that portion repeats so that the images are always in perfect register. The signals on the 13th track provide synchronizing means. The reference point on the tape loop is the time-break impulse. This is separated from the 1,000-cps tone by amplitude discrimination, shaped in the gate multivibrator and applied to the preset counter to start the count.

The 1,000-cps tone is filtered with a parallel resonant circuit to give it purity and to cause it to sustain during instants of dropout which may occur on the magnetic tape. This is then applied to the counter input. When the time break occurs the counter begins to count the 1,000-cps signal. At the end of the preset count a pulse is delivered to a sweep trigger multivibrator which in turn pulses the sweep circuit of the scope. The sweep trigger

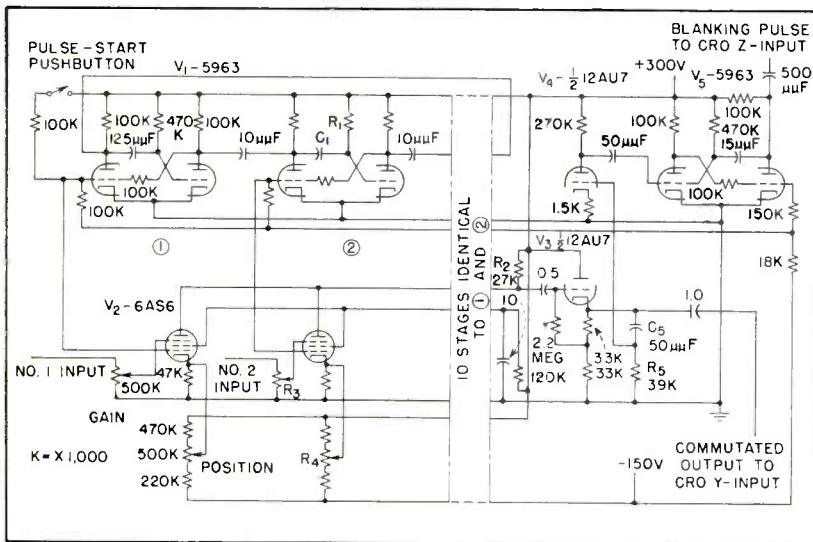

FIG. 4—Ring of monostable multivibrators in electronic switch serves to gate the twelve 6AS6 signal tubes in sequence at 20-microsecond intervals

multivibrator serves also to block subsequent pulses, coming out of the counter, from triggering the sweep.

The sweep circuit of the scope generates a pulse at the end of the sweep which is used to reset the gate multivibrator, the preset counter and the sweep trigger multivibrators. Both multivibrators are bistable units which respond only to the first impulse which hits them, until reset. The counter has four decade units with a total count of 9,999, so that within this limit the sweep may be initiated any selected millisecond after the time break each time the tape loop repeats.

The speed of the sweep is independently adjustable to have any duration from 0.1 second to 10 seconds as desired by the operator. The entire record may be viewed in compressed form if the sweep speed is made slow and the counter is preset on 0000 so that the sweep starts with the time-break impulse. On the other hand, a reflection occurring at 1.5 seconds may be viewed in fine detail if the counter is preset to start the sweep at about 1,490 milliseconds and the 0.1-second sweep duration is used.

The timing lines on the paper record of the oscillograph are derived from the 1,000-cps tone of track 13. Output pulses are taken from three of the decade units in the counter. The first decade delivers a pulse every 0.01 second, the

second gives a pulse every 0.1 second, and the third every 1.0 second. These are shaped with monostable multivibrators and combined with a 6AQ5 driver tube to flash a pair of 1131C glow modulator tubes in the oscillograph. These glow tubes have sufficient brilliance to make dark straight lines across the full 8-inch width of the recording paper. The optical arrangement is shown in Fig. 3.

The period of repetition of the endless loop of magnetic tape may be any time from 3 seconds to 10 seconds and is generally made as short as the data will permit so that screen brightness is enhanced by higher repetition of sweeping.

Electronic Switch

The electronic switch is a hard-tube commutator which provides the means for displaying twelve information signals on a single-gun cro. A self-sustaining ring of twelve monostable multivibrators is the source of pulses used sequentially to gate the No. 1 grids of twelve 6AS6 pentode amplifier tubes. The No. 3 grids are used as signal grids. In this manner there is no tube conduction except in the amplifier, which is gated to the on or amplifying condition. Although capable of higher switching speeds, the rate is set at approximately 50 kc to minimize the commutation interval and reduce the power which would be required for a system of greater bandwidth. The resulting

sampling rate, in excess of 4,000 cps, is adequate for sweep durations as short as 0.1 second. A blanking pulse is derived from a 13th monostable multivibrator which runs at the 50-kc rate in synchronism with the ring-of-twelve. It is desirable to apply this pulse as a Z-signal to blank the cro during the commutation interval. The definition of each trace on the cro screen then approximates that of the normal single trace.

Figure 4 is a schematic diagram of the electronic switch. For simplicity only two of the twelve identical stages are shown. The multivibrators are coupled by 10- μ f capacitors to form a ring. After warmup the pushbutton is momentarily depressed. Upon release, a starting pulse triggers monostable multivibrator 1. Upon recovery, stage 2 is triggered and a positive gating pulse is advanced from amplifier 1 to amplifier 2. This advance is sustained since the recovery of each multivibrator triggers the one succeeding. Although this ring is not critical of component tolerances, timing components R_1 and C_1 should provide uniform time constants. The brightness of the cro traces would otherwise not be uniform.

The No. 1 grid voltage of the amplifiers is normally -25 volts, representing cutoff. The gating pulse rises to approximately zero volts, being limited by the low grid-cathode impedance of the left half of the multivibrator, which is heavily conducting. As the multivibrator cathodes are tied to ground, the level to which the gating pulses rise is stable and uniform. The plates of the amplifier tubes are connected to a common plate load resistor R_2 across which appear the twelve information signals, sequentially commutated.

Each amplifier has a gain control, R_3 , and a trace position control, R_4 . The latter is a No. 1 grid bias control which serves to adjust the plate-voltage level when the amplifier is gated. When there are no signals at the No. 3 grids, therefore, the signal across load resistor R_2 will be a repetitive sequence of pedestals, normally adjusted in a uniform stair-step fashion by position controls R_4 . The range of these

controls is limited so that linear dynamic operation of the tube as an amplifier is not exceeded.

A positive spike having a sharp leading edge occurs at the trailing edge of each pedestal during the commutation interval when tube conduction is switched from an amplifier to the one succeeding. The switch output is differentiated by C_s-R_s . The leading edge of this spike is amplified and inverted by V_4 and then used to trigger monostable multivibrator V_6 . This multivibrator is the blanking pulse generator which supplies negative pulses to the Z-input of the cro.

Cathode-Ray Oscilloscope

The DuMont 304AR scope was chosen for reasons of low cost, rack mounting, response from d-c to 200 kc and full screen deflection on a flat-face tube. Before the development was completed, however, the circuit was modified as in Fig. 5. Two push-pull stages were eliminated to improve stability and cut down noise, power drain and heat. Response to d-c was maintained. This is desirable because if the response is not held up in the low frequencies there will be intercoup-

ling of signals among the 12 traces, or, if one trace is shifted in position, all the others will shift slightly as well.

The sweep circuit was considerably simplified. A phantastron sweep generator was chosen because of its excellent linearity with wide voltage excursion, simplicity and low drain features, and because it delivers an excellent pulse at the screen for beam gating and end-of-sweep indication. A long sweep time of 10 seconds could be provided in this circuit with only a 0.1- μ f capacitor.

The sweep function switch has three functions. OFF gives no sweep; spots are centered and steady for focus and position adjustment. TRIG is for an external triggered sweep, with spots blanked just off the left edge of the screen prior to sweeping. RECUR gives a recurrent sweep with no trigger or sync; spots are blanked between traces and on retrace.

The TRIG position is normal when portions of a magnetic tape record are to be viewed with the sweep triggered on each recurrence of the desired data.

The sweep generator is coupled

to the horizontal deflection plates with a 12AT7 cathode-coupled push-pull driver. The direct coupling is necessary because of the low sweep speeds and repetition rates involved. The sweep is triggered with application of a short positive pulse to the suppressor grid through the 0.001- μ f capacitor.

To hold the beam in blanked condition between sweeps a 1-mc intersweep blanking oscillator was added. It is a conventional circuit with r-f coupling to a rectifier in the No. 1 grid circuit of the c-r tube to provide control of intensity. The oscillator, employing a 6BJ6 pentode, is turned on at its suppressor grid. When the sweep starts, the screen grid potential of the sweep generator goes highly positive. This turns on the r-f oscillator, applying positive excursion to the No. 1 grid of the c-r tube to brighten the traces for the duration of the sweep. At the end of the sweep the 6BH6 screen grid returns to its former potential, turning off the oscillator and blanking the beam. This negative excursion of the 6BH6 screen is differentiated and the resulting pulse serves as the end-of-sweep reset pulse.

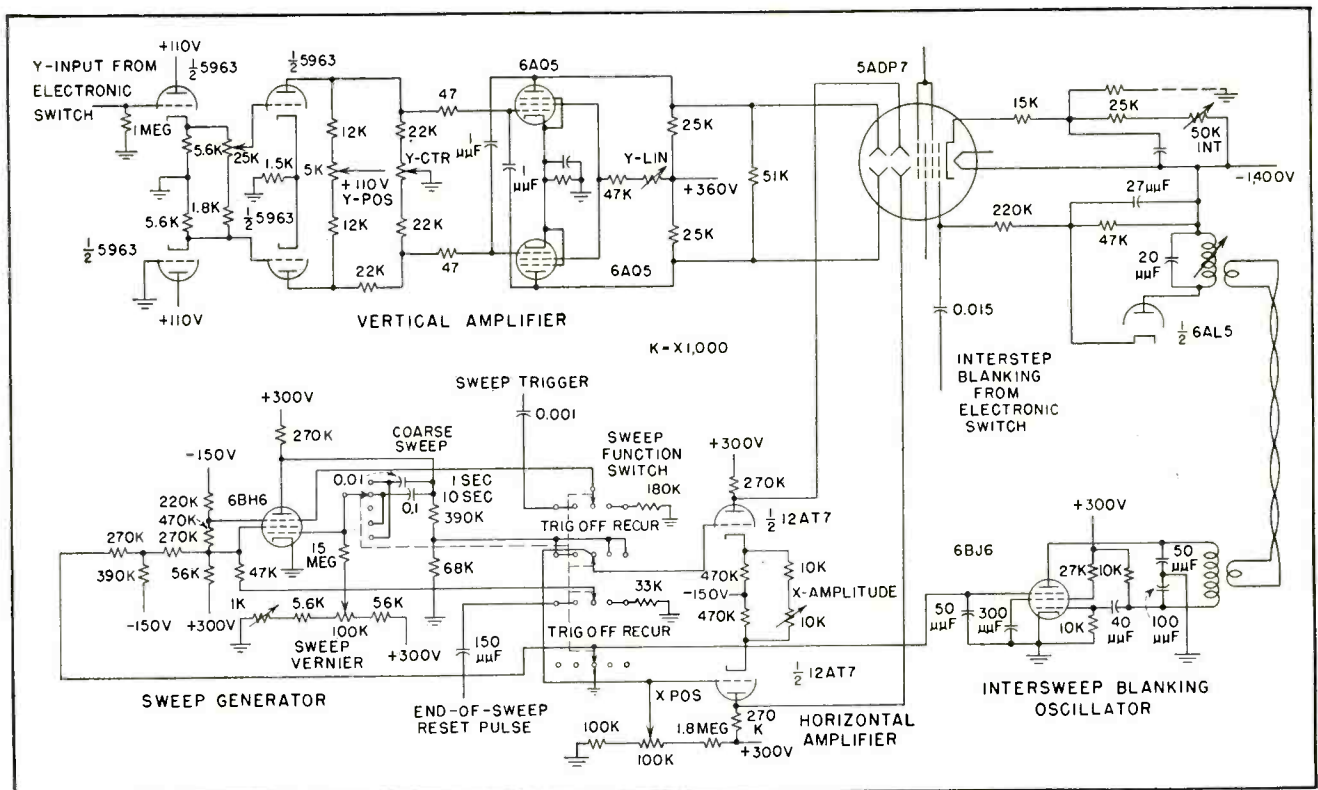

FIG. 5—Modifications made in oscilloscope include simplified vertical amplifier, phantastron generator and r-f blanking stage connected as shown here

The preset counter was modified so that the gating signal is supplied externally by a gate multivibrator as previously described. This signal is applied to the suppressor grid of the regular 6AS6 pentode gate in the counter which feeds shaped pulses to the first preset decimal counting unit. The end-of-sweep transient resets the decimal counting units through the normal circuitry of the counter. However, these counting units are modified to reset on the count of 9 instead of the count of 0. This is desirable since the first count will then clear all counting units, and the first time-line on the oscillogram will be accentuated as are all subsequent 1.0-second lines.

Bistable multivibrators V_2 and V_3 , shown in Fig. 6, serve to initiate the cro sweep at the preset time. This time is set by depressing the numbered pushbuttons on the panels of the decimal counting units. Counter gate multivibrator V_2 is triggered by the positive-going time-break impulse which is selected, amplified and inverted in V_1 . Selector V_1 is biased near cut-off. The sensitivity control sets this bias, and is found desirable because of track-13 signal-level variation, associated with amplitude modulation. When V_2 is triggered, the gate signal to the counter rises from -30 v to slightly higher than ground potential, being limited by grid-cathode conduction since the left half of V_2 is then heavily conducting. The negative-going end-of-sweep transient which resets the decimal counting units also resets

V_2 to its original state and the counter is prepared for the next time-break impulse.

The cro sweep generator is triggered by V_3 , which is similar to V_2 in operation. Tube V_3 in turn is triggered by the preset pulse from the counter, at which time the signal to the sweep generator rises to a steady value of approximately 15 v and is coupled to the sweep generator through a $0.001\text{-}\mu\text{f}$ capacitor located with the sweep generator circuitry. Tube V_3 is reset by the end-of-sweep transient simultaneously with V_2 .

When the equipment is first turned on, V_2 and V_3 may set up in the triggered state, in which case the counter will not function. A switch actuated by a spring-return pushbutton produces a synthetic end-of-sweep impulse to reset these multivibrators. This pushbutton also starts the electronic switch.

Transfer of Timing to Paper Records

The paper speed during recording is approximately 15 inches per second. Time lines are provided by glow modulator lamps, beginning with the time-break impulse and repeating every 10 milliseconds. Each tenth line is enhanced by a longer pulsing of the glow time lamp. Each 100th line (1-second marker) is further enhanced by a still longer pulsing time.

Figure 7 shows the time-line circuitry. Tubes V_4 and V_5 form a monostable multivibrator which is triggered by the negative pulse output of the first decimal counting

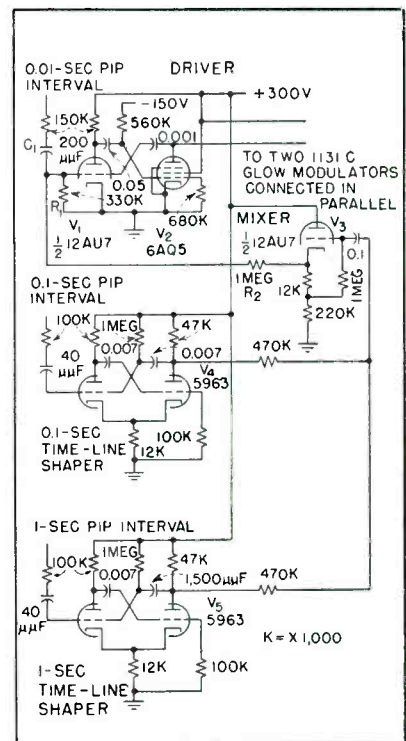

FIG. 7—Outputs of decade units in counter are combined to flash glow tubes used to make time lines

unit. The duration of the conduction of V_2 through the glow modulators is determined by the time constant of C_1 and the parallel combination of R_1 and R_2 , and also by the voltage level to which the grid of V_1 begins to rise immediately after each trigger. This level is approximately $+50$ v when V_4 and V_5 are not triggered, and is influenced by the voltage level of the cathode of V_3 . The pulse duration is accordingly about 50 microseconds. Tubes V_4 and V_5 form monostable multivibrators triggered by the outputs of the 2nd and 3rd decimal counting units respectively. The outputs of V_4 and V_5 are mixed and applied to the grid of V_3 as shown. The pulse times of V_4 and V_5 are respectively 100 and 250 microseconds. These pulses lower the cathode voltage of V_3 so that the recovery time of driver V_1 - V_2 is accordingly delayed to 100 or 250 microseconds.

For permission to publish this article and for their cooperation, the authors are grateful to the Magnolia Petroleum Co. and to the Seismograph Service Corp. of Tulsa, Oklahoma who, under license from Magnolia, are manufacturing equipment of the type described.

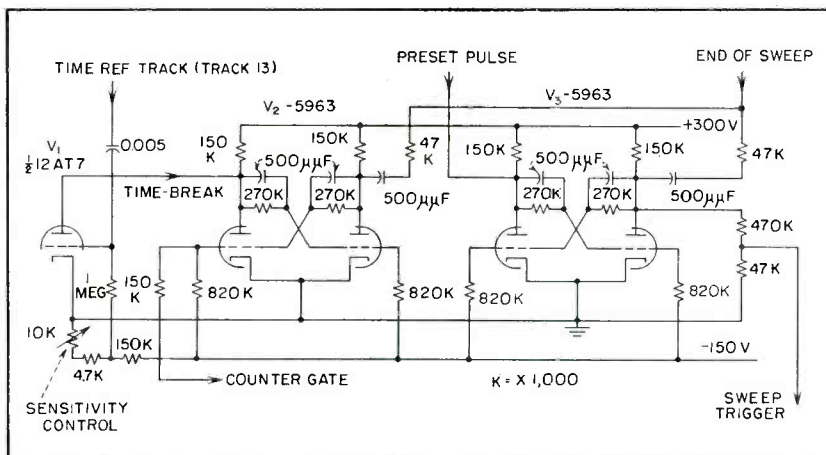

FIG. 6—Circuit of time break selector, counter gate multivibrator and sweep trigger multivibrator

COMMON RADAR local oscillator design practice involves a loop consisting of a klystron oscillator, afc mixer, some type of frequency discriminator and a feedback amplifier controlling the klystron frequency with respect to the transmitter frequency. This paper describes a system which eliminates the need for a klystron and handles the frequency-control problem without additional components and with a considerable reduction in complexity. The system was designed for an X-band c-w system with a 60-mc i-f but nothing in the theory precludes the use of any other combination of transmitted and intermediate frequencies.

A simplified block diagram of a c-w radar system is shown in Fig. 1A. The c-w oscillator, either a klystron or c-w magnetron, feeds the antenna. Before entering the antenna, a portion of the r-f oscillator output power is diverted to a microwave mixer circuit where it is mixed with 60-mc power from a crystal-controlled oscillator. Assuming a transmitter frequency of 9,000 mc, the modulation products from the mixer will consist of upper and lower sidebands, 9,060 and 8,940 mc, together with some carrier leakage signal of 9,000 mc. The desired sideband can be separated from the other signals by a cavity filter while at the same time removing the noise sidebands of the local-oscillator signal.

If the transmitted frequency changes from 9,000 to 9,001 mc, the sidebands generated by the mixer become 9,061 and 8,941 mc. Either of these sidebands, mixing with the transmitted frequency, will still give an i-f of 60 mc within the accuracy of the 60-mc crystal oscillator.

Mixer System

A diagram of the mixer circuit is shown in Fig. 1B. The circuit consists of a standard microwave balanced mixer utilizing a magic T with crystal mounts on each of the collinear arms. Arm 3 in the figure is the H-plane arm and arm 4 the E-plane arm.

A signal entering arm 3 divides equally between the collinear arms with signals of the same phase in each arm. The signal entering arm

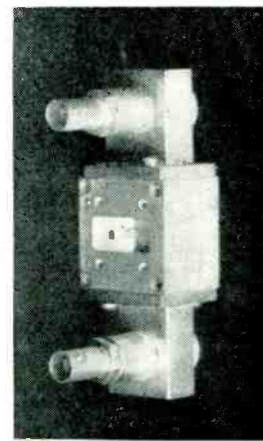
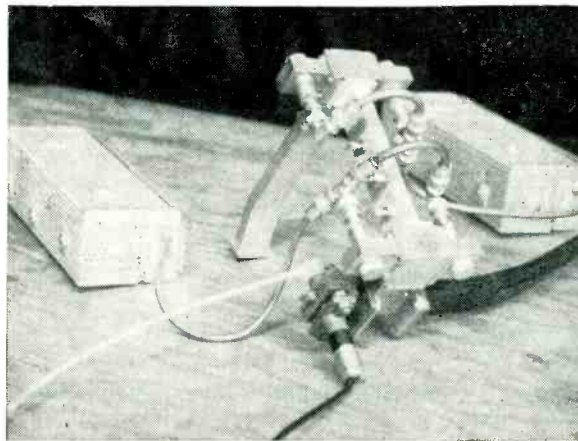

Radar transmitter for X-band has component units arranged in order shown on block diagram. Closeup shows mixer network using magic T

Local Oscillator

By HAROLD B. GOLDBERG

Laboratory for Electronics, Inc.
Boston, Massachusetts

4 also divides equally in amplitude but with opposite phase in the two collinear arms. By reciprocity, if signals of equal amplitude and opposite phase travel down the collinear arms toward the junction of the T, they will add and emerge from arm 3.

In the radar system, a portion of the transmitted signal is sent into arm 3 of the T and a 60-mc signal fed into the two diodes on the collinear arms. The diodes generate sidebands which travel back toward the junction. Since the local-oscillator signal is to be extracted from arm 4, there must be a 180-deg phase difference between the signals returning in the two arms.

If arm 1 of the magic—T mixer is made $\lambda_g/4$ longer than arm 2, the 9,000-mc signal at crystal 1 is 90-deg out of phase with the signal at crystal 2. This will result in a 90-deg phase difference in the sidebands generated by the crystals in the two arms. The sideband from arm 1 will receive an additional 90-deg shift in traveling towards the junction due to the $\lambda_g/4$ difference in line lengths,

thus giving the desired 180-deg difference in sideband phase at the junction of the T. This method has the advantage of using the same type of crystal and crystal mount on each of the arms. There is, however, an unfavorable effect on the carrier leakage in the sideband output arm. If the two crystals have the same r-f impedance but are not perfectly matched to the line, the carrier reflections from each arm will be of the same phase, assuming arms 1 and 2 are of equal length. They will add in arm 4 and not appear in the local-oscillator arm. If, however, a $\lambda_g/4$ difference exists between arm 1 and 2, the reflected carriers at the junction of the T will be 180-deg out of phase and they will add in the l-o arm giving poor carrier rejection.

A second method of realizing the 180-deg phase shift is to have arms 1 and 2 of equal length but to feed the 60-mc to the two crystals from a balanced system so that there is a 180-deg phase difference between the signals at the crystals. This results in a 180-deg difference in the phase of the generated sidebands.

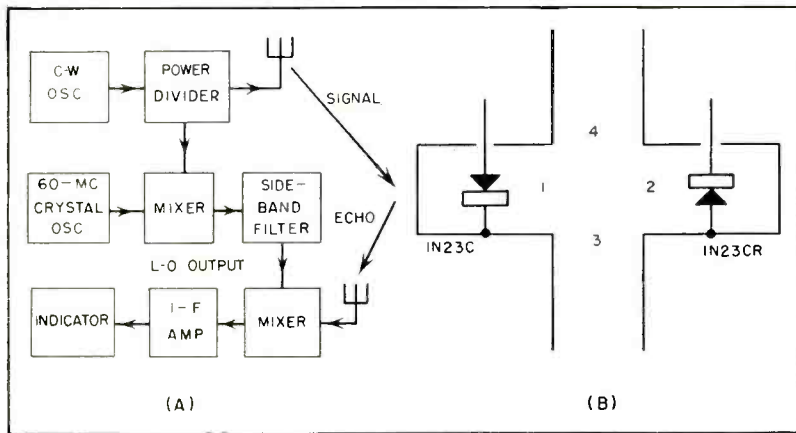

FIG. 1—Arrangement of functional units comprising c-w radar (A) and detail of mixer using magic T with crystal diodes (B)

Pair No.	Power Output (mw)	Pair No.	Power Output (mw)
1	13.6	11	14.7
2	15.6	12	14.2
3	14.7	13	16.5
4	13.6	14	13.6
5	15.4	15	13.9
6	13.0	16	13.6
7	11.8	17	15.9
8	15.3	18	16.1
9	14.2	19	12.5
10	15.9	20	13.6

Table I—Sideband Power Output with Twenty Crystal Pairs

for C-W Radars

SUMMARY — Design eliminates klystron in local-oscillator of X-band c-w radar. Crystal-controlled oscillator on intermediate frequency beats with r-f output creating sidebands one of which is mixed with received signal to obtain desired i-f

If carrier and i-f signals of the same relative phase are applied to two crystals, one of which has its positive end grounded and the other its negative end grounded, the sidebands generated in the crystals will be opposite in phase. The difference in grounding can be obtained by using an inverted crystal mount or a regular mount and a crystal whose elements are reversed in the crystal package. The use of one regular and one inverted crystal mount, besides adding to the number of different components required in the system also contributes some unbalance to the system due to different i-f input capacitances of the two mounts. This difficulty is eliminated by the use of one regular and one inverted crystal in identical crystal mounts.

Experimental Results

Since it was desired to generate a local-oscillator signal of 10 to 20 milliwatts for the specific application, it was necessary to find a crystal that could stand over 100 mw of incident microwave power together with about the same magnitude of i-f power. As the only

crystals available for use at X band are the 1N23 series, designed for a nominal input of 1 mw, tests were conducted using Microwave Associates 1N23C and 1N23CR crystals, to determine the effect of increased power input upon the crystal performance.

Single 1N23 crystals were run for 300 consecutive hours with 150 mw of incident X-band power. After this period, the crystals were checked for conversion efficiency and noise temperature and were still within the JAN specs on the 1N23C.

In the local-oscillator generator 150 mw of carrier power was fed into arm 3 of the T, dividing equally between the 1N23C and 1N23CR crystals on arms 1 and 2. Four volts of 60-mc energy was impressed across the two crystals in parallel.

Table I shows the upper-sideband power output for 20 pairs of 1N23CR crystals. These are random pairs and no attempt was made to match the crystals.

The sideband power output as shown in the table ranged from a low of 11.8 mw to a high of 16.5 mw. The average figure of 14 mw

corresponds to a conversion efficiency of 10.3 db referred to the carrier input signal. The carrier leakage in the sideband output arm at the T was 10 db down from the sideband level.

The photograph shows the arrangement of components which corresponds to Fig. 1A. The oscillator, consisting of a Varian V-55 reflex klystron, feeds the power divider which sends power to the transmitter and to the local-oscillator generator T. The local-oscillator signal is fed to the receiver mixer through a sideband filter. The filter is a 4-stage, quarter-wavelength iris-coupled waveguide filter. It has the characteristic of passing the upper sideband with only 1.5-db insertion loss and rejecting the carrier by 55 db. Since the carrier output of the local-oscillator arm was already 10 db down from the sideband level due to the balancing action of the mixer, the carrier level into the receiver mixer is 65 db down from the sideband level.

The writer thanks Dr. M. A. Meyer for his many valuable suggestions and overall supervision of this work.

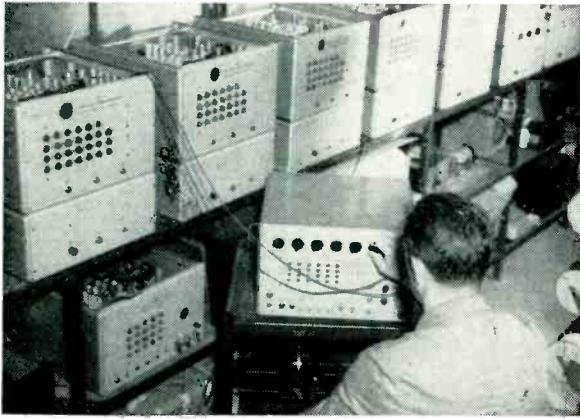

Production testing of high-speed counter chronographs using preset interval generator

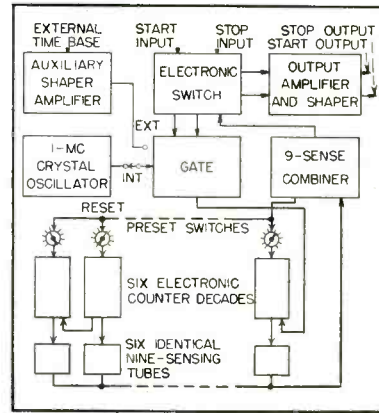

FIG. 1—Interval generator allows timing of intervals as short as 1-mc

Short-Interval Timer

By N. A. MOERMAN

Chief Engineer
Potter Instrument Co.
Great Neck, N. Y.

TESTING and calibrating radar systems, sonar systems and other equipment depending on precise time interval measurements requires a means for measuring and generating exact time intervals. Where the intervals approach the time-base period, the techniques to be described can be employed to preserve the inherent accuracy of the counting system.

Predetermining electronic counters involves setting the complement of the desired number with respect to the count capacity of the instrument. The interval is terminated when the counters reach count capacity. The desired number is set directly on six interval-selector switches, one for each digit. These switches route a single preset pulse to condition appropriate counter stages to the complement number.

Nine Sensing

The start pulse for triggering external equipment coincides with the externally applied start pulse. The stop pulse in a conventional circuit is delayed a few microseconds in the electronic counter stages, thus limiting the minimum obtainable interval to that value.

This limitation can be eliminated by use of the technique illustrated in Fig. 1. As the counters approach

count capacity of 1,000,000, each stage must assume a nine condition. The last decade reaches this condition when the count reaches 900,000 or 0.1 second before the end of the interval. Likewise, the next-to-last counter reaches the nine condition at 90,000 or 0.01 second before the end of the interval, and so on.

To avoid the counter delay of the stop pulse, it is possible to electronically monitor each counter decade and bypass the 1,000,000th pulse directly to the output rather than causing it to pass through the counters and be delayed.

Dual Triodes

This technique is referred to as nine sensing. Using binary decades, a nine is represented by the first and fourth tubes being on. A single dual-triode tube with its grids connected to the normally conducting grids of these counting tubes serves as a nine-sensing circuit. The plates of all such nine-sensing tubes are connected through a common load resistor.

The voltage present at the common plate connection is low by virtue of plate current conduction except when all sensing-tube grids are negative as a result of all counter stages registering nines. When this condition occurs, a nine-

sense combiner routes the next time-base pulse to an amplifier rather than through the counters.

It is possible to preset any interval from one period of the time base frequency to the count capacity of the instrument. In the case illustrated in Fig. 1, the range is 1 microsecond to 1 second in steps of 1 microsecond.

The nine-sensing tubes are shown in the circuit diagram of Fig. 2. The grids of the six nine-sensing tubes are connected to the grids of the first and fourth binary counter tubes in such a way that all nine-sensing tube grids are negative when each of the six counter decades indicates nine (a total count of 999,999).

At that time (grids negative) conduction through the common 22,000-ohm plate resistor ceases and the resulting voltage rise is capacitively coupled through a 1,000- μ f capacitor to the control grid of a type 5919 gate tube. This positive gate voltage permits the 1,000,000th time base pulse to pass through the gate tube to the output circuit.

The circuit that routes the first time-base pulse to the output is shown in Fig. 3. Application of the external start pulse flips the electronic switch, causing a negative gate to be applied to the norm-

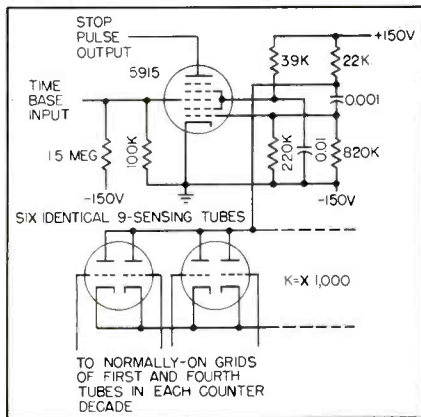

FIG. 2—Circuit bypasses counter so that last pulse goes directly to output

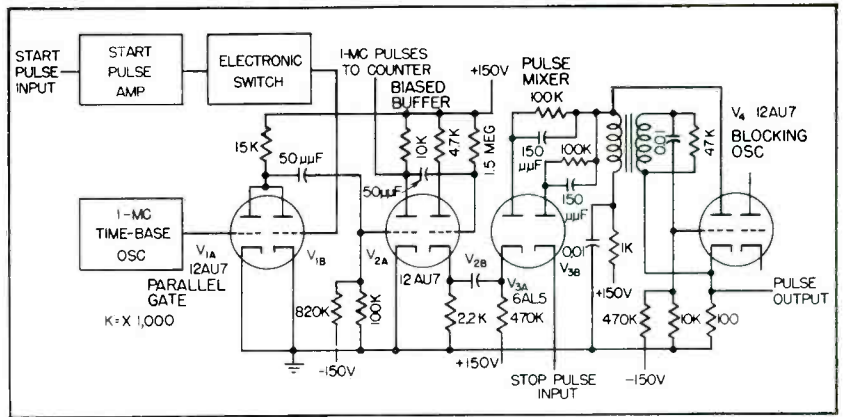

FIG. 3—Circuit eliminates gating error when starting pulse falls between two pulses of count generator

SUMMARY — Nine-sensing technique eliminates usual counter delay by having stop pulse bypass counter so that it goes directly to output and stops external equipment. Gating error produced when starting pulse falls somewhere between two count-generator pulses is also eliminated

ally positive grid of gate V_{1B} . Tube V_1 is connected as a parallel gate in such a way that amplified time-base pulses appear at the common plate connection only when the grid of V_{1B} is negative. Thus the external start pulse opens the gate, allowing 1-mc pulses to pass.

These positive 1-mc pulses are amplified and inverted in V_{2A} . The resulting negative pulses are capacitively coupled to the grid of V_{2B} and the negative pulses appearing across the 2,200-ohm cathode resistor are applied to the cathode of diode V_3 . Diode V_3 is normally zero-biased by the connection of its cathode (through 470,000 ohms) to +150 volts. The 150- μ f capacitor in its plate circuit is completely discharged (through the 100,000-ohm resistor). When the negative pulses are applied to the cathode of V_3 it starts conducting and the 150- μ f capacitor quickly charges to the voltage developed across the 100,000-ohm resistor.

The time constant of the 150- μ f capacitor and 100,000-ohm resistor combination is such that the capacitor will not discharge between the 1-mc pulses. The first pulse triggers blocking-oscillator tube V_4 , causing a start output pulse to be generated, but subsequent pulses are held down by the charge de-

veloped across the capacitor.

The stop pulse is applied to the cathode of V_{3B} , and since the capacitor in the plate circuit of that diode is uncharged, the stop pulse will trigger the blocking oscillator and a second pulse will be formed.

Thus the instrument produces two pulses on a common line and defines a time interval to within a fraction of a microsecond.

Gating Error

In high-definition interval-measuring equipment, the output of the time-base oscillator is gated by an electronic switch that is turned on by a sharp voltage pulse. External equipment being calibrated or tested is actuated by the same pulse that turns on the electronic switch.

Appreciable error may occur when the interval is of the order of a few cycles of the time-base frequency. Accuracy depends on the time a start is initiated with respect to the phase of the time-base pulse. If the start pulse coincides with a time-base pulse, the interval will be the exact number of time-base increments selected. If the start pulse falls between two time-base pulses, the interval generated will be in error since the interval is terminated only after a prescribed number of counts are registered.

It is possible to avoid this gating error by using the first time-base pulse to trigger the external equipment being tested. This starts the interval measurement. This first pulse does not affect the counter stages. The second pulse occurs exactly 1 microsecond later and registers the first count. Accuracy is limited only by the ability of the electronic switch to open and close the gate on corresponding portions of the time-base oscillator pulses and by the oscillator stability.

Interval Measurements

These techniques can be applied to measurement of unknown intervals that can be defined by electrical pulses. The number of 1-mc pulses admitted by the electronic switch during the unknown interval corresponds to the number of microsecond increments in the interval, in the case of the 1-mc time base.

The interval generator gives any desired delay corresponding to exact target range in yards or feet for testing reflection-type ranging equipment. The use of a lock-out circuit permits application of start and stop pulses on a common line when the equipment is used to measure intervals. Pulses other than those intended for starting and stopping are ignored.

Airborne Interrogator

SUMMARY — Distance measuring equipment employs pulse transmitter in aircraft to query automatic ground beacon. Tracking circuits in airplane lock on the return pulses and servo system measures time delay between outgoing and incoming pulses. Distance is a dial reading

AIR NAVIGATION by the long-heralded system known as VOR-DME^{1,2} has now reached the stage where both the VOR (vhf omnirange) and DME (distance measuring equipment) are available as packaged items for aircraft installation. The VOR has been in

widespread use for several years, but DME with its greater complexity has required more extensive development and has only within recent months become commercially available. This article describes the airborne DME interrogator.

The DME system consists of a

bidirectional radio link between an aircraft and any one of some 450 fixed ground stations distributed throughout the U.S. A few are also operating in Europe³. The airborne set transmits an interrogation signal comprising a series of narrow pulse pairs at a slow pulse-rate frequency on any of ten channels between 963.5 and 986.0 mc. If the DME ground station receives these pulse pairs and the interpulse time interval is correct, the ground station transmits a reply signal consisting of pulse pairs having a different interpulse time interval on one of ten channels between 1,188.5 and 1,211 mc.

The airborne interrogator, on receiving the reply signals from the ground station, tests to see that the pulse spacing is correct. If it is, one-way distance equivalent to the time interval between the original interrogation signal and receipt of the reply signal is displayed on a distance indicator dial. Since the interrogation-reply process repeats at a rate between 15 and 30 times per second, the distance indicator continuously reads the slant range between the aircraft and the chosen ground station to provide the pilot with distance information as an aid to navigation.

The airborne equipment includes a pulsed transmitter, operating on 10 channels, a pulse receiver, also operating on 10 channels and a range unit. This latter unit is required to key the transmitter with accurately spaced pulse pairs and select only correctly spaced pulse pairs from the receiver output. In addition, it measures the time interval between the interrogation

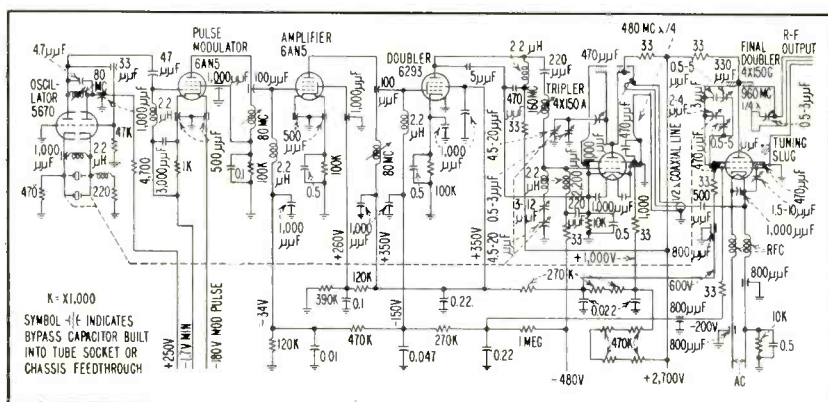

FIG. 1—Transmitter unit is crystal controlled on one of ten channels. Doubler and output stages employ cavities tuned by ganged capacitors

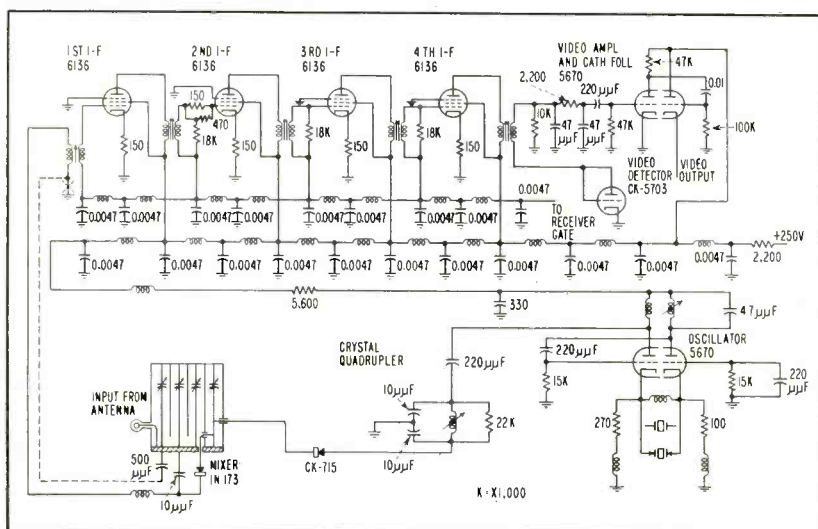

FIG. 2—Crystal-controlled superheterodyne receiver uses resonant-line preselector and semiconductor quadrupler

Spots Location

By **A. R. APPEGARTH**

*Chief Engineer
National Aeronautical Corp.
Ambler, Pa.*

and reply pulse pairs and supplies it to the distance indicator. It also provides an identity signal.

A remote-control device permits remote channel selection.

Transmitter Assembly

The transmitter unit (Fig. 1) employs a type 5670 tube as a Butler-type crystal master oscillator using any one of ten fifth-mode crystals⁴ oscillating at about 80 mc. The next stage is a type 6AN5 tube operating as a pulse-modulated r-f amplifier in which negative pulses are applied simultaneously to the grid and cathode elements, while the plate and screen remain at ground potential. This arrangement permits direct operation from the delay-line type pulser without a pulse transformer.

A following 6AN5 tube in a low-level class-C r-f amplifier at 80 mc drives a higher-level frequency-doubler stage using a type 6293 tube. Similar to a 6146, this tube is designed for pulse operation. The 160-mc output from the doubler is fed to a type 4X150A tripler stage mounted in a cavity resonant at about 480 mc.

This signal is coupled through a resonant-line network to a type 4X150G doubler-output stage mounted in a cavity resonant at the final output frequency—about 960 mc. The last three tank circuits including both resonant cavities are tuned by variable capacitors ganged to the crystal selector switch to provide tracking.

Receiver Components

The receiver unit (Fig. 2) is a superheterodyne with crystal con-

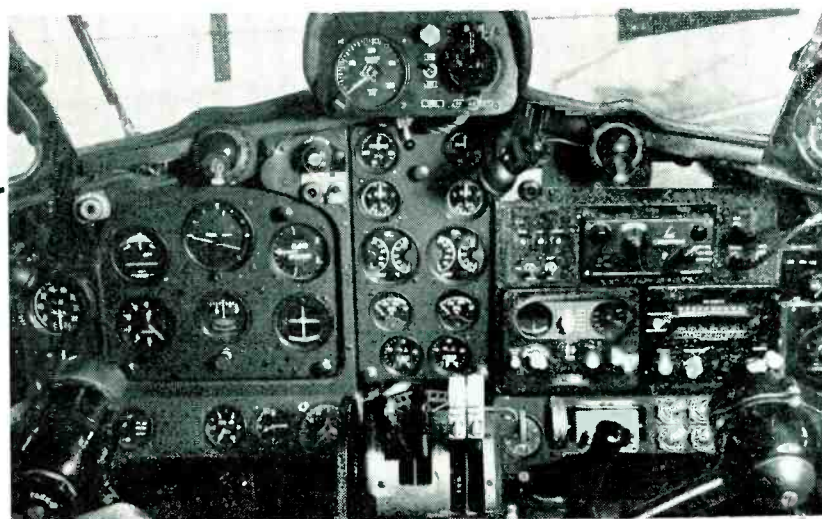

Typical installation of DME controls in airplane cockpit. Mileage indicator is at top left. Selector controls tied in with VOR-ILS facility are tuned to airport frequency

trol of the local oscillator. The signal from the antenna is passed through a broadband preselector comprising three resonant lines with aperture coupling, having a bandwidth of 32 mc at the 3-db points. A Butler-type crystal oscillator using a type 5670 tube and any one of ten fifth-mode crystals oscillating at about 76 mc has a 152-mc tank circuit⁴ to select second-harmonic energy.

This signal is passed through a crystal quadrupler circuit to a 608-mc resonant line, from which it is coupled to a crystal mixer along with the signal from the preselector. The 25-mc heterodyne output from the crystal mixer is amplified by a four-stage i-f strip having a total gain of about 100 db and a 3-db bandwidth of about 1 mc. A type 5703 tube is used as a diode detector, which is followed by a type 5670 serving as a video amplifier and a cathode-follower output stage.

Range Unit

In the range unit (Fig. 3) both sets of transmitter pulses are generated through gas-tube discharge of a pulse-forming network (pfn). The type 5696 tube generating the first pulse is biased to permit self-triggering at about 25 pps. A

noise signal is produced by passing a small reverse current through a germanium diode. The noise produced by this method amounts to about 0.5 volt. It is coupled to the grid of the gas tube to cause an irregular jittering of its firing.

Jitter is introduced to avoid possible erroneous distance information that might be caused by receiving reply signals intended for some other interrogator operating simultaneously with the same ground station and pulsing in accidental synchronism. The jitter is sufficient to cause adjacent interrogations to vary at least 400 microseconds. The first pfn has inserted within its coil windings the end of a length of $\frac{1}{8}$ -in. diameter nickel tubing.

By the phenomenon of magnetostriction, the magnetic field set up by the pfn during the pulse formation creates a mechanical strain in the nickel that propagates along the tube⁵ as a sound wave. Pickup coils are located along the tube at selected distances from the pfn to provide ten discrete time delays at multiples of 7 microseconds from 14 to 77. A selector switch chooses the desired pickup coil, which provides a one-volt signal to a type 5654 voltage amplifier.

The output of the voltage ampli-

fier triggers the type 5696 gas tube second-pulse generator, which is biased to fire only when externally triggered. It discharges a second pfn creating the second pulse, which is precisely delayed with respect to the first one by the magnetostriction system described above. Outputs of both pulse generators feed a common load resistor to provide the pulse modulating signal to the transmitter.

The second portion of the range unit decodes the receiver output signal to determine whether the interpulse interval is correct. A magnetostriction delay system is used, similar to the one described above, but driven by a pulse amplifier. It includes a two-stage output amplifier because of the reduced amount of energy available from the receiver for magnetizing the nickel. The delayed decode output signal is fed to the coincidence tubes along with the undelayed receiver output and the gate signals described below.

Time Measuring System

The time interval between the second pulse of each transmitted pulse pair and the second pulse of the corresponding reply pulse-pair is the basis for distance determination. A phantastron time-delay circuit⁶ is triggered by the second transmitted pulse. This stage, which is stabilized by two clamp-diodes and is provided with regulated plate and filament power, generates an output signal in its cathode circuit.

The time delay between the trigger and the output signals is a very linear function of the d-c control voltage applied to the plate clamp diode of the phantastron. It is displayed as the distance indication. The phantastron output signal triggers a monostable blocking oscillator that generates a 10-microsecond early gate. A short time-delay circuit consisting of a diode-damped resonant circuit is shock-excited by the early gate oscillator. The delayed output from this circuit triggers the 10-microsecond late-gate oscillator to provide a 3-microsecond overlap. Each gate signal is applied to the screen grid of a triple-coincidence amplifier tube.

The undelayed receiver output

pulses are applied to the control grids of both coincidence tubes and the delayed decode output signal is applied to the suppressor grids. If there is a triple coincidence between the second pulse of the undelayed receiver output signal, the first pulse as delayed in the decoder and the early or late gate signals, one or both of the coincidence tubes will amplify the coincident portion of the signals and pass it to the pulse detector and time discriminator circuits.

Pulse Detector

The pulse detector is a monostable blocking oscillator that responds to the output of either coincidence tube. When triggered, it generates a large negative bias-voltage, which is filtered and applied to the grid of a relay amplifier tube. The presence of the large negative bias cuts off the plate current of this tube and thereby deenergizes the search track relay causing the input to the servoamplifier to switch from the slow repetitive search function to the time discriminator output for tracking.

The time discriminator is a double-diode circuit that rectifies the pulse output from each coincidence tube separately. It develops a d-c output voltage that rises or falls depending on which coincidence tube is active. The diodes are biased to allow any existing potential between 0 and -6 volts to remain unchanged in the absence of output from either coincidence tube. A signal present only during the early gate will produce a d-c output voltage that will swing the servoamplifier grid more negative, while a signal present only during the late gate will swing it more positive. Signals occurring during the overlap appear in both gates and cause no change in the d-c output voltage.

The servoamplifier performs a dual function. During search it slowly sweeps the phantastron control voltage (indicated as equivalent miles on the distance indicator) from below 0 miles (115 microseconds) to beyond maximum range (2,255 microseconds). At about 110-percent maximum range a contact closes within the distance indicator that discharges the Miller

run-up capacitor coupling the plate to the grid of the servoamplifier and restarts the cycle below 0 miles.

The large grid-plate capacitor serves to increase the natural time constant of the circuit to require about 30 seconds to search through the distance range. During tracking, the search-track relay transfers the servoamplifier grid to the time-discriminator output. This action corrects the grid voltage as needed to change the phantastron control voltage to keep the decoded reply signal within the 3-microsecond gate overlap.

Identity Detector

During certain prescribed time intervals, the DME ground stations add a third reply pulse 10.5 microseconds after the second pulse. This pulse is keyed to provide station identification. The range unit includes an identity detector comprising another monostable blocking oscillator with a gating pulse applied to its cathode, which is obtained by differentiating the late gate signal. Thus a third reply pulse occurring 10.5 microseconds after the second pulse (which is in the overlap during tracking) will coincide with this gating pulse and will trigger the identity detector. The energy from this detector operates a small neon lamp located on the instrument panel of the aircraft.

The distance indicator is a 270-deg, 0-1 milliammeter having a specification accuracy of ± 1 percent of the actual current (down to 20 percent of full-scale current). The overall accuracy is specified as $\pm 2\frac{1}{2}$ percent or $\pm \frac{1}{4}$ mile, whichever is greater. However, this allows for tube aging and severe environmental conditions. Under normal conditions, the maximum error does not exceed $\pm 1\frac{1}{2}$ percent or ± 0.2 mile.

Memory Holds Range

The range is actually determined by the phantastron control voltage, which is measured by the distance indicator milliammeter with an arrangement of multiplier resistors selected by the range switch. The range switch is a part of the distance indicator assembly that simultaneously changes scale numbers as

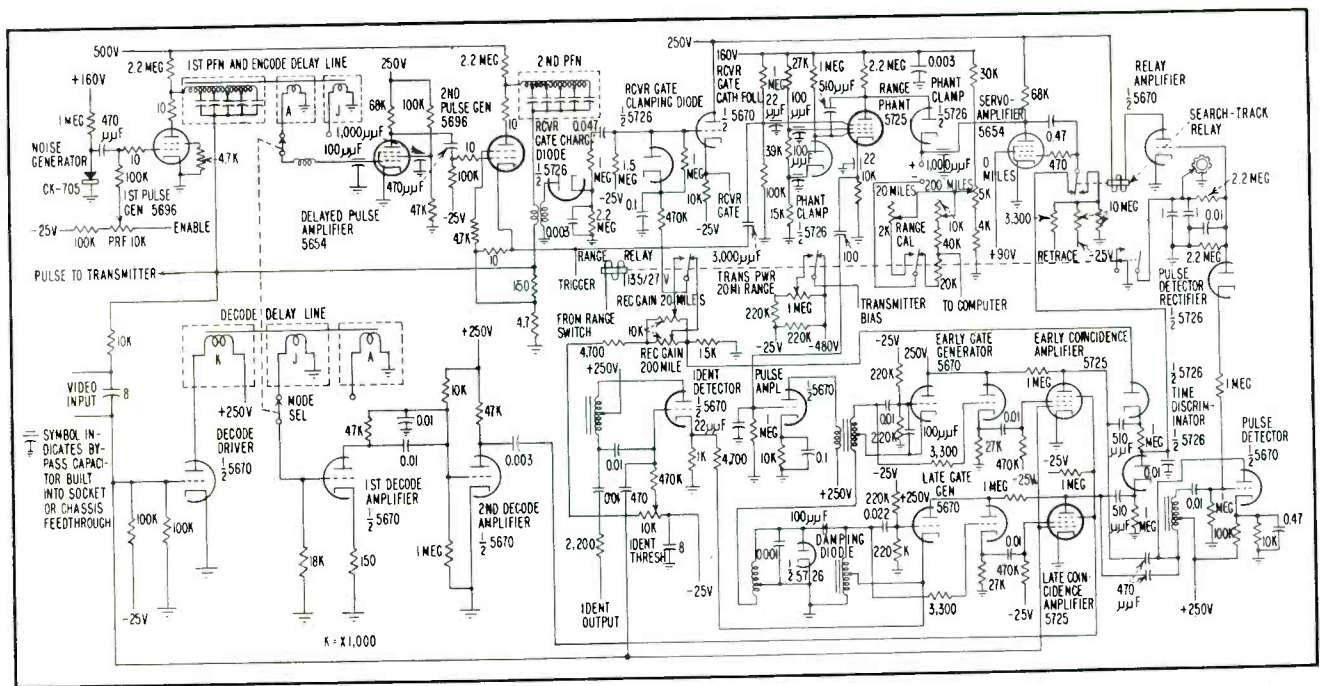

FIG. 3—Heart of airborne interrogator is the range unit that pulses transmitter, measures and identifies time delays and provides memory during periods of weak signal when the aircraft is maneuvered

it selects multiplier resistors.

Because of the prominent shadows characteristic of uhf propagation, reception of DME reply signals is frequently interrupted for periods ranging up to several seconds. This is particularly noticeable during aircraft maneuvers. To prevent the ranging circuits from resuming search immediately upon the temporary loss of reply signals, a simple memory is built into the set.

It consists of an R-C circuit that slows up the decay of the negative voltage built up by the pulse detector prior to loss of signal, thereby delaying the operation of the search-track relay by about 15 seconds. During this memory interval, no change in the d-c output voltage of the time discriminator takes place, so the distance indicator continues to show the reading displayed at the time the signal faded. If the signal returns, even momentarily, prior to the expiration of the 15-second memory interval, tracking is resumed.

To conserve plate current, the four receiver i-f stages are biased to cutoff except during the 3,000-microsecond time interval following each interrogation when replies are possible. The receiver is therefore operative only about 10 percent of

the time between interrogations. The enabling gate is formed in the range unit by first generating a large pulse signal that closely follows the second interrogation pulse, then shaping it into a truncated saw-tooth having a flat top 3,000 microseconds wide. This signal is then applied to the receiver i-f grid returns through a cathode follower to lower the impedance level.

Remote Control Unit

The remote channel selector consists of two independent concentric rotary switches arranged to permit selection of any 0.1-mc channel between 108.0 and 117.9 mc. These are frequencies of the VOR or ILS stations that have associated DME stations and are paired to specific DME channels. The 108-109-110 dial actually selects the DME reply channel (1,188.5 to 1,211 mc) while the 0.1-0.2-0.3 dial actually selects the DME interrogation channel (963.5 to 986 mc). The pulse spacings, or mode, are a somewhat complex function of both interrogation and reply frequencies.

The channel-selector mechanisms within the interrogator are powered by rotary ratchet motors that home to the switch positions selected by the remote-channel selector. In addition, the mechanisms

also set up the mode as specified by the particular combination of interrogation and reply frequencies. A third ratchet motor sets the pulse spacing switch sections to conform with the mode as set up.

Antennas

Separate quarter-wave ground-plane antennas are used for the transmitter and receiver. Since the individual bands are only 25-mc wide at 975 and 1,200 mc adequate broad-banding can be obtained by using rods of about $\frac{1}{8}$ -in. diameter. Each antenna consists of a modified BNC connector having an enlarged flange with a center conductor extension rod serving as the radiator. A cone-shaped Teflon insulator is added along with a circular clamping disk to strengthen the aircraft skin at the point of installation.

REFERENCES

- (1) A. A. McKenzie, Electronic Aids to Air Navigation, *ELECTRONICS*, p 66, Feb. 1950.
- (2) G. C. Hurley, S. R. Anderson and H. F. Kearny, The CAA VHF Omrange, *Proc IRE*, p 1,506, Dec. 1951.
- (3) R. C. Borden, C. C. Trout and E. C. Williams, Description and Evaluation of 100 Channel Distance Measuring Equipment, *Proc IRE*, p 612, June 1951.
- (4) G. H. Lister, Overtone Crystal Oscillator Design, *ELECTRONICS*, p 88, Nov. 1950.
- (5) E. M. Bradburd, Magnetostrictive Delay Line, *Elec Comm*, p 46, March 1951.
- (6) R. N. Close and M. Lebenbaum, Design of Phantatron Time Delay Circuits, *ELECTRONICS*, p 100, April 1948.

Feedback-Stabilized

ATTEMPTS to build a precision transistor amplifier with gain accurately stabilized by inverse feedback have generally failed because the low input impedance of the transistors loads down the feedback network. When the transistors are replaced or when the transistor parameters vary because of aging or changes in ambient temperature, the feedback factor may vary.

A transistor differential amplifier¹ employed in the first stage of a feedback amplifier provides a convenient terminal for feedback which does not load down the feedback network. In Fig. 1, e_1 is the equivalent input signal of source resistance R_{s1} and e_2 is the equivalent feedback voltage of source resistance R_{s2} . The stage gain is

$$\frac{e_o}{e_2} = -\frac{e_o}{e_1} \approx R_L \alpha_2 / [r_{e1} + r_{e2} + (r_{b1} + R_{s1})(1 - \alpha_1) + (r_{b2} + R_{s2})(1 - \alpha_2)] \quad (1)$$

if $R_e \gg r_e$; R_b , r_b and $R_i \ll r_e$.

Subscripts differentiate between the two transistors. Equation 1 shows that the amplified signal developed across R_L is proportional to the difference between e_1 and e_2 . The presence of a small amplified signal voltage across R_L when $e_1 = e_2$ is due to common-mode effect, usually defined² as the ratio of this signal voltage to that which is present when either e_1 or e_2 alone is amplified. Its magnitude increases as the inequalities decrease. Common-mode effect due to signal-source

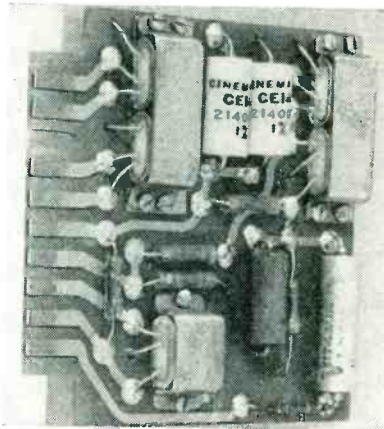

Complete amplifier, shown actual size

resistance and common emitter resistance is

$$\hat{v} \approx \frac{R_{s1}}{r_{e1}} - \frac{R_{s2}}{r_{e2}} + \frac{r_{e1}}{R_e} \quad (2)$$

Typical values of r_e and r_e for a junction transistor are 1 megohm and 40 ohms. A source resistance R_{s1} of 10,000 ohms results in a common-mode effect of about 1 percent.

The overall amplifier gain (Fig. 1) as determined by the feedback network is

$$A = (R_1 + R_2) / R_1 \quad (3)$$

subject to two conditions. The first requires an amplifier internal gain without feedback A' much greater than gain with feedback A . The variation in A denoted as ΔA , resulting from variations in A' denoted as $\Delta A'$, is

$$\Delta A = \Delta A' A / A' \quad (4)$$

The second condition states that gain A varies in direct proportion to the amount of common-mode effect present in the differential-input stage, that is $\Delta A = \delta$. Variation in gain due to signal-source resistance R_{s1} or feedback circuit-source resistance R_{s2} can be computed directly from Eq. 2. Increasing R_{s1} or R_{s2} also reduces the differential-amplifier gain with a corresponding reduction in internal gain A' . Variation in gain resulting from the factor r_e/R_e can be reduced to negligible proportions by replacing R_e with a constant-current source, as shown in Fig. 2.

Figure 3 is a feedback-stabilized

By DEAN W. SLAUGHTER

Jet Propulsion Laboratory
California Institute of Technology
Pasadena, California

amplifier employing germanium junction transistors. The gain A' without feedback is about 10,000. If R_1 and R_2 are selected for a gain of 10, it is possible to replace either of the transistors in the input circuit with an unselected transistor. The gain of 10 does not change by more than a few tenths of one percent.

Low-Drift Amplifier

Variations in base-to-emitter bias and collector cutoff current due to changes in ambient temperature may cause the output of transistorized d-c amplifiers to drift. However, when a differential circuit is employed in the first stage of these amplifiers, equal variations in the parameters of both transistors are not amplified because of the rejection of common-mode signals. For maximum reduction of d-c drift, matched transistors may be selected. They should be mounted in close proximity on a common heat sink.

The use of germanium transistors above room temperature in d-c amplifiers is not recommended. Figure 4 shows a d-c amplifier employing *npn* silicon transistors which perform satisfactory at 200 F or higher. By employing a differential circuit in the second as well as the first stage, a worthwhile increase in common-mode rejection and a decrease in overall amplifier drift is obtained. Power-supply regulation of from 2 to 5 percent is adequate. Amplifier internal gain is about 2,500.

Table I compares drift versus temperature of a differential amplifier employing silicon transistors with other amplifier configurations. Drift is given in terms of equiv-

Table I—Amplifier Drift

Input Stage	D-C Offset*	
	120 F	200 F
Germanium differential amplifier	10 to 25 mv	
Single-ended silicon amplifier	25 mv	120 mv
Silicon differential amplifier		
Pair 1.....	3 mv	10 mv
Pair 2.....	negligible	1 mv
Pair 3.....	2 mv	8 mv
Pair 4.....	negligible	1 mv
Pair 5.....	1 mv	3 mv

* Based on initial zero at 70 F

Transistor Amplifier

SUMMARY — Gain of transistor amplifier is accurately stabilized by inverse feedback to avoid drift, from aging or temperature change. Amplifier can be built with silicon junction transistors for stable operation despite high ambient temperatures

alent input drift, that is that voltage which must be applied to the amplifier input terminal to return the output terminal to zero. These data assume that all the drift is generated by the transistors and none by the circuit resistances. Amplifier zero does not offset by more than a few millivolts over a period of hours or weeks if the amplifier is permitted a 20-minute warmup.

The supply voltages applied to the output stage TR_5 permit an output swing of at least ± 10 volts. The 10,000-ohm collector load resistor may be safely decreased to 2,500 ohms without exceeding the collector dissipation rating of 150 mw. Because of feedback, the amplifier input impedance may approach but never exceed the collector resistance of TR_1 . The output impedance is approximately equal to the output load resistance divided by the amplifier loop gain A'/A .

The resistor and capacitor connected between the collector of TR_4 and ground provide the phase correction necessary to prevent oscillation. Their values must be determined experimentally.

The values shown were suitable for a gain of 10. The resulting frequency-response curve is essentially flat to 10 kc, rises 3 to 6 db at 60 kc and cuts off at 150 kc.

This paper presents the results of one phase of research carried out under Contract No. DA-04-495-Ord 18, sponsored by the Department of the Army, Ordnance Corps.

REFERENCES

(1) D. W. Slaughter, The Transistor Emitter-Coupled Amplifier, WESCON paper, Los Angeles, 1954.

(2) G. Valley and H. Wallman, "Vacuum Tube Amplifiers," McGraw-Hill Book Co., Inc., New York, 1948.

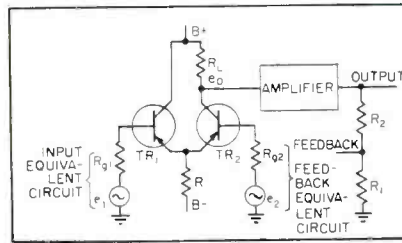

FIG. 1—Transistor differential amplifier

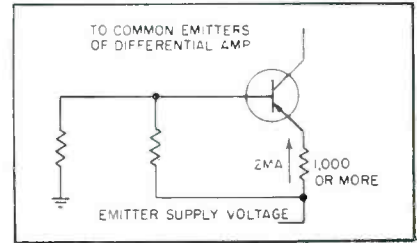

FIG. 2—Emitter constant-current source

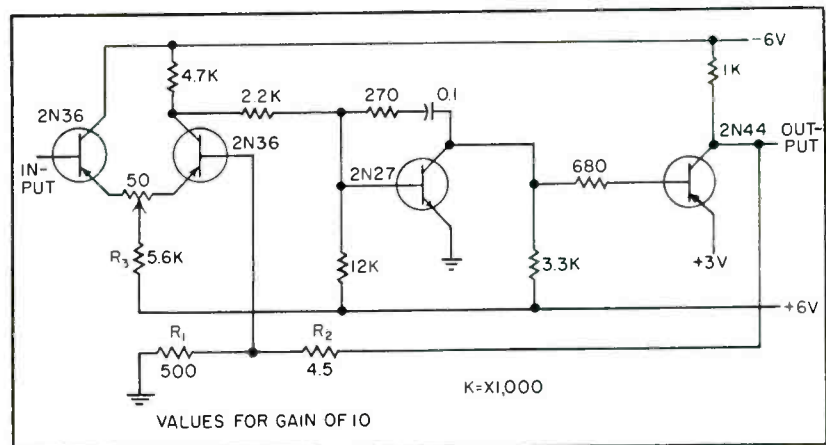

FIG. 3—Feedback-stabilized amplifier using germanium junction transistors

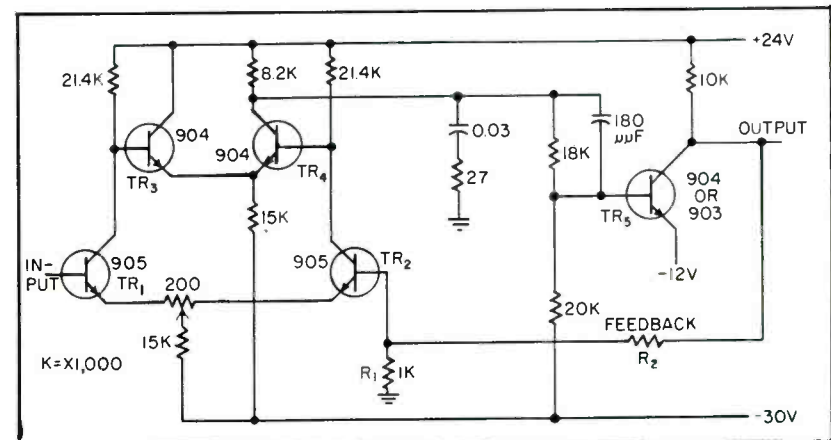

FIG. 4—Low-drift d-c amplifier employing npn transistors

Standard Symbols for Electronics

SUMMARY — Further simplification speeds drafting and cuts costs. Simple half-circles are now favored for coils. Basic switch loses arrowhead. Metallic rectifier symbol now serves for crystal diodes. Antenna goes back to triangle. Many microwave, transistor and photocell symbols appear here for first time

MOST-USED schematic symbols for electronic components are collected here on three pages for convenient reference, as abstracted from the new 54-page American Standards Association publication Y32.2-1954, "Graphical Symbols for

Electrical Diagrams" and (for transistors) from MIL-STD-15A, "Military Standard Electrical and Electronic Symbols". Symbols may have any orientation, size and line weight. The open-circle terminal symbol may be added to leads if desired. Ar-

rowheads may be either filled or open unless otherwise noted. Electrically actuated devices are normally shown in the power-off position. One-line symbolism has been adopted for waveguide diagrams, as indicated for microwave symbols.—J.M.

A-C SOURCE



AMPLIFIER

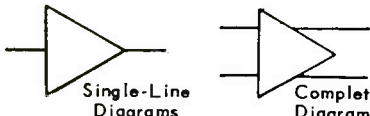

(Triangle points in direction of transmission. Rectangle may be used in place of triangle.)

ANTENNA



ATTENUATOR

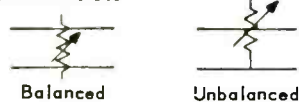

BATTERY

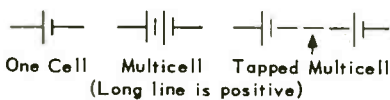

BELL



CAPACITOR

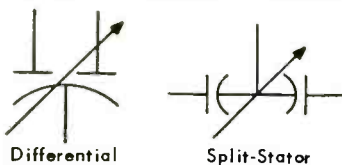

(When electrode identification is necessary, curved element represents outside electrode of paper and ceramic units, negative of electrolytics and low-potential electrode of feed-through capacitors.)

CHASSIS

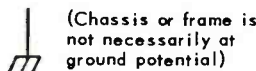

(Chassis or frame is not necessarily at ground potential)

COIL

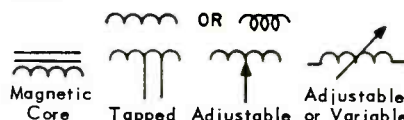

Saturable-Core Inductor or Reactor (Upper coil is d-c winding)

CONNECTOR



(Not an arrowhead; draw lines at 90°)



CONTACT



CRYSTAL



Piezoelectric (For crystal diode, see RECTIFIER)

COUNTER



DIRECTION

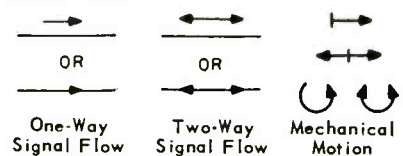

FUSE



GROUND



KEY



LAMP



LOUDSPEAKER

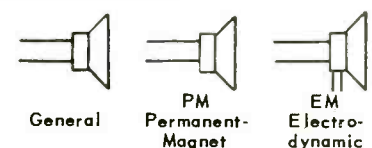

(continued on page 178)

SHORTEST ELECTRICAL PATH TO THE GROUND...SIMPLIFIES WIRING...REDUCES SPACE REQUIRED BY CIRCUIT COMPONENTS—

A JOINT DEVELOPMENT OF ERIE RESISTOR CORP., AND CINCH MANUFACTURING CORPORATION,

now in universal use, commercial and military types, available in seven pin miniature, nine pin Noval, and Octal

Capacitors built into socket may be either by-passed to ground directly, or left open for coupling applications. On by-pass applications, ground strap contacting outer plate of capacitor is connected to metal chassis when tube socket is mounted.

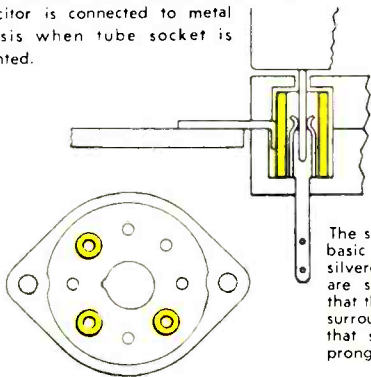

The schematic diagram shows basic design principle. The silvered ceramic condensers are shown in yellow. Note that the condenser completely surrounds the tube pin, and that specially designed tube prong terminals are used.

CINCH-ERIE

"Plexicon"

VACUUM TUBE SOCKET

With built-in ceramic condensers, Plexicon Tube Sockets, no larger than standard receiver socket, provide the most effective method of by-passing . . . with condenser close to tube element providing shortest path to the ground.

. . . capacity up to 1,000 MMF—the tube element may be coupled or by-passed as desired.

Reduces set assembly costs—saves space; permits moving other components closer to tube socket. Where space and weight make compactness mandatory, as in airborne equipment, the Plexicon socket is the solution.



CINCH components available at leading electronic jobbers—everywhere.

CINCH MANUFACTURING CORPORATION

1026 South Homan Ave., Chicago 24, Illinois

Subsidiary of United-Carr Fastener Corporation, Cambridge, Mass.



SHIELD

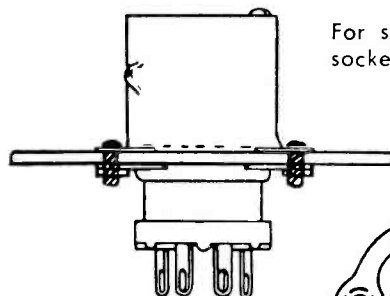

BAYONET SHIELD BASE

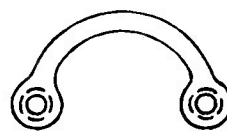

MOUNTING STRAP

For shielding tube, two types are available for miniature socket as shown, Bayonet with three lengths of shield cans available and Snap-on, two lengths of shields available. Bayonet type shown here.

The Mounting strap is a CINCH development for ease and simplicity in mounting miniature sockets. One strap nut takes the place of two conventional type nuts and is generally used in assembling sockets having attached base.

Write for detailed information

Standard Symbols for Electronics

(continued from page 176)

METER

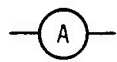

A--Ammeter
CRO--Oscilloscope
G--Galvanometer
MA--Milliammeter
 μ A or UA--Microammeter
V--Voltmeter

MICROPHONE



MICROWAVE

Guided Path, General



Coaxial Cable

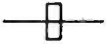

Rectangular Waveguide

DIEL

Path other than Air

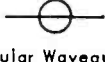

Circular Waveguide

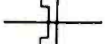

Ridged Waveguide

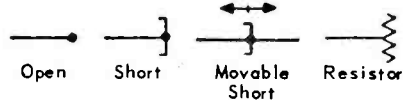

Coax and Waveguide Terminations

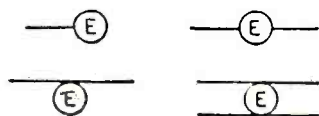

E-Plane Coupling by Aperture, with 1, 2, 3 & 4 Path Ends Available

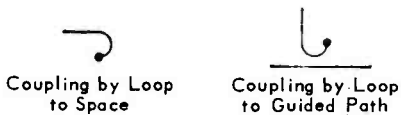

Coupling by Loop to Space

Coupling by Loop to Guided Path

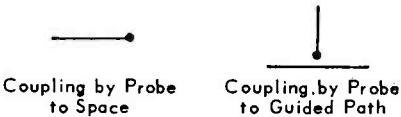

Coupling by Probe to Space

Coupling by Probe to Guided Path

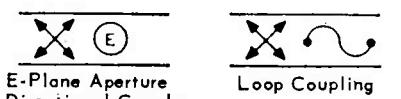

E-Plane Aperture Directional Coupler

Loop Coupling



Probe Coupling

Resistance Coupling



Equivalent Series Element, General

Resistance

Capacitive Reactance



Inductive Reactance

L-C with Infinite Reactance at Resonance

L-C with Zero Reactance at Resonance

(For conductance and susceptance discontinuities in coax and waveguide, rotate symbols 90° clockwise inside triangles.)



Hybrid, General



Hybrid Junction



Circular Hybrid
(Use single letter for principal transverse field in plane of ring; use HE for all other cases.)

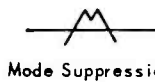

Mode Suppression



Mode Transducer



Resonator for Coax & Waveguide

MICROWAVE EXAMPLES

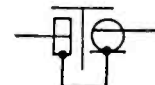

Transducer from rectangular guide to coax, with d-c grounds connected

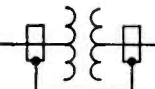

Transformer with d-c grounds and mode suppression between 2 rectangular guides

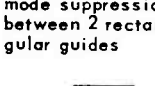

Resonator with mode suppression, coupled by E-plane aperture to guided path and by loop to coax

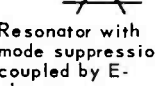

Tunable resonator with d-c ground, connected to electron device and adjustably coupled by E-plane aperture to rectangular guide



Resonant magnetron with coaxial output



Transit-time split-plate magnetron with stabilizing deflecting electrodes and internal circuit

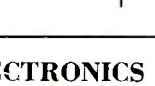

Tunable magnetron, aperture-coupled

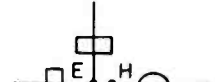

Hybrid--Rectangular Guide & Coax Coupling

Reflex klystron, integral cavity, aperture-coupled

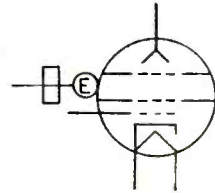

Double-cavity klystron, integral cavity, permanent external ganged tuning, loop coupling

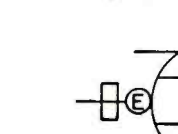

Transmit-receive (TR) tube, gas-filled, tunable integral cavity, aperture-coupled, with starter

MOTOR & GENERATOR



Motor



Generator



Series



Shunt



Separately Excited

PAD



Balanced



Unbalanced

PATH



No Connection



Connection



Connections



Conductive Path



Air or Space Path



Shielded Single Conductor



2-Conductor Cable, Unshielded

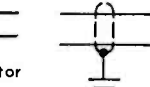

2-Cond. Cable with Grounded Shield



Terminal

PERMANENT MAGNET



PHONES



General



Single

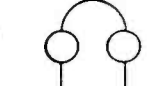

Double

(continued on page 180)

Rugged New Mounting for MALLORY Tantalum Capacitors



ESPECIALLY DESIGNED for circuits that must withstand heavy shock and vibration is this latest version of the famous Mallory XT Tantalum Capacitor.

The case has a sturdy threaded neck that fits through a keyed slot in the chassis. Lock washer and hex nut are supplied to give you an assembly that will withstand the most severe service. Mounting requires only seconds to complete . . . needs no strap or other hardware.

Next time you need capacitors for extreme-temperature, high-acceleration duty, plan to use these new Mallory units. They come in a complete range of ratings and sizes up to 2 1/4" height. Write to Mallory today for complete data.

Parts distributors in all major cities stock Mallory standard components for your convenience.

Type TAW 

Subminiature Silverlytics*

*The smallest capacitor for its rating . . . 4 or 6 mfd. at 4 VDC. Only .115" in diameter, 3/8" long. Electrical characteristics comparable to larger capacitors. *Trade Mark*

MALLORY
Tantalum Capacitors
meet the toughest
specifications

- Long life at temperatures up to 175° C. . . . can be supplied for use at 200° C.
- Low-temperature stability down to -55° C.
- Closer tolerances . . . only +50 per cent, when desired.
- Lower leakage currents than ever before.



Standard Symbols for Electronics

(continued from page 178)

PHOTOCELL



Asymmetrical Photoconductive Transducer
(Resistive. Use solid arrowhead; λ means element varies with light)

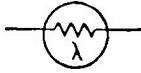

Symmetrical Photoconductive Transducer; Selenium Cell

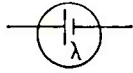

Photovoltaic Transducer; Barrier or Blocking-Layer Cell

PICKUP



RECTIFIER



Metallic Rectifier; Crystal Diode; Electrolytic Rectifier; Asymmetrical Varistor
(Use solid arrowhead. Arrow shows direction of forward or easy current, not electron flow)

Example: Full-wave bridge rectifier.
Polarity of d-c output voltage is as shown when a-c is applied between top and bottom leads of bridge

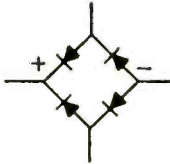

RELAY



SPDT Contacts

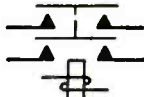

Two-Circuit



Thermal

RESISTOR



Basic Tapped Adjustable Variable

SHIELDING



SWITCH



Basic



DPDT



Selector



Selector

SYNCHRO



Basic



Synchro Control Receiver, Transmitter or Transformer



Differential Synchro Receiver or Transmitter

THERMISTOR



General



With Heater

TRANSFORMER

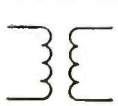

General

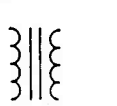

Magnetic Core



Shielded

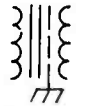

Shield between Windings, Connected to Frame



One Winding Adjustable



Both Windings Adjustable



Adjustable Mutual Inductor



Auto-transformer



Tapped

(There is now no special core symbol for powdered iron cores; symbol for adjustable inductance serves instead to indicate a movable core)

TRANSISTOR



N or PNP Triode



N, NPN or NPNP Triode



Tetrode



Pentode

(Arrowhead on emitter is solid and shows current flow, not electron flow. Arrowhead must not touch circle or base line. Letters are not part of symbol; e = emitter, c = collector and b = base. These are MIL-STD-15A symbols, not yet in ASA)

TUBES



Directly Heated Cathode



Indirectly Heated Cathode



Photocathode



Cold or Ionically Heated Cathode



Ionically Heated, with Supplementary Heating



Pool Cathode



Grid
Exciter, Contactor Type



Deflecting, Reflecting or Repelling Electrode



Ignitor for Pool Tubes; Starter for Gas Tubes



Anode; Collecting Electrode; Fluorescent Target



Target or X-Ray Anode

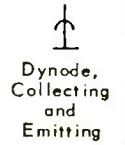

Dynode, Collecting and Emitting



Composite Anode and Photocathode



Composite Anode and Cold Cathode

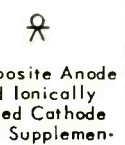

Composite Anode and Ionically Heated Cathode with Supplementary Heating

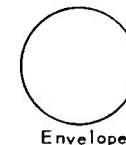

Envelope

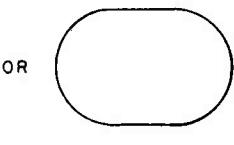

OR

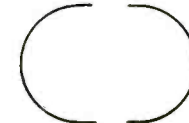

Split Envelope

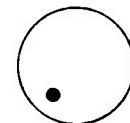

Gas-Filled Envelope

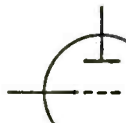

Triode

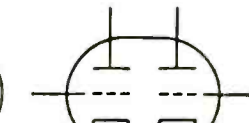

Twin-Triode



Voltage Regulator



Vacuum Phototube



Multiplier Phototube



Cathode-Ray Tube, Electrostatic

VARIATOR



Asymmetrical, Metallic Rectifier



Symmetrical

(Arrowhead is solid and shows direction of forward or easy current, not electron flow)

VIBRATOR

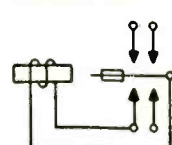

Shunt Drive

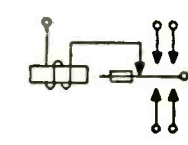

Separate Drive

(Showing of terminals is optional)

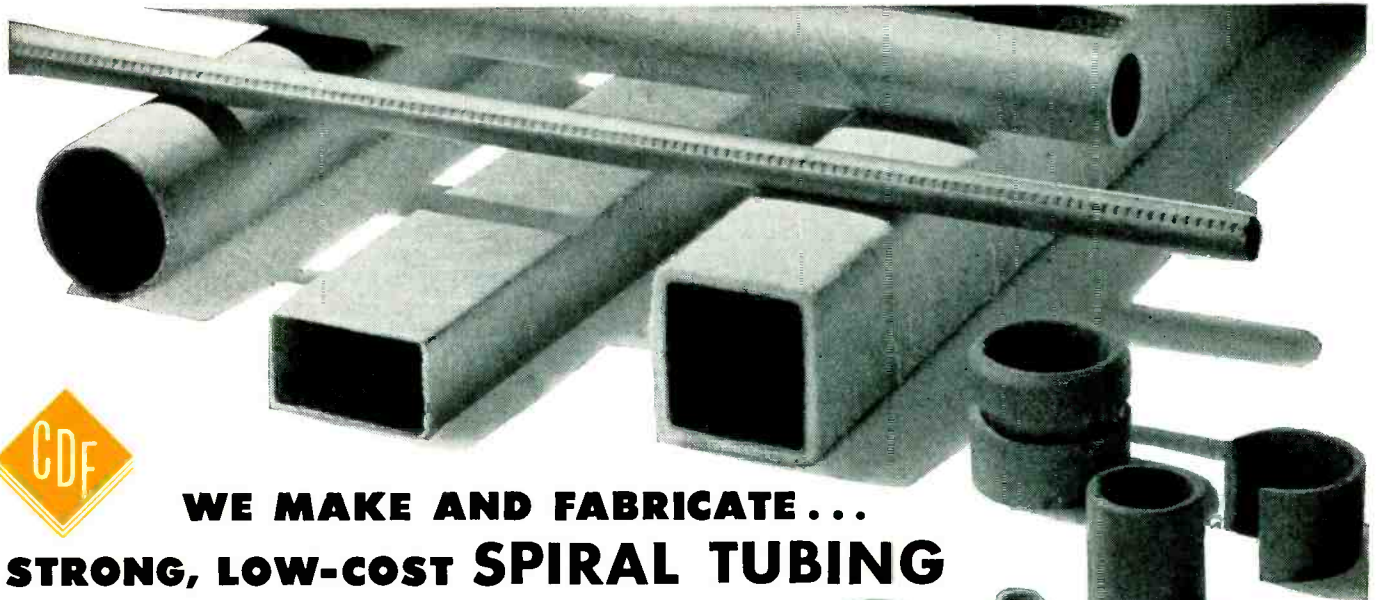

WE MAKE AND FABRICATE ... STRONG, LOW-COST SPIRAL TUBING

Spiral Tubing, another outstanding C-D-F product, is an important new material for the progressive, cost conscious design engineer (and purchasing agent). It is a high strength plastic made from paper or fibre that is spirally wound, then impregnated with phenolic resin or insulating varnishes and carefully cured at high temperatures. The resulting tubes (round, square, rectangular or formed to special shapes) are stiff, sturdy, resistant to crush, with good tensile strength.

This unique product has good dielectric strength with low dielectric loss properties. Moisture resistance and dimensional stability is easily controlled in the manufacturing process. The wide variety of sizes, shapes, forms; the strength; low cost; ease of fabrication; speed of delivery; all combine to make C-D-F Spiral Tubing worthy of your investigation.

SIZES

The round tubing ranges from 3/32 to 8" ID, with wall thicknesses from .0075 to 1/4". The minimum ID of square and rectangular tubing is 3/8", with 2 1/8" the maximum ID. Wall thicknesses range from .010 to 3/32".

Standard lengths are from 2 to 4', with special sizes and grades, plain or impregnated, open for your discussion with our C-D-F sales and engineering staff.

FABRICATION

Spiral Tubing is readily sawed, punched, drilled, tapped, riveted, stamped, painted, depending on the grade; it is suitable for automatic machine operations, but not recommended for conventional machine threading. Waxing or varnish impregnation to improve moisture resistance is usually done on the finished coils by the user.



PRIMARY APPLICATIONS

- COIL FORMS OF ANY SIZE OR SHAPE**
for tuned or untuned RF, IF, oscillator, and other coils used in radio, television, electronic circuits
for solenoids, relays, circuit breakers
for transformers
for permeability tuners
- INSULATORS**
for selenium rectifiers
for electric motors
relays
- BUSHINGS OR SPACERS**
armature shaft spacers
for mechanical support
- SHIPPING PROTECTORS AND FOR SPECIALIZED PACKAGING**
- BOBBIN TUBES**
- BODIES FOR PAINT ROLL APPLICATORS**
- AS A COMBINATION MATERIAL**
with other C-D-F high strength plastics or electrical insulating materials

GRADE SELECTION

C-D-F has mass production facilities for both the manufacture and fabrication of eighteen distinct grades of Spiral Tubing. For example, there's a special punching grade, fine for punching rectangular or square holes near the end of the tube. A relatively soft tube is supplied for difficult stapling or riveting. C-D-F makes high strength automotive electrical bushings from a very hard tubing with high axial compressive strength. Combinations of kraft, chipboard, Diamond "fish paper" Insulation, and other materials are available.

FORMS: ROUND • FORMED • FORMED AND NOTCHED • SQUARE AND RECTANGULAR

See our general catalog in Sweet's Design File for more data, the address and telephone number of your nearest C-D-F sales engineer. Also, write for C-D-F Spiral Tubing folder ST-53, (a workbook showing grades, applications, properties), free test samples, or send us your print for quotation.



Continental-Diamond Fibre

CONTINENTAL-DIAMOND FIBRE COMPANY
NEWARK 16, DELAWARE

New Transmission Techniques Extend Range Sevenfold

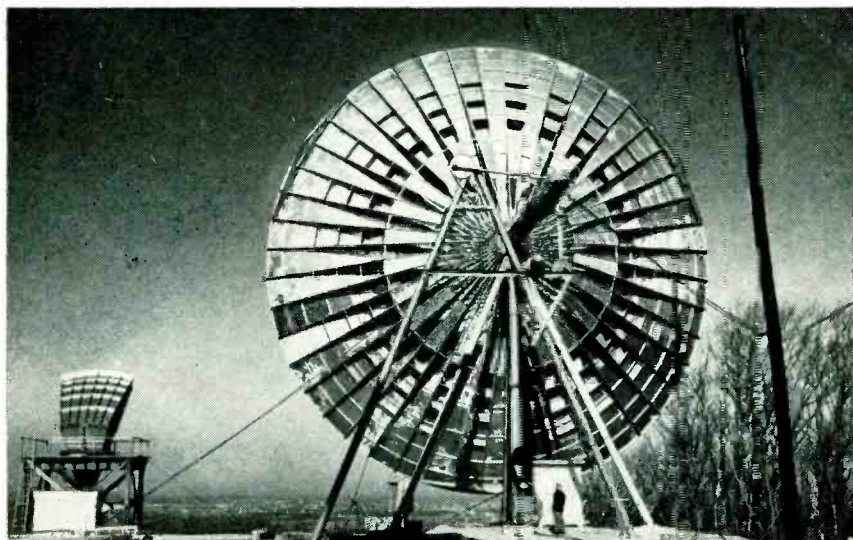

Rear view of 60-foot experimental antenna used in 200-mile broadband propagation experiments at uhf. It is compared with modern scoop antenna now being used in conventional microwave circuits up to 30 miles

RELIABLE communication over long distances using frequencies in the ultrahigh region of the spectrum has been accomplished by engineers of Bell Telephone Laboratories and Massachusetts Institute of Technology. Television and multichannel telephone transmission has been

proved possible over a 200-mile circuit without relays. This contrasts favorably with present microwave radio relays across the United States in which the relay stations are 30 miles apart.

Although early experimenters presumed that uhf signals traveled

only in straight lines so that the receiver could be assured satisfactory operation only if the transmitter was within line of sight, it was discovered in the early 1930's that transmitted signals could often be picked up at much greater distances.

The practical contribution of the most recent work has been use of powerful transmitters in the order of 10 kw and high-gain, directive antennas having 30 times the antenna area used in the present transcontinental microwave system—60 feet in diameter.

Television was first successfully transmitted over the horizon in 1954 between Holmdel, N. J. and New Bedford, Mass., a distance of 188 miles.

Over-the-horizon signals should not be confused with so-called ionospheric scatter useful for radiotelegraph communication at relatively low frequencies. Unlike signals propagated by means of the ionosphere, the new technique provides a suitable medium for broadband signals.

Transducer Tube Changes Signals To Letters

HIGH-SPEED PRINTING, required for the output of various devices, like computers, may be possible with a new electron-image tube. Developed by W. H. Bliss and J. E. Ruedy under the supervision of C. J. Young and G. A. Morton of RCA, the tube simulates typesetting. It selects letters and figures one by one from a font and places them in luminous form on a 5-inch circular tube face in lines or any desired pattern.

The font comprises a lantern slide bearing a chart of letters and figures that are projected from outside the tube onto a sensitive layer at the rear of the tube. This photoemissive layer emits a stream of



W. H. Bliss of RCA, Princeton, inspects resolution of letters on the face of an electron-image tube that translates coded information into printing

KEPCO KR SERIES

7 NEW

VOLTAGE REGULATED POWER SUPPLIES
for powering electronic equipment

SAVE TIME AND MONEY
Build these compact Power Supplies
into your equipment!

Kepeco Voltage Regulated Power Supplies are conservatively rated and are designed for continuous duty at 50°C ambient. The regulation specified for each unit is available throughout its output voltage range for line voltage variations from 105-125 volts and load variations from 0 to full load.

FEATURES:

- Superior Regulation.
- Ultra-Stable 85A2/0G3 Reference Tube.
- Low Ripple.
- Low Output Impedance.
- Fast Recovery Time, Suitable for Square Wave Pulsed Loading.
- Voltage Range continuously variable without Switching.
- Either Positive or Negative may be Grounded.
- Oil Filled Condensers.
- Wire Harness and Resistor Board Construction.
- Power Requirements 105-125 volts, 50-60 cycles. Units operate up to 400 cycles.
- Terminations and locking type voltage control on rear of unit.
- AC, DC Switches, Fuses, and Pilot Lights on Front Panel.
- Color Grey Hammertone.
- Guarantee One Year.

To Include 3" Current and Voltage Meters, Add M to Model number (e.g. KR 1-M) and Add \$30.00 to the Price.

To include Dust Cover and Handles for Table Mounting, Add C to Model number (e.g. KR 1-C) and Add \$10.00 to the Price.

To include Meters, Dust Cover and Handles, Add MC to Model number (e.g. KR 1-MC) and Add \$40.00 to the Price.

PRICES F.O.B. Flushing.



KEPCO LABORATORIES

131-38 SANFORD AVENUE • FLUSHING 55, N. Y.
INDEPENDENCE 1-7000

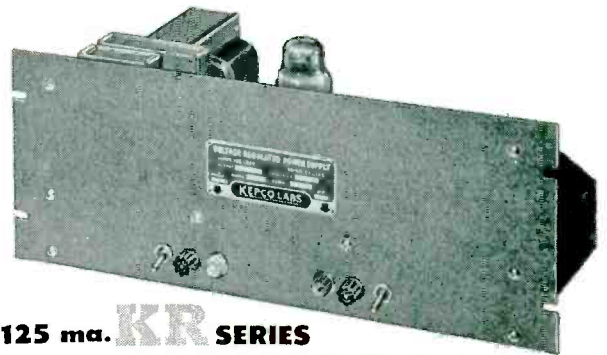

125 ma. **KR** SERIES

MODEL	OUTPUT	VOLTS	CURRENT	REGULATION		RIPPLE (RMS)	19" Rack Mount		
				line 105-125v	load 0-max		W	H	D
KR1 \$90.	1	100-200	0-125 ma	0.3 volts	0.3 volts	3 mv.	19"	7"	7½"
	2	6.3 AC	3 amp.	*	*				
KR2 \$90.	1	200-325	0-125 ma	0.2 volts	0.2 volts	3 mv.	19"	7"	7½"
	2	6.3 AC	3 amp.	*	*				

*AC Voltages unregulated.



300 ma. **KR** SERIES

MODEL	OUTPUT	VOLTS	CURRENT	REGULATION		RIPPLE (RMS)	19" Rack Mount		
				line 105-125v	load 0-max		W	H	D
KR3 \$180.	1	100-200	0-300 ma	0.3 volts	0.3 volts	3 mv.	19"	7"	11"
	2	6.3 AC	5 amp.	*	*				
	3	6.3 AC	5 amp.	*	*				
KR4 \$180.	1	200-325	0-300 ma	0.2 volts	0.2 volts	3 mv.	19"	7"	11"
	2	6.3 AC	5 amp.	*	*				
	3	6.3 AC	5 amp.	*	*				

*AC Voltages unregulated.



600 ma. **KR** SERIES

MODEL	OUTPUT	VOLTS	CURRENT	REGULATION		RIPPLE (RMS)	19" Rack Mount		
				line 105-125v	load 0-max		W	H	D
KR5 \$240.	1	100-200	0-600 ma	0.3 volts	0.3 volts	5 mv.	19"	10½"	13"
	2	6.3 AC	10 amp.	*	*				
	3	6.3 AC	10 amp.	*	*				
KR6 \$240.	1	145-305	0-600 ma	0.2 volts	0.2 volts	5 mv.	19"	10½"	13"
	2	6.3 AC	10 amp.	*	*				
	3	6.3 AC	10 amp.	*	*				
KR7 \$250.	1	245-405	0-600 ma	0.2 volts	0.2 volts	5 mv.	19"	10½"	13"
	2	6.3 AC	10 amp.	*	*				
	3	6.3 AC	10 amp.	*	*				

*AC Voltages unregulated.

electrons in the pattern of the projected letters. The stream is accelerated by a voltage applied to the wall coating of the tube.

Selection of letters in the required order is accomplished with a tiny aperture at the neck of the tube, permitting only one character at a time to pass through. The stream is shifted by a magnetic deflection coil around the outside of

the tube to choose the desired letter or character.

Another set of coils focuses and deflects the character to its proper place where it appears in visible form on a phosphor screen. Enlargement can also be accomplished by the second set of coils.

As many as 4,000 characters have been produced clearly in a single pattern on the 5-inch tube face. The

typesetting process can take place at speeds up to 10,000 letters a second.

Source of information for tests has been perforated paper tape, but output of magnetic tape, wire or radio signals or electronic storage unit could also be used.

In the laboratory, 2,000 characters a second have been clearly recorded on standard 35-mm film.

Producing Oscillations With A Colpitts Circuit

BY RICHARD WHITE MCCUSKER
Merced, Calif.

FAILURE to obtain oscillations from a class A Colpitts oscillator without changes in initial component values is sometimes encountered. Analysis may show that the circuit of (A) is equivalent to the circuit shown in (B) which can then be redrawn in the form shown (at right) in (C).

Components are now arranged in the configuration of a bridged-T network in which a null is produced at the output. With pure

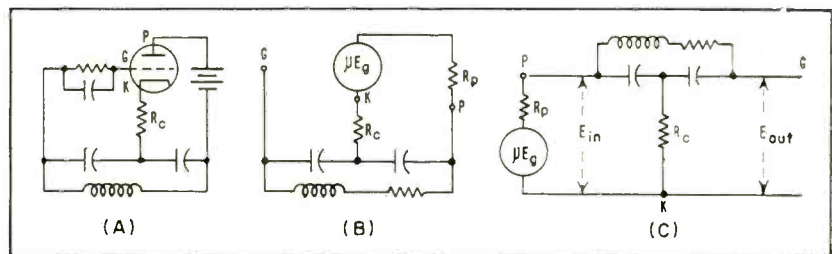

Colpitts oscillator circuit (A) redrawn in equivalent form (B) and rearranged to show bridged-T network configuration (C)

sine-wave input, it may actually give zero output.

In those cases where an oscillator fails to function, it may be that the constructor has paradoxically built

a bridged-T network that produces a null grid voltage at or near the very frequency the oscillator was designed to generate.

(continued on page 186)

DEW Line Radar Network In The North Spots Planes



Experimental radar unit in the Arctic is prototype of those for Distant Early Warning (DEW) Line to be constructed for detection of approaching unauthorized aircraft. Mushroom-shaped rubber dome houses a radar antenna and protects it from weather. Western Electric is prime contractor



Tractors and other heavy equipment are transported in Arctic by aircraft. Transport shown shuttles between Alaska and forward base

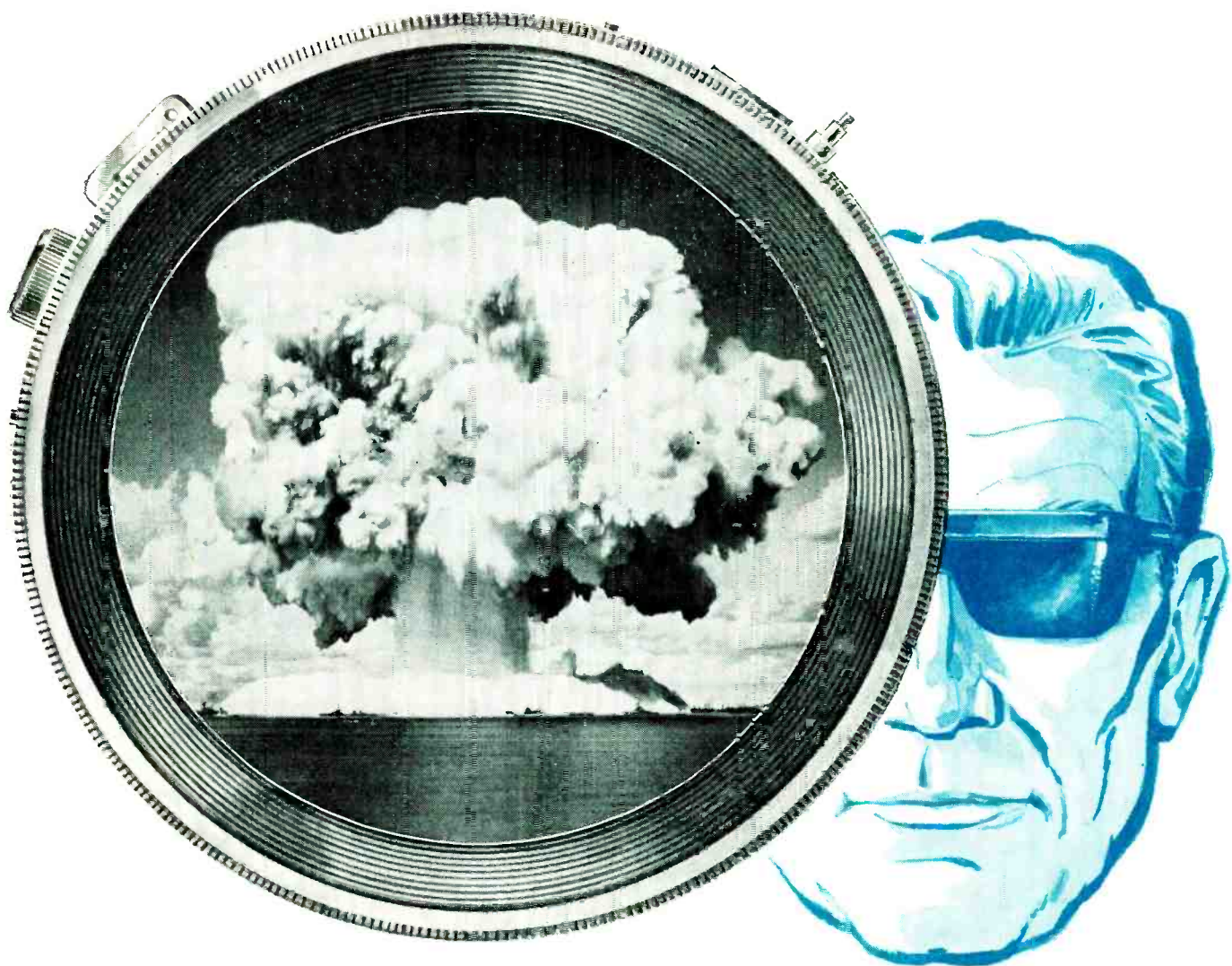

how to stop an h-blast

WANTED: a camera to stop the action of a nuclear explosion at a pre-selected microsecond, with high quality image-definition . . . that was the problem handed by the AEC and its Los Alamos Scientific Laboratory to the Boston firm of Edgerton, Germeshausen & Grier, Inc. EG&G solved it by inventing the non-mechanical Rapatronic shutter . . . employing the Faraday Effect of magnetically rotating the plane of polarized light as it traverses an optical element . . . and relying on HELIPOT* precision potentiometers and DUODIAL* turn-counting dials for sensitivity setting and calibration.

A light-pulse from the blast falls on a photocell . . . generates a signal that passes through a variable time-delay to trigger a condenser-discharge circuit . . . releasing energy which surges through a coil wound around a lead-glass lens. The resulting magnetic field rotates polarized light from the blast as it passes through the lens . . . effecting a one-microsecond exposure.

Sensitivity of the photocell circuit is controlled by a standard-linearity Model A 10-turn HELIPOT, calibrated with a Model RB DUODIAL. Time-delay from photocell pick-up to shutter operation . . . continuously variable from 0 to 100 microseconds . . . is controlled by a Model A 10-turn HELIPOT of 0.1% linearity, calibrated with a Model W10 DUODIAL.

The coil of the HELIPOT is wound with more than 10,000 turns of resistance wire . . . the DUODIAL is settable to a

fraction of any of its thousand scale-divisions . . . and the Rapatronic shutter can be tripped at any preselected fraction of a microsecond.

For complete details of this and other HELIPOT applications, write for Data File 501



MODEL A HELIPOT



W10 DUODIAL



Helipot

first in precision potentiometers

Helipot Corporation/South Pasadena, California
Engineering representatives in principal cities
 a division of BECKMAN INSTRUMENTS, INC.



* 342
T.M.REG.

THE FRONT COVER

MULTICHANNEL recorder designed and built by Beckman Instruments, Inc. speeds static testing of aircraft structures at Convair in San Diego. The instrument automatically measures and records the output of as many as 200 resistance strain gages within 5 minutes.

As hydraulic rams apply calculated loads to the aircraft structure, the strain gages attached to the structure produce unbalance voltages. Fast-cycling stepping switches momentarily connect the recorder's measuring circuit to each gage circuit. During this brief contact period, strain voltage from the gage is compared with a slide-wire reference voltage and the analog result—in terms of strain vs known load—is printed on a tabulating card.

Before a test run begins, gage circuits are balanced at zero load by means of 200 10-turn Helipot and a portable servomotor. Any voltage differential in an unbalanced circuit drives the servo motor, which spins the correspond-

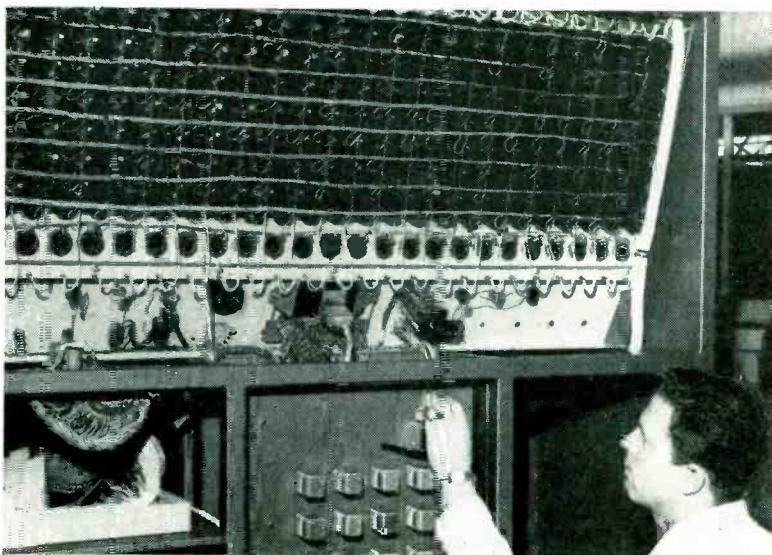

Technician testing multichannel recorder used to collect strain-gage data during aircraft structural tests. The equipment measures and records output of 200 strain gages within five minutes. Beckman Instruments, Inc. built the device for Convair

ing Helipot shaft until the circuit balance point is reached.

Immediate availability of information permits structures engineers and stress analysts to maintain a constant check as a

test progresses. The recorder can also be equipped with a digital conversion unit so that digital data can be printed, punched on tape or preserved in some other form.

Designing 2,000-Mc Components For Communications

By N. C. COLBY
RCA Victor Division
Radio Corporation of America
Camden, N. J.

WHEN DESIGNING ultra-high frequency circuits for commercial applications some of the factors that must be considered are the parasitic capacitance of tubes, the desired tuning range, tube accessibility, means of ventilating the tubes, power output coupling methods and manufacturing costs.

The physical size of tuned circuits, usually of the transmission-line type, is determined by the characteristic impedance of the transmission line, the working frequency and the input or output capacitance

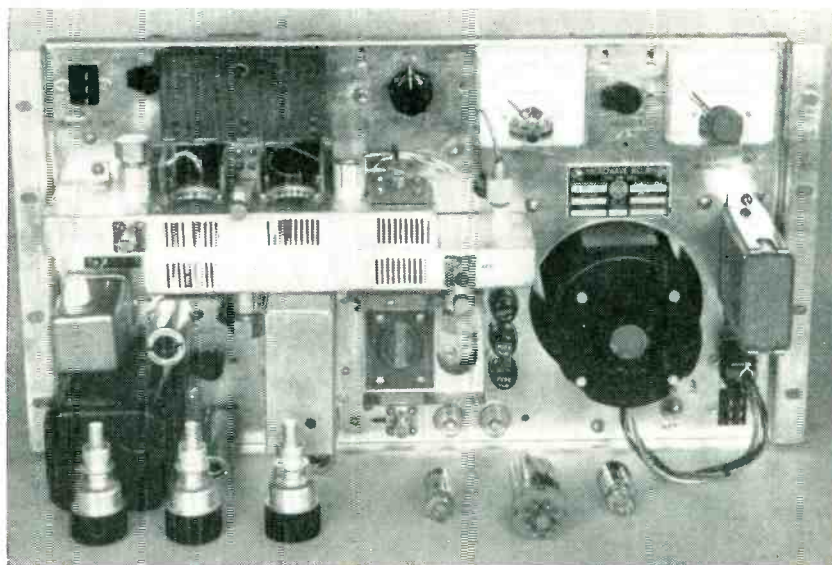

Tuned cavities at left center of chassis provide coupling between oscillator mixer and amplifier

★ THIS IS IT! ★



NEW 3-WATT Blue Jacket[®]
miniaturized axial-lead wire wound resistor

This power-type wire wound axial-lead Blue Jacket is hardly larger than a match head *but it performs like a giant!* It's a rugged vitreous-enamel coated job—and like the entire Blue Jacket family, it is built to withstand severest humidity performance requirements.

Blue Jackets are ideal for dip-soldered sub-assemblies . . . for point-to-point wiring . . . for terminal board mounting and processed wiring boards. They're low in

cost, eliminate extra hardware, save time and labor in mounting!

Axial-lead Blue Jackets in 3, 5 and 10 watt ratings are available without delay in any quantity you require. ★ ★ ★

SPRAGUE TYPE NO.	WATTAGE RATING	DIMENSIONS L (inches) D		MAXIMUM RESISTANCE
151E	3	1/2	1 3/4	10,000 Ω
27E	5	1 1/8	3/8	30,000 Ω
28E	10	1 3/8	3/8	50,000 Ω

Standard Resistance Tolerance: ±5%

SPRAGUE

WRITE FOR ENGINEERING BULLETIN NO. 111 B

SPRAGUE ELECTRIC COMPANY • 35 MARSHALL ST. • NORTH ADAMS, MASS.



26 SERIES OF RACK & PANEL CONNECTORS

Interconnection of vital electronic equipment demands a wide variety of connector designs. At AMPHENOL this demand has resulted in the most comprehensive connector line available to the electronics industry—AN connectors, RF connectors, *Blue RIBBONS*, and hundreds of special components. In the latter category are the 26 series of Rack & Panel connectors, which includes three distinctly different designs, each offering excellent design and mechanical characteristics.

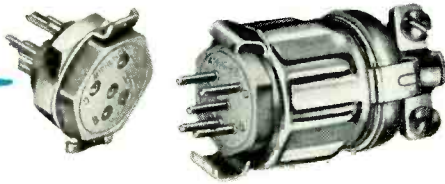

4, 5, 7 & 9 Contact Miniature Connectors

Designed to cover a wide range of miniaturized applications by the use of interchangeable hardware and contacts. Hex nut type has threaded body for panel mounting without the use of external shells. Locking Clip type permits positive mating with Hood & Cable Clamp type. All with male or female contacts. Bodies molded of AMPHENOL 1-501 blue; gold plated contacts.

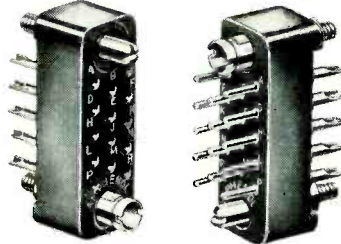

14, 15, 18, 21 & 34 Contact Miniature Connectors

Extremely small pin and socket type connectors available in numerous contact arrangements. Have guide pins and bushings for positive alignment. Contacts are brass, gold over silver plated. Bodies are melamine.

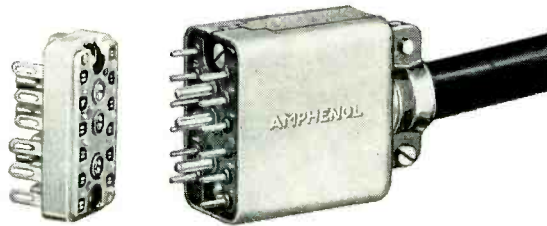

11, 15 & 20 Contact Connectors

Available with protective aluminum housings with top or side cable outlets. Connectors have eyelets inserted in the mounting holes for extra strength. Interlocking barriers prevent accidental shorting. Bodies are mica-filled phenolic; contacts are brass, gold over silver plated, and are molded into the insert.



AMERICAN PHENOLIC CORPORATION

chicago 50, illinois

In Canada: AMPHENOL CANADA LIMITED Toronto

of the tube. Physical size of the circuits is inversely proportional to both the characteristic impedance and the capacitance. This fact usually rules out parallel-line circuits whose characteristic impedance is of the order of 240 ohms. Coaxial structures are widely used because they provide good shielding, high Q, and can be built to have a characteristic impedance as low as five or ten ohms, but their size also is governed by the capacitive loading at any given frequency.

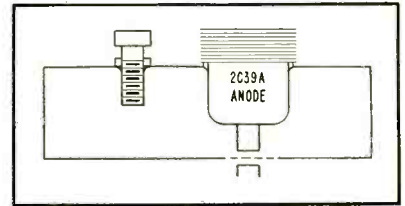

FIG. 1—Resonant cavity using single tube and tuning slug

Using a 2C39A tube in a coaxial circuit at 2,000 megacycles it is found that the output line or cavity is 0.97 inch long, assuming a quarter-wavelength section, and has an output capacitance of $2 \mu\text{mf}$ and a characteristic impedance of 30 ohms. The length of the tube from the grid ring to the end of the cooling fins is 1.6 inches—a difficult situation. In many applications a possible way out is to use multiples of a quarter wavelength but in applications where maximum bandwidth is desired the additional stored energy is a serious problem. What is needed is a resonant cavity whose dimensions are essentially independent of capacitive loading.

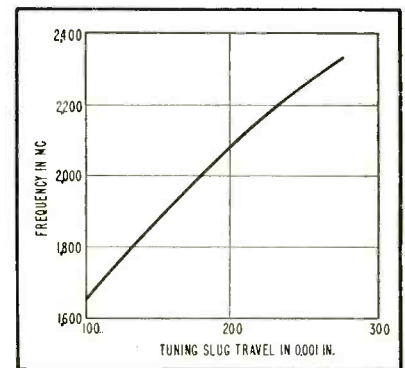

FIG. 2—Change in frequency with adjustment of tuning slug in single-tube cavity

A ridge waveguide cavity provides approximately this feature. If a cavity is constructed from a

STABILITY...

One of the Many Outstanding Characteristics of the DU MONT TYPE 6292 Multiplier Phototube

Stability — the ability of a multiplier phototube to operate over extended periods of time without appreciable change in output characteristics — is essential to *reliable* quantitative measurements and to high-quality flying-spot scanner applications, particularly those involving color signals. The stability of the Type 6292, achieved with silver-magnesium dynodes and a construction exclusive to Du Mont multiplier phototubes (see below) assures reproducible results without continual recalibration of equipment or, in the case of flying spot scanners, continual readjustment of video level.

Unparalleled stability, added to excellent sensitivity and cathode uniformity, very low dark current, and high signal to noise ratio makes the Type 6292 particularly well suited for those applications where quality of performance must not be compromised.

The unique Du Mont Dynode Structure

Note independent screen between photocathode and first dynode, which is brought out to a base pin. By varying the potential on the screen, optimum electron collection is achieved, greatly improving signal to noise ratio. Linear arrangement of box-type dynodes provides longest possible leakage paths between low- and high-voltage dynodes, greatly minimizing dark current and noise. This construction also provides effective shielding of electron stream, minimizing the effects of external fields.

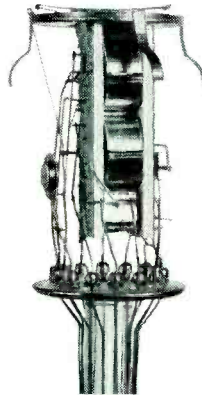

SPECIFICATIONS

Spectral Response	S11
Cathode Luminous Sensitivity (at 210 V, 0 cps) between cathode and all other electrodes	60 μ A/lumen
Anode Luminous Sensitivity	13 A/lumen
105 v/stage; 0 cps	120 A/lumen
145 v/stage; 0 cps	
Current Amplification at:	
105 v/stage	215,000
145 v/stage	2,000,000
Average Anode Current	5 ma
Peak Anode Current	25 ma
Tube Diameter	2 \pm 1/16 in.
Seated Height to Center of Window	4-7/8 \pm 3/16 in.

The performance features of the Type 6292 are representative of those of the entire line of Du Mont Multiplier phototubes, covering the entire range of sizes from $\frac{3}{4}$ -inch to 16 inches. All are built to Du Mont's rigid specifications for quality, and are backed by the well known Du Mont guarantee. For full technical details on the Type 6292, or other Du Mont multiplier phototubes, write the *Technical Sales Department, Allen B. Du Mont Laboratories, Inc., 2 Main Avenue, Passaic, N. J.*

DU MONT

Technical Sales Department

ALLEN B. DU MONT LABORATORIES, INC.

760 BLOOMFIELD AVENUE, CLIFTON, NEW JERSEY

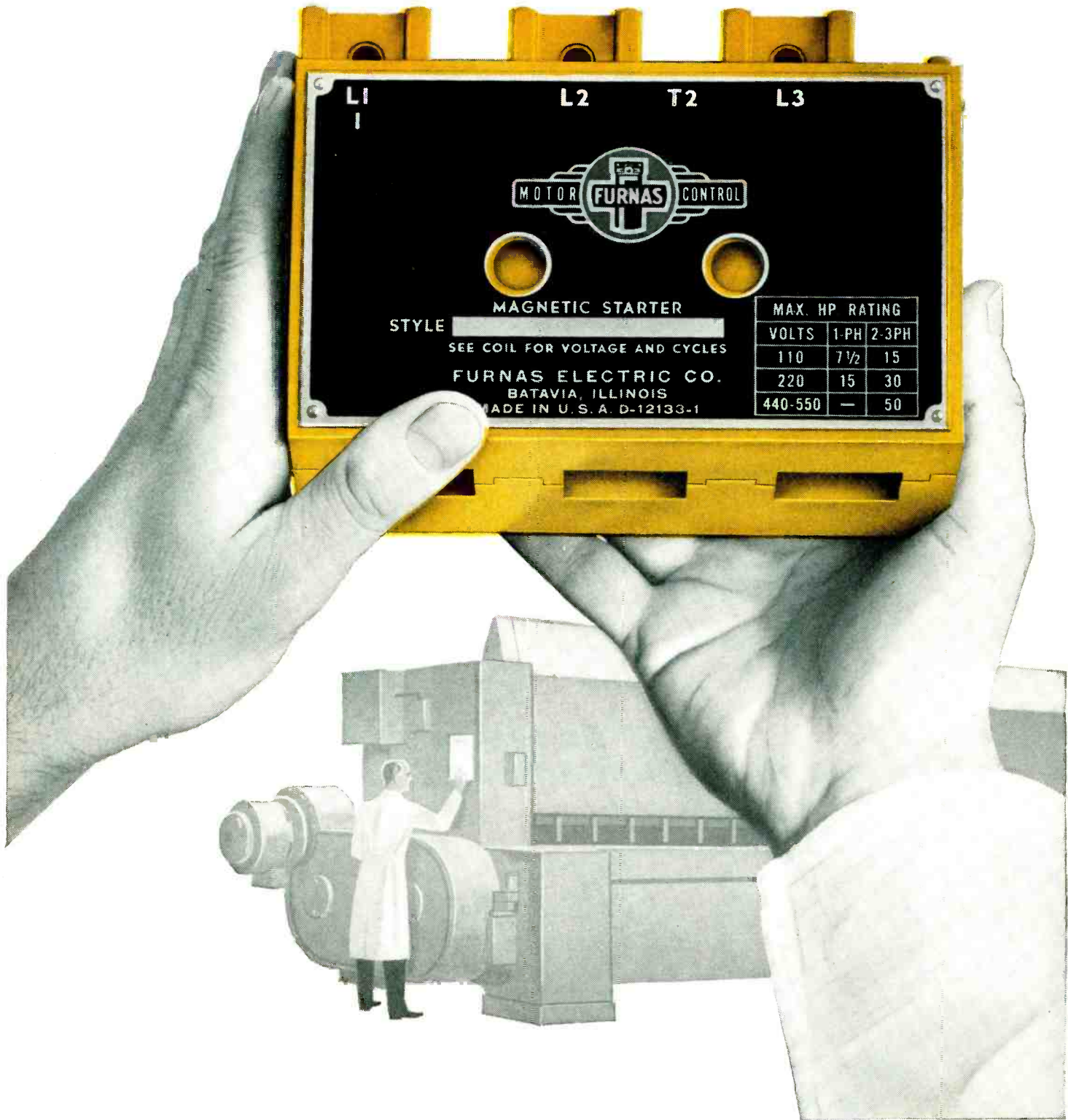

One insulating material that has all the answers? Sure! It's **PLASKON[®]** alkyd

The Furnas Electric Company of Batavia, Illinois, needed a very special plastic to meet the electrical and physical requirements for contact blocks in their line of magnetic motor controls. PLASKON Alkyd Molding Compound 422 filled these specifications. Alkyd's outstanding arc resistance and high dielectric strength could be counted on to resist tracking and burning due to arc rupturing during interruptions of the circuit. Because of PLASKON Alkyd's higher insulation value, it was possible to increase the rating of these motor controls without increasing their dimensions . . . they operate efficiently with greater electrical loads than is possible with other tested materials.

Like so many other electrical manufacturers, Furnas Electric found that PLASKON Alkyd was the *one* plastic that could do *all* the things required of it. Having the right material can make the difference between success and failure of a product. And time after time, PLASKON Alkyd has proved itself to be exactly right for tough electrical jobs.

PLASKON Alkyds can also save you money in time and labor costs. They mold rapidly at low pressures, with cure-time cut to a minimum.

Dimensional stability, moisture resistance, heat-dissipating qualities and minimum after-shrinkage make PLASKON Alkyds popular with the many electrical and electronic manufacturers who have found them to be the only satisfactory plastic for their top quality needs.

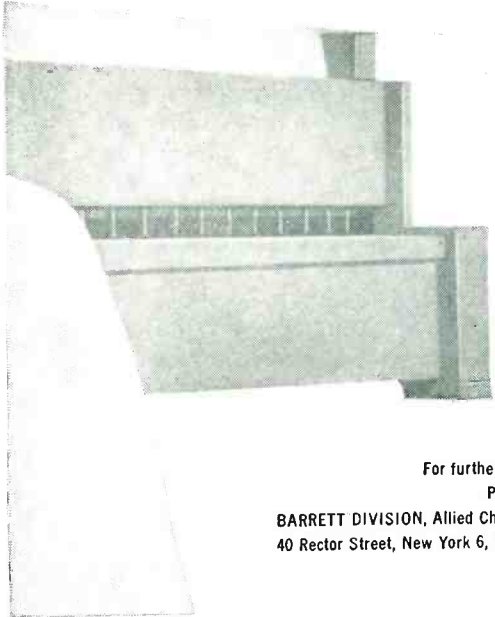

For further information on PLASKON
Plastics and Resins, address
BARRETT DIVISION, Allied Chemical & Dye Corporation,
40 Rector Street, New York 6, New York, HAnover 2-7300



To build a better flyback transformer...

start with a

RESINITE



COIL FORM



RESINITE

flyback transformer coil forms are fabricated from select materials and resin impregnated by a special process to provide optimum dielectric characteristics.

In volume resistivity . . . low power factor . . . resistance to voltage break down . . . excellent thermal properties . . . and low moisture absorption . . . Resinite outperforms all other resinated products.

Resinite flyback transformer coils are available in any size or shape and are notched to your specification.

Delivery is prompt in any quantity.

Request full information and samples

RESINITE CORPORATION

Sales Representatives in:

New England: Framingham, Massachusetts, Trinity 3-7091

Metropolitan New York, New Jersey: Jersey City, New Jersey, Journal Square 4-3574

Upstate New York: Syracuse, New York, Syracuse 4-2141

Northern Ohio, Western Pennsylvania: Cleveland, Ohio, Atlantic 1-1060

Indiana, Southern Ohio: Logansport, Indiana, Logansport 2555

Missouri, Southern Illinois, Iowa: St. Louis, Missouri, Sterling 2318

Maryland: Baltimore, Maryland, Plaza 2-3211

Philadelphia, Camden: Philadelphia, Pa., Chestnut Hill 8-0282

California: Pasadena, California, Sycamore 8-3919

Canada: Montreal, Quebec, Canada, Walnut 0337

Division of

PRECISION PAPER TUBE COMPANY

2035E W. CHARLESTON ST. • CHICAGO 47, ILLINOIS

Want more information? Use post card on last page.

section of ridge waveguide by soldering a conducting sheet over each end there will be a resonant frequency associated with it having a field configuration corresponding to the TE_{10} mode in rectangular guide. If the ridge is extended across the cavity to increase the capacitance between the broad faces of the cavity, it will be necessary to reduce the length of the cavity to maintain resonance at a given frequency, but as the capacitance is increased indefinitely the resonant length of the box approaches, as a limit, one half wavelength in free space.

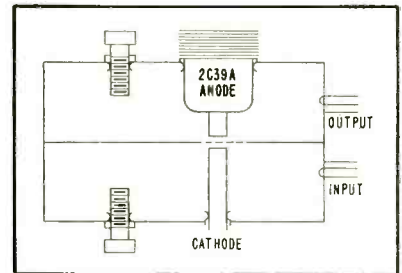

FIG. 3—Dual-cavity amplifier with separate cavities for anode-grid and cathode-grid circuits

On the assumption that the capacitance of the ridge could be simulated by the capacitance of a tube and tuning slugs distributed along the length of a cavity, a model was built using a single 2C39A tube and a tuning slug, as shown in Fig. 1. The model consisted of a rectangular copper box proportioned to accommodate the tube and to resonate in the desired frequency range. Connections to the anode and grid structures of the tube were made by means of spring fingers. Measurements of the tuning range showed the assembly to be tunable from 1,200 to 3,500 mc. No objectionable spurious resonances were observed. The wide tuning range and the quite linear relationship between resonant frequency and tuning slug insertion as shown in Fig. 2 are desirable characteristics.

Following these simple experiments an amplifier was built using two cavities, one in the anode-grid circuit and one in the cathode-grid circuit. Figure 3 shows the arrangement. The two cavities were identical in size and had a common wall. The tuning range of the two cavities was essentially the

THE MOST TRUSTED NAME IN ELECTRICAL CONNECTORS

Pioneers in Development of Vibration-Resistant Electrical Connector

The unsatisfied demand for a rugged, dependable connector capable of meeting the exacting requirements of modern aircraft led the Scintilla Division of Bendix* to develop the *first* vibration-resistant electrical connector. These connectors using the revolutionary new insert material known as Scinflex were first used on Scintilla Division's ignition equipment for piston engines.

So outstanding was the performance of this new and better connector that its acceptance and use have now become world-wide. Today the Scintilla Division is a major contributor to the electrical connector industry.

This pioneering has never stopped. Bendix was first in the field with cadmium plated connectors, which were later made a requirement of military specifications. Our latest contribution is the best engineered closed entry socket contact available anywhere—one which cannot be mechanically overstressed.

*TRADE-MARK.

SCINTILLA DIVISION



SIDNEY, NEW YORK

AVIATION PRODUCTS: Low and high tension ignition systems for piston, jet, turbo-jet engines and rocket motors . . . ignition analyzers . . . radio shielding harness and noise filters . . . switches . . . booster coils . . . electrical connectors.

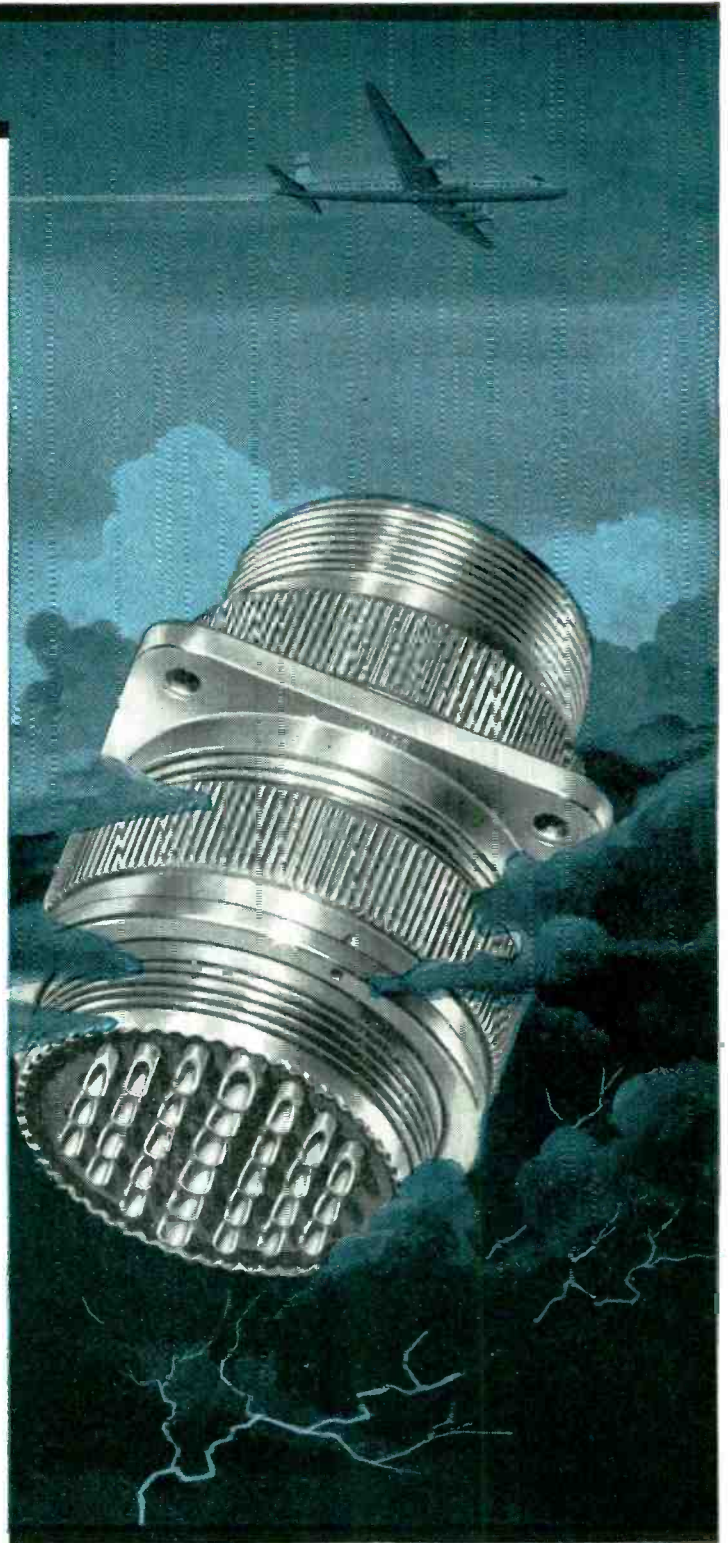

Export Sales: Bendix International Division • 205 East 42nd St., New York 17, N. Y.

FACTORY BRANCH OFFICES: 117 E. Providencia Ave., Burbank, Calif. • Stephenson Bldg., 6560 Cass Ave., Detroit 2, Mich. • 512 West Ave., Jenkintown, Pa. • Brouwer Bldg., 176 W. Wisconsin Ave., Milwaukee, Wisc. • American Bldg., 4 South Main St., Dayton 2, Ohio • 8401 Cedar Springs Rd., Dallas 19, Texas • Boeing Field, Seattle 8, Washington • 1701 "K" Street, N. W., Washington 6, D. C.



SUPERIOR TO CERAMIC BUSHINGS

HV CONNECTION COMPLETELY RECESSED

HV CONCEALED-DISCONNECT BUSHINGS

60 KV — 100 KV

Pronouncedly superior to ceramic bushings: connection between HV source and output lead is deeply within unit—corona completely eliminated, maximum safety provided operator.

Molded of tough, flexible resin of high impact and dielectric strength. High dielectric and assembly method permit increased performance and reduced size—advantageous where restricted space precludes internal bushing. A copper sleeve at contact point curtails breakdown from bombardment.

- HVD-60 (60 KV) and HVD-100 (100 KV) handle 1.5 KW • Height 5 $\frac{3}{4}$ " (2 $\frac{3}{4}$ " above base of mounting flange), base diameter 3 $\frac{1}{2}$ "
- Operating temperature —50°C to 150°C • Two feet of HV lead with each unit—longer leads available.

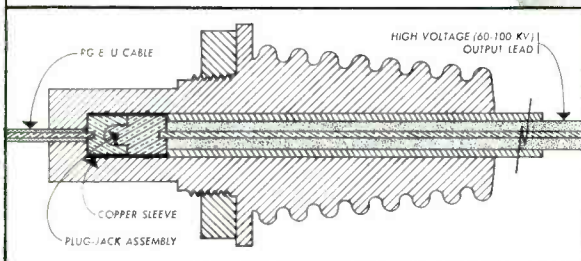
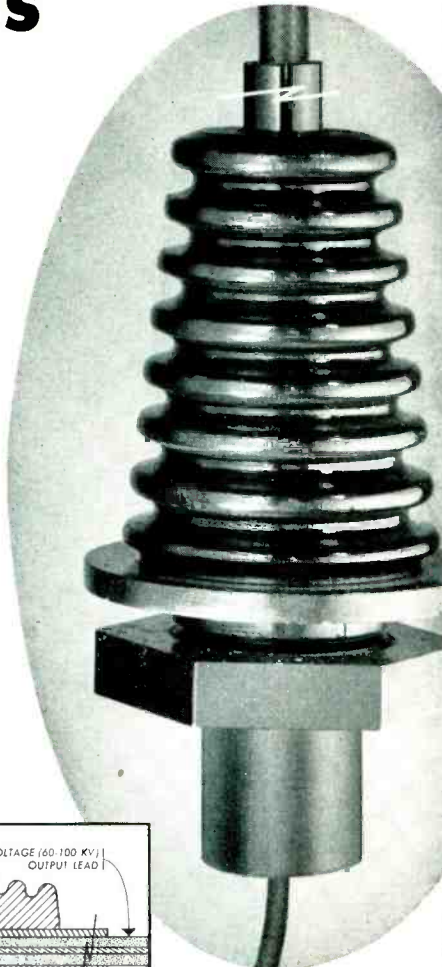
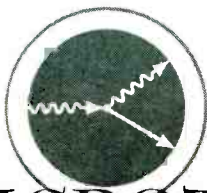

Diagram showing completely recessed HV connection.



Special assemblies available for your higher wattage requirements

MTL produce HV components such as Power Supplies, Pulse Transformers, Capacitors, etc., developed for their instrumentation for the radiographic recording of ultra speed phenomena but applicable to unrelated fields. They invite extraordinary commissions.



MICROTIME LABORATORIES

7247 ATOLL AVENUE, NORTH HOLLYWOOD, CALIFORNIA

same despite the fact that the input capacitance of the tube is three times as large as the output capacitance.

Performance of the amplifier was good. Gain depended on signal level and bandwidth. The exact design used in a particular application is governed by the requirements of the application. Interesting variations in the designs can be achieved through the use of actual ridges in the cavities to vary the coupling between tube and cavity.

Coupling in and out of the cavities is done with loops placed in regions of strong magnetic fields. The optimum position of the coupling loops changes little over the tuning range, eliminating the necessity of coupling loops that move as the cavity is tuned.

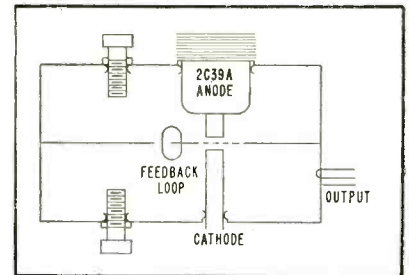
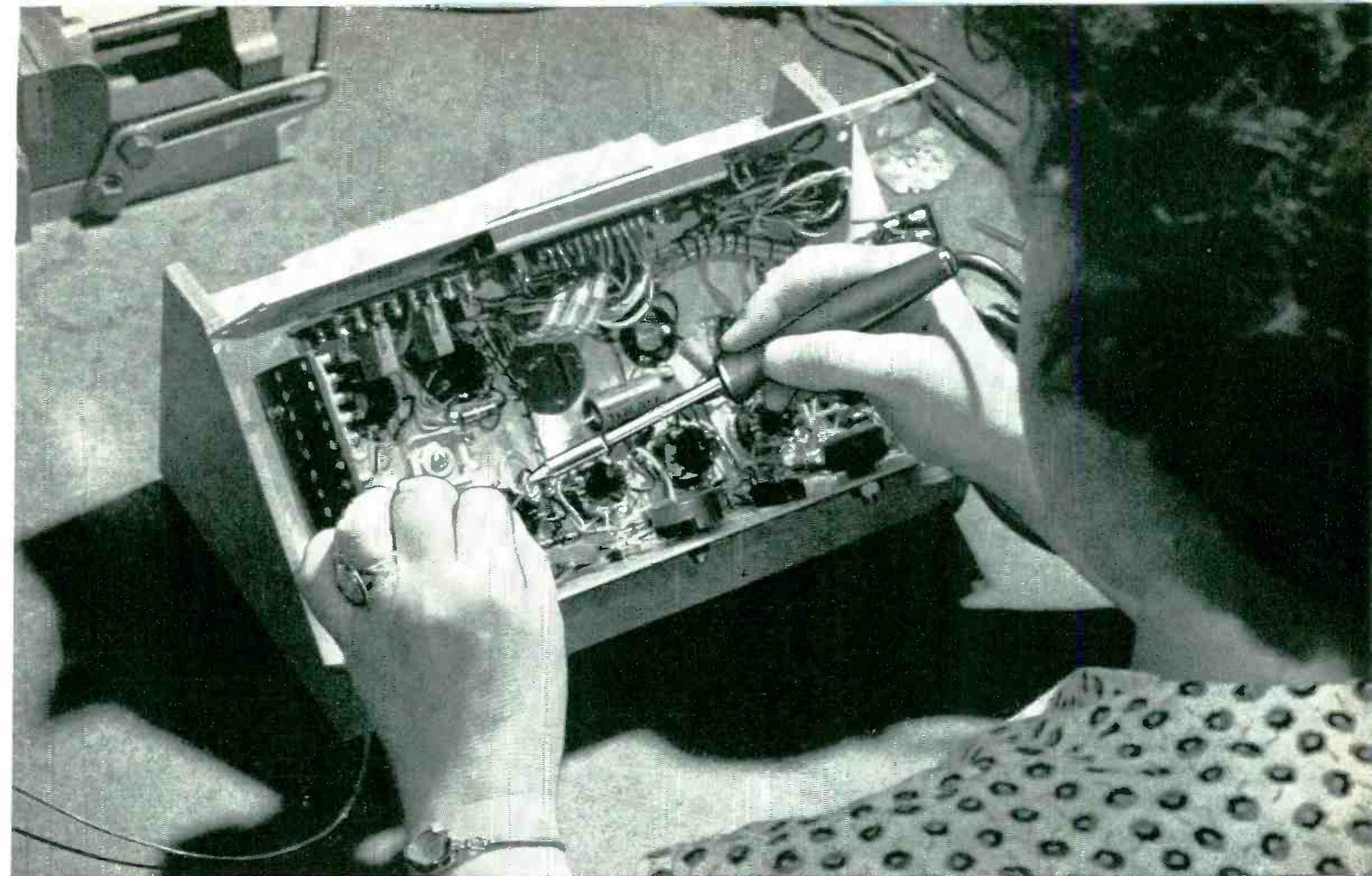

FIG. 4—Oscillator uses same configuration as amplifier with feedback loop added

To make an oscillator it was only necessary to provide feedback of the correct magnitude and phase. This was accomplished as shown in Fig. 4. The method shown employs the feedback structure at a point as close to the tube as possible to obtain operation over a wide band of frequencies.

With a given feedback-loop size, operation over a 300-mc band is achieved with power output variation of two decibels. An output of ten watts can be expected at 2,000 mc with 500 volts on the anode. Better performance could be obtained, possibly, with a symmetrical feedback system and with a cavity in which the current distribution is symmetrical but the cost of the symmetry was not justified for the use to which this cavity was put.

In practice, useful power is taken from the grid-cathode cavity. As a result of the external loading and the inherently low input imped-



HARD-TO-REACH JOINTS in Sanborn Co.'s electro-cardiographs are soldered quickly with the fine-point G-E Midget iron—with no damage to adjacent parts. Weight of iron—less

than 3 ounces—helped increase output by reducing operator fatigue. The Midget's ironclad-copper tip saves Sanborn ½ hour cleaning and tinning time daily, per operator station.

Sanborn speeds assembly 13% with G-E Midget iron, a small soldering iron with big-iron efficiency

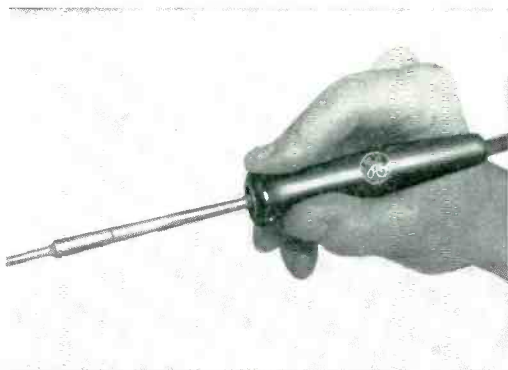

HANDLES LIKE A PENCIL—Weighing less than a package of cigarettes, the General Electric Midget soldering iron speeds production by reducing operator fatigue.

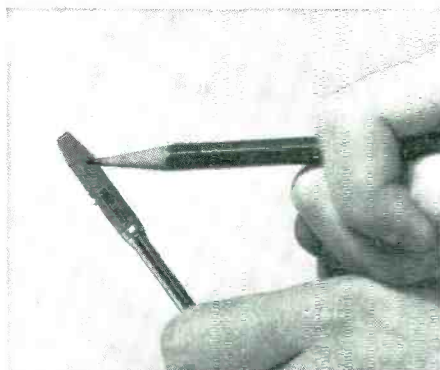

RAPID HEAT TRANSFER is achieved through a famous Calrod* heater located in the ironclad-copper tip. Result—the G-E Midget iron's heat efficiency is 90%.
*Reg. trademark of the General Electric Company



THREE-IN-ONE IRON with ⅛", ¼", ⅜" tip sizes gives you greater versatility to meet your soldering requirements. Tips can be changed in only 5 seconds.

For more information write for GED-2263, G-E Midget Soldering Iron, Section 724-2, General Electric Co., Schenectady 5, N. Y.

GENERAL  **ELECTRIC**

SUPERSEDES 100-1000 MC SLOTTED SECTIONS!



- READS VSWR AND REFLECTION COEFFICIENT ANGLE DIRECTLY
- SMALL AND COMPACT
- LOW IN COST

SPECIFICATIONS

Frequency Range:
100 to 1000 mc/s

Residual VSWR:
Less than 1.05

Accuracy of Reflection Coefficient Angle:
Better than $\pm 5^\circ$

Characteristic Impedance:
50 ohms

Output Terminals:
Type N jack.
Other interchangeable connectors

Min. Input Signal:
Approx. 1 volt at 100 mc/s,
0.1 volt at 1000 mc/s

Dimensions:
8" l. x 5" w. x 5 3/4" h.

Weight:
4 1/2 lbs.

The PRD Type 219 Standing Wave Detector is the *small package, low cost* solution for making measurements easily and accurately in the 100 to 1000 mc/s region. By connecting the output to a VSWR indicator, such as the PRD Type 277, VSWR may be read directly on the indicator meter. No special detection equipment is required. The reflection coefficient angle is easily determined merely by rotating the top drum dial to a minimum indication on the meter and reading the angle on the dial *directly in electrical degrees*. No calculations are required. The probe and crystal detector are self-contained.

Usually it is more convenient to work with VSWR and reflection coefficient angle directly instead of with other components of the measured impedance. When other quantities are also of interest, they can easily be read from a conventional impedance chart. Only \$475 f.o.b. N.Y. Write for PRD Reports, Vol. 3, No. 2, and for 1955 catalog.

Polytechnic RESEARCH & DEVELOPMENT CO. INC

202 TILLARY STREET
BROOKLYN 1, N. Y.
Telephone:
ULster 2-6800



Midwest Sales Office:
1 SO. NORTHWEST HWY., PARK RIDGE, ILL. — TAICot 3-3174
Western Sales Office:
741 1/2 NO. SEWARD ST., HOLLYWOOD 38, CAL. — HO 5-5287

ance of the tube the grid-cathode circuit is a relatively low-Q circuit compared to the grid-anode circuit. Since the grid-anode circuit has a high Q it is the main frequency-determining circuit. The oscillation frequency can be changed over a ten-percent range by tuning only the grid-anode cavity. This characteristic is exploited in the application of automatic frequency control.

The practical problem of applying d-c voltages for bias and anode voltages is solved by the use of fabricated mica-dielectric bypass capacitor structures. The grid is operated at d-c ground potential with self-bias obtained with a cathode resistor.

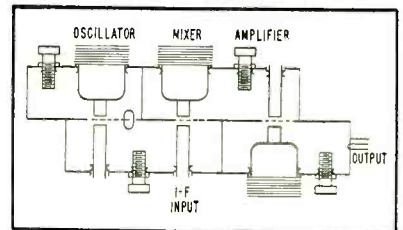

FIG. 5—Oscillator, high-level mixer and amplifier system. Oscillator grid-cathode cavity is shared with mixer

Tube ventilation is obtained by means of slots in the cavity walls. The slots are cut parallel to the lines of current flow to minimize losses due to leakage. A blower properly placed relative to the cavity will force air through the slots and also through the cooling fins attached to the tube anode. This arrangement makes it possible to cool the glass-to-metal seals of tube as well as the anode, thus prolonging the life of the tube.

The cooling arrangement and the construction of the r-f bypass capacitors do not interfere with ready accessibility of the tubes.

Cavities of the type just described were used to make an oscillator, a high-level mixer and an amplifier for use in a microwave transmitter. To achieve a compact economical easily tuned r-f head the cavity configuration shown in Fig. 5 is used. The tube on the left is the oscillator with the feedback loop located near it. The middle tube is the high-level mixer, and the right-hand tube is the r-f amplifier.

As can be seen in Fig. 5, the

THE CHALLENGE OF CREATIVE ENGINEERING

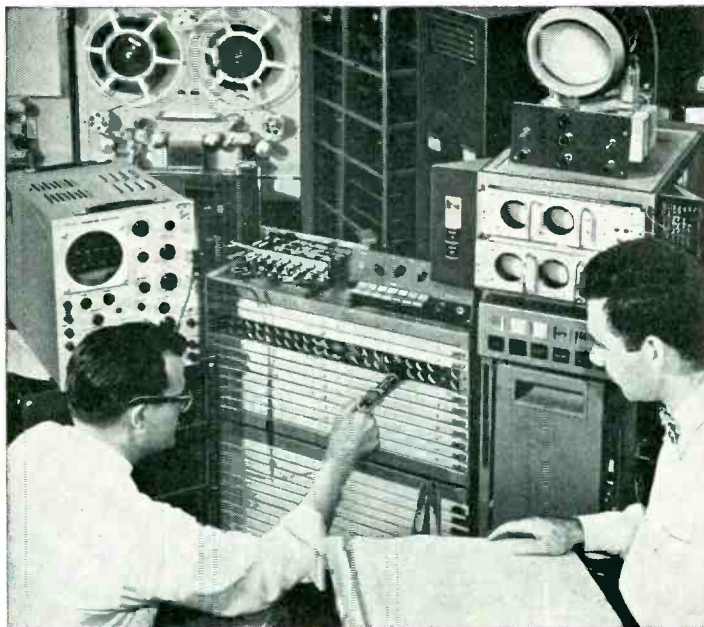

At IBM, engineers are continually exploring the frontiers of man's knowledge in the expanding field of electronics.

Here, where the known meets the unknown, they are confronted every day with challenges that call for truly creative thinking—new ideas, new concepts, new applications.

In IBM's modern laboratories, engineers find the advanced facilities and, even more important, the atmosphere of freedom so vital to the search for knowledge and the stimulation of achievement.

If you are interested in this kind of engineering opportunity, and have the necessary background we would like to have you visit our Poughkeepsie, N. Y., Laboratory. Here we can demonstrate—beyond the power of printed words—that IBM provides the environment and opportunity you have been seeking. We suggest that you write, outlining your interests, to William M. Hoyt, Room 405, IBM, 590 Madison Avenue, New York 22, N. Y.

INTERNATIONAL BUSINESS MACHINES CORPORATION



A section of the
IBM Laboratory
in Poughkeepsie, N. Y.

IBM
TRADE-MARK

World's
Largest Producer
of Data
Processing Machines

accent Quality WITH



Telephone Answering Set
Bell Telephone System

STANDARD CONTROL KNOBS

by **RAYTHEON**



70 Series Round



90 Series Skirted Round



90 Series Pointer



90 Series Skirted Pointer



125 Series Flat Skirted Round



175 Series Crank

The quality of fine electric and electronic equipment is obvious at every look and touch when you use Raytheon standard control knobs.

These injection molded knobs add the appeal of custom styling at standard cost. They are available in an integrated family of 54 items — in a choice of *six* basic types and *five* widely used sizes.

Made of tough, durable "Tenite II" (cellulose acetate butyrate) with anodized aluminum inserts and dual setscrews. All types and sizes available in black with gleaming *mirror finish* or with non-reflecting *matte finish*, for government equipments. Also available in color or with knob parts assembled in striking color combinations.

Write for complete information. Address Department 6120-KA, Raytheon Manufacturing Company, Equipment Sales Division, Waltham 54, Massachusetts.

DRESS UP YOUR PRODUCT



oscillator grid-cathode cavity is shared with the mixer, thus supplying an r-f signal to the mixer between its grid and cathode. A low-frequency signal is applied between the cathode of the mixer and ground by circuits not shown. The grid-anode cavity of the mixer is tuned to the upper or lower sideband as desired.

The mixer anode shares a cavity with the cathode of the amplifier tube which gets its driving signal in this manner. The amplifier anode cavity contains a coupling loop by means of which power is taken out and fed to an antenna. The novel feature of this cavity configuration is the equivalent single-tuned coupling circuit between tubes. This particular arrangement eliminates frequency sensitive connecting cables and permits changing frequency and tuning the transmitter in the field by inexperienced persons. All transmitter adjustments are made to maximize output power. With the compact arrangement shown a single blower is used to cool all three tubes with a minimum of duct work.

A microwave transmitter that operates in the 1,700-2,000-mc band and employs the cavity configuration just described is shown in the photograph. Acknowledgment is made of the assistance of J. A. Liggett, who is responsible for the mechanical design, and of R. H. Fricke, who contributed many of the electrical refinements during the developments of the assembly.

Observing Whistlers

SWISHES, tweeks, the dawn chorus and whistlers are names that have been given to an old electrical phenomenon recently enlisted to study effects of lightning storms.

When the phenomenon is in effect, sounds for which the names are descriptive can be heard in the output of a high-gain audio amplifier to which a loop or antenna has been connected. A sensitive recorder-player amplifier or hearing aid amplifier may suffice.

The sounds are thought to be caused by lightning flashes that generate radio waves of low fre-

Stromberg-Carlson uses new Du Pont MYLAR* to increase switchboard wire production rate 46%

REG. U. S. PAT. OFF.

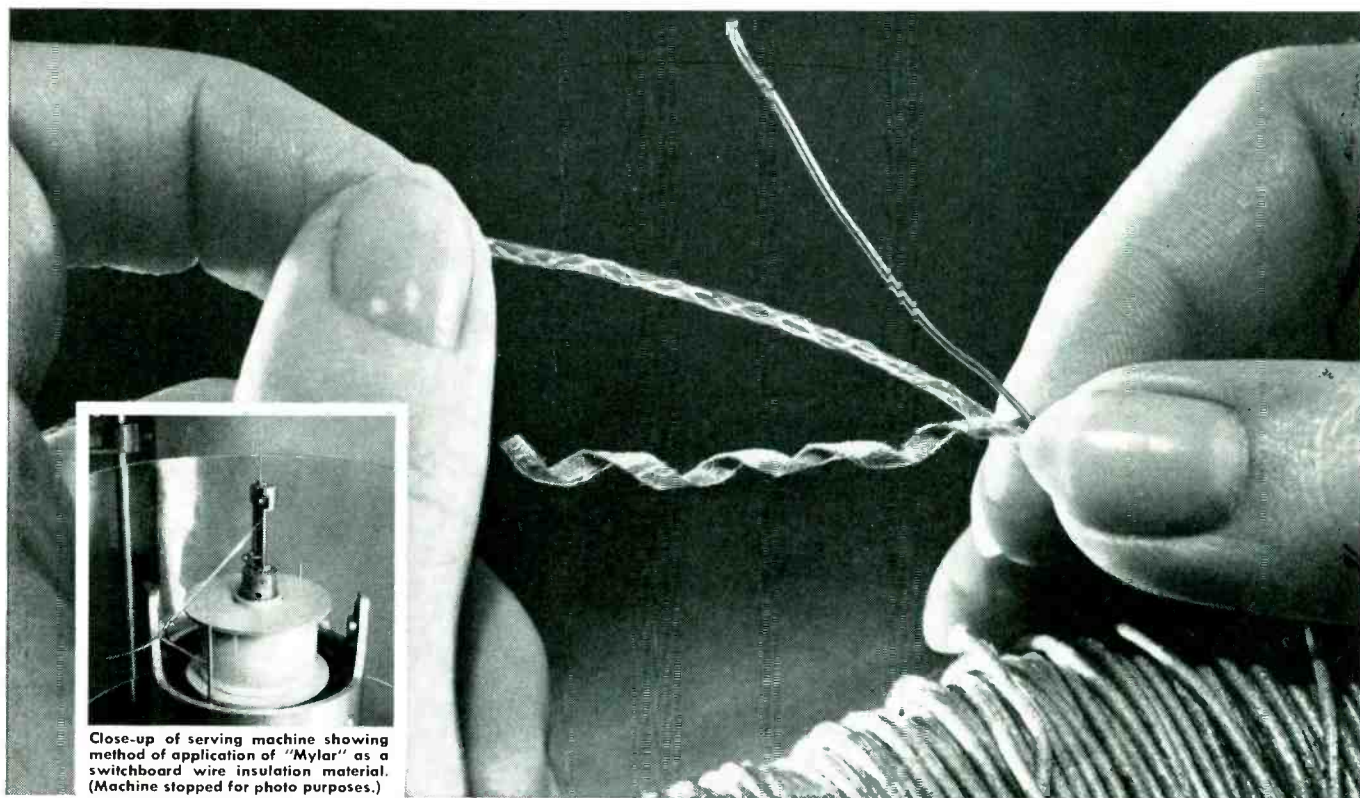

Close-up of serving machine showing method of application of "Mylar" as a switchboard wire insulation material. (Machine stopped for photo purposes.)

Unusual properties of "Mylar" make possible improved insulation

Here's another example of the outstanding improvements now possible with Du Pont "Mylar" polyester film—switchboard wire made by Stromberg-Carlson. The company reports that "Mylar," one-half the thickness but twice the tensile strength of the material formerly used, increases the production rate of the switchboard wire insulating machines up to 46%. And the superior insulating properties of "Mylar," along with its physical properties, give many other important advantages.

For example, Stromberg-Carlson tests show a three-to-one improvement, after humidity exposure, for the insulation made with Du Pont "Mylar." What's more, "Mylar" is tough, flexible, heat-stable, has good aging

qualities . . . and it reduces the outside diameter of finished wire by approximately 5 mils.

HOW CAN YOU MAKE YOUR PRODUCT BETTER WITH "MYLAR"?

New Du Pont "Mylar," used alone or in combination with other materials, may well offer you an opportunity for improving your own products. "Mylar" has an average dielectric strength of 4,000 volts/mil. Tensile-strength average of 23,500 p.s.i. permits its manufacture in gauges as thin as $\frac{1}{4}$ of a mil (0.00025 inch). "Mylar" is inert to the attack of most solvents and insensitive to moisture. Its thermal stability permits an operating range of -60°C. to 150°C.

***"Mylar" is a registered Du Pont trade-mark for its brand of polyester film.*

Du Pont
MYLAR[®]
polyester film



REG. U. S. PAT. OFF.

BETTER THINGS FOR BETTER LIVING
... THROUGH CHEMISTRY

Find out more about new Du Pont "Mylar." Send for your free copy of the new booklet that gives you the facts and figures . . . shows you how this versatile film is already being used to advantage as slot and phase insulation in motors . . . layer insulation in transformers . . . as primary insulation and barrier tape for wire and cable.

E. I. du Pont de Nemours & Co. (Inc.)
Film Department, Room 4-E, Nemours Bldg.
Wilmington 98, Delaware

Please send me sample and further information on "Mylar" polyester film.

Name _____

Firm _____

Street Address _____

City _____ State _____



OLDEST
AND
MOST
TRUSTED
NAME IN
PRECISION
METAL
ENCLOSURES

FALSTROM

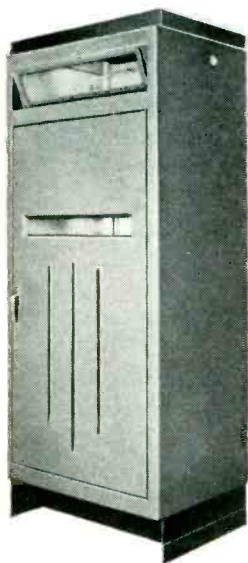

When you call on Falstrom 85 years of experience in manufacturing quality sheet metal enclosures, cabinets and weldments are at your disposal. Large, modern facilities, experienced engineers, meticulous craftsmen enable us to produce quality units—on schedule—at low cost. See what Falstrom has done for others . . . what Falstrom can do for you on long or short runs, in aluminum, steel and any other metal, to the most rigid specifications. Write for bulletin 142.

*"FALSTROM means
—it's that
much better"!*



SINCE 1870



FALSTROM COMPANY

93 Falstrom Court, Passaic, N. J.

PRescott 7-0013



quency that follow the earth's lines of magnetic flux. The waves apparently travel from one hemisphere to another, crossing back and forth over the equator.

The fact that swish or whistler may sometimes be heard in multiples may indicate that it has traveled from one hemisphere to another, bounced back to its point of origin and then duplicated its path.

It is believed that the waves go to the outer reaches of the earth's ionosphere, to a distance in space twice the earth's radius or 7,127 miles.

Tweeks, which sound like their name, may sometimes be heard on a rural telephone line. They result from lightning flashes that send a pulse of energy generated by the discharge bouncing back and forth between the earth and the lower inosphere.

The dawn chorus is sometimes heard early in the morning and sounds like spring frogs peeping in a swamp, according to Millett G. Morgan, director of research at the Thayer School of Engineering at Dartmouth College. Dr. Morgan has set up a co-operating network for simultaneous observation with stations at Hanover, N. H.; Knob Lake, Labrador; Washington, D. C.,

TV Previews New Tube

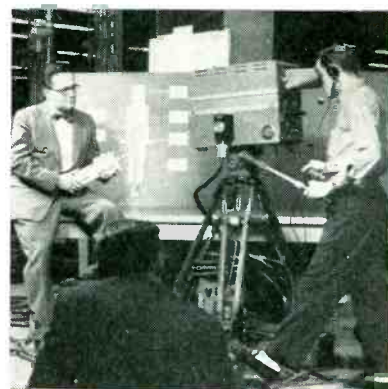

Closed-circuit television was used by General Electric to announce a new lighthouse tube on the occasion of the IRE national convention. Information on the type 6442 tube (similar in many ways to the 2C39) was transmitted from the company plant in Schenectady to New York City. The tube, of which a model is shown in cross-section, has a coaxial form and operates at frequencies as high as 4 kmc



Alan Press, Traffic Manager of Screen Gems, Inc., TV subsidiary of Columbia Pictures Corp., tells:

“Why Rin Tin Tin is never late!”

“Every Thursday, kids are waiting for Rin Tin Tin in Miami, Fla., and Bay City, Mich., and fifty-three other cities. They’d be awfully disappointed if he didn’t show up.

“How do we get him there? It’s simple,” says Alan Press.

“We ship him on film — by Air Express. We also meet rigid schedules for our other TV network shows: Ford Theater, Captain Midnight and Damon Runyon Theater. All

told, over 200 unbreakable dates to meet every week.

“Using Air Express *exclusively*, we’ve never missed a single show!

“Yet, we save real money with Air Express. It costs \$3.78, for instance, on our typical 10-lb. shipment from New York to Bay City. It’s the lowest of all — \$1.37 less than by the next lowest-priced air service.”



Air Express



GETS THERE FIRST via U.S. Scheduled Airlines

CALL AIR EXPRESS . . . division of RAILWAY EXPRESS AGENCY

PERKIN...HAS A STANDARD POWER SUPPLY FOR YOUR EVERY NEED
IMMEDIATE DELIVERY!!



PERKIN

TUBELESS!!
MAGNETIC AMPLIFIER
REGULATED DC
POWER SUPPLIES

MODEL
 MR 532-15
 5 TO 32 V.
 @ 15 AMP.
 (CONT.)



REGULATION: $\pm 1\%$ (a) from 5-32V DC (b) from 1.5 to 15 amps. (c) from 105-125V AC. (single phase, 60 cps.)

RIPPLE: 1% rms @ 32V and full load, increases to max. of 2% rms @ 5V and full load. **RESPONSE:** 0.2 sec.

METERS: 4 1/2" AM and VM; 2% accuracy.

MOUNTING: Cabinet or 19" rack panel.

FINISH: Baked Grey Wrinkle.

WEIGHT: 150 lbs.

DIMENSION: 22" x 17" x 14 1/2"

MODEL
 M60 VMC
 0 TO 32 V.
 @ 25 AMP.
 (CONT.)



REGULATION: $\pm 1\%$ * (a) at 28V DC; increases to 2% max. over the range 24-32V; does not exceed 2V regulation over the range 4-24V DC (b) from 1/10 full load to full load (c) at a fixed AC Input of 115V.

RIPPLE: 1% rms @ 32V and full load; 2% rms max. @ any voltage above 4V.

AC INPUT: 115V, single phase, 60 cps.

FINISH: Baked Grey Wrinkle.

WEIGHT: 130 lbs.

DIMENSIONS: 22" x 15" x 14 1/2"

MODEL
 MR 1040-30
 10 TO 40 V.
 @ 30 AMP.
 (CONT.)



REGULATION: $\pm 1\%$ (a) from 10 to 40V DC (b) from 100 to 130V AC (c) from 3 to 30 Amps DC. **RIPPLE:** 1% rms.

AC INPUT: 100-130V, 1 phase, 60 cycles.

RESPONSE: 0.2 sec. **METERS:** 4 1/2" AM and VM.

MOUNTING: Cabinet with 19" rack panel.

FINISH: Baked Grey Enamel.

WEIGHT: 200 lbs.

DIMENSIONS: 22" x 15" x 23"

MODEL
 MR2432-100X
 24 TO 32 V.
 @ 100 AMP.
 (CONT.)

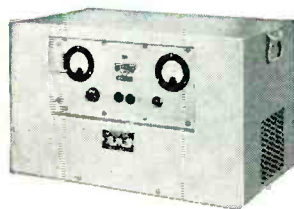

REGULATION: $\pm 1/2\%$ (a) from no load to full load. (b) from 24-32V DC. (c) for 230* (or 460) V $\pm 10\%$.

DC OUTPUT: 24-32V @ 100 amps.

AC INPUT: 230 or 460V $\pm 10\%$, 3 phase, 60 cycles.

RIPPLE: 1% rms. **RESPONSE TIME:** 0.2 sec.

MOUNTING: Cabinet or 19" rack panel.

WEIGHT: 250 lbs.

DIMENSIONS: 25" x 15" x 15"

*This unit will be supplied for 230V AC Input unless 460V is specified.

ALSO AVAILABLE: Standard 6 and 115 Volt models; Guided and Airborne Radar and Missile Range Supplies. Write for Perkin Bulletins.

PERKIN ENGINEERING CORP.

345 KANSAS ST. • EL SEGUNDO, CALIF. • ORegion 8-7215 or EAstgate 2-1375



and Gainesville, Fla. Observations were also made aboard the U. S. S. Atka off the Palmer Peninsula in the Antarctic.

It is thought that understanding the mechanism of propagation of whistlers may lead to new means of communication and aids to navigation.—A. A. McK.

Insect Control by Electron Irradiation

BY VERNON H. BAKER
*Research Professor
 Agricultural Eng. Dept.
 Virginia Polytechnic Institute
 Blacksburg, Va.*

OSCAR TABOADA
*Assistant in Entomology
 Michigan State College
 East Lansing, Mich.*
 and DENNIS E. WIANT
*Professor of Agricultural Eng.
 Michigan State College
 East Lansing, Mich.*

TWO OF THE WORST pests that infest grain products, the granary weevil and the flour beetle, were selected for tests to determine the effectiveness of accelerated electrons as an insect control.

Tests made by the Agricultural Engineering, Entomology and Home Economics Departments at Michigan State College in cooperation with The Upjohn Company of Kalamazoo, Michigan, indicate that adult granary weevils and flour beetles can be killed^{1,2} with accelerated electrons from a Van de Graaff generator. Relatively low doses of accelerated electrons sterilized eggs of these insects and also prevented adults from reproducing.

Testing procedure consisted of counting a known number of insects into a dish containing a weighed sample of wheat or flour. These samples were then placed in a constant-temperature constant-humidity incubator to allow sufficient time for the insects to lay their eggs. The samples were then irradiated with various doses of accelerated electrons. Some samples were left untreated as controls.

The Van de Graaff generator used for irradiation built up a charge of about 2-million volts. The electron beam is passed through a thin aluminum window into the product

WHEN YOU SPECIFY . . . MAGNETIC SHIELDS SPECIFY . . .

MAGNETICS inc.

*Performance -
Guaranteed*

HERE'S WHY . . .

Shielding is a vital element in circuit design, and the Magnetics, Inc. "Performance-Guarantee" on your shields is your assurance that they have been designed and manufactured to meet *your* performance specifications. You then know, whether your shields have been made from Mumetal, A.E.M. 4750, or from any other commercially available magnetic or non-magnetic material selected to meet your needs, they will make money for you on the assembly line by eliminating waste.

You also know that these Performance-Guaranteed Magnetic Shields cost no more—indeed, despite the fact that you have a guarantee of performance, they are sold at prices standard in the industry. Let our Engineering Department design your shields and production engineer to your cost requirements . . . one more important Magnetics, Inc. service to our customers.

How Do You Like Your Shields? . . .

Painted, lacquered . . . or unfinished? Painted . . . to match any equipment shade you select? From *any* commercially available material to meet your performance and cost needs? That's exactly how they're furnished by Magnetics, Inc. . . . to meet *your* specifications.

WANT THE COMPLETE STORY?

Write us . . . on your company letterhead . . . we'll be delighted to answer your questions. No obligation, of course. . . .

MAGNETICS inc.

DEPT. E-14 BUTLER, PENNSYLVANIA

WORLD'S BEST

RELAY*

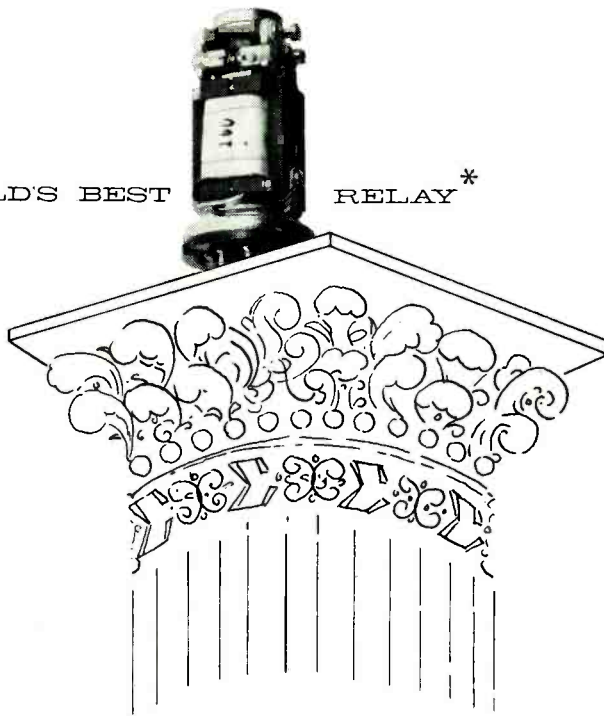

That thing up there is one of our Series 72 High Speed Relays. It is basking in the warmth of that glorious moment which only comes to the most fortunate products — the moment when the designer still feels his dreams are realized, just before the murmurings start coming in from the field to shatter it all.

With most products it never happens because the complaints arrive soon after shipment of the first samples. Such was the case with its precursor, our Type 7, which was to be an improvement over all the old line telegraph relays (American relays, that is). Though it was less than half their size, as a telegraph relay it was disappointing, finding principal application in other work. The 72 has been "out" nearly two years and we cautiously permit ourselves to think the objective in hand. One or two Very Important Customers seem to agree.

FEATURES OF THE SIGMA SERIES 72 RELAY

Operating characteristics	Polarized
Contact arrangement	SPDT
Contact life and load rating	5×10^8 @ 60 ma DC (contacts easily replaced)
Contact separation	.004"
Max. aperiodic pulse rate	400 cps
Max. following pulse rate	1200 cps
Vibration immunity	15 g to 500 cps even at highest sensitivity
Height and diameter above octal plug	2 1/2" x 1 5/16"

*We can't prove this, but it is the opinion of the man who designed it.

While hair is down it may be admitted that this little wonder* is Sigma's first serious challenge to European relays. In fact, it is alleged by certain "independent laboratories" to excel them, particularly for high speed transmission. If so, we're in, because in addition the 72 has provision for maintenance and adjustment that combines features of the old fashioned phonograph needle and the timeless water faucet. Bias and sensitivity are "micrometer" adjustable; contact screws and armature are easily replaceable.

We are now in a position to sell these paragons in fair quantity. If you buy them for the type of application for which they are designed, we won't even cross our fingers — hardly.

SIGMA

62 Pearl Street, So. Braintree, Boston 85, Mass.

being irradiated on a conveyor belt.

Applied doses of electrons are measured in rep (roentgens equivalent physical). The rep is a very small quantity of energy and may be defined in terms of calories, or kilowatt-hours. A dose of 100,000 rep is equal to about 0.20 calorie per gram. A dose of 100,000 rep will raise the temperature of a one-gram sample of wheat or flour about 0.5 C. A dose of 500,000 rep will raise the temperature of this same sample about 2.5 C.

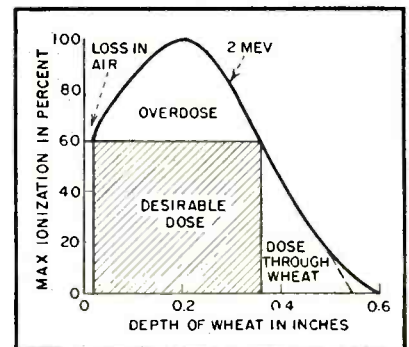

FIG. 1—Depth of penetration of 2-mev electron beam in wheat with 60-percent ionization at top and bottom of layer

Results of some of the first tests show that 80 percent of adult granary weevils died within one week after receiving a dose of 100,000 rep. About 90 percent of adult flour beetles died one week after receiving a dose of 250,000 rep. Complete kill, immediately after treatment, was obtained with 250,000 rep for the granary weevil and 500,000 rep for the flour beetle.

For practical purposes, doses much lower than mentioned above may be sufficient for insect control. It was found that a dose as low as 10,000 rep will sterilize granary weevil and flour beetle eggs already laid and this same dose prevents adults of these insects from reproducing.

Preliminary baking and taste tests conducted at Michigan State College showed that a satisfactory loaf of bread can be made from wheat flour irradiated with doses great enough to kill the adult insects immediately after treatment, which is a dose 50 times greater than is needed for egg sterilization. Some differences were noted in tenderness, flavor, moistness of bread baked with treated flour when

NEW HIGH VOLTAGE SILICON JUNCTION DIODES

NEWLY EXPANDED TI LINE NOW INCLUDES 15 SINGLE CRYSTAL JUNCTION TYPES IN 20% VOLTAGE RANGES FROM 4.7 TO 470 VOLTS!

high temperature conditions call for silicon diodes from Texas Instruments — your most experienced source of supply for silicon semiconductor devices. The first commercial producer of silicon transistors, TI has produced for commercial and military use many thousands of silicon junction diodes and triodes. TI now introduces a completely new line of silicon diodes including many high voltage types, greatly increasing the application for these reliable devices. This new line features types with characteristics stable to 150°C.

600C

TI

low back current, another important characteristic of TI silicon junction diodes, opens up still more space and weight saving circuit design possibilities. With back current as low as 0.001 microamp at rated voltage for many types, these silicon junction diodes can be used in applications where high operating temperatures and low back current requirements make germanium diodes unsuitable.

100 per cent inspection and aging of every TI diode assures maximum reliability. Thoroughly tested at high temperatures, these uniformly high quality silicon diodes will increase electronic equipment dependability where heat, shock and vibration are problems. Every unit is hermetically sealed, providing maximum protection against ambient moisture.

TI Type	Max. Rev. Working Voltage	Min. Junct. Break-down Voltage	Minimum Forward Current 25°C		Maximum Ratings at 25°C			Maximum Ratings at Elevated Temperatures				Typical Capacity $\Delta I_{\mu A} I_d$ f = 500 kc Temp. = 25°C Rev. Volts -12V†
			Ma.	Volts	Reverse Current Amperes*	Dissipation mw	Average Rectified Forward Current ma	Ambient Temp. °C	Reverse Current Amperes*	Dissipation mw	Average Rectified Forward Current ma	
600C	—	30.0	3	1	$1 \cdot 10^{-6} @ -1V$	100	25	100	$0.4 \cdot 10^{-4}$	40	15	2.5
601C	—	50.0	3	1	$1 \cdot 10^{-8} @ -1V$	100	25	150	$0.5 \cdot 10^{-4}$	20	10	2.5
604C	4.7	5.5	60	1	$1 \cdot 10^{-7}$	150	100	150	$0.5 \cdot 10^{-4}$	40	40	20
606C	6.8	7.5	35	1	$1 \cdot 10^{-7}$	150	90	150	$0.5 \cdot 10^{-4}$	40	35	16
608C	10.0	11.0	25	1	$1 \cdot 10^{-7}$	125	75	150	$0.5 \cdot 10^{-4}$	20	25	12
610C	15.0	17.0	12	1	$1 \cdot 10^{-7}$	125	60	150	$0.5 \cdot 10^{-4}$	20	20	7
612C	22.0	25.0	7	1	$1 \cdot 10^{-7}$	125	50	150	$0.5 \cdot 10^{-4}$	20	20	5
614C	33.0	37.0	5	1	$1 \cdot 10^{-7}$	125	35	150	$0.5 \cdot 10^{-4}$	20	15	3.5
616C	47.0	52.0	3	1	$2 \cdot 10^{-7}$	100	30	125	$0.4 \cdot 10^{-4}$	20	15	2.5
618C	68.0	75.0	1.5	1	$2 \cdot 10^{-7}$	100	25	125	$0.4 \cdot 10^{-4}$	20	10	2.0
620C	100.0	110.0	0.9	1	$2 \cdot 10^{-7}$	100	20	125	$0.4 \cdot 10^{-4}$	20	8	1.4
622C	150.0	170.0	6.5	4	$2 \cdot 10^{-7}$	90	15	100	$0.3 \cdot 10^{-4}$	30	5	1.2
624C	220.0	250.0	3	4	$0.4 \cdot 10^{-6}$	80	10	71	$0.2 \cdot 10^{-4}$	40	5	1.0
626C	330.0	370.0	2	4	$1 \cdot 10^{-6}$	75	7	71	$0.2 \cdot 10^{-4}$	30	4	0.9
628C	470.0	520.0	1	4	$1 \cdot 10^{-6}$	70	5	71	$0.2 \cdot 10^{-4}$	20	3	0.7

* At maximum working voltage.
† On types 604C, 606C, and 608C reverse voltage was reduced below breakdown voltage.

628C

For detailed information about TI's complete line of silicon junction diodes, write for Bulletin No. DL-S 431.

TEXAS INSTRUMENTS
INCORPORATED
6000 LEMMON AVENUE DALLAS 9, TEXAS





chem·o·sol

solves another problem by WEATHER - PROOFING AUTOMOTIVE LIGHT SOCKETS

An automobile's light sockets are in a particularly vulnerable spot and for safety's sake must function reliably. Above all, dust and moisture must be kept out.

The answer was found in the use of **chem-o-sol**, a 100% solids liquid vinyl dipping and molding compound which was formulated to be applied economically on a continuous line production basis. This **chem-o-sol** is not only tough and flexible but has completely sealed the socket from moisture, dirt and chemicals.

Here is another example from our files showing how a product was improved through using **chem-o-sol**.

Chem-o-sols are available for many application methods. New products are constantly being developed and established products improved by spraying, molding, die-wiping and knife- or roller-coating this versatile basic material.

Our completely equipped laboratory and trained chemists stand ready to assist you in formulating the *exact* **chem-o-sol** to improve your product.

Dipped sockets are a product of Watts Electric and Manufacturing Company, Birmingham, Mich.

Write for Bulletin 141

Chemical Products CORPORATION

KING PHILIP ROAD • EAST PROVIDENCE, R. I.

compared to bread baked with the same flour untreated. Some tasters preferred bread made from treated flour. Further tests are needed using flour treated with reduced doses before definite conclusions can be reached.

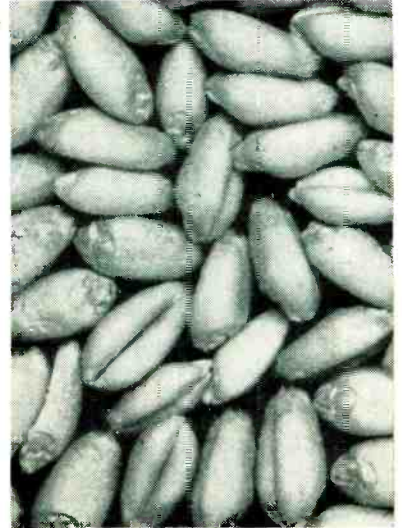

Irradiated sample of weevil-infested wheat after 43-day incubation period



Control sample of nonirradiated infested wheat after 43-day incubation

The doses of electrons used definitely damage wheat for use as seed. Seed receiving a dose as high as 500,000 rep will sometimes germinate, but will not emerge and grow when planted. Wheat plants from seed receiving doses of 10,000 rep, which is enough to sterilize insect eggs, are definitely retarded in growth.

The effect of accelerated electrons on vitamins has been studied by B. E. Proctor and his associates at

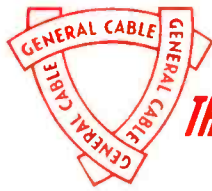

THE GREATEST NAME IN ELECTRICAL WIRE AND CABLE

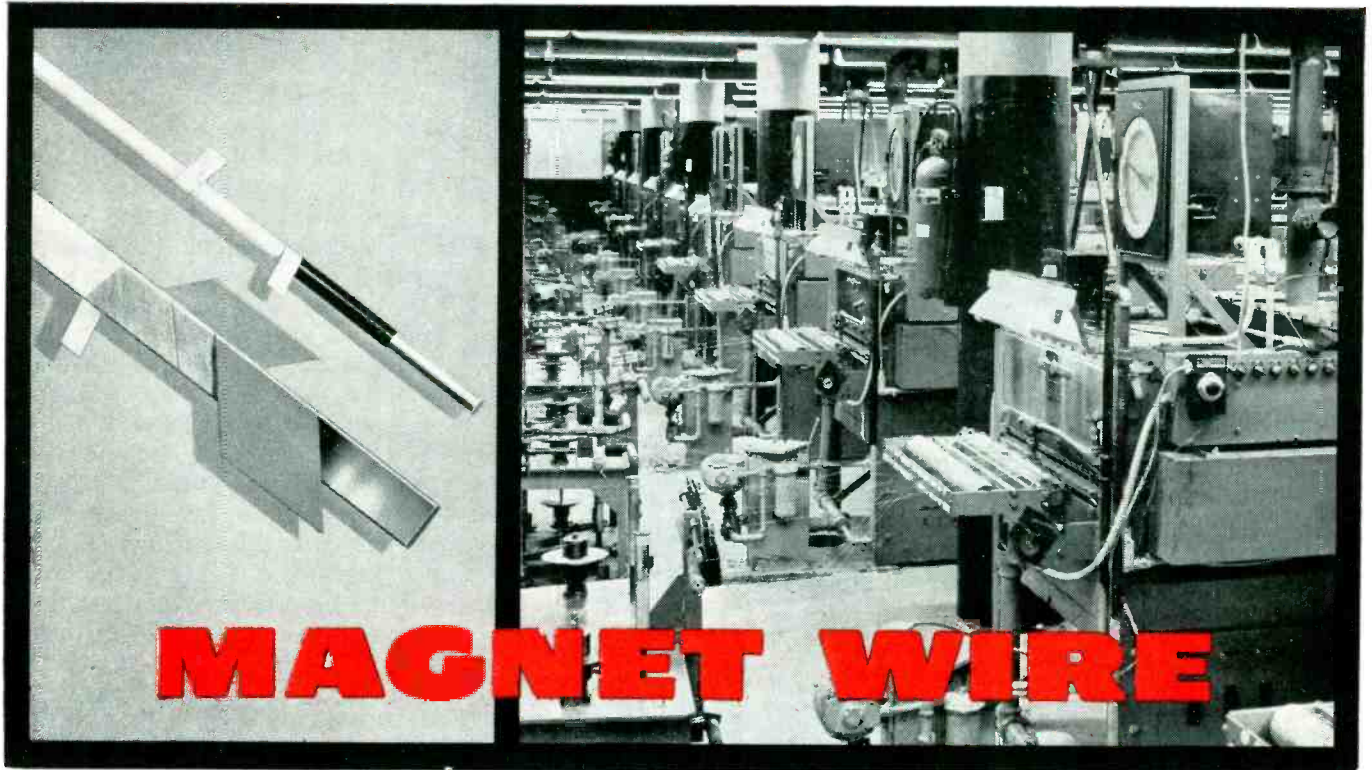

Modern methods assure product uniformity.

It takes a unique combination of modern production facilities, rigid quality control techniques and skilled workers to make *consistently* top quality magnet wire...and General Cable has it! That's why General Cable magnet wire is noted throughout industry for its extraordinary uniformity...providing the ultimate in high level performance.

Important, too, General Cable can always supply you with *exactly* the magnet wire you want...when you want it! They make every type, shape and size:

Formvar, Plain Enamel, Nylon Enamel, Silicone, and other synthetic enamels, with light, intermediate or heavy coatings.

Cotton, Paper, Silk, Nylon, Glass and Special High Temperature Covering with single and double wrappings, similar and dissimilar materials.

Plus bonded paper and glass, or other specialized types. You name it and General Cable makes it... and makes it *right!* So look to General Cable for *all* your electrical wire and cable needs!

GENERAL CABLE CORPORATION



BARE, WEATHERPROOF, INSULATED WIRES and CABLES FOR EVERY ELECTRICAL PURPOSE

GENERAL CABLE CORPORATION

Executive Offices: 420 Lexington Ave., New York 17, N. Y.

SALES OFFICES: Atlanta • Baltimore • Boston • Buffalo
Chicago • Cincinnati • Cleveland • Dallas • Denver • Detroit
Erie (Pa.) • Greensboro (N. C.) • Houston • Indianapolis
Kansas City • Lincoln (Neb.) • Los Angeles • Memphis
Milwaukee • Minneapolis • New Haven • Newark (N. J.)
New York • Philadelphia • Pittsburgh • Portland (Ore.)
Richmond (Va.) • Rochester (N. Y.) • Rome (N. Y.)
St. Louis • San Francisco • Seattle • Springfield (Ill.)
Syracuse • Tampa • Tulsa • Washington, D. C.

HIGH GAIN INDUSTRIAL POCKETSCOPE

by

Waterman

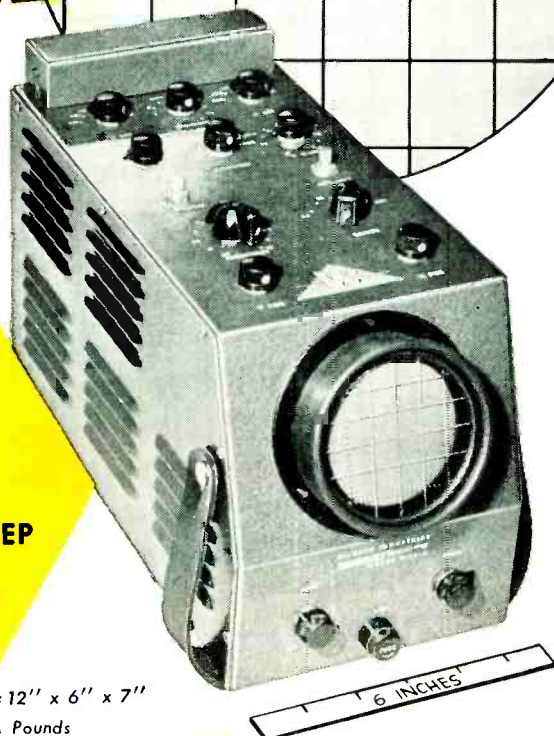

MODEL S-14-A

DC COUPLED
10 mv/inch
½ CYCLE SWEEP

Size: 12" x 6" x 7"
12¾ Pounds

ANOTHER EXAMPLE OF **Waterman** PIONEERING...

The HIGH GAIN POCKETSCOPE, model S-14-A, is an outstanding achievement in the field of oscilloscopes. The high vertical and horizontal sensitivities of 10 and 15 millivolts rms/inch respectively; frequency responses within -2 db from DC to 200 KC; non-frequency discriminating attenuators and gain controls; plus individual calibration voltages are but a few of the heretofore unobtainable characteristics of DC coupled oscilloscopes. The sweep is operated in either a repetitive or trigger mode over a range from 0.5 cycles to beyond 50 KC with synchronization polarity optional. All this and portability too! The incredibly small size and light weight of the S-14-A now permits "on-the-spot" use of the oscilloscope in all industrial, medical, and electronic fields. Its rugged construction assures "laboratory performance" regardless of environment.

WATERMAN PRODUCTS CO., INC.

PHILADELPHIA 25, PA.
CABLE ADDRESS: POKETSCOPE

WATERMAN PRODUCTS INCLUDE

S-4-C SAR PULSESCOPE®
S-5-A LAB PULSESCOPE
S-6-A BROADBAND PULSESCOPE
S-11-A INDUSTRIAL POKETSCOPE®
S-12-B JANized RAKSCOPE®
S-14-A HIGH GAIN POKETSCOPE
S-14-B WIDE BAND POKETSCOPE
S-15-A TWIN TUBE POKETSCOPE
RAYONIC® Cathode Ray Tubes
and Other Associated Equipment

MEMO

Write
for
details
today!

Waterman

WATERMAN PRODUCTS

Massachusetts Institute of Technology. Their data indicated no appreciable destruction of niacin and carotene in a concentration of 100 micrograms per ml when treated* with a dose of 10,000 rep. There was about 95-percent retention of riboflavin with the same dilution as above, when treated with a dose of 100,000 rep.

For treatment on a continuous basis the wheat can be fed onto a conveyor belt and passed through the electron stream. A depth of about ⅜-inch of wheat or flour can be treated with a 2-million volt machine, a depth of about ⅙-inch of wheat or flour with a 3-million volt machine, and a depth of about ⅓-inch of wheat with a 5-million volt machine. The width and speed of the conveyor belt can be adjusted to give various rates within the electrical capacity of the machine.

The calculated cost of electrical energy for treating wheat and flour with a dose of 100,000 rep using an overall efficiency of 10 percent, is about 15 cents per ton when electricity costs 2 cents per kwh. With a dose of 10,000 rep the cost of energy is about 1.5 cents per ton. Major cost to be considered is the installation or initial costs.

REFERENCES

- (1) V. H. Baker, O. Taboada and D. E. Wiant, Effects of Electrons on Insects which Infest Wheat and Flour, *Agric. Eng.*, Nov 1953.
- (2) V. H. Baker, O. Taboada and D. E. Wiant, Effects of Electrons on Insects which Infest Wheat, Flour, and Beans, *Agric. Eng.*, June 1954.
- (3) S. A. Goldblith and B. E. Proctor, Effect of High Voltage X-Rays and Cathode Rays on Vitamins (Riboflavin and Carotene) *Nucleonics*, 5, No. 2, p. 50, 1949.

Autopilot Magnetic Servo Amplifier

BY MARCEL ZUCCHINO

Signal Corps Engineering Laboratory
Fort Monmouth, N. J.

A MAGNETIC AMPLIFIER for use in laboratory experiments on a flight control system is shown in Fig. 1 and the photograph. The two-stage amplifier is designed for phase-sensitive d-c input signals and provides a phase-sensitive d-c output. As shown in block form in Fig. 2, the rate and displacement error signals are picked off gyro-operated potentiometers, while the displace-

Autofab assembles 20 of these circuits a minute... AUTOMATICALLY

Here's a machine that can automatically assemble any unit calling for standard electronic components—including tube sockets and I.F. cans—on a printed circuit card. *Autofab* gives you fast, low-cost production of complex assemblies, and it offers many unusual features:

SELF INSPECTING! Besides turning out completed circuits at remarkable speed (1,200 per hour), *Autofab* does its own "inspecting" and refuses to pass any but perfect mountings.

FLEXIBLE! The length of the machine can be varied to fit production needs. And switching from one circuit assembly to another is a fast, easy job. *Autofab* assembles components flat against the boards with leads bent in any direction, or offsets them from the board—or both.

COMPONENTS EASILY HANDLED! *Autofab* feeds components individually from big 8-magazine turrets. Polarized components are kept in alignment automatically.

NO MOUNTING OF CIRCUIT CARDS! *Autofab* positions cards accurately with no lost motion.

EASY TO INSTALL! Standard electric power and compressed air are all you require to power *Autofab*. And its simple mechanical linkages are easy to maintain.

Full details on Autofab will be gladly sent on request to Dept. E-7, Mechanical Division of General Mills, 1620 Central Avenue, Minneapolis 13, Minnesota.

Autofab is a G.M.I. trademark

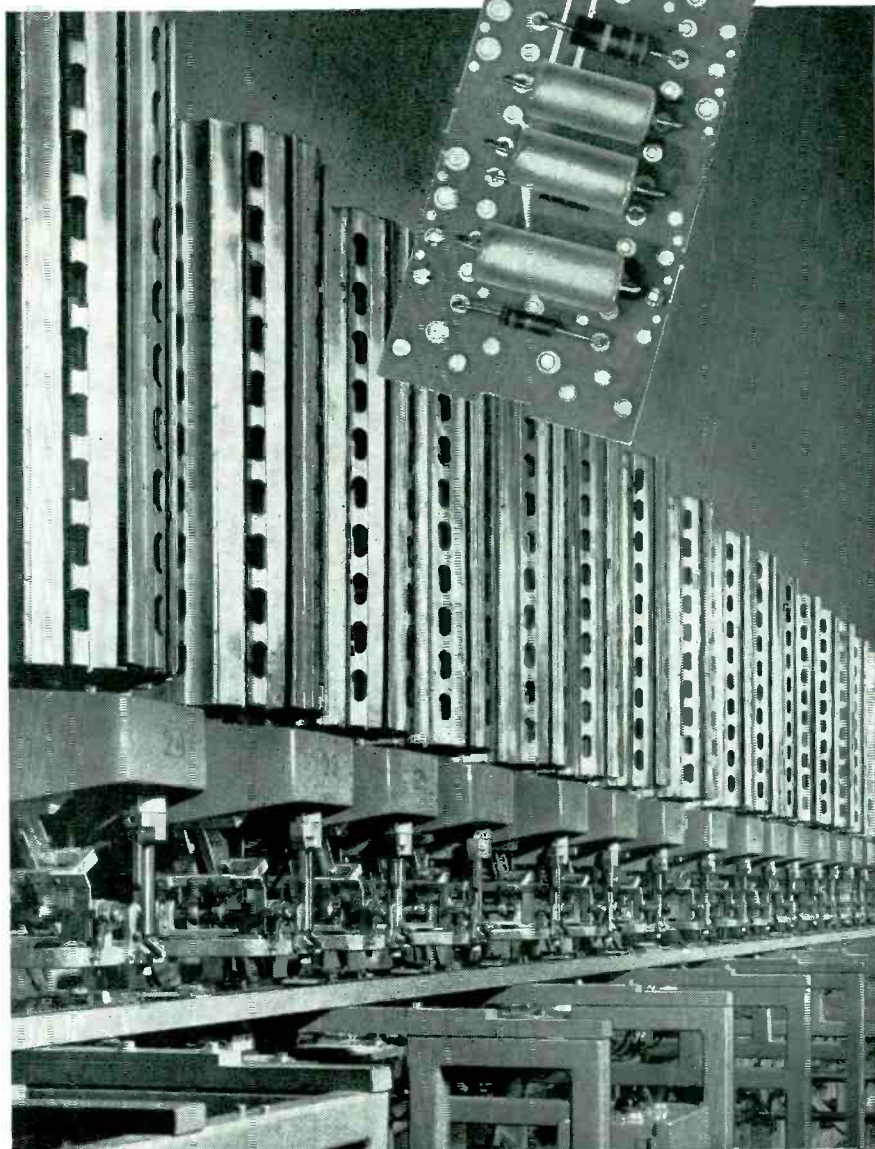

THIS 24-HEAD AUTOFAB MACHINE is now at work for IBM helping to produce printed circuit assemblies for use in air defense computers. Other models are now available for producing circuits used in radios, television sets and other electronic devices.

MECHANICAL DIVISION OF General Mills, Inc.

Job opportunities available for creative engineers. Work closely with outstanding men on interesting projects.

ELECTRICAL TEST EQUIPMENT

IMMEDIATE
DELIVERY
FROM STOCK



WHEATSTONE BRIDGES

Precision Wheatstone Bridges designed for highly accurate measurement of all types of resistance devices. Completely portable. Utilizes self-contained battery supply. Ratio dial settings of: .001; .01; 0.1; 10; 100; 1000; M10; M100; M1000; 1/4; 1/9. Built in resistance decades of: 1; 10; 100; and 1000 ohms. Ratio accuracies $\pm 0.05\%$. Resistance accuracy $\pm 0.1\%$.

Model RN-1	\$138.00
Model RN-2 (Same as above but with Murray and Varley loops)	\$154.00
Model RN-3 (Same as RN-2 but with additional ratios and variable galvanometer sensitivity)	\$198.00



RESISTANCE DECADES

Self-contained Resistance Decades featuring non-inductive windings. Ideal for experimental circuitry work, or as a resistance standard used in conjunction with other test equipment. Resistance ranges from 0.1 ohm to 9.999 megohms in various decade steps depending upon model selected. Accuracy $\pm 0.1\%$. Self-cleaning switches assure positive contact on any resistance selection.

Type DR (Depending upon model selected) \$22.00 to \$153.00



CAPACITY DECADES

Capacity Decade designed for making bridge measurements, experimental filter design, research, and experimenting with tuned circuits. Switches permit selection of any capacitance within range of instrument. Dials calibrated directly in capacitance. Accuracy ranges from $\pm 0.5\%$ to 2% depending upon model selected. Range can be extended from .0001 to 11.1 mfd. by group assembly. Completely self contained.

Type DK (Depending upon model selected) \$85.00 to \$165.00

COMPLETE CATALOG ON REQUEST

The complete catalog listing all the specific models of these and the many other instruments is yours upon request.

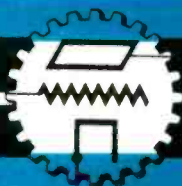

Industrial Instruments

89 COMMERCE ROAD, CEDAR GROVE, N. J.

ment feedback is picked off a potentiometer mounted on the output shaft of the actuator.

The actuator consists of a constant-speed motor coupled to the load through two magnetic clutches. One clutch engages the motor and load for positive signals while the other engages for negative signals. The result is a phase-sensitive output torque proportional to the sum of the rate and displacement error signals.

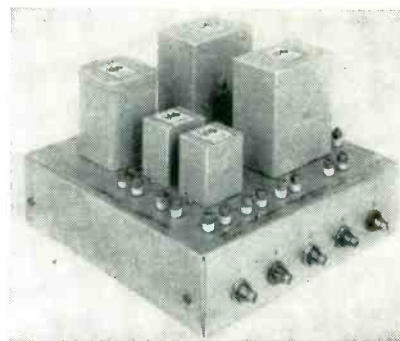

Laboratory model of autopilot magnetic amplifier

The input windings are designed to the following specifications. The displacement-error winding has an input resistance adjustable from 1,000 to 6,000 ohms with an input signal of 0 to 350 μ a.

The rate winding has the same input resistance range with an input signal of 0 to 175 μ a. Input resistance of the displacement-feedback winding is adjustable from 2,000 to 7,000 ohms with an input signal of 0 to 175 μ a.

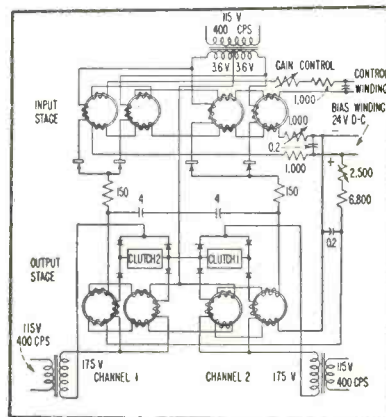
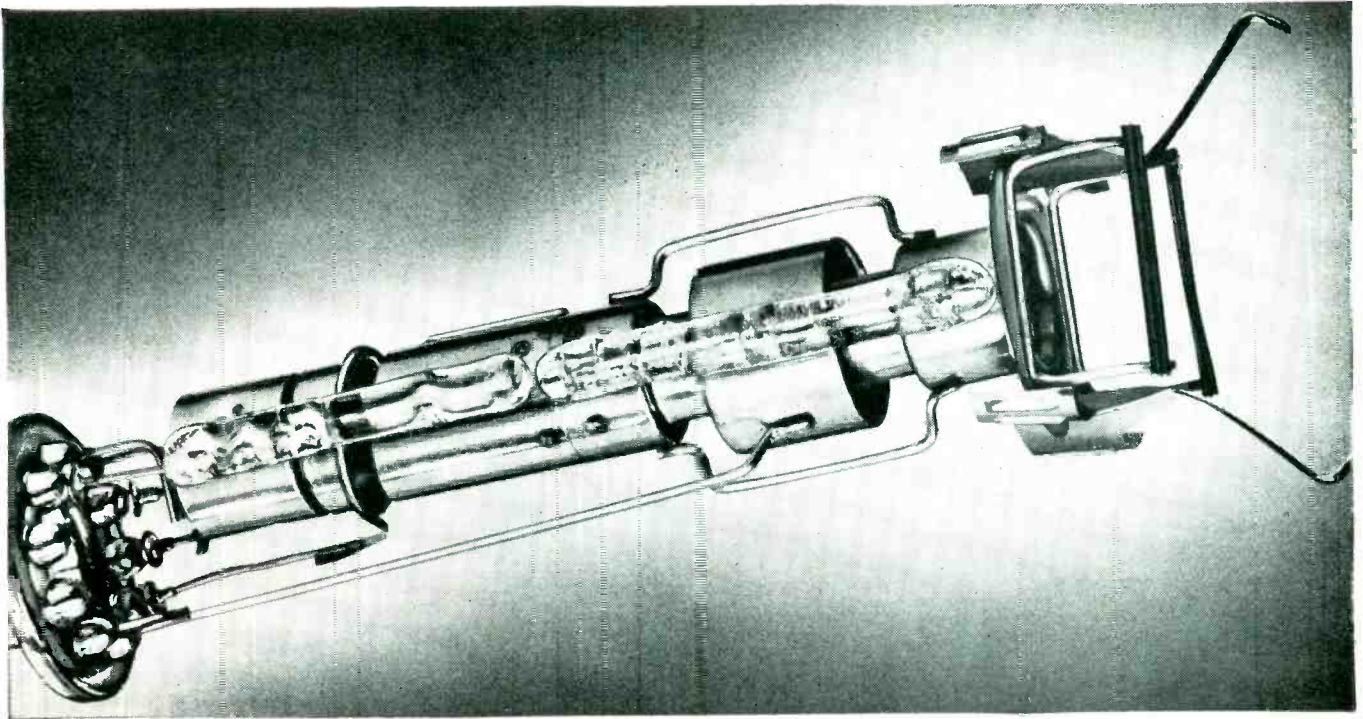

FIG. 1—Dual-channel magnetic amplifier controls magnetic clutches in autopilot system

The output stage of the magnetic amplifier operates into the field windings of the two clutches. Each winding has a resistance of 10,000



The new Westinghouse electrostatic gun improves picture tube focus, extends tube life, eliminates arcing at high voltages. That's why you can . . .

Now...Get Safe, Reliable 20 KV Picture Tube Operation

With the new Westinghouse electrostatic gun, *reliable* high voltage operation is now a reality. Westinghouse design engineers have successfully developed a new electrostatic gun capable of withstanding extreme voltages, without arcing. For *your* equipment this means improved picture tube performance, extended picture tube life, better focus.

Check These Advantages:

YOU GET . . .

- Arc-free high voltage operation
- Better focus over a wider range of anode voltages.
- More uniform spot shape
- Extended life
- Possible Leakage Paths reduced by 50%

FROM . . .

- Increased focus electrode to anode spacing
- (see graph)
- Use of split ring positioning between gun parts
- Use of new cathode base metal and broadening of active getter area
- Elimination of 2 Glass Beaded side arms

This new Westinghouse electrostatic gun is presently available in all Westinghouse picture tubes. Be sure your sets give *top picture tube performance*. See your Westinghouse representative or write to the address below — today.

Focus Voltage vs. Anode Voltage

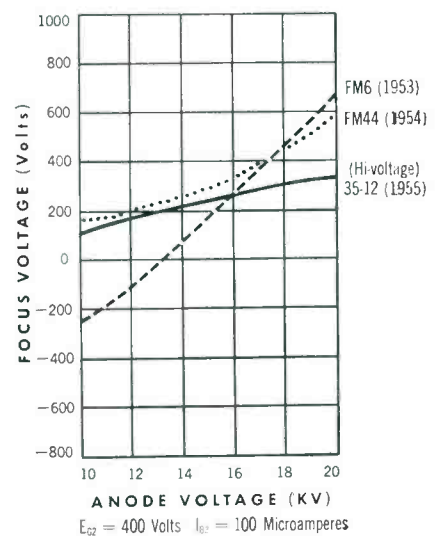

YOU CAN BE SURE...IF IT'S
Westinghouse

RELIATRON® TUBES

WESTINGHOUSE ELECTRIC CORPORATION, ELECTRONIC TUBE DIVISION, ELMIRA, N. Y.

ET-95071

Condense and Save!

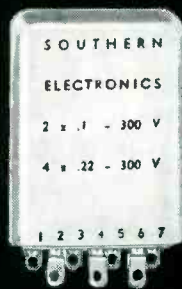

*plastic condenser block capacitors
save you Space, Labor, Money!*

Multiple capacitors in one block! Now you can install one capacitor case and use 125% less space as before —at a saving in labor costs of up to 300%.

Available with polystyrene or MYLAR* dielectric to tolerances as close as 1%.

NOW!

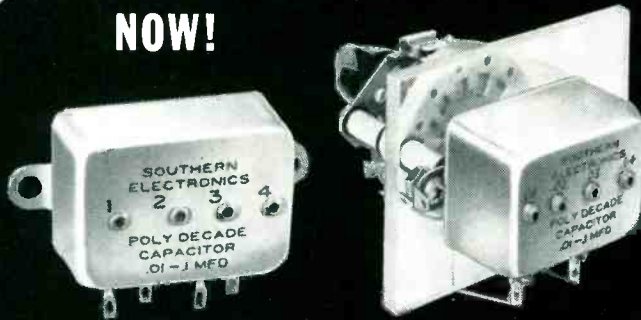

Precision Decade Capacitors

with attached rotary switch or completely boxed.

CAPACITANCE
... FROM .001
TO 10 M F D

CHECK THESE OUTSTANDING FEATURES:

- STANDARD VOLTAGE RATING . . . 200 V. D. C.
- VERY HIGH INSULATION RESISTANCE
- LOW DISSIPATION FACTOR
- LOW DIELECTRIC ABSORPTION
- SMALL SIZES

Available with polystyrene or MYLAR* dielectric to tolerances as low as 1%.

*DuPont T.M.

Join America's leading electronic equipment manufacturers in specifying Southern Electronics' precision polystyrene capacitors for your most exacting requirements. Write for complete catalog today!

SOUTHERN ELECTRONICS



Corporation

239 West Orange Grove Ave., Burbank, Calif.

ohms and a current rating of 0 to 10 ma.

The magnetic amplifier consists of two identical channels. One channel responds to positive signals and the other to negative signals. The first stage of each channel has a full-wave d-c output and is doubler connected. The output of this stage ranges from 0.5 to 9 ma through a 150-ohm load and is biased at 2 ma. It is then driven to 6 ma or 0.5 ma, depending on the polarity of the d-c signal.

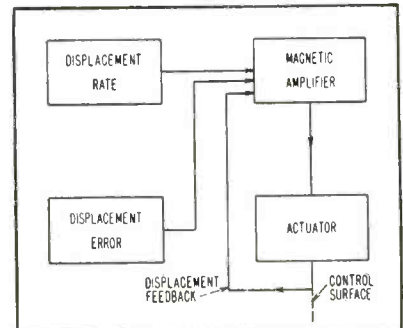

FIG. 2—Control-actuator motor is coupled to clutches controlled by magnetic amplifier

The input stage is coupled to the output stage through an R-C network that isolates it from power-supply voltages induced in the control winding of the output stage. It was found experimentally that 150 ohms in series with the control winding of the output stage and 4- μ f shunting capacitance would provide suitable isolation, with negligible effect on the over-all time constant of the amplifier.

The second stage has a full-wave d-c output and is bridge connected. This connection is used for inductive loads because it provides a discharge path for the back voltages induced in the load by quickly changing load current.

The output of the second stage ranges from 0.5 to 10 ma through a 10,000-ohm load and is biased at 0.5 ma. The bias current in this stage not only sets the operating point, but cancels the 2-ma quiescent current present in the output of the first stage.

The over-all power gain is about 8,000 and the time constant, as determined from frequency response measurements, is 0.013 second.

Core material in each stage is Supermalloy. It is used in the first stage because it results in high

*Superior
in every way*

Moldite Core "Standards"

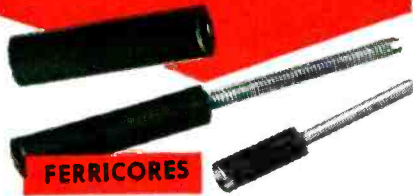

They are precision mixed, precision made, and precision controlled for every electronic use.



Give your products the advantages of MOLDITE Core Standards that offer you . . .

ECONOMY	INTERCHANGE- ABILITY
AVAILABILITY	HIGH QUALITY
UNIFORMITY	FLEXIBILITY

MAGNETIC IRON CORES



NATIONAL MOLDITE COMPANY

ELECTRONICS — May, 1955

MOLDITE

"WROTE THE BOOK" for IRON CORES



MOLDITE'S record of performance for the past ten years in producing millions of cores, coil forms and ferrites has contributed substantially to the accomplishments of the electronic industry.

To check with MOLDITE is a Must, because only MOLDITE leads in all three . . . iron cores, coil forms and ferrites.

MOLDITE iron cores, ferrites and molded coil forms (iron and phenolic) are being selected for use in high quality equipment by all leading television, radio and electronic manufacturers as well as all branches of the Armed Forces. Only MOLDITE makes them all . . . for your service and convenience. One source for all three — iron cores, ferrites and molded coil forms.

We are particularly proud of a Certificate of Cooperation awarded us by the U. S. Foreign Operations Administration for furnishing technical assistance.

Our success is measured by the ever increasing number of loyal satisfied customers. MOLDITE'S quality, service and spirit of progress sets the keynote for tomorrow. No specifica-

tion is too difficult, no order too small, no requirement too rigid. The MOLDITE label is your guarantee of complete satisfaction.

MOLDITE'S world-wide reputation is a result of . . .

1. Creative research and engineering.
2. Specialized materials processing techniques.
3. High quality mass production facilities
4. Modern core manufacturing facilities for precision molding.
5. Exclusive, specially designed, press controls.



Send for our Catalog NM #110

1410 CHESTNUT AVE., HILLSIDE 3, N. J.

Bill Franklin
3 Holly Road
North Syracuse, N. Y.

Robert T. Murray Co.
614 Central Avenue
East Orange, N. J.

Jerry Golten Co.
2750 W. North Ave.
Chicago 22, Ill.

Perlmuth-Colman Assoc.
2419 So. Grand Ave.
Los Angeles 7, Calif.

José Luis Ponte
Cardoba 1472
Buenos Aires

Want more information? Use post card on last page.

BALLANTINE Sensitive, Wide Band Electronic Voltmeter



MODEL 314
Price \$285

To measure 1 millivolt to 1000 volts
from 15 cycles to 6 megacycles
with accuracy of 3% to 3 mc; 5% above
with input impedance 7.5 mmfds shunted by 11 megs

When used without probe, sensitivity is increased to 100 MICRO-VOLTS but impedance is reduced to 25 mmfds and 1 megohm

Featuring customary Ballantine

SENSITIVITY — ACCURACY — STABILITY

- Same accuracy at ALL points on a logarithmic voltage scale and uniform DB scale.
- Only ONE voltage scale to read with decade range switching.
- No "turnover" discrepancy on unsymmetrical waves.
- Easy-to-use probe with self-holding connector tip and unique supporting clamp.
- Low impedance ground return provided by supporting clamp.
- Stabilized by generous use of negative feedback.
- Can be used as 60 DB high fidelity video pre-amplifier.

Write for catalog for more information about this and other BALLANTINE voltmeters, amplifiers, and accessories.

BALLANTINE LABORATORIES, INC.

100 FANNY ROAD, BOONTON, NEW JERSEY



sensitivity and in the second stage because of its low magnetizing current. While the second stage would be smaller with Deltamax cores, the minimum current could not be reduced below 2 ma, which is sufficient to engage the clutch.

Table I—Specifications for Magnetic Amplifier Components

First Stage Reactor

Core—Arnold Eng. 5340 S2
Power winding—500 turns, No. 40 wire
Displacement-error winding—90 turns, No. 40 wire
Rate-error winding—180 turns, No. 40 wire
Displacement-feedback winding—180 turns, No. 40 wire
Bias winding—150 turns, No. 36 wire

Second Stage Reactor

Core—Arnold Eng. 5387 S2
Power winding—6,000 turns, No. 38 wire
Control winding—350 turns, No. 38 wire
Bias winding—150 turns, No. 38 wire

When designing magnetic amplifiers on Supermalloy cores, rectifier leakage current is more critical than usual because of the narrow hysteresis loop exhibited by this material. It follows that the rectifier leakage must be maintained at a

Analog Computers Simulate Engines



Eight analog computers simulate the four 3,500-hp aircraft engines of the C-124A Douglas Globemaster. Electronic equipment shown is a simulator used by the Electronics Division of Curtiss-Wright Corp.

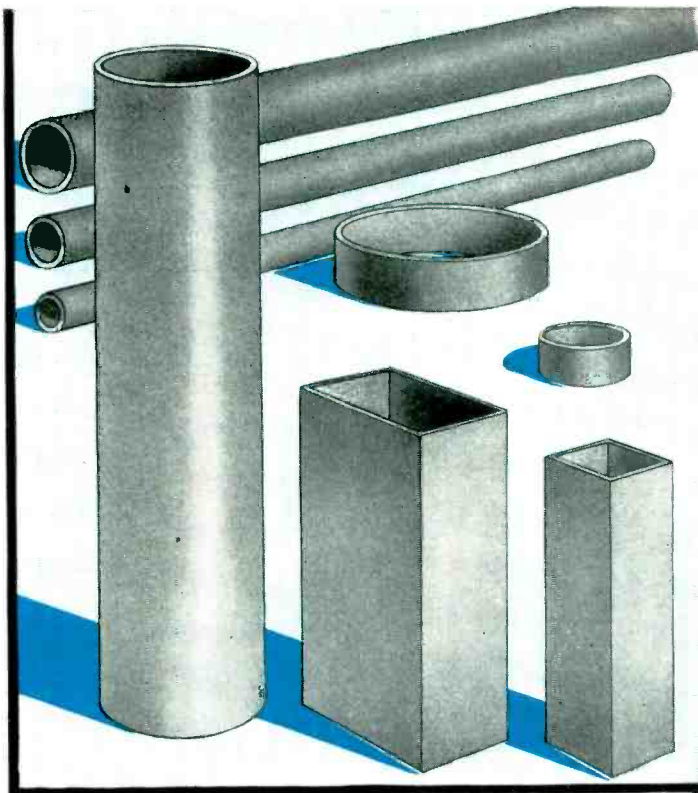

CLEVELITE* LAMINATED PHENOLIC TUBING

Moisture Resistant
Mechanically Strong
High Dielectric Strength
Dimensional Stability
Low Loss Factor

PROVEN
IN HUNDREDS OF CRITICAL
APPLICATIONS EVERY DAY

QUALITY
TO MEET UNLIMITED NEW APPLICATIONS

USE CLEVELITE
to make a good product better
... and at lower costs!

★ ★ ★
FOR INTERNALLY THREADED AND
EMBOSSED TUBING SPECIFY AND
USE . . .

TORKRITE

It eliminates those torque and stripping
problems.

Electronic Engineers find that this newly
designed and constructed Coil Form has
definite advantages over all other types
requiring the use of threaded cores.

Available in lengths 3/4" to 3 1/8" and to
fit core sizes of 8/32, 10/32, 1/4-28
and 5/16-24.

*Reg. U. S. Pat. Off.

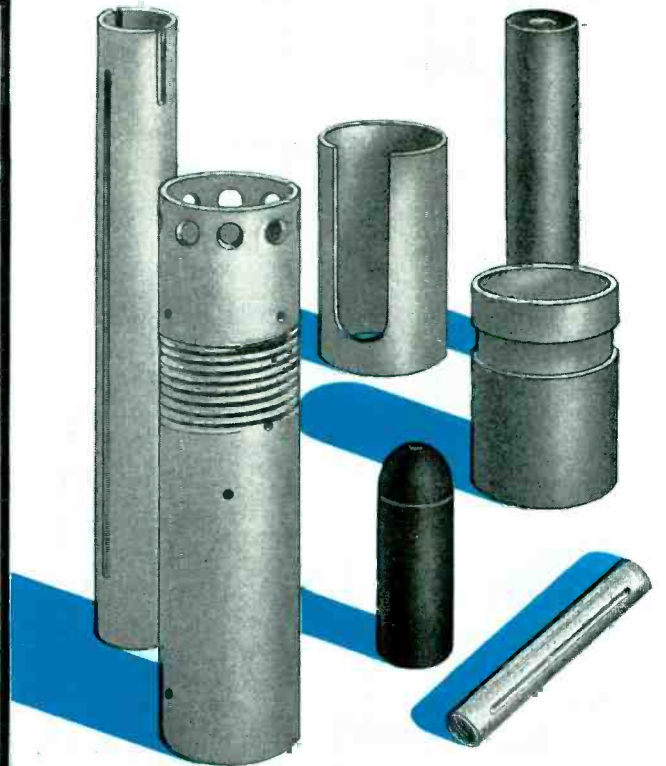

Why Pay More?
For Good Quality
... call CLEVELAND!

THE CLEVELAND CONTAINER

6201 BARBERTON AVE.

COMPANY
CLEVELAND 2, OHIO

PLANTS AND SALES OFFICES:

CHICAGO • DETROIT • MEMPHIS • PLYMOUTH, WIS. • OGDENSBURG, N.Y. • JAMESBURG, N.J. • LOS ANGELES

ABRASIVE DIVISION of CLEVELAND, OHIO

Cleveland Container Canada, Ltd., Prescott and Toronto, Ont.

Representatives:

NEW YORK AREA: R. T. MURRAY, 604 CENTRAL AVE., EAST ORANGE, N. J.
NEW ENGLAND: R. S. PETTIGREW & CO., 62 LA SALLE RD., WEST HARTFORD, CONN.
CHICAGO AREA: PLASTIC TUBING SALES, 5215 N. RAVENSWOOD AVE., CHICAGO
WEST COAST: IRV. M. COCHRANE CO., 408 S. ALVARADO ST., LOS ANGELES

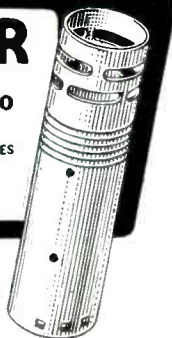

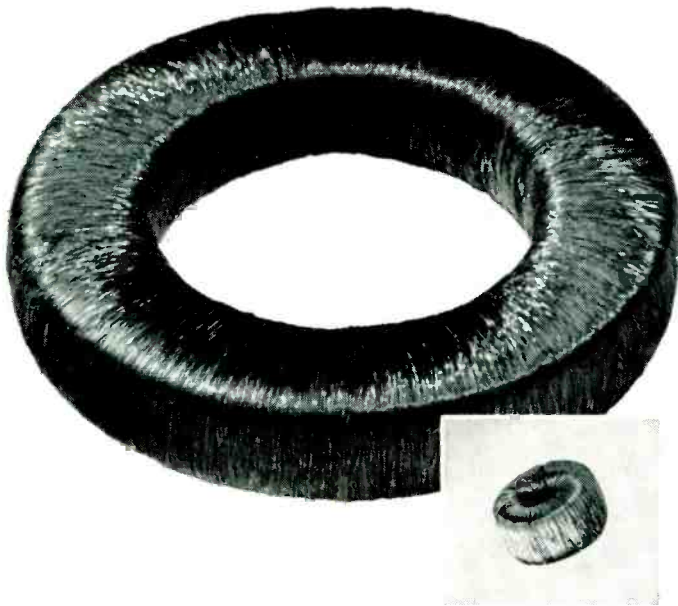

How Big is a Toroid?

As large or as small
as your needs require . . .

if your source is B&W.

Barker & Williamson can
provide precision toroidal
coils wound on a production
line basis from doughnut
size to aspirin size.

A sure cure for production
and miniaturization
headaches.

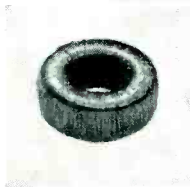

B&W

Barker & Williamson, Inc.
237 Fairfield Ave., Upper Darby, Pa.

low value over a wide range of temperature. With this in mind, fused-junction silicon diodes are used in the first stage and high-quality cartridge-type selenium rectifiers are used in the output stage.

This unit was developed with the aid of the Telesynd Research Section, Wire Communications Branch, Coles Signal Laboratory.

BIBLIOGRAPHY

Minneapolis-Honeywell Aero Document U-ED9006, "The Mechanization of Automatic Flight Stabilization Systems."

G. F. Schoreders, "What Magnetic Amplifiers Can Do To Increase Aircraft Reliability" Ford Instrument Co.

Mobile Power Supply for 6 and 12 Volts

BY KENNETH BACKMAN
Senior Development Engineer
Motorola, Inc.
Chicago, Ill.

ADVENT of 12-volt batteries for vehicles resulted in a challenging problem to the mobile communications equipment manufacturers.

Because of the long-life of two-way equipment, a unit capable of operation from 6 and 12 volts interchangeably was desirable. The 12-to-6 volt converter developed for the purpose may be described as a d-c version of an autotransformer.

The transformer used is a 6-volt center-tapped unit with a 1-to-1 turns ratio. Assume that the vibrator reed in Fig. 1 is in motion and is in the upper position engaging contacts *A* and *B*. The instantaneous current flow will be from the battery through the upper half of the primary winding through contacts *A* and *B*, which are connected by the reed, through the upper half of the secondary to ground. Since the two winding halves are of equal turns and are connected as an autotransformer, the reed will be at one-half the input potential or 6 volts, as long as the flux is changing in the core. When the reed moves to the opposite side, shorting *C* and *D*, a flux reversal will take place and currents will flow through the other halves of the transformer but the reed will still be at a positive 6-volt potential. The reed, therefore becomes a source of pulsating d-c voltage

RADIO RECEPTOR

selenium rectifiers used in induction furnace controls

*"Pouring molten metal calls
for reliable controls with
reliable components"*

says AJAX ELECTROTHERMIC
CORPORATION

It's built-in dependability and flexibility of control that keeps all those AJAX-NORTHROP induction furnaces operating constantly at full rated capacity — and AJAX insures that dependability by using "Really Reliable" RRco. rectifiers.

For example, the control panel illustrated includes five industrial type units which "go in and stay in" as part of a strong team. AJAX, a Radio Receptor customer for many years, knows from long experience that it can rely on RRco. rectifiers.

The Radio Receptor line is a comprehensive one and our engineers are semiconductor specialists. May we study your specs *now* without obligation and offer recommendations not only on rectifiers, but on transistors and other germanium and silicon products. See our rectifier catalog in Sweet's Product Design File and write us for our latest bulletin E-8.

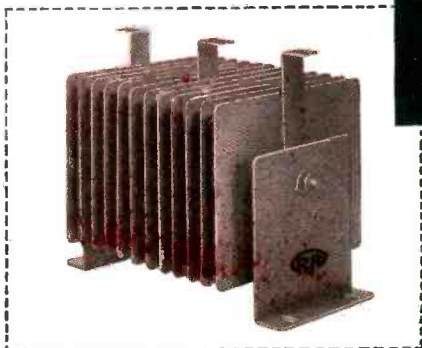
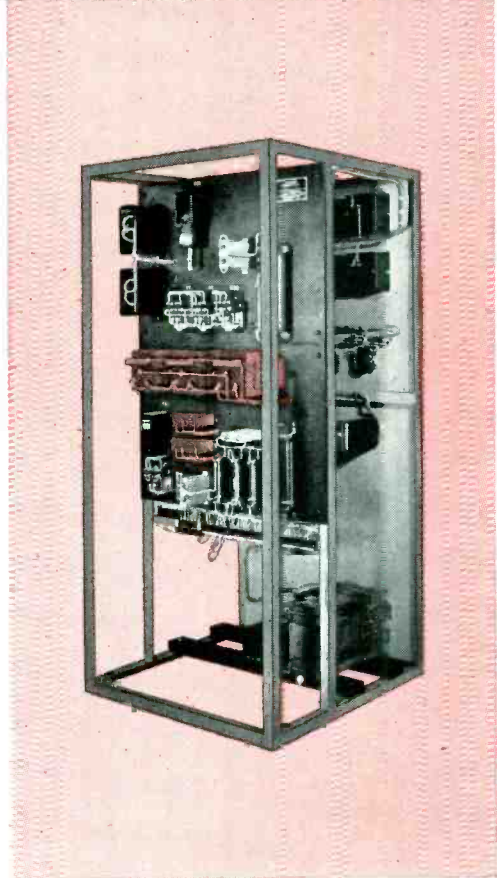
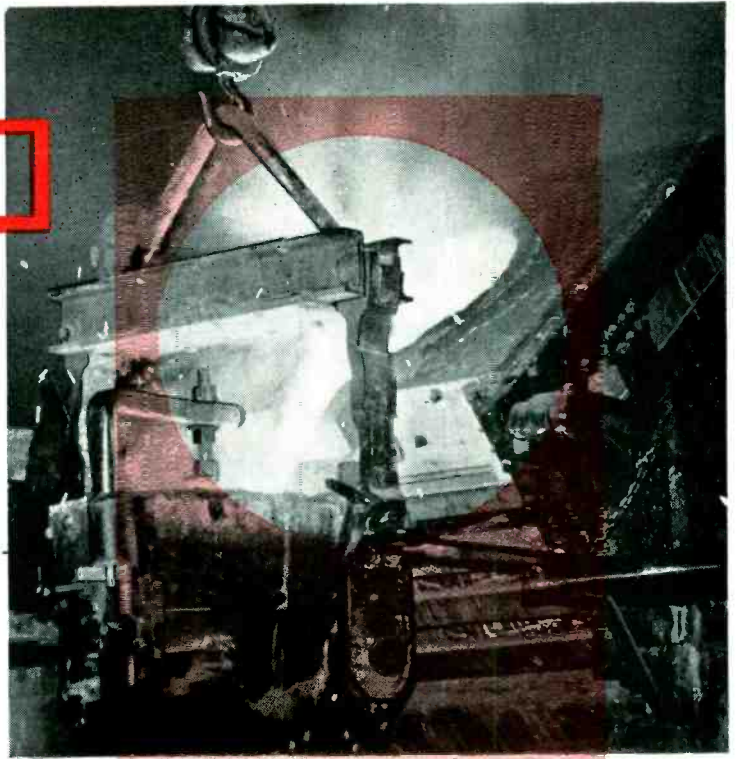

Semiconductor Division

RADIO RECEPTOR COMPANY, INC.

In Radio and Electronics Since 1922

SALES OFFICES: 251 WEST 19TH STREET, NEW YORK 11, N. Y.

Telephone: WAtkins 4-3633 • Factories in Brooklyn, N. Y.

TRANSISTORS • GERMANIUM & SILICON DIODES • SELENIUM RECTIFIERS • THERMATRON INDUSTRIAL ELECTRONIC HEAT SEALING GENERATORS & PRESSES • RADAR, NAVIGATION & COMMUNICATIONS EQUIPMENT

DO YOU USE Current Regulator Tubes?

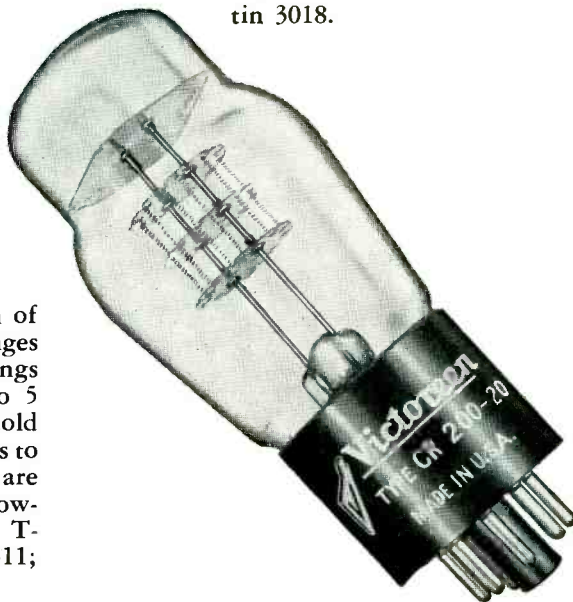
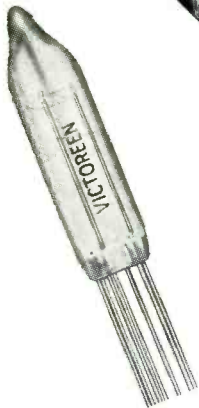
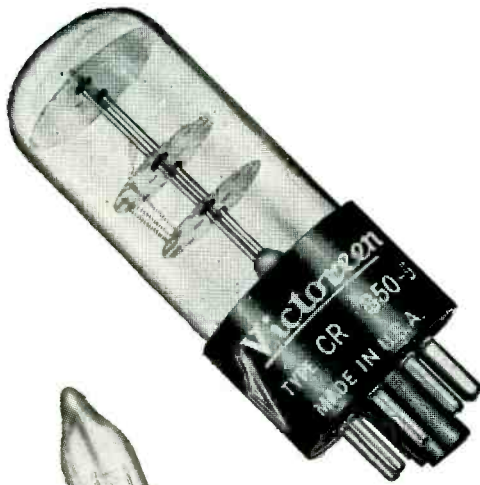

Victoreen production of current regulators ranges over hundreds of ratings from 0.15 ampere to 5 amperes, with threshold voltages from 1.5 volts to 35 volts. These units are produced in the following tube sizes: T-3; T-5½; T-6½; T-9; T-11; ST-12; ST-14; ST-16.

Our engineering staff is available to assist you.



The Victoreen Instrument Co.

COMPONENTS DIVISION: 3810 Perkins Ave., Cleveland 14, Ohio

Victoreen can supply current regulator tubes in a wide range of values to meet the exact requirements of your application. The exceptionally fine regulation of current and wide latitude between the threshold voltage and maximum voltage, is an indication of their remarkable performance. If you use current regulators, write for Bulletin 3018.

that is then filtered in a conventional pi-section filter. Again, as in a 2-to-1 ratio autotransformer, the primary and secondary will each supply one-half the current to the load through the respective contacts, thereby permitting greater current-handling capabilities.

Once the vibrator is in motion, the driving coil is operating between a 6 and 12 volt potential or actually across 6 volts and therefore a standard 6-volt vibrator is used. When the unit is first turned on, the vibrator reed is essentially at ground potential and there will be 12 volts across the driving coil but this will only be of a 0.01 to 0.02 second duration until the reed engages the main power contacts and will not harm the vibrator. The vibrator used is a heavy-duty tandem type that has four opposing sets of contacts and the load current is therefore divided equally across all four sets.

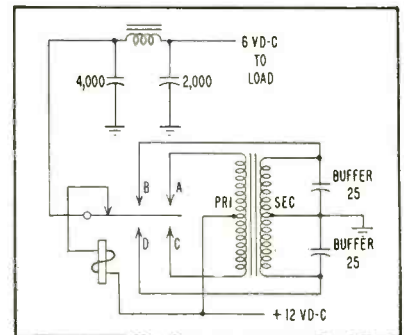

FIG. 1—Basic circuit of 12-to-6 volt converter

The next problem was that of developing a complete mobile system that would operate from either a 6 or 12 volt source. It did not appear too difficult to produce a unit to work off both voltages by changing taps on the transformers and rearranging jumpers, but there would always be the danger of plugging into an incorrect voltage, resulting in serious damage to the radio. For this and other reasons, it was desirable to have a unit which would work interchangeably from either voltage without making any such modifications.

With this goal in mind, a split-reed vibrator was developed that has two independent interrupters within a single envelope, driven by a common driving coil to give a



Call
**WESTERN
GEAR**

**...your best source for
high precision gears,
miniature motors**
*plus complete engineering
service to insure
correct application*

HIGH PRECISION GEARS and precision fine pitch gearing available from 200 to 6 diametral pitch and dimensions from .125" to 10" in diameter for electronic application.

MINIATURE MOTORS, more than 50 basic types available including axial and centrifugal blower designs to cover any type of equipment adaptation. Designs range from .001 to 2 HP and from 50 to 1,000 cycles in frequency, any desired voltage.

Feel free to call on Western Gear's 67 years experience in the manufacture of gears and special machinery. Write for further information or detail your requirements so that we may submit quotation. Address Executive Offices, Western Gear, P.O. Box 182, Lynwood, California.

*"The difference is reliability" * Since 1888*

5460

WESTERN GEAR 

PACIFIC-WESTERN PRODUCTS | POWER TRANSMISSION GEARS • MACHINERY •

PLANTS AT LYNWOOD, PASADENA, BELMONT SAN FRANCISCO (CALIF.), SEATTLE AND HOUSTON... REPRESENTATIVES IN PRINCIPAL CITIES

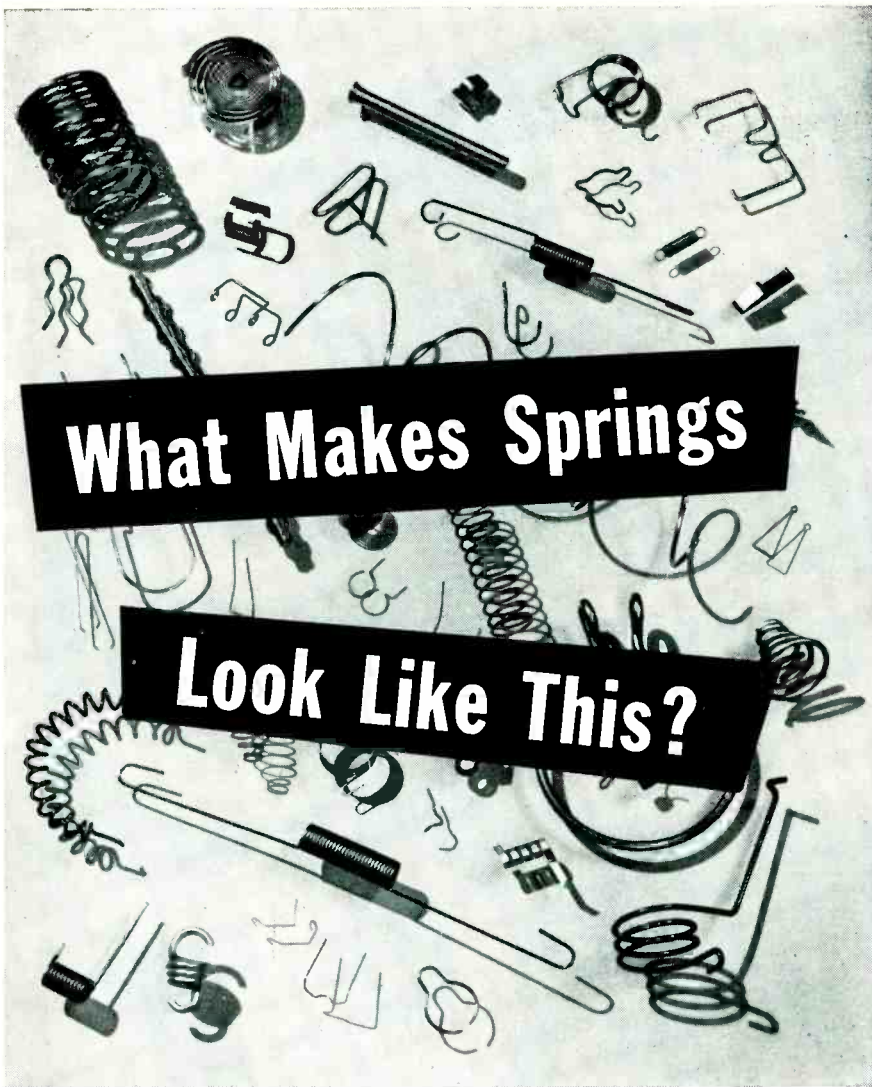

● Springs and wireforms take on some pretty queer shapes at times. They're designed that way to do unusual jobs. However, many springs are unnecessarily complex in design—they may do the job, but they cost too much. Here's a good suggestion:

When you have an unusual or "tricky" spring application let Lewis Engineers work with you. They have a wealth of experience to offer in helping you find the simplest, lowest cost answer to your spring problem.

Lewis engineering experience is just one of the many "extras" you get when you make Lewis your source for springs. Whether it's help in spring design, packaging springs for efficient assembly line handling, or simply a case of getting top quality springs at competitive prices—call on Lewis . . . springs and wireforms are our business.

LEWIS SPRING & MANUFACTURING COMPANY
2656 W. North Avenue, Chicago 47, Illinois

Lewis  **PRECISION SPRINGS**

The finest light springs and wireforms of every type and material

completely interchangeable 6-12 volt set.

The basic circuit of the new 6-12 volt unit, shown in Fig. 2, consists of a power transformer with two separate 6-volt vibrator primary windings. Each winding has its own independent reed, but the two reeds are ganged together to operate in synchronism. This arrangement permits operating the windings either in series or in parallel as required. The proper connections are determined in the primary power plug.

Assume that the vibrator reed is in the upper position. With a 6-volt primary source as shown, the input currents will be in the directions indicated by the solid arrows. Separate currents will be fed from

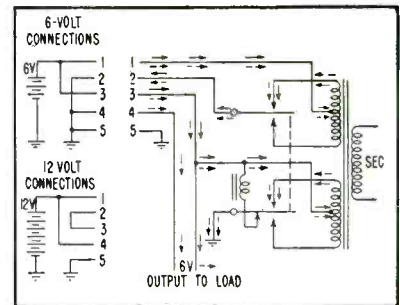

FIG. 2—In final model of converter connection to wrong voltage is avoided by wiring of power plugs

the battery to the two primary windings, but each will be in phase, aiding. The same action will take place when the reed is in the lower position, but the currents will be through the lower halves of the windings in the reverse direction.

The filaments, relays and other 6-volt elements are connected in a series-parallel, 6-12 volt arrangement with a common bus in the center. When operating from 6 volts, the two outer buses are grounded and the center bus is fed directly from the battery. The lower bus is permanently grounded but the top bus is grounded in the power plug.

When a 12-volt cable is connected to the systems, the upper and lower primary windings are placed in series by the jumper across pins 2 and 3 in the power plug. If the reed is again in the upper position, the primary current will now be in the direction indicated by the dashed arrows. The current is still,

Solve your problems quickly
and economically with —

STANDARD SIZE
**ANTENNA
CORES**

— by
**GENERAL
CERAMICS**

Standardized Parts...

Specifying General Ceramics standard antenna rods assures maximum economy, greater uniformity of quality and faster deliveries. These new components of Ferramic "Q" are available in five standard lengths in both rods and plates.

Ferramic "Q" offers...

Complete stability in respect to age, shock, vibration and temperature. Additional advantages are higher Q and lower losses at all frequencies up to 30 megacycles. Basic toroidal and typical antenna rod measurements are shown below. Call, write or wire for prices, today!

BASIC TOROIDAL MEASUREMENTS

Initial Permeability μ_0 (1Mc)	125
Figure of Merit Q (1Mc)	400
Loss Factor $\frac{1}{\mu_0 Q}$ (1Mc)	.000020
$\mu_0 Q$ (5Mc)	.000050
(10Mc)	.000130
(20Mc)	.000500
μ_0 vs Frequency Characteristics	Good to over 30 Mc
Q vs Frequency Characteristics	Good to over 30 Mc
Curie Temperature (°C)	350
Temp. Coeff. of μ_0 (1Mc) %/°C (25°C to 70°C)	+0.10 max.
Temp. Coeff. of Q (Same units as above)	-0.75
Saturation Flux Density	
Bs (gauss) at Hdc = 25 oersteds	3300
Max. Permeability μ max	400
Coercive Force H (oersteds)	2.10
Residual Magnetism Br	1800

	F-125 DIA. ROD .250" ± .015"*	F-214 DIA. ROD .330" ± .020"*	F-429 WIDTH .725" ± .025" THICKNESS .125" + .030" - .000"
LENGTH	PART NO.	PART NO.	PART NO.
7.520 ± 7/32	1	6	11
6.250 ± 3/16	2	7	12
5.300 ± 5/32	3	8	13
4.625 ± 1/8	4	9	14
4.100 ± 1/8	5	10	15

*Camber .011 per inch

TYPICAL ANTENNA ROD MEASUREMENTS

FREQUENCY	Q	C = mmf.
0.6	310	360
0.8	331	200
1.0	325	126
1.2	325	85
1.4	310	63

TEMPERATURE COEFFICIENTS

Antenna Rod No. F-214 (.330 x 7.520"). Standard Test Coil—Space wound solenoid 85 turns #26 AWG. Formex copper, occupying approx. 90% of length of rod and centered on rod. (Resonates at 1 Mc. with 126 mmf.)

$$TC = \frac{\% \Delta \mu_0}{\mu_0} (25^\circ \text{ to } 75^\circ \text{C})$$

Temp. Coeff. of Rod. +1.0 to +2.0
Temp. Coeff. of Coil only = 0



General CERAMICS CORPORATION
TELEPHONE: VALLEY 6-5100
GENERAL OFFICES and PLANT: KEASBEY, NEW JERSEY

MAKERS OF STEATITE, ALUMINA, ZIRCON, PORCELAIN, SOLDERSEAL TERMINALS, LIGHT DUTY REFRACTORIES, CHEMICAL STONWARE, IMPERVIOUS GRAPHITE, FERRAMIC MAGNETIC CORES

WANT TO CUT INSPECTION COSTS ELIMINATE CIRCUIT DEFECTS



Automatic quality control with the **CTI Supertester**

Here is the answer to the problem of maintaining high standards of inspection and reliability with the ever-increasing complexity of modern equipment.

The CTI Supertester is an automatic precision instrument for production testing, fault analysis, and preventive maintenance. It checks electronic and electrical products more completely and in a fraction of the time required by present methods.

Profit three ways by reduced labor costs, higher efficiency, and improved customer relations.

Here are a few widely varied applications. Others will suggest themselves immediately. Completely automatic checking for:

electronic and electrical assemblies
aircraft-engine nacelles
equipment in routine maintenance
guided missile pre-flight tests
computers
cable harnesses

The CTI Supertester automatically programs any combination or sequence of these measurements:

Impedance
Resistance
A-C Voltage
D-C Voltage
Leakage
Continuity

COLOR TELEVISION INCORPORATED



SAN CARLOS 1, CALIF.

however, in the same direction through each winding, that is, in phase, aiding.

Also, since the 12-volt input is divided equally across halves of both the upper and lower windings, each half will still be operating from 6 volts and the same number of ampere-turns will exist, producing the same secondary voltage. The 12-volt input is also connected to the top bus of the filament and relay arrangement supplying power to all the 6-volt elements. The center bus is connected to the center junction of the two transformer primary windings.

This connection offers an advantage. With the windings connected in series, the unit acts as an autotransformer in much the same manner as the 12-to-6 volt converter, producing 6 volts at this junction. It is therefore not necessary to have a balance between the 6 and 12 volt sides of the filament arrangement. Any unbalance will be supplied by the autotransformer action of the primary windings. This means that power wasting voltage dropping resistors are no longer needed in series with the odd

Tradic Computer Uses Transistors



Miniature electronic brain in the form of a digital computer has been developed by Bell Labs particularly for aircraft flying at supersonic speeds. It uses transistors to cut electric current drain and generates practically no heat. Preproduction memory package shown above is plugged into computer that employs nearly 800 transistors. The name Tradic evolves from transistor digital computer

cppe OFFERS HIGH QUALITY SYNCHROS Consistently!

By Customer's Testing—
REJECTION RATE .00095



ACTUAL SIZE

Out of 9000 synchros recently supplied a customer for a single job, the rejection rate by his testing of some 20 characteristics was .095% on each test. Nearly $\frac{3}{4}$ of the rejections were on minute differences of calibration measurements.

According to the customer, "this is far below rejection rates of 20% and 30% which we have experienced with regard to other sources of supply for like items."

A second customer reports that he has found CPCC synchros to have the next to the lowest rejection rate out of 500 suppliers. The only vendor having a lower rejection rate was a resistor manufacturer. (Names of both customers available on request.)

It costs no more to have the best! For highest consistent quality and accuracy, specify CPCC.

For full engineering information on size 10, 11, 15 and 22 synchros of virtually every type and available for 3 weeks or less delivery, write or phone, T. W. Shoop, Sales Mgr. Phone (Suburban Phila.) MADison 6-2101.

West Coast Rep Wm. J. Enright, 988 Kensington Rd., Los Angeles. MUtual 6573

Direct Export Sales inquiries to: Andrew S. Szucs, Inc., 50 Broad St., New York 4, N.Y.

LOOK TO CPCC FOR **cppe** SYNCHRO PROGRESS
CLIFTON PRECISION PRODUCTS COMPANY, INC.
CLIFTON HEIGHTS PENNSYLVANIA

for your most
demanding
tests . . .

today's
most versatile
recording system

Combine* Consolidated's Type 5-119 Recording Oscillograph with the Consolidated Amplifier System D, and you have an analog data-recording system usable on over 90% of all static-dynamic tests. As a compatible team of instruments, the 5-119 and System D can go anywhere (it's an ideal flight-test

system), can record over a surprising range. And both instruments offer operating features and conveniences that make the combination truly today's most advanced analog instrumentation system. And every instrument is backed by Consolidated's nation-wide engineering and service organization.

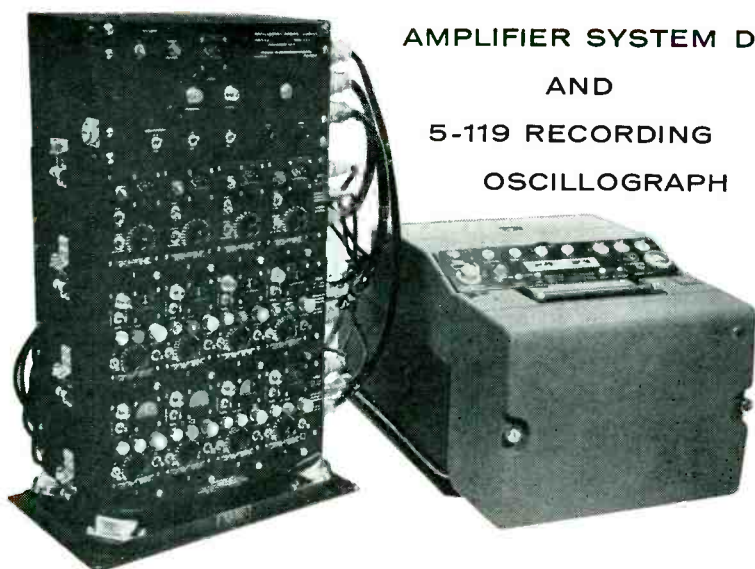

AMPLIFIER SYSTEM D
AND
5-119 RECORDING
OSCILLOGRAPH

AMPLIFIER SYSTEM D . . . usable with both self-generating and modulation-type pickups . . . interchangeable 3-kc carrier and 5-5000 cps linear/integrating plug-in amplifiers . . . capacity up to 12 channels . . . rugged enough for field and flight use. SEND FOR BULLETIN CEC1403D-X7

THE 5-119 RECORDING OSCILLOGRAPH . . . 36 or 50 channels . . . 12"x250-ft records at speeds from 0.1 to 100 inches per second . . . 10:1 instant speed change by simple switch control . . . unique warning and safety devices to insure against loss of vital test data. SEND FOR BULLETIN CEC1536A-X7

*Or use them separately . . . either the 5-119 or System D may be combined with other recording and amplifying instruments. Write to us or talk to a CEC Field Engineer about your requirements.

Consolidated Engineering Corporation

ELECTRONIC INSTRUMENTS FOR MEASUREMENT AND CONTROL

300 North Sierra Madre Villa, Pasadena 15, California

Sales and Service Offices Located in: Albuquerque, Atlanta, Buffalo, Chicago, Dallas, Detroit, New York, Pasadena, Philadelphia, Seattle, Washington, D. C.

tubes and relays. Note also that the vibrator driving coil is connected between this junction and ground. Since this bus is always at 6 volts, it is possible to use a 6-volt vibrator for either 6 or 12-volt operation.

The two vibrator halves share the heavier current load on 6 volts while on 12 volts, which is more difficult to commutate because of arcing, the contacts form a double-break circuit.

Magnetic Frequency Multiplier for Fluorescent Lighting

By E. G. DOWNIE

General Electric Co.
Fort Wayne, Ind.

PRACTICAL OPERATION of fluorescent lamps at frequencies higher than 60 cps requires a dependable source of power. Rotating frequency converters or motor-generator sets may be used, but they bring up maintenance problems not encountered in the usual building power distribution systems. Conversion of standard 60-cycle power to 360 cycles at a suitable voltage level and with preferred waveshape, by means of a static device presenting no more installation and maintenance problems than a distribution transformer is desirable.

The magnetic frequency multiplier is such a device. Using magnetic, metallic rectifier and capacitor components, the multiplier converts 480-volts, 60-cps 3-phase power to 700 volts, 360 cps, single phase, with automatic current limit and wide range of current control. The multiplier's square or flat-topped wave of current into a lamp load is equivalent in lamp performance to a 7,000 cycle sine wave.

The diagram shows the basic circuit used in the multiplier. There are three elements: the frequency tripler stage (60 to 180 cps), the frequency doubler stage (180 to 360 cps), and the current limiting and controlling stage.

The tripler stage is made up of six saturating transformers, a center-tapped choke and selenium rectifiers to supply saturating direct current. The transformers are



Photo courtesy of Associated Spring Corp.

Need a spring for service above 500° F.?

When it is a question of strength and resistance to fatigue and relaxation under corrosive conditions —

Particularly when temperatures range over 500° F. and other materials do not perform satisfactorily —

That is the time to see how INCO Nickel Alloys may solve the problem for you.

Inconel and Duranickel, for example, are widely used for springs that must resist relaxation at stresses up to 70,000 psi and temperatures up to 650° F.

Inconel "X" goes even further. It maintains 90 per cent of its room-temperature mechanical properties up to 900° F., 80 per cent up to 1100° F. Combines excellent resistance to heat, corrosion, and *relaxation* at stresses up to 100,000 psi. (Maximum recommended design stress,

corrected, decreases as heat exceeds 700° F.)

Other Inco Nickel Alloys—Monel, "K" Monel, Perma-nickel® — help solve special spring problems. Perma-nickel, for example, combines good electrical conductivity with excellent heat and fatigue resistance.

Why don't you let Inco engineers help you find the right spring for severe service.



Nickel Alloys

MONEL® • "R"® MONEL • "K"® MONEL • "KR"® MONEL
 "S"® MONEL • INCONEL® • INCONEL "X"®
 INCONEL "W"® • INCOLOY® • NIMONIC® Alloys
 NICKEL • LOW CARBON NICKEL • DURANICKEL®

THE INTERNATIONAL NICKEL COMPANY, INC.

Technical Service Section,
 Development and Research Division,
 67 Wall Street, New York 5, N. Y.

E-5-55

Please send me information on:

1. Springs for use at _____° F.
2. Names of manufacturers of Inco Nickel Alloy springs.

Name _____ Title _____

Company _____

Company Address _____

Product _____

a $\frac{1}{4}$ turn for the better...

CAMLOC

Quick, easy access to interiors of cabinets is a problem many manufacturers are solving with Camloc quarter-turn fasteners. Camloc fasteners not only speed up maintenance and service, but also speed up production line fabrication... because they're easy to install, permit greater tolerances between sheets, and support heavy loads without binding. The finished job will withstand severe shock and vibration since Camloc fasteners cannot spring loose... and products look neater, have greater customer appeal!

QUARTER-TURN FASTENERS

- save production time
- simplify installation
- ease maintenance
- add product appeal

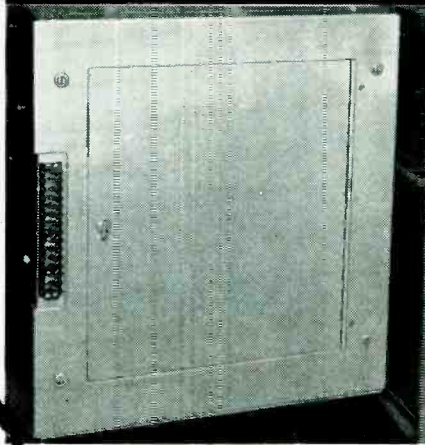

Camloc quarter-turn fasteners with wing heads secure access doors on Du Mont Multi-Scanner TV equipment, while four slotted-head quarter-turn fasteners hold face plate to frame. These two types of Camloc fasteners are also used on Du Mont high power TV transmitters. Thanks to Camloc fasteners, all vital components are quickly accessible for adjustment and servicing.

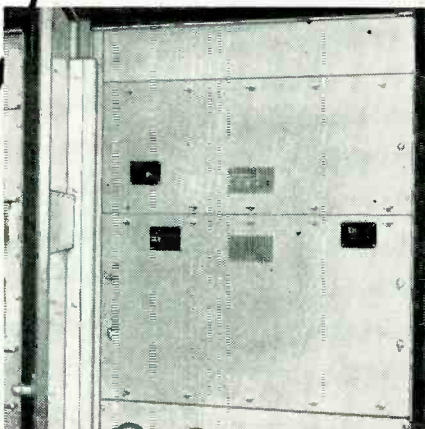
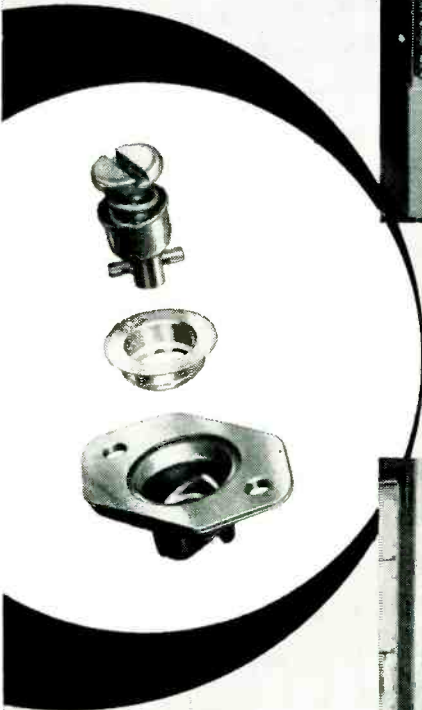

CAMLOC

FASTENER CORPORATION

75 Spring Valley Road, Paramus, N. J.

WEST COAST OFFICE: 5410 WILSHIRE BLVD., LOS ANGELES, CALIF.

not saturated by the a-c applied voltage, but are saturated by the secondary d-c, which is many times the normal a-c magnetizing current. One core is always saturated, and the voltage at points A and B becomes successively that of the three lines. The output voltage, which is half the sum of the six secondary voltages, is a 180-cps voltage of reasonably good wave-shape. A bank of capacitors at the output of the tripler stage corrects for the highly inductive loading of the following doubler stage.

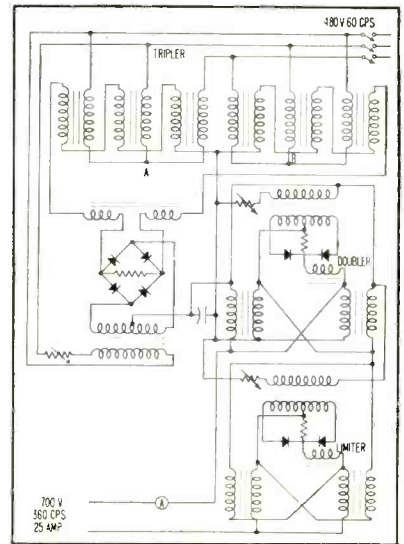

Magnetic multiplier gives 700-v, 360-cps output from 480-v 60-cps input

The second, or doubler stage uses two saturating transformers, a choke reactor, and a selenium rectifier. Low voltage a-c excitation for the saturating current rectifiers is furnished to all stages by isolating step-down transformers. Operation of the second and third stage saturating circuits from the first stage 180-cps output, rather than from incoming 60-cps power, insures proper starting sequence.

As in the first stage, the transformers are not saturated by the a-c applied voltage, but are saturated by the secondary d-c which is many times greater than needed to bring the excitation over the saturation curve knee. The choke reactor keeps the d-c saturating current essentially free of alternating current components. The secondary or output voltage is equal in magnitude to the 180-cps input voltage, but by effect of the d-c saturation, switches in polarity each half

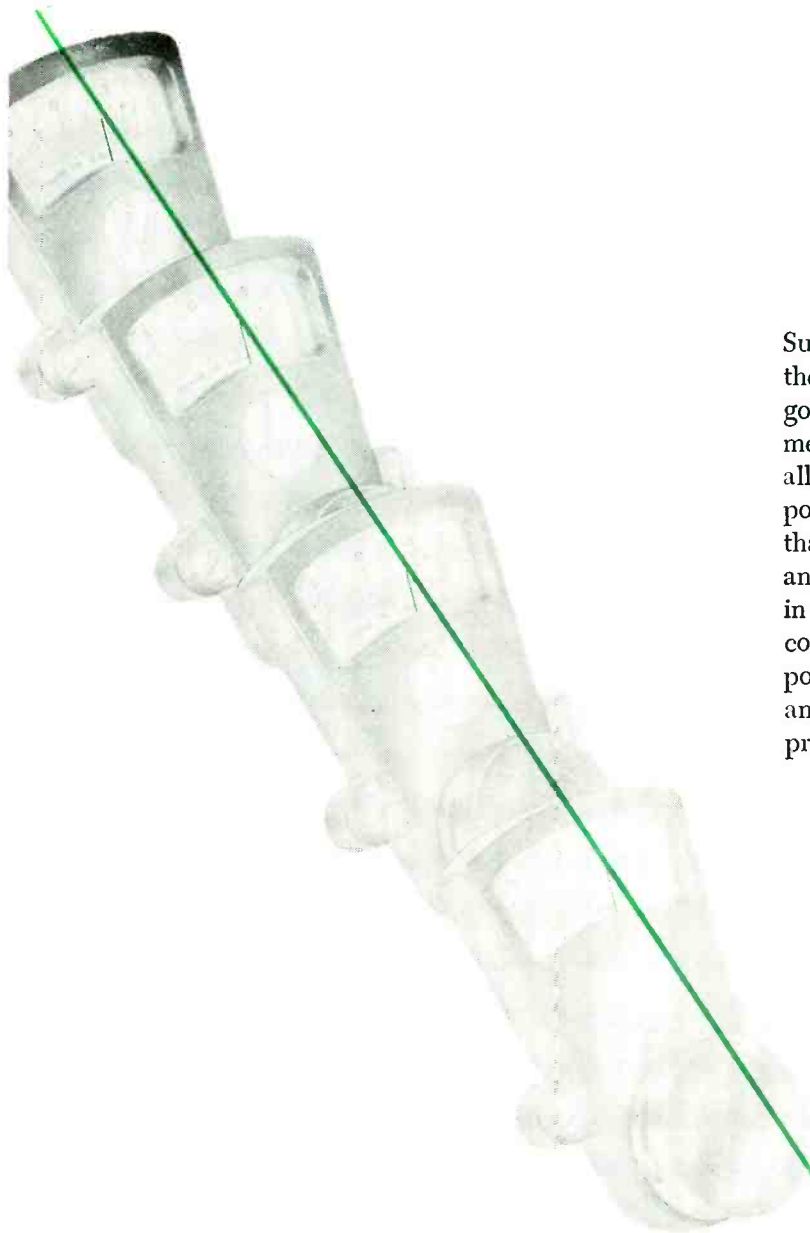

Sustained electrical accuracy throughout the life of a potentiometer is largely governed by the unit's ability to resist mechanical dimensional changes. The all-metal-case construction of Fairchild potentiometers assures mechanical rigidity that maintains superior initial accuracies and tolerances throughout a long life cycle—in spite of severe changes in environmental conditions. This is another advance made possible by Fairchild's continuous research and quality control program on materials, processes and manufacturing.

SUSTAINED ACCURACY

through mechanical rigidity

Now for the first time Fairchild brings you the sustained accuracy of all-metal-case construction in a 10-turn potentiometer. This unit has only $\frac{1}{2}$ the diameter and $\frac{1}{3}$ the weight of usual standards. It is the Fairchild Standard Type 920. Its $24\frac{1}{2}$ " coil length assures linearities of $\pm 0.25\%$ in a resistance range of 1,000 to 200,000 ohms, with $\pm 0.1\%$ available for special applications. Your choice of servo, threaded bushing or three-hole pilot bushing mountings.

This is another example of how Fairchild's complete line can give you the answers, no matter what factors govern your choice of precision potentiometers. Write Fairchild Camera and Instrument Corporation, 225 Park Avenue, Hicksville, L. I., N. Y., Dept. 140-62A1.



FAIRCHILD
PRECISION POTENTIOMETERS

Lapp

ENTRANCE INSULATORS

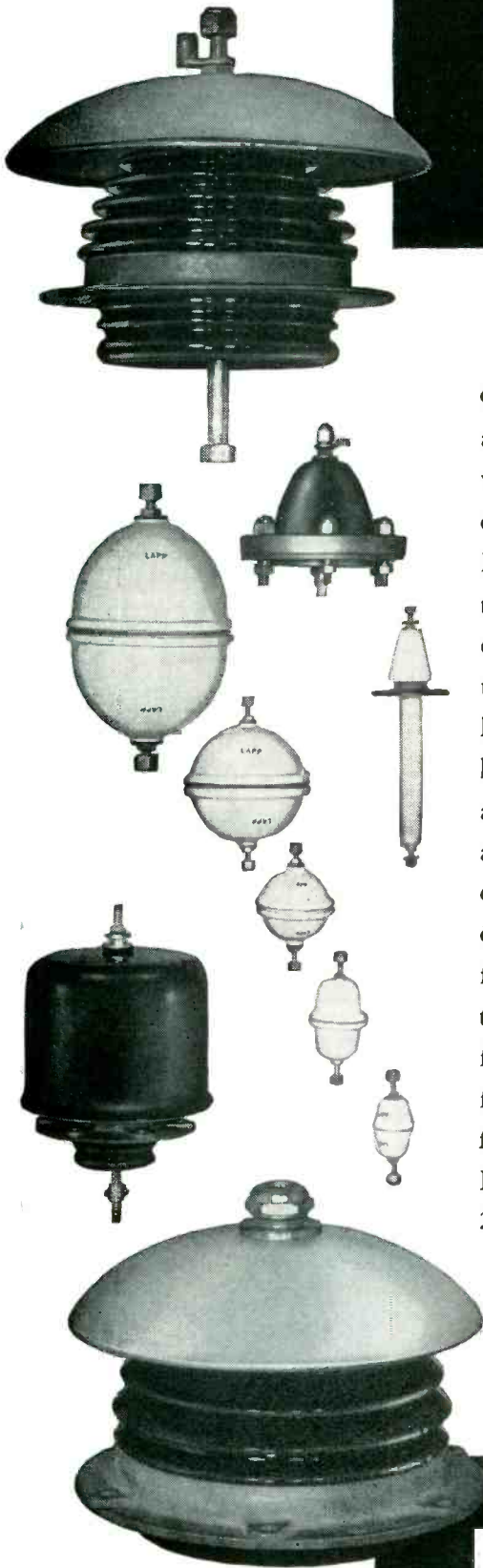

• Lapp has pioneered in design and production of heavy duty wall and deck insulators for radio applications. To eliminate losses which occur in ordinary types of bushings at radio frequency, Lapp designed units to use air as major insulation, lengthening the porcelain path by forming it into a bowl. Now available as "catalog items" are a wide variety of types for most electrical and mechanical requirements. Our experience and facilities are admirably suited, too, to design and production for special applications. Write for descriptive data and specifications. Lapp Insulator Co., Inc., Radio Specialties Division, 237 Sumner St., Le Roy, N. Y.

Lapp

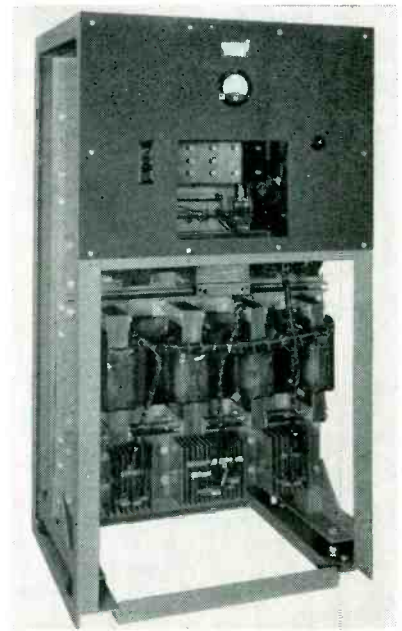

Twenty-five ampere, 700 volt output of frequency multiplier is sufficient to start 96-in. fluorescent tubes without auxiliary equipment

cycle, so that it becomes 360 cycles of peaked waveform.

A final stage is required to provide control and proper waveshape of output current for best operation of a fluorescent lamp load. This stage is a series saturable reactor designed and connected so that the windings carry a-c load current and d-c saturating current simultaneously. When the demagnetizing effect of the a-c load current overcomes the d-c saturation, the reactor windings begin to absorb voltage and prevent greater flow of load current.

Adjustment of the d-c saturating current, by varying the series resistance in the primary of the rectifier supply transformers, thus controls the output current, which has the characteristic flat-topped or square-wave shape of a series-connected saturable reactor with high control-circuit impedance. The components of this limiter stage are very similar to those of the doubler stage except that the saturating transformers have less core area.

Actual performance approximating the theoretical operation depends a great deal on the sharpness of saturation of the various saturating transformers. Manufacture of this device for sale has been made practical by the use of cold

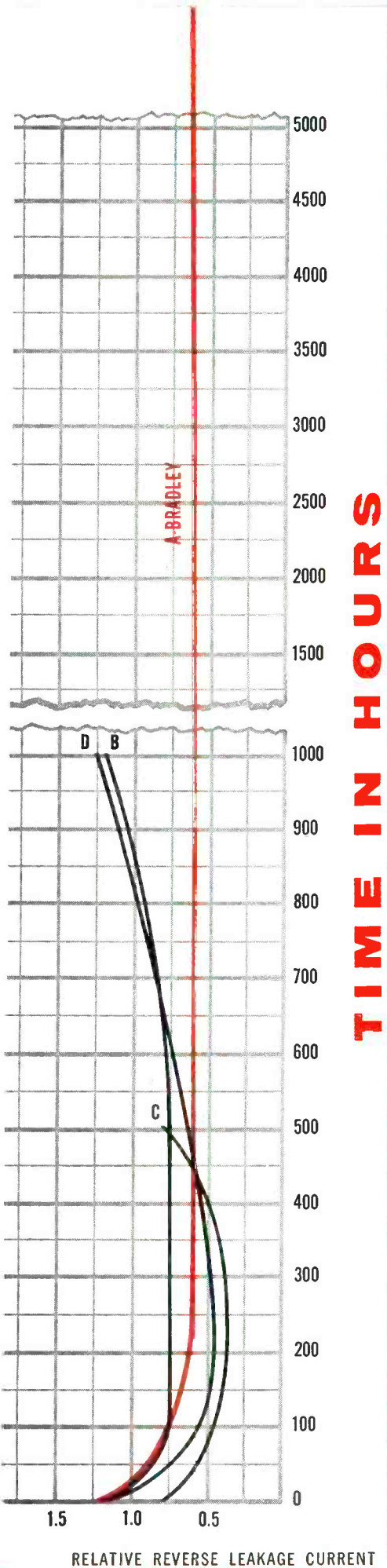

TIME IN HOURS

THE LONGER LIFE TEST PROVES

the greater superiority of



RECTIFIERS

What happens when you test a rectifier? You get an indication of forward and reverse current and power characteristics. But, the ultimate value of a selenium rectifier must be determined as a function of time plotted against electrical characteristics and environmental conditions.

Adequate, long-lasting circuit control should be accomplished in the design stage, not by replacement every few hundred hours.

On extended life tests Bradley vacuum processed selenium rectifiers consistently outperform and outlast similarly rated rectifiers produced by other manufacturers using other processes.

Write for a set of life test curves. They prove the superiority of Bradley Laboratories' vacuum processed selenium rectifiers.

THE BRADLEY METALLIC RECTIFIER MANUAL is today's most comprehensive treatment of selenium and copper oxide rectifiers. Circuitry, applications, testing, construction, design considerations. \$2.00



VACUUM PROCESSED FOR PERFORMANCE AS RATED

BRADLEY LABORATORIES, INC.

168 E. Columbus Avenue, New Haven 11, Connecticut



RELATIVE REVERSE LEAKAGE CURRENT

Life test curves comparing reverse leakage of Bradley vacuum processed selenium rectifiers with units produced by different processes by other manufacturers.

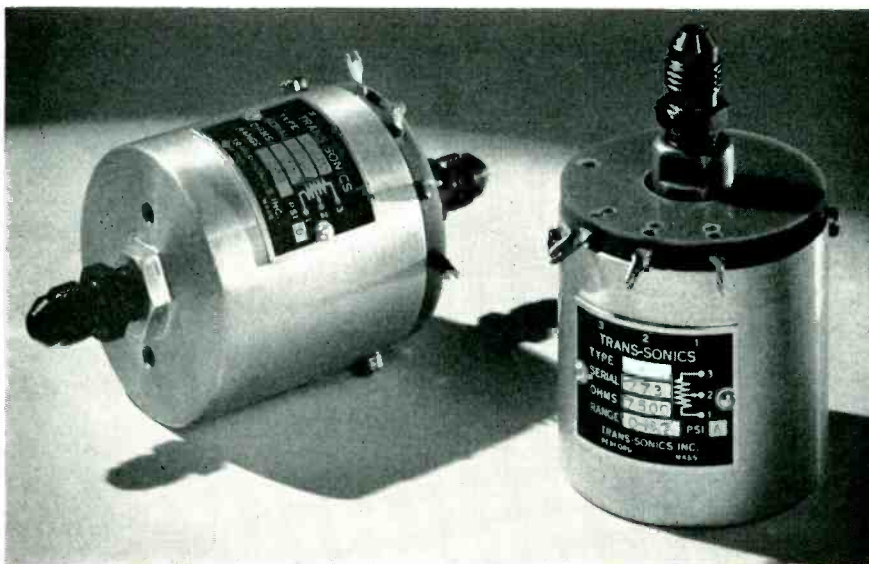

Illustration is approx. two-thirds actual size

PRESSURE TRANSDUCER FOR USE UNDER SEVERE VIBRATION

THE TRANS-SONICS® TYPE 75 PRESSURE-OPERATED POTENTIOMETER will operate satisfactorily while subjected to ± 25 G vibration at any frequency up to 2000 cycles per second.

This is 2½ times the acceleration and 4 times the frequency range of Paragraph 4.7.1, MIL-E-5272A.

No vibration mounts or other trouble causing gadgets are employed to accomplish this. The resistance to shock and vibration is built in the instrument mechanism itself. For further information request technical data on Type 75 BARORESISTORS.

TRANS-SONICS, INC.

5 FOREST STREET, BEDFORD, MASS.

reduced 3-percent silicon steel in core assemblies, which takes advantage of its superior with-grain magnetic quality.

The cores are stacked with U-punchings, which have end sections twice the width of the legs, and with-grain end insert pieces, which provide a constant cross-section with-grain path around the magnetic circuit. The choke reactors are of more conventional E-I construction, but have internal air gaps for minimum noise.

The rated continuous output of the multiplier is 25 amperes at approximately 700 volts, 360 cps in a capacitive ballasted lamp load. The current control permits adjustment of output current between approximately 13 and 30 amperes. The useful range may be limited by characteristics of the attached lamp load and multiplier continuous current rating. The output voltage is enough to start 96-in. cold cathode lamps without auxiliary means.

The efficiency of the multiplier in transforming incoming line watts to actual lamp watts at full load is 72 percent. Additional losses with power-factor correction reduce this to 70 percent. The overall efficiency of light production with the recommended lamps is approximately the same as realized from these lamps controlled by conventional ballasts on 60-cycle power.

Errata

DRAFTING and proof-reading errors appeared in two recent articles in this department. In "Transistor Amplifier Performance" by Cecil E. Williams, p 196, Feb. 1955, the capacitor across R_s in Fig. 2 has a value of $0.5 \mu\text{f}$; voltage gain is incorrectly designated "voltage gain in volts" in both Fig. 3 and Fig. 4 (top). Base current should be in microamperes rather than milli-amperes in the center drawing of Fig. 4.

The caption for Fig. 2 of "Pulse-Series Generator", by N. T. Grisamore and G. U. Uyehara, p 224, Mar. 1955, should describe values in millimicroseconds rather than microseconds.—A. A. MCK.

NEW SIZES AVAILABLE NOW!

STANDARD ROUND CASES

HU-693:
OUTSIDE DIA. 1 5/16"
LENGTH 1 7/16"

HU-703:
OUTSIDE DIA. 1 23/32"
LENGTH 1"

HU-694:
OUTSIDE DIA. 1 49/64"
LENGTH 5 1/4"

HU-695:
OUTSIDE DIA. 2 15/32"
LENGTH 6"

STANDARD RECTANGULAR CASES

HU-714:
DIMEN. A 11/32"
DIMEN. B 17/32"
LENGTH 1 1/8"

HU-690:
DIMEN. A 3/4"
DIMEN. B 1 41/64"
LENGTH 1 1/32"

HU-704:
DIMEN. A 59/64"
DIMEN. B 1 25/64"
LENGTH 1 3/16"

HU-705:
DIMEN. A 29/32"
DIMEN. B 1 15/32"
LENGTH 1 5/16"

HU-720:
DIMEN. A 1 1/32"
DIMEN. B 1 3/16"
LENGTH 2 1/2"

HU-710:
DIMEN. A 2 1/4"
DIMEN. B 3 3/4"
LENGTH 4 1/4"

HU-716:
DIMEN. A 2 5/8"
DIMEN. B 2 57/64"
LENGTH 2 5/8"

HU-701:
DIMEN. A 2 13/16"
DIMEN. B 3 5/16"
LENGTH 4 7/8"

HU-712:
DIMEN. A 3 1/16"
DIMEN. B 3 9/16"
LENGTH 4 7/8"

CLIP THIS PAGE AND
FILE WITH YOUR NEW
HUDSON CATALOG!

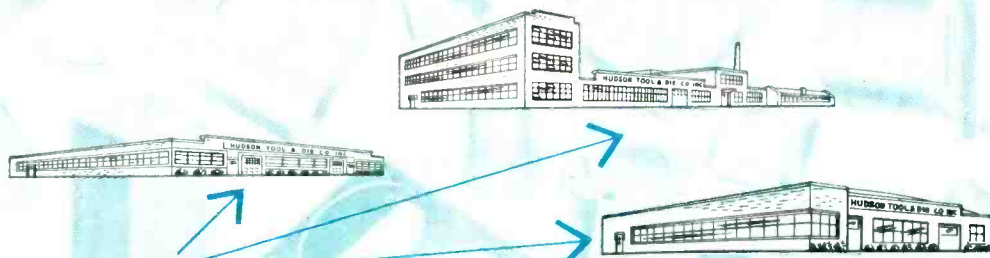

3* FULLY-EQUIPPED PLANTS

Offering the Most
Complete Line of
Precision Drawn
Cases and Covers
in the Industry!

...THREE COMPLETE SERVICES!*

Hudson Standard Metal Closures

Over 1000 economical standard types mean HUDSON can supply precision components at commercial prices. A wide variety of optional features make it possible to solve all but the most unusual closure requirements with standard types selected from HUDSON stocks.

Hudson Quality Metal Stampings

Metal parts produced to your exact specifications at prices that reflect the economies of mass production methods. Hudson can work to close tolerances and maintain uniformity throughout production runs. Quotations supplied promptly on receipt of drawings.

Hudson Sheet Metal Facilities

Depend on HUDSON for expert fabrication of simple or complex sub-assemblies. Facilities include certified welding of alloys, silver soldering, brazing and chrome plating.

NEW
CATALOG
READY,
NOW!



The Hudson story is contained in one handy catalog. Full descriptions of all standard items and complete information on Hudson metal working facilities. Call or write for your copy, now!

Precision Components of
Steel, Aluminum, Copper,
Brass, Mu Metal



HUDSON
TOOL & DIE COMPANY • INC.
118-122 SOUTH 14th ST., NEWARK 7, N. J.

Unitized Production Benches Facilitate Assembly-Line Changes



Seven-bench assembly line using unitized design. Each worker has own fluorescent fixture with two 4-foot lights, storage compartment above fixture and plywood box on floor alongside chair for tote boxes. Utility connections are on ceiling

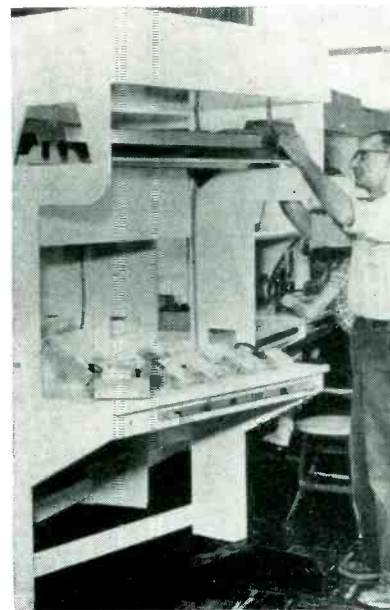

Construction of bench. Two may be placed back-to-back if desired. Fluorescent fixture gives ample illumination

INDIVIDUAL production-line tables designed by engineers of Assembly Products Inc., Chesterland, Ohio are equipped with built-in lights,

electrical plug-mold and air connections. The single-worker tables are easy to move and have simplified utility connections. They are

currently used in assembling panel meters, indicating pyrometers and automatic controls. The universal design facilitates changes.

Wishbone-Shaped Soldering Staples Save Space on Panels

WHEN the Lenkurt Electric Co. of San Carlos, Calif. began producing a new type of miniaturized carrier equipment for the first time, the soldering staples for phenolic boards had to be miniaturized. Insertion of the staples in boards was being done with a machine manufactured by the Acme Staple Co. of Camden, N. J. The standard staples were improperly shaped and much too big for the new subassemblies because after insertion, the staples were shaped like inverted pyramids with wide loops at the top. The staples also took up too much space at the base where they were fastened to the board.

Since no staples were available in the shape or size needed, the problem was solved by a Lenkurt industrial engineer who redesigned

the driving mechanism of the stapling machine and made a die to reform the staples into a different shape before use.

The staples now are reformed into a shape somewhat like a chicken wishbone. When fastened in the phenolic boards, the bases of

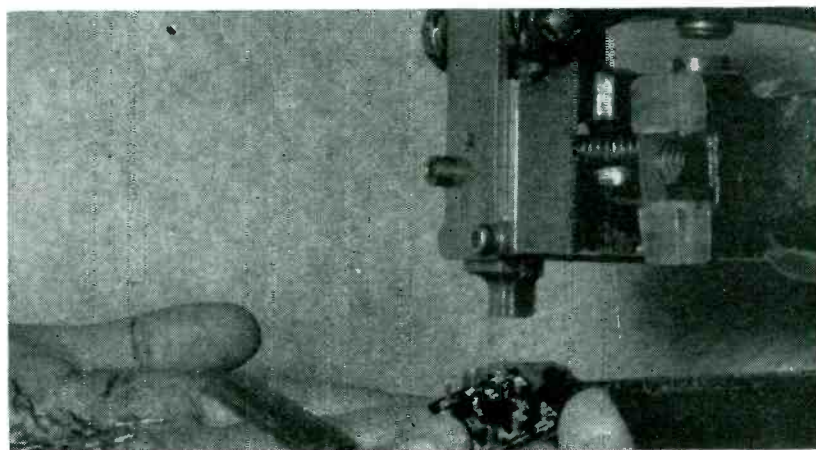

New staple-type terminals permit miniaturization of subassemblies

Tunes UP TIRED ASSEMBLY LINES



"44" RESIN, "RESIN-FIVE" and PLASTIC ROSIN—
Kester Flux Core Solders belong at the very top
of the solder hit parade when it comes to quality,
speed, uniformity and economy. An unbroken rec-
ord of dependability is what makes Kester a sure-
fire "cure" for lagging production. Better switch
now to Kester . . . a real production record maker!

WRITE TODAY for Kester's New 78-
Page Informative Textbook, "SOLDER...
Its Fundamentals and Usage."



KESTER SOLDER

COMPANY 4204 Wrightwood Avenue, Chicago 39, Illinois; Newark 5, N. J.; Brantford, Canada

the staples are small enough that they can be placed close together in both directions. The portion of the

staple protruding from the board is now straight and narrow, so that minimum space is needed at both

the top and bottom. The new staple is also easier to wire or solder than the previous staples.

Rubber Band Protects Panel Finish During Assembly on Bench

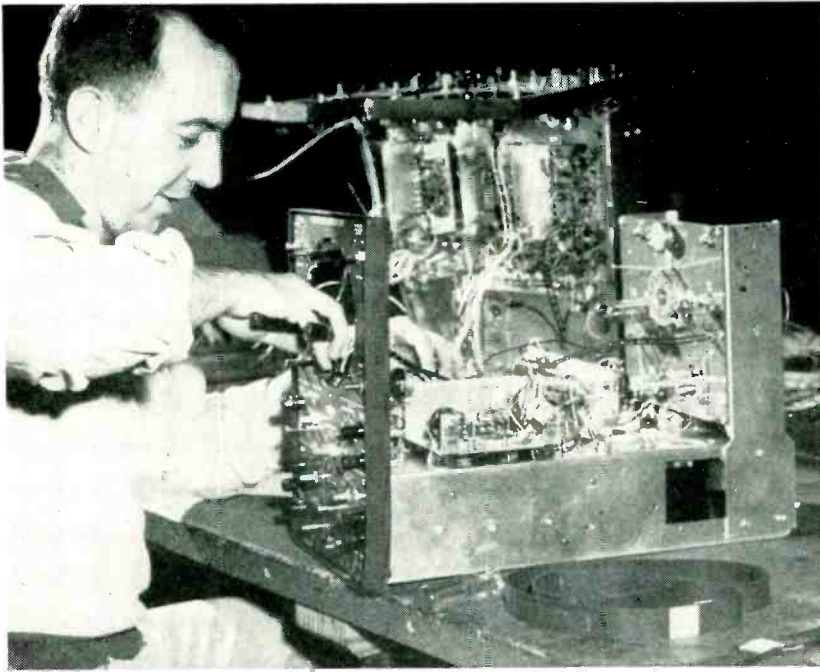

A SIMPLE method of preventing instrument cabinet panels from having their edges scratched or chipped during production is in use at the Instrument Division plant of Allen B. Du Mont Laboratories, Inc., Clifton, New Jersey. Large strips of rubber are stretched around the panel edges in rubber-band fashion, held in place by the rubber's elasticity.

Bands are made up in correct sizes for various products by cutting strip rubber to the required lengths and cementing the ends together with auto inner-tube patches.

Large rubber band protects panel of cathode-ray oscilloscope during assembly

Pictorial Inspection Records Expedite Flow of Quality Data

By FRANK H. SQUIRES
Quality Manager
Lear, Inc., LearCal Division
Santa Monica, Calif.

A WORKSHEET for electronic assembly inspectors should accomplish the following objectives: (1)

Serve as a simple check list for the inspector; (2) indicate at a glance the number of defects, the nature of the defects and their location; (3) become an easily maintained record or history sheet. These re-

quirements are met by pictorial inspection records, which have outlines of electronic assemblies on which the soldered connections and components are clearly indicated.

To simplify the inspector's job



Inspection Form #110
Lear, Inc., California

INSPECTION CHECK LIST & RECORD
CROSS-POINTER OMNICHASSIS

Rev. No. _____
Date _____
Inspector _____

1	2	3	4	5	6	7	8	9	10	11	12
---	---	---	---	---	---	---	---	---	----	----	----

Prepared by: Bob Bevers

Quantity Accepted _____

Method of marking pictorial inspection record to show defects Example of inspection record for cross-pointer omnichassis

From **VERY SMALL**...to **LARGE CAPACITY**

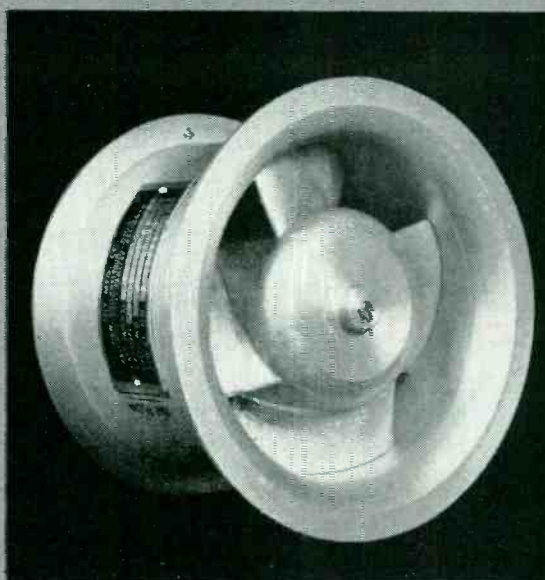

JOY AXIVANE[®] FANS

are available to meet any
ELECTRONIC COOLING NEED

Joy AXIVANE Electronic Cooling Fans are expressly designed to meet the needs of this exacting field of service. They are built in a complete range to suit any requirements, such as: spot cooling of ventilated units where local high-temperature conditions arise; heat removal from pressurized or hermetically-sealed units; or heat removal where space is so restricted that natural ventilation through the unit or over its surface is insufficient. Important operating advantages of these fans are their strength, high resistance to shock and vibration, and efficiency in low or high-pressure service. Aluminum and magnesium construction keeps weight at a minimum.

Available in sizes from 2" I.D. up, these Joy Fans are built to meet all present Air Force and Naval electronic specifications. They can be furnished with totally enclosed or explosion-proof motors, if desired.

In general, keep these facts in mind: that the light, compact design, low power consumption and high overall efficiency of Joy AXIVANE Fans provide more satisfactory cooling for electronic equipment in either air-borne or surface units.

If you have a problem in heat dissipation from electronic units, let us place at your disposal JOY'S experience as the world's largest manufacturer of vane-axial-type fans. • Write *Joy Manufacturing Company, Oliver Building, Pittsburgh 22, Pa.* In Canada; *Joy Manufacturing Company, (Canada) Limited, Galt, Ontario.*

Consult a Joy Engineer

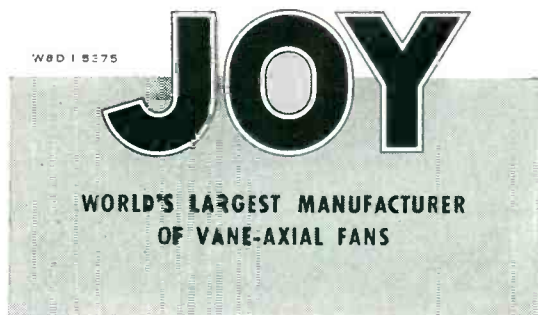

Here's the fastest way to produce finished wire leads!



Allen-Bradley Co., producers of motor controls, use several Artos CS-6 automatic wire cutting and stripping machines in their Milwaukee plant.

high speed ARTOS

AUTOMATIC MODEL CS-6

3000 STRIPPED WIRE LEADS in one hour ...each precision-cut with both ends perfectly stripped. That's the speedy pace set by the Artos CS-6 in producing wire leads up to 15 inches in length! Production rates vary in proportion to the length cut.

Highly accurate machine operation reduces work spoilage to an absolute minimum. Errors due to the human element are eliminated. There is no cutting of strands or nicking of solid wire.

PROVED PERFORMANCE

Time-consuming hand stripping jobs which once were a bottleneck in many plants are gone forever. As a result, Artos automatic wire strippers are paying their way in the mass production of television and radio sets, electrical appliances, motor controls and instruments of all kinds.

Plan now to cut wire stripping costs in your plant...with the high speed, automatic Artos CS-6.

CS-6 CAPACITY

Finished Wire Leads Per Hour: lengths to 15", 3000; 64"-97" lengths, 500.

Stripping Length: 1½" max. both ends.

Cutting Length: max., 97"; min., 2"; special, ⅞":

**MEASURES,
CUTS and
STRIPS
wire, cord
and cable
at speeds up to
3000
pieces per hour**

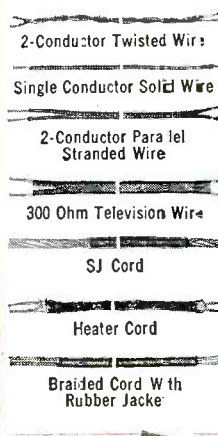

WRITE FOR BULLETIN

Descriptive technical sheet tells how the Artos CS-6 can save you money, manpower and time.

ARTOS ENGINEERING CO.

Automatic Wire Cutting and Stripping

2743 South 28th Street • Milwaukee 46, Wisconsin

of describing defects, the twelve most common causes for rejection are coded 1 to 12, and 12 columns or boxes are provided on the pictorial record for recording them. An additional box is provided for recording the number of units inspected.

Method of Marking

In daily use the inspector makes a check mark in the number-inspected box as each unit is inspected, checks the appropriate box as discrepancies are found and also makes check marks in red at the points on the outline where they occur.

Each pictorial is good for one assembly for one day. Thus, at the end of the day, or at any moment during the day, it will indicate: (1) number of units inspected; (2) number of discrepancies found; (3) quality level in average defects per unit; (4) which discrepancy occurred the most frequently; (5) where the discrepancies occurred (indicated by the clustering of check marks at various points on the outline).

Most effective is the line of 12 boxes in which check marks for discrepancies accumulate. This easy-to-read frequency distribution is a constant stimulus to corrective action. It is a sensitive indication of the quality of workmanship, and production supervisors look to it for prompt indications of change.

Use of Reports

The information which is being generated at every inspection station on the line is collected and consolidated into a summary for management. In the journey from line to front office it reaches into every part of the organization where a knowledge of product quality is required.

The pictorials are seen by:

(a) Production group leaders, who learn at a glance what defects are occurring most frequently and where.

(b) The supervisor of assembly line inspectors, who keeps an eye on the pictorials throughout the day and combines all of them into one bundle at the end of the day. He

ANOTHER CENTRALAB **FIRST!**

NEW ISO-KAP*

Molded Disc Ceramic Capacitor

As precise as a fine watch



Nothing else like it! The only molded, completely insulated ceramic disc capacitor. Not merely a dipped covering—breakdown to ground in excess of 3000 V.D.C.

Highest mechanical strength. One-piece construction is unaffected by extremes of vibration; by ozone, salt water, or any known acid or solvent at room temperature.

Mechanically accurate. Thickness, diameter, and lead spacing are always exact. And leads are always on perfect center line—never offset. The answer for automatic assembly.

Highest dependability. New basic ceramic body. Capacitance characteristics are virtually flat over a wide temperature range (see graph).

Highest lead strength. Above the tensile strength of No. 22 wire itself. Leads can't pull out.

Easiest identification. Clearly labeled to avoid confusion and mistakes. Stamped with capacity, voltage rating, and tolerance.

TYPICAL ISO-KAP CURVE

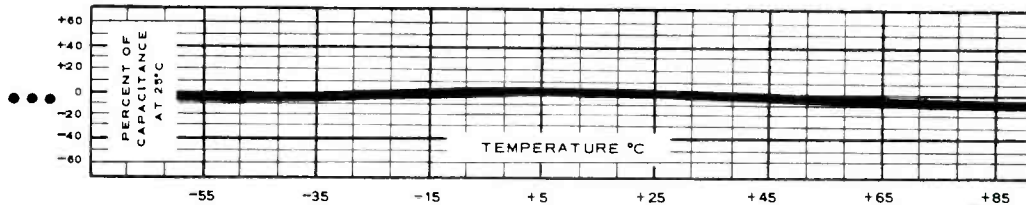

Get detailed facts that help you visualize Iso-Kap's exciting possibilities. Write for engineering bulletin EP-48.

**More proof that
if it's a job
for electronic components,
it's a job for Centralab**

Centralab's advanced engineering continues to create the prototypes of the components industry



Volume Controls



Capacitors



Switches

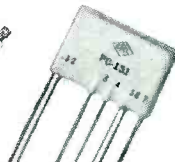

Printed Electronic Circuits



Ceramics

Would you like to win a top-quality outdoor grill for cooking fun?

Enter this month's **Electroni-Kwiz†**

Answer this question in 50 words, more or less: How has electronics improved our standard of living?

A leading editor will pick the winner of this month's major prize.

Mail your entry to us before May 30.

†Nothing to buy. Employees of Centralab and their advertising agency not eligible. Duplicate prizes awarded in case of tie.

D-556

Centralab

A DIVISION OF GLOBE-UNION INC.

914E E. Keefe Avenue • Milwaukee 1, Wisconsin
In Canada: 804 Mt. Pleasant Road, Toronto, Ontario

*Trademark

SINCE 1922, INDUSTRY'S GREATEST SOURCE OF STANDARD AND SPECIAL ELECTRONIC COMPONENTS

Shallcross

for
precision
resistors

SINCE 1929

AKRA-OHM Precision Wirewounds



Bulletin L-35

High-quality, yet moderately-priced precision resistors suitable for the majority of applications. Reverse-pi wound on accurately-machined ceramic bobbins. Coated, if desired, with moisture-resistant varnish. Std. tolerance—1%, 0.5%, 0.25%, 0.1%, and 0.05%. Meets MIL-R-93A. Five mounting styles available.

"P" TYPE Encapsulated Wirewounds



Bulletin L-30

Small, hermetically-sealed resistors at a truly low price. Unmatched stability for critical applications. Std. tolerance—same as Akra-Ohm types above. Meet and exceed MIL-R-93A requirements including salt water immersion tests. Radial leads, axial leads, or lug type terminals.

BOROHM Deposited Boro-Carbon Resistors



Bulletin L-33

Small, low-temperature-coefficient resistors. Exceptional stability achieved through deposition of uniform, uncontaminated, soot-free carbon film. Std. tolerance—1%, 2%, and 5%. Meet characteristic R of MIL-R-10509A. 1/2, 1, and 2 watt sizes.

CASTOHM[®] Ceramic Power Resistors



Bulletin L-29

Unusually light-weight wirewound power resistors with a unique integral core and coating having exceptional resistance to thermal shock and excellent heat conductivity. Ten humidity-resistant, tab-terminal styles available with ratings from 8 to 225 watts at 350°C. hot-spot. Meet MIL-R-10566, Amendment 1.

CMP and MP Miniature Power Wirewounds



Bulletin L-36

Lead-mounting, miniature power wirewounds for crowded chassis or printed circuits. MP types enclosed in a Fibreglas sleeve and coated with silicone-impregnated ceramic. CMP types encased in ceramic tube with ends hermetically sealed with silicone cement. Designed to MIL-R-26B. 3 to 10 watt sizes available.

SPECIALS



Bulletin L-37

Hermetically-sealed Steatite resistors, Ayrton-Perry resistors, high-voltage surge resistors, card-type resistors, multi-section bobbin resistors, and many other special types are regularly produced to individual specifications.

SHALLCROSS MANUFACTURING CO., 522 Pusey Ave., Collingdale, Pa.

scans them for any unusual deviations and advises the production general supervisor that the situation is normal or that there is trouble on a particular product or in a particular area.

(c) The production general supervisor, who gets the combined bundle at the end of the day, together with the inspection supervisor's summary. If there is trouble, the pictorials pinpoint the exact location.

(d) The quality control engineering office, where the pictorials are analyzed daily. The tabulation shows average defects per unit for all products and average defects per unit on particular products which are being watched.

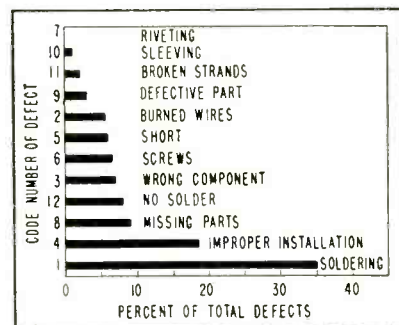

Relative frequency of defects, as obtained from inspection records over 1-month period

(e) The quality manager, who develops the weekly quality report from the analyzed pictorials and other inspection records.

(f) The general manager and all department heads, who receive the quality report routinely.

(g) The entire personnel of assembly, to whom their original data comes back condensed to a point plotted on the quality curve.

The pictorial was originally meant to be no more than a useful inspection technique; it has, however, become the nucleus of an effective communication system. Each check mark made by an inspector is, as it were, one drop in a stream of information which collects from every point along the assembly lines and flows to top management informing everyone in its course. The analyzed summary, which returns and is posted as a point on the quality curve, closes a circular path of com-

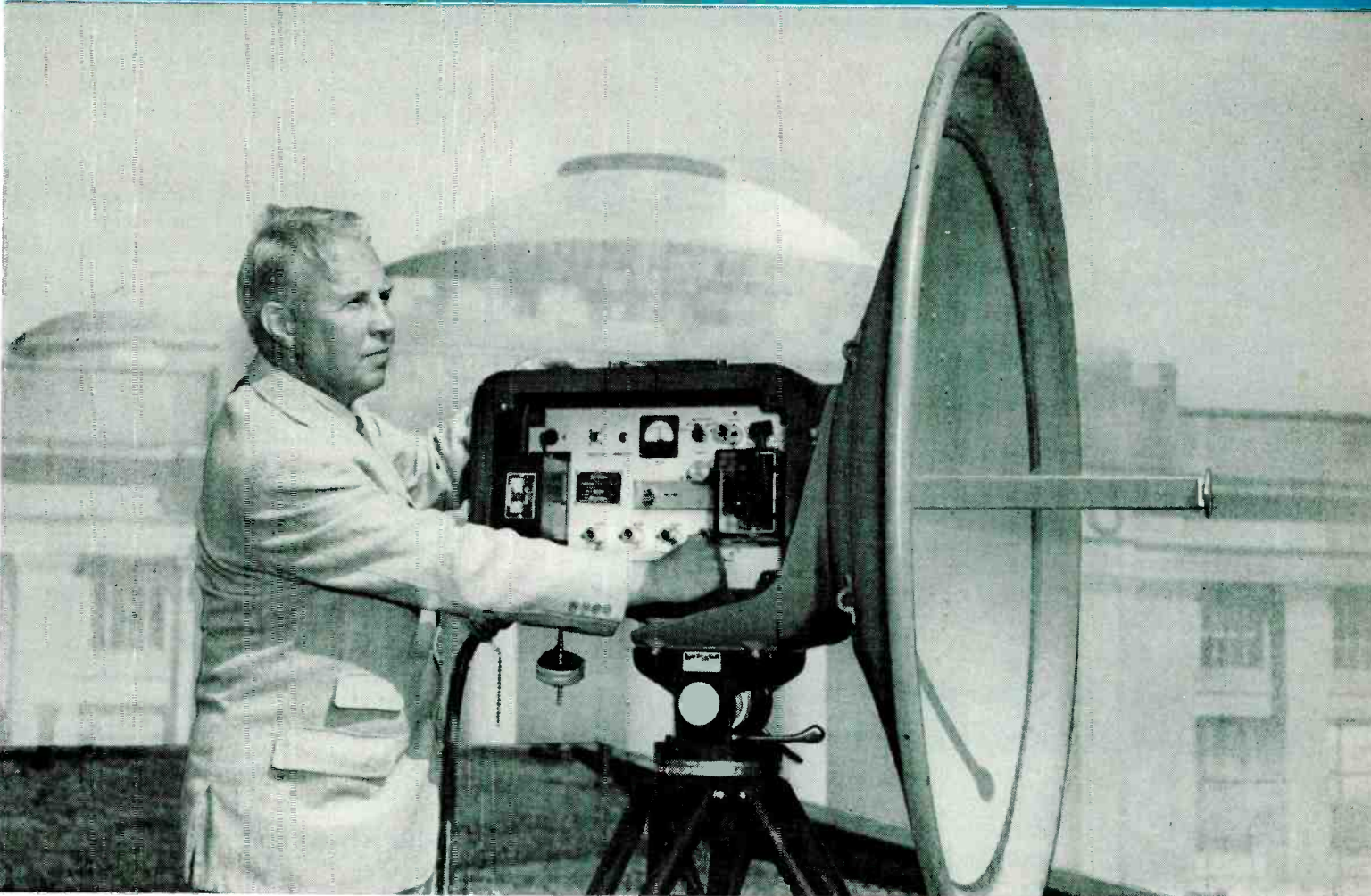

Arthur W. Richardson, Chief Engineer, Station WGBH-TV, Boston, Mass., at station's Raytheon KTR-100 microwave relay which transmits picture and sound simultaneously.

More than 75 TV stations using this equipment for STL, remotes, and network intercommunication have proved the performance of the 5976 Klystron.

Color TV relay uses Raytheon 5976 Klystrons

The new, compact Raytheon KTR-100 microwave relay is a good example of the use of the long-life Raytheon 5976 in regular and color TV relay equipment. This reliable Klystron has also been selected for additional applications by other leading manufacturers—for these five reasons:

Over 22,000 hours of life—many users report more than 22,000 hours (over 2½ years) of continuous service.

Low temperature coefficient—temperature need not be held to close tolerance. No forced air cooling.

Low power requirements—only 300 volts at 25 mA. Easy to install.

Low initial cost—lowest cost Klystron in its class. Immediate delivery in any quantity.

Low maintenance cost—long life means absolute maximum of trouble-free operation... ideal for isolated installations.

Condensed Operating Data—5976 Klystron

	3¾ Mode	2¾ Mode
Power output	110 mW av. (6750 Mc)	150 mW av. (6750 Mc)
Frequency range	6200-7425 Mc	6200-7425 Mc
Reflector voltage	-78 to -158 Vdc	-200 to -285 Vdc
Resonator voltage	300 Vdc	300 Vdc
Current	25 mA	25 mA
Modulation sensitivity	1.0 Mc/v	0.5 Mc/v
Temp. coefficient	-.10 to +.10 Mc/C°	-.10 to +.10 Mc/C°
Pulling figure	0.2% of oper- ating freq.	0.1% of oper- ating freq.

Write for valuable Data Booklets on Raytheon Magnetrons and Klystrons, including the stable, reliable 5976. Our Application Engineer Consultation Service is also available to you without cost or obligation. Call us when you have a microwave tube problem.



RAYTHEON MANUFACTURING COMPANY

Microwave and Power Tube Operations, Section PL-21

WALTHAM 54, MASSACHUSETTS

ERIE TRIMMERS FOR

RADIO & TV APPLICATIONS

- ECONOMICAL
- EASY TO INSTALL
- VARIETY OF LEAD ARRANGEMENTS AND POSITIONS



MILITARY APPLICATIONS

- RELIABLE
- RUGGED
- AVAILABLE IN VARIETY OF TEMPERATURE COMPENSATING CHARACTERISTICS
- STABLE
- EXCEED REQUIREMENTS FOR JAN-C-81

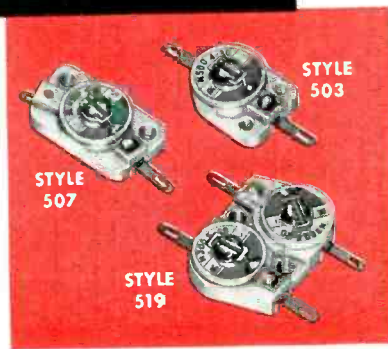

CUSTOM TRIMMER ASSEMBLIES

ERIE Style 557 Trimmer is manufactured for Military use and is widely used in Test Equipment and other Industrial Applications. It can be Compactly Mounted in Multiple Groups on practically any desired Phenolic Base Design. Shown here are typical examples of Single and Multiple Space Saving Assemblies.

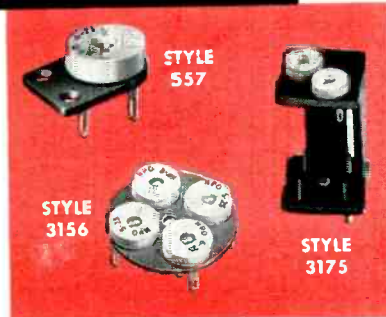

Write for a copy of the new Erie Trimmer catalog

ERIE
electronics

ERIE ELECTRONICS DIVISION

ERIE RESISTOR CORPORATION

Main Offices and Factories: ERIE, PA.

Manufacturing Subsidiaries

HOLLY SPRINGS, MISSISSIPPI • LONDON ENGLAND • TRENTON, ONTARIO

munication back to the line.

The communication can be conceived of as flowing round the circle at an irregular or spasmodic pace according to the varying quality of the work and the relative urgency of management's reaction. It follows a uniform rate of flow only when the quality is maintained at a high level.

Much useful information has been obtained from the analysis of the pictorial inspection records. The predominance of soldering defects over other causes for rejection was demonstrated most emphatically by the bar chart shown in the illustration. The reaction was to set up a soldering school for new operators and for those whose work fell below the minimum quality levels.

Inspectors and producers meet in conference periodically to discuss the progress of quality revealed by the pictorial summaries. Comparisons are made and competition between groups is stimulated.

The pictorial helps to build quality into the product by making quality information readily available to all levels of the organization.

Formica Bench-Tops Reduce Rejects

USE OF GLOSSY, easy-to-clean Formica panels as tops for assembly benches has paid for itself in improved quality of product and reduced rejection rate during assembly of precision potentiometers in the South Pasadena, Calif. plant of Helipot Corp.

The benches are made in the



Method of anchoring Formica-faced plywood bench top to wood frame



NEW

... **15 Microvolts D-C Sensitivity**

... **Absolutely Stable**

... **Complete Versatility**

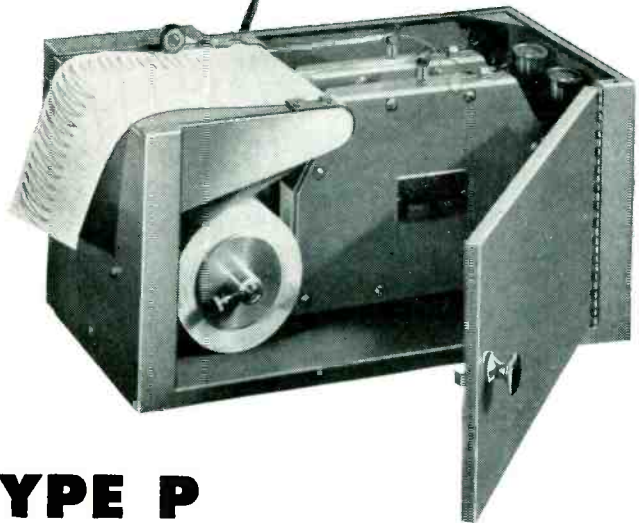

NEW...OFFNER TYPE P PORTABLE DYNOGRAPH

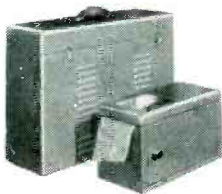

This high speed, direct writing oscillograph recorder provides exceptionally high, absolutely stable, d-c or a-c amplification. It may be used with reluctance type gauges without auxiliary equipment. The exceptional stability, sensitivity, and versatility of the Dynograph are made possible by the exclusive, patented chopper amplifier. It is used for recording a wide variety of transient variables, such as strain, vibration, temperature, analog computer write-out, etc.

The performance specifications of the Type P Portable Dynograph are identical with those of the Type M Console model, but it is mounted in two convenient carrying cases as illustrated. The Type P is available with one or two channels.

Check these exclusive features:

Speed plus sensitivity. The Dynograph gives you the maximum in speed and sensitivity—15 mi-

crovolts d-c per millimeter deflection with a response speed of less than 1/120th second.

Large easy to read records. Over 8 cm excursion, permitting the recording of large dynamic variations. Chart speeds 1 to 100 mm per second.

Absolute non-drifting stability. The Dynograph is absolutely stable and non-drifting—it is stable when it starts working and has *absolutely zero* base line drift.

No Hysteresis. The high-torque movement always returns the stylus to the base line—even with the paper stationary. Linearity is within one percent for four cm.

Compare and you will select the Dynograph



Write for your copy of Bulletin L-742. It gives you complete details and application information on both portable and console models of the Offner Dynograph.

OFFNER ELECTRONICS INC.

5324 North Kedzie Avenue • Chicago 25, U.S.A.

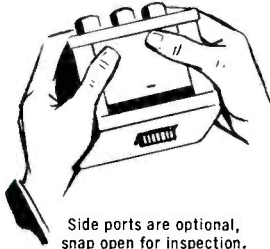

Side ports are optional, snap open for inspection.

with Snap-open
SIDE PORTS

For a perfectly designed, handsome and compact plug-in, assemble your components in Vector Lip-Loc cases. You'll find it quicker, more convenient and economical.

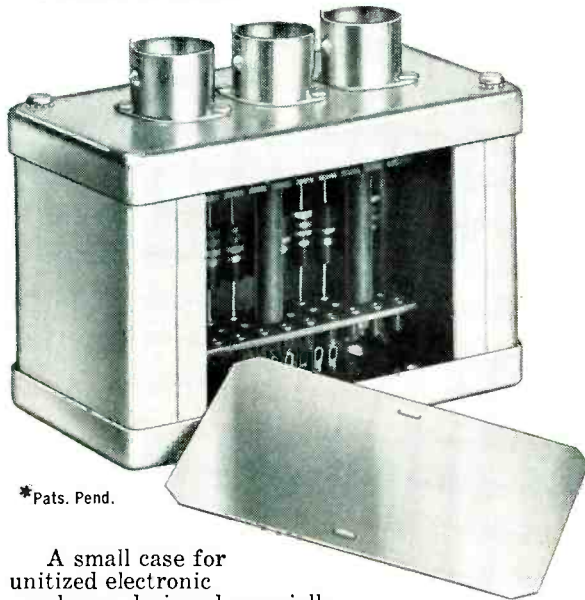

*Pats. Pend.

A small case for unitized electronic packages designed especially for plug-in assemblies. Modular turret structures are accessories and are furnished to your requirements.

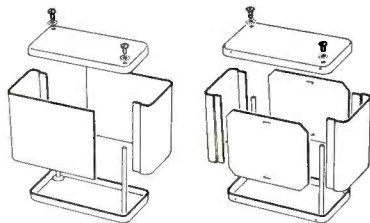

Lip-Loc cases are also made with the more economical two piece center section where snap open feature is not required. Removal of only two screws allows complete disassembly of both types.

Available with a choice of plugs, quarter turn locks, ventilated or solid wall, and in a variety of sizes. Vector Socket-Turrets are available in many types—Post, Deck, Wall or Tinker-Turrets—provide ideal internal structure to carry circuitry.

Write for free catalog.



VECTOR ELECTRONIC COMPANY
3352 SAN FERNANDO ROAD, LOS ANGELES 65, CALIF.
TELEPHONE Cleveland 7-8237

Representatives

- New York**—B. B. Taylor Co., 241 Sunrise Highway
Rockville Centre, N.Y. ROckville Centre 6-1014-5
- San Carlos**—David H. Ross Co., 534 El Camino Real
San Carlos, Calif. LYtell 3-8224
- Chicago**—Harry Holinton, 5500 West Devon
Chicago 30, Illinois ROdney 3-2132

plant's own carpenter shop. The bench frame is constructed conventionally, the Formica-faced plywood is clamped to the frame and the plywood is then anchored in position by toeing finishing nails through the backing into the framework. Wood or metal trim is then applied to the edges, much as for kitchen counters, to complete the bench.

Universal Holding Jig for Terminal Boards

ASSEMBLY of components on standard turret terminal boards is expedited in the Baltimore plant of The Glenn L. Martin Co. by use of a jig that holds six boards at a time at the optimum working angle. The empty boards are inserted in

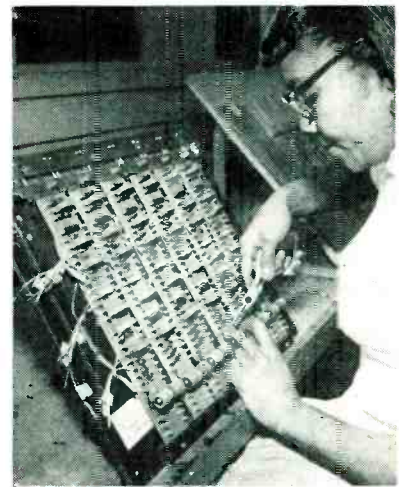

Method of using universal fixture for holding component boards. External leads for first board are in front at left, but corresponding leads for other boards project behind through slots



Rear view of fixture, showing method of attaching legs. Wing nut for adjusting angle of legs is near right hand of operator

COMMON CHARACTERISTICS OF ALL TYPE 2131 GEARED MOTOR GENERATOR UNITS

O.D. of Case.....1.000 inch
 Case Length.....3.301
 Weight.....7.5 ounces
 Frequency.....400 cycles

No. of Poles (Motor).....6
 *No Load Speed (Min.).....6500 rpm
 Rotor Inertia.....1.1 gram-cm²

*Motor Speed at input to gear train.



NEW

integral gear head in small servo motors

OUTSTANDING FEATURES OF TYPE 2131 GEARED MOTOR GENERATOR

- New methods of manufacture result in high efficiency
- High torque to inertia ratio to give fast response
- Available for 115 volt—115 volt two phase or single ended tube operation
- High impedance winding for direct plate to plate operation available
- High generator output voltage with excellent signal to noise ratio
- Zero degree phase shift in generator
- All metal parts corrosion resistant
- Extremely wide operating temperature range

*Other models
of one inch O.D. units*

TYPE NO.	DESCRIPTION
2103	Induction Motor
2101	Geared Induction Motor
2028	Motor Generator

Latest catalog and/or complete specification drawings will be sent upon request.

A new line of units has been added to the Kollsman "Special Purpose Motors" family combining precision machining, advanced electrical design and the latest in new materials. An unusual feature of the new line is the integral gear head unit. Contained within a single case is the gear train and motor; or gear train, motor and generator. Gear ratios as high as 300:1 can be supplied.

This new line consists of Induction Motors and Induction Generators supplied separately or combined in a single case one-inch in diameter. The new motors have been designed to give the maximum torque per watt ratio with the minimum rotor inertia. The generators have been designed to give the maximum output voltage with the minimum residual voltage and phase shift.

One of the principal features of the Kollsman "Special Purpose Motors" is the interchangeability of parts which permits numerous electrically different combinations of motor and generator windings within the same case.

INPUT PER PHASE ONLY 1.8 WATTS ELECTRICAL CHARACTERISTICS OF TYPICAL TYPE 2131 GEARED MOTOR GENERATORS

TYPE NO.	EXCITATION		INPUT PER PHASE	MOTOR			GENERATOR	
	FIXED	CONTROL		STALL TORQUE	Theoretical Acceleration At Stall	EXCITATION FIXED	INPUT	OUTPUT PER 1000 rpm
2131-0411110	26	26	2.3	0.4	25600	26	1.8	.51
2131D-0412120	26	26	4.0	0.6	38500	26	2.2	.68
2131D-0413120	26	26	1.8	0.3	19200	26	2.2	.68
2131-0460600	115	115	4.0	0.6	38500	115	2.6	1.00
2131-0463600	115	55	4.0	0.6	38500	115	2.6	1.00
2131-0470600	115	P-P	4.0	0.6	38500	115	2.6	1.00
	volts	volts	watts	Oz-in	rad/sec ²	volts	watts	volts



kollsman INSTRUMENT CORPORATION

80-10A 45th AVE., ELMHURST, NEW YORK • GLENDALE, CALIFORNIA • SUBSIDIARY OF *Standard* COIL PRODUCTS CO. INC.

Engineer using BURROUGHS PULSE UNITS loses no time designing test equipment

PRODUCTION TECHNIQUES

(continued)

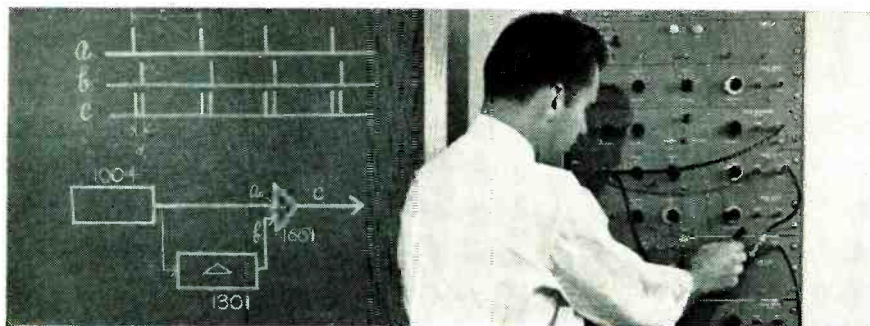

- 1. FAST SET-UP.** Engineer draws pulse sequence, then determines by block diagram how to connect his Burroughs Pulse Units. Usually this can be done in a matter of minutes.

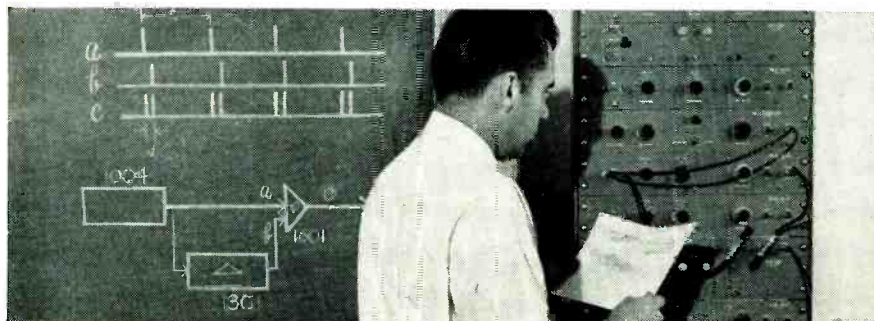

- 2. JOB COMPLETED.** No time lost. Because engineer spends no time designing test equipment, he can spend his full time on the real problem. This means he can do more, accomplish more.

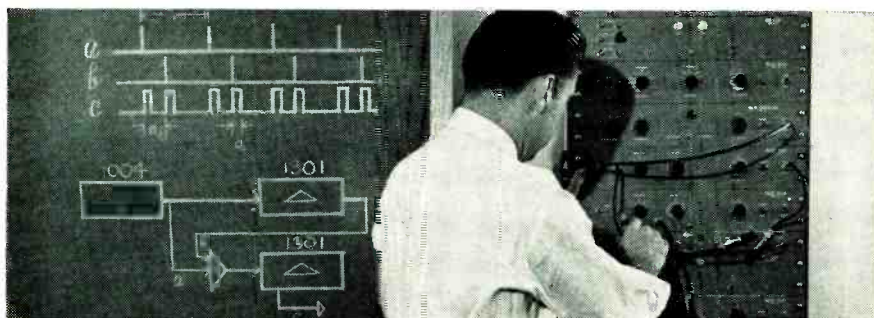

- 3. NEXT ASSIGNMENT.** Without losing time, engineer simply determines the block diagram needed to produce the next pulse sequence and sets up his Burroughs Pulse Units. He shifts quickly from one assignment to the next—saving considerable time otherwise needed to design and build special test equipment.

GET THE FACTS

Learn how you can make your time worth more. Burroughs Pulse Units save weeks of engineering, uncertainty, and considerable equipment cost. Can be used over and over again on different future projects. Immediate delivery from stock. Write for detailed brochure. *Burroughs Corporation, Electronic Instruments Division, Dept. 3-E, 1209 Vine St., Phila. 7, Pa.*

ELECTRONIC INSTRUMENTS DIVISION
Burroughs

FIRST IN PULSE HANDLING EQUIPMENT

recesses at the bottom, then pushed down into spring-loaded holding pieces at the top. The six top clamps are mounted on a single strip of pressed wood that is held in position by bolts with wing nuts. This upper strip can be moved up or down to accommodate different lengths of terminal boards, by loosening the wing nuts so that the bolts can slide in the vertical slots of the fixture panel.

Five other slots, each about 1 inch wide, are also cut in the panel, directly behind the spaces be-

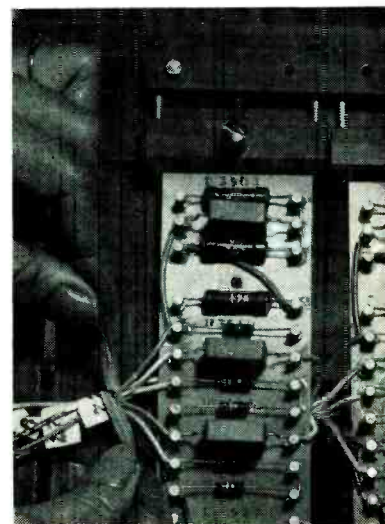

Method of tying leads together in groups with wire-reinforced paper tape

tween terminal boards. These allow the operator to push connecting leads behind the panel where they do not interfere with the wiring of adjacent terminal boards.

Hinged legs made from half-inch pressed wood hold the fixture up on the bench. The angle of support can be changed by loosening a wing nut on a bolt going through one leg.

Wires projecting from the boards are held together temporarily in three logical groups per board with wire-reinforced paper pieces known as Wire Ties, made by H. F. Hanscom and Co. This tape is similar to that used by gardeners for tying plants to stakes. A single twist suffices to hold the tape around a group of leads, permitting easy removal later. The same tape is used throughout the plant in various pre-cut lengths, for temporary grouping of leads in the many cables used in

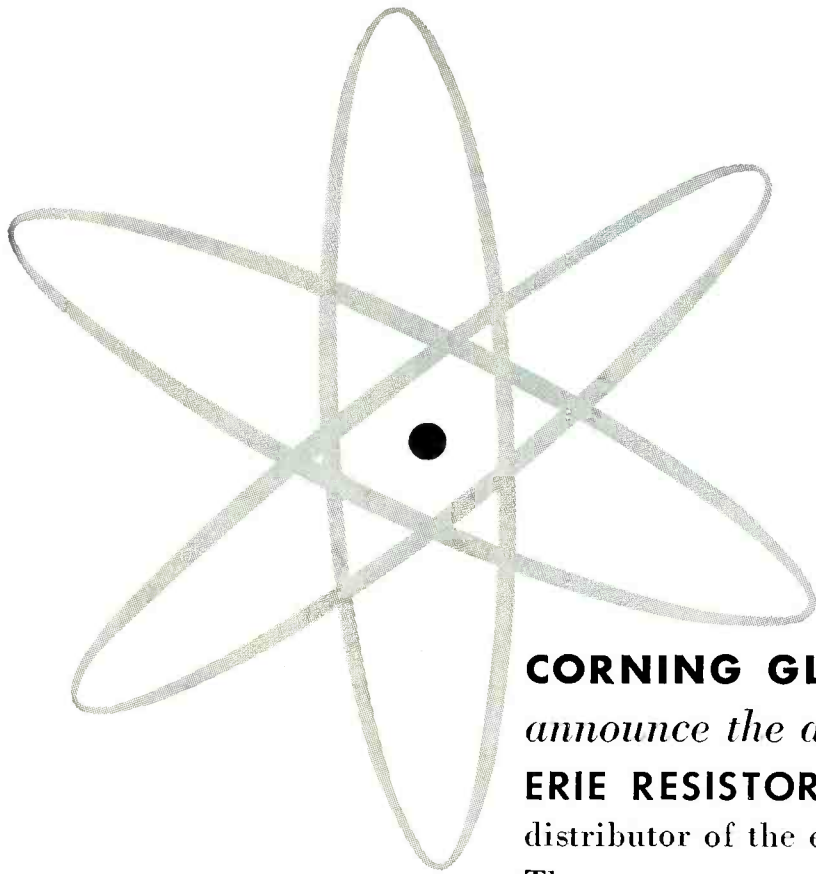

CORNING GLASS WORKS is pleased to announce the appointment of the **ERIE RESISTOR CORPORATION** as a stocking distributor of the electronic components listed below. These components are available for immediate delivery through authorized ERIE distributors in the United States and Canada



For information and prices, write, wire, or phone Erie Resistor Corporation, 644 West 12th St., Erie, Pa., or your Erie Distributor.

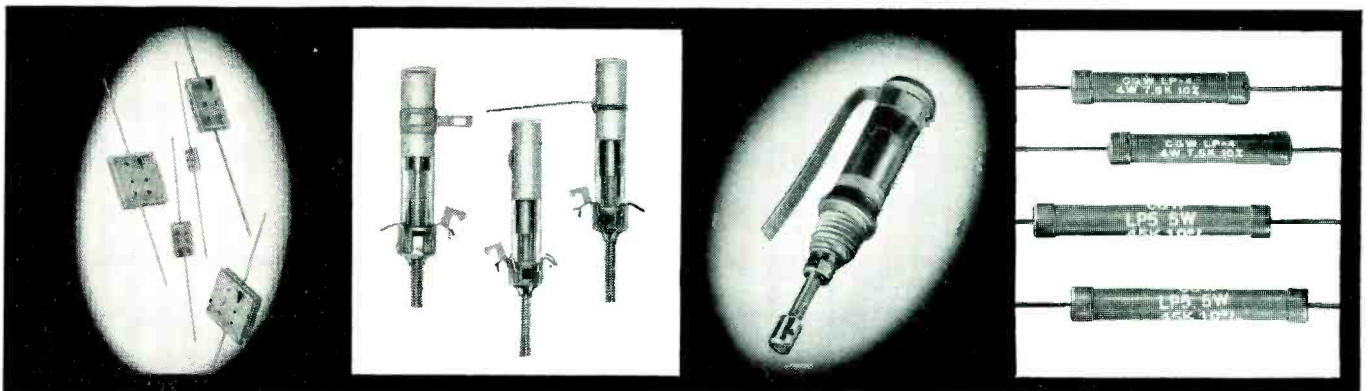

Corning Fixed-Glass Capacitors CY10, CY15, CY20 and CY30 300 and 500 VDCW
Corning Fixed-Glass Capacitors for extreme miniaturization, strength, stability.

Corning Midget-Rotary Trimmer Capacitors. Wide mounting variety in range from 1-12.0, 1-8.0, 0.3-3.0 mmfds. Accurate. Economical.

Corning Direct-Transpose Trimmer Capacitors. For critical applications where you need an absolutely smooth capacitance curve even under extremely variable ambient temperatures.

Corning Low-Power Resistors LP4—4 Watt, 200-40,000 Ω
LP5—5 Watt, 200-45,000 Ω
Corning Low-Power Resistors give you the highest resistance range of any low-power resistors available.



CORNING GLASS WORKS, Corning, New York.

New Products Division

Corning means research in Glass

the Matador guided missile and in other electronic equipment for aircraft.

Ultrasonic Soldering Tools



Obtaining hermetic seal on aluminum housing with ultrasonic soldering tool

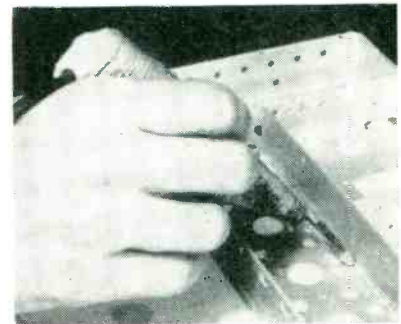

Using hand-held ultrasonic soldering tool to achieve continuous bonding of aluminum shield to chassis

ULTRASONIC soldering provides a simple and inexpensive method of grounding an aluminum chassis, even after the parts have been anodized or alodized. The chassis sections are grounded by soldering a small fillet at the intersection of the pieces. This can be done readily with a hand-held Sonobond ultrasonic soldering unit.

In the assembly of electronic tubes, the copper wires on the base of the tube can be soldered to silver-plated pins without the use of flux. The possibility of subsequent corrosion is thus eliminated, and the operation can be completed in the short time of about 3 seconds. A shallow bath of solder is supported on the tip of an inverted Sonobond unit, and the tube is placed in the bath with the pins down. The ends of the pins and wires are soldered in this way and the solder travels about 1/4 inch up inside each pin.

Selection of the correct size of

When the job demands precision

dimensional accuracy

- there's no substitute for MYCALEX® glass-bonded mica insulation

The coil form shown in this RCA-Victor precision tank coil is injection-molded of MYCALEX 410 glass-bonded mica insulation. The coil, operated at approximately 1000 rpm, is subject to high start and stop stresses. The winding contacts a traveling disc and operates at high potential and high frequency. MYCALEX was selected for this application after careful evaluation. The extreme dimensional accuracy, attainable with MYCALEX glass-bonded mica—the unique ceramoplastic—insures perfect contacting and at the same time eliminates balance problems. High dimensional accuracy also affords absolute uniformity of parts, facilitating assembly and replacement. The excellent dielectric properties of MYCALEX insure efficient electrical performance.

— and MYCALEX offers **OUTSTANDING SUPERIORITY** in almost every other category!

- IMMUNITY TO REPEATED ARCING
- PERMANENT DIMENSIONAL STABILITY
- VERY LOW LOSS FACTOR
- EXCELLENT DIELECTRIC STRENGTH
- ZERO MOISTURE ABSORPTION
- UNLIMITED DESIGN FLEXIBILITY



Note: MYCALEX 410 glass-bonded mica, described above, is an exclusive formulation of, and manufactured only by, the Mycalex Corporation of America. It meets all the requirements for Grade L-4B under Joint Army-Navy Specifications JAN-1-10.

For similar economical solutions to your problems, phone or write J. H. DuBois, Vice President-Engineering at the Clifton, N. J. address below.



MYCALEX CORPORATION OF AMERICA

World's largest manufacturer of glass-bonded mica products
Executive Offices: 30 Rockefeller Plaza, New York 20, N. Y.

ADDRESS INQUIRIES TO—

General Offices and Plant: 114 Clifton Blvd., Clifton, N. J.

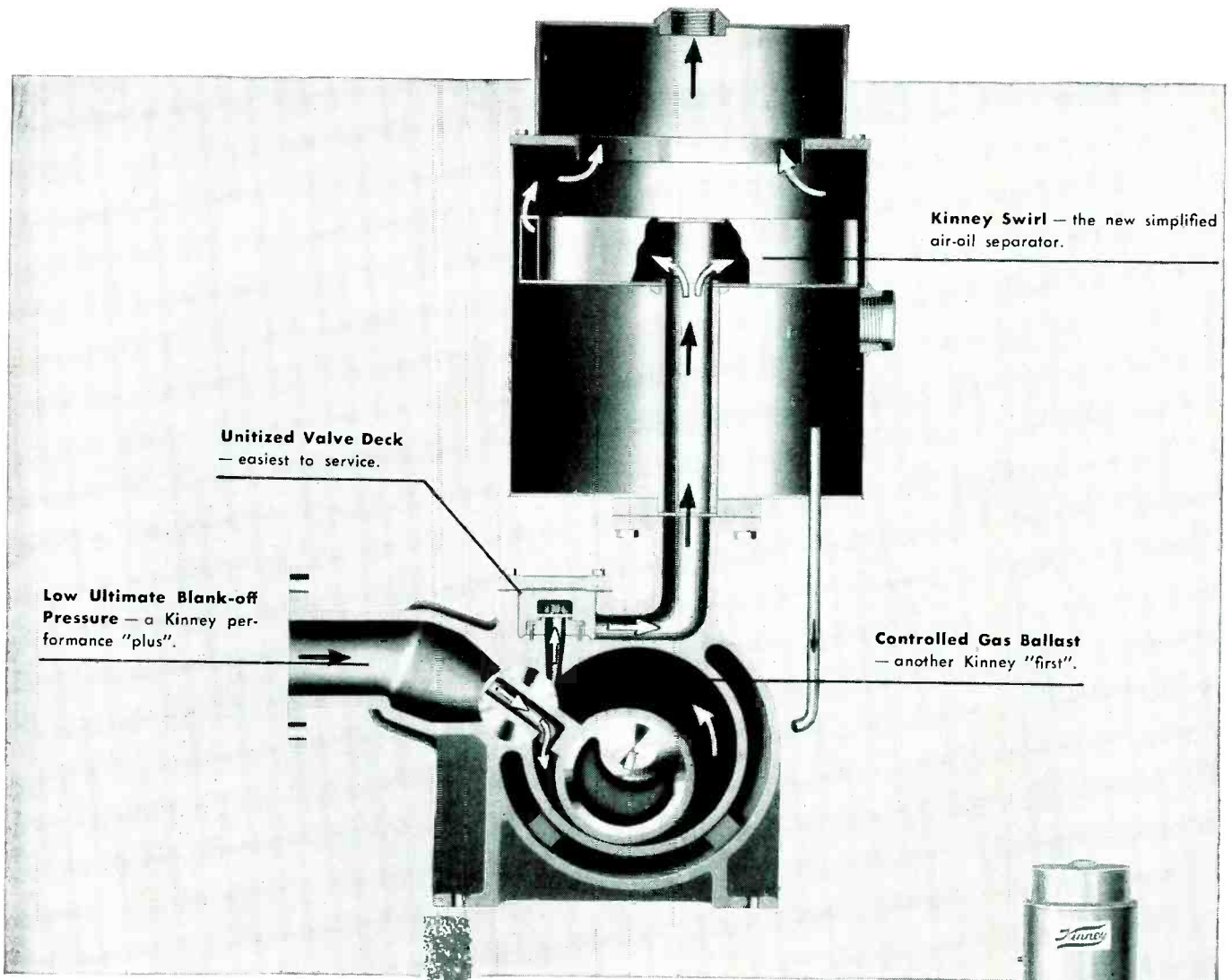

**the NATURAL
way
to get
UNNATURALLY
low
pressures**

More and more companies are coming to Kinney with their vacuum problems every day — it's the natural thing to do. Originator of the cam and piston vacuum pump, Kinney offers more mechanical vacuum pump models, more answers to the water-vapor problem, and more highly specialized vacuum experience and knowledge to help you. SEND COUPON FOR DETAILS . . . or tell us about your own vacuum problems. Consult the competent vacuum engineers in our district offices — in Boston, New York, Philadelphia, Cleveland, Chicago, and Los Angeles. Kinney Manufacturing Division, Boston 30, Massachusetts.

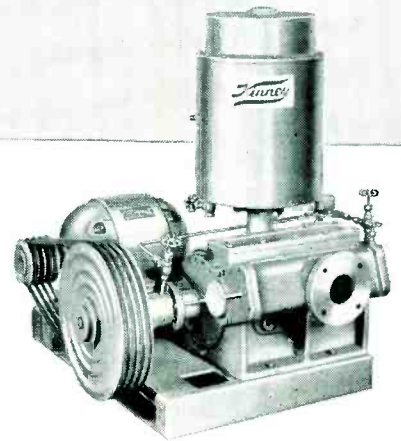

KINNEY MFG. DIVISION
THE NEW YORK AIR BRAKE COMPANY

3565 WASHINGTON STREET • BOSTON 30 • MASS.



Please send Bulletin V54 describing the complete line of Kinney Vacuum Pumps.

Our vacuum problem involves.....

Name.....

Company.....

Address.....

City..... State.....

Does your plant equipment
need modernization?

Investigate the advantages
of the U.S.L. leasing plan

United States Leasing Corporation will buy the machinery or equipment you select, from the manufacturer or dealer of your choice, at the price you have agreed upon...and place it in your plant on flexible lease terms based on your specific requirements.

Accelerated lease payments to meet the specific needs of the aviation and electronics industries. Lease payments may be tailored to meet existing present contracts.

ASK FOR OUR 1955 LEASE PLAN

Write, Phone or Wire



UNITED STATES LEASING CORPORATION

"America's Pioneer in Leasing"

HOME OFFICE: 130 Montgomery Street, San Francisco 4, California · YUkon 2-6550

SOUTHERN CALIFORNIA OFFICE: 407 Commercial Center Street, Beverly Hills, California
Crestview 4-5294 · Bradshaw 2-4923

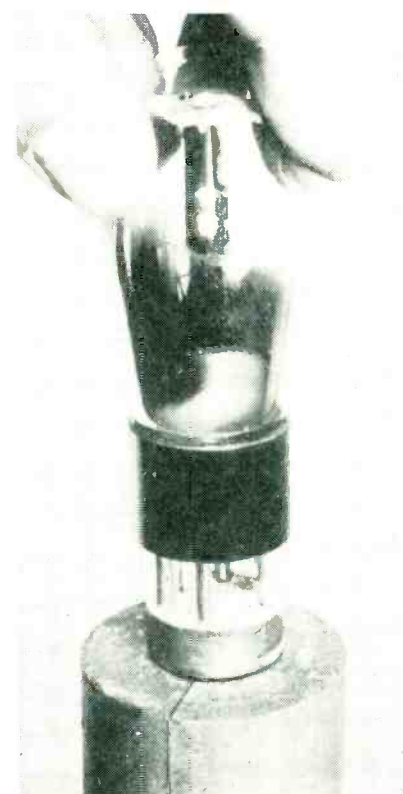

Solder pot set into inverted Sonobond unit serves for soldering tube lead wires to pins of base without flux

hand-operated ultrasonic soldering unit to suit the parts to be tinned is important for efficient production. Small hand units, $\frac{1}{8}$ inch in diameter, are best for small wire connections and for hermetic sealing of small cans. Larger hand units are more efficient for applications where larger areas must be tinned.

In all sizes of units it is important that sufficient ultrasonic energy is delivered to the soldering tip to cause cavitation, the phenomenon which removes the oxide coatings and allows the solder to alloy with the base material.

Specially designed tips often improve the transfer of ultrasonic energy to the surface being soldered. Thus, tips shaped to fit contoured surfaces help to increase the cavitation level at the area to be soldered.

An ultrasonic soldering shop is maintained by Areoprojects Inc., West Chester, Pennsylvania, for experimental or production orders of 1 to 10,000 parts. In this way companies interested in the new process can prove its usefulness as a production method before pur-



target

tomorrow

Shown here is a giant step
toward tomorrow.

Conceived and developed
by a team of Martin people
who have been working with
Navy scientists since 1946,
Viking 12 is the latest of a series of
high-altitude research vehicles.

It was designed to explore the
problems of controlled flight
in the near-vacuum conditions
of the outer atmosphere and
at speeds in excess of 4,000 m.p.h.

In this long-range Viking program,
technical problems are
continuously being solved
which support advancements that
are now being made toward the next
frontier of flight—rockets having
intercontinental ranges.

And beyond that lies space itself!

MARTIN
BALTIMORE · MARYLAND



OHMITE AMRECON[®] RELAYS

High quality, general purpose relays featuring compactness, dependability and long life!

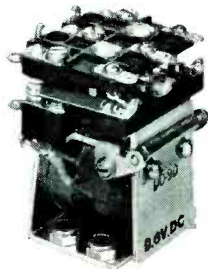

MODEL DO

Ideal for mobile equipment and aircraft. Contact Rating: 10 amp at 115 VAC or 32 VDC noninductive load.



MODEL DOS

Meets rigorous aircraft standards. Contact Rating: 15 amp at 115 VAC or 32 VDC noninductive load.

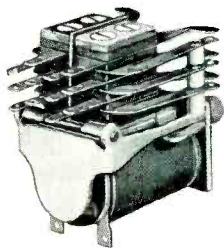

MODEL TKL

Miniature of long telephone type relay. Contact Rating: 1 amp at 115 VAC or 32 VDC noninductive.

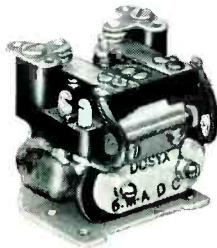

MODEL DOSY

Twin coils provide extra sensitivity. Contact Rating: 15 amp at 115 VAC or 32 VDC noninductive load.

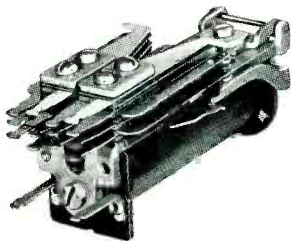

MODEL TG

Use where fine adjustment is needed. Contact Rating: 1 amp at 115 VAC or 32 VDC noninductive.

**30 TYPES
AVAILABLE
FROM STOCK**

Write for
Catalog
R-10



**American Relay
& Controls, Inc.**
3625 Howard St.
Skokie, Ill.
(Suburb of Chicago)

a subsidiary of

OHMITE[®]

MANUFACTURING COMPANY

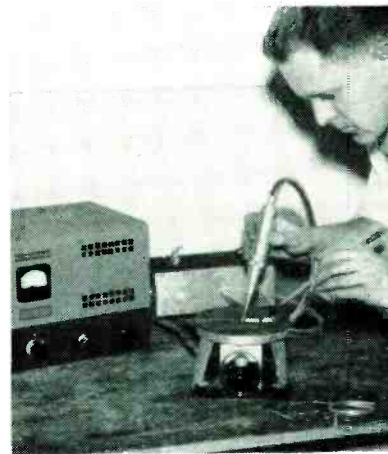

Use of 600-watt electric heating platen eliminates need for heating element in ultrasonic soldering head, thereby reducing its weight to 10 ounces. Aluminum, copper, brass, magnesium or silver parts placed on platen can be tinned rapidly without flux

chasing ultrasonic equipment. When a company is satisfied with the process, and production methods have been worked out, it can then procure the equipment best suited to its needs and install the operation in its own plant.

Embedding Technique for Three-Tube Plug-in Unit

By Roy C. Fox
Westinghouse Electric Corp.
Baltimore, Maryland

ONE OF THE most serious problems encountered in casting circuits in plastic is removal of heat from the components, principally the tubes. Although circuits can be designed with very low plate and screen dissipations, filament power alone amounts to approximately 1 watt per tube. When three or four tubes are incorporated into a unit approximately the size of a cigarette package, the normal heat dissipation through the plastic is inadequate to maintain safe glass-bulb temperatures.

Commercially available spring tube shells were first considered for conducting heat away from the tubes. A rough calculation will quickly show, however, that the thin cross-section of these shells is insufficient to maintain an adequately low temperature gradient. The shells finally used were made

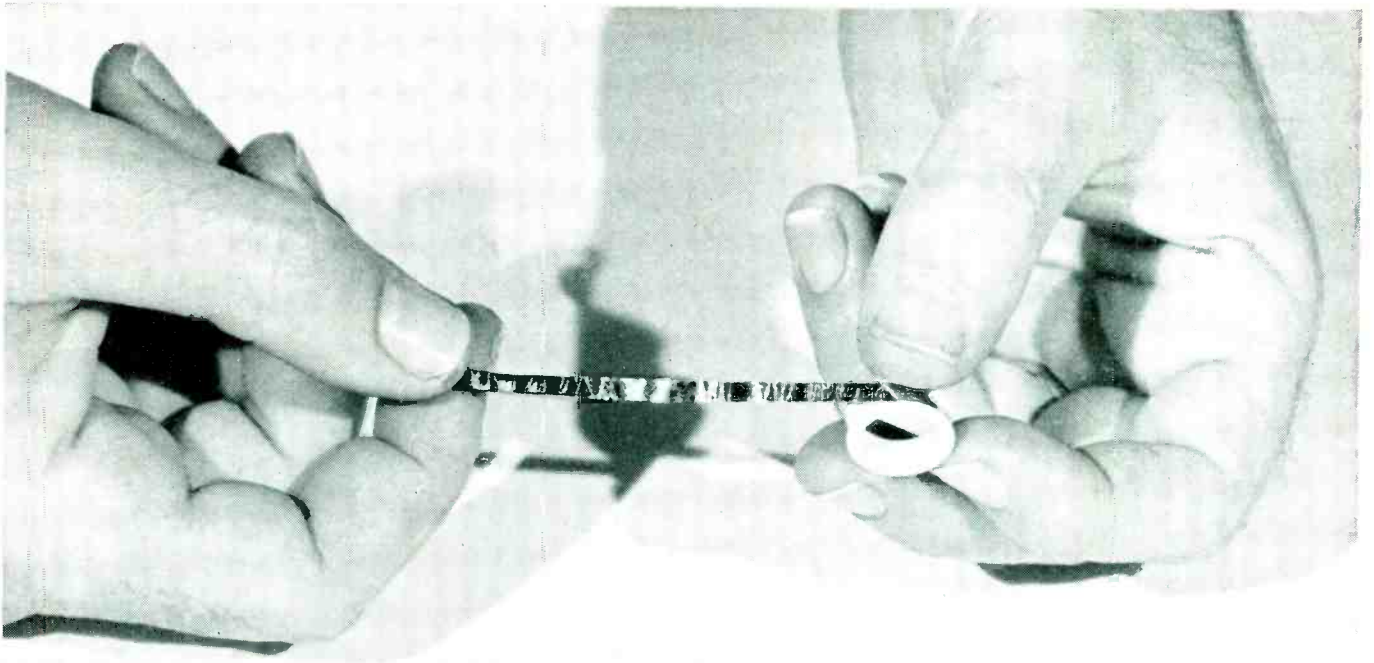

Here's the Magnetic Material that Remembers

Here is magnetic iron alloy that's high in nickel content. It is only one of the grades that Armco produces for memory cores of digital computers and reactors in servo-networks requiring a high rate of change of flux with respect to time. These are the grades available:

ARMCO 48 ORTHONIK

This grade, containing approximately 48 per cent nickel, is rolled in thicknesses of 6 mils down to $\frac{1}{8}$ -mil. It has a high degree of crystal orientation resulting in a hysteresis loop of maximum rectangularity.

Thicknesses 1 mil and less are especially useful in high-speed memory cores and reactors using high rates of magnetization. In thicknesses up to 6 mils the grade is ideal for magnetic amplifiers that must handle relatively large loads with high gain.

ARMCO 48 NI

This nickel grade offers high permeability at low and moderate inductions of 40 gaussses to 10,000 gaussses. It is made in thicknesses of 14 through $\frac{1}{8}$ -mil. The heavier thicknesses

are used for stamped laminations; thicknesses under 5 mils are for wound cores.

OTHER THIN MAGNETIC MATERIALS

In addition, Armco produces Thin Silicon Steels in thicknesses of 7, 5, 4, 2 and 1 mil. They are used for frequencies of 400 to 200,000 cycles per second for radio, television and other electrical devices. They offer exceptionally high permeabilities for silicon steels, low hysteresis losses for such thin material, and excellent stacking factors.

ARMCO STEEL CORPORATION

1145 Curtis Street, Middletown, Ohio

Send me information on Armco 48 ORTHONIK and Armco 48 Ni. These are our requirements _____

NAME: _____

FIRM: _____

STREET: _____

CITY: _____ ZONE: _____ STATE: _____



ARMCO STEEL CORPORATION 1145 CURTIS STREET, MIDDLETOWN, OHIO

SPECIAL STEELS

SHEFFIELD STEEL DIVISION • ARMCO DRAINAGE & METAL PRODUCTS, INC. • ARMCO INTERNATIONAL CORPORATION



They're here in quantity...

"Selenium Slims"
**NEW HI-VOLTAGE
 SELENIUM RECTIFIERS**

... at low prices



Highest quality and low prices seldom come together—but you get them in these new UNION Tubular Selenium Rectifiers.

The secret lies in a new manufacturing process perfected by Union Switch & Signal engineers, the original developers of the copper-oxide rectifiers more than 30 years ago. Higher quality selenium discs are now being produced with greater precision and at lower cost than ever before.

You can snap these rectifiers into your circuits with standard fuse clips or solder in with pig-tail leads. They outlast rectifier tubes, stand up better under vibration, use less power and give trouble-free service... all this at low cost.

Maximum peak inverse voltages run from 36 to 9360 volts with condenser input filter. Maximum DC current rating is 2.5 ma., but other current ratings can be supplied on special order. Stacks may be combined in series, as full-wave bridge circuits, or as voltage doublers.

Send for complete specifications. These new UNION Selenium Rectifiers can lower your costs and give you the big advantage of rugged, trouble-free operation.

EXPLODED VIEW showing symmetrical arrangement of selenium cells (spacers not required), spring-loaded in a tough, durable phenolic tube.

GENERAL APPARATUS SALES

UNION SWITCH & SIGNAL

DIVISION OF WESTINGHOUSE AIR BRAKE COMPANY

PITTSBURGH 18  PENNSYLVANIA

NEW YORK
 IVanhoe 3-2424
 (Hempstead)

BALTIMORE
 Valley 5-3431

CHICAGO
 Longbeach 1-3042

ST. LOUIS
 Jefferson 5-7300

LOS ANGELES
 Clinton 6-2255

of 0.045-inch copper, silver-plated. The rigidity of these shells makes it necessary to keep the holes larger than the largest diameter permitted by tube tolerances. Conduction from tube to shell is aided by vacuum-filling the interstices with a flexible silicone elastomer material. This also minimizes large temperature gradients on the

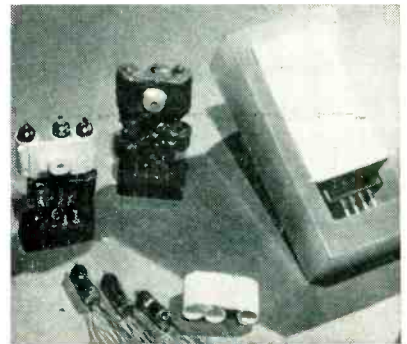

Special tube shell conducts heat away from three subminiature tubes in assembly, shown at upper left before and after dipping in silicone elastomer. Finished plastic-embedded plug-in unit is shown in its flexible mold at right

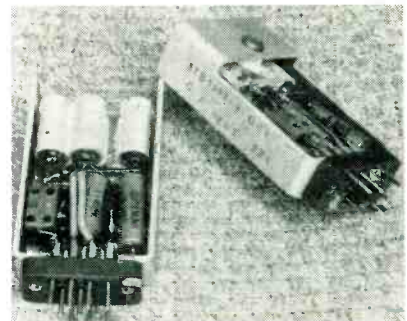

Metal guide-jigs serve to determine limits of space for components and act as handles during production testing

glass bulb, which would normally occur with a spring shell contacting the glass only in spots.

A solid brass boss welded to the tube shells serves to conduct heat out of the plastic plug-in unit to a metal bracket on the chassis. Experimental units utilizing thin tube shells yielded a temperature gradient of 73C from tube base to the end of the brass boss. The final design reduced this gradient to less than 14C.

Wiring within the cast units is direct. Most components are supported by their own leads. The tube shell assembly is held in position during wiring by a special aluminum form bracket that maintains

Now Puerto Rico Offers 100% Tax Exemption to New Industry

by BEARDSLEY RUMI

"We don't want runaway industries" says Governor Muñoz. "But we do seek new and expanding industries." Federal taxes do not apply in Puerto Rico, and the Commonwealth also offers full exemption from local taxes. That is why 300 new plants have been located in Puerto Rico, protected by all the guarantees of the U. S. Constitution.



Beardsley Rumi

IN A dramatic bid to raise the standard of living in Puerto Rico, the Commonwealth Government is now offering U. S. manufacturers such overwhelming incentives that more than three hundred new factories have already been established in this sun-drenched island 961 miles off the Florida coast.

First and most compelling incentive is a completely tax-free period of ten years for most manufacturers who set up new plants in Puerto Rico.

For example, if your company is now making a net profit after taxes of \$53,500, your net profit in Puerto Rico would be \$100,000—a gain of 87 per cent as a result of non-applicability of U. S. Corporate Income Tax in Puerto Rico.

Your dividends in Puerto Rico from a corporation there could be \$50,000 against \$25,000 net in the U. S.—owing to the non-applicability of the U. S. Income Tax.

What About Labor?

Puerto Rico's labor reservoir of 650,000 men and women has developed remarkable levels of productivity and efficiency—thanks, in part, to the Commonwealth's vocational training schools. These schools also offer special courses for managers and supervisors.

The progress made in technical skills may be gauged from the fact that there are now twenty-eight factories producing delicate electronic equipment.

Among the U. S. companies that have already set up manufacturing operations in Puerto Rico are Sylvania Electric, Carborundum Company, St. Regis Paper, Remington Rand, Univis Lens, Shoe Cor-

CORPORATE TAX EXEMPTION

If your net profit after U. S. Corporate Income Tax is:	Your net profit in Puerto Rico would be:
\$ 17,500	\$ 25,000
29,500	50,000
53,500	100,000
245,500	500,000
485,500	1,000,000

DIVIDEND TAX EXEMPTION

If your income* after U. S. Individual Income Tax is:	Your net income in Puerto Rico would be:
\$ 3,900	\$ 5,000
7,360	10,000
10,270	15,000
14,850	25,000
23,180	50,000
32,680	100,000
43,180	200,000
70,180	500,000

*These examples are figured for dividends paid in Puerto Rico to a single resident. Based on Federal rates effective Jan. 1, 1954.

poration of America, and Weston Electric.

"Close to Paradise"

Listen to what L. H. Christensen, Vice President of St. Regis Paper, says:

"The climate is probably as close to paradise as man will ever see. I find Puerto Ricans in general extremely friendly, courteous and cooperative.

"This plant in Puerto Rico is one of our most efficient operations, in both quality and output. Our labor has responded well to all situations."

Mr. Christensen might have added that the temperature usually stays in the balmy 70's twelve months a year.

The swimming, sailing and fishing are out of this world. Your wife will rejoice to hear that domestic help is abundant.

The Commonwealth will leave no stone unturned to help you get started. It will build a factory for you. It will help you secure long-term financing. It will even

screen job applicants for you—and then train them to operate your machines.

Transportation

Six steamship companies and four airlines operate regular services between Puerto Rico and the mainland. San Juan is just 5½ hours by air from New York.

Light-weight articles such as radar components come off the line in Puerto Rico one day and are delivered by air freight next day in Los Angeles, Chicago and other mainland cities. And, of course, there is no duty of any kind on trade with the mainland.

Are You Eligible?

Says Governor Muñoz: *Our drive is for new capital. Our slogan is not "move something old to Puerto Rico," but "start something new in Puerto Rico" or "expand in Puerto Rico."*

The Commonwealth is interested in attracting all suitable industries, and especially electronics, men's and women's apparel, knitwear, shoes and leather, plastics, optical products, costume jewelry, small electrical appliances, hard candy and pharmaceuticals.

To get all the facts, and to find out whether you and your company would be eligible for complete tax exemption, mail the coupon below.

MAIL THIS COUPON

Economic Development Administration
Commonwealth of Puerto Rico, Dept. V2
579 Fifth Avenue, New York 17, N. Y.

Mail me "Facts for Businessmen," your report of the advantages of Puerto Rico for plant location.

Name _____

Company _____

Product _____

Address _____

POWER

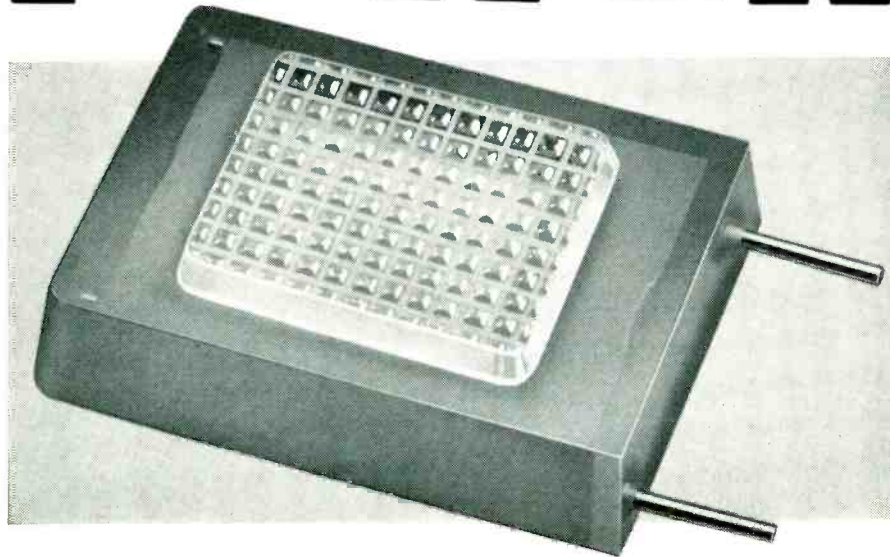

IN PHOTOCELLS

The superiority of Canadian Marconi Photoconductive Cells is shown in this review of its characteristics.

- Dissipation.....0.3 watts max.
- Voltage.....1.5 to 120 max. volts
(a.c. or d.c.)
- Current.....20 ma max.
- Temperature.....-70°C. to 75°C. ambient
- Spectral Response approximates that of the eye.
- Wavelength at max. response.....5100 angstroms
- Dark resistance.....10 to 1000 megohms
- *Sensitivity at 1 ft. candle (100 volts)..0.15 to 0.4 amp/lumen
- Capacitance.....20-30 mmfd
- Rise-time at 50 ft. candles.....5 m. sec
- Decay-time at 50 ft. candles.....10 m. sec

*Measured with a 2854°K colour temperature tungsten lamp.

NOW AVAILABLE

For further information contact **F. HASELL**

CANADIAN MARCONI COMPANY
2442 TRENTON AVENUE, MONTREAL 16, P.Q., CANADA

a firm assembly and serves as a protector for the components while plugging units into sockets during testing. The bracket is so dimensioned that it also serves as a guide for the shape of the wired unit. If all components and wire leads are kept within the extremities of the bracket, the unit will be properly sized and positioned on the socket for casting.

The plastic connector plug should be well abraded on all surfaces that mate with plastic resin, to assure a good bond. Upon completion of testing, the form bracket is removed and the unit is coated.

A synthetic lastic is applied over the entire subassembly before casting in plastic. This provides a cushion between the plastic and materials having a different coefficient of expansion, such as glass and metal. When the completed unit is subjected to a rise in temperature, the plastic expands more than the glass or metal. High temperatures usually cause no difficulty. When units are cooled, however, the plastic shrinks more than glass or metal. If no buffer is used, either the plastic cracks open, or if heavy enough to remain intact, crushes the glass tubes.

The heat-conducting boss is

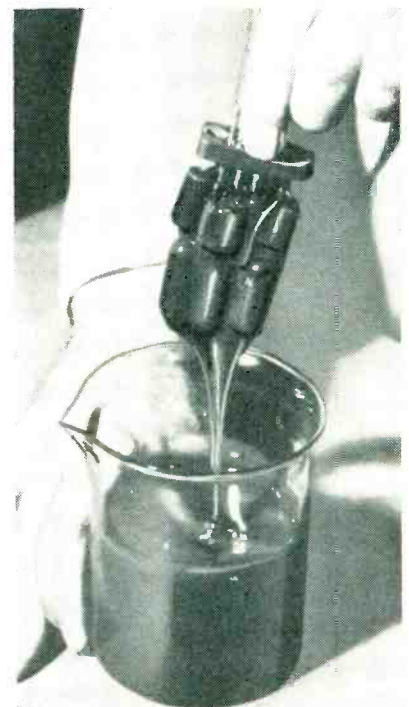

Dipping assembled unit in silicone elastomer to obtain cushioning coating before embedment

SHOPPING FOR

LOW COST

CLASS B

Insulation?

**Nothing on the market today excels the
low priced Class B protection of Varflo Tubing and Sleeving**

Flexible Varflo is solvent-, oil-, moisture-, flame-, and fungus-resistant. Passes the NEMA heat endurance test of 15 minutes at 225°C. Also passes 100 hours at 125°C. Will not lose dielectric strength when subjected to severe handling, bending and twisting. Has good shelf life.

Available in Grades A-1 and B-1 tubing and Grades C-1 and C-2 sleeving.

Let us help you with your problem. Describe it in a letter—no cost, no obligation.

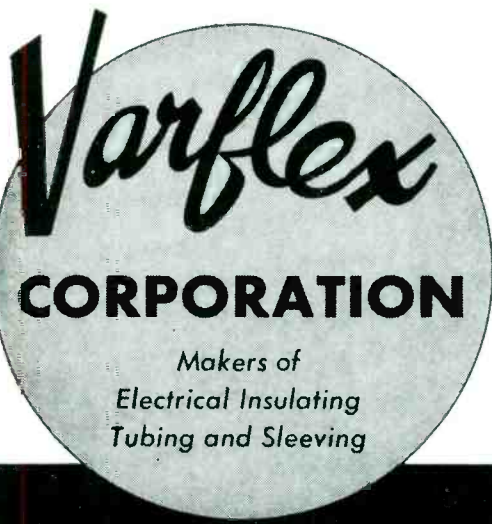
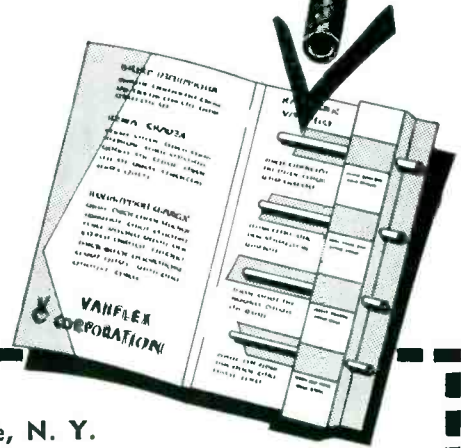

VARFLEX CORPORATION
506 W. Court St., Rome, N. Y.
 Please send me free folder containing description and samples of Varflo Tubing and Sleeving.

I am particularly interested in insulation for _____

Name _____

Company _____

Street _____

City _____ Zone _____ State _____

FREE SAMPLES... Mail Coupon Today!

What are YOUR paper tube requirements?

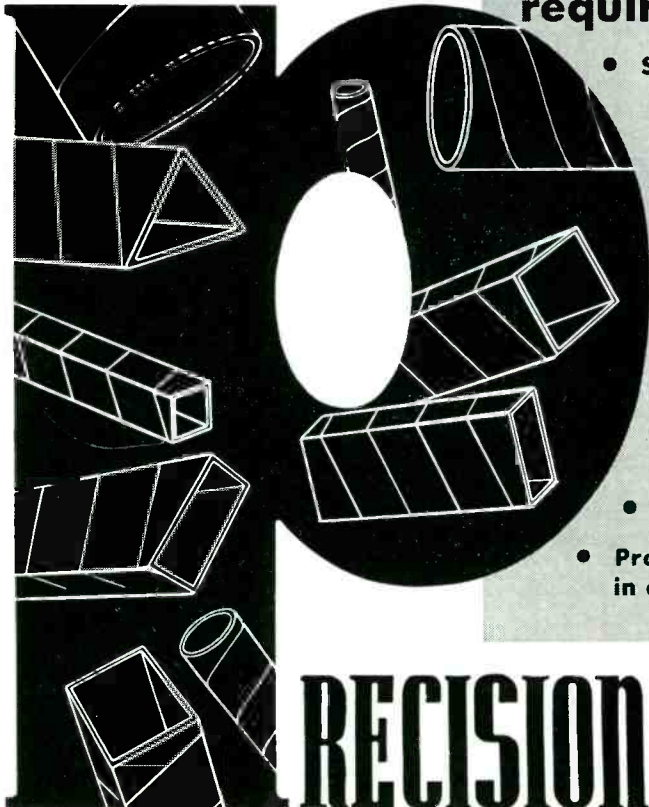

- Special size or shape
- Critical tolerances
- High dielectric strength
- High tensile strength
- Dimensional stability
- Low unit cost
- Prompt delivery in any quantity

PRECISION can

meet your exact specifications

You can order from Precision in an infinite variety of sizes, shapes, I.D.'s or O.D.'s and be sure of the finest quality and construction, plus uniformity throughout. You can specify kraft, fish paper, acetate, combinations, phenol impregnation, etc., whichever material is best suited to your particular application.

Precision's modern high production facilities and rigid manufacturing control bring you all these advantages at lowest possible cost!

Request samples and Arbor List of over 2000 sizes.

PRECISION BOBBINS CUT COIL COSTS

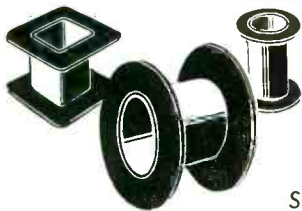

Eliminate rejects, waste, loss of time. Order in any size or shape, plain or fitted with leads, slots or holes. Flanges cut to your specification. Ask for samples and bulletin.

Sales Representatives in:

New England:
Framingham, Massachusetts, Trinity 3-7091

Metropolitan New York, New Jersey:
Jersey City, New Jersey, Journal Square 4-3574

Upstate New York:
Syracuse, New York, Syracuse 4-2141

Northern Ohio, Western Pennsylvania:
Cleveland, Ohio, Atlantic 1-1060

Indiana, Southern Ohio:
Logansport, Indiana, Logansport 2555

Missouri, Southern Illinois, Iowa:
St. Louis, Missouri, Sterling 2318

Maryland:
Baltimore, Maryland, Plaza 2-3211

Philadelphia, Camden:
Philadelphia, Pa., Chestnut Hill 8-0282

California:
Pasadena, California, Sycamore 8-3919

Canada:
Montreal, Quebec, Canada, Walnut 0337

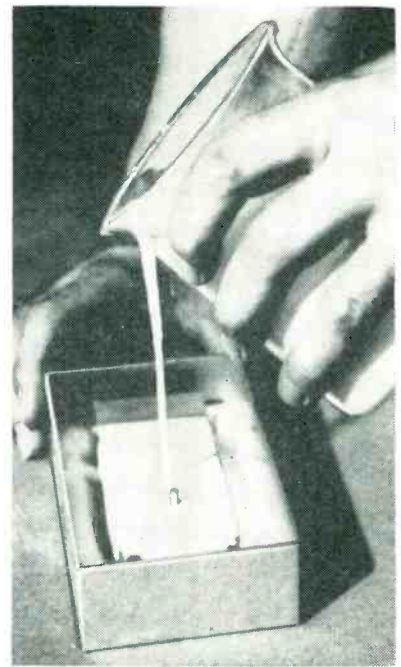

Making flexible mold by pouring vinyl plastisol mold material over polished aluminum pattern

brought out without lastic coating to avoid creating a moisture leakage path. Bosses up to $\frac{7}{16}$ inch in diameter have not cracked the plastic even when cooled to minus 65C. Completed units have been subjected to temperature tests from -65 to +85C without failure.

Some plastic resin mixes are now available that have a thermal coefficient of expansion very close to that of aluminum. It might be inferred, therefore, that unlimited masses of aluminum can be used in contact with this resin. However, there is another factor that must be considered. Although aluminum and the plastic have the same coefficient of expansion, they have different coefficients of heat conductivity. Rapid temperature changes will therefore cause faster heat absorption by the aluminum and thus the aluminum will expand faster than the plastic. This again creates stresses in the unit and possible destructive cracking. It is important, therefore, to keep metal and glass masses small unless they can be adequately protected by a cushioning coating.

The synthetic lastic supplied by the manufacturer is reduced 50 percent in xylene. Before using, this is further reduced with xylene to 30-percent solids content. The material is applied by dipping, flow-



PRECISION PAPER TUBE CO.

2041 W. CHARLESTON ST. CHICAGO 47, ILL.
Plant No. 2: 79 Chapel St., Hartford, Conn.



WALKIEPHONE

**PORTABLE RADIO TELEPHONE FOR
PERSONAL CONTACT WITH KEY MEN**

Policemen, Firemen, Foremen, Airfield Supervisors and many other key men are more effective when in constant radio contact with their headquarters. The Pye Walkiephone, which weighs only 10½ lb., is ideal for this purpose. An outstanding tribute to the Walkiephone was paid by Sir John Hunt, who praised the part it played in the victorious assault on Everest.

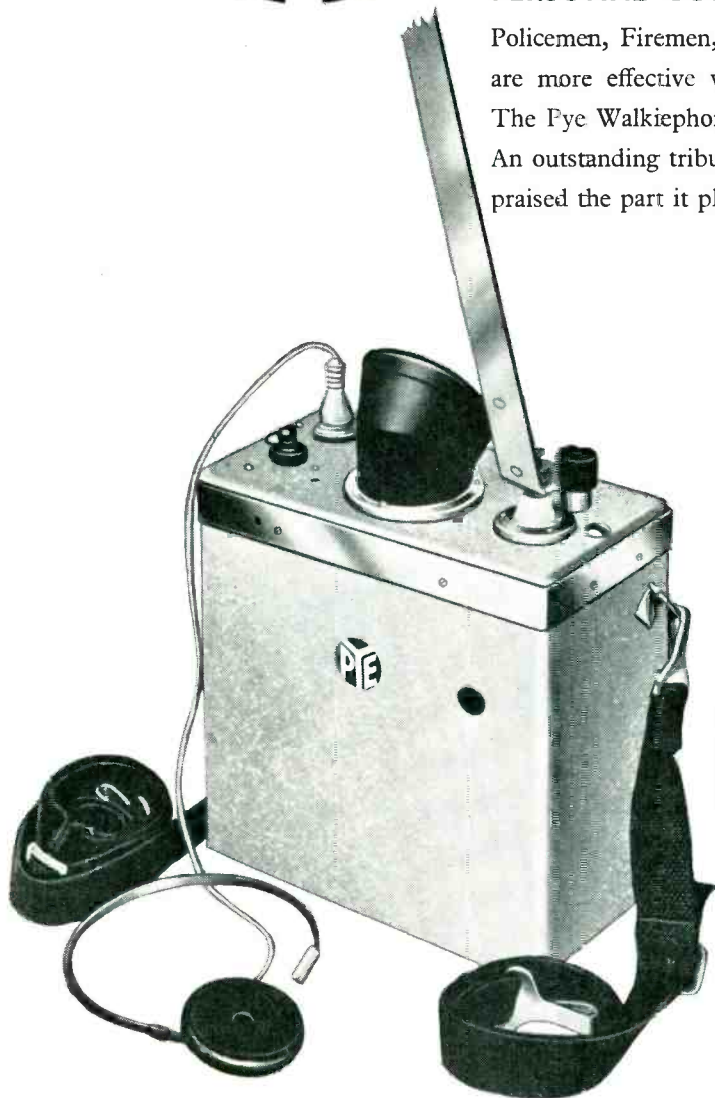

Telecommunications

CAMBRIDGE

ENGLAND



<p>Pye (New Zealand) Ltd. Auckland C.I., New Zealand</p> <p>Pye Radio & Television (Pty.) Ltd. Johannesburg South Africa</p>	<p>Pye Canada Ltd. Ajax, Canada</p> <p>Pye Limited Mexico City</p>	<p>Pye-Electronic Pty., Ltd. Melbourne, Australia</p> <p>Pye Limited Tucuman 829 Buenos Aires</p>	<p>Pye (Ireland), Ltd. Dublin, Eire</p> <p>Pye Corporation of America 5th Avenue Building 200, 5th Avenue, New York</p>
PYE LIMITED		CAMBRIDGE	ENGLAND

ing or brushing, depending on the assembly to be coated. The coating is allowed to air-dry for 20 to 30 minutes and is then heat-cured for one hour at 60C.

More than one coat of lastic may be required to build up a coating approximately $\frac{1}{32}$ inch on all surfaces. Sharp corners and ends of long rigid parts of glass or metal should be given special consideration.

The synthetic lastic has good electrical insulator properties, yet contains sufficient extenders to render it heat-conductive. It remains pliable at very low temperatures.

Flexible molds are used for casting the final assembly. The mold material is poured over a polished

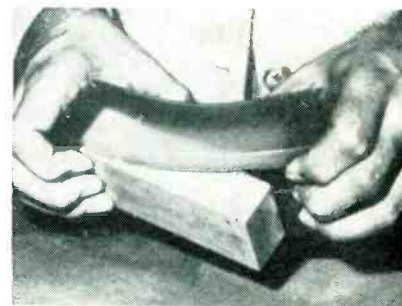

Removing aluminum pattern from flexible mold

aluminum pattern. This is then baked for $\frac{1}{2}$ hour or longer depending upon the size and shape of the pattern.

Where close tolerances are not required or where the final cast unit is machined to size, the flexible molds offer the advantage of low tooling cost and simplified casting methods since the cast part will not adhere to the mold.

The unit to be embedded is placed in the mold with a vertical dam made of polyethylene (or similar material inert to casting resins). This keeps plastic away from the bottom side of the connector plug. The brass boss, which serves as a heat sink, is flush with the surface. A hole is tapped in the center. In the equipment, the completed unit is secured in place by a screw which clamps the unit to an aluminum angle-bracket mounted on the chassis. The boss therefore serves as heat conductor, electrical ground and mechanical retainer to

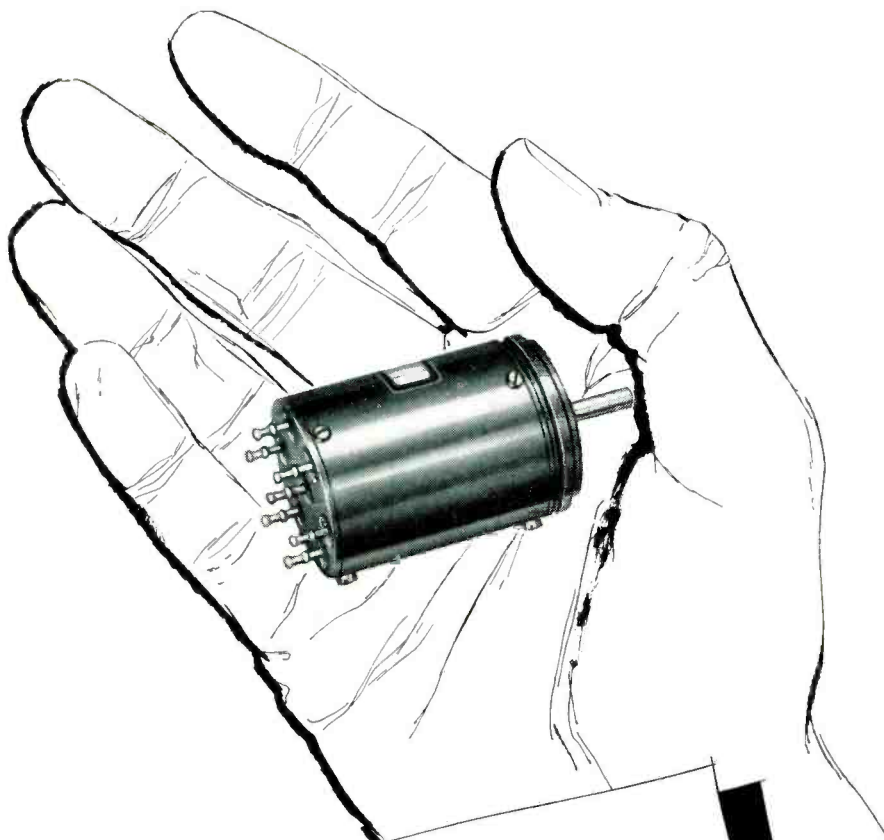

Here is the new
GAMEWELL
 Miniature Sine-Cosine Potentiometer

This miniature version of the conventional RL-11 and RL-14 sinusoidal potentiometers is $1\frac{1}{16}$ " diameter x $1\frac{1}{16}$ " long.

Functions of this new Gamewell Precision Potentiometer are accurately and smoothly developed. Four brush contacts move over a uniformly wound rectangular card and pick off output voltages that are proportional to the sine and cosine of the input angle at speeds up to 60 RPM. Standard resistance value is 16K, but resistance from 4K to 25K can be supplied. Accuracy at higher values is $\pm 1\%$. Power rating: 1 watt $\pm 40^\circ\text{C}$.

THE GAMEWELL COMPANY
 NEWTON UPPER FALLS 64, MASS.
 In Canada: Northern Electric Co., Ltd.



PRECISION POTENTIOMETERS

For information about this new sine-cosine Gamewell Potentiometer, write today.

Manufacturers of Precision Electrical Equipment Since 1855

“The World’s Most Promising Technological Revolution”

The Electronics industry is truly “the world’s most promising technological revolution.”

Even though it grew phenomenally during World War II, Electronics really came into its own following the war. By 1948, it had become a \$3,000,000,000 business, and was rapidly becoming a major industry.

Today, Electronics is a \$9,000,000,000 industry—counting television, radio, military electronics, commercial electronics, broadcasting, and related areas. There is every indication that by 1960 it will be a \$15 billion dollar industry and \$20 billion by 1964. And it will keep right on climbing.

No other major industry will grow that fast in the next decade.

The Armed Services, by far the largest customers of electronic products, spent an estimated \$145,000,000 in 1948 for electronic equipment for communications, navigation, gunnery systems, etc. Today, government electronic purchases amount to \$2,300,000,000 (or 6.3 per cent) of its total defense expenditures. Within the decade, this

may increase to 10 per cent of total government buying as the Armed Services become increasingly electronified. It is estimated that government electronic purchases will amount to over \$4,000,000,000 by 1964.

The potential volume in commercial and industrial electronics is unprecedented, especially in the field of computers, the heart of data processing, and “automation.” Sales of electronic equipment to commerce and industry amounted to \$1,000,000,000 in 1954, and the surface was barely scratched. This figure will more than double within the next ten years, for this area of electronics has a future limited only by one’s imagination.

The future of Electronics has no horizon. Many of the nearly 2,000 scientists and engineers throughout Sylvania are working on Electronics, constantly finding new and better ways to put Electronics to work. *They are keeping an eye to the future—assuring constant progress in the years ahead . . .* “the world’s most promising technological revolution.”

(Engineers: Sylvania has many opportunities in a wide range of defense projects. If you are not now engaged in defense work, you are invited to contact David W. Currier, Supervisor of Professional Placement, Sylvania Electric Products Inc., 1740 Broadway, New York 19, N. Y.)



SYLVANIA



Sylvania Electric Products Inc. • 1740 Broadway, New York 19, N. Y.

In Canada: Sylvania Electric (Canada) Ltd., University Tower Building, St. Catherine Street, Montreal, P. Q.

LIGHTING • RADIO • ELECTRONICS • TELEVISION • ATOMIC ENERGY

Cramer

TIME TOTALIZER

a highly accurate electrical stop clock . . .

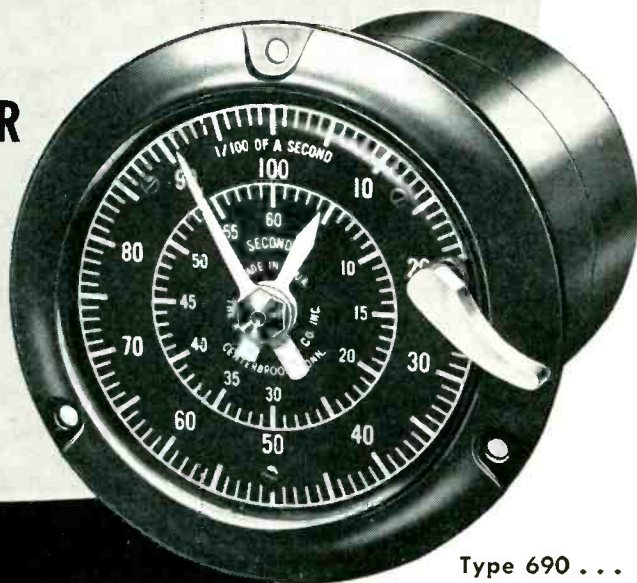

Type 690 . . .

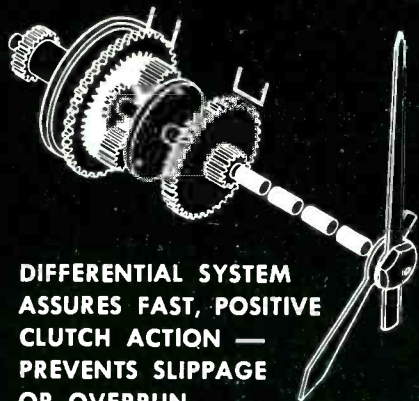

DIFFERENTIAL SYSTEM ASSURES FAST, POSITIVE CLUTCH ACTION — PREVENTS SLIPPAGE OR OVERRUN.

Positive engagement of pawl with gear combined with fine gear teeth provides the instant response necessary for a timing accuracy of $\pm .01$ seconds on the 60-second timer, and $\pm .005$ minutes on the 60-minute unit.

On the dial face, a large sweep hand makes possible fast, exact readings from the outer scale, while an accumulator pointer records larger time units on a separate scale in the center of the dial.

This compact unit is available for AC or DC operation in commercial and military applications. It is used in laboratory experimentation, for testing communications equipment and systems, and in the field of nuclear research, as well as for timing critical industrial processes.

For complete information on the Type 690, write for bulletin PB-610.

prevent loosening by shock and vibration.

A polyester resin is used as the casting resin. A filler, 50 percent by weight, is added. This improves the mechanical characteristics by reducing brittleness. Presence of the filler reduces shrinkage during curing.

Just prior to casting there is added to the mix cobalt naphthanate and tertiary butyl hydroperoxide. The cobalt drier is stirred in well, then the peroxide catalyst is added, being careful not to cause unnecessary trapping of air bubbles during mixing.

After pouring, the assembly is placed under vacuum. The cast is next cured at room temperature, then removed from the mold and given an oven-bake cure.

Symbol number and other identification is engraved or hot stamped directly into the plastic material. As a further aid to identification, the entire unit is colored by addition of pigment to the plastic resin before casting. This color coding is used to identify the various blocks such as discriminator, multivibrator and other block components. Bright colors are used, of the same series as used for color-coding resistor and capacitor values. In any one chassis, the colored units are arranged in the

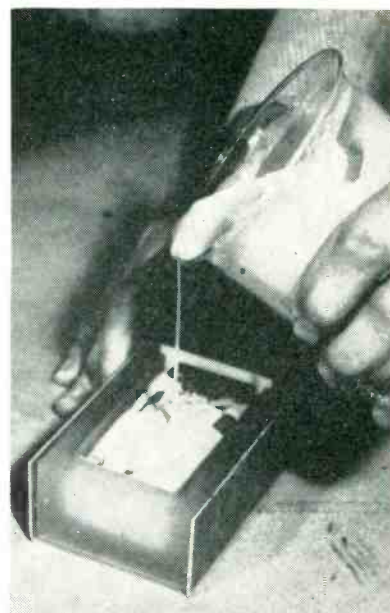

Pouring polyester casting resin over assembly in flexible mold. Metal channel prevents sides of mold from bulging, and polyethylene vertical dam keeps plastic away from terminal plug



SPECIALISTS IN TIME CONTROL

The R. W. CRAMER CO., Inc.

BOX 3, CENTERBROOK, CONNECTICUT

11CR55

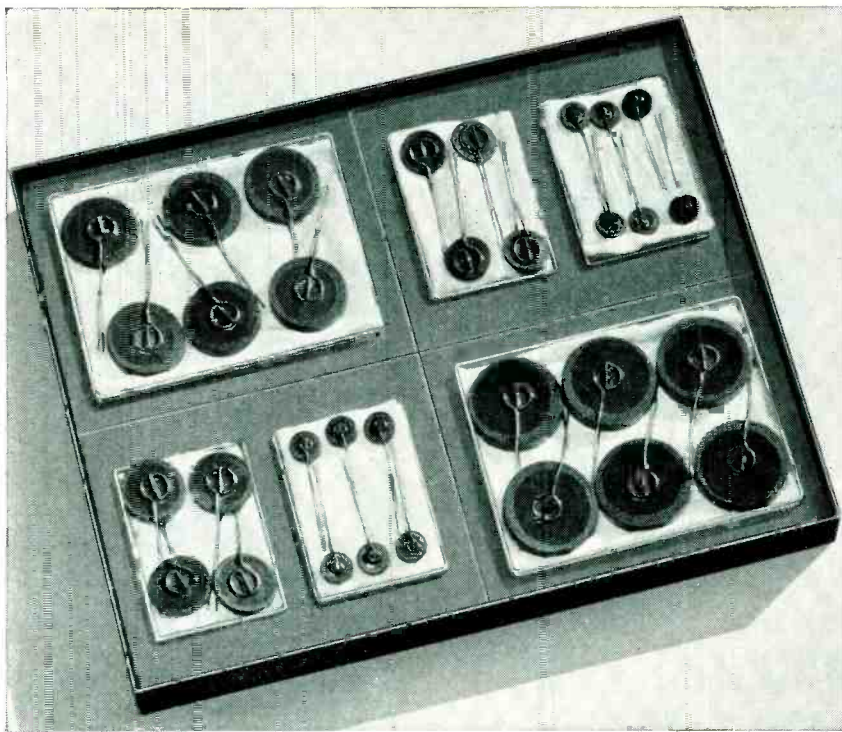

NEW TEST KIT of
GLOBAR®
 Type BNR VARISTORS
for design and application work

Quantity	Cat. No.	R @ Calibration Voltage	Load Watts
6	432	100000 @ 10 volts	0.25
6	479	100000 @ 100 volts	0.3
6	328	10000 @ 40 volts	0.5
6	463	24000 @ 40 volts	1.0
6	524	24000 @ 100 volts	1.5
6	430	17500 @ 175 volts	2.7

KIT No. 3 Type BNR VARISTORS PRICE \$20.00
to evaluate use of GLOBAR® Type BNR Varistors for

- Reduction of surge voltage peaks from 50% to 90%.
- Reduction of contact arcing time up to 95%.
- Reduction of R. F. radiation.
- Stabilizing amplifier gain.
- Stabilizing speed and voltage.
- Stabilizing of rectifier circuits by limiting peak voltages.

OTHER TEST KITS

of GLOBAR® Ceramic Varistors and Thermistors now available to help you solve your circuitry problems include:

KIT No. 1 PRICE \$29.25
 Type F THERMISTORS

- To evaluate series filament circuit application in radio and television receivers.

Quantity	Cat. No.	R @ 25 C	R @ Rated Current	B Constant	Load Watts
6	763	15		1500	0.5
6	441	880	100 ohms @ 150 ma	1900	2.7
6	341	375	40 ohms @ 300 ma	1950	3.6
6	525	250	20 ohms @ 600 ma	1900	7.2
6	327	460	35 ohms @ 600 ma	1900	12.6
6	421	125	43 ohms @ 600 ma	1100	16.5

KIT No. 2 PRICE \$24.50
 Type H THERMISTORS

- To evaluate time delays in relay and solenoid circuits; temperature compensation in field coils and meters.

Quantity	Cat. No.	R @ 25°C	B Constant	Load Watts
6	416	1200	3200	0.7
6	479	1000	3800	1.85
6	373	10	2700	3.0
6	343	20	2700	3.0
6	549	5000	3200	1.5
6	588	11000	3200	2.0

KIT No. 4 PRICE \$18.25
 Type F, Type BNR VARISTORS and THERMISTORS

- To evaluate stabilizing rectifier circuits by limiting peak voltages.

Quantity	Type BNR Cat. No.	R @ Calibration Voltage	Load Watts	
6	432	25000 @ 10 volts	0.25	
6	432	100000 @ 10 volts	0.25	
6	432	200000 @ 10 volts	0.25	
Quantity	Type F Cat. No.	R @ 25 C	B Constant	Load Watts
6	763	15	1500	0.50
6	763	120	1750	0.50
6	763	330000	2150	0.50

EACH KIT CONTAINS 36 resistors — 6 of each specified type, packaged in attractive transparent plastic boxes. Pertinent engineering bulletins giving detailed engineering data are sent with each kit. Kits will be shipped postpaid to any point in the United States and Canada. All resistance values specified carry standard production tolerance.

ORDER YOUR KITS NOW...

use this Handy Coupon

GLOBAL Division
 THE CARBORUNDUM COMPANY
 Dpt. EL87-58, Niagara Falls, New York

Please ship kits as follows:

____ No. 1 _____ No. 2
 (Quantity) (Quantity)
 ____ No. 3 _____ No. 4
 (Quantity) (Quantity)

- Check enclosed (to which we have added applicable local tax)
 Please invoice us.

NAME _____ TITLE _____

COMPANY _____

ADDRESS _____

CITY _____ ZONE _____ STATE _____

Please send FREE engineering bulletin on Kit No. _____

TIC's New 800A

EXTENDED RANGE



VACUUM TUBE VOLTMETER*

**A MEASUREMENT LABORATORY IN ONE
COMPACT INSTRUMENT**

featuring

- Wider ranges of current, voltage and resistance
- High accuracy
- Portability
- Very high stability
- Wide frequency range
- Rugged construction

UNMATCHED IN RANGE

DC and AC Volts a full decade lower (0.1V to 1000V, full scales)

Resistance values a full decade lower and higher (0.02 ohms to 5000 megohms)

Current values from 1 millimicroampere to 100 MA (full scales)

Write for FREE brochure and Laboratory Report No. 16

*Patents applied for

TECHNOLOGY INSTRUMENT CORP.

533 Main Street, Acton, Mass. Colonial 3-7711
West Coast Plant — Box 3941, No. Hollywood, Calif. POplar 5-8620

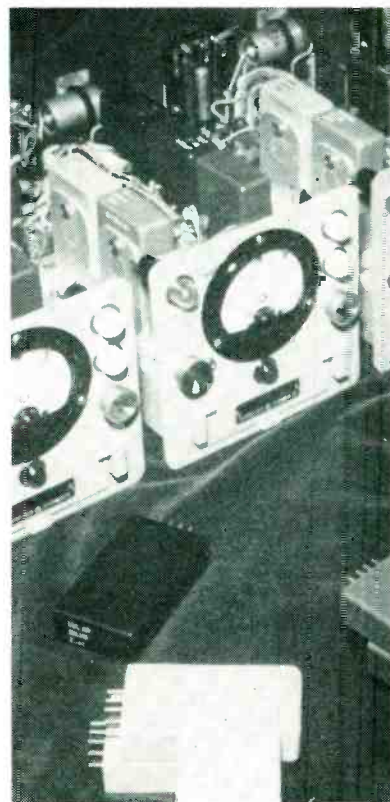

Finished plug-in units and method of mounting against heat sink made of heavy vertical plates fastened to chassis

proper numerical-color sequence, such as black, brown, red and yellow. In practice, this color coding has proved to be of great value in development work, testing and servicing by speeding identification and preventing errors.

The colored mixes are obtained by adding color pastes in amounts varying from 2½ percent for violet to 7½ percent for white, based on the total mixture.

Casting of circuit subassemblies in the manner described provides excellent stability of the completed unit in the presence of shock, vibration and moisture. However, crowding of components and flexibility of self-supporting components has meant that considerable care must be exercised in design and wiring of units to avoid failures during the casting process. Special attention is given to such things as alternate placement of composition resistors and metal-case capacitors to preclude the possibility of short-circuits should the components touch.

High-impedance circuits are usually protected by ground barriers from high-voltage components

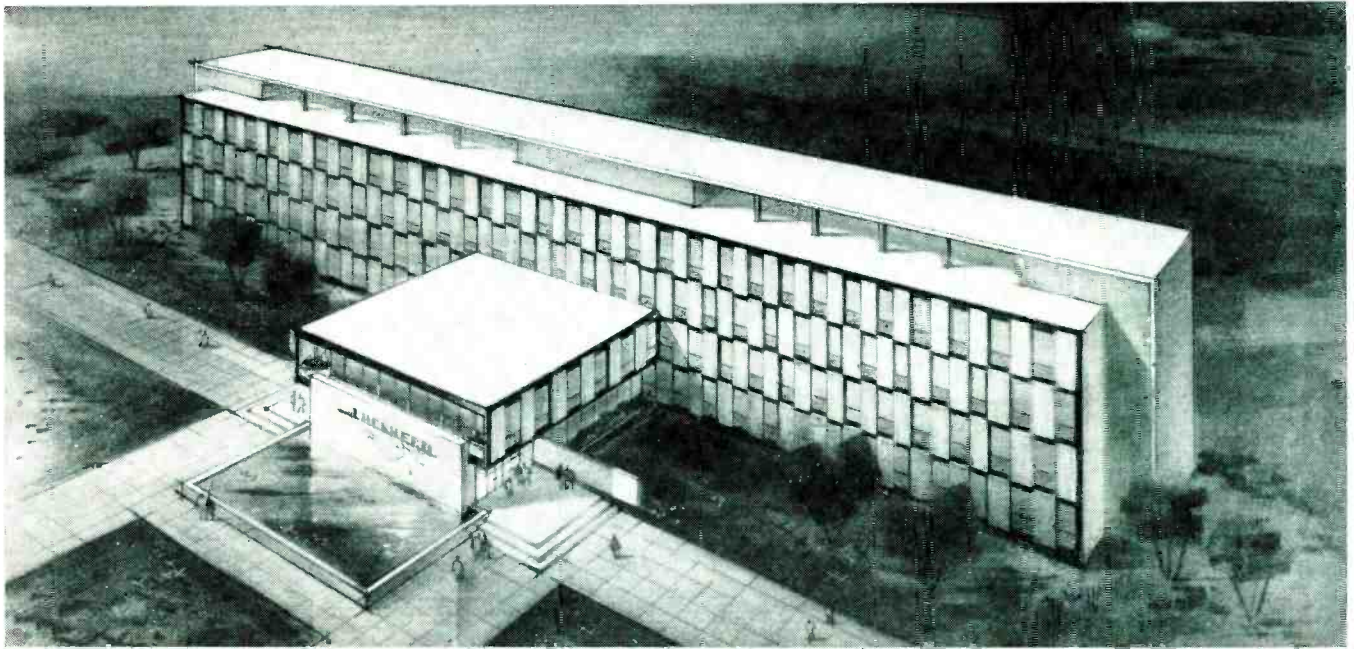

NEW MISSILE SYSTEMS RESEARCH LABORATORY RISES AT LOCKHEED

Scheduled for occupation this fall, Lockheed's new Missile Systems Research Laboratory is now well along in construction. First step in a \$10,000,000 research laboratory program, it is especially designed to provide the most modern facilities for meeting the complex problems of missile systems research and development.

Scientists and engineers able to contribute importantly to the technology of guided missiles are invited to write.

Lockheed MISSILE SYSTEMS DIVISION

research and engineering staff

National Conference on Aeronautical Electronics

May 9-11
Dayton, Ohio
Dayton-Biltmore Hotel
Telephone: Adams 2161

National Telemetering Conference

May 18-20
Chicago, Ill.
Morrison Hotel
Telephone: FRanklin 2-9600

C.T. Petrie and senior members of the technical staff will be available for consultation at both convention hotels.



Dr. E. H. Krause, Research Laboratory head (left), examines blueprints of the new laboratory with E. R. Quesada, Missile Systems Division vice president and general manager (center), and W. M. Hawkins, chief engineer, during ground-breaking ceremonies.

LOCKHEED AIRCRAFT CORPORATION • VAN NUYS • CALIFORNIA

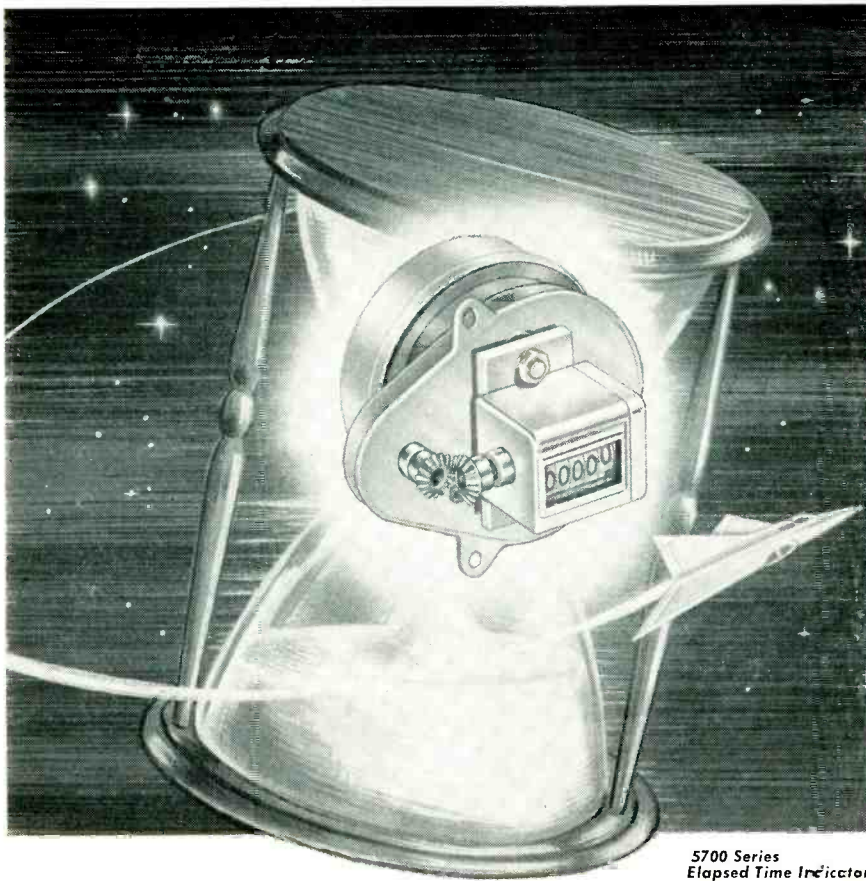

5700 Series
Elapsed Time Indicator

where high-impedance leakage may interfere with circuit function. For example, a low-resistance cathode-bias resistor serves as an effective barrier between a high-value grid resistor and a high-voltage component.

In some cases, additional grounded leads may be added to divert leakage currents away from high-impedance grid circuits. A typical unit assembled and wired in a straightforward manner may present five or six potential failure points due to slight repositioning before and during casting procedures. Careful rearrangement of the same components will yield a unit virtually free of such accidental failures. This type of preventive design pays big dividends in reduction of failures during manufacture and in the field.

Cable Plug Wrench

SPECIAL CABLE plug wrenches in various sizes are used in the Baltimore plant of The Glenn L. Martin Co. for setting the keyways of plugs and for closing the plugs. A projection on the inner surface of the tool mates with the keyway of the plug to hold this part securely during the tightening operation.

Although the wrench can be hand-held, it is generally supported by a multiple-position X block,



Inserting wrench in holding block

MEASURING THE COURSE OF TIME

with

HAYDON*

TIMING DEVICES

TIME — and its measure — are positive factors in man's progress. And helping man to control this inescapable element, HAYDON has designed and developed small, rugged devices that track its course with precision and dependability.

If TIME is a factor in the progress of YOUR product or process . . .

. . . HAYDON Devices offer efficient, accurate performance plus important economies in space and cost.

. . . HAYDON's complete Timing Services, engineering counsel and manufacturing facilities, are at your disposal.

TAKE TIME . . . call in the HAYDON Field Engineer; write for his name and for informative catalogs on HAYDON Timing Motors and Devices.

*Trademark Reg. U.S. Patent Office

HAYDON
AT TORRINGTON

HEADQUARTERS FOR
TIMING

A SUBSIDIARY OF GENERAL TIME CORP.

HAYDON Manufacturing Company, Inc.
2429 ELM STREET, TORRINGTON, CONN.

AN ADVENTURE

in *SILICON*

One example of junction technology at Bell Laboratories. Here a junction is produced on the surface of silicon by bombardment with alpha particles. Bombardment enhances silicon's performance at very high frequencies.

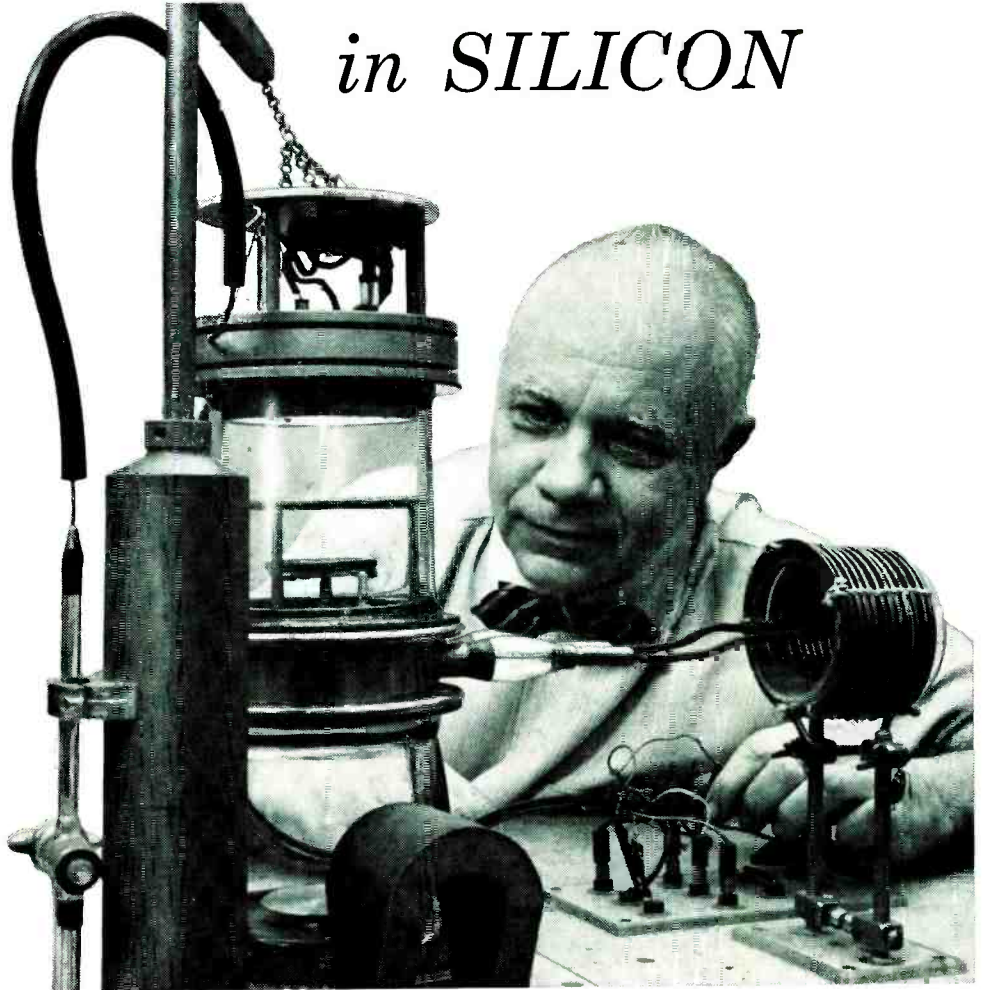

One day in the 'thirties a revolutionary adventure began for Bell scientists. They were testing an experimental silicon crystal they had grown to make microwave detectors.

Intriguingly, they found that one end of the crystal conducted by means of positive charges, the other end with negative. Positive and negative regions met in a mysterious barrier, or junction, that rectified, and was sensitive to light. It was something entirely new . . . with challenging possibilities.

The scientists went on to develop a theory of junction phenomena. They showed that two junctions placed back-to-back make an amplifier. They devised ways to make re-

producible junctions. Thus, junction technology came into being, and the 20th Century had a new horizon in electronics.

This technology has already produced at Bell Telephone Laboratories the versatile junction transistor (useful in amplifiers and switches); the silicon alloy diode (surpassingly efficient in electronic switching for computers); and the Bell Solar Battery which turns sunshine directly into useful amounts of electric current.

This is one of many adventures in science which make up the day-to-day work at Bell Laboratories . . . aimed at keeping America's telephone service the world's best.



Bell Telephone Laboratories

Improving telephone service for America provides careers for creative men in scientific and technical fields

Want more information? Use post card on last page.

News in X-Y Recording

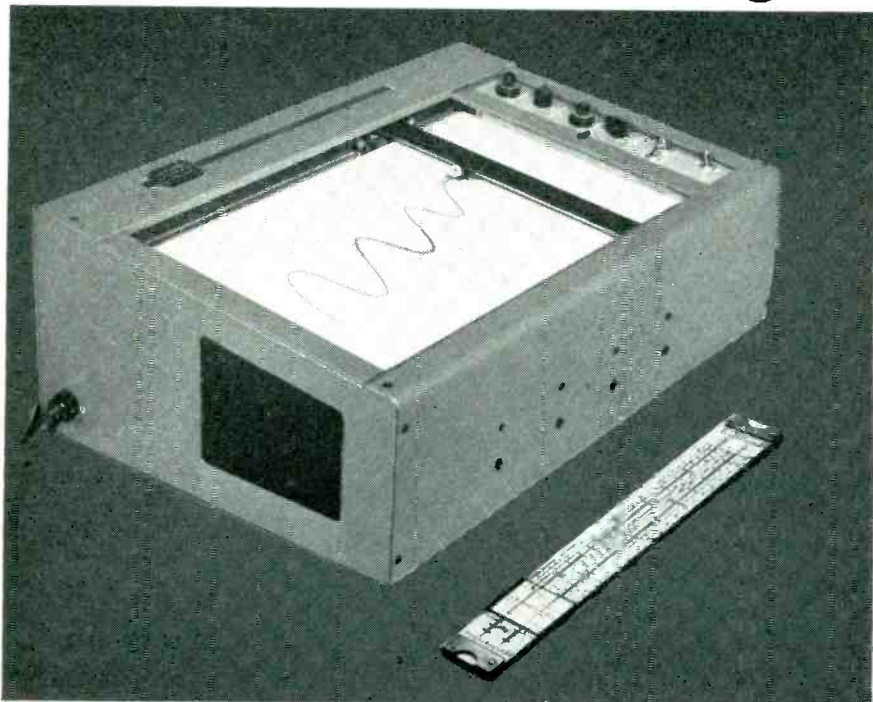

The new Variplotter Model 1100 Plotting Board

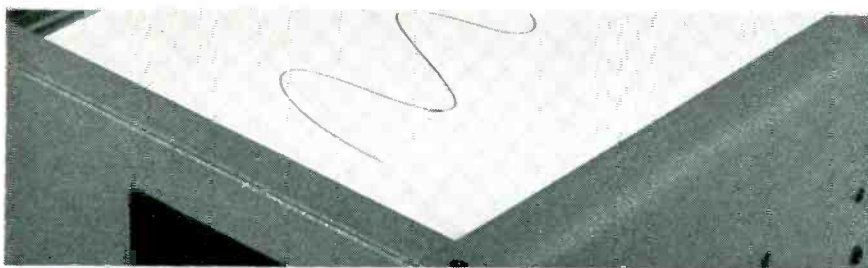

Including vacuum hold-down for plotting paper, finer accuracy, faster response

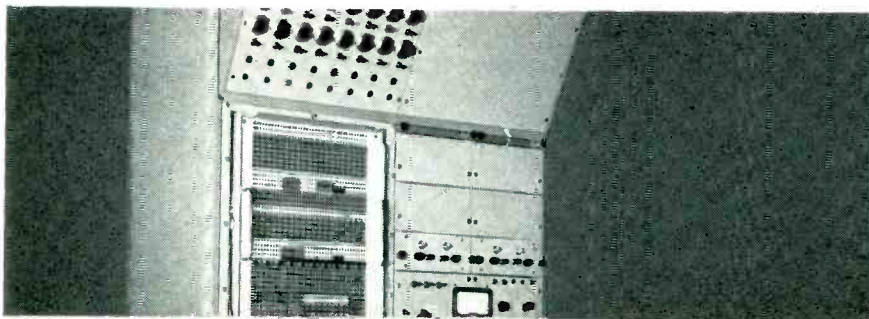

For use with Precision Analog Computing Equipment, Digital Systems, Instrumentation, etc.

Variplotter Model 1100 — Provides rapid (pen slews at approximately 20" per second) graphic recording of any data that can be reduced to electrical form. Same reliable accuracy as the well-known 205 series Variplotter. Ideal where compactness is essential without loss of speed or performance. Designed for use in recording computer outputs (as with EAI 16-31R pictured above), generating functions, or with additional equipment — for plotting digital information from punch cards or tape. For complete brochure write Department EL-7 Electronic Associates, Inc., Long Branch, New Jersey.



Tightening connector while wrench in block holds plug. Rack at rear holds other sizes of wrenches

leaving both hands of the operator free for work. The hardwood block is clamped in a holding fixture that can be adjusted to the optimum working angle.

Specifications for Printed-Wiring Production

To standardize production techniques for printed-wiring boards that are to be set into magnesium picture-frame mountings, engineers of the Electronic Division in the Baltimore plant of Westinghouse Electric Corp. established the following specifications:

- (1) Layouts are to be done on a scale of 2:1.
- (2) Layouts are to be on glass cloth, component outlines on one side, circuitry on the other. Give one outside (longest) dimension on both sides of board to be used as a scale target for the photographer.
- (3) Component cutouts, on a 2:1 scale, are available in drafting department for use in making the layouts.
- (4) The minimum spacing between any conductors after soldering must be at least $\frac{1}{16}$ ".
- (5) All leads shall be $\frac{1}{16}$ " wide actual size except $\frac{1}{8}$ " for filament leads and other leads carrying 500 ma and over. Wider leads shall be used for r-f grounds. Engineer to specify all leads wider than $\frac{1}{16}$ ".
- (6) Tube socket holes are to be punched 0.807" diameter actual for

ELECTRONIC ASSOCIATES
Incorporated

EAI SETS THE

P	A	C	E
PRECISION	ANALOG	COMPUTING	EQUIPMENT

LONG BRANCH, NEW JERSEY

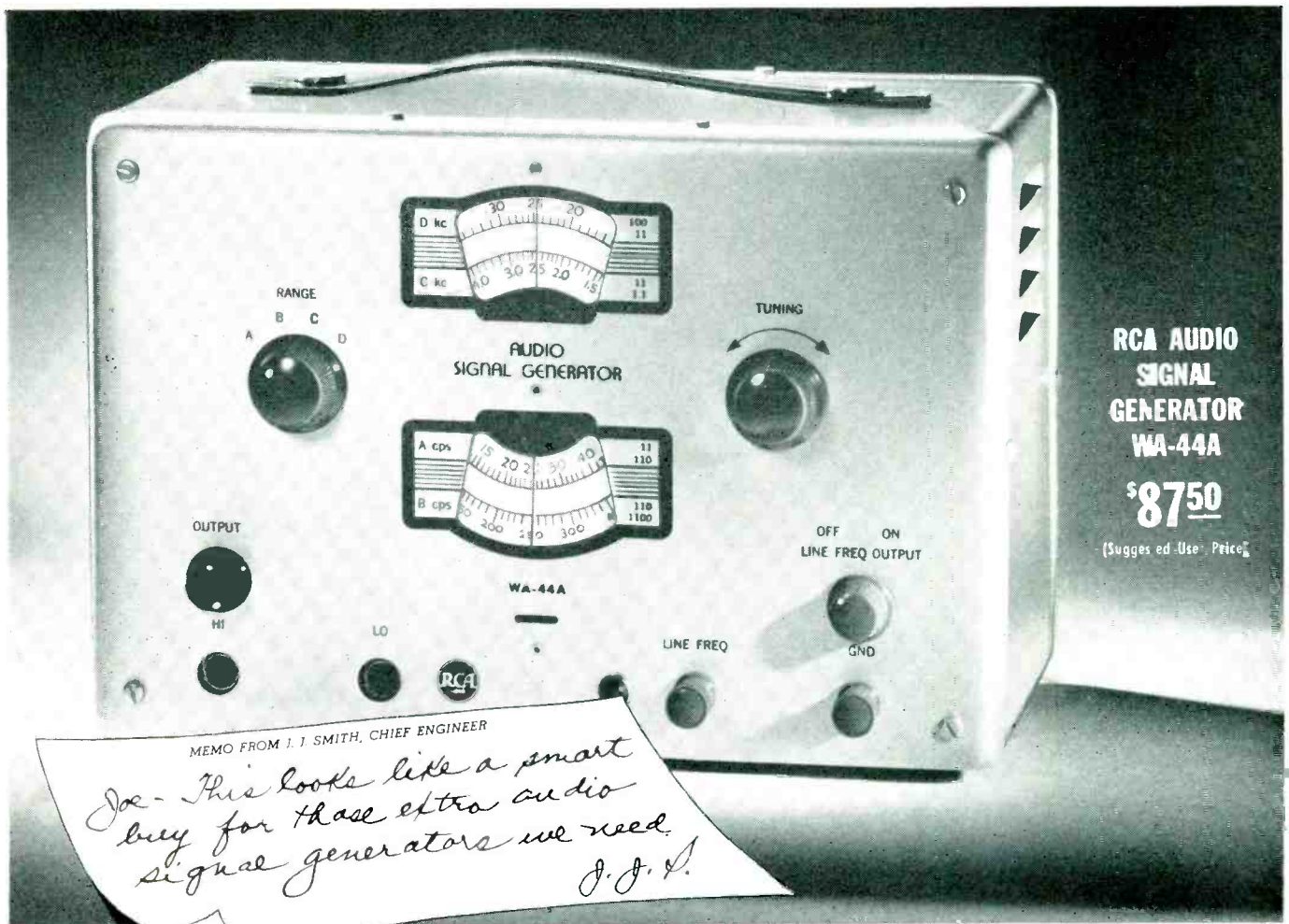

RCA AUDIO
 SIGNAL
 GENERATOR
 WA-44A

\$8750

(Suggested Use Price)

Here are basic features that make the RCA WA-44A a smart buy for your general-purpose audio work

- Wide Frequency range—11 cps to 100 Kc!
- Uniform output assured by amplified agc (within ± 1 db over entire frequency range)
- Separate high-output—15v rms, maximum
 Separate low-output—2.5v rms, maximum
- Hum level is extremely low—only 0.1% or less of rated maximum output
- Total harmonic distortion is 2% or less—from 30 cps to 15 Kc
- New RC oscillator provides good frequency stability ($\pm 3\%$, or better)
- Voltage-regulated oscillator power supply
- Excellent performance—in either high- or low-impedance circuits
- Compact (7" h, 10½" w, 6" d), and lightweight (10 lbs.) for easy portability

Compare the performance of the RCA WA-44A with that of any other audio signal generator costing up to one-third more—and see for yourself. Ask your local RCA Distributor for complete technical details. Or write RCA, Commercial Engineering, Section E19W, 415 S. Fifth St., Harrison, N. J.



RADIO CORPORATION of AMERICA
 TEST EQUIPMENT
 HARRISON, N. J.

WHICH IMPROVEMENT DOES YOUR PRODUCT NEED?



**ELECTRONIC
ELECTRICAL
MECHANICAL**

I.E. offers all three on a reasonable contract basis

INLAND ELECTRONICS brings a basic *plus* to any phase of your design or development program: I-E engineers solve the toughest problems first . . . by keeping *production* and *cost* firmly in mind as they create your improved design!

This bed-rock approach is solidly based on years of successful specialization—in design, engineering and manufacture—on high volume production at low unit cost.

For the electronic, mechanical or electrical solution to your immediate problem, consult your best source for creative and cost-conscious service . . . I-E, that is!

INLAND ELECTRONICS OFFERS YOU THESE PRODUCT SERVICES

DESIGN—I-E is ready to assume complete creative responsibility

PRODUCTION—from a simple part to thousands of complex mechanisms

TESTING—through production, assembly and final inspection

WRITE for **FREE**
booklet on



I-E Electronic, Mechanical,
Electrical Product Develop-
ment Facilities

*Product Design,
Engineering
and Contract Manufacturing*

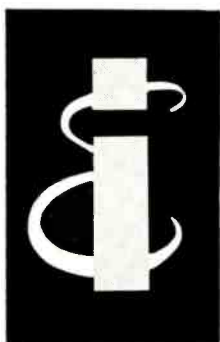

INLAND ELECTRONICS CORPORATION
500 RATHBONE AVE., AURORA, ILLINOIS

Telephone: AUrora 6-7745

9-pin sockets, 0.687" diameter for 7-pin sockets and 1 $\frac{1}{2}$ " for octal sockets.

(7) Holes in bullseyes for components are to be punched 0.070" diameter +0.000 and -0.001.

(8) Eyelets are to be installed in the 0.070" component holes. On layouts use $\frac{1}{4}$ " o.d. bullseye.

(9) All leads on the layout going to the connector or ground shall be identified on component side, such as +150, TRIG, GATE OUT and GND.

Ground Lead

(10) Because of the magnesium picture-frame mounting planned for the boards, a $\frac{1}{4}$ " actual-width ground lead shall be put along both edges and along one end of the board on one side only. The outer edges of this ground strip on the sides shall indicate the maximum overall width of the board. Because of the magnesium frame, all bullseyes shall be kept out of the $\frac{1}{4}$ " ground strip.

(11) Reverse printing shall not be used unless approved by the Section Manager.

(12) The proper positions of the components and tube JAN No. shall be suitably designed on the top or tube side of the board, and shall be identified by symbol number. All designation markings and lettering must be kept $\frac{1}{8}$ " minimum away from the spun-over eyelets or other conducting leads such as jumpers.

NOTE: No lettering or eyelets shall be placed either wholly or partially within the circle formed by the outer edge of the tube pin contact wedges, on either side of the board. This is to prevent contact being made with any shield bases.

(13) Tube sockets shall be indexed as to contact positions on the wiring side of the board. The center connection must have a contact point for grounding. Tube shield must be identified by a ground symbol. Socket holes must be keyed to match socket.

(14) All jumpers shall be printed and riveted on component side of board.

(15) Two holes, whose only purpose is for registration, shall be shown on the layout. They shall be dimensioned on the drilling plan

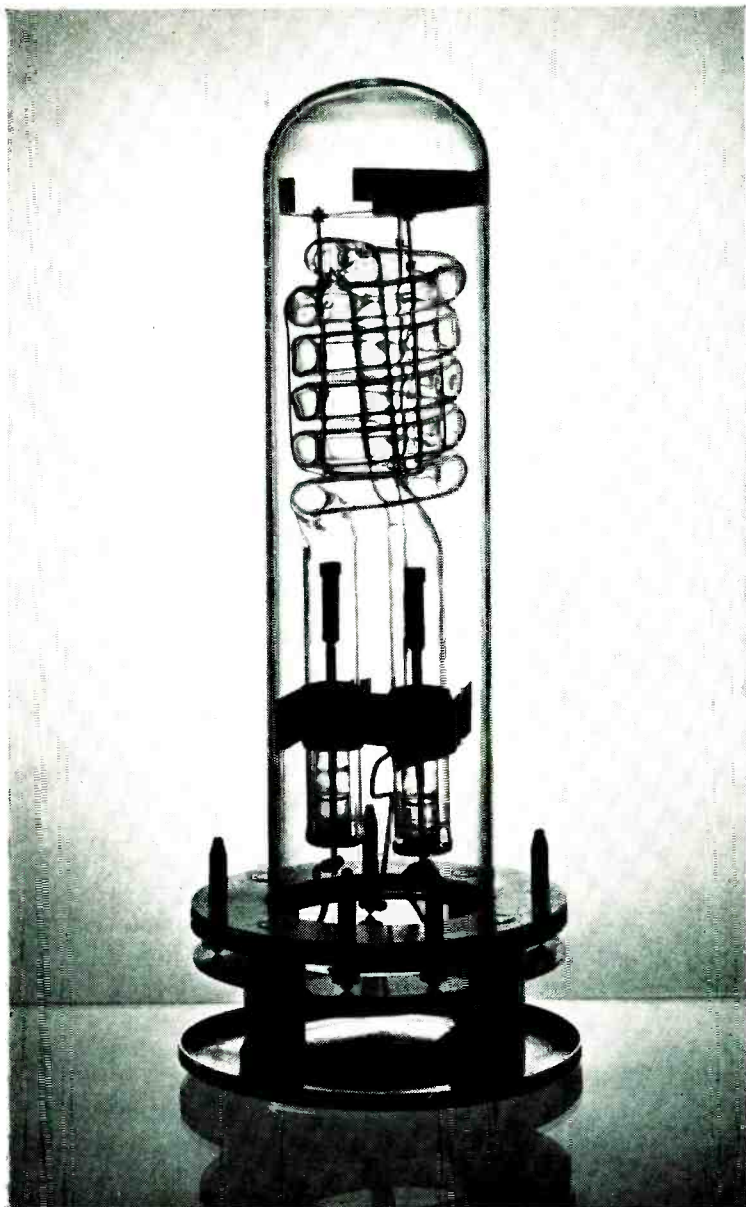

*More
Electronics
Manufacturers
choose*

AMERICAN AIRLINES AIRFREIGHT

To be certain vital component parts arrive on time, more and more electronics manufacturers are now relying on American Airlines Airfreight. With fast and frequent flights to all 23 leading industrial states, American is better able to provide rapid, direct one-carrier service and dependable on-time deliveries *than any other airline.*

If you would like to see how American's speed and service can benefit your business, wire collect to: American Airlines, Inc., Cargo Sales Division, 100 Park Avenue, New York 17, New York.

*to get
missing parts
on time*



A GREAT NAME CONTINUES GREAT NEW ACHIEVEMENTS

Thomas A. Edison

How Edison achieves extraordinary timing accuracy in a thermal relay



By calibrating each 501 Thermal Relay after hermetic sealing, EDISON provides unequalled timing accuracy — assures absolute production uniformity. Circuit designers can realize all of the benefits of a thermal relay without concern for changes in atmospheric pressure — or the problems of relay maintenance.

This exclusive method of calibrating, developed in the world-famous EDISON Laboratory, is just one of the features that have earned the EDISON 501 Relay an outstanding in-use record. A high degree of vibration and shock resistance, extreme light weight and typical EDISON construction ruggedness are but a few of the other features of the EDISON 501 Relay that lend it to such applications as these:

- ▶ Sustained over-current or over-voltage protection
- ▶ Integration of pulses or intermittent current
- ▶ Improving sensitive contact operation
- ▶ General control use
- ▶ Cathode protection
- ▶ "Holdover" circuits
- ▶ Motor starting



Send for complete information on the dependable EDISON 501 Thermal Relay — now.

Thomas A. Edison INCORPORATED

INSTRUMENT DIVISION • 54 LAKESIDE AVENUE • WEST ORANGE, NEW JERSEY

drawing as they will be used as a basis for all tooling.

(16) If any cases arise in making the layouts where Scotch tape must be used, use only the non-reflective Scotch Tape No. 810.

(17) All lettering on the layouts shall be Leroy 120 minimum in size.

(18) The printed boards shall be tin-plated before eyeletting, mounting components and dip soldering.

Producing Formed and Inside-Out Grids for UHF Pencil Tubes

By H. J. ACKERMAN

Tube Division
Radio Corporation of America
Harrison, N. J.

GRIDS used in typical commercial pencil-tubes triodes consist of lateral wire wound at a relatively coarse pitch around many supporting siderods as shown in Fig. 1. The siderod array, rather than the grid lateral wire, serves as the effective electron-control element.

The extent to which this type of structure can be used in high-frequency tubes is limited, however, because the minimum size of the siderods and the closest practical spacing between them depend on mechanical considerations and the need for thermal conduction of heat from the grid.

Two modifications of grid configuration which overcome these limitations, currently being employed in developmental uhf pencil tubes, are the formed grid and the inside-out grid.

In the formed grid structure, shown in Fig. 2, the lateral wire is formed against an internal mandrel so that the inside diameter of the grid is substantially the same as

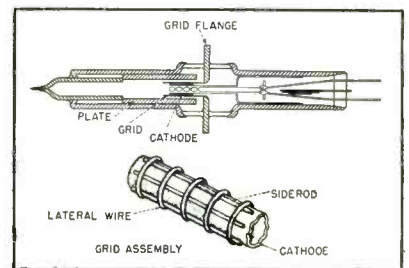

FIG. 1—Cross-section of typical pencil-tube triode and enlarged view of conventional coaxial grid and cathode

Latest in HF

COMMUNICATIONS BY Collins

Collins new high frequency equipment has wide application in the ground-to-plane, shore-to-ship and point-to-point communication field. Modern circuitry assures the highest performance over a wide frequency range. Excellent receiver selectivity, together with maximum transmitter harmonic attenuation assures freedom from interference in areas where channel frequencies are closely spaced.

COLLINS 430 Series offers a choice of 12 transmitters to meet your individual communications requirement. Frequency range is 2.0 to 30.0 mc. Automatic channel switching on ten pre-set frequencies from a local or remote position is available when Collins Autotune is employed. Provision is made for use of master oscillator. Power output: 431 series — 1,000 watts CW, FSK or AM voice; 432 series — 2,500 watts CW or FSK, 2,000 watts voice. Frequency stability is .003% for CW or voice and .0005% for FSK.

COLLINS 512B-2 RF Impedance-conversion unit may be used in the range of 2 to 30 mc to couple unbalanced 52-ohm transmitter output to a 600-ohm balanced transmission line. No tuning is required.

COLLINS 51J-4 Double Conversion Superheterodyne Receiver is designed for top performance from 0.54 to 30.5 kilocycles. A crystal controlled high frequency oscillator and highly stable low frequency oscillator permit accurate linear calibration of one dial division per kilocycle on all bands. The Collins Mechanical Filters give the 51J-4 the closest approach to ideal selectivity ever achieved in a communications receiver designed for AM, CW, MCW, and FSK reception.

COLLINS 51N-2 Receiver provides voice, CW and MCW reception at any one crystal controlled frequency in the 2 to 24 megacycle range. Image rejection is 60 db throughout the range. Sensitivity is better than 5 uv for a 10 db signal-to-noise ratio. Provision is made for remote control.

Write for descriptive literature.

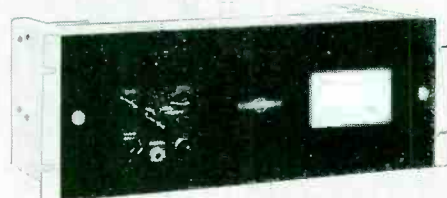
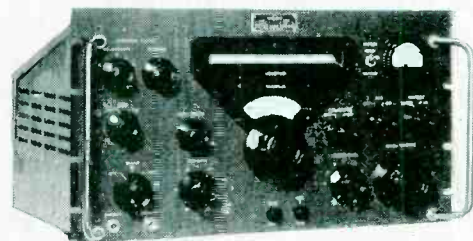
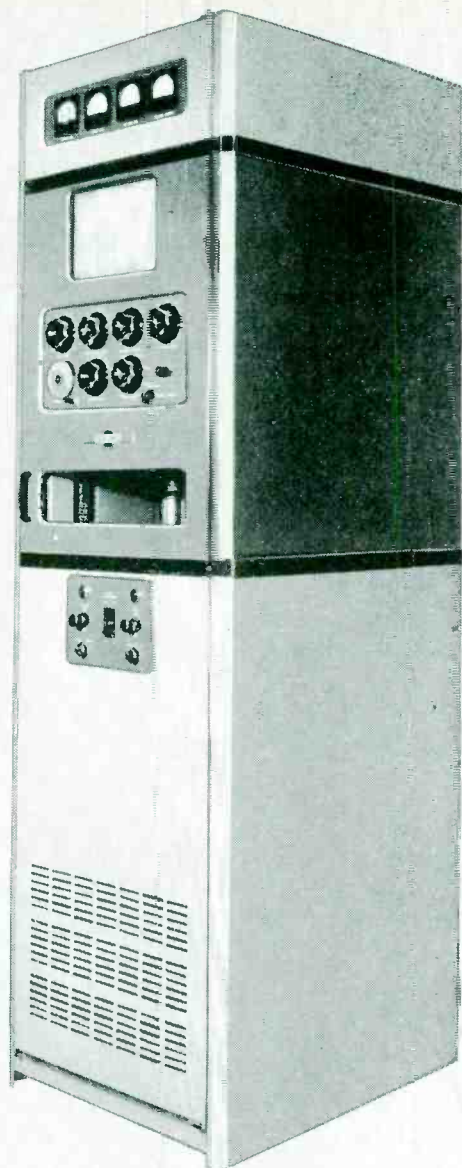

COLLINS RADIO COMPANY

CEDAR RAPIDS, IOWA

261 Madison Avenue, NEW YORK 16, NEW YORK
1200 18th Street N. W., WASHINGTON, D. C.
1930 Hi-Line Drive, DALLAS 2, TEXAS
2700 W. Olive Avenue, BURBANK, CALIFORNIA
COLLINS RADIO COMPANY OF CANADA LTD.
74 Sparks Street, OTTAWA, ONTARIO





SINCE 1915 LEADERS IN AUTOMATIC CONTROL

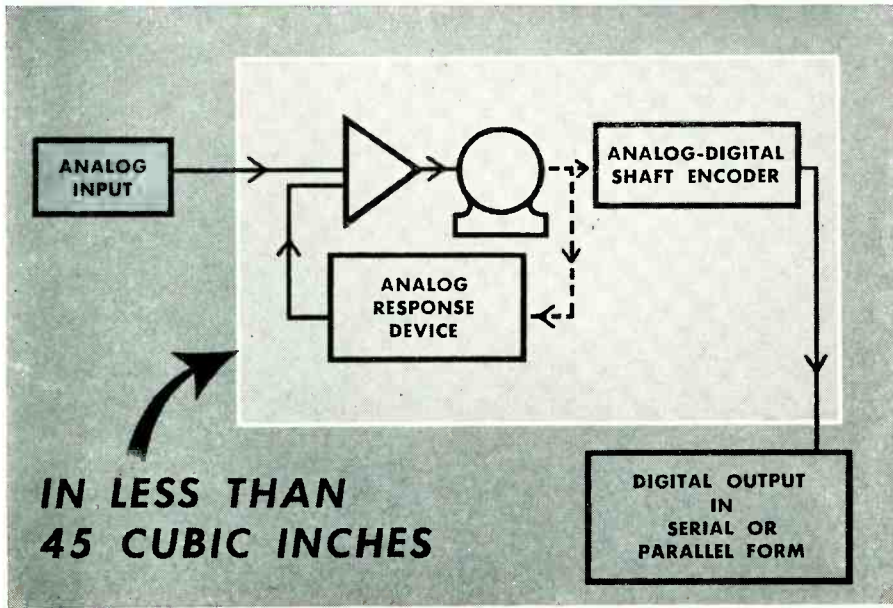

IN LESS THAN
45 CUBIC INCHES

ANALOG TO DIGITAL CONVERSION in less than 45 cubic inches

In an aircraft navigational system, input information (such as compass headings, speeds, etc.) is received in analogs. The Ford Instrument Company engineers recently had a problem which required the presentation of this information in digital forms. Along with this was the physical problem of weight and size minimization. An Analog-Digital converter was developed which solved the problem. This unit occupied less than 45 cubic inches and required only line voltage with no special power supply.

This is typical of the way Ford Instrument engineers solve problems in the computing and control field. For forty years Ford has been pioneering techniques in servomechanisms; developing, designing and manufacturing systems and components to solve the complex problems of automatic control. Should you have a problem in control engineering it will pay you to talk to one of the Ford Instrument Company engineers.



⁵⁶
FORD INSTRUMENT COMPANY
DIVISION OF THE SPERRY CORPORATION
31-10 Thomson Avenue, Long Island City 1, N.Y.

ENGINEERS

of unusual abilities can find a future at FORD INSTRUMENT COMPANY. Write for information.

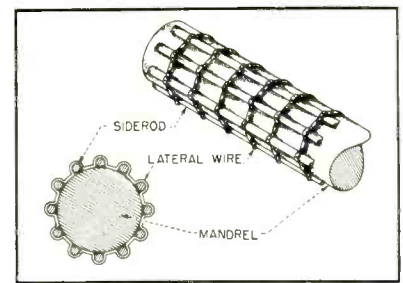

FIG. 2—Formed grid, showing lateral wire formed against internal mandrel

the diameter of the mandrel. The lateral wire is then the dominant control element.

In the fabrication of a formed pencil-tube grid, a conventional grid is first made on the equipment shown in Fig. 3. Eighteen 0.002-inch nickel-clad copper siderods are positioned around a continuously moving mandrel of oxidized nickel-chrome alloy. The diameter of the mandrel is substantially equal to the desired internal diameter of the grid. A silver-plated nickel-cobalt alloy lateral wire having a diameter of 0.0005 inch is then wound under tension around the siderods at 400 turns per inch, which is suitable for effective control. The lateral wire is r-f brazed to the siderods in a hydrogen atmosphere at a mandrel temperature of about 1,000 C in the coil region. The silver plating of the lateral wire serves as the brazing material so that a joint is obtained between the lateral wire and the siderods at each crossover point.

To form the grid, a mandrel-and-grid assembly is positioned on a rubber pad in the die as shown in Fig. 4, just under the punch, which also contains an attached

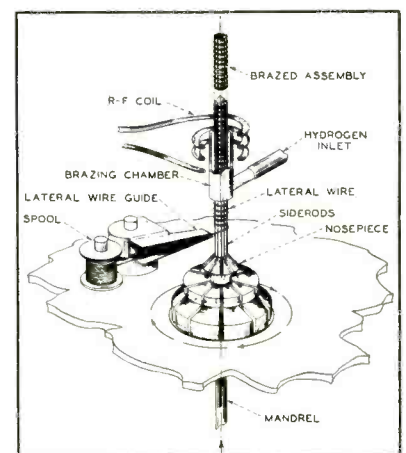
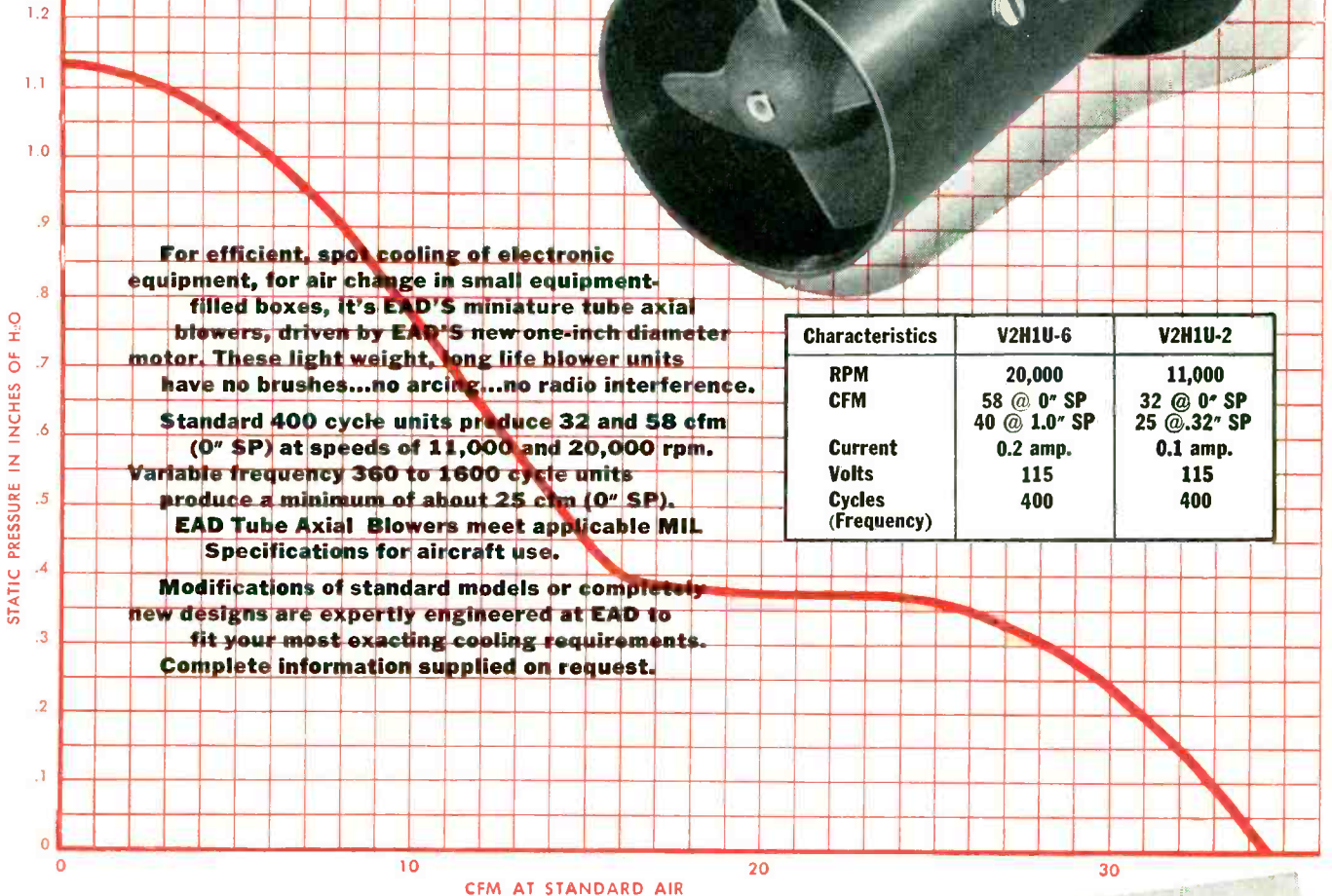
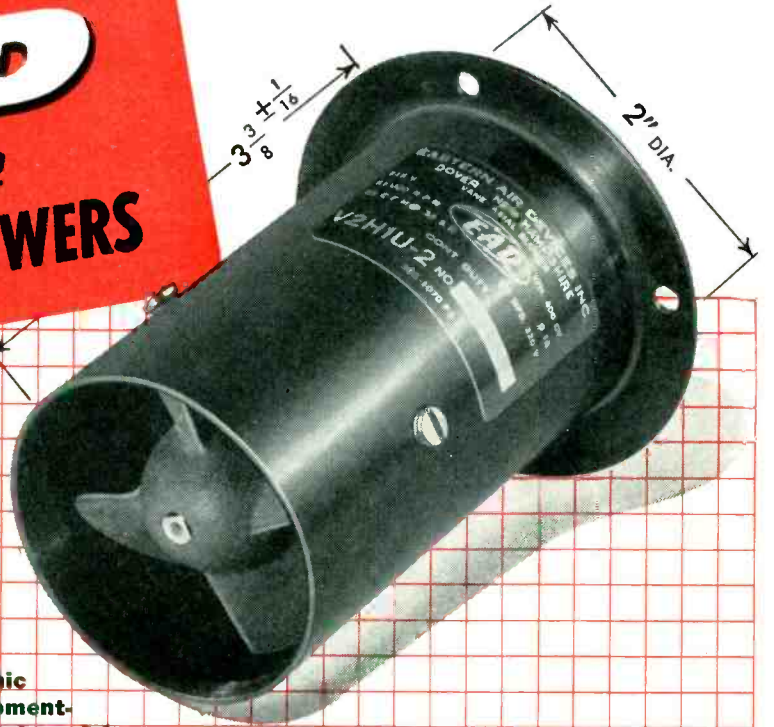

FIG. 3—Apparatus used for fabrication of conventional pencil-tube grids

High CFM even with HIGH SP

(static pressure)

EAD miniature TUBE AXIAL BLOWERS



For efficient, spot cooling of electronic equipment, for air change in small equipment-filled boxes, it's EAD'S miniature tube axial blowers, driven by EAD'S new one-inch diameter motor. These light weight, long life blower units have no brushes...no arcing...no radio interference.

Standard 400 cycle units produce 32 and 58 cfm (0" SP) at speeds of 11,000 and 20,000 rpm. Variable frequency 360 to 1600 cycle units produce a minimum of about 25 cfm (0" SP).

EAD Tube Axial Blowers meet applicable MIL Specifications for aircraft use.

Modifications of standard models or completely new designs are expertly engineered at EAD to fit your most exacting cooling requirements. Complete information supplied on request.

Characteristics	V2H1U-6	V2H1U-2
RPM	20,000	11,000
CFM	58 @ 0" SP 40 @ 1.0" SP	32 @ 0" SP 25 @ .32" SP
Current	0.2 amp.	0.1 amp.
Volts	115	115
Cycles (Frequency)	400	400

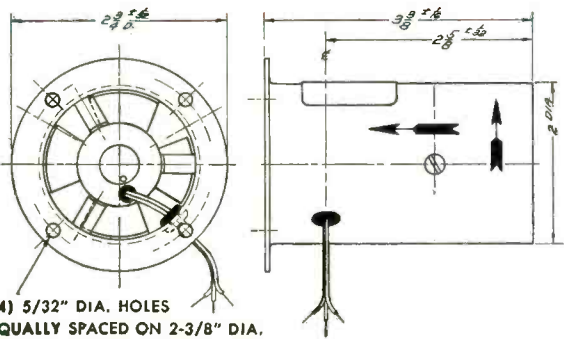

(4) 5/32" DIA. HOLES EQUALLY SPACED ON 2-3/8" DIA.

EASTERN AIR DEVICES, INC.
SOLVING SPECIAL PROBLEMS IS ROUTINE AT EAD

INDUCTION MOTORS TACHOMETER GENERATORS CENTRIFUGAL BLOWERS FANS ALTERNATORS GEAR MOTORS

387 CENTRAL AVENUE, DOVER, NEW HAMPSHIRE

DEPEND ON



RELIABLE ELECTRON TUBES



With electronic controls taking over more and more operational functions in military and industrial applications, it is becoming increasingly important that the electron tubes used be dependable under extremely severe conditions. This applies particularly to installations in aircraft where tubes must operate reliably at high altitudes, while subjected to continuous vibration, varying voltages and frequent shock. Because of their advanced design and construction . . . born of never-ceasing research and special production skills . . . Bendix Red Bank Reliable Electron Tubes have the dependability necessary to meet these severe operating conditions. You can depend on our long, specialized experience to give you the right answer . . . for all types of regular as well as special-purpose tube applications. Tubes can be supplied to both commercial and military specifications. Call on us for full details.

Manufacturers of Special-Purpose Electron Tubes, Inverters, Dynamotors, Voltage Regulators and Fractional D. C. Motors

DESIGNATION AND TYPE					TYPICAL OPERATING CONDITIONS		
Type	Proto-type	Bendix No.	Description	Base And Bulb	Heater Voltage	Plate Voltage Per Plate	M.A. Load
5838	6X5	TE-3	Full Wave Rectifier	Octal T-9	12.6	350.	70.
5839	6X5	TE-2	Full Wave Rectifier	Octal T-9	26.5	350.	70.
5852	6X5	TE-5	Full Wave Rectifier	Octal T-9	6.3	350.	70.
5993	6X4	TE-10	Full Wave Rectifier	9-Pin Miniature	6.3	350.	70.
6106	5Y3	TE-22	Full Wave Rectifier	Octal T-9	5.0	350.	100.

Type	Proto-type	Bendix No.	Description	Base And Bulb	Heater Voltage	Plate Voltage	Screen Voltage	Grid Voltage	Gm	Plate Current	Power Output
5992	6V6	TE-8	Beam Power Amplifier	Octal T-9	6.3	250.	250.	12.5	4000	45. MA	3.5 W
*6094	6AQ5 6005	TE-18	Beam Power Amplifier	9-Pin Miniature	6.3	250.	250.	12.5	4500	45. MA	3.5 W
6385	2C51 5670	TE-21	Double Triode	9-Pin Miniature	6.3	150.	—	-2.0	5000	8. MA	—

*Tube Manufactured with Hard (Nonex) Glass for High Temperature Operation (Max. Bulb Temp. 300°C.)



DIVISION OF



EATONTOWN, N. J.

West Coast Sales and Service: 117 E. Providencia Ave., Burbank, Calif. • Export Sales: Bendix International Division, 205 East 42nd St., New York 17, N. Y.
Canadian Distributor: Aviation Electric Ltd., P.O. Box 6102, Montreal, P. Q.

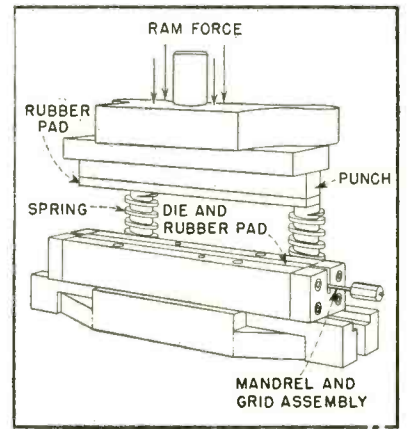

FIG. 4—Grid-forming apparatus

rubber pad. A ram force of 3,000 pounds per square inch is applied to the rubber pads and transmitted to the lateral grid wire. The portions of the lateral wire between adjacent siderods are formed against the mandrel. Thus, this technique serves both a grid-sizing and grid-forming function. After the grid is formed, the grid assembly on the mandrel appears as shown in Fig. 2.

After the grid strip is formed, it is cut into grids of required length and these grids, still on the mandrel, are washed in a degreasing agent, rewashed in water, rinsed in methanol and dried. The grids are then fired in a hydrogen atmosphere at a temperature of 600 C for 5 minutes and removed from the mandrel for use in tubes. When these formed grids are used, the grid-cathode spacing in a pencil tube is not limited by the thickness of the supporting rods, but only by tube-assembly techniques.

The inside-out grid has the lateral wire fastened to the portion of the siderods nearest the cathode, as shown in Fig. 5. To make this, the lateral wire is wound around the mandrel prior to insertion in the nosepiece. A securing wire is used to hold the siderods in position

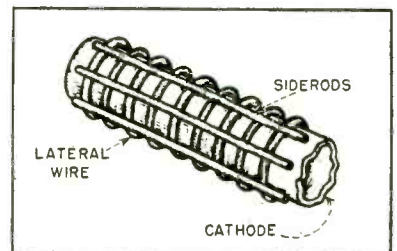

FIG. 5—Inside-out grid with side rods outside the lateral wire

A combination to make

ELECTRONICS HISTORY...

MACK TRUCKS'
extensive research, manufacturing and
quality production facilities

plus **WHITE INDUSTRIES'**
electronic engineering skill, experience
and know-how

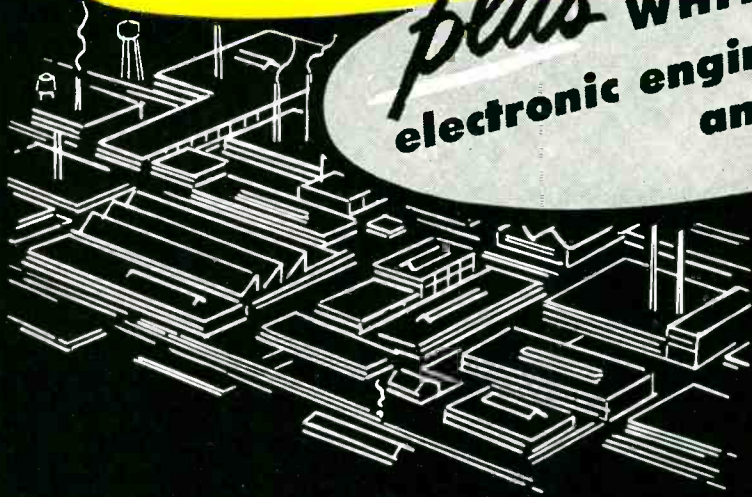

Mack Trucks, for over 54 years a great name in the field of quality manufacture of automotive products, combines its manufacturing, production, engineering and metallurgical research facilities with the electronic engineering techniques of White Industries, Inc.

This brings to the electronics field a combination which provides unmatched production and technical resources serving avionics, marine and industrial markets and the military.

- Complete fire control systems
- Missile control systems
- Weapon procurement systems
- Radar antennae
- Industrial applications of ultrasonics
- Environmental engineering
- Nuclear and electronic test equipment
- Metallurgical specialists



WI



WHITE INDUSTRIES INC.

421 WEST 54TH STREET, NEW YORK 19, NEW YORK

A Wholly-owned Subsidiary of MACK TRUCKS, Inc.

©411

Why REGOHM Regulators are preferred by design engineers for these applications

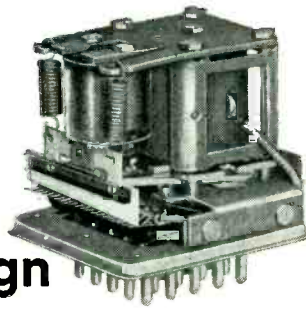

Selenium Rectifier
Power Supplies

REGOHM regulates voltage of this selenium rectifier power supply used in testing aircraft equipment. Despite widely varying input voltage of the equipment, stability problems are solved by REGOHM's built-in, thoroughly reliable dashpot. No anti-hunt networks are required. System design is simplified.

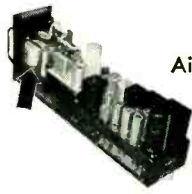

Aircraft
Inverters

REGOHM controls the frequency of the aircraft inverter that powers the B-47's automatic fire control system. It withstands severe shock, vibration, temperature ranges from -65°C to $+71^{\circ}\text{C}$ and 50,000 foot altitudes. Its performance cannot be matched by any equipment of comparable size, weight or cost.

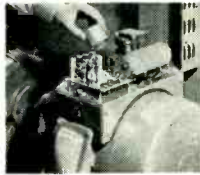

Motor
Generator Sets

REGOHM means close-tolerance voltage control on motor generator sets up to 40KW that power machine tools. The regulator's fast speed of response saves wear and tear when tools are started and stopped. REGOHM's long life is measured in years. Its plug-in feature simplifies replacement by unskilled personnel.



Infrared
Spectrometers

REGOHM controls current to assure constant radiation from infrared source, enhancing the accuracy of this infrared spectrometer. The regulator's characteristics, compactness and reliability simplify system design. It replaces heavier, more expensive and complex, but less accurate, equipment.

Check this list:

- | | | | |
|--|---|---|--|
| <input type="checkbox"/> Battery Chargers | <input type="checkbox"/> Railroad Signal Systems | <input type="checkbox"/> Railroad Car Lighting Systems | <input type="checkbox"/> Oil Field Exploration Systems |
| <input type="checkbox"/> Airborne Equipment | <input type="checkbox"/> Refrigeration Equipment | <input type="checkbox"/> Locomotive Braking Systems | <input type="checkbox"/> Signal and Alarm Systems |
| <input type="checkbox"/> Portable and Stationary Generators | <input type="checkbox"/> Filament Regulation | <input type="checkbox"/> Wire and Radio Communication Systems | <input type="checkbox"/> Instrumentation Systems |
| <input type="checkbox"/> Marine Radar | <input type="checkbox"/> Computers | <input type="checkbox"/> Air Navigational Systems | <input type="checkbox"/> Magnetic Clutches |
| <input type="checkbox"/> Underwater Sound Systems | <input type="checkbox"/> Airport Lighting Systems | <input type="checkbox"/> Guided Missiles | <input type="checkbox"/> Tension Control Equipment |
| <input type="checkbox"/> Telephone Central Station Equipment | <input type="checkbox"/> Inverters | | <input type="checkbox"/> Saturable Reactors |

If you find your equipment or system listed, or have a problem in other fields, contact Electric Regulator Corporation,

100 Pearl Street, Norwalk, Conn. Our engineers will help you design required circuitry... recommend the proper REGOHM type... calculate the resistor network... suggest design modifications for optimum performance... analyze final designs... assist in testing pre-production models... service your requirements. Write us today.



Electric Regulator Corporation
Norwalk, Connecticut Temple 8-4311

against the lateral wire as they are positioned by the winding machine, as shown in Fig. 6.

A typical inside-out grid is made as follows: Silver-plated nickel-cobalt alloy or gold-plated tungsten lateral wire having a diameter of 0.0005 inch is wound under tension at the desired pitch around a nickel-chrome alloy mandrel having an oxidized surface. The mandrel then passes through a pencil-tube grid-winding machine, and 18 nickel-clad copper or silver-plated

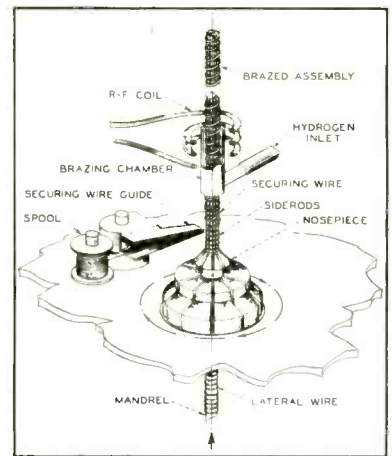

FIG. 6—Apparatus used for fabrication of inside-out grid

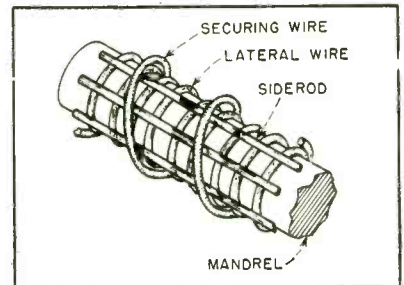
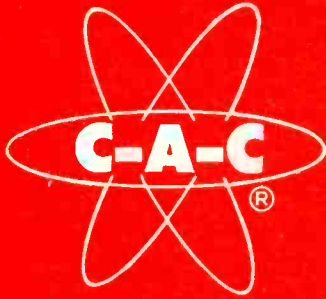

FIG. 7—Inside-out grid strip assembly, showing mandrel, lateral wire, siderods and external securing wire

nickel-clad copper siderods are positioned around the helix parallel to the axis of the mandrel. The siderods are held in place around the outer surface of the helix by an external wrapping of oxidized stainless steel wire having a diameter of 0.0015 inch; the securing wire is wound at a coarser pitch than that used for the grid lateral wire. The grid strip is r-f brazed in a hydrogen atmosphere so that the grid lateral wire and the siderods are joined to each other at the points of contact. Because both the mandrel and the external securing wire have oxidized surfaces, they do not



Airborne Components...

a C. A. C. Specialty



POWER TRANSFORMERS

Range—400-6000 cps
Efficiency—up to 95%
Wattage—6mw-200 watts
Temperature—-55 to +155° C.

Depicted—6KC 100 Watt Unit
Less than 1.65 cubic inches

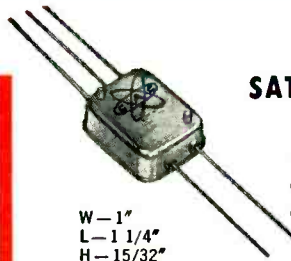

SATURABLE REACTORS

Applications

- Servo Systems
- Data Telemetering
- Remote Frequency Control

W—1"
L—1 1/4"
H—15/32"

Illustrated—High Frequency Reactor Tuned by Varying D. C. Current

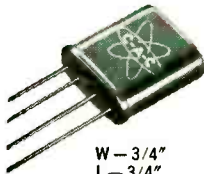

PULSE TRANSFORMERS

Pulse Width—.2-50 microseconds
Rise Time—from .03 microseconds

- Blocking oscillator
- Pulse coupling
- Toroidal construction

W—3/4"
L—3/4"
H—5/16"

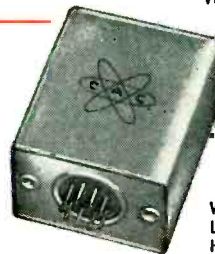

MAGNETIC AMPLIFIERS

Wattage (output) .5-200 watts
Response—1 cycle up

W—1 1/4"
L—1 3/4"
H—2 5/32"

Illustrated—Auto Pilot Application for Printed Circuit Mounting



SUB-MINIATURE FILTERS

For Chassis Mount

Frequency—2.3-35Kc
Impedance in—600-10K Ohms
Impedance out—Grid

- Hermetic Sealed
- Temperature Compensated
- Internal D. C. Isolation
- Balanced or Unbalanced
- Military Specifications

W—23/32"
L—23/32"
H—1 1/16"

Illustrated
4KC
Band Pass



SUB-MINIATURE TUNED CIRCUITS

For Printed Circuit Applications

- Multiple Tuned Transformers
- Delay Lines
- Tuned Circuits

W—1"
L—4 1/4"
H—7/16"

FOR ADDITIONAL INFORMATION CONTACT

COMMUNICATION ACCESSORIES COMPANY

3-55/1.0

HICKMAN MILLS, MISSOURI • PHONE KANSAS CITY, SOUTH 5528

INFRA INTRODUCES SERVO MOTOR-GENERATOR



MG 110
GOVERNMENT DESIGNATION MK-12



MG 110-A COMMERCIAL

DELIVERY ON PROTOTYPES — 30 DAYS

	FIXED PHASE			VARIABLE PHASE 2			MEASURED AT STALL	
	PHASE	SERIES	PARALLEL	Effective Resist., Ohms	Generated Volts at 70° Term's.	At 0 Rpm, Rms	At 0 Rpm, Fundamental	
Voltage	115	115	57.5	2440	8 & 9	.013	.008	
Frequency, Cps	400	400	400	At 1000 Rpm, Rms	3.2	16.0	5500	
Connections, Line	1 & 3	2 & 4	2 & 6	Max. Speed for Linear Output, Rpm	5500	PHASE SHIFT:		
Strap		5 to 6	2 to 6	At 0 Rpm	85° Leading	At 50 Rpm		
			4 to 5	At 3000 Rpm	5° Lagging	At 5000 Rpm		
Current, Amperes	.110	.110	.220	Output Impedance, Ohms	2200	Duty		
Power Input, Watts	6.1	6.1	6.1		Continuous			
Power Factor	.49	.49	.49					
R, Ohms	490	490	122.5					
X, Ohms	890	890	222.0					
Z, Ohms	1030	1030	257.0					
Effective Resist. Ohms	2200	2200	550.0					

MEASURED AT STALL
Tachometer Generator:

Voltage	115
Frequency, Cps.	400
Connections	7 & 10
Current, Amperes	.073
Power Input, Watts	5.4
Power Factor	.64
R, Ohms	1012
X, Ohms	1210
Z, Ohms	1575

**WRITE FOR FREE
DATA SHEETS**

INFRA ELECTRONIC CORP.
555 Eagle Rock Ave.
Roseland, N. J.

Gentlemen:
Please send specification sheets

Name & Title _____

Company _____

Address _____

join with the materials of the lateral wire and the siderods during the brazing process. Figure 7 shows a portion of the grid strip assembly consisting of the mandrel, the lateral wire, the siderods and the external securing wire.

After the grid strip assembly is brazed, the external securing wire is removed and the strip is cut into grids of required length. The grids are then washed, fired and removed from the mandrel for use in tubes. A finished grid positioned about a cathode is shown in Fig. 5. Because the grid-cathode spacing in a pencil tube employing this inside-out grid is not limited by the thickness of the supporting siderods, the minimum spacing is limited only by tube-assembly techniques.

Induction Soldering of Coaxial Tuned Stubs

AFTER ASSEMBLY of quarter-wave coaxial tuned stubs for tuned circuits of 400 to 470-mc two-way radio equipment, a soldered hermetic seal is achieved by induction soldering in Motorola's Chicago plant. A Reeves 5-kw induction heating generator is used as the power source. The water-cooled work coil is constructed from 1/8-inch square copper tubing.

An alignment jig is used inside the coaxial unit to establish correct alignment of the adjustable center plunger and the quarter-wave stub. The solder used is Kester 60-40 No. 44 rosin-core solder, applied during heating as well as by means of pre-forms.

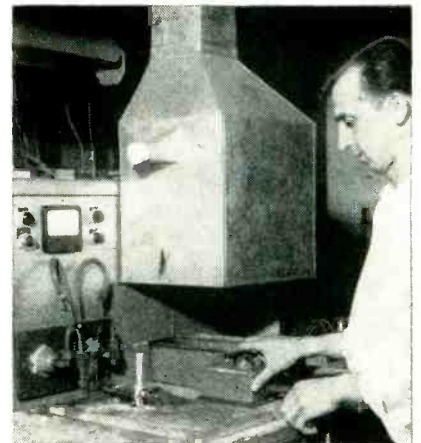

Induction soldering setup. Hood carries away soldering fumes

NEW IMPROVED MAGNETIC AMPLIFIERS

keystone

“Moto Mag”*



KP-10-400-A

Engineered and precision manufactured for extra sensitivity, higher amplification, excellent linearity — seven key models available immediately. All meet MIL specs with minimum size and weight.

The slightest flaw in the performance of a magnetic amplifier can throw an entire control system out of order.

Don't trust an important computer, missile, motor or any other equipment to a bargain amplifier—get a Keystone “Moto Mag” for dependable performance.

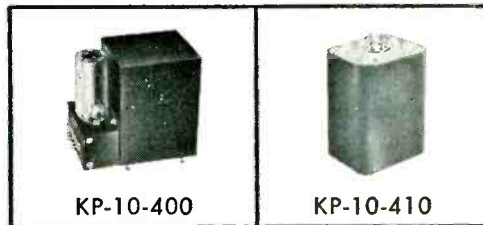

KP-10-400

KP-10-410

PART NUMBER

QUANTITIES

	1/25	25/49	50/99	100/299	300/499	500/999	1000/2500
KP-5-400	\$48.00	\$32.00	\$28.00	\$25.00	\$23.75	\$22.50	\$21.50
KP-10-400	49.75	34.00	29.50	26.00	24.75	23.75	22.50
KP-15-400	56.75	37.75	32.50	29.50	28.50	27.00	25.75
KP-10-400-A	58.00	40.00	35.00	32.00	30.00	28.00	27.00
KP-5-410 Class A	33.00	22.50	19.50	17.00	16.50	15.50	15.00
KP-5-410 Class B	43.25	29.50	25.50	22.50	21.50	20.50	19.50
KP-10-410 Class A	33.25	22.50	19.50	17.50	16.50	15.75	15.00
KP-10-410 Class B	43.75	30.00	26.00	23.00	22.00	21.00	20.00
KP-15-410 Class A	37.00	25.25	22.00	19.50	18.50	17.50	16.75
KP-15-410 Class B	54.50	37.25	32.25	28.50	27.25	26.00	25.00

©NTI

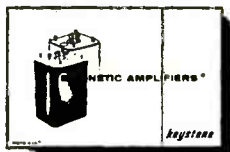

Send today for new Magnetic Amplifier catalog showing complete specifications and performance data.

keystone 
PRODUCTS COMPANY

*Reg. Trademark

904 23RD STREET UNION CITY 2, N. J.

New Products

Edited by WILLIAM P. O'BRIEN

84 New Products and 54 Manufacturers' Bulletins Are Reviewed
. . . Control, Testing and Measuring Equipment Described and
Illustrated . . . Recent Tubes and Components Are Covered

MAGNISTORS

transient and permanent

POTTER INSTRUMENT CO., INC., 155 Cutter Mill Rd., Great Neck, N. Y. Magnistors are basic circuit elements with all the advantages of transistors and magnetic cores without the attendant disadvantages. They are small saturable reactors having unique shapes and flux paths, and are divided into two general classes — transient and permanent. The transient type class has no memory while the permanent will remember its set or reset con-

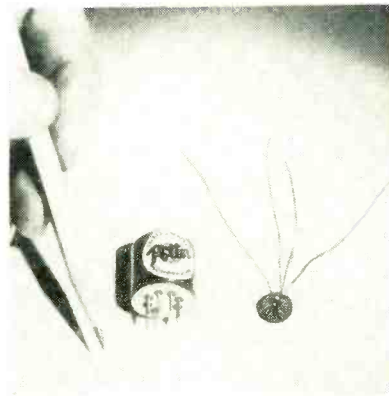

dition indefinitely even if all power is removed. They contain either 2 or 3 windings on special ferro-ceramic material. Principal applications of the new magnetic elements will be in high-speed computers, business data handling systems, automation control systems, high-speed counters and magnetic tape systems. Magnistors will last indefinitely and are not affected by temperature extremes encountered in commercial and government equipments. Another feature is the wide frequency range—from d-c to 30,000,000 cps.

LIGHTHOUSE TRIODE

delivers up to 4,000 mc

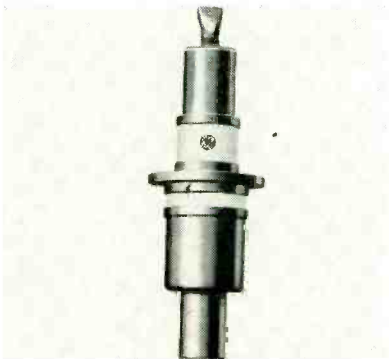

GENERAL ELECTRIC Co., Schenectady, N. Y. The GL-6442 miniaturized lighthouse triode is capable of delivering power up to 4,000 mc. It is designed for use in low-power radar, beacons, navigation, microwave relays, special test equipment and telemetering. It features an exceptionally strong grid flange for rigid mounting. Together with coplanar construction and the use of metal and ceramic,

this provides greater resistance to shock and vibration than conventionally-constructed tubes of this class. Extra-large silver-plated terminals assure low-loss contacts. Peak power output at 3,500 mc is 2.0 kw with a peak positive-pulse plate supply of 3,000 v. As a Class C r-f power amplifier operating at approximately 2,500 mc, the triode is rated at 8 w plate dissipation with 350 v and 35 ma on the plate. In plate-modulated service the maximum ratings are 6 w input and 275 v and 35 ma on the plate.

COUNT RATE METER

with very wide range

NRD INSTRUMENT Co., 6429 Etzel Ave., St. Louis 14, Mo. Model CRM-560 precision count rate meter has an unusually wide range, from 5 to 10,000 counts per sec full scale. It incorporates a sensitive linear amplifier and discriminator, with 2 mv sensitivity. Statistical error may be chosen as 1, 2, 5, 10 or 20 percent. There is no needle kick when switching ranges or

error settings. The well regulated high voltage is variable over a

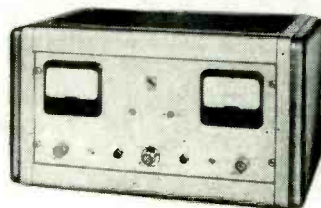

range of 750 to 2,000 v, and is indicated on a 4-in. meter. Count rate is shown on a separate 4-in. meter, so that both values are visible at all times. An external recorder may be used, and is controlled by a panel switch.

MINIATURE RELAY

for operation up to 125 C

RADIO CORP. OF AMERICA, Harrison, N. J. A hermetically sealed,

Important developments in

COLOR TV Receiving Tubes

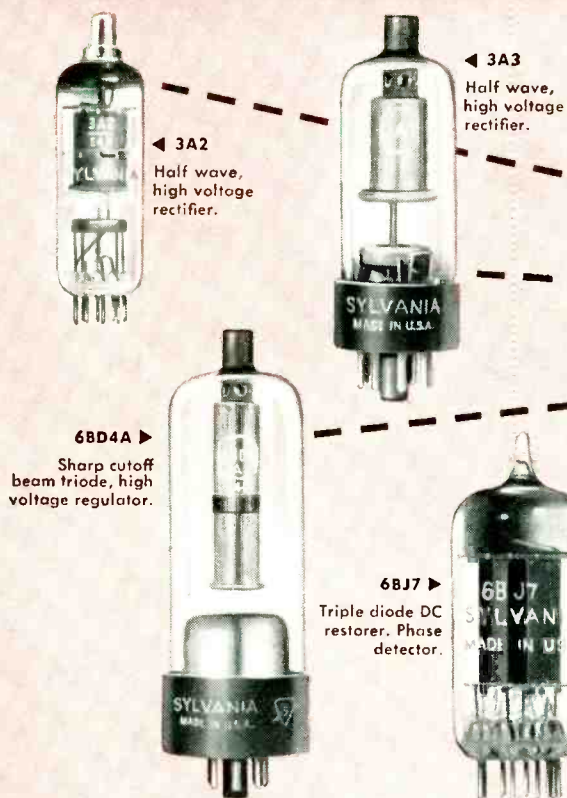

Expect them to keep coming from Sylvania

To make the color TV picture better as it gets bigger, Sylvania tube research, in close liaison with leading set designers, is busy developing and testing new tube types . . . designed especially for big-screen color TV.

Development of the 6BD4A to fill the need for a higher-rated voltage regulator is a typical example of Sylvania

pioneering in color TV receiving tubes.

These tubes, together with important Sylvania prototypes being offered to the industry today, will be color TV's "bread and butter" types tomorrow, and will be available from Sylvania in production quantities.

Expect Sylvania to supply your color TV picture tube requirements, too.



SYLVANIA

SYLVANIA ELECTRIC PRODUCTS INC.
1740 Broadway, New York 19, N. Y.
In Canada: Sylvania Electric (Canada) Ltd.,
University Tower Bldg., Montreal

LIGHTING • RADIO • ELECTRONICS • TELEVISION • ATOMIC ENERGY

rotary-type miniature electric relay designed for efficient operation in electronic equipment with ambient temperatures ranging from -65 to $+125$ C has been announced. The relay (RCA-204W1) is a 26.5-v 6-pole, double-throw type engineered for use in a wide range

of critical applications, including airborne intercommunications systems, signaling and control equipment, guided missiles, rockets and radar systems. It will withstand an impact acceleration of 50 g maximum, and a vibrational acceleration of 10 g maximum up to 500

cps. The palladium contacts are rated at 2 amperes for a resistive load and 1 ampere for an inductive load. The relay has an average life expectancy of more than 1 million operating cycles at no load, or 100,000 cycles with full-rated load at 125 C.

XENON THYRATRON

for motor control circuits

TAYLOR TUBES, INC., 2312 W. Wabansia Ave., Chicago 47, Ill. A new inert gas grid controlled rectifier featuring use of high shock multi-form glass wafer stem, the 6044 is designed especially for motor control circuits where short deionization time is required. The tube will also serve on applications requiring high peak current carrying capacity such as timing control. Using a design where the electrical contacts and mechanical supports are provided by the same set of

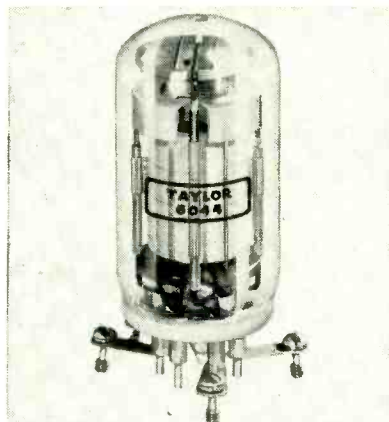

connections, the 6044 can be fastened to the mounting panel by captive screws on the tube terminals. This gives extreme rigidity and eliminates tube sockets for simplified mounting. The tube features a 6.4-ampere average anode current and a low average arc drop of 12 v. Ambient temperature limits are -65 to $+85$ C. Filament voltage is 2.5 a-c or d-c, and filament current is 17 amperes. Peak current is 77 amperes and peaked forward or inverse voltage is 500 v. Maximum physical dimensions of the tube are 5.5 in. high and 2.2 in diameter.

POTENTIOMETERS

in 8 different models

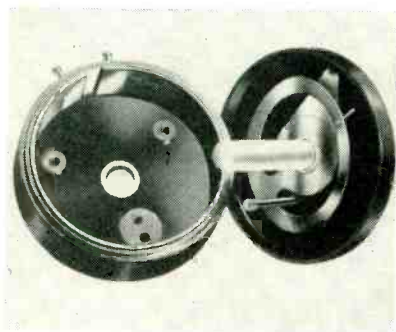

GENERAL RADIO Co., 275 Massachusetts Ave., Cambridge 39, Mass., has announced 8 different models in the 970 series of wire-wound potentiometers. Power ratings range from 2 to 20 w at 40 C ambient, and 17 stock resistance values cover the range from 2 to 500,000 ohms. Linearity runs from ± 0.2 percent on largest models to ± 2 percent on the smallest. Resolution similarly

runs from less than 0.05 percent to 1 percent. All models are totally enclosed, yet capacitance is kept low by the use of phenolic body and cover plus a glass-reinforced-polyester shaft. Simple and rigid mounting is provided, and a positive stop is used with no force on the brush. The bearing and brush designs have been chosen for long wear with very low electrical noise. Ganged assemblies as well as units for other special requirements are available on order.

TUBE SHIELD

for T-12 envelope size

INTERNATIONAL ELECTRONIC RESEARCH CORP., 177 W. Magnolia Blvd., Burbank, Calif., has available a new tube shield for use with tubes of the T-12 envelope size similar to the 6080, 6146 and 6293. The base fits the following JAN-approved submounted sockets: TS 101P 01, TS 101P 02, TS 101C 01 and TS 101C 02. A handle has been made an integral part of the shield

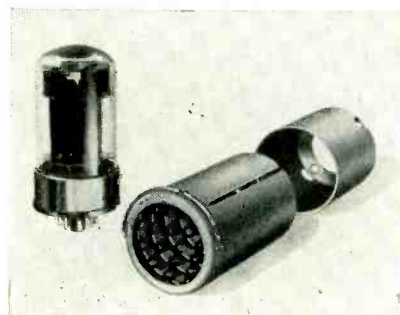

to aid in its removal from tight places. For greater stability under vibration and shock two additional counter-sunk holes have been added to the base, the use of which is optional. Ask for technical bulletin 1014-255.

EMBEDDED CIRCUITS known as Encapsors

ALCOR ELECTRONICS CORP., 180 Lafayette St., New York 13, N. Y.,

**INSTRUMENT CORPORATION
OF AMERICA**

slip ring & commutator assemblies

**One-piece construction*
assures high accuracy and
super-dependability to the
most rigid specifications.**

*Proven for
performance in
precision instruments
and equipment including
SYNCHROS, GYROS, RADAR,
FIRE CONTROL, TEST TABLES
and other CRITICAL APPLICATIONS*

Instrument Corporation of America Slip Ring and Commutator Assemblies for closer tolerances, absolute uniformity and the ultimate in miniaturization. Wherever extreme dimensional precision, accurate concentricity and high dielectric qualities, are required, Instrument Corporation of America assemblies are specified with confidence. One-piece, unitized construction eliminates dimensional variation due to accumulated errors, provides jewel-like finish, uniform ring hardness and reduced weight. Engineering "know-how" resulting from years of specialization and continuous collaboration with leading manufacturers all over the world is at your immediate service.

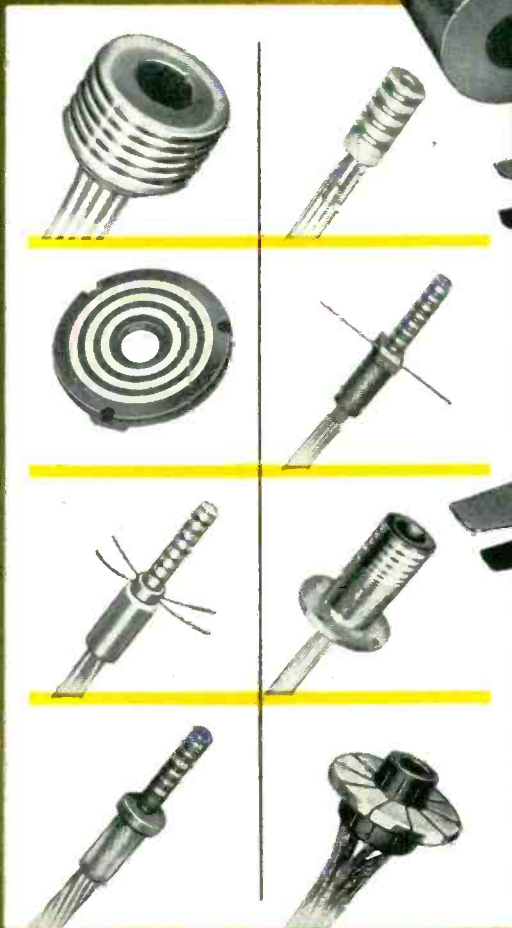

TYPICAL SPECIFICATIONS

- SIZES: .035" to 36" Diameter, Cylindrical or Flat
- CROSS-SECTIONS: Ring Thickness .005" to .060" or More
- FINISH: 4 Micro-Inches or Better
- BREAKDOWN: 1000 V or More Hi-Pot Inter-Circuit
- RING HARDNESS: 70 to 95 Brinell
- SURFACE PROTECTION: Palladium and Rhodium, or Gold Prevent Tarnish, Minimize Wear & Noise

INSTRUMENT CORPORATION OF AMERICA

BLACKSBURG · VIRGINIA

*ELECTRO DEPOSITION PROCESS AVAILABLE UNDER EXCLUSIVE LICENSE AGREEMENT WITH ELECTRO TEC CORP.



SERIES "E-Z 16" EASY RELEASE



SERIES "16" POWER

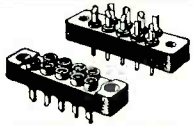

SERIES "14" POWER

new... precision Continental Connectors

simplify your connector problems

11 CONTACT
SERIES "SM-20"
with top opening
aluminum hood

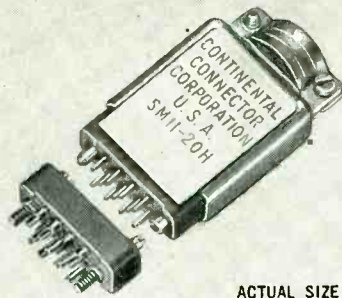

ACTUAL SIZE



SERIES "20" MINIATURE



SERIES "SM-20" SUBMINIATURE



SERIES "P-C" PRINTED CIRCUIT



SERIES "H-20" HERMETIC SEAL



SERIES "C-20" HEXAGONAL

Rectangular Series 'SM-20' SUBMINIATURE CONNECTORS

When your miniaturized equipment needs subminiature connectors with the same durability and current carrying capacity of larger connectors, specify Continental Series SM-20. This series is available in 7, 11, 14, 20, 26 and 34 contacts, in a choice of Mineral filled Melomine, Ploskon reinforced (glass) Alkyd 440A or Diallyl Phthalate.

Polarization is unusually positive with a reversed guide pin and guide socket. Engagement and disengagement forces have been reduced without sacrificing millivolt drop. Voltage breakdown is 2700 at sea level, and 800 volts at 60,000 feet.

For illustrated technical literature, write Dept. E, Electronic Sales Division, DeJUR-Amsco Corporation, 45-01 Northern Blvd., Long Island City 1, N. Y.

Now! S M—20 also available with 50 contacts.

Electronic
Sales
Division **DeJUR**

45-01 NORTHERN BLVD., LONG ISLAND CITY 1, N. Y.



introduces the new lock-in and plug-in Encapsor, a durable plastic embedded electronic circuit arranged in the form of a small cylindrical cartridge having means to accept a vacuum tube and which plugs into and is securely locked to a tube socket. They are used in place of conventional methods of assembly and wiring components associated with vacuum tubes. Maintenance time is vastly reduced for by simple substitution with a new Encapsor, a faulty unit can be replaced. Made of Alcorite plastic, gold-plated receptacle contacts, plug pins of phosphor bronze, A-B type resistor, Mylar capacitors, silicon diodes and other high quality components, it is available for both standard and printed circuits application. Literature and schematics are available upon request.

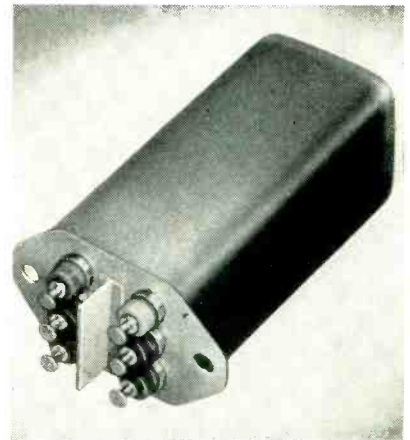

ELECTRONIC CHOPPER with no moving parts

AVION INSTRUMENT CORP., 299 State Highway No. 17, Paramus, N. J., has developed the model 307 electronic chopper with no moving parts. It is able to modulate d-c to frequencies up to 400 cps, for a minimum life period of 3,000 hours. Modulation is accomplished by illumination of a photoconductive

New products developed by
GUARDIAN

in step with today's electronic designs



SERIES 805 D.C. RELAY

Guardian 32-pole Series 805 can simultaneously connect together 32 circuits. Individual contact blades molded in thermo-setting phenolic; all contacting members enclosed in aluminum cover. Wt.—5 oz.

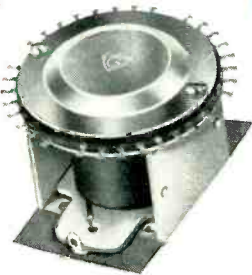

SERIES 2005 RELAY

This 6 P.D.T. hermetically sealed 5 Amp. sub-miniature relay meets specs. MIL-R-6106-A and MIL-R-5757-B. Rugged unit withstands 100 G shock, 10 G vibration at 75—2000 cyc. Wt.—4.25 oz.

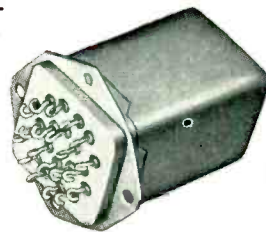

SERIES 210 UM RELAY

New magnetic motor controller unit carries full Underwriters' Laboratories approval. Contacts rated at 115v. A.C. 60 cyc., single phase, 1/4 H.P. Combinations SPST up to DPDT.

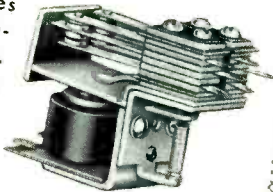

SERIES 595 D.C. RELAY

Midget telephone type, Series 595 with contacts capable of withstanding an inrush current of 50 amperes and rated for continuous operation at 15 amperes. Also available hermetically sealed.

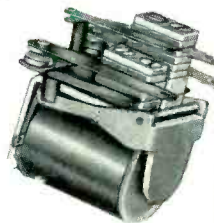

STEPPERS

The new electrical reset P.E.R. stepper operates up to 20 steps per second. Also available from Guardian are various add and subtract, continuous rotation, electrical reset, pulsing, ratchet and other types.

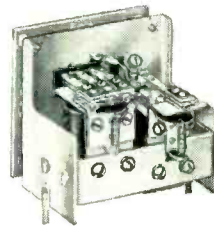

P E R STEPPER

These new Guardian developments have already earned an enviable reputation for dependable performance. Each unit is a "best seller" to important military and industrial users. Such preference should justify *your* selection of these and other associated Guardian controls.

Write for NEW GUARDIAN CATALOG NO. 11

GUARDIAN  **ELECTRIC**
 1625-F W. WALNUT STREET CHICAGO 12, ILLINOIS
 A COMPLETE LINE OF RELAYS SERVING AMERICAN INDUSTRY

ENGINEERS

Fulfill professional and personal objectives . . . with an outstanding firm in its field.



Challenging openings for experienced engineers with degrees or equivalent experience in:

• ELECTRICAL • ELECTRONIC • MECHANICAL

Research, Development, Design & Field Engineering on:

- Countermeasures
- Fire Control Radar Systems
- Underwater Sound Systems
- Magnetic Amplifiers
- Communications Equipment
- Navigation Systems
- Beacons
- Flight Simulators
- Radar & Sonar Trainers
- Circuit Design
- Guidance Systems
- Electronic Installation
- Antennas
- Telemetry

• DEVELOPMENT ENGINEERS

Junior & Senior

• FIELD ENGINEERS

(Local & Field Assignments)

WHAT STAVID OFFERS YOU

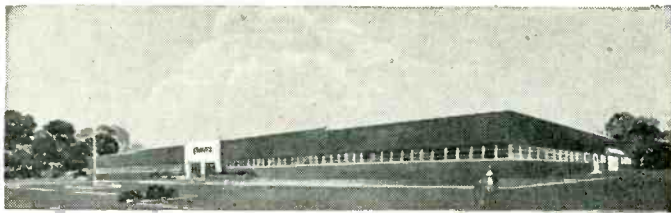

LOCATION:

On U. S. Highway 22, thirty miles (45 minutes) from New York City, near the beautiful Watchung Mountains, and within one hour's drive to the seashore. Enjoy all the advantages of the city, the mountains, and the seashore, as well as excellent schools, homes, churches and shopping facilities all conveniently located.

ENVIRONMENT:

One of the finest plants of its kind . . . spacious, modern, air-conditioned. Conducive to bringing out the best of your abilities!

ABOUT THE COMPANY:

Organized in 1945. Engaged in research, design and development for the Armed Services. The company has steadily progressed and grown since its inception, and now employs over 400. Positions are permanent, with opportunities for your development matching our own constant expansion.

ITS BENEFITS:

- Pension Plan
- Group Life Insurance
- Paid Holidays
- Paid Sick Leave
- Recreational programs: golf, softball, bowling, picnics, dances.
- Paid Vacations
- Education & Tuition Assistance
- Other Group Insurances

Interviews in Your Community by Appointment

Send resume, write or call for additional information.



STAVID ENGINEERING, INC.

U. S. Highway 22, Watchung, P. O. Plainfield, N. J. Plainfield 7-1600

element in a typical voltage divider. The new features which have been provided include: (1) temperature insensitive operation over a range of -50 to $+100$ C; (2) d-c to a-c conversion ratio over 0.5; (3) noise pickup of less than $200 \mu\text{v rms}$; (4) 115-v, 3-ma, a-c excitation. The chopper measures only $\frac{1}{8}$ in. high $\times \frac{1}{8}$ in. wide $\times 2$ in. long and weighs 1.6 oz.

UHF-TV TUNER reduces interference

RADIO CONDENSER Co., Davis & Copewood Sts., Camden 3, N. J., has developed a new uhf-tv tuner to meet the r-f interference objectives of both RETMA and the FCC. Model T-90 tuner features a re-arrangement of the usual tv tuner components and better shielding which combine to act as oscillator radiation fixes, thereby preventing the oscillator from radiating interference outside the recommended limits. Ask for bulletin T-90.

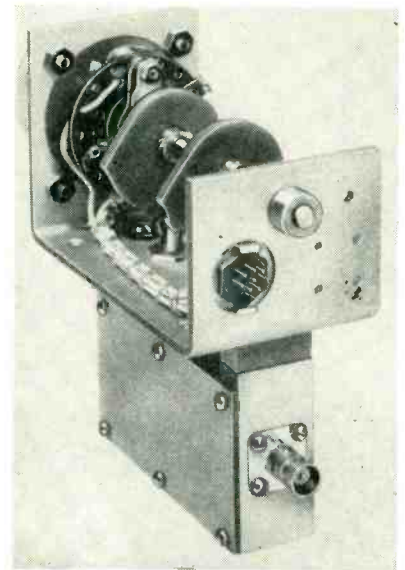

R-F ATTENUATOR with remote control

THE DAVEN Co., 191 Central Ave., Newark, N. J., has made available a new remote control adaptation of its standard r-f attenuator. The new unit, series 544, is cam operated and solenoid driven. Its salient feature is a special arm which permits remote selection of any of the following cam operated positions: (1) First position and



Variety that spurs imagination

Designed with either matched glass or Vac-Tite* compression construction . . . with O. D.'s that range from .152 to .962 . . . these Hermetic Condenser Seals are produced to fit standard condenser cans. They provide the design engineer and manufacturer with an unprecedented variety of economical, low-cost packages for use in the design and production of impregnated paper capacitors, rectifiers and filter networks.

*Vac-Tite is Hermetic's new vacuum-proof, compression construction glass-to-metal seal.



Hermetic Condenser Seals

Design Variations . . . Hermetic Condenser Seals are offered in 2-tube configurations from .377 O. D. and 3-tube configurations from .477 O. D.

Mounting Variations . . . These Condenser Seals can be supplied with mounting lugs attached to the tubular terminals or with flattened and pierced tubing. They can be mounted on flat sheet metal covers that have a recess in which the part can be positioned and the solder confined.

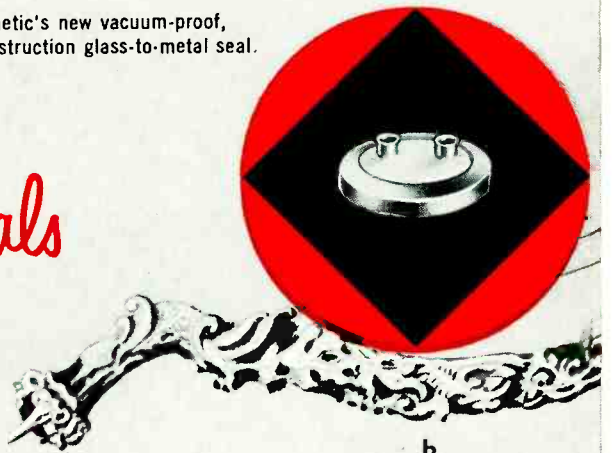

- (a) Iron, five-necked spur, German, 17th Century.
- (b) St. George, King's Coronation spur.
- (c) French ornamental spur, 16th Century.

Write for engineering data, drawings, prices and samples on these and the many other Hermetic standard parts available that satisfy the most extreme requirements of industry and the Services.

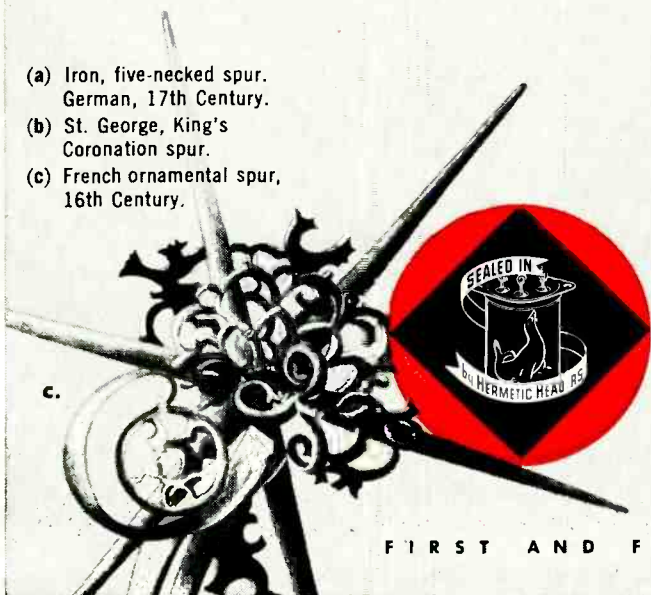

Hermetic Seal Products Company

31 South 6th Street, Newark 7, New Jersey

FIRST AND FOREMOST IN MINIATURIZATION

30 Years of Leadership

POTTER Capacitors

1925

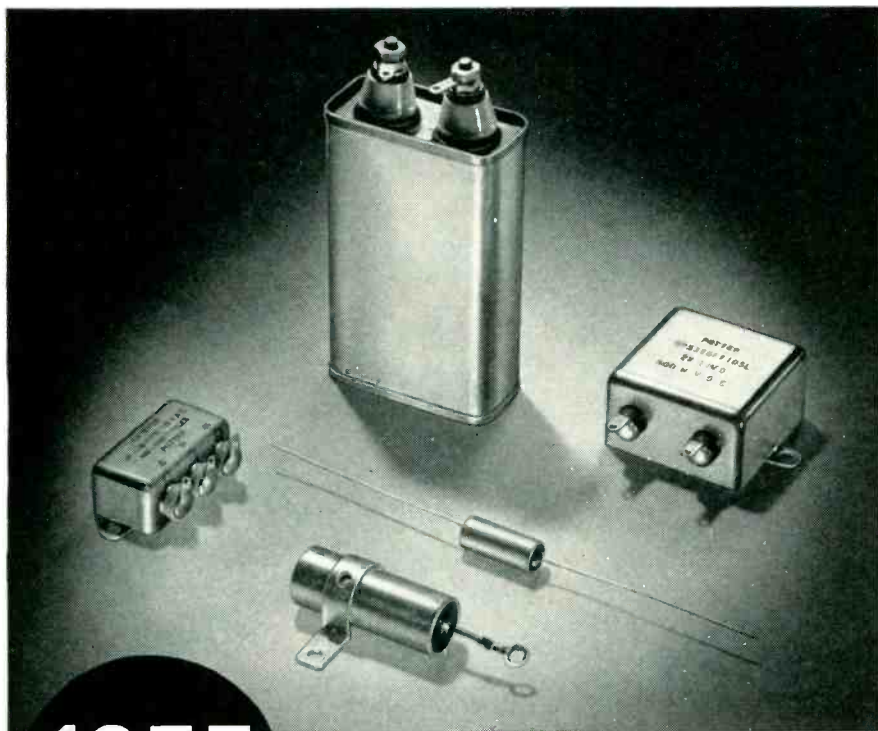

1955

...marks the Thirtieth Year that The Potter Company has devoted its efforts to the design and construction of special capacitors to meet specific customer application...so

If your product reputation hinges on dependable performance of quality components —

SPECIFY POTTER CAPACITORS

If you need flexible production facilities for capacitors engineered to fit your needs —

SPECIFY POTTER CAPACITORS

Write today for Free Catalog of the complete Potter Line of Capacitors and Radio Noise Filters. Address Department A.



THE
potter
COMPANY

1950 SHERIDAN ROAD
NORTH CHICAGO, ILL.

SPECIALISTS IN
FIXED PAPER
CAPACITORS
SINCE 1925

NEW PRODUCTS

(continued)

second position, entirely out of circuit; (2) first attenuation position in the circuit, and second attenuation position out of the circuit; (3) both attenuation positions in the circuit. This cycle can be repeated indefinitely. The unit shown has 3 steps, but variations can be provided with up to 5 steps plus zero attenuation. A maximum of 20 db per step can be supplied.



TRANSFORMER CONTROL measures displacement

ALLEN B. DUMONT LABORATORIES, INC., 760 Bloomfield Ave., Clifton, N. J. Type 332 differential transformer control is a complete, self-contained unit designed for use with medium-frequency differential transformers and c-r oscillographs. When used with the type 324 oscillograph, the type 332 can measure static or dynamic displacements in the region of ± 0.000025 to 0.1 in. per major scale division of deflection. It is very useful as a static or dynamic micrometer for measurements of displacement, velocity, acceleration or vibration. It has a frequency response extending from d-c to 1 db down at 1,000 cps.

MAGNETRON for weather radar service

RADIO CORP. OF AMERICA, Harrison, N. J., has announced a magnetron designed specifically for service as a pulsed oscillator at a fixed frequency of $5,400 \pm 20$ mc in weather radio equipment. The 6521 magnetron has a maximum peak anode voltage rating of 16 kv and a peak anode current rating of 10 to 16 amperes. It operates with high



for telephones, too

CRUCIBLE PERMANENT MAGNETS

mean maximum energy . . . minimum size

You get *consistently higher* energy product from Crucible *prescription-made* alnico permanent magnets.

That means more energy from a smaller magnet . . . greater design freedom for manufacturers of telephone sets, high-fidelity sound equipment, controls, instruments, and magnet-equipped devices of all kinds.

Crucible, the nation's leading producer of *special purpose steels*, has been making these quality magnets ever since the development of alnico alloys. They're available sand cast, shell molded, or investment cast to meet every size, tolerance, shape and finish need.

For prompt delivery — or helpful advice on magnet problems — call Crucible. *Crucible Steel Company of America, Henry W. Oliver Building, Pittsburgh 22, Pa.*

CRUCIBLE

first name in special purpose steels

Crucible Steel Company of America

**20
TO
200 D.P.**

**SEND YOUR
PRINTS FOR
QUOTATION**

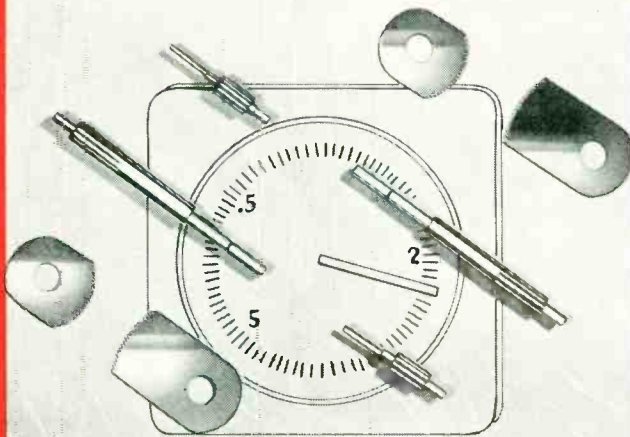

SPURS • HELICALS • WORM AND WORM GEARS • STRAIGHT BEVELS
LEAD SCREWS • RATCHETS • CLUSTER GEARS • RACKS • INTERNALS • ODD SHAPES

THE *Finest* IN GEARS



Beaver Gear Works Inc.

1021 PARMELE STREET, ROCKFORD, ILLINOIS

Craig supplies
TRANSIT CASES
for

BOMB DIRECTOR SYSTEM AN/ASB-1 RADIO DIRECTION FINDER AN/CRD-6

RADAR SYSTEM
AN/GPX-11

RADAR SYSTEM
AN/TP5-10D

RADAR SYSTEM
AN/GPX-17

GUIDED
MISSILES
(CLASSIFIED)

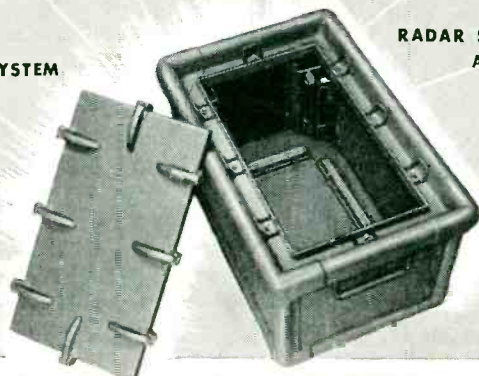

AND VANS, BUILDINGS, SHELTERS, TRAILERS
for systems such as AN/TRN-6, AN/TRT-3, AN/FPN-16, AN/MRN-12, AN/MRN-14 (XW-1)

Craig MACHINE, INC., Danvers, Mass.—Danvers 1870

efficiency at pulse durations up to 2.2 μ sec. Peak power outputs ranging from 60 kw to approximately 100 kw are attainable. Full ratings may be used at altitudes up to 16,000 ft without pressurization. Design of the magnetron incorporates a large, sturdy cathode and an integral Alnico magnet which is covered by a protective die-cast aluminum jacket. Large-area cooling fins provide efficient cooling with little air flow. A waveguide output flange, conforming to proposed RETMA standards, is designed for coupling to a 1-in. \times 2-in. rectangular waveguide.



IMPREGNANT
for transformers and coils

EMERSON & CUMING, INC., 869 Washington St., Canton, Mass., has announced a new class H impregnant for transformers, coils and electronic components. The solvent-free, epoxide base material is designated ECCO W 28 G. It is suitable for continuous use at 200 C. It is simple to use and no catalyst is required. A filler designated A-21 is also supplied so that it can be used simultaneously as an impregnant and embedment compound. Properties are available on request.



SMALL MOTORS
hysteresis or a-c induction

INSTRUMENT MOTORS, Box 5, Acosta St., Stamford, Conn., has announced a new line of miniature, high-power motors in its recently developed Frame 43 models for continuous-duty, class A service. They are available as either hysteresis or a-c induction units. Improved design



*the efficient socket
for your printed-circuit*

Sylvania Printed-Circuit Sockets



**7-pin and 9-pin
sockets now available**

- ... for more efficient *printed-circuit* design
Contacts fit through smaller holes in the circuit board, providing more space and greater freedom in design of circuitry. Circuits can be arranged for shorter conductor paths and greater compactness, including cross circuits between contacts.
- ... for more efficient *printed-circuit* production
Sockets lend themselves to automatic socket-to-board assembly techniques. Tube shield ground strap location keys the socket for positive orientation. Strap retains and grounds the tube shield. Sockets are supplied with ground strap loose, eliminating the need to stock two production assemblies.
- ... for more efficient *printed-circuit* performance
Sylvania's printed circuit socket, provided with an all-molded insulator, eliminates moisture traps, offers higher insulation qualities and superior contact characteristics. Top surface installation allows greater heat dissipation.

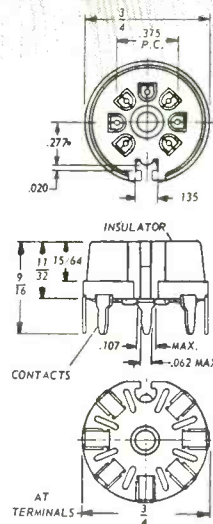

INSULATOR:
General Purpose or
Low Loss Phenolic

CONTACTS:
Brass, Cadmium
plated

**TUBE SHIELD
GROUND STRAP:**
Brass, Cadmium
plated

Sylvania manufactures a complete line of high quality sockets, terminal strips, and other electronic components. Write for the complete catalog. Address literature or quotation requests to Department E20S.



SYLVANIA

Sylvania Electric Products Inc.
1740 Broadway, New York 19, N. Y.
In Canada: Sylvania Electric (Canada) Ltd.,
University Tower Bldg.,
St. Catherine Street, Montreal, P.Q.

LIGHTING • RADIO • ELECTRONICS • TELEVISION • ATOMIC ENERGY

physicists and physical chemists

... with baccalaureate or advanced degrees and those with basic experience in these sciences now are offered an unusual opportunity to enter the new semiconductor field and at the same time become associated with General Motors.

The scope of the semiconductor field is virtually limitless, and our new permanent program is to explore wide areas of it and engage in research and development—starting with a power transistor suitable for automotive use and continuing on toward basic research and the development of semiconductor types suitable for military and other commercial uses. The work is independent of Government support.

The most up-to-date research facilities for this type of work are provided, with leadership by a physicist with an outstanding record in this field. You also obtain the advantages of being among the first to join this new and vital General Motors activity.

Location is the Midwest. Expenses for arranged interviews and relocation allowed. Unusual employe benefits of General Motors are included.

If you find this of interest or if you wish further information, write, wire or telephone Mr. H. J. Claypool, Executive Engineer, Delco Radio Division, General Motors Corporation, Kokomo, Indiana (phone 2-8211).

Delco Radio



DIVISION OF **GENERAL MOTORS**

NEW PRODUCTS

(continued)

and built-in air conditioning give a very low temperature rise with ratings up to $\frac{1}{4}$ hp in a frame only $4\frac{3}{8}$ in. o-d \times $5\frac{1}{2}$ in. long. The induction-type motors incorporate rotors that are insulated silicon-steel, pressure die-cast with 99.5 percent aluminum. The hysteresis type have rotors of cobalt steel machined and heat-treated, then fitted to aluminum spiders, pressed and pinned to the shaft. Both types are specially designed for easy modification to meet a wide range of requirements.

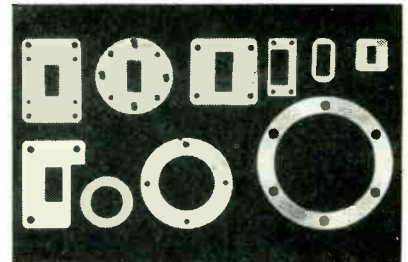

WAFER FLANGES for all waveguide sizes

AMERICAN RADAR COMPONENTS INC., Box 418, Whippany, N. J., has available a new series of wafer flanges WF-100. These flanges are now stocked for all sizes and types of waveguides, a few of which are shown. Particular emphasis has been placed on the transition size Xs-X1. They should prove equally valuable for test setups as well as for production. Complete engineering specifications are available on request.



FREQUENCY STANDARD is compact signal generator

D & R, LTD., 402 E. Gutierrez St., Santa Barbara, Calif., has announced production of a new compact signal generator which acts as

HERE IT IS! . . .

*the greatest improvement
in
Vinyl Glass Sleeveings
in 5 years*

BH Vinyl-Sil 8000 Sleeveing . . . for unequalled heat resistance and non-corrosiveness . . . plus 8000 volt *minimum* short-time dielectric breakdown.

The new BH Vinyl-Sil 8000 Sleeveing combines stabilized organic resins with those of the silicone group to provide these outstanding features of each . . . high dielectric strength and unusual heat resistance. Flexibility permanence has been increased far beyond previous records. Even after 2000 hours at 130°C. — with tests continuing — BH Vinyl-Sil 8000 continues to provide a short-time dielectric breakdown of 8000 volts *minimum* and shows no appreciable change in physical characteristics. It meets and surpasses *all* NEMA and ASTM Specifications for Class B-A-1.

BH Vinyl-Sil 8000 Sleeveing is non-wicking (note illustration at the right). There can be no entrapped moisture to impair the effectiveness of varnish impregnation. Data Sheets and samples of BH Vinyl-Sil 8000 are yours for the asking. Write today and use the advantages of this *new* superior vinyl-glass sleeveing.

BENTLEY, HARRIS MANUFACTURING CO.
1305 Barclay Street
CONSHOHOCKEN, PENNSYLVANIA
Telephone: Conshohocken 6-0634

BENTLEY, HARRIS *Fiberglass**
SLEEVIINGS

*BH Non-Fraying Fiberglass Sleeveings are made by an exclusive Bentley, Harris process (U.S. Pat. Nos. 2393530; 2647296 and 2647288). "Fiberglass" is Reg. TM of Owens-Corning Fiberglass Corp.



BH Vinyl-Sil 8000 Sleeveing has no capillarity. Shown above, are two sleeveing samples in a beaker of water. They have been split to show braided construction. On the left, is new BH Vinyl-Sil 8000. Note how light in color it is. The sample on the right is ordinary vinyl-glass sleeveing, noticeably darker in color from water which rose by capillary action . . . the bottom edge is completely water soaked.

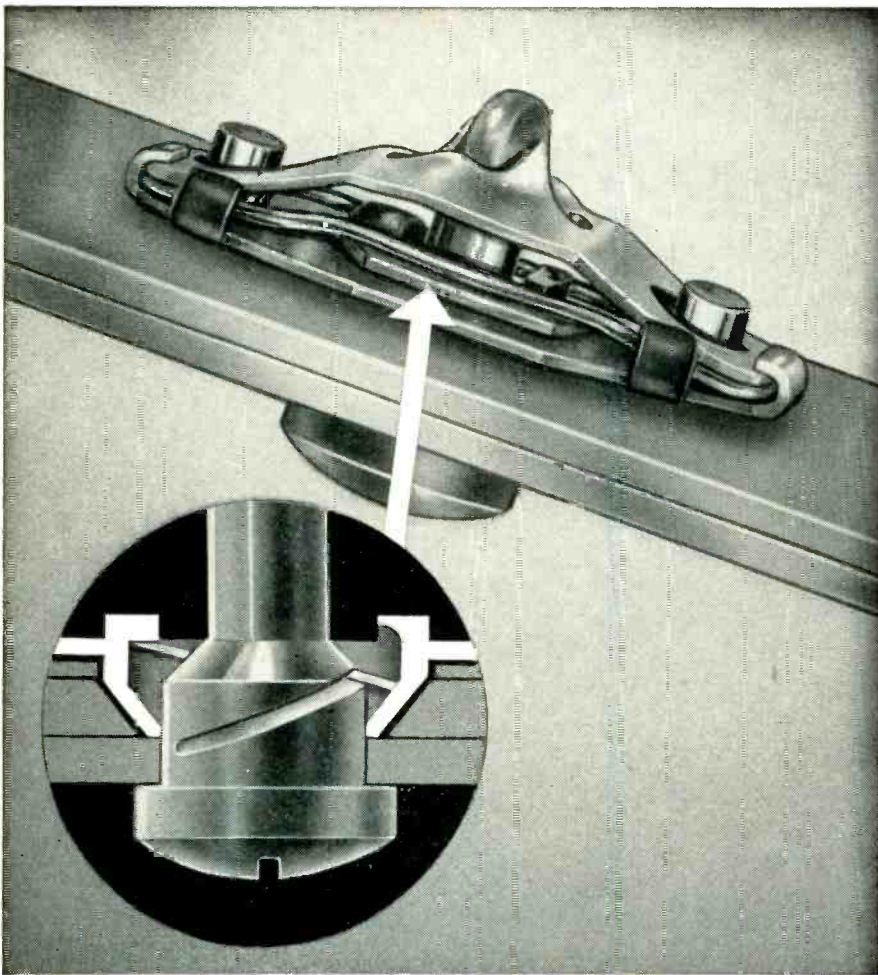

New Lion "Hi-Strength" fastener completely assembled. Cutaway shows the beveled counter sink. Beveling substantially increases the area over which stress is distributed.

NOW! Shear strength twice that of any other fastener!

New Lion "Hi-Strength" design fills every need for parts that must be fastened, taken apart, buttoned tight quickly

Here's a new and better answer to your problem of metal-to-metal fastening where high shear stress and vibration are factors.

It's the Lion "Hi-Strength" fastener, combining speedy quarter-turn opening and closing with a shear strength of 4750 lbs!

This "Hi-Strength" fastener is remarkably strong because shear load is distributed evenly over the area of the fastened parts. The secret lies in the beveled counter sink in the sheet and the nut. It's the same high shear prin-

ciple used for years by the automotive industry for wheel lugs.

In addition to high shear strength, its tensile strength is 3000 lbs. Sheet separation is zero up to 4750 lbs. Misalignment is as much as .125 with high shear qualities. Regardless of the number of times it's opened or closed, there is no wear. It cannot be overtorqued (up to 3750 lbs.). It cannot be fastened incorrectly. It is no larger than a standard No. 5!

To test it yourself, write for a free mounted working sample. Just drop us a line on your company letterhead.

L I O N
FASTENER, INC.

500 Main St., Honeoye Falls, N.Y.

In Canada: A. T. R. Armstrong Co., 50 St. Clair Ave. West, Toronto

a secondary frequency standard with a short-time accuracy of 1 part per million. Generating 12 selected standard frequencies between 100 kc and 20 cps, the model FS-1 has a long-time accuracy of the stabilized characteristic 100 kc standard crystal of 20 parts per million over normal room temperature ambient range. Eleven sine-wave frequencies, available at approximately 1-v level, selected by front-panel controls are: 20, 15, 10, 5, 3 and 1 kc; 400, 300, 100, 60 and 20 cycles. In addition, a constant 100-kc signal may be used for reference to a primary standard or to WWV for precise correlation. All frequencies delivered have the same accuracy as the 100-kc crystal.

ATTENUATOR covers 4,000 to 12,400 mc

POLARAD ELECTRONICS CORP., 43-20 34th St., Long Island City 1, N. Y., has announced a continuously variable, stub-tuned, mutual inductance attenuator designed for external use in making microwave measurements with spectrum analyzers, signal sources, receivers and for power measurements. Model SIJ attenuator (waveguide beyond cut-off type) will insure r-f circuit isolation and may be used to convert a signal source or laboratory oscillator to perform many of the functions of a signal generator. Frequency range is from 4,000 to 12,400 mc.



MANUAL KEYCARD for X-Y plotting

LIBRASCOPE, INC., 1607 Flower St., Glendale, Calif., has developed a

YEARS AHEAD of the industry...



Type 105 Model 6

New!

**Northern Radio
FREQUENCY
SHIFT
KEYER**

New! Highest Stability achieved
by any Frequency Shift Keyer

New! Increased Frequency Range
1.0 to 7.0 mc

New! Pre-selection of Proper
Frequency Shift for any
particular transmitter fre-
quency multiplication

New! Permits use with
external oscillator
without need of adapters

New! Improved
Accessibility —
for even easier
maintenance

Sets a new standard for
the Industry. It supersedes and
directly replaces its
LEADER PREDECESSOR,
the Type 105
Model 4.

The new Northern Radio Frequency Shift Keyer Type 105 Model 6, is a very high stability RF oscillator which provides a means for shifting an RF carrier in accordance with the intelligence. This exciter replaces the crystal oscillator in a transmitter and produces "Mark" and "Space" carrier shift for transmission of teleprinter or telegraph signals, or a linear carrier shift for transmission of FM telephone, facsimile or telephoto. In addition to the technical advancements mentioned above, this new Keyer continues to embody the following performance-proven features:

- Direct-reading frequency calibration of shift from 0 to 1000 cps.
- Frequency shift dial adjusts "Mark" and "Space" frequencies equally above and below the carrier position, which remains fixed.
- Simplified frequency setting makes only the upper sideband tuning indication visible on the meter over substantially all of the tuning range.
- Direct-reading frequency calibration of mixer and output tuning dials from 1.0 to 7.0 mc.
- Direct-reading calibration of output frequency vernier ± 600 cps.
- Pulse-shaping circuit to permit operation within assigned bandwidth with no adjacent channel radiation.
- Highly stable temperature-controlled oven with control of $\pm 0.1^\circ\text{C}$. at 60°
- Linear carrier shift up to 1400 cps for Fax operations.
- Component ratings according to JAN specs for greater assurance of trouble-free operation.



Pace-Setters in Quality Communication Equipment

NORTHERN RADIO COMPANY, inc.

147 WEST 22nd ST., NEW YORK 11, NEW YORK

In Canada: Northern Radio Mfg. Co., Ltd., 1950 Bank St., Billings Bridge, Ottawa, Ontario.

Write for Free Catalog E-5.

BOURNS

sub-miniature

TRIMPOTS

TRADE MARK



PROVIDE THE ULTIMATE IN CIRCUIT TRIMMING

Simple screwdriver adjustment...

The *TRIMPOT* is a 25 turn, fully adjustable wire-wound potentiometer, designed and manufactured exclusively by BOURNS Laboratories. Electrical settings in increments of $\frac{1}{4}$ to $\frac{1}{2}$ % are securely maintained during vibration of 20 G's up to 2,000 cps or sustained acceleration of 100 G's. BOURNS' unique self-locking design eliminates cumbersome locknuts. Power rating is $\frac{1}{4}$ watt at 100° F. Standard resistance values from 250 ohms to 25,000 ohms are available for immediate delivery. Information on higher and lower resistances on request.

BOURNS *TRIMPOTS* are accepted as standard components by aircraft and missile manufacturers and major industrial corporations.

**9 TRIMPOTS
TAKE LESS
SPACE THAN
A 2¢ STAMP**



Tiny cross-sectional size—only $\frac{1}{4}$ " x $\frac{5}{16}$ "—and rectangular shape save valuable panel space. Instruments are easy to mount individually or in stacked assemblies with two standard screws through the body eyelets.

BOURNS also manufactures precision potentiometers to measure Linear Motion; Gage, Absolute, and Differential Pressure and Acceleration.



BOURNS LABORATORIES

6135 MAGNOLIA AVENUE • RIVERSIDE, CALIFORNIA

Technical Bulletin On Request, Dept. 12

© B. L. PATENTS PENDING

new manually operated decimal keyboard that activates a plotter by supplying excitation for the X and Y input transducers. A major innovation is the elimination of the problem of sticking switch contacts and high contact resistance. Self-wiping, slide-type contacts, linked directly to the keys, completely eliminate the necessity for any adjustments of the switches and contacts. The keyboard simulates resistance potentiometers by means of two voltage dividers, each consisting of 3 banks of series-connected precision resistors which are switched into the input circuit by pressing the front panel keys. It is energized by voltage from the recorder. No external power sources are required. The unit measures 6 in. x 11 in. x $8\frac{1}{2}$ in. and weighs only 12 lb. A variety of contact configurations are available which make possible the manual feeding of decimal or binary coded decimal inputs to computer and other systems.



VACUUM CAPACITORS available in many ranges

DOLINKO & WILKENS, INC., 1901 Summit Ave., Union City, N. J., announce a new line of heavy-duty vacuum capacitors featuring extra-rugged end terminal connectors ($1\frac{1}{8}$ in. o-d x $1\frac{1}{8}$ in. i-d x $\frac{3}{4}$ in. long). Units are available in many capacitance ranges including 250 μf (VC250-A), 100 μf (VC100-A), and 50 μf (VC50-A), with voltage ratings of 32 kv. The new larger terminal surfaces plus increased heat dissipation from both interior and exterior of the terminal connectors allow for cooler operation under heavy load than

INSTANTANEOUS MEASUREMENT OF INSULATION RESISTANCE...

500 MILLION MEGOHMS

Tera-Ohmmeters are outstanding for accuracy, stability, and the unprecedented sensitivity of 500 tera-ohms (500×10^{12} ohms).

Instantaneous response of electrometer circuit makes it possible to measure rapid variations of insulation resistance as a function of time, temperature, voltage, moisture and other parameters. This is of extreme value since insulation resistance is rarely of a fixed magnitude.

Partial and complete breakdown of insulating materials can be observed without chance of damage to the equipment. Major applications include insulation measurement of resistors, capacitors, tube sockets, switches, transformers, wires, cables, electrical machines and other equipment.

Greatest accuracy and stability of test conditions are assured by battery-supplied test voltages . . . equipped with charger circuit. Fixed test voltages of 3, 10, 100, and 500 volts are available in several models. One model, the type H, provides a continuously adjustable test voltage from 100 to 1000 volts. Accuracy of measurement is $\pm 3\%$ in center of scale for all ranges.

Widely used by government and industrial laboratories . . . today's most versatile insulation measuring equipment . . . assures efficient and thorough evaluation of all insulation problems.

Calibrated Comparison Resistors mounted in shielded holders are available for reference purposes. These resistors, in values from 10^9 to 10^{13} ohms, are calibrated to an accuracy of 1%.

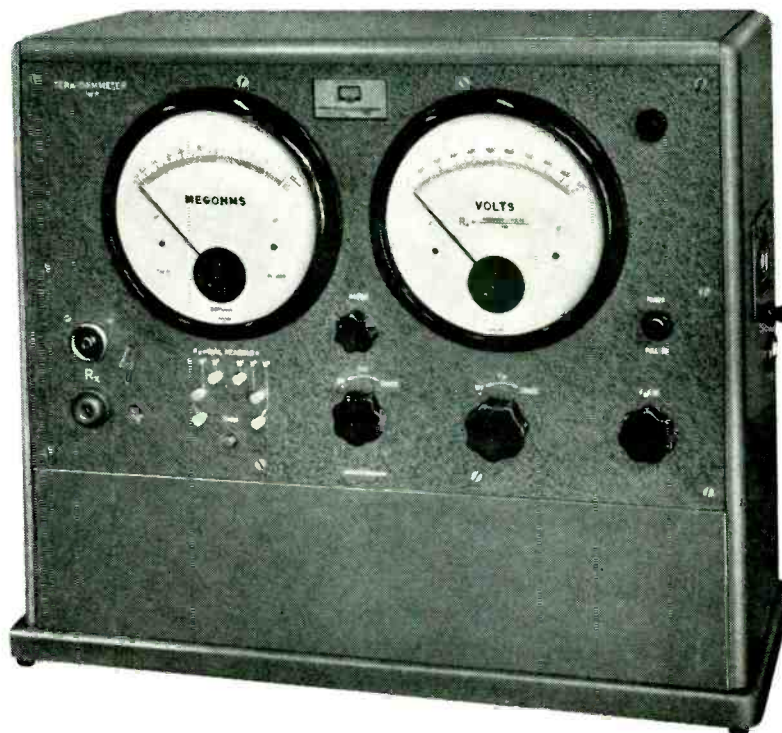

Type FT-H Tera-Ohmmeter

Measurements in accordance with ASTM standards

FEATURES

- Measures instantaneous changes in resistance
- Direct reading on 7" precision meters with knife-edge pointer
- Wide range from .2 megohms to 5×10^{14} ohms
- High accuracy of measurement: $\pm 3\%$ in scale center
- Simplicity of operation—readily used by unskilled personnel
- Test samples can be measured grounded, ungrounded, or with guard-ring electrode
- Charge button for rapid charge of capacitors

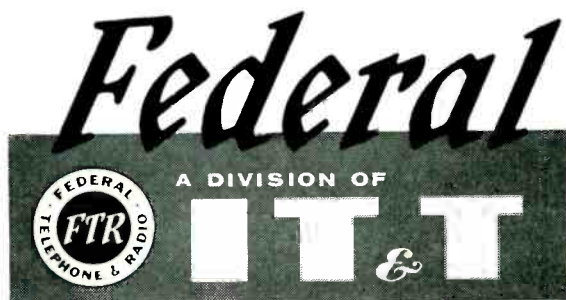

Federal Telephone and Radio Company, A Division of INTERNATIONAL TELEPHONE AND TELEGRAPH CORPORATION
Instrument Division, 100 Kingsland Road, Clifton, N. J.

- Please send further information on Tera-Ohmmeters. Please send latest Instrument Catalog.
- Please arrange for demonstration.

Name _____ Position _____
Company _____
Address _____
City _____ Zone _____ State _____
Dept. S-513



GEARS

DIAMETERS .125" to 60"

*We
invite
your
inquiry*

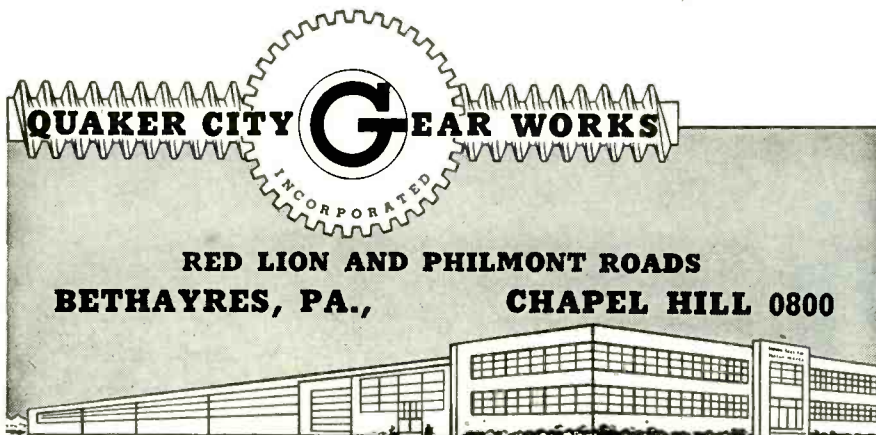

previously possible. Conservative current ratings of 100 amperes rms without external cooling, and 150 amperes rms with an air blast of 7 cfm are given. The capacitors are of all oxygen-free, high-conductivity copper and Pyrex glass construction with overall dimensions of $6\frac{5}{8}$ in. o-l and $2\frac{7}{8}$ in. o-d.

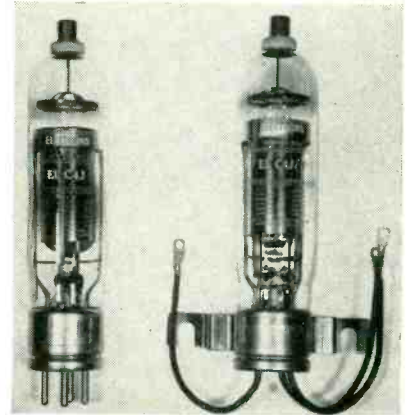

THYRATRONS for socket, panel mounting

ELECTRONS, INC., 127 Sussex Ave., Newark 3, N. J., is manufacturing two new xenon-filled thyratrons having identical electrical characteristics. They are ideal for application in motor control and ignitor firing circuits. The ELC4J is designed for socket mounting; the ELC4J/F for panel mounting wherever conventional sockets might not be desirable. Ratings of both are 4 amperes d-c continuous average anode current; 30 amperes oscillograph peak current with maximum peak forward and peak inverse of 900 v. The average arc drop is 12 v and heating time is 60 sec. Stable grid characteristics are maintained throughout life and the critical grid current is less than 10 μ a.

JUNCTION TRANSISTOR for high-temperature use

CBS-HYTRON, a Division of Columbia Broadcasting System, Inc., Danvers, Mass., has announced a *pn*p junction transistor for high temperature amplifier applications. The type 2N82 germanium transistor is capable of 35 mw collector dissipation at 71 C. Its metal case,

E-I*presents***NEW EXPANDED*****PATENTS
PENDING—
ALL RIGHTS
RESERVED****LINE OF HERMETICALLY SEALED**

COMPRESSION TYPE END SEALS

**FOR HERMETICALLY SEALING
CONDENSERS, RESISTORS AND
OTHER TUBULAR COMPONENTS**

E-I standardization now makes it possible to offer designers and engineers the economy of standard components in a wide selection of types and sizes. These rugged compression type end seals are available in a broad range of dimensions, in either flared tube or pierced terminals, with single or multiple lead terminations. Inquiries invited.

-here's how**COMPRESSION
CONSTRUCTION
PROVIDES THE
TIME-PROVEN
LASTING SEALS**

In this exclusive E-I compression construction, the glass remains under constant compression and is therefore extremely strong. These seals possess extraordinary immunity to shock, vibration and pressure changes. For all practical purposes E-I Compression Seals are indestructible. No special skill is required to apply and assembly is rapid as all metal parts are tin dipped for easy soldering.

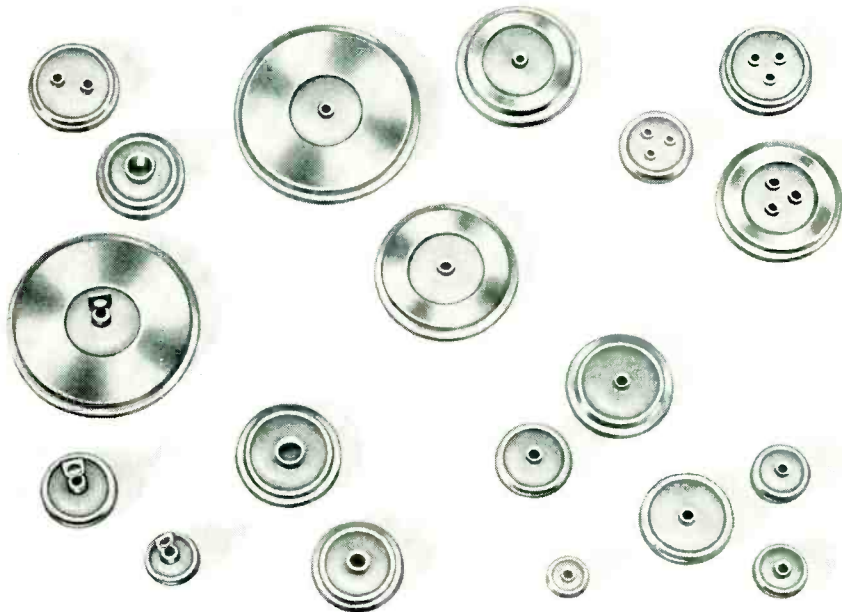

E-I Leadership—in the field of hermetic sealing assures dependability, economy and fast delivery . . . specify E-I for multiple headers, octal plug-ins, transistor bases and closures, sealed terminals, end seals and color coded terminals.

**ELECTRICAL INDUSTRIES**

Division of Amperex Electronics Corporation • 44 SUMMER AVENUE, NEWARK 4, NEW JERSEY

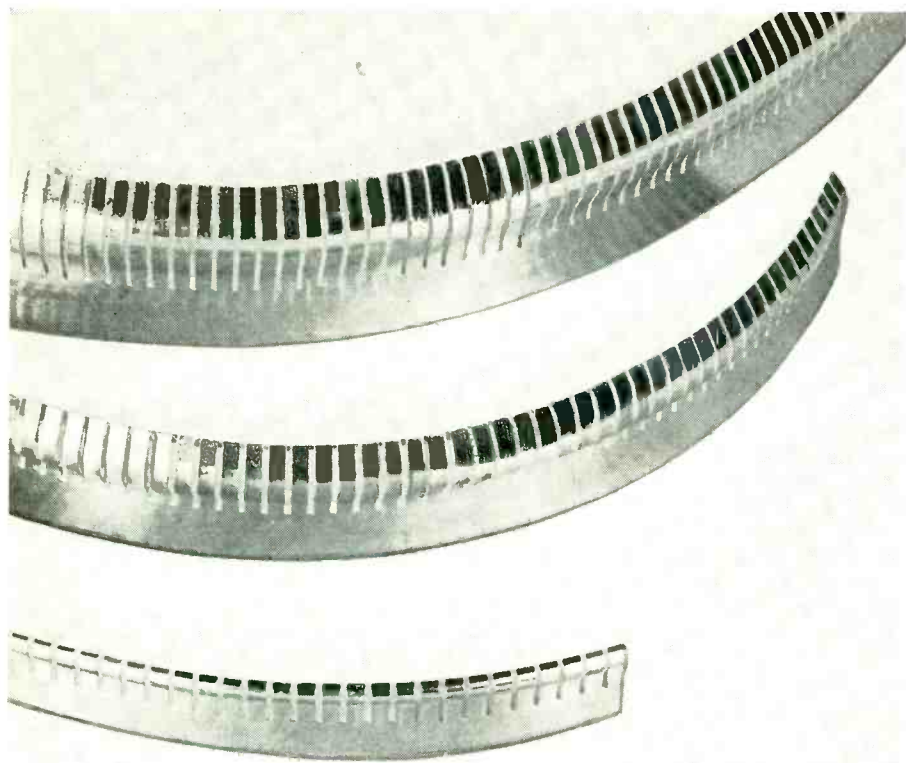

Eimac finger stock

... IDEALLY SUITED FOR

- providing good circuit continuity with adjustable or moving contact surface components
- making connections to tubes with coaxial terminals
- electrical weather stripping around access doors to equipment cabinets
- making connections to moving parts such as long line and cavity type circuits

Eimac preformed contact finger stock is a prepared strip of heat treated alloy spring material slotted and formed into a series of fingers. Silver plated for efficient RF conductivity, it comes in widths of $1\frac{1}{32}$ ", $3\frac{3}{32}$ " and $1\frac{1}{16}$ ".

For a complete Eimac Finger Stock data sheet, contact our Technical Services department.



EITEL-McCULLOUGH, INC.
SAN BRUNO • CALIFORNIA

only 0.33 in. long by 0.225 in. in diameter, is hermetically sealed against surface contamination, light excitation and humidity.

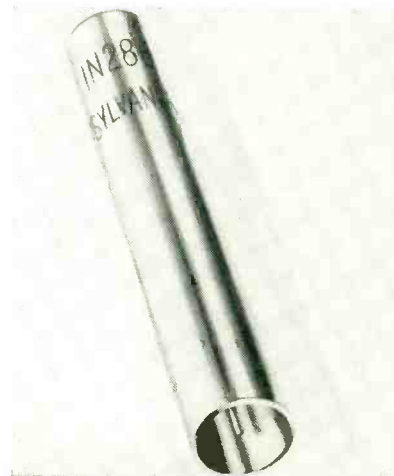

CRYSTAL DIODE is point-contact type

SYLVANIA ELECTRIC PRODUCTS INC., 1740 Broadway, New York 19, N. Y. The 1N286 silicon crystal diode is a broadband, coaxial, point-contact type. It is designed for use as a crystal mixer and its internal geometry makes it possible to cover the band of frequencies from 10,000 to 20,000 mc. With the crystal holder made in WR-75 waveguide the band of frequencies from 10,000 to 15,000 mc can be covered and with the crystal holder made in WR-51 waveguide the band of frequencies from 15,000 to 22,000 mc can be covered. Because of its broadband characteristics, it is particularly useful in such applications as tunable frequency radar systems and countermeasures devices.

CATHODE ALLOY has high hot strength

SUPERIOR TUBE Co., 1523 Germantown Ave., Norristown, Pa. Cathaloy A-32 can be used for cathodes in virtually any electron tube—entertainment, computer, instrument—requiring an active cathode alloy. It contains 2.25 percent tungsten and 0.10 percent aluminum. The 2.25 percent tungsten in Cathaloy A-32 gives it high strength at both room temperature



MYLAR[®] DIELECTRIC

*Du Ponts Trade Mark for its Polyester Film

COMMERCIAL CONSTRUCTION AT COMPETITIVE PRICES

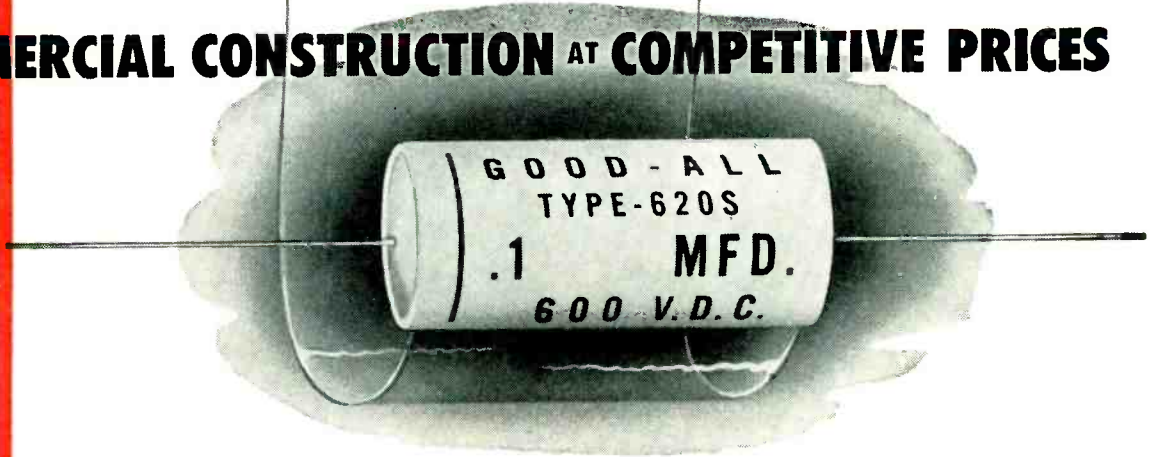

Good-ALL SERAMELITE Capacitors MODELS 620S and 621S

... combine the excellent electric characteristics of "MYLAR" with the superior humidity resistance properties of "Seramelites" to produce a completely new capacitor for exacting applications at reasonable prices.

These competitively priced new miniature capacitors closely approximate the performance of expensive hermetically sealed units. They are designed to cover the entire capacitance and voltage range.

CHARACTERISTICS:

- Insulation resistance 20,000 megohm-microfarads
- Power Factor is Less than 1%
- Operating Temperature -55° C to +125° C
- Generally smaller than RETMA Standards
- Tolerances as close as 1/2 of 1%

CONSTRUCTION FEATURES:

- Tubular Ceramic Enclosure
- New Plastic End Seal
- Inserted Tab or Extended Foil
- Miracle X Impregnated

OTHER GOOD-ALL "MYLAR" CAPACITORS

FILM-X (Hermetically Sealed) • MARBELITE (Plastic Impregnated Paper Tube)

*Available for printed circuit or other applications in all mounting styles.
Built to your specifications.*

So Superior . . . They are being used extensively by leading Electronic, TV, and Radio Manufacturers throughout America.

GOOD-ALL ELECTRIC MFG. CO. 120 FIRST ST • OGALLALA, NEBRASKA



Lamination users can now correlate va. and core loss figures with applications

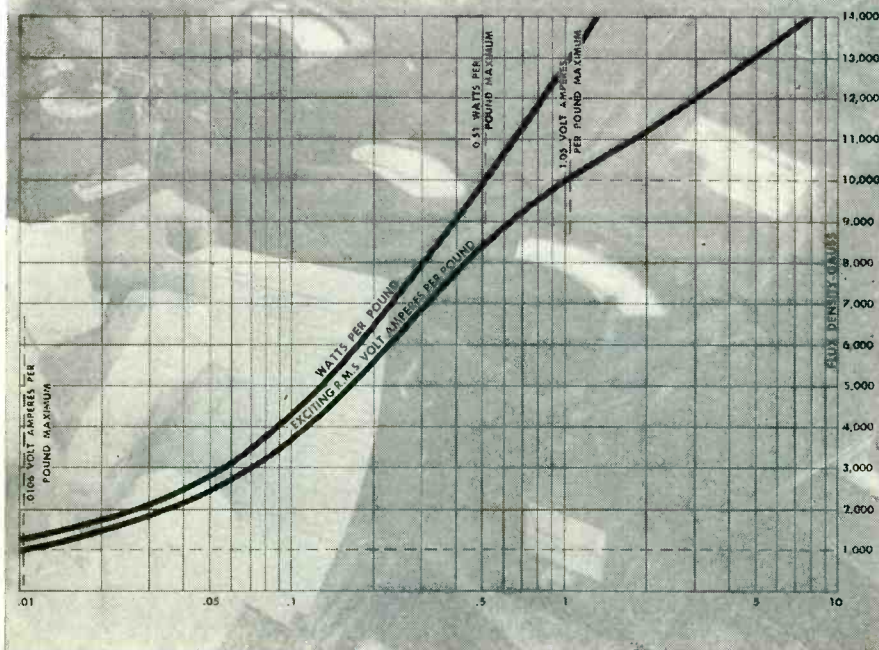

The above curve shows the maximum va. and watt loss of EI 1 1/4" 29 gauge Orthosil 3X laminations.

As a lamination user, you will want to know that guaranteed maximum va. and core loss is available for standard EI transformer laminations and that you can correlate the figures for your own applications.

This valuable information is offered exclusively by Thomas & Skinner. For several years, Thomas & Skinner has accumulated data on standard EI laminations. Based upon an analysis of this information, T&S has established maximum va. and maximum core loss values of each EI lamination at 1,000 and 10,000 gauss, 60 CPS.

A MATERIAL CERTIFICATION is furnished with each shipment of T&S laminations, and gives test figures for both core loss and exciting current on each heat annealed.

This CERTIFICATION attests that each shipment meets the specifications set by the customer.

To you — as a lamination user — these test figures mean elimination of need for retesting, adding up to important savings in your production.

WRITE TODAY for Technical Bulletin DMF-1 giving test details and tables showing core loss and maximum va. Also request new 40-page Bulletin No. L-355 (illustrated below), on special and standard laminations.

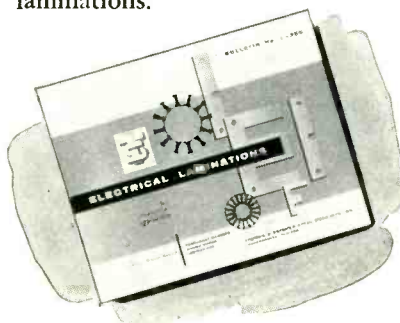

SPECIALISTS IN MAGNETIC MATERIALS . . .

Permanent Magnets Laminations and Wound Cores



THOMAS & SKINNER Steel Products Company, Inc.

1122 E. 23rd Street—Indianapolis 7, Indiana

and operating temperatures. The alloy's hot deflection strength—the stress necessary to withstand elastic deformation of one mil—is 3,750 lb per sq in. at 900 C. It is particularly recommended where resistance to shock and vibration is required.



SEALING BOOT for wide range of cables

WHITNEY BLAKE Co., Electronics Div., New Haven 14, Conn., has available a new type sealing boot to replace cable clamp adaptors AN3057, AN3057A and AN3057B. This boot is used on jacketed cables and on wires covered by sleeving to furnish support at the plug or connector and to relieve strain on the connections. Made of oil-resistant neoprene with a threaded ring of light weight aluminum, this boot is self-centering. An aircraft-type hose clamp supplies positive sealing action. The boot seals on cables over a range of sizes three times as great as for any other Army-Navy type cable clamp adapter. Gripping power is sufficiently great so that when the cable is pulled there is never a strain on the soldered terminals.

SWITCHING DEVICE for computing and control

COMPUTER INSTRUMENTS CORP., 1964 Utica Ave., Brooklyn 34, N. Y., has introduced the precision commutator and impulse generator, as a standard component in their integrated line of miniature precision potentiometers. The unit is intended for use as a high-speed switching device for counting, digital indication of shaft rotation, pulse shaping, pulse gating, se-

YOUR STATION HAS **COLOR TV** FILM EQUIPMENT

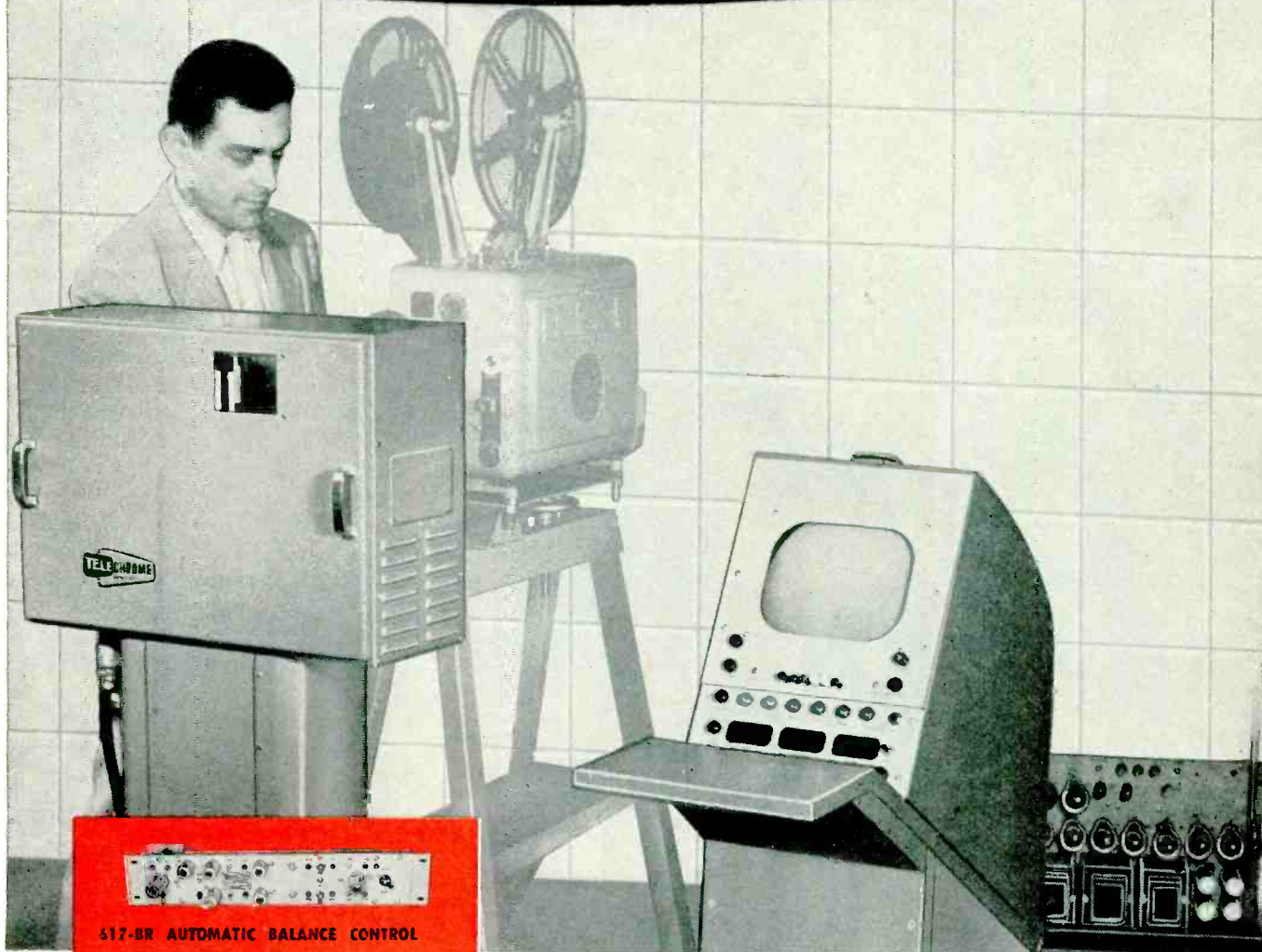

617-BR AUTOMATIC BALANCE CONTROL FOR ALL COLORPLEXERS

(Regardless of Manufacture)

An ingenious circuit locks the entire encoding equipment in balance within 20 seconds after being turned on. Thereafter balance is held under even the most difficult operating conditions.

1601-AR CHROMASCOPE



Signal Certification Equipment. Accurately measures the performance, alignment, and phase errors of color TV equipment. New secondary phase standard for accurate reading to .01°. Presents on a cathode ray screen a continuous polar plot of the phase and amplitudes of all colors in a composite color video signal. Capable of .02° accuracy with 1604-AR phase magnifier.

636-B

CHROMALYZER

Portable Precision Color Bar Generator for checking color broadcast studios and transmission facilities, receivers, and monitors. Can be tied into a system. Provides complete composite color signals of 100 or 75% chroma.



BUT YOU MAY NOT REALIZE IT

Your present 16 mm., 35 mm. or slide projectors used with the TELECHROME 3-Vidicon Color Film Chain are full color film facilities.

The vidicon principle for black and white film, widely proven for best signal to noise ratio and highest resolution detail is now applied to COLOR . . . one vidicon each for Red, Green, Blue.

TELECHROME 3-V provides highest quality color pictures. It is most compact, easy to operate and least expensive since you need not purchase additional film projectors. A built-in folded optical system multiplexes three light sources. Films of light and heavy density are equally accommodated. The 3-V may also be used as a single channel monochrome film chain.

IMMEDIATE DELIVERY

Literature on these and more than 150 additional instruments for color TV by TELECHROME are available on request.



The Nation's Leading Supplier of Color TV Equipment
88 Merrick Road Amityville, N. Y.
Amityville 4-4446

See us at location 32-NARTB Convention



problem: gravity

Interested in it? So are we. For part of the advanced development program at Martin includes an overall search into the basic laws of the universe — probing the unknown in any field that relates to airborne systems.

Gravity is a personal problem to many creative engineers today: men who are lost in large engineering organizations; anchored to non-creative and futureless jobs. Ceiling Zero, Altitude Zero.

If you are one of those, you'd do well to look into the Martin story. For exciting new long-range developments have created many exceptional opportunities on projects of the highest priority and importance.

Contact J. M. Hollyday, Dept. E-5, The Glenn L. Martin Company, Baltimore 3, Maryland.

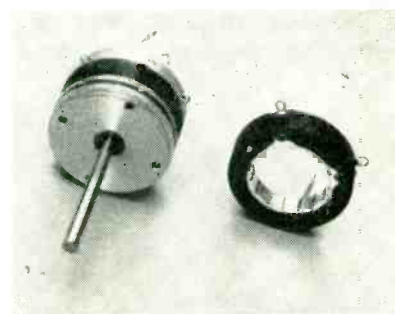

quence circuit control and the like. The commutator-generator consists of a series of conducting segments, bonded to a high-temperature plastic base, insulated from one another, and interconnected to form a wide variety of coded commutation or pulse sequences. The use of multiple isolated wipers permits commutation in several circuits simultaneously, and increases total pulse count per revolution. The element is approximately 1 in. in diameter and weighs 2/10 oz. Precious metal contacts are used throughout. Operational speeds up to 1,000 rpm are permissible, with a life in excess of one million revolutions.

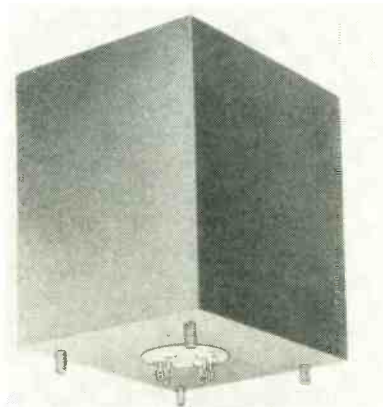

SERVO AMPLIFIER performs without rectifiers

POLYTECHNIC RESEARCH & DEVELOPMENT Co., INC., 202 Tillary St., Brooklyn 1, N. Y. The T6C16W1 saturable transformer will drive 115-v, 60-cps servo motors requiring up to 16 w to the control phase. Performing without the use of rectifiers, this inexpensive unit provides low drift and exceptionally long, trouble-free life over a wide range of temperature from -55 to $+85$ C. Containing only static, magnetic components, it is highly resistant to shock and vibration. Bandwidth is 0 to 3 cps, and a power

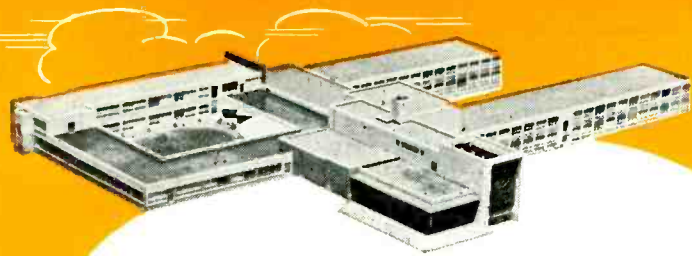

Newest ELECTRONIC CONCEPT BY
BURROUGHS CORPORATION RESEARCH CENTER

BEAM SWITCHING TUBE...

AVAILABLE NOW IN PRODUCTION QUANTITIES

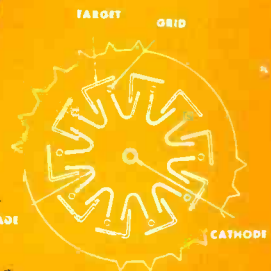

Cross Section showing
Cathode, Grids,
Spades and Targets for
10 position switching.

The beam switching tube offers a new basic device to the engineer of electronic equipment. Versatility of the basic ten-position tube is such that any desired type of sequential, simultaneous or random switching of any number of positions may be obtained. The simplicity of the tube design and associated required circuitry results in a new standard of reliability. It reduces the total number of tubes required in a circuit, space, weight, and heat in control and switching systems.

Perfected by the Burroughs Research Center... rigidly tested and accepted by key electronic plants and communications labs throughout the world...this revolutionary new tube is now precision-manufactured in production quantities with complete accuracy and dependability by the Haydu tube division, specialists in the electronic industry.

The simplicity and reliability of this new basic building block have been demonstrated in applications performing the following functions:

- DISTRIBUTING
- SAMPLING
- FREQUENCY DIVIDING
- COUNTING
- CODING
- MODULATING
- GATING
- TIMING
- CASCADING
- MULTIPLEXING
- MATRIXING
- OSCILLATING

HAYDU

BROTHERS OF NEW JERSEY
PLAINFIELD, NEW JERSEY

Subsidiary of Burroughs Corporation 



An Applications Engineering Department, offering engineering services and consultation, has been set up to assist you in taking full advantage of this device. For further information, contact:

APPLICATIONS ENGINEERING DEPARTMENT
HAYDU BROTHERS OF NEW JERSEY
c/o BURROUGHS RESEARCH CENTER
PAOLI, PENNSYLVANIA

SOME SAUCERS DON'T FLY!
THESE DISHES STAND UP!

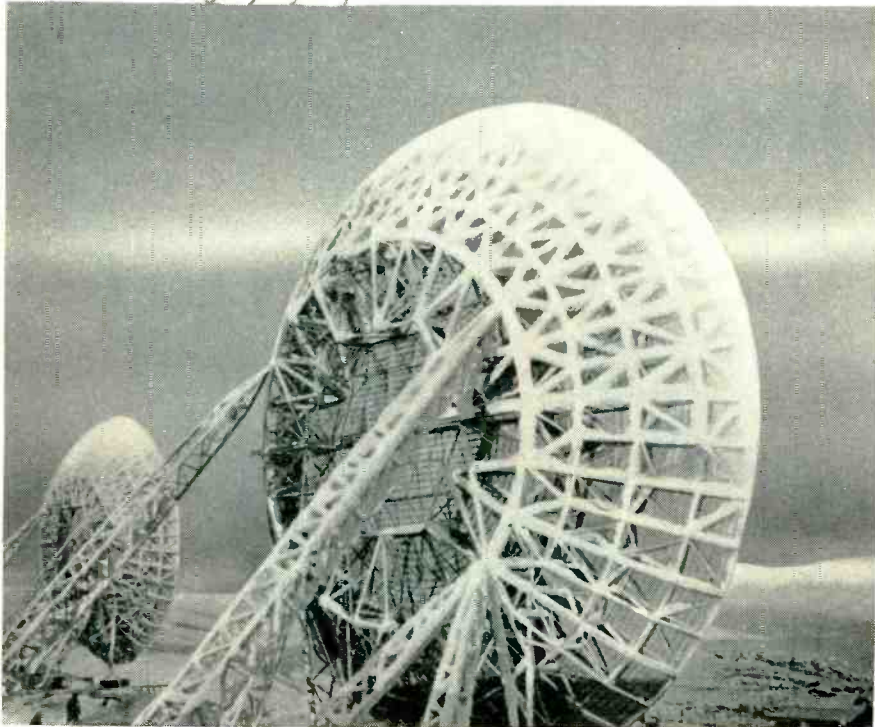

PROOF OF THE "EXTRA PLUS"

... built into all Kennedy antennas (even in a "crash program")! These 60-ft. diameter parabolic dishes, although designed for 1 inch of ice and a 116 mph wind, have repeatedly withstood ice loads in excess of 5 inches and winds over 150 mph.

The installation shown is one of a series of Kennedy dishes forming the critical SCATTER communications link in our Northern Defense Perimeter.

Antennas in 14, 18, 28, and 60-ft. diameters are presently in production.



ANTENNA EQUIPMENT

D. S. KENNEDY & CO.

COHASSET, MASS. — TEL: CO4-0699

gain of 20 is realized. Hermetically sealed in a MIL type can, the unit is 3 7/8 in. long x 3 1/8 in. wide x 5 1/2 in. high. It weighs 6 1/2 lb. It is designed to operate with a simple v-t voltage preamplifier, such as a 12AU7. Neither the T6C16W1 nor its preamplifier requires a d-c power supply.

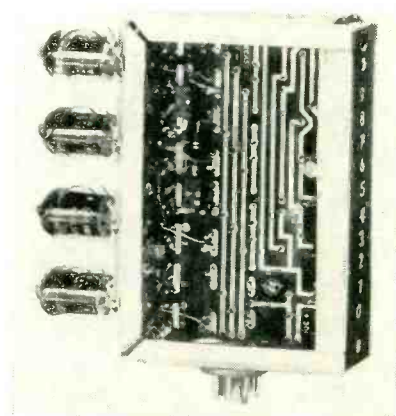

DECADE COUNTER
operates recorders

HEWLETT-PACKARD Co., 395 Page Mill Rd., Palo Alto, Calif. Model AC-4A decade counters provide a 120-kc counting rate and have an output voltage suitable for recorder operation. They feature etched circuits wherein every circuit segment is fully visible, clearly labeled and arranged diagrammatically, for simple servicing. These decade counters are engineered to fit all standard electronic counters, regardless of make, and also may be used separately in experimental or special setups. The new etched circuits give good balance and uniform incidental capacities for the high 120-kc counting rate. Resistors are premium quality 5-percent tolerance units; coupling capacitors are silver mica; and the 4 electronic tubes employed in each counter are of the computer type. Price is \$45.

BACKWARD-WAVE
OSCILLATOR
for microwave use

STEWART ENGINEERING Co., Box 277, Soquel, Calif., has developed a helix-type backward wave oscillator type OX-7-11-50 for service in microwave equipment. The tube operates as a continuously voltage-

Midwestern Instruments'

NEW CURRENT SOURCE



A PRECISION INSTRUMENT TO SUPPLY A few Microamperes to 100 Milliampères

This unusually accurate instrument was originally designed to be used in Midwestern's Galvanometer Shop for precision calibration. It was so extremely valuable there we are now making it available for commercial sale. It is a finely-regulated dc power supply, with unusually small ripple content, operated in conjunction with a network of precision, temperature-stable resistors. Output is controlled by a 10-turn precision potentiometer in the bias circuit of the electronically-regulated power-supply section. A highly accurate voltmeter measures voltage across the precision resistor and output load network, and is calibrated in terms of current.

WRITE FOR COMPLETE DETAILS.

products

- OSCILLOGRAPHS
(LABORATORY AND FLIGHT TEST)
- MAGNETIC STRUCTURES
- GALVANOMETERS
- AMPLIFIERS
- HYDRAULIC SERVOVALVES
- TORQUE MOTORS
- SERVOAMPLIFIERS
- DATA REPEATERS
- WATERPROOF CONNECTORS
- GEOPHYSICAL EQUIPMENT



MIDWESTERN INSTRUMENTS

41st and Sheridan Road

Tulsa, Oklahoma

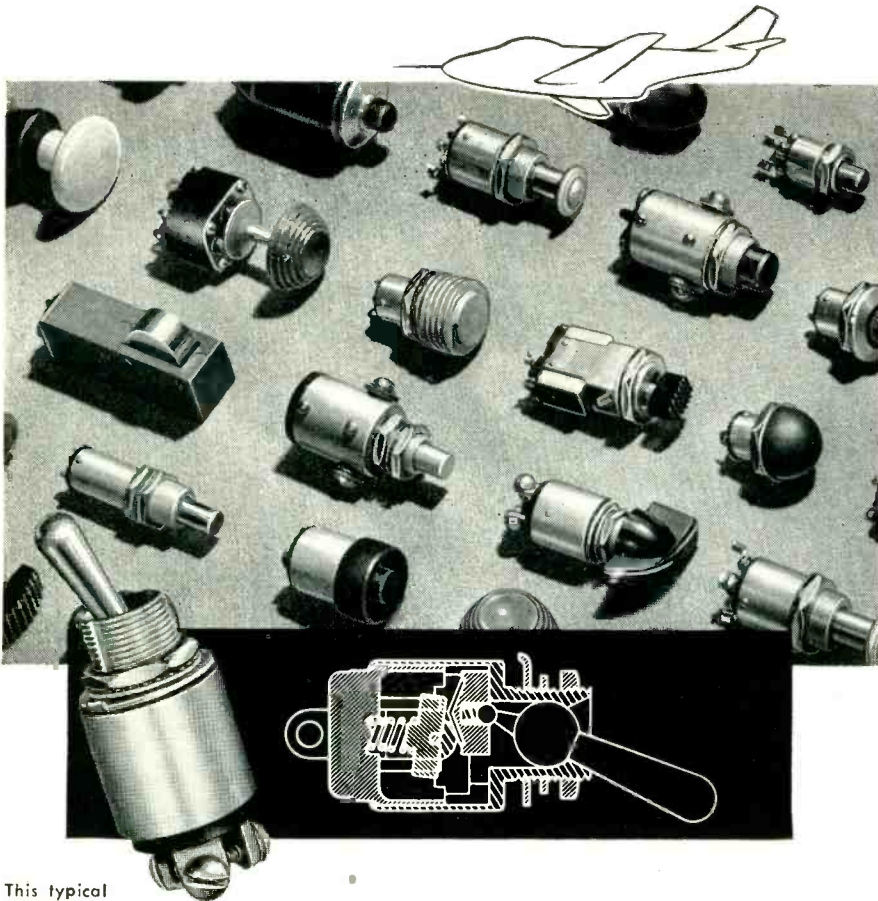

This typical Hetherington T1000 Switch designed for MIL-S-6745 uses reduces size by 25%.

Built to meet your
TOUGHEST
PERFORMANCE STANDARDS
...with weight and space savings
in the bargain...

Switch Types for
 Fire detection indicators
 Trim tab control
 Seat positioning
 Auto pilot release
 Tank jettison
 Microphone circuits
 Audible signal silencers
 Equipment testing
 Fire detection test
 Canopy release
 Seat ejectors
 Bomb or rocket firing mechanisms
 Auto pilots (holding coil types)
 Instruments
 Appliances . . .
 and many others

Whether for MIL or for the toughest commercial uses, Hetherington Switches and Switch-Pilot Light combinations are designed to do the job—with safety margin to spare. Unique, patented design provides positive switching (to exceed military life cycle requirements) in less space with less weight. Dozens of special aviation types in the 15-50 ampere range plus adaptations for exacting commercial jobs.

HETHERINGTON
Switches

HETHERINGTON, INC. • SHARON HILL, PA.

West Coast Division: 8568 W. Washington Blvd., Culver City, Calif.

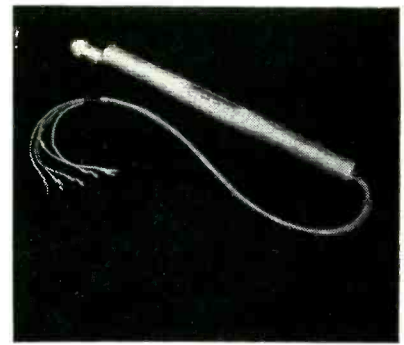

tuned oscillator over the frequency range 5.8 to 11.6 mc, by varying the helix voltage from 250 to 1,500 v. It provides a stable microwave signal source having a minimum power output of 50 mw over the band 7 to 11.6 mc and at least 5 mw over its entire frequency range. Frequency of oscillation of the oscillator is relatively independent of changes in its load. A less than 1-percent frequency change results when the load is varied, from a perfect match to a short circuit of any phase, in the absence of pads between the tube and its load.

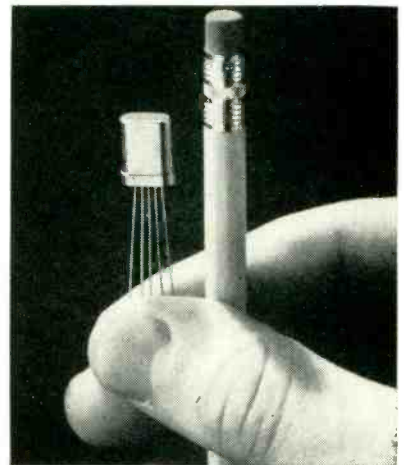

TINY RELAY
 is shock resistant

ELGIN NATIONAL WATCH Co., Elgin, Ill., has introduced the Neomite shock-resistant relay housed in a standard transistor case half an inch high. It is expected to have particular application in guided missiles. The spdt relay is designed for applications in which capacity, weight, size and reliability are of extreme importance. It can withstand severe shock and vibration, together with violent extremes in temperature. The Neo-

Slips Easily Over Stranded Lines

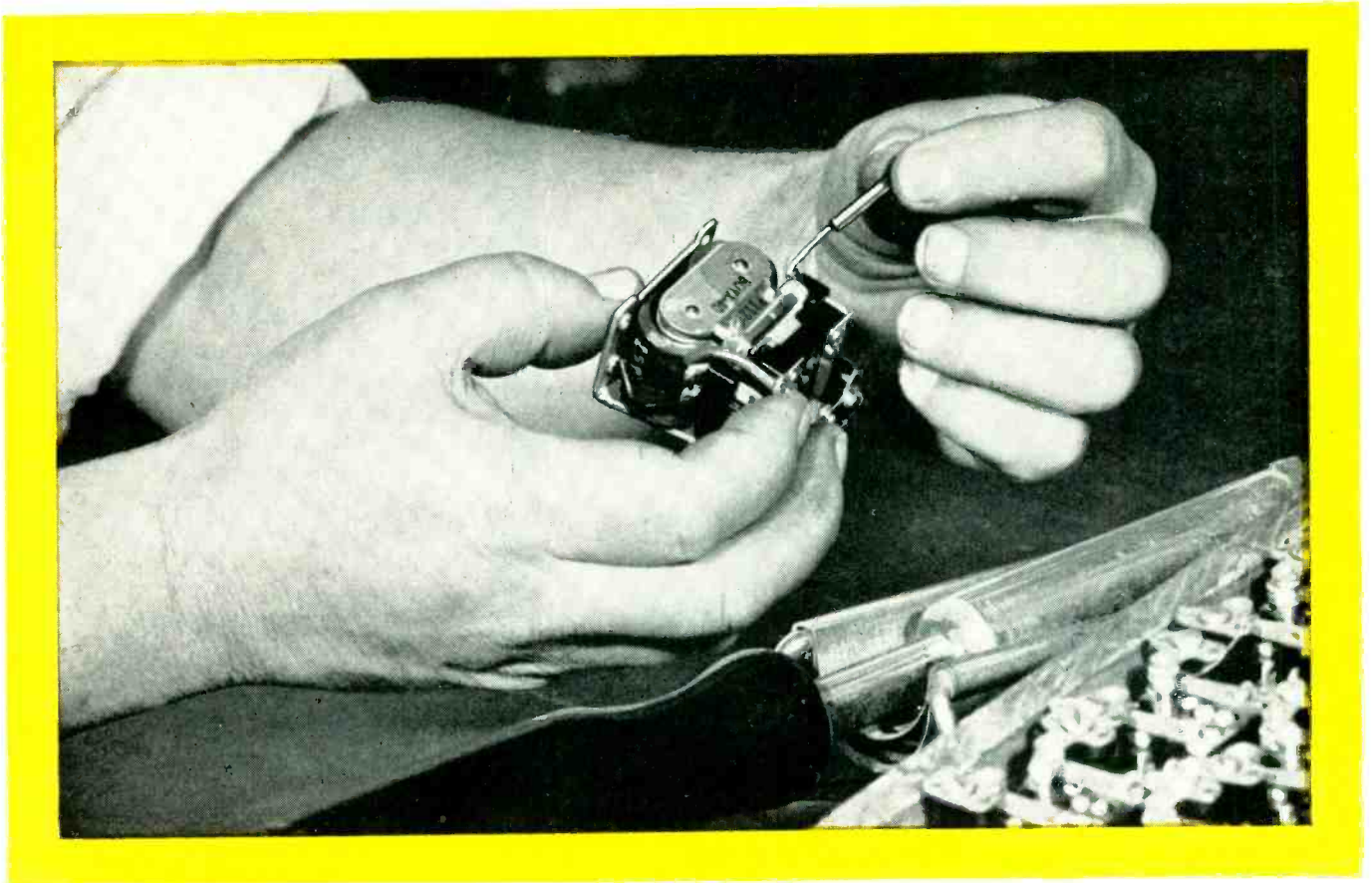

"Flexible at Low Temperatures"... Reports Allied Control Co. on IRV-O-LITE XTE-30

Ability to retain its initial flexibility over long periods of operation at low temperatures is one of the major reasons why Allied Control Company, Inc., New York, has selected Irvington's IRV-O-LITE XTE-30 extruded plastic tubing. Tubing is used for insulating the flexible pigtail connections to the moving contact arms on Allied's Type BOY relays.

Because of its smooth interior surface, XTE-30 tubing slips easily over the finely stranded wire leads without breakage of strands. In addition to its high dielectric strength, the tubing affords mechanical protection from abrasion and tearing.

Other features of XTE-30 include high tensile strength and resistance to acids, alkalis and most solvents.

Send for data sheet which gives technical specifications, dimensions and color range.



PLASTICS PRODUCTS

IRVINGTON DIVISION

MINNESOTA MINING & MANUFACTURING COMPANY

11 ARGYLE TERRACE

IRVINGTON 11, N. J.

HIGH RESOLUTION LABORATORY STANDARD DC VOLTMETERS

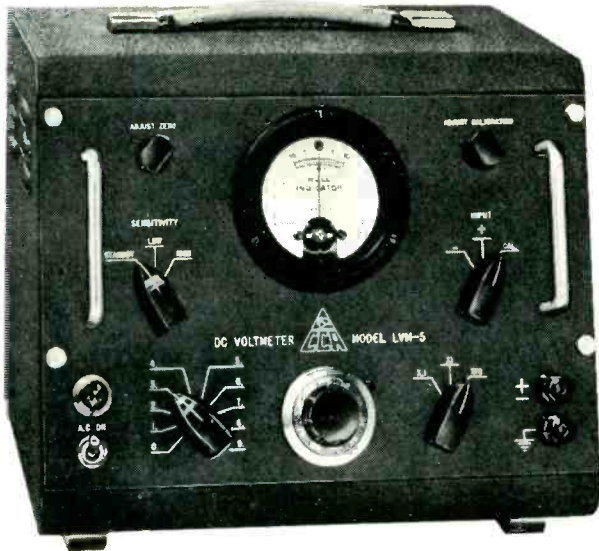

For most applications these rugged portable, self-contained nulling voltmeters replace a potentiometer, voltmeter, galvanometer and standard cell combination. They are suitable for laboratory use, production line testing and field service.

Model LVM-5

Voltage Range: 0-100 Volts DC
 Resolution: At least 50 microvolts between 0 and 1 volt
 500 microvolts between 1 and 10 volts
 5 millivolts between 10 and 100 volts
 Absolute Accuracy: $\pm 0.1\%$ of reading
 Input Impedance: Infinite at null

Model PVM-4

Voltage Range: 0-600 Volts DC
 Resolution: At least 5 millivolts between 0 and 10 volts
 50 millivolts between 10 and 600 volts
 Absolute Accuracy: $\pm 0.1\%$ of reading
 Input Impedance: Infinite at null

Computer Company of America, Division of Bruno-New York Industries Corp. also manufactures the IDA analog computers and accessories. Their usefulness in the field of dynamics has been proven over the years.

A complete line of standard computers, instruments and regulated power supplies is supplemented by the ability to design and manufacture specialized equipment for your particular applications. Your inquiries are invited.

The Model LVM-5 may also be used as a deflection potentiometer, a sensitive null indicator and a precision millimicroammeter. Write for catalog PL which describes these instruments completely. Address Dept. E5D

COMPUTER COMPANY OF AMERICA
 Division of BRUNO-NEW YORK INDUSTRIES CORP.
 460 WEST 34th STREET • NEW YORK 1, N. Y.



mite weighs 0.035 oz. It has a $\frac{1}{4}$ ampere contact rating (noninductive) and a 26.5-v d-c rating. Sensitivity is 100 mw and it can be adjusted down to approximately 40 mw.

MINIATURE TUBE for television receivers

RADIO CORP. OF AMERICA, Harrison N. J. The 6AZ8 general-purpose multiunit miniature tube contains a medium-mu triode and a semi-remote-cutoff pentode in one envelope and utilizes a 9-pin base. The triode unit with its relatively high zero-bias plate current is useful in i-f oscillator, sync separator, sync-clipper and phase-splitter circuits. The pentode unit, which has high transconductance and features a semiremote-cutoff characteristic to minimize cross-modulation effects and overload distortion in picture i-f stages, may be used as an i-f amplifier, video amplifier, age amplifier and as a reactance tube. Coupling between the triode and pentode units is virtually eliminated by the basing arrangement and internal construction of the tube. The 6AZ8 has a maximum overall length of $2\frac{1}{8}$ in. and a maximum diameter of $\frac{3}{8}$ in.



TIME DELAY RELAY is silicone-controlled

HEINEMANN ELECTRIC Co., 455 Plum St., Trenton 2, N. J. Type A Silic-O-Netic relay is available with standard timings from $\frac{1}{4}$ to 120 sec. Variable flux operation, caused by the changing relationship of a solenoid coil and its core, produces

"PIG-TAILORING"

... a revolutionary new mechanical process for higher production at lower costs. Fastest PREPARATION and ASSEMBLY of Resistors, Capacitors, Diodes and all other axial lead components for TERMINAL BOARDS, PRINTED CIRCUITS and MINIATURIZED ASSEMBLIES.

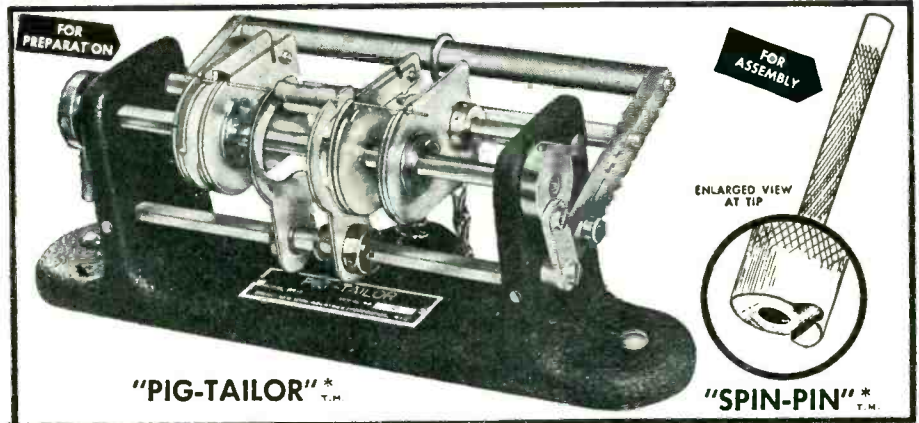

The "PIG-TAILOR" plus "SPIN-PIN" — Accurately Measures, Cuts, Bends, Ejects and Assembles both leads simultaneously to individual lengths and shapes — 3 minute set-up — No accessories — Foot operated — 1 hour training time.

PIG-TAILORING provides:

- | | |
|-------------------------------------|-------------------------------------|
| 1. Uniform component position. | 6. Individual cut and bend lengths. |
| 2. Uniform marking exposure. | 7. Better time/rate analysis. |
| 3. Miniaturization spacing control. | 8. Closer cost control. |
| 4. "S" leads for terminals. | 9. Invaluable labor saving. |
| 5. "U" leads for printed circuits | 10. Immediate cost recovery. |

PIG-TAILORING eliminates:

- | | |
|--------------------------------|-----------------------------------|
| 1. Diagonal cutters. | 6. Broken leads. |
| 2. Long-nose pliers. | 7. Short circuits from clippings. |
| 3. Operator judgment. | 8. 65% chassis handling. |
| 4. 90% operator training time. | 9. Excessive lead tautness. |
| 5. Broken components. | 10. Haphazard assembly methods. |

* PATENT PENDING

Write for illustrated, descriptive text on "PIG-TAILORING" to Dept. E5-P

BRUNO-NEW YORK INDUSTRIES CORPORATION
DESIGNERS AND MANUFACTURERS OF ELECTRONIC EQUIPMENT
460 WEST 34th STREET • NEW YORK 1, N. Y.



Broadband RF Power Meters

THE CHOICE OF ALL ARMED SERVICES
FOR MICROWAVE POWER MEASUREMENTS

POWER: PULSE and CW — $5\mu\text{W}$ to 5W average
FREQUENCY: 20MC — 10,000MC
ACCURACY: 5% Absolute at all ranges,
frequencies, temperatures

- INDICATIONS: Direct Reading
- CALIBRATION: Compensates for All Variables
- R-F COMPONENTS: 3, 6, 10 and 20db Attenuators, Bolometer Mount and Elements, R-F Cable
- BOLOMETER: Broadband, High Overload Capacity
- PLUMBING: $\frac{3}{8}$ " and $\frac{7}{8}$ " 50-ohm Coaxial
- POWER SOURCE: 115VAC $\pm 15\%$, 50-1000 cps
- CONSTRUCTION: Rugged, meets all JAN, MIL requirements

TYPICAL APPLICATIONS

Microwave Links . . . Television . . . Communications . . .
Radar . . . Telemetry . . . Signal Generators . . .
Laboratory Standards.

Write for descriptive literature to Department E5-M

Bruno - New York Industries Corporation
DESIGNERS AND MANUFACTURERS OF ELECTRONIC EQUIPMENT
460 WEST 34th STREET • NEW YORK 1, N. Y.



"PRINTED CIRCUIT OUTPUT UPPED *when we switched to HUNT R.C.E.*"

(RAPID CIRCUIT ETCH)

—the FASTEST ETCHING SOLUTION for PRINTED CIRCUITS

Here indeed is good news for all makers of etched printed circuits. Philip A. Hunt Company, world-famous makers of photographic and photo-engraving chemicals, now offers Hunt R.C.E. Solution, a special etching solution with these BIG advantages, guaranteed:

1. Controlled rapid etching speed, permitting standardization of a high production etching schedule
2. Instant and uniform etching over entire circuit
3. Maximum etching capacity
4. Full protection of tops

Contact your nearest Hunt branch, or write us at Palisades Park, N. J., today for full information on Hunt R.C.E. Solution.

*Hunt R.C.E.
Solution is
supplied in
145 lb. rubber
drums*



PHILIP A. HUNT COMPANY

PALISADES PARK, N. J.

Chicago • Cleveland • Cambridge • Brooklyn • Atlanta • Dallas • Los Angeles • San Francisco



NEW PRODUCTS

(continued)

highly definitive contact action. A movable iron core, hermetically sealed in a nonmagnetic metal tube extending through a solenoid coil, is drawn into the magnetic field resulting when the coil is energized. The silicone fluid slows the rate of core travel, thus controlling the response time. Contacts are actuated as the core touches the pole piece and check valve construction within the core allows faster resetting of the relay. The relays are furnished with coil ratings from 24 to 240 v, a-c; 6 to 125 v, d-c.

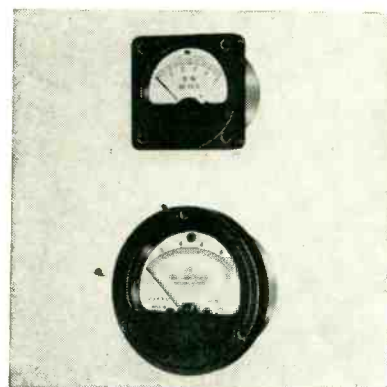

PANEL METERS either ruggedized or sealed

DEJUR-AMSCO CORP., 45-01 Northern Blvd., Long Island City 1, N. Y., has available a new group of 2½ in. and 3½ in. panel instruments in a choice of ruggedized or sealed models. The ruggedized versions withstand heavy duty military and ASA standard shock and vibration extremes under a wide range of temperature conditions as defined by Signal Corps specifications MIL-M-10304. Both ruggedized and sealed meters are calibrated for magnetic and nonmagnetic panel mounting, and are available in a variety of special ranges, scale divisions, markings and color combinations. Complete specifications and a table of standard ranges are available.

FILTER helps sound reproduction

CINEMA ENGINEERING Co., Division of Aerovox Corp., Burbank, Calif. Type 7052 is a variable high and low frequency filter for use in

a "midget"* in size

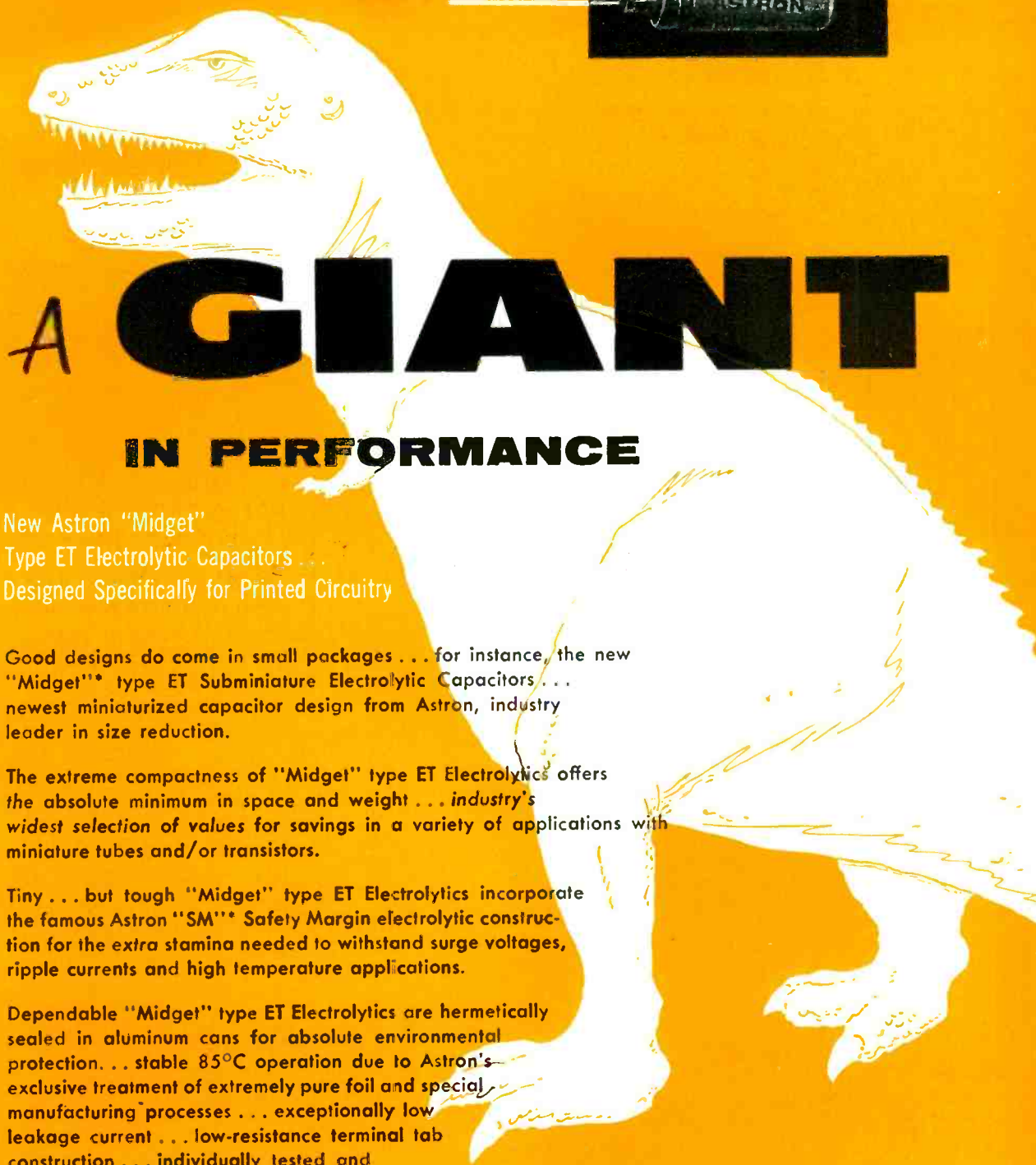

A GIANT IN PERFORMANCE

New Astron "Midget"
Type ET Electrolytic Capacitors . . .
Designed Specifically for Printed Circuitry

Good designs do come in small packages . . . for instance, the new "Midget"* type ET Subminiature Electrolytic Capacitors . . . newest miniaturized capacitor design from Astron, industry leader in size reduction.

The extreme compactness of "Midget" type ET Electrolytics offers the absolute minimum in space and weight . . . industry's widest selection of values for savings in a variety of applications with miniature tubes and/or transistors.

Tiny . . . but tough "Midget" type ET Electrolytics incorporate the famous Astron "SM"* Safety Margin electrolytic construction for the extra stamina needed to withstand surge voltages, ripple currents and high temperature applications.

Dependable "Midget" type ET Electrolytics are hermetically sealed in aluminum cans for absolute environmental protection. . . stable 85°C operation due to Astron's exclusive treatment of extremely pure foil and special manufacturing processes . . . exceptionally low leakage current . . . low-resistance terminal tab construction . . . individually tested and guaranteed.

Save valuable space, increase
your designing flexibility
and reduce ultimate
costs . . . write for
Bulletin AB - 22
today!

ASTRON
CORPORATION
255 GRANT AVENUE
EAST NEWARK, N. J.



Export Division: Rocke International Corp. 13 E. 40 St., N. Y., N. Y. In Canada: Charles W. Pointon 6 Alcina Ave., Toronto 10, Ontario

*Trademark

BIG NEWS...IN SEALED THERMOSTATS!

G-V's Series C8 is Undamaged By 150 G Shock, Vibration up to 2000 Cycles, Exposure to -100°F . and $+300^{\circ}\text{F}$.

This new series of electrical thermostats is specially designed to meet the difficult operating conditions of electronic and aircraft applications. Operating points, regardless of setting, are not changed by exposure to temperatures from -100°F . to $+300^{\circ}\text{F}$. Shocks up to 150 G for 3 milliseconds, vibration of 25 G up to 1000 cps, and vibration of 10 G up to 2000 cps do not damage these thermostats or change their setting.

Hermetically Sealed But Rapid in Response

Sealed in a metal shell which is also its sensing element, the G-V Series C8 Thermostat responds as rapidly as a laboratory thermometer. Temperature settings may be made at the factory or by the user. Contacts are rated at 5 amps. 115 volts AC, or 3 amps. 28 volts DC, non-inductive load. Differential is about 1°F . Insulation test is 1250 v. between circuit and shell, and insulation resistance is over 100 megohms. These thermostats are suitable for direct control of heaters and for over-temperature and under-temperature indication, alarm, or cut-off.

Available In Numerous
Convenient Mounting Forms

WRITE...

for Bulletin with
complete technical and
application data.



G-V **G-V CONTROLS INC.**
24 Hollywood Plaza • East Orange, N. J.

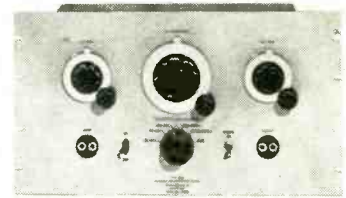
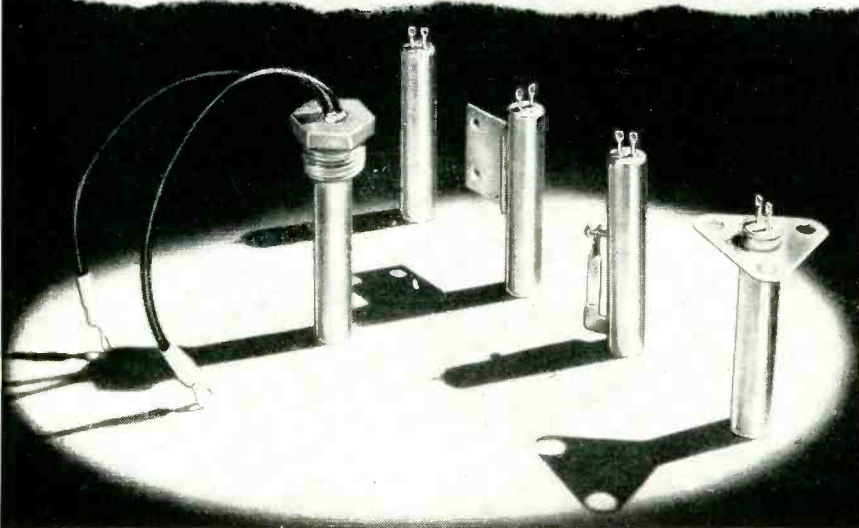

sound reproduction to eliminate unwanted noises, arc rumble, whistles and the like. The dip filter is also designed as a laboratory tool to measure harmonic distortion. It incorporates a 4-stage amplifier having an R-C interstage coupling network. Features include "in-and-out" switch, triple mu-metal shielding of transformers, shock mounting of tubes and general electrostatic and electromagnetic shielding to permit operation in low-level circuits. Frequency range is 20 to 15,000 cps; response, ± 1 db. Output level is -2 dbm with output impedances to work into 200-250, 500-600 ohm balanced lines. Power requirements are 250 v d-c at 5 ma, and 6.3 v at 1.2 amperes.

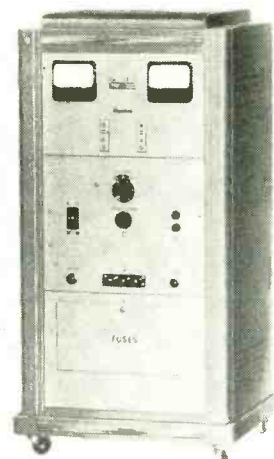

COMPUTER uses new control system

ELECTRONIC MEASUREMENTS Co., Lewis St., Eatontown, N. J. Model 210-A employs the Regatron control system which affords super-regulation and long-time stability for both low and high voltages. This model provides 0 to 3 amperes at 0 to ± 360 v directly calibrated on a multiturn panel dial, plus a 3-v electrical vernier which permits extremely fine control. Regulation error is measured in mv, ripple voltage in μv , and output imped-

They're on the Way...!

HIG-4 GYROS BEING SHIPPED BY

Greenleaf



More and more guided missile and fire control system manufacturers are now utilizing the Greenleaf HIG-4 Gyro. This Hermetically-sealed Integrating Gyro has been thoroughly proven and production quantities are ready to go to work for you.

DATA

Spin Motor: 12 Volts, 400 cps, 2 phase

Synchronous Speed: 8,000 R.P.M.

Angular Momentum:

10⁴ Gram-Centimeter²/second

Gimbal Travel: ±5° Maximum

Signal Generator Sensitivity:

10 mv/mr, with 55 ma, 400 cps

Torque Generator Linearity Deviation:
less than 1%

Heater Power: warm-up 100 watts,
running 25 watts, 115V, 400 cps

Weight: 1.5 pounds

ENGINEERING • DEVELOPMENT • PRODUCTION

THE Greenleaf MANUFACTURING COMPANY

7814E Maplewood Industrial Court • Saint Louis 17, Missouri

Where quality control works on the production line... producing the new HIG-3 and the HIG-4 Gyros, Rate Gyros, Differential Pressure Switches, Synchros, Air Speed Indicators, Actuators, Transducers and many other precision-built components.

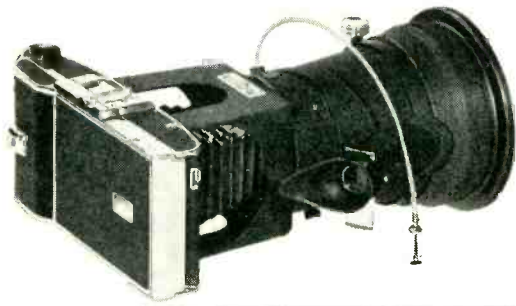

*in
sixty
seconds...*

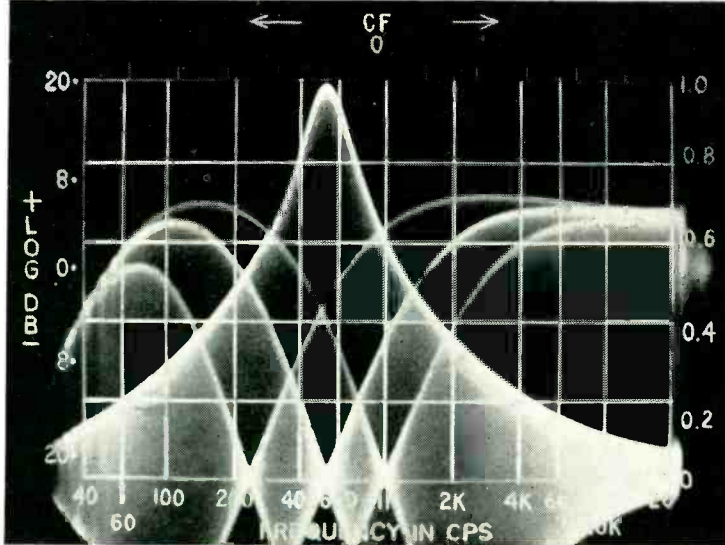

Performance evaluation of a Fischer electronic (low frequency—high frequency) filter; wave forms signify the following: Variable null marker to check points on response curve at 1 Kc, 2.2 Kc and 5.5 Kc. This is a log amplitude presentation where the frequency is multiplied by a factor of 10. Instrument used is SGI Sweep Generator; courtesy Panoramic Radio Products Corporation.

a full-size photo of any scope pattern for evaluation of transient phenomena!

This special Fairchild adaptation of the Polaroid-Land principle delivers a permanent, photographically accurate, full-size record of single transients or identical repetitive phenomena in 60 seconds after they appear on the C-R Tube. It is the only practical method to obtain a quick, permanent record of scope patterns like the one above. Because this photographic method is so fast, laboratory work can proceed continuously without interruptions or delays so usual where conventional film is used. The life size $3\frac{1}{4} \times 4\frac{1}{4}$ in. image makes evaluation easy and accurate. Camera is automatically in focus when attached to the oscilloscope. Also provides for critical focusing adjustment where thick grids or filters are interposed between the tube face and camera hood.

For accurate records of continuously varying phenomena or single transients and stationary patterns on 35 mm. film, the Fairchild Oscillo-Record Camera is available. For more information, write Fairchild Camera and Instrument Corporation, 88-06 Van Wyck Expressway, Jamaica, New York, Department 120-23A.

FAIRCHILD

OSCILLOSCOPE RECORDING CAMERAS

NEW PRODUCTS

(continued)

ance in milliohms. Individual monitoring of series tubes, forced air, and multiple overload protection (available at the front) are provided to reduce down time. Auxiliary potentials and other features are available on order.



WIDE-BAND SCOPE for tv and industrial uses

SUPPLY DIVISION, NATIONAL RADIO INSTITUTE, 16th & You Sts., N. W., Washington 9, D. C., announces an inexpensive oscilloscope having many laboratory-quality features. The instrument can be used for industrial applications where square-wave and pulse type signals must be observed. Vertical amplifier response is flat from 10 cycles to 4.5 mc (± 3 db). The 4-step frequency-compensated vertical attenuator is calibrated for direct peak-to-peak voltage measurement. Sensitivity is 0.014 v (rms) per in. of deflection. Linear sweep range is 10 cycles to 100 kc.

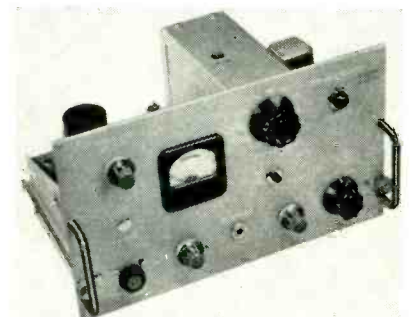

PREAMPLIFIER is servo monitor

SANBORN Co., 195 Massachusetts Ave., Cambridge, Mass. Model

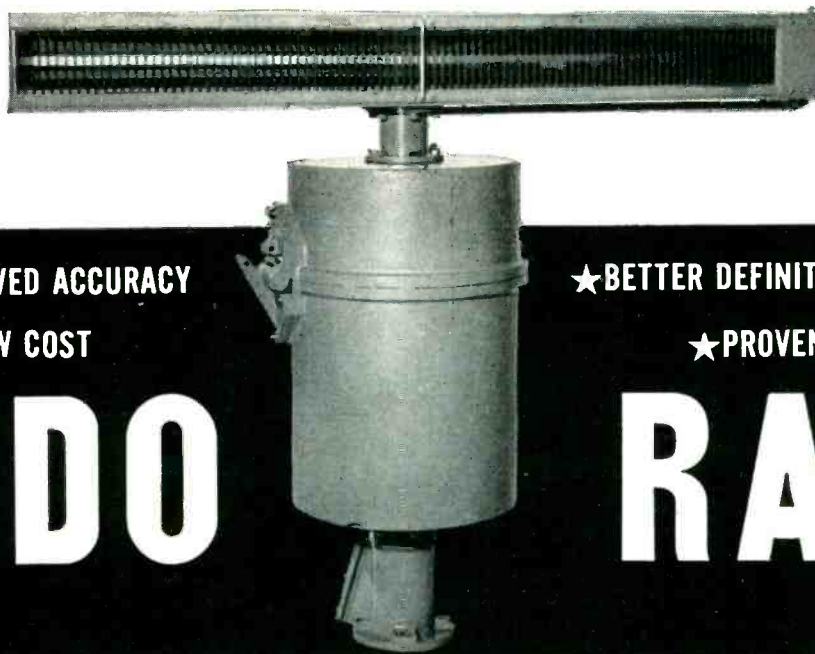

★IMPROVED ACCURACY

★LOW COST

EDO

★BETTER DEFINITION

★PROVEN DEPENDABILITY

RADAR

with **PATENTED SLOTTED WAVEGUIDE ANTENNA**

Now, EDO, famed builder of high performance sonar for the United States Navy and other fine marine electronic equipment for commercial craft, announces the Edo Model 320 Radar.

This fine, thoroughly-tested piece of electronic equipment has been created especially for use in small craft where space and generator capacity are limited. Operating on a wave length of 3.2 centimeters (X-band), it provides clear, precise definition of shore line, buoys, boats or other hazards on five scales — 1, 2, 5, 10 or 20 miles—and showing objects as close as 25 yards—making it useful for operation in both open and restricted waters.

The exceptional performance of the Edo Model 320 Radar stems from the use of the compact, patented, slotted waveguide antenna which reduces side lobe reflections. This exclusive antenna cuts down windage and is impervious to weather. The Edo Radar has been designed for ease of operation, long life and simple maintenance. Despite its superior performance it is in the lowest-priced bracket bringing the time and money-saving advantages of radar to many owners of smaller boats who could not previously afford this latest aid to navigation.

You can install Edo Radar in your craft with utmost confidence, for it bears the famed Edo Flying Fish emblem, known and respected as the mark of superior, dependable performance on depth sounders, survey depth recorders, the famed Edo Fishscope, the Edo Loran and other marine electronic equipments. Write for further information.

Another example of
EDO's ever-increasing
role in the field of
MARINE ELECTRONICS

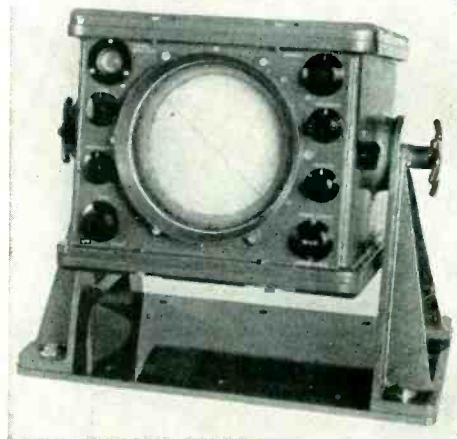

PPI Display Unit can be conveniently mounted on bulkhead, desk or overhead and is designed for greatest possible ease of operation. It can be fitted with hood for viewing under bright-light conditions.



CORPORATION

College Point, L. I., N. Y.

SINCE
1925

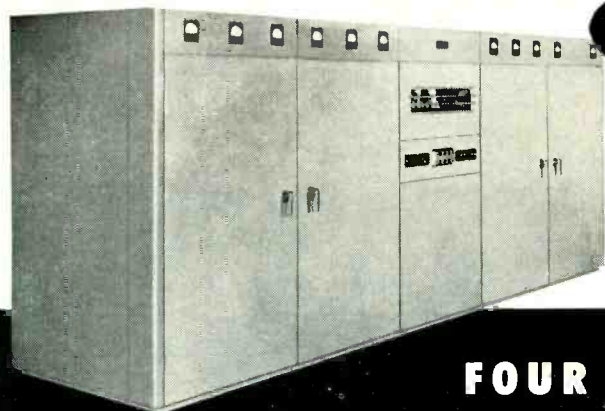

GATES 20 kw,
2 to 22 mc,
Short Wave
Broadcast
Transmitter
for Indonesia

FOUR REASONS WHY GATES RADIO USES JENNINGS VACUUM CAPACITORS

1. TOP PERFORMANCE IN ALL CLIMATES

They are impervious to dust and moisture and are self-healing after moderate overloads.

Two UH 10-75 mmfd
Neutralizing Capacitors.

2. TROUBLE-FREE OPERATION

They require no maintenance and are designed to last the life of the transmitter.

Two VMMHC 25-450 mmfd
Main Tank Capacitors.

3. WIDE CAPACITY RANGE

They make possible a continuously variable frequency range of 2 to 22 mc without complicated switching circuits.

4. SMALL PHYSICAL SIZE

Their vacuum dielectric has inherent advantages of high voltage and current ratings in a small physical space.

Four UCS 25-500 mmfd capacitors in a pi network in the driver stage. Two are also used in a line coupling circuit.

Send for our catalogue summary of vacuum capacitors and switches.

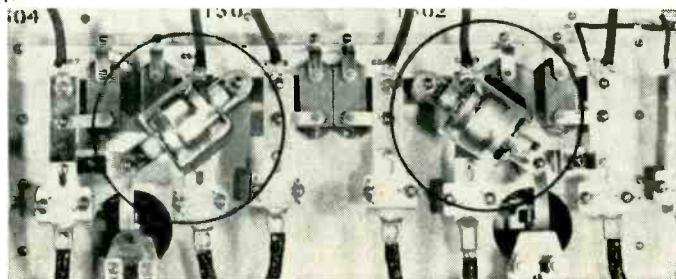

Two JCS 250 mmfd coupling capacitors.

**JENNINGS RADIO MFG. CORP. 970 McLAUGHLIN AVE.
POST OFFICE BOX 1278 • SAN JOSE 8, CALIFORNIA**

150-1200 servo monitor preamplifier, one of several interchangeable front ends for use with a power supply-driver amplifier unit in Sanborn 150 systems, is a phase discriminating a-c amplifier designed for use in recording the error signal of a servo system. The preamplifier measures the components of an a-c voltage that are in phase or 180 deg out of phase with a fixed or reference voltage of the same frequency. Basic sensitivity is 10 mv per cm, which can be reduced by attenuator ratios from 2 to 1,000. Input voltage range is 50 mv to 50 v; reference voltage, 10 to 125 v; frequency range, 60 cps to 10 kc. Further specifications are available on request from the company.

AUDIO SHIFT NETWORK designed for ssb use

BARKER & WILLIAMSON, INC., 237 Fairfield Ave., Upper Darby, Pa., has available an audio phase shift network especially designed for single-sideband receiving and transmitting applications. Designated model 350, type 2Q4, the unit provides a constant 90-deg phase shift ± 1.5 deg, over the audio range of 300 to 3,000 cycles, yet requires no more space than a 6J5 tube.

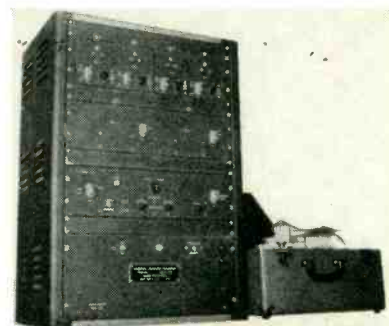

TRANSIENT RECORDER is a 4-channel unit

MAGNE-PULSE CORP., 140 Nassau St., New York 38, N. Y. Type 104 transient recorder magnetically records up to 4 signals simultaneously. Providing a frequency response of d-c to 2 kc, a 1-second period, and simultaneous playback of

Bogen

HIGH FIDELITY
BECAUSE IT SOUNDS BETTER

TRANSFORMERS ARE INSULATED

with

NATVAR

Straight Cut V.C.



With the new Bogen R-765 Auto-Lock Tuner, you simply tune until you hear the FM station you want. Then the R-765 automatically "zeros in" to optimum adjustment and locks into position.

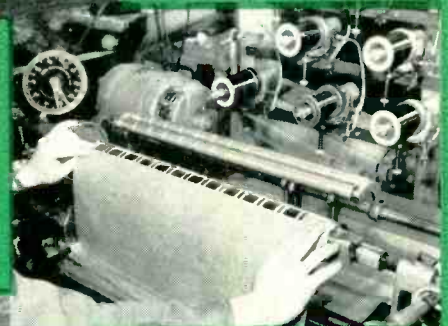

Operator of this multi coil winder finds it easy to insert Natvar V.C. as interwinding insulation, because it is always pliable and never sticky.



Leads are dead soft, but are easily inserted in Natvar Varnished Fiberglass Sleeving because it is so smooth inside. Operator slips sleeving back while stripping the enamel before hot tin dipping.



Natvar Products

- Varnished cambric—cloth and tape
- Varnished canvas and duck
- Varnished silk and special rayon
- Varnished—Silicone coated Fiberglas
- Varnished papers—rope and kraft
- Slot cell combinations, Aboglas®
- Vinyl coated—varnished—lacquered tubing and sleeving
- Extruded vinyl tubing and tape
- Styraflex® flexible polystyrene tape
- Extruded identification markers

Ask for Catalog No. 23

THE DAVID BOGEN Co., Inc., manufactures high fidelity home music systems of highest quality. Their matched tuners, amplifiers, record players and accessory units are noted for their flat frequency response over the entire audio range, minimal distortion, and other features such as the Bogen Auto-Lock tuning circuit to simplify tuning and eliminate drift.

Engineering and design are up to the minute, and components are carefully built of the best of suitable materials. Natvar straight cut varnished cambric is used as transformer interwinding insulation because "it is soft, pliable, and easy to handle, of uniform thickness throughout the sheet, with no thin spots. It is consistently good. Each shipment is exactly like the last."

Natvar flexible insulations are uniformly dependable no matter where or when purchased. They are available either from your wholesaler's stock or direct from our own.

NATVAR CORPORATION

FORMERLY THE NATIONAL VARNISHED PRODUCTS CORPORATION

TELEPHONE

RAHWAY 2-8800

CABLE ADDRESS

NATVAR; RAHWAY, N. J.

201 RANDOLPH AVENUE • WOODBRIDGE, NEW JERSEY

3 BASIC Sealnuts*

TYPE H-1267

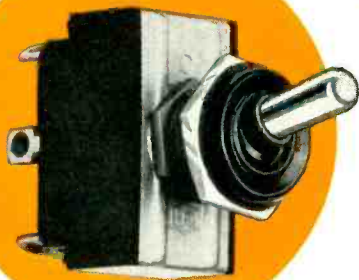

**SEAL OUT
WATER ••
DIRT •• FUMES
CORROSION**

GOV'T. APPROVED *U. S. Patent 2462023

**PROTECT YOUR
EQUIPMENT!
at Vital Mounting
and Sealing Spots!**

**FOR TOGGLE, CONTROL SHAFT,
AND PUSH BUTTON SWITCHES**

SEALNUTS serve dual function of mounting and sealing electrical switches. Twelve stock styles fit most toggle, rotary and push-button types. They provide rigid, metal-to-metal contact with panel for secure mounting, while Silicone sleeve and O-ring seal against external pressures to 200 p.s.i., stay flexible at -65°C , meet requirements of MIL-B-5423. Over a million have been used to protect commercial and military equipment.

any 2 channels, this equipment also features the use of magnetic disks which can readily be removed and stored permanently, or erased and used again. The equipment should find wide application for the recording of transients in aircraft, power lines, petroleum exploration, medical research, electronic analysis and other related fields.

TUBING & SLEEVING conforms to MIL specifications

ALPHA WIRE CORP., 430 Broadway, New York 13, N. Y., have announced the new Alphlex line of tubing and sleeving for industrial electronic applications. It includes extruded plastic tubing, impregnated tubing and sleeving, high temperature glass fiber sleeving, plastic coated glass fiber tubing and sleeving, silicone impregnated glass fiber sleeving and silicone-rubber-coated glass fiber tubing. The line conforms to MIL specifications and UL standards.

NEW FAST ACCESS

Chassis Slides

**Pull out, Tilt & Lock
in 2 Seconds**

Chassis Slides, Type H-5798, are designed to fit most standard relay racks. These inexpensive Slide assemblies, although light in weight, will hold more than 100 lbs. without distortion.

Tilt-lock mechanism securely holds chassis when tipped for service or repair. Chassis can be quickly removed from Slides by drawing two locking pins. Meet Spec. MIL-E-16400 (Ships).

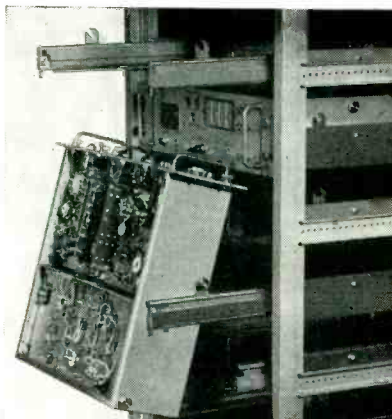

PART NO. H-5798

THERMALLY INSULATED

Vinyl Coated Handle

WITH MOUNTING PLATE

Design conforms to MIL-T-945A. comfortable, hinged grip is black anodized aluminum coated with black or gray vinyl, swings 180° and lies flat when not in use. Lifts 125 lbs. Stock delivery.



TYPE H-5371

**Combines Appearance
WITH
Comfort and Utility**

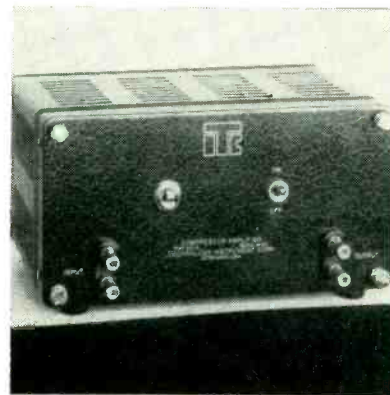

COMPRESSOR AMPLIFIER provides constant output

TECHNOLOGY INSTRUMENT CORP., Acton, Mass., announces the type 501-A compressor amplifier. It accepts input signals of variable amplitude between 1.25 and 50 v and delivers an output signal of the waveform but held at a substantially constant amplitude of 0.25 v by a servo-controlled distortionless variable attenuator. Compression ratio is 40 to 1 (32 db) from 500 cps to 1 mc; slightly less below 500 cps. Frequency range for complex signals at any compression condition is 50 cps to 50 kc,

Kindly send Literature describing the Products checked, to:

- Sealnuts NAME _____
- Slides FIRM _____
- Handle ADDRESS _____

Radio Frequency
LABORATORIES, INC.



BOONTON 3, N. J., U. S. A.

DESIGNERS AND MANUFACTURERS OF ELECTRICAL EQUIPMENT SINCE 1927

DEPT. _____
PHONE _____

When Heat Treating

Stainless Steels

**"KNOW
HOW"**

makes the difference!

A large new plant, ultra-modern equipment, fast service, plus an interested "know-how" staff make Sargeant & Wilbur stainless steel heat treating services worth money to you.

SAMPLE PROCESSING FREE

Write, Wire & Phone



SARGEANT & Wilbur

Heat Treating Corp.

170 York Avenue, Pawtucket, Rhode Island

U. S. Air Force Certified

● BRAZING ● ANNEALING ● HARDENING

BE SAFE WITH

Q-max

A-27

LOW-LOSS LACQUER & CEMENT

• Q-Max is widely accepted as the standard for R-F circuit components because it is chemically engineered for this sole purpose.

• Q-Max provides a clear, practically loss-free covering, penetrates deeply, seals out moisture, imparts rigidity and promotes electrical stability.

• Q-Max is easy to apply, dries quickly and adheres to practically all materials. It is useful over a wide temperature range and serves as a mild flux on tinned surfaces.

• Q-Max is an ideal impregnant for "high" Q coils. Coil "Q" remains nearly constant from wet application to dry finish. In 1, 5 and 55 gallon containers.

*Communication
Products Company, Inc.*

MAPLEBORO, NEW JERSEY
(MONMOUTH COUNTY)

Telephone: FReehold 8-1880



An Invitation TO MANUFACTURERS OF ELECTRONIC EQUIPMENT

1. Friendly labor supply.
2. Unusual city, county, and state tax advantages.
3. Industrial sites plentiful.
4. Good banking facilities.
5. Full cooperation guaranteed.
6. Strategic location

for
**SMALL
or
MEDIUM
INDUSTRIES**

Businessmen of Lakeland, Florida will cooperate fully and furnish complete information to manufacturers who will consider relocating or establishing a branch unit in this fast-growing central Florida city

INDUSTRIAL DEVELOPMENT COMMITTEE OF 100
LAKELAND TERRACE HOTEL

LAKELAND, FLORIDA

The Sign of precision engineered
TRANSFORMERS
for greater **DEPENDABILITY**
QUALITY
CONSTRUCTION



**AUDIO—POWER
PULSE**
Transformers and Inductors
High Temperature—Miniaturized
Encapsulated Units.

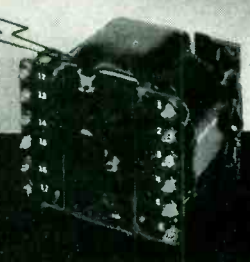
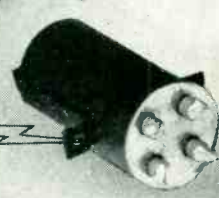

Write for our
Latest
Brochure

INDUSTRIAL ITC TRANSFORMER
Corporation
GOULDSBORO PENNSYLVANIA



miniaturization

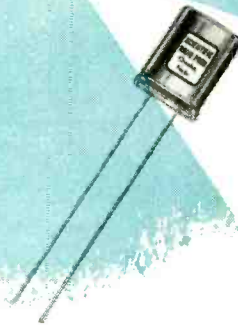

Let Scientific help you keep pace in this new era of electronics

Putting maximum equipment in minimum space is a problem Scientific can help you solve in frequency control devices.

Scientific's new high frequency miniature crystals will enable you to reduce the size of your crystal component up to 75 per cent!

These miniatures have a frequency range of from 5 to 125 mc. and come with wire leads that may be mounted on a wafer switch or wired directly into your circuit. Scientific's miniatures have a proved performance record better than standard size crystals.

Scientific is working today with the country's great electronics companies on further developments in miniaturization. If space is a consideration in a project you are working on — or if you feel new trends in your industry will soon demand more compact construction — contact Scientific's research department for information and analysis at no obligation.

SCIENTIFIC RADIO PRODUCTS, INC.

215 South 11th St. • Atlantic 9787 • OMAHA, NEBR.

One of the Oldest Manufacturers of Crystals in the United States



SCIENTIFIC

CRYSTALS
OF THE HIGHEST
QUALITY

BE SPECIFIC — SAY SCIENTIFIC

within ± 3 percent. Total harmonic distortion is less than 1.5 percent under all normal operating conditions and less than 0.5 percent up to 40 v input. The unit is ideal for stabilizing varying signals to eliminate necessity for adjusting levels when measurement or observation of signals are to be made with oscilloscopes, bridges, phase comparators or wave analyzers.

LACING TAPE of rubber-covered Nylon

GUDEBROD BROTHERS SILK Co., 225 W. 34th St., New York 1, N. Y. Gudlace-H is a braided, rubber-covered Nylon lacing tape which offers knot security with either continuous or interrupted ties in all electrical harnesses. It is coated with special fungistatic synthetic rubber containing no corrosive compounding ingredients and is unaffected by heat within the temperature range of Nylon yarn. The flat tape with its special finish provides nonslip holding power. It does not cut through insulation and complies with the fungus-resistant requirements of Government Specification JAN-T-713.



MERCURY RECTIFIER for 1-v industrial uses

NATIONAL ELECTRONICS, INC., Geneva, Ill., has developed a new 6-ampere rectifier designated as the NL-619. It is a mercury-vapor tube designed for long life, low arc drop and high efficiency. It is especially designed for low-voltage industrial rectifier applications. Ratings are: filament volts, 2; filament current, 12 amperes; peak inverse, 300 v;

THE PROMISE

An Exciting
New
Investment Study

OF ELECTRONICS

Today, the science of electronics affects all of us in our daily lives... our food and clothing, the buildings we live and work in, our entertainment, and our national defense. Practically all industry has put the electron to work.

Yet, as exciting as the recent electronics' past has been, it pales into insignificance when compared to a look into the future. Our research department has recently concluded a searching analysis of this fascinating new industry. The results, in booklet form, are now available to the investing public without cost or obligation. For *your* copy, write, telephone, or pay a visit to the Harris, Upham & Co. office nearest you. Just ask for "Investing In The Electronic Age."



HARRIS, UPHAM & CO

Members New York Stock Exchange

14 Wall Street, New York 5, N. Y.

35 offices from coast to coast

STOCKS
BONDS
COMMODITIES
MUTUAL FUNDS

*Improved
Performance!*

A versatile instrument...
newly revised... for research
and applications involving
high repetition rates

MODEL B-2A PULSE GENERATOR

PULSE WIDTH: variable in 4
ranges from .1 μ s to 1,000 μ s

PULSE RISE TIME: .025 μ s

PULSE AMPLITUDE: 40 volts into
93 ohms

INTERNAL DELAYS: variable in
5 ranges from 0 to 10,000 μ s
with respect to synchronizing pulse

INTERNAL REPETITION RATES: variable
in 4 ranges from 10 cycles to 100 KC

SYNCHRONIZING PULSES: 5—indepen-
dently available at separate output jacks



- High duty factors
- Can be triggered externally through Schmidt trigger input circuit
- Calibrating potentiometers are provided for each range

Write for complete data: our Bulletin E-B-2A

Rutherford ELECTRONICS CO. 3707 S. ROBERTSON BLVD.
CULVER CITY, CALIFORNIA



Makes Razor-Sharp Impressions
On Tiny Uneven Surfaces!

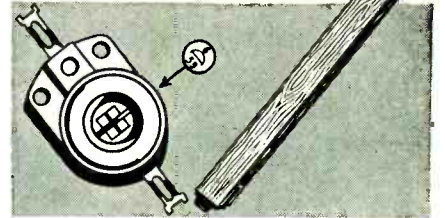

For Markings From 1/16 inch up,
Engraved Vinylite Replaces
Old Fashioned Rubber Because

ENGRAVED Vinylite IS ACID-PROOF

Acid etching inks, used for permanent stamping on metal and all non-porous surfaces will eat away at rubber. Vinylite resists this action—gives longer life by far!

ENGRAVED Vinylite STAMPING GIVES
RAZOR-SHARP IMPRESSIONS EVERY TIME

Opaque inks will clog shallow rubber stamp faces rapidly. Our deep-moulded engraved VINYLITE stamp faces have more than three times the depth of ordinary rubber stamps. Markings always remain super sharp even on irregular surfaces... an important advantage since this mark is your record.

ENGRAVED Vinylite HAS
CUSHION-LIKE RESILIENCE

Our VINYLITE molding process includes a timed curing that imparts to this versatile plastic all the elasticity of rubber. Resilient VINYLITE resists abrasive action... and lasts much longer!

Engraved Vinylite stamp faces
are adaptable to any marking
device. They can be used to
stamp on every surface,
metal, wood, fabric, paper,
plastic, etc.

Some of the many
industries now using

ENGRAVED Vinylite STAMPS

AVIATION
ELECTRICAL
ELECTRONICS
PLASTICS
POTTERY & CHINA
PACKAGING

INSPECTION
POCKET STAMP

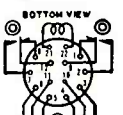
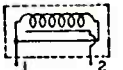

KRENGEL MANUFACTURING CO., INC.
227 Fulton St., N. Y. 7, N. Y. Tel. CO 7-5714

Please check the following: Dept. 1H
 FREE Vinylite Sample & Price List.
 Please have salesman call for appointment.

Name.....
Company.....
Street.....
City..... Zone..... State.....

POLYPENCO® NON-METALLIC SHAPES

Use stock shapes for low cost fabrication

With POLYPENCO shapes, you can economically obtain the advantages of nylon, Teflon*, and Q-200.5 for a wide variety of components by fabricating them on standard metalworking tools. You also receive uniform high quality in every piece of stock. Most standard sizes are stocked now for immediate delivery.

NYLON

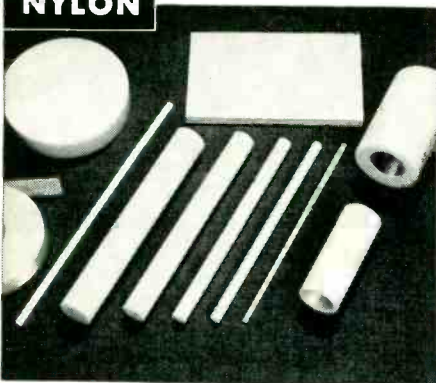

ROD: Diameters from $\frac{1}{8}$ " to $6\frac{1}{2}$ " in lengths from 8' to 6".

STRIP: .010" to .125" thick, $\frac{1}{4}$ " to 4" wide.

TUBING: .035" to .500" O.D., .020" to .410" I.D.

TUBULAR BAR: O.D.'s from 2" to 10" with wall thicknesses of $\frac{3}{8}$ " to $1\frac{1}{2}$ ".

SLAB: $\frac{1}{4}$ " to 1" thick, standard 10" width, discs from $\frac{1}{4}$ " to 2" thick in 6" to 12" diameters.

TEFLON*

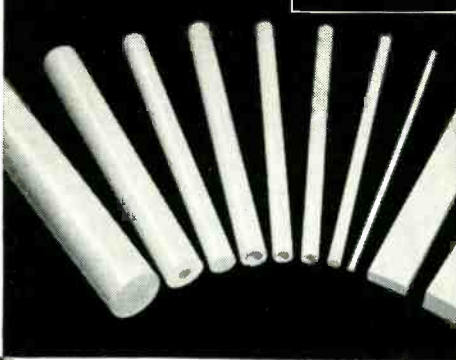

ROD: Diameters from .030" to 4" in lengths ranging from continuous coils down to 6".

TUBING: $\frac{1}{4}$ " to $4\frac{3}{8}$ " I.D. with walls from $\frac{1}{8}$ " to 2" thick.

SPAGHETTI TUBING: I.D.'s corresponding to American Wire Gauges 22 through 8, in lengths up to 1,000'.

TAPE: .002" to .125" thick, $\frac{1}{4}$ " to 12" wide.

SLAB: 24" or 48" squares from .125" to 1.50" thick.

Q-200.5

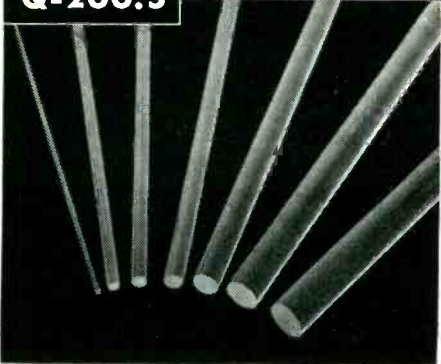

ROD: Diameters from $\frac{1}{8}$ " to $3\frac{3}{8}$ " in lengths from 4' to 8".

Other shapes and sizes can be supplied on special order.

SEND FOR TECHNICAL BULLETINS AND PRICE LISTS.

THE POLYMER CORPORATION of Penna. • Reading, Penna.
In Canada: Polypenco, Inc., 2052 St. Catherine W., Montreal, P.Q.

P

POLYPENCO NON-METALLICS

nylon . . . Teflon* . . . Q-200.5

Warehouses: Reading • Chicago • Los Angeles • Newton (Mass.) • Branford (Conn.)

*trademark for Du Pont tetrafluoroethylene resin

anode average current, 6 amperes; and peak anode current, 20 amperes.

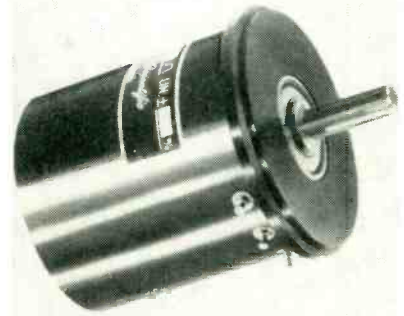

POTENTIOMETER is extremely precise

GENERAL SCIENTIFIC CORP., North Hollywood, Calif., has available a new, extremely precise potentiometer, known as the M10-3000 HT. This 10-turn, high-resolution potentiometer is recommended for applications where extreme accuracy is required, such as fire control equipment and analog computers. It is provided with servo mountings and will function in ambient temperatures up to 200 C. The unit is very compact and rugged.

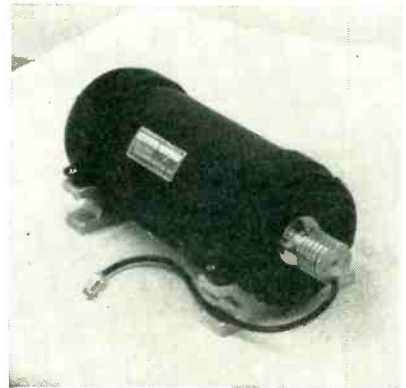

OSCILLATORS are backward-wave type

ROGER WHITE ELECTRON DEVICES, INC., Route 17 and Erie R. R., Ramsey, N. J. Backward-wave oscillators are voltage tunable microwave oscillator tubes. These tubes are constructed with an r-f structure which has an internal feedback mechanism, the frequency of which is controlled by the voltage applied to the electron beam. There is no associated inertia or wear and the tube can be operated

Over 85% of the torque wrenches used in industry are

STURTEVANT

TORQUE WRENCHES

Read by Sight, Sound or Feel.

- Permanently Accurate
- Practically Indestructible
- Faster—Easier to use
- Automatic Release
- All Capacities

in inch grams...inch ounces...inch pounds...foot pounds
(All sizes from 0-6000 ft. lbs.)



Every manufacturer, design and production man should have this valuable data. Sent upon request.

PA STURTEVANT CO
ADDISON [QUALITY] ILLINOIS

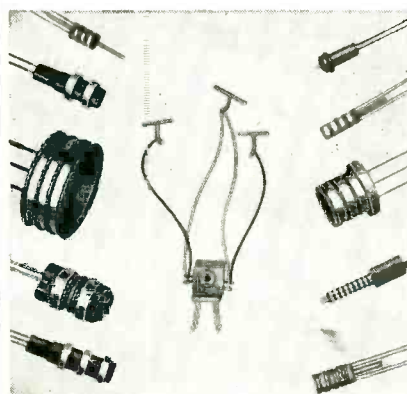

Miniature and Sub-Miniature
SLIP RING ASSEMBLIES
BRUSH BLOCK ASSEMBLIES
COMMUTATORS
and other
Electro-Mechanical Components

PRECISION MADE TO YOUR OWN SPECIFICATIONS

Precision molded products with exacting tolerances in precious and non-precious solid metals of all alloys. All types of Thermo-Plastic and Thermo-Setting materials.

Slip Ring Assemblies fabricated or one-piece precision molded to your specifications in Nylon, Kel-F, Mineral filled Mellamine, Phenolic, and other materials. Rings and leads spot welded or brazed together for positive electrical circuit.

Our Swiss methods and techniques are geared to meet exacting requirements. We invite your inquiries.

COLLECTRON CORPORATION

Murray Hill 2-8473 • 216 East 45th Street • New York 17, N. Y.



DESIGN GROUP OPENING

Do You Have:

1. An interest in and a technical background for the product design aspects of electronic equipment?
2. The ability to lead a group of engineers through
 - Problems of high altitude?
 - Subminiature techniques?
 - Heat transfer, etc.?

If you believe that you have these talents, can't we get together? Please write, giving full particulars concerning education and experience to

A. H. Nile
RAYTHEON MFG. CO.
(Boston Area)
190 Willow Street
Waltham, Mass.

Specialists in the *Unusual*

DIRECT TEMPERATURE MEASUREMENT
UP TO **3700°F.**

IRIDIUM vs. RHODIUM IRIDIUM THERMOCOUPLE WIRE

The only thermocouple material which may be used at these very high temperatures in an oxidizing atmosphere.

Ductile wire made possible by high purity and our advanced melting and drawing techniques.

Output: Over 10 millivolts at 3700°F
Uniform • Reproducible

SINCE 1901



Write for List of Products

SIGMUND COHN CORP.

121 So. Columbus Avenue • Mount Vernon, N.Y.

AVERAGE
CHANGE
IN
RESISTANCE
WITH
MOISTURE
TEST*

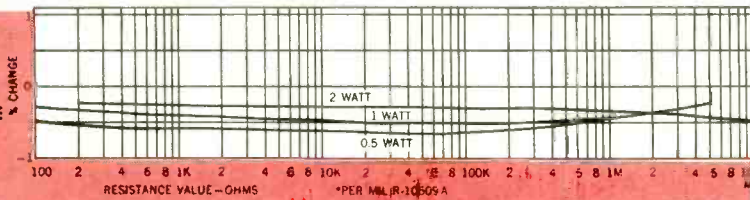

For *Lasting* precision...

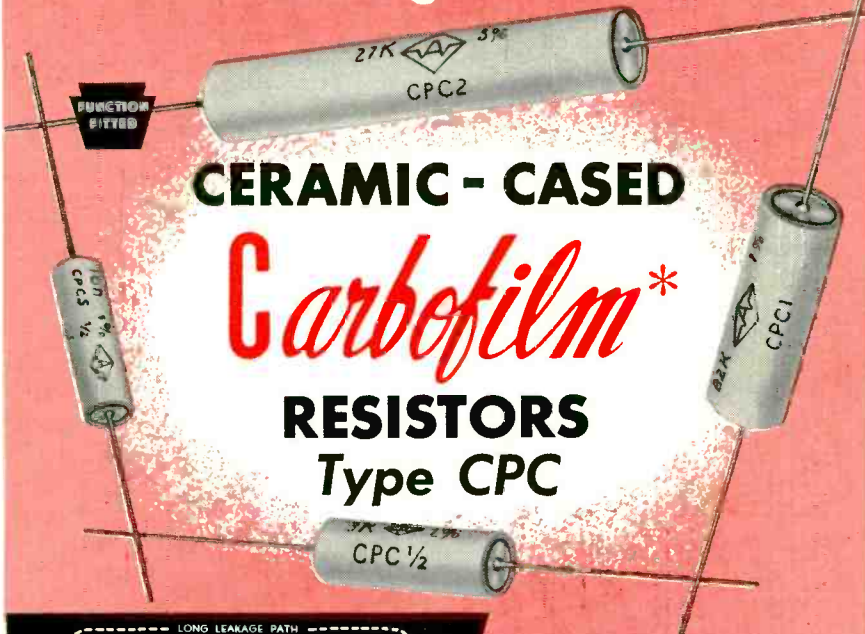

CERAMIC-CASED

*Carbofilm**

RESISTORS
Type CPC

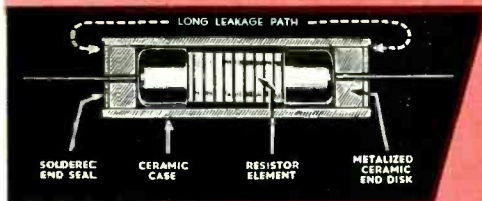

Carbofilm means precision resistors. And Ceramic-Cased (Type CPC) means lasting precision, plus additional advantages over metal-cased (Type CPH) units such as:

1. Ceramic case eliminates need for insulating sleeves, making these units more readily adaptable where space is at a premium.
2. Resistor can be mounted on terminal board, with body in contact with eyelets or rivet lugs, without shorting.
3. Capacitance effect between resistor and outward casing is eliminated.
4. Leakage path considerably increased over metal-cased unit.

Plus superlative characteristics — temperature vs. load; average change in resistance with temperature cycling; low temperature exposure; short-time overload; moisture test; solder dip test; load-life test; etc. Available in three types: Coated, Metal-Cased, Ceramic Cased. 1/2, 1 and 2 watt ratings. Standard tolerances of plus/minus 1, 2 and 5%.

GET THE FACTS! Description, performance curves and specifications (Form No. NPQ-101) sent on request. Consult us about your precision resistance needs.

*Trade mark

HI-Q
DIVISION

AEROVOX CORPORATION

OLEAN, N. Y.

In Canada: AEROVOX CANADA, LTD., Hamilton, Ont.

Export: Ad. Auriema., 89 Broad St., New York, N. Y. • Cable: Auriema, N. Y.

AEROVOX CORPORATION, NEW BEDFORD, MASS. • ACME ELECTRONICS, INC., MONROVIA, CALIF.
CINEMA ENGINEERING CO., BURBANK, CALIF. • HENRY L. CROWLEY & CO., WEST ORANGE, N. J.

continuously at high sweep rates with no effect on tube life. The tubes are ideally suited for sweep frequency sources, local oscillators in high speed afc circuits and laboratory signal sources. Specifications and a characteristics chart are included in bulletin BWO 12-54.

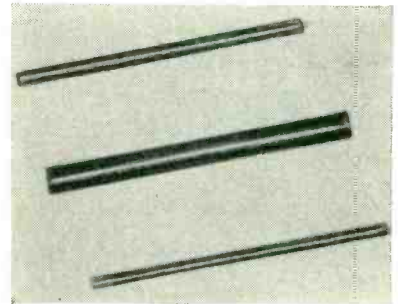

TUNGSTEN ROD
is microscopically inspected

ELECTRONICS PARTS MFG. CO., INC., Union City, N. J., has available ground seal tungsten rod, 100 percent microscopically inspected for defects. The inspection insures that when the rod is used in production, there will be no splits, cracks or other flaws to cause costly rejects. The ground seal tungsten rod is used for precision leads in electronic tubes and many other applications.

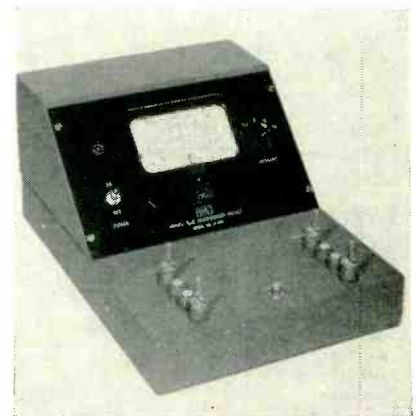

COMPARISON BRIDGE
and go-no-go gage

SOUTHWESTERN INDUSTRIAL ELECTRONICS Co., 2831 Post Oak Road, Houston, Texas. The E-2 comparison bridge can now be operated by means of an optional foot switch, as well as by the conventional push button. Improved stability, accu-

acy and sensitivity enable resistors, capacitors and inductors to be compared over a range of 1 ohm to 5 megohms at 60 cps. Differences as small as 0.1 percent may be easily measured on the 1-percent full scale meter range; other scale ranges of 2.5, 5, 10 and 25 percent are also provided. In addition to its use as a comparator and go-no-go gage, the E-2 may be combined with a decade box to make quick and accurate measurements of absolute values.

PICTURE TUBES are of the aluminized type

SEL-SON ELECTRONIC & TUBE CORP., 9th and Summit Sts., Darby, Pa., has added to its line aluminized picture tubes in all sizes from 10 in. to 27 in. They are being marketed under the trade name Alumilite.



HIGH-POT TESTER operates automatically

INDUSTRIAL TEST EQUIPMENT CO., 55 E. 11th St., New York 3, N. Y. Model A Hi-Pot tester automatically tests, in sequence, the dielectric strength between any 10 conductors and indicates the location of breakdown when it occurs. The test interval can be accurately controlled up to 120 sec, and the applied voltage is continuously variable up to 2,000 v rms. A dual scale, hand-calibrated meter insures accurate setting of the test voltage. High sensitivity to breakdown is made possible by employing a specially designed relay in series with the h-v circuit. The instrument can be used for production

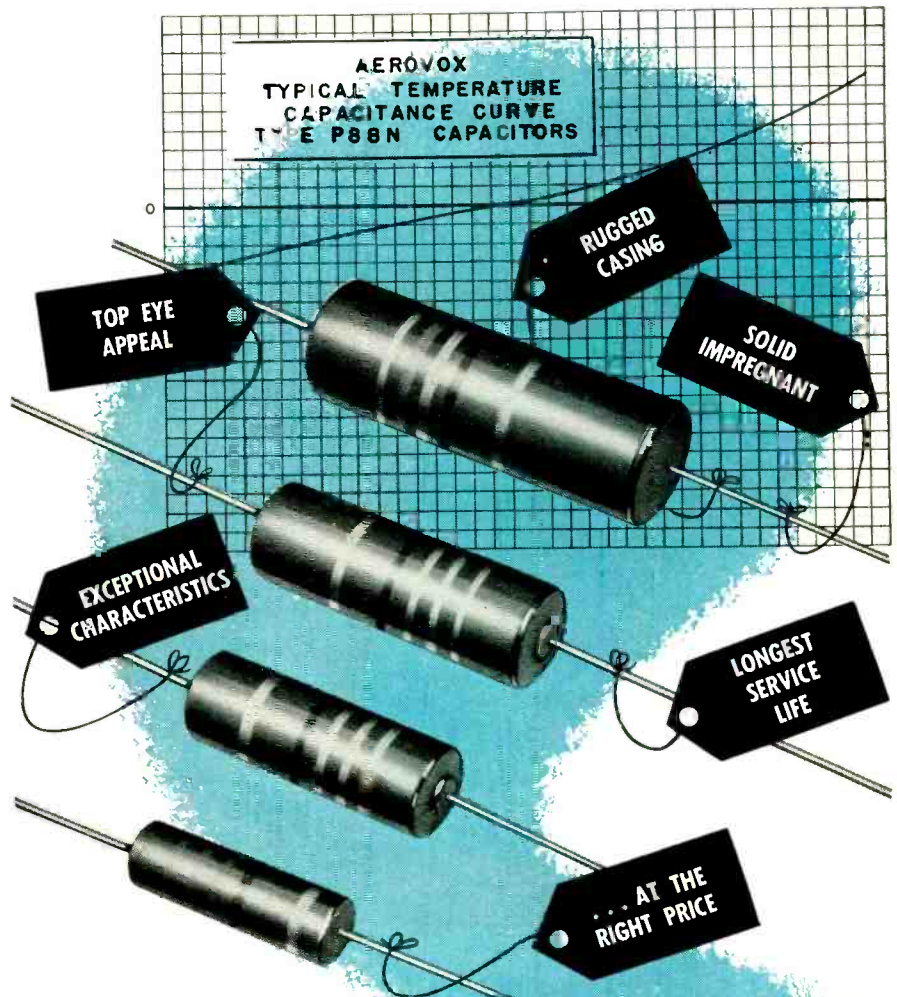

DURANITE* MOLDED TUBULAR PAPER CAPACITORS

The new and improved Duranite (Type P88N) paper tubulars still feature Aerolene*—the solid impregnant—combining the advantages of wax and oil impregnants. No need of stocking both types. No risk of shelf deterioration.

And now Duranites are molded in blue non-flammable plastic. Top eye appeal—and outstandingly rugged. Pigtails, centered and firmly imbedded, won't work loose or pull out.

Units essentially immune to moisture penetration. Exceptional performance characteristics—insulation resistance; power factor vs. temperature; 100° C. operating temperature.

Get the FACTS!

Descriptive literature on request. Write on business letterhead for sample. Standard values stocked for immediate delivery. Let us quote on your needs.



*Trade-mark

AEROVOX CORPORATION

NEW BEDFORD, MASS.

HI-Q
DIVISION
OLEAN, N. Y.

ACME
ELECTRONICS, INC.
MONROVIA, CALIF.

CINEMA
ENGINEERING CO.
BURBANK, CALIF.

Exports: Ad Auriema, Inc., 89 Broad St., New York, N. Y. Cable: Auriema, N. Y.

New Bi-Directional Power Monitor



25 to 1,000 mc

10 to 500 watts

Only 2 plug-in elements

MODEL 164

Quickly measures incident or reflected power, simplifies matching loads to lines

New Sierra Model 164 is a compact, versatile, bi-directional monitor for intermittent or continuous measuring of incident or reflected power, or convenient and precise matching of loads to lines. The instrument offers unequalled measuring ease and economy, since only two plug-in elements are required for coverage of all frequencies 25 to 1,000 mc and wattages 10 to 500 watts. Two plug-in elements cover, respectively, 25 to 250 mc and 100 to 1,000 mc. Both have 4 power ranges: 10, 50, 100 and 500 watts. Accuracy is $\pm 5\%$ full scale on all ranges and frequencies. No auxiliary power is required to operate the instrument.

Because of its compact size and wide range, Model 164 is ideal for portable applications (mobile, aircraft, etc.) as well as laboratory use. It is supplied in a sturdy carrying case (one or both plug-in elements supplied as ordered) and both meter and directional coupler may be removed from the case for remote monitoring. The monitor may be equipped for most connectors normally employed with 50 ohm lines. A twist of the wrist selects incident or reflected power, or any power range, without requiring removal of power. No exchange of plug-in elements is necessary to read low levels of reflected power.

TENTATIVE SPECIFICATIONS

Power Ranges: 10, 50, 100 and 500 watts full scale direct reading.

Accuracy: $\pm 5\%$ of full scale on all power ranges and at all frequencies.

Insertion VSWR: Less than 1.08.

Frequency Ranges: 25 to 1,000 mc. Two plug-in elements.

Low Frequency Element: 25 to 250 mc.
High Frequency Element: 100 to 1,000 mc.

Impedance: 50 ohm coaxial line.

Data subject to change without notice.

sierra

3317



Sierra Electronic Corporation
San Carlos 2, California, U. S. A.

Sales representatives in major cities
Manufacturers of Carrier Frequency Voltmeters, Wave Analyzers, Line Fault Analyzers, Directional Couplers, Wideband RF Transformers, Custom Radio Transmitters, VHF-UHF Detectors, Variable Impedance Wattmeters, Reflection Coefficient Meters.

testing of slip rings, commutators, cable connectors, synchros, transformers and similar devices.

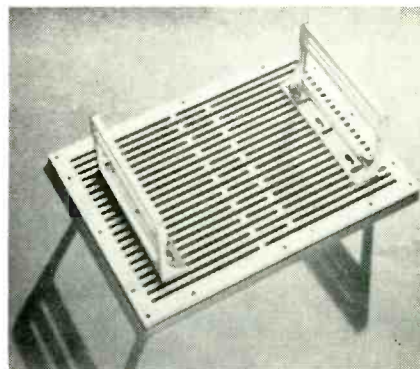

SERVO PLATE with precision alignment

STERLING PRECISION INSTRUMENT CORP., 34-17 Lawrence St., Flushing 54, N. Y., is offering a new type of breadboard equipment featuring top-side fastening and precision alignment. The servo plates are reinforced with stainless steel sheets for extra rigidity and the hangars and accessories are fastened to the plate from the top side with special T-nut cap screws. The need for supporting legs or suspensions is eliminated. Slots in the hangars permit additional fine adjustments ensuring optimum alignment and mesh.

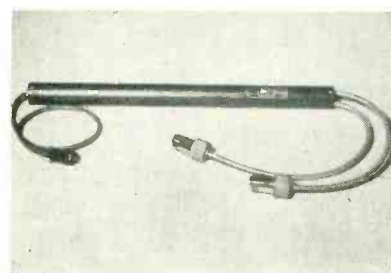

T-W TUBE AMPLIFIER operates over 7-14 kmc band

HUGGINS LABORATORIES, INC., 711 Hamilton Ave., Menlo Park, Calif., has announced a new broadband low-power traveling-wave tube amplifier designed to operate over the 7 to 14-kmc band. The tube finds its greatest use in applications where wide bandwidth and high gain are required at a low level such as r-f preamplifiers, untuned r-f receivers and in laboratory

microwave measurement work. Grid control is provided for modulation and age applications. Approximate operating characteristics over this band are 30 db gain and 5 mw output. The unit requires a 400 gauss field and a 1,200-v regulated power supply.

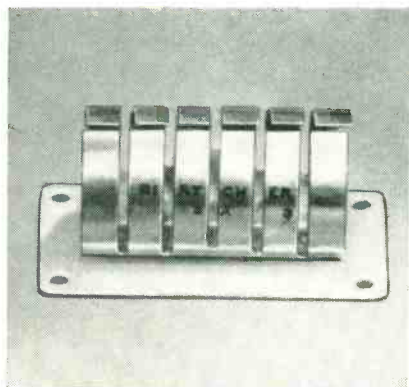

TUBE CLAMPS
are sleeve-type devices

THE BIRTCHE CORP., 4371 Valley Blvd., Los Angeles 32, Calif. Number 6A-3 Kool Klamp is designed for miniature tubes with T-6½ and T-7 envelopes. The same design is readily available for tubes with sizes T-5 and T-5½ envelopes. The sleeve-type clamp features the company's multiple finger construction. These fingers act independently of each other and provide excellent contact between tube and clamp. This construction improves heat conduction, simplifies tube insertion, and reduces tube breakage, particularly when slightly irregular tube envelopes are encountered.

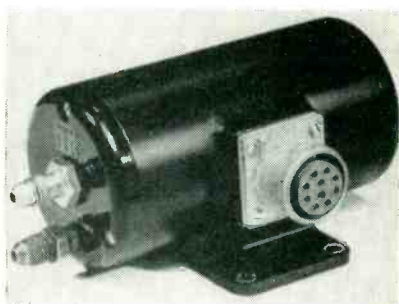

PRESSURE TRANSDUCER
is dual element unit

TECHNOLOGY INSTRUMENT CORP., Acton, Mass., announces a dual element air flow differential pressure

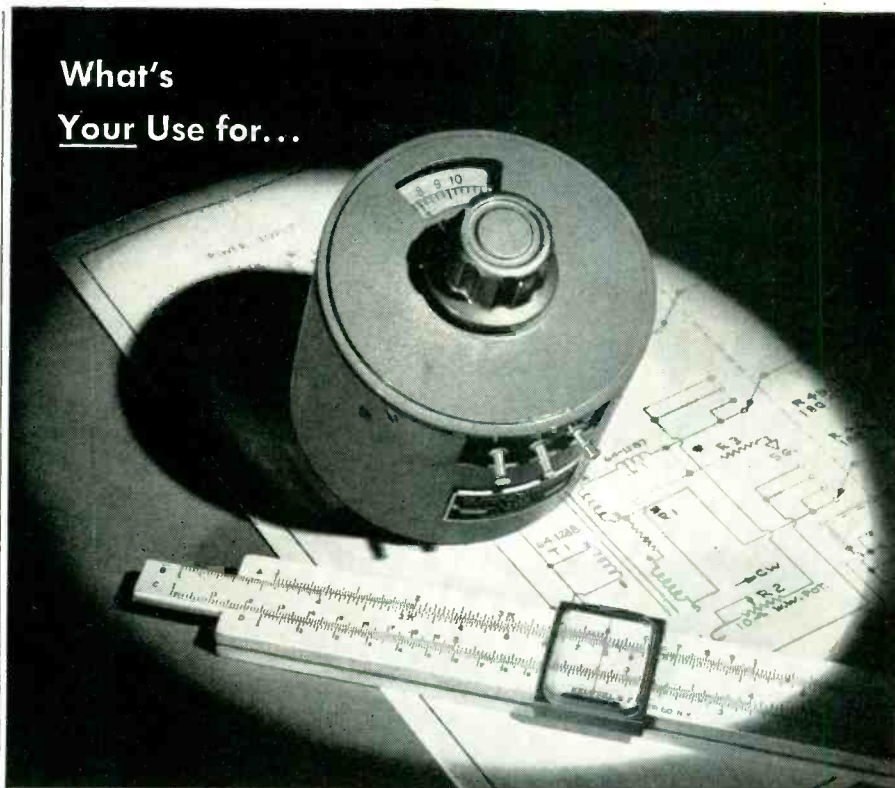

What's
Your Use for...

vernistat...The Revolutionary
New Precision Variable-Ratio Transformer

Analog Computers? Servos? Control Systems? Vernistat is a completely different type of voltage divider combining **low output impedance with an inherently high resolution and linearity** not ordinarily attainable by precision potentiometers.

The Vernistat consists of a tapped auto-transformer which provides the basic division of voltage into several discrete levels. These levels are selected and further sub-divided by a continuous interpolating potentiometer that moves between 30 transformer taps.

Because of its unique operating principles, electrical rotation is held to close tolerances eliminating the need for trim resistors. In many applications there is also no need for impedance matching amplifiers.

Specifications of the standard model Vernistat are shown below. Other versions are under development to meet specific end uses.

What are your requirements for this unique precision voltage divider? Fill in the coupon now.

vernistat division PERKIN-ELMER CORPORATION
NORWALK, CONNECTICUT

SPECIFICATIONS	
Linearity Tolerance	better than $\pm 0.05\%$
Resolution	better than .01%
Output Impedance	130 ohms (max.)
Max. Output Current	50 ma
Frequency	50-3000 cps
Other models including a miniaturized 400 cps version will be available in the near future.	

vernistat division  PERKIN-ELMER CORPORATION
825 Main Avenue, Norwalk, Connecticut

Send me more information on the Vernistat.
The application I have in mind is as follows:

NAME

TITLE

COMPANY

ADDRESS

Big
or
LITTLE...

McCoy Precision Quartz Crystals
deliver the **SAME FINE PERFORMANCE**

You can expect the same precision performance from both the McCoy M-1 and the M-20 "McMite," although the "McMite" is only 1/5th as big. Both crystals are produced up to 110 mc on the 5th overtone. The fact that these two crystals perform equally well in meeting widely varied job specs illustrates the versatility of McCoy design and production facilities. Whatever you need in quartz crystals, McCoy either makes them or can develop them for you. Send for free catalog today on the McCoy line of high quality, precision-made quartz crystals.

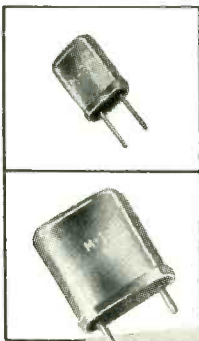

M-20 "McMite" is a sub-miniature hermetically sealed unit, adaptable to multi-channel design for communications and frequency control equipment. Can be wired into a sub-miniature selector switch assembly or soldered to a printed circuit terminal board. Furnished with either .018 inch dia. flexible wire leads or with .040 inch dia. rigid "plug-in" type pins.

M-1 is an hermetically sealed, plated crystal preferred when fundamentals below 5 mc are desired. Easily interchangeable, it plugs into a standard socket. Meets government specification MIL-C-3098A and CAA-R-916; also ARINC No. 401.

McCoy ELECTRONICS COMPANY
MT. HOLLY SPRINGS, PENNA.
Phone 376 and 377

Licencee under patents of
Western Electric Company

transducer. It is designed for high output to speed-altitude-time computers, telemeter systems, electric recorders, servo systems, meter display or alarms. The pressure response movements of each of two metal bellows is translated into motion of sliders of paired precision potentiometers. Through an external electrical combining network, dynamic data may be automatically normalized or corrected with respect to static data as required by the application. Typical application to speed-altitude measurement provides a range from 0 to 580 knots over an altitude range of -1,000 to 20,000 ft. Potentiometer resistance ratio vs pressures is linear within 0.5 percent; hysteresis within 0.5 percent; change with temperature (-55 C to +71 C), not over 0.5 percent; resolution increment, less than 0.2 percent of pressure range. Construction withstands 40-g shock. Size is 2 7/8 in. × 4 3/8 in. × 5 1/8 in.; weight, 1.3 lb.

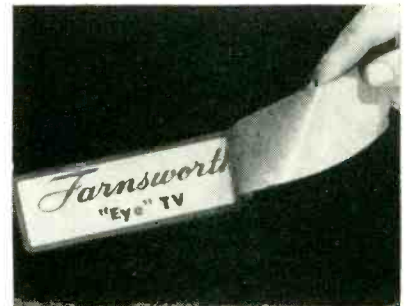

METAL NAMEPLATES of etched aluminum

C & H SUPPLY Co., Inglewood, Calif., has developed premasked Metal-Cals, suitable for application to unpainted surfaces. The thin anodized, etched aluminum nameplates are completely masked to allow painting of an article after the trademark or label is applied, thus building up the paint around the edge of the trademark and making it an integral part of the item to which it is affixed. The masking is easily stripped of the Metal-Cal after painting. The Metal-Cals are backed by the same pressure-sensitive adhesive which has been used on the unmasked plates and which makes them permanent, as well as easy to apply without screws or rivets. Available in a wide range

of colors, they may be applied to any smooth, curved or flat surface. Samples and literature are available on request.

COUPLER
for vswr measurement

COLOR TELEVISION INC., San Carlos, Calif. Model 110B X-band vswr measuring system combines high accuracy with simplicity of operation, and simultaneously fills the need for a continuously-tunable, direct-reading laboratory instrument and a production line go-no-go test device. For checking waveguide components, the instrument takes a fraction of the time required for slotted-line tests, covers every point in its spectrum, needs no readjustments for frequency changes, avoids probe and slot error, and is not affected by r-f power changes. An illustrated description, showing chief features and specifications, is given in bulletin Form 110-255.

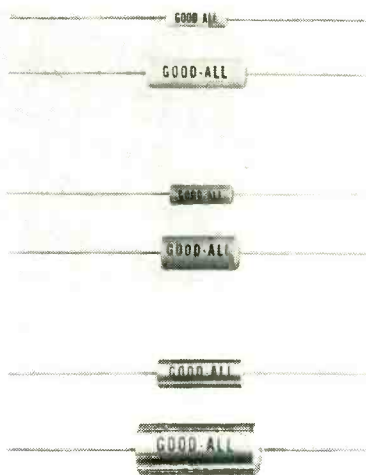

MYLAR CAPACITORS
are miniature in size

GOOD-ALL ELECTRIC MFG. Co., Ogalala, Neb., has announced a new line of Mylar capacitors that incorporate the humidity resistance features of its Seramelite capacitors and the electrical characteristics of DuPont's Mylar. Models 620S and 621S are miniature in size and are available in extended foil or inserted tab construction. Miracle X liquid impregnate is used in the capacitors and they are housed in ceramic tubular enclosures using a new thermosetting plastic end seal. They easily exceed RETMA speci-

Electronic equipment back in action
at "tube-reheating" speed

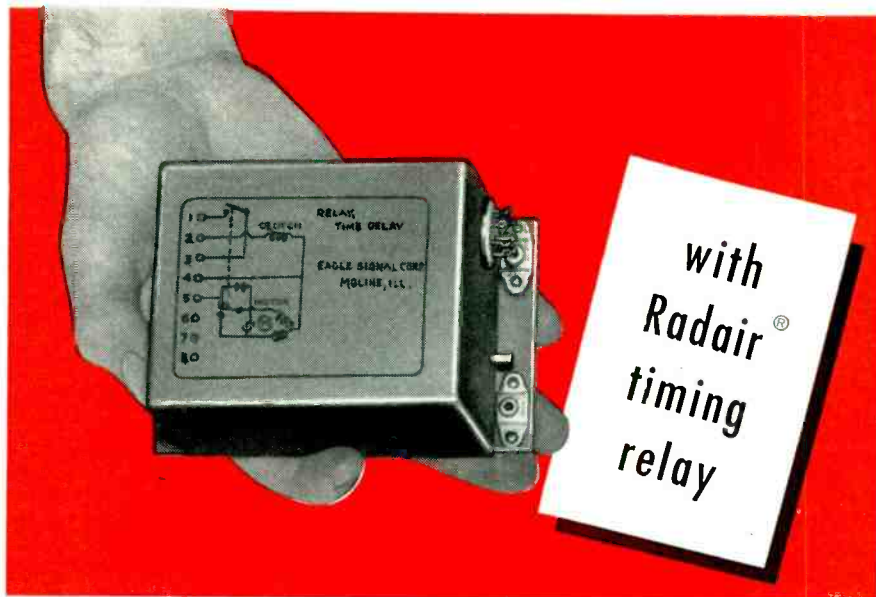

For aircraft and industrial applications

It's now possible to get electronic equipment back into service just as quickly as warm tubes reheat to safe operating temperature . . . instead of waiting the full time required to heat cold tubes. Quick-action Radair timing relay starts operation minutes sooner when tubes have not completely cooled from previous operation.

The Radair timing relay has a reset timed to the cooling rate of the tubes. It automatically recloses the plate circuit in the quickest time that will insure full protection to the tubes and other electronic components. In radar equipment, quick-action Radair is a vital safety factor. In transmitters and other industrial applications, it cuts lost operating time. Available for use on 115V, 400 cycle and 28V D.C. aircraft requirements. Send for FREE BULLETIN 815 containing a complete timing curve and full data on Radair.

EAGLE TIMERS SAVE TIME • SAVE MONEY



SIGNAL CORPORATION
Industrial Timers Division
MOLINE, ILLINOIS

MAIL COUPON TODAY

Eagle Signal Corporation, Dept. E-55
Industrial Timers Division
MOLINE, ILLINOIS

Please send Bulletin 815 with complete timing curve and full data on Radair.

NAME AND TITLE _____

COMPANY _____

ADDRESS _____

CITY _____ ZONE _____ STATE _____

fication REC 118A. Both models are available for standard printed circuit or specialty applications.

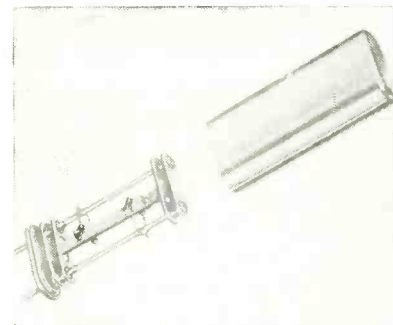

QUARTZ CRYSTALS in two new types

CRYCO, INC., 1138 Mission St., South Pasadena, Calif. Both CR-38/U and CR-50/U quartz crystals conform to MIL-C-309 8A specifications. The CR-38/U frequency range is from 16 to 100 kc; load capacitance, 20 μmf ; frequency tolerance, ± 0.012 percent; temperature range, -40 C to $+70$ C. Holder is HC-13/U. The CR-50/U is the same with the exception of load capacitance, which is in series. All units are ultrasonically cleaned and hermetically sealed. Recommended drive level is 0.1 mw.

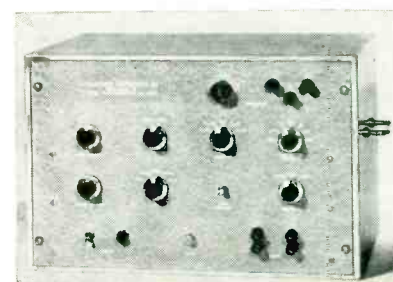

TRANSISTOR TESTER is family curve tracer

POLYPHASE INSTRUMENT Co., Bryn Mawr, Pa., announces the model TA-3A transistor analyzer, a transistor family curve tracer. It displays on an oscilloscope the R_{12} , R_{22} and H_{12} families in the grounded-base connection and the R_{22} family in the grounded-emitter connection. Either n , p , npn , or pnp transistors can be tested. Collector current power supply has a peak rating of 100 ma at 100 v enabling the instrument to be used

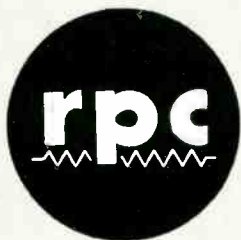
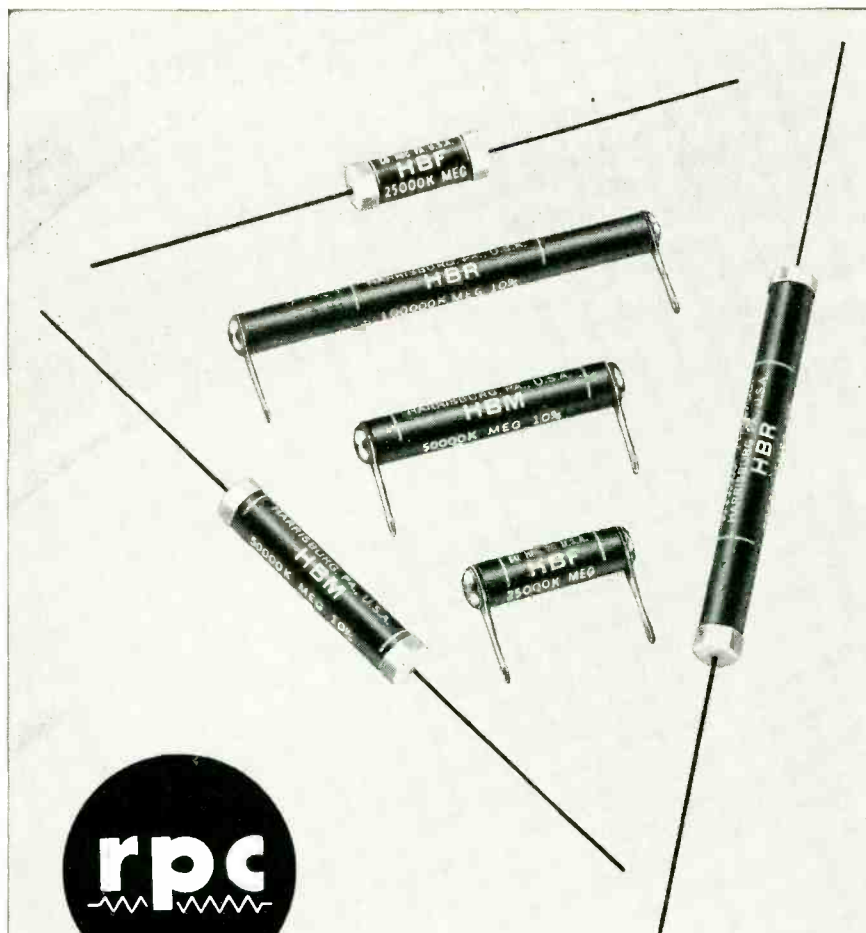

WHEN RESISTANCE OF HIGHEST QUALITY IS A MUST..

rpc High Megohm Resistors Fill The Bill!

Time tested and approved, RPC's High Megohm Resistors, Type H, are eminently suited for electrometer circuits, radiation equipment and as high resistance standards in measuring equipment. Resistance values as high as 100 million megohms! Used by leading laboratories and manufacturers.

STABILITY. Permanent resistance changes over long periods of time will not exceed $\pm 3\%$. Resistance returns to original value after normal atmospheric conditions are resumed. Noise level extremely low. Effect of high humidity kept to a minimum. Low voltage and temperature coefficients.

CONSTRUCTION. High stability carbon coating on strong, non-hygro-

scopic steatite rod. Coating applied as a helix, provides very long effective resistor length in small space. This permits use of low specific resistance coatings to obtain high resistance with good stability. Permanent connection is made to ends of resistors with silver contact coating.

TOLERANCE. Standard is $\pm 10\%$. Also available $\pm 5\%$. In matched pairs $\pm 2\%$ to 10,000 megohms.

TERMINALS. Your choice. Tinned brass soldering terminals fastened by machine screws; with axial wire leads; or without terminals for mounting into special assemblies.

RESISTANCE PRODUCTS Co.

914 South 13th St. • Harrisburg, Penna.

Makers of Resistors — High Megohm, High Voltage, High Frequency, Precision Wire Wound.

for testing power transistors as well as conventional transistors.

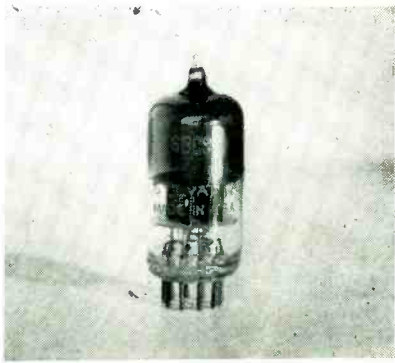

DUAL TRIODE for use in vhf tv tuners

SYLVANIA ELECTRIC PRODUCTS INC., 1740 Broadway, New York 19, N. Y. A new tube type, the 6BC8, a miniature 9-pin, medium-mu dual triode with semiremote cutoff characteristics, has been announced. It lends itself very readily to applications as a cascode amplifier in vhf tv tuners, and also gives more satisfactory performance in agc systems under both strong and weak signal conditions. The tube also provides relief from objectionable cross modulation effects when reception of a weak signal is degraded because of strong adjacent channel station interferences. This effect is minimized because the transfer curve of the tube approaches the desirable square low characteristic, which is the optimum shape for minimizing cross modulation.



STRAIN GAGE BRIDGE used with indicating devices

ALLEN B. DUMONT LABORATORIES, INC., 760 Bloomfield Ave., Clifton,

TEFLON

PARTS OR MATERIALS
FOR UHF APPLICATION?

FOR MINIATURE AND
SUB-MINIATURE COMPONENTS?

YOU CAN GET JUST WHAT YOU WANT

from

JOHN CRANE

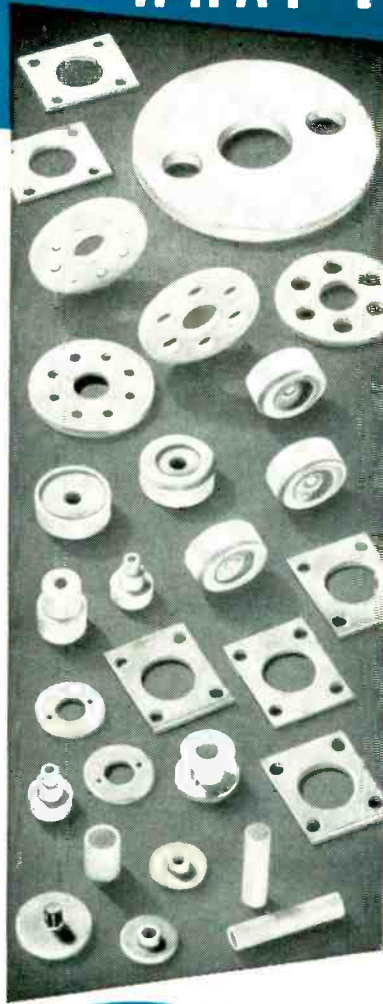

* **TEFLON** DuPont trademark

Dielectric Strength: 480 v/mil.
Dielectric Constant (60 to 10⁸ cycles): 2.0
Power Factor (60 to 10⁸ cycles): < 0.0005
Volume Resistivity: 10¹⁵ ohm-cm
Surface Resistivity: 3.6x10⁶ megohms
Surface Arc-Resistance: does not track
Temperature Range: -450° to +500°F.
Chemical Resistance: completely inert
Moisture Absorption: zero

FOR: insulators of all types, sleeves or inserts, capacitor seals, feed through insulators, bushings, slot liners, coaxial spacers, layer insulation or any other parts or forms subject to high charge, extended frequency range, mechanical and thermal shock, extreme temperatures and climatic conditions.

You can order in any quantity and be sure of true Teflon performance, because "John Crane" gives you these *plus* factors: complete uniformity throughout, high density control, freedom from flaws and rigid adherence to your specifications.

"John Crane's" complete fabrication facilities assure you prompt delivery on *exactly* what you want. If you have an entirely new requirement, no standard design or procedure—"John Crane's" laboratory facilities, know how, research and engineering experience go to work on *your particular need*.

Now is a good time to put "John Crane" to test. Contact Crane Packing Company today.

Crane Packing Co.,
1802 Cuyler Ave.,
Chicago 13, Illinois

In Canada: Crane
Packing Co., Ltd.,
617 Parkdale Ave.,
N., Hamilton, Ont.



JOHN CRANE

CRANE PACKING COMPANY

OFFICES IN ALL PRINCIPAL CITIES

38
YEARS
INDUSTRIAL PROGRESS

Microwave Absorbing Materials

PLASTIC FOAM ABSORBER



High absorption, broadbanded for permanent antenna test rooms and outdoor installations.

THIN FLEXIBLE ABSORBERS

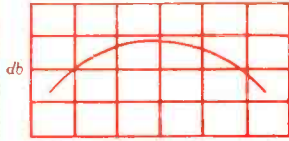

Lightweight, peaked for any frequency band, for airborne installations.

HAIRFLEX ABSORBER



Economical, lightweight for portable and temporary test ranges.

McMillan

INDUSTRIAL CORPORATION
BROWNVILLE AVENUE
IPSWICH • MASSACHUSETTS

NEW PRODUCTS

(continued)

N. J. Type 335 strain gage bridge is designed to permit the use of any commercially available strain gages with virtually any c-r oscillograph using suitable preamplifiers, or directly with the DuMont type 324 c-r oscillograph. It may also be used with indicating devices such as recording galvanometers and meters. By proper selection of gages, strains in the range of 15 μ in. per in. to 1,000 μ in. per in. can be measured and recorded. Catalog No. 1725-K gives complete information and specifications.

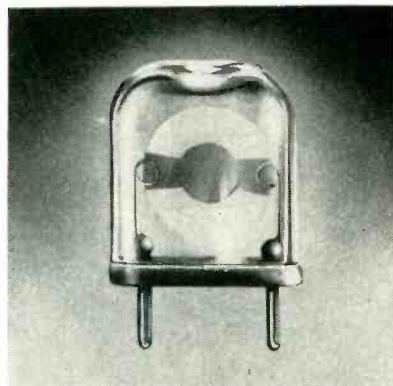

QUARTZ CRYSTAL UNIT is hermetically sealed

MCCOY ELECTRONICS Co., Mt. Holly Springs, Pa., is producing a Cryst-O-glas quartz crystal unit. Featuring an all-glass case and holder, this new development places the crystal in a perfectly hermetically sealed container. Because heat alone is used in the bonding operation, the crystal itself is never subjected to the chemical fumes given off by conventional sealing compounds. This absence of contamination results in greatly increased crystal stability and virtually eliminates the possibility of even slight frequency changes.

I-F AMPLIFIERS with low-noise front ends

RS ELECTRONICS CORP., 435 Portage Ave., Palo Alto, Calif., announces standard production of miniature lightweight i-f radar amplifiers incorporating low-noise front ends. New techniques, materials and methods are used to provide, for example, a 9-tube com-

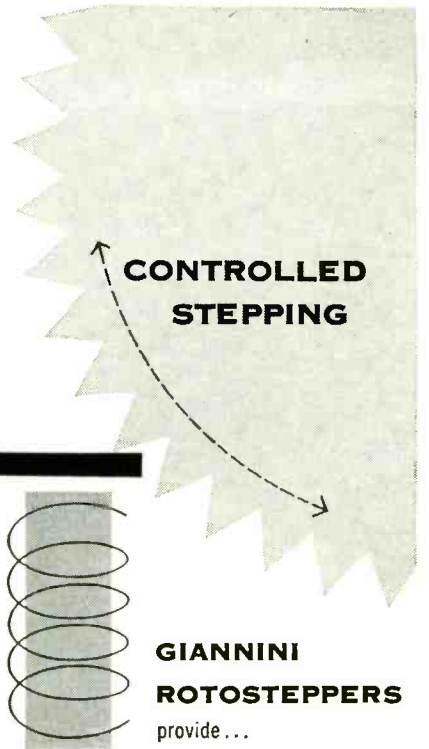

Controlled shaft rotation in 2° increments through 360° in both cw and ccw direction. Rates up to 60 steps per second. Standard models available with any combination of the following features...



MODEL 8915 ROTOSTEPPER

Weight: from 0.8 to 1.2 pounds.
Size: 2.62" diameter x 2.25" long to 3.88" long, depending on model.
Shaft output torque: 14 in. ozs.

Pulsed, controlled stepping — to 60 steps/second.
Continuous automatic stepping.
Automatic return to homing points.
Potentiometer output optional.

Giannini

Product of Electromechanical Division
EAST ORANGE, NEW JERSEY



for information write
G. M. GIANNINI & CO., INC.
PASADENA 1, CALIFORNIA

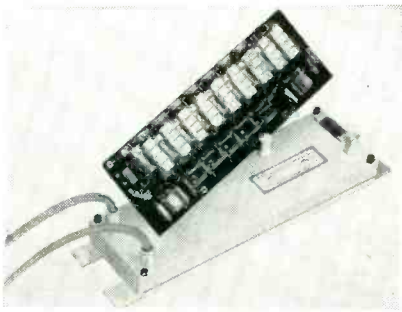

pletely enclosed amplifier that measures only 8½ in. × 3 in. × ½ in. and weighs only 1 lb. Center frequency is 20 to 100 mc; bandwidth, 2 to 12 mc; gain, up to 120 db; automatic and/or manual gain control, 100 db or greater; noise figures, better than 2 db; ambient temperature operating range, -65 C to +100 C. These amplifiers will operate under 30 G shock and 10 G vibration for extended periods. Standard circuits are available to provide for low-impedance output, video detection, fast time constant, tuning detection, video amplification and video limiting. Variations of standard circuits are available on special order.

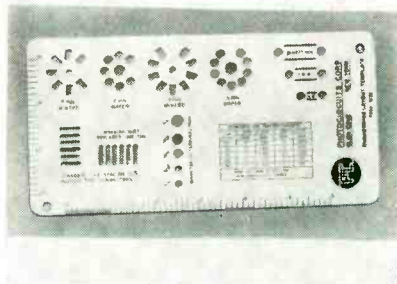

LAYOUT TEMPLATE for printed circuit design

PHOTOCIRCUITS CORP., Glen Cove, N. Y. A newly designed plastic template facilitates drafting of components for printed circuitry. The engineering layout template is pocket size, 4 in. × 8 in. in dimension, and is satin finished for clearly indicated markings, scales and stencils. A variety of stencil die cuts provides for accurate resistor spacings, standard component spacings and plug-in tab spacings as well as 7 and 9-pin molded and wafer socket layouts and terminal pads from ¼ in. to ½ in. A current carrying capacity chart is

More Engineers on A-N and civilian projects are proving—

It pays to specify
AMPERITE
DELAY RELAYS
and
BALLAST REGULATORS

... they're finest



... cost less!

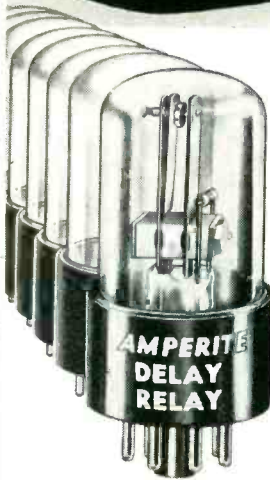

STANDARD

Thermostatic DELAY RELAYS

MOST COMPACT, HERMETICALLY SEALED

Provide delays ranging from 2 to 150 seconds.

- Actuated by a heater, they operate on A.C., D.C., or Pulsating Current.
- Hermetically sealed. Not affected by altitude, moisture, or other climate changes.
- Circuits: SPST only — normally open or normally closed.

Amperite Thermostatic Delay Relays are compensated for ambient temperature changes from -55° to +70°C. Heaters consume approximately 2 W. and may be operated continuously. The units are most compact, rugged, explosion-proof, long-lived, and — inexpensive!



MINIATURE

TYPES: Standard Radio Octal, and 9-Pin Miniature.

PROBLEM? Send for Bulletin No. TR-81

Also — a new line of Amperite Differential Relays — may be used for automatic overload, over-voltage, under-voltage or under-current protection.



T9 BULB

BALLAST REGULATORS

- Amperite Regulators are designed to keep the current in a circuit **automatically regulated** at a definite value (for example, 0.5 amp).

- For currents of 60 ma. to 5 amps. Operates on A.C., D.C., Pulsating Current.

- Hermetically sealed, light, compact, and most inexpensive.

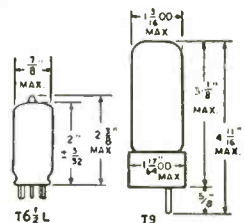

Amperite Regulators are the simplest, most effective method for obtaining **automatic regulation** of current or voltage. **Hermetically sealed**, they are not affected by changes in altitude, ambient temperature (-55° to +90° C), or humidity. Rugged; no moving parts; changed as easily as a radio tube.

Write for 4-page
Technical Bulletin No. AB-51

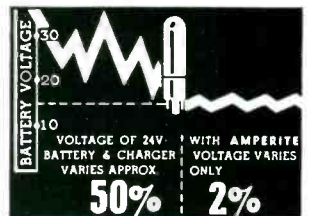

AMPERITE CO. Inc., 561 Broadway, New York 12, N. Y.

In Canada: Atlas Radio Corp., Ltd., 560 King St. W., Toronto 2B

IT'S GOOD FOR YOUR SYSTEM



BEFORE

tone up your spectrum with a LITTON High Power MAGNETRON ISOLATOR



AFTER

Use a Litton Magnetron Isolator to insure concentration of energy in the useful pass band of your system. Without this device mismatched loads coupled with long lines spread transmitted energy into unused portions of the spectrum, seriously impairing system performance. By employing the unidirectional properties of magnetically polarized ferrites at microwave frequencies, these new circuit elements isolate the microwave source from load reflections, permitting high power magnetrons or klystrons to operate satisfactorily into long lines terminated in poorly matched loads. With a particular VSWR usable length of line for stable magnetron operation may be increased four to five times by incorporating a Litton Load Isolator with isolation of 10 db or more.

included, and on two edges are scale divisions.



POLARIZED RELAY for teletypewriter uses

KURMAN ELECTRIC CO., INC., 35-18 37th St., Long Island City, N. Y., is now manufacturing a polarized relay utilizing a reed type, Permalloy armature with antichatter contacts. The armature is equipped with extra heavy (3/8 in. diameter) palladium copper contacts. The contact screws have 1/8-in. diameter tungsten contacts rated at 2 amperes, 110 v d-c. The P255A relay, ideal for use in teletypewriter applications, consists of a coil with two parallel windings of 136 ohms each.

In addition, Litton Magnetron Load Isolators ...

- Reduce frequency pulling.
- Provide broad band operation with high isolation.
- Present low input VSWR.
- Reduce moding.
- Decrease AFC requirements.
- Minimize variation in power output with changing loads.
- Require no separate cooling system.
- Require no external power supply.

New ferrite circuit elements are designed to improve system operation by minimizing long-line effects and other loading problems.

Developed and manufactured by specialists in the production of microwave systems and components, Litton Magnetron Isolators greatly improve tube performance.



LITTON MODEL X250
LITTON MODEL X-101
MAGNETRON LOAD ISOLATOR

for improved performance in high-power radar and other microwave systems.

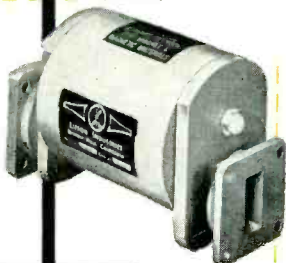

LITTON MODEL X20L
LABORATORY LOAD ISOLATOR

for laboratory use, to obtain maximum performance from your "X" band test equipment.

CONDENSED SPECIFICATIONS

	X250	X101	X20L
Frequency Range	8.6-9.6 kmcs	8.6-9.6 kmcs	8.6-9.6 kmcs
Isolation (minimum) (Attenuation in reverse direction)	10 db	10 db	18 db
Insertion Loss (maximum)	0.5 db	1 db	1.5 db
Power Handling Capacity	300 KW peak 300 W average	100 KW peak 100 W average	20 watts (output terminated)
Magnetic Field	Permanent magnet	Permanent magnet	Permanent magnet
Input VSWR (output terminated)	1.05 max.	1.10 max.	1.2 max.
Flange	UG 51/U	UG 39/U	UG 39/U*
Weight		Less than 2 lbs.	

*Special flanging upon request.

Other precision products of the Litton Components Division include: Microwave Rotary Joints, multi-turn Potentiometers, single-turn Potentiometers, Metal Film Resistors, Delay Lines.



COMPONENTS DIVISION

Write for complete data and name of nearest representative...

356 N. FOOTHILL ROAD, BEVERLY HILLS, CALIFORNIA • CRESTVIEW 4-7344
215 S. FULTON AVE., MOUNT VERNON, NEW YORK • MOUNT VERNON 7-6609



CIRCUIT ANALYZER for complex testing

DIT-MCO, INC., Electronics Div., 505 W. 9th St., Kansas City, Mo. Model 200 universal automatic electrical circuit analyzer is a new development in the field of aircraft electrical systems testing. It is designed to test automatically for line and insulation resistance simultaneously up to 200 megohms featuring 28 and 500-v d-c test ranges. Multiplier sections can be

a 600 or 1,200 circuit capacity. It's simple in operation.



TINY TRANSISTOR
for use in hearing aids

CBS-HYTRON, Danvers, Mass. No bigger than a match-head, this tiny transistor is designed for hearing aids. It is produced in three types: HA-8 and HA-9, which are low-level, high-gain units for the first and second stages of hearing-aid circuits; and HA-10, for the power output stage. These space-saving transistors are hermetically sealed. Besides hearing aids the transistors have many other applications.



TEST OSCILLATOR
with pushbutton controls

TELETRONICS LABORATORY, INC., 54 Kinkel St., Westbury, L. I., N. Y. Any of 19 different preselected frequencies in the range from 20 cps to 20 kc may be selected by pushbutton controls on the model TO-100A pushbutton test oscillator. A deviation dial permits calibrated deviation from the center frequencies up to ± 10 percent. The output frequencies include those recommended by the FCC for distortion measurements on broadcast transmitters. The output amplitude is calibrated from 1 to 25 v open circuit from a 600-ohm source. A low impedance (approximately

An earnest
electronics engineer
kept worrying
'bout gains non-linear.



.....
Unmeasurable
phase angles
kept him in tangles
And threatened to
wreck his career ...



Tsk, tsk—too bad he didn't know about

Only SERVOScope gives you these 4 features in one piece of equipment:

1. Applicable to both AC carrier and DC servo systems.
2. Built-in electronic sweep, phaseable with respect to generated signals.
3. Comes in 4 models offering frequency ranges from 0.0001 to 60 cps.
4. Generates 3 types of signals:
Sine wave modulated carrier.

SERVOScope[®]

No need to beat around the breadboard . . . SERVOScope speedily and accurately measures gain and phase shifts of L-F amplifiers, servo mechanisms, recorders and other circuits in the subsonic frequency ranges. It takes just a few flicks of the dial to get the values for plotting magnitude and phase curves.

Whether you're developing designs, or production testing—SERVOScope will save you man hours and prevent costly errors.

Low frequency sine waves.



Low frequency square waves.

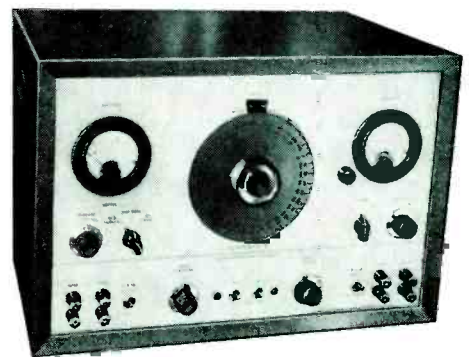

SERVO CORPORATION of AMERICA



New Hyde Park
Long Island, N. Y.

SERVO CORPORATION OF AMERICA
New Hyde Park, Long Island, N. Y.

PLEASE SEND ME . . . engineering specs and actual test set-ups on SERVOScope.

Name.....

Position.....

Company Name.....

Company Address.....

City..... Zone..... State..... EL-5

Stupakoff

Negative Temperature-sensitive Resistors

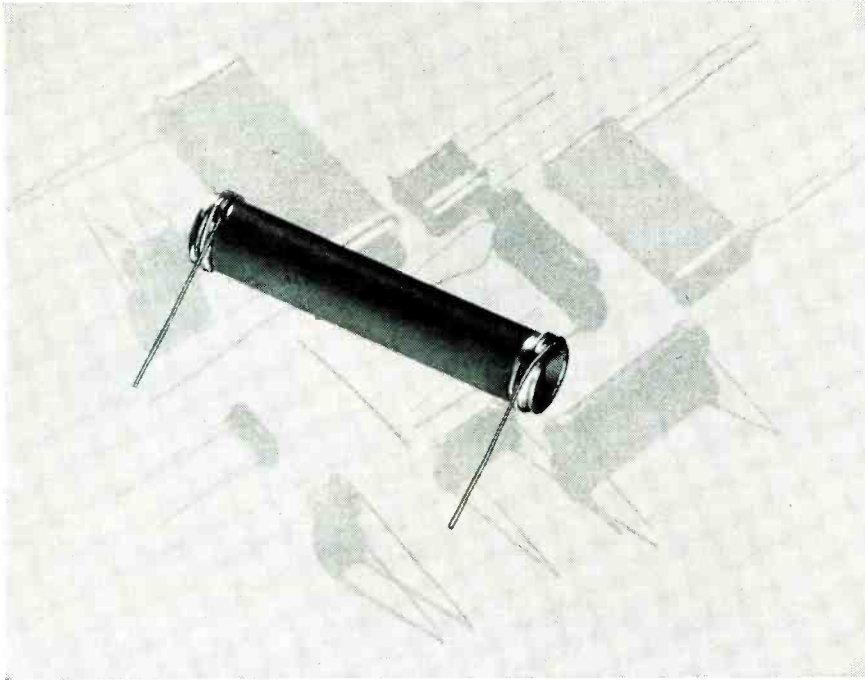

THERMISTORS

for temperature measurement, control or compensation

Stupakoff Thermistors are made from specially formulated ceramic bodies. Furnished with radial or axial wire leads, and with reflective or moisture-proof coating, or uncoated as desired. Some general characteristics are:

Resistivities: 10 ohms / cm³ and up

Resistance: decreases approx. 3% for each degree C temperature rise (see curve)

Made in the form of rods, tubes, bars, discs, washers, etc.

Send for Thermistor Inquiry Questionnaire for prompt and accurate estimate.

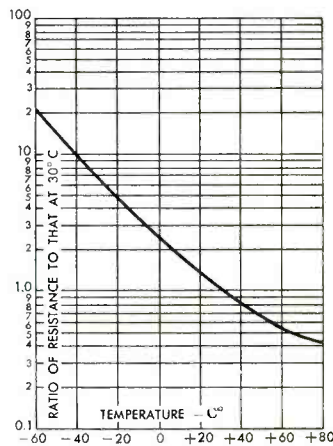

Above curve shows typical temperature-resistance characteristic of Thermistor. Resistance drops approximately 3% for each degree C temperature rise. As temperature varies up and down, resistance retraces its path precisely, regardless of number of reversals.

Stupakoff

CERAMIC & MANUFACTURING COMPANY • LATROBE, PA.

Division of The CARBORUNDUM Company

NEW PRODUCTS

(continued)

18 ohms) is also included. Waveform distortion at 18 mw output is less than 0.25 percent above 100 cps and less than 0.5 percent below 100 cps. Facilities for calibrating an unknown external signal by means of a zero beat indicator are provided. Factory modifications can be made to extend the frequency range to 100 kc.



RING ASSEMBLY meets varied applications

D. E. MAKEPEACE Co., Attleboro, Mass., has available a slip ring and brush assembly designed to meet a wide variety of applications for rotating electromechanical devices. From 2 to 10 circuits can be obtained in 1 assembly, and 2 or more assemblies of 10 each can be stacked together to achieve a greater number of circuits. Currents up to 20 amperes and extremely low noise levels make these assemblies useful for a great variety of applications, including strain gages, telemetering, radar test equipment and controls.

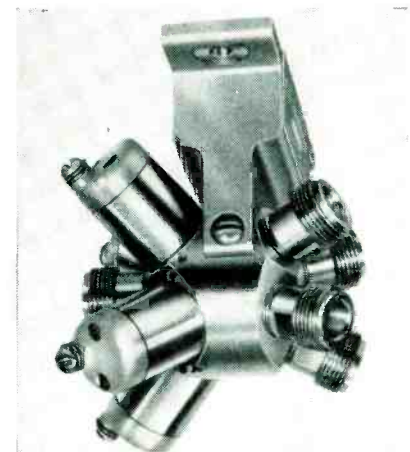

R-F COAX SWITCH weighs only 12 oz

TRANSCO PRODUCTS, INC., 12210 Nebraska Ave., Los Angeles 25, Calif. A new addition to the com-

pany's line of miniature broad-band r-f coaxial switches permits switching of 4 circuits by remote control. The unit weighs 12 oz and occupies only 3 in. \times 3½ in. \times 2½ in. space. Performance is excellent for frequencies up through X band. Switch models are available with two r-f circuit combinations. The SP4T unit has an actuator power rating of 18 to 30 v d-c at 0.18 ampere maximum per coil. Ambient operating temperature range is -65 F to + 225 F; actuating time, 10 milliseconds. Life duration is 500,000 operations minimum. The unit is designed to meet MIL-E-5272 specifications.

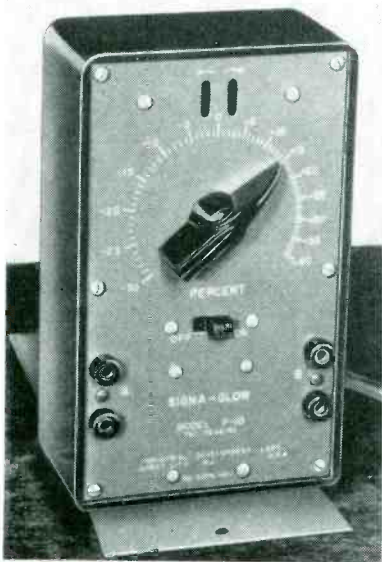

COMPARISON TESTER has dual-null indicator

INDUSTRIAL DEVELOPMENT LABORATORIES, INC., 17 Pollock Ave., Jersey City, N. J., has announced the Signa-Glow, model P-10, a new instrument for rapid comparison tests. It features a dual-null indicator incorporated into a Wheatstone bridge circuit. The unit tests over the wide resistance or impedance range of 100 ohms to 5 megohms by comparing a component or circuit with a reference standard. To sets of jacks are used, one for the standard and one for the unknown. In operation, the dual-null visual indicator shows the direction of unbalance; and a pointer-knob, which is turned to reach the null, indicates the percentage of deviation from the standard. Range of the scale is

Stupakoff

Kovar **HARD GLASS** Seals

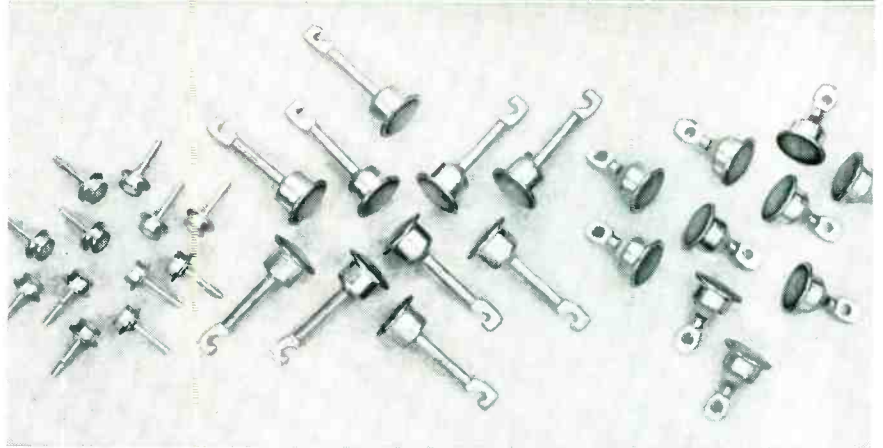
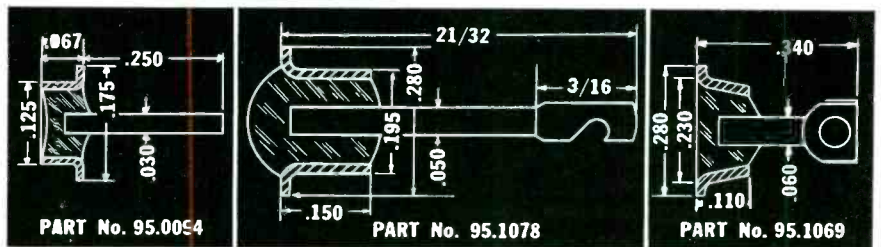

Kovar **HARD GLASS** Stand-offs for test or connection points.

Fused oxides guarantee **TRUE HERMETIC SEALING**

Stupakoff Seals are made by bonding together Kovar metal and hard borosilicate (Pyrex Brand) glass, through a heating process which fuses the oxides of these materials. The strain-free bond thus formed guarantees true hermetic sealing over a wide range of temperatures.

The smooth glazed surface of these compact, light weight seals has high insulating value, and minimizes accumulation of moisture and foreign materials. High thermal endurance permits operation at elevated temperatures, and maximum efficiency is retained even at minus temperatures.

Proper design of a Kovar **HARD GLASS** stand-off or lead-through terminal insures incorporation of these advantages in your product to provide the desired safety factor. See the "Design Information" section of Catalog 453A, on pages 29 and 30.

Complete data of hundreds of sizes, styles and ratings of standard Stupakoff Kovar **HARD GLASS** hermetic seals is given in this catalog. Send for a free copy of Bulletin 453A.

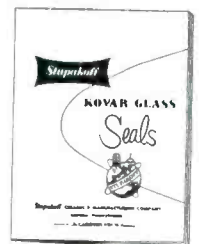

Stupakoff

CERAMIC & MANUFACTURING COMPANY • LATROBE, PA.

DIVISION OF *The CARBORUNDUM Company*

from -30 percent to +40 percent deviation.

Thompson's
Magnetic
Amplifier

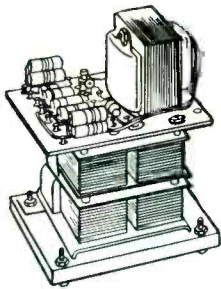

Thompson's
Airborne Rotary
Selector Switch

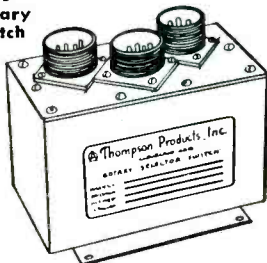

ideas...

facilities...

experience

Thompson has all three

It's no accident that more and more manufacturers are turning to Thompson to solve tough electronics problems.

Thompson has ideas! Thompson engineers will not admit "it can't be done" for they are continually finding the answers to tough research, development and production problems.

Thompson has facilities! Complete development and testing laboratories, and modern production equipment are available to the skilled electronics engineers who make up the highly successful Thompson team!

Thompson has experience! For 52 years, Thompson has been blazing trails and making vital contributions to the automotive, aircraft and general industries of the nation. The highly valuable skills and experience of the entire Thompson organization are at your service for research, development and production of all things electronic.

FOR COMPLETE INFORMATION on how Thompson's Electronics Division can work for you, write to Thompson Products, Inc., Electronics Division, 2196 Clarkwood Road, Cleveland 3, Ohio. You will receive details of Thompson ideas... facilities... experience.

One of the
many
Thompson
Coaxial
Switches

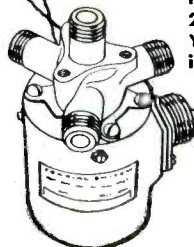

Electronics Division

Thompson Products, Inc.

2196 CLARKWOOD RD., CLEVELAND 3, OHIO

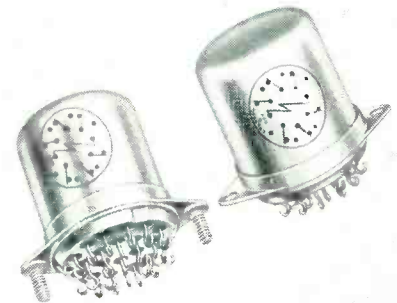

SEALED RELAY
features simplified design

STRUTHERS-DUNN, INC., Pittman, N. J. Type FC-6 six-pole, double-throw relay is low-priced due to its simplified construction. It withstands 0 to 2,000-cycle vibration to 30 g and withstands 60 g shock without contact opening. It is designed to exceed MIL-R-5757B and to meet MIL-R-25018 and MS-24115 specifications. It is available for both 85 C and 125 C ambients. Nominal coil voltage is 26.5 v d-c. The relay incorporates safety factors that make it ideally suited for difficult applications, even in low-energy circuits.



JUNCTION DIODES
with high forward conductance

TRANSITRON ELECTRONIC CORP., Melrose 76, Mass., has available silicon junction diodes for operation up to 150 C and featuring high forward conductance and high inverse resistance. They are ideally suited to nearly all low and medium-frequency diode applications. Designed primarily for signal magnetic amplifier and power supply use, these diodes are also finding

application in voltage regulator and limiter service. Their extremely sharp Zener break provides a stable voltage reference.

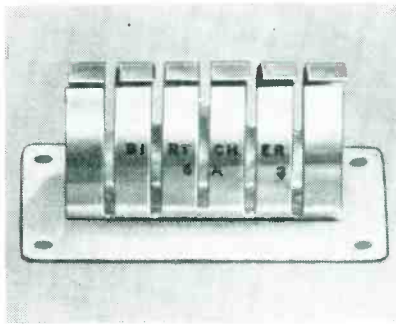

**TUBE CLAMPS
are slotted type**

THE BIRTCHEER CORP., 4371 Valley Blvd., Los Angeles 32, Calif., has announced the 6A-3 Kool Klamp, designed for miniature tubes with T-6½ and T-7 envelopes. The sleeve-type clamp features the multiple-finger construction. These fingers act independently of each other and provide excellent contact between tube and clamp. This construction improves heat conduction, simplifies tube insertion and reduces tube breakage.



**COAXIAL RELAY
is moving-coil type**

MARION ELECTRICAL INSTRUMENT CO., Manchester, N. H., has developed a new moving coil relay design incorporating the advantages of the company's coaxial mechanism. Very sensitive, rugged and reliable, the coaxial relay is a hermetically sealed, miniature unit mounted on a standard 7-pin tube base. It weighs 1½ oz, and is ⅜ in. in diameter, 1⅞ in. high, 1⅜ in. overall. Engi-

NEW!

MINIATURE

SERVO

Magnetic Amplifiers

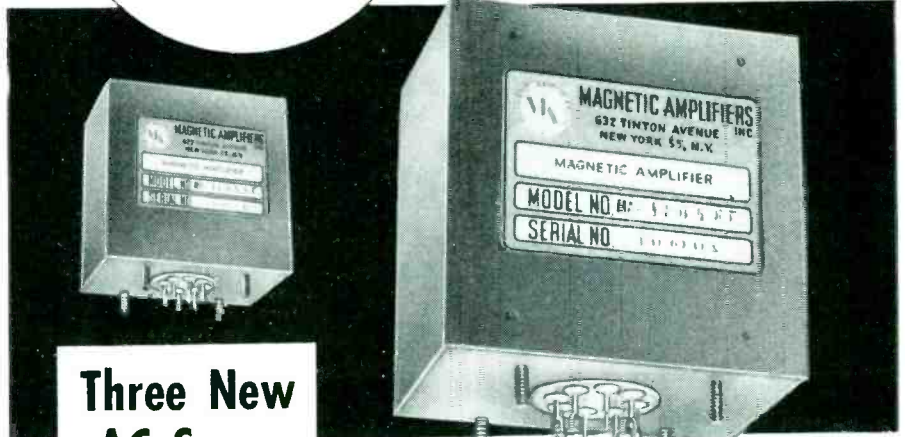

**Three New
AC Servo
Types
Available..**

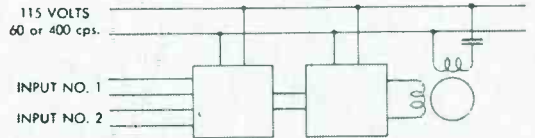

**STANDARDIZED
SERVO SYSTEMS
AND OTHER
STANDARD TYPES
FOR AUTOMATIC
CONTROL —**

In addition to new lines illustrated, many standard and higher power magnetic amplifiers are available for applications involving automatic control.

**CUSTOM DESIGNS
FOR SPECIAL
REQUIREMENTS**

— we design
and engineer
complete servo
or automatic
control systems

AFFILIATE OF
THE GENERAL
CERAMICS
CORPORATION



**● MAGNETIC PRE-AMP +
SATURABLE TRANSFORMERS**

Supply: 115 volt 400 cps.
Power output: 3.5, 6, 10, 18 watts
Sensitivity: 1 volt AC
Response Time: .03 sec.
Lowest Cost — Smallest Size
For further information request Form S493

**● MAGNETIC PRE-AMP +
HIGH GAIN MAGNETIC AMPLIFIER**

Supply: 115 volt 400 cps.
Power output: 5, 10, 15, 20 watts
Sensitivity: .1 volt AC
Response Time: .008 to .1 sec.
Highest performance — All magnetic
For further information request Form S496

**● TRANSI-MAG*: TRANSISTOR +
HIGH GAIN MAGNETIC AMPLIFIER**

Supply: 115 volt 400 or 60 cps.
Power output: 2, 5, 10, 15, 20 watts
Sensitivity: .08 volt AC into 10,000 ohms
Response Time: .01 sec.
Fast response at high gain
For further information request Form S499
(400 cps.); Form S497 (60 cps.)

*TRADE NAME

**MAGNETIC
AMPLIFIERS • INC**

Telephone: CYPRESS 2-6610
632 TINTON AVE., NEW YORK 55, N. Y.

For Super-Service

on

**INSULATED WIRES
CABLES and
CORD SETS**



Call any of these
PHALOMen anytime!

ATCHESON & ADAMS

Suite No. 315
601 N. Elm St. Bldg.
Greensboro, N. C.

ARTHUR J. ELLIS COMPANY

1607 West Howard Street
Chicago 26, Illinois

GEORGE L. HERRICK CO.

15326 Lorain Avenue
Cleveland 11, Ohio

M. F. KLICPERA

P. O. Box 3113
Houston 1, Texas

EDWARDS-LOHSE & CO.

2123 E. 9th St., Room 510
Cleveland 15, Ohio

GEORGE E. HARRIS & CO.

1734 N. Hillside
Wichita, Kansas

KAELBER & MACK

One Park Avenue
Manhasset, New York

MEYER & ROSS

113 10th Street
San Francisco 3, California

PARAGON SALES COMPANY

111 South 22nd Street
Philadelphia, Pennsylvania

WILLARD SPENSER CO.

20158 Santa Rosa Drive
Detroit, Michigan

WILLIAM C. WALSER

7 Barnesdale Road
Natick, Massachusetts

R. G. RAGON, INC.

1406 West Idaho Avenue
St. Paul 13, Minnesota

RICHARD LEGG COMPANY

2118 S. E. Division Street
Portland 2, Oregon

H. GEORGE SHEFLER CO.

P. O. Box 1587
Phoenix, Arizona

JOHN B. TUBERGEN CO.

2232 West 11th Street
Los Angeles, California

GILBERT GISLASON

82 St. Paul Street
617 Case Building
Rochester, New York

J. B. SMYTH

2063 Victoria Street
Montreal 2, Canada

PHALO

PLASTICS CORPORATION

Corner of Commercial St.
WORCESTER, MASSACHUSETTS

Southern Plant — Monticello, Mississippi

Visit us at
Booth 890
Chicago Show

NEW PRODUCTS

(continued)

neering data are available on request.

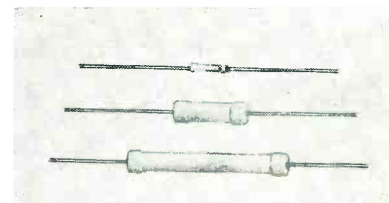

METAL FILM RESISTORS with axial leads

CONTINENTAL CARBON, INC., 13900 Lorain Ave., Cleveland 11, Ohio, has available metal film resistors (Noblette) with axial leads in $\frac{1}{2}$, 1 and 2-w ratings. Resistance range is: 1 ohm to 1 megohm in $\frac{1}{2}$ w; 1 ohm to 5 megohms in 1 w; and 2 ohms to 10 megohms in 2 w. Tolerances available are ± 1 percent, ± 2 percent and ± 5 percent. Write for the new 1955 catalog.

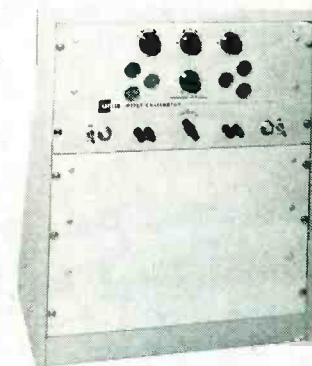

METER CALIBRATOR a standard d-c reference

KALBFELL LABORATORIES, INC., 1090 Morena Blvd., San Diego 10, Calif. Model M100A-20 meter calibrator is a standard d-c reference providing both voltage and current calibration ranges from 0 to 1,000 v at 200 ma maximum and from 0 to 100 ma at 1,000 v maximum. The unit maintains long time stability of 0.01 percent, accuracy of 0.05 percent, and regulation for ± 10 -percent line voltage change of 0.01 percent. Voltage output is variable in 0.1-v steps and current output is adjusted in 4 ranges. On the lowest range of 0 to 0.1 ma the output varies in 0.01- μ a steps. Other full scale current ranges are

1 ma, 10 ma and 100 ma. The unit is useful in analog computer facilities, telemetering, instrumentation groups, a/c calibration and as a secondary standard voltage source.

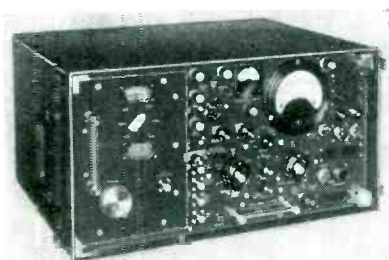

L-F TUNER

covers from 150 kc to 20 mc

EMPIRE DEVICES PRODUCTS CORP., 38-15 Bell Blvd., Bayside, L. I., N. Y. A new tuning unit covering the 150-ke to 20-mc range has been developed for noise and field intensity meter model NF-105. Addition of this tuning unit, catalog No. TA, NF-105, makes it possible to conduct measurements of r-f interference and field intensity over the 150-ke to 1,000-mc range by means of only one instrument. The wide frequency range is obtained by use of 4 separate tuning units. The new 150-ke to 20-mc tuner employs one stage of tuned r-f amplification. It utilizes a 6-band turret arrangement for frequency range switching. As in the other ranges, an impulse generator furnishes the calibrating voltage.

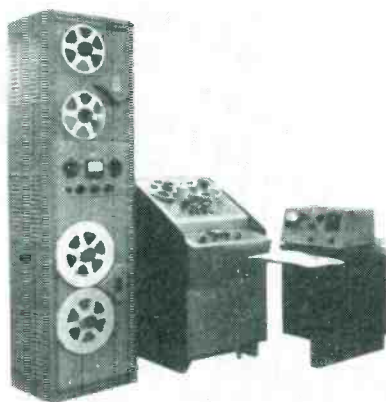

BROADCAST SYSTEM
operates automatically

AMPEX CORP., 934 Charter St., Redwood City, Calif. A new automatic

CHICAGO
CONTROL AND
POWER CIRCUIT
TRANSFORMERS

compact
dependable
rugged

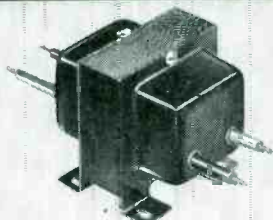

TYPE NCF, PCF

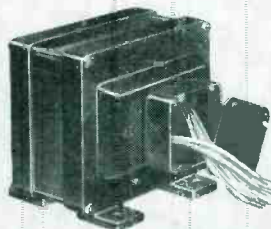

TYPE PCB

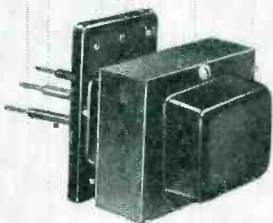

TYPE PCC

FREE CATALOG describing the full line of CHICAGO transformers for industrial use is available from your CHICAGO distributor or by writing the Chicago Standard Transformer Corporation.



CHICAGO STANDARD TRANSFORMER CORPORATION

ADDISON AND ELSTON • CHICAGO 18, ILLINOIS

Export Sales: Roburn Agencies, Inc., 431 Greenwich Street, New York 13, N.Y.

CONTROL TRANSFORMERS

All Primary Windings for 115 Volts, 50-60 cycles

Catalog Number	Secondary Volts	Secondary Amps.	Capacity V-A
NCF-650	6	8.33	50
NCF-825	8	3.15	25
NCF-850	8	6.25	50
NCF-1625	16	1.55	25
NCF-1650	16	3.15	50
NCF-2425	24	1.05	25
NCF-2450	24	2.1	50
NCF-2475	24	3.15	75
NCF-24100	24	4.15	100
NCF-24150	24	6.25	150
NCF-3250	32	1.55	50
NCF-3275	32	2.35	75
NCF-32100	32	3.15	100
NCF-32150	32	4.7	150
NCF-1550	550	(NL)	50
NCF-1775	775	(NL)	50

POWER CIRCUIT TRANSFORMERS

1/2 to 10 VKA, for use with Conduit Wiring.

Catalog Number	Primary Volts	Secondary Volts	KVA Capacity
PCB-24500	230/460	115	.500
PCB-24750	230/460	115	.750
PCB-241M	230/460	115/230	1.0
PCB-242M5	230/460	115/230	2.5
PCB-245M	230/460	115/230	5.0
PCB-247M5	230/460	115/230	7.5
PCB-2410M	230/460	115/230	10.0

POWER CIRCUIT TRANSFORMERS

25 to 250 va. capacity, for In-Compartment Wiring.

Catalog Number	Primary Volts	Secondary Volts	Secondary Amps.	Capacity V-A
PCF-2025	230	115	.25	25
PCF-2050	230	115	.45	50
PCF-24075	230/460	115	.65	75
PCF-24100	230/460	115	.85	100
PCF-24150	230/460	115	1.5	150
PCF-24250	230/460	115	2.2	250

POWER CIRCUIT TRANSFORMERS

Mounted on rectangular covers that fit standard FS and FD conduit boxes.

Catalog Number	Primary Volts	Secondary Volts	Secondary Amps.	Capacity V-A
PCC-24100	230/460	115	.85	100
PCC-4100SP	460	115	.85	100
PCC-24150	230/460	115	1.5	150
PCC-24250	230/460	115	2.2	250

6 Instruments in 1

without
plug-ins!



BERKELEY Model 5571 Frequency Meter

Another BERKELEY first! Model 5571 offers for the first time the combined functions of six instruments in one compact, light weight unit—without plug-ins. Additional features include:

1. 0-42 mc frequency meter (extendable to 515 mc)
2. Frequency ratio meter
3. 0-1 mc period meter
4. 1 μ sec to 10,000,000 sec time interval meter.
5. 0-2 mc events-per-unit time meter.
6. 1 mc counter

features

- Frequency range extendable to 515 mc
- Direct-coupled input amplifiers
- Direct connections to digital printer, digital-to-analog converter, or data converters for IBM card punches, electric typewriters or telemetering systems
- Provision for external frequency standard input
- Coupling to WWV receiver
- Relay rack mounting if desired

CONDENSED SPECIFICATIONS

Frequency Meas. Range:	0 cycles to 42 mc
Time Interval Meas. Range:	1 μ sec. to 10 ⁷ seconds
Period Meas. Range:	0 to 1 mc (Period x 10, 0 to 100 kc)
Input Requirements:	0.1 v. peak to peak
Time Bases:	Frequency: 0.000002 to 20 seconds, decade steps. Time Interval and Period Meas: 1 mc to 1 cps, decade steps
Accuracy:	± 1 count of unknown (or time base) \pm crystal stability
Crystal Stability:	Temperature stabilized to 1 part in 10 ⁷ (short term)
Display Time:	0.2 to 5 seconds
Power Requirements:	117 v. $\pm 10\%$, 50-60 cycles, 260 watts
Dimensions:	20 $\frac{3}{4}$ " W x 19" H x 16" D. Weight, 100 lbs.
Price:	\$1,650.00 (f.o.b. factory)

Write today for complete technical data and application information; please address Dept. E-5

Berkeley

division

M-51

BECKMAN INSTRUMENTS INC.
2200 WRIGHT AVE., RICHMOND 3, CALIF.

INDUSTRIAL INSTRUMENTATION AND

CONTROL SYSTEMS • COMPUTERS • COUNTERS • TEST INSTRUMENTS • NUCLEAR SCALERS

broadcast system consists of two electronically interlocked tape playback units, one capable of playing eight hours of recorded material from a single tape, and the other, up to four hours. On the first unit is placed program material, either from a library built up by the station over a period of time or from a network or commercial transcription service. Spot announcements, local programs and station breaks are recorded daily in the station's own studio and placed on the second machine. After each segment of program material and after each local announcement, a subaudible tone is recorded. At the end of a program segment the electronic brain hears this tone and starts the announcement machine. After the announcement, another tone starts the program. This saw-saw action continues until, at each half-hour, a timing device corrects for any slight time deviation in the system and inserts a station break.

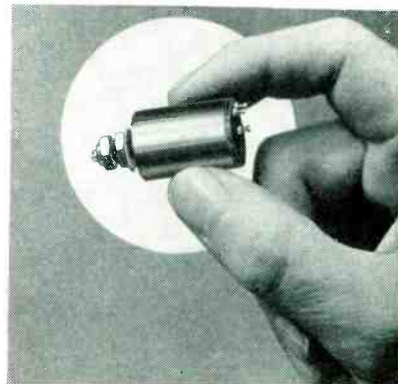

POTENTIOMETER in 7 standard values

MAUREY INSTRUMENT CO., 2450 E. 72nd St., Chicago 49, Ill. A $\frac{1}{2}$ -in. diameter wire-wound potentiometer is now available in values of 25, 500, 1,000K, 5,000K, 10,000K, 50,000K 100,000K ohms. A 5-percent resistance tolerance is standard with a temperature coefficient of 0.00002 and a resolution of 0.1 percent available in the higher resistance values. The trimmer was especially designed for use in military aircraft instruments. A standard locking device firmly holds the resistance setting under rugged vibration and shock conditions. The unit is moisture re-

sistant with a Teflon gasket sealing the shaft. The pot is designed to operate at a temperature range of -55 to $+125$ C with a dielectric breakdown exceeding 1,000 v rms at 25 C.

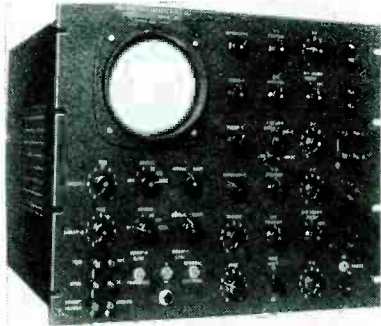

OSCILLOSCOPE for the research worker

AMERICAN ELECTRONIC LABORATORIES, INC., 641 Arch St., Philadelphia 6, Pa., has available a specialized dual-beam oscilloscope for the research worker. It is particularly useful in the investigation of long-time phenomena using sweeps up to 10 sec (200 sec on special order). Signals on the two beams may be related using the variable delay trigger, so that a slowly moving signal displayed on sweep 1 can have small detail occurring at mid-sweep displayed on sweep 2 on a much faster time scale. Amplifier frequency response is flat from d-c to 100 kc, at 1 v per in. Power supply is remote; critical voltages are regulated. Photographic recording, either by single frame or with moving film or paper, is aided by the high accelerating voltage (4,000 v), sharp focus and the axis shift, which, either locally or remotely, changes the mode of operation from viewing to recording by stopping the sweeps and transferring the signals from Y to X axis.

DEMONSTRATORS for educational use

THE AQUATRON Co., 90 Jordan St., Brockton 14, Mass., has available a radio transmission demonstrator and an equivalent plate circuit demonstrator, and other types of educational display boards and

Measure Frequency to 515 mc

READ IT DIGITALLY, PRINT IT AUTOMATICALLY! Add a Model 5580 VHF-UHF Converter and 1452 Printer (below) to a BERKELEY Frequency Meter*—get the most convenient, inexpensive means yet devised for frequency measurement to 515 mc. Exclusive BERKELEY Modular design uses low cost fixed-band plug-in units in place of costly wide-band amplifiers. Accuracy of measurement is ± 1 cycle, \pm crystal stability (1 part in 10^7).

*Model 5580 connects directly to BERKELEY Model 5570 or 5571.

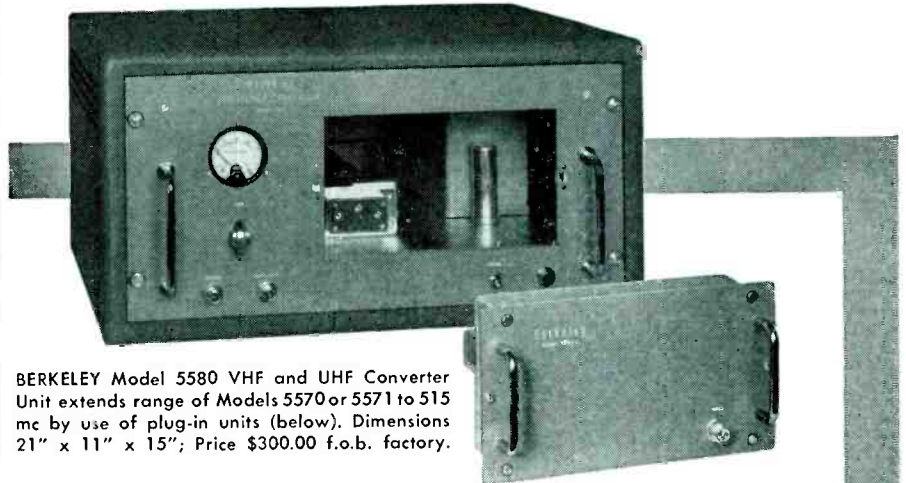

BERKELEY Model 5580 VHF and UHF Converter Unit extends range of Models 5570 or 5571 to 515 mc by use of plug-in units (below). Dimensions 21" x 11" x 15"; Price \$300.00 f.o.b. factory.

Plug-in units covering 13 fixed bands from 42-515 mc eliminate costly wide-band amplifiers. Price, \$100.00 each except for 42-155 mc Model 5581/4, which is \$150.00 f.o.b. factory.

Automatic Digital Recorder Completes System

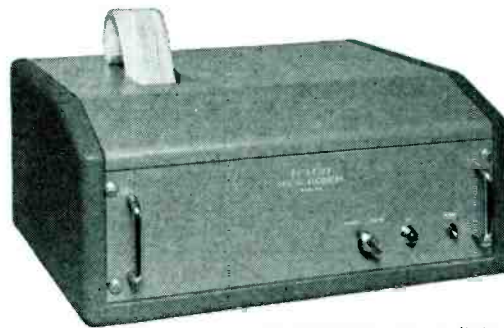

Model 1452 prints 6 digits (8 or 10 on special order) on standard adding machine tape. Only 19" wide x 10½" high x 14" deep, weighs 60 lbs. Price, \$750.00 f.o.b. factory.

BERKELEY Model 1452 Digital Recorder operates directly from any late model BERKELEY meter, automatically prints up to 10-digit read-out on standard adding machine tape. Scanner and printer are combined in one compact unit. Can be modified to print "Time" or "Code" information simultaneously with count data on same tape.

Write for complete specifications and data; please address Dept. E-5

Berkeley

division

M-52

BECKMAN INSTRUMENTS INC.
2200 WRIGHT AVE., RICHMOND 3, CALIF.

INDUSTRIAL INSTRUMENTATION AND

CONTROL SYSTEMS • COMPUTERS • COUNTERS • TEST INSTRUMENTS • NUCLEAR SCALERS

FROM ONE ENGINEER TO ANOTHER

As engineers, we're pretty much in demand these days. The air is heavy with glowing promises of one sort or another, and at times boiling this material down to the basic job facts is a somewhat complicated task. So I'm going to give it to you straight.

Link Aviation, Inc.—one of the subsidiaries of General Precision Equipment Corporation—has openings for engineers capable of independent activity, yet able to direct and coordinate the activities of others when necessary.

These men are needed in all phases of engineering activity—project engineering, production engineering and design—in the following fields: Advanced optics, analog computers, digital computers, radar simulation, pulse circuitry, mechanical design, electrical design. And they must be stimulated by the challenge of untried approaches, complex electronic or mechanical design problems, or new production techniques.

If you are one of these engineers, Link offers an unusual opportunity for professional growth to establish a solid, successful career while receiving generous employee benefits concurrently with raising your family in an ideal suburban environment.

For an interview or additional information, contact
WM. W. WOOD, JR.,
Vice President, Engineering



A SUBSIDIARY OF GENERAL PRECISION EQUIPMENT CORPORATION

Manufacturers of world-famous Link trainers and simulators (such as F3D, B-47, F-89, F2H-2, F2H-3) • simulated aircraft instruments • specialized computers • servo mechanisms • computer components • gear boxes • friction over-drive clutches • precision potentiometers • ratio voltmeters • phase angle meters • and other electronic devices

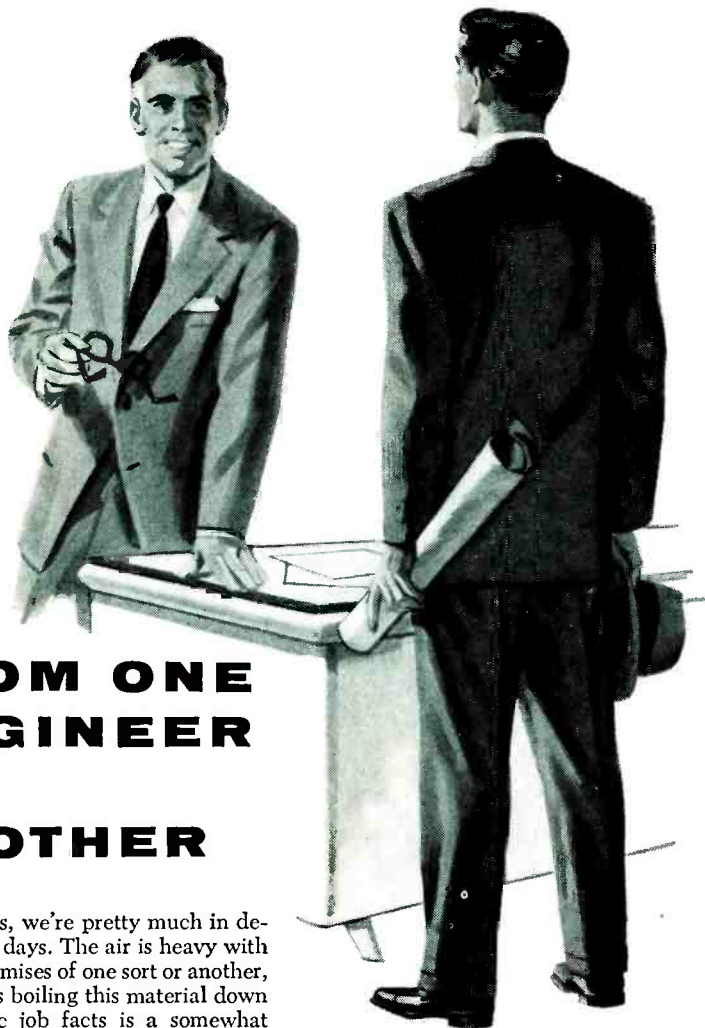

class-room demonstration equipment. Each unit comes with suitable lecture text and detailed demonstration instructions.

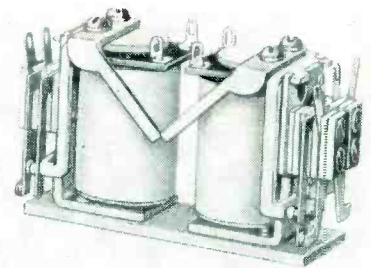

LATCH-IN RELAY is mechanically interlocked

MAGNECRAFT ELECTRIC CO., 3350 W. Grand Ave., Chicago 51, Ill., has announced a new miniature latch-in relay in which the armature mechanically latches in the energized position. It comprises an operating relay and a reset relay with mechanically interlocking arms. When the operating coil pulls the armature into the energized position the levers mechanically lock the armature in place. The armature may be reset electrically or manually. The latching levers are alloy steel, heat treated and hard chrome plated for long wear. Available for 6, 12, 24, 48 and 115-v d-c operation, they can be furnished with a wide variation of contact ratings and contact combinations. Approximate overall length is 2 $\frac{3}{8}$ in.; width, 1 in.; height, 1 $\frac{3}{8}$ in.

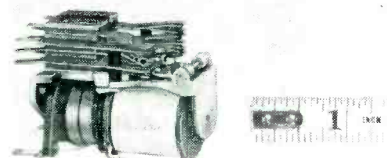

MIDGET RELAY has self-contained rectifier

PHILLIPS CONTROL CORP., Joliet, Ill. Type 8AC relay has its own self-contained rectifier thereby eliminating exterior wiring and requiring less space. The rectifier occupies only a fraction of an inch of space

adjacent to the coil. One section of the rectifier is for half-wave control while the other section shunts the coil to prevent a-c vibration. This relay can operate 4 Form C up to 55 C, whereas the usual 400-cycle relay operates only 1 Form C. In military applications where operation is necessary at 85 C the relay can be used continuously for approximately 10,000 hr while limited to 2 Form C. Likewise for any frequency greater than 400 cycles the power is reduced, limiting the relay to smaller pile-ups. The relay can be supplied in hermetically-sealed enclosures for commercial, military and aircraft use.

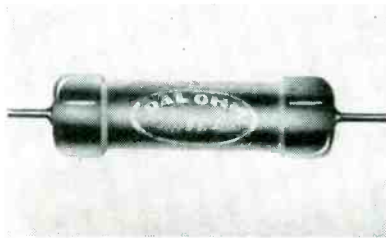

RESISTORS are deposited carbon type

DALE PRODUCTS, INC., Columbus, Nebraska, announce availability of the type DCM deposited carbon resistors to specification MIL-R-10509A, type RN20. They are manufactured in resistance values from 10 ohms to 2 megohms with tolerances of 1 percent. Higher or lower values are available on request.

Literature

Current Ratio Indicator. Thomas A. Edison, Inc., West Orange, N. J. A catalog-sheet technical bulletin illustrates and describes model 222-1J meter which indicates the ratio of two direct currents. Included are a wiring diagram, dimensional drawings, and data on accuracy and coil current strength.

Pilot Light. Industrial Devices, Inc., Edgewater, N. J., announces its latest catalog covering the series 1000 Omni-Glow neon pilot lights. The catalog is intended as



*Varian fills
a growing
research need...*

with a **completely matched** four-inch electromagnet system...

This outstanding matched magnet system features Varian's new V-4004 Four-inch Laboratory Electromagnet . . . a versatile instrument designed to meet a variety of general purpose applications, particularly where the exceptional field homogeneity and stability of Varian's larger magnets is not required. The V-4004 magnet with its matching power supply and optional current regulator is ideal for studies of susceptibility, Zeeman or Hall Effects . . . for testing magnetic materials . . . for lecture demonstrations . . . for many other applications requiring a magnetic field. Priced within the limits of a modest laboratory equipment budget, it can be purchased complete with matched power supply, current regulator and accessories . . . or in any combination your needs warrant.

These Components Comprise the Complete V-4004 Magnet System:

V-4004 Four-inch Magnet	V-4084 Tapered Pole Caps
V-2300 Power Supply (unregulated)	V-4084-1 Cylindrical Pole Caps
V-2301 Current Regulator (for V-2300 Power Supply)	V-4055 Rolling Cabinet (houses complete magnet system)

For Complete Information . . . on the new, completely matched V-4004 Magnet System, write to the Special Products Division for data sheets and specifications.

THE
MARK OF
LEADERSHIP

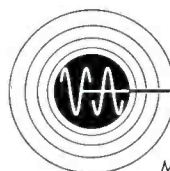

VARIAN associates

PALO ALTO 1, CALIFORNIA

MICROWAVE TUBES—SPECIAL PRODUCTS

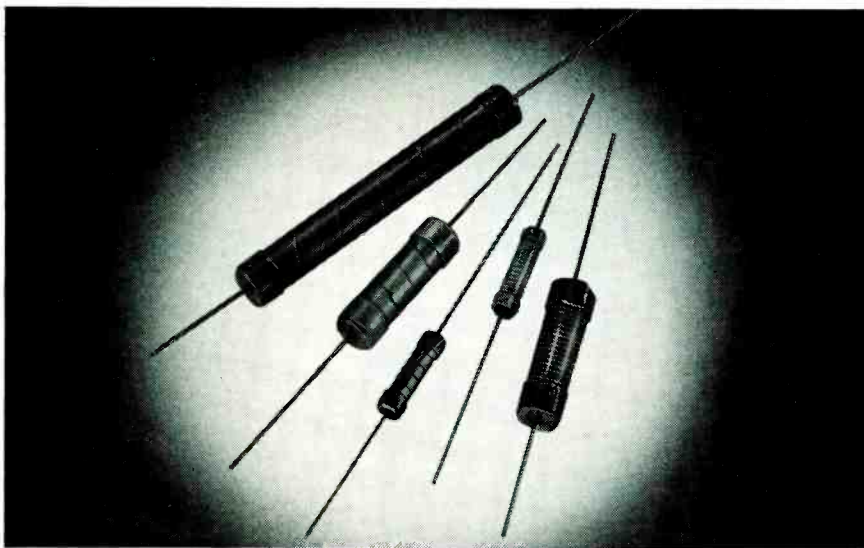

Corning Type N Precision Resistors.
Rugged. Stable. And Economical.

For critical accuracy, extreme stability ... Rugged Corning Type N Film-Type Resistors

When you need a precision resistor for really hard work, our Type N accurate grade is a likely job candidate.

We make it to a standard tolerance of 1%, but we can tighten up if you wish. You can operate Type N's at ambient temperatures up to 140°C. with derating. Their noise level is so low, you'll have difficulty measuring it.

They have a negligible voltage coefficient averaging less than .001% per volt. You needn't worry about moisture because both core and film are absolutely impervious.

Stability means that the average change of resistance after 500 hours at maximum dissipation is less than 0.5%. A standard 5-second overload of 6.25 times rated power causes a permanent resistance change of less than .75%. Type N resistors are non-inductive.

These accurate grade resistors overcome the inadequacies of convention-

al resistors in many advanced circuits. We recommend them to you for use in circuits where other resistors aren't up to the task or cost too much.

Specifically, you'll find these resistors most useful for radio and TV equipment, HF circuits, test equipment, and low-signal, hi-gain amplifier stages. Their stability and ruggedness make special handling unnecessary. Made to MIL-R-10509A Specs.

Fine as they are, Corning Type N Resistors cost remarkably little. For complete technical information and price lists, use the coupon.



Corning Type R High-Power Resistors—Range from 25 to 1,000,000 ohms, ratings from 7 to 115 W. are non-inductive. Exceptionally good noise and frequency characteristics. Excellent moisture resistance and overload capacity recommend them for stable long-life service under adverse conditions. Meet MIL-R-11804A Specs.

a guide to basic data on pilot lights for application and design in industrial devices. The book is replete with detail drawings and photographic illustrations showing the standard model and practicable combinations of all elements to meet specific requirements. A copy of the 8-page presentation is available on request.

Shock and Vibration. Barry Controls Inc., 1000 Pleasant St., Watertown, Mass. Bulletin 804A is designed to provide a quick reference sheet for electronics and aviation design engineers. Each of the military specifications is listed with the specific vibration and shock requirements summarized. Such requirements as resonance, durability, cycling, crash safety and performance are listed.

Digital Multitester. Laboratory for Electronics, Inc., 75 Pitts St., Boston 14, Mass. A single-page catalog sheet covers the model 503 digital multitester, a versatile instrument of high precision for the measurement of positive or negative d-c voltages up to 1,000 v, a-c voltages from 50 cps to 100 kc up to 1,000 v rms, and resistances up to 10 megohms. Complete specifications are given.

Flexible Shafts. The S. S. White Dental Mfg. Co., 10 E. 40th St., New York 16, N. Y. Bulletin 5306 contains basic information and data on the company's line of flexible shafts for remote control and for power drives. Functions, advantages, construction and characteristics are given. Also included is information on flexible casings for use with the shafts.

Precision Phase Detector. Advance Electronics Co., Inc., 451 Highland Ave., Passaic, N. J. A single-page bulletin illustrates and describes the type 205 precision phase detector which measures envelope delay, time delay or phase angle with an accuracy of 1 percent or 0.1 deg. The instrument described consists essentially of two cathode followers, a continuously variable delay line, a differential tuned amplifier, bal-



Corning means research in Glass

CORNING GLASS WORKS, 36-5 Crystal St., Corning, N. Y.

New Products Division

Please send me descriptive catalog sheet on Corning Type N Film-Type Resistors.

Name..... Title.....

Address.....

Company.....

City..... Zone..... State.....

anced phase detector and a sensitive output indicator.

Pressure Potentiometer. Bourns Laboratories, 6135 Magnolia Ave., Riverside, Calif. Model 304 miniature gage pressure potentiometer is covered in a 4-page brochure. Chief features are illustrated and describes; and dimensions and full specifications are given.

Resistors. Leeds & Northrup Co., 4934 Stenton Ave., Philadelphia 44, Pa. Specifications of the firm's complete line of d-c electrical standards as well as secondary standard a-c resistors are given, and significant design and manufacturing techniques are described. Electrical characteristics are tabulated and construction features are included as well as ordering instructions.

Ceramics Buyers Guide. Centralab, a division of Globe-Union Inc., 900 E. Keefe Ave., Milwaukee 1, Wisc. Bulletin 42-221 is a 16-page, 2-color engineered ceramics buyers guide designed for the use of purchasers and designers of ceramic parts. Advantages of engineered ceramics over other materials and the types of ceramic for specific uses are given. A tour through the CRL plant showing how ceramics are manufactured is a special feature of the guide.

Voltage Reference and Stabilizer Tubes. Mullard Ltd., Century House, Shaftesbury Ave., W. C. 2, London, England. A new booklet is entitled "A Guide to the Application of Voltage Reference and Stabilizer Tubes." It contains sections on fundamentals of voltage reference and stabilizer tubes; the interpretation of published characteristics; and applications. There are also tabulated data on the company's current tubes.

Picture Tube Guide. General Electric Co., 1 River Road, Schenectady 5, N. Y., has announced a new edition of its quick selection guide for tv picture tubes (ETD-1001A). Purpose of the booklet is to help designers select a particular tube from the large number of types now on the market. It

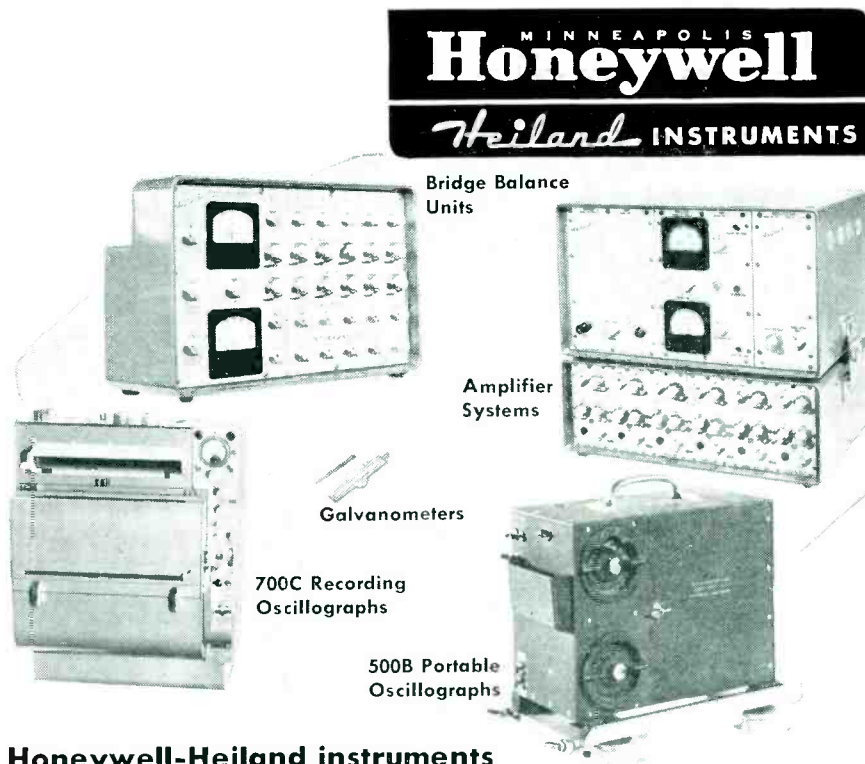

Honeywell-Heiland instruments are now being handled through the INDUSTRIAL DIVISION OF MINNEAPOLIS-HONEYWELL REGULATOR CO.

Sales engineers and field representatives are available through the following offices:

Albuquerque, New Mexico • 2500 Garfield Ave., S.E.
 Atlanta, Georgia • 1415 Howell Mill Road, N.W.
 Boston 15, Massachusetts • 108 Cummington Street
 Chicago 11, Illinois • 351 East Ohio Street
 Cleveland 14, Ohio • The Tower Press Bldg., 1900 Superior Ave.
 Dayton 4, Ohio • 1441 Milburn Ave.
 Denver 4, Colorado • 1600 W. 13th Ave.
 Detroit 27, Michigan • P.O. Box 3901, Strathmoor Station
 Houston 1, Texas • P.O. Box 2631
 Long Island City 1, New York • 24-30 Skillman Ave. (New York Branch)
 Los Angeles 22, California • 6620 Telegraph Road
 Minneapolis 14, Minnesota • 621 E. Hennepin Ave.
 Odessa, Texas • 2020 E. 8th Street
 Philadelphia 32, Pennsylvania • 3345 W. Hunting Park Ave.
 St. Louis 8, Missouri • 4354 Olive Street
 Seattle 9, Washington • 401 Pontius Ave.
 San Francisco 3, California • 1136 Howard Street
 Washington 16, D.C. • 4926 Wisconsin Ave., N.W.
 Wichita, Kansas • P.O. Box 305

Heiland®



A DIVISION OF MINNEAPOLIS-
HONEYWELL
 130 E. 5th Ave., Denver 3, Colo.

Completely New 
DESIGNED AND MADE BY

WHITNEY  BLAKE

Sealed Instrument Receptacles

COMPOSED OF ONLY TWO PIECES

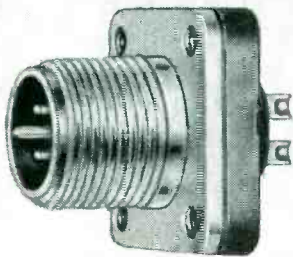

PIN INSERT
ASSEMBLY

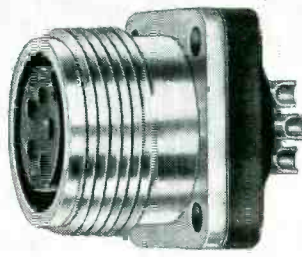

SOCKET INSERT
ASSEMBLY

Aluminum shell and neoprene or silicone rubber inserts with permanently bonded pin or socket contacts.

**SIMPLE IN DESIGN . . . EASY TO ASSEMBLE . . .
 INTEGRAL "O" RINGS SEAL AUTOMATICALLY**

Already available in four sizes . . . Write for fully descriptive
 CATALOG SHEET 674.7

AND A BRAND NEW

Sealing Boot

**TO REPLACE CABLE CLAMP ADAPTERS
 AN 3057, AN 3057A and AN 3057B**

Positive sealing . . . self centering . . .
 Adaptable to a wide range of cable
 diameters. Made of oil resistant neoprene
 with light weight aluminum threaded ring. Aircraft type hose
 clamp supplies positive sealing.



AVAILABLE NOW IN FIVE SIZES

Write for fully descriptive CATALOG SHEET 674.6

© 1955

Well Built Wires Since 1899



Electronics Division
WHITNEY BLAKE COMPANY

New Haven 14, Connecticut

lists 205 types and for each of these the following information is listed: whether it is aluminized or not, external conductive coating capacitance, type of ion-trap magnet, face, dimensions and style of anode terminal.

Powder Cores. Magnetics Inc., Butler, Pa. Bulletin PC-103 deals with the company's line of molybdenum Permalloy powder cores. A full page of tabular data gives information on standard sizes, electrical specifications and tolerances and types of core finish.

Test Measurement. Wm. Miller Instruments, Inc., 325 N. Halstead Ave., Pasadena 8, Calif., has published a 4-page folder illustrating and describing electronic instruments for precision test measurement. Included are such instruments as recording oscillographs, amplifiers, bridge balancers and the Milac analog computer.

Instruments Folder. Krohn-Hite Instrument Co., 580 Massachusetts Ave., Cambridge 39, Mass., has published a 4-page folder introducing five new electronic instruments. Illustrated and described are an ultra-low distortion power amplifier, ultra-high regulation power supplies, wide-range audio oscillators and variable electronic filters.

Industrial Relays. Sterling Engineering Co., Inc., Laconia, N. H. Description, coil and pile-up information, and sizes of ten industrial relays are given on a single-page bulletin, form 13C033.

Relays. Potter & Brumfield, Princeton, Ind., has available a 1-sheet bulletin that illustrates and points out advantages of 15 of the more than 110 of the company's standard relay structures. It also discusses the general purpose series KA, appliance series AB and multiple leaf series GA relays.

Industrial Oscilloscope. Precise Development Corp., Oceanside, N. Y. A recent bulletin covers the model 305R industrial oscilloscope—a basic laboratory instrument with an extended low frequency,

highly linear, horizontal circuit. The unit described also incorporates an internal sweep delay up to 100 milliseconds. Electrical characteristics are given.

Power Supplies for Transistors. Burgess Battery Co., Freeport, Ill., has available literature dealing with a line of small batteries that meet the exacting specifications required in transistor operation so far as those requirements have been ascertained. Complete descriptions, and curves showing battery requirements for transistor circuits are given.

Capacitor Microphones. Frank L. Capps and Co., 20 Addison Place, Valley Stream, N. Y., has announced an 8-page brochure entitled "Technical Information on Condenser Microphones." The publication is aimed at helping engineers and others doing professional sound work to utilize capacitor microphones to their best advantage. It details the basic construction of capacitor microphones, their operational theory and gives in chart form typical characteristics of Capps capacitor microphones, with comparisons to other types. Nine formulas and four charts are included.

Servo Literature. Norden-Ketay Corp., 99 Park Ave., New York 16, N. Y., has published a bulletin describing its products and services, and another listing characteristics and specifications of over 130 servomechanism components now in production. Both are available on request.

Crystal Calibrators. Measurements Corp., Boonton, N. J. A 4-page folder illustrates and describes models 111 and 111-B crystal calibrators. Specifications and circuit diagram are shown. One page is devoted to the company's "famous firsts" in laboratory standards.

Audio Amplifier. Westinghouse Electric Corp., P. O. Box 2099, Pittsburgh 30, Pa. Bulletin 85-950 describes the type FG 5-or-10-kw variable frequency audio ampli-

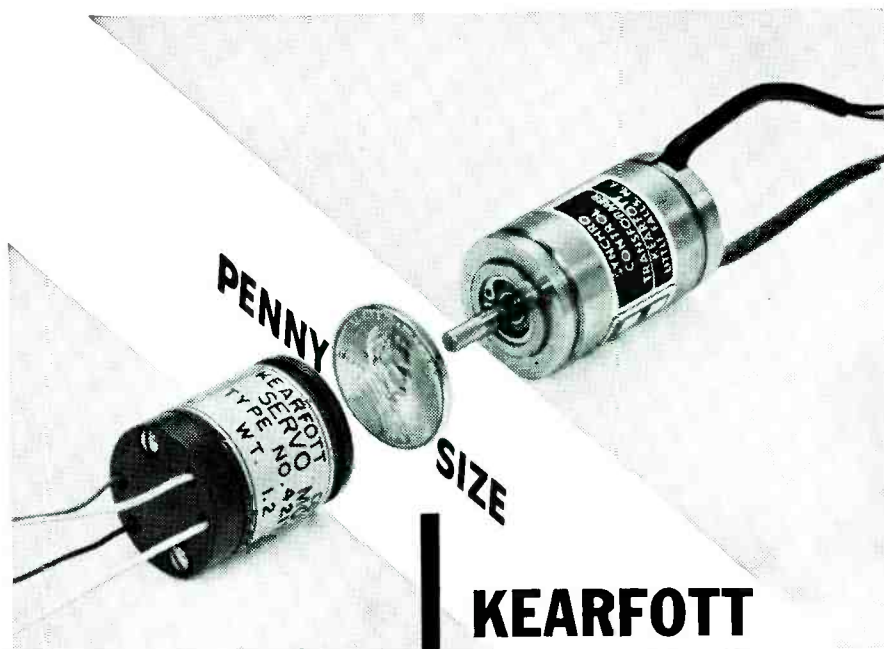

KEARFOTT "Penny Size" Servo Motors and Synchros

Lighter, more compact Servo Systems

Kearfott developed components to fill the need today, for tomorrow's Servo Systems.

SERVO MOTORS

- 3/4" Diameter x 1.5" long
.33 in. oz. Stall Torque
6500 RPM, 26 Volt 400 Cycle
- 3/4" Diameter x .937" long
.10 in. oz. Stall Torque
6500 RPM, 26 Volt 400 Cycle

SYNCHROS

- 3/4" Diameter x 1.240" long
Transmitter, Control Transformers,
Resolvers and Differentials
10 minute maximum error,
26 volt, 400 cycle excitation

Straight thru bore and potted stator construction provide environmental resistance and high order of performance to these Motors and Synchros. Technical data sheets sent on request.

KEARFOTT COMPONENTS INCLUDE:

Gyros, Servo Motors, Synchros, Servo and Magnetic Amplifiers, Tachometer Generators, Hermetic Rotary Seals, Aircraft Navigational Systems, and other high accuracy mechanical, electrical and electronic components.

ENGINEERS:

Many opportunities in the above fields are open—please write for details today.

A SUBSIDIARY OF GENERAL PRECISION EQUIPMENT CORPORATION

KEARFOTT COMPANY, INC., LITTLE FALLS, N. J.

Sales and Engineering Offices: 1378 Main Avenue, Clifton, N. J.
Midwest Office: 188 W. Randolph Street, Chicago, Ill. South Central Office: 6115 Denton Drive, Dallas, Texas
West Coast Office: 253 N. Vinado Avenue, Pasadena, Calif.

safety protection by A. W. Haydon!

"icing conditions heavy —
de-icers working fine —
bandits on screen . . ."



Lockheed's F-94C Starfire, USAF All-weather Interceptor, can get "upstairs" in a hurry, even in severe icing conditions that could paralyze its operation in seconds. Efficient wing de-icers with positive circuit transfer make it possible for the "Starfire" to reach the enemy — through ice and storm — whenever and wherever he may attack — and to knock him out of the air.

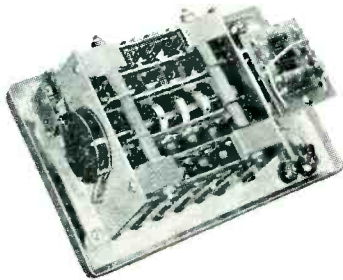

A. W. HAYDON COMPANY

*7800 series repeat cycle timer was
custom designed for Lockheed's
wing de-icing system*

Designed to control the power for 10 de-icing circuits, carrying 3 phase 400 cycle current to the heaters in 10 wing sections, providing accurate circuit transfer from one section to the next in 10 second intervals. Each 10 second load pulse is held within $\pm .25$ second tolerance, with an A. W. Haydon Chronometrically Governed D. C. Timing Motor, over a voltage range of 22 to 28 volts DC and a temperature range of -65°F to $+160^{\circ}\text{F}$.

The load switches have a contact rating of 35 amps at 220 volts 400 cycle 3 phase A.C.

Life rating — 10,000 cycles.

Hermetically sealed, special housing — Fail-Safe Switch.

(General Catalogs Sent on Request)
When timing poses a problem consult . . .



The
A.W. HAYDON Company

235 NORTH ELM STREET, WATERBURY 20, CONNECTICUT

Design and Manufacture of Electro-Mechanical Timing Devices

fier. Applications of the amplifier are suggested. The type FG can take a signal from any conventional 30 to 10,000-cps source and amplify it tremendously without distortion. Design and construction features of the equipment are discussed, and operation is described. Complete electrical characteristics are included.

Molded Terminal Boards. General Products Corp., Union Springs, N. Y. A new 15 page, illustrated catalog, T-55, describes and shows details on a complete line of Navy type and new miniature molded terminal boards. Molded-in stud advantages, molding compound characteristics and electrical operating values are fully explained.

Sync Switching Unit. Allen B. DuMont Laboratories, Inc., Clifton, N. J. Bulletin TR-844 deals with the type 5240-C sync switching unit that provides means for selecting signals from either of two sync generators for routing to studio terminal equipment. Illustrations, chief features and specifications are shown.

Eyelets. United Shoe Machinery Corp., 140 Federal St. Boston, Mass. A new folder, SE-15, illustrates more than 60 different standardized eyelets. Included are pictures of eyelets used in such electronic products as tv tuners, switch and chassis components and terminal strips. In addition, the folder also lists the maximum thickness of noncompressible material in which the eyelet can be set to give normal roll.

Microwave System. Radio Corp. of America, Camden, N. J., has announced a comprehensive guidebook to the nature and applications of the first microwave radio system designed for use in the unused frequency band of the microwave spectrum, 2450 to 2700 mc. The booklet describes the MM-26 microwave system which makes available 250 mc of uncrowded channel space, provides up to 30 voice channels, and permits establishment of new microwave stations in geographic areas already closed or crowded. In addition to

technical and application data the booklet illustrates how up to 9 parallel duplex systems can be used in this frequency range in a given locality to meet requirements of utilities, pipeline operations, railroads, turnpikes and commercial carriers.

Power Supplies. Lambda Electronics Corp., 103-02 Northern Blvd., Corona 68, N. Y., has published a 24 page booklet on power supplies for laboratory and industry. Special features and specifications are given for over 15 regulated (portable) and unregulated (rack and bench) power supplies. Ordering information is included.

Test Equipment. Lavoie Laboratories, Inc., Morganville, N. J. Electronic test equipment is described and illustrated in a 4-page folder. This literature covers communications sets, radar, air navigation systems and precision components.

Aircraft Instruments and Controls. Kollsman Instrument Corp., 80-08 45th Ave., Elmhurst, N. Y. A 6-page foldout bulletin gives a brief history of the company and lists its products. Products are listed under the following headings: (1) aircraft instruments; (2) precision controls; (3) precision computers and components; (4) optics; (5) radio communications and navigation equipment; (6) motors and synchros; and (7) instruments for simulated flight trainers.

Transformers. Kenyon Transformer Co., Inc., 840 Barry St., New York 59, N. Y. Hermetically sealed units and portable broadcast transformers are described and illustrated in a 4-page bulletin. Export data and technical specifications are included.

Precision Electronic Measuring Equipment. New London Instrument Co., P. O. Box 189, New London, Conn. A recent 8-page folder illustrates and describes a line of precision electronic measuring equipment. Included are descriptions of the model 100C f-m signal generator; model 130A uhf tv

**FLEXIBLE
but RUGGED**

Technicraft Flexible Waveguides offer more electrical and mechanical advantages in combination than other flexible waveguides on the market. For instance the Technicraft Type "V" is the only flexible waveguide that will bend, twist, extend or compress, and shear simultaneously. The Technicraft Type "S" is not only RF leakage-free, but it is the **ONLY SEAMLESS** flexible waveguide made. Available in Beryllium Copper. Technicraft's Type "L" has a very low VSWR, attenuation and is also capable of carrying higher power than any other flexible waveguide of the same cross sectional size.

For complete details and characteristics ask for our specification sheets.

TECHNICRAFT LABORATORIES
INCORPORATED

1550 THOMASTON RD. • THOMASTON, CONNECTICUT

Designers and Manufacturers of Rigid and Flexible Waveguide Assemblies, Microwave Test Plumbing and Components, Waveguide Systems.

DIGITAL

PRESET INTERVAL GENERATOR

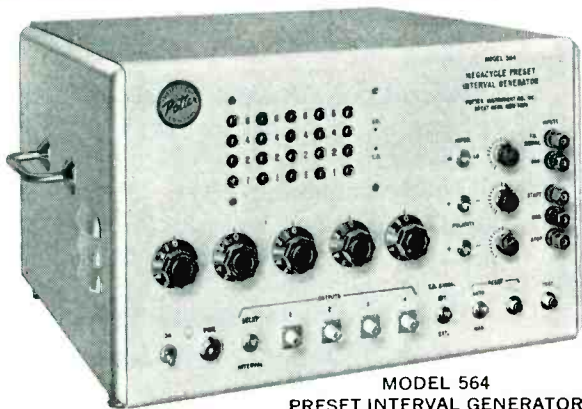

MODEL 564
PRESET INTERVAL GENERATOR

EXACT DIGITAL
SELECTION

NO CALIBRATION
REQUIRED

SINGLE RANGE,
100,000 STEPS

The "PIG" will —

● GENERATE DELAYS

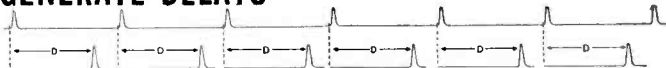

● GENERATE PULSE BURSTS



● GENERATE VOLTAGE GATES



● MEASURE TIME INTERVALS



- Internal 1 megacycle crystal oscillator time base
- Accepts any external time base up to 1 megacycle
- Fast reset—recycles in 50 microseconds
- Independent and simultaneous outputs
- Preset counter up to 1 megacycle

For complete information, write or call

Potter

POTTER INSTRUMENT COMPANY, INC.

115 Cutter Mill Road, Great Neck, N. Y.

sweep frequency generator; model 131 uhf sweep test rack; model 200 uhf grid dip oscillator; model 175 vhf-uhf noise source; model 155 signal generator; model 160 broadband amplifier; model 167 uhf balun; model 701 frequency standard; model 252 modulation monitor; model 183 square wave generator; and model 901 transconductance analyzer and circuit simulator. Specifications for each are given.

Germanium Diode Bulletin. International Rectifier Corp., 1521 E. Grand Ave., El Segundo, Calif. Bulletin GD-2 lists ratings and specification on germanium diodes. Describing the company's complete germanium point contact diode line, it offers specifications on the high temperature diodes, computer diodes, uhf mixer diodes, meter protection diodes and general-purpose diodes. A complete interchangeability and replacement chart is also included in this literature.

Military Transformers. Microtran Co., 84-11 Rockaway Beach Blvd., Rockaway Beach 93, N. Y., has published a 12-page catalog listing detailed information on typical transformers designed and available for specific military ruggedized application. Complete photographs, electrical data and mechanical dimensions are given to aid the design engineer in properly specifying his requirements. The catalog is available upon letterhead request.

Precision Potentiometer. Helipot Corp., 916 Meridian Ave., So. Pasadena, Calif. The 1½-in. long × ⅜-in. diameter, 1-oz series AJ precision potentiometer is the subject of data sheet 54-06. A 10-turn precision potentiometer for servo or bushing mounting, the series AJ combines high resolution and close linearity characteristics with minimal weight and size. The illustrated data sheet lists specifications, construction, coil characteristics and available modifications.

Oscillographic Recorder. Technology Instrument Corp., 531 Main

St., Acton, Mass., has available literature on its new oscillographic recorder which has a response up to 900 cycles. The 4-page brochure tells how oscillograms are traced on blackened 35-mm acetate film by styli directly actuated by small excursions of galvanometer type movements. The magnified image of the film is directly projected on a built-in screen for studying or monitoring the progress of the recording. In the unit described eight recording channels are provided plus a ninth for use as timing or reference marking.

Induction-Heating Equipment. Westinghouse Electric Corp., Box 2099, Pittsburgh 30, Pa. An 8-page bulletin describes a complete line of induction-heating equipment. The h-f motor-generator sets and associated apparatus discussed are specifically designed for induction heating operations such as hardening, annealing, brazing, forging and heat-treating of metals. The motor-generator sets described have standard output frequencies of 960, 3,000, and 9,600 cps, with power ratings of 30 to 1,500 kw and higher.

Silicon Diode Catalog. Microwave Associates, Inc., 22 Cummington St., Boston, Mass., has published a new 4-page 2-color catalog 55S which describes over 54 types of silicon diodes. Sections include Low Noise Mixer Diodes, Video Detectors, Diodes for Balanced Mixer Use, Modulator Diodes and complete tabular specifications.

Electronic Timers. G. C. Wilson & Co., 1950 Eighth Ave., Huntington, W. Va., has available a 5-page brochure with current information describing its standard line of electronic timers. Included in the line described are delay, repeat cycle and interval timers, all of which are available from stock.

Panel Meters. DeJUR-Amsco Corp., 45-01 Northern Blvd., Long Island City 1, N. Y. A 2-page bulletin illustrates and describes the series 100 1-in. round and square watertight panel meters. It gives

Estimated Savings:

2,000 man-hours per year

AIRCRAFT FLEET SERVICE TIME
AND REPLACEMENT COSTS
GREATLY REDUCED

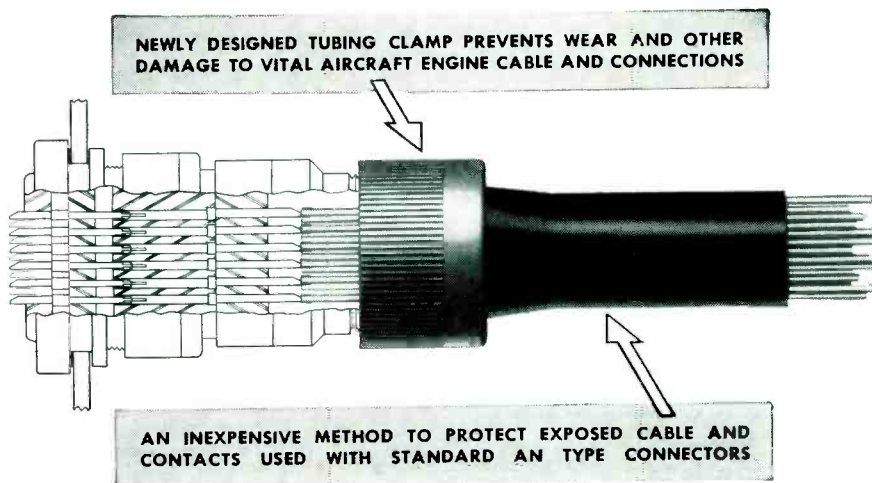

Here's Savings! . . . a leading commercial airline estimates fleet service time (76 planes) reduced by 2,000 man-hours per year, in addition to replacement costs, by the application of the HHB TUBING CLAMP for use with AN Type Connectors.

Whether it's aircraft, marine, automotive, communications, or a general type of AN connector application, the results in savings can be the same as the above example.

The HHB Tubing Clamp is simple in design, providing positive protection. No hand tools required—field application practical. Machined from aluminum to be rustproof and light in weight—gray anodize finish. All AN Connector sizes from 12 to 48.

A waterproof joint is provided between the connector and protective plastic tubing when used in connection with a gasketed adapter.

Request catalog data—Form No. AN-15-16-54.



Skilled in

- RESEARCH • DESIGN
- ENGINEERING • MANUFACTURING

of Electronic Components and Connectors
for Communications and Industry

H. H. BUGGIE, Inc.

726 STANTON STREET

TOLEDO 4, OHIO

Sales-Engineers in All Principal Cities

DUMONT SPECIAL ELECTRONIC APPLICATION CAPACITORS

PIONEERED BY DUMONT . . . FIRST CHOICE OF ENGINEERS

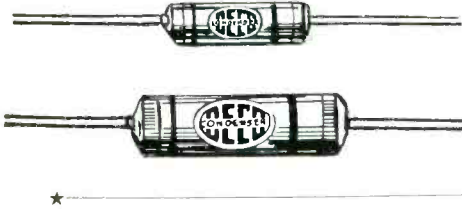

(DU PONT)
MYLAR
DIELECTRIC
CAPACITORS

PLASTIC FILM 150°C
IN CERAMIC CASE . . .

FOR PRINTED CIRCUIT APPLICATION

TYPE-PL60

BAKELITE TUBE—PLASTIC FILM

150°C

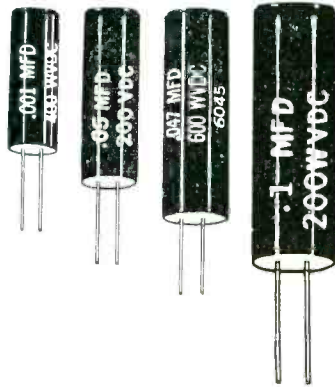

PLASTIC FILM CAPACITORS

IDEAL FOR:

- ★ Computers
- ★ Radiosondes
- ★ Nuclear Instruments
- ★ High Frequency Amplifiers
- ★ Time Devices

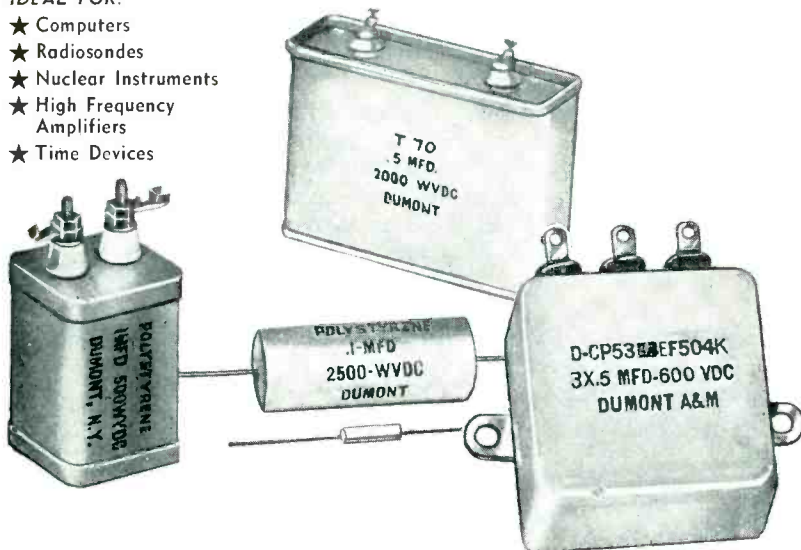

1. POLYSTYRENE FILM . . . HIGHLY STABLE—70°C
2. THERMOFILM (MYLAR) 150°C HIGH TEMPERATURE OPERATION
3. UNCASED SECTIONS

WRITE FOR
DESCRIPTIVE
LITERATURE

DUMONT-AIRPLANE & MARINE INSTRUMENTS, Inc.

OFFICE
15 William Street
New York 5, N. Y.

FACTORY
Clearfield
Pennsylvania

general specifications, a table of standard ranges and approximate resistances, outline drawings and ordering information. The meters described meet MIL M-3823 specifications.

Precision Potentiometer. Helipot Corp., 916 Meridian Ave., South Pasadena, Calif. The single-turn, high precision series G potentiometer is the subject of data sheet 54-36. Compact, rugged and long-lived, yet low-priced, the series G units construction, specifications and linear coil characteristics are described in detail in the sheet.

Metallized Ceramic Coating. Frenchtown Porcelain Co., Trenton 9, N. J. Bulletin 155 is a 4-page folder discussing Nicote, a metallized ceramic coating for use with both hard and soft solder. Chief features, applications and handling information are included. The bulletin also contains a page of tabular data showing properties of the company's various ceramics.

Electromechanical Products. Transitron, Inc., 154 Spring St., New York 12, N. Y. A 20-page illustrated booklet describes modern facilities for the design and production of precise electromechanical and electronic products. Production facilities illustrated include precision machining, electronic and mechanical production, silver soldering, model making, and electromechanical and electronic testing and tropicallizing. The text outlines available services for government agencies and industrial organizations, engineers and contractors.

Facilities Brochure. Varian Associates, 611 Hansen Way, Palo Alto, Calif. The company's principal products—klystron tubes, nmr spectrometers and laboratory electromagnets, are fully illustrated and described, and related products, such as radar subsystems, microwave components, uhf water loads and stalos are discussed in the new brochure. Facilities of the company's two plants are set forth, together with an account of advanced manufacturing tech-

niques and processes. Unusual and interesting aspects of the firm's operations are presented with explanatory photographs. Current product applications, for both military and commercial uses, are discussed.

Radar Antennas, Mounts, Components. General Electric Co., Schenectady 5, N. Y., announces a new bulletin showing the company's radar antennas, mounts, components and accessories for use with land and ship based radar systems. Designated GEA-6279, the 8-page bulletin includes photographs of complete antennas and mounts, and various accessories and components. Also included is a description of production facilities, testing and inspection techniques and a short history of the company's antenna design and manufacturing experience.

Resistor Brochure. The Daven Co., 191 Central Ave., Newark 4, N. J. The series 850 Davohm metal-film type resistor is the subject of a 6-page brochure now available. Hermetically sealed, with temperature coefficient independent of resistance value, the resistor described is ideal for aircraft and radar use. The covering brochure gives full details of performance in the $\frac{1}{2}$, 1, and 2-w sizes. Write to the company on your letterhead.

Tiny Jack and Plug Combinations. Telex, Inc., Telex Park, St. Paul 1, Minn. Advantages and applications of the company's miniature jack and plug combination are given in a new catalog sheet. One-third the size of previous models, the combination can be installed in computers, dictating machines, tape recorders and miniature radios. The illustrated literature reports that the unit is available with L-shaped plug molded to cord or detachable straight plug. Complete specifications are given.

Metal Detector Bulletin. Allis-Chalmers Mfg. Co., 935 S. 70th St., Milwaukee, Wisc. A description of what the a-c electronic metal detector is and what it does is told in bulletin 15B7217B. Used to in-

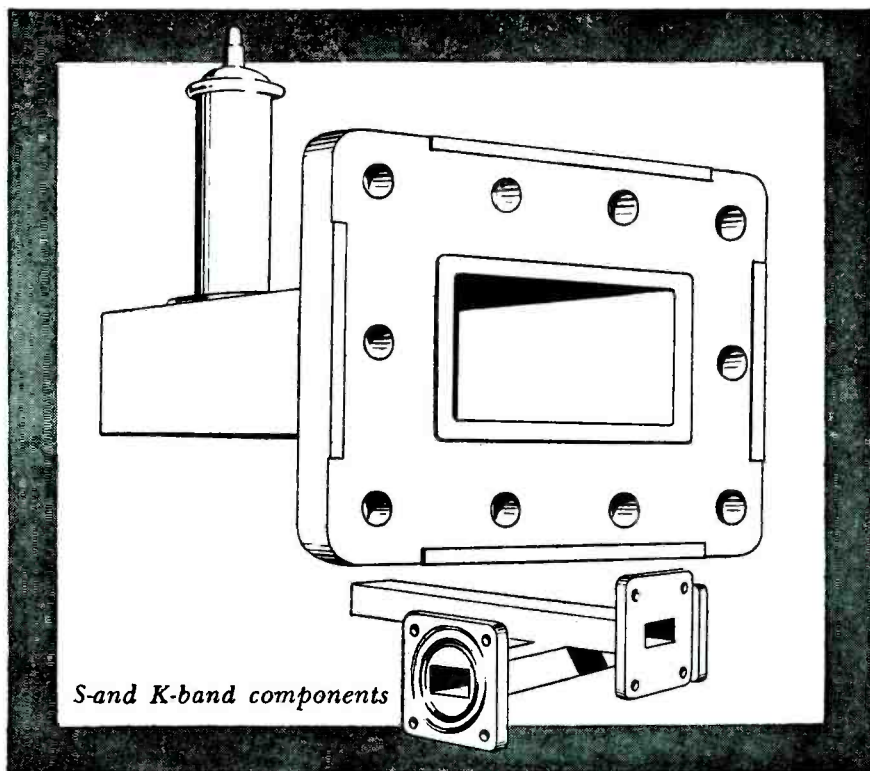

S-band K-band components

how
small
can a
wave
guide
get?

Well, alongside some of the stuff we're working with now, the radar plumbing we used during World War II gets to look like air-conditioning duct. What's more, some of our boys here seem to regard anything below S-band as practically pure D.C. Naturally, we're up to our hips as usual in work on military equipment. However, we do occasionally have some extra creative capacity available, so if you have a problem involving something special in wave guide components (real small ones, too) and like that, maybe we can help. Drop us a line.



L. H. TERPENING COMPANY

DESIGN • RESEARCH • PRODUCTION

Microwave Transmission Lines and Associated Components

16 West 61st St. • New York 23, N. Y. • Circle 6-4760

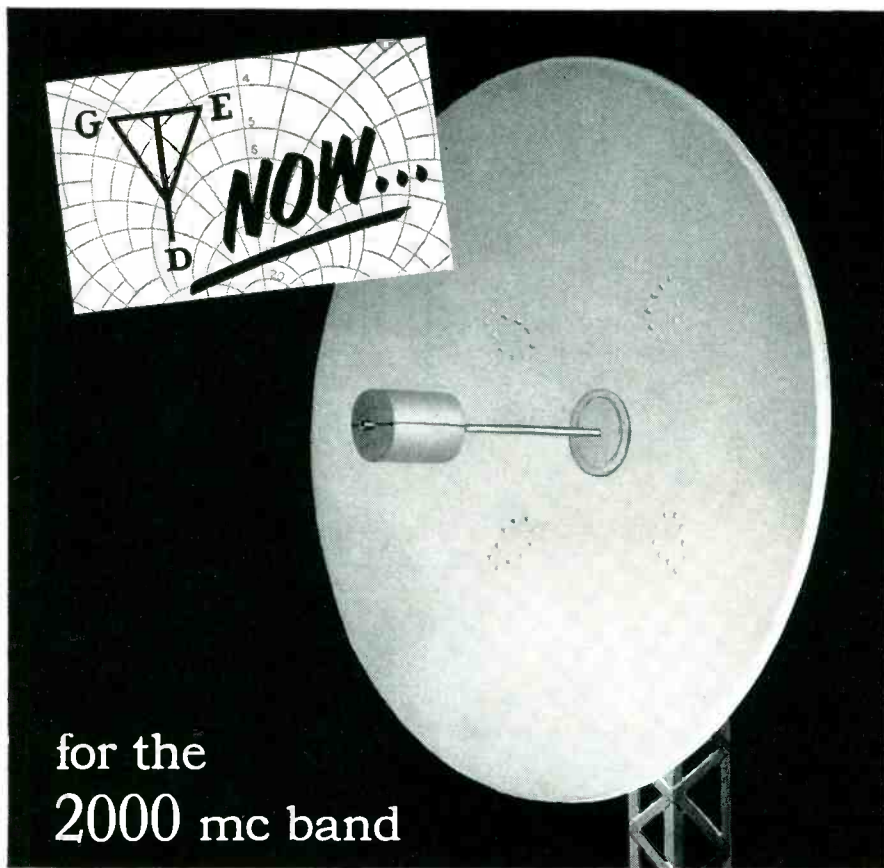

for the
2000 mc band

Model 2K6CF
6-ft. Parabolic Antenna

new **GABRIEL** narrow beam parabolic antenna

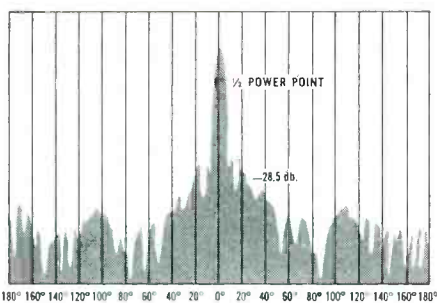

Model 2K6CF Beam Pattern, E. Plane, at 1920 MC

- Low Side and Back Lobes
- Low VSWR
- High Gain
- Pressurized and Weatherized
- Easily Installed

For non-interfering operation in the crowded 2000 mc microwave relay band, Gabriel announces a radically new antenna with highly directive feed. A combined dipole-corner reflector unit, developed by the famous Gabriel Laboratories, remarkably improved primary radiation pattern, and secondary radiation pattern is 3 db better than the various types of previous feeds. Read the Design and Development Report on the facing page.

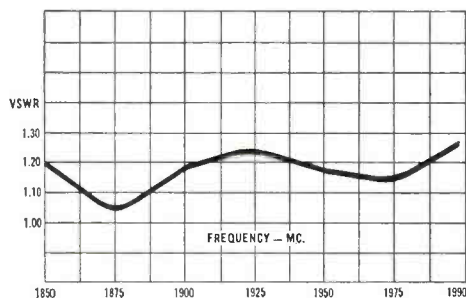

VSWR for Model 2K6CF with radome

For detailed specifications, write for Bulletin GF.



GABRIEL ELECTRONICS DIVISION
THE GABRIEL COMPANY, Endicott Street, Norwood, Mass.

spect plastics, food, confectionery, tobacco, paper, rubber, textiles, medicines, explosives, glass, ceramics, leather, and wood, the metal detector helps to maintain product purity and prevent damage to equipment. The bulletin also tells how the detector is built and how it works to provide positive electronic inspection. The detector is easy to install and adapts readily to production line use, the bulletin points out.

Reflex Klystron. Varian Associates, Palo Alto 2, Calif. A 1-page bulletin announces the rugged VA-203 reflex klystron for airborne radar and beacon local oscillator service. Chief features are outlined and guaranteed specifications are listed.

Coil Winding Machines. Geo. Stevens Mfg. Co., Inc., Pulaski Rd. at Peterson, Chicago 30, Ill. Catalog No. 55 is a 54-page booklet illustrating and completely describing machines for rapidly winding practically every type of coil including armature, transformer, bobbin, repeater, solenoid, resistor, lattice-wound universal, space-wound, variable pitch, toroidal, deflection yoke and field coils. Among the accessories pictured and described are 12 tensions, 3 counters, model 105 wire scraper, a variety of gears and cams, a pi attachment, wax pot, wire takeoff guide and 6 wire guides. A full page of winding formulas is also given.

Analog Instruments. George A. Philbrick Researches, Inc., 230 Congress St., Boston 10, Mass., has available a single sheet showing a representative selection of analog instruments. The bulletin offers a quick survey of products and computing techniques. New items include a plug-in d-c stabilizing amplifier, the electronic graph-paper display, and modernized versions of the earlier building-block components.

Sound Equipment. Altec Lansing Corp., 9356 Santa Monica Blvd., Beverly Hills, Calif., has issued a 36-page catalog containing complete technical data on all its engi-

Developers
of the
Corporal
Guided
Missile.

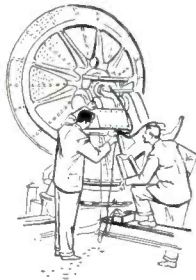

JET PROPULSION LABORATORY

CALIFORNIA
INSTITUTE OF
TECHNOLOGY

*Active in all phases
of electronics and physics
related to guided missiles
and jet propulsion.*

The nation's foremost guided-missile research and development facility, established in 1940, offers exceptional opportunity for engineers and research scientists in the fields of guidance and control, information theory, computers, electro-mechanical devices, instrumentation, and related aspects of electronic research. The Laboratory offers an ideal blend of academic and industrial environments and maintains a high level of technical competence. Attractive salaries are offered.

*A brochure describing
opportunities and activities
at the Laboratory will be
sent upon request.*

JET PROPULSION LABORATORY



California Institute of Technology
4800 OAK GROVE DR.,
PASADENA 3, CALIFORNIA

neering sound products. It covers a-m/f-m tuners, transcription reproduction arms, 12 different broadcast, p-a and scientific microphones, more than 20 amplifiers and preamplifiers, power supplies, control consoles, 19 different speakers, horns, cabinets, and matching transformers. The catalog items are of sufficient scope to provide sound systems of any size.

Electronic Assembly Machine. Mechanical Division of General Mills, Inc., 1620 Central Ave., Minneapolis, Minn., has published a 4-page folder on the Autofab, a complete automatic assembly machine for electronic circuits. The machine described is readily adaptable to the assembly of any unit that uses standard electronic components on a printed circuit card. The bulletin is fully illustrated and gives chief features of the unit that completes an operation at the rate of 20 circuits every minute.

Ceramics Buyers Guide. Centralab, a division of Globe-Union Inc., 900 E. Keefe Ave., Milwaukee 1, Wisc. A 2-color, 16-page guide is designed for the use of purchasers and designers of ceramic parts. Advantages of engineered ceramics, other materials and the types of ceramic for specific uses are given. A tour through the CRL plant showing how ceramics are manufactured is a special feature of the Guide.

Tubing Guide. Superior Tube Co., Germantown Pike, Norristown, Pa. An 8-page catalog contains pertinent information needed for the selection and application of 46 principal analyses of tubing. Bulletin 40 groups the analyses into five classifications: (1) stainless steel, (2) nickel and nickel alloys, (3) carbon and alloy steels, (4) beryllium copper and (5) titanium. A short summary of the principal properties of each analysis and its normal production limits is given. The properties of six glass sealing alloys, used primarily for glass-to-metal seals in the electronic and electrical manufacturing industries, also are given.

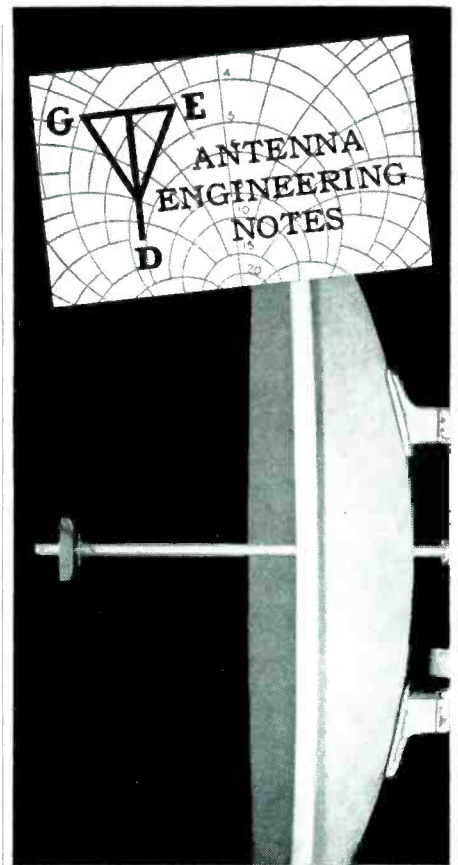

PROBLEM:

DEVELOP A HIGH DIRECTIVE FEED FOR CROWDED 2000 MC BAND. *The feed must (1) have very low side and back lobe levels, (2) have low VSWR, (3) have no beam "squint" or deviation over the band, (4) be small for least aperture blocking, (5) be weatherized and pressurized.*

SOLUTION:

A coax-fed dipole feed offers minimum size and weight over slots, horns, conicals, etc. But to meet critical requirements of high directivity, with low side and back lobes, circular reflecting discs were rejected in favor of a corner reflector as a directive element.

Pattern tests verified this new design idea, with near-in side lobes better than 25 db — a 3 db improvement over previous circular disc types. (See radiation pattern on facing page.)

To eliminate beam deviation over the band, the dipole is symmetrically fed, using a coaxial slot-type feed. Tests evidenced no discernible "squint".

The feed was matched over the band with VSWR of less than 1.3 for production units. For reliability under weather extremes, a dielectric sandwich-type radome encloses the slot and dipole sections of the feed. The feed is pressure-sealed directly behind the slot opening and the entire transmission line and most of the feed is pressurized.

This is a typical Gabriel Solution to meet commercial requirements. All of America's leading manufacturers and the Armed Services have brought antenna problems to The Gabriel Laboratories.

Submit your inquiries — write or phone: NEedham 3-0005

**THE GABRIEL
LABORATORIES**



THE GABRIEL COMPANY
135 Crescent Street, Needham Heights, Mass.

Plants and People

Edited by WILLIAM G. ARNOLD

Electronic manufacturers expand plant facilities for civilian and military equipment. Companies plan merger actions and acquire assets of electronic and non-electronic firms. Engineers advance to new positions in the industry.

NBC-TV's Color City In Burbank Starts Operations



REPRESENTING an overall investment of more than \$7,000,000, NBC's new color city in Burbank, Calif. features a studio built specifically for colorcasting. Built and equipped at a cost of \$3,600,000, it is one of the world's largest television studios, with floor space of 140 feet by 90 feet and 42 feet of clearance from floor to ceiling.

The studio takes its place with two existing studios and a service building, all of which were constructed on NBC's 50-acre tract in Burbank in 1952. Other new construction includes a control building, a technical building and a rehearsal studio which can also be used for commercials and orchestral scoring. In addition, the service building, housing set-decoration shops and other facilities, has been extended to double its former size.

The new facilities total 12,600 sq ft, bringing the total color city space to 55,900 sq ft.

The new technical building serves as the nerve center for all NBC facilities at Burbank. On its

first floor are the audio and video controls necessary to tie the studios into one manageable operation. On the second floor, is a film center with two RCA three-vidicon camera chains, each of which can be patched out to any of the live

studios. The film control room is equipped with a console similar to those used in live studios. Also on the second floor is an announcer's booth designed for newscasts and commercials, and large enough to accommodate two camera chains.

Westinghouse To Build Electronics Plant

WESTINGHOUSE plans the construction of a combined manufacturing plant, engineering and office building for production of military electronic equipment in Baltimore.

Site of the proposed electronics division structure is adjacent to the air arm division plant. It will comprise a total of 350,000 sq ft of floor space with 210,000 sq ft being devoted to manufacturing space and the remaining 140,000 sq ft to engineering and office facilities.

The new installation will provide an expanded and up-to-date development for the continued manufacture of electronic equipment for the Defense Department. Plans

now call for full occupancy and full operation by January 1956. It is hoped that expanded engineering facilities can be occupied prior to that time.

The new building will provide space in the division for approximately 150 additional engineers.

Westinghouse also announced that Trevor Clark has been appointed assistant to the engineering manager of the firm's air arm division.

Clark, prior to his present appointment, was associate director of Southwest Research Institute.

In 1938, he was sent to the Paris, France, laboratories of IT&T.

He returned to the U. S. in 1941

CAPACITORS by General Electric

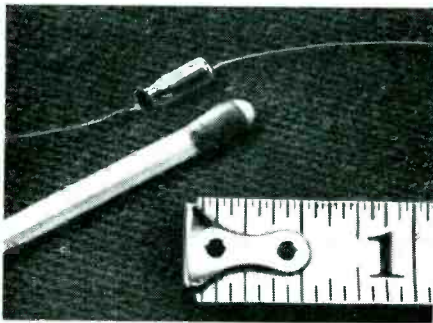

MICRO-MINIATURE

For low voltage d-c miniaturized electronic equipment (hearing aids, walkie-talkies, paging systems). Ideal for transistorized assemblies. **Ratings** 1-8 uf at 4 v. d-c, 1 uf at 8 v. d-c, 0.5 uf at 16 v. d-c. **Tolerance** -0 to +200%. **Temp. range** -20 to +50° C. BULLETIN GEA-6065.

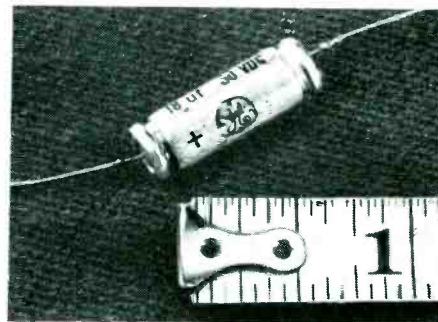

TANTALYTIC*

For electronic equipment requiring small size, low leakage current, long shelf life, wide temperature range. Plain or etched foil, and polar or non-polar types, suitable for a-c or d-c. **Ratings** 0.25-580 uf, 3.75-150 v. **Tolerance** ±20% (plain foil), -15 to +75% (etched). **Temp. range** -55 to +85° C. BULLETIN GEC-808.

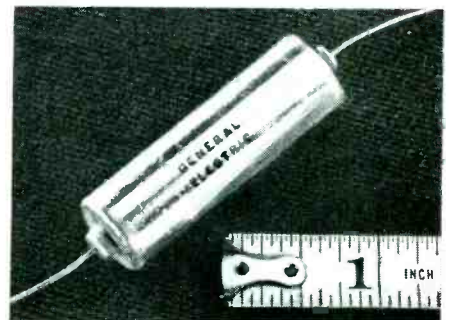

METAL-CLAD TUBULAR

For d-c uses where reliability under severe operating conditions is required (military electronic equipment). **Ratings** 0.001-1 uf at 100, 200, 300, 400 and 600 working v. d-c. (Can be applied to a-c circuits with adequate derating.) **Tolerances** ±5, ±10, or ±20%. **Temp. range** -55 to +125° C. BULLETIN GEC-987.

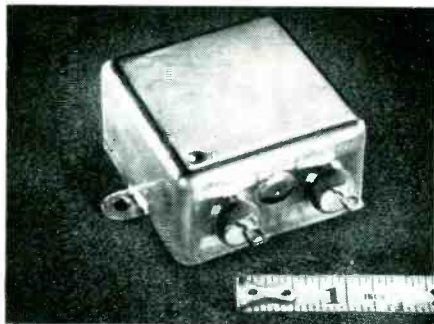

PERMAFIL-IMPREGNATED

Designed to meet requirements of MIL-C-25A, characteristic K specifications, and are suitable for high-temperature operation. **Ratings** 0.05-1 uf at 400 v. d-c. **Tolerance** ±10%. **Temp. range** -55 to +125° C. BULLETIN GEC-811.

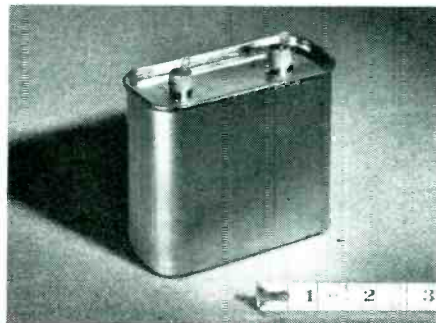

STANDARD COMMERCIAL

For motors, filters, communication equipment, luminous-tube transformers, industrial control. **Ratings** dual rated units (a-c or d-c) rated at 0.01-50 uf, at 236-660 v. a-c, 400-1500 v. d-c. Single rated units also available. **Tolerance** ±10%. **Temp. range** -55 to +85° C. BULLETIN GEC-809.



DRAWN-OVAL

For air conditioning and refrigeration equipment, fluorescent lamp ballasts, business machines, voltage stabilizers. Single, dual or triple-section types. **Ratings** 1-20 uf at 236-660 v. a-c, and 1-15 uf at 600-1500 v. d-c. **Tolerance** ±10%. **Temp. range** -30 to +70° C. BULLETIN GEA-5777.

*Reg. trademark of General Electric Company.



ENERGY STORAGE

For use in high magnetic fields and high intensity arc discharge. **Ratings**: may be built as high as 2000 joules (watt-seconds). **Tolerance** ±10%. BULLETIN GEA-4646.

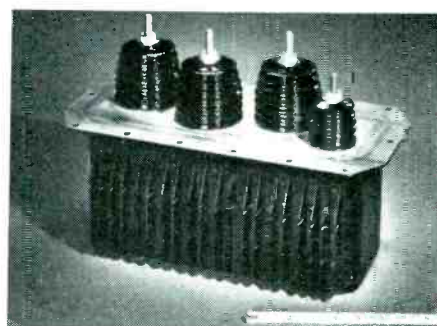

NETWORK

For guided missiles, aircraft, radar equipment. **Ratings**: built to user specifications. **Temp. range** -55 to +125° C, or to user specifications. BULLETIN GEA-4996.

NOTE: All capacitance tolerances are given at +25° C.

Progress Is Our Most Important Product

GENERAL ELECTRIC

SEND COUPON BELOW for complete information about G-E capacitors.

General Electric Co.
Section G442-25
Schenectady 5, N. Y.

Please send me capacitor bulletins checked below.

- | | |
|-----------------------------------|----------------------------------|
| <input type="checkbox"/> GEA-4646 | <input type="checkbox"/> GEC-808 |
| <input type="checkbox"/> GEA-4996 | <input type="checkbox"/> GEC-809 |
| <input type="checkbox"/> GEA-5777 | <input type="checkbox"/> GEC-811 |
| <input type="checkbox"/> GEA-6065 | <input type="checkbox"/> GEC-987 |

Name.....

Position.....

Company.....

Address.....

City..... Zone..... State.....

to **NEW** heights of
ACHIEVEMENT
 IN
CANADA
 WITH
COMPUTING DEVICES OF CANADA LIMITED

A FAST GROWING, ENTERPRISING AND ENTHUSIASTIC COMPANY ENGAGED MAINLY IN SPECIALIZED DEVELOPMENT WORK. TWO MODERNLY EQUIPPED PLANTS & LABORATORIES WITH A THIRD UNDER CONSTRUCTION, ALL LOCATED IN OR NEAR THE ATTRACTIVE CITY OF OTTAWA, CANADA'S CAPITAL.

C.D.C. offers excellent and stimulating career opportunities for qualified Electronic and Instrumentation Engineers with experience in the following fields;

AVIATION ELECTRONICS
AIRBORNE INSTRUMENTATION and flight testing
RADAR
SEMI-CONDUCTORS
DIGITAL COMPUTERS
ANALOG COMPUTERS
GUIDED MISSILES

At C.D.C. you will work in the congenial atmosphere of a cheerful team doing creative work.

OTTAWA is situated in a delightful valley. Good houses and apartments readily available at modest price.

Assistance in removal expense is offered.

Please write for application forms or send a resume of your education and experience to;

PERSONNEL MANAGER,

**Computing Devices
 of Canada Limited**

P. O. Box 508, Ottawa, Canada

Computing **DEVICES**

OF CANADA LIMITED
 311 RICHMOND ROAD
 OTTAWA, CANADA

chanization program in the various plants.



Philco Advances Joseph Gillies

JOSEPH H. GILLIES in addition to his duties as vice-president and general manager of the government and industrial division, has been appointed vice-president in charge of manufacturing for Philco Corp.

In his enlarged responsibility, he will have charge of the coordination and direction of all Philco manufacturing activities, including government production, transistors, microwave equipment, industrial products and consumer goods.

Gillies joined Philco in 1929. He was named works manager in 1939 and became vice-president in charge of radio production in 1942.

He was in charge of all government production during World War II, and directed the manufacture of over 500,000 advanced airborne radar equipments for the Armed Forces. He assumed the responsibilities of vice-president in charge of operations for Philco's newly established government and industrial division in April, 1951, and became vice-president and general manager of the division in September of the same year. Since 1947 he has been a member of the board of directors of Philco.

Magnavox Expands Research Laboratories

THE MAGNAVOX Co. of Fort Wayne, Indiana plans expansion of their new research laboratories in West Los Angeles, Calif.

Ragnar Thorensen has been ap-

pointed director of research for the new laboratories. He directed work on the SWAC digital computer at U.C.L.A. and has many years experience in the electronic field. John Salzer, formerly with M.I.T. and Hughes Aircraft, has been appointed assistant director of research. The labs specialize in digital computers, fire control, missile guidance systems and other electronic projects. Data conversion equipment is being designed and manufactured for industrial and military organizations.

William H. Graham has been appointed general manager of the Magnavox plant in Greenville, Tenn.

Graham comes to Magnavox from Avco where he has been general manager in charge of manufacturing, engineering and purchasing of the Crosley division since 1947.

From 1937 to 1947 he was with National Cash Register as industrial engineer and production superintendent.

IBM To Enlarge Kingston Plant

IBM PLANS the expansion of its Kingston, N. Y. plant, which will allow an increase in personnel from 1,600 to 2,000.

The plant will be increased in size from 320,000 sq ft to 459,000 sq ft. The 139,000 square feet of additional space will be required for the manufacture of a defense project.

The expansion will consist of a two-wing extension of the central structure, now being built, and a warehouse, to be constructed near the east boundary of the property.

Clevite Buys Houston Firm

CLEVITE CORP. has purchased the business of Technical Instrument Co. of Houston, Texas, manufacturers and distributors of precision instruments for geophysical exploration for oil.

The acquisition is designed to complement Clevite's recently developed magnetic recording techniques in the field of seismography.

Technical Instrument will be

VLF

... Very Low Frequencies



• **RADIO INTERFERENCE**
• **and FIELD INTENSITY***
• **measuring equipment**

• **Stoddart NM-10A • 14kc to 250kc**

• **Commercial Equivalent of AN/URM-6B**

VERSATILITY... The NM-10A is designed to meet the most exacting laboratory standards for the precise measurements, analysis and interpretation of VLF radiated and conducted radio-frequency signals and interference. Thoroughly portable, yet rugged, the NM-10A can be supplied with accessories to fulfill every conceivable laboratory and field requirement.

EXCELLENT SENSITIVITY... The NM-10A sensitivity ranges from one microvolt-per-meter to 100 microvolts-per-meter, depending upon whether rod or shielded loop antennas or line probe are used.

ACCURACY... Each equipment is "hand calibrated" in the Stoddart Test Laboratories by competent engineers. This data is presented in simplified chart form.

DRIPPROOF... Sturdy dripproof construction allows long periods of operation in driving rain or snow without adverse effects.

FLEXIBLE POWER REQUIREMENTS... The ac power supply permits operation from either 105 to 125 volts or 210 to 250 volts ac, at any frequency between 50 cps and 1600 cps.

Stoddart RI-FI* Meters cover the frequency range 14kc to 1000mc

HF NM-20B, 150kc to 25mc
Commercial Equivalent of AN/PRM-1A. Self-contained batteries. A.C. supply optional. Includes standard broadcast band, radio range, WWV, and communications frequencies. Has BFO.

VHF NM-30A, 20mc to 400mc
Commercial Equivalent of AN/URM-47. Frequency range includes FM and TV bands.

UHF NM-50A, 375mc to 1000mc
Commercial Equivalent of AN/URM-17. Frequency range includes Citizens band and UHF color TV band.

STODDART AIRCRAFT RADIO Co., inc.
6644-A Santa Monica Blvd., Hollywood 38, California • Hollywood 4-9294

Designed for



Application

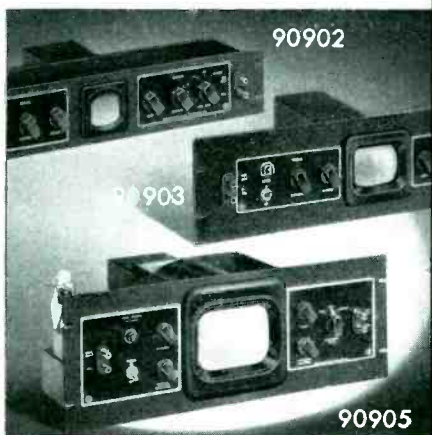

90900 Series Cathode Ray Oscilloscopes

The No. 90902, No. 90903 and No. 90905 Rack Panel Oscilloscopes, for two, three and five inch tubes, respectively, are inexpensive basic units comprising power supply, brilliancy and centering controls, safety features, magnetic shielding, switches, etc. As a transmitter monitor, no additional equipment or accessories are required. The well-known trapezoidal monitoring patterns are secured by feeding modulated carrier voltage from a pickup loop directly to vertical plates of the cathode ray tube and audio modulating voltage to horizontal plates. By the addition of such units as sweeps, pulse generators, amplifiers, servo sweeps, etc., all of which can be conveniently and neatly constructed on companion rack panels, the original basic 'scope unit may be expanded to serve any conceivable industrial or laboratory application.

JAMES MILLEN MFG. CO., INC.

MAIN OFFICE AND FACTORY
MALDEN
MASSACHUSETTS



operated as part of Clevite's Brush Electronics unit. The company will continue to be under the direction of C. W. Boccock III, founder and president.

Edward R. Wagenhals has joined Clevite-Brush Development Co. as vice-president and director of components development.

Wagenhals has been with Booz, Allen & Hamilton, management consultants, in New York since 1950. His previous experience covers technical and management work in the electronics field, beginning with GE in Cleveland in 1927, and including 16 years with RCA. For three years before joining Booz, Allen & Hamilton he was works manager in charge of the operations of Sonotone Corp.



Motorola Communications Promotes Olson

ROY H. OLSON has been appointed director of engineering in the communications & electronics division of Motorola. In this capacity he will direct the technical activity of the division's industrial products department. He is in charge of engineering co-ordination for industrial products on non-military research and development efforts.

Olson has been associated with Motorola since 1951, when he joined the company's Phoenix Research Laboratory as an engineering section leader.

In 1934 he began a 13-year association with Collins Radio Co. Later he operated his own manufacturing and consulting firm before coming

New Miniature LATCH-IN RELAY

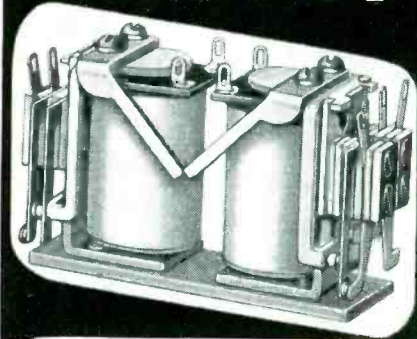

featuring

- Reliability of the popular Magne-craft Class 11 D.C. Relay.
- Latching levers of alloy steel, heat treated and hard chrome plated.
- Electrical or manual reset.
- Wide range of contact ratings.
- Widely varied contact combinations.
- D.C. operation; 6 to 115V.
- Small size—Approximate overall length, 2 $\frac{3}{4}$ "; width, 1"; height, 1 $\frac{1}{2}$ ".

Send for Catalog describing the new LATCH-IN RELAY, also Class 33, Class 11 and Class 22 Relays for A.C. or D.C., open, plug-in, dustproof, hermetically sealed and many special models.

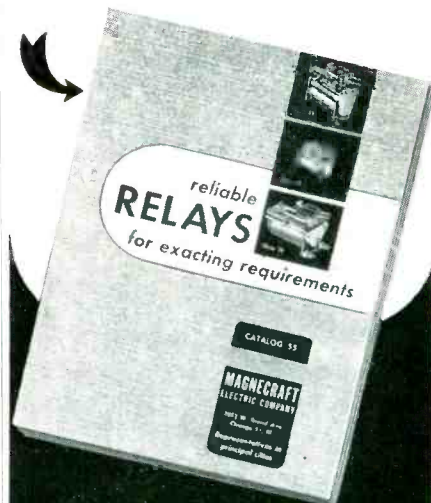

MAGNECRAFT ELECTRIC CO
3350B W. Grand Ave. Chicago 51, Ill

to Motorola.

Since joining Motorola, Olson has been co-ordinator of National Bureau of Standards missile fuse projects and project leader for special military development tasks.

More recently his work has been with subminiature missile electronic fuses.

National Vulcanized Fibre Elevates Two Executives

NATIONAL VULCANIZED FIBRE announced that Gerard A. Albert, formerly staff manager, has been named manager of manufacturing. He has been with the company since 1929.

Henry C. Guhl, formerly manager of process engineering, has been named manager of engineering. Guhl, who joined National in 1954, was associated with Westinghouse as manager of engineering for the Micarta division.

Fairchild Builds In California

FAIRCHILD Camera and Instrument Corp. broke ground for a new 24,000 sq ft plant in Los Angeles, Calif. to house expanded manufacturing of the potentiometer division and offices for other divisions concerned with aerial cameras, graphic arts products and portable power tools.

A second 24,000 square foot unit is planned. Eventual employment will be approximately 300 persons. Completion of the first unit is expected by June this year.

Steel Companies Enter Electronics

ALLIED Structural Steel Companies have acquired a substantial interest in Electronics Protection of Chicago, formerly a division of Continental Communications, and have named V. Lee Cook president of the new company. Cook, who has been president of Continental, manufacturers of precision testing equipment, frequency measuring devices, and communications equipment, will continue to serve as head of that company.

The newly formed company spe-

MEASURE NOISE AND FIELD INTENSITY FROM 150 KC TO 1000 MC— WITH ONE METER!

Quickly • Accurately • Reliably

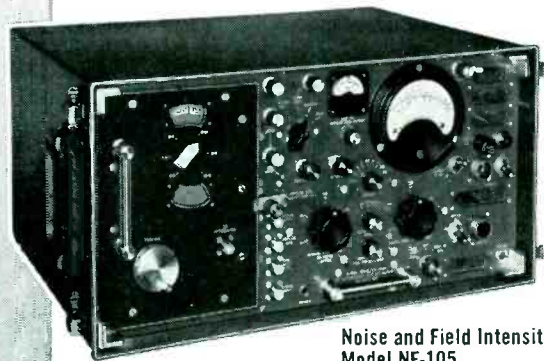

Noise and Field Intensity Meter
Model NF-105
(Commercial Equivalent of AN/URM-7)



TA/NF-105:
150 KC-20MC

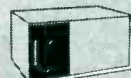

T1/NF-105:
20-200MC



T2/NF-105:
200-400MC

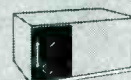

T3/NF-105:
400-1000MC

Empire Devices Noise and Field Intensity Meter Model NF-105 permits measurements of RF interference and field intensity over the entire frequency range from 150 kilocycles to 1000 megacycles. It is merely necessary to select one of four individual plug-in tuning units, depending on the frequency range desired. Tuning units are readily interchangeable . . . can be used with all Empire Devices Noise and Field Intensity Meters Model NF-105 now in the field.

Each of the four separate tuning units employs at least one RF amplifier stage with tuned input. Calibration for noise measurements is easily accomplished by means of the built-in impulse noise calibrator. With this instrument costly repetition of components common to all frequency ranges is eliminated because only the tuners need be changed. The same components . . . indicating circuits, calibrators, RF attenuators, detectors and audio amplifier, and power supplies . . . are used at all times.

Noise and Field Intensity Meter Model NF-105 is accurate and versatile, it may be used for measuring field intensity, RF interference, or as an ultra-sensitive VTVM. A complete line of accessories is available.

Additional information and literature upon request

NEW YORK—Digby 9-1240 • SYRACUSE—SYracuse 2-6253 • PHILADELPHIA—Sherwood 7-9080 • BOSTON—Waltham 5-1955 • WASHINGTON, D. C.—DEcatur 2-8000 • DETROIT—BROADway 3-2900 • CLEVELAND—EVERgreen 2-4114 DAYTON—Fullon 8794 • CHICAGO—Columbus 1-1566 • DENVER—MAIn 3-0343 FORT WORTH—WEBster 8811 • ALBUQUERQUE 5-9632 • LOS ANGELES—REpublic 2-8103 • CANADA: MONTREAL—UNiversity 6-5149 • TORONTO—WAlnut 4-1226 HALIFAX 4-6487 • EXPORT: NEW YORK—MURray Hill 2-3760

EMPIRE DEVICES
PRODUCTS CORPORATION

38-15 BELL BOULEVARD • BAYSIDE 61 • NEW YORK

manufacturers of

FIELD INTENSITY METERS • DISTORTION ANALYZERS • IMPULSE GENERATORS • COAXIAL ATTENUATORS • CRYSTAL MIXERS



cializes in the manufacture of electronic equipment designed to regulate traffic for the safe conduct of emergency vehicles, fire, police, ambulances, on city streets. A number of other items will be turned out during the coming year.

IRC Buys Hycor Companies

THE HYCOR COMPANIES of California and Puerto Rico have been acquired by the International Resistance Company. Management of the Hycor Companies will continue operations independently.

Annual sales of Hycor, manufacturers of magnetic and audio devices and precision resistors, exceed one million dollars.

In addition to Hycor IRC has two other wholly-owned subsidiaries—Ircal Industries of Los Angeles, California and Circuit Instruments of St. Petersburg, Florida.



Admiral Moss Heads Hoffman Laboratories

VICE ADMIRAL JOHN B. MOSS, U.S. Navy (Ret.) has been elected president of Hoffman Laboratories, wholly owned subsidiary of Hoffman Electronics.

Admiral Moss has been corporate-wide consultant for Bell Aircraft Corp. since his retirement from the Navy in 1953. He operated between Bell's Niagara frontier division in Buffalo, the Texas Helicopter division in Fort Worth and Bell's Washington office covering the company's activities in the guided missile, electronic, helicop-

aircraft servo
computers
mechanical filters
navigation equipment
guided missiles
d. c. amplifiers
laboratory instruments
mechanical gating switches

applications limited only
by the imagination

MINIATURIZED

NEW JAMES DPDT CHOPPER

INCREASED RELIABILITY
ADDED LIFE



Models are available with these features:

- Frequency—20 cps through 420 cps.
- Contact Rating—Micro volts to 100 volts including dual circuit design for modulator/demodulator applications.
- Meets mil specs.
- Sealed or unsealed for field adjustment.
- Temperature: -55° to $+85^{\circ}\text{C}$.
- Electrical connections—Available with octal and miniature 9 pin header, with or without external coil connection.
- Moderate cost.

JAMES 
VIBRAPOWR COMPANY
4036 N. Rockwell St. • Chicago 18, Ill.

Write for engineering
specifications and catalog.

YOU CAN PROFIT

with the **BEAD CHAIN**
ECONOMICAL
MULTI-SWAGE
METHOD



this
FREE
catalog
can help
you to...

LOWER PRODUCTION COSTS on Tiny Metal Tubular Parts

Bead Chain's exclusive multi-swage method automatically swages almost any type of tiny metal tubular part from flat stock into precision forms with positive, tight seams. High-volume production can be delivered speedily and at far less cost than with conventional methods of manufacture! Parts can be beaded, grooved, shouldered and made of almost any metal. Diameters up to 1/4", lengths to 1 1/2".



WRITE
TODAY!

**THE BEAD CHAIN
MANUFACTURING CO.**

88 Mountain Grove St., Bridgeport, Conn.

ELECTRONIC ENGINEERS • PHYSICISTS • MATHEMATICIANS

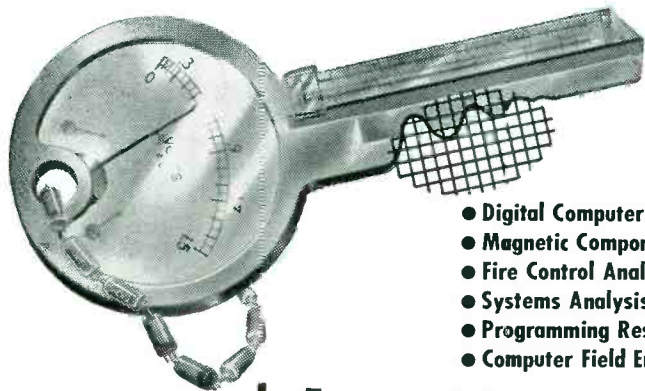

- Openings at all levels of experience.
- Training in digital techniques provided.
- Salaries commensurate with experience.
- Interview travel at our expense.
- Moving expenses paid for household goods.
- Liberal employee benefits.

- Digital Computer Development
- Magnetic Components and Circuits
- Fire Control Analysis
- Systems Analysis
- Programming Research
- Computer Field Engineering

The country's foremost computer development organization has permanent positions open in the above fields for qualified professional personnel. Opportunities for personal advancement and professional growth are exceptional in today's most rapidly expanding technological field.

HERE IS THE KEY TO YOUR FUTURE
... share in the satisfaction of contributing to the advancement of this important art.

Remington Rand

ENGINEERING RESEARCH ASSOCIATES DIVISION

1902 West Minnehaha • St. Paul W4, Minnesota

XCELITE Hand Tools
PREFERRED BY THE EXPERTS

IT'S A TREAT TO USE THE BEST!

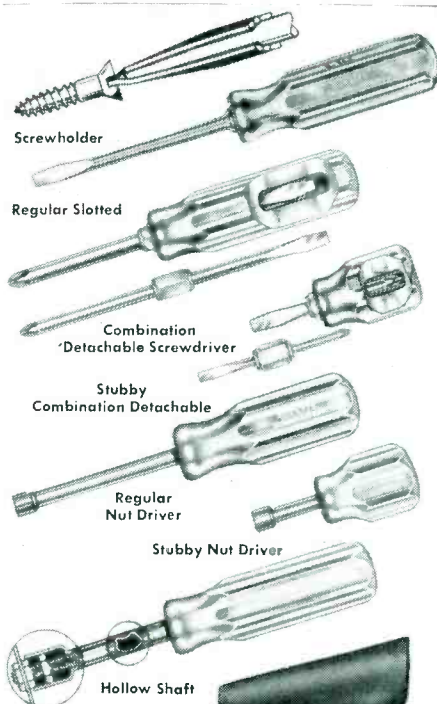

Screwholder

Regular Slotted

Combination
Detachable Screwdriver

Stubby
Combination Detachable

Regular
Nut Driver

Stubby Nut Driver

Hollow Shaft

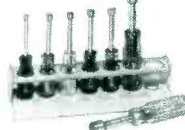

No. 137 Bench
Nut Driver Set



No. 99 Roll Kit Set
13 combination tools

And Now!
**XCELITE
PLIERS**
available
**CHROME
PLATED!**

At slight extra cost, you can get this complete line of electronic pliers in gleaming, rust-resistant chrome finish. Ask your jobber!



No. 51C
long nose
side cutter



No. 66C
6-in.
diagonal

JOBBERS! See these and other popular XCELITE tools at Booth 679, Electronic Parts Show, May 16-19, Conrad Hilton Hotel, Chicago!

XCELITE, INCORPORATED
(formerly Park Metalware Co.)

Dept. C
Orchard Park, N. Y.

**For Originality
LOOK TO XCELITE**

MANUFACTURERS REPRESENTATIVES!

SELL YOUR ELECTRONIC PRODUCTS & SERVICES

THROUGH OUR NEW SECTION . . .

"MANUFACTURERS REPRESENTATIVES"

This new section will start in the forthcoming June BUYERS' GUIDE issue and appear thereafter in every monthly issue of ELECTRONICS.

This section will be headed: "MANUFACTURERS REPRESENTATIVES" and will consist of advertisements of the leading Manufacturers Representatives throughout the country.

Every man of importance in the electronic industry is a subscriber to ELECTRONICS and will receive a copy of the BUYERS' GUIDE. Since its inception fourteen years ago, the "GUIDE" has become the accepted reference book of the electronic industry. An advertisement in the "MANUFACTURERS REPRESENTATIVES" section presents your product story to key people who most naturally will be interested in your products and services as a source of supply or as a sales outlet for their products.

If you have not already reserved your advertising space, there is still time. There's a choice of space units to fit every advertising budget.

Full information and rates are available from your ELECTRONICS representative, or write:

ELECTRONICS

330 West 42nd Street, New York 36, N. Y.

ter and convertiplane fields.

Admiral Moss' most recent military assignment was assistant chief of the Navy's Bureau of Aeronautics, a position he held from March, 1951 until his retirement August 31, 1953. James T. McAllister has been appointed to the post of quality control manager of Hoffman Radio division. For the past three years, he has been national service manager for the firm.

In his new assignment, McAllister will report directly to the president and will have complete responsibility and authority for quality control on the Hoffman line of television, radio and high fidelity record players.

Helipot Appoints Development Chief

JAMES F. GORDON has been appointed chief development engineer of Helipot corp. in South Pasadena, Calif.

He was formerly chief engineer of the Berkeley division of Beckman Instruments and prior to that, principal research engineer of Bendix Radio.

Du Mont Forms Systems Group

DU MONT Labs has established a systems engineering group to assist industry by the application of electronic techniques to automatic production and quality control methods.

The new Du Mont activity makes available to industry and other interested users information and experience in the solution of problems of measurement and control in many diverse fields.

The systems engineering group is equipped to investigate specific problems in manufacturing processes and to make recommendations for their solution either by designing new automatic electronically controlled equipment or by integrating electronic control systems into existing installations.

The field of applications being covered includes all phases of manufacture and research from raw materials to finished products,

NEY'S SMALL PARTS PLAY A BIG PART IN PRECISION INSTRUMENTS

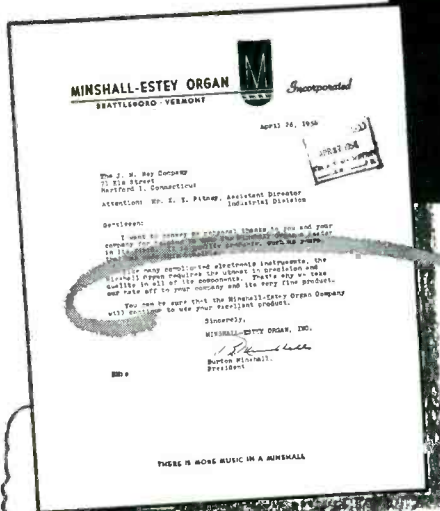

"Like many complicated electronic instruments, the Minshall Organ requires the utmost in precision and quality in all of its components. That's why we take our hats off to your company and its very fine product."

With ideal physical and electrical properties, resistance to tarnish and most corrosive atmospheres, Ney Precious Metals, fabricated into slip rings, brushes, wipers, and contacts, have again demonstrated their superiority for use in precision electrical and electronic apparatus. Improve the accuracy and prolong the life of your instrument by using Ney Precious Metal Alloys. Write today to...Engineering Department.

THE J. M. NEY COMPANY

Specialists in Precious Metal Metallurgy Since 1812

179 ELM STREET, HARTFORD 1, CONNECTICUT

13NY549

SPEED UP

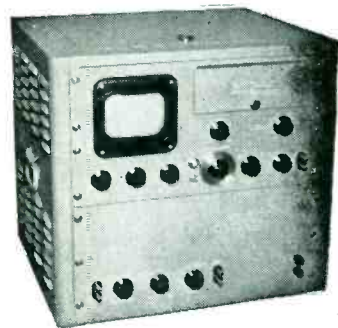

AUDIO WAVE FORM ANALYSIS

PANORAMIC SONIC ANALYZER LP-1

Many engineers find that Panoramic's LP-1 expedites their entire measurements program. LP-1 analyzes sound vibrations and electrical waveforms quickly, conveniently, accurately. Designed to eliminate the tedious problems commonly associated with audio waveforms analysis, the Panoramic technique provides valuable visual information in seconds.

- visualizes frequency and amplitude of waveform components between 40 and 20,000 cps; magnifies small portions of spectrum for detailed analysis; displays easily photographed; scans spectrum in 1-second; analyzes changing and static phenomena.

It will pay you to investigate the many unique advantages of LP-1.

• SPECIAL APPLICATIONS

- Investigations of closely spaced sound and vibration frequencies. Harmonic analysis of waveforms having low frequency fundamentals. Spectrum analysis requiring constant band width.

- Panoramic's LP-1 offers scores of unique advantages; it will pay you to check their application to your problems; write today for complete specifications.

WRITE TODAY for

Complete Specifications
Made by the
makers of
Panadaptor,
Analyzer,
Panoramic
Sonic Analyzer
and Panoramic
Ultrasonic
Analyzer



10 South Second Ave., Mount Vernon, N. Y.
Phone: MOUNT Vernon 4-3970

unique in design — rugged in construction

GREEN PANTOGRAPH ENGRAVERS

THE NEW
HEAVY-DUTY MODEL D-2



THE FAMOUS
MODEL 106

The three-dimensional bench Model 106 cuts costs — engraves, routs, models and profiles, giving you expert results even by unskilled workers.

The Model D-2 heavy-duty two dimensional Pantograph is a precision machine with a multitude of new features. Open on three sides, it permits complete freedom for engraving, milling, profiling large panels (up to 30" in diameter) or bulky pieces. Single, micrometer adjustment controls vertical depth of cut, automatically adjusting copy table with pantograph. Range of reduction ratios from 2-to-1 to infinity! Vertical range over 10 inches!

For complete information, write to

GREEN INSTRUMENT COMPANY

363 Putnam Ave.

Cambridge, Mass.

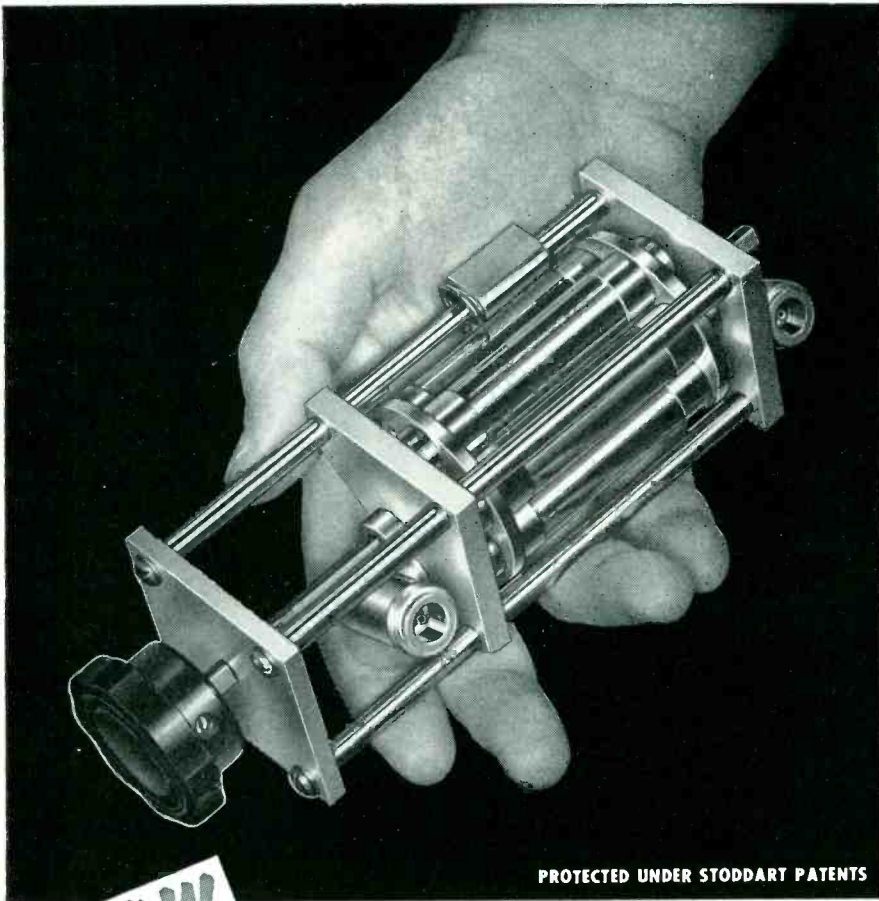

PROTECTED UNDER STODDART PATENTS

NOW

Precision Attenuation to 3000 mc!

TURRET ATTENUATOR featuring "PULL-TURN-PUSH" action

SINGLE "IN-THE-LINE"
ATTENUATOR PADS
and
50 ohm COAXIAL
TERMINATION



FREQUENCY RANGE:

dc to 3000 mc.

CHARACTERISTIC IMPEDANCE:

50 ohms

CONNECTORS:

Type "N" Coaxial female fittings each end

AVAILABLE ATTENUATION:

Any value from .1 db to 60 db

VSWR:

<1.2, dc to 3000 mc., for all values from 10 to 60 db

<1.5, dc to 3000 mc., for values from .1 to 9 db

ACCURACY:

±0.5 db

POWER RATING:

One watt sine wave power dissipation

*Send for free bulletin entitled
"Measurement of RF Attenuation"*

*Inquiries invited concerning pads or
turrets with different connector styles*

STODDART AIRCRAFT RADIO Co., Inc.

6644-A Santa Monica Blvd., Hollywood 38, California • Hollywood 4-9294

with special emphasis on non-destructive control testing.

Among the projects encompassed are the design of automatic test and control systems for oil and gasoline refineries, for production of metal alloys, metal cables, plastics, paint, electrical and electronic products and for a wide variety of other mechanical and electrical manufacturing equipment.

The firm also announced the appointment of Alfred Y. Bentley as assistant manager of the cathode-ray tube division. In his new position he will provide administrative assistance to the divisional management in the fields of engineering, manufacturing, sales, budgets and planning.

Bentley has a ten year background with Du Mont in technical and administrative positions. He has progressively served as assistant engineering manager of the cathode-ray tube division and manager of the division's engineering department. He was then named as manager of the engineering department of the television receiver division, after which he served as technical assistant to the president of the company.

Baldwin-Lima Buys Ruge-de Forest

BALDWIN-Lima-Hamilton Corp. has acquired complete ownership of Ruge-de Forest, of Cambridge, Mass. industrial testing-equipment and electronics manufacturer.

Operation of Ruge-de Forest will complement activities of the O. S. Peters Co. of Washington, D. C., makers of testing instruments and electronic devices. The Peters Company, also a wholly-owned B-L-H subsidiary, was purchased in June, 1954.

Ruge-de Forest's present officers, Dr. Arthur Ruge, Frank Hines and Edgar J. Jones, will continue to direct its operations.

Philamon Labs Acquires New Plant

PHILAMON LABORATORIES, formerly of Brooklyn, N. Y., has acquired a new 15,000 sq ft plant in Westbury,

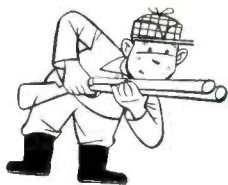

Hunting
COILS
For High Temp.
Application

DANO makes them!

For specifications calling for coils to be used for high temperature applications, Dano will supply the exact coils needed.

Dano, makers of a wide variety of coils, is fully equipped to meet the increasing demand for these special coils. Keeping pace with modern design, Dano offers incapsulated coils with tough, molded covers that spell extra electrical insulation with freedom from moisture.

Every Dano Coil is custom-made to your specific requirements. Call or write today, and Dano's quote will be on the way!

- Incapsulated Coils • Form Wound
- Bakelite Bobbin • Cotton Interweave
- Paper Section • Acetate Bobbin
- Coils for High Temperature Applications
- Also, Transformers Made To Order

The DANO Electric Co.
MAIN ST., WINSTED, CONN.

when there's a soldering job to be done...



On industrial assembly lines
... in home workshops ...
in electronic labs ... for
production, repair, and
maintenance ... the
world's most versatile
family of pencil soldering
irons is on the job,
doing a better job! No
wonder they're called
"Ungar's Little Angels"!

- Interchangeable tips
for every soldering need
from repair to high-
speed production
soldering.



Write for
Catalog U-16

UNGAR ELECTRIC TOOLS, INC.
P.O. Box 312, Venice, California

the BEST WAY to SOLVE YOUR PROBLEMS

Specify **MAGNATRAN** TRANSFORMERS

When you are up against a tough problem and need special high voltage equipment consult with us. The 20 KV unitized rectifier illustrated here is only one example of how we helped to solve one problem. The result was a rectifier that did away with long leads to the tubes, yet was compact and ready to hook up.

Write us your problem

TRANSFORMERS FOR THE ELECTRONICS INDUSTRY

MAGNATRAN INCORPORATED
TRANSFORMERS AND ELECTRICAL EQUIPMENT
246 SCHUYLER AVE., KEARNY, NEW JERSEY



"HOW MEYERCORD
SERVES INDUSTRY"
No. 4 of a Series

MEYERCORD
Nameplate **DECALS**
Help Consumers USE
Your Product Correctly

MeyerCORD Nameplate Decals on your product promote proper use by the consumer. Use MeyerCORD Decal Nameplates for operating instructions, safety signs and warnings, indicators and guides, lubrication charts, dial and gauge markings, and wiring diagrams. MeyerCORD Dealer nameplates refer the user back to the dealer for parts and replacement. MeyerCORD Decals are individually engineered for quick, easy application to any commercial surface, without change in your present assembly line, for long or short production runs ... at astonishingly small cost per unit. Permanently secured, MeyerCORD Decal Nameplates can be designed to withstand extreme temperatures, abrasion, or wear.

Let a MeyerCORD Decal engineer show you how to get maximum consumer use for your product through application of informative, instructional decals. He'll study your product and make specific recommendations ... another MeyerCORD service to industry.

FREE! "Mark-It" Manual of Decal Nameplates

Send today, on your company letterhead, for this valuable full-color guide to every industrial problem in marking, identification, instruction and information. Gives you hundreds of new ideas for the application of decals to your products.

THE MEYERCORD CO.
World's Largest Decalomania Manufacturers

DEPT. G-303
5323 WEST LAKE ST.
CHICAGO 44, ILLINOIS

COAXSWITCH

COAXIAL SELECTOR SWITCH

50 Ohms—
Type N Connectors—Manually Controlled
Low VSWR—4 Models

CUT-A-WAY VIEW, MODEL 74

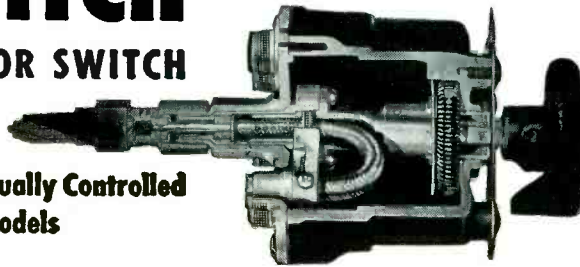

The COAXSWITCH is an RF switch for use in coaxial circuits where it is important that the 50 OHM impedance of the cables be maintained. In a circuit sense, this switch consists of two pairs of "N" connectors spaced 4½" apart using RG-8/U as the connecting link. The COAXSWITCH itself introduces no VSWR other than that of connectors. Characteristic impedance is maintained thru all switch details. Cut-a-

way view shows that shield as well as center conductor is switched. Beryllium copper contacts, on the gooseneck, mate directly with male "N" (Type UG-21B/U) connectors, which connect directly to back plates of switch. Since all connectors come out in line with axis of switch, right angle connectors are usually unnecessary.

Literature Gladly Sent

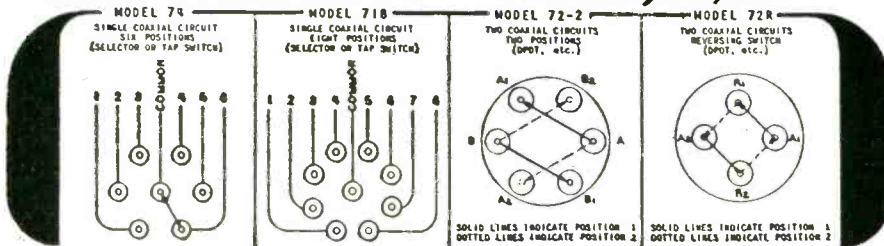

BIRD ELECTRONIC CORP.
1800 EAST 38TH ST., CLEVELAND 14, OHIO
TERMALINE Coaxial Line Instruments

NEELY ENTERPRISES
Hollywood • San Francisco
Albuquerque
RON MERRITT COMPANY
Seattle

Long Island, N. Y.

The increased space will be employed for stepped-up production, design and development of its line of frequency standards.



Ampex Elects Long New President

ALEXANDER M. PONIATOFF was elected founder and chairman of the board of directors of Ampex Corp. and G. I. Long will replace him as president.

Named vice-chairman of the board was T. Kevin Mallen who, for the past year, has been in Europe consolidating Ampex export activities.

Minnesota Mining Realigns Executives

LOUIS F. WEYAND, executive vice-president and director of Minnesota Mining & Manufacturing Co., has been named sales director for 3M, succeeding George H. Halpin, also an executive vice-president and board member, who will remain active as a consultant in specific sales and operating problems.

Halpin, who reached retirement age last year, had asked to be relieved of the responsibilities of director of sales.

Weyand is just completing 40 years of service at 3M. He joined the firm as a salesman in Chicago in 1915.

Halpin joined 3M as sales manager in 1930. He was elected a vice president of 3M and was made general sales manager of the company in 1938. He was elected to the board of directors in 1939. He has

BE *Sure* with **CORNISH** *Electronic* WIRES and CABLES

MICROPHONE CABLES Designed for low capacitance, high insulation resistance, low attenuation—in plastic or rubber insulation to stand severe service

T-V LEAD-IN CABLES Furnished only in pure virgin polyethylene to insure best electrical properties and long life under severe operating conditions

T-V LEAD-IN CABLES Made hollow, of pure virgin polyethylene, for maximum efficiency in receiving Ultra High Frequency signals

INTERCOMMUNICATION CABLES These quality cables are made in various constructions, utilizing plastic insulation for both conductors and jacket

SHIELDED INTERCOMMUNICATION When installation conditions dictate, shielded cables are recommended. Made with internal or external shield—2 and 3 conductors

MADE BY ENGINEERS. FOR ENGINEERS.

CORNISH WIRE COMPANY, INC.
50 Church Street New York 7, N. Y.

ZOPHAR

---WAXES
---COMPOUNDS

Zophar Waxes, resins and compounds to impregnate, dip, seal, embed, or pot electronic and electrical equipment or components of all types; radio, television, etc. Cold flows from 100°F. to 285°F. Special waxes non-cracking at -76°F. plain or fungicidal. Let us help you with your engineering problems.

For immediate service contact:

L. E. Mayer, Sales Manager
A. Saunders, Technical Director
H. Saunders, Chemical Laboratory

Phone S0uth 8-0907



ZOPHAR MILLS, INC.
112-130 26th Street,
Brooklyn 32, N. Y.

400 cycle High Frequency Power Supplies

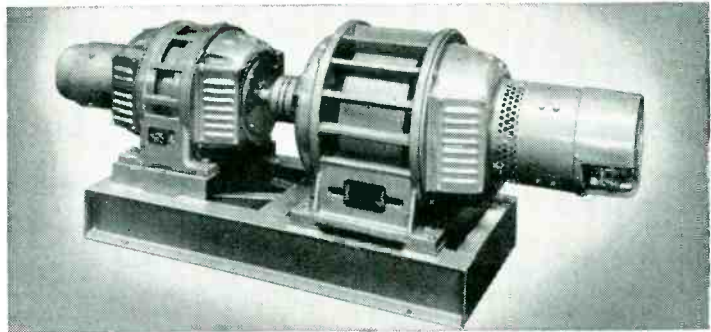

This typical 400 cycle High Frequency Generator is available from 1 KVA to 100 KVA. Variable frequency power supplies can be designed with outputs as low as 3 cycles and as high as 2000 cycles.

Hertner also manufactures high frequency motor generators that can be either synchronous motor-drive, induction motor-drive, or direct current motor-drive.

Consult Hertner for your unusual power supply requirements.



THE HERTNER ELECTRIC COMPANY
12690 ELMWOOD AVE. • CLEVELAND 11, OHIO

MOTORS • MOTOR GENERATORS • GENERATOR SETS

A SUBSIDIARY OF GENERAL PRECISION EQUIPMENT CORPORATION



THE NEW MODEL 201A STROBO- SYNC



Automatically synchronizes stroboscopic light sources with high frequency shakers to permit inspection in slow motion from zero to two cycles per second. This visual frequency is adjusted with a front panel control, and once adjusted remains constant over the entire shake frequency range of 20 to 2000 cps. No adjustment of input level is required over a 40 db range. No other adjustments exist or are required. Write for bulletin to:

Winkler Laboratories
5225 N. 20th St. • Phoenix, Arizona

Idea to Reality... Put WHEELER Microwave Experience to Work for You!

Wheeler Laboratories' outstanding achievements in better engineered microwave components for radio and radar place it in a unique position to handle your microwave needs.

Under the direction of Harold A. Wheeler, our competent engineering staff, with complete supporting facilities, is equipped to tackle your toughest design problem... and come up with positive results.

Submit your idea for immediate analysis, or arrange a meeting with our engineers. A brief summary of our work is available on request.

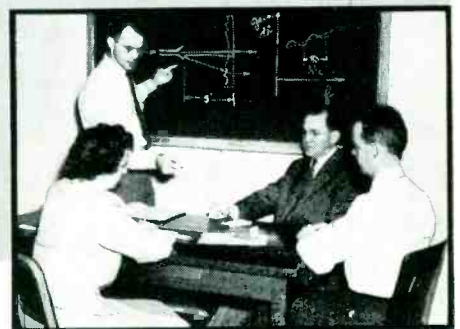

Members of the engineering staff discuss a problem in antenna design with Mr. Wheeler.



WHEELER
Laboratories, Inc.
122 Cutter Mill Road
Great Neck, N. Y.
HUNter 2-7876

MIDGET TELEPHONE TYPE RELAYS in hermetically sealed containers

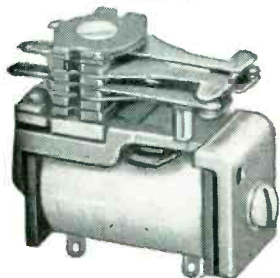

Surface mounting, open type, Series 80 Relay — size: $1\frac{15}{32}$ " l. x $\frac{5}{8}$ " w. x $1\frac{25}{64}$ " h.

Compact, multiple contact with vibration and shock-proof characteristics. Designed to meet various operating requirements typical of Armed Services applications.

Unique pile-up arrangement reduces width below the conventional relay, thereby reducing over-all space volume.

Coils are varnish-impregnated to resist high humidity conditions. All ferrous parts are treated to pass salt-spray tests.

Engineering Representatives in Principal Cities

WRITE FOR
BULLETIN
MTR-6



**this is what
a good
COLOR TV
TRANSFORMER
looks like**

• Nothing takes the place of an Acme Electric power transformer to provide the proper performance, long life and minimum of service expense in color TV as well as monochrome receivers. As cooperating pioneers in the development of transformer components for television applications, Acme Electric has accumulated valuable experience which may benefit you.

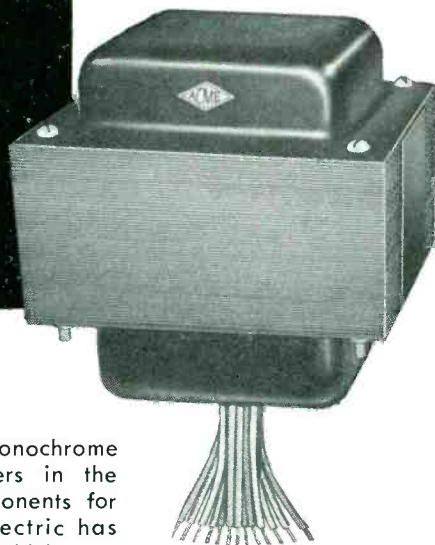

ACME ELECTRIC CORPORATION

315 WATER STREET

CUBA, N. Y.

West Coast Engineering Laboratories: 1375 W. Jefferson Blvd. • Los Angeles, Calif.
In Canada: ACME ELECTRIC CORP. LTD. • 50 Northline Rd. • Toronto, Ontario

Acme ACME Electric
TRANSFORMERS

been executive vice-president in charge of sales since 1949.

It was also announced that Wilfred W. Wetzel has been appointed general manager of the magnetic products division of the company.

He joined 3M in 1944 and became chief physicist of the central research department in 1946. Since 1948 he has been technical director of the magnetic products division.

Admiral Promotes Top Executives

JOHN F. GILBARTE, manager of Admiral's government sales division, has been elected to the newly created position of vice-president-government laboratories division.

Edmond I. Eger, vice president-advertising was elected to the board of directors.

Other appointments include the election of John B. Huarisa, executive vice president and one of the original founders of Admiral, to the additional post of treasurer, and George E. Driscoll, secretary, to assistant treasurer as well.

Lynn C. Park, treasurer of Admiral and a member of the board, has retired due to ill health after serving the company since 1937.

RCA Opens Waltham Lab.

THE RCA Aviation Systems Engineering Laboratory has been officially opened in Waltham, Mass. It will develop specialized electronic fire-control systems for military aircraft. Now in an initial operating stage, it is expected to employ by year's end approximately 100 scientists, engineers, and laboratory personnel. Manager of the new installation is Robert C. Seaman, Jr., for many years a member of the teaching staff at MIT.

Silicone Seals Formed In Chicago

SILICONE SEALS, has been formed in Chicago for the design and production of silicone rubber hermetic terminals.

The company has been organized

make it better
with
**STAR
LAVOLAIN®**

Here's another outstanding member of the Star family of electrical porcelains. This steatite ceramic is ideal for small parts which must provide excellent mechanical strength plus good thermal shock resistance.

LAVOLAIN'S high dielectric strength at elevated temperatures makes it basic for small rods, bushings, resistance-wire holders, and switch bases for use in a wide variety of electrical products. It is available in various colors to conceal assembly stains or to provide identification of electrical circuits or parts of equipment.

Ball and socket insulating bushings made of LAVOLAIN provide superior high temperature wire insulation, especially when flexibility is a must. These ball and socket bushings are stocked in 13 standard sizes.

Complete information of LAVOLAIN and the complete Star family of electrical porcelains is contained in a 26-page, fact-filled catalog.

Write for a free copy.

Star Porcelain Company
42 Muirhead Ave., Trenton 9, New Jersey

STAR
porcelain company

**WIDE-RANGE
FREQUENCY METER
85-1000 MEGACYCLES**

TS-175A/U

Government
Approved
Calibration
Accuracy:
.005%
Stability:
.0025%
Resettability:
.0025%



**IMMEDIATE
DELIVERY**

**A VERSATILE PRECISION MEASURING
INSTRUMENT** Recommended Applications:

- Precise Measurements of Frequencies
- Production Testing
- Alignment of Transmitters and Receivers
- Laboratory Testing
- Portable Field Testing
- A Secondary Frequency Standard
- Signal Generator Calibration
- U.H.F. and V.H.F. Television Alignment

COLORTONE
ELECTRONICS, Incorporated
200 Frank Road, Hicksville, L. I., N. Y. HI 4-2124

THE NEW WAY TO
MARK EQUIPMENT....

with

GRAVO
flex

the first chip-proof, flexible engraving stock

on the versatile

Engravo
graph

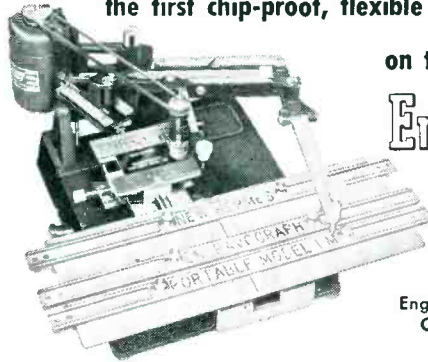

Send for booklets:
Engravograph Booklet 1M-29
Gravoflex Booklet G-29

So simple to engrave Gravoflex. Lettering stands out permanently on contrasting background. No paint needed. 10,000 Engravographs used for engraving on metals and plastics. Only Engravograph has these patented features:

- Adjustable for 15 ratios.
- Self-centering holding vise.
- Automatic depth regulator.
- Adjustable copy holders.

NEW HERMES ENGRAVING MACHINE CORP.

13-19 UNIVERSITY PLACE, NEW YORK 3, N. Y.

shear it



bend it



form it



punch it

**SHOCK
PROOF**

**VACUUM TUBE
RETAINERS**

These retainers are used to secure Vacuum Tubes and to resist side motion of Vacuum Tubes used in radio equipment which is subject to shock and vibrations. These retainers meet the requirement of all JAN specifications. The insulated portion is made of a melamine base Fibre Glass Phenol which provides 300 volts insulation to ground and withstands a temperature of 350 F. The insulated plate can readily be fastened or released by hand.

Available for envelope types T7, T8, MT8, T9, T12, ST12, T122DI, ST14, S14, ST16, T5 1/2, T6 1/2, MT-IC, ST19, T14, ST128CT-9.

Manufacturers of
Electronic Components

JAMES IPPOLITO & CO., INC.
401 CONCORD AVENUE, BRONX 54, N. Y.

by Leonard E. Brown and Robert Shattow, both of whom have had considerable experience in engineering, design, production, and sales of hermetic terminals.

Hamilton Named Chief Engineer

G. EDWARD HAMILTON has been appointed chief engineer of WABC-TV in New York. In this capacity he has full responsibility for the technical operation of the station. Prior to this assignment he served as eastern division television engineer of ABC where he supervised the technical facilities.



General Mills Appoints Kober

CARL L. KOBER has been appointed to be in charge of airborne systems evaluation work for the mechanical division of General Mills.

Dr. Kober, who was chief of the German naval fire-control and shipborne radar board and worked on the Wasserfall and V-2 rocket tele-guiding systems, has been working for the U. S. Air Force's Wright Air Development Center since the USAF brought him to this country in 1949. His last work for the USAF was on strategic bombing systems. He expects his U.S. citizenship this year.

At General Mills he will devote his time to creative work in airborne systems—radar, bombing, navigation and guidance. His background in these fields includes the

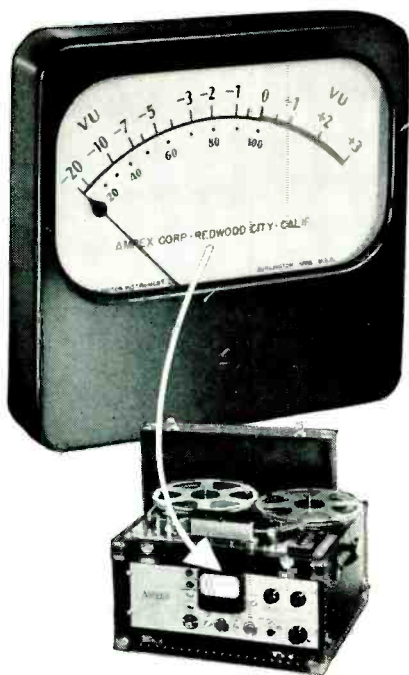

Try this on your recorder!

Model 745
4½" Semi-Flash

Famous names choose Burlington for consistent quality and prompt service. Burlington offers the widest range of VU meters—from 1½" to 4½" in a variety of case materials and styles including bakelite, metal, hermetically sealed and sealed ruggedized. Square, Round, Rectangular and Fan-shaped. Standard meters of every description. "If you don't see it—ask for it"—

WRITE FOR CATALOGUE N1
Shows cases, ranges, prices

BURLINGTON INSTRUMENT COMPANY
127 N. Third St. Burlington, Iowa



It's

for—
**PRECISION METAL
stampings
AND DEEP DRAWING**

*Quality Components
and Sub-Assemblies of*

**ALUMINUM, COPPER, BRASS,
KOVAR, NICKEL, STEEL, ETC.**

The Engineering Company can supply long or short runs to your exact specifications on reasonably short notice. The most modern metal forming machines permit mass production methods that assure economical unit costs. Micro-precision tools, dies and jigs assure accuracy on simple or complex designs.



CALL OR WRITE now for
quotations on metal components,
DKE lead-in wires and tube bases.

THE engineering CO., 27 WRIGHT ST., NEWARK 5, N. J.

**ELIMINATE REJECTS!
MINIMIZE BREAKAGE!**

use *Bird* jewel assemblies

Why chance rejects and breakage that add to production costs when you can eliminate these time-wasting "headaches" with Bird complete jewel assemblies — ready to install in your equipment. Bird's many years of precision production mean jewel bearings of the highest quality. These jewels are set according to your specifications by skilled craftsmen, in less time, for less money, and eliminate special set-ups in your plant.

Why not bring us your jewel problems — you specify — Bird will supply assemblies that fit your product and schedule. Our engineering staff is at your service for all your jewel bearing problems.

For information on jewel assemblies write for Bulletin 15.

Over 40 years of serving industry with Quality jewel bearings

Richard H. Bird & Co., Inc.

Sapphire and glass jewels • Precision glass grinding • Ferrite precision products • Sapphire styli
1 Spruce Street, Waltham 54, Mass.

**ELECTRONIC ENGINEERS
and PHYSICISTS**

We invite you to investigate the fine professional opportunities at Sperry. An enviable record of 43 years constant growth and expansion plus Sperry's 15 year club of more than 1500 employees is ample evidence of opportunity, good salaries, benefits and fine working conditions that make for a bright future.

Design Engineers — Klystron and traveling wave tubes, Magnetrons, Image orthicon, Solid state devices, Microwave measuring equipment.

Production Engineers — Power tube operation. Knowledge of tube assembly and processing techniques is essential.

Measurements Engineers — For microwave measurements on Klystrons and traveling wave tubes.



- RELOCATION ALLOWANCES
- LIBERAL EMPLOYEE BENEFITS
- ADEQUATE HOUSING IN BEAUTIFUL SUBURBAN COUNTRY TYPE AREA
- TUITION REFUND PROGRAM (9 graduate schools in area of plant)
- MODERN PLANT WITH LATEST TECHNICAL FACILITIES
- ASSOCIATION WITH OUTSTANDING PROFESSIONAL PERSONNEL

Apply in person or submit resume to Employment Office

SPERRY GYROSCOPE CO. (Division of the Sperry Corp.)

Marcus Ave. and Lakeville Road, Great Neck, Long Island, New York

FILTORS, INC.
SUB-MINIATURE RELAYS

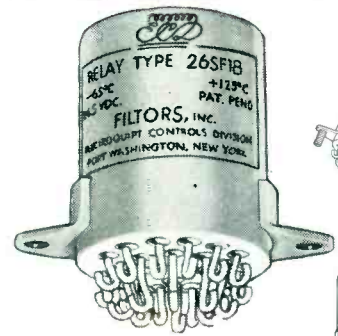

ACTUAL SIZE

*The Smallest
6PDT
Subminiature
Relay
Available
Today!*

**MOUNTING STYLES
TO MEET ALL
YOUR REQUIREMENTS**



STYLE 'SA'

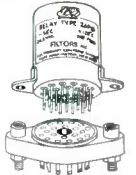

STYLE 'SP'



STYLE 'SE'



STYLE 'SC'



STYLE 'SR'



STYLE 'SJ'



STYLE 'SL'

Filtors, Inc. is a major supplier of subminiature 6-pole and 4-pole relays. Our facilities are now utilized 100% for the development and production of relays of the highest quality.

**Outstanding
Features**

1. COMPACT
 2. RUGGED
 3. LIGHTWEIGHT
 4. ROTARY MOTOR
- Precision built, with hydrogen annealed parts.*
5. LONG LIFE

Also available in LATCHING construction, electrical reset, in contact arrangements up to and including 4PDT. This relay is the same as shown above, except for the number of terminals and the height of the enclosure, which is $\frac{1}{4}$ " greater.

Meets or exceeds requirements of MIL-R-5757B.

Send for **NEW CATALOG** today

FILTORS, Inc. 30 Sagamore Hill Drive
Port Washington, L.I., N.Y.

Please send us your **NEW CATALOG** on Sub-miniature Relays.

NAME

TITLE

COMPANY

CITY ZONE STATE

CO-AX

4 mmf/ft

★
ULTRA LOW capacitance & attenuation

WE ARE SPECIALLY ORGANIZED
TO HANDLE DIRECT ORDERS OR
ENQUIRIES FROM OVERSEAS

SPOT DELIVERIES FOR U.S.

BILLED IN DOLLARS—
SETTLEMENT BY YOUR CHECK
CABLE OR AIRMAIL TODAY



TYPE	$\mu\mu\text{F/ft}$	IMPED. Ω	O.D.
C 1	7.3	150	.36'
C 11	6.3	173	.36'
C 2	6.3	171	.44'
C 22	5.5	184	.44'
C 3	5.4	197	.64'
C 33	4.8	220	.64'
C 4	4.6	229	1.03'
C 44	4.1	252	1.03'

NEW 'MX and SM' SUBMINIATURE CONNECTORS
Constant 50 Ω -63 Ω -70 Ω impedances

TRANSRADIO LTD. 138A Cromwell Rd. London SW7 ENGLAND CABLES: TRANSRAD, LONDON

24-CHANNEL VHF FM RADIO SYSTEM FOR LONG LINKS

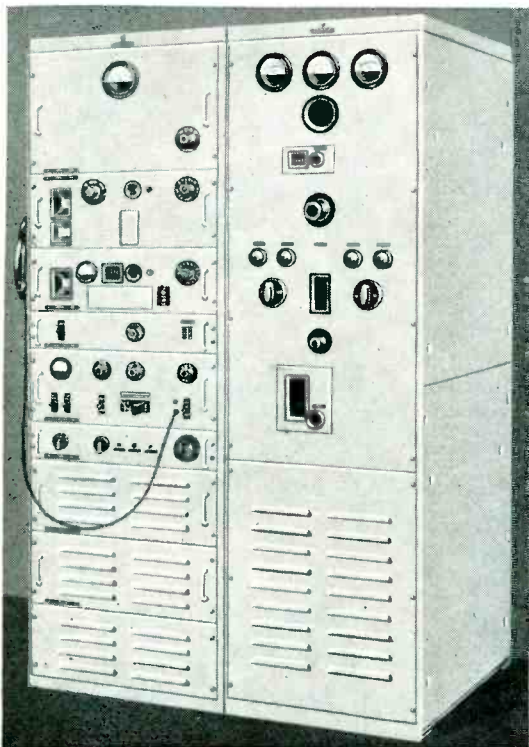

This radio system makes possible toll-grade transmission of up to 24 3400-cycle telephone circuits over links of 100 miles or more in length. Transmission is in the band of 41 to 68 mc, which is ordinarily available for fixed point-to-point service in remote or inaccessible areas. Transmitter powers of 30, 250 and 1500 watts and antenna gains of 12 to 24 db are available. A single broad-band antenna is used for both transmitting and receiving. The associated carrier-telephone system consists of two 12-channel groups of the type F60 system, and operates in the band of 6 to 108 kc.

Type FM24/50 Radio Transmitter of 1.5 KW output power.

RADIO ENGINEERING PRODUCTS

1080 UNIVERSITY STREET, MONTREAL 3, CANADA

Telephone: UNiversity 6-6887

Cable Address: Radenpro, Montreal

MANUFACTURERS OF CARRIER-TELEGRAPH, CARRIER-TELEPHONE AND BROAD-BAND RADIO SYSTEMS

guidance work mentioned; infrared work in Germany for airborne target detection and fire-control; supervision of fire-control systems for the Bismarck and Tirpitz; snorkel radar for submarines; and heading of the projects for a large portion of German radars like the early warning FREYA and the Wasserman.

Panellit Acquires Jordan Electronic

JORDAN ELECTRONIC Mfg. Co. of Pasadena, Calif., manufacturers in the radiation monitoring field, has been acquired by Panellit, of Chicago. Panellit manufactures automatic control and data reduction information systems.

Panellit plans to accelerate research and development activities of Jordan in the field of industrial measurements in addition to its activities in the nuclear field. Jordan also plans to adapt Panellit's alarm and scanning devices to its present monitoring system.

Jordan is to be operated as a wholly owned subsidiary of Panellit with M. Jordan Nathason, the former owner, serving as president. Albert Sperry, president of Panellit, will serve as chairman of the board of Jordan. Other key personnel also will be retained.

Panellit will construct a new manufacturing plant in Alhambra, California. The first unit of 10,000 sq ft is expected to be ready for occupancy some time in May. This plant will be occupied jointly by Panellit's western division, now located in Los Angeles, and by Jordan.

Pye Establishes U. S. Subsidiary

PYE LIMITED, of Cambridge, England, has formed a wholly-owned subsidiary, Pye Corporation of America, in New York for promotion and distribution of its communication equipment. These products are designed and manufactured by the Pye Telecommunications Division in Cambridge, England.

The president of the new U.S. organization is C. O. Stanley and

PORTABLE PHONOGRAPHS · TV BOOSTERS · INDUSTRIAL and MEDICAL EQUIPMENT

SERVICING KITS · TAPE RECORDERS · ANTENNA ROTATOR · CONTROL CABLES

PORTABLE RADIOS · SERVICEMEN'S CARRYING CASES · PORTABLE PA SYSTEMS

When You Need



Coated fabrics...



Fabric-covering problems vary with the size and shape and function of the carrying case. Here's the cue for APEX specialists! For fast-colored, durable fabrics to make your units SELL faster and LAST longer... ask men who KNOW.



It will cost you nothing to let APEX specialists consider your problems.



For 29 years "THE HOUSE of SERVICE"

APEX COATED FABRICS, Inc.

12-16 East 22nd St., N. Y. City 10

SPring 7-3140

SOUND and PROJECTION EQUIPMENT · PORTABLE TV SETS · TEST INSTRUMENTS



FIVE STAR
ELECTRICAL
COMPONENTS

★ ★ ★ ★ ★

COILS

Wound to Your Specifications



★ ★ ★ ★ ★

SOLENOIDS

Light and Miniature Types



★ ★ ★ ★ ★

RELAYS

Power and Sensitive Types



Send for catalog sheets describing these items in detail. Prompt quotations will be furnished on receipt of your complete specifications and requirements.

THE FIVE STAR COMPANY
10 WEST MAIN STREET
PLANTSVILLE, CONN.

SIMPLYTROL AUTOMATIC PYROMETER

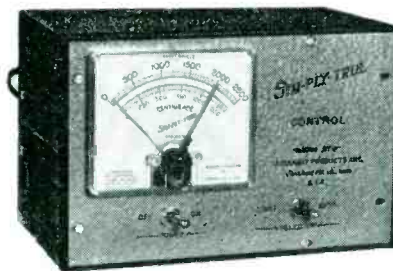

Cat. No. 4531 0/2500° F.
Price \$132.00

Thermocouple type Automatic Pyrometer for controlling temperature in furnaces, ovens, and processes. The Simplytrol is economical and reliable with few moving parts. There are no vacuum tubes. The regular load relay is S.P.D.T. 5 Amps. Optional heavy duty relays to 40 Amps.

10 temperature ranges cover from -75° to 3000° F. Several special ranges to -400° F. "On & Off" control for holding the desired temperature works on gas, oil or electric heat. Indicating meter-relay is medium high resistance and has bimetal cold junction compensation. For use with all standard thermocouples. Accuracy 2%.

"Auto-Limit" switch changes Simplytrol from automatic controller to limit pyrometer for safety shut down or warning. Cabinet: 6½x 6½x9½ inches. Also flush panel mount models. Send for new Bulletin G-7 for more data. Assembly Products, Inc., Chesterland 4, Ohio.

Closely Regulated
D-C Power Source of
Permanent
Stability

For mobile or stationary use

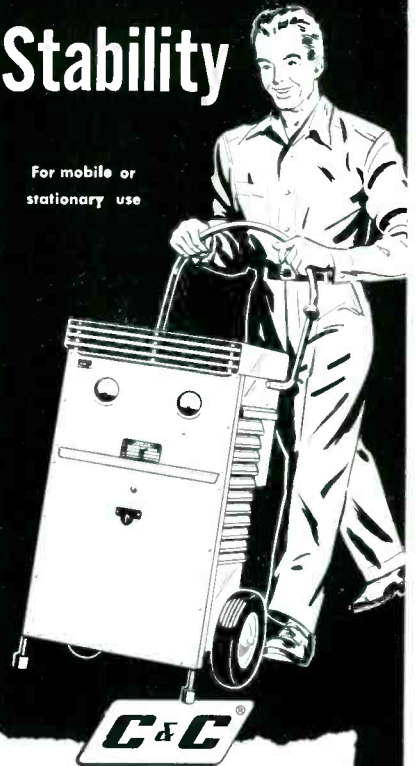

STAVOLT®
POWER
RECTIFIERS

- Greatly simplified circuit with fast responding magnetic control of highest reliability.
- No warm-up time, no hunting or drifting.
- Lighter weight, more compact, rugged and field proven. Encapsulated components.
- 11 standard models up to 1500 amps. Meets Spec. MIL-E-7894.

Write for interesting information on STAVOLT rectifiers.

MCCOLPIN-CHRISTIE CORP.

3410 W. 67th Street, Los Angeles 43, California
Specialists in Rectifier Manufacturing for 26 Years

Need special transformers fast?

You can get them from us, engineered to your specifications and produced faster than you may think possible.

Our staff of design engineers have long experience in communications. They know how to design around special problems of size, weight, high voltage or temperature; and they understand over-all circuit requirements. They can design what you need.

And our manufacturing and inspection facilities can put the engineers' design into quality-controlled production in a remarkably short time.

When you have a transformer problem, call on

CALEDONIA ELECTRONICS AND TRANSFORMER CORPORATION

Dept. E-5, Caledonia, N. Y.

for service and lab. work

Heathkit PRINTED CIRCUIT OSCILLOSCOPE KIT FOR COLOR TV!

① Check the outstanding engineering design of this modern printed circuit Scope. Designed for color TV work, ideal for critical Laboratory applications. Frequency response essentially flat from 5 cycles to 5 Mc down only 1½ db at 3.58 Mc (TV color burst sync frequency). Down only 5 db at 5 Mc. New sweep generator 20-500,000 cycles, 5 times the range usually offered. Will sync wave form display up to 5 Mc and better. Printed circuit boards stabilize performance specifications and cut assembly time in half. Formerly available only in costly Lab type Scope. Features horizontal trace expansion for observation of pulse detail — retrace blanking amplifier — voltage regulated power supply — 3 step frequency compensated vertical input — low capacity nylon bushings on panel terminals — plus a host of other fine features. Combines peak performance and fine engineering features with low kit cost!

Heathkit TV SWEEP GENERATOR KIT ELECTRONIC SWEEP SYSTEM

② A new Heathkit sweep generator covering all frequencies encountered in TV service work (color or monochrome). FM frequencies too! 4 Mc — 220 Mc on fundamentals, harmonics up to 880 Mc. Smoothly controllable all-electronic sweep system. Nothing mechanical to vibrate or wear out. Crystal controlled 4.5 Mc fixed marker and separate variable marker 19-60 Mc on fundamentals and 57-180 Mc on calibrated harmonics. Plug-in crystal included. Blanking and phasing controls — automatic constant amplitude output circuit — efficient attenuation — maximum RF output well over .1 volt — vastly improved linearity. Easily your best buy in sweep generators.

management will be under the direction of W. M. Cagney.

ECA Appoints Chief Engineer



Harvey L. Hansberry

HARVEY L. HANSBERRY has been appointed chief engineer of the Fireye division of Electronics Corporation of America.

He was previously chief of the power plant branch of the CAA's technical development and evaluation center at Indianapolis. He was primarily responsible for development of aircraft power plant fire protection equipment and fire prevention design criteria.

He joins the ECA organization after a 15-year association with the CAA.

Carstedt Industries Plans Production Center

CARSTEDT RESEARCH of Downey, Calif. will move into the first unit of the new Carstedt Electronics Center, now being developed on a 10-acre tract in Long Beach, Calif.

The 36,000 sq ft facility will be the first of eight units owned and leased by Carstedt Industries, now being formed. The center will provide an integrated production area for companies working in related electronics fields on devices applicable to guided missiles, high-fidelity sound equipment and computers. Full employment at the center

is expected to be 800 when the project is complete, about two years from now.

Carstedt Research expects to quadruple production of its core-loop transformer components with the installation of equipment recently purchased from Westinghouse's transformer core-loop plant in Lima, Ohio. In addition to the expanded production equipment at the new site, approximately 150 more employees will be hired.

Winder Aircraft Plans New Plant

THE WINDER AIRCRAFT Corp. of Winder, Georgia, will build a new plant in the Southeast to manufacture electronic equipment. Present plans are for a structure of approximately 25,000 sq ft of floor space.

Eventual employment at the plant will be over one hundred employees.

Much of the new capacity will be used in manufacturing a new type of navigational equipment.

Link Promotes Seven Engineers

A TOTAL of seven appointments have been made in the engineering and manufacturing divisions of Link Aviation of Binghamton, N. Y.

Laurence E. Fogarty was named Link's chief engineer.

John M. Hunt was appointed director of research and development.

Robert F. Hall was appointed manager of manufacturing engineering.

Vincent S. Kraeger assumed the duties of manager of administrative engineering.

Milton S. Wade was named manager of standardization.

Melvain Oliphant was appointed project manager for the Link T-37A simulator and E-600 trainer projects.

James F. Newlon was named production manager for the company's main plant in Binghamton.

Dr. Fogarty moved up from his position as project engineer on the T-37A and E-600 projects. He joined Link four years ago as head

WELD SEMI-CONDUCTOR DEVICES WITH SPEED AND PRECISION

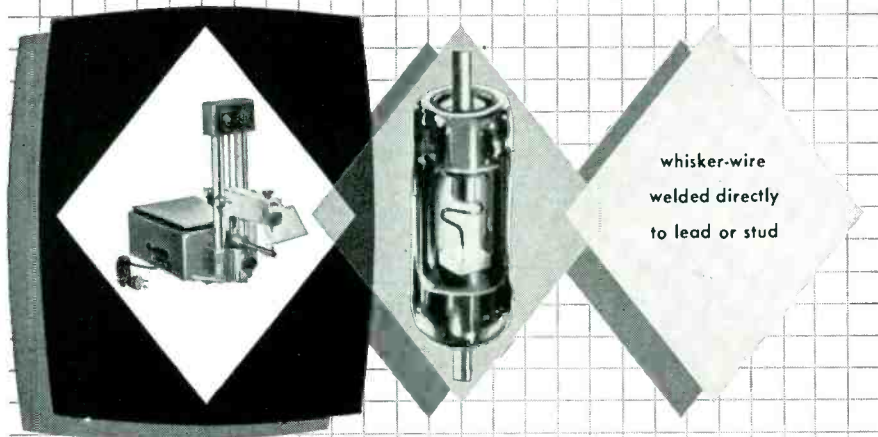

whisker-wire welded directly to lead or stud

precision stored-energy welding

WELDMATIC MODEL 1015 welds molybdenum, tungsten, gold, iridium-platinum, or other fine wire to Dumet, Kovar, steel, etc. Diameters 0.0003 to 0.060 inch welded easily without oxidation or annealing.



UNITEK CORPORATION
259 North Halsted • Pasadena 8, California
Write for Complete Technical Information on Stored Energy Welding

These PILOT LIGHTS give you 180° VISIBILITY for the most effective indication plus BUILT-IN RESISTORS (a patented Dialco feature) for operation on 105-125V. or 210-250V.

The required RESISTOR is an integral part of the unit — BUILT IN (Pat. No. 2,421,321). Also, simple external resistors for all higher voltages.

Every assembly is available complete with lamp.

SAMPLES ON REQUEST AT ONCE — NO CHARGE



FREE Brochure on "Selection and Application of Pilot Lights"

Also write for our latest Catalogues.

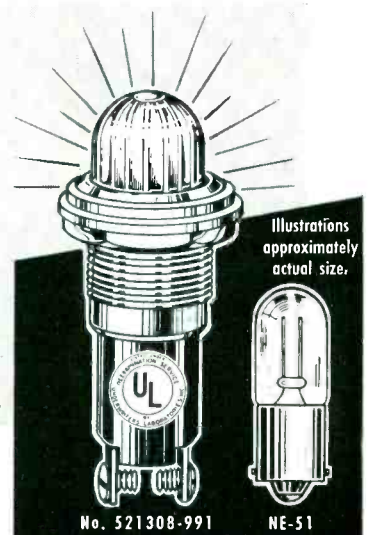

Illustrations approximately actual size.

For NEON Lamps

Choice of fluted or clear caps; binding screws or soldering terminals.

Available for both 9/16" and 11/16" mounting clearance holes.



PLANT AT BROOKLYN, N. Y.

Foremost Manufacturer of Pilot Lights DIALIGHT CORPORATION

60 STEWART AVE., BROOKLYN 37, N. Y. • HYACINTH 7-7600

Aerohm Precision wire-wound Potentiometers



"Lo-TORK" POT

For minimum-torque uses in computer, servo, and selsyn service. Stainless-steel precision ball bearings. Minimum torque is 0.01 inch-ounce. Dissipates one watt at 80°C. Resistances — 100 to 100,000 ohms. Weight is only 1/2 ounce. Ganging to six decks; internal clamps hold 7/8" diameter. Standard linearity 0.5%; on special order 0.25%; toroidal winding allows winding angles to 360°; standard 354°.

AP 1-1/8

AP 1/2

RT/RTS 7/8

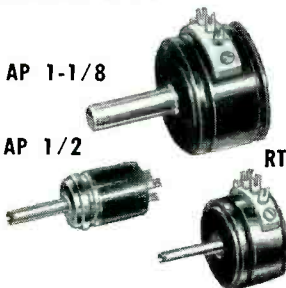

MICRO-MINIATURE and MINIATURE

Series AP 1/2 — 2 watts continuous at 80°C; resistances 10 to 20,000 ohms, 5% tolerance standard; diameter 1/2", depth 1/2", weight 1/4 ounce; sealed well enough for potting.

Series RT/RTS 7/8 — 3 watts continuous at 80°C; resistances 10 to 100,000 ohms; diameter 7/8", depth 3/8", weight 1/2 oz.; standard linearity 3%.

Series AP 1 1/8 — 4 watts continuous at 80°C; resistances 10 to 150,000 ohms; diameter 1 1/8", depth 1/2", wt. less than 3/4 oz.; standard linearity 2%.

All precision-machined, with anodized aluminum bodies, line-reamed phosphor bronze bearings, centerless-ground stainless steel shafts, and gold-plated fork terminals. Fully sealed and fungus-proofed. Can be processed, on special order for use at 125°C. Aerohm potentiometers are individually checked for quality and performance.



Write today for detailed information and prices

WATERS MANUFACTURING, inc.

Waltham 54, Massachusetts

APPLICATION ENGINEERING OFFICES IN PRINCIPAL CITIES

Want more information? Use post card on last page.

of the aerodynamic section.

Hunt formerly had been Link's chief development engineer.

Hall, who had been production manager, has been with Link for four years.

Kraeger was formerly a Link staff engineer.

Wade, a 15-year Link employee, was manager of project engineering before his new appointment.

Oliphant was manager of administrative engineering at Link. He has been with the company for six years.

Newlon, who has been with Link for 10 years, had served as manager of manufacturing engineering prior to his new appointment.

Sylvania Selects Computer Site

THE TOWN of Camillus, N. Y., near Syracuse, has been selected by Sylvania as the site of its new data processing center.

Construction work is expected to start soon on a building of approximately 50,000 sq ft.

The center, which will be company-wide in scope, will provide centralization of data processing functions in one large facility.

Under the new system, Sylvania's various installations—including division headquarters, plants, sales offices and warehouses—will feed financial and production information via a communications network to the center where the data will be instantly summarized for corporate and decentralized management.

The center will be linked with four Sylvania area reporting offices, which have not yet been designated, by a leased communications network. In turn, four to six facilities will report to each area office. When in full operation the center will employ approximately 300 persons.

The company also announced that Matthew D. Burns, recently appointed general manager in charge of electronic tube operations of Sylvania, has been elected a vice-president.

A member of the Sylvania organization and its predecessor com-

CHECK DIODES

- Instantly • Visually
- In Operation



You can tell good diodes from bad — at a glance — when you check them with this compact, self-contained, visual tester.

- Shows dynamic characteristics of point-contact-type germanium diodes on a cathode-ray tube.
- Calibrated scale allows direct reading of voltage on horizontal axes and current on vertical axes.
- Can be used by unskilled operators, for production-line testing and stock maintenance.
- Pays for itself in a short time by spotting rejects and units having insufficient shelf life.
- Shows forward and backward characteristics between 10 ohms and 20 megohms
- Operates on 115 volts 50/60 cycles.
- Overall size. 11 x 12 x 9 inches.
- Price\$400.00

Data sheet giving detailed information on the Model 1003-A Crystal Diode Curve Tracer will be sent on request.



WATERS MANUFACTURING, inc.

Waltham 54, Massachusetts

APPLICATION ENGINEERING OFFICES IN PRINCIPAL CITIES

Want more information? Use post card on last page.



it takes two

DISPLAY ADVERTISING

- AROUSES INTEREST
- CREATES PREFERENCE

DIRECT MAIL

- GETS PERSONAL ATTENTION
- TRIGGERS ACTION.

After your prospect has been convinced by DISPLAY ADVERTISING, he still must take one giant step. He must act. A personalized mailing piece direct to his desk, in conjunction with a display campaign, is a powerful action getter.

McGraw-Hill has a Direct Mail Division ready to serve you with over 150 specialized lists in the Industrial Field.

To get your copy of our free INDUSTRIAL DIRECT MAIL CATALOGUE (1954) containing complete, detailed information about our services, fill in the coupon below and mail it to McGraw-Hill.

Do it now! The best advertising programs are planned well in advance.



Direct Mail Division,
McGraw-Hill Publishing Co., Inc.
330 West 42nd St., N. Y. 36, N. Y.

Please forward my free copy of the McGraw-Hill
"Industrial Direct Mail Catalogue."

NAME _____

COMPANY _____

ADDRESS _____

CITY _____ STATE _____



7 times actual size

Electronic HOOK-UP Wire NYLON-INSULATED

Insulated with ZYTEL (Trade-Mark Registered, by Dupont) this ductile but durable hook-up wire by CONTINENTAL saves time, labor and uncertainty in assembly. Its adaptability to extreme operating temperatures — from minus 50°C to plus 125°C — also means money and space saved from stocking several specialized wires.

Extremely thin — even down to 1 mil — Zytel insulation is efficiently tough against abrasion, and resistant to acids, alkalis and petroleum solvents.

Zytel is also unique for its non-shrinking qualities. For example, the photograph at left — unretouched, but magnified seven times — shows a slipping assembly for electronic motors. Here, Continental Hook-up Wire is soldered to the ring by the iron direct, without any creep-back or shrink-away in the insulation.

Available in AWG sizes 18 to 32; or tell Wallingford your special requirements.

CONTINENTAL WIRE CORPORATION

Heat- and Moisture-Resistant
Wires, Cables and Cords

PLANTS at YORK, PENNA.
and WALLINGFORD, CONN.



Serving 600 to 5000 Volts,
Sizes 18 AWG to 2,000,000 CM
SALES: Box 363, DEPT. L
WALLINGFORD, CONN.

(Phone COlony 9-7718)

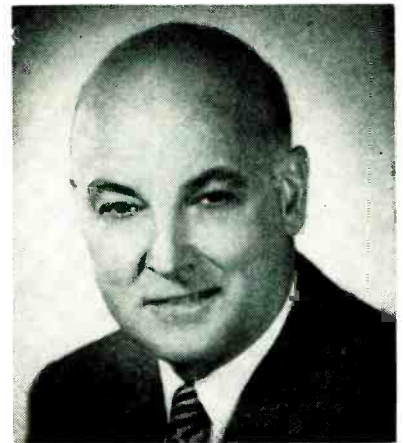

Matthew D. Burns

panies since 1921, Burns has executive direction of the overall operations of the company's radio tube division, television picture tube division and the electronic product sales department.

He joined the company as an industrial engineer in charge of lamp quality. He later was placed in charge of radio tube quality and worked in the engineering department on production engineering problems. In 1932 he was appointed factory superintendent at Emporium, and successively held the positions of manager of the Emporium receiving tube plant, general manufacturing manager of the radio tube division, and general manager of the radio tube division until his most recent appointment.

Glass-Solder Names President

GLASS-SOLDER ENGINEERING of Pasadena, Calif., manufacturer of hermetic seals for the electronics industry, has named Hugh P. Moore, president and general manager. He was president of Acme Electronics division of the Aerovex Co. in Monrovia.

Felix Elected Vice-President Of Avco

CLARENCE FELIX, vice-president and general manager of Crosley government products division, has been elected a vice-president of the parent company, Avco Manufacturing Corp.

He will continue to act as general

**SPACE SAVERS FOR
MODERN CIRCUITRY —
MONEY SAVERS FOR
PRODUCTION ECONOMICS —**

**IN-RES-CO
TYPE IR
WIRE WOUND
RESISTORS**

The practical, low cost solution for circuit designers striving for the subminiature. Type IR units offer precision resistance values capable of retaining stability through long periods of continuous or intermittent service. Type IR resistors are available at prices based on mass production methods of manufacture. Wound to a tolerance of ±1%, they are permanently accurate. Conservative ratings allow ample safety margin in all classes of service. Special Bakelite forms eliminate shrinking, swelling and temperature effects. IN-RES-CO moisture and fungus proof coating offers absolute protection against climatic extremes. Specify IR Type resistors for all applications where precision performance and limited space are important determining factors.

**WRITE FOR NEW RESISTOR
HANDBOOK —** Contains complete data and recommended applications for resistors for every purpose.

**INSTRUMENT
RESISTORS CO.**

COMMERCE AVENUE UNION NEW JERSEY

APPLICATION-DESIGNED RESISTORS FOR ELECTRONICS AND INSTRUMENTATION

RF Leakage can be

STOPPED!



... simply and economically

**A MUST in MILITARY
and MANY COMMERCIAL
EQUIPMENTS**

**YOU CAN IMPROVE
YOUR DESIGNS GREATLY,
THIS SIMPLE, INEXPENSIVE WAY**

The place to stop RF leakage is "on the drawing board." In other words if you design your product so that RF leakage is reduced to a minimum you'll have no difficulty in meeting military radio noise specs and FCC regulations, and you'll have a better product too. In the design of many military equipments during the last 10 years effective sealing in of RF leakage has been accomplished with a simple application of METEX Electronic Weather-strip and other METEX Shielding Products made from Metal Textile's highly resilient compressed knitted wire. You can achieve comparable results in your own designs. Send today for our new brochure describing METEX Shielding Products in detail with a most helpful section on design.

get your
copy today



METAL TEXTILE CORPORATION

Knitters of Wire Mesh for more than a Quarter Century
ROSELLE, NEW JERSEY

Want more information? Use post card on last page.
ELECTRONICS — May, 1955

manager of government products.

Felix, who was named a vice-president in 1954, joined Crosley 28 years ago in the engineering department. He was appointed chief engineer of automobile radios in 1934 and of all radio production in 1939.

In 1941, when Crosley entered full time war production, W. A. Felix became product manager of government electronics and later manager of all government products. After the war in 1945, he was appointed product manager of radio and television and in 1947 he was promoted to works manager of Crosley's Cincinnati plant. He became assistant to the general manager in 1949.

In 1953, with the establishment of an autonomous defense manufacturing division, he became general manager of government products.

Dunn Receives Army Award



LOUIS G. DUNN, right, associate director of the guided missile division of Ramo-Wooldridge has received the Certificate of Appreciation from the Army, for his work in missile ordnance including development and completion of the Corporal, the Army's surface-to-surface guided missile.

Presentation of the Certificate, the Army's highest civilian award, one of three awarded within the past ten years, was made by Major General Leslie E. Simon, chief of ordnance research and development division in behalf of the Army's chief of ordnance, Major General E. L. Cummings.

The citation honored Dr. Dunn for his work from 1947 to 1954 as director of the Jet Propulsion

FOR TRUE MAGNETIC SHIELDING

SPECIFY

**JAN'S
MU-METAL
SHIELDS**

- DE-IONIZED and TOTALLY ANNEALED under HYDROGEN
- EFFICIENT PRODUCTION to provide LOWEST COST
- FUNCTIONAL DESIGN

*"The most advanced
know-how in
Magnetic
Shielding"*



AVAILABLE FROM STOCK — Over 150 combinations of engineered Bezel and Shield assemblies including heavy rubber cushions and calibrated filters FOR ALL POPULAR C. R. T. AND PHOTOMULTIPLIER TUBES.

QUICK DELIVERY OF SPECIAL PROTOTYPES.



**HARDWARE MANUFACTURING
CO., INC.**

75 NORTH 11th STREET, BROOKLYN 11, N. Y.
Want more information? Use post card on last page.



for
MIL-I-7444A(1)
SPECIFICATION
VINYL SLEEVING

Resinite
EP-93

NOW
AVAILABLE
IN ALL 3 SIZE
RANGES

- Low Temperature Flexibility to -90°F (impact test)
- Flame resistant — all sizes self extinguishing in less than 15 sec.
- High Temperature Stability up to 260°F
- Completely fungus resistant

For use wherever Air Force Specification MIL-I-7444A(1) applies, Resinite EP-93 Vinyl Insulation Sleeving is now available. Here is one outstanding source — one material — to meet the requirements of all 3 size ranges of this specification.

The quality of Resinite sleeving is rigidly controlled through meticulous compounding, precision manufacturing and thorough inspection. Laboratory Test Reports of EP-93 and other Specification Grades of Resinite Sleeving are furnished with each shipment at no extra cost.

One order will show you why more Resinite Specification Vinyl Sleeving than all others is used by the aircraft and electronics industries. Write for samples and performance data.

Resinite
RESIN INDUSTRIES, INC.
315 Olive St. • Box 1589 • Santa Barbara, Calif.
SPECIALISTS IN VINYL SLEEVING AND TUBING FOR THE
AIRCRAFT, ELECTRONICS AND PHARMACEUTICAL FIELDS

Want more information? Use post card on last page.

388

PLANTS AND PEOPLE

(continued)

Laboratory operated for the Army by California Institute of Technology.

Veeder-Root Selects Research Director



Allan L. Burton

ALLAN L. BURTON has been appointed research director of Veeder-Root, manufacturers of counters and computing instruments.

Market and product research will be combined under his direction.

He joined the firm a year ago, following specialized work in new product administration at RCA. Prior to that, he was manager of industrial sales of Tracerlab. During World War II, he carried out research work with the underwater sound laboratories at Harvard University.

Topp And Bonner Complete Merger

TOPP INDUSTRIES, of Los Angeles, Calif., electronics engineering and development company has merged with Bonner Machine Works, manufacturer of aircraft electronics systems, through a stock exchange. The merged companies are retaining the name Topp Industries with B. F. Gira, co-founder and president of Bonner as president; H. J. Peterson, founder and former president of Topp as executive vice-president and a director and Glendon L. Tremaine as secretary and a director.

Topp has filed with the Securities

Negative temperature and voltage coefficients

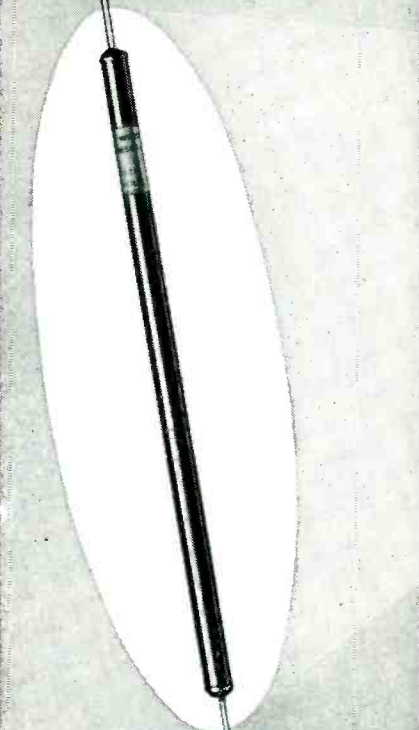

Sillwhite 80X
MOLDED RESISTORS

RATING — 3 watts — 100 to 100,000 megohms

SERVICE — High voltage equipment such as electrostatic generators, atomic energy equipment, etc.

CHARACTERISTICS

- Negative temperature coefficients
- Negative voltage coefficients
- Good stability, durability, mechanical strength
- Non-deterioration of values due to age
- Non-hygroscopic base specially processed against humidity
- Compactness

BULLETIN 5409
has full details. Send for a copy. Attention Dept. R



THE *Sillwhite* INDUSTRIAL DIVISION
DENTAL MFG. CO.  10 EAST 40th ST.
NEW YORK 18, N. Y.

Western District Office • Times Building, Long Beach, Calif.

Want more information? Use post card on last page.

May, 1955 — ELECTRONICS

here's what **DIE CAST**
GRC ZINC ALLOY
 THREADED
FASTENINGS

mean to you...

in terms of a better product, in terms of a more economical product!

Gries' unique techniques make possible closer tolerances, cleaner threads, greater dependability, durability, die-cast uniformity. Mass production means lower costs!



NEW BULLETIN AVAILABLE!
 Fact-packed—shows how Gries ingenuity and money-saving methods can solve your fastenings problems.

Send today for your Copy, prices and samples.

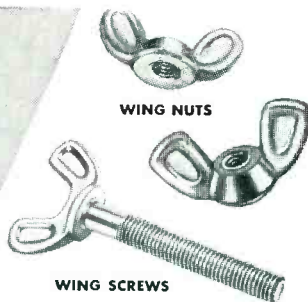

WING NUTS

WING SCREWS

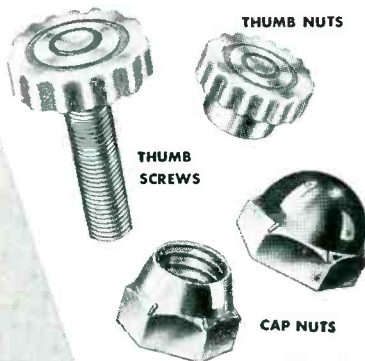

THUMB NUTS

THUMB SCREWS

CAP NUTS

World's Foremost Producer of Small Die Castings

GRIES REPRODUCER CORP.

151 Beechwood Ave. • New Rochelle, N. Y.
 Phone: NEW Rochelle 3-8600



SEALING
 DIPPING
 POTTING
 IMPREGNATING



INSULATING
 FUNGUSPROOFING
 MOISTUREPROOFING
 HEAT CONDUCTING

WAXES BIWAX COMPOUNDS

Developed and produced for manufacturers of electronic components and other electrical units.

Specifications and samples available on request. Information relative to your problem or application will enable us to make suggestions and recommendations.

BIWAX CORPORATION 3445 HOWARD STREET
 SKOKIE, ILLINOIS

NEW PRICE REDUCTIONS

Up to 25% on Corning Low-Power Resistors
 4- and 5-watt sizes

Write New Products Division, Corning Glass Works, Corning, N.Y.

**MOLDED
 OPEN TYPE
 TRANSFORMERS**
 THE
CLIPPER
 SERIES

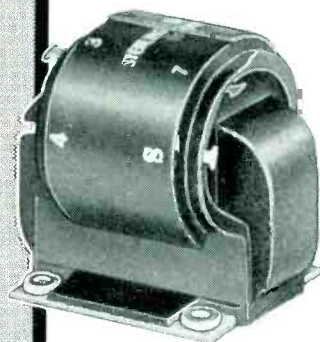

Built to pass MIL-T-27 specifications, including Grade 1 humidity tests, and to operate continuously at 150°C (Class C).

Result: Savings up to 50% in space and weight without sacrifice in performance.

**SAMPLES?
 SPECIALS?
 SHORT RUNS?**

The Clipper is only one of the many types we make. We specialize in custom-built transformers to your specifications. Let our engineering staff help solve all your transformer problems.

Samples delivered in 1 to 3 weeks

Write for Literature

STERLING
 TRANSFORMER
 CORPORATION

297 North 7th St. Brooklyn 11, N. Y.
 STagg 2-4200

**ALLIED
CONTROL**
starts with
the finest.....



**GARFIELD
WIRE**

*Garfield
Wire*

When you specify Allied Control, you're asking for the best. For example, take the relay shown here. It's the finest there is — in split-second response, unflinching accuracy, rugged dependability.

Design — construction — materials — all have to be the best for Allied... and the heart of this relay is wound with Garfield Enameled Magnet Wire.

You'll start with the finest in wire, too, when you specify Garfield. Our modern drawing and enameling equipment, our rigid production control and our stringent inspection system are geared to produce only top-quality wire with tolerances closer than NEMA specifications.

Write for price lists and specification chart on Garfield bare wire, plain and heavy enamel additions today.



142 Monroe Street, Garfield, N. J., GRegory 2-3661-2

*At any stage of
Design and/or Production*

call . . .

**ROWE
INDUSTRIES**

Accuracy Test Stand
developed and
produced by ROWE



AWAITING WORD FROM YOU

- A staff of development engineers and project men—familiar with general electrical, electronic and mechanical practices.
- A laboratory equipped with the very latest testing equipment.
- Designing for specific applications, custom test equipment, prototype development, pilot runs; or production of highly specialized equipment, sub-assemblies, general manufacturing, corona free type cables, harness assemblies, wiring and structures of complex nature.

If you have a problem that might benefit from Rowe's experience in development and production services, we'd be pleased to discuss it with you—no matter what stage it may be in.

ROWE *Industries* 1702 WAYNE ST.
TOLEDO 9, OHIO

and Exchange Commission for authorization to issue 139,000 shares of common stock, underwritten by Dempsey-Tegeler & Co. Proceeds from the sale are planned for use in the acquisition of Standard Electronics Manufacturing Co., plus leasehold improvements, equipment and increased working capital.

The merged companies' combined sales for the eight months ending December 31, 1954, totalled \$1,299,870.

American Electronics Buys Pierson

AMERICAN ELECTRONICS of Los Angeles, Calif., has acquired Pierson Electrical & Engineering Corp. of Los Angeles.

Pierson manufactures miniature d-c motors and generators and develops miniature power supplies for guided missiles and electronic systems for atomic energy application.

By the acquisition, American Electronics augments its miniature components which were limited to a-c products.

R. T. Pierson continues as president of Pierson Electrical.

Norden-Ketay Acquires Acragage

ACRAGAGE Corp. of Milford, Conn. has been acquired by the Norden-Ketay Corp.

The Acragage Corp., formerly Clapp Instrument, was formed in 1942 to design and manufacture quality pressure and vacuum gages and is currently filling orders for some of the nation's largest users of these gages. In 1954, Acragage produced over 130,000 gages.

GE To Build Military Plant

GE's heavy military electronic equipment department plans the erection of the third building in the HMEE "Systems Center" in Syracuse, N. Y.

The new 69,000 sq ft structure will house the department's marketing section and engineering laboratories.

The HMEE "Systems Center" is

headquarters for the development and manufacture of complex electronic defense systems for the armed forces.

Ground will be broken for the new structure in the spring, and it is expected to be ready for occupancy by about 700 employees by the year's end.

The employees now work at other locations in the Syracuse area, where HMEE employs over 3,300 people in facilities with a total area of over 500,000 sq ft.

Radio Condenser Forms Automation Division

A NEW automation division for design and engineering connected with the manufacture of electro-mechanical assemblies has been formed by the Radio Condenser Co. of Camden, N. J.

Consisting of design and production specialists representing the various fields of engineering, the new group will design its own electro-mechanical assemblies to fit into customers' automation programs.

The new division will be headed by Joseph S. Robb, director of engineering, and Edward J. Penberthy, sales manager.

Servomechanisms Names General Manager



Harold R. Larsen

HAROLD R. LARSEN, vice-president of Servomechanisms of Garden City, N. Y., has been appointed general manager of the company's eastern and western divisions.

He joined Servomechanisms in

sub-miniature

ACEPOT

the smallest wire wound precision potentiometer

1/2" Size — Linearity .3% — High Resolution — 200Ω to 50K*

torque: .035 oz./in. @ 20° C.
power rating: 2 watts for 60° C. rise
meets applicable portions of MIL-E-5272A standards

ambient temperature: -55° C. to 125° C.

*Resistance Range: 200Ω to 50K standard. Higher or lower on special order.

Standard, servo or flush mountings . . . dual or up to 5-gang units.

The case and threaded mounting bushing is one-piece anodized aluminum for maximum heat dissipation. The shaft is centerless ground stainless steel. Standard bearing in aluminum or bronze insert. Available for lower torque requirements with ball or jewel bearings. All units fully sealed, moistureproofed, fungicide treated.

Through our unique manufacturing and testing facilities, you are assured of controlled quality. Each ACEPOT is performance tested and a Polaroid picture record is supplied showing linearity and resolution.

Send for specification sheet, application data sheet and prices. Your inquiry will receive prompt attention.

ACEPOT

ACE ELECTRONICS ASSOCIATES

125 Rogers Avenue, Somerville 44, Mass.

Trademark applied for.

Laboratory Standards



PULSE GENERATOR

MODEL 79-B

SPECIFICATIONS:

FREQUENCY: continuously variable 60 to 100,000 cycles.

PULSE WIDTH: continuously variable 0.5 to 40 microseconds.

OUTPUT VOLTAGE: Approximately 150 volts positive.

OUTPUT IMPEDANCE: 6Y6G cathode follower with 1000 ohm load.

R. F. MODULATOR: Built-in carrier modulator applies pulse modulation to any r.f. carrier below 100 mc.

MISCELLANEOUS: Displaced sync output, individually calibrated frequency and pulse width dials, 117 volt, 40-60 cycles operation, size 14"x10"x10", wt. 31 lbs.

Immediate Delivery

MEASUREMENTS CORPORATION

BOONTON • NEW JERSEY

Here Are The Electronics Engineers You Need!

A TEAM of Electronics Engineers
thoroughly experienced in . . .

- Instrumentation
- Digital and Analog Computers
- Complex Electronics Circuitry
- Panoramic Receivers
- Sweep Generators
- Servos

This Team Is Available Now!

Ours is an unusually imaginative and productive staff—experienced men of high inventive ability and outstanding analytical skill—with the knack for running a project efficiently and successfully. We have designed and are manufacturing commercially some of the leading developments in our field, including:

The INCREDUCTOR . . .
high frequency controllable inductor.

The TRAK Code Converter . . .
for conversion of Morse code to teletype printing.

TRAK Tuning Lock . . .
for automatic control of tuning of frequency-shift code receivers.

If your engineering staff is hard-pressed to meet a government schedule, or if you have a difficult research or design problem, we'll be glad to handle it for you from its initial stage to successful completion of finished prototype. Write or phone Melvin L. Jackson, Vice President.

C. G. S. LABORATORIES, INC.

391 Ludlow Street

Stamford, Connecticut

Phone: DAvis 4-9508

Want more information? Use post card on last page.

392

PLANTS AND PEOPLE

(continued)

1950, and from 1952 until his recent appointment, he was manager of the company's western division. In his new capacity of general manager, Larsen will have the responsibility of directing the sales, engineering and production activities of the eastern and western divisions of the company and will report directly to the president, William W. Shannon.

Blonder-Tongue Opens New Plant

BLONDER-TONGUE LABS of Westfield, N. J. has put into full operation its second plant located in Newark, N. J. The new building provides over 30,000 sq ft of additional manufacturing space



Hermetic Seal Appoints Neidorf

HERMETIC SEAL PRODUCTS of Newark, N. J., appointed Samuel W. Neidorf as vice-president and general manager in charge of operations. He will supervise and take charge of the complete operation of Hermetic's three plants.

Neidorf joined the firm in 1948 as chief engineer and factory manager. Before his present appointment, he was in charge of all engineering departments.

He was formerly associated with IT&T and Tung-sol Electric. With the latter company he helped pioneer the engineering and devel-

let Williams
help you apply

**FERRIC
OXIDES**

to the manufacture
of your

FERRITES

You'll be well repaid by getting the facts on a special group of Pure Ferric Oxides, developed by Williams especially for use in the manufacture of ferrites.

Williams Ferric Oxides analyze better than 99% Fe₂O₃. They contain a minimum of impurities. They are available in a broad range of particle sizes and shapes. Among them, we're certain you'll find one that's "just right" for your requirements. The proper application of Ferric Oxides to the manufacture of Ferrites is our specialty.

Tell us your requirements . . . we'll gladly send samples for test. Chances are good that our Ferric Oxide "Know How" can save you considerable time and money. Address Dept. 25, C. K. Williams & Co., Easton, Pa.

WILLIAMS
COLORS & PIGMENTS

C. K. WILLIAMS & CO.
Easton, Pa. • East St. Louis, Ill.
Emeryville, Cal.

P.S. We also produce IRN Magnetic Iron powders for the Electronic Core Industry, the Magnetic Tape Recording Industry and others. Write for complete technical information.

Want more information? Use post card on last page.

May, 1955 — ELECTRONICS

MOLYBDENUM

PURE and THORIATED TUNGSTEN

For ELECTRONIC APPLICATION

RIBBONS

STRIPS

FORMED PIECES

Your special metals
rolled to thin sizes
- close tolerances

H. CROSS CO.

15 BEEKMAN ST., N. Y. 38, N. Y.
Worth 2-2044 and COrlandt 7-0470

**HERE'S
BIG HELP
IN
TERMINAL WIRING!**

The New

JONES FANNING STRIP

Connections are made through Fanning Strip, on bench or anywhere apart from barrier strip, and quickly slipped into assembly.

Use with Jones Barrier Terminal Strips, Nos. 141 and 142, for 1 to 20 terminals.

Simplifies soldering. Insures correct connections. Saves time. Ideal for harness or cable assembly. Brass terminals, cadmium plated. Bakelite mounting. Send for complete data.

The correct wire to correct terminal every time!



9-141
Barrier
Strip

9-161
Fanning
Strip.
Pat.
applied
for.

Jones
HOWARD B. JONES DIVISION
CINCH MANUFACTURING CORPORATION
CHICAGO 24, ILLINOIS
SUBSIDIARY OF UNITED-CARR FASTENER CORP.

for all applications requiring exceptionally high insulation resistance and unusual stability at high temperature

**HOPKINS
"HY-THERM"
New sub-miniature
high temperature
CAPACITORS**

Hermetically sealed and metal encased, new HY-THERM capacitors have been designed to meet or exceed military requirements (Mil-C-25A). Example: At 125°C the minimum insulation resistance is 20 megohm-microfarads and maximum insulation resistance is 500 megohms. Available in all standard values and tolerances. Variety of mounting and circuit combinations. Special units designed to meet individual requirements.

Have a special problem?
Write, wire or phone for
details, TODAY!



Catalog available

2082 Lincoln Ave., Altadena, Calif.,
SYcamore 8-1185 • Offices in
WASHINGTON, D.C. and DETROIT

experience pays

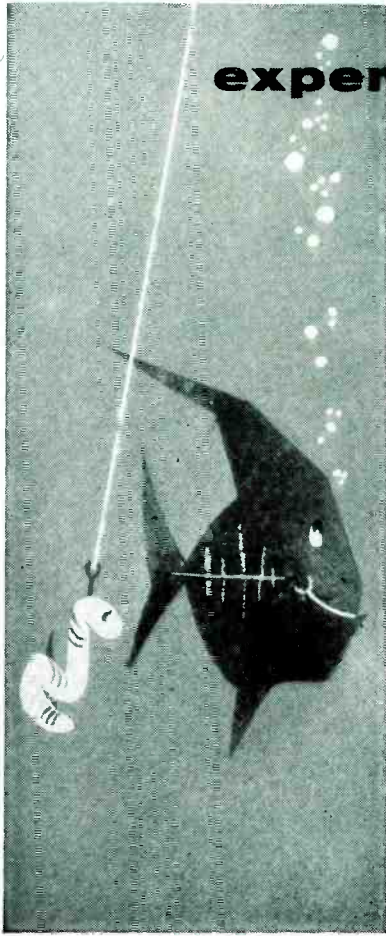

Yes, experience does pay in many ways. Our clients know from experience they have a dependable, responsible source for preparation of better industrial and business literature.

Why not do the job right? It saves time, money and produces results. Let us give you a proposal on your next publication.

We'll do the whole job—from planning to printing—or just those parts that you need.

- product literature
- military manuals
- company publications
- training material

Call or write for more information.

TECHNICAL WRITING SERVICE
McGraw-Hill Book Co., Inc. • 330
West 42nd Street • N. Y. 36, N. Y.

CATHODE RAY TUBES!

PRICED TO SAVE MONEY!
BUILT TO LAST LONGER!

Now available for export as well as domestic use . . . the finest quality Sel-Son standard or aluminized cathode ray tubes . . . in all sizes from 10-inch to 27-inch . . . made by America's foremost independent tube manufacturer . . . with the most modern facilities . . . under the most careful quality controls . . . and priced to bring you the best for less money.

SEL-SON ELECTRONIC TUBE CORP.
DARBY, PENNSYLVANIA

Exclusive Export Distributors



Distributors of Radio, Electronics
and TV Parts and Equipment

TUBES!

STANDARD
ALUMINIZED



All Sel-Son
tubes carry a
full 100%
one-year
warranty.

Write for General Catalog

opment of the all-metal vacuum tube and supervised the engineering and production of the miniature tube.

Packard-Bell Enlarges Staff



Robert S. Bell, left, and Neil H. Jacoby

NEIL H. JACOBY, dean of the School of Business Administration at the University of California at Los Angeles, has been elected to the board of directors of Packard-Bell.

A former member of President Eisenhower's three-man Council of Economics Advisers in Washington D. C., September 1953 to December 1954, Dr. Jacoby has been assisting in the writing of the administration's economic reports to Congress. He resigned in January.

The company also has appointed Major Gen. Edmund C. Langmead (ret.) former Commanding General of the San Bernadino Area of the Air Material Command, to assist in the direction of its technical products division.

Brush Electronics Elects New President

W. RUSSELL BURWELL, vice-chairman of the board, advances from the presidency of Brush Electronics, a Clevite unit, to full-time responsibilities as vice-chairman and as chairman of Clevite's research and development committee.

Douglas C. Lynch, executive vice-president, has been elected president of Brush Electronics.

He joined the company in 1952, having previously been head of the international operations of the Crosley division of Avco Manufac-

you can depend on
SECON for
PRECISION WIRE & RIBBON
if your product-need is here

ELECTRONIC TUBE COMPONENTS AND ELEMENTS

Filament wire, filament ribbon, grid wire, tabbing ribbon, Pirani gauge ribbon and other wire components for use in electronic tubes.

From initial selection of melt components through production and final completion, Secon puts a *complete metallurgical unit* at your service.

Tell us your wire and ribbon problems and we'll gladly submit prompt recommendations. Small quantity inquiries and orders specially invited.

Write for Pamphlet E-5.

- Fine Wire drawn to 0.0003" diameter
- Ribbon rolled to 0.0001" in thickness
- Electro-Plated Wire and Ribbon
- Special Solder
- Enameled and Insulated Wire
- Pirani Gauge Wire
- Electric Primer Ignition Wire
- Galvanometer Suspension Strip
- Etched Wire
- Precision Potentiometer Wire
- Transistor Components
- Experimental Melts

for wherever the
element calls for PRECISION

SECON METALS CORPORATION
7 Intervale Street, White Plains, New York
WHite Plains 9-4757

Among important activities at Hughes is a program involving comprehensive testing and evaluation in connection with Hughes-developed radar fire control and navigation systems for latest type military all-weather interceptors.

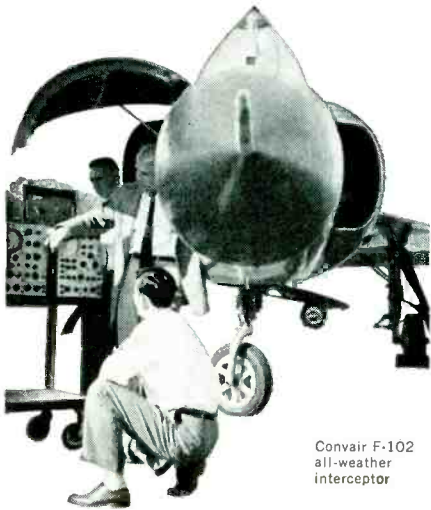

Convair F-102
all-weather
interceptor

System Test Engineers

There is need on our Staff for qualified engineers who thoroughly understand this field of operation, and who have sufficient analytical and theoretical ability to define needed tests; outline test specifications; assess data derived from such tests, and present an evaluation of performance in report form.

Engineers who qualify in this area should have **1** a basic interest in the system concept and over-all operation of test procedures; **2** experience in operation, maintenance, "debugging," development, and evaluation testing of electronic systems, and knowledge of laboratory and flight test procedures and equipment; **3** understanding of basic circuit applications at all frequencies; **4** initiative to secure supporting information from obscure sources.

Hughes

RESEARCH AND DEVELOPMENT
LABORATORIES

SCIENTIFIC AND ENGINEERING STAFF

Culver City, Los Angeles County, Calif.

Want more information? Use post card on last page.

ELECTRONICS — May, 1955

PLANTS AND PEOPLE

(continued)

turing Corp. and later a senior staff executive of Willys-Overland Motors. From 1937 to 1947 he was with Westinghouse in a number of engineering, sales and management positions and as assistant general manager of Westinghouse International.

Cooper Union Honors Dubilier



WILLIAM DUBILIER (left) received the first Gano Dunn medal of Cooper Union at the school's Founder's Day ceremony in New York, N. Y. The medal, for outstanding professional achievement, was presented by Irving Rossi, a member of the board of governors of Cooper Union Alumni Association. Dubilier was honored for his many important contributions and inventions.

Cornell-Dubilier also announced completion and formal opening of its new Los Angeles division plant.

Paul M. Keuffler of Los Angeles has been appointed general manager and the plant will be under his direct supervision.

U. S. Testing Names Perenic

LAWRENCE J. PERENIC has been named manager of the electronics department of the United States Testing Co. of Hoboken, N. J.

He will supervise the electronic services of the firm which include electrical testing, precision measurements over wide frequency spectrums, environmental testing under extreme conditions, manufacturing, design and development for assem-

advanced
technique

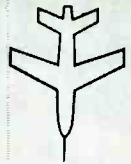

sweep signal
generator

7 to 70 mc

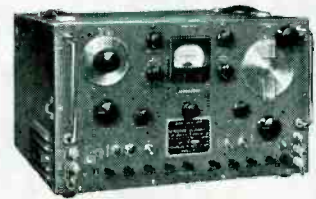

multi-purpose generator for
wide band amplifier testing

Continuously tunable CW, sweep or pulsed RF output.

0.25% frequency accuracy and stability.

Continuously tunable spike or blanking marker derived from the CW oscillator. Range 4.9 to 85 mc.

Frequency deviation adjustable up to $\pm 30\%$ or 15 mc.

Independent use of 101 db attenuator. High output — 0.5 volt across 50 ohm load.

Pulse output identical to modulating source

Internal 5 mc crystal frequency standard.



See this equipment demonstrated during the National Conference on Aeronautical Electronics in the Avion suite at the HOTEL VAN CLEVE Dayton, Ohio May 9, 10, 11

AVION

INSTRUMENT CORP.

SUBSIDIARY OF QCF INDUSTRIES, INC.

299 Highway No. 17, Paramus, N.J.

Want more information? Use post card on last page.

395



NEW

Allenpoint Set Screws

WITH
SCIENTIFICALLY-DESIGNED
SMALLER CUP POINTS

Smooth, deep point penetration for greater holding power and resistance to vibration; precision formed threads and accurate thread lead for maximum locking action. Comparative tests by leading laboratory prove Allen Set Screws unmatched in performance. Write to Advertising Department for Bulletin C-33A.

When ordering through your local industrial distributor, specify Genuine Allenpoint Set Screws.



ALLEN

MANUFACTURING COMPANY
Hartford 2, Connecticut, U.S.A.



Want more information? Use post card on last page.

396

PLANTS AND PEOPLE

(continued)

blies, systems and components of various types.

Prior to joining the company, Perenic was superintendent of engineering for Bogart Manufacturing in Brooklyn. Before that, for Western Electric in New York City, he was product engineer and staff engineer.

Stahl Forms Production Engineering

ALFRED R. STAHL has formed Production Engineering in Garnet Lake, Johnsbury, N. Y. for consulting work and building equipment. He was with GE for 6 years in advanced development of automatic equipment for such fields as component placement, tube production and automatic tube mounting. The new company will specialize in these fields.

Radio Frequency Elects Engineers

CHARLES A. HIGGINS and William A. Yonkers were elected to the board of directors of Radio Frequency Laboratories. Higgins joined Aircraft Radio Corp. of Boonton, N. J. in 1935, transferring to Radio Frequency Laboratories in 1945 as senior engineer.

Yonkers, executive engineer of Radio Frequency, joined the company in 1944.

Radioplane Expands Plant Facilities

RADIOPLANE Co. of Van Nuys, Cal., a subsidiary of Northrop Aircraft, has added a 28,000 sq ft office and laboratory building to its facilities. The new building brings to 200,000 sq ft the total space occupied by Radioplane.

Radioplane is a supplier of radio-controlled drones for the armed services and has built more than 40,000 pilotless aircraft, according to Northrop.

Kramer Promoted By Radio Receptor

STANLEY KRAMER has been appointed assistant manager of sales

Couch Rugged



RELAYS

Specify the COUCH MODEL 2A or 4A relay whenever HIGH SHOCK-HIGH VIBRATION capabilities are required and for DRY-CIRCUIT applications.

VIBRATION . . . 5 to 25 cps @ 0.4" peak to peak excursion; 25 to 2000 cps @ 20G acceleration; No contact opening, relay energized or de-energized.

SHOCK ELECTRICAL . . . 75G for 10 milliseconds minimum. No contact opening, relay energized or de-energized.

SHOCK MECHANICAL . . . 200G minimum . . . no physical damage to relay or change in electrical characteristics.

Models 2A and 4A are subminiature, hermetically sealed, D.C. relays which meet and in several respects exceed the requirements of MIL-R-5757B. They are actuated by a "balanced-armature" rotary motor. Both models are particularly suited to dry-circuit switching applications.

LEADING PARTICULARS

Ambient Temp.:	-65°C to +125°C
Weight:	3.2 oz. maximum
Height of Case:	1½" maximum
Diameter of Case:	1¾" maximum
Terminals:	Flattened & pierced
Contact	DPDT — Model 2A
Arrangement:	4PDT — Model 4A
Contact Material:	Fine silver to molybdenum
Operation:	Simultaneous operation, simultaneous release, no contact bounce
Pull-in-power (Coil):	¾ watt — Model 2A ½ watt — Model 4A

Test Data and Literature on Request
Built-in Dependability



NORTH QUINCY 71, MASSACHUSETTS

Want more information? Use post card on last page.

May, 1955 — ELECTRONICS

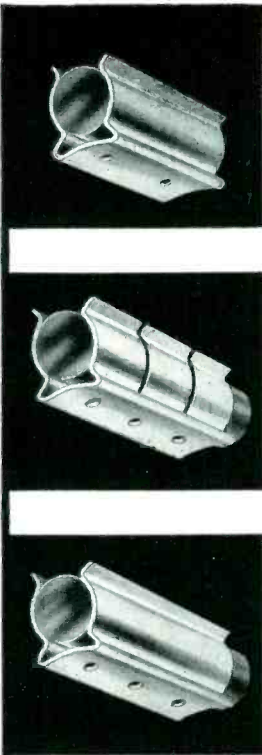

AUGAT

Sub-miniature Tube Cradles

- HEAT DISSIPATION
- CUSHION FROM SHOCK AND VIBRATION

Protect the efficiency of your sub-miniature tubes, resistors and capacitors in electronic equipment with Augat Tube Cradles. These mite-sized marvels reduce tube temperature by conducting the heat and dissipating it rapidly. Augat Tube Cradles hold tubes firm and steady regardless of external shock and vibration. Once your tubes are inserted in the cradles, they stay put!

Augat Tube Cradles come in three types as shown on the left and may be obtained in cadmium plated spring steel; beryllium copper, silver plated; or silver magnesium nickel where heat dissipation is desired. The base of cradles is convex shaped to provide additional tension when cradle is fastened to chassis. Where additional conductivity is required, shields are available in copper silver plated with gold flash or in silver magnesium nickel material.

Write for additional information and samples

AUGAT BROS. INC.

31 PERRY AVENUE • ATTLEBORO, MASS.

For the Communications Industry

A NEW SINGLE-SIDEBAND TRANSMITTING SYSTEM

It is now possible to adapt AM transmitters to twin-channel Single-Sideband telephone, telegraph and facsimile operation. Single-Sideband operation, besides providing additional channels, improves the signal-to-noise and jamming ratios, as well as appreciably reducing fading effects. This new system uses Class-C amplifiers and therefore is the most efficient and non-critical method of producing Single-Sideband waves.

We also have available a new system for producing Phase-Locked FSK waves and by the use of this equipment up to 12 channels of teletype may be transmitted over one transmitter.

KAHN RESEARCH LABORATORIES

Elizabeth Bldg., 22 Pine St.

Freeport, L. I., New York

Freeport 9-8800

Export: RCA International — 30 Rockefeller Plaza, New York 20, N. Y.

YOKES

Industrial Camera Yokes
Alignment Yokes
Image Orthicon Yokes
Focus Coils Image Orthicon
Terminal Board Assemblies

COILS

Variable R.F.
Variable I.F.
Plate Coils
Oscillator Coils
Crystal Heater Units

COIL ASSEMBLIES

Impedance Coils
Peaking Coils
R.F. Chokes
Video Peaking Coils
Transmitter Coils

TELE COIL CO., Inc.

SAMUEL FELDMAN, Pres.

2733 Saunders St.

Camden 5, N. J.

Phone EMerson 5-7528

HIGH VOLTAGE



F-C-I

Type D Capacitors

with
Characteristics never before achieved!



EMPLOYING a newly developed plastic film dielectric, Film Capacitors, Inc. has produced a line of capacitors that are superior in performance, smaller and lighter in weight, and lower in cost. Nothing presently available approaches the high level of Type D for practically every type of high voltage D.C. application. Its versatility enables you to stock one type which performs the functions of many.

F-C-I Type D capacitors are furnished in glass tubes with hermetically sealed end caps and either wire leads or threaded studs.

ELECTRICAL CHARACTERISTICS

Operating Temp. Range	-55° C. to +125° C.
Voltage Range, D.C.	600V to 60 KV
Capacitance Range	.0001 to 0.1 MF
Power Factor	0.3% @ 1 KC
Dielectric Absorption	0.1%
Voltage Derating at 85° C.	30%
Voltage Derating at 125° C.	66%
Temperature Coefficient	+500 PPM/° C.
I.R. at Room Temperature	10 ⁶ megohms/MF
Capacitance Stability	0.5%

When your industrial capacitor specs. call for precision and stability, specify F-C-I.

Excellent delivery on standard or special types ... Capacitors made to your specifications.

For more complete technical data, write for catalog.

film capacitors, inc.

3400 Park Ave., New York, N.Y.

Telephone CYpress 2-5180



536K Multimeter Kit \$12.90
Wired \$14.90
1000 ohms/volt

425K 5" Scope
Kit \$44.95
Wired \$79.95

470K 7" Push-Pull Scope
KIT \$79.95. WIRED \$129.50.

**YOU BUILD
EICO
KITS
IN ONE
EVENING—
but they
last a lifetime...
and you
save 50%**

38 Kits and 42 Instruments —
the Industry's most complete
line of **MATCHED
TEST INSTRUMENTS**

1/2-million EICO Instruments are now in use the world over! That's the proof of EICO's leadership in Value.

For latest precision engineering, finest components, smart professional appearance, lifetime performance and rock-bottom economy — see and compare the EICO line at your Jobber before you buy any higher-priced equipment! You'll agree with over 100,000 others that only EICO Kits and Instruments give you the industry's greatest values at lowest cost.



22BE VTVM Kit \$25.95
Wired \$39.95



565K Multimeter Kit \$24.95
Wired \$29.95
20,000 ohms/volt



377K
Sine & Square Wave Audio Gen.
Kit \$31.95. Wired \$49.95

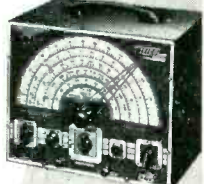

300K Sweep Gen.
Kit \$34.95. Wired \$49.95



105DK Battery Elim.
Kit \$29.95. Wired \$38.95



625K Tube Tester
Kit \$34.95
Wired \$49.95

Write NOW for FREE latest Catalog E-5



©1954

ELECTRONIC INSTRUMENT CO., Inc.
84 Withers Street, Brooklyn 11, N. Y.

Want more information? Use post card on last page.

PLANTS AND PEOPLE

(continued)

engineers of the Radio Receptor semi-conductor division. Kramer joined the company several years ago as project engineer later becoming an applications engineer and sales engineer for the division. Prior to that he spent ten years doing project engineering in design and development work for several major radio and electronics companies.

Haydu Brothers Name Chief Engineer



Victor Le Gendre

VICTOR LE GENDRE has been appointed as chief engineer of the Haydu Brothers Division of Burroughs Corp., Plainfield, N. J.

Le Gendre comes to the firm from Chatham Electronics Corp. where he was design and development engineer for the past two and a half years. He holds a patent on fine pitch grid winding and has another patent pending on grid winding structures.

Between World War II and his experience with Chatham, Le Gendre was with Tung-Sol for five years and was quality control supervisor for a year and a half with National Union Electric.

Ohio State Antenna Lab Expands

THOMAS E. TICE has been made supervisor of the antenna laboratory of Ohio State University. Since last spring he has been acting supervisor of the laboratory, replacing V. H. Rumsey.

C. T. Tai has joined the Laboratory and has also been appointed associate professor in the depart-

To help you MOVE AHEAD in INDUSTRIAL ELECTRONICS

This library makes plain methods used by today's electronics engineers

Here's a library that will help you prepare yourself for a top job in the booming industrial-electronics field! It gives you basic theory, practices, and methods that outstanding men in this work need and use every day!

The experts who wrote these 4 books save you time and effort because they've worked out many of the fundamental problems you'll face in electronics work. They explain electronic circuits and devices... vacuum tubes... the analyses and use of electron-tube circuits... and provide a vast amount of other data on electronics equipment!

INDUSTRIAL ELECTRONICS ENGINEERING LIBRARY

4 volumes, 1998 pages, 6 x 9, 1637 charts, diagrams, and illustrations

\$24.95—payable on easy terms

In this library are the sort of practical facts that can help you step out in front of the "average" electronics man—they give the kind of help that could very well mean a top-paying job in electronics work.

You get practical data on electronic instrumentation of both electrical and non-electrical quantities, and on electronic control and power.

There is a wealth of facts on vacuum tubes—vital information on the physical laws of their behavior and their individual operating characteristics.

You're shown how electron-tube circuits can go to work in a broad variety of operations, including radar, television, pulse communication, and general electronic control.

Moreover, you are shown the basic laws governing the motion of free electrons, and how they are applied in determining electron motions. And all this is just a sample of the help you get!

See these books before you buy!

Just mail the coupon below and get the Library for 10 days free. After 10 days, if satisfied, start the small monthly payments and in a short time they'll be yours, right while you've been using them. If you decide you don't want the Library, simply return the 4 books and the matter will be closed—at no obligation to yourself.



4 big volumes

CASE'S THEORY AND APPLICATION OF INDUSTRIAL ELECTRONICS

HARMAN'S FUNDAMENTALS OF ELECTRONIC MOTION

SPANGENBERG'S VACUUM TUBES

SEELY'S ELECTRON-TUBE CIRCUITS

10 DAYS' FREE EXAMINATION

McGraw-Hill Book Co., Dept L-5
330 West 42nd St., New York 36, N. Y.

Send me for 10 days' examination the *Industrial Electronics Engineering Library*. If satisfactory, I will send \$4.95 in 10 days and \$4.00 monthly until the price of \$24.95 is paid. If not wanted, I will return the books postpaid.

(PRINT)

Name

Address

City..... Zone... State...

Company

Position

For price and terms outside U. S., write McGraw-Hill Int'l., N. Y. C. L-5

Want more information? Use post card on last page.

May, 1955 — ELECTRONICS

ment of electrical engineering. He comes to Ohio State from the Stanford Research Institute.

Robert G. Kouyoumjian of the lab's staff has been appointed assistant professor in the department of electrical engineering.

Plans for a new field station for antenna testing have been completed by the University. This new station costing about \$250,000 is expected to be completed by 1956.

General Transistor Elects President

HERMAN FIALKOV has been elected president of General Transistor Corp. of Jamaica, N. Y., manufacturer of transistors and germanium diodes.

Fialkov, formerly chief engineer of the germanium division of Radio Receptor Co. brings to General thirteen years of experience in electronics. He has served in engineering capacities with Emerson Radio, the Mutual Broadcasting System and Tele-tone Radio Corp.

Ratray Appoints General Manager

S. GANGI has been appointed as general manager of George Ratray & Co., manufacturers of precision potentiometers.

Gangi has had 25 years experience in the engineering and production of precision instruments and components.

Navy Promotes Trolese And Bernard

LOUIS G. TROLESE, who joined Navy's Electronics Lab as a radio engineer in 1942, was selected as head, Radar Branch succeeding Royal V. Keeran, who left the San Diego Laboratory for private employment. Trolese was formerly head of the Atmospheric Studies Branch at the Laboratory. He spent 8 years with RCA and General Air Conditioning companies before coming to what was then the Navy Radio and Sound Laboratory on Point Loma.

Commander William B. Bernard has been appointed to regular as-

MARKEM[®] MACHINES

Solve "IN-PLANT" PRINTING PROBLEMS
- FASTER - NEATER - AT LOWER COST

COLOR BANDING WIRE LEAD COMPONENTS

The Markem 69A Machine semi-automatically applies up to six color bands to wire lead components such as resistors and condensers. Band width and color changes are easily made. Automatically feeds and ejects; bands about 50 objects per minute. The 69A will also mark cylindrical objects with complete label detail, in one or two colors.

Other Markem machines available for marking electrical parts and products of all sizes and shapes. Write for detailed information.

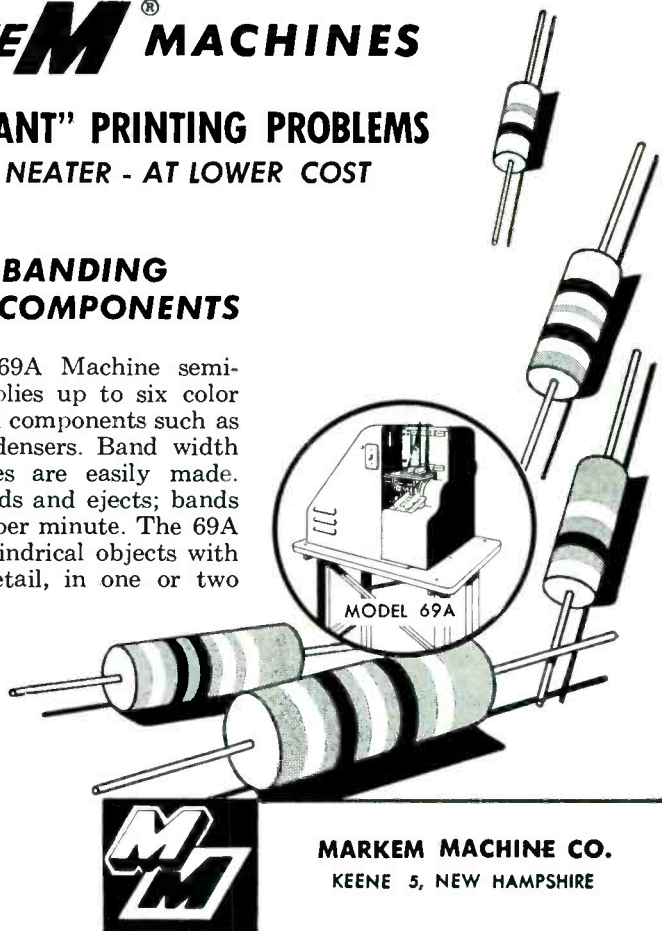

MARKEM MACHINE CO.
KEENE 5, NEW HAMPSHIRE

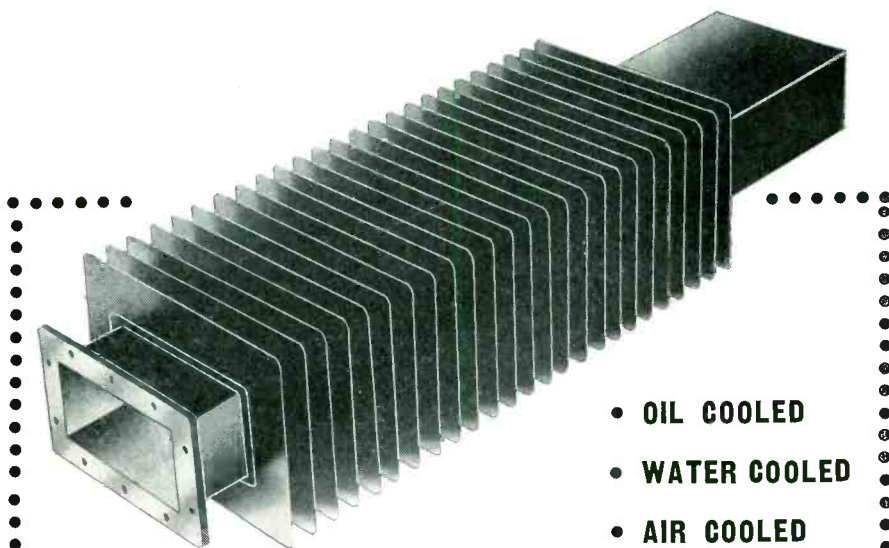

- OIL COOLED
- WATER COOLED
- AIR COOLED

NEW High Power DUMMY LOADS

WAVEGUIDE AND COAXIAL

- Coaxial Loads: up to 10 KW Average Power.
- Waveguide Loads: X-Band Loads up to 1000 Watts Average Power.
- S-Band Loads up to 4000 Watts Average Power.
- L-Band Loads up to 6000 Watts Average Power.

WRITE FOR NEW CATALOG AND QUOTATION ON SPECIAL DUMMY LOADS

ELECTRO IMPULSE Laboratory

200 RIVER STREET • RED BANK, N. J. • Phone: Red Bank 6-0404



NULL METER

**A PHASE
SENSITIVE
NULL METER
WHEREIN NOISE
AND HARMONIC
VOLTAGES ARE
EFFECTIVELY
ELIMINATED**



MODEL 100A

- Allows separate balance of in-phase or quadrature in null circuits.
- Eliminates the necessity for filters.
- High sensitivity.
- Direction of null clearly shown on zero centered meter.
- Synchro zeroing without recourse to coarse and fine switching.

PRICE
\$22950
F.O.B.
NEW YORK

For further information contact your nearest representative or write for brochure

REPRESENTATIVES

BROGER INSTRUMENT CO., 739 Boylston St., Boston 16, Mass.
LOREN F. GREEN & ASSOC., 4949 W. Diversey Ave., Chicago 39, Ill.
F. R. JODON, INC., Suite 338, 3000 Connecticut Ave., Washington 8, D. C.
KITTLESON CO., 416 No. La Brea Ave., Los Angeles 36, Calif.
LEEMARK ASSOCIATES, P. O. Box 8467, Kansas City 14, Mo.
RON MEREDITH CO., 2410 Beacon Ave., Seattle 44, Wash.
G. G. WILLISON CO., 1821 W. Alabama, Houston 6, Texas

INDUSTRIAL TEST EQUIPMENT CO.
55 E. 11th ST. · NEW YORK 3 · GR. 3-4684

Manufacturers of:

PHASE
METERS

•

NULL
DETECTORS

•

IMPEDANCE
COMPARATORS

•

POWER
OSCILLATORS

•

Other Electronic
Test
Equipment

signment as executive officer for the Laboratory. From 1937 to 1941 he worked for the FCC then went into active naval service in 1942. He served on the staff of Commander-in-Chief Atlantic Fleet, in the Electronics Branch, Office of Naval Research, Washington D. C., and as electronics officer, staff of the Commander Operational Developments Force before coming to NEL in 1953.

Teleregister Elects Schmidt V-P

THE TELEREGISTER CORP., manufacturer of special purpose electronic data handling and display systems, elected Edwin L. Schmidt as vice-president in charge of industrial sales.

Schmidt has been with the company since 1929 and holds numerous patents on data handling systems including the company's Magnetronic Reservoir for automatic processing of airline and railroad passenger reservations.

He has served as project engineer, associate director of engineering and manager of the company's Cleveland, Ohio office.

Marion Instrument Selects Gaffney

F. J. GAFFNEY has been named vice-president for engineering of Marion Electrical Instrument Co. of Manchester, N. H. Gaffney was most recently director of engineering for the guided missiles division of the Fairchild Engine and Airplane Co. During World War II he served as head of the test and measurements group of the MIT radiation laboratory. From 1945 until early 1953 he was general manager of the Polytechnic Research and Development Co.

Machlett Names X-Ray Manager

D. T. O'CONNOR has been appointed director of industrial x-ray of Machlett Labs. He was previously with the Naval Ordnance Laboratory as chief of radiology section.

April 18, 1955

WE ARE PLEASED TO ANNOUNCE THAT

FIELDING S. ROBINSON

IS NOW ASSOCIATED WITH US AS
CONSULTANT ON INVESTMENTS
IN THE ELECTRONICS INDUSTRY

Smith, Barney & Co.

Members New York and American Stock Exchanges

14 Wall Street, New York 5, N. Y.

CODE MARK Anything!

WITH



INDUSTRIAL MARKING INK



★ **CODE MARKING INKS**

For Resistors and Capacitors. For Machine or Hand Application.

Whatever the substance, Phillips has an ink to mark it permanently and legibly—or can make one. Marking experts insist on "Clear Print" Wood Block Stamp Pads and Opaque Inks. They get clear, sharp, fast-drying impressions. Also inks for brush, pen, stencil or machine application available in a variety of colors and quantity containers.

★ **Quick Laboratory Service On Your Problem Markings.**

★ **To Permanently Mark . . . Metals, Plastics, Glass, Wood, Paper, Leather, Ceramics—glazed, varnished or lacquered surfaces and virtually every other known material.**

CANC



RECO



35



PART NO 10

BU

WRITE FOR FREE BOOKLET

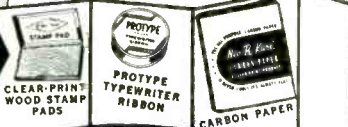

L. A. PHILLIPS, President

PHILLIPS PROCESS CO. INC.

192 MILL STREET ROCHESTER 14, N. Y.

NEW BOOKS

Handbook of Microwave Measurements

EDITED BY M. WIND AND H. RAPAPORT, Polytechnic Institute of Brooklyn, N. Y., 1954, Vol I & II, 1,000 pp., \$12.00.

HERE IS AN ATTEMPT to bring together the various techniques and procedures used in making measurements in the frequency range where circuits must be considered distributed in nature. Measurement techniques in almost all the microwave fields are included. There are sections on the measurement of basic quantities such as frequency, power, impedance, attenuation, noise generation and spectrum analysis. In addition, there are sections dealing with measurements on microwave tubes, crystals, receivers, some microwave components and cables.

Several sections of the book are very good. The best of these is probably the section on the Precision Measurement of Impedance and Equivalent Representations. To this reviewer's knowledge, this is the first time that the material contained herein has been brought together and adequately coordinated. This section should prove useful to those people engaged in precision impedance measurements. Other sections which are particularly good are those dealing with attenuation measurements and power measurements. In the power measurements section, it is unfortunate that the efficiency of various bolometers as a function of frequency was not discussed as this is bound to be an important subject in the region of 1 cm and higher.

The Handbook has been written by several authors and it is unfortunate that there was not considerably more editing of the overall book. This lack of editing becomes apparent in the use of symbols which are not always consistent from chapter to chapter. There are also a rather large number of typographical errors, particularly in the equations. Many of the procedures are repetitious and some of them

Want more information? Use post card on last page. ELECTRONICS — May, 1955



CHECK*

- | | |
|--|--|
| <input type="checkbox"/> Insulating coatings | <input type="checkbox"/> Radio-active oxides |
| <input type="checkbox"/> Amorphous metal | <input type="checkbox"/> Dirt |
| <input type="checkbox"/> Discoloration | <input type="checkbox"/> Grease |
| <input type="checkbox"/> Lacquer | <input type="checkbox"/> Oil |
| <input type="checkbox"/> Plastic flash | <input type="checkbox"/> Rust |
| <input type="checkbox"/> Rubber flash | <input type="checkbox"/> Varnish |
| <input type="checkbox"/> Glass flash | <input type="checkbox"/> Paint |
| <input type="checkbox"/> Enamel flash | <input type="checkbox"/> Plate |
| <input type="checkbox"/> Imbedded metal | <input type="checkbox"/> Core sand |
| <input type="checkbox"/> Lead deposits | <input type="checkbox"/> Silicate coatings |
| <input type="checkbox"/> Carbon | <input type="checkbox"/> Excess solder |
| <input type="checkbox"/> Brazing flux | <input type="checkbox"/> Ceramic deposits |
| <input type="checkbox"/> Weld spatter | <input type="checkbox"/> Graphite |
| <input type="checkbox"/> Stains | <input type="checkbox"/> Slag |
| <input type="checkbox"/> Heat treat scale | <input type="checkbox"/> Polishing compound |

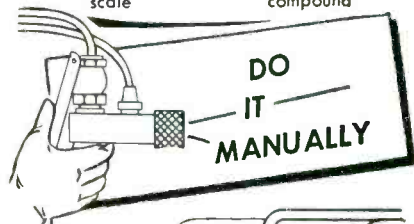

OR

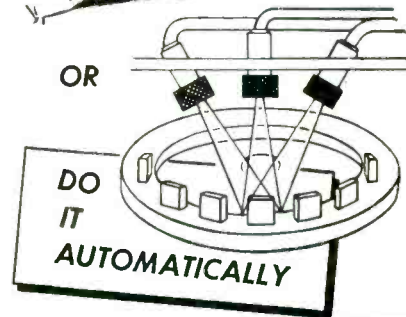

WITH **PRESSURE BLAST WET BLASTING**

TWO SPEED

* This ad is your coupon. Check off your problem(s) and mail today for free illustrated literature . . . application data . . . case history information!

THE **CRO-PLATE COMPANY INC.**

747-A WINDSOR STREET
HARTFORD 5, CONNECTICUT

Want more information? Use post card on last page.

RELIABLE AND STABLE PERFORMANCE

A.C. servo and computer components



Sizes 23, 15
& 11

Induction Resolvers



Size 15

Brushless Induction Potentiometers



Sizes 18, 15
& 11

Servo Motors

Let us quote on your detailed requirements.

American Electronic Mfg., Inc.

INSTRUMENT DIVISION OF



9503 W. JEFFERSON BLVD. • CULVER CITY, CALIF.
Telephone: TEXAS 0-5581 • VERMONT 8-6402

Application Engineering Offices in Principal Cities

Want more information? Use post card on last page.

contain extremely elementary steps. It is felt that coordinating the various procedures and elimination of some of the elementary steps would have made the Handbook considerably easier to read and much more useful.

In several places, there has been a very loose use of terms. For example, the terms primary and secondary frequency standard have been used on the basis of accuracy rather than on the basis of whether their accuracy is determined by a time or a frequency check. Another term which has come into rather wide usage is the power standing wave ratio. This term is really a misnomer and is not based upon physical facts. The only justification for using this term is that it avoids extracting the square root when a standing-wave ratio is read with a square-law detector and a linear meter.

In various sections, certain rather fundamental points have been glossed over a little too freely. For example, in the measurement of standing-wave ratios one is always faced with the problem of decoupling the probe as much as possible from the slotted section. The largest amount of decoupling is generally determined by the noise level in the meter following the detector. Thus it becomes important to know the error caused by noise when the signal-to-noise ratio is small.

Another point which would bear more consideration is the relation between sweep speeds and resolving power in swept systems and spectrum analyzers. This is a consideration that can lead to serious errors if certain fundamental limitations are not observed.

Standing-Wave Measurements

The section on the measurement of standing-wave ratio includes some good material on the measurement of connectors and general procedures used in slotted line work. There are, nevertheless, several powerful techniques for use when measuring standing-wave ratios which should have been included. One of these techniques is the use of a sliding load in conjunction with a slotted line to measure the re-

THOMAS

100 FOOT

SKY-HI

STAINLESS STEEL HYDRAULIC MAST

ONLY

MAST THAT RAISES IN
CORRECT SEQUENCE
FOR EASY GUYING...

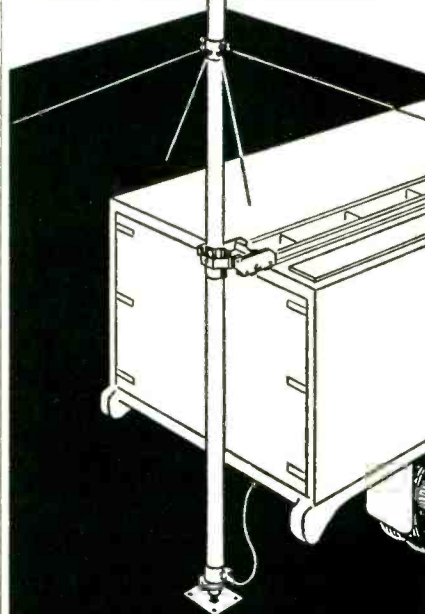

MOBILE EQUIPMENT
MICRO WAVE-RADAR
COMMUNICATIONS
WEATHER INSTRUMENTS

THOMAS MOLD & DIE BOX 126 WOOSTER, OHIO

Want more information? Use post card on last page.

RAWSON THERMOCOUPLE METERS



R.M.S. Readings

No Wave Form Errors

SINGLE RANGES from 1 ma full scale to 10 amperes full scale. Good from DC to 2 megacycles and higher.

MULTIPLE RANGE INSTRUMENTS
RAWSON THERMAL MULTIMETERS
Write for Bulletin 502

Other Rawson Instruments
DC METERS AND MULTIMETERS
FLUXMETERS
ELECTROSTATIC VOLTMETERS
WATTMETERS
ELECTRODYNAMOMETER TYPES
SINE COSINE POTENTIOMETERS
ROTATING COIL GAUSSMETERS

RAWSON ELECTRICAL INSTRUMENT COMPANY

111 Potter Street

Cambridge, Mass.

SINCE 1920 QUALITY WENCO PRODUCTS SPADE BOLTS



Specialists in designing and manufacturing of all-purpose fasteners and wire forms. Tooled to produce over 1000 styles in any screw size, material, finish, quantity, or to your specifications.

SERVING INDUSTRY FOR THIRTY-FIVE YEARS
OTHER PRODUCTS

Simplex WIRE STRIPPERS & CUTTERS

• TOOLS • DIES • STAMPINGS

Bulletins on complete line upon request

WENCO MANUFACTURING CO.
1133 W. Hubbard St., Chicago 22, Ill., U.S.A.

HIGH VACUUM PRODUCTION and MEASUREMENT

25 years experience in the power vacuum tube business with recognized leadership in *exhaust* processing, is available to you with Litton High Vacuum equipment.



Vapor Pumps • Traps

Vapor Pump Oils

Vacuum Measurement equipment

Model PB Pump, less valves and charcoal \$268.00 f.o.b. Grass Valley, Calif.

Charcoal Baffle Assembly \$53.00 f.o.b. Grass Valley, Calif.

- All Metal High Speed Oil Vapor Pump.
- Sectionalized Combinations for Charcoal Cell, Water Baffle, Valves, straight or angle Manifold connection.
- Liquid cooled, insuring uniform results regardless of environment.
- Interchangeable heaters; any voltage.
- Use with any organic medium.



**MODEL L-3032
VACUUM GAUGE**
\$75.00 f.o.b. Grass Valley, Calif.

- Phillips type gauge.
- Built-in magnetic field.
- Built-in heater for outgassing after long idleness, or contaminating runs.

- Adapted to metal or glass systems.
- No tungsten clean-up.
- No filament burnout.
- Repeatable measurements.

Day in, day out dependable, rugged production or long idle and intermittent laboratory use, with consistent dependable results.

Built to take it!



**MODEL 4301
VAC GAUGE
AMPLIFIER AND
CALIBRATION UNIT**
\$255.00 f.o.b. Grass Valley, Calif.

A rugged production unit with all controls necessary for the outgassing, calibration and operation of the L-3032 gauge.

The demand for long shelf life and dependable snap-on operation of vacuum tubes is bringing to a close the day of mediocrity in vacuum procedure.

Let us help you in modernizing your techniques and equipment to meet these competitive needs.

3239



Litton Engineering Laboratories
Grass Valley, California - P. O. Box 949



A copy of this quick-reading, 8-page booklet is yours for the asking. It contains many facts on the benefits derived from your business paper and tips on how to read more profitably. Write for the "WHY and HOW booklet."

McGraw-Hill Publishing Company, Room 2710, 330 West 42nd St., New York 36, N. Y.



new
BROWNING
 low-priced
 laboratory
OSCILLOSCOPE
 combines

- High Band Width — 5 cps to 10 mc., ± 3 db, useful up to 20 mc.
- High Sensitivity — 16 mv p-p/cm; 40 mv p-p/in
- Rise Time — 0.35 μ sec.
- High Input Impedance — 2 Megohms paralleled by 25 MMF
- Vertical Delay — 0.25 μ sec. to display leading edge of pulses (Model 701-D only)
- Large Vertical Display — 4 inches of useful deflection
- Sweeps, Triggered and Recurrent — 0.1 to 10,000 μ sec/cm
- High Stability with Electronically Regulated Power Supply

with

- Simple Operation — few controls functionally arranged
- Low Weight — 43 lbs.
- Low Power Consumption — 280 watts, no blower required
- Compact Size — 11" x 15" x 18 $\frac{1}{2}$ "; one handle — easy to carry
- Universal Power Supply — 115/230 volts, 50-500 cps
- Ease of Service — only 4 tube types besides CRT, voltage regulator and reference tube
- Conservatively Rated Components and Tubes
- New High Voltage Power Supply — compact potted unit

and low price

- Model 701 \$545.00
- Model 701-D — with 0.25 μ sec. delay line 585.00

For more information, write for complete specifications

browning
 LABORATORIES, INC.

750 Main Street, Winchester, Mass.

Want more information? Use post card on last page.

flection of four-terminal devices.

Another technique which is extremely useful, especially for low standing-wave ratios, is the use of directional couplers. Actually, directional couplers overcome many of the inherent disadvantages of slotted lines when used for low reflection coefficients and they are capable of a very high order of accuracy. These are extremely powerful methods and certainly deserve consideration.

Because of the scope of this handbook, it should prove useful to people concerned with microwaves. While it is quite complete, some of its real utility has been lost because of repetition of various procedures, the inclusion of many elementary steps and the inclusion of many steps peculiar to a certain type of equipment which could have been obtained from appropriate instruction books.—W. B. WHOLEY, *Hewlett-Packard Co., Palo Alto, Calif.*

The Present State of Physics

ARRANGED BY FREDERICK S. BRACKETT. *American Association for the Advancement of Science, Washington, D. C., 1954, 261 p, \$6.75.*

THIS BOOK constitutes a collection of papers based on a symposium held by the American Association for the Advancement of Science in New York on December 30, 1949. From the length of some of the papers and the fact that several contain references to 1952 literature, it is evident that the three years delay in publication is in part due to efforts of the several authors to present a more complete picture of the field than was possible at the symposium.

Content

The ten papers or monographs cover special topics in the fields of elementary particles, the physics of the solid state, chemical physics and biophysics. While most of them are of no more than passing interest to those of us whose activities are concerned primarily with electronics, a few of them are of considerable importance. These are

FOR HIGH FREQUENCY HIGH VOLTAGE

SPACE SAVING APPLICATIONS

GARDE

Miniature & Sub-Miniature
 INSULATED STAND-OFFS,
 FEED THROUGH & SPACERS

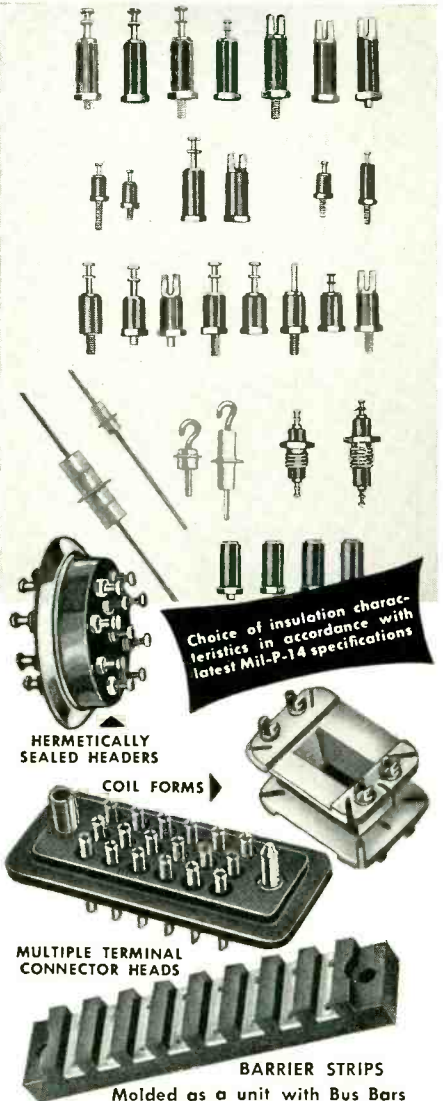

For users to properly assess the outstanding features and advantages of Garde Components, samples will be sent on request. A detailed technical catalog is now available. Be sure your name is on our mailing list.

We have complete facilities to accommodate your special requirements, ranging from Engineering Consulting Service to Precision Design and Production.

GARDE
MANUFACTURING COMPANY
 MOLDERS OF THERMOPLASTIC AND THERMOSETTING MATERIALS
 588 Eddy Street, Providence 3, Rhode Island
 Sales Representatives in Principal Cities

Want more information? Use post card on last page.
 May, 1955 — ELECTRONICS

the three papers on solid-state physics:

The New Electronics, by K. Lark-Horovitz (70 pages)

Flow of Electrons and Holes in Semiconductors, by J. Bardeen (32 pages)

Barium Titanate Ferroelectrics, by A. von Hippel (19 pages)

Solid-State Physics

Professor Lark-Horovitz's paper, while assuming a fair knowledge of basic physics and mathematics on the part of the reader, presents an excellent description of the principal concepts of solid-state physics for the nonspecialist. Beginning with the experiments and speculations of more than a century ago, the development of modern views concerning the nature of the conductivity, Hall and thermoelectric effects, rectification and other properties are described. The band picture and the effects of lattice defects are developed in a simple, straightforward manner although a fuller discussion of electron pair bonding would have been worthwhile. The nature and usefulness of the *p-n* junction was not described, presumably because these topics are covered in the second paper of this group.

Transistor Theory

Dr. Bardeen's paper is understandable to the nonspecialist if the one by Lark-Horovitz is read first. The processes of carrier injection, the flow of electrons and holes, the characteristics of rectifying contacts and the descriptive theory of transistors are clearly and concisely covered.

Titanate Ferroelectrics

While ferromagnetic materials have been known for a long time, their use in electronic devices is still in a very early stage of development, largely because they are not as widely understood as they must be if full use is to be made of them. Interest in barium titanate ferroelectrics has been increasing during the past ten to fifteen years because of such factors as the high dielectric constant that can be achieved when these ceramics are made under certain conditions. Dr. von Hippel's paper, while rather

Davies

MAGNETIC TAPE DATA RECORDING AND ANALYSIS

Davies Laboratories—the foremost producer of magnetic tape data recording and analysis systems can reduce, to its simplest terms, your data problems. Their standard and specially designed equipment is being successfully used throughout industry. Whatever your problem is—compactness, extreme environmental conditions—for use in aircraft, mobile or field, consult Davies first for the correct, economical solution.

• STANDARD DAVIES EQUIPMENT •

RECORDERS

Send for Bulletins 54D-54E

From 7" cube, 6-channel affairs to 14-channel, 10½" reel equipment, standard models of Davies airborne and portable recorders will fulfill almost every requirement. They feature a wide range of recording speeds, extreme flexibility as to recording technique, plug-in electronic circuitry, and "battleship" construction to withstand severe environmental conditions. The same plug-in electronic units provide equivalent flexibility in laboratory recording applications. Flutter and wow compensation provides topnotch performance, unattainable otherwise.

REPRODUCERS

Send for Bulletin 54D

Single or multi-speed tape transports for rack mounting, combined with unitized playback amplifiers for direct recording, pulse reconstituting amplifiers for pwm systems, and wide frequency range high output FM discriminators especially designed for wow and flutter compensation, complement in reproduction the unequalled flexibility of our recording equipment, and provide the necessary tools for data reproduction, processing, and analysis for modern instrumentation systems.

ANALYZER

Send for Bulletin 54C

First of a line of automatic data processing equipment is the time-tested Davies Automatic Wave Analyzer for completely automatic frequency analysis of tape recorded or "live" data. Capable of clearly delineating components as low as 3 cps, with bandwidth variable from ½ cps to 45 cps, this analyzer provides data otherwise unobtainable, and saves untold man hours.

SPECIAL DATA REDUCTION EQUIPMENT

Davies engineers will design and build equipment to handle any unusual data reduction requirement. Tell us your problem—we'll come up with an answer—quick.

NOW AVAILABLE

The multi-channel, completely shielded, precision alignment instrumentation heads which had to be developed for full utilization of the vast potentialities of magnetic tape recording. Excellent resolution, negligible crosstalk, and precise interchannel time and phase relationships are inherent in the design of these heads. 20 tracks on 2" tape, all gaps in line, for general instrumentation work, 20 or more tracks per inch for digital recording applications, can be packed in these heads.

THE

Davies

PIONEER MANUFACTURERS OF AIRBORNE MAGNETIC
TAPE DATA RECORDING SYSTEMS AND EQUIPMENT

LABORATORIES INCORPORATED

4705 QUEENSBURY ROAD • RIVERDALE, MARYLAND

TELEPHONE: WASHINGTON, D. C., APPLETON 7-1133

TEMPCLAD GLASS BRAIDED LEAD WIRE

Primary insulation is Teflon; secondary insulation is Teflon-impregnated glass braid. A stranded construction with unusual abrasion resistance. Non-flammable.

see #7 below

From the list below select the wire which meets your needs:

- TEMPRITE TEFLON MAGNET WIRE**—Sizes from 14–50 AWG incl. Withstands temperatures from -90°C – -260°C . Single, heavy, triple or quad thickness.
- TEMPRITE-X SPECIAL TEFLON MAGNET WIRE**—Same characteristics and sizes as regular Temprite magnet wire, but specially processed for severe applications.
- THERMALON SILICONE MAGNET WIRE**—Sizes from 14–50 AWG incl. Used for temperatures from -54°C – 180°C . Made in single or heavy thickness.
- TEMPVAR W.A. ENAMEL MAGNET WIRE**—Sizes from 14–50 AWG incl. Excellent physical and electrical properties, is impervious to Freon 22. Standard space factor.
- TEMPRENE TEFLON HOOK-UP WIRE**—Sizes from 30–10 AWG incl. Unaffected by temperatures from -90°C – 260°C . Excellent dielectric, impervious to all commercial solvents. Solid colors or spiral striped in 55 different color combinations. Made to meet MIL-W-16878A.
- TEMPREX TEFLON EXTRUDED HOOK-UP WIRE**—Sizes from 30–10 AWG incl. Types E and EE of MIL-W-16878A in 14 solid colors. Same characteristics as Temprene.
- TEMPCLAD TEFLON-FIBERGLAS LEAD WIRE**—Sizes from 30–8 AWG incl. Made to MIL-W-7139, for temperatures from -90°C – 260°C . Suitable where maximum abrasion protection or resistance to mechanical stress is required.
- RETEP TEFLON SATURATED GLASS BRAID LEAD WIRE**—Low cost, low voltage push-back type for the range -90°C – 260°C . Retains flexibility after impregnation.
- NEBROC TEFLON-FIBERGLAS LACING CORD**—Developed especially for wiring harnesses or coil tying. Made in sizes from .009"–.076" and in tape form.
- TEMPTUBE TEFLON-FIBERGLAS TUBING**—Sizes up to 1 1/4" ID. Fully saturated for high dielectric and maximum abrasion resistance. Colors on request.

For complete engineering specifications write

H I T E M P W I R E S

26 WINDSOR AVENUE

MINEOLA, LONG ISLAND

SPECIALISTS IN HIGH-TEMPERATURE INSULATION

Want more information? Use post card on last page.

406

NEW BOOKS

(continued)

short, presents a nice summary of the principal facts and theory.—**GEORGE D. O'NEILL**, *Research Laboratories, Sylvania Electric Products Inc., Bayside, N. Y.*

THUMBNAIL REVIEWS

Transistor Circuit Components. Wright Air Development Center, 22 p, 1954, available from Library of Congress, Publication Board Project, Washington, D. C., microfilm \$2.25, photocopy, \$4.00. Survey discussing miniature components now available as well as those under development.

Table of Sine and Cosine Integrals for Arguments from 10 to 100. NBS Applied Mathematics Series 32, 186 p, 1954, \$2.25, Government Printing Office, Washington 25, D. C. Useful in the theory of numbers, calculus of probabilities, antenna theory, nuclear physics and electromagnetic theory.

Materials for Product Development—1954. Clapp & Poliak, New York 17, N. Y. 1954, 160 p, \$7.50. Proceedings of the Basic Materials Conference, Chicago, May 1954. Thirteen papers covering new materials, new methods, management policies, questions and answers.

Distribution of Radio Brightness on the Solar Disk. Special Report No. 4, 72 p, 1954, U.R.S.I., 42 rue des Minimes, Brussels, Belgium, 72 p, 100 francs. Review of the history and methods for measuring radio noise. Includes Report No. 5 on interstellar hydrogen.

Understanding High Fidelity. By Louis Biancolli and Lester H. Bogen. David Bogen Co., New York 14, N. Y., 56 p, 1954, 25¢. A second edition of a handy and useful explanation for laymen and engineers of the ins and outs of hi-fi.

Electrical and Electronics Patents. Office of Technical Services, Department of Commerce, Washington 25, D. C., 1954, \$4.00. Abstracts of 1915 government-owned patented inventions available to the public on a royalty-free license basis.

Television and Radar Encyclopedia. Edited by W. MacLanachan. Pitman Publishing Corp., New York, Second Edition, 1954, 216 p, \$6.00. New terms added to 1953 edition. Definitions are nonmathematical yet authoritative and clear, representing both British and American terminology. Appendix includes detailed comparison of BBC, RETMA and CCIR television standards.

Advanced Television Servicing Techniques. By RETMA Pilot Training Course Teaching Staff (P. B. Zbar and S. Schildkraut). John F. Rider Publisher, Inc., New York, 1954, 163 p, \$3.60. Laboratory Workbook, 48 p, \$.95. Sponsored by Radio-Electronics-Television Manufacturers Association to provide technicians with a systematic industry-approved troubleshooting procedure utilizing the most efficient techniques and the latest test instruments.

HYCOR TELEMETERING FILTERS

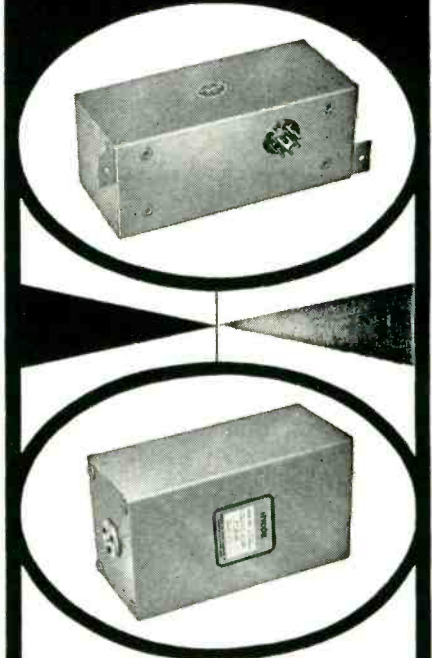

Features...

- HYCOR telemetering filters have excellent characteristics due to the use of high "Q" toroid inductor elements. The filters may be used in low level circuits with negligible hum pickup resulting.
- In addition, only the finest capacitors are employed to assure stability.
- Available in standard RDB frequencies.

GENERAL SPECIFICATIONS Impedance 500/500

TYPE	BANDWIDTH	ATTENUATION	FREQUENCY RANGE
1500	—7½%	—3 db or less	400 cps to 14.5 kc
	—20%	—30 db or more	
4300	—7½%	—3 db or less	400 cps to 960 cps 1300 cps to 14.5 kc
	—20%	—40 db or more	
4000	—7½%	—3 db or less	400 cps to 960 cps 1300 cps to 14.5 kc
	—15%	—45 db or more	
	—28%	—45 db or more	
			22 kc to 70 kc

Other frequencies and impedances available on request.

Representatives at
Principal Cities

HYCOR
Company, Inc.

Subsidiary of International Resistance Company
11423 VANOWEN STREET
NORTH HOLLYWOOD 1, CALIF.

Want more information? Use post card on last page.

May, 1955 — ELECTRONICS

he's working for you



THIS FELLOW IS TRAINED IN YOUR BUSINESS. His main duty is to travel the country — and world — penetrating the plants, laboratories and management councils . . . reporting back to you every significant innovation in technology, selling tactics, management strategy. He functions as your all-seeing, all-hearing, all-reporting business communications system.

THE MAN WE MEAN IS A COMPOSITE of the editorial staff of this magazine. For, obviously, no one individual could ever accomplish such a vast business news job. It's the result of many qualified men of diversified and specialized talents.

AND, THERE'S ANOTHER SIDE TO THIS "COMPOSITE MAN," another complete news service which complements the editorial section of this magazine — the advertising pages. It's been said that in a business publication the editorial pages tell "how they do it"—"they" being all the industry's front line of innovators and improvers — and the advertising pages tell "with what." Each issue unfolds an industrial exposition before you—giving a ready panorama of up-to-date tools, materials, equipment.

SUCH A "MAN" IS ON YOUR PAYROLL. Be sure to "listen" regularly and carefully to the practical business information he gathers.



McGRAW-HILL PUBLICATIONS

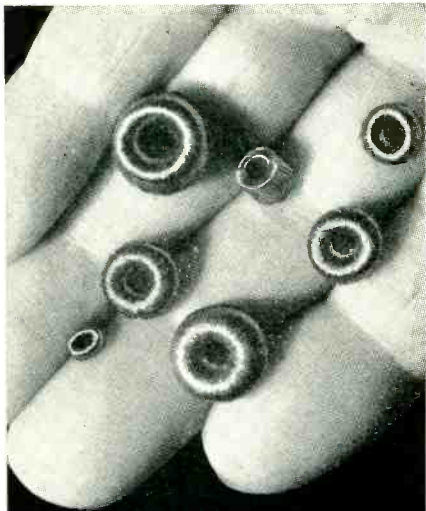

Toroids!
Tiny in Size!
Light in Weight!

Envision the potentialities of these bantam coils in solving space and weight problems! Sub-miniature toroids from the BOESCH Model SM reveal a new horizon in equipment design.

Write for detailed information on the NEW Model SM Sub-miniature Toroidal Coil Winding Machine.

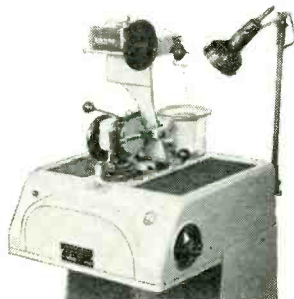

Model SM

Now — no licensing, no royalties required in the sale and use of BOESCH Machines

BOESCH
 MANUFACTURING CO., INC.
 DANBURY, CONN.

Want more information? Use post card on last page.

408

BACKTALK

Pot Design Problem

DEAR SIRs:

MR. COLEMAN'S article "Potentiometer Design for Minimal Loading" on pages 184-190, Feb. 1955, contains an omission which causes the data presented to lead to false conclusions.

The curves showing loading error indicate maximum error at 50 percent of rotation. The author states his equations are relative to a 2-percent error. Fine and well, this information may be accurate and correct, but due to the omission, 2 percent of what, the curves and data mean little.

With voltmeters and other equipment percentage of error is based on full-scale readings. The author of this article based his percentage of error as ± 2 percent, of expected voltage at any specified degree of rotation. On that basis, his information is correct. Utilizing standard technique however, maximum error occurs at approximately two-third rotation from the zero-voltage end. Curves on this may be found in Helipot catalog 540, an article by the writer, and in other published literature. Also his ratio of the load being four times higher than the potentiometer to limit the error to 2 percent is in error. The referenced curves indicate at least a 10:1 ratio must be maintained.

ALVIN B. KAUFMAN
 Los Angeles, Calif.

Fast Tube Rate

DEAR SIRs:

WE WERE PLEASED to read the article, "Counting Circuit Batches Components," on p 157 of the February ELECTRONICS. We were, however, surprised to see "These (GS10C Dekatron selector tubes) have a counting rate of 550 a second—", and think this misleading phrase may be an inadvertant contraction of "The combination of a GTE 175M trigger tube and a GS10C Dekatron has a counting rate of 550 per second."

The GS10C Dekatron alone is

NEW DEVELOPMENT

TYPE
 ANT

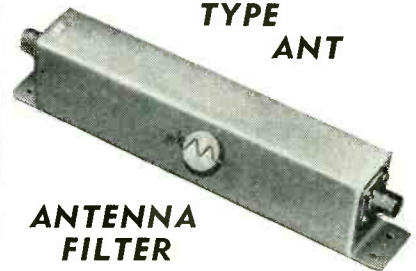

ANTENNA
 FILTER

Ortho Filter Corporation, announces availability of a complete line of antenna filters with cut off frequencies in the 20-500 MC range. Pass Band attenuation of less than 1 DB and VSWR of 1.5 max. Adaptable to 50, 72 and 100 ohm application. Maximum peak power handling capacity of 1000 watts in pass band also available. Operates into type N, BNC or UHF connectors. Highlight features are high stop band attenuation, compactness, light weight and rigidness which makes it ideal for mobile and airborne application.

Also available are composite low and high pass filters designed to permit using one antenna for both transmitter and receiver.

ORTHO-FILTER

CORPORATION



Dept. E55

196 ALBION AVENUE • PATERSON, N. J.
 MULberry 4-5858

Want more information? Use post card on last page.

May, 1955 — ELECTRONICS

MICROWAVE ENGINEERING

To
ENGINEERS
and
PHYSICISTS
qualified in this area...

The Microwave Laboratory at Hughes conducts fundamental research and long-range development in the field of microwave antennas and microwave electronics. New positions are now open in this area.

THE ANTENNA PROGRAM has to do with research on linear and two-dimensional arrays of slot radiators; transmission and radiation of surface-guided waves; very high resolution radar antennas; development and engineering of airborne communication, navigation, and fire control antennas.

THE MICROWAVE ELECTRONICS program is concerned with (1) basic research involving study of ferrites, and the discharge of gases at microwave frequencies, and (2) applied research and development involving microwave circuits, ferrite applications, microwave instrumentation, and circuits for developmental microwave vacuum tubes.

Scientific and Engineering Staff

HUGHES

RESEARCH AND DEVELOPMENT
LABORATORIES

Culver City, Los Angeles County, California

BACKTALK

(continued)

rated at 4,000 digits per second when driven by rectangular or sine waveforms.

L. C. BURNETT

Cold Cathode Tube Applications Lab
Eitelco Limited
Nottingham, England

Noise Calculations

DEAR SIRS:

I WISH TO call your attention to an error in the article, "Low Noise Input Stage for Audio Pre-amplifier," which appeared in your February issue, p 147. The authors purport to give a curve showing the rms noise voltage appearing across an R-C circuit as a function of the value of R . Their treatment is somewhat misleading as they do not specify the frequency limits used in the calculation, and furthermore, the curve shown is numerically in error.

It is well known that the rms noise voltage appearing across an R-C circuit is given simply by $(kT/C)^{1/2}$, where k is Boltzman's constant in joules/°K, T the absolute temperature in degrees Kelvin, and C the capacitance in farads. This expression gives the noise in the entire spectrum from zero to infinity, and is seen to be independent of the value of R .

Using the numerical values of $T = 23^\circ \text{C}$ and $C = 6 \mu\text{mf}$, one finds that the total noise is $26 \mu\text{v}$. When a finite bandwidth is assumed, the noise will obviously be less than $26 \mu\text{v}$. This does not check with the maximum value given in Fig. 1C, which rises above $80 \mu\text{v}$.

A little pencil pushing reveals that the authors assumed a bandwidth of 20 cps to 20 kc. Using these values, the asymptotes of their curve are correct. However, in calculating the points in the region of 10^7 and 10^8 ohms, they have obviously slipped a decimal point, making the curves high by a factor of $\sqrt{10}$ in this region.

CLIFFORD E. BERRY

Assistant Director of Research
Consolidated Engineering Corporation
Pasadena, California

DEAR MR. BERRY:

THE EDITOR OF ELECTRONICS has forwarded to me a copy of your

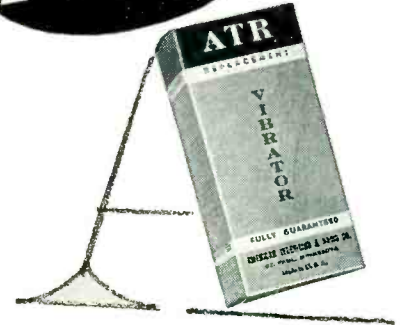

auto
radio

VIBRATORS

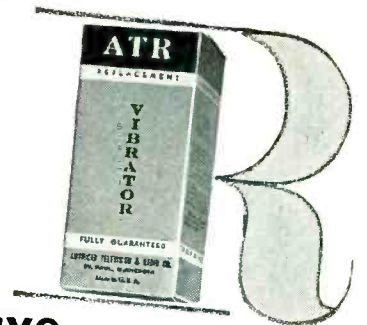

have
ceramic
stack spacers



Free



NEW MODELS
NEW DESIGNS
NEW LITERATURE

A COMPLETE LINE OF VIBRATORS

Designed for Use in Standard
Vibrator-Operated Auto Radio
Receivers. Built with Precision
Construction, featuring Ceram-
ic Stack Spacers for Longer
Lasting Life. Backed by more
than 22 years of experience in
Vibrator Design, Develop-
ment, and Manufacturing.

"A" Battery Eliminators,
DC-AC Inverters,
Auto Radio Vibrators

See your jobber or write factory

AMERICAN TELEVISION & RADIO CO.

Quality Products Since 1931

SAINT PAUL 1, MINNESOTA—U. S. A.

Want more information? Use post card on last page.

ELECTRONICS — May, 1955

Want more information? Use post card on last page.

409

CONTACTS

FOR THE FIELD OF ELECTRONICS

CINEMA'S
TAPE AND FILM

Degausser

CLEAN ERASURE OF MAGNETIC TAPE & FILM



TYPE 9205 DEGAUSSER

Noise & program erasure. Use the best. Cinema's Bulk-Tank Type Degausser 9205 Economically priced. Buy yours today

CINEMA ENGINEERING CO.
DIVISION AEROVOX CORPORATION
1100 CHESTNUT STREET • BURBANK, CALIF.

• **PLATING** •

Precision

Industrial
GOLD and SILVER
of all Description
GOVERNMENT CERTIFIED

GARREPY PLATERS INC.
11-19 Bartlett St., Worcester, Mass.
PLeasant 3-6472

\$175
f.o.b.

SHORTED TURN
INDICATOR
FOR UNMOUNTED COILS
SENSITIVE, RUGGED, NON-SHOCKING



Kartron LEhigh 9-4606
Huntington Beach, Calif.

ASK FOR
BULLETIN
NO. 1



**Toroidal
Winder**

REX RHEOSTAT
COMPANY
BALDWIN, L. I. N. Y.
Telephone BALdwin 3 5160

F M MODULATION METER
Measures maximum modulation deviation on mobile-system FM transmitters, all frequencies, 25 to 500 MC. Price \$240.00.

LAMPKIN LABORATORIES, INC.
BRADENTON, FLORIDA

Complete Service
FOR SMALL PARTS

- TOOLS
- STAMPINGS
- ASSEMBLIES
- SOLDERING
- PLATING
- PORCELAIN ENAMELING
- BRIGHT ANNEALING

Established 29 Years.

ORBER MANUFACTURING CO.
DUNNELL LANE PAWTUCKET, R. I.

World's Only Recorder of its Kind
WALKIE-RECORDALL
8-LB SELF-POWERED BATTERY RECORDER

- AUTOMATIC UNDETECTED RECORDING up to 4 hrs
- PICKS UP WITHIN 50 FT. RADIUS
- VOICE ACTIVATED "SELF-START-STOP"
- NO WIRES OR PLUGS

Records noiselessly in or out of closed briefcase, containing hidden mike while walking, riding, typing, conferences, lectures, dictation, 2-way phone. Permanent, unalterable, indexed recording at only 3c per hr.

MILES REPRODUCER CO., INC.
812 Broadway, N. Y. 3, N. Y. Dept.

POWER SUPPLIES

Design
Production
Development

Mercury ELECTRONIC COMPANY
BOX 450A red bank/new jersey

One inexpensive modern device . . .

can frequently help speed up operation and maintenance or production.

One product advertised in the "Contacts" Section may be the answer to your problem . . . a real money-saver.

To be informed—and reminded—on modern aids to economical operation, maintenance and production, check "Contacts" advertising regularly . . . every issue.

letter regarding the article, "Low Noise Input Stage for Audio Pre-amplifier." I must apologize for the error in calculating the curve for thermal noise produced by the parallel R-C network.

As you point out, the greatest value is about 26 microvolts and computes to be maximum when $R = 4.6 \times 10^7$ (the capacitor value is actually 5.5 rather than $6 \mu\text{f}$ and was used for the computations). The qualifying frequency band was omitted in editing, as were several other pertinent details.

We thank you for calling this to our attention.

JAMES J. NOBLE
Altec Lansing Corporation
Beverly Hills, California

Another Staple Technique

DEAR SIRs:

ON THE PROBLEM of removing staples: I find it easy to just push them through.

Clip off the top with a sharp diagonal cutter and grab the bent-over end and pull. Very easy this way since one goes with the grain rather than against it.

R. A. GRUNER
Dept. of Physics
University of Wisconsin
Madison, Wisconsin

Acknowledgment

DEAR SIRs:

DUE TO AN undetected editing on the part of one of our people, the acknowledgement originally at the end of my article, "Tape Controlled Servos Speed Chemical Analysis," was omitted. This article appeared in your February issue, p 136.

The electronic development for this project was performed primarily by R. G. Madsen. Important contributions were made by M. S. Stickney and R. C. Hawes. Portions of this paper were adapted from previous notes compiled by these persons.

WALT DONNER
Research & Engineering Dept.
Beckman Instruments, Inc.
Fullerton, Calif.

PROFESSIONAL SERVICES

Consulting—Patents—Design—Development—Measurement

in

Radio, Audio, Industrial Electronic Appliances

AIRPAX PRODUCTS CO.

Development Division

Specialists in the
Design and Manufacture of
UNUSUAL TRANSFORMERS AND RELAYS

Middle River

Baltimore 20, Md.

Consult these SPECIALISTS

Let them save your time by bringing
their broad experience in their specialty
to bear on your problems.

NIAGARA ELECTRON LABORATORIES

CONSULTATION - DESIGN - CONSTRUCTION
MFG. THE THERMOCAP RELAY

Specializing in solution of problems of electronic
and electro-physical instrumentation for the re-
search or analytical laboratory. Industrial plant
problems also invited.

Andover, New York Cable Address: NIATRONLAB

ANALYSIS INSTRUMENT CO.

Consultants on Magnetic Problems

Magnetic Materials Tested
Special Magnetic Devices Designed
Magnetizing & Testing Equipment Supplied

P. O. Box 7

Pequanook, New Jersey

HANSON-GORRILL-BRIAN INC.

Product & Mfg. Development

ELECTRICAL - ELECTRONIC
HYDRAULIC - MECHANICAL

One Continental Hill

Glen Cove, N. Y.

Glen Cove 4-7300

PICKARD & BURNS, INC.

Consulting Electronic Engineers

Analysis and Evaluation
of Radio Systems

Research, Development and Production
of Special Electronic Equipment

240 Highland Ave.

Needham 94, Mass.

THOMAS H. BRIGGS & ASSOCIATES

Electronics Consultants

Electron Tubes - Automation - Product Surveys
Tube Materials & Reliability - Servo-mechanisms
Engineering and production facilities.

Box 185 RD#2 Norristown, Penn. Tel No. 8-7671

INTERFERENCE MEASUREMENT LABORATORY

Interference Study per Government Specifications
Shielded Space for Interference Investigation
Field Surveys for F.C.C. Certification of Induction
and Dielectric Heating Equipment

907 East 51st Street • Brooklyn 3, New York
Ingersoll 9-1765

ALBERT PREISMAN

Consulting Engineer

Television, Pulse Techniques, Video
Amplifiers, Phasing Networks,
Industrial Appliances

Affiliated with
MANAGEMENT-TRAINING ASSOCIATES
3224-16th St., N. W. Washington 10, D. C.

CROSBY LABORATORIES, INC.

Murray G. Crosby & Staff

Radio - Electronic
Research Development & Manufacturing
Communication, FM & TV

Robbins Lane, Hicksville, N. Y.
Hicksville 3-3191

THE KULJIAN CORPORATION

ELECTRONICS DIVISION

Consulting Electronic Engineers

Research, Development, Production of
Automatic Controls — Special Instrumentation
1200 No. Broad St., Philadelphia 21, Pa.
Stevenson 2-9000

THE TECHNICAL MATERIAL CORPORATION

Communications Consultants

Systems Engineering

General Offices and Laboratory
700 Fenimore Rd., Mamaroneck, N. Y.

EDGERTON, GERMESHAUSEN & GRIER, INC.

Consulting Engineers

Stroboscopy — Transient Oscillography
Photoelectricity — Pulse Techniques — Timing
High-Speed and Electronic Flash Photography
Telemetering - Industrial Television Applications
180 Brookline Avenue Boston 15, Mass.

ROBERT McCABE

Radio Noise Measurement and Elimination
Field Intensity Surveys

1781 Bide-a-Wee Park

Columbus 5, Ohio

TELECHROME, INC.

Electronic Design Specialists

COLOR TELEVISION EQUIPMENT

Flying Spot Scanners, Color Synthesizers, Keyers,
Monitors, Oscilloscopes and Related Apparatus
J. R. Popkin-Curman, Pres. & Ch. Engr.

88 Merrick Rd.

Amityville, L. I., N. Y.

Eldico of New York, Inc.

Pioneers of Television Interference Elimination from
Transmitters, Induction Heaters, Diathermy and etc.

Donald J. S. Merten & Engineering Staff

70 E. Second St.

Mineola, L. I., N. Y.

Garden City 7-0383

Measurements Corporation

Research & Manufacturing Engineers

HARRY W. HOUCK MARTIAL A. HONNELL
JOHN M. VAN BREUNEN

Specialists in the Design and
Development of Electronic Test Instruments

Boonton, New Jersey

WALSH ENGINEERING CO.

Specialists in design of

ELECTRONIC and MAGNETIC
Apparatus to solve unusual problems.

Complete Model Shop.

34 DeHart Place

Elizabeth, N. J.
Elizabeth 2-7600

ELECTRONIC RESEARCH ASSOCIATES, INC.

"TRANSISTORIZE" YOUR PRODUCT!

Complete Service in consulting, research, develop-
ment, and production on Transistor circuitry, prod-
ucts and instrumentation.

67 East Centre Street

Nutley, N. J.

Nutley 2-5410

MERCURY ELECTRONIC COMPANY

Power Supplies

Electronic • Magnetic • Static

Red Bank

New Jersey

WHEELER LABORATORIES, INC.

Radio and Electronics

Consulting — Research — Development

R-F Circuits — Lines — Antennas

Microwave Components — Test Equipment

Harold A. Wheeler and Engineering Staff

Great Neck, N. Y.

Hunter 2-7876

ERCO RADIO LABORATORIES, INC.

Radio Communications Equipment

Engineering - Design - Development - Production

Our 25th Year in Air to Ground

Communications and Radio Beacons

Garden City • Long Island • New York

NEW ROCHELLE TOOL CORP.

FOR CERTIFICATION OF INDUCTION
AND DIELECTRIC HEATING EQUIPMENT
IN ACCORDANCE WITH F.C.C. RULINGS

Mobile Test Unit Available Entire U. S.

320 Main St.

New Rochelle, New York

Phone NE 2-5555

YARDNEY LABORATORIES, INC.

Research-Design-Development

Electro-Chemical Generators of Energy

40-46 Leonard Street

Worth 6-3100

New York 13, N. Y.

ENGINEERS AND

Your future measures up to your ability. . .

in these positions open now at RCA!

You'll find RCA opportunities in:

AVIATION ELECTRONICS
ELECTRON TUBES
COMPUTERS
MISSILE GUIDANCE
RADIO SYSTEMS

A whole new program of expansion at RCA—in Research, Systems, Design, Development and Manufacturing—opens a broad variety of permanent positions with all the features that appeal to the alert, creative engineer. These are opportunities with a future . . . available *today* for the man who wants to move ahead professionally with the world leader in electronics. They include work in fields of phenomenal growth. At the RCA engineering laboratories *listed in the chart on the right*, you'll find the kind of living and working conditions attractive to the professional man and his family.

Engineers and scientists find every important factor that stimulates creative

effort . . . including a quality and quantity of laboratory facilities unsurpassed in the electronics industry . . . and everyday association with men recognized at the top of their profession.

RCA's benefits add up to an impressive list of "extras." Among them: tuition for advanced study at recognized universities . . . a complete program of company-paid insurance for you and your family . . . a modern retirement program . . . relocation assistance available.

Your individual accomplishments and progress are recognized and rewarded through carefully planned advancement programs. Financially as well as professionally, you move ahead at RCA!

SCIENTISTS:

Check the chart below for openings in your field.

FIELDS OF ENGINEERING ACTIVITY	TYPE OF DEGREE AND YEARS OF EXPERIENCE PREFERRED											
	Electrical Engineers			Mechanical Engineers			Physical Science			Chemistry Ceramics Glass Technology Metallurgy		
	1-2	2-3	4+	1-2	2-3	4+	1-2	2-3	4+	1-2	2-3	4+
SYSTEMS <i>(Integration of theory, equipments, and environment to create and optimize major electronic concepts.)</i>												
AIRBORNE FIRE CONTROL			W							W		
DIGITAL DATA HANDLING DEVICES			C			C				C		
MISSILE GUIDANCE			M			M				M		
INERTIAL NAVIGATION			M			M				M		
COMMUNICATIONS		F	C O F					F		C O F		
DESIGN • DEVELOPMENT												
COLOR TV TUBES —Electron Optics—Instrumental Analysis—Solid States (Phosphors, High Temperature Phenomena, Photo Sensitive Materials and Glass to Metal Sealing)	L	L	L	L	L	L	L	L		L	L	L
RECEIVING TUBES —Circuitry—Life Test and Rating—Tube Testing—Thermionic Emission	H	H	H		H	H		H			H	H
MICROWAVE TUBES —Tube Development and Manufacture (Traveling Wave—Backward Wave)		H	H	H				H	H		H	H
GAS, POWER AND PHOTO TUBES —Photo Sensitive Devices—Glass to Metal Sealing	L	L	L	L	L			L	L		L	L
AVIATION ELECTRONICS —Radar—Computers—Servo Mechanisms—Shock and Vibration—Circuitry—Remote Control—Heat Transfer—Sub-Miniaturization—Automatic Flight—Design for Automation—Transistorization		F	M C F		F	M C F		F		M C F		
RADAR —Circuitry—Antenna Design—Servo Systems—Gear Trains—Intricate Mechanisms—Fire Control		F	M C F		F	M C F		F		M C F		
COMPUTERS —Systems—Advanced Development—Circuitry—Assembly Design—Mechanisms—Programming	C	C F	M C F	C	C F	M C F	C	C F		M C F		
COMMUNICATIONS —Microwave—Aviation—Specialized Military Systems		F	M C F		F	M C F		F		M C F		
RADIO SYSTEMS —HF-VHF—Microwave—Propagation Analysis—Telephone, Telegraph Terminal Equipment		O	O F		O	O F		O		O F		
MISSILE GUIDANCE —Systems Planning and Design—Radar—Fire Control—Shock Problems—Servo Mechanisms		F	M F		F	M F		F		M F		
COMPONENTS —Transformers—Coils—TV Deflection Yokes (Color or Monochrome)—Resistors		C	C		C	C		C		C		
MACHINE DESIGN Mech. and Elec.—Automatic or Semi-Automatic Machines		H	H		H	H		H		H		

Location Code

C—Camden, N. J.—in Greater Philadelphia near many suburban communities.
F—Florida—on east central coast.
H—Harrison, N. J.—just 18 minutes from downtown New York.

L—Lancaster, Pa.—about an hour's drive west of Philadelphia.
M—Moorestown, N. J.—quiet, attractive community close to Phila.
O—Overseas—domestic and overseas locations.
W—Waltham, Mass.—near the cultural center of Boston.

Please send resume of education and experience, with location preferred, to:



Mr. John R. Weld, Employment Manager
 Dept. C-3E, Radio Corporation of America
 30 Rockefeller Plaza
 New York 20, N. Y.



RADIO CORPORATION OF AMERICA

Copyright 1955 Radio Corporation of America

ELECTRONIC ENGINEERS:

NEW OPPORTUNITIES AT WESTINGHOUSE CAN MEAN A NEW FUTURE FOR YOU!

At the Westinghouse Electronics Division, you will find that the emphasis is on "projects of tomorrow" that are vital to our nation's superiority in the field of electronics. Your creative contributions to this effort can yield rich dividends and lasting satisfaction.

Design and development positions at the Electronics Division offer income, benefits, professional atmosphere and other advantages that are as important to you, the engineer, as you are to us.

We urge you to write today. Confidential interviews will be arranged with qualified applicants, and an illustrated brochure "Gateway to an Engineering Future" will be mailed to you at once.

OPENINGS EXIST FOR EXPERIENCED ELECTRICAL AND MECHANICAL ENGINEERS AND PHYSICISTS IN THE FIELDS OF CIRCUITS, RADAR SYSTEMS (INDICATOR), ANTENNAS, WAVEGUIDES, TRANSFORMER MAGNETICS, DIGITAL ANALOG TRACKING, TECHNICAL WRITING.

WATCH FOR NEWS ABOUT EXPANSION FOR THE FUTURE!

ADDRESS REPLIES TO —

Employment Supervisor, Dept. 143
Westinghouse Electric Corporation
2519 Wilkens Avenue
Baltimore 3, Maryland

DRAKE PERSONNEL

National Placement Center for
**EXECUTIVE AND
TECHNICAL PERSONNEL**

*General and Plant Managers
Plant Superintendents—Foremen
Accounting—Staff Personnel
Engineers: Design—Production
Sales Managers—Engineers*

Please outline briefly your experience or personnel needs to:

John Cope

7 W. Madison St., Chicago 2, Ill.
Financial 6-2100

ELECTRONICS ENGINEERING HEADQUARTERS

A specialized division of America's largest Executive Placement Service. Representing 400 of the nation's best electronics firms.

Many management, administrative, and executive positions now open.

Salaries: \$6,000 to \$50,000

Completely confidential, present position protected. No contacts made without permission.

**NO CHARGE TO APPLICANT
EMPLOYING CONCERNS PAY OUR FEE.**

Write for application, or send resume to:
Eugene B. Shea, Electronics Division.

CADILLAC EMPLOYMENT AGENCY, INC.
220 S. State St. Chicago 4, Ill.

America's Finest — Since 1930

ENGINEERS—ADMINISTRATORS —SALESMEN—EMPLOYERS

Confidential, rapid and professional service for nation wide placement in the Electronics field. Write giving age, education and brief experience. Employers send us job description. We will let you know how we can help you by return mail.

Graehner's Electronics Exchange
"The Nation's Largest"

116 South Michigan Chicago 3, Illinois

ASSISTANT CHIEF ENGINEER

Company pays interview, relocation and agency expenses. Satisfactory challenge and opportunity to a truly creative young electronic or electro-mechanical engineer. Supervisory experience or potential, plus knowledge of tooling and production problems will receive favorable consideration. Starting salary \$10,000-\$12,000.

28 E. Jackson Chicago 4, Illinois
MONARCH PERSONNEL

REPLIES (Box No.): Address to office nearest you
NEW YORK: 330 W. 42nd St. (36)
CHICAGO: 520 N. Michigan Ave. (11)
SAN FRANCISCO: 68 Post St. (1)

Engineer—Television receiver deflection systems engineers wanted. Development and product design. Both color and monochrome. Send resume to Department RT-E, Technical Employment Office, General Electric Company, Electronics Park, Syracuse, New York.

SELLING OPPORTUNITY OFFERED

Sales Engineers Wanted—excellent opportunities for several engineers with well established East Coast instrument manufacturer now expanding its line of aviation products which includes electronic and electro-mechanical components for jet engines and guided missiles. Electrical engineering background essential. Contacts within the aircraft industry desirable. Openings in Los Angeles, Dallas, and East Coast areas. Generous company paid benefits include hospitalization, pension, insurance, and vacation plans. SW-5630, Electronics.

POSITIONS WANTED

Electronics Engineer, 31, exp. design develop. circuitry; present teaching acered. N. Y. school, seeks summer perm position N. Y. metro area; non-citizen, phone HA 6-8492 or write PW-6177, Electronics.

Electronics Engineer, 31, exp. design develop. Electronics Welding Engineer. 15 years exp. Fully responsible for all metal joining development, standardization, instruction on tubes, lamps, hi-temp metals for major multi-plant electrical manufacturer. Proven record, many Nat. Soc. papers, M.S. degree, top references. Age 35. Relocation sought with new challenges, incentives, mgt. advancement opportunities. PW-6086, Electronics.

(Continued on page 416)

Lockheed antenna program offers wide range of assignments

Airborne Antenna Design is one of the fastest-growing areas of endeavor at Lockheed. Advanced development projects include work on stub, slot, reflector-type, horn and various dipole antennas.

These diverse antenna activities reflect the full scope of Lockheed's expanding development and production program. For with 13 models of aircraft already in production and the largest development program in the company's history underway, the work of Lockheed Antenna Designers covers virtually the entire spectrum of aircraft, commercial and military.

Lockheed's expanding antenna development has created a number of new positions on all levels for qualified antenna designers. Those interested are invited to write E. W. Des Lauriers, Dept. A-9-5.

Research Specialist Edward Lovick (right) discusses application of experimental slot antenna in the vertical stabilizer of a high-speed aircraft with Electronics Research Engineer Fred R. Zboril and Electronics Research Engineer Irving Alne.

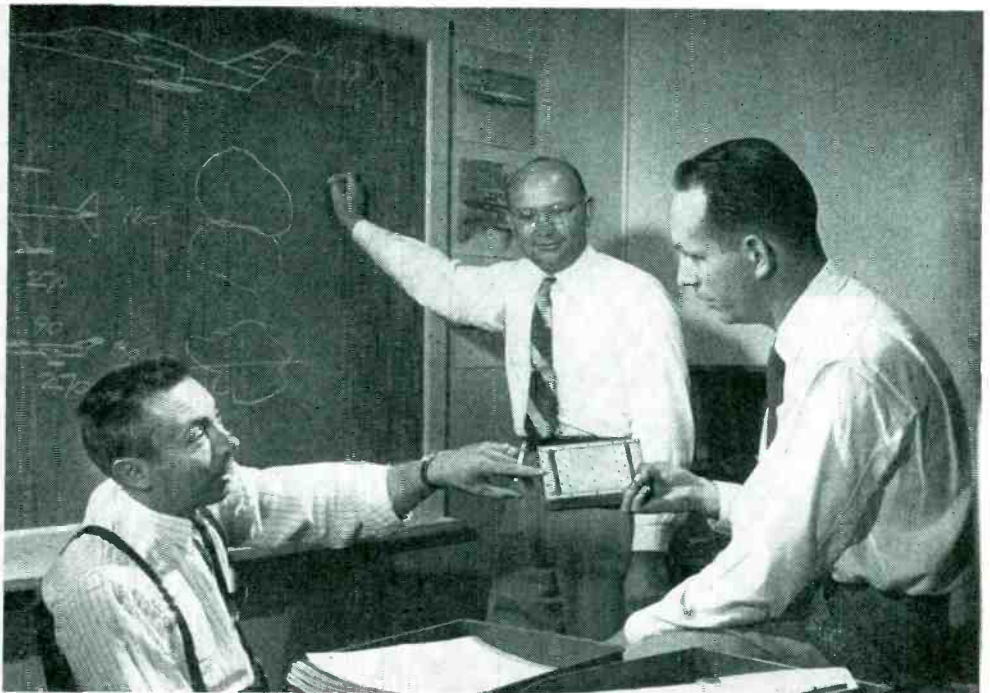

Lockheed increases engineers' salaries

Salaries, rate ranges and overtime benefits have been increased. In addition, employe benefits add up to approximately 14% of each engineer's salary in the form of insurance, retirement pension, etc.

Generous travel and moving allowances enable you and your family to join Lockheed at virtually no expense to yourself.

An address by Edward Lovick on "An Electronic Square-Rooter and Pattern Integrator for use with Antenna Range Systems" is available to interested engineers. Address inquiries to Mr. Lovick.

Lockheed AIRCRAFT CORPORATION

CALIFORNIA DIVISION • BURBANK **California**

CHALLENGING CAREERS AT RAYTHEON

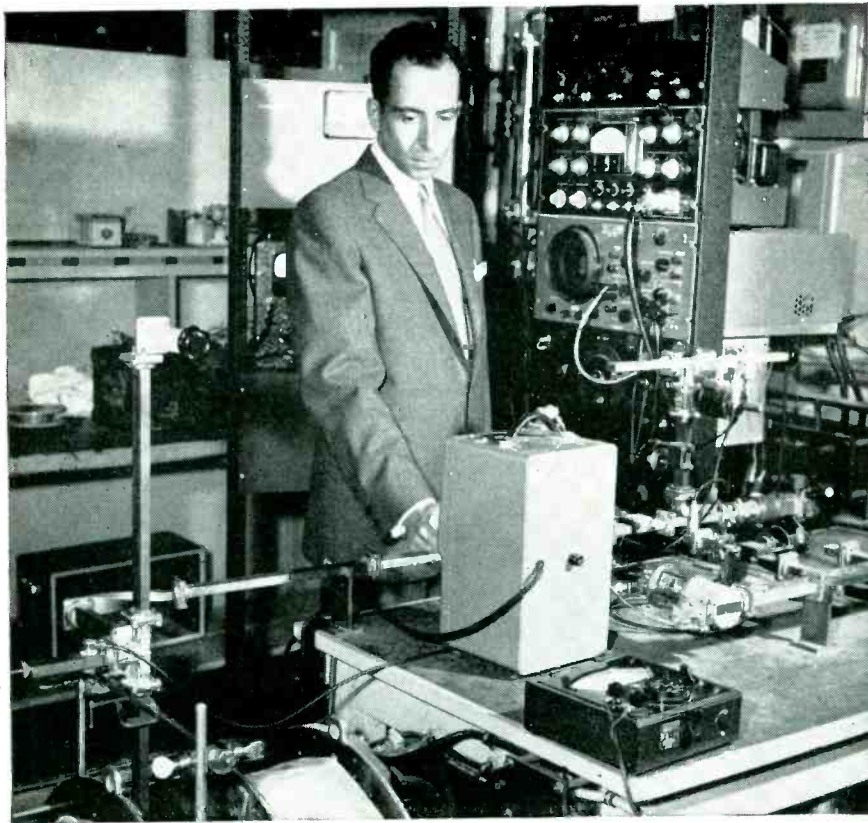

Studying ferromagnetic resonance. A cavity perturbation method is used, in which a ferrite specimen placed in a high Q microwave cavity changes cavity properties in accordance with electrical and magnetic properties of the material.

Looking for a good place to grow?

Advanced work on ferrites for microwave applications is being done in Raytheon's modern ceramic research facilities. Various types of gyrators, isolators, and other ferrite microwave devices have resulted from development work in the equipment systems and component development laboratories.

When you join Raytheon you work in an atmosphere of progress. Openings now for engineers, scientists in many areas including:

microwave tubes • special purpose tubes • guided missiles
transistors • diodes • receiving tubes • TV receivers
radar • sonar • computers • ultrasonics
metallurgy • ceramics • communications systems
servomechanisms • control equipment • solid state physics

Join a team where performance pays off. Please address inquiries to L. B. Landall, Professional Personnel Section.



RAYTHEON MANUFACTURING COMPANY
190 Willow St., Waltham 54, Mass.
Plants also located in California and Illinois

ENGINEERING SALES REPRESENTATIVES

Available

Manufacturers of precision instrumentation, computers and automatic controls can benefit from our sales experience, technical competence and industry-wide contacts.

Facilities include demonstrations, field engineering, direct mail and repairs. Concentrating on industrials, aircraft, gov't., in Metro. N. Y. and North N. J.

RA-5608, Electronics
330 W. 42 St., New York 36, N. Y.

★ MANUFACTURERS

Let us handle technical sales representation of your products

★ INVENTORS

We will share the cost of protecting your invention if accepted for commercialization

We Specialize In Electronics, Nucleonics, Instrumentation, Servomechanisms & Cybernetics.

R. W. HODGSON CO.
Technical Sales Representation &
Research & Development Engineering
3406 W. Washington Blvd. Los Angeles 18, Calif.
REpublic 2-2651

Manufacturers Representative

Engineer desires newly manufactured electronic and electro-mechanical products for sale to Guided Missile and Aircraft Companies located in Southern California. Reply to:

LEE GRANT SNYDER CO.
Technical Sales & Contract Administrators
1418 N. Highland Ave., Hollywood 28, California
Phone Hollywood 9-6278

POSITIONS WANTED

(Continued from page 414)

Glassblower-Industrial—Experienced in fabrication and processing of production and experimental electron tubes and associated high-vacuum equipment. desires position. PW-6087, Electronics.

Technician communications, broadcast, sound, motion picture projectors, TV and radio receiver experience. Good mechanic. Desire relocate prefer South or Southwest. Electronic factory work acceptable. O. K. Falor, 216 S. Birney St., Bay City, Mich.

CONTRACT WORK WANTED

Small Electronic units or assemblies to wire. Eastern Electronic Service, Box 213, Maple Shade, New Jersey.

Fully equipped electronics production line for sub assembly, laboratory, and machine shop. Automatic power presses, die making facilities, and metal working machinery. Staff of engineers, technicians, and tool and die makers. Available for prime and sub contract work. Located in New York area. CWW-6050, Electronics.

Small electronic units or assemblies to wire. CWW-6102, Electronics.

We Can Construct and Wire

Your small and medium sized assemblies better and cheaper.

THETA CO. P. O. Box 1110
Grand Junction, Colo.

GOOD INDUSTRIAL PLANT

available for lease in Winston Salem, N. C., the home of the Electronics Division of Western Electric Company. The building which is in excellent condition has been occupied by Bell Laboratories. Forty thousand square feet floor space. Large parking lot.

W. C. WRIGHT, Owner
Robert E. Lee Hotel Winston Salem, N. C.

ENGINEERS

with forceful, creative thinking are the key to Goodyear's progressive research and development programs.

Positions are open to qualified engineers in these fields:

- | | |
|----------------------|------------------|
| Electro-mechanical | Pulse Techniques |
| Microwave | Weapons Systems |
| Servomechanisms | Antenna Design |
| Electronic Packaging | Miniaturization |

Send a résumé of your qualifications or request application —

C. G. Jones, Salary Personnel Department

GOODYEAR AIRCRAFT CORPORATION

Akron 15, Ohio



GOODYEAR AIRCRAFT CORPORATION

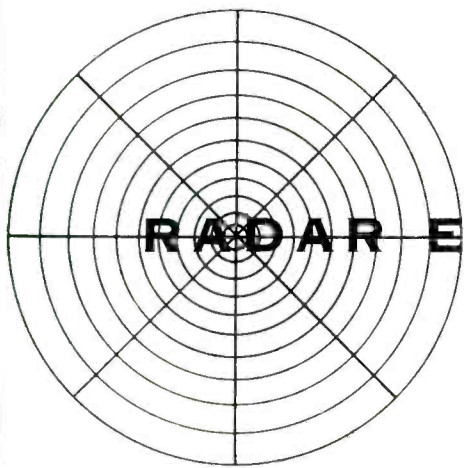

EMERSON of St. Louis
AIRCRAFT ARMAMENT DIVISION

needs

RADAR ENGINEERS

*Immediate Openings on the
 Highest Technical Level for*

**MICRO-WAVE AND/OR
 CIRCUIT DESIGN WORK**

Also Immediate Openings for

**SERVO AND COMPUTER
 ENGINEERS**

WHERE YOU'LL WORK

- We're a national leader in armament and commercial projects, particularly in research, design and development of airborne fire control systems and guided missiles.
- We're a medium-sized company (5000 employees—300 armament engineers) where you're never "lost in the shuffle" but rewarded and advanced according to your abilities.
- We're located in one of St. Louis' nicer suburbs, within 5 to 15 minutes of new residential areas with attractive, moderately-priced homes.

THE BENEFITS YOU'LL ENJOY

- Graduate study program.
- Profit-sharing bonus and pension plan.
- Accident, life and health insurance.

Send complete resume, including salary requirements and phone number for local interview. St. Louis interview arranged at our expense. Write Engineering Personnel Manager.

MOVING AND TRANSPORTATION EXPENSES PAID TO ST. LOUIS

EMERSON ELECTRIC
OF ST. LOUIS

8100 W. Florissant, St. Louis 21, Mo.

UNIVERSITY of MICHIGAN
ENGINEERS and
SCIENTISTS

Unusual opportunities for outstanding and experienced men are available at the University of Michigan's Willow Run Research Center. Research Engineers and Physicists with advanced degrees and/or experience in the fields of:

DIGITAL COMPUTER LOGICAL DESIGN • INFRARED • ACOUSTICS • DIGITAL COMPUTER PROGRAMMING ELECTROMAGNETIC THEORY • COMMUNICATIONS CIRCUIT DESIGN • COMPONENT DEVELOPMENT • RADAR • OPTICS ENGINEERING • SYSTEMS DESIGN

Salary commensurate with training and experience. Excellent working conditions. Liberal vacation policy along with other fringe benefits. Unusual opportunity to carry on University graduate studies while working full time. Moving expenses paid. U. S. Citizenship required.

Write, giving details of education and experience, to

W. N. MacDonald, Personnel Office
University of Michigan

Willow Run Research Center,
Ypsilanti, Michigan

ELECTRONIC
ENGINEERS

Positions are available in all levels of experience for the following fields of electronics:

HI-VOLTAGE POWER SUPPLIES
 CONDENSERS
 AND
 PULSE FORMING NETWORKS

Excellent positions with future are offered to men capable of working with a minimum of supervision.

Salaries are commensurate with background and ability.

Send complete resume to:

Personnel Manager, Electronics Division,

THE NEW HAVEN CLOCK & WATCH CO.
 140 Hamilton St., New Haven, Conn.

ENGINEERS

PRODUCT DEVELOPMENT

E.E. Degree plus demonstrated ability in design of electronic equipment. Experienced in development of AC and DC Amplifiers, Transducers and Carrier Amplifiers, Switching and Control Circuits and Electronic Counters. Practical production background also desirable.

Positions offer secure futures with aggressive and expanding organization. Excellent working conditions and associations. Starting salaries commensurate with training and experience.

Send your complete resume in confidence to:

BRUSH ELECTRONICS COMPANY

3631 Perkins Avenue

Cleveland 14, Ohio

(Division of Clevite Corp.)

CHIEF ENGINEER — ELECTRONICS

Prominent Eastern Instrument Manufacturer requires graduate E.E. with extensive industrial experience to assume responsibility for all electronic development activities, supervising engineering and laboratory technical personnel, and reporting to Vice President. Instrument background helpful. Please submit complete resume and state approximate salary requirements in first letter to

P-6121, Electronics
 330 W. 42 St., New York 36, N. Y.

ENGINEERS • *Electronic • Electromechanical* PHYSICISTS SALES ENGINEERS

*Enjoy
 These Advantages!*

In addition to paid vacations, liberal pension plans and numerous other valuable health and hospitalization benefits for you and your family, we provide cooperative educational aid at one of the many technical schools in the Philadelphia area for qualified applicants who find our center an ideal work-shop in which to secure the desired recognition in their chosen fields.

Your family, too, is important! And, here at Paoli, a delightful suburban community, thirty minutes from Philadelphia, you will find the cultural atmosphere as well as the educational facilities required for your children.

We will pay travel expenses for all applicants invited to visit our NEW Research Center to consider the application of their educational and/or work background to the many challenging problems we are engaged in for industry and the nation's welfare.

If you want the BEST for yourself and your family, consider NOW your qualifications for the openings listed on the right and —

Write **L. E. DICK**, Personnel Manager
BURROUGHS RESEARCH CENTER
 Paoli, Pa.

Located on
PHILADELPHIA'S
 "MAIN LINE"

Burroughs

Research Center, Paoli, Pa.

Invites You

To Inspect Its Openings on Both
 Commercial & Sponsored Projects

If you possess an educational and/or work background in Communications, Data Handling, Electronic, or Electro-Mechanical Business Machines...including such specifics as High Speed Mechanisms, Paper Handling Devices, Magnetic-Tape Transport Mechanisms, Magnetic-Drum or Tape Applications, Radar, Telemetry, Guided Missiles, Process Control Instrumentation, Digital and Analog Computers, Transistor and Magnetic Circuit Design and Analysis, Magnetic Amplifiers, Servo Mechanisms, and Electronic Packaging Design . . .

CONSIDER THESE OPENINGS AS

- ELECTRICAL ENGINEERS; Junior & Senior
- MECHANICAL ENGINEERS; Junior & Senior
- LOGICAL DESIGNERS ● PHYSICISTS
- PROJECT ENGINEERS

- SALES ENGINEERS to sell E-101 electronic desk computers in all sections of the country. Sales & Technical experience in allied lines desirable.

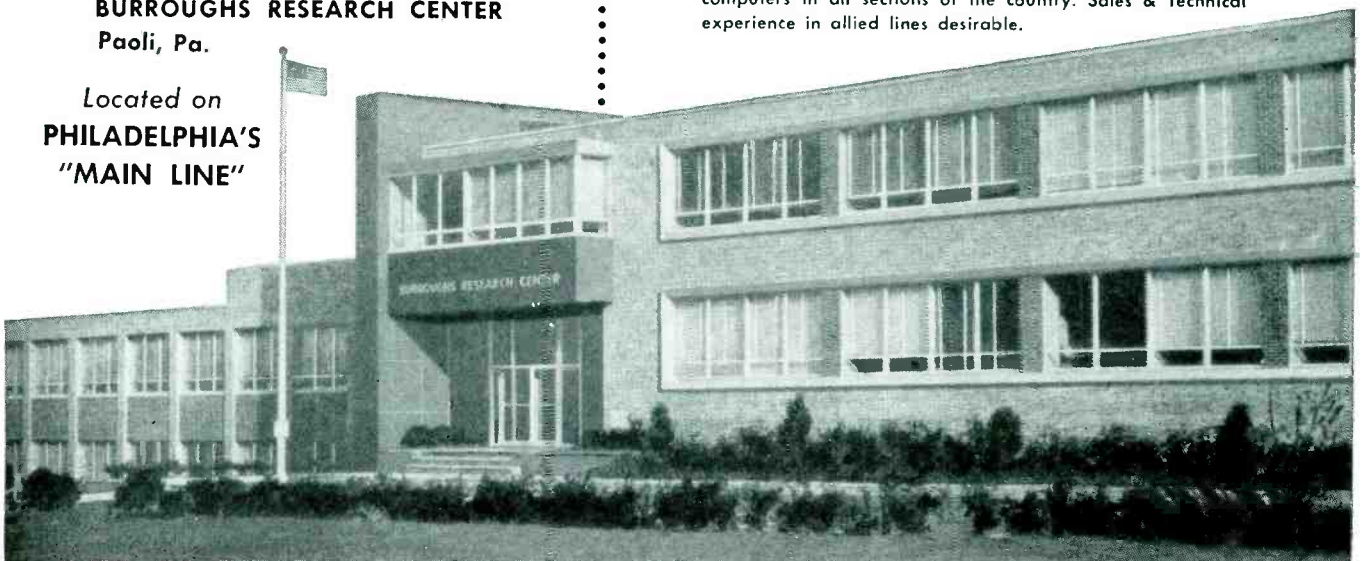

Creative Engineering Opportunities with Republic

Research

Antenna Engineer

To conduct pattern studies, design prototype antennas and supervise flight tests of new antenna installations. College graduate in Physics, Math or E.E.

Electronic Instrumentation Engineer

Three to five years aircraft instrumentation experience required. Knowledge of transducers, amplifiers and recording equipment used in experimental research testing of hi-speed jet aircraft is essential. Knowledge of servo loop theory as applied to aircraft systems coupled with ability to properly instrument, record and analyze is desirable. Graduate with E.E. degree preferred.

Electronics Engineer

Familiar with airborne electronic equipment (communications, navigation I.F.F., Radar and Autopilots), preferably with 2 to 4 years aircraft experience. Should be a college graduate. Duties will include system investigations, establishing test procedures and conducting environmental tests on airborne electronic equipment and components.

Computer Engineer

To supervise maintenance and to design special circuitry for computers. Experience with either analogue or digital computers required. College graduate preferred.

Senior Power Plant Engineer

Three to eight years aircraft power plant experience. Capable conducting power plant testing in conjunction with jet engine and induction system analysis. B.S. in M.E. or A.E.

Please address complete resume, outlining details of your technical background, to:

Mr. R. L. Bortner
Administrative Engineer



REPUBLIC AVIATION FARMINGDALE, LONG ISLAND, NEW YORK

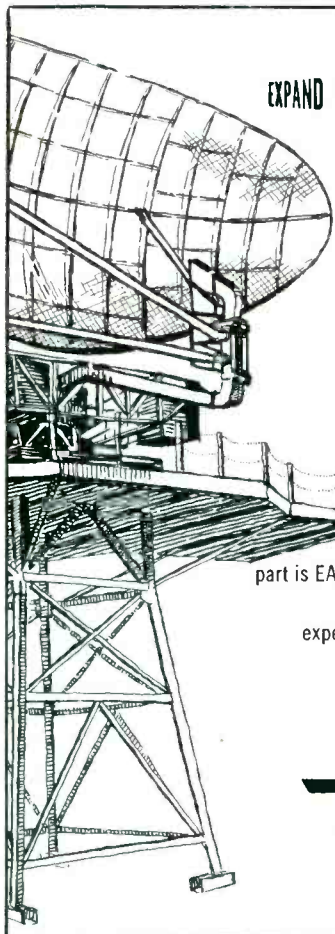

EXPAND YOUR HORIZON!

Bendix Radio
has new, exceptional
opportunities for:

ELECTRONIC ENGINEERS ELECTRONIC PHYSICISTS

Expand the horizon of your future with Bendix Radio—a leader and pioneer in the electronics field, one that has the knowledge, strength and resources to stay out front during the competitive days ahead! Your part is EASY! Wire, phone, write . . . or send us a post card. Simply state your name, address and phone number, your education and experience. We'll carry the ball from there! All replies held in strictest confidence, and we guarantee speedy action!

Address: Mr. L. H. Noggle
Dept. J
Phone: VAlley 3-2200

Bendix Radio

DIVISION OF BENDIX AVIATION CORP.
Baltimore 4, Maryland

Ramo-Wooldridge Los Angeles

Has Immediate Openings For

Physicists Electronic Engineers Mechanical Engineers

with ability to undertake advanced development work on new types of communication systems. Applicable experience would include work in the fields of COMMUNICATION

System Design
System Analysis
Circuit Development
Modulator Development
Signal Detection
Demodulation Techniques
Transmitter Development
Receiver Development
Equipment Miniaturization
Electro-Mechanical Devices

Applicants must be U. S. citizens.
Please submit a complete résumé of
qualifications and experience to

The Ramo-Wooldridge Corporation

Dept. E, 8820 Bellanca Avenue
Los Angeles 45, California



paceing **canada's** growth creating **engineering opportunities**



ELECTRONICS SECTION CHIEF

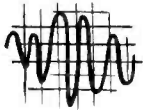

Responsible to the Chief Design Engineer for the design of all aircraft radio, radar and electronic installations and systems for a broad field of military aircraft. Candidates should have an engineering degree in Engineering Physics or Electrical Engineering and 12 years experience including 4 years in a senior supervisory capacity. Experience in the field of A.S.W. installations is desirable.

ELECTRONICS SUPERVISOR



To direct missile electronics design and development. Requires an Engineering Physics or Electrical Engineering degree, some graduate work in electronics preferred, with 8 to 10 years electronic design experience related to radar or fire control systems (including at least 3 years on guided missiles) and a strong background in systems analysis.

The future potential for those engineers who join Canadair is as apparent as the rapid industrial expansion now in progress in Canada itself.

Along with Convair and Electric Boat Company, Canadair is a division of General Dynamics Corporation, with the vast and varied facilities of each at its disposal toward the manufacture of military and commercial aircraft of all types.

On Canadair's engineering staff are men from all parts of the globe, contributing a wealth of new ideas and stimulating new thoughts on engineering practice.

The location is adjacent to a residential community where housing at moderate cost is readily available. The heart of historic Montreal is less than 6 miles away, and hunting, fishing and other outdoor recreations are near at hand. Generous relocation assistance will be given those who join the staff.

If you qualify for one of the positions listed above, please send a complete resume to E. H. Higgins, Chief Project Engineer, Dept. E-3. All replies will be held in strict confidence.



CANADAIR
LIMITED

P.O. Box 6087, Montreal, P.Q., Canada

GENERAL ELECTRIC

**PLANS
FAR INTO THE FUTURE**

The development of new technologies at General Electric has opened the door on a program of advanced electronics work requiring the skills of top engineers and physicists. To engineers this means long-range, continuing opportunity enabling them to build a solid future as they enjoy the vast facilities, stimulating challenges and many incentives and rewards offered by General Electric.

ENGINEERS PHYSICISTS

*Positions available
in the following fields:*

**Advanced Development, Design, Field Service
and Technical Writing in connection with:**

- MILITARY RADIO & RADAR**
- MULTIPLEX MICROWAVE**
- MOBILE COMMUNICATION
COMMUNICATIONS**
- ELECTRONIC COMPONENTS**
- TELEVISION, TUBES & ANTENNAS**

Bachelor's or advanced degrees in
Electrical or Mechanical Engineering,
Physics, and experience in
electronics industry necessary.

Please send resume to: Dept. 5-5-E, Technical Personnel

GENERAL ELECTRIC

Electronics Park, Syracuse, N. Y.

• • • for those
who qualify

Security

Understanding

Know how

Send resume to



offers

ELECTRONIC ENGINEERS

- HEAVY BACKLOGS
- SOUND FINANCING
- TOP BENEFITS
- MANAGEMENT BY ENGINEERS
- EDUCATIONAL AID
- MINIMIZED RED-TAPE
- VARIED SPECIALIZATION
- FLEXIBLE ORGANIZATION
- VERSATILE PERSONNEL

R. F. LANDER

Electronic Engineering Company
of California



180 SOUTH ALVARADO STREET
LOS ANGELES 52 • CALIFORNIA

Airline COMMUNICATIONS ENGINEER

BSEE or equivalent required

PREFER AIRLINE EXPERIENCE in ground and aircraft radio maintenance, modification & installation. Must have ability to handle broad field of communications, including planning, purchasing, and supervising.

Maximum age 35 years. Salary and advancement commensurate with experience and capability.

IDEAL CLIMATE

Excellent Future for qualified man in high-level supervision.

Reply, giving full details, to

P-5896, Electronics
520 No. Michigan Ave., Chicago 11, Ill.

TAPE RESISTOR SPECIALISTS

Openings at junior and supervisory engineering levels for men qualified to conduct advanced research and development work in the tape resistor field beyond the present state of art for printed circuit applications. Mid-west location. Salary open. Will assume moving expense. Inquiries held in confidence. Send complete background information to:

P-5752, Electronics
520 N. Michigan Ave., Chicago 11, Ill.

ENGINEERS

LONG-RANGE,
CONTINUING
OPPORTUNITY

FOR
ELECTRICAL
AND
MECHANICAL

ENGINEERS

AT

Bendix

OPENINGS EXIST FOR—

COMPUTER ENGINEER

Requiring an engineering degree in electrical engineering or math and physics, plus a minimum of three years of computer activity. To handle programming in the simulation and study of jet and reciprocating engine fuel systems. Problems involved would be linear and non-linear in nature and applied to product design as well as research into basic phenomena. No maintenance ability necessary.

MAGNETIC AMPLIFIER SYSTEMS ENGINEER

Electrical engineer supervisory capacity on research and development of magnetic amplifier circuitry, control systems, and component design and testing, supervising other engineers and technicians.

LIQUID PROPELLANT ROCKET CONTROLS ENGINEER

Mechanical or electrical engineer to supervise the research and development of liquid propellant rocket controls, systems design, component design, development, and testing.

The salary of these positions will be determined by your ability and experience.

Send detailed resume listing education, engineering experience, and salary requirements to:

Technical Employment Department
Box 255-E

Bendix Products Division of
Bendix Aviation Corporation

401 Bendix Drive
South Bend 20, Indiana

We guarantee you an immediate reply.

ENGINEERS

Success Comes Early to Men of Talent

AT SYLVANIA

Here are challenging opportunities in a newly formed Division of a pioneer electronics firm for continued growth and responsible positions.

INVESTIGATE SYLVANIA'S OPPORTUNITIES NOW!

The following
CAREER POSITIONS
are now open

BOSTON Engineering Laboratory

Majors in E.E., M.E.,
Math, Physics. Research
& Development experi-
ence in —

Countermeasures
Systems Analysis
Transistor Applications
Noise Studies
Antenna Res. & Dev.
Systems Development
Mechanical Design
Miniaturization
Digital Computer
circuits & systems
Circuit Design
Shock & Vibration
Technical Writing
Missile Analysis

BUFFALO Engineering

Majors in E.E., M.E.,
or Physics. Experience
in Product Design and
Advanced Development
in —

Mechanical Design
Shock & Vibration
Subminiaturization
Microwave Applications
Pulse Techniques
Servo Mechanisms
F. M. Techniques
Equipment Specifications
Circuit Design
Heat Transfer
Systems Development
Components
Mechanization

INTERVIEW and RELOCATION EXPENSES will be paid by Sylvania

Sylvania provides financial support for advanced education as well as liberal insurance, pension and medical programs.

Please forward resume to:

Professional Placement Supervisor
SYLVANIA ELECTRIC PRODUCTS INC.
Thomas A. Tierney | Randall A. Kenyon
70 Forsyth Street | 175 Great Arrow Ave.
Boston, Mass. | Buffalo 7, N. Y.

SYLVANIA

ELECTRIC PRODUCTS INC.

Your inquiries will be answered
within two weeks.

ENGINEERS

for immediate placement

ENGINEERING AT NCR:

1. Immediate, permanent positions in Mechanical and Electrical Engineering Divisions.
2. Engineering project work involving design and development of mechanical, electronic, electromechanical devices, and electronic data processing equipment in Business Machine applications.
3. Some experience in development, design, and application of high-speed, light-weight mechanisms of the intermittent motion type is desirable.
4. Openings also for Mechanical and Electrical personnel for writing technical and application literature describing newly-developed machines.
5. Ample training and indoctrination is available to all employees.

ACT AT ONCE—Send resume of your education and experience to: **EMPLOYMENT DEPARTMENT, TECHNICAL PROCUREMENT SECTION**

THE NATIONAL CASH REGISTER COMPANY

Dayton 9, Ohio

**ELECTRONIC ENGINEERS
ELECTRICAL ENGINEERS
MECHANICAL ENGINEERS
MECHANICAL DRAFTSMEN**

AS AN NCR ENGINEER you, with your family, will enjoy:

1. **UNLIMITED OPPORTUNITY** in the broad, ever-expanding field of Business Machine Engineering.
2. **AN EXCELLENT SALARY**, plus exceptional benefits of life-time value for you and your family.
3. **A RECREATIONAL PROGRAM** for year-round enjoyment of the entire family including a new Country Club with 36 holes of golf, and a 166-acre park for outings with swimming, boating, and supervised play for the children.
4. **LIVING IN DAYTON . . .** considered one of the cleanest and most attractive cities in the Midwest with outstanding school facilities.
5. **YOUR WORK AT NCR** with its friendly, family atmosphere, with its employee morale at a very high level, and with people who, like yourself, have decided to build their professional future with NCR.

ENGINEERS

Electronics

Component
Application

Analogue
Computer

Environmental
Test

Senior
Microwave
Research

DOES YOUR CAREER INCLUDE THESE IMPORTANT FEATURES?

Provision for delightful living for the entire family. Westchester County, New York, site of General Precision Laboratory is famous throughout the U. S. for its high standard of living, the scenic beauty of its rolling hills, yet only an hour from New York City and its wealth of cultural, educational and recreational facilities.

A stable future. This is possible at GPL not only because it is engaged in work of a long-term nature, but also because of its association with the large and diversified parent organization, General Precision Equipment Corporation.

Growth and advancement. Because the group at GPL is small and closely integrated, recognition for outstanding work—and advancement—come quickly.

Men with interests in the above and related fields should submit resumes to Mr. Hollis F. Ware. Expenses will be paid for qualified applicants who are invited for interviews. We regret we can consider only U. S. citizens.

GENERAL PRECISION LABORATORY INCORPORATED

A subsidiary of General Precision Equipment Corporation
63 Bedford Road, Pleasantville, N. Y.



PROCESS ENGINEER for Cathode Sub-miniature Tubes

Excellent opportunity in Raytheon's expanding Cathode Sub-miniature Production Program for an engineer with experience in the manufacture of cathode sub-miniature type vacuum tubes. Minimum qualifications B.S. degree and three years experience in this field.

For appointment write to

G. W. Lewis,
Personnel Mgr.
Raytheon Mfg. Co.
55 Chapel St.,
Newton 58, Mass.

COMMUNICATIONS ENGINEERS and TECHNICIANS

EXCELLENT SALARIES
MINIMUM PREREQUISITES

ENGINEER EE Graduate with 3 years experience
TECHNICIAN 2 years technical school in communications and 3 years experience.

Require installation adjustment and maintenance experience with communication receivers and associated terminal equipment. Also, men with similar experience with high-powered transmitters, antennas, transmission lines.

Must be willing to travel in United States and Overseas.

Page Communications Engineers, Inc.
710 Fourteenth St., N.W., Washington 5, D.C.

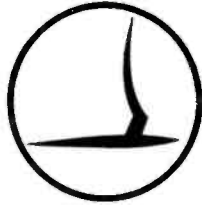

ELECTRONIC ENGINEERS

You can work in the stimulating atmosphere of an applied research and development laboratory where ideas are important, initiative is encouraged and associates are competent. The project areas listed below are typical of our extensive electronics interest; a complete list would include almost every branch of modern electronics. We are interested in men of all levels with sound training, imagination and potential, regardless of their specialty.

Communications

Dynamic Control Systems

Aircraft Instrumentation

Radar

Computers

Electrical Measurements

Varied Electronic Circuits

Servo-Mechanisms

Missile Guidance

Microwave

ENGINEER WRITER

Must be a competent Electronics Engineer with an avocation for technical writing. Writing will include specifications, test procedures, operating procedures and reports.

If you are interested in working at your maximum professional level in an organization that combines the most desirable elements of academic and industrial research and development, we invite you to communicate with our Employment Manager.

B.S. degree and experience required; advanced degree with experience to back it up is even better.

Hospitalization, surgery; group life, sickness, accident, and retirement insurance is available with most of the cost paid by the Laboratory. Salaries are comparable with industry. Merit reviews occur semi-yearly assuring recognition of work well done and expediting advancement. Other personnel policies are very liberal, such as our self-sponsored internal research program. Graduate study at University of Buffalo is encouraged through generous tuition refund program.

Cornell Aeronautical Laboratory

Buffalo 21, New York

wholly owned by Cornell University

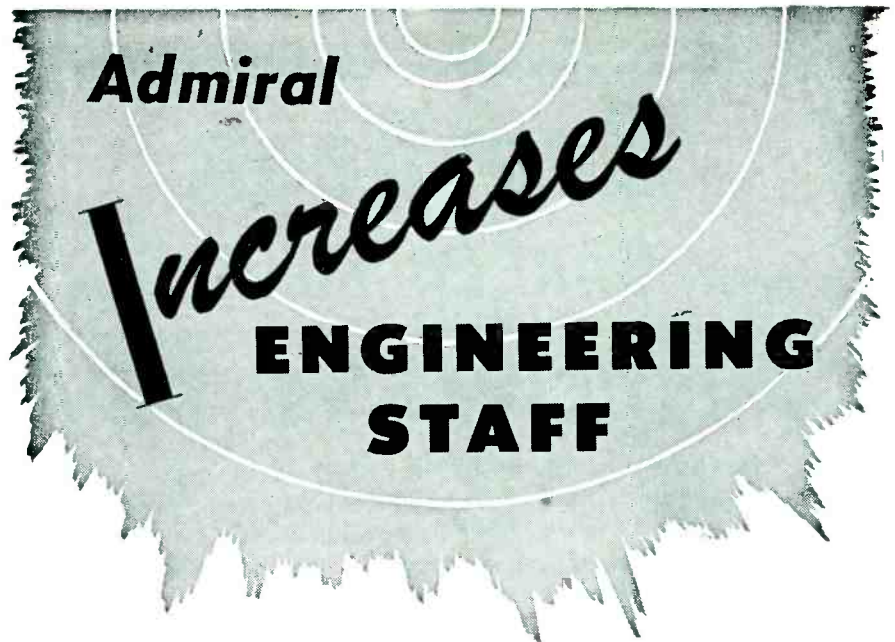

Diversification at ADMIRAL is making itself felt in more and better engineering careers.

Real ability and originality can find new challenge and opportunity with a leader in electronic development and manufacturing.

Positions available for engineers with the following backgrounds:

★ MICROWAVE ENGINEERS

Experienced in UHF and SHF circuitry and components, with understanding of wave guides, cavities, and duplexers.

★ ELECTRONIC ENGINEERS

Junior and Senior engineers for television receiver circuit design. Experienced men also needed for V.H.F. and U.H.F. tuner work.

★ RADIO ENGINEERS

Duties involve designing household and portable radio receivers. FM and AM experience preferred.

★ MECHANICAL ENGINEERS

Electro-Mechanical designers. Assignments involve the design and layout of small mechanical devices at the development level.

★ COMMUNICATIONS ENGINEERS (MILITARY)

Applied development and design of radar and other specialized military systems.

★ AUTOMATION ENGINEERS

A special opportunity exists in the field of applying automation and printed circuit techniques in the above categories. Your imagination and engineering talents can be used in furthering this development.

Good starting salaries and working conditions with complete program of employee benefits. Opportunity for professional development with excellent facilities in Chicago area to carry on University graduate work while working full time.

• Send complete resume to Mr. Walter Wecker, Personnel Department, to get more information on these opportunities.

Admiral Corporation

3800 W. Cortland St.
Chicago 47, Illinois

ELECTRONICS ENGINEERS

Raytheon

offers **CAREER-FUTURE** in

EXCELLENCE IN
ELECTRONICS



MICROWAVE DEVELOPMENT

We have two openings on our staff for engineers with varied design experience in the microwave field particularly with a background of experience in SHF, SLOW WAVE STRUCTURES and FRONT-END APPLICATIONS. The men who will fill our openings will have an

ELECTRICAL ENGINEERING or PHYSICS DEGREE and a minimum of 3 years experience in microwave and related fields. You will have an opportunity to work in the field of ADVANCED DEVELOPMENT of MICROWAVE THEORY and APPLICATION.

Please send a complete resume with education, experience, and salary requirements to

Looking for a Future

T. F. COLLINS

RAYTHEON MANUFACTURING COMPANY
CHICAGO DIVISION, EQUIPMENT OPERATIONS

Telephone
SPRING 7-3300

4132 W. BELMONT AVE. CHICAGO 41, ILLINOIS

**Stability and Opportunity for
ELECTRONIC ENGINEERS
who want more room to grow**

Top opportunities for achievement and recognition are open at FTL... key unit of the world-wide, American-owned IT&T System. FTL's long-range development program offers stability and security. Finest facilities—plus broad and generous employee benefits.

INTERESTING ASSIGNMENTS IN:

- Radio Communication Systems • Electron Tubes
- Microwave Components • Electronic Countermeasures
- Air Navigation Systems • Missile Guidance
- Transistors and other Semiconductor Devices
- Rectifiers • Computers • Antennas
- Telephone and Wire Transmission Systems



**SEND RESUME TO:
PERSONNEL MANAGER,
BOX EL-5**

Federal Telecommunication Laboratories

A Division of INTERNATIONAL
TELEPHONE AND TELEGRAPH CORPORATION
500 Washington Avenue, Nutley, N. J.

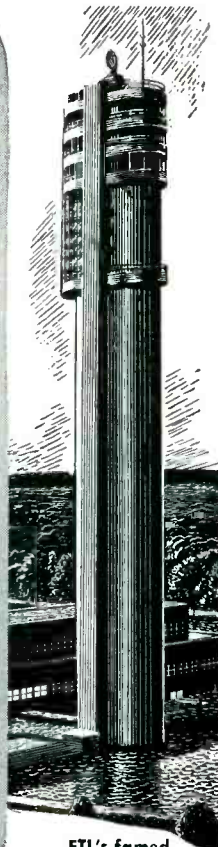

FTL's famed
Microwave Tower
— 28 minutes
From N. Y. C.

To
EMPLOYERS
who advertise
for **MEN:**

WHEN there are many applicants for a single position it frequently happens that the only letters acknowledged are those of the most promising candidates. Others may not receive any indication that their letters have even been received by a prospective employer much less given consideration. These men often become discouraged, will not respond to future advertisements, and sometimes question their bona fide character.

Every advertisement printed in the Searchlight Section is duly authorized.

It will help to keep our readers interested in this advertising if you will acknowledge every application received, even if you merely return the letters of unsuccessful applicants with, "Position filled, thank you" written or stamped on them. If you don't care to reveal your identity, mail them in plain envelopes.

We suggest this in a spirit of cooperation between employers and the men replying to Positions Vacant advertisements.

★

"Put yourself in the other fellow's place."

★

Classified Advertising Division

McGraw-Hill Publishing Co., Inc.

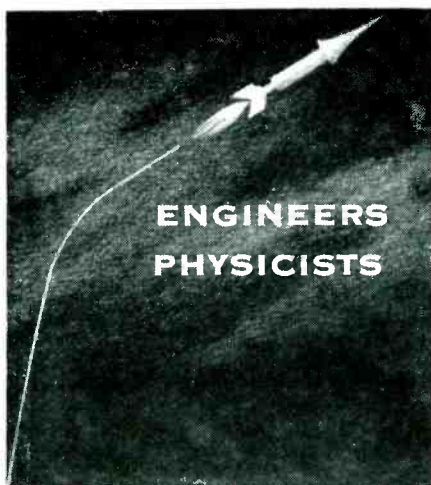

How SYLVANIA Can Help You in the Missiles Field thru its Stability and Diversity

Sylvania has established a Missile Systems Laboratory. New laboratory facilities are nearing completion. This 54 year old company, renowned for its consumer products, and supplying vital "heart" parts to other manufacturers, now brings its research, know-how, stability and diversity to the guided missiles field. Behind this important new Sylvania laboratory stands the versatility, drive and dedication that has seen Sylvania expand to 45 plants and 16 laboratories, while *doubling* its engineering staff and almost tripling sales in the past 6 years.

Permanent positions
are now open in these fields:

ANALYSIS & DESIGN OF
SEARCH RADAR SYSTEMS
ANTENNA THEORY & DESIGN
ANALYSIS OF MISSILE
GUIDANCE SYSTEMS
MATHEMATICAL ANALYSIS &
SYSTEM DESIGN OF FIRE CONTROL
& COMPUTER EQUIPMENT
INERTIAL GUIDANCE OR
INFRA-RED FOR DETECTION
& TRACKING
SERVO SYSTEM
DESIGN & ANALYSIS
AERODYNAMICS
PROPULSION
AIRCRAFT OR MISSILE
STRUCTURES

Relocation and interview expenses will be paid.

Please forward resume to:

Mr. Robert Koller
Supervisor of Professional Placement

missile systems laboratory



SYLVANIA

ELECTRIC PRODUCTS INC.

151 Needham Street, Newton, Massachusetts
(A suburban location just 8 miles from downtown Boston)

TO THE FINE ENGINEERING MIND
SEEKING THE CHALLENGING PROJECTS IN

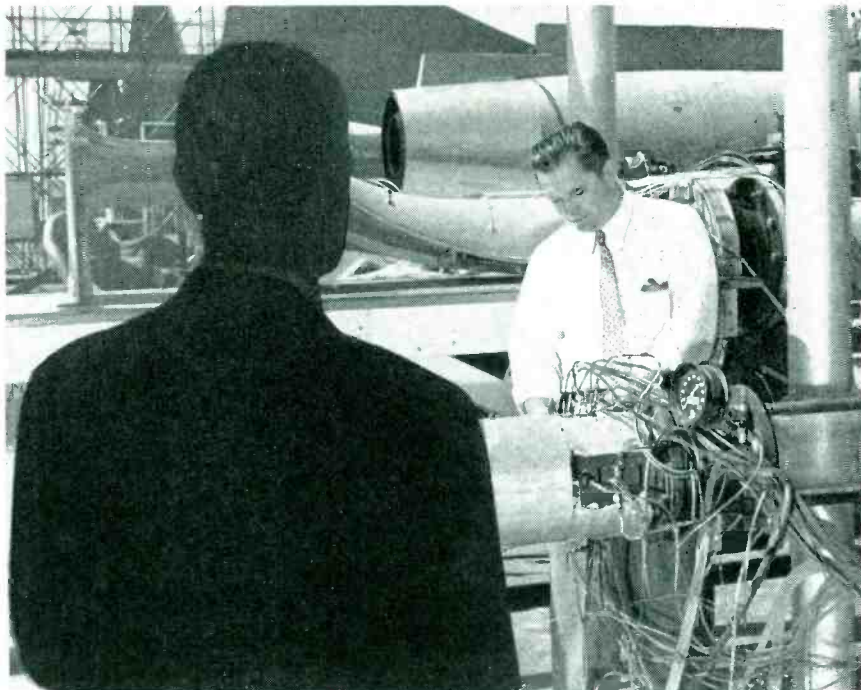

INSTRUMENTATION

INSTRUMENTATION ENGINEERS experienced in the development and design of static and flight test instrumentation systems are offered unusual career opportunities now at Convair in beautiful San Diego, California. These responsible engineering positions call for experience in one or more of the following areas: instrumentation systems planning and study; transducer design, selection, and application; airborne and ground-based telemetering equipment development and design; instrumentation systems installation design.

CONVAIR offers you an imaginative, explorative, energetic engineering department... truly the "engineer's" engineering department to challenge your mind, your skills, your abilities in solving the complex problems of vital, new, long-range programs. You will find salaries, facilities, engineering policies, educational opportunities and personal advantages excellent.

SMOG-FREE SAN DIEGO, lovely, cool city on the coast of Southern California, offers you and your family a wonderful, new way of life... a way of life judged by most as the Nation's finest for climate, natural beauty and easy (indoor-outdoor) living. Housing is plentiful and reasonable.

Generous travel allowances to engineers who are accepted. Write at once enclosing full resume to:

H. T. Brooks, Engineering Personnel, Dept. 905

CONVAIR

A Division of General Dynamics Corporation

3302 PACIFIC HIGHWAY

SAN DIEGO, CALIFORNIA

M. I. T.

LINCOLN LABORATORY

Staff research positions available for exceptional **electrical engineers** with advanced training or experience in **electronics** as applied to . . . Radar, Communications and High Speed Digital Computers.

Please reply to:
Personnel Department, P. O. Box 73,
Lexington 73, Mass.



FIELD ENGINEERS

For field representative work on electronic communications equipment. Must be free to travel or relocate. E. E. grads or equivalent experience. Top salary plus liberal expense allowance.

Write Personnel Director
STEWART-WARNER ELECTRIC
 1300 N KOSTNER AVE. • CHICAGO 51, ILL.

ELECTRONIC ENGINEERS

Required: Degree in Electrical Engineering or Physics and two or more years instrumentation and development of electronic circuits.

TEST ENGINEERS

Experimental dynamic performance testing, equipment evaluation for electrical and mechanical performance, developmental work on new test equipment. State qualifications.

PROJECT ENGINEER

Capable of responsible direction of project to develop complex equipment. Background in Aeroelasticity, Structural dynamics, Machine Design, Electronics helpful.

THE CALIDYNE COMPANY

Manufacturers of Vibration Test Equipment
 120 CROSS STREET WINCHESTER, MASSACHUSETTS

Attention . . . EMPLOYMENT ADVERTISERS

Effective with the July issue, a new section will start in **ELECTRONICS**. We will head this section: **EMPLOYMENT OPPORTUNITIES**. All Displayed Employment Opportunity advertising will be placed in this new section, with the exception of those advertisers who contract for run-of-book position. Advertisements in the **EMPLOYMENT OPPORTUNITIES** section will be billed at the new open rate of \$21.50 per inch. Contract rates furnished on request. Advertisements are subject to Agency Commission.

For full information write:

ELECTRONICS

330 West 42nd St.,
 New York 36, N. Y.

Bendix

needs

**ELECTRONIC
ENGINEERS**

in

SOUTHERN CALIFORNIA

Unusual engineering positions in Radar, Sonar and Telemetering are available at Pacific Division, Bendix Aviation Corporation in North Hollywood, California. These positions, which are directly associated with our long-range projects for industry and for defense, are available at all levels.

Please address inquiries to:

W. C. WALKER

Engineering Employment Manager

Pacific Division
Bendix Aviation Corporation
NORTH HOLLYWOOD, CALIF.

**ENGINEERS
OR
PHYSICISTS**

with

**PHOTO-EMISSIVE
EXPERIENCE**

Old established firm manufacturing electronic tubes desires services of several engineers or physicists familiar with photo-emissive and photo-conductive devices. Firm is embarking on manufacture of pickup and storage tubes.

Chance to get in at the start of a new operation. Location New England.

State complete qualification, salary desired, citizenship status and references. Reply:

P-5952, Electronics
330 W. 42 St., New York 36, N. Y.

UNIVACThe FIRST Name

in Complete Electronic Computing Systems

As the UNIVAC takes its place in more and more industries, REMINGTON RAND has greatly expanded its research and development work in order to continue its leadership in electronic computing equipment.

There are many positions recently opened at all levels in all phases of research, design, developments, and application of computing and allied equipment. Even though your training and experience may not be connected with computers, we are willing in many cases to provide the necessary training. Individual cases can be evaluated during interview.

- System Studies
- Logical Design
- New Components
- Solid State Physics
- Semi-conductors
- Magnetic Materials
- Storage Techniques
- Circuit Design
- Pulse Techniques
- Input-Output Devices
- Product Design
- Test Equipment Design
- Computer Development and Design
- High Speed Electro-Mechanical Devices
- System Test and Maintenance

The rapidly expanding engineering program has created many permanent positions paying excellent salaries. These positions offer personal challenge as well as outstanding opportunities for professional development. The possibilities for graduate study in this area are excellent and the company has a liberal plan for reimbursement of tuition expenses. Other company benefits include retirement and group insurance.

Replies Kept Strictly Confidential

FOR INTERVIEW, WRITE TO

Remington Rand

ECKERT-MAUCHLY DIVISION

2300 West Allegheny Ave.

Philadelphia 29, Pa.

ENGINEERS

DESIGNERS-DRAFTSMEN

Electronic

Mechanical

What's *NEW* at Melpar

NEW laboratories

NEW opportunities

NEW projects

- Network Theory
- Systems Evaluation
- Automation
- Microwave Technique
- UHF, VHF or SHF Receivers
- Analog Computers
- Digital Computers
- Magnetic Tape Handling Equipment
- Quality Control & Test Engineers
- Radar & Countermeasures
- Packaging Electronic Equipment
- Pulse Circuitry
- Microwave Filters
- Flight Simulators
- Servomechanisms
- Subminiaturization
- Electro-Mechanical Design

Melpar has just opened its new plant at Falls Church, Virginia, in a beautiful suburban location. We have also moved to larger quarters at Watertown, Mass., and opened a new research department at Cambridge, Mass.

Melpar's continued expansion offers new career opportunities for individual growth and recognition. Men of vision and imagination who plan for the future are quick to sense the potential with this growing, dynamic organization.

Continued leadership in electronic research and development is reflected in our current group of projects with long-range military and industrial application.

For personal interview send resume to
Technical Personnel Representative,



melpar, inc.

Subsidiary of Westinghouse Air Brake Co.

3000 Arlington Blvd., Dept. E-17
Falls Church, Virginia
or 11 Galen St., Watertown, Mass.

ENGINEERS NEEDED FOR RESEARCH AND DEVELOPMENT POSITIONS IN THE

Design of electronic instrumentation for underwater ordnance, including high gain amplifiers, conventional filters, power amplifiers, oscillators and detectors in the ultrasonic range.

Analytical and experimental treatment of scientific research problems in the fields of hydrodynamics, acoustics, electronics, network theory, servomechanisms, mechanics, information theory and noise analysis including analogue and digital computations.

Design of transducers, fundamental problems in underwater acoustics involving transmission, attenuation, reflection, etc. Problems in sound control and noise reduction. Acoustical aspects of systems research including operations research and feasibility studies.

Opportunities for graduate study

Liberal Vacation Policies

Excellent Working Conditions

**THE PENNSYLVANIA STATE UNIVERSITY
ORDNANCE RESEARCH LABORATORY**

University Park, Pennsylvania

Send Resume to **ARNOLD ADDISON, Personnel Director**

Poor Aladdin . . .

The best service at Aladdin's command was rubbing a lamp and WISHING for what he wanted. YOU have "Searchlight" to help you find what you want!

"CAN SEARCHLIGHT" SERVE YOU?"

MANUFACTURERS REPRESENTATIVES!!

Sell Your Electronic Products & Services Through Our

New Section

"MANUFACTURERS REPRESENTATIVES"

This new section will start in the forthcoming June BUYERS' GUIDE issue, and appear thereafter in every monthly issue of ELECTRONICS.

This section will be headed: "MANUFACTURERS REPRESENTATIVES" and will consist of advertisements of the leading Manufacturers Representatives throughout the country.

Every man of importance in the electronic industry is a subscriber to ELECTRONICS and will receive a copy of the BUYERS' GUIDE. Since its inception fourteen years ago, the "GUIDE" has become the accepted reference book of the electronic industry. An advertisement in the "MANUFACTURERS REPRESENTATIVES" section presents your product story to key people who most naturally will be interested in your products and services as a source of supply or as a sales outlet for their products.

If you have not already reserved your advertising space, there is still time. There's a choice of space units to fit every advertising budget.

Full information and rates are available from your ELECTRONICS representative, or write:

ELECTRONICS

330 West 42nd St., New York 36, N. Y.

DEVELOPMENT & FIELD SYSTEMS ENGINEERS

- ANTENNA
- RADIO COMMUNICATIONS
- RADAR
- MICROWAVE
- NAVIGATIONAL AIDS
- TERMINAL EQUIPMENT
- TELETYPE

With a progressive, expanding, well established corporation. Interviews will be arranged for qualified applicants. Send complete biographical resume, experience and education to

Mr. J. E. Richardson
Personnel Director

MARYLAND ELECTRONIC MFG. CORP.
5009 Calvert Road
College Park 9, Maryland

Electrical Engineers and Physicists

- Radar Simulation
- Advanced Circuitry
- Analog Computers
- Ballistics
- Mapping
- Telemetry

Senior and Junior Engineers

Opportunities Ultl.*

We offer you an opportunity to grow with us . . . an opportunity: for steady advancement . . . individual recognition by working closely with technical management . . . rapid individual development by contact with all phases of projects . . . an interesting and stimulating association with other engineers . . . a suburban location for working and living . . . to ally yourself with a firm with a future. If you are looking for *opportunities unlimited* . . . write:

Industrial Research Laboratories
Division of Aeronca Manufacturing Corp.
Dept. A-5, Hilltop & Frederick Rds.
Baltimore 28, Maryland
* Unlimited

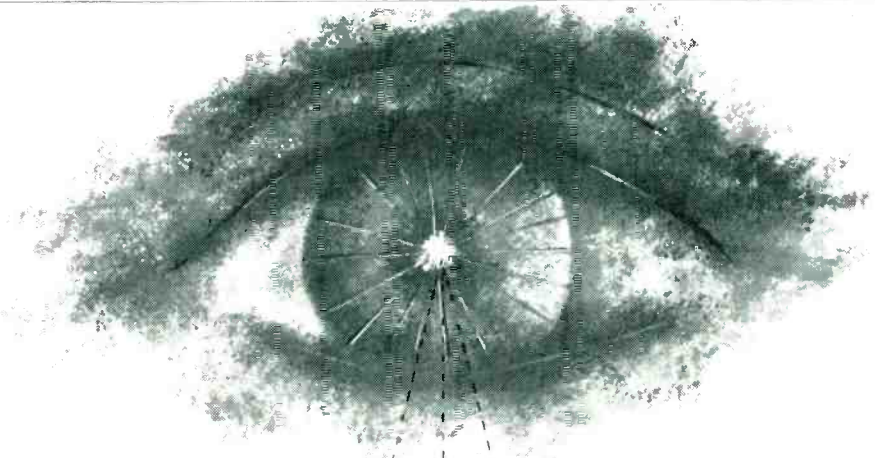

Looking for NEW ELECTRONIC WORLDS to conquer?

Beyond the range of sight lies the vast potential of tomorrow's electronic world. How this new world will affect the scientist, surgeon, farmer, housewife, business man, can only be surmised. But the possibilities are inspiring. The world of the electron is infinite.

Wresting electronic secrets from Nature has been Farnsworth's sole function for over a quarter of a century. Expansive, aggressive diversification into new and challenging fields of activity, implemented by the addition of men with significant capacity for professional growth, marks the direction of the Company's progress. Association with an organization slated for continuing major success can lead to highly satisfying individual responsibility and awards, and result in a stimulating and fruitful career.

To scientists and engineers possessing the professional potential and who are looking ahead to new electronic worlds to conquer, Farnsworth offers worthwhile opportunities in these fields: Pulse Circuitry, Microwave Antennas, Information Theory, Infra-Red Systems and Devices, Mechanical Packaging, Receivers, Optics, Data Recording, Transistor Circuitry, Microwaves, Radar, Electronic Countermeasures, Operations Research, Missile Guidance and Control Systems and Test Equipment.

Farnsworth DIVISION OF **IT&T**

Address Inquiries to
FARNSWORTH ELECTRONICS CO.,
Technical Employment Dept.
Fort Wayne, Indiana

ELECTRONIC ENGINEERS PHYSICISTS MATHEMATICIANS

Permanent positions in the Vitro Laboratories for career-minded men providing challenging assignments in:

**Systems Studies Design & Evaluation
Equipment Development
Circuit Analysis**

in the fields of

**Underwater Ordnance
Guided Missiles
Test Facilities
Data Processing
Instrumentation
Ballistics
Optics**

• For additional information, write complete details of your background and experience, including salary history, to the Personnel Director at the Vitro location of your choice.

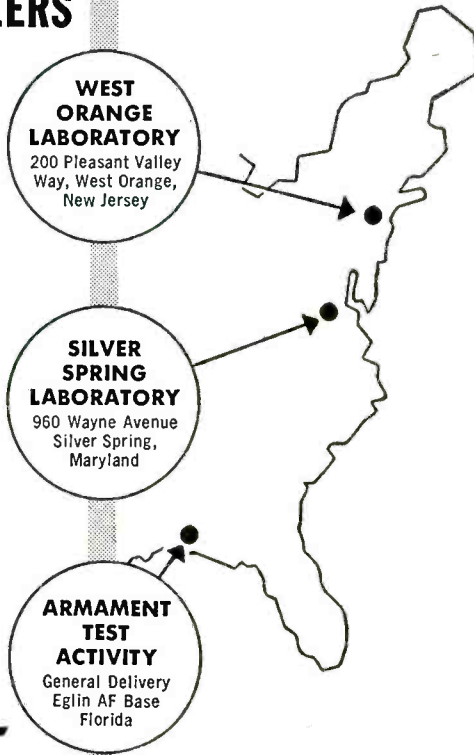

WEST ORANGE LABORATORY
200 Pleasant Valley Way, West Orange, New Jersey

SILVER SPRING LABORATORY
960 Wayne Avenue Silver Spring, Maryland

ARMAMENT TEST ACTIVITY
General Delivery Eglin AF Base Florida

VITRO LABORATORIES
DIVISION OF VITRO CORPORATION OF AMERICA

DO YOU NEED ENGINEERS WITH EXPERIENCE IN:

- Research
- Development
- Design
- Instrumentation
- Servomechanisms
- Missiles
- Audio Systems
- Control Systems
- Radar
- Computers
- Transistors
- Other Fields

Place an "ENGINEERS WANTED" advertisement in this SEARCHLIGHT SECTION of ELECTRONICS. It's an inexpensive, time saving method of selecting competent personnel for every engineering job in the electronics industry. The selective circulation of ELECTRONICS offers you an opportunity to choose the best qualified men available throughout the industry.

For Rates and Information Write:

CLASSIFIED ADVERTISING DIVISION

McGraw-Hill Publications

330 West 42nd St.,
New York 36, N. Y.

SUPERVISOR Guidance Design

Attractive supervisory assignment now available for an experienced electronics engineer to direct the analysis, design and flight test of systems for the guidance of pilotless aircraft. Applicants must possess supervisory experience and specialized knowledge of U.H.F. and microwave frequencies.

Requirements include Bachelor degree with advanced study preferable. Minimum of eight years of experience necessary.

Generous travel allowance; insurance, hospitalization and retirement programs.

For detailed information and to arrange for a personal interview, submit resume of education and experience with salary desired to

G. H. Orgelman, Supervisor — Engineering Personnel

VOUGHT AIRCRAFT
INCORPORATED

P. O. BOX 5907 • DALLAS, TEXAS

ELECTRONIC ENGINEERS

Unique opportunity to get in on ground floor of young successful company applying atomic energy to industrial uses (non-government).

Graduate engineers are needed in two major functions: sales and applications engineering, and development and design engineering.

Rapid expansion of company offers promotion opportunities found in few organizations. Only men with top academic and work records who desire and are capable of hard work and rapid promotion will be considered.

INDUSTRIAL NUCLEONICS CORP.
1205 Chesapeake Ave. Columbus 12, Ohio

A leader in Nuclear Instrumentation and Automation Equipment.

ELECTRONIC ENGINEER OR PRODUCTION SUPERINTENDENT

Los Angeles, California

If you are capable of assuming complete direction of development and production of a high-potential component part for use in the electronics industry, this is your opportunity to go into business for yourself. We have the finances and sales contacts. We need technical know-how. Ownership interest without investment guaranteed, but ambition and technical ability essential. Replies and discussions in strictest confidence.

P-6133, Electronics
1111 Wilshire Blvd., Los Angeles, Calif.

ENGINEERS

The APPLIED PHYSICS LABORATORY OF THE JOHNS HOPKINS UNIVERSITY offers an exceptional opportunity for professional advancement in a well-established laboratory with a reputation for the encouragement of individual responsibility and self-direction. Our program of

GUIDED MISSILES DEVELOPMENT

provides such an opportunity for men qualified in:

ELECTRONIC CIRCUIT DESIGN AND ANALYSIS
DEVELOPMENT AND APPLICATION OF TRANSISTOR CIRCUITRY
SERVOMECHANISMS AND CONTROL SYSTEM ANALYSIS
ELECTRONIC EQUIPMENT PACKAGING
MISSILE SYSTEMS DEVELOPMENT
FLIGHT TESTING
ANTENNA DESIGN AND ANALYSIS

Please Send your resume to

Professional Staff Appointments

APPLIED PHYSICS LABORATORY

THE JOHNS HOPKINS UNIVERSITY

8621 Georgia Avenue
Silver Spring, Maryland

ELECTRONIC ENGINEERS!



**Big opportunities
await you at
Bendix York!**

To the Engineer who is a recent college graduate, as well as to those with experience in all phases of advanced design, Bendix York offers opportunities outstanding in its field. As a young and expanding division, Bendix York provides fascinating and challenging assignments. Good salaries, all employee benefits, ideal living conditions in a beautiful suburban area are yours.



Send resume of Education and Experience to: Mr. L. D. Smith, Employment Supervisor

Bendix

AVIATION CORPORATION
YORK DIVISION
Phone: York 5521 York, Penna.

We're Looking for People... Not Just Engineers

At ECA it's not only technical proficiency that counts. We're looking for more permanent staff members — imaginative, well-rounded, broad of outlook — men with varied interests.

We know they are uncommon. As a matter of fact, only one in twenty meets our standards. But we've found that these stay for good.

ECA's field — the science of automatic control — calls for an imaginative approach... and imagination can't exist in a vacuum. Ideas come easiest to men who are doing the work they enjoy, in a stimulating atmosphere.

In our flexible organization, the technical man must work with and through many other people. Human relations, in fact, may be the hardest part of his job. That's why we look for people, rather than just engineers.

What statisticians call "engineering turnover" is just about non-existent at ECA. The success of our established commercial products... the demand for our services in developing automatic controls, electronic business machines, computers... explain our growth with stability. Satisfaction from a job well done makes ECA a good place to work.

Please address inquiries to
Mr. W. F. Davis, Dept. 705



**ELECTRONICS
CORPORATION
OF AMERICA**

77 Broadway Cambridge 42, Mass.

ENGINEERS

ELECTRONIC

For work in the research & development of pulse circuitry, computing components and servo systems.

SYSTEMS (E. E.)

For work in the development of airborne navigational equipment.

The above positions require previous experience in allied fields.

MECHANICAL

2-3 years design experience on precision instruments.

DESIGNERS

ELECTRONIC ELECTRO-MECHANICAL MECHANICAL

1. Electronic or electrical packaging. Knowledge of subminiaturized techniques, for work associated with servos, amplifiers and computers.
2. Mechanical or electro-mechanical packaging of precision flight instruments.

The modern facilities and congenial atmosphere at Kollsman, designers of America's finest aircraft instruments, provide an environment conducive to truly creative work.

Please submit resumes to Employment Manager.



kollsman INSTRUMENT CORPORATION

80-08 45th AVENUE, ELMHURST, NEW YORK • SUBSIDIARY OF *Standard* COIL PRODUCTS CO. INC.

PROGRESSIVE ENGINEERS LOOK WEST

Qualified Electronic and Electro-Mechanical engineers find happy association with a Western electronics pioneer and leader.

*design
development
production*

Commercial and military projects. Radar, DME, Communications, Noise, Test Equipment including color T.V. — Many others with real interest & challenge. Relocation expenses — excellent working conditions — Central location. Scheduled reviews & advances. Fine insurance plan. Move should not disturb urgent military projects.

Send complete resume, income history & requirements to engineering employment mgr.

Hoffman LABORATORIES, INC.

(A SUBSIDIARY OF HOFFMAN RADIO CORP.)

3761 SO. HILL ST.

LOS ANGELES 7, CALIF.

ENGINEERS

FIELD ELECTRONICS

5 yr installation, maintenance, and/or instruction, exp. ECM and/or ground-to-air navigation ILS, VOR. Ground radar and control—guided missiles.

Dynamic Electronics of New York, Inc.
73-39 Woodhaven Blvd., Glendale, N. Y.
Mr. Schwartz, Illinois 9-7000

PRINTED COMPONENTS SPECIALIST

A mid-western electronics company has an excellent opportunity for an engineer possessing a comprehensive background in the printed circuit component field.

The technical requirements for this position include:

1. Extensive general knowledge of currently used printed circuit manufacturing processes.
2. Extensive detailed knowledge of tape resistor and deposited film resistor manufacturing processes. Ability to conduct advanced research and development in this field.
3. Extensive detailed knowledge of currently used printed circuit capacitor manufacturing processes. Ability to conduct advanced research and development in this field.

Salary open. Will pay moving expense.

Inquiries treated confidentially.

P-5750, Electronics
520 N. Michigan Ave., Chicago 11, Ill.

EMPLOYMENT PROBLEM?

When you are in need of specialized men for specialized jobs, contact them through a *classified ad* in a McGraw-Hill Publication.

Management, Engineering, Production, Maintenance, Selling . . . these represent broadly the principal functions in business and industry. And it is principally to the men and executives who fill key jobs in these important divisions that McGraw-Hill publications are directed.

McGraw-Hill Domestic Publications

AMERICAN MACHINIST
AVIATION WEEK
BUS TRANSPORTATION
BUSINESS WEEK
CHEMICAL ENGINEERING
CHEMICAL WEEK
COAL AGE
CONTROL ENGINEERING
CONSTRUCTION METHODS AND EQUIPMENT
ELECTRICAL CONSTRUCTION AND MAINTENANCE
ELECTRICAL MERCHANDISING
ELECTRICAL WHOLESALING
ELECTRICAL WORLD
ELECTRONICS
ENGINEERING AND MINING JOURNAL
ENGINEERING NEWS-RECORD
FACTORY MANAGEMENT AND MAINTENANCE
FLEET OWNER
FOOD ENGINEERING
NATIONAL PETROLEUM NEWS
NUCLEONICS
PETROLEUM PROCESSING
POWER
PRODUCT ENGINEERING
TEXTILE WORLD

THE MEN YOU NEED ARE
THE MEN WHO READ THE

McGraw-Hill PUBLICATIONS

330 West 42nd St.,
New York 36, N. Y.

ELECTRONIC ENGINEER EXECUTIVE

Well established manufacturer and developer of electro-mechanical and mechanical instruments is expanding its facilities and offers a challenging opportunity to a graduate electrical-electronic engineer, who will spear-head the design and development of electrical and electronic products. Must have background of experience which has demonstrated ability to fulfill the requirements of this position.

All replies held in strict confidence. Please send a complete resume including salary requirements to:

STURGESS, INC.
711 W. Broadway
Glendale, California

RECEIVER ENGINEERS With Experience in VHF and UHF Frequencies

Career Opportunities
With Old Established
Central Connecticut Firm
Interesting Projects
Top Salaries
Suburban Living

Replies Held in Strict Confidence
Wire or Phone Collect
Personnel Mgr. SHerwood 7-2741

**THE ALLEN D. CARDWELL
ELECTRONICS PRODUCTIONS
CORPORATION**
Plainville, Connecticut

SENIOR ELECTRONICS ENGINEERS

EE degree or equivalent experience. Background in communications and navigation desirable. Permanent positions in design and development. Citizenship required. Position at Rochester, New York. Excellent living and recreational conditions in this area.

ADDRESS:

Chief Electronics Engineer
STROMBERG-CARLSON COMPANY
ROCHESTER 3, NEW YORK

OPPORTUNITY FOR

ELECTRONIC ENGINEERS *and* ELECTRONIC TECHNICIANS

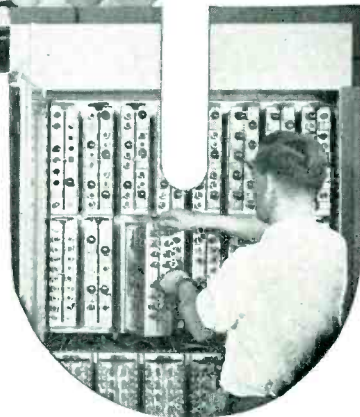
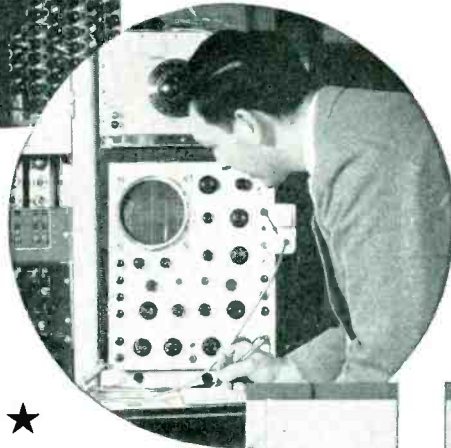
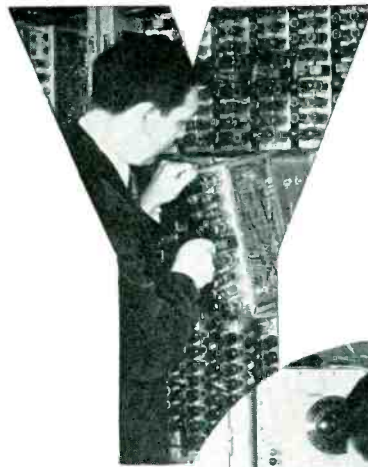

These are
PERMANENT
Positions with a
leader in the dynamic
field of
**ELECTRONIC
COMPUTERS**

Your best chance for increasing responsibility and rapid advancement in the electronic field is in the challenging field service work associated with digital computers. *Computer experience is not necessary.* You will receive extensive training in computer logic and circuitry and specialized training on specific computers. Good salaries start with the training period. After training you will be assigned to one of our large computer installations in continental United States. You will enjoy liberal travel allowances and other employee benefits.

The practical knowledge of computers obtained from actual experience at field installations will aid you greatly in advancement.

Minimum qualifications for
ELECTRONIC ENGINEERS
Bachelor Degree—2 years
electronic experience

Minimum qualifications for
ELECTRONIC TECHNICIANS
High school plus electronic school
(armed forces acceptable)
and four years electronic experience

For further information regarding our computers and training programs, send a brief resumé of your education and experience to **Mr. R. A. Nelson, Employment Manager.** Interviews at our expense by arrangement. All contacts are held in strict confidence.

Remington Rand

ENGINEERING RESEARCH ASSOCIATES DIVISION

1890 W. MINNEHAHA AVENUE

ST. PAUL W4, MINNESOTA

ENGINEERS

• ELECTRONICS • MECHANICAL

For progressive Chicago firm expanding in all types of research projects in military work. Positions also available for Lay-out detail and Design Draftsman.

Salary will commensurate with ability and qualifications. All details will be treated strictly confidential.

Address to:

Hallicrafters Company
4401 W. Fifth Avenue
Chicago 24, Illinois

Personnel
Division

PERSONNEL MANAGERS

LOOKING FOR ENGINEERS TECHNICIANS?

Write for free copy of

"RESERVOIR OF ENGINEERS AND TECHNICAL MEN"

The engineers and technicians you want to reach are gathered in convenient, compact groups—as this 12-page booklet points out.

It keys the job titles these men hold to the McGraw-Hill publications they read for on-the-job information. It explains how you can make contact . . . channel,

concentrate your employment advertising to just the men with the job qualifications you want . . . without wasting advertising money for higher-priced space in publications with general circulation, in which you pay for perhaps 999 unqualified readers for every 1 who may meet your job requirements.

Write for your free copy to: *Classified Advertising Division*
McGraw-Hill Publishing Company, Inc., 330 W. 42nd St., New York 36, N. Y.

When you WANT or OFFER

- EQUIPMENT
(Used, or Surplus New)
- PRODUCTS
to manufacture
- CAPITAL
- INDUSTRIAL PROPERTY

USE THE SEARCHLIGHT SECTION

RATES

DISPLAYED—RATE PER INCH

The advertising rate is \$16.10 per inch for all advertising appearing on other than a contract basis. Contract rates quoted on request.

AN ADVERTISING INCH is measured $\frac{3}{8}$ inch vertically on one column, 3 columns—30 inches—to a page.

UNDISPLAYED RATE

\$1.80 a line, minimum 3 lines. To figure advance payment count 5 average words as a line

POSITION WANTED undisplayed advertising rate is one-half of above rate, payable in advance.

BOX NUMBERS count 1 line additional.

DISCOUNT 10% if full payment is made in advance for four consecutive insertions of undisplayed ads (not including proposals).

EQUIPMENT WANTED OR FOR SALE Advertisements acceptable only in Displayed Style.

CLOSING DATE INFORMATION

Searchlight Section closes
May 3rd for the June issue.

"SEARCHLIGHT" is LOW-COST NATIONAL

CLASSIFIED ADVERTISING

Send NEW ADVERTISEMENTS to N. Y. Office, 330 West 42 St., N. Y. 36, N. Y. The publisher cannot accept advertising in the Searchlight Section, which lists the names of the manufacturers of resistors, capacitors, rheostats, and potentiometers or other names designed to describe such products.

SALES MANAGER

Thoroughly experienced in Government and Industrial Sales with extensive knowledge of Advertising, Sales Promotion, Marketing and Market Analysis. Able to organize and direct complete sales force. Electrical Engineering degree or equivalent. Should have a proven record of 10 years of sales management with first rate company. Need man 38-50 years of age willing to locate in New York City. Products: Control and Communication equipment, Variable Capacitors and Radio Receivers.

Send complete Resumé and salary requirements to

HAMMARLUND MFG. CO., INC.
460 W. 34th St., N. Y. 1, N. Y.



OFFERS OUTSTANDING OPPORTUNITIES IN FIELD ENGINEERING

E E graduates or equivalent with field experience in radar will find unequalled opportunities for professional advancement with Raytheon — a world leader in electronics. Foreign and domestic assignments. Excellent salaries. Liberal allowances.

Write

RAYTHEON
GOVERNMENT FIELD ENGINEERING
WALTHAM 54, MASS.

ENGINEER—TAPE RECORDER PROJECT LEVEL
EXPERIENCED IN ALL PHASES OF MAGNETIC TAPE RECORDER MFG. TOP SALARY—PERMANENT POSITION SEND COMPLETE RESUME TO
FEDERAL MANUFACTURING & ENGINEERING CORP.
BROOKLYN 5, New York

REPRESENTATIVES WANTED
Manufacturer of electronic test equipment for military and commercial applications needs technically qualified representatives. Write giving qualifications, lines handled, territory covered.
RW-2178, Electronics
1111 Wilshire Blvd., Los Angeles 17, Calif.

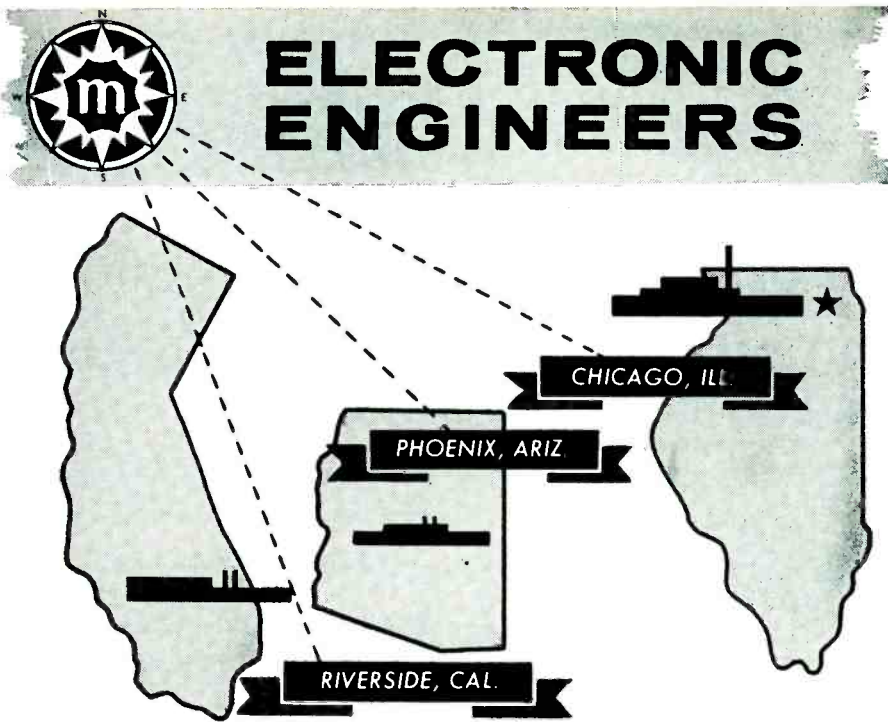

Motorola

One of America's Fastest-Growing Organizations — Offers the Location where You want to Live and Work!

- MECHANICAL ENGINEERS • ELECTRONIC ENGINEERS • PHYSICISTS • CHEMISTS
- METALLURGISTS • MATHEMATICIANS

MILITARY ELECTRONICS Has a Place for You

- navigational devices
- radar
- countermeasures
- analog computers
- communications equipment
- carrier transmitters
- VHF receivers
- UHF multiplexing systems
- microwave
- data transmission
- data processing and presentation indicators
- plotting systems
- telemetry
- remote control
- servomechanisms
- transistor circuitry
- operations research
- dynamic systems analysis
- subminiaturization
- solid state physics*
- semi conductor research*
- transistor development*
- *Phoenix only

... 12 plants and 11,000 employees devoted exclusively to electronic research, development, manufacture for the military, public safety, civil defense and general industry . . . MOTOROLA offers a great diversity of occupations in specialized fields. You can set your own course of growth in our great applied industrial projects

CHICAGO, ILLINOIS—headquarters—three laboratories in the communications and transportation center of the country.

PHOENIX, ARIZONA—research laboratories—staffed with 800 scientists and engineers—special opportunities for experienced men in transistor research (chemists, physicists, metallurgists).

RIVERSIDE, CALIFORNIA—research laboratories—new, modern laboratory buildings—dynamic systems analysis—all electronic military weapon systems.

State your geographical choice and your preferred interest—Give important facts of education, training and experience—We require a minimum of 4 years' experience.

Motorola

WRITE—Attention: Daniel E. Noble, Vice President in Charge

COMMUNICATIONS AND ELECTRONICS DIVISION
4501 AUGUSTA BLVD., DEPT. E—CHICAGO 51, ILLINOIS

SEARCHLIGHT SECTION

WANTED
BC-788, T-47A/ART-13,
BC-348R, R-5/ARN-7,
RT-18/ARC-1

RADALAB
 87-17 124th STREET
 Richmond Hill 18, New York
 Phone Virginia 9-8181-2-3

Prices FOB NYC. Rated firms open account. Prices subject to change without notice.
CABLE: Radalab, NY
TELETYPE: NY-4-4361

AN/TXC-1, RC-120 FACSIMILE SETS

Page sending and receiving equipment. These sets will transmit and receive a 12 by 18 inch or a 7 by 8 inch page of written or picture material over a telephone line or a radio circuit in 20 minutes. The copy may be sent on or received on either photographic printing paper or on direct recording paper. Power input is 110v 60 cyc. POR.

AN/ASQ-1 and 1A MAGNETOMETERS

This is an airborne magnetometer used to measure the magnetic flux of the earth and to locate submarines and other metallic objects by their distortion of the magnetic field. Sensitivity 2-3 gamma or better. POR.

AN/GSQ1-A SPEECH SCRAMBLERS

Speech scrambler for use on any comm. channel to insure privacy. We can supply complete installations of this equipment 28v DC input. Also 110v 60 cyc.

RC-115V 75 MC FAN MARKER

This is a 75 C Marker Beacon Ground Station. This equipment comes mounted in a transporting trunk. The set can emit either inner, outer, or airways signals. The transmitter is crystal controlled and operated from 110 Volts 60 cyc. POR.

SCR-291A

Automatic ground direction finder covering 1.5mc-30mc. Provides instant bearings on a C.R. indicator of any signal in its range. This equipment is transportable and can be set up quickly. 110v 60 cyc. POR.

AN/ARC-1

100-156 mc. VHF transmitter-receiver. This equip. provides phone operation in 10 crystal controlled automatically selected channels from 100-156 mc. with one guard channel. We can also modify these sets for 20 and 30 channel operation and can supply complete sets for ground operation from 110v 60 cye supply. Normal input 28v DC. POR.

AN/APQ-15

Multiple echo equipment. This set will pick up signals from a ground search radar and re-transmit from making the plane carrying it look like an entire fleet of planes on the ground radar. POR.

SCR-682 A RADAR

100CM high power long range harbor surveillance and early warning RADAR. This equipment is a 3000 mc mobile search radar that can be transported in a truck. The equipment incorporates a 7" PPI for operation up to 240,000 yards. Azimuth accuracy is ± 1%. Range accuracy is 100 yards at 10,000 yard range and 5000 yards at 240,000 yard range. Trans. output is approx. 225 KW. pulse width is one microsecond. Antenna beam width is 6°. Input is 110v 60 cyc. Can be supplied with or without operating shelter or antenna tower. POR.

SCR-718C

The SCR-718C is a high altitude radar altimeter to be used in aircraft. 2 ranges are provided in the 0-10000 foot range. The aircraft altitude is read directly on a cathode ray indicator. The set has an output of app. 100 watts pulse at 400 mcs. CAA approved. Input 110v 400 cyc. POR.

We can supply many types of radars, test sets, communications equipments, manufactured after 1947. Write us if you cannot find it.

AN/APR-4 38-4000 MC RECEIVER

This is a precision receiver covering 38-4000 mc. The set utilizes 5 tuning units with direct reading dials in megacycles. The receiver has a wide and narrow band-width 30mc. I.F. strip which may be selected at will. An output meter is provided to measure signal strength. Outputs are provided for a pulse analyzer and pan adaptor. Each tuning unit has an automatic sweeping mechanism which enables any portion of the tuning range to be scanned automatically. Input 110v 60 cye. POR.

L-BAND SIGNAL GENERATOR

This is a high precision signal generator covering 500-1300 mc. A precision attenuator is built in providing accurate determination of output from 0-100,000 microvolts. Either CW or pulsed carrier output with the following characteristics are provided. Pulse rate 60-2,500 CPS. Pulse length 2-30 microseconds. Output line 50 Ohm impedance. Accuracy better than one percent. Input 110v 60 cyc. With calibration charts. Price. \$249.50

U.H.F. SIGNAL GENERATOR

This set covers 90-600 mc. with an accuracy of one percent or better. C.W. or pulse output with the following characteristics are provided. Output from 0-100,000 microvolts 2-30 microseconds long. Pulse rate 60-2500 cye. Pulse delay 3-300 microseconds. Output 50 ohm line. Input 110v 60 cyc. Price. \$249.50

CF-3A CARRIER REPEATER

This is a transportable 4 wire carrier telephone repeater. This set amplifies all signals when used in an intermediate position on a carrier system to extend the range. DC signaling and telegraph communications can be performed to the terminal equipments or to other repeaters. Monitoring and transmission circuits are built in. Power input 110 or 220v or 12v DC. This set can be used with all CF terminals and commercial equipments. Brand New in original cases. POR.

AN/APA-17 DIRECTION FINDER

This is an automatic direction finder covering 300-1,000 mc to be used with the APR-1 and APR-4 radar search receivers. The bearing is presented on a cathode ray screen in a cardoid pattern. The set can be used in aircraft or on the ground. Input 110v 400 cye and 28v DC. POR.

AIRCRAFT TOGGLE SWITCHES
SINGLE POLE

STOCK NO.	CONTACT ARRANGEMENT	MFG. TYPE NUMBER	GOVT. NUMBER	LUMINOUS TIP
4B86	SPST H	C. H.		
4C120	SPST H w/leads	KUKLA		X
4A18	SPST H	8201K4	B5A	
*4B13	SPST H	168553		X
4A9	SPST M N.O.	8211K6		X
4B34	SPST M N.O.	8211K5	B6B	
4A12	SPST M N.O.	8905K528		X
*4B7	SPST M N.O.	8211K8	3022-8B	X
4A5	SPDT H	8210K5	B1B	
4B5	SPDT M	8215K1		X
4B19	SPDT M	8215K3	B7A	X
4A6	SPDT M CO H	8208K4	B7A	X
*4A13	SPDT M CO H	8208K7	3022-6B	X
*4B10	SPDT M CO H	8209K7	3022-5B	X
4B22	SPDT M CO H	8214K2	B14	X
4A20	SPDT H CO	C. H.		
4A17	SPDT H CO	8200K5	B9A	X
*4A4	SPDT H CO	8200K8	3022-1B	X

ALL ABOVE SWITCHES RATED 5 AMP. 125V OR 20 AMP. 24V.
 1 TO 100 OVER 100 OVER 1,000
 30c 25c 22c

DOUBLE POLE

STOCK NO.	CONTACT ARRANGEMENT	MFG. TYPE NUMBER	GOVT. NUMBER	LUMINOUS TIP
4B12	DPST H	8701K2	C5A	X
4B16	DPST H	8721K1	C1	X
4C130	DPST H	8701K3		X
4B6	DPST M N.O.	8711K2	C6B	X
4B11	DPST H	8711K3		X
4B4	DPDT M	8715K3		X
*4B20	DPDT M	8715K5	3023-10B	X
*4C132	DPDT M CO H	8715K5	3023-6B	X
4B18	DPDT M	8715K2		X

ALL ABOVE SWITCHES RATED 20 AMP. 125V.
 1 TO 100 OVER 100 OVER 1,000
 55c 45c 35c

H—HOLD N.O.—NORM. OPEN M—MOMENTARY
 CO—CENTER OFF *HAVE WELD MOUNTING NUTS.



Write for the new Wells Sales 1955 CATALOG of electronic components at lowest prices
833 W. Chicago Avenue
Dept. 7, Chicago 22, Ill.

Specialists in TUBES

All Famous Name Brand Radio and TV Receiving Tubes, Transmitting Tubes, Special Purpose Tubes

You get immediate delivery on these high quality, low priced tubes taken from one of the most extensive selection of tubes available. Order now!

We handle such brands as: Hallicrafters, National Union, Zenith, Admiral, Stewart-Warner, Raytheon, RCA, Philco, Sylvania, Crosley, B-E, Motorola, Testron.

SPECIALS: Transmitting Tubes

807	\$1.00	3B28	\$2.00
2X2A	.90	2C46	\$6.00
2D21	.65	6A56	\$1.75
6080	\$2.25	HF200	\$6.00

This is just a partial list of types available. Phone or mail your order. Send for our complete tube listing.

B & C DISTRIBUTORS COMPANY
 180 Spring Street • Paterson, N. J.
 MUibarry 4-4010

ART-13 APR-4 BC-610-E
 BC-348, BC-312, BC-342, RAK, RAX,
 BC-221, TS-174, ±241 Scope, LM
 ARC-1, APA-10, DY-17, DY-11
 Alltronics, Box 19, Boston 1, Mass.
 Telephone: Richmond 2-0048, 2-0916

YOUR MOST COMPLETE SOURCE OF ELECTRONIC EQUIPMENT

SERVO MOTORS • RESOLVERS • OSCILLATORS • INVERTERS • GENERATORS
AUTOSYNS • SELSYNS • TORQUE UNITS • SYNCHRONOUS AND FRACTIONAL MOTORS



PIONEER TORQUE UNITS

Type 12606-1-A Torque Unit—manuf. by Eclipse-Pioneer. Has Type CK-5 motor connected to the output shaft through a 125:1 gear reduction and with a Type AY-43 Autosyn used as a control transformer. Output shaft revolves 30 revolutions for each revolution of follow-up Autosyn. Particularly suitable for use with Type 12077 Amplifier **\$4.95**

Type 12602-1-A Torque Unit—Identical to Type 12606-1-A except has a base mounted housing with terminal leads, rather than Amphenol connection. **\$4.95**

Type 12604-3-A Torque Unit—manuf. by Eclipse-Pioneer. Similar to Type 12606-1-A except output shaft revolves 15 revolutions for each revolution of follow-up Autosyn, and includes base mounted housing for motor and gear assemblies. **\$4.95**

Type 12626-1-B — Precision Torque Unit has Type CK-5 motor connected to the output shaft through a gear reduction and with a Type 201-3B autosyn used as a control transformer **\$9.50**



INVERTERS

MG 119F HOLTZER CABOT
Output: 26 VAC @ 250 VA; 115 V. @ 500 VA; single phase; 400 cycle;
Input: 24 VDC @ 36 amps. ... **\$49.50**
PIONEER 12123-1-A
Output: 115 V; 3-phase; 400 cycle;
Amps .5; Input: 24 VDC; 12 amp. ... **\$69.50**

PIONEER 12126-2-A
Output: 26 volts; 3 phase; 400 cycle;
10 VA; .6 PF Input: 27.5 volts DC;
1.25 amps **\$24.50**

DMF2509M
CONTINENTAL ELECTRIC
24-30 volts input; 5.5-1.5 amps; cont. duty. Output: 115 volts; .44 amps; 400 cyc; 1 phase; PF 1.0 50 watts. ... **\$39.50**

10563 LELAND ELECTRIC
Output: 115 VAC; 400 cycle; 3-phase; 115 VA; 75 PF. Input: 28.5 VDC; 12 amps. **\$39.50**

PIONEER 12117
Output: 26 volts; 400 cycles, 6 volt amperes, 1 phase. Input: 24 VDC; 1 amp. **\$19.95**

PE 218 LELAND ELECTRIC
Output: 115 VAC; Single Phase PF 90; 380/500 cycle; 1500 VA. Input: 25-28 VDC; 92 amps; 8000 rpm; Exc. Volts 27.5 BRAND NEW. **\$39.95**

PE 109 LELAND ELECTRIC
Output: 115 VAC; 400 cyc; single phase; 1.53 amp; 8000 rpm. Input: 13.5 VDC; 20 amp. **\$65.00**

MG153 HOLTZER-CABOT
Input: 24 VDC; 52 amps. Output: 115 volts—400 cycles, 3-phase, 750 VA and 26 volt—100 cycle, 250 VA. Voltage and frequency regulated. **\$95.00**

PIONEER 12130-3B
Output: 125.5 VAC; 1.5 amps, 400 cycles single phase, 141 VA. Input: 20-30 VDC, 18-12 amps. Voltage and frequency regulated. **\$69.50**

12116-2-A PIONEER
Output: 115 VAC; 400 cyc; single phase; 45 amp. Input: 24 VDC, 5 amp. **\$39.95**

10285 LELAND ELECTRIC
Output: 115 volts AC, 750 VA, 3 phase, 400 cycle, .90 PF and 26 volts, 50 VA, single phase, 400 cycle, .40 PF. Input: 27.5 VDC, 60 amps, cont. duty, 6000 rpm. Voltage and frequency regulated. **\$59.50**

10486 LELAND ELECTRIC
Output: 115 VAC; 400 cycles; 3-phase; 175 VA; .80 PF. Input: 27.5 DC; 12.5 amps; cont. duty. **\$90.00**

PIONEER 10042-1-A
DC input 14 volts; output: 115 volts; 400 cycle, 1-phase; 50 watt. ... **\$39.50**

10339 LELAND ELECTRIC
Output: 115 volts; 190 VA; single phase; 400 cycle; .90 PF and 26 volts; 60 VA; 400 cycle, .40 PF. Input: 27.5 volts DC 18 amps cont. duty, voltage and freq. regulated. **\$49.50**

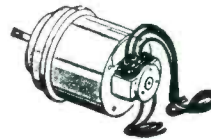

SYNCHRONOUS SELSYNS

110 volt, 60 cycle, brass cased, approximately 4" dia. x 6" long. Mfd. by Diehl and Bendix
QUANTITIES AVAILABLE
REPEATERS **\$20.00 ea.**
TRANSMITTERS **\$20.00 ea.**

SYNCHROS

GENERAL ELECTRIC MOD. 2J15M1:
115-57.5 volts, 400 cycle **\$22.50**
KOLLSMAN AUTOSYN MTR. TYPE-403: 32 VAC; 60 cycle; single phase **\$9.95**

BENDIX AUTOSYN MTR. TYPE-851: 32 VAC; 60 cycle, single phase. **\$9.95**

MICROSYN UNIT TYPE IC-006A: **\$15.00**
IF SPECIAL REPEATER: 115 volt-400 cycle **\$15.00**
21F3 GENERATOR: 115 volt-400 cycle **\$10.00**

5CT CONTROL TRANSFORMER: 90-50 volt; 60 cycle **\$45.00**
5F MOTOR: 115-90 volt; 60 cycle **\$45.00**

5SDG DIFFERENTIAL GENERATOR: 90-94 volts; 400 cycle, **\$30.00**
BENDIX TRANSMITTER TYPE C-78248: 115 volt; 60 cycle **\$22.50**
DIFFERENTIAL TYPE C-78249: 115 volt; 60 cycle **\$5.00**

BENDIX REPEATER TYPE C-78410: 115 volt; 60 cycle **\$37.50**
REPEATER, Type C-78663, AC Synchronous 115 volt, 60 cycle **\$9.95**
DIEHL REPEATER TYPE FJE 22-2: 115 volt; 400 cycle; secondary 90 volt. **\$27.50**

5G GENERATOR: 115/90 volt; 60 cycle **\$45.00**
7G SYNCHRO GENERATOR: 115/90 volt; 60 cycle **\$75.00**
6G SYNCHRO GENERATOR: 115/60 volt; 60 cycle **\$60.00**
6DG SYNCHRO DIFFERENTIAL GENERATOR: 90/90 volt; 60 cycle. **\$50.00**

215F1 SELSYN CONTROL TRANSFORMER: 105/55 volts; 60 cycle **\$22.50**
21D5HAI SELSYN GENERATOR: 115/105 volts; 60 cycle **\$50.00**
21JF1 GENERATOR: 115/57.5 volts; 400 cycle **\$12.50**
21IH1 DIFFERENTIAL GENERATOR: 57.5/57.5 volt; 400 cycle, **\$12.50**
21IG1 CONTROL TRANSFORMER: 57.5/57.5 volts; 400 cycle **\$7.50**
215H1 SELSYN GENERATOR: Mfr. G.E.; 115/105 volts, 60 cycle. **\$27.50**



RESOLVERS

Kearfott type R235-1-A. **22.50**

Rotor: 2 phase 26 volts
Stator: 2 phase 11.8 volts 400 cycle

Reeves type R600. **47.50**
Arma No. 213018 Limited Rotation 8:1 **27.50**
Arma No 213044. **49.50**

RESOLVERS

(sine-cosine generators)

Type FJE-43-9 Resolver: manufactured by Diehl; Designed for 400 cycle excitation of 115 volts, but will operate satisfactorily at reduced 60 cycle voltage. The two outputs (90 electrical degrees apart) give sine-cosine signals of a maximum value of 55 volts at designed input. Shaft 0.125" dia. extends 3/4". Case is 2 1/2" long and 2 1/4" dia. **\$25.00 each**

Type FPE-43-1 Resolver: manufactured by Diehl. Identical to type FJE-43-9 (S-7) except has primary-secondary step-up ratio such that 115 volt excitation induces a stator signal of 220 volts maximum. **\$25.00 each**

TACHOMETER or RATE GENERATOR

Elenco Type B-68 A-C Rate Generator; Input volts: 120-60 cycles; input amps: 96 m.a.; DC OHM input phase: 770; DC OHM output phase: 770. **\$22.50**
AC Generator 67V 22.50
2 phase .015 amps; type PM-1 1200 r.p.m. 15.00

400 CYCLE SERVO MOTORS

Kollsman "Teletorque" type 1377-0410.	\$ 9.95
Kollsman type 999-0411.	15.00
Kollsman type 1515B-0410.	22.50
Kollsman type 9446-0110202.	15.00
Kollsman type 776-01 Drag Cup.	12.50
Kollsman type 775-01 Drag Cup.	12.50
Pioneer type 10047-2A Drag Cup.	10.50
Pioneer type CK-2 Induction.	35.00
Pioneer type CK-5 Drag Cup.	22.50
Pioneer type CK 13.	25.00
Kearfott type R110-2A-B.	20.00
American type 172B.	17.50
Western Electric KS 9154.	12.50
Transcoil type 2900.	15.00

PRECISION AUTOSYNS

Eclipse Pioneer AY 201-s-2B.	\$17.50
Eclipse Pioneer AY 202-s-1B.	\$17.50
Eclipse Pioneer AY 201-3B.	17.50
Eclipse Pioneer AY 200-4-B.	15.00
Kearfott R-212-1A-A Transmitter.	15.00
Kearfott R-200-1-A Control Transformer.	15.00
Kearfott R-210-1-A Transmitter.	15.00

WRITE OR WIRE FOR INFORMATION ON OUR COMPLETE LINE OF SURPLUS ELECTRONIC COMPONENTS. ALL PRICES NET F. O. B. PASADENA, CALIFORNIA.



SALES CO.

2176-E East Colorado St.
Pasadena 8, California
RYan 1-7393

INTERSTATE DOES IT AGAIN!

"HI-STAB" DEPOSITED CARBON RESISTORS

Hi-STAB

DESIGNED TO MEET MIL-R-10509A SPECS.

100 TO 470,000 OHMS—RN15 OR RN20
1% TOLERANCE—½ WATT

This resistor employs a highly stable resistance film that is applied in the form of carbon deposited at high temperature on the surface of a ceramic rod. Precise D.C. resistance values as close as 1% tolerance are produced by spiral cutting on the outside resistance film. This resistance rod then has axial leads firmly attached and the rod is encased in thermo-setting molded plastic insulation, a unique feature for resistors of this type.

IMMEDIATE DELIVERY FROM STOCK

MINIMUM ORDER—\$4.00

Order by Part Number from Table Below

Inter-state Part No.	Resistance (Ohms) ½ Watt ±1%	Inter-state Part No.	Resistance (Ohms) ¼ Watt ±1%	Inter-state Part No.	Resistance (Ohms) ¼ Watt ±1%
1000F	100	2201F	2,200	4702F	47,000
1500F	150	3301F	3,300	6802F	68,000
2200F	220	4701F	4,700	1003F	100,000
3300F	330	6801F	6,800	1503F	150,000
4700F	470	1002F	10,000	2203F	220,000
6800F	680	1502F	15,000	3303F	330,000
1001F	1,000	2202F	22,000	4703F	470,000
1501F	1,500	3302F	33,000		

SUBJECT TO PRIOR SALE ALL MERCHANDISE BRAND NEW
Certificate of compliance enclosed with each shipment. Mail orders promptly filled.
All prices F.O.B. NYC. Rated Firms Send P. O. Others, 25% with Order, Balance C.O.D.



Interstate Electronics, Inc.

227 Fulton St. BEekman 3-8780 New York 7, N. Y.

FOR SALE

Wholesale to Industrials
and Dealers Only

- RECEIVERS
- TRANSMITTERS
- MODULATORS
- SYNCHRONIZERS
- JUNCTION BOXES
- CONTROL BOXES
- MICROWAVE ACCESSORIES
- KLYSTRON MOUNTS
- WAVE GUIDE
- DUPLEXERS
- MAGNETS
- I.F. STRIPS
- NETWORKS
- TRANSFORMERS
- TEST EQUIPMENT
- METERS
- INSTRUMENTS
- RELAYS
- CONTACTORS
- DYNAMOTORS
- MOTORS
- BLOWERS
- SYNCHROS
- TORQUE UNITS
- SWITCHES
- CAPACITORS
- RESISTORS
- POTS
- CONNECTORS
- TUBES

AMBER INDUSTRIAL CORPORATION—Metals Division

732 E. Monument Ave. Dayton, Ohio
Michigan 3804 - By Appointment

4PDT RELAYS Time Delay Relays

ERIE trimmers, etc. Hundreds of other items.
See our ad in previous issues. Write for list.

EMPIRE ELECTRONICS CO.
400V Ave. L Brooklyn 30, N. Y. CL 2-4000

REVERSIBLE GEARED-MOTOR Delco-PM-Permanent Magnet Alnico Field Motor



#5071895 ¼ SHAFT or 11/16 GEAR.... \$17.50
#5069000 \$18.50
Clamps to hold motor: \$1.50 ea.

GRAIN OF CORN LAMPS 10 for \$3.00 — 100 for \$25.00



#328, 6 Volts #326, 2½ Volts #321, 28 Volts

TELECHRON Motors

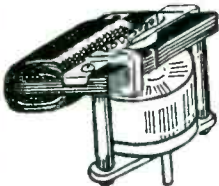

4 RPM on 50 cycles or 4¾ RPM on 60 cycles... 2.85
2 RPM 2.90
3 RPM 3.90
4 RPM 2.90
3.6 RPM 3.15
1 RPM 3.95
3 R.P. Hr. 2.85
1 R.P. 2 Hr. 2.80
1 R.P. 12 Hr. 3.25
60 RPM 4.85

Laboratory Special 1 of Each Above \$25.00

please include postage

BLAN



BLOWERS 115 Volts A. C. 60 c.
REDMOND 5" 18 watts.... \$8.95
DELCO 60 cfm. 40 watts.... \$14.50
#5062369 used in 584 RADAR
EASTERN AIR DEVICES 70 watts.
3400 RPM. labeled 80 cfm, but
blows like blazes!..... \$17.50

HAND WOUND 10 Sec. to 24 Min. TIMER SWITCH... \$1.25

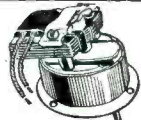

6 Watt Most POWERFUL TELECHRON 1 RPM 110 volts 60 cy \$6.50
10 for \$50.00



3" Round Elapsed Time Meter \$1375
Square Case \$14.50



MARKTIME 5 HOUR SWITCH
A 10 amp. timing device. Pointer moves back to zero after time elapses. Ideal for shutting off radios and TV sets when you go to bed. Limited supply at this special PRICE.... \$4.90
Also available in 15 min. or 30 min. or 1 hr. at \$6.50



HAYDON TIMING MOTORS
110v. 60 cycle 30 RPM... \$2.60
110v 60 cycle 1 RPM.... 2.85
230V 1 RPM..... 1.00
60C 12 RPM..... 1.00

EST. 1932

64K Dey Street
New York 7, N. Y.

NEED METERS?

STANDARD or SPECIALS
ANY QUANTITY — NEW — SURPLUS

FOR ELECTRONIC — MILITARY
AIRCRAFT — HAMS

ALL MAKES — MODELS
RANGES — SIZES

METERS REPAIRED
RESCALED
RECALIBRATED

WRITE - PHONE - WIRE

INSTRUMENT SERVICE

455 B. 67th St.
Arverne, New York
CAA No. 4264 Ltd. NE 4-8594

FOR ALL BEST RESISTORS POTENTIOMETERS CAPACITORS

Legri S Company

391 Riverdale Ave. Yonkers 5, N.Y.

SPECIAL PURPOSE TUBES

OA2	.75	3B25	4.00	7BP7	2.50	WE-249C	3.00	706AY-GY	10.00	902P1	4.50
OA3/VR75	1.00	3B26	3.00	7C29	50.00	250R	4.75	707A	3.50	905	2.00
OA5	4.00	3B28	6.00	7CP1	15.00	250TH	20.00	707B	3.00	913	12.50
OB2	.75	3C23	3.75	9GP7	5.00	250TL	15.00	708A	1.00	917	2.00
OB3/VR90	.75	3C24/24G	1.00	9LP7	3.50	WE-251A	30.00	709A	1.00	918	2.00
OC3/VR105	.75	3C45	7.00	9MP7	7.50	WE-252A	7.50	713A	.25	920	2.50
OD3/VR150	.75	3D21A	6.00	10Y	.25	WE-253A	3.50	714AY	17.50	922	1.00
ELC1B	3.00	3D22	9.75	12A6	.50	WE-254A	5.00	715A	1.25	923	1.00
1B22	1.50	3DP1	3.75	12GP7	12.50	WE-257A	2.00	715B	5.00	925	1.75
1B24	4.50	3DP1A	7.50	12J5WGT	2.50	WE-264C	3.00	715C	15.00	927	1.00
1B27	8.75	3E29	10.00	12K8Y	.50	WE-267B	6.00	717A	.50	931A	2.75
1B32	1.00	3EP1	1.50	12L8GT	1.00	WE-271A	7.50	719A	10.00	934	.25
1B35	4.75	3FP7	1.50	LM-15	200.00	WE-272A	5.00	721A	1.00	955	.25
1B42	4.50	3FP7A	5.00	FG-154	25.00	WE-274A	4.75	721B	8.75	956	.25
1B59	10.00	3GP1	2.50	FG-17/5557	3.00	WE-274B	3.00	722A	1.00	957	.25
1C21	2.00	3HP7	3.00	RK-19	1.25	274B	.50	723A/B	10.00	958A	.25
1P23	2.00	3J21	75.00	RK-20A	9.75	WE-275A	5.00	724B	.75	959	1.00
1P24	1.50	4AP10	3.75	RK-49	3.00	276A	3.00	725A	3.50	991/NE-16	.25
1P30	2.00	4B22/EL5B	6.50	TZ-20	2.00	WE-282A	2.50	726A	7.50	CK-1006	1.50
1P34	1.75	4B26	3.50	RK-21	1.00	WE-283A	3.50	726B	25.00	R-1100	5.00
1P36	2.50	4B27	2.50	RK-23	3.00	WE-286A	6.00	726C	25.00	1500T	100.00
2AP1	5.00	4B31	25.00	HK-24	2.00	304TH	10.00	730A	7.50	1608	3.50
2C21/1642	.50	4C22	7.50	HK-24G	1.00	304TL	10.00	801A	.25	1611	2.00
2C26A	.50	4C27	3.50	CE-25A/B	2.00	WE-305A	3.50	802	2.50	1613	1.00
2C33	.75	4C35	15.00	RK-25	2.50	307A/		803	2.50	1614	1.50
2C34/RK-34	.25	4E27	10.00	28D7	.75	RK-75	1.00	804	9.75	1616	.50
2C39A	7.00	4I30	45.00	28D7W	1.25	WE-300B	7.50	805	2.75	1619	.25
2C40	7.50	4I34	20.00	FG-166	35.00	WE-310A	3.50	806	9.50	1622	1.50
2C43	12.00	4J35	75.00	FG-32/5558	7.25	WE-311A	5.00	807	1.25	1624	1.00
2C44	.50	4J42	20.00	FG-33/5720		WE-313C	2.50	807W	4.50	1625	.25
2D21	.75	4J52	50.00		11.50	316A	.50	808	1.50	1630	.50
2D21W	1.25	5AP1	2.00	RK-39	2.50	WE-323A	10.00	809	2.75	2050	1.00
2E22	2.25	5B21	2.00	FP-54/		323B	5.00	810	10.00	2051	.50
2E24	2.25	5BP1	2.00	5740	60.00	327A	2.75	811	3.00	ZB-3200	75.00
2E26	3.25	5BP1A	12.50	HK-54	3.00	WE-328A	2.75	811A	4.00	R-4330	10.00
2J21A	3.50	5BP2A	2.50	RK-60/1641	1.50	WE-336A	5.00	812	2.25	5551/652	40.00
2J26	5.00	5BP4	2.00	RK-62	1.75	WE-339A	15.00	813	12.00	5556/PJ-8	6.75
2J27	5.00	5C22	28.00	FG-67/		WE-349A	7.50	814	1.75	5610	1.25
2J29	25.00	5C30/C5B	1.00	5728	10.00	WE-350A	3.00	815	1.25	5645	6.50
2J30	50.00	5CP1	2.50	RK-61	2.00	WE-350B	3.00	822	10.00	5656	8.00
2J31	15.00	5CP7	7.50	RK-65	7.50	WE-352A	10.00	826	1.00	5696	1.00
2J32	15.00	5D21	6.50	RK-69	2.00	WE-353A	3.50	828	7.50	5703	1.00
2J33	15.00	5FP7	1.50	RK-72	.75	WE-354A	15.00	829	5.75	5725	2.00
2J34	15.00	5FP14	5.00	RK-73	.75	WE-355A	15.00	829B	10.00	5801	2.50
2J36	35.00	5GP1	5.00	T-55	5.00	368A	3.00	830B	1.00	5820 (See 2P21)	
2J37	10.00	5J23	25.00	75T	5.00	371A	.75	832	4.00	5827	2.50
2J38	15.00	5J29	7.50	75TL	5.00	WE-393A	7.00	832A	5.50	CK-5829	1.50
2J39	10.00	5J30	7.50	VR-78	.50	394A	2.00	833A	35.00	5933	4.50
2J40	25.00	5J32	25.00	FG-81A	5.00	410R	100.00	834	7.50	5963	1.00
2J50	35.00	5JP1	12.50	FG-95/		GL-417A	4.50	835	10.00	5948/	
2J55	50.00	5JP2	7.50	5560	14.00	GL-434A	3.00	836	2.25	1754	250.00
2J56	50.00	5JP4	7.50	100R	7.50	446A	.50	837	1.00	5981/5650	50.00
2J61	15.00	5JP5A	7.50	100TH	5.75	446B	2.00	838	1.25	R-7301	10.00
2J62	5.00	5JP11	25.00	WE-121A	3.50	450TL	40.00	842	2.50	8002R	10.00
2K25	12.50	5LP1	8.00	WE-123A	3.50	WL-460	5.00	843	.25	8005	4.00
2K30	100.00	5LP1A	25.00	WE-124A	3.50	464A	2.25	845	5.00	8011	.25
2K33A	75.00	5NP1	5.00	VT-127A	1.75	WL-468	10.00	845W	10.00	8012	1.00
2K41	90.00	5R4GY	.85	F-128A	25.00	SS-501	7.25	846	50.00	8012A	2.50
2K54	15.00	C6A	6.00	HK-154	5.00	CK-510AX	.75	849	20.00	8013	2.75
2K55	10.00	C6F	8.00	VT-158	10.00	527	15.00	850	10.00	8013A	3.75
2P21 (Image Orthicon)	250.00	C6J	6.00	FG-190	3.50	WL-530	15.00	851	12.50	8014A	50.00
2V3G	2.25	C6L/5528	3.75	HF-200	9.50	WL-531	5.00	860	2.50	8020	1.25
2X2/879	.25	6ACTW	1.25	203Z	5.00	559	.50	861	7.50	8025	1.75
2X2A	1.00	6AJ5	1.25	WE-122A	2.50	575A	12.50	864	.25	8025A	2.75
EL3CJ	7.30	6A16	2.50	WE-205B	.50	WL-579B	10.00	65	.50	8026	3.50
3A4	.50	6AL5W	.85	207	35.00	HY-615	.50	866A	1.00	PD8365	50.00
3A5	.50	6AN5	3.00	211	.50	WL-632A	15.00	868/PJ-23	2.00	9001	.75
3AP1	5.00	6AS6W	2.00	WE-212E	25.00	WL-670A	8.75	869B	20.00	9002	.75
3B22/EL1C	1.50	6BM6	35.00	217A	1.50	WL-681		872A	1.00	9003	1.00
3BP1	2.00	6C21	15.00	WL-218	15.00	5550	35.00	GL-872A	2.00	9004	.25
3B21	5.00	6J4	3.75	220C	182.50	701A	3.00	874	.50	9005	1.00
3B24	2.00	6SB7Y	1.00	221A	.75	702A-B	.50	876	.75	9006	.25
3B24W	5.00	6SC7GT	2.00	CE-235	5.00	703A	2.00	878	.50	9906R	1000.00
		6SK7Y	.50	WE-242C	5.00	704A	.75	884	1.00		
		6SN7WGT	2.00	WE-249B	3.00	705A	.75	885	1.25		

western engineers

* Prices do not include transportation

ELK GROVE, CALIFORNIA

GEORGE WHITING, OWNER

* Fully guaranteed

SELSYN

115 VOLT 60 CYCLE. Synchronous Transmitter C-78414. 5" x 3-1/2", Long Leads w/Bracket. Removed from New Equipment. **PAIR \$15.00**



BC-221 FREQUENCY CASE

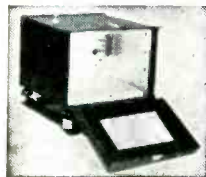

BC-221, FREQ. CASE—Aluminum Case for BC-221 or TS-164. FREQ. METER — W/Voltage Regulator Supply using 1/4"K-105. 2/Ballast Tubes. Relay. Cable, etc. Front Compartment 9-3/4" x 7-1/2" x 7-3/8". Rear Comp. 2" deep. Shock-mounted.

NEW: \$5.95

CLASSIFIED ITEMS:

- BC-212G Amplifier 2/6C5 Tubes. N: \$3.95—U: \$1.95
- BC-216A Amplifier—6P7 & 39/44 Tubes. U: 1.95
- BC-229/429 Receiver—2500-7700 KC w/Coils. U: 5.95
- BC-347 Amplifier—1/76S0 Tube. N: \$3.95—U: 1.95
- BC-357 Marker Beacon Receiver. U: 4.95
- BC-367 Amplifier—2/6V6GT Tubes. N: \$4.95—U: 3.95
- BC-375 TRANSMITTER U: 29.95
- BC-453 RECEIVER—190 to 550 KC. U: 14.95
- BC-455 RECEIVER—6 to 9 MC. U: 4.95
- BC-459 TRANSMITTER (to 9 MC. U: 8.95
- BC-463 TRANS. & MODULATOR—67 to 74 MC. U: 16.95
- BC-605 Amplifier—2/1619 Tubes. U: 3.95
- BC-645 Transceiver—Converts 420 to 500 MC. U: 24.95
- BC-709 Amplifier. Batt. Op., 1 Tube, N: \$3.95—U: 1.95
- BC-745 TRANSCIEVER—3 to 6 MC. U: 14.95
- BC-745 Transceiver—CHASSIS ONLY. N: 5.95
- BC-966 IFF SET—160 to 211 MC. 13 Tubes. U: 5.95
- BC-1206 RECEIVER—200 to 400 KC. N: 9.95
- R-25/ARC-5 Receiver—1.5—3 MC.—Less Tubes U: 9.95
- R-27/ARC-5 Receiver—6—9 MC.—Less Tubes U: 3.00
- R-1/ARR-1 RECEIVER — Converts 2 or 6 Meters N: 3.95
- RT-7/APM-1 ALTIMETER U: 9.95
- RT-34/AP5-13 Transceiver, Complete, Less Tubes. U: 3.95
- BD-72 Switchboard—Portable—12 Line. U: 39.95
- FL-8A Range Filter. \$1.49—FL-5 Filter. U: 1.00
- TS-9 Carbon Handset, U: \$3.95—TS-13 Hand-set. U: 6.95
- TS-10 Soundpowered Handset or Head & Chest Set U: 3.95

METERS:

WESTON AC AMMETER:



(Pictured) In portable leather case, with Test Leads, 2 1/2", 0-15 AC and 0-3 AC Scale \$5.95

DC AMMETER HOYT:

In portable metal case, with Test Leads, 4 1/2", Fan. Mirrored Scale—0-15 ADC \$4.95
 0-3 RF AMMETER IS-128—2 1/2" Rd. Flush Mtg. Calibrated P/Non Mag Panel. P/O BC-233 Transmitter **NEW: \$2.95**
 0-500 Milliamp DC—2 1/2" Rd.; IS-22 \$4.95
 0-5 MA DC WESTINGHOUSE, 2 1/2" Sq. \$3.95

FM RECEIVER

27 TO 38.9 MC

Four Preselected Channels—Frequency Ranges 27 to 29.5—29 to 32—31.5 to 34.4—and 34.4 to 38.9 MC. Complete with 16 Tubes: 1/12SA7; 3/12SC7; 2/12SG7; 2/12SJ7; 1/1V-150; 1/6H6; 1/6SJ7; 2/6SL7; 1/6V6; 2/6AC7; 1/NE-20; and DC-14 Crystal. 1000 KC.; Crystal, Calibrator, and Speaker. Power required: 12 or 24 V. DC and 275 V. DC 150 MA. Size: 6-3/4" x 11-5/16" x 11-1/2".



MAGNETRON MAGNET

HEAVY DUTY PM MAGNET—Approx. 2000 Gauss—Size: 6-1/4" x 7-3/8" x 1-1/2" gap. 10-1/2 lbs. Removed from New Equipment. **\$5.95**

BLOWERS:



12/24 VDC—AC CAST ALUMINUM BLOWER (Pictured at left)—100 CFM; 3" intake; 2" outlet. Shunt Motor 4"x2"; 3000 RPM @ 24 VDC. \$5.95

6 VDC SINGLE—100 CFM—No. G100 \$4.95

6 VDC FLANGE—150 CFM—No. G150 \$6.95

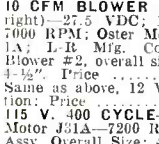

24 VDC DUAL—20 CFM—Min.—No. 2420 \$7.95

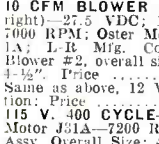

10 CFM BLOWER (Pictured right)—25 VDC—1/100 HP—7000 RPM; Oster Motor C2BP-1A; L-R Mtg. Co. Bakelite Blower #2, overall size: 3-1/2" x 4-1/2". Price \$5.95
 Same as above, 12 VDC operation. Price \$5.95
 115 V. 400 CYCLE—10 CFM—Eastern Air Devices Motor 3A1A—7200 RPM, 1/100 HP. L-R #2 Blower Assy. Overall Size: 4-1/2" x 3-3/4". No. 3110 \$5.95

10 CFM BLOWER (Pictured at left)—25 VDC—6 A.; 5000 RPM; Pioneer Motor SS-2345. Aluminum Blower Housing; Overall Size: 4-1/2" x 3-3/4". Price \$5.95

115 V. 60 CYCLE BLOWERS:

- 115 VAC 60 cycle SINGLE TYPE—100 CFM; 2-1/2" intake; 2" outlet. Complete size: 5" x 6" —No. 1C939 **\$8.95**
- 115 VAC 60 cycle DUAL TYPE—100 CFM; 4" intake; 2" Dis. Each Side. Complete size: 8" x 8" —No. 1C850 **\$13.95**
- 115 VAC 60 cycle COMPACT TYPE—108 CFM; Motor built inside squirrel cage; 4-1/2" intake; 3-3/8" x 3" Dis. Complete size: 4-1/2" W x 8-3/8" H x 8-1/2" D—No. 2C067 **\$14.95**
- 115 VAC 60 cycle FLANGE TYPE—140 CFM; 3-1/2" intake; 2-1/2" Dis. Complete size: 7-1/2" W x 7-3/4" H x 6-3/4" D—No. 1C807 **\$13.95**
- 115 VAC 60 cycle FLANGE TWIN—275 CFM; 4-1/2" intake; 3-1/2" x 3" Dis. Complete size: 11-3/4" W x 3-3/8" H x 8-1/16" D—No. 2C069 **\$21.95**

HUNDREDS OF OTHER ITEMS — WRITE US FOR YOUR PARTICULAR NEEDS!

FAIR RADIO SALES • 132 SOUTH MAIN ST. LIMA, OHIO

SELLING

- Receivers
- Transmitters
- Radar
- Special Purpose Tubes
- Relays
- Meters
- Switches
- Connectors
- Rectifiers
- Transformers
- Motors & Generators
- Wiring Cable
- Instruments and All Electronic Components

WILL BUY ALL

New or Used

	Leach Relay #5059-R
	#5058
	#5055
	#5053-SM
	#5053
Price Bros. Relay #10	
Relay	#5586
	#5587
Antenna Switching Relay	
Box #	CBY 23049
	BG-AN-198
	BC -408
Tubes #53A	
	VT-127A
	35T
	WL-530

Highest prices paid for most all types of aircraft sparkplugs any condition

RADIO & ELECTRONIC SURPLUS
 13933-9 BRUSH STREET
 Detroit 3, Mich. TO 9-3403

Wholesale Only

HARJO'S Moving Sale!

SPECIAL PURCHASE!
 New Surplus RCA TV Cameras

for Labs!
 Export!
 Industrials!
 Medicine!
 Closed Circuit TV!

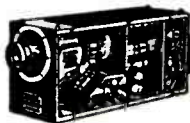

Rig up your own TV watchdog for swim pools and other uses—plus training and experimental work. 1846 Iconoscope, 6-stage video amplifier and clipper. Write for complete technical data. Now SOLD AT FRACTION OF FORMER PRICE!

TEST EQUIPMENT

Our volume buying gives you volume savings! Order Now!

W.E. 1-183A FREQUENCY METER: Freq. approx. 200 MC. Contains plumbing and 6 tubes. dual micro-meter tuning, 110 V. 60 cye. self con. \$2495
 tained power supply. Wt. 75 lbs. \$2495
 W.E. 1-185A OSCILLATOR. Freq. approx 200 MC. Uses cavity with 6 tubes. Self-contained 110 V. 60 cye. power supply. Heavy duty unit. \$2250
 Wt. 75 lbs. Only

RCA TYPE 308-A FIELD INTENSITY SET TS-481/U

Overall frequency range in 6 bands. 540-18,000 Kc. Field intensity range 20 microvolts to 20 per meter. Excellent condition. COMPLETE WITH ONH LOOP. Less power supply. Shipping wt. \$29500
 48 lbs.—Limited quantity

I-83 DYNAMOTOR TEST SET: Complete \$1995
 with 5 meters. Excellent condition
 TS-24/ARR-2 GOLD PLATED CAVITY TEST SET. Tunes 234-258 MC.

Also includes 8-channel BDCST tuner, alignment tool, whip ant., test jacks and test point tips, also 2-955 acorn tubes. Limited quantity. \$300

BC-733-D LOCALIZER RECEIVER: With all tubes and crystals. Excellent cond. \$1495

R156/ARR-16B RADIOSONDE RECEIVER
 Excellent cond. WITH ALL TUBES AND DYNAMOTOR. \$1995

INTERPHONE AMPLIFIER: With tubes. Less dynamotor. \$495
 RL-7 \$695
 DYNAMOTOR \$1.00 extra
 RL-9 \$6.95

METERS COMBINATION SPECIAL!
 3 in. Rd. Bacter dial face. 0-750 MA
 Excell. cond. \$350
 500-0-500 Microamps. 3 in. Rd.
 Excell. cond. \$350
 0-2.5 amps. DC 3" Sq. Excell. \$350
 ANY THREE \$10.00 POSTPAID!

TS45/APM X-Band Signal Gen.
 For small labs, schools and service shops. Hurry—while they last!
 New Low Price. \$6950

NEW 24 V TRANSFORMER & RECTIFIER COMB. a basic 24V. 100 power supply of 110V AC primary. 24V secondary and Rectox Rectifier. Operates intermittently up to 1 or 2 amps. \$295
 Ship. wt. 3 lbs.

1-222 SIGNAL GENERATOR-MICROVOLTER
 Freq. range: 8-15 Mc. & 150-230 MC. Complete with all tubes and 5 MC Calibrating Crystal. Self-contained 110 V. 60 cycle power supply. With schematic. Excellent cond. Cost the Govt. approx. \$3995
 \$700.00. ONLY

ADF AUTOMATIC DIRECTION FINDER RECEIVER
 Model CAATC-980. Mark I mfg. by Sperry Gyro-scope. Self-contained. 12 V. vibrator supply. This unit is used by major airlines. Freq. range: 200-500 Kc. AND 550-1500 Kc. Complete with all tubes. Used, good cond. Ship. wt. \$2495
 65 lbs.

RT48A/TPX-1 17-TUBE TRANSMITTER-RECEIVER
 Receiver easily converted to 2 meter band. Covers 157-185 MC. Receiver has acorn tube front end and 30 MC I.F. strip. Tube line-up: 3—95A, 1—95B, 6—6AC7, 1—6SL7, 1—61FG7, 1—6SN7, 1—2C26, 1—5U4G, 1—2X2A. Brand \$1295
 new. Ship. wt. 60 lbs.

W.E. TELEPHONE HAND SET
 Complete with units and cord. Perfect for mobile and phone use. Postpaid. Only \$295
MINIATURE LINE MATCHING XFMR: 1:000's of radio, TV & electronics uses. Postpaid. \$125

PULSE GENERATOR
 Hazeltine Model 1017. Less tubes. Ship. \$2950
 wt. 100 lbs. ONLY

GN-39 DUAL OUTPUT D.C. GENERATOR
 Puts out 1,000 V. @ 350 ma. 12 V. @ 25 amps. Generator may be driven from fan belt of car, an auxiliary pulley on rear wheel, or by a direct coupled gasoline engine. Great unit for Field Day! \$1295
 BRAND NEW! Ship. wt. 100 lbs.

RG34U 71 OHM COAX. 825 dia. 5 KW rating. 85' roll with pl-173 plug at one end. \$495
 New

Look! 701A XMTR. TUBES \$295
 2 for \$5

DuMont 3GP1 Cathode Ray Tubes \$179
 3 for \$5

While they last at this reduced price! New, orig. boxes.
 FILAMENT TRANSFORM. Same as used in Dumont EHS for these. \$295
 224A oscilloscope. New! only \$1.50
 Free dope sheet available on request.

All items F.O.B. Whse., subject to prior sale and change of price without notice. Note New Address!

Harjo Sales Co.
 Mailing Address: Box 1187-E MAGNOLIA PARK STA-TION, BURBANK, CALIF.
 Office-Warehouse: Dept. E 503 N VICTORY BLVD., BURBANK, CALIF.

COMMUNICATIONS EQUIPMENT CO.

MICROWAVE COMPONENTS

10 CM.—RG48/U Waveguide

10 CM ECHO BOX: Tunable from 3200-3333 Mc. For checking out radar transmitters, for spectrum analysis, etc. Complete with pickup antenna and coupling devices. \$17.50
 POWER SPLITTER for use with type 726 or any 10 CM Shepherd Klystron. Energy is fed from Klystron antenna through dual pick-up system to 2 type "N" connectors. \$12.50
 LHTR. LIGHTHOUSE ASSEMBLY. Parts of 1T39 APG 5 & APG 15. Receiver and Trans. Cavities w/ assoc. Tr. Cavity and Type N CPUG. To Recv. Uses 2C40, 2C43, 1B27, Tunable APX 2400-2700 MCs. Silver Plated. \$15.00
 BEACON LIGHTHOUSE cavity p/o UPN-2 Beacon 10 cm. Mfg. Bernard Rice, each. \$27.50
 MAGNETRON TO WAVEGUIDE Coupler with 721-A Duplexer Cavity, gold plated. \$31.50
 721A TR BOX complete with tube and tuning plungers. \$12.50
 FINALLY KLYSTRON CAVITIES for 707B or 2K28, 2700-2900 MC. \$4.00
 ASI4A AP-10 CM Pick up Dipole with "N" Cables \$4.50
 HOLMDELL-TO-TYPE "N" Male Adapters, W. E. #D167284. \$2.75
 I.F. AMP. STRIP: 30 MC. 30 db. gain, 4 MC Bandwidth, uses 6AC7's—with video detector, A.F.C. loss tubes. \$17.50
 BEACON ANTENNA, AS31/APN-7 in Lucite Ball. Type "N" Feed. \$22.50
 ANTENNA, AT49A/APR: Broadband Conical, 300-3300 MC Type "N" Feed. \$12.50
 "E" PLANE BENDS, 90 deg. less flanges. \$7.50

3 CM.—RG 52/U Waveguide

3 CM Motor-Driven Echo Box

Cavity Q to 30,000. Tuning range 80 mc Motor operates from 24 VDC Type "N" INPUT. \$32.50

3CM. DIPOLE FEED, 15" L. for APS-15. \$14.50
 MITRED BOW. Cast aluminum, 1 1/2"x3/4" W.G. W.E. Flanges, "E" Plane. \$3.50
 FLEX. WAVEGUIDE SECTION, 1 ft. long. With UG-40/UG-39 flanges. Attenuation is less than 0.1 db. at 9575 mc. and VSWR is less than 1.02. \$7.50
 3 CM ANTENNA ASSEMBLY: Uses 1T39 paraboloid dish, operating from 24 vdc motor. Beam pattern: 5 deg. in both Azimuth and elevation. Sector Scan: over 100 deg. at 35 scans per minute Elevation Scan: over 2 deg. Tilt: Over 24 deg. \$35.00
 Cross-Guide Directional Coupler, UG-40 output flange. Main Guide is 8" long, with 90 Deg. "E" Plane bend at one end, and is fitted with Std. UG 39/UG40 flanges. Coupling figure 20 db Nominal. \$22.50
 RG52/U Waveguide in 5' lengths, fitted with UG 39 flanges to UG40. Silver plated. per length \$5.00
 Rotating Joints supplied either with or without deck mountings. With UG40 flanges. each. \$17.50
 Bulkhead Feed-thru Assembly. \$10.00
 Pressure Gauge Section with 1/8" gauge. \$17.50
 Directional Coupler, UG-40/U Take off 20db. \$17.50
 MAGNET AND STABILIZER CAVITY For 2441 Magnetron. \$24.50
 Rotary joint choke to choke with deck mounting \$17.50
 ADAPTER, waveguide to type "N". \$7.50
 UG 81-U, p/o TS 12, TS-13. \$7.50
 ADAPTER, UG-163/U round cover to special BTL Flange for TS-45, etc. \$2.50 ea.

1 1/4" x 5/8" WAVEGUIDE

CG 98B/APQ 13 1/2" Flex. Sect. 1 1/4" x 5/8" O.D. \$10.00
 X Band Wave GD, 1 1/4" x 5/8" O.D. 1/16" wall aluminum. per ft. 75c
 Slug Tuner Attenuator W.E. guide, Gold plated. \$6.50
 B1-Directional Coupler, Type "N" Takeoff 25 db coupling. \$27.95
 B1-Directional Coupler, UG-52, Takeoff 25 db Coupling. \$24.95
 Waveguide-to-Type "N" Adaptor, Broadband. \$22.50

K BAND—1/2" x 1/4" W.G.

Right Angle Bend E or H Plane, specify combination of couplings desired. \$12.00
 45° Bend E or H Plane, choke to cover. \$12.00
 Mitred Elbow, cover to cover. \$4.00
 TR-ATR-Section, Choke to cover. \$4.00
 Flexible Section 1" choke to choke. \$5.00
 "S" Curve Choke to cover. \$4.50
 Adapter, round to square cover. \$5.00

I. F. AMPLIFIER STRIPS

Model 15: 30 Mc Center frequency. Bandwidth 2.5 Mc. gain figure; 65 db. Uses 5 stages of 6AC7's, Has D. C. Restorer and Video Detector A.F.C. Strip included. Input impedance: 50 Ohms. Less tubes. \$17.50
 60 MC. Miniature IF strip, using 6AK5's 60 Mc center Freq. Gain: 95 db at Bandwidth of 2.7 Mc. New. Complete with tubes. \$15.00

BARGAIN SPECIALS

500 MC. RECEIVER, Type ASF. Uses lighthouse cavity-tuned RF Amp. and Mixer, plus GL-446 oscillator. I.F. is 60mc. New, less tubes. \$7.50
 CAPACITOR, Split Stator, 30-200 MAF, per section, 6 KV working. \$14.50
 NFI-1 Noise Filters, lated 100A/35 volts DC. AAF = 3300-399870005. Mallory. .79c
 POWER SUPPLY and modulator, MP-28. For TA-12 transmitter. Dynamotor rated: Input: 28 VDC/14.8A. Output: 540V/450 MA. New. \$21.50
 TU-6 Tuning Units for IC 375 transmitter. Brand New, complete with case. \$3.95
 RANGE CALIBRATOR, Sickles, Mod III, For Accurate checking of Sweeps, Markers, and Range Stopes. \$185.
 RA-58 Power Supply, Input: 115 VAC, 60 cy. 1 phase. Output: 10KV/35 MA. Ideas, HI-11 Supply. \$85.
 CONVERTER, Type CAJO-211444. Input: 115 VDC. Output 28V DC/20 A or 12 V DC/40 A. New, complete with Filter, Starting Box, etc. \$67.50
 WIRE: TYPE WD3/TT. Similar to W-130, except cotton-braid covered. On 1-mile reels. \$5 per reel
 PANORAMIC ADAPTER AN/APA-10. A combined Panoramic Adapter and Scope. Has 3 inputs for feeding in receiver I.F.'s of 455KC, 5.2Mc or 30 Mc. Designed also to be used as regular scope for testing other equipment. Has both vertical and horizontal push-pull amplifier inputs, etc. Complete with 21 tubes including 3" CR tube and instruction manual. \$1150
 For operation on 115V 400-500 Mc. in two ranges. Harmonics above 2000 Mc. Provides a calibrated (dial accuracy ± 0.7 per cent) H.F. source for testing receiving equipment. Output 3MW or more up to 400 Mc. less on harmonics. C.W., mod. pulse or sine wave output. Operates on 115/230 60 Cy. or batteries. Part of APIT countermeasures equipment. \$16500
 NAVY ADF Receiver DZ-1, made by RCA. Continuous 15 to 1750 kc in 6 bands, gear-train tuning with vernier and coarse scales, broad or sharp band-pass. CW or MCW. All controls on front panel. No headaches of mechanical or electrical control interconnections. Beautifully built with 5-gang tuning capacitor, shielded tubes and coils. 8 tubes: 3-6D6, 2-7E, 2-6C6, 1-41. Complete with tubes, less \$2295 power supply.
 Hydrophone, MODEL MI-2. A lattice of 3 crystals in a disk-like structure; 17-37 Kc. High Imp. \$27.50
 AN/CRW-3A Remote control receiver for operating in set planes, etc. New, with soundproof mtg. box \$34.50
 TEL. REPEATER, EE 89, complete with tubes and tech. manual. \$17.50
 TEL. REPEATER, EE 99, with 12 vdc. vibrator power supply (PE 204). \$49.50
 F.T.&R. 101-A, Two-wire applique, contains equalizing devices, and balancing circuit. Used for adapting line 2-wire military circuits to 4-wire systems. \$47.50
 RADAR TRAINER, Model 15-C. Brand new, complete with pulse generator, power supply, main unit, all cables and instruction book. \$125
 ID-60/APA-10 PANADAPTER, may be used with 1P of 455, 5.25, or 30 mc. operates from 115V, 400 Cy. \$150
 UNDERWATER MICROPHONES, Model JR—Consists of a mosaic of 7 crystals. May be used at 17-37 Kc. omnidirectional. 50 ohm output. \$27.50
 SA4A/APA-1 Motor Driven Coaxial Ant. Switch DPDT. Continuous Operation from 24VDC. Completely enclosed. \$24.50
 MP-22 MAST BASE Mobile Antenna Mount. 4.59
 SAIA/APN-1 Altitude Limit Switch for APN-1 Altimeter. 7.95
 ALTITUDE INDICATOR for APN-1. 12.50
 C-387-D Final P.A. Coil for BC610 2-3.5 MC. Variable Link. 4.89
 RA-74 Power Supply for Super Pro. 69.50
 C48/ARC-5 Control Box for ARCS. 4.49
 J-22/ARC-5 Junction Box. 3.49
 T-21 Artillery Microphone complete with preamp. tube. Condenser type. \$24.50



POWER TRANSFORMERS

COMBINATION—115V/60 ~ INPUT
 CT-133 150-C-150V/65MA, 6.3V, 2.5A, 6.3V, 0.6A \$1.79
 CT-127 900V/25MA PK. 5V, 2A, 2V, 7.5A \$2.79
 CT-006 350-0-350V/120MA, 5VCT/3A, 2.5VCT/12.5A, 2.5VCT/3.5A \$4.39
 CT-965 1340-0-1340V, 6.3V/2A \$1.95
 CT-004 350-0-350V/90MA, 5VCT/3A, 2.5VCT/12.5A \$4.60
 CT-002 350-0350V/50MA, 5VCT/2A, 2.5VCT/7.5A \$3.65
 CT-479 7000V/.018V, 2.5V/5A/17,800 V. Test \$22.50
 CT-013 450-0450V @ 200MA, 10V/1.5A, 2.5, 3.5A, 5V/3A \$4.35
 CT-403 350VCT .026A 5V/3A \$2.75
 CT-931 585VCT .086A 5V/3A, 6.3V/6A \$4.25
 CT-929 4200V/.001A, 2.5V/2A, 6.3VCT/.6A \$5.35

PLATE—115V/60 ~ INPUT
 PT-07 400VCT/4.0 AMPS For RA43. \$17.50
 PT 034 125V/45MA (For Preamp) \$1.15
 PT 157 650-0-650VAC (500VDC) or 550-0-550 VAC/100V/100C @ 250 MADC. \$8.70
 PT 167 1400-0-1400 VAC (300MADC) or 1175-0-1175 VAC (100VDC) @ 300 MADC. \$22.50
 PT 168 2100-0-2100 VAC (175VDC) or 1800-0-1800 VAC (150VDC) @ 300 MADC. \$33.00
 PT 371 210-0-210V @ 2.12 Amp \$8.00
 FT-924 3140-1570V, 2.36KVA \$9.45
 PT 801 22,000V/234 MA, 5.35 KVA \$115.00
 PT 521 7500V/.06A, Half Wave \$59.50
 PT 913 2500V/12 MA H'SLD \$4.95
 PT 12A 280VCT/1.2A \$3.95
 PT-38-2 37.5/40V AT 750 MA \$2.15

FILAMENT—115V/60 ~ INPUT
 FT-140 5VCT @ 10A 25KV Test \$17.50
 FT-157 4V/16A, 2.5V/2.75A \$2.95
 FT-101 6V/25A \$7.79
 FT-801 5.25A/21A, 247.75V/6.5A \$14.95
 FT-824 2x26V/2.5A, 16V/1A, 1.2V/7A, 6.4V/10A 6.4V/2A \$8.95
 FT-463 3.6VCT/1A, 5VCT/3A, 5VCT/3A \$5.49
 FT-55-2 7.2V/21.5A, 6.5V/6.85A, 5V/6A, 5V/3A \$2.79
 FT-38A 6.3V/21.5A, 6.2/27.7A 5KV Test \$7.50
 FT-650 1.5V/10A-3KV TEST LO-CAP \$7.50
 FT-025 2.5VCT/10A, 10KV TEST \$6.95

FILTER CHOKES

Stock	Description	Price
CH-914	12HY/250 MA 2500 V. Test	\$3.25
CH-CEC 117	9-60H/.05-400 MA, 10 KV Test	\$14.95
CH-113	2.5H/700 MA, 2.5 KV Test	5.75
CG-244	8.5H/350 MA, 3.5 KV Test	6.35
CH-291	1.1H/12 A, DCR: 0.3 Ohms	12.50
CH-322	.35H/350 MA—10 Ohms DCR	2.75
CH-141	Dual 7H/75 MA, 11H/60 MA	4.85
CH-69-1	Dual 120H/17 MA	2.35
CH-8-35	2.5H/380 MA, 25 Ohms	1.79
CH-776	1.28H/130 MA, 75 Ohms	2.25
CH-344	1.5H/445MA/1200V Test	2.35
CH-43A	10HY 15 MA—850 ohms DCR	1.75
CH-366	20H/300 MA—	6.95
CH-999	15HY/15 MA—400 ohms DCR	1.39
CH-445	0.6HY/200 MA, 32.2 ohms, 3000 V-T.	2.79
CH-170	2x0.5H/380 MA, 25 Ohms	2.79
CH-533	13.5H, 10 AMP DC, 13.5 KVINS.	29.95

MICROWAVE ANTENNAS

3 cm. Horn, 1" x 1/2", with twist and 180 deg. bend. With dielectric window. \$22.50
 AT49/APR—Broadband Conical, 300-3300 MC. Type N Feed. \$8.95
 Relay System Parabolic reflector approx. range 2000 to 6000 mc. Dimensions 4 1/2" x 3". New. \$72.50
 Discone Antenna, AS 125 AFR. 1000-3200 mc. Stub supported with type "N" connector. \$14.50
 ASI4A/AP. 10 CM pick up dipole assy, complete w/ length of coax and "N" connectors. \$4.50
 AS46A/AP. 3" Long Antenna, 5 element array. \$22.50
 30" Parabolic Reflector Spun Aluminum dish. \$4.85
 AN/APA-12—Sector Scan adaptor for AP'S-2 radar—Complete Kit. \$37.50
 TPS-3, 10 Ft. Dish, "Chicken Wire" Parabolic. Extremely lightweight, portable. \$125.00
 AN-154 3 vertical dipoles working against a rectangular mesh approx. 7 1/4" Freq. 140-200 mc. with lobing switch (15v, 60 cy) and portable slatted crate. Extremely rugged. \$27.95
 LP-24 Alford loop, for use with glide-path transmitters (MRN-1, etc.) 100-108 mc. \$12.50

H. V. SWITCH

15 KV Switch (For RA-381) Operates from 115V AC. 60 cy. Contacts will handle 100 Amp. Provision for Fuses. \$24.95

THERMISTORS

D-164699 Bead Type DCR, 1525-2550 Ohms @ 75 Deg. F. Coefficient: 2% Per Deg. Fahr. Max. Current: 35 MA AC/DC \$1.80
 D-167332 Bead Type DCR is 2525-2550 Ohms. Rated 25 MA at 82.5-117.5 VDC. \$1.00
 D-167613 Disk Type DCR: 355 Ohms @ 75 Deg. F. P.M. 2.5% Watt. \$1.00
 D-166228 Disk Type 7120 Ohms @ 60° F. 4220 Ohms @ 80° F. 2590 Ohms @ 100° F. 1640 @ 120° F. \$1.00

DYNAMOTORS

TYPE	INPUT		OUTPUT		Price
	VOLTS	AMPS	VOLTS	AMPS	
BDAR 83	14	19	375	.150	\$6.50
35X-059	19	3.8	405	.095	4.35
POSX-15	14	2.8	220	.08	4.85
DM 33A	28	1.75	540	.250	3.95
23350	17	3.2	285	.075	3.95
B-19	12	9.4	275	.110	6.95
			500	.050	
			300	.260	3.95
			150	.010	
			14.5	5.	
PE 73CM	28	19	1000	.350	17.50
BD 60:	14	2.8	220	.08	8.95
DAG-33A	18	3.2	450	.06	2.50
DM 25:	12	2.3	250	.05	6.95
BDAR 93	28	3.25	375	.150	6.95

1 1/2" filter.
 † Used. Excellent.
 PE 94-, Brand New \$5.95

INVERTERS

800-1B Input 24 vdc, 62 A. Output: 115 V, 800 cy. 7A. 1 phase. Used. excellent. \$18.75
 PE-218H: Input: 25/38 vdc, 92 amp. Output 115V/400/500 cy. 1500 Volt-ampere. NEW \$22.50
 PE209: Input: 28 vdc, 36 amps. Output: 80 V 800 cy. 500 volt-amp. Dim. 13 x 5 1/2 x 10 1/2. New. \$22.50
 EICOR—ML 3011-5. Input: 13.75V; 18.4A. Output: 115 V/400—, 3p, 0.95 PF, 100 VA. New. \$19
 PU 7/AP. Input: 28 vdc/160A. Output: 115 VAC, 400—, 1p, 500 VA., 21.6 Amp. Volt. and Freq. Reg. Used, Exc. \$75

MAIL ORDERS PROMPTLY FILLED ALL PRICES F.O.B. NEW YORK CITY. 25% DEPOSIT WITH ORDER. BALANCE C.O.D. RATED CONCERNS SEND P.O.

131 Liberty St., New York 7, N. Y. Dept E-5 Chas. Rosen Phone: DIgby 9-4124

● CALVERT ELECTRONICS, INC. ●

LARGE STOCK OF TUBES

Receiving, Television, Transmitting, Special Purpose Klystrons, Magnetrons, etc.

MORE THAN A MILLION TUBES IN STOCK



SPECIAL PURPOSE

KC4	19.00	30 Special	.22	730A	10.00
KC4-3	19.00	FG32	1.99	S02	3.25
1AB5	.39	RK34	.29	807	1.35
1B32	.44	35T Ion	.815	813	10.00
1B35	3.25	Gauge	1.75	815	4.75
1B56	14.00	39/44	.12	826	.55
1N21	.25	T40	2.00	830B	1.75
1P23	.39	HY40Z	2.00	832	6.50
2C22	.77	RK62	2.00	832A	7.75
2C22/RX	.44	RK65/5D23	7.50	841	.19
233A	.88	VR65	.39	842	3.25
2C40	12.00	RK72	.77	843	.25
2C43	12.75	RK73	.77	851	19.00
2C51/396A	3.75	100TH	5.95	861	9.75
2D21W	1.75	101F	1.35	864	.17
2E24	1.75	313E	3.75	864A	1.29
2J21	1.95	VU-111S	.77	872A	2.75
2J21A	1.95	F-127A	17.75	880R	99.00
2J22	1.75	VT-127A	1.75	891	77.50
2J26	4.75	FG-172	17.50	902P1	3.75
2J32	.44	205B	.66	921	.39
2K28	25.00	207	50.00	921A	3.35
2K31	55.00	211	.99	954	.14
2K45	57.00	212A	.45	955	.24
2K48	95.00	215A W.E.	2.00	CK-1006	1.25
2K56	55.00	217C	3.75	CK-1089	.84
2X2/879	.22	249B	3.75	1616	.49
3A5	.22	249C	3.75	1619	.22
3B7	.35	250R	3.75	1625	.19
3BP1	2.75	307A	3.50	1626	.19
3B24W	9.45	311A W.E.	2.75	1629	.10
3B27	7.75	312A	2.95	1630	.55
3C24	1.12	313C	2.75	1632	.22
3CP-1S1	2.00	322CA	9.45	1680	1.00
3E29	9.45	371B	.75	1846	55.00
3JP7	3.75	373A W.E.	1.75	5687	3.50
4B28	3.75	374A W.E.	1.75	5691	5.00
4E27	12.00	388A W.E.	1.75	5692	6.75
4J28	25.00	393A W.E.	4.99	CK-5702	1.45
4X100A	20.00	394A W.E.	3.85	5726	1.00
5AP1	2.15	404A W.E.	12.50	CK-5744	.77
5B21	2.75	407A W.E.	2.95	CK-5784	2.25
5BP1	.99	408A W.E.	2.95	5803	
5BP4	1.75	416A W.E.	2.95	Victoreen	1.75
5CP1	3.95	Write		5814	2.25
5D21	7.95	417A W.E.	13.75	5825	5.50
5FP7	1.75	421A W.E.	4.45	5933	7.50
5HP1	3.75	422A W.E.	4.45	5964	.44
5MP1	3.75	404	3.75	6035	10.00
5R4WGY	1.45	471A	2.00	6038	3.85
6AC7W	1.25	CK507AX	.44	6045	1.00
6AJ5	1.25	WL532-A	.44	6096	1.00
6AS6W	2.25	575A	19.45	6099	.75
7BP7	2.75	615	.50	6101	1.35
7C4/1203A	1.12	WL616	19.00	7193	.14
9GP7	3.75	WL681-686	25.00	8002R	25.00
10	.19	705A	.95	8011	.44
10 Special	.19	713A	.39	8012	1.95
10Y	.19	715B	3.50	8019	1.55
12A6	.29	717A	.55	8025	2.95
15R	.29	721A	1.00	8025A	3.45
T20	2.00	722A	.77	9002	.65
TZ20	2.00	723A/B	8.75	9006	.24
T21	2.00	724B	.77	38111A	.55
23D4	.44	726C	25.00		

AT ALL TIMES

RECEIVING TUBES

01A	.29	6R7GT	.22
1A5GT	.45	6S7C	.99
1A7GT	.50	6SA7GT	.55
1F7C	.99	6SC7	.77
1H6G	.59	6S7S	.55
1LA4	.50	6SC7	.77
1LA5	.61	6SC7GT	.59
1LC5	.61	6SH7	.55
1LG5	.79	6SH7GT	.55
1LH4	.65	6SL7GT	.65
1P5GT	.34	6SK7GT	.44
1Q5GT	.61	6SN7GT	.65
2A3	.85	6SQ7GT	.40
2A5	.55	6V6GT	.55
2A6	.49	6Y6C	.77
2A7	.66	7A6	.22
2X2/879	.22	7C1/120 3A	.12
3A5	.22	12A6	.29
3B7	.35	12AH7GT	.77
5R4WGY	1.45	12AU7	.66
5X4	.50	12B8GT	.29
5Y4C	.55	12C8	.22
5Z3	.55	12K8	.44
6-7 Ballast	.29	12SG7	.65
6AC7	.66	12SK7GT	.48
6AC7W	1.25	12SL7GT	.55
6AG5	.55	12SQ7GT	.44
6AG7	.77	12SR7	.33
6AJ5	1.25	14A4	.75
6AK5	.55	14C7	.64
6AL5	.42	19	.65
6AQ5	.45	25L6GT	.50
6AS7C	3.35	26	.44
6B2	.55	28107	.99
6D6	.55	30	.75
6F5	.22	33	.15
6F6GT	.55	3Z3	.45
6F8C	.29	35Z5GT	.37
6G6G	.60	37	.12
6J5GT	.39	38	.12
6J6	.55	39/44	.12
6J7	.65	41	.40
6K7	.44	43	.49
6K8C	.60	46	.50
6L5G	.59	57	.50
6L6M	1.25	70L7GT	1.00
6L6GA	.97	71A	.45
6L7C	.39	76	.39
6N7	.44	77	.45
6N7GT	.39	83V	.75
6R7	.50	89Y	.25

Facilities for export packing delivery to pier

Cable Address: CALVERTRON

Calvert Electronics Incorporated

59 FOURTH AVENUE, NEW YORK 3, N. Y. Oregon 4-3027

SELLING OUT OUR MOTOR INVENTORY

- Delco—Permanent Magnet Alnico Field Motor with Brake #5070200—12 V. 140 RPM. @ \$8.00 each
- Delco—#5072400 with Worm Gear—27V. D. C. @ 7.50 each
- Diehl—#SSFD6-25 with and without Follower—27V. D. C. @ 6.50 each
- Oster—#1/67 HP—27V. D. C.—5000 RPM. @ 1.25 each

RAWAY SALES

4 Forsyth St. Walker 5-8150 New York 2, N. Y.

TUBE TESTING LABORATORY

TEST YOUR TRANSMITTING, RECEIVING, AND SPECIAL-PURPOSE TUBES TO JAN, MIL-E-18 AND/OR COMMERCIAL SPECS. LAB. CERTIFICATES SUPPLIED
BARRY ELECTRONICS CORP.
512 BROADWAY, N. Y. 12, N. Y. Walker 5-7000

FOR SALE

Transmitter Tubes
Eimac - Machlett - 750TL
List \$137.00. Our price \$32.50
J. BEEBER CO. INC.
838 Broadway AL 4-3510 New Yrkr

WRITE FOR OUR 1955 CATALOG

- Precision Mod. E400PM Sweep Generator FM-TV A.M. New \$99.50
- TS323/UR Frequency Meter, 20-480 mc. Exc. 350.00
- TS173/UR Frequency Meter 90-450 mc with modulation and PP79/UR Power Supply Exc. 350.00
- LM Frequency Meter with Mod. 125KC.-20mc. Exc. 99.50
- LM 110V. AC Power Supply. Exc. 49.50
- RA-38 Power Supply 115VAC. 60 cy. input. 1500VDC 500 ma. output. Exc. 350.00
- JE36 Test Set used for bench testing of SCR-522 With I-39A meter. 32.50 Less I-39A meter. 24.50
- General Radio 620A Hetrodyne Frequency Meter 300 kc. to 300 mc. Exc. PUR*
- IE-19A Test Set for SCR-522 etc. 100-156 mc. less tools. Exc. 200.00
- TS-36/AP Power Meter freq. range 8700-9500mc. Exc. PUR*
- Weston Model 685 True Mutual Conductance Vacuum Tube Tester. New 450.00
- R65/APN9 Loran Receiver-Indicator Like New PUR*
- AN/APN-4B Loran Set with ID6B/APN4 Indicator RB/APN4 Receiver, Crystal Mounts, Plugs, and Manual. New 129.95
- PE-206 Inverter 14.95
- RT18/ARCI Transmitter-Receiver with tubes, dynamotor. 100-156 mc. 10 channel. Exc. PUR*
- T67/ARCS. TCS, BC348, TS-323, LM. 1E-19A, APA10, etc. PUR*

*PUR—Price Upon Request.

WANTED!

All Types of Radio and Electronic Surplus.

PHOTOCON SALES

417 N. Foothill Blvd. SY camore 2-4131
Pasadena 8, Calif. RY an 1-6751
CABLE: Photocon, Pasadena

TS-56A/AP TEST EQUIPMENT

Slotted line test equipment designed for operation over a frequency of 500-875 MC. Has impedance of 51 ohms. Ideal test set for matching antennas, measurement of characteristics of transmission line. With instructions \$95.50 manual. New. Shipping wt.: 41 lbs.

RADAR TEST SET

Phantom Target RF4/AP is used for permanent installation in planes equipped with radar set in the S band while plane is in flight. With instruction book, new condition. Wt. \$49.50 10 lbs.

ECHO BOX

A hand tuned ring box with an associated dipole which picks up the RF energy from the radar set. Frequency range of 3140-3640 MC. Ideal unit for experimental lab. Wt. 7 lbs. New Condition \$4.95

NEW CATALOGUE NO. 114

1955 ISSUE
LISTS LATEST INVENTORY OF AIRCRAFT, INDUSTRIAL AND MILITARY ELECTRONICS EQUIPMENT. SEND FOR YOUR COPY TODAY!

ARROW SALES INC.

Western Division
Mailing Address: P.O. BOX 3878-E, N. HOLLYWOOD, CAL.
Office-Warehouse: 7460 VARNA AVE., N. HOLLYWOOD, CAL.
Phones: Stanley 7-6005 • Poplar 5-1810
Sales-Showroom: 2005 EMPIRE AVENUE, BURBANK, CAL.
Phone, Victoria 9-2834
Cable Address: ARROWSALES, NORTH HOLLYWOOD
Telegraph Address: WUX, NORTH HOLLYWOOD

Central Division
Mailing Address & Sales-Showroom:
2441 S. MICHIGAN AVE. CHICAGO 16, ILLINOIS
Phone: CALumet 5-4750

2K28 Tubes - Fully Guaranteed \$2850

Write for Quotations on Any Types

ALLIED ELECTRONIC SALES

74 COURTLANDT ST.—NY. 7, N. Y.
BARElay 7-5839

Biggest & Best in Surplus Communications

RADIOTELEPHONES, TRANSMITTERS, WALKY-TALKIES, ETC.

SCR-536 (BC-611); SCR-508; SCR-511; SCR-300 (BC-1000); VRC-3; SCR-284; SCR-510; SCR-610; SCR-508, 528, 608, 628; SCR-619; SCR-522; SCR-624; SCR-543; BC-447; BC-604; BC-669; BC-684; BC-797; TBS; TCS; TDE; TBK; TBL; TAJ; TAQ; TRV; etc. LARGE QUANTITIES AVAILABLE IN MOST TYPES.

RECEIVERS, DIRECTION FINDERS, ETC.

BC-312, BC-342, BC-224, BC-348, BC-733, BC-728, BC-1068, RAK, RAL, RRS, RBL, RRM, RCK, DZ-2, TCS, Bludworth Standard Arrow, ARR-3, BC-969-T1, BC-974-T2, CRV-46136 (DP-12 or 13), VHR-401A (VHF-109-144 mc), LRN-1A (Loran), APS-15 Receivers, R-44/ARR-5, OW-3, SCR-206F, etc.

GE 10KW RF POWER AMPLIFIERS (With Rectifier-Power Supply),

Type BF-3-A. Designed for 88-108 mc operation, but easily converted to lower frequency operation, with power output to 17.5 KW possible. NEW EQP'T., not Gov't. surplus.

WESTERN ELECTRIC MODEL 248A RADIOTELEPHONE EQP'T.

250/350 W. output, 2-20 mc. 30-Channels transmit and up to 30-Channels receiving; crystal control, Remote Control, 110 V. AC. etc. many other features. NEW EQP'T., not Gov't. surplus.

PORTABLE RADIO BROADCASTING STATION, Model TWT-PB-50A,

Complete Station in 5 carrying Trunks, includes 2-speed turntable, Studio-Console, Transmitter, Power Supply, Microphone, Cables, Spare Parts, etc. Frequency 1100 to 1500 KC. crystal or VFO controlled. Power Output 50 watts; operates from 90 to 240 volts, 50/60 cycles AC. ALL NEW EQP'T. Available in Quantity.

POWER SUPPLIES, DYNAMOTORS, ETC.

DM-35, DY-10, DM-28 (for BC-348), DM-21 (for BC-312), RA-20 (for BC-342), DM-32/DY-2A (for ARR-3), TCS (12 V. DC Power Supply; also 110 V. AC Power Supply), PE-104-A Vibrator Power Supply (for SCR-284), PE-110 (for SCR-543 or BC-669), PE-157, PE-237 (for SCR-694 or GRC-9), PE-75 (Gas Engine Set—2.5 KW), Kato 32 V. DC to 110 V. AC (1.225 KVA) Rotary Converters, etc.

SPECIAL! PE-218 INVERTERS

24-27.5 V. DC Input, 110 V. 400 cycles, 1500 VA Output. NEW UNITS\$14.95 EACH

INFRA-RED "SNOOPERSCOPE" TUBE. EXTRA-SPECIAL!!

We've sold thousands of them to Labs, experimenters, Industrials, studios, etc. By using Infra-Red rays, this tube enables you to see in the dark. No scanning, no amplifiers, just a high-voltage power supply is all you need with this tube. Shows image in greenish-white on 1 3/4" screen. For night photography, signalling, snooper or sniffer scopes, underwater detectors, etc. British mfr. SOLD IN LOTS OF 6 ONLY. Literature and diagrams furnished with each sale. Shpg. wt. 2 lbs.

Slashed to 3 for \$10.00

FRONT-END LENS, for Infra-Red Tube.
Bausch & Lomb Ea. \$15.00
Plain, Mounted Type Ea. 7.00

EXTRA SPECIAL: SELECTIVE RINGERS, For mobile or ship-to-shore radiotelephones, Western Electric model 107A, new—guaranteed, each \$85.00

Write for Prices & Literature.

EXPORTERS, GOVERNMENT AGENCIES, INDUSTRIALS!

We have a large stock of Transmitters, Receivers, Walkie-Talkies, VHF Equipment, Ship & Shore Communications, FM Broadcast Stations, Radar, Accessories, etc. Write and tell us of your requirements. Descriptive literature and prices available upon request.

ALL MATERIAL SUBJECT TO PRIOR SALE! CABLE ADDRESS: TELEMARINE, N. Y.

TELEMARINE COMMUNICATIONS CO.

3040 W. 21st Street, Brooklyn 24, N.Y.
Phone: ES 2-4300

world's largest stock

RELAYS

immediate delivery!

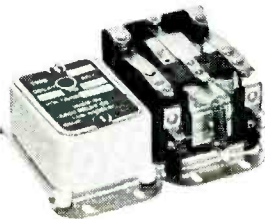

ADJUSTABLE THERMAL TYPE TIME DELAY RELAY

Operates on 115 V.A.C. Continuously adjustable delay from 5 to 20 seconds. 1/4 Inch D.P.D.T. 12 1/2 amp. contacts. Primarily designed for use with radio transmitters but has wide variety of other applications. Catalog No. R 686 Price \$6.10 each

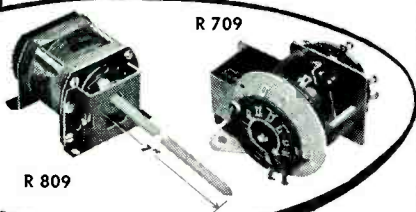

STEPPING UNIT

Operates on 22 to 30 V.D.C. 12 Position driving mechanism operates through 360° in progressive steps. Indexes one position for each momentary current impulse. Attached wafer switch may be used for self interruption. 7 inch flatted shaft will drive pulley, gear or one or more wafer switches. Catalog No. R 809 Price \$2.45 each

SOLENOID OPERATED RATCHET STEPPER

Operates on 6 V.D.C. Operates three 12 position wafer switches. Most standard wafers are interchangeable with those supplied. Rotates 30° with each impulse. Catalog No. R 709 Price \$3.90 each

HUNDREDS OF RELAY TYPES IN STOCK

- | | |
|----------------------------------|-----------------------------------|
| Standard Telephone Relays | Differential and Polarized Relays |
| Short Telephone Relays | Special Relays BK-Series |
| Midget Relays | Antenna and Ceramic Relays |
| Timers | Motor and Control Relays |
| Aircraft Contactors | Relay Assemblies |
| Rotary Relays | Latching and Interlocking Relays |
| Western Electric Type "E" Relays | Mechanical Action Relays |
| Keying Relays | Ratchet and Stepping Relays |
| Hermetically Sealed Relays | |
| Voltage Regulators and Cutouts | |

All relays are new, individually inspected and unconditionally guaranteed. They are first line products of leading manufacturers. Special attention given to orders of one or more relays. 24 Hour delivery.

Write for new catalog. Phone, write or wire your requirements.



Austin 7-0709
4717 W. Madison St.
Chicago 44, Ill.

IMMEDIATE DELIVERY PRODUCTION QUANTITIES



MIN. AIRCRAFT And Many Others TELEPHONE TYPE
SEND FOR LATEST CIRCULARS LISTING NEW ITEMS—NEW LOW PRICES
WESTON TYPE 705 SENSITROL

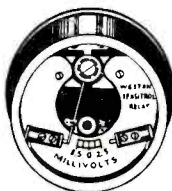

Operation is as follows: The stationary contact is a small powerful permanent magnet and movable contact is iron "rider" mounted on pointer which travels over relay scale. Operating torque moves pointer into magnetic field of stationary contact. This contact then draws movable contact and holds it firmly. Contacts remain closed until reset. Will operate directly from a photocell or a group of thermocouples. Net weight 14 oz.

Double contact with Solenoid Reset; Sensitivity 7.5 Microamps; Reset coil 6-24 VDC or 24 VAC; Makes contact on increasing or decreasing values; Contacts: "Twin-tacts", Capacity 100 ma at 110 volts; Nickel plated. Brass cover; Weston Model 705 Type 6 #R500 18.75; 10 for 170.00 Same as #R560 but with glass face; Weston Model 705 Type 6 #R51 19.75; 10 for 180.00 Single contact (Normally Open), Solenoid Reset; Sensitivity: 10 Microamperes; Reset coil: 6-24 VDC or 24 V AC; Contact: "Twin-tact", capacity 100 ma at 110 volts; Glass Face; Weston Model 705 Type 4 #R523 17.75 10 for 160.00 Same as #R523 with Brass Cover Weston Model 705 Type 4 #R523N 16.75 10 for 150.00

STEPPING SWITCHES

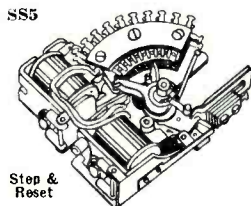

Mfg by Western Electric, Automatic Electric Sales
Minor Switch 10 steps and off Contacts: Gold plated brass; Bridging Wiper; Operating Voltage 6.0 to 12.0 V DC Net Wt. 1 lb.

#R960; Single Level; 6 to 12 VDC	10.95	9.00
#R975; Single Level; 24 to 36 VDC	11.95	10.00
#R976; Single Level; 48 to 60 VDC	12.95	11.00
#R977; Two Level; 6 to 12 VDC	12.95	11.00
#R978; Two Level; 24 to 36 VDC	13.95	12.00
#R979; Two Level; 48 to 60 VDC	14.95	13.00

SS6 Mfg. by Western Electric Co.; 22 step; 5 levels; Bridging Wipers; Contacts: Gold plated brass; Interrupter Switch; 1 Break-Make; Net Weight: 2 lb. 2 oz.

"Homing" Type; Double-Ended Wipers; Step in One Direction
#R926; 6 to 12 VDC 14.75 12.00
#R980; 24 to 36 VDC 15.75 13.00
#R981; 48 to 60 VDC 16.75 14.00

SS7 Mfg. by Western Electric Co.; 44 step; 2 Levels; Bridging Wipers; Contacts: Gold plated brass; Interrupter Switch; 1 Break-Make; Net Weight 1 lb. 14 oz.

"Homing" Type; Double-Ended Wipers; Step in One Direction
#R927; 6 to 12 VDC 14.75 12.00
#R982; 24 to 36 VDC 15.75 13.00
#R983; 48 to 60 VDC 16.75 14.00

Production Quantities Available, Call Us for Prices.

TERMS—All Prices F.O.B. Our Plant, Rated Firms Net 10 Days; All Others Remittance with Order. Orders Under \$10 Remittance With Order. Plus Approximate Shipping Charges (coverage will be returned.) Cable Address: UNIGENCOR, N. Y.

324 CANAL ST., N.Y.C., 13, N.Y. WALKER 5-9642
Universal general corp.

MANY NEW TUBE TYPES IN STOCK!

We specialize in GM counter tubes and regulator tubes and Scintillation multiplier tubes as well as Western Electric subminiature, ruggedized, JAN, 5000 and 6000 series electronic tubes.



FULL-WAVE BRIDGE TYPE

DIRECTRON SELENIUM RECTIFIERS

Max. Amps	18/14 Volts	36/28 Volts	54/42 Volts	72/56 Volts	130/100 Volts
1	1.35	2.35	3.80	4.60	7.50
2	2.00	2.75	5.40	6.00	9.25
3	2.95	4.15	6.00	7.90	12.90
4	3.50	6.50	11.50	14.50	22.00
6	4.10	8.00	13.00	17.50	29.95
10	5.95	11.50	20.00	25.00	41.50
12	7.50	14.50	22.50	30.00	44.50
20	12.00	23.00	38.00	49.00	72.00
24	14.50	29.00	45.00	58.00	81.50
30	18.00	34.50	57.50	72.00	110.00
36	22.50	42.50	66.00	88.00	135.00
50	29.75	54.50			175.00
100	60.00	120.00			

We build other Selenium Rectifiers, Transformers and Chokes to your specifications. Buy from the Direct Source for Quick Delivery.

NEW RECTIFIER TRANSFORMERS

1 Amp.	55.60
2 Amps.	6.60
4 Amps.	8.60
12 Amps.	16.60
24 Amps.	35.60
30 Amps.	46.60
50 Amps.	58.60

Pri. 115V., 60 cycles in.
SEC: 9, 12, 18, 24 and 36 Volts
Continuous Ratings.

NEW RECTIFIER CHOKES

1 Amp.	.1 Hy.	1.5 ohm	53.95
2 Amps.	.04 Hy.	.9 ohm	4.15
4 Amps.	.07 Hy.	.6 ohm	7.95
12 Amps.	.01 Hy.	.1 ohm	14.95
24 Amps.	.004 Hy.	.025 ohms	29.95
30 Amps.	.005 Hy.	.02 ohms	37.95
50 Amps.	.005 Hy.	.02 ohm.	53.95

FILTER CAPACITORS

Capacity	W. Voltage	Each
500 MFD	200 V.	51.95
500 MFD	50 V.	.85
1000 MFD	25 V.	.35
2000 MFD	50 V.	2.25
6000 MFD	15 V.	1.50

SELENIUM POWER SUPPLY KIT

115 VAC to 24-30 VDC, at 6 amps (conservative rating) consists of one hermetically sealed transformer with tapped primary and secondary and full wave bridge selenium rectifier. \$11.95

Victoreen Voltage Regulator VXR-130, subminiature. Brand New. Users net cost \$6.50. Quantity in stock. only **75¢**

NOW AVAILABLE!

WHITE COATED TUBE CARTONS

SIZE	EACH	SIZE	EACH
Miniature	5 .01	LARGE GT.	.015
1"x1"x3"		1 1/2"x1 1/2"x4"	.85
6AU6, 6AL5, etc.		1B3, 6B, 6CGT, etc.	.02
GT	.0125	LARGE G.	
1 1/2"x1 1/2"x3 1/2"		2"x2"x6"	
6SN7, 6W4, etc.		5U4G, 6BG6G, etc.	

Also in Super-Gloss Red and Black.
Both types with new safety partitions—they meet U. S. Government specifications! Attractive discounts for quantity users. Minimum order 100 of a size. Be sure to specify white or color when ordering.

SNOOPERSCOPIES

Army Snooperscope, in like new condition, complete with 1P25 Tube (but less 6 v. Battery pack.) **16000**

Kit, same as above, with 1P25 Tube. Requires only power pack and rear eye piece **11000**

Kit, as above, less tube. **6000**

BH	\$3.00	5D21	7.75	800	2.00
BR	2.00	5JP5	10.00	803	1.75
OA4G	1.00	7BP7	4.50	829B	8.75
OB3/VR90	.85	7EP4	12.50	838	1.50
OC3/VR105	.85	7GP4	12.50	891	125.00
OD3/VR150	.85	8D21	455.00	958A	.50
1B26	1.50	9GP7	5.00	1619	.30
1B32	2.00	10BP4	9.00	1620	4.75
1B35	6.50	12DP7	10.00	1851	1.75
1B85	9.95	15E	1.00	1960	.60
1B86	7.75	15R	.10	5514	4.50
1P30	2.00	FG27A	11.95	5516	6.50
2B22	1.75	FG41	12.50	5634	7.00
2C33	1.00	FG67	12.00	5641	6.00
2C39A Surplus	13.75	CRP72	.60	5642	.95
2C40	12.75	FG98A	20.00	5651	1.40
2C43	12.75	100R Surplus	5.00	5656	7.95
2C44	.50	100TH Surplus	6.75	5670	2.15
2C46	6.60	100TL Surplus	8.50	5676	1.00
2C51	3.00	FG105	15.00	5678	1.15
2D21	.78	VT127A	2.50	5686	2.00
2E26	3.70	VXR130	.75	5687	3.00
2E30	1.75	FG172	45.00	5691	5.50
2E31	1.90	QK181	25.00	5692	5.25
2E35	1.95	211	.50	5693	4.75
2J33	10.00	249A	3.50	5696	1.15
2J36	35.00	249B	3.50	5702	2.00
2J21A	4.00	253	5.50	5703	.95
2J22	4.00	274B	1.00	5704	1.90
2J27	8.00	275A	3.50	5718	4.25
2J32	15.00	276G	8.50	5726 6AL5W	1.10
2J37	10.00	300B	6.00	5732	3.00
2J49	35.00	304TH Surplus	8.75	5744	1.00
2J50	35.00	304TL Surplus	8.75	5751	2.50
2J54	35.00	311A	5.50	5762	100.00
2K25	22.50	311C	2.50	5763	1.10
2K45	65.00	316A	.40	5780	250.00
2K59	25.00	337A	6.50	5795	250.00
2K60	25.00	350A	3.00	5812	2.75
2K61	25.00	WE355A	19.75	5814	1.60
2K62	25.00	359A	2.00	5820	Write
3B24	1.80	394A	3.50	5829	2.00
3B24/W	5.00	401A/5590	3.10	5840	5.00
3B27	3.50	403B/5591	3.15	5844	4.00
3B28	6.00	404A/5847	12.00	5879	1.40
3B29	6.00	416A	46.50	5881	2.65
3C22	52.50	416B	Write	5886	2.50
3C23	7.50	417A	4.00	5899	5.50
3C24/24G Surplus	1.75	417A/5842	12.50	5963	1.20
3C31/C1B	2.25	422A	9.95	6021	5.00
3C45	7.95	429A	8.75	6080	3.25
3D21A	6.00	446A	.75	6080WA	4.25
3J30	45.00	464A	2.55	6095	1.25
3J31	45.00	CK503AX	1.00	6096	Write
3BP1	4.50	GL673	13.00	6097	1.50
3BP11	7.00	WL678	33.00	6098	1.90
3DP1	3.30	703A	1.25	6099	1.50
3FP7	2.50	705A	.85	6101	1.50
4B24	5.00	707A	4.00	6113	1.25
4B28	3.00	707B	5.00	6187	4.00
4E27	9.50	708A	2.00	6189	3.75
4J36	75.00	709A	1.75	8020 Surplus	1.25
4J37	75.00	715B	3.00	6A7	.85
4PR60A Surplus	75.00	715C	8.00	6AG5	.60
4X150A Surplus	35.00	717A	.50	6B4G	.75
4X500F Surplus	65.00	721A	.75	D171584	8.75
5BP1	2.25	722B	1.00	GE217283	5.00
5BP4	3.95	723A/B	9.50		
5C22	29.95	725A	4.50		

Terms: F O B—N Y C—25% Deposit with order—or send full remittance to save C O D charges—D & B Rated Firms (F2 1/2 or Better) Net 10 Days. CABLE BARRYELECT. N. Y. TELEGRAPH BARRY ELECTRONICS. FAX, N. Y.

BARRY ELECTRONICS CORP.

Authorized Distributors of Eimac, CBS-Hytron (CBS), Cetron, Lewis & Kaufman and Penta Tubes.

512 Broadway, New York 12, N. Y. Dept. 5-E PHONE: WALKER 5-7000

WANTED

VIBRATORS
Loops LP 21
Microphones, all types
Keys J-38
Keys J-45
T-17 Mikes
APN-3
ARC-1
ARC-3
ARC-13
ART-13
CH 88A
CH 89A
CH119A
CH 120A
CPN-6
CPN-8

CPN 17
FT 107
IE-17
Kites
PE 210 & PE 95
SCR 211
JK-55
Boom Mikes
307A Tubes
RM52, RM53, RM29
APN-2 Material
SCR 720 Material
SCR 522 Material
H 4/AR Headsets
Gibson Girl Material
Telephone Material

CORDS & CABLES

Cable CC 358 CC59
Cords CC 338 Cable CC 338
CD335 CD1108
CD267

FIELD EQUIPMENT

BC788 BC348 or parts
BC939 BC221 or parts
BC614

FOR SALE!

TS 100/AP 10 @ \$30.00
MT 96/APS-3 150 @ .75¢
TUBES
2J 21 200 @ \$ 1.50
2J 22 300 @ 1.50

TELEPHONE RELAYS:
W. E 215A RY 20... \$5.00 new boxed

TELETYPE CAPACITORS:
3DB-500-7 50
3DA 750-1 50

GENERATORS:
GN 38B \$4.00

C30/ARC-5 7 Push button Control box,
with switch, plugs, and cable new # 25¢

C39/ARC-5 Control Box with switches,
Jacks, Terminals, Allan Bradley Pot
Relay ARC 7251, Cable new @ 25¢

HANDSETS—FIAW-3, W.E. new @ \$4.00

DESK PHONES, Leich #90 with Handset
and Dial & Cord. \$4.50

PE 120 Inverters 200 ea. \$ 5.50
6-12 or 24 volts

PE 94 Dynamotor 2.00
PEA 118 Inverter 5.00
PE 103 Power Unit 15.00
PE 73 Dynamotor 5.00
PE 112 Power Unit 5.00
PE 115 Inverter 5.00
PE 186 Dynamotor 10.00
PE 206 Inverter 12.00
PE 218 Inverter 7.50
2J 26 Tubes 1.75
707A Tubes 1.75
Lip Mikes85
Throat Mikes15
MR 44A Mount for TA 2J 24.. 3.50

CRYSTALS IN 21
Brand new—Sylvania—each in lead
Sheath 50,000 @ .06 ea.

TALLEN CO., INC.

159 Carlton Ave. Brooklyn 5, N. Y.
Triangle 5-8241

PANORAMIC ADAPTER AN/APA-10

Provides 4 Types of Presentation:
(1) Panoramic (2) Aural
(3) Oscillographic (4) Oscilloscopic

Designed for use with receiving equipment AN/ARR-7, AN/ARR-5, AN/ARR-4, SCR-587 or any receiver with I.F. of 465 kc. 5.2mc or 80 mc. 21 tubes in— \$97.50



INSTRUCTION MANUAL. 80 pages of technical data covering the panoramic adapter, AN/APA-10 including circuit analysis, parts lists, sectional photographs, etc. \$2.75

NEW SCR-522A EQUIPMENT

Complete BC-624C receivers and BC-625AM Transmitters including mounting racks, plugs, connectors, dynamotor. Brand new equipment with instruction manuals. Write for full details.

NEW REPAIR PARTS FOR BC-348 (Models H, K, L, R only)

4 gang tuning capacitor \$ 1.95
Aluminum front panel \$ 2.00
1st, 2nd, 3rd, and 4th I.F. transformer assy. Each \$ 2.00
Crystal filter assy. inc. 915 Kc. Crystal \$ 6.50
C.W. Oscillator assembly \$ 2.40
915 Kc. Mounted Crystal \$ 2.75
R.F. Unit Assembly in can. \$12.50
Dual Volume Control \$ 2.75
Spinner tuning knob \$.50
Ant., RF, Det. and Osc. coils for bands 1 to 6. Per Band \$ 2.00
Complete Dial assembly \$ 9.95

10 CM RADAR ANTENNAS

SO-1 (1CM) assembly with reflector, waveguide nozzle and drive motor. \$279.50
SO-3 (3CM) Surface Search type with reflector and drive motor, but less plumbing. \$92.50
SO-13 (10CM) Complete assembly with 24" dish, dipole, drive motor and gearing. \$49.50

RA38 RECTIFIER

Variable output 0-15000 V DC @ 500 MA. Input 115V 60 cy. 1 ph. Size 63 x 53 x 66 in. Write for detailed information.

HIGH POT TRANSFORMER

Westinghouse. Pri: 115, 60 cy. Sec: 15,000V C.T., @ .060A, C.T. ungrounded. Excellent for high potting tests. Size OA 12H x 8 1/2 W x 9 1/4 D. Weight 67 lbs. Fully enclosed steel case. Price \$29.50

30-10,000 CYCLE MODULATION TRANSF.

For RCA, Type 250-K Broadcast Transmitter (M1-7242) P to P Primary Imp. 15,000 ohms. Secondary Loads 5,030 ohms. Size 11 1/4 x 9 1/2 x 13". Wt. 143 lbs. New. \$39.50

6 KVA. STEPDOWN TRANSFORMER

G. E. Step-Down. 6KVA. Pri: 230/460. Sec: 115/125, 60 cy. Size: 20" x 11" x 9 1/2". Weight 225 lbs. Navy grey finish, integral junction box and mounting brackets \$49.50

HIGH VOLTAGE OIL CAPACITORS

MFD.	Volts	Price
.001	50 KV	22.50
.01	5 KV	2.50
.02	8 KV	4.50
.02	20 KV	6.75
.025	50 KV	17.95
.025-.025	50 KV	34.50
.1	3 KV	1.75
.1-	4.5KV	3.50
.13E	7.5KV	6.95
.2	50 KV	29.50
.25	15 KV	13.95
.25	20 KV	15.95
.25	50 KV	44.50
1.	7.5KV	6.95
1.	15 KV	29.50
2.	5.5KV	9.50
2.	6 KV	12.50

SPECIAL

1.0 MFD. 7500 VDC

OIL FILLED CAPACITOR.

Cat. No. 26F681

Price \$6.95

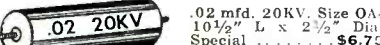

.02 mfd. 20KV. Size OA-10 1/2" L x 2 1/2" Dia. Special \$6.75

G.E. SERVO AMPLIFIER

Used in B29 planes for Central Station Fire Control Systems B2, B3 and B4. Used to drive Ampidyne 5AM31N9A and Control Motor 5BA50-L2A listed below. New less tubes. \$29.50

AMPLIDYNE

G.E. 5AM31N9A. 530 Watts. 7500 RPM. Input: 27 VDC. Output: 60VDC. Weight 34 1/2 lbs. \$23.50

CONTROL MOTOR

G.E. 5BA50LJ2A. Armature 27VDC at 8.3 Amps. Field 60VDC at 2.3A RPM 4000. H.P. 0.5 New \$27.50

9 CONDUCTOR CABLE

Army spec. CO-215 Weather-proof 9 Cond. No. 20 AWG stranded tinned copper, plastic ins., color coded, double vinyl jackets with tinned copper braid between Dia. 9 1/16" made by G.E. Available 1000, 1500, 2000 ft. reels. Price \$10 ft. Sample 100 ft. Coil \$10.00

Phone: DEerfield 7-0044

ELECTRONICRAFT
27 MILBURN ST. BRONXVILLE 8, N. Y.

TELEPHONE RELAYS



Large Stock of
CLARE, TYPES C D & E
COOKE, AUTOMATIC—ELECTRIC
ALL TYPES OF COILS and PILE-UPS

Send Us Your Specs. for Our Quote

Coil	Contacts	Operates at	Price
1) 6500 ohms	2A	4 MA	\$2.50 ea.
2) 5800 ohms	3A	4 MA	2.50 ea.
3) 5800 ohms	2B-1C	5 MA	2.50 ea.
4) 4850 ohms	1C	4 MA	2.50 ea.
4) 2600 ohms	1C	6 MA	2.00 ea.
5) 4850 ohms	1A	5 MA	2.00 ea.
6) 3300 ohms (None)	ACTUATOR		
7) 3300 ohms	1A	Micro-Switch	2.50 ea.
8) 3000 ohms	1C	5 MA	1.75 ea.
9) 3000 ohms	1B	5 MA	1.50 ea.

All above Relays may be used for continuous duty operation on 110V. D.C.

Coil	Contacts	Operates at	Price
1) 1300 ohms	1A-1C	24 or 48V	\$2.50 ea.
2) 400 ohms	1A	24V	1.65 ea.
3) 500 ohms	1D	24V	1.65 ea.
4) 200 ohms	1A	24V	1.50 ea.

Coil	Contacts	Operates at	Price
1) 1300 ohm	1B	24 to 85V	\$2.25 ea.
2) 1300 ohm	2A-1B	24 to 85V.	2.75 ea.
3) 1300 ohm	2C-1A	24 to 85V	3.00 ea.
4) 1300 ohm	4C-2A	30 to 85V.	4.00 ea.
5) 1300 ohm	2A-1B-1C-1D	30 to 85V	3.00 ea.
6) 1300 ohm	6C	30 to 85V	4.50 ea.
7) 2500 ohm	1A	24 to 110V.	2.25 ea.
8) 2000 ohm	2C-1A	24 to 110V.	3.00 ea.
9) 2000 ohm	4C-2A	30 to 110V.	4.00 ea.
10) 2000 ohm	6C	30 to 110V.	3.50 ea.
11) 2000 ohm	8A	35 to 110V.	4.50 ea.
12) 3000 ohm	3A	24 to 150V.	2.75 ea.
13) 3300 ohm	1A	24 to 150V.	2.50 ea.
14) 3600 ohm	2C-1A	24 to 150V.	3.00 ea.
15) 110V. A.C. 2C-1A		110V. A.C. 60cy	3.50 ea.

CONTACT SYMBOLS

A=Norm. Open B=Norm. Closed C=S.P.D.T.
D=Make Before Break

Allied Type LKX-58 Tel. Relay. Coil-5,000 ohm contacts—3A Operates at 6 MA. Price—\$2.50 ea.

Signal Wheellock Relays #KS9665 Coil—2,000 ohms Contacts—1A, 1B, 1C Oper. at 9 MA. Price—\$2.75 ea.

MINIATURE TEL. RELAY, 300 ohms, 24 volt SPDT \$1.65 ea.
FIVE Prong CR-2791 G.E. Plug In Relays:
1) C-103C25 2900 ohms SPDT 4.5 MA. \$4.00 ea.
2) C-104B28 700 ohms SPDT 6 MA. \$3.00 ea.

Bulletin #700 Allen Bradley Contactors 110V AC 60 cy. D.P.S.T. N.O. 25 Amps. \$7.50 ea.

Coil	Contacts	Price
1) 24V. 260 ohms	DPDT	\$1.25 ea.
2) 24V. 100 ohms	DPST NO	1.00 ea.

Clare SK-5032 (Herm. Sealed) Plug-In Relays. Coil—30 ohms 6 volts contacts—DPDT. Price \$4.00 ea.

SIGMA TYPE 5F SENSITIVE RELAYS. Has two 70 ohm coils. Contacts—SPDT. Price—\$3.00 ea.

POWER RELAYS

1) GM #13017 Relays, 24 volts 150 ohm. Contacts—3PDT 10 Amp. Price—\$2.00 ea.
2) Leach Relays Type 1025-SN-BE, Coil—24V. 425 ohms. Contacts—D.P.S.T. Norm. closed. Rated at 10 Amps. Price—\$1.25 ea.

Chase Electronic Supply Co.
105-07 225 St.
Queens Village, N. Y.
HOLLIS 4-5033

Component Bargains!

LARGE QUANTITY

3BPI—RCA. Yalgine, Individ. Box \$1.00
6F8G (6SN7 with Top Cap) standard brand. 25c
1632 Jan Box (in lots of 100) 15c
Quantity Prices on Request

CARBON 1/2 W \$10 per M. Min. Order
RESISTORS 1 W 20 per M. 100 of
2 W 30 per M. Each

8 mfd 450V Condensers 15

CONTROLS—1/2 & 1meg w/switch 28c

CERAMIC CONDENSERS—Tubular. All Sizes
\$25 per M. Min. order 100

70° CONSOLE YOKE \$1.25
90° CONSOLE YOKE 2.00

TRIMMER CONDENSER NPO 3-12 MMF white round 250 to a Box 12c each
TRIMMER, CONDENSER, AIR—4 and 5 plate type 12c each

And Many Other Items

We Also Purchase Your Surplus Inventory

BELVISION, INC
254 Greenwich St., N. Y. 7, N. Y. BA 7-6063

National

CLASSIFIED ADVERTISING

for bringing business needs or opportunities to the attention of men associated in administrative, executive, management, sales and responsible technical, engineering and operating capacities with the industries served by

The CLASSIFIED SECTIONS of

- | | |
|---------------------------------------|----------------------------------|
| American Machinist | Electronics |
| Aviation Week | Engineering & Mining Journal |
| Bus Transportation | Engineering News-Record |
| Business Week | Factory Management & Maintenance |
| Chemical Engineering | Fleet Owner |
| Chemical Week | Food Engineering |
| Coal Age | National Petroleum News |
| Control Engineering | Nucleonics |
| Construction Methods & Equipment | Petroleum Processing |
| Electrical Construction & Maintenance | Power |
| Electrical Merchandising | Product Engineering |
| Electrical Wholesaling | Textile World |
| Electrical World | |

For advertising rates or other information address:

Classified Advertising Division

McGRAW-HILL PUBLISHING CO., INC.

330 W. 42nd St., New York 36, N. Y.

SEARCHLIGHT Equipment Spotting Service

This service is aimed at helping you, the reader of "SEARCHLIGHT", to locate Surplus new and used electronic equipment and components not currently advertised. (This service is for USER-BUYERS only). No charge or obligation.

How to use: Check the dealer ads to see if what you want is currently advertised. If not, send us the specifications of the equipment and/or components wanted on the coupon below, or on your own company letterhead to:

SEARCHLIGHT EQUIPMENT SPOTTING SERVICE

c/o ELECTRONICS—Classified Advertising
330 West 42nd Street, New York 36, N. Y.

Your requirements will be brought promptly to the attention of the equipment dealers advertising in this section. You will receive replies directly from them.

NO CHARGE • NO OBLIGATION

SEARCHLIGHT EQUIPMENT SPOTTING SERVICE, c/o Electronics, 330 W. 42nd St., New York 36, N. Y.

Please help us locate the following used equipment:

.....

 NAME TITLE COMPANY.....
 STREET CITY..... ZONE..... STATE.....

5/55



COMPASS ELECTRONICS SUPPLY

A Division of Compass Communications Corporation

WE MAINTAIN OUR OWN FULLY EQUIPPED TESTING LABORATORY TO TEST AND GUARANTEE ANYTHING WE SELL

Wholesale, Industrial and Institutional Sales Only

TEST SETS RECEIVERS

- | | |
|--------------|--------|
| TS-3A*AP | ARB |
| TS-10A and B | ARC-1 |
| TS-12*AP | ARC-3 |
| TS-13*AP | ARC-4 |
| TS-14 | ARC-5 |
| TS-16*AP | AR-88 |
| TS-36*AP | ART-13 |
| TS-61*AP | CR-91 |
| TS-62*AP | SLR |
| TS-74*UPM | RAK |
| TS-89*AP | RAL |
| TS-101*AP | RAO |
| TS-125*AP | RBB |
| TS-173*UR | RBO |
| TS-278 | RBG |
| TS-323 | RBL |
| TS-UPM-1 | RBA |
| OAA | RBM |
| OAP | RCH |
| OBU | BC-224 |
| LAE | BC-312 |
| LM | BC-314 |
| LU | BC-344 |
| IE-19 | BC-348 |
| 1-46 | |
| 1-56 | |
| 1-208 | |
| 1-222 | |
| SCR-211 | |

AND OTHERS

AND OTHERS FIELD EQUIPMENT

- | | |
|---------------|---------|
| TRANS-MITTERS | SCR-274 |
| TAJ | 284 |
| TAQ | 300 |
| TBL | 399 |
| TBK | 503 |
| TBM | 536 |
| TBN | 808 |
| TCE | 828 |
| TCP | BC-191 |
| TDE | 375 |
| TDO | 603 |
| TDO | 604 |
| | 610E |
| | 683 |
| | 684 |
| | 923 |
| | 924 |
| AND OTHERS | 1000 |
| | 1306 |

TEST SETS

- TS-13/AP-X BAND RADAR TEST SET—Measures power, freq. signal-to-noise ratio, I.P. Bandpass, etc. Input—115/1/60—800 **WRITE**
- TS-35A/AP-X-BAND—Measures transmitted power & frequency of Radar Transmitters, also used for receiver adjustments **NEW . \$375.00**
- TS-100/AP—TEST SCOPE, type A, R, J & X indications, gated & ungated sweep, Int. or Ext. trigger **WRITE**

SPECIAL PURPOSE TUBES

Write for Latest Listing at Great Savings, of New Tubes, Standard Brands Only—Guaranteed!

MICROWAVE ACCESSORIES

- 15 LB. ALNICO-V MAGNET—approx 4800 gauss \$16.00
- WAVEGUIDE, FLEX, with flanges, 3 cm., 12" L. \$12.50 ea.
3 CM., 24" L.,—\$14.00 ea. 10 CM., 60" L.,—\$22.50 ea.
- BENDS, E. & H. plane; 3 & 10 CM. **WRITE**
- DUPLXER, Mixer & Preamp Ass'y., 3 CM. **WRITE**
also cavities, klystron mounts, rotating joints, circular waveguide stubs, etc. **WRITE**
- WESTERN ELECTRIC VARISTORS, THERMISTORS, Res. Networks, Relay Ass'y, Precision Potentiometer, ±60 A Key Selectors, etc. **WRITE**

RADAR BEACONS

- YJ and YG . . . for shipboard use AN/CPN-8 10 cm.
AN/CPN-6 3 cm. AN/APS-2, APS-3, APS-4, APS-6, APS-15
- Also SA, SF, SG, SD, SJ, SK, SN, SQ—both equipment and spare parts

SA-2 RADAR

Used for air traffic control, tracking and search, both land-based and ship-borne, 5 microsec. pulse, PPI indication, operates at 200 mcs, peak power of 150 K.W. Input 110/120 volts a.c. 4 complete installations in stock.—Write for price.

Write for More Details on Any Particular Item in Which You are Interested. These are partial listings only of our stock. Please write for other types.

393 Greenwich St. New York 13, N. Y.
BECKMAN 3-6510 Cable: COMPRADIO, N. Y.

MOTOR GENERATORS AND CONVERTORS

- 50, 60, 400 and 800 cycle and DC Power Supplies
- 28dc to 110/1/800@1kva **\$49.50**
(Overall length: 12 inches)
- 110dc to 110/1/800@350va **150.00**
- 110ac to 110/1/800@350va **235.00**
- 110dc to 110/1/400@2kva **395.00**
- 110/1/60 to
110/1/400@2kva **435.00**
- 220/1/60 to
110/1/400@2kva **435.00**
- 440/3/60 to
110/1/400@2kva **435.00**
- 32dc to 110/1/60@350va **100.00**
- 110dc to 110/1/60@350va **100.00**
- 110dc to 28dc@250va **95.00**
- 110/1/60 to 28dc@250va **115.00**
- 220/1,3/60 to 28dc@250va **115.00**
- 110dc to 110/1/60@1.25kva **135.00**
- 220dc to 110/1/60@1.25kva **145.00**

Partial listings write for others

SYNCHROS & SELSYNS

- | | | | |
|----------------|---------|-----------------|---------|
| 5F | \$40.00 | 7G | \$70.00 |
| 5G | 45.00 | 2J1F1 | 10.00 |
| 5CT | 45.00 | 2J1G1 | 10.00 |
| 5SDG | 27.50 | 2J1H1 | 10.00 |
| 6G | 55.00 | | |

115 V AC BLOWER

w/motor, 1/150 h.p. 3000 RPM **\$10.00**

WANTED WANTED

BC610-E, 614-E, 939
ART-13, ARC-1, ARP-4

ALLTRONICS, Box 19, Boston 1, Mass.
Telephone: Richmond 2-0048, 2-0916

WILL BUY ALL

- | | | |
|--------------------------|-------------------------|----------|
| Art-13 T47A Transmitters | BC-348 Rec'r modified | \$25.00 |
| Art-13 T-47 Transmitters | BC-348 Rec'r unmodified | \$50. |
| BC-788C Altimeters | ARC-1 Radio complete | \$150.00 |
| RS/ARN7 Radio Compass | BC-312 Receiver | \$200.00 |
| ARC-3 Complete | BC-342 Receiver | \$50.00 |
- Ship via Express C.O.D., Subject to Inspection to:
H. FINNEGAN
49 Washington Ave. Little Ferry, N. J.

WANTED

ART-13 transmitters, parts, and components, DY-12 and DY17 dynamotors, CU-25 etc. Also ARC-1 and ARN-7 material.
Advise price, condition first letter.

FLORIDA AIRCRAFT RADIO & MARINE, INC.
International Airport Branch
P. O. Box 205 Miami 48, Florida

WANTED

Type R19/TRC-1 Receivers

W-3652, Electronics
330 W. 42 St., New York 36, N. Y.



AN/APR-4 LABORATORY RECEIVERS

Complete with all five Tuning Units, covering the range 38 to 4,000 Mc; wideband discone and other antennas, wavetraps, mobile accessories, 100 page technical manual, etc. Versatile, accurate, compact—the aristocrat of lab receivers in this range. Write for data sheet and quotations.

We have a large variety of other hard-to-get equipment, including microwave, aircraft, communications, radar, and laboratory electronics of all kinds. Quality standards maintained.

NEW TS-13/AP X-BAND SIGNAL GENERATORS with manual \$575.00; T-47A/ART-13 Transmitters, \$450.00; H-P, Boonton, G-R, Measurements, many others in stock.

ENGINEERING ASSOCIATES

434 PATTERSON ROAD

DAYTON 9, OHIO

Manufacturers Does your
Experimenters AC Line-
Laboratories Voltage vary?
THEN THIS BARGAIN IS FOR YOU!

The U. S. Air Force abandoned a project that required ABSOLUTELY CONSTANT 115 V. from a nominal 115 V. line or nominal 220 V. line in either 50 or 60 cycle locations. So—IN THIS ONE SOLA CONSTANT-VOLTAGE TRANSFORMER THEY INCORPORATED ALL OF THESE INPUTS (by your choice of connections per instructions on etched plate).

115 V. input can vary from 95 to 125 V., 220 V. input can vary from 190 to 250 V.—but output is always 115 V. (with negligible variations) at any output current up to 17.4 amps (2000 VA). Secondary is isolated from primary. Sola Cat. No. 30768. BRAND NEW in original wood box 1 1/4 cu. ft. Ship wt.: 254 lbs. F.O.B. Pasco, Wash. Only . . \$149.50
(Exporters: Note choice of 50 cycles.)

THE M. R. COMPANY
P. O. Box 1220-B Beverly Hills, Calif.

OFFERING IN MARINE SPECIALTIES

- SONAR DOMES—Navy 60"—Standard all window. CW-177A/U. B. F. Goodrich.
- DEAD RECKONING ANALYZERS—Navy Mark VI. Complete with Dummy Log. Arma.
- DEAD RECKONING TRACERS—Navy Mark VI. With Auxiliary Plotting. Arma.
- ELECTRIC MEGAPHONES—Navy PAE-1. 20-watt audio. With Charge Rack & Spares.

CUNNINGHAM ENGINEERING COMPANY
P. O. Box 707 Beaumont, Texas

BRAND NEW GUARANTEED ENTIRE INVENTORY NEW LOW PRICES

POWER RHEOSTATS	
"H" 25 ohm—25 watts (W/SH).....	89¢
<i>(Largest Variety Available)</i>	
2-WATT POTENTIOMETERS	
Type "J" 10K Ω (½" Bu. 1½" SH).....	75¢
<i>(Largest Variety Available)</i>	
4-WATT WIREWOUND POTS	
500-ohms, ¾" Bu.-½" SH.....	39¢
<i>(Largest Variety Available)</i>	
POWER RESISTORS	
500-ohms, 200-watt.....	95¢
<i>(Largest Variety Available)</i>	
PRECISION RESISTORS	
WW4 1.0 meg.-1%.....	\$1.50
<i>(Largest Variety Available)</i>	
KOOLOHM RESISTORS	
22-ohms 10KT (10 W.).....	15¢
<i>(Largest Variety Available)</i>	
GLASS FERRULE RESISTORS	
<i>(Types 15P to 120P—Largest Variety Available)</i>	
HIGH-POWER TRANSMITTING MICAS	
Type #G1 V. .09 - 1500 V. (22A/1000KC).....	\$5.95
<i>(Largest Variety Available)</i>	
MEDIUM-POWER TRANSMITTING MICAS	
Type #F2L - .002 - 6000 V.....	\$1.98
<i>(Largest Variety Available)</i>	
LOW-POWER TRANSMITTING MICAS	
Type #4LS - .01 " 1200 WVDC.....	49¢
<i>(Largest Variety Available)</i>	
TERMINAL (JONES) STRIPS	
Series: #140, #141, #142, #240, #150, #2000.....	
<i>(Largest Variety Available)</i>	
PLUGS (JONES) SOCKETS	
Series: #101, #300, #400, #500, #2400.....	
<i>(Largest Variety Available)</i>	
OVER 250,000 IN STOCK "AN" CONNECTORS "UG" AMPHENOL—CANNON	
TO YOUR SPECS MOSSMAN 4101 SWITCHES <i>(Largest Variety Available)</i>	
MISCELLANEOUS	
JK 48 Jacks.....	18
IE 48 Lamps.....	20
12-Terminal Westinghouse Blocks.....	1.49
Weston 252, 0-1A (1KW) Meters.....	14.95
GP Switchette CR1070-C103-R3.....	.29
RCA 1268 GT TUB2 "Tan" Ind. boxed.....	.49
Haydon 1600A-1RPM—115 VAC.....	1.50
JK 26 Jacks.....	.21
Omrite #412-6 50A, Tap Switch.....	5.49

SPECIAL SALE

15 MFD 600 VOLTS D.C.

Famous Make Oil Filled Condenser
3" wide & 2-1/2" thick x 4-1/2" high, 3-1/2" mounting centers

Production Quantity **1.79 ea.**
Available At Lowest Prices

BATHTUB CAPACITORS	
Type CB - 2 Mtd. 600 V.....	75¢
<i>(Largest Variety Available)</i>	
CHANNEL TYPE CAPACITORS	
618 MC - 1 Mtd. 600 VDC.....	59¢
<i>(Largest Variety Available)</i>	
BIRTCHEER TUBE CLAMPS	
Type #926 A.....	25¢
<i>(Largest Variety Available)</i>	
LORD SHOCKMOUNTS	
Type 100 P-2 (2-lbs.).....	15¢
<i>(Largest Variety Available)</i>	
SELECTOR SWITCHES	
1315-L (2P - 5 Pos - N/SH).....	35¢
<i>(Largest Variety Available)</i>	
TUBE SOCKETS	
Johnson 226 Series (4-5-6-7-8).....	18¢
<i>(Largest Variety Available)</i>	
OVERCURRENT RELAYS	
GE CR2801726—C6B/230 V-60 e—4A.....	
—C6A/115 V.....	4.95
—C3B/230 V.....	15A
INSTRUMENT FUSES	
8 AG—1/100 A Cnd 1/32 A.....	.05 ea
5 AG—40 A Type #1100.....	.20 ea
5 AG—25 A Type #1098.....	.20 ea
NOISE FILTERS	
Filttron FA-308A 2A, 50 VDC.....	49¢
<i>(Largest Variety Available)</i>	
FUSE EXTRACTOR POSTS	
Littlefuse #442001 (4AG).....	18¢
<i>(Largest Variety Available)</i>	
RESISTANCE WIRE	
Cupron #28 Double Nylon Covered 1.8 ohms pr. ft. 3½-lb Spools.....	(per spool) \$2.49
FLEXIBLE COUPLINGS	
Johnson #104-250.....	25¢
<i>(Largest Variety Available)</i>	

**(COMPLETE LISTS AVAILABLE.)
Get On Our Active Mailing List**

A. MOGULL CO.

17 Warren St., N. Y. 7, N. Y.
Phone: WORTH 4-0365

INDEX TO THE SEARCHLIGHT ADVERTISERS

SEARCHLIGHT SECTION (Classified Advertising) H. E. Hilty, Mgr.

EMPLOYMENT

Positions Vacant.....	412-437
Selling Opportunities Offered.....	404, 437
Positions Wanted.....	414, 416
Selling Opportunities Wanted.....	416
Employment Agencies.....	414
Employment Services.....	414

SPECIAL SERVICES

Contract Work Wanted.....	416
---------------------------	-----

PROPERTY

For Rent.....	416
---------------	-----

EQUIPMENT

(Used or Surplus New)	
For Sale.....	438-454

WANTED

Equipment.....	451
----------------	-----

ADVERTISERS INDEX

Admiral Corp.....	425
Allied Electronic Sales.....	444
Alltronics.....	438, 451
Amber Industrial Corp.....	440
Arrow Sales Inc.....	444
Barry Electronics Corp.....	444, 447
B & C Distributors Co.....	438
Beeber Co., Inc. J.....	444
Belvision Inc.....	448
Bendix Aviation Corp.....	
Pacific Division.....	429
Products Division.....	423
Radio Division.....	420
York Division.....	433
Blan.....	440
Brush Electronics Co.....	418
Burroughs Research Center.....	419
Cadillac Employment Agy., Inc.....	414
Calidyne Co., The.....	428
Calvert Electronics.....	444
Canadair, Ltd.....	421
Cardwell Electronics Prod., Corp., Allen D.....	435
Chance Vought Aircraft Inc.....	432
Chase Electronic Supply Co.....	448
C & H Sales Co.....	439
Communications Equipment Co.....	443
Compass Electronics Supply.....	451
Convair, A Division of General Dynamics Corp.....	427
Cornell Aeronautical Laboratory.....	427
Cunningham Engineering Co.....	451
Drake Personnel Inc.....	414
Dynamic Electronics of N. Y. Inc.....	434
Electronic Engineering Co. of Calif.....	422
Electroncraft Inc.....	448
Electronics Corp. of America.....	433
Emerson Electric Mfg. Co.....	418
Empire Electronics Co.....	449
Engineering Associates.....	451
Fair Radio Sales.....	442
Farnsworth Electronics Co.....	431
Fay-Bill Distributing Co.....	449
Federal Mfg. & Eng. Corp.....	437
Federal Telecommunication Labs.....	426
Finnegan, H.....	451
Florida Aircraft Radio & Marine Inc.....	451
General Electric Co.....	422
General Precision Labs Inc.....	424
Goodyear Aircraft Corp.....	417
Graebner's Exchange.....	414
Hallierafters Co., The.....	436
Hammarlund Mfg. Co., Inc.....	437
Hodgson Co.....	416
Harjo Sales Co.....	442
Hershel Radio Co.....	453
Hoffman Laboratories Inc.....	434
Industrial Nuclonics Corp.....	432
Industrial Research Labs.....	431
Instrument Service.....	440
Interstate Electronics Inc.....	440
Johns Hopkins University, The.....	433
JSH Sales Co.....	445
Kato Engineering Co.....	449
Kollman Instrument Corp.....	434
Legri S. Co., Inc.....	440
Liberty Electronics Inc.....	453
Lockheed Aircraft Corp.....	415
Maryland Electronic Mfg. Corp.....	431
Massachusetts Institute of Technology.....	428
Medical Salvage Co., Inc.....	453
Melpar Inc.....	430
Michigan, University of.....	418
Mogull Co., Alexander A.....	452
Monarch Personnel.....	414
Motorola.....	437
M. R. Company.....	451
National Cash Register Co.....	424
New Haven Clock & Watch Co.....	418
Page Communications Engineers, Inc.....	424
Pennsylvania State University.....	430
Photocon Sales.....	444
Radalab.....	438
Radio Corp. of America.....	412, 413
Radio & Electronic Surplus.....	442
Radionic Products.....	449
Ramo-Wooldridge Corp.....	420
Raytheon Manufacturing Co.....	416, 424, 426, 437
Raway Sales.....	444
Relay Sales.....	446
Remington Rand Inc.....	
Engineering Research Associates Div.....	435
Eckert-Mauchly Division.....	429
Republic Aviation Corp.....	420
Snyder Co., Lee Grant.....	416
Stewart-Warner Electric.....	428
Strickland Electric Co.....	453
Stromberg-Carlson Co.....	435
Sturgess, Inc.....	435
Sylvania Electric Products, Inc.....	423
Missile System Lab.....	427
"TAB".....	454
Tallen Co., Inc.....	448
Telemarine Communications Co.....	446
Theta Co.....	416
Universal General Corp.....	446
Vitro Laboratories.....	432
Wells Sales Inc.....	438
Western Engineers.....	441
Westinghouse Electric Corp.....	414
Wright, W. C.....	416

This index is published as a convenience to the readers. Care is taken to make it accurate but ELECTRONICS assumes no responsibility for errors or omissions.

MAY SPECIALS

TRANSTAT 100 AMP

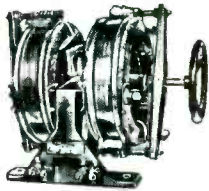

ONLY
\$149.

Pri. 115 VAC 60 cy.
11.5 KVA Sec. 0-115 VAC 60 cy 100 Amp
Max. MPD. Amertron. BRAND NEW.

ALL PURPOSE FILAMENT TRANSFORMER

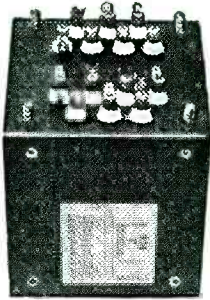

\$4.95
PRI-115AC
60 CY.

BRAND NEW
Sec.
6.4v 12 amp.
6.4v 10 amp.
5v 3 amp.
5v 3 amp.
5v 3 amp.
2.5v 1.75 amp.

SIZE: 5 9/16" x 5 1/16" x 5 3/4" H.

CONTRACTOR RELAY

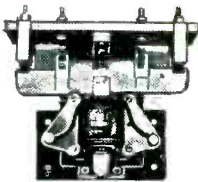

\$9.95

110 VAC 60 cy
D. P. - D. T. 15
Amp. Contacts
2500 V. RMS
to Ground My-
calex. I n s.
Brand New.

VACUUM SWITCH

Type VS-2



\$2.75

15000 V Con-
tacts 30 Amp
Operates with
DC Coil Spdt
Mfg. by Elmec

PLATE TRANS.



Only
\$9.95

Pri. 90 VAC 60 cy 3
Amp. Sec. 6400 V. .1
Amp 6 1/2" x 5 1/2" x 6 1/2"
H.



TYPE A

196 to 320 MC.
Can Use 9 5 5
Type Tube.



TYPE B

135 to 485 MC
Silver Plated.



TYPE C

300 to 1000
MC Can Use
368AS Tube.
Silver Plate.

YOUR
CHOICE

\$9.95

BRAND NEW



TYPE D

300 to 1000
MC Has Clip
For Xtal De-
tector

HERSHEL RADIO CO.

5245 GRAND RIVER

DETROIT 8, MICHIGAN

PHONE TYLER 89400

ALL PRICES NET F.O.B. DETROIT

NEW YORK'S RADIO TUBE EXCHANGE

NEW TUBES

Standard brands. First grade only. No pull outs. No rejects. No rebrands. At lowest prices. Wholesale and export only.

Type	Price	Type	Price	Type	Price	Type	Price	Type	Price	Type	Price	Type	Price
OA2	\$1.00	2J42	36.00	3GP1	5.00	LM15	225.00	371B	1.50	728B	45.00	958A	.60
OA3	1.10	2J36	98.00	3Z1	75.00	15E	1.75	385A	4.50	720C	45.00	959	2.25
OB2	.99	2J38	8.95	4B26	5.40	15R	.75	388A	1.50	730A	22.50	E1148	.25
OB3	1.10	2J39	8.59	4C27	10.00	NE16	.59	393A	7.50	7501L	45.00	1280	.95
OC3	.96	2J40	29.00	4C28	35.00	20-4	.75	394A	3.95	801A	.90	1500T	135.00
OD3	.89	2J42	135.00	4E27	15.00	KV21A	8.25	NK408U	1.50	807	1.25	1554	75.00
C1B	2.95	2J49	60.00	4J26	150.00	RK21	2.50	417A	15.00	803	5.95	1603	5.00
1B22	1.50	2J50	55.00	4J26	150.00	RX21	8.00	434A	15.00	805	4.95	1612	1.50
1B23	6.95	2J55	150.00	4J27	150.00	R124G	1.50	446A	1.95	807	1.25	1618	1.25
1B24	12.00	2J56	110.00	4J28	150.00	25T	2.95	446B	3.95	808	1.95	1616	1.25
1B26	1.75	2J61	35.00	4J29	150.00	RK30	2.75	460T	45.00	809	2.95	1619	.45
1B28	1.75	2J62	35.00	4J30	130.00	1P30	1.75	450TH	52.50	810	10.50	1622	1.50
1B38	35.00	2K22	29.00	4J31	150.00	HK54	4.50	464A	7.50	811A	3.75	1624	1.75
1B30	23.00	2K23	15.00	4J32	150.00	RK72	1.00	471A	1.25	812A	3.95	1625	.35
1B31	7.50	2K28	15.50	4J33	150.00	100TH	1.00	527	18.00	813	13.75	1626	.75
1B58	35.00	2K29	68.00	4J34	100.00	FG95	19.95	WLS30	23.00	814	3.75	1631	1.80
1B60	35.00	2K28	35.00	4J35	150.00	100TH	7.95	WLS31	22.50	815	3.25	2000T	150.00
1N21	1.25	2K29	35.00	4J36	150.00	FG105	20.00	WLS33	15.00	816	1.45	2050	1.80
1N21A	1.75	2K33A	75.00	4J37	150.00	122A	1.75	HK854	35.00	829	11.00	2051	1.00
1N31B	2.75	2K39	140.00	4J38	150.00	203A	7.50	700A/D	10.00	829A	12.00		
1N31C	14.50	2K41	135.00	4J39	150.00	211	.95	701A	4.50	829B	12.50		
1N22	1.00	2K42	180.00	4J40	150.00	217C	12.00			832A	9.95		
1N28	1.95	2K43	199.00	4J41	150.00	242C	10.90	703A	3.95	832A	9.95		
1M23A	2.75	2K48	44.00	4J42	150.00	244C	9.50	704A	1.95	833A	45.00		
1M23B	2.75	2K50	275.00	4J51	190.00	249C	4.25	705A	2.75	834	7.50		
1N23C	7.50	2K54	35.00	4J52	225.00	250TH	19.95	706A/Y/FY		836	3.95	5280	475.00
1N25	4.50	2K55	25.00	4J53	225.00	250TL	12.00			837	2.75	8012	2.00
1N26	6.75	2K56	72.00	5J1P1	3.95	262A	3.00	707A	9.75	838	5.95	8012A	2.50
1N27	3.50	3A1P1A	10.00	5HP2A	12.00	274B	2.75	707B	15.00	849	35.00	8013	3.00
1N31A	1.75	3B1P1	7.20	5B4	3.95	304TH	10.00	714A	18.00	880	1.50	8013A	3.50
1N43	2.25	3B24	5.50	6CP1	10.00	304TL	4.95	715A	4.50	881A	25.00	8018	1.75
1P25	75.00	3B25	5.50	6CP7	9.95	307A	3.50	715B	9.00	886A	1.50	8020	1.80
2C39A	13.50	3B26	5.00	6CP7A	18.00	310A	4.50	715C	22.50	889B	67.50	8023	3.75
2C40	3.00	3B28	8.00	6CP8	15.00	310B	4.95	717A	1.50	889BX	50.00	1B365	96.00
2C43	14.50	EL3C	5.50	5J1P1	27.50	312A	6.50	719A	22.50	872A	3.50	9001	1.52
2C44	.60	3C22	75.00	5J1P2	19.50	319A	3.50	720A/Y/GY		874	1.50	9002	.90
2C46	1.50	3C24	1.75	5J1P4	27.50	323A	15.00			879	5.00	9003	1.25
21A	12.00	3C31	2.95	5J23	25.00	327A	3.75	721A	1.50	884	1.50	9004	.35
2J22	9.00	3D1P1	7.50	6A	11.00	323A	6.75	721A	1.50	885	1.50	9005	2.75
2J26	15.00	3D1A	10.50	5J21	16.00	310A/B	18.00	931A	5.00	9008	5.00	9008	.25
2J27	15.00	3D1A	10.50	7BP7	5.00	350B	5.95	724A	1.95	954	.35		
2J31	24.00	5Z	10.00	7DP4	9.00	HK364C	15.00	724B	2.25	955	.50		
2J32	25.00	3F1	5.00	12AP4	50.00	725A	18.00	725A	18.00	956	7.50		
2J33	32.00	3E29	15.50	12DPTA	59.00	368AS	4.95	726A	18.00	957	.25		

Various 5000 and 6000 series of new production
Thousands of other tubes

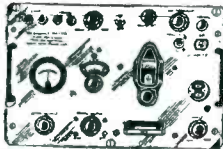

NEW TS-147 B AND C/UP TEST SET SIGNAL GENERATOR

Hard-to-get X-Band Now Available

Test Set TS 147 UP is a portable Microwave Signal Generator designed for testing and adjusting beacon equipment and radar systems which operate within the frequency range of 8500 MC to 9600 MC.

NEW UNUSED SURPLUS TS 259 K BAND 23400-24500 MEGACYCLES SIGNAL GENERATOR

NEW MICROWAVE TEST EQUIPMENT TS148/UP SPECTRUM ANALYZER

Field type X Band Spectrum Analyzer. Band 8430-9580 Megacycles.

Will Check Frequency and Operation of various X Band equipment such as Radar Magnetrons, Klystrons, TR Boxes. It will also measure pulse width, c-w spectrum width and Q or resonant cavities. Will also check frequency of signal generators in the X band. Can also be used as frequency modulated Signal Generator etc. Available new complete with all accessories, in carrying case.

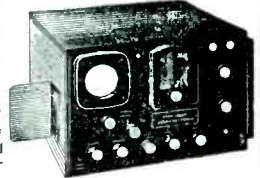

SPECIAL! 5,000 V. POWER SUPPLY

For IP25 Infrared Image Converter from 3 V. Battery Source.
NEW, Complete with RCA 1654 Tube

\$990

OTHER TEST EQUIPMENT USED CHECKED OUT, SURPLUS

- | | | | | |
|---------|-----------|----------|----------------|-------------|
| TSK1/SE | T35/AP | TS108 | TS182 | APA 38 |
| TS3A/AP | TS36/AP | TS110/AP | TS226 | APS 3 APS 4 |
| RF4/AP | 1-96A | TS125/AP | TS239A-TS239C | APR4 |
| TS12/AP | TS45 | TS126/AP | TS251 | APR5A |
| TS13/AP | TS47/APR | TS147 | TF890/1 | APR2-APT5 |
| TS14/AP | TS69/AP | TS170 | 83 | |
| TS15/AP | TS100 | TS174/AP | SURPLUS EQUIP. | |
| TS34/AP | TS102A/AP | TS175/AP | APA10 | |

You Can Reach Us on
TWXNY1-3235

Large quantities of quartz crystals mounted and unmounted.

Crystal Holders: FT243, FT171B others.
Quartz Crystal Comparators.
North American Philips Fluoroscopes Type 80

Large quantity of Polystyrene beaded coaxial cable.

Minimum Order 25 Dollars



Phone: WOrth 4-8262

LIBERTY ELECTRONICS, INC.

135 LIBERTY STREET,
NEW YORK 6, N. Y.

Cables: TELSERUP

CLOSE-OUTS

#36 Fahnstock clips: 90-A soldering lugs: Ammeters for 6 ampere battery chargers: 0-15 precision DC (Triplet) #321 ammeters: 6 ampere, 115 volt G-E rectifiers (220 V. input) Nos. 29, 30 & 31 SCE, #31 DCC & #44 HE magnet wire at closeout prices.
Special rectifiers, battery chargers & transformers made to order in any quantities.

STRICKLAND ELECTRIC COMPANY
COLUMBUS II, OHIO

INDUSTRIAL X-RAY INSPECTION EQUIPMENT

General Electric OX-200, XRD Diffraction, Picker, Standard, Westinghouse and Keleket units from 100 KV up. Special inspection booths made to order.

MEDICAL SALVAGE CO., INC.
217 E. 23rd St. N. Y. 10, N. Y.

TAB THAT'S A BUY

New Rectifier X fms

Table listing various rectifier models and their prices, including primary and secondary voltages.

110-115 V DC Power Supplies

For Fans, Shavers, Motors, Bells, Drills, Soldering, Business Machines, Battery Chrgs, Machine Tools & Signal Systems.

Table listing DC power supply models and their prices, including output voltage and current.

NEW 106W/SEC FOTOFASH KIT

AC & Dry Battery. Includes condenser, capacitor, rectifier, flash tube, and other components.

PHOTOFASH & STROBE LAMPS

Table listing various photoflash and strobe lamp models and their prices.

VARIABLE VOLTAGE XFMRs

Table listing variable voltage transformer models and their prices.

NEW "TABTRON" SELENIUM RECTIFIERS

ENGINEERED FOR INDUSTRY. "TAB" manufactures power rectifiers to your specifications.

Table listing selenium rectifier models and their prices, including full wave bridge and dated one year GTD.

Rectifier Chokes

Table listing rectifier choke models and their prices.

Convert Your 6V "Fast" Charger to 12V/50A as well as 6V/100A Use

Details & Rectifier. BCT 2/1A 2V Battery "T" Chg. BCT 6-12/2A & 12V Battery "T" Chg.

PULSE TRANSFORMERS

W.E. TR 1/3A & Y/0.25 u sec pulse 40-52 500 ohms/13 & 4.8 & 3 wdg. 1:1 ratio.

New "Cook" Diaphlex Ram Air Pressure Switch

W.F.D. adjustable, handles 5 amps. MFGD/1200VDC or 10MFD/600VDC.

BARGAINS! BARGAINS!

Planetary Drive, 4 & 1 to 1. Special \$2.49; 3 for \$7.00. Kilvstron Socket, Cinet 5/51.

High Current Power Supplies

ONE YEAR GTD. Variable 0-28VDC. Completely Build. Ready to Go.

Table listing high current power supply models and their prices.

New Power Your Gov't Surplus Recr's & Xmitters from the Set Power Pack

Dynamotor from 115 or 230 VAC. B28V/5A for ARCS, BC312, BC342, BC348.

New! Basic Supplies, 115 VAC In

Stock No. 115 WVD/DC at 5 Amp. B115P10A 115 WVD/DC at 10 Amp.

NEW VARIABLE 6 & 12 VOLT/12A

DC POWER SUPPLY. Battery Eliminator, Charger, Model RR, Player, Aircraft, Marine.

VARIATORS-THERMISTORS

Thermistor W.E. D168391... \$2.95 @ 3 for 58. Thermistor W.E. IC... \$2.00 @ 3 for 55.

MINIATURE HF Q INDUCTOR, 0.5 HENRY, MU METAL CORE

GLOBAL T2FD Ohms/500W-RF Ant. Resistor & Clips. New "Ames" Jeweled, Shockless #111 Precision.

FLEXIBLE WAVE GUIDES

CG168U/12/UG82U (E137858)... \$6.3/512. CG168U/12/UG82U (E137858)... \$2.3/55.

INFRARED SNOOPERSCOPE

Image-Converter Tube Hi-Sensitivity simplified design 2" dia. Willemite screen-Resolution up to 280 Lines/Inch.

230 TO 115V AUTOFORMERS

For 220V/50 60Hz Input. To 110-120V or Step up with Cord, Plug & Receptacle.

Table listing autoformer models and their prices.

SPECIALS ★ TEST EQUIPMENT

EMC #206 Mutual Cond. Tube Tester... \$67.50. Hickock #600A Tube Tester... \$164 Reg. \$150.

NEW SONIC SOUND GENERATOR

115VAC Input. Cleans! Agitates! Washes & Mixes. "TAB" SPECIAL \$29.95.

PHOTOFASH & STROBE LAMPS

TRIGGER COILS, HI VOLT LAMP. Write for "TAB" Flash Tube Data 50.

VARIABLE VOLTAGE XFMRs

Table listing variable voltage transformer models and their prices.

NEW PRECISION POTENTIOMETERS

Helipot 1000 Ohm/0.5%/10 Turn. Helipot 2000 Ohm/0.5%/10 Turn. Helipot 5000 Ohm/0.5%/10 Turn.

WE BUY MICRO & HELIPOTS

Table listing micro and helipot models and their prices.

Large table listing various electronic components and their prices, including resistors, capacitors, and diodes.

1st Quality • Hickock Mu Tested • FULL RETMA WARRANTY

TUBES!! FULL RETMA WARRANTY

NO ELECTRICAL OR MECHANICAL REJECTS

Table listing vacuum tube models and their prices.

PRECISION RESISTORS

All 1% Accuracy Gtd. "TAB" SPECIAL 25c EACH: 20c ea. 100 OF ONE VALUE... \$15.00.

THAT'S A BUY

Dept. SE5 111 Liberty St., New York 6, N. Y., U. S. A. PH. RECTOR 2-4245. CABLE: "TABPARTS".

Money Back Guarantee

(Cost of Mds. Only) \$5 Min. Order FOB N. Y. C. Add shpg. charge or for COD 25% Dep. Prices Subject to Change Without Notice.

SPHERICAL MICROWAVE LENS

(Luneberg Type)

APPLICATIONS:

- Rapid Scanning and Tracking
- Wide Angle Volumetric Scanning
- Multiband Simultaneous Lobing
- Multidirection Simultaneous Lobing

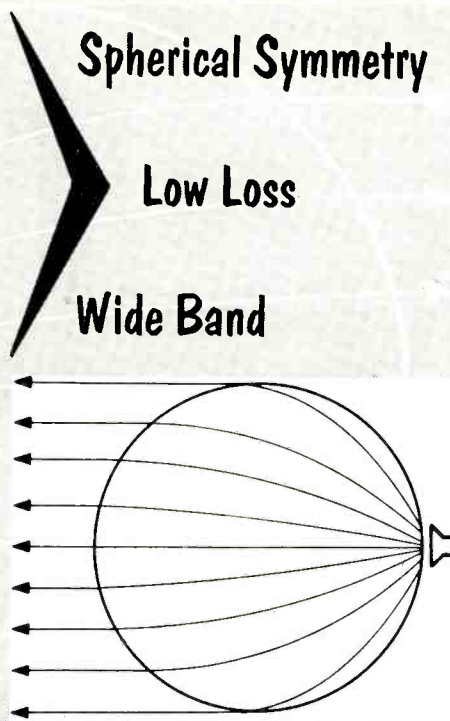

SCIENTIFIC ASSOCIATES, Inc.

engineering • development • manufacturing
580 Virginia Avenue, N.E. • Atlanta, Georgia

Two week delivery on lenses
1 and 2 feet in diameter.

Reasonable Prices

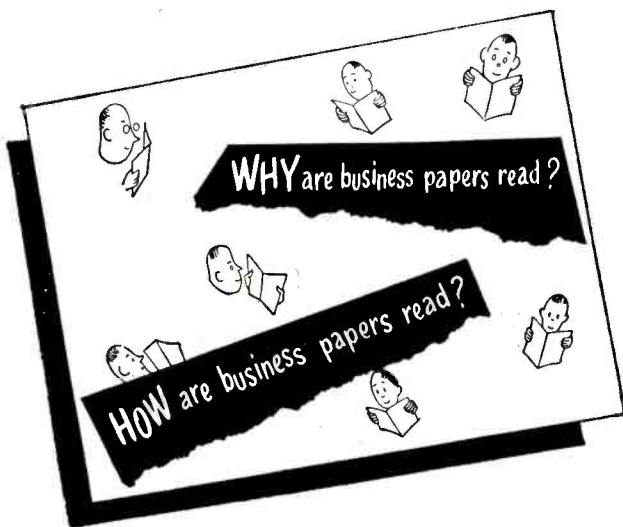

A copy of this quick-reading, 8-page booklet is yours for the asking. It contains many facts on the benefits derived from your business paper and tips on how to read more profitably. Write for the "WHY and HOW booklet."

McGraw-Hill Publishing Company, Room 2710, 330 West
42nd St., New York 36, N. Y.

Electro Motive Mfg. Co., Inc.	101
Electronic Associates, Inc.	266
Electronic Instrument Co., Inc. (EICO)	398
Elgin-Neomatic, Inc.	458
Empire Devices Products Corp.	367
Engineering Co., The	378
Engineering Research Associates, Div. Remington-Rand, Inc.	369
Erie Electronics Div. Erie Resistor Corp.	240

Fairchild Camera & Instrument Corp.	227, 316
Falstrom Company	200
Federal Telephone & Radio Co.	297
Film Capacitors, Inc.	397
Filtors, Inc.	379
Five Star Company	381
Ford Instrument Co.	272
Freed Transformer Co., Inc.	43
Frenchtown Porcelain Co.	49

G-V Controls, Inc.	314
Gabriel Electronics, Div. of Gabriel Co.	358
Gabriel Laboratories, Div. of Gabriel Co.	359
Gamewell Co.	258
Garde Manufacturing Co.	401
Garfield Wire Div. of the Overlakes Corp.	390
Garrepy Platers, Inc.	410
General Cable Corp.	207
General Ceramics Corp.	221
General Electric Co. Apparatus Dept.	72, 73, 195, 361
Electronics Dept.	44, 45
General Mills, Inc. Mechanical Div.	209
General Radio Co.	17
Giannini & Co., Inc., G. M.	334
Good-all Electric Mfg. Co.	301
Green Instrument Co.	371
Greenleaf Manufacturing Co.	315
Gries Reproducer Corp.	389
Guardian Electric Mfg. Co.	285

Hammarlund Mfg. Co., Inc.	25
Harris, Upham & Co.	323
Haydon Co., A. W.	352
Haydon Manufacturing Co., Inc.	264
Haydu Brothers of New Jersey	305
Heath Company	382
Heiland A Div. of Minneapolis-Honeywell	349
Helipot Corp., Div. of Beckman Instru- ments, Inc.	185
Hermetic Seal Products Co.	287
Hertner Electric Co.	375
Hetherington, Inc.	308
Hewlett-Packard Co.	40, 41
Hitemp Wires, Inc.	406
Hopkins Engineering Co.	393
Hudson Tool & Die Company, Inc.	231
Hughes Aircraft Co.	115
Hughes Research & Development Labora- tories	395, 409
Hunt Company, Phillip A.	312
Hycor Company, Inc.	406
Hydro-Aire Inc., Electronics Div.	85

Indiana Steel Products Co.	120, 121
Industrial Instruments	210
Industrial Test Equipment Co.	400
Industrial Transformer Corp.	321

Infra Electronic Corp.	278
Inland Electronics Corp.	268
Instrument Corp. of America	283
Instrument Resistors Co.	386
International Business Machines Corp.	197
International Crystal Mfg. Co., Inc.	99
International Nickel Co., Inc.	225
International Rectifier Corp.	46
Ippolito & Co., Inc., James	377
Irvington Div., Minnesota Mining & Mfg. Company	309

James Vibrapowr Company	368
Jan Hardware Mfg. Co., Inc.	387
Jennings Radio Mfg. Corp.	318
Jet Propulsion Laboratory	359
Jones Div., Howard B., Cinch Mfg. Co.	393
Joy Manufacturing Co.	235

Kahle Engineering Co.	15
Kahn Research Labs.	397
Kartron	410
Kay Electric Co.	27
Kearfoot Co., Inc.	351
Kennedy & Co., D. S.	306
Kepeo Laboratories	183
Kester Solder Co.	233
Keystone Products Co.	279
Kinney Mfg. Division, New York Air Brake Company	247
Knights Company, James	108, 109
Koch Fiberglas	53
Kollsman Instrument Corp.	243
Krengel Mfg. Co., Inc.	323

Laboratory for Electronics, Inc.	50, 51
Lakeland, Florida Industrial Development Committee of 100	321
Lambda Electronics Corp.	52
Lampkin Laboratories, Inc.	410
Lapp Insulator Co., Inc.	228
Lewis Spring & Mfg. Co.	220
Librascope, Inc.	88
Link Aviation Inc.	346
Lion Fastener, Inc.	294
Litton Engineering Laboratories	403
Litton Industries	336
Lockheed Missile Systems Div.	263

Magnatron, Inc.	373
Magnecraft Electric Co.	366
Magnetic Amplifiers, Inc.	341
Magnetics, Inc.	203

3 RCP INSTRUMENTS FOR COLOR TELEVISION OR BLACK AND WHITE

Completely integrated to meet all necessary laboratory and industrial standards of measurements. Designed to the same rigid specifications demanded of RCP by the Government

DC MIDGETSCOPE—MODEL 534

This fine little job is packed with the latest circuit designs to give an excellent frequency response over a wide range with fine sensitivity. DC amplifiers make it ideal for color television circuits and all industrial applications and service needs.

OUTSTANDING FEATURES:

1. Top Performance assured by use of the "Circuits of the Future"—DC amplifiers for industrial use—Undistorted response and elimination of parallax by push-pull deflection—Full Vertical and Horizontal expansion of trace—Automatic Astigmatism control circuit—Linear time base and sweep—Returned trace automatically blanked.
2. True Portability, compact and streamlined for use—Set it up vertically or horizontally—All controls on front panel for convenience—Tilted CR Tube for best viewing angle.

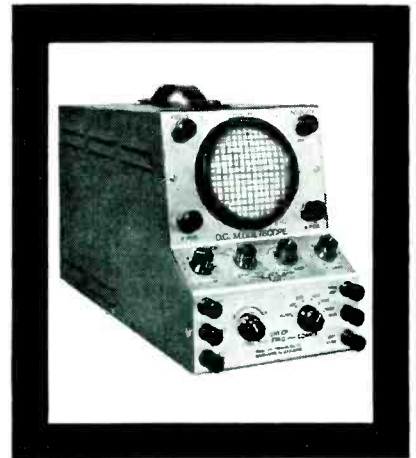

All-Electronic Sweep Generator

Model 780

Unexcelled in performance and versatility, the Model 780 is an All-Electronic Sweep Generator for black and white and color television. Unique electronic unidirectional coupling provides for sweep in one direction only at a uniform output level (AGC)

Model 780 Special

Incorporated 34 MC. sweep width having amplitude linearity within ± 2 DB at 54 to 88 MC. for checking community television antenna systems and alignment of front end television circuits.

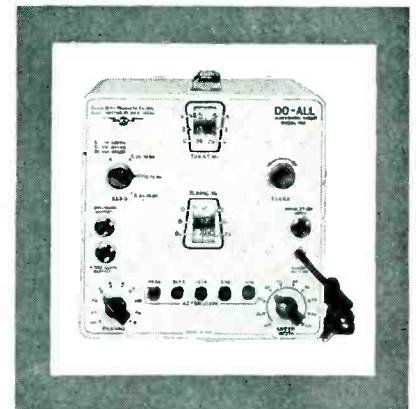

VERSATILE VTVM—Model 657A

62 Individual Electronic Range Measurements

Here are combined in one instrument five independent instruments—capacity meter—VT voltmeter—peak-to-peak voltmeter—inductance meter—megohmmeter—measuring low frequency sinusoidal and both low and high repetition rate non-sinusoidal waveform.

- DC Voltage: 16 ranges $0 \pm 1.5 \pm 3 \pm 6 \pm 30 \pm 150 \pm 600 \pm 1500 \pm 6000$
- DC Voltage: Zero Center 14 ranges $\pm .75 \pm 1.5 \pm 3 \pm 15 \pm 75 \pm 300 \pm 750$
- AC Voltage: Peak-to-Peak 7 ranges $0 - 4.2 - 8.5 - 17 - 85 - 420 - 1700 - 4200$
- AC Voltage: RMS—7 ranges $0 - 1.5 - 3 - 6 - 30 - 150 - 600 - 1500$
- AC High Voltage: RMS—Range $0 - 6000$ Volts.
- Ohmmeter: 8 ranges $0 - 1000 - 10,000 - 100,000$ ohms, $0 - 1 - 10 - 100 - 1000$
- 10,000 Megohms. Center Scale 10.
- Capacity meter: 6 ranges 1 micro-microfarad to 1,000 microfarads: 1-10 muf; .0001 - .001 mfd; .001 - .01 mid; .001 - 0.1 mid; 1 - 10 mid; 10 - 1000 mfd.

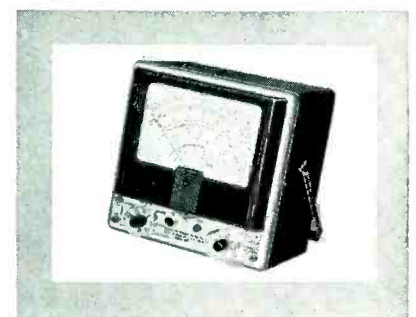

Write for Complete information to Dept. E-4

RADIO CITY PRODUCTS CO. Inc.
EASTON, PENNSYLVANIA

Manufacturers of quality Laboratory and Service Test Equipment Since 1932

BEST POWER

for electronic installations

CLOSE VOLTAGE REGULATION

for all types of electronic power installation is offered by Sheppard Diesel's extremely close governor regulation.

Send for Literature giving complete details

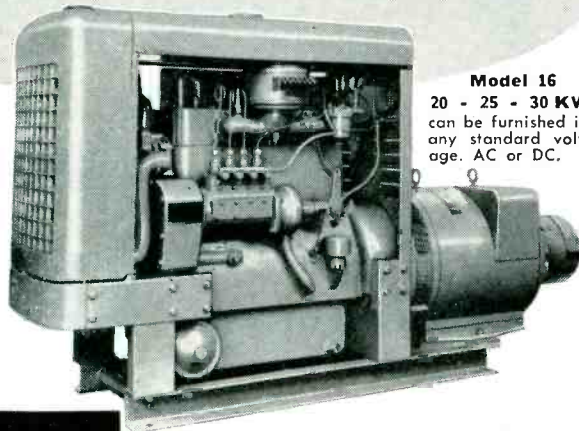

Model 16
20 - 25 - 30 KW
can be furnished in any standard voltage. AC or DC.

Sheppard Diesel Generating Sets offer complete protection against highline power failure or voltage drops. They are widely used both as main and standby power sources. In some cases 2 or more Sheppard Diesels are used to provide BOTH main and standby power. The 2 units alternate as the main power supply through fully automatic controls. Extremely close governor regulation makes Sheppard Diesels ideally suited to all electronic power supply installations.

SHEPPARD DIESELS, HANOVER, PA.

Sheppard
DIESEL
GENERATING SETS
from 2 to 40 KW

a complete line of relays



SUPER RUGGED
Vibration 10 G's—500 cps
MIL R 5757B

SUB-MINIATURE
½ cu. in.—½ oz.

HIGH CONTACT RATINGS
5 amp., 24VDC, 115 VAC
RESISTIVE

SENSITIVE
from .020 Watts

HI-TEMPERATURE
—65° to 200° C.

FAST OPERATING
HERMETICALLY SEALED

ALL TO MIL R 5757B
SPECIFICATIONS

Manufacturer's of High Precision Sub-Miniature Electro-Mechanical Devices.

ELGIN-NEOMATIC, INC.

A SUBSIDIARY OF ELGIN NATIONAL WATCH COMPANY
9010 BELLANCA AVE. • LOS ANGELES 45, CALIF. • OR 8-3814

Magnatron, Inc.	373
Makepeace Co., D. E.	119
Mallory and Co., Inc., P. R.	124, 179
Marconi Instruments, Ltd.	48
Marion Electrical Instrument Co.	34
Markem Machine Co.	399
Martin Company, Glenn L.	249, 304
McCoplin-Christie Corp.	381
McCoy Electronics Co.	330
McGraw-Hill Book Co., Inc.	398
McMillan Industrial Corp.	334
Measurements Corporation	391
Mercury Electronics Co.	410
Metal Textile Corporation	387
Metals & Controls Corp., General Plate Div.	116
Meyercood Co., The	373
Microtime Laboratories	194
Midwestern Instruments	307
Miles Reproducer Co., Inc.	410
Millen Mfg. Co., Inc., James	366
Minneapolis-Honeywell Regulator Co., Industrial Div.	122
Minnesota Mining & Mfg. Co.	62
Monsanto Chemical Co.	103
Muirhead & Co., Ltd.	5
Mycalex Corporation of America	246

National Moldite Co.	213
Natvar Corporation	319
New Hermes Engraving Machine Corp.	377
Ney Company, J. M.	371
Northern Radio Company, Inc.	295

Offner Electronics, Inc.	241
Ohmite Manufacturing Co.	32A, 32B
Orber Manufacturing Co.	410
Ortho-Filter Corporation	408
Oster Manufacturing Co., John	81

Pacific Semiconductors, Inc.	117
Panoramic Radio Products, Inc.	371
Perkin-Elmer Corp.	329
Perkin Engineering Corp.	202
Pesco Products Division, Borg-Warner Corp.	63
Phalo Plastics Corp.	342
Phelps Dodge Copper Products Corp., Inca Mfg. Div.	104, 105
Phileo Corporation	79, 80
Phillips Process Co., Inc.	401
Pix Manufacturing Co., Inc.	455
Polarad Electronics Corporation	30, 31, 107
Polymer Corporation of Penna.	324

Polytechnic Research & Development Co., Inc.	196
Potter Company, The	288
Potter Instrument Company, Inc.	354
Precision Apparatus Co., Inc.	460
Precision Paper Tube Co.	256
Pye, Ltd.	257

Quaker City Gear Works, Inc.	298
-----------------------------------	-----

Radio City Products Co., Inc.	457
Radio Corporation of America, 267, 4th Cover	
Radio Engineering Products	380
Radio Frequency Laboratories, Inc.	320
Radio Materials Corp.	96
Radio Receptor Co., Inc.	217
Railway Express Agency, Air Express Div.	201
Ramo-Wouldridge Corp.	58
Rawson Electrical Instrument Co.	403
Raybestos-Manhattan, Inc.	100
Raytheon Mfg. Company ... 18, 19, 29, 198, 239, 325	
Resin Industries, Inc.	388
Resinite Corp., Div. of Precision Paper Tube Co.	192
Resistance Products Co.	332
Rex Rheostat Co.	410
Richardson Company, The	106
Roller-Smith Corporation	28
Rome Cable Corp.	95
Rowe Industries	390
Rutherford Electronics Co.	323

Sargeant & Wilbur Heat Treating Corp. ...	321
Scientific Associates, Inc.	456
Scientific Radio Products, Inc.	322
Scintilla Div. Bendix Aviation Corp.	193
Secor Metals Corp.	394
Sel-Son Electronic Tube Corp.	394
Servo Corporation of America	337
Shalleross Mfg. Co.	238
Sheppard Co., Inc., R. H.	458
Sierra Electronic Corporation	328
Sigma Instruments, Inc.	204
Signal Engineering & Mfg. Co.	376
Simmons Fastener Corp.	82
Smith, Barney & Co.	400
Sola Electric Co.	113
Sorensen & Co., Inc.	4
Southern Electronics Co.	212
Sperry Gyroscope Company	379

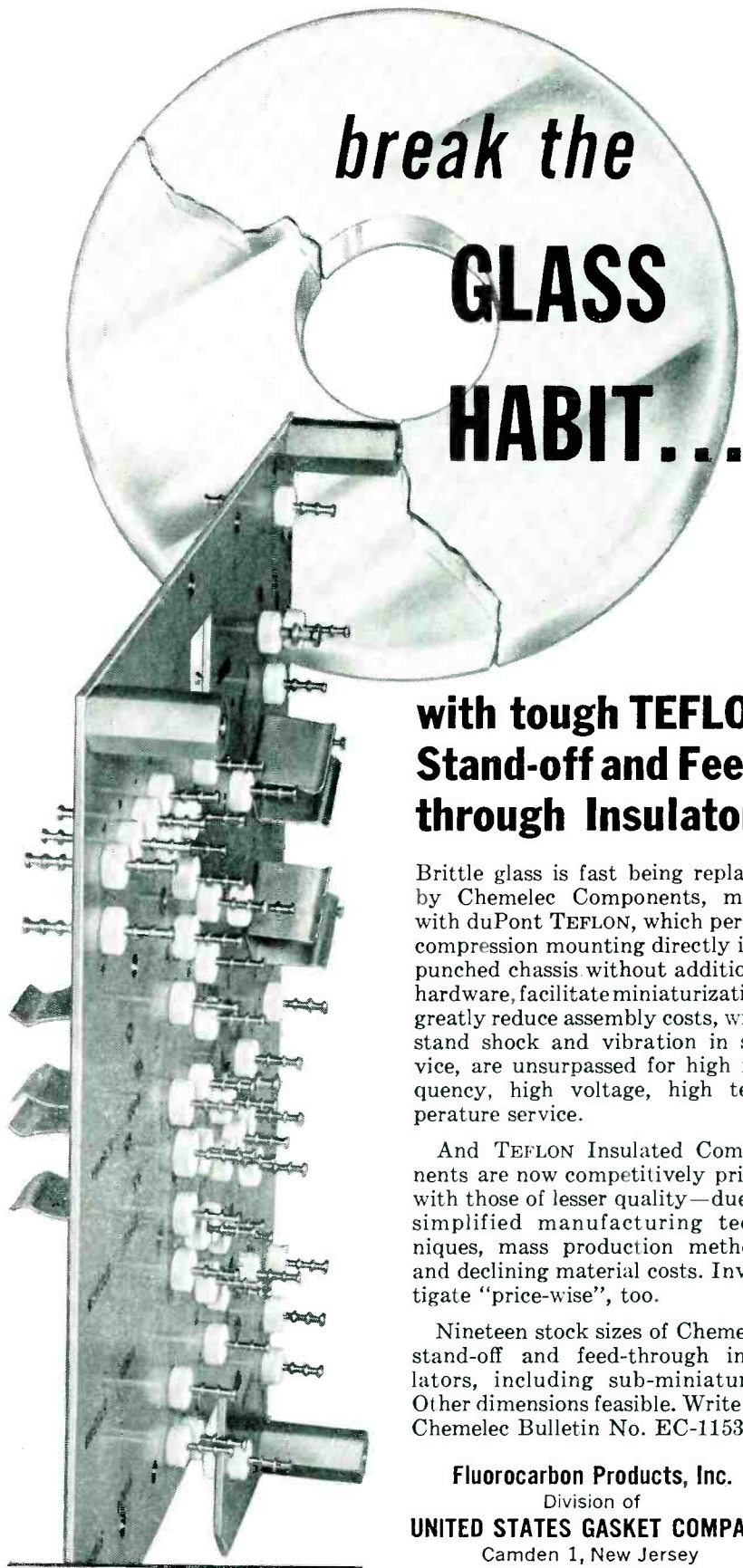

with tough TEFLON Stand-off and Feed- through Insulators

Brittle glass is fast being replaced by Chemelec Components, made with duPont TEFLON, which permit compression mounting directly into punched chassis without additional hardware, facilitate miniaturization, greatly reduce assembly costs, withstand shock and vibration in service, are unsurpassed for high frequency, high voltage, high temperature service.

And TEFLON Insulated Components are now competitively priced with those of lesser quality—due to simplified manufacturing techniques, mass production methods and declining material costs. Investigate “price-wise”, too.

Nineteen stock sizes of Chemelec stand-off and feed-through insulators, including sub-miniatures. Other dimensions feasible. Write for Chemelec Bulletin No. EC-1153.

Fluorocarbon Products, Inc.
Division of
UNITED STATES GASKET COMPANY
Camden 1, New Jersey

USG

**FABRICATORS OF
FLUOROCARBONS & OTHER PLASTICS**
Representatives in principal
cities throughout the world





THE NEW
PRECISION 120
MODEL

GIVES YOU WHAT YOU WANTED
IN A

**HIGH SENSITIVITY
MULTI-RANGE TEST SET**

20,000 OHMS PER VOLT D.C.
5,000 OHMS PER VOLT A.C.

The '120' gives you . . .

- ✓ MORE RANGES
- ✓ AN EXTRA-LOW RESISTANCE RANGE
- ✓ AN EXTRA-LOW VOLTAGE RANGE
- ✓ AN EXTENDED LOW CURRENT RANGE
- ✓ A LARGER METER SCALE FACE
- ✓ SIMPLE, POSITIVE RANGE SELECTION
- ✓ POSITIVE CONTACT JACKS and PLUGS

Compare These Wide Spread Ranges
and Special Features:

- ★ 8 DC VOLTAGE RANGES: 20,000 ohms per volt.
- ★ 8 AC VOLTAGE RANGES: 5,000 ohms per volt.
0-1.2-3-12-60-300-600-1200-6000 volts.
- ★ 8 AC OUTPUT RANGES: same as AC volt ranges.
Built-in 600 volt blocking capacitor.
- ★ 7 DC CURRENT RANGES:
0-60-300 Microamperes. 0-1.2-12-120-600 Ma.
0-12 Amperes.
- ★ 5 RESISTANCE RANGES: self-contained.
0-200-2000-200,000 ohms. 0-2-20 megohms.
- ★ 8 DECIBEL RANGES: -20 DB to +77DB.
0 DB = 1 Milliwatt, 600 ohms.
- ★ EXTRA LARGE 5/4" RUGGED 'PACE' METER:
40 microamperes sensitivity, 2% accuracy.
- ★ 1% MULTIPLIERS and SHUNTS:
Wire-wound and deposited film types.
- ★ TWO JACKS SERVE ALL STANDARD RANGES:
Separately identified and isolated jacks
provide for extra high ranges.
- ★ "TRANSIT" SAFETY POSITION on range selector
protects meter during transport and storage.
- ★ CUSTOM-MOLDED PHENOLIC CASE and PANEL:
Compact, laboratory styled instrument.

MODEL 120...complete with internal ohmmeter
batteries, banana-plug test leads and detailed
operating manual. Overall case dimensions:
5 3/8 x 7 x 3 3/8" Net Price \$39.95

PRECISION Apparatus Co. Inc.

70-31 84th Street, Glendale 27, L. I., N. Y.

Export Division, 458 Broadway, New York 13, U.S.A. - Cables - Morhanez
In Canada Atlas Radio Corp. Ltd. 560 King Street, W. Toronto 28

Want more information? Use post card on last page.

Sprague Electric Co.	11, 187	Waldes Kohinoor, Inc.	123
Stackpole Carbon Co.	87	Waterman Products Co., Inc.	208
Standard Electric Time Co.	67	Waters Manufacturing, Inc.	384
Star Porcelain Co.	377	Wenco Manufacturing Co.	403
Stavid Engineering, Inc.	286	Western Gear Works	219
Sterling Transformer Corp.	389	Westinghouse Electric Corp.	211
Stoddart Aircraft Radio Co., Inc.	365, 372	Weston Electrical Instrument Corp.	68
Stupakoff Ceramic & Mfg. Co. Div. of the Carborundum Company	338, 339	Wheeler Laboratories, Inc.	375
Sturtevant Co., P. A.	325	White Dental Mfg. Co., S.S.	388
Superior Electric Company	81	White Industries, Inc.	275
Superior Tube Co.	114	Whitney Blake Company	350
Sylvania Electrical Products, Inc.	259, 281, 291	Williams & Co., C. K.	392
		Winkler Laboratories	375

Taylor Fibre Co.	78	Xcelite, Inc.	369
Technicraft Laboratories, Inc.	353		
Technology Instrument Corp.	102, 262		
Tektronix, Inc.	70		
Telechrome, Inc.	303		
Tele Coil Co., Inc.	397		
Terpening Company, L. H.	357		
Texas Instruments, Inc.	205		
Thomas Mold & Die	402		
Thomas & Skinner Steel Products Co., Inc.	302	Zophar Mills, Inc.	375
Thompson Products Inc.	340		
Transradio, Ltd.	380		
Transitron Electronic Corp.	83		
Trans-Sonics, Inc.	230		
Triplett Electrical Instrument Co.	77		
Tung-Sol Electric, Inc.	363		

PROFESSIONAL SERVICES 415

Ucinite Company	94
Union Switch & Signal, Div. of Westing- house Air Brake Company	252
Ungar Electric Tools, Inc.	373
United States Gasket Co.	459
United States Leasing Corp.	248
United States Rubber Company	60
United Transformer Co.	2nd Cover
Unitek Corporation	383
Universal Winding Co.	33

SEARCHLIGHT SECTION

(Classified Advertising)

H. E. HILTY, Mgr.

SEARCHLIGHT ADVERTISING INDEX 452

Vacuum Metals Corp.	66
Vareflex Corporation	255
Varian Associates	347
Varo Mfg. Co., Inc.	97
Vector Electronic Corp.	212
Veeder-Root, Inc.	86
Victoreen Instrument Co.	218
Volkert Stampings, Inc.	56

This index is published as a convenience to the
readers. Every care is taken to make it accurate, but
ELECTRONICS assumes no responsibility for errors or
omissions.



Try this for size

**For guided missiles, airborne equipment,
portable and mobile ground equipment**

In these and related fields, where lack of space is the problem, manufacturers have turned to miniaturization. Daven's new ceramic switch occupies a panel area of less than 1½ square inches—incorporates features that ensure long life and trouble-free operation.

Despite its small size, this switch is extremely rugged and has been designed to withstand all types of field service. Coin silver contacts, rotors and slip rings are provided for low and uniform contact resistance and excellent electrical characteristics. Ceramic parts are silicone impregnated to function under extreme humidity. Sturdy solder terminals are supplied for wiring.

Single pole style has 18 shorting type contact positions available. 2 or 3 pole types may also be obtained. Several sections may be "ganged" by adding supplementary wafers. Flash-over voltage at 60 cycles is 1000 volts peak . . . current carrying capacity is 2 amperes.

This sturdy, high-quality switch is precision produced . . . will give years of service in fine commercial and military equipment. DAVEN's expert engineering staff is at your service for help with special problems or orders to your specifications. Write today for further information.



**Miniature Ceramic
Switch... Series M**



THE **DAVEN** CO.

191 Central Avenue, Newark 4, N. J.

WORLD'S LARGEST MANUFACTURER OF ATTENUATORS

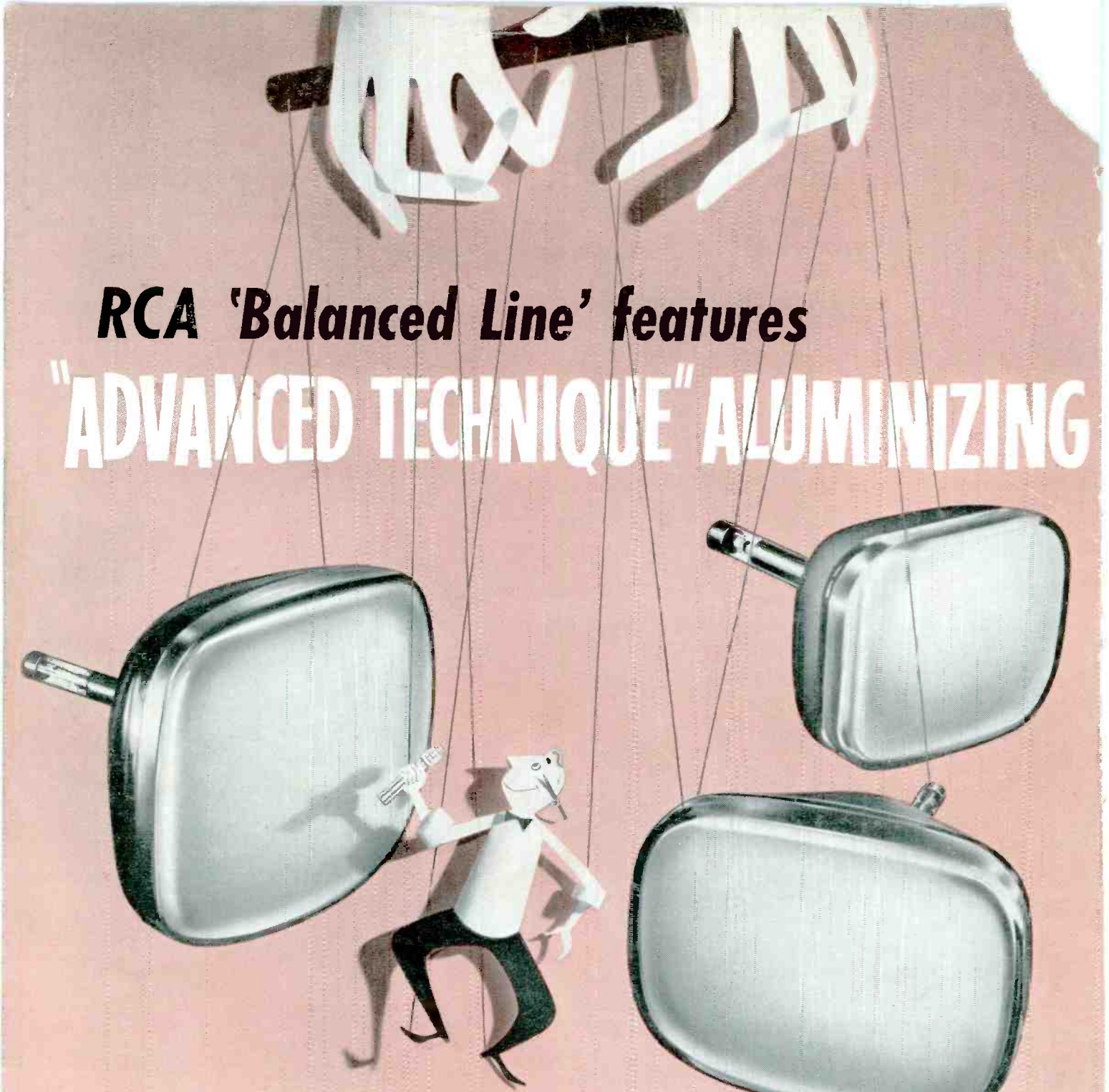

RCA 'Balanced Line' features "ADVANCED TECHNIQUE" ALUMINIZING

NEW 24-INCH Aluminized Picture Tubes—RCA-24CP4-A, RCA-24DP4-A, and RCA-24YP4—round out the RCA 'Balanced Line' for the new look in your receiver line.

These new tubes bring you the advantages of RCA "Advanced Technique" Aluminizing—an example of the forward thinking, planning, and engineering that make RCA Tubes famous for quality.

See for yourself how RCA top-quality aluminized picture tubes emphasize clarity and sharp detail in your new set designs. See your RCA Field Representative for your needs.

For technical data, write RCA, Commercial Engineering, Section E19Q Harrison, N. J.

RCA "Advanced Technique" Aluminized Picture Tubes		
type	diagonal deflection angle	focus
21ALP4-A	90	E
21AMP4-A	90	M
21ATP4	90	E
21AVP4-A/21AUP4-A	72	E
21AWP4	72	M
21YP4-A	70	E
21ZP4-B	70	M
24CP4-A	90	M
24DP4-A	90	E
24YP4	90	E

E = low-voltage electrostatic M = magnetic



RADIO CORPORATION of AMERICA
ELECTRON TUBES

HARRISON, N. J.