

FEBRUARY • 1951

# electronics

A M c G R A W - H I L L P U B L I C A T I O N



MICROPHONICS TEST  
OF SUBMINIATURE TUBE



# FILTER SPECIALISTS

PRODUCERS OF PERMALLOY DUST TOROID COILS AND FILTERS FOR OVER A DECADE

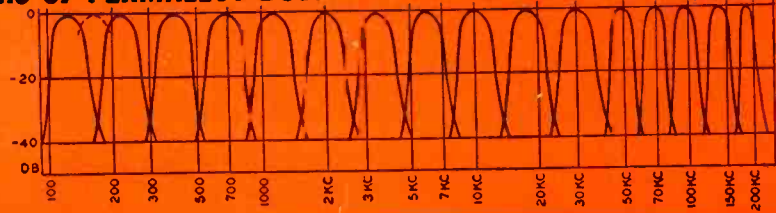

## FOR FILTERS

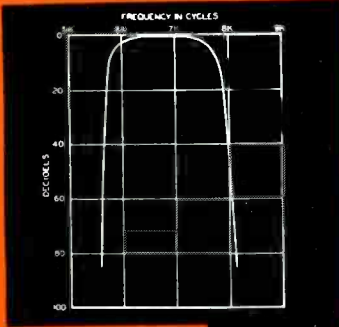

**BROAD BAND SHARP CUTOFF FILTER**

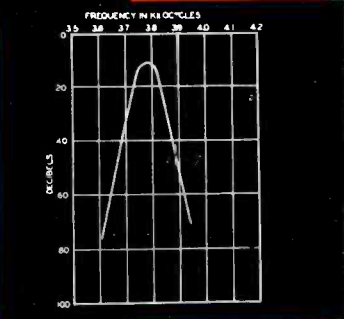

**NARROW BAND SHARP CUTOFF FILTER**

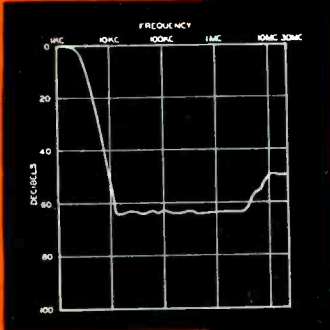

**ATTENUATES 10KC TO 30 MEGACYCLES**

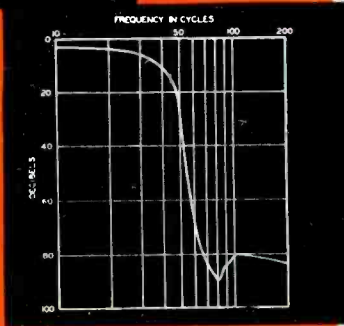

**LOW FREQUENCY — LOW PASS FILTER**

### SUB-OUNCER TOROID FILTERS

Filters employing SUB-OUNCER toroids and special condensers represent the optimum in miniaturized filter performance. The band pass filter shown weighs 6 ounces.

## FOR HIGH Q COILS



**HQA, C, D TOROID COILS**

1 1/8" Dia x 1 1/8" High.

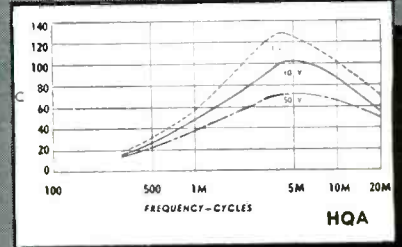

**HQB TOROID COIL**

2 5/8" L. x 1 3/8" W. x 2 1/2" H.

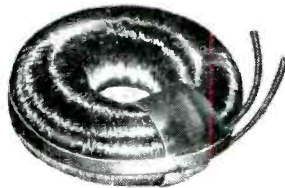
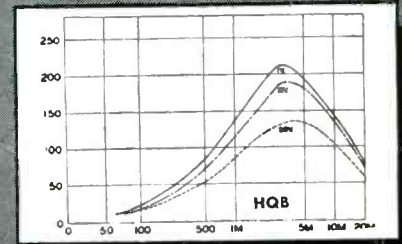

**UNCASED TOROIDS**

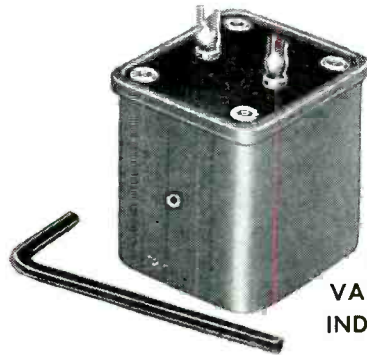
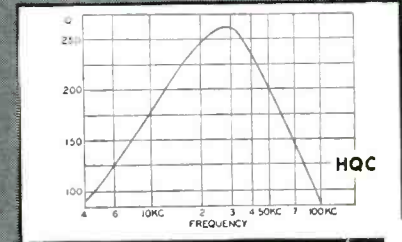

**VIC VARIABLE INDUCTOR**

1 3/8" L. x 1 1/4" W. x 1 1/2" H.

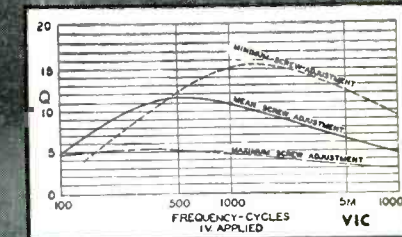
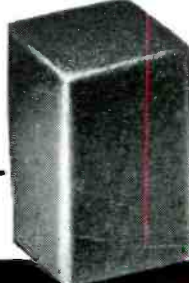
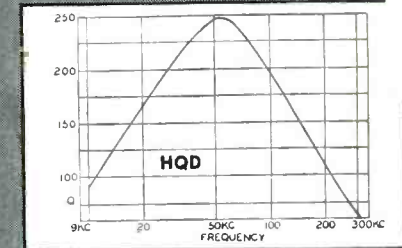

write for catalog PS-409

*United Transformer Co.*

150 VARICK STREET

NEW YORK 13, N. Y.

EXPORT DIVISION: 13 EAST 40TH STREET, NEW YORK 16, N. Y.

CABLES: "ARLAB"



# electronics



A McGRAW-HILL  
PUBLICATION

FEBRUARY • 1951

<b>MICROPHONICS TESTS OF SUBMINIATURE TUBE</b> .....	<b>COVER</b>
Energized tube is vibrated from 25 to 10,000 cps and output signals recorded. (See p 122) Photograph by John Schinkel, Sylvania Electric Products, Inc.	
<b>TELEVISION TOTEM POLE, by Frank G. Kear and O. B. Hanson</b> .....	<b>66</b>
Five video-station antennas coaxially mounted on single mast operate without serious interaction	
<b>LOAD SHARER FOR WELDER IGNITRONS, by G. M. Chute</b> .....	<b>71</b>
Thyratrons transfer load automatically from one pair of ignitrons to another every two seconds to reduce duty cycle	
<b>DEFENSE COMMUNICATIONS IN NEW YORK CITY</b> .....	<b>74</b>
Report on citizen warning and disaster communications for the New York metropolitan area	
<b>ELECTRONIC MUSIC FOR FOUR, by L. A. Meacham</b> .....	<b>76</b>
Novel "wobble organ" has separate soprano, tenor, alto and bass oscillators	
<b>PROGRESS IN DOT-SEQUENTIAL COLOR TV</b> .....	<b>80</b>
Increased brightness, resolution and color fidelity are achieved with new tricolor tube and improved circuitry	
<b>AUTOMATIC GCA, by J. T. McNaney</b> .....	<b>82</b>
Completely automatic approach system utilizes existing GCA equipment and plane's automatic pilot	
<b>TELEMETERING SYSTEM FOR RADIOACTIVE SNOW GAGE, by John A. Doremus</b> .....	<b>88</b>
Unattended f-m transmitters and repeaters forward data to central recording station	
<b>COMPARATIVE ANALYSIS OF COLOR TV SYSTEMS, by A. V. Loughren and C. J. Hirsch</b> .....	<b>92</b>
Comparison between full-simultaneous and mixed highs and extension to include field-sequential system	
<b>PRODUCTION-LINE FREQUENCY MEASUREMENTS, by George J. Kent</b> .....	<b>97</b>
Simplified equipment permits accurate measurements by relatively inexperienced personnel	
<b>DATUM STABILIZER FOR RADAR-ALTIMETER SURVEYING, by B. I. McCaffrey</b> .....	<b>100</b>
Aneroid-controlled electronic circuit automatically corrects altitude record for air bumps on survey flights	
<b>COLOR FUNDAMENTALS FOR TV ENGINEERS, Part III, by D. G. Fink</b> .....	<b>104</b>
Color distortion in a tv system and standards specified in the reference receiver	
<b>AUTOMATIC A-C BRIDGES, by J. F. Graham</b> .....	<b>110</b>
Design data for measuring inductance, capacitance and effective resistance in production	
<b>MINIMUM-LOSS MATCHING PADS (Reference Sheet), by Joseph C. Bregar</b> .....	<b>118</b>
Simple nomograph gives resistance values for L-type impedance-matching network, along with loss in db	
<b>BUSINESS BRIEFS</b> .....	<b>60</b>
<b>CROSSTALK</b> .....	<b>65</b>
<b>TUBES AT WORK</b> .....	<b>120</b>
<b>ELECTRON ART</b> .....	<b>124</b>
<b>NEW PRODUCTS</b> .....	<b>128</b>
<b>NEWS OF THE INDUSTRY</b> .....	<b>132</b>
<b>NEW BOOKS</b> .....	<b>136</b>
<b>BACKTALK</b> .....	<b>136</b>
<b>INDEX TO ADVERTISERS</b> .....	<b>(Last Page)</b>

**DONALD G. FINK**, Editor; **W. W. MacDONALD**, Managing Editor; **John Markus**, **Vin Zeluff**, **A. A. McKenzie**, Associate Editors; **William P. O'Brien**, **James D. Fahnstock**, Assistant Editors; **John M. Carroll** (on Military Leave), **Ronald Jurgen**, **Ann Mastropolo**, **Marilyn Wood**, Editorial Assistants; **Gladys T. Montgomery**, Washington Editor; **Harry Phillips**, Art Director; **Eleanor Luke**, Art Assistant

**KEITH HENNEY**, Consulting Editor

**H. W. MATEER**, Publisher; **WALLACE B. BLOOD**, Manager; **R. S. Quint**, Buyers' Guide Manager; **D. H. Miller**, **James Girdwood**, New York; **Wm. S. Hodgkinson**, New England; **Warren W. Shew**, Philadelphia; **C. D. Wardner**, Chicago; **J. L. Phillips**, Cleveland; **J. W. Otterson**, San Francisco; **Carl W. Dysinger**, Los Angeles; **Ralph C. Maultsby**, Atlanta; **Bernard H. Butler**, London, England



February, 1951

ELECTRONICS

Member ABC and ABP

Vol 24, No. 2



Published monthly with an additional issue in June by McGraw-Hill Publishing Company, Inc., James H. McGraw (1860-1948), Founder. Publication Office, 99-129 North Broadway, Albany 1, N. Y.

Executive, Editorial and Advertising Offices: McGraw-Hill Building, 330 W. 42nd St., New York 18, N. Y. Curtis W. McGraw, President; Willard Chevalier, Executive Vice-President; Joseph A. Gerardi, Vice-President and Treasurer; John J. Cooke, Secretary; Paul Montgomery, Senior Vice-President, Publications Division; Ralph B. Smith, Editorial Director; Nelson Bond, Vice-President and Director of Advertising; J. E. Blackburn, Jr., Vice-President and Director of Circulation.

Subscriptions: Address correspondence to Electronics—Subscription service, 99-129 N. Broadway, Albany 1, N. Y., or 330 W. 42nd St., New York 18, N. Y. Allow ten days for change of address. Please indicate position and company connection on all subscription orders.

Single copies 75c for United States and possessions, and Canada; \$1.50 for Latin America; \$2.00 for all other foreign countries. Buyers' Guide \$2.00. Subscription rates—United States and possessions, \$6.00 a year; \$9.00 for two years; \$12.00 for three years. Canada, \$10.00 a year; \$16.00 for two years; \$20.00 for three years. Pan American countries, \$15.00 a year; \$25.00 for two years; \$30.00 for three years. All other countries \$20.00 a year; \$30.00 for two years; \$40.00 for three years. Entered as second class matter August 29, 1930, at the Post Office at Albany, N. Y., under act of Mar. 3, 1879. Printed in U. S. A. Copyright 1951 by McGraw-Hill Publishing Co., Inc.—All Rights Reserved. BRANCH OFFICES: 520 North Michigan Avenue, Chicago 11, Ill.; 68 Post Street, San Francisco 4; Aldwych House, Aldwych, London, W. C. 2; Washington, D. C. 4; Philadelphia 3; Cleveland 15; Detroit 26; St. Louis 8; Boston 16; Atlanta 3, Ga.; 1111 Wilshire Blvd., Los Angeles 17; 738-9 Oliver Building, Pittsburgh 22. ELECTRONICS is indexed regularly in The Engineering Index.



# marion

helps Reed Research Inc.

**measure true rms values**

**of non-sinusoidal  
wave forms**

A new aid to true RMS instrumentation is the Reed DIOTRON, developed and manufactured by Reed Research, Inc., of Washington, D. C. This amazing instrument measures true rms values of non-sinusoidal or otherwise erratic wave forms. It is a vacuum tube voltmeter whose indication depends entirely on true rms values. It is a small, compact, portable instrument used by engineers, technicians and scientists interested in the measurement and evaluation of power regardless of wave form.

Marion makes the meter upon which the Reed DIOTRON depends for much of its accuracy of indication. It provides a linear power scale and allows full scale measurements of 1 mw, 10 mw, 100 mw, 1 watt and 10 watts into 600 ohms. A corresponding true root mean square voltage scale is also included.

When you want special or standard instruments for any application that requires accurate indication — think of Marion. Marion Ruggedized Meters are the most advanced electrical indicating and measuring instruments of our time. Advanced in both construction and application, count on them for prolonged peak performance under extreme conditions of temperature, climate and actual physical violence. We invite comparison.

Marion Electrical Instrument Company,  
401 Canal Street, Manchester, New Hampshire.

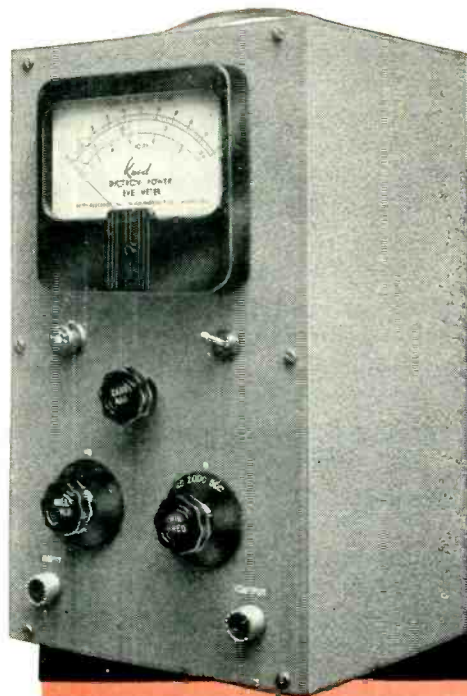

Manufacturers of Hermetically Sealed Meters since 1944



**marion meters**



# MUIRHEAD INSTRUMENTS

For

*Earning & Earning*

**MUIRHEAD & CO. LTD.**  
**BECKENHAM · KENT · ENGLAND**

**PRECISION ELECTRICAL INSTRUMENT MAKERS**

TELEGRAMS & CABLES : MUIRHEADS ELMERS-END

MUIRHEAD & CO. LTD.  
BECKENHAM · KENT · ENGLAND

NAME \_\_\_\_\_  
COMPANY \_\_\_\_\_  
POSITION \_\_\_\_\_

MAILING ADDRESS \_\_\_\_\_  
\_\_\_\_\_  
\_\_\_\_\_

Please send me, free of charge, your  
1951 CATALOGUE.

25



# Exploration

for resistors too!



**S**pecialization in resistors lets IRC concentrate on research and quality control to a greater degree than any other supplier. *Result:—IRC exploration anticipates future resistor needs—improves existing products—and controls quality and uniformity in every IRC unit. Largest resistor manufacturer in the world, IRC attracts the finest of engineering talent. We're using more of such talent than ever, now, to keep step with today's electronic requirements—while we plan for tomorrow's advances.*

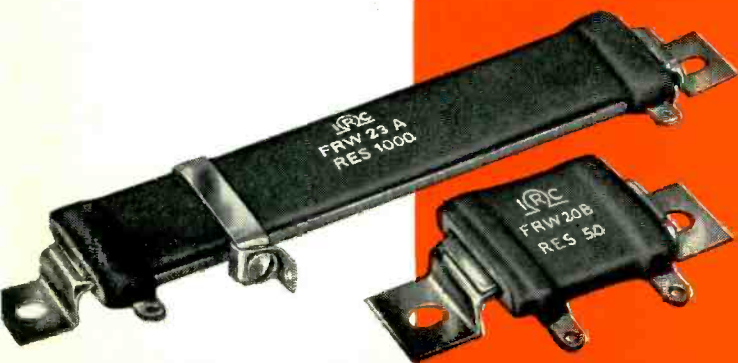

## FLAT POWER WIRE WOUND RESISTORS

For high-wattage dissipation in limited-space applications, IRC Type FRW Flat Wire Wound Resistors have higher space-power ratios than standard tubular units. FRW's can be mounted vertically or horizontally—singly or in stacks. Non-magnetic mounting brackets permit easy, economical mounting, aid in heat distribution along the entire length, and transfer internal heat to the chassis. Available in 9 sizes—fixed and adjustable. Send for full details in Bulletin C-1.

# is important

## HIGH OHMIC RESISTORS

Engineered for high voltage applications where high resistance and power are required, IRC Type MVX Resistors are particularly suited to many types of television and electronic circuits. Unique application of IRC's proven filament resistance coating in helical turns on a ceramic tube provides a conducting path of long, effective length. Result: A unit of high resistance value with resistance materials having relatively low specific resistance. Type MVX's have 2 watt rating, are exceptionally stable—permit the use of high voltage on the resistor while keeping voltage per unit length of path comparatively low. Send coupon for complete details in Bulletin G-2.

## DEPOSITED CARBON PRECISTORS

A unique combination of accuracy, stability and economy makes IRC Deposited Carbon PRECISTORS ideal for applications where carbon compositions are unsuitable or wire-wound precisions too expensive. Instrumentation, advanced electronics and critical television circuits also benefit from their wide range of values, low voltage coefficient, excellent frequency characteristics, predictable temperature characteristics, high voltage rating, low noise level and small size. Coupon brings full particulars in Bulletin B-4.

## VOLTMETER MULTIPLIERS

Sealed-precision IRC Type MF Resistors are completely impervious to moisture—have proved themselves dependable voltmeter multipliers for use under the most severe humidity conditions. Each multiplier consists of a number of IRC Precision Resistors, mounted, interconnected, and encased in a glazed, hermetically sealed ceramic tube. MF's are compact, rugged, stable, easy to install, and may be used with very little drain on the power supply. Individual precision resistors may be either inductive or noninductive, so that they may be used on AC as well as DC. Mail coupon for full data in Bulletin D-2.



**INTERNATIONAL  
RESISTANCE COMPANY**

401 N. Broad Street, Philadelphia 8, Pa.

In Canada: International Resistance Co., Ltd., Toronto, Licensee

*Wherever the Circuit Says*

Power Resistors • Voltmeter Multipliers  
• Insulated Composition Resistors • Low  
Wattage Wire Wounds • Volume  
Controls • Voltage Dividers • Precision  
Wire Wounds • Deposited Carbon  
Precistors • Ultra-HF and High  
Voltage Resistors • Insulated Chokes

**INTERNATIONAL RESISTANCE CO.**  
403 N. BROAD ST., PHILADELPHIA 8, PA.

Please send me complete information on the items checked below:—

- Flat Wire Wound Resistors (C-1)       Deposited Carbon PRECISTORS (B-4)
- High Voltage Resistors (G-2)       Voltmeter Multipliers (D-2)
- Name and address of local IRC Distributor

NAME .....

TITLE .....

COMPANY .....

ADDRESS .....

CITY ..... ZONE ..... STATE .....



# QUICK, RELIABLE

## impedance measurements up to 500 megacycles



FTL-42A IMPEDOMETER

**Any signal generator with 0.1 volt maximum into 51.5 ohms output furnishes sufficient power for operation.**

**Crystal detector and audio amplifier with output meter have sufficient sensitivity as a detector above 100 megacycles.**

Compact, simple, accurate instrument for the measurement of impedance, attenuation, reflection coefficient and standing-wave ratio at frequencies up to 500 megacycles.

Read relative voltages of incident wave, reflected wave, and resultant. Plot diagram of voltages on Smith Chart and impedance can be determined to  $\pm 5\%$ .

Requires no unusual accessories — only those found in every laboratory and test shop working in the frequency range of the instrument: signal generator with 0.1 volt maximum output, crystal detector, audio amplifier, and output meter. Below 100 megacycles a radio receiver is desirable for its greater sensitivity.

In addition, the FTL-42A Impedometer can be operated with input power up to several hundred watts when it is desired to drive the load in this manner.

Adapters for  $1\frac{1}{8}$  inch line to type N are furnished so that the instrument can be used with flexible cables.

The FTL-42A Impedometer can be used directly with  $1\frac{1}{8}$  inch line, or with other sizes of lines or cables by use of various adapters that are available.

It can be built for other impedances such as 72 ohms coaxial, according to requirements of user.

Dimensions of cabinet:  $6\frac{13}{16}$  inches long by  $5\frac{1}{16}$  inches wide by  $5\frac{3}{8}$  inches high. Net weight including adapters is 7 pounds.

Price — \$400.00

Write for FTL-42A brochure.

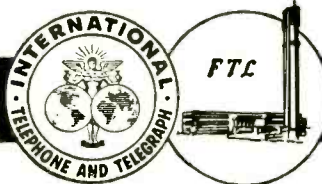

**Federal Telecommunication Laboratories, Inc.**

500 Washington Avenue

Nutley 10, New Jersey



No. 11  
of a  
Series

# Another Engineer's Problem Solved\*

**SUBJECT:** High Power  
Pulse Capacitors

**PROBLEM:** To supply a small  
capacitor handling peak pulses  
of 630,000 VA

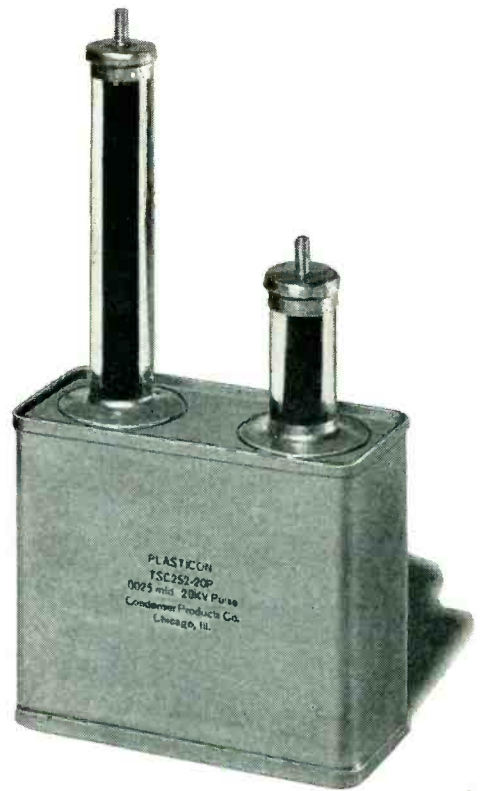

## SOLUTION:

An .0025 mfd. capacitor was required to pass 70 Amp. pulse at 9,000 volts and withstand occasional peaks as high as 18 K.V. The pulse repetition rate was 1500 pulses per second with a pulse duration of .25 microseconds. The equivalent wavefront approximated 10 mc.

We designed a teflon film dielectric, silicone fluid filled capacitor which has no internal corona under the above operating conditions. The size of this type TSC252-20P metal can is  $3\frac{3}{4}$ " x  $1\frac{1}{4}$ " base x  $3\frac{1}{4}$ " high. A JAN-C-5—CM95 size mica capacitor ( $8\frac{1}{2}$ " O.D. x 10" high) was not recommended for the above electrical specifications.

Send us your specifications on pulse capacitors and other capacitor and power supply problems.

Your inquiries will receive immediate attention.

• • •

Write for catalog on our standard line of Plasticon Capacitors, Forming Pulse Networks and High Voltage Power Supplies.

## Condenser Products Company

1375 NORTH BRANCH STREET • CHICAGO 22, ILLINOIS



# Presenting **hp** PRECISION EQUIPMENT

...THE BASIC TOOLS YOU

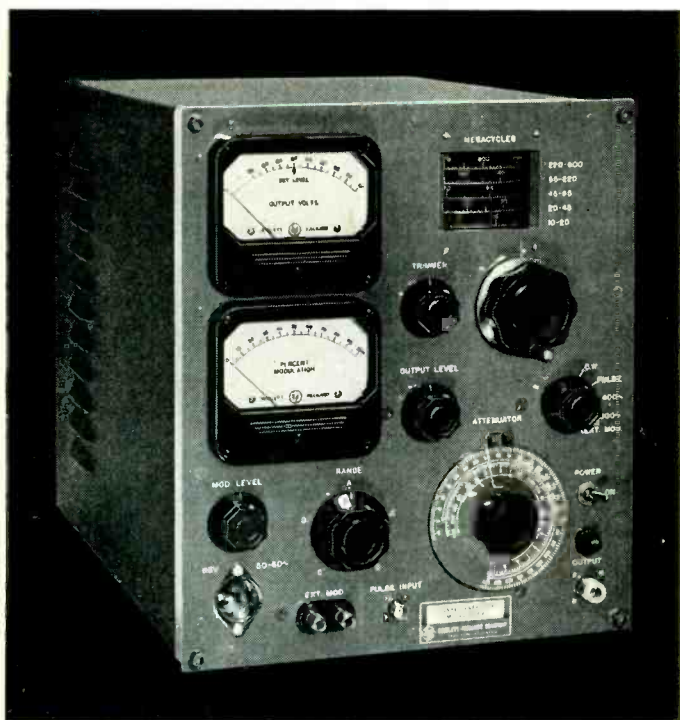

—hp— 608A VHF SIGNAL GENERATOR

## SPECIFICATIONS

**FREQUENCY RANGE:** 10 to 500 mc. in 5 bands.

**ACCURACY:** Calibration  $\pm 1\%$ . Re-setability better than 1 mc. at high frequencies. Total scale length approx. 90".

**OUTPUT:** 0.1  $\mu\text{v}$  to 1.0 v. continuously variable. Calibrated in volts and dbm.

**IMPEDANCE:** 50  $\Omega$ . Maximum VSWR 1.2.

**ACCURACY:**  $\pm 1$  db entire range.

### MODULATION:

**AMPLITUDE:** From 0 to 90% indicated by front panel meter.

**ENVELOPE DISTORTION:** 1% to 30% modulation.

**INTERNAL:** Fixed modulation at 400 and 1,000 cps.

**EXTERNAL:** Any frequency 50 cps to 1 mc. 4.0 v. input.

**EXTERNAL PULSE:** Positive, 4 v. peak. Good pulse shape. Square wave to 1  $\mu\text{sec}$  length (At 100 mc. and above).

**LEAKAGE:** Less than 1  $\mu\text{v}$ .

**RESIDUAL FM:** Not over .0025% at 30% modulation.

**POWER:** 115/230 v. 50/60 cps. 150 watts.

**SIZE:** 12" x 14" x 18" deep. —hp— grey finish. Cabinet mounting.

**PRICE:** \$850.00 f.o.b. Palo Alto.

*Data Subject to Change Without Notice*

## VHF SIGNAL GENERATOR

10 to 500 mc

**High power output...Constant internal impedance...Wide frequency range...Broad modulation capabilities...Master oscillator power amplifier circuit...Microsecond pulses...Small residual FM...CW, AM or pulsed output**

Here is a new general purpose laboratory generator of broadest application. It offers a directly calibrated output from 0.1  $\mu\text{v}$ . to 1 v. for measuring gain, selectivity, sensitivity or image rejection of receivers, I-F amplifiers, broad band amplifiers and other VHF equipment. The 1 v. output (to a 50 ohm load) is available throughout the entire frequency range for driving bridges, slotted lines, antennas, filter networks, etc. The output circuit is directly calibrated in volts and dbm for fast reading. No charts are necessary.

### DIRECT CALIBRATION

Frequencies from 10 to 500 mc. are covered in 5 bands, and calibrated directly in mc. on a drum-type dial having effective scale length of 90". The single-dial, ball-bearing frequency control insures maximum convenience and accuracy in tuning and re-setting.

Master oscillator and power amplifier circuits are enclosed in a heavy cast aluminum shield, insuring high stability and low electrical leakage.

### —hp— 417A VHF DETECTOR

This new —hp— instrument is a super-regenerative (AM) receiver covering all frequencies between 10 and 500 mc. in 5 bands. It is designed for use with the —hp— 803A VHF bridge. It offers 5  $\mu\text{v}$  sensitivity over entire band, quick, easy operation, and a direct-reading frequency control. The instrument is thoroughly shielded, and is suitable for general laboratory use; for making approximate frequency checks, determining noise, interference, etc. Price \$200.00 f.o.b. Palo Alto.



HEWLETT **hp** PACKARD



# FOR THE *10 to 500 mc* BAND!

ASKED US FOR!

## VHF BRIDGE

50 to 500 mc

**First commercial VHF bridge...Based on an entirely new principle...Direct impedance readings, 2 to 2,000 ohms... Wide phase angle... Useful to 700 mc... Makes every kind of VHF impedance measurement**

The new *-hp-* 803A VHF Bridge is the first commercial instrument built to give you fast, direct impedance readings in the 50-to-500 mc. band. It can be used for any type of VHF impedance measurement. This includes characteristics of transmission lines, antennas, resistors, rf chokes and condensers; impedance of connectors, standing wave ratios; percentage of reflected power, VHF system flatness, etc.

### BROAD FREQUENCY RANGE

The Model 803A operates on an entirely new principle suggested by Mr. John Byrne of the Airborne Instrument Laboratories.\* It determines impedance by sampling the magnetic and electric fields of a transmission line. Phase is measured by determining the point of cancellation of these samples along a second transmission line. This method effectively overcomes the narrow frequency limitations of conventional bridges, and permits the new *-hp-* VHF bridge to make readings at frequencies up to 700 mc and down to 5 mc.

\*A complete description of this principle and its application in the *-hp-* VHF Bridge appeared in a recent issue of the *-hp-* Journal. Free copy on request.

SEE THESE AND OTHER NEW *-hp-* INSTRUMENTS

I. R. E. SHOW



BOOTHS 40, 41

## HEWLETT-PACKARD COMPANY

2046A Page Mill Road • Palo Alto, California

Sales representatives in all principal areas. Export: Frazar & Hansen, Ltd., San Francisco, Los Angeles, New York City



*-hp-* 803A VHF BRIDGE

### SPECIFICATIONS

**MEASUREMENT RANGE:** Impedance magnitude, 2 to 2,000 $\Omega$ . (Higher and lower values may be measured by using a known length of transmission line as an impedance transformer.)

Phase angle from  $-90^\circ$  to  $+90^\circ$  at 50 mc and above.

**CALIBRATION:** Impedance: Directly in ohms.

Phase angle: Directly in degrees at 100 mc. May be readily computed at other frequencies.

[ $\ominus$  (actual) =  $\oplus$  (read) x Frequency, mc/100.]

**ACCURACY:** Impedance magnitude, approx.  $\pm 5\%$ .

Phase angle, approx.  $\pm 3$  degrees (over range 50 to 500 mc). With calibration chart provided, accuracies of 2% and 1% are possible.

**FREQUENCY RANGE:** Maximum accuracy 50 to 500 mc. Useful down to 5 mc and up to 700 mc. Maximum measurable phase angle at 5 mc is  $-9^\circ$  to  $+9^\circ$ .

**EXTERNAL rf GENERATOR:** Requires an AM signal source of at least 1 mw. High signal level is desirable. (*-hp-* Model 608A VHF Signal Generator is ideal for this purpose.)

**rf DETECTOR:** Requires a well-shielded VHF receiver of good sensitivity. (*-hp-* Model 417A VHF Detector is designed for this use.)

**SIZE:** 14" x 14" x 8" deep. Smooth *-hp-* grey finish. Cabinet mounting.

**PRICE:** \$495.00 f.o.b. Palo Alto.

*Data Subject to Change Without Notice*

# HEWLETT PACKARD

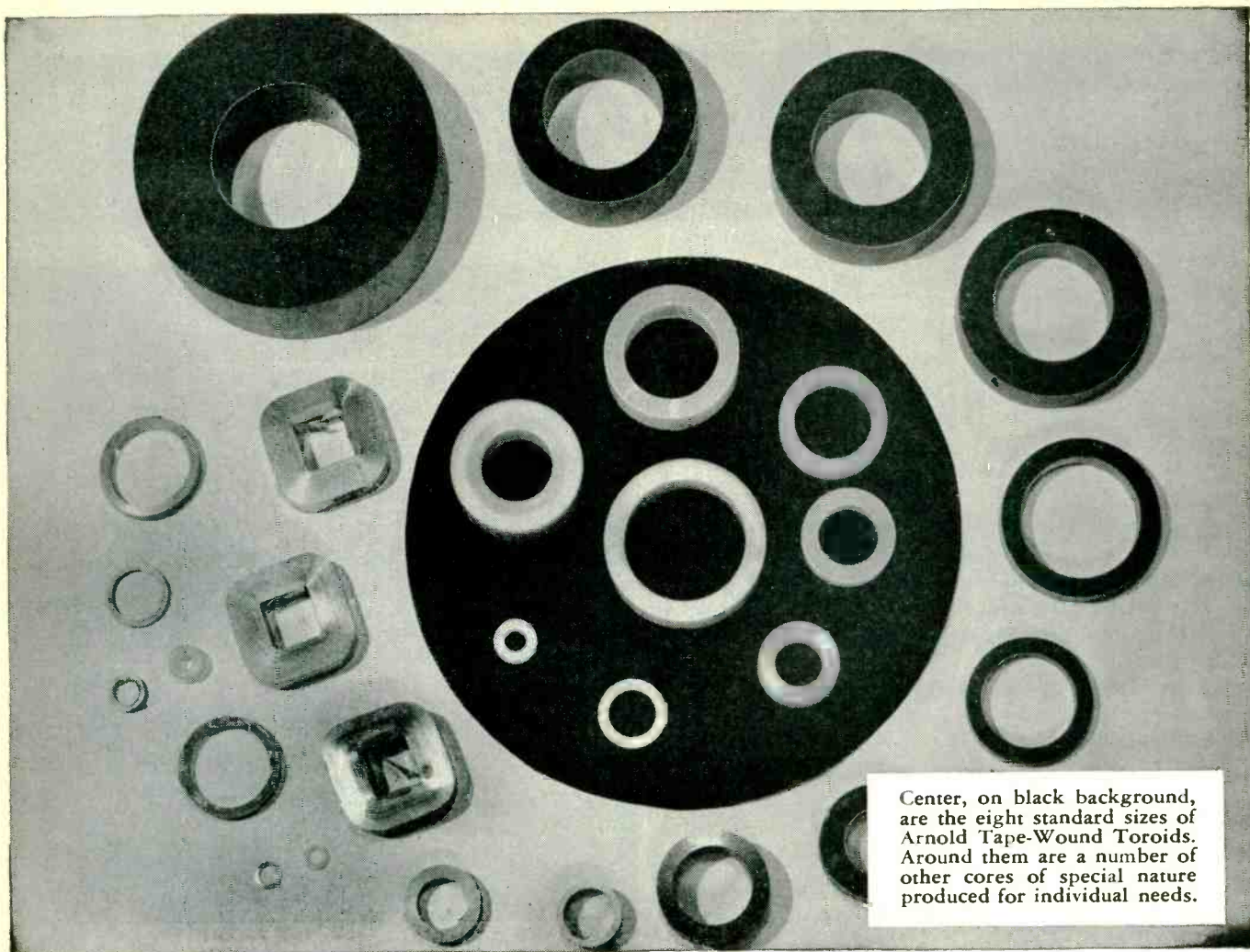

Center, on black background, are the eight standard sizes of Arnold Tape-Wound Toroids. Around them are a number of other cores of special nature produced for individual needs.

# ARNOLD TAPE-WOUND TOROIDAL CORES

## of DELTAMAX 4-79 MO-PERMALLOY SUPERMALLOY\*

### APPLICATIONS

MAGNETIC AMPLIFIERS  
PULSE TRANSFORMERS  
NON-LINEAR RETARD COILS  
and TRANSFORMERS  
PEAKING STRIPS, and many other  
specialized applications.

### RANGE OF SIZES

Arnold Tape-Wound Toroids are available in eight sizes of standard cores—all furnished encased in molded nylon containers, and ranging in size from 1/2" to 2 1/2" I.D., 3/4" to 3" O.D., and 1/8" to 1/2" high.

### RANGE OF TYPES

These standard core sizes are available in each of the three magnetic materials named, made from either .004", .002" or .001" tape, as required.

In addition to the standard toroids described at left, Arnold Tape-Wound Cores are available in special sizes manufactured to meet your requirements—toroidal, rectangular or square. Toroidal cores are supplied in protective cases.

\*Manufactured under licensing arrangements with Western Electric Company.

W&O 3182

## THE ARNOLD ENGINEERING COMPANY



SUBSIDIARY OF ALLEGHENY LUDLUM STEEL CORPORATION

General Office & Plant: Marengo, Illinois



# WILKOR

**FIRST** IN THE INDUSTRY WITH **CARBOFILM RESISTORS**

AND NOW

**FIRST** AGAIN WITH **BORO-CARBOFILM RESISTORS**

★ Greatly Increased Range of Resistance

★ Temperature Coefficient as Low as 20 Parts Per Million Per Degree C

★ Increased Stability

★ Lower Noise Level

### Attention All Electronic Engineers

We are in production on the most advanced development in the history of resistors. It is the BORO-CARBOFILM RESISTOR. After over two years of intensive laboratory work the introduction of Boron in the making of Deposited Carbon Resistors has been perfected.

The result of this new development assures greatly increased range of resistance, temperature coefficient as low as 20 parts per million per degree C, greater stability and lower noise level.

### What This Means to You

Briefly, this makes it possible for you to use the new, much improved BORO-CARBOFILM RESISTOR in place of larger and more costly wire-wound types. It also provides access to resistance ranges heretofore impossible to attain in film-type resistors. With their low temperature coefficient and small aging you will find wide-spread use for these new resistors in communications and nearly all types of electronic applications. Remember the name "BORO-CARBOFILM". Available in  $\frac{1}{4}$ ,  $\frac{1}{3}$ ,  $\frac{1}{2}$ , 1 and 2-watt sizes.

In writing, kindly give your requirements in sizes and volume.

BORO-CARBOFILM RESISTORS are made under license arrangement with Western Electric Co., Inc.

## WILKOR PRODUCTS, INC.

2882 Detroit Avenue • Cleveland 13, Ohio

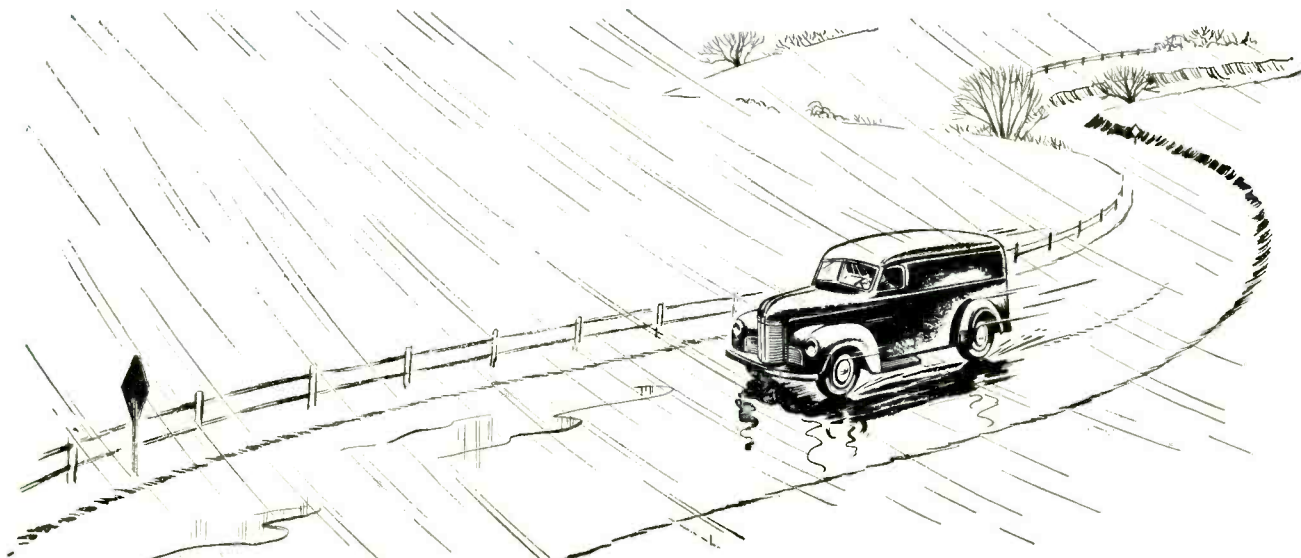

## "...and George had to drive 8 miles"

It was Sunday afternoon—and raining cats and dogs. The phone rang. It was Mrs. Gilbert from Fairlawn, a new subdivision about eight miles from town . . . She had just spilled some hot grease on her brand new Electric Stove—and the whole thing had short-circuited . . . And her guests were due to arrive in two hours! . . . So George hauled out the truck—and in half an hour he was at Mrs. Gilbert's . . . It was the same old story—somebody in order to save a few pennies had used an electrical insulation that was not grease-proof.

**A**n electric kitchen is wonderful—when it's working. But, let the insulation short out and failure is complete.

That's why America's leading manufacturers of home appliances use BH Special Treated Fiberglas Sleeving at every critical insulation point . . . like the unit leads for an electric range, or the leads to the clock mechanism of a toaster.

BH Special Treated Fiberglas Sleeving is the same high heat insulation that protects electrical equipment for industry. Consider these safety factors: withstands temperatures up to 1200° F without stiffening or cracking—combustion resistance—freedom from crystallization at -67° F.

Here is insulation that spreads readily over knobs and terminals, and doesn't ravel or fray when cut to lengths. Extreme flexibility plus tubular shape means easy handling, faster production.

BH Special Treated Fiberglas Sleevings are only a branch of the BH Insulation Family. There are many others. We'll be glad to send you testing samples if you'll tell us your requirements—write today!

Address Dept. E-2  
Bentley, Harris Manufacturing Co.  
Conshohocken, Pa.

# BH *Fiberglas*<sup>\*</sup> SLEEVINGS

\*BH Non-Fraying Fiberglas Sleevings are made by an exclusive Bentley, Harris process (U. S. Pat. No. 2393530). "Fiberglas" is Reg. TM of Owens-Corning Fiberglas Corp.



# CENTRALAB CERAMIC CAPACITORS GIVE YOU THE WIDEST CHOICE PLUS FINEST QUALITY AT ANY PRICE!

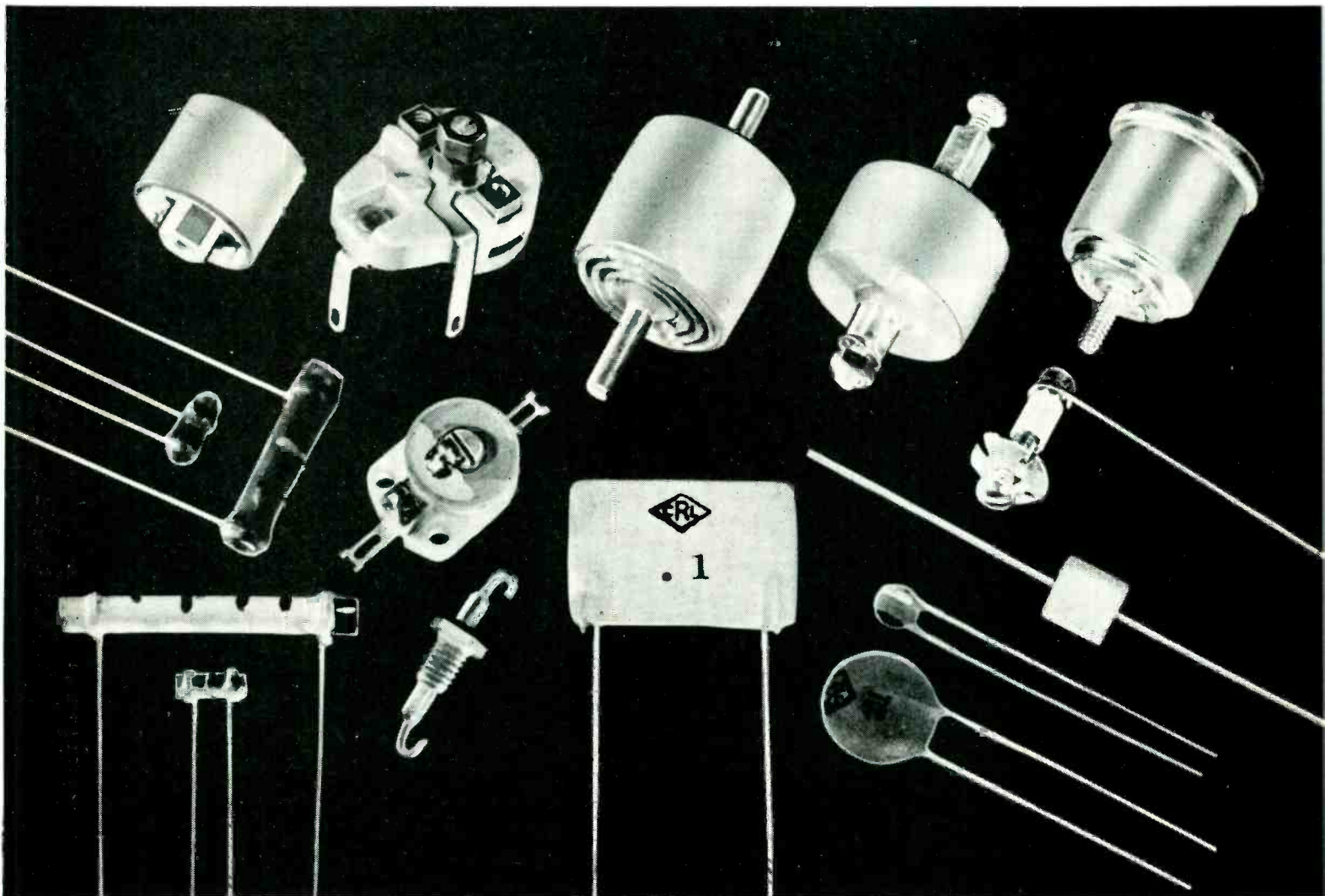

## HERE'S WHAT YOU GET FROM CENTRALAB CERAMICS

Centralab ceramic capacitors provide a permanence never before achieved with old-fashioned paper or mica condensers. The ceramic body provides imperviousness to moisture, plus unmatched ability to withstand any temperatures normally encountered in electrical apparatus. What's more, ceramics make possible tremendous savings in space; many Centralab ceramic capacitors are  $\frac{1}{4}$ th the size of ordinary capacitors. This is particularly important

where new design requirements call for less bulk. You can rely on Centralab ceramic capacitors for close tolerance, high accuracy, low power factors, and excellent temperature compensating qualities. Compare Centralab Ceramic capacitors for small size, wide range of ratings, variety of types and top quality characteristics. Compare their price. The results will show you why you'll standardize on Centralab—first in the field of electronic ceramics.

WANT MORE INFORMATION? **SEE NEXT TWO PAGES** 

# CENTRALAB Offers America's Most

FOR COMMERCIAL AND

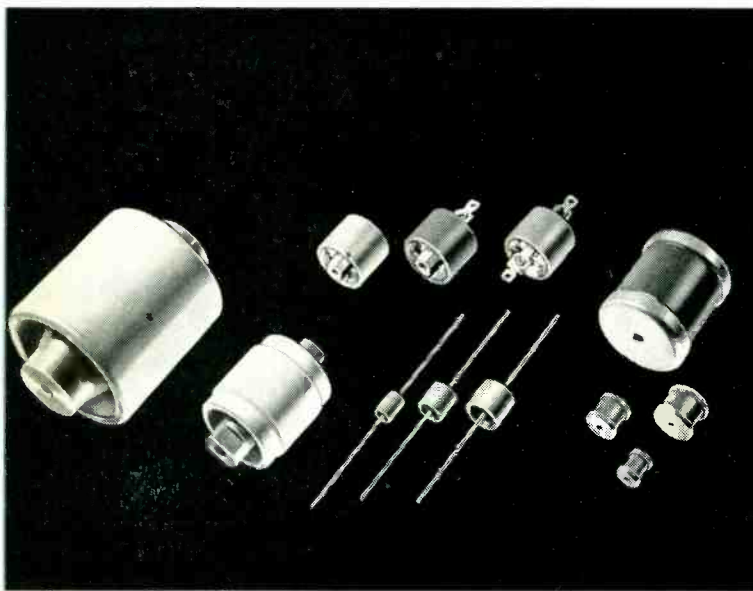

High voltage ceramic capacitors. Capacitance: 5 to 500 mmf., 5 KV to 40 KV D.C. working. Ideal for portable or mobile equipment. Primarily designed for high voltage, high frequency gear. For complete information, check Bulletin No. 42-102 in coupon below.

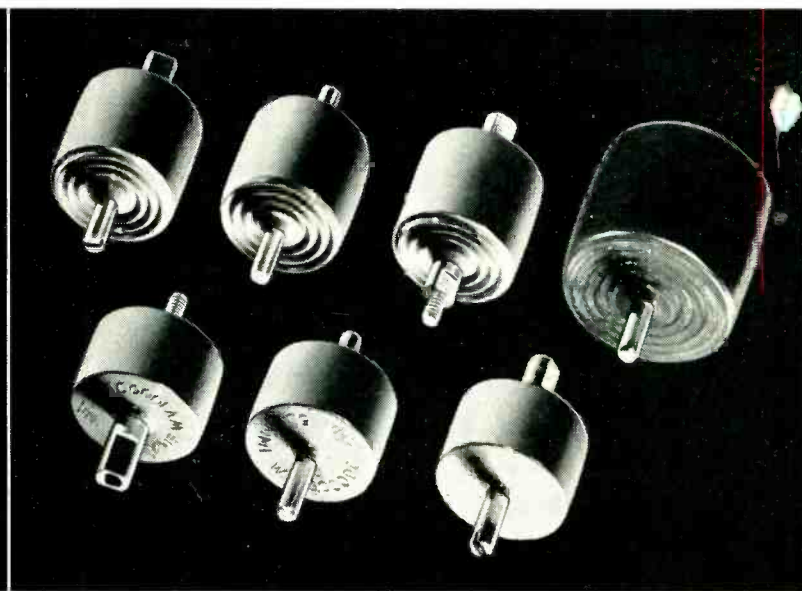

Centralab's famous TV Hi-Vo-Kaps are the standard for the TV industry. Capacitance: 500 mmf., 10 KV, 20 KV and 30 KV D. C. working. Best suited for high voltage, low power applications. For complete information, check Bulletin No. 42-10R in coupon below.

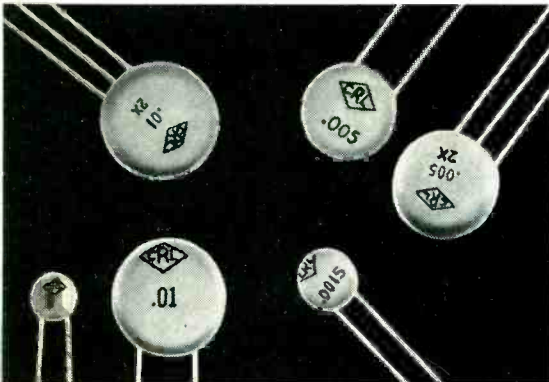

Ceramic Disc Hi-Kap Capacitors hold thickness to a minimum. Make possible very high capacity in extremely small size. Use in HF bypass and coupling. Bulletin No. 42-4R.

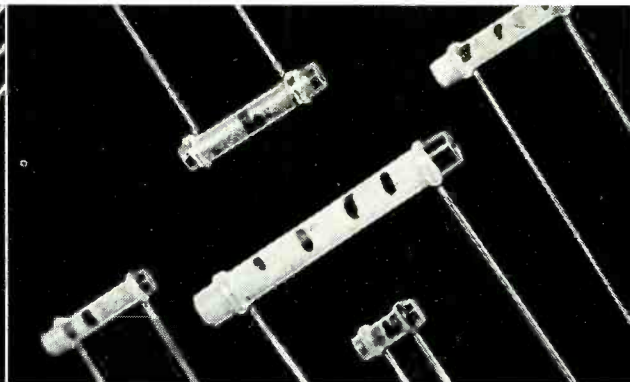

TC (Temperature Compensating) Tubulars—Type TCZ show no capacitance change over wide range of temperature. Type TCN have special ceramic body to vary capacitance according to temperature. Bulletin No. 42-18.

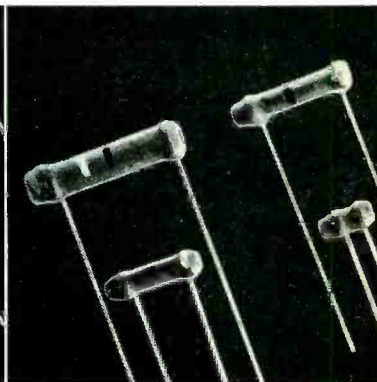

BC (Bypass Coupling) Tubulars — Recommended for by-pass coupling. Well suited to general circuit use. Bulletin No. 42-3.



FT (Feed Through) Hi-Kaps — Designed for single hole mounting with ground to chassis or shield. Bulletin No. 975.

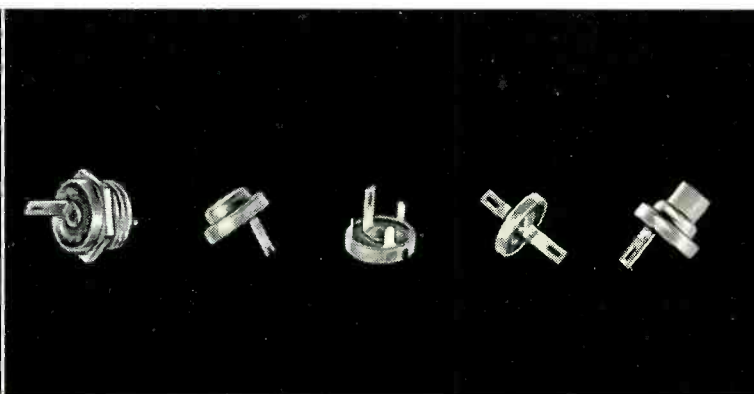

Something new in miniature ceramic capacitors! These "button types" are available in 5 different styles. Used for bypassing in low-power, high frequency applications where small size, low inductance and light weight are essential. Check Bulletin No. 42-122 in coupon for more information.

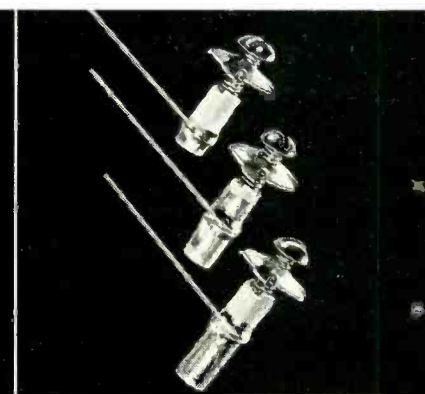

TV Trimmer Capacitors — ceramic tubulars—threaded. Complete with lock-nut and screw. Use in TV, FM. Bulletin No. 42-59.



# Complete Line of Ceramic Capacitors

(JAN) MILITARY APPLICATION

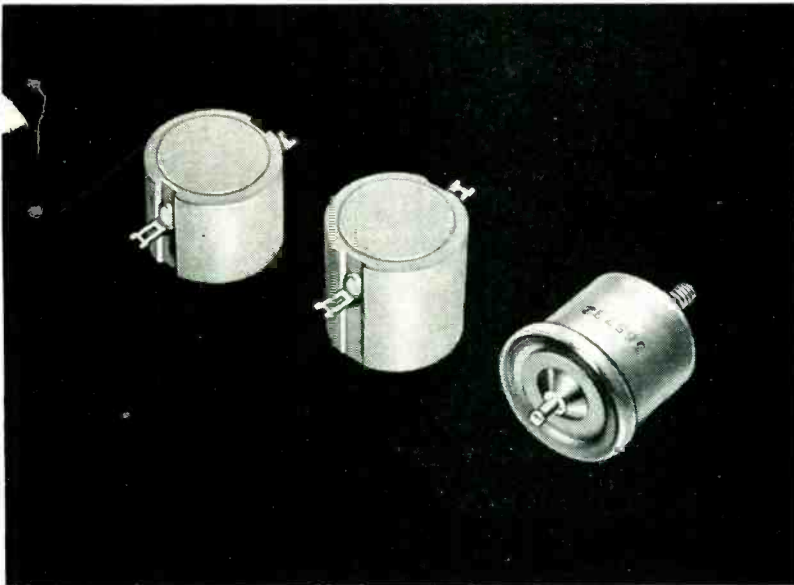

High Accuracy capacitors. Precision units to meet exacting requirements involving extremely rigid frequency control. Extensively used for holding oscillator frequencies to close limits. For complete information, check Bulletin No. 42-123 in coupon below.

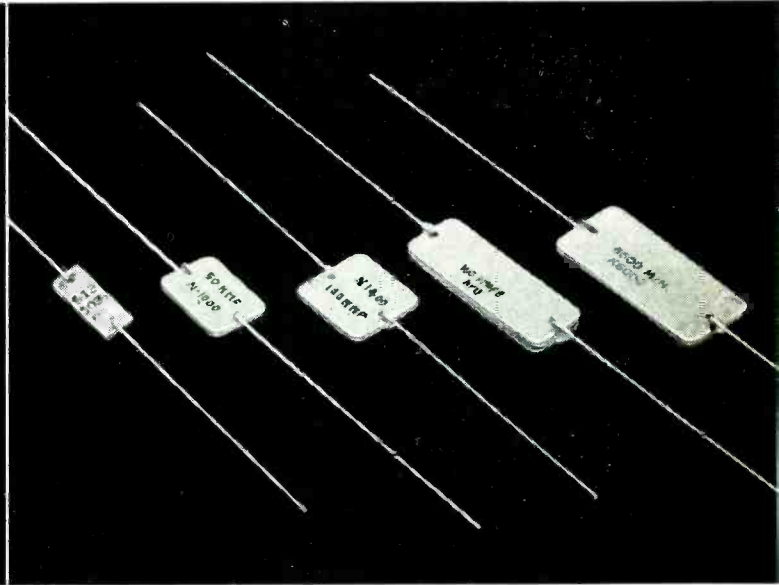

Flat Plate, end-lead capacitors. Temperature compensating. Capacitances: 5, 10, 20, 50 and 100 mmf., 500 volts D. C. working. Temperature Compensating Tolerance: 15% or 30 PPM whichever is larger. For complete information Check Bulletin No. 42-124 in coupon below.

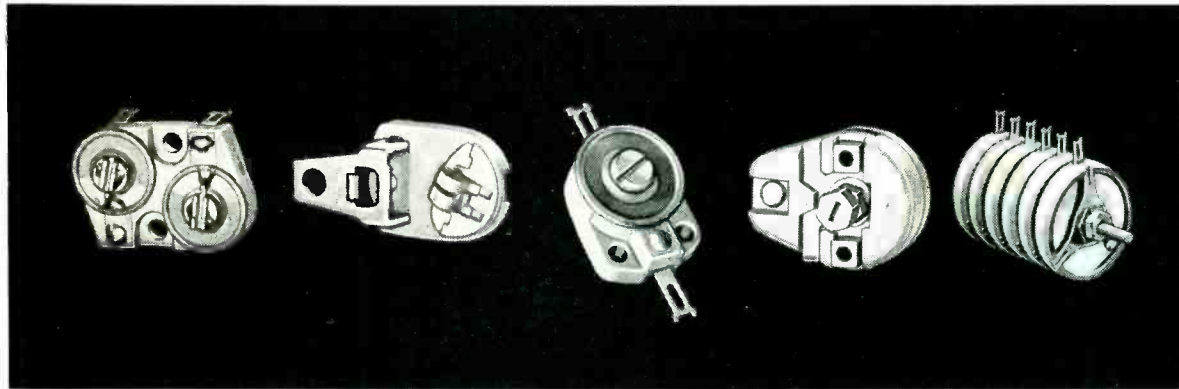

Centralab Ceramic and Steatite Trimmers provide high quality stable capacitors, with small size, light weight, easy mounting. Readily adjustable with screw driver and give full capacity range with 180° rotation. Equal stability maintained in any position — minimum to maximum. Have excellent stability under vibration. Rotor and stator contact under spring pressure on optically ground flat surface. Check Bulletin No. 42-101 for more data.

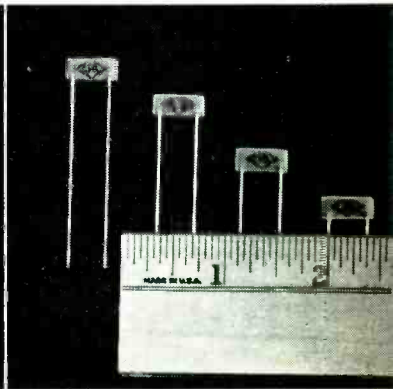

Min-Kaps are very tiny capacitors used where space is at extreme premium. Ask for Bulletin No. 42-24.

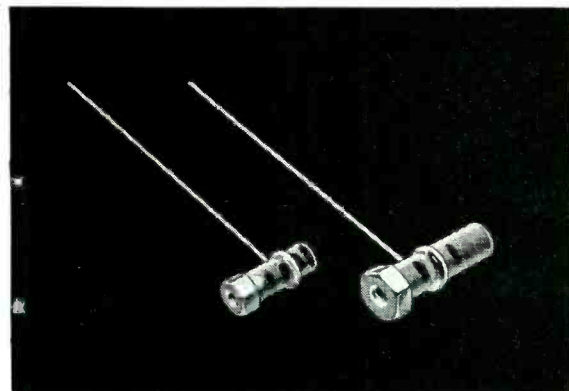

Stand-off ceramic capacitors — both Bypass Coupling and Temperature Compensating types. One end threaded. For complete information check No. 42-121 in coupon below.

## Centralab

Division of GLOBE-UNION INC. • Milwaukee

CENTRALAB  
Division of Globe-Union Inc.  
914 East Keefe Avenue, Milwaukee, Wisconsin

Yes — I would like to have the CRL bulletins, checked below, for my technical library!

- |                                 |                                 |                                 |                                 |                                 |
|---------------------------------|---------------------------------|---------------------------------|---------------------------------|---------------------------------|
| <input type="checkbox"/> 42-102 | <input type="checkbox"/> 42-124 | <input type="checkbox"/> 42-3   | <input type="checkbox"/> 975    | <input type="checkbox"/> 42-122 |
| <input type="checkbox"/> 42-10R | <input type="checkbox"/> 42-4R  | <input type="checkbox"/> 42-101 | <input type="checkbox"/> 42-121 |                                 |
| <input type="checkbox"/> 42-123 | <input type="checkbox"/> 42-18  | <input type="checkbox"/> 42-24  | <input type="checkbox"/> 42-59  |                                 |

Name.....

Address.....

City..... State.....

# HICKOK

announces

For Industrial and  
Electronic  
Laboratories

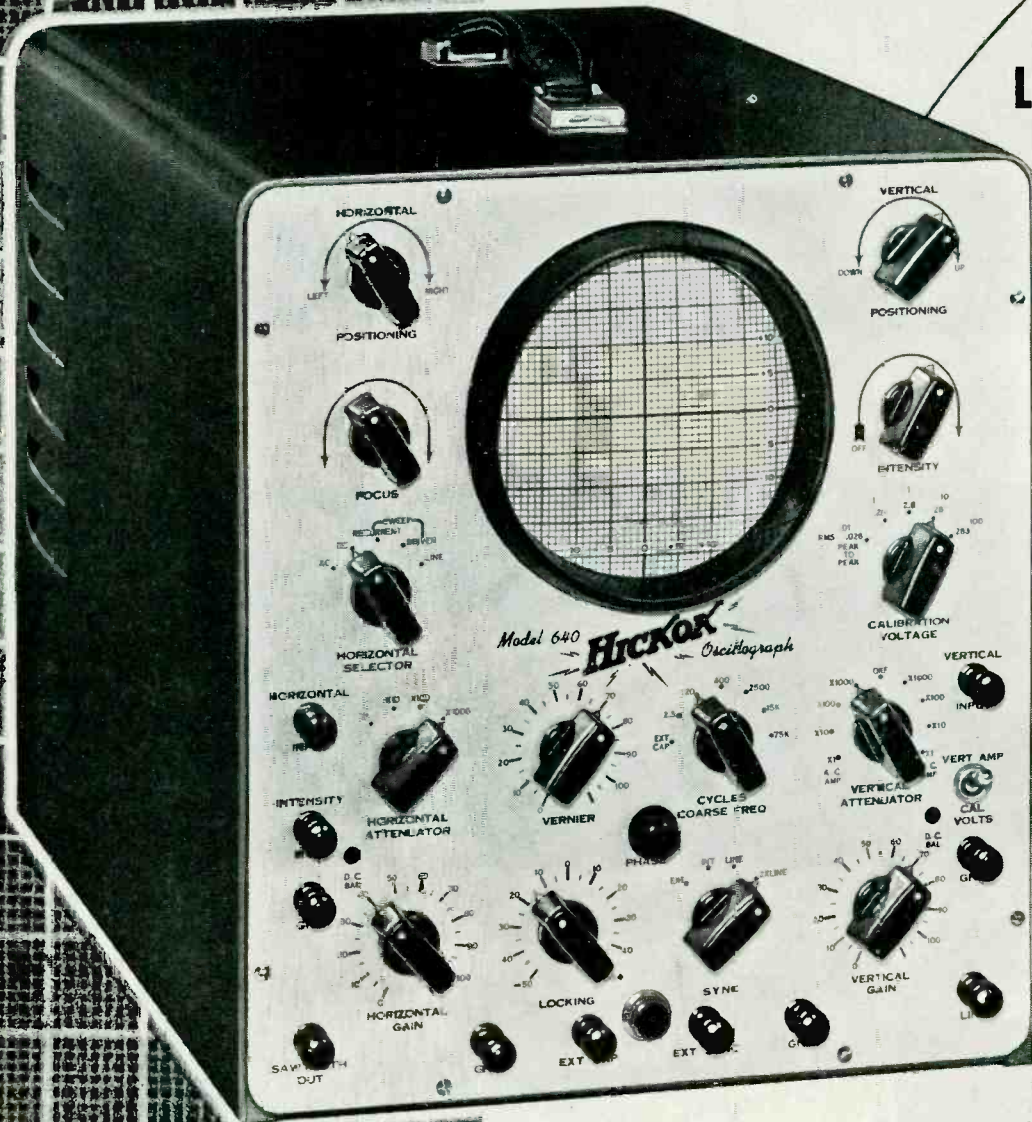

MODEL 640

The new HICKOK Model 640 Oscilloscope with its exceptional design features and characteristics provides an outstandingly versatile instrument for the engineer in observing regular recurring or transient phenomena.

The Model 640 has been rigidly field tested and proved in the HICKOK laboratories. All components are the best obtainable and in keeping with the HICKOK 40-year reputation for highest quality, accuracy and dependability.

**STABLE • ACCURATE • VERSATILE**



*the new model*

640

## OSCILLOGRAPH

### DESIGN FEATURES

**WIDE BAND AMPLIFIER:** Frequency response DC, 0 to 4.5 mc, (down 3 db).

**VERTICAL DC AND AC AMPLIFIER:** 10 M.V. per inch with sensitivity switch in high position. 25 M.V. per inch in low position.

**FREQUENCY RESPONSE:** 0 to 1,000,000 cycles, (3 db point), in high position. 0 to 4,500,000 cycles, (3 db point), in low position.  
No jitter, even with high gain amplifiers.  
Maximum Input Potential: 1000 volts peak.  
Input Impedance: 2 megohms, 50 mmf.  
Excellent stability and minimum microphonics and drift.

**HORIZONTAL AMPLIFIER:**

Deflection Factor—  
Direct: 20 volts RMS per inch.  
Full Gain Setting: 50 millivolts RMS per inch.  
Frequency Response: 0 to 200,000 cycles, with 3 DB down at upper limit.  
Maximum Input Potential: 1000 volts peak.  
Input Impedance: 2 megohms, 50 mmf.

**BUILT-IN CALIBRATING VOLTAGES:**

Peak-to-Peak—100, 10, 1, .1 volts.

**TEST SIGNALS:** Line Frequency: 3 volts RMS per inch.

Sawtooth: Available from front panel.  
Direct connection to both horizontal and vertical deflection plates.

**LINEAR TIME BASE:** Recurrent and Driven Sweep: 2 cycles to 30,000 cycles.

Provision for external capacities for slower frequency sweeps of 10 seconds and slower.

Sweep Speeds: Faster than 0.75 inch per microsecond.

Television fixed frequencies; 30 and 7,875 for observing blanking and sync waveforms in the horizontal and vertical circuits of TV receivers.

Synchronization at line or 2-times line frequency.

**EXPANDABLE SWEEP:** 6 times expansion, or equivalent to 30 inches of screen diameter.

**LINE FREQUENCY PHASING CONTROL:**

Zero, plus or minus 90° phase shift.

**"Z" AXIS MODULATION:** Capacitively coupled to the grid of the cathode ray tube. 15 volts will blank trace fully at normal intensity.

**INTENSITY:** Standard Model 640 includes 5UP1 cathode ray tube with medium persistence screen. High accelerating potentials give excellent intensity for viewing transient waves and high frequencies.

Some engineers may prefer a 5UP11 tube for short persistence, or a 5UP7 tube for long persistence. Either is available in the Model 640 at slight additional cost.

**SHOCK MOUNTED:** Provides minimum microphonics due to external mechanical vibrations.

**SHIELDED:** Mu Metal magnetic shield gives maximum protection to the cathode ray tube against effects of external magnetic fields.

**CALIBRATED SCALE:** Provided for quantitative measurements and comparisons.

Combination light shield and camera base provided.

**STABILIZED:** Designed so that sweep lengths and synchronizations are maintained as signal level varies.

**DIMENSIONS:** Portable steel case, 14" x 11½" x 19", approximately 35 lbs. \$355.

Price subject to change without notice.

*Write for further information today!*

**THE HICKOK ELECTRICAL INSTRUMENT CO.**

10527 Dupont Avenue · Cleveland 8, Ohio

**BUILT TO THE HIGHEST QUALITY STANDARDS**

# Here's Why...

you now get  
**Quick Delivery**  
on these  
**Top Quality**

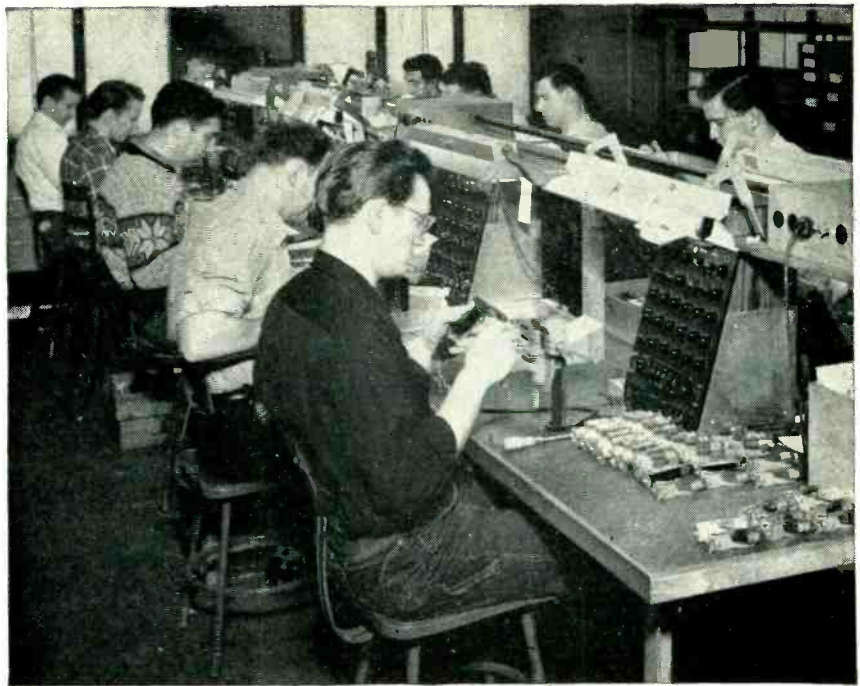

One of the assembly lines in our Relay Department

## AUTOMATIC RELAYS



## ELECTRIC SWITCHES

This special—and separate—department has but one function . . . to process your orders promptly and accurately. Here, stocks of all standard parts are maintained, ready for expert assembly in accordance with your specific requirements. "Engineering Samples" are shipped

within 10 to 14 days after receipt of order (for hermetically sealed relays, allow 10 days more). Quantity shipments can start within 30 to 60 days on schedules to meet your requirements. With high-g geared volume production, thousands of these superior components are being delivered quickly.

**WHEREVER DEPENDABILITY COMES FIRST:**—The men who know insist upon Automatic Electric Relays and Switches for top quality. Here are a few examples:

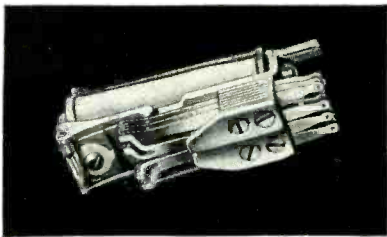

**CLASS "B" RELAYS**—For requirements up to 26 terminals—greater sensitivity, contact pressure, compactness, versatility. And here's dependable long life even under extremely high speed operation. Hermetically sealed, where desired, to maintain highest performance standards.

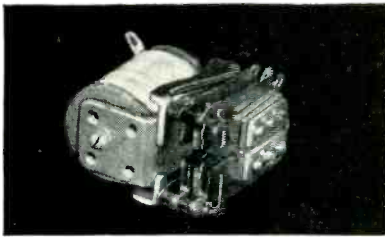

**CLASS "S" RELAYS**—For aircraft and other applications requiring small size, light weight, and hermetic sealing, if desired. Astonishing power in small space. Unaffected by extreme vibration, temperature changes, high humidity. Supplied with coils up to 10,000 ohms or more.

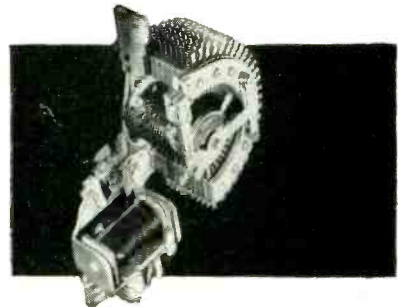

**TYPE 45 ROTARY SWITCH**—Up to 10 or more bank levels, adaptable to 25- or 50-point operation. Speed to 70 steps a second. Simpler . . . only one field adjustment. For d-c service or completely self-contained for a-c service to suit a wide variety of control applications.

For help on your control problems, call one of our field engineers, or write for literature. Address **AUTOMATIC ELECTRIC SALES CORPORATION**, Chicago 7, Illinois. In Canada: **Automatic Electric (Canada) Ltd.**, Toronto.

## RELAYS



## SWITCHES

# AUTOMATIC ELECTRIC

## CHICAGO



# for VACUUM

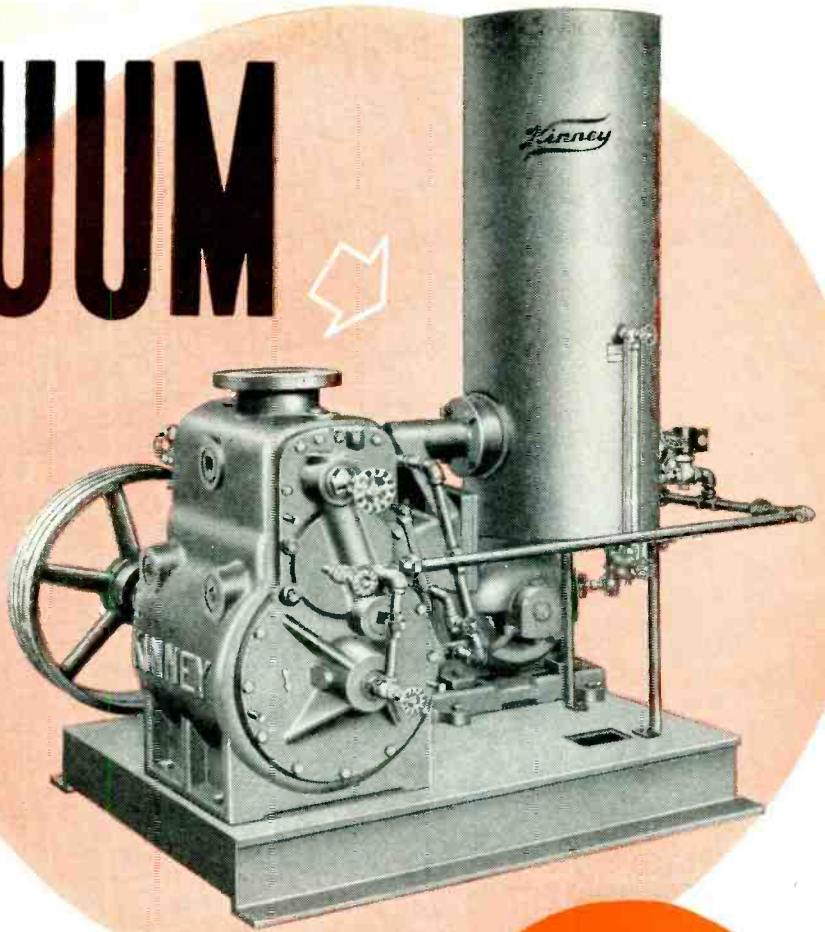

## ... OR VACUUM

Come to KINNEY for the vacuum pump that's right for your vacuum problem.

Kinney High Vacuum Pumps range from the big 40 HP unit with 702 cu. ft. per min. displacement to the little 1/3 HP pump rated at 4.9 cu. ft. per min. Kinney offers two basic pump designs — Single Stage and Compound — for low absolute pressures to 10 microns or 0.1 micron, respectively. You can also choose the type of outlet valve that's best for your job — for extremely low pressures, the efficient feather valve, or for air-vapor mixtures, the exclusive stainless steel poppet valve. Return the coupon today for your copy of Bulletin V45 . . . the full story on Kinney's complete line of vacuum pumps. KINNEY MANUFACTURING COMPANY, 356<sup>5</sup> Washington St., Boston 30, Mass. Representatives in New York, Chicago, Cleveland, Houston, New Orleans, Philadelphia, Los Angeles, San Francisco, Seattle.

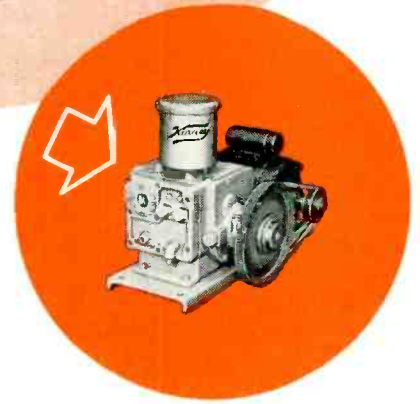

*Foreign Representatives:*

General Engineering Co. (Radcliffe) Ltd., Station Works, Bury Road, Radcliffe, Lancashire, England . . . Horrocks, Roxburgh Pty., Ltd., Melbourne, C. I. Australia . . . W. S. Thomas & Taylor Pty., Ltd., Johannesburg, Union of South Africa . . . Novelectric, Ltd., Zurich, Switzerland . . . C.I.R.E., Piazza Cavour 25, Rome, Italy.



### SEND COUPON TODAY

KINNEY MANUFACTURING CO.  
3565 WASHINGTON ST., BOSTON 30, MASS.  
Gentlemen:

Please send illustrated Bulletin V45. We are interested in:

- |   |  |
|---|--|
| <input type="checkbox"/> Vacuum exhausting  | <input type="checkbox"/> Vacuum distillation |
| <input type="checkbox"/> Vacuum coating     | <input type="checkbox"/> Vacuum metallurgy   |
| <input type="checkbox"/> Vacuum dehydration |  |

Name ..... Company .....

Address .....

City ..... State .....

# Now Corning gives You...

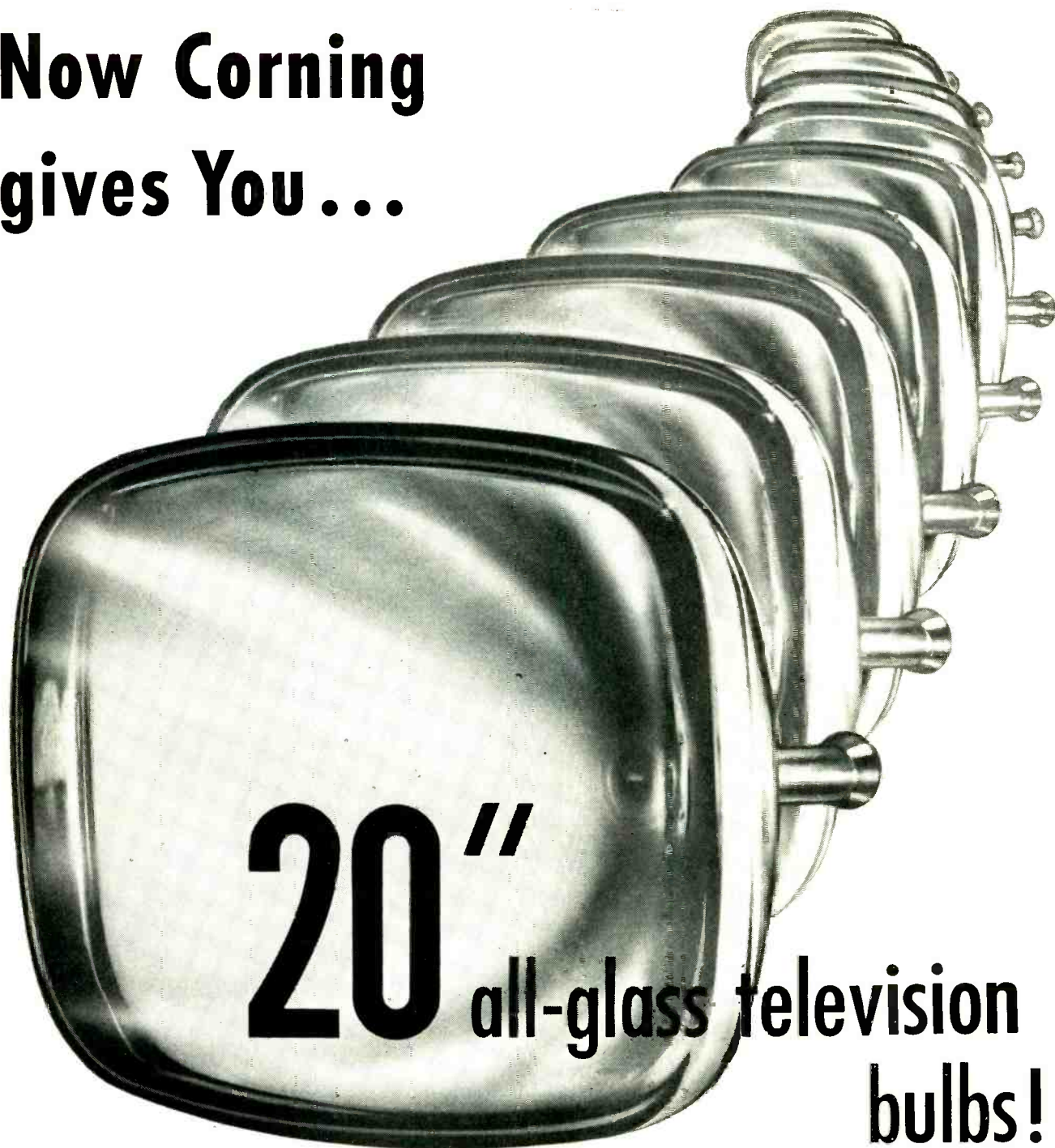

## 20" all-glass television bulbs!

When television was still a laboratory curiosity, Corning made the *first* experimental bulbs. All during the early stages of television set production, Corning was the principal manufacturer of television bulbs. In keeping with this tradition, and in answer to demands from the Television Industry, Corning has introduced the *all-glass 20" rectangular bulb!*—the largest television bulb in volume production today.

The first of this size on the market, the new 20" bulb combines all the improvements developed through years of research at Corning. Among these are light-weight, lead-free glass ideally suited to electronic applications, stronger bulb assemblies from electric sealing, and constant quality and color transmission from improved glass melting and forming techniques. The new Corning 20" all-glass bulb is the last word in quality, durability and size.

**CORNING GLASS WORKS**

Electronic Sales Department, Electrical Products Division



**CORNING, N. Y.**

*Corning means research in Glass*

1851 · 100 YEARS OF MAKING GLASS BETTER AND MORE USEFUL · 1951



OVER

90%

of the TRANSMISSION  
MEASURING SETS

Used Today  
Are Made by

DAVEN

Not only is the Daven Company the largest supplier of transmission measuring sets, but it is also a source for every needed type of instrument for the measurement of the transmission characteristics of communication systems. It furnishes units to check all types of broadcast equipment and audio devices for commercial and industrial use as well as for organizations such as utilities, telephone and power companies. Therefore, whatever your requirements are in this field, write to Daven for complete catalog material, and outline your own particular problems for specific assistance from our engineering staff.



THE DAVEN CO.

191 CENTRAL AVENUE • NEWARK 4, NEW JERSEY

## DAVEN TRANSMISSION MEASURING SET 7A

Equipment specially designed for use by utilities, telephone and power companies. May be directly applied to measuring gains or losses through amplifiers, repeaters, attenuating networks or communication lines.

### TRANSMISSION SECTION

GENERATED FREQUENCIES: 500, 1000, 2500 cycles per second.

OUTPUT LEVEL: -13, 0, +4 and +10 dbm.

INPUT and OUTPUT IMPEDANCE: 600 ohms over entire frequency range.

### RECEIVING SECTION

FREQUENCY RESPONSE: Within  $\pm 1.0$  db from 50 to 15,000 cps.

AMPLIFICATION RANGE: -10 to +30 db in 2 db steps.



## DAVEN TRANSMISSION MEASURING SET 11A

A moderately priced instrument for broadcast equipment. A simplified, accurate, direct reading instrument, designed to make measurements in accordance with FCC regulations.

FREQUENCY RANGE: 20 CY to 20 Kc.

ACCURACY:  $\pm 0.1$  db, 20 CY to 20 Kc.

RANGE OF LEVEL:

+ 4 to -110 db } in steps of 0.1 db.  
-10 to -124 db }

### APPLICATIONS:

- (a) Audio gain and loss measurements.
- (b) Measurements of matching and bridging devices.
- (c) Complex circuit measurements.
- (d) Measuring mismatch loss.
- (e) Frequency response measurements.

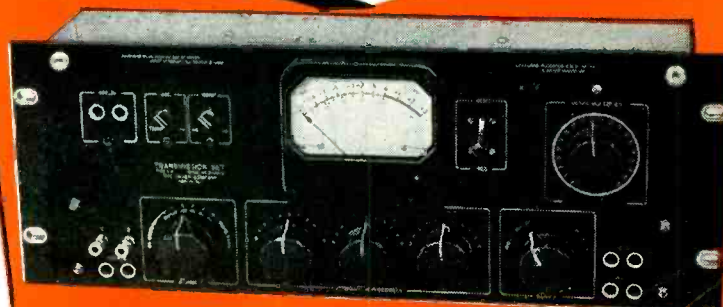



# safe\* guards your reputation

Obviously, the focal point of every television set is the picture tube. On it, to a great extent, hinges the reputation of the set manufacturer, the dealer or the service-man. Rarely does the consumer place blame for failure on the tube, because his first reaction, when reception falters, is to blame the set or the installation. You don't take chances when you use a Zetka picture tube. Zetka safeguards your reputation because Zetka products are unrivaled for safety, sharp focus, brilliance and fabulously long life. Every Zetka tube is set-tested in the factory to protect you.

THE SAFEST PICTURE TUBE

IN THE WORLD

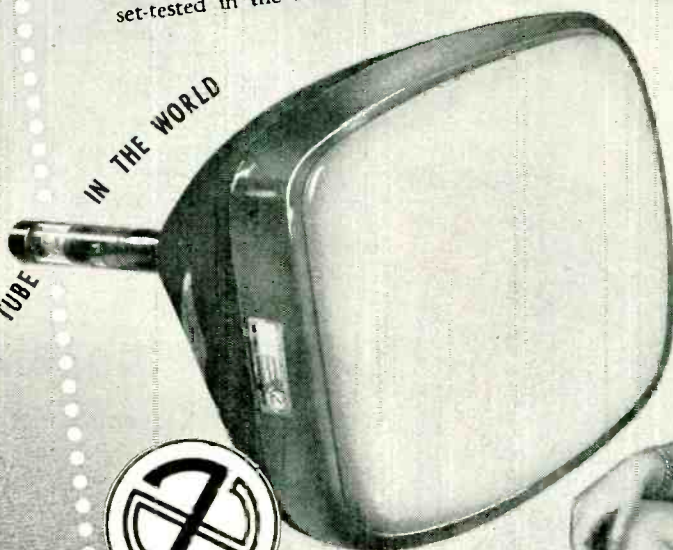

\* Most Trusted Name in Picture Tubes

# zetka\*

THE ARISTOCRAT OF TELEVISION TUBES

# zetka

TELEVISION TUBES, INC. 131-37 GETTY AVE. • CLIFTON, N. J.

For 37 years, Zetka has been a respected name in the radio and television industry.



# WHY BRADLEY RECTIFIERS CONSISTENTLY EXCEL IN

# PERFORMANCE

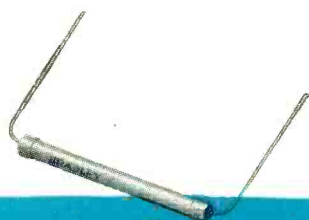

**SE8 SERIES — SELENIUM  
FOR HIGH VOLTAGE USES**

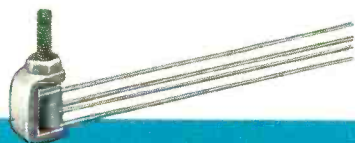

**CX14 SERIES — COPPER OXIDE  
FOR INSTRUMENTS**

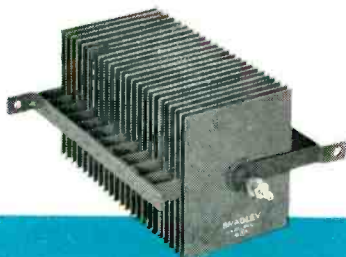

**SE11 SERIES — SELENIUM  
FOR HIGH CURRENT USES**

## PHOTOELECTRIC CELLS



Bradley Luxtron\* photoelectric cells convert light directly into electrical energy without external power source. Wide range of models, sizes and shapes available.

\*T. M. Reg. U. S. Pat. Off.

**PERFORMANCE AS RATED** is not a hoped for characteristic with Bradley selenium or copper oxide rectifiers. It can be counted upon and planned for.

**THROUGHOUT MANUFACTURE** our rectifiers are subjected to the most rigorous quality control technique ever developed for rectifiers — the Bradley Vacuum Process.

**IN BRADLEY SELENIUM RECTIFIERS**, our unique and exclusive vacuum method eliminates impurities in the raw selenium, prevents contamination during manufacture and assures a secure, even bonding of selenium to the plates.

**IN BRADLEY COPPER OXIDE RECTIFIERS**, the 24K gold counter electrodes and contact surfaces are placed on the copper oxide plates under high vacuum.

**PERFORMANCE AS RATED** is thus an inherent characteristic of Bradley rectifiers — a constant that assures stability of power conversion in your product under all conditions.

**BRADLEY RECTIFIERS... FOR PERFORMANCE AS RATED**

**BRADLEY LABORATORIES, INC.**  
82 MEADOW STREET, NEW HAVEN 10, CONNECTICUT

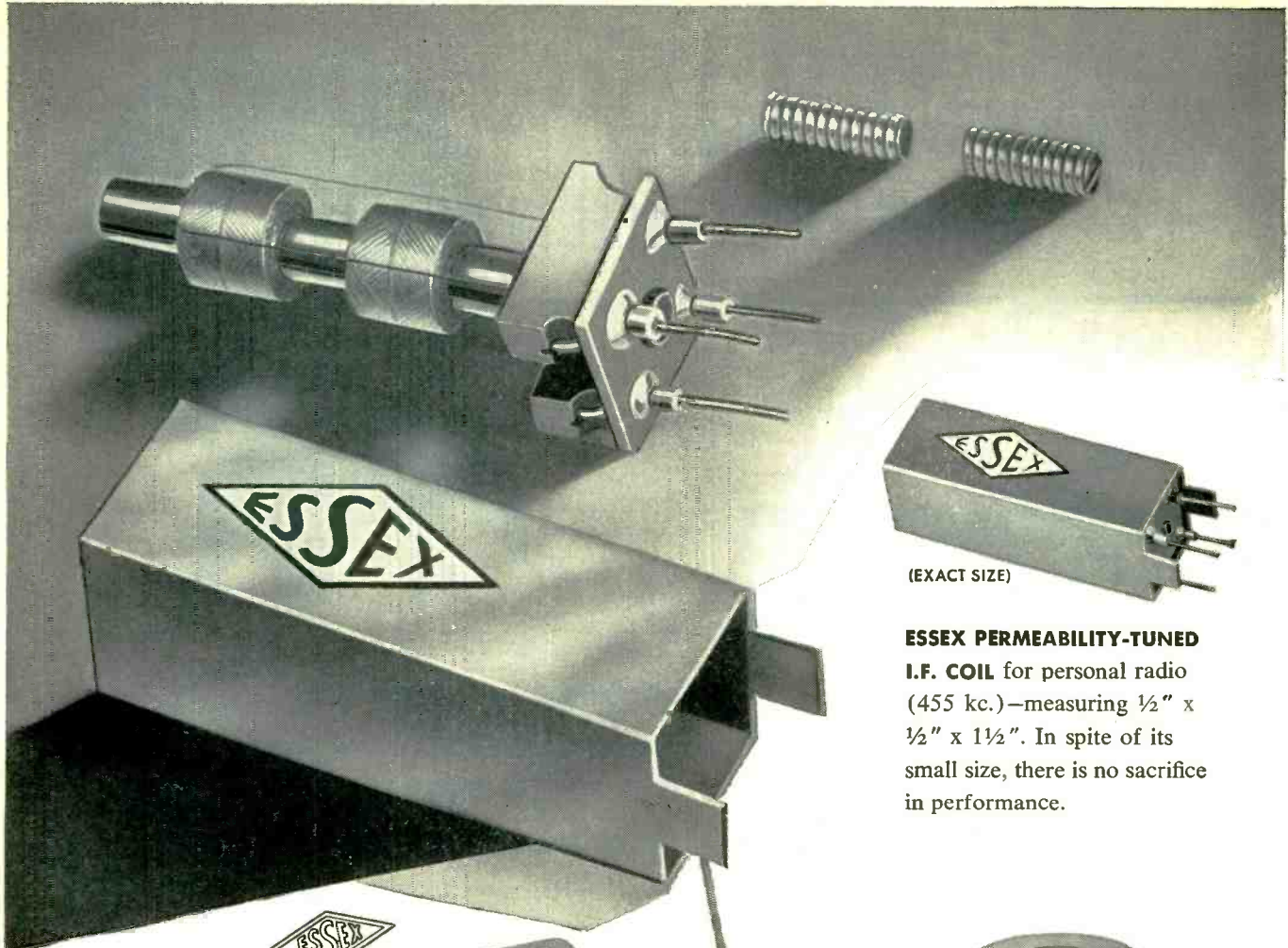

(EXACT SIZE)

**ESSEX PERMEABILITY-TUNED I.F. COIL** for personal radio (455 kc.)—measuring 1/2" x 1/2" x 1 1/2". In spite of its small size, there is no sacrifice in performance.



**ESSEX PERMEABILITY-TUNED R.F. TRANSFORMER** for United Nations translation receiver—measuring 7/8" in diameter and 5/8" in height. Same type of construction has been made in 262 kc. I.F. Transformer—measuring 1/2" x 1/2".

**ESSEX ELECTRONICS**  
*Manufacturers of coils, chokes and transformers*  
 STATION STREET AND SPRINGFIELD AVENUE  
 BERKELEY HEIGHTS, N. J. — SUMMIT 6-5432

December 21, 1950

Antara Products Division  
 General Dyestuff Corporation  
 435 Hudson Street  
 New York 14, N. Y.

Gentlemen:

Ministrization is a word that has become ever more important in our business. Over the past four years we have received one assignment after another of this type. The solutions to these problems do not always go by formula; they are not exactly simple. But -- on each and every occasion -- G A & F Carbonyl Iron Powders have been one of our major tools in the successful completion of these assignments.

A typical application was for the translation receivers which permit a United Nations delegate to select the language in which he wishes to hear any talk....Another was for the tuning coils on a hearing-aid, radio-receiving attachment. Another was for I.F. coils for a tiny personal receiver. And the nation's armament program -- to which we hope we are making full contribution -- calls for sub-miniature coils. These, too, we are developing with the help of your product.

At all times, our design work is aimed at top quantity production of top quality items. In every assignment of this type, we rely on the fully dependable properties of Carbonyl Iron Powders.

Sincerely yours,  
 ESSEX ELECTRONICS

*Bernard M. Goldsmith*  
 Bernard M. Goldsmith  
 President

**G A & F Carbonyl**



# Each and every problem of **MINIATURIZATION** solved with the help of **CARBONYL IRON POWDERS**

Essex Electronics ranks today as one of the major suppliers of coils to the leading makers of receiving sets. Their reputation is based upon sound engineering and efficient production. With ten years of experience in this field, Essex Electronics testifies that G A & F Carbonyl Iron Powders have been one of the major tools in the successful completion of their many assignments. . . . .

Other makers—of both cores and coils—have testified that *it costs less* to work with these top quality materials and that major gains are effected in both weight reduction and increased efficiency. We urge you to ask your core maker, your coil winder, your industrial designer, how G A & F Carbonyl Iron Powders can improve the performance of the equipment you manufacture. It will cost you nothing to get the facts.

**THIS FREE BOOK** — fully illustrated, with performance charts and application data — will help any radio engineer or electronics manufacturer to step up quality, while saving real money. Kindly address your request to Department 21.



**ANTARA® PRODUCTS**  
DIVISION OF  
**GENERAL DYESTUFF CORPORATION**  
435 HUDSON STREET • NEW YORK 14, NEW YORK

# Iron Powders . . .



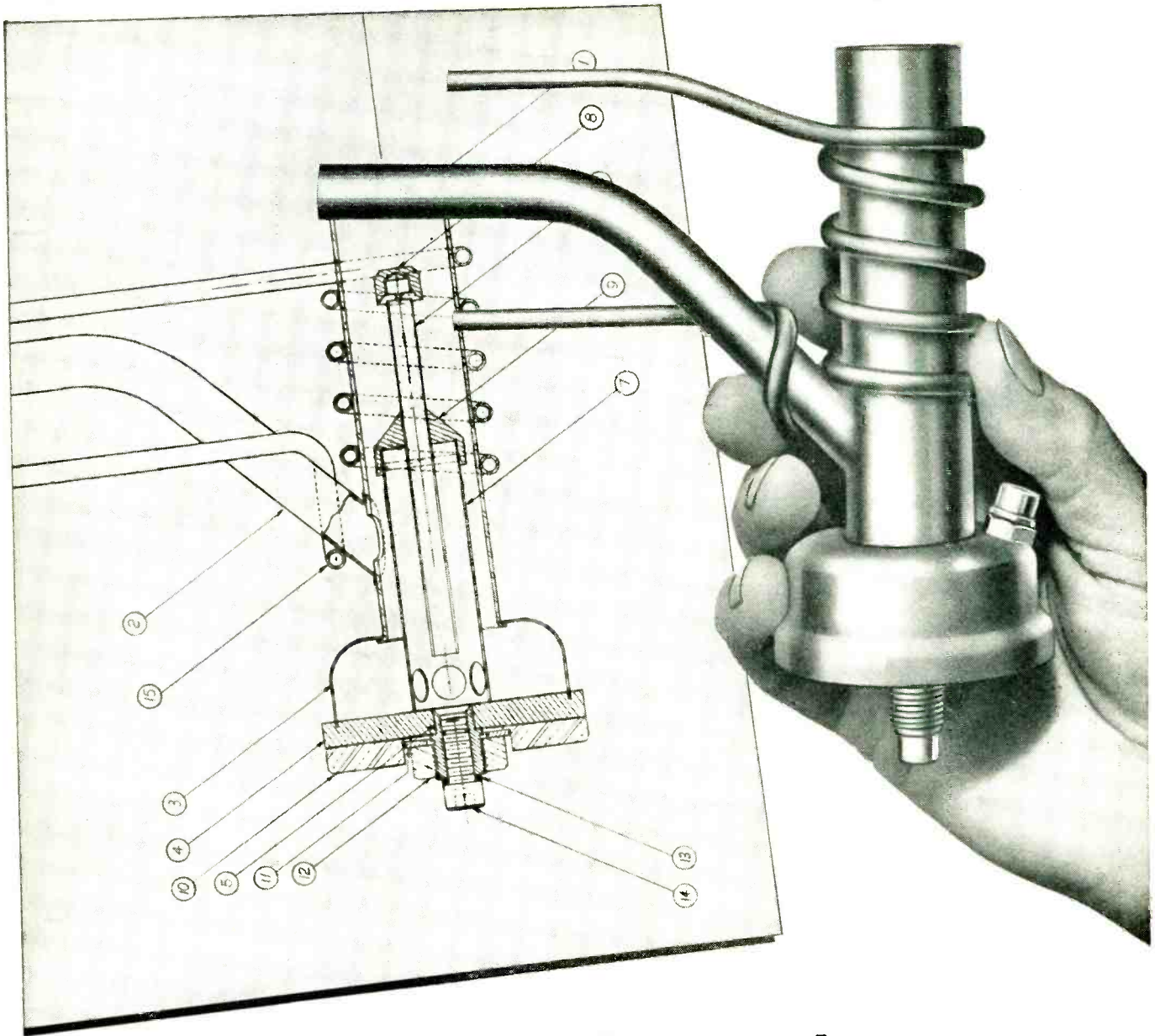

## New Booster Pump reduces the exhaust cycle of rotary units

This tiny booster pump was specially designed to increase the efficiency of rotary exhaust units. It is able to produce a total pressure of  $0.5 \mu$ , or less, in one-half the time of other available equipment because it has high pumping speed in the *right range of pressure*. It is ideally small — only  $2\frac{1}{2}$ " in diameter by 6" long. You'll have

no trouble mounting it at each exhaust port on most rotary equipment.

Because of its speed, this new diffusion pump can cut your exhaust cycle. At the same time, it gives the higher vacuum needed in the production of better quality tubes. Write today for complete information.

INDUSTRIAL RESEARCH • PROCESS DEVELOPMENT  
HIGH VACUUM ENGINEERING AND EQUIPMENT



METALLURGY • DEHYDRATION • DISTILLATION  
COATING • APPLIED PHYSICS

# National Research Corporation

Seventy Memorial Drive, Cambridge, Massachusetts

In the United Kingdom: BRITISH-AMERICAN RESEARCH, LTD., London S. W. 7 — Wishaw, Lanarkshire

Try these new, low cost  
diffusion pump fluids . . .  
Narcoil 10 • Narcoil 20  
Narcoil 30





# uniform

Yes, UNIFORM! There's no such thing as a "better tube" or a "poorer tube" when you insist on Du Mont Teletrons. Advanced engineering, precise mechanization second to none, and the most rigid quality control account for *uniformly dependable performance* that has made the Du Mont label symbolic of the finest in TV tubes. Best of all, with a productive capacity in excess of one million BIG picture tubes a year, the giant Du Mont Allwood plant meets *quantity* as well as *quality* requirements. Literature on request.

# DU MONT

*Teletrons*\*

\*TRADE-MARK

**FIRST WITH THE FINEST IN TV**  
**ALLEN B. DU MONT LABORATORIES, INC.**  
**Cathode-ray Tube Division, Clifton, N. J.**



## RCA TAPE RECORDER Type RT-11A

50 to 15,000 c.p.s. ( $\pm 2$  db) at 15 in/sec  
50 to 7,500 c.p.s. ( $\pm 2$  db) at  $7\frac{1}{2}$  in/sec

**COMPLETE**—with motor board, plug-in type recording amplifier, plug-in playback amplifier, two standard NAB reels, power supply and panel and shelf.

- Split-second start and stop

- Push-button operation

- Extremely accurate timing—  
with synchronous capstan

- Smooth tape runs—via  
sapphire guides

- Automatic tape lift for fast  
“forwards” and rewinds

- Microswitch “tape-break”  
control—no tape spills, snarls

- Remote control of all  
operations

- Rack or console mounting

- Plug-in amplifiers

- Interlock system for vital  
controls

- 3 heads—Erase—Record—  
Playback

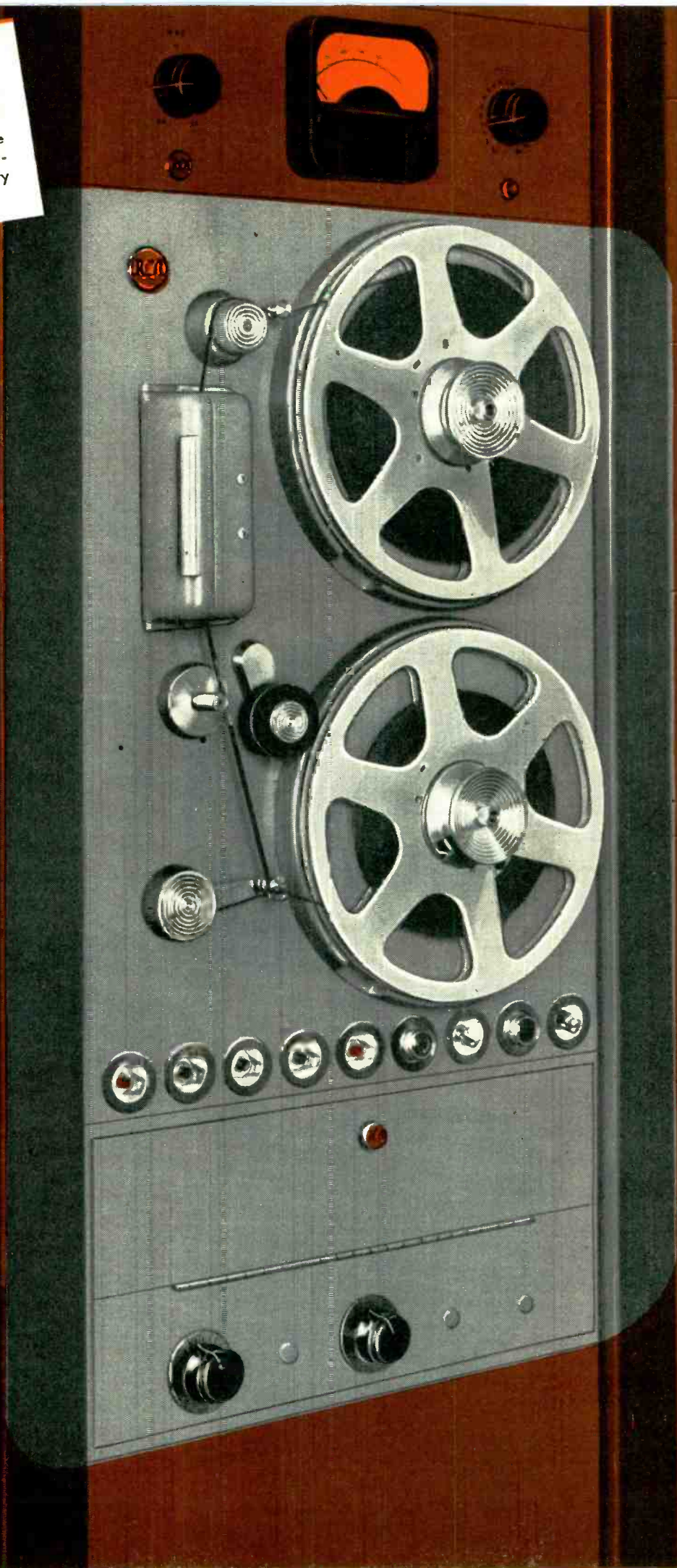



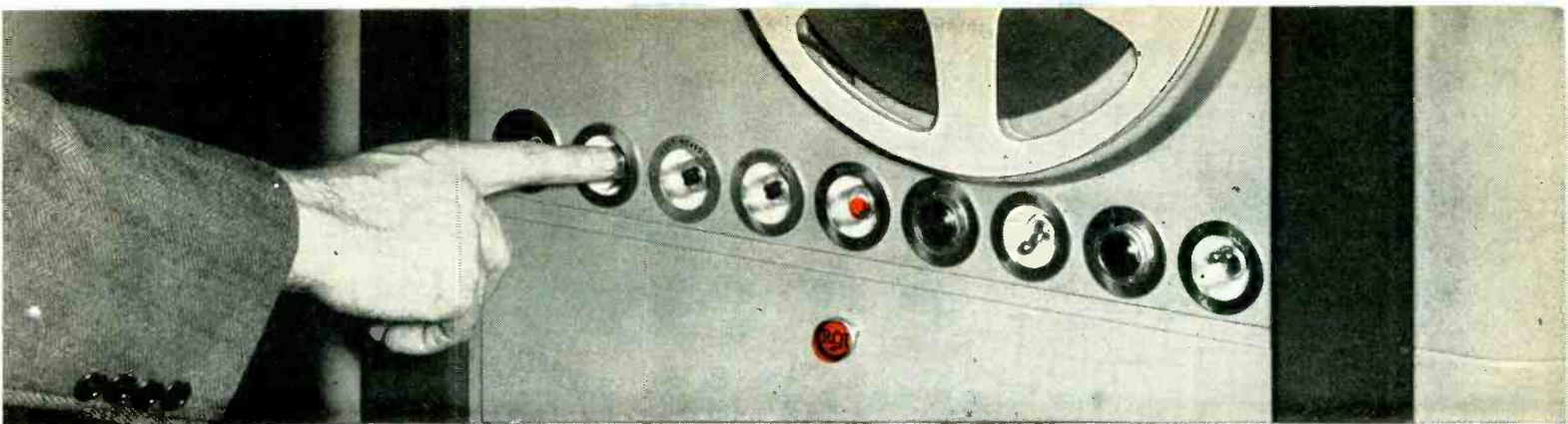

PUSH-BUTTON CONTROL puts tape recording facilities at your fingertips.

←←← **NEW-**

# High-Fidelity Tape Recorder

## -the finest money can buy!

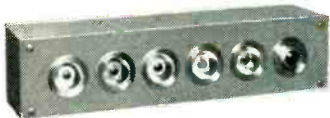

Remote Control Unit, MI-17948. Available extra.

This is the world's foremost professional tape recorder, the one recorder that has *everything*—accurate timing,

low wow and flutter, plus quick starting. All operations are push-button controlled. All functions—including cueing—can be extended to remote positions.

Designed for applications where operating TIME and RELIABILITY are prime factors, the new Type RT-11A Recorder offers a number of exclusive features. For example, you can start or stop the tape in 0.1 second. You can jockey the tape back and forth for cueing without stopping. You can rewind a standard 10½-inch reel in one minute!

A synchronous capstan makes it practical to hold recording time to  $\pm 2\frac{1}{2}$  seconds in a 30-minute run.

And with synchronizing equipment . . . for which provision is made . . . *timing can be held to 0.3 second on any length program!*

### Many more important features, too.

Self-centering "snap-on" hub adaptors assure perfect reel alignment with either RMA or NAB reels. A complete system of control interlocking virtually eliminates the possibility of accidentally erasing a program—makes it impossible to snarl or "spill" the tape. "Microswitch" control stops the machine if the tape is severed—applies reel brakes instantaneously. The tape automatically lifts *free and clear* of heads during fast forward runs or rewinds. Tape alignment over the heads is held precisely by a floating casting. Starting wow is reduced to the vanishing point.

BY ALL MEANS, call your RCA Broadcast Sales Engineer for complete details. Or mail the coupon.



**AUDIO BROADCAST EQUIPMENT**  
**RADIO CORPORATION of AMERICA**  
 ENGINEERING PRODUCTS DEPARTMENT, CAMDEN, N.J.

In Canada: RCA VICTOR Company Limited, Montreal

RCA Engineering Products,  
 Department N36,  
 Camden, New Jersey

Send me more information (including price and delivery) on your new De Luxe Tape Recorder, Type RT-11A.

NAME \_\_\_\_\_

ADDRESS \_\_\_\_\_

STATION OR FIRM \_\_\_\_\_

CITY \_\_\_\_\_ STATE \_\_\_\_\_



Here's the Man That Can Help You  
**CUT COSTS**  
 with **GENERAL PLATE**  
*Precious and Composite Metals  
 and Assemblies*

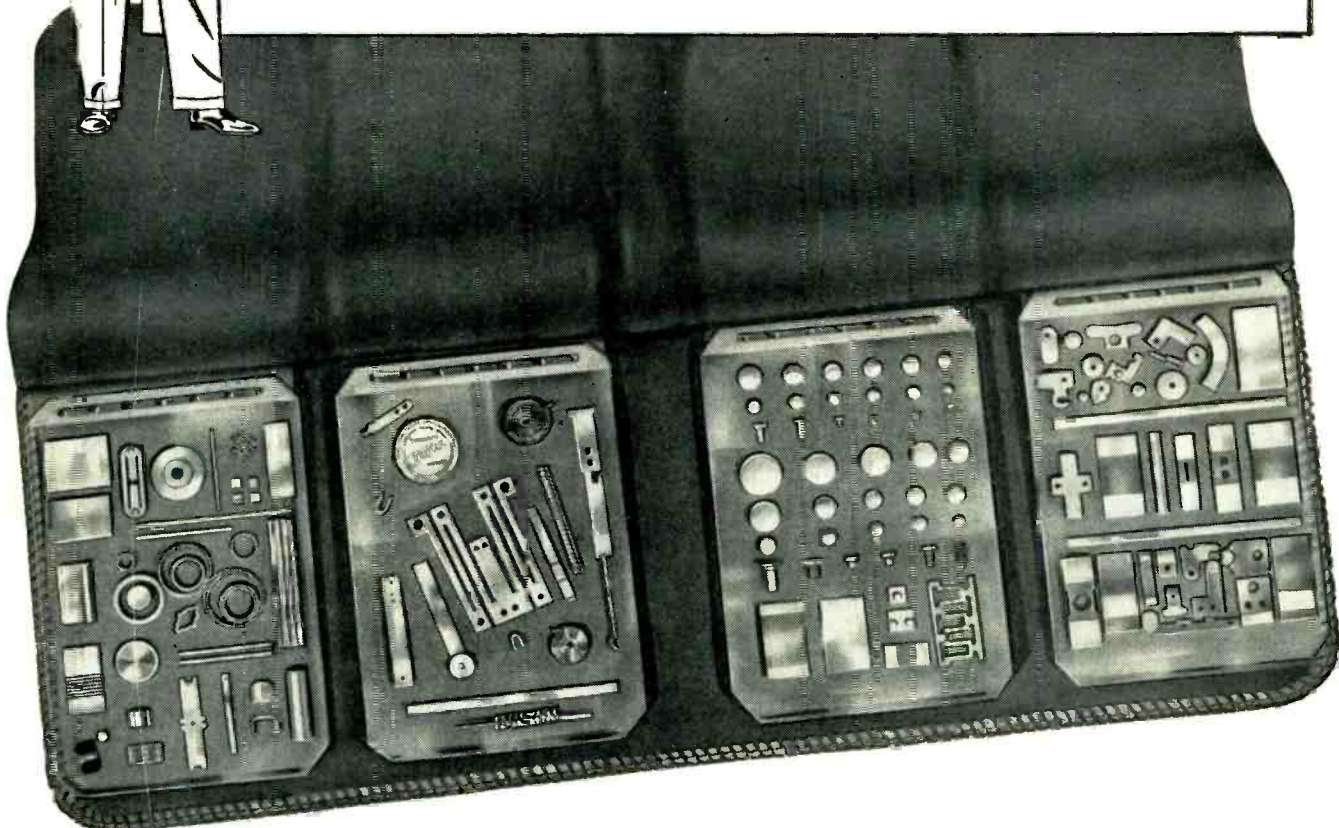

The best opportunity for cutting costs, increasing production and at the same time obtaining maximum performance is to investigate other metals or metal combinations. That's why we say, "A General Plate Field Engineer can help you cut costs."

Especially trained in the application of precious and composite metals for industrial uses, he is able to work with you on your specific problems. He will not give you a build-up on generalities, but will talk your problem over with you and come up with an answer that usually means savings for you.

A General Plate Field Engineer will show you how base to precious combinations save dollars by eliminating a large waste of precious metal . . . how base to base metals provide physical properties not found in single metals. And best of all, he can help you apply them to your products. He will also show you proof where General Plate Com-

posite metals and products have provided an economical solution to the problem.

Remember, too, General Plate Field Engineers are backed-up by an extensive resident research laboratory that is always available for help on your unusual requirements.

Look for the General Plate Field Engineer and his "proved performance list." He'll show you how you can benefit at a savings with General Plate Products. Write for his services, today.

**GENERAL PLATE PRODUCTS INCLUDE:**

- Triflex Thermostat Metals
- Precious to base metal laminations
- Base metal laminations
- Aleuplate (copper or aluminum)
- Silver solders
- Laminated contacts, buttons, rivets
- Platinum — fabrication — re-finishing
- Age-hardening Manganese Alloy 720

**GENERAL PLATE**

Division of Metals & Controls Corporation  
 30 FOREST STREET, ATTLEBORO, MASSACHUSETTS



# PRESTO SR-950's

## pay off for WFDR

Chief Engineer **BUD ARNOW**  
praises PRESTO's performance...  
low maintenance after 1,000-reel test



WHEN NEW YORK'S STATION WFDR went on the air last summer they were faced with a major recording assignment: "taping" a Kaiser-Frazer sponsored news program with Joseph C. Harsch and Marquis Childs which was sent over-the-line from Washington. Not only did this show have to be recorded for delayed broadcast on WFDR, but the station was responsible for sending copies of the program, with specially dubbed commercials, to its sister stations in Detroit, Cleveland and Chattanooga and Los Angeles the same night.

Within half an hour of the time the show is recorded, commercials are added. Additional copies are recorded and the tapes rushed to airport and railroad station for immediate shipment across the country. Additional flexibility and fast operation is provided by the coupling of four PRESTO SR-950's with a remote control system, allowing the operator to completely control the machines from his chair at the console.

More than 1,000 reels of tape have been used since WFDR installed its new PRESTOS. "The speed of such an operation and the need for dependable, high quality equipment were reasons for our selecting the PRESTO SR-950's," says Chief Engineer Bud Arnow. "After several months of rigorous use, we find the selection completely justified."

*WFDR's unique use of  
PRESTO equipment is  
further evidence that  
wherever fine recording  
is done . . . it's PRESTO  
two to one.*

**PRESTO**  
RECORDING CORPORATION  
Paramus, New Jersey  
Mailing Address:  
Box 500, Hackensack, New Jersey

In Canada:  
Walter P. Downs, Ltd.  
Dominion Sq. Bldg.  
Montreal, Canada

Overseas:  
M. Simon & Son Co., Inc.  
25 Warren Street  
New York, New York

wherever you go  
... there's  
**PRESTO!**

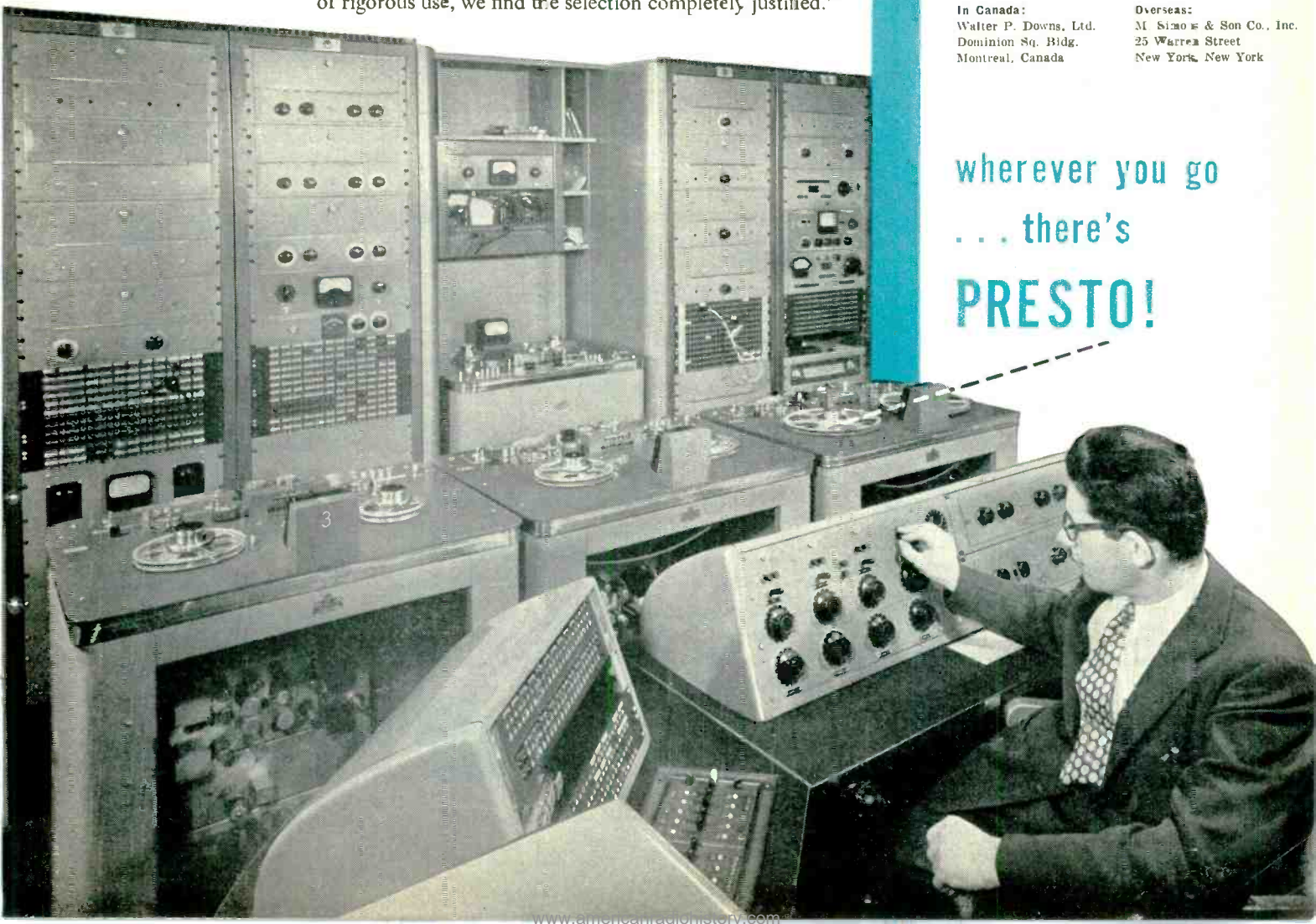

# How to be sure you get



## the Best Capacitor

**YOU CAN** test the paper for density . . . thickness . . . porosity . . . power factor . . . chloride content . . . dielectric constant . . . dielectric strength.

And then test the foil for thickness . . . purity . . . softness of the anneal . . . freedom from oil . . . cleanliness of surface . . . absolute smoothness.

And then test the liquid dielectric for specific gravity . . . viscosity . . . power factor . . . color . . . acidity . . . flash point . . . dielectric strength . . . dielectric constant . . . insulation resistance . . . water content.

And after that, test every single finished capacitor for shorts, grounds, and opens at overvoltage between terminals and between terminals and case . . . and measure the capacitance of every single unit . . . and then check every single capacitor to see that it has a leak-proof hermetic seal.

**OR YOU CAN** buy General Electric capacitors . . . product of outstanding research and know-how . . . which have already passed every one of these tests

- . . . on the materials when they were made.
- . . . and again before they were used.
- . . . and on the capacitors during manufacture.
- . . . and then, finally, on every single capacitor before shipment.

For full information on types, ratings, dimensions, types of mounting, and prices of capacitors, address the nearest *General Electric Sales Office or Apparatus Department, General Electric Company, Schenectady 5, N. Y.*

**Need square waves?**

Pulse-forming networks are used where the normal capacitor discharge wave shape is not suitable, and where an impulse must have definite energy content and duration. Their design involves several tricky problems—one being suitability for high temperature operation. Nevertheless, networks are one of our specialties—we have built them by the thousands, and our experienced and capable engineers will be glad to discuss any of your design problems. We invite your inquiries.

**GENERAL**  **ELECTRIC**

407-170



# A New Tube For HIGH-POWER VHF TV



*Eimac*

**4W20000A**  
Water-Cooled Power Tetrode

- ★ 20 Kw Peak Sync. Output
- ★ 5 Mc. Bandwidth
- ★ 216 Mc. Operation
- ★ LOW COST

TYPE 4W20000A POWER TETRODE CLASS-B LINEAR AMPLIFIER—TELEVISION SERVICE TYPICAL OPERATION (Per tube, 5-Mc. Bandwidth, 216 Mc.)	
Peak Synchronizing Level	
Load Impedance	400 Ohms
Effective Length of Plate Line	Quarter Wave
D-C Plate Voltage	5500 Volts
D-C Plate Current	7.1 Amps
D-C Screen Voltage	1000 Volts
D-C Screen Current	600 Ma.
DC- Grid Voltage	-310 Volts
Peak R-F Grid Input Voltage (approx.)	485 Volts
Plate Power Input	39 Kw.
Plate Dissipation	19 Kw.
Plate Power Output	20 Kw.

For the practical approach to high-power TV through channel 13, here is the tube . . . the new Eimac 4W20000A power tetrode.

Among the features of the 4W20000A are a unipotential cathode of thoriated tungsten heated by electron bombardment, a water-cooled anode rated at 20 kw dissipation, and coaxially arranged terminals.

This new tube's potential applications are not limited to TV service. Data on typical operation in class-C telegraphy or FM telephony as well as class-B linear TV amplifier service are included in a comprehensive data sheet . . . available for the asking.

**Eitel-McCullough, Inc.**  
**San Bruno, California**

Export Agents: Frazer & Hansen, 301 Clay St., San Francisco, California

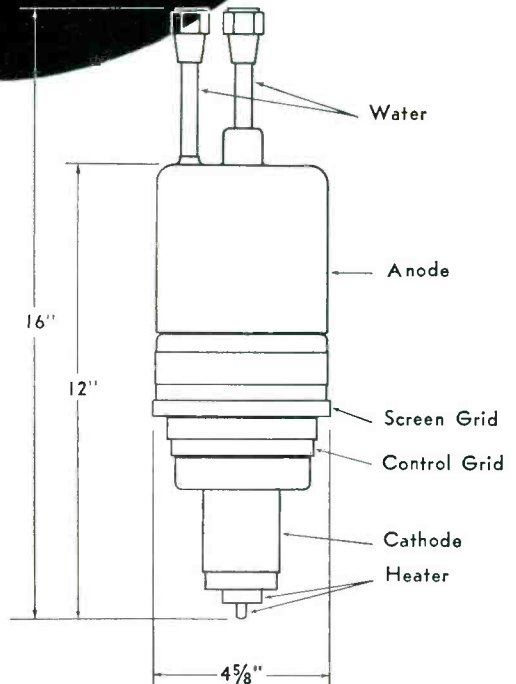

276

**SEE THE 4W20000A  
at the March IRE Show, Booth 36**



POWERSTAT  
TYPE 20

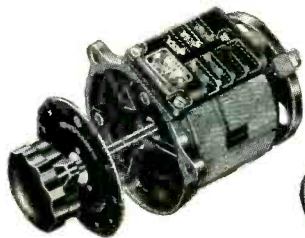

POWERSTAT  
TYPE 116U



POWERSTAT  
TYPE 116



POWERSTAT  
TYPE 2PF1126

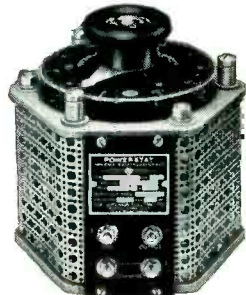

POWERSTAT  
TYPE 1126

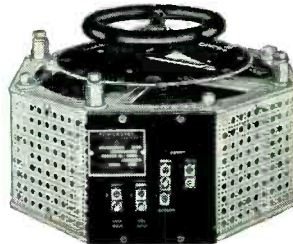

POWERSTAT  
TYPE 1256

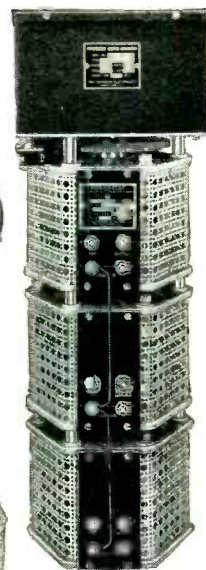

POWERSTAT  
TYPE MZ1126-3Y

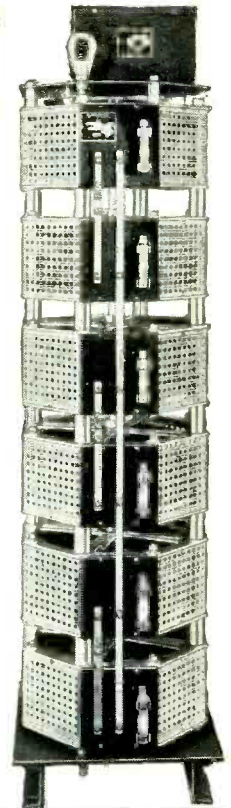

POWERSTAT  
TYPE MW1156-6Y



# NE SOURCE FOR ALL



STABILINE  
TYPE EM6220Y

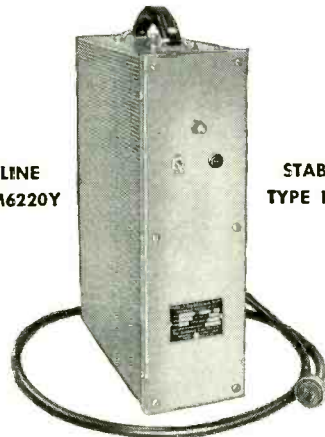

STABILINE  
TYPE IE5100S

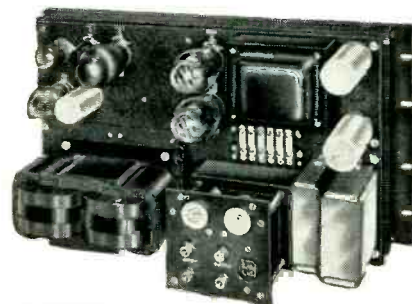

STABILINE  
TYPE IE510TR



STABILINE  
TYPE EM4115



VARICELL  
TYPE 13015



VOLTBOX  
TYPE UC1M



# POWERSTAT Variable Transformers

For variable a-c voltage control, a complete line of standard POWERSTAT variable transformers is available in air-cooled, oil-cooled and explosion-proof models for manual or motor-driven operation. They are the ideal source of continuously adjustable voltage from a-c power lines — featuring excellent regulation, high efficiency, conservative ratings, zero wave-form distortion, rugged mechanical construction, smooth control and easy mounting. The standard types are offered in 115, 230 and 460 volts, 25 and 50/60 cycles, single and three phase ratings in capacities from 405 VA to 100 KVA. For 400 cycles and higher frequency applications and for those requirements involving JAN specifications, there is a line of non-cataloged POWERSTAT variable transformers. Bulletin P550 describes in detail the complete line of standard POWERSTATS.

# STABILINE Voltage Regulators

For maintaining constant output voltage from fluctuating a-c power lines STABILINE automatic voltage regulators are offered in two models — Type IE (Instantaneous Electronic) and Type EM (Electro-mechanical) to suit the needs of individual requirements. Type IE provides almost instantaneous correction . . . is completely electronic in action with no moving parts. Waveform distortion never exceeds 3%. Output voltage is held to within  $\pm 0.1$  percent of nominal for wide line variations; to within  $\pm 0.15$  percent of nominal for any load current change or load power factor change from lagging .5 to leading .9. Capacities range from 250 VA to 5 KVA. Type EM is ideal for those applications where zero waveform distortion, low cost and high efficiency is required but instantaneous correction is not essential. They feature insensitivity to magnitude and power factor of load and do not affect the system power factor. Numerous types are available in ratings to 100 KVA. Bulletin S351 fully describes both types of standard STABILINES. For information on STABILINES built to JAN requirements and for 400 cycle operation, send the engineering details of your application to Superior.

## VOLTAGE CONTROL EQUIPMENT

### VARICELL D-C POWER SUPPLIES

The VARICELL is the ideal source of low d-c voltages. It operates from an a-c power source to deliver a stabilized and regulated variable range of d-c voltages. Stabilization and regulation is  $\pm 0.25$  volts and R.M.S. ripple voltage never exceeds 0.1 volts. More engineering data in SECO form 2504.

### VOLTBOX A-C POWER SUPPLIES

The VOLTBOX is a much needed instrument in the laboratory, inspection, test and plant maintenance departments. It is a compact, portable source of variable a-c voltage with all the necessary components in a lightweight case. Further information is found in Bulletin P550.

The Superior Electric complete line of voltage control equipment provides from one source apparatus to meet any and all requirements. With Superior equipment, you are assured of the highest quality and top electrical performance. If you are in doubt regarding your requirements, SECO engineers are in your territory to assist you. Meanwhile, use the coupon below to obtain complete information on any voltage control equipment in which you are interested.

**THE SUPERIOR ELECTRIC CO.**  
BRISTOL, CONNECTICUT



THE SUPERIOR ELECTRIC CO., 402 CHURCH STREET, BRISTOL, CONNECTICUT

Please send me more information on \_\_\_\_\_

My Name \_\_\_\_\_

Company Name \_\_\_\_\_

Company Address \_\_\_\_\_

City \_\_\_\_\_ Zone \_\_\_\_\_ State \_\_\_\_\_



**NEW DESIGN THRILLS AT YOUR FINGER TIPS...**

**Type SPE Bantams\***—The smallest electrolytics yet. Especially suitable for personal radios, filter circuits and similar functions. Hermetically-sealed aluminum can with diameter-reducing stud terminals. Improved processing and materials combined with more efficient space utilization, means smaller sizes—but no reduction in life.

**Type '87 Aerocons**—Self-molded plastic tubulars with new impregnant, Aerolene\*; new rock-hard Duranite\* end seals. All the performance characteristics of molded-plastic capacitors at a price close to that of conventional paper tubulars. Excellent heat and humidity resisting qualities. Operating temperatures of  $-30^{\circ}\text{C}$  to  $+100^{\circ}\text{C}$ .

**Type 89ZXY Aerolites\***—Aerovox-improved metallized paper capacitors were developed to meet present-day requirements for capacitors of improved reliability and reduced size. Type 89ZXY Aerolites\* are metallized-paper capacitors in hermetically-sealed metal cases. Other Aerolite\* capacitors are available in tubular, bathtub and other case designs.

**Type P123ZG Miniatures**—Metal-cased, metallized-paper capacitors featuring vitrified ceramic terminal seals for maximum immunity to climatic conditions—heat, cold, humidity. For severe-service applications and for usage in critical as well as ultra-compact radio-electronic assemblies.

**Type P83Z Micro-Miniatures\***—Smaller than previous "smallest"—a distinct departure from conventional foil-paper and previous metallized-paper constructions. Radically new metallized dielectric makes possible exceptionally small physical sizes. Available in two case sizes ( $3/16'' \times 7/16''$  and  $1/4'' \times 9/16''$ ); voltages of 200, 400, 600; operating temperatures range from  $-15^{\circ}\text{C}$  to  $+85^{\circ}\text{C}$  without derating.

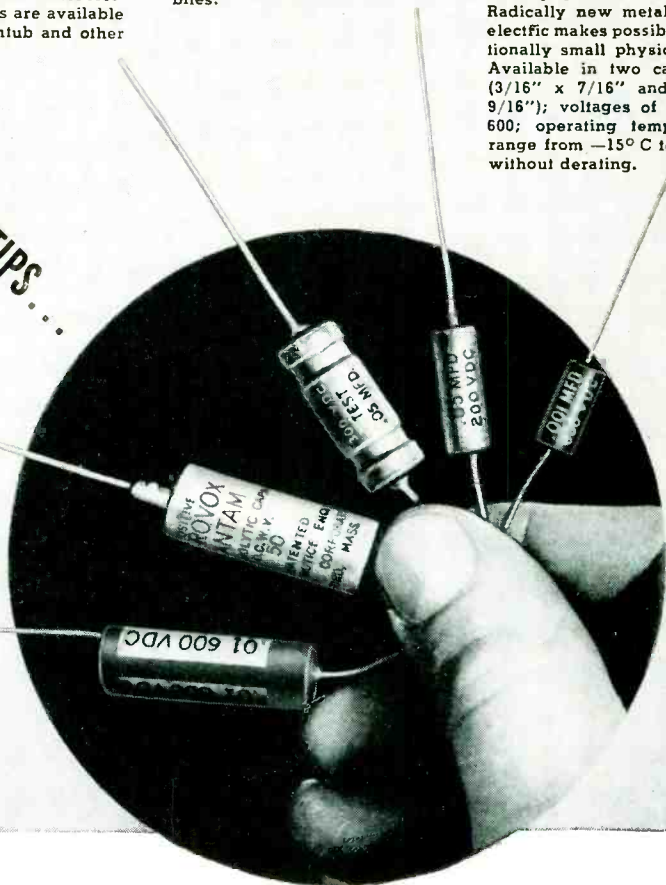

\*Trade-mark

**AEROVOX**

**"Space Miser"**

**CAPACITORS**

● Tell us what you are designing or producing. Our engineers will gladly show you better assembly possibilities with marked economies. Literature on request. Write on your letterhead to Aerovox Corporation, Dept. DF-65, New Bedford, Mass.

**There is something new in sizes!**

● Never was so much capacitance packed into so little bulk. And with improved performance and life, too. Aerovox Research and Engineering have developed capacitor materials that now challenge the thinking of the progressive radio-electronic designer on several counts:

For *elevated temperatures*: Immunity of Aerolene impregnant and Duranite end fills. For *humidity extremes*: perfected hermetically-sealed metal-can casings

even in tiniest sizes. For *miniaturizations*: perfected metallized-paper sections. For *compact filters*: smallest electrolytics yet. For *maximum reliability*: the most conservative ratings. For *lower prices*: advanced engineering backed by highly mechanized fabrication.

New design thrills at your finger tips! That's what these latest Aerovox capacitors mean to you by way of still better radio-electronic assemblies.

CAPACITORS • VIBRATORS • TEST INSTRUMENTS



*For Radio-Electronic and Industrial Applications*

AEROVOX CORPORATION, NEW BEDFORD, MASS., U. S. A. • Sales Offices in All Principal Cities  
Export: 41 E. 42nd St., New York 17, N. Y. • Cable: AEROCAP, N. Y. • In Canada: AEROVOX CANADA LTD., Hamilton, Ont.





## We're Racing with Time on Defense Production

### **BUT WE CAN FILL SOME ORDERS FOR CIVILIAN NEEDS**

The majority of our customers in the electronics field are making equipment needed for our expanding national defense program.

We are manned and have the facilities to produce increased quantities of cabinets, chassis, and housings for this equipment—and as rapidly as possible. Speed, however, is not being gained at the sacrifice of quality, for American industry cannot put "jerry-built" equipment in the hands of our Armed Forces.

It is still possible for us to handle certain types of civilian orders, provided they are of such a nature that they will not tie up that part of our facilities engaged in more urgent operations.

Defense production must come first—but we are not closing the door on any customers whom it is possible to serve.

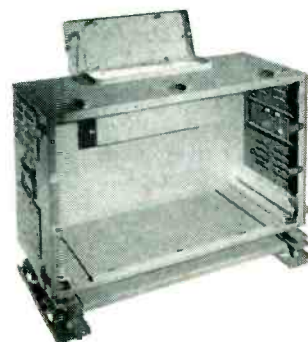

## **KARP METAL PRODUCTS CO., INC.**

**215 63rd STREET, BROOKLYN 20, NEW YORK**

*Specialists in Fabricating Sheet Metal for Industry*

# Let INDIANA Magnet Engineers Help Make Your Change-Over Easier

Permanent magnets are indispensable in many types of equipment used by the armed forces. Thus, an early discussion of your plans with INDIANA engineers is advisable. Recent improvements give "packaged energy" even greater utility.

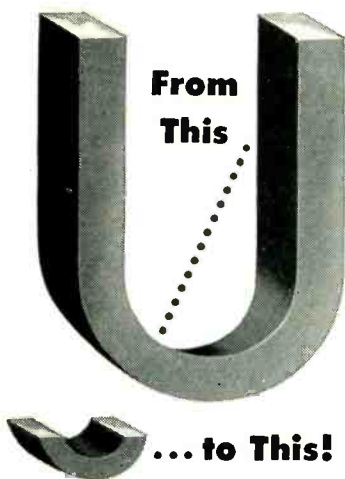

THESE TWO MAGNETS PRODUCE THE SAME AMOUNT OF ENERGY. Above is a chrome magnet, the best of fifteen years ago; below, as made of INDIANA'S exclusive HY-FLUX Alnico V—strongest of today's magnet materials—introduced in 1950.

Quick conversion to Defense Production requires *seeing* problems and solving them without false starts or delay. So, if your "tomorrow's products" involve permanent magnets (or, if permanent magnets would simplify their manufacture or use) confer *now* with the industry's *leading* magnet designers and application specialists... The Indiana Steel Products Company's experienced staff of engineers.

INDIANA'S engineers established an enviable record in World War II for their work on permanent magnets used in radar, sonar, ranging equipment, aircraft magnetos, proximity fuses, guided missiles, etc. For example, they aided in the development of the *first* "packaged" magnetron tube, and—working with the Signal Corps—made portable telephones practical by reducing both the size and weight of the ringing generator required.

## BENEFITS LIKE THESE CAN BE YOURS

INDIANA Permanent Magnets are components of many mechanical and electrical devices because they are so compact, easy to install, and deliver *uniform energy* without heat or operating parts. And improvements in materials and design have resulted in a wide range of wholly new uses.

## INCREASED CAPACITY

As the world's largest producer of permanent magnets, with the accumulated know-how of more than 30,000 different applications... with facilities and personnel that won the Army-Navy "E", *now expanded by 50%*... The Indiana Steel Products Company offers you many unequalled facilities. Many types and sizes of magnets are immediately available for experimentation. Write or phone INDIANA today.

**INDIANA  
PERMANENT  
MAGNETS**

**THE INDIANA STEEL PRODUCTS COMPANY**

VALPARAISO, INDIANA • • • Sales Offices Coast to Coast

SPECIALISTS IN "PACKAGED ENERGY" SINCE 1908



# MODERN APPLICATION DEMANDS...

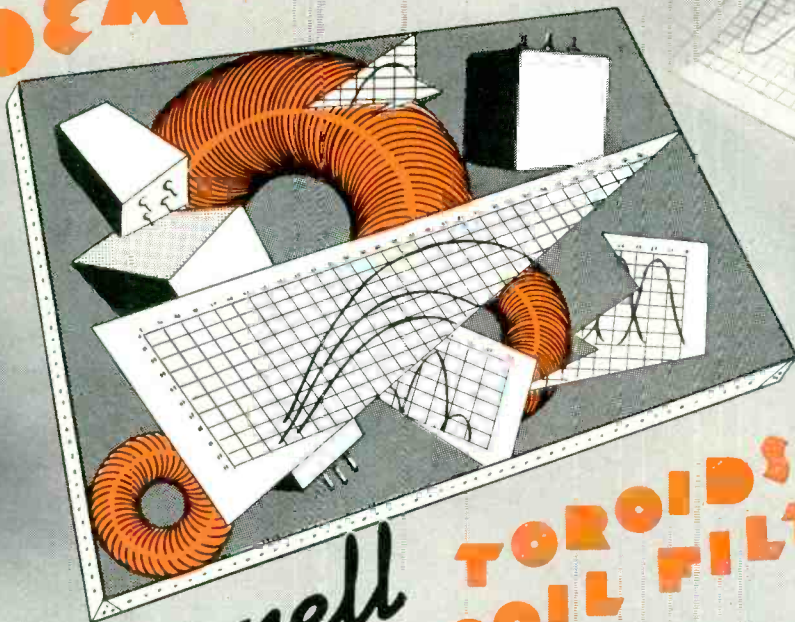
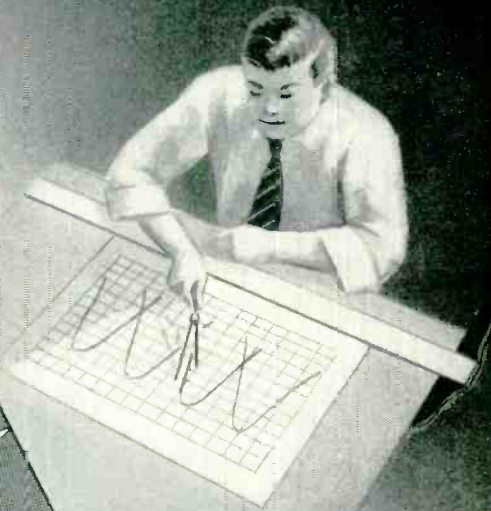

## Burnell TOROIDAL COIL FILTERS & TOROIDS

We know only too well what is modern today in Electronics can be obsolete tomorrow. We can retard obsolescence by designing our products with an eye toward the future and what future applications may demand of our products.

Burnell & Company has shaped its engineering policy with this viewpoint — by striving to keep well ahead — not just abreast of developments in the Hi Q Coil and Filter business.

We search constantly for new design ideas that will permit the reduction of size and weight of Filters that "fly"; new circuits and components that will give our customers "more for their money" — and new production methods that will speed output and guarantee the reliability and life of our products.

Even our price structure has been streamlined to conform with the increasing industry-wide demand for economy, with no sacrifice in our high standard of quality.

We say that modern applications demand Burnell & Company's toroids and toroidal filter products because we are modern in every sense of the word: modern in outlook and technique as well as in price.

**Exclusive Manufacturers of Communications Network Components**

We particularly invite your inquiries concerning difficult filter applications

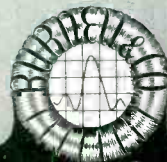

**Burnell & Company**

**YONKERS 2, NEW YORK**

CABLE ADDRESS "BURNELL"



**CUTS REJECTS 70%.** High voltage capacitors made by Centralab for use in television sets are subjected to a high voltage breakdown test. Rejections were cut 70% when Centralab switched to Plaskon Alkyd.



**REDUCTION IN SIZE.** Exhaustive arc resistance tests faithfully reproducing actual service conditions convinced Arrow, Hart & Hegeman engineers of the unexcelled arc resistance of molded Plaskon Alkyd. This benefit enabled them to redesign and reduce the overall size of their complete line of magnetic starters.

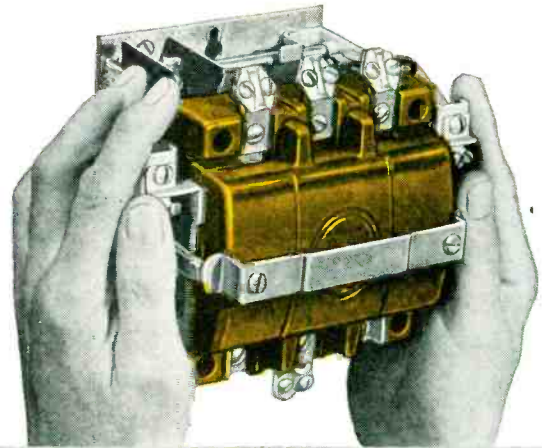

## more evidence of savings with **PLASKON ALKYD**

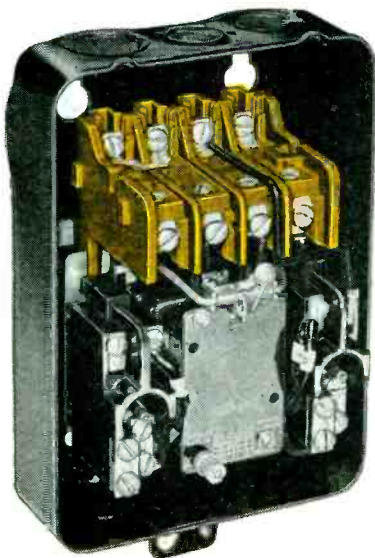

**TIME SAVING 50%; MONEY SAVING 25%.** Furnas Electric Company found that the fast molding characteristic of Plaskon Alkyd cut production time 50%. A cost saving of 25% has been realized on the cost of the finished product.

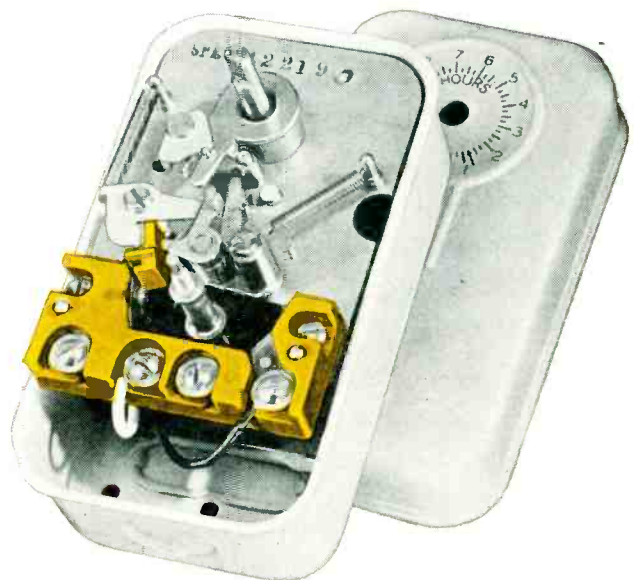

**PRODUCTION INCREASED 392%.** Switching to Plaskon Alkyd enabled Sangamo Electric Company to produce plastic parts for their time switch nearly 4 times as fast as was possible with a competing material.



# HOW

## **you can produce for less . . . TO SELL MORE PROFITABLY**

Leading producers of electrical and electronic parts have found Plaskon Alkyd a real helper in producing better parts, faster . . . often for less.

Plaskon Alkyd is an ultra high-speed, thermosetting plastic molding compound with excellent electrical properties. It can be molded three to four times faster than conventional thermosetting materials . . . assuring greater production from molding equipment.

Loss from profit-robbing rejects is reduced because Plaskon Alkyd just doesn't require a lot of fussy, kid-glove care to mold. It's much less sensitive to variations in pressure, temperatures and time than other thermosetting materials.

And you can save some real money on tooling costs with Plaskon Alkyd. Simple, less expensive dies are required to mold it. Plaskon Alkyd's high-speed molding characteristics assure greater production from each mold cavity. And fewer cavities are needed to maintain your production schedules.

Plan to use Plaskon Alkyd to produce for less . . .  
to sell more profitably!

***... mold it better and faster with***

**PLASKON<sup>®</sup>**  
**ALKYD**

**PLASKON DIVISION • LIBBEY • OWENS • FORD GLASS CO.**

2136 Sylvan Avenue • Toledo 6, Ohio

*In Canada: Canadian Industries, Ltd., Montreal, P. Q.*

*Branch Offices: Boston, Chicago, New York, Los Angeles, Rochester*

*Manufacturers of Molding Compounds, Resin Glues, Coating Resins*



TYPE LR  
without line switch

**Space and Cost Savers...**



TYPE LRD  
with SP ST line  
switch

**Only  $57/64$ " in diameter...**

**CONSERVATIVELY RATED .5 WATT**

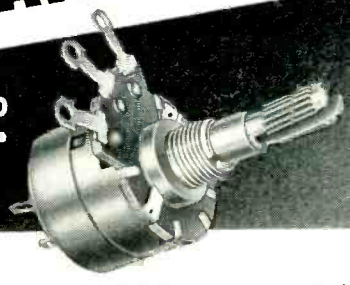

TYPE LRA-10  
with DP ST line  
switch

**DUAL  
CONCENTRICS  
FOR TV**



These sturdy little Stackpole LR type controls handle higher wattages more dependably than most controls that are a good bit larger in size. Less than an inch in diameter, they're conservatively rated at .5 watt for use where voltage across the units does not exceed 350 volts for linear tapers, or for non-linear ones having a taper of no less than 10% of the total resistance at 50% rotation, provided that 225 volts is not exceeded. Thus there is plenty of wattage capacity for a wide variety of present day uses including many television applications. Stackpole LP type controls, slightly larger, are rated .6 watt at linear taper if 500 volts is not exceeded and also at .6 watt if the resistance is not less than 10% at 50% rotation, provided that 250 volts is not exceeded.

LR controls are available as concentric shaft duals.

*Electronic Components Division*

**STACKPOLE CARBON COMPANY**  
ST. MARYS, PA.

**STACKPOLE**



# If You Need Coils Like These . . .

you need **UNIVERSAL Coil Winders**

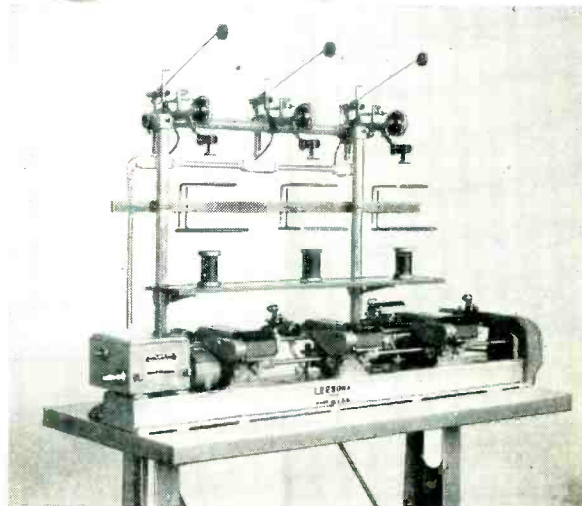
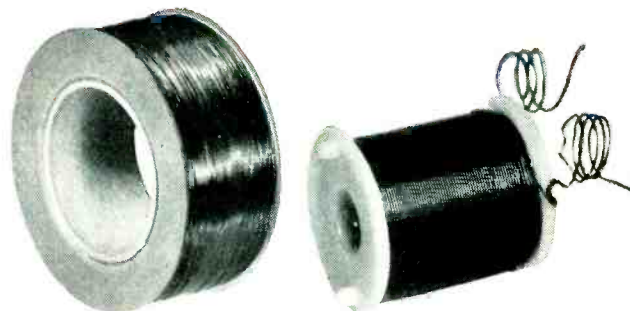
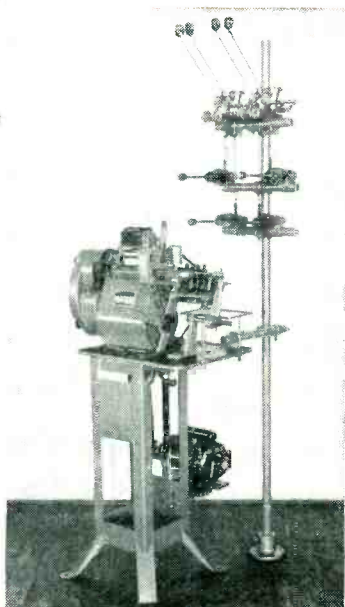

**Lattice-type coils** for television and radio. Wind one to four coils at once on the Universal No. 84 Coil Winder, with (in most cases) a single operator for two machines.

Speeds are from 400 to 950 rpm, and a counter control provides instant automatic stop upon completion of coil.

Quickly-adjustable "gainer" mechanism, which accurately positions wire turns, and strap-type tensions help you get accurate, uniform winding. In-built calibration facilitates change-over.

Write for Bulletin 84-LM.

**Non-insulated spool-wound coils.** Wind coils on several heads at once, using the new Universal 102 High Speed Coil Winder, and synchronize output on the basis of handling time per coil.

Each head is individually operated, and you can so schedule the winding that certain heads will be producing while manual operations are performed on other heads.

With a maximum speed of 5000 rpm, the High-Speed 102 is efficient for coils having up to 15,000 turns. Oil seals make the machine *oil-tight*.

Write for Bulletin 102-LM.

## UNIVERSAL WINDING COMPANY

P. O. Box 1605 Providence 1, R. I.



FOR WINDING COILS IN QUANTITY  
ACCURATELY . . . AUTOMATICALLY  
USE UNIVERSAL WINDING MACHINES

# A NEW Insulating Laminate...

## INSUROK\* GRADE T-812

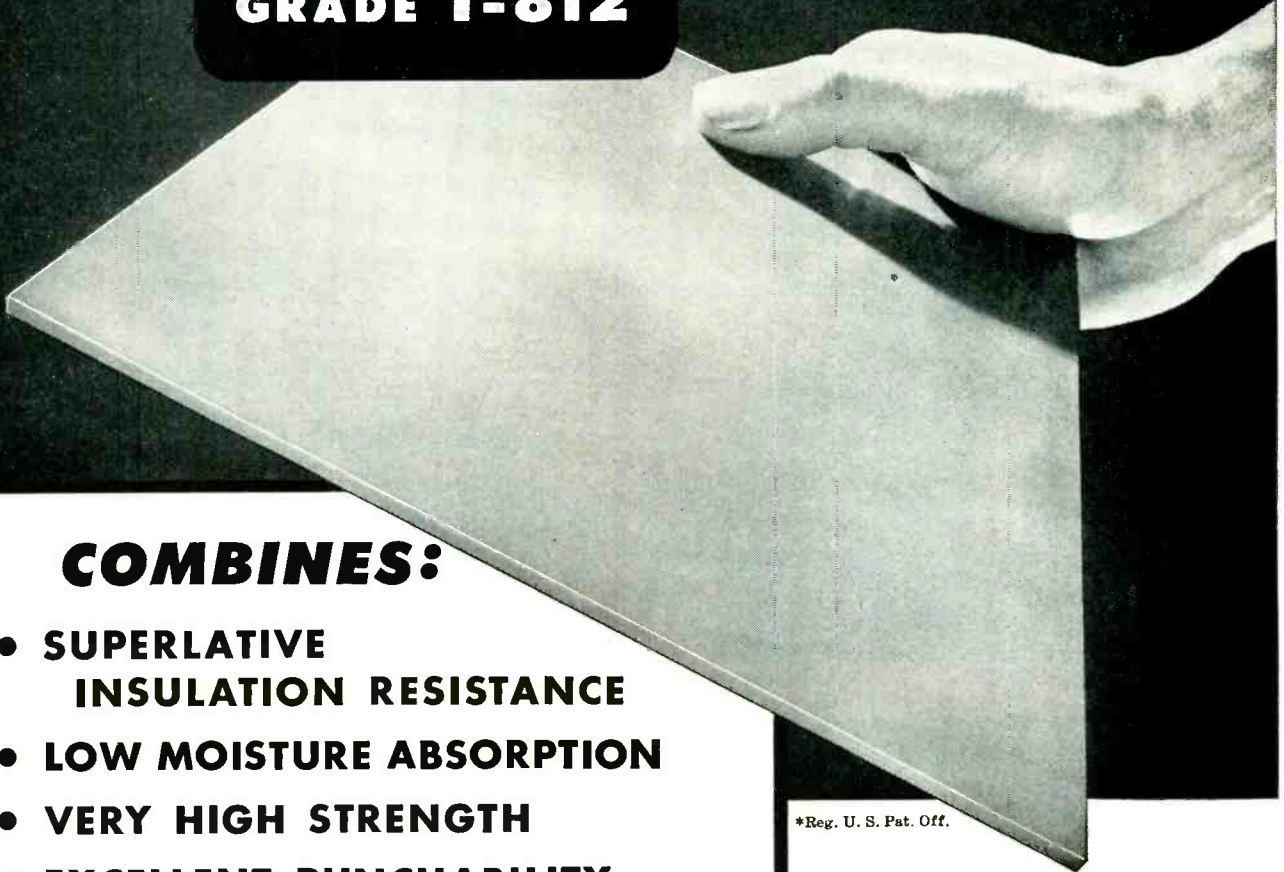

### COMBINES:

- SUPERLATIVE INSULATION RESISTANCE
- LOW MOISTURE ABSORPTION
- VERY HIGH STRENGTH
- EXCELLENT PUNCHABILITY

\*Reg. U. S. Pat. Off.

INSUROK T-812 is a new paper-base punching stock that laughs at heat and humidity! It has outstanding properties that have never before been combined in one insulating laminate. T-812 has excellent electrical characteristics, plus a spectacular ability to retain them through extremes of heat and humidity. Its insulation resistance after humidity conditioning is particularly noteworthy.

INSUROK T-812 retains all of the properties of the well-known INSUROK T-725 and, in addition, has lower moisture absorption and much higher insulation resistance. It punches readily into intricate shapes. Investigate INSUROK T-812 for your product. Information upon request.

### T-812's Property Combination —Unmatched by any other material!

Thickness tested.....	1/16"	
Moisture Absorption (24 hours).....	0.38%	
Expansion after 24 hours' immersion in water at 77°F. Center.....	0.0001"	Edge..... 0.0002"
Tensile Strength, psi.....	Main Direction..... 19,500	Cross Direction..... 14,500
Flexural Strength, psi.....	Main Direction..... 23,000	Cross Direction..... 18,000
Dielectric Strength (perpendicular to laminations) V/Mil, Short Time.....	725 Step by Step..... 625	
	Tests at Room Conditions	After 96 hrs. at 90% Rel. Hum. at 104°F.
Power Factor at 1 megacycle.....	0.028	0.030
Dielectric Constant at 1 megacycle.....	4.4	4.5
Loss Factor at 1 megacycle.....	0.13	0.14
Insulation Resistance, megohms.....	1,000,000	

## The RICHARDSON COMPANY

FOUNDED 1858—LOCKLAND, OHIO

2797 Lake St., Melrose Park, Illinois (Chicago District)

SALES OFFICES: CLEVELAND • DETROIT  
INDIANAPOLIS • LOCKLAND, OHIO • MILWAUKEE  
NEW BRUNSWICK, (N. J.) • NEW YORK  
PHILADELPHIA • ROCHESTER • ST. LOUIS



# Built-in VOLTAGE REGULATION at Moderate Cost

Insure constant plate and filament voltage for your electronic products with standard SOLA "CVE" POWER TRANSFORMERS.

Specify the new SOLA "CVE" Constant Voltage Power Transformers in your circuit design to eliminate the variable of fluctuating line voltage at unusually low cost. Regulation of filament and plate supply is  $\pm 3\%$  at line voltage variations from 100 volts to 130 volts.

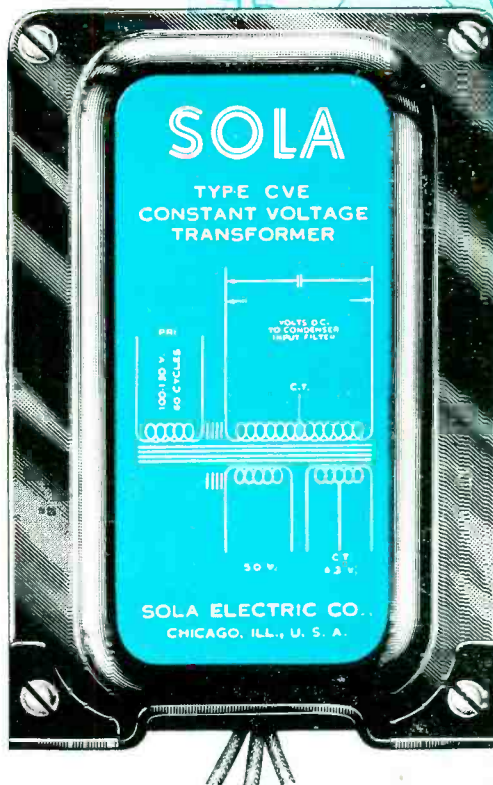
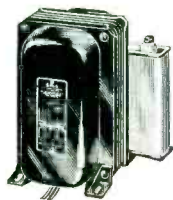

The SOLA "CVE" standard Power Transformers are completely automatic and continuous in regulation . . . have no moving parts or tubes . . . and are self-protecting against short circuit. They are stocked in 42 V.A., 75 V.A. and 210 V.A. capacities to cover most electronic power supply requirements. We invite your inquiries on the application and benefits of the moderately priced "CVE" Constant Voltage Power Transformers to your product. For full electrical and mechanical specifications write for Bulletin D-CVE-138.

## SOLA *Constant Voltage* TRANSFORMERS

"CV" for high precision voltage regulation. "CVE" for regulated electronic power supplies. "CVH" for constant voltage with less than 3% harmonic distortion. "CVA" for constant voltage on television receivers.

**Transformers for:** Constant Voltage • Cold Cathode Lighting • Airport Lighting • Series Lighting • Fluorescent Lighting • Luminous Tube Signs • Oil Burner Ignition • X-Ray • Power • Controls • Signal Systems • etc. • SOLA ELECTRIC COMPANY, 4633 W. 16th Street, Chicago 50, Illinois

Manufactured under license by: ENDURANCE ELECTRIC CO., Concord West, N. S. W., Australia • ADVANCE COMPONENTS LTD., Walthamstow, E., England • UCOA RADIO S.A., Buenos Aires, Argentina • M. G. B. & VERITABLE ALTEE, Courbevoie (Seine), France



Slide Under one  
to show of the  
to having pressure  
2.1 85.7 5  
2.3 85.1  
and 1.5 cents per

REGULATION COMPARISON  
SOLA "CVE" Power Transformer—

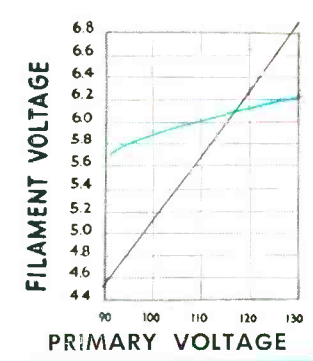
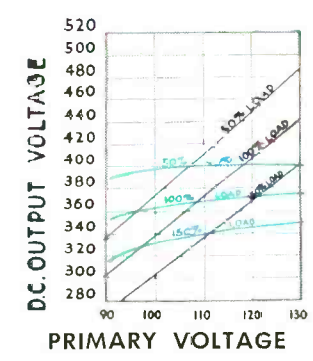

Good names to know for -

# finer electronic metals & alloys



FILAMENT BASE METALS:  
**SYLVALOY**  
**MODIFIED HILO**  
**COBANIC**  
**TENSITE**  
**UNIMET**

CARBONIZED NICKEL:  
**RADIOCARB**  
**DUOCARB**  
**POLICARB**  
GRID WIRE:  
**MANGRID**

**— BACKED BY YEARS OF SPECIALIZED PRODUCTION**

Since the inception of AC radio, Wilbur B. Driver Company has pioneered in the development and production of filament alloys, carbonized nickel and grid wire. Thus it is a logical conclusion that Wilbur B. Driver Company is the dependable source of supply for radio and electronic requirements . . . the choice when materials must be held to exacting and precise specifications.

**It's WILBUR B. DRIVER for Critical Tube Alloy Requirements!**

**WILBUR B. DRIVER COMPANY**

150 RIVERSIDE AVENUE, NEWARK 4, NEW JERSEY





## Something New

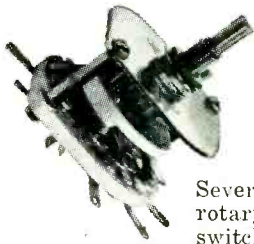

### NEW OVAL SELECTOR SWITCHES

Several new oval rotary selector switches are described in Bulletin L13 just issued by the Shallcross Manufacturing Co., Collingdale, Pa. Six basic plates and three rotor types produce switches having from one to three poles per deck or gang and with other desired mechanical and electrical details. As many as 18, 9 or 6 positions may be obtained in single-, double-, or triple-pole types respectively. These may be single-, double, or triple-pole decks exclusively or a combination of different types.

### VERTICAL STYLE PRECISION RESISTORS FOR JAN USES

Improved vertical style precision wire-wound resistors for use where mounting requirements make it desirable to have both terminals at the same end of the resistor have been introduced by the Shallcross Manufacturing Co., Collingdale, Pa. These units provide a longer leakage path from the mounting screws to the terminals. Known as Shallcross Types BX120, BX140, and BX160, they are designed to meet JAN requirements for styles RB40B, RB41B and RB42B respectively. For commercial uses, the resistors carry somewhat higher ratings than for JAN applications. Wire leads instead of terminals can be furnished if desired. Complete details will gladly be sent on request to the manufacturer.



### FLAT, METAL-ENCASED WIRE-WOUND RESISTORS

Flat, metal-encased, Type 265A wire-wound power resistors introduced by the Shallcross Manufacturing Company, Collingdale, Penna. are space wound, have mica insulation, and are encased in aluminum for mounting flat against a metal chassis. At 175° C. continuous use they are conservatively rated for 7½ watts in still air and 15 watts when mounted on a metal chassis. Write for Bulletin 122.

ADV.

# A RELIABLE SOURCE FOR YOUR Custom Built Electric-Electronic Specialties

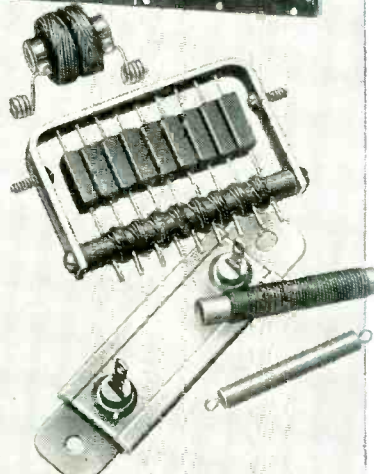
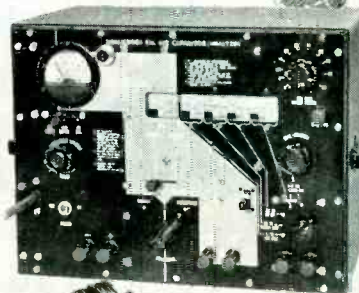
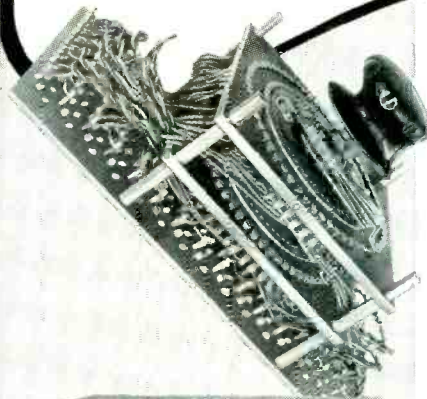

Leading equipment manufacturers find that it pays to turn specialized assignments over to Shallcross for development, design or production...

From critical components to sub-assemblies and instruments, Shallcross' broad experience and precision facilities assure better results...

Often, they assure an appreciable cost saving as well.

- A capable staff of electrical, electronic, mechanical, chemical and instrumentation engineers...

- A fully equipped plant...

- Plus over 20 years of specialization in high quality products for military, industrial and public utility use... are here at your disposal.

### AMONG RECENT SHALLCROSS CUSTOM-BUILT ASSIGNMENTS HAVE BEEN:

- ROTARY SWITCHES
- POTTED AND THERMALLY-CONTROLLED R-C NETWORKS
- PRECISE DECADES AND NETWORKS FOR COMPUTER DEVICES
- CALIBRATING INSTRUMENTS FOR STRAIN GAUGE BRIDGES
- HIGH RESISTANCE STANDARDS
- CRITICAL COIL ASSEMBLIES
- HERMETICALLY SEALED CHOKES
- HIGH-VOLTAGE MEASURING EQUIPMENT, ETC.

# SHALLCROSS

ENGINEERS  
DESIGNERS  
MANUFACTURERS

SHALLCROSS MANUFACTURING CO.

COLLINGDALE, PA.

# NEW

## SENSITIVE RELAY *built for long service*

**SW RELAY**

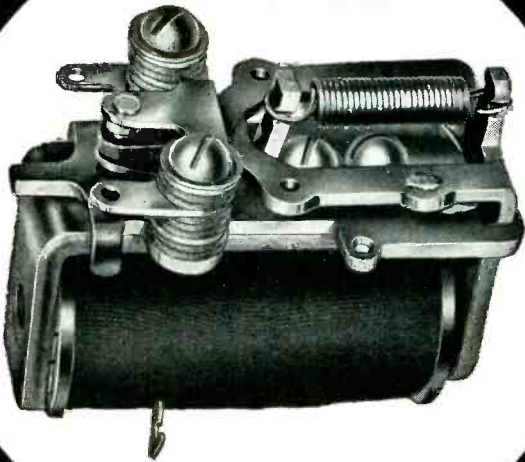

**Hermetically Sealed**

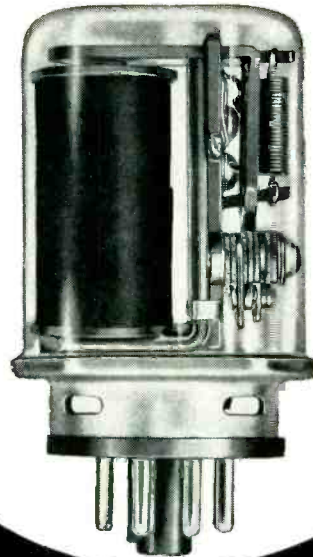

*Supplied  
with  
OCTAL PLUG  
or SOLDER  
TERMINALS*

### **Sensitivity Plus Dependability!**

The new Allied SW relay offers an economical combination of both these important qualities. Here are the facts on this newest relay in the famous Allied line

*Bulletin SW gives complete details.  
Send for your copy today.*

Be sure to send for your copy of Allied's new Relay Guide. It shows 24 small, compact relays with a detailed table of characteristics and specifications.



## **ALLIED CONTROL COMPANY, INC.**

2 EAST END AVENUE, NEW YORK 21, NEW YORK

<b>SENSITIVITY:</b>	S.P.D.T. .012 watts d.c. } Can be supplied D.P.D.T. .05 watts d.c. } in A.C.
<b>COIL:</b>	Acetate insulated, bobbin or layer wound, 12,500 ohms max.
<b>CONTACTS:</b>	Silver, one ampere non-inductive load at 24 volts d.c. or 115 volts a.c. Armature contact at frame potential.
<b>MOUNTING:</b>	One hole with locating lug. Also available with dust cover or hermetically sealed, plug-in or solder terminals.
<b>DIMENSIONS:</b>	Open Relay—1-19/32", 1-1/16", 1-7/16" Sealed Relay—3-3/16" long, including plug, 1-13/32" wide, 1-19/32" high.
<b>WEIGHT:</b>	2.5 oz.
<b>WEIGHT HERMETICALLY SEALED:</b>	4.5 oz.
<b>SPECIAL APPLICATIONS:</b>	Sensitivity down to .003 watts S.P.D.T., or .012 watts D.P.D.T. Palladium or other precious metal contacts for audio or low voltage circuits, tungsten or alloy contacts for higher current or voltage circuits. Maximum input 4.0 watts at 20°C for 85° rise.



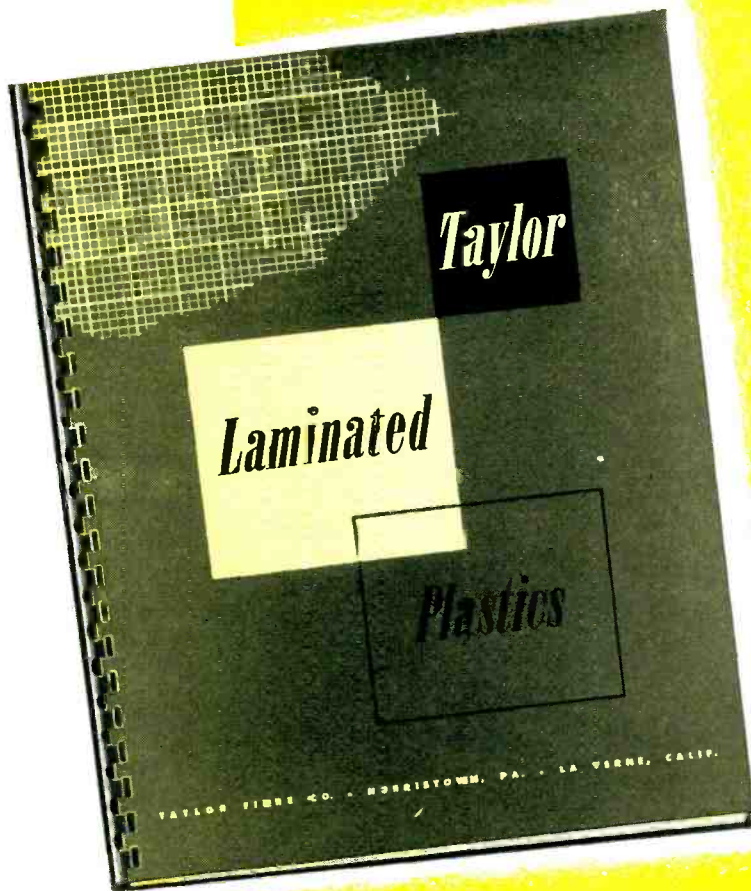

# HERE'S HELP

**FOR THE  
PLASTICS  
USER**

It's the new Taylor Catalog . . . 48 fact-filled pages of descriptive and engineering data on Vulcanized Fibre, Phenol Fibre and Special Laminates. If you are looking for new ways and means to improve your product, *and save money too*, here's an idea source guaranteed to spark the imagination and give you a hat full of hints, tips and suggestions.

In this new Taylor Catalog you will find all the details you need to know about electrical, physical and chemical properties of sheets, tubes and rods. It tells you how to design, plan, and buy for maximum

economy. It offers valuable tips and suggestions on how to select the right Taylor material for the job. It shows you how to machine these versatile materials . . . gives you weights, suggested applications . . . specifications.

And that's not all! There's a lot more information as well . . . tables, diagrams and technical data that you'll find of constant value.

This new Taylor Laminated Plastics Catalog should be in your files. For your free copy, just fill in the coupon below . . . mail it *today* . . . we'll do the rest!

**Taylor**

**TAYLOR FIBRE CO.**  
NORRISTOWN, PENNSYLVANIA  
WEST COAST FACTORY: LA VERNE, CALIF.

TAYLOR FIBRE CO., Dept. E 11  
Norrstown, Pa.

Send me my free copy of the new Taylor  
Laminated Plastics Catalog

NAME \_\_\_\_\_

TITLE \_\_\_\_\_

COMPANY \_\_\_\_\_

STREET \_\_\_\_\_

CITY \_\_\_\_\_ ZONE \_\_\_\_\_ STATE \_\_\_\_\_

# HERMETIC SEALING COMPONENTS



*Welcomes Exacting Demands*

NEO-SIL is the result of ten years of engineering research and development. Its application to our hermetic sealing components has been proven under severe and exacting tests in both our own and our customers laboratories. NEO-SIL components will help reduce your rejects resulting from breakage, strain, cracks, physical shock, etc.

NEO-SIL components will pass the grade one, class A requirements for Army, Navy and aircraft military equipment.

It costs no more to use these hermetic sealing components and their use will save you money.

For performance, quality and economy—specify NEO-SIL hermetic sealing components. Manufactured by NEO-SIL Corporation—to meet the most exacting performance demands.



## SPECIALTY PRODUCTS

- 1 Molded Cables With Plugs Attached
- 2 Female 4 Pin Panel Connector
- 3 Meter Hermetic Seal Gasket
- 4 Panel Type Hermetic Seal Fuse Holder
- 5 5 Pin Female Panel Connector
- 6 Rotary Hermetically Sealing Panel Bushing

The above items are all pressure checked at 25 pounds per square inch.

The materials and processes used in the manufacture of all sealed components are made to conform to the most rigid JAN specifications.

Your special problems are solicited.



### PLUG IN TYPE HEADERS

OC-8  
1/16 CHARACTERS  
0.93 D PIN  
0.50 I.D.  
FLASH OVER VOLTAGE  
6000 V. PIN TO RIM

OC-12  
1/16 CHARACTERS  
0.93 D PIN  
0.50 I.D.  
6500 V PIN TO RIM

### MULTIPLE TYPE HEADERS

1000 SERIES AVAILABLE  
WITH 2 TO 10 TERMINALS

1/16 CHARACTERS  
15 D PIN  
0.32 D PIN CIRCLE  
0.40  
36°  
0.65 D PIN  
FLASH OVER VOLTAGE  
6500 V PIN TO RIM

2000 SERIES AVAILABLE  
WITH 2 TO 6 TERMINALS

1/16 CHARACTERS  
15 D PIN  
0.32 D PIN CIRCLE  
0.40  
RETAINER RING  
0.49 D PIN  
6500 V PIN TO RIM

### NEO-SIL HERMETIC SEALS INDIVIDUAL TYPE TERMINALS

E-1  
0.125  
0.187  
0.32  
0.32  
0.32  
0.32  
2500V  
FLASH OVER VOLTAGE

E-3  
0.125  
0.187  
0.32  
0.32  
0.32  
0.32  
5500V  
FLASH OVER VOLTAGE

E-4  
0.125  
0.187  
0.32  
0.32  
0.32  
0.32  
5500V  
FLASH OVER VOLTAGE

### NEO-SIL TECHNICAL DATA

NEO-SIL is a synthetic compound, which was developed expressly for the purpose of providing a suitable insulating material, which could be satisfactorily bonded to various metals, under a wide range of temperatures, be impervious to most acids and alkalis, provide a comparatively non-wetting surface, have a high insulation resistance, and meet the exacting requirements of the Janization program of the Armed Services. These compounds, in their various forms, produce component parts which are able to meet these exacting requirements.

### TEST DATA

The result of the Electrical Testing Laboratories Inc., Report #330655, dated March 18, 1949, on this material shows the following:

Volume Resistivity at 800 Volts d-c  
Room Temperature 25°C R.H. 30 percent  
Megohm-inches  $1.4 \times 10^9$  ohm-centimeters  $3.5 \times 10^{12}$

Dielectric Constant and Dissipation Factor

Dielectric Constant	Dissipation Factor	Loss Factor
9.22	@ 60 cycles per second .058	5.32
6.17	@ 1 megacycle per second .0455	.28
5.35	@ 50 megacycles per second 0.20	1.1

Dielectric Strength at 60 cycles  
Volts per mil — 370

Durometer Average — 80 ± 5  
Temperature — Rated as a Class A material conservatively + 105° to -70° centigrade.

The Flashover Voltages indicated were taken at a temperature of 68° Fahrenheit, and 47% Relative Humidity.

26 CORNELISON AVE., JERSEY CITY 4, N. J.



Presenting  
 another great new G-E  
 triode for FM and  
**TELEVISION**



**GL-6039**



**RATINGS**

- Has an output over one-third higher than the famed GL-9C24, its predecessor.
- Requires 1,100 w less filament power, or a 75-percent reduction.

**Plenty of output...** Two GL-6039's will put out 25 kw in FM—10 kw in television. Here's sufficient final power for medium-size transmitters . . . or output to spare for the intermediate stage of large commercial installations.

**Low operating cost...** The modest 5-v, 78-amp requirement of the GL-6039's filament, slashes by three-quarters the watts needed for Type GL-9C24, itself a pioneering FM-TV triode with fine performance. Thoriated-tungsten construction, among other filament features, cuts your power bills materially.

**Real v-h-f operation...** 220 mc at max plate input gives you full FM-TV band coverage.

**Easy to install...** The GL-6039 needs no neutralizing, when employed in a properly designed

grounded-grid amplifier circuit. Features which help make the tube so efficient, are its low lead inductance, the fact that all outer metal parts are silver-plated to cut r-f losses, and the large terminal-contact areas made possible by G-E ring-seal design.

**Sturdy, dependable...** Newest of a family of modern G-E power tubes for FM-TV that has proved its worth in hard station service, Type GL-6039 is engineered to stand up! The tube is trim, with real built-in structural strength—mounts solidly and closely in today's compact transmitters. You can rely on its full-time, full-life performance. Ask for a visit by a G-E tube engineer, to prove that the GL-6039 will give your new circuit peak power, improved economy! *Electronics Department, General Electric Company, Schenectady 5, New York.*

Filament voltage	5 v
Filament current	78 amp
Grid-plate transconductance	11,000 micromhos
Interelectrode capacitances:	
Grid-filament	24 micromicrofarads
Grid-plate	15.7 micromicrofarads
Plate-filament	0.47 micromicrofarads
Type of cooling	water and forced air

**Plate ratings per tube, Class B r-f power amplifier (video service, synchronizing peak conditions):**

Max voltage	6,000 v
Max current	2.25 amp
Max input	13.5 kw
Max dissipation	7 kw
*Useful power output, typical operation (at 4,000 v and 2.1 amp, band width 5 mc)	5.4 kw

**Plate ratings per tube, Class C r-f power amplifier (key-down conditions without amplitude modulation):**

Max voltage	7,500 v
Max current	2.25 amp
Max input	16 kw
Max dissipation	7 kw
*Useful power output, typical operation (at 7,000 v and 2.08 amp)	12.8 kw

\*Includes power transferred from driver to output of grounded-grid amplifier.

**GENERAL  ELECTRIC**

185-K2

# ASK *Erie* RESISTOR



## ... about custom designed trimmers

Pictured above are several custom designed trimmers that incorporate the elements of standard Erie Disc and Tubular Ceramicon Trimmers. Each has been developed for a specific purpose, and each does its job efficiently and economically. Proper design and precision manufacturing, plus our years of experience, are the keynote to Erie quality.

Look at these units carefully. They should suggest the possibility of using Erie Resistor know-how and facilities to make your equipment more compact and more efficient.

Erie has the most complete trimmer line in the industry. We would like to work with you on combining trimmers, fixed capacitors, and other circuit elements into integrated sub-assemblies. Inquiries should specify complete mechanical and electrical requirements.

- ① Standard Style TD2A Dual Trimmer with mounting pillars.
- ② Special ribbon type terminals on standard Style TS2B Trimmer for direct connection to other components.
- ③ Compact Trimmer—Capacitor—Resistor—Coil Design. A complete oscillator unit.
- ④ Where special mounting is desired, standard Erie Style TS2A and Style 557 Trimmers can be supplied mounted on brackets.
- ⑤
- ⑥
- ⑦ Two trimmer elements become an integral part of this coil form and I. F. top section.
- ⑧
- ⑨ Special bracket and terminal arrangements on dual trimmer unit.
- ⑩ A compact pluggable assembly for mounting a trimmer in parallel with a plug-in crystal.
- ⑪ Special tubular ceramic trimmer and variable inductance having one common terminal.
- ⑫ Special steatite tubular dual trimmer.
- ⑬ Standard Erie Style 557 Trimmer with special bent rotor terminal.

*Electronics Division*

**ERIE RESISTOR CORP., ERIE, PA.**

LONDON, ENGLAND . . . TORONTO, CANADA





*Specify Sorensen*

# NOBATRONS

(DC VOLTAGE REGULATORS)

DO YOU WANT the *advantages* of storage battery characteristics without the *disadvantages*? Then equip with Sorensen NOBATRONS! You get adjustable output voltage, stabilized against changing line AND LOAD conditions. You eliminate battery charging and maintenance, gas, acid hazard.

Like all Sorensen regulators, the NOBATRON is a painstakingly engineered combination of fine workmanship and top-quality components. That means accurate, trouble-free operation; long life!

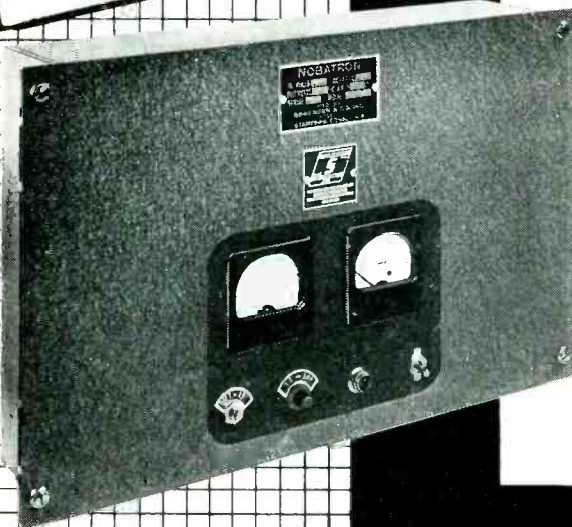

MODEL NO. E-6-15

#### STANDARD MODELS

##### 6-VOLT SERIES

E-6-5                      E-6-40  
E-6-15                     E-6-100

##### 12-VOLT SERIES

E-12-5                    E-12-30  
E-12-15                  E-12-50

##### 28-VOLT SERIES

E-28-5                    E-28-70  
E-28-10                  E-28-150  
E-28-30                  E-28-350

##### 48-VOLT SERIES

E-48-15

##### 125-VOLT SERIES

E-125-5                   E-125-10

Model numbers indicate voltage and current; for example, E-6-5 indicates 6 VDC with 5 amp total capacity.

#### COMMON ELECTRICAL SPECIFICATIONS

Input voltage range	95-130 VAC; adapter transformers available for 230 VAC operation*
Output voltage range	Adjustable $\pm 10\%$
Regulation accuracy and load range	$\pm 0.2\%$ from 1/10 load to full load
Ripple voltage RMS max.	1%
Recovery time	0.2 second—this value includes charging time of filter circuit for the most severe change in load or input conditions
Input frequency range	50-60 cycles

\* Some high current units require three-phase input

Write for Complete Literature

For other regulation problems investigate Sorensen's line of AC Voltage Regulators, Voltage Reference Standards, DC Power Supplies.

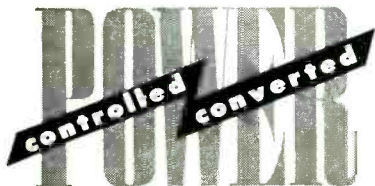

**Sorensen and company, inc.**  
375 FAIRFIELD AVE. • STAMFORD, CONN.

MANUFACTURERS OF AC LINE REGULATORS, 60 AND 400 CYCLES; REGULATED DC POWER SOURCES; ELECTRONIC INVERTERS; VOLTAGE REFERENCE STANDARDS; CUSTOM BUILT TRANSFORMERS; SATURABLE CORE REACTORS

YOU CAN BE **SURE**.. IF IT'S  
**Westinghouse**

**GREATER HEAD-ON READABILITY**

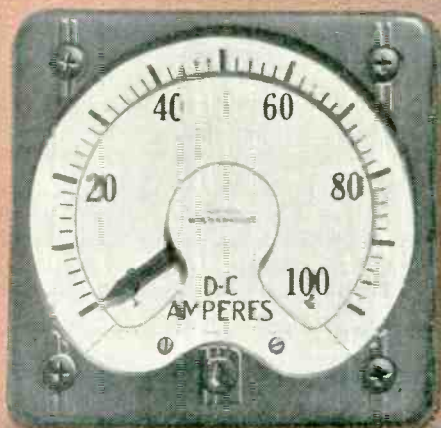

**NEW**



**OLD**

**GREATER ANGLE READABILITY**



**NEW**



**OLD**

**The New, Full-View Type K-24** is another example of the constant effort Westinghouse is making to meet customer requirements for better instruments. It is typical of the extreme attention that goes into every detail . . . *for better performance and better usability.*



**FROM**

**ANY ANGLE**

**Easier, quicker**  
**Instrument Read-Ability**

Here's the new switchboard instrument that you've been asking for and hearing about! Developed by Westinghouse in co-operation with customer engineers . . . to meet user suggestions and requests . . . it brings a new concept of instrument read-ability. Again Westinghouse leads the way in the instrument field . . . another step that helps you get more for your instrument dollar.

**GREATER READABILITY...**

The Full-View K-24 line is the easiest reading instrument on the market. New improved dial and open face direct attention instantly to the scale divisions and pointer. You will take measurements quickly . . . accurately . . . from greater distances . . . from greater angles. The possibility of reading errors is reduced to an absolute minimum . . . no waste of time in "walking over" to take a reading.

**ELIMINATES SHADOWS—REDUCES GLARE...**

The full, open window and unique dial structure prevent shadows on the scale, regardless of lighting conditions. The flat, single window surface keeps the problem of glare under control. These features eliminate distortion and confusion . . . eyestrain is minimized . . . operator satisfaction is assured.

**INTERCHANGEABLE...**

Panel drilling dimensions are identically the same as the superseded design. ASA mounting dimensions are maintained. All parts are interchangeable with those in the superseded design.

Westinghouse has this line of instruments

ready for you now. Insist on it for your next control board job. For complete information, ask your Westinghouse representative for Catalog Section 43-200. Whatever your electrical measuring requirements, ask for the planning help of a Westinghouse Instrument Specialist. Westinghouse Electric Corporation, 95 Orange St., Newark, N. J.

J-40393

*Specify Westinghouse—get more for your instrument dollar!*

**Westinghouse**

**INSTRUMENTS**





what about color TV?  
what are you doing about it?

*Du Mont Announces*  
the **UNIVERSAL  
COLOR SCANNER**

**A SIGNAL SOURCE FOR ALL  
TV COLOR SYSTEMS**

Operating on the principle of the flying spot scanner, the Du Mont Universal Color Scanner provides for the Broadcaster, Receiver Manufacturer, Development Laboratory — tri-color signals from any 35 mm. 2 x 2" color transparency. Available as outputs are an FCC approved field sequential video color signal and three simultaneous video color signals which may be fed to any external sampling equipment for experimental work with line or dot

sequential systems. Horizontal line frequencies may be set at 15.75 or 29.16 kc and vertical field rates at 60 or 144 fields per second (intermediate values may be specified as desired). This assures a flexible equipment embracing both present black and white standards as well as FCC approved color standards and adaptable for use with any of the other presently proposed color systems.

SEND  
FOR  
DETAILED  
TECHNICAL  
LITERATURE

**DU MONT**

**First  
with the Finest  
in Television**

ALLEN B. DU MONT

LABORATORIES, INC. • TELEVISION TRANSMITTER DIVISION, CLIFTON, N. J.



BROWN  
INSTRUMENTS  
ACCELERATE  
RESEARCH

## For Rapidly Measuring Minute Voltages with Extremely High Accuracy

... the  
**BROWN-RUBICON**  
Precision Indicator

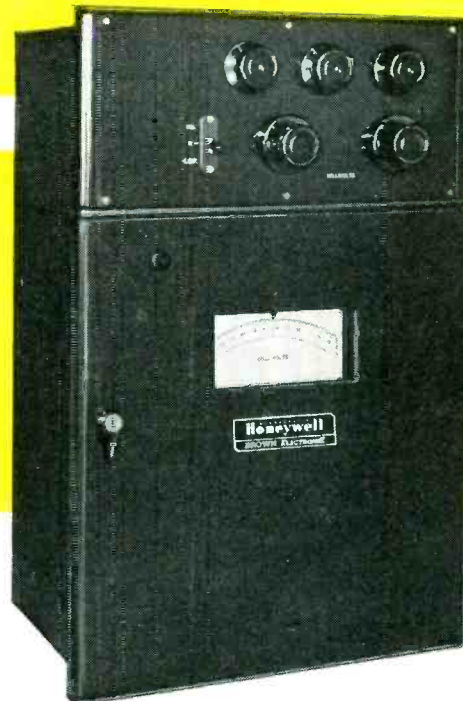

### Ranges and Operating Characteristics

- OVER-ALL RANGE—0 to 70.1 millivolts.
- SELF-BALANCING SCALE RANGE—0 to 1.1 millivolts
- READABILITY—one microvolt.
- SENSITIVITY—one microvolt.
- ACCURACY—within three microvolts, or 0.02 per cent of indication, whichever is greater.
- FULL SCALE TRAVEL TIME—12 seconds.
- VARIABLE SUPPRESSION AND NARROW SPAN—provided by a combination of these three elements: (1) a manually positioned seven-point switch, 10 millivolts per point; (2) a manually positioned ten-point switch, one millivolt per point; and (3) a helical slidewire, 25 inches long, with 1600 convolutions, 1.1 millivolts over-all.
- SIZE OF SCALE—28 5/8 inches long, with 550 one-sixteenth-inch divisions of two microvolts each.

THIS INSTRUMENT combines the high accuracy of the *Rubicon* laboratory potentiometer with the automatic continuous balance principle of the *ElectroniK* Precision Indicator. In addition, it features a speed and ease of operation that eliminates operator fatigue from such work as the checking, calibrating and standardizing of meters, potentiometers and thermocouples... as well as the plotting of large numbers of frequent, repetitive readings. Being unaffected by vibration, it is ideal for use in moving vehicles or in situations where this factor is encountered. For detailed information, write for a copy of Data Sheet 10.0-2. MINNEAPOLIS-HONEYWELL REGULATOR CO., Industrial Division, 4428 Wayne Ave., Philadelphia 44, Pa. Offices in more than 80 principal cities of the United States, Canada and throughout the world.

MINNEAPOLIS  
**Honeywell**

BROWN INSTRUMENTS



# Make Containers Count



(and everything else, too)



with  
**VEEDER-ROOT** **COUNTERS**

Containers . . . coin machines . . . compressors . . . corn-husking machines . . . (or what have you?) . . . all these and scores more count to the greater advantage of their users or producers, or both . . . with Veeder-Root Counters. These infinitely useful devices, electrical or mechanical . . .

may be either applied to a process or built into a product as original equipment. WRITE: Veeder-Root Inc., Hartford 2, Conn. (New Phone: 7-7201). In Canada: Veeder-Root of Canada, Ltd., 955 St. James St., Montreal 3. In Great Britain: Veeder-Root Ltd., Kilspindie Rd., Dundee, Scotland.

**"VEEDER-ROOT COUNTS EVERYTHING ON EARTH"**



# INCREASED ALSIMAG<sup>®</sup> PRODUCTION

PLANT  
NO. 4

MAIN OFFICE AND  
PLANT NO. 1

PLANT NO. 2  
WILLIAMS ST.

PLANT NO. 3

Production facilities, already the largest in the steatite industry, are being rapidly expanded to take care of your needs. Plant No. 3 is just going into production. All plants are running 24 hours a day, 7 days a week. Plant No. 5 is on the way.

Current deliveries are not satisfactory to you or to us. We were swamped with rearmament orders for the last quarter of 1950. But great strides are being made toward taking care of your requirements for AlSiMag custom made technical ceramics.

Every effort is being made to keep American Lava Corporation your most dependable source for quality and for delivery according to promise.

## AMERICAN LAVA CORPORATION

49TH YEAR OF CERAMIC LEADERSHIP  
CHATTANOOGA 5, TENNESSEE

OFFICES, METROPOLITAN AREA: 671 Broad St., Newark, N. J., Mitchell 2-8159 • CHICAGO, 223 North LaSalle St., Central 6-1721  
PHILADELPHIA, 1649 North Broad St., Stevenson 4-2823 • LOS ANGELES, 232 South Hill St., Mutual 9076  
NEW ENGLAND, 38-B Brattle St., Cambridge, Mass., Kirkland 7-4498 • ST. LOUIS, 1123 Washington Ave., Garfield 4959



# BUSINESS BRIEFS

By W. W. MacDONALD



## PYRAMID

"HEARING-AID"

TYPE 65 PTR

### TUBULAR PAPER CAPACITORS

for 65° C  
applications —  
150 v.d.c. rating

- Small, compact and sturdily constructed.
- Designed for continuous operation at D.C. voltage rating
- Will withstand a 5-second test of 300 V.D.C.
- Will meet standard RMA humidity test.

WRITE FOR COMPLETE LITERATURE  
Representatives and Distributors  
throughout the U.S.A. and Canada



## PYRAMID

### PYRAMID ELECTRIC COMPANY

1445 Hudson Boulevard

North Bergen, N. J., U. S. A.

TELEGRAMS: WUX North Bergen, N. J.  
CABLE ADDRESS: Pyramidusa

National Emergency pulls the teeth of the FCC's color-television decision; producing black-and-white sets will be difficult enough. By the time the question comes up again technical advances will have altered the picture and, from what we have seen and heard recently in Washington, compatibility will be part and parcel of it.

The industry has, in a sense, been saved by the bell.

**Military Equipment Contracts** often include maintenance manuals and many a bidder has stubbed a financial toe by failing to include in his figures enough to cover their production. Others have had equipment acceptances delayed because manuals were not ready to go with the gear.

There are several satisfactory ways of handling the production of manuals, but all of them are expensive. Take it from us that technicians who can write are becoming hard to find and that printing and paper costs are steep. More important still, securing the approval of government agencies on anything so subject to differences of opinion as the quality of the written word can be a long-drawn-out proposition.

**Some Civilian Services** are vital to the emergency effort. We know of no better proof than the fact that two manufacturers were recently directed to expedite shipment of 12,000 tubes to civilian airlines, the directive taking priority over military orders.

**November Land Hurricane** that ripped and tore the eastern part of the country damaged a lot of antenna towers. Among the stations requesting FCC permission to reduce power or to use temporary skywires were WAAT, WALD, WAWZ, WBRY, WDAS, WLVA, WMGM, WMID, WNEW, WOV and WPRO.

By one of those rare coincidences gratefully accepted by editors, the storm hit on the very day

that our December issue containing the article "How to Select Antenna Towers and Masts" went into the mails.

**Computer Tubes** most frequently used appear to be the following:

Beam Tetrodes	Pentodes	Switch Tubes	Gating Tubes
6AN5	6AK5	2C51	6AS6
6AQ5	6AU6	6J6	6BE6
6L6	6SJ7	6SN7	7AK7
25L6	7AD7	6SL7	5915
50B5		12AT7	
		12AU7	
		12AX7	
		5687	
		5963	
		5964	

This, at any rate, was the consensus of opinion around the recent Joint Conference on Electron Tubes for Computers at Atlantic City.

**Creeper, dancer, dillidallier, wiggler, up-drifter and down-drifter.** These words are currently being used to describe the antics of malfunctioning germanium diodes, further enriching our technical vocabulary.

**Long Island Railroad** wreck investigators have suggested that the management might look into, among other things, the possible use of radar to avoid future collisions. The suggestion is indeed flattering to the electronics industry, but it seems to many of us who ride the line that it might first be necessary to jack up the radar and build a railroad under it.

**Highway Maintenance** is greatly facilitated by the use of radiotelephones, according to H. A. Radzickowski of the Department of Commerce, who furnishes the following interesting statistics;

Some 68 State, County and City highway departments are already using or are planning to use radio. Forty of them report that present facilities cover a combined operating area of 709,784 square miles and 129,075 miles of highways. Installations for statewide coverage cost as much as \$500,000; smaller county installations cost between \$10,000 and \$20,000, about



# Now 6

## SYLVANIA GERMANIUM DIODES SEALED-IN-GLASS

*They're individually  
engineered to meet YOUR  
circuit requirements*

**1N34A—General Purpose Diode.** The workhorse of the Sylvania line. *New* higher quality standards guarantee back resistance higher than  $\frac{1}{3}$  megohm at  $-10$  volts.

**1N38A—High-Resistance, 100-Volt Diode.** *Now* specially engineered to guarantee still higher back resistance at both high and low voltage levels. 0.6 megohm at  $-3$  volts; 0.2 megohm at  $-100$  volts.

**1N54A—Here's a real high back resistance crystal.** *Now* guaranteed to show at least 1.4 megohms at  $-10$  volts—averages better than 2! Use it for high efficiency in high load resistance circuits.

**1N55A—150-Volt Diode.** *New* more rigid specifications guarantee at least 0.3 megohm back resistance at  $-150$  volts.

**1N56A—Low Forward Impedance Diode.** Average forward resistance less than 60 ohms at one volt. Ideal for

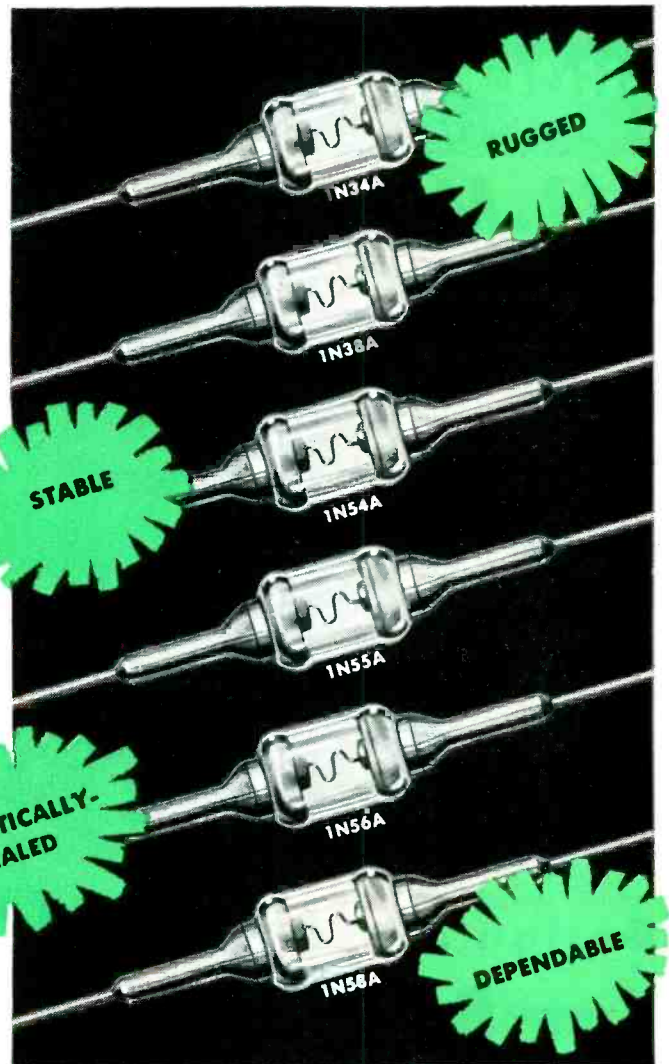

high efficiency operation into low impedance loads.

**1N58A—General Purpose 100-Volt Diode.** *Now* guaranteed to have resistance of at least 0.16 megohm at  $-100$  volts. Use it for gating or clamping circuits where dependable high voltage hold-off is required.

Try these new, finer-quality Sylvania "Sealed-in-Glass" Germanium Diodes. You'll find them ideal for scores of applications calling for low power rectification at frequencies up to several hundred megacycles.

Mail the coupon today for a new FREE, 8 page booklet describing Sylvania's complete line of both glass and ceramic style Germanium Diodes and for Varistor types.

ELECTRONIC DEVICES;  
RADIO TUBES; TELEVISION  
PICTURE TUBES; ELECTRONIC  
TEST EQUIPMENT;  
FLUORESCENT TUBES,  
FIXTURES, SIGN TUBING,  
WIRING DEVICES; LIGHT  
BULBS; PHOTOLAMPS;  
TELEVISION SETS

# SYLVANIA ELECTRIC

Sylvania Electric Products Inc.  
Dept. E-1002  
Emporium, Penna.

*Please send me full information concerning  
the complete line of Sylvania Germanium  
Diodes.*

Name \_\_\_\_\_  
Company \_\_\_\_\_  
Street \_\_\_\_\_  
City \_\_\_\_\_ Zone \_\_\_\_\_ State \_\_\_\_\_

## ALL-METL BARRYMOUNTS

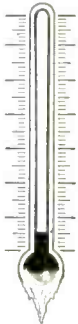

FOR EXTREME LOW TEMPERATURES

for  
unusual  
airborne  
applications

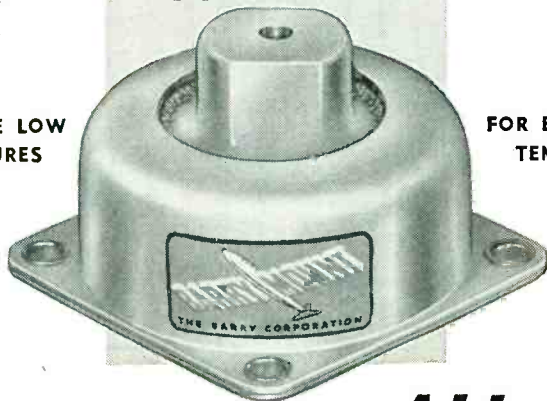

FOR EXTREME HIGH TEMPERATURES

## Design Features of ALL-METL BARRYMOUNTS

- ① . . . Outstanding vibration isolation under severe temperature and environmental conditions.
- ② . . . High shock protection in accelerated take-offs and arrested landings.
- ③ . . . Unit mountings are interchangeable with mountings now in use.
- ④ . . . Complete line of ALL-METL mounting bases to JAN-C-172-A dimensions.
- ⑤ . . . Special ALL-METL bases made to customers' requirements.

**FREE CATALOGS** give dimensions and load ratings of stock BARRYMOUNTS. Write today for Catalog 509 describing ALL-METL unit mountings and mounting bases. Catalog 502, covering general aircraft applications, and Catalog 504, covering industrial mountings, are also free on request.

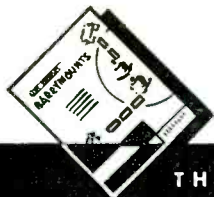

THE **BARRY** CORP.

Main Office 707 Pleasant St. • Watertown 72, Massachusetts

New York Rochester Philadelphia Washington Cleveland Dayton Detroit  
Chicago Minneapolis St. Louis Seattle Los Angeles Dallas Toronto

the same as one heavy motor grader.

Onondaga County, New York, recently figured interest on investment, depreciation, repair and operation of its single-base-station and 54-mobile-unit system at 8 cents per hour for each radio-equipped vehicle. The system is used to manage a fleet of 100 trucks and other road equipment.

**Receiver Sales** by licensees for the first nine months of 1950 totalled 14,684,184, worth \$1,061,641,271. Here's the way the total broke down:

Type	Units	Dollars
<i>Electric</i>		
Table (under \$12.50 billing price)	1,984,752	\$20,662,085
Table (over \$12.50 billing price)		
A-M	1,855,986	33,221,330
A-M/F-M	264,617	8,083,812
F-M (including converters)	10,078	226,603
<i>Consoles</i>		
A-M	6,219	409,026
A-M/F-M	3,871	433,695
<i>Table-Radio-Phonos</i>		
A-M	267,186	11,121,908
A-M/F-M	14,644	947,257
<i>Console-Radio-Phonos</i>		
A-M	55,089	4,611,161
A-M/F-M	343,502	42,154,949
<i>Battery</i>		
Portable A-C/D-C	1,240,872	22,053,471
Table	72,150	1,134,132
Consoles	42	3,799
<i>Auto</i>	3,473,837	89,846,277
<i>Television</i>		
Converters	4,060	482,171
<i>Radio Table Models</i>		
1,995,522	274,816,075	
<i>Radio Consoles</i>		
Direct Viewing	2,196,957	409,326,839
Projection	8,633	2,170,634
<i>Radio Phonos</i>		
Direct Viewing	474,245	126,902,582
Projection	37	17,915
<i>Phonographs</i>		
Phono only	310,644	5,334,496
With radio attachment	19,769	620,182
<i>Without Cabinets</i>		
A-M	11,432	259,991
A-M/F-M	13,883	597,578
Television	56,154	6,203,303

**Viennese Engineers** dial B 34-504 and hear a 1,000-hertz (1,000-cps) audio tone, very handy for testing. Dialing A-069 produces the musical note "A" (440 hertz). Austrian Telephone Company picks up the tones from the Austrian Bureau of Standard's quartz-crystal-controlled clock, which is correct within one-tenth of a million of one hertz scale degree.

**Reliable Tubes** for industry, about which we have long harped in this column, are exemplified by those used in a recently publicized telephone company submarine-cable repeater unit. Why are these tubes reliable? Among the



many reasons, they are operated well below ratings.

Other users please copy.

A Reader out in Palo Alto has invented a crash-locator beacon that is automatically ejected and sends out a continuous radio signal when an airplane cracks up. He's looking for a manufacturer.

Ray Guy, president of IRE, thinks that eastern television programs will reach Pacific Coast receivers by way of telephone lines and microwave relays early in 1952.

Slip Showing in the columns of one of our contemporaries but noted only by people with a penchant for proofreading: "Modern comical antennas are so effective on all bands that in some instances they even outperform separate high-band antennas."

Radio Free Europe broadcasts by Crusade for Freedom (National Committee for a Free Europe, Inc.) have been in progress since July 4th. Several new transmitters are planned and at least one is understood to be on order in Switzerland.

Overseas: Danish-made television receivers have been demonstrated to the public. Components, with the exception of picture tubes, can be made by some 30 plants and assembled by about 20 others, the two groups at present employing 25,000-odd people. Copenhagen and Malmo are within range of the first station to render regular program service, which is scheduled to start about the time this item goes to press, operating one hour three times a week. Set owners will pay a license fee.

The Philips-Valve Works in Hamburg, Western German Republic, has turned out 10,000,000 radio tubes since the end of World War II. Production, which totalled 600,000 tubes in 1946, has now reached an annual rate of 6,000,000.

This Month's Understatement: "West German radio manufacturers say there is no immediate danger of overproduction of radio sets." (*Reuters*)



**SERIES 4**

SPDT GENERAL PURPOSE SENSITIVE D.C.

RELAY. Inexpensive balanced armature for vibration resistance on aircraft at 50 milliwatt adjustment. Sensitive enough for V-T operated relay circuits; can be set to operate down to 10 milliwatts. Precision adjustments for pull-on and drop-out. 2 amp. nominal contact rating. Coil resistance up to 14,000 ohms.

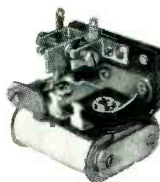

**SERIES 5**

SPDT VERY SENSITIVE D.C. RELAY. Balanced

armature and magnetic efficiency resist aircraft vibration on inputs as low as 5 milliwatts. Withstands 500g shock without damage. Precision adjustments. 2 amp. nominal contact rating. Coil resistance up to 16,000 ohms. Special adaptations: Built-in rectifier, two-coil differential operation, constant voltage temperature compensation.

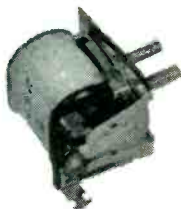

**SERIES 41**

SPDT SENSITIVE RELAY A.C.-D.C. — KEYING. Unusual

characteristics at low cost. Same D. C. sensitivity as Series 4 but less flexibility of adjustment. Available with long life and bounce-free contacts, it is suited to high speed counting and keying. Mechanical life exceeds 10<sup>9</sup> operations. Good for plate circuits needing moderate precision and vibration immunity. Contact ratings up to 5 amps. Coil resistance to 14,000 ohms. A. C. sensitivity exceeds 0.1 V. A. at 60 cps. Serviceable on frequencies from 16-400 cps.

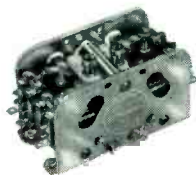

**SERIES 6**

MULTICIRCUIT POLARIZED SENSITIVE RELAY. Single or double (differential) windings. Resistance up to 25,000 ohms total. Contacts up to 4PDT, 5 amp. nomi-

nal rating. Balanced armature for strong vibration resistance. FORM X — Three Position or Null Seeking. For automatic positioning or 2-Way process control. Sensitivity (depending on contact complexity) from 10 to 100 milliwatts. FORM Y — Biased (Spring Return). Use as an ordinary sensitive relay if a complex contact combination is needed. Responds only to one polarity. Combines function of pilot relay and contactor. Sensitivity same as Form X. FORM Z — Latching (permanent magnetic). Replaces mechanical latch electrical reset relays, where longer life and greater vibration resistance is required. Sensitivity from 100 to 250 milliwatts.



**SERIES 7**

SPDT SENSITIVE HIGH SPEED POLARIZED RELAY. Single or multiple windings up to 14,000 ohms (single). Balanced armature. Nominal contact rating 2

amps. For repeating telegraphic signals at speeds up to 250 WPM. Small in size and weight. Hermetically sealed. Mechanical life exceeds 10<sup>9</sup> operations. FORMS X, Y and Z (see Type 6 above) available in Series 7. Sensitivities from less than 1 to 10 milliwatts depending on form and requirements. Form X is useful as the detecting element in positioning bridge circuits.

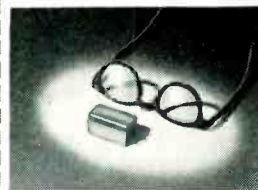

**SERIES 22**

Miniaturized double-pole double-throw Direct Current Sensitive (45 milliwatt) relay. 2-amp contact rating, coils up to 12,000 ohms. Hermetic seal enclosure only, 1 inch square mounting space. Specially designed for highly stable and precise operating adjustments, extreme immunity to vibration and to thermal and mechanical shock. Will operate under 50 g's sustained acceleration if operating and releasing margins are increased.



**VARIETY OF ENCLOSURES**  
In addition to the open styles shown, SIGMA Relays are available with dust-proof or hermetically-sealed enclosures. Most types are available for either plug-in or permanent solder-lug connections.

Write for fully descriptive catalog.

**SIGMA**  
*Sensitive Relays*

SIGMA INSTRUMENTS, INC., 62 CEYLON STREET, BOSTON, MASS.

**Service  
Beyond  
The Sale!**

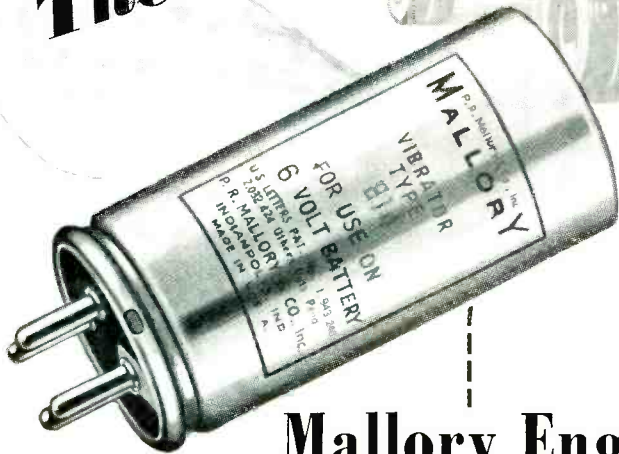
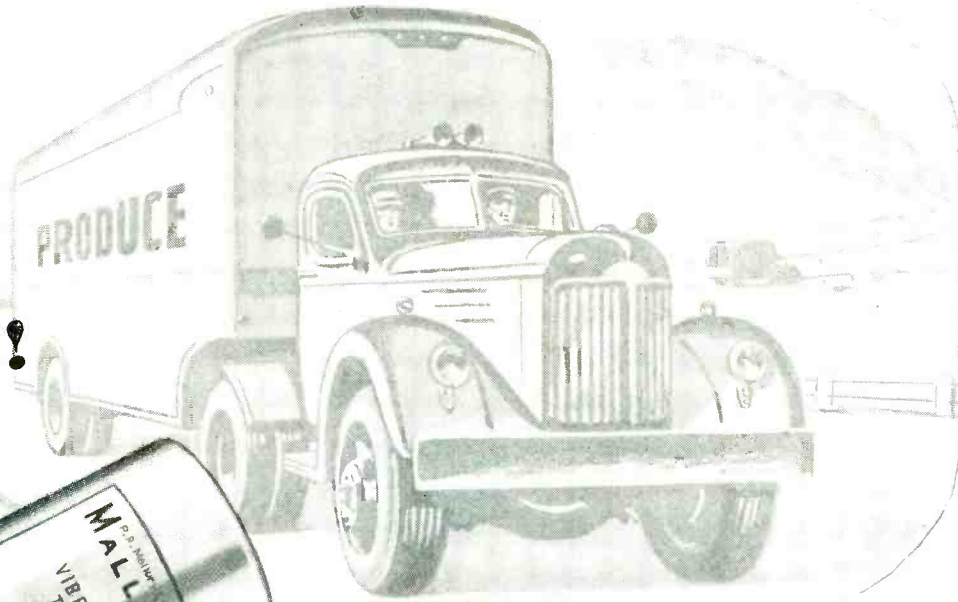

## Mallory Engineering Experience

*Solves Power Supply Problem*

*With Unique Vibrator Application*

### MALLORY VIBRATORS

Mallory Vibrators are based on exclusive design and manufacturing methods that assure long, trouble-free service. Send the details of your application. Get Mallory's recommendation on the Vibrator or Vibrapack\* power supply best suited to your needs.

*\*Reg. U.S. Pat. Off.*

The versatility of the Mallory Vibrator and the practicality of Mallory engineering have been demonstrated in a growing variety of power supply applications.

One customer had been experimenting with germicidal lamps in produce trucks to retard bacterial action... but was stumped by the need for an efficient power supply. Mallory tackled the problem and came up with an ingenious application of the Mallory Vibrator... plus complete technical data for producing the complete power unit assembly.

*That's service beyond the sale!*

Mallory electronic know-how is at your disposal. What Mallory has done for others can be done for you!

Vibrators and Vibrapack\* Power Supplies

**P. R. MALLORY & CO., Inc.**  
**MALLORY**

**P. R. MALLORY & CO., Inc., INDIANAPOLIS 6, INDIANA**

### SERVING INDUSTRY WITH

Electromechanical Products  
*Resistors*      *Switches*  
*TV Tuners*      *Vibrators*

Electrochemical Products  
*Capacitors*      *Rectifiers*  
*Mercury Dry Batteries*

Metallurgical Products  
*Contacts*      *Special Metals*  
*Welding Materials*





## CROSS TALK

► **WATCHES** . . . Suppose piezoelectricity were a property of materials as yet undiscovered. Without quartz crystals and the like, how would we maintain the frequencies of radio transmitters to the accuracy required for full occupancy of the spectrum? Tuning forks? General Radio has a 100-cps temperature-controlled fork accurate to 0.001 percent, relative to a mean frequency specific to 0.0001 percent. This is plenty good enough, even for television broadcasting, for which the allowed tolerance is 0.002 percent. For vhf television frequencies, frequency multiplication of the order of 200,000,000 times from fork to final amplifier would be required, but experience with f-m broadcast stations has proved this practical, if somewhat more expensive than a quartz slab.

Dr. J. A. Van Horn, in a fascinating article "Physics in the Watch Industry" (December issue of *Physics Today*) suggests that the job can be done in still another way, by a pocket watch! A good watch has an integrated error over a 24-hour period better than 0.006 percent, and a chronometer is at least ten times better, or in the class of the temperature-compensated tuning fork. At first glance this seems an attractive idea. One would divide the carrier frequency down to the audio range and run an electric clock, comparing its second hand with the second hand of the chronometer.

This might work, provided the transmitter had very good short-time stability, so that one could safely wait several hours for a visible discrepancy to appear be-

tween the two second hands. But this begs the question, since a transmitter without crystal control would probably drift in random fashion by ten times the allowed tolerance in a few seconds or minutes. This would never show up without microscopic examination of the relative position of the second hands. For example, the maximum allowable a-m broadcast drift of 20 cycles at a carrier frequency of one megacycle, occurring in 10 seconds, would advance or retard the second hand only 20 millionths of a radian, a quite undetectable amount. Under the assumed circumstances, the fellow who discovered the electrical activity of quartz (actually Pierre and Jacques Curie in 1880) would find a ready purchaser of the patent rights in Cambridge, Mass.

► **DX** . . . We understand that Bill Crawford, the weather reporter on station WFBM-TV in Indianapolis, is conducting a post-card survey on a 10:00 PM nightly telecast. As in many another one-station town, viewers in Indianapolis (281,000 families, 84,000 tv sets) are simply crazy about dx (long-distance to youse physicists) reception from tv stations a hundred or so miles away in Cincinnati, Louisville, and Dayton. So said weathercaster is asking his televiewers to send him a postcard whenever dx is visible, telling what station, the date and time when seen, and the quality of reception. And what is the weather man going to do with the cards? Yep, he's going to correlate the reports with temperature inversions

and other weather conditions, eventually may try his hand at predicting good dx weather. A cute idea which, if followed in other cities, might well develop a great deal of badly needed information on tropospheric propagation.

► **STANDARDS** . . . Amid the current welter of invective regarding the function of government in setting standards for an industry, it is refreshing to report that the late lamented 81st Congress enacted into law new electrical and photometric standards about which there is no argument. In effect, the new law adopts the recommendation made by the AIEE in 1928 that electrical units be defined in terms of the absolute (c-g-s or m-k-s) units, thus eliminating the column of mercury and the standard cell as standards of resistance and voltage. The largest change amounts to less than 1/20th percent of the old values, which have been on the books since 1894. While they were at it, the Congressmen also got around to legalizing the units of light which had not been written into Federal law. The standard candle, which used to be referred to a set of incandescent lamps, is now 1/60th of the intensity of the radiation from one square centimeter of a black body at the temperature of freezing platinum, and the standard lumen is the flux radiated within a unit solid angle by such a source.

All of which sounds sufficiently like the accepted language of the experts to be very reassuring, even if it did take 22 years.

# TELEVISION



New York's 1,250 foot Empire State Building as it looked when topped by WNBT's 32-foot pole and, in the insert, architect's sketch of the new 222-foot structure which will serve five television stations

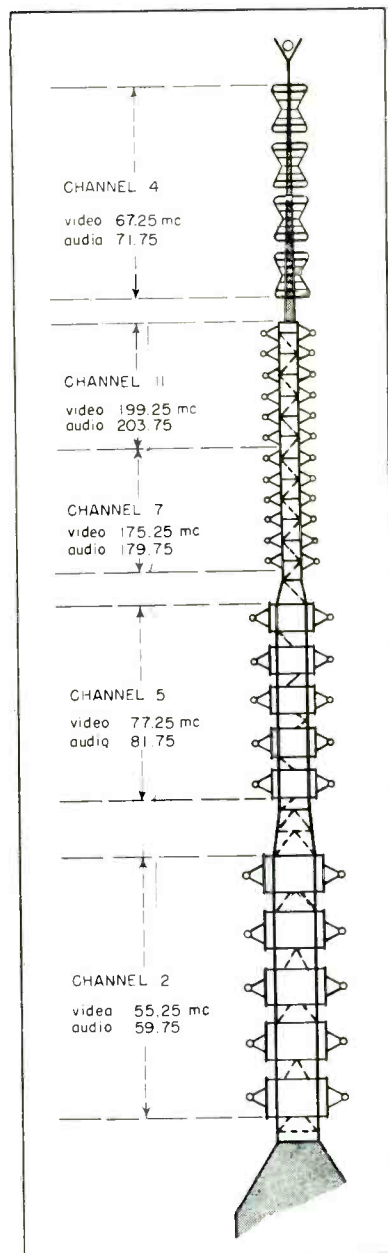

Simplified sketch of the television totem pole, showing areas to be occupied by various antennas

**T**ALLEST MANMADE STRUCTURE in the world, New York's 1,250-foot Empire State Building achieved a pinnacle of publicity during construction when it was topped off with a tower on which dirigibles were expected to moor. But the almost continuous presence of severe wind gusts, together with the disappearance of commercial dirigibles, nullified the plan.

Aviation's loss was electronics' gain, for today the tower supports

a 222-foot "television totem pole" upon which five of the seven locally licensed stations are erecting their transmitting antennas, with considerable benefit to the public and to the trade as well as to themselves. Service areas will in all cases be increased, shadows and ghosts will be reduced, and orientation of receiving antennas made very simple indeed in a market containing more than 15,000,000 people. Location of transmitters high up in the

building itself, near the antennas, permits the use of short transmission lines and other innovations resulting in important operating economies.

### Men, Money and Motivation

Leasing exclusive television broadcasting privileges since 1931, the National Broadcasting Company (WNBT) early in 1950 agreed with Empire State, Inc. that the building's unique facilities should



# TOTEM POLE

Five stations will operate into their own individual arrays coaxially mounted on a 222-foot structure atop New York's 1,250-foot Empire State Building. Common-point signal source and comparative freedom from shadows and ghosts benefits broadcasters, trade and public. Substantial antenna gains are obtained without detrimental interaction

By **FRANK G. KEAR** and **O. B. HANSON**

*Consulting Engineer  
Kear & Kennedy  
Washington, D. C.*

*Vice President and Chief Engineer  
National Broadcasting Co., Inc.  
New York, N. Y.*

be made available to other companies. Applications for antenna and transmitter space were received during the year from American Broadcasting (WJZ-TV), WPIX, Inc., Columbia Broadcasting (WCBS-TV) and Allen B. DuMont (WABD) in this order.

Overall responsibility for the design, construction, erection and proper initial operation of the required multiple-antenna structure was placed in the hands of a refreshingly small committee \* consisting of the two authors, who were authorized to consult Shreve, Lamb & Harmon on architectural problems, Edwards & Hjorth on structural, Radio Corporation of America on electronic and Starrett Brothers & Eken on general contracting problems. The committee developed preliminary specifications and RCA, employing Wayne Masters of Ohio State University as a consultant, contracted to check the electronic aspects experimentally, recommend revisions where experience with mock-ups indicated their desirability and perform final on-location tests for antenna gain, pattern circularity and mutual coupling. Mock-up tests are still in progress.

The cost of the entire structure, the mast, antennas, transmission lines and associated fixtures will be approximately \$850,000. Empire State itself paid \$250,000 of this total for the mast and necessary building reinforcement and shares antenna design, development and test expense with its five television tenants. The stations pay for fabrication, installation and adjust-

\* Bruce S. Old, On the Mathematics of Committees, Boards, and Panels, *Scient. Month.*, August 1946.

ment of their own antennas and transmission lines.

## Major Technical Considerations

Winds above 90 mph have been recorded at the top of the mid-Manhattan skyscraper and the roof area upon which an antenna-loaded rectangular mast topped by a similarly cluttered steel pole can be mounted is limited. These two factors, primarily, determined the maximum safe height of the structure.

Mast height determined the total number of vertically stacked antenna elements that could be accommodated and the desire for approximately equal overall antenna-system gains dictated the number of bays allocated to each station.

Physical considerations indicated that five systems, each providing an overall power gain of about four, could be accommodated and this figure will probably be bettered in actual practice despite the different transmission-line lengths and operating frequencies. Aside from the impracticability of obtaining greater gain by further extending the height of the mast and installing additional bays, calculations on more highly directive arrays operated 1,472 feet above street level disclosed that in all likelihood the resulting decrease in vertical radiation component would create a shadow area within a radius of a mile or more of the building, in a heavily populated area.

Some departure from optimum

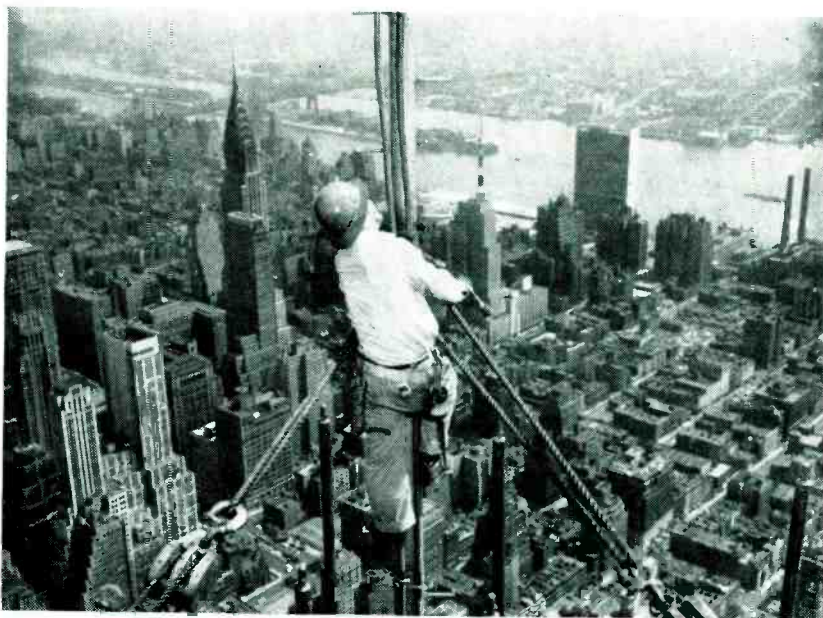

Looking northeast over Manhattan toward Long Island. WCBS-TV at present operates from the Chrysler Building, the spike of which is visible just to the left of the construction worker, while WPIX uses a mast on the Daily News Building seen just to the right



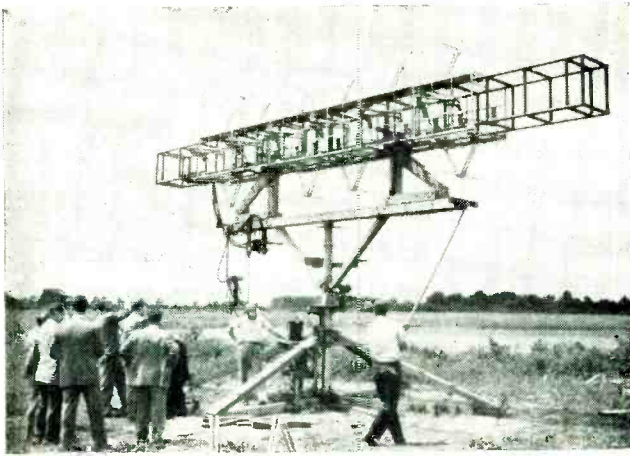

A completed array is tested for gain and directivity at Medford Airport, near Camden, New Jersey

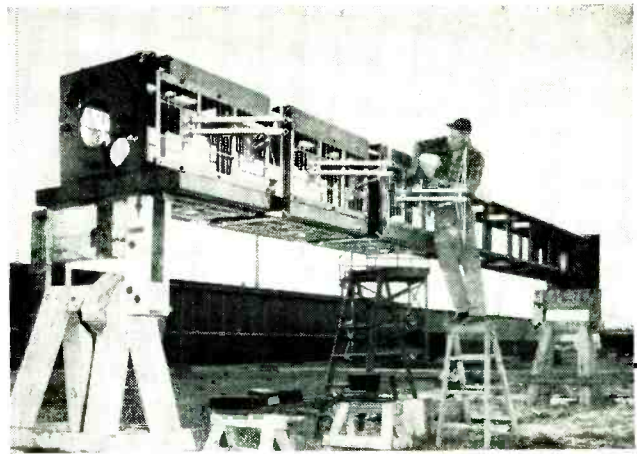

The bays are assembled around a mock-up of the mast section upon which they are eventually to be installed

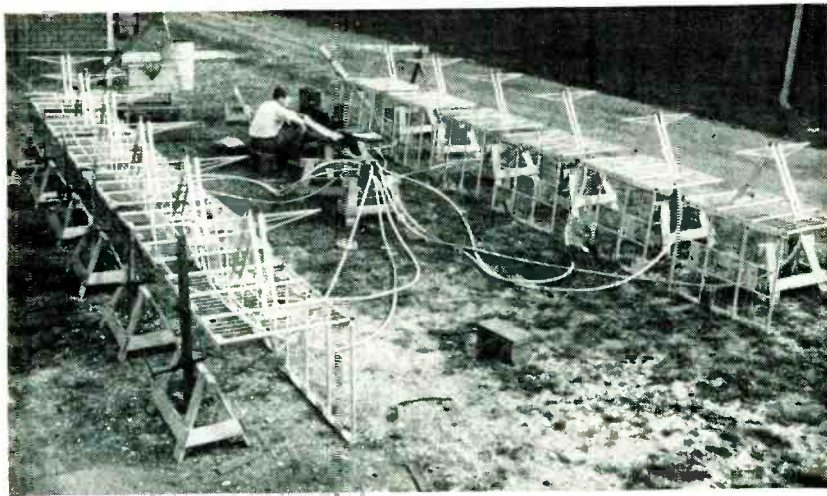

East-west elements of a supergain array are tested for termination at Camden

circularity of individual antenna radiation patterns was anticipated as a possible effect of other closely adjacent antennas and setbacks in the mast, which decreases in size between the base and the top. This has not materialized in tests, and noncircularities of horizontal pattern are in no instance expected to be greater than 2 db from the mean value for the video signal.

Mutual coupling between antennas, the possibility that one might pump inordinate amounts of r-f into others, was an early design consideration. Two items in an otherwise lean larder of technical experience provided the answer; first, the fact that existing television transmitters function satisfactorily when video and audio signals are decoupled by 20 db or more and, second, the fact that horizontally directive and coaxially mounted antennas on the crowded "islands" of aircraft carriers exhibit remarkably little tendency to interact due to their small vertical radiation

component. Adjacent bays of the various Empire State antennas are being mounted a noncritical distance of about one-half wavelength apart and decoupling between any two at video-transmitter fundamental frequencies will be held to 26 db or better without employing special isolation tricks. There are no shields or other gimmicks between adjacent arrays. Coupling at harmonic frequencies is of secondary order and inconsequential; conventional filters are used at the output of final amplifiers in any event where appreciable radiation at some multiple of the fundamental might prove generally troublesome.

For those who wish to pursue the subject of mutual coupling further, a study undertaken by RCA during preliminary design stages of the job will be of interest. It produced a mathematical expression for predicting the amount of power received on one tv broadcasting antenna from another mounted coaxially on the same mast, expressed as

the ratio of power received to power transmitted:

$$\frac{P_R}{P_T} = \left( \frac{\lambda}{4\pi} \right)^2 \frac{G_T G_R}{n_t n_r R^2} \frac{(E_L/E_R)^2}{1 + (E_L/E_R)^2}$$

where

- $\lambda$  = wavelength
- $G_T, G_R$  = directivities of transmitting and receiving bays in each other's direction and at each other's frequency relative to an isotrope
- $n_t, n_r$  = number of bays in the transmitting and receiving antennas
- $E_L, E_R$  = right and left-hand components of an elliptically polarized wave
- $R$  = distance between centers of the adjacent bays of the two antennas, in wavelengths

It is assumed that first-order coupling occurs between the two adjacent bays only, that inverse-distance-squared laws hold, that each element of each antenna is perfectly matched to its feed line at the frequency of the transmitting antenna, and that all feed lines of each antenna are effectively in parallel at a common junction point for that antenna. In practice, the fact that individual elements of a transmitting array do not match their branch lines at the frequencies of other nearby transmitting antennas provides additional isolation. Also, any coupling between bays other than adjacent ones acts in a favorable direction, since it tends to increase the random nature of phase amplitudes of received signals on the various individual antenna elements.

Calculations using this formula indicated that the degree of isolation required would be attained by the proposed configuration. Subsequent measurements proved the calculations to be substantially correct.

#### Individual Antenna Details

In solving the problem of accommodating a maximum number of



television antennas on a structure the dimensions of which were determined by mechanical load considerations, while at the same time employing previously developed antennas, it was determined that the topmost antenna should be one of the familiar superturnstile types. The four lower arrays are to be of the relatively new supergain or "ladder" type, each of their bays consisting of four broad-band horizontal dipoles backed up by infinite-screen reflectors 0.3-wavelength away and arranged around the sides of the tower. There are five bays spaced 0.77-wavelength apart for the lower-frequency channels and six bays spaced 0.8-wavelength apart for the higher channels. The increase in the number of bays for the higher-frequency channels offsets, by providing increased antenna gain, the additional transmission-line loss at the higher frequencies. The resulting effective gain determined at the transmitter source is substantially the same for all channels. Electric heating elements are incorporated in all antennas.

Video and audio signals are dplexed on all five antennas, WCBS-TV and WARD avoiding detrimental interaction between their picture and sound transmitters by using dual-bridge dplexers, gas-filled single coaxial lines between equipment and mast and power-equalizing bridges up at the junction boxes for their respective bays. WJZ-TV, WPIX and WNBT employ conventional bridge dplexers with two lines each between transmitters and antenna-array junction boxes to accomplish the required balance. Transmitter-to-array lines are  $3\frac{1}{8}$  inches in diameter except in the case of WPIX, which uses a  $6\frac{1}{8}$ -inch line. The vswr is 1.1 or better over each visual band and 1.5 or better over each aural. All phasing and feed lines between junction boxes and individual antenna elements or bays are to be RG-35/U flexible solid-dielectric coaxial cable, or similar special cable.

Because of the manner in which the Channel-2 and Channel-5 arrays are connected for dplexing with a single coaxial-line feed, it is possible to isolate portions of these arrays in the event of failure of components, or for normal servicing. Coaxial switching is provided at the

transmitter room so that power can be fed to the two top bays, the three bottom bays or all five bays, as desired. The switching is designed so that power normally fed to the section to be isolated can be diverted to an equivalent dummy load and so maintain a constant load on the transmitter and avoid overloading of the feed lines when operating at maximum power. This is not true of the three top arrays, so two of

their users will install simple stand-by antennas on the building's tower parapet.

Columbia's video transmitter is located on the 83rd floor and feeds its antenna through 275 feet of line, DuMont is on the 82nd operating into 338 feet, American on 85 with 324 feet, PIX on 81 with 405 and National puts its energy into a 385-foot-long line from the 85th floor. All transmitters are rated at 5 kw;

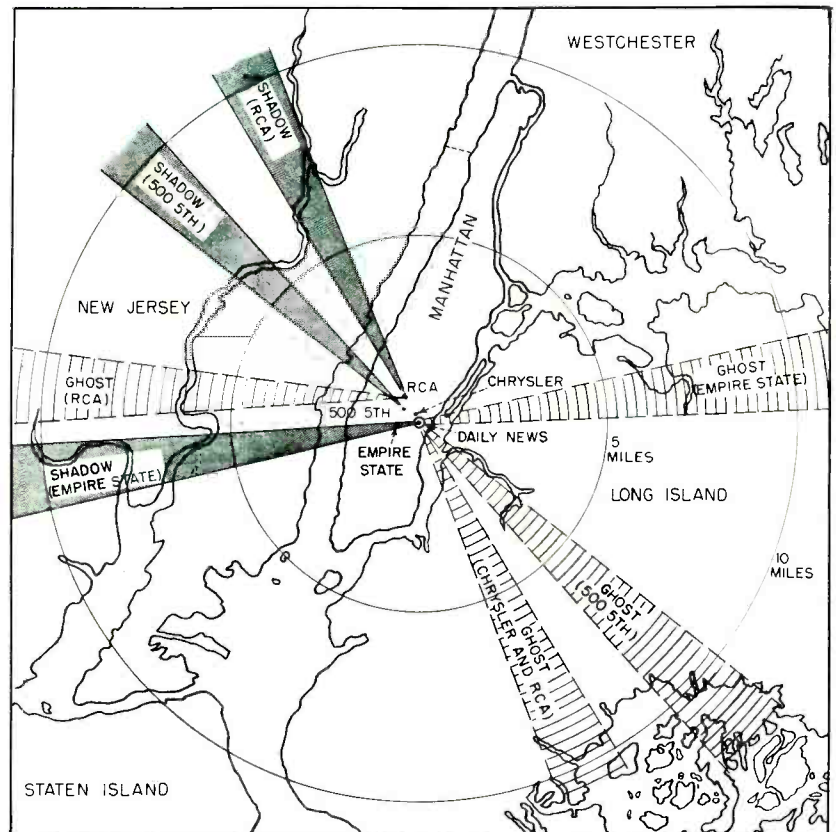

Shadows and ghosts experienced by WPIX due to nearby higher buildings before its move to Empire State

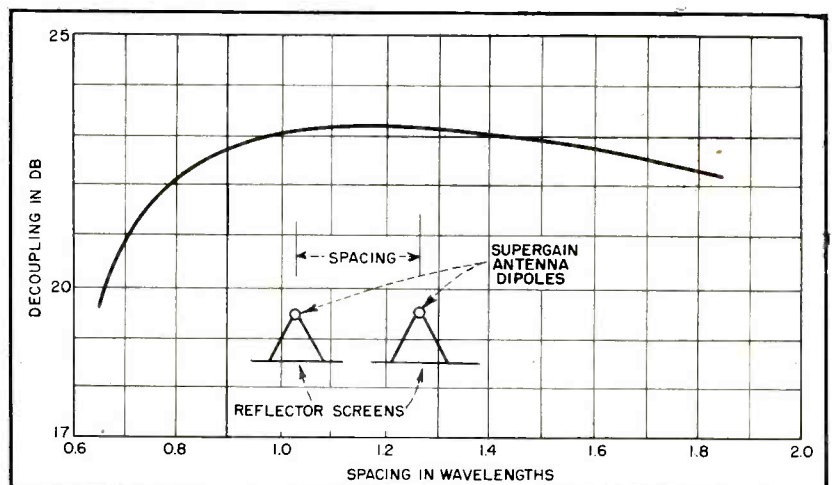

Interaction between two dipoles tuned to exactly the same frequency. This condition does not apply in multiple-transmitting-structure practice and isolation of 26 db or more is readily obtained

## HOW IT WAS DONE

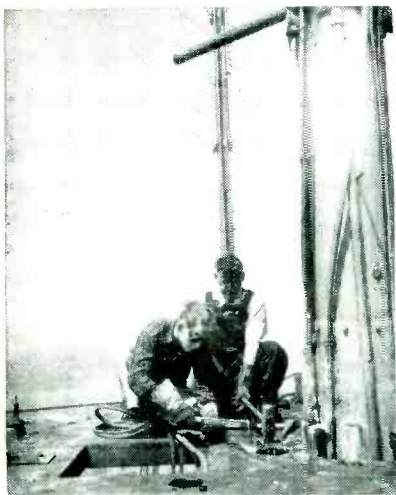

WNBT's old 4½-ton pole was telescoped into the tower, cut up and lowered beneath building elevators. New steel came up the same way

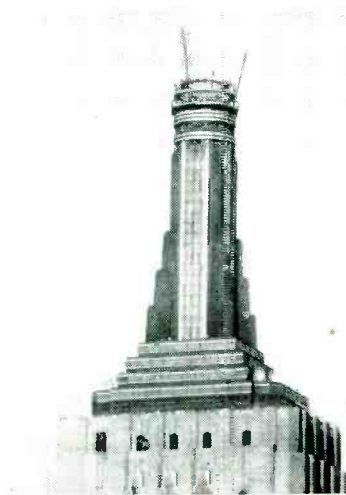

Temporary antennas were erected for WNBT (left) and WJZ-TV (right). Concentric work platforms provided an assembly point for materials



A scaffold encircling the mast went along as 57 tons of steel capable of withstanding at least 110 mph of wind pressure moved skyward



The first mast section was assembled piece by piece as it rose with the aid of the movable scaffold and a small but sturdy crane

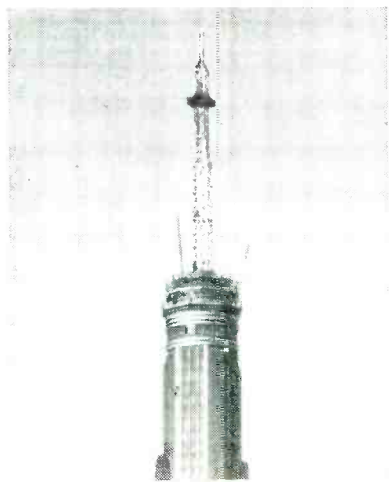

Second section was assembled much like the first, while the third was partially assembled below. Painting started at this stage

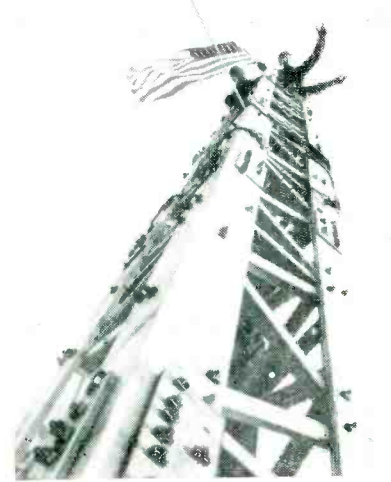

End of steel, insofar as the mast is concerned. WNBT's pole is to be raised in one piece and superturnstile elements installed later

but actual power output has not yet been determined because of feed problems and uncertainty as to FCC standards.

### Other Important Facilities

While no actual tests have yet been made, there appears to be no technical reason why two or more television transmitters operating on closely related channels cannot use the same antenna. Thus a Channel-13 station might share the array for Channel 11 (WATV, at present operating in nearby Newark, N. J., is already negotiating along these lines). The affected arrays could readily be retuned by means of available stubs to a satisfactory compromise

frequency and additional transmission-line bridging installed to achieve the required isolation. Filters having some slight insertion loss might also be involved. Main coaxial lines were designed to handle 100 kw of effective radiated power. The RG-35/U cable, however, must work near its safe limit so any material increases in power require the development of new cable or techniques for this highly specialized application. The perfect solution is proving elusive.

If FCC licenses uhf television stations in New York City it will probably be possible to accommodate several antennas required for such service between present vhf antennas on the mast and on the pole.

Columbia, American and National have, in fact, already installed simple antennas for their respective local frequency-modulation stations in such positions without ill effect on television transmissions.

Arrays for uhf theatre television, should this service materialize, would be installed around the building tower, rather than on the mast. AT & T's microwave-relay receiving antennas remain undisturbed on the balcony just below the tower.

Approaching technical perfection, with outstanding advantages for broadcasters, the trade and the public alike, Empire State's new skyhook will undoubtedly inspire other cities to erect similar television totem poles.



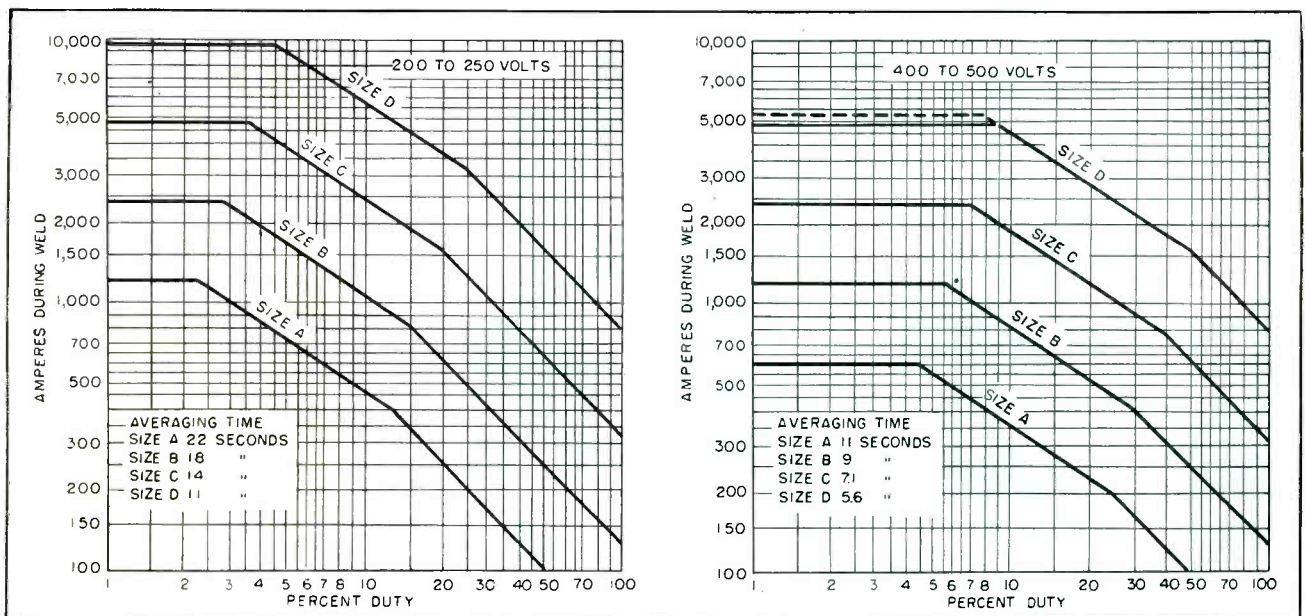

FIG. 1—Rating curves for the four sizes of welder ignitrons, for 220-volt service (left) and 440-volt service (right). Percent duty is computed from ratio of on-time to on-plus-off time, provided the on-plus-off time is greater than the averaging time specified for the size of tube in use; if it is not, percent duty is computed from ratio of on time to averaging time

# Load Sharer for Welder Ignitrons

Flip-flop thyatron circuit transfers the welding load automatically from one pair of ignitrons to another every two seconds. This reduces duty cycle per tube, permitting use of a given welder for a heavier weld or a longer time than was originally specified

**I**N A HEAVY-DUTY electronic welding control, the ignitron tubes may be easily overloaded when the welding machine is used for a heavier weld or a longer time than first intended. Figure 1 shows the rating curves for each of the four sizes of welder ignitrons, with size A being the smallest and size D the largest. At 220 volts (left-hand chart) these tubes often may carry greater current than at 440 volts (right-hand chart). However, when operating continuously (at 100-percent duty, shown at right-hand edge of each chart) the tubes have the same rating at both voltages. Size-

This article is based on material in a book by the author, "Electronic Motor and Welder Controls," soon to be published by McGraw-Hill Book Co.

By **GEORGE M. CHUTE**

*Application Engineer  
Apparatus Dept.  
General Electric Company  
Detroit, Michigan*

D ignitrons are the largest now available for welding service.

Figure 1 shows that a pair of size-B ignitrons may carry 130 amperes continuously at 220 volts. At 30-percent duty at 220 volts, however, the current that can be handled increases to 400 amperes. In 60-cycle service, for example, this 400-ampere current may flow to make two 9-cycle welds per second or 120 welds per minute. Here current flows 18 cycles out of each 60 cycles, which is 30-percent duty.

These same tubes must not be ex-

pected to carry a 400-ampere current for a weld 9 seconds long, twice per minute, even though the duty cycle still is 30 percent. The reason for this is that the rated averaging time for size-B tubes is 18 sec at 220 volts.

For size-B tubes at 220 volts, the operation must be figured within a total time not greater than 18 sec. Since a 9-sec weld is 50 percent of 18 sec, these tubes are working at 50-percent duty; here Fig. 1 shows 250 amperes as the highest load. Similarly, in a 440-volt circuit, the operation of these same tubes must be figured within 9 sec. If a single weld is 9 sec long, the tubes are working during the whole averaging time, or at 100-percent duty, and their load should be only 130

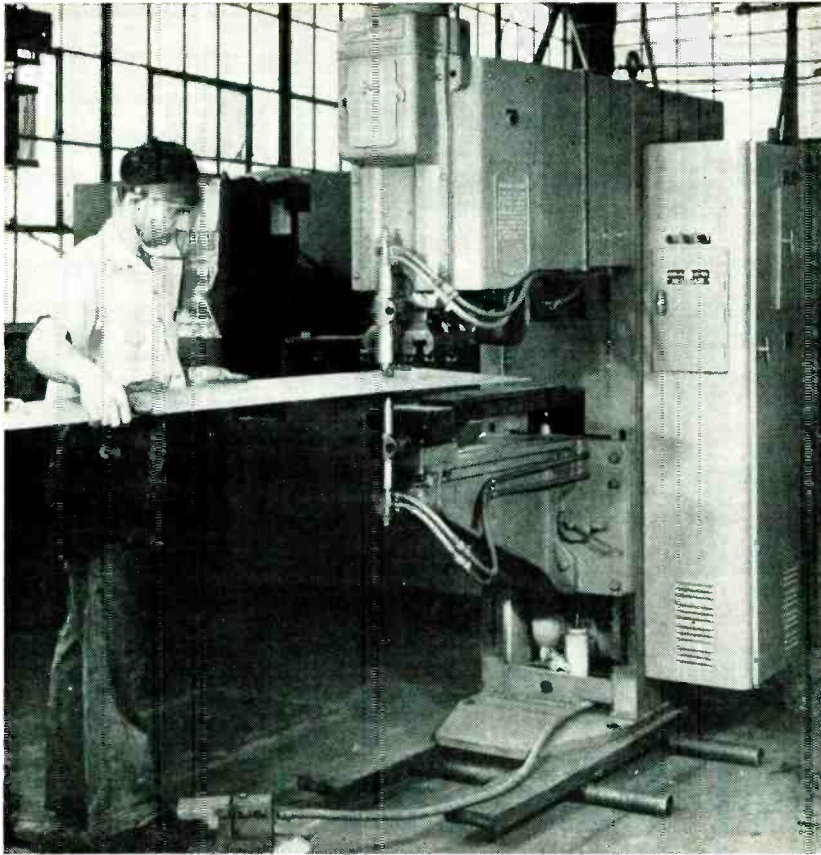

Example of press-type spot welder whose capacity can be increased by adding a flip-flop load-sharing control so that the duty cycle is shared by two pairs of ignitrons each operating well within safe limits

amperes. This holds true even if the welder rests a minute or an hour between welds.

Now let us see if size-C tubes will handle this 400-ampere load for a 9-sec weld. At 220 volts the size-C averaging time is 14 sec. Since  $9 \text{ sec} \div 14 \text{ sec}$  is about 65-percent duty, Fig. 1 shows that nearly 500 amperes may be carried; size-C tubes are thus large enough at 220 volts.

At 440 volts the size-C averaging time is only 7.1 sec. To make a 9-sec weld, the tubes are firing during the whole 7.1 sec so they are working at 100-percent duty. Since Fig. 1 permits only 330 amperes of load for size-C tubes at 100-percent duty, the 400-ampere 9-sec weld will overload size-C tubes in a 440-volt circuit. Capabilities of other sizes of ignitrons for various duty cycles can similarly be found from Fig. 1.

### Ignitron Controls for Larger Loads

If a new welding machine will require say 6,000 amperes from a 440-

volt supply feeder, Fig. 1 shows this current to be greater than size-D tubes can carry even at very low duty. Nothing is gained by connecting together several pairs of size-D tubes and firing them all at the same time. Ignitrons do not divide the total current in the manner of high-vacuum tubes; whichever ignitron is first to fire will carry the whole load, sharing none of it with another tube in parallel. Ignitrons sometimes may divide large-current loads only if reactors are added in their anode circuits.

For the 6,000-ampere load, it is best to supply two separate welding transformers, each controlled by its pair of ignitrons carrying 3,000 amperes (at less than 18-percent duty, from Fig. 1). The secondary windings of these two transformers should not be connected together; their separate sets of electrodes should not be close together where they press onto a single piece of work.

Consider another heavy welding load, such as 2,000 amperes for 3.8

sec at 440 volts. Here size-D tubes have 5.6-sec averaging time, and they would be working at  $3.8 \text{ sec} \div 5.6 \text{ sec}$  or 68-percent duty. The tubes are badly overloaded, for Fig. 1 shows that size-D tubes must not work above 35-percent duty at 2,000 amperes. But why not use two pairs of size-D tubes arranged so that each pair carries the 2,000 amperes for half of the weld time, as described below? In this way each pair of tubes works  $1.9 \text{ sec} \div 5.6 \text{ sec}$  or 34-percent duty; this is within the rating of size-D tubes.

### Flip-Flop Control

A separate equipment may be added to two ignitron contactors and a single heat control, so as to fire the tubes of each contactor in turn for about 2 sec each. In this way two pairs of size-D tubes may share the heavy load of the preceding example by dividing the weld time between them. This added control includes two relays which flip-flop in and out every 2 sec during the entire weld time. Relay 1 connects the heat control to the first ignitor circuit so as to fire one pair of ignitrons; 2 sec later, relay 2 connects the heat control to the other ignitor circuit so as to fire two other ignitrons, and relay 1 drops out. The contacts of relay 2 close before those of relay 1 open. When these contacts operate during a continuous weld, current flows to the welder without interruption.

The two pairs of ignitrons are connected in parallel as shown at the right in Fig. 2, so each pair in turn passes current into the single large welding transformer when the tube ignitor circuits are completed by the relay contacts. The relay coils are in the plate circuits of the thyratrons in the flip-flop control circuit. The 200-volt d-c plate voltage is applied to both tubes continuously, so that each can fire when its grid permits. When  $VT_1$  fires, its plate current pulls in relay 1, closing the contacts that fire ignitrons  $VT_2$  and  $VT_3$ . When  $VT_1$  is conducting, its anode is about 15 volts more positive than its cathode.

When plate voltage is applied to the flip-flop control,  $VT_1$  fires first



because of  $C_1$ . Next  $VT_2$  fires, turning off  $VT_1$ . These tube circuits alternate every 2 seconds, as determined by the sizes of  $C_2$ ,  $R_1$ ,  $C_1$  and  $R_4$ . This timing action may be seen in Fig. 3, which shows the voltage wave shapes in various parts of the circuit.

To hold the operation of this circuit still for a moment, let us open the plate circuit of  $VT_2$ , right at the tube. In this condition, corresponding to the start of the curves at the left in Fig. 3, no electrons flow through  $R_2$  so point B is at +200 v. Electrons flow from the cathode to the control grid of  $VT_1$ , then through  $R_3$  and  $R_4$  to B+. Since this grid is positive,  $VT_1$  is firing and relay 1 is picked up. Since the plate of  $VT_1$  is only 15 volts above its cathode,  $C_3$  has a high-voltage charge that is + at point B.

Point C is also about 15 volts above the cathode, so timing capacitor  $C_4$  is charged to the same voltage as  $C_3$ . The 10,000-ohm resistance of  $R_3$  is very small compared with the 6.2 meg of  $R_4$ , so voltage drop across  $R_3$  is negligible; the arc drop holds the grid of  $VT_1$  about 15 volts above the cathode. Meanwhile, point D likewise is about 15 volts above the cathode of  $VT_2$ , so both ends of  $C_2$  are at the same potential;  $C_2$  has no charge. The grid of  $VT_2$  is positive, so this tube is ready to fire at once when its anode circuit is reclosed.

Now suppose we let  $VT_2$  fire (by reclosing its plate circuit); relay 2 then picks up. At once the poten-

tial at B drops to K in Fig. 3, which is 15 volts above the cathode (the arc drop), and  $C_3$  starts discharging. Since a capacitor cannot lose its charge instantly (unless shorted), this charge on  $C_3$  forces the potential of terminal A down from +15 v to L in Fig. 3; in this way the plate of  $VT_1$  is driven negative long enough to stop the plate current, deionize the tube and permit its grid to regain control. At the same time the charge on  $C_4$  forces C down from +15 v to M in Fig. 3; grid current in  $VT_1$  stops and the grid remains negative for several seconds.

This high negative grid voltage keeps  $VT_1$  from firing, even though  $C_3$  quickly recharges (by electrons flowing up through  $VT_2$  to  $C_3$  and from the other terminal of  $C_3$  through  $R_4$  or relay coil 1 to B+), thereby letting the plate of  $VT_1$  again become positive. While  $VT_1$  is shut off, relay 1 is of course dropped out. The new charge on  $C_3$  is reversed; terminal A now is + and B is -.

The contacts of relay 2 fire ignitrons  $VT_7$  and  $VT_8$ , but there is a time delay of two seconds while  $C_4$  loses its charge, letting point C rise gradually from M to +15 v in Fig. 3. As  $C_4$  changes its charge, electrons flow from terminal C through  $R_4$  to B+. The potential at point C rises at a rate set by the RC time constant ( $R_4 \times C_4$ , which is 3.1 sec). When point C has risen about 15 volts above the cathode, grid current of  $VT_1$  again flows

through  $R_3$ , preventing C from rising higher.

When the potential of point C approaches N (cathode potential) during its rise to +15 v, the grid of  $VT_1$  is high enough to fire the tube, which then picks up relay 1. At once the plate of  $VT_1$  is pulled down to P, so the charge on  $C_3$  now forces point B negative to Q in Fig. 3, shutting off  $VT_2$  and dropping out relay 2. This time the charge on  $C_3$  forces point D to the negative potential at R, so  $VT_2$  will not refire when its anode quickly returns to B+. Capacitors  $C_3$  and  $C_4$  recharge. Again there is a two-second delay while  $C_2$  discharges through  $R_1$ , letting point D rise from R to S. At S,  $VT_2$  fires again, picking up relay 2; the anode of  $VT_2$  drops and the  $C_3$  charge again turns off  $VT_1$ . In this manner thyatrons  $VT_1$  and  $VT_2$  will continue to fire in turn. At the end of the weld, machine controls open the relay connections to B+ to prevent further operation,

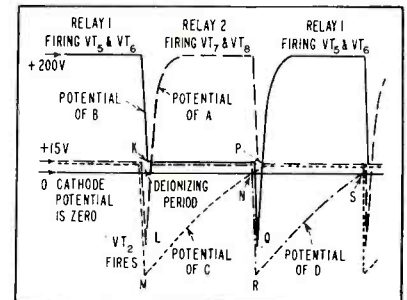

FIG. 3—Voltage wave shapes at points A, B, C and D of flip-flop circuit of Fig. 2

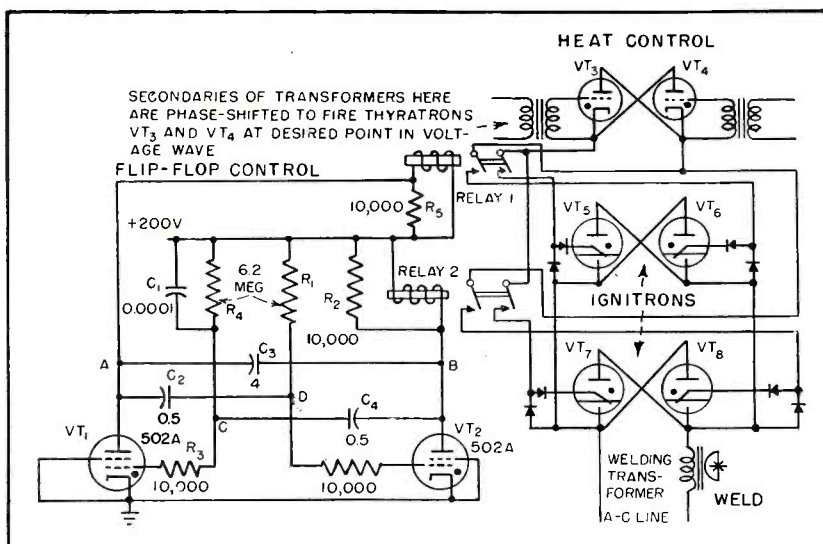

FIG. 2—Circuit of thyatron flip-flop control circuit for two pairs of ignitrons

but  $VT_1$  and  $VT_2$  continue to fire at 2-sec intervals since they still get plate voltage through  $R_3$  and  $R_2$ .

When taking turns every 2 sec, size-D ignitrons may be overloaded during a higher-current short-time weld (such as 3,500 amperes at 440 volts flowing for 1½ sec, once every 8 sec). For such service, the flip-flop control may be furnished with time-delay action of only ¼ second (or 20 cycles); relays 1 and 2 operate several times each second, firing the ignitrons for shorter periods and letting them rest more often. To produce this faster action,  $C_2$  and  $C_4$  are changed to 0.05  $\mu$ F, while  $R_4$  and  $R_1$  are increased to 10 meg.

# Defense Communications

The pattern developing for the largest metropolis in the U.S. can be modified for application to smaller cities and towns. This plan for establishing emergency essential warning broadcasts and emergency communications facilities makes most efficient use of presently available stations and equipments

**T**HE POSSIBLE DISLOCATIONS to what is generally considered normal metropolitan life are many and blow with an exceedingly warm breath upon the neck of any city dweller. However, the occasional subway tieup, the blockage of subfluvial tunnels and the rush-hour opening of a drawbridge are as nothing compared to the fury of modern warfare with its methodical, high-explosive bombing.

In the opinion of civilian defense experts, atomic bombing of New York City would result in incalculable destruction and loss of life. With proper warning and precautions, together with an organized followup after the disaster, upwards of fifty percent of the possible loss of life might be averted.

There are many facets to the problems arising from a major disaster. Our particular concern is communications, with emphasis on radio. The foremost means is the telephone system that hourly handles many thousands of calls. Normal major dislocations to this service are few, owing to preventive maintenance, alternate emergency circuits, stockpiles of materials and a nationwide standardization of equipment and operating practice.

Failure of the telephone system can arise by accident or design when too many calls are placed for the central office equipment to handle. As a classic example, when a rear-end collision between two Long Island Railroad trains occurred Nov. 20, 1950, with 78 people killed, an unprecedented number of calls was handled by the Virginia 7 exchange. The greatest previous demand upon the equipment was 40,000 calls an hour. After the rail wreck, calls were completed at

a rate of 82,000 an hour. During this period, many subscribers were unable to obtain dial tone—including a number of lines assigned to the emergency police and medical groups.

If the telephone system were to be destroyed or sabotaged, relatively small quantities of information could be transmitted in message services employing existing vhf radiotelephone equipment. Again, the example of what occurred after the Long Island wreck serves as a warning against too great dependence upon these services. The frequencies available to all citizens for common carrier and limited common carrier radiotelephone service in and around New York City were jammed with calls to doctors who are subscribers, to the exclusion of all others.

Broadcasts of information to the general public could probably be made not too long after any disaster. Although individual receivers might be damaged in large numbers, or, more probably, commercial power to operate the receivers would be lacking, community receivers with strategically located loudspeakers can spread accurate information better than word of mouth.

## Basic System

Although the exact plans can not be revealed, the general block diagram (Fig. 1) shows the essentials of the New York City warning system. In the warning phase, Police Headquarters, or an alternate Headquarters already established outside the heart of Manhattan, will send appropriate warnings not only to the public via the municipal broadcasting system of WNYC, as shown,

but also to the various fire stations and to police divisional headquarters. The sirens on the police cars (now muted for normal traffic-clearing use) can either be keyed on directly through the police mobile radio equipment or by the driver on order. Police headquarters will also notify all strategic city officials so that they can assume their appointed tasks in the defense setup.

Fortunately, most New York City a-m radio broadcast transmitters are located out of the center of the city. In many cases they have auxiliary power plants. The f-m transmitters are not so favorably dispersed and most of them have no independent power.

The city has planned to make available a relatively large number of mobile vhf studio-transmitter link equipments that can be used from within a disaster area to program the a-m broadcast stations that are generally located on the periphery of the city. Such means can be used during a period when destroyed studio facilities and telephone lines are being replaced.

There are presently three types of signals employed in civilian defense. The YELLOW is a confidential warning for key personnel and may be followed by the WHITE all-clear signal. The RED signal, accompanied by sounding of sirens, is the first and only warning received by the general populace. Owing to the swift and unknown hazards of disaster or modern warfare, only a very short time may elapse between the RED and the eventual disaster.

Many of the wire connections shown are regularly in existence, others have been installed for defense purposes and are already in



# in New York City

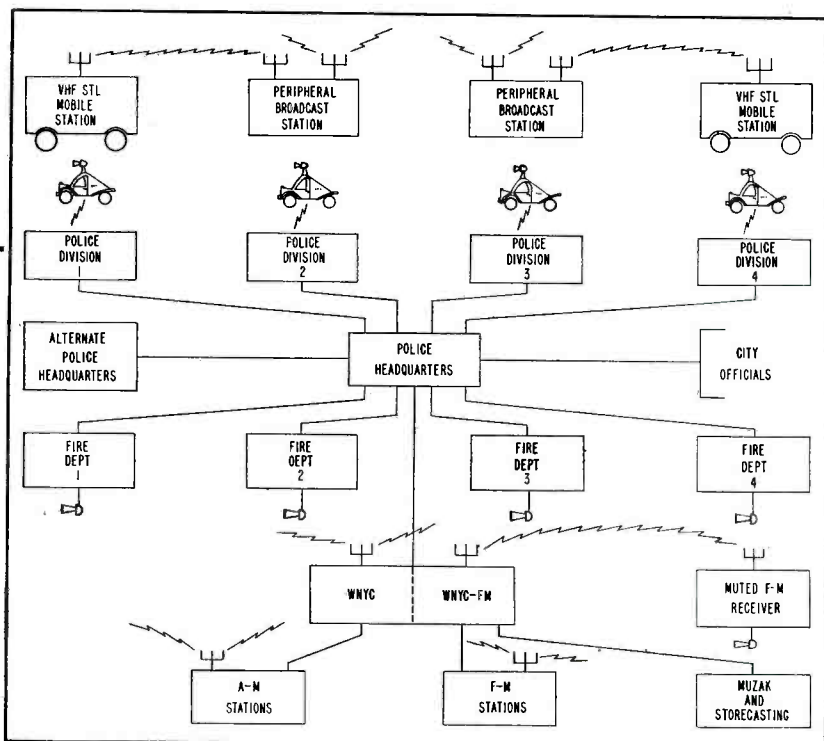

FIG. 1—Block diagram to show the interconnection of warning facilities that can be set into operation from a central headquarters

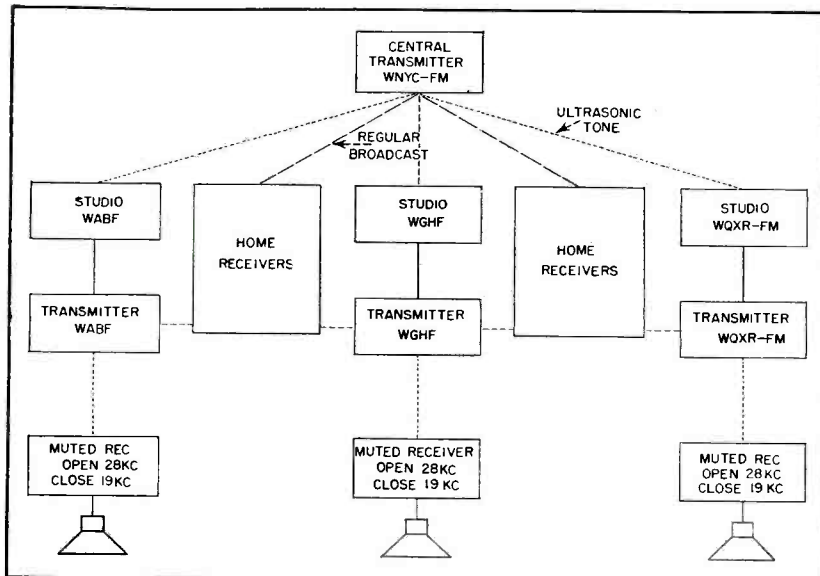

FIG. 2—Tentative plan for controlling a large number of normally muted warning receivers from a central point by use of ultrasonic tones

Ultrasonic tones ranging between 15 and 35 kc are now in use to mute or to raise the gain on certain types of f-m broadcast receivers on buses and in stores. Tentative plans are being formulated to utilize such receivers, normally muted, together with giant loudspeakers. A recording of a siren played at the WNYC studio could be keyed on by an ultrasonic tone or combination of tones for the RED warning.

## Central Control

The manner in which the system would be operated is suggested in Fig. 2. The warning tone sent out from the central transmitter could be used to shut off normal program and key in the output of a special receiver tuned to the central station. Retransmission of the tone would unlock the muted receivers. These tones would be in addition to the normal tones used in some cases for commercial service. The warning tone indicated is merely representative. Although this system is technically feasible, it has some hazards. A saboteur or prankster could spread panic by gaining control of the central control for even a few seconds.

The means of emergency communications after a disaster are still in a formative stage. There is the possibility that the military would insist upon taking over all communications. However, since there is evolving a philosophy that local needs must be met locally, it is likely that the local civilian defense organizations will be allowed to solve their own problems. Only when it is determined that operation of transmitters will not serve for homing missiles and aircraft will the answer be clear.

Health, welfare, policing and similar functions will each have their own communications needs. These needs will probably be served, in the disaster stage, by police, taxi, public service, industrial and amateur radio working together under Red Cross or Civilian Defense authorization.

The kind assistance of Seymour Siegel, Director of the Municipal Broadcasting System and Director of Civil Defense Communications, New York City, is gratefully acknowledged.—A. A. MCK.

use for tests. For example, at a specified time each hour, all broadcast stations now receive a test tone from the control room of WNYC and WNYC-FM. Each broadcast control has available specially marked patch cords and, if so directed, can feed this test tone or

other program material to the various broadcast transmitters.

Arrangements are being completed to furnish a warning tone or siren recording to all Muzak and Storecasting controls so that these facilities can be used to warn patrons and their customers.

# ELECTRONIC MUSIC

By L. A. MEACHAM

*Bell Telephone Laboratories, Inc.  
Murray Hill, N. J.*

**A**T one time or another, every musically inclined communications engineer has connected a laboratory oscillator to a speaker and twiddled the frequency dial to play himself a tune. But did anyone ever provide four people with four oscillators, so that they might play like a barber-shop quartet?

Here is a facet of electronics which up to now, so far as the author has been able to discover, has been left unexplored. The question occurred to him while searching for a novelty to entertain members of a glee club at their annual party. The results of preliminary research (conducted in the author's cellar, since it was not an official company project) were received so enthusiastically that improved models were designed (in the same cellar), playing techniques were improved, and concert experience was obtained before several surprised and delighted audiences.

The present state of the art is represented by the "wobble organ" described in this article. It uses inexpensive radio parts, and offers interesting possibilities for home recreation of the participation kind,



FIG. 1—The wobble organ and its first four players: Ann Codington, Phyllis Taylor, the author and B. McMillan, all of Bell Labs

## TIME OUT TO PLAY

**AUTHOR TO EDITORS:** "Once in awhile we engineers need a light touch in the midst of our serious striving for progress and profit. With this in mind, it seems to me that the attached paper would not be out of place in **ELECTRONICS**."

**EDITORS TO AUTHOR:** *When we first read your paper it immediately created a desire to build a wobble organ in our own basement. So here it is in print. We think it will create the same desire among many of our readers*

as well as for various entertainment fields involving large groups.

The four players sit around three sides of a card table, as shown in Fig. 1. The fourth side is turned toward the audience, and may conveniently be faced by a music rack if desired. In front of each player is a small "playing console". On the floor near the table is a cabinet containing a power supply, an amplifier, and a speaker. Pairs of consoles which are adjacent to one another are plugged together mechanically (see Fig. 2), and electrically, the whole set of four being connected to the speaker cabinet by a single 6-conductor cable.

Each console contains a thyatron sawtooth oscillator, with suitable control circuits and a simple waveform-shaping network which emphasizes or suppresses various harmonics in the complex sawtooth wave and thus affords a distinctive and different tone quality for each player. The physical arrangement of a console is shown in Fig. 3. The main control device is the "wobble arm", carried on a potentiometer shaft which extends through the sloping front. This control is designed to vary the pitch over a range of about  $2\frac{1}{2}$  octaves (about 6-to-1 in frequency). The range is at least that of the human voice,



# for FOUR

Novel "wobble organ" has separate soprano, alto, tenor and bass oscillators and a common power pack, amplifier and loudspeaker. The instrument plays anything from barber-shop ballads to Bach with a pleasing vibrato quality from which it gets its name

and in the present model is located differently on the frequency spectrum for each console, so that the four of them cover the vocal ranges of soprano, alto, tenor and bass respectively. (A male quartet model could be obtained merely by changing capacitance values.) The pitch control, or wobble arm, is operated by the right hand of the player in relation to the musical scale designations on the sloping scale quadrant. These designations need be used only as a rough guide, but they are of great value even to an experienced player in making rapid and accurate changes over large musical intervals, and they are indispensable to a beginner.

Operation of the tone source or oscillator is not continuous; each console can be turned on and off at will by the individual performer. The four consoles are normally silent. Oscillation is started by a slight downward pressure of the player's left hand on the knob at the left front of the console. This pressure closes a contact applying plate voltage to the oscillator. Thus the player may use a "portamento" between notes (leaving the tone on) or "detache" (momentarily interrupting it) as desired. The volume of sound delivered by the individual console to the common speaker is also under the control of this same knob, which may be turned as well as pressed by the player's left hand. The rotation can be calibrated in musical symbols, *pp*, *p*, *mp*, *mf*, *f*, and *ff*, indicating different degrees of loudness from pianissimo to fortissimo, but in the present model this is left to the musical taste of the player and only *p* and *f* are marked as rough guides near the opposite ends of the range. The

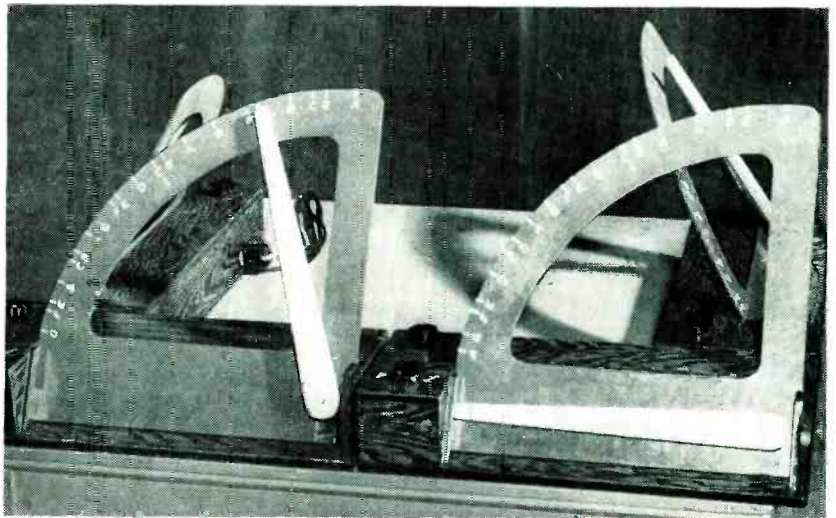

FIG. 2—The four-man (or woman) instrument from the players' point of view

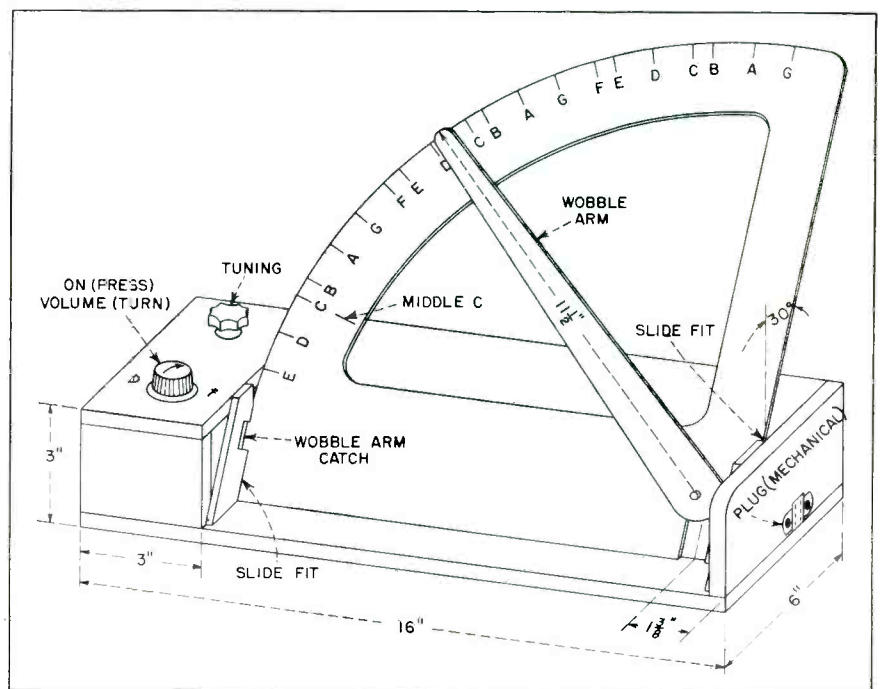

FIG. 3—The bass console. Others are similar mechanically except for calibration of the scale quadrant and placement of interconnecting plugs

switch action mentioned above is obtained very simply by mounting the potentiometer near the free end of a flat cantilever spring, the fixed end of which is screwed to the underside of the console top. A downward motion of about  $\frac{3}{8}$ -inch brings the free end into electrical contact with a fixed metal contact that also limits travel.

One other control, a tuning adjustment to compensate for such variables as temperature and aging, is required, as in almost any other musical instrument. This tuning knob is initially adjusted by the player's left hand while the corresponding wrist presses down the "on" knob and his right hand aligns the wobble arm with a scale mark (such as middle C) corresponding to the pitch of the reference source to which he wishes to tune.

The present consoles are made of  $\frac{3}{8}$ -inch plywood, with scale quadrants of  $\frac{1}{8}$ -inch pressed hardboard. Each scale quadrant is made removable to facilitate storage, being mounted in slides at its edges. A simple catch is provided to support the free end of the wobble arm when not in use. The bottom of the console is made removable for access to component parts. Principal dimensions are shown in Fig. 3.

The layout of the speaker cabinet

is conventional, the only novel feature being the provision of storage space for the four consoles, two at each side of the loudspeaker as shown in Fig. 4.

### Circuits

Complete schematics are given of the consoles in Fig. 5 and the power supply and amplifier in Fig. 6. The thyatron relaxation oscillator in each console is of the type commonly used in oscilloscope sweep circuits, with the variable timing resistance used for the main pitch control and the grid bias for tuning. Different timing capacitors and waveform-shaping networks are shown (terminals A, B, C) for the respective consoles. When the consoles are plugged together a common shielded path is formed from the networks to the amplifier input.

The use of a 1-megohm logarithmic potentiometer in series with a fixed 10,000-ohm resistor for each frequency control provides a relationship between shaft angle and musical pitch which is substantially linear over a resistance range of 16,000 to 450,000 ohms, with a slope of about 30 degrees per octave. Accordingly, each half-tone occupies 2.5 degrees and each whole tone 5 degrees. The wobble arm

swings over more than 75 degrees, giving the desired  $2\frac{1}{2}$  octaves, and is set on its shaft so that the minimum total resistance actually used is 75,000 ohms. The potentiometer should have a molded carbon element or equivalent so as to minimize effects of mechanical wear on scale calibration.

A voltage divider across the 150-volt supply (resistors  $R_1$  and  $R_2$  in Fig. 5) is arranged to hold the plate of the thyatron at about 40 volts above cathode potential while the "on" contact is open. The tube does not conduct in this condition, because its firing point for normal tuning is designed to be near 80 volts. The effect of the bias is to make the d-c potential at point A, while the oscillation is off, substantially equal to the d-c component of the sawtooth wave at the same point when it is on. Figure 7 shows how the bias eliminates a starting transient in the sawtooth wave as it is delivered to the input of the shaping network. If present, the transient would give a noticeable thump at the beginning of each note, particularly if the volume were turned up until excessive initial voltage rise overloaded the final stage of the amplifier.

A voltage-doubling selenium-rectifier type of power supply (Fig. 6) delivers 100 milliamperes at 250 volts, and two voltage regulators are arranged in series to provide stable plate and bias potentials. This regulation is quite important, not only to avoid fluctuations of pitch with line voltage, but to keep the four consoles independent of one another in spite of the fact that their mean plate currents change as they are started and stopped or as their pitches are varied.

The audio amplifier is conventional; it includes a volume control, allowing the over-all instrument to be adjusted to a room of any size.

### Playing Techniques

Several interesting facts have developed from playing and experimenting on this instrument. First, although steady tones, without vibrato, are desirable in some kinds of music, a much more live effect can be obtained by wobbling the pitch control smoothly through a small range above and below the

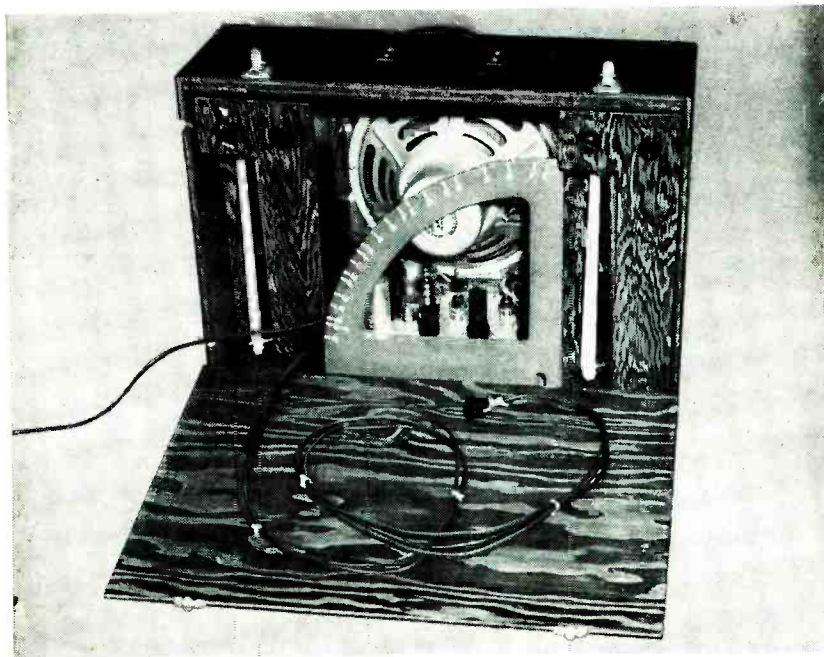

FIG. 4—Rear view of portable case containing the wobble organ's common power supply, speaker and amplifier, with the four individual consoles knocked down and stowed away



position of true intonation. This corresponds to the vibrato used in playing a violin or trombone, or occurring naturally in the human voice. All who have learned to play thus far agree that a vibrato of small extent (less than a quarter tone peak-to-peak) and at a rate of about 4 or 5 per second is desirable. This motion, as may be

guessed, accounts for choice of the name wobble organ.

To allow the player's right hand to produce vibrato with a comfortable wrist motion the notes should be spaced well apart on the dial. A spacing of about one inch per whole tone appears to be a reasonable minimum. This figure, taken with the potentiometer calibration of 5

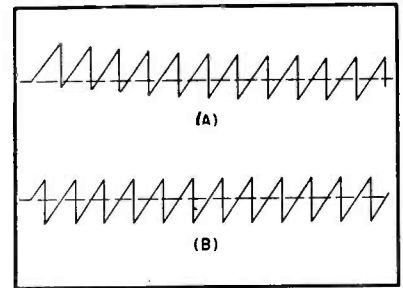

FIG. 7—Waveform at point X of Fig. 5 at start of oscillation (A) without bias derived from the bleeder  $R_1$ ,  $R_2$  and (B) with the bias

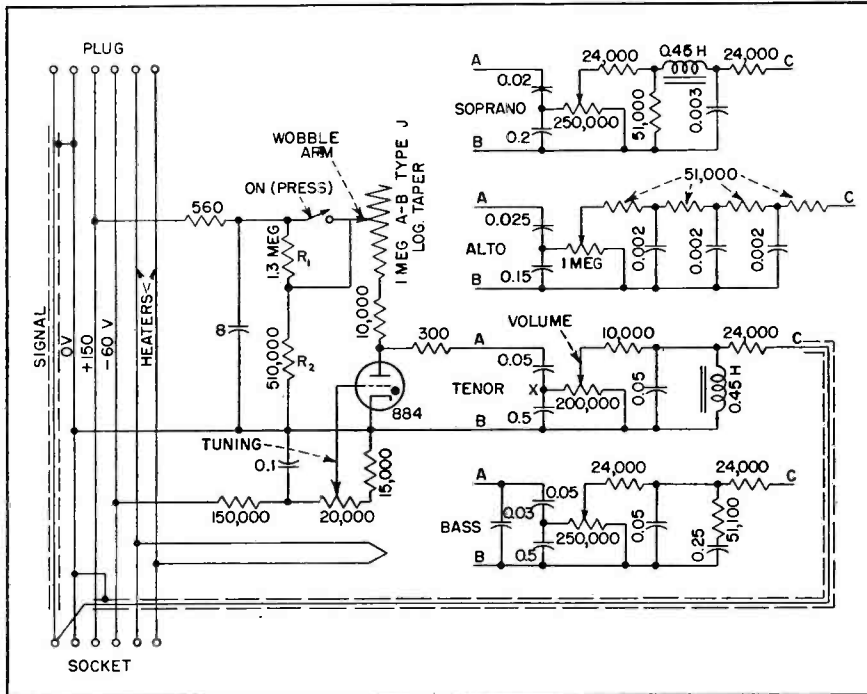

FIG. 5—Circuit of one of the four consoles, in this case the tenor console. The other three are identical electrically except for timing and waveform-shaping networks. Component-part values and circuits are shown for the soprano, alto and bass units

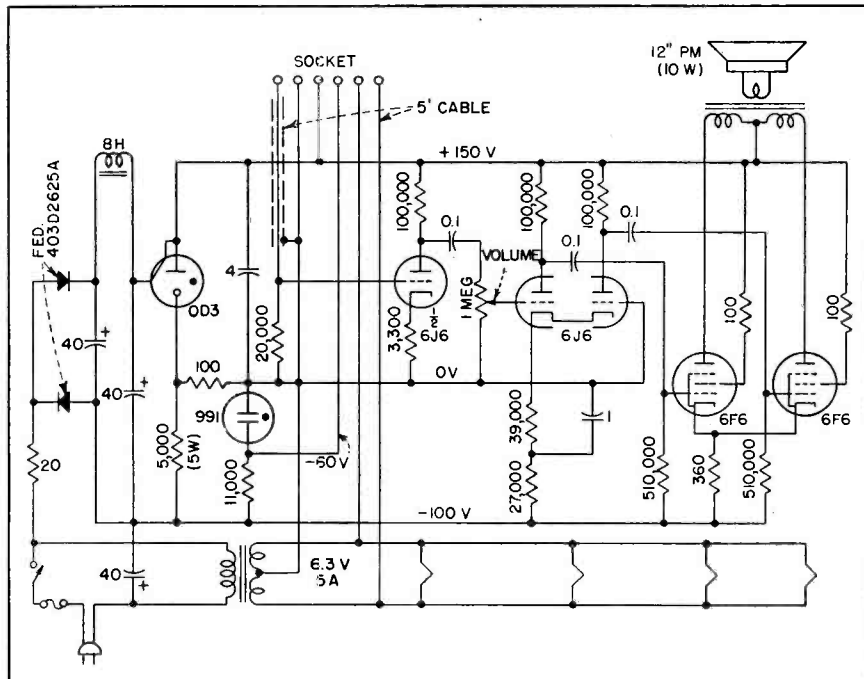

FIG. 6—Circuit of the common power supply, amplifier and loudspeaker unit

degrees per whole tone noted earlier, leads to a figure of about one foot for the length of the wobble arm.

It may be noticed in Fig. 3 that the scale quadrant (in this bass console) is calibrated with high notes toward the left and low notes toward the right. This comes about because logarithmic potentiometers having a left-handed taper are not commonly stocked in suitable sizes. Although players quickly become accustomed to this arrangement, it has been found that most of them would prefer to have the scale reversed to match the convention of the piano keyboard.

Experience has been obtained both with family groups playing for their own entertainment, and with quartets well rehearsed for public performance. Some solo work has also been done using a single console with piano accompaniment. In every case enjoyment and recreation value have been strikingly evident. Even two professional symphony players who took part in one of the quartets were highly entertained and, incidentally, behaved like the amateurs in that they played awkwardly at first but improved very rapidly.

The music used has varied from simple "rounds" and folk songs to Bach chorales. Although no suggestion is intended that the wobble organ may ever join the ranks of the serious musical instruments, nevertheless it can do things with Bach that are actually rather satisfying. It has a voice-like quality, and yet overcomes certain vocal restrictions. The soprano never strains for high passages, the alto cannot possibly run short of breath, the tenor never cracks and the bass has power at his command for his very lowest note.

# Progress in Dot-Sequential Color TV

New tricolor tube, having nearly double resolution of earlier model, shown to press and industry at Washington in "status-report" demonstration. New phosphors and by-passed monochrome circuit produce marked improvement in color fidelity and image structure

**T**HE CURRENT STATUS of the dot-sequential color television system was revealed to the press and industry groups in a series of demonstrations by RCA-NBC at the Translux Theater Building in Washington. Noteworthy progress has been made in the nine-month interval since the last press showing, based on three new developments: a new tricolor tube having higher resolution and improved red and blue phosphors, the introduction of the by-passed monochrome system of transmission, and improved circuitry designed to stabilize the brightness and chromaticity values of the image. The net results are a substantial gain in the brightness, resolution and color fidelity of the images, and virtual elimination of spurious patterns due to beats between the image structure and the dot structure.

## **New Tricolor Tube**

The new tricolor tube operates on the same basic principle as the earlier version. It contains three separate electrostatically-focused electron guns, arranged symmetrically in the neck of the tube, parallel to its axis. The beams from the guns pass through holes in a flat nickel plate ("mask"), arranged parallel to and about one-half inch behind the phosphor screen. In the new tube this mask contains 200,000 dots arranged in the form of about 480 horizontal lines of 420 holes each. Each hole corresponds to one picture element in the image and the total number, 200,000, corresponds roughly to the maximum

number of picture elements which can be transmitted over a 6-mc channel at 60 fields per second. The earlier tube had only 117,000 holes in the mask plate, owing to the limitations of processing which have since been overcome.

The phosphor screen consists of small dots which fluoresce individually in each of the three primary colors. Three such phosphor dots are grouped as a cluster in front of each hole in the metal plate, making 600,000 phosphor dots in all. The phosphor dots and the holes are so aligned that the electron beam from one gun passes through the hole and hits a phosphor dot of one color, to the exclusion of the other two in the cluster. The other two electron guns and phosphor dots are similarly paired off, so that each gun is capable of exciting light of one primary color only, but the three guns together can produce any combination of the primaries in each cluster of three phosphor dots.

The difficult problem of aligning the 600,000 elementary areas of three different phosphors with the 200,000 holes in the mask has been solved by mounting the mask and viewing screen on a metal collar prior to assembly in the picture tube. The mask and screen form a subassembly which is joined to the metal shell of the tube, the collar forming a part of the shell. The viewing screen proper lies within the tube, about one inch behind the clear-glass face of the tube, which forms the forward wall of the envelope.

The outer dimensions of the tube

are similar to the 16AP4 metal picture tube, except that the neck is thicker to accommodate the three guns and the overall length is about 4 inches greater. The scanning angle is about 55 degrees. The useful diameter of the phosphor screen is  $13\frac{1}{2}$  inches. No details of the manufacture of mask or screen have been announced, but it is understood that techniques akin to photoengraving and three-color printing are used to form the mask and to deposit the phosphor dots on the viewing screen.

In the earlier demonstrations the brightness of the image was limited to about 5 footlamberts, due primarily to the inefficiency of the then-available phosphors. New red and blue phosphors having higher light output were developed for the new tube, which permits a proportionate increase in the brightness of the red and blue primary images. Highlight brightness in the range of 10 to 15 footlamberts was measured at the press demonstration, and values up to 20 footlamberts were reported later.

Another forward step appeared in the red phosphor. When the initial model of the tube was constructed, only orange phosphors of suitable brilliance were available. To produce the required red light with the early tube a subtractive (minus-yellow) optical filter was used. The new version of the tube employs a red phosphor having the required chromaticity, and no optical filter is required.

As a result of these changes, it was the consensus of observers that



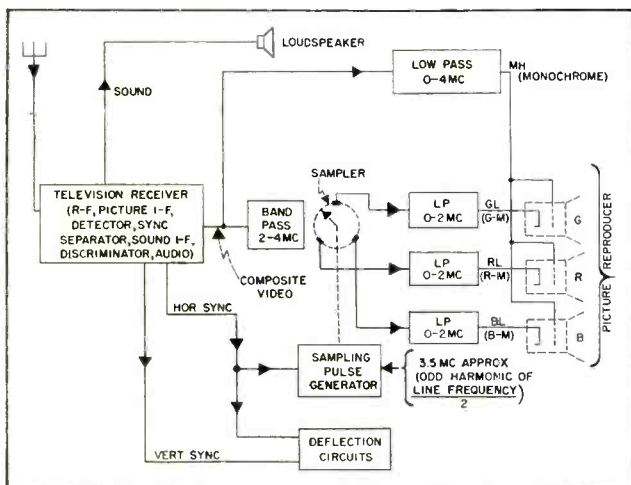

Block diagram of by-passed monochrome color receiver. Primary-minus-monochrome signals (G-M, R-M, B-M) introduce color values

Rear view of 43-tube color receiver. The viewing screen is 13½ inches in diameter, contains 600,000 phosphor dots

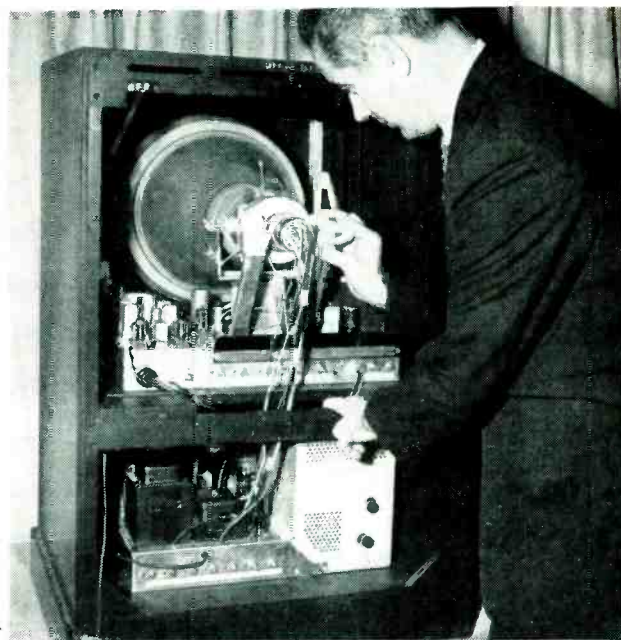

very considerable improvement had been made in rendering the color and texture of objects. In the press demonstration the tricolor tube did not reproduce highly saturated reds and blues as well as the rotating-disk receivers currently demonstrated in New York by CBS. But the gap between phosphor colors and filter colors has been narrowed to such an extent that either can be considered satisfactory from a commercial standpoint. This fact is considered to be of great importance, since a tricolor tube will be an essential part of any future color system, irrespective of the method of scanning used.

### By-Passed Monochrome

Apart from the improvements in resolution, brightness and color fidelity, the most striking aspect of the images was the substantial reduction in the visibility of the dot-structure. In the earlier version of the system, the conventional mixed-highs transmission was used, that is, the image structure corresponding to video frequencies higher than 2 mc was transmitted in monochrome. Larger areas, corresponding to frequencies below 2 mc, were transmitted by three separate interspersed color signals. When the color signals are transformed into corresponding dots of color on the viewing screen, the image displays

a dot structure having a coarseness corresponding to 2 mc. This structure appears even in areas having no color (that is, white or gray) since these areas were formed by adding successive amounts of the three primaries at each point.

In the latest version of the system, the by-passed monochrome transmission method developed by Hazeltine (see p 92 this issue), has been adopted. In this method, the whole video frequency range from 0 to 4 mc is transmitted in monochrome, in the form of a continuous (nonsampled) monochrome signal derived continuously from all three camera tubes and applied continuously to all three guns of the tricolor tube. This part of the transmission is essentially identical to the standard black-and-white transmission, and it renders white and gray areas in the color image without dot structure.

To introduce the colors in the larger areas (2-mc coarseness), the color signals are arranged to subtract, from the white light of the monochrome signal, an amount which produces the required intensity of each primary color. That is, for the red primary, the signal applied to the red electron gun from the color sampler circuit corresponds to a red-minus-monochrome value which, when added to the monochrome value already present,

produces a net red output.

In the Hazeltine system the technique of constant-luminance sampling (ELECTRONICS, August 1950, p 154), is used to reduce the effect of interference. In this method, the sampling vectors have unsymmetrical angles and amplitudes, so arranged that the color signals carry no brightness information, but hue and saturation information only. The constant-luminance method had not been introduced into the RCA system at the time of the demonstrations.

### Receiving Equipment

The receiving units demonstrated included two color receivers, having 43 tubes each, a 16-inch black-and-white table model receiver converted for color, and a color companion unit, intended to operate as an attachment to a black-and-white receiver. Neither the converted receiver (standard 24-tube black-and-white chassis plus an auxiliary chassis of 13 tubes) or the companion unit performed as well as the 43-tube color receivers in color fidelity. In all receivers a small degree of misregistration was noticeable in portions of the image, but the fact that good registration was maintained at the corners of the images showed that this difficulty is being brought under progressively greater control.—D.G.F.

# AUTOMATIC GCA

Simultaneous control of five aircraft spaced at two-mile intervals along a ten-mile approach corridor is provided. Azimuth, elevation and range information are converted into phase displacements at ground station and automatically transmitted to plane where information is used by auto-pilot to perform blind approach

By **JOSEPH T. McNANEY\***

*Senior Electric Engineer  
Consolidated Vultee Aircraft Corp.  
San Diego, California*

**G**CA RADAR is being pressed into more and more widespread use by aviation throughout the world. More than 150 military air bases are now depending on GCA for blind-landing purposes.

This paper describes a system for eliminating completely the human element. The ground link between radar presentation and transmitter is replaced by an electronic link, the necessary information being presented to the pilot by means of instruments. Finally, this same information is fed through suitable equipment to allow the automatic pilot in the plane to perform the approach. The pilot guides his plane to the glide path by conventional means, and takes over controls just before touchdown when visual contact is established.

The success of such a system depends on the ability of the radar to select a specific target and to lock itself to that target in order to control its approach. All measurements in range, elevation and azimuth are based on a phase difference between a reference and a signal current. Airborne and ground indicators are simple phase meters, thereby eliminating the complexities of c-r tubes and their associated circuits.

Conventional precision approach

\*Preliminary research on the work described was conducted by the author while associated with Bendix Radio Division of Bendix Aviation Corporation, which organization furnished the above photograph.

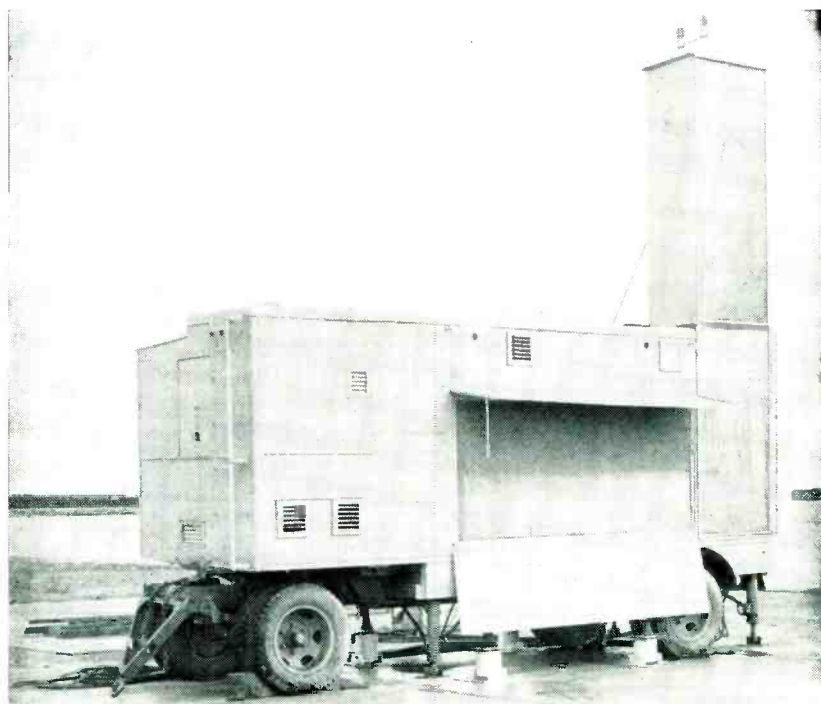

FIG. 1—Standard precision approach radar furnishes data for operation of automatic approach system

radar, illustrated in Fig. 1, is used to obtain the required radar information. A single radar unit may be used to control the approaches of five planes simultaneously. There are actually six independent servo loops, five of which are in operation at any one time, while the sixth awaits the entrance of the next plane into the approach corridor as the first in line lands. The planes are spaced at two-mile intervals.

Figure 2 shows the pick-off units and a selector switch in the antenna scan mechanisms. Synchro-resolver  $R_1$  is geared to azimuth mechanism, and  $R_2$  is geared to elevation mechanism. These units replace, in certain respects, angle coupling capaci-

tors normally used in conventional GCA equipment. Switch  $S_1$ , which is operated in unison with the T-R switch, controls the switching of selected target video to azimuth and elevation indicator systems, while the r-f switch controls the switching of the transmitter to azimuth and elevation antennas.

## Antenna Switching

While the r-f switch and  $S_1$  are in the positions shown, the elevation antenna is radiating and receiving r-f energy, and synchro resolver  $R_2$  is being supplied with selected target signal current. Under these conditions the output of  $R_2$  represents the angular position of the elevation antenna at



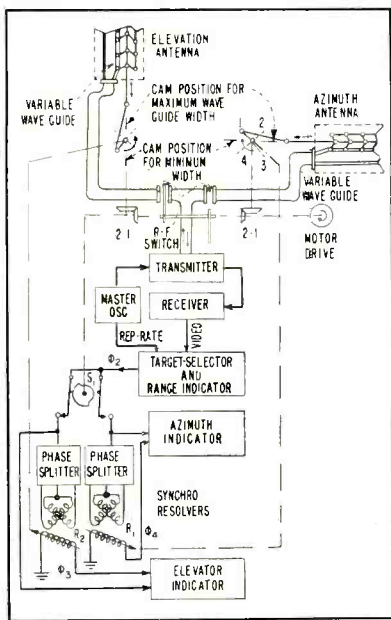

FIG. 2—Azimuth and elevation antennas are used with a common transmitter and receiver on a time-shared basis

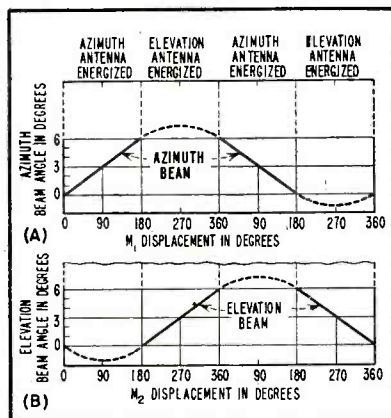

FIG. 3—Azimuth and elevation are swept alternately in opposite directions to reduce target to a point source

those instants that r-f energy is being returned from the plane under control. In this manner, the elevation approach angle of the desired aircraft is determined.

When  $R_1$  and  $R_2$  are initially adjusted they are set to provide zero output signal conditions when respective antenna beams are at the start of a normal sweep. For zero output conditions, for instance, current phase  $\phi_2$  from  $R_2$  will be leading current phase  $\phi_1$ , applied to the input circuits, by  $90^\circ$ . Current phase differences are therefore used as a measure of azimuth and elevation glide angles.

Figure 3 shows angular relationships between azimuth and elevation antenna beam angles and the

angular positions of  $R_1$  and  $R_2$  respectively. These curves represent a tentative arrangement where, in the case of the elevation antenna, the relationship of beam angle travel to current phase  $\phi_2$  angle of travel is 30 to 1. A similar relationship of the azimuth angles is also 30 to 1.

The r-f switch positions are also shown as a function of antenna beam angles. Two revolutions of the r-f switch blades are shown. During the first 180 degrees the azimuth antenna is energized. During the next 180 degrees, the elevation antenna is energized. This procedure of antenna energization is again repeated during the second switch revolution.

It should be noted that the antenna beam scans are made at one-half rate. This arrangement allows a target to be swept, alternately, from one direction and then from the other. Such action aids in reducing a target to a point source. The antenna beams are made to scan through two complete cycles per second, giving four looks per second, each look being  $\frac{1}{4}$  second in duration. Through the use of a 4,000-cycle antenna beam repetition rate each scan duration will contain 500 pulses of r-f energy.

Figure 4 shows the indicating system. Video from the radar receiving system is coupled to the target selector. A repetition rate from the master oscillator is fed to the range indicator. Azimuth information is transferred to the azimuth indicator from synchro  $R_1$ , and elevation information is coupled to the elevation indicator from synchro  $R_2$ .

### Target Selector

The target selector allows an aircraft to be selected by virtue of its range and speed. Video representing the aircraft brought under control is then used to actuate the range, azimuth and elevation indicators. The three indicators are essentially servo-type phase meters. The range meter measures the phase between the time a radar pulse is generated and the time it is returned from a target. The azimuth meter measures the phase of a pulse return in azimuth with respect to a known reference angle,

and the elevation meter measures the phase of a pulse return in elevation with respect to a known reference angle.

The theoretical dimensions of the two beams at ten miles are similar, and it is assumed that, between half-power points, the beams are 2 degrees in width and 0.5 degree thick. At ten miles a box-like opening, 200 yards by 200 yards, represents the start of an approach corridor. With the aid of a radar search system, a plane is talked into the opening of the corridor. Upon entry, it is immediately detected by the range, azimuth and elevation equipment on the ground.

Under normal operating conditions, the corridor will assume a fixed location in space. The center of the box-like opening at ten miles represents the location of the glide path at this point. When a plane enters the corridor at 10 miles,  $\pm 0.5$  mile, a range indicator in the ground equipment becomes essentially locked to the plane. The azimuth and elevation indicators very rapidly measure the plane's deviation from the prescribed path.

The range indicator synchro resolver ( $R_3$  in Fig. 4) is adjusted to 154 degrees with respect to a zero angle of reference; a 154-degree adjustment is equal to 10 miles. Resolver  $R_3$ , through suitable phase splitting means, is supplied from a 4,000-cycle sine-wave oscillator. This supply of current is designated as phase  $\phi_1$ . The 4,000-cycle oscillator is under the precise control of the repetition-rate frequency from the master oscillator.

Each cycle of a 4,000-cps signal is completed in  $150 \mu\text{sec}$ , or 1.44 deg per  $\mu\text{sec}$ . Since r-f travels 1 mile in  $10.7 \mu\text{sec}$ ,  $10.7 \times 1.44$  deg, or 15.4 deg of each cycle is equal to 1 mile.

Current phase  $\phi_2$ , taken from  $R_2$ , is therefore made to lag current phase  $\phi_1$  by 154 deg. By means of a pulse generator each cycle of current  $\phi_2$  is converted into  $10\text{-}\mu\text{sec}$  pulses and applied to the grid of a range gate. The midpoints of the  $10\text{-}\mu\text{sec}$  pulses are made to coincide with a cross-over point of phase  $\phi_1$  sinusoidal currents. Therefore each midpoint lags behind the initiating pulse from the master oscillator by  $107 \mu\text{sec}$ . The latter time is equal

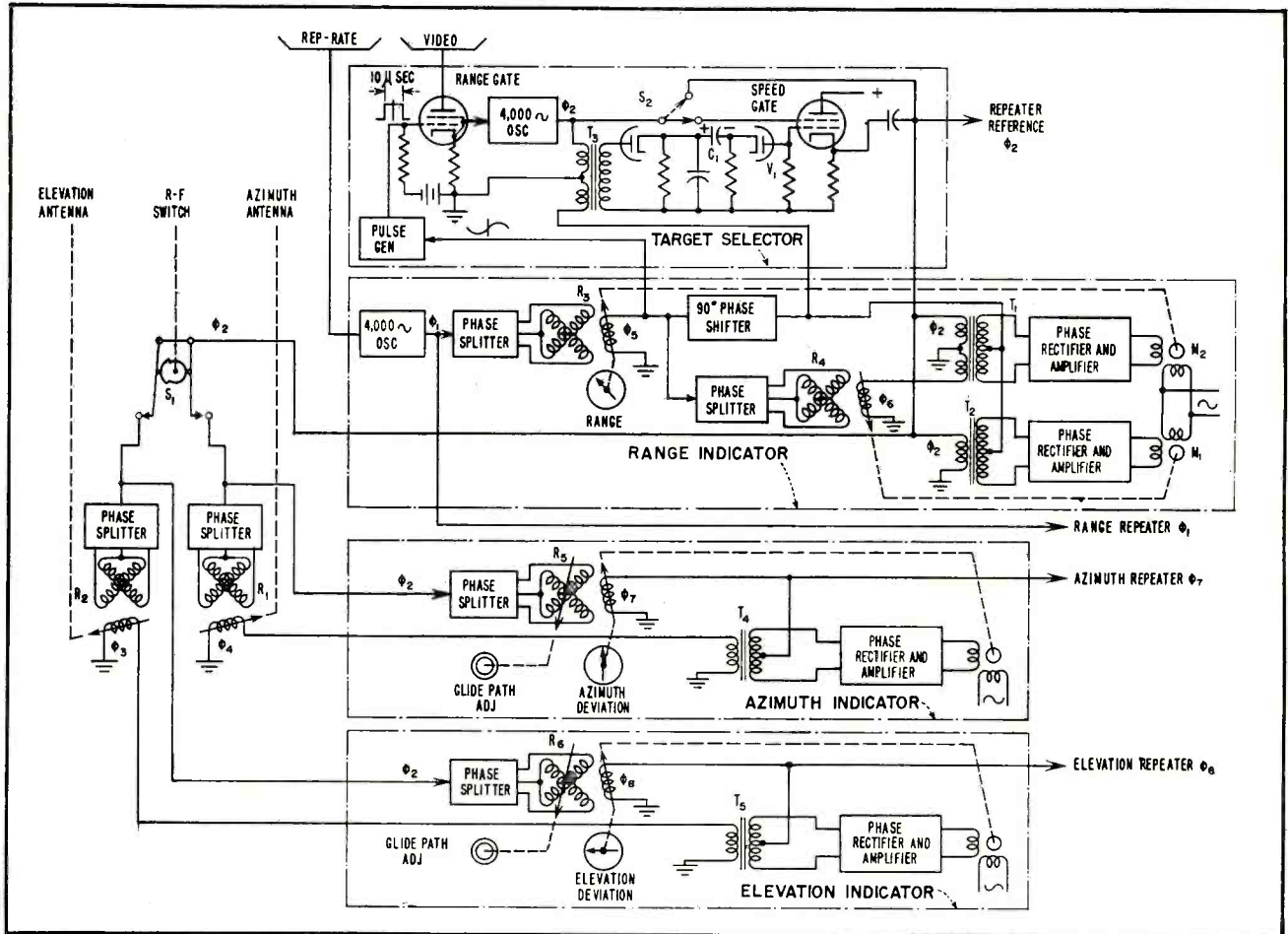

FIG. 4—Indicating system provides range, azimuth-deviation and elevation-deviation data

to video returning from a target 10 miles away.

All video received is applied to the anode of the range gate, but the latter is normally biased to cutoff. However, when the 10- $\mu$ sec pulses are applied to the control grid, the tube is made conductive. This means that for 10  $\mu$ sec out of every cycle of 250- $\mu$ sec duration, the range gate is receptive. The only video conducted through the gate during a ten-mile adjustment of  $R_3$ , therefore, will be that returning from targets at ten miles out,  $\pm 0.5$  mile.

When a plane is talked into the approach corridor opening at a ten-mile range, video is applied to input control circuits of another 4,000-cycle sine-wave oscillator through the range gate. Through the use of a video repetition rate of 4,000 per second, the start of every cycle generated by the oscillator will be under the control of a video pulse. If a plane is flying in at a speed of 120 miles an hour, for example, the phase of the output currents  $\phi_2$  will

be changed at a rate of 0.5 deg per second, or 0.000125 degree for each succeeding video pulse.

Until a plane reaches a 9-mile point in the corridor the contact arm of  $S_2$  is in the dotted position. Currents  $\phi_2$  are thereby connected to servo amplifier coupling transformers  $T_1$  and  $T_2$ . Circuits associated with  $T_2$  may be referred to as an integral control loop, while circuitry associated with  $T_1$  will function as a proportional plus integral control loop. Phase  $\phi_5$  currents are applied to the two control circuits continually, and serve as a reference current. Currents  $\phi_5$  are shifted 90 deg for this purpose.

Video-controlled  $\phi_2$  currents may be considered in phase with  $\phi_5$  currents when the plane is at ten miles and when  $R_3$  is set at 154 deg. Under these conditions motor  $M_1$  will be stationary.

If the speed of the plane is 120 miles per hour at the instant it is passing the ten-mile point,  $R_4$  will be set at an angle necessary to produce a corresponding  $M_2$  motor

speed. The phase angles of synchro  $R_3$  rotor current  $\phi_5$  and current  $\phi_2$  will be changing in unison at a rate of 0.5 deg per second. The only conditions under which  $M_1$  and  $R_4$  will have assumed a different angular setting are when the plane changes its forward speed.

### Range Indication

An indication of aircraft range is taken from the synchro  $R_3$  rotor shaft. Because of the integral control servo in the range indicator loop, the range of the aircraft under control will be followed with a high degree of accuracy. The integral signal  $\phi_6$  actually replaces the proportional signal  $\phi_2$  in the primary of  $T_1$ . During a constant-speed approach, a signal current  $\phi_2 - \phi_5$  differential is zero, while a  $\phi_6 - \phi_5$  differential functions as the constant-velocity servo error.

When the plane reaches the nine-mile point  $S_2$  is automatically thrown to the position of the solid line connection. This puts  $\phi_2$  potentials on the grid of the speed gate



tube. Although  $\phi_2$  currents are now coupled to  $T_1$  and  $T_2$  through this cathode follower, the operation of the range indicator is essentially the same.

While the phase of  $\phi_2$  currents is shifting at the rate of 0.5 deg per second, the 10- $\mu$ sec pulses are kept in synchronism with the video. Very close synchronism is again maintained by virtue of the integral control loop in the range indicator. By this process, the trailing and leading sides of a control box in the space occupied by the approach corridor escort the plane to within approximately 50 feet of the runway.

The speed gate distinguishes speed differences between the aircraft under control and all other targets. Currents  $\phi_2$  and  $\phi_5$ , which are of approximately equal magnitudes, are combined in the primary of  $T_3$ . Currents  $\phi_5$  are applied as a reference, and  $\phi_2$  serves as the signal current;  $\phi_2$  currents are applied intermittently, at antenna scan rates. The two currents are combined 90 degrees out of phase, and are each changing their phase with respect to  $\phi_1$  currents, at a rate of 0.5 deg per second. Current  $\phi_5$  is used as the reference since it is the constantly applied current. The output of  $T_3$  is rectified and places a constant charge on capacitor  $C_1$ .

Because of the phase relationship of  $\phi_2$  and  $\phi_5$ , there is no appreciable alteration in the charge on  $C_1$  during the applications of  $\phi_2$  currents. In the event the charge on  $C_1$  is increased, a positive potential is impressed on the cathode of  $V_1$ . When the charge on  $C_1$  is decreased, the polarity of this potential will be reversed. Current will then flow through  $V_1$ . Negative voltage, which is a function of the rate at which the charge on  $C_1$  is decreasing, is placed on the control grid of the speed gate tube. When the presence of  $\phi_2$  currents represent video of a plane under control, this tube functions as a normal cathode follower. Signal currents, as previously explained, will be applied to  $T_1$  and  $T_2$ .

### Stationary Targets

If a stationary target is detected within the control box, resulting  $\phi_2$  currents will be allowed to flow in

the primary of  $T_3$ . Since the control box is traveling in the direction of the touch-down point at the speed of 120 miles per hour,  $\phi_2$  current flow in  $T_3$  will be shifting phase with respect to  $\phi_5$  at a rate of 0.5 deg per second. This change will be in the direction which increasingly opposes the current flow of  $\phi_5$ . Under these conditions the charge on  $C_1$  will be decreasing also. A resulting negative voltage on the speed gate tube introduces a blocking action. In this manner, undesired targets are isolated from the indicator circuits.

### Az-El Indicator

Target video in the form of  $\phi_2$  current, selected by virtue of an aircraft's range, its speed, and its position in azimuth and elevation, is now coupled to azimuth and elevation indicating circuits through  $S_1$ . This switch allows the azimuth indicator to receive signal currents when the azimuth antenna is in operation, and then allows the elevation indicator to receive similar currents when the elevation antenna is in operation.

Again referring to Fig. 3, the start of each antenna scan coincides with a synchro zero reference angle. A mechanical relationship may allow, for example, the synchro to rotate 180 deg during a beam angle scan of 6 deg. If during the sweep of a beam the controlled aircraft's position corresponds with a 3-deg beam angle, it will be repeated as a 90-deg synchro rotor position. This 90-deg position will be the

only angle at which  $\phi_2$  currents are coupled to the respective indicator systems.

Target and beam dimensions in the directions of scan are reduced to a point source, insofar as the indicators are concerned, by sweeping the target from opposite directions. During one sweep the beam angle and the synchro angle are increasing together, from a zero reference. In the following sweep the beam angle reverses its direction while the synchro repeats in the same direction. The response characteristics of the servo loops in the indicators provide an averaging process of the beam angle currents.

In the azimuth unit (Fig. 4)  $\phi_2$  current is fed through a phase splitter to  $R_6$ . Output current  $\phi_7$ , from the rotor of  $R_6$ , is supplied to the midtap of  $T_4$  as a reference current. Current  $\phi_4$  from  $R_1$  is coupled to the primary of  $T_4$ . In combination,  $\phi_4$  and  $\phi_7$  currents are coupled to phase rectifier and amplifier circuits wherein phase differences are amplified and used to energize the azimuth indicator motor which is geared to  $R_6$ . The latter is servoed to an angular setting which satisfies an equilibrium condition in  $T_4$ .

A state of equilibrium is reached when the rotor of synchro  $R_6$ , from a zero reference angle, is given a position of 90 deg. This angle coincides with the 90-deg angle of  $R_6$ , at which angle video is returned from the plane on the approach path. A brief sampling during each sweep of the antenna beam is sufficient for keeping  $R_1$  and  $R_6$  in step. By means of integration the servo loop remembers its adjustment from one antenna sweep until the next, and assumes an average of broad target effects.

If for example a 3-deg azimuth beam angle represents the correct glide path, a corresponding angle of  $R_1$  will be 90 deg. By means of a glide-path adjustment,  $R_6$  may be turned until the azimuth deviation indicator reads zero. A similar adjustment is provided for in the elevation indicator. These glide-path adjustment shafts may be linked in with the range mechanism, in the event a glide angle is required to change as a function of range.

Connecting points are provided

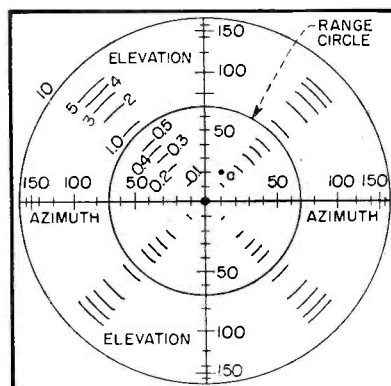

FIG. 5—Indicator dial proposed for use in automatic GCA system. Target *a* is 10 yards to the right of the correct glide path, 20 yards high, and the range circle indicates he is 0.75 mile from touch-down

for range, azimuth and elevation repeaters. Currents of  $\phi_2$  are used as a reference in each case.

A complete automatic system contains six independently controlled range-azimuth-elevation indicator units, all of which are operated in parallel and supplied with range information from a common radar receiving system. The units are also furnished with azimuth and elevation data from a common pair of radar antennas.

A type of indicator presentation is shown in Fig. 5. In combination, and on a single dial face, Az-El position deviation and aircraft range are presented.

Aircraft range is shown by means of a circle of reflected green light on the underside of the translucent dial. Range is indicated by the diameter of the circle. When a plane enters the approach corridor at ten miles, the circle appears and then becomes progressively smaller as the plane proceeds from the ten-mile point.

The plane's position in the approach corridor will be indicated on the dial face by a dot of white light. The position shown at point *a* is at  $\frac{1}{2}$  mile in range, 20 yards high in elevation and 10 yards to the right of the approach path. The dot of light (*a*), under properly controlled conditions, will be kept as close as possible to the point of cross-over. However, the importance of holding the plane on the glide path increases with the nearness to the touch-down point. Therefore, this type of presentation will prove to be highly desirable, in that the pilot, or the control operator, will extend every effort to at least keep the dot of light, which represents his plane, within the circle.

### Aircraft Spacing

The pilot or control operator is supplied with the position in range of the plane directly ahead of him by means of a red range circle on the dial face. The red circle in Fig. 5 has been reduced to a dot in the center of the scales, which indicates that the other plane has already touched down.

An indicator of the above type is representative of the instrumentation carried in the plane. A set of six such indicator dials will be em-

ployed on the ground. Under actual operating conditions, the instrument in a plane is made to function as a repeater of a corresponding unit on the ground, after the plane reaches the ten-mile point. If a plane is not equipped with such a unit, the pilot may be supplied with oral instructions from the ground.

The circuit in Fig. 6 illustrates the aircraft spacing system. As previously stated in connection with Fig. 5, there are six independently controlled range-azimuth-elevation indicator units in the ground equipment. Certain essential range-measuring components of the six units are again represented in Fig. 6. Components of the respective units are identified by letters. The independent range circuits are supplied from a single source of video and master oscillator currents of the radar set.

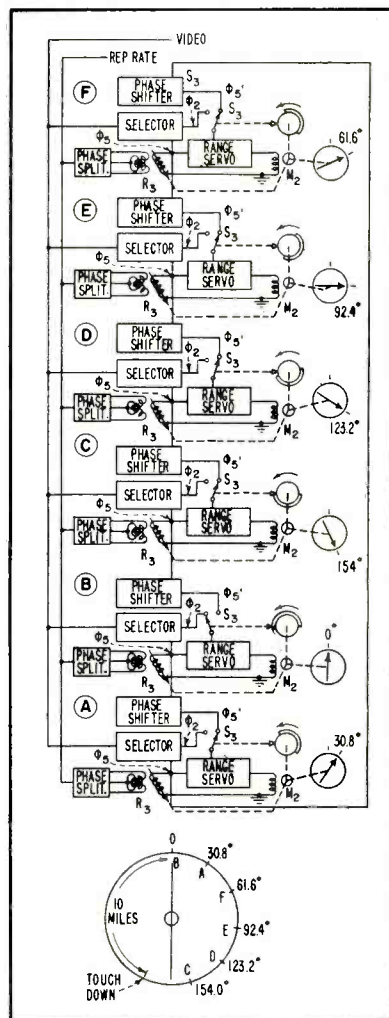

FIG. 6—Aircraft spacing equipment maintains approximately 2-mile intervals, which corresponds to 30.8 radar degrees

With reference to any one range unit, it will be noted that video is coupled to a selector, and the repetition rate is coupled to synchro  $R_3$  through phase-splitting circuits. Current  $\phi_5$  from  $R_3$  and current  $\phi_2$  from the selector are coupled to a range servo. In response to phase differentials a motor  $M_2$  corrects for misadjustments of  $R_3$ . To this extent, the system was more fully described in conjunction with Fig. 4.

Important additions to these range circuits include a switch  $S_3$ , actuated by a cam and follower, and a phase shifter. Switch  $S_3$  allows either  $\phi_2$  currents from the selector, or  $\phi_5'$  currents from another range unit, to be coupled as a reference to the range servo. By means of  $S_3$ , the six range units may be connected in series.

When two range units are connected by an  $S_3$ , a synchro  $R_3$  of one unit operates as a director and a similar synchro  $R_3$  of the second unit functions as a responder. The phase shifter between each synchro rotor  $\phi_5$  output and switch contact of  $S_3$  provides for a 30.8-deg differential between  $\phi_5$  currents of respective rotors when a condition of balance is established. A series of phase meters may therefore assume alignment differentials of 30.8 deg. A range of one mile is equivalent to 15.4 deg.

An examination of the entire system will show a series connection of range units C, D, E, F, A and B. There is a disconnection between B and C. The cam assembly of unit B is in a position which connects  $\phi_2$  current to the range servo. The associated dial indication of zero is equal to a range setting of ten miles. This is further indicated on the sample dial face shown at the bottom of Fig. 6. The range indicator B retains its ten-mile setting until a plane enters the approach path. When the latter occurs  $\phi_2$  currents under control of the plane allow the range meter B to follow the plane in toward the touch-down point.

The range unit A, under the control of range unit B, had previously assumed an adjustment of 30.8 deg behind unit B. Unit A will remain in this position until a plane takes over the control of unit B. In this



event, a rotation of  $R_3$  in unit  $B$  will be closely followed by  $R_3$  in unit  $A$ . In the process, a cam is rotated in the arrow direction until a follower rides upon the larger-diameter portion of the cam. A director control current  $\phi_5$  from unit  $B$  is disconnected by  $S_3$ , and unit  $A$  will then have assumed a setting of ten miles. While this action is taking place the remainder of the range units in the complete system will have likewise advanced 30.8 deg.

### Aircraft Equipment

The diagram of Fig. 7 shows the equipment included in the plane. If a plane is merely equipped with a communication receiver, the pilot may be talked in. If an indicator is included in the plane the various data, in the form of phase-displaced currents, will be used to control the indicator. Or, if the plane is equipped with an auto-pilot, the latter data may be coupled directly to it for control of the plane.

Plane-ahead range data will consist of phase-displaced currents  $\phi_5$  and  $\phi_5'$ . Phase  $\phi_5$  represents range from touch-down of the pilot's own plane, and phase  $\phi_5'$  represents range from touch-down of the plane ahead. The resultant information furnished the pilot will be the distance between his plane and the one directly ahead of his plane. Phase differences between  $\phi_5$  and  $\phi_5'$  currents are coupled to a servo-type phase meter. The latter consists of a synchro resolver  $R_7$  and its associated control circuits and motor. An assumed position of  $R_7$  is a measure of aircraft spacing, which is mechanically transferred to the indicator.

Touch-down range is represented by currents  $\phi_1$  and  $\phi_2$ . Phase relationships of these currents are detected by means of a second servo-type phase meter, and converted into an indication of distance to the touch-down point. This phase meter consists of synchro resolver  $R_8$  and its control circuits and motor. Aircraft range is closely followed by a changing angular position of  $R_8$ , which is transferred to the indicator.

Azimuth position deviation data consists of phase-related currents  $\phi_7$  and  $\phi_8$ , and elevation position deviation data consists of phase-related

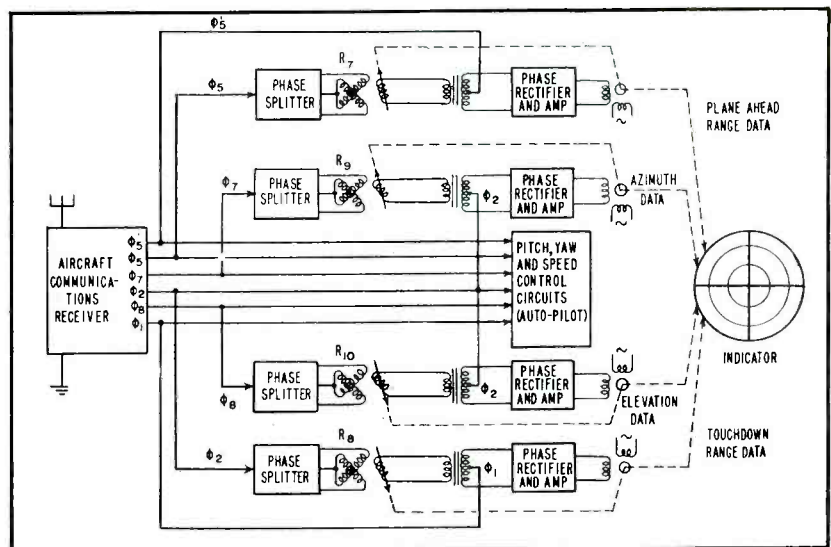

FIG. 7—Airborne equipment. Information may either be applied to indicator or to automatic pilot for completely automatic approach

currents  $\phi_2$  and  $\phi_8$ . These currents are likewise coupled to phase-meter circuits, wherein electrical differentials are converted to positional information. The mechanical output of each meter is likewise transferred to the indicator. The indicator is similar to that described in connection with Fig. 5.

Conventional auto-pilot equipment may be modified to respond to the same control data supplied to the indicator. The auto-pilot is shown in Fig. 7 by a block diagram. Current phases  $\phi_5$ ,  $\phi_7$  and  $\phi_8$  will be used to control the plane in pitch and yaw. Current phases  $\phi_1$  and  $\phi_2$  in combination with  $\phi_5$  and  $\phi_5'$  will be used to control the plane's speed.

### Potential Advantages

In summarizing, it will do well to point out that systems in the past, for the most part, have been limited to the control of aircraft singularly and have involved the use of several skilled operators to interpret cathode-ray scope indications and then convey the results of their interpretations to the craft under control. The means provided by these systems for the indications of the location of the craft with respect to the glide path require, at best, the interpretation and correlation of separate indications for each of the coordinates used to determine the position.

There is no certainty with existing systems that an indication of a craft on the glide path will not be

confused with indications of other craft or objects in the vicinity.

The indicating facilities of the present system, however, portray on one instrument face a correlated indication of the position of an aircraft with respect to a desired glide path. The indication obtained is assuredly representative of the plane under control, by virtue of the inherent ability to discriminate against targets having a velocity relative to the desired glide path, which differs from that of the desired target.

The indicators are mechanically actuated devices that respond to signal inputs which lend themselves readily to the actuation of repeater indicators. When such repeaters are located in aircraft, the pilot may make his approach by radar-controlled instrument readings. For a more accurately controlled approach the pilot may couple the received signals to the auto-pilot for a completely automatic operation.

As explained, the system is adapted for the simultaneous control of as many as five aircraft by the provision of a plurality of sets of range, azimuth and elevation determining circuits mechanically interlocked through their range-responsive servo motors. This is accomplished in a manner such that each in turn becomes responsive to the reception of target echo signals from targets at a predetermined range limit.

# TELEMETERING SYSTEM

Snowfall in isolated mountain areas is measured in terms of radiation between slug of Cobalt-60 embedded in ground and Geiger-Muller tube suspended above it. Unattended f-m transmitters and repeaters forward data to central recording station. Commitments for hydroelectric power and irrigation water are made on basis of measurements

By JOHN A. DOREMUS

Motorola, Inc.  
Chicago, Ill.

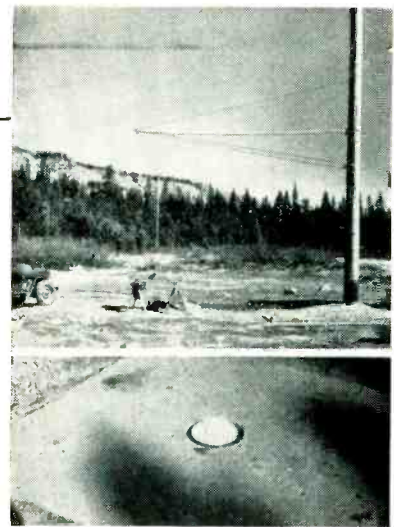

Sensing-unit arm and, below, radioactive Cobalt-60 and collimator set in concrete base under sensing unit

**T**HE ECONOMIC IMPORTANCE of efficient use of natural precipitation in the western part of our country has become well known in recent years. This requires accurate measurement of precipitation as it falls and as it is stored in the snow pack in mountainous areas.

Commitments for both hydroelectric and irrigation water supplies are made on the basis of snow measurements. Snow-survey and precipitation-gage data give only limited information because of the inaccessibility of many important watersheds during the winter.

## Instrumentation

During the past two years, R. W. Gerdel and B. Lyle Hansen of the U. S. Weather Bureau and W. C. Cassidy and Forrest L. Rhodes of the U. S. Army Corps of Engineers<sup>1</sup> have developed a thickness gage, using radioactive isotopes of common metals, to measure the water equiv-

alent of snow cover in isolated areas.

Only gamma rays appear to have sufficient energy to penetrate a deep snow pack. The intensity of radiation, after passing through an absorbing medium, depends upon the original intensity and the thickness of the medium, in accordance with Lambert's law  $dI = \mu I dx$ . The proportionality constant,  $\mu$ , (also called the linear-absorption coefficient) is the reciprocal of the thickness of the medium which will reduce the intensity of radiation to  $1/e$  of its original value. The linear-absorption coefficient, when divided by the density of the substance,  $\rho$ , produces the mass-absorption coefficient,  $\mu/\rho$ , which is constant regardless of the state of the medium whether it be solid, liquid, or gaseous.

The water equivalent of a snow pack may be expressed in terms of measured attenuation through the snow, provided three conditions are

met in the measuring equipment:

- (1) Cosmic radiation must be determined, and subtracted from the measurement, unless it is very small compared to the intensity from the source being measured.
- (2) Radiation must be essentially monochromatic, since the absorption coefficient is constant only for a specific wavelength.
- (3) The beam of radiation must be collimated to reduce excessive scattering, which would produce an apparent variation in the absorption coefficient.

After investigating all available sources of gamma radiation, Dr. Gerdel and his associates chose Cobalt-60 because it has high activity, its radiation is essentially monochromatic (1.1 and 1.3 mev) and it has a long half-life (5.3 years). Decay correction within a season is small.

Two units (40 millicuries) of Cobalt-60 were mounted at the lower end of a heavy lead tube. The tube was installed vertically in the ground, with the upper end flush

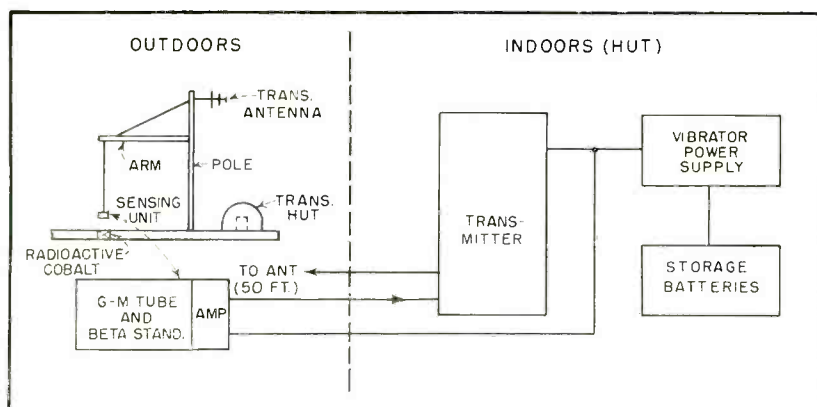

Physical arrangement of equipment at a data-transmitting station. A single pole supports the sensing unit and antenna

This article is based on a paper presented at the 1950 National Electronics Conference. The conference paper will appear in the *NEC Proceedings*.



# for Radioactive Snow Gage



Typical unattended repeater that receives signals from several radioactive-snow-gage data-transmitting stations located in remote mountain areas and relays them to a more accessible recording station

with the surface. This method of mounting effectively collimates emission so that at 15 feet the principal energy is contained within a circle approximately  $1\frac{1}{2}$  feet in diameter.

A Geiger-Muller tube was chosen as the sensing device because it is rugged and can readily withstand conditions of operation imposed upon it by this application. It provides an output that can be readily used in electronic circuits. To provide continuous calibration, a small sample of Strontium-90 is included in the housing with the G-M tube. Emission is essentially beta radiation, with a half life of 25 years. The sample is placed close to the G-M tube but separated from it by a magnetically-operated metal shield. The radiation from the beta

standard is superimposed on the count rate for a portion of the sampling period, as a means of checking the entire system from the sensing element to the recorder.

Calibration of the radioactive snow gage has been undertaken both by the use of hand-packed snow piles and by the use of known depths of water between the radiation source and the sensing tube. The linear-absorption coefficient obtained was very close to the theoretical value for absorption of 1.2-mev energy by water. Slight differences can be attributed to unequal distribution of 1.1 and 1.3-mev energy from the Cobalt-60 and to the finite resolving power of the self-quenching tube.

Unlike most instruments, the radioactive snow gage has an error

which increases in percentage as the quantity measured increases. However, practical measurements show that up to a reading of 45 inches of water equivalent the error is less than 5 percent. This is far better accuracy than can be attained by other methods of measurement.

### **Telemetry System**

To form a useful system, the information from many gaging stations must be transmitted to a central collecting station far removed from the data-transmitting sites. These sites are by their nature at locations inaccessible to pole line facilities. Radio is the only practical medium for transmitting data to the recording station. For simplicity, a one-way radio system

is used and data stations are actuated according to a program controlled by a time clock at each station.

A count rate as high as 20,000 per minute or as low as 120 per minute (background rate) must be transmitted. Since the lower count-rates represent the maximum depth of snow cover and since minimum count is limited by background count, it is important to study the probable error due to the random nature of the background count. This follows the well-known distribution of random events, where the maximum deviation is  $D = \sqrt{N}$ . Thus a maximum deviation of 11 counts might be expected with a background count of 120 cpm. A longer counting period would improve the accuracy of reading. Using five minutes as a counting period,  $D = \sqrt{600/5}$ , or 4.9 counts per minute. A five-minute counting period was therefore chosen as a practical compromise between the number of stations to be handled in a given period of time and the probable error incurred due to the random nature of the impulses.

The bandwidth required of the transmission system is directly proportional to the rate of data transmission. However, the noise power affecting the system is also proportional to the system bandwidth. It is desirable, therefore, to reduce the bandwidth of the system

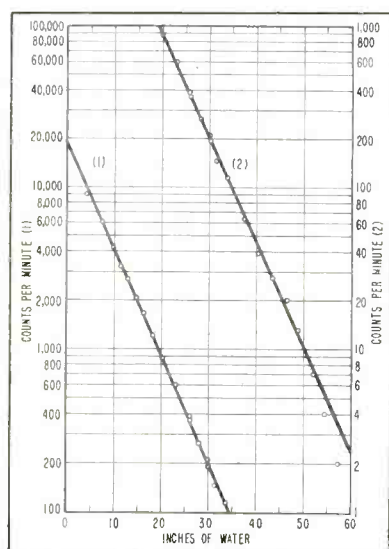

Calibration of radioactive gage in counts per minute above cosmic background versus water equivalent of snow



Receiving equipment used at central recording station to handle the audio sub-carriers of remote repeater stations

to a minimum, provided that this reduction does not incur an intolerable error in the reading.

In the data-transmission system chosen, an audio subcarrier is used to frequency-modulate an r-f carrier in the 169 to 173-mc range. The frequency of the audio subcarrier is shifted from its nominal value to a second value by the first count signal from the G-M tube. The next count shifts it back to its original value. Each count is identified as a point in time when received at the recording station. However, the average frequency of modulation of the audio subcarrier is only half the count rate.

If a further division by two is incorporated, using a conventional divider circuit, an error of + zero to minus-one count is incurred. Dividers can be used, with the following errors being incurred:

Division by	Maximum errors in count	Maximum error in count rate (cpm in 5-min. period)
2	-1	-0.2
4	-3	-0.6
8	-7	-1.4
16	-15	-3.0
32	-31	-6.2

It should be noted that the error incurred by the use of dividers is an error in basic count. When taken over a five-minute period, the maximum error in counts per minute is only one-fifth of the basic count error as shown above. Since the quantity being measured was shown previously to have a possible error of 4.9 counts per minute (at minimum counting rate) it is practical to divide the basic count-rate by

eight and incur a maximum error that is small compared with the uncertainty already existing.

The maximum expected average count-rate of 20,000 cpm is equivalent to 333 counts per second. However, with currently-available Geiger-Muller tubes having a dead time of 150 microseconds the maximum frequency of pulses could be as high as 6,667 per second. Since two pulses are required to provide a full cycle of frequency-shift modulation, this is equivalent to 3,333 cycles per second. A further division by eight reduces the requirement to 416 cycles per second. The bandwidth required to transmit this modulation width is generally taken as 2.3 times the highest modulating frequency.<sup>2</sup> Thus a 1,000-cycle-wide system would provide practical operation.

The system used is equivalent to a double-frequency-modulation system. The signal-to-noise improvement factor is represented by the relation<sup>3</sup>

$$F = \sqrt{\frac{3}{2}} \left( \frac{D_1}{f_m} \right) \left( \frac{D_2}{j_{sc}} \right)$$

Signal-to-noise ratio improvement is set at 12 db over an equivalent amplitude-modulated system.

The use of frequency-modulated subcarriers has two more important attributes. In a practical snow-gaging system, many data-transmitting stations are spread over a wide area. Repeater stations are required to receive and to retransmit the signals to the recording station. Simultaneous reception at a repeater station of two or more data-transmitting stations



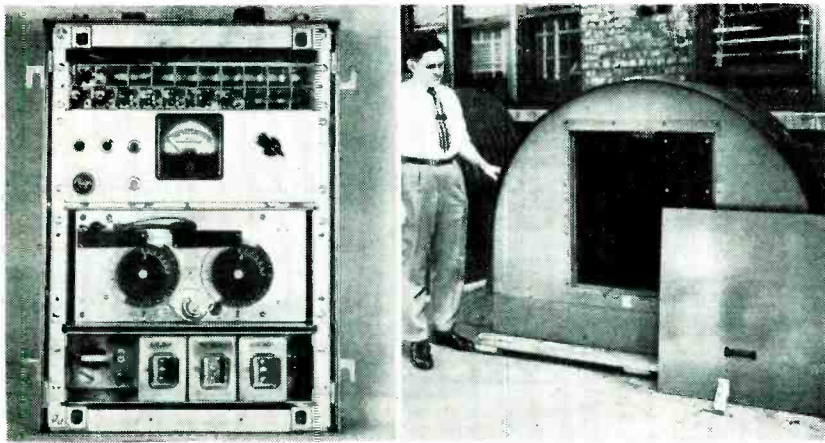

Half-watt f-m transmitter and Quonset-type hut that protects it from the elements, bears and other animals at remote data-transmitting locations

is possible through the use of multiple receivers on separate r-f carrier frequencies. If the audio subcarriers of these several stations are at different selected points in the audio spectrum, then the audio signals may be combined and sent to the recording station simultaneously on a single r-f circuit. At the recording station, separate decoding equipments, one operating at each of the audio subcarrier frequencies, provide simultaneous records of data. This greatly simplifies the radio network needed to handle large volumes of data in a given period.

The second important attribute of the audio-frequency subcarrier is that it can be transmitted through one or more repeater stations without demodulation and, therefore, without materially affecting its signal-to-noise ratio and without affecting in any way the accuracy of the reading which it is carrying.

### Station Equipment

When designing equipment for transmission of meteorological data, the system and components must be the most dependable possible within limitations imposed by physical location. Of major importance is the primary power source, since it will materially affect circuit design, transmitter power-outputs and operating program.

In the system under discussion the nickel-cadmium storage battery was chosen because of its freedom from self-discharge and its effectiveness at low temperatures. This battery shows 70 percent of nomi-

nal capacity at  $-20^{\circ}\text{F}$ , while a charge-retaining type of lead battery shows 50 percent and a vehicular-type lead battery less than 20 percent.

A jewelled-escapement time switch was developed for this application. It is wound periodically by a small electric motor. Compensation is included for operation at very low temperatures.

Miniature Quonset-type shelters are provided for each of the data-transmitting stations. They are rugged enough to stand the elements and attacks by brown bears and other animals.

The G-M tube and beta standard are mounted at the end of a Hubbard truss arm. The arm is mounted on a standard telephone pole which also supports the antenna.

Antennas of both directional and nondirectional types are used. All are ruggedized to stand the severe torture of the elements.

The battery-operated transmitters and receivers are mounted in small stainless-steel cases which themselves are weather proof. Power is brought in through gasketed glands. Individual sections such as oscillators, dividers, transmitter and receiver stages and the time switches are individually removable for easy servicing in the field.

Storage batteries and power supplies are mounted in wooden chests to facilitate recharging. It is expected, however, that recharging will be done on location during summer months by a gasoline-

driven charger mounted on a jeep.

At the recording station, data is taken in terms of counts over a five-minute period using a conventional scaler-divider and time clock. These data need only be multiplied by the division factor of the system and referred to the calibration data for the station to obtain water equivalent of the snow pack.

This system is being constructed under contract with the Corps of Engineers and is being installed at the Central Sierra Snow Laboratory in California. It will be operated through the 1950-1951 snow season. Following satisfactory tests and acceptance by the contractor, a detailed report on design and operation characteristics will be prepared for publication through the contract agency.

### Future Development

Future aims of this project are in the direction of providing more accurate data at a faster rate.

The use of scintillation detectors will provide a great improvement in efficiency and resolution of the sensing device. Counting efficiencies of 50 percent and a dead time of less than a microsecond can be obtained, as compared to the currently-used self-quenching Geiger-Muller tube with an efficiency of  $\frac{1}{2}$  percent and a dead time of 150 microseconds.

Evaluation of the data at the field station will allow transmission of a quantity representing only the count rate rather than the actual count. This will greatly shorten the time required to obtain data from a given station. Automatic recording will be possible, precluding the need for an operator to be constantly monitoring the system.

The author wishes to acknowledge the assistance of Edward Bauman, Robert Q. Stanton, Walter A. Kelley and William Bowman, all of Motorola, in developing the data transmission system which makes this complete system possible.

### REFERENCES

- (1) R. W. Gerdel, B. Lyle Hansen and W. C. Cassidy, The Use of Radio Isotopes for Measurement of the Water Equivalent of a Snow Pack, *Trans. Amer. Geophysical Union*, 31, No. 3, June 1950.
- (2) F. H. Cusack and A. E. Michon, A Frequency Modulation Telegraph Terminal Without Relays, *AIEE Trans.*, Feb. 1947.
- (3) Vernon D. Landon, Theoretical Analysis of Various Systems of Multiplex Transmission, *RCA Review*, IX, No. 2, June 1948.

# Comparative Analysis of

By **ARTHUR V. LOUGHREN**  
*Vice-President in Charge of Research*

and **CHARLES J. HIRSCH**  
*Chief Engineer, Research Division  
 Hazeltine Electronics Corporation  
 Little Neck, N. Y.*

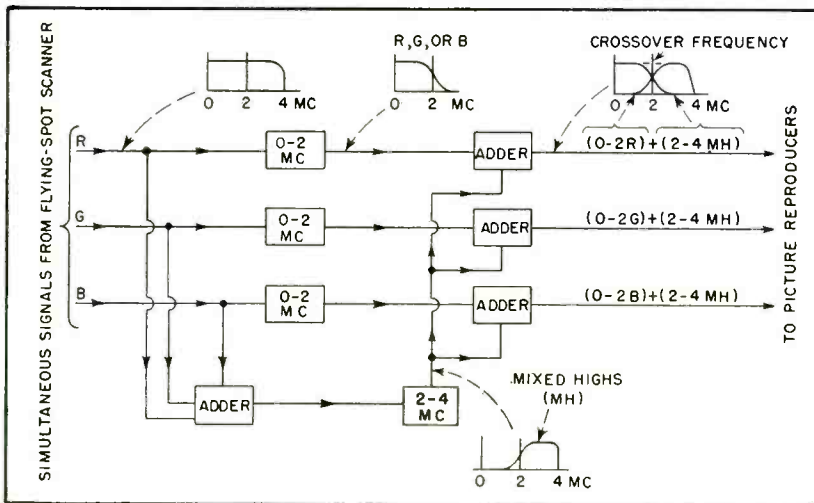

FIG. 1—Experimental arrangement of components for transmission of the mixed-highs signal, based on a 2-mc crossover frequency

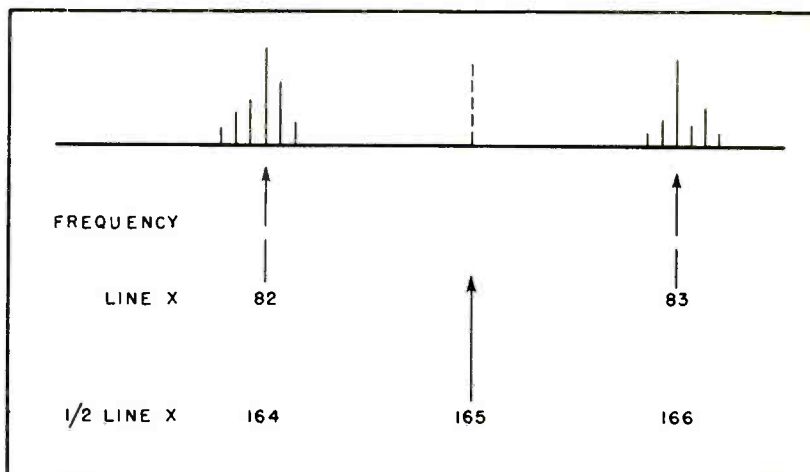

FIG. 2—Spectrum occupancy arising from scanning. Shown solid are the spectrum components of the 82nd and 83rd harmonic of the line frequency. Odd harmonic of half the line frequency, shown dashed, falls midway between and can be transmitted over same channel with little interference

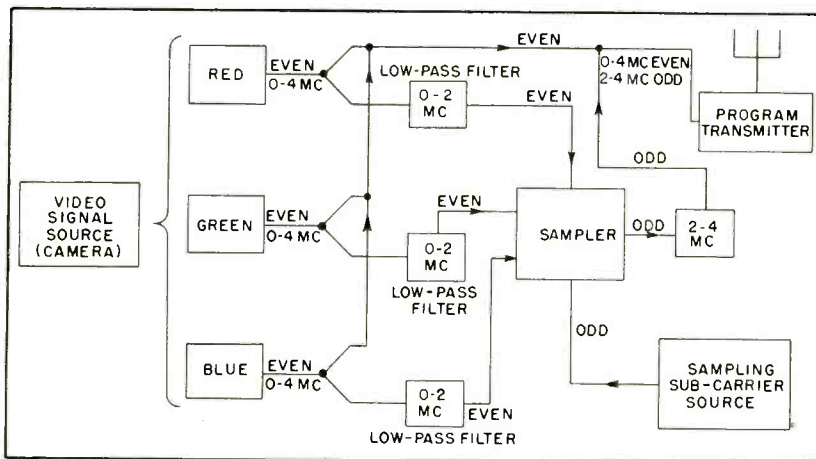

FIG. 3—Method of synthesizing by-passed mixed-highs signal at transmitter. Even and odd designations refer to order of harmonic of half the line frequency

**T**HIS ARTICLE presents some of the facts basic to color television and the numerical consequences of these facts as they affect color television system performance.

As a starting point for the analysis, consider the monochrome pictures produced by the present FCC standards. These are broadcast in a 6-mc channel with 525 lines per picture and 30 pictures per second. The bandwidth effectively useful for picture information is about 4 mc. Counting positive and negative alternations, pictorial information to the extent of 8,000,000 elements per second may thus be transmitted. With the rate of thirty pictures per second, this permits 267,000 elements per picture. The acceptance of present television by the public indicates that pictures of the grade now provided are acceptable in quality.

In a monochrome picture each distinguishable element requires for its description a single number, to represent the element's brightness. If a color picture is to be produced, however, three quantities must be given with respect to each distinguishable element if reasonably true reproduction is to result. Practical three-color reproduction systems can be made to give color rendition which is highly satisfactory to the public.

If all that is known about color vision were what is implied by the foregoing remarks, then it is apparent that to reproduce a color picture with detail equivalent to that now given in black and white television and with color rendition as good as that offered by Kodachrome, the amount of information transmitted per picture must be



# Color TV Systems

Based on the color-system research of the Hazeltine Laboratories, this review specifies numerically the improvement resulting from the use of band-sharing and mixed-highs transmission in the dot-sequential system, and compares its performance with that of the field-sequential system

trebled. If for comparative purposes we assume that the picture repetition rate shall be maintained, then the system bandwidth must also be trebled. Pictures transmitted on this basis should however, have all of the resolution exhibited by the presently acceptable monochrome pictures and should show this resolution in full color with color rendition which is at least potentially equal to that afforded by Kodachrome.

The color plate which appeared on the cover of *ELECTRONICS* for December 1950 shows as Fig. A the reproduction of a color television picture in which a separate 4-mc band was devoted to each of the three primary colors, or 12 mc in all. In the original television reproduction the resolution is in all respects as good as that which is currently satisfying the public in our monochrome television. The color behavior is at least potentially the equal of that which has been found acceptable to the public in Kodachrome. It seems appropriate, therefore, to say that color television performance of this grade would be found acceptable to the public. This 12-mc simultaneous picture may therefore be looked on as a yardstick.

It is undesirable to have to treble the system bandwidth to introduce color into a monochrome picture. Is it necessary that this increase in bandwidth be provided? The viewing of a colored image is highly subjective in character, and for this reason both the characteristic of the eye that sees the picture and the mind that interprets it must be taken into consideration.

Figure B of the cover plate shows the effect produced when the

bandwidth is increased only 5 percent rather than 200 percent. Although this picture contains such a small amount of color information added to the full detail monochrome picture, it gives reasonable satisfaction to the viewer. If one had not seen Fig. A, one would not realize that the color has disappeared from areas of fine detail such as the awning stripes. Since there has inevitably been some small degradation of all pictures in the photographic and magazine printing processes, the comparison is even more striking when seen on the tube face.

## Mixed Highs

The detailed circuit arrangements by which the picture of Fig. B is produced are based upon the concept of "mixed highs." This concept and its physiological basis are described by its originator, A. V. Bedford, in his paper in the September 1950 issue of the *IRE Proceedings*. The principle is based on the physiological fact that the eye is insensitive to color in fine areas. In other words, it is less

sensitive to changes in hue and saturation than to changes in brightness.

From the point of view of mixed highs, it can be said that in Fig. B individual information was provided for each of the primary colors in the range between 0 and 0.1 mc and that common information was provided for all three in the range between 0.1 and 4 mc. Figure C shows all the color information present in Fig. B. It consists of 0.1 mc of each primary color, or a total of 0.3 mc.

Figure D shows the components of Fig. B lying between 0.1 and 4.0 mc; these are a mixture of the information picked up in all three colors in the range 0.1 to 4.0 mc. Figure B therefore requires a total bandwidth of 4.2 mc, which is made up of 0.1 mc each of red, green, and blue, and 3.9 mc of mixed highs. This represents an increase of 5 percent in required bandwidth over the requirements of a 4-mc monochrome picture. Figure A requires an increase of 200 percent.

The frequency at which the change from color to mixed highs takes place is called the crossover frequency. A schematic circuit arrangement for using mixed highs is shown in Fig. 1, with the crossover frequency set at 2 mc. This illustration shows that mixed highs can be used advantageously only in a simultaneous (or essentially simultaneous) system, because the heart of the method lies in using one signal simultaneously for the fine detail in all three colors.

The numerical relations between total effective bandwidth, resolution, and color information for a number of crossover frequencies

## FULLER EXPLANATION

The cover of the December issue of *Electronics* illustrated the spectrum-saving property of mixed-highs transmission of color images in terms of the final result, a direct comparison in color between full-simultaneous and mixed-highs renditions of the same subject. This paper, based on the material presented at the 1950 Syracuse Fall Meeting, goes into detail on the theoretical and practical background of this comparison and extends it to cover the field-sequential system.—The Editors

are shown in more detail in Table I. Subjective comparisons under critical conditions by a number of observers at a normal viewing distance of four times picture height led to the following conclusions:

First, at a 2-mc crossover, with an effective band of 8 mc, the reproduction is virtually indistinguishable from the 12-mc yardstick picture; for most scenes, no difference is exhibited. Second, at a 1-mc or 0.5-mc crossover, with total bands of 6 and 5 mc respectively, reproduction is as good as the 12-mc picture in all respects save that very small colored areas are partially desaturated. Third, a crossover as low as 0.1 mc may not be fully satisfactory on some subjects. Other observers might reach even more liberal conclusions favoring values under 0.1 mc.

The evidence, such as the pictures in the cover plate, supports completely the statement that, by means of the mixed-highs technique, color television pictures can be produced fully as sharp as the best monochrome pictures, with excellent general color rendition, using a band not materially greater than that required for monochrome television. However, to obtain this bandwidth advantage, the color television system must be essentially simultaneous in character.

### Possibilities for Band-Sharing

Consideration of the frequency spectrum of a television transmission indicates that over the major

portion of the band, say from line frequency on up, the spectrum consists (as shown in Fig. 2) of components at the successive harmonics of the line frequency, and groups of sidebands associated with each of these components and spaced apart by the field frequency and its harmonics.

Each group occupies only a minor fraction of the frequency space between successive component groups. The scanning of any television picture always results in a spectrum of this character, the differences between one picture and another being represented by changes in the relative amplitudes and phases of the various components. In no case does any component arise midway between successive harmonics of the line frequency.

Let us now interject artificially a component midway between two harmonics of line frequency (and therefore at an odd harmonic of one-half the line frequency, as shown dotted in Fig. 2). If such a component is added to a television picture signal and the result viewed on a display, the amplitude of the injected component at each point in the picture is of opposite polarity in one frame from the polarity of the preceding and succeeding frames.

To idealize the situation slightly, by regarding the display as linear in its amplitude characteristic and by saying that the eye will integrate perfectly over a two-frame interval, then this artificially-injected component integrates out completely and is invisible. In practice, these

two idealizing assumptions are only moderately well approximated. The component at an odd harmonic of half the line frequency is of low visibility rather than being completely invisible. However, to the extent that we are satisfied that the visibility is low enough to be unimportant, use may be made of a substantial portion of the television signal band to insert a complete new set of components derived in any fashion and transformed to frequencies which are odd multiples of one-half the line frequency.

### Transmitter for Composite Color Picture

For example, consider the method of deriving a color signal shown in Fig. 3. Signals are generated for each of three primary colors. These signals consist primarily of components which are harmonics of the line frequency and which are therefore even harmonics of one-half the line frequency. The word "EVEN" adjacent to the signal paths indicates this.

The outputs of the three channels are combined in one path to form a brightness signal. In another path the outputs are fed to a three-phase sampling device. This sampling device is also a heterodyning device. Its output includes the sampling frequency as a subcarrier and sidebands about the subcarrier spaced from it by the frequencies present in the sampled signals.

The frequency of sampling (frequency of the subcarrier) is chosen to be an odd harmonic of one-half the line frequency. All of the output of the sampler (of such frequencies as to be transmitted through the bandpass filter) consists of odd harmonics of one-half the line frequency, since all these components represent frequency sums or differences between the odd subcarrier and the even modulation components. Moreover, the addition of an odd and an even component produces an odd component.

All of these components are therefore suitable for direct addition to the signal from the brightness branch of the transmitter where they will interleave between the components of that branch. In other words, the composite color picture signal consists of a mono-

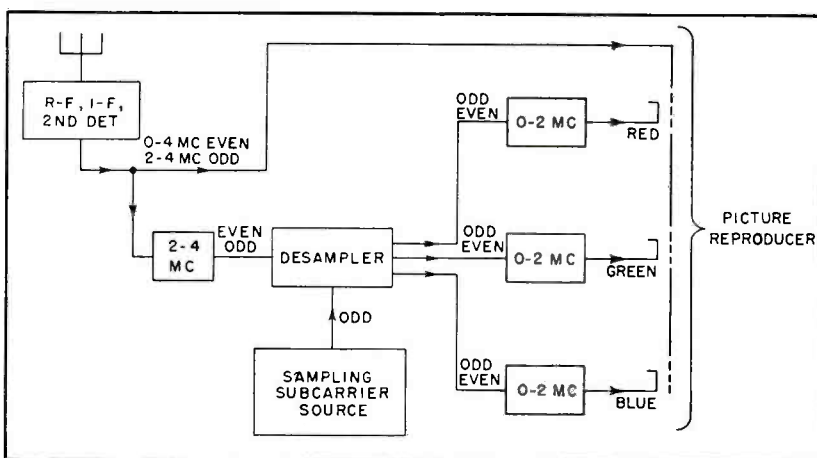

FIG. 4—Method of utilizing by-passed mixed-highs signal at receiver. Upper path carries full monochrome signal, while sampled signals below introduce color components



chrome picture signal to which has been added a low-visibility color picture signal.

In the typical receiver shown in Fig. 4, the video signal branches into two paths. One of these paths applies the entire signal to one set of terminals of some form of 3-color display. The even components applied through this path affect the display visibly but the odd components produce only low-visibility effects.

In the other path, the portion of the signal containing the odd components is selected by the bandpass filter and is then heterodyned in the receiver desampler, using the same heterodyne frequency as before. Since this frequency is an odd multiple of one-half the line frequency, the subtraction from it of odd-order components in the signal produces visible even-order components in the output. The subtraction from it of even-order components produces low-visibility odd-order components in the output.

The three outputs of the sampler provided at different phase positions in the sampler cycle are applied through filters to their respective terminals in the second set of input terminals of the three-color display. At the transmitter we have included an additional signal of 2-mc total bandwidth in the transmission and at the receiver we have rederived this signal and the original signal free of interference with each other except for the approximations of receiver linearity and perfect integration by the eye. This added 2 mc of information may, by system proportioning, be applied in any desired fashion to the transmission of information descriptive of the hue and saturation of the original picture.

#### **Bandwidth Requirements for System**

We have noted that a 4-mc band produces good monochrome pictures and that in an independent three-color simultaneous system a 12-mc band is needed to produce pictures which are in all respects as good as the 4-mc monochrome pictures. Further, in a simultaneous system employing mixed highs, pictures in all respects as good as the monochrome picture can be obtained in

**Table 1—Economy of Bandwidth Obtained by Use of Mixed Highs**

Crossover Frequency Where Mixed Highs Start, mc	Effective Video Band, mc	Elements per Second	Elements per Picture		
			Total	Contributing to Fine Detail	Used for Color
0.0 (Standard Monochrome)	4.0	8,000,000	267,000	267,000	—
0.1 (Simultaneous Color)	4.2	8,400,000	280,000	267,000	13,000
0.5	5.0	10,000,000	333,000	267,000	67,000
1.0	6.0	12,000,000	400,000	267,000	133,000
2.0	8.0	16,000,000	533,000	267,000	267,000
4.0	12.0	24,000,000	800,000	267,000	533,000

an 8-mc band and that pictures as sharp as a monochrome picture and lacking only in small-area color saturation can be obtained with a 5-mc band. Also, by a process of band-sharing, taking advantage of the gaps in the spectrum of a simple television signal, appreciable amounts of information can be added over and above what had been contained in the monochrome signal.

It is clear therefore, that a signal of full color and full definition compared to good monochrome can be transmitted within the 4-mc effective band of a standard 6-mc television channel, and that to the extent that the approximations previously mentioned are valid, there will be no spurious patterns. The system operates in such fashion that, for white or neutral gray shades, equal signal amplitudes reach the sampler from the three primary channels and the sampler therefore exhibits no output. A substantial advantage results from this, since in white and gray areas even the residual imperfections vanish.

A practical aspect of color television systems is their susceptibility to interference.

In the diagram of Fig. 4, the direct channel by which the composite signal reaches the display is no more or no less susceptible to interference than a monochrome receiver would be. The channel with the sampling unit represents a different case. Consider, for example, a c-w interfering signal at approximately 3 mc, with a sampling frequency of 3.5 mc. The sampling process being also a heterodyning process,

it follows that the sampler output will contain the difference frequency of 0.5 mc. This frequency of course produces a much coarser interfering pattern in the display than the original 3-mc signal would produce.

In small areas, the eye is much less sensitive to changes in hue and in saturation than it is to changes in brightness. A similar statement may be made with respect to short time intervals, regardless of area; that is, a flicker produced by brightness modulation is far more readily perceptible than is flicker of equal energy content representing a change in hue or saturation only. It seems reasonable, therefore, so to proportion the system that the output of the sampler conveys information with respect only to hue and saturation, thus deriving all brightness information from the signal which takes a direct path from receiver to display.

For instance, an interfering signal, such as the c-w interference mentioned, which brightens the green element of the display at a given instant shall at the same time decrease the combined brightness of the red and blue elements of the display by the same amount, thus keeping the total brightness constant. It is practical to design a system on this basis. Such an arrangement, originated by B. D. Loughlin, has been constructed.

This system, called the Constant-Luminance System, reduces the susceptibility of the receiver to interference in the color picture by 6 to 8 db. The improvement is apparent both on the interfering signals from external sources and on the inter-

**Table II—Comparison of Color Television Systems**

Channel Width, mc	Effective Video Band, mc	Elements per Second	Pictures per Second	Elements per Picture			Relative Fine Detail
				Total	Contributing to Fine Detail	Used for Color	
Standard Monochrome							
6.0	4.0	8,000,000	30	267,000	267,000	—	1.0
Simultaneous Color							
15-18	12.0	24,000,000	30	800,000	267,000	533,000	1.0
Simultaneous Color							
6.0	4.0	8,000,000	30	267,000	89,000	178,000	0.33
Field-Sequential Color							
6.0	4.0	8,000,000	24	330,000	110,000	220,000	0.41
Field-Sequential Color with Dot Interlace							
6.0	0-4*	8,000,000	24	330,000	110,000	220,000	0.62
	2-4	4,000,000	24	165,000	55,000	110,000	
				495,000	165,000	330,000	
Band Shared Color with Mixed Highs							
6.0	0-4*	8,000,000	30	267,000	267,000	—	1.0
	2-4	4,000,000	30	133,000	—	133,000	
				400,000	267,000	133,000	

\* 0-4 band transmitted normally  
2-4 band transmitted as interleaved low-visibility components

ference produced by the fact that the interleaved components are of low rather than zero visibility.

For a quantitative comparison of interference susceptibilities, it may be said that field-sequential color as proposed by the FCC and dot-sequential color (as shown recently in Washington) appear to be about equal. Monochrome is only two-thirds as susceptible, and dot-sequential color using the constant-luminance principle is nearly as good as monochrome.

**Ability of Color Systems to Supply Detail**

Table II shows the data on which a comparison of color systems can be based quantitatively. Column 1 shows the bandwidth which would have to be assigned to each system to transmit the full television picture complete with sound and guard bands. Column 2 gives the effectively available video band, and column 3 the number of pieces of information which can be reproduced within such a band in one

second. Column 5 is obtained by dividing column 3 by the numbers in column 4 and gives the total amount of information available in a complete picture. Of these, column 6 states those which contribute to geometrical resolution and column 7 those which carry the color information. The last column gives the ratio, relative to present monochrome standards, of the number of elements available for reproducing the fine detail.

The most important comparison is to note that the slow-switching-rate field-sequential color systems devote twice as many elements to color information as to black and white, as do also the simple simultaneous color systems. This is forced by their inability to use the mixed-highs techniques, requiring that each separate color picture be painted as a unit, rather than a composite. This drastically limits the elements available for fine detail.

In the simple field-sequential system, there are 110,000 elements per

picture carrying the all-important fine detail as compared to 267,000 elements in the present monochrome pictures. This is about 41 percent.

The band-shared system using mixed highs also has available 267,000 elements to portray the detail. On the other hand, the field-sequential system devotes 220,000 elements to carrying color information as contrasted with 133,000 in the band-shared system and 13,300 in Fig. B of the cover plate.

**Conclusions**

We believe, from the evidence upon which this paper is based, that these points are established:

Color vision requires only slightly more information than monochrome vision (5 percent to 50 percent more). Television systems can take advantage of this fact by using mixed highs, which allow the effective bandwidth to be reduced from 12 to 8 mc at no sacrifice of quality in any respect, and with a trivial sacrifice, reduced further to 6 or even 5 mc.

By band-sharing techniques, moderate additions may be made to the transmission capacity of the television band.

The combination of band-sharing techniques and mixed highs permits the transmission in a 4-mc effective band (6-mc channel) of a good three-color picture having the full resolution and detail which the public has come to expect from monochrome television.

No other system so far known comes at all close to this result.

With a fully simultaneous three-color system, or a slow-sequential three-color system, only one-third of the transmitted information contributes to detail and sharpness. If the picture is to avoid degradation, compared to present monochrome, it must occupy an effective band of 12 mc.

The use, for color television broadcasting in a 6-mc channel, of any system incapable of using that channel to the fullest effectiveness which present knowledge permits is a wasteful squandering of a precious national resource—our frequency spectrum—and to that extent is clearly not in the public interest.



# Production-Line Frequency Measurements

Simplified equipment allows relatively inexperienced personnel to make extremely accurate measurements of frequencies up to 10 mc. Entire system is standardized against WWV by simple adjustments while frequency measurement is being made

By **GEORGE J. KENT\***

*Senior Engineer  
Western Electric Company  
New York, N. Y.*

**M**OST MODERN frequency-measuring devices depend, to a great extent, on the skill and experience of the operator. In cases where qualified operating personnel is readily available, these systems are satisfactory, but in most instances, skilled labor is at a premium.

The equipment described here and illustrated in the photographs permits accurate frequency measurements to be made by relatively inexperienced operators. After about twenty hours training and practice, an operator can make rapid measurements at 100 kc to 10 mc within 1 or 2 cps.

## **Method of Measurement**

Frequencies are measured by a system of bracketing. The first digit (usually 2 to 10 mc) is determined by the calibration of a communications receiver. The second digit is determined by bracketing the unknown signal between known harmonics of a 100-kc harmonic generator whose fiftieth harmonic is constantly kept at zero beat with WWV. Subsequent digits are obtained by a combination of brackets and finally the last two significant figures are taken from a calibrated audio oscillator using a scope and Lissajous figures.

A block diagram of the equipment involved is shown in Fig. 1.

The frequency standard consists of a 100-kc oscillator and a series of three 10-to-1 frequency dividers. The beat between the 5-mc signal of WWV and the fiftieth harmonic

of the 100-kc oscillator is heard constantly by the operator from a loudspeaker connected to the receiver. In this way, the 10-kc, 1-kc and 100-cps subharmonics and the 100-kc fundamental are all kept standardized during the measure-

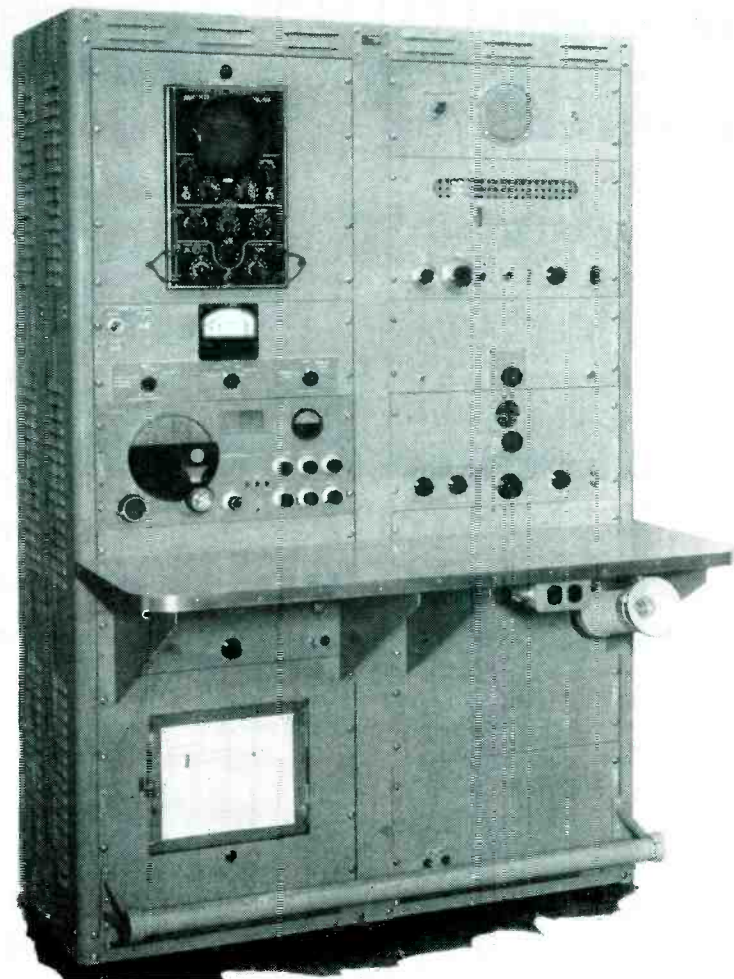

Frequency-measuring equipment. First significant figure is obtained from communications receiver calibration. Subsequent digits are found by a system of 100-kc oscillator subharmonic brackets and an accurately calibrated audio interpolation oscillator

\* Also Instructor in Charge at The Polytechnic Institute of Brooklyn, Brooklyn, N. Y.

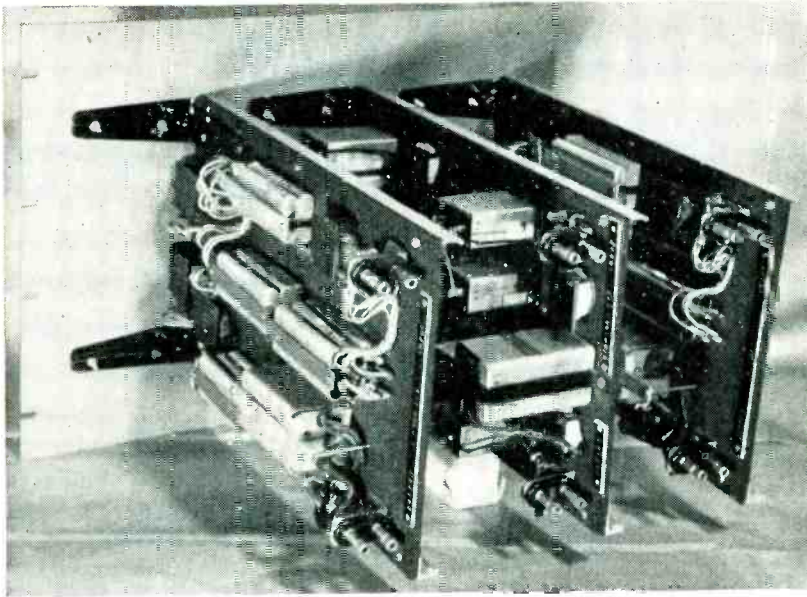

The three filter circuits are contained on a separate chassis and panel

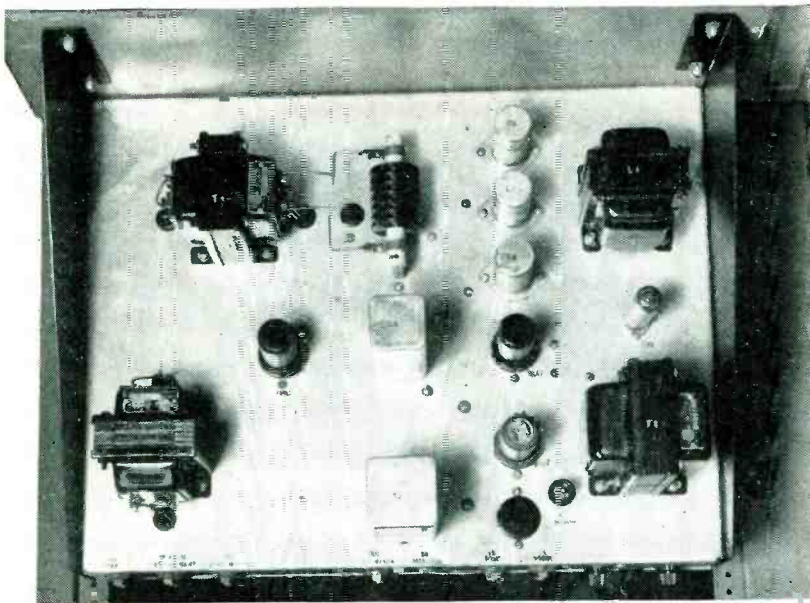

Top view of frequency generator and mixer chassis

ment procedure. When the standard is so adjusted, the receiver is tuned to the unknown frequency  $f_x$  radiated by the apparatus under test. The first digit of  $f_x$  is read from the receiver tuning dial and the second digit approximated from the tuning dial setting. Then, the unknown signal is bracketed between two harmonics of the 100-kc oscillator, thereby verifying the second digit. The next digit of the unknown frequency is then found by bracketing between harmonics of the 10-kc standard, which are readily identified also by tuning the receiver to each harmonic in turn. The 10-kc harmonic  $f'_k$  that is

closest to the unknown frequency is recorded.

The unknown, and all of the 10-kc harmonics, are then injected into the first mixer. Out of the numerous beats, a low-pass filter selects the lowest,  $f'_b = f'_k - f_x$  or  $f_x - f'_k$  depending on whether  $f'_k$  is higher or lower than  $f_x$ . Beat frequency  $f'_b$ , always between 0 and 5,000 cps, is applied to the Y terminals of an oscilloscope through  $SW_1$ , set at 1. A calibrated audio interpolation oscillator is connected to the X terminals of the oscilloscope, and by means of Lissajous figures, an approximate measurement is made.

Beat note  $f'_b$  is then applied to

the second mixer. Knowing the approximate value of  $f'_b$  from the reading of the interpolation oscillator, the operator selects the 1-kc harmonic that is closest to that frequency by means of the frequency booster. This signal he applies to the second mixer. A high-attenuation low-pass filter selects the lowest beat  $f''_b = f''_k - f'_b$  or  $f'_b - f''_k$  depending on whether  $f'_b$  is higher or lower than  $f''_k$ . The second beat frequency  $f''_b$  is always between 0 and 500 cps.

When  $f''_b$  is between 0 and 25 cps, difficulties with a-f transformers arise. Therefore the harmonic of 1 kc is selected which produces beat  $f''_b$  between 975 and 1,000 cps. A band-pass filter for this frequency range is provided for such cases.

The output  $f''_b$  is applied to the scope through  $SW_1$  and measured in the same way as in the approximate measurement. To obtain maximum accuracy at this point, the frequency standard is now kept at exact zero beat with WWV, as indicated aurally over a loudspeaker. In this way, the last two digits are found, and the fine measurement step is completed.

#### Description of Equipment

The frequency standard used is basically accurate within  $\pm 0.001$  percent. The frequencies of all outputs of this standard are adjusted simultaneously by means of a vernier-operated trimmer, thereby providing a momentary accuracy of better than 1 part in 10 million.

The 100-kc and 1-kc harmonic generators are of the germanium diode type. The separate 100 and 10-kc harmonic generator employs a 6SJ7 and provides sufficient harmonic output that the 2,000th harmonic can be identified in the receiver. Harmonics up to the 1,000th have been used for measurements.

The first mixer employs a pentagrid converter type 6SA7. The three filters discriminate against unwanted beats produced by adjacent harmonics of 10 kc and 1 kc. Figure 2 shows the characteristics of the two low-pass filters. The sum of the wanted and main unwanted beats is always 10 kc or 1 kc. The curves show the desired beat  $f'_b$  or  $f''_b$  plotted on the abscissa



against the attenuation of the unwanted frequency. Other unwanted beats are either more attenuated or too weak to interfere with operation.

The second mixer is shown in Fig. 3. The important advantage of the push-pull germanium diode balanced-bridge arrangement is that only odd mixing modulation product frequencies appear in its output. Also, both  $f_b'$  and  $f_b''$  disappear from the output of the mixer.

The receiver used has a main dial that is accurately calibrated in 100-ke steps. Vernier and bandsread dials facilitate the measurements. A crystal-controlled variable-selectivity circuit provides a very narrow pass band. This feature is important, since in some measurements the receiver is used both as a mixer and filter. The S meter allows the operator to count and identify the harmonics as well as to estimate the relative strengths of the measured signal and harmonics.

The audio-frequency interpolation oscillator covers a band of frequencies from 6 to 6,000 cps. Its dial is broad enough to permit evaluation of about 2 cps on the most congested range below 500 cps. The oscilloscope is conventional.

### Applications

The equipment described is used mainly for measurement and calibration of fundamental frequencies of crystals in frequency monitors and oscillator circuits. It is also

used for adjusting crystals and for calibrating and measuring frequency drift of signal generators and audio oscillators.

The percent accuracy of measurements depends on the measured frequency. Since at the instant of measurement the 10-ke and 1-ke harmonics are standardized against WWV, the main source of inaccuracy lies in the interpolation oscillator. As has already been mentioned, the inherent accuracy of this apparatus is better than 1 percent. However, by means of a switch, the interpolation oscillator can quickly be checked by comparing it with the outputs of the 1-ke

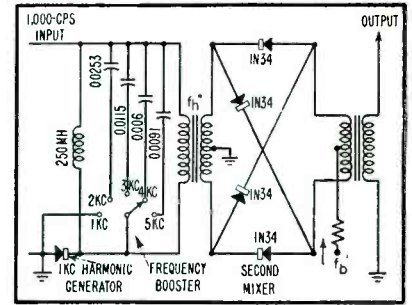

FIG. 3—Frequency booster circuit picks out desired harmonic of 1-ke harmonic generator. Push-pull crystal mixer produces only odd mixing modulation products

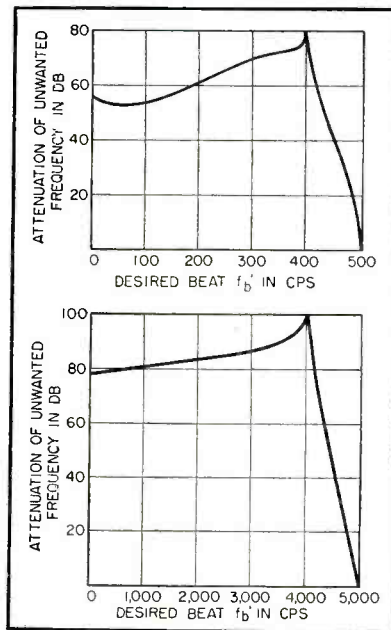

FIG. 2—Curves show characteristics of 0 to 500 and 0 to 5,000 low-pass filters

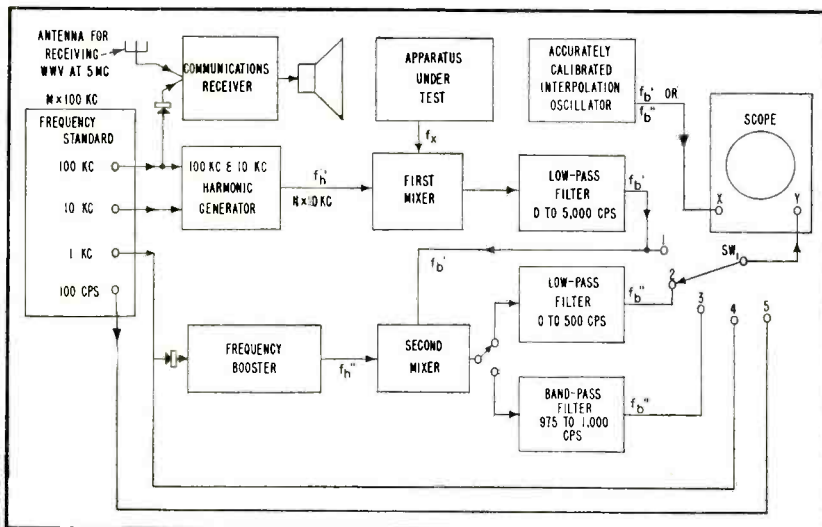

FIG. 1—Equipment is standardized by beating fiftieth harmonic of 100-ke oscillator with 5-mc signal from WWV. Interpolation oscillator calibration may be checked against 1,000 and 100 cps subharmonics of 100-ke oscillator

and 100-cps standards. When utmost accuracy is needed, this calibration may be performed immediately after the reading is made using Lissajous patterns.

It has been established in practice that maximum error made when measurements are performed is about  $\pm 2$  cps. This happens only when  $f_b''$  is close to and below 500 cps. In most other cases the error is about  $\pm 1$  cps. Thus when referred to the frequencies usually measured, namely from 2.5 to 10 mc, the average error is from 4 to 1 part in ten million. The higher the measured frequency, the smaller the percent error.

After the identification of the harmonics producing the wanted beats, the main operations that the operator has to perform are: to zero beat from the speaker, to stop simultaneously the elliptical pattern on the oscilloscope screen and immediately after that to read the dial of the interpolation oscillator. Then, he simply fills in the readings on a form and performs two simple additions or subtractions.

Actual in-use experience with the equipment for the past two years indicates that results of measurements of the same frequency, independently obtained by different operators, do not differ by more than 1.5 cps.

The author wishes to thank Brynjulf Berger whose suggestions and cooperation contributed greatly to the success of this project, and Joseph Bagdon for his constructive criticism. He also wishes to express his appreciation to Ernest Reuther for his assistance in construction and adjustment of this equipment.

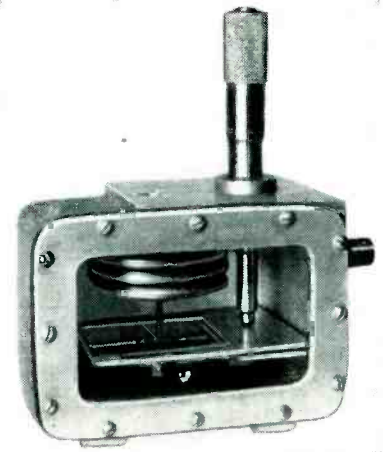
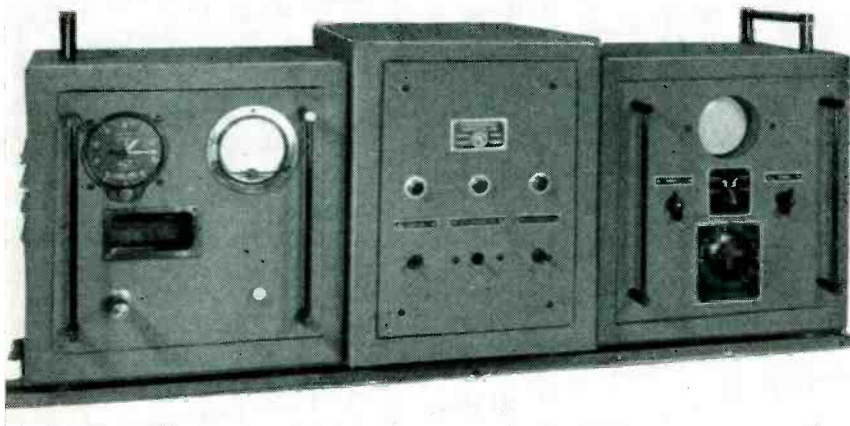

Complete airborne profile recorder instrument, with datum stabilizer in left-hand bay

Aneroid-driven capacitor

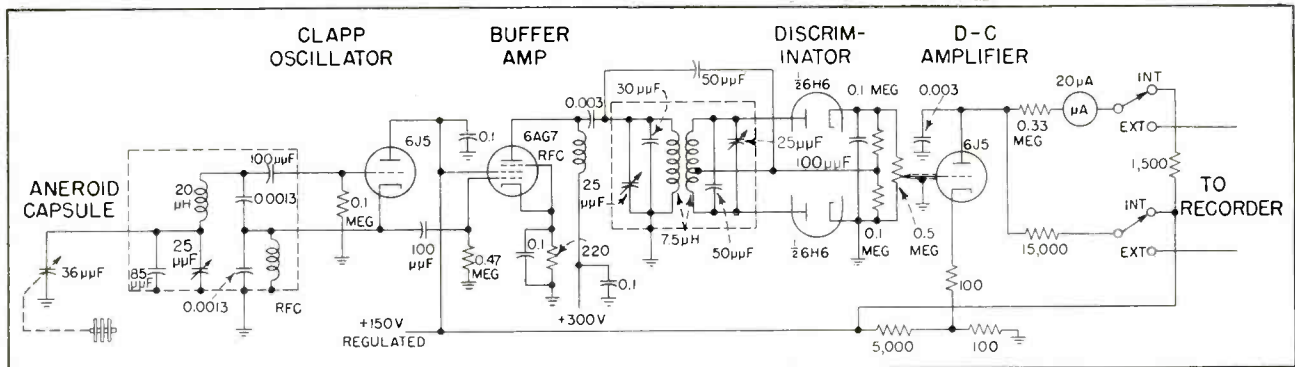

FIG. 1—Circuit of datum stabilizer. Power supply uses 5Y3GT in full-wave circuit with 310 v each side of power transformer secondary center tap, with pi filter for high voltage and VR 150 for regulated output

# DATUM STABILIZER for

To correct for altitude fluctuations due to turbulence when using airborne profile recorder, electronic stabilizer circuit operating from aneroid element senses deviations of aircraft from level flight and applies corrections automatically to radar record of terrain elevation

**I**N THE PAST, the discrepancy between the rate at which planimetric maps could be produced using airborne vertical photography, and the rate at which these maps could be transformed into topographic maps by the addition of ground elevation information obtained by field parties using spirit levels, caused the production of topographic charts to lag years behind the planimetric.

The expediency of an airborne method for obtaining ground elevation information has led to the de-

**By B. I. McCAFFREY**

*Project Engineer  
The Photographic Survey Corp., Limited  
Toronto, Canada*

velopment of a radar instrument known as an airborne profile recorder, capable of measuring terrain elevation with an accuracy of  $\pm 10$  feet.

The technique of surveying by this method employs an aircraft flying at constant-pressure altitude while a radar altimeter measures

the terrain clearance below. A permanent record of the measurements is made on a graphic millimeter using a constantly moving chart. The result is a continuous ground elevation profile along the flight path, the scale of the graph depending on the speed of the airplane.

While it is quite feasible to produce a ground radar instrument for measuring distances with great precision, difficulty arises in an airborne instrument in attempting to determine accurately the air position of the aircraft above sea level.





Lockheed Hudson equipped for elevation-profile surveying, with 4-foot parabolic reflector for radar altimeter mounted in bomb bay. New datum stabilizer circuit corrects for vertical excursions of plane in turbulent air, giving elevations accurate to within 10 feet

# Radar-Altimeter Surveying

The airplane's position with respect to sea level must be constant to make the system practicable. That is to say, the reference datum must be stable if the graphic record is to be a true profile of the ground.

## Constant-Altitude Flying

Obviously it is impossible for a pilot to maintain a perfectly constant flying altitude over long periods. Moreover, it is impossible to avoid vertical excursions due to turbulence. It therefore becomes necessary to record the vertical deviations and apply appropriate corrections. A photographic process is satisfactory for small-scale operations. Such a process necessitates the photographing of aircraft instruments at the rate of at least 30 frames per minute or about 2,000

times per hour. Following this the film must be processed, instrument readings tabulated, and corrections deduced and applied.

An automatic compensator became very expedient at an early date. This paper describes a device designed to record continuously any deviations of an aircraft from level flight and apply these corrections automatically to the radar record during the survey.

The datum stabilizer is an electronic device which produces an electrical output current proportional to a change in altitude. The resonant frequency of a high-stability oscillator is varied by a small capacitor plate driven by a three-element aneroid of the type used in aircraft instruments. A discriminator and d-c amplifier transform

the resulting frequency changes to current variations which are proportional to height modulations. Simultaneously with the radar signals and by the same recording pen, the datum stabilizer current is recorded. Then, in spite of any excursions from level flight, the ground profile along the flight track is faithfully plotted by the airborne profile recorder.

Years of observations have demonstrated the consistency of the earth's atmospheric pressure. For heights up to almost eight miles above sea level, height and pressure bear the relationship

$$h = 18,400 \log_{10} \frac{b_0}{b} (1 + atm) \quad (1)$$

where  $h$  is height in meters,  $b_0$  is atmospheric pressure at sea level,

$b$  is atmospheric pressure at height  $h$ ,  $a$  is coefficient of gas expansion and  $t_m$  is mean temperature. Humidity produces a third-order effect and is insignificant, especially in this application where relatively small differential pressures, not absolute altitudes, are being measured. Temperature could affect the equation in some regions but not over the range of height change experienced in profile recording.

### Datum Stabilizer Design

Design of the datum stabilizer circuit is straightforward and standard techniques are used, as shown in Fig. 1. The only special components are the variable capacitor and associated parts driven by the aneroid capsule.

Discriminators are reasonably flexible so far as bandwidth and response curve are concerned. The chief obstacle was considered to be the construction of a variable capacitor for the oscillator circuit to have a convenient physical size and yet give adequate frequency swing with the limited motion available from the aneroid unit. The capacitor must have small physical dimensions but must undergo measurable capacitance changes for minute displacements of the plates. In addition, the plates must impose a minimum inertia load on the aneroid in order to maintain high speed of response.

Taking the practical formula for capacitance

$$C = 0.2244 K A / D \quad (2)$$

where  $C$  is in  $\mu\text{f}$ ,  $A$  is area of plate

in sq in.,  $K$  is dielectric constant (1 for air) and  $D$  is spacing in inches, and differentiating gives an expression for the rate of change in capacitance with spacing

$$\frac{\Delta C}{\Delta D} = 0.2244 A / D^2 \mu\text{f per inch} \quad (3)$$

A solution of Eq. 3 is not difficult since some of the variables can be set by certain arbitrary conditions. The instrument was intended to operate over a range of  $\pm 175$  feet. The displacement of the aneroid for the full swing from  $-175$  to  $+175$  feet is 0.002 in. We have, then,

$$\Delta D = 0.002 \text{ in.}, A = 2.5 \text{ sq in.},$$

and therefore

$$\Delta C = 11.2 \times 10^{-4} / D^2 \mu\text{f} \quad (4)$$

Final solution was effected by plotting  $\Delta C$  versus  $D$  as in Fig. 2 and choosing a suitable value from the curve to give a measurable  $\Delta C$ .

### Accuracy Requirement

It was not considered feasible to measure a smaller change than 0.1  $\mu\text{f}$  in an airborne instrument with the accuracy required. Such a measurement would have to correspond to a change in height not greater than 10 feet, and this would produce less than 0.0006-inch displacement of the aneroid. While the instrument is accurate within one or two feet under laboratory conditions, considerations of limits closer than  $\pm 10$  feet are precluded by effects of pitch, roll and yaw. These maneuvers produce changes in wind velocity across the static head, introducing apparent errors in pressure altitude of that order.

The tremendous increase in  $C$  as

the spacing becomes of the order of 15 thousandths or less is useful where microinches are to be measured. On the other hand, along with sensitivity must be considered the danger of having the plates touch under severe vibration and acceleration conditions. Insertion of a dielectric insulation is not advisable due to temperature and humidity effects. It is not permissible to dampen the action by increasing friction on the bearings since doing so would restrain the aneroid and introduce hysteresis. Slight vibration of the aneroid is essential to overcome gravity and other acceleration effects.

A spacing of 0.02 inch was arrived at as a suitable design figure for the capacitor assembly. Experiments later showed that a closer spacing of 0.015 inch could be safely used, with the advantage of increased sensitivity. The assumed vibration factor was overly pessimistic, and closer spacing did not cause the plates to touch.

### Choice of Frequency

In choosing the operating frequency of the oscillator, physical dimensions were again important. The choice of oscillator circuit defined a high-Q coil of rather large physical size to meet stability requirements, and even at frequencies of several megacycles the dimensions proved to be rather large. However, decreasing the value of inductance to maintain small physical size would have required increasing the capacitance.

Differentiating the equation for

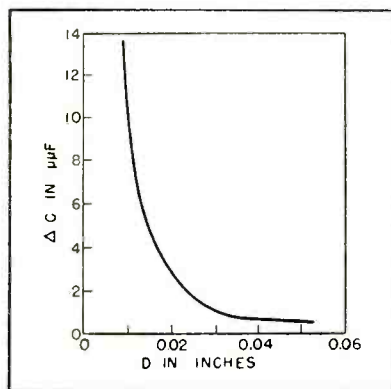

FIG. 2—Effect of spacing of aneroid capacitor plates on capacitance change produced by 350-ft change in altitude when plate area is 2.5 sq in.

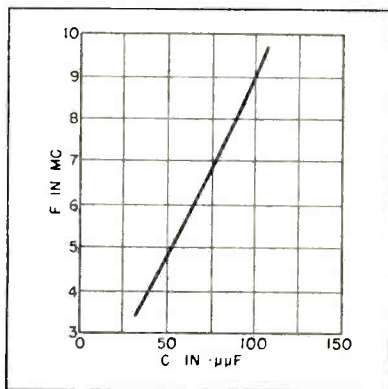

FIG. 3—Relation between aneroid capacitor value  $C$  and oscillator frequency, showing that operating frequency is not critical

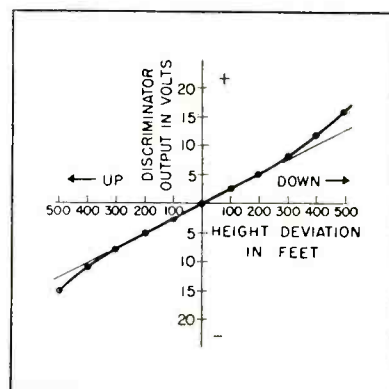

FIG. 4—Discriminator response curve, showing linearity for altitude fluctuations up to 200 feet up or down. This is ample for normal flying



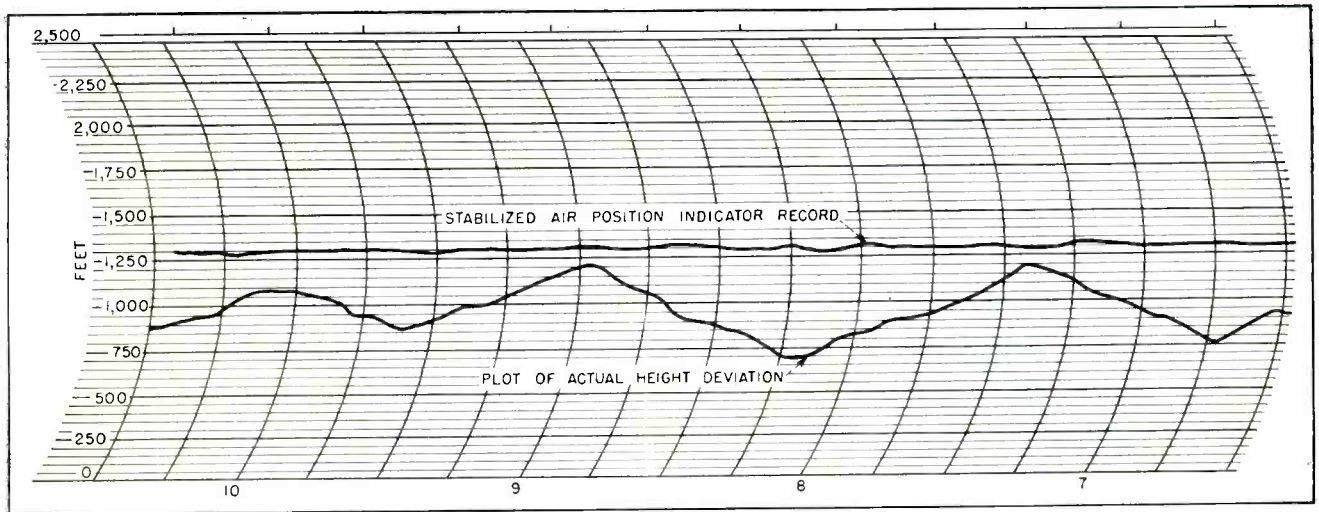

FIG. 5—Test record showing how datum stabilizer irons out altitude deviations when flying over level terrain and maneuvering the plane up and down to simulate air bumps

the frequency of a tuned circuit, with  $L$  constant, gives

$$\frac{dF}{dC} = -\frac{1}{4\pi\sqrt{LC^3}} \quad (5)$$

This shows that increasing  $C$  decreases the quantity  $dF/dC$ .

We can expect a change in capacitance of about  $3.0 \mu\mu\text{f}$  for a change in height of 350 ft (plus or minus 175 ft about a given mean). Such a capacitance variation must ultimately result in useful linear output from a discriminator. Standard f-m technique is to design a discriminator to be linear over a range of 150 kc ( $\pm 75$  kc). Using the values  $dC = 3.0 \mu\mu\text{f}$  and  $dF = 150$  kc (corresponding finally to a height change  $dh$  of 350 ft) and rearranging Eq. 5 gives

$$LC^3 = 2.53 \times 10^{-36} \quad (6)$$

This equation lends itself to graphical solution since values for  $C$  have a limited practical range. Values of  $L$  were determined for various practical values of  $C$ . Corresponding values of frequency  $F$  were then found and used to plot the frequency—capacitance curve of Fig. 3.

Apparently any frequency between 2.5 mc and 10 mc is suitable but experiments showed that, from the standpoints of  $Q$  and size, 3.5 mc was the most satisfactory choice.

### Circuit Stability

In the interests of stability it is not advisable to extract large amounts of power from the oscillator circuit, hence a buffer amplifier was found necessary between the

oscillator and discriminator. In anticipation of possible regeneration between amplifier and oscillator the frequency was doubled in the buffer stage. This served to prevent interaction, make shielding unnecessary and reduce sizes.

The discriminator is a Foster-Seeley circuit adjusted to compensate for the nonlinearities of the aneroid capacitor. Whereas the barometric pressure varies logarithmically with height, the sensitive aneroid has been constructed in such a way that height and displacement bear a straight-line relationship. However, the frequency of the oscillator changes inversely as the square root of the capacitance. In addition, the capacitance varies inversely as the plate spacing and is not symmetrical about its mean position.

By suitable adjustment of the discriminator padders a balance is achieved which produces in the indicating meter a current directly proportional to height. This indication is linear over a range of  $\pm 200$  feet, as shown in Fig. 4. By using a good grade of steatite as a former for the discriminator coil and by using high-quality padding capacitors, excellent stability was realized. In fact, after six months of field operations no adjustments were required in any of the tuned circuits.

Temperature compensation has proven unnecessary. For a rise of 30 deg from a cold start the maximum frequency drift was 20 cps. This corresponds to an error in

indicated height of less than 5 inches.

For anode supply voltage changes of  $\pm 50$  volts the corresponding error in recorded height is  $\pm 2$  inches.

### Performance

Many hours of flying have proven the worth of this instrument as a means for ironing out air bumps. Results of initial tests are shown in Fig. 5. In this case the datum stabilizer was used as a component of the airborne profile recorder system. Flying over a flat surface (Lake Ontario) so that any deviations from a straight line on the record could be assessed as errors, the aircraft was caused to execute vertical excursions of  $\pm 250$  feet from an arbitrarily chosen zero level. Simultaneously a calibrated aircraft-type altimeter was photographed at the rate of 20 times per minute. Height information recorded photographically was later plotted adjacent to the radar line on the recorder chart. Comparison of the two lines reveals that the datum stabilizer is capable of correcting for height deviations of  $\pm 200$  feet with an accuracy of  $\pm 10$  feet; and up to  $\pm 250$  feet with an accuracy of  $\pm 15$  feet.

### BIBLIOGRAPHY

- B. F. Cooper, "A Narrow Beam Recording Radar Altimeter for Topographic Survey", National Research Council ERA-138, Ottawa, October 1947.
- B. I. McCaffrey, "A Pressure-Height Corrector for Radar Altimetry", National Research Council, ERA-160, Ottawa, September 1948.

# COLOR

## PART III of a series

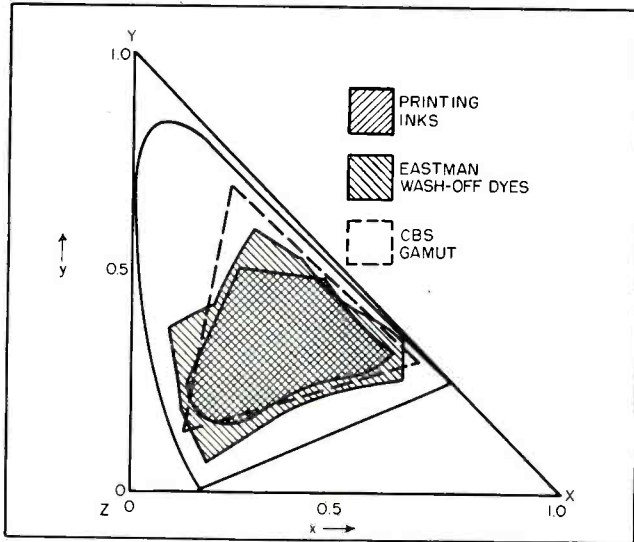

FIG. 22—Color gamuts covered by printing inks and dyes used in color photography, compared with the range covered by the CBS television primaries

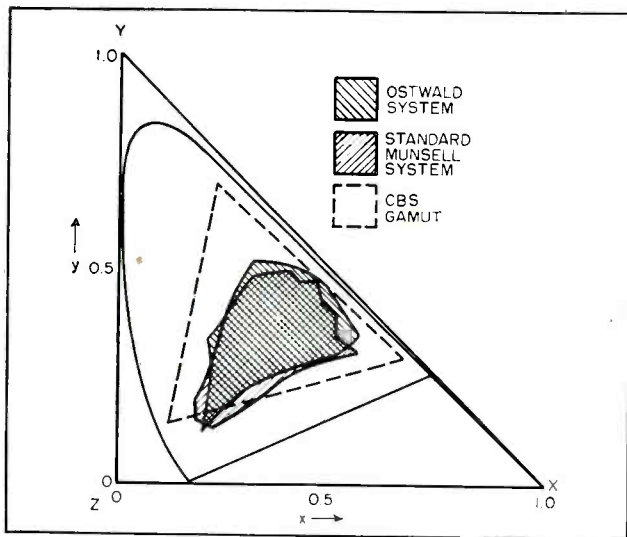

FIG. 23—Gamuts covered by the Ostwald and Munsell color-atlas cards. These permit specification of colors by direct visual comparison with printed samples

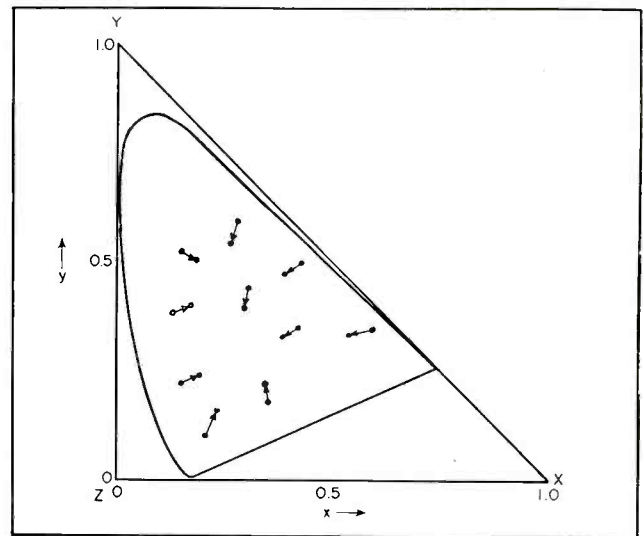

FIG. 24—Color distortion vectors. The point at the base of each vector represents the color in the object, that at the head the color in the corresponding portion of the reproduced image

By **DONALD G. FINK**  
Editor, *ELECTRONICS*

**T**HE COLOR-TELEVISION primaries cover a considerably wider gamut than that of color printing, indicating that the color rendition in a television system can be more comprehensive than that of this widely accepted method of reproduction. This is illustrated in Fig. 22, which shows the gamut of colors covered by color printing and color photography (Eastman washoff relief dyes).

Figure 23 shows the gamut on which the color cards of the Munsell and Ostwald systems are based. These are printed cards, numbered in accordance with a system of specification. This method of specification is particularly convenient for color matching outside the laboratory where quantitative measurements with a colorimeter are not feasible.

### Specification of Color Distortion

The ability of a television or other color reproduction system to recreate the hues and saturations of an object can be represented

by pairs of points on the  $x$ - $y$  diagram. One point represents the color coordinates of a particular portion of the televised object, the other the coordinates of the same portion of the reproduced image. A line connecting the two points, with an arrow head attached to the image point, indicates the color distortion introduced by the system. Strictly speaking this indicates only the chromaticity distortion, since no indication is given of the brightness distortion which may also be present. The brightness distortion is indicated by the over-all transfer characteristic.

This material is taken from the forthcoming second edition of "Principles of Television Engineering" and is reproduced by permission of the McGraw-Hill Book Co., Inc.



# FUNDAMENTALS for Television Engineers

In this concluding installment are treated the specification of color distortion in a tv system and its relation to brightness distortion, the color standards specified in the "reference receiver", congruence requirements in the primary images, and the color-transfer process

A systematic comparison of the coordinates of different colored objects and the corresponding image color coordinates provides a number of color-distortion vectors at various positions on the chromaticity diagram. An example is shown in Fig. 24. Unfortunately, the magnitude and direction of these vectors, while providing a numerical index of color distortion, do not give an accurate indication of the subjective effect of the color distortion. This is true because the eye is much more tolerant of a color mismatch in certain regions of the diagram than in others.

A comprehensive study of this effect has been made by Wright, with the result shown in Fig. 25. This is the  $x-y$  diagram, covered by a series of lines within the area enclosed by the spectral locus, the length of each line being three times as great as the just perceptible visual color difference, when the field of view is 2 degrees. In the regions where the line segments are short (as at the blue end of the spectral locus) the eye can detect slight differences in the hue or saturation of a color.

A transformation of the  $x-y$  diagram to other coordinates ( $x''$  and  $y''$ ) has been proposed by Breckenridge and Schaub which gives a more nearly uniform distribution of color-distortion vectors. This is shown in Fig. 26, the data being replotted from Fig. 25.

## Grays and Gray Mixtures

A class of subjective color impressions not previously discussed comprises the grays and gray mix-

tures, including browns, olive greens and the like. Colors do not appear grayish unless they are viewed in the presence of colors of greater luminosity.

A simple experiment will verify this fact. Consider two identical sheets of white paper, viewed simultaneously, one illuminated by an intense beam of white light, the second by a substantially weaker beam of the same color. The first sheet then appears white, the second gray. If the beams are interchanged, the first sheet appears gray, the second white. If pieces of orange paper are substituted, the piece receiving the weaker illumination appears brown. Finally, if the stronger beam is turned off, as the pupil of the eye adjusts itself to the weaker illumination, the brown color changes to orange.

It thus appears that rendition of grays and gray mixtures depends on the scale of luminosities of the various colors in a scene. Accurate reproduction of such colors requires, therefore, that the scale of luminosities be transmitted accurately, that is, that brightness distortion be kept to a minimum. It is on this account, among others, that the transfer characteristic applicable to the reproduction of each primary color (object brightness versus image brightness plotted on log-log coordinates) should be a straight line of unity slope.

The distortionless condition must apply equally to the rendition of each of the primary colors. Stated differently, the brightness of each primary color (say red) in the image, expressed in foot-lamberts,

must be directly proportional to the brightness of the corresponding (red) color in the camera. When this condition obtains, the values of brightness of the three primaries in the image bear a fixed relationship to each other throughout the scale of brightness, and balance between the primaries is maintained, whether the absolute brightness of the image is equal to, greater, or less than that of the object.

The statement that the transmission of each primary color must be wholly free of brightness distortion is a technical criterion, not an artistic one. It may suit the convenience of the program director to alter the appearance of the image with respect to the object to create a particular effect. Such alterations may often be obtained more quickly and at less expense by adjusting a transfer control ("gamma") amplifier or the d-c level than by changing the lighting, sets and costuming in the studio. But the program director may also call for, and in the majority of cases may require, accurate rendition in the technical sense. Accordingly, the television system should be capable of distortionless transmission, and the settings of the transfer gradient and d-c level which correspond to the distortionless condition should be identified as references from which artistic departures can be made.

A convenient method of testing a system for brightness distortion and color balance is to transmit a scale of grays (photographic step wedge). This is a card or trans-

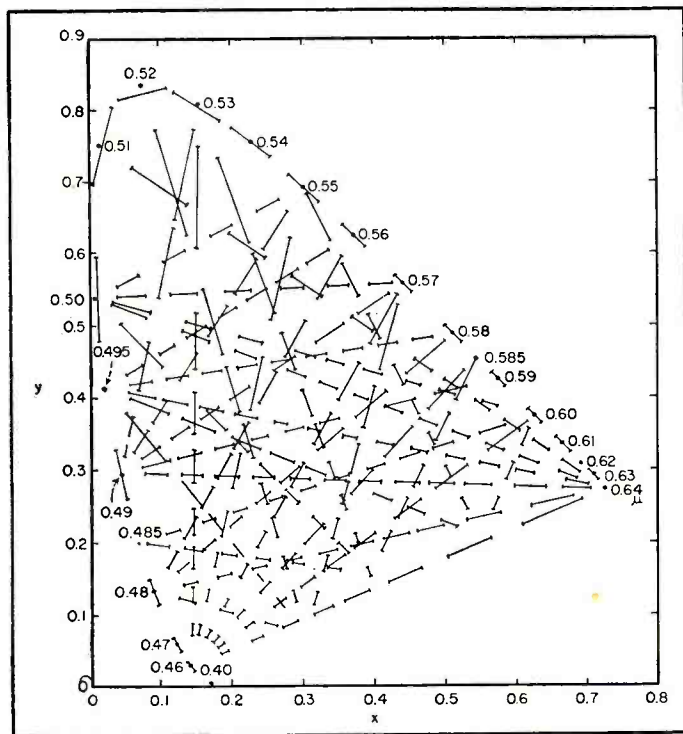

FIG. 25—Relative perceptibility of color distortion in different regions of the chromaticity diagram, after Wright. The length of each line is about three times the just-perceptible difference in chromaticity

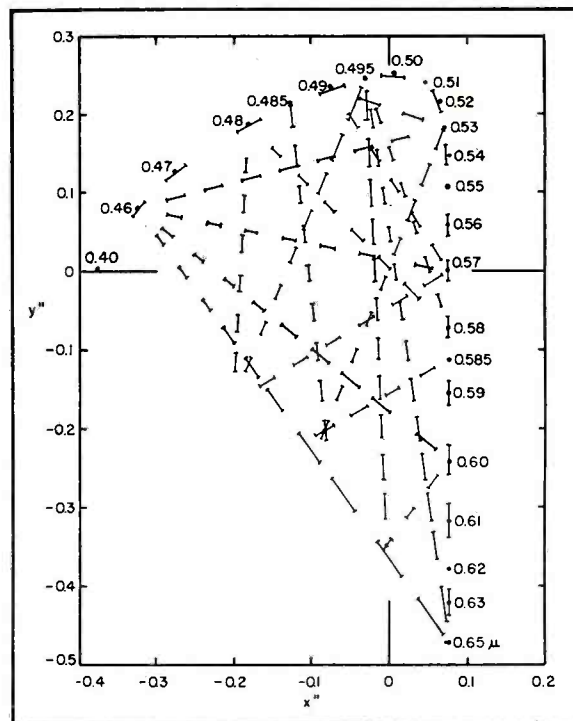

FIG. 26—The Breckenridge-Schraub diagram, a transformation of Fig. 25 in which the lines representing equally perceptible color differences are of approximately equal length

parency having patches of neutral gray whose photographic density (logarithm of transmission or reflectance) increases in uniform steps from black to white. The gray scale should be illuminated with a white light source which has substantially no hue (saturation zero).

When such a card is viewed as the object, inspection or measurement of the brightness and hue (if any) of the corresponding patches in the image will reveal the presence of brightness distortion and color imbalance. If all steps in the scale appear as neutral tones of gray, the color balance is correct. This result implies that the shape of the transfer characteristic in the transmission of each primary is the same, but does not necessarily indicate that brightness distortion is absent. The latter condition is satisfied only if the brightnesses of the successive steps in the image of the scale of grays are in logarithmic progression, as may be determined by measurement with a photometer.

### Color Standards and the Reference Receiver

The color standards for television are set up in terms of a hypothet-

ical reference receiver, whose characteristics are stated for the guidance of receiver and transmitter designers. The characteristics required to specify the color performance of the reference receiver are (see Fig. 27): (1) the trichromatic coefficients ( $x$  and  $y$  values) describing the primary colors produced by the receiver; (2) the trichromatic coefficients of a reference white light ("characteristic white"); (3) the gain, from the antenna terminals to the picture tube or tubes, applicable to the respective primary colors (relative voltage gain expressed as ratios among the primaries, not absolute gain); and (4) the brightness transfer characteristics applicable to the primary colors.

The first standard indicates not only the gamut of the colors which may be reproduced by the receiver, but also indicates (through the value of the  $y$  coordinate of each primary) the relative luminosity of the primary colors. The third standard specifies the relative amount of voltage, at the antenna terminals of the receiver, needed to actuate each primary color so as to reproduce the white light specified in the second standard. The fourth standard indicates the brightness

distortion present in the receiver.

It is not expected that commercial receivers will necessarily possess the characteristics of the standard reference receiver, since it may prove uneconomical to meet brightness distortion specifications, or to reproduce precisely a standard characteristic white.

### Essential Aspects of a Color Television Image

We proceed now to consider a composite television image (in full color) and to analyze its essential aspects. To the four basic aspects of a black-and-white image (gross structure, fine structure, continuity, and tonal gradation) must be added two others, the *chromaticity values* and *congruence*. The chromaticity values (hues and saturations) in an image, taken together with the tonal gradation (brightnesses), specify the colors reproduced in the image.

The congruence characteristic refers to the fact that color television images are superpositions of three images in the primary colors. Congruence, "the condition of fitting exactly when superimposed", exists when each primary color image is precisely positioned with respect to the others. There



are a variety of faults exhibited by color television images in respect to congruence, of which faulty register, color break-up and color fringing are the most prominent.

So far as the individual primary-color images are concerned, each can be described in terms of its gross structure, fine structure, continuity and tonal values, as if it were a black-and-white image.

When the primary images are superimposed to form the composite color image, the color-image characteristics must be re-examined. If the gross structure of each primary-color image is not identical, and if it does not so remain continuously, errors of congruence occur. A similar requirement exists with respect to fine structure. Finally, the continuity (motional continuity and flicker) of the composite image may differ markedly from that of the primary images, particularly if the primary images are presented in time sequence, as they are in the sequential color systems. In particular, lack of continuity in the full-color image can produce apparent errors of congruence, if one image differs in shape from the next successively scanned or if the successively scanned images do not occupy the same position in the retina of the eye.

The signal representing an image in a primary color is generated, transmitted and reproduced by the basic process illustrated in Fig. 28. The object is viewed by a camera fitted with a color filter, the filter allowing light to pass in a limited region of the visible spectrum, say red light. The sensitive plate of the camera has response to light of this color and hence the camera generates a video signal corresponding to the red light in the object. This video signal is transmitted, as faithfully and as free from disturbances as possible, to a picture tube. The tube produces red light  $L$ , which bears a known relationship to the red light  $L_r$  on the sensitive plate of the camera tube. The image so reproduced is the red primary-color image.

In a similar manner, another chain of equipment (the same equipment in the sequential systems) can reproduce an image in blue

light, representing the blue light in the object, and a third chain can reproduce an image in green light. If care is taken to see that the images in the three cameras have precisely the same shape and precisely the same orientation with respect to the respective camera scanning patterns, and if the scanning patterns in the cameras are in themselves precisely congruent, it is possible to reproduce three primary color images having the same size and shape.

Finally, if the over-all brightness transfer characteristics of the three chains are identical and distortionless, the three primary-color images will display corresponding scales of brightness and identical black levels. Then, and only then, the three images may be superimposed (either simultaneously or interspersed in time) to form a full-color composite image having proper color values, correct gross structure and fine structure, and freedom from congruence defects. If the primary images are free of continuity errors, that is, if the field scanning rate of the primary images is high enough, the combined image will also be free of continuity errors, and the resulting

image may be said to be a satisfactory full-color image of the object.

### The Color-Transfer Process

Faithful color reproduction involves a color match between the light entering the camera and the light emerging from the receiver screen. If the trichromatic coefficients  $x$  and  $y$  of the entering light are the same as those of the emerging light, within the tolerances indicated in Fig. 25 and 26, the color match is satisfactory. We now relate this over-all color-matching requirement to the characteristics of the transducers in the television system. We are concerned, in other words, with the *color-transfer process*.

The color transfer process involves the following seven items of the system (see Fig. 28): (1) the *light source*, which illuminates (2) the *object* before the camera, (3) the "taking filter" through which the light passes from the object to the camera tube, (4) the *sensitive plate* of the camera tube, (5) the *transmission system* which connects the camera and the picture tube, (6) the *phosphor* which generates the light on the receiving

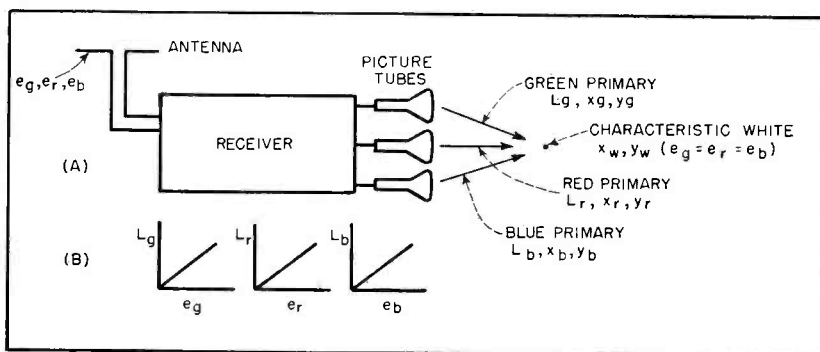

FIG. 27—Block diagram of the reference receiver (A) of a color system, showing the standard trichromatic coefficients, voltages, luminosities and transfer characteristics (B) necessary to specify the performance of the system

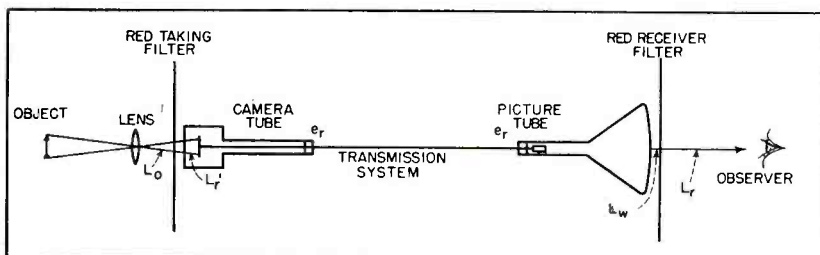

FIG. 28—Essential elements of the color system on which the color-transfer process depends. Correct color transfer implies a definite relationship between the light entering the camera tube and that entering the observer's eye

screen and (7) the *receiver filter*, if one is used in conjunction with the phosphor.

Each of these items, except (5), can be described by a spectroradiometric curve which represents the relative amount of radiant power generated, reflected, transmitted or converted as a function of the wavelength.

Figure 29 shows typical examples of the six spectral curves in a typical chain of equipment designed to reproduce the green primary image. The first four curves, describing the light source, televised object, filter, and camera tube are multiplied together, ordinate by ordinate, to determine the magnitude of the halftone (video) signal generated during the scanning of the object. Of these, the product of the taking filter curve and the camera spectral sensitivity curve, for a particular primary, is known as the *taking characteristic* for that primary.

The amplitude of the video signal varies not only as the intensity of the light source changes (its color remaining unchanged), but also as the color of the light source of the object changes. It is evidently essential that the receiver be capable of following independently both types of change (brightness and chromaticity), although both are represented by one quantity.

The distinction between brightness changes and chromaticity changes can be made only if there is a particular relationship between the spectral curves of taking filter and camera tube at the transmitter on the one hand, and the spectral curves of the phosphor and receiver filter on the other. This "particular relationship" between the taking and reproducing characteristics is computed in terms of (1) the trichromatic coefficients describing the primary colors and characteristic white of the reference receiver and (2) the relative antenna voltage amplitudes required to actuate each primary so as to produce the characteristic white. The complete computation is so complicated as to be beyond the scope of the present treatment, but the general approach is as follows:

The characteristic white is produced by contributions from all

three primaries, that is, the *x*-coordinate of the characteristic white may be considered as being created by the sum of the *x*-coordinates of the primaries, multiplied by constants descriptive of the amount of each primary present. We have then the following set of equations:

$$k_r x_r + k_g x_g + k_b x_b = k_w x_w \quad (15)$$

$$k_r y_r + k_g y_g + k_b y_b = k_w y_w \quad (16)$$

$$k_r z_r + k_g z_g + k_b z_b = k_w z_w \quad (17)$$

where the subscripts *r*, *g* and *b* refer to the coefficients of the primaries and *w* to the characteristic white. These equations may be solved simultaneously to obtain *k<sub>r</sub>*, *k<sub>g</sub>* and *k<sub>b</sub>* in terms of the *x* and *y* coordinates of the primaries and a unit amount of the characteristic white (*k<sub>w</sub>* = 1/*y<sub>w</sub>*). If the transmission system is linear (free from brightness distortion), and if it is taken as a standard condition that equal amounts of voltage applied to the receiver to actuate each primary will create the characteristic white, it is possible to convert the *k<sub>r</sub>*, *k<sub>g</sub>* and *k<sub>b</sub>* values into corresponding amounts of video signal, required to be generated at the camera output, when the char-

acteristic white is present in the object.

When this computation is carried out it is found that negative values of voltage are required in certain regions of the taking characteristics (product of taking filter curve and camera sensitivity curve for the respective primaries). Consider for example the receiver primaries given in Fig. 30A. These are produced by the white light of illuminant *C* in conjunction with Wratten color filters numbered 25 (red), 58 (green) and 47 (blue). If the characteristic white is taken as illuminant *C* (Fig. 21) and the above-described computation is performed it is found that the required transmitter output, in volts per lumen, during the scanning of the red primary is

$$S_r = K (2.284 \bar{x} - 0.796 \bar{y} - 0.375 \bar{z}) \quad (18)$$

and similarly for the green and blue signals

$$S_g = K (-0.808 \bar{x} + 1.721 \bar{y} + 0.0597 \bar{z}) \quad (19)$$

$$S_b = K (0.045 \bar{x} - 0.096 \bar{y} + 0.891 \bar{z}) \quad (20)$$

These equations uniquely determine the required taking characteristics. The red taking characteristic is formed by adding the distribution coefficient curves of Fig. 17 (Part II), each multiplied by the factor given in Eq. 18 and similarly for the green and blue taking characteristics. The resulting taking characteristics are shown in Fig. 30B.

It will be noted that negative values of output voltage are required at certain wavelengths in each of these taking characteristics, and that the red curve has two peaks or "lobes", a major lobe at about 600 millimicrons and a minor lobe at 440 millimicrons. Unless the negative values of voltage are produced, and unless the minor lobe is present in the red taking characteristic, it is not possible to reproduce all the colors in the gamut bounded by the receiver primaries.

It is customary to omit transmission of the negative values of voltage and the minor lobes. At first glance it might appear that the negative values correspond to negative values of light and hence are

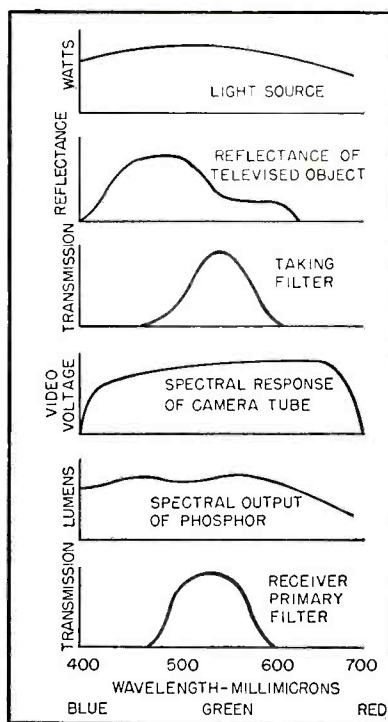
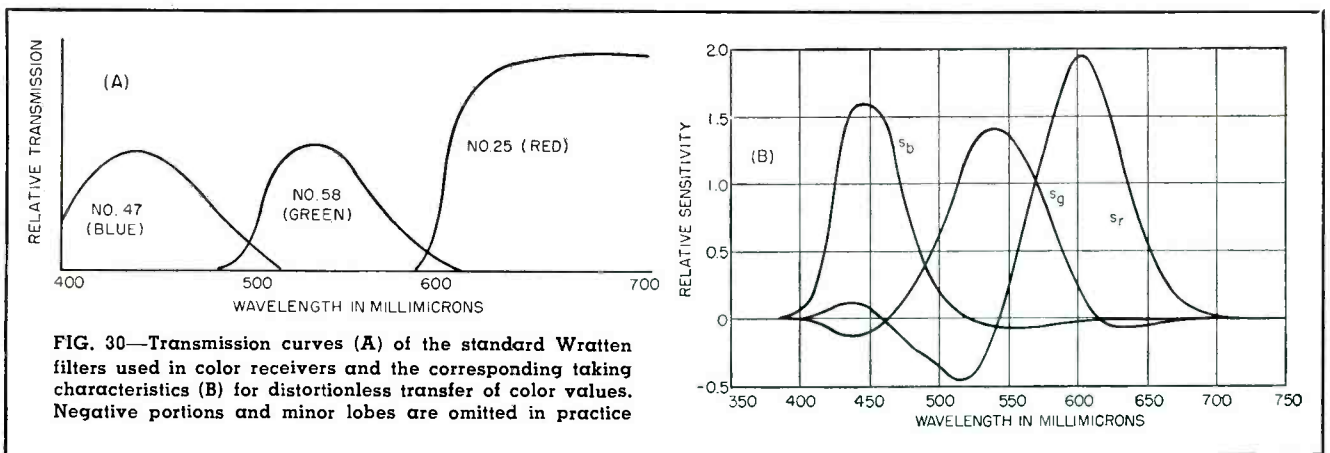

FIG. 29—The six spectroradiometric curves on which the color-transfer process depends. The product of the taking filter curve and camera response curve is known as the "taking characteristic"





physically unrealizable in any case. However, in color photography a technique known as "masking" has been developed in which a negative image is combined with a positive image in printing, thus effectively introducing negative light in the final result. A similar technique may be used in color television, in which a negative image, formed from the positive image by reversing polarity, is combined with the positive image before transmission. This technique is feasible in the simultaneous and dot-sequential systems, but not in the field-sequential system (unless frame-storage devices are used).

Even when the negative and minor-lobe portions of the taking characteristics are disregarded, it is possible to find taking filters which, in conjunction with the spectral sensitivity curve of the camera tube, match the required taking characteristics sufficiently closely to limit the magnitudes of the color distortion vectors to those of the size shown in Fig. 25.

In summary we note the following general requirements which must be met to produce a satisfactory color-transfer from object to image: (1) the camera must have no response outside the visible region of the spectrum; (2) the taking characteristic applicable to each primary color must bear a definite relationship to the primaries, the characteristic white, and the relative gain proportion of the reference receiver. The ideal taking characteristics involve negative values and minor lobes which may be safely omitted in practical applications; (3) the relative gains

applicable to the three primaries, from camera to picture tube, must remain in fixed proportion irrespective of signal level; and (4) the brightness transfer must be distortionless.

#### Resolution Requirements

In the early development of color television systems it was commonly supposed that the fine structure of each primary image should be the same. The effective resolution of the composite image would then be equal to that of each primary image, provided that the primary images were perfectly superimposed. Physiological studies of vision had proved at a much earlier date that the ability of the eye to distinguish fine detail varies markedly with color, under usual viewing conditions.

According to measurements reported in 1911 by Luckiesh, the visual acuity at a brightness of 4 foot-lamberts is highest for yellow and white light, about 90 percent as great for red and blue-green, and 75 percent as great for violet. Later tests by Baldwin showed that the acuity increases by a factor of about two when the brightness is increased from 1 to 10 foot-lamberts. The luminosity of the blue (violet) image in color television does not exceed ten percent of the green primary (the  $y$ -coordinates, representing luminosity, of primaries  $C$  for example, are in the ratio  $0.6885/0.0412=16.7$  for the green and blue respectively). It thus appears that the acuity for the blue image is not greater than 35 percent of that for the green. Similar experimental studies lead

to the conclusion that the visual acuity for the red image is not greater than 75 percent of that for the green image.

It follows that the resolution of the three primary images need not be the same. In fact, if the resolution of the blue image is equal to that of the green, a large part of the resolution provided in the blue image is wasted, since the eye cannot perceive it at the limiting viewing distance set by the resolution of the green image. This fact has been abundantly proved in tests of color television systems.

If the color television system is such that the resolution of the primary images can be adjusted until each satisfies the corresponding value of visual acuity, and if the lower resolution of the red and blue images can be realized as a reduction in bandwidth, it follows that an image of greater resolution can be transmitted over a given channel, with a given excellence of continuity, than can be transmitted by a system in which the resolutions of all primary images are the same. This ability to economize on bandwidth is not possessed by all systems to the same degree. In particular the simultaneous system and the dot-sequential system can make use of this technique, whereas the field-sequential and line-sequential systems cannot (that is, not without the use of image-storage devices not now available).

Permission to reproduce certain diagrams from "Color Television and Colorimetry" by W. T. Winttingham of the Bell Telephone Laboratories is gratefully acknowledged.

# AUTOMATIC

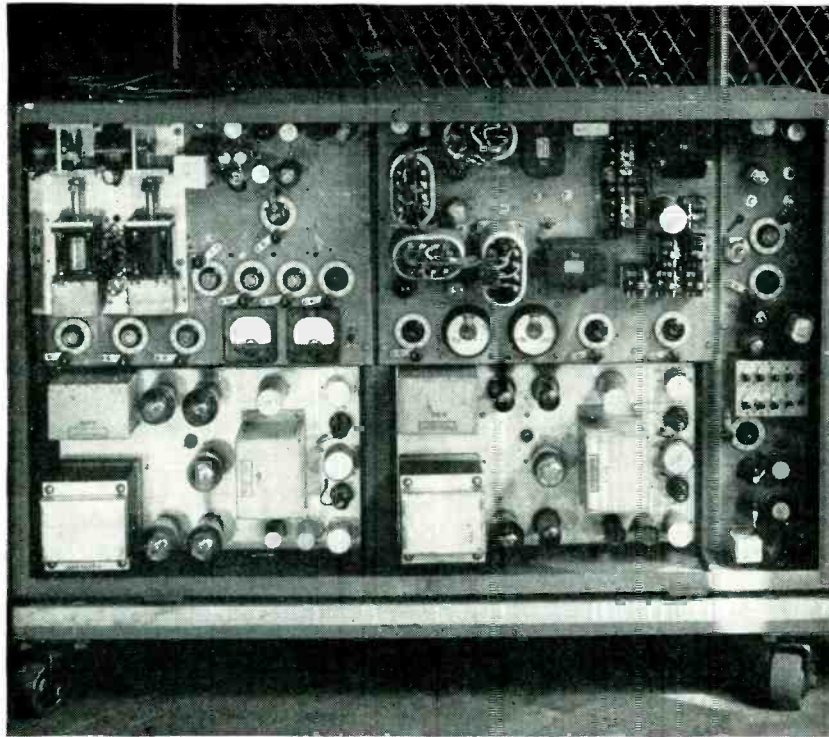

Production-line test equipment using a self-balancing Owens bridge, at top left, which contains motor-driven standards

By **J. F. GRAHAM**

*Design Engineer  
Test Set Design and Methods  
Northern Electric Co., Ltd.  
Montreal, Canada*

system can materially extend this range.

## Phase Discriminator

Detectors for automatic a-c bridges almost universally depend on the principle of phase discrimination. The circuit of Fig. 1 shows a simple phase discriminator. A d-c output voltage  $E_o$  is obtained which is a measure of the phase difference between  $e$  and  $e_R$ . The voltages supplied to the rectifiers are  $e + e_R$  and  $e - e_R$ . The rectified voltages across the load resistances are proportional to the amplitudes of these two voltages. The d-c difference is  $E_o$ .

It can be shown from the vector diagram that

$$E_o = K \cdot e_R (e \cos \theta) \quad (1)$$

where  $\theta$  is the phase angle between  $e$  and  $e_R$ . Thus if  $e_R$  is constant,  $E_o$  is directly dependent only on the component of  $e$  in the direction of  $e_R$ . In practice, this relationship is somewhat modified by rectifier characteristics and other factors.

The conditions for proper operation of the phase discriminator must usually be set up by shifting the phase of one of the input voltages. Figure 2 shows a simple phase shifter. This circuit has the virtue of allowing easy shifting of phase up to 180 degrees without

**P**RODUCTION EQUIPMENT performing continuity, insulation breakdown, d-c resistance and simple a-c impedance tests is readily made automatic. But in the measurement of inductance, capacitance and effective resistance, manually operated a-c bridges are still widely employed in spite of costly operator time.

Partly or fully automatic bridges have been developed which perform such tests with accuracy comparable to that of manual bridges.

In the design of any measuring device there are two general approaches. In one method, a quantity is measured accurately and figures are presented to the operator. An example is a bridge with a calibrated indicator. In the second method, no effort is made to determine actual magnitude. It is simply determined as being less than a set upper limit, and greater than a set lower limit, or within limits.

Most industrial requirements are stated in the form of limits. (For

example, inductance of a particular coil must not exceed 0.51 henry and must not be less than 0.50 henry). This would seem to make the limit-type of measurement the solution to most problems of industrial testing. However, the necessity of measuring reactance or effective resistance introduces certain limitations. If the inductance of a coil is to be measured on a limit bridge with one-percent accuracy, then the effective resistance of the coil must lie within a certain range. Usually, the wider this range can be made the more dependable the test will be. Proper attention to the design of the limit-bridge-plus-detector

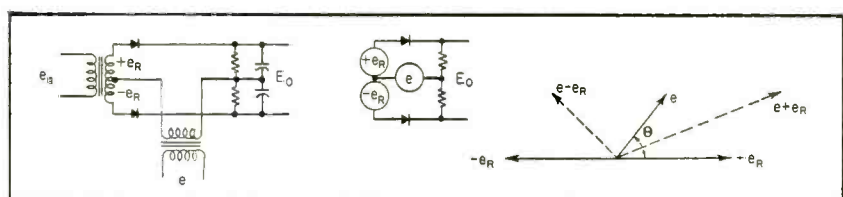

FIG. 1—Simple phase discriminator and vector relationship of voltages involved



# A-C BRIDGES

Design of bridge and detector circuits used in production lines for automatic measurement of inductance, capacitance, and effective resistance. To cut down computations required, a graphical method of determining phase and amplitude of bridge unbalance voltage is included

changing signal amplitude. It is, however, frequency sensitive.

## Typical System

Figure 3 shows a typical arrangement of various elementary circuits. Output  $E_o$  is a measure of bridge unbalance and can be made to depend chiefly on signals of preferred phase, discriminating against those of unfavorable phase.

Figure 4 is an idealized version of a bridge output-voltage chart. The chart is drawn relative to the bridge input voltage  $E = A'C'$ . Let the potential of the bridge corner  $B$  be represented by the point  $B'$  (more correctly, by the vector  $A'B'$ ). Since the ratio arms, which are not necessarily resistive, are considered here to be fixed, then the point  $B'$  is fixed.

The potential of the bridge corner  $D$ , however, depends on the value of the unknown, the settings of the standards, and the supply frequency. Let the standard settings and the frequency be held constant. Then the potential of point  $D$  can be located by means of the grid of labelled lines. In this example, resistance  $R$  of the test is allowed to vary from 100 to 700 ohms. Inductance  $L$  of the test is allowed to vary from 0.1 to 0.7 henry. Unbalance voltage  $e$  is the

difference between the potentials of corners  $B$  and  $D$ . In this case, balance is achieved when  $R = 400$  ohms and  $L = 0.4$  henry. Vector  $e$ ,

drawn on the chart, is the result of  $R$  becoming 300 ohms and  $L$  becoming 0.1 henry.

Assume a desire to measure  $R$  with minimum dependence on  $L$ . A voltage is taken from supply  $E$  and revolved through an angle  $\psi$  to get  $e_R$ . Then by Eq. 1, voltages of this phase will have maximum effect on  $E_o$ , and those at 90 degrees will have zero effect.

Furthermore, the only component of  $e$  that registers on  $E_o$  is the component  $B'N$ . Now,  $B'N$  is of exactly the same magnitude as the unbalance voltage which would result from the unbalance of the resistance alone. Thus variations of inductance have zero effect on the output voltage  $E_o$ , as required. A positive  $E_o$  means that  $R$  is greater than 400 ohms; a negative  $E_o$  means that  $R$  is less than 400 ohms. A voltmeter reading  $E_o$  could be calibrated linearly in ohms resistance unbalance.

A separate discriminator and phase shifter could be used in the same way to measure inductance (reference voltage  $e'_R$ ).

Such a system would lend itself ideally to an automatic limit test set, say rejecting all product with resistance above 400 ohms, and/or inductance below 0.4 henry. Unfortunately, the rectangular character of the voltage chart of Fig. 4 can seldom be approximated for practical bridges.

## Behavior of Typical Bridges

Practical bridge voltage charts appear here in two forms, the grid type of Fig. 5, and the calibrated-arc type of Fig. 6. Figure 5 is read in the same manner as the chart of

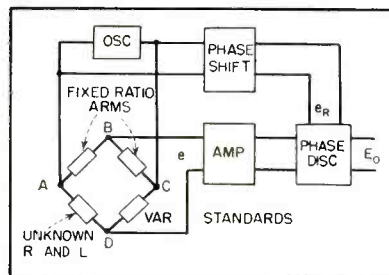

FIG. 3—Arrangement of basic elements for obtaining data of Fig. 4

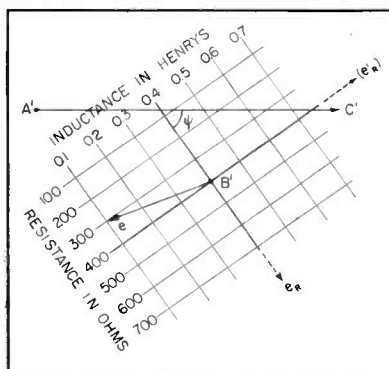

FIG. 4—Ideal bridge output voltage

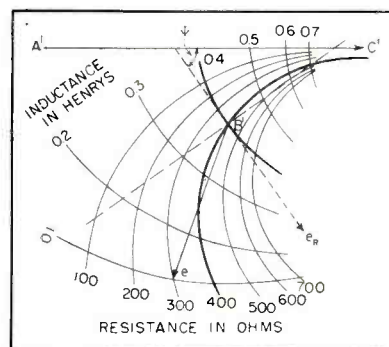

FIG. 5—Grid-type of bridge-voltage chart, with arcs replacing straight lines

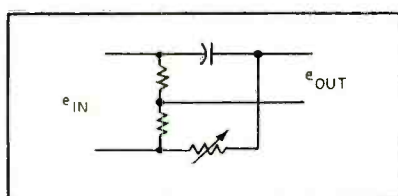

FIG. 2—Capacitor and resistor form simple phase shifter

Fig. 4, with arcs replacing the straight lines.

Figure 6 is read in the following manner: each end of the unbalance-voltage vector  $e$  is located by a point on one of the calibrated arcs. The example shown is for  $L = 0.2$  henry,  $R = 600$  ohms.

For measurement of  $R$ , with a minimum of error caused by variations of  $L$ , let  $e_R$  be the same phase as the line tangent to the balance-arc  $L = 0.4$  as drawn in Fig. 5. The unbalance voltage  $e$  is shown for the same case as in Fig. 4,  $L = 0.1$  henry and  $R = 300$  ohms. But this time the component of  $e$  in phase with  $e_R$  is positive in direction. Hence  $E_o$  is positive, erroneously indicating that  $R$  is greater than 400 ohms.

The correct negative polarity is not assumed by  $E_o$  until the inductance is increased to about 0.3 henry. Voltage  $E_o$ , which should be an accurate index of the constant resistance unbalance, varies widely as the inductance changes, and it even assumes the wrong polarity for large deviations of inductance.

Assume the precision of the test must be  $\pm 1$  percent. Product having a resistance of 404 ohms would be accepted were  $L$  to increase slightly from 0.4 henry; or resistances of 396 ohms would be rejected were  $L$  to decrease slightly from 0.4 henry. Inductive unbalance here can result in two undesirable actions: rejection of good product and acceptance of defects.

An alternative setting of  $e_R$  suggests itself: at a phase angle such that  $e_R$  is normal to the balance-arc  $R = 400$  ohms. In such a case, in-

ductive unbalance could not lead to the acceptance of faulty product. But it could lead to rejection for resistance under 400 ohms, an equally unsatisfactory condition.

A judicious choice of the phase of  $e_R$  is desirable. The main factors influencing this choice are the precision demanded in measurement of  $R$ , the expected deviation of  $L$  in normal production runs, and the relation of one variable to the other. For instance, other things being equal,  $R$  could reasonably be expected to be larger when  $L$  is larger.

A helpful step would be redesign of the bridge to have more favorable characteristics. In this example, the  $R = \text{constant}$  arcs should be made flat enough that the phase angle of  $e_R$  is not critical. However, this special bridge design might lead to unfavorable characteristics in the measurement of  $L$ . Failing an acceptable compromise, the easiest solution is to switch the product into another bridge designed specifically for the measurement of  $L$ .

### Self-Balancing Considerations

The preceding discussion applies primarily to a limit-type measurement. However, suppose the roles of the standard and unknown elements in the bridge are reversed. An impedance is to be measured and the grid chart of Fig. 5 applies to the settings of the variable bridge standards. Further, let each standard be driven by a servomotor whose direction of rotation depends on the polarity of  $E_o$  in its own particular channel, and which tends to reduce the unbalance, as in Fig. 7.

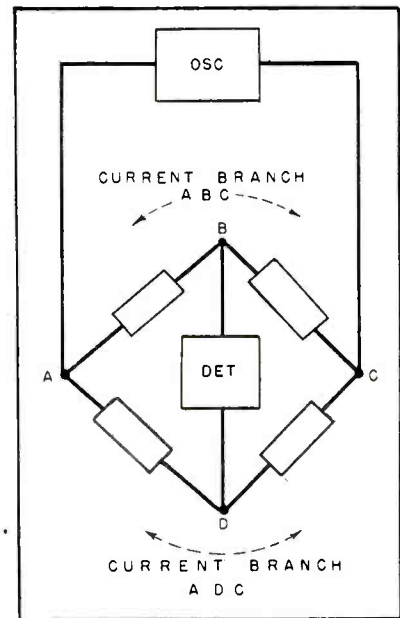

FIG. 8—Current branches set up by high-impedance detector

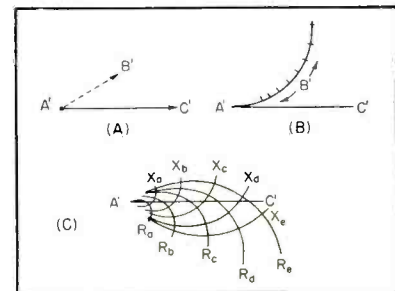

FIG. 9—Charts of corner potentials

The reference voltage is  $E$  and the phase shifting is done, as is generally preferable, in the bridge signal circuits. (The net operation of the system remains identical to that with the shifting done in the reference voltage circuit). For an average bridge,  $e_{SL}$  and  $e_{SR}$  are set about 90 degrees different in phase.

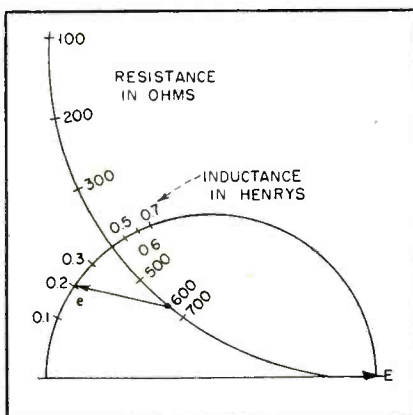

FIG. 6—Calibrated-arc chart for another bridge circuit

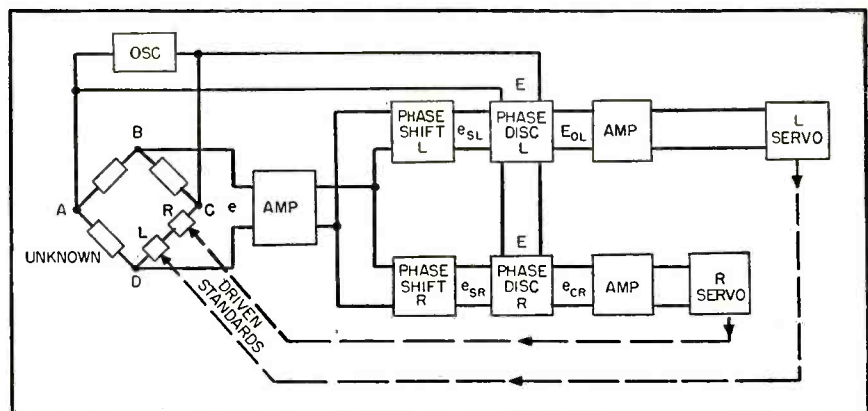

FIG. 7—Self-balancing bridge arrangement in which servomotors drive the variable standards



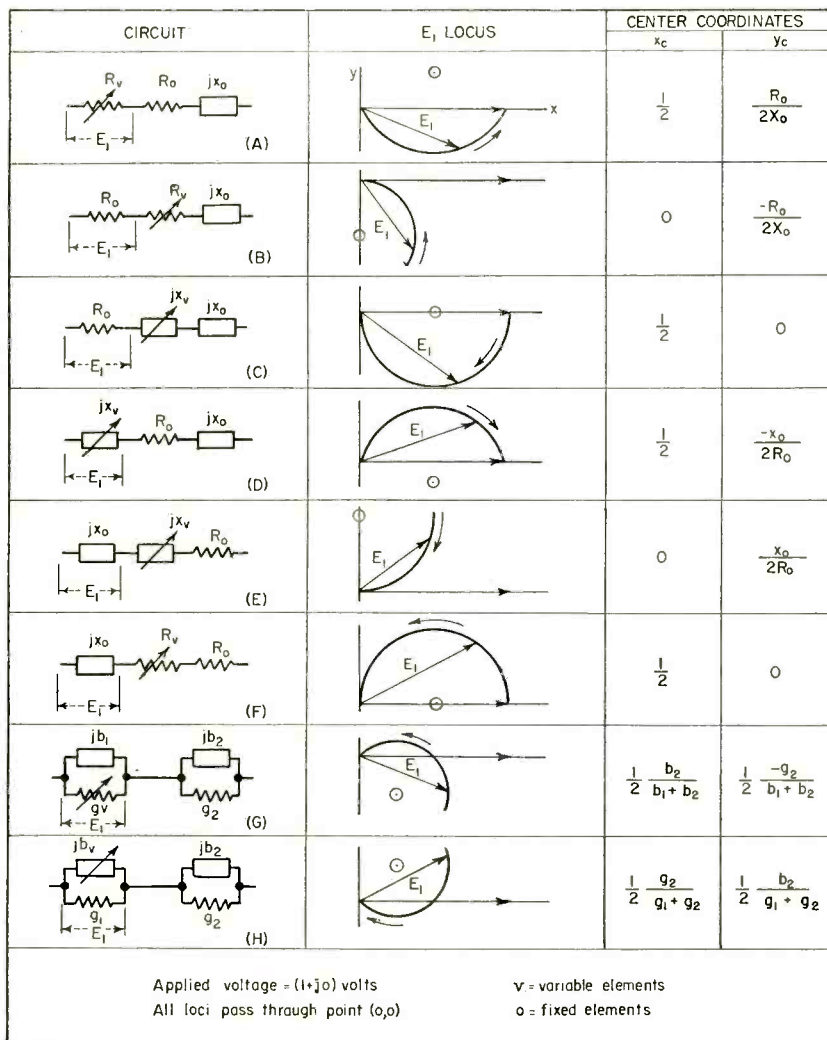

FIG. 10—In cases (B) and (C) if  $E_1$  is across  $R_a$ , where  $R_o = R_a + R_b$ , multiply both center coordinates by  $R_a/R_o$ .

If  $E_1$  is across  $X_a$  in (E) and (F), where  $X_o = X_a + X_b$ , multiply both center coordinates by  $X_a/X_o$ .

In (G) and (H)  $b$  is susceptance and  $g$  is conductance

In general, both servomotors will run in the correct direction for a prompt balance. It is possible, however, for one motor to run in the wrong direction temporarily. But final balance is nevertheless achieved. To illustrate, in Fig. 5, the unbalance voltage  $e$  for  $R = 300$  ohms,  $L = 0.1$  henry, has a positive component along  $e_r$ . But it should have a negative one, because  $R$  is less than 400 ohms, and since the servo in Fig. 7 is connected to decrease resistance for positive  $E_o$ . The variable resistance standard would seemingly be driven to its lower limit and stay there. But meanwhile, the  $L$  servo has steadily been reducing the inductance unbalance. As this happens, the  $R$  servo slows down, stops, and then

begins to rotate in the right direction. Thus balance is finally obtained.

As both servos approach balance, they become progressively more independent of each other, due to the phase discrimination in each channel. This works against interactive hunting, which, however, is not a great problem at moderate sensitivities. Thus the self-balancing bridge always reaches a true null if the unknown impedance is within the range of the bridge. The effect of one test component on the accuracy of measurement of the other component is eliminated, precisely as in the case of a manually operated bridge. This is the main advantage of this type over the simpler, cheaper limit bridge.

For limit-type measurements, a directional relay is the usual terminal device. It may be of the meter type or of the standard sensitive relay type.

The use of germanium diodes such as the 1N35 in the discriminator results in a very stable zero point. In general, d-c amplification of  $E_o$  means a sacrifice of this stability, so that  $E_o$  should be impressed directly on the terminal device when possible. For self-balancing bridges, unless a d-c servo is used,  $E_o$  must drive a d-c to a-c converter.

In the equipment illustrated in the photographs, one of four sections includes a self-balancing Owens bridge. The variable standards are both resistive.

The true terminal device in a self-balancing test is the one which electrically indicates the position of the driven standards when null is obtained. An arrangement of contacts actuated by the driven shafts is a possible solution. This may mean a critical mechanical setup, however.

In the equipment illustrated, the problem has been met on an electrical basis. Achievement of balance is signified by the operation of a relay which senses the absence of unbalance voltage via an auxiliary

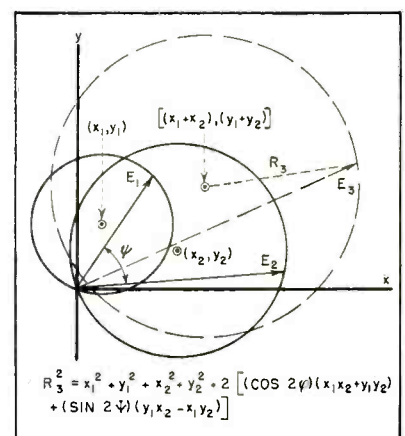

FIG. 11—Addition of the two voltage vectors to provide  $E_3$

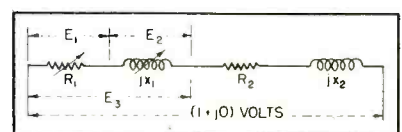

FIG. 12—Circuit employed in text Example 1

circuit; this relay initiates a switching system which transfers each Helipot into a simple d-c limit bridge. The d-c resistance indications then actuate the proper subsequent accept-reject circuits. The d-c bridges themselves are accurate to 0.1 percent and are easily adjustable.

The overall action of the test is analogous to the use of calipers to transfer a certain length from an awkward to a convenient location for measurement. Here, inductance and effective resistance are translated into d-c resistance, and then transferred to convenient measuring circuits as separate items. The same principle can be used, no matter what the driven variable standard is, by mounting a pilot rheostat on the driven shaft.

### Unbalance Voltages

Numerical computation of bridge unbalance voltages is notoriously tedious. Since the voltage to be determined is the difference between two much larger potentials (the potentials of the corners across which the detector is connected), any error in the calculation of corner potentials represents a much larger error in unbalance voltage. Thus a series of slide-rule calculations is apt to be significantly in error. Also, an attempt to correlate such a series of results usually leads to some form of graphical representation. For these reasons, a direct graphical approach is generally simplest and most flexible. A

vectorial method especially applicable to bridge problems will be presented here. Better than slide accuracy is readily obtainable on letter size paper.

Accurate determination is best obtained by direct experiment or detailed algebraic analysis. For this reason we will neglect small residuals. In practical cases, a vacuum-tube detector is used. The resultant high detector impedance permits a valuable simplification in bridge calculations: the bridge can be considered to consist of two entirely separate current branches as shown in Fig. 8.

We are interested in the relative potentials of two points, one in each current branch. These points are the two bridge corners across which the detector is connected. The other two corners are common to both current branches. Let one be assigned zero potential, and the other 1.0 volt. The frequency will not be specified, since it enters directly into the expressions for reactance. The majority of bridges do not have intentional coupling between current branches, therefore this complicating case will not be treated here.

### Unbalance-Voltage Charts

Considering one current branch only, we may represent the potential of the mid-way corner as follows:

(1) No variables. The potential of corner *B* is represented by a point on the plane as in Fig. 9A

(more precisely, by vector *A'B'*).

(2) One variable. The potential is represented by a point which travels along a calibrated arc as in Fig. 9B. The calibration marks correspond to the value of the variable.

(3) Two variables. The potential of corner *B* is represented by a point which is located by means of a grid of labelled arcs as shown in Fig. 9C.

Because of the large number of possible locations and types of variables, no further effort will be made to list the combinations of variables and the corresponding types of voltage charts. The examples to be given will show typical results.

### Basic Voltage Arcs

In Fig. 10, a number of arcs are shown and the location of their centers is given. All these arcs pass through the origin. They are the

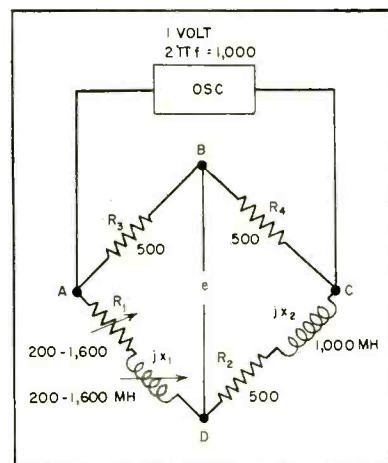

FIG. 14—Chart of Fig. 13 can be applied to this bridge circuit

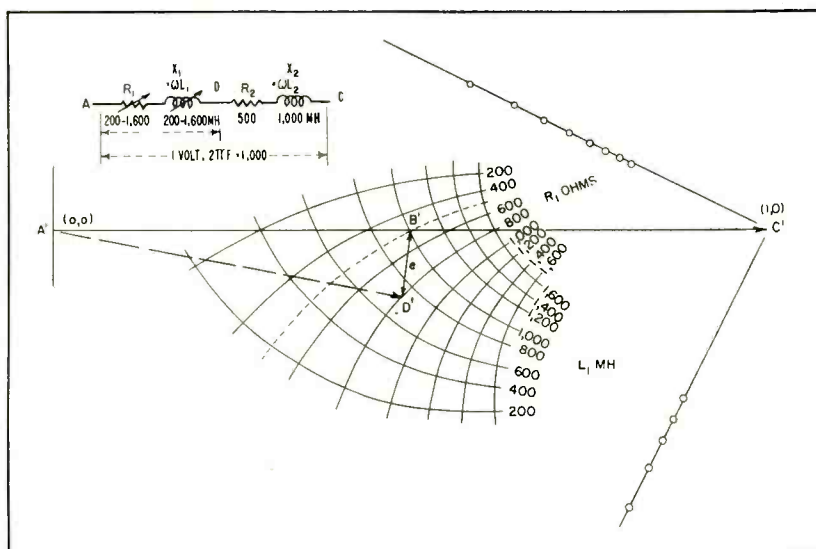

FIG. 13—Grid chart provides  $E_2$  for any value of  $R_1$  and  $L_1$

loci of the voltage vector  $E_1$  as the variable element in the corresponding circuit varies without limit. The curved arrow shows which way the vector head travels as the variable element increases in a positive direction.

The arcs drawn represent the loci when all circuit reactances are positive. The coordinates for the arc-centers are correct providing the correct signs are used for the various reactances. The locus may shift to another segment of the circle if negative reactances are present. However, the only information usually needed is the expression for center coordinates.



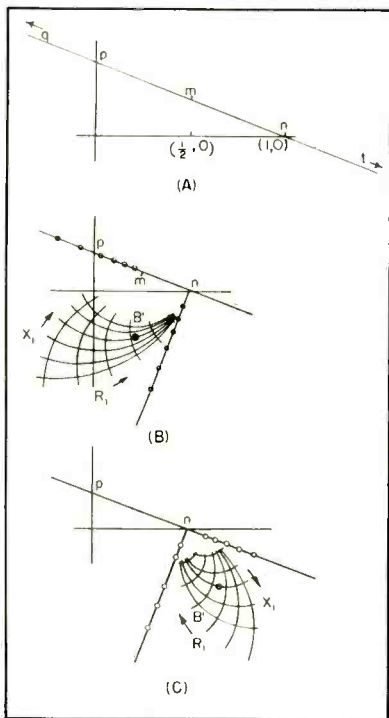

FIG. 15—Grid charts constructed for text Example 2

The voltage vectors associated with the elements along a common current branch will always bear a constant phase relation to one another since the same current flows in each element.

**Theorem I:** Consider two vectors  $E_1$  and  $E_2$  which have a constant angle  $\psi$  between them, and whose ends are defined by circles passing through the origin, the circle centers being at  $(x_1, y_1)$  and  $(x_2, y_2)$  respectively, as in Fig. 11. Addition of  $E_1$  and  $E_2$  results in a vector  $E_3$  which also follows a circular locus. The center of the  $E_3$  locus is at  $[(x_1 + x_2), (y_1 + y_2)]$ . Further, the radius  $R_3$  is given by the expression shown.

Two important cases are:

(a) When  $\psi = 0$ ,

$$R_3^2 = (x_1 + x_2)^2 + (y_1 + y_2)^2$$

(b) When  $\psi = 90^\circ$ ,

$$R_3^2 = (x_1 - x_2)^2 + (y_1 - y_2)^2$$

The radius is seldom computed, since it usually can be determined by inspection.

**EXAMPLE 1.** Required, Fig. 12: find  $E_3$  as  $R_1$  and  $X_1$  vary. This will be done for two conditions:

(a)  $R_1$  free to vary,  $X_1$  takes temporary values  $X_1'$ :

$$\text{Center } E_1 \text{ arc (Fig. 10A) at } \left[ \frac{1}{2}, \right]$$

$$\left[ \frac{1}{2} \frac{R^2}{X_1' + X_2} \right]$$

Center  $E_2$  arc (Fig. 10F) at

$$\left[ \frac{1}{2} \frac{X_1'}{X_1' + X_2}, 0 \right]$$

Center  $E_3$  arc (Theor I) at

$$\left[ \frac{1}{2} + \frac{1}{2} \frac{X_1'}{X_1' + X_2}, \frac{1}{2} \frac{R_2}{X_1' + X_2} \right]$$

The radius need not be computed, since by inspection, whenever  $R_1$  approaches  $\infty$  the  $E_3$  locus approaches  $(1, 0)$ .

(b)  $X_1$  free to vary,  $R_1$  takes temporary values  $R_1'$

Center  $E_1$  arc (Fig. 10C) at

$$\left[ \frac{1}{2} \frac{R_1'}{R_1' + R_2}, 0 \right]$$

Center  $E_2$  arc (Fig. 10D) at

$$\left[ \frac{1}{2}, -\frac{1}{2} \frac{X_2}{R_1' + R_2} \right]$$

Center  $E_3$  arc (Theor I) at

$$\left[ \frac{1}{2} + \frac{1}{2} \frac{R_1'}{R_1' + R_2}, -\frac{1}{2} \frac{X_2}{R_1' + R_2} \right]$$

Again, the radius need not be computed, since whenever  $X_1$  approaches  $\infty$  the  $E_3$  locus approaches  $(1, 0)$ .

The arc centers can now be plotted for various numerical values of  $R_1$  and  $X_1$ . The graphical construction can be speeded up by noting that in each case above the  $E_3$  arc-centers fall on a straight line. The line is easily drawn for each case. (a) When  $X_1' = \infty$ , the line passes through  $(1, 0)$ ; when  $X_1' = 0$ ,

through  $\left( \frac{1}{2}, \frac{R_2}{2X_2} \right)$ . (b) When  $R_1' = \infty$ , the line passes through  $(1, 0)$ ; when  $R_1' = 0$ , through  $\left( \frac{1}{2}, -\frac{X_2}{2R_2} \right)$

Only the abscissa of each arc-center need be computed, since the center must lie on the associated line. Further, each arc may be quickly drawn since each is known to pass through  $(1, 0)$ .

Fig. 13 shows a plot of  $E_3$ , the elements having been given numerical values. The grid allows  $E_3$  to be found for any  $R_1$  and  $L_1$ .

An immediate conclusion is that the chart also applies to the bridge of Fig. 14. Output voltage  $e$  is the difference in potential between corners  $D$  and  $B$ . The grid gives the potential of  $D$ , and that

of  $B$  is a fixed point at  $\left( \frac{1}{2}, 0 \right)$  for the element

shown. Any  $ABC$  branch could be accommodated, whether the potential of  $B$  were defined by a fixed point, a calibrated arc, or another grid.

**EXAMPLE 2.** It is of interest to let  $X_1$  of Fig. 12 become negative (substitute a capacitor for coil  $X_1$ ). The line  $tmq$  of Fig. 15A contains all the centers for condition (a) of Example 1, plus those appearing for  $X_1$  negative. As  $X_1$  decreases from 0 to

$-\frac{1}{2} X_2$ , the center travels from  $m$  to  $p$ . (See the

expression for the arc-center coordinates). As  $X_1$  closely approaches  $-X_2$ , the center retreats to  $q$  at an infinite distance; the circuit approaches resonance.

As  $X_1$  takes up values more negative than  $-X_2$ , drawing away from resonance, the center appears along  $tm$ . Finally, as  $X_1$  approaches  $-\infty$ , the center again approaches  $(1, 0)$ .

The arcs being swung off from these centers must still pass through  $(1, 0)$  as before. This results in the grids of Fig. 15B, where  $X_1$  is between 0 and  $-X_2$  ohms; or of Fig. 15C, where  $X_1$  is between  $-X_2$  ohms and  $-\infty$ .

For the case of Fig. 15B, a convenient potential  $B'$  is needed. This is readily obtained by putting a capacitor in arm  $AB$  and a resistance in arm  $BC$ . The completed bridge circuit becomes the standard Owens bridge of Fig. 16.

In Fig. 15C, it is more difficult to obtain a suitable balancing potential  $B'$  since it must be larger than the supply voltage feeding the other current branch  $ADC$ . However, it can be obtained in a number of ways, and some practical advantage may accrue

from the fact that  $X_1$  represents a relatively small capacitance. If  $DC$  is the test arm, and  $X_1$  and  $R_1$  are variable standards, a variable air capacitor will suffice for  $X_1$  at fairly low frequencies.

**EXAMPLE 3.** The Owens inductance bridge is often operated in a different mode from that mentioned in Example 2.

By writing out the standard balance equations for

Fig. 16, it appears that  $\frac{X_1}{R_2} = \frac{X_3}{R_4} = \text{constant}$ ;

and  $\frac{R_1}{X_2} = \frac{X_3}{R_4} = \text{constant}$ , so that  $R_2$  is balanced

by  $X_1$  and  $X_2$  is balanced by  $R_1$ . Rather than make  $X_1$  a variable,  $R_2$  is held constant. This is done by adding resistance from a calibrated variable to the effective resistance of the test so as to make up the correct balance resistance. The resistance of the test can be deduced from the setting of the variable. Thus both inductance and effective resistance of the test appear in terms of a resistance setting.

Required: draw a voltage chart for the bridge of Fig. 16 as  $R_1$  and  $R_2$  vary over their ranges.

(a)  $R_1$  free to vary,  $R_2$  takes temporary values  $R_2'$

Center  $E_1$  arc (Fig. 10F) at

$$\left[ \frac{1}{2} \left( \frac{-177}{953} \right), 0 \right] = \left[ -0.093, 0 \right]$$

(continued on p 116)

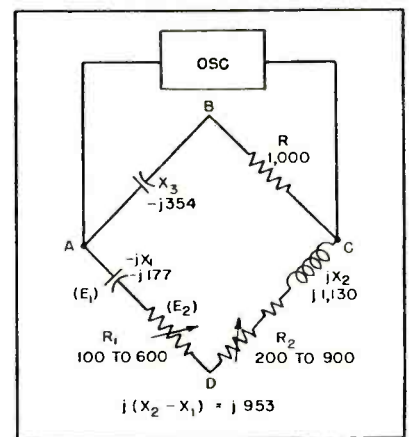

FIG. 16—Circuit of Owens bridge

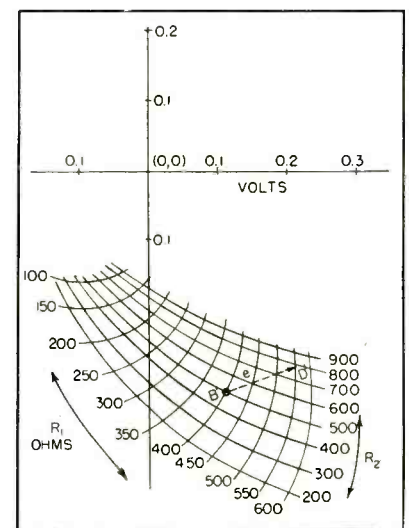

FIG. 17—Grid chart constructed for Owens bridge in text Example 3

Center  $E_2$  arc (Fig. 10A) at

$$\left[ \frac{1}{2}, \frac{R_2'}{2(953)} \right] = \left[ 0.5, \frac{R_2'}{1,906} \right]$$

Center  $E_{AD}$  arc at  $\left[ 0.407, \frac{R_2'}{1,906} \right]$

When  $R_1$  approaches  $\infty$ ,  $E_3$  approaches (1,0), so all arcs pass through (1,0).

(b)  $R_2$  free to vary,  $R_1$  takes temporary values  $R_1'$ .

Center  $E_1$  arc (Fig. 10F) at

$$\left[ \frac{1}{2} \left( \frac{-177}{953} \right), 0 \right] = (-0.093, 0)$$

Center  $E_2$  arc (Fig. 10B) at

$$\left[ 0, \frac{-R_1'}{2(953)} \right] = \left( 0, \frac{-R_1'}{1,906} \right)$$

Center  $E_{AD}$  arc at  $\left[ -0.093, \frac{-R_1'}{1,906} \right]$

When  $R_2$  approaches  $\infty$ ,  $E_3$  approaches (0,0), so all arcs pass through (0,0).

Figure 17 is a grid drawn for the bridge with the numerical values as shown. Point  $B'$  is located for the ratio arms specified.

**EXAMPLE 4.** Fig. 18 is the circuit of a conventional capacitance comparison bridge. Let  $C_1$  and  $g_1$  be the capacitance and conductance of arm  $AD$  and let them be free to vary. Fixed values  $C_2$  and  $g_2$  are in arm  $DC$ . To draw an output voltage chart:

(a)  $g_1$  free to vary,  $C_1$  takes temporary values  $C_1'$ .

Center of  $E_{AD}$  arc (Fig. 10G) at

$$\left( \frac{1}{2} \frac{\omega C_2}{\omega C_1' + \omega C_2}, \frac{1}{2} \frac{-g_2}{\omega C_1' + \omega C_2} \right)$$

All arcs pass through (0,0) per Fig. 10G.

The line containing the arc-centers is easily drawn in: when  $C_1'$  approaches  $\infty$ , line passes through (0,0); when  $C_1' = 0$ , through

$$\left( \frac{1}{2}, \frac{-g_2}{2\omega C_2} \right)$$

(b)  $C_1$  free to vary,  $g_1$  takes temporary values  $g_1'$ .

Center of  $E_{AD}$  arc (Fig. 10H) at

$$\left( \frac{1}{2} \frac{g_2}{g_1' + g_2}, \frac{1}{2} \frac{\omega C_2}{g_1' + g_2} \right)$$

All arcs pass through (0,0) per Fig. 10H.

To draw the line containing the arc-centers: when  $g_1'$  approaches  $\infty$ , line passes through

$$(0,0); \text{ when } g_1' = 0, \text{ through } \left( \frac{1}{2}, \frac{\omega C_2}{2g_2} \right)$$

Figure 19 is a grid drawn for this bridge with the elements having values as shown. It is a matter of choice whether the grid is regarded as applying to the excursions of the test impedance, a given comparison standard being used, or the excursions of variable standards, the test impedance being fixed.

**EXAMPLE 5.** Figure 20A is the circuit of a Maxwell inductance bridge. The test item is in the D-C arm. A common mode of operation is to vary  $C_1$  for reactive balance, and to add a calibrated resistance to that of the test item such that the total resistance in the D-C arm is correct for balance.

Required: draw an unbalance-voltage chart for this bridge, the test item having specified characteristics while  $C_1$  and  $R_2$  vary throughout their ranges.

There is only one variable per current path so this will lead to a calibrated-arc type chart. A calibrated arc is merely a rudimentary grid in which one family of arcs is reduced to a single arc, and the other is reduced to a set of calibration marks. The simplest way to draw and calibrate an arc is to proceed as if a grid were being drawn.

**ABC branch:**

(a)  $C_1$  varies,  $g_1$  constant. (Main arc)

Center  $E_{AB}$  arc (Fig. 10H) at  $\left( \frac{1}{2} \frac{g_2}{g_1 + g_2}, 0 \right)$

(b) Although  $g_1$  is not a variable, let it be free to vary, that is, not defined.  $C_1$  takes values  $C_1'$ . (Calibration arcs)

Center  $E_{AB}$  arcs (Fig. 10G) at  $\left( 0, \frac{1}{2} \frac{-g_2}{\omega C_1'} \right)$

**ADC branch:**

(a)  $R_2$  varies,  $X_2$  constant. (Main arc)

Center  $E_{AD}$  arc (Fig. 10B) at  $\left( 0, \frac{1}{2} \frac{-R_1}{\omega L_2} \right)$

(b) As above, let  $X_2$  be free to vary,  $R_2$  takes values  $R_2'$  (calibration arcs).

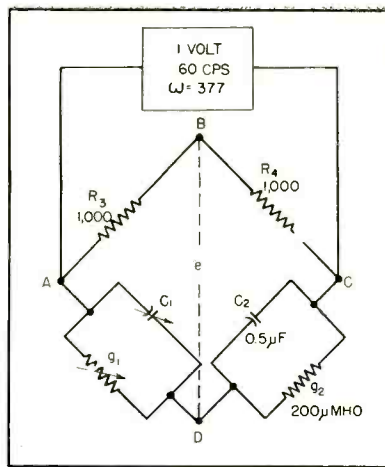

FIG. 18—Circuit of capacitance-comparison bridge

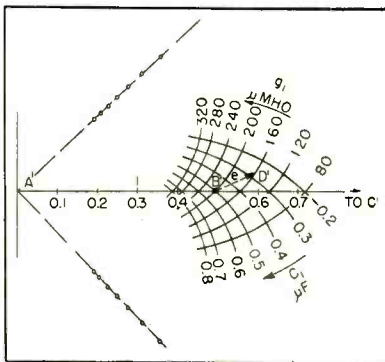

FIG. 19—Grid chart constructed for capacitance bridge of text Example 4

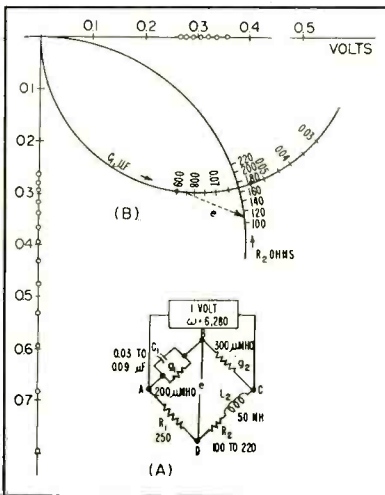

FIG. 20—Circuit of Maxwell inductance bridge, and unbalance-voltage chart

Center  $E_{AD}$  arcs (Fig. 10C) at

$$\left( \frac{1}{2} \frac{R_1}{R_1 + R_2'}, 0 \right)$$

Figure 20B is a chart drawn for the numerical values shown.

Each example presented the behavior of bridge unbalance volt-

age  $e$  as bridge parameters varied. However, the number of variables was limited to two. A chart might be required for, say, the inductance bridge of Fig. 14, when there are four variables present, two variables in the item under test plus the two variable standards.

### For Cases Involving More Than Two Variables

The test item and the variable standards may be in different current branches. This is the current-bridge connection, so-called because at balance the current through the test is readily computed when the total supply current is known. A grid can be drawn for each current path, and  $e$  is thus determined, each end of the vector being located by one of the grids. Thus up to four variables per bridge can be accommodated providing that there are no more than two per current branch.

The test item and the variable standards may be in the same current branch. This is the voltage bridge connection, so-called because at balance the voltage across the test is readily computed when the supply voltage is known. (While a balanced bridge remains balanced for either supply connection, the unbalance voltages in general do not correspond.) Here, the presence of four interacting variables precludes two-dimensional graphical representation; we must resort to the determination of voltages for particular conditions of interest.

In such a case, graphical determination of voltages, one by one, presents about the same amount of labor as straight algebraic methods. However, if entirely complete data is not essential, much pertinent information on voltage trends can be obtained by drawing several grids, selecting values of interest for two of the variables and letting the other two vary freely. If a large number of points were computed algebraically and then correlated graphically, we would finally arrive at just such a set of grids.

### Acknowledgment

The author wishes to thank R. M. Lester for his valuable criticism during preparation of this paper.



# CINCH IS READY

... TO DESIGN AND PRODUCE  
MILITARY VERSIONS OF ANY  
COMMERCIAL ELECTRONICS  
COMPONENT.

Already in production are variations  
of standard electronic components  
for military use. Consult CINCH.

... TO PRODUCE ANY COMPONENT  
ASSEMBLY NEEDED FOR WAR THAT  
FALLS WITHIN THE GENERAL CATE-  
GORY OF CINCH ELECTRONIC  
PARTS MANUFACTURE

The CINCH organization is flexible, readily adapted to  
any requirement . . . in military or commercial emer-  
gency, ample physical properties in space and produc-  
tion facilities, development, design, and production en-  
gineering personnel. Consult CINCH today.

CINCH components are  
available at leading elec-  
tronic jobbers—everywhere.



**Cinch**  
ELECTRONIC  
COMPONENTS

**CINCH MANUFACTURING CORPORATION**

1026 South Homan Ave., Chicago 24, Illinois

Subsidiary of United-Carr Fastener Corporation, Cambridge, Mass.

# Minimum-Loss Matching Pads

Simple nomograph gives the two resistance values needed in an L-type network for matching unequal impedances with minimum power loss, and also gives directly the amount of loss in db. Multiplying factors are easily used to extend ranges

**A** TWO-RESISTANCE network for matching two unequal impedances provides proper matching with a minimum of power loss. The accompanying nomograph solves for the resistance values needed.

*Example 1.* Match a 72-ohm line to a 52-ohm line with a minimum of power loss. Determine the loss in db.

By **JOSEPH G. BREGAR**

Engineer

Western Electric Company Radio Shops  
Winston-Salem, N. C.

*Solution.* Adjust a straight-edge to connect 72 on the  $R_a$  scale and 52 on the  $R_b$  scale ( $R_a$  must be greater than  $R_b$ , and therefore  $R_a = 72$  and  $R_b = 52$ ). The intercept on the db loss scale

shows the matching-pad loss as 5.1 db. Next, adjust the straight-edge at right angles to the loss line and through the 5.1-db point, and read the X and Y values as  $X = 0.53$  and  $Y = 1.9$ . The desired resistor values are then  $R_1 = XR_a = 0.53 \times 72 = 38$  ohms, and  $R_2 = YR_b = 1.9 \times 52 = 99$  ohms.

The scale ranges are chosen for common impedance values. The nomograph may be used for any values by the application of the same multiplier to the  $R_a$  and  $R_b$  scales. No multipliers are required for the loss scale or the X and Y values. The X and Y values are applied to the original problem values of  $R_a$  and  $R_b$  in determining  $R_1$  and  $R_2$ .

*Example 2.* Match a 3,000-ohm source to a 600-ohm load with a minimum of loss. Determine the loss.

*Solution.* A convenient scale factor is 1/10. Applied to the problem values,  $R_a$  becomes 300 and  $R_b$  becomes 60. Connect these points with a straightedge and read the pad loss as 12.5 db. Next, read the X and Y values as 0.89 and 1.12 respectively. Applying these values to the original problem impedances of 3,000 and 600 ohms gives  $R_1 = 0.89 \times 3,000 = 2,700$  ohms and  $R_2 = 1.12 \times 600 = 670$  ohms.

The matching of impedances of more than 30-to-1 ratio involves high power losses, and other types of coupling networks are employed. For impedance matching when power loss is unimportant and the ratio of impedances is more than 30-to-1, the X and Y values approach 1; then  $R_1 = R_a$  and  $R_2 = R_b$  for proper matching.

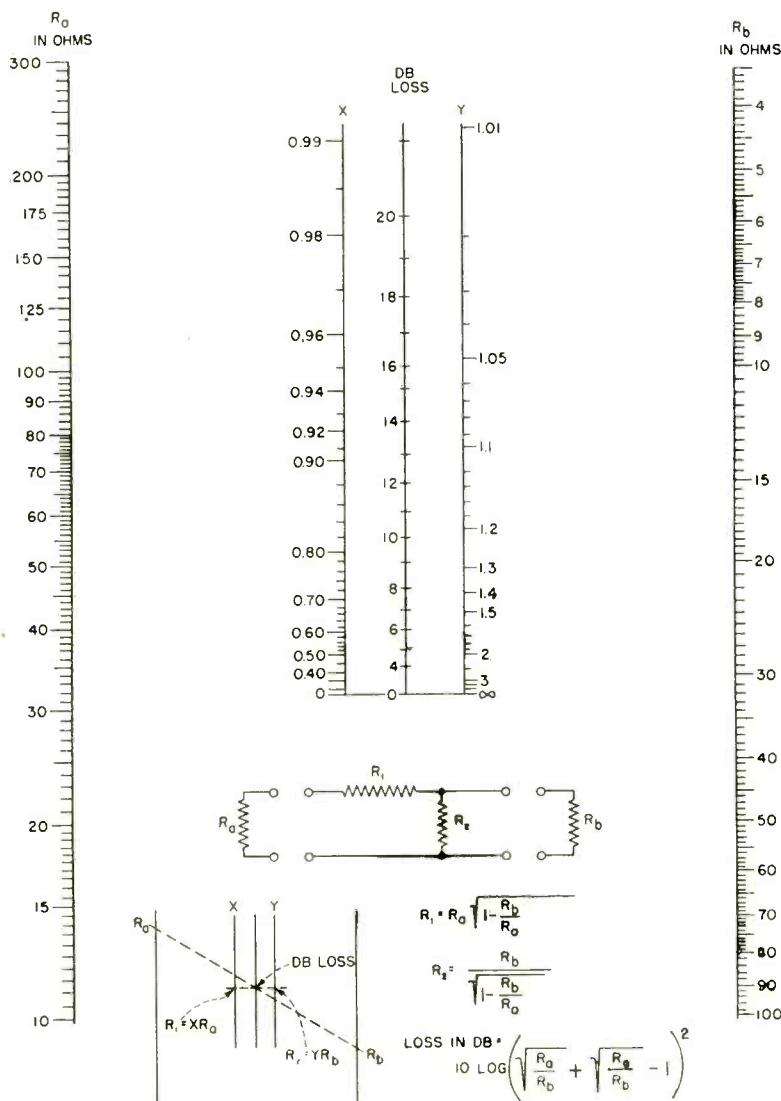



**Service  
Beyond  
The Sale!**

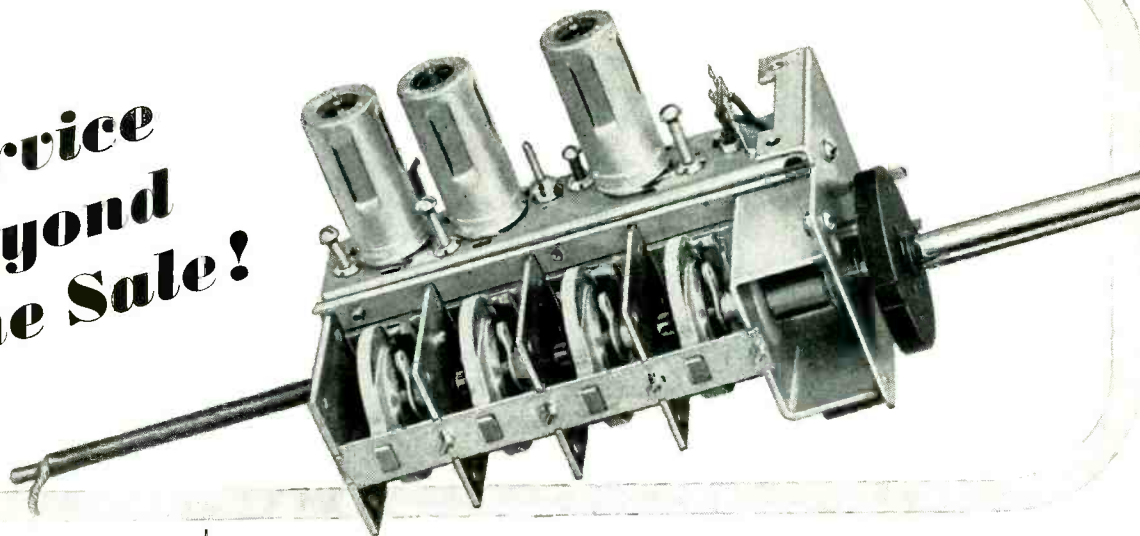

## Mallory TV Front End Limits Oscillator Radiation

### *Outstanding Advantages of the new Mallory Spiral Inductuner*

1. A single control for easy selection and fine tuning of any television or FM channel.
2. Easily adapted to UHF converter use.
3. Excellent stability eliminates frequency drift.
4. Supplied in two-, three- or four-section designs.
5. Far more quiet operation; permits high signal-to-noise ratio in front end designs.
6. Free from microphonics.
7. Greater selectivity on high frequency channels.
8. Eliminates "bunching" of high band channels.
9. Simplifies front end design and production.
10. Reduces assembly costs.
11. Choice of: 6 turn unit continuously tunes from channels 2 to 13; 4 turn unit tunes only channels 2 to 6, FM, 7 to 13; 3 turn unit tunes only the 12 television channels.

Mallory engineering has accomplished the development of a TV Front End Assembly which avoids interference by the receiver with nearby sets and other electronic equipment.

Built around the four-tuned circuit Spiral Inductuner\*, this new front end is designed to restrict radiation from the oscillator. In addition, the oscillator and converter are shielded from the RF amplifier. And, each section of the Inductuner is provided with its own special shielding. Thus, Mallory now offers TV manufacturers a front end that is ready to perform within the strict standards contemplated for oscillator radiation.

*That's service beyond the sale!*

The Mallory Front End is universally adaptable. It features higher gain, and lower signal-to-noise ratio. Designed around the Inductuner, it is available with or without indexing provisions, in 3 and 4 revolution designs. Also available in 6 turns without the indexing feature.

\*Reg. trade mark of P. R. Mallory & Co., Inc. for inductance tuning devices covered by Mallory-Ware patents.

Television Tuners, Special Switches, Controls and Resistors

#### SERVING INDUSTRY WITH

Electromechanical Products  
Resistors                      Switches  
TV Tuners                      Vibrators

Electrochemical Products  
Capacitors                      Rectifiers  
Mercury Dry Batteries

Metallurgical Products  
Contacts                      Special Metals  
Welding Materials

**P. R. MALLORY & CO., Inc.**  
**MALLORY**

**P. R. MALLORY & CO., Inc., INDIANAPOLIS 6, INDIANA**

# TUBES AT WORK

Including INDUSTRIAL CONTROL

Edited by VIN ZELUFF

Improved Vacuum-Tube Acceleration Pickup.....	120
The Front Cover .....	122
Multiple Output Predetermined Counter .....	122
Complex Tone Generator For Deviation Tests.....	184
Antenna Installation for Stratovision Airplanes.....	196
Single Input Attenuators with Multiple Outputs.....	200
Wideband Amplifier for Central Antenna Installations.....	210
Electronic Christmas Tree .....	214
New Version of Schering Bridge.....	214

## Improved Ramberg Vacuum-Tube Acceleration Pickup

THE RAMBERG vacuum-tube accelerometer (previously reported in the January, 1947, issue of *ELECTRONICS*, p 152) has been further developed at the National Bureau of Standards so that the new pickup tube provides more sensitive and reliable acceleration measurements than did the earlier version.<sup>1,2</sup>

Field tests of the improved device have provided results that suggest the wide variety of uses to which the instrument may be applied in industry. For example, vibrations of a structural model of an airplane wing have been measured. The laboratory setup is

shown in Fig. 1. The accelerometer at the wing tip on the back at the left is used to keep the vibration at a constant level. The other accelerometer on the front at the left is moved from station to station to measure the variation of vibration amplitude with position along the length of the model.

With the accelerometer clamped to the dashboards in 1936 and 1947 automobiles and a filter used to eliminate natural frequency response, comparative records were obtained of the vertical accelerations to which the vehicles were subjected when crossing multiple

streetcar or railroad tracks.

Variations in the vertical accelerations of a freight elevator going from the first to the second floor were revealed by the accelerometer as well as vertical accelerations experienced by the rear cockpit of a TBD airplane during takeoff, approach and landing. The natural frequency response of the instrument itself at 160 cps in these records is small compared to the response proportional to the imposed accelerations.

The vacuum-tube pickup is a twin diode consisting of a fixed, indirectly heated cathode and two plates, one on each side of the cathode. The plates are elastically mounted so that they will be deflected if the base of the tube is accelerated in a direction perpendicular to the plane of the plates. The new model differs from earlier versions in having stops to limit the motion of the plates, support rods



Improved vacuum-tube pickup contains stops that limit plate excursions

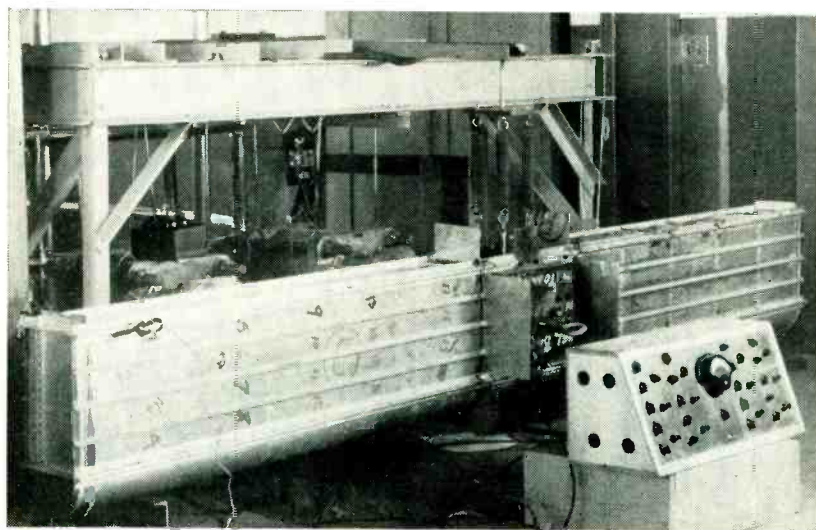

FIG. 1—Laboratory setup for measuring vibration of the structural model of an airplane wing. Note the two pickup tubes at the front and rear of the left end of the wing

0.010 inch in diameter to increase the sensitivity of the tube and a second getter.

The primary design requirement met by the Ramberg accelerometer is its provision for an electrical signal of sufficient strength to drive directly a high-frequency recording galvanometer and, at the same time, have a relatively high natural vibration frequency.

In the operation of the original model erratic changes or zero shifts in its balance point were sometimes encountered. The source of this difficulty has been eliminated in the new model. The zero shift resulting from excessive accelerations to





*The finest solder made  
for all television and radio work  
... Everything Electrical*

# Kester Solder

# Uniform

# Efficient

Kester Plastic Rosin-Core and Kester "Resin-Five" Core Solders are recognized by the trade as outstanding for the finest type of radio, television and electrical work.

These two Solders, which are available in the usual single-core type, can now also be had in a 3-core form.

Only highly skilled craftsmen are employed by the Kester Solder Company. Flux formulas and specifications are rigidly adhered to for perfect uniformity.

Making Kester Solder is an exact science from the raw material to the finished product. Everyone knows and prefers Kester because it can be relied upon to do the job right every time, even under the most difficult soldering conditions.

WRITE FOR FREE COPY "SOLDER AND SOLDERING TECHNIQUE"



Be sure to get your free copy of Kester's Technical Manual filled with valuable information regarding the most advanced and efficient industrial solders and fluxes.

Kester... Standard for the TV and Radio Fields

**KESTER SOLDER COMPANY**

4204 Wrightwood Avenue, Chicago 39, Illinois  
Newark, N. J. • Brantford, Canada



EASIER TO USE  
MADE FROM VIRGIN METALS  
FASTER  
ELIMINATES REJECTS  
DEPENDABLE  
SAVES TIME



## THE FRONT COVER

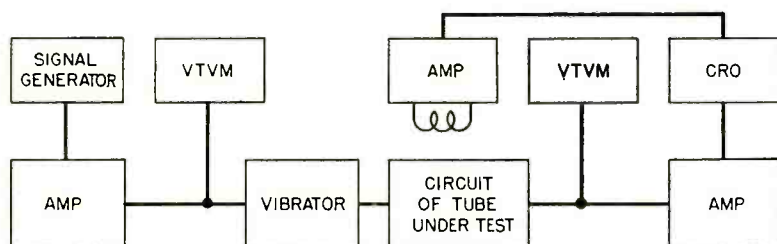

**T**HE COVER PHOTOGRAPH shows a method of investigating subminiature tubes for microphonism used in the Product Development Laboratories of Sylvania Electric Products Inc., Flushing, N. Y. The apparatus imparts a controlled motion to the tube and measures the mechanical displacement of the various parts and the electrical response of the tube.

The tube is rigidly held in a fixture which is firmly attached to a moving coil in a magnetic field. The motion of the moving coil is controlled in frequency and amplitude by a signal generator and amplifier as shown in the block diagram. About 5 watts of power is required at frequencies from 25 to 10,000 cps. Displacement of the parts within the tube is observed by a calibrated telescope (cathetometer) in conjunction with a stroboscope to slow down the motion optically.

Circuit connections are made by placing the ends of the lead wires of the tube into small pools of mercury. Normal voltages are applied and the output signal due to microphonism is developed across the plate load resistor and measured with a vtvm. A check on the motion of the system is maintained by observing the waveform on an oscilloscope.

## Multiple-Output Predetermined Counter

BY D. L. GERLOUGH AND H. R. KAISER\*

*Institute of Transportation and Traffic Engineering  
University of California  
Los Angeles, Calif.*

IN CERTAIN INDUSTRIAL applications, single-output predetermined counters<sup>1,2</sup> are not suitable and multiple-output predetermined counters must be used. In the multiple-output counter, output signals may occur at several predetermined points during the counting process whereas in single-output counters an output signal occurs only when a single predetermined count is reached.

The circuit of a counter having a counting capacity of  $2^n$  and  $m$  predetermined outputs is shown in Fig. 1. This counter consists of two

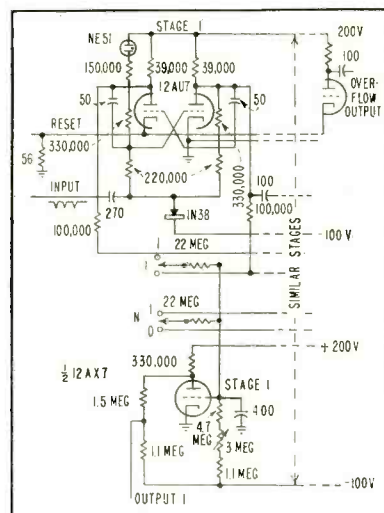

FIG. 1—Schematic diagram of a multiple-output predetermined counter having a capacity of  $2^n$  and  $m$  predetermined outputs. Each NE51 socket contains a 50,000-ohm series resistor

the pickup while handling and installing is prevented by the stops added to limit the plate excursion and thus prevent overloading.

Zero drift, believed to be due to small fluctuations in the cathode electron emission, has been effectively reduced by three steps. First, the accelerometer was given an aging treatment which made its emission nearly constant. Second, two getters instead of one were used to improve the electrical characteristics and, third, the sensitivity was

increased by a factor of 25 to make the remaining random output negligible compared with the output due to acceleration.

The circuit used in field tests of the improved pickup is an adaptation of the Kelvin double bridge designed to minimize the effect of contact resistance both in the tube socket and in the adjustable rheostats. A blocking filter was used ahead of the galvanometer to eliminate the possible 160-cycle output at the natural frequency of the device.

Characteristics of the over-all circuit are flat within five percent up to 20 cps and attenuate gradually to nearly 100 percent at 160 cps.

### REFERENCES

- (1) Walter Ramberg, "Vacuum Tube Acceleration Pickup", *Journal of Research*, National Bureau of Standards, 37, p 391, 1946.
- (2) Walter Ramberg, "The Measurement of Acceleration With a Vacuum Tube", *AIEE Transactions*, 66, p 735, 1947.

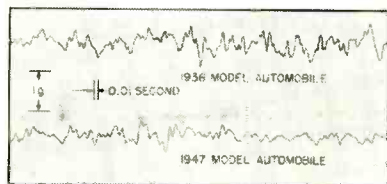

Oscillogram tracings showing the vertical accelerations experienced by a 1936 and 1947 automobile crossing multiple streetcar tracks

parts, a binary counter section and an interpretation section. The counter may have as many stages as necessary to give the desired counting capacity but with the component values shown there is a limit of about twelve stages.

The binary counter uses a standard circuit except for crystal diodes in the bias return of each stage to increase the ability of the stage to

(Continued on p 168)

\* H. R. Kaiser is now with Hughes Aircraft Co., Culvert City, Calif.



**TINY • DEPENDABLE • SPACE-SAVING**

# *Cera-mite* Capacitors

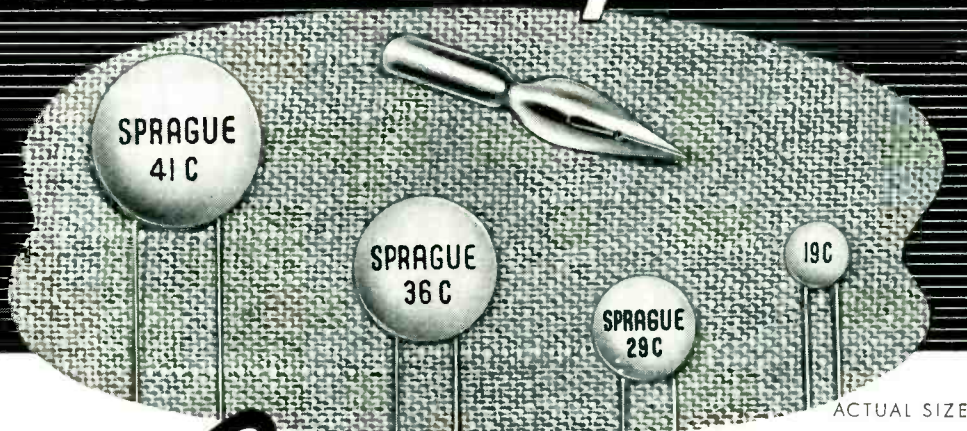

## THE *First* COMPLETE DISC CERAMIC LINE

Sprague-Herlec Cera-mite Capacitors are a "must" for modern television circuits.

Now available in both temperature-compensating (TC) and general application (GA) types, Cera-mites meet most application needs in the 10 mmf to 15,000 mmf capacitance range.

These miniature capacitors offer set designers maximum space economy, ease of mounting, and improved very-high-frequency performance.

The flat disc with uni-directional lead construction has minimum self-inductance and a higher self-resonant frequency than a tubular design; hence improved v-h-f bypass efficiency.

Sprague-Herlec Engineering Bulletin 601B gives the complete list of standard ratings as well as performance specifications. Write for your copy today!

\*Trademark

# SPRAGUE

PIONEERS IN

**SPRAGUE ELECTRIC COMPANY**  
North Adams, Massachusetts

ELECTRIC AND ELECTRONIC DEVELOPMENT

**THE HERLEC CORPORATION • Milwaukee 3, Wisconsin**  
(Wholly owned Sprague Subsidiary)

# THE ELECTRON ART

Edited by JAMES D. FAHNESTOCK

Inexpensive Analog Computer .....	124
Automatic Stabilization of High-Impedance D-C Amplifiers.....	124
An Incremental Delay Pulse Generator .....	218
Aids to CRO Display of Phase Angle .....	226
Theoretical Limitations to Impedance Matching .....	234

## Inexpensive Analog Computer

AN ELECTRONIC analog computer costing less than \$5,000 but with a six-variable capacity in solving dynamic problems has been developed by the Boeing Airplane Co., with five units now being used in as many of the company's engineering research departments.

The computer requires but five basic operational components—coefficient potentiometers, integrators, a limiter, two voltmeters and a volt box. Twelve integrators and 24 coefficient potentiometers are used to attain the six-variable capacity.

To solve a typical problem, the engineer writes a set of differential equations which describes the actual dynamic system under investigation. Then the computer's "erec-

tor" units are interconnected in such a manner that they satisfy this same formal mathematical description. Because the computer, under these conditions, becomes analogous to the dynamic system under investigation, it will react to any stimulus in the same manner as would the dynamic system. Each component can be reused to make new analogies in succeeding problems.

The new computer is expected to become a companion instrument to the slide rule and desk calculator to engineers dealing in problems of dynamics. In a recent study, use of a single computer enabled the completion by one man in one week of problems whose solution normally would require more than a year.

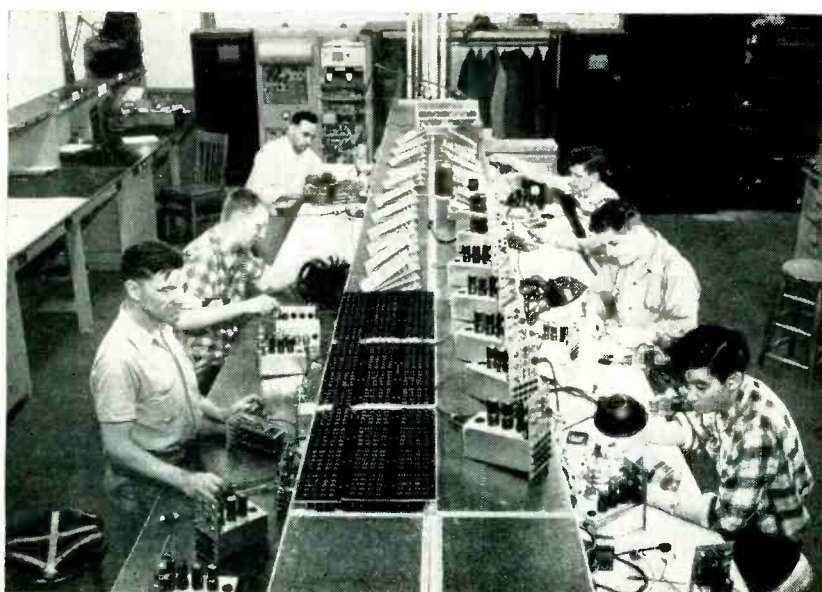

Boeing Airplane Company's new BEAC computer was made on this small assembly line basis by workmen in the company's physical research unit. The computer units (on workbenches and right table top) can be interconnected to make different analogies through the switchboard-like panels in left-center

The computer may be used to simulate a change in gear ratio, relocation of a wing, an airspeed change or a new rudder installation. One computer is capable of solving the lateral and longitudinal rigid body flight equations of an airplane and its control surface actuators simultaneously.

Nicknamed BEAC for Boeing Electronic Analog Computer, the machine is patterned after a similar computer (BEMAC) developed by Boeing in connection with its guided missile program. BEMAC has a mechanical element, however, while BEAC is entirely electronic, basically an electronic erector set in which each component can be reused to make new analogies in succeeding problems.

## Automatic Stabilization of High-Impedance D-C Amplifiers

By FRANCIS RAWDON SMITH  
*Scientific Director  
Reed Research, Inc.  
Washington, D. C.*

IN DESIGNING an analog computer for the analysis of transient heat flow (the Simulator), the problem of standardizing current-measurement circuits arose. Most current measurements have to be made at levels so far above ground ( $10^{12}$  ohms and over) that special tube d-c amplifiers seemed a logical solution. The use of such amplifiers, however, means that over-all computer accuracy can only be assured by effectively counteracting amplifier drift.

One way to accomplish this is to standardize each amplifier periodically. However, to do so manually—and sufficiently often—on a system of the scope of the computer would be impossible. An automatic method of standardization, therefore, was indicated.

### Computing Procedure

Most computations with the Simulator involve a greatly expanded time scale. Thus, amplifier drift in the measuring circuit is a more than usually serious menace to sustained accuracy.

In practice, known data such as skin temperature, solar radiation



# For the Measurement of Q and Inductance

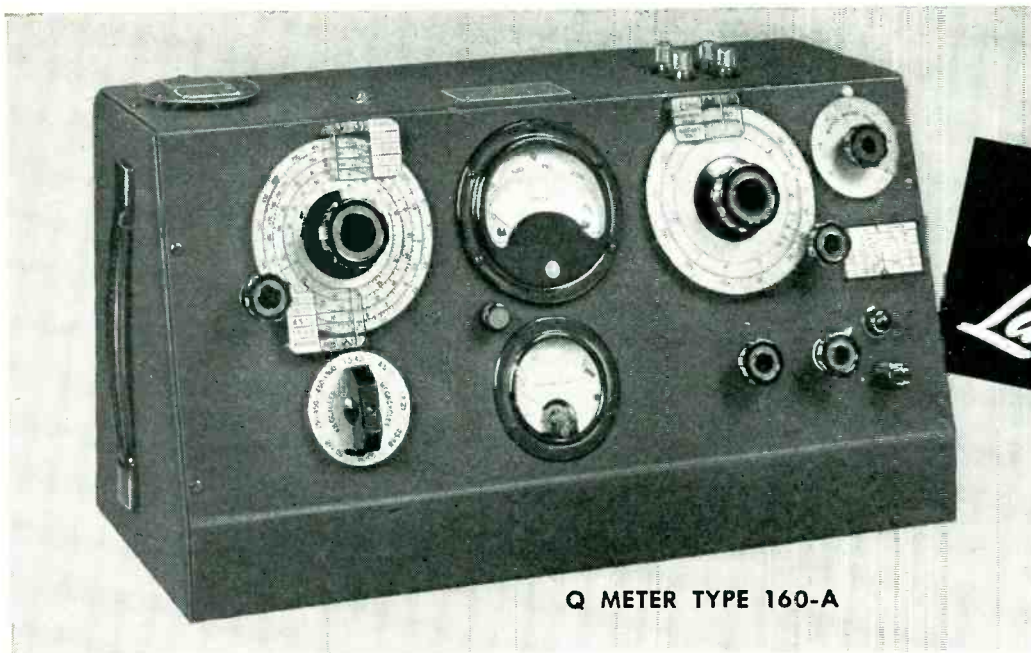

Q METER TYPE 160-A

*in the  
Laboratory*

*on the Production Line*

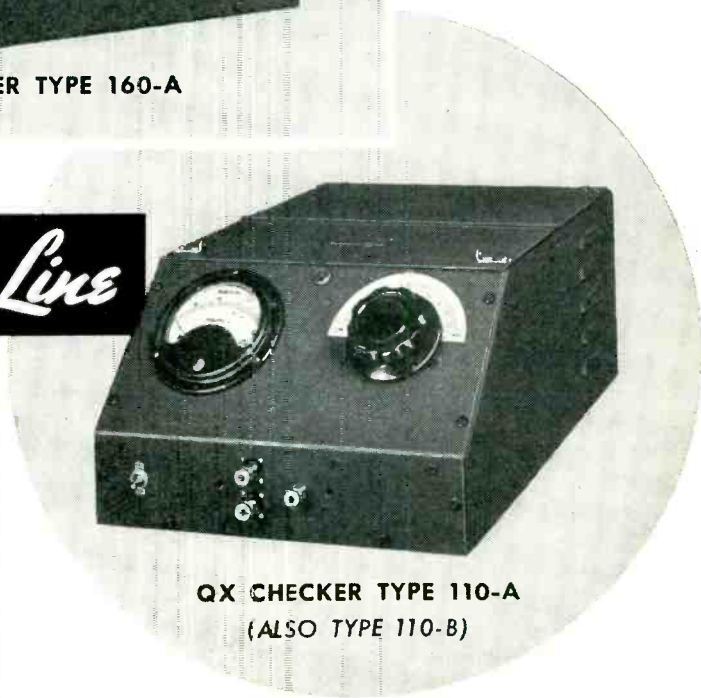

QX CHECKER TYPE 110-A  
(ALSO TYPE 110-B)

The Type 160-A Q-Meter offers the electronic engineer a simple, reliable means of measuring Q, inductance, and capacitance, at any frequency within the range of 50 kc. to 75 mc. Each component part and assembly used in the manufacture of this instrument is designed with the utmost care and exactness. Circuit tolerances are held to values obtainable only in custom built instruments.

The Type 110-A QX-Checker has been designed as the production counterpart of the Type 160-A Q-Meter to rapidly and accurately compare the relative Q and reactance of components with established standards. Manufacturers of television receivers and those engaged in producing R. F. components will appreciate the time and effort saved by employing this unit for production line use or at incoming inspection points.

Be sure to include both of these versatile and dependable instruments in your new equipment plans for 1951.

### 160-A Q-METER SPECIFICATIONS

OSCILLATOR FREQUENCY RANGE: 50 kc. to 75 mc. in 8 ranges.

OSCILLATOR FREQUENCY ACCURACY:  $\pm 1\%$ , 50 kc.—50 mc.  
 $\pm 3\%$ , 50 mc.—75 mc.

Q MEASUREMENT RANGE: Directly calibrated in Q, 20-250. "Multiply-Q-By" Meter calibrated at intervals from x1 to x2, and also at x2.5, extending Q range to 625.

(In Canada, direct inquiries to RCA Victor Co., Ltd., Montreal)

**BOONTON RADIO**  
BOONTON · N.J. · U.S.A. *Corporation*



Q MEASUREMENT ACCURACY: Approximately 5% for direct reading measurement, for frequencies up to 30 mc. Accuracy less at higher frequencies.

CAPACITANCE CALIBRATION RANGE: Main capacitor section 30-450 mmf, accuracy 1% or 1 mmf whichever is greater. Vernier capacitor section +3 mmf, zero, -3 mmf, calibrated in 0.1 mmf steps. Accuracy  $\pm 0.1$  mmf.

### 110-A QX-CHECKER SPECIFICATIONS

FREQUENCY RANGE: 100 kc. to 25 mc. in 6 ranges using plug-in coils.

ACCURACY OF COIL CHECKS: May be checked against standard to within about 0.2% with coil values of 10 microhenries to 10 millihenries and Q of 100 or greater.

CAPACITANCE RANGE: Capacitance values ranging between approximately 2-1000 mmf may be checked against a standard to an accuracy of a few tenths of one mmf if the Q of the capacitor is high.

TYPE 110-B QX-CHECKER also available for accurate comparison of very small inductors.

DESIGNERS AND MANUFACTURERS OF THE Q METER · QX CHECKER  
FREQUENCY MODULATED SIGNAL GENERATOR · BEAT FREQUENCY  
GENERATOR AND OTHER DIRECT READING INSTRUMENTS

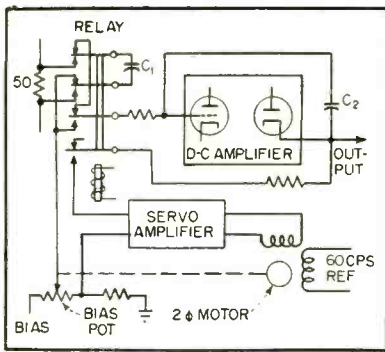

FIG. 1—Block diagram of automatic d-c amplifier stabilizing circuit

and the thermal conductivity of the materials involved are fed into the computer, and precise values of temperature distribution as a function of time are computed by the machine. In the circuits of the computer, voltage is proportional to absolute temperature—current is proportional to heat flow—resistance is proportional to the thickness of the material in the object under test, and inversely proportional to its thermal conductivity; values of electrical capacitance are proportional to thermal capacity.

Once the proper values are set up, the equipment produces an analogous record of heat flow on an extended time basis. The final data are furnished in graph form, on a specially designed, 30-channel, electric-stylus recorder. These data comprise four records of current-versus-time and 24 records of voltage-versus-time (two spare circuits are left for future modifications).

The final recorded values of voltage and current flow in the R-C networks of the computer are obtained through d-c amplifiers, as noted previously. The current

amplifiers measure current flow into capacitors, as they charge. Thus it is essential, from the standpoint of accuracy, to standardize the zero of these d-c amplifiers in the various measuring circuits and, because of the extended time basis, to keep them standardized throughout the entire computation. A convenient method of doing this is by using a servo system to change a bucking or bias voltage, thereby automatically standardizing each d-c amplifier as often as is necessary.

#### Operation

The d-c (current-measuring) amplifier system is shown schematically in Fig. 1. In the over-all computer circuit, the input to this amplifier is inserted into certain R-C networks in the computer. So as not to disrupt the circuit into which it is inserted, the input resistor has a value of 50 ohms—very low by comparison with the value of  $R$  in the R-C circuit.

The voltage developed across the 50-ohm resistor is used to charge  $C_1$ , which is connected across the moving contacts of the relay. When the relay moves to the position in Fig. 1,  $C_1$  is connected across the input of the current amplifier, the output of which is therefore proportional to the charge across  $C_1$ .

In practice, with any ordinary amplifier this condition would, of course, prevail only momentarily, since  $C_1$  would discharge, more or less rapidly, into the input resistance of the amplifier. In the present instance this would be wholly unsatisfactory, since the recorder would not necessarily be at the

point of record at the instant at which the output reading was at its initial, peak value. This has been overcome, in the present case, in two ways: by the use of a special electrometer-type tube for the amplifier input, in which the grid-current is far lower than with normal tubes; and, secondly, by the use of a somewhat elaborate integrating circuit, of which the capacitor  $C_2$ , which goes from amplifier output to input, is the principal component.

Note that the phasing of the amplifier is such that the resultant loop is degenerative, thereby becoming an integrating circuit of very long time-constant.

When the relay is energized—during the time that  $C_1$  is being charged by the passage of current through the 50-ohm resistor—the input of the amplifier is switched to the bias potentiometer. At the same time, the output of the d-c amplifier is connected to the servo amplifier input, to provide the automatic zero-setting.

#### Automatic Standardization

The grid bias of the current-measuring amplifier is varied by positioning the potentiometer as shown in Fig. 1. Mechanical positioning is accomplished by means of a servomechanism which comprises a Brown converter, Electronik amplifier, and balancing motor. The output of the servo amplifier is applied to one field winding of the two-phase balancing motor which, in turn, is geared to the grid bias potentiometer, adjustment of which will correct for drift in the d-c amplifier.

Any drift in the current-measuring amplifier produces an error signal in its output. The error signal is a d-c voltage whose polarity is determined by the direction of drift, and whose size is determined by the magnitude of drift. The magnitude of the d-c signal is equivalent to input signals of the order of microvolts.

In the servo amplifier, the d-c error signal is changed to a-c by the converter or chopper. The resulting a-c error signal differs in phase by 180 degrees according to the direction of the amplifier drift. The

(Continued on p 218)

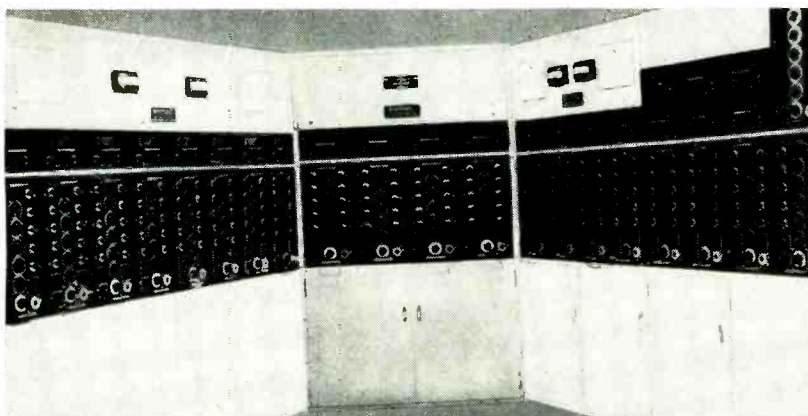

Operation of analog computer for the analysis of transient heat flow depends on measurement of d-c currents at very high impedance levels. Automatic stabilization of d-c amplifiers facilitates accuracy and speed of measurements



In this panel are illustrated standard models of HELIPOT multi-turn and single-turn precision potentiometers—available in a wide range of resistances and accuracies to fulfill the needs of nearly any potentiometer application. The Beckman DUODIAL is furnished in two designs and four turns-ratios, to add to the usefulness of the HELIPOT by permitting easy and rapid reading or adjustment.



**MODELS A, B, & C HELIPOTS**  
 A—10 turns, 46" coil, 1-13/16" dia., 5 watts—resistances from 10 to 300,000 ohms.  
 B—15 turns, 140" coil, 3-5/16" dia., 10 watts—resistances from 50 to 500,000 ohms.  
 C—3 turns, 13-1/2" coil, 1-13/16" dia., 3 watts—resistances from 5 to 50,000 ohms.

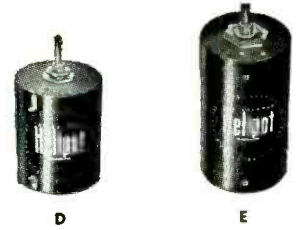

**MODELS D AND E HELIPOTS**  
 Provide extreme accuracy of control and adjustment, with 9,000 and 14,400 degrees of shaft rotation.  
 D—25 turns, 234" coil, 3-5/16" dia., 15 watts—resistances from 100 to 750,000 ohms.  
 E—40 turns, 373" coil, 3-5/16" dia., 20 watts—resistances from 200 ohms to one megohm.



**MODELS F AND G PRECISION SINGLE-TURN POTENTIOMETERS**  
 Feature both continuous and limited mechanical rotation, with maximum effective electrical rotation. Versatility of designs permit a wide variety of special features.  
 F—3-5/16" dia., 5 watts, electrical rotation 359°—resistances 10 to 100,000 ohms.  
 G—1-5/16" dia., 2 watts, electrical rotation 356°—resistances 5 to 20,000 ohms.

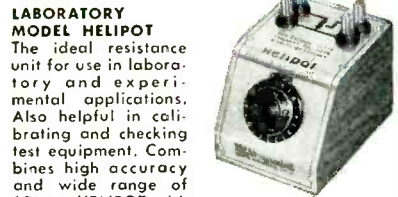

**LABORATORY MODEL HELIPOT**  
 The ideal resistance unit for use in laboratory and experimental applications. Also helpful in calibrating and checking test equipment. Combines high accuracy and wide range of 10-turn HELIPOT with precision adjustability of DUODIAL. Available in eight stock resistance values from 100 to 100,000 ohms, and other values on special order.



**MODELS R AND W DUODIALS**  
 Each model available in standard turns-ratios of 10, 15, 25 and 40 to 1. Inner scale indicates angular position of HELIPOT sliding contact, and outer scale the helical turn on which it is located. Can be driven from knob or shaft end.  
 R—2" diameter, exclusive of index.  
 W—4-3/4" diameter, exclusive of index. Features finger hole in knob to speed rotation.

# FOR PRECISION POTENTIOMETERS

come to **Helipot**

For many years The HELIPOT Corporation has been a leader in the development of advanced types of potentiometers. It pioneered the *helical* potentiometer—the potentiometer now so widely used in computer circuits, radar equipment, aviation devices and other military and industrial applications. It pioneered the DUODIAL®—the turns-indicating dial that greatly simplifies the control of multiple-turn potentiometers and other similar devices. And it has also pioneered in the development of many other unique potentiometric advancements where highest skill coupled with ability to mass-produce to close tolerances have been imperative.

In order to meet rigid government specifications on these developments—and at the same time produce them economically—HELIPOT® has perfected unique manufacturing facilities, including high speed machines capable of winding extreme lengths of resistance elements employing wire even less than .001" diameter. These winding machines are further supplemented by special testing facilities and potentiometer "know-how" unsurpassed in the industry.

So if you have a problem requiring *precision potentiometers* your best bet is to bring it to The HELIPOT Corporation. A call or letter outlining your problem will receive immediate attention!

\*Trade Marks Registered

The versatility of the potentiometer designs illustrated above permit a wide variety of modifications and features, including double shaft extensions, ganged assemblies, the addition of a multiplicity of taps, variation of both electrical and mechanical rotation, special shafts and mounting bushings, high and low temperature operation, and close tolerances on both resistance and linearity. Examples of potentiometers modified for unusual applications are pictured at right.

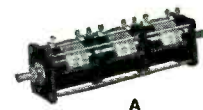

**3-GANGED MODEL A HELIPOT AND DOUBLE SHAFT MODEL C HELIPOT**  
 All HELIPOTS, and the Model F Potentiometer, can be furnished with shaft extensions and mounting bushings at each end to facilitate coupling to other equipment. The Model F, and the A, B, and C HELIPOTS are available in multiple assemblies, ganged at the factory on common shafts, for the control of associated circuits.



**MULTITAPPED MODEL B HELIPOT AND 6-GANGED TAPPED MODEL F**  
 This Model B Helipot contains 40 taps, placed as required at specified points on coil. The Six-Gang Model F Potentiometer contains 19 additional taps on the middle two sections. Such taps permit use of padding resistors to create desired non-linear potentiometer functions, with advantage of flexibility, in that curves can be altered as required.



THE **Helipot** CORPORATION, SOUTH PASADENA 2, CALIFORNIA

# NEW PRODUCTS

Edited by WILLIAM P. O'BRIEN

**Nondefense Production Continues High Despite Materials Shortage . . . Audio Equipment Is Prominently Featured . . . Forty New Literature Items Are Covered**

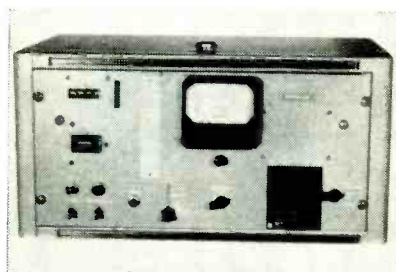

## Scintillation Counter

R-C SCIENTIFIC INSTRUMENT CO., 335 Culver Blvd., Plaza Del Ray, Calif. Model CX14 Scintiscaler incorporates a scintillation counting chamber and is provided with inputs for use with external scintillation or G-M counters. It is intended to be used in the laboratory as a universal scaler for use in the detection of alpha, beta and gamma radiation. The instrument's stable, electronically regulated h-v supply is variable from 700 to 1,500 v. It has a scale of 64 and operates on a 115-v, 60-cps line, requiring 150 watts of power. Cost is \$960.00.

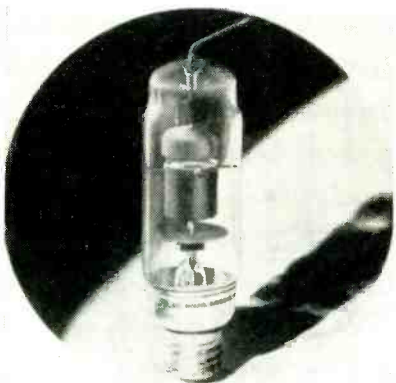

## Mercury Rectifier

NATIONAL ELECTRONICS, INC., Geneva, Ill., has introduced a new quick-heating, 15-ampere rectifier tube for heavy-duty industrial applications. Designated as NL-643, it is mercury-vapor filled and has a peak inverse voltage rating of 700

volts. Filament voltage is 2.5 volts at 23 amperes; filament heating time, 120 seconds; and maximum peak current, 90 amperes.

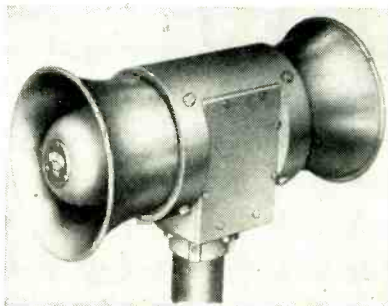

## Dual Speaker

RACON ELECTRIC CO., INC., 52 E. 19th St., New York 3, N. Y. Model RR40 dual speaker designed for railroad and industrial sound systems consists of a heavy noncorrosive-center aluminum casting with a weatherproof steel-bell re-entrant speaker at each end of the opening. Magnet material is Alnico 5; dispersion angle per speaker, 45 deg; frequency range, 350 to 6,000 cycles; total operating capacity, 40 watts; peak capacity, 70 watts; impedance (speakers in parallel), 8 ohms; and sensitivity (4 ft, 1-watt input, 1,000 cycles), 108.5 db.

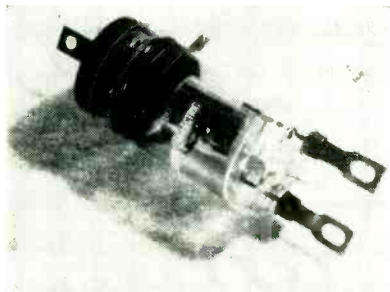

## Gas Thyatron

GENERAL ELECTRIC Co., Syracuse, N. Y. Model GL-5855 three-elec-

trode inert-gas-filled thyatron is designed mainly for general control-circuit applications. It has a quick-heating cathode that takes only a minute to reach operating temperature. A commutation factor rating of 200 makes it useful in motor control without the need for snubber circuits and without the occurrence of gas clean-up. Maximum ratings include: maximum peak anode voltage, 1,500 volts; maximum cathode current, peak 150 amperes, average, 12.5 amperes; maximum negative control-grid voltage, 250 volts before conduction and 10 volts during conduction.

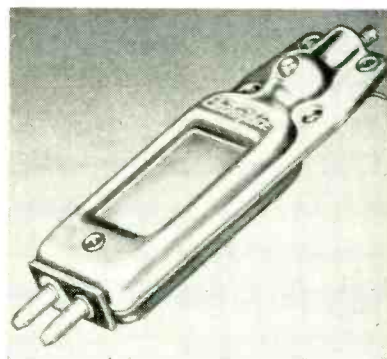

## Phono Cartridge

ELECTRO-VOICE, INC., Buchanan, Mich. Model 60 Econo-Cartridge has a tracking force of  $\frac{3}{4}$  oz on 78 rpm and 8 grams on 33 $\frac{1}{2}$  and 45 rpm; and a frequency response to 6,000 cps. The unit weighs 7.3 grams, and measures 13/16 in. wide x 5/16 in. high x 2 $\frac{1}{8}$  in. long. Price is \$5.50.



## Predetermining Counters

STREETER-AMET Co., 4101 N. Ravenswood Ave., Chicago 13, Ill., has developed an electrical predetermining counter having wide application in industrial control problems. When the preset count has been



# NEW AND HIGHER RATINGS FOR RAYTHEON CK5702/CK605CX SUBMINIATURE TUBES

1. 500 hour life for maximum bulb temperature of **250°C**
2. Shock ratings similar to the "W" Military Ruggedized tube types **450G**
3. Fatigue tested the same as Military Ruggedized tubes **2.5G for 96 hrs.**
4. Long Life Reliability Rating **5000 hrs.**
5. Centrifuge acceleration ratings for any **1000G** position

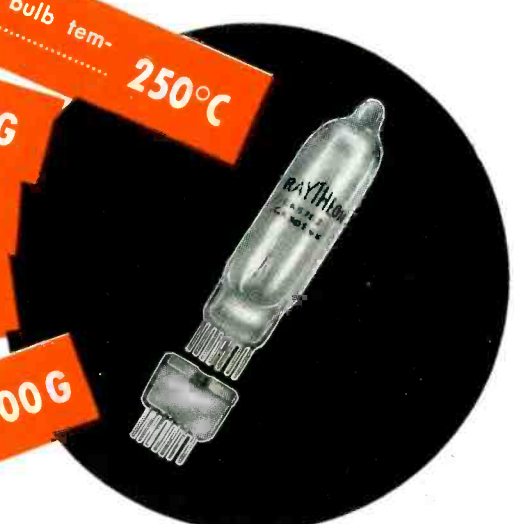

This chart gives you at a glance the characteristics of representative Raytheon Subminiature Tubes

Type No.	Remarks	Maximum Diameter Inches	Maximum Length Inches	Filament Or Heater		Mutual Conductance umhos	Power Output MW	TYPICAL OPERATING CONDITIONS					
				Volts	Ma.			Plate Volts	Ma.	Screen Volts	Ma.	Grid Volts	
<b>HEATER CATHODE TYPES</b>													
CK5702/CK605CX	Characteristics of 6AK5	0.400	1.5	6.3	200	5000		120	7.5	120	2.5	Rk=200	
CK5703/CK608CX	Triode, UHF Oscillator, ¼ watts at 500 Mc	0.400	1.5	6.3	200	5000		120	9.0			Rk=220	
CK5704/CK606BX	Diode, equivalent to one-half 6AL5	0.315	1.5	6.3	150		150ac	9.0					
CK5744/CK619CX	Triode, High mu.	0.400	1.5	6.3	200	4000		250	4.0			Rk=500	
CK5784	Characteristics of 6AS6	0.400	1.5	6.3	200	3200		120	5.2	120	3.5	-2.0	
CK5829	Similar to 6AL5	0.300x0.400	1.5	6.3	150		117ac	5.0 per section					
CK5995	Half Wave Rectifier	0.400	1.75	6.3	300			45				Inverse peak 850 volts	
<b>FILAMENT TYPES</b>													
1AD4	Shielded RF Pentode	0.300x0.400	1.5	1.25	100	2000		45.0	2.8	45.0	0.8	Rg=2meg	
CK571AX	10 ma. filament Electrometer Tube, I <sub>g</sub> = 2x10 <sup>-12</sup> amps. max.	0.285x0.400	1.5	1.25	10	1.61		10.5	0.20			Triode Conn. -3.0	
CK573AX	Triode, High-Freq. Osc.	0.300x0.400	1.5	1.25	200	2000		90.0	11.0			-4.0	
CK574AX	Shielded Pentode RF Amplifier	0.290x0.390	1.25	0.625	20	160		22.5	0.125	22.5	0.04	-0.625	
CK5672	Output Pentode	0.285x0.385	1.5	1.25	50	650	65.0	67.5	3.25	67.5	1.1	-6.5	
CK5676/CK556AX	Triode, UHF Oscillator	0.300x0.400	1.5	1.25	120	1600		135.0	4.0			-5.0	
CK5677/CK568AX	Triode, UHF Oscillator	0.300x0.400	1.5	1.25	60	650		135.0	1.9			-6.0	
CK5678/CK569AX	Shielded RF Pentode	0.300x0.400	1.515	1.25	50	1100		67.5	1.8	67.5	0.48	0	
CK5697/CK570AX	Electrometer Triode Max. grid current 5x10 <sup>-12</sup> amps.	0.285x0.400	1.25	0.625	20	1.5†		12.0	0.22			-3.0	
CK5785	High voltage rectifier	0.300x0.400	1.5	1.25	15				0.1			Inverse peak 3500 volts	
<b>VOLTAGE REGULATORS</b>													
CK5783	Voltage reference tube — like 5651	0.400	1.625					Operating voltage 87. Operating current range 1.5 to 3.5 ma.					
CK5787	Voltage regulator	0.400	2.06					Operating voltage 100. Operating current range 5 to 25 ma.					
CK	Ⓡ	RK	Ⓡ										†Voltage Gain Ratio.

**RAYTHEON**

*Excellence in Electronics*

**RAYTHEON MANUFACTURING COMPANY**

SPECIAL TUBE SECTION • Newton 58, Massachusetts

SUBMINIATURE TUBES • SPECIAL PURPOSE TUBES • MICROWAVE TUBES • CATHODE RAY TUBES • RECEIVING TUBES

reached a circuit is put into operation which may be used to actuate various other electrical equipment. The counter may be operated when a set of external normally-open contacts are closed. Thus it may be used with photoelectric cells, limit switches and like equipment. It can count accurately at a rate of 1,000 counts per minute, and this rate may be extended by use of a decade scaler unit. An automatic reset to zero is provided in preparation for the next counting operation.



### D-C Power Supplies

OPAD-GREEN Co., 71 Warren St., New York 7, N. Y. has introduced a new series of general purpose, low-voltage d-c power supplies featuring continuously variable outputs and carrying continuous duty ratings of 10 amperes. They are available in ranges of 0 to 8 v, 0 to 12 v and 0 to 28 v d-c. The a-c input requirements are 115 v, 60 cycles single phase. The d-c voltage and current may be read directly on two 3-in. meters. The ammeter is calibrated in steps of 200 ma and has a full scale value of 10 amperes. Descriptive bulletin GPA1 is available on request.

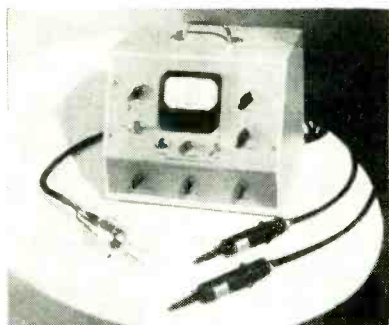

### High-Vacuum Gage

NATIONAL RESEARCH CORP., 70 Memorial Drive, Cambridge, Mass. Type 710 thermocouple and emission-regulated ion gage control is

designed to fill all the needs of the laboratory or plant high-vacuum installation. Pressure range covered is 1 mm Hg absolute to  $1 \times 10^{-8}$  mm Hg absolute. A specially designed low-leakage shielded connecting cable eliminates errors at pressures below  $10^{-6}$  mm where the ionization currents are less than  $10^{-7}$  amperes. Filament emission is regulated at 1, 5 or 10 ma at the operator's choice.



### R-F Step-Up Coil

SPELLMAN TELEVISION CORP., 3029 Webster Ave., Bronx 67, N. Y. By using the h-v r-f step-up type coils illustrated in a special circuit, voltages as high as 90 kv can be obtained. Rated at 35 kv, the coils find application in tv circuits, electrostatic paint spraying, insulation testing, spectroscopic analysis, nuclear fission, and so on. The primary is separate from the secondary winding, which is 7 in. high and consists of 10 pie windings 3 in. in diameter. The primary is 4 in. high and  $4\frac{1}{2}$  in. in diameter. Secondary voltage output is 35 kv, secondary current is 5 ma and the approximate frequency is 70 kc.

### Half-Wave Rectifier Tube

GENERAL ELECTRIC Co., Syracuse, N. Y. Type 1X2A half-wave rectifier tube, designed for tv receivers, is suitable for use in both radio-frequency and flyback types of power supplies. Maximum ratings and characteristics include: peak

inverse plate voltage, 20 kv; peak plate current, 11 ma.

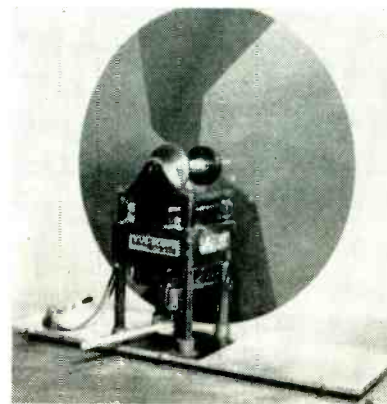

### TV Converter Kit

CELOMAT CORP., 521 W. 23rd St., New York, N. Y., has developed a color tv converter kit to receive CBS color television. The Vue-Scope uses a color disk of Fibestos cellulose acetate plastic sheeting made up of three primary colors—red, blue and green. The kit includes a manual synchronization unit, a fractional horse-power motor and assembly brackets. It will produce about a six-in. picture and retail under \$15.00.

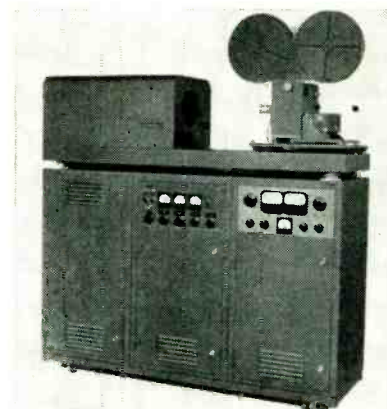

### Video Recorder

GENERAL PRECISION LABORATORY, INC., Pleasantville, N. Y., has developed a video recorder with electronic control that will record tv programs with picture quality equal to the original live telecast. The electronic design eliminates double exposures, under exposures, film fuzziness, garbled sound and vibration. A counter setup to monitor

(Continued on p 244)



# SOMETHING NEW has been ADDED

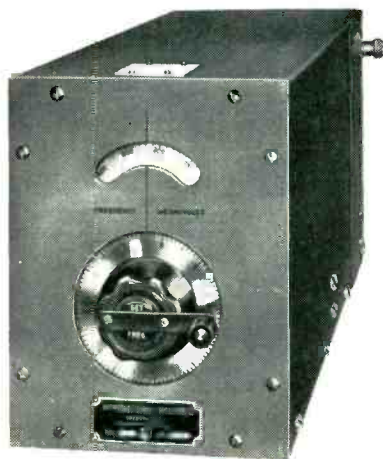

## FREQUENCY METERS

NEW precision coaxial frequency meters cover frequencies from 550 to 3950 megacycles per second with stability and accuracy previously available only in high frequency waveguide units.

—extending the coverage of

# PRD

Test Equipment  
to new limits

## POWER SUPPLIES

NEW low voltage range in the Type 801-A Universal Klystron Power Supply permits the use of 300 volt oscillator tubes with convenience and stability.



## ATTENUATORS

NEW fixed coaxial pads now provide coverage over the entire spectrum from 10,000 megacycles per second right down to DC in three ranges. Other designs include units rated up to 5 watts of average input power.

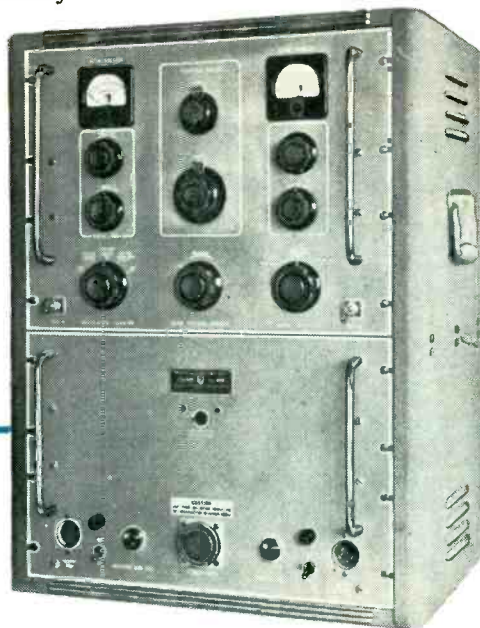

See these instruments and others on display at the 1951 IRE SHOW — BOOTHS 268 & 269  
For full specifications write for a copy of the new PRD catalog to Dept. E-11 today.



*Polytechnic* RESEARCH  
& DEVELOPMENT COMPANY, Inc.

202 TILLARY ST., BROOKLYN 1, NEW YORK



# NEWS OF THE INDUSTRY

Edited by WILLIAM P. O'BRIEN

## New Computer Aids Air Defense

PROJECT TYPHOON, a new electronic analog computer for evaluating the performance of guided missiles, ships, planes and submarines and aiding in the air protection of American cities, was recently shown in operation at a joint Navy Special Devices Center—RCA demonstration in Princeton, N. J. The calculator, which employs 4,000 electron tubes, several miles of intricate wiring and components that are exact to better than one part in 25,000, can solve in one minute problems that would require two mathematicians six months.

The apparatus obviates the need of building costly models and testing them in flight. A staff of nine engineers and mathematicians as well as six technical assistants are required to operate the unit while it solves complex problems. By setting dials and switch-board plugs scientists can represent the physical features of a projectile in the form of mathematical equations. That section of the machine becomes a mathematical picture of the missile.

Then the missile, flying 1,600 mph, is given a problem such as intercepting an 800-mph high-flying bomber which has been tagged by a radar beam. Just such a problem was solved at the recent demonstration.

Under contract with the Special Devices Center of the Office of Naval Research, engineers of RCA Laboratories designed and built the instrument for use by the Navy Bureau of Aeronautics. To keep it free of climatic influences, Typhoon is housed in a special air-conditioned room at RCA Laboratories which has a constant temperature of 75F and a relative humidity of not more than 50 percent.

## SMPTE Establishes New Award

ESTABLISHMENT of the David Sarnoff Gold Medal as an annual award for an outstanding contribution to television engineering was announced recently by Earl I. Spon-

able, president of the Society of Motion Picture and Television Engineers. The award was proposed by Frank M. Folsom, president, on behalf of the Radio Corporation of America, and named for General Sarnoff, chairman of the board of directors of RCA.

The medal will be presented at the society's fall meeting each year to that individual selected by a special award committee who has done outstanding work in some technical phase of the field of television engineering, whether in research, development, design, manufacture or operation, or in any similar phase of theater television.

In addition to the gold medal, the award will include a bronze replica and a citation describing the recipient's qualifications. The recipient will be selected by a special committee to be appointed each year by the president of the SMPTE, consisting of a chairman and four members who are fellows or honorary members of the society or previous recipients of some formal society award, and each of whom is qualified to judge the importance or value of current work in some technical phase of television.

In the selection of candidates for the award, it is stipulated in the terms under which it is to be administered, contributions which have led to greater fidelity in reproduction of an original scene, or to simplification of the processes involved, shall be important considerations. The purpose of the award, it is stated in these terms of administration, is to recognize recent technical contributions to the art of television, and to encourage the development of new techniques, new methods, and new equipment which hold promise for the continued improvement of television.

## IRE's 1951 Convention

THE INSTITUTE of Radio Engineers is holding its 1951 National Convention on March 19-22 in New York City. Its theme will be "Advance with Electronics in the National Emergency."

Headquarters for the convention will be a new location, the Wal-

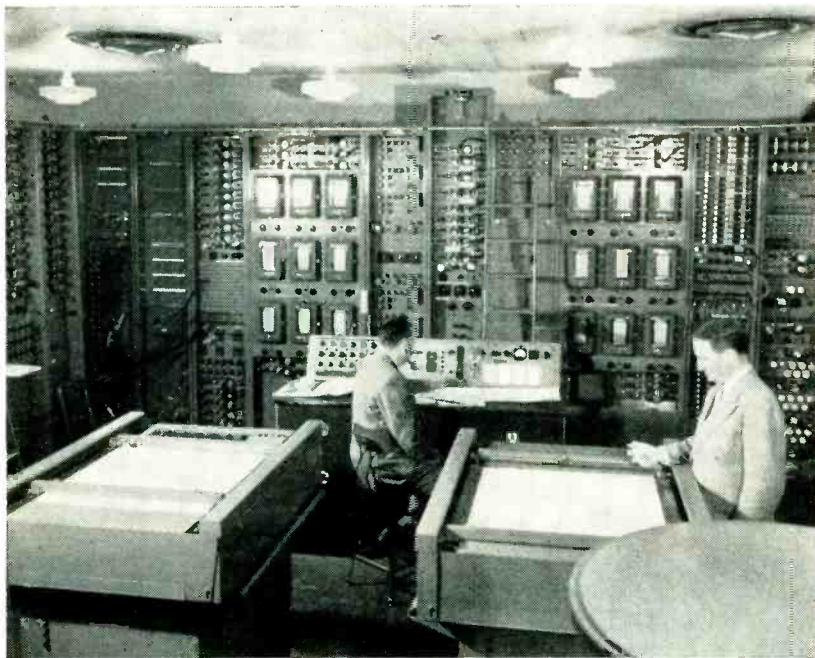

A. W. Vance of RCA Laboratories operates the Typhoon computer from the control console while R. S. Holmes checks the missile and target projectory on one of the plotting boards. Shown in the background are some of the panels containing thousands of electron tubes and miles of intricate wiring



*The amazing*

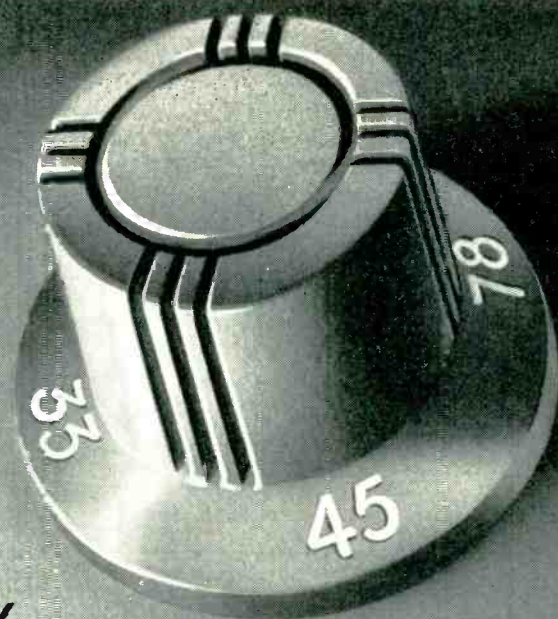

# BSR "Rotocam"

*3 speed phonomotors*

*78, 45 & 33 1/2 r.p.m.*



- Speed change is simple, foolproof and reliable.
- No rubber belts to stretch or perish.
- Smooth constant speed. 'Wow' negligible (under 0.2%)
- Incorporates the well-known B.S.R. 4 pole motor.
- Heavy 10" turntable fitted on precision ground taper steel spindle.
- Turntable fitted with special removable rubber mat—pioneered by us to meet the exacting "hygiene" demanded by the L.P. records.

*Transcription quality at competitive prices.*

Illustrated is the popular MU14 3 speed unit. Other 3 speed models are available complete with pickup and automatic stop.

Advanced design and a modern well equipped factory enable us to offer good delivery at moderate prices.



*U.S. and Canadian Warehouse and Offices.*

**SAMCO PRODUCTS COMPANY**

1' Spruce Street, New York 7. N.Y.

Telephone: Worth 4-0152.

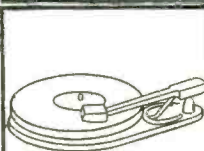

Three speed gramophone units complete with pickup and auto-stop.

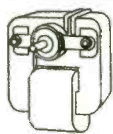

Heavy duty two pole, shaded pole induction motors for every application.

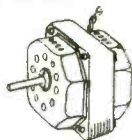

Precision engineered well balanced 4 pole shaded pole induction motors.

## BIRMINGHAM SOUND REPRODUCERS LTD.

CLAREMONT WORKS. OLD HILL, STAFFS. ENGLAND. GRAMS: 'ELECTRONIC, OLD HILL, CRADLEY HEATH'



dorf-Astoria Hotel. The Radio Engineering Show will, as in prior years, occupy the Grand Central Palace, two blocks south of the Waldorf on Lexington Ave. Technical sessions will be held in both locations.

A speaker of national prominence will address the banquet on Wednesday, March 21. The luncheon on Tuesday, March 20, and the cocktail party on Monday evening will both be held in the Starlight Roof of the Waldorf.

## TV Engineers Attend Antenna Symposium

MORE than twenty-five broadcasting engineers and television consultants recently attended a symposium dealing with practical considerations in the use of superturnstile and supergain antennas conducted at the RCA Victor plant in Camden, N. J.

The engineers later made an inspection of the plant to view work in progress on the multiple antenna for the Empire State Building in New York City. The symposium was led by Herman E. Gihring, manager of the broadcast antenna design section of the RCA Engineering Products Department.

Those present at the symposium

were: Edward Talbott of KROD, El Paso; J. M. DeBell, Jr., of DuMont Laboratories, Passaic, N. J.; Ray Craig of WCAU, Philadelphia; John G. Preston of American Broadcasting Co., New York; J. E. Mathiot of WGAL, Lancaster, Pa.; Henry L. Dubrowski of WATV, Newark; A. M. Hopwood of WPTZ, Philadelphia; James W. Kyle of WTVR, Richmond; T. W. Howard of WPIX, New York; Henry E. Rhea of WFIL, Philadelphia; P. B. Laeser of WTMJ-TV, Milwaukee; Ralph N. Harmon of WRC, Washington; Charles H. Singer of WOR-

TV, New York; N. F. Smith of WOR-TV, New York; George E. Hagerty of Westinghouse, Washington; Louis H. Stantz of WNBC, Binghamton; Benjamin Wolfe of WAAM-TV, Baltimore; Carl J. Nopper of WMAR-TV, Baltimore; E. J. Love of WWJ, Detroit; Albert Preisman of Preisman and Biser, Washington; A. Josephsen of RCA, New York; Glenn D. Gillett of Gillett and Associates, Washington; Oscar Reed, Jr. of Jansky & Bailey, Washington; Millard M. Garrison of Chambers and Garrison, Washington; George C. Davis, consultant, Washington; George P. Adair, consultant, Washington; Robert E. Baluta of McIntosh & Ingles, Washington; Julius A. Renhard of RCA, Washington; and William L. Foss, consultant, Washington.

## Radioactivity Monitor Specifications Released

THE Federal Civil Defense Administration has released specifications for two basic types of monitoring instruments to determine the extent of radioactive contamination following an atomic attack. These specifications have been sent to all state governments, civil defense directors, and manufacturers in the instrument field.

Manufacturers are being urged to put special effort toward developing a high-intensity instrument based on the published specifications. Such an instrument, measuring up to five hundred roentgens per hour, would be needed in area

(Continued on p 280)

## MEETINGS

MARCH 5-9: ASTM Spring Meeting and Committee Week, Cincinnati, Ohio.

MAR. 19-22: IRE Annual Convention, Hotel Waldorf Astoria and Grand Central Palace, New York City.

APR. 20-21: Southwestern IRE Conference, Southern Methodist University, Dallas, Texas.

APR. 30- MAY 4: SMPTE Spring Convention, Hotel Statler, N Y

MAY 23-24: Fifth National Convention, American Society for Quality Control, Hotel Cleveland, Cleveland, Ohio.

JUNE 18-22: ASTM Annual Meeting, Atlantic City, New Jersey.

JUNE 25-29: AIEE Summer General Meeting, Royal York Hotel, Toronto, Ontario, Canada.

AUG. 28-SEPT. 8: Eighteenth British National Radio Show, Earls Court, London, England.

AUG. 29-31: Seventh Annual Pacific Electronic Exhibit and West Coast Annual IRE Convention, San Francisco Civic Auditorium, San Francisco, Calif.



Among the television engineers and consultants attending a symposium dealing with antenna problems at the RCA Little Theatre in Camden recently were (left to right): Edward Talbott, KROD, El Paso; James W. Kyle, WTVR, Richmond; Phillip B. Laeser, WTMJ-TV, Milwaukee; Al Josephsen, RCA broadcasting field sales representative, New York; Glenn D. Gillett, Gillett and Associates, consultants, Washington; and Henry L. Dubrowski, WATV, Newark





## THESE LIFE LINES OF AMERICA...

*use long life dependable Sylvania Tubes*

Progressive railroads everywhere are now using Sylvania radio tubes for multiple communications systems.

In engine-caboose-signal-tower networks, where clear tone and unfailing dependability are of utmost importance, Sylvania tubes are winning increased acceptance. These tubes are designed, built and tested to take more than their share of vibration and rough treatment.

Also, their clarity and freedom from internal noises make them ideal for critical transportation applications . . . in trains, buses, police cars, taxi cabs.

The Sylvania quality tube line is a complete

line. Made in miniature and standard sizes. Also low-drain battery tubes for efficient, compact portable sets.

### Get new listings

Call your distributor for new listings and full information. If he cannot serve all your needs immediately, please be patient. Remember, the tube situation is still tight and your distributor is doing his best to deal fairly with all his customers. For further information address: Sylvania Electric Products Inc., Dept. R-1102, Emporium, Pa. *Sylvania representatives are located in all foreign countries. Names on request.*

# SYLVANIA ELECTRIC

RADIO TUBES; TELEVISION PICTURE TUBES; ELECTRONIC PRODUCTS; ELECTRONIC TEST EQUIPMENT; FLUORESCENT TUBES, FIXTURES, SIGN TUBING, WIRING DEVICES; LIGHT BULBS; PHOTOLAMPS; TELEVISION SETS

# NEW BOOKS

## Antennas

BY JOHN D. KRAUS. *McGraw-Hill Book Co., Inc., New York, 1950, 553 pages, \$8.00.*

ANY REVIEW of this book would be incomplete without a word of warning to the prospective buyer that it will be of little value unless he is able to juggle integral calculus and to interpret and understand theoretical analyses.

The book is intended for use as a text and reference for senior or graduate courses in antenna theory. As such, it serves admirably, in that it is in line with texts now used in parallel courses in other phases of the science of communications. The practical aspects of antenna engineering have, however, been overshadowed by the more theoretical ones.

The material presented is based on a series of lectures given by the author at Ohio State. It reflects his vast knowledge of the subject and his experience at teaching. There is probably no more complete book on the various types of very-high

and ultrahigh-frequency antennas now in print.

The antenna is first treated as a point source and then as an aperture, after which the text methodically presents in turn thin linear antennas, loops, helical antennas, biconicals, cylindricals, reflector types, slot and horn antennas and all the special versions and combinations that are in use today. A special section is devoted to antenna measurements, and a generous appendix provides a wealth of reference information in exceptionally

### RELEASED THIS MONTH

**Applied Nuclear Physics; E. Pollard and W. L. Davidson; Wiley; \$5.00.**

**Electronic Fundamentals and Applications; J. D. Ryder; Prentice-Hall; \$9.00.**

**Propagation of Short Radio Waves; Vol. 13 of Radiation Lab Series; Donald E. Kerr; \$10.00.**

**Waveguide Handbook; Vol. 10 of Radiation Lab Series; M. Marcuvitz; \$7.50.**

convenient form. Abundant references are given for further study on specific subjects.—J.D.F.

## Traveling Wave Tubes

BY J. R. PIERCE. *Bell Laboratories Series. D. Van Nostrand, Inc., New York, 1950, 260 pages, \$4.50.*

MORE and more communication engineers are desirous of understanding the principles of operation of one of the latest members of the family of microwave tubes—the traveling-wave tube. This is due to the fact that with the expansion of the frequency spectrum the question of bandwidth has become of great importance and the tube's outstanding feature is its enormous bandwidth.

Until the appearance of Pierce's book any information about traveling-wave tubes had to be gained by reading scattered articles. The author's clearly organized and well digested treatise on the subject has largely dispensed with this task. The author is well-known for his many contributions to the theory of these tubes as well as to other fields of electronics, and his presentation

(Continued on p 140)

# BACKTALK

This Department is Operated as an Open Forum Where Readers May Discuss Problems of the Electronics Industry or Comment Upon Articles that ELECTRONICS has Published

## More References

DEAR SIRs:

As is borne out on page 275 of the November 1950 issue and otherwise, ELECTRONICS is always anxious to give the reader as many and as good references as possible.

I refer to the excellent paper by Cunningham, May and Skalnik, "Integration Noise Reducer for Radar", published in the September 1950 issue of ELECTRONICS. In this paper, my research work since 1945 in the signal integration field is

referred to via the Government Report E5038. Actually, I never issued report E5038, since it contains a number of technical and printing errors, but instead, in 1948, gave a lecture in the National Electronics Conference in Chicago, entitled "Extraction of Weak Signals from Noise by Integration", which was published later in the *Proceedings of the NEC*, Vol. 4, 1948. This paper also bears the names of Dr. Dickey and Dr. Emslie, who contributed much to the final results. Since my *NEC*

paper is technically correct, properly issued, and generally available, it should as a reference take the place of the erroneous report E5038.

Still further technical information may be derived from the fact that I conceived of the integration method as described in reference (3) of the Cunningham-May-Skalnik paper when doing research work for USAF in 1946, and submitted a patent application via USAF, Wright Field, which describes my early integration system, applied to a radar receiver. Later this system, in less elegant form than the one described in ELECTRONICS, yielded an improvement in signal-to-noise ratio of 24 decibels, and I, therefore, took steps to bring the invention into the experienced hands of Professor Cunningham of Yale University, who later carried

(Continued on p 292)



# NORTH'S

## "Wigglestick"

IS A VERSATILE

## RELAY

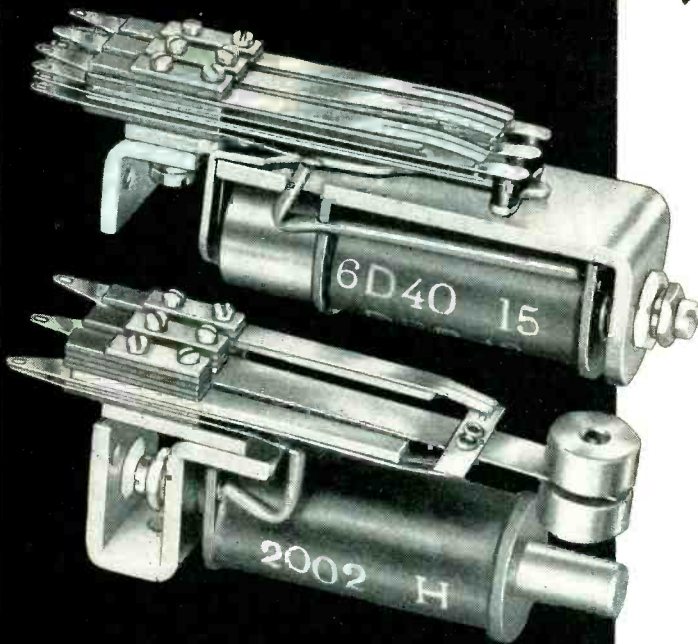

The odd little relay at left with the protruding schnozzle was nicknamed "Wigglestick" by an engineer in one of his lighter moments. Its usefulness to designers of electrical circuits is not to be regarded lightly, however.

Used alone, this vibrating reed relay in a self-interrupting circuit will generate time pulses. Hooked up with a slow-release relay, like the one shown above it, the pair may be used in special delayed circuits, adjustable to any value from one to eight seconds. Other combinations provide a still wider range of application.

These stock relays are typical of a wide variety made by North, one of the oldest manufacturers of relays and switching equipment in the country. The choice ranges from midgets to multiples, from single-makes to pile-ups controlling up to thirty-two circuits with one double-wire control circuit.

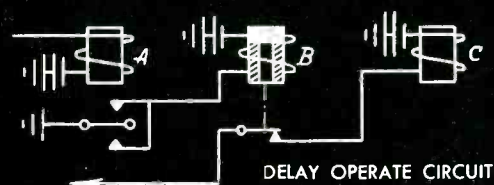
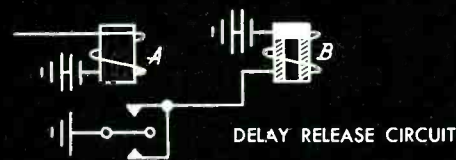
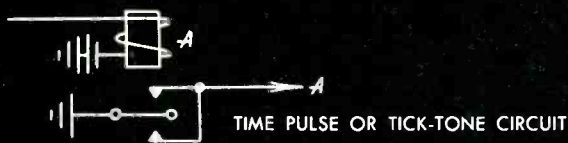

## NORTH RELAYS

Set a high standard of performance and permanence because this company specializes in all-relay switching equipment. North relay engineering service is second to none.

**SPECIAL RELAYS? Let North Engineer Them For You**



**THE NORTH ELECTRIC MANUFACTURING CO., Galion, Ohio, U. S. A.**

*Originators of ALL RELAY Systems of Automatic Switching*

**FOR PROMPT REPLY  
ADDRESS DEPT. T**

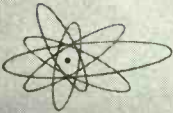

# Designers



## AMPLIDYNES— 500 to 25,000 WATTS

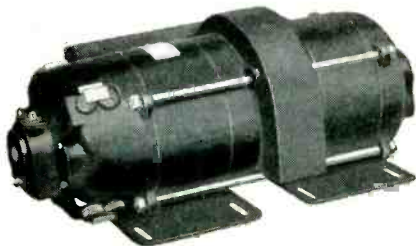

▼ 5-kw Amplidyne generator

▲ 1-kw Amplidyne motor-generator set.

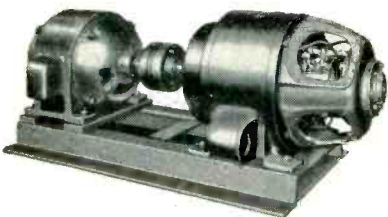

◀ 3-kw Amplidyne motor-generator set

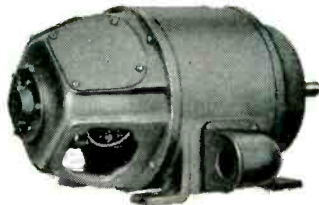

**PRECISE CONTROL OF position • torque • speed  
tension • power factor • voltage • current**

The General Electric amplidyne is a simple d-c generator which, through the arrangement of field and armature circuits, possesses extremely high speed of response and amplification.

First used in radar and fire-control apparatus, it now has many new jobs. That's why G-E amplidyne generators and motor-generator sets are made in a wide variety of sizes and frames with output ratings from 500 watts to 25 kilowatts.

What are your requirements? For further data, write, giving complete details, to *Electrical Industries Sec., Resale Industries Div., Apparatus Dept., General Electric Co., Schenectady 5, N. Y.*

**A G-E 25-KW AMPLIDYNE AMPLIFIES A 9/10 WATT INPUT 22,200 TIMES**

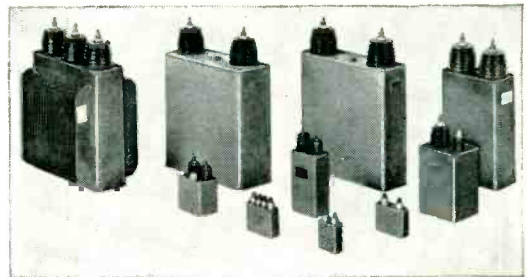

### PULSES —MADE TO ORDER

Specially designed General Electric Type-E networks will generate pulses within  $\pm 5$  per cent of any length you require from 0.1 to 40 microseconds. These networks consist of capacitor and coil sections adjusted to close tolerances and hermetically sealed in single metal containers. In the last war G-E Type-E networks were produced on a large scale to meet radar demands. Now they are available for commercial or military use in a wide variety of designs, impedances, ratings, and sizes. See Bulletin GEA-4996.

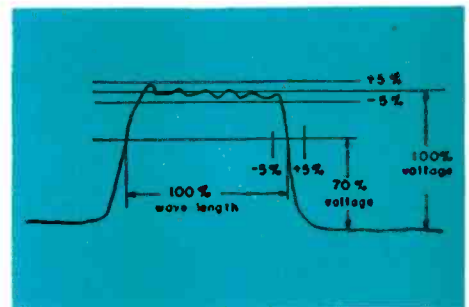

Typical design and operational limits of G E Type-E pulse-forming network: Ripple at top of pulse  $\pm 5\%$ ; Wave length  $\pm 5\%$  measured at 70% amplitude; Capacitance tolerance  $\pm 10\%$

# GENERAL ELECTRIC



# Digest

TIMELY HIGHLIGHTS  
ON G-E COMPONENTS

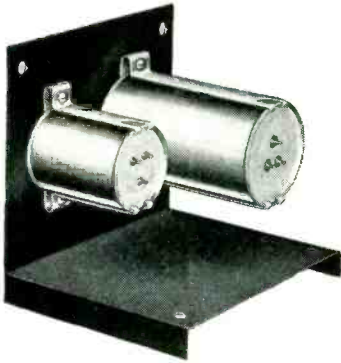

## OIL-IMMERSED SELENIUM RECTIFIERS —use them “ANYWHERE”!

G-E hermetically sealed, oil-immersed selenium rectifier stacks make it possible for you to design metallic rectifiers into equipment that will be subjected to corrosive fumes, salt air, dust, fungus, or other atmospheric conditions. Because they're immersed in oil, these stacks will stand higher current drains than equivalent-size “open” units. Available in single- or full-wave circuits. Ratings: from 12 to 180 d-c volts output, 15.5 to 270 a-c volts input, .25 to 27.0 d-c amps. Write for complete data on ratings and dimensions to *Electrical Industries Section, Resale Industries Division, Apparatus Dept., General Electric Co., Schenectady 5, N. Y.*



## PUSH-BUTTON STATIONS—make your selection from the COMPLETE G-E LINE

There's a General Electric push-button station or unit for virtually any electronic application. The complete line includes dozens of types. All stations have sturdy nonbreakable steel frames and covers with ample clearance between terminals. G-E units for built-in applications have terminals anchored to a molded base for firm support. Contact maintenance on all stations and units is virtually unnecessary because large fine-silver double-break contacts are used. For full data, check Bulletin GEA-3469.

## NEW! SHADOW-PROOF DIALS MAKE SWITCHBOARD INSTRUMENTS EASIER-TO-READ

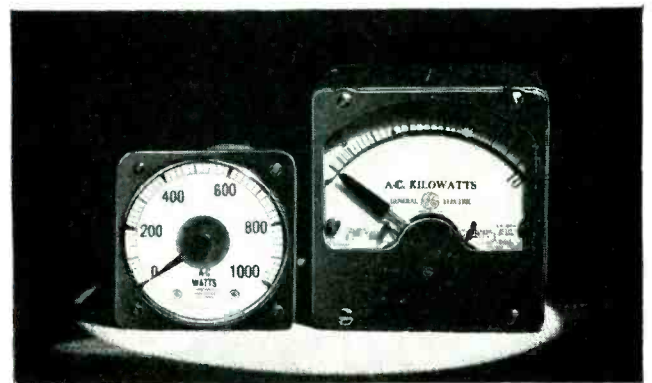

Here is a new switchboard instrument that can be read easily—anytime. Its dial can be clearly illuminated from almost any angle because it is set forward flush with the front of the case. A protruding anti-glare convex-type glass front prevents reflections. The new meter is available in 4¼- or 8¾-inch models, both with long 250-degree scales. D-c ammeters, volt-ammeters; a-c ammeters, volt-meters, wattmeters, frequency and power-factor meters, temperature indicators, and synchroscopes. Send for Bulletin GEC-218.

General Electric Company, Section B667-10  
Apparatus Department, Schenectady 5, N. Y.

Please send me the following bulletins:

- (V) Indicate for reference only  GEA-3469 Push-button stations  
(X) for planning an immediate project  GEA-4996 Pulse-forming networks  
 GEC-218 Switchboard instruments

Name \_\_\_\_\_

Company \_\_\_\_\_

Address \_\_\_\_\_

City \_\_\_\_\_ State \_\_\_\_\_

# TEFLON

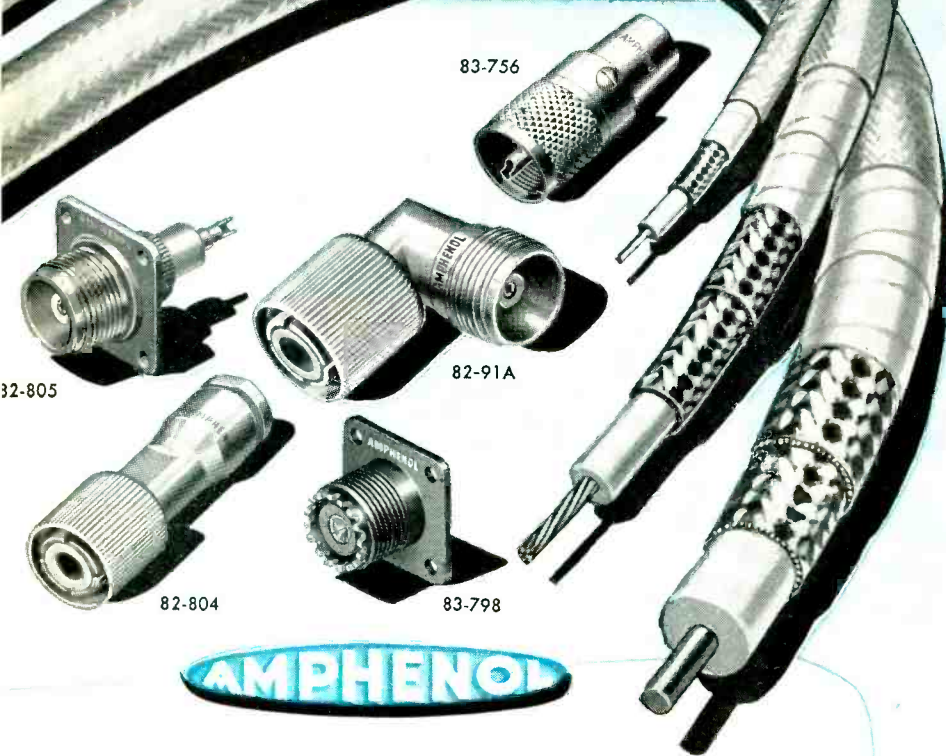

## CABLES

AMPHENOL coaxial cables made with Teflon dielectric have low loss and perform satisfactorily at temperatures as high as 500° F. Covering the Teflon dielectric are two silver coated shields and two wrappings of Teflon tape. The jacket consists of two fibre glass braids impregnated with silicone varnish which is oven baked to provide maximum moisture and abrasion resistance.

## CONNECTORS

Because impedance specifications of Amphenol RF Connectors can be depended on, no line unbalance is inserted, nor is the standing-wave ratio increased. Amphenol RF Connectors meet the exacting requirements of laboratory applications—have longer leakage paths, lower loss.

The 82 series connectors illustrated are weather-proof type HN connectors for use with 50 ohm cable. These connectors have full 4Kv. rating when used with Silicone Compound and may be used with 70 ohm cables when impedance is not critical.

The 83 series UHF connectors illustrated are low cost general purpose connectors ideal for laboratory applications. Not constant impedance, but suitable for general RF transmission below 160 megacycles.

Teflon inserts are standard on the connectors illustrated and will be supplied with any AMPHENOL RF connector on special order.

AMPHENOL

**AMERICAN PHENOLIC CORPORATION**

1834 SOUTH 54th AVENUE

CHICAGO 50, ILLINOIS

reveals this intimate relationship with the subject.

Traveling-wave tubes consist of a circuit which is capable of supporting electromagnetic waves whose phase velocity is much lower than that of light. The book contains several chapters on the theory of these waveguiding structures such as helices, linear arrays of coupled resonant slots and cavity or filter-type circuits. Wherever possible field solutions are given, while in other cases the circuits are treated by considering the behavior of lumped-circuit analogies.

The term impedance, which requires special definition for the case of hybrid waves, is well explained and thus much misunderstanding should now be cleared up.

### *Small-Signal Theory Used*

Interacting with the slow wave are the electrons which travel in beam formation along the axis of propagation. This interaction is of the nature of an energy exchange between the beam and the electromagnetic field all along the axis. Because of it such quantities as current, space charge and velocity may be described by d-c terms superimposed by a-c terms which are of wave nature. In describing the process of interaction, small-signal theory is used throughout the book with the exception of one short chapter on power output where reference is made to some results of Nordsieck's large-signal computations.

When the electrons travel with a d-c velocity equal or nearly equal to the phase velocity of electromagnetic waves which the guide is capable of supporting, waves with increasing amplitude appear and the whole structure may function as an amplifier. An extensive theory on the gain of the tube is presented. The influence of various factors such as the velocity of the electrons, the d-c beam current, the attenuation of the guide and space-charge properties of the beam are investigated. The design engineer will find there a method for the computation of the gain for a helix-type traveling-wave tube.

The question of relative merit of various possible traveling-wave tube



# For *educating electrons*

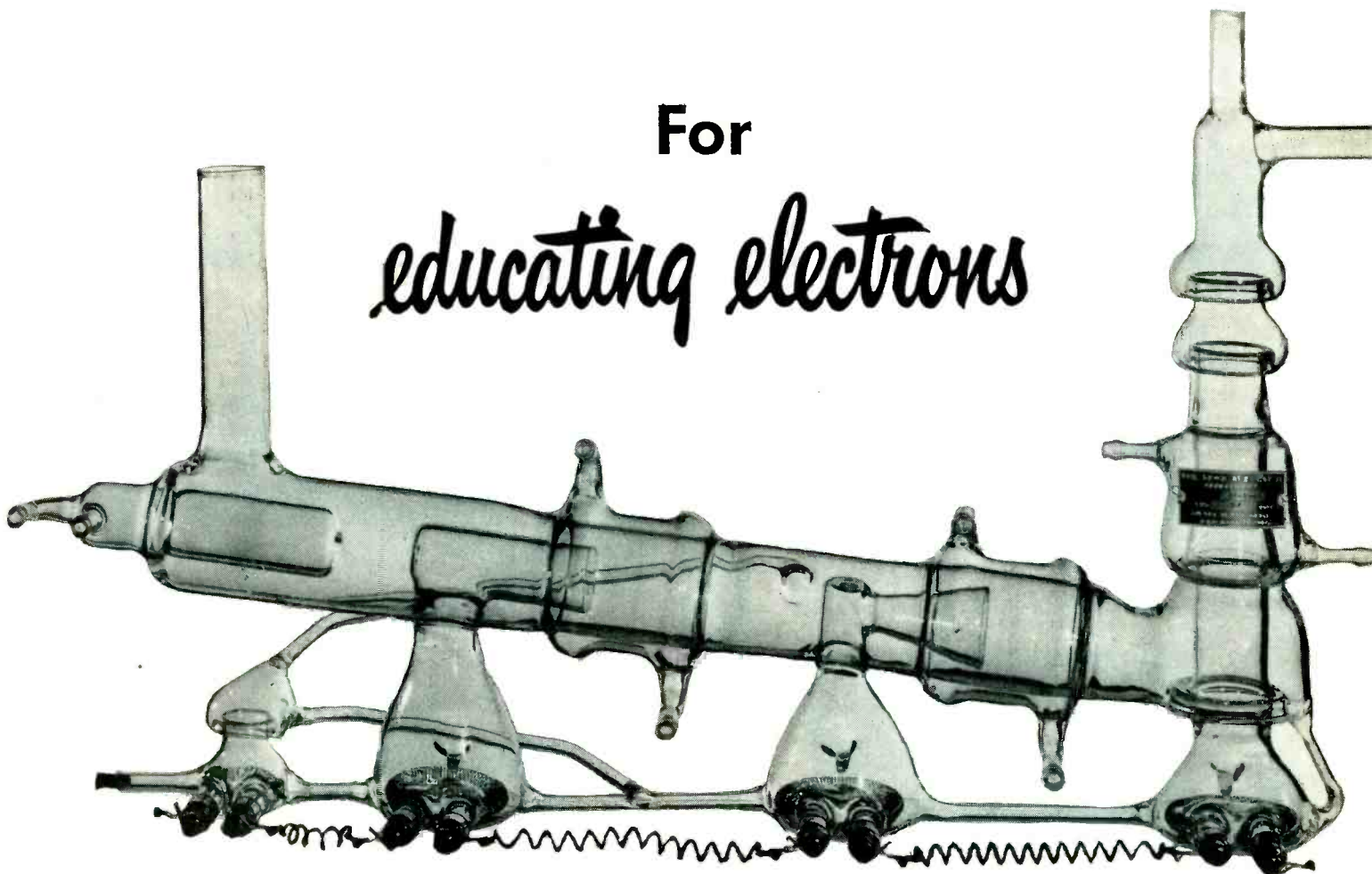

Educated electrons are being called on for more and more difficult tricks in today's "vacuum" tubes. The higher the vacuum, the better they perform. The sharpest-focussed beams and the longest reliable operating lives are found in tubes exhausted to the utmost degree that modern technology permits.

For the development laboratory, a DPi glass diffusion pump as pictured here can give you the best vacuum that man can produce. The ultimate vacuum it gives without the aid of a cold trap is  $5 \times 10^{-8}$  mm. Hg. With a cold trap,  $10^{-9}$  mm. Hg is attainable.

DPi invented the multi-stage fractionation principle and the Octoil®-S Vacuum Pump Fluids that make such vacuum possible. DPi's program to make really high vacuum work with ease and economy goes on continuously. Whether you're interested in a pound of low-vapor pressure gasketing, a chamber where experimental models of new electron tube ideas may be tried out quickly and inexpensively, or a complete exhaust system for a tube factory, your problems will receive careful attention. Merely write *Distillation Products Industries*, Vacuum Equipment Department, 727 Ridge Road West, Rochester 3, New York. (Division of Eastman Kodak Company).

**high vacuum  
research  
and engineering**

**DPi**

Also . . . vitamins A and E . . . distilled monoglycerides . . . more than 3400 Eastman Organic Chemicals for science and industry

# INSTRUMENTS FOR MILITARY RESEARCH and DEVELOPMENT

Send for Catalog of specifications and complete line



### THE RADA-SWEEP

A new wide band sweep with markers for aligning radar IF amplifiers.



### THE MEGA-SWEEP

The widest-range sweeping oscillator

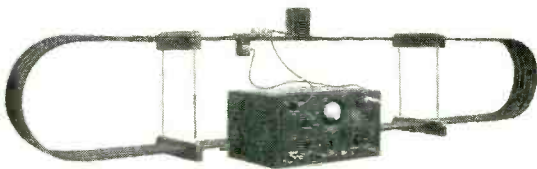

### THE MICROWAVE MEGA-MATCH

Completely electronic. Measures reflected energy. Displays mis-match over wide frequency bands in the X-Band.



### THE MEGA-MATCH

Measures reflected energy. Displays mis-match over wide frequency range

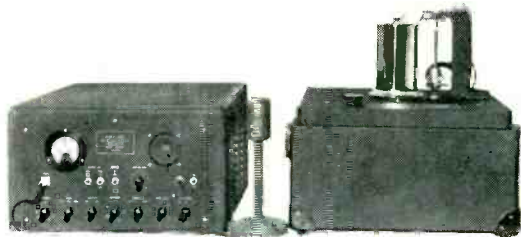

### THE VIBRALYZER

A new instrument for analyzing vibrations and noise

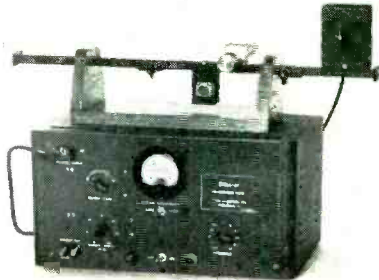

### THE MEGA-X

An X-Band signal source

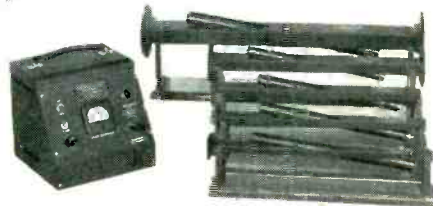

### THE MICROWAVE MEGA-NODES

Calibrated noise source at microwaves primary standard in the microwave spectrum.



### THE MEGA-PULSER

Generator of ultra narrow pulses.

ELECTRIC

**KAY**

COMPANY

25 Maple Avenue

Pine Brook, N. J.

Phone CAldwell 6-4000



they

may

look

alike,

but:

there

is

only

one

**C-D**

# "VIKANE" IMPREGNATED

## "GREY TIGER" Paper Tubular Capacitors

only  
Cornell-Dubilier  
can  
offer you:

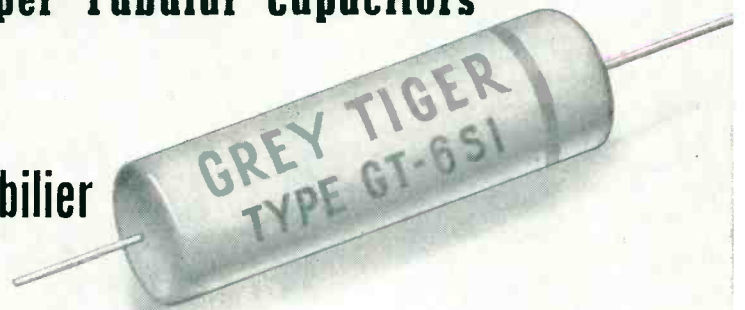

- 1 "Vikane"\* impregnation — an exclusive C-D development—results in extra long life and outstanding performance over a temperature range of  $-35^{\circ}\text{C}$ . to  $100^{\circ}\text{C}$ . Special high temperature and moisture end-fill seals unit.
- 2 A tubular of exceptionally high insulation resistance. At  $25^{\circ}\text{C}$ ., resistance is over 10,000 megs per unit or 2,000 megs per mfd.
- 3 A standardized line of paper tubulars that will fill both high and low temperature requirements. No duplication of stock and record keeping! No production delays! Less inventory loss! A feature of "Vikane" impregnation.
- 4 A tubular with a power-factor average of 0.35% at 1,000 cycles.
- 5 A tubular with excellent capacity stability over both the high, low temperature range.

Tinned-copper leads, standard sizes. Attractive grey case, red lettering. Available in all commercial capacity and voltage ratings.

For further details on the "Grey Tiger" line of paper tubulars, write for Bulletin No. NB116. CORNELL-DUBILIER ELECTRIC CORPORATION, Dept. K-21 South Plainfield, New Jersey. Other plants in New Bedford, Brookline and Worcester, Mass.; Providence, R. I., Indianapolis, Ind., and subsidiary, The Radiart Corp., Cleveland, Ohio.

SPECIFY "GREY TIGER"—A TYPICAL C-D FIRST!



CONSISTENTLY DEPENDABLE

# CORNELL-DUBILIER

CAPACITORS • VIBRATORS • ANTENNAS • CONVERTERS



# GOT A RELAY PROBLEM?

## USE R-B-M GENERAL PURPOSE RELAYS

*Low in Cost — Small in Size — Dependable  
in Performance — AC or DC*

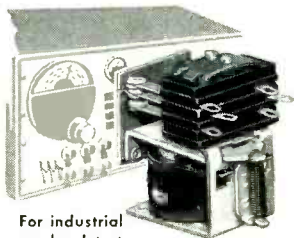

For industrial smoke detectors

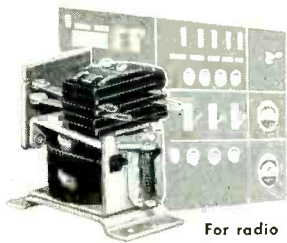

For radio transmitter panels

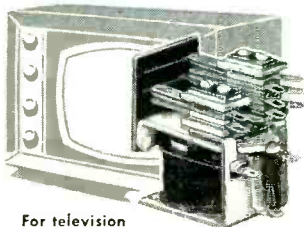

For television screen enlargers

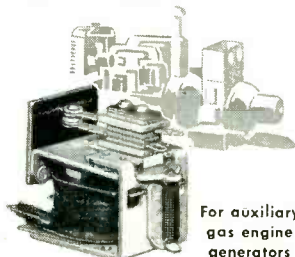

For auxiliary gas engine generators

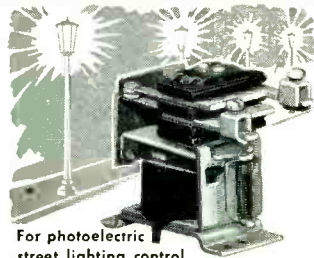

For photoelectric street lighting control

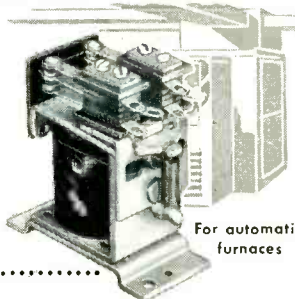

For automatic furnaces

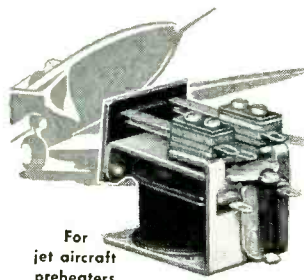

For jet aircraft preheaters

**I**N ADDITION R-B-M General Purpose Relays are used on X-Ray apparatus, permanent wave machines, wire recorders, automotive radio telephone communication equipment, vending machines, coin operated phonographs and many other applications.

*What is your relay problem?  
Write Dept. F-2 today for Bulletin 570*



**R-B-M DIVISION  
ESSEX WIRE CORP.**  
*Logansport, Indiana*

MANUAL AND MAGNETIC ELECTRIC CONTROLS  
— FOR AUTOMOTIVE, INDUSTRIAL, COMMUNICATION AND ELECTRONIC USE

circuits is taken up. As may be expected, the amplifier will have wideband properties if the phase velocity of the circuit waves does not vary much with frequency.

One of the important properties of an amplifier is its noise characteristic. The book outlines an approximate method of approach to a noise theory for the traveling-wave tube. The subject discussed here, however, is still controversial in nature, a fact which does not stand out too clearly in the author's discourse.

Two close relatives of the traveling-wave tube are also dealt with. One of these is the double-stream amplifier, also known as the electron-wave tube, which does not employ a circuit but produces amplification by the interaction between two electron streams traveling at different speeds. The other one is the magnetron amplifier, which is of interest chiefly because of its higher efficiency compared with traveling-wave tubes.

This reviewer can highly recommend the book to anyone interested in communication engineering and microwave electronics.—**RUDOLF G. E. HUTTER**, *Head of Electronics Section, Physics Laboratories,sylvania Electric Products Inc.*

### Receiving Tube Substitution Guide Book

By H. A. MIDDLETON. *John F. Rider Publisher, Inc., New York*, 1950, 224 pages, paper-covered, \$2.40.

EQUALLY valuable for designers and servicemen in periods of tube shortages is this compilation of permissible substitutions for approximately 750 different receiving tube types, with detailed diagrams to simplify the changing of sockets or construction of adapters where necessary. Each substitution is rated E, G or P according to the performance of the substitute tube in the circuit of the original tube. Where changes in filament or heater wiring are required, they are described, along with any other electrode voltage changes required. As a rule, however, the author presents only practical substitutions that do not demand redesigning of circuits.

The author uses the rating E to



# PULL MINIATURES PAINLESSLY!

WHY STRAIN, fry, and slice your fingers? Why break tubes? Pull or insert 7-pin miniatures the e-a-s-y way. With economical Hytron Tube Puller. Result of two years' research. Positive grip pulls first time from meanest sockets. Special Neoprene rubber resists heat. Does not harm tube. Adjusts automatically to varying tube diameters. Tube Puller works by suction and friction on top of tube. Removes even tiny 6AK5 and 6AL5 from shielded sockets. Reaches into tightest spots — to pull or insert.

Only 75¢! You cannot afford to be without this temper-time-and-money saver. Get *your* Hytron Tube Pullers from your Hytron jobber today.

**It's Easy!** **TO PULL:** Push Tube Puller onto top of 7-pin miniature. Just enough for firm grip, and without depressing release button at top. Pull straight up and out; no need to bend pins by violent rocking. Hold tube securely in one hand. With other, push release button quickly. Compressed air pops out tube. Or, holding down release button, remove Tube Puller by rocking it. **To insert:** Align arrow on skirt of Tube Puller with keyway of tube. Push tube into Tube Puller. Using arrow as guide, insert tube. Push button quickly to release. Maintain pulling action at peak. Wipe inside of Puller occasionally with clean cloth to remove dirt and grease.

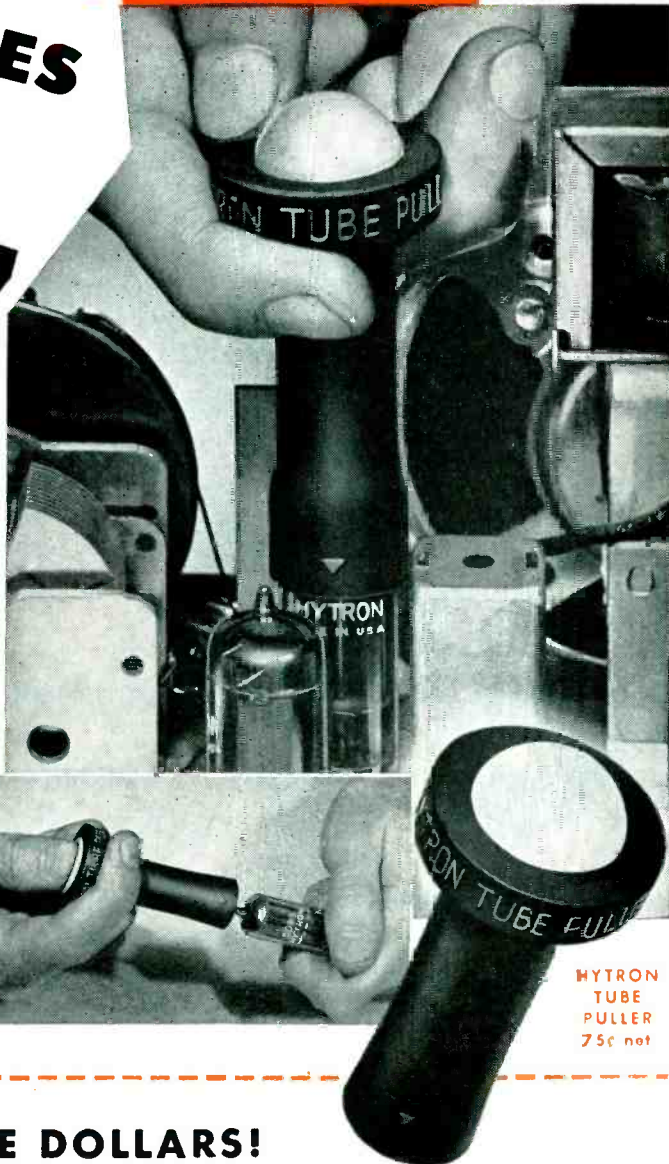

## THEY COST PENNIES, BUT SAVE DOLLARS!

OVER 50,000 SERVICEMEN know! These Hytron tools pay for themselves again and again. Save time . . . temper . . . dollars — daily. Read what they'll do for you. Write for complete Tool Catalogue. Better still — get these tools from your Hytron jobber today!



**PIN STRAIGHTENERS, 7-Pin and 9-Pin — 55¢ net ea.** You merely press tube gently into Hytron Straightener until button base seats squarely. Presto, pins are straight! Fast . . . safe. Avoiding one broken tube pays for Straightener twice over. Precise, stainless-steel insertion die. Comfortable knurled aluminum holder. For hand, bench, or tube tester use.



**AUTO RADIO TOOL — 24¢ net.** Substitutes for control cables of universal auto radio. Quickly, precisely turns set on/off, tunes, adjusts volume and tone, re-aligns dial. Square also fits splines. Vee fits spade and other key fittings. Minimum backlash. Compact. Bright-zinc plated. Non-rolling large handle for fine adjustments.



**SOLDERING AID — 49¢ net.** Fork tip effortlessly, quickly unwraps "mechanically solid" joints. Straddles wire, grips, unwraps, pulls it free. Guides new wire; holds it firm while soldering. Spade tip reams solder from lug hole; pushes other wires aside. Tips are hardened, twist-proof, insulated, hard-chromed to shed solder. Tool handles like pencil. Reaches tight spots. Has dozens of other uses.



**TUBE LIFTER — 15¢ net.** Lift 'em all the e-a-s-y prybar way. Tubes (GT, C, standard, lock-in, metal). Vibrators and plugs (Jones, Amphenol) — and knobs. A natural for compact auto radios, etc. Slotted end lifts lock-ins, snap-in trimovats . . . easily, safely. Of stainless steel with comfortable rolled edges.



**TUBE TAPPER — 5¢ net.** Handy combination pencil, eraser and tube tapper. Discovers microphonism, shorts, and opens in tubes, etc. Compact, non-metallic, rugged. Doubles in brass for writing orders, etc.



MAIN OFFICE: SALEM, MASSACHUSETTS



# The Remarkable New Dielectric Gas

## SULFUR HEXAFLUORIDE SF<sub>6</sub>



*For Transformers—Co-axial Cables—  
Capacitors—and other High Voltage Equipment.*

### Some practical advantages of Sulfur Hexafluoride:

- 1 Permits operation at higher voltages or lower pressures than are possible with air or nitrogen; i.e. increased voltage at the same pressure, or the same voltage at reduced pressure.
- 2 Reduces or eliminates corona.
- 3 Offers opportunity for simplified design and reduced dimensions of equipment; also lower construction and maintenance costs occasioned by lower pressure required.
- 4 Makes it possible to maintain voltages over greater distance in cables with lower power loss.
- 5 Has minimum permanent or cumulative effect in event of breakdown.
- 6 Is non-flammable.

### SULFUR HEXAFLUORIDE

Formula: SF<sub>6</sub>  
 Molecular Weight: 146.06  
 Melting Point: -50.8°C  
 Sublimation Temperature: -63.8°C  
 Critical Temperature: 45.6°C  
 Critical Pressure: 540 p.s.i.a.  
 Vapor Pressure:

Temp. (°C)	Pressure (p.s.i.a.)
-80	5 (subl. press.)
-50	34
-20	102
+10	240
+40	481

60 cycle Dielectric Strength (tungsten rod and 1" diam. sphere, 1" spacing)

	Pressure, p.s.i.g.			
	0	10	20	30
Sulfur Hexafluoride, kilovolts	70	107	120	122
Nitrogen, kilovolts	13	17	21	25

WHEREVER A GASEOUS OR LIQUID DIELECTRIC has application, General Chemical Sulfur Hexafluoride merits prompt investigation. This remarkable new insulating gas has a dielectric strength comparable to that of mineral oil at moderate pressures! With it, operating efficiency can be stepped up in many types of electrical equipment, while overall construction and maintenance costs may often be lowered.

GENERAL'S Sulfur Hexafluoride is an extremely pure material that meets the most exacting dielectric requirements: it is remarkably inert; possesses exceptional thermal stability, and has a dielectric strength substantially higher than that of air or nitrogen.



For commercial quantities or more detailed technical information, consult General Chemical's Product Development Department. Please use business letterhead when writing.

PRODUCT DEVELOPMENT DEPARTMENT

## GENERAL CHEMICAL DIVISION

ALLIED CHEMICAL & DYE CORPORATION

40 Rector Street, New York 6, N. Y.

Offices: Albany • Atlanta • Baltimore • Birmingham • Boston • Bridgeport • Buffalo  
 Charlotte • Chicago • Cleveland • Denver • Detroit • Houston • Jacksonville  
 Los Angeles • Minneapolis • New York • Philadelphia • Pittsburgh • Providence  
 San Francisco • Seattle • St. Louis • Yakima (Wash.)

In Wisconsin: General Chemical Company, Inc., Milwaukee, Wis.

In Canada: The Nichols Chemical Company, Limited • Montreal • Toronto • Vancouver





... THE  
INSIDE STORY  
OF THE  
"FLYING DISCS"...

People say that they've seen flying discs.

They say they're bright shiny metal, 90 feet in diameter, and travel at incredible speeds. Reports about them always seem to make page one.

Another kind of "flying disc" that never rates a headline is made of black wax. It's about 16 inches in diameter, and it, too, flies at incredible speeds.

We're speaking of radio transcriptions that fly by Air Express.

They don't get page-one mentions because, by now, the idea of flying discs to the various stations is commonplace to the radio industry. The time they save permits them to keep their recorded broadcasts right up to the minute.

But, you don't have to be in radio to profit from the regular use of Air Express. Here are unique advantages which any business can enjoy:

**IT'S FASTEST**—Air Express gives the fastest, most complete door-to-door pick up and delivery service in all cities and principal towns, *at no extra cost.*

**IT'S MORE CONVENIENT**—One call to Air Express Division, Railway Express Agency, does it all.

**IT'S DEPENDABLE**—Air Express provides one-carrier responsibility all the way and gets a *receipt upon delivery.*

**IT'S PROFITABLE**—Air Express expands profit-making opportunities in distribution and merchandising.

Like to know more? Call your local Air Express Division of Railway Express Agency.



**AIR EXPRESS**  
**GETS THERE FIRST**

precision built...

powerful...

highly efficient...

Cramer

timing  
motors

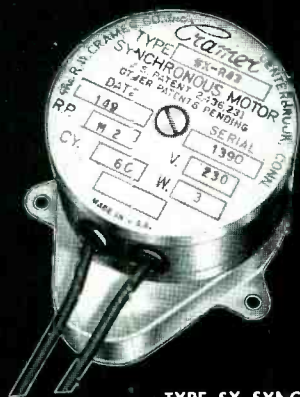

TYPE SX SYNCHRONOUS MOTOR

A permanent magnet type motor producing an exceptionally high torque, the Cramer Type SX Synchronous Motor is widely used with timing devices, recording instruments, communications equipment ... and for many other applications throughout the instrument and control fields requiring a constant speed at a given frequency. Self-starting ... operates at synchronous speed only. Compact ... precision-built ... available with output speeds from 60 RPM to 1/24 RPH.

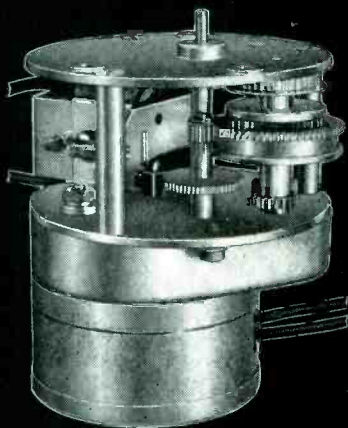

TYPES SCS & SCR CLUTCH MOTORS

Designed to meet the needs of many timing, recording, indicating, and switching applications where an accurate reset operation is essential, Cramer Clutch Motors combine the Type SX Motor and a differential gear drive. Two basic types ... Type SCS equipped with direct-acting clutch ... Type SCR with reverse-acting clutch ... each available in a wide range of speeds.

Cramer motors are also available as Reversible and Chart Drive Types. Write for complete information.

THE R. W. CRAMER CO., INC.

BOX 3, CENTERBROOK, CONN.

Builders of dependable timing devices for more than 25 years.

INTERVAL TIMERS • TIME DELAY RELAYS • RESET TIMERS • CYCLE TIMERS  
PULSE TIMERS • RUNNING TIME METERS • PERCENTAGE TIMERS

signify an excellent electrical equivalent that may either be directly interchangeable or merely require basing changes and/or filament or heater voltage changes. The G rating calls for examination of the electrical characteristics of both tubes and evaluation thereof in connection with the circuit being used, as there is a strong likelihood that circuit requirements are not completely met by the substitute tube. For convenient reference, a table of receiving tube characteristics is included in the book. Although a G substitute may give some deterioration in performance, it can definitely be used where necessary to continue operation of a device. Substitutions bearing a P (poor) rating are to be used only as a last resort where performance of sorts is better than nothing at all in an emergency.

Other features of this book include an excellent theoretical section discussing one by one the problems of making substitutions of tubes and other components in oscillator systems, r-f and i-f amplifiers, audio amplifiers, signal rectifiers, power rectifiers, wideband amplifiers and other circuits. A separate table lists identical tubes with unlike heater voltage and current ratings. An entire section covers television receiver filament circuit arrangements, with diagrams giving the basic circuits employed in parallel, series and series-parallel filament systems. An accompanying tabulation that includes most television receiver models tells which type of circuit is used in each, for convenience in making substitutions involving filament circuit changes. All in all, this manual is a must for anyone anticipating trouble in getting a needed tube for radio, television or electronic equipment.—J. M.

**Ionization Chambers and Counters**

BY D. H. WILKINSON. Cambridge University Press, New York, 1950, 265 pages, \$4.50.

THIS book treats the three classical particle counters, namely, the ionization chamber, the proportional counter and the Geiger counter. In





Get out of the Magnetic Doghouse

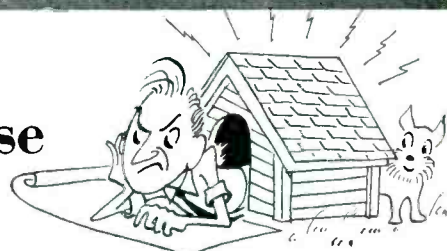

with

# MUMETAL SHIELDS

Write for  
**BLUE SHEETS**

on Allegheny Ludlum  
Electrical Materials

Complete, laboratory-certified data on each grade—its physical properties, electrical characteristics, uses, methods of handling, etc. Write for Blue Sheets on the materials in which you are interested.

ADDRESS DEPT. E-14

Mumetal shields will give instant relief to interference caused by extraneous magnetic fields. This material can cure many troubles—solve many a problem for you. Always consider it where high permeability is required at low flux densities, such as in input and microphone transformers, hearing aid diaphragms, instruments, wire and tape recorders, etc. For properly heat treating Mumetal, we can also offer commercial hydrogen annealing facilities.

A fund of technical data on shields and other applications for Allegheny Mumetal is available—let us help with your problems.

**ALLEGHENY  
LUDLUM**  
STEEL CORPORATION  
Pittsburgh, Pa.

*Steel Makers  
to the*  
**ELECTRICAL  
INDUSTRY**



W&D 2570

# High score every time with "Safe Centers!"

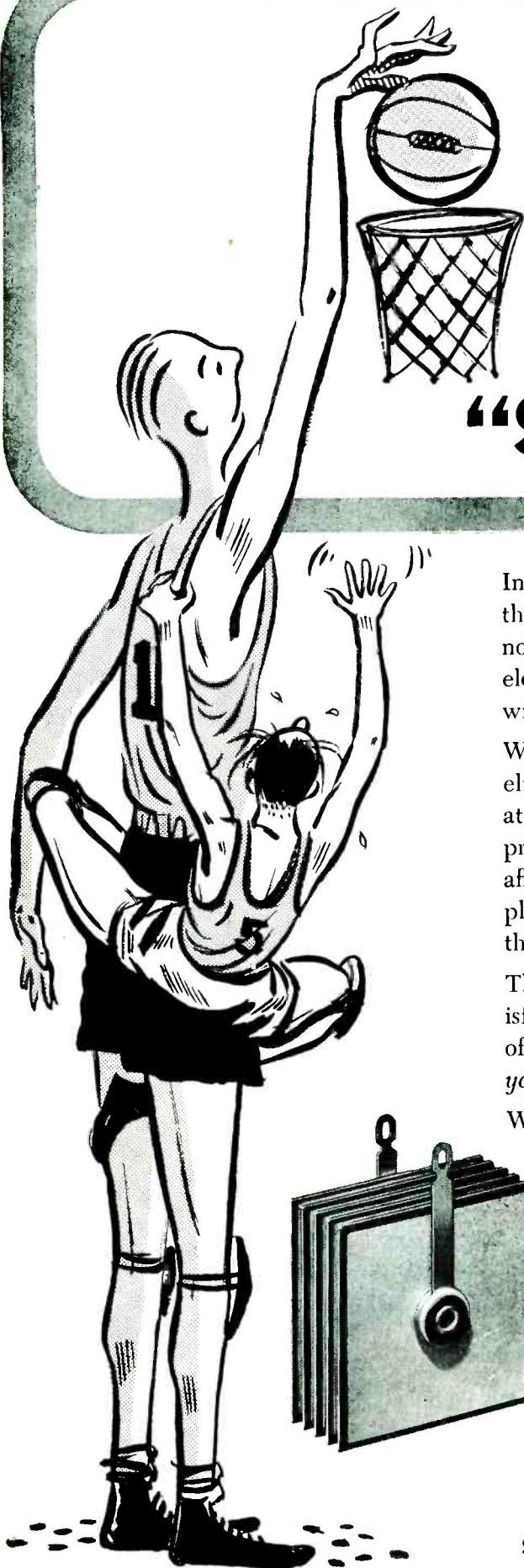

In Basketball there's no better assurance of victory than a lengthy lad jumping center . . . and there is nothing that scores higher in radio, TV and other electronic circuits than SELETRON miniature rectifiers with "Safe Center" plates.

When you specify SELETRON Selenium Rectifiers you eliminate arc-over danger, short circuits and heating at the center contact point. Assembly pressure, or pressure applied in mounting the rectifier cannot affect its performance — A SELETRON feature accomplished by deactivating the area of the plate under the contact washer.

The millions of SELETRON Selenium Rectifiers in satisfactory service as original equipment in the products of leading manufacturers are millions of reasons why *you* can specify SELETRON and be *safe!*

Write us for Rectifier Bulletin No. ES-36.

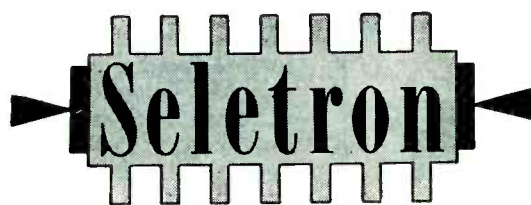

SELETRON DIVISION

**RADIO RECEPTOR COMPANY, Inc.**



Since 1922 in Radio and Electronics



Sales Department: 251 West 19th St., New York 11, N. Y.

Factory: 84 North 9th St., Brooklyn 11, N. Y.



**Just 60 SECONDS**  
**from now...**

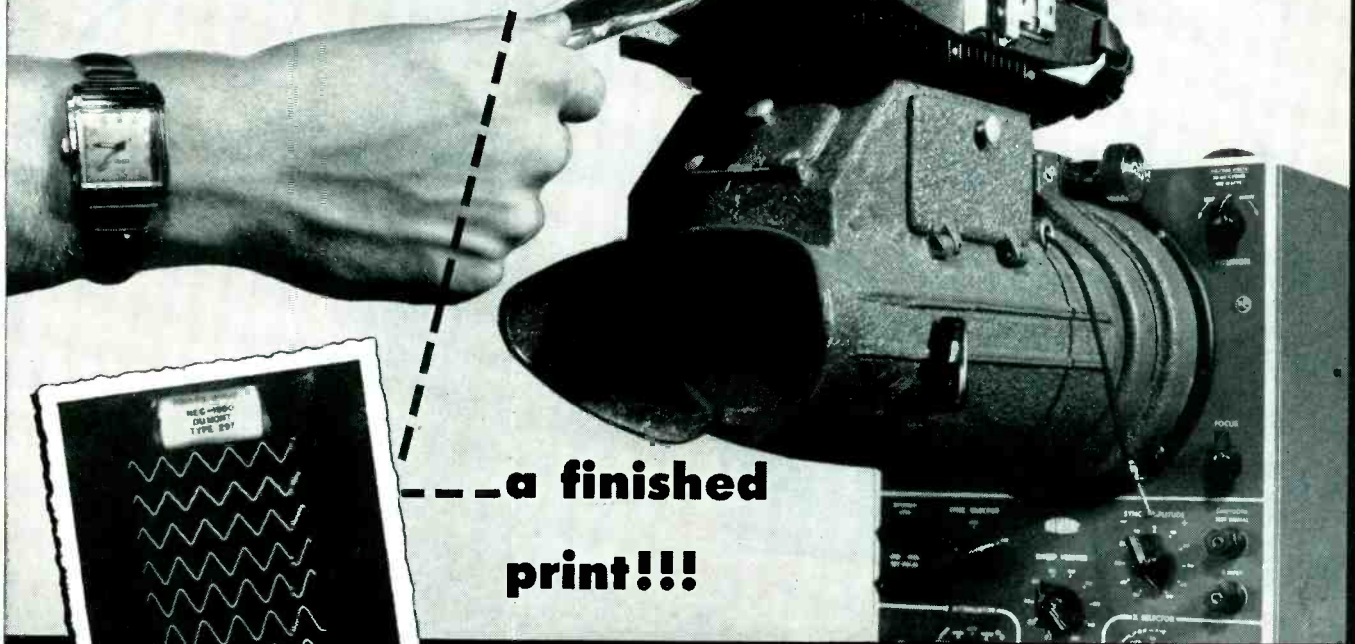

... a finished  
print!!!

... with the camera that brings a new speed and efficiency to oscillograph-recording techniques

... and for thrifty  
SINGLE-FRAME  
recording



**THE DU MONT TYPE 296**  
**Oscillograph-record Camera**

◆ The Type 296 is an inexpensive oscillograph-record camera, greatly improved for general-purpose application with any standard 5-inch cathode-ray oscillograph. It incorporates a compact, all-metal, 35mm camera, calibrated shutter and a high-quality 1/2.8, 75mm, coated lens which increases its capability 57% over the Type 271-A which it supersedes. Construction is rugged and durable; operation simple and foolproof. The Type 296 weighs only 4½ lbs.

PRICE... \$149.50

**The DU MONT TYPE 297**  
**Oscillograph-record Camera**

◆ You've just advanced the film after making an exposure. That starts the Polaroid-Land "packaged" developing process. And while you're waiting for its completion—in just 60 seconds—you can start the next exposure or set of exposures. With the Type 297, once you've snapped the shutter, its self-contained, 60-second, developing process lets you forget

about the variables of the darkroom.

And with such special oscillographic features as simultaneous viewing and recording, an illuminated data-card, sturdy and easily attached mounting, and overall economy of the Polaroid film, Du Mont has added even greater meaning to this excitingly fast method for "printing" the oscillograph image.

**SPECIFICATIONS**

**LENS**—Du Mont-Wollensak f/2.8 or f/1.9, 75mm, coated.

**SHUTTER**—Wollensak Alphax; shutter speeds of 1/25, 1/50, 1/100 sec. Time and Bulb.

**FOCUS**—Fixed. May be adjusted for special oscillographic work.

**WRITING SPEED**—Writing rates of 3.5 in usec. have been recorded consistently at 12,000 volts accelerating potential.

**PRINT SIZE**—3¼ x 4 ¼ in.—one, two, three, or more exposures per print.

**IMAGE REDUCTION RATIO**—2.25:1.

**PHYSICAL SIZE**—Length, 14½ in.; height, 10 in.; width, 6 in.

**WEIGHT**—12 lbs.

**PRICE**... \$285.00 with f/2.8 lens  
\$355.00 with f/1.9 lens

Write for bulletin on photographic techniques.

ALLEN B. DU MONT LABORATORIES, INC., INSTRUMENT DIVISION, 1000 MAIN AVENUE, CLIFTON, NEW JERSEY

*Watch*  *Master*

# Frequency Standards



**GUARANTEED  
ACCURACY**  
1 part in 100,000  
(.001%)

## *Uses*

Time bases, rate indicators, clock systems, chronographs, geo-physical prospecting, control devices and for running small synchronous motors.

## *Features*

1. Bimetallic, temperature-compensated fork, no heating or heat-up time is required.
2. Fork is hermetically sealed, no barometric effects on frequency.
3. Precision type, non-ageing, low coefficient resistors used where advantageous.
4. Non-linear negative feedback for constant amplitude control.
5. No multi-vibrators used.
6. Synchronous clock simplifies checking with time signal.

## *Specifications*

Accuracy—1 part in 100,000 (.001%).

Temperature coefficient—1 part in 1,000,000 per degree centigrade (or better).

Outputs—

1. 60 cycles, sine wave, 0-110 volts at 0 to 10 watts (adjustable).
2. 120 cycle pulses, 30 volts negative.
3. 240 cycle pulses, 30 volts positive and negative. Pulse duration, 100 micro-seconds.

*product of*

**AMERICAN TIME PRODUCTS  
INC.** New York 19, N. Y.  
580 Fifth Avenue

*Operating under patents of the Western Electric Company*

### **Type 212**

#### **TERMINATION**

Front and Rear

#### **CONSTRUCTION**

Standard 8¾" x 19" Panel

#### **HOUSING**

8¾" x 19" x 8" Metal Cabinet

#### **WEIGHT**

25 pounds

American Time Products, Inc.,  
580 Fifth Ave., New York 19, N. Y.

Gentlemen:

Please send descriptive folder, No. 212

Name.....

Company.....

Address.....

City..... State.....



the words of the author: "It will be the aim of this book to expose the principles of operation and construction of these devices, and to present the relevant theoretical considerations rather than to give a detailed account of applications."

This aim has been achieved in an excellent fashion, for the book gives a well-documented account (including over 200 references), which details the theoretical aspects of such topics as build-up and decay of the ionization in the counters, formation and shapes of the pulses, pulse differentiation, counter speed and the errors that may arise in quantitative work. Many practical matters related to counter design, such as the choice of geometrical arrangement, electrode materials, insulators and of the gas and gas pressure are also treated.

The author considers the amplifier input circuit arrangements and the relation of such matters as amplifier rise time and noise to the counting problem, but otherwise does not discuss the electronic circuits used with these counters. Furthermore, the more recently introduced devices such as the crystal counter, the spark counter and the scintillation counter are not treated.

This volume should prove of great value to the specialist concerned with the design and application of counters, and to those who wish to make a serious study of counter theory and behavior.— R. R. BENEDICT, *Electrical Engineering Dept., University of Wisconsin.*

**Response of Physical Systems**

By JOHN D. TRIMMER. *John Wiley and Sons, Inc., New York, 1950, 268 pages, \$5.00.*

THIS excellently written, well-integrated, nicely printed book comprises preface, 11 chapters of content, 3 appendices and a comprehensive index. The carefully-detailed mathematical analyses, the illustration of each major point of theory by solution of one or more interesting physical systems, the number and diversity of these illustrative examples, and the general clarity

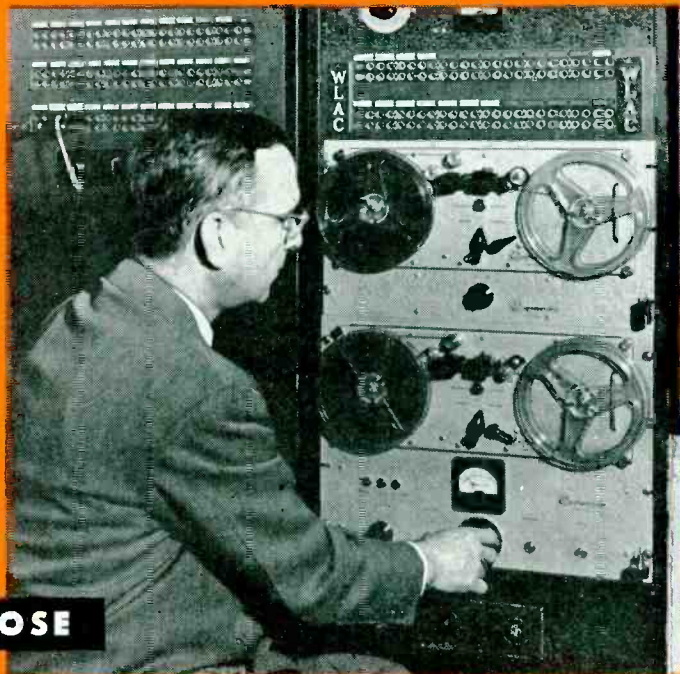

**HE CHOSE**

*Magne recorder*

**THE FIRST CHOICE OF RADIO ENGINEERS FLEXIBILITY**



In rack or console, or in its really portable cases, the Magne recorder will suit every purpose. PT6 Series shown is the most widely used professional tape recorder in the world, and is available with 3 speeds (3 3/4, 7 1/2, 15") if preferred.

**FIDELITY**

Lifelike tone quality, low distortion meet N.A.B. standards — and at a moderate price! PT63 Series shown in rack mount also offers three heads to erase, record, and play back to monitor from the tape while recording.

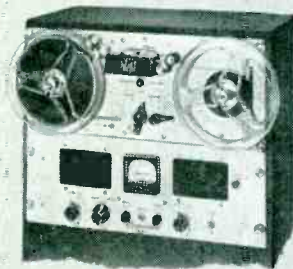

**FEATURES**

PT7 accommodates 10 1/2" reels and offers 3 heads, positive timing and pushbutton control. PT7 Series shown in complete console model is also available for portable or rack mount. For outstanding recording equipment, see the complete Magne recorder line — PT6, PT63 and PT7.



**WRITE FOR NEW CATALOG**

*Magne recorder, INC.*

360 NORTH MICHIGAN AVENUE CHICAGO 3, ILLINOIS

Magne recorder, Inc., Dept. EA-2 360 N. Michigan Ave., Chicago 1, Ill.

Send me latest catalog of Magne recorder Equipment.

Name.....  
 Address.....  
 City..... Zone..... State.....



GRACOIL

*Transformers*

COILS

FOR YOUR **GOVERNMENT** REQUIREMENTS

Conventional and *Hermetically Sealed Types*

IT'S EASY... Simply submit your  
blueprint and an estimate will be  
promptly forwarded to you.

IF you desire a sample built to your  
specifications, it can be made for  
you in a short time.

SEND B/P FOR COST-FREE RECOMMENDATIONS

**GRAMER**

TRANSFORMER

C O R P O R A T I O N

2734 N. PULASKI ROAD • CHICAGO 39, ILLINOIS



# Simplify analysis

## WITH THESE *Brush* INSTRUMENTS

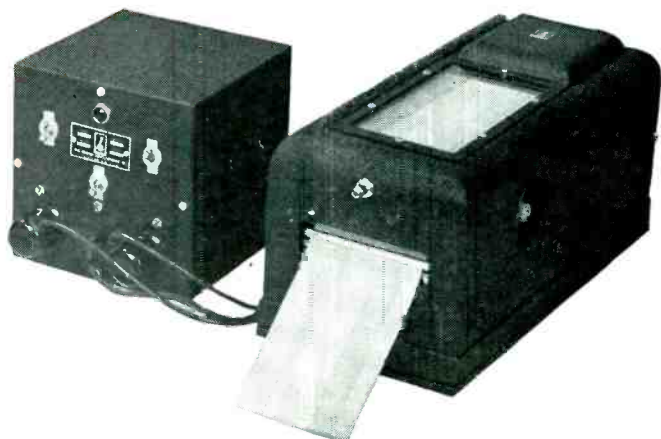

### BL-932 D-C AMPLIFIER

Designed for use with the Brush Magnetic Direct Inking Oscillograph, and used to make recordings of many types of phenomena heretofore measured only with the aid of complicated intermediate equipment. Studies of such static or dynamic conditions as strains, displacements, pressures, light intensities, temperatures, d-c and a-c voltages or currents, and many others, are simplified by the use of the Brush Direct Inking Oscillograph with the BL-932 Amplifier. Voltage gain is sufficient to give one chart mm deflection per millivolt input. Novel design features reduce the effects of power line fluctuation. Zero signal drift amounts to not more than one chart mm per hour. Frequency response is essentially uniform from d-c to 100 cycles per second. The control panel at the front of the amplifier contains a factor-of-10 attenuator, gain control, calibrating meter, and controls for determining input voltages. A balancing potentiometer is provided for electrically biasing the oscillograph pen to any position on the chart.

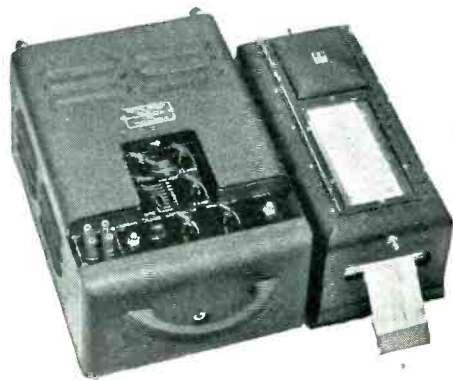

### COMBINATION MAGNETIC OSCILLOGRAPH

The Model BL-221 Single Channel Magnetic Combination Oscillograph is similar to the Model BL-201 unit, except that circuit changes have been made to permit use of either a standard inking pen or an electric stylus. Magnetic penmotor Model BL-943 is used on the BL-221 Oscillograph and includes the proper connections for use of the electric stylus. A Power Supply, Model BL-944, furnishes voltage for the electric stylus operation. A switch on the front panel of the Power Supply permits the operator to increase the stylus voltage when recording high frequency phenomena. The main switch opens circuit to Power Supply to eliminate the possibility of receiving electric shock when handling stylus. Instruments are supplied with a standard pen and inkwell as well as the electric stylus. The Model BL-222 Double Channel Oscillograph (shown in illustration) is supplied on the same chassis as the BL-221.

### MODEL BL-103 SURFACE ANALYZER

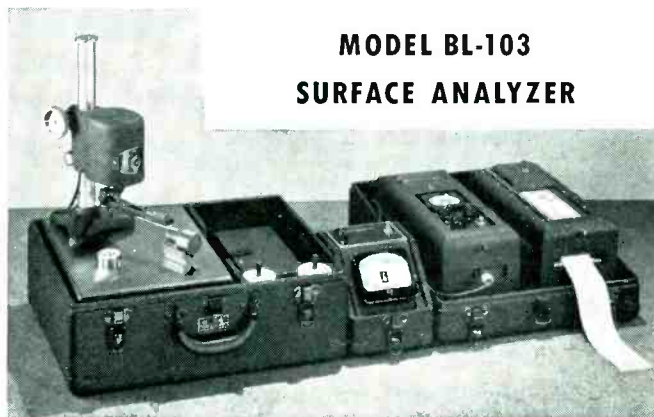

For exploration and instantaneous charting of surface finishes—metals, glass, plastics, paper, plated and painted surfaces from less than 1 to 5000 micro-inches. Complete with PA-2 Pickup Arm, Drive Head, Amplifier, Magnetic Oscillograph, Surface Plate, Carrying Cases, Glass Calibration Standard, 2 V-Blocks, 6 rolls Chart Paper, one 2 oz. bottle Red Ink, connecting cords and operating instructions. Brush RMS METER: "average reading" type calibrated in terms of the "RMS" of an equivalent sine wave. It provides a constant visual check of "RMS" surface roughness in cases where "hill and dale" chart profiles are not needed. Large illuminated dial is set at an easy reading angle. "RMS" Meter may be purchased separately or with the Surface Analyzer.

### UNIVERSAL STRAIN ANALYZER

The BL-320 Universal Strain Analyzer, when used with the Brush Magnetic Direct Inking Oscillograph, provides a complete package unit for the measurement of strain or other phenomenon where a resistance sensitive pickup is employed. It can be simply operated, producing records which are immediately available and easily interpreted. This combination equipment records either static or dynamic strains up to 100 cps, and direction as well as magnitude of the measured strain can be read from the chart. Connections are brought out so that one to four active gages may be used. Provision is made for connecting an internal calibrating resistor in the bridge circuit and adjusting the overall gain.

*Write for complete details.*

**THE *Brush* DEVELOPMENT COMPANY**  
DEPT. K-1, 3405 PERKINS AVENUE • CLEVELAND 14, OHIO, U. S. A.

Canadian Representatives:  
A. C. Wickman (Canada) Limited, P. O. Box 9, Station N, Toronto 14, Ontario



*Put it in writing with a*

## BRUSH RECORDING ANALYZER

STRAIN ANALYZERS • SURFACE ANALYZERS • CONTOUR ANALYZERS • UNIVERSAL ANALYZERS • UNIFORMITY ANALYZERS



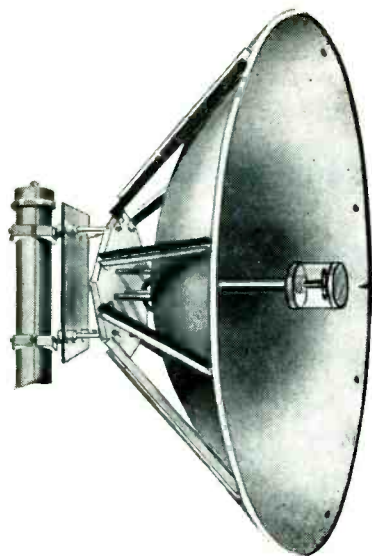

# WHAT ARE *Your* REQUIREMENTS IN PARABOLIC ANTENNAS ?

For microwave systems . . . check these advantages of ANDREW Parabolic Antennas:

- DEPENDABILITY** — An actual record of 100% dependability. There has never been a single mechanical or electrical failure on an ANDREW Parabolic Antenna . . . anywhere in the world.
- COST** — Exceptionally low; made possible by high production.
- LIGHT WEIGHT — HIGH STRENGTH** — Achieved by spun aluminum reflectors braced by formed steel struts.
- ADJUSTABLE MOUNTING** — Through  $\pm 10$  degrees in azimuth and elevation.
- DEICING KITS** — Thermostatically controlled, available where required.
- CABLE** —  $\frac{7}{8}$ " air dielectric Teflon insulated cable. Radiator is pressure tight. Fittings for solid dielectric cables also available.

SPECIFICATIONS									
Frequency Range	... 890-960 MCS ...				... 1750-2110 MCS ...				
	Type Number	1002	1004	1006	1010	2002	2004	2006	2010
Diameter of Parabola feet		2	4	6	10	2	4	6	10
Gain Over Half Wave Dipole Decibels		10	15	20	25	15	20	25	29
Beam Width, Half Power Points, Degrees		36°	22°	16°	11°	18°	10°	7°	5°
Net Weight, Pounds		10	64	150	380	10	65	150	380
Thrust Due to Wind Loading at 30 Pounds/FT Pounds		127	509	1145	3200	127	509	1145	3200



Your antenna problems can best be solved by ANDREW—the largest firm of antenna equipment specialists in the world. Write today.



WORLD'S LARGEST ANTENNA EQUIPMENT SPECIALISTS

TRANSMISSION LINES FOR AM-FM-TV • ANTENNAS • DIRECTIONAL ANTENNA EQUIPMENT  
ANTENNA TUNING UNITS • TOWER LIGHTING EQUIPMENT

and quality of the exposition bespeak the soundness of the text.

Chapter I (A Pattern for Systems) formulates terminology sufficiently broad to encompass various kinds of systems yet specific enough in meaning to suggest the essential structure and action of particular systems, and advances general statements of the five types of problems associated with a system. Chapter 2 (Physical Systems) comprises classification of systems on the basis of the nature of the differential equations governing their performance and the parametric structure of the system. Chapters 3 (First-Order Systems), 4 (Second-Order Systems) and 6 (Higher-Order Systems) detail the classical mathematical solution of the responses of systems governed respectively by first, second and third-order ordinary linear constant-coefficient differential equations to step, pulse and sinusoidal forcing; physical interpretation of certain important terms in the solutions; algebraic and graphic investigation of stability; and illustration of application of this theory by solution of appropriately ordered systems chosen from various physical domains.

Chapter 5 (Sinusoidal Forcing of Linear Systems) details the important role of the response to sinusoidal forcing in ascertaining the general character and quality of a transmitting system. Chapter 7 (Measuring Instruments) discusses the philosophy and basic terminology of measurements in general, the quality of performance of certain indicating instruments, and the nature of various kinds of error. Chapter 8 (Feedback Systems) comprises good discussion of the essentials of single-loop feedback systems. Chapter 9 (Parametric Forcing) details the basic concepts of parametric forcing through time-variation of one or more system parameters and illustrates, through several examples, the analytical difficulties encountered in solving such systems. Chapter 10 (Distributed Systems) embraces an account of the method of solving partial differential equations by separation of variables and illustrative solution of several sys-



## **"dag"** CRT Exterior Wall Coating Gives Better Adhesion on Any Glass

**"Dag"** Exterior Wall Coating is a semi-colloidal dispersion of pure graphite in a lacquer-base vehicle. It is easily applied to CRT surfaces by spraying, and forms a smooth, uniform, conductive black coating that adheres tenaciously to all types of glass.

This ideal CRT coating dries very rapidly, permitting handling of the tubes after two or three minutes. Maximum adhesion is obtained by drying at room temperature for twenty-four hours. For a fast job, infra-red will do the trick in one-half hour at 100° C.

When thoroughly dried, the resulting film resists scratching and cannot be readily loosened by immersion in water.

The versatility of **"dag"** colloidal graphite in the electronic industry is explained thoroughly in a recent bulletin. Write today for your free copy of Bulletin #433-5B.

**dag**  
DISPERSIONS®

Acheson  
Colloids  
Corporation  
Port Huron, Mich.

... also Acheson Colloids Limited, London, England

# COPPER ALLOY BULLETIN

REPORTING NEWS AND TECHNICAL DEVELOPMENTS OF COPPER AND COPPER-BASE ALLOYS

Prepared Each Month by BRIDGEPORT BRASS COMPANY "Bridgeport" BRASS CO. Headquarters for BRASS, BRONZE and COPPER

## Proper Annealing for Cost Reduction

Work-hardened metal can be softened by annealing—that is, by raising its temperature high enough to affect its microstructure. Different degrees of softness are obtained by controlling the temperature which the metal attains in the furnace and the length of time it is exposed to the heat. Under the microscope a piece of annealed metal that has been prepared by polishing and etching for microscopic examination appears to be made up of irregularly shaped crystals or grains—the higher the annealing temperature, the larger the crystals, the softer the metal, and the greater its elongation or ductility.

### Annealing Hints for Fabricators

Variable factors such as the weight and distribution of load, size and shape of article and/or sequence of anneals, type and condition of furnace play such an important part in maintaining uniform metal temperature that it is impossible to set up specific rules for the fabricator on time and temperature for annealing copper and its alloys.

The table, shown below, on suggested temperatures should only be used as a guide.

Included also in these variables are the amount and method of cold-working, previous grain size and severity of operations to follow. Because of these variables, it is advisable to experiment

with sample lots to determine correct time and temperature for annealing before setting up a schedule for volume production.

### Danger of Too High Temperature

Extra large grain size and orange peel effect are usually products of temperatures that are too high with subsequent increase in finishing costs. Excessively high temperatures will also increase the amount of oxidation of the

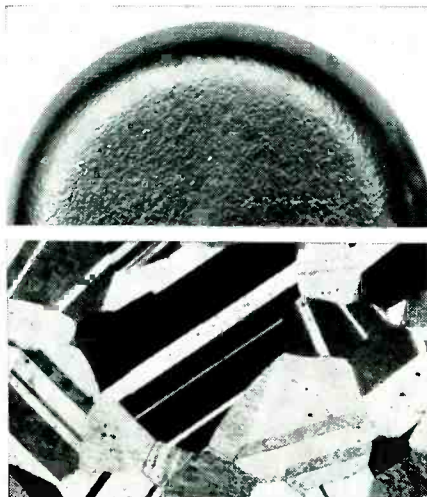

Orange-peel surface on the bottom of drawn brass cup was caused by excessively large grain structure resulting from annealing at too high a temperature. Micrograph: mag. 75 x etch NH<sub>4</sub>OH and H<sub>2</sub>O.

metal (if non-atmosphere controlled furnaces are used) and thereby necessitate longer pickling and dipping operations, with the associated danger of pitting and thinning of the material.

It is safer to anneal at the lowest temperature possible. Work can always be returned to the furnace if not annealed sufficiently, but the damage done by too high a temperature cannot be corrected.

### Good Annealing Practice

Thorough cleaning of work to remove drawing compounds before annealing especially at low temperatures, will help to maintain cleaner surfaces. Dirt and dust picked up from the air and held on the work by compounds, can also produce stains and scale which if not completely removed, will cause scratching of work and dies as well as loading of tools.

The ability to obtain uniform metal temperatures in the work being treated is essential. For this reason convection-type annealing furnaces are widely used for temperatures from 1200° F and lower. By placing the thermocouple at the hottest location of the incoming gases and being careful not to exceed the desired temperature is an assurance metal will not be overheated.

The practice of speeding up the annealing operation by first operating the furnace at temperatures considerably above the desired annealing temperature is dangerous because the top or edges of the load may become overheated while the rest of the load is coming up to the desired annealing temperature. In other words, there is time lag in heat penetration. It is advisable to bring the furnace to heat before starting the day's annealing operations. This method reduces the danger of local overheating and facilitates uniform heating.

The influence of time in an annealing operation after the metal reaches the desired temperature throughout does not seriously increase grain growth or softening and this factor permits uniformity of heating in convection furnaces even when section or portions of a load are of uneven mass. Direct-fired furnaces, on the other hand, are usually operated with a thermal head and are more susceptible to uneven heating of a load, especially if the masses are uneven.

## Suggested Annealing Temperatures for Fabricated Articles

### Approximate Metal Temperatures

Material	Alloy No.	Anneal for Additional Cold Working	Fine Grain Anneal for Finishing	Stress Relief Anneal
Copper	102	750- 950F	650- 800F	400F*
Red Brass—85 copper, 15 zinc	85	900-1150F	750- 900F	400F*
Cartridge Brass—70 copper, 30 zinc	37	850-1100F	700- 850F	400F*
High Brass—66 copper, 34 zinc	1	850-1100F	700- 850F	400F*
Commercial Bronze—90 copper, 10 zinc	25	925-1175F	775- 975F	400F*
Silicon Bronze—97 copper, 3 silicon	632	1000-1200F	925-1000F	400F*
Silicon Bronze—98 copper, 2 silicon	609	1100-1200F	925-1000F	400F*
Phosphor Bronze—Grade A—94.35 copper, 5.5 tin, 0.15 phosphorus	36	1080-1200F	900-1050F	400F*
Nickel Silver—18% Grade A—65 copper, 18 nickel, 17 zinc	565	1100-1300F	1050-1150F	400F*

\*Stress Relief Annealing Temperatures and Time depend upon the amount of cold working on the part and the alloy. A nominal temperature of 400F for a one hour anneal may be tried and the parts so treated then checked for residual stress by a mercurous nitrate test. Should failure occur, a higher temperature would be indicated.



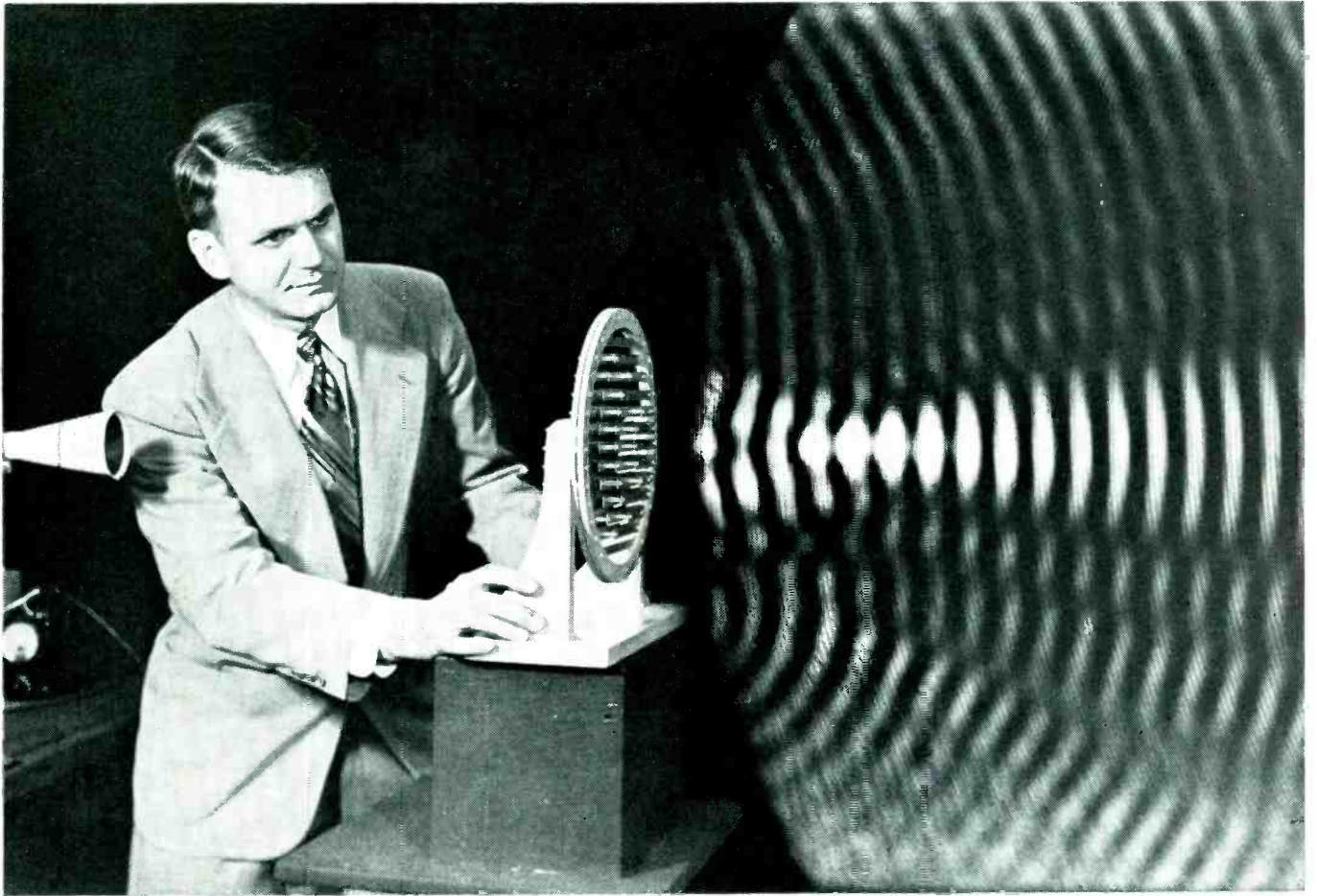

## WAVE MAKING

*—for better  
telephone  
service*

*Waves from the sound source at left are focused by the lens at center. In front of the lens, a moving arm (not shown) scans the wave field with a tiny microphone and neon lamp. The microphone picks up sound energy and sends it through amplifiers to the lamp. The lamp glows brightly where sound level is high, dims where it is low. This new technique pictures accurately the focusing effect of the lens. Similar lenses efficiently focus microwaves in radio relay transmission.*

At Bell Telephone Laboratories, radio scientists devised their latest microwave lens by copying the molecular action of optical lenses in focusing light. The result was a radically new type of lens — the array of metal strips shown in the illustration. Giant metal strip lenses are used in the new microwave link for telephone and television between New York and Chicago.

The scientists went on to discover that the very same

type of lens could also focus sound . . . thus help, too, in the study of sound radiation . . . another field of great importance to your telephone system.

The study of the basic laws of waves and vibrations is just another example of research which turns into practical telephone equipment at Bell Telephone Laboratories . . . helping to bring you high value for your telephone dollar.

# BELL TELEPHONE LABORATORIES



• WORKING CONTINUALLY TO KEEP YOUR TELEPHONE SERVICE ONE OF TODAY'S GREATEST VALUES



high voltage  
**Selenium Rectifiers**

# Make your own **COMPARISON TEST** Know Which Is Best



Since most selenium rectifiers look alike, but vary greatly in quality, it is important to the user to have some simple means of determining quality. Side-by-side comparison tests are the time-honored way to compare quality. Take any 26-volt RMS selenium rectifier stack on the market—get a new G-E high-voltage stack of similar ratings and see for yourself which is the better.

These new G-E 26-volt cells thrive on comparison tests because they are outstanding in the three characteristics which mean quality in selenium rectifiers.

## **LOW FORWARD RESISTANCE**

G.E.'s new 26-volt cells have extremely low forward resistance. This means a low voltage drop giving higher output, cooler operation, and greater rectifier efficiency. This often results in savings to you in the design and costs of other circuit components.

## **LOW BACK LEAKAGE**

Since reverse current through a rectifier serves no useful purpose but does increase losses and heating, the low back leakage of these cells results in higher output, higher efficiency, and cooler operation.

## **DEPENDABLE LONG LIFE**

These cells are the slowest aging of any selenium cells we have tested. These dependable cells have a life expectancy of well over 60,000 hours.

Prove for yourself the superiority of these new G-E selenium cells. Write Section 461-13, Apparatus Department, General Electric Company, Schenectady 5, New York for a copy of GEA-5524 which gives complete instructions for comparative testing. Contact your local General Electric Apparatus Sales Representative or authorized G-E agent to arrange your sample purchase.

**GENERAL**  **ELECTRIC**

461-13



# flexite

**APPROVED**  
by the  
**UNDERWRITERS**  
**LABORATORIES**  
under their reexamination service

**ABOVE 105°C**

**the flexible,  
extruded plastic tubing  
that resists high temperatures**

**YES, FLEXITE** is the electrical insulation tubing that sets new standards for resistance to extreme high temperatures. Compounded of a plasticized copolymer of vinyl chloride and vinyl acetate and manufactured with a true wall thickness, smooth inside and outside, **FLEXITE PLASTIC TUBINGS** offer the greatest resistance to high and low temperatures, are extremely flexible and have great tensile strength.

**FLEXITE** compares more than favorably with tubings of similar nature. Check the specifications of **FLEXITE**, compare them with the requirements for your products and against other insulations for identical use . . .

**YES, you will find that FLEXITE** sets a new high standard for protection against high temperatures, high dielectric, stretching, tearing, abrasion, exposure to acids, oils and alkalis, flammability, etc. — samples and additional information will be sent upon request.

And for a Plastic Tubing to Withstand Normal High Temperatures Mitchell-Rand Offers Flexite-Norm . . . write for specifications.

flexite		physical & electrical properties	
a. tensile strength, minimum average	2500 PSI	Colors	Black, white, red, green, yellow and blue are standard colors.
b. ultimate elongation, min. average	300%	Dimensions and Tolerances	Standard sizes to fit B & S wires #20 to #0 inclusive, as specified by ASTM Spec. D922-47T.
c. dielectric strength, minimum	800 v/mil	Wall Thickness	In accordance with ASTM Spec. D922-47T, as follows: #20 — #10 incl. — .016" ± .003" #9 — #0 incl. — .020" ± .003"
d. flammability	non-inflammable	Standard Lengths	Standard 36" lengths or continuous lengths in coils. Sizes #20 — #10 incl. will be supplied on paperboard spools when so ordered.
e. heat resistance	After 100 hrs. at 300° F. the tubing is not brittle and when flexed does not crack.	Quality	Uniform in quality and condition, smooth on both inside and outside, free of defects such as pin-holes, blisters, foreign inclusions and other imperfections.
f. heat endurance	Recommended for continuous operating temperatures up to 105° C., and when baked at 125° C. for 2,000 hours does not become brittle.	Test Methods	Properties enumerated in above specifications shall be determined according to Tentative Methods of Testing Non-rigid Polyvinyl Tubing, American Society for Testing Materials, Designation D876-46T.
g. low temperature flexibility	-30° C.		
h. heat shrinkage	ASTM Standards #20 — #17 incl. — less than 8% #16 — #6 incl. — less than 5% #5 and larger — less than 3%		
i. oil resistance	Highly resistant to effects of transformer and lubricating oils, does not stiffen when continuously exposed to them.		

**WHATEVER YOUR ELECTRICAL INSULATION PROBLEM MITCHELL-RAND HAS THE ANSWER**  
And for a Plastic Tubing to Withstand Normal High Temperatures Mitchell-Rand Offers • Flexite-Norm • write for specifications.

M-R THE ELECTRICAL INSULATION HEADQUARTERS FOR 61 YEARS.



**MITCHELL-RAND INSULATION CO. Inc.**

51 MURRAY STREET • Cortlandt 7-9264 • NEW YORK 7, N. Y.

A PARTIAL LIST OF M-R PRODUCTS: FIBERGLAS VARNISHED TUBING, TAPE AND CLOTH • INSULATING PAPERS AND TWINES • CABLE FILLING AND POTHEAD COMPOUNDS • FRICTION TAPE AND SPICE • TRANSFORMER COMPOUNDS • FIBERGLAS SATURATED SLEEVING • ASBESTOS SLEEVING AND TAPE • VARNISHED CAMBRIC CLOTH AND TAPE • MICA PLATE, TAPE, PAPER, CLOTH, TUBING • FIBERGLAS BRAIDED SLEEVING • COTTON TAPES, WEBBINGS AND SLEEVINGS • IMPREGNATED VARNISH TUBING • INSULATED VARNISHES OF ALL TYPES • EXTRUDED PLASTIC TUBING

# BALLANTINE

## STILL THE FINEST

in

## ELECTRONIC VOLTMETERS

Ballantine pioneered circuitry and manufacturing integrity assures the maximum in  
**SENSITIVITY • ACCURACY • STABILITY**

- All models have a single easy-to-read logarithmic voltage scale and a uniform DB scale.
- The logarithmic scale assures the same accuracy at all points on the scale.
- Multipliers, decade amplifiers and shunts also available to extend range and usefulness of voltmeters.
- Each model may also be used as a wide-band amplifier.



MODEL 300

MODEL	FREQUENCY RANGE	VOLTAGE RANGE	INPUT IMPEDANCE	ACCURACY	PRICE
300	10 to 150,000 cycles	1 millivolt to 100 volts	1/2 meg. shunted by 30 mmfds.	2% up to 100 KC 3% above 100 KC	\$210.
302B Battery Operated	2 to 150,000 cycles	100 microvolts to 100 volts	2 megs. shunted by 8 mmfds. on high ranges and 15 mmfds. on low ranges	3% from 5 to 100,000 cycles; 5% elsewhere	\$225.
304	30 cycles to 5.5 megacycles	1 millivolt to 100 volts except below 5 KC where max. range is 1 volt	1 meg. shunted by 9 mmfds. on low ranges, 4 mmfds. on highest range	3% except 5% for frequencies under 100 cycles and over 3 megacycles and for voltages over 1 volt	\$235.
305	Measures peak values of pulses as short as 3 micro-seconds with a repetition rate as low as 20 per sec. Also measures peak values for sine waves from 10 to 150,000 cps.	1 millivolt to 100C volts Peak to Peak	Same as Model 302B	3% on sine waves 5% on pulses	\$280.
310A	10 cycles to 2 megacycles	100 microvolts to 100 volts	Same as Model 302B	3% below 1 MC 5% above 1 MC	\$235.

For further information, write for catalog.

# BALLANTINE LABORATORIES, INC.

100 FANNY ROAD, BOONTON, NEW JERSEY



NEW BOOKS

(continued)

data. German equivalents are given for most of the terms. Each member of the known radioactive families has an entry, indicating symbol, atomic number, mass number, parent isotope, daughter isotope, type of radiation and half-life.

**POWER SYSTEM STABILITY.** Volume II—Power Circuit Breakers and Protective Relays. Edward W. Kimbark. John Wiley & Sons, Inc., New York, 1950. 288 pages, \$8.00. For graduate students and engineers.

**CAPACITORS FOR INDUSTRY.** By W. C. Bloomquist, C. R. Craig, R. M. Partington and R. C. Wilson. John Wiley & Sons, New York, 1950, 246 pages, \$4.50. Practical data on use of capacitors to correct power factor of industrial electric power loads, with methods of determining most economic capacitor installation for each job.

**SYMPOSIUM ON DYNAMIC STRESS DETERMINATIONS.** Publication No. 104, American Society for Testing Materials, 1916 Race, Philadelphia, 64 pages, \$1.50. Scope, applicability, possibilities and limitations of electronic measuring and recording devices, as summarized in four papers presented at an ASTM meeting in Oct. 1949.

**TELEVISION, Vol. V (1947-1948) and Vol. VI (1949-1950).** RCA Review, Princeton, N. J., 1950, 461 and 422 pages respectively, \$2.50 each. Compilations of selected published papers by RCA authors on television, grouped in six categories in each book: Pickup; Transmission; Reception; Ultra-High Frequencies; Color Television; General. Suitably balanced presentation is achieved by including some papers in full, some in summary form, and omitting others entirely to avoid duplication of content. Appendix in Vol. VI has bibliography of some 506 technical papers on television written by RCA authors and published during the period 1929-June 1950.

**DESIGN OF ELECTRICAL APPARATUS.** By John H. Kuhlmann. John Wiley & Sons, Inc., New York, 1950, 3rd edition, 512 pages, \$6.50. Revised to include new wire insulating materials, new ASA calculating procedures, new methods for determining motor dimensions, and method of designing small transformers used in electronic control circuits and for power supplies for electronic devices.

**TELECOMMUNICATIONS AND EQUIPMENT IN GERMANY, 1939-1945.** British Information Services, 30 Rockefeller Plaza, New York, 56 pages, paper-cover, \$0.40. Summary of status of research and development in various branches of wire and radio communication.

**A GLOSSARY OF TERMS IN NUCLEAR SCIENCE AND TECHNOLOGY.** American Society of Mechanical Engineers, 29 W. 39, New York. Section III—Reactor Engineering, 48 pages, \$0.75; Section V—Chemical Engineering, 36 pages, \$0.60; Section VI—Biophysics and Radiobiology, 52 pages, \$0.60. First three of the nine sections eventually to be published, each containing encyclopedia-type discussions as well as definitions of terms in that branch of nucleonics. Each book contains a 20-page alphabetical arrangement of terms, giving the section in which each term is defined.

**INDUSTRIAL AND SAFETY PROBLEMS OF NUCLEAR TECHNOLOGY.** Edited by M. H. Shamos and S. G. Roth. Harper & Brothers Publishers, New York, 1950, 368 pages, \$4.00. Compilation of contributions of some twenty authors who presented lectures at a conference conducted by New York University on the same subject early in 1950. Arrangement is in four parts: U. S. Atomic Energy Commission Activities; Radiochemistry and Isotopes; The Radiochemical Laboratory; Hazards, Safety and Insurance. A 37-page appendix presents panel discussions.



# Stupakoff Ceramics

## FOR ELECTRONIC APPLICATIONS

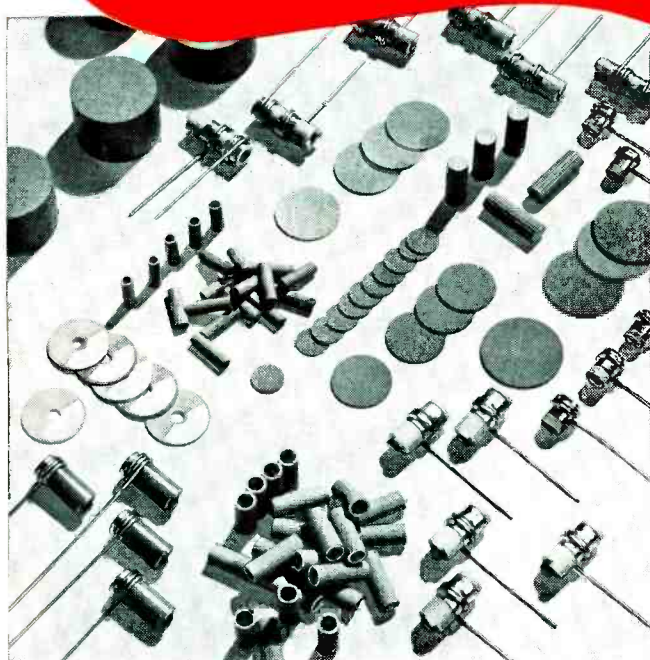

### CERAMIC DIELECTRICS

Stupakoff makes a wide variety of CERAMIC DIELECTRICS as tubes, discs and special shapes, plain or silvered for temperature compensating capacities to reduce frequency drift in RF, TV and other circuits. Also, general purpose ceramic dielectrics for by-pass, lead-through blocking, stand-offs and trimmer applications, and temperature compensating ceramic dielectrics with coefficients from P-100 to N-2700 and high K materials up to K-6000.



### STUPACITORS

Two new Stupakoff electronic products are the STUPACITOR Trimmers and Stand-offs.

Stupacitor Trimmers are ideal for standard and temperature compensating capacitors, starting at 0.5 mmf. The stand-offs serve, in addition, as capacitors. Advantages are: low cost, neat, easy assembly, compact.

### STUPALITH

The ideal ceramic for *Extreme Thermal Shock*, Stupalith designates a group of ceramics which may be formulated and processed to possess zero, low positive and low negative expansivities. Formed by conventional methods. May be machined or ground to precision tolerances. For temperatures up to 1200° C.

### TEMPERATURE SENSITIVE RESISTORS

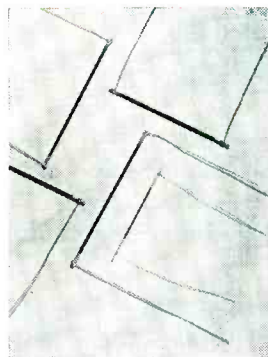

Made to exacting standards and specifications, Stupakoff Negative Temperature Coefficient Resistors are supplied complete with terminals in the form of rods, tubes and simple shapes, including discs, bars and washers. Sizes currently available in rods are .010" to .500" diameter. Tubes are from .020" to .500" O.D., with I.D. up to 75% of O.D. Resistance decreases approximately 3% for each degree C. temperature increase.

### OTHER CERAMIC PARTS

Precision-made ceramics for all temperatures, voltages and frequencies—plain, metallized or assembled. Stupakoff offers exceptional engineering and manufacturing facilities for the design, application and production of high-quality ceramic parts.

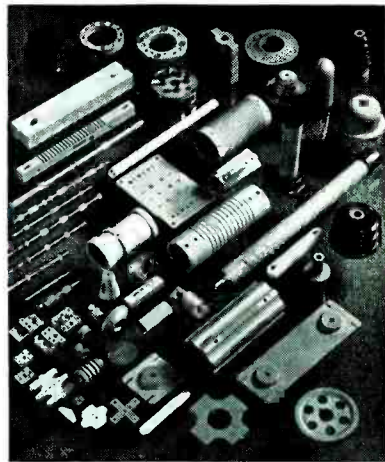

STUPAKOFF CERAMIC & MANUFACTURING COMPANY

TELEPHONE: LATROBE 1400

Latrobe, Pennsylvania

CABLE: STUPAKOFF LATROBE

# POPULATION -

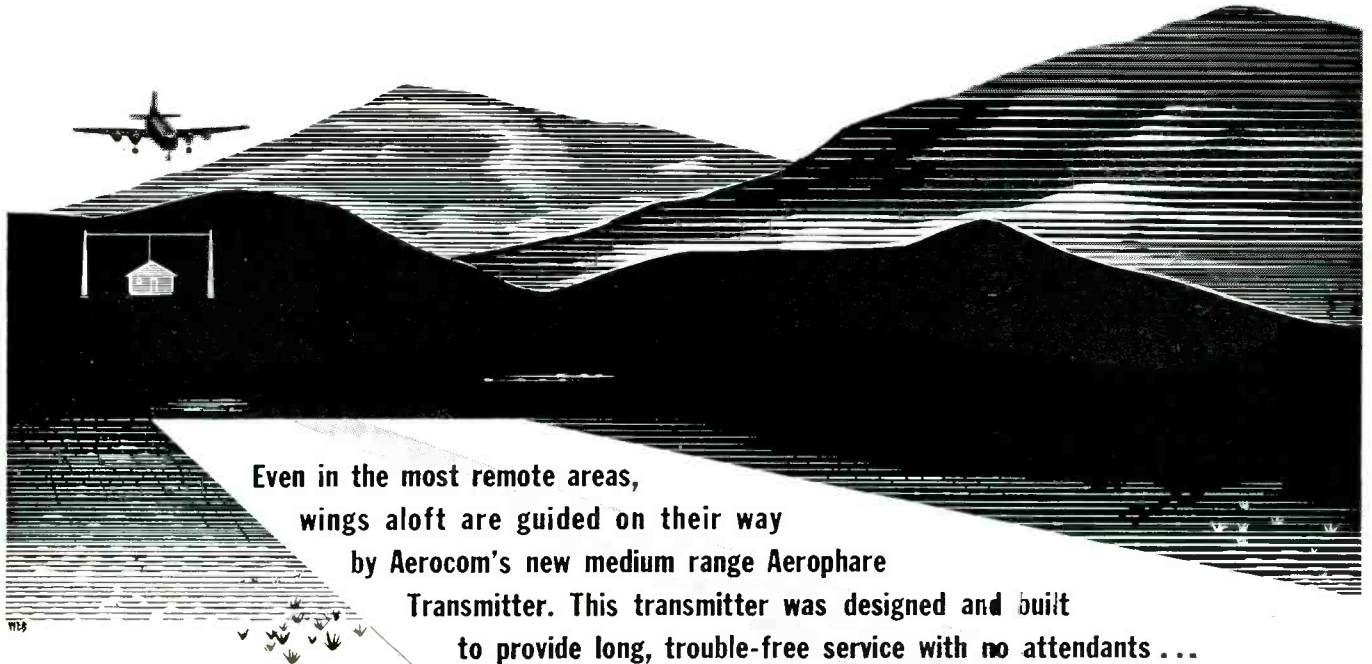

Even in the most remote areas,  
wings aloft are guided on their way  
by AeroCom's new medium range Aerophare  
Transmitter. This transmitter was designed and built  
to provide long, trouble-free service with no attendants ...  
even where the total population is Zero.

## AEROPHARE

The 100 Watt Aerophare illustrated consists of the following units -- AK-3 automatic keyer; Model 100 XL transmitter, (100 Watt carrier power, 35% high level tone modulation for identification); and antenna tuner.

The smaller unit is the same physical size except transmitter carrier power is 50 Watts with 35%-50% high level tone modulation for identification.

Voice modulation can be used with either unit, with peaks to 50%-60% for the 100 Watt unit and 75%-80% for the 50 Watt unit. When Microphone P-T Switch is depressed tone is interrupted, permitting voice operation.

For both units, permanently mounted final amplifier circuit covers 200-415 kcs. "Plug-in" oscillator coils cover 200-290 kcs. and 290-415 kcs; (these are available with crystal for .02% stability or self-excited for 0.1% stability).

Continuous duty operation in air temperatures: 0°C to +45°C with mercury vapor rectifiers; -35°C to +45°C with gas filled rectifiers.

*Engineering data on this unit and other AEROCOM products is available upon request.*

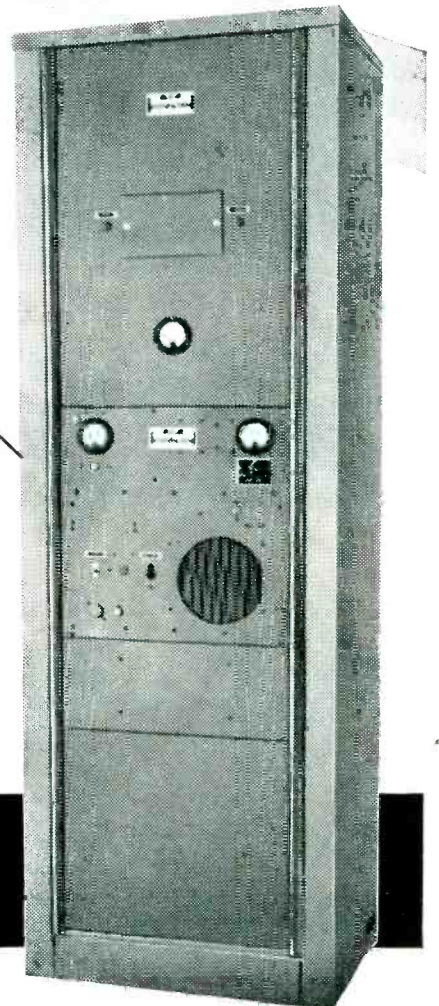

**AER - O - COM**  
Reg. U. S. Pat. Off.

**AERONAUTICAL COMMUNICATIONS EQUIPMENT, INC.**  
3090 Douglas Road, Miami 33, Florida

**CONSULTANTS, DESIGNERS AND MANUFACTURERS OF STANDARD OR SPECIAL  
ELECTRONIC, METEOROLOGICAL AND COMMUNICATIONS EQUIPMENT.**



**4 TRUARC RINGS CUT ASSEMBLY TIME 40%  
CUT UNIT COST 25%  
PROLONG PRODUCT LIFE 9 YEARS**

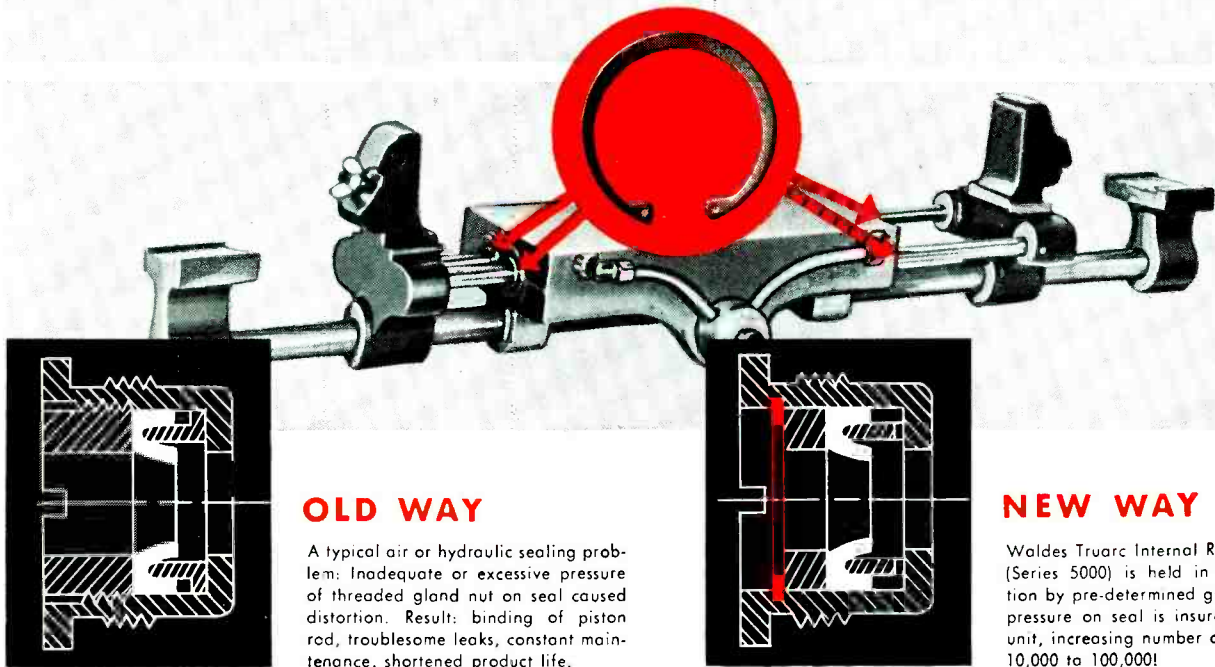

**OLD WAY**

A typical air or hydraulic sealing problem: Inadequate or excessive pressure of threaded gland nut on seal caused distortion. Result: binding of piston rod, troublesome leaks, constant maintenance, shortened product life.

**NEW WAY**

Waldes Truarc Internal Retaining Ring (Series 5000) is held in correct position by pre-determined groove. Proper pressure on seal is insured for life of unit, increasing number of cycles from 10,000 to 100,000!

Using 4 Waldes Truarc Retaining Rings in their Check-N-Spect Air Power Units (for tire inspection and repair) saves Bowes Seal Fast Corp., Indianapolis, 40% in assembly time, 25% in cost. With Waldes Truarc Rings, assembly is simple...maintenance unnecessary. New design increases unit life from 1 to 10 years!

Redesign with Truarc Rings and you too will cut costs. Wherever you use machined shoulders, bolts, snap rings, cotter pins, there's a Waldes Truarc Retaining Ring designed to do a better job of holding parts together.

Truarc Rings are precision-engineered...quick and easy to assemble and disassemble. Always circular to give a never-failing grip. They can be used over and over again.

Find out what Truarc Rings can do for you. Send your blueprints to Waldes Truarc engineers for individual attention, without obligation.

Waldes Truarc Retaining Rings are available for immediate delivery from stock, from leading ball bearing distributors throughout the country.

**REDESIGN WITH 4 WALDES TRUARC RETAINING RINGS BRINGS THESE BIG SAVINGS...**

- Eliminates skilled-labor milling and threading operations . . . . .
- Eliminates maintenance . . . . .
- Gives greater accuracy in positioning seal . . . . .
- Saves 40% in assembly time . . . . . \$ .09
- Cost of old-type parts . . . . . .24
- Less Cost of four Waldes Truarc Rings . . . . . .08
- Net savings on parts . . . . . .16

**TOTAL UNIT SAVING . . . \$ .25**

**SEND FOR NEW CATALOG** →

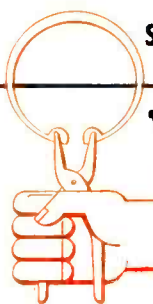

**WALDES TRUARC**

REG. U. S. PAT. OFF.

**RETAINING RINGS**

WALDES KOHINOOR, INC., LONG ISLAND CITY 1, NEW YORK

WALDES TRUARC RETAINING RINGS ARE PROTECTED BY THE FOLLOWING PATENT NUMBERS:  
U. S. PATENTS 2,382,948; 2,420,921; 2,411,761; 2,487,803; 2,487,802; 2,491,306 AND OTHER PATENTS PENDING



Waldes Kohinoor, Inc., 47-16 Austel Place  
Long Island City 1, N. Y.

E-023

Please send selector guide catalog (4k-w)  
on Waldes Truarc Retaining Rings.

Name \_\_\_\_\_

Title \_\_\_\_\_

Company \_\_\_\_\_

Business Address \_\_\_\_\_

City \_\_\_\_\_ Zone \_\_\_\_\_ State \_\_\_\_\_ ★

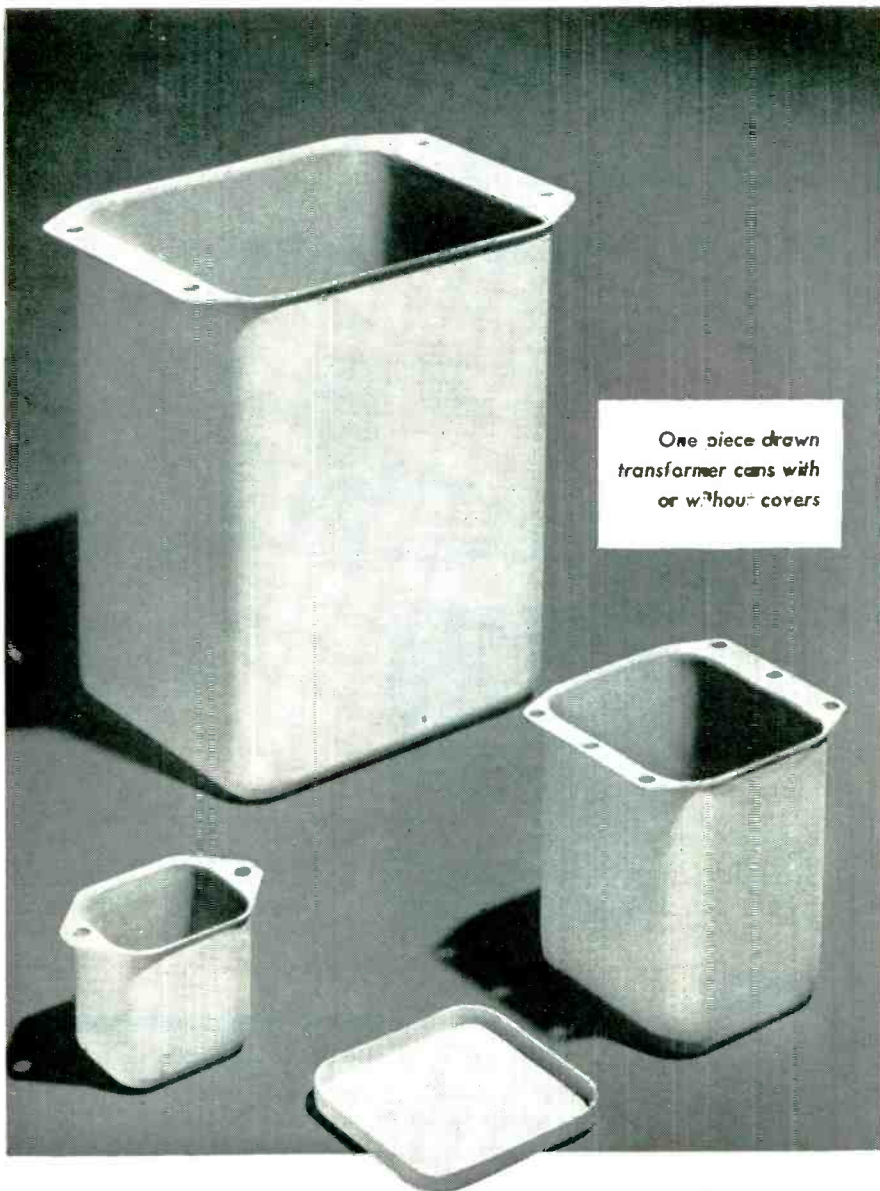

One piece drawn  
transformer cans with  
or without covers

## TRANSFORMER CANS STOCKED IN STANDARD SIZES

We can save you die costs on all stock size transformer cans, and will make IMMEDIATE DELIVERY. A full range of sizes are available with or without covers. List of stock sizes and prints furnished on request.

### SPECIAL SHAPES AND SIZES

We are also equipped to fabricate special sizes and shapes (round, square and rectangular) to your own specifications. Tell us your transformer can requirements and we will be glad to submit estimates.

Craft Transformer Cans are  
drawn in one piece.



**Craft** MANUFACTURING CO.  
3949 W. Schubert Ave., Chicago 47  
*Stainless Steel Specialists*

### TUBES AT WORK

(continued from p 122)



One of the authors, D. L. Gerlough, records data from the vehicle speed-distribution recorder

discriminate between positive and negative input pulses. Resetting of the binary counter on completion of any operation is accomplished by means of a positive pulse applied to the cathode of the left-hand triode of each stage.

The interpretation section contains a separate circuit for each predetermined output, consisting of a resistance-type voltage-adding network and a coincidence detector. Each voltage-adding network is made up of  $n$  22-meg resistors and  $n$  double-throw switches, where  $n$  is the number of stages in the binary counter.

Each switch connects its associated resistor with one of the stages of the binary counter. Switch positions 0 and 1 are connected to the normally conducting and normally nonconducting plates of the counter stage. In setting up the predetermined count for an output a switch has the same binary value as the counter stage with which it is associated. The predetermined setting for any output is the total binary value of all switches related to that output.

#### Circuit Operation

The coincidence detector consists of a triode ( $\frac{1}{2}$  a 12AX7) whose apparent grid voltage at any instant is the resultant of the voltages applied to the  $n$  22-meg resistors and the  $-100$  volts applied to the grid-return resistor.

When the contents of the binary counter are such that all plates con-



# These examples of GRAY product engineering ... typify GRAY results!

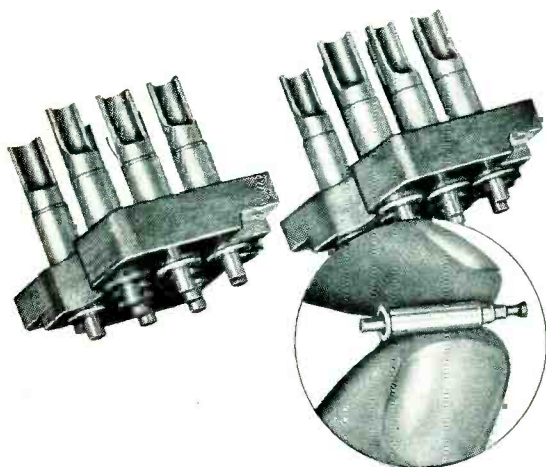

**SPRING PIN CONNECTOR:** made on centers of .01 inch. Some types carry current through spring; on one design, the connection to the pin is made directly to an extension of plunger. Contact surfaces Silver or Palladium for lower contact resistance, greater contact life. Contacts are arc-resisting. Spring pressure 5 oz. at full depression of .21". Pin is coin (75%) silver. Spring of Beryllium Copper, heat treated, silver flashed. Barrel and cap silver-plated on brass.

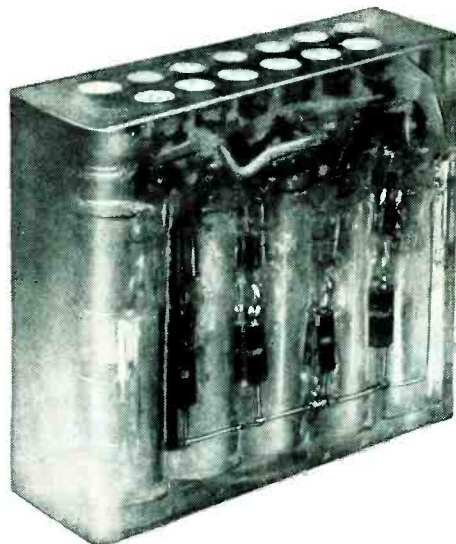

**POTTED ASSEMBLY:** Containing 29 resistors and condensers and 5 thyratrons. GRAY does its own potting, wiring.



- TELEPRINTER TECHNIQUES
- OPTICAL DEVICES
- COMMUNICATIONS
- TELEVISION COMPONENTS
- AERONAUTICS
- AUDIO- & ELECTRO-MECHANICS

More often than you might surmise GRAY RESEARCH designers and engineers come up with ideas and components that become important factors in product improvement and performance. The exclusive products shown above are but two examples. Many can be cited.

GRAY scientific know-how on product development and engineering plus modern plant facilities are available to organizations and laboratories seeking this specialized type of work.

A brochure describing GRAY will be mailed on request.

## GRAY RESEARCH

and Development Co., Inc., 16 Arbor St., Hartford 1, Conn.

Division of The GRAY MANUFACTURING COMPANY—Originators of the Gray Telephone Pay Station and the Gray Audograph



*Walter E. Ottewill*  
President

# Still in Supply...

**WESTON**

## test and Research Instruments

Equally valuable in electronic research, production testing or special circuit investigation, these versatile Weston instruments are available through your local Weston Representative. Consult him, or write for booklet on WESTON Test Instruments, Weston Electrical Instrument Corporation, 595 Frelinghuysen Avenue, Newark 5, New Jersey... *manufacturers of Weston and Tagliabue instruments.*



**Model 564 Volt-Ohmmeter** provides a broad selection of resistance and d-c voltage ranges. Self-contained battery for resistance measurements. Sensitivity 1,000 ohms per volt.



**Model 697 Volt-Ohm-Milliammeter** combines a-c and d-c voltage, direct current, and resistance ranges. Self-contained battery. Sensitivity 1,000 ohms per volt.



**Model 769 High Frequency Electronic Analyzer** makes most electronic measurements for FM, AM and TV service work in the vhf and uhf fields. Three instruments in one: volt-ohm-milliammeter, high impedance electronic volt-ohmmeter, probe type vacuum voltmeter.



**Model 779 Supersensitive Analyzer** checks tube circuits in electronic control equipment, transmitters, receivers. Measures current, potentials; indicates power levels in decibels in audio, public address and communications equipment. Sensitivity 20,000 or 1,000 ohms per volt... 26 practical ranges.

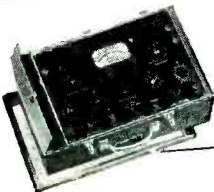

**Model 798 Proportional Conductance Tubechecker** for industrial, laboratory and general testing of receiving tubes, voltage regulator tubes, low power Thyatron tubes. Uses differential frequency system; provides mutual conductance ranges to 12,000 micromhos.

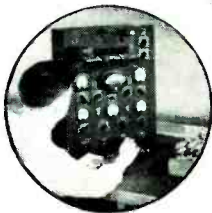

**Model 686 Mutual Conductance Electronic Tube Analyzer** tests tubes under exact operating potentials. Accurately determines true mutual conductance of all tubes, both in accordance with manufacturers' rated operating conditions and at other values for non-standard applications.

# WESTON Instruments



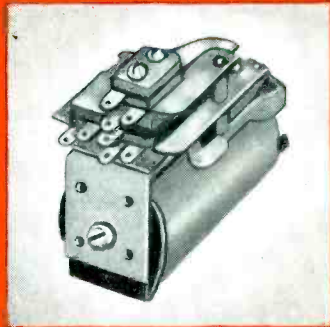

**SERIES 695 D.C.**

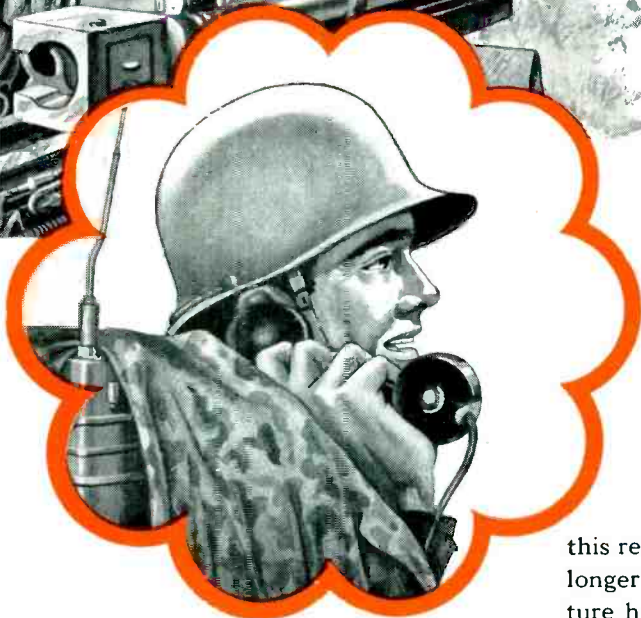

*The*  
**GUARDIAN**  
 SERIES 695 D.C.  
**RELAY**

**ONE OF A LINE**

A tiny telephone type—the Guardian Series 695 D.C. Relay has distinguished itself in wartime communications equipment. For inter-plane—intra plane—ground to plane—ship to shore radio—walkie talkie—field telephone equipment—the Guardian Series 695 D.C. is unexcelled. Contrary to conventional design, armature on this relay is formed outward, away from coil, permitting use of a longer coil without increasing overall length of the unit. Armature hinges on a frictionless bearing which requires no lubrication. Proper balance of copper winding and volume of iron on field piece result in maximum flux density without oversaturation of iron. Series 695 D.C. Relay is capable of carrying up to 6 single pole, single throw contact combinations. Can be hermetically sealed as a standard unit in Lug Header type housing or, to specification, in A. N. Connector, Screw Terminal, or Lug Header type housings.

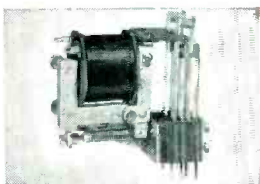

Series 30 A.C.

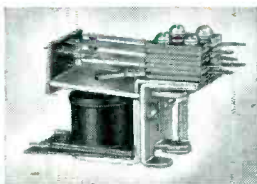

Series 210 A.C.—215 D.C.

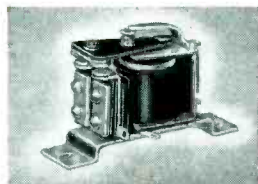

Series 220 A.C.

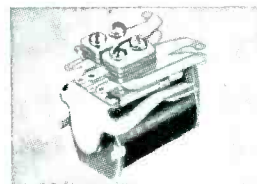

Series 595 D.C.

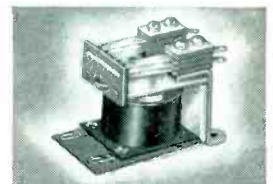

Series 610 A.C.—615 D.C.

**WRITE OR WIRE... FREE CATALOG, SPECIFIC RECOMMENDATIONS, NO OBLIGATION.**

**GUARDIAN**  **ELECTRIC**  
 1625B W. WALNUT STREET CHICAGO 12, ILLINOIS  
 A COMPLETE LINE OF RELAYS SERVING AMERICAN INDUSTRY

# You can get it— at **MILO!**

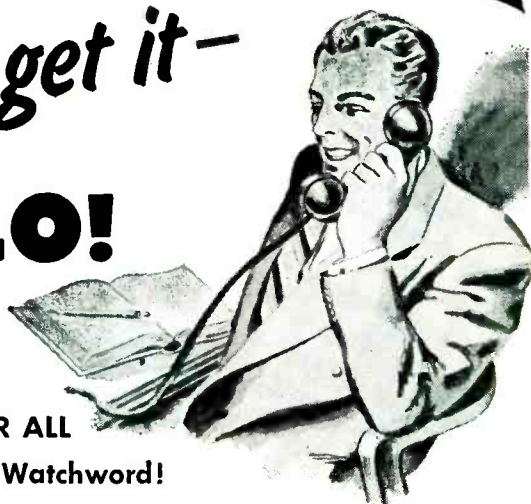

**FAIR DISTRIBUTION FOR ALL**  
is the **MILO** Watchword!

Yes, in these days of war and re-armament there are plenty of shortages in electronic components and equipment. But **Milo comes through for you!** And here's why:

Because Milo believes in **just and equitable distribution to all** its customers, whether old or new. This is the fair-play creed of service

and cooperation that built Milo—and Milo sticks to it, scarcities or no.

Because Milo's great warehouse holds **complete stocks of all the best lines.** Just look at this partial list of the more than 150 first-rate manufacturers whose products are available now from Milo:

ADVANCE ELECTRIC  
AEROVOX  
ALPHA WIRE  
AMERICAN TELEVISION & RADIO  
BELDEN • BLILEY  
DAVID BOGEN  
BUD • BURGESS  
BUSSMANN  
CLAROSTAT  
CONDENSER PRODUCTS  
CORNELL-DUBILIER  
CONTINENTAL CARBON  
DEJUR-AMSCO  
DIALCO • DRAKE  
EITEL-McCULLOUGH

ERIE  
GENERAL CEMENT  
GENERAL ELECTRIC  
GUARDIAN ELECTRIC  
HAMMARLUND  
HICKOK • HYTRON  
INSULINE • IRC  
E. F. JOHNSON  
KESTER  
KINGS ELECTRONICS  
LITTELFUSE  
JAMES MILLEN  
NATIONAL COMPANY  
OHMITE  
PAR-METAL  
POTTER & BROMFIELD

PRECISION APPARATUS  
PREMAX  
SANGAMO  
SHALLCROSS  
SHURE BROS.  
SIMPSON ELECTRIC  
SOLA ELECTRIC  
SPRAGUE  
STANDARD TRANSFORMER  
SUPERIOR ELECTRIC  
SYLVANIA • TUNG-SOL  
TRIPLETT  
UNGAR ELECTRIC  
WARD LEONARD  
WESTON



Write for  
your  
**MILO**  
Catalog

Milo's newest catalog, jam-packed with 1053 pages of descriptions, specifications, illustrations and prices, is the key to the latest electronics products you want. Write for it today—on your company letterhead, please, stating your position, since it is limited to responsible officials only.

**MILO doesn't just talk cooperation.  
MILO GIVES YOU COOPERATION!**

**MILO**  
PHONE  
**BEekman 3-2980**

**Radio & Electronics Corp.**  
200 Greenwich Street, New York 7, N. Y.  
Cable Address: **MILOELECTRO**  
The ONE source for ALL your electronic needs

needed to the  $n$  22-meg resistors are nonconducting, representing a total disagreement between the counter contents and the switch settings, the apparent grid voltage of the coincidence detector measured with the tube removed from the socket is approximately 77.5 volts. With the tube in the socket the actual grid voltage will go only slightly positive because of grid current flow.

When the contents of the binary counter are such that all plates connected to the  $n$  22-meg resistors are conducting, representing total agreement between the counter contents and the switch settings, the apparent and actual grid voltages will be approximately  $-6.5$  volts. Between total agreement and total disagreement the apparent grid voltages will change in increments of approximately 10.5 for a counter of eight stages.

Changing the grid voltage from a positive value to  $-6.5$  volts will cause a 12AX7 to go from full conduction to cutoff, resulting in an output signal. This signal may be adjusted to the proper level for succeeding equipment by means of a voltage divider.

Because of the variations in the exact cutoff voltage of 12AX7's, a potentiometer is provided in the grid return to adjust the bias for maximum output signal.

In addition to the predetermined output signals, there is an output signal when the binary counter overflows. The multiple-output predetermined counter with the component values shown has been op-

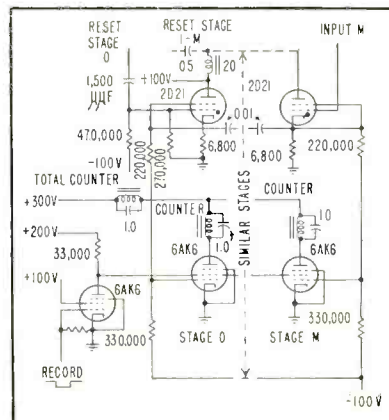
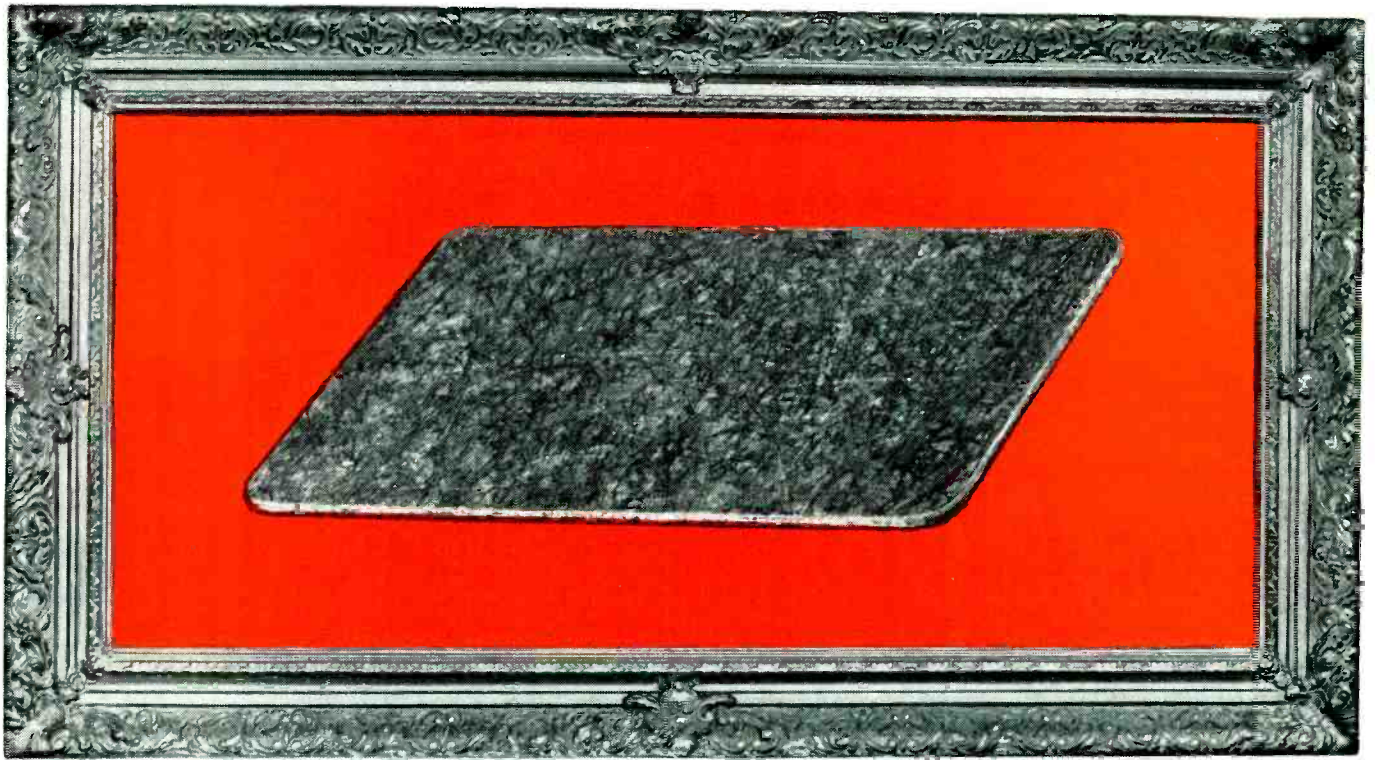

FIG. 2—Schematic diagram of statistical frequency-distribution recorder having  $m + 1$  groups and  $m$  inputs





## PORTRAIT OF A 50% SAVING !

This is a picture of a laminate reinforced with Fiberglas\* mat.

It matches—even surpasses—the electrical and mechanical properties of laminates reinforced with organic materials . . . *yet it costs as much as 50% less!*

Because the Fiberglas materials used for reinforcement in this new laminate panel resist the destructive action of water, oils, and most chemicals, the laminate is ideal for insulating apparatus which is subject to extreme operating conditions. Electrical properties of this glass-reinforced material are superior. Arc resistance has an ASTM rating of 150 sec. It machines readily and cleanly in production op-

erations where carbide tipped cutting tools are used.

If you make or use electrical apparatus, and want top-flight insulation at rock-bottom cost, consider laminates reinforced with Fiberglas mat.

Sheet stock and molded shapes made of Fiberglas glass-base laminates give superior service for—

**COIL WASHERS | • TERMINAL BLOCKS  
BARRIERS and SHIELDS • SLOT WEDGES  
END LAMINATIONS • BASE PLATES  
LAYER INSULATION**



**IS IN YOUR LIFE...FOR GOOD!**

\*Fiberglas is the trade-mark (Reg. U. S. Pat. Off.) of Owens-Corning Fiberglas Corporation for a variety of products made of or with glass fibers.

**OWENS-CORNING FIBERGLAS CORPORATION**  
Electrical Sales Division, Dept. 860  
16 E. 56th Street, New York 22, N. Y.

Please give me more information about Fiberglas glass-base laminates.

NAME.....

TITLE.....

COMPANY.....

STREET.....

CITY.....ZONE.....STATE.....

# bringing

# Your METALS

# to market

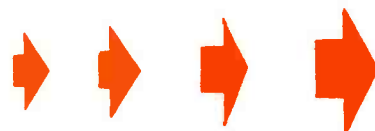

# is a full time job for...electronics

Metals play an important part in the design of electronic equipment and components—important from a technical as well as a dollar and tonnage standpoint. The photo and detailed description on the opposite page provide an idea of the amount required based on an average company's needs.

But remember this, metals in this field are not just ordered—they are carefully selected before they can be designed-in. Why? Because electronic products are the results of a highly specialized science and all metals must meet the most rigid requirements as to electrical or mechanical characteristics. Purchasing specifications are prepared by engineers who, by their very training, are precise and particular as to products. You will find no such loophole phrases as "or equal" and "or comparable" in specs ... products specified are the products bought.

Engineers who specify and thereby direct purchasing are subscribers and readers of *ELECTRONICS* for whom its sales pages have been for years, the chief source ... sometimes the only one ... of the technical information they must have in order to do that specifying.

And these engineer readers of *ELECTRONICS*, in reality, constitute your market. They are the men to whom you must bring your product—the men you must reach and influence. They exist in every industry—with a myriad of titles—but *ELECTRONICS* reaches every important one.

If you feel the metal market in electronics is not big enough to warrant close attention, the facts on the next page may prove an eye opener.



# electronics



**12 REGULAR ISSUES**  
supplying latest technical information, design and product news

A McGraw-Hill Publication • 330 West 42nd St., New York 18, N. Y.

**ANNUAL BUYERS' GUIDE**  
supplying all basic product source and technical specifying data





Pictured above is what might be called a drop in the ELECTRONICS' metals markets bucket . . . the current inventory in one stock room in one plant. 40 tons of metals a month — 20,000 lbs. brass, 10,000 lbs. stainless steel, 40,000 lbs. nickel and tin coated steel, and lesser amounts of beryllium, phosphor bronze, copper coated steel and other metals — and the plant\* is not a big metals user. It is engaged in the production of miniscular metallic components for use in tv picture tube electron guns: flange spacers, anode and grid assemblies, cathode spacers and supports — average piece size about that of a dime. Assuming, as the management does, that this plant supplies one-third of the industry's needs for these tiny tv tube parts we arrive at a figure of one thousand four hundred and forty TONS of metals a year for these tiny items alone.

Visualize, if you can, the variety and quantity of metallic products such as these, designed and specified for by ELECTRONICS' engineer readers . . . and the amount of metals they require. To help in that take the U. S. Census figures for 1947, latest and best available. They show that

\*John Volkert Metal Stampings, Inc., Queens Village, New York

the big users of metals in the radio, related products and miscellaneous communications industry alone bought 242,481 tons of certain selected types and shapes of iron, steel, copper and aluminum in 1947, a quarter of a million tons. The Census doesn't tabulate the multitudinous small fry's metals use. For comparison, take the Census figures for the also ELECTRONICS-reading-engineer-dominated telephone and telegraph equipment industry, an acknowledged big metal market. It used only half as much of the same Census-selected types and shapes in 1947 — 136,712 tons, and that was probably the total figure. There are no small fry in that business.

But all that was 1947. Tv set production totalled less than 200,000 units. It topped six million in 1950. Forty-seven figures no longer tell the story in television or any other segment of the economy. But it is sales, not statistics, that are important to you as a marketer of metals. That's where ELECTRONICS specializes — taking sales stories to the important buying factors for metals in every industry — and returning sales. That's ELECTRONICS' full time job: Taking products to market.

**THE DIRECT ROUTE TO — — — — — A \$2,000,000,000 MARKET PLACE**

# New JOHNSON KNOBS and DIALS

DISTINCTIVE!  
VERSATILE!  
RUGGED!

Meant for the discriminating designer or buyer who seeks accessories in keeping with high grade equipment; apart from the too common, yet in quiet good taste.

Combining new, distinctive styling with unusually sturdy construction, these JOHNSON Knobs and Dials will enhance the appearance of any electronic or electrical control equipment. The use of twelve flutes eliminates the usual octagonal, bumpy effect. Although essentially round, they retain excellent gripping surfaces. The "feel" is comfortable, positive, without sharp ribs or edges.

Knobs are molded of black phenolic material. Walls are extra thick for added strength and all types have heavy brass inserts. Metal dials are of nickel silver with beautiful chromium plating in satin etched finish. Visibility of dial readings is unusually good.

**MANY STYLES AVAILABLE**

Matching knobs in three sizes, 1 1/8", 1 5/8" and 2 3/4" diam., or assembled with phenolic skirts 1 1/2", 2 1/16", and 3" diam., or with metal dial plates 1 1/2", 2 3/4" and 4" diam. in various calibrations, and a spinner with the 2 3/8" knob.

**OTHER TYPES ON SPECIAL ORDER**

In production quantities, pointer types, friction disc vernier drives, special markings and calibrated dials, extra set screws, and other variations may be obtained.

Knob Diam.	Shaft Diam.	Knob Only Cat. No.	Spinner Knob Cat. No.	Knob with Phenolic Skirt Cat. No.	Dia.	Knob with Chrome Dial Cat. No.	Scale
2 3/8"	3/4"	116-280	116-286	116-281	3"	116-282	4" 0-100 180°
2 3/8"	3/4"	116-280-3					
1 5/8"	3/4"	116-260		116-261	2 1/16"	116-262	2 3/4" 0-100 180°
1 1/8"	3/4"	116-220		116-221	1 1/2"	116-222-1	1 1/2" 100-0 180°
1 1/8"	3/4"					116-222-2	1 1/2" 0-10 270°
1 1/8"	3/4"					116-222-3	1 1/2" 1-7 180°
1 1/8"	3/4"					116-222-4	1 1/2" On-off 60°
1 1/8"	3/4"					116-222-5	1 1/2" Indicator

Write for illustrated sheet describing these exceptional JOHNSON Knobs and Dials.

**JOHNSON** a famous name in Radio!  
E. F. JOHNSON CO. WASECA, MINN.

erated successfully at frequencies up to 50 kc.

In one application, an  $m$ -output predetermined counter has been used to distribute automatically counts into  $m + 1$  class intervals of a statistical frequency distribution using a special recorder. This recorder, whose circuit is shown in Fig. 2, employs  $m + 1$  electromechanical counters.

The electromechanical counter of stage 0 records the number of items having counts 0 or greater, but less than  $a_1$ ; the counter of stage 1 records items having counts greater than  $a_m$  up to the maximum capacity of the binary counter, where  $a_1$  to  $a_m$  are the predetermined output settings of the  $m$ -output counter. Thyratrons are used to "remember" the greatest class interval to which counting has progressed.

*Sequence*

Initially, in the operation of the predetermined counter and recorder circuits, the thyatron of stage 0 of the recorder is fired and the thyratrons of all other stages are extinguished. As counting takes place, stage 0 remains fired indicating class interval 0 to  $a_1$ , until stage 1 receives a signal from the first output of the predetermined counter. At this point the thyatron of stage 1 fires and extinguishes the thyatron of stage 0 by means of the 0.01- $\mu$ f commutating capacitor.

The thyatron of stage 1 remains fired until the recorder receives a signal from the second output,  $a_2$ , of the predetermined counter through stage  $m$ . If counting continues after  $a_m$ , the memory thyatron of stage  $m$  remains fired indicating a count of  $a_m$  or greater.

The overflow signal from the

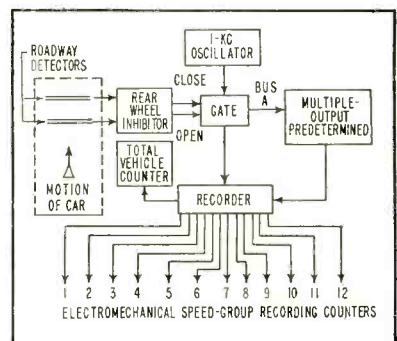

FIG. 3—Block diagram of vehicle speed-distribution recorder



# 3

## Outstanding Advantages Of

# HEINEMANN

(FULLY MAGNETIC) **CIRCUIT BREAKERS** (NON-THERMAL)

### 1. MAGNETIC-HYDRAULIC TIME DELAY

HEINEMANN Magnetic Circuit Breakers are available with any one of three different inverse time delays controlled by a hermetically sealed trip unit. The breaker acts instantly on excessive overload or short circuit, but is not affected by minor overloads or temporary inrush current.

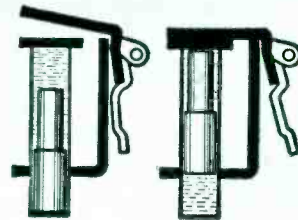

### 2. HIGH SPEED LATCH

One of the fastest operating latch mechanisms known. It functions with minimum friction, opening the breaker with the least mechanical delay and independently of handle operation.

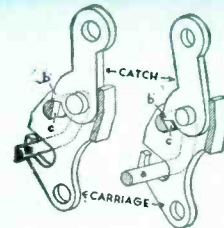

### 3. MAGNETIC HIGH SPEED BLOWOUT

It adds speed to the arc interruption. Magnetic blowout contacts are mounted in individual arcing chambers carefully insulated from each other. As the value of the current to be interrupted increases, the quenching effect becomes greater due to the intensified magnetic blowout field.

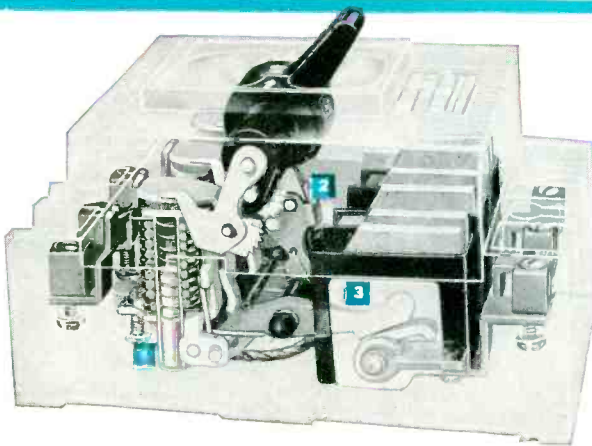
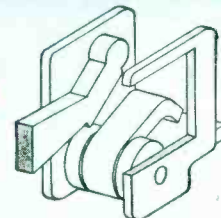

Heinemann Magnetic Circuit Breaker showing location of (1) Time Delay (2) High Speed Latch (3) High Speed Blowout

This breaker has *entirely* magnetic action. The full time delay provided for is available up to rated current, as it does not depend on any thermal unit and is independent of surrounding temperature.

The point at which the breaker becomes instantaneous is in direct ratio to the rating of the breaker (10 times the breaker rating). For example, a 15 amp. breaker will trip instantly on a 150 amp. current.



## HEINEMANN ELECTRIC COMPANY

97 PLUM STREET

TRENTON, NEW JERSEY

# 400-800 CYCLE AC

From 5.5v to 230v  
DC Input

New **Carter\*** High Frequency

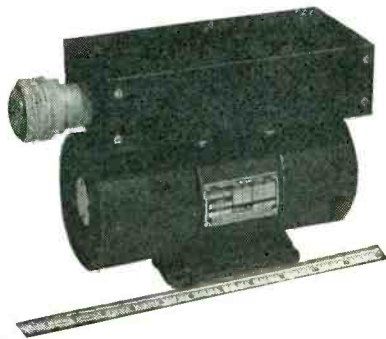

## INDUCTOR ALTERNATOR

Newly developed in the Carter research and engineering departments, this new rotary power supply is ideal for aircraft, geophysical, government and laboratory research, and other applications demanding a small, mobile source of up to 100 watts high frequency AC. Primarily designed for 24-29v. DC airborne equipment, but available at any input voltage 5.5v to 230v. Inductor principle eliminates slip rings and brushes. Electrically isolated input and output units. Separate DC plate output also available in addition to the h.f. AC.



WRITE for Bulletin #350. Contains complete illustrated information on the New Carter Inductor Alternator, mechanical and electrical specifications, performance chart, etc. Yours FREE for asking!



2646 N. Maplewood Ave., Chicago

- **LIGHT WEIGHT**  
Filter Model Shown Weight only 22 lbs.
  - **SMALL SIZE**  
10" x 4 1/2" x 7 3/4"  
(Filter Model as shown)
  - **PRECISION BUILT**  
Shaft and bore fits held to less than .0002"
  - **ARMATURE**  
Triple and quadruple insulated windings statically and dynamically balanced
  - **BALL BEARINGS**  
Require no maintenance or lubrication in normal service
- \*T.M. Reg. U.S. Pat. Off.

# American Beauty

## ELECTRIC SOLDERING IRONS

are sturdily built for the hard usage of industrial service. Have plug type tips and are constructed on the unit system with each vital part, such as heating element, easily removable and replaceable. In 5 sizes, from 50 watts to 550 watts.

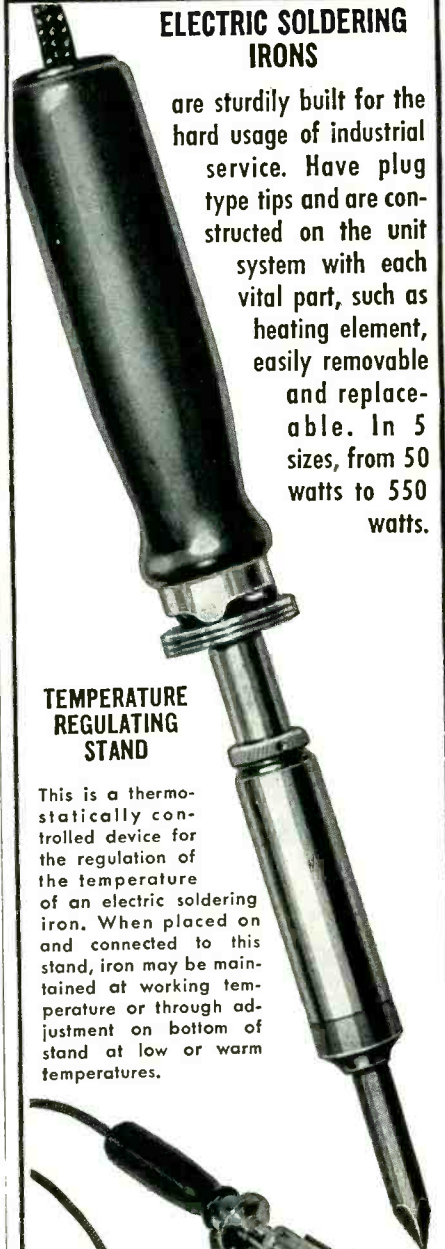

## TEMPERATURE REGULATING STAND

This is a thermostatically controlled device for the regulation of the temperature of an electric soldering iron. When placed on and connected to this stand, iron may be maintained at working temperature or through adjustment on bottom of stand at low or warm temperatures.



For descriptive literature write

110-1

**AMERICAN ELECTRICAL  
HEATER COMPANY**  
DETROIT 2, MICH., U. S. A.



# ELECTROLYTIC CAPACITORS

Consecrated  
to Quality Output and  
Golden Rule Service

Because of LONGER LIFE on the job . . . because of compactness, easy mountability and perfect compliance with today's set-engineering requirements . . . these dependable Electrolytic Capacitors are rapidly becoming a MUST with leading radio and television manufacturers. We believe they belong in YOUR plans for 1951. Get acquainted with them, and the rest of the extensive ASTRON line.

WRITE FOR CATALOG AC-2



**CORPORATION** 255 Grant Ave., East Newark, N. J.

Manufacturers

HIGH QUALITY FIXED CAPACITORS AND FILTERS



it's revolutionizing 2-way radio

it's permanent!

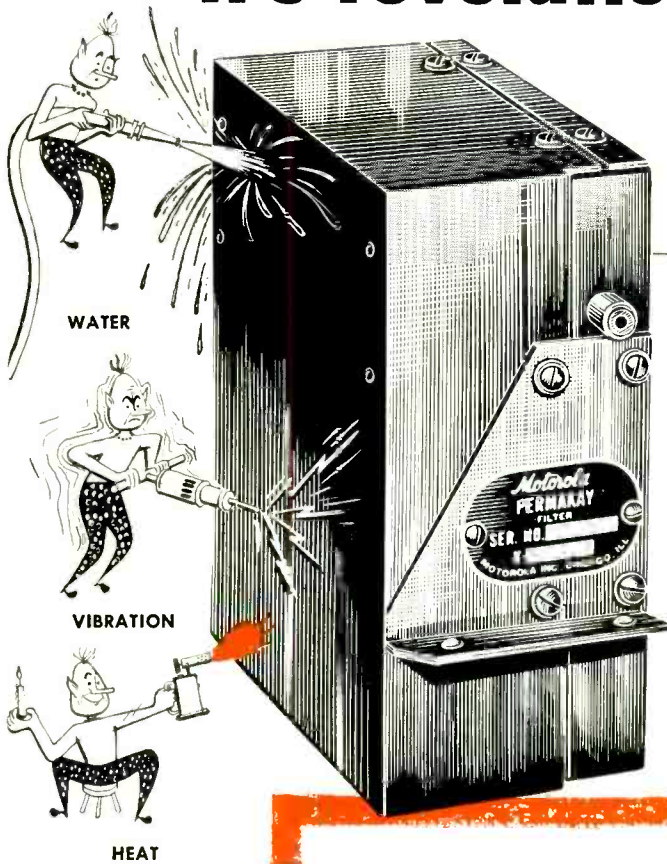

**Motorola's amazing invention . . . THE SENSICON PERMAKAY FILTER FOR GUARANTEED PERMANENT SELECTIVITY!** *Thousands in the field, operating year in and year out, without failure.*



Permakay is here to stay as the keystone of the Sensicon Circuit

The Permakay I.F. Wave Filter for PERMANENT SELECTIVITY—*guaranteed for the life of the set!* This coil and capacitor filter network is noise-balanced for optimum signal-to-noise ratio, achieved by counterphasing. These super-precision elements are cast in solid waterproof plastic which will not melt, crack, loosen, or deteriorate. PERMAKAY thus assures *permanent* precision selectivity, reduces maintenance, and increases all-around serviceability of your Motorola equipment.

. . . AND HERE AGAIN THE *MOTOROLA GUARANTEE* provides perfect radio service today and protects against obsolescence tomorrow. When radio channels are split you need not buy a new receiver—simply exchange the standard-channel Permakay filter for a new split-channel filter and your receiver is up to date and ready for years of service.

## Motorola FIRSTS

TRUE ADJACENT CHANNEL  
SPLIT CHANNEL  
SENSICON CIRCUIT  
PERMAKAY\*

statomeric oscillator  
iso q cavities  
differential squelch  
capacitance discriminator  
instantaneous deviation control  
bridge balanced crystal oven

SO INSIST ON SENSICON and protect your investment!

# Motorola

Communications and Electronics Division  
4545 AUGUSTA BLVD. • CHICAGO 51  
In Canada:  
Rogers Majestic Electronics Ltd., Toronto, Ont.

SPECIALISTS IN MOBILE RADIO FOR 21 YEARS

# Browning OSCILLOSYNCHROSCOPES

for high-speed pulse work, radar, hf, TV,  
communications, facsimile



## MODEL OJ-17 OSCILLOSYNCHROSCOPE

THESE ARE THE HIGHLIGHTS of equipment for laboratory research and development requiring a variety of time bases, triggers, phasing and delay circuits, and extended-range amplifiers for use in the study of wave shapes, very short pulses, and irregular transients.

A wide-band oscillosynchroscope for high-speed pulse work and study of complex wave shapes with hf components. Entire equipment is mounted in vertical rack cabinet; convenient mounting for camera to record screen images.

### Circuit Features

- 5" SRP or 5XP CR tube; anode voltage variable 10 to 20 kv.
- Vertical amplifier bandwidth flat to 16 mc with response beyond 30 mc.; deflection sensitivity 0.05 volts/inch; video delay 0.2 microseconds
- Horizontal amplifier bandwidth 2 mc.; deflection sensitivity 0.25 volts/inch
- Driven sweep variable 0.05 to 500 microseconds/inch; saw-tooth sweep 5 to 500,000 c.p.s.
- Trigger-generator output 100 volts from 500 ohms; running rate 20 to 20,000 c.p.s.
- Internal blanking or deflection markers at 0.1, 1, 10, and 100 microsecond intervals
- External grid connection for beam intensity modulation
- Delay continuously variable to 2000 microseconds; directly calibrated dial.

Size: 81 $\frac{3}{8}$ "x25 $\frac{5}{8}$ "x24"  
Weight: 500 lbs;  
shipping weight: 750 lbs.

## MODEL ON-5 OSCILLOSYNCHROSCOPE

Gives you the basic equipment for viewing any voltage wave shapes — pulse or sine wave — radar or TV to audio — in a single, compact unit.

### Circuit Features

- 5" CR tube 5UP1
- Triggered sweep continuously variable 1 to 25,000 microseconds/inch with direct panel calibration
- Saw-tooth sweep 10 cycles to 100 KC
- Vertical amplifier flat  $\pm$  3db from 5 cycles to 5 mc. @ 0.075 volts/inch
- Self-contained vertical-deflection calibration means
- Horizontal amplifier d.c. to 500 KC @ 2 volts/inch
- Portable
- Low cost.



Bulletins containing detailed information about these two versatile instruments will be sent at your request.

In Canada, address:  
Measurements Engineering Ltd.  
Auriprior, Ontario.



ENGINEERED  
FOR  
ENGINEERS

**BROWNING**  
Laboratories, Inc.  
Winchester, Mass.

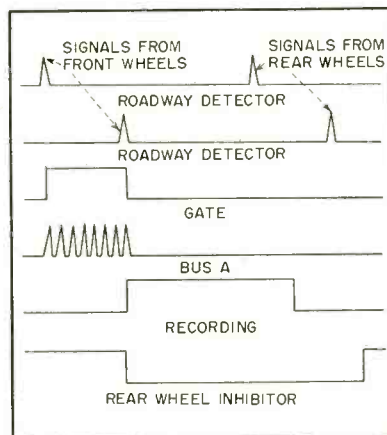

FIG. 4—Diagram showing sequence of operations within the speed-distribution recorder. The rear-wheel inhibitor blanks out signals from the roadway detectors long enough to permit the rear wheels to pass

binary counter may be used to cut off the counter input so that recycling will not occur. When counting is completed, a 0.1-sec negative signal is applied to the grid of the 6AK6 at the left in Fig. 2, raising the screen potential on the 6AK6's of stages 0 to  $m$ . This allows any of these tubes not biased to cutoff to conduct.

The only tube not biased to cutoff will be the 6AK6 associated with the 2D21 thyatron which has remained fired. When this 6AK6 fires, its associated electromechanical counter in series with the electromechanical counter for totals is energized and a record of the count in the appropriate class interval and a cumulative record of the number of items in all class intervals is produced. After the recording operation is completed, resetting signals are sent to the binary counter, the thyatron of recorder stage 0 and the thyatrons of the other stages.

The multiple-output predetermined counter and recorder described have been used as principal elements of a vehicle speed-distribution recorder.<sup>3</sup> In this instrument, block diagram in Fig. 3, the times required for vehicles to traverse a specified distance are translated into counts by means of a 1-kc gated oscillator.

Impulses from the roadway detectors pass through the rear-wheel inhibitor to open and close the gate. While the gate is open, pulses from the 1-kc oscillator pass through the gate into the multiple-output



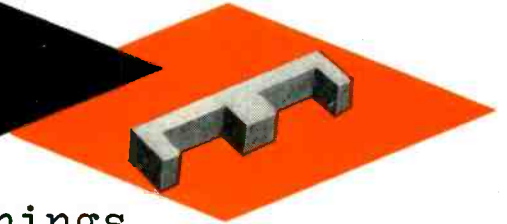
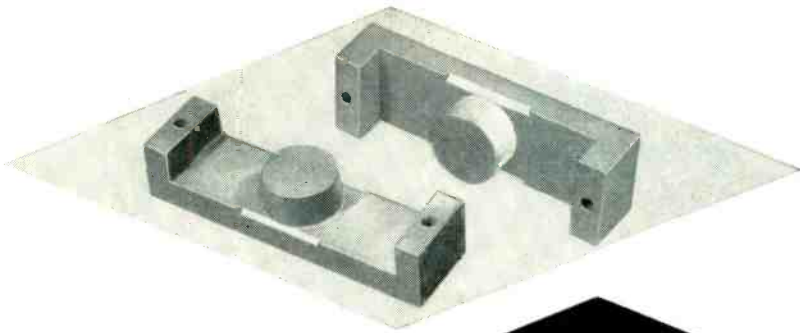

doing great things  
in radio and tv...

**CROLOY\***  
\*TRADE-MARK

DX reception with a portable in Chicago's worst radio spot (the Loop) . . . Mesabi Range iron deposits no longer barring enjoyable radio . . . man-made static noises cancelled out . . .

Complete radio-chassis assembly and test on production line before going into cabinet . . . wider deflection TV picture tubes of greatly abbreviated length . . . big slash in TV cabinet sizes and costs . . .

Yes, doing great things in radio and TV! Such is the impact of Croloy — the magnetic ceramic

of extraordinary "Q's". Croloy Radio Rods replacing usual loops in today's most advanced receivers, spell new reception standards. Croloy deflection yokes are expanding TV tube deflection angles without corresponding voltage increases or longer necks. Croloy cores are slashing TV transformer bulk and cost. Croloy slug tuners and I. F. coils are lowering costs and raising gains.

Definitely, Croloy offers electronic designers and builders brand new performance and economy opportunities.

Let us collaborate  
on your TV, radio or electronic  
problems and needs.  
Samples, engineering aid,  
and quotations.

**HENRY L. CROWLEY & COMPANY, INC.**  
Pioneering POWERED-IRON and STEATITE products  
1 Central Avenue  
West Orange, N. J.

**RMB** offers **PRECISION QUALITY**  
**EXTRA LIGHT RADIAL BEARINGS**

for Computers, Servo mechanisms,  
Precision Instruments and  
similar exacting applications



For light loads, low torque,  
high sensitivity, use R.M.B.  
Extra Light Ball Bearings — designed  
specifically for this purpose.

**COMPARE THESE TYPICAL RELATIONSHIPS:**

No.	Bore	O.D.	Width
205	.0787"	.1969"	.0591"
409	.1575	.3543	.0984
714	.2756	.5512	.1378
1019	.3937	.7480	.1772

There are 8 additional stock sizes in this series.

Write today for Catalog, Price List and  
Substantial Quantity Discounts

Good Deliveries — Experimental  
Quantities from Stock

**LANDIS & GYR, INC.**

104 Fifth Avenue, New York 11, N. Y.

# ZOPHAR

WAXES  
COMPOUNDS

Anti-Corona high heat-resistant compounds for  
Fly Back Transformers.

Waxes and compounds from 100° F to 285° F  
Melting Points for electrical, radio, television,  
and electronic components of all types.

Pioneers in fungus-resistant waxes.

Our efficient and experienced laboratory staff  
is at your service.



**ZOPHAR MILLS, INC.**  
112-130 26th Street,  
Brooklyn 32, N. Y.

## PHYSICISTS And SENIOR RESEARCH ENGINEERS

## POSITIONS NOW OPEN

Senior Engineers and Physi-  
cists having outstanding  
academic background and  
experience in the fields of:

- Microwave Techniques
- Moving Target Indication
- Servomechanisms
- Applied Physics
- Gyroscopic Equipment
- Optical Equipment
- Computers
- Pulse Techniques
- Radar
- Fire Control
- Circuit Analysis
- Autopilot Design
- Applied Mathematics
- Electronic Subminiaturization
- Instrument Design
- Automatic Production Equipment
- Test Equipment
- Electronic Design
- Flight Test Instrumentation

are offered excellent work-  
ing conditions and opportuni-  
ties for advancement in our  
Aerophysics Laboratory.  
Salaries are commensurate  
with ability, experience and  
background. Send informa-  
tion as to age, education,  
experience and work prefer-  
ence to:

**NORTH AMERICAN AVIATION, INC.**

Aerophysics Laboratory  
Box No. K-4, 12214 S. Lakewood Blvd.  
DOWNEY, CALIFORNIA



PRODUCED BY THE MILLIONS

- by the top specialists in the ceramic field

**Hi-Q**

## CERAMIC DISK CAPACITORS

Hi-Q Ceramic Disk Capacitors for by-passing, blocking, or coupling are being used by the millions by television receiver manufacturers who demand the utmost in performance.

Unit cost, time and labor may be saved by using several of the multiple capacity Hi-Q Disks where applicable in your television circuit. Multiple capacities having a common ground are available in standard units as shown in the chart below. Hi-Q Disks are coated with a non-hydroscopic phenolic to insure protection against moisture and high humidities. Hi-Q Disks like all other Hi-Q components assure you of the highest quality workmanship at the lowest possible cost.

Our Engineers are ready and willing to discuss the application of these highly efficient, dependable capacitors in your circuits. Write today for your FREE copy of the new Hi-Q Datalog.

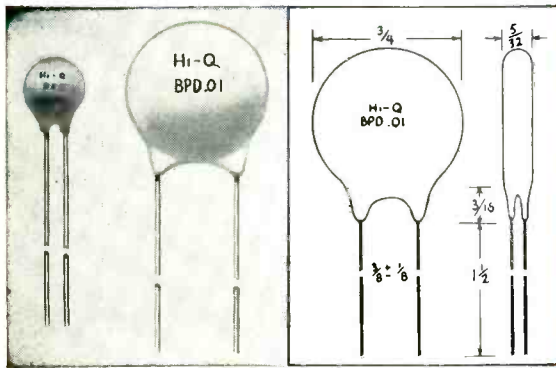

**Hi-Q**  
**COMPONENTS**

Capacitors  
Trimmers • Choke Coils  
Wire Wound Resistors

**BETTER 4 WAYS**

UNIFORMITY ✓ DEPENDABILITY ✓  
PRECISION ✓ MINIATURIZATION ✓

Type	A Diameter	B Lead Width	C Thickness
B.P.D. .00047	5/16" max.	3/16" ± 1/16"	5/32" max.
B.P.D. .0008	5/16" max.	3/16" ± 1/16"	5/32" max.
B.P.D. .001	3/8" max.	1/4" ± 1/16"	5/32" max.
B.P.D. .0015	3/8" max.	1/4" ± 1/16"	5/32" max.
B.P.D. .002	7/16" max.	1/4" ± 1/8"	5/32" max.
B.P.D. .004	19/32" max.	1/4" ± 1/8"	5/32" max.
B.P.D. .005	19/32" max.	1/4" ± 1/8"	5/32" max.
B.P.D. .01	3/4" max.	3/8" ± 1/8"	5/32" max.
B.P.D. 2x.001	19/32" max.	3/8" ± 1/8"	5/32" max.
B.P.D. 2x.0015	19/32" max.	3/8" ± 1/8"	5/32" max.
B.P.D. 2x.002	19/32" max.	3/8" ± 1/8"	5/32" max.
B.P.D. 2x.003	3/4" max.	3/8" ± 1/8"	5/32" max.
B.P.D. 2x.004	3/4" max.	3/8" ± 1/8"	5/32" max.
B.P.D. 3x.0015	3/4" max.	3/8" ± 1/8"	5/32" max.
B.P.D. 3x.002	3/4" max.	3/8" ± 1/8"	5/32" max.

Insulation: Durez and Wax impregnated.  
Leads: 22 gauge pure tinned dead soft copper.  
Capacity: Guaranteed minimum as stamped.  
All capacitance measurements made at 25°C at 1 KC at a test voltage not over 5 volts RMS.

Insulation Resistance: 7500 megohms min.  
Power Factor: Max. 2.5% at 1 KC at not over 5 volts RMS.  
Test Voltage: 1500 volts D. C.

JOBBERS — ADDRESS: 740 Belleville Ave., New Bedford, Mass.

**Hi-Q**

*Electrical Reactance Corp.*

OLEAN, N. Y.

SALES OFFICES: New York, Philadelphia  
Detroit, Chicago, Los Angeles

PLANTS: Olean, N. Y., Franklinville, N. Y.  
Jessup, Pa., Myrtle Beach, S. C.

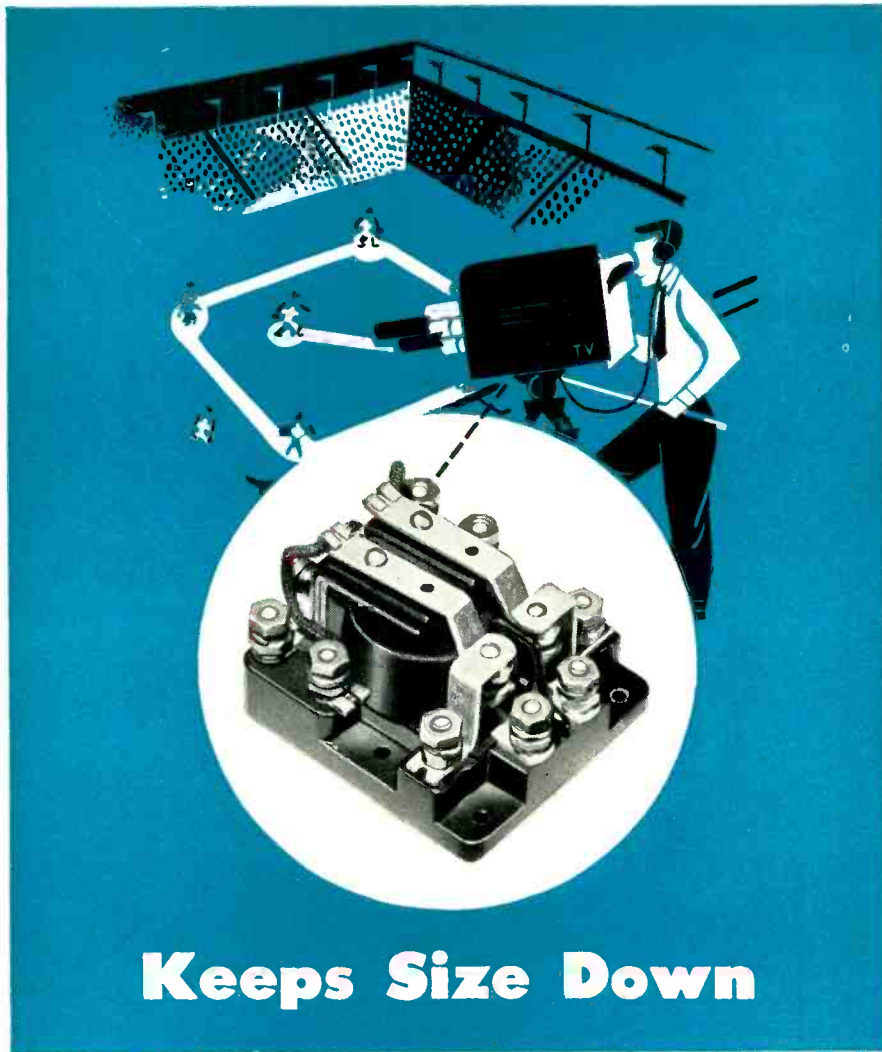

## Keeps Size Down

### by keeping one jump ahead in design

The smaller the equipment—the more trouble from high inrush currents . . .

This portable telecast equipment first used a single pole supply line relay—but the high inrush currents the instant after closing, sometimes welded the contacts. Solution appeared to be to use a larger relay or to alter the equipment, increasing its size.

Then: Ward Leonard suggested a *heavy-duty midget* parallel contact relay—no larger than before—with poles paralleled and with silver-to-carbon contacts on one pole making contact before the silver-to-silver contacts close on the other pole.

Investigate Ward Leonard facilities for *variations* of standard designs to simplify your control.

WARD LEONARD ELECTRIC CO., 31 South Street, Mount Vernon, N. Y. Offices in principal cities of U. S. and Canada.

**WARD LEONARD  
ELECTRIC COMPANY**

*Result-Engineered Controls*

RESISTORS • RHEOSTATS • RELAYS • CONTROL DEVICES

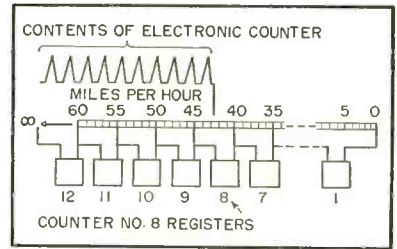

FIG. 5—Diagram showing typical electromechanical counter settings as set up by toggle switches on front panel of instrument

counter via bus A, as shown in Fig. 4. As the gate closes, counting is stopped and the recorder is set in operation. The recorder registers the counts, Fig. 5, on an electromechanical counter for the appropriate speed group.

Speeds are divided into twelve class intervals by setting up the time equivalents of the desired speeds. The upper panel of the instrument contains the electromechanical counters for the twelve class intervals and the total. The center panel contains the toggle switches for setting up the predetermined counter and the neon indicators for the binary counter. The lower panel contains the power-supply controls and meters.

Credit is due J. Robert Hall for most of the construction of the vehicle speed-distribution recorder.

#### REFERENCES

- (1) John J. Wild, Predetermined Counter, *ELECTRONICS*, p 121, March 1947.
- (2) Richard J. Blume, Predetermined Counter for Process Control, *ELECTRONICS*, p 83, Feb. 1948.
- (3) Robert Bromberg and D. L. Gerlough, Applications of Electronic Techniques to Traffic Instrumentation, *Proc. Highway Research Board*, 28, p 348, 1948.

### Complex Tone Generator For Deviation Tests

By FRANK A. BRAMLEY

*Supervisor of Radio Maintenance  
Department of State Police  
State of Connecticut  
Hartford, Conn.*

A SIMPLE device to make deviation measurements consistent and meaningful is important to maintenance men working on all f-m communications equipment because of the recent FCC ruling that measurements must be made on such equipment at regular intervals for both frequency and modulation deviation.

Manufacturers have put new equipment on the market to make



# **Kenyon TRANSFORMERS**

**for standard  
and special  
applications**

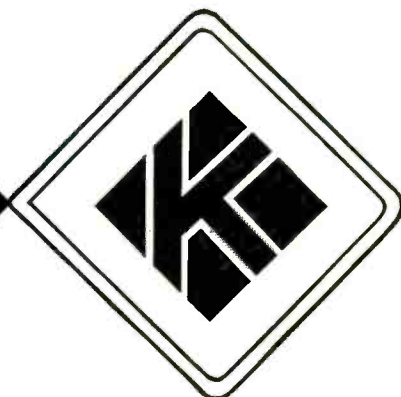

For more than 25 years, Kenyon has led the field in producing premium quality transformers. These rugged units are (1) engineered to specific requirements (2) manufactured for long, trouble-free operation (3) meet all Army-Navy specifications.

## ***Kenyon Transformers for***

- JAN APPLICATIONS
- RADAR
- BROADCAST
- ATOMIC ENERGY EQUIPMENT
- SPECIAL MACHINERY
- AUTOMATIC CONTROLS
- EXPERIMENTAL LABORATORIES

*Write for details*

## **KENYON TRANSFORMER CO., Inc.**

**840 Barry Street**

**New York 59, N. Y.**

# PRECISION POTENTIOMETERS

The linear Type RL-275 illustrated is one of a series ranging from 1 1/4" to 5" in diameter, with resistance ranges of 80 ohms to 500,000 ohms.

GAMEWELL Potentiometers are precision instruments in every respect. They feature extremely close limits in electrical characteristics and mechanical construction, low electrical noise, low torque, and long life—far in excess of 1,000,000 cycles of operation.

All types will operate within specified limits of performance at temperatures —55° C. to +55° C., 95% relative humidity at altitudes up to 50,000 feet. Corrosion resistant materials are used throughout and all insulating parts are fungicided. Our potentiometers meet AN-E-19 specifications.

We invite your inquiries and will gladly study and quote on special requirements.

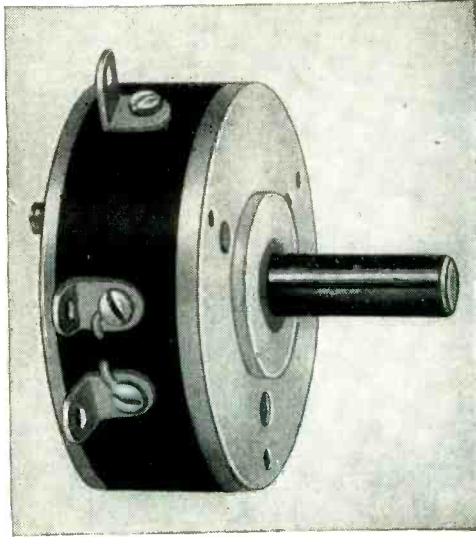

Write for Bulletin F-68.

**THE GAMEWELL COMPANY**

Newton Upper Falls 64, Massachusetts



# AMPERITE

Thermostatic Metal Type

*Delay Relays*

**PROVIDE DELAYS RANGING FROM 1 TO 120 SECONDS**



**FEATURES:** — Compensated for ambient temperature changes from —40° to 110° F... Hermetically sealed; not affected by altitude, moisture or other climate changes... Explosion-proof... Octal radio base... Compact, light, rugged, inexpensive... Circuits available: SPST Normally Open; SPST Normally Closed.

**PROBLEM? Send for "Special Problem Sheet"**

*Regulators*

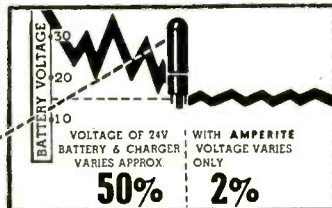

Amperite REGULATORS are the simplest, lightest, cheapest, and most compact method of obtaining current or voltage regulation... For currents of .060 to 6 Amps... Hermetically sealed; not affected by altitude, ambient temperature, humidity.

Write for 4-page Illustrated Bulletin.

**AMPERITE CO., Inc.**, 561 Broadway, New York 12, N. Y.

In Canada: Atlas Radio Corp., Ltd., 560 King St., W., Toronto

*Spincraft*  
SKILL WILL DO IT

offers an approach to the **Production of Electronic Parts** that is **fast, simple economical**

**CONICAL ENVELOPE**... a stainless steel spinning for cathode ray assembly made of 1/8 in. thick type 446 chrome iron. 16 in. diameter. 1 1/2 in. deep.



**RECTANGULAR ENVELOPE**... a special mass production product made for the television industry of 1/8 in. thick type 430 chrome iron. 24 in. wide. 16 in. high. 9 in. deep.



**CORONA SHIELD**... an aluminum spinning combining hemispherical and spherical forms. Made of 250 aluminum, 1/8 in. thick. Overall length 20 in.

● Immediate cost reduction is today's most urgent demand — requiring more alert thinking in the designing of parts and more ingenious tooling methods. Progressive new Spincraft techniques may help simplify your production problems, just as they have helped other large and small manufacturers.

Some examples of this advanced engineering are shown here. It will pay you to study them... and ask yourself if you can use this pioneer company's versatile ability to help solve your electronic problems. You'll find the Spincraft Data Book a good source for ideas. Write for your copy—without obligation.

*Spincraft Inc.*  
SKILL WILL DO IT

4143 W. State St. Milwaukee 8, Wis.  
Heretofore known as Milwaukee Metal Spinning Co.



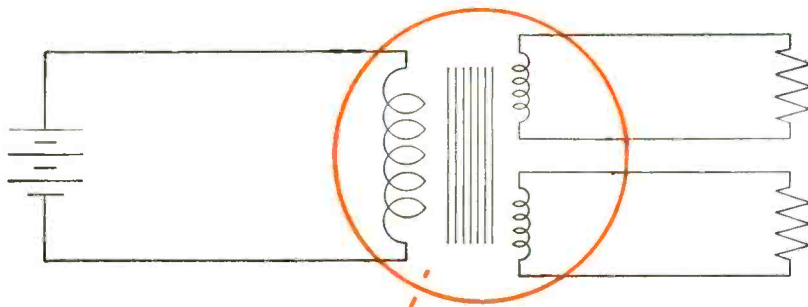

# a DC transformer?

*Certainly...*

## **Bendix Specialized Dynamotors** are made for the Job!



Whenever DC power is required at other than the supply voltage, Bendix\* Specialized Dynamotors function as DC transformers. They can be wound for any input or output voltage between 5 and 1200 volts, and they can deliver power up to 500 watts. Multiple outputs can be supplied to correspond with several secondaries on transformers, and their output voltages can be regulated within close limits regardless of input voltage or load variations. Bendix Specialized Dynamotors are tailored to the exact requirements of each application by the design of the windings used in standardized frames. This reduces the cost, size and weight to an absolute minimum, consistent with the operational requirements. Compliance with Government specifications is assured by the choice and treatment of materials and the basic design. *A complete description of your requirements will enable our engineers to make concrete recommendations . . . All orders are filled promptly and at moderate cost.*

\*REG. U. S. PAT. OFF.

**RED BANK DIVISION OF  
BENDIX AVIATION CORPORATION**

**RED BANK, NEW JERSEY**

Expert Sales: Bendix International Division, 72 Fifth Avenue, N. Y. 11, N. Y.

Write for this colorful and informative book  
—it's free. You'll find it loaded with facts  
and figures about all types of dynamotors.





### C.T.C. can get you "out from under!"

Long experience with the ever-increasing, constantly changing government specifications for electronic components has gained C.T.C. nationwide acceptance as a supplier to manufacturers handling U. S. contracts — especially for the armed forces.

With complete, up-to-date facilities for manufacturing electronic components in production quantities, C.T.C. meets the most exacting government standards for materials, tolerances, finishes, moisture prevention, anti-fungus treatment and similar requirements the government demands in the units you make.

Years of designing and manufacturing to government specifications enable us to handle *your* problems and save you time, money and worry! So, if "spec" problems are getting you down, why not unload them on recognized experts?

#### Here's What C.T.C. Can Furnish:

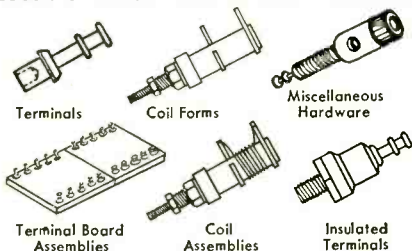

bottom wiring. Remove the screw and you can mount components directly to the screw end. Or you can adapt terminal to provide removable link connections at screw end. Unit is plated with bright alloy for corrosion resistance and easy soldering. Shank heavily knurled for secure mounting. Comes in three sizes. Send for more information.

#### SPECIAL CONSULTING SERVICE

To aid you in securing exactly the *right* components to meet the requirements of your designs, prototypes, etc., C.T.C. maintains a staff of thoroughly experienced component engineers. These experts will work closely with you for the most economical and satisfactory results — and where standard parts are not suitable will design special units. *This service is always available to you — without cost!*



#### Have You Seen This C.T.C. Combination Terminal?

With a screw on top and a terminal lug on the bottom, this combination simplifies top and



Chassis and case for the deviation test device

deviation measurements due to modulation very simple, but this solves only half the problem. If tone is used in making deviation tests the measurements are quite consistent, but with voice it is difficult to get the same results twice even with the same voice used to make all tests.

Preliminary tests with new type deviation meters prove that there are wide differences in the amount of deviation caused by various operators' voices even when compression or modulation limiters are used.

Older sets are usually not provided with any adjustments whatever and parts must be replaced in order to standardize the circuit. New sets with compression and limiter circuits provide some adjustment, but these circuits do not operate the same on tone as they do with voice. The amount of compression produced with tone differs just as deviation produced by tone differs from that produced by voice.

If average settings on a given piece of equipment are used, and the equipment has no limiter or compression circuits, a fair sample of voices will be found to cause deviations that vary up to twice the required deviation. Adjustments are difficult to arrive at in such cases and some means of standardization is essential.

In many early type f-m transmitters the adjustments provided to tune the oscillator circuit not only cause considerable center frequency change but can cause deviation changes from practically zero to as much as three times the required deviation.

The device to be described makes it possible for one man to make ac-

#### CAMBRIDGE THERMIONIC CORPORATION

437 Concord Ave., Cambridge 38, Mass.

Please send me:

- More information on how C.T.C. can lighten my "spec" load.
- More information on C.T.C.'s cooperative engineering service.

More information on the following C.T.C. products:

Name ..... Position .....

Firm .....

Street .....

City ..... Zone ..... State .....

*custom or standard the guaranteed components*





FOR EXTRA FAST STOPS

STARTS

REVERSES



**New** TYPE R-24  
process control motor

Holtzer-Cabot Type R-24 motors are designed especially to provide the rapid starts, stops and reverses required by modern, high-speed process control equipment. Extremely low rotor inertia, *plus* high accelerating and decelerating torques, provide extremely quick response. Tests show that, with the dynamic braking connection, the unloaded rotor will *always stop within three-quarters of one revolution!* On geared motors, of course, this means that the output shaft stops in a very small fraction of a revolution.

These motors are 2-phase, squirrel-cage, nonsynchronous induction type. For operation on a single-phase circuit, a capacitor is used in series with one phase. Special high impedance windings are available, suitable for matching standard power tubes.

Available speeds, 1300 RPM (1800 synchronous speed) to 34 RPM (geared), with torque ratings from 0.5 to 75 oz. in. Can be provided for odd voltages and frequencies, with ball or sleeve bearings. These motors are ideal for Servo-Mechanisms.



INVESTIGATE NOW . . . Holtzer-Cabot welcomes inquiries involving special motors

**HOLTZER-CABOT**

DIVISION OF NATIONAL PNEUMATIC CO., INC.

BOSTON 19, MASSACHUSETTS

“Manufacturers of fine electrical apparatus since 1875”

# Wayne



# Kerr

a new  
range of

OF ENGLAND

## V. H. F. BRIDGES

Transformer Ratio-Arm principle covers 15 kc to 250 mc

Wayne-Kerr Laboratories have recently developed a range of H.F. and V.H.F. Transformer Ratio-Arm Bridges which are as stable in operation as the normal type of low frequency bridge. This has been achieved with a design which gives an extremely low impedance across the bridge terminals and between terminals and ground. Consequently, freedom from errors due to parasitic reactances permits a much greater accuracy of measurement.

Up to 100 Mc/s balanced or unbalanced measurements can be made with equal facility.

*Demonstrations in New York by the U.S. Distributors :-*

**Marconi Instruments Limited, 23-25, Beaver Street, New York 4.**

Telephone :

HAnover 2-0197.

WAYNE-KERR LABORATORIES LTD., NEW MALDEN SURREY ENGLAND

### NOW

a really high-powered

## RADIO ENGINEERING LIBRARY

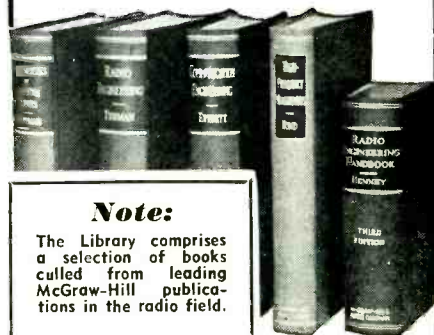

### Note:

The Library comprises a selection of books culled from leading McGraw-Hill publications in the radio field.

- especially selected by radio specialists of McGraw-Hill publications
- to give most complete, dependable coverage of facts needed by all whose fields are grounded on radio fundamentals
- available at a special price and terms

These books cover circuit phenomena, tube theory, networks, measurements, and other subjects—give specialized treatments of all fields of practical design and application. They are books of recognized position in the literature of the field—books you will refer to and be referred to often. If you are a practical designer, researcher or engineer in any field based on radio, you need these books for the help they give in hundreds of problems throughout the whole field of radio engineering.

5 volumes, 3872 pages, 2770 illustrations

Eastman's FUNDAMENTALS OF VACUUM TUBES 3rd edition

Terman's RADIO ENGINEERING 3rd edition

Everitt's COMMUNICATION ENGINEERING, 2nd edition

Hund's HIGH FREQUENCY MEASUREMENTS

Henney's RADIO ENGINEERING HANDBOOK, 4th edition

**SPECIAL LOW PRICE • EASY TERMS**

Special price under this offer less than cost of books bought separately. In addition, you have the privilege of paying in easy installments beginning with \$4.50 in 10 days after receipt of books, and \$6.00 monthly thereafter. Already these books are recognized as standard works that you are bound to require sooner or later. Take advantage of these convenient terms to add them to your library now.

**FOR 10 DAYS' EXAMINATION SEND THIS**

**ON APPROVAL COUPON**

McGraw-Hill Book Co., Inc., 330 W. 42nd St., N. Y. 18

Send me Radio Engineering Library for 10 days' examination on approval. In 10 days I will send \$4.50 plus few cents postage, and \$6.00 monthly till \$34.50 is paid, or return books postpaid. (We pay postage on orders accompanied by remittance of first installment.)

Name .....

Address .....

City ..... Zone ..... City .....

Company .....

Position ..... L-2-51

## new! 1951 ALLIED CATALOG

free!  
212-Page  
Buying  
Guide

World's Largest Stocks  
**ELECTRONIC SUPPLIES**  
for **INDUSTRY** and  
**BROADCAST STATIONS**



### One Complete Dependable Source for Everything in Electronics

Simplify your purchasing—send your consolidated orders to ALLIED—the single, complete source for all Electronic Supplies. Depend on ALLIED for the world's largest stocks of special tubes, parts, test instruments, audio equipment, accessories—complete quality lines of electronic supplies. Our expert Industrial supply service saves you time, effort and money. Send today for your FREE copy of the 1951 ALLIED Catalog—the only complete, up-to-date guide to Electronic Supplies for Industrial and Broadcast use.

**ALLIED RADIO CORP.**

833 W. Jackson Blvd., Dept. 11-B-1, Chicago 7, Illinois

We Specialize in Electronic Equipment for Research, Development, Maintenance and Production Operations

**SEND FOR  
FREE 1951  
ALLIED CATALOG**



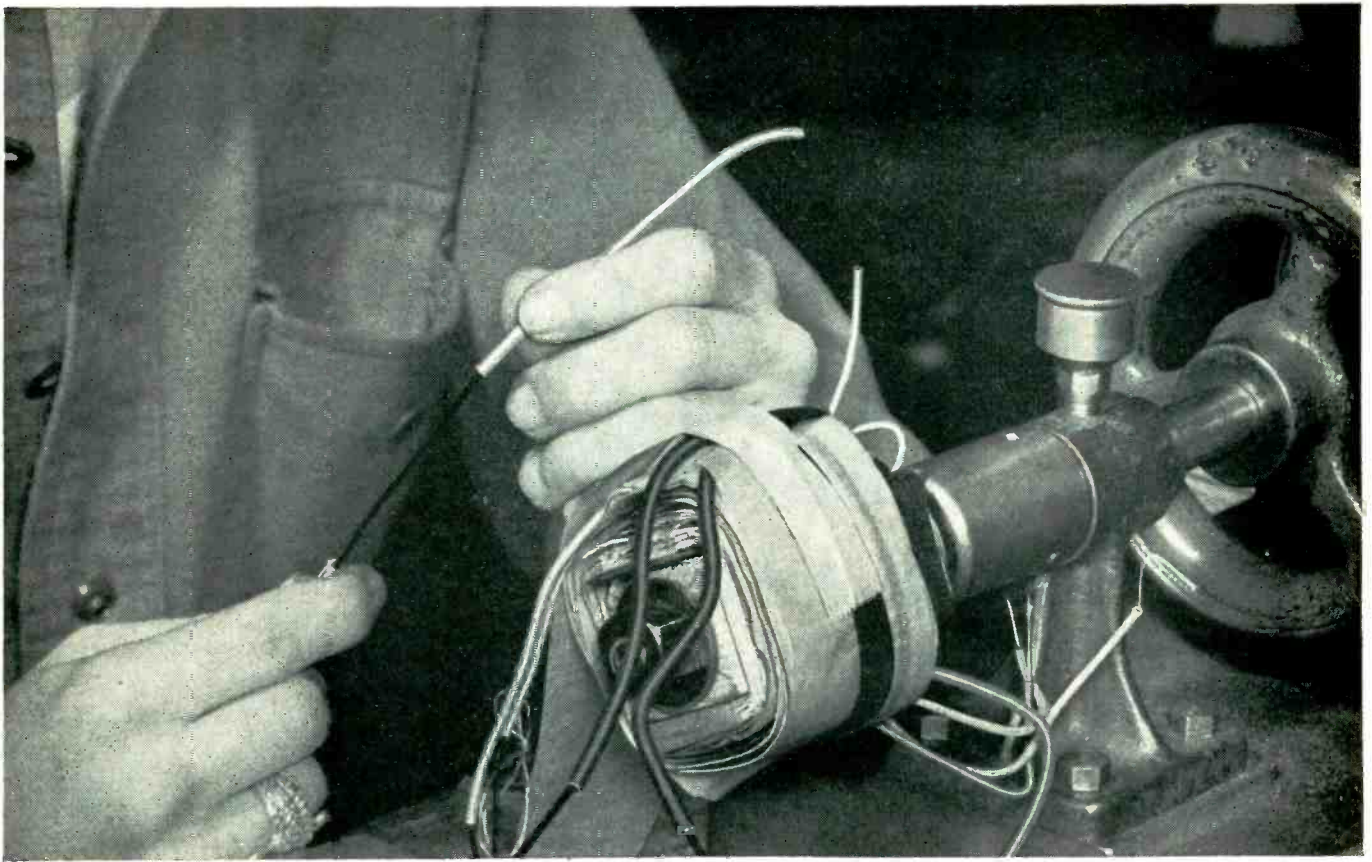

**This tubing stays** { **STRONG** at 105°C  
**FLEXIBLE** at -40°C

**TEMFLEX 105 PLASTIC TUBING** starts off with exceptionally high tensile and dielectric strength—3000 psi, 1200 vpm. And it *keeps* these mechanical and electrical properties to an amazing extent, even in continuous service at temperatures as high as 105° C.

Or let the temperature go plummeting down to -40° C—Temflex 105 retains its flexibility—its ease of give-and-take under the severest conditions.

Subject Temflex 105 to baking temperatures or the action of potting compounds—immerse it in water—bring it into prolonged contact with solvents, oils, acids, alkalis. It shrugs off their effects as easily as it does temperature extremes!

Yet . . . it is low in cost, easy to assemble—other reasons for making it your first choice for insulating leads on transformers, coils or motors that *must* work where the going is tough.

Samples are yours for the asking—along with full technical data. Send coupon today.

Look to  
**IRVINGTON**  
 for insulation leadership  
 INSULATING VARNISHES  
 VARNISHED CAMBRIC  
 VARNISHED PAPER  
 VARNISHED FIBERGLAS  
 INSULATING TUBING  
 CLASS "H" INSULATION

Send this convenient coupon now

**Irvington**

VARNISH & INSULATOR COMPANY

Irvington 11, New Jersey

Irvington Varnish & Insulator Company EL-2/51  
 6 Argyle Terrace, Irvington 11, N. J.

Please send me technical data on Temflex 105 tubing.  I'd like a sample I.D. O.D. for testing.

Name..... Title.....

Company.....

Address.....

City..... Zone..... State.....

# WORKSHOP

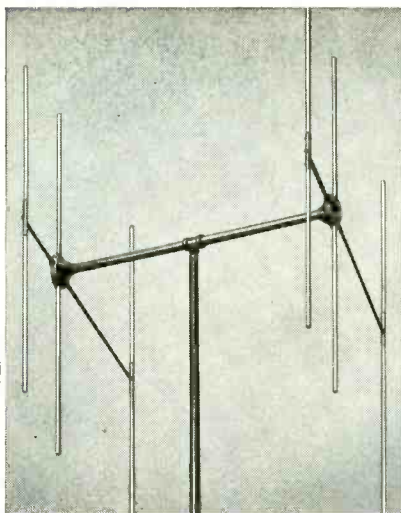

## DIRECTIONAL ANTENNAS

Workshop directional (and bi-directional) antennas are designed expressly for point-to-point communications, particularly — railway, highway patrol, public safety, police, utility, pipe lines, forestry, and other similar uses. Their high gain and sharp directivity provide strong, clear reception and long-range coverage at minimum cost. Rugged, heavy-gauge aluminum elements and enameled steel supports guarantee long, dependable service with no maintenance expense. Installation is very simple, requiring only an iron pipe mast and cable. Ten different models are available, one for each operating band.

**GAIN** — Conservatively rated at 7.6 db. over a 1/2-wave dipole; 15.2 db. for system when used in pairs — one at each end of circuit

**RUGGED CONSTRUCTION** — Withstands steady 65 mph wind with 1/2" radial ice; 85-90 mph without ice with adequate safety factor

**1/2-POWER ANGLES** — 64° Horizontal, 68° Vertical

**FRONT-TO-BACK RATIO** — 20 db., measured

**VSWR** — Less than 1.5:1

**IMPEDANCE** — 52 ohms

**VERTICAL POLARIZATION** — Horizontal on request

**MOUNTING** — 1 1/2" standard threaded pipe

**ENGINEERING and CONTRACT SERVICE.** The WORKSHOP handles scores of special government and commercial antenna problems every year from design through production. If your product or service requires high-frequency antennas — research, design, or production — get in touch with the WORKSHOP. Write, or phone Needham 3-0005. No obligation.

**The WORKSHOP ASSOCIATES, Inc.**

*Specialists in High Frequency Antennas*

135 Crescent Road, Needham Heights 94, Massachusetts

curate, consistent adjustments that can be standardized. It consists of a two-tube battery-operated complex tone generator arranged to start automatically when a microphone is inserted in a special holder, see Fig. 1.

Insertion of the microphone depresses a snap-action switch in the filament circuit of the instant-heating tubes. A headphone unit placed just below the holder supplies the microphone with a complex tone. A volume control is provided to adjust the output to a level that will cause a standard amount of deviation. A jack is installed for connection of an external db meter so that standard output can be maintained. The volume adjustment may be recessed

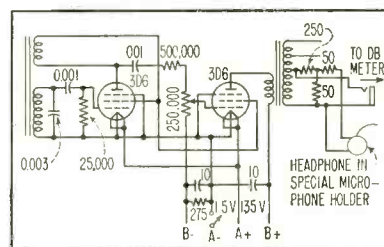

FIG. 1—Circuit of the complex tone generator

or provided with a locking device.

The oscillator-amplifier circuit used is not as simple as it might be but is stable and reasonably simple to build. It consists of a tickler-type feed-back oscillator and is adjusted by means of the grid-circuit constants to generate a complex tone having components over a wide band of frequencies. In this way the human voice is simulated to some degree and a more realistic measurement is provided.

The amplifier stage is necessary to isolate the transducer and volume-control circuits from the oscillator. Simpler circuits cause the tone to change when the volume is adjusted; the resistance-coupled amplifier eliminates this tendency.

The device shown was built to be used with Western Electric type-F3 handsets or the equivalent, but the circuit may be easily adapted to most other types of microphones.

It is important to place the microphone in a stable position over the reproducer. This can be further insured by mounting a leaf-actu-

**OTHER WORKSHOP ANTENNAS**

**Aeronautical Ground Station**  
For aircraft communications — omnidirectional.

**Parabolic Antennas**  
For radio, microwave, STL and TV relay and communications.

**Beacon**  
For fire, police, taxicab, and private fleet communications.  
TV, FM and Amateur



# NEED A MIXER FOR YOUR UHF TV CONVERTER DESIGN?

## SPECIFY GENERAL ELECTRIC 1N72\* UHF GERMANIUM DIODES

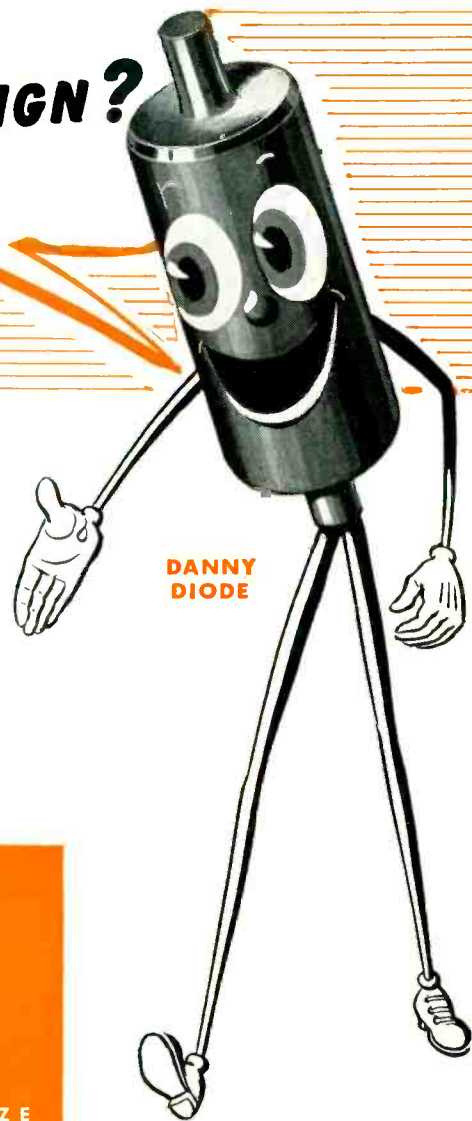

DANNY  
DIODE

Designed specifically for the TV market and performance tested for a full year, this low noise, high stability diode is now available in production quantities at new low prices.

**CHARACTERISTICS:** Low noise factor . . . improved burn-out resistance . . . operation not affected by overloads . . . snap-in design for use with miniature clips to avoid inductive leads . . . input and output impedances approximately 100-500 ohms . . . no contact potential . . . welded whisker construction.

**New Plant Facilities To Meet Total Industry Requirements**—A complete new G-E plant devoted exclusively to the man-

ufacture of diodes is now in operation near Syracuse, New York. These facilities enable us to handle the total industry requirements for UHF television mixer crystals. General Electric application engineers are at your service to help your designers interpret the characteristics of this crystal to your circuit's advantage. For full information, call the G-E electronics office nearest you or write for Bulletin X57-015A: *General Electric Company, Section 411, Electronics Park, Syracuse, New York.*

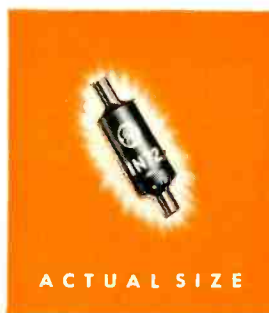

\*formerly designated G-7

### SPECIFICATIONS UHF TYPE 1N72 (Formerly Designated G-7)

Specifications at 25° C:

Design frequency . . . . . 500 mc  
Useful frequency range . . . . . DC to over 1,000 mc  
Noise figure . . . . . 14 to 19 db\*

\*Measurements made with Measurements Corp. Model 84 Signal Generator, R.C.A. Model A Converter with 0.7 ma rectified local oscillator current and G-E Model 814 television receiver with television channel 3 used as IF frequency with noise band width of 3.5 mc. Noise figure is measured by noting signal required to double zero signal noise power output of converter. Similar measurements made on average 1N21B diodes indicated noise figure of 16 db.

#### Maximum Ratings:

Average rectified current . . . . . 25 ma max.  
Peak rectified current . . . . . 75 ma max.  
Temperature range . . . . . -50 to +75°C

#### . . . Other Applications, Too

For example, as harmonic generators to provide local oscillator injection from the low frequency local oscillator . . . As detectors in high frequency RF voltage measurements . . . and in low frequency circuits where a low impedance crystal is needed.

**OVER 3000 COPIES SOLD ALREADY! GET YOURS NOW!**



**NEW  
DIODE  
HANDBOOK**

Now in 3rd Printing! Here are 98 pages of facts on characteristics, advantages, and circuitry of diodes. Charts, curves, diagrams, typical applications. Leatherette bound, loose-leaf style. Supplementary sheets furnished free as published. Worth many times its modest price of \$1.25. Send check or money order to: *General Electric Company, Section 421, Electronics Park, Syracuse, New York.*

*You can put your confidence in—*

**GENERAL  ELECTRIC**

LARGE OR SMALL  
SQUARE, ROUND OR RECTANGULAR  
**Coil-Proved**

**PARAMOUNT**  
Spiral-Wound  
**PAPER TUBES**

Lengths from 1/2" to 30"  
Inside Perimeters, .450" to 25"

PARAMOUNT Paper Tubes facilitate coil winding—insure coil accuracy and stability. Proved by use, they have become standard with leading manufacturers of electrical, radio and electronic products. Here you are sure to obtain the exact size and shape you need for coil forms and other uses... from stock arbors, or specially engineered to your specifications. *Hi-Dielectric. Hi-Strength. Kraft, Fish Paper, Red Rope*, or any combination, wound on automatic machines. Tolerances plus or minus .002" • Also Shellac Bonded Kraft Paper Tubes for absolute moisture resistance.

WRITE ON COMPANY  
LETTERHEAD FOR  
STOCK ARBOR LIST  
OF OVER 1000 SIZES

**PARAMOUNT PAPER TUBE CORP.**

616 LAFAYETTE ST., FORT WAYNE, IND.

Manufacturers of Paper Tubing for the Electrical Industry



**UNBRAKO**

**knurled heads  
don't slip, either**

That's why UNBRAKOs are so easy to start in tapped holes, even with slippery fingers. And it's surprising how far you can screw them in by hand before you need a wrench. Think of the assembly time this could save!

WRITE FOR LITERATURE TODAY.



Knurling of Socket Screws originated with "Unbrako" in 1934.

**-SPS-**

STANDARD PRESSED STEEL CO.  
JENKINTOWN 10, PENNSYLVANIA

**STANCOR**

**TRANSFORMERS**  
for every  
electronic application

450 types carried in stock • Write for catalog.  
**STANDARD TRANSFORMER CORPORATION**  
3578 ELSTON AVENUE • CHICAGO 18, ILLINOIS



# FERRAMIC

*Cores*

by  
**GENERAL CERAMICS**

Ferramics are soft magnetic materials featuring:

- HIGH PERMEABILITY**
- HIGH VOLUME RESISTIVITY**
- HIGH EFFICIENCY**
- LIGHT WEIGHT**
- ELIMINATE LAMINATIONS**



T Y P E O F F E R R A M I C M A T E R I A L

PROPERTY	UNIT	A 34	B 90	C 159	D 216	E 174	G 254	H 419	I 141	J 472
Initial permeability at 1mc/sec	—	15	95	220	410	750	410	850	600	330
Maximum permeability	—	97	183	710	1030	1710	3300	4300	1010	750
Saturation flux density	Gauss	840	1900	3800	3100	3800	3200	3400	1540	2900
Residual magnetism	Gauss	615	830	2700	1320	1950	1050	1470	660	1600
Coercive force	Oersted	3.7	3.0	2.1	1.0	0.65	0.25	0.18	0.40	.80
Temperature coefficient of Initial permeability	%/°C.	0.65	0.04	0.4	0.3	0.25	1.3	0.66	0.3	0.22
Curie point	°C.	280	260	330	165	160	160	150	70	180
Volume resistivity	Ohm-cm	1x10 <sup>9</sup>	2x10 <sup>5</sup>	2x10 <sup>3</sup>	3x10 <sup>7</sup>	4x10 <sup>5</sup>	1.5x10 <sup>8</sup>	1x10 <sup>4</sup>	2x10 <sup>5</sup>	—
Loss Factor:										
at 1 mc/sec	—	—	.00016	.00007	.00005	.00008	.00008	.00030	.0003	.000055
at 5 mc/sec	—	.0004	.0011	.0008	.0012	.002	.00075	.00155	.005	—
at 10 mc/sec	—	.0005	—	—	—	—	.0017	.00275	—	—

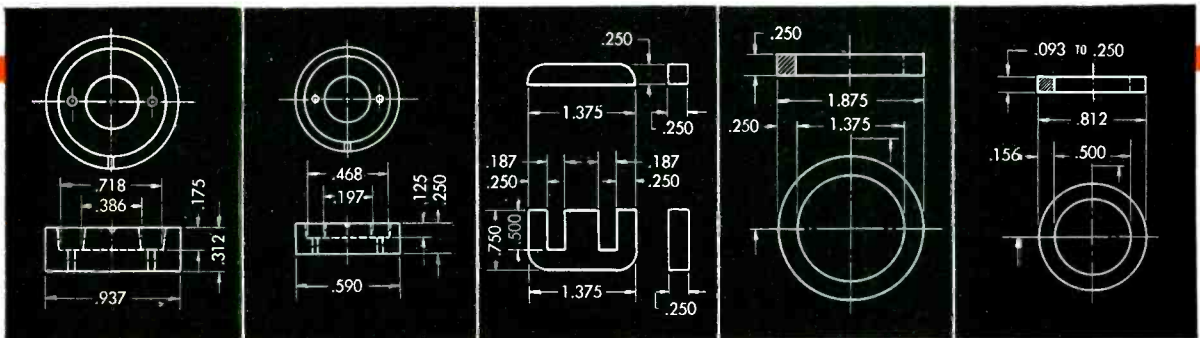

**General CERAMICS AND STEATITE CORP.**  
GENERAL OFFICES and PLANT: KEASBEY, NEW JERSEY

MAKERS OF STEATITE, TITANATES, ZIRCON PORCELAIN, FERRAMICS, LIGHT DUTY REFRACTORIES, CHEMICAL STONWARE, IMPERVIOUS GRAPHITE



# MOSINEE

*"More than Paper"*

In the field of electronics and the electrical goods industry, MOSINEE stands for paper-base processing materials with scientifically controlled chemical and physical properties, high quality standards and dependable uniformity... with good dielectric strength, high tensile or tear strength; proper softness or stiffness; creped with controlled stretch or flexibility; specified pH for maximum-minimum acidity or alkalinity; accurate caliper, density, liquid repellency or absorbency... or other technical characteristics vital to your quality standards and production requirements.

**MOSINEE PAPER MILLS COMPANY • MOSINEE, WIS.**

*"Essential Paper Manufacturers"*

ated switch so that the tubes will not be lighted unless the microphone is properly placed.

The reproducer is mounted inside the metal case just under the microphone holder and a hole is cut in the box to release the sound.

A gimmick may be fastened to the box by means of a short chain to hold the pushbutton down.

The oscillator transformer may be any low or medium-grade transformer having a turns ratio of two or three to one. Low-grade units usually oscillate better. It is not possible to specify the exact size of the other grid circuit components because they will be dependent on the transformer used.

The output transformer matches the output pentode to a pad in the 500-ohm range so that standard db meters can be used without a correction factor. The pad reduces the level and matches the 50-ohm ear-piece.

Standard portable batteries fit within the case and since the device operates only when the microphone is inserted in the holder, battery life is long.

In deciding upon grid-circuit values, it may be helpful to view the waveform on an oscilloscope while listening to the reproducer. A pleasing tone of apparent medium frequency seems desirable, one that looks quite complex but does not have any one predominating component. Strong high frequency or supersonic components are undesirable and very low frequencies are unnecessary.

By comparing the deviation produced by this device with a number of average voices that produce satisfactory deviation, a standard setting can be reached. If compression and limiting are employed the result should be a satisfactory and uniform deviation for all units.

## **Antenna Installation for Stratovision Airplanes**

IN BROADCASTING or rebroadcasting radio or tv programs from an airplane, the transmitting antenna must be spaced well away from major structural parts of the plane to avoid distortion of the field pattern and to prevent or minimize



# The MOST CHINESE COPIED \* TUNER on the Market Today...

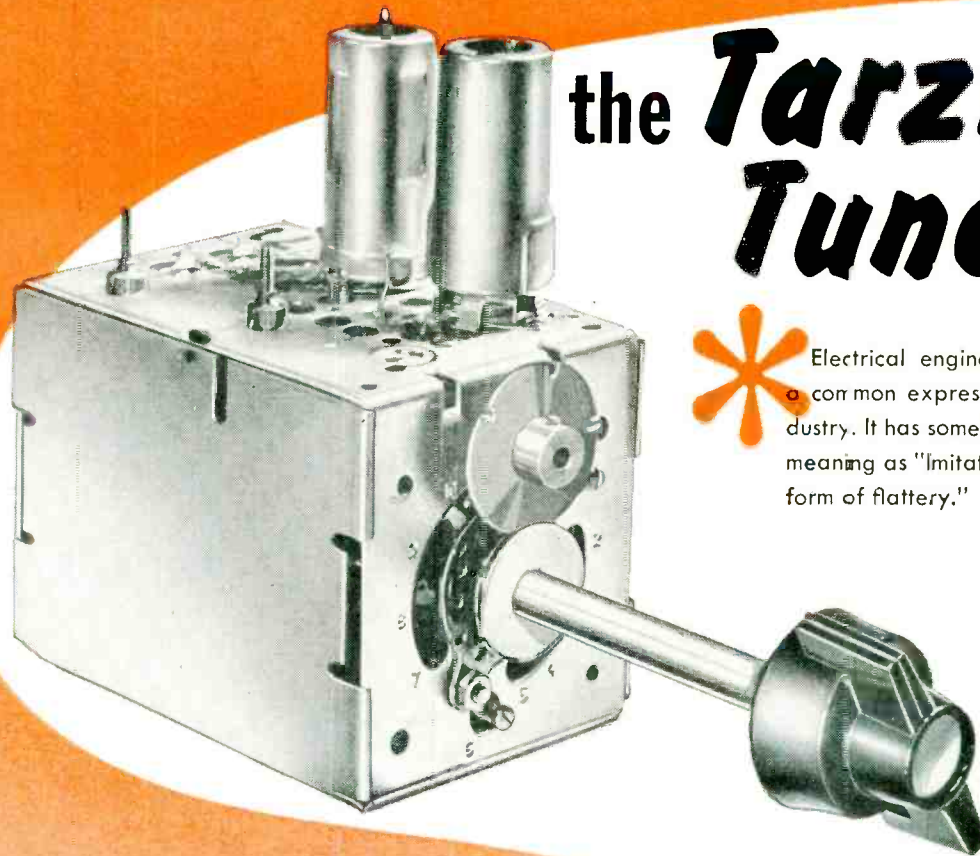

## the *Tarzian Tuner!*



Electrical engineers tell us that's a common expression within the Industry. It has something of that same meaning as "imitation is the greatest form of flattery."

### Only the TARZIAN front-end TUNER has ALL of these desirable features

- Low oscillator radiation
- High gain and low noise
- Designed for 21 or 41 megacycle I.F. systems
- Insulated shaft design available at low cost
- Anti back lash, air dielectric fine tuning, giving uniform coverage on low and high channels
- Three tube performance with two tubes
- Each channel individually aligned for maximum performance
- Good input balance—no tracking difficulties
- Completely shielded
- Oscillator tube shield provides rigid horizontal and vertical positioning of the tube
- Extra terminals provided for tie-points

Write for complete information, specs and technical data. Engineering service available upon request.

*Sarkes Tarzian, inc.*

TUNER DIVISION, DEPT. E-1

537 South Walnut Street • Bloomington, Indiana

The SARKES TARZIAN  
stations in Bloomington

**WTTS - WTTV**

5000 Watts

Channel 10

# THE ACCEPTED STANDARD HEYCO STRAIN RELIEF BUSHINGS



C. S. A.



Save time—reduce costs—increase product life. Securely anchor wires to chassis without injury. Heycos absorb push, pull and torque. Eleven sizes clock wire to S-10/3 cable.

Specification Sheet on Request

HEYMAN  
MANUFACTURING CO.  
KENILWORTH 2, N. J.



HEYCO ELIMINATES STRAIN ON TERMINALS!



## NATIONAL

- Proven
- Dependable
- Quality

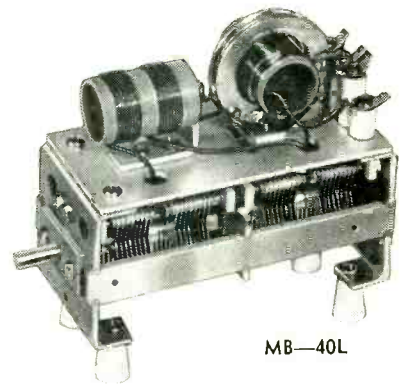

MB-40L

## MULTI-BAND TANK ASSEMBLY

A completely redesigned version of the popular, unique, low-power multi-band tank which tunes all bands from 80 through 10 meters with a 180° rotation of the shaft and without changing coils. This version features improved mechanical construction and an electrostatic shield to aid in the elimination of harmonics. Choice of impedances assures uniform loading over entire range. (See article in December, 1950 issue of QST, p. 77) \$12.90 net.

EXPORT DIV., Dept. E-251



## EISLER Television Tube MACHINERY

- ECONOMICAL
- MODERN DESIGN
- PRODUCTION ENHANCING

EISLER'S Electronic Equipment is especially Designed and Built to your exact requirements.  
From 5" to huge 24" Television Tube

EISLER specializes in GLASS WORKING MACHINERY for the manufacture of: Cathode Ray; Radio Tubes (Standard, Miniature, Sub Miniature); Fluorescent Lamps; Glass Ampoules; Vials; Incandescent Lamps.

- Consultation without any obligation on your part is cordially invited.

**EISLER ENGINEERING CO., INC.**  
751 SOUTH 13th ST. • NEWARK 3, NEW JERSEY

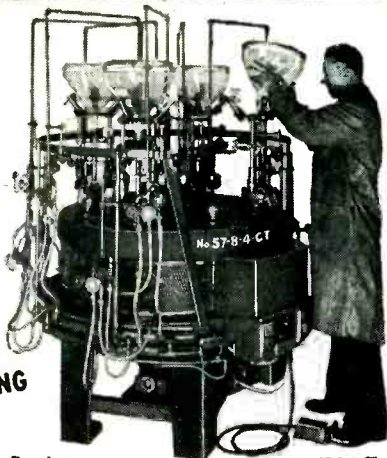

No. 57-R-4 CT



RESISTANCE  
WELDERS  
•  
¼ to 300 KVA



EISLER TRANSFORMERS  
STANDARD • SPECIAL  
Air, Oil or Water  
Cooled  
•  
Sizes From ¼ to 500 KVA



No. 102-VID



No. 57-VID



YOU CAN BE SURE.. IF IT'S  
**Westinghouse**



Single Phase Bridge Comparison  
with only One Cell in Parallel\*

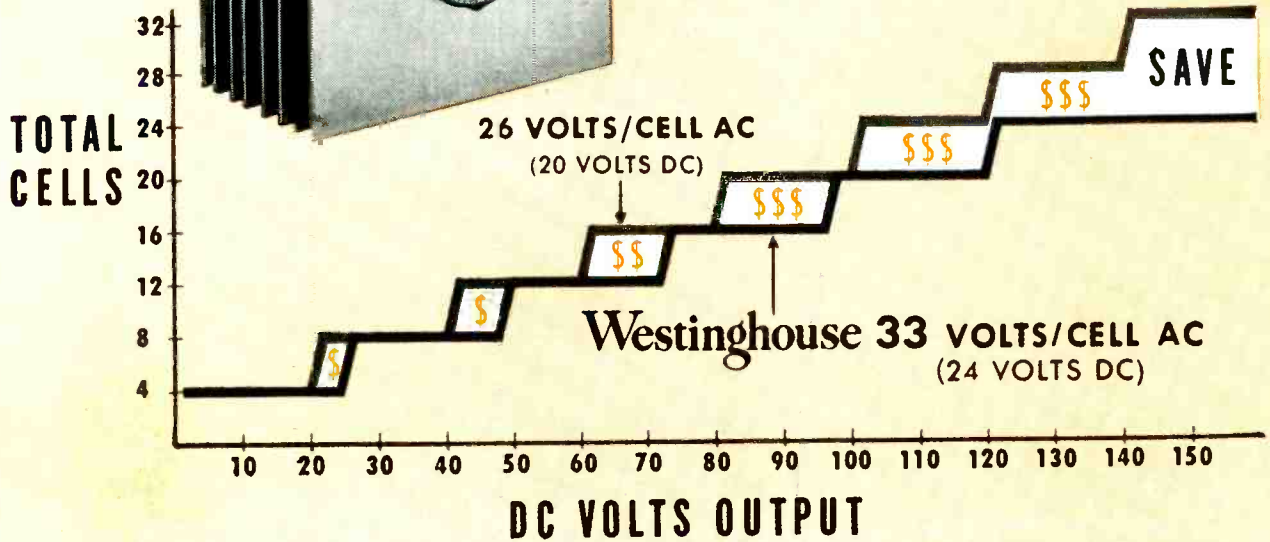

## SAVE THE DIFFERENCE

### with Rectox Selenium Rectifiers

The above graph shows, strikingly, the dollars and cents savings possible with Rectox Selenium Rectifiers.

*The reasons?*

High-voltage cells—24-volt d-c; 33-volt RMS compared to conventional 20-volt d-c; 26-volt RMS—mean fewer cells per watt output. And since each plate stands more voltage, smaller, lighter stacks result.

An exclusive Westinghouse process of manufacture assures lowest rate of forward aging and constant, uniform cell performance.

Test the Rectox under your own conditions. Try a sample. Figure your own savings—in space... in weight... in dollars. Phone or write your local Westinghouse office for details. Westinghouse Electric Corporation, P. O. Box 868, Pittsburgh 30, Pennsylvania. J-21591

\* In a bridge circuit, total savings are the product of: the cells saved in series (due to 24 volts d-c per cell) times 4 (the number of arms in the bridge) times the number of cells in parallel in each bridge arm. For example: A 4-5-3 connection cut to 4-4-3 by use of one fewer cell in series per arm means 1 saved x 4 x 3 or 12 total cells saved.



**Westinghouse**  
*Rectox*  
Rectifiers & Chargers for  
**ALL INDUSTRIES**

# CHECK "Proof of Performance"

with these **PROVED B&W PERFORMERS**

For those "proof-of-performance" tests required by the FCC, here's a combination that will enable you to comply with the least amount of time . . . trouble . . . and money!

## AUDIO OSCILLATOR MODEL 200 . . . . . \$138

Provides a low distortion source of audio frequencies between 30 and 30,000 cycles. Self-contained power supply. Calibration accuracy  $\pm 3\%$  of scale reading. Stability 1% or better. Frequency output flat within 1 db, 30 to 15,000 cycles.



## DISTORTION METER MODEL 400 . . . . . \$168

For fundamentals from 30 to 15,000 cycles measuring harmonics to 45,000 cycles; as a volt and db meter from 30 to 45,000 cycles. Min. input for noise and distortion measurements .3 volts. Calibration: distortion measurements  $\pm 5$  db, voltage measurements  $\pm 5\%$  of full scale at 1000 cycles.



## LINEAR DETECTOR MODEL 404 . . . . . \$85

Provides combined RF detector and bridging transformer unit for use with any distortion meter. RF operating range: 400 kc to 30 mc. Single ended input impedance: 10,000 ohms. Bridging impedance 6000 ohms with 1 db insertion loss. Frequency is flat from 20 to 50,000 cycles.



## SINE WAVE CLIPPER MODEL 250 . . . . . \$10

Speeds accurate analysis of audio circuits by providing a test signal for examining transient and frequency response . . . at a fraction of the cost of a square wave generator. Designed to be driven by an audio oscillator.



SEE YOUR DEALER OR WRITE TODAY  
FOR COVERING LITERATURE, DEPT. EL-21.

# BARKER & WILLIAMSON, Inc.

237 Fairfield Avenue

Upper Darby, Penna.

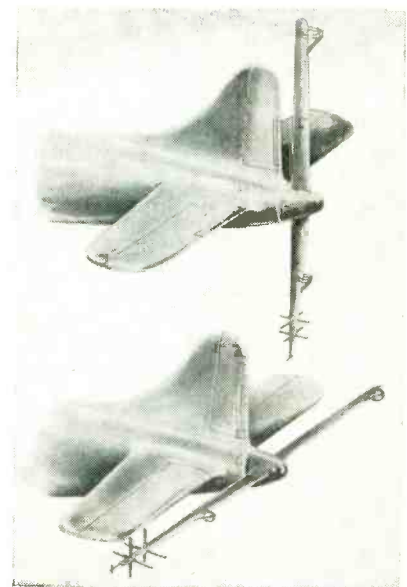

The new Stratovision antenna in vertical operating condition (above) and horizontal position (below) for landings, takeoffs and when plane is on the ground

objectionable interference effects.

An antenna installation designed by Carroll H. Matson of The Glenn L. Martin Co. and recently patented possesses many advantages over installations previously developed.

The new installation provides a mast which will support an antenna below the airplane and at a point widely spaced from the wings and motors of the plane without interfering with landing. The mast is mounted for rotation so that it may be swung from a vertical operating position extending below the airplane to a horizontal landing position.

The rotating antenna mast has control surfaces which are deflectable to set up a turning couple for rotating the mast while the airplane is in flight.

## Single-Input Attenuators With Multiple Outputs

BY CARL W. ULRICH  
Chief Engineer  
Radio Stations WAAF, WAAF-FM  
Chicago, Illinois

THE FOLLOWING method is a simple means of designing a network for feeding one or more outputs from a single source, see Fig. 1. The input and output branches all present equal impedances and any of the terminations can be used for either



# STOKES HIGH VACUUM EQUIPMENT... for every requirement of vacuum processing

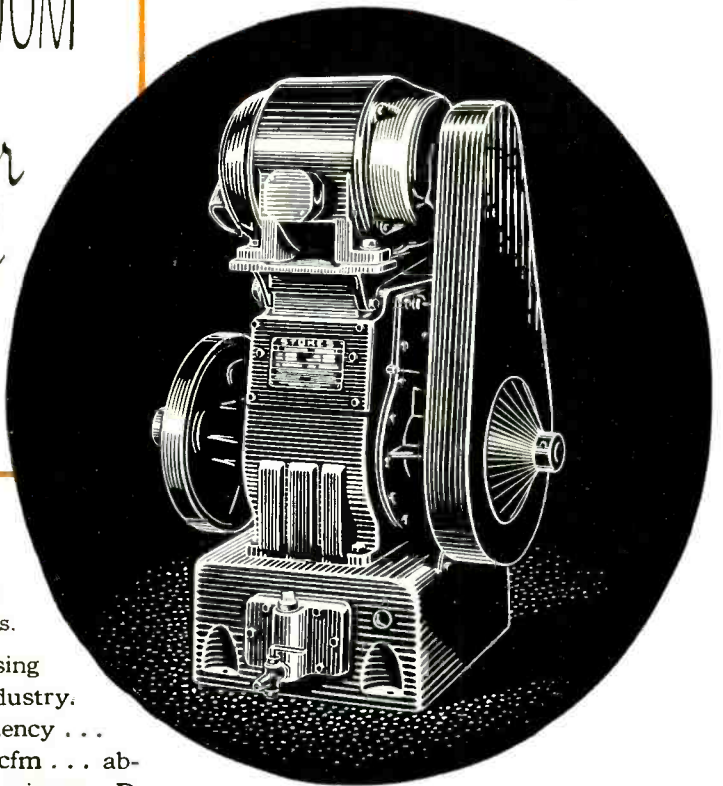

Modern design of Stokes vacuum equipment develops from the continuing contact of Stokes Engineers with processors in many fields.

Stokes Microvac Pumps — basic to vacuum processing — are designed for the broadest requirements of industry.

They have high volumetric and mechanical efficiency . . .

capacities of 15 to 500 cfm . . . ab-

solute pressures to 10 microns. Power

consumption is low. Compact design

with top-mounted motor requires minimum floor space.

There are but four moving parts including the high speed, full-opening exhaust valve of corrosion-resistant Teflon. Lubrication is completely automatic, without packing, stuffing-boxes or grease fittings.

Wear is kept to a minimum, and long trouble-free service assured.

Parts are precision-finished, standard and interchangeable.

Stokes is the only manufacturer of equipment for complete vacuum systems, including Microvac mechanical pumps, oil diffusion pumps, McLeod Gages and Vacuum Valves.

Consult with Stokes on the application of vacuum to rotary exhaust machines, house vacuum systems, vacuum impregnation, vacuum furnaces, vacuum metallizing, and to other applications in which vacuum deserves exploration.

Send for Catalog 700, "Stokes Microvac Pumps for High Vacuum", now a standard reference work on High Vacuum, containing charts, graphs, diagrams, schematics, typical problems, tables, formulas, constants, conversion factors.



## STOKES

### STOKES MAKES

Plastics Molding Presses,

Industrial Tableting

and Powder Metal Presses,

Pharmaceutical Equipment,

Vacuum Processing Equipment,

High Vacuum Pumps and Gages,

Special Machinery

F. J. STOKES MACHINE COMPANY, 6046 TABOR ROAD, PHILADELPHIA 20, PA.

# METAL CASES Custom Built for YOUR PRODUCT

by

**CENTRAL**



As specialized builders in metal cases, we stand ready to solve your cabinet or carrying case problem.

Central's Engineering Department will work direct with your designing engineer and handmade samples are submitted for your approval.

Whether interested in carrying cases, repair kits, cabinets, or chests, write, wire or call direct—include blue prints with written inquiries.

{ SERVING LEADING NAMES IN INDUSTRY—  
Experienced in meeting rigid military specifications }

**Central Stamping and Mfg. Co., (Dept. 3) Polo, Ill.**

# THE HI-GAIN Industrial POCKETSCOPE

BY WATERMAN



Wt. 12 3/4 lbs.  
12" x 5 3/4" x 7"

Another Waterman POCKETSCOPE providing the optimum in oscilloscope flexibility for analyses of low-level electrical impulses. Identified by its hi-sensitivity and incredible portability, S-14-A POCKETSCOPE now permits "on-the-spot" control, calibration and investigation of industrial electronic, medical and communications equipment. Direct coupling without peaking, used in the identical vertical and horizontal amplifiers, eliminates undesirable phase shifting. Designed for the engineer and constructed for rough handling, the HI-GAIN POCKETSCOPE serves as an invaluable precision tool for its owner.

Vertical and horizontal channels: 10mv rms/inch, with response within -2DB from DC to 200KC and pulse rise of 1.8μs. Non-frequency discriminating attenuators and gain controls with internal calibration of trace amplitude. Repetitive or trigger time base, with linearization from 1/2cps to 50KC with ± sync. or trigger. Trace expansion. Filter graph screen. Mu metal shield. And a host of other features.

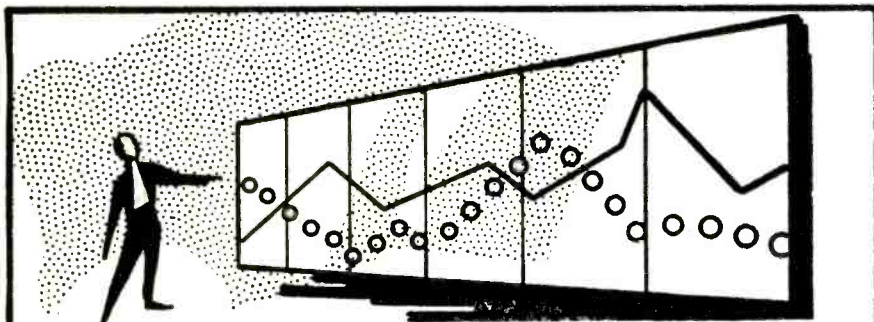

## TIME AND NUMBERS

Do you need a permanent record of time and numbers, that apply to your laboratory or production work? Streeter-Amet has the instrument which will accurately and speedily record either numbers or time or both at the same time on paper tape for easy readability.

The counter operates by any means capable of supplying a switch closure or an electrical impulse. Counts may be indexed by time or number printed alongside the count.

For high speed counting of a predetermined number of articles, Streeter-Amet Predetermined Counters automatically count then shut off or control associated machinery when the predetermined number is reached. An outstanding timesaver when packing a given number of articles in a carton, measuring lengths of wire or sheets in a bundle. Tell us your specific counting problem. We know we can help you economically.

Write for illustrated circular  
SC 26



FOUNDED  
1888

SCALES · WEIGHT RECORDERS · HI-SPEED COUNTERS  
**STREETER - AMET COMPANY**  
4101 N. RAVENSWOOD AVE., CHICAGO 13, ILL.

## WATERMAN PRODUCTS CO., INC.

PHILADELPHIA 25, PA.  
CABLE ADDRESS: POKETSCOPE

WATERMAN PRODUCTS INCLUDE:

S-10-B GENERAL POCKETSCOPE  
S-11-A INDUSTRIAL POCKETSCOPE  
S-14-B WIDE-BAND POCKETSCOPE  
S-15-A TWIN TUBE POCKETSCOPE  
S-21-A LINEAR TIME BASE

Also RAKSCOPES, LINEAR  
AMPLIFIERS, RAYONIC® TUBES  
and other equipment





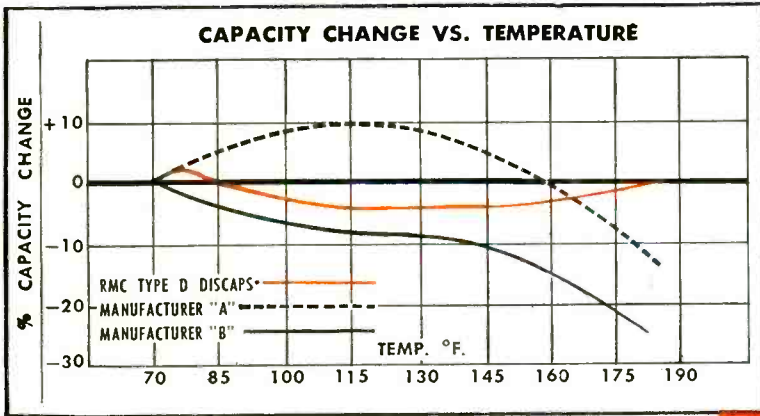

**NOW... a Really Stable Condenser for Coupling and Filter Network By-passing**

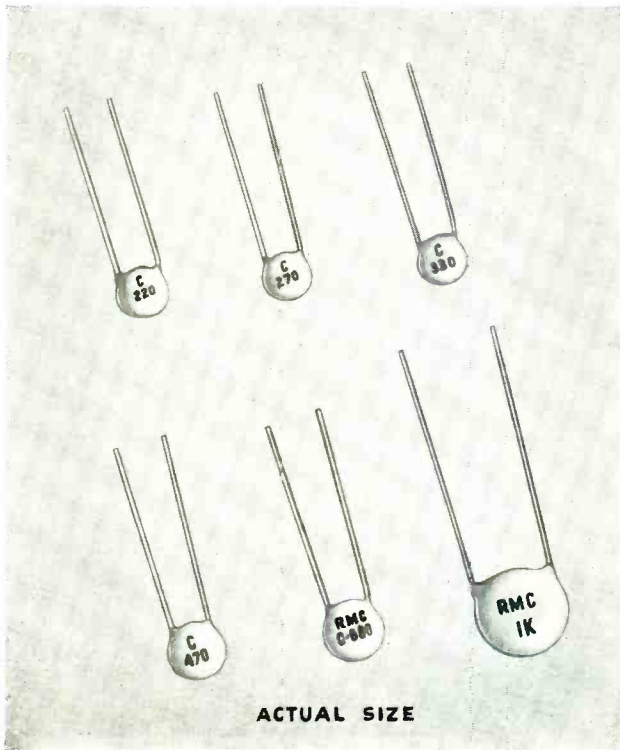

**Every DISCAP is 100% Tested for Capacity, Leakage Resistance and Breakdown**

**ANOTHER  
RMC  
FIRST!**

**RMC Type D "Stable Capacity" DISCAPS**

Specify RMC Type D DISCAPS when a more stable capacity is required for coupling and by-passing in filter networks. The actual capacity between +75°F and +185°F is +1% at 75°F, -4% at 130°F and ±0% at 185°F.

These new Type D DISCAPS, available in a capacity range between 220 MMF and 1000 MMF with a tolerance of ±20% at 25°C offer the advantage of low self inductance, small size and low cost.

POWER FACTOR	.....1.5% at 1KC
WORKING VOLTAGE	.....600 V.D.C.
TEST VOLTAGE	.....1200 V.D.C.
INSULATION	.....Durez Phenolic-Vacuum Waxed
RESISTANCE	.....Initial 5000 Megohms After Humidity 1000 Megohms
LEADS	.....#22 tinned copper (.026 DIA.)
BODY SIZE	...220 MMF to 330 MMF 1/4" DIA. 330 MMF to 800 MMF 5/16" DIA. 800 MMF to 1000 MMF 1/2" DIA.
CAPACITY TOLERANCE	.....±20% at 25°C.

**SEND FOR SAMPLES AND TECHNICAL DATA**

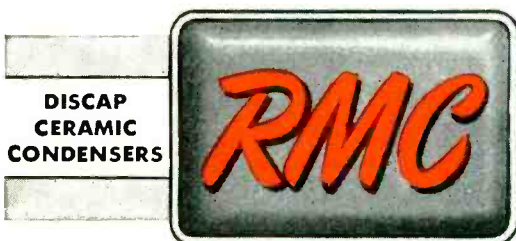

**RADIO MATERIALS CORPORATION**  
GENERAL OFFICE: 1708 Belmont Ave., Chicago 13, Ill.

FACTORIES AT CHICAGO, ILL. AND ATTICA, IND.

Two RMC Plants Devoted Exclusively to Ceramic Condensers

# Look to *Permoflux* for the **NEWEST...FINEST...MOST SENSATIONAL** **AUDIO COMPONENTS**

*Newest!*

## MINIATURES AND SUBMINIATURES

The MRB-3 miniature dynamic receiver and microphone has excellent wide-range frequency response characteristics, maintained flat by the Patented Permoflux acoustical damping method. Utilizes a self-formed voice coil. Sensitivity—115 db in 6 cc coupler with 1 m. w. input. Overall diameter 1" — height 1 1/16". Can be supplied with miniature input or output transformers in any impedance.

T1 and T2 Transformers — and Chokes — These sub-miniature units provide power efficiency from 80-90% with high voltage breakdown characteristics and extremely low susceptibility to electrolytic deterioration. Frequency response is  $\pm 2$  db from 100 to 8000 $\sim$ . Impedances up to 200,000 ohms and windings with inductive reactances up to one megohm. Ideal for use with Permoflux microphone-receiver units and headsets.



Model MRB-3



Model T1



Model T2

*Finest!*

## STANDARD HIGH FIDELITY SUPER HIGH FIDELITY DYNAMIC HEADPHONES

are world famous and quality-recognized products of Permoflux Corp. Sturdy and comfortable, they are built to withstand excessive shock, high humidities and a wide range of temperatures without impairing their high efficiency and dependable performance. Patented acoustical damping provides a flat frequency response to 4500 $\sim$  in standard models and through 10,000 $\sim$  in Super High Fidelity models. Unparalleled in performance for broadcast studio, aviation, laboratory, and audiometer work.



DHS-17  
CAA Approved

*MOST Sensational!*

## ROYAL EIGHT"

Compares with any 12" speaker

This average laboratory response curve of the Permoflux 8T-8-1 proves that it compares with the finest speakers regardless of size or price.



8T-8-1  
Eight-Inch  
Speaker  
with the  
Blue Cone

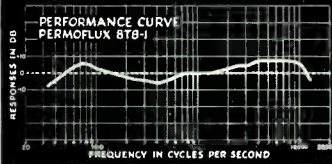

**PERMOFLUX CORPORATION**  
4900 W. GRAND AVE., CHICAGO 39, ILL. • 236 S. VERDUGO RD., GLENDALE 5, CALIF.

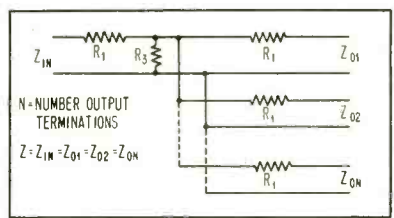

FIG. 1—Attenuator network for feeding one or more outputs from a single source

an input or an output. Thus a network designed to feed three outputs from one input can also be used to feed two inputs to two outputs or three inputs to one output.

The insertion loss between any two branches is equal to that between any other two branches. There is a certain minimum insertion loss dependent on the number of branches. The attenuator can be designed for any loss, equal to or greater than the minimum loss. This feature may be of value in controlling the degree of isolation between any two output branches.

### Design Equation

Since input and output impedances are equal

$$\frac{E_{in}}{E_{out}} = \text{Log}_{10}^{-1} \frac{\text{db loss}}{20} = B$$

$$\text{Insertion loss in db} = 20 \log_{10} \frac{E_{in}}{E_{out}} = 20 \log_{10} B$$

$$Z_{in} = Z = R_1 + \frac{\left(\frac{R_1 + Z}{N}\right) R_3}{\frac{R_1 + Z}{N} + R_3} =$$

$$R_1 + \frac{R_3 (Z + R_1)}{Z + R_1 + NR_3}$$

From which,

$$R_3 = \frac{Z^2 - R_1^2}{Z - NZ + R_1^2 + NR_1}$$

$$\text{or } \frac{Z^2 - R_1^2}{(N + 1) R_1 - (N - 1) Z} \quad (1)$$

$$\frac{E_{out}}{E_{in}} = \frac{1}{B} = \frac{\frac{R_3 (Z + R_1)}{Z + R_1 + NR_3}}{\frac{R_3 (Z + R_1)}{Z + R_1 + NR_3} + R_1} \left(\frac{Z}{Z + R_1}\right)$$

this reduces to,

$R_1 (Z + R_1) = R_3 (BZ - Z - R_1 - NR_1)$   
substituting for  $R_3$  the value obtained in Eq. 1

$$R_1 (Z + R_1) = \frac{Z^2 - R_1^2}{NR_1 + R_1 - NZ + Z} (BZ - Z - R_1 - NR_1)$$

OR

$$R_1 = \frac{(B - 1) Z}{B + 1} \quad (2)$$

(Continued on p 208)



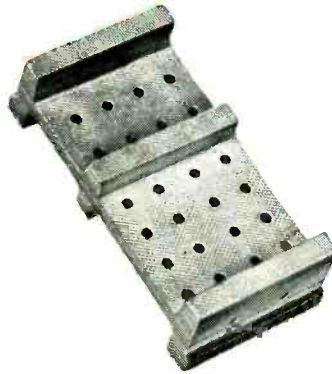
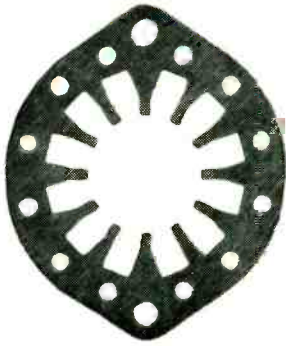

you specify the properties...in *Lamicoid*<sup>®</sup>

- High Dielectric Strength
- Low Power Factor
- Heat Resistance
- Low Moisture Absorption
- High Impact Resistance
- Dimensional Stability
- Light Weight
- Tensile Strength
- Resistance to Abrasion

Essential characteristics are "built-into" LAMICOID to meet the needs of *your* application—mechanical, structural and/or insulating. Because LAMICOID—a thermo-setting plastic laminate—is made with fillers such as glass, nylon, fabric, paper, etc. with a variety of resins, many combinations of properties are possible.

LAMICOID is used for tube socket supports, coil forms, dials, name-plates, panels, antenna parts and many other applications. For example, in combination with synthetic rubber it is used for end seals of electrolytic capac-

itors to keep out moisture and provide a non-corrosive seal.

Take advantage of LAMICOID's versatility to give *your* product peak efficiency. LAMICOID can be supplied in standard sheets, rods and tubes or fabricated into parts to your specification. We will be glad to apply the knowledge gained through 58 years of experience in developing and producing electrical insulating materials to your problem. Send your blueprint and specification today for a prompt quotation.



**MICA** *Insulator* **COMPANY**

Schenectady 1, New York

*Offices in Principal Cities*

# DO YOU KNOW?

— that a **PILOT LIGHT**  
CAN IMPROVE YOUR PRODUCT  
... add attraction — safety — service?

Ask



- what lamp to use
- how to use it
- what it will do
- what it will cost

**THIS MAY BE THE ONE**  
Designed for low cost NE-51 Neon

- Built-in Resistor • Patented
- U/L Listed • Rugged

Catalogue Number 521308 — 997  
for 110 or 220 volts.

**SAMPLES**  
for design purpose  
**NO CHARGE**

**NEW!** Write for the  
"HANDBOOK OF PILOT LIGHTS."  
Write us on your design problems.



**The DIAL LIGHT COMPANY of AMERICA**

Foremost Manufacturer of Pilot Lights.

900 BROADWAY, NEW YORK 3, N. Y. TELEPHONE SPRING 7-1300



## SPECIALTY OFFERS

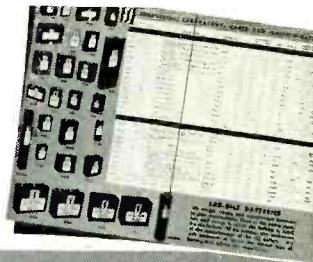

### LAB-BILT DRY BATTERIES Standard or Custom-made



INDUSTRY

LABORATORY



RADIO AND  
IGNITION



#### Write for FREE CATALOG

This catalog gives complete specifications of 78 Lab-Bilt Batteries of industrial and hard-to-get types.

#### CUSTOM-MADE BATTERIES

Battery Specification Sheet illustrated in catalog enables you to get any type dry battery designed and made to your individual specifications — even in small quantities!

#### SUPER SERVICE

Specialty Battery Company is specially equipped to make all Lab-Bilt Batteries FRESH for each order and ship immediately. Give your customers this valuable service. Write for a new catalog today.

## SPECIALTY BATTERY COMPANY

A Subsidiary of the **RAY-O-VAC** Ray-O-Vac Company

MADISON 10, WISCONSIN

## "CALL A MERIT DISTRIBUTOR FOR STOCK TRANSFORMERS!"

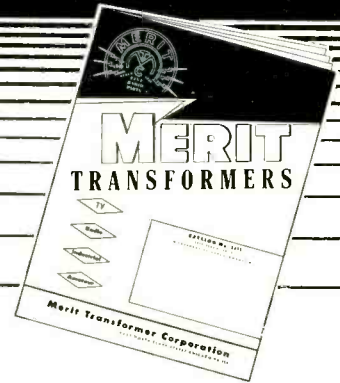

*Merit has been  
making the best  
for over a quarter  
of a century!*

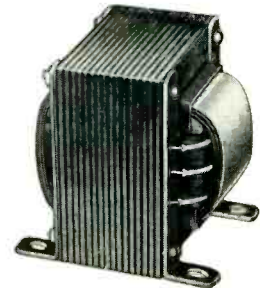

You can rely on dependable fast service from MERIT distributors.

Merit top quality, standard transformers will improve your production, reduce your inventory and step-up your deliveries.

Call your Merit distributor today or write for the new Merit catalog #5111.



#### TAPE-MARKED TO HELP YOU!

Handy tape marking on every Merit Transformer shows permanent hook-up data for quick reference. ORIGINAL BY MERIT.



## MERIT

TRANSFORMER CORP.

4416 NORTH CLARK ST., CHICAGO 40, ILL.



*Do you know about these*

**NEW TUBES** for  
Pulse Modulator Applications

**UNITED**

**HIGH VOLTAGE—HIGH VACUUM DIODES**

These new United Graphite Anode Diodes have been developed to fulfill the important aims of the Armed Services program for decreased size . . . increased ruggedness . . . and increased reliability of Electron Tubes. Complete technical data sent on request.

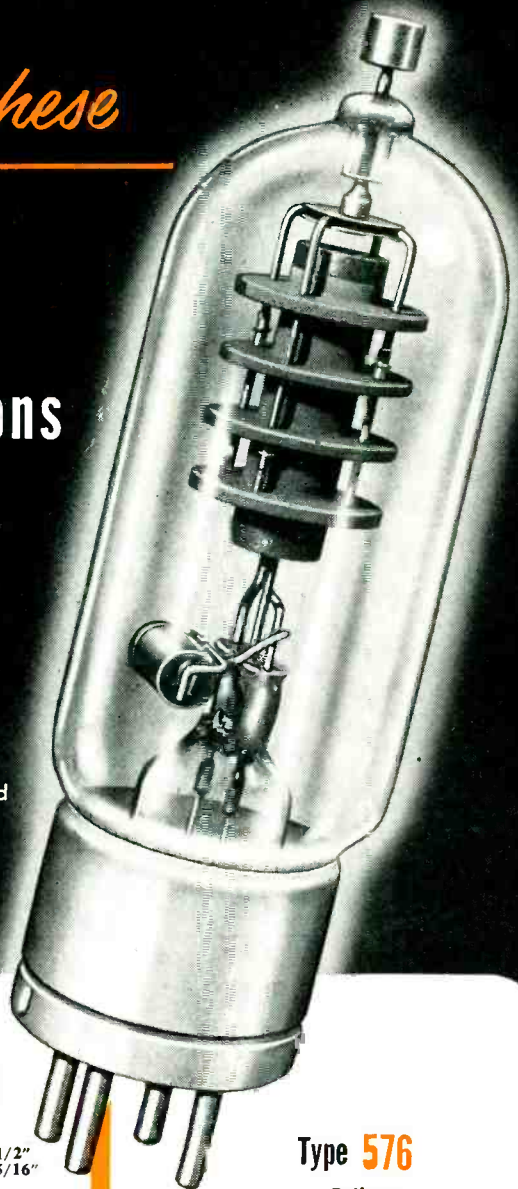

**Type 577**

Max. Dimen.:

Height 7-3/8"  
Diameter 2-1/16"

Ratings:

Ef 5.0 volts  
If 10.25 amps.  
epx 25 kv  
Io 300 ma  
ib 1.50 amps.



**Type 578**

Max. Dimen.:

Height 6-1/2"  
Diameter 2-5/16"

Ratings:

Ef 5.0 volts  
If 6.0 amps.  
epx 40 kv  
Io 100 ma  
ib 750 ma

**Type 576**

Ratings:

Ef 5.0 volts  
If 14.0 amps.  
epx 25 kv  
Io 500 ma  
ib 2.5 amps.

Max. Dimen.:

Height 7-1/2"  
Diameter 2-5/16"



**Type 371-B**

Max. Dimen.:

Height 8-3/4"  
Diameter 2-5/16"

Ratings:

Ef 5.0 volts  
If 10.3 amps.  
epx 25 kv  
Io 300 ma  
ib 1.5 amps.



**Type 3B24W**

Max. Dimen.:

Height 4-1/2"  
Diameter 1-9/16"

Ratings:

Ef 5.0 volts  
If 3.0 amps.  
epx 20 kv  
Io 60 ma  
ib 300 ma



**Type 3B29**

Max. Dimen.:

Height 4-3/4"  
Diameter 1-9/16"

Ratings:

Ef 2.5 volts  
If 4.75 amps.  
epx 16 kv  
Io 65 ma  
ib 250 ma

**UNITED**



**ELECTRONICS, 42 Spring Street, Newark 2, N. J.**

# NEW F-86A JET IS **LEDEX** EQUIPPED!



## NORTH AMERICAN AVIATION Chose **LEDEX ROTARY SOLENOIDS** for **DEPENDABILITY!**

Humid tropics, sand-laden desert skies, frozen North or extremely high altitudes . . . the new Air Force North American F-86A Sabre Jet Fighter is prepared to defend our nation under *any* conditions. Ledex Rotary Solenoids play an important part in this *dependability*. Several vital mechanisms are remotely controlled and powered by Ledex Rotary Solenoids.

The same Ledex standard of dependable remote control and power is available for your product. The vast production applications of Ledex Rotary Solenoids vary from the dependable snap-action operation of aircraft mechanisms to the powerful actuation of rugged hydraulic valves in heavy duty materials handling equipment.

We supply to quantity users and solicit the opportunity to be of assistance in engineering a Ledex Rotary Solenoid to meet the requirements of your product.

Write today for LEDEX ROTARY SOLENOID  
BASIC ENGINEERING DATA

*G. H. Leland* INC.

160 WEBSTER STREET, DAYTON 2, OHIO



The condition for minimum possible loss is realized when  $R_3 = \infty$ . This condition is obtained when the denominator of Eq. 1 = 0.

Equating the denominator to 0 and substituting for  $R_1$  the value obtained in Eq. 2

$$(N + 1) \frac{(B - 1)Z}{(B + 1)} - (N - 1)Z = 0$$

$$B - N = 0, \quad B = N$$

This means that the minimum possible loss is obtained when  $B = N$ . If  $B$  is less than  $N$ ,  $R_3$  will be negative and not physically realizable. If  $B$  is greater than  $N$ ,  $R_3$  will be positive and have a finite value. Therefore  $B$  may be equal to, or greater than  $N$  and the minimum possible insertion loss in db =  $20 \log_{10} N$

### Pad Design

To design a pad using this method, determine the minimum insertion loss for the desired value of  $N$  output terminations.

Suppose  $N = 4$ , then minimum insertion loss in db =  $20 \log_{10} 4 = 20(.602)$  or 12 db

The pad may now be designed for any value of insertion loss equal to or greater than 12 db. Suppose a loss of 20 db is desired and  $Z = 600$  ohms.

$$\text{Then, } B = \log_{10}^{-1} \left( \frac{20}{20} \right) = 10$$

$$R_1 = \frac{9}{11} (600) \text{ or } 490.9 \text{ ohms}$$

$$\text{and } R_3 = \frac{600^2 - 490.9^2}{5(490.9) - 3(600)} = 181.8 \text{ ohms}$$

For the special case where minimum loss is desired  $B = N$  or 4

$$\text{and } R_1 = \frac{3}{5} (600) \text{ or } 360 \text{ ohms}$$

$$R_3 = \frac{600^2 - 360^2}{5(360) - 3(600)} = \text{infinity}$$

Thus it is evident that for the minimum loss condition, when  $B = N$ , resistor  $R_3$  can be eliminated.

Another special case occurs when  $N = 1$ . If  $B$  is also 1 then  $R_1 = 0$  and  $R_3 = \infty$ , and a direct connection is indicated without a network.

For any other value of  $B$  greater than 1,  $R_1$  can be determined as before by means of Eq. 2.

Equation 1 reduces to

$$R_3 = \frac{Z^2 - R_1^2}{2 R_1} \text{ or } \frac{Z^2}{2 R_1} - \frac{R_1}{2}$$

It is believed that this method



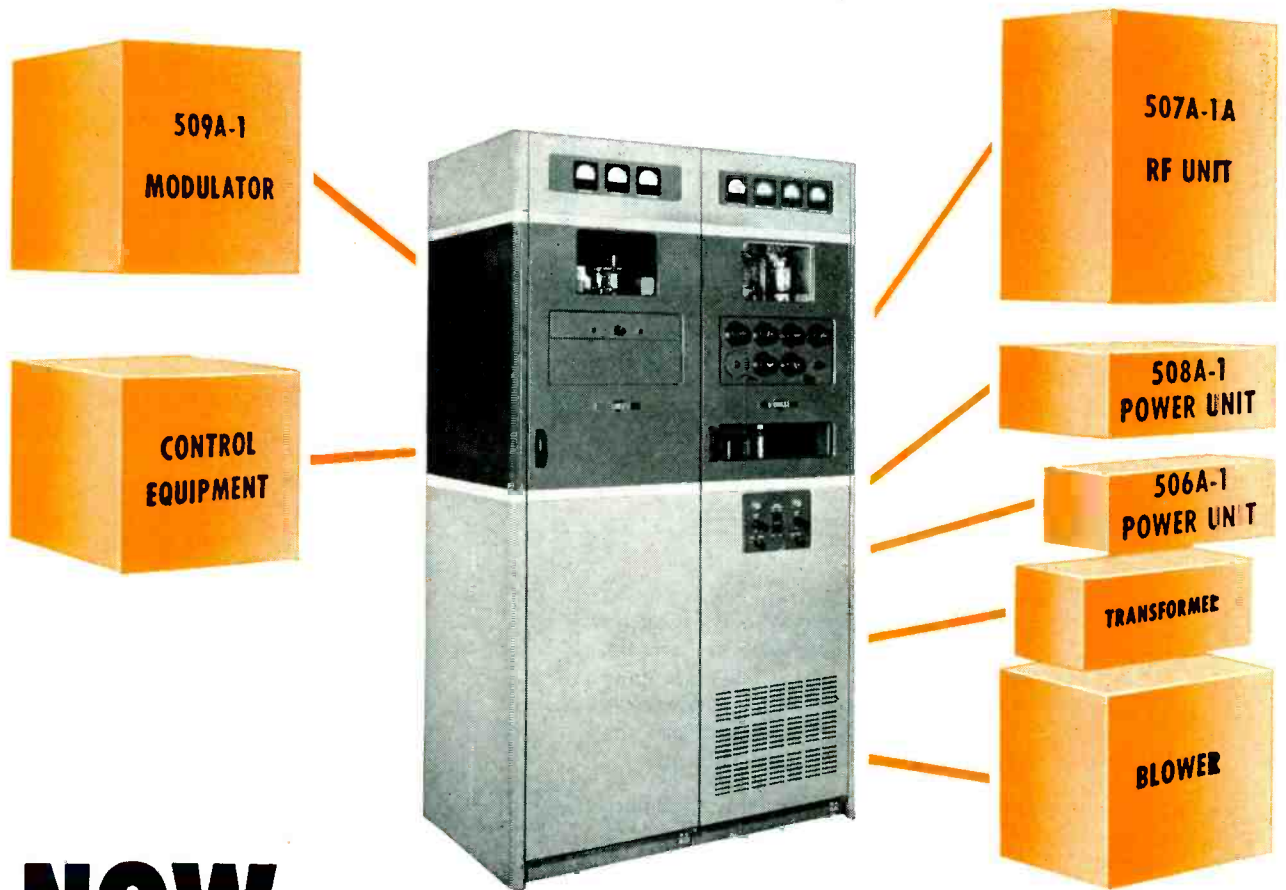

# NOW . . . custom transmitters from prefabricated assemblies

You can now get the benefit of production line economies in a new Collins series 430 one or two kilowatt communications transmitter tailored for your specific requirements.

Completely constructed RF, power supply, and modulator components of new design are available for integrating in different combinations, forming finished transmitters to fulfill all requirements of ground-to-plane, shore-to-ship and point-to-point systems. The frequency range of these transmitters is 2 to 30 megacycles.

RF units can be supplied with or without Auto-tune\* control. Manual tuned RF units may be worked in multiple to provide a multiplicity of fixed tuned instantly selectable channels or simultaneous transmissions on two or more frequencies.

Among the combinations available are the Type

431D one kilowatt, ten channel CW-FSK and phone autotuned transmitter illustrated here. It is made by combining a 507A-1A RF unit, a 506A-1 power unit, a 508A-1 power unit, a 509A-1 modulator unit, a 2-bay cabinet and a 1 KW blower.

Another combination, not illustrated, is the Type 434B-1 one KW, two simultaneous-channel CW-FSK only, manual tuned transmitter, which is made by combining two 507A-1 RF units, two 506A-1 power units, a 508A-1 power unit, a 2-bay cabinet, and a 1 KW blower. Several other combinations are available, one of which is certain to satisfy your exact needs.

Final assembly, and testing, may be accomplished at the Collins plant or at the installation site. We will be glad to give you details about the 430 series transmitter to fulfill your own requirements.

\*Reg. U.S. Pat. Off.

IN RADIO COMMUNICATIONS, IT'S . . .



**COLLINS RADIO COMPANY, Cedar Rapids, Iowa**

11 West 42nd Street, NEW YORK 18

2700 West Olive Avenue, BURBANK

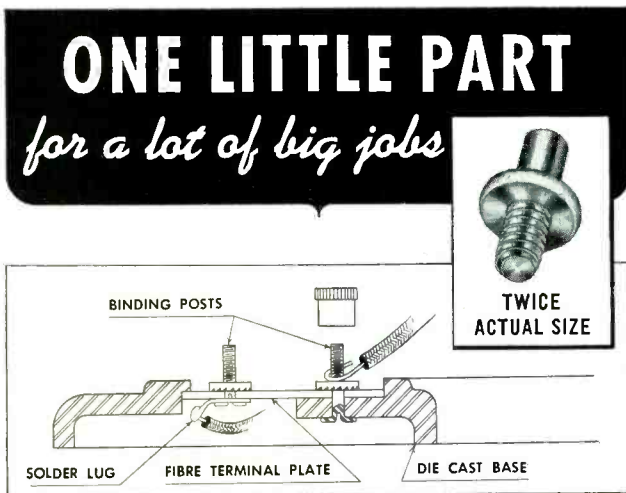

Lionel designed this non-turning, self-fastening binding post for making electrical connections to model railroad equipment, such as coal loaders. A multi-purpose fastener for a high quality product, it must be prefabricated with precision, speed and economy. Progressive provides the perfect facilities for specials such as this.

A combination tubular rivet and threaded post, the connector eliminates separate parts such as nuts and lock-washers, excludes expensive hand operations and permits multiple assembly. Made of headed stock, it curls without cracking. Serrations lock the post to keep it from turning. Tubular section holds the post to its base and may be used further to hold a soldering lug, etc. Drawing detail above shows the multiple functions performed by the fastener.

Special fasteners are our specialty. IF IT'S SPECIAL, see PROGRESSIVE.



WRITE FOR OUR CATALOG  
IT MAY SAVE YOU MONEY

Other typical PROGRESSIVE "Specials"



**THE PROGRESSIVE  
MANUFACTURING COMPANY**

50 NORWOOD ST., TORRINGTON, CONN.

SALES OFFICES: SAN FRANCISCO, LOS ANGELES,  
PORTLAND, DETROIT, PHILADELPHIA, CLEVELAND,  
SEATTLE, BOSTON, SYRACUSE, ST. LOUIS, CHICAGO.

involves less computation for  $T$  pads having equal input and output impedances.

To convert to balanced attenuators simply use  $\frac{R_1}{2}$  on each side of the terminations instead of  $R_1$  on one side.

### Wide-Band Amplifier for Central Antenna Installations

By J. B. CRAWLEY

Chief Engineer  
Station WTCO  
Campbellsville, Ky.

ADDITIONAL AMPLIFICATION is needed in central antenna locations such as display areas of radio stores and final test areas in radio-receiver production to overcome the inherent high noise level produced by street-car lines, neon signs and fluorescent lighting systems. Signal strength of the desired station may also be weak because of steel building structures which decrease signal-to-noise ratio.

This problem has been magnified in recent years because of the increased use of built-in loop antennas in radios. Connecting an outside antenna might work in some cases but in others would offer little improvement.

The circuit shown in Fig. 1 was designed to solve this interference problem. The system consists of an antenna installed as far away from the noise field as possible. It may

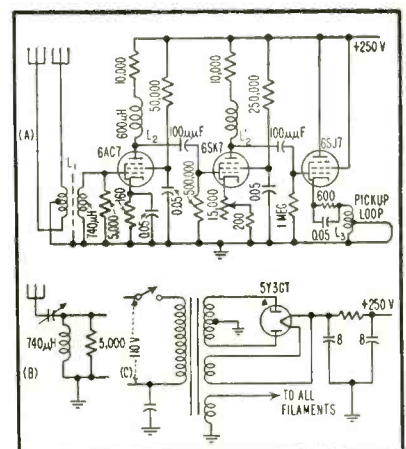

FIG. 1—Circuit of wide-band amplifier with noise-rejecting doublet antenna (A), alternate lead-in for straight-wire antenna (B) and amplifier power supply (C)





ALL-PURPOSE RECORDING IS A *Sound* INVESTMENT



**with General Industries' Model 250  
TAPE-DISC RECORDER ASSEMBLY**

There's literally no end to the merchandising possibilities of all-purpose recorders in which this GI Tape-Disc Assembly is used. In home entertainment units . . . in straight recorders for professional men . . . as an aid to overall business efficiency . . . it has excellent profit potential.

Designed and built to General Industries' customary high quality standards, the Model 250 incorporates many novel, fool-proof operating features. Its cost is amazingly low.

Write *today* for a catalog sheet containing a full description of *all* the recording and play-back features of this popular new tape-disc recorder assembly.

- When connected with suitable amplifier, the Model 250 records on discs . . . records on tape . . . records from tape to disc or disc to tape . . . plays back both tape and discs . . . plays 78 R.P.M. records. A complete service manual, included with each unit, contains a suggested amplifier circuit and complete amplifier parts list.

**The GENERAL INDUSTRIES Co.**



**Department B • Elyria, Ohio**

# "Controlled Reluctance"

MICROPHONES PROVED\* TO BE THE  
FINE-QUALITY-ECONOMICAL ANSWER TO  
MANY MICROPHONE PROBLEMS

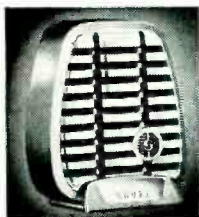

MODEL 510

The "HERCULES"—Here is a revolutionary new microphone that provides the ruggedness, the clear reproduction, and the high output long needed for public address, communications, recording at an amazingly low price! Can be placed on a desk, in the hand, or on a stand.

Model 510C . . . . . Code: RUTUF  
Model 510S (with switch) . . . Code: RUTUS



MODEL 520

The "GREEN BULLET"—Specially designed to provide quality music and speech reproduction at moderate cost. A streamlined unit that lends itself to fine-quality, low-cost installations where durability is an important factor. Features high output, good response, high impedance without the need of a transformer.

Code: RUDAL



MODEL 505

The "RANGER"—Recommended for those applications where long lines are used and a rugged hand-held microphone is needed. Ideal for outdoor public address, mobile communications, hams, audience participation shows, etc. Designed for clear, crisp natural-voice response of high intelligibility. Has heavy-duty switch for push-to-talk operation.

Model 505B (Medium Impedance) . Code: RUDAY  
Model 505C (High Impedance) . . Code: RUDAX



MODEL 520SL-7  
(7' cable)  
Code: RUDAN

Model 520SL-20 (20' cable) . . . Code: RUDAF

The "DISPATCHER"—Complete dispatching unit. Designed to handle the most severe field requirements of paging and dispatching systems. Ideal for police, railroad, taxicab, airport, bus, truck and all emergency communications work. Operates both microphone and relay circuits. High output, high speech intelligibility. Unit is preassembled.

Code: RUTUC

\* Specific information provided on request.

Patented by Shure Brothers, Inc.

## SHURE BROTHERS, Inc.

Microphones and Acoustic Devices

225 West Huron St., Chicago 10, Ill. • Cable Address: SHUREMICRO



MODEL R5



be a noise-rejecting doublet type or preferably the straight-wire type because most noise is horizontally polarized in contrast to the broadcast signal which is vertically polarized.

Coil construction details for the circuit are as follows:  $L_1$  secondary is made up of 255 turns on 1-in. form in a 2-in. winding space, the primary is 20 turns center tapped;  $L_2$  and  $L_2'$  are made up of 213 turns of No. 38 enameled wire on a 1-watt 500,000-ohm resistor and  $L_3$  is made up of 92 turns on  $\frac{1}{2}$ -in. form in a 1 $\frac{1}{2}$ -in. winding space with the tap 37 turns from ground.

The system has a balanced lead-in and an input transformer to the amplifier with a Faraday shield between primary and secondary. The amplifier itself is a two-stage high-gain broad-band amplifier followed by a cathode-follower stage.

### Circuit

Design of the amplifier section is similar to the front end of many broadcast sets employing untuned r-f stages. A 6AC7 is used in the first stage to provide high gain. The second stage is a 6SK7 or similar remote-cutoff type. Remote cutoff is necessary because the gain control is incorporated in the second stage and a sharp-cutoff tube might show nonlinearity with a resultant garbling of signals.

The amplifier is designed to cut off slightly above the broadcast band. By changing the values of the plate resistors and the peaking coils, shortwave coverage may be obtained. However the over-all gain of the amplifier would be less.

To couple the amplifier output to the loop antenna of the receiver or receivers without a physical connection, a low-impedance output loop is used. This stage is matched by a 6SJ7 operated as a cathode follower fed to a single-turn loop.

The output loop may consist of any reasonable length of wire running under a shelf or table near the sets to be operated. It acts as the primary of a coil which inductively couples the signal into the secondary or loop of the receivers.

Care must be taken to prevent regeneration by keeping the input and output wires of the amplifier



Electromax in Simplest Form, for On-Off Control

Signal Lights  
Center (amber) glows when Electromax is Operating  
Left (green) glows when temperature is High  
Right (red) glows when temperature is Low

Control Temperature Is Set By Turning This Knob

Leadwire to Thermohm has no limits to length

Thermohm detector of 1000 F type; hermetically sealed; rugged

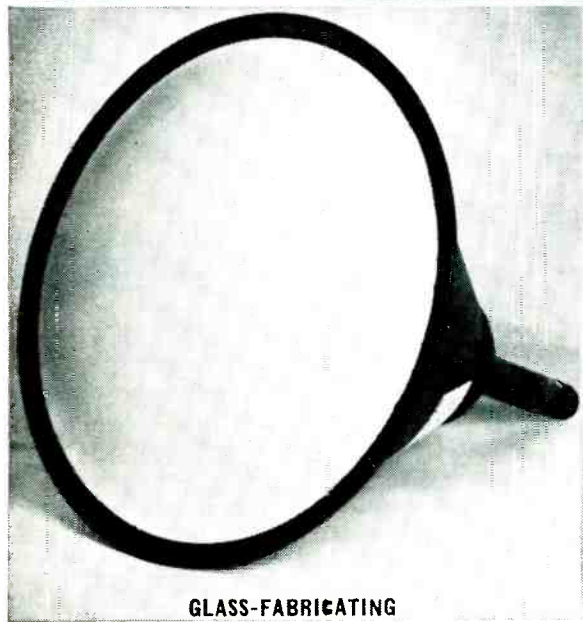
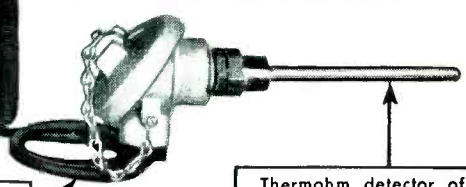
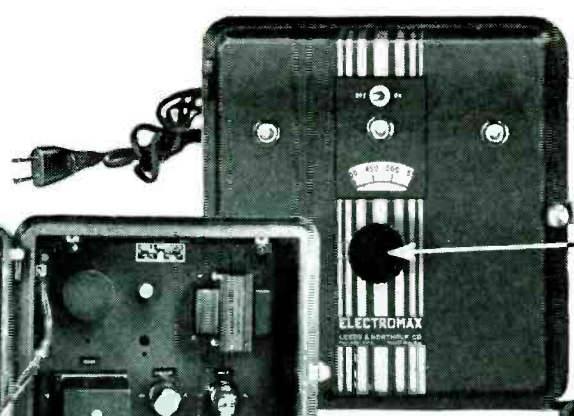
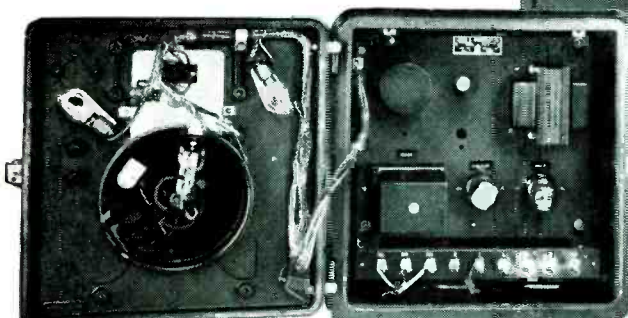

GLASS-FABRICATING



PLASTIC MOLDING

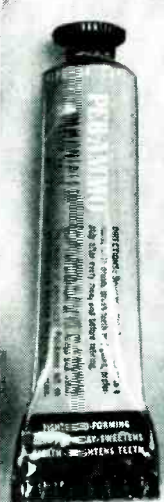

METAL DECOATING



METAL PICKLING, TINNING & GALVANIZING



PLASTIC-WRAPPER SEALING

# PROTECT PRODUCTION WITH ELECTROMAX CONTROL

**E**LECTROMAX CONTROLLERS give modern *electronic* regulation to thousands of important manufacturing processes. They exactly fill the bill for non-recording controllers of outstanding dependability.

Electromax has the sensitivity, accuracy and dependability of its big brother Speedomax Recording Controller. Likewise, it is not affected by vibration or building tremors—can even be mounted on the frame of a molding press. The instrument needs almost no attention, because it has only one moving part—a covered, plug-in type relay. There's usually no need to open its door for months at a time.

You can specify any one of 3 types of control action:

1. On-Off or 2-position Control
2. Proportioning, automatic reset and rate (D.A.T.) Control
3. Proportioning and manual reset (P.A.T.) Control

For further information, write our nearest office, or 4979 Stenton Ave., Philadelphia 44, Pa.



Jrl. Ad ND47(1)

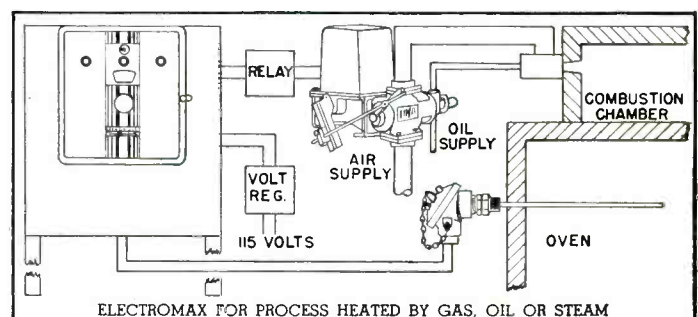

ELECTROMAX FOR PROCESS HEATED BY GAS, OIL OR STEAM

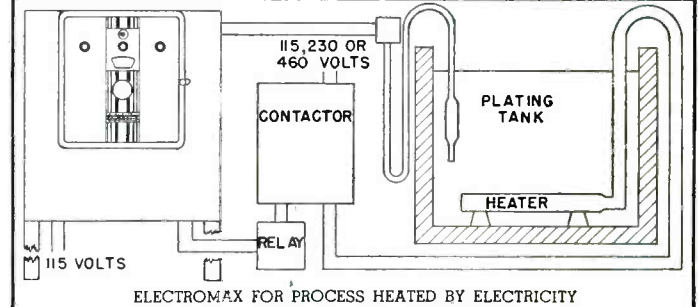

ELECTROMAX FOR PROCESS HEATED BY ELECTRICITY

from running side by side. A wave trap may be installed if a strong local station should tend to overload the amplifier.

Tests made on a five-tube Sentinel radio showed that with the volume control set at normal it was possible to receive six stations fairly well and four others were barely audible. Turning on the amplifier allowed the same set to receive a total of 18 stations without noise.

### Electronic Christmas Tree

A GRADUATE STUDENT of Case Institute of Technology, Richard C. Hahn, designed an electronic Christmas tree with its lights thyatron-controlled to respond to Christmas carols for Tomlinson Hall of the school's campus.

The electronic tree graduates color and brightness of five dozen bulbs while its color organ amplifies traditional music. The control mechanism sorts out the music signals into bass, middle range and treble frequencies. Blue lights on the tree are controlled by bass tones, yellow by the middle range and red by treble.

The device consists of three a-f filters feeding their output into a phase-shift thyatron control circuit which, in turn, controls the firing of a thyatron regulating lamp brightness.

### New Version of Schering Bridge

BY JOHN H. JUPE  
Middlesex, England

A VARIATION of the Schering bridge, an instrument commonly used for measuring capacitance and power loss in dielectrics at high voltages, has been developed here.

The bridge is intended for use at voltages up to 200,000 and has visual indication of the null condition. To obtain high sensitivity and to avoid the use of an a-c galvanometer, the detector unit was designed with a three-stage R-C coupled amplifier, a thermionic rectifier and

Need **VOLUME**  
on Small Parts  
Like  
These?



Investigate

## MULTI-SWAGE

Economy Way to Get Volume!

If it's VOLUME you need on small tubular metal parts similar to these, be sure to look into Bead Chain's MULTI-SWAGE Process. Send the part (up to  $\frac{1}{4}$ " dia. and to  $1\frac{1}{2}$ " length) and your specs for a quotation. Chances are you'll find a new way to effect important savings.

Much Cheaper Than Solid Pins

Many prominent users of solid pins for electronic and mechanical purposes have cut costs by switching to Multi-Swaged tubular pins . . . without sacrificing strength or accuracy. Often this is possible to accomplish.

Typical Applications —

As terminals, contacts, bearing pins, stop pins, male-female connections, etc., in a wide variety of electronic and mechanical products:—Toys . . . Business Machines . . . Ventilator louvres . . . Radio and Television apparatus . . . Terminal-boards . . . Electric Shavers . . . Phono Pick-ups, etc. For DATA BULLETIN, write to



The **BEAD CHAIN** Mfg. Co.

88 Mountain Grove St., Bridgeport 5, Conn.

Manufacturers of BEAD CHAIN—the kinkless chain of a thousand uses, for fishing tackle, novelty, plumbing, electrical, jewelry and industrial products.



Shown:

Bliley type  
SR-5

**QUALITY is**

**BASIC with BLILEY**

One of the BASIC reasons why BLILEY has been top choice for twenty years is our continued emphasis on product QUALITY, regardless of the pressure of urgent delivery dates. We are pleased to be known to so many concerns as "The Standard of the Industry!"

**Bliley**  
CRYSTALS

BLILEY ELECTRIC COMPANY  
UNION STATION BUILDING  
ERIE, PENNSYLVANIA



# *Federated* ROSIN CORE SOLDER

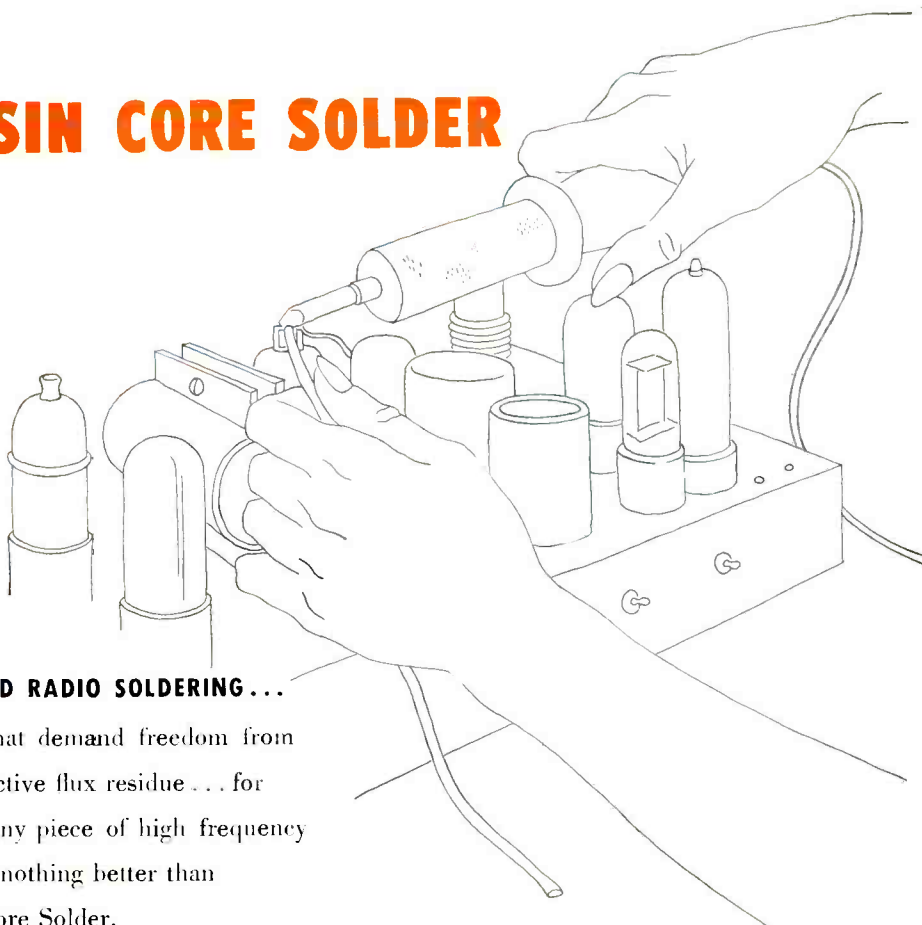

*for* TELEVISION AND RADIO SOLDERING...

for operations that demand freedom from corrosion and conductive flux residue... for soldering on any piece of high frequency equipment... there is nothing better than Federated Rosin Core Solder.

Each Rosin Core Solder composition is a precise alloy of tin and lead with a pure turpentine distillate flux that is effective but not corrosive. This means that current leakage at radio frequencies is prevented.

Federated Rosin Core Solder is unequalled for consistency and ease of working... for the permanence of the bond it produces. Look for it on the familiar orange and black metal spool, 1, 5, and 20-pound sizes.



## *Federated Metals Division*



AMERICAN SMELTING AND REFINING COMPANY • 120 BROADWAY, NEW YORK 5, N. Y.

**this print saved half a day!**

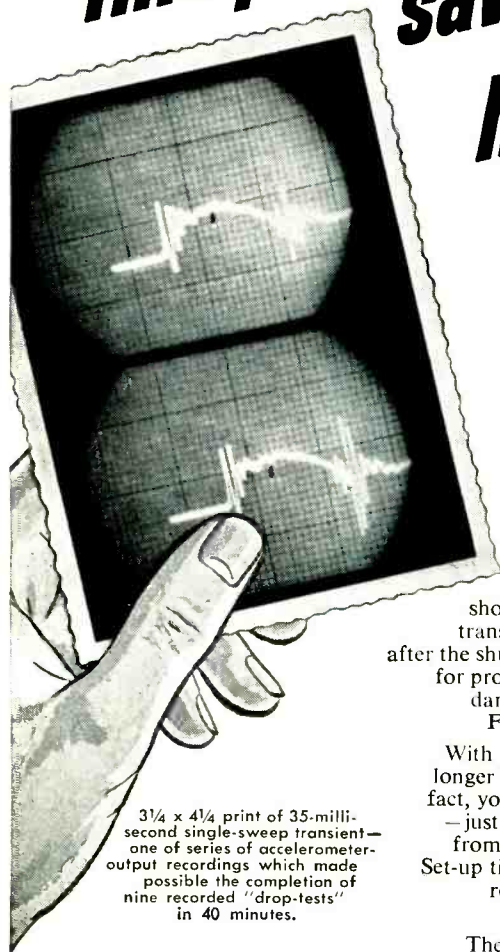

3 1/4 x 4 1/4 print of 35-milli-second single-sweep transient—one of series of accelerometer-output recordings which made possible the completion of nine recorded "drop-tests" in 40 minutes.

**IT WAS MADE  
IN ONE MINUTE  
WITH THE  
FAIRCHILD-POLAROID®  
OSCILLOSCOPE CAMERA**

This 3 1/4 x 4 1/4 print of an oscilloscope image saved a laboratory engineer at least half a day in his work on a series of shock tests. The print, which shows clearly a 35-millisecond single-sweep transient, was ready for evaluation a minute after the shutter was snapped. There was no waiting for processing in the laboratory's hard-working darkroom as was the case before use of new Fairchild-Polaroid Oscilloscope Camera.

With the Fairchild-Polaroid camera, you no longer need wait for darkroom processing. In fact, you can even forget the bother of focusing—just snap the shutter and remove the print from the back of the camera a minute later. Set-up time is less than two minutes. Each print records two traces for easy comparison and cost saving.

The complete equipment consists of *scope adapter* for any 5-inch oscilloscope, *light-tight hood* with viewing port, and *Polaroid-Land Camera body* with special lens and shifting mechanism.

Send for more data and prices on the F-284 Oscilloscope Camera Kit (camera, carrying case, and film) to: *Fairchild Camera and Instrument Corporation, 88-06 Van Wyck Boulevard, Jamaica 1, N. Y. Dept. 120-13A1.*

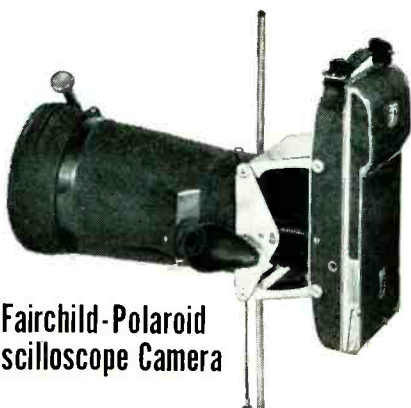

**Fairchild-Polaroid  
Oscilloscope Camera**

**Specifications**

**Lens**—Special 75 mm. f/2.8 Wollensak Oscillo-anastigmat.

**Shutter**—Wollensak Alphax; speeds 1/25 sec. to 1/100 sec., "time," and "bulb."

**Focus**—Fixed (approx. 8 in.)

**Picture Size**—3 1/4 x 4 1/4 in. (2 images per print; 16 exposures per roll of film).

**Image Size**—One-half reduction of scope image.

**Writing Speed**—to 1 in./ $\mu$ sec at 3000V accelerating potential; higher speeds at higher voltages.

**Dimensions**—Camera, 10 1/2 x 5 1/4 x 6 1/4 in.; hood, 11 in. length, 7 1/2 in. dia.; adapter, 2 in. width, 6 3/8 in. max. dia.

**Weight**—Complete, 7 3/4 lb.

**FAIRCHILD**  
**OSCILLOSCOPE RECORDING CAMERAS**

a d-c moving-coil milliammeter.

The first stage of the amplifier has a feedback filter in order to attenuate any harmonics that may be present. A parallel-T filter between the second and third stages provides a frequency-selective feedback circuit. Variable sensitivity is provided by means of a potentiometer located between the last amplifier stages.

Cathode-follower networks are employed between the bridge, test specimen and standard capacitor to counteract the effects of stray capacitance and the capacitance of connecting cables.

The type of decade switch in the variable arms of the bridge must be considered carefully if accurate and consistent results are to be obtained. Also, inductive loops must be kept to a minimum.

The power supply unit used with the bridge is designed to supply smooth d-c to the detector unit and to the cathode-follower networks housed in the ratio-arm unit. Direct filament voltage is supplied to tubes in the ratio-arm and detector units so that any interference with the detector because of a-c pickup and hum will be eliminated. This arrangement permits the use of separate a-c supplies for the detector and high-voltage parts of the bridge.

The high-voltage arms of the bridge, comprising the standard capacitor and test object, are placed in a protected test area remote from ratio-arm and detector units.

Spark-gap protective devices are mounted on both the standard capacitor and test object.

The standard capacitor has a value of 98.5  $\mu$ f and can withstand 200,000 volts rms. It consists of two concentric polished brass cylinders mounted vertically and housed in an insulating cylinder. The inner tube is the high-voltage electrode and is supported from a top casting. The outer tube is the low-voltage electrode and is connected to the center pin of a socket mounted on the base of the capacitor.

Guard rings arranged at the termination of the low-voltage electrode are used for stress control. Metal shields minimize the effects of stray capacitance. The dielectric is dry nitrogen at 200 psi.



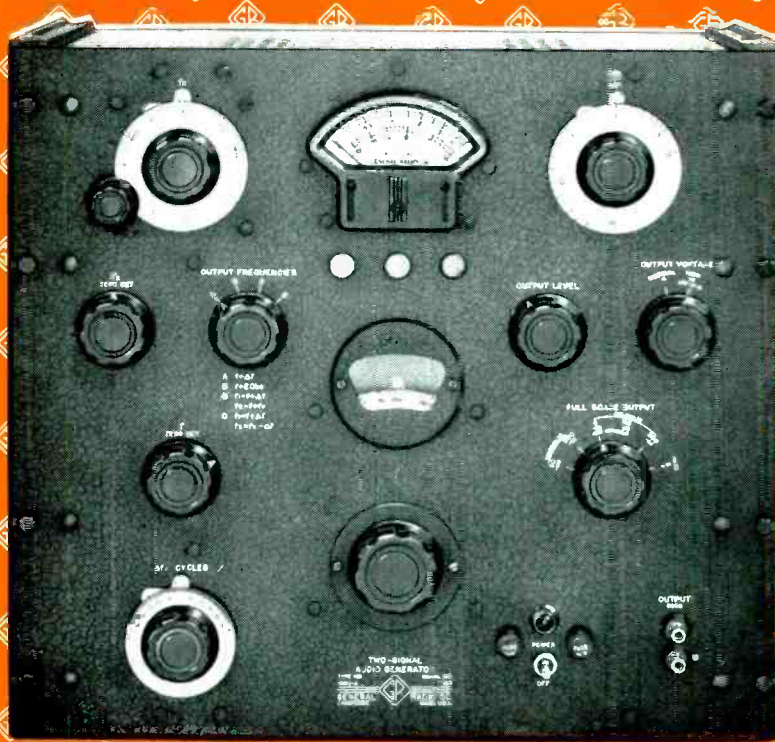

**TYPE 1303-A  
TWO-SIGNAL GENERATOR  
\$1050**

## a *New* Two-Signal Audio Generator

**Ideal for Non-linear Tests On: ★ Audio Amplifiers ★ Hearing Aids ★ Filter Networks ★ Noise Suppressors ★ High-Efficiency Speech Reproducing Systems ★ Loudspeakers ★ F-M Systems with Pre-Emphasis ★ Recording Systems ★ Any System of Restricted Frequency Range**

The new G-R Type 1303-A Two-Signal Audio Generator supplies signals by the beat-frequency method. Three oscillators and three mixers are used to provide a number of output-signal combinations. The output of the mixers are combined in a linear adding network and then amplified through a very low-distortion power amplifier. The output from the amplifier is fed into a 600-ohm attenuator system, with a voltmeter to monitor the level at the input of the attenuator. The harmonic content and inter-modulation products in the final output are at a very low level. High stability of voltage and frequency are provided. The frequency drift from cold start is only a few cycles.

*This A-F Signal Generator will supply the following signals:*

- A single low-distortion sinusoidal voltage, adjustable in frequency from 20 cycles to 40 kilocycles, in two ranges.
- Two low-distortion sinusoidal voltages, each separately adjustable, one to 20 kc and the other to 10 kc.
- Two low-distortion sinusoidal voltages with fixed

difference in frequency maintained between them as the frequency of one is varied. The fixed difference frequency is adjustable up to 10 kc, and the lower of the two frequencies is adjustable up to 20 kc.

The output is continuously adjustable and is calibrated both in volts and in db with respect to 1 mw into 600 ohms. The frequency calibration can be standardized within one cycle at any time. Its accuracy is  $\pm (1\% + 0.5 \text{ cycle})$ .

*This generator is an excellent and versatile signal source for the three standard non-linear distortion tests:*

1. The widely used harmonic distortion test.
2. The intermodulation method that evaluates distortion in terms of the resultant modulation of a high-frequency tone by a low-frequency tone.
3. The difference-frequency intermodulation test, which evaluates distortion in terms of the amplitude of the difference-frequency components produced by intermodulation of two sinusoidal test signals of equal amplitude.

**Write for Complete Information**



# GENERAL RADIO COMPANY

**Cambridge 39,  
Massachusetts**

90 West St., New York 6    920 S. Michigan Ave., Chicago 5    1000 N. Seward St., Los Angeles 38



**THE ELECTRON ART**  
(continued from page 126)

balancing motor will rotate in a direction determined by the phase of the servo amplifier output. By appropriate circuit arrangement, the motor can be made to rotate the grid bias potentiometer in the direction necessary to compensate for the existing drift.

**An Incremental Delay Pulse Generator**

By G. FRANKLIN MONTGOMERY

*Radio Engineer  
Ionospheric Research Section  
Central Radio Propagation Laboratory  
Washington, D. C.*

A PULSE GENERATOR was completed in the summer of 1949 at the Central Radio Propagation Laboratory of the National Bureau of Standards for use in high-frequency radio propagation experiments.

Operation of the instrument depends on the combination of a series of harmonic waveforms to generate a waveform of fundamental frequency and variable phase<sup>1</sup>.

Spaulding and Rod<sup>2</sup> have described a loran indicator using this method, and the technique itself has been discussed by Freas<sup>3</sup>. The CRPL generator or a modification may be useful for radar range calibration or in any application where delay times must be measured, and therefore this description has been prepared.

The generator is driven by the

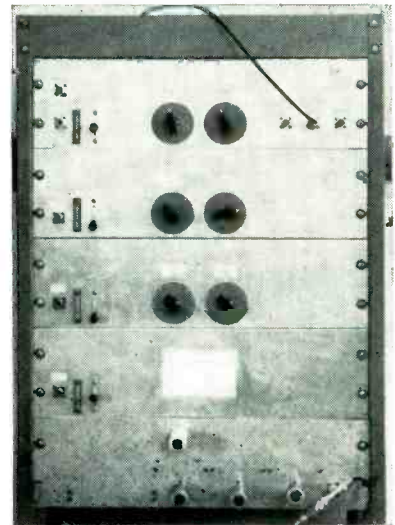

FIG. 1—Front panel view of incremental delay pulse generator. Three coax outlets at upper right provide reference pulse and two pulses of variable phase



# FREED

"PRODUCTS OF EXTENSIVE RESEARCH"

## TRANSFORMERS & INSTRUMENTS

### DECADE INDUCTORS BY FREED

A complete line of precision high stability decade inductors covers the range from one tenth of milli-henry to hundred henries and frequencies from 30 cycles to 300,000 cycles.

The inductors can be used either as secondary laboratory standards or as high Q components in wave filters, equalizers and tuned circuits for audio and radio frequencies. Individual inductors are wound on temperature stabilized molybdenum permalloy toroidal core. Four coils (nominal values 1, 2, 3, 4) are combined in an individual decade. A special low loss ceramic switch combines the coils in such a way as to give the eleven successive values from 0 to 10.

Special silver alloy contacts insures very low contact resistance.

#### OUTSTANDING FEATURES

Very high Q at frequencies up to 300,000 cycles.

High natural frequency.

Astatic to external magnetic fields.

Very low temperature coefficient.

Electrostatic and magnetic shielding.

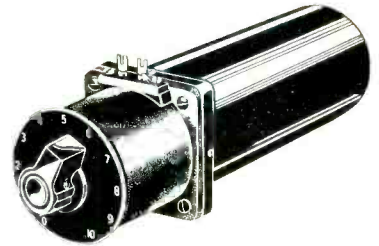

1010 COMPARISON BRIDGE  
RAPID TV PARTS TEST



NO. 1030 LOW  
FREQUENCY "Q" INDICATOR



NO. 1210 NULL  
DETECTOR & VACUUM  
TUBE VOLTMETER

FREQUENCY RANGE 30 TO 2000 CYCLES Q = 50 @ 200 CYCLES		
#1164	DECADE INDUCTOR 111	Henry total in steps of .1 Henry
FREQUENCY RANGE 100-2000 CYCLES Q = 80 @ 500 CYCLES		
#1341	DECADE INDUCTOR 100	Henry total in steps of 10 Henry
FREQUENCY RANGE 500-20,000 CYCLES Q = 60 @ 1000 CYCLES		
#1160	DECADE INDUCTOR 11.1	Henry total in steps of .01 Henry
#1163	DECADE INDUCTOR 1.11	Henry total in steps of .001 Henry
#1260	DECADE INDUCTOR 11.11	Henry total in steps of .001 Henry
FREQUENCY RANGE 500-20,000 CYCLES Q = 160 @ 1000 CYCLES		
#1220	DECADE INDUCTOR .01	Henry total in steps of .001 Henry
#1230	DECADE INDUCTOR .1	Henry total in steps of .01 Henry
#1240	DECADE INDUCTOR 1	Henry total in steps of .1 Henry
#1260	DECADE INDUCTOR 11.11	Henry total in steps of .001 Henry
#1270	DECADE INDUCTOR 10	Henry total in steps of 1 Henry
#1280	DECADE INDUCTOR 1.11	Henry total in steps of .001 Henry
#1290	DECADE INDUCTOR 11.11	Henry total in steps of .001 Henry
#1310	DECADE INDUCTOR 11.1	Henry total in steps of .01 Henry
FREQUENCY RANGE 2000-50,000 CYCLES Q = 200 @ 10,000 CYCLES		
#1161	DECADE INDUCTOR 1.11	Henry total in steps of .001 Henry
FREQUENCY RANGE 10,000-300,000 CYCLES Q = 200 @ 100,000 CYCLES		
#1162	DECADE INDUCTOR .111	Henry total in steps of .1 millihenry
*#1164 DECADE INDUCTOR is wound on a special nickel alloy core.		

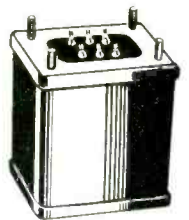

HI FIDELITY  
1/2 DB 20-30000 CYCLES



HERMETICALLY SEALED  
TO MEET MIL-T-27 SPECS.



SUB MINIATURE  
HERMETICALLY SEALED  
TRANSFORMERS

SEND FOR LATEST CATALOG!

# FREED TRANSFORMER CO., INC.

DEPT. F.E. 1718-36 WEIRFIELD ST., (RIDGWOOD) BROOKLYN 27, NEW YORK

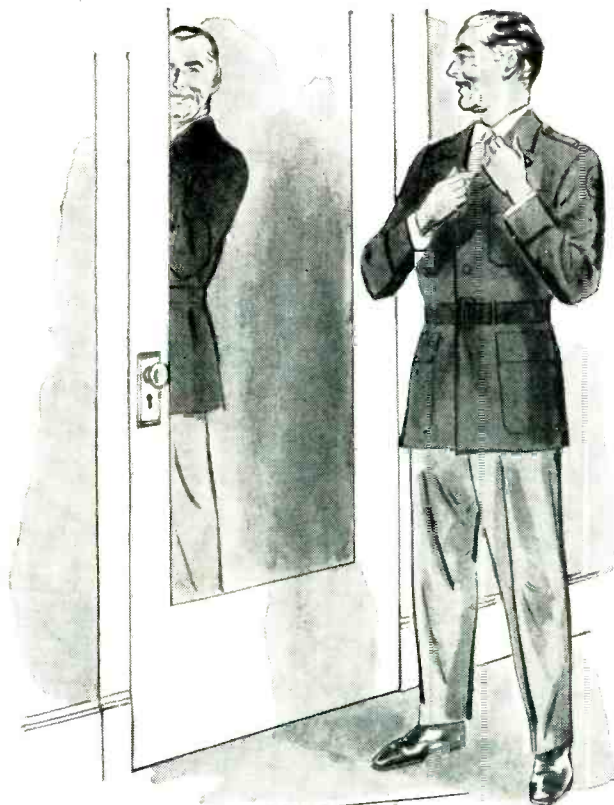

**WE'RE GETTING BACK  
INTO UNIFORM AGAIN!**

**Corry-Jamestown is ready to  
supply you with precision-made  
sheet metal CABINETS, CHASSIS,  
HOUSINGS and SHELF ASSEMBLIES**

**D**O you need a dependable supply of sheet metal housings, cabinets, panels, or shelf assemblies? Corry-Jamestown has once again geared its manufacturing facilities to make products for the electronics industry. We're ready with the latest, time-saving, metal fabricating equipment . . . skilled craftsmen . . . a staff of highly specialized engineers . . . and the production know-how developed from thirty years experience fabricating steel, stainless steel, and aluminum. You can depend on Corry-Jamestown for accuracy—for apertures that register perfectly—whether you order a hundred, or thousands of pieces. You can count on Corry-Jamestown for precision and a high regard for quality. Call, write or wire your needs today!

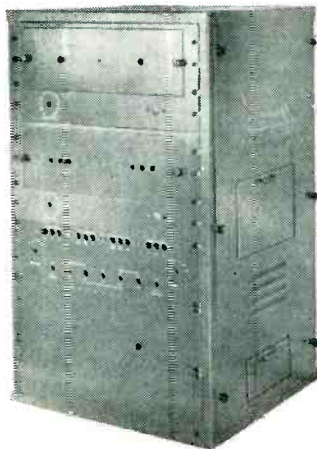

**CORRY-JAMESTOWN MFG. CORP.**

CORRY, PENNSYLVANIA

*Makers of famous Steel Age office furniture*

output of a 100-kilocycle oscillator. Three pulse outputs at 25 pulses per second are provided—a reference pulse of constant phase, and two pulses whose phases may be adjusted independently to any part of the 40-millisecond period in 0.1-millisecond steps. A marker scale output provides selectable markers at 0.1, 1, 10, and 40-millisecond intervals, and a 50-cycle counter and amplifier are included to power a 50-cycle clock.

Figure 1 is a front panel view of the instrument. The three coaxial connectors at the upper right furnish the reference pulse and the two variable-phase outputs. Two vertical sets of three decade dials in the panel center are used to set the delay from the reference pulse in steps of 10, 1, and 0.1 milliseconds. The coaxial connectors along the left edge furnish marker scale and auxiliary synchronizing outputs, and markers are selected by means of the adjacent toggle switches.

#### *Synthesis Principle*

Consider a voltage  $e_1$  of rectangular waveform having a frequency  $f_1$  and duty cycle  $1/N_1$  (see Fig. 2). Voltage  $e_2$  has a frequency  $f_2$  (greater than  $f_1$ ) and duty cycle  $1/N_2$ . Now suppose that  $e_2$  is passed through an amplifier that is gated on by  $e_1$ . Then in order that one, and only one, pedestal of  $e_2$  shall appear in the amplifier output per cycle of  $e_1$ , it is necessary that the period

$$\frac{1}{f_2} = \frac{1}{N_1 f_1}$$

and therefore

$$f_2 = N_1 f_1 \quad (1)$$

But if the pedestal is to appear at the same point in each successive gate,  $N_1$  must be an integer. Thus  $f_2$  is a harmonic of  $f_1$ . (Over a cer-

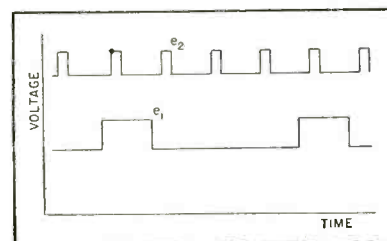

FIG. 2—Basic waveforms illustrate synthesis principle



# This may be the solution to your D. C. AMPLIFICATION problems

## MICROSEN

### D. C. AMPLIFIER

Simple in operation, the Microsen D. C. Amplifier is designed to meet the need for stable and accurate amplification. It is compact to provide easy portability and convenient general use, is moderate in cost. The amplifier has many applications in both laboratory and field work. Three different ranges are furnished in a single model. The Microsen Balance, an electro mechanical feedback amplifier, combines the advantages of high torque to current input ratio with rugged, shock-resistant construction. Available models include Voltage, Current and Potentiometer Type Amplifiers, Direct Current Converters, Direct Current Transformers, and Engineered Designs to meet special requirements.



#### TYPICAL APPLICATIONS OF THE MICROSEN D. C. AMPLIFIER

Field of Measurement	Input Element	Output Instrument	Application	Design Advantages
Thermometry	Thermocouple	Recorder	Combustion Research Gas Turbine Development Thermocouple Inspection Meteorology Distillation Processes	High Speed Response Accuracy Sensitivity Stability
Photometry	Photo Cell	Recorder	Polarimetry Physiology of Blood Fluid Flow & Turbulence Density	Stability Sensitivity Responsive Accuracy
Gas Analysis	Catalytic Filament Thermocouple	Recorder	Detecting Explosive Mixture Efficiency of Filters Mixture Control	Sensitivity Stability Accuracy High Speed Response
Electrical Bridges	Resistors Resistance Elements	Recorder	Resistor Inspection Moisture Detection Conductivity Measurements	Sensitivity Stability Accuracy Fast Response
	Pirani Gauge		Vacuum Gauging	Stability
	Strain Gauge		Transient Stresses	Accuracy
Electronics	Inductance Ionization Thermionic	Recorder	Wave Guide Studies Vacuum Gauging Tube Development	Sensitivity Stability Low Resistance Input
Electrolysis	Electrolytic Cells Current Shunt	Recorder	Production Control Electrolytic Plating Electrolytic Process	Isolated Input Stability Accuracy

In each of the above applications, the Recorder could be replaced with a suitable millimeter indicator, or the output can be used to actuate automatic control relays or signal devices. Inquiries for modification within the useful scope of the Microsen D. C. Amplifier are invited. If possible, such inquiries should contain complete application specifications.



# MICROSEN



## ELECTRICAL INSTRUMENTS

A PRODUCT OF

**MANNING, MAXWELL & MOORE, INC.**  
STRATFORD, CONNECTICUT

Makers of 'Microsen' Electrical and 'American' Industrial Instruments, 'Hancock' Valves, 'Ashcroft' Gauges, 'Consolidated' Safety and Relief Valves. Builders of 'Shaw-Box' Cranes, 'Budgit' and 'Load Lifter' Hoists and other lifting specialties.

Manning, Maxwell & Moore, Inc.  
250 East Main Street  
Stratford, Conn.

We are interested in your Microsen D. C. Amplifier. Please send the bulletin describing the instrument to the following address:

Name \_\_\_\_\_  
Position \_\_\_\_\_  
Company \_\_\_\_\_  
Street Address \_\_\_\_\_  
City \_\_\_\_\_ State \_\_\_\_\_

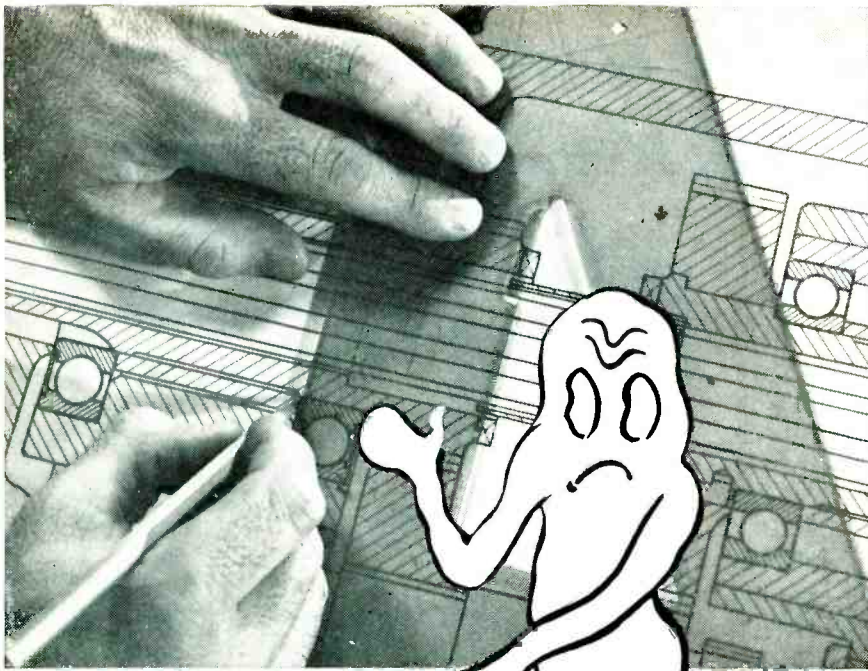

# Ever been haunted by an "ERASURE GHOST"?

The beauty of Arkwright Tracing Cloth is its permanent translucency — built all the way through the cloth by a special process. Arkwright will take the heaviest erasures without "ghosting". You can count on clear, clean prints from drawings on Arkwright cloth years after you make them.

You can re-ink over erasures on Arkwright Tracing Cloth without feathering or "blobbing". You can be sure there are no pinholes, thick threads or other imperfections in the cloth to bother you. Every roll is carefully inspected before leaving the factory.

Think a moment. Isn't it an unnecessary risk to put your important drawings on inferior tracing cloth or paper? A sample will show you the difference. Write Arkwright Finishing Company, Providence, R. I.



# ARKWRIGHT

*Tracing Cloths*

AMERICA'S STANDARD FOR OVER 25 YEARS

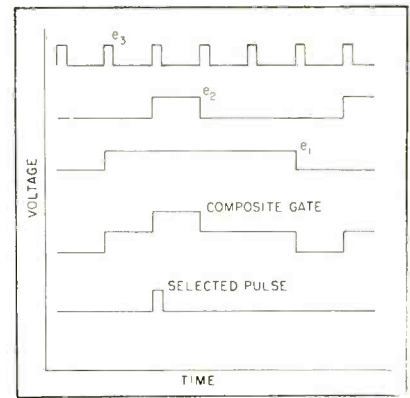

FIG. 3—Coincident leading edges for  $e_3$  and  $e_2$  prevent pulse splitting

tain range of positions the pedestal appearing within the gate may be split, a part of one pedestal appearing at the end of the gate and the corresponding remainder of the previous pedestal appearing at the beginning.)

This argument can be extended to a series of any number of harmonic rectangular waveforms; for, if a harmonic voltage  $e_n$  is gated by the peak voltage of a sum of  $e_1$  and harmonic voltages  $e_k$  such that

$$f_k + 1 = N_k f_1 \quad (2)$$

$k = 1, 2, \dots, (n-1)$

then one, and only one, pedestal of  $e_n$  will appear per cycle of  $e_1$ . This result is illustrated in Fig. 3.

A consequence of Eq. 2 is that

$$F_n / f_1 = N_{n-1} \dots N_2 N_1 \quad (3)$$

If the phases of the fundamental and harmonic voltages comprising the gate are independently adjustable, then  $f_n / f_1$  is the number of possible positions of the  $e_n$  pedestal within the  $e_1$  period. If, as in Fig. 3, the phase adjustments are so constrained that each low-frequency pedestal has a leading edge coincident with a leading edge of  $e_n$ , it will be impossible for a split  $e_n$  pedestal to appear; the number of possible positions of the pedestal remains the same.

### The Circuit

In the CRPL generator,  $n = 4$ ,  $f_1 = 25$  cps,  $N_1 = 4$ ,  $N_2 = 10$ , and  $N_3 = 10$ . The instrument is essentially a frequency divider consisting of a cascade of ring counters of the type described by Sharpless'. Ring counters divide an in-





# LAMINATES News

News of General Electric Plastics Laminates that can be of importance to your business.

## G-E PLASTICS LAMINATES Give You EXTRA QUALITY AT LOW COST!

The engineering and manufacturing experience gained through many years in both the production and use of plastics laminates by General Electric is your assurance of extra quality at low cost.

For example, General Electric is one of the world's largest producers of naval and industrial control panels for both electrical and electronics applications. Through extensive work with this equipment, G.E. has developed a complete, high-quality line of laminated sheets for a wide variety of industrial and military applications.

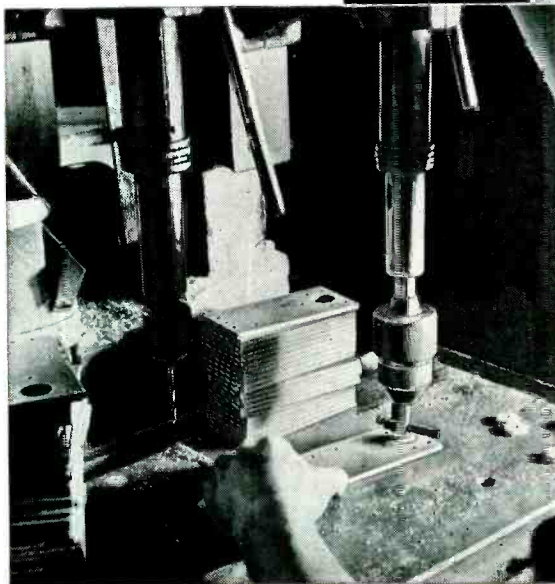
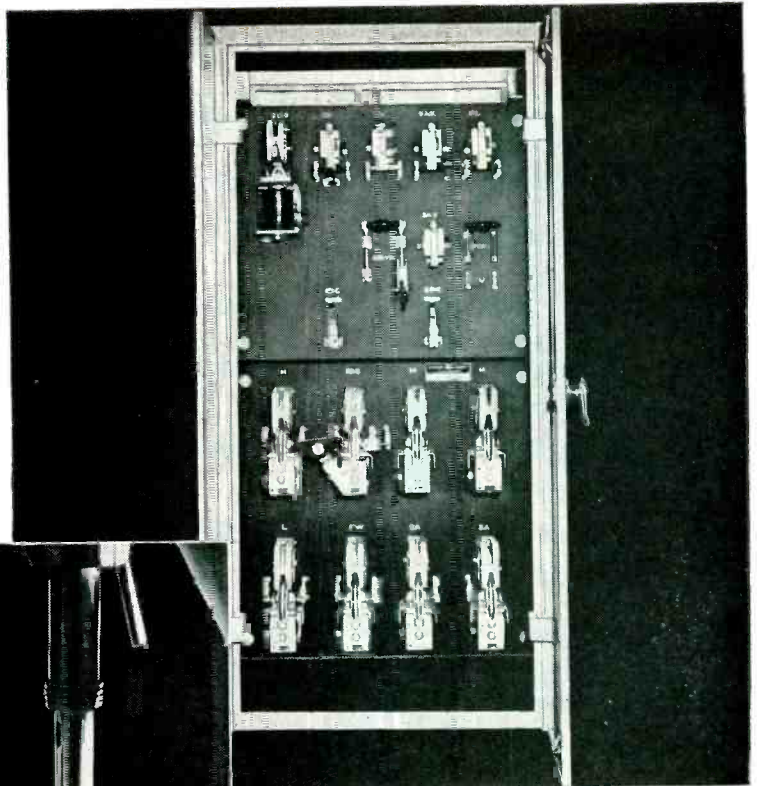

### FAST WORK!

With G-E Laminates, most high-speed machining operations are easily performed on standard wood and metal-working tools. Intricate shapes and fine cross sections can be machined to close tolerances with a minimum of rejects. Work can usually be performed dry, for easier handling of finished pieces.

### COMPLETE LINE OF LAMINATES

General Electric produces a complete line of plastics laminates including sheets, tubes, and rods with cloth, paper, glass fabric, or special bases for a wide variety of applications. For more information about G-E Plastics Laminates write to Section Y-1, Chemical Department, General Electric Company, Pittsfield, Mass.

Also look to General Electric for silicone insulation, insulating varnishes, sealing and filling compounds, mica insulation, varnished cloth and tape.

### DEPENDABILITY THROUGH EXPERIENCE

Sheets . . . . . Tubes . . . . . Rods . . . . . Insulating Materials

You can put your confidence in

# GENERAL ELECTRIC





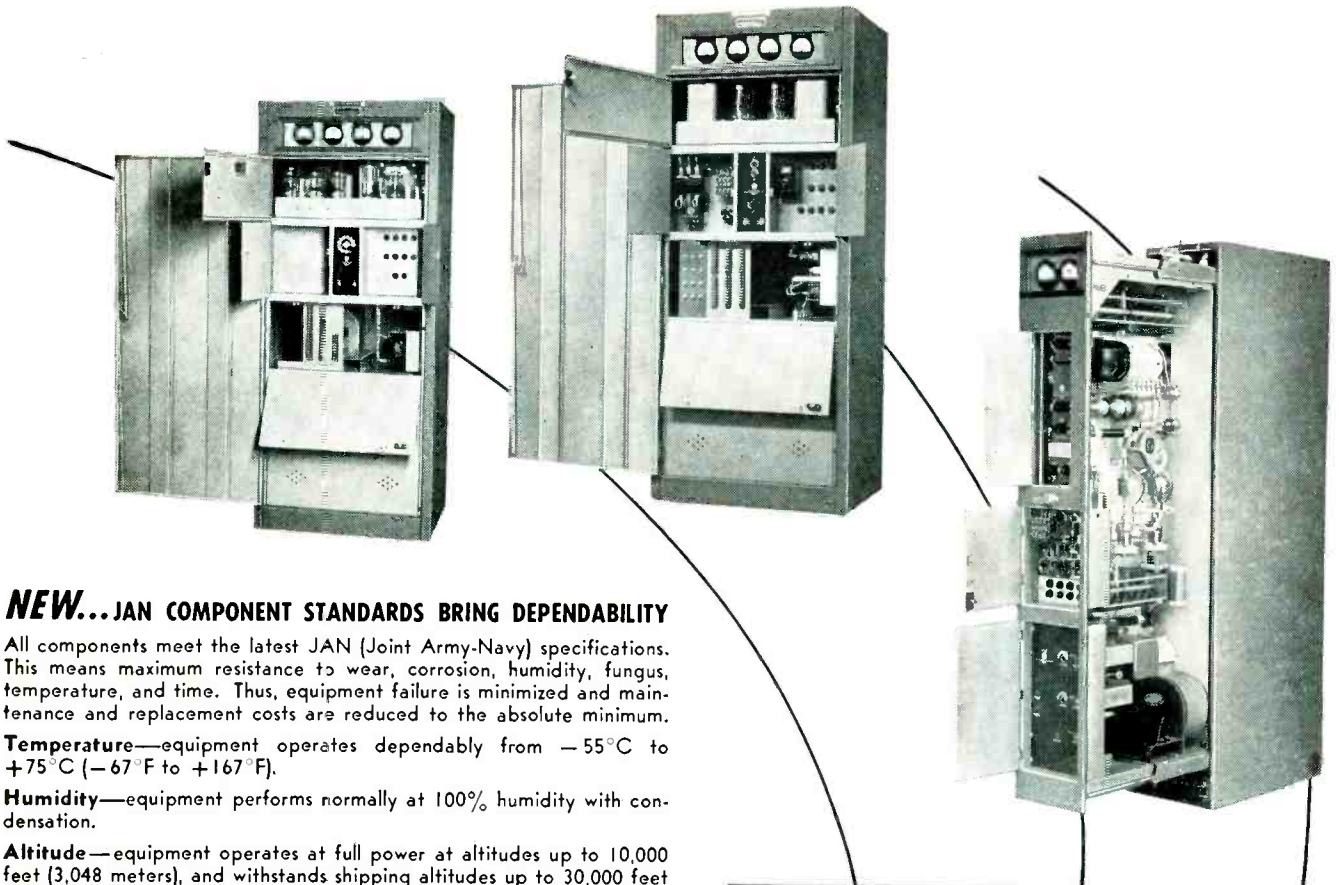

**NEW...JAN COMPONENT STANDARDS BRING DEPENDABILITY**

All components meet the latest JAN (Joint Army-Navy) specifications. This means maximum resistance to wear, corrosion, humidity, fungus, temperature, and time. Thus, equipment failure is minimized and maintenance and replacement costs are reduced to the absolute minimum.

**Temperature**—equipment operates dependably from  $-55^{\circ}\text{C}$  to  $+75^{\circ}\text{C}$  ( $-67^{\circ}\text{F}$  to  $+167^{\circ}\text{F}$ ).

**Humidity**—equipment performs normally at 100% humidity with condensation.

**Altitude**—equipment operates at full power at altitudes up to 10,000 feet (3,048 meters), and withstands shipping altitudes up to 30,000 feet (9,144 meters).

**NEW...UNIT CONSTRUCTION PROVIDES OPERATING FLEXIBILITY**

A flexible, multifrequency station can be formed from a combination of 96D and 96-200C Transmitters, one or two 50H Modulators and a 36D Rectifier. This provides for either simultaneous transmission on several frequencies or the selection of an individual frequency best suited to your particular communication problem.

**NEW...FRONT CONTROLS PROVIDE ADJUSTMENT CONVENIENCE**

All controls are located on the front of the transmitter; all R. F. stages and antenna tuning, under and overload and tone-keying adjustments, selection switch for external frequency shift excitation, rotary meter switch, exciter output control.

**NEW...DRAWER-TYPE CONSTRUCTION Means Easy Maintenance**

Ball bearing, drawer-type construction permits the transmitter to be quickly withdrawn from cabinet. All components are instantly accessible . . . no components are hidden or buried.

**WILCOX ANNOUNCES A**  
***COMPLETELY NEW***  
**96 Series**  
**Transmitting Station**  
**2-18 mc/s                      2500 Watts**

**Write Today**

for complete information and specifications.

**WILCOX**  
**ELECTRIC COMPANY**  
**KANSAS CITY 1, MISSOURI • U. S. A.**

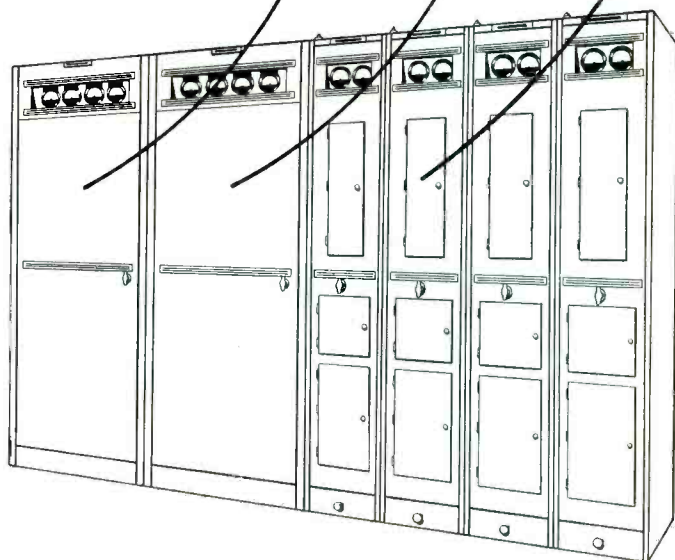

ACTUAL SIZE



**ALTEC  
21B**

★ The only microphone ever selected to receive the "Electrical Manufacturing" award for "outstanding achievement in product design, engineering and development"...the Altec 21B again proves that it deserves the title of "the world's finest microphone."

★ Setting a new standard in microphone performance in every field ...broadcast, recording, motion picture, television and public address.

★ If you still haven't heard this amazing condenser microphone call your Altec dealer for a demonstration and the 21B will prove that it is "the world's finest microphone." Immediate deliveries on all models: stand, chestplate and lapel.

*...the  
world's  
finest  
microphone*

**ALTEC**  
LANSING CORPORATION

9356 Santa Monica Blvd., Beverly Hills, Calif.

161 Sixth Avenue, New York 13, New York

cause faulty operation of the rings.

The reference pulse is the output, suitably differentiated and amplified, of the count-of-four. The marker scale is generated by combining the differentiated outputs of the rings in a mixing stage, markers being added separately to the scale, as desired, by means of the front panel toggle switches. The pulse output of each ring is available at a separate connector for auxiliary synchronizing service.

#### Uses

In radio propagation experiments, a high-frequency pulse transmitter is keyed with the reference pulse output of the generator. The variable-phase outputs are then used to trigger auxiliary circuits, such as an oscilloscope sweep generator, at predetermined delays. Large, stable delays are obtained easily in this manner. The marker scale output is used to place range or transmission-delay markers on a monitor oscilloscope. The delay flexibility of the generator should make it useful in other kinds of experimental work.

#### REFERENCES

- (1) B. Chance, "Waveforms", McGraw-Hill, 1949, Chap. 10.
- (2) F. E. Spaulding, Jr. and R. L. Rod, A New Direct-Reading Loran Indicator for Marine Service, *RCA Review*, 10, p 567, December 1949.
- (3) R. R. Freas, Direct-Reading Electronic Timer, *RCA Review*, 10, p 554, December 1949.
- (4) T. K. Sharpless, High-Speed N-Scale Counters, *ELECTRONICS*, 21, p 124, March 1948.

### Aids to CRO Display of Phase Angle

By L. FLEMING

*Falls Church, Virginia*

AUDIO-FREQUENCY NETWORKS are commonly measured in terms of transmission level versus frequency, without particular reference to phase angle. The use of the ordinary elliptical Lissajous figure on a cathode-ray oscilloscope screen suffers from the drawback of poor precision, and difficultly in conveniently determining the phase angle in degrees from measurements made on the elliptical display. Where the amount of work to be done justifies the fairly large cost, a direct-reading phase meter



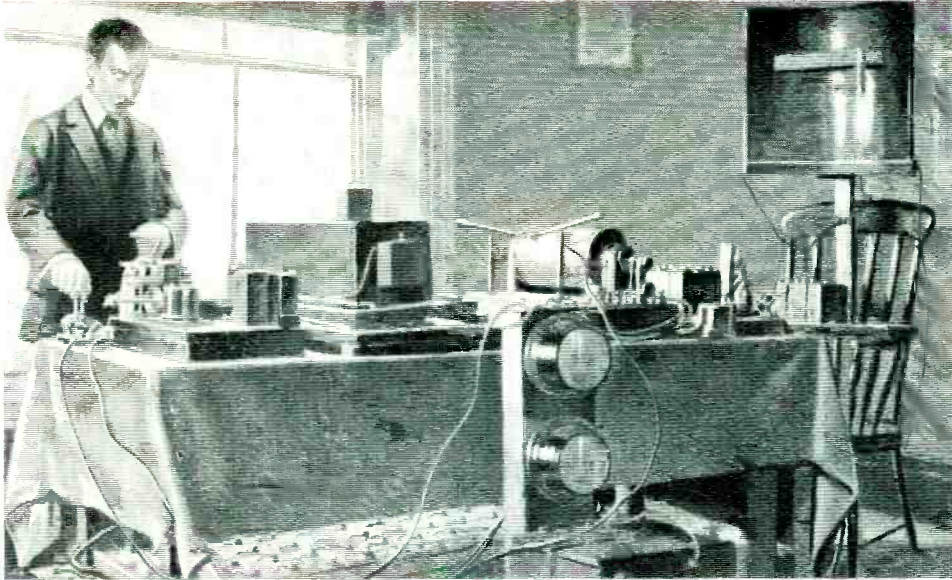

Above: Wireless telegraphy apparatus employed by Guglielmo Marconi in 1899. Right: 150-ft aerial mast at his Boulogne, France, experimental station.

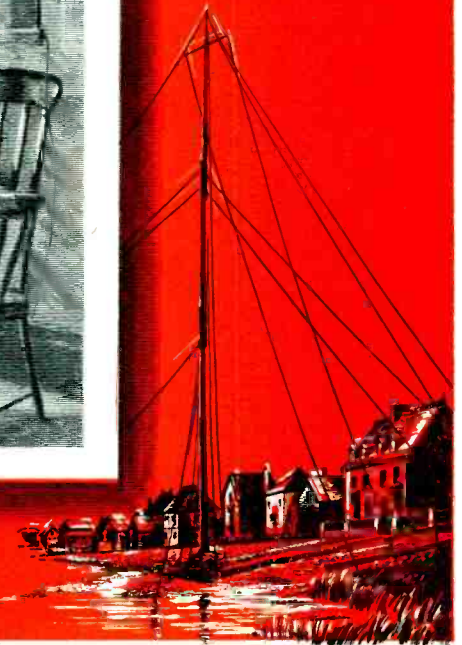

## Rendezvous With MASTERY

**1899**—and a young man, near Boulogne, France, presses the key of a transmitter. Instantly, his message clicks out on a receiver in Dover, England—32 miles distant. The way has been opened to mastery of instantaneous, world-wide communication.

**1899**—and a Board of Directors of an infant firm, convening for its initial meeting in Newark, N. J., hears the Treasurer state that \$1,400 is at the disposal of Driver-Harris Company with which to commence business. The way has been opened to mastery of new facts and techniques which will provide industry with quality metal products never before available.

"Wireless" has been developed with phenomenal speed since the day Marconi's message was successfully transmitted from Boulogne. Within fifty years—as radio, television, and radar—it has been made to circle and serve the world.

And Driver-Harris, expanding within the same fifty years until represented on all five continents, has produced many of the alloys required. For example: Gridnic\* for electron tube grid wire, alloys for radio cathode sleeves and glass seal metals, Karma\* and D-H Manganin for resistors, and universally famous Nichrome\* and Nichrome V for resistors, plates and other components.

Today, Driver-Harris' specialized knowledge and extensive facilities are employed in supplying superior alloys for a host of applications in numerous fields. The name "Driver-Harris", indeed, has become so widely accepted as a synonym for quality that the demand for D-H products is engaging the resources of the firm to an unprecedented extent. Driver-Harris can only say it is utilizing all the mastery at its command to meet this exceptional demand as fully as possible.

*Makers of Nichrome and over 80 other alloys for the electrical, electronic, and heat-treating fields.*



### Driver-Harris Company

HARRISON, NEW JERSEY

BRANCHES: Chicago, Detroit, Cleveland, Los Angeles, San Francisco

In Canada: The B. GREENING WIRE COMPANY, LTD., Hamilton, Ontario, Canada

\*T.M. REG. U. S. PAT. OFF.

**HARDWICK,  
HINDLE'S**  
**new**  
**NATIONAL  
RESISTORS**  
Completely Sealed - Completely Satisfactory

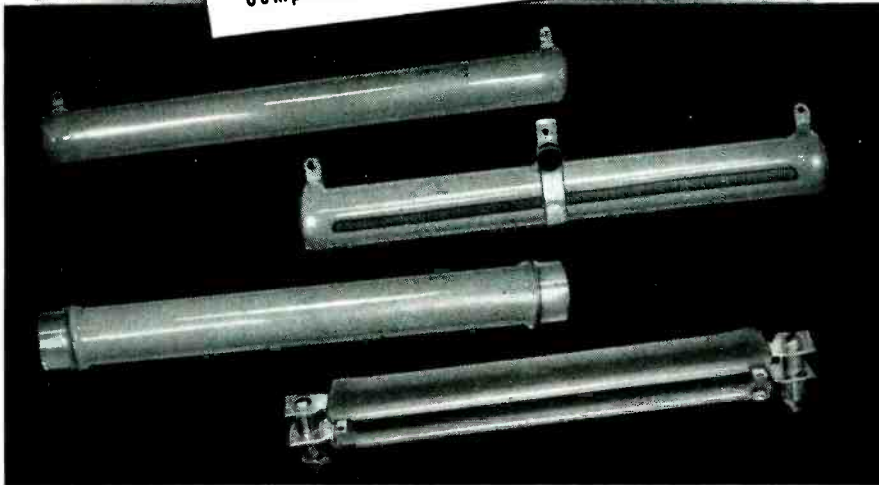

- ✓ the core is stronger, and has higher resistance to vibrations and shock.
  - ✓ the resistance wire—made to H.H. specifications especially adapted to these resistors—is more uniformly wound so that failures under stress are eliminated.
  - ✓ the special alloy terminals are more securely fastened to the ceramic body by spot-welding—highly resistant to corrosion.
  - ✓ all wire connections are protected by a positive, non-corrosive bonding.
- and...**
- ✓ new—blue-gray enamel coating—crazeless, thermo-shockproof gives greater protection throughout the most rugged service—longer life under extremes of humidity, salt water and severest atmospheric conditions. And by withstanding higher heat these resistors afford a greater safety factor.
  - ✓ The fixed, the ferrule and the flat types are especially designed for and manufactured in accordance with JAN-R-26A specifications.

SEND FOR NEW RESISTOR BULLETIN TODAY

**HARDWICK, HINDLE, INC.**  
RHEOSTATS and RESISTORS  
Subsidiary of  
**THE NATIONAL LOCK WASHER COMPANY**  
Established 1886  
40 HERMON STREET NEWARK 5, N. J., U. S. A.

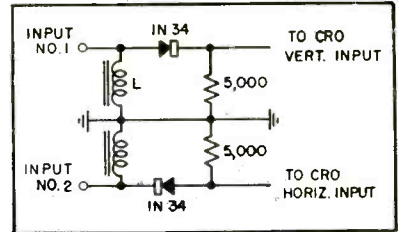

FIG. 1—Half-wave rectifier circuit for displaying phase angle between two sine waves as shown in Fig. 2

or a Z-angle meter is ideal<sup>1,2,8</sup>. Sulzer has described an instrument<sup>9</sup> for use in conjunction with a cro to give vectorial display of voltages in the form of radial lines. Wide-band phase splitters<sup>4,5</sup> are employed to derive a circular sweep from one signal, and Z-axis modulation of the cro is obtained from both.

These devices are all somewhat complex. Where only occasional measurements are made, one may look for a simpler instrument. Such simple devices can be built in at least two ways, without using any tubes. The principle involves half-wave clipping of one or both signals, or sharpening into pips.

*Half-Wave Clipping*

A simple arrangement of considerable utility is shown in Fig. 1. The positive half of one sine wave is clipped off, and the negative half of the other, by means of two identical circuits. One output is fed to the horizontal input of a cro, and the other to the vertical input. The two voltages appear alternately. The resulting display is an L-shaped figure when the two voltages are in phase, as shown in Fig. 2. When the phase angle is between 0 and 90 degrees, the display takes

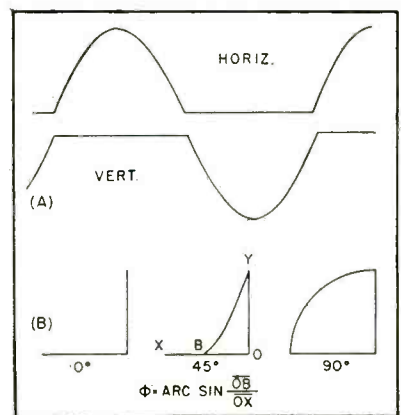
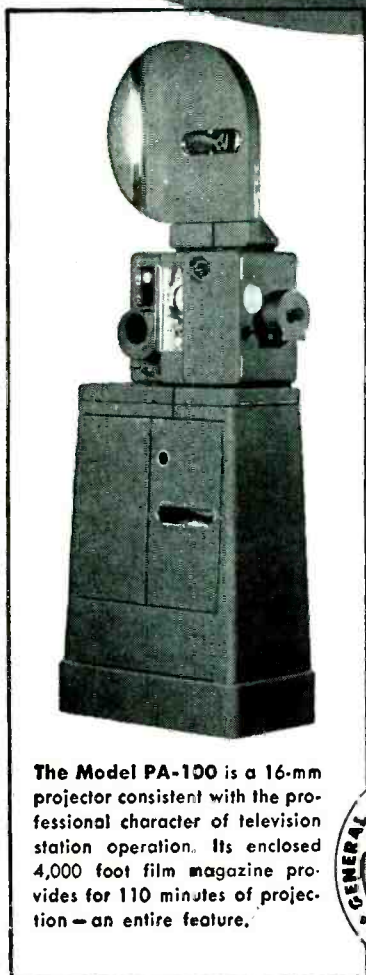
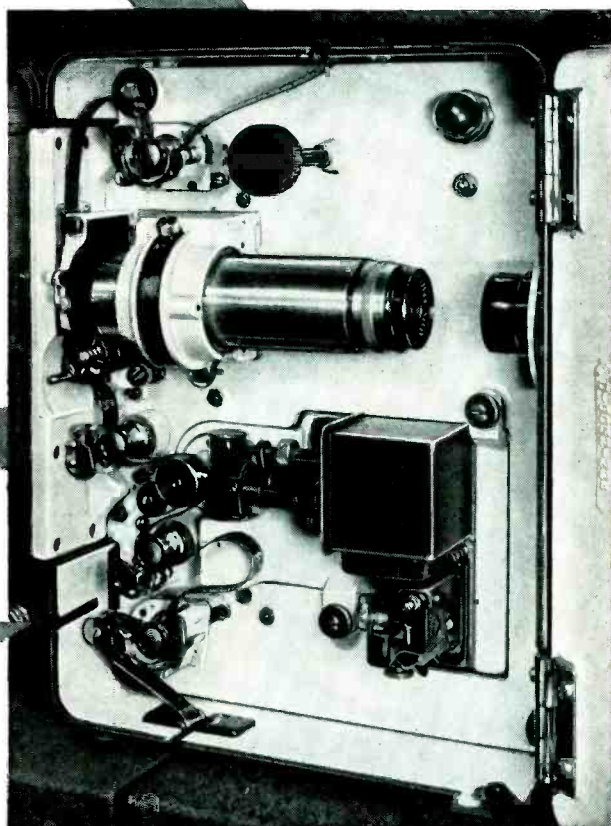

FIG. 2—Oscilloscope voltages and resulting display for circuit shown in Fig. 1



*Look into this*  
**PROFESSIONAL**  
**Telecast Projector**  
*and see years of*  
*Dependable Service*

The GPL Model PA-100 — a 16-mm Studio Projector with the basic features and performance reliability of the famous Simplex 35-mm Theatre Projectors.



The Model PA-100 is a 16-mm projector consistent with the professional character of television station operation. Its enclosed 4,000 foot film magazine provides for 110 minutes of projection — an entire feature.

**Sharper Pictures . . . Finer Sound**  
**From Any Film in Your Studio**

The importance of 16-mm film in television programming has called for new standards of projection quality and dependability. The GPL Model PA-100 is the first projector designed and built specifically for television studio use. It is a heavy-duty film chain projector for operation with any full-storage type film pick-up.

The professional, sprocket-type intermittent, similar to that used in the finest 35-mm equipment, is quiet and trouble-free. It provides a vertical stability of better than 0.2% over years of service. Film is protected — tests show more than 4,000

passages without noticeable film wear.

The high quality optical system resolves better than 90 lines per mm, with illumination so uniform that corner brightness is at least 90% of center. With a 1,000 watt light source, the projector delivers 100 foot-candles to the camera tube. The sound system provides a frequency response truly flat to 7,000 cps, with flutter less than 0.2%.

The Model PA-100 is one of a complete line of GPL 16-mm television studio and theatre projectors built to highest 35-mm standards.

**WRITE, WIRE OR PHONE FOR DETAILS**



**General Precision Laboratory**

INCORPORATED

PLEASANTVILLE NEW YORK

TV Camera Chains • TV Film Chains • TV Field and Studio Equipment • Theatre TV Equipment

# BENDIX-PACIFIC TELEMETERING EQUIPMENT PROVIDES COMPLETE INSTRUMENTATION

Bendix-Pacific standard telemetering components can be combined into a compact, highly efficient assembly to meet *exactly* your specified requirements. This extreme flexibility has been accomplished through the use of the building-block principle which permits the purchaser to assemble readily an instrumentation system exactly suited to his specific needs—thus effecting the utmost economy in volume, weight and cost.

In addition to its standard components Bendix-Pacific provides application engineering and custom system design, fabrication and test of complete systems, installation and field test and data reduction. Complete receiving station facilities can also be supplied.

Inquiries are invited.

Bendix-Pacific has recently developed new band pass and low pass filters for telemetering receiving stations. The band pass filters are characterized by high attenuation outside the pass-band by low insertion loss and by extremely flat frequency response and constant phase-shift within the pass band.

The low pass filters are designed to improve the quality of telemetering recordings through the reduction of inter-modulation noise and by providing ideal electrical dampening at the input of the recording galvanometer.



TO MEASURE...TO INDICATE...TO WARN AT A DISTANCE

EASTERN ENGINEERING OFFICE: 475 FIFTH AVE., NEW YORK 17, N.Y.

the form of a shelf-bracket, due to the difference between trace and retrace paths of the beam. In this range between 0 and 90 degrees, the lengths of the two legs of the L measure the relative amplitudes of the respective input voltages. The phase angle is measured by the location of the intercept of the fillet along the horizontal leg of the L. As indicated in Fig. 2, the sine of the phase angle is equal to the intercept distance  $OB$  divided by the length of the base line  $OX$ .

This display is ambiguous about 0 degrees, that is, it will not distinguish between lead and lag. Above 90 degrees the legs of the L shorten, and the figure is not readily interpreted. Its value is in the measurement of small angles, less than about 60 degrees, and its accuracy is greater for the smaller angles.

In order for clipping to occur accurately at the zero line, the d-c resistance on the source side of the rectifiers must be low compared to the load resistance. Inductances  $L$  (Fig. 1) are shown for this purpose. For work between about 50 and 10,000 cps these inductances may be ordinary radio replacement type filter chokes, of 15 henrys or so.

### Sharpening Into Pips

Another useful accessory in indicating phase is a differentiating network that sharpens one of the two signals into pips. The pip breaks at the positive-going zero-axis crossing of the voltage wave in the circuit illustrated, Fig. 3. This circuit is intended to operate out of a source such as an audio oscillator, supplying 10 volts or more with a source impedance of a few hundred ohms or less. The first crystal rectifier clips off the negative halves of the wave. Following the crystal load resistor are two R-C differentiators  $C_1R_1$  and  $C_2R_2$ , each with a back-connected shunt

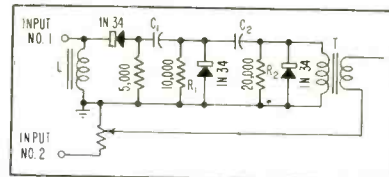
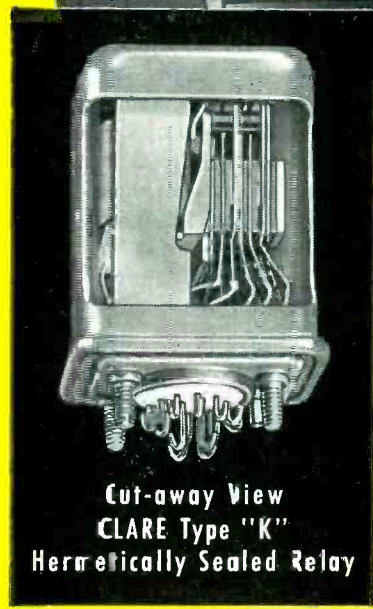
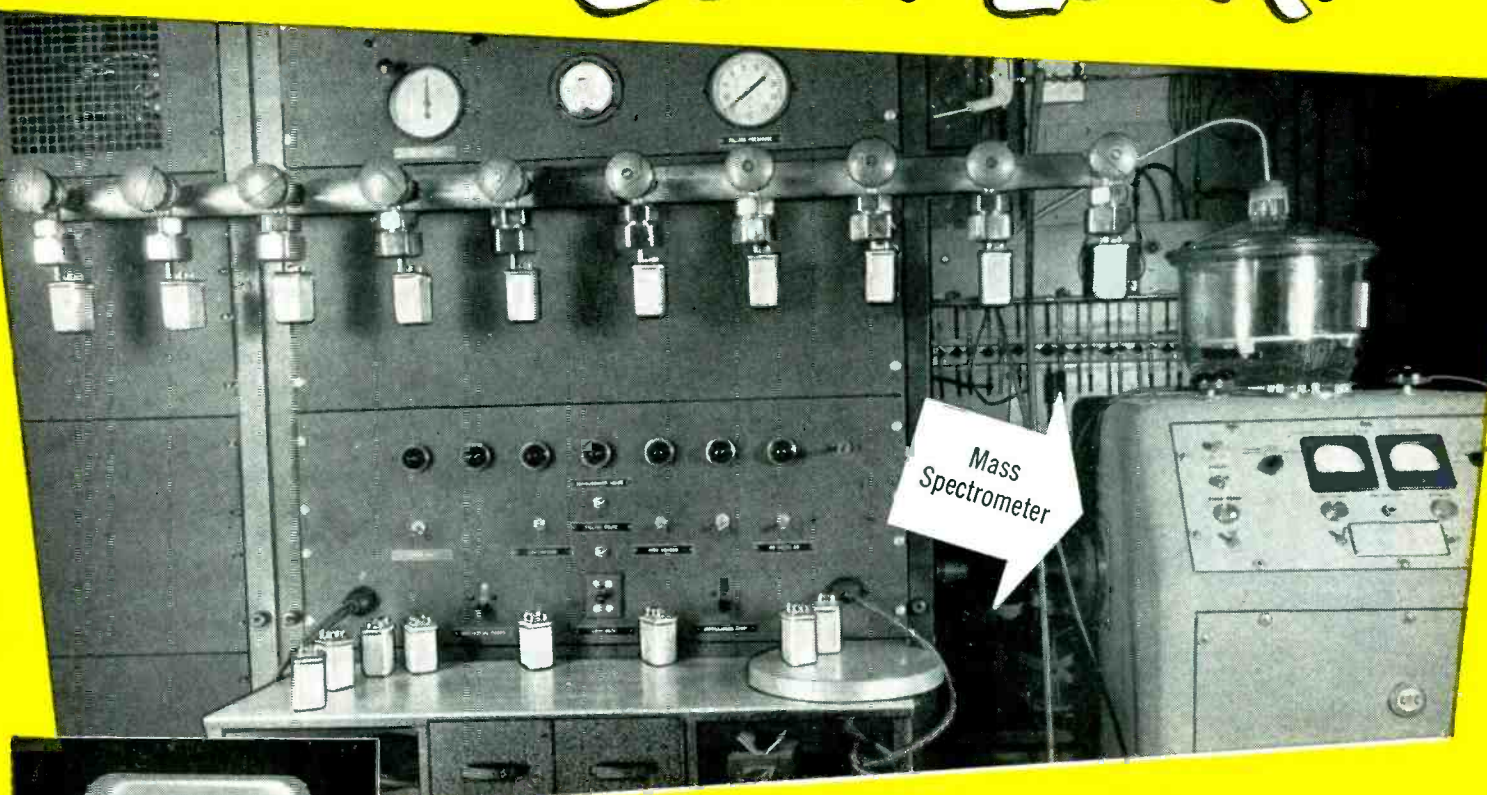

FIG. 3—Tubeless circuit for converting sine waves into pips for crt indication of phase angle between two signals



# THIS IS THE REASON CLARE SEALED RELAYS

## *Can't Leak!*



● Pictured here are ten CLARE Sealed Relays from which every trace of moisture and gas is being removed by a high vacuum pump.

After the first pumping, the enclosures are flushed with dry nitrogen and again pumped down to a few microns pressure. While under this extreme vacuum, enclosures and seals are tested for leaks by means of the mass spectrometer (right). This device can detect a leak so small that it would take 31 years for one cubic centimeter of air to pass through it.

Containers are next filled with dry nitrogen to a pressure of at least one atmosphere. When the evacuating tubes are pinched off,

the enclosures are hermetically sealed. More than forty different series of CLARE hermetically sealed relays . . . immune to every type of climatic or environmental conditions . . . are now available to relay users. Innumerable variations of coil and contact specifications are possible.

If your relay requirement calls for the utmost in relay dependability under difficult operating conditions, get in touch with the CLARE sales engineer nearest you or C. P. CLARE & CO., 4719 West Sunnyside Avenue, Chicago 30, Illinois. In Canada: Canadian Line Materials Ltd., Toronto 13. Cable address: CLARELAY.

Write for 36-page Clare Bulletin No. 114

# CLARE RELAYS...○○○

*First in the Industrial Field*



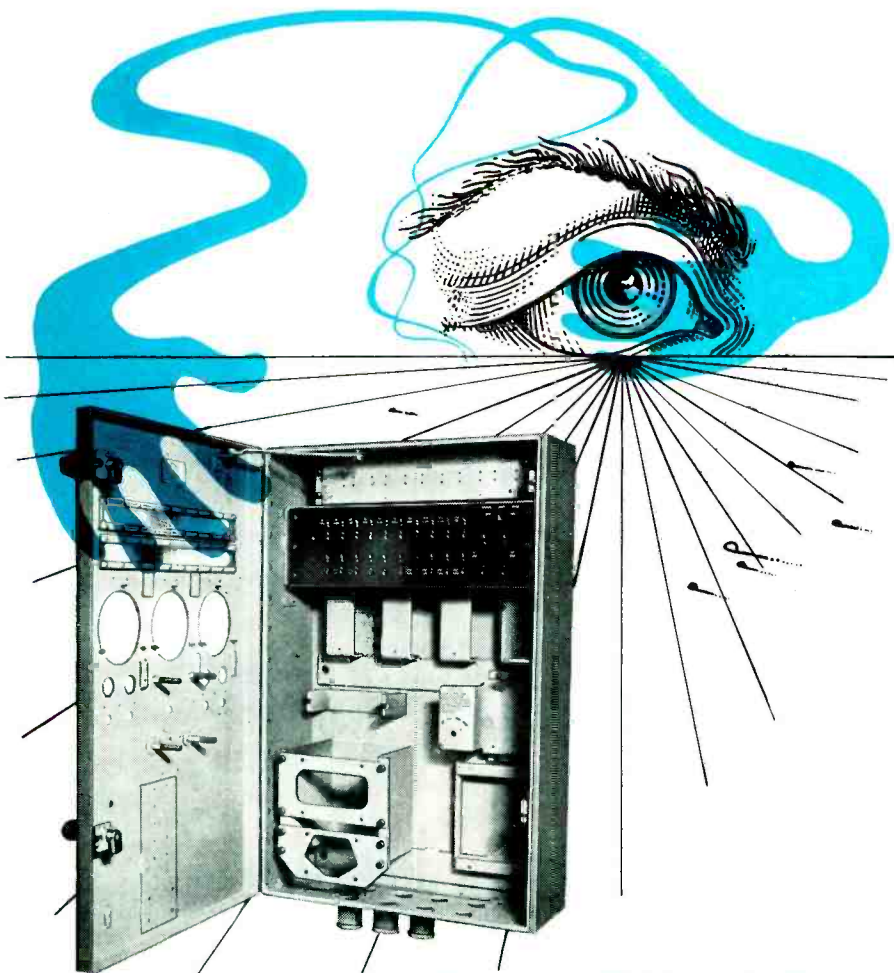

## Don't Reach Blindly!

When converting for defense purposes, don't reach blindly for your sheet metal work supplier. There's no substitute for *know-how*. We're Armed Forces Certified (men and machines) in steel, aluminum, other non-ferrous metals.

Donnelly regularly produces close tolerance parts and enclosures for the top military manufacturers of radar, sonar, bombsight, fire control and jet engine equipment and is *fully geared* to the Nation's mobilization program.

We're ready *today* to discuss your sheet metal requirements. Why take a chance? Take Donnelly!

# Donnelly MANUFACTURING

A DIVISION OF JOHN DONNELLY & SONS  
3134 WASHINGTON ST., BOSTON, MASS.

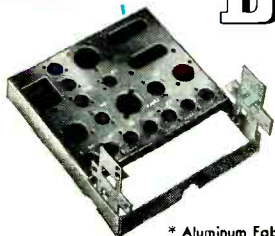

\* Aluminum Fabrication

PRECISION SHEET METAL & PRESSED WOOD FABRICATION

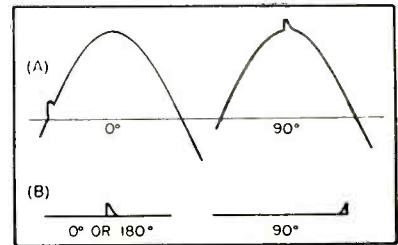

FIG. 4—Typical phase-angle indication using pip method. In A a saw-tooth sweep is used—in B sweep is sinusoidal

rectifier to permit only the positive pips to appear in the output. The transformer  $T$  (a standard 500 to 500 ohm audio unit) is a convenient means for mixing the pips with the other signal.

The pips so derived are mixed or added directly with the other signal and fed to the vertical input of a cro. The display consists of a sine wave with a pip superimposed on each cycle at a location dependent on the phase relation between the two voltages. Figure 4 illustrates the type of figure obtained. Since the pips start at the positive-going zero-axis crossing, the occurrence of pips at this point on the composite wave indicates zero phase angle. This type of display is unambiguous all the way to 360 degrees.

A differentiator of this sort, unfortunately, has a large signal loss. With a 10-volt input, the height of the pips, by the time they have been made suitably short, is only about 50 millivolts. Hence the comparison voltage should be adjusted in level to around 0.5 volt or perhaps less. The upper frequency limit of Fig. 3 is about 3,000 cycles, due to the difficulty in obtaining sharp pips with such a simple tubeless circuit. The time constants of the differentiators are usable over a frequency range of about 2 to 1. For the range 250 to 500 cps the best value for  $C_1$  is 0.002  $\mu\text{f}$ , for  $C_2$ , 0.001  $\mu\text{f}$ . For other frequencies the capacitances should be varied accordingly.

The true zero-axis crossing point is announced by the left-hand or leading edge of the pip. If the pip is a bit long, the crest and the trailing edge should be ignored.

At a gain in simplicity of operation and a loss in clarity, the cro connections may be changed to give the type of display illustrated at



# "YES—48-HOUR SERVICE ON TV TUNERS!"

*Says*  
**AMIL GUMULA**  
 A. G. Radio Parts Co.  
 Philadelphia, Penna.

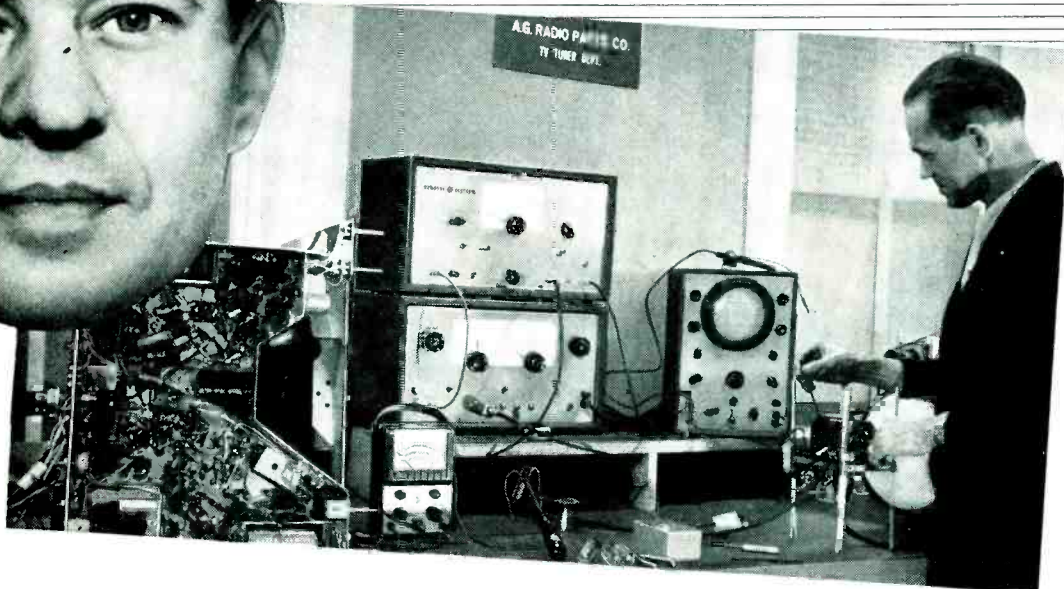

"THANKS to this G-E test equipment, we now give our dealer customers 48-hour service on head end repairs. The TV receiver you see in the picture will be back on a dealer's floor tomorrow, ready for sale. Six months ago it would have been a 'sick baby' tagged for return to the factory, with several weeks' delay."

**Alignments No Problem**—"Fast, accurate alignments are no problem for my G-E scope, sweep and marker. In our shop we now complete ten times the number of alignments we used to do in one working day."

As a distributor, Mr. Gumula offers a unique



service. He repairs TV tuners, and also demonstrates and sells G-E test equipment to dealers and servicemen.

**Expand Your Business**—By the end of 1950 nearly ten million receivers will be in daily use. Are you geared to handle your share of this multi-million dollar service market? Let us show you how General Electric test equipment can expand your business at minimum cost. Call your distributor and ask him about availability and prices of this G-E equipment. Meanwhile, mail the coupon today for complete information.

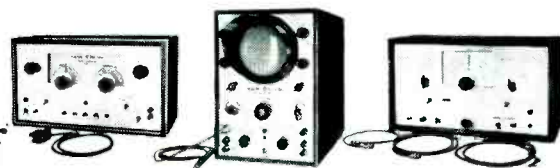

General Electric Company, Section 421  
 Electronics Park, Syracuse, New York  
 Rush me latest bulletins plus price information on  
 General Electric test equipment.

NAME.....  
 ADDRESS.....  
 CITY.....STATE.....

*You can put your confidence in—*

**GENERAL  ELECTRIC**

# CHICAGO

## Transformer Best Sellers

### worth knowing about!

Here are the quick facts on a number of the most popular industry-specified CHICAGO Transformers. Featuring famous Sealed-in-Steel construction, these units offer de-

signers higher product acceptance, long-life dependability, improved performance and desirable appearance. These units are typical of CHICAGO preferred design.

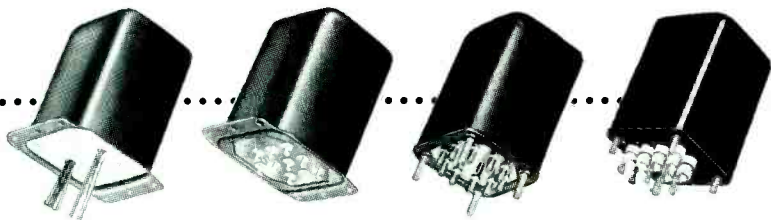

#### PLATE AND FILAMENT TRANSFORMERS

Catalog No.	High Voltage A-C Volts	Secondary		Rectifier		Filaments			
		D-C Ma.	D-C V. Output	Volts	Amps	No. 2		No. 3	
PCC-55	270-0-270	55	260	5	2	6.3 CT	2		
PCR-55	350-0-350	55	260	5	2	6.3 CT	2		
PSC-105	345-0-345	105	320	5	2	6.3 CT	3.5		
PCC-105	345-0-345	105	320	5	2	6.3 CT	3.5		
PCC-120	375-0-375	120	380	5	3	6.3 CT	4		
PSR-300	550-370-75-0-75-370-550	300	420	5	6	6.3 CT	5	6.3 CT	1

#### FILAMENT TRANSFORMERS

Catalog No.	Volts	Secondary	Amps	Insulation Volts RMS
F-65	6.3 CT		5.5	2500
F-610	6.3 CT		10.	2500

#### PUBLIC ADDRESS RANGE OUTPUT TRANSFORMERS

Catalog No.	Typical Output Tubes	Class	Impedance Primary-Secondary	Max. D-C in Pri.	Power Level
PCO-150	P-P 6V6's, 6F6's	AB	Pri: 10,000 ohms CT Sec: 600/150/16/8/4 ohms*	200 ma.	15 watts
PCO-200	P-P 6L6's	B	Pri: 6,000 ohms CT Sec: 600/150/16/8/4 ohms*	250 ma.	30 watts

\*Has tertiary winding to provide 10% inverse feedback.

•• THE SEALED-IN-STEEL LINE—CHOICE OF ENGINEERS ••



**WRITE FOR  
COMPLETE CATALOG**

Have the full details at your fingertips on CHICAGO'S *New Equipment Line*—the line that offers transformer engineering geared to *today's* trends in circuit design. Write for your free copy of this important catalog today—or get a copy from your distributor.

**NOW  
QUICK SERVICE  
FROM STOCK  
ON  
JAN-T-27  
Hermetically  
Sealed Units**

# CHICAGO TRANSFORMER

DIVISION OF ESSEX WIRE CORPORATION

3501 ADDISON STREET • CHICAGO 18, ILLINOIS



the bottom of Fig. 4. Here, instead of the internal sweep of the cro being employed, one of the sinusoids is used to provide horizontal deflection. The pips obtained from the other signal are fed to the vertical input. When the phase angle is zero, the leading edge of the pip will appear at the middle of the horizontal line. With lagging or leading angles, the pip will move to the right or left. The loss in clarity lies in the ambiguity of this display about 180 degrees.

An attractive possibility for phase measurement lies in the scheme of sharpening both signals into pips, using one pip to trigger the sawtooth sweep of a cro, and applying the other pip to the vertical cro input. The display would consist of a horizontal line carrying a pip, and the position of the pip along the line would be a direct linear measure of the phase angle. The accuracy would depend entirely on the linearity of the cro sweep and the relative shortness of the retrace time.

#### REFERENCES

- (1) J. Kritz, A Precision Phasemeter for Audio Frequencies, *ELECTRONICS*, p 102, Oct. 1950.
- (2) Florman and Tait, An Electronic Phasemeter, *Proc. IRE*, 37, p 207, Feb. 1949.
- (3) P. G. Sulzer, Vector Voltage Indicator, *ELECTRONICS*, p 107, June 1949.
- (4) D. G. C. Luck, Properties of some Wide-Band Phase-Splitting Networks, *Proc. IRE*, 37, p 147, Feb. 1949.
- (5) R. B. Dome, Wide Band Phase Shift Networks, *ELECTRONICS*, p 112, Dec. 1946.
- (6) Hilary Moss, Cathode Ray Tube Traces, p 66, pub. by Electronic Engineering, 28 Essex St., London, Sept. 1949.
- (7) Samuel Sabaroff, Technique for Distortion Analysis, *ELECTRONICS*, p 114, June 1948.
- (8) E. O. Kretzmer, Measuring Phase at Audio and Ultrasonic Frequencies, *ELECTRONICS*, Oct. 1949.

### Theoretical Limitations to Impedance Matching

By ROBERT L. TANNER  
Stanford University  
Stanford, California

THIS PAPER outlines a procedure whereby the theoretical limitations to impedance matching of simple circuits can be determined. It is shown that many antennas can be represented with adequate accuracy by a simple RLC circuit. Curves are included which show the relation between attainable vswr and a factor equal to (Bandwidth × Q). An example is worked out showing





# CLEVELITE\* and COSMALITE\* PHENOLIC TUBING

MEETS THE MOST EXACTING SPECIFICATIONS!

**A GRADE FOR EVERY NEED:**

*Why Pay More?*

ALSO USED WIDELY  
BY MANUFACTURERS  
OF ELECTRICAL  
EQUIPMENT . . .  
FOR ITS HIGH  
DIELECTRIC STRENGTH  
. . . LOW MOISTURE  
ABSORPTION . . . STRENGTH,  
LOW LOSS AND GOOD  
MACHINEABILITY.

AVAILABLE IN  
DIAMETERS,  
WALL THICKNESSES  
AND LENGTHS TO  
MEET ENDLESS  
SPECIAL OR NEW  
ADAPTATIONS.

INQUIRIES  
ARE GIVEN  
IMMEDIATE  
ATTENTION.

ASK FOR SAMPLES

## CLEVELITE

Grade E . . . . . Improved post cure fabrication and stapling.  
Grade EX . . . . . Special grade for TV deflection yoke sleeve.  
Grade EE . . . . . Improved general purpose.  
Grade EEX . . . . . Superior electrical and moisture absorption properties.  
Grade EEE . . . . . Critical electrical and high voltage applications.  
Grade XAX . . . . . Special grade for government phenolic specifications.

## COSMALITE

Grade SP . . . . . Post cure fabrication and stapling.  
Grade SS . . . . . General purpose.  
Grade SSP . . . . . General purpose—punching grade.  
Grade SLF . . . . . Thin wall tubing—high dielectric and compression strength.

## CLEVELAND PHENOLIC TUBING

THE FIRST CHOICE OF THE RADIO AND TELEVISION INDUSTRIES.  
EXCELLENT SERVICE AND PROMPT DELIVERIES ASSURED.

\* Trade Marks

*The* **CLEVELAND CONTAINER Co.**  
6201 BARBERTON AVE. CLEVELAND 2, OHIO

PLANTS AND SALES OFFICES at Plymouth, Wisc., Chicago, Detroit, Ogdensburg, N.Y., Jamesburg, N.J.  
ABRASIVE DIVISION at Cleveland, Ohio  
CANADIAN PLANT: The Cleveland Container, Canada, Ltd., Prescott, Ontario

### REPRESENTATIVES

NEW YORK AREA	R. T. MURRAY, 614 CENTRAL AVE., EAST ORANGE, N. J.
NEW ENGLAND	R. S. PETTIGREW & CO., 968 FARMINGTON AVE. WEST HARTFORD, CONN.
CANADA	WM. T. BARRON, EIGHTH LINE, RR #1, OAKVILLE, ONTARIO



# A Better Product through "Sound" Research

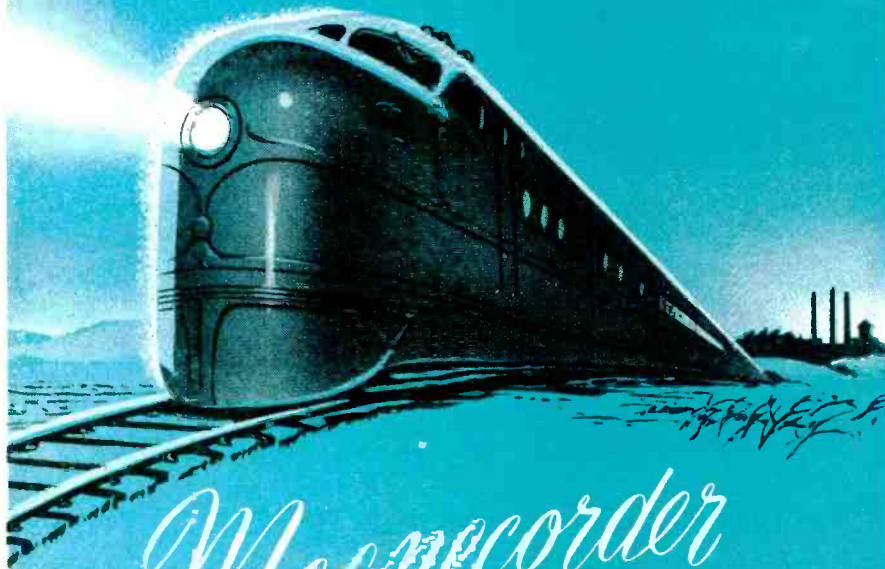

## Magnecorder

High Fidelity Tape Recorders For Industry

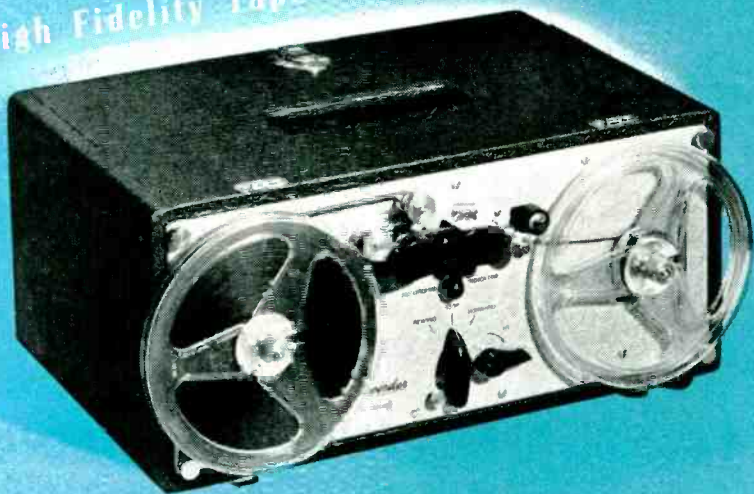

**NOISE ANALYSIS • PROCESS CONTROL  
VIBRATION TESTS • TELEMETERING**

Used by more engineers  
than all other professional  
tape recorders combined

**Magnecord, Inc.**

360 NORTH MICHIGAN AVENUE  
CHICAGO 1, ILLINOIS

### Write for NEW CATALOG

Magnecord, Inc., Dept. EE-2  
360 N. Michigan Ave., Chicago 1, Ill.  
Send me further information on Magnecord  
tape recordings for industrial "Sound" Research.

Name.....

Company.....

Address.....

City..... Zone..... State.....

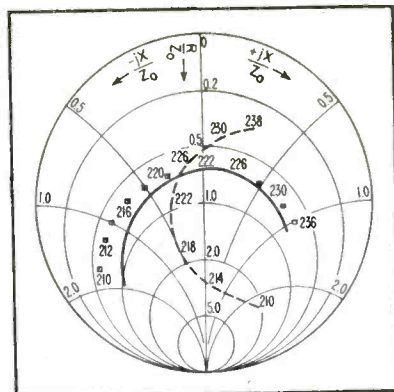

FIG. 1—Smith Chart shows antenna characteristic before (dashed) and after (solid) compensation

the agreement between theory and experiment for a flush antenna with a 10-percent bandwidth.

The dotted line on the Smith Chart (Fig. 1) is the measured impedance curve for an antenna before compensation. Rotation through a section of 50-ohm line, the impedance takes the form of the solid line curve. This latter impedance can be quite accurately represented by the equivalent circuit of Fig. 2A.

When the shunting susceptance of the parallel resonant circuit has been subtracted, the impedance follows the curve defined by the square points. This curve represents the series resonant circuit shown in the figure.

Inspection of the series resonant impedance curve shows the circuit to have a Q of approximately 15. This is determined from the definition for Q,  $Q = f_r/\Delta f$ , where  $\Delta f$  is the frequency band between the half-power frequencies, and  $f_r$  is the resonant frequency. The half-power frequencies are the frequencies at which the series resistance is equal to the series reactance. Inspection of the Smith Chart shows

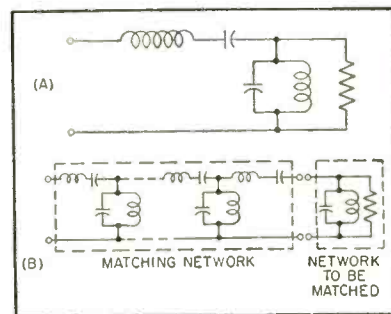
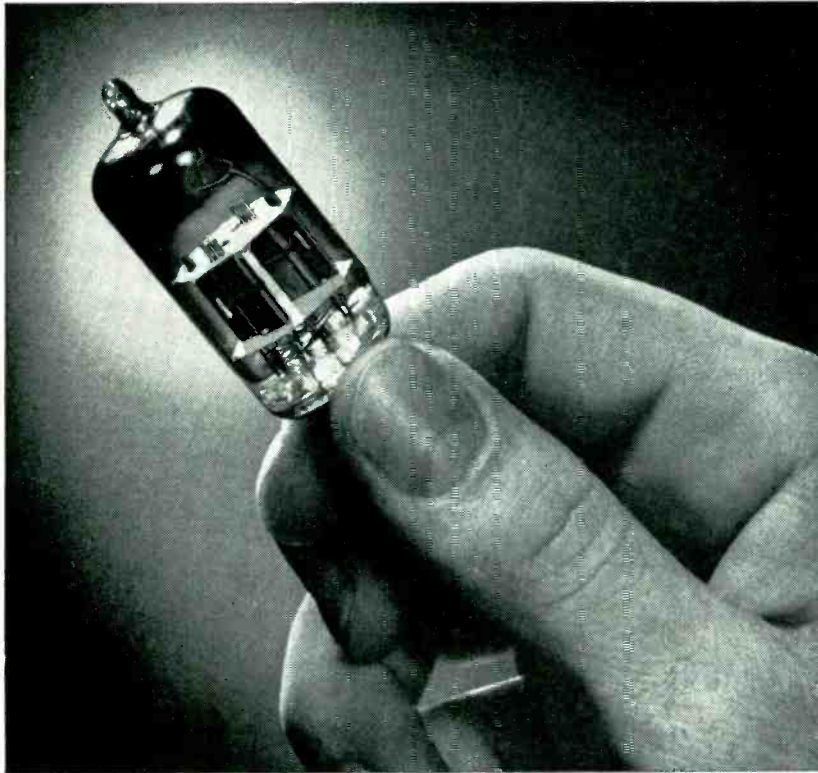

FIG. 2—Equivalent circuit of antenna after rotation through section of line (A) and equivalent circuit (B) of antenna and matching network



# Inside Information on the Inside of a Tube



● The public-at-large does not know, as you do, that within nearly every electronic or television tube are other tubes. Or that these other tubes—of metal—can be as troublesome as they are tiny.

To see that they behave properly, the Electronics Division of Superior maintains excellent tubing research facilities, exercises tight control over production and product, helps you think your way out of problems in design and specification.

Superior was one of the early birds in electronics tubing—is always one of the first to come to your aid when you have tubing trouble... and is definitely a leader in tubing technology.

If you are one of the few electronic tube manufacturers who are not now enjoying all the help Superior can give you, get in touch with us today. Superior Tube Company, 2500 Germantown Avenue, Norristown, Pennsylvania.

## Which Is The Better For Your Product . . .

**SEAMLESS...?** The finest tubes that can be made. Standard production is .010" to .121" O.D. inclusive, with wall thicknesses of .0015" to .005". Cathodes with larger diameters and heavier walls will be produced to customer specification.

**Or LOCKSEAM\* . . . ?** Produced directly from thin nickel alloy strip stock, .040" to .100" O.D. in standard length range of 11.5 mm to 42 mm. Round, rectangular or oval, cut to specified lengths, beaded or plain.

\*MFG. UNDER U. S. PATS. SUPERIOR TUBE COMPANY

Electronic Products for export through Driver-Harris Company, Harrison, New Jersey • Harrison 6-4800

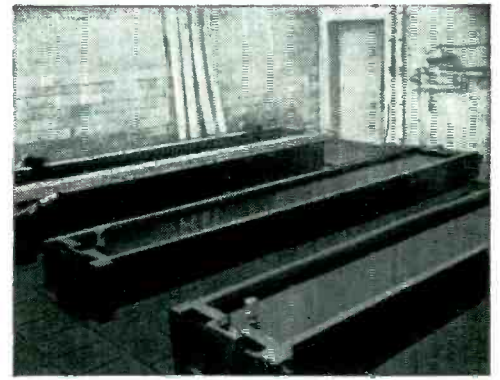

**Acid House Equipment** where material is cleaned and rinsed before bright annealing.

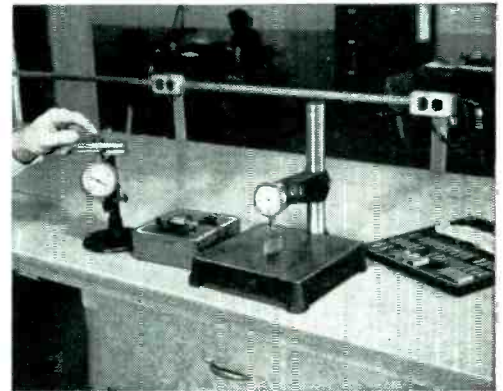

**Inspection and Gaging** . . . equipment for checking dimensions of Seamless and Lockseam Cathodes.

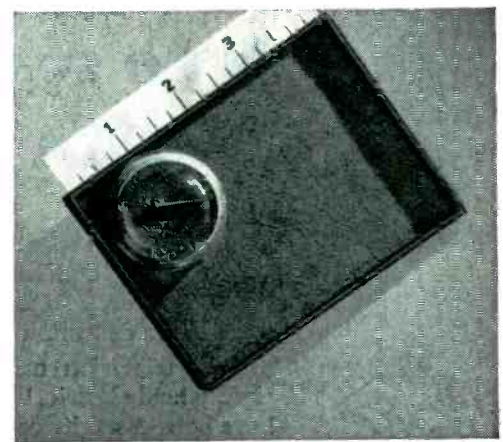

**52,600 Seamless Nickel Cathodes** . . . standing on end compared with a ruler, and an ordinary pin under a lens.

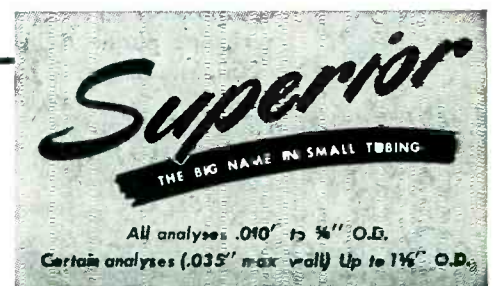

# RCA TELEVISION COMPONENTS

*The Standards of the Industry*



## There's no substitute for RCA experience

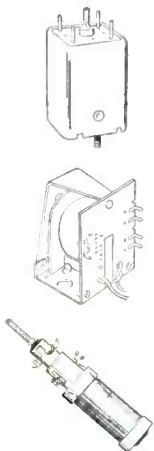

RCA TV Components reflect RCA's vast experience in TV design... and incorporate the most advanced engineering features. RCA TV components are unexcelled for wide-range deflection systems.

RCA television components are "originals" built to rigidly held electrical and mechanical specifications which have been carefully co-ordinated with tube and circuit requirements. They are "performance proved" and competitively priced.

RCA Application Engineers are ready to work with equipment designers in the adaptation of RCA television components to specific designs. For further information, write or phone RCA, Commercial Engineering, Section 42BS, Harrison, N. J., or your nearest RCA field office.

**FIELD OFFICES:** (EAST) Harrison 6-8000, 415 S. 5th St., Harrison, N. J. (MIDWEST) Whitehall 4-2900, 589 E. Illinois St., Chicago, Ill. (WEST) Trinity 5641, 420 S. San Pedro St., Los Angeles, California.



**RADIO CORPORATION of AMERICA**  
ELECTRONIC COMPONENTS HARRISON, N. J.

these frequencies to be approximately 216.5 mc and 230 mc, while the resonant frequency is approximately 222 mc. Thus

$$Q = \frac{222}{230 - 216.5} = 15.3$$

Fano has shown<sup>1</sup> that optimum matching to a simple series resonant circuit is achieved by a matching network of the form shown in Fig. 2B, which consists of alternate shunting parallel resonant circuits, and series circuits.

When the network to be matched already includes, as in this case, a shunting circuit of smaller susceptance than the first element of the matching network, this susceptance can be considered as being lumped with the first element of the matching network. For such a condition the match which can be achieved is the same as when the series circuit alone is to be matched.

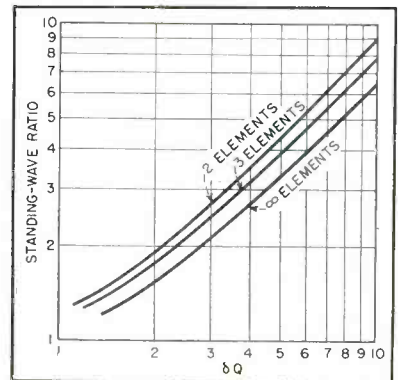

FIG. 3—Optimum matching to simple resonant circuit obtainable with network of *n* elements

The curves of Fig. 3, which are derived from results obtained by Fano, give the optimum match to a simple resonant circuit which can be achieved with a matching network of *n* elements. For the present example the circuit to be matched has a Q of 15.3. The fractional bandwidth  $\delta$  over which the match is required is defined by the formula  $f_2 - f_1 / \sqrt{f_2 f_1}$ , and in the present instance has the value

$$\delta = \frac{f_2 - f_1}{\sqrt{f_2 f_1}} = \frac{234 - 214}{\sqrt{234 \times 214}} = 0.0895$$

thus  $\delta Q$  has the value

$$\delta Q = 15.3 \times 0.0895 = 1.37$$

Referring to the curves of Fig. 3



practical imagination

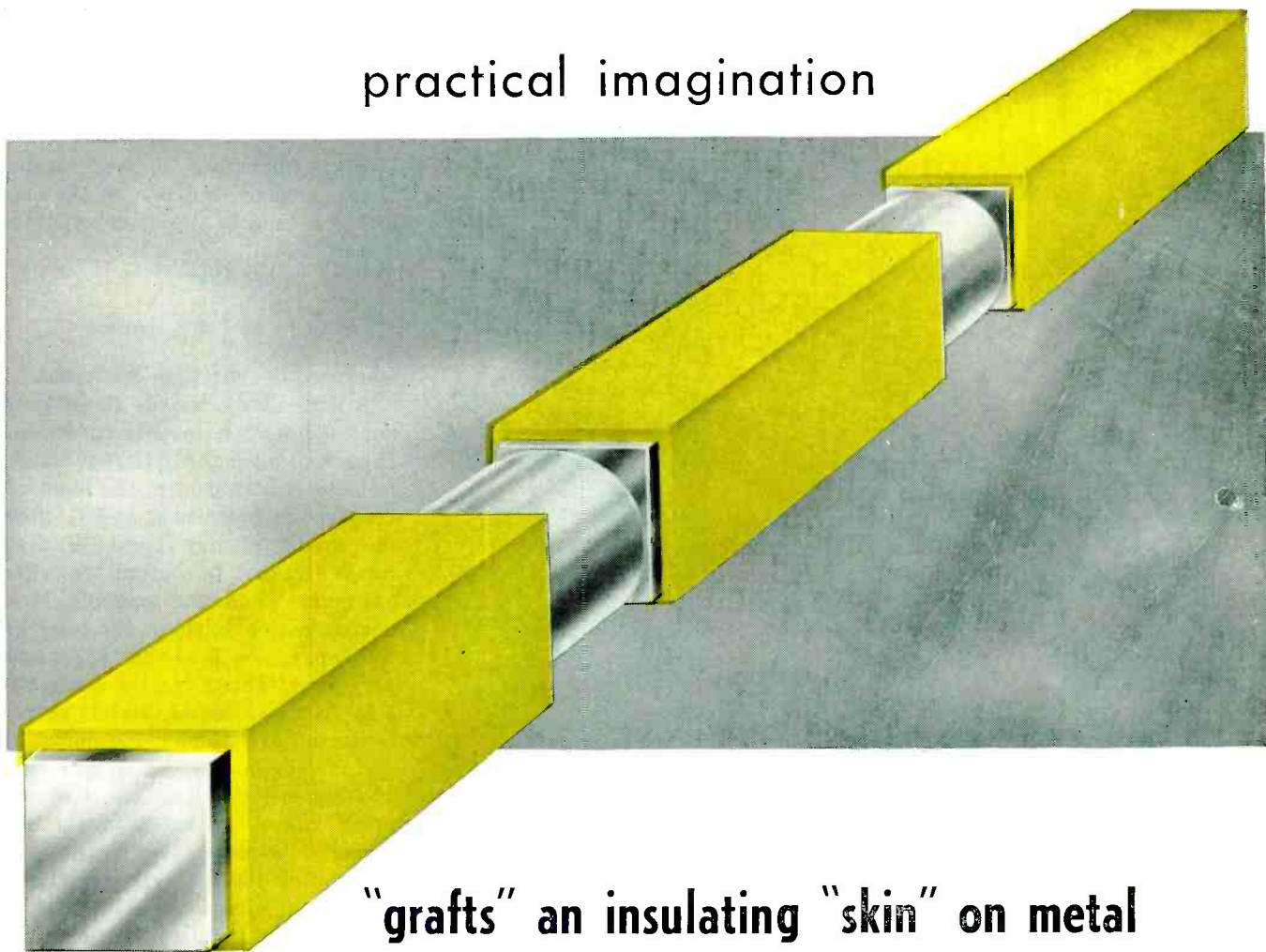

## "grafts" an insulating "skin" on metal

Here is another example of the practical imagination C-D engineers can put to work to solve your problems. In this case a heavy electrical connector had to be covered with a safe, efficient insulation. The material best suited to do the job was C-D Dilecto.

The next requirement was to make this insulation an integral part of the whole piece. Here is where practical imagination went to work. The solution was to laminate and mold the Dilecto directly on the metal bar.

When you have a problem involving plastics—whether it is simple or complex—be sure to check with C-D engineers for a practical, unbiased recommendation. They can choose the material best suited to your needs from a wide range of grades of five basic plastics to give you any combination of mechanical, electrical or chemical characteristics. A call to your nearest C-D office will bring you this kind of help any time—all the time.



*your partner in producing better products*

- DILECTO** (Laminated Thermosetting Plastic)
- CELORON** (Molded High-Strength Plastic)
- DIAMOND FIBRE** (Vulcanized Fibre)
- VULCOID** (Resin Impregnated Fibre)
- MICABOND** (Bonded Mica Splittings)

DE-1-51

BRANCH OFFICES: NEW YORK 17 • CLEVELAND 14 • CHICAGO 11 • SPARTANBURG, S. C. • SALES OFFICES IN PRINCIPAL CITIES.  
WEST COAST REPRESENTATIVE: MARWOOD LTD., SAN FRANCISCO 3 • IN CANADA: DIAMOND STATE FIBRE CO. OF CANADA, LTD., TORONTO 8

# Continental = Diamond FIBRE COMPANY

Established 1895.. Manufacturers of Laminated Plastics since 1911—NEWARK 16 • DELAWARE

we see that the optimum match which can be achieved with a two-element matching network (one shunt element and one series element) results in a vswr of approximately 1.5.

Fano shows that

$$\int_{f_1}^{f_2} \ln \frac{1}{\rho} df \leq \text{constant}$$

where  $\rho$  = reflection coefficient.

A little study reveals an importance application in this condition. It shows that if the optimum match is to be achieved over the band of frequencies between  $f_1$  and  $f_2$ , then the match at any point in that range can not be better than the optimum. Thus, for example, if a perfect match exists at one point in the range,  $\rho = 0$  at that point and  $1/\rho \rightarrow \infty$ . Therefore, the contribution to the integral, which represents the area under the curve  $\ln 1/\rho$ , is very large for a small range of frequencies in the vicinity of the point. Since the value of the integral is bounded, this means that the contribution at other sections of the range must be small; that is,  $1/\rho$  must be small,  $\rho$  large, and the match poor.

The performance of the antenna after matching gives substantial confirmation of the theory. The vswr oscillates about the value 1.5. A match better than optimum at the ends of the band has been obtained at the expense of a match poorer than optimum in the center.

The foregoing discussion applies to impedances which can be represented by the circuits of the type shown in Fig. 2A, in which the

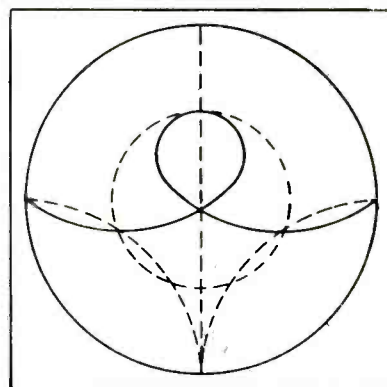

FIG. 4—Impedance curve of network which cannot be matched to value given by Fig. 3

# Leach RELAYS

**TROUBLE-FREE PERFORMANCE**

*“as specified”*

Because all *Leach Relays* are *quality engineered* for dependable duty... they are specified *first* by leading manufacturers of industrial equipment of all types. If your equipment demands relays that are first and foremost, more dependable and longer lasting, specify *Leach Relays* ... they're more dependable... *performance proves it*. Whatever your relay control problem... it's a challenge to *Leach*. Illustrated are but a few of the wide selection *Leach* provides industry, as standard equipment.

RELAYS SHOWN ABOVE CAN BE SUPPLIED WITH VARIOUS CONTACT ARRANGEMENTS. WRITE FOR DETAILS.

BETTER CONTROLS THROUGH BETTER RELAYS



✓ MOTOR STARTING RELAY



✓ OVERLOAD TRIP LIGHT DUTY



✓ HERMETICALLY SEALED



✓ MIDGET LATCHING RELAY

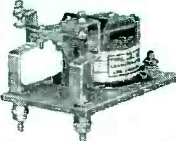

✓ RADIO AND HIGH VOLTAGE

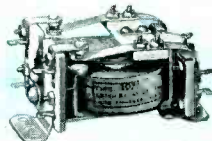

✓ ANTENNA TRANSFER



✓ MULTIPOLE RELAY

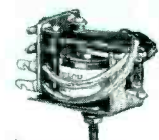

✓ MIDGET RELAY



✓ CIRCUIT CONTROL



**LEACH RELAY CO.**

5915 AVALON BOULEVARD, LOS ANGELES 3, CALIFORNIA

Representatives in Principal Cities of U. S. and Canada



# The Light

## THAT MUST NOT FAIL

*Automatic Airway Beacon  
Controlled by  
Telechron Timing Motor*

**Today's modern airfields leave nothing to chance.** Airway beacons and airstrip lights flash on *automatically* at the first approach of dusk. Whether "dusk" occurs in mid-afternoon or at its duly appointed time, pilots need not fear for proper guidance while in flight. Lights respond to pre-determined light levels and function the instant they are needed.

Weston illumination controls permit this uniformly reliable regulation of lighting. Independent of human judgment or arbitrary light schedules, it is a great advance in aviation safety. These controls owe their dependability to Telechron Timing Motors — also used in aircraft instruction markers, street lighting and industrial lighting.

Instantly, constantly synchronous, Telechron Timing Motors give dependable performance every time.

### *Timing On Your Mind?*

If you have a timing problem to contend with, a Telechron application engineer can be of great help to you. Backed by broad field experience, he can lead you to important savings in time and money. Consult him early in your planning. For immediate facts, send coupon below. TELECHRON INC. A General Electric Affiliate.

# Telechron<sup>®</sup>

ALL TELECHRON TIMING MOTORS ARE

INSTANTLY...CONSTANTLY SYNCHRONOUS

**TELECHRON INC.**  
42 Union Street  
Ashland, Massachusetts

Please send me information on sizes and types of Telechron Synchronous Motors. My possible application is:

- |                                     |                          |  |                          |
|-------------------------------------|--------------------------|--|--------------------------|
| Instruments                         | <input type="checkbox"/> | Communications Equipment                         | <input type="checkbox"/> |
| Timers                              | <input type="checkbox"/> | Other (please fill in)                           | <input type="checkbox"/> |
| Electric Appliances                 | <input type="checkbox"/> | .....  | <input type="checkbox"/> |
| Cost Recorders                      | <input type="checkbox"/> | .....  | <input type="checkbox"/> |
| Advertising, Display Items          | <input type="checkbox"/> | .....  | <input type="checkbox"/> |
| Juke Boxes                          | <input type="checkbox"/> | .....  | <input type="checkbox"/> |
| Air Conditioning & Heating Controls | <input type="checkbox"/> | <input type="checkbox"/> Please send new Catalog | <input type="checkbox"/> |

NAME.....

COMPANY.....

ADDRESS.....

CITY..... ZONE.....

STATE.....



# ...FOR CRITICAL ANALYSES

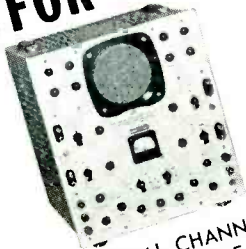

**H-21 DUAL CHANNEL OSCILLOSCOPE**  
Indicates 2 independent signals simultaneously. Sensitivity better than 0.085 Vdc/in. (30 MV rms/in.)

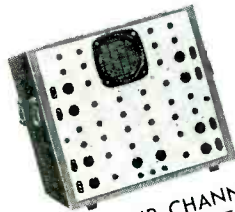

**H-45 FOUR CHANNEL OSCILLOSCOPE**  
Offers choice of any combination of high sensitivity dc amplifiers or wide band ac amplifiers.

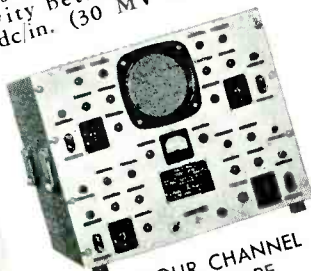

**H-43 FOUR CHANNEL OSCILLOSCOPE**  
Designed for strip-film recording of up to 4 variables on a single 5" tube. Readily portable.

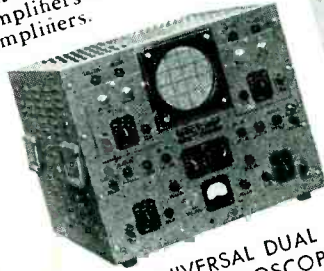

**H-22 UNIVERSAL DUAL CHANNEL OSCILLOSCOPE**  
Plug-in ac or dc amplifiers. Two independent channels on a single tube register phenomena from dc to 1 megacycle.

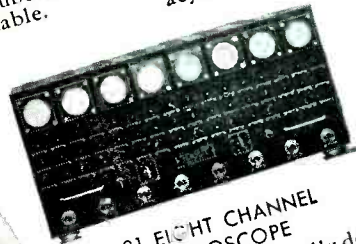

**H-81 EIGHT CHANNEL OSCILLOSCOPE**  
A unique design originally developed for film strip recording of seismographic phenomena. Frequency response 20 to 150,000 cps. ADC model with sensitivity of 2 MV dcl/in. also available.



### MULTI-GUN CATHODE TUBES

The answer to problems involving registration of a multiplicity of transients on a single screen. 2-, 4-, 6-, 8- and 10-gun types. Also a complete line of standard 5" cathode ray tubes.



## Multi-Channel Oscilloscopes

As specialists in multi-channel 'scopes, ETC offers a broad line for critical testing, production and research needs. In addition to standard types incorporating 2, 4, and 5 wave forms on a single tube, many special designs and adaptations are regularly produced for specific uses. Full details on any type will gladly be sent on request.

*electronic tube corporation*

PHILADELPHIA 18, PENNSYLVANIA

shunting element has susceptance smaller than that required for the first element of the optimum matching network. If the susceptance of the shunt element is larger than this value, the excellence of the match which can be achieved is poorer than the value indicated by the curves of Fig. 3. In terms of the impedance curve on the Smith Chart, too large shunt susceptance means that the impedance curve of the uncompensated impedance is already wrapped too tightly as shown in Fig. 4.

Although the example which has been considered in the above discussion was a series resonant circuit shunted by a parallel resonant cir-

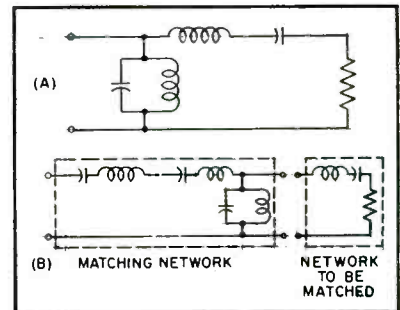

FIG. 5—Counterpart of impedance of Fig. 1 for which matching criteria apply is shown in A. Associated matching network is shown in B

cuit, the curves of Fig. 3 apply equally well to an impedance of the type shown in Fig. 5A.

Furthermore, all the arguments which were applied to the matching of a series resonant circuit apply equally well to the matching of a parallel resonant circuit if reactance is substituted for susceptance, and so on.

Thus, a parallel resonant circuit is best matched by a network such as the one shown in Fig. 5B which begins (at the load end) with a series element.

The match to a circuit such as the one in Fig. 5A is only as good as is indicated by the curves of Fig. 3 if the reactance of the series element is smaller than that required for the first element of the optimum matching network of Fig. 5B.

### REFERENCE

(1) R. M. Fano, "Theoretical Limitations on Broadband Matching of Arbitrary Impedances," Technical Report No. 41, MIT Research Lab. of Electronics.





# SURE!

say **SPEER**  
before you say **RESISTORS**



...for consistent long-life

Complete your circuits  
with R. F. coils... chokes  
...tubular and disc capa-  
citors... high voltage con-  
densers... capristors by  
**JEFFERS ELECTRONICS, INC.**  
DU BOIS, PA.  
Another Speer Carbon Co. Subsidiary.

Ⓢ 7275

**SPEER**  
*Resistor* **CORP.**

A SPEER CARBON COMPANY SUBSIDIARY

ST. MARYS, PENNSYLVANIA

# Are you safe?



**WHY WORRY?** Let Victoreen's three old stand-bys . . . stand-by to protect you.



Proteximeter Model 300

**AREA SAFE?** Victoreen's area monitor; the Proteximeter for visual indication of accumulated scattered radiation up to 200 milliroentgens. No cords to stumble over; the Proteximeter's self contained batteries last long, cost little. Buy the finest and be sure; Victoreen's Proteximeter.

**YOU SAFE?** Personally yours, a Victoreen pocket chamber clipped beside your fountain pen goes everywhere you do . . . and tells the story. With one Minometer, and a pocket chamber for each worker you know the daily dosage.

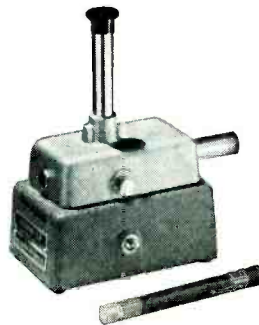

Minometer Model 287

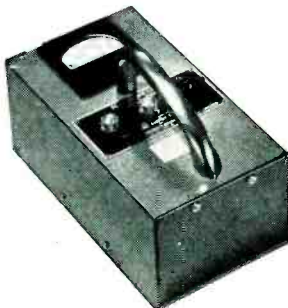

Alpha Meter Model 356

**ALPHA SAFE?** Alpha particles do not penetrate very far, but they contaminate just the same. Erroneous results, especially in delicate tracer and isotope work, may result from alpha contamination. Be sure with a Victoreen Alpha Meter.



## Victoreen

5806 HOUGH AVE. • CLEVELAND 3, OHIO

### NEW PRODUCTS

(continued from page 130)

the tv images has an accuracy of one-half of one line. A light beam of 0.0005 in. records high-fidelity sound over the entire range of frequencies.

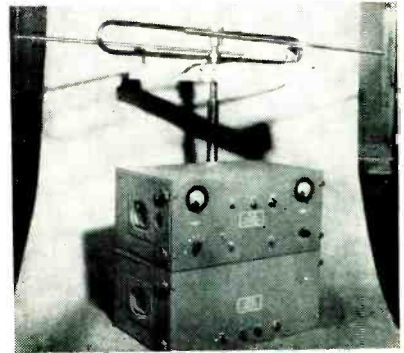

### Remote Broadcast Equipment

RADIO ENGINEERING LABORATORIES, INC., 36-40 Thirty-Seventh St., Long Island City 1, N. Y., is producing the model 695 50-watt, 153-mc f-m remote pickup equipment. It is of interest to broadcasters not only for regular program pickup use, but also for emergency broadcasts because the program can be on the air as soon as the pickup truck gets its microphones to the site of the remote. Another use is as an emergency studio-to-transmitter link to replace normal facilities during temporary failures due to storm or other causes.

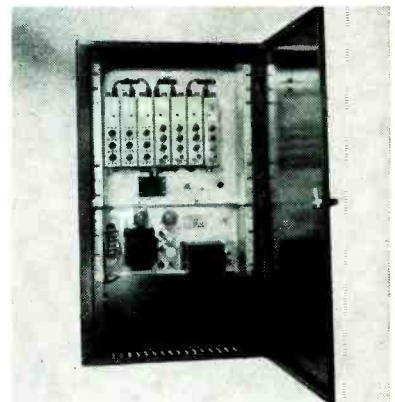

### Multiple-Outlet TV Antenna System

RADIO CORP. OF AMERICA, Camden, N. J. Type SX-8B tv Antenaplex system can furnish high-quality picture reception at as many as 350



# MYCALEX

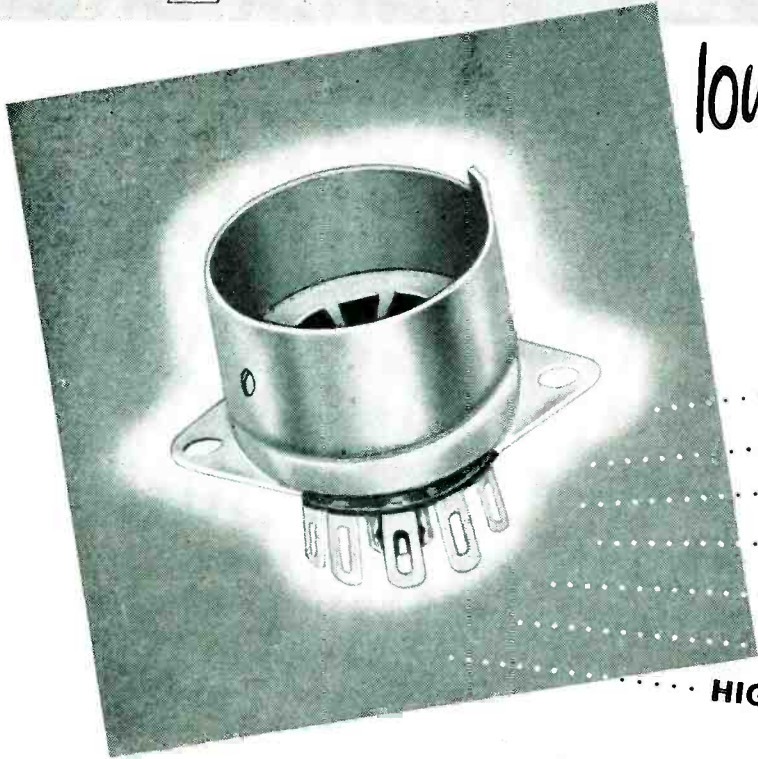

## low loss miniature **TUBE SOCKETS**

**OFFER ALL THESE ADVANTAGES:**

- ..... CLOSER TOLERANCES
- ..... LOWER DIELECTRIC LOSS
- ..... HIGH ARC RESISTANCE
- ..... HIGH DIELECTRIC STRENGTH
- ..... GREAT DIMENSIONAL STABILITY
- ..... IMMUNITY TO HUMIDITY
- ..... HIGH SAFE OPERATING TEMPERATURE

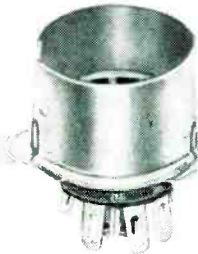
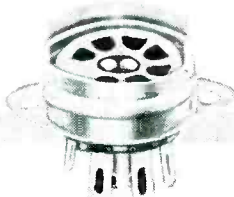

-cost no more than

### **PHENOLIC TYPES**

These glass-bonded mica sockets are produced by an exclusive MYCALEX process that reduces their cost to the level of phenolic sockets. Electrical characteristics are far superior to phenolics while dimensional accuracy and uniformity exceed that of ceramic types.

MYCALEX miniature tube sockets, available in 7-pin and 9-pin types, are injection molded with great precision and fully meet RTMA standards. They are produced in two grades,

described as follows, to meet diversified requirements.

MYCALEX 410 conforms to Grade L-4 specifications, is priced comparable to mica-filled phenolics. Loss factor is only .015 at 1 mc., insulation resistance 10,000 megohms.

MYCALEX 410X is low in cost but insulating properties greatly exceed those of ordinary materials. Loss factor is only one-fourth that of phenolics (.083 at 1 mc.) but cost is the same. Insulations resistance 10,000 megohms.

#### **MYCALEX TUBE SOCKET CORPORATION**

*Under Exclusive License of*  
MYCALEX CORPORATION OF AMERICA  
30 ROCKEFELLER PLAZA, NEW YORK 20, N. Y.



### **CORPORATION OF AMERICA**

*"Owners of 'MYCALEX' Patents"*

Executive Offices: 30 Rockefeller Plaza, New York 20 • Plant and General Offices: Clifton, New Jersey

# THE MEASURE OF MICROPHONE VALUE

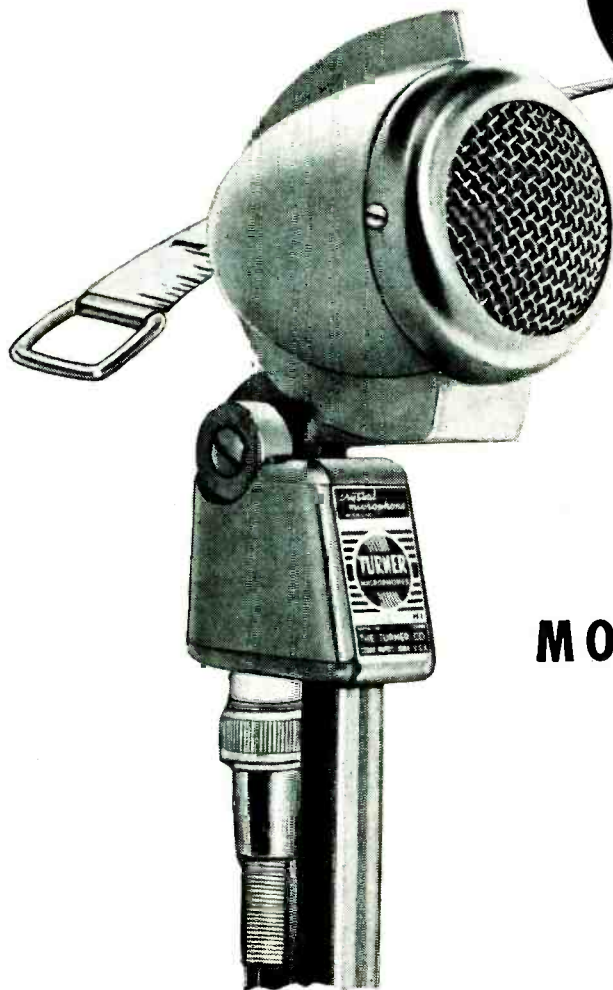

**MODEL 22**

## EVERY INCH A SOUND PERFORMER

An all around value. Right for performance, style, dependability and price. Specified as the standard by leading manufacturers of communications, sound, and recording equipment. For standards of comparison Turn to Turner crystal, dynamic, cardioid, ceramic and carbon microphones.

**Write for Literature. THE TURNER COMPANY**  
**905 17th Street N. E., Cedar Rapids, Iowa**

*In Canada: Canadian Marconi Company, Toronto, Ontario*  
*Export: Ad. Auriema, Inc., 89 Broad Street, New York 4, N. Y.*



Crystals licensed under patents of the Brush Development Company

### NEW PRODUCTS

(continued)

outlets simultaneously with a single amplifier assembly in use. It is designed for apartments, hotels, department stores and other large buildings where individual antennas are impracticable. In the cabinet illustrated are the high-gain r-f amplifiers for each local tv channel and the self-contained power supply, each mounted on a master chassis.

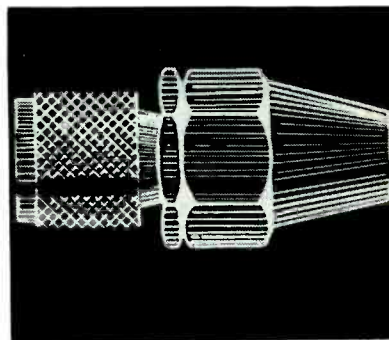

### Cable Connector

JERROLD ELECTRONICS CORP., 121 N. Broad St., Philadelphia 7, Pa. Type C-51 solderless coax fitting is a male connector for RG-59/U cable and mates with the model C-61 heavy-duty female receptacle and model C-81 cable coupler which is used to splice two RG-59/U cables. Fittings are made of brass and plated with silver. The C-51 is 1½ in. long by ½ in. in diameter.

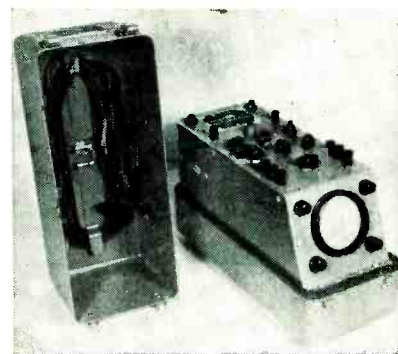

### Miniaturized Oscilloscope

HYCON MFG. Co., 2961 E. Colorado St., Pasadena 8, Calif., has announced a miniaturized oscilloscope designed for rugged mobile applications but adequate for testing h-f equipment and portraying pulse-type wave forms. It weighs 17 lb and measures 9 in. high x 6 in. wide



# Specify **GLENCO** MINIATURE CERAMIC PLATE CAPACITORS

... for minimum size  
... maximum dependability  
... convenient rectangular shape

GLENCO SUBMINIATURE CAPACITORS FOR COUPLING AND BYPASS APPLICATIONS									
CBM MINIATURE 500 V. D.C. SINGLE PLATE		SMCB SUB-MINIATURE 250 V. D.C. SINGLE PLATE		CAPACITY MFD.	SMCB SUB-MINIATURE 250 V. D.C. DOUBLE LAYER		SMCB SUB-MINIATURE 250 V. D.C. MULTILAYER		
SIZES IN INCHES					SIZES IN INCHES				
L	W	L	W		L	W	L	W	
.19	.14	.12	.12	.0005					
.25	.19	.18	.15	.001					
.50	.40	.28	.25	.005					
.70	.52	.50	.40	.01	.30	.19			
		.80	.60	.05	.61	.43	.48	.33	
				.10	.88	.62	.65	.45	
				.50			.70	.55	
				1.0			1.0	.80	
D=.120		D=.080			D=.120		D=.150-.800		

### SPECIFICATIONS FOR CBM AND SMCB\* COUPLING AND BYPASS CAPACITORS

- FLASH TESTED AT 3 TIMES RATED D.C. VOLTAGE
- POWER FACTOR LESS THAN 1%
- INSULATION RESISTANCE EXCEEDS 10,000 MEGOHMS
- MEET ALL RMA SPECIFICATIONS

\*Types CBM and SMCB are shown as typical examples of the space saving possible with GLENCO capacitors. Many more standard types, including a great variety of temperature compensating ceramic capacitors, are available. Quotations on these or types to customers' specification will be supplied promptly on request.

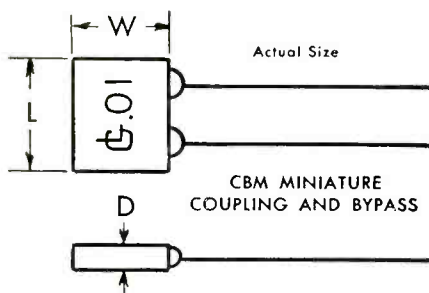

**GLENCO CORPORATION**  
DURHAM AVENUE, METUCHEN, NEW JERSEY

NOTE! A FEW TERRITORIES ARE STILL OPEN FOR WIDE AWAKE REPRESENTATIVES IN SELECTED AREAS—INQUIRIES INVITED.

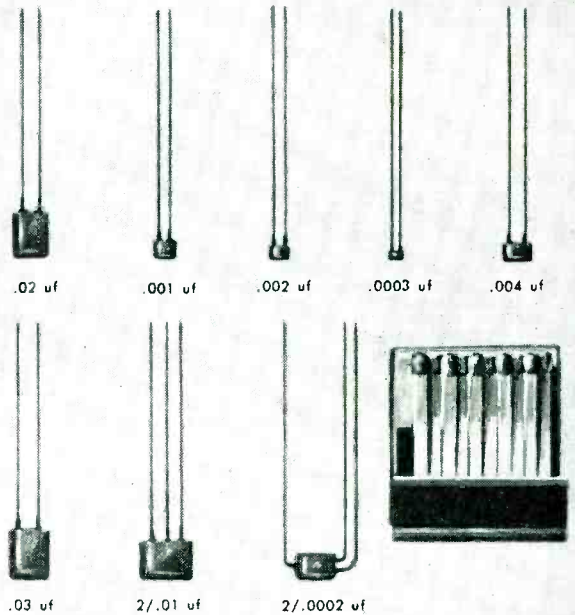

**TYPE TC—TEMPERATURE COMPENSATING CERAMIC PLATE CAPACITORS**

**TYPE CBM—MINIATURE COUPLING AND BYPASS CAPACITORS**

**TYPE SMCB—SUB-MINIATURE COUPLING AND BYPASS CAPACITORS**

## GLENNITE\* ACCELEROMETER

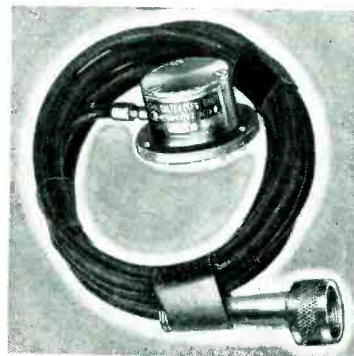

MODEL A403  
(ILLUSTRATED)

We are currently designing a number of other types of accelerometers and strain gauges. We invite inquiries concerning units of special design. Electronic equipment can also be supplied for use in conjunction with this equipment—cathode followers, amplifiers, filters and recording equipment.

\*Registered Trademark

- SENSITIVITY: 10 mv/g
- RESONANT FREQUENCY: 8 kc
- USEFUL FREQUENCY RANGE: 3 to 4000 cps
- CAPACITANCE: 1500 mmf
- SIZE: 1 1/4" diam. x 3/4"
- WEIGHT: Approx. 1 ounce
- MOUNTING: 3—2 x 56 machine screws spaced 120° apart on a 1 1/4" diameter circle
- MAX. DIRECTIVITY: Perpendicular to mount
- TEMPERATURE RANGE: —60°C to +90°C
- ACCELERATION RANGE: 0.1 to 600g
- CABLE: 4 ft. shielded cable supplied
- CALIBRATION: Instruments individually calibrated at 2g from 20 to 1500 cps
- MOVEMENT: Compressional

**GULTON MFG. CORP.**  
METUCHEN • NEW JERSEY



# SYNCHROS

PRECISION-BUILT BY

## ECLIPSE-PIONEER

**GUARANTEED ACCURACY TO WITHIN 15  
MINUTES ON ALL PRODUCTION UNITS**

For more than 17 years Eclipse-Pioneer has been a leader in the development of high precision synchros for aircraft, marine and industrial applications. Today, thanks to this long experience and specialization, Eclipse-Pioneer Autosyn<sup>®</sup> Synchros give you a *guaranteed* accuracy of 15 minutes (maximum) on all individual AY 200 type 400 cycle transmitters, differential generators, control transformers and resolvers. Furthermore, this phenomenal accuracy applies to *all production units* in this series. Where special applications are involved, Eclipse-Pioneer will supply Autosyn Synchros with an even *finer* degree of accuracy. And remember, when you buy from Eclipse-Pioneer, this high precision is yours at the lowest possible cost.

\*REG. TRADE MARK BENDIX AVIATION CORPORATION

LOOK FOR THE PIONEER MARK OF QUALITY  
REG. U.S. PAT. OFF.

### Typical Performance Characteristics for one AY-201-3 Autosyn Synchro when transmitting to:

	One Control Transformer	Two Control Transformers	Three Control Transformers
<b>INPUT</b>			
Voltage	26-volts, single-phase	26-volts, single-phase	26-volts, single-phase
Frequency	400 cycles per second	400 cycles per second	400 cycles per second
Current	105 milliamperes	130 milliamperes	155 milliamperes
Power	0.90 watts	1.4 watts	1.9 watts
Impedance	85 + j240 ohms	80 + j180 ohms	77 + j149 ohms
<b>OUTPUT</b>			
Voltage max. (rotor output)	18.0 volts	15.5 volts	13.3 volts
Voltage at null	30 millivolts	20 millivolts	20 millivolts
Sensitivity	315 millivolts/degree	270 millivolts/degree	230 millivolts/degree
Voltage phase shift	18.5 degrees	24.5 degrees	28.0 degrees
System accuracy (max. possible spread)	0.5 degrees	0.5 degrees	0.5 degrees

#### Other E-P precision components for servo mechanism and computing equipment:

Servo motors and systems • rate generators • gyros • stabilization equipment • turbine power supplies • remote indicating-transmitting systems and special purpose electron tubes.

For detailed information, write to Dept. C

**ECLIPSE-PIONEER DIVISION of**

TETERBORO, NEW JERSEY



Export Sales: Bendix International Division, 72 Fifth Avenue, New York 11, N. Y.

x 14½ in. long. The circuit contains 9 tubes including rectifiers. Sweep frequency range is from 3 cycles to beyond 50,000 cps. Vertical amplifier response is flat within 3 db from d-c to 2 mc, while horizontal response is flat within 2 db from d-c to 100 kc. It also features faithful reproduction of wave forms with 3-μsec rise times and 100-kc square waves. Deflection sensitivity exceeds 0.5 v per in. at all line voltages from 105 v to 125 v and at all line frequencies from 50 cycles to 1,000 cycles.

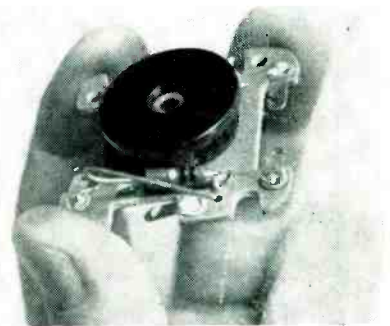

### Static Magnetic Memory

ALDEN PRODUCTS Co., 117 North Main St., Brockton 64, Mass. Model 5100RA static magnetic memory, a device for recording and storing information in digital calculating machinery, has a built-in coupling circuit in each unit to facilitate two-core operation. Pulse handling rate ranges from 0 to 25 kc. The device operates essentially as a magnetic trigger pair which requires no vacuum tubes to maintain position. Illustrated is a single unit showing the damping resistor and rectifier tab.



### H-V Resistors

RESISTANCE PRODUCTS Co., 714 Race St., Harrisburg, Pa. Type T high-voltage resistors are specially designed to withstand the high d-c,



# We are ready NOW...



## Can we serve YOU?

For **IMMEDIATE ACTION**, phone—wire—  
or write direct to the attention of Mr.  
Albert Finkel, Vice-President.



... One of the world's largest producers of television antennas and accessories, has allocated a most substantial portion of its facilities for prime and sub-contract orders.

We offer:

**EXPERIENCE!** Leaders in the industry whom we have serviced in the past, include such outstanding organizations as RCA, PHILCO, ADMIRAL, MOTOROLA, BENDIX, EMERSON, PILOT, STROMBERG-CARLSON, etc.

**80,000** square feet of floor space with modern production machinery and high-speed assembly lines.

**TRAINED** manufacturing personnel geared to the type of mass-production that meets "deadlines" and lowers costs.

**EXCELLENT** sources of supply for raw material.

**KNOW-HOW** in purchasing and delivery expediting.

**FINANCIAL** resources that are ample and liquid.

DIVISION OF CONTRACT OPERATIONS



**MANUFACTURING CO., Inc.**  
6145-B 16th AVENUE, BROOKLYN 4, N. Y.  
FIRST in Television Antennas and Accessories

# MORE GEO. STEVENS COIL WINDING EQUIPMENT IS IN USE THAN ALL OTHER MAKES COMBINED!

- **MORE OUTPUT . . . LOWER COSTS . . .** from EXCLUSIVE SPEED FEATURE. Universal motors permit variable speeds without changing belts and pulleys. Coil design permitting, speeds as high as 7500 RPM are not uncommon.
- **PORTABILITY.** Conveniently carried from place to place. Machines come mounted on bases to constitute one complete unit.
- **MUCH LOWER ORIGINAL COST.** The same investment buys more GEO. STEVENS machines than any other coil winding machines.
- **LONG LIFE.** Most of the original

GEO. STEVENS machines bought 14 years ago are still operating daily at full capacity.

- **MUCH FASTER CHANGING OF SET-UPS** than any other general purpose coil winding machine. Quickly changed gears and cams save time between jobs.
- **VERY LOW MAINTENANCE.** Replacement parts are inexpensive, can be replaced in minutes, and are stocked for "same day" shipment, thus saving valuable production time.
- **EASIEST TO OPERATE.** In one hour, any girl can learn to operate a GEO. STEVENS machine.

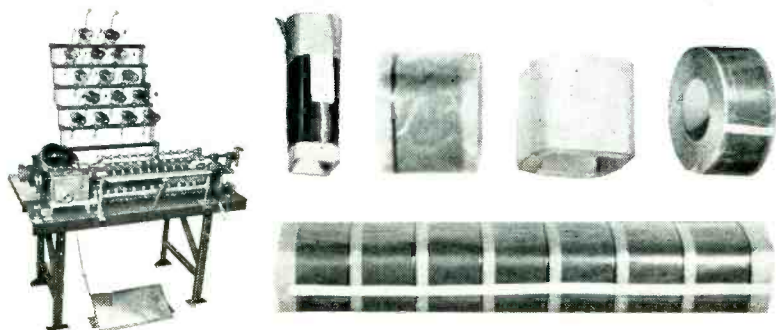

Transformer winder Model 37S multiple winds power, audio, automotive, fluorescent ballast and similar types of coils. Winds wire from No. 18 B&S to 46 B&S up to 9" O.D. Maximum economy is possible by using mandrels up to 30" long. Thirty or more coils may be wound at one time. All turns are accurately registered by Model 50 or 51 6" full vision clock face Dial Counter. Set-ups can be changed in less than 5 minutes. A gear chart is furnished to quickly determine wire spacing.

No loss of turns (an exclusive feature) and accurate margins are assured by a screw feed traverse and an electrically controlled clutch. Highly polished wire guide rollers are ball-bearing mounted for free running. Traverse is quickly adjusted from 1/16" to 6".

Paper feed:—A tilting table for pre-cut paper is furnished making paper feed simple and fast, or a new roll paper feed for extra economy is available at a small additional cost.

Motor equipment:—Variable speed, uniform torque 1/2 H.P. motor with foot treadle control.

Tension equipment:—12 T-1 tensions and spool rack. Tensions will handle 6" spools.

Mounting:—Ground steel channel base ensures rigidity and permanent alignment. Machine is shipped mounted on bench ready for use.

There is a GEO. STEVENS machine for every coil winding need. Machines that wind ANY kind of coil are available for laboratory or production line. . . . Send in a sample of your coil or a print to determine which model best fits your needs. Special designs can be made for special applications. Write for further information today.

*World's Largest Manufacturer  
of Coil Winding Machines*

#### REPRESENTATIVES

Frank Tatro  
6022 No. Rogers Ave., Chicago 30, Illinois  
Ralph K. Reid  
1911 W. 9th St., Los Angeles 6, California  
R. A. Staff & Co.  
1213 W. 3rd St., Cleveland 13, Ohio

## GEO. STEVENS MFG. CO., INC.

Pulaski Road at Peterson  
Chicago 30, Illinois

pulse and transient voltages encountered in tv power supplies. They are of particular use in voltage doubler circuits and as bleeders where ordinary resistors have a limited life. The temperature coefficient of resistance is approximately 0.05 percent per deg C; voltage coefficient of resistance, approximately 0.0001 percent per volt.

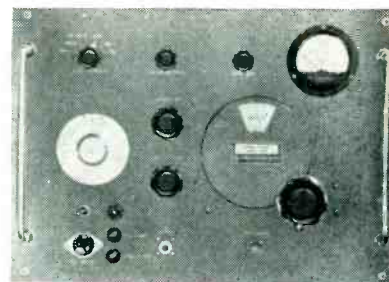

### SHF Signal Generator

HEWLETT-PACKARD Co., 395 Page Mill Rd., Palo Alto, Calif. Model 618A shf signal generator offers continuous coverage of frequencies from 3,800 to 7,600 mc. It provides a 1-mw signal into a 50-ohm coaxial load at zero dbm. The instrument also offers a variety of output types. It may be externally frequency modulated with maximum deviation of 10 mc. It may be externally pulse modulated with a positive or negative peak voltage of approximately 15 v. Internal square wave modulation is also provided within the frequency range of 400 to 1,000 cps.

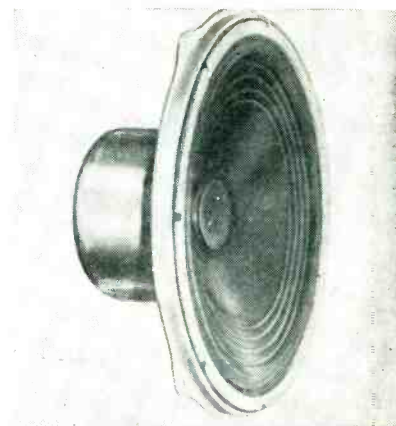

### High-Fidelity Speaker

RADIO CORP. OF AMERICA, Harrison, N. J. Type 515S2 is a new 15-inch duo-cone loudspeaker designed for



**Greatest PORTABLE  
of them all!**



Weight approx. 62 lbs.

**AMPEX**  
MAGNETIC TAPE RECORDER  
15,000 cps • 7½ inches per second  
**HALF TRACK!**

- Extended range 15,000 cycle half-track recording at 7½ inches per second.
- Incredible performance that equals or exceeds most full-track 15 i.p.s. recorders.
- Saves 75% on tape by combining 132 min. of recording on a single 2400-ft. N.A.B. reel.
- Can be furnished with Single Track Heads.

Write for Complete Specifications and Control Arrangement

**AMPEX ELECTRIC CORPORATION**  
San Carlos, California

STANDARD OF THE GREAT RADIO SHOWS

**PRODUCTION LINE TESTING**

**SERVOSCOPE**



OF  
**SERVOMECHANISMS**

**SERVO CORPORATION OF AMERICA**

NEW HYDE PARK  
LONG ISLAND  
NEW YORK

INVALUABLE IN RESEARCH  
RAPID INSPECTION ON THE PRODUCTION LINE

**A SERVO ANALYZER**

- STANDARD RANGE: .1 TO 20 CYCLES PER SECOND
- SINE WAVE
- SQUARE WAVE
- MODULATED CARRIER
- READS DIRECTLY
- 50 TO 800 CYCLES
- SERVO LAG OR LEAD IN DEGREES

For Precision Washers... For Precision Stampings...

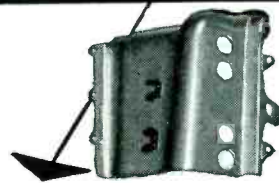

**WHITEHEAD STAMPING CO.**

A preferred source of precision-made WASHERS and STAMPINGS. 46 years of experience and up-to-the-minute facilities, assure highest quality and service.



EST. 1903

**WHITEHEAD STAMPING CO.**

1691 W. Lafayette Blvd.

Detroit 16, Michigan

**VULCAN**  
ELECTRIC HEATING UNITS

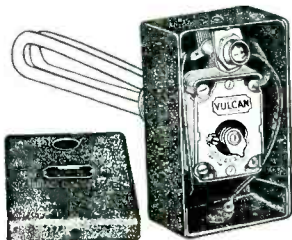

Automatic  
WATER IMMERSION HEATER  
Thermostat Control

Heats water electrically in large and small tanks, range boilers, etc. Easily installed. Does not disturb existing plumbing. Low cost hot water for small factories, stores, offices, laboratories and a host of other places. Special types for heating oils, chemicals and other liquids.

**VULCAN**  
ELECTRIC COMPANY  
DANVERS 10 MASS.



An Accredited Technical Institute  
Pioneer in Radio Engineering  
Instruction Since 1927.....

**CAPITOL RADIO ENGINEERING INSTITUTE**

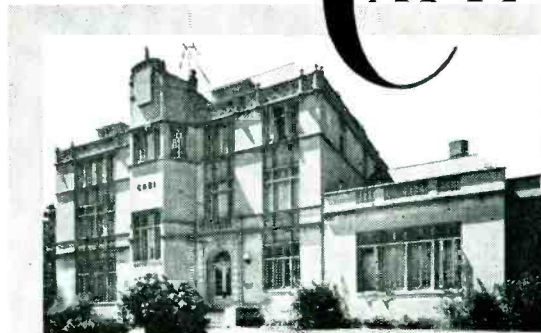

- Advanced Home Study, and Residence Courses approved for Veteran Training, in Practical Radio-Electronics and Television Engineering.

• Request your free home study or residence school catalog by writing to Dept. 282 C

16th & Park Road, N.W., Washington 10, D.C.

# Kahle

specialists in custom-built, ultra-precision  
**ELECTRON TUBE MACHINERY**

KAHLE CUSTOM-BUILDS machines to make the exact tubes you require—from big 20-inchers to tiny sub-miniature—from laboratory types to those for high-speed production. Kahle puts each unit through exhaustive trial runs in our plant to assure trouble-free operation in yours.

### #337 BUTTON STEM MACHINE FOR MINIATURE AND SUB-MINIATURE TUBES

This 24-head machine has two upper moulds for making non-tubulated stems with short lead wires. Important features include: dual-motor drive, one for heads, one for indexing and cam mechanisms, independent of each other; optional automatic wire feed; optional automatic glass feed (not shown); automatic unloader; individual head units, readily removable; harmonic barrel cam and roller index. Capacity: 1000 per hour.

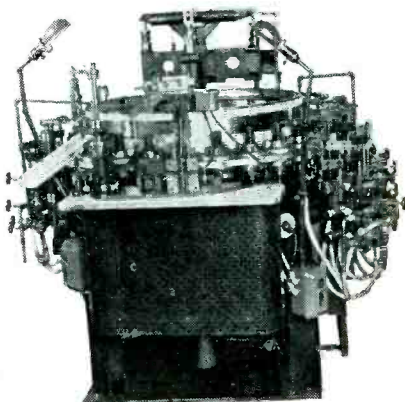

Production-boosting, labor-saving equipment for complete manufacture of cathode ray tubes, standard, miniature and sub-miniature radio tubes, sub-miniature tubes, fluorescent lamps, photocells, x-ray tubes, glass products.

## Kahle ENGINEERING CO.

1309 Seventh Street, North Bergen, New Jersey

Consultations invited  
Send for our new catalog

**ONLY  
SPECIFIC COILS  
CAN DO  
THIS JOB-**

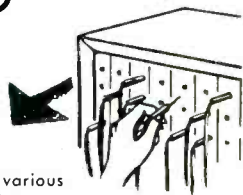

One of various coils that go into making communications equipment is shown below. This acetate interleave coil is made from fine wire, and the acetate film interleaved with the winding provides a high dielectric between winding layers. Rigid quality control, at Coto, assures perfect operation.



**Builds Them!**

When you need electrical coils, why not take advantage of 34 years of experience, engineering competence, and modern production facilities. Coto coils are built for you, to your specifications.

**COTO-COIL CO., INC.**  
COIL SPECIALISTS SINCE 1917  
65 PAVILION AVE  
PROVIDENCE 5, R.I.

## THREE DECADES OF RADIO-TELEVISION "KNOW-HOW"

an **insuline** cabinet or chassis for every need

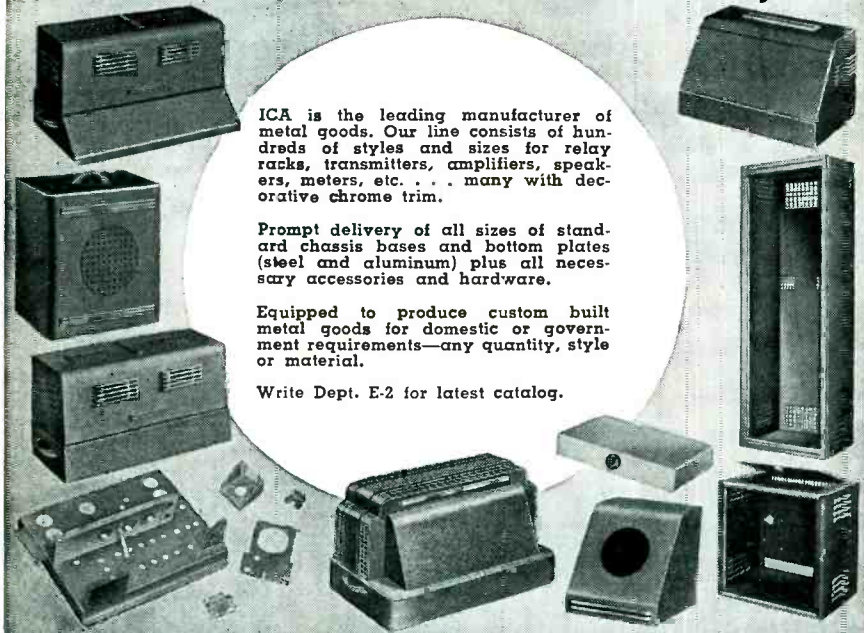

ICA is the leading manufacturer of metal goods. Our line consists of hundreds of styles and sizes for relay racks, transmitters, amplifiers, speakers, meters, etc. . . many with decorative chrome trim.

Prompt delivery of all sizes of standard chassis bases and bottom plates (steel and aluminum) plus all necessary accessories and hardware.

Equipped to produce custom built metal goods for domestic or government requirements—any quantity, style or material.

Write Dept. E-2 for latest catalog.



### insuline CORPORATION OF AMERICA

INSULINE BUILDING • 36-02 35th AVENUE • LONG ISLAND CITY, N. Y.  
West Coast Branch and Warehouse: 1335 South Flower Street, Los Angeles, Calif.  
Exclusive Canadian Sales Agents: CANADIAN MARCONI COMPANY, Montreal



high-quality reproduction at both high and low-power levels. The permanent-magnet-type unit features high sensitivity between 40 and 12,000 cps and is capable of handling a 25-watt input. It is intended particularly for use in equipment such as high-quality radios, phonographs, tv receivers and monitors. The duo-cone arrangement avoids the crossover interference characteristic of conventional high-low speaker combinations in which the woofer and tweeter are spaced apart. Each cone is mounted in its own housing and is driven by its own voice coil operating in its own air gap.

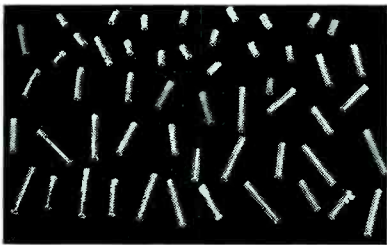

**Insulator Bushings**

AMERICAN PRODUCTS Co., 1652 No. Honor St., Chicago 22, Ill., are now making molded Nylon and Styron insulator bushings for the radio and electronic industries. They feature low moisture absorption, easy assembly and retention of shape. The bushings are available in lengths from 1/8 in. to 1 3/8 in. x 3/8 in. Outside diameter is 0.187 in. to 0.188 in., and inside diameter is 0.126 in. to 0.128 in. Other sizes are made to order.

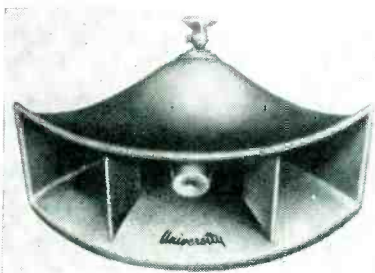

**Paging Speaker**

UNIVERSITY LOUDSPEAKERS INC., 80 S. Kensico Ave., White Plains, N. Y., has introduced model Cobra-12 paging-type speaker of radically

**THE ESSENTIAL COMPONENT**

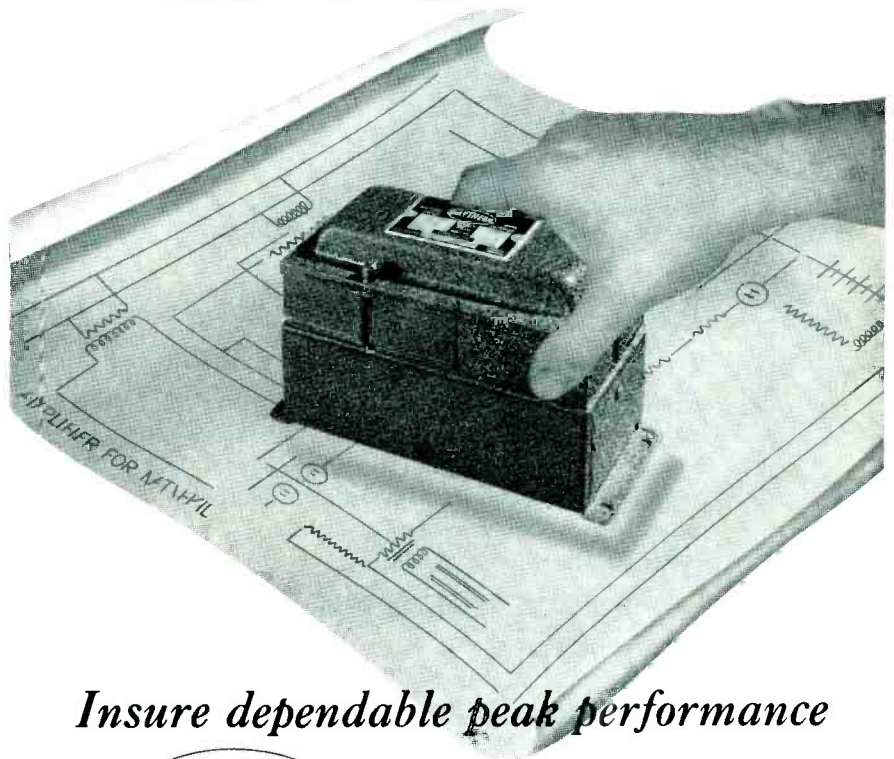

*Insure dependable peak performance*

WITH **RAYTHEON** VOLTAGE STABILIZERS

Build optimum performance right into your electrical or electronic product. Make sure, right from the start, of complete protection from the hazards and problems of fluctuating line voltage. Raytheon Voltage Stabilizers are compact, light in weight, ruggedly built, low in cost. These patented, precision-built magnetic units will deliver constant AC voltage regardless of line variations. Automatic, with no moving parts, they never need adjustment or maintenance. Choose from a wide range of catalog types — or special models can be custom-built to meet your special needs. Write for our new Voltage Stabilizer Bulletin. Use the coupon below.

**NOTE THESE FEATURES**

- Constant AC output voltage ( $\pm 1/2\%$ )
- Wide AC input voltage limits ( $\pm 15\%$ )
- Quick response — stabilizes varying input voltage within 1/20 second
- Self-Protecting Against Overload
- Low Operating Cost
- Designs are available in ratings from 5 to 10,000 watts

Raytheon Products include Mariners Pathfinder\* radar; Fathometers\*; radio and television receivers; tubes; microwave communications; electrostatic air cleaners; Weldpower\* welders; voltage stabilizers; Recticharger\* battery chargers; Rectifilter\* battery eliminators; Rectifingers\*; transformers; Microtherm\* diathermy; fractional hp motors, and other electronic equipment.\*®



**VOLTAGE STABILIZER HEADQUARTERS**  
Since 1927

**RAYTHEON MANUFACTURING COMPANY**

Magnetic Components Division, Dept. 6460-A  
Waltham 54, Massachusetts

Please send me your new Voltage Stabilizer Bulletin

Name .....

Position .....

Company .....

Address .....

City..... Zone..... State.....

# PATTON-MacGUYER

## PARTS MATCHED

### SMALL METAL STAMPINGS

In Accordance With Your Prints

Extensive modern plant, complete equipment, engineering and toolmaking skill for producing your stamped metal parts accurately, economically, promptly. Moderate die charges. Facilities for large volume production. We welcome stamping problems.

#### TERMINALS for ELECTRIC WIRES

Specialists in the terminal field, we have dies to produce over 400 different kinds of separate terminals. Every modern facility to meet your standard or special requirements.

**PATTON-MacGUYER COMPANY**  
Edgewood Station Providence 5, R.I.

*You saw it at the Audio Fair...*

**"exciting current test"** Another in a series which demonstrates **PEERLESS** transformer superiority!

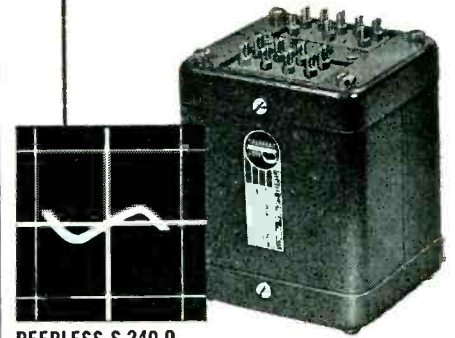

PEERLESS S-240-Q

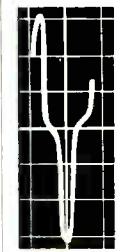

Competitor No. 1

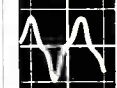

Competitor No. 2



Competitor No. 3



Competitor No. 4

Since the 1949 Audio Fair, comparative square wave tests on transformers shown all over the country have demonstrated Peerless superiority... Now Peerless emphasizes another very important property of transformers as shown by the "exciting current test."

An output transformer's ability to deliver plenty of clean, low-frequency power (the goal of every music lover) is inversely proportional to the amplitude and distortion of its exciting current.

PEERLESS superior low-frequency power handling capacity is illustrated in these comparative oscillograms.

Write for complete data.

**PEERLESS**  
Electrical Products



Division

161 Sixth Avenue  
New York 13, N.Y.

9356 Santa Monica Blvd.  
Beverly Hills, Calif.



## Announcing! A NEW AND IMPROVED OVEN . . .

### the JKO7E

#### With Thermostat Sealed In Helium

Here's another important JAMES KNIGHTS development, the JKO7E Oven. It features a thermostat that's sealed in a glass envelope that has been filled with helium. Contact arcing is eliminated—temperature differential is greatly minimized by providing closer thermo-coupling to the thermostat! In addition, it's completely dust and tamper proof!

The new design results in greater frequency stability—longer life—greater reliability than is possible with mercury thermostats! The JKO7E is available with either a 6.3 volt 10 watt heater, or a 115 volt 12 watt heater. It's broadcast, FM & TV, F.C.C. approved!

#### Addition JKO7E Specifications

Will hold any JK type crystal except H-6, H-18T and H-19.  
Normal operating temperature 50° C ± 2° C.  
Will hold any temperature as much as 75° C above the ambient.  
Supplied complete with Johnson No. 237 Socket.

#### Also Ideal As Frequency Standard When Used With JK Stabilized H-18

The JKO7E, when used with the JK H-18, 100 KC Crystal, or similar type, is also ideal for extremely accurate frequency measurements.

#### JK Stabilized H-18 Specifications

Frequency Range: 80 KC to 2 MC.  
Hermetically sealed metal holder.  
Wire mounted silver plated crystal.  
Octal base.

**Complete Information On Request**

*The James Knights Company*  
SANDWICH, ILLINOIS



new design. With power input capacity of 12 watts continuous, and a frequency response of 250 to 10,000 cps, it is capable of unusually wide-angle dispersion of sound in the horizontal plane, while limiting the vertical dispersion to the optimum degree for paging and talk-back purposes. Impedance is 8 ohms. The speaker features heavy-gage metals, die castings, and hermetically sealed integral driver unit design.

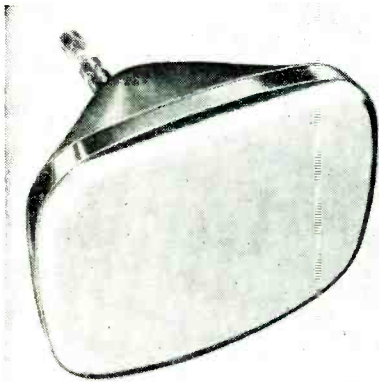

**Rectangular Picture Tube**

ALLEN B. DU MONT LABORATORIES, INC., 750 Bloomfield Ave., Clifton, N. J. Model 20CP4 rectangular Teletron is a new tv picture tube featuring the bent gun that results in sharper over-all trace, and the dark face plate that enhances contrast. Screen size is 17 in. wide x 12 1/4 in. high. Deflection angle is 70 deg. Heater voltage is 6.3 v at 0.6 ampere; maximum anode voltage, 18,000 v. Ion trap magnet strength is 52 gauss at 14-kv anode voltage.



**Intermodulation Meter**

MEASUREMENTS CORP., Boonton, N. J. Model 31 intermodulation moni-

*A New Advance* IN HERMETICALLY SEALED, MINIATURE **Aircraft Type Relays** by "Diamond H"

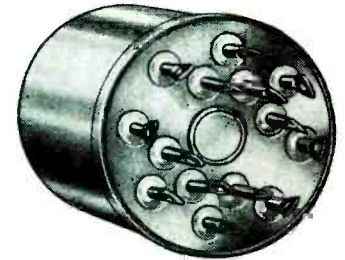
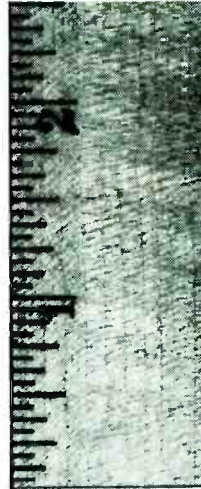
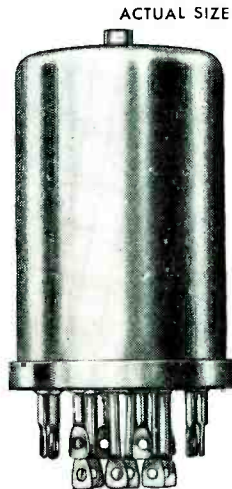

**Basic Data**

**4 POLE DOUBLE THROW**

**SIZE:** *smallest of its type, 1.5 cubic inches*

**WEIGHT:** *lightest of its type, 3.5 ounces*

**SHOCK RESISTANCE (operating):**  
*greatest of its type, 50 G.*

**TEMPERATURE RANGE:**  
*widest of its type, -65° C. to +200° C.*

**PLUS THESE OTHER IMPORTANT SPECIFICATIONS:**

1. **CONTACT RATING:** 2 A, 28 V, D. C.; 2 A, 115 V, A. C., 400 cycle.
2. **CONTACT OVERLOAD RATING:** 12 A, 28 V, 20 sec.
3. **ALTITUDE RATING:** Dry, inert gas, pressure filled; hermetically sealed.
4. **COIL RESISTANCE:** 50 to 10,000 ohms.
5. **COIL VOLTAGE:** 18 to 250 V, D. C.
6. **TERMINAL ARRANGEMENT:** soldered connections; plug-in optional.
7. **MOUNTING:** Variable.
8. **VARIATIONS:** Virtually innumerable, in voltage, amperage, number of poles (4 maximum) and temperatures.

To meet exacting requirements of missiles, rockets and other air, ground, and marine applications, this new relay incorporates a hitherto unmatched combination of characteristics. The combination is achieved through several unique design features developed by The Hart Manufacturing Company, producer of dependable electrical controls and devices for more than half a century.

*Write today for complete information on this new relay. We'll gladly work with you to develop any special variation to meet your specific need.*

The Hart Mfg. Co.  
202 Bartholomew Ave.  
Hartford, Conn.

Send me further information about your new relay.

Name \_\_\_\_\_

Title \_\_\_\_\_

Company \_\_\_\_\_

Street \_\_\_\_\_

City \_\_\_\_\_ State \_\_\_\_\_

# Standard TIMERS

AN ECONOMICAL INVESTMENT IN LONG-LIFE PERFORMANCE AND EXTREME ACCURACY. RUGGED, FOR HEAVY-DUTY SERVICE: FLEXIBLE IN APPLICATION.



Model	Scale Divisions	Totalizes	Accuracy
S-100	1/5 sec.	6000 sec.	±.1 sec.
S-60	1/5 sec.	60 min.	±.1 sec.
SM-60	1/100 min.	60 min.	±.002 min.
S-10	1/10 sec.	1000 sec.	±.02 sec.
S-6	1/1000 min.	10 min.	±.0002 min.
S-1	1/100 sec.	60 sec.	±.01 sec.
MST	1/1000 sec.	.360 sec.	±.001 sec.
MST-500	1/1000 sec.	30 sec.	±.002 sec.

The clutch coil can be connected directly in the plate circuit of electronic tubes. For this use the coil has a resistance of 2000 ohms and requires 50 to 60 milliamperes. When ordering for this purpose, always specify 120V DC clutch coil. Write for Bulletin 153.

**THE Standard Electric Time Co.**  
97 Logan Street **STANDARD** Springfield, Mass.  
FOUNDED 1884

## INSULATION FORMVAR • FORMEX • ENAMEL

### STRIPPED CLEAN IN SECONDS

with **X-VAR**

IN



1. DIP WIRE in X-VAR for 3 seconds.

OUT



2. WITHDRAW and watch coating disintegrate.

WIPE



3. WIPE CLEAN. Operation completed in seconds.

X-VAR is non-corrosive, non-creeping — leaves wire ready for soldering. Now in use by leading manufacturers of electrical products. Write for FREE SAMPLE for testing.

**FIDELITY CHEMICAL PRODUCTS CORP.**  
472 Frelinghuysen Avenue, Newark 5, New Jersey

THE  
NEWEST  
**SMALLEST**  
SWITCHES



2 5/16"

FOR  
ONE-HOLE  
MOUNTING



2 17/32"

FOR  
STANDARD  
MOUNTING  
CENTERS

The new Type MCT-1 telephone-type switch — the smallest made — mounts in a single round hole — eliminates need for slotting panel and drilling and tapping four small holes — provides versatile switching action in addition to its standard features.

"Universal" Type MCT-4

Mounting plate has two sets of four, tapped, mounting holes to fit all standard mounting centers.

**BOTH MODELS FEATURE**

**Electrostatic shielding** between two sets of contact sections reduces coupling between circuits; grounding tab, integral with frame, is included in terminal assembly.

**Versatile lever action** provides either locking on both sides, non-lock on both sides, non-lock on one side, lock on one side.

**Contact buildups** permit all popular as well as special circuit arrangements.

**Cam-spring mechanism** is especially designed for quiet operation and to reduce contact bounce to a new minimum.

**MCT Ratings**  
Palladium contacts rated at 1 amp. at 115 volts, 60 cycles, non-inductive load.

Request Catalog Sheet and B/P #D35-100 giving details of contact arrangements, dimensions, and prices.



**GENERAL  
CONTROL  
COMPANY**

1202 SOLDIERS FIELD ROAD  
BOSTON 34, MASSACHUSETTS



tor consists of two principal sections, a test signal generator and an analyzer. The generator section produces two sinusoidal voltages, one a low frequency and the other a high frequency, which are mixed in a 4-to-1 voltage ratio and applied to the apparatus under test. The signal from the equipment being tested is then received by the analyzer section to be filtered, amplified, demodulated and metered. The instrument is useful for evaluating the performance of audio systems and for checking the linearity of film and disc recordings and reproductions.

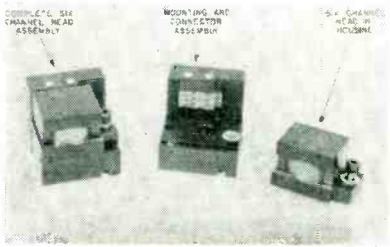

**Magnetic Recording Heads**

RAYTHEON MFG. CO., Waltham 54, Mass., is producing magnetic recording heads for use in multichannel digital recorders. They feature good performance, relative thinness, interchangeability and adaptability for fabrication of multichannel assemblies by a stacking process where recording and reproduction of data on magnetic tapes or drums is desired on parallel tracks. The units are intended primarily for the recording and reproduction of scientific or statistical data in such broad fields as research, computation, measurement and control.

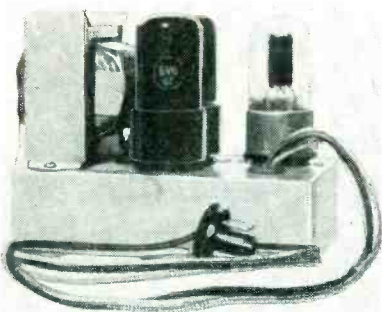

**Audio Amplifier**

MIL0 SOUND, 200 Greenwich St., New York 7, N. Y. Model 10MT

APPROVED BY UNDERWRITERS LABORATORIES AT 90°

**“NOFLAME-COR”**  
the TELEVISION hookup wire

fits perfectly  
into this  
picture

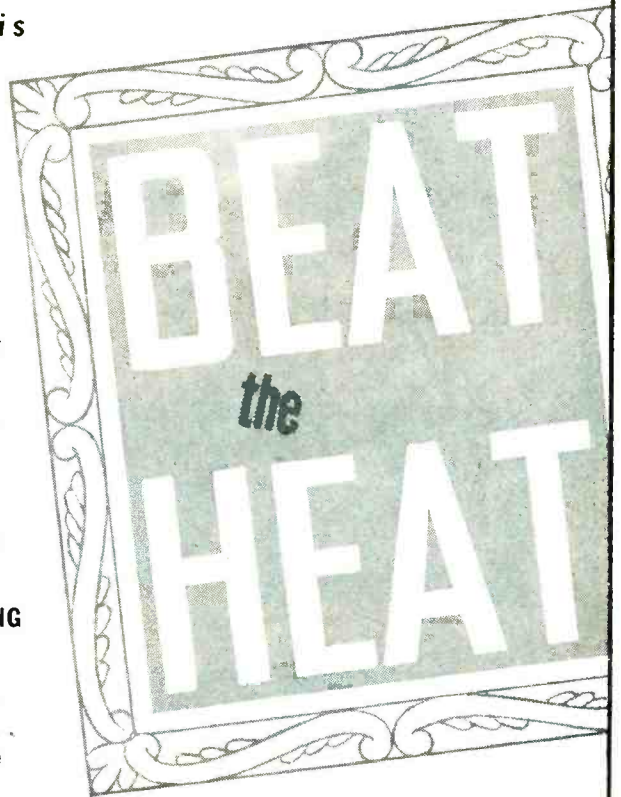

Meets government specification AN-J-C-48a

- FLAME RESISTANT
- HEAT RESISTANT
- HIGH INSULATION RESISTANCE
- EASY STRIPPING
- HIGH DIELECTRIC
- FACILITATES POSITIVE SOLDERING

Also is not affected by the heat of impregnation . . . making it an ideal wire for use in connection with coil and transformer leads



“made by engineers for engineers”

No “Nicking” problem in using this proven wire. Not being an extruded plastic, its diameter uniformity can be absolutely guaranteed. This eliminates nicking of conductors and constant re-setting of blades in the cutting process. Available in all sizes, solid and stranded, in over 200 color combinations . . . “NOFLAME-COR” assures maximum output and minimum rejects.

No “blobbing” of insulations under soldering heat, because “NOFLAME-COR” is NOT an extruded plastic. Production executives specify it as the most efficient heat-resistant wire yet developed. Save time, money and assembling headaches. Investigate!

**CORNISH WIRE COMPANY, Inc.**  
50 Church Street, New York 7, N. Y.

Branch Offices  
PHILADELPHIA BRIDGEPORT CLEVELAND CINCINNATI CHICAGO  
DETROIT MINNEAPOLIS ST. LOUIS ATLANTA  
DALLAS DENVER LOS ANGELES SAN FRANCISCO SEATTLE  
MANUFACTURERS OF QUALITY WIRES AND CABLES FOR THE ELECTRICAL AND ELECTRONIC INDUSTRIES

Standard • STANDARDIZE ON Standard • STANDARDIZE ON Standard

# Eliminate CRYSTAL TEMPERATURE CONTROL COSTS . . .

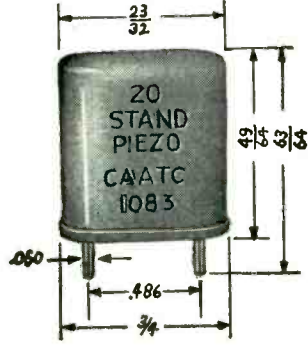

Now you can forget temperature control. Just specify Standard's Type 20 Crystal Unit for your products.

In addition to lowering power requirements and weight, it increases compactness, durability and dependability. Type 20 meets all Government specifications, too.

Discover how the Standard Type 20 can cut costs and increase sales for you. A letter will bring Engineering data and complete details by return mail.



## Standard

**Piezo COMPANY**

CARLISLE, PENNSYLVANIA



Standard • STANDARDIZE ON Standard • STANDARDIZE ON Standard

## THE NEW 'Economy' OSCILLOGRAPH

Long the world's most popular oscillograph, the Type S-14 has been redesigned and improved to meet exacting demands of modern research. The NEW Type S-14C 'Economy' Oscillograph is the simplest to operate and maintain, and the most versatile in application. No research or testing laboratory is complete without it.

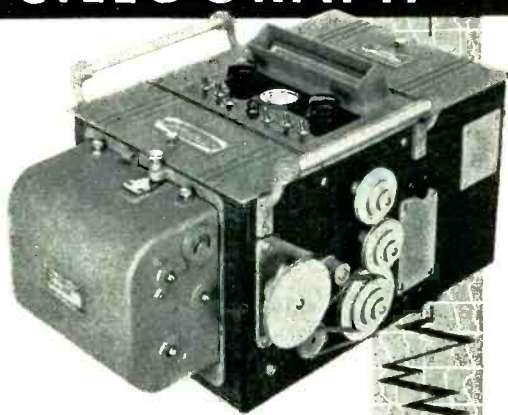

- Wide range of galvanometer types and characteristics. Natural frequencies to 10,000 cps; sensitivities to 50,000 mm per ma; single and polyphase watts.
- Precision optical system for very high writing speeds and high-quality records.
- Continuous-drive magazine for records to 100 or 200 feet long.
- Wide range of record speeds. Any of 9 speeds available by shifting single external belt. Standard speeds: 40, 20, 10, 4, 2, 1, 0.4, 0.2 and 0.1 in./sec.
- Internal motor and gear reducer shock mounted and vibrationless.
- Light-socket operation.
- Daylight loading and unloading.
- Automatic transiend recording attachments.
- Complete list of accessories for extreme versatility.

FOR FURTHER INFORMATION WRITE FOR BULLETIN 2D1-G



**Hathaway INSTRUMENT COMPANY**

1315 SO. CLARKSON STREET • DENVER 10, COLORADO

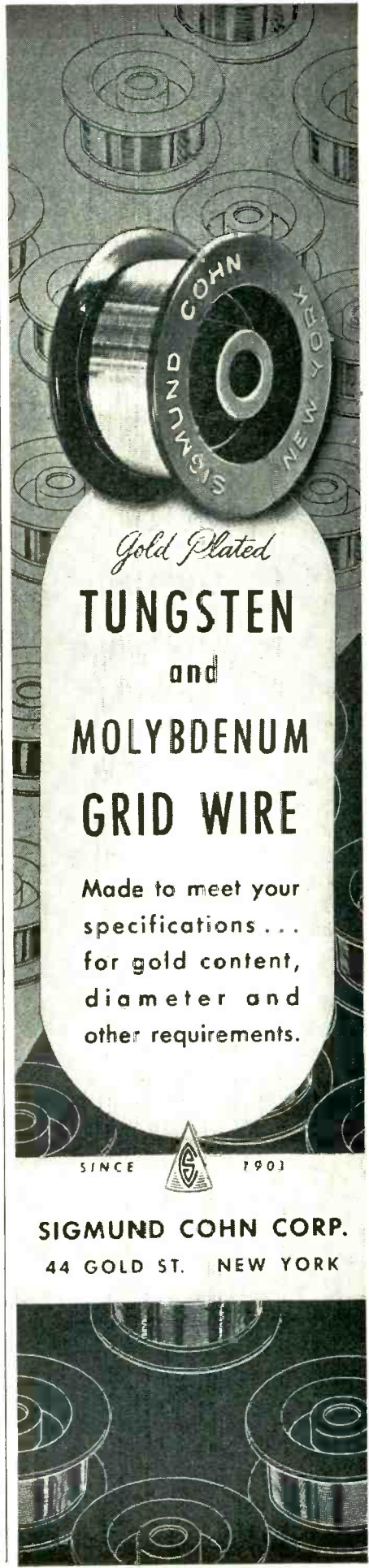

Gold Plated

# TUNGSTEN and MOLYBDENUM GRID WIRE

Made to meet your specifications . . . for gold content, diameter and other requirements.

SINCE  1903

**SIGMUND COHN CORP.**  
44 GOLD ST. NEW YORK



audio amplifier, specially designed for television and the 630TS chassis, is used either with the receiver's given speaker or a higher quality reproducer. With the tv set's own speaker, a 75-percent aural improvement is noted; with a quality speaker, it delivers its full range of 100 to 13,000 cps. It uses two 6K6 or two 6V6 tubes in push-pull; one 6J5 driver. Harmonic distortion is less than 3 percent. Power output is 6 to 8 watts, current consumption, 45 ma. Price is \$12.95.



**Power-Tube Caps**

NATIONAL Co., 61 Sherman St., Malden, Mass., has announced new heat-radiating caps for use with all popular types of power tubes. Designed to government specifications, the new caps feature aluminum contact fingers that are integral with the radiating fins. Tension on the fingers is maintained by an encircling steel spring. A 6/32-in. tapped center hole is provided for attaching grid ribbon or other lead. A crimped, silver-plated beryllium copper grid ribbon, 3 1/4 in. long, is supplied with each cap. Special lengths can be supplied in quantity.

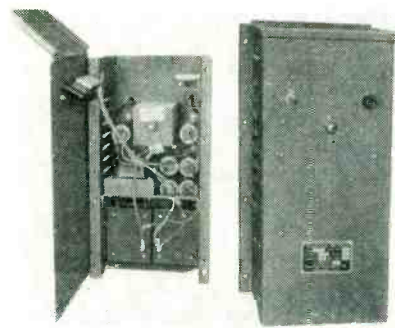

**Telephone Battery Eliminator**

ELECTRONIC RECTIFIER CO., INC., Rochester, N. Y. Type ZF3DP tele-

# NEED BEAM-SPLITTERS OR FILTERS?

Liberty Hi-Efficiency beam-splitters or filters divide the incident light into a reflected beam and a transmitted beam. Having little or no light absorption, they permit the use of practically all of the incident light. More than two beams of light can be provided by the use of more than one beam-splitter.

These new, more efficient beam-splitters have made possible the design and production of new optical and electronic instruments. They also have improved the performance of cameras, as well as special optical and electronic apparatus for the defense program.

Their field of use includes a wide variety of applications where it is desirable to produce visual images and/or photographic images simultaneously, or to operate electronic control devices.

Liberty Hi-Efficiency beam-splitters and filters are made, as standard products, with visible light reflection values of approximately 15%, 30%, 40%, 50%, 60%, 70%, 80%, and 90%, the remainder of the incident light being transmitted.

Where required, special Hi-Efficiency beam-splitters and filters can be made to possess other than standard reflection and transmission values, with little or no light absorption. They also can be made with electrical conducting properties in the order of 20 to 40 ohms resistance per square.

All of these products have ex-

cellent durability and have served satisfactorily in all applications where they have been used.

Reflection and transmission curves for all standard reflection percentages, as listed above, are available on request.

Our unique manufacturing facilities allow us to offer top quality on every order, from the largest to the smallest. We invite your comparison test order. For quotations, use the coupon below.

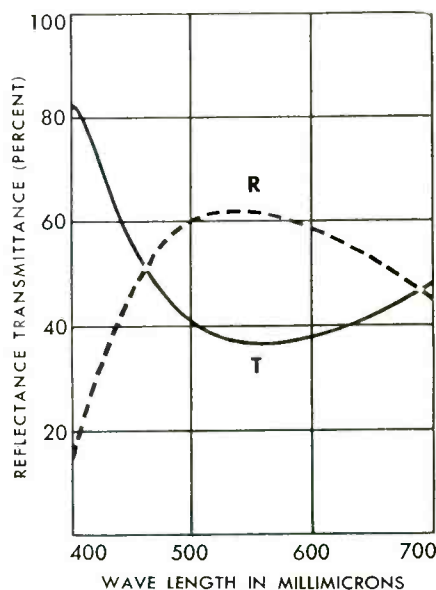

A recording spectrophotometric curve of a standard production 60% reflection beam-splitter of Liberty's No. 601 Hi-Efficiency film on commercial plate glass with refractive index of 1.52. The average reflectance (R) and transmittance (T) of this film as measured by a viscor filter is 60.6% and 38.3% respectively.

LIBERTY MIRROR DIVISION, LIBBEY • OWENS • FORD GLASS CO.  
1221 NICHOLAS BUILDING, TOLEDO 3, OHIO

I am interested in your Liberty Hi-Efficiency beam-splitters and filters for

(Application) \_\_\_\_\_

Please quote me on \_\_\_\_\_ in size \_\_\_\_\_

Please have salesman call. (Quantity) \_\_\_\_\_

Name \_\_\_\_\_ Title \_\_\_\_\_

Company \_\_\_\_\_ Address \_\_\_\_\_

City \_\_\_\_\_ Zone \_\_\_\_\_ State \_\_\_\_\_

**LIBERTY VACUUM DEPOSITED COATINGS**

Liberty Mirror Division • Libbey-Owens-Ford Glass Co • Nicholas Bldg., Toledo 3, Ohio

# TWO-in-ONE

**D·C·P\* adds  
or subtracts  
two input variables**

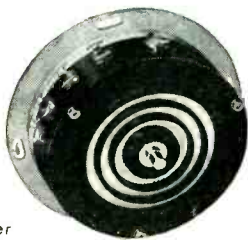

\*Differential Computing Potentiometer

"Two potentiometers in one" most aptly describes the Fairchild Differential Computing Potentiometer. This versatile unit makes it possible to combine two input variables and obtain an output that is proportional to their sum or difference.

Available in quantity, the D-C-P costs less than two separate type 748 units while offering high resolution and accuracy of a single potentiometer. Linearity of  $\pm 0.10\%$ , high resolution, long life, low noise level, and low torque—all Fairchild Linear Potentiometer features—are built into the D-C-P.

Suggested applications include servomechanisms, instrument controls, and computing and analyzing instruments. The D-C-P will directly replace two single potentiometers when one is used for compensation or correction purposes. For more data, write to Fairchild Camera and Instrument Corporation, 88-06 Van Wyck Boulevard, Jamaica 1, N. Y. Dept. 140-12A1.



## Steatite

for **ELECTRONIC**  
Applications

You can specify LOUTHAN low-loss Steatite products with complete confidence in the high quality and dimensional accuracy of the parts. Made to exacting standards, Louthan Steatite insulations have the mechanical and electrical characteristics needed for electronics applications and other electrical service. They are formed to meet your needs and made to close tolerances. Surfaces are smooth, hard, clean and non-absorbent.

Write for Catalog 49-E, describing Louthan Insulations.

**THE LOUTHAN MANUFACTURING COMPANY**

A Subsidiary of Harbison-Walker Refractories Co.

**EAST LIVERPOOL, OHIO**

Representatives: H. B. Zeiger, New York 17, N. Y.

Glenn Garner Company, Chicago 6, Ill.

Where the  
Requirements  
are Extreme...

Use  
**SILVER  
GRAPHALLOY\***

For extraordinary  
electrical performance



**THE SUPREME BRUSH  
AND CONTACT MATERIAL**

### IN BRUSHES

- for high current density
- minimum wear
- low contact drop
- low electrical noise
- self-lubrication

### IN CONTACTS

- for low resistance
- non-welding character

\* Graphalloy is a special silver-impregnated graphite

Accumulated design experience counts — call on us!

**GRAPHITE METALLIZING  
CORPORATION**

1055 NEPPERHAN AVENUE, YONKERS 3, NEW YORK



phone power supply is designed to eliminate the nuisance of dry-cell batteries on private phone systems such as are used in factories, apartment houses, office buildings and schools. The power supply consists of a properly filtered full-wave selenium rectifier that is designed for long life without maintenance. Operation is from 115-v 60-cycle a-c line with 3 amperes d-c output capacity. Taps are provided for 8, 10 and 12 volts. Also provided is an 8-volt a-c tap for operation of a-c buzzers or other equipment. Another model is rated at 1½ amperes 24 volts.

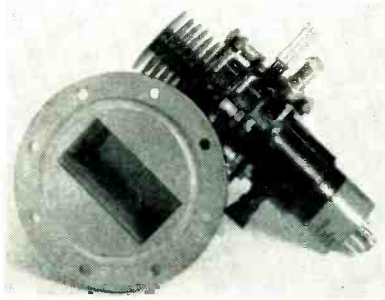

### Microwave Amplifier Tube

SPERRY GYROSCOPE CO., Great Neck, N. Y., has developed a three-cavity klystron amplifier tube that has wide-band modulation characteristics with high power output for operation in the 4,000-mc common carrier band. It increases the output of transmitters to 10 watts. The tube also may be used as a synchrodyne or heterodyne mixer which makes it possible to avoid distortion in telegraph and television use by transmitting through stations in the tall towers about 30 miles apart without demodulation. Thus large numbers of repeaters may be connected in tandem to provide high quality long distance circuits.

### Literature

**Dynamic Pressure Measurement.** Electronic Associates, Ltd., 778 El Camino Real, San Carlos, Calif., describes in form SA5-950 a newly developed measuring system for directly obtaining true dynamic

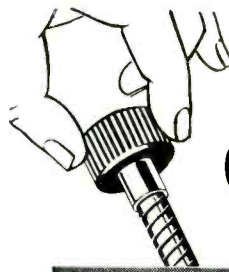

*Design for...*  
**CUSTOMER CONVENIENCE**



**Make your TV sets  
easier to tune with**

**S.S.WHITE FLEXIBLE SHAFTS**

Mount the tuning knobs where they can be operated from a comfortable standing position. You can easily do this by using S.S.White Flexible Shafts to couple the tuning knobs to their respective circuit elements. The shafts will remove all limitations on the placement of coupled parts. The knobs can be grouped in any desired arrangement on the cabinet. And the elements can be placed to best advantage to improve circuit efficiency and to facilitate wiring, assembly and servicing.

Tuning convenience is a selling feature prospective buyers will like. Keep it in mind when you design your sets. And when you do, remember that S.S.White flexible shafts are the simple, easy way to get it.



**WRITE FOR NEW BULLETIN 5008**

*It contains the latest information and data on flexible shafts and their application. Write for a copy today.*



**THE S.S.White INDUSTRIAL DIVISION**  
**DENTAL MFG. CO.**



Dept. E 10 East 40th St.  
NEW YORK 16, N. Y.

All types of  
**AGASTAT**  
**TIME**  
**DELAY**  
**RELAYS**

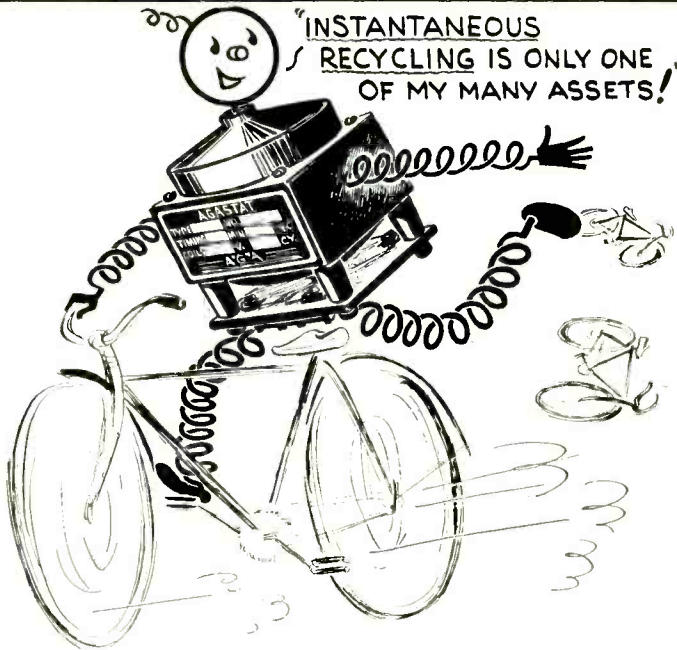

are solenoid actuated — pneumatically timed. For AC and DC service. It will pay you to take time out to investigate Agastat Time Delay Relays. Information and literature on request.



**AMERICAN GAS ACCUMULATOR COMPANY**  
1027 NEWARK AVENUE • ELIZABETH 3, N. J.

# Polarad

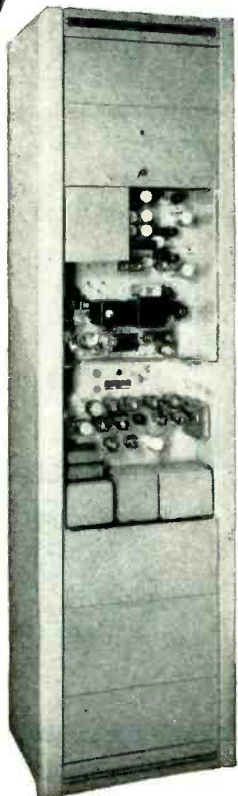

## TELEVISION MONOSCOPE SIGNAL SOURCE

### Model PT-102

Used in transmitting stations, laboratories and in receiver factories where a reliable standard video signal in the form of a test pattern is a prime requisite for testing overall video performance.

- Composite Video Signal.
- Wide Band Video Amplifier, 3 db down at 7 mc.
- Dual outputs for feeding two 75 or 100 ohm lines.
- Black positive or Black negative output.
- Resolution greater than 500 lines.

INPUT: Vertical and Horizontal Driving Pulses. Camera and Kinescope Blanking Pulses.

OUTPUT: Composite Video Signal, 2 Volts peak to peak. Complete with tubes, high and low voltage power units, cabinet rack.

# Polarad

Electronics Corporation

100 Metropolitan Ave. • Dept. E-2 • Brooklyn 11, N. Y.

Engineers and consultants to the Nation's Great TV Stations

Visit our Booth  
S-7 at the  
IRE Show

# TEFLON

has outstanding  
insulating properties

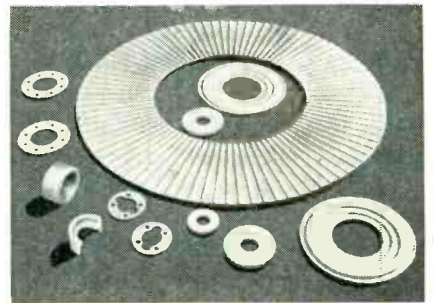

Power factor, less than 0.0005; dielectric constant, only 2.0—over entire frequency measured to date. Excellent dielectric and mechanical strength; zero water absorption. Serviceable in the temperature range -90°F. to 500°F. Tough, resilient, unaffected by outdoor weathering, and completely chemical-proof.



Teflon is ideal for high-voltage, high-temperature, high- or ultra-high-frequency service in TV transmitters, radio, radar and other electrical equipment. We supply Teflon spacers for coaxial cables,

Teflon inserts for coaxial connectors, all types of molded and/or machined Teflon parts.

### Teflon Stock and Fabricated Parts

Sheets  
Cylinders  
Rods  
Tubing  
Bars



Immediate delivery—experimental or production quantities—from the country's most complete selection of Teflon stock. Also, variations of stock shapes and sizes or special molded or machined parts exactly to specifications.

### Teflon Products Division

# UNITED STATES GASKET COMPANY

600 N. 10th St.

Camden, New Jersey

February, 1951 — ELECTRONICS



pressure variations. It contains a discussion of the problems involved in correcting conventional measurements for phase and amplitude errors inherent in tubing-connected pressure-sensing cells. Types and capacities of cells are tabulated from the  $\pm 2.5$  to  $\pm 10$ -psi ratings and from the  $\frac{1}{4}$  in. long x  $\frac{1}{2}$ -in. diameter to the  $1\frac{1}{2}$  in. long x  $\frac{1}{2}$ -in. diameter sizes, including special wedge-shaped units for difficult mounting situations such as near an airfoil trailing edge.

**Electronic Cores.** Metal Powder Association, 420 Lexington Ave., New York 17, N. Y., has released Standard 11-50T defining the terms commonly associated with electronic cores made from iron powder. It also specifies the preferred dimensions of standard insert iron cores and threaded iron cores. Specifications include core diameters, lengths, screw inserts, insert size of tuning and insert cores, screw driver slots for inserts, spaded inserts and screw driver slots molded in cores. Price is 25 cents per copy.

**Geophysical Transformers.** Triad Transformer Mfg. Co., 2254 Sepulveda Blvd., Los Angeles 64, Calif. Catalog GP-51 discusses a new line of miniaturized Geofomers (geophysical transformers) designed for use in the frequency range from 5 to 500 cycles. By the use of improved winding techniques more efficient magnetic materials, and new shapes in core and case, the units described perform all the functions of the items they replace in one-seventh the volume and one-sixth the weight.

**Selenium Rectifiers.** Syntron Co., Box 220, Homer City, Pa., has available a four-page bulletin dealing with metallic, dry-cell selenium rectifiers. It gives illustrations, advantages, applications, a table showing cell sizes and ratings, and ordering information. Thirty-eight applications are listed.

**Distribution Transformers.** Marcus Transformer Co., Inc., 32-34 Montgomery St., Hillside 5, N. J. Safety in avoiding explosion and

## ALDEN COMPONENTS FOR PLUG-IN UNIT CONSTRUCTION

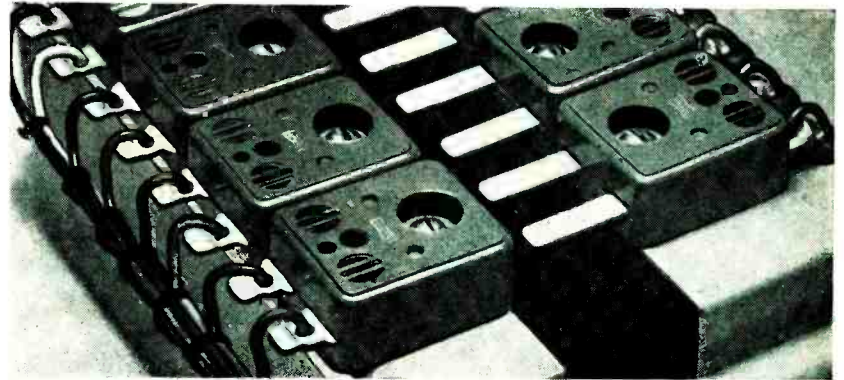

Until recently there has been no one place where components specifically designed for plug-in unit construction were available. It was necessary for engineers to have parts custom made or improvise with standard components in makeshift arrangements. To provide the type of design necessary, Alden engineers are working with the industry developing a whole series of components specifically for plug-in construction.

A recent development, the Alden 462 Back Connector for plug-in slide-in chassis construction, meets the standards and solves many engineering problems not adequately taken care of with conventional connectors. Engineers working on this problem were looking for more than just a jumbled conduit connector. The connector they needed had to provide the most direct efficient wiring from connector to component to permit rapid check and it had to go together and come apart easily to allow instant accessibility.

To meet the requirements and satisfy the demands, an entirely new design approach was taken by Alden's. The Alden Back Connectors are individual units that can be mounted where desired and really allow you to plan your chassis for performance and efficiency. Generous bell-mouth and floating clip action eliminates abnormal, precise sheet metal work and critical chassis alignment problems; ruggedizes electronic equipment for mobile, industrial, or other similar taxing applications.

Illustrated below are the design features which are rapidly making Alden connectors the standard for modern plug-in chassis construction. For quality and performance incorporate Alden Back Connectors in your design.

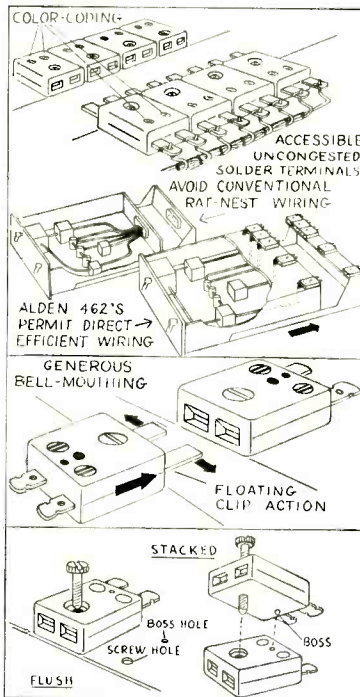

### Easy Servicing and Rapid Circuit Checks

Solder terminals are easily accessible and uncongested for multiple contact wiring. Color-coding on back connector identifies each lead for instantaneous check to main circuit or trunk line.

### Efficient Circuit Wiring

Connectors can be mounted where desired—to allow for isolation of critical voltages or frequencies—to provide most direct wiring from component to connector—to eliminate ratnest wiring of conventional methods.

### Easy Insertion and Removal

Generous bell mouthed entries and ample float of rugged contacts provide automatic mating. Wide mating tolerances eliminate critical unit alignment problems.

### Easy Mounting

Single screw for mounting flush or stacked. Molded locating boss positions and locks connector in place on unit when flush mounted—boss accurately lines up and positions connectors together in stack mounting.

Send for descriptive booklet, "Components for Plug-in Unit Construction".



## ALDEN PRODUCTS COMPANY

117 NORTH MAIN STREET, BROCKTON 64, MASSACHUSETTS

# FOR COMPLETE TESTING

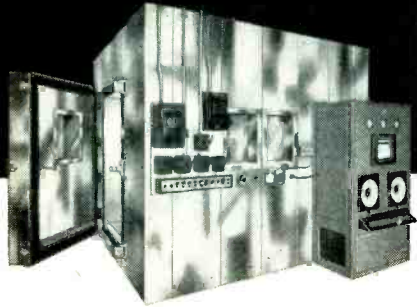

## WALK-IN ROOMS

by **BOWSER TECHNICAL REFRIGERATION**

Bowser Walk-In Rooms have a temperature range from +180°F. to -100°F. and relative humidity simulation from 20% to 95%. Because of sectionalized panel construction any size or shape room can be manufactured for final assembly in the field. Smaller sizes are preassembled at the factory. Extended ranges of temperature, humidity and provision for altitude simulation can be provided. Special accessories and instrumentation also available.

*Standard Environmental Simulation Chambers — Wide range of sizes and performance ratings. Meet all Govt. test specs.*

**BOWSER TECH. REFRIG., Terryville, Conn.**

Send me more information on the following:

- |                         |                          |                         |                          |
|-------------------------|--------------------------|-------------------------|--------------------------|
| Walk-in Chambers        | <input type="checkbox"/> | High Altitude Tests     | <input type="checkbox"/> |
| High Temp. Tests        | <input type="checkbox"/> | Mildew Resistance Tests | <input type="checkbox"/> |
| Low Temp. Tests         | <input type="checkbox"/> | Sand & Dust Tests       | <input type="checkbox"/> |
| Fungus & Humidity Tests | <input type="checkbox"/> | Explosion Proof Tests   | <input type="checkbox"/> |

Name \_\_\_\_\_ Pos. \_\_\_\_\_

Company \_\_\_\_\_

Street \_\_\_\_\_

City \_\_\_\_\_ Zone \_\_\_\_\_ State \_\_\_\_\_ SE

# BOWSER

**TECHNICAL REFRIGERATION**  
DIVISION BOWSER INC.  
TERRYVILLE • CONN.

*Preferred where performance is paramount*

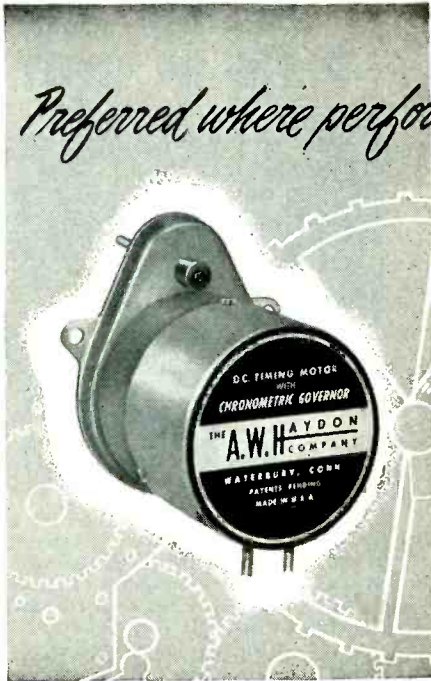

**A. W. HAYDON**  
**D. C. TIMING MOTORS**  
with *Chronometric Governor*

A primary power source of extreme accuracy, this revolutionary development of the A. W. Haydon Company is the first successful production combining the accuracy of a clock with the power of a motor. Made with jeweled movements, this extraordinary timer permits the solution of problems heretofore considered insurmountable.

*Special Features:*

- Extreme accuracy
- Wide range of voltage, load and temperature
- Reversible
- Compact
- Light weight



The **A.W. HAYDON**  
**COMPANY**

235 NORTH ELM STREET  
WATERBURY 20, CONNECTICUT

*Design and Manufacture of Electrical Timing Devices*

Write Today for catalog sheet giving full information of A. W. Haydon D.C. Timing Motors with Chronometric Governors.

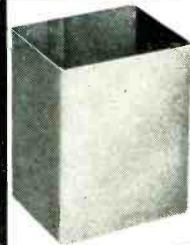

## MIL-T-27 CANS ARE STOCK ITEMS

AT *Heldor*

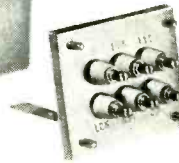

We can supply all standard sizes of MIL-T-27 cans with or without brackets, weld studs, centrifugal hot tinned, blind inserts, compression type hermetic seal bushings on 3/8"-1/2"-5/8"-3/4" centers, and stamped ratings. Custom sizes can also be supplied.

Our other services include special tube bending and specialized screw machine products.

Write for specifications and price list.

**HELDOR METAL PRODUCTS CORP.**

NOTE NEW ADDRESS: 85 Academy St., Belleville 7, N. J.

# HIGH VOLTAGE POWER Supplies

Up to 250,000 volts

A.C. or RECTIFIED and FILTERED

**SPECIAL INDUSTRIAL X RAY EQUIPMENT**  
FOR INSPECTION • GAGING • ANALYSIS . . .

*We Will Design, Engineer and Manufacture to your requirements.*  
SEND FOR BULLETIN 131

**BRACKE-SIEB X RAY COMPANY INC.**

293 B THIRD AVENUE

NEW YORK 10, N. Y.



fire hazards, economy of installation and maintenance are the key-notes of bulletin 50-FC on air-cooled distribution transformers. The four-page bulletin illustrates and describes the 1,000 kva, type F, unit substation showing a cut-away picture of a transformer section. It also shows various types of air-cooled power-center and packed-power units. Included are details about a line of lighting transformers, single and three-phase types.

**Control Apparatus.** Electrical Remote Control Co., Ltd., 13 Evanson Ave., Highams Park, London, E. 4, England, has available bulletins dealing with the type TPH heavy-duty photoelectric control apparatus, type PRP time control unit, type MDC, synchronous cam-operated timers and type DS heavy-duty relays. Write for list numbers 72, 31, 26 and 11.

**Precision Instruments.** Dawe Instruments Ltd., 130 Uxbridge Rd., Hanwell, London W7, England, has available a catalog containing over forty bulletins giving full details on a wide range of precision electronic instruments for scientific, industrial and photographic applications. Illustrations and specifications for each instrument are included.

**High-Fidelity Sound Equipment.** Hudson Radio & Television Corp., 212 Fulton St., New York 7, N. Y. The latest catalog contains complete descriptions of all the standard brand components required to assemble a high-fidelity sound system for home or professional use. It includes an explanation of high fidelity, what it is, how it functions, how to evaluate the performance of the various components, explanation of terminology, how to install, and so on. It also gives a complete description of each unit, with prices.

**Phono Accessories.** General Electric Co., Syracuse, N. Y., has prepared a 16-page phono accessory catalog, with descriptions and data on variable reluctance cartridges, replacement baton styli, tone arms and phono preamplifiers. Photo-

*Here's why  
those in the know  
demand—*

**CANNON  
PLUGS**

*superior  
contact  
design*

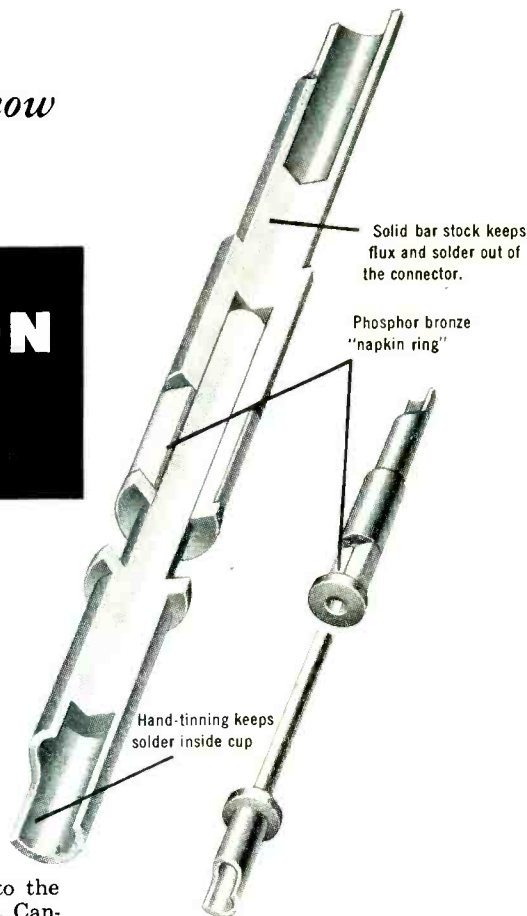

Because the contact is the key to the success of any electric connector, Cannon has always applied the highest order of skill and care to this all-important detail. Cannon pin and socket contacts are all precision machined from solid bar stock. Silver or gold plating maintains high conductivity after years of constant use. Phosphor bronze "napkin ring" of the socket keeps pressure on large areas of heavy metal, preventing current loss. There are no thin metal

tangent contact points in Cannon contacts. (See below). Solder cups are carefully tinned by hand to keep the solder inside the cup. Cannon socket contacts are full floating to assure perfect alignment. You'll find these design features throughout the great variety of precision contacts used in all Cannon connectors. For real value demand Cannon.

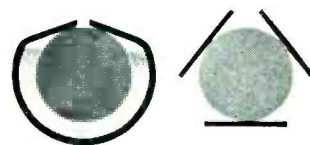
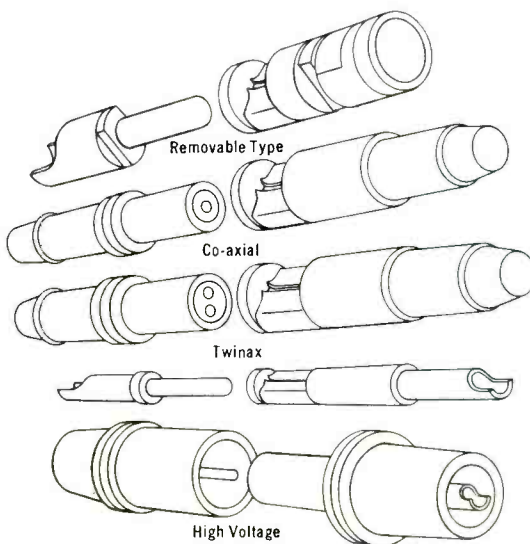

Cannon design (above left) makes contact on large, heavy metal surfaces. Current is not carried through spring section. In Cannon Connectors there are no thin metal tangent contact points, like the design shown at right.

**CANNON  
ELECTRIC**

Since 1915  
LOS ANGELES 31, CALIFORNIA  
REPRESENTATIVES IN  
PRINCIPAL CITIES

In Canada & British Empire: Cannon Electric Co., Ltd., Toronto 13, Ontario. World Export (Excepting British Empire): Frazar & Hansen, 301 Clay St., San Francisco, California.

you can depend upon

# PYROFERRIC

Your best bet for

## POWDERED IRON CORES

**PYROFERRIC** engineers are specialists and pioneers in the technique of powder metallurgy development and iron core manufacture. Consult with them on your iron core or powder metallurgy requirements...no requirement either too small or too large.



**OUR SPECIAL DEFENSE CONTRACT DEPARTMENT ASSURES PROMPT SERVICE FOR ALL GOVERNMENT WAR WORK.**



Address all communications to

# PYROFERRIC

621 EAST 216 ST.,

NEW YORK 67, N. Y.

• With a new and second plant at 14 North Bleeker Street, Mt. Vernon, N. Y., PYROFERRIC is able to meet the increasing demands for iron cores and powdered metallurgy development.

NEW PRODUCTS

(continued)

graphs, characteristics charts and outline drawings are shown.

**Voltage Measurement.** Hewlett-Packard Co., 395 Page Mill Rd., Palo Alto, Calif. Volume 2, No. 3 of the Journal covers the model 410B h-f vtvm, a unit designed to have an input capacity of approximately 1.5  $\mu\text{f}$ . Frequency range of the instrument described is from 20 cps to 700 mc, and its a-c voltage range is from 1 volt full scale to 300 volts full scale in six ranges.

**Scintillation Counting Equipment.** R-C Scientific Instrument Co., 335 Culver Blvd., Playa Del Rey, Calif., has issued a brochure containing information on an entirely new line of instruments for scintillation counters. Models covered are the CX14 Scintiscaler, AX10 Scintimometer, LAX12 gamma Scintimeter and TAX11 Scintilocalizer. Illustrations, applications, description, features, specifications and prices for all are given.

**Sand Core Drying.** Allis-Chalmers Mfg. Co., 935 South 70th St., Milwaukee 1, Wisc. A recent four-page folder deals with the advantages involved in the use of the new electronic sand core drying method whereby heat is furnished by a 20-kw dielectric heater and current is transmitted through heavy coaxial cable. The process is completely described and illustrated.

**TV and F-M Servicing.** Simpson Electric Co., 5200 W. Kinzie St., Chicago 44, Ill., is issuing a small illustrated folder on six instruments for f-m and tv servicing. Included in the group are: model 335 plate conductance tube tester; model 488 field strength meter; model 476 Mirroscope; model 303 v-t volt-ohmmeter; model 260 a-c/d-c volt-ohm-milliammeter and the model 480 Genescope. Pictures of all six are shown and descriptions include sizes, weights, specifications as to ranges, and prices.

**Transmission Lines & Antenna Equipment.** Andrew Corp., 363 E. 75th St., Chicago 19, Ill. Bulletin 10-D is a thirty-page description and price list of a long line of coax cables for uhf, transmission lines



ADVERTISEMENT

HF and UHF power leakage positively and economically controlled by new gasket material

The unique combination of controlled resiliency, stability and conductivity found in Metex "Electronic Weather Stripping" makes it particularly effective as a shielding material for such electronic applications as radar equipment, high frequency heating, television broadcasting and high frequency communication.

It is available in strips or in die-formed gaskets of the shape, size and volume required by the particular application. Economical in cost, the use of this material permits further savings in assembly time and eliminates much costly machining of closure surfaces that would normally be required.

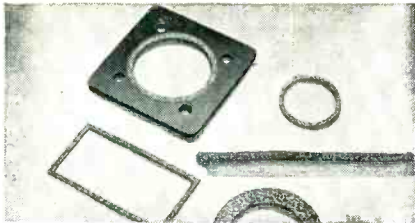

### "Electronic Weather Stripping"

The base material is a knitted—not woven—wire mesh which is made from any metal that can be drawn into wire. Knitting produces a mesh consisting of a multiplicity of interlaced loops which increase the normal resiliency of the wire and, by their hinge-like action, permit freedom of motion without loss of stability.

These characteristics are retained even when multiple layers of this mesh are compressed to form gaskets or strips. The result is a compressible, resilient, cohesive, conducting material with a large internal surface area. Where hermetic sealing is also required, these gaskets are made in combination with neoprene or similar materials.

### Applications

Among the varied applications where Metex "Electronic Weather Stripping" has already proved its effectiveness and economy are: Air craft pulse modulator shields, waveguide choke-flange gaskets, shielding metal housings, replacing beryllium-copper fingers and springs on TR or ATR tubes, and ignition shielding to prevent radio noise interference. The facilities of our engineering department are available at any time to assist you in determining the possible adaptability of "Electronic Weather Stripping" to your specific requirements. A letter, addressed to Mr. R. L. Hartwell, Executive Vice President, and outlining briefly your particular problem will receive immediate attention.

**Metal Textile Corporation**

641 East First Ave.

Roselle, N. J.

ELECTRONICS — February, 1951

# 1500 VOLT POWER SUPPLY FOR PHOTO MULTIPLIER TUBES



Regulated and Continuously Adjustable  
from 600 to 1500 V.D.C. at 0-1 Milliamperes.  
Positive Terminal Grounded.

Regulation: Output voltage varies less than .01% per volt change of line voltage. Output voltage varies less than 1 volt with variations of output current between 0—1 milliampere. (Internal impedance less than 1000 ohms.)

MODEL 710P  
Cabinet Mounted  
\$190.00\*

Also available with 2 or 3 independently regulated and independently adjustable outputs.

MODEL 710PR  
Standard Rack Mounting  
\$195.00\*

We produce a wide variety of regulated power supplies to the most critical standards. Write for full particulars or send us your requirements.

Models Available With Negative Terminal Grounded. (Substitute letter "S" for "P" in model designation)

\* Prices net F.O.B. Chicago



**FURST ELECTRONICS**

10 S. JEFFERSON STREET

CHICAGO 6, ILLINOIS

**CABINETS • CHASSIS • PANELS • RACKS**

Planning ELECTRONIC EQUIPMENT?  
Investigate the ECONOMIES  
of PAR-METAL HOUSINGS!

We manufacture Metal Housings for every purpose — from a small receiver to a deluxe broadcast transmitter. And the cost is low!

Because we specialize in the Electronics field, Par-Metal Products excel in functional streamlined design, rugged construction, beautiful finish, and economy.

Remember, Par-Metal equipment is made by electronic specialists, not just a sheet metal shop.

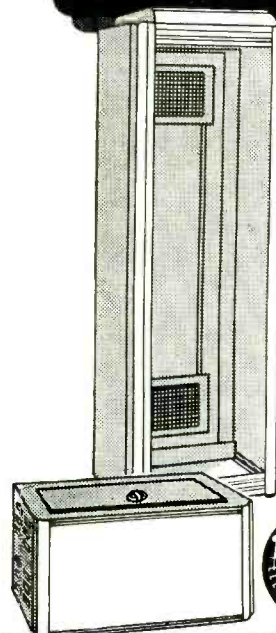
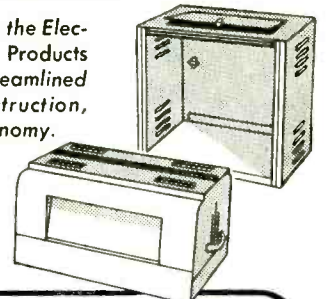

**PAR-METAL**  
PRODUCTS CORPORATION

32-62 — 49th ST., LONG ISLAND CITY 3, N. Y.

Export Dept.: Rocke International Corp.

13 East 40 Street, New York 16, N. Y.

**WRITE FOR CATALOG!**

# NEW STEVENS THERMOSTAT

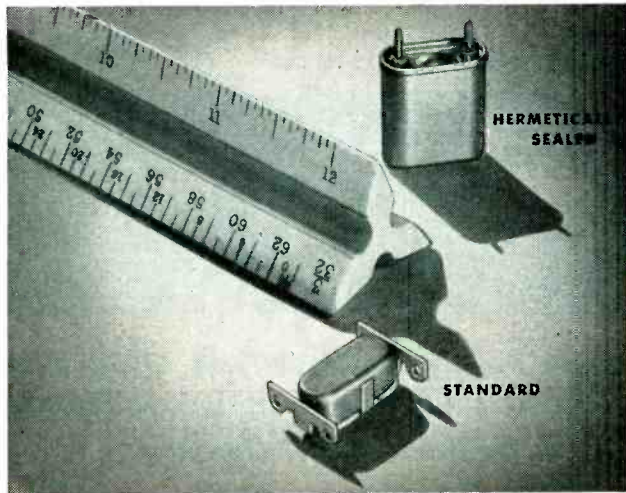

- close temperature control
- clean make and break
- fast response

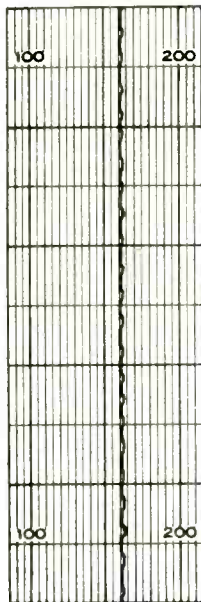

Compactly designed for use in communications equipment, electronic devices and apparatus demanding a high degree of temperature stability, Stevens Type C\* thermostats feature an electrically independent bi-metal that responds *only to heat from controlled device.*

Typical temperature curve at left shows how this construction completely eliminates artificial cycling or life-shortening "jitters." Current flows readily through stainless steel or alloy contact spring . . . does not pass through high resistance bi-metal. Contacts open only when bi-metal overcomes spring pressure and friction of bi-metal strip against contact spring surface—for a *clean, positive break.*

Components are permanently riveted to dimensionally stable Alsimag base to further insure against erratic operation. Heavy-duty silver contacts assure long life.

Standard and hermetically sealed Stevens Type C thermostats are carefully pre-calibrated in pots simulating actual service conditions; spot life-tests assure quality control. Specify Stevens Type C thermostats for closer temperature control—*longer life.*

A-2299

\* PATENT APPLIED FOR

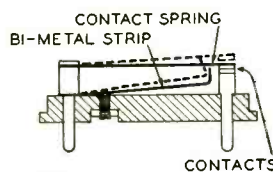

**STEVENS** manufacturing company, inc.  
MANSFIELD, OHIO

for tv and microwave, antennas, and antenna-tuning equipment and components. The booklet is cross-indexed.

**Radiation-Detection Densitometers.** The Atomic Center, 489 Fifth Ave., New York 17, N. Y., has available bulletin 490 describing model 400-R Photovolt self-contained densitometer for the accurate measurement of density of dental-size x-ray films as employed in film badge systems for personnel monitoring in radioactivity laboratories and x-ray installations. Price of the unit discussed in the bulletin is \$225. Also available is bulletin 270 describing the model 500-R photoelectric instrument having similar functions, but priced at \$370.

**Rack-and-Panel Type Connectors.** Cannon Electric Development Co., 3209 Humboldt St., Los Angeles 31, Calif. A new bulletin coded DPM-2 covers the two miniature rack-and-panel connectors, types DPM-14 and DPM-A20 for radio, aircraft and special instrument applications. Dimensional sketches and photos are shown.

**Broadcast Audio Equipment.** Radio Corp. of America, Camden, N. J. Full description, features, uses and specifications of the type RT-11A magnetic tape recorder are outlined in Form 2J6934, a recently issued two-page brochure. Other available literature includes Form 2J6936, describing the Starmaker ribbon-pressure microphone; Form 2J6834-Re, featuring a new wall housing for the LC-1A Olson speaker; and Form 2J6935, which presents information on a new lightweight pickup tone arm combination for use with the type 70-D turntable.

**Tube Insulators.** American Lava Corp., Chattanooga 5, Tenn. Bulletin 502 discusses the requirements of vacuum-tube insulators and outlines the main facts about various technical ceramics especially adapted to those requirements. A chart gives detailed physical characteristics of the five most frequently used ceramic compositions. Particular attention is



**ELECTRO TEC**  
MINIATURE

**SLIP RING  
ASSEMBLIES &  
COMMUTATORS**

— for Gyros, Computers,  
Resolvers, Instruments,  
Selsyns, Motors

ACTUAL SIZE

- DIAMETERS FROM .05 TO 24.0 INCHES
- ABSOLUTE MINIMUM TORQUE FRICTION
- MINIMUM 1000 V.A.C. HI-POT BETWEEN CIRCUITS
- PALLADIUM AND RHODIUM FINISH TO PREVENT TARNISH, MINIMIZE FRICTION

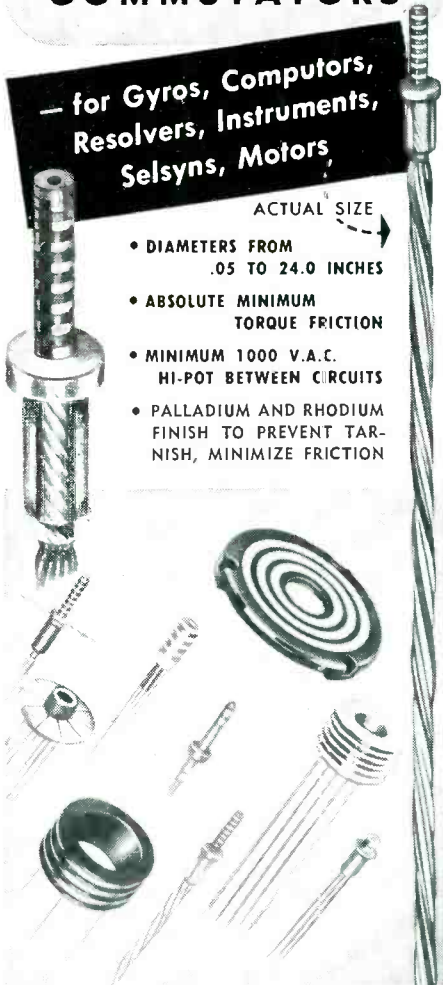

**E**LECTRO TEC supplies virtually any type of Precision Miniature Slip Ring Assembly or Commutator to rigid mechanical and electrical specification. An exclusive manufacturing technique—hard silver plated to a precision machined plastic base and wire—forms a rigid assembly that easily withstands up to 12,000 rpm. Concentricity and dielectric strength are superior to any other method of construction. Although Electro Tec products provide improved performance and extra dependability, prices are strictly competitive. Write today for details.

**ELECTRO TEC  
CORPORATION**



SO. HACKENSACK, NEW JERSEY

**PRECISION PAPER TUBES**  
are best for COILS...

ANY  
SIZE  
ANY  
SHAPE  
ANY  
LENGTH

Round  
Oval  
Square  
Rectangular

- No coil forming after winding
- Wire saved by closer engineering of coil
- Automatic stacking
- No side bow

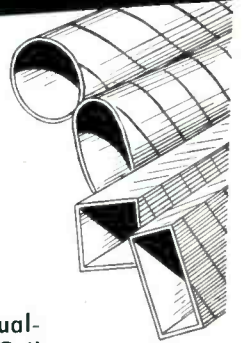

Precision gives you plus quality at no extra cost. Coil bases are formed under heat and pressure... result, a coil base weighing less... greater strength... more thorough insulation... more effective resistance to moisture and heat. All at minimum cost. Any coil is a better coil if it has a Precision base. Precision Di-formed Paper Tubes made to your special specifications of finest dielectric kraft, fish paper, cellulose acetate or combinations.

Write For Free Sample and Complete Mandrel List of Over 1,000 Sizes, Today!

**PRECISION PAPER TUBE CO.**

2041 W. Charleston St.  
Chicago 47, Ill.

Plant No. Two, 79 Chapel St., Hartford, Conn.

**Completely Accessible**  
from operating surface

dependable instruments

*Heiland*  
DENVER

Type A-708... 24-channel

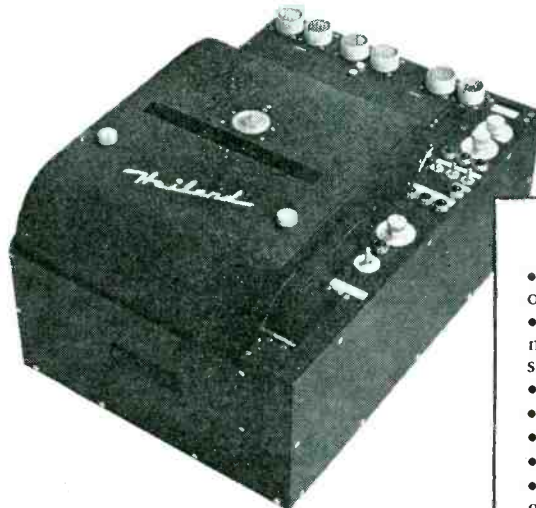

**AUTOMATIC OSCILLOGRAPH RECORDER**

Affording complete accessibility from operating surface and requiring only a minimum of space for mounting, the HEILAND A-708 meets the exacting specifications of research and development personnel in aircraft flight testing, laboratory and industrial testing.

Write for complete details

**FEATURES**

- Completely accessible from operating surface
- Compact... can be mounted in a minimum of space... lightweight
- Can be panel mounted
- 6 to 24 channels
- Paper widths 5", 8", 12", 18"
- Simplicity of loading
- Direct monitoring of galvanometer light spots
- Flexibility of operation
- Simultaneous viewing, recording and scanning
- Trace identification... zero mirror... synchronizing reference trace
- Adjustable automatic record length

**HEILAND RESEARCH CORPORATION • 130 East Fifth Ave. • Denver, Colo.**

# PHALO

## Offers ASSURED QUALITY

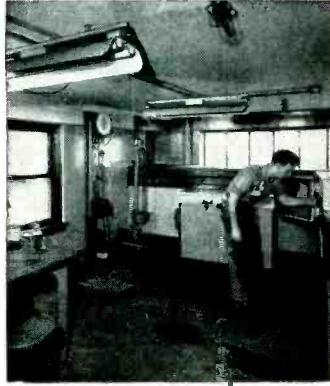
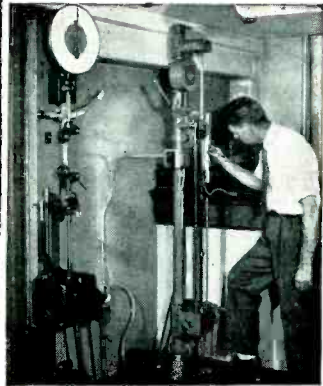

All PHALO plastic insulated wire and cables, cord sets and other assemblies have one characteristic in common . . . they are all *quality assured!* The latest in testing equipment and methods guarantee this to every PHALO customer.

Your inquiry will have our prompt attention!

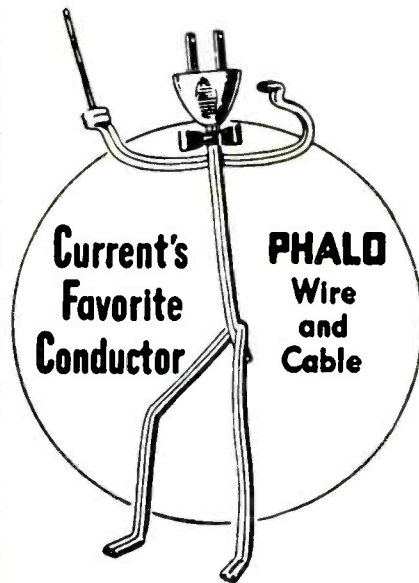

Ask for the latest PHALO catalog.

**PHALO**  
*Plastics Corporation*

Manufacturers of Thermoplastic insulated wire, cables, cord sets and tubing

CORNER OF COMMERCIAL STREET,  
WORCESTER, MASS.

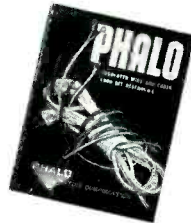

NEW PRODUCTS

(continued)

invited to Al Si Mag 548, the safe temperature of which at continuous heat is 3,452 F.

**Insulation Resistance Testing.** Associated Research Inc., 3758 West Belmont Ave., Chicago 18, Ill. Bulletin 2-A covers a line of Vibrotest models for insulation resistance testing. The units described require no cranking or levelling and are fully portable and rugged. Illustrations and complete technical specifications are given.

**Isometric Engineering.** The Isometric Co., 1819 Broadway, New York, N. Y. Great need for acceleration in today's production line prompted publication of a booklet describing Isometrics, a method which shows the untrained worker, by means of illustrated charts, the correct rotation of assembled parts. The method described, which eliminates special training and supervisory aid is adaptable for use in radio wiring assembly, radar mechanical assembly, the aircraft industry and essential government work. Also discussed is the company's engineering service.

**Audio Equipment.** Sun Radio & Electronics Co., Inc., 122-124 Duane St., New York, N. Y. The second edition of the audio equipment catalog contains much technical information written for the layman on the principles involved in fine music reproduction. A large section of the 100-page book is devoted to questions and answers most common to high-fidelity aspirants or owners. The balance contains listings, prices and specifications on hundreds of components and subassemblies relative to high-fidelity music reproduction in the home or public places.

**Bolometer Amplifier.** Pickard & Burns Inc., 240 Highland Ave., Needham, Mass. Bulletin No. L100 deals with model 100 bolometer amplifier which is designed to meet the basic problem of amplification and metering of testing devices for antenna systems and various r-f networks. The instrument described incorporates a tunable variable-bandwidth filter,



THIS FEATHERWEIGHT WILL  
**LICK  
SOLDERING  
FATIGUE!**



THE NEW  
**HEXAACON  
BANTAM  
MODEL 30H**

Weight—5½ Ounces • Watts—  
40 or 60 • Tip Dia.—Both ⅛" and ¼" Tips  
Furnished with Each Iron • Price—\$5.50

So light its weight is hardly noticeable. Out-  
performs any iron of equal size. Hatchet de-  
sign makes it more comfortable and practical  
to use than a pencil iron. No transformer re-  
quired. Write for complete catalog.

**HEXAACON**

**HEXAACON ELECTRIC CO.**  
130 WEST CLAY AVE., ROSELLE PARK, N. J.

**SPECIALISTS IN  
ELECTRONIC GEARS**

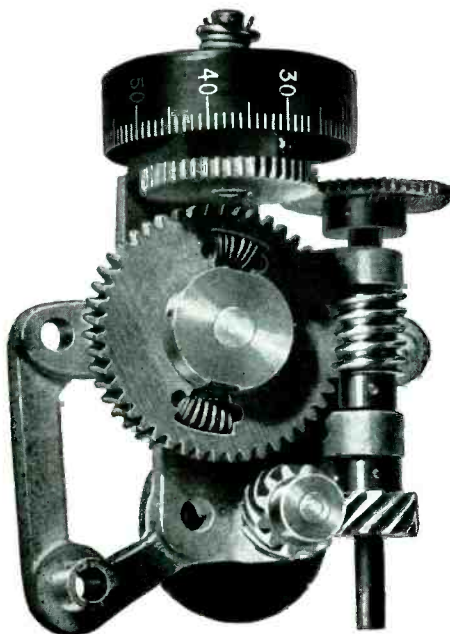

**QUAKER CITY  
GEAR WORKS**

1910 N. FRONT ST.  
PHILADELPHIA 22, PA.

**Lock 'em in—  
CURTIS TYPE "K"  
Lock-in TERMINAL BLOCKS**  
Factory assembled in 1 to 18 terminals

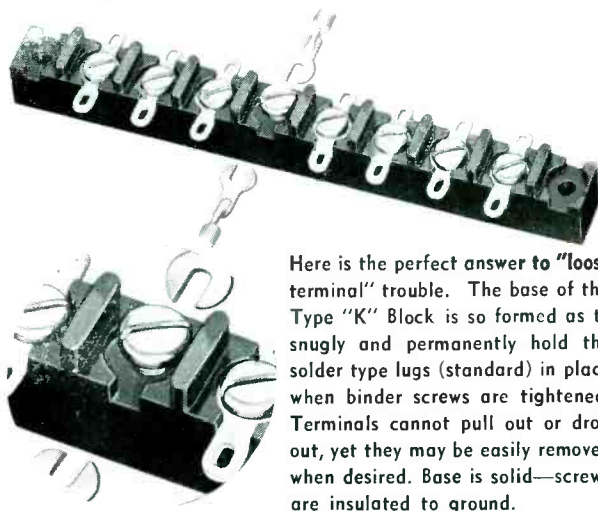

Here is the perfect answer to "loose terminal" trouble. The base of the Type "K" Block is so formed as to snugly and permanently hold the solder type lugs (standard) in place when binder screws are tightened. Terminals cannot pull out or drop out, yet they may be easily removed when desired. Base is solid—screws are insulated to ground.

Write for Bulletin DS-114—or consult our condensed catalog in the McGraw-Hill Electrical Catalog for Product Engineers

**CURTIS DEVELOPMENT & MFG. CO.**

Terminal Block Sales — 4522 West Madison St.  
Chicago 24, Illinois  
Factory — Milwaukee 16, Wisconsin

**There's only 1 FIRST  
IN HIGH VOLTAGE POWER SUPPLIES**

**beta**

**ENGINEERS** . . . are specialists in the design and construction of high voltage equipment. They have pioneered in developing and supplying this type of apparatus to the fields of Electronic Engineering, Research, and Manufacturing. Beta Electric Corporation is proud to list, among its many pioneering innovations in the High Voltage field, these Beta "First's":



- FIRST** to SPECIALIZE in High Voltage Power Supplies.
- FIRST** to build 30-KV and 50,000 Ohm-per-volt Kilovoltmeters.
- FIRST** to provide AC operated Electronic Microammeters for insulation resistance measurements.
- FIRST** to make available a Nation-wide Engineering Service on High Voltage Power Supply problems.
- FIRST** with Reversible Polarity 0-30 KV DC Portable Power Supply.
- FIRST** with Portable 0-30 KV Adjustable Power Supplies.

Our Field Engineers throughout the country are ready to discuss your high voltage problems and equipment needs with you. Beta builds power supplies to fit specific requirements for Voltage, Current, Regulation, Size, etc. Beta also makes and carries in stock a standard line of rugged compact DC Power Supplies up to 30 KV. Power supplies up to 250 KV are readily available from standard designs, and Beta can build your special power supplies up to 500 KV.

WE WELCOME YOUR INQUIRIES

**BETA ELECTRIC CORPORATION**  
333 East 103 St., New York 29

# Leading Manufacturers\* Specify COMMUNICATION ACCESSORIES TOROIDAL COMPONENTS

\* Names on request...

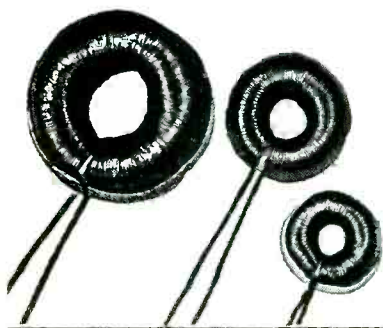

## UNCASED COILS

Toroids close-tolerance adjusted to your specifications. Coils are heat cycled to maintain accuracy even in toughest service conditions. Toroids have low T/C characteristics, extremely low magnetic pickup and external field. Coils may be supplied with balanced windings, also can be tapped, or have multiple winding for tight coupled impedance transformation.



## PLASTIC COATED TOROIDS

Another C A C First. Our most progressive customers specify thermo-setting plastic coating for their coils, transformers, and tuned circuits. This tough resilient covering protects the coils and seals out moisture. Just another reason why the people who use toroids year after year specify C A C Toroidal Components.



## CASED TOROIDS AND FILTERS

Rugged steel cases, construction meeting military specifications. Coils giving highest Q per unit volume and special capacitors provide sharper and more stable filters with a compactness never before possible. A special design for your every requirement.

Send for this FREE booklet today...



**COMMUNICATION ACCESSORIES**  
*Company*

HICKMAN MILLS, MISSOURI

NEW PRODUCTS

(continued)

an eighth power voltage ratio expander, automatic normalization of input signals and an undecaded output voltage for operating automatic recording equipments.

**Precision Instrument.** Kalbfell Laboratories, Inc., 1076 Morena Blvd., San Diego 10, Calif. A recent mailing piece discusses the model 402A dynamic Micro-Miker, a precision instrument for the measurement of capacitance and inductance in video amplifier design and maintenance. Description, important features and chief uses, as well as illustrations, are included.

**TVI Suppression.** Don Good, Inc., 1014 Fair Oaks Ave., South Pasadena, Calif. A small brochure deals with a line of accessories that will effectively eliminate or reduce interference to tv reception from such sources as: amateur radio stations, diathermy equipment, x-ray, industrial induction heaters, household appliances, neon signs and the like. Included are a Telepass (a tv high-pass filter), two variable Teletraps and two variable TVI Traps (one high and one low band).

**Test Systems for TV Manufacturers.** Radio Corp. of America, Harrison, N. J. Custom-built test systems which provide complete facilities for mass-production test and alignment of tv receivers are described in a new brochure available to television manufacturers. The system discussed can be adapted to a wide range of production requirements varying from as few as 100 units to over 1,000 units per day. It provides three major test operations: i-f and trap alignment, r-f alignment, and video, chassis and final tests.

**Tiny Volt-Ammeter.** Pyramid Instrument Corp., 49 Howard St., New York 13, N. Y. The 16-page manual No. 110 tells how to make one's job easier with the Amprobe, a pocket-size snap-on a-c volt-ammeter. It describes the functions of the new tool for anyone who installs, repairs, services or maintains electrical equipment. The unit discussed measures only 7½



## TEST YOUR MAGNETIC CIRCUITS



**RAWSON FLUXMETER  
TYPE 504**

The only portable fluxmeter available which returns rapidly to zero when a single button is depressed. Simple and fast in operation. Convenient and light in weight.

Not limited to a single type of measurement. Has universal application for laboratories or production. Measures strength of magnets and electromagnets, permeability and hysteresis loops for iron and steel, total flux lines in circuit, flux lines developed in air gap, etc.

Has a mechanical clamp to protect the pivots and jewels when in transit.

See October Electronics Adv't For  
**ROTATING-COIL GAUSS METER**

## RAWSON ELECTRICAL INSTRUMENT COMPANY

111 POTTER STREET, CAMBRIDGE 42, MASS.  
Representatives  
CHICAGO LOS ANGELES

REDUCE TESTING TIME TO A MINIMUM  
WITH THIS SIMPLIFIED GRAYHILL  
TEST CLIP. MERELY SLIP THE LEAD  
BETWEEN THE SPRING TYPE PRONGS. NO  
OPENING OR CLOSING OF JAWS . . . NO LOST  
MOTION. LEAD HELD SECURELY.  
ASK FOR SAMPLES AND  
GIVE THEM A TRY!

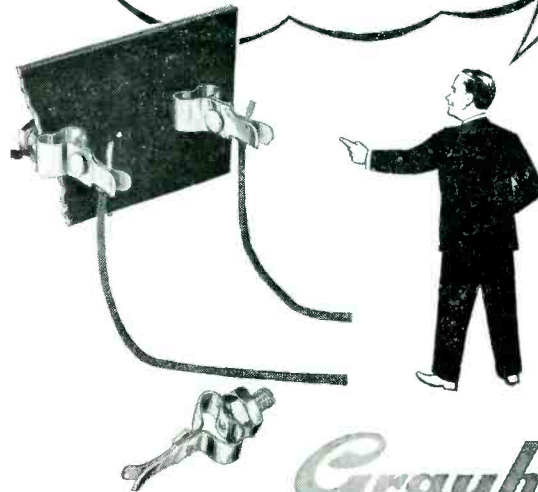

GET DETAILS—  
Write for the  
Grayhill Catalog  
now.

**Grayhill**

4522 West Madison Street  
Chicago 24, Illinois

## Lavite STEATITE CERAMIC

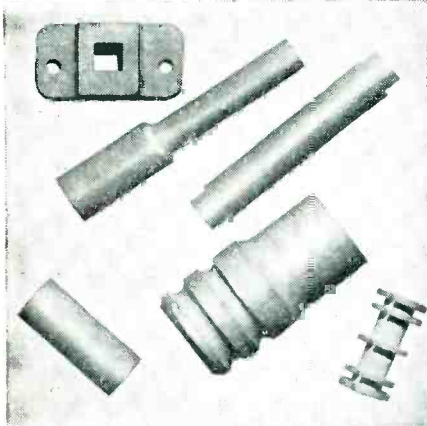

Design engineers and manufacturers in the radio, electrical and electronic fields are finding in LAVITE the precise qualities called for in their specifications . . . high compressive and dielectric strength, low moisture absorption and resistance to rot, fumes, acids, and high heat. The exceedingly low loss-factor of LAVITE plus its excellent workability makes it ideal for all high frequency applications.

Complete details on request

### D. M. STEWARD MFG. COMPANY

Main Office & Works: Chatham, Mass.  
Branches: Chicago, Los Angeles,  
New York, Philadelphia

# Only with CO-AX

air-spaced articulated  
R.F. CABLES

## 4mmf/ft

Patents Regd. Trade Mark

### THE LOWEST EVER CAPACITANCE OR ATTENUATION

We are specially organized  
to handle direct enquiries  
from overseas and can give

**IMMEDIATE DELIVERIES FOR U.S.A.**  
Billed in Dollars Settlement by your check.  
Transaction as simple as any local buy.

**TRANSRADIO LTD**  
CONTRACTORS TO H.M. GOVERNMENT  
138A CROMWELL ROAD LONDON SW7 ENGLAND  
CABLES: TRANSRAD. LONDON

LOW ATTEN TYPES	IMPED OHMS	ATTEN db/100ft at 100 Mc/s.	LOADING Kw at 100 Mc/s.	O.D."
A 1	74	1.7	0.11	0.36
A 2	74	1.3	0.24	0.44
A 34	73	0.6	1.5	0.88

LOW CAPAC TYPES	CAPAC mmf/ft.	IMPED OHMS	ATTEN db/100ft at 100 Mc/s.	O.D."
C 1	7.3	150	2.5	0.36
PC 1	10.2	132	3.1	0.36
C 11	6.3	173	3.2	0.36
C 2	6.3	171	2.15	0.44
C 22	5.5	184	2.8	0.44
C 3	5.4	197	1.9	0.64
C 33	4.8	220	2.4	0.64
C 44	4.1	252	2.1	1.03

HIGH POWER  
FLEXIBLE

PHOTOCELL  
CABLE

V. L. C. ★

★ Very Low Capacitance  
cable.

**E-V MOBIL-MIKE**

**SELECTED**  
for  
**Hallicrafter-Built SCR-399**

Again E-V serves in vital communications! The 600-D Dynamic Microphone (T-50) is standard equipment on the famous SCR-399. It insures high intelligibility speech transmission—helps get the message through clearly. It is an example of E-V research-engineering that, over the years, has created such fine electro-acoustic products for military and civilian use.



#### E-V 600-D MOBIL-MIKE

- *Substantially Flat Frequency Response*
- *High Articulation—Less Listener Fatigue*
- *More Usable Power Level*
- *Acoustalloy Diaphragm*
- *Light Weight (8 oz.)*
- *Extra Rugged—Withstands Toughest Use.*

Experienced Staff and Complete Laboratory Facilities for Original Research-Engineering

**Electro-Voice**

401 CARROLL ST. • BUCHANAN, MICH. • Export: 13 E. 40th St., New York 16, U. S. A. Cables: Arlab  
MICROPHONES • PHONO-PICKUPS • HI-FI SPEAKERS • SELF-TUNING TV BOOSTERS

in. x. 2 9/16 in. and is one-third the usual weight of such instruments.

**Automatic Controls.** Barber-Colman Co., Rockford, Ill. The Control Story is a new booklet outlining in nontechnical language the operation of automatic controls for heating, ventilating and air conditioning. Cartoons scattered through the text highlight the points covered. Copies are available free for the writing.

**Electronic Voltmeters.** Ballantine Laboratories, Inc., Boonton, N. J. Catalog 14 tells the story of the company's line of sensitive precision vacuum-tube voltmeters. This issue is a revision of the previous catalog and in addition features two new voltmeters, models 302B and 310, and a new line of multipliers. Chief features, illustrations and specifications for all types are included.

**All-Band Generator.** The Hickok Electrical Instrument Co., 10514 Dupont Ave., Cleveland 8, Ohio. A recent 4-page folder illustrates and completely describes the model 292X microvolt signal generator which covers all a-m, f-m, tv and mobile frequencies in 7 ranges. The unit discussed herein is crystal controlled and has a modulated and unmodulated output from 0.2 to 100,000  $\mu$ v through a 10 to 1 attenuator.

**Solderless Connectors.** Buchanan Electrical Products Corp., 1290 Central Ave., Hillside, N. J. Bulletin 750 gives a four-page treatment of a line of Underwriters' approved "pres-Sure-connectors" for solderless splicing and terminating of electrical wires. It contains detailed descriptive data, installation instructions and ordering information on splice caps, insulators, Termend lugs and a four-way "pres-Sure" crimping tool.

**Mercury Plunger Relays.** Ebert Electronics Corp., 185-09 Jamaica Ave., Hollis 7, N. Y. A four-page catalog illustrates and lists a line of heavy-duty one-, two- and three-pole mercury plunger relays and



# The New STAVER MINI-SPRING

TRADE MARK REG. AND PAT. PEND.

A quality  
Tube  
Guard  
that is  
Bargain  
Priced

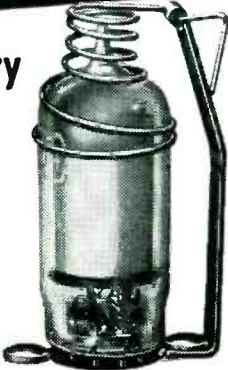

Gives support two ways—Keeps pressure downward and gives sideway support. The spring action is constant and resilient permanently. Send for catalog sheet.



91 PEARL ST. • BROOKLYN 1, N. Y.  
ULSTER 5-6303

## New ZIP-GRIP® Self-Locking SET SCREWS

used on a new  
Nationally Known Washing Machine!

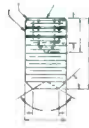

A puzzling set screw problem on a new nationally known Washing Machine was successfully solved with ZIP-GRIP® Self-Locking Set Screws. In less than a year, over 100 manufacturers have adopted ZIP-GRIP® for the same reason. Perhaps ZIP-GRIP® is the answer to your puzzling set screw problems, too.

Send for Free ZIP-GRIP® Action Demonstrator that shows exclusive, Contra-Thrust Action; we'll also include ZIP-GRIP® Data Sheet and tell you how to get Free Engineering Test Samples. Write today.

\*PAT. PENDING

Makers of



SET SCREWS

Set  
Screw  
& Mfg. Co.

470 Main St. Bartlett, Ill. (Chicago suburb)

We specialize in Solving Puzzling Set Screw Problems.

6572

## Wizardry in WIRE FORMS

Small diameter wire formed  
in any shape you need!

### STRAIGHTENING & CUTTING

Perfect straight lengths to 12 ft.  
.0015 to .125 diameter

### WIRE FORMS

.0015 to .080 diameter

### SMALL METAL STAMPINGS

.0025 to .035 thickness  
.062 to 3 inches wide

Here's the "know how" and mass production capacity to turn out any quantity of small wire forms, parts and stampings in ferrous and non-ferrous metals and alloys—accurately, economically, speedily!

★

Specializing in Production of Parts  
for Electronic and Cathode Ray Tubes

Write for Illustrated Folder  
Send Blueprints or Samples for Estimate

ART WIRE & STAMPING CO.  
227 HIGH STREET, NEWARK 2, N. J.

## DYNAMIC WIRE WOUND RESISTORS

Each is precision wound to close tolerance. DEVITRIFIED MOISTURE-PROOF ENAMELED, will stand salt-water tests, a quality product. Standard or custom types to meet your requirements.

Whatever your resistor requirements DYNAMIC has the resistor you need, or will produce it on short notice.



# DYNAMIC

RESISTOR CORPORATION

6 Cutter Mill Road Great Neck, N. Y.

## Try Remler for Service-Tested "Hard-to-Get" Components

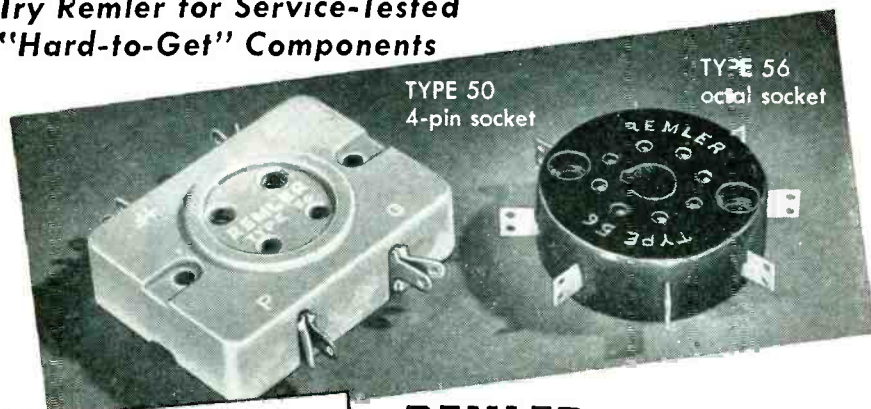

TYPE 50  
4-pin socket

TYPE 56  
octal socket

### Custom Components

Metal-plastic components designed and manufactured to order. Write for quotations specifying electrical and mechanical characteristics. Describe application. No obligation.

## REMLER TUBE SOCKETS

● STANDARD FOR 30 YEARS...  
THE BEST IN THE INDUSTRY

Heavy duty phenolic sockets with high current wiping action contacts... for industrial, transmitter and test applications. Rugged. Years of tube insertions and withdrawals do not impair contact effectiveness. Black phenolic is standard, low loss phenolic or alkyd on order.

Remler Company Ltd. 2101 Bryant St. San Francisco 10, Calif.

*Remler*  
Since 1918 PIONEERS IN ELECTRONICS AND PLASTICS

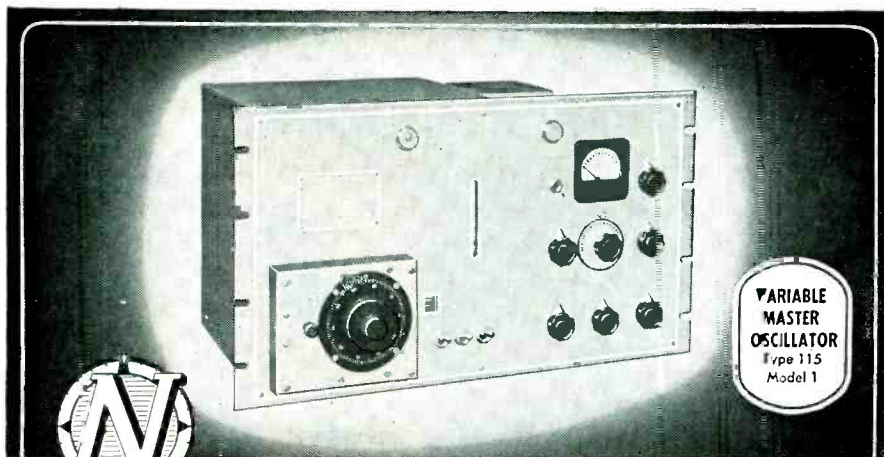

VARIABLE  
MASTER  
OSCILLATOR  
Type 115  
Model 1

### The Variable Oscillator with CRYSTAL STABILITY

High versatility, plus wide range, plus crystal stability and accuracy—that's the unbeatable combination for the best in diversity reception. You get all three with the Northern Radio VARIABLE MASTER OSCILLATOR. The HFO's stability is  $\pm 20$  cps/mc for ambient change of  $\pm 25^\circ\text{C}$ .—matching that of any non-temperature controlled crystal. Its range is 2-32 mc continuous. Crystal check points, with 40 curves supplied, permit absolute frequency setting to  $\pm 25$  cps/mc. Three crystal-controlled frequencies provide fixed frequency reception. There's a LF crystal oscillator for BFO.

**And, this unit also serves as an excellent transmitter exciter and laboratory measuring standard.**

See the specifications on this outstanding model in the 1950 Electronics Buyers Guide. For complete data on the precision-built Northern Radio line, write today for your free latest Catalog E-2.

**NORTHERN RADIO COMPANY, inc.** : 143-145 West 22nd Street  
: New York 11, N. Y.

Pace-Setters in Quality Communication Equipment

sensitive relays. It contains an outline of typical features and prices, as well as relay hookups and dimensional diagrams.

**D-C Indicating Amplifier.** Leeds & Northrup Co., 4901 Stenton Ave., Philadelphia 44, Pa., has published an 8-page folder describing and illustrating a stabilized d-c indicating amplifier that can be used as a direct-reading microvoltmeter, a preamplifier for recorders to extend range down to low levels, and a high-sensitivity, short-period null point detector. Diagrams and specifications are included.

**Soldering Booklet.** Weller Electric Corp., Easton, Pa., has announced a new revised edition of Soldering Tips, a 20-page pocket manual discussing in nontechnical language a variety of difficult operations, time-saving methods, fluxes and solder tables. Step-by-step illustrations make each point clear and easy to remember. Price is 10 cents.

**Tube Engineering.** Electronics, Inc., Newark, N. J., has published a new engineering manual and catalog completely covering the subject of gaseous discharge rectifier and control-rectifier tubes. Amply illustrated with diagrams, it includes data on the ratings, applications and life expectancy. Information is also given on tube protection, efficiency, regulation, filters, load, mechanical design and tube variations.

**Precision Potentiometers.** The Gamewell Co., Newton Upper Falls 64, Mass. A new engineering bulletin comprised of 11 data sheets describes a line of precision potentiometers. General features, linear and nonlinear units, condensed specifications and special applications are covered. Curves representing interesting functions are included.

**Magnetic Amplifiers.** Vickers Electric Division, Vickers Inc., 1815 Locust St., St. Louis 3, Mo., has issued a new group of Service Sheets for the DH-2 handbook dealing with magnetic amplifier output characteristics. It is quite



ENGRAVING

ROUTING

PROFILING

MODELING

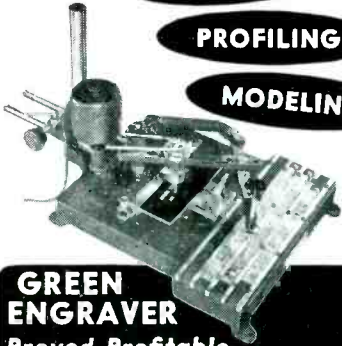

**GREEN ENGRAVER**

*Proved Profitable —*

*Machine Tool, Radio, Electrical and Instrument Mfrs., Sales Promotion and Advertising.*

Fast, rugged, convenient—and inexpensive. The Green Engraver is tops for low-cost performance—zips out precision work on metal, plastics or wood . . . cuts four lines of letters from 3/64" to 1" on curved or flat surfaces . . . operates by tracing . . . makes anyone an expert . . . engraves panels, name plates, scales, dials, molds, lenses and instruments. (Also widely used for routing, profiling and three dimensional modeling.) Electric etching attachment available.

*Special attachments and engineering service available for production work.*

FREE—Fact-packed folder. Send for yours, today

**GREEN INSTRUMENT COMPANY**

**GREEN**

363 PUTNAM AVENUE  
CAMBRIDGE, MASS.

**ELECTRONICALLY REGULATED  
LABORATORY  
POWER SUPPLIES**



• STABLE  
• DEPENDABLE  
• MODERATELY PRICED

MODEL 28  
STANDARD  
RACK  
MOUNTING

PANEL SIZE  
5 1/4" x 19"  
WEIGHT 16 LBS.

- **INPUT:** 105 to 125 VAC, 50-60 cy
- **OUTPUT #1:** 200 to 325 Volts DC at 100 ma regulated
- **OUTPUT #2:** 6.3 Volts AC CT at 3A unregulated
- **RIPPLE OUTPUT:** Less than 10 millivolts rms

For complete information write for Bulletin E



**LAMBDA ELECTRONICS**  
CORPORATION  
CORONA NEW YORK

**S.S. White** **MOLDED RESISTORS**

*The All-Weather Resistors*

**ARE USED IN HIGH VOLTAGE "HIPOT" COUPLERS**

S.S.White resistors are connected in series to permit a current flow to ground, when the "Hipot" Coupler is used to measure or to synchronize voltage of high voltage lines.

Canadian Line Materials, Ltd.—maker of "Hipot" Couplers and other transmission, distribution and lighting equipment says, "We have always found S.S.White resistors of the highest quality". This checks with the experience of the many other producers of electrical and electronic equipment who use S.S.White resistors.

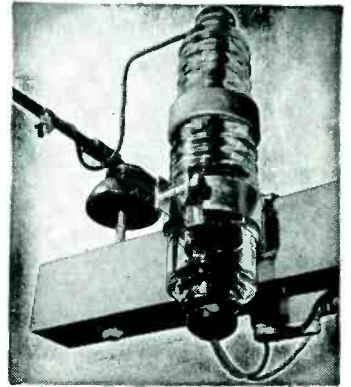

**S.S.WHITE RESISTORS**

are of particular interest to all who need resistors with *low noise level* and *good stability* in all climates.

**HIGH VALUE RANGE**  
10 to 10,000 Megohms

**STANDARD RANGE**  
1000 Ohms to 9 Megohms

**WRITE FOR BULLETIN 4906**

It gives details of S.S.White Resistors including construction, characteristics, dimensions, etc. Copy with price list on request.



**THE S.S. White INDUSTRIAL DIVISION**

**DENTAL MFG. CO.**



Dept. R 10 East 40th St.  
NEW YORK 16, N. Y.

**GRANT Electronic EQUIPMENT  
SLIDES**

for Consoles • Chassis • Racks



GRANT manufactures standard slides to carry from 25 pounds to 2000 pounds for your every requirement.

GRANT No. 392 Electronic Equipment Slide—Three section, progressive action type slide which locks in open position. Slide includes mechanism for unlocking from outside of chassis and for tilting to 90° angle. Mechanisms vary to suit the individual installation. This slide has been adapted to the standard 19" rack. Load capacity: 100 lbs. per pair depending on length of slide and travel.

- Other outstanding advantages:
- Continuous ball bearing action
  - Closely fitted sides eliminate chassis rattle

- GRANT also manufactures:
- Single or double acting slides
  - Side or undercarriage mounting types
  - Slides with locking and pivoting devices

Consult with our engineering department on any slide problem. Write Dept. E2 for complete illustrated information.

**GRANT PULLEY & HARDWARE CO.**

31-87 Whitestone Parkway, Flushing, L. I., N. Y.



*The foremost name in Sliding Devices*

Designed for



Application

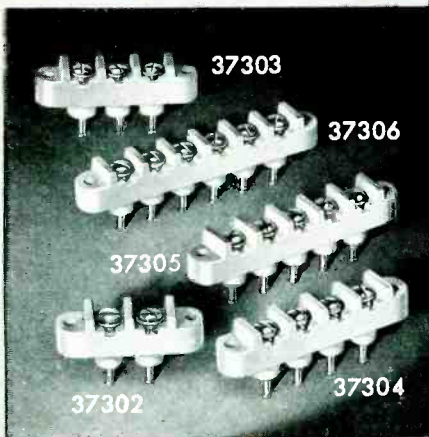

### The No. 37300 Series Steatite Terminal Strips

Another exclusive Millen "Designed for Application" product is the series of steatite terminal strips. Terminal and lug are one piece. Lugs are Navy turret type and are free floating so as not to strain steatite during wide temperature variations. Easy to mount with series of round holes for integral chassis bushings. Ideal answer to the "tropicalization" problem.

**JAMES MILLEN  
MFG. CO., INC.**

MAIN OFFICE AND FACTORY  
**MALDEN  
MASSACHUSETTS**



NEW PRODUCTS

(continued)

similar to the plate-characteristics type of presentation used for vacuum tubes and allows easy determination of magnetic amplifier performance for any value of load resistance. Output characteristics are given for each of the standard 400-cycle high-performance magnetic amplifiers in the individual bulletins of the issue. A 4-page supplement to bulletin 2000 is also available.

**Electrical Resistance Instruments.** Tech Laboratories, Inc., Bergen and Edsall Blvds., Palisades Park, N. J., has issued bulletin 431, a catalog made up of a series of bulletins showing a variety of precision resistance instruments. Included are several types of attenuators and potentiometers, microhmeters, special transmitters and oscillators, and special electronic control devices.

**Instrument Catalog.** Wheelco Instruments Co., 847 W. Harrison St., Chicago 7, Ill. In the new condensed catalog just released, a selection of typical indicators, controllers and combustion safeguards are illustrated and briefly described. An accompanying 4-page price list contains the listing, description and current price applying to nearly all of the company's standard instruments.

**Plug-In Assemblies.** Dietz Design & Mfg. Co., Grandview, Mo. A single-sheet bulletin announces and illustrates a complete line of plug-in housings and assemblies—for coils, relays, filters, crystals and so on. Catalog numbers and dimensional drawings for the thirty standard models are given. Use of the units described will benefit any electronic equipment subject to frequent servicing.

**Tape Drive Recording Mechanism.** Cook Research Laboratories, 1457 Diversey Parkway, Chicago, 14, Ill. Bulletin PD-14 treats of the type MR-12, a portable 12-information channel tape drive recording mechanism for use in geophysical seismic analysis work. The unit described is also useful for high-quality audio recordings. Complete specifications are given.

FOR  
**ABSOLUTE TOP QUALITY**  
... at Popular Prices!  
**REK-O-KUT**  
**TURNTABLES**



### CONTINUOUSLY VARIABLE SPEED RECORD PLAYER

Plays without "wow" at any setting within its speed range of 25-100 R.P.M. Speed can be varied while in operation to produce varied sound effects. The indispensable turntable for TV, AM, FM broadcast stations, dance studios, musicians, singers, record collectors and wherever audio-visual methods are employed. Plays through any amplifier, radio, TV set, or phonograph. Operates on 50 or 60 cycles. The only turntable to use in areas of varying voltages and frequencies or with portable power plants. CVS-12 (illustrated) ..... \$84.95 NET  
CVS-12P in portable case with  
10" Dual-Stylus Pickup ..... \$124.95 NET

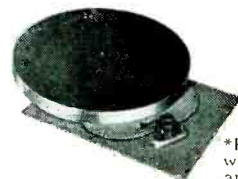

### Famous Models T-12H and T-43H

\*Recommended for use with Hi-Fi amplifiers and speaker systems because of low noise and rumble level, which is maximum-50 db. The only 11" dual speed turntables equipped with Hysteresis synchronous motors, thereby meeting standards for speed regulation and "wow" content specified by the N.A.B. Instantaneous speed shift engages either 78 or 33 1/3 R.P.M. idler without stopping turntable or removing disc.  
T-12H ..... 78 — 33 1/3 ..... \$119.95 NET  
T-43H ..... 45 — 33 1/3 ..... \$119.95 NET  
Interchangeable idlers for third speed optional



### Model LP-743 Three-Speed 12" Transcription Turntable

Designed to meet the growing demand for a good turntable which is priced between the deluxe models and ordinary phono motors... and dimensioned for easy replacement of obsolete motors in average consoles. Instantaneous speed changes — 78, 45, 33 1/3 R.P.M. ... without stopping turntable or removing disc ..... \$54.95 net

\*As attested to by America's top  
authorities on sound equipment.  
Reprints on request.

Available at Your Regular Parts Distributor.  
Manufacturers Discounts Quoted on Request.

**REK-O-KUT CO.**  
38-23 QUEENS BOULEVARD  
LONG ISLAND CITY 1, N. Y.

February, 1951 — ELECTRONICS



# ALLISON RADAR

FOR

## MULTI-ENGINE AIRCRAFT

Military  
Airline  
Executive

Models E ES ES B

58-65 lbs. Overall Weight

1. Long range. 80-150 miles.
2. Exclusive scanning method.
3. Compact. Sturdy.
4. Easy to operate. Pilot control.
5. Simplicity of maintenance.
6. Gyro-stabilized.
7. JAN components.
8. RACON beacons.

**ALLISON  
RADAR CORPORATION**  
11 W. 42 St., N.Y. 18 PEnn 6-5811-12

MEGOHMS  
MEGOHMS  
MEG  
MEG  
MEGOHMS  
MEGOHMS  
MEGOHMS  
MEGOHMS  
MEGOHMS

**Cheaper** by the dozen with

## JELLIFF ALLOY 1000 RESISTANCE WIRE

This new material packs 1000 ohms/cm<sup>2</sup>—48% more than the widely-used nickel-chromium alloys.

And what's more, there's no loss of other important physical and electrical properties. High tensile strength—excellent solderability—TC of Resistance is 20—EMF vs Copper + 7 micro-volts—Coefficient of Expansion 13.9—remarkable Surface-Corrosion Resistance—and many more vital characteristics make ALLOY 1000 a money-making, prestige-building component of compact, precision resistors. For complete data, get Bulletin 17



**AT LAST...**

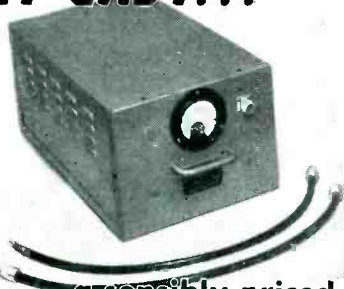

a sensibly priced  
**VHF R-F  
POWER METER**

The COMCO 232-F \$110<sup>00</sup>  
FOB Factory

Invaluable instrument for the VHF technician! Designed especially to provide direct reading, in watts R-F (0-50 watts), of VHF transmitters. Suitable for use with any transmitter using 52 ohm load, operating on frequencies from 30 to 175 Mc. Ideal for fast bench testing of output of VHF mobile and aircraft equipment -- no conversion tables necessary. Accurate to within 10%. Quickly detects aging tubes. Finished in attractive, durable grey hammerstone.

WRITE, WIRE or PHONE TODAY  
for prompt shipment!



**COMMUNICATIONS CO.**  
Inc.  
300 Greco Avenue P. O. Drawer 6250  
Coral Gables, Florida

**NEW!**

# TELECHROME

## FLYING SPOT PICTURE GENERATOR

Model 300-A

Used in TV stations,  
development laboratories,  
schools, factories, service  
organizations and wherever  
a reliable, easily changed  
video picture source  
is required

Supplied with  
driven sweep  
10" monitor

**\$965<sup>00</sup>**

Complete

LIMITED PRODUCTION ON ABOVE MODELS

Write today for catalog of  
our color equipment line.

**TELECHROME**  
INCORPORATED  
88 Merrick Rd, Amityville, L.I., N.Y.

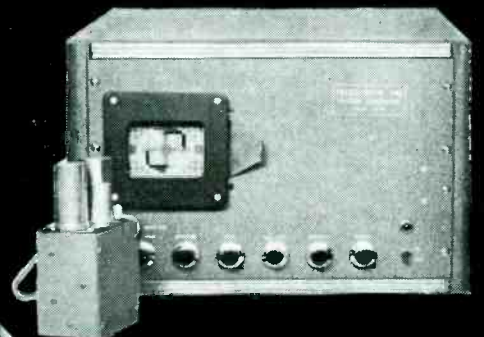

- Resolution greater than 500 lines
- Supplied with standard RMA 3x4" test pattern
- Slide Holder for positive or negative transparencies
- Excellent picture tonal rendition
- Supplies pictures without driving pulses from a sync generator
- Low and high impedance outputs, black positive or negative polarities

Complete with all tubes, self-contained high and low voltage regulated power supplies, sweep and video circuits, in rack width metal cabinet.

# INCREASED ACCURACY

- **SWEEPS .01 sec/cm to .1  $\mu$ sec/cm**  
Accuracy 5% or greater.
- **.04  $\mu$ sec RISE TIME**
- **FULLY REGULATED POWER SUPPLY.**
- **VOLTAGE CALIBRATOR**  
5% Full Scale Accuracy.

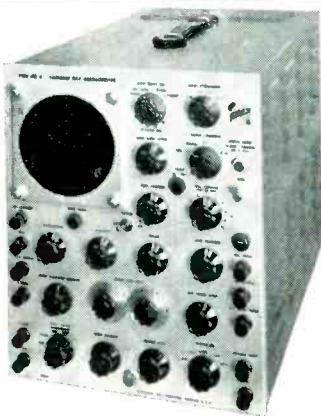

TEKTRONIX TYPE 511 AD OSCILLOSCOPE  
Price \$845.00 f. o. b. Factory

Increased accuracy in sweep time calibration is made possible by the use of dual Sweep Multiplier dials. The 2 megohm variable carbon resistor formerly used has been replaced by a combination of 1% fixed resistors and a variable element which comprises only 10% of the total. Electronic regulation of all DC voltages preserves the inherent accuracy regardless of severe line voltage variations.

Write for further information on the Type 511 AD and other Tektronix instruments.



## TEKTRONIX, INC.

712 S. E. Hawthorne Blvd. Portland 14, Ore.

## NEWS OF THE INDUSTRY

(continued from page 134)

survey work and personnel protection immediately following an atomic attack.

Specifications are also given by Civil Defense for a low-intensity instrument measuring up to five hundred milliroentgens for long-range surveys, which probably would not start for several days following an atomic disaster. Existing low-level and middle-range instruments are described.

A procurement pool for states wishing to purchase training instruments of the kind recommended will be provided by Civil Defense. This would enable states to purchase the instruments at a lower cost than would be available to them otherwise.

Specifications for the instruments were determined by a special NSRB Civil Defense Radiological Committee composed of representatives from the Atomic Energy Commission, the Armed Forces Special Weapons Project of the Department of Defense, the U. S. Public Health Service, the National Bureau of Standards, and the Federal Civil Defense Administration.

Personal dosage indicators now existing are not considered suitable for civil defense. Research is under way to modify these instruments or develop new ones.

### New Recommended Standards Published

THE RTMA recently issued new standards for home phonograph playback needles. Designated as REC-126-A, the publication specifies that for 78-rpm records the needle tip shall have the following radius: (a) for metal point 0.0027 in. with tolerance + 0.0003 in., - 0.0002 in.; (b) for jewel points 0.003 in. with tolerance + 0.0002 in., - 0.0003 in.

Needles for 45-rpm and 33 $\frac{1}{3}$ -rpm l-p records shall be 0.001 in. plus 0.0001 in. minus 0.0002 in. Needles with a 0.001-in. radius shall be color-coded red and their pickup cartridges are to be color-coded with a red dot.

Radius of the needle tip shall be determined by comparison with a series of circular segments of

# ALLIED

world's largest distributor of

# RCA



## ELECTRON TUBES FOR INDUSTRY

### All types in stock

- Vacuum Power Tubes
- Thyratrons
- Vacuum & Gas Rect.
- Ignitrons
- Cold-Cathode Tubes
- Phototubes
- Oscillograph Tubes
- Camera Tubes
- Monoscopes
- Special Tubes

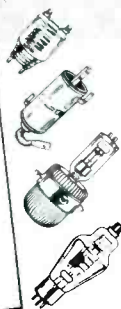

### Quick, Expert Industrial Service

ALLIED maintains in stock for quick shipment the world's largest inventory of RCA special-purpose electron tubes—of all types. We specialize in supplying the tube needs of industrial, broadcast, governmental and other users. Shipments are made from stock to any part of the nation within hours after we receive your order. Save time, effort and money—fill all your tube needs from a single, dependable source.

## FREE

### Interchangeability Directory

Valuable guide to selection of proper RCA tube type replacements. Lists 1600 type designations, covering non-receiving electron tubes. Write for your FREE copy of RCA Guide No. 37-046.

### REFER TO YOUR ALLIED CATALOG

Make ALLIED your central supply source for all electronic supplies—parts, tubes, test instruments, tools, audio amplifiers, accessories—available immediately from the world's largest stocks. Order from your ALLIED Catalog—the leading Electronic Buying Guide.

## ALLIED RADIO

833 W. Jackson • Dept. 11-BB-1 • Chicago 7, Ill



Send for **FREE**  
**1951 CATALOG**

Everything in Electronics from ONE Source



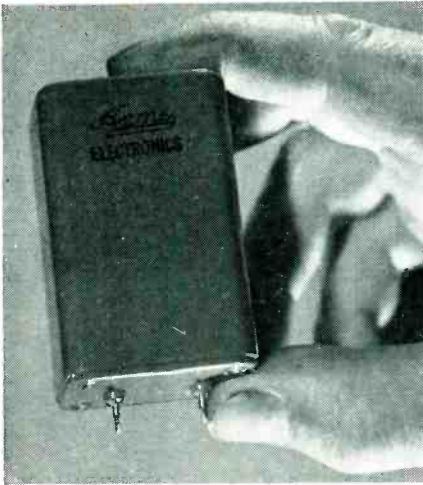

## ACME

### 500 CYCLE LOW PASS FILTER

Acme solved one major manufacturer's problem by designing and producing this miniature filter with extremely low insertion loss within the pass band and 60 DB attenuation.

This is an example of what Acme is doing. Your problems will receive prompt attention. All wave filters and other products are built in careful conformance to military specifications. Your inquiry is invited.



Division of Acme Metal Die, Inc.

212 E. 17th St., Los Angeles 15, P.O. Box 7457

Wave Filters • Delay Lines • Magnetic Amplifiers • Special Transformers & Chokes • Toroidal, Universal & Solenoid Wound Inductors

## ENGINEERS

### ELECTRONICS RESEARCH AND DEVELOPMENT

In Baltimore, Maryland

Career Positions

for

Top Engineers and Analysts  
in

Radar Pulse, Timing and Indicator  
Circuit Design

Digital and Analogue Computer  
Design

Automatic Telephone Switchboard  
Design

Also

Electro-Mechanical Engineers

Experience in servo-mechanism, special weapons, fire control, and guided missile design.

Recent E.E. graduates and those with at least one year electronics research and development work will also be considered.

Salary commensurate with ability. Housing reasonable and plentiful. Submit resume outlining qualifications in detail. Information will be kept strictly confidential. Personal interviews will be arranged.

THE GLENN L. MARTIN COMPANY

Employment Department  
Baltimore 3, Maryland

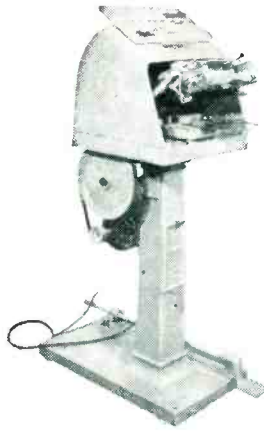

crystal cases

relay boxes

selenium rectifier stacks

transformers

parts identification

on boxes and cartons

## YOU CAN MARK THEM ALL WITH THE KD 8

Here's a really versatile machine—the Markem KD 8. And its talents are particularly suited for saving money in the electronics field. With a KD 8, you can mark many different sizes of parts, containers, labels, tags with imprints up to 2 1/2" wide by 6 1/2" long. Type changes, using either rubber plates or metal type, are quick and easy. That means you can imprint exactly the quantity of articles you want, when and where you want them. The KD 8 is a really flexible, money-saving production tool that will cut marking bottlenecks in your plant. Write today for more details that will pleasantly surprise you.



Keene 27,  
New Hampshire

# HERMETIC SEALING COMPONENTS

**Now Available!**

An extended range of types and sizes in the popular

## 90-G SERIES MULTIPLE HEADERS

The 90-G Series is now supplied in a wider range of types than ever before. These include 5 and 10 amp lead sizes with from 2 to 14 terminals as well as plug-in bases for miniature 7, noval 9, and special 14-prong sockets. Voltage ratings are 1600 peak.

Write for These Descriptive Bulletins:

- 849 — Hermetically Sealed Terminals
- 850 — Hermetically Sealed Headers
- 851 — Gasket Type Bushings

90 G/40-HS-14

90 G/40-HS-8

90 G/P-7  
(Miniature)

90 G/P-14

90 G/60-NS-12

90 G/P-9  
(Noval)

**ELECTRICAL INDUSTRIES**  
INCORPORATED  
44 SUMMER AVENUE • NEWARK 4, N. J.

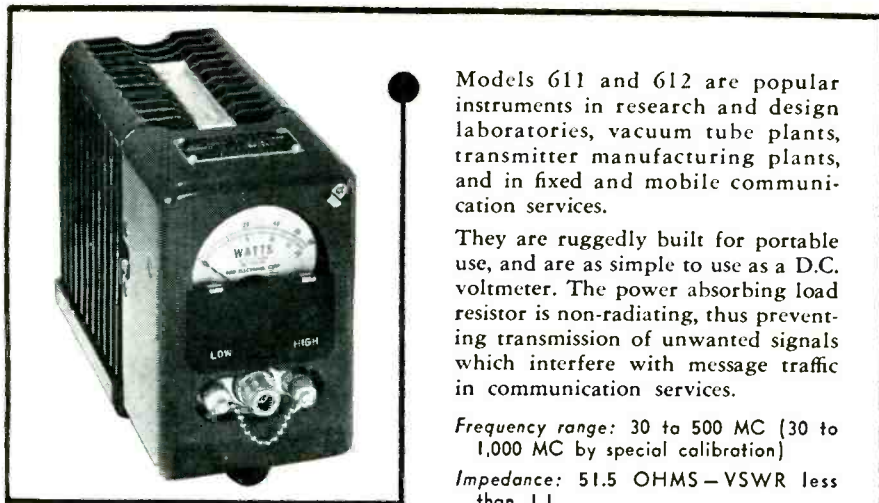

Models 611 and 612 are popular instruments in research and design laboratories, vacuum tube plants, transmitter manufacturing plants, and in fixed and mobile communication services.

They are ruggedly built for portable use, and are as simple to use as a D.C. voltmeter. The power absorbing load resistor is non-radiating, thus preventing transmission of unwanted signals which interfere with message traffic in communication services.

*Frequency range:* 30 to 500 MC (30 to 1,000 MC by special calibration)

*Impedance:* 51.5 OHMS—VSWR less than 1.1

*Accuracy:* Within 5% of full scale

*Input connector:* Female "N" which mates with UG-21 or UG-21B. Adapter UG-146/U is supplied to mate with VHF plug, PL259.

Special Scale Model "61s" are available as low as 1/2 watt full scale, and other models as high as 5 KW full scale.

*Catalog Furnished on Request*

## TERMALINE DIRECT READING R. F. WATTMETERS

(DUAL RANGE)

MODEL 611—0-15 and 0-60 Watts

MODEL 612—0-20 and 0-80 Watts

IMPEDANCE—51½ Ohms

**BIRD ELECTRONIC CORP.**  
*Instrumentation for Coaxial Transmission*  
1800 East 38<sup>th</sup> Street • Cleveland 14, Ohio  
West Coast Representative • NEELY ENTERPRISES • Hollywood 46, Calif.

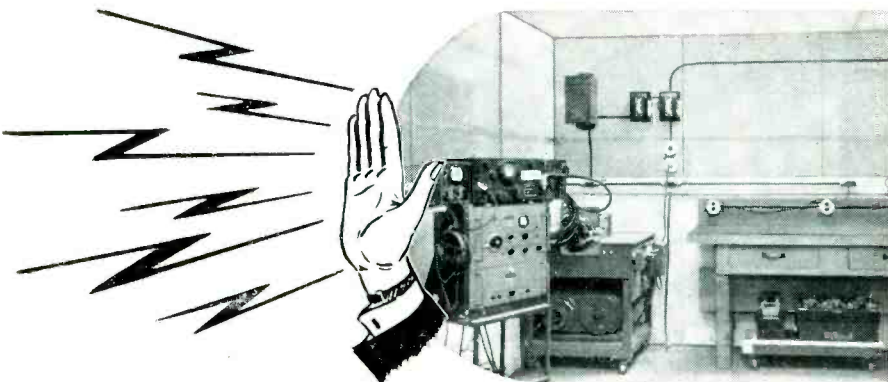

## SUPPRESS RADIO INTERFERENCE ...Eliminate Errors in Critical RF Measurements

Reduce the area background level of radio interference to a negligible minimum for critical tests and measurements! Ace Pre-Built Screen Rooms are moderately priced—suppress interference far more efficiently than ordinary screen rooms or enclosures—and provide for a high degree of accuracy by eliminating gross systematic errors in your test setup and calculations. They're easy to install and easy to enlarge or move. Write, wire or 'phone for further details.



**ATTENUATIONS of 100 to 140 db.  
FROM 0.15 to 10,000 mc.**

**ACE ENGINEERING and MACHINE CO., INC.**

Telephone:  
REgent 9-1019

3644 N. Lawrence St.

Philadelphia 40, Pa.

known radii and an angular length of 110 deg. Included angle of tip of the needle shall be no less than 40 deg and no more than 50 deg.

The publication is available from Radio-Television Manufacturers Association, 1317 F Street, NW, Washington 4, D.C. Price is 25 cents.

## Radar Helps Forecast Jet Weather

GETTING ready to provide meteorological services for high-flying jet aircraft, the Australian Department of Civil Aviation is setting up a network of fifteen radar stations at selected points in Australia and New Guinea.

The radars will be used to track the course of meteorological balloons enclosed in a mesh of nylon. The mesh is treated with silver to make it reflect the radar pulses.

Two operators keep the 54-inch parabolic dish of the station trained on the balloon, taking readings of elevation, bearing and range of the balloon at intervals of one minute. Plotting of the balloon's course enables wind velocity to be determined at all altitudes up to 40,000 ft. The altitude correlations are derived from the known rate of ascent.

A second use of the radar is the detection of heavy cumulus clouds, which show up on the screen with a characteristic echo. Thunderclouds approaching an airport can be located with ease and their speed and course can be plotted for the benefit of aircraft flying in the vicinity.

As the network of meteorological radar stations could be turned to defense uses at short notice, their locations will be kept secret.

## TV To Aid Test Pilots

A SYSTEM employing tv for testing airplanes has been tried out at Wright-Patterson Air Force Base in Dayton, Ohio. Radio waves from the ground control the maneuvers of the airplane being tested while one or two video cameras focus on the instrument panel, recording the data on screens set up in the ground control station. All tests indicate that the use of tv to replace test



Your FREE copy  
of the latest  
**IN-RES-CO**  
CATALOG  
will be sent  
promptly on request

contains complete  
data including  
**ELECTRICAL**  
AND  
**MECHANICAL**  
Specifications

of  
the  
com-  
plete  
line  
of



**IN-RES-CO**  
**RESISTORS**

Please write  
on company  
letterhead

# IN-RES-CO RESISTORS

meet all instrumentation needs

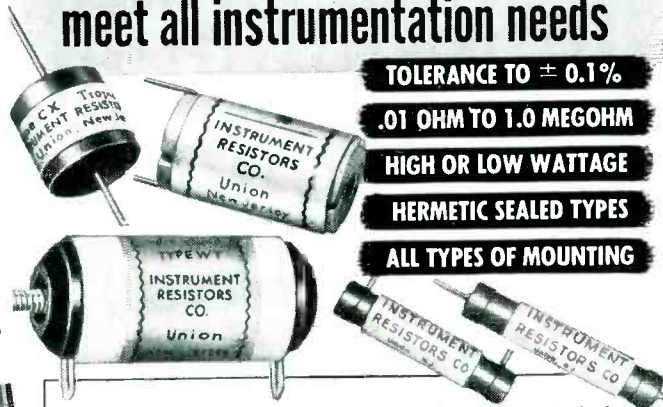

**TOLERANCE TO  $\pm 0.1\%$**

**.01 OHM TO 1.0 MEGOHM**

**HIGH OR LOW WATTAGE**

**HERMETIC SEALED TYPES**

**ALL TYPES OF MOUNTING**

INRESICO Resistors are a product of high-speed winding techniques that introduce a new measure of economy in precision wire wound resistors.

They are available for **IMMEDIATE DELIVERY**, in diversified types that meet practically every circuit requirement of load, ohmic value, size, and shape.

When planning a new circuit design, investigate the advantage of INRESICO resistors for economy, dependability and permanently fixed characteristics. For complete details, call or write today for catalog.

Manufacturers and designers of wire wound resistors—exclusively. Estimates on custom built resistors furnished without obligation; inquiries are invited.



**INSTRUMENT RESISTORS COMPANY**  
1036 COMMERCE AVENUE, UNION, NEW JERSEY

## 2 KW VACUUM TUBE BOMBARDER OR INDUCTION HEATING UNIT



For Only **\$650.**

Never before a value like this new 2-KW bench model "Bombarder" or high frequency induction heater . . . for saving time and money in surface hardening, brazing, soldering, annealing and many other heat treating operations.

Simple . . . Easy to Operate . . .  
Economical Standardization of  
Unit Makes This New Low Price  
Possible.

This compact induction heater saves space, yet performs with high efficiency. Operates from 220-volt line. Complete with foot switch and one heating coil made to customer's requirements. Send samples of work wanted. We will advise time cycle required for your particular job. Cost, complete, only \$650. Immediate delivery from stock.

Scientific Electric Electronic Heaters are made in the following ranges of Power:  
1-2-3½-5-7½-10-12½-15-18-25-40-60-80-100-250KW.

*Scientific  
Electric*

Division of

"S" CORRUGATED QUENCHED GAP CO.

107 Monroe St., Garfield, N. J.

WHEN CONSIDERING  
COILS . . . CALL **DANO**



Your exact coil made to perform perfectly and sold to you at favorable prices is Dano's policy. Consider this the next time you need coils.

Also, Transformers Made To Order

- Form Wound
- Paper Section
- Acetate Bobbin
- Molded Coils
- Bakelite Bobbin
- Cotton Interweave
- Coils for High Temperature Application



**THE DANO ELECTRIC CO.**  
MAIN ST., WINSTED, CONN.



4E27

## CHECK WITH LOS GATOS

for your power-tube needs

Call on Lewis & Kaufman with your full tube-complement problems. Both JAN-IA and commercial types, including tantalum- and zirconium-molybdenum-anode tubes in long-lived Los Gatos Brand—backed by pioneers in the field.

**LEWIS & KAUFMAN, INC.**

LOS GATOS

CALIFORNIA



*mecha*

**development apparatus**



**Servomechanisms, Inc.,  
Mechanical Development**

**Apparatus** provides the designer with an extensive selection of precision components for rapid and economical assembly of gear trains and actuator devices. Typical applications are analog computers, signal generators, process programmers.

- Foundation Boards
- Bearing Blocks
- Mounting Brackets
- Gears and Shafts
- Miscellaneous Accessories

Write for  
Descriptive  
literature  
MDA

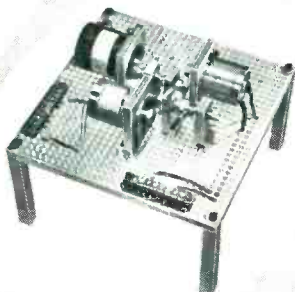

Old Country & Glen Cove Roads  
**MINEOLA, N. Y.**  
Garden City 7-0754-5-6

**SERVOMECHANISMS**  
INC.

pilots on dangerous flights is entirely practical and it is anticipated that this tv testing will prove effective on even such high-speed planes as the X-1 and the F-86.

Lear, Inc., of Grand Rapids, Mich., and the Philco Corp., of Philadelphia, Pa., are working on the project with engineers of the Air Materiel Command's Equipment Laboratory and Electronic Subdivision.

**BUSINESS NEWS**

TRACERLAB, INC., Boston, Mass., recently contracted to purchase a site of approximately 17 acres in West Concord, Mass., to construct a new building to house its engineering and manufacturing operations as well as certain phases of its radio-chemical program.

MASSA LABORATORIES, INC., Cleveland, Ohio, has announced the opening of its new laboratories and manufacturing plant in Hingham, Mass., for the development and production of electroacoustic apparatus.

HUDSON WIRE Co. will soon establish another magnet plant at Caspapolis, Mich., for the production of bare and insulated wires for electrical and radio-electronic applications.

SONOTONE CORP., Elmsford, N. Y., manufacturer of hearing aids, has started production of miniature tubes for radio and television sets.

RAYTHEON MFG. Co. has started production in its new pilot plant in Quincy, Mass. The new plant is operated by the Receiving Tube Division of the company and is engaged in the manufacture of electronic tubes of subminiature and miniature construction for military requirements exclusively.

H. LESLIE HOFFMAN AND HOFFMAN RADIO CORP.'s bid of \$11,200,000 for Don Lee Enterprises has been accepted by the Los Angeles County Public Administrator. Hoffman Radio Corp. will own 100 percent of the stock in Don Lee Enterprises, which include a-m stations in Los Angeles, San Francisco, San Diego,

*Specify*  
**ZENITH**  
**program**  
**TIMERS**  
**FOR ACCURACY**

Products requiring precision time performance need this dependable time control.

The ZENITH PROGRAM TIMER is an automatic switch which can be set to close an electrical circuit at any desired 5 minute intervals of the 24 hours. This circuit closure can be from 5 to 60 seconds as specified and occurs precisely at the time selected. As many as 288 operations per day are possible.

There are nine other models to meet all types of operation schedules.

Also Transfer, Remote control, Automatic time, Automatic reset and Magnetic switches; Magnetic contactors; Reversing starters; Synchronous motors; Interval, Process, Impulse and Work cycle timers. Units made to your specifications.

Write for catalog today

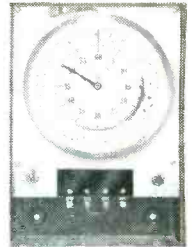

**ZENITH ELECTRIC CO.**

151 W. Walton St.

Chicago 10, Ill.

*instrument*  
**DIALS**

**SPECIAL CHECK LISTS**

- LUMINESCENT
- BLACK & WHITE
- MADE TO YOUR SPECIFICATIONS

**PRECISION**  
**INSTRUMENT**  
**SERVICE**

WE REPAIR, OVERHAUL  
AND STANDARDIZE LABORATORY  
AND PORTABLE INSTRUMENTS

Our laboratory is equipped with new Leeds & Northrup potentiometric standardization equipment calibrated in terms of the Absolute units which were adopted internationally as of January 1, 1948.

*Standard Products Inc.*  
650 EAST GILBERT • WICHITA, KANSAS



## Simplify Your Wiring With KULKA TERMINAL BLOCKS

Eliminate Splicing • Stop Leaks and Shorts • Increase Insulation



Blocks of high tensile strength Bakelite (or other plastics to gov't spec.) and come in 4 sizes—with 1 to 23 terminals. Screws and solder lugs of nicked brass. Lugs in several styles, also eyeletted to block. Marker strips come plain or printed, or blocks can be engraved.

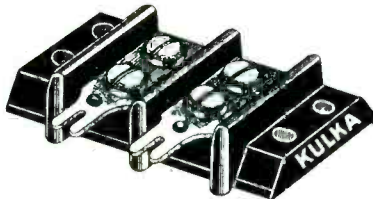

Write Dept. E for Catalogue

# KULKA

ELECTRIC  
MFG. CO. INC.  
Mt. Vernon, N. Y.

An invitation from Lockheed in California to

## SENIOR ELECTRONIC SYSTEMS ENGINEERS

Lockheed invites you to participate in its long-range production program, developing the aircraft of the future.

Lockheed offers an attractive salary commensurate with your ability and background, a future in aeronautical science. In addition, Lockheed provides generous travel allowances for those who qualify.

If you have:

1. An M.S. or Ph.D. in Electrical Engineering or Physics—
2. A minimum of three years' experience in advanced electronic systems development, including radar microwave techniques, servomechanisms, computers and fire control—
3. Familiarity with airborne electronics equipment requirements—

Write today—giving full details as to education, experience and salary requirements. Address:

Karl R. Kunze, Employment Manager  
LOCKHEED Aircraft Corporation  
Burbank, California

## AN IMPRESSIVE LABORATORY STANDARD



Video Oscillator TF 885 is a wide range beat frequency oscillator, impressive alike in performance, stability and appearance. It embodies thermally screened oscillators, dual frequency standardisation, a ladder-network attenuator and really effective automatic level control. The output, monitored by a vacuum tube meter, may be of sine or square waveform and is continuously

variable from 316 $\mu$ V up to 31.6V—1 watt into 1000 $\Omega$  sine, or 64V peak-to-peak. The frequency cover—2 bands on a generous 8-inch dial—is 25 c/s to 5 Mc/s sine and 50 c/s to 150 kc/s square. At full load individual harmonics are generally below 3%, falling considerably at lower outputs. The frequency characteristic is within 1db, as are the attenuator steps at other than extreme h.f. attenuation.

Further particulars are obtainable from any of the addresses below.

## MARCONI INSTRUMENTS LTD

U.S.A. Sales and Service: 23-25 Beaver Street, NEW YORK, 4  
CANADA: CANADIAN MARCONI LIMITED, Marconi Building, St. Sacramento Street, MONTREAL  
ENGLAND (Head Office and Works): ST. ALBANS, HERTFORDSHIRE

## LOOK! No Hands! KLIPZONS CLIP ON

New SELF HOLDING KLIPZON\*  
TEST PRODS • PROBES • ADAPTORS  
MINI-PROD CONNECTORS



BRING MAXIMUM CONVENIENCE and SAFETY in TESTING. Both HANDS are FREE for soldering or adjustments when you use KLIPZONS. The self-holding jaws slip on to wires, lugs and terminals... grip test points until pulled off... connect and disconnect from hot circuits with safety to user. Or, you can convert your old style non-selfholding prods to KLIPZONS by slipping on a pair of TYPE M or J ADAPTORS

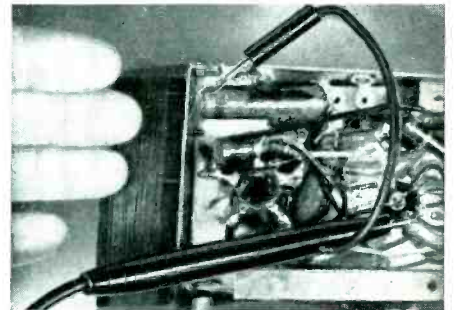

IT'S A TREAT TO TEST WITH KLIPZON PRODS

Slender and streamlined Klipzons are designed to add minimum capacity to circuits and make contact with inaccessible wires or terminals easy.

Fit into PINJACKS, SOCKETS, BINDING POSTS, ETC.

TYPE J ADAPTOR

KLIPZON V.H.F. CRYSTAL PROBES  
Bring added versatility to your VTVM or VOM.

Use KLIPZON MINI-PROD CONNECTORS for quick, easy to make TEST HOOKUPS

Write for folder showing how to make "one man" TV antenna installations

TYPE V&C Crystal Probe



At Your Local Parts Distributors. If not in stock write us direct for free KLIPZON folder B

UNITED TECHNICAL LABORATORIES

MORRISTOWN, New Jersey

# NOTHELFER

## Special TRANSFORMERS

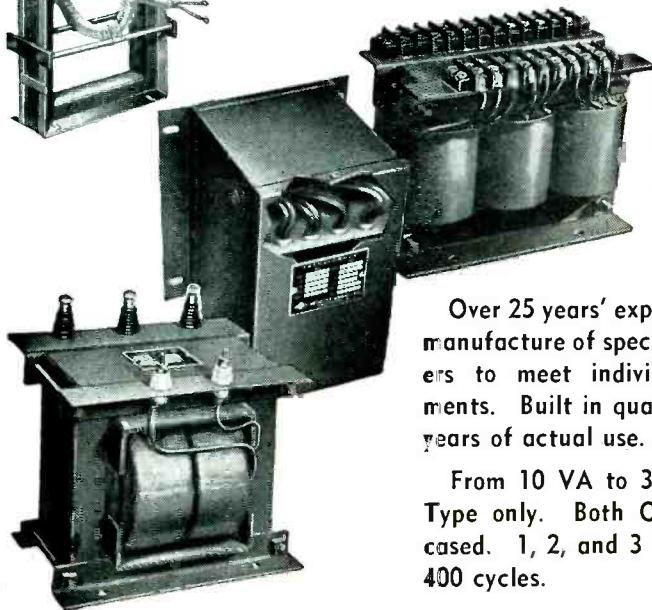
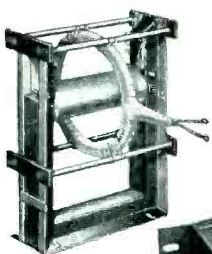

Proven by  
Past  
Performance

Over 25 years' experience in the manufacture of special transformers to meet individual requirements. Built in quality proved by years of actual use.

From 10 VA to 300 KVA Dry-Type only. Both Open and Encased. 1, 2, and 3 Phase. 15 to 400 cycles.



**NOTHELFER**  
WINDING LABORATORIES

9 ALBEMARLE AVE., TRENTON 3, N. J.



# Emergency

## ELECTRIC POWER

For A.M., F.M., and Television Stations



**ONAN**  
STANDBY  
ELECTRIC  
PLANTS

Model 10 EL  
10,000 watts

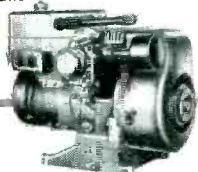

PORTABLE A.C. ELECTRIC PLANTS  
FOR FIELD AND MOBILE RADIO

Supply power for transmission at scene of events. Can be carried by hand or in trunk of car. Take up only a few square inches of space in mobile unit. Weigh as little as 80 pounds. Lightweight models: 350 to 3,000 watts. Other models to 35,000 watts.

**Stay on the air during power failures.** When storms, floods, or breakdowns interrupt electric service to your station and force you off the air, you lose listeners, you lose income. Protect yourself against loss . . . make sure of your ability to give vital service to your community during disaster periods by installing a dependable Onan Emergency Electric Plant.

An Onan plant will take over the job of supplying electricity for studios and transmission automatically when power is interrupted. Plant stops itself when power is restored. Upkeep costs are negligible.

Write for Folder  
or Engineering Service



**D. W. ONAN & SONS INC.**  
7019 Royalston Avenue, Minneapolis 5, Minnesota

Santa Barbara, Los Angeles' tv station KTSL, and KHJ-FM, Los Angeles, as well as 45 affiliate stations in California, Washington, Oregon, Nevada, and Idaho. In addition, there is a substantial stock interest in the Mutual Broadcasting System. The transfer is still subject to formal approval of the Los Angeles Probate Court and to permission for transfer of existing licenses to the new ownership by the FCC.

PYROFERRIC Co., New York, N. Y., has acquired a manufacturing plant at 14 N. Bleeker St., Mt. Vernon, N. Y., to meet the increased demands for its iron cores and powdered metallurgy developments.

ELECTRO-VOICE, INC., announces the expansion of their laboratory and research facilities. A new r-f double-screen room for tv-booster research and a polycylindrical-surfaced speaker-comparison room have been added. New test and measurement equipment for the laboratory and additional model-making tools and machinery are included in the program.

LENKURT ELECTRIC Co., San Carlos, Calif., manufacturer of radio and wireline telephone and telegraph carrier equipment, has begun construction on 16,000 sq ft of added production space to its present plant.

SKINNER, HARLAN AND IRELAND, INC., Indianapolis, Ind., is a newly organized consulting engineering firm. The firm will specialize in permanent magnets and soft magnetic materials but will accept consulting projects in any allied field.

THOMPSON PRODUCTS, INC., Cleveland, Ohio, manufacturers of parts for the automotive and aircraft industries, have entered the electronics field to help solve problems arising from coaxial switch needs.

PLATCO RADIO, INC., has been organized as a radio transmitter and receiver manufacturing firm by Murray Platt with quarters at 489 Broome St., New York, N. Y.

SIMPSON ELECTRIC Co., manufacturers of panel instruments and



*ALL these GRC tiny zinc die castings  
were produced in one automatic operation!*

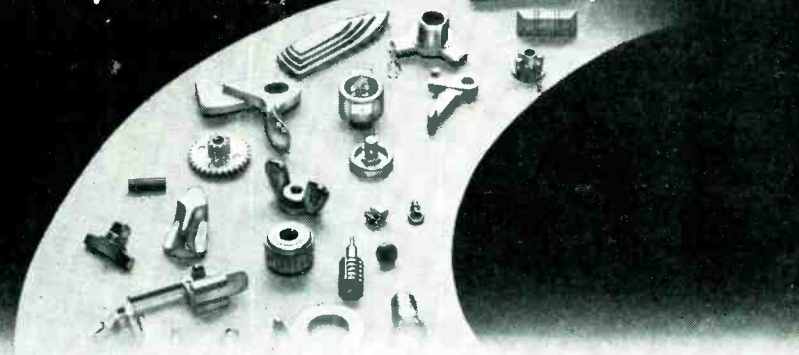

*What a saving of time and money for you!*

We can offer zinc die castings as small as  
.000004 of a lb. (250,000 to the lb.)

**—SMALLNESS UNLIMITED!**

GRC's method of die casting *really small* parts has opened up new fields in designs, products and economies for hundreds of manufacturers. Our exclusive, high-speed mass production facilities turn out simple or intricate parts automatically—completely trimmed ready for use—100,000 pieces to many millions. Discover GRC's small parts possibilities for yourself—

Write Today for Bulletin and Samples.



**GRIES REPRODUCER CORP.**

100 WILLOW AVENUE, NEW YORK 54, N. Y.



Maximum Weight: ½ oz.  
Maximum Lengths: 2 in.  
**SMALLNESS UNLIMITED**

**Little thought-of facts about capacitors**

The short time breakdown voltage of a well-made D.C. capacitor is not less than 5 to 6 times the actual working voltage at 20°—

$$E = 5 \times e \text{ min}$$

E = Breakdown voltage

e = Rated d.c. working voltage

**INDUSTRIAL CAPACITORS** are unvaryingly held to this formula.

Designed for maximum safety and the smallest possible volume, **INDUSTRIAL CAPACITORS** are the most widely used capacitor in industrial applications.

WRITE TODAY FOR DETAILED CATALOG

**INDUSTRIAL CONDENSER CORP.**

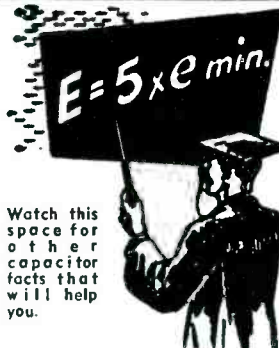

Watch this space for other capacitor facts that will help you.

Sales Offices in  
All Principal Cities  
3243 N. California Ave.  
Chicago 18, Illinois

**SPECIAL TUBE SOCKETS**

For high power tubes Gates has designed several very attractive tube sockets.

◀ To the left, a socket for the Eimac 3X2500 tube.

To the right, a socket for such tubes as the 889R, 891R, 892R and others.

Available in small or large quantities at proportional prices.



**GATES RADIO COMPANY**

Manufacturing Engineers Since 1922  
QUINCY, ILLINOIS, U. S. A.



**ATR**

**"A" BATTERY  
ELIMINATORS**

*Makes it easy  
to DEMONSTRATE  
AND TEST  
D.C. APPARATUS  
FROM A.C. LINES*



**for DEMONSTRATING AND  
TESTING AUTO RADIOS**

New Models . . . Designed for testing D. C. Electrical Apparatus on Regular A. C. Lines. Equipped with Full-Wave Dry Disc Type Rectifier, Assuring Noise-less, Interference-Free Operation and Extreme Long Life and Reliability.

NEW MODELS NEW DESIGNS  
NEW LITERATURE

"A" Battery Eliminator, DC-AC Inverters  
Auto Radio Vibrators

**ATR**

See your jobber or write factory

**AMERICAN TELEVISION & RADIO CO.**

Quality Products Since 1931

SAINT PAUL, MINNESOTA-U. S. A.

*Another  
Murex contribution*

## TO THE ELECTRONICS AND ELECTRICAL INDUSTRIES TANTALUM

We also supply Tungsten and Molybdenum metals and powders, and Tantalum powders, Titanium Hydride, Zirconium Hydride, and many other metallurgical products.

In addition to Tungsten and Molybdenum we are now making pure TANTALUM ROD, SHEET and WIRE—the first time these materials have been made in Great Britain.

We shall be pleased to have details of your requirements.

**MUREX LTD** (Powder Metallurgy Division) **RAINHAM • ESSEX • ENGLAND**

LONDON OFFICE: CENTRAL HOUSE, UPPER WOBURN PLACE, W.C. 1.

test equipment, recently leased its fifth plant. The new factory is located at 932 Benton St., Aurora, Ill.

MEASUREMENTS CORP., manufacturers of precision electronic testing equipment, is now occupying its



New Measurements Corp. plant

new 25,000-sq ft plant at Intervale Road, Boonton, N. J.

FLEETWOOD LABORATORIES, INC., Bronxville, N. Y., has been formed to manufacture x-ray thickness gages for foil and light-gage metals. President and chief engineer is W. B. Lurie, former design engineer in charge of the high-voltage laboratory at Machlett Labs.

### PERSONNEL

THOMAS G. BANKS, JR., former sales engineer, has been appointed to the newly created position of director of research and development at Gates Radio Co., Quincy, Ill.

F. C. CAHILL, supervisor of the receiver section at Airborne Instruments Laboratory, Mineola, N. Y., has been named supervising engineer of a combined engineering group to be known as the radar section. The new group, a combination of the former receiver and radar sections, now comprises about 40 engineers.

J. GILMAN REID, JR., chief of the engineering electronics section of the National Bureau of Standards since 1939, has been appointed chief of the Bureau's electronics division.

JOHN B. LITTLE, for 13 years a member of the technical staff at the Bell Telephone Laboratories, has joined the International Business

## MEASUREMENTS CORPORATION MODEL 80 STANDARD SIGNAL GENERATOR

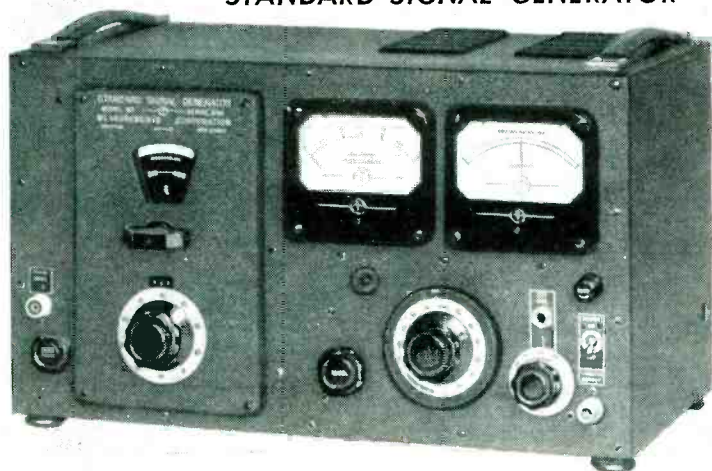

### 2 to 400 MEGACYCLES

MANUFACTURERS OF  
Standard Signal Generators  
Pulse Generators  
FM Signal Generators  
Square Wave Generators  
Vacuum Tube Voltmeters  
UHF Radio Noise & Field  
Strength Meters  
Capacity Bridges  
Megohm Meters  
Phase Sequence Indicators  
Television and FM Test  
Equipment

**MODULATION:** Amplitude modulation is continuously variable from 0 to 30%, indicated by a meter on the panel. An internal 400 or 1000 cycle audio oscillator is provided. Modulation may also be applied from an external source. Pulse modulation may be applied to the oscillator from an external source through a special connector. Pulses of 1 microsecond can be obtained at higher carrier frequencies.

**FREQUENCY  
ACCURACY**  $\pm .5\%$

**OUTPUT VOLTAGE**  
0.1 to 100,000  
microvolts

**OUTPUT  
IMPEDANCE**  
50 ohms

**MEASUREMENTS CORPORATION**

BOONTON  NEW JERSEY



# OPPORTUNITIES for ENGINEERS SCIENTISTS

GENERAL ELECTRIC COMPANY, Electronics Dept., has excellent opportunities for experienced technical personnel in the following areas:

**ADVANCED DEVELOPMENT DESIGN**—Circuit, component, and product  
**FIELD SERVICE**  
**TECHNICAL WRITING**

These positions available in the following fields:

TRANSMITTERS, RADAR,  
TUBE, RECEIVERS—  
TELEVISION AND  
COMMUNICATIONS

If you have a bachelors or advanced degree in Electrical or Mechanical Engineering, Physics, Metallurgy, or Physical Chemistry and experience in the electronics industry it will be worth your while to investigate these opportunities.

Send complete resume (Listing salary requirements and availability) to: TECHNICAL PERSONNEL, ELECTRONICS PARK, SYRACUSE, N. Y.

General



Electric

**For HEAVY DUTY**  
**WORK!** Severest Electrical Services!



P-506-CE  
Plug with Cap



S-506-DB  
Socket with  
deep Bracket

**JONES  
PLUGS &  
SOCKETS**  
500 SERIES  
*Proven  
Quality*

**For 5,000 Volts,  
25 Amperes per  
Contact Alter-  
able by circuit  
Characteristics.**

Socket contacts phosphor bronze, knife-switch type, cadmium plated. Plug contacts hard brass, cadmium plated. 2, 4, 6, 8, 10, and 12 contacts. Plugs and sockets polarized. Long leakage path from terminal, and terminal to ground. Caps and brackets, steel parkerized (rust-proofed). Plug and socket blocks interchangeable in caps and brackets. Terminal connections most accessible. Cap insulated with canvas bakelite.

Write for Jones BULLETIN 500 for full details on line.

**Jones** **HOWARD B. JONES DIVISION**  
CINCH MANUFACTURING CORPORATION  
CHICAGO 24, ILLINOIS  
SUBSIDIARY OF UNITED-CARR FASTENER CORP.

IN MINIATURE BEARINGS . . .

# The Trend's to *Micro*

The Sales Chart at right tells the story. On application after application, MICRO, America's first and only *tully ground* miniature bearings, have proved their superiority. That's why more and more engineers specify MICRO for top performance, long wear, uniform high precision. That's why MICRO'S sales today are up 580% over 1948 and still climbing.

Write today for Technical Bulletin No. 50. 70 sizes and types available from  $\frac{3}{8}$ " to  $\frac{1}{8}$ " O.D. with tolerances to ABEC-7 standards.

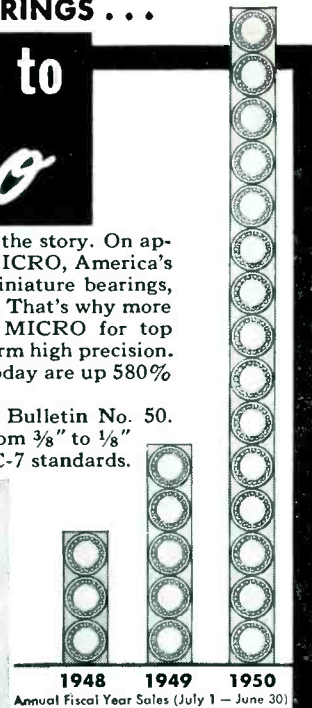
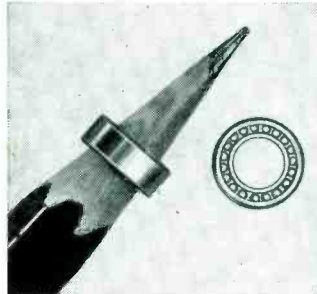

**New Hampshire *Micro* Ball Bearings, Inc.**

5 Main St.,

Peterborough, New Hampshire

**The GROUND Miniature Bearing**

★ ★ ★ ★ ★ ★ ★ ★ ★ ★ ★ ★ ★ ★ ★ ★

We know nothing about nose tests, throat tests, 30-day tests and sniffing — but we do “challenge them all” to a drawing board test which will prove to you that Micro-Weave Tracing Cloth is “easy on the draw.”

Send for generous samples and give Micro-Weave any test you please — others have, and they switched to Micro-Weave.

**THE HOLLISTON MILLS, INC.**  
**NORWOOD, MASS.**

**NEW YORK PHILADELPHIA CHICAGO**

MICRO-WEAVE is backed by Holliston's 50 years of leadership and experience in developing special cloths for industry.



# MICROPOT

PRECISION TEN-TURN POTENTIOMETER

1. You get permanent accuracy because the resistance wire is laced in place. It is precision positioned and moulded integrally with the housing.
2. You get permanently accurate settings, smooth action and low uniform torque provided by the stainless steel, precision ground, double thread lead screw guiding the moving contact.
3. You get precise positioning of the moving contact because of the two bearings supporting the rotor assembly.
4. You get good rigid terminals because they are moulded integrally with the housing.
5. Terminals soldered to ends of resistance element before moulding. Entire resistance circuit is an integral part of the housing.
6. You get accurate setting and re-setting due to anti-backlash spring in contact guide.
7. You get a fine resolution because of the  $43\frac{1}{2}$ " length of resistance wire in the spiral element.
8. You get a resistance output directly proportional to shaft rotation within  $\pm 0.1\%$  of the total resistance. Every potentiometer is automatically machine tested for linearity at 101 points.

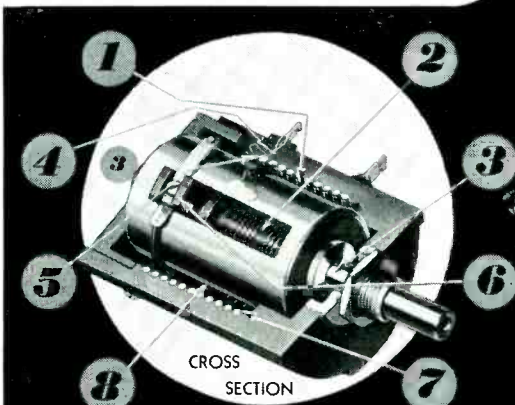

**LINEARITY  
ACCURACY  $\pm 0.1\%$**

Units for immediate shipment:  
1,000 to 30,000 ohm range.  
Special resistance values made to order.

WRITE TODAY FOR  
ENGINEERING INFORMATION



GIBBS DIVISION

**THE GEORGE W. BORG CORPORATION**

DELANA • WISCONSIN

## New BIRTCHER TUBE CLAMP FOR MINIATURE TUBES

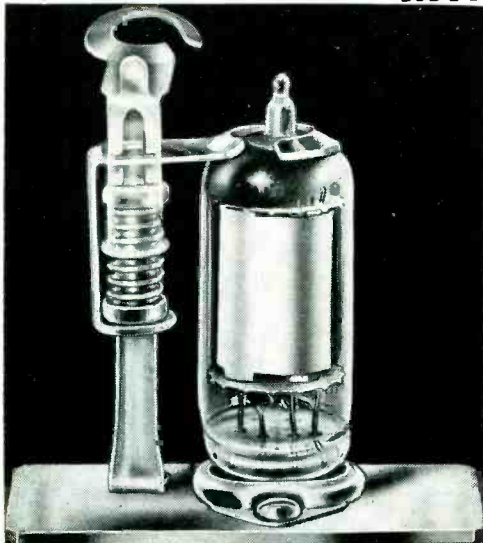

**POSITIVE PROTECTION  
AGAINST LATERAL AND  
VERTICAL SHOCK!**

The New Birtcher Type 2 Tube Clamp holds miniature tubes in their sockets under the most demanding conditions of vibration, impact and climate. Made of stainless steel and weighing less than  $\frac{1}{2}$  ounce, this New clamp for miniature tubes is easy to apply, sure in effect. The base is keyed to the chassis by a single machine screw or rivet...saving time in assembly and preventing rotation. There are no separate parts to drop or lose during assembly or during use. Birtcher Tube Clamp Type 2 is

all one piece and requires no welding, brazing or soldering at any point.

If you use miniature tubes, protect them against lateral and vertical shock with the Birtcher Tube Clamp (Type 2). Write for sample and literature.

Builder of millions of stainless steel Locking Type Tube Clamps for hundreds of electronic manufacturers.

*The* **BIRTCHER Corporation**

5087 HUNTINGTON DRIVE • LOS ANGELES 32

Machines Corp. as a technical engineer in their engineering laboratories at Poughkeepsie, N. Y. He will be in charge of the mechanical aspects of electron tube research and development.

HARRY R. SMITH, formerly senior development engineer in television broadcasting equipment at the television transmitter division of the Allen B. Du Mont Laboratories, Inc., was recently appointed head of the television transmitter development department of Standard Electronics Corp., subsidiary of Claude Neon, Inc., New York, N. Y.

PHILIPS B. PATTON, former field engineer, has become manager of the sales engineering department of Lenkurt Electric Co., Inc., San Carlos, Calif., carrier equipment and component manufacturer.

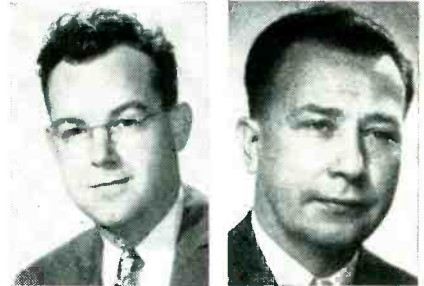

P. B. Patton

G. M. Lebedeff

GEORGE M. LEBEDEFF, formerly chief engineer at Heintz and Kaufman and an engineer with Federal Telegraph Co., has taken the post of chief engineer of Lenkurt Electric Co.

WILLIAM J. JACKSON, formerly associated with WPIX television and also the NBC development laboratory in New York, was recently appointed chief engineer of tv station KEYL, San Antonio, Texas.

JOHN W. McNALL, in charge of the emission section of the Westinghouse Electric Corp.'s Lamp Division Research Department, Bloomfield, N. J., has been appointed division engineer of the department.

BENJAMIN MARGOLIN, formerly engaged in design and development engineering with General Motors and Baird Associates, has been appointed to the Henry P. Segel Co., Boston, Mass., in a sales capacity.



■ **electronic engineers (3 seniors) wanted by**

*Freed-Eisemann*

The manufacturer of world-famous Freed-Eisemann Radio-Phonographs and Television Consoles requires 3 engineers to act as group leaders on design and production of communication equipment on important government contracts. Must have a minimum of 7 years experience in this field.

■ Write, giving complete outline of education, experience and salary required to Freed Radio Corp., 200 Hudson Street, New York 13, N. Y.

**electronics**

PUBLISHES

**13**

ISSUES YEARLY

*including the*

MID-JUNE

**BUYERS' GUIDE**

# MICRODIAL

TEN TURN-COUNTING DIAL

Microdial is composed of two concentrically mounted dials... one for counting increments of each turn and the other for counting turns. The incremental dial has 100 equal divisions and is attached rigidly to the shaft so there is no backlash. Thus the contact position is indicated to an indexed accuracy of 1 part in 1000. Rotation is continuous in either direction. There are no stops on the Microdial assembly.

**COMPACT...** Microdial has same O.D. as Micropot... requires no more panel space.

**CLEAR READING...** Forced fast-reading tests showed only 1/20th as many errors with Microdial open window as with next most legible dial. Turn counter distinguishes between 0 and 10 turn readings, and accelerates to avoid confusion on readings near integral turns. Precise readings are made from larger dial with maximum separation of graduations and wide angle visibility.

**CONVENIENT...** delivered completely assembled with dials synchronized. Easily mounted in a few seconds. All dials may be locked.

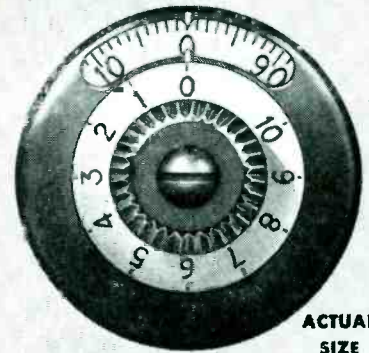

ACTUAL SIZE

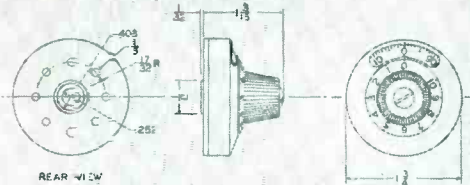

Microdial... turn-counting dial, primarily designed for use on Micropot ten turn linear potentiometers... use it on any multiturn device having ten turns or less.



GIBBS DIVISION

**THE GEORGE W. BORG CORPORATION**

DELAWAN • WISCONSIN

**"JOHN CRANE" FABRICATED TEFLON\* INSULATORS**

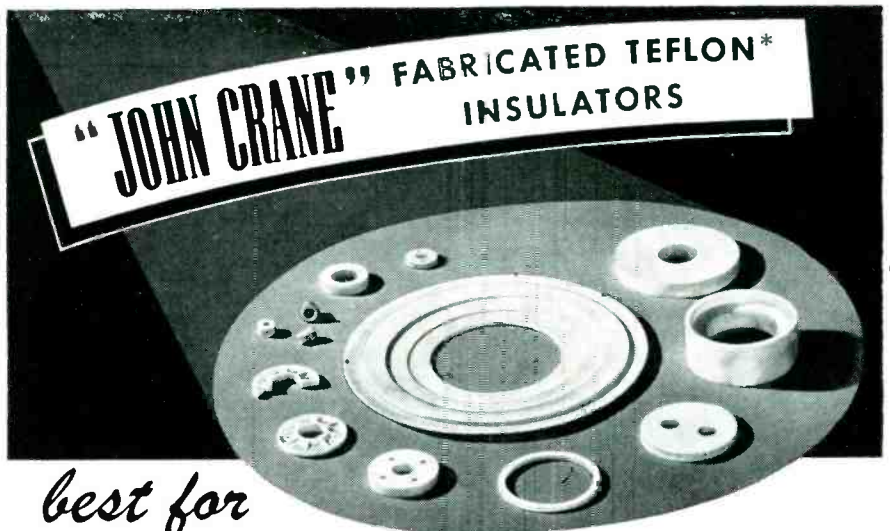

*best for*

**ULTRA HIGH FREQUENCY NEEDS!**

You can't beat the properties of Teflon when you're looking for hf and uhf insulators... and you'll never find more perfectly fabricated Teflon parts than those made by "John Crane".

Teflon insulators combine low dielectric constant, low loss factor, high heat resistance, toughness and resiliency.

As pioneers in the fabrication of Teflon products, we can fill your requirements. Scores of "John Crane" insulating spacers, connectors, beads, etc. are in use throughout the world on installations such as coaxial cables and radar units.

*If you need Teflon insulators, let "John Crane" solve your problem. Write for full information*

\* John Crane products fabricated from DuPont Teflon are sold under the registered trade name "Chemlon"



**CRANE PACKING COMPANY**

1802 CUYLER AVENUE • CHICAGO 13, ILLINOIS

Offices in all Principal Cities in United States and Canada



on the basic research attempt on USAF contract W-19-122ac-10.

HARRY STOCKMAN, S. D.  
*Director of Research*  
*Tobe Deutschmann Corporation*  
*Norwood, Massachusetts*

**Electronics Quiz**

THIS MONTH'S puzzle problem was submitted by William H. Fritz of Mamaroneck, New York.

Several years ago a circuit was needed that would modulate the positive peaks of a carrier wave with one pulse or recurrent wave and at the same time modulate the negative peaks of the same carrier wave with a second and unrelated pulse or recurrent wave . . . and each modulation envelope had to be independent of the other. No vacuum tubes or moving parts were to be used. Design an appropriate "black box" to accomplish the desired purpose.

The solution arrived at by Fritz will be published in next month's *Backtalk* along with a new problem. Readers are encouraged to submit problems. For each problem that is printed in this department, a payment of five dollars will be made. The correct solution must accompany each problem.

*Last Month's Solution*

Last month's problem was:

After having designed and constructed an entirely conventional full-wave rectifier circuit feeding a purely resistive load, the direct current through which is to be adjusted to exactly one ampere, the ham doing the work is suddenly siezed by a spasm of caution (obviously a purely fictitious person) and decides to fuse the circuit. At first he decides to place a one-ampere fuse in the center leg, that is, between the load and the center tap of the transformer. But then he realizes that this might not prevent damage to the transformer from a short occurring from plate to plate. He wishes to employ the smallest fuses that are just able

**DC - AC  
 CHOPPER**

*A model for every use.*  
**10 — 50C cycles AC**  
 Meets AN Specifications  
 also 60 cycles  
 Single pole and double pole  
 Make-before-break contacts  
 Contacts in air or in liquid

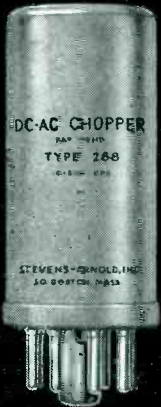

These Choppers convert low level DC into pulsating DC or AC so that servo-mechanism error voltages and the output of thermocouples and strain gauges, may be amplified by means of an AC rather than a DC amplifier.  
 They are hermetically sealed, precision vibrators having special features which contribute to long life and low noise level.

WRITE FOR THESE CATALOGS . . .  
 #280 10-500 cycles  
 #246A 60 cycles

**STEVENS  
 ARNOLD  
 INCORPORATED**

22 ELKINS STREET  
 SOUTH BOSTON 27, MASS.

SA-4

**Controlled  
 HEAT FOR  
 ALL TYPES  
 OF  
 SOLDERING**

**With 250-Watt  
 WELLER GUN**

No need to change tools for *light or heavy* soldering. The 250-watt Weller Soldering Gun does both with *controlled* dual heat. 5-second heating saves time and current on every job. Your Weller Gun pays for itself in a few months.

**Check These  
 Time-and-  
 Money  
 Saving  
 Features**

**TRIGGER-SWITCH CONTROL**—Governs heat for light or heavy work. Saves power because no need to unplug gun between jobs.

**SOLDERLITE**—Spotlights the work. Lets you see what you're doing at all times.

**5-SECOND HEATING**—No waiting, no wasted current. Saves hours and dollars each month.

**LONGER REACH**—Lets you get at any job with ease. Slides between wiring—into the tightest spots.

**STREAMLINED**—Compact and comfortable to hold. Pistol-balanced for fast precision soldering.

**RIGID-TIP**—Chisel-shaped. More soldering area for faster heat transfer. "Over-and-under" terminals give bracing action.

**DUAL HEAT**—Single heat 200 watts; dual heat 200/250 watts; 120 volts, 60 cycles.

See the new 250-watt Weller Soldering Gun today at your distributor—or write for bulletin direct.

**SOLDERING GUIDE**—Get your new copy of **SOLDERING TIPS**—revised, up-to-date and fully illustrated 20-page booklet of practical soldering suggestions. Price 10c at your distributor, or order direct.



**WELLER  
 ELECTRIC CORP.**

806 Packer Street, Easton, Pa.



The  
**FISHER-PIERCE**

**PHOTOELECTRIC  
TOWER LIGHTING  
CONTROL**



Turn-on 35 ft.-candles—off at 55 ft.-candles—independent of time of day or weather conditions.  
Low first cost—negligible maintenance.  
3000 watts contact capacity.  
Over 20,000 in use for tower and street lighting.  
Complete details available—ask for Bulletin 63305.

The **FISHER-PIERCE**  
**COMPANY, Inc.**  
42 Ceylon St., Boston 21, Mass.

**PRODUCTS OF  
WESTERN  
GERMANY**

**MORE WORK  
THAN YOU  
CAN HANDLE?**

**LET GERMAN INDUSTRY  
HELP YOU OUT . . . . .**

A number of electrical manufacturers in Germany are looking for contract work to utilize available plant capacity and highly skilled labor.

They will manufacture, to your specifications and blueprints, electrical or mechanical parts for radio, television and other electronic equipment.

As representatives of the West-Germany Industry we can, through our offices in Germany, help you select reputable companies equipped with suitable and up-to-date production machinery. This service is available to you without charge or obligation.

Send us your prints and specifications, and we will have a German manufacturer submit his bid to you, directly.

**GERMAN-AMERICAN TRADE PROMOTION OFFICE**  
Suite 6921 Empire State Building  
New York 1, New York  
Wisconsin 7-0727

*Tensolite*  
TRADE MARK

**MINIATURE WIRE**  
**PLASTIC INSULATED  
WIRE AND CABLE**

Insulators of Stranded Flexible  
Conductors from #20 to #40 AWG

- SHIELDED WIRES
- TINSEL CORDAGE
- MULTI-CONDUCTOR CABLES
- TEXTILE AND PLASTIC BRAIDS

Tensolite is devoted exclusively to high grade precision insulation of small diameter flexible materials to which its patented process is uniquely suited.

Special Constructions Made to  
Manufacturers Specifications

Free wire samples and descriptive literature sent to manufacturers, engineers, and purchasing executives—requesting same on company letterhead.

**TENSOLITE**  
**INSULATED WIRE CO., INC.**  
196 MAIN ST., TARRYTOWN, NEW YORK  
Telephone: Tarrytown 4-2616

**—UNICON—** . . . . .

**A Dependable Source for SPECIAL CAPACITORS**

When special capacitors with unusual characteristics are required, we can fulfill your requirements and give excellent delivery. Outstanding characteristics of our plastic dielectric capacitors are as follows:

- 1. COMPACTNESS IN HV RATINGS**  
A capacitance of .08 MF at 7.5 KV, or .02 MF at 15 KV, or .005 MF at 30 KV (with tape if desired) can be furnished in a case occupying less than 35 cu. in. Other capacities and voltage ratings are sized in proportion. The ability to cut down the size and weight of high voltage power supplies with these capacitors is obvious.
- 2. ULTRA-HIGH I.R.**  
These capacitors will hold more than 99.8% of their original charge for 14 days at room temperature. A time constant of 10<sup>7</sup> seconds

or better is regularly attained. Applications in computer circuits and in batteryless operations of low current tubes are a natural result of this property.

Prices are extremely attractive. Write giving your exact requirements for a prompt quotation.

**United Condenser Corporation**  
337 East 139th St. New York 54, N. Y.  
CYpress 2-5180

MODEL 330-A

**ULTRA-LOW FREQUENCY  
BAND-PASS FILTER**



variable from **0.02 to 2,000 cps**

**FEATURING:**  
ADJUSTABLE CENTER FREQUENCY AND BAND WIDTH •  
UNITY PASS BAND GAIN • 24 DB/OCTAVE SLOPE • COR-  
NER FREQUENCY PEAKING • LOW INTERNAL NOISE

**DESCRIPTION:** Unity pass band gain and 24 db/octave slope outside the pass band. Both high and low cut-off frequencies are independently adjustable from 0.02 to 2,000 cps.

Especially useful for vibration studies, for electro-medical research and geophysical and seismological instrumentation.

**KROHN-HITE INSTRUMENT CO.**  
580 MASSACHUSETTS AVE., CAMBRIDGE 39, MASS., U.S.A.

**SPECIFICATIONS:**  
BAND WIDTH:  
Variable to maxi-  
mum width, from  
0.02 to 2,000 cps.  
FREQUENCY RANGE:  
High and low cut-off  
frequencies independ-  
ent, from 0.02 to  
2,000 cps.  
SLOPE:  
24 db/octave with  
peaking at cut-off  
frequencies.  
INTERNAL NOISE:  
Less than 100  
microvolts.

# VARIABLE DC HIGH VOLTAGE! RADIO FREQUENCY TYPE DC POWER SUPPLIES



## MODEL 86—1 TO 20 KV

The Model 86 will deliver 250 microamperes at any voltage output up to 20 KV. For voltages up to 10 KV this unit can deliver 500 microamperes.

**THE CAPACITY LOAD OF A LONG OUTPUT CABLE WILL NOT DISTURB THE RADIO FREQUENCY OSCILLATOR**

## MODEL 101—5 TO 50 KV

The Model 101 will deliver 1.00 milliampere at an output voltage of 30 KV and 500 microamperes at any voltage up to 50 KV.



We are now engaged in several research and development contracts in the fields of industrial and medical electronics, ultrasonics, induction heating and memory and computer circuits. We are available for additional contracts in these or allied fields. Send us your problems.

## INDUCTOGRAPH PRODUCTS, INC.

236 W. 55th Street, New York 19, N. Y. • JUdson 6-1549

Plant—Brookfield, Conn.

to carry the load current.

Assuming that fuses were available in any desired rating, and would blow at exactly this rating, would the choice of one ampere in the center, or presumably one-half ampere in series with each plate, be correct?

Solution: A fuse in the center leg would have to be able to carry at least 1.11 amperes, whereas the two fuses in series with the plates of the rectifier tube would each have to be good for 0.785 ampere.

## Engine Analyzers

DEAR SIRs:

IN regard to the article "Aircraft Ignition Tester" by Bauer and Sands published in your October 1950 issue, the authors point out that their tester is the only one that can find intermittently firing spark plugs and bad spark plug connections.

To support this claim, Bauer and Sands cite a case, involving a Wright G-200 engine, in which their tester indicated intermittent ignition in a cylinder where a new spark plug had been installed. Examination showed failure to connect the ignition lead properly to the plug. "No other type of tester could have found this trouble", said the authors in their article.

This statement is not entirely accurate. The criticism presented here is not intended to snipe at or squelch pioneering work in the field of engine instrumentation. On the contrary, more attention to this field of investigation should be strongly encouraged. Perhaps the authors' oversight is due to their enthusiasm or the fact that their work was done earlier than their report indicates. It is, however, desirable to put the record straight.

At least eight other types of ignition testers (sometimes called analyzers) which can locate this type of trouble have been developed in recent years. Two are fairly well known in the United States. The best known of these devices has existed since early 1946 when its first tests were made on the engine stands at Wright Aeronautical Corp. During these tests, more

# di-acro PUNCH

## NEW DOUBLE PURPOSE PRESS

Available in two sizes, 6" and 12" throat depth

Now you can punch holes of various shapes as large as 4" diameter in 16 gauge steel—also blank, draw, emboss, form—all with the new DI-ACRO Punch. It is ideal for both experimental and production work.

The precision ground triangular ram of this double purpose press prevents punch head from turning, assuring perfect alignment at all times for accuracy in duplicated parts.

A Turret Stripper of exclusive DI-ACRO design automatically strips material from punches of all shapes. Roller Bearing cam action develops 4-ton pressure with minimum effort. Adjustable gauges assure exact location of holes.

## Send for "DIE-LESS DUPLICATING" Catalog

Gives the full story of the DI-ACRO Punch, and also DI-ACRO Benders, Brakes, Shears, Rod Parters, Notchers, as well as the new DI-ACRO Vari-O-Speed Powershear and Hydra-Power Bender.

DI-ACRO is pronounced "DIE-ACK-RO"



# O'NEIL-IRWIN MFG. CO.

321 EIGHTH AVENUE • LAKE CITY, MINN.





# INSULATION SERVICE

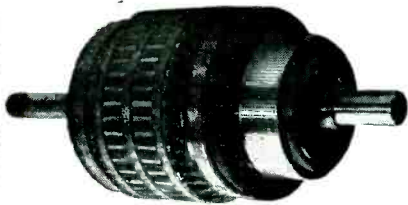

**To:**  
**manufacturers**  
**of armatures,**  
**transformers,**  
**and other wound**  
**electrical units.**

Based upon our many years of experience in the research and development of varnishes for Acme coil windings, Acme offers you a complete line of electrical insulating varnishes for every possible application and of unusual and superior qualities.

#### HERMOSSETTING VARNISHES

Outstanding advantages: Flexible baking schedules—low viscosity and high solids content—low drip coefficient—thorough impregnation with material reduction of voids and rapid deep-drying—high dielectric (over 1800 v. per mil)—excellent chemical and insulation resistance—unusual bonding strength.

#### OXIDIZING BAKING VARNISHES

Another Acme specialty. Available in clear or black. Make flexible, moisture-resistant, outside films of fine insulating quality under elevated temperatures. A permanent impregnant for shallow-wound coils. A good outside dip for field and controller coils, transformer windings, etc.

#### AIR DRYING VARNISHES

Supplied in clear or black. Coil dipping, masking, and adhesive lacquers, spirit varnishes. Some Acme air-drying varnishes when baked will cure in 30 to 60 minutes and provide good protection against corrosives, oils, water, and chemicals.

Acme also offers a complete line of Molding, Impregnating, and Potting Compounds. Practically 100% solids, thermosetting materials designed to eliminate voids, resist moisture and heat and to eliminate internal corona. Molding, impregnating, or potting can be accomplished in one operation.

Send for the Acme Catalog

## Acme



## Wire

THE ACME WIRE CO., NEW HAVEN, CONN.  
 INSULATING VARNISHES MAGNET WIRE  
 ACME-MOLD COILS  
 VARNISHED INSULATIONS

BACKTALK

(continued)

than 20 major types of ignition troubles, including the type referred to above, were detected by the tester.

An "Airborne Engine Analyzer" is described by V. C. Cetrone in a six-page article in the March 1948 issue of *ELECTRONICS*. This unit is designed so it can be used either as a permanently installed airborne unit or as a ground testing unit for maintenance and engine test stand work. It is used by airlines, the Air Force, Navy, CAA, engine manufacturers, fuel research projects and executive aircraft. In some cases, it has been specified as standard equipment on fleets of certain types of airplanes.

According to Cetrone, "The two principal functions of the engine analyzer are: the location and identification of engine ignition system malfunctions such as fouled plugs, faulty magneto capacitors, and grounded high-tension leads; and the location and identification of what might be termed vibration faults, such as detonation, incorrect valve clearances and valve bounce."

#### Other Troubles

In addition to grounded high-tension leads, Cetrone also lists among troubles detectable by the analyzer "shorted secondary (identifiable either in individual leads or in the magneto), large plug gap, small plug gap, shorted primary capacitor, no combustion, and magneto mistiming." In addition to "breaker point bounce" Cetrone also shows a photograph of an "open secondary" which the analyzer also can identify specifically as being in the magneto or in a particular plug lead.

Each of the troubles cited here is a possible variation of the intermittent firing condition caused by troubles the same as or different from what Bauer and Sands detected.

These troubles also show the more specific and much finer degree of analysis obtainable with the analyzer described by Cetrone.

In addition, Cetrone noted the necessity of using an analyzer during flight. His article points out that "experience has shown that checks made during actual

## PARTRIDGE

The

## AUDIO TRANSFORMERS

that pass  
 all tests!



The test of time, no less than test by leading technicians, has proved the range of Partridge Audio Transformers to be the most efficient and reliable. For example the famous

★ **WILLIAMSON** Output TRANSFORMER, of which there is said to be no U. S. equivalent (vide "Audio Engineering" Nov. 1949) is produced to the original specification and comes to you for \$21.00, mail and insurance paid. Then there is the

★ **PARTRIDGE CFB** 20 Watt output type, universally accepted as without rival anywhere. Here are some brief figures: Series leakage induct. 10 m.H.; primary shunt induct, 130 H, with 'C' core construction and hermetically sealed—to you for \$30.00, mail and insurance paid.



Send for fullest data, including square wave tests, distortion curves etc. We'll rush this Air Mail together with list of U. S. stock-lists.



**YOU CAN  
 JUDGE FOR YOURSELF**

at the

**RADIO**

**ENGINEERING SHOW, N. Y.**

(STAND 363) March 19th—23rd 1951

where the range of Partridge Audio transformers is being exhibited.

NOTE. We despatch by insured mail per return upon receipt of your ordinary dollar check.

Jobbers are invited to handle the transformer that the States is eager to buy—remember immediate delivery from large stocks in New York!

**PARTRIDGE TRANSFORMERS, LTD.**

ROEBUCK ROAD TOLWORTH  
 SURREY - ENGLAND

# Are COILS Your BOTTLENECK?

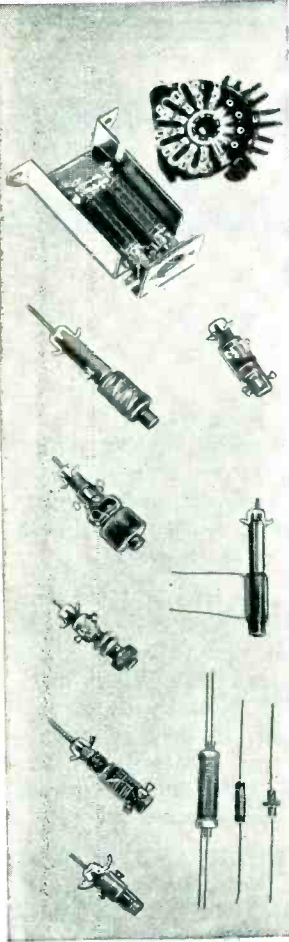

Is the manufacture of R.F. Coils a "step-child" operation in your plant? Does it lead to snarled-up production because of inadequate facilities and endless engineering detail? If so, Clippard Instrument Laboratory can help you out in a hurry!

Now at your disposal is efficient new high-speed coil winding equipment of our own design, plus a staff of production and control technicians schooled in laboratory accuracy. We deliver the quality coils and sub-assemblies you want when you want them with a minimum of rejects, fuss and bother.

Call on us, like many of the biggest names in radio and television today, to free your production facilities for more important work. For intelligent help and a prompt quotation, mail your requirements, now, to Department 5E.



## Clippard

**INSTRUMENT LABORATORY, INC.**

1125 Bank Street Cincinnati 14, Ohio  
 MANUFACTURERS OF R. F. COILS  
 AND ELECTRONIC EQUIPMENT

# NEW! FREQUENCY AND TIME MEASUREMENTS ACCURATELY . . . CONVENIENTLY!

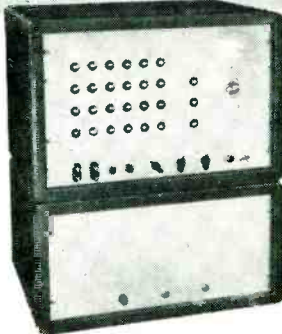

-using  $f = \frac{N}{t}$

ANY FACTOR MAY BE MEASURED FOR FIXED VALUE OF THE OTHER

## Universal 6-in-One MEGACYCLE FREQUENCY-TIME COUNTER

Model 801  
 by **Potter**

Now, the Potter Instrument Company offers all in one equipment, the features heretofore available only in separate counting systems. Two complete counting channels, a 100 kc crystal oscillator time base and unique gating circuits are combined to provide the new FREQUENCY-TIME COUNTER.

FREQUENCY MEASUREMENTS	0 to 1 mc range by counting cycles per pre-selected time or by measuring time per pre-selected count. Accuracy 0.001% minimum.
TIME INTERVAL MEASUREMENTS	0 to 10 seconds ± 10 micro-seconds.
FREQUENCY RATIO MEASUREMENTS	Ratio of two external frequencies can be measured.
SECONDARY FREQUENCY	100 kc crystal oscillator with divided frequencies available at 10, 1 kc and 100, 10, 1 cps
TOTALIZING COUNTER	Six decades, pulses 0 to 1 mc, sine wave 10 cps to 1 mc.
DIRECT RPM READING TACHOMETER	Through the use of an external 60 count per revolution photoelectric disc generator an accuracy of ± 1 rpm is obtained.

Please address inquiries to Dept. 6W



**POTTER INSTRUMENT COMPANY**  
 INCORPORATED  
 115 CUTTER MILL RD., GREAT NECK, NEW YORK

flight often reveal faults not detectable by ground test methods."

This condition was demonstrated conclusively by Pan American World Airways during an engine analyzer evaluation program begun in 1946. An experimental installation was made on Constellation Clipper NC-68 and operated in regular scheduled airline service between New York and Johannesburg, South Africa. The analyzer was operated by more than 100 regularly assigned flight engineering personnel only 13 of whom had received any briefing in the operation of the instrument. For the purposes of the program, base maintenance personnel were instructed to ignore analyzer reports and to continue using standard trouble-shooting methods. Analyzer reports were withheld.

In February 1947, enroute from Dakar to Roberts Field, the analyzer showed an "open secondary circuit" to the front plug on No. 1 cylinder of No. 4 engine. At Roberts Field the lead was checked with a tester and no fault was found by the ground crew.

Enroute to Johannesburg, the trouble persisted, showing the same indication on the analyzer. The ground crew at Johannesburg checked the lead again and reported it OK.

The analyzer still indicated the trouble continuously but the ground personnel reported they could find no trouble on the ground.

This sequence of events was duplicated at every base stop on the return trip from Johannesburg to La Guardia, N. Y. At La Guardia the analyzer report was checked by the ground crew. The lead pointed out so many times in flight by the analyzer was removed and carefully inspected. A badly frayed cigarette wire was found and repaired. The trouble then disappeared.

This was only one of the many hard-to-find troubles which the analyzer put the finger on directly. Not long after, ground crews were instructed to follow analyzer reports.

JAMES W. WHEELER  
 Dept. Head for Engine Instruments  
 Sperry Gyroscope Company  
 Great Neck, New York



# PROFESSIONAL SERVICES

Consulting—Patents—Design—Development—Measurement

in

Radio, Audio, Industrial Electronic Appliances

## AMERICAN SPEEDLIGHT CORP.

(AFFILIATED WITH J. G. SALTZMAN, INC.)  
HARRY L. PARKER, PRESIDENT and  
CHIEF ENGINEER

Specialist in Flash and Electronic Equipment  
for Photography.  
Consultation—Development—Design and  
Manufacture

480 Lexington Avenue New York 17, N. Y.

## PAUL GODLEY CO.

*Consulting Radio Engineers*

GREAT NOTCH, N. J.

Est. 1926

Little Falls 4-1000

## ALBERT PREISMAN

*Consulting Engineer*

Television, Pulse Techniques, Video  
Amplifiers, Phasing Networks,  
Industrial Appliances

Affiliated with  
MANAGEMENT-TRAINING ASSOCIATES  
3308-14th St., N.W. Washington 10, D. C.

## CROSBY LABORATORIES, INC.

*Murray G. Crosby & Staff*

Radio-Electronic Engineering,  
Research & Development,  
FM, Communications, TV  
Test Equipment

Offices, Laboratory & Model Shop at:  
126 Herricks Rd., Mineola, N. Y.  
Garden City 7-0284

## HANSON-GORRILL-BRIAN INC.

*Products & Mfg. Development*

ELECTRICAL - ELECTRONIC  
HYDRAULIC - MECHANICAL

One Continental Hill Glen Cove, N. Y.  
Glen Cove 4-1922

## SKINNER, HARLAN AND IRELAND, INC.

*Consulting Engineers*

Specializing in Magnetic Materials and  
Their Application

Office and Laboratory Indianapolis 7, Indiana

## DUBROW DEVELOPMENT CO.

*Design — Development — Mfr.*

Quality Electronic Equipment

347 High St. Burlington, N. J.  
Burlington 3-0446

## HOGAN LABORATORIES, INC.

John V. L. Hogan, Pres.

*Applied Research, Development, Engineering*

Est. 1929. Exceptionally competent staff.  
Electronics, Optics, Mechanisms, Facsimile  
Communication, Electro-sensitive recording  
media, Instrumentation.

155 Perry Street, New York 14 CHelsea 2-7855

## The Robert H. Streeter Co.

*Electronic Design Specialists*

Engineering Consultants  
Representing Manufacturers  
of Electronic Equipment  
in Southern United States

Specialists in the design and construction of speci-  
alized pieces of equipment for specific applications  
Tel. 97 Greenwood, Miss.

## EDGERTON, GERMESHAUSEN & GRIER, INC.

*Consulting Engineer*

Research Development and Manufacture  
of Electronic and Stroboscopic Equipment  
Specialists in High-Speed Photography

160 Brookline Avenue, Boston 15, Mass.

## MEASUREMENTS CORPORATION

*Research & Manufacturing Engineers*

Harry W. Houck Jerry B. Minter  
John M. van Beuren

Specialists in the Design and  
Development of Electronic Test Instruments

Boonton, N. J.

## THE TECHNICAL MATERIEL CORPORATION

*Communications Consultants*

Systems Engineering  
General Offices and Laboratory

121 Spencer Place, Mamaroneck, N. Y.

## ELECTRONIC ENGINEERING CO. of CALIFORNIA

Radio and Electronic Consulting and  
Designing.

180 S. Alvarado Los Angeles  
DUmkirk 2-7353 California

## Eugene Mittelmann, E.E., Ph.D.

*Consulting Engineer & Physicist*

High Frequency Heating—Industrial Electronics  
Applied Physics and Mathematics

549 W. Washington Blvd. Chicago 6, Ill.  
State 2-8021

## TELECHROME, INC.

*Electronic Design Specialists*

COLOR TELEVISION EQUIPMENT

Flying Spot Scanners, Color Synthesizers, Keyers,  
Monitors, Oscilloscopes and Related Apparatus

Robert S. Mautner, Pres.  
J. R. Popkin-Clurman, Ch. Engr.  
88 Merrick Rd. Amityville, L. I., N. Y.

## ERCO RADIO LABORATORIES, INC.

*Radio Communications Equipment*

Engineering - Design - Development - Production  
Pioneers in Frequency Shift Telegraph

Garden City • Long Island • New York

## NIAGARA ELECTRON LABORATORIES

CONSULTATION - DESIGN - CONSTRUCTION  
MFG. THE THERMOCAP RELAY

Specializing in solution of problems of electronic  
and electro-physical instrumentation for the re-  
search or analytical laboratory. Industrial plant  
problems also invited.

Andover, New York Cable Address: NIATRONLAB

## WHEELER LABORATORIES, INC.

Radio and Electronics

Consulting—Research—Development

R-F Circuits—Lines—Antennas  
Microwave Components—Test Equipment

Harold A. Wheeler and Engineering Staff  
Great Neck, N. Y. Great Neck 2-7806

## EDWARD A. GAUGLER, Ph.D.

*Consulting Physicist*

Magnetic Materials and their Applications

419 Shepherd St. Chevy Chase, Md.  
Wisconsin 6106

## PICKARD AND BURNS, INC.

*Consulting Electronic Engineers*

Analysis and Evaluation  
of Radio Systems

Research, Development & Design  
of Special Electronic Equipment  
240 Highland Ave., Needham 94, Mass.

## YARDENY LABORATORIES, INC.

*Research-Design-Development*

Electro-Chemical Generators of Energy

105 Chambers Street WOrth 2-3534, 35, 36  
New York 7, N. Y.

**THE  
REAL  
VALUE**

*of placing your unusual problem in the hands of a competent con-  
sultant is that it eliminates the elements of chance and uncertainty  
from the problem and provides real facts upon which to base decisions.*

# NOW AVAILABLE ON EASY TERMS

Save trouble, time, and money with the aid of this practical **RADIO ENGINEERING** help . . .

HERE is a handy volume embracing a great deal of constantly needed reference material covering all fields and aspects of radio engineering — concise, dependable, arranged in easy-to-get-at form.

What the Standard Handbook, Marks' Handbook, and others are in their respective fields, Henney's Handbook is in the radio field. And now this new Fourth Edition is available, with new data on the physical, mathematical, psychological, and acoustical bases on which all electrical communication exists . . . on the means of transmitting and utilizing energy in the very high frequency portions of the radio spectrum, with completely rewritten sections on radio communication, inductance, radio-frequency amplifiers, modulation and detection, electron tubes, receiving systems, radio aids to aviation, and many other subjects, with revision throughout to make the book as useful as possible in modern practice.



Presents **RADIO PRINCIPLES, STANDARDS, and PRACTICES** for the designer, engineer, and radio technician

Now Ready! New 4th Edition

## RADIO ENGINEERING HANDBOOK

**Keth Henney, Editor-in-Chief**  
Consulting Editor of *Electronics*  
1197 pages, 6 x 9, 1038 illustrations, \$10

IN scope, this book ranges from fundamentals to discussion of newest circuits, amplifiers, power supply systems, short-wave systems, Frequency modulation, developments in television and aircraft radio, and other applications are covered. The book abounds in circuit diagrams, tables, charts, formulas, design equations and data. The circuits described quantitatively are those in use today, or soon to be widely used.

In **RADIO ENGINEERING HANDBOOK** you get—

### SPECIAL OFFER

When you receive a copy of Henney's **RADIO ENGINEERING HANDBOOK** you can look over the book for 10 days before deciding whether or not to buy it. Then, if you decide to keep the book, you can pay for it in easy monthly terms—\$4.00 at the end of 10 days, and \$3.00 per month until balance is paid.

- 1,197 pages of carefully selected, accurate data—charts, tables, circuits, diagrams, formulas.
  - 23 sections covering all the most needed subjects for engineers and radio technicians, from fundamentals to specialized applications.
  - Every section prepared by one or more specialists, to assure you dependable, expert answers to your problems in design and practice.
- Not only the radio technician, but every man interested in the design or manufacture of radio or television transmitters and receivers, and apparatus utilizing vacuum tubes and photocells, will find this improved handbook a helpful, day-to-day guide.

SEE THIS BOOK 10 DAYS FREE



McGraw-Hill Book Co., Inc.  
330 W. 42nd St., New York 36  
Send me Henney's **RADIO ENGINEERING HANDBOOK** for 10 days' examination on approval.

If I find the book satisfactory, I will send you \$4.00 in 10 days, plus a few cents for delivery, and \$3.00 a month until \$10.00 has been paid. Otherwise I will return the book postpaid.

Name .....  
Address .....  
City ..... Zone ..... State .....  
Company .....  
Position ..... L-2-51

This offer applies to U. S. only.

# CONTACTS

FOR THE FIELD OF ELECTRONICS

The nonmelting **SILICONE** insulating and waterproofing compound, stable at temperatures from -70°F. to +400°F.



MEETS ALL REQUIREMENTS OF AN-C-128a

More water repellent than paraffin, Dow Corning 4 Compound is highly resistant to oxygen, ozone and to deterioration caused by corona discharge.

**POWER FACTOR** up to 10 megacycles . . . 0.001  
**VOLUME RESISTIVITY** ohm centimeters . . . . . 10<sup>11</sup>  
**DIELECTRIC STRENGTH** volts/mil . . . . . 500

Write Today!

for your copy of our new booklet on Dow Corning 4 Compound, Address Dept. J

DOW CORNING CORPORATION, Midland, Michigan



for switches and contacts in the POWER INDUSTRY



for ELECTRONIC EQUIPMENT



FIRST IN SILICONES

**FINE RIBBONS OF TUNGSTEN and Molybdenum**  
Quality and accuracy in our fabrication of Tungsten & Molybdenum Ribbons have characterized our service to the Electronic industry.  
A development of  
**H. CROSS Co.**  
15 Boekman St., New York 7, N. Y.

high speed high sensitivity  
**SHORTED TURN INDICATOR**

The Kartron Shorted Turn and Open Circuit Coil Checker — Model 101B — indicates single shorted turns of #14 wire in unmounted coils. Standard mandrel 3/16 x 1/4 for all average size coils. Regulated vacuum tube circuit. Jack for audio indication to supplement 1-ma. meter. Prompt deliveries. Price \$150.

KARTRON Huntington Beach, Calif.



MORE THAN 70 DIFFERENT TYPES & SIZES

**MINIATURE BALL BEARINGS** for application in precision mechanisms minimize friction and wear. High load capacity. Least weight and space. Special designs and complete engineering service for your application. Write for catalog E.



**EISLER** Manufactures Complete Equipment for:

- SPOT WELDERS, Electric, for 1/4 to 250 KVA.
- TELEVISION TUBE GLASS WORKING EQUIPMENT.
- TRANSFORMERS, Special and Standard Types.
- INCANDESCENT LAMP Manufacturing Equipment.
- FLUORESCENT TUBE Manufacturing Equipment.
- NEON SIGN MAKERS EQUIPMENT.
- ELECTRONIC EQUIPMENT, Vacuum Pumps, etc.
- WET GLASS SLICING and Cutting machines for Laboratory use.

EISLER ENGINEERING CO., Inc. 751 So. 13th St., Newark 3, N. J.

**EL-TRONICS, INC.**  
Research, development, and manufacture of electronic equipment—a single model to large quantities.  
Write Today for Free Resume of Our Plant Facilities  
Specialists in Geiger-Muller equipment  
2647-67 N. Howard St., Phila. 33, Pa. GARfield 5-2026

**ROUND POWER RHEOSTATS**  
50 to 500 Watt.  
Vitroeous enameled  
UL approved  
**REX RHEOSTAT CO.**  
BALDWIN, N. Y.

A EUROPEAN SOURCE OF SUPPLY INVITES YOUR ENQUIRIES FOR  
**TELEVISION & RADIO PARTS**  
**FLUORESCENT LAMPS & ACCESSORIES**  
Speakers, Resistors, Radio Coils, Potentiometers, Radio Knobs, Lamp Sockets, Pilot Lamp Sockets, Radio-TV & Industrial Condensers, Variable Condensers, Paper- & Mica Capacitors, Crystal Pickups & Cartridges, Transformers, Radio-TV & Microphone Wires and Cables, Wiring Devices, Fluorescent Lampholders, Starters, Ballasts, Fluorescent Lamps, etc. etc.  
**SOCIETE INDUSTRIELLE ALFA, S.A.**  
80, rue de la Senne Cable: RALFA Brussels - BELGIUM  
— Manufacturers & Exporters of World-Wide Reputation —



# SEARCHLIGHT SECTION

EMPLOYMENT • BUSINESS • OPPORTUNITIES • EQUIPMENT—USED or RESALE

## UNDISPLAYED RATE

\$1.50 a line, minimum 4 lines. To figure advance payment count 5 average words as a line. EMPLOYMENT WANTED & INDIVIDUAL SELLING OPPORTUNITY undisplayed advertising rate is one-half of above rate, payable in advance.

PROPOSALS \$1.20 a line an insertion.

NEW ADVERTISEMENTS received at the N. Y. Office, 330 W. 42 St., N. Y. 18, by Feb. 1st will appear in the March issue, subject to limitation of space available. The publisher cannot accept advertising in the Searchlight Section which lists the names of the manufacturers of resistors, capacitors, rheostats, and potentiometers or other names designed to describe such products.

## INFORMATION:

BOX NUMBERS count 1 line additional in undisplayed ads.

DISCOUNT 10% if full payment is made in advance for four consecutive insertions of undisplayed ads (not including proposals).

EQUIPMENT WANTED OR FOR SALE Advertisements acceptable only in Displayed Style.

## DISPLAYED—RATE PER INCH

The advertising rate is \$12.80 per inch for all advertising appearing on other than a contract basis. Contract rates quoted on request.

AN ADVERTISING INCH is measured 7/8 inch vertically on one column, 3 columns—30 inches—to a page.

ELECT.

March issue, subject to limitation of space available.

## EXCEPTIONAL OPPORTUNITIES

For

## ELECTRON TUBE ENGINEERS

for work on advanced development, design, and manufacture of

CATHODE RAY TUBES  
RECEIVING TUBES  
MICRO-WAVE TUBES  
POWER TUBES

CHEMISTS and METALLURGISTS required for both development and manufacture of electron tubes of all types.

Good pay, excellent working conditions and opportunities for advancement.

Send resume of experience and education to:

MANAGER,  
INDUSTRIAL RELATIONS DEPARTMENT  
WESTINGHOUSE ELECTRIC CORPORATION  
LAMP DIVISION  
BLOOMFIELD, NEW JERSEY

## PROJECT ENGINEERS

For Microwaves . . . Magnetrons . . .  
Klystrons . . . and Pulse Modulators

Experienced personnel required in our expanding Microwave and Vacuum Tube facilities, with the following background: Microwave Measurement, Magnetron Development and Manufacturing, Klystron Development, Vacuum Tube Technique, Pulse and Modulator Circuits.

Permanent positions with one of the oldest tube companies in America, associated with a world-wide research organization. Unlimited possibilities are available to the proper people. Write full details, in confidence.

AMPEREX ELECTRONIC CORP.  
25 Washington St. Brooklyn 1, N. Y.

Additional  
Positions Vacant  
Advertisements

on  
Pages 300, 301, 302, 303  
& 304

REPLIES (Box No.): Address to office nearest you  
NEW YORK: 330 W. 42nd St. (18)  
CHICAGO: 520 N. Michigan Ave. (11)  
SAN FRANCISCO: 68 Post St. (4)

## POSITION VACANT

POSITION AVAILABLE in the midwest for a competent electronic circuit engineer. Duties consist of directing the operation of an electronic instrument group in an A.E.C. laboratory. The candidate should have broad experience in electronic circuitry, particularly that used in connection with nuclear physics measurements. Salary commensurate with qualifications. P-8645, Electronics.

## EMPLOYMENT SERVICES

SALARIED PERSONNEL, \$3,000-\$25,000. This confidential service, established 1927, is geared to needs of high grade men who seek a change of connection under conditions assuring, if employed, full protection to present position. Send name and address only for details. Personal consultation invited. Jira Thayer Jennings, Dept. L, 241 Orange St., New Haven, Conn.

## SELLING OPPORTUNITY OFFERED

VARNISH SALESMAN—Opportunity with a future offered by substantial established eastern manufacturer for young experienced aggressive salesman who knows trade. Our own men know of this offer. State complete personal, education and experience background, with salary requirements. SW-8694, Engineering News-Record.

## POSITION WANTED

ELECTRICAL, ELECTRONIC Engineer—16 years, all phases of engineering in the radio receiving, transmitting, and cathode ray tube industries. Also experienced electro-mechanical product design and project engineering. Excellent organizer, and good administrative abilities. Wishes position as chief engineer, chief project engineer, or plant manager. PW-8546, Electronics.

## SELLING OPPORTUNITY WANTED

MANUFACTURERS' REPRESENTATIVE D. C.—Maryland, Virginia, covering government and industrial accounts, desires new lines; components, instruments, etc.—S. S. Lee Associates, 832 Southern Bldg., Washington 5, D. C.

## BUSINESS OPPORTUNITY

If you are contemplating relocating, you should request a copy of "Business Opportunities in Watertown, South Dakota." Call or write Mayor Gilbert or the City Promotional Director, J. G. Innet.

## EXECUTIVE ENGINEER

10 years management background. EE, electronics. Familiar all administrative functions. Recently treasurer medium multi-plant manufacturing group. Age 37. Salary \$8-\$15,000.

PW-8607, Electronics  
330 W. 42 St., New York 18, N. Y.

## AVAILABLE ELECTRONIC TUBES EXPERT

Physicist, Ph.D., 20 years' experience in research, development and design of gaseous discharge and vacuum tubes desires advanced position. Would also consider teaching.

PW-8642, Electronics  
330 W. 42 St., New York 18, N. Y.

## Field Engineers

DOMESTIC

OVERSEAS

To supervise installation and maintenance of radar equipment and to train personnel in its operation.

Salaries from \$4200 to \$6900 per year plus extra pay for presently scheduled overtime. 25% bonus for time spent overseas.

Traveling and living expenses paid by Bendix. Liberal employee insurance plan. Family hospitalization and surgical benefits. Attractive retirement plan for professional personnel.

All applicants must be free to travel extensively.

Write or call:

A. H. FORD

BENDIX RADIO DIVISION  
BENDIX AVIATION CORP.

Baltimore 4, Maryland  
TOWSON 2200.

## PROJECT ENGINEERS

Five years or more of experience in charge of design and development of radio and communication equipment. Must be a graduate of a credited Engineering School. Well equipped laboratory in modern radio and television plant, with excellent opportunities for advancement.

Send resume of qualifications to Mr. S. F. Cascio, Personnel Director of the Hallcrafters Company

4401 West Fifth Ave., Chicago 24, Illinois

## ELECTRICAL ENGINEER

Graduate electrical engineer with experience in the design of filter networks and audio transformers. Permanent position with progressive firm located in Chicago. Give details stating age, education, experience, references, availability for work and salary expected.

P-7849, Electronics  
330 W. 42nd St., New York 18, N. Y.

# ENGINEERS

## CHOOSE YOUR AREA OF SPECIALIZATION AT MINNEAPOLIS-HONEYWELL

Minneapolis-Honeywell Regulator Company, the leader in the field of automatic controls and instrumentation, is presently engaged in research and design work in the areas listed below in both the aeronautical and general engineering divisions. Much of this work borders closely on so called "pure" or "basic" research.

If you as an engineer are primarily concerned with the type of engineering work you engage in; if you have the proper background; and if you are interested in becoming associated with a stable progressive firm, please let us hear from you.

- |                              |                            |
|------------------------------|----------------------------|
| electronics                  | gyros                      |
| servo-mechanisms             | relays                     |
| hydraulics                   | computers                  |
| electro-magnetics            | electro-mechanical devices |
| heat transfer                | aeroelasticity effects     |
| vacuum tubes                 | aerodynamics               |
| electrical contact phenomena |                            |

Excellent opportunities for advancement in an expanding organization. Promotions granted on basis of merit. Salaries commensurate with background. Address reply to:

H. D. Elverum

**MINNEAPOLIS-HONEYWELL REGULATOR COMPANY**  
2753 Fourth Avenue South Minneapolis, Minnesota

# PHYSICISTS - MATHEMATICIANS - ENGINEERS

Applied Physics Laboratory  
The Johns Hopkins University  
*has openings for*  
**SENIOR STAFF MEMBERS**

**Physicists**  
Theoretical and Experimental

**Mathematicians**  
Applied—Dynamics Analysis

**Electrical Engineers**  
Micro-waves, UHF Pulse Circuits, Telemetry, Radar

*Excellent opportunities in modern research laboratory. Interviews will be arranged for qualified candidates. All replies confidential.*

For further information write to— **E. M. Lane**  
Applied Physics Laboratory  
The Johns Hopkins University  
8621 Georgia Avenue  
Silver Spring, Maryland

**Aerodynamicists**  
Dynamics, General Supersonic Performance

**Mechanical Engineers**  
Servo-mechanisms, Engineering Design

**Project Engineers**  
Engineering Test Program Coordination

**Computing Machine Operators**  
Maddida, React, Simulators

## WANTED SALES REPRESENTATIVES

Man experienced in component sales to television, industrial electronics, and communication equipment fields. Exclusive territories available.

**RW-8598, Electronics**  
330 W. 42 St., New York 18, N. Y.

## SALES REPRESENTATIVE

Cathode Ray TV Picture Tube Manufacturer—one of the oldest in field—seeks representation. Sell to manufacturers, jobbers or stores. Exclusive territory. Write

**RW-8566, Electronics**  
330 W. 42 St., New York 18, N. Y.

The University of Michigan is expanding its research organization and will have a number of excellent opportunities open in important research programs for **ENGINEERS, PHYSICISTS and MATHEMATICIANS.**

Work classifications are in the field of:

- Electronics
- Systems Analysis
- Stimulation and Automatic Computation
- Propulsion and Combustion
- Servo-mechanisms

Researchers have an opportunity to complete their requirements for graduate degrees while employed. Salaries are commensurate with training and experience. Applicants are invited to send a resume of education, background and experience to

**Personnel Office**  
**UNIVERSITY OF MICHIGAN**  
Ann Arbor, Michigan

## ELECTRONIC ENGINEERS

Physicists or Electrical Engineers with a minimum of 3 years industrial experience in the field of communication engineering. To assist in the design of electro-mechanical devices. Excellent opportunity with progressive Ohio organization. Salary.

**P-8627, Electronics**  
520 N. Michigan Ave., Chicago 11, Ill.

## VIBRATION ENGINEER

Product development laboratories Kew Gardens, L. I. needs experienced engineer to do shock and vibration work relating to microphonism and strength of vacuum tubes. Must be able to work with and design electro-mechanical devices. EE or ME degree plus minimum 2 years experience in electronics preferably with specific vibration experience. Please address replies to personnel manager,

**SYLVANIA ELECTRIC PRODUCTS INC.**  
40-22 Lawrence St. Flushing, N. Y.

## REQUIRE KEY MEN FOR RESEARCH LABORATORIES

Outstanding opportunities now available in undertaking highly responsible research and development work in important electro-mechanical instrumentation laboratories. Require section chiefs with MS or PHD degree in E.E., M.E., or Physics with scholastic achievement in upper 10% of class.

Important to have more than 5 years practical experience in developmental work, supervision of projects or group activities to qualify applicant to supervise and direct several diversified projects and administer related activities.

Men with proven ingenuity, imagination, creative ability and with a record of tangible accomplishments can command attractive salaries.

**COOK RESEARCH LABORATORIES**  
Division of Cook Electric Company  
1457 W. Diversey Parkway, Chicago 14, Ill.



## Electronic Engineers

BENDIX RADIO DIVISION  
Bendix Aviation Corporation

PRODUCTION DESIGN      RESEARCH

Openings for experienced engineers or recent graduates who are seeking a permanent position in a modern, well-equipped electronics organization working with a specialized and highly technical professional group.

Positions available for work on: Search and Airport Surveillance Radar; G.C.A.; Communication and Navigation Equipment; Broadcast and Television; Mobile Equipment; Test Equipment.

*Housing and rentals in area are plentiful*

*Send resume to:*

MR. W. L. WEBB, *Director*  
Engineering and Research

**BENDIX RADIO DIVISION**

Baltimore 4, Maryland



### RESEARCH - DEVELOPMENT - DESIGN

#### ENGINEERING WITH A FUTURE

The steady growth of several established research and development projects has created a number of exceptional engineering opportunities with a future.

#### PHYSICISTS—ENGINEERS

Positions are now available in our organization for qualified physicists and engineers with backgrounds in circuit analysis, microwaves, servomechanisms, analog computers, etc. Openings exist at several levels with salaries dependent on education, ability, and experience.

If you are qualified and interested in a position which combines stability and unusual opportunity, write, giving full details to Mr. C. G. Jones, Manager, Salary Personnel.

GOODYEAR  
AIRCRAFT CORPORATION

Akron 15, Ohio

## ATOMIC POWER Westinghouse Electric Corporation

### Immediate Openings

For Experienced  
Senior and Junior Engineers

- Circuit designers, sequence control and regulating systems.
- Designer of amplifiers for indication, detection and control functions.
- Designer for servosystems in the instrument range.

For application write—

**Manager,  
Technical Employment,**

306 FOURTH AVE.  
PITTSBURGH 30, PA.

### RESEARCH OPPORTUNITIES IN THE LOS ANGELES AREA

Unusual opportunity for Senior men with degrees and at least five years of outstanding proven accomplishment to achieve further growth by working with some of the nation's outstanding scientists on commercial and military projects in large, modern electronic laboratories.

ELECTRONIC ENGINEERS

PHYSICISTS-CIRCUITRY

PHYSICISTS-ANALYSIS

PHYSICISTS-OPTICS

PHYSICISTS-ELECTRON TUBES

SERVOMECHANISMS

ENGINEERS

ELECTRO MECHANICAL

ENGINEERS

MECHANICAL DESIGNERS

Long term program of research and development in the fields of Radar, Guided Missiles, Computers, Electron Tubes, and related equipment.

*Please do not answer unless you meet the above requirements.*

### RESEARCH AND DEVELOPMENT LABORATORIES

Hughes Aircraft Company  
CULVER CITY, CALIFORNIA

# POSITIONS OPEN IN RESEARCH *and* ADVANCED DEVELOPMENT PROGRAMS

*to*

Research Physicists  
Senior Electronic Engineers  
Senior Mechanical Engineers  
Engineering Physicists  
Circuit Engineers  
Microwave Engineers  
Vacuum Tube Research Engineers  
Technical Report Writers  
Electronic Technicians

Experienced or Holding Advanced Degrees For Research, Design, or Development In

Radar, Servomechanisms, Computers, Receivers, Photo Emission, Secondary Emission, Converters, Pulse and Timing Techniques, Special Test Equipment, Special Purpose Tubes, Circuit Design, Solid State Physics, Light and Electron Optics, etc.

We invite interested personnel with experience in the above fields to submit a complete and detailed resume of education and experience, together with salary requirements and availability date, to:

The Employment Department  
**CAPEHART-FARNSWORTH  
CORPORATION**  
FORT WAYNE 1, INDIANA

## SENIOR ELECTRONIC CIRCUIT PHYSICISTS

*for  
Advanced Research  
and Development*

### MINIMUM REQUIREMENTS:

1. M.S. or Ph.D. in Physics or E.E.
2. Not less than five years experience in advanced electronic circuit development with a record of accomplishment giving evidence of an unusual degree of ingenuity and ability in the field.
3. Minimum age 28 years.

**Hughes Aircraft Company**  
Attention: Mr. Jack Harwood  
CULVER CITY, CALIFORNIA

## NATIONAL UNION RESEARCH DIVISION

Senior engineers and physicists are needed for research and development of Cathode Ray, Subminiature, Secondary Emission, and highly specialized types of Vacuum Tubes.

Junior Electrical Engineers are desired for training as tube or circuit design engineers.

Men qualified by virtue of education or experience to handle problems in the field of tube or circuit design are invited to send their resumes to:

*Divisional Personnel Manager*

**NATIONAL UNION RESEARCH DIVISION**  
350 Scotland Rd. Orange, N. J.

### SEMI CONDUCTOR RESEARCH

Physicists, chemists or EE's with PhD or equivalent and experience in the field of solid state physics for research work on semi-conductor devices employing germanium and silicon. An excellent opportunity in a research laboratory of a leading manufacturer with laboratories in New York State. Send complete resume. Our employees have been notified.

P-8023, Electronics  
330 W. 42 St., New York 18, N. Y.

The W. L. MAXSON  
CORPORATION

IS SEEKING  
**Outstanding  
ENGINEERS  
AND  
PHYSICISTS**

with AMBITION to  
**FURTHER  
PRESENT STANDING  
Immediately**

*Minimum Requirements are:*

1. Five to ten years experience in advanced electronic research and development.
2. Outstanding record of ingenuity.
3. Ph.D., M.S. or equivalent.

Please send resume and salary requirements to:

**The W. L. MAXSON  
CORPORATION**  
460 W. 34th St.  
New York 1, N. Y.

## ELECTRONIC ENGINEERS

For production design of aircraft radio receivers, transmitters, omni, ADF equipment. Outstanding opportunity for experienced capable design engineers and for supervisor to head group.

**LEAR, INC.**

11916 W. PICO BLVD.  
LOS ANGELES 64, CALIF.

## ELECTRONIC ENGINEERS

SENIOR ENGINEERS or PHYSICISTS Degree and experience in Radar, Pulse Circuits, Digital or Analogue Computers, or Servomechanisms JUNIOR ENGINEERS and recent graduate in EE or Physics.

**ELECTRONIC ENGINEERING COMPANY  
OF CALIFORNIA**  
180 S. Alvarado St. Los Angeles 4, Calif.



**RADAR,  
COMMUNICATIONS  
and  
SONAR  
TECHNICIANS  
WANTED**

For Overseas Assignments

*Technical Qualifications:*

1. At least 3 years' practical experience in installation and maintenance.
2. Navy veterans ETM 1/c or higher.
3. Army veterans TECH/SGT or higher.

*Personal Qualifications:*

1. Age, over 22—must pass physical examination.
2. Ability to assume responsibility.
3. Must stand thorough character investigation.
4. Willing to go overseas for 1 year.

Base pay, bonus, living allowance, vacation add up to \$7,000.00 per year. Permanent connection with company possible.

Apply by Writing to  
A-1, P. O. Box 3414  
Philadelphia 22, Pa.

Men qualified in RADAR, COMMUNICATIONS or SONAR give complete history. Interview will be arranged for successful applicants.

**ENGINEERING  
OPPORTUNITIES  
In  
Westinghouse**

**Wanted:**

**DESIGN ENGINEERS  
FIELD ENGINEERS  
TECHNICAL WRITERS**

Must have at least one year's experience.

For work on airborne radar, shipborne radar, radio communications eqpt., micro-wave relay, or micro-wave communications.

Good pay, excellent working conditions; advancement on individual merit; location Baltimore.

Send resume of experience and education to: Manager of Industrial Relations,

**WESTINGHOUSE ELECTRIC CORP.**  
2519 Wilkens Ave. Baltimore 3, Maryland

**ELECTRONICS ENGINEERS  
FOR SOUTHWEST ATOMIC ENERGY INSTALLATION**

2 to 10 years experience in research, design, development, or test

A variety of positions open for men with Bachelor's or advanced degrees qualified in one or more of the following fields:

- UHF TECHNIQUES
- PULSE CIRCUITS
- SERVO-MECHANISMS
- TELEMETERING
- RELAYS
- LOW POWER APPLICATION
- INSTRUMENTATION
- STATISTICAL ANALYSIS
- TEST EQUIPMENT RELATING TO ABOVE FIELDS

Patent History Desirable But Not Necessary

These openings are for permanent positions at the Sandia Laboratory in Albuquerque, New Mexico. Albuquerque is the largest city in New Mexico, a mile above sea level, with a sunny, warm, dry climate, and a population of 100,000. Located in the Rio Grande Valley at the foot of the Sandia Mountains, which rise to 11,000 ft., Sandia Laboratory is operated by Sandia Corporation, a subsidiary of the Western Electric Company, under contract with the Atomic Energy Commission. This laboratory offers pleasant working conditions and liberal employee benefit plans.

MAKE APPLICATION TO:

PROFESSIONAL EMPLOYMENT DIVISION  
SANDIA CORPORATION SANDIA BASE  
ALBUQUERQUE, NEW MEXICO

**MANAGEMENT  
CONSULTING**

Established management consultant seeks an engineer with the following qualifications: electrical, mechanical or industrial engineering degree and preferably graduate training. At least 5 years' experience with one or more manufacturers of electronic or electrical components in one or more of these areas: industrial engineering, production management, plant engineering or process engineering. Must be willing to travel. Base Chicago or New York. Salary open.

P-8567, Electronics  
520 N. Michigan Ave., Chicago 11, Ill.

**Physicists  
Mathematicians  
Electronics Engineers  
Mechanical Engineers**

Cornell Aeronautical Laboratory, an affiliate of Cornell University, has permanent positions open for men of project engineer caliber with advanced degrees and experience in physics, applied mathematics, electronics, and instrument design. Assignments are varied and professionally challenging in fields of pure and applied physics.

The position of our laboratory is between those of universities and commercial research institutes. We believe it combines many of the traditional advantages of both. Inquiries will be treated as confidential; they should be addressed to

Employment Manager  
Dept. G, Cornell Aeronautical Laboratory,  
P.O. Box 235, Buffalo 21, New York

Additional Positions Vacant Advertisements on page 304

**LIQUIDATION BY AUCTION**  
**AIREON Manufacturing Corporation**  
 on the premises Mon. Tue. & Wed., January 29, 30 and 31st, 1951 at 10 a. m. (C. S. T.)  
**ALL MACHINERY LATE TYPE INDIVIDUALLY MOTOR DRIVEN**

1401 Fairfax Trafficway  
 Kansas City, Kansas

Machinery—Machine Tools—Equipment—Factory Supplies—Precision Equip.—Electronic & Radio Inst.—Testing Equip.—Plating & Polishing Dept.—Metal Stamping—Woodworking Mach.—Material Handling Equip.—Office Machines, Furniture & Equip.

Names — Trademarks — Patents — Dies — Blueprints — of these nationally known products  
 \* Cinéautograph Speakers  
 \* Aireon Music (Juke) Boxes  
 \* Ideal — Aire Spot Coolers

MACHINE SHOP CONSISTS OF APPR. 175 PCS: KEARNEY & TRECKER Millers \* B & S, GISHOLT & W S Auto Screw Machs. \* MONARCH, SO. BEND, LE BLOND, P & W Lathes \* SMITH & MILLS Shapers \* BAKWELL Precision Tappers \* CINCINNATI, NORTON & DO. ALL Centerless & Surface Grinders \* DO-ALL & KALAMAZOO Band Saws \* NATCO 32 Sp. Drill \* EXCELLO Boring Mach. \* FOOTBURT, WALKER TURNER, DELTA & BUFFALO Drill Presses \* METAL STAMPING MACH: CINCINNATI, NIAGARA & VERNON Power Shears, Brakes & Benders \* BLISS, FEDERAL & ROCKFORD 15 to 65 Ton Punch Presses \* WELDING EQUIPMENT: PROGRESSIVE & REX Welders from 2 1/2 to 75 KVA. COMPLETE PLATING & POLISHING SHOP—Also—WOODWORKING SHOP. PAINTING EQUIP: BINKS & HOWARD Washers, Degreasers & Auto Water & Air Spray Booths— APP. 664 ELECTRONIC & RADIO INSTRUMENT AND TESTING EQUIPMENT: R.C.A., GENERAL RADIO, LEEDS & NORTHRUP, WESTON, INDUSTRIAL INSTR. and HALLICRAFTER Oscilloscopes, Output Power Meters, Multitesters, H.F. Receivers, V.H.F. Signal Generators, Analyzers, Volt. Ohm & Milliammeters, also many other meters and testers too numerous to mention — APP. \$56,000 PRECISION TOOLS & TOOL CRIB SUPPLIES OF EVERY DESCRIPTION MISC. EQUIPMENT: Towmotors, App. 1000, Fluorescent Lights—Transformers—Motors—Lift Trucks—Chain Hoists—Conveyors—Shop Cabinets & Bins, etc.

**App. \$700,000 INVENTORY**

Consisting of App. 100 Tons Sheet, Tool & Bar Steel, Aluminum, Bronze & Brass—App. 3 1/2 Million Machine, Allen & Wood Screws—App. 400,000 Ft. of Electrical Wire—App. 6,000 Panels of Glass— Plexiglass Plastic & Lucite—Hardware Hinges, Bolts, Door Stops—Ball Bearings, etc. CINAUDAGRAPH SPEAKERS: App. 15,500 New Speakers, Huge Quantities of Speaker Cones, Baskets, Magnets & Transformers — ELECTRONIC & RADIO PARTS: App. 250,000 Resistors — App. 8,000 Potentiometers — App. 10,000 Bakelite Terminal Boards — Radio Tubes — Micro Switches — Ballasts — Fuses — Sockets — Bake-ite — Condensers — Starters — Relays, etc. OFFICE MACHINES, FURN. & EQUIP.: BRUNING & OZALID Drafting & Blueprint Machs. — NATIONAL Payroll and Bookkeeping Machines — ADDRESSOGRAPHS & MIMEOGRAPHS — App. 66 FRIDEN, MONROE, BURROUGHS, I.B.M., UNDERWOOD, FELT & TARRANT Elec. Calculators, Comptometers, Elec. Typewriters, Elec. Adding Machines — App. 290 All Types of Files — App. 315 Exec. & Secr. Desks & Chairs — etc.

LEASE Arrangement Available to Responsible Parties — Modern One Story Building App. 200,000 Sq. Ft. Floor Space, Sprinklered, and U.P. R.R. Siding With Leasehold Improvements Valued at Approx. \$58,000.

SALE BY THE ORDER OF, AND SUBJECT TO CONFIRMATION BY THE RFC. TERMS OF SALE: CASH OR CERTIFIED CHECK, TO BE SOLD IN BULK AND LOTS. PLANT WILL BE OPEN FOR INSPECTION FROM JAN. 25, 1951 to DATE OF SALE. FOR ADDITIONAL INFORMATION CONTACT MR. W. ROBERTS, REPRESENTATIVE ON PREMISES, TEL. NO. FAIRFAX 3200, KANSAS CITY, KANSAS.—This advertisement will only appear once—keep it for reference. FOR FREE BROCHURE AND FURTHER INFORMATION — WRITE — PHONE — WIRE

**AARON KROCK & CO. AUCTIONEERS**

THE ORIGINAL AND ONLY AUCTIONEERING FIRM BY THIS NAME  
 288 Main St. Worcester, Mass.



Tel. 3-7261—3-7262 Est. Since 1915—Greater Results Thru Experience

**ELECTRONICS Sales Engineers**

Positions open for mature graduate sales engineers over 28 years of age, preferably with practical experience in application of dielectric heating to industrial problems. Excellent opportunities for type of individuals interested in affiliation with successful rapidly expanding organization. Locations in Chicago and other territories.

P-8543, Electronics  
 330 W. 42 St., New York 18, N. Y.

**WANTED ENGINEERS**

With power and transmitting tube design experience. State draft status and experience

Write Direct To:

**TAYLOR TUBES, INC.**  
 2312 W. Wabansia Ave. Chicago 47, Ill.

**SURPLUS COMPONENTS FOR SALE**

Bothtubs, oils, micas, xformers, chokes, relays, trimmers, sockets, odd items, etc. Surplus lots purchased.

**EMPIRE ELECTRONICS**  
 Box 41, Midwood Stat., Brooklyn 30, N. Y.  
 Phone BRyant 9-1220

**CONDENSERS OUR SPECIALTY OIL FILLED TYPES**

All Values and Voltage Ratings  
 We Invite Your Inquiries

**TECHNICAL RADIO PARTS CO.**  
 557 McDonald Ave., Brooklyn 18, N. Y.

**WANTED**

(Additional Wanted Ad on Page 326)

**WANTED**

**TUBES TYPE 6AN5 TYPE 6AK5**

ANY QUANTITY

W 8594, Electronics  
 330 West 42nd St., New York 18, N. Y.

**WANTED**

Sylvania Electric Spectrum Analyzers. Give complete details to

W-8664, Electronics  
 330 W. 42 St., New York 18, N. Y.

**Will Buy All BC-348'S WITH DYNAMOTORS**

Letters "J" "N" & "Q" ..... \$60.00 ea.  
 All others except "C" ..... \$50.00 ea.  
 Ship via Express C.O.D. subject to Inspection—TO

H. FINNEGAN  
 49 Washington St. Little Ferry, N. J.

**WANTED**

**Telephone or Telegraph Transmitters.**

2.5 kw to 20 kw, 4 to 20 mcs or higher  
 W-8658, Electronics  
 330 W. 42 St., New York 18, N. Y.

**WANTED**

Tubes, Test equipment, Condensers, & general inventories. Highest prices paid.

W-7965, Electronics  
 330 W. 42nd St., New York 18, N. Y.

**WANTED**

INSULATORS; POLE LINE HARDWARE; GUY STRAND WIRE; COPPERWELD WIRE; WESTERN ELECTRIC TOOLS; SPLICING SLEEVES.

**VICTOR-BERNARD INDUSTRIES**  
 NE Cor. 22nd & Lehigh Aves., Phila. 32, Pa.

**WANTED**

Equipment for the manufacture of electronic tubes. Make or condition not important. Give details.

W-8651, Electronics  
 330 W. 42nd St., New York 18, N. Y.

**WANTED:**

Small lot of

**HALLICRAFTER SX-42 RECEIVERS**

Serial No. over 90,000. Must be in very good operating condition. Advise selling price and quantity on hand.

W-8593, Electronics  
 330 W. 42nd St., New York 18, New York

**WANTED**

**WESTERN ELECTRIC VACUUM TUBES**

Types 101F, 102F, 272A, 274A or B, 310A or B, 311A, 313C, 323A, 328A, 329A, 348A, 349A, 352A, 373A, 374A, 393A, 394A, 121A Ballast Lamps.

W-6863, Electronics  
 330 W. 42nd St., New York 18, N. Y.

**WANTED**

Teletypewriters complete, components or parts. Any quantity and condition.

W-6864, Electronics  
 330 W. 42nd St., New York 18, N. Y.

**New Searchlight Advertisements**

received by February 1st will appear in the March issue, subject to space limitations.

Classified Advertising Division

**ELECTRONICS**  
 330 West 42nd St., New York 18, N. Y.



# RADAR - SONAR

APS-2

APS-3

APS-4

APS-6

APS-6A

APS-10

APQ-13

APS-15

APS-31

CPN-8

CXHX

FD MARK-4

MARK-1D

SA

SC

SD

## 8500 Mc to 9600 Mc BENCH TEST PLUMBING

Variable Stub Tuner, D3536, 180 degree phase shifting, \$70.00  
 Low Power Termination, D1381, \$18.50  
 Uni-Directional Coupler, D3930, 25 DB type "N" output, \$18.50  
 Pick Up Horn, Type "N", output, \$4.50  
 Wavemeter, 8500 to 9400 mcs., with calibration, Micrometer adjust head, Reaction type, \$85.00  
 Waveguide Length, Plated and fitted with couplings available in 6", 12", 24", 30", 60" sections, \$2.00 per ft.  
 90 Degree Elbows, E or H plane, 2 1/2" radius, \$12.50  
 90 Degree Twist, 6" long, \$8.00  
 Bulkhead Feed-Thru Assembly, \$15.00  
 Pressure Gauge Section 15 lb. gauge and press nipple, \$10.00  
 Pressure Gauge, 15 lbs., \$2.50  
 Dual Oscillator-Beacon Mount, P/O APS10 Radar for mounting two 723A/B klystron with crystal mts. matching slugs, shielded, \$42.50  
 Dual Oscillator, Mount. (Back to back) with crystal mount, tunable termination attenuating slugs, \$8.50  
 Directional Coupler, UG51, Take off 20 DB, \$17.50  
 Directional coupler, APS-6 type "N" take off 20 DB calibrated, \$17.50  
 Rotary Joint Choke to Choke, \$10.00  
 2K25/723 AB Receiver local oscillator klystron mount, complete with crystal mount, iris coupling and choke coupling to TR, \$22.50  
 TR-ATR Duplexer section for above, \$8.50  
 CU 105/APS 31 Directional Coupler 25 DB, \$25.00  
 723AB Mixer-Beacon dual Osc. Mnt. w/xal holder, \$12.00  
 TR-ATR Sect APS 15 for 1B24 TR-ATR cavity w/1B24 & 724 Tubes, Complete, \$21.00  
 Stabilizer Cavity with bellows, \$21.50  
 3 cm. 180° bend, with pressurizing nipple, ea. \$6.00  
 3 cm. 90° bend, with pressurizing twist with pressurizing nipple, ea. \$6.00  
 3 cm. "S" curve 18" long, ea. \$5.50  
 3 cm. "S" curve 6" long, ea. \$3.50  
 3 cm. right angle bend, 18" plane 18" long cover to cover, ea. \$6.50  
 3 cm. Cutler feed dipole, 11" from parabola mount to feed back, ea. \$8.50  
 3 cm. directional coupler, One way waveguide output, ea. \$15.00  
 Circular Choke Flanges, solid brass, .55¢  
 Sq. Flanges, Flat Brass ea. .55¢  
 APS-10 TR/ATR Duplexer section with additional iris flange, \$10.00  
 "X" Band Pre-amplifier, con-

## 1" x 1/2" Waveguide

sisting of 2-723 A/B local oscillator-beacon feeding waveguide and TR/ATR Duplexer sect. incl. 60 pic. IF amp., \$47.50  
 Waveguide Run 1 1/2" x 1/2" guide, consisting of 4 ft. long, \$10.00  
 "X" Band Pressurizing gauge section w/15 lbs. gauge and pressurizing nipple, \$18.50  
 45 Deg. Twist 6" long, \$10.00  
 12" Section 45 deg twist, 90 deg bend, \$6.00  
 straight waveguide section choke to cover, special heavy construction, silver plated, \$4.50  
 15 Deg Bend 10" choke to cover, \$4.50  
 5 Ft. Sections choke to cover, Silver Plated, \$14.50  
 16" Flexible Section, \$17.50  
 Bulkhead Feed Thru, \$15.00  
 Waveguide 1" x 1/2" I.D., \$1.50 per foot  
 TR Cavity for 724 A TR Tube, \$3.50  
 724 TR Tube (41 TR 1), \$2.50  
 SWR Meas. Section, 6 L with 2 type "N" output probes MTD full wave apart. Bell size guide, Silver plated, \$10.00  
 Rotary Joint with slotted section and type "N" output pickup, \$17.50  
 Waveguide Section 12" long, choke to cover 45 deg. twist, 2 1/2" radius, 90 deg. bend, \$4.50  
 Twist 90 deg. 5" choke to cover w/press nipple, \$6.50  
 Waveguide Sections 2 1/2 ft long silver plated with choke flange, \$5.75  
 Rotary Joint choke to choke with deck mounting, \$17.50  
 3 cm mitred elbow, E plane unplated, \$12.00  
 1 1/4" x 5/8" WAVEGUIDE  
 Tunable Termination, Precision adjust, \$65.00  
 Low Power Termination, \$25.00  
 Magic Tee, \$45.00  
 Oscillator Mount, for four 723 AB klystron, \$38.50  
 90 Degree Elbows, E or H plane, \$12.50  
 Waveguide Lengths, Cut to size and supplied with 1 choke, 1 cover, per length, \$2.00 per ft.  
 Wavemeter, Absorption type, Precision micrometer adjust, Very high "Q", \$150.00  
 BI Dir-Coupler WG output calibrated -25 db nominal, \$17.50  
 Flex sections, 12" Rubber Coated, \$14.50  
 Mitred Elbow H Plane UG51, \$12.00  
 6" St. sect. choke to choke \$3.50  
 APQ 13 Constant Z Rotat Jnt., \$22.50  
 CG 98B/APQ 13 12" Flex. Sect. 1 1/2" x 5/8" OD, \$10.00  
 Wave Gd Run 1 1/2" x 1/2" OD consists of 4 ft. sect. w/RT angle bend on one end, 2" 45 deg bend on other end, \$8.00  
 X Band Wave Gd, 1 1/2" x 5/8" O.D. 1/16" wall aluminum, \$7.50  
 Slug Tuner Attenuator, W.E. guide, Gold Plated, \$6.50

## 3000 Mc BENCH TEST EQUIPMENT

10 CM Wavemeter WE type 1343549 Transmission type, Type 1343549 Vee-Dir Root Micro-meter dial, Gold Plated W/Calib. Chart P/O Prog. Meter X86404A, New, \$99.50  
 AS14A/AP 10 CM Pick up Dipole with "N" Cables, \$4.50  
 LIGHTHOUSE AS-SEMBLY Part of RT89 APQ 5 & APG 15. Receiver and Trans Cavities w/assoc. TR Cavity and Type N CPLG. To Revr. Uses 2C40, 2C43, 1B27, Tunable APX 2400-2700 MCS, Silver Plated, \$49.50  
 Beacon Lighthouse cavity 16 cm with miniature 28 volt DC FM motor. Mfg. Bernard Rice, \$47.50 ea.  
 Magnetron to Waveguide Coupler with 721A Duplexer Cavity, gold plated, \$45.00  
 721A TR Box complete with tube and tuning plungers \$12.50

## TEST PLUMBING

McNally Klystron Cavities for 707B or 2K28. Three types available, \$4.00  
 23 SPR-2 Filters, Type "N" Input and output, \$12.50  
 WAVEGUIDE TO 7/8" (RIGID) COAX "DOORKNOB" ADAPTER, CHOKE FLANGE, SILVER PLATED BROAD BAND, \$32.50  
 WAVEGUIDE DIRECTIONAL COUPLER, 27 db. Navy type CABV 47AAN, with 4 in. slotted section, \$32.50  
 SQ. FLANGE to rd choke adapter, 18 in. long OA 1 1/2 in. x 3 in. guide, type "N" output and sampling probe, \$27.50  
 AN/APRSA 10 cm antenna equipment consisting of two 10 cm waveguide sections, each polarized, 45 degrees 75.00 per set.  
 POWER SPLITTER: 726 Klystron input dual "N" output, \$5.00

## 6000 Mc to 8500 Mc BENCH TEST PLUMBING

1 1/2" x 3/4" Waveguide Klystron Mount, D1381 complete with shield and tunable termination, \$125.00  
 Flap Attenuator, D1381 \$45.00  
 WRITE FOR LIST OF

## 4000 to 6000 Mcs BENCH TEST PLUMBING

2" x 1" Waveguide Flap Attenuator, \$48.00  
 Variable Stub Tuner and Low Power Termination, \$48.00  
 Wavemeter Tee, \$48.00  
 OTHER EQUIPMENT

## MAGNETRONS

QK 915  
 QK 62  
 QK 59  
 QK 61  
 QK 60  
 2121  
 2122  
 2126  
 2127  
 2131  
 2132  
 2137  
 2138  
 2139  
 2140  
 2149  
 2134  
 2161  
 2162  
 3131  
 5130  
 7144Y  
 718DY  
 720BY  
 720CY  
 725-A  
 730-A  
 706  
 709  
 700

## KLYSTRONS

723A  
 707B  
 417A  
 2K41

## TEST SETS

TS 12  
 TS 13  
 TS 33  
 TS 35  
 TS 56  
 TS 45/APM3  
 TS 62 3CM  
 TS 108  
 1-105A  
 1-158  
 1-233  
 RC 438  
 RF Preamp.  
 G. R.  
 Brgd #216  
 G. R.  
 Shunt #229  
 G. R.  
 Osc. #213  
 TS 226A/AP  
 Sig. Gen. #804  
 BC 221  
 TS 10A/AP  
 TS 69/AP  
 1-114  
 1-126  
 Meter 43A  
 Sig. Gen. 78B  
 Megometer 0-5 Meg  
 TS 1-49  
 1-166  
 Sig. Gen. 9.5-500 MC  
 CY 81/AP  
 TS 59/APN1  
 CW 60/ABM

## SONAR SYSTEMS and COMPONENTS IN STOCK

QBF  
 QBG  
 QOC  
 QCL  
 QCO  
 QCS  
 QCU  
 WEA

## 23,000 to 27,000 Mc BENCH TEST PLUMBING

Precision Slotted Line, Adjustable probe, \$200.00  
 Mt. 12DB Directional Coupler-Wavemeter, \$60.00  
 Precision Var Attenuator, mfg. Bernard Rice, \$90.00  
 Low Power Load, \$20.00  
 Shunt Tee, \$35.00  
 Waveguide Lengths, 2" to 6" long, gold plated with circular flanges and coupling nuts, \$2.25 per inch  
 APS-34 Rotating Joint, \$49.50  
 Right Angle Bend E or H Plane, specify combination of couplings desired, \$12.00  
 45° Bend E or H Plane, Choke, \$49.50 ea.

1/2" to 1/4" Waveguide  
 to cover, \$12.00  
 Mitred Elbow, cover to cover, \$4.00  
 TR-ATR-Section, Choke to cover, \$4.00  
 Flexible Section 1" choke to choke, \$5.00  
 "S" Curve Choke to cover \$4.50  
 Adapter, round to square cover, \$5.00  
 Feedback to Parabola Horn with pressurized window, \$27.50  
 K Band Mixer Block, \$45.00  
 Waveguide 1/2 to 1/4" \$1.00 per ft.  
 90° Twist, \$10.00  
 "K" Band Directional Coupler, \$49.50 ea.

## 7/8" RIGID COAX—3/8" I.C.

7/8" rigid coaxial tuning stubs with vernier stub adjustment, Gold Plated, \$17.50  
 7/8" RIGID COAX ROTARY JOINT, Pressurized, Sperry #81013, Gold Plated, \$70.00  
 Dipole assembly, Part of SCR-584, \$25.00 ea.  
 Rotary joint, Part of SCR-584, \$35.00 ea.  
 RIGHT ANGLE BEND, with flexible coax output pickup loop \$8.00  
 SHORT RIGHT ANGLE BEND, with pressurizing nipple, \$3.00  
 RIGID COAX to flex coax connector, \$3.50  
 STUB-SUPPORTED RIGID COAX, gold plated 5' lengths, \$5.00 per length  
 RT. ANGLES for above, \$2.50  
 RT. ANGLE BEND 15" L. OA, \$3.50  
 FLEXIBLE SECTION, 15" L. Male to female, \$4.25  
 MAGNETRON COUPLINGS to 7/8" rigid coax. with TR pickup loop, gold plated, \$7.50  
 FLEX COAX SECT., Approx. 30 ft. \$16.50  
 CG 54/U-4 foot flexible section 1/4" IC pressurized, \$15.00  
 7/8" RIGID COAX, Bend Supported, \$1.20  
 SHORT RIGHT ANGLE BEND, \$2.50

## WAVEGUIDE

3/4" x 1/4" ID, \$1.00 per foot  
 1" x 1/2" OD, \$1.50 per foot  
 3/4" x 1 1/4" OD, \$1.65 per foot  
 1 1/2" x 3/4" OD Aluminum, .75 per foot  
 1 1/2" x 3/4" OD, 3.00 per foot  
 2 1/2" x 3/4" OD, 3.50 per foot  
 1 1/2" x 1/2" OD Flexible, 4.00 per foot  
 7/8" rigid coax 1/4" I.C., 1.20 per foot (Available in 10 ft. to 15 ft. lengths or smaller.)

## GENERAL TEST EQUIPMENT

Multifrequency Generator, American Time Product type 80-16, Frequency 10 to 190, Precision Standard "Watch-Master" UHF Signal Generator, R. C. A. type 710A, 370 to 560 mcs. Wheatstone Bridge, Industrial Inst. type RN-1, FM Signal Generator, Boonton Radio type 155A, Freq. range 1 to 10 mcs., 33 to 50 mcs. Condenser Weld Power, Cap. 56 mfd max., max. chg. 1500 Volts. Frequency Meter, Lavoie Model 105-300 to 600 mcs. Megohm Bridge, Industrial Instruments type MB. Visual Alignment—Signal Generator, General Electric—0 to 60 mcs.

## PULSE TRANSFORMERS

G.E.K.-2745, \$39.50  
 G.E.K.-2744-A, 11.5 KV High Voltage, 3.2 KV Low Voltage @ 200 KW oper. (270 KW max.) 1 microsec. or 1/2 microsec., 600 PPS, \$39.50  
 W.E. #166173 Hi-Volt Input transformer, W.E. Impedance ratio 60 ohms to 900 ohms, Freq. range: 10 ks to 2 mc, 2 sections parallel connectedotted in oil, \$36.00  
 W.E. KS 9800 Input transformer, Winding ratio between terminals 3-5 and 1-2 is 1:1:1 and between terminals 6-7 and 1-2 is 2:1. Frequency range: 380-520 c.p.s. Permalloy core \$60.00  
 G.E. #K2731 Repetition Rate: 635 PPS, Pri. Imp: 50 Ohms Sec. Imp: 450 Ohms, Pulse Width: Microsec. Pri. Input: 9.5 KV 1PK, Sec. Output: 28 KV-1PK, Peak Output: 800 KW Riflar 2.75 Amp., \$64.50  
 W.E. #D169271 Hi Volt Input Pulse Transformer, \$27.50  
 G.E. K2450A, Will receive 13 KV, 2 micro-second pulse on pri. secondary delivers 14KV, Peak power out. 100KW \$34.50  
 G.E. #K2748A, Pulse Input line to magnetron, \$36.00  
 #9262 Utah Pulse or Blocking Oscillator, 1PKB Freq. Limits 40-810 cy, 3 winding turns ratio 1:1:1 Dimensions 1 1/8" x 1 1/2" x 1 1/2" \$1.50  
 Pulse 131-AWP L-421435, \$6.00  
 Pulse 134-BW-2F L-440895 \$3.25  
 RAY-WK4298F, \$39.50  
 G.E.-K824730, \$50.00  
 G.E.-K910945, \$50.00  
 #7766490-2533, \$50.00  
 A 7766490, \$50.00  
 UX-7356, \$6.95  
 #2-9250 (#18961), \$2.00  
 #352-7181, \$2.00  
 AVAIL in Stock 9318 9280 - Write

## MICROWAVE ANTENNAS

AN-122 Dipole Assy, \$22.50  
 LP-21-A ADF Loop w/Selwyn and Housings, New, \$8.00  
 DAK Bellino Tossi DF Loops \$125.00  
 Adecock DF Arrays, Complete \$65.00  
 SA Radar 200 MC Red Springs, Complete with Pedestal, Less Drive for Parabola, \$600.00  
 Drive for Parabola, \$4.85  
 APS-15 Antenna, New, \$99.50  
 AN MPG-1 Antenna, Rotary feed type high speed scanner antenna assembly, including horn parabolic reflector, Less internal mechanisms, 12 deg. sector scan, Approx. 12 L, 4" W x 3" H Unused, (Gov't Cost—\$450.00), \$250.00  
 APS-4 3 cm. antenna, Complete, 1 1/2" dish, Cutler feed dipole directional coupler, all standard, \$100.00  
 1" x 1/2" waveguide, Drive motor and gear mechanisms for horizontal and vertical scan, New, complete, \$65.00  
 AN/TP53, Parabolic dish type reflector approx. 10" diam. Extremely lightweight construction, New in 3 carrying cases, \$89.50  
 RELAY SYSTEM PARABOLIC REFLECTORS: Approx. range: 200 to 6000 mc, Dimensions: 4" x 3" rectangle, new, \$35.00  
 TDY "JAM" RADAR ROTATING ANTENNA, 10 cm, 30 deg. beam, 115 v.a.c. drive, New, \$100.00  
 DBM ANTENNA, Dual, back-to-back parabolas with Apollon, Freq. coverage 1,000-4,600 mc. No drive mechanisms, \$65.00  
 AS125/APR Cone type receiving antenna, 1080 to 3208 megacycles, New, \$45.00

## SCR 545 RADAR TRAILER

"L" BAND SEARCH—"S" BAND TRACK

All merch. guar. Mail orders promptly filled. All prices, F.O.B. N.Y.C. Send M.O. or Chk. Only shipping chgs. sent C.O.D. Rated concerns send P.O.

MIN. ORDER \$3.00 COMMUNICATIONS EQUIPMENT CO. MIN. ORDER \$3.00

131 Liberty St., New York, N. Y. Dept. E-2 P. J. PLISHNER Phone: Main 4-8373



# SEARCHLIGHT SECTION

## Comb. Transformers—115/50-60 cps input

Item	H.V.	Amp	Filaments	Price
CT-861	2100VCT	.175	7.5VCT/4A, 2.5V/10A	\$7.29
CT-142	645VCT	.060	5V/2A, 6.3V/1.2A	4.25
CT-825	360VCT	.340	6.3VCT/3.6, 6.3VCT/3A	3.95
CT-076	600V	.100	2x12.6V/1	1.95
CT-626	1500V	.160	2.5/12, 30/100	9.95
CT-154	350VCT	.070	6.3/6, 6.3/1.8 3 lbs.	2.95
CT-071	110V	.200	33/200, 5V/10, 2.5/10	4.95
CT-378	230V	4 MA	2.5/2	2.95
CT-367	580VCT	.050	5VCT/3A	2.25
CT-721	550VCT	.100	6.3/1, 2.5VCT/2	2.95
CT-99A	2x110VCT	.010	6.3/1A, 2.5VCT/7A	3.25
CT-91A	726V	.100	5V/3A, 6.3/3.5	3.25
CT-080	700VCT	.205	5V/3.5V/2A	3.95
CT-441	50V	.200	5V/2.4, 5V/1.2	2.29
CT-408	350VCT	.028	6.3V/3A	2.75
CT-931	585VCT	.086	5V/3A, 6.3V/6A	4.25
CT-610	1250	.002MA	2.5V/2.1A, 2.5V/1.75A	4.95
CT-137	350VCT	.026MA	5V/2, 6.3/7.5, 6.3/3.	3.25
CT-102	1080VCT	.055	25V/3A, 6.3V/1.8A, 6.3V/1.2A	5.95
CT-866	330V	.065	6.3V/1.2, 6.3V/600MA	1.75
CT-319	330VCT	.085	5V/2, 6.3/7.5, 6.3/3	2.95
CT-526	510VCT	.025	12.5/900 MA, 6.3/5A	1.95

## Filament Transformers—115V/50-60 cps input

Item	Rating	Each
FT-852	23V	\$1.79
FT-589	78V/300, 6.3V/2A	.79
FT-719	1.3V/6A	.79
FT-029	13.5V/1.1A	.79
FT-074	2.5V/10A, 6.3/9A	1.79
FT-367	5VCT/3A, 58VCT/40A	1.10
FT-346	5VCT/13.5, 5VCT/6.75, 5VCT/6.75	2.95
FT-781	866 Trans. 2 x 2.5/5A	5.25
FT-511	3.4V/300A, 7/4H x 10" x 5" 2W	14.95
FTG-31	2.5V/2.5, 7V/7A (Tapo @ 2.5V/2.5A), 16 lbs.	9.95
FT-674	8.1V/1.5A	1.10
FT-157	4V/16A, 2.5V/1.75A	2.95
FT-391	6.4V/3A	1.10
FT-736	2 x 6.3VCT/3.2-1.2A	1.10
FT-461	2 x 6.3VCT/1A	1.10
FT-899	2.5V/5.5A 29000 Rms.	15.95
FT-418	6.3VCT/1A, 6.3VCT/7A	1.95
FT-735	6.3VCT/5A, 6.3VCT/1A	1.79
FT-101	6.3V/25A	1.79
FT-738	6.3VCT/1, 2.5V/2	1.59
FT-774	6.3V/1.6A	.79

## Plate Transformers—115V/50-60 cps input

Item	Rating	Each
PT-976	Auto: 120VCT/10 MA	\$.69
PT-31A	2 x 300V/5 MA	.79
PT-46A	4030VCT N. L. 3% to 1 8" H x 6" W x 7" L 20 lbs.	29.95
PT-033	4150V/400 MA 1 1/2" x 9 1/4" W x 9" D 70 lbs.	49.95
PT-75-2	3780/3446/3112VCT/77 MA	10.95
PT-28-1	1460VCT/877 MA	12.95
PT-403	Auto: 70V/1A	2.29
PT-160	120VCT/770 MA, 590VCT/82 MA, 25 lbs	24.95
PT-170	Auto: 156/146/137/138—71 MA	3.29
PT-848	3140VCT/750 MA for 68345, 5C1069A	69.95
PT-139	42V/45V/750V/55V/15.2A 7 1/2" x 7" x 6 3/4" H	10.95
PT-637	400V/20 MA	.99
PT-589	9V/1.6A	.99
PT-31A	2 x 300V/5 MA	.79
PT-12A	280VCT/1.2A	2.95
PT-997	78V/.0075A KVA	1.49

## SPECIAL TYPES

Item	Pri.	Output	Price
STF-946	210/220/230	25V/4A 3 1/2" H x 2 1/4" x 2 1/4" D	\$1.29
STF-638	230	5V/9A 5 1/2" H x 4 1/2" x 3 1/2" D	1.25
STF-05A	115/230	3 1/2" x 5 1/2" x 7 1/2" H x 7" x 5" D	4.25
STF-682	220	30-25-20V/1 MA	.69
STF-968	230	2.5V/6.5A	1.10
STF-405	230/115	5V 12/9A	2.95
STF-370	220/440	3 x 2.5V/57, 2.5V/15A, 2.5V/50A, 7 x 5 1/2" x 5 1/2" x 5 1/2" D	5.25
STF-619	110/220	2 x 40V/.05/2 x 5V/6A, 12.6/1A	19.95
STF-631	230	2 x 5V/27A 2 x 5V/9A, 103/4H x 5 x 7 3/8 lbs	24.95
STF-968	230	2.5V/6.5A	1.95
STF-608	220	24V/600, 5V/2A, 2 x 6.3V/1A	2.25
STF-45A	43/78/90	2 x 2.5/6.5, 6.3V/4	2.25
STF-111	115/180/230	Few	3.25
STF-306	100/120 200/240	5VCT 10 amp 10000 VT	19.95

## SPECIAL PLATE TRANSFORMERS

Item	Pri.	Output	Price
STP-945	210/20/30	1100VCT/300 5/4 x 4 x 3 1/2"	\$5.95
STP-444	230/460	230/105/115/125/ 15 lbs.	14.95
STP-643	230V	2 x 230/.05	1.29
STP-823	137V	222VCT/300 MA	2.95
STP-780	82V	4000V/.002	1.29
STP-08B	50V	2 x 750V/1 MA	.59
STP-311	30/35/40	95 NL-50VFL 1 Amp. COMB.	.59
STC-627	230V	1500/160, 110V/200, 3.3V/200, 5V/10, 2.5-1.4/100, 6.3V/9.	5.95
STC-611	230V	260V/.03, 100V/1, 6.3V/4.2	2.95
STC-16A	220V	700VCT/75 MA, 40VCT/100, 15/10/15V/100 MA	3.95
STC-612	230V	400V/30, 190/30, 2 x 5V/2.5 w/2-866 Socket	3.95

Write for Flyers of Others in Stock

## There Are No Shortages of Equipment at C.E.C.

Our warehouses are full of surplus radio, radar, electronic equipment, for your needs, as a manufacturer, jobber, amateur, experimenter, engineer, everything at surplus prices. We own what we sell, phone or write us your needs and let us quote. Mr. Chas. Rosen Digby 9-4124

## DYNA-MOTORS AT SURPLUS PRICES

Type	Input Volts	Input Amps	Output Volts	Output Amps	Radio Set
PE88	28	1.25	250	.060	RC 36
DM416	14	6.2	330	.170	RU 19
DY-2/ARR-2	28	1.1	250	.060	ARC-5
DM36	28	1.4	220	.080	SCR 508
DM25	12	2.3	250	.050	BC 367
	28	1.25	275	.070	BC 348
DM31A	28	7	540	.250	BC 456
DM42	14	46	515	1.10	SCR 506
			1030	.050	
			2/8		

PE10C	13/26	12.6	400	.135	SCR 515
			6.3	800	.020
BD AR 93	28	3.25	375	.150	
			27	1.75	285
			28	1.2	260
35C0458	28	1.2	260	.060	
ZA-085	12/24	4/2	500	.050	
ZA-056	12/24	8/4	12/275	3/110	
B-19pack	12	9.4	275	.110	Mark II
			500	.050	
			225	.100	
D-104	12		440	.200	
			300	.060	
DA-3A	28	10	300	.060	SCR 522
			150	.010	
			14.5	.5	

5053	28	1.4	250	.060	APN-1
PE73CM	28	19	1000	.350	BC 375
DM21	14	3.3	235	.090	BC 312
CW21AAX	13	12.6	400	.135	
	26	6.3	800	.020	
			9	1.12	
BD77KM	14	40	1000	.350	MC 191
PE94	28	10	300	.200	SCR
			150	.010	522
			14.5	.5	

## PE 86 DM 32A IDY 22 ARC 3 DAG 33A

## INVERTERS

Item	Rating	Price
866 Filament Xmm		
2x2.5v6 Amp		
8000 V Test Size. Approx 3 1/2" S Q.		
Easy to Mount. Price—\$2.95		
6V Input Dynamotor		
Output 150V/75MA or 12V Input. 500V 50 MA. Out. \$3.49		
FEED THRU		
2 1/2" L x 1 3/4" W Type XSI 10c ea. 1st For 50c		

## AUDIO TRANSFORMERS

ITEM AT668	Input 6 ohms: 250K ohms	.79
AT SUB	Multimatch Subcancer 200 ohms 15K ohms C. T.: 100K ohms/20K ohms	.69
AT070	Input to Grid 250 ohms: 60K ohms H1 F1	1.19
AT566	Input to Grid. 500/200 ohms 50K ohms	.95
AT227	Output to line, 7500K 500 ohm CT 200-5kay	1.45
AT353	Output PP 6L6 to 300/20/12/16 ohms 25 Watt	2.95
AT871	UNIV. Output. H1 F1, Pri 20K ohms nec. 15/7.5/3.75/1.25/500 ohms	2.79
AT554	Interstage. 10K ohms: 250K ohms 15db Level	1.95
AT765	Input 600 ohms: 50K ohms	.79
AT707	Interstage uncancer 10K ohms: 125/125K ohms	.79
AT750	Input Pri: 15/15 ohm Sec: 180K ohm	.59
AT449	Driver 5k ohm to 4K ohm PPL6L to PPL80 Class B	3.89
AT21	Dual XFRMR 300 ohms: 300 ohms and 600 ohms: 250K ohms	1.35
AT383	Output 8500 ohms: 19 ohms 25V	1.79
AT415	Output 18K ohms CT to Line 125 ohms 175V	2.95

MANY OTHERS



400 MA 12 HY Choke 90 ohms Herm. sealed. Special \$3.75

## Choke Swinging

9/60Hv. 400/.05 Amp. 10000V ins. Mfg. Super. Elect.	\$7.95
---	--------

## 872 FIL XFRMR

Pri: 115-125V 60cy Sec: 2x2.5/20A \$6.95

## CHIME XFRMR

Pri: 110V 60cy Sec: 24V/1A \$1.25

## POWER XFRMR

Pri: 110V 60 cy Sec: 4V/16A 2.5V/1.75A Ideal for 2x2 & 826 Tubes \$1.95

## HF-185—120 watt

Modulation 211 with push-pull former—as used in the Army BC-191 and RC-375 Xmters. Designed for class B modulating a single 211—9000 ohm plate to plate load impedance into a 7000 ohm load. With this transformer and 211's you can build yourself a good economical modulator for an 804, 811 or similar final. \$1.49 each

## T.V. Transformer, 110v 50 cy 7" or 8" 3000v/5MA, 720 vct/200 MA, 6-4, 6.4, 8.7 A, 6.4, 6A, 5/3A, 1.25/.3A. New \$3.95

## WIRE WOUND POTS

20000 Ohm Precision 4 watt. \$95  
5000 Ohm 1070 8 watt \$95  
20000 Ohm Precision 8 watt. \$1.25  
100000 Ohm Precision 25 watt. \$1.49  
Dual 500 25 watt. \$95  
Dual 2500 50 watt. \$1.95  
10000 50 watt. \$95  
2000 25 watt. \$95  
150 25 watt. \$95  
50 250 watt. \$2.95

## Voltage Stabilizer

VR3 95-130V 2.4A 60 cy Id out 115V 120V 100% Raytheon w/ Excl. Box. Each \$1.49  
Used but good. Price—\$19.95

## Voltage Regulator VII

623 95-130V 1.75A 60cy Id CU 115V 150V 100%. Slightly used. Excellent. Price—\$19.95

## G.E. FILAMENT XFRMR.

115/50 60cy Primary. Sec. 6.3V/2A, 6.3V/2A, 6.3V/2A, 5V/2A. Price—\$2.25

## 115/50 60cy Primary. Sec. 6.3V/2A, 6.3V/2A, 5V/2A. Price—\$2.25

## P/O AN/APS-15

400VCT/35 MA, 6.4, 6.4V/2.5A 650VCT/25 MA, 6.3VCT/2A, 5VCT/2A. P/O R58/ARQ8 2400CT/5MA, 640V/.5MA. 2.5V/1.75A 1.35VCT/1.75A 59.2V/.118, 63V/8.1, 5V/2A. P/O APQ 13 6.3V/.9, 6.3V/.6, 5V/6, 640/200 MA 2 x 14CV/00014A, 12CV/00012A. P/O APG2 3640V/400 MA, P/O APT 4 23.5V Tapped 22V/47 MA 600VCT/36 MA 780V/27V/4.3, 6.3V/2, P/O APQ 7 6.4V/11 Amp. P/O APQ7 2 x 6.3V/1.25A, P/O APQ13

## 80V 400 CYCLE INPUT

6.3V/1A, 2.5V/2A, P/O PE172A | 3.95

## FILTER CHOKES RATINGS PRICE

CH488	10 HY .030A	45c
CH791	Dual 1.75-125 HY 100 MA	59c
CH917	10HY .450A	12.95
CH10C	20HY .060A	1.10
CH86C	Dual .01-3.5HY 950-75MA	1.10
CH981	15HY 110A	1.50
CH22-1	20HY 80MA	1.49
CH22-1	1HY 100	



**CRYSTALS Low Freq.**

FT-241. A holder 1/2" pin spacing, for ham and general use. Xtal controlled Signal Generators, marked in army Mc harmonic frequencies—Directions for determining fundamental frequencies enclosed. Listed below by fundamental frequency, fractions omitted.

370	390	462
372	391	463
373	392	464
374	393	465
375	394	466
376	395	467
377	396	468
378	397	469
379	398	470
380	399	471
381	400	472
382	401	473
383	402	474
384	403	475
385	404	476
386	405	477
387	406	478
388	407	479
389	408	480
390	409	481
391	410	482
392	411	483
393	412	484
394	413	485
395	414	486
396	415	487
397	416	488
398	417	489
399	418	490
400	419	491
401	420	492
402	421	493
403	422	494
404	423	495
405	424	496
406	425	497
407	426	498
408	427	499
409	428	500
410	429	501
411	430	502
412	431	503
413	432	504
414	433	505
415	434	506
416	435	507
417	436	508
418	437	509
419	438	510
420	439	511
421	440	512
422	441	513

each 39¢  
5 for \$1.90

**RL9 or RL7**

Interphone Amplifier Convert to high fidelity Phone Amp. or Spec. Amp. Output w/ 12AB, 12SL7, 2 Chokes. 12AR6M, DYN for 24v operation, etc. \$2.29



**Xmfrs VFO Drivers 40 Watts Output 274N (ARCS)**

Used Good Cond.

2.1-3 MC	\$14.95
3-4 MC	9.95
4-5 MC	5.95
5-7 MC	5.95
7-9.1 MC	13.95

each 79¢  
10 for \$4.50

**BC-733D SUPERHER RECEIVER**

w/10 tubes. 6 Selector - Relays operate on Xtal Cont. freq. 108.3-110.3 Mc. Can easily be converted to 2 Mtr. ham bands.



**ARC 5 MODULATOR**  
MDT/ARC5 w/ dynamotor complete w/ Tubes 1-12B5, 2-18Z5, 1-UR10. Good cond. Price...\$8.95

**SCR274**  
Screen Mod. XFRMR for pair of 807's Parli Sidetone Wndg. \$9.50

**EE89A Telephone Repeater**  
Used to extend range of field telephones. Simplex Tele. and 20 cycle ringing possible over lines equipped w/ 12AB, 12SL7, 2 Chokes. Unit. Supplied w/ 305 tube. Phone supply. (weight) \$9.59

**BATHTUBS**

Mfd.	Volt	Type	Cat. No.	Price	
.01	600	2ST	HC 3755	25¢	
.02	600	2ST	BA31227-E	30¢	
.03	1000	2ST	CG14931B-B10	40¢	
.06-1	1500	2TT	305-1526B	50¢	
3x.05	600	3ST	CP50B80F050V	30¢	
.05	600	2TT	CSF-481391-10	30¢	
.05	600	2ST	DYR 6005	30¢	
2x.05	600	3ST	CG48315B-10	40¢	
2x.05	600	2ST	DYR 6005	45¢	
1	600	2TT	A-8B-373	25¢	
1	600	2TT	630T	25¢	
1	600	1ST	NDN	25¢	
1	1000	2ST	CAW48197-B10	30¢	
2x.1	400	2TT	1574	25¢	
2x.1	400	2TT	1572	25¢	
2x.1	600	3ST	305-1133	30¢	
2x.1	400	2TT	CBY48678	25¢	
2x.1	600	3BT	305-1133	30¢	
2x.1	600	2TT	CSF48680-A20	30¢	
2x.1	200	2ST	CP-204D P11	20¢	
2x.1	600	3ST	CG14931B-B10	40¢	
2x.1	600	3ST	CG48712B-10	30¢	
2x.1	600	3ST	DYR6011	30¢	
2x.1	600	3ST	305-1133	30¢	
2x.1	600	3ST	2XDMRW6-1	30¢	
2x.1	600	3ST	CP50B80F104X	30¢	
2x.1	600	3BT	305-1133	30¢	
2x.1	600	3BT	305-1133	30¢	
3x.1	600	3TT	7890481-P1	35¢	
3x.1	600	3ST	CQU48713-B10	35¢	
3x.1	600	3TT	305-16838	35¢	
3x.1	600	3TT	22F402	35¢	
3x.1	600	3TT	3XDMRW6-1	35¢	
3x.1	400	3BT	CAW48709	35¢	
3x.1	600	3ST	A-18933-1	35¢	
3x.1	600	2TT	630MT	25¢	
3x.1	400	2TT	430T	25¢	
3x.25	400	2TT	7253775	40¢	
3x.25	400	2TT	8B-71880	25¢	
3x.25	400	3BT	CAW-481372	25¢	
5	120	2TT	CC26806-2	20¢	
5	600	2TT	305-1154	20¢	
5	400	1TT	25	25¢	
5	200	2ST	XDMR2-5	25¢	
5	600	2ST	DYR6050G	25¢	
5	400	2ST	14862	25¢	
5	600	2BT	CSF48704-A20	25¢	
5	400	2TT	R05	25¢	
5	400	2ST	48205A	25¢	
5	200	2ST	8A31251-C2	20¢	
5	400	2TT	25	25¢	
3x.5	100	3ST	B-215563-5	25¢	
2x.5	250	2TT	A8B-515	25¢	
2x.5	400	2ST	T1065A	25¢	
2x.5	300	3TT	541B	25¢	
2x.5	400	2TT	1575	25¢	
3x.5	400	3BT	CBY48763	30¢	
7	200	1TT	47157	25¢	
1	200	1ST	55907	30¢	
1	600	2ST	305-1391	35¢	
1	400	2BT	48B-361	35¢	
1	600	2TT	305-1507SND0	35¢	
1	600	2TT	2ST NDPS	35¢	
1	400	2ST	A-8B-1104	35¢	
1	600	2ST	W5-13	35¢	
2x.1	200	4ST	W22671-1	35¢	
2.5	100	2TT	W-226671-2	35¢	
3x.1	400	3ST	K7101881-P1	30¢	
4	50	2ST	678667-5	25¢	
4	500	2ST	55844	25¢	
30	150	2ST	D11206	1.15	
5-20	2TT	5417			
.025	600	2ST	NCN	35¢	
2x.1	400	3TT	P8887	30¢	
2x.1	600	3TT	CP51B4EF104V	30¢	
2x.1	600	3TT	CP52B4EF104V	30¢	
3x.1	400	3ST	400	30¢	
3x.1	400	3TT	CMR-4849-A	35¢	
3x.1	600	3ST	CP50B80E104V	30¢	
3x.1	400	3ST	CP50BEE104X	30¢	
3x.1	600	3ST	CSF48709-A20	35¢	
3x.1	400	2TT	CP-1066-11V	25¢	
1	600	1TT	NKE	25¢	
1	600	1TT	7283	25¢	
6	400	2TT	CE648060G	1.00	
3x.05	300	3TT	5414	08¢	
.05-.01	.05	300	3TT	5415	08¢
3	300	1TT	7552	25¢	
3x.22	300	1TT	692643 NAO	05¢	

Write for Latest Flyer

**UPRIGHTS**

Mfd.	Volt	Type	Cat. No.	Price
.0025	1500	2TT	D164209	30¢
.03	600	2ST	R03	25¢
2x.0515	600	2TT		45¢
.05	400	2BT	616M	25¢
.05	600	2BT	C51481918-20	28¢
.05	600	2BT	7700BR	28¢
3x.05	300	3BT	N10CA195	30¢
3x.05	300	3BT	CA195	30¢
12.5-.05	400	2TT	CMR481380-10	25¢
1	600	2BT	616M-14842	35¢
1	600	2BT	RL1-616MB	35¢
1	400	2BT	418CB	30¢
1	600	2BT	7701BR	35¢
1	600	2BT	CP69181AF104K	35¢
1	400	2BT	NMRW4-1	30¢
1	600	2BT	CG9181AF104	35¢
2x.1	600	2BT	P9711	39¢
3x.1	400	3BT	CA255	39¢
3x.1	400	3BT	ROBC	39¢
3x.1	400	3BT		39¢
3x.1	600	3TT	C168B5EF104V	42¢
3x.1	600	3BT	7710BR	42¢
3x.1	600	3BT	CD516	42¢
2x.125	400	2TT		69¢
.25	800	2TT	WMT	30¢
.4	800	2BT	M-7725RR	30¢
.25	600	2BT	C168B1EF254K	30¢
.5	600	2BT	SO1	32¢
.5	600	2BT	PO8	32¢
.5	400	2TT	418T	30¢
.5	600	2BT	616MB	30¢
2x.5	250	2TT	A-8B155	32¢
2x.5	400	3BT	418MCB	35¢
2x.875	400	2BT	CWS-P-72076-5033P	35¢
1	400	2TT	305-1605S	35¢
1	600	2BT	616MCB	35¢
1	600	2BT	YA86100	35¢
1	250	2TT	CBV48563-15	30¢
1	100	1BT	104M59	25¢
1	600	2BT	616MCB	35¢
1	400	2BT	418MCB	35¢
1.75	50	2TT	CLV48661	45¢

**CONDENSER TUNING UNITS FOR BC 191**

Write up in CCT QST for Conv to vhf freq meter

TU 5	1500 to 3000 KC
TU 6	3000 to 4500 KC
TU 7	4500 to 6200 KC
TU 8	6200 to 7700 KC
TU 9	7700 to 10000 KC
TU 26	20 to 500 KC

Price \$2.49 ea.

**COLLINS ART. 13 FREQ. MULT. UNIT**

2-18 Mo for two 12B5 Tubes. Comp. w/ carry less Tubes & Coils w/ opt dia \$8.95

**AMPLIFIER**

AM-32/PR51 less batt w/ carry case for Mine Detector AN/PR51. Price ea. \$7.95

**A.C. Cond.**

13-15	220-1.20
20-24	110-1.00
26-30	220-1.35
43-65	110-1.25
43-48	110-1.25
50-75	110-1.25
53-60	220-1.50
53-60	320-1.60
64-72	110-1.25
72-87	110-1.25
75-84	110-1.25
88-106	110-1.50
107-129	110-1.65
107-129	320-1.60
130-150	70-1.50
130-180	110-1.85
158-191	110-1.85
161-180	110-1.75
189-210	110-1.95
202-220	110-1.75
270-300	110-2.10
324-360	110-2.40
378-420	175-3.00
432-480	110-2.75
485-540	110-2.85

**DS Filter Condensers**

40x20	135	10c
20	150	15c
2x20	150	29c
30x30	150	29c
2x40	40	39c
30x50	150	39c
3x50	150	39c
3x30	150	39c
50x240	25/150	39c
2x120	150	39c
2x40/20	150	39c
3x40	150	39c
2x20/20	150/25	39c
2x50/10	150	39c
60-30/150		39c
80-40-30	150/25	39c
100	150/25	39c
40-30	200	39c
20-10/10	200/25	39c
2x32	250	39c
30	350	39c
2x32	350	39c
50x30	350	39c
20	450	49c
16-8	450	49c
32x16	450	55c
32x16	450/75	55c
80-20/20	450/25	49c

**SELSYN TESTER**

Magnesium Instrument Field Tester AAP 43G2330 Spec. 40772 To test individual mag. Ind. & Xmitters for Isolating Faults in magnesium systems. Brand new \$125.00

**Multimeter Mvmt.**

0-100 Meg. 0-600/30/14VDC (0-5 Ma. Bnc) 3" Rd. Met. 5-7/8 x 3 1/8" Al. Sim to Simpson #23 \$23.95  
0-100-0-1000 micro-amp 1/2" Bake. Same as Model 801 (Weston). Mfg. by Sun Elect & Beede Elect. Model 4AW \$21. Price ea. \$27.95  
0-1MA 3 1/4" Rd. DeJure Mod S-310. Price ea. \$4.75  
0-1MA 3 1/4" Rd. Same as above. Mfg. Sun Mfg. Mod 3AP259. Price ea. \$3.95  
0-10MA 3 1/4" Rd. DeJure Mod S-130. Price ea. \$4.95  
0-10MA 3 1/4" Rd. Same as above. Mfg. Sun Mfg. Mod 3AP236. Price ea. \$3.95

**0-30V DC Meter Wisting. Type AX Aircraft type**

Price \$2.49

Model 542 Supreme Sensitivity, 5.000 Ohms/v 3" square meter. Reads: D.C. 0-30-150-300-1,500. AC Volts 0-30-150-300. D.C. ma. 0-30-300-1500. Ohms. 2,000-20,000-200,000. 2 megs. Ohms - to +50. Output. 6-30-150-600 volts. Bakelite case. 5-7/8 x 3 1/



# FULLY GUARANTEED BRAND NEW SURPLUS OFFERED BY A LEADING

## A.C. MOTORS

5071930, Delco, 115 V., 60 Cycle, 7000 r.p.m. Price \$4.50 each net.

36938-2, Haydon Timing Motor, 110 V., 60 cycle, 2.2 w., 4/5 r.p.m.

Price \$3.00 ea. net.



Telechron Synchronous Motor, type BC, 110V, 60 cycle, 60 RPM, 6 W. Price \$4.00 each net.

Type 1600 Haydon Timing Motor—110 V., 60 cycle, 2.2 w., 1/240 r.p.m. Price \$3.00 each net.

Type 1600 Haydon Timing Motor 110 V., 60 cycle, 2.3 w., 1 r.p.m. Price \$2.70 each net.

Type 1600 Haydon Timing Motor 110 V., 60 cycle, 2.2 w., 1 1/5 r.p.m. Price \$2.70 each net.

Type 1600 Haydon Timing Motor 110 V., 60 cycle, 3.5 w., 1 r.p.m. With shift unit for automatic engaging and disengaging of gears. Price \$3.30 each net.

Type 1600 Haydon Timing Motor, 110 V., 60 cycle, 2.2 w., 1/60 r.p.m. Price \$3.00 each net.

Eastern Air Devices Type J33 Synchronous Motor 115 V., 400 cycle, 3 phase, 8,000 r.p.m. Price \$8.50 each net.

Telechron Synchronous Motor, Type B3, 115 V., 60 cycle, 2 r.p.m., 4 w. Price \$5.00 each net.

Barber-Colman Control Motor, Type AYL 5091, reversible 24 volts D.C. .7 amps 1 R.P.M., Torque 500 in. lbs. Contains 2 adjustable limit switches with contacts for position indication. Ideal for use as a remote positioner or a beam or television antenna rotator, will operate on A.C. 60 cycle. Price \$6.50 each net.

## SERVO MOTORS

CK 1, Pioneer, 2 phase, 400 cycle. Price \$10.00 each net.

CK 2 Pioneer, 2 phase, 400 cycle. Price \$10.00 each net.

10047-2-A Pioneer 2 phase, 400 cycle, with 40:1 reduction gear. Price \$10.00 each net.

FPE-25-16 Diehl Low-Inertia 20 V., 60 cycle, 2 phase, 1600 r.p.m., 85 amps. Price \$10.00 each net.

CK2, Pioneer, 2 phase, 400 cycle, with 40:1 reduction gear. Price \$11.50 each net.

MINNEAPOLIS-HONEYWELL TYPE B Part No. G303AY, 115 V., 400 cycle, 2 phase, built-in gear reduction, 50 lbs. in torque. Price \$10.00 each net.

Kallsman Type 776-01 400 cycle 2 phase drag-cup type, fix phase voltage 29, variable phase 35V. maximum, frequency 400 cycle.

Price \$10.50 each net.

## REMOTE INDICATING MAGNESYN COMPASS SET

Pioneer Type AN5730-2 Indicator and AN5730-3 Transmitter 26 V., 400 cycle.

Price \$40.00 per set new sealed boxes.



Kallsman Remote Indicating Compass Set Transmitter part No. 679-01, indicator part No. 680k-03, 26 V., 400 cycle. Price \$12.50 each net.

## GYROS

Schwein Free & Rate Gyro type 46800. Consists of two 28 V. D.C. constant speed gyros. Size 8" x 4.25" x 4.25".

Price \$15.00 ea. net.



Sperry A5 Directional Gyro, Part No. 656029, 115 volts, 400 cycle, 3 phase.

Price \$20.00 each net.



Sperry A5 Vertical Gyro, Part No. 644841, 115 V., 400 cycle, 3 phase. Price \$20.00 each net.

Sperry A5 Amplifier Rack Part No. 644890. Contains Weston Frequency Meter. 350 to 450 cycle and 400 cycle, 0 to 130 voltmeter.

Price \$15.00 each net.

Sperry A5 Control Unit Part No. 644836. Price \$7.50 each net.

Sperry A5 Azimuth Follow-Up Amplifier Part No. 656030. With tube. Price \$5.50 each net.

Sperry A5 Autopilot Indicator: contains Pioneer AY20 Autosyn 26 V., 400 cycle. Price \$9.50 ea. net.

Pioneer Type 12800-1-D Gyro Servo Unit. 115 V., 400 cycle, 3 phase. Price \$15.00 each net.

Norden Type M7 Vertical Gyro. 26 V., D.C. Price \$19.00 each net.

Allen Calculator, Type C1 Bank and Turn Indicator, Part No. 21500, 28 V. D.C. Contains 28 V. D.C. constant speed gyro.

Price \$10.00 each net.

Type C1 auto-pilot formation stick, part No. G1080A3. Price \$15.00 each net.

GOVERNMENT approved instrument repair station No. 3564.

## D.C. MOTORS



5069625, Delco Constant Speed, 27 V., 120 r.p.m. Built-in reduction gears and governor. Price \$7.50 each net.

C-28P-1A, John Oster Series Motor, 27 V., 0.7 amps., 7000 r.p.m., 1/100 h.p. Price \$4.50 each net.

Jaeger Watch Co. Type 44-K-2 Contactor Motor, Operates on 3 to 4.5 volts D.C. Makes one contact per second. Price \$2.00 each net.

General Electric Type 5BA10AJ52C, 27 V. D.C., 0.65 amps., 14 oz. n. torque, 145 r.p.m. Shunt Wound, 4 lead reversible. Price \$6.50 each net.

General Electric Type 5BA10AJ37C, 27 V.D.C., 0.5 amps., 8 oz., in. torque, 250 r.p.m. Shunt Wound, 4 leads reversible. Price \$6.50 each net.

General Electric Type 5BA10J18D, 27 V. 0.7 amps. 110 R.P.M. 1 oz. ft. torque. Price \$6.50 ea. net.

## D.C. ALNICO FIELD MOTORS

S. S. FD6-18, Diehl, 27 V., 10,000 r.p.m. Price \$6.50 each net.

S. S. FD6-21, Diehl, 27 V., 10,000 r.p.m. Price \$6.50 each net.

5069466 Delco 27.5 V. 10,000 R.P.M. Price \$10.00 ea. net.

706343 Delco 27.5 V. 10,000 R.P.M. Shaft 0.5 in. long. Price \$7.50 ea. net.

5068571 Delco 27.5 V. 10,000 R.P.M. with blower assembly. Price \$10.00 ea. net.

5071895 Delco 27.5 V. 250 R.P.M. Price \$10.00 ea. net.

5072400 Delco 27.5 V. 10,000 R.P.M. Shaft 0.5 in. long with worm gear. Price \$6.75 ea. net.

## GENERAL ELECTRIC D. C. SELSYNS



8TJ9-PAB Transmitter, 24 V.

Price \$3.75 each net.

8DJ11-PCY Indicator, 24 V. Dial marked  $-10^{\circ}$  to  $+65^{\circ}$ .

Price \$4.50 each net.

8DJ11-PCY Indicator, 24 V. Dial Marked 0 to  $360^{\circ}$ .

Price \$7.50 each net.

## AMPLIFIER

Pioneer Gyro Flux Gate Amplifier, Type 12076-1-A.

Price \$25.00 ea. net, with tubes.

G. E. Servo Amplifier Type 2CV2A1, 115 V. 400 cycle. Price \$10.00 ea. net.

Minneapolis Honeywell Amplifier Type G403, 115 V. 400 cycle. Price \$8.00

# INSTRUMENT ASSOCIATES

37 EAST BAYVIEW AVE., GREAT NECK, N. Y.  
Telephone Great Neck 4-1147

Write for Catalog NE100

U. S. Export License-2149



**SUPPLIER OF ELECTRONIC & AIRCRAFT EQUIPMENT****IMMEDIATE  
DELIVERY****INVERTERS**

**Wincharger Corp.** Inverter PU/16 type MG 750, Input 24 V.D.C., 60 amps. Output 115 V, 400 cycle, 1 phase, 6.5 amps. **Price \$60.00 each net.**

**Leland type 10285**, Input 28 V. D.C. at 60 amps. Output 115 V. 3 phase at 750 V.A., 26 V., 400 cycle, single phase at 50 V.A.

**Price \$100.00 each net**

**149H, Holtzer Cabot.** Input 28 V. at 44 amps. Output 26 V. at 250 V.A., 400 cycle and 115 V. at 500 V.A., 400 cycle. **Price \$50.00 each net.**

**149F, Holtzer Cabot.** Input 28 V. at 36 amps. Output 26 V. at 250 V.A., 400 cycle and 115 V. at 500 V.A., 400 cycle. **Price \$50.00 each net.**

**12117, Pioneer.** Input 12 V.D.C. Output 26 V., 400 cycle, 6 V.A.

**Price \$22.50 each net.**

**12117-2 Pioneer.** Input 24 V.D.C. Output 26 V. 400 cycle, 6 V.A.

**Price \$20.00 each net.**

**12116-2-A Pioneer.** Input 24 volts D.C., 5 amps. Output 115 volts 400 cycle single phase 45 watts.

**Price \$100.00 each net.**

**5D21NJ3A General Electric.** Input 24 V.D.C. Output 115 V., 400 cycle at 485 V.A. **Price \$25.00 each net.**

**PE 218, Ballentine.** Input 28 V.D.C. at 90 amps. Output 115 V., 400 cycle at 1.5 K.V.A. **Price \$50.00 each net.**

**ACTUATORS**

**White Rodgers Electric Co.** type 6905, number 3, 12 V., D.C., 1.3 amps., 1½ RPM, torque 75" in lbs., contains adjustable limit switches.

**Price \$10.50 each net**

**METERS**

**Weston Frequency Meter,** Model 637, 350 to 450 cycles, 115 volts.

**Price \$10.00 each net.**

**Weston Voltmeter.** Model 833, 0 to 130 volts, 400 cycle. **Price \$4.00 each net.**

**Weston Voltmeter.** Model 606, Type 204 P, 0 to 30 volts D. C.

**Price \$4.25 each net.**

**Weston Ammeter.** Model 506, Type S-61209, 20-0 100 amps. D. C.

**Price \$7.50 each net with ext. shunt.**

**Weston Ammeter.** Type F1, Dwg. No. 116465, 0 to 150 amps. D. C.

**Price \$6.00 each net.**

**With ext. shunt \$9.00 each net.**

**Westinghouse Ammeter.** Type 1090-D-120, 120-0-120 amp. D. C.

**Price \$4.50 each net.**

**Westinghouse Ammeter,** type E1, part No. 1162965, range 0-300 amps. D.C.

**Price \$7.50 each net.**

**Weston Voltammeter,** type 201-P, Mod. 606, range 0-30 volts D.C. and 0-30 amps. with shunt.

**Price \$12.50 each net.**

**CARBON PILE VOLTAGE  
REGULATOR**

**Leland Electric Co.,** type B, Philco Spec. 451-1288, input 21 to 30 Volts D.C., regulated voltage 18.25 at 5 amps. **Price \$6.50 each net.**

**RECTIFIER POWER SUPPLY**

**General Electric,** Input 230 V. 60 cycle 3 phase. Output 130 amps. at 28 V. D.C. Continuous duty, fan cooled, has adjustable input taps. G.E. model No. 6RC146F. Size: Height 46", width 28", depth 17½". **Price \$225.00 each net.** New

**PIONEER AUTOSYNS**

**AY1, 26 V., 400 cycle.**

**Price \$7.50 each net.**

**AY14D, 26 V., 400 cycle,** new with calibration curve.

**Price \$15.00 each net.**

**AY20, 26 V., 400 cycle.**

**Price \$7.50 each net.**



**AY5, 26V., 400 cycle.** Has hollow shaft.

**Price \$7.50 ea. net.**

**AY54D, 26 V., 400 cycle,** with pointer for I 81 & I 82 Indicator.

**Price \$10.50 each net**

**PRECISION AUTOSYNS**

**AY131D,** new with calibration curve.

**Price \$35.00 each net.**

**PIONEER AUTOSYN  
POSITION INDICATORS**

**Type 5907-17.** Dial graduated 0 to 360°, 26 V., 400 cycle.

**Price \$20.00 each net.**

**Type 6007-39,** Dual, Dial graduated 0 to 360°, 26 V., 400 cycle.

**Price \$30.00 each net.**

**PIONEER TORQUE UNIT**

**Type 12606-1-A.** **Price \$40.00 each net.**

**MAGNETIC AMPLIFIER  
ASSEMBLY**

**Pioneer Magnetic Amplifier Assembly** Saturable Reactor type output transformer. Designed to supply one phase of 400 cycle servo motor.

**Price \$12.50 each net.**

**PIONEER TORQUE UNIT  
AMPLIFIER**

**Type 12073-1-A,** 5 tube amplifier, Magnesyn input, 115 V., 400 cycle.

**Price \$17.50 each net with tubes.**

**BLOWER ASSEMBLY  
MX-215/APG**

**John Oster,** 28 V.D.C., 7000 r.p.m. 1/100 h.p. **Price \$5.00 each net.**

**Westinghouse** Type FL Blower, 115 V., 400 cycle, 6700 r.p.m., Airflow 17 C.F.M. **Price \$5.00 each net.**

**RATE GENERATORS**

**F16, Electric Indicator Co.,** two-phase, 22 V. per phase at 1800 r.p.m.

**Price \$12.00 each net.**

**J36A, Eastern Air Devices,** .02 V. per r.p.m. **Price \$9.00 each net.**

**B-68, Electric Indicator Co.,** Rotation Indicator, 110 V., 60 cycle, 1 phase

**Price \$14.00 each net.**

**PM-1-M Electric Indicator Co.** Same as type B35. 2 V. per 100 R.P.M. Max speed 5,000 R.P.M. Can be used as D.C. motor, 1/77 H.P. 115 V. D.C.

**Price \$14.00 ea. net.**

**SINE-COSINE GENERATORS**

(Resolvers)

**FPE 43-1, Diehl,** 115 V., 400 cycle.

**Price \$20.00 each net**

**SYNCHROS**

**IF Special Repeater,** 115 V., 400 cycle. Will operate on 60 cycle at reduced voltage.

**Price \$15.00 each net.**

**2J1F3 Selsyn Generator** 115 volts, 400 cycle. **Price \$5.50 each net.**

**2J1G1 Control Transformer,** 57.5/57.5 V., 400 cycle. **Price \$1.90 each net.**

**2J1H1 Selsyn Differential Generator,** 57.5/57.5 V., 400 cycle.

**Price \$3.25 each net.**

**W. E. KS-5950-L2,** Size 5 Generator, 115 V., 400 cycle.

**Price \$10.00 each net.**

**1G Generator** 115 V., 60 cycle.

**Price \$40.00 each net**

**5G Generator** 115 volts, 60 cycle.

**Price \$50.00 each net**

**2J1F1 Selsyn Generator,** 115 V., 400 cycle. **Price \$3.50 each net.**

**5SDG Differential Generator** 90/90 V., 400 cycle. **Price \$15.00 each net.**

**1CT Control Transformer,** 90/55 volts, 60 cycle. **Price \$40.00 each net.**

**POSITION TRANSMITTER**

**Pioneer** Type 4550-2-A Position Transmitter, 26 volts 400 cycle, gear ratio 2:1. **Price \$15.00 each net.**

**INSTRUMENT  
ASSOCIATES**

ALL PRICES,  
F. O. B.  
GREAT NECK,  
N. Y.

**37 EAST BAYVIEW AVE., GREAT NECK, N. Y.**  
**Telephone GReat Neck 4-1147**

Write for Catalog NE100

Western Union address:  
WUX Great Neck, N. Y.

**SEARCHLIGHT SECTION**

**RCA HI-VOLTAGE TRANSFORMER**

Pri—115/230V. 60Cy  
Sec—6000V—80 MA

**\$14.80**

Insulated for  
Voltage Doubler Use

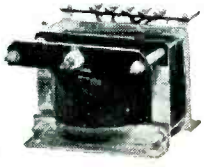

**KOLLSMAN INSTRUMENT  
LOW INERTIA SERVO MOTORS**

Type 937-0240—85/68 Volts—100 Cycles  
2 Phase—5 Watts—2650 RPM  
Will Operate Satisfactorily at 60 Cycles  
Original Price \$34.50—

**\$12.95 EACH—Our Price**

**COAXIAL CONNECTORS**

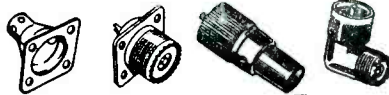

83-1AC	.42	UG-12/U	.63	UG-86/U	1.22
83-1AF	.30	UG-21/U	.67	UG-87/U	.79
83-1B	1.30	UG-22/U	.86	UG-171/U	1.33
83-1H	.10	UG-23/U	.85	UG-175/U	.15
83-1J	.80	UG-24/U	.67	UG-176/U	.15
83-1R	.40	UG-27/U	.68	UG-181A/U	7.85
83-1SP	.45	UG-29/U	.83	UG-191/AF	.63
83-1SPN	.40	UG-30/U	1.60	MX-195/U	.41
83-1T	1.12	UG-34/U	12.80	UG-197/U	1.33
83-22AP	1.10	UG-37/U	12.80	UG-255/U	1.22
83-22R	.48	UG-58/U	.63	UG-264/U	1.74
83-22SP	.85	UG-85/U	.88	UG-290/U	1.40

FULL LINE OF JAN APPROVED COAXIAL CONNECTORS IN STOCK

**WESTINGHOUSE  
HYPERFIL  
TRANSFORMER**

PRI-115V. 60CY 1/2 KVA  
SEC #1 - 240V - 1.56A  
SEC #2 - 240V - 1.56A  
WT. 30 LBS.

**\$14.50 EACH**



**GENERATORS**

• Eclipse-Pioneer type 716-3A (Navy Model NEA-3A)  
Output—AC 115V 10.4A 800 to 1400 cy. 1 φ; DC 30  
Volts 60 Amps. Brand New—Original Packing \$38.50  
• Eclipse-Pioneer type 1235-1A. Output—30 Volts  
DC 15 Amps. Brand New—Original Packing...\$9.50

**STANDARD  
BRANDS ONLY**

**TUBE SPECIALS**

**BRAND NEW  
FIRST QUALITY**

**COMPLETE STOCK OF RECEIVING, TRANSMITTING, CATHODE RAY, THYRATRON,  
IGNITRON, MAGNETRON, KLYSTRON, PHOTOCCELL, T-R & ATR TUBES.  
QUOTATIONS UPON REQUEST**

**PULSE TRANSFORMERS**

UTAH 9262 and 9340 (X124T-2)	\$3.75
UTAH 9278	2.75
G. E. 68G-627	8.95
AN/APN-9 (901756-501)	1.50
AN/APN-9 (901756-502)	1.50
AN/APN-4 Block Osc	1.25
Philco 352-7149—Modulator to 50 ohm line. 115 KW peak power	17.95
Philco 352-7150—50 ohm line to magnetron. 115 KW peak power	17.95

**SPRAGUE PULSE NETWORKS**

7.5 E3-1-200-67P 7.5 KV, "E" Circuit 1 microsec. 200 PPS. 67 ohms Imped. 3 sections	\$4.30
7.5 E3-3-200-67P 7.5 KV, "E" Circuit 3 microsec. 200 PPS. 67 ohms Imped. 3 sections	\$6.75
7.5 E4-16-60-67P 7.5 KV, "E" Circuit 4 sections, 15 microsec. 60 PPS. 67 ohms Imped.	\$8.25
15—E4-1.5-600-50P 15 KV "E" Circuit 1.5 micro- sec. 600 PPS. 50 ohms Imped. 4 sections	\$12.00

**MISCELLANEOUS EQUIPMENT**

ID-6/APN-4 Indicator	\$29.50
R-7/APS-2 Receiver	49.50
R-7/APS-15 Receiver	49.50
SCR-522 Transceiver	36.95
RT-7/APN-1 Transceiver—less tubes	6.95
FL-8 1020 cycle filter	1.37
RM-29 remote control unit	8.95
RM-14 remote control unit	8.95
RTA-1B 12/24 V dynamotor	40.00
BC-1206-CM2 Receiver	7.95
CY-230/MPG-1 Radar Console	575.00
G. E. Type JB-1 portable current transformer	32.50
ASB-4 Radar equip. Complete	69.75
AN/APS-13 less tubes	12.95
T-9/APQ-2 less tubes	16.50
BC-645A complete	18.95
RCA AVR-15 Beacon Recvr.	15.50
TBY Trans-Recvr	29.95
T-47/ART-13 Transmitter	165.00
T-47A/ART-13 Transmitter	165.00
G. E. 2CV2A1 Servo Amplifier	6.95
Sperry A-3 Hydraulic Servos	3.95
EIMAC 35 TG Ionization Gauge	5.95
CP-11/APS-15 Range Unit less tubes	32.50
ATR Inverters 6VDC to 110 VAC 60 cy 75W—Orig. Cartons	19.95
Pioneer Type 800-1B inverters—28VDC to 120V 800 cy 7 amp AC (used)	22.65
G. E. Inverter—28VDC to 120VAC 800 cy 750VA 1 φ (new)	39.50

**SOUND POWERED TELEPHONES**

• U. S. INSTRUMENT Type A-260  
• WESTERN ELECTRIC Type D-173013  
• AUTOMATIC ELECTRIC Type GL-832BAO  
U. S. NAVY TYPE M HEAD AND CHEST SETS  
These are high quality heavy-duty units not to be  
confused with cheaper units now available. Designed  
to withstand exacting shock, vibration, salt water  
corrosion, temperature and pressure tests. ANY  
TYPE \$14.88 ea., \$28.00 per pair.  
TS-10 HANDSETS \$8.92 each

**METERS**

500 Microamps, DC—2 1/2" round—Sun	\$4.30
1 ma, DC 3 1/2" R. (4 KV scale)—Roller Smith	4.17
1 ma, DC Fan type—4" scale (rem. from equip)	3.95
500 ma, DC 2 1/2" R.—General Electric	2.95
3 amp, RF 3 1/2" R.—Weston	4.95
2 amp, RF 2 1/2" Sq.—Simpson	3.15
5 amp, AC 4 1/2" R.—JBT	4.11
1 ma, DC 4 1/2" Sq.—Marion	6.95
50 VAC 3 1/2" R.—General Electric	2.95
58-62 Cycles (115 V.) 3 1/2" R.—JBT	6.45
10 amp, RF 3 1/2" R.—Simpson	4.95
50 amp AC 3 1/2" R.—General Electric	4.11

**MAGNETRONS**

2J21A	\$8.95	2J39	24.50	700C	16.90
2J22	8.95	2J40	24.50	700D	16.90
2J26	7.80	2J41	132.50	706AY	45.00
2J27	13.70	2J45	14.95	706BY	45.00
2J31	9.60	2J49	39.50	706CY	17.95
2J32	14.45	2J61	36.20	706FY	45.00
2J33	19.90	4J50	197.00	706GY	45.00
2J34	19.90	4J52	197.00	714AY	6.95
2J36	85.00	5J23	14.20	720B/C/D/Y	75.00
2J37	13.70	5J29	14.20	725A	8.95
2J38	12.70	700B	16.90	730A	16.95

**KLYSTRONS**

2K23	\$23.95	2K33	295.00	707B	12.95
2K25	23.50	2K54	135.00	723A	6.95
2K26	75.00	2K55	135.00	723A/B	12.95
2K28	27.50	417A	10.65	726A	14.50
2K29	29.95	707A	6.95	726B	29.50
				5611	135.00

**TYPE "J" POTENTIOMETERS  
\$1.00 each**

Resis.	Shaft	Resis.	Shaft	Resis.	Shaft	
100	SS" 10K	SS	50K	SS	SS	
200	SS" 15K	1/2"	100K	5/16"	SS	
500	1/2" 15K	SS	100K	3/8"	SS	
650	SS" 20K	SS	100K	7/16"	SS	
6500	SS" 25K	1/2"	100K	SS"	SS	
	10K	3/4"	SS	150K	SS	
	10K	3/4"	30K	1 1/2"	1 MEG	SS

Dual "JJ" Potentiometers—\$1.60 each  
50-50 Ω SS 100-100 Ω SS 250-250 Ω SS  
Triple 100K "JJJ" Potentiometers—3/8" shaft, \$1.95  
All shaft lengths beyond bushing—SS (screw slot)

**TEST EQUIPMENT**

- A. W. Barber Labs. VM-25 VTVM \$86.00
  - TS-10A/APN Def Line Test Set \$25.00
  - TS-19/APQ-5 Calibrator \$75.00
  - AT-48/UP "X" Band Horn \$4.95
  - REL W-1158 Frequency Meter 160-220 MC. \$32.95
  - CWI-60AAG Range Calibrator for ASB, ASE, ASV  
and ASVC Radars \$39.95
  - CRV-14AAS Phantom Antenna for Transmitters  
up to 400 MC. \$11.75
  - TS-146/AP X-Band Test Set \$595.00
  - TS-184/AP \$60.00
  - CPR-60AAJ and CPR-60AAK—IFF Test Sets,  
(pair) \$16.95
  - AN/APA-23 Recorder \$95.00
  - TN-1B/APR-1 Tuning Unit \$95.00
  - C-D Quietone Filter Type IF-16 110/220 V AC/DC  
20 Amps \$9.00
  - TS-127/U Freq. Meter w/spares \$89.50
  - TS-143/CPN Oscilloscope \$95.00
  - Dumort 175A Oscilloscope \$225.00
  - Telrad 18 A Frequency Std. \$29.50
  - LM-20 Frequency Meter \$49.50
  - Gen. Radio 757-P1 Power Supply \$27.00
  - Gen. Radio 670-F Octade \$38.00
  - I-130 A Signal Generator \$70.00
  - TS-6/AP Frequency Meter \$42.00
  - L & N KS-9470 Null Volt Test Set \$60.00
  - Measurements 79B Pulse Generator \$200.00
  - MIT TTX-10RH 3 cm FM Test Set \$325.00
- All Items New Except Where Noted \* (Exc. Used Condition)

**SYNCHROS**

General Electric 2J1G1	ea. \$1.65
Caps for connecting to above	ea. .50
G. E. 2J1F1 Generators	ea. 2.85
C-7824S Transmitters—110V 60 cy.	ea. 5.25
C-78411 Transmitters—50V 50 cy.	ea. 4.90
C-78249 Differentials—110V 60 cy.	ea. 2.95
C-78410 Repeaters—110V 60 cy.	ea. 6.75
C-78415 Repeaters—110V 60 cy.	ea. 6.75
C-69406-1 Repeaters—110V 60 cy.	ea. 12.00

Many additional types in stock including:  
Types B, M, N, X, FJE 43-1  
Sizes 5CT, 5D, 5DG, 5F, 5G, 5SF, 6G, 70G

**CONSTANT VOLT. TRANSFORMERS**

Federal Constant Voltage Transformer Input 95-135V  
60cy Output 115V 210W \$34.00  
Sola Constant Voltage Transformer Input 95-125V  
60cy-Output 15.8V 285VA \$24.70  
Sola Constant Voltage Transformer Input 105-125V  
60cy-Output 115V 80VA \$15.95

**SELENIUM RECTIFIER STACKS  
FULL WAVE BRIDGE**

MAXIMUM RATINGS		MAXIMUM RATINGS	
AC VOLTS INPUT - 18	DC VOLTS OUT - 14.5	AC VOLTS INPUT - 40	DC VOLTS OUT - 34
1.2 Amps	\$2.90	0.6 Amps	\$3.30
2.4	3.38	1.2	3.78
6.4	4.50	3.2	5.66
13.0	8.44	6.0	10.25
17.5	9.56	9.0	11.05
26	16.86	12	20.50
39	25.30	18	22.13
52	33.74	24	39.56
65	42.26	36	45.36

**W. E. MERCURY CONTACT RELAYS**

Glass sealed mercury wetted SPDT contact assemblies.  
Magnetically operated. Used in Western Electric  
D-168479 high speed plug in relays. Supply your  
own coil \$2.00 each

**PIONEER SERVO SYSTEM UNITS**

• Type 12073-1A Torque Amplifier, Input 115 V  
400 cy. Complete with Tubes \$16.95  
• Magnetic Amplifier Assy. Saturable Reactor Type  
to supply one phase of 400 cycle Servo Motor \$7.95

**OIL FILLED CONDENSERS**

MFD	VDC	Price	MFD	VDC	Price
2	600	\$ .45	2	2000	\$2.70
4	600	1.95	4	2000	3.95
4	600 R'd	1.95	1	2500	.49
8	600 (R'd)	1.39	1-1	2500	3.85
10	600	1.95	32	2500	15.80
10	600 (R'd)	1.52	1	5000	4.88
8-8	600	1.49	.01-.03	6000	1.65
1	1000	.62	1	7000	1.79
2	1000	.89	2	12500	28.95
3.5-.5	1000	1.39	.045	16K	4.70
1	1500	.89	.05	16K	4.95
4	1500	2.95	.075	16K	8.95
-.1-.5	2000	.87	50	220VAC	3.95
-.5	2000	.95	60	330VAC	5.75
1	2000	1.50	7	600VAC	3.35

**ANTENNAS**

AT-38A/APT (70 to 400MC)	\$13.70
AT-49/APR-4 (300 to 3300MC)	13.70
AT-48/UP 3 cm horn antenna	4.95
DZ-2 Loop antenna with pedestal	14.50
AN-74B (125 to 150MC)	1.65
AN-65A (P/O SCR-521)	.95
AN-66A (P/O SCR-521)	1.15
A1A—3CM conical scan	125.00
ASB Yagi—5 element 450 to 560MC	7.00
ASB Yagi—Double stacked 6 element	12.70
ASA Yagi—Double stacked 370 to 430MC	29.40

**COMPONENT SPECIALS**

FUSES	4AG	10 Amp.	\$3.00/c
	4AG	20 Amp.	\$3.00/c

**MOLDED PAPER CONDENSERS—**

.02 MFD	200 VDC	\$4.50 per 100
.05	200	4.50
.1	200	5.00
.1	400	9.00
.005	600	4.50
.01	600	8.00
.05	600	9.00

**CRYSTAL DIODES—**

IN21	1.19	IN23	1.49	IN45	.94
IN21A	1.59	IN23A	2.55	IN52	1.05
IN21B	3.25	IN27	1.79	IN63	1.39
IN22	1.09	IN34	.79		

PHASE SHIFT CAPACITOR—Type D—150734—  
4 stator single rotor \$3.30

All material brand new and fully guaranteed.  
Terms 20% cash with order, balance C. O. D.  
unless rated. All prices F.O.B. our warehouse,  
Phila., Penna., subject to change without notice.

**ELECTRONIC RESEARCH LABORATORIES**  
1021-A CALLOWHILL ST. PHILA. 23, PA.  
Telephones - MARKET 7-6590 and 6591



- TRANSMITTING
- RECEIVING
- INDUSTRIAL
- SPECIAL PURPOSE

# TUBES

*Guaranteed  
by*  
**WELLS**

Many Types Are Now Scarce At These Low Prices. Check your requirements at once for your own protection. All tubes are standard brand, new in original cartons, and guaranteed by Wells. Order directly from this ad or through your local Parts Jobber.

**Wide Selection of Electronic Components at WELLS—Tubes • Resistors  
Condensers • Wire and Cable Volume Controls • Co-ax Connectors •  
Relays • Rectifiers • Transformers • Chokes • Micro Switches • Toggles  
• Antennas • Accessories • Electronic Assemblies • Dial Light Assemblies**

TYPE	PRICE EACH	TYPE	PRICE EACH	TYPE	PRICE EACH	TYPE	PRICE EACH	TYPE	PRICE EACH
IASGT	.85	4B27/CE201A	2.40	REL-21	2.10	274B	2.65	826	.75
IB1	1.00	4B28/CE225	2.40	21-2 Ballast	.45	282B	7.95	830B	3.00
IB4P	1.90	4B35/CE212B	7.65	CE-22 D/924	1.20	287A/722A	9.50	832	6.50
IB22	2.90	5AP1	3.75	CE-23 D/923	1.10	293A	2.85	834	5.75
IB27	7.75	EL-C5B	4.25	23D4 Ballast	.45	304TH	12.95	835/38111A	1.00
IB32/532A	1.85	5BP1	2.95	HK24/3C34		307A	6.85	836	1.45
IB42	6.75	5BP4	3.95	24G/3C24	.45	CE-309	3.90	837	1.35
IB48	9.90	5CP1	2.45	CE-25 D/927	1.25	316A	.85	838	2.30
EL-C1A/	3.95	5D21	18.80	25T/3C34		327A	2.50	841	.40
CE-1C/918	1.45	5FP7	1.75	30 VT-67	.40	331A	12.85	843	.35
CE-1D/918	4.85	5GP1	2.95	CE-30-C/930	1.20	WL-332 (X-Ray)	90.00	849	29.45
ID8	1.75	5H-4 Ballast	.45	33	1.00	356B	4.95	851	39.00
IE7GT	1.45	B-5H Ballast	.45	34	.90	368AS/703A	3.75	860	6.90
IG6GT	1.30	5HP4	4.75	RK-34/2C34	.40	371A	.59	864	.35
IH4G	.80	5J29	12.85	35/51	.90	371B	.59	865	1.40
IJ6G	1.20	5MP1	3.75	36	.90	388A	1.80	866A	19.75
ILH4	1.25	6-A Ballast	.35	37	.75	417A	8.90	868B	26.35
IN21 (Xtal Diode)	1.20	6-7 Ballast	.35	38	.75	446A	1.15	872A	2.45
IN21A	1.40	6A3	1.60	39/44	.75	GL-451	1.90	876	.35
IN22	1.40	6A6	1.21	41	.75	GL-471A	2.75	878	1.65
IN23	1.30	6AF6G	1.30	45 Spec. 7 Volt Fil.	.30	507AX	9.90	879/2X2	.65
IN23A	2.25	6B7	1.50	46	.90	527	12.85	884	1.50
IN27	3.25	6B8	1.30	EF-50	.65	WL-530	12.20	918/CE-1C	1.45
IN29	3.25	6B8G	1.20	56	.75	WL-531	1.75	920/CE21D	2.40
IQ5GT	1.25	6C8G	1.30	59	1.75	WL-532	1.85	923/CE23D	1.10
IR4/1294	.95	6G12 Ballast	.45	RK-60/1641	.80	532A	1.85	927/CE25D	1.25
IT4	1.40	6H16 Ballast	.45	VT-62 British	1.00	559	2.10	930/CE30C	1.20
2B7	1.20	6J5	1.30	VR-65 British	1.00	KU-610	6.90	931A	3.95
2B22/GL-559	.70	6J8G	1.45	CEQ-72	1.45	HY615	.35	954	.30
2C21	.75	6K7G	1.30	CFP-72	.95	WL-632A	8.75	955	.45
2C22/7193	.55	6R7G	1.20	CYN-72	1.62	700E	17.95	957	.35
2C26	.28	6R7GT	1.10	RKR-72	.90	700C	17.95	958A	.50
2C26A	.30	6R7GT	1.20	RKR-73	1.23	700D	17.95	991/NE-10	.24
2C34/RK34	.40	6U7G	.85	77	.80	701A	2.90	1005	.30
2C40	5.25	7-7 I Ballast	.35	VR-78 British	.85	702A	2.60	CK1089	3.90
2C44	1.25	7A4	.85	FG-81-A	3.95	703A	2.35	CK1090	2.65
2I21	7.95	7B8	.80	83V	1.20	704A	1.00	1148	.35
2I21A	7.95	7C4/1203A	.35	89	.30	705A	.85	1201	.45
2I32	12.85	7E6	.75	89Y	.35	706AY	17.50	1203A	.65
2I33	18.75	7F7	1.10	VR-92	.65	706CY	16.90	1291	.25
2I34	17.50	7H7	1.80	100F1	1.50	707A	12.95	1294	.95
2I36	95.00	7I7	1.33	100T1	11.50	707B	14.75	1295	.30
2I37	12.75	7N7	1.50	101/837	1.35	708A	3.45	1298A	.60
2I38	9.85	7Y4	.80	FG-104	14.95	709A	3.95	1616	.70
2V3G	.80	9-3 Ballast	.35	FG-105	9.75	710A	.80	1619	.35
2X2/670	.65	10 Acorn	.55	VU-111S	.45	713A	.75	1624	.95
3-16 Ballast	.45	REL-10	.35	114B	1.20	714AY	3.25	1625	.35
3A4	.35	10 Spec. VT-25-A	.53	VT-127 British	.35	715A	6.25	1626	.35
3B7/1291	.25	10T1 Ballast	.50	VT-127A	2.95	715B	6.55	1629	.35
3B22	1.95	10Y (VT-25)	.45	VR-150	.95	715C	20.50	1630	2.25
3BP1	3.45	12AN7GT	1.25	V.T.-158	14.95	717A	.90	1638	.60
3C21	4.85	12C8	1.25	FG-172	19.25	721A	2.20	1641	.80
3C24/24G	4.45	12F5GT	.75	CE-201A/4B27	2.40	722A	9.50	1642	.55
3CP1-S1	1.95	12J7GT	.82	205B	1.35	724A	3.85	1910	.75
3D6/1299	.30	12K8	.80	211	.40	724B	2.50	2051	.75
3D21A	1.65	12K8Y	.85	215A	.19	725A	6.45	7193	.55
3DP1	3.75	12SF7	.70	CE-221	7.85	726A	4.50	8011	1.95
3FP7	1.95	18X625 (2 Amp Tungar)	1.45	221A	1.75	730A	8.50	8012	2.25
3FP7A	2.25	13-4 Ballast	.35	CE-224	3.25	801	.40	8013	1.25
3GP1	4.95	R-15-A/CE235 (15 Amp Argon Rectifier)	6.00	CE-225	2.40	801A	.65	8020	1.50
3H-1-7 Ballast	.45	15R	.55	CE-226	1.90	804	6.20	8025	3.65
3HP7	2.80	FG-17/CE-309	3.90	231D	1.20	805	5.75	9003	.95
3Q4	1.25	19	1.20	RX-233A	1.95	808	1.65	9004	.50
4B24/CE224	3.25	20-4 Ballast	.45	CE-235	6.00	814	2.20	9006	.80
4B25/CE221	7.85	CE-20D/927	1.25	258A	2.95	815	2.20	3811A/835	1.00
4B26/CE226	1.90	CE-21-D/920	2.40	274A	5.40				

Many Other Types in Stock. Send Us Your Requirements. Order From Your Parts Jobber or Directly From Wells.

**WRITE FOR NEW  
WELLS CATALOG**

World's Largest Display of Radio and Electronic Components. 9000 Square Feet of Display All on One Floor.



**320 N. LA SALLE ST. DEPT. SL, CHICAGO 10, ILL.**

1000 KC crystal BT cut.....	\$3.95
3" scope shield.....	1.29
2 speed dial drive for 1/2 shaft ratios 5:1 1 to 1.....	.39
ATC 100 mmid air trimmer screwdriver shaft.....	.29
Sigma Sens Relay w/100 ohms.....	1.98
Centralab 850 S 50AMP 5KV BUTON COND.....	.39
500 watt 12.5 ohm power rheostat.....	3.49



50 mmfd 5 KV vacuum condenser.....	\$1.49
6v. 12v vibrators any type.....	.98
Rotary switch Mycalex, 2 deck SP3T.....	.39
1 mfd 5000u oil condenser.....	2.98
2 mfd 3000u oil condenser.....	3.25
3 mfd 4000u oil condenser.....	3.95
24 mfd 1500v DC 3KV flash. Excellent for speed lamp.....	3.95

**TUBES!! BRAND NEW! STANDARD BRANDS! NO SECONDS! COMPARE! TUBES!!**

0A3/VR75	\$1.29	3C23	\$ 9.95	204A	\$69.50
0B3/VR00	2.29	3C24/21G	2.25	211A	6.69
0C3/VR105	1.49	3C30	2.95	212E	49.50
0D3/VR150	1.29	3C31/CIH	3.49	215A	1.19
1B23	3.45	3C32	1.75	217C	8.95
1B23	12.50	3CP1	2.25	227A/5C27	5.95
1124	6.95	3CP1-S1	2.95	240C	3.95
1126	3.45	3CP1-S2	2.95	240D	12.95
1127	24.50	3DD1A	6.95	250TH	21.50
1129	2.75	3DP1-S2A	8.95	250TT	21.50
1132	8.95	3D21A	1.95	271A	5.59
1134	2.45	3E25	14.95	274B	2.65
1138	32.50	3EP1	5.95	276A	9.95
1N21 Xtal	1.25	3FP7	3.95	293A	2.95
1N21A Xtal	1.35	412A	4.75	304TH	27.50
1N21B Xtal	3.25	3H1P7	3.95	304T	27.50
1N22 Xtal	1.35	412A	4.75	304TH	27.50
1N22A Xtal	3.25	412A	4.75	304T	27.50
1N23A Xtal	3.25	412A	4.75	304T	27.50
1N23B Xtal	3.25	412A	4.75	304T	27.50
1N23C Xtal	3.25	412A	4.75	304T	27.50
1N23D Xtal	3.25	412A	4.75	304T	27.50
1N23E Xtal	3.25	412A	4.75	304T	27.50
1N23F Xtal	3.25	412A	4.75	304T	27.50
1N23G Xtal	3.25	412A	4.75	304T	27.50
1N23H Xtal	3.25	412A	4.75	304T	27.50
1N23I Xtal	3.25	412A	4.75	304T	27.50
1N23J Xtal	3.25	412A	4.75	304T	27.50
1N23K Xtal	3.25	412A	4.75	304T	27.50
1N23L Xtal	3.25	412A	4.75	304T	27.50
1N23M Xtal	3.25	412A	4.75	304T	27.50
1N23N Xtal	3.25	412A	4.75	304T	27.50
1N23O Xtal	3.25	412A	4.75	304T	27.50
1N23P Xtal	3.25	412A	4.75	304T	27.50
1N23Q Xtal	3.25	412A	4.75	304T	27.50
1N23R Xtal	3.25	412A	4.75	304T	27.50
1N23S Xtal	3.25	412A	4.75	304T	27.50
1N23T Xtal	3.25	412A	4.75	304T	27.50
1N23U Xtal	3.25	412A	4.75	304T	27.50
1N23V Xtal	3.25	412A	4.75	304T	27.50
1N23W Xtal	3.25	412A	4.75	304T	27.50
1N23X Xtal	3.25	412A	4.75	304T	27.50
1N23Y Xtal	3.25	412A	4.75	304T	27.50
1N23Z Xtal	3.25	412A	4.75	304T	27.50
1N24 Xtal	3.25	412A	4.75	304T	27.50
1N24A Xtal	3.25	412A	4.75	304T	27.50
1N24B Xtal	3.25	412A	4.75	304T	27.50
1N24C Xtal	3.25	412A	4.75	304T	27.50
1N24D Xtal	3.25	412A	4.75	304T	27.50
1N24E Xtal	3.25	412A	4.75	304T	27.50
1N24F Xtal	3.25	412A	4.75	304T	27.50
1N24G Xtal	3.25	412A	4.75	304T	27.50
1N24H Xtal	3.25	412A	4.75	304T	27.50
1N24I Xtal	3.25	412A	4.75	304T	27.50
1N24J Xtal	3.25	412A	4.75	304T	27.50
1N24K Xtal	3.25	412A	4.75	304T	27.50
1N24L Xtal	3.25	412A	4.75	304T	27.50
1N24M Xtal	3.25	412A	4.75	304T	27.50
1N24N Xtal	3.25	412A	4.75	304T	27.50
1N24O Xtal	3.25	412A	4.75	304T	27.50
1N24P Xtal	3.25	412A	4.75	304T	27.50
1N24Q Xtal	3.25	412A	4.75	304T	27.50
1N24R Xtal	3.25	412A	4.75	304T	27.50
1N24S Xtal	3.25	412A	4.75	304T	27.50
1N24T Xtal	3.25	412A	4.75	304T	27.50
1N24U Xtal	3.25	412A	4.75	304T	27.50
1N24V Xtal	3.25	412A	4.75	304T	27.50
1N24W Xtal	3.25	412A	4.75	304T	27.50
1N24X Xtal	3.25	412A	4.75	304T	27.50
1N24Y Xtal	3.25	412A	4.75	304T	27.50
1N24Z Xtal	3.25	412A	4.75	304T	27.50
1N25 Xtal	3.25	412A	4.75	304T	27.50
1N25A Xtal	3.25	412A	4.75	304T	27.50
1N25B Xtal	3.25	412A	4.75	304T	27.50
1N25C Xtal	3.25	412A	4.75	304T	27.50
1N25D Xtal	3.25	412A	4.75	304T	27.50
1N25E Xtal	3.25	412A	4.75	304T	27.50
1N25F Xtal	3.25	412A	4.75	304T	27.50
1N25G Xtal	3.25	412A	4.75	304T	27.50
1N25H Xtal	3.25	412A	4.75	304T	27.50
1N25I Xtal	3.25	412A	4.75	304T	27.50
1N25J Xtal	3.25	412A	4.75	304T	27.50
1N25K Xtal	3.25	412A	4.75	304T	27.50
1N25L Xtal	3.25	412A	4.75	304T	27.50
1N25M Xtal	3.25	412A	4.75	304T	27.50
1N25N Xtal	3.25	412A	4.75	304T	27.50
1N25O Xtal	3.25	412A	4.75	304T	27.50
1N25P Xtal	3.25	412A	4.75	304T	27.50
1N25Q Xtal	3.25	412A	4.75	304T	27.50
1N25R Xtal	3.25	412A	4.75	304T	27.50
1N25S Xtal	3.25	412A	4.75	304T	27.50
1N25T Xtal	3.25	412A	4.75	304T	27.50
1N25U Xtal	3.25	412A	4.75	304T	27.50
1N25V Xtal	3.25	412A	4.75	304T	27.50
1N25W Xtal	3.25	412A	4.75	304T	27.50
1N25X Xtal	3.25	412A	4.75	304T	27.50
1N25Y Xtal	3.25	412A	4.75	304T	27.50
1N25Z Xtal	3.25	412A	4.75	304T	27.50
1N26 Xtal	3.25	412A	4.75	304T	27.50
1N26A Xtal	3.25	412A	4.75	304T	27.50
1N26B Xtal	3.25	412A	4.75	304T	27.50
1N26C Xtal	3.25	412A	4.75	304T	27.50
1N26D Xtal	3.25	412A	4.75	304T	27.50
1N26E Xtal	3.25	412A	4.75	304T	27.50
1N26F Xtal	3.25	412A	4.75	304T	27.50
1N26G Xtal	3.25	412A	4.75	304T	27.50
1N26H Xtal	3.25	412A	4.75	304T	27.50
1N26I Xtal	3.25	412A	4.75	304T	27.50
1N26J Xtal	3.25	412A	4.75	304T	27.50
1N26K Xtal	3.25	412A	4.75	304T	27.50
1N26L Xtal	3.25	412A	4.75	304T	27.50
1N26M Xtal	3.25	412A	4.75	304T	27.50
1N26N Xtal	3.25	412A	4.75	304T	27.50
1N26O Xtal	3.25	412A	4.75	304T	27.50
1N26P Xtal	3.25	412A	4.75	304T	27.50
1N26Q Xtal	3.25	412A	4.75	304T	27.50
1N26R Xtal	3.25	412A	4.75	304T	27.50
1N26S Xtal	3.25	412A	4.75	304T	27.50
1N26T Xtal	3.25	412A	4.75	304T	27.50
1N26U Xtal	3.25	412A	4.75	304T	27.50
1N26V Xtal	3.25	412A	4.75	304T	27.50
1N26W Xtal	3.25	412A	4.75	304T	27.50
1N26X Xtal	3.25	412A	4.75	304T	27.50
1N26Y Xtal	3.25	412A	4.75	304T	27.50
1N26Z Xtal	3.25	412A	4.75	304T	27.50
1N27 Xtal	3.25	412A	4.75	304T	27.50
1N27A Xtal	3.25	412A	4.75	304T	27.50
1N27B Xtal	3.25	412A	4.75	304T	27.50
1N27C Xtal	3.25	412A	4.75	304T	27.50
1N27D Xtal	3.25	412A	4.75	304T	27.50
1N27E Xtal	3.25	412A	4.75	304T	27.50
1N27F Xtal	3.25	412A	4.75	304T	27.50
1N27G Xtal	3.25	412A	4.75	304T	27.50
1N27H Xtal	3.25	412A	4.75	304T	27.50
1N27I Xtal	3.25	412A	4.75	304T	27.50
1N27J Xtal	3.25	412A	4.75	304T	27.50
1N27K Xtal	3.25	412A	4.75	304T	27.50
1N27L Xtal	3.25	412A	4.75	304T	27.50
1N27M Xtal	3.25	412A	4.75	304T	27.50
1N27N Xtal	3.25	412A	4.75	304T	27.50
1N27O Xtal	3.25	412A	4.75	304T	27.50
1N27P Xtal	3.25	412A	4.75	304T	27.50
1N27Q Xtal	3.25	412A	4.75	304T	27.50
1N27R Xtal	3.25	412A	4.75	304T	27.50
1N27S Xtal	3.25	412A	4.75	304T	27.50
1N27T Xtal	3.25	412A	4.75	304T	27.50
1N27U Xtal	3.25	412A	4.75	304T	27.50
1N27V Xtal	3.25	412A	4.75	304T	27.50
1N27W Xtal	3.25	412A	4.75	304T	27.50
1N27X Xtal	3.25	412A	4.75	304T	27.50
1N27Y Xtal	3.25	412A	4.75	304T	27.50
1N27Z Xtal	3.25	412A	4.75	304T	27.50
1N28 Xtal	3.25	412A	4.75	304T	27.50
1N28A Xtal	3.25	412A	4.75	304T	27.50
1N28B Xtal	3.25	412A	4.75	304T	27.50
1N28C Xtal	3.25	412A	4.75	304T	27.50
1N28D Xtal	3.25	412A	4.75	304T	27.50
1N28E Xtal	3.25	412A	4.75	304T	27.50
1N28F Xtal	3.25	412A	4.75	304T	27.50
1N28G Xtal	3.25	412A	4.75	304T	27.50
1N28H Xtal	3.25	412A	4.75	304T	27.50
1N28I Xtal	3.25	412A	4.75	304T	27.50
1N28J Xtal	3.25	412A	4.75	304T	27.50
1N28K Xtal	3.25	412A	4.75	304T	27.50
1N28L Xtal	3.25	412A	4.75	304T	27.50
1N28M Xtal	3.25	412A	4.75	304T	27.50
1N28N Xtal	3.25	412A	4.75	304T	27.50
1N28O Xtal	3.25	412A	4.75	304T	27.50
1N28P Xtal	3.25	412A	4.75	304T	27.50
1N28Q Xtal	3.25	412A	4.75	304T	27.50
1N28R Xtal	3.25	412A	4.75	304T	27.50
1N28S Xtal	3.25	412A	4.75	304T	27.50
1N28T Xtal	3.25	412A	4.75	304T	27.50
1N28U Xtal	3.25	412A	4.75	304T	27.50
1N28V Xtal	3.25	412A	4.75	304T	27.50
1N28W Xtal	3.25	412A	4.75	304T	27.50
1N28X Xtal	3.25	412A	4.75	304T	27.50
1N28Y Xtal	3.25	412A	4.75	304T	27.50
1N28Z Xtal	3.25	412A	4.75	304T	27.50
1N29 Xtal	3.25	412A	4.75	304T	27.50
1N29A Xtal	3.25	412A	4.75	304T	27.50
1N29B Xtal	3.25	412A	4.75	304T	27.50
1N29C Xtal	3.25	412A	4.75	304T	27.50
1N29D Xtal	3.25	412A	4.75	304T	27.50
1N29E Xtal	3.25	412A	4.75	304T	27.50
1N29F Xtal	3.25	412A	4.75	3	



# Reliance Specials

## CAPACITORS

### POSTAGE STAMP MICAS

MMF	MMF	MMF	MMF	MMF	MFD	MFD
8.2	43	100	250	580	.0013	.0051
10	47	110	300	600	.00136	.006
15	50	120	330	620	.0015	.0062
20	51	125	350	680	.001625	.0065
22	56	130	370	750	.002	.0068
24	60	150	390	800	.0025	.007
25	62	160	400	820	.0025	.0075
26	75	175	430	910	.0027	.008
30	82	180	470	MFD	.003	.0082
35	85	200	500	.001	.0033	.01
39	90	220	510	.0011	.0037	
40		240	560	.0012	.005	

### Price Schedule

8.2 MMF to .001 MFD	5¢
0011 MFD to .002 MFD	7¢
0025 MFD to .0082 MFD	12¢
01 MFD	22¢

### SILVER MICAS

MMF	MMF	MMF	MMF	MMF	MFD	MFD
10	51	120	270	470	815	.00282
18	60	125	325	488	820	.002826
22	62	130	330	500	875	.003
23	66	150	360	510	MFD	.0033
24	68	160	370	525	MFD	.0033
30	75	200	390	560	.001625	.005
39	82	208	400	660	.0022	.0051
40	100	225	410	700	.0023	.0056
50	110	240	430	750	.0024	.006
	115	260	466		.0028	.0082

### Price Schedule

10MMF to .001625MFD	10¢
.0022MFD to .0024MFD	20¢
.00282MFD to .0082 MFD	50¢

### OIL FILLED

MFD	V. D. C.	Price	MFD	V. D. C.	Price
.03	20,000	\$16.75	8	1,000	\$1.95
.03	16,000	11.95	4	1,000	1.39
.375 @	16,000 and	1.6	4	1,000	.80
.75 @	8,000	5.95	2	1,000	.65
1	7,500	1.69	1	800	.39
1-1	7,000	1.69	10	600	1.95
.01	6,000	.95	8	600	1.60
.03-.03	6,000	1.25	4	600	.89
.02-.02	7,000	1.25	2	600	.45
1	6,000	5.25			
2	5,000	4.50			
2	4,000	3.95			
2	3,000	2.15			
2	3,000	1.10			
2	750 AC	.49			
8	2,000	4.50			
4	2,000	3.85			
2	2,500	1.95			
1	2,000	.95			

## AN CONNECTORS

— IMMEDIATE SERVICE —  
PHONE! WIRE! WRITE! YOUR NEEDS

### DELAY NETWORK—ALL 1400Ω

T 113—Approx. 1.2 micro sec. delay	95¢ EACH
T 114—Approx. 2.2 micro. sec. delay	
T 115—Similar to T 114 with tap brought out	

### FILAMENT TRANSFORMERS

Pri. 115 V., 60 Cyc.—Sec. 5V., 115A. 6000 volt insulation	\$9.95 each
Pri., 115V., 60 Cyc.—Secondary: { 6 V. @ 35 A. 12 V. @ 18 A. 24 V. @ 9 A.	\$6.50 EACH

### PULSE TRANSFORMERS

9262 & 9340 UTAH (X 124 T2)	
Ratio 1:1:1; hypersil core	\$3.75
D161310, 50 Kc to 4 Mc. 1 3/4" dia. x 1 7/8" high. 120 to 2350 ohms...	\$1.75
KS9800. Ratio. 1:1:1, 2:1, Freq. range 380 to 520 C.P.S.	\$3.50
D106173. W.E. Freq. resp. 10Kc to 2 Mc. ....	\$9.80
800 KVA G.E. #2731, 28,000 Volt peak output; Bifilar; one microsecond pulse width.	\$37.50
UTAH 9278	\$3.75

### SOUND POWERED HANDSET

Brand New!  
Includes 6 ft. cord. No batteries or external power source used.  
\$8.92 ea. \$17.60 pr.

CERAMICONS		500 VOLT CERAMIC CONDENSERS			
MMF	MMF	MMF	MMF	MMF	MMF
2	35	2	18	62	150
5	6	3	44	22	180
10	45	4	7	27	200
12	62	8	30	82	220
15	82	12	33	91	270
20	110	15	40	100	300
22	150	16	47	140	1000
30	200				

\$6.50 per hundred \$5.00 per hundred



Universal Joint—1/4" hole x 1/2" O.D., 1 1/2" long. Aluminum: similar to above. 60¢

### WATER TIGHT JUNCTION BOX

14 gauge steel. 17"x25"x6 1/2", hinged lid, 2 access panels. Approx. wt., 50 lb. \$3.50

## WIRE WOUND PRECISION RESISTORS

### 1% OR BETTER

1/4 WATT—30c			
6.68Ω	12.32Ω	16.37Ω	125Ω
10.48	13.02	62.54	147.5
10.84	13.52	79.81	220.4
11.25	13.99	105.8	301.8
11.74	14.98	123.8	366.6

1/2 WATT—30c			
250Ω	1.53Ω	75Ω	260Ω
354	2.04	90	270
444	11.1	97.8	298.3
502	13.15	100	400
557	18.75	125	723.1
627	46	180	2,500
76	52	210	2,850
1.01	55.1	235	3,427

1 WATT—35c			
1.01Ω	5.21Ω	270Ω	9,000Ω
2.58	10.1	3,300	18,000
3.39	10.9	7,000	65,000

1 WATT—45c			
100,000Ω	128,000Ω	320,000Ω	600,000Ω
120,000	130,000	522,000	700,000

### 1 Megohm—1 Watt 1%—65c; 5%—45c

### DIFFERENTIAL

115 V., 60 Cyc. #78249

3 3/8" dia. x 5 3/8" long  
\$3.95 ea.

Used between two #C78248's as dampener. Can be converted to 3600 RPM Motor in 10 minutes. Conversion sheet supplied. (Converted).....\$4.50

Mounting Brackets (Bakelite) for selsyns and differentials shown above.....35¢ pair

### 2J1G1 SELSYNS

BRAND NEW

400 Cycle  
Can be used on 60 cycle

**\$1.90**

3AG FUSES					
AMP	Per 100	AMP	Per 100	AMP	Per 100
1/4	\$4.00	1	\$3.00	5	\$3.00
1/2	4.00	1 1/2	3.00	10	3.00
3/4	4.00	2	3.00	15	3.00
1	4.00	3	3.00	20	3.00

4AG FUSES					
AMP	Per 100	AMP	Per 100	AMP	Per 100
1/10	\$4.00	2	\$2.00	10	\$2.50
1/4	3.50	3	2.00	15	2.50
1/2	3.50	3.2	2.00	25	2.50
1	2.00	5	2.00		

Fuse Holder—for 3AG Fuse. (Littlefuse or Buss).....25¢  
Fuse Holder—for 4AG Fuse. (Littlefuse or Buss).....18¢

### PRECISION CONTROLS

6 WATT			4 WATT		
20,000Ω	Muter 314A	\$1.70	5K	De jur	\$2.96
6,000	De jur 260	1.70	500Ω	Centralab 48-501	1.00
6,000	Muter 314A	1.70	200Ω	GR 301	1.25
5,000	Muter 314A	2.50	50	De jur 292	1.00
2,000	De jur 260	1.70	12	GR 301	1.10
			12	De jur 292	1.00
10,000Ω	De jur 271T	\$2.00	2	GR 301	1.25
10,000	Muter 471A	2.00			
5,000	De jur 271T	2.00			

### PRECISION CAPACITOR—W.E.

D-161270. 1 mfd @ 200 VDC: -40° +65°C.....\$8.50

SELENIUM RECTIFIERS	
Full Wave—200 ma., 115 V.	\$1.57
Half Wave—100 ma., 115 V.	.72

### TIME DELAY RELAY

Raytheon CPX 24166 KS 10193-60 Sec. 115 V., 60 Cycle • Adj. 50-70 Seconds • 2 1/2 second recycling time spring return Micro-switch contact, 10A • Holds ON as long as power is applied • Fully cased • ONLY \$6.50

### CHOKES

30, Henry, 80 ma.	\$1.29
6 Henry, 80 ma.	.72

### Get On Our Mailing List!

# RELIANCE MERCHANDIZING CO.

Arch St. Cor. Croskey Phila. 3, Pa. Telephone Rittenhouse 6-4927

## COAXIAL CABLES

### GUARANTEED!! NEW!!

Price per Ohms 1,000 ft		Price per Ohms 1,000 ft	
RG-6/U	76	RG-34/U	71
RG-7/U*	97.5	RG-35/U	450
RG-9/U*	51	RG-37/U	55
RG-10/U	52	RG-39/U	72.5
RG-15/U	76	RG-41/U	67.5
RG-21/U	53	RG-43/U	65
RG-22/U*	95	RG-54/U	54
RG-24/U	125	RG-55/U	53.5
RG-25/U	48	RG-57/U*	95
RG-26/U	48	RG-58/U*	53.5
RG-27/U	48	RG-59/U*	70
RG-28/U	48	RG-77/U*	48
RG-29/U*	53.5	RG-78/U	48

\*No minimum order—others 250' minimum  
Add 25% for orders less than 1,000 feet

## COAXIAL CABLE CONNECTORS

Angle Adapter	Plug	Socket	Hood
30c	45c	40c	9c
M-359	PL-259	SO-239	83-1H
83-1AP	83-1SP	83-1R	

Adapter for PL-259 A for use on small coax. \$10.00 per 100

Type	Price	Type	Price	Type	Price
83-1AC	\$0.42	UG-19/U	.73	UG-85/U	.88
83-1P	1.30	UG-21/U	.67	UG-87/U	.79
83-1J	.80	UG-22/U	1.10	UG-103/U	.48
83-1SP	4.5	UG-23/U	.85	UG-104/U	.85
83-18PN	5.00	UG-24/U	.67	UG-167/U	2.00
83-1T	1.12	UG-25/U	.60	UG-171/U	1.33
83-22AP	1.10	UG-27/U	.68	UG-175/U	.15
83-22R	.48	UG-29/U	.83	UG-176/U	.15
83-168	.15	UG-30/U	1.20	UG-197/U	1.33
83-185	.15	UG-33/U	14.80	UG-206/U	.63
UG-7/AP	2.14	UG-34/U	16.00	UG-255/U	1.22
UG-12/U	.63	UG-36/U	12.80	UG-264/U	1.74
UG-13/U	.63	UG-37/U	12.80	UG-281/U	.60
UG-18/U	.63	UG-58/U	.63		

### JONES BARRIER STRIPS

Type	Price	Type	Price	Type	Price
2-140Y	\$0.13	5-141Y	.37	2-142	.14
3-140 1/2 W	.19	7-141	.36	3-142	.21
5-140	.21	7-141 1/2 W	.49	3-142Y	.29
6-140	.25	8-141 1/2 W	.58	4-142	.26
2-141	.13	9-141W	.62	5-142 1/2 W	.46
3-141 1/2 W	.24	9-141 1/2 W	.64	11-142 1/2 W	.95
3-141W	.24	9-141Y	.64	2-150	.39
4-141W	.30	10-141Y	.71	2-150 1/2 W	.47
4-141 1/2 W	.30	13-141 1/2 W	.89	3-150	.54
5-141	.26	14-141 1/2 W	.96	4-150	.70
5-141 1/2 W	.37	17-141Y	1.17		

### Brand New—METERS—Guaranteed

0-1 Amp. RF.	2 1/2"	\$3.29
0-300 V.D.C.	2 1/2"	3.50
0-80 Amp. D.C.	2 1/2"	2.25
0-7.5 V. A. C.	3 1/2"	3.46

### VERNIER DIAL or DRUM (From BC-221)

DIAL—2 1/2" dia. 0-100 in 360°. Black with silver marks. Has thumblock. DRUM—0-50 in 180°. Black with silver marks. either, 85¢

VARIAC—General Radio. 100 watts. Removed from equipment \$10.00

CARBON MIKE—T-17, slightly used, guaranteed. Has 5 foot cord and PL68 \$8.9c

THROAT MIKE—MT 81-A—2 mikes in leather zipper case with 56" cord & PL68—Brand New \$5.9c



**RADAR ANTENNAS**

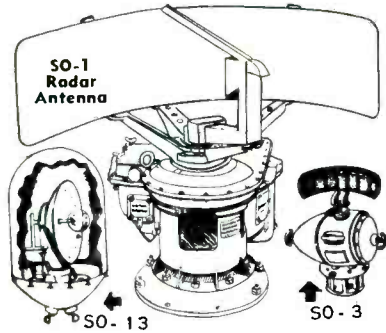

Type SO-1 (10 CM.) Complete assembly with reflector, waveguide nozzle, drive motor and synchros, etc. New in original cases. \$279.50  
 Type SO-3 (3 CM.) Surface Search type complete with reflector, drive motor, synchro, etc., but less plumbing. New in original cases. \$189.50  
 Type SO-13 (10 CM.) Complete assembly with 24" dish with feedback dipole. Complete with synchros, drive motor, gearing, etc. New in original cases. \$149.50  
 Also in stock—spare reflectors, nozzles, probes, right angle bends for SO-1 antennas.

**400 CYCLE TRANSFORMERS**

**AUTO.** 400 cy. G.E. Cat No. 80G184  
 KVA .945S—520P. Volts 460/345/230/115. New \$4.95  
**FILAMENT.** 400/2600 cy. Input: 0/75/80/85/105/115/125V. Output: 5V3A/6V3A/6V3A/5V3A/5V6A/5V6A/8.3V6A/6.35A. New \$2.95  
**THYRATRON POWER.** 400/1600 cy. Raytheon UX-8876. 400/1600 cy. Pri: 115. Sec: 50-0-50V at 0.5A, 6.3V at 1.2A. Test r.m.s. 1780. New... \$2.75  
**PLATE WECO KS9560.** 400/800 cy. Pri: 115V. Sec: 1350-0-1350 at .057A (2700 V Total). Elecstat shlded. Wt. 2.3 lbs. New... \$2.95  
**SCOPE PL. & FIL. WECO 9556.** 400/2400 cy. Pri: 115. HV. Wdg. 1125V at .008A. Fil. Wdgs. 6.4V4A/2.5V1.75A/6.4V.6A. Elecstat shlded. Wt. 1.4 lbs. New... \$2.75  
**FILAMENT.** 400/2400 cps. WECO KS9553. Pri: 115V. Sec: 8.2V1.25A/6.35V1.5A Elecstat shlded. Wt. 0.5 lbs. New... \$1.95  
**PLATE & FIL.** 400/2600 cy. Pri: 0/80/115V. Sec #1=1200VDC at 1.5MA. Sec #2=400VDC at 130MA. Fil. Secs: 6.4V4.5A/6.35V0.8A. (Ins. 1500V)/5V2A/5V2A. New... \$4.95  
**RETARD.** 400 cy. WECO KS9598. 4 Henry 100MA \$1.75

**60 CYCLE TRANSFORMERS**

**FILAMENT.** Raytheon Hypersil Core. Pri: 115V. Sec: 6.3V22A/6.3V2.4A/6.3V2.25A/6.3V0.6A Ins. for 1700V \$5.95  
**Plate.** Thordarson #T46880. 1650 VA. Pri: 105-120V 60 cy. 1 PH. Sec: 5600V. Center tapped. 7.5KV insulation. Brand new... \$49.50  
**High Reactance Trans.** G. E. type Y-3502A.—60 cy. Voltage 11200-135. Inductance H.V. Winding 135 Henries. Output Peak Voltage 22.8KV. Cat. 8318065G1. New \$89.50  
**High Voltage Trans.** Westinghouse 7,500 volt or 15000V Voltage Doubler at 35MA... \$24.50

**PULSE TRANSFORMERS**

**PULSE.** WECO KS-9563. Supplies voltage peaks of 3500V from 807 tube. Tested at 2000 Pulses/sec and 5000V peak. Wdg. 1-2=18 ohms. Wdg. 1-3=72 ohms. L of Wdg. 1-3=073-.082H at 100 cps. \$5.50  
**PULSE.** WECO KS-161310. 50 KC. to 4MC. 1 1/2" Dia. x 1 3/8" high. 120 to 2350 ohms. New... \$3.95

**SOUND POWERED BATTLE PHONES**

Western Electric No. D173312. Type O. Combination headset and chest microphone. Brand new including 20 ft. of rubber covered cable... \$17.50  
 Automatic Elec. Co. No. G1S43A0. Similar to above but including Throat microphone in addition to chest microphone. Brand new with 20 ft. rubber covered cable... \$13.50  
 U. S. Instrument Co. Navy Type M. Dr. No. A-260 ALP. 1. Complete with 20' cable and navy plug. Brand new \$17.50

**MICROWAVE RECEIVERS**

**AN/APR-1** Receivers and tuning units TN-1 (38 to 95 MC) TN-2 (76-300 MC) TN-3 (300-1000 MC)  
**AN/APR-4** Receivers and tuning units TN-16 (38-95 MC) TN-17 (76-300 MC) TN-18 (300-1000MC)  
**AN/APR-5A** Receivers. 1000 to 6000 MC Range.

**LAVOIE FREQ. METER**  
 375 to 725 MCS

Model TS-127/U is a compact, self-contained, precision ( $\pm 1$  MC) frequency meter which provides quick, accurate readings. Requires a standard 1.5V "A" and 45V "B" battery. Has 0-15 minute time switch. Contains sturdily constructed HT-"Q" resonator with average "Q" of 3000 working directly into detector tube. Uses 957, LS6 and 384 Tubes. Complete, new with inst. book, probe and spare kit of tubes. Less batteries. Write for descriptive circular. \$69.50

**PARABOLOIDS**

Spun Magnesium dishes 17 1/2" dia. 4" deep. Mounting brackets for elevation and azimuth control on rear. 1 1/2 x 1 1/8" opening in center for dipole. Brand new per pair. \$8.75

**SPEED GENERATOR CAPACITOR**

High speed ball bearings. Split stator silver plated coaxial type 5/10 mmfd. Brand new... \$2.50

**RAYTHEON VOLTAGE REGULATOR**

Adj. input taps 95-130V. 60 cy. 1 Ph Output: 115V. 60 Watts, 1/2 of 1% Reg. Wt. 20 lbs. 6 1/2" H x 8 1/4" L x 4 1/2" W. Overload protected. Sturdily constructed. Tropicalized. Special... \$14.75

**MODEL AN/APA-10 PANORAMIC ADAPTER**

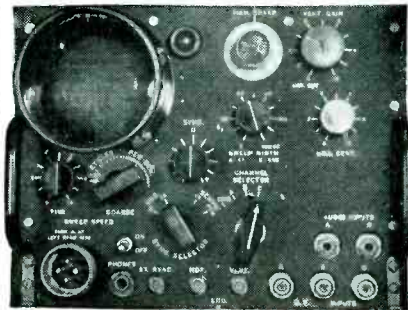

Provides 4 Types of Presentation:  
 (1) Panoramic (2) Aural  
 (3) Oscillographic (4) Oscilloscope

Designed for use with receiving equipment AN/ARR-7, AN/ARR-5, AN/APR-4, SCR-587 or any receiver with I.F. of 455kc. 5.2mc. or 30mc.  
 With 21 tubes including 3" scope tube. Converted for operation on 115 V. 60 cycle source.  
**PRICE** 245.00  
 AN/APA-10 80 Page Tech Manual... \$2.75

**G. E. SERVO AMPLIFIER**

Type 2CV1C Aircraft Amplidyne control amplifier. 115 volts—400 cycles. Dual channel. Employs 2-6SN7GT and 4-6V6GT tubes. Supplied less tubes. New \$22.50

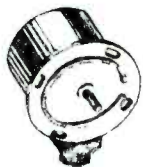

**LINEAR SAWTOOTH POTENTIOMETER**  
 W.E. KS-15138

Has continuous resistance winding to which 24 volts D.C. is fed to two fixed taps 180° apart. Two rotating brushes 180° apart take off linear sawtooth wave voltage at output. Brand New \$5.50

**HIGH VOLTAGE CAPACITORS**

.25 MFD., 20KV.....\$17.75  
 .25 MFD., 15KV..... 15.75  
 .5 MFD., 25KV..... 26.50  
 1 MFD., 7.5KV..... 7.95  
 All brand new. Made by prominent manufacturers.

**MOTOR GENERATORS DYNAMOTORS, INVERTERS, ETC.**

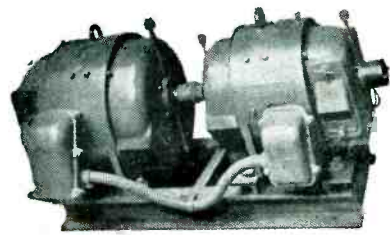

2.5 KVA MG SET. Diehl Elec. Co. 120V DC to 120V AC, 60 cy. 1 Ph. Complete with Magnetic Controller, 2 Field Rheos and Full Set of Spare Parts including Spare Armatures for Generator and Motor. Full specs. on request. New. \$285.00

2 KVA MG SET. O'Keefe and Merritt. 115V DC to 120V AC, 60 cy. Idles as 3 Ph. syncs motor on 208V, 50 cy. New. Export crated. \$165.00

1.25 KVA MG SET. Allis-Chalmers. 115V DC to 120V, AC, 60 cy. 1 Ph. Fully enclosed. Splashproof. Ball Bearings. New... \$125.00  
 Same machine but for 230V DC operation... \$125.00  
 Spare parts for either machine... \$25.00

MG Set. Onan MG-075. Navy type PU/11. Input 115/230, 60 cy. 1 Ph. Output 115, 480 cy. 1 Ph. 5.3 amps and 26V DC at 3.8 amps. New... \$198.50

MG Set. Onan MG-215H. Navy type PU/13. Inut 115/230, 60 cy. 1 Ph. Output 115, 480 cy. 1 Ph. 1200V and 26V DC at 4 amps. New... \$295.00

MG SET FOR NAVY TBS TRANSMITTER. Type CG-21302. 440V AC, 60 cy. 3 Ph. 1500 VA to 875V DC and 300V DC. New... \$69.50

DYNAMOTOR. Navy Type CAJO-211444. 105/130V-DC to 13V DC at 40A or 26V DC at 20A. Radio filtered. Complete with Line Switch. New. \$69.50

DYNAMOTOR. Elcor. 32V DC to 110V AC, 60 cy. 1 Ph. 2.04 Amps. New... \$24.50  
 Also available for 64 volts input. Same price.

DYNAMOTOR. Elcor. 32V DC to 110V AC. 60 cy. 1 Ph. 0.43 Amps. New... \$17.50

DYNAMOTOR—Type PE94C. For use with SCR522 Transmitter-Receiver. Brand new in export cases. \$9.50

AMPLIDYNE—G. E. Model 5AM31N79A. 530 Watts. 7500 R.P.M. Input: 27V DC, Output: 60V DC. Weight 3 1/2 lbs. New... \$16.50

AMPLIDYNE—G. E. Model 5AM21J7. 4600 R.P.M. Motor Compound wound. 150 Watts. Input: 27V DC. Output: 60V DC Sig. Corps. U. S. Army MG-27-B. New... \$26.50

AMPLIDYNE—Edison type 5AM31N18A. Input: 27 volts 44 Amps., 8300 RPM. Output: 60V DC at 8.8 amps. 530 Watts. New... \$22.50

INVERTER—Leland Elec. Co. Model PE206A. Input: 28V DC, 38 Amps. Output: 80V., 800 cy, 485 VA. New... \$17.50

PE 218 INVERTER—G. E. J8169172. Input: 28V DC, Output: 115V, 400 cycles at 1.5 KVA... \$50.00

D. C. MOTOR—G. E. Model 5BA 50LJ2A 0.5 HP. Armature: 27V. at 8.3 Amps. Field: 60V. at 2.3 Amps. R.P.M. 400. New... \$16.75

**Synchro Differential Generator**

Ford Inst. Co. Type 5SDG. Brand New \$22.50

**WESTERN ELECTRIC CRYSTAL UNITS**

Type CR-1A /AR

Available in quantity—following frequencies  
 5910—6350—6370—6470—6510  
 6610—6670—6690—6940—7270  
 7350—7380—7390—7480—7580  
 9720—Kilocycles  
 Brand New \$1.29 each



All prices indicated are F O B Tuckahoe, New York. Shipments will be made via Railway Express unless other instructions issued.

**ELECTRONICRAFT INC.**

- 27 MILBURN ST. BRONXVILLE 8, N. Y.

PHONE: BRONXVILLE 2-0044

All merchandise guaranteed. Immediate delivery, subject to prior sale.  
 All Prices Subject to Change Without Notice



# IMMEDIATE DELIVERY • LOW PRICES • FULLY GUARANTEED

## BROWN TELEPLOTTER RECEIVER

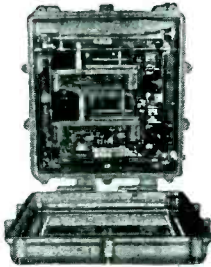

**Model 791X1R**  
115 volt 60 cycles

Contains a pen driven by two balancing motors which writes on rear of a translucent chart. Pen arm position is in terms of two coordinates supplied balancing motors thru two amplifiers. Originally intended for recording plotted or written data from central plotting board. Writes at one half scale on 18 in. chart. Discriminator input circuit designed to operate unit as function of two varying R.F. frequencies varying about mean of approx. 430 KC. Further data on request. (Shipping weight 435 lbs.)

Price \$375.00



**Aircraft Generator Eclipse NEA-3**

Output 115 VAC; 10.4 amps 800 cycles at 2400 rpm. Also 30 VDC at 6 amps. Stock #SA-306. Price \$39.50 each.

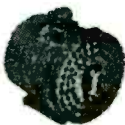

**400 Cycle Generator**

G. E. 5ASB31JJS. 400 cycles out at 115 volts 7.3 amps. Ideal for lab. 6" lg. x 6" diam. 8000 rpm. Stock #SA-292. Price \$79.50 ea.



**A-5 Autopilot Indicator**

Autosyn Type Pilot Indicator for A-5 Autopilot. 26 v. 400 cycles. Stock #SA-299. Price \$12.50 each.



**Pioneer Servo Motor**

Type 10047-2A. 2  $\phi$  400 cycle low inertia. 26 v fixed phase. 45 v. max. variable phase. Stock #SA-90. Price \$12.50 each.



**PRECISION AUTOSYN**

Pioneer Type AY-150 Control Autosyn. Precision type. 26 v. 400 cycle. Stock #SA-297. Special low price \$14.50 each.

## SYNCHROS

### Navy Types

1G, 1CT, 5G, 5CT, 5DG, 5HCT, 5SF, 5HSF, 5SDG, 6DG, 7G, etc.

Prices on Request



Prices F.O.B. Paterson  
Phone ARmory 4-3366  
WRITE FOR LISTING



**Compass Indicator**

I-82F Compass Indicator. 0-360°-5 in. dial. 26 v. 400 cy. 8-12 v. 60 cy. Ideal position indicator. Stock #SA-284. Price \$6.50 each

## SWEEP GENERATOR CAPACITOR



Hi-speed bearings. Split stator. Silver-plated coaxial type. 5-10 mmf.

Stock #SA-167

Price \$2.75 each

## ALSO IN STOCK

C-1 AUTOPILOT COMPONENTS  
A-5 AUTOPILOT GYROS  
GENERAL ELECTRIC D-C SELSYNS  
AC and DC RATE GENERATORS

## 400 CYCLE AC BLOWERS

E. A. D. J-151—115 v. 400 cy. 22 c.f.m.  
Westinghouse Type FL—115 v. 400 cy. 17 c.f.m.

## DC MOTORS

Haydon-0666, 1/2 rpm. 28 v. d-c. 100 ma.  
Delco 5089625 120 rpm. Gov. cont. 27 v.  
General Electric 5BA501J66—1/4 hp. 27 v. field. Arm. v. 60. Amplidyne controlled.  
Delco-A-7155—1/30 hp. 3600 rpm. Gov. cont.  
W. E. KS-5603-LO2—1/100 hp. 4 lead shunt.  
National Mineral—90600. 1 hp. Int. duty. Fan cooled.  
Diehl FDE-53-5—3600 rpm. Gov. cont. 1/30 hp.  
G. E. 5BA25MJ409—24 v. 7500 rpm. Cont. duty.  
Airsearch—Actuator—25800-24. 2" travel.  
Barber Colman—Actuator—YLC-2066-2. 200 in./lb. 135 degrees in 45 seconds.  
Airsearch—Actuator (Manual Flap) 25080.  
Airsearch—Actuator—(Automatic Flap) 25040.  
Holtzer Cabot—RBD-2220—1/2 hp. 27 v. 3600 rpm.  
Arma Latitude Motor — 8413-30 (Step motor)  
Elinco B-64—1/165 hp. 3100 rpm. 27 v. f. 80 v. armature. (Thyratron control)  
John Oster—A-21E-12R—Split field series reversible. 28 v. 0.4 amps. 2 watts output.  
General Electric 5PS56H018 — Split field series rev. 60 v. 1.4 A. 5500 rpm.

## AC SERVO MOTORS

Kollsman—776-01—400 cy. 2  $\phi$  drag cup type.  
Diehl FP-25-3—2  $\phi$  60 cy. 20 v. 2.5 watts out.  
Pioneer CK-2—2  $\phi$  400 cy. 1.05 in/oz. stall.  
Pioneer CK-17—2  $\phi$  400 cy.  
Minneapolis Honeywell G803AY2CA4. Built in gear reduction. 2  $\phi$  400 cy.

## AUTOSYNS (Pioneer)

B-9A—Dual Oil Pressure Indicator (6007-4F-7A)  
B-9A—Oil Pressure Transmitter, (4150-3B3)  
Pioneer Types—AY-1, AY-14, AY-54, 2320, etc.  
C-14A—Fuel Pressure Transmitter.  
Pioneer I-81A and I-82A Compass Indicators.

## Subfractional Horsepower AC Motors

Eastern Air Devices—J-72B—115 v. 400 cy. 1/50 hp. Cont. duty. 4700 rpm.  
E. A. D. J-49E—115 v. 400 cy. 1/250 hp.  
E. A. D. J-33—115 v. 3  $\phi$  400 cy. Int. duty.  
Diehl FBF-24-1—115 v. 400 cy. 1/100 hp.  
Synchro-600—110 v. 60cy. 1 rpm.  
Haydon 30228—115 v. 60 cy. 1 rpm

## MAGNESYNS

Pioneer Type CL-3, 6 power.  
Pioneer 1006-1E-B1 Indicator. AN-573u-z.

## INVERTERS



**Wincharger PU-7/AP**  
Input 28 VDC at 160 amps. Output 115 v. 400 cy. 1  $\phi$  at 2500 VA. Voltage and frequency regulated. Cont. duty. Stock #SA-164. Price \$80.50 each.



**G.E. 5AS181NJ3 (PE-118)**  
Input 28 VDC at 100 amps. Output 115 v. 400 cy. 1  $\phi$  at 1500 VA. PF 0.8 W.E. Spec. KS-5601LL. Stock #SA-286. Price \$29.50 ea.

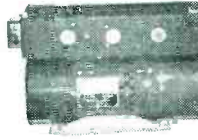

**PE-218E Inverters**  
Russell Electric and Leland. Input 28 VDC at 92 amp. Output 115 v. 400 cycles at 1500 VA. PF 0.9. Stock #SA-112A. Price \$49.50 each.

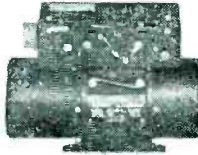

**Pioneer 12130-4-B**  
Input 28 VDC at 14 amps. Output 120 v. 400 cy. Single Phase at 1.15 amps. (140 VA.) Voltage and frequency regulated. Made 1949. Stock #SA-304. Price \$89.50 each.

## JACK AND HEINTZ STARTER

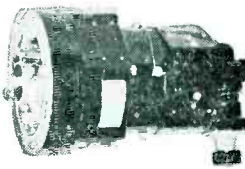

**Dwg. 6-950-E**  
Aircraft engine starter. 28 V D C. Stock #SA-305. Price \$19.50 each

## DC SERVO MOTOR



**Elinco Type B-64.**  
1/165 hp at 3100 rpm. Field volts 27.5 Max. armature voltage 80. Ideal for thyratron servo control. Stock #SA-211. Price \$12.50 each.

## MAGNETIC AMPLIFIER ASSEMBLY

Sperry #81824. Saturable reactor type output transformer. Designed to supply one phase of 400 cycle servo motor. Stock #SA-266. Price \$6.75 each

## FORD INST SERVO MOTOR



115 volt 60 cycle two phase low inertia motor. 15 watts output. BuOrd. 207927. Stock #SA-291. Price \$49.50 each.

**Servo-Tek products co.**  
4 Godwin Ave. Paterson, N. J.

SPECIALISTS IN FRACTIONAL HORSE POWER MOTOR SPEED CONTROL



# SUPERIOR VALUES FROM AMERICA'S LARGEST ELECTRICAL CONVERSION HOUSE

## HIGH FREQUENCY CONVERSION EQUIPMENT

**LELAND-MURRAY MG SET.** Motor: 5 H.P. 220/440 Volts, 3 phase, 60 Cy. directly connected to Alternator: 3 KVA. 120/208 Volts, Wye connected. 400 c.p.s. Price.....\$525.00

**HOLTZER-CABOT MG149F.** Input: 24 VDC, 36 amp. Output: 26 Volts, 400 cycles, 250 VA. Also secondary output of 115 Volts, 400 cycles, 500 VA. Completely rebuilt and guaranteed. Price.....\$345.50  
Brand New Units, Price.....\$245.50

**HOLTZER-CABOT MG153F.** Input: 28 Volts DC at 52 Amp. Output: 115 Volts, 400 cps, 3 phase, 750 r.p.m. P.P. also secondary output of 26 Volts, 400 cycles, single phase at 250 va.; voltage and frequency regulated. **REBUILT LIKE NEW.**.....\$65.00

**GE MG UNITS.** Motor: 110 Volts, D.C. 31.5 Amperes, in a single compact unit with output of 120 Volts, 20.8 Amp, single ph. 500 cycles. Like New. Price.....\$95.00

**500 CYCLE MG SETS.** British made motor generator, 8 KV, 2 bearing unit, input 180-240 VDC, output 180 volts, 1  $\phi$  weight app. 1000 lbs. Price.....\$425.00

**OUR OWN SPECIAL 400 CYCLE MG SET.** Made in our own shop employing 7 1/2 H.P. Motor V belted to Alternator with output of 4.5 KVA, 115 V, 400 cycles. Excitation supplied by selenium rectifier external to unit. With single phase motor, Price.....\$695.00  
with 3 $\phi$  Motor.....\$645.00

**ONAN 400 CYCLE MG SET.** Motor: 7 1/2 H.P. operative at 220/440 V. 3 $\phi$ , 60 cy. V belted to self-excited alternator with output of 4 KVA. 115 Volts, single ph. 400 C.P.S. Alternator is self-excited with secondary output of 14 VDC 40 Amp. With Voltage Regulator built-in. Price.....\$642.00  
With single phase Motor.....\$592.00

**ELECTRIC SPECIALTY FREQUENCY CHANGERS**  
Type DF552/DFRS254 Input: 220 Volts, 3 Ph. 60 cy. 3600 RPM. Output: 250 Volts, 20 Amp, single ph. 180 Cy. 5000 VA. 3000 Watts. Brand New. Compact ball bearing units for operation of HI-cycle equipment. **SPECIAL PRICE.**.....\$160.00

**ONAN 800 CYCLE MG UNIT.** Employing 5 H.P. Motor operative at 220/440 Volts, 3 $\phi$ , 60 Cy. V belted to self-exc. generator with output of 1.5 KVA, 115 Volts, single ph. 800 CPS, and secondary output of 500 Watts, 28.5 VDC 17.5 amperes. **PRICE.**.....\$289.00

**GENERAL ELECTRIC MG SET.** 4 Bearing unit directly coupled consisting of Motor of 5 H.P. operative at 220/440 V. 3 $\phi$ , 60 cy. Alternator: 2.5 K.V.A. 115 Volts, single ph. 420 CPS. Brand new factory built units. Price.....\$469.00

**INVERTER UNIT PE206A.** Input: 27.5 VDC. 38 amp. Output: 80 Volts, single ph. 800 CPS, 500 VA. Price.....\$19.00

**KINGSTON-CONLEY MG SETS.** Motor: 15 H.P. 220/440 V. 3 $\phi$ , 60 Cy. on which there is flange mounted aero generator with output of 120/208 Volts, 9 KVA, 3 Phase, 300 Cycles. Also available for 600 Cycle output. Blast cooled. Completely rebuilt. Either type, price.....\$799.50

**G. E. HIGH FREQUENCY MG UNITS.** Motor operative at 115 Volts, DC Generator: 2.5 KW, 24/32 Volts, 78 Amp. D.C. Alternator: 120 VAC, 20.8 amp. .9 PF, single ph. 720 cycles. All three components in a single compact housing. Price.....\$200.00

**800 CYCLE UNIT.** Operate at 440 V. 3 $\phi$ , 60 cy. directly connected to self-exc. alternator with output of 120 Volts, single phase, 6.6 amp. .8 K.W. 800 Cycles. Price.....\$119.75

**CROCKER-WHEELER 500 CYCLE MG SET.** Compact 2 bearing Unit, Operative at 120 VDC, 7.3 amps. Output: 250 Volts, 5 amp. 500 cycles. Rebuilt. Price.....\$88.88

**RX DUAL GENERATORS.** Flange mounted. Output: 500 Watts, 1300-2000 Cycles, also 12-14 VDC 750 Watts. Price.....\$25.50

**HOMELITE 400 CYCLE MG UNIT.** Consist of motor and self excited alternator mounted on common bed plate. V belted. Motor: 5 H.P. 220/440 Volts, 3 $\phi$ , 60 Cycles. Alternator: 120 Volts, 11.7 amperes, single phase, 400 cycles. Also output of 28 VDC, 14.3 amps. **PRICE.**.....\$224.00

**HOLTZER-CABOT HIGH FREQUENCY MG SETS.** Compact 2 bearing units with input of 120 VDC, 7 amps. Output: 120 Volts, 3 $\phi$  320 Cycles. Has shaft extension permitting use as dual generator. Price.....\$112.90

**WESTINGHOUSE HIGH FREQUENCY UNITS.** Operate with input of 15 VDC to deliver 17 VAC, 10.0 to 1650 cycles. An excellent value. Price.....\$25.50

**ESCO DUAL FREQUENCY UNITS.** Motor operates at 120 VDC, 10 amperes. Delivers 70 Volts at 120 Cycles or 200 Volts at 120 Cycles. Price.....\$95.00

**ESCO 500 CYCLE UNITS.** Operate at 100 VDC and deliver 110 VAC 1.38 amp. 150 VA. 500 C.P.S. Price.....\$25.00

**GE HIGH FREQUENCY MG SETS.** Motor: 250 VDC, 4 amp. Alternator: 600 watts, 125 single ph. 4.8 amp. 500 cycles. Brand new. Price.....\$90.00

**BENDIX-ECLIPSE 800 CYCLE AERO UNIT.** Input: 24-28 VDC, 75 amps. Output: 115 V, 10.5 Amp. 800 C.P.S. Complete filter system mounted thereon. Price.....\$22.50

**CROCKER-WHEELER 500 CYCLE SET.** Operate at 110 Volts, D.C. 20.8 Amps. Output: 120 Volts, single ph. 500 cycles 2.5 KW. Price.....\$146.95

**WESTINGHOUSE HIGH FREQUENCY UNITS.** Input: 115 Volts, D.C. 2.7 Amps. Output: 14.4 Volts, .130 Amp. 450-2550 Cycles. Frequency variation is obtained with built-in controller on end of unit. Price.....\$48.50

**GE DUAL OUTPUT MG SETS.** Consist of Motor rated 3 H.P. 220/440 V. 3 $\phi$ , 60 Cy. directly coupled to 2 generators. Output: 5 K.W. 220 Volts, 2.27 Amp. 525 Cycles. Also 5 K.W. 110 Volts, D.C. 4.55 Amp. 3 separate units mounted on common bed plate. Price.....\$150.00

**ESCO HIGH FREQUENCY UNITS.** Operate at 120 Volts, D.C. 25 Amp. 4 H.P. Output: 2 K.V.A. 115 Volts, 17.4 Amp. 2 K.W. Price.....\$175.00

**KINGSTON-CONLEY MOTOR GENERATOR SETS.** Employs Continental Motor rated at 15 HP. 220/440 Volts, 3 ph. 60 Cy. directly coupled to aero type self-excited alternator, rated at 9 KVA with output of 120/208 Volts, 3 cooling. An exceptionally fine unit, completely rebuilt like new. Price.....\$1120.00

**ONAN 2 BEARING MG UNITS.** Motor: 115/230 Volt, single phase, 60 cy. Generator: .6 KVA 115 Volts, 5 Amps. 480 C.P.S. Price.....\$165.00

**ESCO HV-HF UNITS.** Operative at 11.5 VDC 28 Amp. Output: 575 VDC, .25 Amp. also 55 VAC. .91 Amp. 1 $\phi$ , 500 Cycles. Price.....\$39.75

**ONAN 800 CYCLE ALTERNATORS.** Brand New. Mounted on base with guard for V Belts. Alternator is self-excited, rated at 1.5 KVA, 115 Volts, single ph. 800 Cye. 2666 RPM. Also output of 28.5 VDC 17.5 Amp. 500 Watts. Price.....\$199.00

**GENERAL ELECTRIC 400 CYCLE UNITS.** Operate at 27 VDC 40 Amp. Output: 115 VAC 1 $\phi$ , 400 CPS, 1500 V.A. With filter system built-in. Price.....\$29.50

**HOLTZER-CABOT 500 CYCLE MG SET.** Motor: 110 VDC GENERATOR: 5 KVA, 230 VAC, 1 $\phi$ , 500 Cye. Rebuilt. Price.....\$271.50

**MARCONI MG UNITS.** Operative at 110 VDC to deliver 500 VAC, 6 Amp, 3 K.W. 240 CYCLES. Extending shaft permits driving complete unit to obtain dual self-excited generator. Price.....\$99.00

**LOUIS ALLIS FREQUENCY CHANGER SETS.** We have 3 sizes in stock, all brand new. (1) Pri: 220/440-3-80; Sec: 30 K.W. 306 Volts, 2 Ph. 500 Cye. .8 P.F. Units are belted on common bed plate. Price.....\$1250.00  
(2) Pri: 25 H.P. 220/440-3-60; Sec: 15/10.8 K.W. 3300/2200 RPM, 306/220 Volts 35/35 Amps. 2 ph. 500/360 C.P.S. Price.....\$1050.00  
(3) Pri: 10 H.P. 220/440-3-80; Sec: 7.5 K.W. 440/220 V. 17/8.5 Amp. 3000/1200 RPM. 360/180 Cycles. 2 ph. Price.....\$750.00

We can supply these units for 400 cycle output and with transformers to supply 3 phase, wye output. Write for further information.

**ECLIPSE 800 CYCLE GENERATORS.** Flange mounting with spline shaft. Output is 115 VAC 10.4 Amp. .90 P.F. 800 Cycles, 1200 V.A. with secondary output of 28.5 VDC, 60 Amperes. Self excited. Price.....\$39.00

**BRITISH MADE 500 CYCLE MG SETS.** Motor: 250 Volts, 3 Ph. .50 Cycles. XX-Alternator: 5 K.W. 180 Volts, 27.8 Amp. 500 Cycles. Excitation—110 VDC. When used at 60 Cycle current. Output is 600 cycles 220 Volts. Price.....\$353.00

**WINCHARGER PU-7/AP.** Input: 28 VDC, 160 Amps. Output: 115 VAC, single ph. 2500 V.A. 400 C.P.S. Frequency and Voltage regulation built-in. Price.....\$87.00

**HOMELITE 400 CYCLE POWER PLANTS.** PU-6/TPS-1 Single cylinder engine, air-cooled governed to operate at 4000 RPM. Generator rated at 1400 Watts, 120 Volts, 400 Cycles also secondary output of 27 VDC, 400 watts. Brand new in original cases with instruction book, and complete spare parts. An exceptional unit to procure 400 cycle current or to be used as a lighting plant. Price.....\$150.00

**WESTINGHOUSE 180 CYCLE ALTERNATORS.** 750 V.A. Output: 110 Volts, 3 Phase, 180 C.P.S. 3000 R.P.M. Separately excited at 110 VDC. Price.....\$44.00  
Also available with built in exciter. Price.....\$78.00

**ELECTRIC SPECIALTY HIGH FREQUENCY CONVERTER UNITS.** Primary: 32 VDC, 16 amperes, 3000 R.P.M. Ball Bearings. Secondary: 350 volts, 1500 cycles, .75 amps, 275 V.A. Single Ph. Built in frequency control. Specially Priced at.....\$30.00

**GENERAL ELECTRIC HIGH FREQUENCY UNIT.** Operative at 440-3-60, 75 amp. Output: 70 Volts, 3 ph. 148 cye. 220 Watts, 1.8 amperes. An ideal unit for experimental work or for operation of equipment. **SPECIAL PRICE.**.....\$34.50

## HERE IS EXCEPTIONAL VALUE

Robbins and Myers Motor Generator Units. Operate at 110 Volts, AC, single phase, 60 cy. and deliver 32/40 Volts, DC. Can be used with field rheostat to supply 24/28 VDC for the operation of aero equipment from lighting line. Rated at 40 watts but will deliver 200 watts for Intermittent operation. Gear head built into one end rotates external shaft at 225 RPM. An exceptional value at \$18.75 each. With field rheostat \$20.00. Also available for operation at 115 VDC at \$12.50 and with rheostat at \$13.75 each. Both units have 1/4 HP Motor. Stock up on these sets while they are available. Special price on quantity. Rebuilt.



## GEN. ELECTRIC AMPLIDYNES

Model 5AM78AB47: 750 watts; Input: 440-3-60; Output: 250 Volts, DC, 8 amperes; 3450 R.P.M. \$185.00

Model 5AM49AB30 Input: 440 Volts, 3 phase, 60 cy. 1 amp. output: 115 Volts, D.C. 3.25 amp. 3450 RPM.....\$88.00

Model 5AM49AB3: Input: 440 Volts, 3 ph. 60 cy. 1 amp. Output: 250 Volts, D.C. 1.5 amp. 375 Watts.....\$91.00

Model 5AM73AB58: Input: 110/220 volts, single phase, 60 cye. Output: 250 Volts, D. C. 1.5 amp. 375 watts. 3450 RPM.....\$100.00

Model 5LY132A4: Input: 440 Volts, 3 ph. 60 cy. 3.5 H.P. 7 amps. 3570 RPM; Output: 105 Volts, D. C. 18 amp. 1.9 K.W. ....\$268.50

Model 5AM610A10 Amplidyne Generator. 3 K.W. 125 Volts, DC 24 amp. 1765 RPM, BB, DP.....\$224.00  
Input: 27 VDC, 44 amp. 8300 RPM. Output: 60 VDC, 8.8 amp. 530 watts.....\$12.95

Model 5AM78AB10; Input: 32 VDC, 60 amp. 2 H.P. 2200 RPM; Output: 250 Volts, D.C. 3 amperes; 750 Watts .....\$190.00

Model 5AM73AB89; Input: 115 VAC, 1 $\phi$ , 60 cye. 9 amp. Output: 375 K.W. 250 VDC, 1.5 amp.....\$86.00

Model 5AM65FB2A; Input: 115 VAC, 3 $\phi$ , 60 cye. 5 amp. Output: 500 watts, 250 Volts, 2 Amp.....\$144.00

Model 5AM73AB62; Input: 115/230 VAC 6.2/3.1 Amp. 60 cye. Output: 250 watts, 125 volts, 2 amp.....\$65.00



## WESTINGHOUSE TRANSFORMERS

390 VA: 115/240 Volts: Brand New.  
**SPECIAL PRICE**.....\$1.90

**GENERAL ELECTRIC DC/AC MG SETS**  
Four Bearing Marine Units: 25 HP 230 Volts, DC charged to alternator 18.75 KVA: 80% PF: 1800 RPM Output: 115 Volts, AC, Single Ph. 60 cycles, Ball Bearings, 4 bearing set; marine duty. Brand New.....\$545.00

**CENTURY MOTOR GENERATOR SETS**  
7.5 KVA: 230 Volts, DC to 115 Volts, AC, single phase, 60 Cycles. Complete with automatic controller and push button station.....\$445.00

**ALLIS-CHALMERS MOTOR GENERATOR**  
Input: 115 VDC at 14 amp, 3600 RPM. Ball Bearings. Output: 1.25 KVA: 80% PF 120 Volts, AC, 1 Ph. 60 cye. 10.4 amp. Centrifugal automatic controller permits line start operation. Fully enclosed. Brand New \$99.95. Also available for 230 VDC operation at the same price

**RAYTHEON HIGH VOLTAGE TRANSFORMERS:**  
Pri: 214/246 Volts; Sec: 5500 Volts, 1.0 amperes; test 13,500 V. Brand New.....\$74.00

**ESCO DC/AC MG SETS.** Motor: 115 Volts, 1 1/2 HP. Line start; built in voltage regulator, frequency control, filtered; ideal for television, radar or any application requiring constant voltage and frequency. Output: 115 V.A.C. 1 $\phi$ , 60 Cye. 460 V.A. Brand New.....\$120.00

**IF IT'S FROM ONE FREQUENCY TO ANOTHER; FROM DC TO AC OR AC TO DC;  
IF IT'S FROM ONE VOLTAGE TO ANOTHER, THEN CALL ON US.**

Established 1922  
409 ATLANTIC AVE.

**WILLIAM I. HORLICK COMPANY**

Tel. HANCOCK 6-2480

BOSTON, 10, MASSACHUSETTS



# NIAGARA'S "GIGANTIC" WAREHOUSE CLEARANCE

"ONE OF AMERICA'S GREAT ELECTRONICS STORES"

### METER BARGAINS

3 SQ.	Supreme	542	Multimeter	\$3.75
3 SQ.	RCP	446	Multimeter	3.75
3 SQ.	Hicheck	0-200	Microamps	6.50
3 RD.	Asst'd	0-200	Microamps	6.50
3 RD.	Triplet	0-500	Microamps	6.25
3 RD.	Weston	0-100	Therm-Galvanometer	10.00
3 RD.	Weston	0-120	Galvanometer	9.80
3 RD.	Asst'd	0-1	MA.	4.95
3 RD.	Asst'd	0-100	MA.	3.95
3 RD.	Weston	0-150	MA.	3.95
3 SQ.	Asst'd	0-150	MA.	3.95
3 RD.	Asst'd	0-300	MA.	3.95
3 RD.	G. E.	0-500	MA.	3.95
3 RD.	Weston	0-8	A. C. Volts	3.75
3 RD.	G. E.	0-10	A. C. Volts	3.75
3 SQ.	West'hse	0-10	A. C. Volts	3.85
2 RD.	West'hse	0-15	A. C. Volts (600 cy.)	2.49
3 RD.	West'hse	0-150	A. C. V.	3.95
3 SQ.	Marion	0-150	D. C. V.	3.95
3 RD.	G. E.	0-350	D. C. V.	3.95
3 RD.	Asst'd	0-500	D. C. V.	3.95
3 SQ.	Simpson	0-1000	D. C. V.	3.95
3 RD.	Asst'd	0-1.5	D. C. K. V.	3.49
3 RD.	West'hse	0-3.5	D. C. K. V.	3.49
3 RD.	F. E.	0-30	D. C. K. V.	3.49

(AMMETER PRICES ON REQUEST)

### OIL FILLED CONDENSERS

All Brand New—Leading Brand Names

CAP.	D. C Volts	No.	Net Each
.005	15,000	14F322	\$7.95
.005-.005-.01	10,000	26FH16g2	10.50
.035	10,000	AX1U36	7.50
.02	15,000	14F321	21.95
.01	6,000	143-806	
.15	2,500	26F345	1.10
2	5,000	C8B2784	2.98
.25	4,000	P9717	3.10
.25	10,000	14F192	19.50
.6	2,500	72041-503	1.25
1	440 AC	KG4010	.59
1	2,500	482616-10	2.55
1	3,000	A1089	2.75
1	3,600	C8B3062	2.95
1	5,000	23F49-G2	3.15
1	6,000	60010GA	4.35
1	12,000	26F628	9.50
2	440 AC	67 x 21	.79
2	600	A14109-2	.85
2	1,000	23F11	1.10
2	2,000	324-138	2.20
2	3,000	2538-16	4.50
2	5,000	C-8B2784	6.50
2.5-2.5-5	600	C8B1256	1.95
4	330 AC	KG3040	.85
4	400	25F785	.95
4	600	B8B1253-1	1.10
4	1,000	10365	1.75
5	1,000	13765	1.85
6	330 AC	67 x 7A	.89
6	44 AC	K64060	.95
6	600	P9718	1.75
8	1,000	143-117	2.50
8	2,000	TJU29080G	4.95
10	400	7DB1AE1D	1.25
10	600	10373	1.85
15	1,000	23F19G2	3.95

**MORE OUTSTANDING BARGAINS IN OUR NEW FLYER**

WRITE FOR YOUR FREE COPY

### IMPORTANT NOTICE:

Minimum Order \$5. Quantity prices on request. All items in stock now—subject to prior sale—prices subject to change without notice. 20% Deposit with orders unless rated. All prices F.O.B. our N. Y. C. Warehouse.



**Niagara Radio Supply Corp.**

Phone Digby 9-1132-3-4

Dept. E-21

160 Greenwich Street, New York 6, N. Y.

### 70% OFF LIST

### POPULAR SPLIT-STATORS

### VARIABLE CONDENSERS

Popular Split Stator Variables at unbelievable low Prices! Well Built, low loss ceramic mounted with bushings at both rotor ends. Ideal for V. F. O., low powered rig and exciter units, receivers, etc. All with 1/4" Shafts.

CAPACITY	LIST PRICE	YOUR COST
15-15	\$3.80	\$1.14
20-35	3.95	1.19
27-27	4.10	1.23
35-35	4.30	1.39
75-75	4.80	1.44

### TUBES

**NEW—BRANDED GUARANTEED LARGE QUANTITIES**

RECEIVING—TRANSMITTING INDUSTRIAL PRICES ON REQUEST

### TRANSMITTING TUBE SOCKETS

Famous make Steatite Sockets. Always useful, never old. You can afford to stock up at these prices.

Tube Type	Net
4 pr. 10 WATT	.69
4 pr. 50 WATT	.95
715 A, B, or C	.75
4-125A, 4-250 etc.	.69
Iso. Wafer—829 or 832	.49
Isolantite Octal Wafers	.29

### CRAMER TIME DELAY RELAY MODEL 1 C2H

110 V. A. C. 60 cy. contains two SPST 15 AMP contact switches. Both spring held to normally open position. Cam action holds one switch closed while spring holds other open. Switch positions change once each hour continuously until circuit to time delay mechanism is interrupted. Guaranteed, Brand New in Original Packing.

YOUR COST \$4.95

### SMASHING VALUES IN BLOWERS

(A):—**DUAL BLOWER.** approximately 100 cu. ft., per min., per section. Constant duty 110 V. A. C. 60 cycle, 3400 RPM motor made by HEINZE. 2 1/2" intake, 2" outlet. Measures 6" high x 6 1/2" deep x 10 1/2" long. NEW—BOXED. \$14.95

(B):—**SINGLE SECTION BLOWER.** Approximately 100 cu. ft., per min. Constant duty 110 V. A. C. 25 and 60 cy., 3200 RPM HEINZE MOTOR. 2 1/2" intake, 2" outlet measures, 6" high x 6 1/2" deep x 6" long. NEW—BOXED \$9.95

(C):—**SINGLE SECTION BLOWER.** Approximately 50 cu. ft., per min. Air cooled 110 V. A. C. 60 cycle F. A. SMITH MOTOR. 2" intake, 1 1/2" outlet. Measures 5" high, 4" deep, 5" long. NEW—BOXED. \$6.95

(D):—**SINGLE SECTION BLOWER.** Approximately 50 cu. ft., per min. Constant duty 24 V. D. C. 6000RPM A. G. REDMOND CO. MOTOR. 2" intake by 1" outlet. Measures 3 1/2" high, 3" deep, 5" long. NEW SURPLUS SPECIAL. \$3.95

### AIRCRAFT TYPE

Vibrator power supply delivering 300 V. D. C. at 80 Ma. Filter Built-in, fully wired, tested and guaranteed \$5.95 new

### TRANSFORMER BARGAINS!

Plate	
1025-0-1025—500 MA	\$17.95
2500 V.—4 MA	3.95

### Filament

2.5V-10A cased	4.95
5 V.C.T.-3A	
5 V.C.T.-10 5A	3.95
6.3 V.C.T.-3.5A	
5V-10A	1.85
5 V.C.T.-15A	5.95
6.4V-8A	2.05
7.5V-5A	2.19

### Power

275-0-275—70 MA.—5V-5A, 2.5V-10.5A	3.00
325-0-325—40 MA.—5 V.C.T.—2A, 2.5 V.C.T.—4A	2.25
325-0-325—70 MA.—6.3V-1.2A, 5V-3A	2.95
350-0-350—100 MA.—6.3V-6A, 6.3V-2A	3.25

### Modulation

807 to P.P. 6L6	\$2.49
P.P. 807 to single 6L6, 4D32 (2400 ohms)	3.49
From 200, 500 ohms to 5, 6, 7, 8, 9, 10K ohms at 150 MA.	4.49

### Driver Xfmsr.

200, 10,000 ohm P. to single G.	\$ .79
10,000 ohm P. to single G.	.80
P.P. 45, 2A3, etc. to P.P. 210, 801, etc.	1.95
P.P. 6L6, 2A3, etc. to P.P. grids.	1.65

### Output

6V6 to 2, 4, 8 ohms.	.69
P.P. par 6N7 Class "B" to 8000 ohms.	1.49

### Input

600 ohm C.T. to 300 ohm mike.	\$1.49
-------------------------------	--------

### Mike to Line

From and to 50, 125, 200, 330, 500 Ohms	\$2.49
30 ohm mike to 600 ohm C.T. Bal. line.	1.65

### Chokes

.875 HY.	2.5 Amps	8.95
2.5 HY.	4 Amps	9.95
2.5 HY.	130 MA.	1.10
4 HY.	40 MA.	.25
8 HY.	200 MA.	2.35
10 HY.	180 MA.	3.49
40 HY.	90 MA.	3.49
10 HY.	200 MA.	2.49
12 HY.	150 MA.	1.75
15 HY.	125 MA.	1.60
15 HY.	200 MA.	2.65
20 HY.	125 MA.	1.75







# SPECIAL SURPLUS BROADCAST OF OUR SUPER SPECIALS!!!

## REORGANIZATION NEW MANAGEMENT NOTE NEW LOCATION



### TRANSTATS

11.5 KVA 50/60 cy. Com-  
mutator range 0-115 V. Max.  
Amps 100. Reconnection dia-  
gram available for 230 V 50A  
open .....\$225.00

### RELAYS

G.E. #CR2791-B100J4, 3PDT, 6VDC, 15A Con-  
tacts .....\$1.25  
Allied DO9D28, 3PDT 6 VDC, 15A contacts .....\$1.35  
Leach Type 1054ARV, 3PST on make, SPST on break,  
20-32 VDC, 15A contacts .....\$1.25  
G.E. #CR2791-B100F3, DPDT 24 VDC 5A contacts 75¢  
G-M #13013, DPDT, 24 VDC, 15A Contacts .....95¢  
Price #311, DPDT, 28 VDC, 10 Amp cont. 1900 ohm  
5011 .....95¢  
G-M #13020, DPST on make, 3PST on break, 24VDC,  
15A contacts .....\$1.25  
Allen Bradley X89309, SPST double make, 24VDC,  
300 A .....\$2.50  
A-B Bulletin X95545, type B6B, SPST Double Make, 24  
VDC, 200 Amp .....\$2.50  
Dunco Thermal Time Delay 115 VAC 60 Cr. SPST, 1  
min delay .....\$1.95

### DECK ENTRANCE INSULATORS (Bowl and Flange Type)



Mfd. by Ohio Brass Co. heavy galv.  
metal flange 10 1/2" D. porc. bowl set in  
rubber gaskets. Top bell 7 1/2" D. brass  
feed thru rod 10 1/2" L. Insul. dist. between  
top bell and flange 6 1/2" .....\$3.95

### MOTORS AND GENERATORS

G.E. Model 5BA10A522, 24VDC, 0.55A, 10 oz/in  
torque 1400RPM .....\$5.95  
Universal Elec, #523, 115VDC, 1.2A 5000RPM. \$4.95  
W.E. #KS5603, 24VDC, 0.6A, 5000RPM, Shunt  
wound .....\$2.95  
G.E. #5BY9E8, Permanent Magnet type, 140VDC,  
.025A 1800RPM .....\$8.95  
EMC, SPN37952, 32VDC, 1/30HP, Gear reduced to  
21RPM .....\$12.95  
Gen'l Industries, 115VAC, 60cy, .65A 80RPM geared  
to 20-30RPM .....\$3.95  
Elec Spec, Type JAI, 24VDC, 15A 1/4HP, 3800  
RPM .....\$14.95  
Warren Synch. Type B3, 115VAC, 60cy, 4W, 12  
RPM .....\$5.95  
G.E. #5BN38HA10, 80VDC .25A, 3000RPM, 1/150  
HP .....\$7.95  
Elec #M24718, 24VDC, 0.32A, 1800RPM .....\$5.95  
Flyer Type 1623, 110VAC, 25cy, 30W 78RPM, gov.  
cont. .....\$7.95  
Dynamic HI-Press Axial Flow Fan, Mod 58SCR4, 24-  
28VDC, 1/2HP, 8000RPM, 225CMM, Used .....\$8.95  
Lear #CO04, 24VDC, 1.5A 7500RPM 8W .....\$8.95  
Ford Inst Synchro Generator, 7G, Mk111 Mod. 3 115/90  
V 60cy LN .....\$49.95  
Arma Synchro Diff. Gen 5DG 60 cy. Oster #C-2B1-1A,  
27.5VDC, 1/20HP 1/100HP, 3650RPM .....\$9.95  
Westinghouse #1171391, 27VDC, 1/8HP, 6.5A, 5000  
RPM, Series .....\$9.95  
Emerson #1610212, 24VDC, 160 oz/ft torque, 100  
RPM .....\$9.95  
Elinco F-16 Rate Generator, 2 ph 1.3 volts/100  
RPM .....\$17.95  
Autosyns, Pioneer AY-59D .....\$24.95



### DC SERVO MOTORS

White Rodgers Elec. Co. (6905X-46),  
24 VDC @ .65 Amps. Torque 50 in/  
lbs. 1/2 RPM reversible, comp. w/limit  
switch, relays and selenium rectifiers on  
top of motor, to keep AC out of motor. 3x5x4 .....\$12.95

### HIGH VOLTAGE CAPACITORS Standard Brands

Cat. #14F338 rated 4.5 Mfd. at 7500 VDC .....\$25.00  
Cat. #14F425 rated 3.5 Mfd. at 10 K.V.D.C. ....\$35.00  
Cat. #14F13 rated 5.0 Mfd. at 10 K.V.D.C. ....\$45.00  
Cat. #14F35 rated 1.0 Mfd. at 20 K.V.D.C. ....\$45.00  
Cat. #14F88 rated 0.75 Mfd. at 25 K.V.D.C. ....\$45.00  
Cat. #AE6734 rated 1.0 Mfd. at 25 K.V.D.C. ....\$55.00

### REACTORS

G.E. Cat. #7479974. Rated 2.5 Henries @ 2.3 A.D.C. \$37.50  
G.E. Cat. #7479964. Rated 50 Henries @ .025 A.D.C. \$27.50

### RECTIFIERS

IT&T Selenium, Bridge, #EE29, 10 plates 1" dia. Input  
18VAC Output 14VDC @ .15A .....\$2.25  
IT&T Selenium, Half Wave, #FE4, 4 plates 1 1/2" dia.  
Input 18VAC Output 7.5VDC @ .45A .....\$1.00  
Westinghouse #103B, Copper Oxide, Half Wave, 4  
plates 1 1/2" D. Input 4VAC Output 3VDC @ .25A \$1.75  
G.E. Model 6RS5F10, Selenium, Full Wave, 24 plates  
1" D. Input 5VAC Output 36VDC @ .2A .....\$3.95  
Benwood Lanze #BL202S1, Selenium, Full Wave, 24  
plates 1" D. Input 220VAC Output 180VDC @ .0075A  
\$3.95  
Westinghouse #S54029A, Copper Oxide 13 plates 3 1/2"  
D. Bridge, Input 65VAC Output 45VDC @ .32A .....\$9.95

### VARIABLE CONDENSERS

Cardwell #5032, Geared 30-100 mmfd. ....\$1.75  
Cardwell #CA256, 50 mmfd. ....\$1.25  
Cardwell #CA228, 16-400 mmfd. ....\$2.45  
Hammarlund Butterfly 10-37 mmfd. ....\$1.65  
Radio Cond. #959-51, 2-gang 365 mmfd each section  
\$1.85  
Gang Capacitor for signal Generator type W2279SC1,  
10-385 mmfd .....\$2.35  
Johnson #250F20, -255mmfd .....\$2.35  
4-Gang Str. Line wave length, #F37946-14, fully en-  
closed .....\$2.50

### SPERRY A-5 VERTICAL GYRO UNIT



#644841, 115V, 400CY 3 ph. Contains  
gyro assembly, erection motor, erection  
relay assembly, pick-off assembly, ele-  
vator and aileron limit switches, and  
roll axes. 15 x 12 x 9 .....\$19.75

Write us your requirements. Send us your listings  
and we will mail our quotations for furnishing same.  
We carry one of the largest surplus stocks in the  
country covering hundreds of hard-to-find items at  
lowest prices. Meters, fuses, switches, condensers,  
wire, tubes, potentiometers, transformers, chokes,  
relays, rectifiers, etc. Write to be put on our  
mailing list.



### DAVEN SOUND ATTENUATORS

Type 350-A, Network, ladder, linear.  
Imped. 30/30 ohms. 2DB attenuation. 10  
W dissipation .....\$3.95

### TRANSFORMERS

G.E. #69G450. Pri: 500/250 Volt, 60 cy. Sec: 72.5  
volt 52.5VA .....\$1.65  
G.E. #69G449. Pri: 200V 60 cy. Sec: 260/130 volt  
52.5VA .....\$1.65  
G.E. #68G457. Pri: 1/1.5/3/6/8/10V 60 cy. Sec: 50/50  
Volts 50 Watt .....\$1.65  
G.E. #69G500. Pri: 450 Volts Sec: 6 Volts 3VA. May be  
reversed. 60 cy .....\$1.00  
Raytheon Interstage UX8442. Pri: Minus 40V, Sec:  
Plus 40V, 1250TV RMS .....\$1.25  
Federal Driver #RA6407-1. Pri: 15,000 ohms tapped,  
.006ADC. Sec: 1770 ohms tapped. Freq Resp: 200 to  
5000 cycles s 1 1/2 DB .....\$2.50  
Raytheon Filament #UX8302C. Pri: 115V 400 cy. Sec:  
6.3V @ 4.7A; 5V @ 3A; 6.3V @ 6A .....\$3.00  
AC Current Type T-23-3 S.C. #229900.5 Pri: 0.5/1/1.5/  
10A Sec: 5-6 Volts @ 1.5MA .....\$1.35  
Federal #RA-6403-1. Pri: 8000 ohms @ 9MA Sec:  
800 ohms .....\$1.25  
Federal #RA-6408-1. Pri: 2000 ohms Sec: Less than  
1 ohm .....\$1.25  
Federal #RA6404-1. Pri: 115/80V 400 cy Sec: 550-0-  
165-550V; 5V @ 3A; 5V @ 3A; 6.3V @ 2A; 25V @  
2.2A .....\$3.95  
W.L. Oscilloscope Input #ES-677584-1, SC#4G16TOR/  
T5 .....95¢  
Federal Input #W15-4, S.C. #229631.29 Pri: 300 ohms  
Sec: 250,000 ohms and 680,000 ohms .....\$1.25  
G.E. #7472410. Pri: 115V 400 cy. Sec: 2.6V @ 6A;  
6.9V @ 2.2A; 8V @ 1A .....\$3.50  
Sperry #702523. Pri: 115V 400 cy. Sec: 700VCT @  
.12A; 2.5V @ 3A; 2.5V @ 3A; 6.3V @ 2.25A; 6.3V @  
2.25A .....\$2.50  
RCA #901697-50. Pri: 790V @ .4A; 5.18V @ 6A;  
5.18V @ 6A .....\$2.75

### MINE DETECTOR SCR 625



Detects metallic objects (ferrous or non-  
ferrous) to a depth of approx. 6 ft. Find  
outboard motors on the bottom of lakes, lo-  
cate underground piping, treasure, me-  
talic fragments in lumber, etc. New,  
complete with inst. book, \$65.00. Used  
but like new .....\$45.00

MT/ARC5 MOUNTING BASE, provides anti-shock  
mtg for any 3 units Trans or Rec. of the AT or ARC5  
equip. ....\$1.75

### HEAVY DUTY TRANSFORMERS

G.E. Cat. #7479965. Pri: 230V 60 cy Sec: 16.4/  
8.2V O.C.; 11/5.5V @ 60 Amps. 8 1/2" H 9 1/2" L 5 1/2" W  
\$25.00  
G.E. Cat. #7471997. Pri: 215/430V 50/60 cy. Sec:  
5/2.5V 150VA 8KV test 6" x 4 1/2" x 8" .....\$5.50  
G.E. Cat. #79G365. Pri: 203.5V 60 cy Sec: 6.3V @  
250 Amps. ....\$39.50  
G.E. Cat. #7479971. Pri: 230/208V 50/60 cy. Sec:  
1365/1300/1235V.M.S. 735VA. 7 1/2" x 5 1/2" x 8 1/2" \$29.50  
G.E. Cat. #7479972. Pri: 230/208V 50/60 cy. Sec:  
2450/2350/2210V.M.S. 2.85 KVA. 7 1/4" x 8 1/4" x 11"  
\$49.50  
G.E. Cat. #7475695. Pri: 115V 60 cy. Sec: 3530/3720/  
3910V.M.S. 1.31KVA .....\$47.50

ALL MERCHANDISE BRAND NEW UNLESS OTHERWISE NOTATED

ALL PRICES F.O.B. BOSTON. ORDERS ACCEPTED FROM RATED CONCERNS ON OPEN ACCOUNTS NET 30 DAYS. MINIMUM ORDER \$3.00



110 Pearl Street

Boston 10, Mass.

LIBERTY 2-7890



**THE BEST IN ELECTRONIC SURPLUS**  
**AVAILABLE FROM OUR STOCK FOR IMMEDIATE DELIVERY**

BC-610 Transmitters with BC-614 Speech Amplifier, 4 Plug-in Coils and Exciter Units for 10, 20, 40, and 80 meter operation, output 400 watts A1, 500 watts A3. Operates from 110/150-60 cycle AC. Used in SCR-299,399,499 eqpt. Spares available at extra cost. Condition Excellent to like new. Export packed. PRICE, EACH.....\$900.00

SF-1 Radar Eqpts. 10 Centimeter, Brand NEW with complete spares to insure over 10 years of continuous operation. Includes motor-generator set in each, all wave-guide plumbing, instruction books, etc. 19 cases per set, export packing. PRICE EACH.....\$2,500.00

TCS, Collins Ship Transmitter-Receiver, for 12/24 V. DC operation, radio telephone and radiotelegraph at 20 & 40 watts, 1.5 to 14.0 mc. Complete with all accessories. Excellent condition. EACH.....\$300.00

Beachmaster, 250 watt Portable Sound Amplifier Systems, with nine speaker rack, tubes, mike, cables, and spares. Operation from 110 volts, one phase, 60 cycles AC. Excellent and New condition units. PRICE, EACH.....\$545.00

PRICE, less case of spares.....\$445.00

Western Electric Model HLAS, 500 watt Sound Amplifier Systems, consisting of 40 watt Pre-Amplifier; 500 watt Power Amplifier with built-in power supply, expander-compressor circuit, internal blower-ventilation, 30 sec erasing oscillator circuit for magnetic tape recording, volume and meter controls; two speaker racks, each with 6-60 watt dynamic horn units. Operation from 115/3/60 AC. New, Unused. Complete with tubes, cables, connectors and instruction manual. EACH.....\$795.00

RMCA, Model 8010 I.F. Ship Main Radio Transmitter, 325 to 500 KC. types CA & E. Excellent condition. Less motor generators. PRICE, EACH.....\$475.00

RMCA, Model 8019A/H.F. Ship Transmitter, complement to 8010 above, for H.F. transmission A1 and A2, 200 watts output. Excellent Condition, less tubes and MG (mg with 8010 powers this unit). PRICE, EACH.....\$400.00

RMCA, 8003 Emergency Transmitter, 500 KC, 50 watts output with 12/15 V. DC, motor generator set, and battery charging unit. Excellent Condition. Complete with tubes. PRICE, EACH.....\$275.00

RMCA, 8007 Lifeboat Transmitter-Receiver, 500 KC, for permanent installation. Complete with installed 12 V. Dynamotor. Excellent Condition. PRICE, EACH.....\$100.00

RMCA, 8600X Auto Alarm Receivers, 500 KC Automatic SOS (4-second dash actuated) Alarm Unit. Complete with Relay Control Box and warning light. For 110 V. DC operation. Excellent Condition, with tube. PRICE, EACH.....\$250.00

RMCA, 8707 Direction Finder (Int. Freq.) consists of receiver, loop, shaft rotating wheel. Excellent Condition except shaft housing not available (can be easily improvised). With tubes. PRICE.....\$750.00

Mackay, Model 150-A1, I.F. Ship Transmitter, 325 to 500 KC, A1 and A2 emission. Excellent Condition. PRICE, with MG, 15 V. DC. EACH.....\$330.00

PRICE, without MG, EACH.....\$275.00

RC-163 Radio Beacon Eqpt. 20-40 MC. Consists SCR-508/528/608/628 to directional transmitters and receivers. Ideal for airports or for homing application. NEW and complete eqpt. Export packed. EACH.....\$90.00

SCR-511 "Poon Stick" Walky-Talky. Portable low-power AM radiotelephone for 2 to 6 mc operation, with 12 plug-in tuning coils containing crystals for crystal control. Both receiver and transmitter. Transmitter-Receiver RC-745 of this SCR-511 includes telescopic antenna and "Press-Talk" Switch as well as all cables. Range 5 miles, plus. With PP-157 Vibrator Power Supply 2-volt battery (less electrolyte). PP-17 tube, ready for immediate operation. PRICE, EACH.....\$95.00

32 Volt DC to AC Rotary Converter, mfd. by Kato. For vacuums, workboats, or farm installation. Output 110 V., 60 cycles AC, rated 225 watt but good to 300 watts. All NEW Units. PRICE, EACH.....\$39.95

Dock Entrance Insulators, bowl and flange type, 3/8" dia. with heavy galvanized metal flange and bell. Top bell 3/4" dia. x 1 1/2" brass feed thru rod. Very high voltage insulation. Individually packed in cartons, all NEW. 12 FOR.....\$18.00

General Electric Amplitudine M. G. Set, generator type. V-5875677, motor type #73AR58, Navy #CG-21ABU. 115/230 V., 60 cycles, motor rated at 1/2 HP. generator output 250 V. DC at 375 watts. NEW. PRICE, EACH.....\$60.00

SD-5 Radar Transmitters, only: 200 cm. Contains variable coil for tuning hi-power to frequency, numerous transformers (except plate), meters, varicac, capacitors, etc. in fact complete transmitter, but less tubes & plate transformer. Excellent Condition. Price, Each.....\$115.00

YJ-1 I.F.F. Emt. Consists of dual transmitters and dual receivers, each working in "A" and "B" bands, 176 and 515 mc respectively. Includes power supply (115-230 volts 60 cycles AC) and tubes, all in one metal cased unit. UNUSED eqpt. Price, Each.....\$165.00

T-9/APQ-2 Radio Transmitters. Noise-modulated Jamming Transmitter, using Electron-Multiplier Photocell. For jamming certain types radar eqpt. New unused transmitters only, with Electron-Multiplier tube less other tubes. PRICE, EACH.....\$32.50

SB-23/GTA-2 & SB-14/GY Switchboard & Power Supply, for operation from 110V, 60 cycles AC (with storage batteries). Each in individual metal cabinet. NEW. Price, Each Set.....\$450.00

BC-319-A Transmitter, CW only 300 watts output. Freq. range 4 to 13 mc. Operates from 110/220 volts, 60 cycles AC. Excellent condition. Less tubes. PRICE, EACH.....\$300.00

Wilcox, 96-200-A, 2-KW RF section. Large cabinet with complete RF end containing the VFO, intermediate sections and PA stage. Almost new, but lacks PA Inductance. Less tubes. PRICE.....\$300.00

Wilcox 96C 3 KW RF Units, 2.0 to 20.0 mc, crystal controlled. Four of these units with Rectifier 36A and Modulator 50A make a complete 4-channel Point-to-Point and Radiotelegraph station. Good Condition, less tubes. EACH.....\$600.00

Wilcox 36A Rectifiers, single cabinet unit containing 4 separate transformer rectifier power supplies, capable of supplying DC voltage to one or more 96C Transmitters described above, and one or more Wilcox 50A Modulators. Others are designed to modulate a 96C 3 KW RF output Transmitter. Has terminal connections for 5 96C Transmitters, and for local or remote operation. Measures: 72" high, 29 1/2" wide, and 24 1/2" deep. Operates from 220/3/60 AC. NEW eqpt., complete with control relays, tubes, power transformer (removed for shipment), instruction manual. WRITE FOR PRICE.

Without 4-Channel CW3 Dual-Diversity Receiving Emt. Enclosed rack-panel arrangement, with 8 CW-3 receivers and 4 Diversity receiving units to provide 4 channels of dual-diversity simultaneous reception. Range 1.9 to 24.0 mc, frequency determined by plug-in coils and crystals, in shield cans. Includes DFO, sensitivity, and audio output controls on each receiver. Operates from 110/150-60 AC. NEW EQPT. with essential spares available. WRITE FOR PRICE.

TBK-10, 500 watt, 2-18.1 MC. CW Telegraph Transmitter designed for ship installation. Almost new condition, complete with tubes, less MG set and accessories. PRICE, EACH.....\$350.00

98-A Ground Station, A-3 omission 50 to 200 mc, 50 W. output, 4-channels dial telephone section, with receiver for above frequency coverage, and remote control unit. For 110 volts AC. Excellent condition. With tubes. PRICE, EACH.....\$600.00

Link FM Transmitter-Receiver, 70-100 mc, 50 watts output. Model 1498 DC wall style cabinet containing transmitter, receiver and 14 V.D.C. power supply, handset. Dim: 34" x 21" x 11". NEW Condition. Complete with tubes, crystals, special telescopic antenna, instruction book. PRICE, EACH.....\$500.00

**"SNOOPERSCOPE" TUBE**  
 Infra-Red Image Converter Tube (British) to make "Snooperscopes," "Sniperscopes," and other devices that see in the dark. Has many useful industrial applications. Operates with invisible infra-red rays, without scanning or amplifiers. Supplied with technical data and diagrams. Every tube guaranteed. EACH.....\$4.95

6 for.....\$25.00

BAUSCH & LOMB Front-End Lens Assembly, for best images. F2, 3.5, 5 E. EACH.....\$10.00

MOUNTED LENS UNIT, also for front-end, results as good as B & L unit. Speed F1.9 f. 1, 91.44 mm, outside dia. at one end 60 mm, length of mount 64 mm. PRICE, EACH.....\$7.00

**580-765 MC SUPERHET RECEIVER, WITH WAVEMETER**  
 Easily modified for Citizen's Band reception, or for experimental use on VHF Television. Uses a 955 Autodine detector-oscillator into 3-stage resistance-coupled IF amplifier. Output is for headphones. Includes VT-150 voltage regulator tube, 625 tuning-eye and 5Y3 rectifier. For 110 volts, 50/60 cycles AC. Calibrated wavemeter mounted as separate portion, with variable tuning rod and hand-plotted calibration curve for each, permits checking frequency of incoming signal. NEW unused surplus. With instruction sheet and diagrams, plus calibration curve, and tubes. PRICE, EACH.....\$75.00

**RADAR TRAINING SET—MARK V**  
 For Student, Schools, Labs or actual radar application. Operates in the 580 to 765 mc region, designed especially to illustrate how radar eqpt. functions, and permits making numerous experiments to put over radar fundamentals. Uses above described receiver; separate transmitter using 8025 triode with 1.5 watts at antenna, with 400 KC internal modulator, using 811 tubes. External modulator, generating audio frequencies of 16,000, 4,000, and 1,000 cycles, and RF at 750, 350, and 175 KC, with selection switch for modulation frequency and wave form control, using 3 tubes, 807, 6X7, and 6J5; set of Antenna Dipole rods. Supplied with full instruction sheets, diagrams, calibration curves, tubes, NEW unused. PRICE, Per Set.....\$175.00

**LIMITED QUANTITIES Following: R-89/ARN-5A Receivers, new; APN-4 Indicators; TBV-2 Portable 28-80 MC Transceivers; TAJ-12B Transmitters; Model NAA Underwater Ultrasonic Beacon Transmitters; Model ZB-3 Aircraft Homing Adapter Equipment; Portable Test Oscillators for ZB Eqpt.; RT-3/ARN-1 or 12 D.F. Receiving Emt.; Radio Receivers BC-733-D; BC-329 Small Airtort Lo-Freq. Transmitters; Model DAG-1 Portable 1.5 to 18.0 mc D.F. Receivers; Model ATD Aircraft Transmitters; BD-72 Switchboards; 500 Watt, 110 DC to 110 AC, 60 cns motor-generators.**

**20-40 MC FIELD STRENGTH AND WAVEMETER**  
 Uses a 0-100 Micro-ammeter with a 1S4 Pentode, to receive signals in the 20-40 mc range, 1.5 volts battery required. Tuning dial has dial lock, for fixing position, and telescopic Antenna permits adjusting for strong or weak signals. Calibration must be self-performed. With instruction sheet and diagram NEW, unused eqpt. Dim: 6 1/2" x 4 3/4" x 5 1/4". PRICE, EACH.....\$14.95

PE-95G & H, 10-12 KVA Gas Engine Generators, 110/220 V. AC, 1-phase, 60 cycles output. NEW. In original export packing, with spare parts and tools. Shpg. wt. 2128 lbs.; cu. ft. 70. PRICE, EACH.....\$1,450.00

HOMELIGHT 1.5 KW GAS-Engine Generators, 110 V., 60 cycles, 1-phase AC. Almost New, all units thoroughly tested and guaranteed. PRICE, EA. \$235.00

AN/CRT-1A Sonobuoy Transmitters, for mine and submarine detection. With parachute, tubes, etc., ready for operation (except standard types dry batteries). Operates at 87.7 mc. Excellent to New condition. PRICE, EACH.....\$55.00

Prices quoted are net, FOB N.Y.C. our warehouse. Export packing extra, except where included in specifications. All material is guaranteed as represented, and offered Subject to prior sale.

**TELEMARINE COMMUNICATIONS COMPANY**  
 CABLE ADDRESS: TELEMARINE, N. Y. 540 W. 27th St., N. Y. 1, N. Y.

**REAL VALUES!**

T23/ARC5 Brand New Transmitter for VHF.....\$29.95

**TEST EQUIPMENT**

EV-10 Precision Vacuum Tube Test Set.....used \$28.00

No. 772 Weston Multi Tester.....used 40.00

No. 803 Radio City Products Tube Tester & Set Tester.....used 35.00

No. 777 Weston Tube Checker.....used 29.00

No. E 200 Precision Signal Generator.....used 25.00

No. M-652 Jackson Audio Oscillator.....used 30.00

No. 224 A Dumont Oscilloscope.....used 80.00

No. 155 A RCA Oscilloscope.....used 90.00

No. M-840 Triumph Oscilloscope.....used 60.00

BC-221 Frequency Meter.....Like New 90.00

Others as Low as.....49.50

IE 36 Test set for SCR 522—less meter. New \$19.95

**PRICES UPON REQUEST**

1-98-A.....TS10A/APN  
 1-114 P/O RC-68.....TS16/APN  
 1-135 P/O IE-17.....TS19/APQ5  
 1-167 Weston Anal.....TS27/TSM-1  
 #772.....TS36/AP  
 1-183 Freq. Meter.....TS47/AP  
 1-185 Oscillator.....TS59/APN-1  
 1-187 Synchronizer.....TS62/AP  
 1-189 Calibrator.....TS102A/AP  
 IE-19.....TS126/AP  
 IS-185 Voltmeter.....TS-251 Less Xtal  
 TS3/AP

**TUBE SPECIALS!**

211	\$ .59	813	6.95
307A	5.50	832	2.95
793A	1.89	832A	7.95
723A/B	12.95	837	1.19
724B	1.89	841	.49
803	2.89	860	4.95
805	3.29	864	.24
807	1.89	5D21	9.95

**SCR 508 RADIO SET—Complete installation includes:**

BC 603 Receiver  
 BC 604 Transmitter  
 BC 605 Interphone Amplifier  
 BC 606 Control Box  
 DM 34—12 volt Dynamotor (Receiver)  
 DM 35—12 Volt Dynamotor (Transmitter)  
 Set of 80 Crystals  
 MP 48 Mast Base  
 3 Mast sections  
 FT 237 Mounting Rack  
 Complete, only.....\$100.00

IS-185 Weston Voltmeter Model 433—02 to 150 VAC 25 to 2400 cycles.....\$24.95

ID6/APN4 Scope unit complete with 5C11 cathode ray tube and shield and all parts except smaller tubes and crystal. Used \$9.95 ea

**CONDENSERS**

1 mfd 6000 VDC, OIL FILLED.....Each \$1.98

.00025 mfd, 25000 VDC OIL FILLED.....2.95

1 mfd. 600 VDC, OIL FILLED.....1.19

5 for 1.00

50 mmfd—5KV—5 Amp. Vacuum Cond.....1.19

AS-138/ARN—10 inch streamline loop as used with direction finding receivers. Fixed position. Is ideal for planes, boats, automobiles. New.....\$1.95

**MISCELLANEOUS SPECIALS!**

RA 10 DA Receiver	Used \$17.50	New \$24.95
RT7/APN1 Transceiver	6.95	9.95
APN 1 Complete		24.50
BC 347 Interphone Amplifier		2.95
I-70 Tuning Meter		.89
APS 13 UHF Antenna, Pair		.98
FL 8 Filter		2.95
I-97 Bias Meter		3.95
RL 42 Antenna Gearbox Motor and Reel		4.85
TS 10—Sound powered phone		6.50
BC 1066 B—150 to 225 MC Portable Receiver adaptable to many amateur uses. In Canvas Carrying Bag. Used.....		55.95
BC 709 Battery operated lightweight interphone amplifier. Complete with tube and shock mount, but less battery.....		35.95
C-18—Antenna coil assembly plug tuned used in BC 603 receiver. Frequency range 20-27.9 Mc—fully shielded.....		New. 10 for \$1.95
I 82 F—Five Inch 360 degree compass indicator and Selsyn receiver.....		New \$4.95
A-81-2 Transmitter set for 182 indicator.....		\$2.45 (Both 182F & Trans. Selsyn for \$7.00)

All shipments FOB warehouse. 20% Deposit required on all orders. Minimum order accepted—\$5.00. Illinois residents, please add regular sales tax to your remittance.

**ARROW SALES, Inc.**  
 Dept. 5  
 1712-14 S. Michigan Ave., Chicago 16, Ill.  
 PHONE: HARRISON 7-9374



# RADAR EQUIPMENT

## Search Radars

APS-2; APS-3; APS-4; APS-15;  
 SCR-717B; SCR-720; APQ-13;  
 APR-1 Receiver & Tuning Units  
 APR-4 Receiver & Tuning Units  
 APR-5 Receivers  
 TPX-1 IFF Transmitters—Receivers  
 R-69/APN-9 Loran Receivers  
 CPN-6 3cm Radar Beacon  
 AN/APG-13 Complete New  
 SO-9 10cm Search Radar  
 APG-8 Units; AS-168/AP Antenna;  
 BC1153 Indicators; BC 1157A  
 Control Boxes;  
 CA-4 Turbo Amplifiers; CN-21  
 APA-15A;  
 MD-12A/AP013 Modulators;  
 RA-10DB Receivers;  
 RF-4A/AP Antenna Boxes; RT-39/  
 APG Recvr-Trans.;  
 RT-48A/TPX-1 Recvr.-Trans.

## TEST EQUIPMENT

TS-3/AP; TS-14/AP  
 TS-15/AP; TS-16/APN  
 TS-19/APQ; TS-23/APN;  
 TS-24/APR-Z  
 TS-26/TSM; TS-27/TSM; TS-33/AP  
 TS-35/AP; TS-36/AP; TS-45  
 TS-47/APR; TS-59  
 TS-61/AP; TS-62/AP; TS-74/VPM  
 TS-76/APM-3; TS-91; TS-98  
 TS-100/AP; TS-102; TS-111/CP  
 TS-118/AP; TS-125/AP; TS-126/AP  
 TS-127/V; TS-131/AP;  
 TS-159/TPX-1  
 TS-146; TS-155/VP; TS-216/AP  
 TS-203A/P; TS-206/AP; TS-226/AP  
 TS-268/VB; BC-376H  
 BC-905; BC-906; BC-978  
 BC-1277; BC-1236A; APA-11  
 LS-1 Frequency Meter  
 LM-15 Frequency Meter  
 804 Measurement Corpor.  
 Signal Generator  
 Test Equipment and Signal Generators  
 for 10 and 3 cm  
 1-208 FM Signal Generator  
 All types of Magnetrons

Write for listing

**LERU LABORATORIES, INC.**  
 360 BLEECKER ST.  
 NEW YORK 14, N. Y.  
 Oregon 5-3525

# TEST EQUIPMENT

X Band Spectrum Analyzer 8500-9600 Mc., calibrated linear below cut-off attenuator, calibrated frequency meter, tuned mixer, 4 i.f. stages, 3 video stages overall gain 125 db., regulated power supply.  
 S Band Spectrum Analyzer 2700-3900 Mc., similar to above.  
 X Band Test Load low power low power \$20.00  
 X Band Below Cut-Off Wave Guide Attenuator, with calibrated dial, type N input connector, output connects to 1/2" x 1" wave guide.....\$55.00  
 X Band Test Load, low power....\$15.00  
 TS-62 X Band Echo Box with r.f. cable and pick-up antenna.  
 TS-33 X Band Frequency Meter, 8500-9600 Mcs. Crystal detector and 50 micro-amp. meter. Indicates Resonance. Connection for scope available.  
 TS-45A-APM-3 Signal Generator, 8700-9500 mc., 110 V. 60-800 cps.  
 TS-35/AP X Band Signal Generator, pulsed, calibrated power meter, frequency meter, 8700-9500 mc.  
 30 MC I.F. STRIP, VIDEO, and AUDIO AMPLIFIER AND 110 Volt 60-2600 cps POWER SUPPLY, Bandwidth 10 mc. new, part of SPR-2 Receiver.  
 AMPLIFIER STRIP AM-SSA/SPR-2 contains I. F. amplifier, detector, video amplifier, pulse stretcher and audio amplifier and Rectifier Power Unit PP-155A/SPR-2 bandwidth 10 mc. center frequency 30 mc. sensitivity 50 microvolts for 10 milliwatts output. Power supply 80/115 V ac, 60-2600 cps 1.3 amps. Send for schematic \$65.00 less tubes.  
 X Band Test Load, 50 watts, average power 1/2" x 1" waveguide. Sand load TS 108.....\$35.00  
 HI POWER X BAND TEST LOAD, dissipates 280 watts of average power for 3/8" x 1 1/4" waveguide, VSWR less than 1.15 between 7 and 10 KMC \$150.00  
 S Band Signal Generator Cavity With Cut-Off Attenuator, 2300-2950 mc., 2C40 tube, with modulator chassis \$30.00  
 High Pass Filter F-29/SPR-2, cuts off at 1000 mc. and below; used for receivers above 1000 mc.....\$12.00  
 UPN-1 S Band Beacon Receiver-Transmitter .....\$75.00  
 S Band Test Load TPS-55P/BT, 50 ohms \$12.00  
 High Pass Filter F-29/SPR-2, cuts off at 1000 mc and below; used for receivers above 1000 mc.....\$12.00  
 TS-125 CALIBRATED S BAND POWER METER with attenuator.  
 TS-155 S BAND SIGNAL GENERATOR and Power Meter.

S Band Mixer, tunable by means of slider, type N connector for the R. F. and local oscillator input, U.H.F. connector for the I.F. output, variable oscillator injection .....\$30.00  
 TS-110 S Band Echo Box 2400-2700 mc. portable .....\$110.00  
 HI POWER S BAND TEST LOAD, dissipates 1000 watts of average power, for 1 1/2" x 3" waveguide. Range 2500 to 3700 MC.  
 X Band Thermistor Mounts, VSWR less than 1.4 8500-9600 MC Fixed triple tuned, 1/2"x1" waveguide.....\$40.00  
 Fixed triple tuned 3/8"x1 1/4" waveguide .....\$50.00  
 Frequency Meter, 8500-9600, variable, absorption type for either 1/2"x1" or 3/8"x1 1/4" waveguide, with calibration, ± 4 MC, precision ground thread.\$150.00  
 X Band Crystal Mount, 1/2"x1" waveguide .....\$25.00  
 X Band Attenuator, double van type, VSWR less than 1.4, 8500-9600 MC 0-30db, calibrated for 1 1/4"x3/8" waveguide .....\$80.00  
 1/2"x1" to 3/8"x1 1/4" adapter, UG80/U \$5.00  
 TS-203/AP CALIBRATED SELSYN..\$10.00  
 GENERAL RADIO PRECISION WAVE-METER TYPE 724A, range 16 kc to 50 mc. 0.25% accuracy, V.T.V.M. resonance indicator, complete with accessories and carrying case NEW...\$175.00  
 HEWLETT-PACKARD-AUDIO SIGNAL GENERATOR 205A.....\$230.00  
 ESTERLINE Angus recording Milliammeter 60 cycles, 110V. AC. 1 ma full scale. \$150.00  
 TS-89 Voltage Divider for measuring high video pulses, ratios 1:10 and 1:100 transmission flat within 2 db 150 c.p.s. to 5 mc., with cable for attaching to syndroscope.  
 Waveguide Below Cut-off Attenuator L 101-A U.H.F. Connectors at each end calibration 30-100 db.....\$15.00  
 WAVEGUIDE BELOW CUT-OFF ATTENUATOR same as above except input is matched in range of 2200-3300 mc. VSWR less than 1.2.....\$54.00  
 PULSE TRANSFORMER 132-AWP...\$8.00  
 HYPERSIL CORE CHOKE, 1 Henry, Westinghouse L-422031 or L 422-32....\$3.00  
 PULSE INPUT TRANSFORMER, permalloy core, 50 to 4000 kc., WE-D161310, impedance ratio 120 to 2350 ohms..\$3.00  
 SQ RADAR, used but in good working order, complete with antenna, control unit .....\$650.00  
 SN RADAR, used, good working order, complete .....\$550.00

# ELECTRO IMPULSE LABORATORY

62 White Street

Red Bank 6-0404

Red Bank, N. J.

# SELENIUM RECTIFIERS and ASSOCIATED COMPONENTS

## SINGLE PHASE Full Wave Bridge

Input: 0-18 VAC		Output: 0-12 VDC	
Type No.	Current	Price	
B1-250	250 Ma.	\$ 2.98	
B1-1	1.0 Amp.	2.49	
B1-1X5	1.5 Amp.	2.95	
B1-3X5	3.5 Amp.	4.50	
B1-5	5.0 Amp.	5.95	
B1-10	10.0 Amp.	9.95	
B1-20	20.0 Amp.	15.95	
B1-30	30.0 Amp.	24.95	
B1-40	40.0 Amp.	27.95	
B1-50	50.0 Amp.	32.95	

Input: 0-36 VAC		Output: 0-26 VDC	
Type No.	Current	Price	
B2-150	150 Ma.	\$ 1.98	
B2-250	250 Ma.	1.25	
B2-300	300 Ma.	1.50	
B2-2	2.0 Amp.	4.95	
B2-3X5	3.5 Amp.	6.95	
B2-5	5.0 Amp.	9.95	
B2-10	10.0 Amp.	15.95	
B2-20	20.0 Amp.	27.95	
B2-30	30.0 Amp.	36.95	
B2-40	40.0 Amp.	44.95	

Input: 0-115 VAC		Output: 0-90 VDC	
Type No.	Current	Price	
B6-250	250 Ma.	\$ 2.95	
B6-600	600 Ma.	5.95	
B6-750	750 Ma.	6.95	
B6-1X5	1.5 Amp.	10.95	
B6-3X5	3.5 Amp.	18.95	
B6-5	5.0 Amp.	24.95	
B6-10	10.0 Amp.	36.95	
B6-15	15.0 Amp.	44.95	

## THREE PHASE Full Wave Bridge

Input: 0-234 VAC		Output: 0-250 VDC	
Type No.	Current	Price	
3B13-1	1.0 Amp.	\$ 22.00	
3B13-2	2.0 Amp.	32.00	
3B13-4	4.0 Amp.	56.00	
3B13-6	6.0 Amp.	81.50	
3B13-10	10.0 Amp.	105.00	
3B13-151	15.0 Amp.	120.00	

**RECTIFIER MOUNTING BRACKETS**  
 For Types B1 through B6, and Type C1 ..... \$ .35 per set  
 For Types 3B ..... 1.05 per set



### POWERSTATS

Smooth, efficient voltage control 0 to 135V. output from 115V. AC line. Type 20. 3 Amps. \$12.50

Type 116U (illustrated) for panel MTG. 7.5 amps. \$18.00  
 Type 112U 15 Amps. 46.00  
 Type 1156 45 Amps. 118.00  
 Also available for 230volt input. Write for descriptive literature.

Minimum Order \$5.  
 All prices FOB our NYC warehouse. Send check or money order. We will ship transportation charges collect. Rated concerns send P.O., Terms Net 10 days.

## POWER SUPPLIES

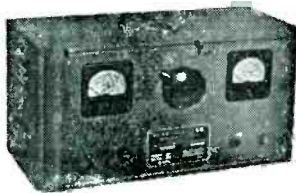

**GENERAL PURPOSE** Low voltage DC power supplies, with variable outputs. Rugged — Dependable — precision control.

### Features

- ✓ Long life Full Wave Selenium Rectifiers
- ✓ Output Voltage Continuously Adjustable from Zero to Maximum
- ✓ 3" Voltmeter and Ammeter 2% acc'y.
- ✓ Stepless Control
- ✓ Instant Power—No Warm-Up Period
- ✓ Assembled and Ready to Operate
- ✓ For 115 VAC 60 Cycles
- ✓ Dimensions 8 1/2" x 16 3/4" x 8"

Write for descriptive bulletin GPA

## RECTIFIER CAPACITORS

Type	Value	Voltage	Price
CF-1	1000 MFD	15 VDC	\$ .98
CF-2	2000 MFD	15 VDC	1.69
CF-7	3000 MFD	35 VDC	3.25
CF-19	500 MFD	50 VDC	1.95
CF-16	2000 MFD	50 VDC	3.25
CF-21	1200 MFD	90 VDC	3.25
CF-10	500 MFD	200 VDC	3.25

Mounting clamps for above capacitors. .15c ea.

## RECTIFIER TRANSFORMERS

All Primaries 115 VAC 50/60 Cyc ea

Type No.	Volts	Amps.	Shpg. wt.	Price
XF15-12	15	12	7 lbs.	\$ 3.95
TXF36-2	36	2	6 lbs.	4.95
TXF36-5	36	5	8 lbs.	6.50
TXF36-10	36	10	12 lbs.	9.95
TXF36-20	36	20	25 lbs.	17.95
XFC18-14	18 VCT	14	10 lbs.	6.95
XFC18-50	18 VCT	50 amp	17 lbs.	18.95

All TXF Types are Tapped to Deliver 32, 34, 36 volts. XFC Type is Tapped to Deliver 16, 17, 18 Volts Center-tapped.

## RECTIFIER CHOKES

Type No.	Hv.	Amps.	DC Res.	Price
HY5A	.028	5	.20	\$ 5.25
HY10A	.014	10	.04	9.95
HY20A	.007	20	.02	13.95

## ATTENTION MANUFACTURERS

We are in a position to furnish Selenium Rectifiers, in quantity, to specifications. Excellent delivery, prompt quotations.

# Opad-Green COMPANY

71-2 WARREN ST., NEW YORK 7, N. Y. PHONE: BEekman 3-7385-6

## DEPENDABILITY IN ELECTRONICS

WE ARE NATIONAL DISTRIBUTORS OF PARTS, TUBES AND EQUIPMENT. WE SOLICIT INQUIRIES FROM ORGANIZATIONS WHO APPRECIATE INTELLIGENT SERVICE AND HONEST PRICES, PARTICULARLY AT THESE CRITICAL TIMES.

# NORMAN RADIO DISTRIBUTORS INC.

94-29 MERRICK BOULEVARD JAMACIA, N.Y. - REpublic 9-4651



**MIRROR** — front surface aluminized on optical glass 1 3/16" diameter 3/32" thick ..... \$ .50



**PRECISION LEVEL** — interior ground tube level with 4 adjusting screws. Overall length 1 1/2", diam. 15/32". One end with shoulder 1/8" diam. \$ .85



**DELCO BLOWER** — sirocco type D.C. Flange diameter 3 1/2" blade 3-3/16" RPM @ 12 volts 3400 RPM @ 6 volts 1600 ..... \$3.95



**SELENIUM RECTIFIERS** — G.E. model 6RS 5FB3 maximum. A.C. volts 56 D.C. amps. 0.150..... \$1.85



**SILVERPLATED REFLECTOR** — Overall Dimensions 4 1/2", Reflecting Surface 4 1/2", Depth 1 1/2", Individually boxed 25¢ ea. \$20.00 per 100.



**Miniature lamp T1 1/4, 3 volt .19 amp. Airplane Indicator, Amb. Ctd.**  
 10 for ..... \$ .85  
 100 for ..... \$7.50



**Lamp Assembly C208**  
 Genl. 1 Made by Eastman Kodak with Iris Diaphragm 12 volt lamp ..... each \$1.95

**TELECHRON B-3-4** watt Synchronous Motors 5/6 RPM on 50 cycles, 1 RPM on 60 cycles ..... \$3.50 ea.

SEND FOR FREE BULLETIN



ALL PRICES F.O.B. N. Y. CITY

FOR SALE BY:—

The President,  
 Tantalum Refining and Mining  
 Corporation of America Ltd.,  
 5th Floor, 185 Bay Street,  
 TORONTO, Ontario.

100 KV "Scientific Electric" AC-DC Rotary Rectifier Unit, Model PS246, Serial 1416; Input—220 Volts, 60 cycles single phase, Rating 10 KW, Regulated to 25,000 volts. .... \$1,900.00

0—18,000 volt Valve Type D. C. "Scientific Electric" Power Supply complete with regulators, meters, etc. Model PS240, Serial 1388, 115 Volt Input, 60 cycles single phase, rating 3 KW. \$625.00

0—16,000 volt "Scientific Electric" AC Power Supply complete with regulators, meters, etc. Model PS198, Serial 1140, etc. Input—220 volts, 60 cycle single phase, rating 10 KW. .... \$509.00

0—28 KV "Scientific Electric" DC Valve type Power Supply complete with Regulators, Meters, etc., Model PS198, Serial 1415, Input 220 Volts, 60 cycles single phase, 6 KW rating. .... \$1,400.00

Two—0—20 KV "Scientific Electric" D. C. Power Supply, Model PS195, Serial 1137, Input 120 volts, 60 cycles single phase, rating 3.6 KW. \$500.00 each

0—5,000 volt "Scientific Electric" DC Power Supply, Model PS203, Serial No. 1166, Input—220 volts, 60 cycles single phase, Rating 2.5 KW \$300.00

This equipment was made in U. S. A. and is practically unused having become redundant owing to changes in process. Prices quoted can be subject to negotiation.

Prices F.O.B. Edmonton

## ELECTRONIC TUBE-MAKING MACHINERY

For manufacturing radio tubes, electronic tubes, cathode-ray tubes, lamps. New and used. Reasonably priced, satisfaction guaranteed.

AMERICAN ELECTRICAL SALES CO.  
 67 E. 8th St. New York, N. Y.



**FEBRUARY CLEARANCE SALE**



**EAGLE ADJUSTABLE TIME DELAY RELAY.** 110 volt 60 cy with double throw Micro Switch. Can be set from 1 1/2 to 58 minutes. Includes attractive 3 1/4 x 4 1/2 x 2 3/4 black cover. 265 pieces in stock. Made to sell for \$26. **SALE PRICE** .....\$6.95

Stock #233

Glass to Metal Seals Only 5¢ Each

Mounting Hole	Overall Length	Stock No.	Color
5/32"	1 1/2"	199	white
9/32"	1 5/16"	200	white
Number 200 to 208		202	blue
all look like #206		203	green
		206	brown
		207	red
		207	green
		208	yellow
1/4"	1 3/16"	210	clear
5/32"	1 3/16"	211	clear
13/32"	1"	214	clear
5/16"	3/4"	215	clear
5/16"	7/8"	216	clear

**GLASS TO METAL HEADER,** eight different color seals in 1x1x5/16" metal cap, Fusite #267335 our stock # 345. 1400 in stock.....\$ 22



**Special High Voltage Glass to Metal Seal for 3/16" hole 1 3/4" overall.** #356 .....\$ .10

**25 WATT WIRE WOUND POTENTIOMETERS** Refer to Jan. Electronics for description. 2, 3-3, 15, 20, 25, 30, 50, 75, 100, 350, 500, 800 ohm—reg. \$3.12. **SALE PRICE**.....\$1.04  
 1K, 3K, 5K .....\$1.20, 20K.....\$1.40

**AN CONNECTORS, COMPLETE STOCKS, Ref. Jan. Elec.**

**SILVER MICA BUTTON TYPE CONDENSERS** 25, 30, 75, 280, 500, 2000 mmf.....\$ .22  
 2400 mmf style FA.....\$ .29

**CERAMIC CONDENSERS, Post & Feed-thru types.**

50 mmf, 2000 mmf style 357.....\$ .25  
 15 mmf style 720A, 1000 mmf w wire.....\$ .19

**CHOKES.** Conservatively rated 165 MA, 5 Henries, 160 ohm dc, 2 Inch High, 3 3/4" Mtg. Ctr. Worth \$3, **SALE PRICE** 89 cents.



#1A-158, 2000 pieces in stock.

**DELAY LINE 15-F4-91-400-50P,** Sprague #S92-5245, H623, 4x5x7 inch oil filled with 3 1/2 inch insulators. .91 Microsecond, 15KV.....\$9.90

**PULSE FORMING LINE,** Millen flexible type, 23 1/2 inches long, form 2 microsecond pulses, Zo-1000 ohm, our #388.....\$3.75

**PULSE TRANSFORMERS**

7P26, Westinghouse .....\$4.50  
 3262, Utah .....2.75  
 69178, Dionon, 3 3/4" x 5 3/4" x 5 3/4" .....7.50  
 901756-501, RCA, 15/16" dia. x 1 1/2" high, 165 turns on primary, 330 turns secondary, core is 3/4" stack of .007 inch "F" laminations, Magnetic Metals Co. Audio 58, used to form 7.3 microsecond pulses, 1744 in stock.....\$1.50  
 901756-502, RCA, same core & can as 501, 100 to 200 turns, used to form 2.2 microsecond pulses, 870 pieces in stock.....\$1.50  
 A117012, Bendix, 1 7/8 x 1 7/16 x 1 13/16" can, nine terminals, Hypersil core.....\$1.50  
 C12A-1318, Jefferson, 50 millihenry & 10 millihenry, 2 3/4" x 3" x 3 1/2" .....\$1.95  
 D161310, WE, frequency response 50kc to 4 Mc. Video input, 120 to 2350 ohm, Perm. core.....\$1.50  
 K2468B, GE Magnetron pulsing, bifilar, 250KVA peak power at 1/4 microsecond pulse, 1000/1 duty cycle, 3.35KV into 50 ohm pulse cable socket gives 17.3 KV to built-in Mag. socket. Only 31 in stock. Cost \$223. **SALE PRICE**.....\$18.00  
 K2469A, GE, Audio Modulator, 50 ohm pulse cable socket to long glass insulator.....\$7.50  
 L406825, Wemco, Pulse Inversion, 25 turns ea winding 200 volts to 200 volts at 3 ampere, 0.93 ohms DC, 3 3/4" dia. x 4 1/2" high.....\$1.50

**CONVERTER,** Electronic Labs Model 1485, 26 VDC input, 115 volts, 60 cy., 50 watts output, complete with NSB134 vibrator.....\$14.95

**POWER SUPPLY, PE204A,** Radiant to operate from 12 volts DC to supply plate & screen & 10 filament volts to telephone repeater EE99 & TY14. Sealed in original packing cases with spare vibrator, cable, schematic, etc.....\$9.95

**ANTENNA AN80-A, SC ZA-275 w MC299** connector for BC645, 418 in stock.....\$ .98  
**RELAY, 24 Volt, Tiny CP** Clare operates on 86 milliamperes, 4 pole DT & make-break, 1 x 1 3/4 x 1 7/16 overall, 1000 in stock.....\$ .90

**RELAY, 24 Volt, Struthers Dunn 10XBK102,** mfd, 24 VDC, but has shaded pole, good for 60 cycle operation, DPDT, 7 amp contact.....\$ .90

**TURRET SOCKETS & PLUG-IN UNITS,** complete stocks on hand for immediate service.

**TURRET LUGS,** complete stocks including new miniature molded melamine tie point only 1/4" diameter by 3/8" high w 2-56 thread, #1426.....\$ .18

**HAROLD H. POWELL**  
 632 Arch St. Phila. 6, Pa.

**← RED ARROW →**

We Specialize in { **★ ARMY AND NAVY SURPLUS ELECTRONIC EQUIPMENT**  
**★ INDUSTRIAL AND AMATEUR ELECTRONIC EQUIPMENT**

We are Jobbers of { **★ ELECTRONIC EQUIPMENT**  
**★ TELEVISION PARTS**

**FILTER UNIT**

This unit is an excellent buy for the parts alone. Some parts are worth more than we're asking for the whole unit.

- 1-40 MFD @ 450V
- 1-1500 MFD @ 12V
- 1-5 MFD @ 400V
- 2-5 MFD @ 50V
- 1-.01 MFD @ 400V
- 2-20 watt Resistors
- 3-Filter Chokes
- 3-RF Chokes
- 1DPST Toggle Switch
- Miscellaneous hardware, wire, etc.



**BRAND NEW, ORIGINAL PACKING.** 89c ea. (10 for \$7.50)

**DYNAMOTOR SALE!**

- BD77—Brand New .....\$8.95
- PE94—Used, excellent .....4.95
- PE73—Used, excellent .....4.95
- DN33A—Used, excellent .....1.45

**RCA Micas**

470 MMFD, 1200 MMFD, 1500 MMFD...6c ea. (\$50.00 per thousand)

**HEAVY DUTY LINE CORD** with molded plugs, 3 ft. long .....9c each  
 10 lengths for 25c

**SLEEVING**—various colors and sizes—3 ft. lengths. 100 lengths for \$2.00

**3 GANG TRF VARIABLE CONDENSER** 365 per section with push buttons .....89c ea. (10 for \$7.25)

**SOLDERING PASTE**—8 oz. cans—U.S.N. Specification 51-FLB .....29c ea. (10 for \$2.50)

**CORDS**

- CD478—5 ft. long with Alligator Clips, can be used as test leads .....19c pair
- PL485 with PL55 and JK26 .....65c each
- PL485 .....20c each
- PL55 .....39c each
- PL54 .....17c each



**STANDARD BRAND RESISTORS**

- 5 ohm—10 watt .....14c
- 85 ohm—10 watt .....14c
- 2500 ohm—25 watt .....17c
- 2500 ohm—33 watt .....20c
- 250 ohm—50 watt, lamp base .....24c
- 105 ohm—100 watt, 4 taps .....48c
- 50 ohm Muter Resistor .....8c ea. (\$6.00 per hundred)

**KIT SALE!**

- Kit of 50 assorted KNOBS .....\$1.19
- Kit of 25 TRIMMERS—single, dual and triple sections .....79c
- Kit of 10 assorted VOLUME CONTROLS .....\$2.79
- Kit of 100 assorted MICA and CERAMIC CONDENSERS .....4.75
- Kit of 100 assorted PAPER TUBULAR CONDENSERS—from 200 to 800 V .....5.75

**SPECIAL! 300 ohm TWIN LEAD TV LINE.** per 100 ft. ....\$3.89

**TSET SET PICK-UP ASSEMBLY**

TS-131/AP  
 Brand New .....\$14.95 complete

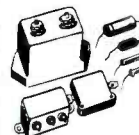

**BATHTUB CONDENSERS**

- 20 MFD @ 350 VDC
- 2 x .25 MFD @ 14c each
- 600 VDC (\$12.50 per thousand)
- .5 x 3 MFD @ per hundred
- 100 VDC (dred)
- 3 x 1 MFD @ 400 VDC

**TERRIFIC TUBE SALE**

Brand New—Standard Brands—Immediate Delivery  
 3C24/24G .....\$9c  
 1626 .....39c  
 10Y .....39c

**TAKE 'EM ALL AT THIS ONE LOW PRICE!**

We have only one set of this kind—so **FIRST COME—FIRST SERVED.**

- 2 RAK 7—R.C.A.
- 2 POWER UNITS
- 1 KIT OF SPARE PARTS
- Brand New, Complete \$350.00

HC 375 Used, Good Condition .....\$18.00 each

**BENDIX MN 26C**

Excellent condition, complete with tubes.....\$17.75

**THERMAL RELAY** Type ER, 110 volts, 30 amps, BRAND NEW.....ONLY \$1.29 each

ARC 4—Used, good condition, \$17.75 with tubes  
 ARN 7—Good, used .....\$13.50 with tubes  
 FL 10—Filter Units, Brand New with cable \$3.75

**← RED ARROW →**

**SALES COMPANY**

Dept. T, 63 East Broadway, N. Y. 2  
 Phone—COrtlandt 7-5425

**MINIMUM ORDERS**

— \$2.00. Send 25% deposit with order, balance C.O.D. Shipped F.O.B., N.Y.C. (N.Y.C. residents add 2% sales tax.)

**RED ARROW INDUSTRIES**

(A subsidiary of Red Arrow Sales)

**AVAILABLE FOR SUB-CONTRACT WORK**

We are manufacturers of electronic equipment with facilities now available for assembly work. We have test equipment, metal fabricating and polishing plant, warehouse with modern loading and packaging equipment and experienced personnel. We can be of invaluable aid to any organization.

# NEW YORK'S RADIO TUBE EXCHANGE

TYPE	PRICE	TYPE	PRICE	TYPE	PRICE	TYPE	PRICE
OA2	\$3.00	2V3G	\$2.10	274B	\$3.00	730A	\$8.95
OA3	1.50	3A5	1.25	304TH	9.00	800	1.00
OA4G	1.45	3B24W	3.50	307A	4.95	801A	1.00
OC2	3.00	3E24W	5.50	310A	7.95	802	3.60
OC3	1.08	EL3C	2.95	312A	3.95	803	2.95
OD3	1.08	3C22	49.50	327A	2.95	804	6.95
IA3	1.00	3C23	5.95	331A	3.95	805	2.95
C1A	4.95	3C24	2.50	350A	3.95	806	12.00
C1B	2.75	3C45	11.45	350B	2.95	807	1.69
1B21A	1.10	3DP7A	1.08	357A	37.50	808	.95
1B22	3.95	3E29	12.50	368AS	2.95	809	2.45
1B23	7.95	SN4	5.50	371B	.95	810	11.00
1B24	7.95	4A1	1.75	385A	4.95	812	2.95
1B26	1.95	4C27	10.80	388A	2.95	813	7.95
1B27	7.95	4J25	99.00	393A	5.95	814	3.95
1B32	4.10	4J26	99.00	394A	5.95	815	2.25
1B38	33.00	4J30	220.00	MX408U	.75	827R	27.50
1B42	5.95	4J31	99.00	417A	7.95	829	6.95
1B56	49.95	4J37	99.00	434A	6.95	829A	8.95
1B60	4.95	4J38	89.00	446A	1.95	829B	11.95
1N21	1.35	4J39	99.00	446B	2.95	832	4.95
1N22	1.75	4J41	99.00	450TL	35.00	832A	9.95
1N23	2.00	4J62	99.00	471A	2.75	833A	39.95
1N23A	3.75	C5B	2.95	527	35.00	836	1.95
1N23B	7.00	5BP4	3.95	WL530	12.50	837	1.95
1N26	5.00	5CP1	2.95	WL531	3.50	838	2.95
1N27	5.00	5D21	15.00	701A	5.50	845	8913
1N48	1.00	5J23	45.00	703A	2.95	849	22.50
1S21	3.95	5J29	9.95	705A	2.95	851	29.50
2B26	1.75	5J31	27.50	706AY	18.00	860	2.95
2C34	.35	5J32	7.50	706CY	18.00	861	29.50
2C40	5.75	5J34	12.50	707A	7.95	866A	1.79
2C43	21.00	5LP1	15.00	707B	18.00	869B	29.50
2C44	.90	6C21	39.50	714AY	7.95	872A	2.95
2C51	5.95	C6A	3.95	715A	9.95	874	1.50
2D21	1.75	7BP7	5.95	715B	9.95		
2E22	3.75	7DP4	10.00	715C	25.00		
2E30	2.25	12AP4	55.00	717A	.75		
2F21	40.00	5L1	.95	718AY/EY	18.00		
2J21 A	9.95	NER16	.95	720A/B/C/D/Y	95.00		
2J22	9.95	FG17	3.95	721A	2.95		
2J26	7.75	RX21	2.95	722A	1.95		
2J27	12.50	RK39	2.95	723A/B	14.95		
2J31	19.95	RK60	1.95	724A	2.95		
2J32	19.95	RK72	1.95	725A	6.95		
2J36	105.00	R73	1.95	726A	6.95		
2J38	7.95	FG95	18.00	726B	36.00		
2J42	150.00	100TH	9.00	726C	69.00		
2J49	69.00	FG105	19.00	728AY	27.00		
2J50	39.50	F123	8.95				
2J61	45.00	203A	5.95				
2K25	27.50	211	.75				
2K28	27.50	217C	18.00				
2K29	27.50	242C	10.00				
2K39	97.50	249C	4.95				
2K45	299.50	250TL	19.95				

## TEST EQUIPMENT

**Microwave K Band 2400 MC.**  
 TSK1-SE Spectrum Analyzer  
 K Brand Flap Attenuator

**X Band**  
 TS 12 Unit I USWR Measuring Amplifier, 2 channel  
 TS 12 Unit 2 Plumbing for above TS13  
 TS 33 X Band Power and Frequency Meter  
 TS 35 X Band Pulsed Signal Generator  
 TS 36 X Band Power Meter  
 TS 45 X Band Signal Generator  
 TS 146 X Band Signal Generator  
 TS 263 Navy Version of TS 146  
 TS 108  
 X Band Magic T Plumbing  
 X Band Tunable Crystal Mounts

**S Band**  
 TS3A/AP S Band Power and Frequency Meter  
 BF 4 Electrically Tuned S Band Echo Box  
 BC 1277/60ABQ S Band Pulsed Signal Generator  
 PE 102 High Power S Band Signal Generator

**L Band**  
 Hazeltine 1030 Signal Generator 145 to 235 Megacycles  
 Measurements Corp. type 84 Standard Signal Generator  
 TS 47, 40 to 400 MC Signal Generator

**Broadcast Wave Bands**  
 162C Rider Chanalyst  
 Short Wave Adapter for 162C  
 TS 174 Signal

**Oscilloscopes**  
 BC 1287A used in LZ sets  
 TS 34 Oscilloscopes WE  
 Supreme 564

**Audio Frequencies**  
 RCA Audio Chanalyst

**Other test Equipment and Meters**  
 TS 15/A Magnet Flux Meter  
 General Radio T Voltmeter 728A  
 Calibrator WE 1-147  
 General Radio 1000 cycles type 213  
 Limit Bridges  
 Boonton Standard Inductances  
 Weston Meters types 430, 429, 741  
 Model 40 Pyrometer  
 Rawson, meters 0-10 Microampere 0-2 Millivolt

**RADAR Sets & Parts**  
 APS 3-APS 4-SCR 284  
 R-111/APR5A Receivers

LIBERTY ELECTRONICS, INC.

PHONE WORTH 4-8262

135 LIBERTY ST., NEW YORK 6, N.Y.

# PHOTOCON SALES

## FEBRUARY SPECIALS

Write for our Latest Sales Bulletins

MAIL ORDER ADDRESS  
 1060-2 N. ALLEN AVE.  
 PASADENA 7, CALIF.  
 SYCAMORE 4-7156  
 RYAN 1-8271

RETAIL SALES STORE  
 1240 EAST COLORADO ST.  
 PASADENA 1, CALIF.  
 SYCAMORE 6-7217

### TEST EQUIPMENT

Hickock Oscilloscope Model 195...NEW \$100.00  
 BC-1060 Oscillograph—Same as Dumont #224  
 LIKE NEW 175.00  
 TS-100/AP Oscilloscope...EXCELLENT 170.00  
 TS-224 Dumont Oscillograph...GOOD USED 75.00  
 Megger—50 megs. 500 volts...EXCELLENT  
 Insulation Tester—Superior Model 610B, 200  
 megohms. Complete...NEW 40.00  
 1-100A Test Set for ARN7 and 269 Compass  
 LIKE NEW 595.00  
 IE-19A Test Set for SCR522—Complete with  
 manual, original factory packing...NEW  
 LM Frequency Meter with calibration books,  
 crystal, tubes...EXCELLENT 79.50  
 BC-221 Frequency Meters. Complete with cal-  
 ibration books, crystal, tubes EXCELLENT 79.50  
 TS-16/APN Test Set...GOOD CONDITION 47.50  
 TS-32/UR Frequency Meter—Calibrated  
 and complete...NEW 400.00  
 Standard Signal Generator—Measurements  
 Corp.—Model 78-B. 15-25MC., 190-230MC  
 LIKE NEW 100.00  
 McMurdo-Silver Model 904 Capacitance Re-  
 sistance Bridge with manual...NEW 29.50  
 Tube Checker—Model CGI-60067—115V., 60  
 cycles...EXCELLENT 49.50  
 Sweep Generator—Model M for AN/APG13,  
 Made by M.I.T. Radiation Laboratory 79.50  
 Weston Model 506 Voltmeter 0-20,000 Volts  
 with 4 Model 505 multipliers...NEW 39.50  
 LU-1 Radar Test Set...NEW 79.50  
 Insulation Tester—Interstate Mfg. Co. Model  
 1000...EXCELLENT 80.00  
 BC-906 Frequency Meter...EXCELLENT 17.50  
 Output Meter CW1-60ALB, 115V. 60 cycles,  
 P.O. ASB Radar with manual LIKE NEW 49.50  
 Engine Cylinder Thermometer Tester—Mark  
 II, Wheelco Inst. Co., Iron-Constantan,  
 Copper-Constantan 0-350°C...EXCELLENT 75.00  
 Engine Cylinder Thermometer Tester  
 Wheelco Inst. Co., Iron-Constantan, Copper  
 Constantan, Chromel-Alumel 0-1400°C  
 EXCELLENT 95.00  
 TS-24A/ARR2 Test Oscillator...EXCELLENT 29.50

### TRANSMITTERS—RECEIVERS

BC-348—24V. D.C. Aircraft Receiver  
 EXCELLENT 125.00  
 ART-13 Transmitter—complete installations  
 with dynamotor, loading units, remote, etc. 350.00  
 ATC Transmitter (Navy ART-13) complete  
 installations with dynamotor, loading units,  
 remotes, etc. 250.00  
 SCR-522 Transmitter-Receiver Sets—Complete  
 with PE-94 dynamotor, BC-602 Control  
 Box, DC-631 Jack Box, AN-104 Antenna,  
 plugs, racks, and mounts, New Accessories  
 EXCELLENT 70.00

Mine Detector SCR625 for locating metal,  
 underground pipes, prospecting, etc.  
 With Manuals...GOOD USED 39.50  
 NEW 69.50

BC-375 Transmitters, Complete with tuning  
 units, plugs, dynamotors, mountings, micro-  
 phones. Export packed...LIKE NEW 89.50  
 ATD-Transmitter 540-9050KC. 50 watt CW  
 and phone. Complete with tubes, coils,  
 dynamotor...NEW 95.00  
 BC-222 Walkie-Talkie—Frequency 28-52MC.  
 with crystal; less tubes, battery, and an-  
 tenna...EXCELLENT 14.50  
 FT-167RY Federal Transmitter operating  
 shelf tubes, crystals. Frequency range  
 2-24MC...NEW 195.00  
 R5/ARN7 Compass—Complete Installation  
 EXCELLENT 95.00  
 BC-464 Target Receiver—5 channel remote,  
 sensitive relays, battery case, antenna—  
 68-73MC...BRAND NEW 14.95  
 APR5AX Receiver...LIKE NEW 325.00  
 RU-19 Receivers—Complete...NEW 27.50  
 RA-10 Bendix Compass Receivers LIKE NEW 24.50  
 BC-640 Transmitter—50 watt rack type—Same  
 Frequency as SCR522...GOOD CONDITION 695.00

### PLUGS

PLQ-171, PL-172, PLQ-60, PLQ-63, PL-147,  
 PL-148, PL-151, PL-152, PL-153, PL-154,  
 PL-156, PLQ-103, Plugs for ARC-1, ARC-3,  
 ARC-5, BC-375, SCR-522, BC-348, GP-6, GP-7,  
 LM Frequency Meters, and many others.

APN-1 Altimeter Indicator, basic movement  
 0-1 ma., 5 ma. shunt, 270° dial. An ex-

cellent basic movement for constructing  
 meters. General Electric...NEW 1.95  
 Crystal and Coil Sets for Handy-Talkie—3885,  
 4250, 4840, 5327.5, 5437.5, 5500 K.C.—2  
 crystals and 2 coils per set...SET 1.95

HS-23 Hi Imp Headset, ear cushions...New 2.45

Sound powered head and chest sets—man-  
 ufactured by U. S. Instrument Co.  
 EXCELLENT USED...\$4.95 EACH, PR.  
 FAIR USED...2.95 EACH, PR.  
 CD-605 Cords—6 ft. tinsel rubber covered  
 NEW .15  
 Matching Transformer for HS-30 Headset  
 NEW .40

Teletype Paper—8 1/2" wide x 3 1/2" dia.  
 rolls—White—single...Roll .50

FL-8 Range Filters...NEW 1.95  
 BC-709 Interphone Amplifier, tubes, battery  
 operated...NEW 4.50

Selsyn Transmitter—Pioneer Inst.—AY  
 14 Excitator for indicator EXCELLENT 3.50  
 Low Inertia Motor Type No. 10047-2A 24  
 volt—Pioneer Inst. Precision type...2.50

Onan Motor Generator Set MG G-1 Generates  
 115V. AC 5.3 amps, 26 DC, 100 watts, 480  
 cycles 3.8 amps, Motor 115-230V, 60 cy-  
 cles, Single phase, 2450 RPM 10.5 amps  
 NEW 170.00

PE-94 Dynamotor Power Supply for SCR-522  
 115V. AC USED \$3.50  
 PE-206 Inverter 800 cycle—Will power APN4  
 and APN9 24V. D.C. Input...USED 8.75  
 NEW 6.95

RA-62 Rectifier Power Supply for SCR-522  
 115V. A.C. LIKE NEW 120.00  
 PE-73 Dynamotor Power Supply for BC-375  
 1000V. D.C. Output...EXCELLENT 6.95  
 Delco Motor—27 volts 2.4 amps—3600 RPM  
 Constant Speed Model A-1155 Governor  
 Type Shunt...NEW 5.95  
 APR4 Receiver with TN17, BRAND NEW.  
 Write for Prices.

### TUBES—BULK & BOXED

TERMS: Prices f.o.b. Pasadena. 25% on all C.O.D.  
 order. Californians add 3% Sales Tax.



**RADIO FREQUENCY AMMETERS**

- 120 Milliamps, Simpson 125, 3/4" Rd. flush bake., arbitrary linear sc. calib. 0-10, with caption OUTPUT UNITS, complete with external thermocouple @ \$7.50
- 1 Amp, General Electric DO-44, 3/4" Round flush bakelite @ \$11.00
- 1 Amp, Weston 425, 3/4" Round flush bakelite case @ \$11.00
- 1.5 Amp, Weston 507, 2 1/2" Round flush metal black scale @ \$4.50
- 1.5 Amp, General Electric DW-52, 2 1/2" Round flush metal black scale @ \$3.50
- 2 Amp, Westinghouse RT-35, 3" Sq. flush bakelite case @ \$5.50
- 2.5 Amp, McClintock MD 3001, 3/4" Round flush bakelite (Signal Corps Stock IS-111) @ \$4.50
- 2.5 Amps, Weston 425, 3/4" Round flush bakelite @ \$8.50
- 3 Amps, Weston 507, 2 1/2" Round flush bakelite, black sc. @ \$4.50
- 3 Amps, Weston 425, 3/4" Round flush bakelite, with external thermocouple @ \$9.50
- 3 Amps, General Electric DO-44, 3/4" Round flush bakelite @ \$6.95
- 5 Amps, General Electric DO-44, 3/4" Round flush bakelite @ \$7.50
- 5 Amps, General Electric DO-44, 3/4" Round fl. bakelite, with external thermocouple @ \$8.50
- 6 Amps, General Electric DW-44, 2 1/2" Rd. flush bakelite, black scale @ \$3.50
- 8 Amps, Westinghouse RT-35, 3" Sq. flush bakelite case @ \$7.50
- 10 Amps, Weston 425, 3/4" Round flush bakelite case @ \$8.50
- 30 Amps, Triplett 0347-A, 3" Square bakelite case, with external thermocouple @ \$6.00

**A. C. AMMETERS**

- 150 Milliampers, General Electric AO-22, 3/4" Round fl. bakelite case @ \$4.95
- 50 Amperes, Westinghouse NA-35, 3/4" Round flush bakelite case, 25 to 500 cycles @ \$5.50
- 75 Amperes, Burlington 32 C, 3/4" Round flush bakelite @ \$4.95
- 150 Amperes, Multirange, General Electric AO-22, 3/4" Round flush bakelite, 5 Amp movement with external current transformer. This unit can contain any or all of following: 5, 15, 30, 50, 75, 150. Simple wiring diagram furnished with meters or free on request... COST ONLY \$7.95

**D. C. MICROAMMETERS**

- 500 Microamperes, General Electric DW-40, 2" Round flush ring-clamp mounted (non-flanged) bakelite case, 100 M.V. sc. calib. 0-1 Milliampere, approx. 200 ohms resistance @ \$3.50
- 500 Microamperes, Simpson 6103, 2 1/2" Round flush bakelite approx. 300 ohms resistance @ \$3.50
- 500 Microamperes, General Electric DO-41, 3/4" Round flush bakelite sc. calib. 0-20 Kilovolts D.C. Supplied with paper Volt-Ohm-Milliammeter sc., approx. 250 ohms resistance @ \$5.95

**D. C. MILLIAMMETERS**

- 1 Milliamp, Westinghouse NX-35, 3/4" Round fl. bakelite, (JAN type MR35W001DCMA) approx. 53.7 ohms resistance @ \$7.50
- 2 Milliamps, Westinghouse NX-35, 3/4" Round flush bakelite, (JAN MR35W002DCMA) @ \$5.50
- 5-0-5 Milliamps, Western Electric, 3/4" Round flush bakete, concentric style movement approx. 160° deflection, sc. calibrated 50-0-50 @ \$4.00
- 15 Milliamps, Simpson 26, 3/4" Round flush bakelite (JAN type MR 26W01DCMA) @ \$6.00
- 20 Milliamps, General Electric DO-53, 3" Sq. fl. bakelite @ \$8.50
- 50 Milliamps, General Electric DO-41, 4 1/4" Rd. fl. bakelite @ \$4.95
- 150 Milliamps, General Electric DO-41, 3 1/4" Rd. fl. bakelite @ \$5.50
- 150 Milliamps, Gruen 508, 2 1/2" Round flush bakelite case @ \$3.00
- 200 Milliamps, Gruen GW-511, 2 1/2" Round flush bakelite case (JAN type MR25W200DCMA) @ \$3.95
- 200 Milliamps, Simpson 26, 3/4" Round flush bakelite (JAN type MR35W200DCMA) @ \$5.95
- 300 Milliamps, General Electric DO-53, 3" Sq. fl. bakelite @ \$5.50
- 500 Milliamps, General Electric DW-41, 2 1/2" Round fl. bakete, black scale (Signal Corps Stock No. IS-22) @ \$3.95
- 500 Milliamps, General Electric DO-53, 3" Sq. fl. bakelite @ \$5.50
- 500 Milliamps, Dejur Amco 312, 3" Square flush bakelite @ \$5.00
- 800 Milliamps, General Electric DO-41, 3 1/4" Round fl. bakete @ \$4.95
- 1000 Milliamps, Eiectel 350, 3/4" Rd. flush bakete, (JAN MR35W100DCMA) Scale calib. 0-1000 caption "DC MILLIAMMETERS x 10" Mfg. by Electrical Division of U. S. Time Corp. @ \$4.50
- 1000 Millilamp I Ampere, Dejur Amco # 310, 3/4" Round flush bakelite case @ \$4.80

**A. C. VOLTMETERS**

- 15 Volts, Westinghouse NA-35, 3/4" Round flush bakelite case (JAN MR35W015ACVV) @ \$5.50
- 15 Volts, General Electric AO-22, 3/4" Round fl. bakelite @ \$5.50
- 15 Volts, General Electric AW-21, 2 1/2" Round fl. bakelite, black sc. with markings & calib. at 0, 10, 15 only (Signal Corps Stock IS-122) @ \$3.00
- 15 Volts, General Electric AW-41, 2 1/2" Round fl. bakete, black sc., red mark at 10 volts, calib. for 300 cycles @ \$3.00
- 40 Volts, Westinghouse NA-33, 2 1/2" Round fl. metal case, black sc. lum. markings (Three were originally calib. for 300 cycle use but have been adj. for 50 cycle) @ \$3.95
- 40 Volts, Westinghouse NA-33, 2 1/2" Round fl. metal case, black sc. lum., markings, calib. for 400 cycles @ \$3.50
- 75 Volts, Weston 517, 2" Rd. flush metal case ring-clamp type mtg. non-flanged @ \$2.95
- 150 Volts, Hoyt Model 584, 3/4" Rd. flush bakelite @ \$5.00

**D. C. VOLTMETERS**

- 5/125 Volts, Dual Range, Weston 506, 2" Round fl. metal, ring-clamp mounted (non-flanged) approx. 135 ohms per Volt, plus button for high range @ \$4.00
- 35 Volts, Simpson 125, 2 1/2" Round fl. metal case, approx. 110 ohms per volt, made for Homeite Corp. @ \$4.00
- 40 Volts, Sun 3AP598, 3/4" Round fl. bakete case, 100 ohms per Volt, made for Mallory Co @ \$5.95
- 750 Volts, General Electric DO-41, 3 1/4" Round flush bakete 1 MA movement complete with 1000 ohms per Volt external resistor @ \$8.95
- 2 Kilovolts, General Electric DO-53, 3" Square flush bakelite, 1 MA movement complete with 1000 ohms per V. precision ferrule-type multiplier @ \$10.95
- 3 Kilovolts, General Electric DO-53, 3" Square fl. bakete 1 MA movement, complete with 1000 ohms per V. precision ferrule-type multipliers @ \$13.50
- 20 Kilovolts, General Electric DO-41, 3 1/4" Rd. fl. bakete 1 MA with multiplier @ \$27.95

**D. C. AMMETERS**

- 1 Amp, Westinghouse NX-35, 3/4" Rd. flush bakelite case (JAN type MR 35W001DCMA) @ \$6.00
- 1.5 Amp, Gen Eltec DO-53, 3" Sq. fl. bakete @ \$5.95
- 15 Amps, Triplett 0321-T, 3 1/4" Rd. flush bakelite case @ \$4.50
- 30-0-30 Amps, General Electric DW-51, 2 1/2" Rd. flush metal @ \$3.50
- 50-0-50 Amperes, Weston 301, 3/4" Rd. flush bakelite @ \$6.50

We specialize in electrical instruments. Over 75,000 meters in stock. Send for our latest circular showing our complete line of Surplus-New-Guaranteed meters.

**MARITIME SWITCHBOARD**  
338 Canal St., N. Y. 13, N. Y.  
Worth 4-8217

Orders accepted from rated concerns, public Institutions and agencies on open account, others please send 25% deposit, balance C.O.D. or check with order. All prices FOB our warehouse, N.Y.C.

**CHECK THESE MONEY-SAVING SURPLUS "BUYS"!**

**TRANSFORMER VALUES**

All 115 V, 60 Cy. unless otherwise listed.

Compare These Prices!

- STANCOR P-4086 FILAMENT TRANSFORMER, Secondary 5 Volts C.T., 14 amps, Cased Heavy duty, 10 KV, Insulation @ \$4.95
- THERMADOR J-29 FILAMENT TRANSFORMER Secondary 5 Volts C.T., 20 amps, 10KV Insulation Case, Heavy duty, 10KV @ \$5.39
- UTC LS-183 POWER TRANSFORMER, 3500-300 CT at 400 MA, 110 or 220 Primary @ \$24.50
- UTC LS-184 POWER TRANSFORMER, 7000-6000-5000, CT at 500 MA 110 or 220 Primary @ \$69.50
- UTC LS-191 POWER TRANSFORMER, 650-500 at 125 MA, 3 filament winding, tapped primary @ \$5.95
- UTC LS-73 POWER TRANSFORMER 1000-800 CT at 500 MA, 140 CT at 50 MA, 5 filament windings, Tapped primary @ \$12.95
- THORDARSON T21F20 FILAMENT TRANSFORMER, Primary 115 V., 60 cycles, Secondary 5 V, center tapped, 15 amps, 10,000 V. Insulation @ \$3.95
- THORARDSON T17R32 Primary 115 v., 60 cycles, Secondary 2300 v., 2 1/2 v., 2 1/2 v., Shielded @ \$3.95
- HERCULES 115 V. 60 cycles primary 1800 V. Secondary 6.3, 2.5, 2.5, Shielded @ \$3.95

**THERMADOR SPECIAL TRANSFORMERS**

Built for Government Laboratory use. All hermetically sealed with glass terminals.

- CS5727, 900, CS5728, 800 V., CS5729, 1000 V 700 V CT at 150 650 CT at 100 850 CT at 250
- MA, 3 filament MA, 3 filament ma, 3 filament
- MA, 3 filament MA, 3 filament ma, 3 filament
- SA, 3-5A, 5-3A, 6.3-1.5A, 5-2A, 6.3-4A, 5-3 A
- Shp. Wt. 20 lbs, Shp. Wt. 14 lbs, Shp. Wt. 25 lbs, \$3.50 \$3.95 \$4.50

**SPECIAL VALUE!**

- STANCOR ISOLATION & STEP-DOWN TRANSFORMER No. P-5065, Primary 220-250 volts, 50-60 cycle, Secondary 110-125 volts, 250-300 watts.
  - THORARDSON T18V22 LINE VOLTAGE REGULATOR 95, 105, 125V to 115 V 60 cycle. Complete with cord and plug, 250 VA.
  - THERMADOR CS 10535 ISOLATION TRANSFORMER 105, 115, 125 v to 115 v 60 cycles. Complete with cord and plug, 250 va.
- YOUR CHOICE \$6.69 Ea. BRAND NEW

New Numbers Arriving Almost Daily!  
**NEW AMPHENOL AN CONNECTORS @ 75% OFF LIST!** Write for latest complete listing!

Now in Everyone's Price Range!

**GRID DIP METER KITS**

For Home Stations, TV Technicians and Experimentors  
Now you can know where your equipment is in the radio spectrum. 955 OCS. Range approx. 1.8 to 170 megs. Ideal for Phone or CW monitor, Harmonic indicator, absorption wavemeter, measures tuned circuits, antennas, etc. Ideal for TVI checking. Power requirements 6.3 filament, 150 V DC, easily obtained from your receiver, etc. Complete with Instructions on Calibration Coils. Etc.



**MARK 1X AIRCRAFT MARINE COMPASS**



Orig. Gov't Cost Appr. \$75 **\$9.95**

Ideal for airplanes, boats, autos, home den. decoration. Illuminated with 12 or 24 V bulb, but can be changed to cheap 6 V auto bulb without modification. Accurate floating-in-alcohol dial reads directly from the front showing direction being headed into. A wonderful buy at this low, low price!

**TS323/U FREQUENCY METER CASES**

See Oct. QST for construction article. Brand new @ \$3.95 ea.

**THORDARSON SWINGING CHOKE**

T-19-C-38 5-20H, 500 ma. Brand new, original wood box @ \$8.95

**JUST ARRIVED! A Real Value Scoop! WESTON AIRCRAFT METERS**

A real precision 1-mil movement, zero center aircraft instrument. Orig. gov't cost \$22.50. Wonderful for field strength meters, grid-dip meters, tuning meters, beam antenna indicators, vacuum tube volt meter, 2" bakelite case, Brand New. While they last!

**\$1.95**

ea. Postpaid in U.S.A.



**Check This List! Part of Our Complete TEST EQUIPMENT**

- All available direct from stock and ready for immediate shipment. Write, wire or telephone your orders and request for prices and information!
- TS-10/AP
  - TS-14/AP
  - TS-16/AP
  - TS-23/AP
  - TS-33/AP
  - TS-35/APCY94
  - TS-38/AP
  - TS-41/CRN-1
  - TS-45/APM-3
  - TS-47/APR
  - TS-59/APN
  - TS-61/AP
  - TS-82/AP
  - TS-74/UPM
  - TS-89
  - TS-92/AP
  - TS-100/AP
  - TS-118/AP
  - TS-126/AP
  - TS-131/AP
  - TS-143/CPM-1
  - TS-164/AR
  - TS-170/ARN-5
  - TS-175
  - TS-189
  - TS-192/CPM-4
  - TS-204
  - TS-233/TPN-2
  - TS-278/AP
  - IE-19 Test Set
  - IE-46B

**ORDER DIRECT FROM THIS AD**

Prompt shipment of all orders. Cash with order. Minimum order \$3.00. 35% deposit on all C.O.D. orders. Shipments by truck or RR Express by collect. California buyers please add state sales tax. All prices subject to change. All merchandise subject to prior sale.

**ALVARADIO SUPPLY CO.**

Dept. L-10, 341 S. Vermont Ave., Los Angeles 5, Calif., DUNkirk 8-2211

# BRAND NEW STANDARD BRAND TUBES

OA3/VR75	1.39	2J40	24.50	5CP7	3.29	304TH	18.95	721A	2.25	837	1.95	1299	25	8020	1.50
OB3 VR90	1.25	2K25	24.95	5D21	24.50	310A	7.95	723A/B	12.95	838	2.95	1608	4.95	8021	2.95
OC3 VR105	.99	2X2	.50	6AJ5	2.25	316A	1.75	724B	3.95	843	.75	1609	4.95	8025	5.95
OD3/VR150	.85	2X2A	1.43	6C24	27.50	329A	8.95	725A	6.45	845W	5.95	1613	.99	9003	1.75
1B22	3.95	2V3G	.99	6D4	2.75	331A	14.95	801A	3.95	860	.50	851	49.50	9004	.45
1B23	8.50	3A4	.55	6F4	5.75	353A	4.95	802	2.95	861	24.50	1622	2.29	9006	4.45
1B24	6.95	3A5	1.15	6J4	5.25	371B	.95	803	2.95	864	.75	1624	.45	9005	1.90
1B26	2.75	3B7	.28	10	.35	417A	8.95	804	9.95	866	1.39	1625	.45	9006	.35
1B27	19.95	3D6	.25	10Y	.75	450TH	39.50	805	3.49	865	1.25	1626	.45	9007	4.45
1B29	4.75	3B24	3.25	24G	2.19	450TL	44.50	807	1.69	866A	1.25	1629	.38	9008	1.98
1B36	23.75	3CP1/S1	2.25	45 Spec.	.35	530	12.50	810	10.95	872A	2.25	1636	3.25	9009	1.75
1B56	47.50	3C24	2.19	106TH	8.95	531	3.59	812	2.75	874	.89	1641	1.95	9010	2.50
1D8	1.25	3C28	4.95	152TH	19.95	538	1.75	813	7.95	879	1.43	1642	.98	9011	.79
1L4	.79	3D21A	1.98	205B	3.95	559	3.95	814	3.95	931A	4.50	1665	1.25	9012	.45
2C25	.75	3D23	4.95	211	.75	559	3.95	814	3.95	954	.35	1851	1.69	9013	1.95
2C26	.39	3E29	11.95	215A	.29	631P1	4.95	815	2.25	955	.45	7193	.35	9014	1.75
2C34	.39	3EP7	1.59	217C	18.00	703A	2.95	829	10.95	956	.69	8011	1.75	9015	1.75
2C40	5.49	4A1	1.75	250R	18.95	705A	2.95	830B	3.95	957	.35	8013A	6.49	9016	3.95
2C44	1.49	4AP10	4.95	250R	18.95	710A	1.75	832B	8.95	958A	.49	8014A	24.95	9017	.29
2J22	8.95	4B28	4.95	152TH	19.95	715B	8.95	833A	43.95	959	.69	8016	2.50	9018	.49
2J26	6.95	4E27/257B	17.50	285A	8.95	715C	24.50	836	1.95	1291	.28				
2J39	24.95	5AP1	3.39	286A	14.95										

## MARITIME INTERNATIONAL COMPANY

11 State Street, New York 4, N. Y. Cable Address "Foxcroft" Phones: Dlgy 4-3192-3

# ACORN

Serves Schools, Labs, Industrials  
Top Values—Same Day Service

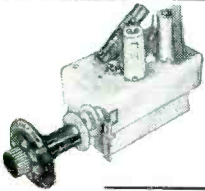

### DUMONT 4-CIRCUIT INPUTUNER Series T-3A

Featuring FM BAND reception, as well as 13 TV channels. Fits into dual channel IF system, Type 630 receivers, without alterations. Higher gain 2-to-1 ration on high channels, low noise, input impedance 300 ohms. 21.25 mcs sound center IF. Continuous tuning. Complete with TUBES and KNOBS. **\$29.95**

### T-17B CARBON MIKE

Single button carbon with press-to-talk switch. 5 ft. rubber cord and PL 68 plug. Used, but in perfect condition. All tested. **\$1.39**

### PIONEER GEN-E-MOTOR

- Type E-3: Input 14 VDC @ 8 amps DC. Output 550 V @ 120 mils **\$14.95**
- SP-125: Input 28 VDC @ 2.2 amps DC. Output 270 V @ 120 mils **\$6.95**
- DS-125: Input 28 VDC @ 1.2 amps DC. Output 260 V @ 60 mils **\$4.95**

### DYNAMOTORS

#### CARTER GENEMOTOR

Stock No. 4037AS  
DC input 6VDC; output 400 V @ 375 mils DC. Perfect for mobile communications in car, plane or boat. BRAND NEW. List \$68. Our Price **\$24.95**

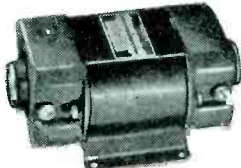

### VIBRATOR TRANSFORMER

Pri. 6v. Sec: 600r C.t. @ 100 mils. Made by Chicago Transformer. Upright mount. Mt. dim. 2" x 2 1/4" H. 3" x D 2 1/4" x W 2 1/4" **\$1.99**

### THERMO-COUPLE RF METER

0-750 milliamps calibrated 0-10. Each division on scale 75 mil. 2 1/2" meter Type DW 52. made by GE **\$2.95**

### WESTINGHOUSE TYPE TD TIME DELAY RELAY

115v. 60 cy. SPST glass enclosed. Adjustable delay 2 seconds to 1 1/2 minutes **\$7.95**

### APPROACH INDICATOR

(Glide path indicator)  
ID-24/ARN-9  
**\$3.95 ea.**

### 2" SPEAKER

4 Ohm Voice Coil  
Self-contained transformer; nylon parchment cone. Excellent for tweeter—can be used as mike. Originally made for Handie-talkie **\$2.29**

### HEAVY DUTY POWER TRANSFORMER

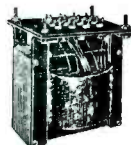

Pri. #1: 110/220 v. 60 cy. Sec. #1: 410-0-410 @ 400 mils. #2: 6.3 v. @ 3 amps. #3: 6.9 v. @ 13.5 amps. #4: 5 v. @ 8 amps. #5: 2.5 v. @ 1.7 amps. Dimensions: H-6 1/2" W-6 1/2" D-5 1/2". Wt. 33 lbs. Made by G. E. for U. S. Navy. Exceptional value! Open frame **\$7.49**  
3 for \$21

Phone WOrth 4-3270

## ACORN ELECTRONICS CORP.

76 Vesey St. Dept. E-2 N. Y. 7, N. Y.

Terms: 20% cash with order, balance C.O.D. If rated, terms 1% net 10 days. All prices F.O.B. our warehouse in N.Y.C. Minimum order \$5. NOTE: Due to conditions beyond our control, prices are subject to change.

## 10 MFD 400 VOLTS 57 CENTS

Although rated at 400V against an operating temperature of 72°C, these nationally famous 5+5 MFD capacitors will meet all commercial specifications and operate at 600V provided that the operating temperature does not exceed 40°C. Measuring 3 1/16 x 2 x 3 25/32 and packed 24 to a carton, weighing 42 pounds this item fills the need for an excellent filter and power correction device. Long lasting, extremely low in dielectric leakage and available in sufficient quantity for a large manufacturer. Small quantities—\$.57. Carton quantities—\$4.45. Samples upon request.

### WESTON LABORATORIES

Weston 93, Massachusetts

## RESISTORS TUBES CONDENSERS

Volume controls and other electronic components  
We need everything. Send us your complete lists.

### ELECTRONIC SURPLUS BROKERS

148 Chambers St. REctor 2-1591 New York, 7, N. Y.

## "AN" "K"

- 3108 WK
- 3106 GK
- 3102 SK
- 3100 NK

## Connectors

FOR  
IMMEDIATE  
DELIVERY

What Types Do You  
REQUIRE?

WRITE—WIRE—PHONE

## WILGREEN

74 Cortlandt St. N. Y. 7, N. Y.  
BA-7-4862

### FOR SALE BY:—

The President,  
Tantalum Refining and Mining  
Corporation of America Ltd.,  
5th Floor, 185 Bay Street,  
TORONTO, Ontario.

- 5 KW "Scientific Electric" Dielectric Heating Unit, Model SP-5, Serial 1045, 20-30 Megacycles complete with timing equipment, etc. Electrodes—6" x 9", Input—220 Volts, 60 cycle single phase. **\$900.00**
  - 6 KW "Scientific Electric" Dielectric Heating Unit, Model SE-68, Serial 1376, 20-30 Megacycles complete with tubes, timing equipment, etc. Electrodes—6 1/2" x 8 1/2" in interlocked heating chamber, Input—220 Volts, 60 cycle single phase. **\$1,200.00**
  - 3 KW "Scientific Electric" Dielectric Heating Unit, Model SE-6A, Serial 1242, 20-30 Megacycles complete with tubes and timing equipment, etc. Electrodes—6 1/2" x 8 1/2" in interlocked heating chamber. Input voltage—220 volts, 60 cycles single phase. **\$900.00**
- This equipment was made in U. S. A. and is practically unused having become redundant owing to changes in process. Prices quoted can be subject to negotiation.

Prices F.O.B. Edmonton





ALL  
MERCHANDISE  
GUARANTEED

**PHONE and CW TRANSMITTERS**  
from 25 watts to 1 kilowatt  
including many navy and  
ground units:

TBL	TCS	ET4332
TBK	TAJ	BC447
TBM	TAQ	ET8010
TDE		ET8023

**RADAR and SONAR  
MARINE and AIRBORNE**

SA	SJ	YJ	APS 2, 3 and 4
SO	SF	YG	ASB
SN	SL	SD	CPN-6
SQ	SK	etc.	CPN-8

QCO, QBE-WEA, NAA, etc.

**TELEPHONE SWITCHBOARDS**  
BD-71 and BD-72

Also: Dynamotors, Converters,  
Invertors; Magnetrons; Klystrons,  
Special Purpose Tubes;  
1/2-million insulators, all types;  
Microwave and test equipment.

1500 BRAND NEW

# DM-32A

Dynamotors, with bases.  
\$12.00 each

## COMPASS

**COMMUNICATIONS CO.**  
393 Greenwich Street, N. Y. C.  
Phone: BEekman 3-6510  
Cable Address: COMPRADIO, N. Y.

### TENNEY

**High Altitude Chamber**  
Temperature Control 70° F to 125° F.  
Humidity control up to 95%.  
Altitude control sea level to 53,000 ft.  
Used little, like new

**KINGS COUNTY MACHINERY EXCHANGE**  
408 Atlantic Avenue, Brooklyn 17, N. Y., Dept. "E"

## HEAD PHONES

Schools, Laboratories, Industrial Users: We have  
available genuine Western Electric type 716-B  
laboratory-type head phones, complete and new.  
Don't confuse these with surplus military offerings.  
Worth \$15, cost you \$3.90.

**THE OVERBROOK COMPANY**  
Massachusetts

# SURPLUS EQUIPMENT

**INVERTER UNIT PE 218**

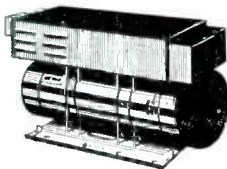

Output: 115 VAC;  
Single phase; PF  
90; 380/500 cycle;  
1500 V.A. Input;  
25-28 VDC; 92  
amps; 8000 rpm;  
Exc. volts 27.5; Le-  
land Electric mfg.  
**BRAND NEW \$29.95**

**ONAN MOTOR GENERATOR SET  
MG 075-G-1**

Generator 115 VAC;  
480 cycle; 5.3 Amps;  
.6KW; PF 1.0; Also  
26 VDC; 100 watt;  
3.8 Amps; Driven by  
115-230 VAC - 2hp  
motor; 60 cycle;  
single phase; 3450  
rpm; 10.5 amps.  
**BRAND NEW**

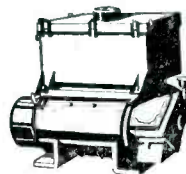

**\$195.00**

**BLACK LIGHT KITS**

Ultra-Violet  
Fluorescence

Now... build your  
own black light lab  
equipment at a new  
low cost with these  
easy - to - assemble  
components. Kit con-  
tains: Ultra-Violet tube brackets, ballast,  
starter, wire, plug and wiring diagram.  
4-Watt Kit—(5 1/2" tube).....\$3.00  
8-Watt Kit—(12" tube).....\$4.00



**G. E. INDUCTION VOLTAGE  
REGULATOR**

Motor Driven (No. 7232100)

Type AIRT; 60 cycle; Form M; Indoor  
service 55° C. rise; KVA 1.73; Cont. Duty;  
Primary Volt 115; Load Amp. 10.5; % Raise  
82.6 - % Lower 82.6; Approx wt. 140 lbs.  
Original cost more than \$600.  
**BRAND NEW.....\$179.00**

**BLOWER UNIT**



Single exhaust with  
squirrel-cage type fan.  
Intake 2 1/2"; Outlet 2".  
Delivers approx. 55 cu.  
ft./min. 115V-AC (60  
cycle) DELCO motor.  
Simple to install for any  
use. Govt. cost more  
than \$20.00.  
**NEW.....\$9.95**

ALL EQUIPMENT F.O.B. PASADENA • PLEASE SEND FULL AMT. WITH ORDER

**C and H Sales Company**

BOX 356-E EAST PASADENA STATION • PASADENA 8, CALIFORNIA

### RADAR

SCR 545A Search and Track. Complete trailer, power supply  
and spare parts. Nearly new. Write for description and price.

### PORTABLE PUMP ASSEMBLY

Leland, 110 v. 60 c. 1 ph. 1/3 H.P. motor and D. Roper #2  
hydraulic pump. 300 lbs PSI max., 125 lbs. PSI continuous  
@ 3.25 gallons per min.....\$52.00

### SEARCH LIGHT

Signaling, 12" Curtis Lighting, Inc. 115 v. a-c or d-o, 1000  
watt. Complete w/bulb. Comes w/mounting assembly that gives  
360° horizontal rotation and 180° vertical rotation.....\$27.50

### AUTO-DRYAIR

Model 220, 115 v. 60 cy. for pressurizing high altitude elec-  
tronic equipment.....\$160.00

### MOTORS

General Electric geared,  
27 v. d-c @ 0.7 a., 110  
RPM, 1 oz/ft torque. \$3.50  
Electric 1/15 H.P., 115 v.  
60 cy. 1 ph. 1800 RPM \$4.75

### GENERATOR

Bendix model NEA3. Out-  
put 115 v. a-c 10.4 amps,  
800 cy. SP. and 28.5 v. d-c,  
60 amps @ 2400 RPM.  
Self excited, spined drive.  
New Orig. packing. \$27.50

### RECTIFIER

Dry Disc, 6.5 v. a-c FWCT.  
2.2 v. d-c @ 3 amps.....75¢  
4 for \$2.00  
Westinghouse Transformer  
18,400-0-18,400 v. @ 9 KVA  
continuous. Westinghouse  
Filament Transformer, 11.5  
v. @ 40 amps. Both trans-  
formers have 115 v. 60 cy.  
1 ph. primaries. Westing-  
house Choke, 50 h. @ 575  
ma., insulated for 17,500 v.  
continuous. (2) WVL-331  
rectifier tubes, 60,000v peak  
inverser. Complete \$160.00

### POWER SUPPLY COMPONENTS TRANSFORMERS

Plate, American Transformer Co. Spec.  
29108. Pri. 115 v. 60 cy. 10.4 KVA. Sec.  
17,600 v., 520 amps., 35 KVA test. \$65.00  
Plate, American Transformer Co. Spec.  
29108. Same as above but center-tapped  
to handle 1 amp @ 8800 v.....\$75.00

### CONTACTOR

Allen-Bradley & Westinghouse, 115 v. 60 cy. coil. DPST, 15  
amps.....\$4.95

### HIGH VOLTAGE RECTIFIER POWER SUPPLY

Variable output 0-15,000 v. d-c @ 500 ma. Input 115 v.  
60 cy. SP. Army type RA-38. Size 6 3/4" x 5 3/4" x 5 6/7".  
Wt. 2040 lbs. Units are new, complete with spare tubes and  
remote control. Write for detailed information.

Filament, American Transformer Co. Spec.  
29106, Type WS, .050 KVA, 50/60 cy.  
SP, 35 KVA test, 12 KV d-c operating.  
Pri. 115 v., Sec. 5 v., 10 amps. w/integral  
stand-off insulator and socket for #371,  
872, etc. rectifier tubes.....\$12.50  
2 for \$22.50—4 for \$40.00

### CAPACITORS

9.12 mfd., 1265 v. 60 cy. a-c or 4000 v.  
d-c power factor correction 5.0 KV. A.R.,  
Cat. #2528908.....\$17.50  
25-.25, 6000 v. d-c or .125 @ 12,000 v.  
d-c, Fast Cat. #A7548, oil.....\$3.75  
1.25/1.25 mfd., 7500 v. Cat. #26F360  
\$12.50

1.0 mfd., 25,000 v. d-c. Cat. #14F59  
\$36.00  
2x.15 mfd., @ 8000 v. or .075 mfd. @  
16,000 v. Vitamin Q.....\$2.90

### RESISTORS

Fixed, w.w. 160,000 ohm, 200 w. ferrule  
ends.....\$1.00  
Fixed, w.w. 5,000 ohm, 200 w. ferrule  
ends.....\$1.00

### METERS

Volt Meter, 3" Weston Model 301, 1 ma  
f.s. calibrated 0-20 KV d-c w/Weston 20  
meg. precision meter multiplier, stand-off  
insulators and clips.....\$18.00  
Meter only, less multiplier.....\$ 4.95  
Ammeter, a-c 3" Westinghouse NA-35 or  
Weston Model 476, 3 amps, f.s. deflection;  
scale calibrated 0-120, includes doughnut  
type current transformer w/200-5 ratio at  
25-133 cy.....\$8.50  
Volt Meter 3" Weston Model 301, 4 KV  
d-c 1 ma. f.s. calibrated 0-4 KV w/4  
meg. Weston precision multipliers.....\$7.50

### RELAY

Magnetic overload, Allen-Bradley #810,  
6.3-18.1 amps, 600 v. max.....\$7.95

### WIRE

Simplex type S. 600 v. (19) conductor #18  
A.W.G. Approx. 1000' reels.....\$170.00/M'

**NEW!**

- low prices
- values
- equipment
- components

Note: All merchandise not  
designated as new is  
guaranteed to be in ex-  
cellent to new condition.

**EPCO**

1527 E. 7th St.  
Los Angeles 21, Calif.

CALLING ALL ENGINEERS!

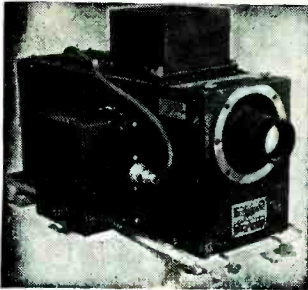

**TELEVISION CAMERA**

3350 line resolution. Easily converted to present RMA standards. Circuits available with camera. Complete, like new.

**WE HAVE**

APS-4 RADAR

APS-6 RADAR

MARK-16 RADAR COMPLETE

MARINE RADIO UNIT FT 102 (167BY Transmitter) 200 W. 4 bands covering range of 2-24 mc. NEW.

BC-1100-A TRANSMITTER with remote control. 125 W. 115 VDC or AC.

BC-452 TRANSMITTER 300 W. 1.5-7.0 mc. Point-to-point and air warning. A1, A2 and A3 emission. 115 and 230 V.

RC-184 IFF EQUIPMENT Brand new. Complete.

COMPLETE LINE OF TEST EQUIPMENT SUCH AS:

- TS-36/AP TS-117 WAVE METER
- TS-35/AP TS-102A/AP
- TS-108 TS-12/AP (Units 1 & 2)
- 1-177 HICKOK TUBE CHECKER
- TS-184A/AP

**WE ARE LOOKING FOR: ALL TYPES OF RADAR, GROUND and AIRCRAFT RADIO EQUIP.**

**We Want:** BC-348 ART-13  
ARC-1 RTA-1B  
MN 62 R5A/ARN7  
BC-1000

TELL US: WHAT YOU HAVE.

**COLUMBIA ELECTRONICS LTD.**  
524 S. SAN PEDRO ST.  
LOS ANGELES 13, CALIF.  
Cable Address: COELECT

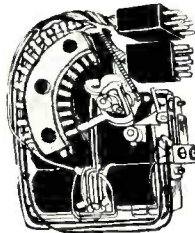

**Automatic Electric**  
**2 Decks 10 Points**  
**TELEPHONE**  
**RELAY**  
**24 VOLTS D.C.**  
**\$11.00**

**CAN'T KINK CABLE**

3 cond. 5/16" dia. Tough rubber covered. For remote or Ant. Control. Foot Switch etc. Cut to your order. 50 ft. or more. 3 1/2¢ ft.  
550 ft. Metal reels Express Collect. \$15.00

**RCA 100A**

Free Floating Cone Type-Magnetic-Loud Speaker. Removed from rooms of a large N. Y. Hotel. Original cost \$32.00. 3 for \$5.00

- WE 24 & 12 volt Telephone lamp...doz. \$1.50
- CH 4 pole 35 ampere 115v. AC relay. \$4.90
- GE 3 ampere Mercury Switch 3 for \$2.50
- 1/2" glass tube

**ISOLATION TRANSFORMER \$1.95**  
Nat. known Mfrs. 50 watt 2 windings, 115 V. to 115 V. 60 cy. Ideal to prevent shocks from small radios and medical and electronic devices. Shipping Weight 3 lbs. Other sizes and 220-110 in stock.

**NEW HOLTZER-CABOT**  
**TOTALLY ENCLOSED MOTORS**

50 R.P.M. Reversible Single Phase Capacitor-Run type. 115 Volts AC 60 cycle 0.3 Amp.

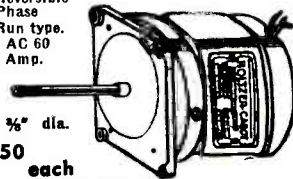

Torque 100 oz. Inches. 4 1/4" shaft 3/8" dia.

**\$17.50 each**  
Shipping weight 12 lbs.

**Genuine TELECHRON Motors**

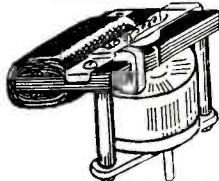

- 2 RPM .....\$2.90
- 3.6 RPM ..... 3.15
- 1 RPM ..... 3.95
- 60 RPM ..... 4.30
- One of Each \$12.00

**STEVENS-ARNOLD**

Stevens-Arnold Resonant Relay Only two types in stock. 442 and 240 CPS either one. \$4.50 Both for \$8.00

- 400 CYCLE 110V A.C. 1 AMP CONVERTER \$49.50
- 1/2 H.P. D.C. 110V MOTOR HOLTZER -CABOT M.G. 218. \$1.00
- ROLLER LEAF MU SWITCH. \$1.00
- 4 FOR 100 for \$20.00

ELAPSED TIME METERS



SONIOMETERS  
Micro Switch  
Solenoids  
Relays  
Electric Counters

EST. 1923 **BLAN** EST. 1923

Experimenters and Inventors Supplies  
64 Dey St., New York 7, N. Y.

**WHOLESALE ONLY**

**ELECTRONIC COMPONENTS**  
**AIRCRAFT EQUIPMENT**  
**HYDRAULICS**  
**RADIO & ELECTRONIC SURPLUS**  
13933-9 Brush St. Detroit 3, Mich.  
Phone Townsend 9-3403

**At Your Service**

—for bringing business needs or "opportunities" to the attention of men associated in executive, management, sales and responsible technical, engineering and operating capacities with the industries served by the following McGraw-Hill publications:

**The SEARCHLIGHT SECTIONS of Classified Advertising**

- American Machinist
- Aviation Week
- Business Week
- Bus Transportation
- Chemical Engineering
- Chemical Industries
- Coal Age
- Construction Methods and equipment
- Electrical Construction & Maintenance
- Electrical Merchandising
- Electrical World
- Electronics
- Engineering and Mining Journal
- E. & M. J. Metal & Mineral Markets
- Engineering News-Record
- Factory Management and Maintenance
- Fleet Owner
- Food Industries
- Nucleonics
- Operating Engineer
- Power
- Product Engineering
- Textile World
- Welding Engineer

For advertising rates or other information address the

Classified Advertising Division

**McGraw-Hill PUBLISHING CO., INC.**  
330 W. 42nd St., New York 18, N. Y.

**CONDENSERS**

Ceramicons, micas, bathtubs, oils. Large quantities on hand for immediate shipment.

See our ads in October, November, December Electronics.

*Inquiries solicited and promptly answered*

**MONMOUTH RADIO LABORATORIES**  
BOX 159 OAKHURST, N. J.



## GLASS BLOWING IN ALL ITS BRANCHES

Special tubes, Lamps, Vacuum, Rare Gases etc. Developed or made to Specification. Kovar, Tungsten, Copper seals. Vacuum Pumps, Glass or Metal.

IN STOCK AT VERY LOW PRICES

Tungsten, Moly, Tantalum, Kovar, etc. in Wire, Ribbon, Strips, Mesh, Tubes, etc., also other materials and equipment used in the Vacuum, Radio Tubes, Lamps, in Industry and Laboratories.

F. ALEXANDER

115 W. 23d St. New York 11, N. Y.

## D.C. MICROAMMETERS

0-200 ua 3" sq. G.E. DO 50.....\$ 9.00  
0-100 ua 3" sq. G.E. DO 50..... 10.00  
0-50 ua 3" sq. G.E. DO 50..... 12.00

## PRECISION PORTABLE INSTRUMENTS

Single or multi-range

D.C. Microammeters, from 5 ua full scale. Thermo-couple Milliammeters, from 1.5 Ma. Thermo-couple voltmeters.

## Precision Electrical Instrument Co.

146 Grand Street New York 13, N. Y.

## FOR SALE BY:—

The President,  
Tantalum Refining and Mining  
Corporation of America Ltd.,  
5th Floor, 185 Bay Street,  
TORONTO, Ontario.

"Scientific Electric" High Frequency Induction Heating Unit or Bombarder, Model WC-25A, Serial 1082 complete with spare tubes and accessories. Input—220 Volts, 60 cycles single phase, 25 KW .....\$2,700.00

"Scientific Electric" High Frequency Induction Heating Unit or Bombarder, Model 18-HF 2, Serial 20115 complete with spare tubes and accessories. Input—220 volts, 60 cycles single phase, 18 KW .....\$1,600.00

"Scientific Electric" High Frequency Induction Heating Unit or Bombarder, Model 6HF2, Input—220 volts, 60 cycles single phase, 6 KW .....\$1,000.00

This equipment was made in U. S. A. and is practically unused having become redundant owing to changes in process. Prices quoted can be subject to negotiation.

Prices F.O.B. Edmonton

# TUBES LARGE STOCK

Most All Types

Write Us Your Needs

Subject to Prior Sale

## NAT ADELMAN

168 Washington St., N.Y. 6, N.Y.

C07-6091

We Buy Surplus Stocks of  
Tubes and Electronic Parts

# "TAB"

That's a Buy!

## PAPER CONDENSER BUYS!

WVDC Mfd Each	For	WVDC Mfd Each	For
150 .002 6¢ \$5.40	1.5	600 .0001 6¢ \$5.40	1.00
200 .047 8¢ 8.10	1.0	.002 8¢ 7.20	1.00
.05 12¢ 10.80	1.0	.004 10¢ 8.98	1.00
.1 14¢ 12.60	1.0	.0042 10¢ 8.98	1.00
.5 21¢ 18.90	1.0	.006 11¢ 9.98	1.00
.002 8¢ 7.20	1.0	5 025 275	10 80
.004 9¢ 8.10	1.0	.015 12¢ 10.80	1.00
.01 10¢ 8.98	1.0	.02 14¢ 12.60	1.00
.02 11¢ 9.98	1.0	.03 15¢ 13.50	1.00
.04 13¢ 11.70	1.0	.05 17¢ 15.30	1.00
.05 15¢ 13.50	1.0	.1 23¢ 20.70	1.00
.1 19¢ 17.10	1.0	.3 25¢ 22.50	1.00
.5 24¢ 21.60	1.0	.5 29¢ 26.10	1.00
1 29¢ 26.10	1.0	.1 10¢ 13.50	1.00

## METAL CASE—OIL IMPREGNATED

200 .04 29¢ \$26.10	009 .05 39¢ 35.10
300 .01 26¢ 23.40	.5 5¢ 58.50
400 .01 28¢ 25.20	.5 6¢ 58.50
.25 46¢ 41.40	1000 .006 29¢ 26.10
.5 54¢ 48.60	1500 .01 75¢ 67.50
.01 29¢ 26.10	1600 .01 79¢ 71.10
.02 33¢ 29.70	.02 95¢ 85.50
.04 37¢ 60.30	.064 99¢ 89.10

## MOLDED BAKELITE ENCASED

200 .02 11¢ \$9.90	500 .003 12¢ 10.80
.05 15¢ 13.50	.006 15¢ 13.50
.01 11¢ 9.90	.01 17¢ 15.30
.01 13¢ 11.70	.005 16¢ 14.60
.05 17¢ 15.30	.003 15¢ 13.50
1 23¢ 20.70	.01 21¢ 18.90
.001 11¢ 9.90	.05 23¢ 20.70

**LINE FILTERS**  
10 Amp/130va dc Csd USN 0.1 to 1.0 A.....\$1.29  
30 Amp/250va dc Csd USN 0.1 to 1.0 A.....\$1.29  
1000 Ma's. Ea. \$3.98; 2 for \$6.00  
50 Amp/600vdc/250vac. Filtrs both sides of line. SOLAR "Elim-O-Stat". New. \$9.98; 2/\$18; 5/\$39  
100Amp/usable 110 va dc GE, SPECIAL 2 for \$1.98

## IN STOCK . . .

9,000 Antennas	2,500 Headsets
4,000 Batteries	2,300 Line Filters
300,000 Capacitors	27,000 Pilot Lights
20,000 Chokes & Coils	2,000 Selsyns
15,000 Circuit Breakers	1,000 Blowers
1,000 Clock Motors	1,100 Tach Generators
40,000 Connectors	2,500 Rectifiers
12,000 Piezo Xtals	20,000 Relays
1,200 Dynamotors	250,000 NW Resistors
15,000 ft. Film	2,500,000 Precision Resistors
1,250,000 Fuses & Holders	65,000 Potentialmeters
10,000 ft. Spaghetti	23,000 Rheostats
45,000 Insulators	8,000 Tech Manuals
5,500 Meters	50,000 Tube Sockets
25,000 Rotary Switches	500,000 pcs Telephone Equip (jacks, plugs, lamps, etc.)
20,000 Toggle Switches	40,000 Transformers
15,000 Microswitches	250,000 Tubes
100,000 ft. Wire & Cable	
5,000,000 pcs Hardware	

Lugs Millions of Odds N' Ends  
Government Contractors, Quantity Users—Write for Your Needs On Your Company Letterhead

"TAB" Dept. 2E, 6 Church St.  
Corner Church & Liberty Sts.  
New York 6, N. Y.  
WOrth 2-7230  
That's a Buy!  
Don't Miss Our Full Page Ad, Last Page

## Precision Resistors— Over 2 1/2 Million in Stock

"TAB"—Specialists in Precision Resistors  
No Mfrs. Choice—We Ship Types in Stock

0.116 209.4	700 1919	6140 23400	147000
0.42 216	711 1922	6200 23500	150000
0.425 220	733 1924	6300 24000	155000
0.607 220.4	740 1926	6495 24600	160000
0.7 225	750 1960	6508 25000	165000
1.03 230	800 1960	6800 25000	175000
1.3 235	806 2000	6990 25400	167000
1.75 240	850 2045	7000 25833	169200
2.5 245	854 2080	7320 26600	175000
3 245.4	899 2095	7500 26500	180000
3.83 250	900 2141	7700 26600	180600
4.35 260	910 2142	7717 27000	185000
5 271	917 2145	7900 27500	186600
5 025 275	946 2150	7930 28000	190000
6.25 280	978 2160	7950 28430	198000
6.5 286	1000 2180	8000 28500	200000
7 289	1030 2187	8094 29000	201000
7.8 299	1056 2195	8250 29500	205000
7.9 300	1059 2200	8500 29990	210000
8 310	1067 2250	8700 30000	215000
10.38 311.5	1100 2300	8770 31000	220000
11.25 320	1110 2400	9000 31500	225000
12 325	1150 2450	9100 32000	229000
13.52 330	1152 2485	9445 33000	230000
14.2 340	1182 2485	9500 35000	335000
14.25 350	1200 2490	9710 37000	238000
14.5 360	1225 2500	9800 38140	240000
15 366.6	1250 2525	9900 38500	245000
16 370	1260 2600	9902 39000	250000
17 375	1300 2625	10000 39500	255000
19 380	1350 2650	10430 40000	260000
19.2 389	1355 2700	10500 42000	270000
20 390	1400 2750	10650 43000	275000
22 400	1488 2850	10900 45000	294000
23 410	1495 2860	10936 47000	300000
24 414.3	1500 2870	11040 47500	307500
25 418.8	1510 2900	11400 48000	311000
26 425	1518 3000	11500 48660	314000
28 426.9	1600 3100	11690 49000	316000
30 427	1640 3163	12000 50000	325000
31.5 440	1646 3259	12500 52000	330000
37 450	1650 3270	12600 52500	335000
48 452	1670 3333	13000 56000	335000
49 460	1680 3384	13100 57065	350000
50 470	1710 3500	13500 58333	353500
51 78 475	1712 3509	13550 60000	375000
55 478	1740 3700	13600 61430	380000
56.7 480	1770 3730	14000 62000	400000
60 482	1800 3760	14000 62000	400000
63 500	1818 4000	14400 65000	420000
68 520	1830 4030	14500 66600	422000
74 525	1865 4200	14550 66650	425000
75 540	1892 4220	14600 67500	450000
80 550	1894 4280	15000 68000	458000
81.4 575	1895 4300	16000 70000	478000
88 580	1896 4314	16500 72000	500000
89.8 588	1897 4440	16800 73500	520000
95 600	1898 4444	17000 75000	521000
100 612	1899 4500	17500 80000	525000
101 625	1900 4720	17977 82000	543000
105 633	1901 4750	18000 84000	550000
105.7 640	1902 4850	18300 85000	570000
107 641	1903 4885	18380 85750	575000
120 645	1904 4900	18500 88000	600000
121.2 649	1905 5000	18800 90000	620000
125 650	1906 5100	19000 91000	650000
130 657	1907 5110	19500 93000	654000
135 665	1908 5235	20000 95000	660000
147.5 668	1909 5270	20441 100000	690000
150 670	1910 5300	20500 110000	700000
160 673	1911 5500	21000 115000	750000
165 675	1912 5600	21500 116667	761300
170 680	1913 5730	22000 120000	800000
175 681	1914 5810	22500 130000	813000
179 684	1915 5910	22990 135000	850000
182 689	1916 6000	23000 140000	900000
182.4 697	1917 6100	23150 141000	930000
200 699	1918 6125	23325 145000	950000

Any Size Above, Each 35¢; Ten for \$3.29  
MEGOMHS  
1. 1.579 2.5 3.9 7 10 11.55  
1.1 1.65 2.7 4 6.7 12  
1.2 1.75 2.75 4.23 7.5 12  
1.25 1.8 2.8 4.25 7.62 12.83  
1.3 1.9 2.855 4.5 7.74 13  
1.35 2 3 5 8 13.85  
1.39 2.11 3 5 8 13.85  
1.4 2.11 3.5 6 8.5  
1.5 2.2 3.673 6.5 9.05  
1.57 2.25 3.75 6.6 9.5  
Any Size Above, Each 70¢; Ten for \$6.49

# LARGE QUANTITIES of RADIO TUBES

TYPE	TYPE	TYPE	TYPE	TYPE	TYPE	TYPE
1R5	6AC7	6H6	6K7GT	12A6	803	866A
1S4	6AL5	6J5	6SG7	12SG7	805	9005
5U4G	6C4	6J7	6SH7	12SK7	807	
5V4G	6C5GT	6J5GT	6SK7	12SR7	808	
6AB7	6D6	6K6GT	6SN7GT	42	813	

Packed in Original Cartons. Prices on request.  
SUBSTANTIAL DISCOUNTS ON LARGE ORDERS

All tubes are brand new standard brands. This offer subject to change without notice and prior sale. Terms: 25% deposit with order balance C.O.D. \$25.00 dollars minimum order.

MANUFACTURERS:

WANT MORE EXPORT SALES? CONTACT: MICHEL LEVIT

METROPOLITAN OVERSEAS SUPPLY CORPORATION

Manufacturers and Distributors of Electronic Products

1133 BROADWAY Phone Chelsea 3-1105 NEW YORK 10, N. Y.



SEARCHLIGHT SECTION

# "TAB" TUBES

TESTED—GUARANTEED  
Prices Subject to Change  
\*Critical Type—Write for Price

OA2	1.69	2B7	.98	5X4G	.90	6K5GT	1.16	7N7*	2.65	65	1.39	720CY	45.00	5686	4.23	Ballast	
OA3/VR75	1.28	2B22/	.98	5Y4GT*	1.25	6K6GT*	1.50	7Q7*	.95	66	1.39	721A	5.98	5687	7.20	BP1	.49
OA4G	1.33	GL559	1.38	5Y4G	1.25	6K6GT*	1.50	7Q7*	.95	67	1.39	722A/287	2.75	5812	1.79	PM3	.98
OB2	1.20	2C21/1642	.36	5Z3	.98	6K8	1.07	757	1.33	68	1.39	723A/B	18.98	5881	5.50	PM4	.98
OB3/VR90	1.29	2C22/7193	.89	5Z4	1.18	6L5G	.98	717	1.03	69	1.39	724A/B	2.39	8002R	99.50	4A1	1.29
OC3/VR105.03	2.26	25	.66	6A	7.45	6L6*	2.26	7V7	1.33	70	1.39	725A	2.89	UX6653	.69	PM5	.98
OC3/VR150.85	2.33	2C34/RK34	.30	6A3	1.39	6L6GA*	1.98	7W7*	2.65	71	1.39	726A	7.98	8013	3.75	PM6	.98
OD4	2.53	2C39	23.98	6A4	1.60	6L6GA*	1.98	7X7*	2.65	72	1.39	727A	15.89	8020	1.95	PM7	.98
OY4	4.86	2C40	2.70	6A5G	3.10	6L7	1.98	7X7*	2.65	73	1.39	728A	15.89	9001	1.95	PM8	.98
CIA	4.90	2C43	28.50	6A6	1.33	6N4	2.39	7Y4*	1.33	74	1.39	729A	15.89	9002	1.65	9-3	.49
OIA	.68	2C43/464A	16.95	6A7	1.05	6N6G	1.95	7Y4*	.87	75	1.39	730A	15.89	9003	1.65	10-4B	.49
SIA	3.95	2C44	1.20	6A8GT	1.05	6N7GT	1.26	10Y1	.79	76	1.39	731A	15.89	9004	1.79	13-4	.49
IA1	1.10	2C50	.30	6A8A*	2.00	6P5GT*	1.57	12A	.89	77	1.39	732A	15.89	9005/RC4B	1.95	20-4	.49
IA4P	.98	2C51	5.69	6A8B/6N5	1.33	6O7	1.89	12A5*	1.39	78	1.39	733A	15.89	9006	1.65	27	.49
IA5GT	.85	2C52	3.06	6A8T/1853	1.42	6R7	1.98	12A6*	1.49	79	1.39	734A	15.89	9007	1.65	K55B	.36
IA6	1.78	2D21	1.80	6AC5GT	1.29	6R8	1.39	12A7	1.49	80	1.39	735A	15.89	9008	1.65	M55B	.36
IA7GT	1.06	2E5	1.16	6AC7*	2.90	6S4*	1.80	12A8GT	1.00	81	1.39	736A	15.89	9009	1.39	L62A	.49
IA8A	1.80	2E22	1.12	6AD7	1.60	6S7	2.29	12A8GT*	1.33	82	1.39	737A	15.89	9010	1.49	WL121A	2.61
IB3/8016*	2.65	2E24	4.50	6AE5*	2.00	6S7GT*	2.29	12B26*	1.00	83	1.39	738A	15.89	9011	1.49	C376	2.98
IB4P	.98	2E25/V	1.16	6AE6*	2.00	6S7GT*	2.29	12B26*	1.00	84	1.39	739A	15.89	9012	1.49	ZB583	3.98
IB5/25S	.98	HY6	5.25	6AF5G	.39	6S7GT*	2.29	12B26*	1.00	85	1.39	740A	15.89	9013	1.49	876	.29
IB7GT	.98	2E30	2.16	6AF6G	1.33	6S7GT*	2.29	12B26*	1.00	86	1.39	741A	15.89	9014	1.49		
IB21/471A	2.85	2J21	10.69	6AG5*	2.65	6S7GT*	2.29	12B26*	1.00	87	1.39	742A	15.89	9015	1.49		
IB22	3.49	2J21A	10.69	6AG7*	2.85	6S7GT*	2.29	12B26*	1.00	88	1.39	743A	15.89	9016	1.49		
IB23	8.25	2J26	6.98	6AG8*	2.85	6S7GT*	2.29	12B26*	1.00	89	1.39	744A	15.89	9017	1.49		
IB24	4.30	2J38	13.90	6AH5G	1.49	6S7GT*	2.29	12B26*	1.00	90	1.39	745A	15.89	9018	1.49		
IB26	3.69	2J30	39.50	6AH6*	3.90	6S7GT*	2.29	12B26*	1.00	91	1.39	746A	15.89	9019	1.49		
IB27	23.85	2J31	8.90	6AJ5	1.49	6S7GT*	2.29	12B26*	1.00	92	1.39	747A	15.89	9020	1.49		
IB29	.98	2J33	18.45							93	1.39	748A	15.89	9021	1.49		
IB32/532A	1.71	2J34	19.39							94	1.39	749A	15.89	9022	1.49		
IB36	10.00	2J36	95.00							95	1.39	750A	15.89	9023	1.49		
IB37	18.00	2J37	12.80							96	1.39	751A	15.89	9024	1.49		
IB38	34.00	2J38	9.95							97	1.39	752A	15.89	9025	1.49		
IB40	4.95	2J39	19.90							98	1.39	753A	15.89	9026	1.49		
IB41	49.95	2J40	24.50							99	1.39	754A	15.89	9027	1.49		
IB42	7.50	2J48	15.70							100	1.39	755A	15.89	9028	1.49		
IB46	3.69	2J49	39.45							101	1.39	756A	15.89	9029	1.49		
IB53	49.95	2J58	139.00							102	1.39	757A	15.89	9030	1.49		
IB54	79.95	2J59	139.00							103	1.39	758A	15.89	9031	1.49		
IB56	40.95	2J56	249.50							104	1.39	759A	15.89	9032	1.49		
IB59	12.95	2J62	49.45							105	1.39	760A	15.89	9033	1.49		
IB60	64.95	2K25	49.98							106	1.39	761A	15.89	9034	1.49		
IC5GT	1.09	2K25/AB	39.98							107	1.39	762A	15.89	9035	1.49		
IC7G	.98	2K29	39.95							108	1.39	763A	15.89	9036	1.49		
ID5GP	.98	2K29	39.95							109	1.39	764A	15.89	9037	1.49		
ID7G	.98	2K39	89.50							110	1.39	765A	15.89	9038	1.49		
ID8GT	.98	2V3G	1.29							111	1.39	766A	15.89	9039	1.49		
IE5GP	.98	2W3GT	.98							112	1.39	767A	15.89	9040	1.49		
IE7G	.98	2X2	.89							113	1.39	768A	15.89	9041	1.49		
IF5G	.98	2X2A	1.49							114	1.39	769A	15.89	9042	1.49		
IF6	.98	3A5	1.25							115	1.39	770A	15.89	9043	1.49		
IF7G	.98	3A8GT	1.90							116	1.39	771A	15.89	9044	1.49		
IG4GT	.98	3B4	2.69							117	1.39	772A	15.89	9045	1.49		
IG5G	.98	3B5	.98							118	1.39	773A	15.89	9046	1.49		
IG6GT	1.19	3B7/1291	.69							119	1.39	774A	15.89	9047	1.49		
IHG4	.98	3B24	4.98							120	1.39	775A	15.89	9048	1.49		
IHG5	.87	3B24	4.98							121	1.39	776A	15.89	9049	1.49		
IHG6	.98	3B26	3.95							122	1.39	777A	15.89	9050	1.49		
IJ5G	1.20	3B27	1.95							123	1.39	778A	15.89	9051	1.49		
IL6G	.98	3B28	7.85							124	1.39	779A	15.89	9052	1.49		
IL4A	1.33	306/XXB	1.60							125	1.39	780A	15.89	9053	1.49		
IL6A	1.33	3C23	5.85							126	1.39	781A	15.89	9054	1.49		
IL8A	1.33	3C31/C1B	3.45							127	1.39	782A	15.89	9055	1.49		
ILC5	1.33	3D6/1219	13.85							128	1.39	783A	15.89	9056	1.49		
ILD6	1.33	3D12A	1.98							129	1.39	784A	15.89	9057	1.49		
ILD5	1.33	3E29	17.49							130	1.39	785A	15.89	9058	1.49		
ILE3	1.33	3L4P	1.33							131	1.39	786A	15.89	9059	1.49		
ILH4	1.33	3Q4	.98							132	1.39	787A	15.89	9060	1.49		
ILN5	1.33	3Q5GT	1.15							133	1.39	788A	15.89	9061	1.49		
IN5GT	.98	3S4	.98							134	1.39	789A	15.89	9062	1.49		
IN6GT	.98	3V4	.98							135	1.39	790A	15.89	9063	1.49		
IP5GT	.98	4B27	4.98							136	1.39	791A	15.89	9064	1.49		
IP24	2.39	4C33	59.00							137	1.39	792A	15.89	9065	1.49		
IQ5GT	.98	4C36	19.79							138	1.39	793A	15.89	9066	1.49		
IR4/1294	.98	4D32	19.90							139	1.39	794A	15.89	9067	1.49		
IR5	1.06	4E27/257	12.45							140	1.39	795A	15.89	9068	1.49		
IS4	1.20	4J31	95.00							141	1.39	796A	15.89	9069	1.49		
IS5	.98	4J42/700	19.00							142	1.39	797A	15.89	9070	1.49		
IS21	3.95	4J47	260.00							143	1.39	798A	15.89	9071	1.49		
IT4	1.05	4T4/2	5.95							144	1.39	799A	15.89	9072	1.49		
IT5GT	1.33	5D21	24.30							145	1.39	800A	15.89	9073	1.49		
IU5	.95	5J23	13.45							146	1.39	801A	15.89	9074	1.49		
IV	.98	5J29	12.40							147	1.39	802A	15.89	9075	1.49		
IX2*	2.65	5J32	99.00							148	1.39	803A	15.89	9076	1.49		
IZ2*	3.98	5J32	99.00							149	1.39	804A	15.89	9077	1.49		
2A3	1.20	5R4GY	1.98							150	1.39	805A	15.89	9078	1.49		
2A4G	.89	5T4*	1.72							151	1.39	806A	15.89	9079	1.49		
2A5	.89	5U4G*	1.50							152	1.39	807A</					







# INDEX

TO QUALITY  
COIL COMPONENTS

Military — Commercial

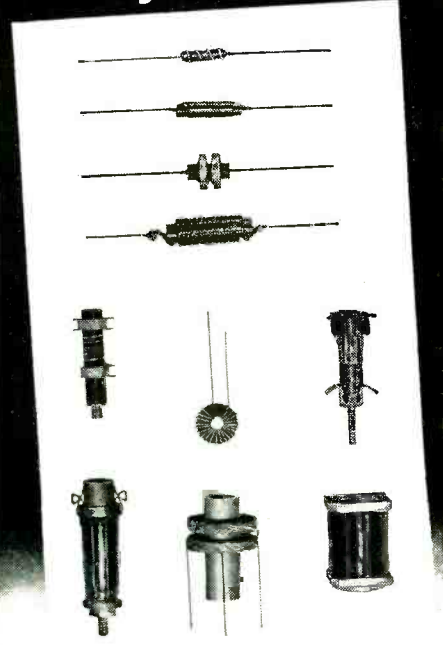

## HERMETICALLY SEALED VACUUM VARNISHED IMPREGNATED

- Bobbins
- Choke Coils
- Oscillator Coils
- Relay Coils
- R.F.—I.F. Coils
- Solenoids
- Toroidal Coils
- Transmitting Coils

Quality Coils At Competitive Prices

Send us your engineering specifications for quotations.



**united states electronics**

CORPORATION

LYNDHURST • NEW JERSEY

Miniature Precision Bearings, Inc.	298
Minneapolis-Honeywell Regulator Co., Industrial Division	57
Mitchell-Rand Insulation Co., Inc.	163
Mosinee Paper Mills Company	196
Motorola	179
Muirhead & Co., Ltd.	3
Murex, Ltd.	288
Mycatex Tube Socket Corp.	245

National Company, Inc.	198
National Research Corporation	26
Neo-Sil Corp.	50
New Hampshire Ball Bearings, Inc.	289
North American Aviation, Inc.	182
North Electric Mfg. Co.	137
Northern Radio Co., Inc.	276
Nothelfer Winding Laboratories	286

Onan & Sons Inc., D. W.	286
O'Neil-Irwin Mfg. Co.	291
Owens-Corning Fiberglas Corp.	173

Paramount Paper Tube Corp.	194
Par-Metal Products Corp.	267
Partridge Transformers, Ltd.	295
Patten-MacGuyer Co.	254
Peerless Electrical Products Division, Altec Lansing Corp.	254
Permolux Corp.	204
Phalo Plastics Corporation	270
Plaskon Division, Libbey-Owens-Ford Glass Co.	40, 41
Polarad Electronics Corporation	262
Polytechnic Research and Development Company, Inc.	131
Potter Instrument Co., Inc.	296
Precision Apparatus Co., Inc.	331
Precision Paper Tube Co.	269
Presto Recording Corporation	31
Progressive Mfg. Co.	210
Pyramid Electric Co.	60
Pyroferic Co.	266

Quaker City Gear Works, Inc.	271
------------------------------	-----

Radio Corp. of America	28, 29, 238, Back Cover
Radio Materials Corporation	203
Radio Receptor Company, Inc.	150
Railway Express Company, Air Express Division	147
Rawson Electrical Instrument Co.	273
Raytheon Manufacturing Co.	129, 253
R-B-M Division Essex Wire Corp.	144
Rek-O-Kut Co.	278
Remler Company, Ltd.	276
Rex Rheostat Co.	298
Richardson Company	44

Sarkes Tarzian, Inc.	197
Scientific Electric Div. of "S" Corrugated Quenched Gap Co.	283
Servo Corporation of America	251
Servomechanisms, Inc.	284
Set Screw & Mfg. Co.	275
Shalleross Mfg. Co.	47
Shure Brothers, Inc.	212
Sigma Instruments, Inc.	63
Societe Industrielle ALFA	298
Sola Electric Company	45
Sorensen and Company, Inc.	53
Specialty Battery Company	206
Speer Resistor Corp.	243
Spincraft, Inc.	186
Sprague Electric Company	123
Stackpole Carbon Co.	42
Standard Electric Time Co.	256
Standard Piezo Company	258
Standard Pressed Steel Co.	194
Standard Products, Inc.	284
Standard Transformer Corporation	194
Staver Company, Incorporated	275
Stevens Arnold Incorporated	292
Stevens Mfg. Co., Inc., Geo.	250
Stevens Manufacturing Company, Inc.	268
Steward Manufacturing Co., D. M.	273
Stoddart Aircraft Radio Co.	160
Stokes Machine Co., F. J.	201
Streeter-Amet Company	202
Stupakoff Ceramic & Manufacturing Co.	165
Superior Electric Co.	34, 35
Superior Tube Company	237
Sylvania Electric Products, Inc.	61, 135

Taylor Fibre Co.	49
Tektronix, Inc.	280
Telechrome Incorporated	279
Telechron, Inc.	241
Teletronic Laboratory, Inc.	298
Tensolite Insulated Wire Co., Inc.	293
Transradio, Ltd.	273
Turner Company	246

United Condenser Corporation	293
United Electronics	207
United States Electronics Corporation	332
United States Gasket Company	262
United Technical Laboratories	285
United Transformer Co.	Second Cover
Universal Winding Company	43

Veeder-Root, Inc.	58
Vietoren Instrument Company	241
Vulcan Electric Company	251

Waldes Kohinoor, Inc.	167
Ward Leonard Electric Company	181
Waterman Products Co., Inc.	202
Wayne-Kerr Laboratories, Ltd.	190

Weller Electric Corp.	292
Westinghouse Electric Corp.	54, 55, 199
Weston Electrical Instrument Corp.	170
White Dental Mfg. Company S. S.	261, 277
Whitehead Stamping Company	251
Wilcox Electric Company	225
Wilkor Products Inc.	11
Workshop Associates, Inc.	197

Zenith Co.	
Zetka Television Tubes, Inc.	32
Zophar Mills, Inc.	32

### PROFESSIONAL SERVICES 297

### SEARCHLIGHT SECTION (Classified Advertising)

EMPLOYMENT	
Positions Vacant	299
Selling Opportunities Offered	299, 300
Positions Wanted	299
Selling Opportunities Wanted	299
Employment Agencies	299

BUSINESS OPPORTUNITIES	
Offered	299

NOTICES	
Auction	304

EQUIPMENT	
(Used or Surplus New)	
For Sale	304-330

WANTED	
Equipment	304

### ADVERTISERS INDEX

Acorn Electronics Corp.	326
Alexander, F.	329
Alvaradio Supply Co.	325
American Electrical Sales Co.	322
Amperex Electronic Corp.	299
Acelman, Nat.	329
Arrow Sales Co., Inc.	320
Bendix Aviation Corp., Radio Div.	299, 301
Blan	328
C & H Sales Co.	327
Capehart-Farnsworth Corp.	302
Cook Electric Co.	300
Columbia Electronics, Ltd.	328
Communications Equipment Co.	305, 306, 307
Compass Communications Co.	327
Cornell Aeronautical Lab.	303
Cottone & Co., A.	322
Electro Impulse Laboratory	321
Electro Sales Co.	319
Electronic Engineering Co. of Calif.	302
Electronic Surplus Brokers	326
Electronicraft, Inc.	314
Empire Electronics	304
EPCO	327
Finnegan, H.	304
French-Van Breems, Inc.	318
Goodyear Aircraft Corp.	301
Hallcrafters Co.	299
Hopkins University, The Johns	300
Horlick Co., William I.	316
Hughes Aircraft Co.	301, 302
Instrument Associates	308, 309
Kings County Machinery Exchange	327
Krock & Co., Aaron	304
Lear, Inc.	302
Lectronic Research Laboratories	310
Leru Laboratories, Inc.	321
Liberty Electronics, Inc.	324
Maritime International Co.	326
Maritime Switchboard	325
Maxson Corp., W. L.	302
Metropolitan Overseas Supply Corp.	329
Michigan, University of	300
Minneapolis-Honeywell Regulator Co.	300
Mogull Co., Inc., Alexander	318
Monmouth Radio Laboratories	328
National Union Research Div.	302
Niagara Radio Supply Corp.	317
Norman Radio Distributors, Inc.	322
Opad-Green Co.	322
Overbrook Co.	327
Photocon Sales	324
Powell, Harold H.	323
Precision Electrical Instrument Co.	329
Radio & Electronic Surplus	326
Radio Ham Shack, Inc.	312
Red Arrow Sales Co.	323
Reliance Merchandizing Co.	313
Sandia Corp.	303
Servo-Tek Products Co., Inc.	315
Sylvania Electric	300
TAB	329, 330
Tantalum Refining & Mining Corp. of America, Ltd.	322, 326, 329
Taylor Tubes, Inc.	304
Technical Radio Parts Co.	304
Telemarine Communications Co.	320
Universal General Corp.	326
Victor-Bernard Industries	304
Wells Sales, Inc.	311
Westinghouse Electric Corp.	301, 303
Westinghouse Electric Corp. (Lamp Div.)	299
Weston Laboratories	326
Wilgreen	326

This index is published as a convenience to the readers. Every care is taken to make it accurate, but ELECTRONICS assumes no responsibility for errors or omissions.



# PUSH-PULL POWER

with **REDUCED CAPACITANCES**

ACTUAL  
SIZE



250 mc. 85 watts output

300 mc. 70 watts output

430 mc. 32 watts output

**NEW!**

## AMPEREX AX-9903/5894

### UHF and VHF Twin Tetrode for W-I-D-E Band Operation

*RF Amplifier, Modulator, Frequency Doubler, Tripler*

#### AX-9903/5894 CHARACTERISTICS

##### Filament Voltage

Series	12.6 v.
Parallel	6.3 v.

##### Filament Current

Series	0.9 a.
Parallel	1.8 a.

##### Maximum

d.c. Plate Voltage	600
d.c. Grid #2 Voltage	250
d.c. Grid #1 Voltage	-175
Plate Dissipation (w.)	2 x 20
d.c. Plate Current (ma.)	2 x 100

Grid to Plate	< 0.08 mmfd.	< 0.12 mmfd.
Input	6.7 mmfd.	14.5 mmfd.
Output	2.1 mmfd.	7.0 mmfd.

**MOUNTING POSITION:** Base up or down. Horizontal with anode leads in horizontal plane.

Fits 829B Type Socket.

COMPARE CAPACITANCES of this tube  
with its nearest equivalent type.

- The AMPEREX AX-9903/5894 is an improved version of the 829B. The design of this tube incorporates features which produce considerably smaller output capacitances and which, therefore, result in higher resonant frequencies (approximately 500 mc. instead of 250 mc.). In addition, because of the low inductances of the connections between the cathode and screen-grid, more stable operation at high frequencies is effected.

- A most desirable design characteristic, also, is the incorporation of internal neutralizing condensers which are connected directly to the control-grids, making impossible self-oscillation in a tuned-plate, tuned-grid transmitter.

- Of importance in this new design are such features as:

1. Direct and short connection between the pins and the anode, causing lower inductance and resistance.
2. No insulating parts (mica or ceramics) between anodes, resulting in lower losses at high frequencies.
3. "Screened" micas, thereby preventing possible losses due to contaminated mica.
4. Zirconium-coated moly anodes, giving a higher degree of vacuum than possible with nickel anodes and barium getters.

- For the full story on how to use the AMPEREX AX-9903/5894 in your particular application, write to Application Engineering, Department N. Or if you prefer, ask for an AMPEREX representative to call.

- **IMMEDIATE DELIVERY\*** Order from your local electronics parts distributor. If unavailable, write direct to our plant.

\*Subject to prior sale

### AMPEREX ELECTRONIC CORP.

25 WASHINGTON STREET, BROOKLYN 1, N. Y.

In Canada and Newfoundland: Rogers Majestic Limited  
11-19 Brentcliffe Road, Leaside, Toronto, Ontario, Canada  
Cable: "AMPRONICS"

re-tube with  
**AMPEREX**



## RCA PREFERRED-TYPE RECEIVING TUBES

Miniature types are shown in italics

RECTIFIERS and DIODE DETECTORS	CONVERTERS	AMPLIFIERS, OSCILLATORS & MIXERS						OUTPUT AMPLIFIERS
		Triodes			Pentodes			
		Single	Twin	With Diodes	Sharp Cutoff	Remote Cutoff	With Diode	
1B3-GT	1R5				1U4	174	354 3V4	
5U4-G	6BA7	6C4	6J6	6AQ6	6AU6	6BA6	6AQ5	
5Y3-GT	6BE6		6SC7	6AV6	6CB6	6B16	6AU5-GT	
6AL5			6SN7-GT	6BF6	6SJ7		6BG6-G	
6W4-GT	12BA7		12AU7	12AV6	12AU6	12BA6	6KA-GT	
6X4	12BE6		12AX7				6LA-G	
12AL5							6V6-GT	
35W4							35CS	
117Z3							50CS	



THE FOUNTAINHEAD OF MODERN TUBE DEVELOPMENT IS RCA

# Performance-Proved in active duty

For civilian and military electronic designs . . . RCA preferred-type receiving tubes offer these important advantages . . .

**FLEXIBILITY**—RCA *preferred-type* receiving tubes are chosen for the advantages they offer from engineering and equipment production viewpoints. They cover an extremely wide variety of tube applications in civilian and military equipment...and offer the engineer flexibility in circuit design.

**PERFORMANCE**—These types have demonstrated their reliability in equip-

ment of widely divergent designs. Proved in service, they are the logical types for future designs.

**ECONOMY**—This group of 44 tube types represents *more than half* of RCA's current receiving tube volume. By concentrating production on these few types having wide application, substantial savings are realized in manufacturing costs which are passed on to

customers . . . and quality and performance capability are sustained at a high level.

**STANDARDIZATION**—By concentrating on RCA preferred receiving-tube types, the equipment manufacturer also benefits by his ability to standardize on component parts . . . resulting in substantial purchasing and stocking economies.



**RADIO CORPORATION of AMERICA**

ELECTRON TUBES

HARRISON, N. J.