

MARCH · 1950

# electronics

A M C G R A W · H I L L P U B L I C A T I O N

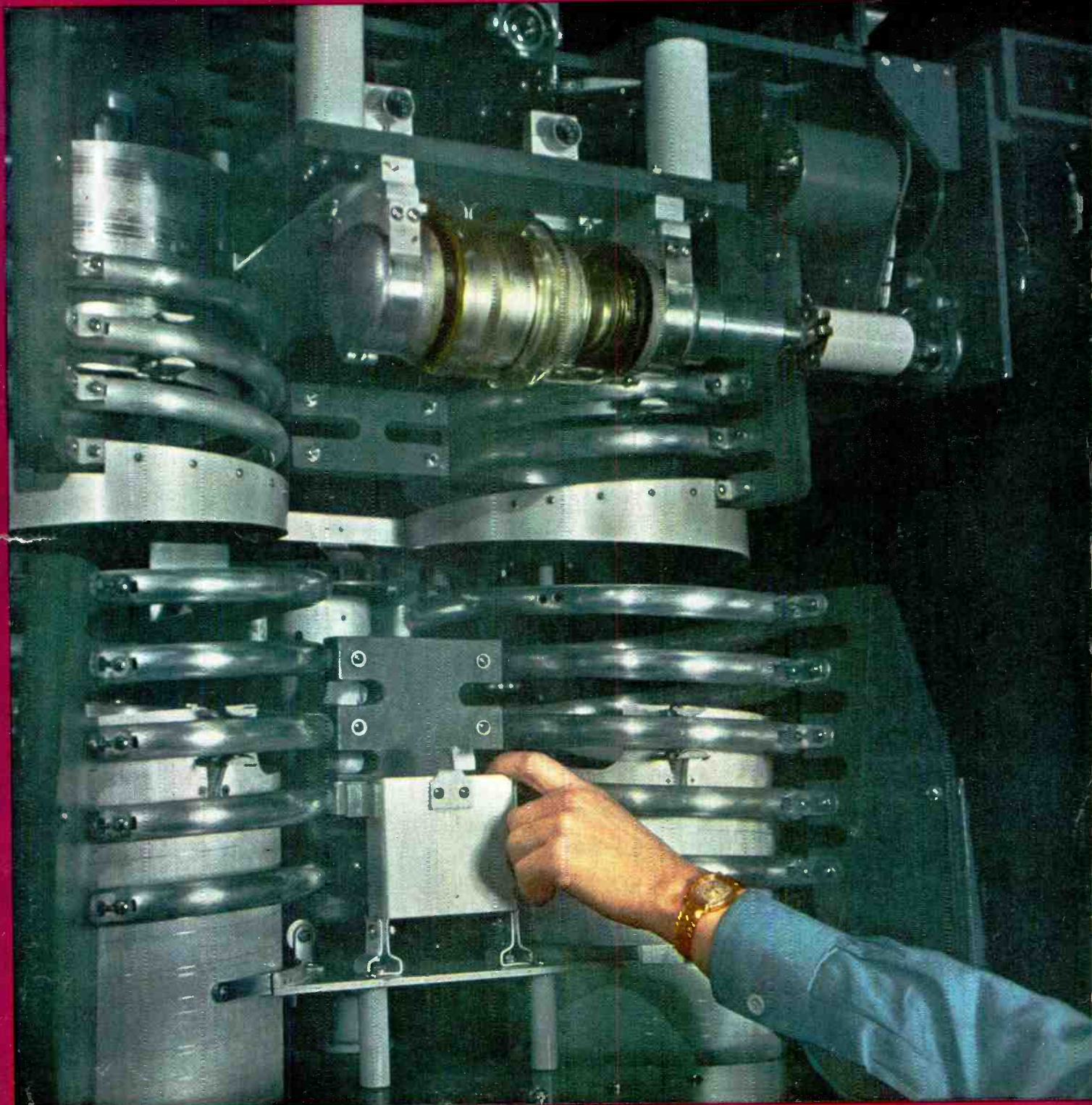

**MOTOR-TUNED 50-KW AMPLIFIER**



## *High Fidelity Components*

*Linear Standard . . . Hipermalloy . . .  
Ultracompact . . . Ouncer. Four  
great lines for every quality  
application.*



## *Hermetic Seal Components*

*Largest producers during the war.  
Largest producers today.*



## *High Q Components*

*Dust Core Toroids . . . Variable  
Inductors . . . Complete fillers . . .  
for every application.*

# *United Transformer Corp.*

150 VARICK STREET

NEW YORK 13, N. Y.

EXPORT DIVISION: 13 EAST 40th STREET, NEW YORK 16, N. Y., CABLES: "ARLAB"

# electronics

A McGRAW-HILL  
PUBLICATION



MARCH • 1950

<b>MOTOR-TUNED 50-KW AMPLIFIER</b> .....	Cover
Collins transmitter can be placed in operation on any frequency from 4 to 26 megacycles in less than one minute (see p 70)	
<b>OUR BUSINESS IN 1950</b> , by Wallace B. Blood .....	66
Facts and figures about the last 20 years, and some predictions for the future	
<b>CONTINUOUSLY-TUNED 50-KW TRANSMITTER</b> , by J. L. Hollis .....	70
Permits high-efficiency operation on any frequency from 4 to 26 mc	
<b>VERSATILE X-RAY INTENSITY METER</b> , by William B. Lurie .....	74
Direct-reading roentgen meter consists of ionization chamber, electrometer tube and amplifier	
<b>MICROPHONICS TESTER FOR VACUUM TUBES</b> , by Norman Alpert .....	78
Built of standard laboratory equipment for quantitative vibration testing	
<b>THE ELECTRON COUPLER</b> , by C. L. Cuccia and J. S. Donal, Jr. ....	80
Experimental two-cavity amplitude modulator improves frequency stability	
<b>IMPROVED C-R PHOTOGRAPHS</b> , by Norman Fulmer .....	86
Single picture shows both electron beam trace and pertinent notations	
<b>FOLDED SIDEBAND MODULATION</b> , by J. L. A. McLaughlin .....	88
Communication system occupies less spectrum space than the message information and eliminates heterodynes	
<b>SIMPLIFIED MULTISTATION INTERCOM SYSTEM</b> , by Andrew Vincent .....	92
Requires only two wires and ground for complete privacy between any two stations among eight	
<b>TESTING EYE MUSCLES</b> , by E. R. Powsner and K. S. Lion .....	96
Low-noise d-c amplifier provides 99-db gain for recording eyeball potentials, useful in evaluating muscle fatigue	
<b>CURVE TRACER WITH ELECTRONIC GRAPH LINES</b> , by J. W. Balde, J. C. Bregar, K. Chapman .....	100
Speeds production-testing of bandpass units by producing calibrated graph lines directly on c-r screen	
<b>D-C AMPLIFIER USING AIR-COUPLED CHOPPER</b> , by Curtiss R. Schafer .....	104
Gives stabilized high gain for weak direct currents in prospecting, logging oil wells and biophysical research	
<b>COMBINING POSITIVE AND NEGATIVE FEEDBACK</b> , by John M. Miller, Jr. ....	106
Includes circuit for low-cost two-stage audio amplifier using combination feedback principle	
<b>MEASURING A VARYING FREQUENCY</b> , by R. L. Chase .....	110
Uses predetermined counter system and crystal standard to count cycles in known time interval	
<b>NOISE FIGURE CHART</b> , by Eugene D. Jarema .....	114
Eliminates computation usually required for noise figure determination	
<b>BUSINESS BRIEFS</b> .....	60
<b>CROSSTALK</b> .....	65
<b>TUBES AT WORK</b> .....	116
<b>ELECTRON ART</b> .....	120
<b>NEW PRODUCTS</b> .....	124
<b>NEWS OF THE INDUSTRY</b> .....	128
	<b>NEW BOOKS</b>
	<b>BACKTALK</b>
	<b>INDEX TO ADVERTISERS</b>

**DONALD G. FINK**, Editor; **W. W. MacDONALD**, Managing Editor; John Markus, Vin Zeluff, A. A. McKenzie, Associate Editors; William P. O'Brien, James D. Fahnestock, Assistant Editors; Ann Mastropolo, Marilyn Wood, Editorial Assistants; Gladys T. Montgomery, Washington Editor; Harry Phillips, Art Director; Eleanor Luke, Art Assistant

**KEITH HENNEY**, Consulting Editor

**H. W. MATEER**, Publisher; **WALLACE B. BLOOD**, Manager; R. S. Quint, Directory Manager; D. H. Miller, James Girdwood, New York; Wm. S. Hodgkinson, New England; Warren W. Shew, Philadelphia; C. D. Wardner, Chicago; J. L. Phillips, Cleveland; J. W. Otterson, San Francisco; Carl W. Dysinger, Los Angeles; Ralph C. Maulsby, Atlanta; Bernard H. Butler, London, England

Contents Copyright 1950, by McGraw-Hill Publishing Company, Inc. All rights Reserved. McGRAW-HILL PUBLISHING COMPANY, INCORPORATED, JAMES H. McGRAW (1860-1948), founder • PUBLICATION OFFICE, 99-129 North Broadway, Albany 1, N. Y., U. S. A. EDITORIAL AND EXECUTIVE OFFICES, 330 West 42nd St., New York 18, N. Y., U. S. A.—Member A. B. P., Member A. B. C.

James H. McGraw, Jr., President; Curtis W. McGraw, Vice-President and Treasurer; Eugene Duffield, Senior Vice-President, Publications Division; Nelson Bond, Vice-President and Director of Advertising; J. E. Blackburn, Jr., Vice-President and Director of Circulation; James A. Gerardi, Secretary; Dexter Keezer, Director Economics Department; Russell F. Anderson, Editor, World News.  
**ELECTRONICS**: March, 1950, Vol. 23: No. 3. Published monthly, with an additional issue in June, price 75¢ a copy for U. S. and possessions, and Canada; \$1.50 for Latin America; \$2.00 for all other foreign countries. Directory issue \$2.00. Allow at least ten days for change of address. All communications about subscriptions should be addressed to the Director of Circulation. Subscription rates—United States and possessions, \$6.00 a year, \$9.00 for two years, \$12.00 for three years, Canada (Canadian funds accepted) \$10.00 a year, \$16.00 for two years, \$20.00 for three years. Latin American countries \$15.00 for one year, \$25.00 for two years, \$30.00 for three years. All other countries \$20.00 for one year, \$30.00 for two years, \$40.00 for three years. Please indicate position and company connections on all subscription orders. Entered as Second Class matter August 29, 1936, at Post Office, Albany, New York, under the act of March 3, 1879. **BRANCH OFFICES**: 520 North Michigan Avenue, Chicago 11, Ill.; 68 Post Street, San Francisco 4; Aldwych House, Aldwych, London, W. C. 2; Washington, D. C. 4; Philadelphia 31 Cleveland 15; Detroit 26; St. Louis 8; Boston 16; Atlanta 3, Ga.; 621 So. Hope St., Los Angeles 14; 736-9 Oliver Building, Pittsburgh 22. **ELECTRONICS** is indexed regularly in The Engineering Index.

EL-MENCO CAPACITORS

Hold!



UNDER STRAIN

In capacitors performance depends on dielectric strength to withstand strain. Before El-Menco capacitors leave the factory they must pass severe tests for dielectric strength — at *double the working voltage*, insulation resistance and for capacity value. El-Menco fixed mica condensers meet and beat strict Army-Navy standards. That's why you can rely on El-Menco performance in your product.

SO ALWAYS

Specify Pretested Capacitors by El-Menco...

THEY HOLD UNDER

STRAIN

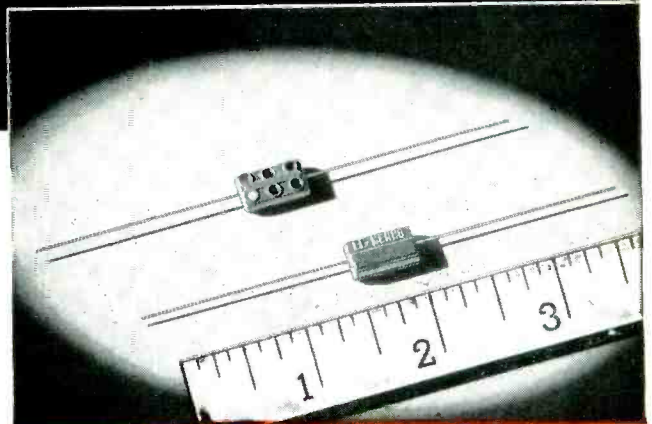

CM 15 MINIATURE CAPACITOR

Actual Size  $\frac{3}{16}'' \times \frac{1}{2}'' \times \frac{3}{16}''$ . For Radio, Television and Other Electronic Applications.

2 to 420 mmf. capacity at 500v DCw.

2 to 525 mmf. capacity at 300v DCw.

Temp. Co-efficient  $\pm 50$  parts per million per degree C for most capacity values.

6-dot color coded



THE ELECTRO MOTIVE MFG. CO., Inc. WILLIMANTIC CONNECTICUT

Write on your firm letterhead for Catalog and Samples

MOLDED MICA

El-Menco

MICA TRIMMER

CAPACITORS

FOREIGN RADIO AND ELECTRONIC MANUFACTURERS COMMUNICATE DIRECT WITH OUR EXPORT DEPT. AT WILLIMANTIC, CONN. FOR INFORMATION. ARCO ELECTRONICS, INC. 135 Liberty St., New York, N. Y.—Sole Agent for Jobbers and Distributors in U.S. and Canada

# A STANDARD CELL

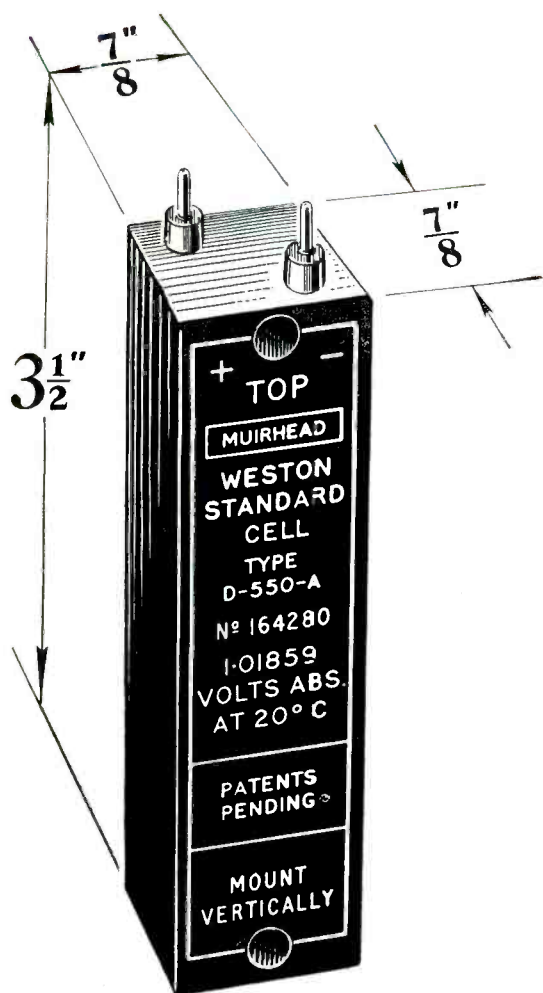

for

# 3.50

IMMEDIATE DELIVERY

IN ANY QUANTITY

POST FREE

IN THE UNITED STATES & CANADA

## SPECIFICATION

THE MUIRHEAD MINIATURE WESTON STANDARD CELL

<b>E.M.F.</b>	1.01859 VOLTS ABS $\pm 100\mu\text{V}$ AT 20°C
<b>TEMPERATURE COEFFICIENT</b>	40 $\mu\text{V}/^\circ\text{C}$ APPROX.
<b>DIMENSIONS</b>	3 $\frac{7}{8}$ " x 7 $\frac{7}{8}$ " x 7 $\frac{7}{8}$ " OVERALL [9.8cm x 2.2cm x 2.2cm]
<b>WEIGHT</b>	2 $\frac{1}{2}$ oz. [70 gm]
<b>MOUNTING</b>	MOLDED CASE—WITH PANEL AND CHASSIS FIXING HOLES

*Our other types of Standard Cells will interest you. Write for literature.*

ORDER BY CABLE—PAY BY YOUR OWN DOLLAR CHECK

**MUIRHEAD & Co. LTD.**  
 PRECISION ELECTRICAL INSTRUMENT MAKERS  
 BECKENHAM · KENT · ENGLAND

Telegrams and Cables: MUIRHEADS ELMERS-END

PRECISION  
**MUIRHEAD**  
 ELECTRICAL INSTRUMENTS

MU.27

# Specialization is



*for resistors too!*

Specialization—and *only* specialization—can keep manufacturers abreast of today's resistance needs.

The constantly-growing multitude of resistor applications demands full-time concentration on resistance products. *IRC has concentrated*—for 25 years! Result:—The widest line of resistance products

in the industry; parts designed to suit specific circuit requirements in virtually every type of application; unbiased recommendations.



**LOW-WATTAGE WIRE WOUND REQUIREMENTS** are met efficiently by IRC Type BW Wire Wound Resistors. Exceptional low-range stability and economy suit these small, completely insulated resistors to use in meters, analyzers, cathode bias resistors, television circuits, low-range bridge circuits, high stability attenuators, low-power ignition circuits. Check coupon for Bulletin B-5.

# important



**IN HIGH VOLTAGE APPLI-**  
 cations, MVX high ohmic, high voltage resistors offer exceptional stability. Compared to Type MV, but distinguished by mounting through a hole in insulating material without the need for solder.

Long resistors permit use of high voltage on resistor while keeping voltage per unit length of path comparatively low. Check coupon for Catalog G-2.



**IN CRITICAL HIGH-FREQUENCY CIRCUITS,** Type MP High Frequency Resistors offer dependable performance and unusual stability. Special resistance film on a steatite ceramic form provides a stable resistor with low inherent inductance and capacity—entirely suitable for broad band RF amplifiers, RF probes, dummy loads for transmitters, television side-band filters, radar pulse equipment, and other circuits involving steep wave fronts. Send coupon for Bulletin F-1.

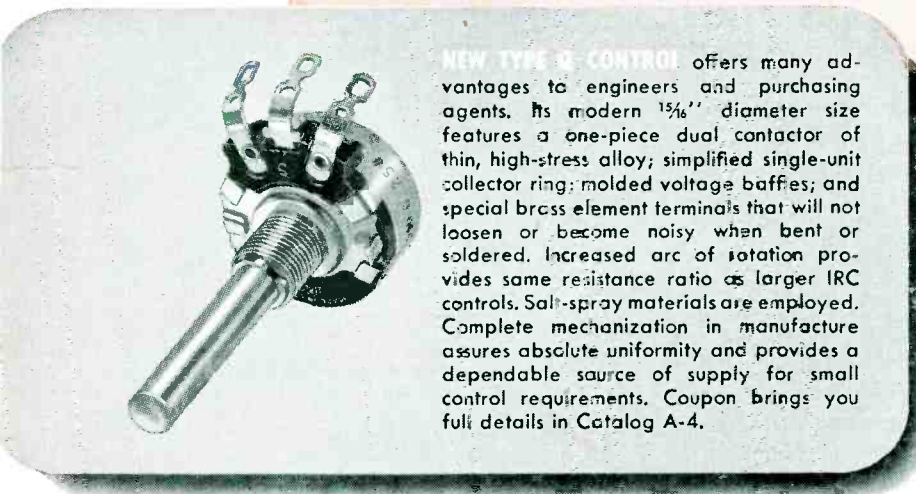

**NEW TYPE Q CONTROL** offers many advantages to engineers and purchasing agents. Its modern 1 3/16" diameter size features a one-piece dual contactor of thin, high-stress alloy; simplified single-unit collector ring; molded voltage baffles; and special brass element terminals that will not loosen or become noisy when bent or soldered. Increased arc of rotation provides same resistance ratio as larger IRC controls. Salt-spray materials are employed. Complete mechanization in manufacture assures absolute uniformity and provides a dependable source of supply for small control requirements. Coupon brings you full details in Catalog A-4.



When you have special need of maintenance or experimental quantities of standard resistors in a hurry, simply phone your local IRC Distributor. IRC's Industrial Service Plan keeps him fully stocked with the most popular types and ranges—enables him to give you 'round-the-corner delivery of small order requirements. We'll gladly send you his name and address.



**INTERNATIONAL  
 RESISTANCE COMPANY**

401 N. Broad Street, Philadelphia 8, Pa.

In Canada: International Resistance Co., Ltd., Toronto, Licensee

*Wherever the Circuit Says*

- Power Resistors • Voltmeter Multipliers
- Insulated Composition Resistors • Low Wattage Wire Wounds • Controls
- Rheostats • Voltage Dividers • Precisions • Deposited Carbon Resistors • HF and High Voltage Resistors • Insulated Chokes.

**INTERNATIONAL RESISTANCE CO.**  
 403 N. BROAD ST., PHILADELPHIA 8, PA.

Please send me complete information on the items checked below:

- New "Q" Controls
- MP High Frequency Resistors
- BW Insulated Wire Wounds
- MVX High Voltage Resistors
- Name of Local IRC Distributor

NAME .....

TITLE .....

COMPANY .....

ADDRESS .....

.....

J. F. ARNOT & CO., ADV. AGENCY

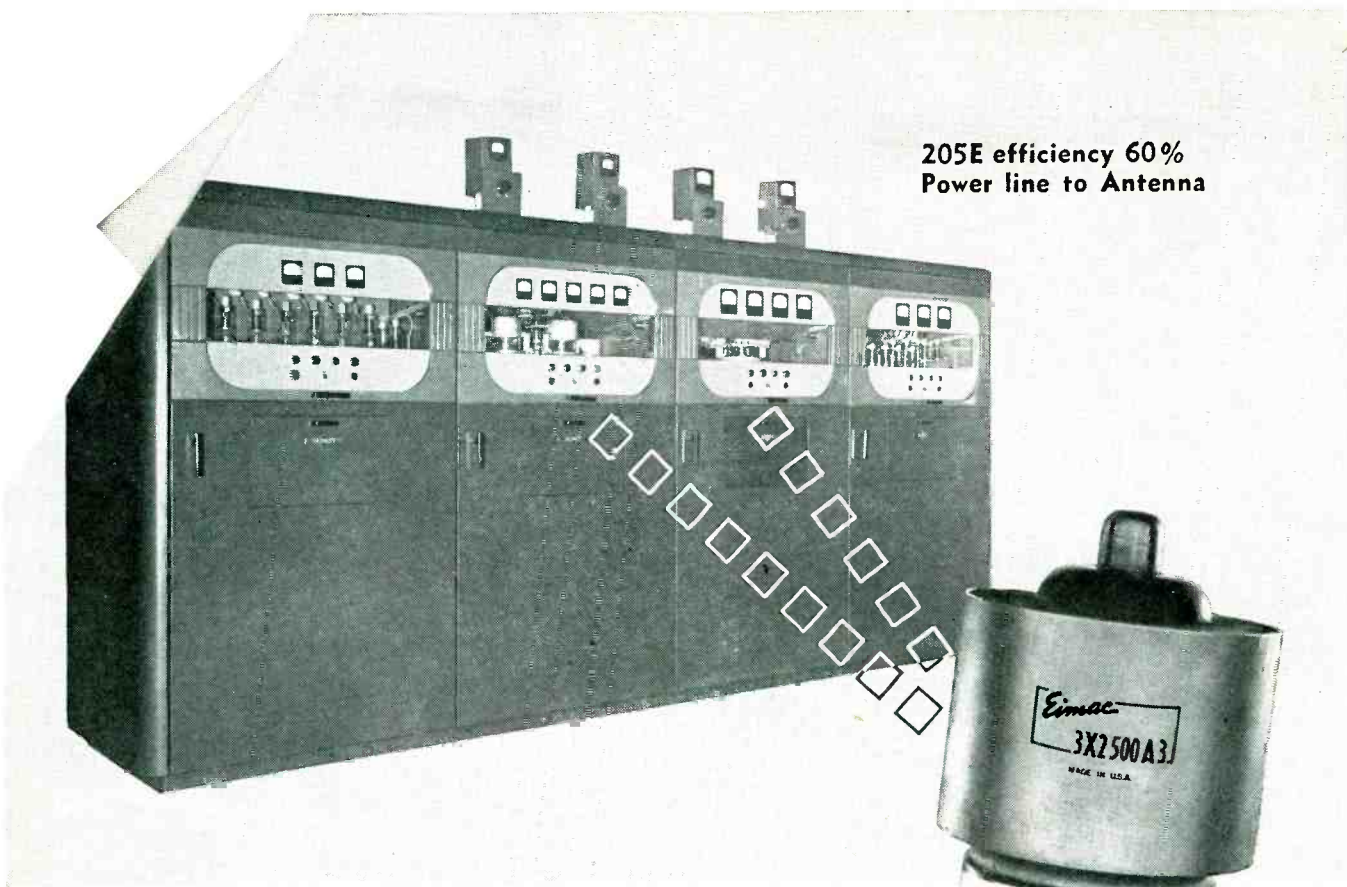

205E efficiency 60%  
Power line to Antenna

## EIMAC TUBES CHOSEN FOR COLLINS' 50 KW CW TRANSMITTER

CW communications transmitter type 205E is an outstanding example of engineering craftsmanship by Collins Radio. Designed for military and civilian service between 4 and 26 Mc. the 205E will provide 50 kw CW output with remarkable economy from the standpoint of both power consumption and tube cost.

**Overall efficiency of the transmitter through all stages, from the 230 volt power line to the antenna, is 55% to 60%.**

Collins engineers say, "We can attribute the largest percentage of this performance to our use of Eimac tubes. The 3X2500A3 triodes operate with low filament-power, and their high power-gain and high efficiency permit economical exciting equipment. Further power saving is effected because of the simple air-cooling requirement."

You, too, can take advantage of Eimac tubes' functional design, economical operation, and higher performance.

Complete catalogues covering operational data and characteristics on all Eimac tubes are available without charge . . . write today.

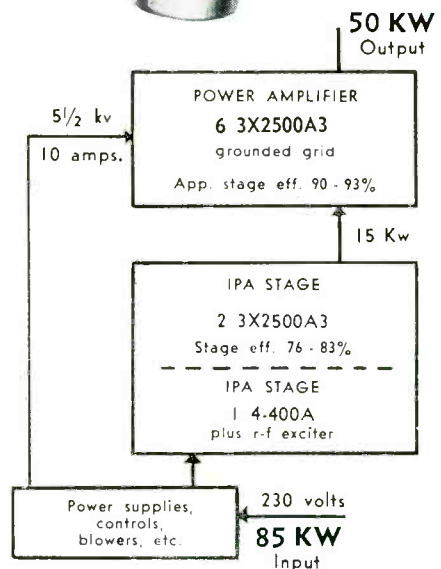

**EITEL-McCULLOUGH, INC.**  
**San Bruno, California**

Export Agents: Frázar & Hansen, 301 Clay St., San Francisco, California

Follow the Leaders to

**Eimac**  
**TUBES**

The Power for R-F

244



# MOUNTAINOUS MOLEHILL!

THE "DRY" JOINT THAT PASSES INSPECTION



... on that tremendous trifle ... the soldered joint ... so common that you never think about it, rests your costly assembly and your reputation as a manufacturer.

All the effort and expense of designing and building a chassis can be lost by one malfunctioning high resistance joint; all the care used in building your reputation with the customer and dealer, wasted.

It costs but the tiniest fraction of a cent to make a soldered joint ... why not use the world's finest solder?

**ERSIN**

# Multicore

**3 Core Solder**

The only solder made with *non-corrosive, extra-active ERSIN FLUX!*



Made of virgin metals only ...  
tin: 99.75% pure  
lead: 99.97% pure

Ersin Flux is exclusive to Multicore and will not be found in any other solder. It insures greater speed and production economy by reducing surface tension of molten solder, causing it to wet metals swiftly.

Ersin Flux is now free from objectionable odor and is non-toxic in use.

Three separate cores of flux guarantee continuity of the flux stream, preventing "dry" joints.

**Have you tested Multicore Solder recently?**

Although there are three cores of flux in Multicore, the total percentage of flux to solder is less than many single cored solders.

Very rapid melting results from the multiple core construction which provides thinner walls of solder than are found in same gauge single cored solder.

Multicore's unique properties make perfect joints possible on difficult metals and alloys, even if oxidized. Ability to tin rapidly produces perfect joints with less solder. Greater coverage per pound.

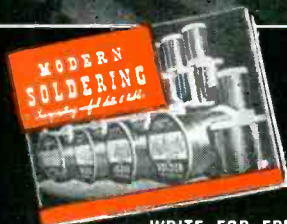

WRITE FOR FREE TESTING SAMPLE AND HELPFUL BOOKLET "MODERN SOLDERING"

Address U. S. A. and Canadian inquiries to

**MULTICORE SALES CORP.**  
164 Duane Street • New York 13, N. Y.

Inquiries regarding other territories to

**MULTICORE SOLDERS LTD.**  
Mellier House, Albemarle Street • London, W. 1, England

# WOR-TV

## CO-AX SPACERS OF "TEFLON"\* HELP ELIMINATE REFLECTIONS . . . INCREASE EFFICIENCY

New spacers of Du Pont "Teflon" boost WOR-tv transmission line efficiency from 66.1% to 76.4%.

WOR-tv coaxial transmission line manufactured and installed by Andrew Corporation, Chicago.

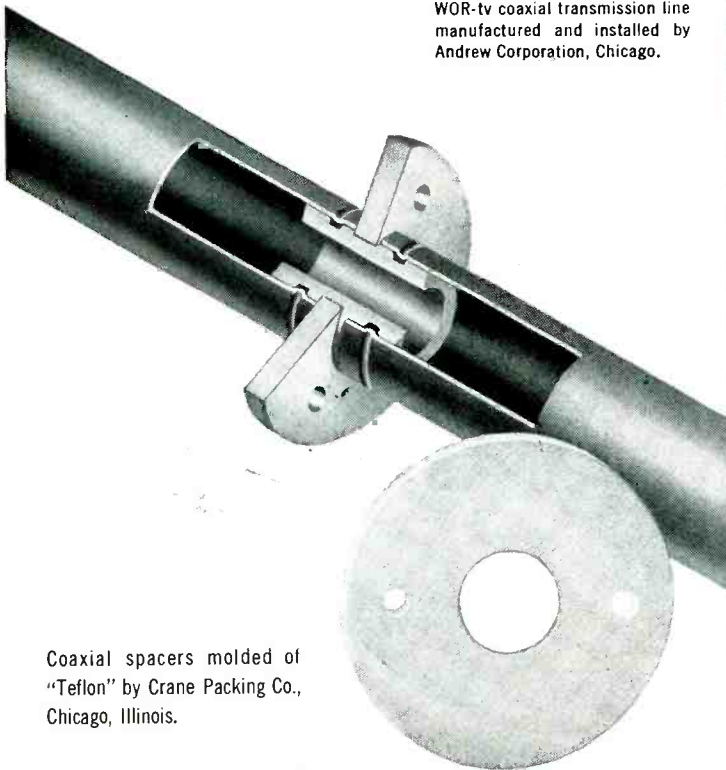

Coaxial spacers molded of "Teflon" by Crane Packing Co., Chicago, Illinois.

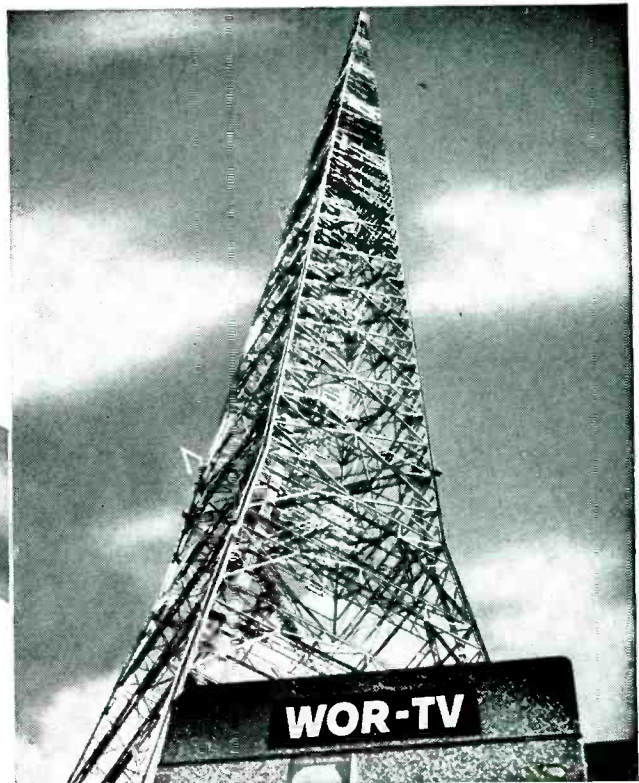

These new coaxial transmission line spacers of Du Pont "Teflon" tetrafluoroethylene resin give WOR-tv the ultimate in efficient performance.

The dielectric constant of "Teflon" (2.0) is only one-third as high as that of ceramic. This simplifies elimination of reflections caused by impedance discontinuities introduced at each insulator.

Total power loss is almost as small as it would be with no insulators at all! Thus, the efficiency of the 850-foot line is boosted from 66.1% for conventional spacers to 76.4% for "Teflon," permitting

the station to operate at a lower power level.

The toughness and resilience of "Teflon," in addition, simplifies installation of the line. And it has the highest heat-resistance (serves up to 500°F.) of all commercial thermoplastics.

"Teflon" is supplied by Du Pont in standard shapes (rods, tubes, sheets and tape). Or we will recommend molders or fabricators who can supply finished parts of "Teflon." Write today for more information. Our technical staff will be glad to help you. E. I. du Pont de Nemours & Co. (Inc.), Poly-

chemicals Department, Plastics Sales Offices: 350 Fifth Ave., New York 1, N. Y.; 7 S. Dearborn St., Chicago 3, Ill.; 845 E. 60th St., Los Angeles, Calif.

\*REG. U. S. PAT. OFF.



No. 2  
of a  
Series

## Another Engineer's Problem Solved\*

**SUBJECT:** 8000 Volt Radar-Indicator Power Supply

**PROBLEM:** To design a 400 cycle power supply to the following specifications:

Input voltage	: 115 VAC $\pm$ 10 volts
Input frequency	: 400 cycles $\pm$ 10%
Output volts	: 8000 VDC
Output current	: 3 milliamperes
Output ripple	: 1%
Regulation	: 80 volts per ma.
Vibration	: Air Corps specs.
Altitude	: 50,000 feet
Size	: Small as possible
Weight	: Light as possible
Temperature range	: $-65^{\circ}\text{C}$ to $+85^{\circ}\text{C}$
Humidity	: 95%

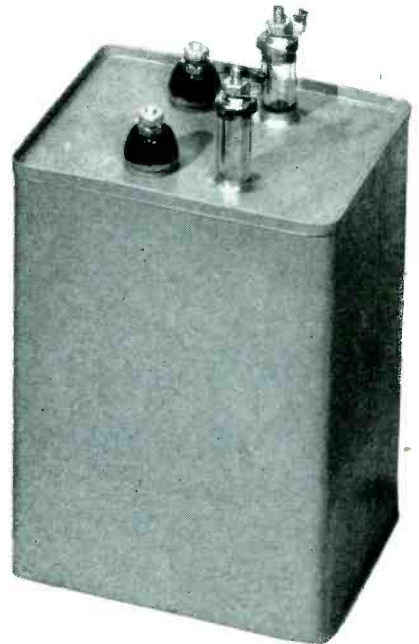

**SOLUTION:** The oil-filled construction used in our HiVolt Power Supplies is ideal for high altitude-high voltage operation. Expensive, heavy, and bulky individual component containers are eliminated. Only two high voltage, corona free insulators are required. All spacings can be reduced. Humidity is no problem.

The 400 cycle 7200 VRMS transformer uses a Hypersil core, but due to the superior insulating characteristics of the silicone fluid, the size and weight is materially reduced over a core and coil operating in a container pressurized to 1 or 2 atmospheres. Silicone fluid was used rather than mineral oil as it remains liquid at  $-65^{\circ}\text{C}$ .

Two 2 ma. output 1Z2 rectifiers are used in parallel. The filter capacitors are Plasticon Glassmikes (Type ASG). They are approximately 1/4th the size of an equivalent 10,000 VDC paper capacitor.

The finished power supply measures 3-3/4 x 3-3/16 base by 5-1/2" high, plus 2-1/2" high metallized-glass terminals. To eliminate voids the can walls are flexible enough to take up the differential expansion of the silicone. The total weight is 3 1/2 lbs.

It is estimated that a conventional supply built on an enclosed chassis would occupy 2-1/2 — 3 times the volume and be 4-5 times as heavy.

• • •

What is YOUR engineering problem?  
Your inquiries will receive immediate attention.

• • •

We manufacture a standard line of Plasticon Capacitors, Pulse Forming Networks and High Voltage Power Supplies. Write for our catalog.

# Condenser Products Company

1375 NORTH BRANCH STREET • CHICAGO 22, ILLINOIS

# MOTOROLA "RESEARCH" LINE OF F.M. 2-WAY RADIO

# Chosen again



and again by city after city for superior adjacent channel performance

**TYPICAL REPORT:** "In compliance with test requirements, Motorola Inc., installed three 250-watt fixed station transmitters (on 155.73 mc.; 155.79 mc.; 155.85 mc.). The Motorola mobile equipment selected the 155.73 mc. station in all conditions with good results. No reception of the adjacent channel station was noted even when the mobile unit was operated in the immediate vicinity of the other transmitter."

- MILWAUKEE
  - ROCHESTER
  - CITY OF MEMPHIS
  - LAKE COUNTY
  - VALLEJO, CAL.
  - ILLINOIS
  - CITY OF BUFFALO
- REPORT (CONTINUED)

## "RESEARCH" LINE OF F.M. 2-WAY RADIO

with revolutionary new developments engineered at Motorola—the World's largest laboratories devoted exclusively to the development of radio communications systems—specialists in this field for over twenty years.

COMPARE Motorola with any other equipment. Write today for complete details.

### protection

... of your long-term investment. PROTECTION against obsolescence for many years to come.

Specify Motorola "Research" Line for permanence in FM 2-way radio operation.



"These tests preclude and safeguard us against future possibility of interference from any other transmitters that may be set up."

"Car to car tests exceeded all reasonable demands for car to car operation in emergency services."

"Collectively the tests have proven that Motorola equipment will amply provide for a modern communications system for our fire and police departments, not only at the present but in the future."

# Motorola

Communications & Electronics Division • 4545 W. AUGUSTA BLVD. • CHICAGO 31, ILLINOIS

# SEE CENTRALAB'S NEW BABY.

AT THE  
**I.R.E. SHOW**  
Grand Central Palace  
New York  
MARCH 6-9



BOOTH NO. 232-33

ANOTHER **Centralab** **FIRST** →



# NEW! NEW! Centralab's

**MARCH  
1950**

**New Model 2  
Radiohm  
Ideal for TV**

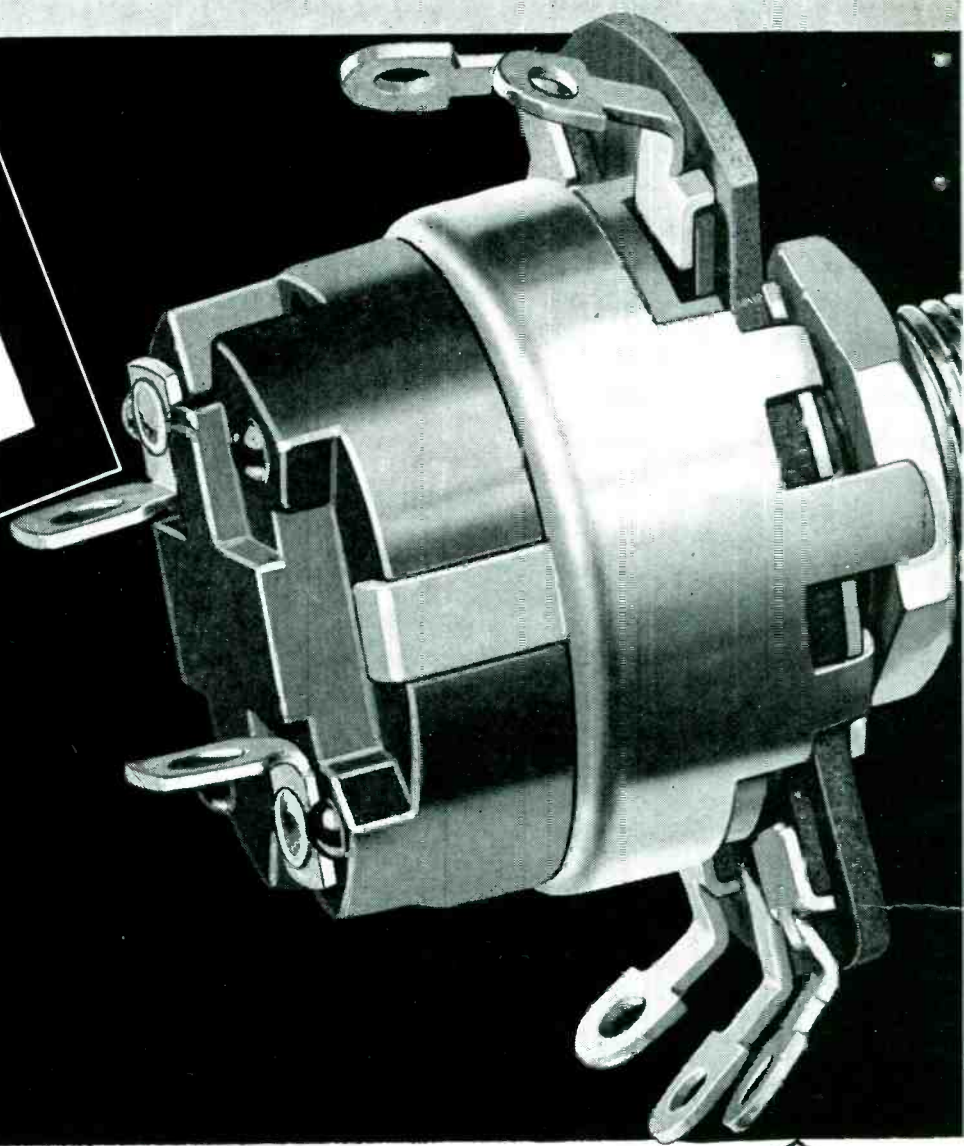

**NOW READY — A COMPLETE LINE OF**



TV

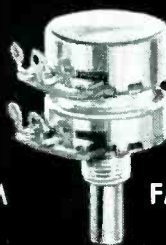

AM

FM



TV

FM

AM



TV

FM

AM

New Centralab Model 2 Radiohm Control — Left, single unit plain type, untapped; right, twin unit plain type, untapped. Both with single shafts.

New Centralab Model 2 Radiohm Control — control shown is a single unit switch type, untapped. Control has single shaft.

New Centralab Model 2 Radiohm Control — this control is a twin unit switch type, untapped. It has a single shaft.

# Model 2 Radiohm Control

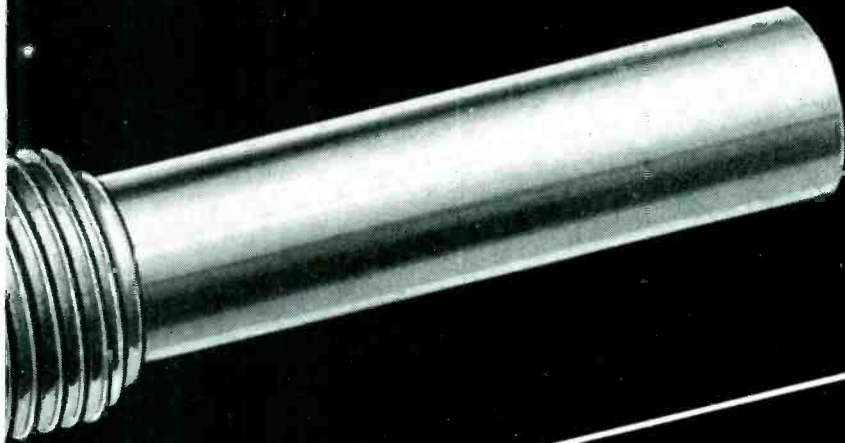

## A NEW CONTROL WITH NEW PERFORMANCE!

Centralab's new Model 2 Radiohm control gives you application possibilities and construction features never before available. (1) New uniform small size (15/16" diameter on all units, regardless of combination or resistance value). (2) New resistance element provides extremely low noise level. (3) New dual resistance contacts and collector take-off. (4) New clinch-type, rock-solid terminals. (5) New choice of line

switch combinations directly operated from shaft. (6) Eight different switch current ratings. (7) Seven standard resistance tapers. (8) All control combinations available with or without taps. (9) Wide variety of single and concentric shaft and bushing combinations. See the Model 2 Radiohm Control display and get complete information at the show — or see your nearest Centralab representative — or write direct.

## CONTROLS TO MEET EVERY DESIGN NEED!

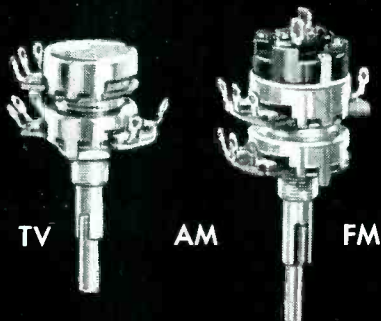

TV AM FM

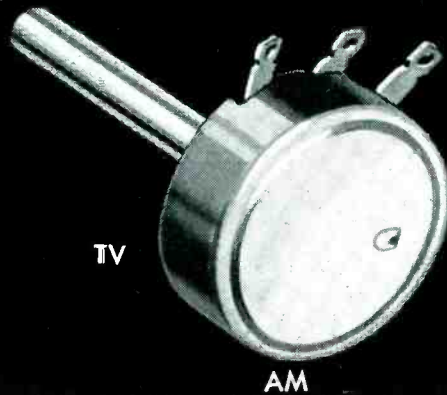

TV AM FM

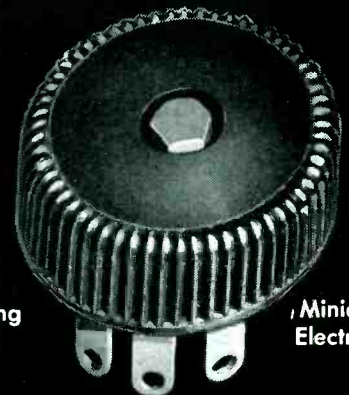

Hearing Aid / Miniature Electronic

New Centralab Model 2 Radiohm Control — Left, twin unit plain type, front section tapped; right, twin unit switch type, rear section tapped. Both units have concentric shafts.

Centralab's Model "R" Radiohm Control — This control is wire-wound, 3 watts, Linear taper. Resistance: 2 to 10,000 ohms.

Centralab's Model 1 Radiohm Control — Model 1 Radiohm control available in plain or switch types. No larger than a dime! Rated 1/10 watt. Ideal for miniature uses.

**...NT BULLETINS FOR YOUR TECHNICAL LIBRARY!**

*They're factual!*



**THEY'RE FREE!**

**Choose From This List!**

**Centralab Printed Electronic Circuits**

- 973 — AMPEC — three-tube P. E. C. amplifier.
- 42-6 — COUPLATE — P. E. C. interstage coupling plate.
- 42-22 — VERTICAL INTEGRATOR — for TV application.
- 42-24 — CERAMIC PLATE COMPONENTS — for use in low-power miniature electronic equipment.
- 42-27 — MODEL 2 COUPLATE — for small or portable set applications.
- 999 — PENTODE COUPLATE — specialized P. E. C. coupling plate.
- 42-9 — FILPEC — Printed Electronic Circuit filter.

**Centralab Capacitors**

- 42-3 — BC TUBULAR HI-KAPS — capacitors for use where temperature compensation is unimportant.
- 42-4 — BC DISC HI-KAPS — miniature ceramic BC capacitors.
- 42-10 — HI-VO-KAPS — high voltage capacitors for TV application.
- 695 — CERAMIC TRIMMERS — CRL trimmer catalog.
- 981 — HI-VO-KAPS — capacitors for TV application. For jobbers.

- 42-18 — TC CAPACITORS — temperature compensating capacitors.
- 814 — CAPACITORS — high-voltage capacitors.
- 975 — FT HI-KAPS — feed-thru capacitors.

**Centralab Switches**

- 953 — SLIDE SWITCH — applies to AM and FM switching circuits.
- 970 — LEVER SWITCH — shows indexing combinations.
- 995 — ROTARY SWITCH — schematic application diagrams.
- 722 — SWITCH CATALOG — facts on CRL's complete line of switches.

**Centralab Controls**

- 42-19 — MODEL "T" RADIOHM — world's smallest commercially produced control.

**Centralab Ceramics**

- 967 — CERAMIC CAPACITOR DIELECTRIC MATERIALS.
- 720 — CERAMIC CATALOG—CRL steatite, ceramic products.

**Look to CENTRALAB in 1950!** First in component research that means lower costs for the electronic industry. If you're planning new equipment, let Centralab's sales and engineering service work with you. For complete information on all CRL products, get in touch with your Centralab Representative. Or write direct.

CENTRALAB  
Division of Globe-Union Inc.  
900 East Keefe Avenue, Milwaukee, Wisconsin

203-6

Yes—I would like to have the CRL bulletins, checked below, for my technical library!

- |                                |                                |                               |                                |                                |                              |                                |
|--------------------------------|--------------------------------|-------------------------------|--------------------------------|--------------------------------|------------------------------|--------------------------------|
| <input type="checkbox"/> 973   | <input type="checkbox"/> 42-24 | <input type="checkbox"/> 42-9 | <input type="checkbox"/> 42-10 | <input type="checkbox"/> 42-18 | <input type="checkbox"/> 953 | <input type="checkbox"/> 722   |
| <input type="checkbox"/> 42-6  | <input type="checkbox"/> 42-27 | <input type="checkbox"/> 42-3 | <input type="checkbox"/> 695   | <input type="checkbox"/> 814   | <input type="checkbox"/> 970 | <input type="checkbox"/> 42-19 |
| <input type="checkbox"/> 42-22 | <input type="checkbox"/> 999   | <input type="checkbox"/> 42-4 | <input type="checkbox"/> 981   | <input type="checkbox"/> 975   | <input type="checkbox"/> 995 | <input type="checkbox"/> 967   |
|                                |                                |                               |                                |                                |                              | <input type="checkbox"/> 720   |

Name.....

Address.....

City..... State.....

**TEAR OUT COUPON**

for the Bulletins you want

**Centralab**  
CRL

Division of GLOBE-UNION INC. • Milwaukee



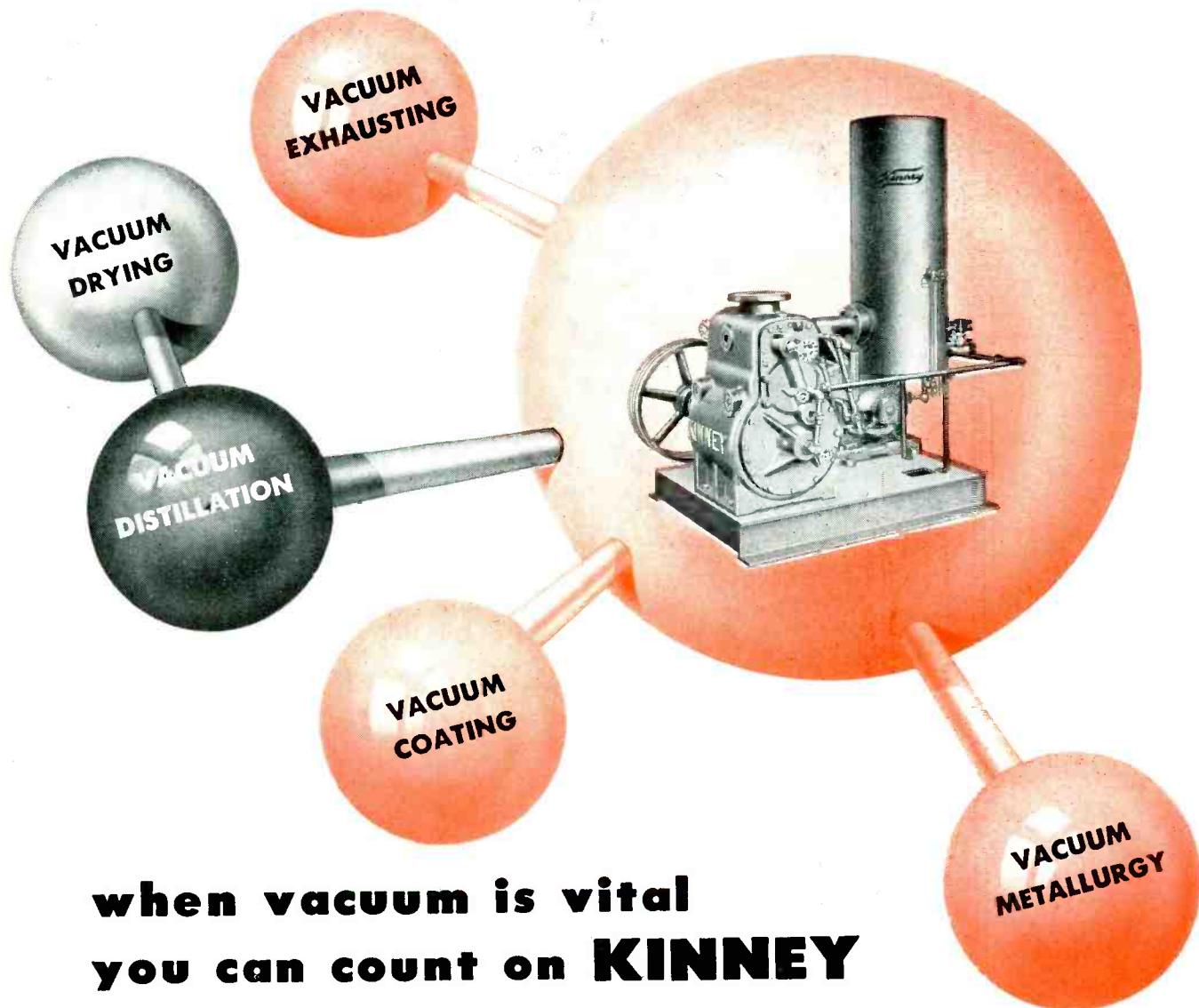

## when vacuum is vital you can count on **KINNEY**

Kinney High Vacuum Pumps are at work in all phases of low pressure processing — in the production of television tubes, titanium, penicillin, electrical condensers, coated camera lenses, dehydrated foods, and scores of other products. Their dependability and high pumping speed have helped bring vacuum out of the laboratory and onto the production line. Kinney Pumps are establishing important records both for length of service and economy of operation. They are virtually a "production must" whenever processes

require fast pump down to low absolute pressures.

**Performance** is the big reason why Kinney Pumps are so often specified "when vacuum is vital". Perhaps they can help speed YOUR processes or improve YOUR products. Write for Bulletin V-45, describing the complete line of Single Stage and Compound Vacuum Pumps. Kinney Manufacturing Company, 3565 Washington St., Boston 30, Mass. Representatives in New York, Chicago, Cleveland, Houston, New Orleans, Philadelphia, Los Angeles, San Francisco, Seattle.

Foreign Representatives: General Engineering Co. (Radcliffe) Ltd., Station Works, Bury Road, Radcliffe, Lancashire, England . . . Horrocks, Roxburgh Pty., Ltd., Melbourne, C. I. Australia . . . W. S. Thomas & Taylor Pty., Ltd., Johannesburg, Union of South Africa . . . Novelectric, Ltd., Zurich, Switzerland.

**Making old things better  
Making new things possible**

# KINNEY Vacuum Pumps

# *New* DU MONT FEATURES

DC

10

100

1000

## OSCILLOGRAPHY THROUGHOUT THE SPECTRUM

Once again, DuMont paces the modern art of oscillography by extending the operation of oscillographs over the entire frequency spectrum from d-c to over 100 megacycles, for the study of new and broader fields of industry and research. In a group of new instruments covering this entire range, superior circuit design has been expertly integrated to give each instrument optimum performance in its particular category of applications.



5 CPS. TO 100,000 CPS.



DC TO 200,000 CPS.

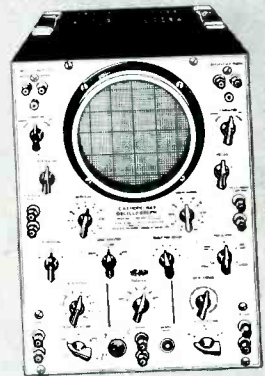

DC TO 500,000 CPS.

**Type 292**—Outstanding development in portable oscillographs employing a new three-inch tube, the Du Mont Type 3RP-A. Type 292 provides, good sensitivity, balanced deflection, and other performance features usually found only in instruments employing a five-inch tube.

**Type 304-H**—A new standard of performance in moderately priced oscillographs. Offers such advances as many times full screen expansion of sweep and vertical signal; complete positioning; high sensitivity at 3,000 volts accelerating potential high-gain a-c and d-c amplifiers; both driven and recurrent sweeps, sync limiting.

**Type 250-AH**—High-voltage operation and high light output for study of transient signals. New, extremely stable sweep circuit provides good linearity over its entire range of sweep-time intervals from 5 seconds to 10 microseconds. Contains built-in voltage calibrator and a variety of input connections.

# at THE I.R.E. SHOW

100,000

1MC

10MC

100MC

## OUTSTANDING DEVELOPMENTS IN CATHODE-RAY TUBES

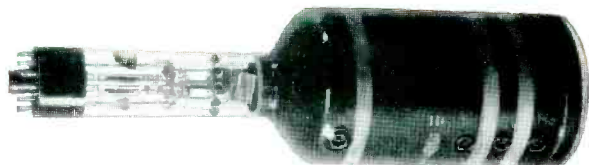

**Type 5XP-** Multi-band intensifier tube providing high sensitivity and high light output at operating potentials up to 29 kv. Flat face insures maximum useful screen diameter with minimum distortion of signals. Writing rates of the Type 5XP- are extended in a modification incorporating metalized screen.

**Type 3RP-A**—New, flat-face three-inch tube permitting operation from balanced deflection circuits. High sensitivity is provided despite extremely short overall length of 9 1/8 inches. Specially designed deflection plates minimize pattern distortions.

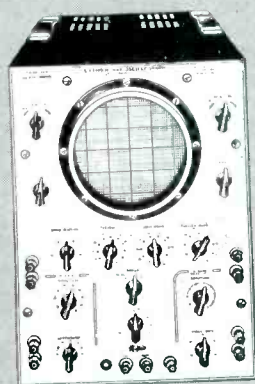

5 CPS. TO 10 MEGACYCLES

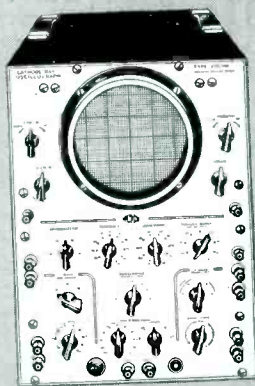

5 CPS. TO 15 MEGACYCLES

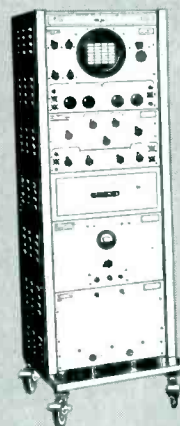

DC TO OVER 100 MEGACYCLES

**Type 303**—This new instrument employs a five-inch cathode-ray tube operated at 3,000 volts accelerating potential and provides over three inches of undistorted deflection at a sensitivity of 0.1 volt per inch. Both sensitivity and frequency response ratings of the Y-axis amplifier include the performance of a built-in signal delay line.

**Type 294**—New high-frequency oscillograph employing the sensitive Type 5XP- Cathode-ray Tube. Selection may be made at the rear panel for accelerating potential of either 7 kv. or 12 kv. Sensitivity at 12 kv.  $\pm$  0.15 rms volt per inch. Built-in signal delay line permits full display of steep wavefronts. Built-in calibrator.

**Special Type**—A specially constructed cathode-ray oscillograph illustrating the possible applications of a newly-developed high-gain, wide-band amplifier having a frequency response, within 3db, from d-c to over 100 megacycles. Sweep speeds as fast as 100 inches per microsecond will be observed on the Type 5XP- Cathode-ray Tube.

© ALLEN B. DU MONT LABORATORIES INC

# DUMONT

*for Oscillography*

# NATION'S MOST POWERFUL Transmitting Tube

made with OFHC COPPER  
supplied by REVERE

OFHC Copper also used by Federal Telephone and Radio Corporation in its 4½" Triode with maximum rating of 600 MC.

THE large tube which you see at left stands 34⅝" high and is the most powerful high frequency transmitting tube in commercial use today. Two of these tubes used in the radio station operated by the State Department make it one of the most powerful short wave transmitters in the country. That these tubes have been in constant use for more than 4 years is a tribute to the ingenuity of their makers and the quality of the materials used in their construction.

These transmitting tubes operate up to 22 MC. delivering 200 kw at that frequency. An unusual feature of construction is the water-cooled anode which is 19" long and is made from Revere 6" copper tubing with ½" wall, fluted for more efficient heat dissipation and tapered to paper thinness where it is sealed to the glass. Bottom of anode is drawn OFHC Revere Copper silver brazed to the OFHC Revere Copper tubing.

The small 4½" high vacuum triode shown in the upper left corner is used as a power amplifier or oscillator and is the only tube of its size that can handle up to 600 MC per second. It will deliver up to 750 watts. Anodes used on both these tubes are Revere Copper.

In this application, where the copper must be free from oxygen to protect the vacuum and must have the ability to expand and contract with the glass to which it is sealed as temperatures change, without altering the characteristics of the metal, only OFHC copper can be used. It is because of the importance of the purity of OFHC copper that Revere is most meticulous in segregating it in processing. Each lot and shipment is kept separate and conducted personally through the mill.

In addition to utmost care in manufacture of copper, brass and its alloys, Revere also offers you the benefits of its Technical Advisory Service. Many manufacturers of materials used in electronics have found this service useful in helping them iron the kinks out of their manufacturing difficulties, so it is entirely possible this Revere service can be of help to you. Why not call us in and see?

## REVERE

COPPER AND BRASS INCORPORATED

Founded by Paul Revere in 1801

230 Park Avenue, New York 17, New York

Mills: Baltimore, Md.; Chicago, Ill.; Detroit, Mich.;  
Los Angeles and Riverside, Calif.; New Bedford, Mass.;  
Rome, N. Y.—Sales Offices in Principal Cities,  
Distributors Everywhere.

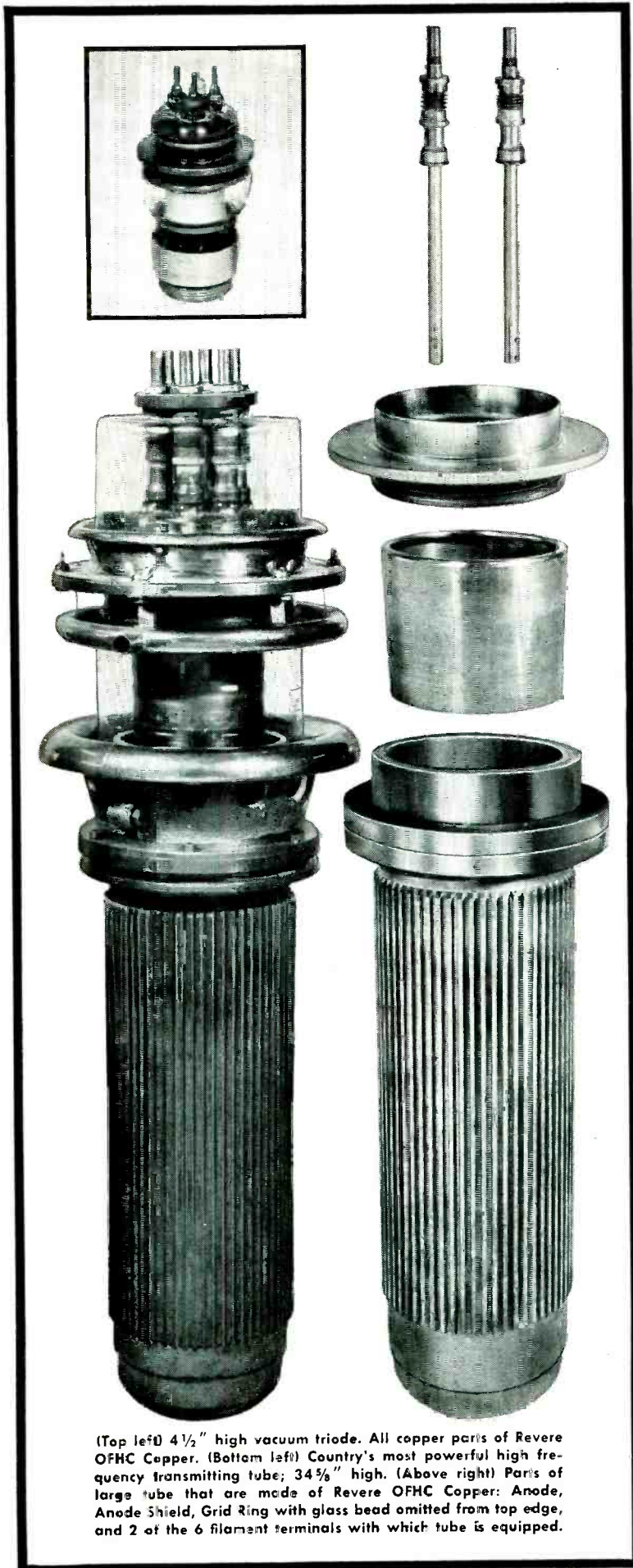

(Top left) 4½" high vacuum triode. All copper parts of Revere OFHC Copper. (Bottom left) Country's most powerful high frequency transmitting tube; 34⅝" high. (Above right) Parts of large tube that are made of Revere OFHC Copper: Anode, Anode Shield, Grid Ring with glass bead omitted from top edge, and 2 of the 6 filament terminals with which tube is equipped.



# quality control

*At every production step, American Lava Corporation makes periodic checks to assure exact compliance with all specifications.*

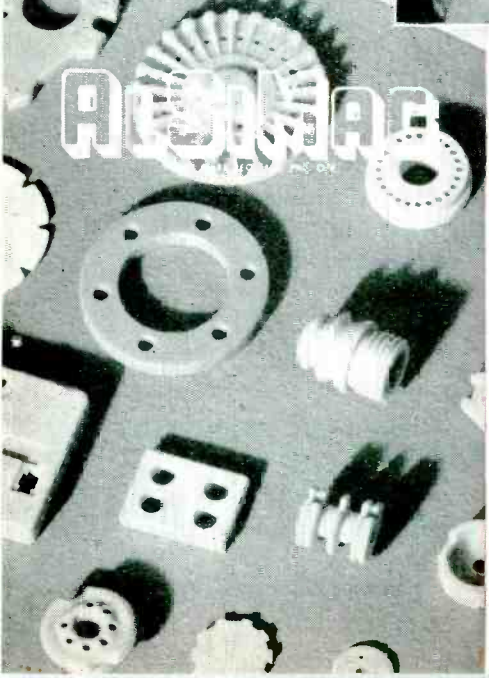
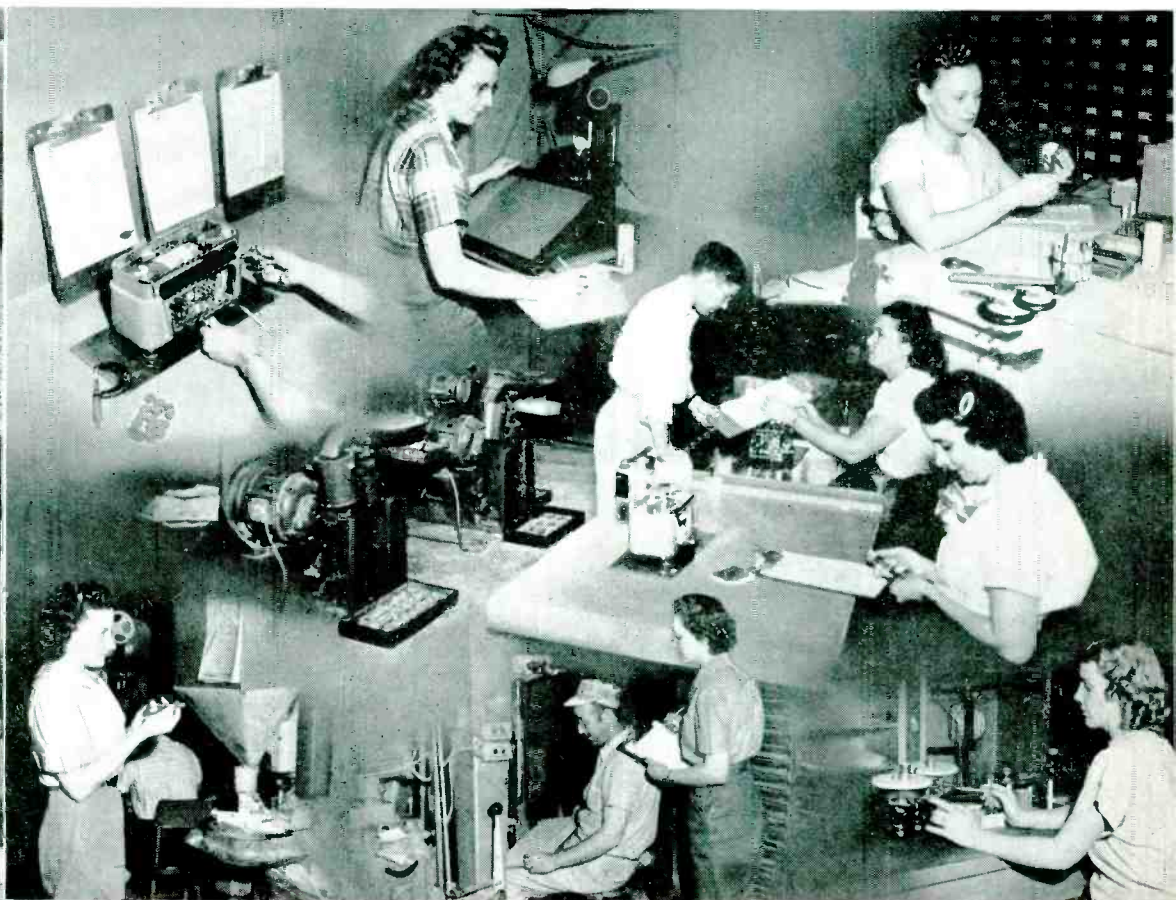
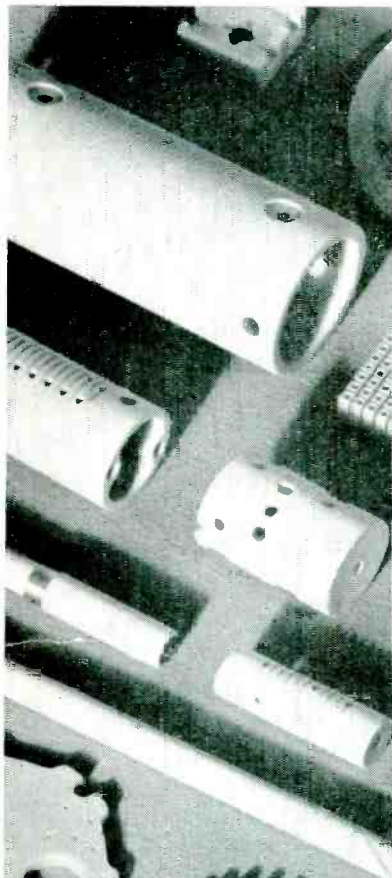

Savings in both time and cost result by preventing sub-standard production. Quality is maintained. Delivery schedules are adhered to more closely. Cost savings permit lower prices.

The well developed system of quality control at the American Lava Corporation is another reason why it is known as Headquarters for quality production of Custom Made Technical Ceramics.

**AMERICAN LAVA CORPORATION**  
48TH YEAR OF CERAMIC LEADERSHIP  
CHATTANOOGA 5, TENNESSEE

Offices: Metropolitan Area: 671 Broad St., Newark, N. J., Mitchell 2-8159 • Chicago, 9 South Clinton St., Central 6-1721 • Philadelphia, 1649 North Broad St., Stevenson 4-2823 • Los Angeles, 232 South Hill St., Mutual 9076  
New England, 38-B Brattle St., Cambridge, Mass., Kirkland 7-4498 • St. Louis, 1123 Washington Ave., Garfield 4959

# Announcing **hp** PRECISION EQUIPMENT

...THE BASIC TOOLS YOU

## A NEW VHF SIGNAL GENERATOR

10 to 500 mc

**High power output... Constant internal impedance... Wide frequency range... Broad modulation capabilities... Master oscillator power amplifier circuit... Microsecond pulses ... Small residual FM... CW, AM or pulsed output**

Here is a new general purpose laboratory generator of broadest application. It offers a directly calibrated output from 0.1  $\mu$ v. to 1 v. for measuring gain, selectivity, sensitivity or image rejection of receivers, I-F amplifiers, broad band amplifiers and other VHF equipment. The 1 v. output (to a 50 ohm load) is available throughout the entire frequency range for driving bridges, slotted lines, antennas, filter networks, etc. The output circuit is directly calibrated in volts and dbm for fast reading. No charts are necessary.

### DIRECT CALIBRATION

Frequencies from 10 to 500 mc are covered in 5 bands, and calibrated directly in mc on a drum-type dial having effective scale length of 90". The single-dial, ball-bearing frequency control insures maximum convenience and accuracy in tuning and re-setting.

Master oscillator and power amplifier circuits are enclosed in a heavy cast aluminum shield, insuring high stability and low electrical leakage.

### NEW -hp- 417A VHF DETECTOR

This new -hp- instrument is a super-regenerative (AM) receiver covering all frequencies between 10 and 500 mc. in 5 bands. It is designed for use with the -hp- 803A VHF Bridge. It offers 5  $\mu$ v sensitivity over entire band, quick, easy operation, and a direct-reading frequency control. The instrument is thoroughly shielded, and is suitable for general laboratory use; for making approximate frequency checks, determining noise, interference, etc. Price \$200.00 f.o.b. Palo Alto.



-hp- 608A VHF SIGNAL GENERATOR

### SPECIFICATIONS

**FREQUENCY RANGE:** 10 to 500 mc in 5 bands.

**ACCURACY:** Calibration  $\pm 1\%$ . Re-setability better than 1 mc, at high frequencies. Total scale length approx. 90".

**OUTPUT:** 0.1  $\mu$ v to 1.0 v. continuously variable. Calibrated in volts and dbm.

**IMPEDANCE:** 50  $\Omega$ . Maximum VSWR 1.2.

**ACCURACY:**  $\pm 1$  db entire range.

#### MODULATION:

**AMPLITUDE:** From 0 to 90% indicated by front panel meter.

**ENVELOPE DISTORTION:** 1% at 30% modulation.

**INTERNAL:** Fixed modulation at 400 and 1,000 cps.

**EXTERNAL:** Any frequency 50 cps to 1 mc. 4.0 v. input.

**EXTERNAL PULSE:** Positive or negative, 4 v. peak. Good pulse shape. Square wave to 1  $\mu$ sec length.

**LEAKAGE:** Less than 1  $\mu$ v.

**RESIDUAL FM:** Not over .0025% at 90% modulation.

**POWER:** 115/230 v. 50/60 cps. 150 watts.

**SIZE:** 12" x 14" x 18" deep. -hp- grey finish. Cabinet mounting.

**PRICE:** \$850.00 f.o.b. Palo Alto.

*Data Subject to Change Without Notice*

HEWLETT **hp** PACKARD

# FOR THE *10 to 500 mc* BAND!

ASKED US FOR!

## A NEW VHF BRIDGE

50 to 500 mc

**First commercial VHF bridge...Based on an entirely new principle...Direct impedance readings, 2 to 2,000 ohms...Wide phase angle...Useful to 1,000 mc...Makes every kind of VHF impedance measurement**

The new *-hp-* 803A VHF Bridge is the first commercial instrument built to give you fast, direct impedance readings in the 50-to-500 mc band. It can be used for any type of VHF impedance measurement. This includes characteristics of transmission lines, antennas, resistors, rf chokes and condensers; impedance of connectors, standing wave ratios; percentage of reflected power, VHF system flatness, etc.

### BROAD FREQUENCY RANGE

The Model 803A operates on an entirely new principle suggested by Mr. John Byrne of the Airborne Instrument Laboratories.\* It determines impedance by sampling the magnetic and electric fields of a transmission line. Phase is measured by determining the point of cancellation of these samples along a second transmission line. This method effectively overcomes the narrow frequency limitations of conventional bridges, and permits the new *-hp-* VHF bridge to make readings at frequencies up to 1,000 mc and down to 5 mc.

*\*A complete description of this principle and its application in the -hp- VHF Bridge will appear in an early issue of the -hp- Journal. Free copy on request.*

SEE THESE & 5 OTHER NEW *-hp-* INSTRUMENTS

I. R. E. SNOW



BOOTHS 40, 41

## HEWLETT-PACKARD COMPANY

2046A Page Mill Road • Palo Alto, California

Export: FRAZAR & HANSEN, Ltd., 301 Clay Street, San Francisco, Calif., U. S. A. Offices: New York, N. Y. and Los Angeles, California



### *-hp-* 803A VHF BRIDGE

#### SPECIFICATIONS

**MEASUREMENT RANGE:** Impedance magnitude, 2 to 2,000 $\Omega$ . (Higher and lower values may be measured by using a known length of transmission line as an impedance transformer.)

Phase angle from  $-90^\circ$  to  $+90^\circ$  at 50 mc and above.

**CALIBRATION:** Impedance: Directly in ohms.

Phase angle: Directly in degrees at 100 mc. May be readily computed at other frequencies.

$[\theta \text{ (actual)}] = \theta \text{ (read)} \times \text{Frequency, mc}/100.]$

**ACCURACY:** Impedance magnitude, approx.  $\pm 5\%$ .

Phase angle, approx.  $\pm 3$  degrees (over range 50 to 500 mc).

**FREQUENCY RANGE:** Maximum accuracy 50 to 500 mc. Useful down to 5 mc and up to 1,000 mc. Maximum measurable phase angle at 5 mc is  $-9^\circ$  to  $+9^\circ$ .

**EXTERNAL rf GENERATOR:** Requires an AM signal source of at least 1 mw. High signal level is desirable. (*-hp-* Model 608A VHF Signal Generator is ideal for this purpose.)

**rf DETECTOR:** Requires a well-shielded VHF receiver of good sensitivity. (*-hp-* Model 417A VHF Detector is designed for this use.)

**SIZE:** 14" x 14" x 8" deep. Smooth *-hp-* grey finish. Cabinet mounting.

**PRICE:** \$495.00 f.o.b. Palo Alto.

*Data Subject to Change Without Notice*

# HEWLETT *hp* PACKARD

YOU CAN BE **SURE**.. IF IT'S  
**Westinghouse**

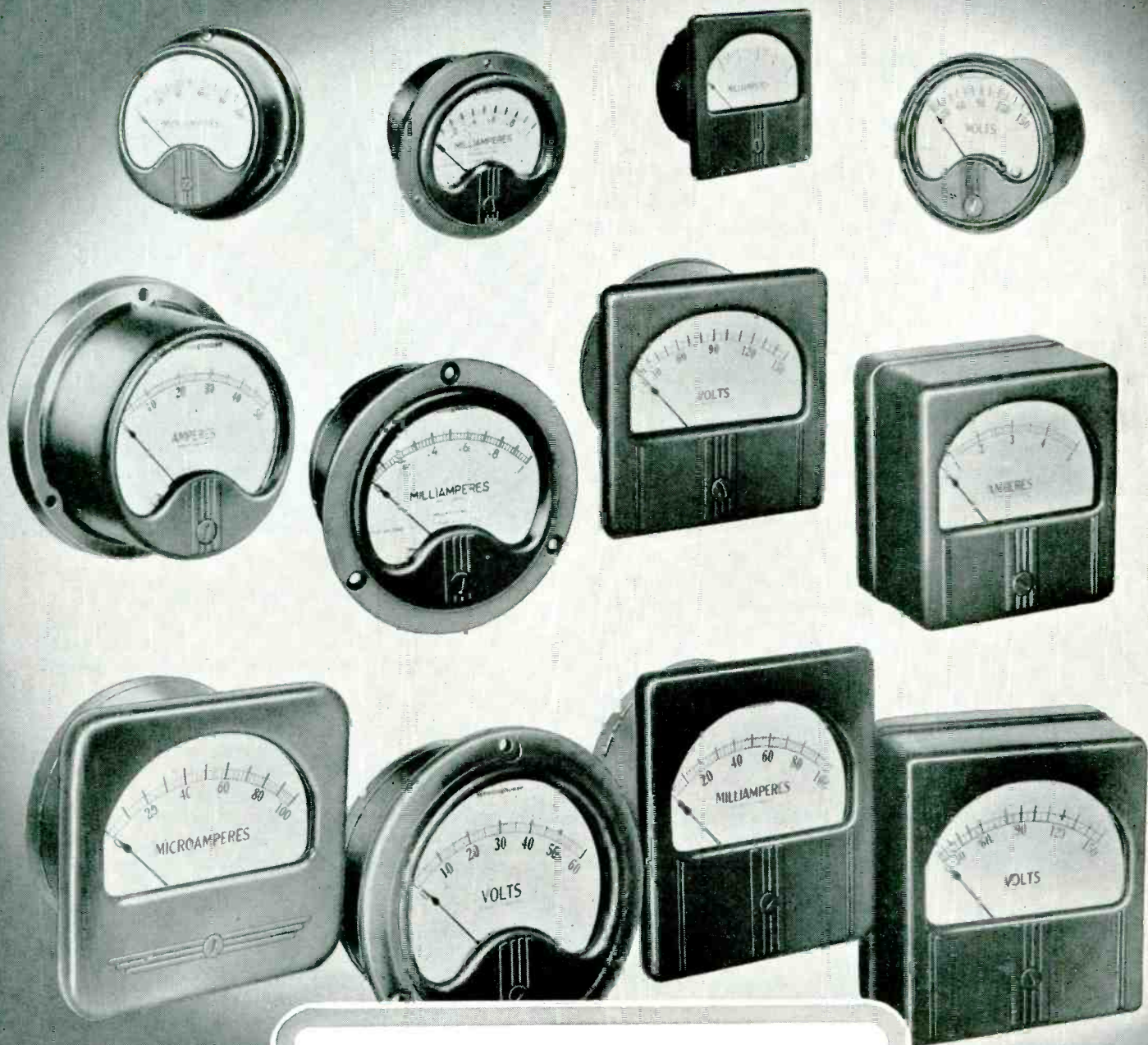

**All of these outstanding advantages** are available in the complete Westinghouse lines of switchboard and portable instruments. Ask your nearest Westinghouse Representative. Write for Catalog Sections 43-200 and 43-100.



# Slash Instrument Inventory!

- ★ **The most complete line**
- ★ **Meets A.S.A. standards**
- ★ **Shipments in 10 days**

Cut overhead on your panel instruments. Maintain production without costly stocks.

Westinghouse now offers the most complete line of panel instruments in the industry . . . every one built to the rigid standards of "The American Standards Association". For emergencies, shipment can be made to meet every electrical requirement within ten days of receipt of order at the factory.

Westinghouse Instrument Specialists are ready to help you plan. These men have nationwide experience in solving instrument application problems of all kinds. Phone, write or wire your nearest Westinghouse Representative, ask for C.S. 43-300, for more information on panel instruments. Westinghouse Electric Corporation, 95 Orange Street, Newark, New Jersey.

J-40390

*Specify Westinghouse and be SURE of all three*

**Westinghouse**  
**INSTRUMENTS**



## Insulation Cements for Electric Heaters

# ZIRCON meets these five basic requirements

**1** Easy application.

**2** Refractoriness.

**3** Current leakage minimized at operating wattage under humid conditions or under an externally applied stress voltage.

**4** Stability of insulation and structure through a 1000 hour-life test.

**5** Reasonable cost.

### TYPICAL CHARACTERISTICS

(The results shown apply to a particular structure for cement applied in a specific manner. Any variation may alter results.)

Type of Cement	A	A	B	C
ASSEMBLY METHOD	Dry Press Flat Iron	Strip Heaters	Mud Cast Range Element	Dry Press Flat Iron
OPERATING LEAKAGE	0.002 M.A.	0.002 M.A.	0.02 M.A.	0.02 M.A.
HUMIDIFICATION LEAKAGE	0.2 M.A.	—	<0.5 M.A.	0.03 M.A.
RETURN TO NORMAL*	15 to 30 sec.	—	10 to 15 sec.	—

\*After current is turned on.

Performance of Zircon insulation cements indicates an outstanding group of compositions, both electrically and chemically. Our trained field engineers will be glad to bring you detailed information on individual characteristics and applications. Write us. No obligation.



TAM is a registered trademark.

**TITANIUM ALLOY MFG. DIVISION**  
NATIONAL LEAD COMPANY

Executive and Sales Office: 111 BROADWAY, NEW YORK CITY · General Offices, Works, and Research Laboratories: NIAGARA FALLS, N.Y.

# "THE STANDARD TUNER"

QUALITY PROVEN

# A MILLION TIMES

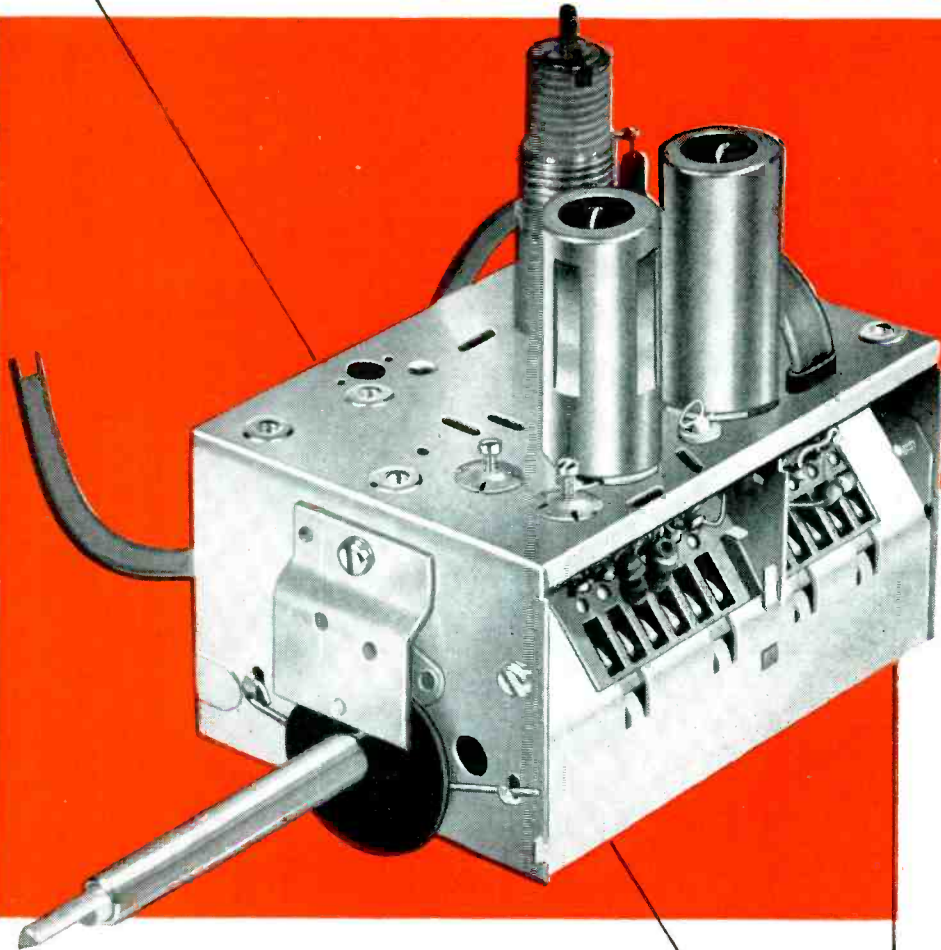

OVER  
**1,000,000**

STANDARD TUNERS  
ARE NOW OPERATING  
IN OVER A MILLION  
OUTSTANDING  
TV SETS

More than one million TV sets produced to date incorporate "The Standard Tuner". These are the sets the consuming public will want and buy. The Standard Tuner's superior performance brings added brilliance and sparkle to the picture. Gives your TV sets that additional sales feature.

"The Standard Tuner." The outstanding front end tuning assembly that an ever-increasing number of TV engineers are specifying. It covers all 12 channels . . . gives higher sensitivity . . . quick interchanging of channel inductors . . . adaptable to U.H.F.

#### GOOD NEWS FOR SERVICE MEN

"The Standard Tuner" is now available to you as a replacement unit. See your jobber for details.

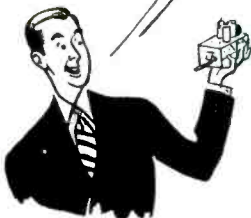

**Standard** COIL PRODUCTS CO., INC.  
CHICAGO • LOS ANGELES • BANGOR, MICH.

They "Stack Up"  
For Heavy  
Industrial Use!

# Seletron

Reg. Trade Mark

## SELENIUM RECTIFIERS

**P**OWER PACKS using Seletron Selenium Rectifiers range in output all the way up to 75 KW — They aren't made just in the "dainty" sizes also available for radio and television. The rugged, high powered Seletron Rectifiers are ideal for diversified industrial applications because of their flexibility and high efficiency over a wide range of load.

Pictured are a few applications for industry as developed by Seletron users. Clockwise from top right: Power Packs for electroplating and similar processes; for general industrial use; and elevator operation.

How about *your* rectification problems? Seletron engineers will be glad to discuss them with you. Write Dept. ES-27

OUTPUT: 1000 Amp.,  
9V. Fan Cooled.  
24"x24"x66"

OUTPUT: 25 KW,  
230V. Fan  
Cooled.  
24"x4"x48"

OUTPUT: 45 KW,  
220V. Convection  
Cooled.  
3 1/2' x 4 1/2' x 2 1/2'

Let us send you our  
bulletin. It includes in-  
teresting technical data  
regarding the use of  
selenium rectifiers.

OUTPUT: 75 KW,  
230V. Fan  
Cooled.  
6'4" x 5'10" x 4'7"

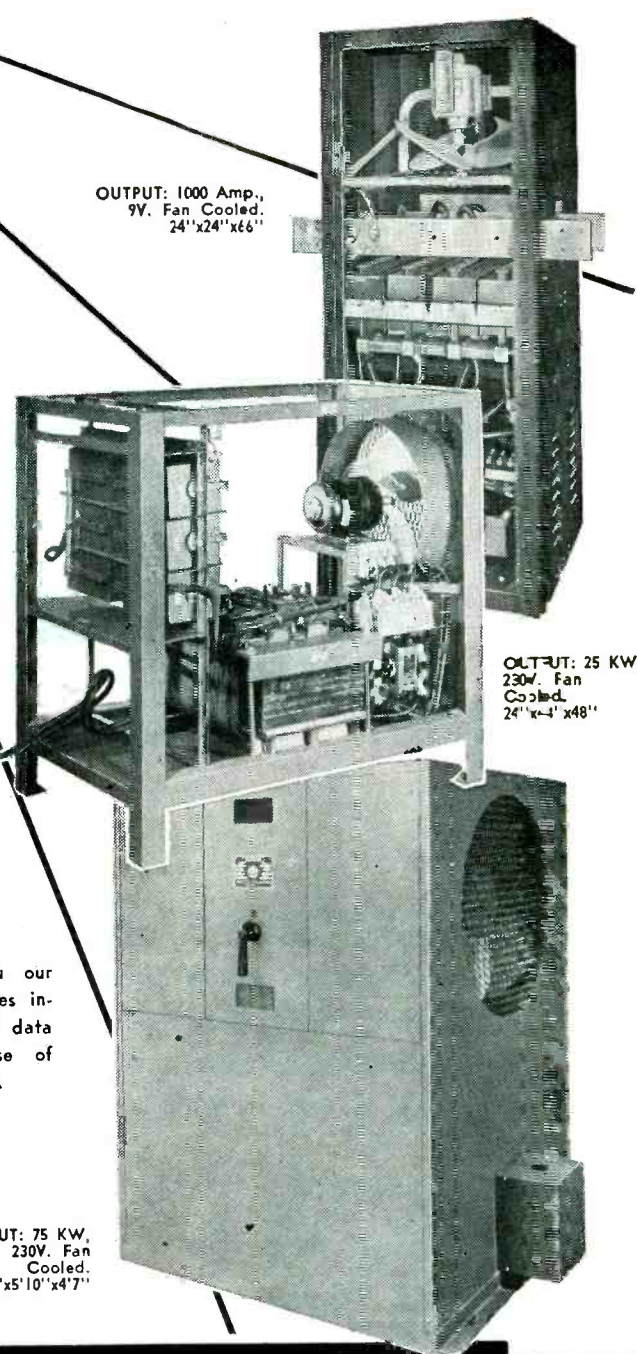
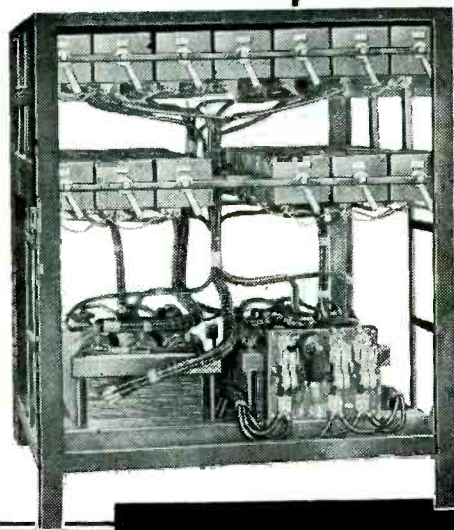

SELETRON DIVISION  
**RADIO RECEPTOR COMPANY, INC.**

Since 1922 in Radio and Electronics

Main Office & Factory: 84 North 9th St., Brooklyn 11, N. Y. • Sales Department: 251 West 19th St., New York 11, N. Y.

# Only the BEST pass these tests

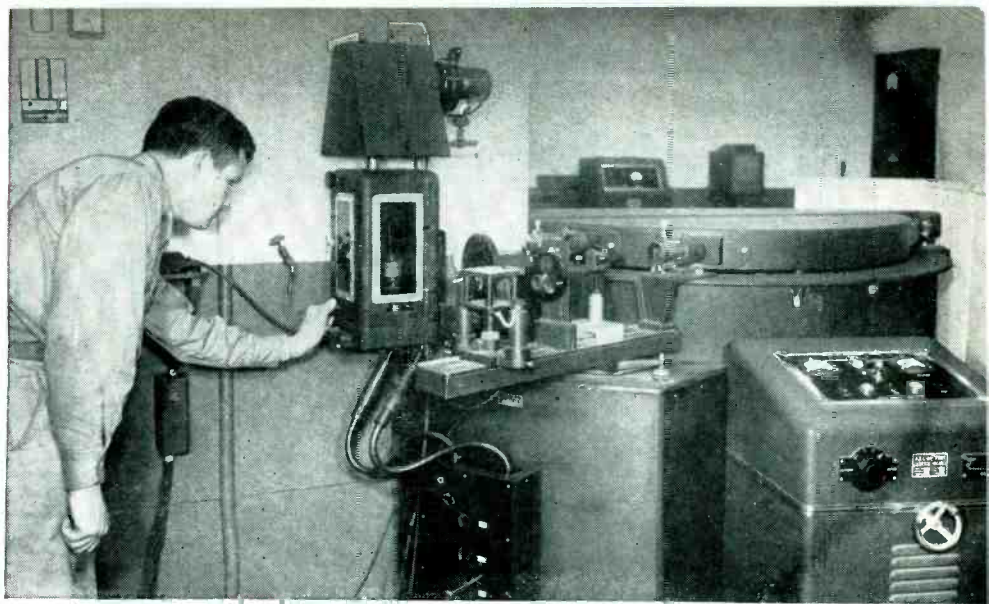

The spectrograph provides one of the most efficient means for precise metallurgical control. Samples taken from a heat in the Driver-Harris melting furnaces are analyzed so rapidly by means of this apparatus, that a complete analysis can be obtained before the next heat is ready for pouring. Thus any necessary adjustments can be made immediately—an outstanding advantage in controlling the constituent elements of alloys being produced to extremely close specifications. The operator is here seen adjusting the size of the analytical gap in the arc-spark stand of the Driver-Harris grating spectrograph at the start of an exposure.

**T**he quality of any manufactured item depends upon a number of factors, but on none so much as "inspection". And here, at Driver-Harris, we give top priority to inspection.

Through every stage of manufacture, precise metallurgical checks and controls are systematically applied to D-H Alloys to insure quality and uniformity that are unsurpassed—recognized the world over.

We have had 50 years' experience in continuous alloy research and manufacture. Every piece of D-H wire, ribbon or strip, and every casting embodies advantages such as only half a century of accumulated know-how can provide.

Whatever your requirements for electrical resistance and heat-resisting alloys, send us your specifications. We shall be glad to make recommendations, and supply you with the alloy best suited to your needs.



This operator is viewing the projection of a series of spectrograms, and is about to measure the intensity of specific spectral lines to determine the quantity of certain chemical elements in the samples being analyzed.



The research metallograph, the ultimate in metallurgical microscopes, is applied to both research and quality control at Driver-Harris.

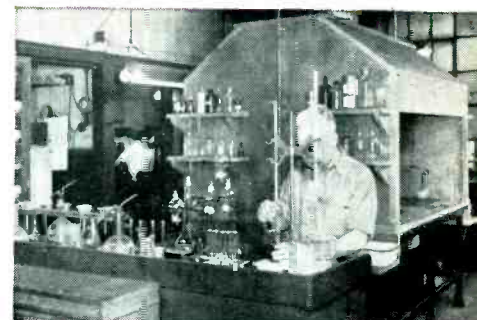

A view in the Driver-Harris chemical laboratory—fully equipped for all standard types of volumetric, gravimetric and colorimetric analyses.



Makers of over 80 alloys for the electronic, electrical and heat-treating fields—including world-famous Nichrome\*

## Driver-Harris Company

HARRISON, NEW JERSEY

BRANCHES: Chicago, Detroit, Cleveland, Los Angeles, San Francisco

# "His receiver or equipment will have a Dependable Stout Heart"

The core is the heart of the circuit — in radio, TV, short wave, FM, radar and in many forms of telephonic apparatus. The dependable, stout heart can only be built with the finest materials available.

Stackpole Carbon Company has unparalleled experience in the manufacture of quality powdered iron cores. They know — and the firms they serve know — the all-importance of minimizing fading and drifting. They know that a core made with a G A & F Carbonyl Iron Powder represents the one surest safeguard.

Stackpole Carbon Company knows — and the firms they serve know — that the *gains* thus made are all but

doubled by the *savings* which also occur — automatically. If you can cut down the space and the weight in your receiver or equipment, if you can make a substantial savings in wire, why specify any core material except G A & F Carbonyl Iron Powders?

We invite you to send for the free booklet described below. We invite you to call upon our highly specialized research facilities for any help we can logically render. We also invite you to ask your core maker, your coil winder, your industrial designer, how G A & F Carbonyl Iron Powders can improve the performance of the equipment you manufacture. It will cost you nothing to get all the facts.



**THIS FREE BOOK** — fully illustrated, with performance charts and application data — will help any radio engineer or electronics manufacturer to step up quality, while saving real money. Kindly address your request to Dept. 14.

## These unique properties tell why G A & F Carbonyl Iron Powders are superior:

PROPERTY	ADVANTAGE
Spherical structure .....	Facilitates insulation and compacting
Concentric shell structure (some types only) .....	Low eddy current losses
High iron content .....	Exceptional permeability and compressibility
Absence of non-ferrous metals .....	Absence of corresponding disturbing influences
Relative absence of internal stress; regular crystal structure .....	Low hysteresis loss
Spheres of small size .....	Low eddy current losses; usable for high frequencies
Variations of sphere size .....	Extremely close packing

## ANTARA® PRODUCTS

**GENERAL  
ANILINE & FILM CORPORATION**

444 MADISON AVENUE

NEW YORK 22, N. Y.

# G A & F® Carbonyl

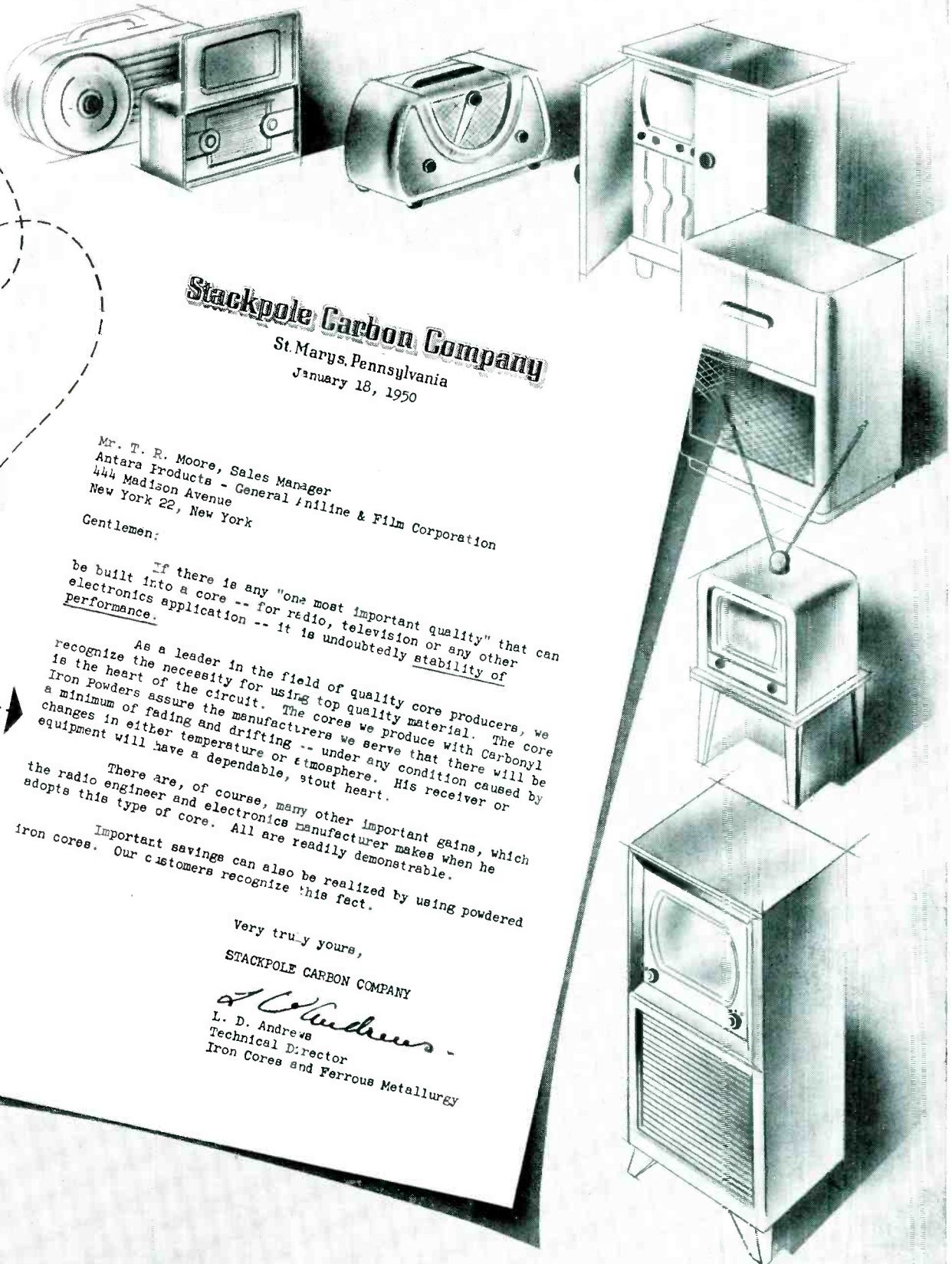

**Stackpole Carbon Company**  
 St. Marys, Pennsylvania  
 January 18, 1950

Mr. T. R. Moore, Sales Manager  
 Antara Products - General /niline & Film Corporation  
 444 Madison Avenue  
 New York 22, New York

Gentlemen:

If there is any "one most important quality" that can be built into a core -- for radio, television or any other electronics application -- it is undoubtedly stability of performance.

As a leader in the field of quality core producers, we recognize the necessity for using top quality material. The core is the heart of the circuit. The cores we produce with Carbonyl Iron Powders assure the manufacturers we serve that there will be a minimum of fading and drifting -- under any condition caused by changes in either temperature or atmosphere. His receiver or equipment will have a dependable, stout heart.

There are, of course, many other important gains, which the radio engineer and electronics manufacturer makes when he adopts this type of core. All are readily demonstrable.

Important savings can also be realized by using powdered iron cores. Our customers recognize this fact.

Very truly yours,  
 STACKPOLE CARBON COMPANY

*L. D. Andrews*  
 L. D. Andrews  
 Technical Director  
 Iron Cores and Ferrous Metallurgy

LDA

# Iron Powders . . .



# GENERAL RADIO announces a COMPLETE Integrated Line of U. H. F. Measuring Equipment

FOR MEASUREMENTS OF POWER • VOLTAGE • IMPEDANCE • ATTENUATION • STANDING-WAVE RATIO

These coaxial elements, each simple in itself, can be combined easily and quickly into many different measurement set-ups. A relatively small investment in these versatile parts provides equipment for most U.H.F. measurement problems. Characteristic impedance is 50 ohms wherever possible, and the Universal Type 874 Coaxial Connector is used throughout.

## FOUNDATION ELEMENTS

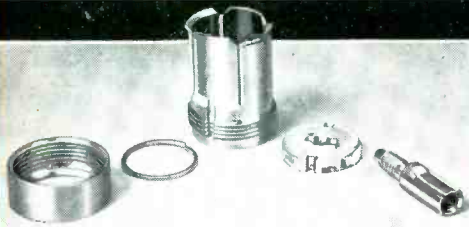

**874-B BASIC CONNECTOR — \$1.50**  
For use on rigid 50-ohm, air-dielectric coaxial lines

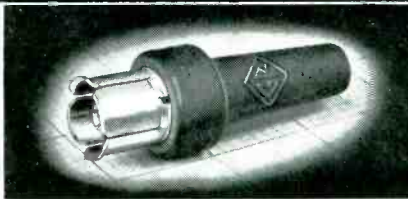

**874-C CABLE CONNECTOR — \$2.00**  
For use on G-R Type 874-A2 Polyethylene Cable  
**874-C8 CABLE CONNECTOR — \$2.00.** For use on Army-Navy Type RG-8/U Cable



**874-P PANEL CONNECTOR — \$2.25**  
For use on panels. Rear end fits Type 874-A2 Cable  
**874-P8 PANEL CONNECTORS — \$2.25**  
For use on panels. Rear end fits Army-Navy Type RG-8/U Cable



**874-PC PANEL CONNECTOR WITH CAP — \$2.75.** For use on panels. Hinged cap shields connector when not in use. Rear end fits Type 874-A2 Cable. **874-PC8 PANEL CONNECTOR WITH CAP — \$2.75.** Same as 874-PC except rear end fits Army-Navy Type RG-8/U Cable



**874-Q1 ADAPTER TO TYPE N — \$6.00.** Plugs into Army-Navy Type UG-22/U and similar jack-type connectors

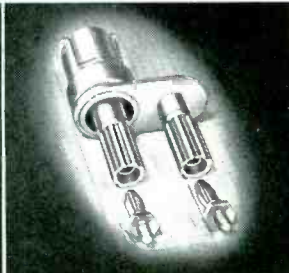

**874-Q2 ADAPTER TO G-R TYPE 274 — \$5.00.** Makes output of a coaxial system available at pair of 3/4-inch-spaced binding posts or banana plugs

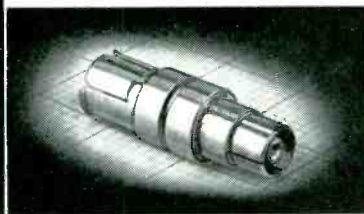

**874-Q7 ADAPTER TO G-R TYPE 774 — \$5.00.** Plugs into any G-R Type 774 Connector



**874-R20 PATCH CORD — \$8.00.** Three feet of Type 874-A2 Polyethylene Cable with a Type 874-C Connector on each end



**874-R31 PATCH CORD — \$4.50.** Three-foot, flexible coaxial cable terminated with Type 874 Connector and phone tips

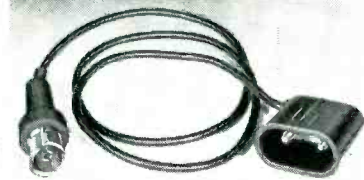

**874-R32 PATCH CORD — \$5.25.** Similar to Type 874-R31, with a Type 274-ND Shielded Plug in place of phone tips

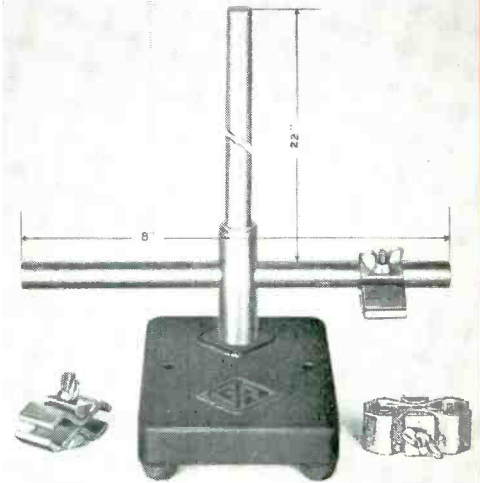

**874-Z STAND — \$15.50.** To support the parts of a wide variety of coaxial systems — heavy bronze base — 22-inch vertical and 8-inch horizontal brass rods — three universal clamps — no rust or corrosion

## FIXED AND ADJUSTABLE LINE ELEMENTS

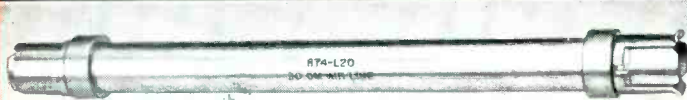

**874-L10 50-OHM AIR LINE (10 CM) — \$10.00**  
**874-L20 50-OHM AIR LINE (20 CM) (illustrated) — \$11.00**  
**874-L30 50-OHM AIR LINE (30 CM) — \$12.00**  
To space stubs or other elements of a coaxial system

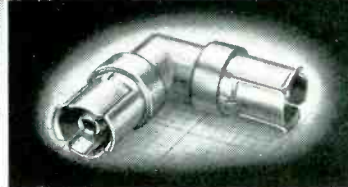

**874-EL 90-DEGREE ELL — \$6.50**

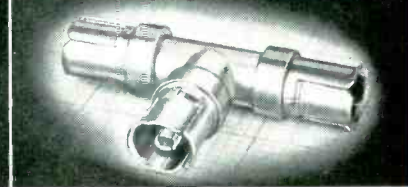

**874-T TEE — \$8.50**



**874-D20 ADJUSTABLE STUB (20 CM) — \$15.00**  
**874-D50 ADJUSTABLE STUB (50 CM) — \$16.00**

For matching or tuning, and use as reactive elements. Coaxial lines with sliding short circuit moved by bakelite tube. Reference marker facilitates use as wavemeter with scale



**874-LA ADJUSTABLE LINE (Line Stretcher) — \$18.00**  
Telescoping line — length change: 25 cm

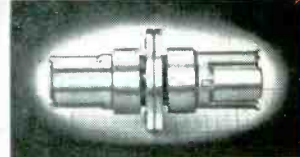

**874-JR ROTARY JOINT — \$8.50**

## FILTERS

**874-F500 500-MC LOW-PASS FILTER — \$22.50**  
**874-F1000 1000-MC LOW-PASS FILTER (illustrated) — \$22.50**

Used to improve accuracy by reducing harmonics from U.H.F. generators



**874-K COUPLING CAPACITOR — \$12.00**  
Short coaxial line with 0.005 microfarad capacitor in series with inner conductor — transmits h.f., blocks d.c.



# GENERAL RADIO COMPANY



**Versatile, Inexpensive Components • New Universal Connectors Eliminate Male-female Adapters • Exceptionally Convenient • Excellent Electrical Characteristics • Ideal for Proposed U.H.F. T-V Band**

**TERMINATIONS**



**874-WM 50-OHM TERMINATION** — \$8.00. Provides good impedance match from D.C. to several thousand megacycles. SWR less than 0.6 db up to 2,000 Mc, 1.0 db up to 4,000 Mc



**874-WN SHORT-CIRCUIT TERMINATION** — \$3.50. A fixed shorting strap mounted in a connector



**874-WO OPEN-CIRCUIT TERMINATION** — \$3.00. A shielding cap for open-circuited lines

**COUPLING ELEMENTS**

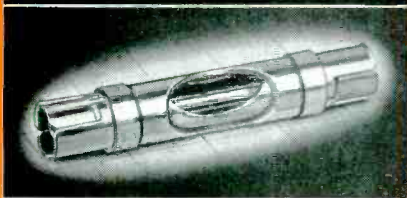

**874-LR RADIATING LINE** — \$12.00. Short coaxial line with hole in outer conductor that can be partially or completely covered by a rotatable sleeve — for coupling to external wavemeter or heterodyne frequency meter



**874-MA ADJUSTABLE COUPLING LOOP** — \$7.50. One-turn loop on coaxial line — collet supplied for panel mounting



**874-MB COUPLING PROBE** — \$5.00. Binding post, acting as a probe, mounted on connector

**ATTENUATORS**

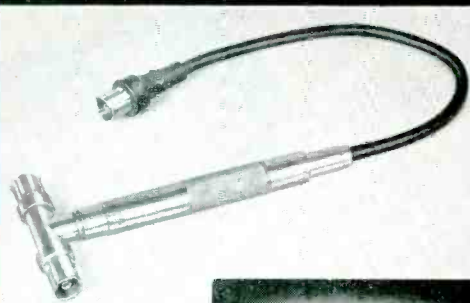

**874-GA ADJUSTABLE ATTENUATOR** — \$55.00. Mutual-inductance (wave-guide-below-cutoff) type attenuator — attenuation is adjusted by turning sleeve — micrometer-type indication — direct reading in db

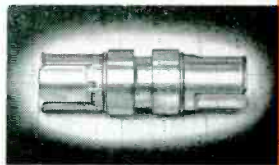

**874-GF FIXED ATTENUATOR (20 DB PAD)** — \$18.00. Pi-type resistance attenuator for frequencies from dc to several thousand megacycles

**POWER MEASURING EQUIPMENT**

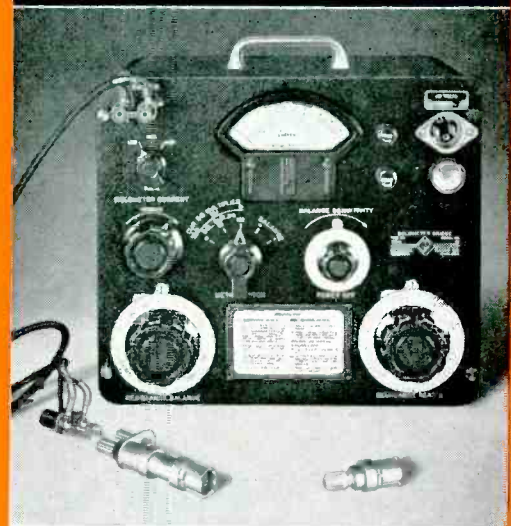

**1651-A BOLOMETER BRIDGE.** For conveniently measuring h-f power by either d-c substitution or direct-reading method with the following three bolometer units:

- 874-H25\* THERMISTOR UNIT (25 MW)** — \$40.00
- 874-H100\* THERMISTOR UNIT (100 MW)** — \$40.00  
Thermistors in coaxial holders with by-pass condenser — useful from 5Mc to several thousand Mc
- 874-HF\* FUSE BOLOMETER HOLDER** — \$34.00  
Similar to thermistor units, but for fuse bolometers — fuse assortment supplied

\*External appearance of all three similar — illustrated at lower left

**874-WL LAMP TERMINATION** — \$5.00. Flashlight bulb for rough power indication — 50 to 100 mw (lower right in photo)

**VOLTAGE MEASURING EQUIPMENT**

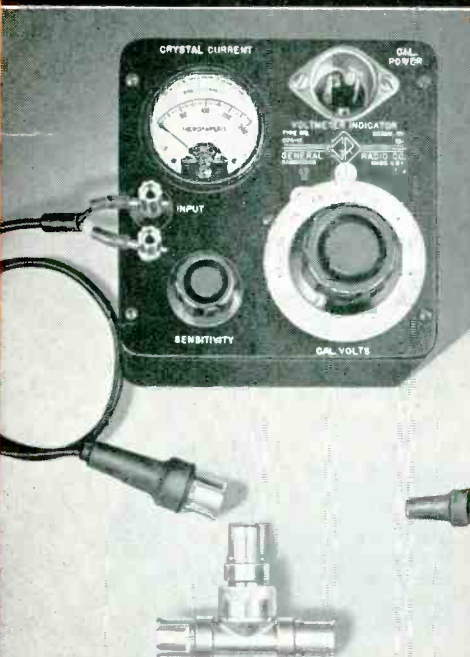

**874-VR VOLTMETER RECTIFIER** — \$25.00. Crystal rectifier across short coaxial line — useful frequency range 15 Mc to 2,500 Mc — resistor in series with inner conductor provides 50-ohm source impedance — also useful as detector (illustrated at bottom)

**874-VI VOLTMETER INDICATOR** — \$65.00. Crystal current indicator and calibrator for Type 874-VR Voltmeter Rectifier. Range: 0.1 to 2 volts — regulated 60-cycle calibration voltage

**STANDING-WAVE RATIO MEASURING EQUIPMENT**

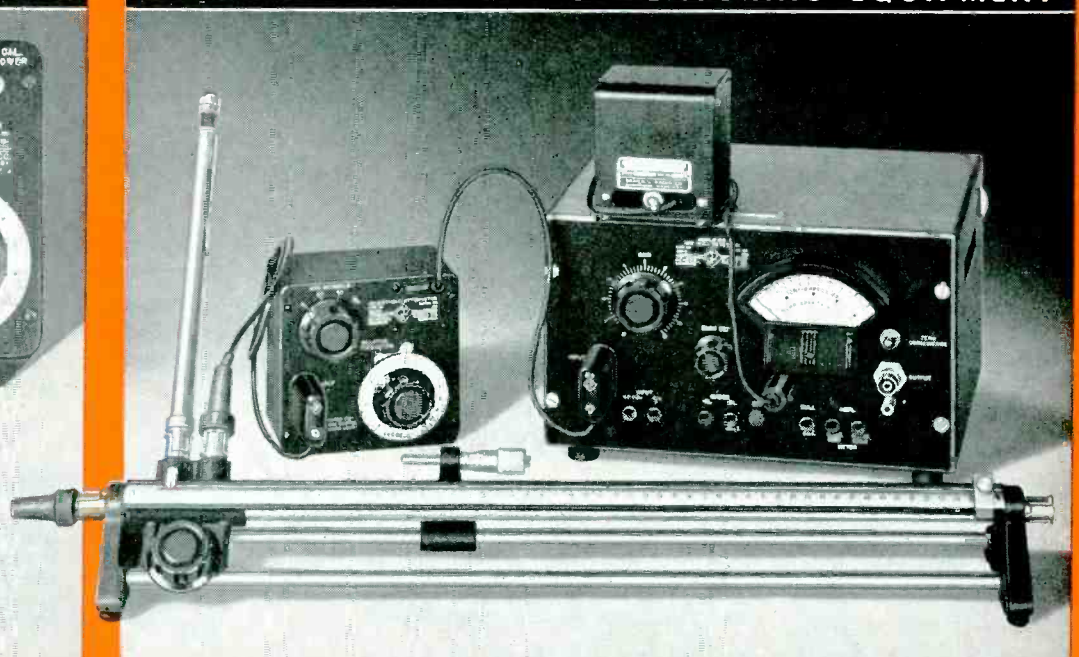

**874-LB SLOTTED LINE** — \$220. For measurements of standing-wave ratio and impedance — 300 to 5,000 Mc — variations in probe coupling along line less than  $\pm 2\frac{1}{2}$  per cent — unique simplicity of design — detector: crystal rectifier supplied, or suitable receiver — (Type 874-D20 Adjustable Stub shown in illustration plugged into slotted line tunes crystal) — slow-motion drive readily disengaged for free sliding

**874-LV MICROMETER VERNIER ATTACHMENT** — \$30.00. For measurement of high standing-wave ratios by the "width-of-minimum" method  
**1231-B AMPLIFIER AND STANDING-WAVE INDICATOR** — \$210.00. Amplifies and indicates slotted-line crystal detector output in db  
**1231-P4 ADJUSTABLE ATTENUATOR** — \$52.50. For increasing the range and accuracy of standing-wave measurements with Type 1231-B Amplifier  
**1231-P2 TUNED CIRCUIT** — \$20.00. 400- or 1000-cycle filter; frequency selected by switch

**WRITE FOR A COPY OF THE JANUARY, 1950 GENERAL RADIO EXPERIMENTER FOR COMPLETE INFORMATION**

**275 Massachusetts Avenue, Cambridge 39, Massachusetts**

90 West St., New York 6

920 S. Michigan Ave., Chicago 5

1000 N. Seward St., Los Angeles 38





**THIS IS NOT NEWS to most designers and engineers. But it is a REMINDER to all!**

# FEDERAL'S 26-VOLTS RMS PER CELL

## High Voltage Selenium Rectifiers

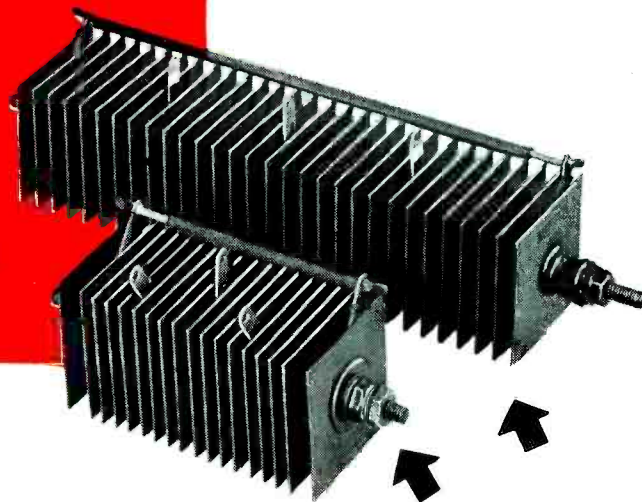

**Tried and Proved by Industry  
in hundreds of thousands  
of installations for  
MORE THAN 3 YEARS**

**COMPARE!** The size of a Federal 26-Volt RMS per cell Selenium Rectifier (front) with an equivalent low voltage type.

The Federal 26-Volt Selenium Rectifier was the *first* power stack to operate at such high voltage, the *first* to be accepted by industry, the *first* to prove itself. No other manufacturer can match this record of performance.

### Here's what Federal's 26-Volt RMS per cell Selenium Rectifier means to you:

- **LOWER COST**... A smaller rectifier with fewer cells does a better job... at lower first cost and at lower operating cost—in addition to the important reduction in cost of components.
- **HIGHER EFFICIENCY**... Fewer cells per stack mean lower losses.
- **SPACE SAVING**... More design freedom resulting from greatly reduced size of the rectifier unit.
- **GREATER VERSATILITY**... New fields of application are opened through the inherent advantages of lower cost, efficiency and compactness.

Every Federal Selenium Rectifier, for every power conversion requirement, is backed by the engineering and production skill of America's oldest and largest manufacturer of Selenium Rectifiers. Write Federal today for information on your rectifier requirements.



**Get the facts on 26-Volt RMS Per Cell Selenium Rectifiers.** Send for your free copies of Federal's new 32-page book, "Federal Selenium Rectifiers From Milliwatts to Kilowatts," and Federal's "Packaged Power Data Sheet." Address Department F-713.



## Federal Telephone and Radio Corporation

SELENIUM and INTELIN DIVISION, 100 Kingsland Road, Clifton, New Jersey

In Canada: Federal Electric Manufacturing Company, Ltd., Montreal, P. Q.  
Export Distributors: International Standard Electric Corp., 67 Broad St., N.Y.



# 1950 . . .

## *Our Industrial Machine Is Running Down*

**I**n his recent Economic Report to Congress President Truman chalked up a constructive advance in his economic reasoning. He pointed out that if we are going to attain the worth-while goal of a \$300 billion national income in the next five years, we must equip ourselves with more and better industrial tools. Of all the dynamic forces of expansion in America, he said, one of the most important is business investment.

That is fine. It is basic common sense. We have been saying that for years and we are glad to hear the President say it too.

But having hit this new high in his economic reasoning, the President failed to draw the right conclusion. He made the mistake of accepting the false conclusion that there is no shortage of business funds to pay for more and better industrial tools. "There are immense opportunities for business investment in nearly every segment of the economy," the President said, and further, "there are in general sufficient funds available to businessmen who want to seize these opportunities."

That just is not so — and the lack is not only serious; it can well be fatal.

It is a matter of the most urgent national importance that the President's recognition of the

need of more and better industrial tools should be followed by effective action. *That calls for changes in the national policies that are now blocking and, unless changed, will increasingly block business from meeting this need. If business cannot get enough new tools, the result will not be higher, but lower standards of living five years from now.*

The President should talk this matter of business investment over with Senator O'Mahoney, the Chairman of the Joint Congressional Committee on the Economic Report. Senator O'Mahoney would take to the discussion knowledge of the investment situation recently acquired through his conduct of a series of Congressional hearings.

If he told the President what he told the press during the course of these hearings, he would say, "the private capitalistic system is being seriously threatened by a lack of venture capital." That is in direct conflict with the President's conclusion that "there are in general sufficient funds available."

**This serious shortage of adequate investment in new plant and equipment is brought forth so that all of us can understand it by McGraw-Hill's annual survey of American industry's plans for investment in new plant and equipment in 1950, which has just been completed.**

*continued on next page*

## BUSINESS' PLANS FOR 1950

These are the major findings of the McGraw-Hill survey of "Business' Plans for New Plants and Equipment" in 1950. Made by the McGraw-Hill Department of Economics, the survey shows:

1. Industry—as represented by manufacturing, mining, transportation, and utilities—now plans to invest \$12.4 billion in new plants and equipment this year. This is 13% less than was actually spent last year.

2. Manufacturing industries alone plan to spend \$6.3 billion in 1950 for new facilities. This is also 13% less than they spent last year.

3. Manufacturers as a whole expect their 1950 sales volume to about equal 1949's.

4. Manufacturers will expand their capacity about 3% in 1950, under present

plans. The largest part of their funds, 65%, will go to replace and modernize existing facilities.

5. Profits and reserves are expected to provide 92% of the 1950 investment funds of manufacturing companies. These companies count on new common stock issues to provide less than one-half of one per cent of the investment funds they will need.

6. Two out of three manufacturing

A copy of a complete report on "Business' Plans for New Plants and Equipment" may be obtained by writing me at McGraw-Hill Publishing Company, Inc., 330 West 42nd Street, New York 18, N. Y.

companies review their investment plans monthly. Almost all companies go over them at least quarterly. The survey shows that companies changed plans rapidly during 1949 to meet changes in their prospects.

7. Other industries are also reducing their investment plans in 1950 by 13%. This coincidence arises from the fact that utility companies, notably the electric light and power companies, plan to spend only slightly less than in 1949. Railroads, on the other hand, are reducing their capital programs in 1950 by more than 40%.

The results of the survey, which are summarized above, show that American Industry—as represented by manufacturing, mining, transportation and utilities—is planning to spend 13 per cent less for new plant and equipment in 1950 than it did in 1949.

Since the rate of investment in new plant and equipment right now is apparently about 15 per cent below the rate for 1949, the present level of business investment may be relatively steady in 1950. That would relieve the fear, expressed by President Truman in his Economic Report, that "if the downward trend in business investment were to continue, our prospects for full recovery and continued expansion would be seriously endangered."

*BUT, at the rate of investment planned by American manufacturing industry for 1950, it would take 40 years to modernize thoroughly our present industrial plant and equipment. That would still leave undone the job of increasing it to meet the needs of an expanding economy of the kind sketched by President Truman in his message.*

In attaining even this rate of investment, the McGraw-Hill survey shows American business must rely overwhelmingly on its own profits, which have declined as the country has left the postwar boom behind it. Most American companies cannot sell new common stock except at ruinously low prices. Here is one case where gov-

ernment action is really needed to help business and help to keep a rising American standard of living.

In order to get enough business investment to assure the "full recovery and continued expansion" sought by the President, our country needs:

1. Lower taxes on business income so as to release more money for new plant and equipment.
2. Liberalized depreciation allowances on old plant and tools so that business can buy new equipment faster.
3. Repeal of the present double taxation of dividends which now are taxed once as corporation income and again as personal income.

It is encouraging to have the President explicitly recognize the key importance of adequate business investment in providing steadily expanding prosperity. The next and most important thing to do is to make this recognition effective by discarding national policies which are blighting an adequate volume of business investment.



President, McGraw-Hill Publishing Company, Inc.

new

TINY  
MIKE®

miniature ceramic  
disc capacitors



Now — take advantage of these new, space-saving, miniature ceramic capacitors, designed for bypass and coupling in ultra-compact assemblies. These ceramics incorporate the same dependable performance built into the highly specialized C-D ceramic capacitors, used for years by the world's largest manufacturers of radio equipment.

**C-D TINYMIKES OFFER YOU DISTINCT ADVANTAGES IN CAPACITOR DESIGN:**

- Ideal for cramped chassis layouts: only 19/32" in diameter, only 5/32" thick.
- TINYMIKES are lighter than other types of same capacity and voltage rating.
- Short current path and parallel leads reduce inductance to lowest possible level.
- Resistance is fixed at a low level by solder-connected leads directly to the high-purity silver electrodes.
- Use of two electrodes accurately positioned in relation to each other reduces eddy current losses to a minimum and increases the Q.

- High dielectric strength of the C-D ceramic, high insulation resistance and low power factor assure constant and dependable service.
- Protected against the effects of humidity by a special phenolic coating and high-temperature wax impregnation.
- Presently available in 500 volts DC working, with units in the range of 1000 mmfd. to 5000 mmfd. rated on a basis of guaranteed minimum capacity over a temperature range of + 10°C to + 65°C. Units in the 100 to 150 mmfd. range can be supplied at a tolerance of ± 10% or ± 20%.

Write today for complete technical data on these new C-D TINYMIKE Ceramic Capacitors. Engineering inquiries solicited. CORNELL-DUBILIER ELECTRIC CORPORATION, Dept. K30, South Plainfield, New Jersey. Other plants in New Bedford, Brookline and Worcester, Mass.; Providence, R. I.; Indianapolis, Ind., and subsidiary, The Radiart Corp., Cleveland, Ohio.

*C-D Best by Field Test!*



CONSISTENTLY DEPENDABLE  
**CORNELL-DUBILIER**  
CAPACITORS — VIBRATORS  
ANTENNAS — ROTATORS — CONVERTERS



See us at  
BOOTH 133  
IRE SHOW

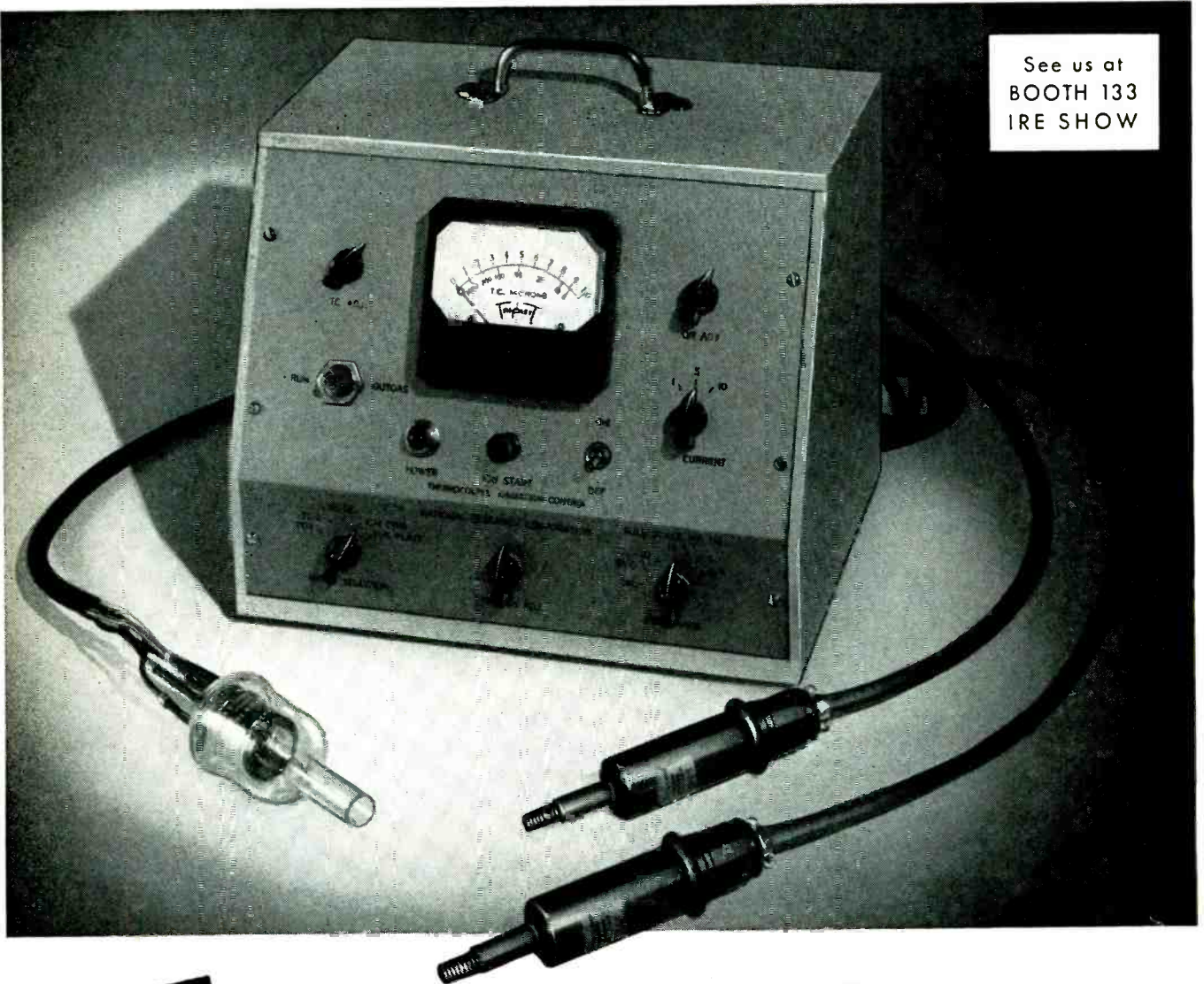

**NOW!** Only \$337.50\*

**for this Unusual New Gauge Control that covers ALL the Useful High Vacuum Range**

This new gauge control represents a real advance in the measurement and control of high vacuum. In designing it, our engineers have ingeniously simplified the long-accepted circuits . . . developed an instrument that is smaller yet more convenient and flexible than ever before. The one Ionization and two Thermocouple Gauges fill *all the needs of scientific and commercial work*. But there are many other advantages, so write . . . *today*.

\* Type 501 Thermocouple Gauges and type 507 Ionization Gauges extra.

INDUSTRIAL RESEARCH • PROCESS DEVELOPMENT  
HIGH VACUUM ENGINEERING AND EQUIPMENT



METALLURGY • DEHYDRATION • DISTILLATION  
COATING • APPLIED PHYSICS

**National Research Corporation**

*Seventy Memorial Drive, Cambridge, Massachusetts*

In the United Kingdom: BRITISH-AMERICAN RESEARCH, LTD., London S. W. 7, England—Glasgow S. W. 2, Scotland

#### FEATURES

**Total Range:**  
1 mm. to  $1 \times 10^{-8}$  mm.

**One Logarithmic Scale:**  
0-1 mm. Hg.

**Five Linear Scales:**  
0 to  $5 \times 10^{-3}$  mm. Hg.  
0 to  $1 \times 10^{-3}$  mm. Hg.  
0 to  $1 \times 10^{-4}$  mm. Hg.  
0 to  $1 \times 10^{-5}$  mm. Hg.  
0 to  $1 \times 10^{-6}$  mm. Hg.

**Protective Circuit** — Ionization Gauges have survived more than 100 bursts to full atmospheric pressure.

**Alarm Circuit** indicates trouble or controls auxiliary equipment.

**Ionization Grid Current** can be stabilized at 1, 5 or 10 mils.

**Instantaneous comparative measurements** of high vacuum and fore-pressure.

**Low Leakage Cable** assures accurate readings at pressures below  $10^{-6}$  mm.

**Readily Portable** (with dimensions of 13" by 11 13/16" x 9 3/8").

**Outgassing Circuit** included.

Let  
**Bendix**  
Solve Your  
Problems

# SPECIALIZED DYNAMOTORS

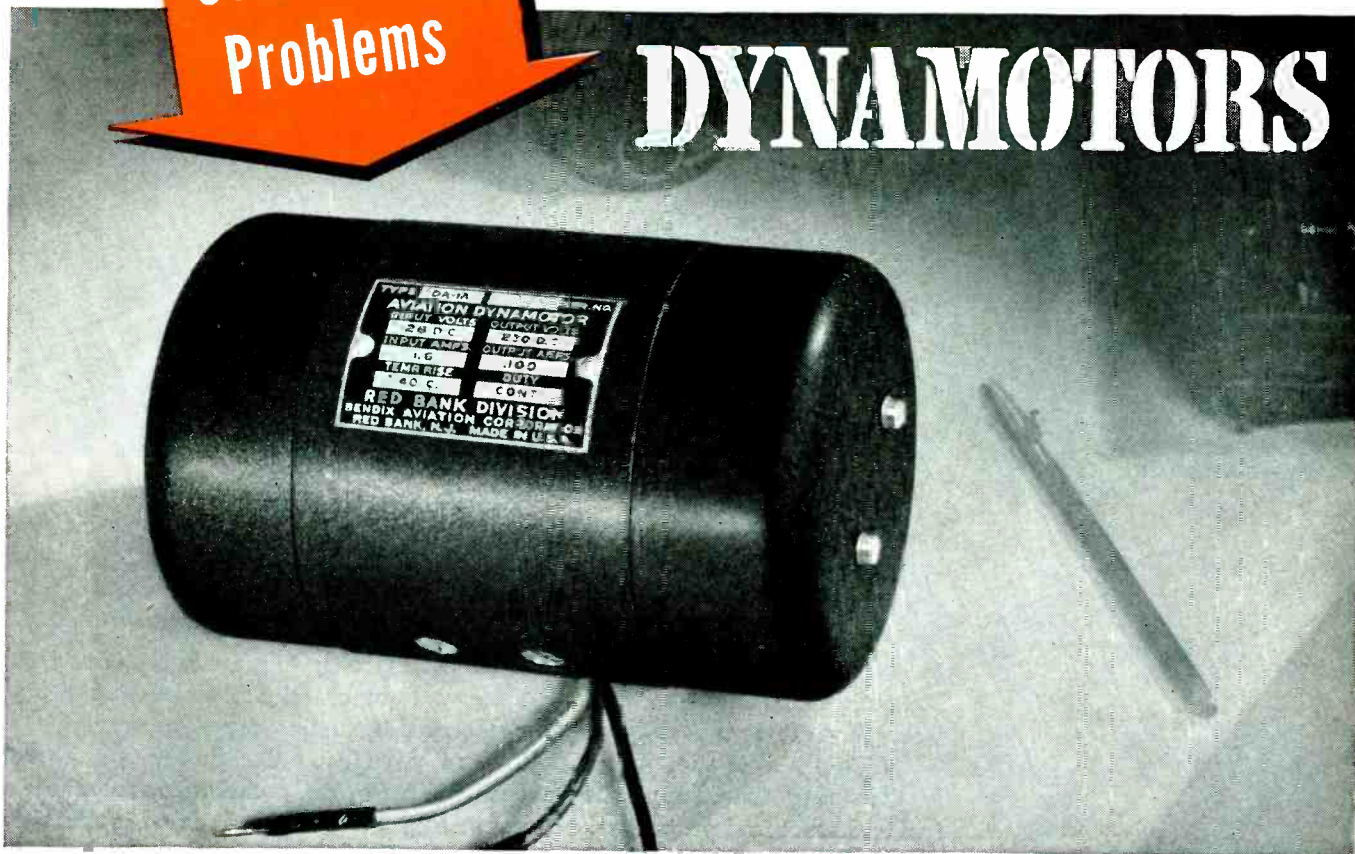

... Promptly and at Moderate Cost!

Bendix dynamotors are built to supply the *exact* power requirements of your equipment—to work from any input voltage and to deliver the necessary power at any output voltage. Dual or triple output voltages are available for high and low-level portions of the circuit, or for biasing. For critical circuits, regulated outputs will simplify your design problems, especially since a regulated filament supply can be obtained as a bonus when regulating the high voltage

output. Bendix will build your dynamotors to the usual military specifications or to meet even more rigid requirements, such as operation at higher temperature, or altitudes in experimental equipment.

*Samples or production units of special dynamotors are priced competitively. A definite proposal will be made upon receipt of the details of your problem. For immediate information call our Engineering Staff—Red Bank 6-3600, Red Bank, New Jersey.*

## THE RIGHT DYNAMOTOR FOR EVERY PURPOSE

- Sizes—2¾" to 5¼" diameter
- Power Range—10 to 500 watts
- Input Voltage—6 to 115 volts
- Output Voltage—6 to 1500 volts
- Single and multiple output and input
- Plain and regulated types

RED BANK DIVISION OF BENDIX AVIATION CORPORATION  
RED BANK, NEW JERSEY



# CELORON

... what's in it for you and your products?

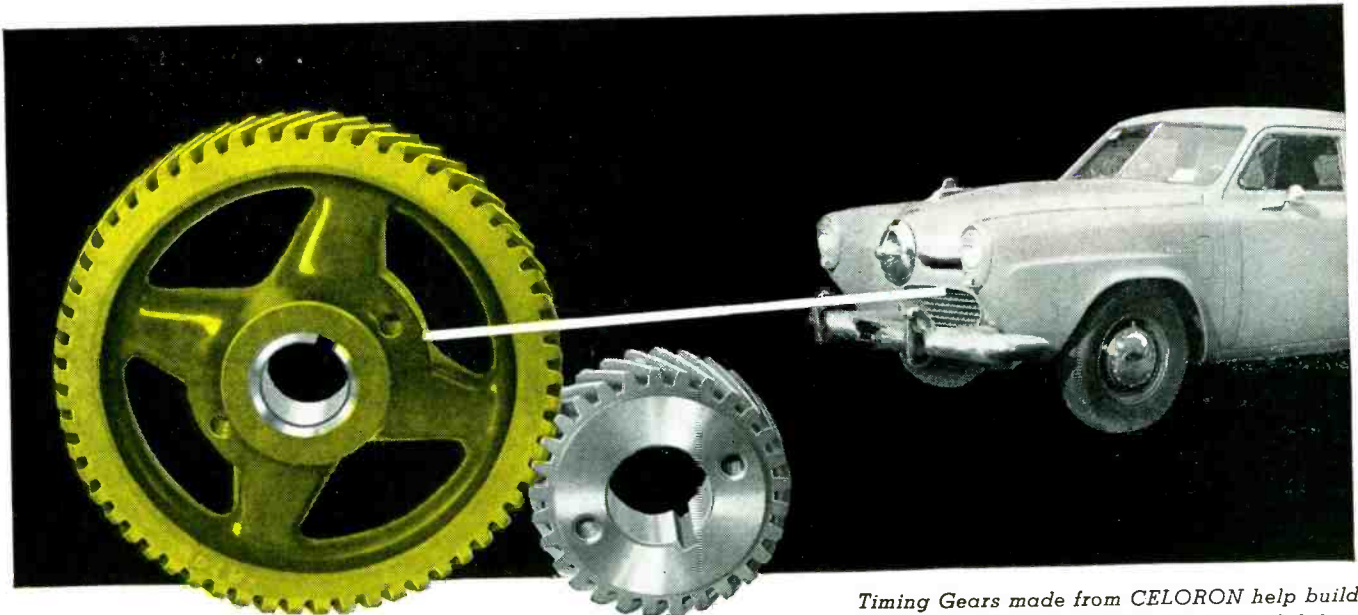

Timing Gears made from CELORON help build STUDEBAKER'S reputation for dependability.

What's in CELORON for you . . . and your products? This different thermo-setting plastic maintains strength and resiliency at temperatures up to 290°F. Resists oil, water and many corrosive chemicals. It is 1/6 the weight of steel—only 1/2 the weight of aluminum! Remarkably easy to machine, Continental-Diamond's CELORON gives you an unusual combination of light weight, high strength, and wear resistance *plus* electrical insulating properties.

CELORON is another example why it pays to see C-D first in your search for the right plastic. For plastics that provide *practical* combinations of mechanical and electrical properties, call your nearest C-D office. Trained technicians on hand at all times to help with your material selection problems.

### CELORON—ideal for many mechanical and electrical applications

Specific Gravity . . . . .	1.35	Impact Strength (Izod)	
Tensile Strength . . . . .	6,500 psi	(per inch of notch) . . . . .	2.3 Ft. Lbs.
Flexural Strength . . . . .	10,000 psi	Brinell Hardness—500 kg. load . . . . .	38
Compression Strength . . . . .	25,000 psi	(10 mm diameter ball—30 seconds)	
Shearing Strength . . . . .	8,500 psi	Rockwell Hardness . . . . .	M105



*Your partner in producing better products*

DE-1-50

BRANCH OFFICES: NEW YORK 17 • CLEVELAND 14 • CHICAGO 11 • SPARTANBURG, S. C. • SALES OFFICES IN PRINCIPAL CITIES.  
WEST COAST REPRESENTATIVE: MARWOOD LTD., SAN FRANCISCO 3 • IN CANADA: DIAMOND STATE FIBRE CO. OF CANADA, LTD., TORONTO 8

**Continental - Diamond** FIBRE COMPANY

Established 1895..Manufacturers of Laminated Plastics since 1911—NEWARK 16 • DELAWARE



filtered by **FILTRON**



**Filtered by FILTRON means  
Radio Interference-Free Performance**

FILTRONS are suppressing RF Interference in modern Military Aircraft, Naval Equipment and Ground Signal Installations.

FILTRON will design the right filter for your circuit conditions to meet size, weight and electrical characteristics — and meet RF Interference Suppression Specifications wherever RF Interference must be eliminated.

FILTRON'S completely equipped Shielded Laboratory is available for the RF Interference Testing of your equipment.

FILTRON'S advanced engineering, due to constant research and development, together with FILTRON'S production know-how, insures quality components to meet your delivery requirements.

**BOEING B-47  
STRATOJET**



100 amp & 200 amp 50 V. Aircraft FILTRONS, 3 1/2" x 3 1/2" x 2 1/2"



2.5 amp FILTRON for 50 V. D.C. operation, 1 3/4" x 1 1/4" x 7/8"



7 amp FILTRON for 115 V. A.C. 400 cycles. 2" x 2" x 1 1/4"

An inquiry on your Company letterhead will receive prompt attention

**THE FILTRON CO., INC.**

38-25 BELL BOULEVARD  
BAYSIDE, NEW YORK, N. Y.

**RADIO NOISE  
FILTERS FOR:**

- Electronic Controls
- Electric Motors
- Electric Generators
- Electronic Equipment
- Fluorescent Lights
- Oil Burners
- Signal Systems
- Business Machines
- Electric Appliances
- Electronic Signs
- Electronic Heating Equipment

**LARGEST EXCLUSIVE MANUFACTURERS OF RF INTERFERENCE FILTERS**

# NEW

## SENSITIVE RELAY *built for long service*

SW RELAY

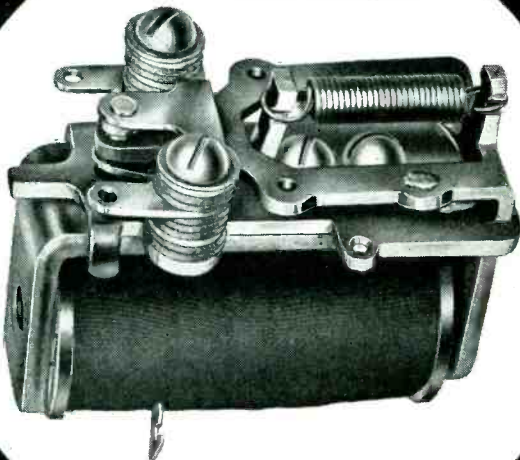

Hermetically Sealed

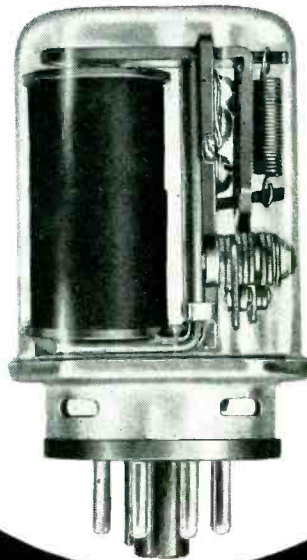

Supplied  
with  
OCTAL PLUG  
or SOLDER  
TERMINALS

### Sensitivity Plus Dependability!

The new Allied SW relay offers an economical combination of both these important qualities. Here are the facts on this newest relay in the famous Allied line

—————→  
*Bulletin SW gives complete details.  
Send for your copy today.*

Be sure to visit the  
Allied exhibit at the I.R.E.  
Show, Grand Central Palace.  
March 6 to 9 • Booth 279

- SENSITIVITY:** S.P.D.T. .012 watts d.c. } Can be supplied  
D.P.D.T. .05 watts d.c. } in A.C.
- COIL:** Acetate insulated, bobbin or layer wound, 12,500 ohms max.
- CONTACTS:** Silver, one ampere non-inductive load at 24 volts d.c. or 115 volts a.c. Armature contact at frame potential.
- MOUNTING:** One hole with locating lug. Also available with dust cover or hermetically sealed, plug-in or solder terminals.
- DIMENSIONS:** Open Relay—1-15/16", 1-3/16", 1-5/8"  
Sealed Relay—3-3/16" long, including plug, 1-13/32" wide, 1-19/32" high.
- WEIGHT:** 2.5 oz.
- WEIGHT HERMETICALLY SEALED:** 4.5 oz.
- SPECIAL APPLICATIONS:** Sensitivity down to .003 watts S.P.D.T., or .012 watts D.P.D.T. Palladium or other precious metal contacts for audio or low voltage circuits, tungsten or alloy contacts for higher current or voltage circuits. Maximum input 4.0 watts at 20°C for 85° rise.



## ALLIED CONTROL COMPANY, INC.

2 EAST END AVENUE, NEW YORK 21, NEW YORK

another **DUMONT** first...

# 4 SECTION INPUT TUNER\*

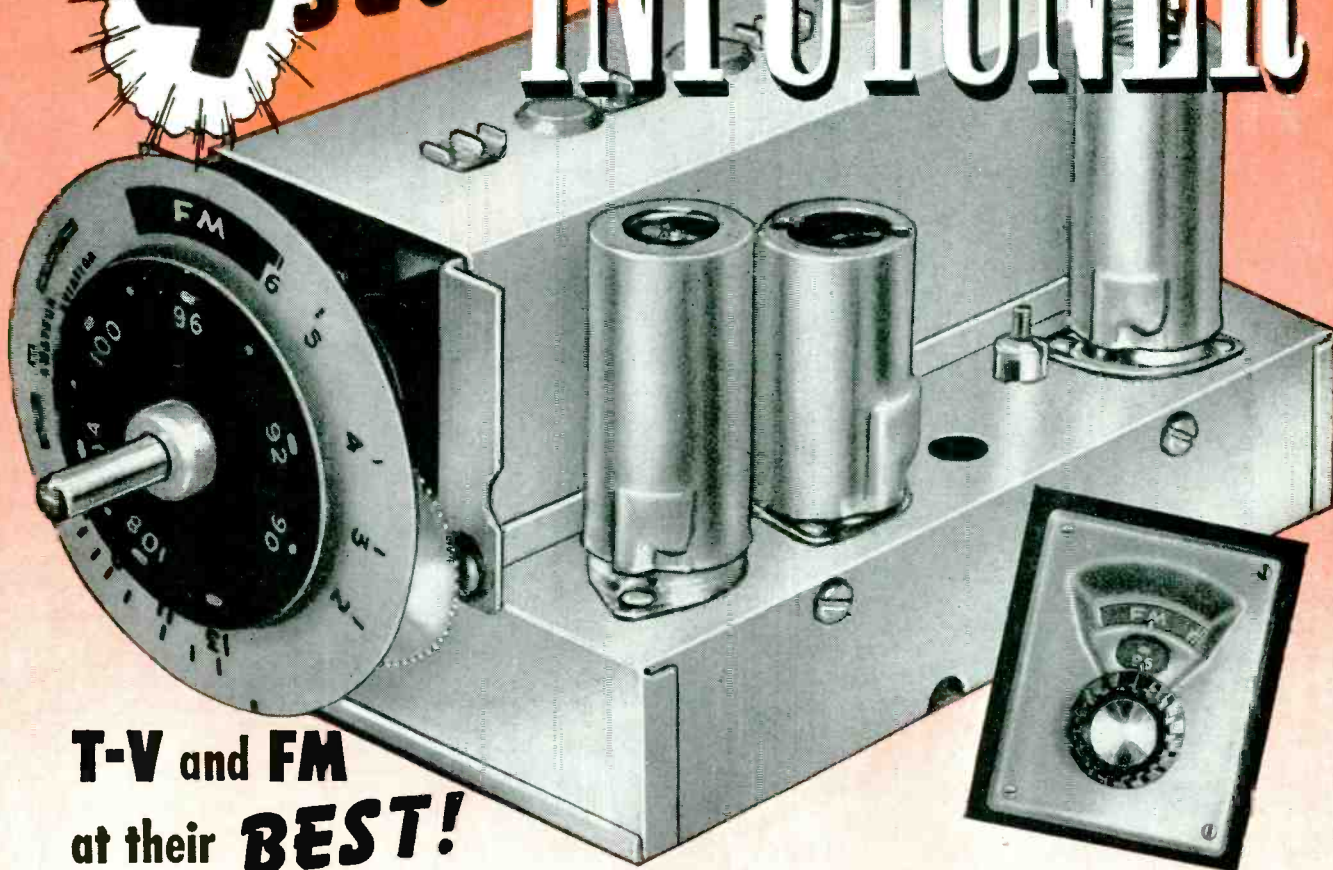

**T-V and FM**  
at their **BEST!**

- **LOWERED COST:** A 4-section Inputuner at a marked saving over previous 3-section Inputuners.
- **REDUCED SIZE:** Far more compact than previous Inputuners. Utilizes latest Mallory-Ware miniature spiral-type Inductuner.\*
- **HIGHER GAIN:** Over twice the r.f. gain of previous Inputuners.
- **TV AND FM CONTINUOUS TUNING:** Provides high-quality reception from standard FM broadcasting stations, at no added cost.
- **IMPROVED SELECTIVITY:** Added tuned input plus improved circuitry permit interference-free reception.
- **UNIFORM BAND PASS CHARACTERISTICS:** Assure excellent picture and sound quality on all channels.
- **CHOICE OF INPUT IMPEDANCE:** Provides for operation with either 72-ohm or 300-ohm antenna systems.
- **COMPLETE SHIELDING:** Affords circuit stability and minimizes oscillator radiation.
- **LOW OSCILLATOR DRIFT:** Accurate temperature compensation provides freedom from necessity of retuning.
- **ATTRACTIVE DIAL AND ESCUTCHEON:** Makes tuning easy and adds eye appeal to the TV set.

▶ **Technical specifications and quotations on request.**

© ALLEN B. DUMONT LABORATORIES, INC.

\*Trade-mark

# DUMONT

FIRST WITH THE FINEST IN **T-V** COMPONENTS

## Electronic Parts

ALLEN B. DUMONT LABORATORIES, INC.

• ELECTRONIC PARTS DIVISION

• 35 MARKET STREET, EAST PATERSON, N. J.



# Designers

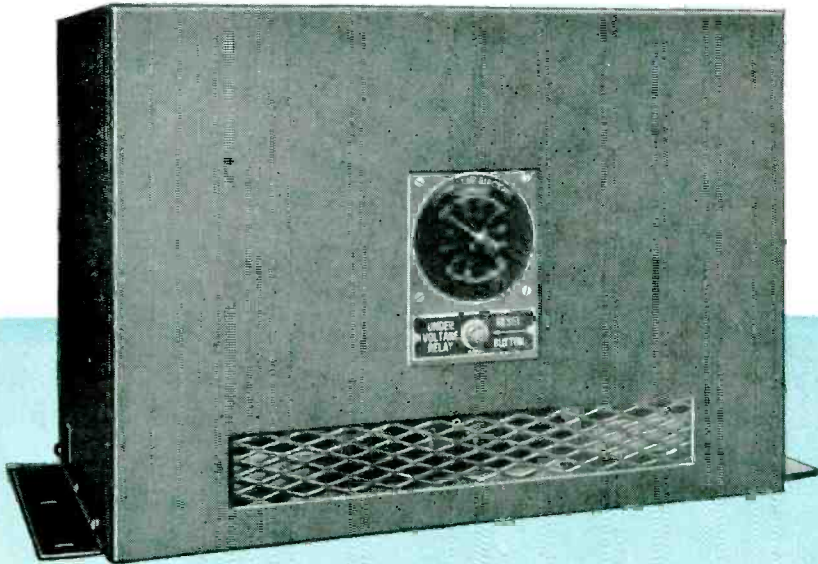

## low-cost welding speeds up production

General Electric engineers have developed a new low-cost method of precision-control resistance welding for use in many expensive assembly operations in the manufacture of electronic equipment.

This new welding method makes it possible for a single operator to weld 15 grounding ribbons and one resistor lead to the chassis of a television set in two minutes.

The control panel shown above provides for welding-current adjustment to control the amount of heat produced in the welds. Once set, this control will keep successive welding currents constant to insure accurate and consistent welding of connections. Write for complete data in Bulletin GEA-4175.

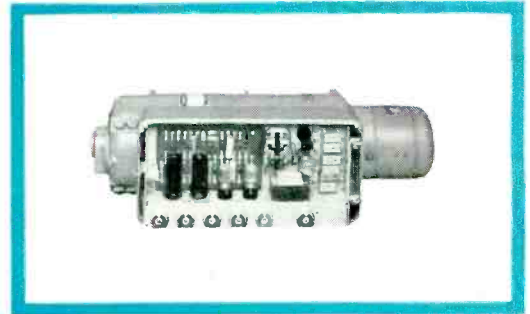

### one package— Amplidyne plus Amplifier

The G-E electronic amplidyne consists of a motor-amplidyne set, a high-gain d-c balanced amplifier, and a reference voltage supply. It is similar to equipments used in drive systems for radar antennas, searchlights, and ship and aircraft gun mounts. Commercially, it can be used in many kinds of motor control systems for close regulation of current, voltage and speed—to limit torque, hold tension, speed up acceleration, and position accurately.

The electronic amplifier makes the amplidyne respond quickly to sudden changes in the control signal, and gives it high sensitivity to small gradual changes. These and other features make it readily adaptable to automatic programming and closed-cycle processing control.

Applications range from power supply for  $\frac{1}{4}$  to  $1\frac{1}{2}$  horsepower motors to field excitation for large adjustable voltage drives up to 200 horsepower. For information, see Bulletin GEA-4889.



# GENERAL ELECTRIC

# Digest

## TIMELY HIGHLIGHTS ON G-E COMPONENTS



250 degrees of meter scale

General Electric's new long-scale panel instruments are designed for applications where space is limited, but ease and accuracy of reading are required. These 3 1/2-inch instruments have a 4.92-inch scale which covers 250 degrees.

The sturdy, attractive, molded Textolite cases (round or square) harmonize with other G-E panel instruments. The mechanism is the internal-pivot type—a reliable unit construction which permits minimum behind-the-panel depth. Accuracy is within 5% of full scale on the rectifier type, 2% on all others. For full details, write for Bulletin GEA-5425.

**If you need it—  
± one degree accuracy**



Electronic engineers are well aware of the usefulness of selsyns. Whether used for indicating or control, they have proved themselves a reliable, accurate, and rapid means of communication.

G.E. produces a complete line of selsyns—the high-accuracy type with an accuracy of ± one degree, and the general-purpose type with a ± five-degree accuracy. All units have high operating torque and are totally enclosed with no exposed terminals. Indicators and transmitters are also available in several models. See Bulletin GEA-2176.

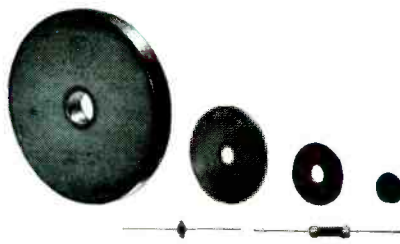

R varies inversely as E<sup>4</sup>

Thyrite® resistance material is inorganic and has the unique electrical property of varying inversely in resistance as the fourth power (or even higher) of an applied voltage. It has stable electrical characteristics over a wide range of operating conditions and can be used with a-c, d-c, or short-duration pulses. Because of this, it has solved many problems for the electronic design engineer.

Its most widely known applications are in the limiting of voltage surges, the stabilization of rectifier output voltages, the controlling of voltage-selective circuits, and the potentiometer division of voltages.

It is usually supplied in disk form in diameters from 0.25 to 6.00 inches, with or without mounting holes. Smaller sizes are furnished with wire leads. Complete information is contained in Bulletin GEA-4138.

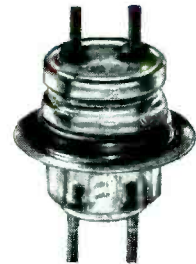

Cast glass bushings  
make possible new designs

Originally developed by General Electric for use in vital communication equipment, these unique bushings are now successfully used on such apparatus as power capacitors, transformers (filament, modulator or pulse), and rectifiers. They're made of cast glass with sealed-in nickel-steel hardware and can be readily welded, soldered or brazed directly to the apparatus. This eliminates the need for gaskets and provides a permanent hermetic seal.

Because they are small and compact, as well as vibration and weather resistant, glass bushings make possible new designs, especially where apparatus is to be airborne or where high humidity or fungus growth are special problems. Glass bushings will not puncture or shatter under excess potentials—either 60 cycle or impulse. For more data, including sizes and ratings, see Bulletin GEA-5093.

General Electric Company, Section D667-4  
Apparatus Department, Schenectady 5, N. Y.

Please send me the following bulletins:

- |  |  |
|--|--|
| <input type="checkbox"/> GEA-2176 Selsyns          | <input type="checkbox"/> GEA-4889 Electronic Amplidyne |
| <input type="checkbox"/> GEA-4138 Thyrite Material | <input type="checkbox"/> GEA-5093 Glass Bushings       |
| <input type="checkbox"/> GEA-4175 Welding Control  | <input type="checkbox"/> GEA-5425 Panel Instruments    |

NAME .....

COMPANY .....

ADDRESS .....

CITY ..... STATE .....

# electronic voltage regulators

by **sorensen**

- MAXIMUM ACCURACY
- MINIMUM DISTORTION
- FREQUENCY INSENSITIVITY

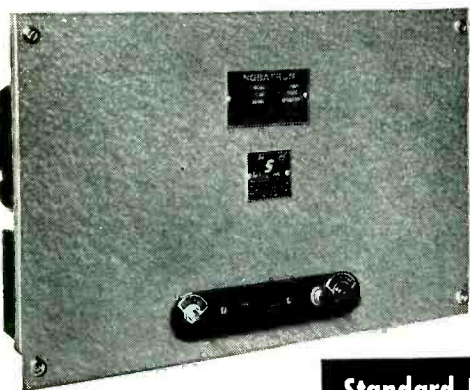

**Standard DC**

*Output voltage	6	12	28	48	125
**Load in amperes	5-15-40-100	5-15-50	5-10-30	15	5-10
Input voltage	95-130 VAC single phase 50-60 cycles: adapter available for 230 VAC operation				
Regulation Accuracy	±0.2% from 1/10 to full load				
Ripple voltage RMS Max.	1%				
Recovery time	0.2 seconds — value includes charging time of filter circuit for the most severe change in load or input conditions				

\*Adjustable +10%, -25%

\*\*Individual models identified by indicating output voltage first then amperes. Example: E-6-5 6 VDC @ 5 amperes



**Standard AC**

Model in VA Capacity	150S	250S	2000S	5000S
	500S	1000S	3000S	15000S
Regulation Accuracy	±0.1%	0.1%	0.1%	0.1%
Harmonic Distortion	3% max.	2% max.	3% max.	3% max.
Input voltage	95-130 VAC also available for 190-260 VAC single phase 50-60 cycles			
Output voltage	Adjustable between 110-120; 220-240 in 230 VAC models			
Load range	0 — Full load			
P.F. range	Down to 0.7 P.F.			

NOTES: Regulators can be hermetically sealed.  
All models temperature compensated.

**SPECIALS** Your particular requirements can be met by employing the ORIGINAL SORENSEN CIRCUIT in your product or application.

SORENSEN REGULATORS can be designed to meet JAN specifications.

SORENSEN engineers are always available for consultation about unusual regulators to meet special needs not handled by THE STANDARD SORENSEN LINE.

*Write for Complete Literature*

**Sorensen** and company, inc.

375 Fairfield Avenue, Stamford, Conn.

# Check YOUR NETWORK PROBLEM WITH LOGIC

In any technical business the specialist has a unique value in his specific field. It is logical that a manufacturer of a specialty product should be of greater value in his particular field.

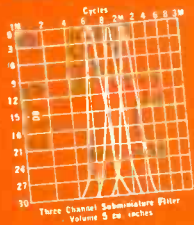
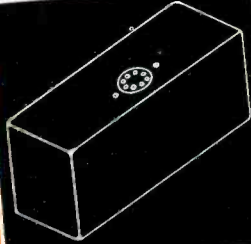
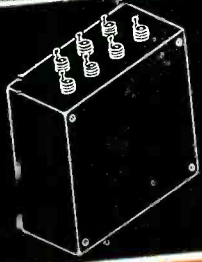

Three Channel Subcarrier Filter  
Volume 5 on inches

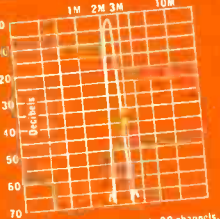

Telemetering Filters in sets up to 20 channels.

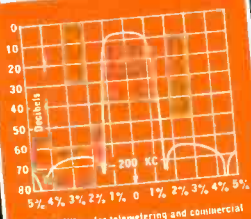
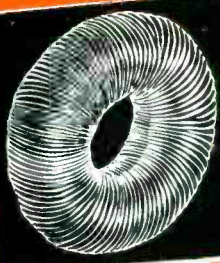

Crystal filters for telemetering and commercial radio.

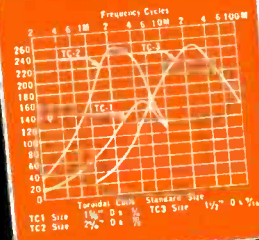
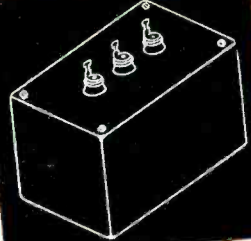

Toroidal Coils Standard Size  
TC1 Size 1 1/2" x 0 1/2"  
TC2 Size 2" x 0 1/2"

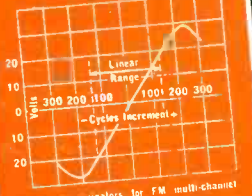
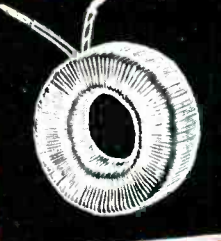

Audio discriminators for FM multi-channel applications.

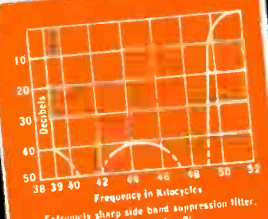

Extremely sharp side band suppression filter.  
Size: 2 1/2 x 4 x 2 1/2

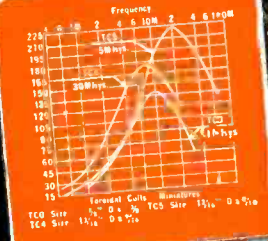

Toroidal Coils Standard Size  
TC3 Size 1 1/2" x 0 1/2"  
TC4 Size 1 1/2" x 0 1/2"

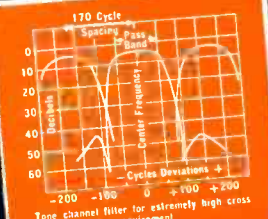
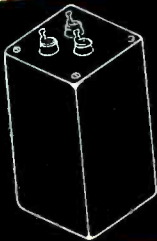

Tone Channel Filter for extremely high cross over attenuation requirement.  
Size: 2 1/2 x 2 1/2 x 5



As one of the largest producers of toroidal coils and filters Burnell & Co's facilities and production experience have been of immeasurable technical and economical value to our customers. Many engineers have benefitted by our prompt technical service. Why not bring your network problem to us for the most practical and economical solution?

**EXCLUSIVE MANUFACTURERS OF COMMUNICATIONS NETWORK COMPONENTS**

WRITE FOR TECHNICAL INFORMATION  
ALL INQUIRIES WILL BE PROMPTLY HANDLED

**Burnell & Company**  
YONKERS 2, NEW YORK  
CABLE ADDRESS "BURNELL"

# Here's light weight and much

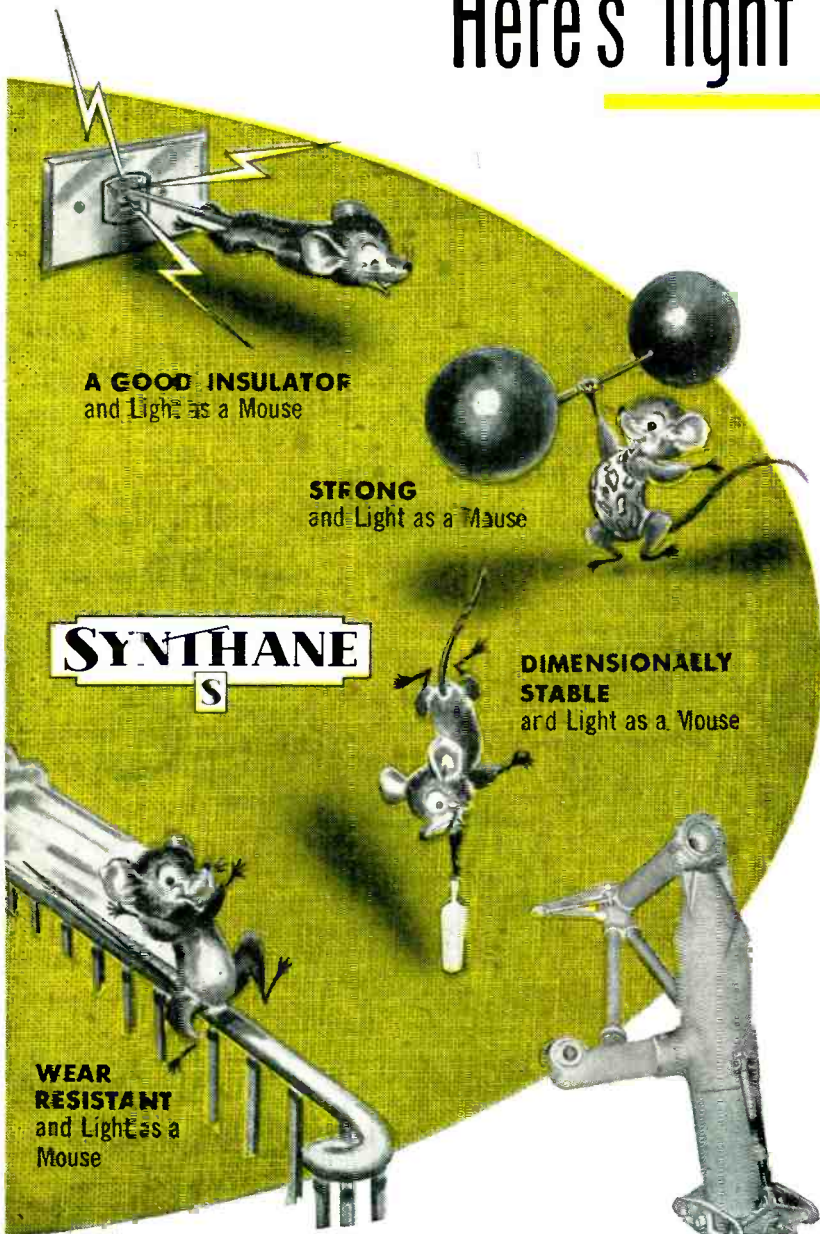

**A GOOD INSULATOR**  
and Light as a Mouse

**STRONG**  
and Light as a Mouse

**SYNTHANE**  
S

**DIMENSIONALLY STABLE**  
and Light as a Mouse

**WEAR RESISTANT**  
and Light as a Mouse

## SYNTHANE AT WORK IN INDUSTRY

Cleveland Pneumatic Tool Company, makers of Aero Landing Gear Shock Strut for the U.S. Air Force Bomber, B-36, selected Synthane as the right material for the bearing shown because of light weight, wear resistance, its antifriction qualities, good compressive strength, excellent shock resistance, and the close tolerances to which it may be fabricated. Are these qualities valuable to you?

## SYNTHANE

**S** is half the weight of

aluminum. Moving parts made from this type of laminated plastics start faster, require less power to start, stop and run . . . and light weight is only one of the Synthane properties that make it a valuable material for you.

With Synthane you get light weight, strength, resistance to wear, dimensional stability and excellent electrical insulation, plus many other desirable mechanical, electrical and chemical characteristics.

This unusual combination of properties has led to the use of Synthane in thousands of applications in almost every industry.

It may be the material you have been seeking to help make a good product better or a process less expensive.

Electrical qualities such as high dielectric strength, low power factor and low dielectric constant, together with light weight and moisture resistance have helped put Synthane in television sets, transformers and many other pieces of electrical and electronic equipment.

Hard, dense and abrasion resistant, yet easy to machine, Synthane is a widely used material for long-wearing, high-speed gears, cams and rubbing blocks.

And so it goes in application after application — Synthane pays for itself in extra advantages over other materials. It may be helpful to you.

If you have a specific material problem, write us outlining the situation. We will be glad to help with material, design, or fabrication of finished parts.

Synthane Corporation,  
Oaks, Pennsylvania.

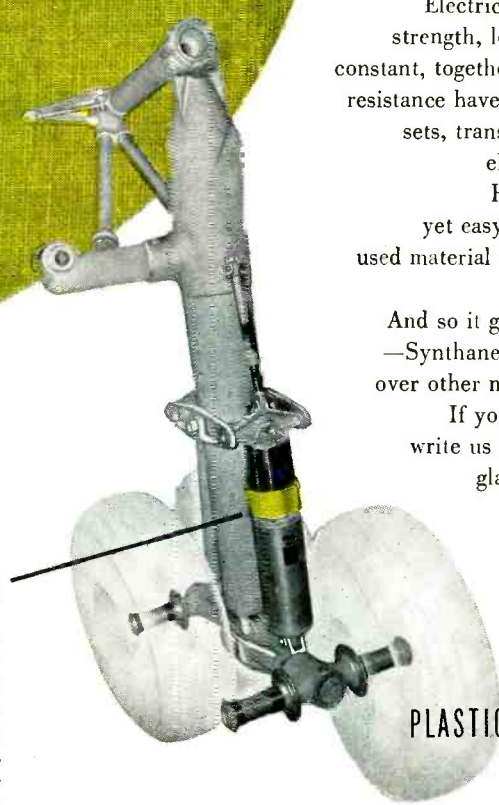

PLASTICS WHERE PLASTICS BELONG



# more in a material

*Here*

## ARE YOUR ADDED VALUES

Synthane was the material selected for each of the four parts shown at the right. Each manufacturer sought one or two specific characteristics. In each application the user found that Synthane was not only a better material for the major requirement but gave him other desirable properties. This is true of almost every application, for Synthane is unusual for its combination of properties.

Synthane is strong, hard, light and dense. Resists abrasion, corrosion, is easily worked on standard machine tools. It is an excellent electrical insulator, has high dielectric strength, low dielectric constant and low power factor. It is a set plastic, dimensionally stable over a wide range of temperatures.

# SYNTHANE

S

WHERE SYNTHANE BELONGS

MOLDED, LAMINATED • MOLDED, MACERATED

ELECTRONICS — March, 1950



**Knuckle Bearing for Rack Crusher.** Manufacturer required good anti-friction qualities. In addition, Synthane gave him excellent mechanical strength, dimensional stability, wear resistance.

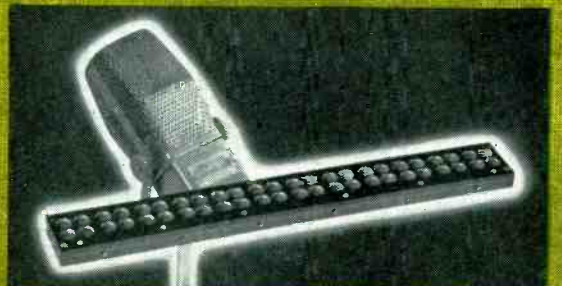

**Rack Panel for Radio Control Console.** Sliding ability was needed. The extra values obtained were low moisture absorption, high mechanical strength, dimensional stability.



**Plating Barrel.** Major requirement was corrosion resistance. The manufacturer found that Synthane also gave him abrasion resistance, mechanical strength, light weight and longer life per dollar, including cost of replacement.



**Bearing Retainer Rings.** Production problem called for dimensional stability. Synthane delivered many extras, including mechanical strength, light weight, corrosion resistance, abrasion resistance, and low inertia.



If these four of Synthane's many desirable properties and abilities suggest its use in your product or process, clip and mail the coupon today.



**SYNTHANE CORPORATION**  
6 River Road, Oaks, Pa

Gentlemen:

Please send me, without obligation, the complete catalog on Synthane Technical Passions.

Name \_\_\_\_\_

Company \_\_\_\_\_

Address \_\_\_\_\_

City \_\_\_\_\_ Zone \_\_\_\_\_ State \_\_\_\_\_

We Be People of



"Simple and reliable...  
and tops for  
fidelity"

SAYS

DAN SEYMOUR

POPULAR M.C. OF RADIO AND  
TV'S "WE, THE PEOPLE"

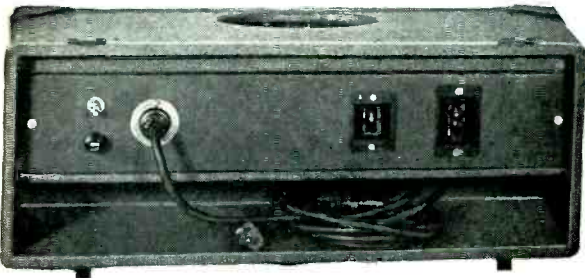
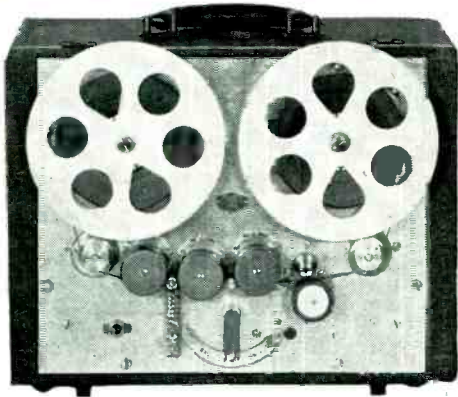

## NEW PRESTO

### PT-900 PORTABLE TAPE RECORDER

Here's the answer for delayed special-events broadcasts—on-the-spot recording—wherever there is a need for field recording of complete broadcast quality. Look at these outstanding engineering features:

Separate recording and playback heads, each with its own associated amplifier, permit monitoring direct from tape. High fidelity unit—50 to 15,000 CPS at 15" per second tape speed. 3 microphone channels with master gain control in recording amplifier. V.U. meter to indicate recording level, playback output level, bias current and erase current, and level for telephone line. 2-speed single motor drive system.

Don't choose your tape recorder until you see the *new* Presto Portable Tape Recorder. Write for complete details today.



RECORDING CORPORATION  
Paramus, New Jersey

Mailing Address: P. O. Box 500, Hackensack, N. J.

In Canada: Walter P. Downs, Ltd., Dominion Sq. Bldg., Montreal

Export: The M. Simons & Son Co., Inc., 25 Warren St., N. Y. Cable Address: "Simontrica" New York

SEE AND HEAR PRESTO AT I R E SHOW • SOUND ROOM D • GRAND CENTRAL PALACE

# HERE'S HELP FOR YOUR TESTING AND MEASURING PROBLEMS

Use one of these 3 instruments... or select from more than 300 other G-E stock instruments



## To Cut Costs of Balancing Rotors

—use the G-E portable dynamic balancer

By using the G-E portable dynamic balancer to balance rotors in their own bearings, you can drastically reduce the time and cost of balancing rotors in generators, motors, and in other machines. One operator alone can balance two-bearing machines, and he needs to make only three runs.

Ideal for factory-testing, you can use the device for installation or maintenance work, and for field service on any rotor within a speed range of 600 to 6000 rpm and weighing more than 30 pounds. Write for GEA-320.

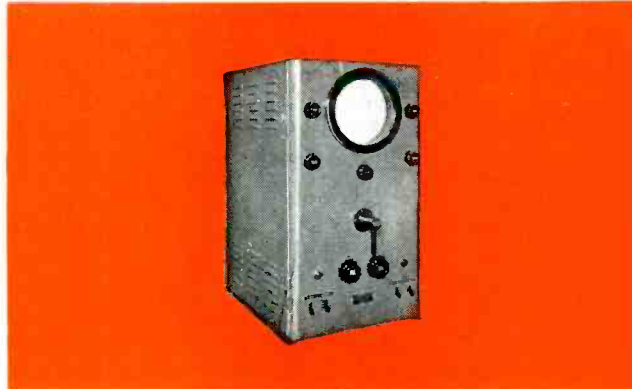

## To Detect Insulation and Winding Faults Quickly

—use the G-E winding-insulation tester

You can speed up production-line testing of motors, transformers, and generators by using the G-E winding-insulation tester. At one G-E plant, for example, more than 4000 motors a week are tested with one device.

Less than one minute is required for a complete test, which includes resistance, impedance, turn-balance, and complete high-potential tests. The operator can determine the nature of the defects by the wave shapes of the oscillograms. Write for GEC-321.

You may find that General Electric engineers can help you by recommending one of the many G-E stock devices and instruments. Your problem, especially if it is one common to industry, may even justify developing new equipment. Send the coupon today to Apparatus Department, General Electric Company, Schenectady, N. Y.



## To Locate Leaks in Closed Systems

—use the G-E Type M Leak Detector

By locating even the smallest leaks while your products are on the production line, you reduce operating costs, cut service expense in the field—and safeguard the good will of your customers. Used in G-E refrigerator production for more than two years, the Type M detector uses helium as a tracer. The detector is so sensitive that it can detect one part of helium in 200,000 parts of air. Write for GEC-336.

FOR HELP on your Testing Problems . . .  
Mail this coupon today to:

General Electric Company  
Section N 687-16  
Schenectady 5, N. Y.

Please send me descriptive information on instruments that will help me to test.....

.....

.....

Name.....

Company.....

Title..... Street.....

City..... State.....

GENERAL  ELECTRIC

# MORE *Andrew* FIXED STATION ANTENNA EQUIPMENT IS USED THAN ANY OTHER KIND!

**HERE'S WHY:** The topnotch engineering that only the world's largest antenna equipment specialists can give . . . the uniform dependability of Andrew equipment . . . its superior performance . . . the fact that only Andrew makes a complete line of fixed station antenna equipment.

But that's not all. An imposing parade of "firsts" maintain Andrew leadership. Some current Andrew "firsts" are 1) the exclusive Folded Unipole Antenna, 2) the new Hurricane Models, 3) the Corner Reflector Antenna, and 4) a Very High Gain Communications Antenna soon to be announced.

**COAXIAL CABLE, Type 737.** Significantly, there is more of this Andrew  $\frac{7}{8}$ " diameter cable now in use than all similar makes combined! You get a bonus of extra miles added to your service radius because loss characteristics are exceptionally low.

**FOLDED UNIPOLE ANTENNAS.** Another Andrew "first" and made only by Andrew. Thousands of these popular antennas are in use at fixed stations throughout the world. More new stations are using it than any other antenna. Users acclaim 1) its quieter reception produced by the grounded radiating element, 2) the excellent impedance match, and 3) its greater transmitting coverage.

Extra! Now available in Hurricane Models to insure uninterrupted operation when you need it the most.

**COAXIAL ANTENNAS.** Most economical where signal-to-noise ratio is high. Above 108 MCS only.

**CARDIOID ANTENNAS.** If you operate along a shore or border line and want your signal to cover only a certain 180° area, this rugged antenna is made to order for you. It concentrates your signal where you want it and doesn't waste radiation where you don't want it.

**CORNER REFLECTOR ANTENNAS.** For narrow angle coverage or point-to-point relaying. Concentrates your signal in the exact area where you want it, using a 60° beam. Avoids interference to and from the remaining area. For the 72-76 and 148-174 MCS bands. Only Andrew makes a commercial model of this special purpose antenna—another Andrew "first."



It will pay you, too, to use Andrew fixed station equipment. Write for further information—today!

## VERY HIGH GAIN COMMUNICATIONS ANTENNA (soon to be announced)

The highest gain antenna in mobile communications history. It actually delivers the full gain of 6.5 db as claimed—the same as increasing your power  $4\frac{1}{2}$  times! Think of the economy. Now, for the first time, you can cover areas you couldn't reach before! It's another pace-setting Andrew "first." Frequency range is 148-174 MCS.

# Andrew

CORPORATION

363 EAST 75th STREET · CHICAGO 19

World's Largest Antenna Equipment Specialists

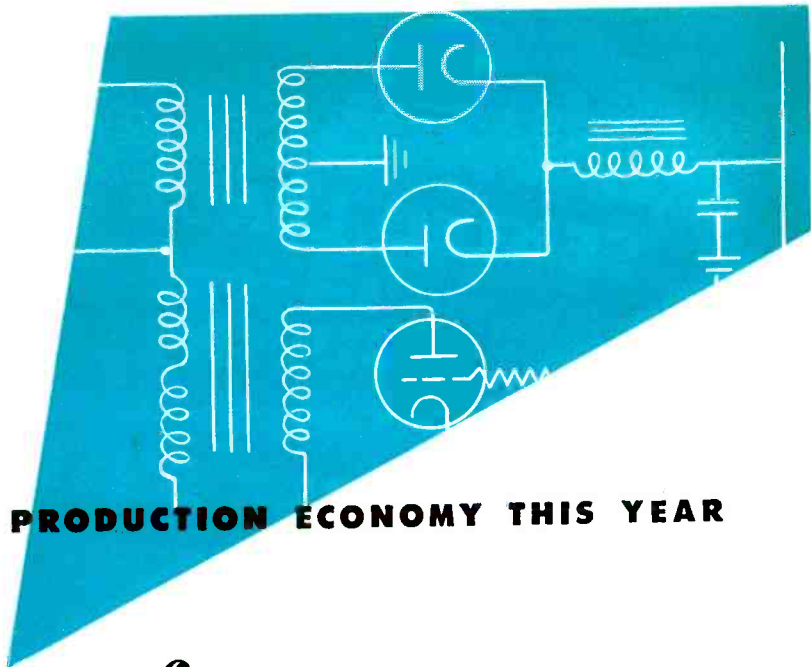

**DESIGN FOR TRUE PRODUCTION ECONOMY THIS YEAR**

# WITH **Transformers**

**BUILT TO MEET YOUR EXACT REQUIREMENTS**

We have specialized knowledge, skill and a full range of facilities for mass-produced economical units and hermetically sealed transformers of all types, as well as for large single and 3-phase transformers.

For a superior product, priced competitively . . . for assured efficiency and long service life, let FERRANTI build transformers to your precise needs.

#### **CHECK YOUR REQUIREMENTS**

Power and Rectifier Transformers up to 50 KVA (High Voltage or High Current) . . . Saturable Reactors . . . Special Cores and High Temperature Insulation . . . Class B Hermetically sealed Types.

●  
Television Transformers . . . Control Transformers . . . Audio Transformers . . . Power and Audio Filter Chokes

*We invite your inquiries*

## **Ferranti Electric, Inc.**

**30 ROCKEFELLER PLAZA, NEW YORK 20, NEW YORK**

# New E-I Catalogs on—

**SEALED LEADS**

**MULTIPLE HEADERS**

**GASKET TYPE BUSHINGS**

*now available!*

All the data you need on sealed terminals, multiple headers and special gasket type bushings for all electronic and electrical connections. Because of wide diversity of design and size in all three types, E-I standard stock items meet most requirements and result in substantial economies. The catalogs illustrated are most complete references and are available to engineers, designers and purchasing officials on request — without obligation.

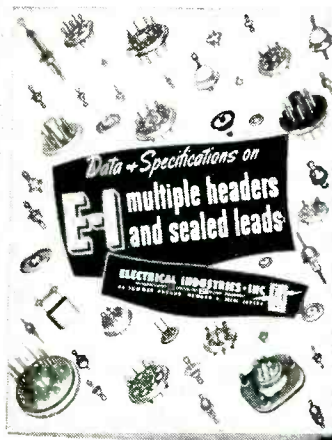

Write for your copies of these FREE catalogs today!

Including many standard types suitable for most applications:

● **E-I HERMETICALLY SEALED LEADS**

With chemically bonded seal easily soldered or welded to housings. Impervious to rust and dust, high moisture, shock and corrosion.

● **E-I HERMETICALLY SEALED MULTIPLE HEADERS**

Every E-I header is of vacuum tight construction and absolutely strain free. Other features are cushioned glass, tin dipping and silicone treatment.

● **E-I GASKET TYPE BUSHINGS**

The ideal bushing for electronic applications. Offers high dielectric strength, easy installation, improved sealing and shock resistant construction throughout.

For applications requiring other than standard types, E-I provides fast service on custom designs. Recommendations and estimates sent promptly on receipt of blueprints or pencil sketches.



**ELECTRICAL INDUSTRIES·INC**  
 MANUFACTURERS OF SPECIALIZED ELECTRONIC EQUIPMENT  
 44 SUMMER AVENUE, NEWARK 4, NEW JERSEY

**NOW** ... the efficient short-length tube  
you've needed for small test equipment!

# ULTRA-COMPACT SUPERIOR IN DESIGN LOW IN PRICE

**GL-3MP1**



★ 8 1/4" max length    ★ 3 1/16" max diameter



## CHARACTERISTICS

Heater voltage	6.3 v
Heater current	0.6 amp
Focusing method	electrostatic
Deflecting method	electrostatic
Screen	phosphor, P1
fluorescence	green
persistence	medium
Over-all length	8 1/4" max
Bulb diameter	3 1/16" max
Min useful screen diameter	2 3/4"
Base	small-shell duodecal 12-pin
Basing	12F

### Max ratings, design-center values

Anode No. 1, voltage	1,000 v d-c
Anode No. 2, voltage	2,500 v d-c

### Typical operation, for Anode-No.-2 voltages of:

	1,000 v	2,000 v
Anode No. 1, voltage	200 v to 350 v	400 v to 700 v
Grid No. 1, voltage for visual cut-off	0 v to 63 v	0 v to 126 v
Deflection factors:		
D1 and D2	115 v to 145 v	230 v to 290 v d-c per inch
D3 and D4	110 v to 140 v	220 v to 280 v d-c per inch

**H**ERE'S a *proved* 3-inch cathode-ray tube that makes it easy for you to design test instruments truly light and compact, convenient to use. The tube may be employed either in small oscilloscopes, or as a substitute for meters in new-design equipment.

Small in size, appealing in price, the GL-3MP1 also is marked by advanced engineering. The tube has exceptionally high light output. Its brilliant spot is made possible by General Electric's special method of applying the P1 screen. The spot is held to a sharp focus through efficient tube design and quality manufacture. Moreover, deflection sensitivity is high; particularly so for a short-length tube.

Tetrode design of the GL-3MP1 includes a No. 2 grid. Because of this feature, fluctuations in first-

anode voltage do not affect the beam current, which remains constant. The electron gun is a Zero-Ib<sub>1</sub> type, meaning that the first anode takes practically no current. This permits use of a low-current voltage-divider system as well as a very small filter capacitor in the power supply—two vital steps toward circuit simplicity and economy.

Ask, today, for price and further facts about this fine G-E cathode-ray tube—a type that opens up new areas of sales for the alert manufacturer of test and service equipment. Also, General Electric tube engineers will be glad to consult with you personally on the GL-3MP1's applications to *your* new design. Wire or write *General Electric Company, Electronics Department, Schenectady 5, New York.*

# GENERAL ELECTRIC

180-J26

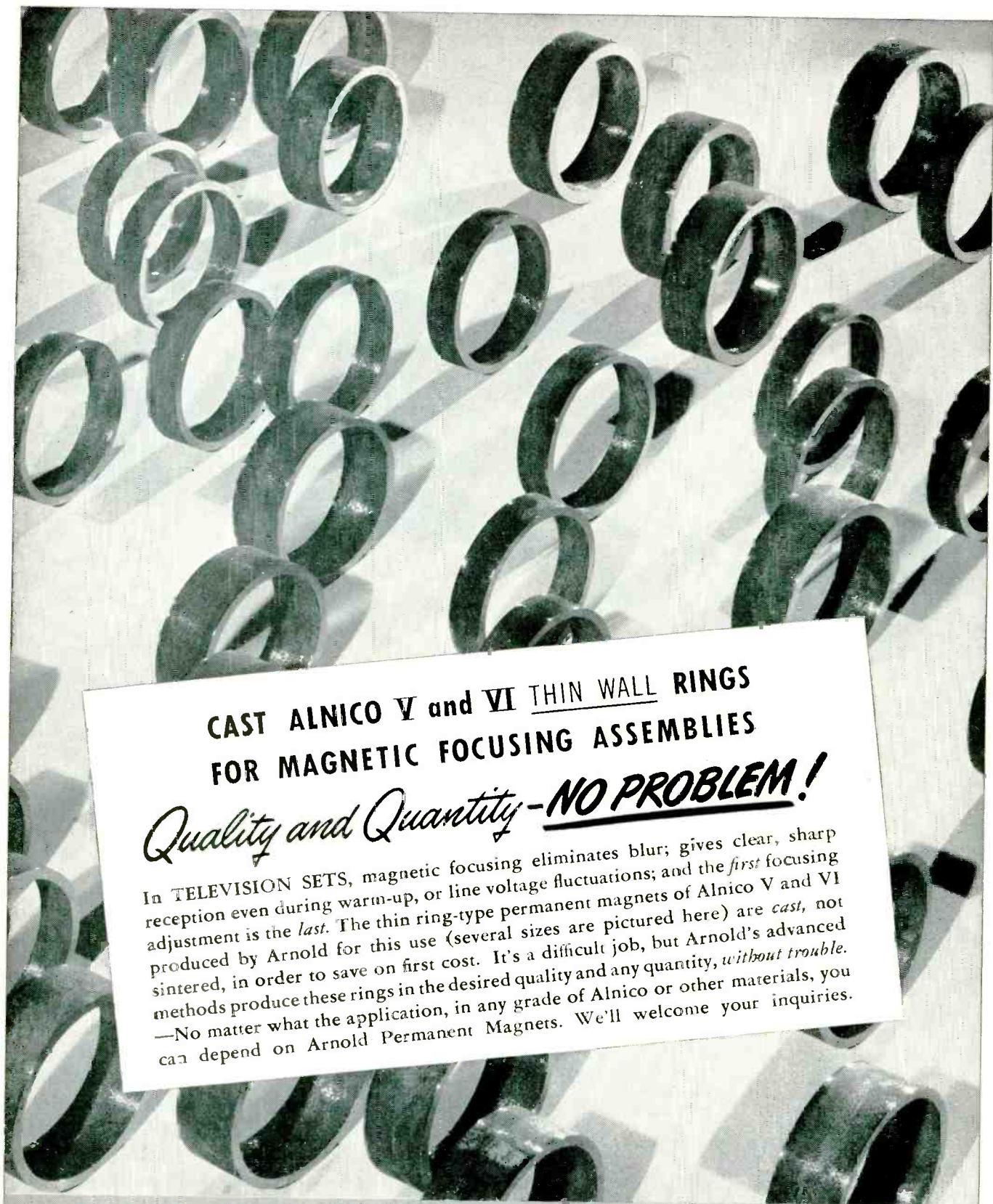

**CAST ALNICO V and VI THIN WALL RINGS  
FOR MAGNETIC FOCUSING ASSEMBLIES**

*Quality and Quantity - **NO PROBLEM!***

In TELEVISION SETS, magnetic focusing eliminates blur; gives clear, sharp reception even during warm-up, or line voltage fluctuations; and the *first* focusing adjustment is the *last*. The thin ring-type permanent magnets of Alnico V and VI produced by Arnold for this use (several sizes are pictured here) are *cast*, not sintered, in order to save on first cost. It's a difficult job, but Arnold's advanced methods produce these rings in the desired quality and any quantity, *without trouble*. —No matter what the application, in any grade of Alnico or other materials, you can depend on Arnold Permanent Magnets. We'll welcome your inquiries.

**THE ARNOLD ENGINEERING COMPANY**

Subsidiary of

ALLEGHENY LUDLUM STEEL CORPORATION

147 East Ontario Street, Chicago 11, Illinois

*Specialists and Leaders in the Design, Engineering and Manufacture of PERMANENT MAGNETS*





**Type 557  
Ceramicon  
Trimmer**



1.5-7 MMF  
3-12 MMF  
5-25 MMF  
5-30 MMF  
8-50 MMF

**Type 554  
Ceramicon  
Trimmer**

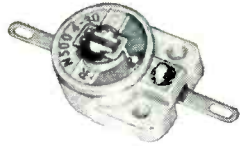

**Type TS2A Ceramicon Trimmer**  
1.5-7 MMF 3-13 MMF 4-30 MMF  
3-12 MMF 5-20 MMF 7-45 MMF

**Type 531 and 532  
Tubular Trimmers**  
0.5-5 MMF  
1-8 MMF

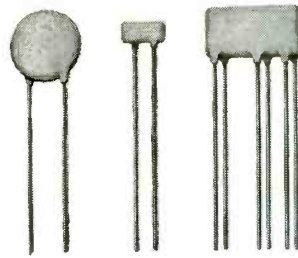

**Erie Disc Ceramicons**  
Up to .01 MFD

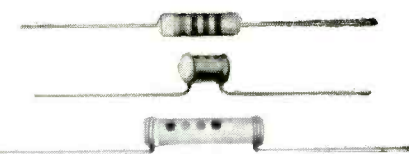

**Temperature Compensating  
Molded Insulated Ceramicons\***  
0.5 MMF—550 MMF  
**Temperature Compensating  
Dipped Insulated Ceramicons**  
0.5 MMF—1,770 MMF  
**Temperature Compensating  
Non-Insulated Ceramicons**  
0.5 MMF—1,770 MMF



**Button Mica Condensers**  
15 MMF—6,000 MMF

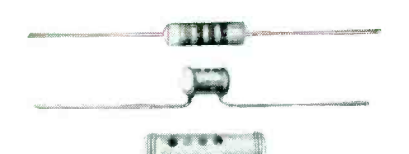

**Erie "GP" Molded Insulated Ceramicons**  
5 MMF—5,000 MMF  
**Erie "GP" Dipped Insulated Ceramicons**  
5 MMF—10,000 MMF  
**Erie "GP" Non-Insulated Ceramicons**  
5 MMF—10,000 MMF

**ERIE RESISTOR  
COMPONENTS**  
for better  
electronic products

**T**HE dependability and accuracy to close tolerances required for Television and Broadcast applications are combined in Erie Ceramicons with compact design, tubular in form, for easy installation on the assembly line.

Erie manufactures a complete line of Ceramic and Button Mica Condensers for transmitter and receiver applications: Carbon Suppressors, Custom Injection Molded Plastic Knobs, Dials, Bezels, Name Plates and Coil Forms. Complete technical information on request.

\*Ceramicon, HiK, GP, Button and Plexicon are registered trade names of Erie Resistor Corporation.



**Cinch-Erie Plexicon Tube Sockets with 1,000 MMF built in by-pass condensers**

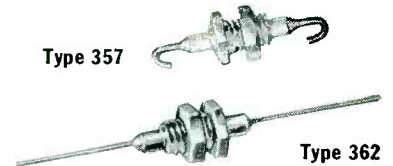

**Type 357**

**Type 362**

**Feed-Thru Ceramicons**  
5 MMF—1,000 MMF  
5 MMF—1,500 MMF



**Types L-4, L-7, S-5 Suppressors for Spark Plugs and Distributors**

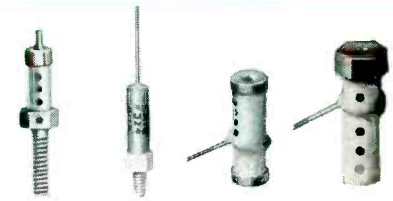

**Type 720A**

**Types 323 and 324 Insulated**

**Type 2322**

**Type 2336**

**Erie Stand-Off Ceramicons**  
5 MMF—5,000 MMF

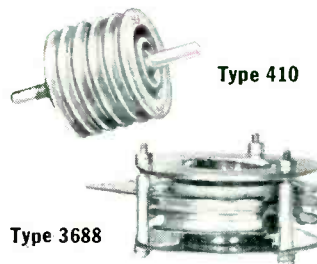

**Type 410**

**Type 3688**

**High Voltage Double Cup and plate Condensers**  
Up to 15,000 VOLTS WORKING



**Custom Injection Molded Plastic Knobs, Dials, Bezels, Name Plates, Coilforms, etc.**

*Electronics Division*

**ERIE RESISTOR CORP., ERIE, PA.**

LONDON, ENGLAND TORONTO, CANADA



# the FIRST all band-direct reading SPECTRUM ANALYZER

10 MCS to 16,520 MCS

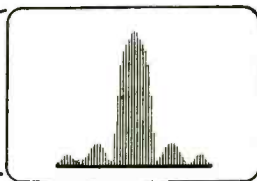
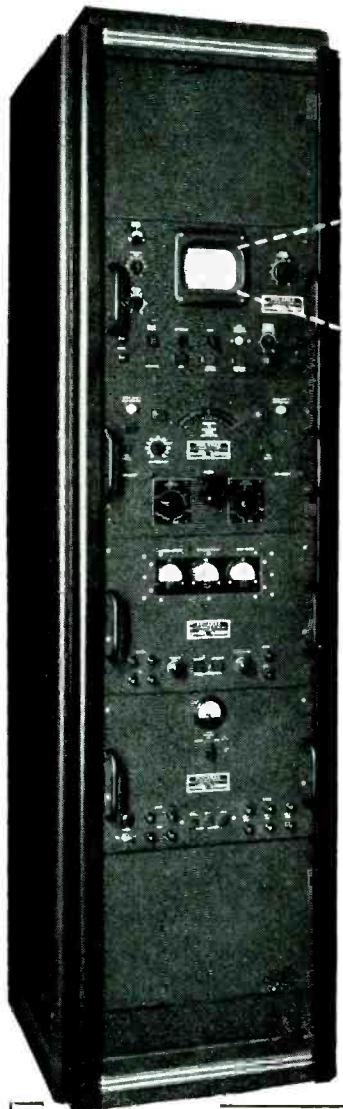

Polarad's Model LSA Spectrum Analyzer is the result of years of research and development. It provides a simple and direct means of rapid and accurate measurement and spectral display of an r.f. signal.

## Outstanding Features:

- Continuous tuning.
- One tuning control.
- 5 KC resolution at all frequencies.
- 250 KC to 25 MCS display at all frequencies.
- Tuning dial frequency accuracy 1 per cent.
- No Klystron modes to set.
- Broadband attenuators supplied with equipment above 1000 MCS.
- Frequency marker for measuring frequency differences 0-25 MCS.
- Only three tuning units required to cover entire range.
- Microwave components use latest design non-contacting shorts for long mechanical life.
- Maximum frequency coverage per dollar invested.
- 5 inch CRT display.

The equipment consists of the following units:

- |   |                                    |
|---|------------------------------------|
| Model LTU-1 R. F. Tuning Unit—<br>10 to 1000 MCS.     | Model LDU-1 Spectrum Display Unit. |
| Model LTU-2 R. F. Tuning Unit—<br>940 to 4500 MCS.    | Model LKU-1 Klystron Power Unit.   |
| Model LTU-3 R. F. Tuning Unit—<br>4460 to 16,520 MCS. | Model LPU-1 Power Unit.            |

### Where Used:

Polarad's Model LSA Spectrum Analyzer is a laboratory instrument used to provide a visual indication of the frequency distribution of energy in an r.f. signal in the range 10 to 16,520 MCS.

Other uses are:

1. Observe and measure sidebands associated with amplitude and frequency modulated signals.
2. Determine the presence and accurately measure the frequency of radio and/or radar signals.
3. Check the spectrum of magnetron oscillators.
4. Measures noise spectra.
5. Check and observe tracking of r.f. components of a radar system.
6. Check two r.f. signals differing by a small frequency separation.

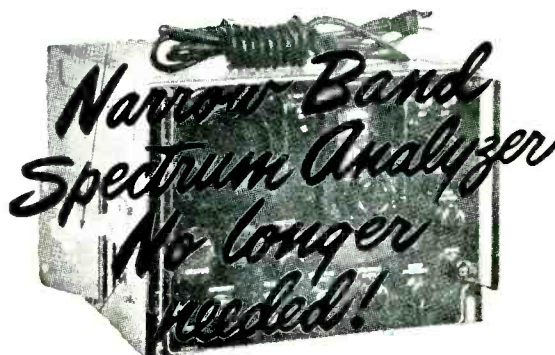

Write for complete details

Visit our Booths 29 and 30  
at the IRE show

# Polarad

Electronics Corporation

100 METROPOLITAN AVE. • BROOKLYN 11, N. Y.

# HERMETIC SEALS IN

*Infinite Variety*

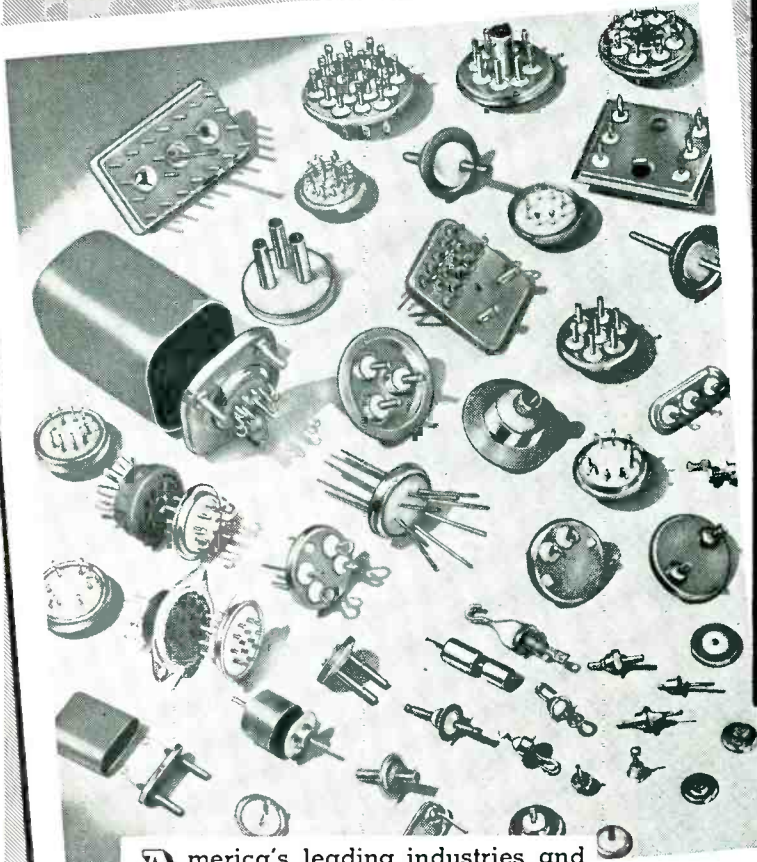

The Only Seals You Can Hot Tin Dip at 525° F. for Easy Assembly Soldering, for a Strain and Fissure-Free Sealed Part with Resistance of over 10,000 Megohms!

America's leading industries and government agencies have made Hermetic Seal Products Company headquarters for glass-metal headers that are impervious to every element, even under the most adverse conditions.

Hermetic headers withstand high vacuum, high pressure, temperature cycling, oils, compounds, chemicals and corrosion.

**TERMINALS AND HEADERS ARE AVAILABLE IN RMA COLOR CODE**

No matter what your requirements are in design or production runs, Hermetic's creative engineering and amazingly flexible processing will save you time, money and effort and will turn out hermetic seals of unrivaled quality for the ultimate in performance.



*Free!*

Your copy of the most complete catalog ever produced on hermetic seals is available without cost or obligation. Here, in 16 data-laden pages, is the most thorough presentation of factual material on hermetic seals. Write for your copy. Let us know how we can help solve your problems in hermetic sealing.



**HERMETIC SEAL PRODUCTS COMPANY** 29-37 So. 6th St., Newark 7, N. J.

Visit Hermetic's Booth Number 129 at the 1950 I.R.E. Show, Grand Central Palace, March 6-9.



# Not on Your Doorstep— when you call in KARP

Every manufacturer faces these two big problems this year. But Karp can help to keep them off your doorstep.

If your product requires metal cabinets, housings, chassis or enclosures, we can build them in a manner that will effect time and money savings on your assembly line. Karp craftsmanship is so accurate and thorough in detail that all units will be completely uniform. All your components will fit quickly and easily into place without forcing—without extra efforts on your part.

The resultant savings of your time and effort can help cut your costs and permit more competitive pricing, without cheapening your product in quality and value.

Let us prove that Karp's superior craftsmanship also means true economy. Pin the coupon below to your letterhead for more information.

Right: Desk panel cabinet rack



Below: Electronic control cabinet

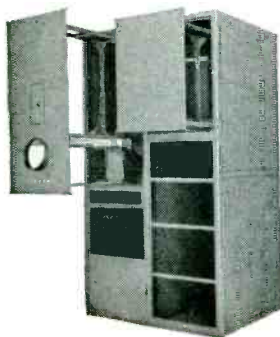

## WHAT KARP CUSTOM CRAFTSMANSHIP OFFERS

- Practical help with design problems, to improve product and cut cost.
- Our large accumulation of tools and dies often can save you special die costs and time.
- The specialized skill of several hundred of the finest metal craftsmen; expert forming, drawing, bending . . . welding with all latest techniques.
- Finest quality painting and finishing of all types in dustproof chambers equipped with water washed spray booth. Baking ovens with timing controls.
- Everything in sheet metal, from a simple chassis or panel to the most elaborate electronic apparatus housings. Any metal, any gauge, any size, any quantity—from a single lot to large run quantities.
- Efficient production and on-time deliveries.

**KARP METAL PRODUCTS CO., INC**  
215 63rd Street, Brooklyn 20, New York

Yes! Please send more information and **PROOF** of how your sheet metal workmanship can help us cut our production costs.

Name .....

Title .....

Company .....

Address .....

City ..... State .....

**KARP METAL PRODUCTS CO. INC.**  
215 63rd Street, Brooklyn 20, N. Y.

*Custom Craftsmen in Sheet Metal*

The FAMOUS GENUINE  
**JENSEN MODEL 510**  
 COAXIAL SPEAKER

**BEST AT ANY PRICE - - -**

*Comparative tests with the most expensive types of two-way speakers will prove that the Jensen Model 510 is the best regardless of price.*

*The new, wide-angle acoustic lens of the "510" is an example of Jensen leadership in loudspeaker engineering. By adapting optical principles to acoustics, this lens acts in conjunction with the h-f horn to distribute h-f radiation uniformly over a wide angle. This insures constant balance and high quality reproduction throughout the whole room.*

*Whether the "510" is used for broadcast monitoring, professional sound reproduction, or for home entertainment systems, the advanced Jensen electroacoustic design assures the finest performance.*

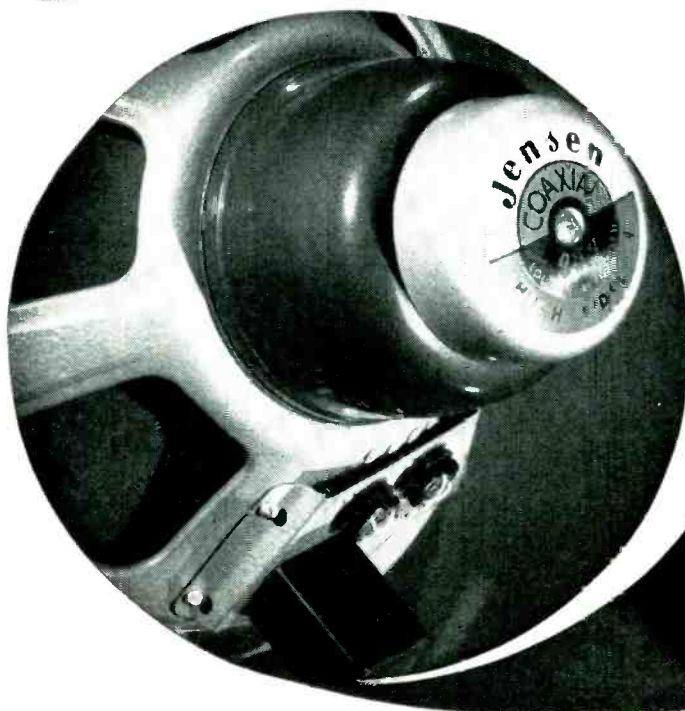

**JENSEN MANUFACTURING COMPANY** DIVISION OF THE MUTER COMPANY  
 6607 South Laramie Avenue, Chicago 38, Illinois • In Canada: Copper Wire Products, Ltd., 351 Carlaw, Toronto

*Announcing*

# NEW MINIATURE ELECTRICAL RESOLVERS FOR COMPUTER PROBLEMS OF INDUSTRY

## ARMA SIZE 03 (8 types)

### KEY COMPONENTS IN ARMA'S POST-WAR TECHNIQUE OF ELECTRICAL "BRAIN BLOCK" INSTRUMENTATION

"Brain Block" instrumentation quickly describes any custom arrangement of light, small, accurate standard Arma components to make precision instruments and controls.

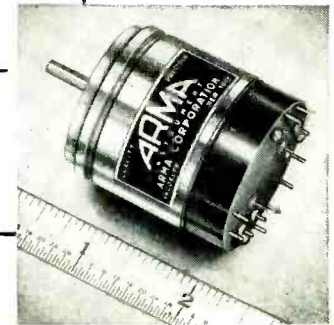
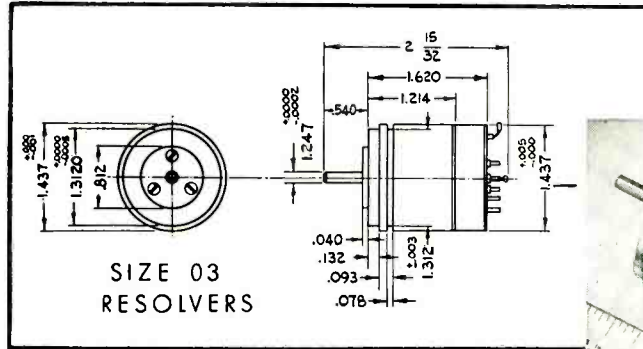

### TYPICAL SPECIFICATIONS

SIZE	TYPE	DRAWING NUMBER	FREQ.	INPUTS	OUTPUTS	TRANSFORMATION RATIO (S/P)	PHASE SHIFT	INERTIA (oz. in <sup>2</sup> )	MAX. STATIC TORQUE (oz. in.)	WEIGHT (lbs.)	MAX. ANGULAR ERROR	MAX. AXIS MISALIGNMENT	REQUIRED TO ATTAIN TABULATED ACCURACIES		
													INPUT VOLTAGE	TEMPERATURE	AMPLIFIER DWG NO. WEIGHT (lbs.)
03	03JJ400	786832	400 ± 0.5	2	2	1.000 ± .0025	0° 0' ± 3.5'	0.05	0.5	.35	0.12% E <sub>s</sub> †	± 7.0'	0.5 to 16.0	15° to 70° C	789640 1.2
03	03KK400	786833	400 ± 0.5	2	1	1.000 ± .0025	0° 0' ± 3.5'	0.05	0.5	.35	0.12% E <sub>s</sub> †	± 7.0'	0.5 to 16.0	15° to 70° C	789640 1.2
03	03LL400	786834	400 ± 0.5	1	2	1.000 ± .0025	0° 0' ± 3.5'	0.05	0.5	.35	0.12% E <sub>s</sub> *	± 7.0'	0.5 to 16.0	15° to 70° C	789640 1.2 Note = 1
03	03MM400	786835	400 ± 0.5	1	1	1.000 ± .0025	0° 0' ± 3.5'	0.05	0.5	.35	0.12% E <sub>s</sub> *	± 7.0'	0.5 to 16.0	15° to 70° C	789640 1.2 Note = 1
03	03NN400	786836	400 ± 0.5	2	2	.955 ± .015	4° 30' ± 30'	0.05	0.5	.35	0.12% E <sub>s</sub> †	± 7.0'	0.5 to 16.0	25° C	Not Required
03	03PP400	786837	400 ± 0.5	2	1	.955 ± .015	4° 30' ± 30'	0.05	0.5	.35	0.12% E <sub>s</sub> †	± 7.0'	0.5 to 16.0	25° C	Not Required
03	03QQ400	786838	400 ± 0.5	1	2	.955 ± .015	4° 30' ± 30'	0.05	0.5	.35	0.12% E <sub>s</sub> *	± 7.0'	0.5 to 16.0	25° C	Not Required
03	03RR400	786839	400 ± 0.5	1	1	.955 ± .015	4° 30' ± 30'	0.05	0.5	.35	0.12% E <sub>s</sub> *	± 7.0'	0.5 to 16.0	25° C	Not Required

Deviations shown are maximum — Average deviation is much less. Quadratures and harmonics each never exceed 0.1% of the sum of the input voltages. Characteristics shown are attainable with indicated required auxiliary equipment and good engineering practices for precision circuits. Note #1. One amplifier may be used with two resolvers of this type.

\*E<sub>s</sub> = Input  
†E<sub>s</sub> = Sum of Inputs

These are the resolvers about which management men have been reading: "One of the means by which the many fast changing variables of industry can be coordinated and electrically translated is Arma's electrical resolver . . . the "brain block" that replaced a formidable aggregation of gears and slides previously used to solve the trigonometric functions. It is used in instrumentation involving computers and action-triggering circuits. And, resolvers come off Arma production lines accurate to a degree seldom equalled outside the precision model shop. They fit interchangeably into instrument assemblies."

RESOLVER CATALOG  
JUST PRINTED GIVES  
COMPLETE DETAILS  
ASK FOR A COPY

## ARMA CORPORATION

254 361st STREET, BROOKLYN 32, N. Y.

SUBSIDIARY OF AMERICAN BOSCH CORPORATION

ARMA  
PRODUCTS  
RELEASED  
FOR  
PRIVATE  
INDUSTRY

ARMA ELECTRICAL RESOLVERS • ARMA SYNCHROS • ARMA INDUCTION MOTORS • ARMA INDUCTION GENERATORS • ARMA MECHANICAL DIFFERENTIALS • ARMA ALTERNATING VOLTAGE COMPARATOR • COMPUTING MECHANISMS • INDUSTRIAL CONTROLS • STABILIZATION DEVICES • NAVIGATIONAL EQUIPMENT • LIMITRON AUTOMATIC INSPECTION SYSTEM

\* Licensed for use under Arma patents Nos. 2,465,624 and 2,467,646. License information available.

QUALITY **ARMA** PRECISION  
INSTRUMENT

**JUST OFF THE PRESS!**

# NEW HANDBOOK

## ON GENERAL ELECTRIC WELDED GERMANIUM DIODES

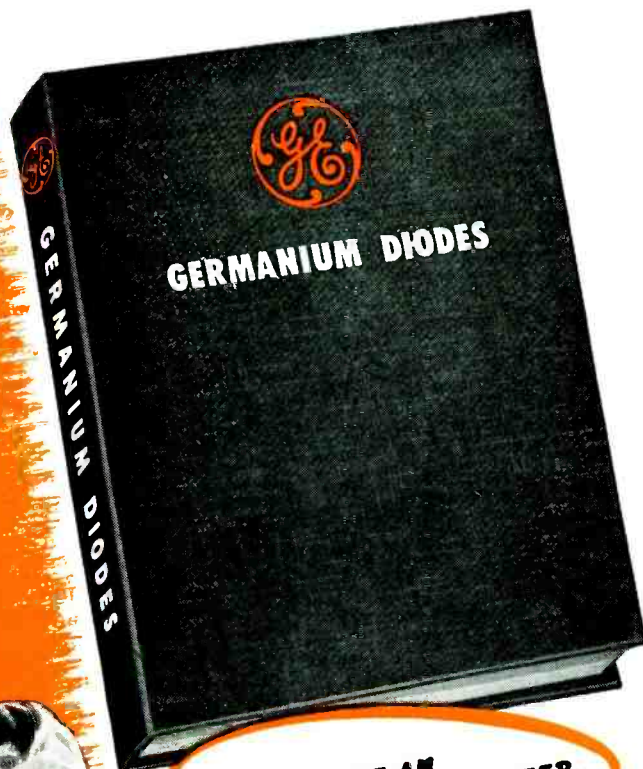

**"IF YOU'RE AN  
ELECTRONICS ENGINEER,  
PAL, YOU NEED  
THIS BOOK!"**

**H**ERE'S the book that digests all the facts you should have on Germanium Diodes. Contains valuable pages of up-to-the-minute information on diodes and their applications in today's widening electronics market!

For designers and engineers who want basic facts on the development, characteristics, advantages and circuitry of diodes, this carefully prepared General Electric manual is a valuable tool. Includes specific data on diode problems, characteristics curves, electrical rating charts, circuit diagrams.

Assembled in loose leaf fashion, the book is tabbed by sections for easy reference. The \$1.25 price of this leatherette bound handbook includes supplementary sheets on new diode developments which will be sent to you as they are published. Your copy is waiting. Mail the coupon today!

### HERE'S WHAT IT TELLS YOU

- Design, manufacture, and specifications of G-E Welded Germanium Diodes
  - General purpose types
  - TV types
  - Quads
  - UHF diodes
- **CHARACTERISTICS CURVES**  
36 curves on resistance, current, voltage, temperature, and efficiency. Also typical distributions.
- **SERVICE NOTES**  
How to install  
How to check and inspect  
Precautions
- **DIODE APPLICATIONS**  
Typical circuit applications and brief descriptions of diode characteristics as used in circuits covering AM & FM receivers, TV receivers, measuring equipment, carrier current, miscellaneous.
- Pertinent articles and public presentations on diode theory and application.

*You can put your confidence in—*  
**GENERAL  ELECTRIC**

General Electric Company—Section 430  
Electronics Park  
Syracuse, New York

Please send me . . . . . copies of the new G-E Germanium Diode Handbook at \$1.25 per copy—Postpaid.

Bill me       Check or M.O. enclosed

NAME.....

ADDRESS.....

CITY.....STATE.....

# BUSINESS BRIEFS

By W. W. MacDONALD

## the New PYRAMID "Humidi-Seal"

(TUBULAR PAPER CAPACITOR)

**Repels Moisture!**

Ruggedly built to withstand undue vibration and rough handling.

Outer tube plastic impregnated to prevent moisture-absorption

Light outer coat of high-temp wax provides double protection

Each end plastic sealed against moisture

Leads anchored securely in solid plastic end



Type 85TOC "Humidi-Seal" capacitors are specially designed for 85° C. operation, even in the most humid atmospheres, and will meet the severe present-day demands of endurance in television receivers, auto radios, etc.

WRITE FOR COMPLETE LITERATURE

Representatives and Distributors throughout the U.S.A. and Canada



**PYRAMID**

**PYRAMID ELECTRIC COMPANY**

155 Oxford Street  
Paterson, N. J., U.S.A.

TELEGRAMS: WUX Paterson, N. J.  
CABLE ADDRESS: Pyramidusa

**Field-Trip Impression:** Price will be king in 1950 television. Some manufacturers think lower prices for 1949 picture sizes, or the same prices for larger pictures, can be achieved by better though simpler circuits and savings effected by improved production techniques. Others think that lowering of lists will be accomplished by just plain corner-cutting, some of it at the expense of performance.

Both schools of thought are probably right.

**Another Field Impression,** slightly mixed, is that the tube is at one and the same time going out and coming in.

We've seen germanium crystals, dry-disc rectifiers and magnetic amplifiers creeping into certain electronic equipment. On the other hand, we've also seen thyatrons and ignitrons substituted for relays and even for heavy-duty contactors in new gear.

All in all, we think it would be silly to sell the tube short.

**Entirely Speculative,** but nevertheless stimulating to some of our friends in the aviation field, is this trend of thought:

A good part of the cost of a modern airplane is in its electronic equipment, so a few extra dollars invested in electronics would not break the bank. Some of this equipment, like an automatic pilot, already moves various flight-control surfaces. This being the case, it is conceivable that similar electronic equipment could be introduced between the pilot and the control surfaces to take over part of the job of manual flying.

Several possibilities come to mind. By a combination of electronic and manual control could a small ship achieving supersonic speeds be given the "feel" of a safe-and-sane transport? Could electronic means of stabilizing flight be substituted to some extent for aerodynamic stability? Would this permit economies to be effected in

the design of the airplane itself? From here on it is your ball.

**Important Trend** everywhere in evidence is an engineering struggle to combine the functions of electronic measuring - telemetering - calculating - indicating - recording devices with those of the garden variety of business machine.

In fields of endeavor ranging all the way from flight research through conventional industrial laboratory and production testing to even more laborious clerical operations modern electronic equipment is gathering so much data that man cannot comfortably digest it. Thousands of people are slaving away converting oscillographic and magnetic squiggles and other hieroglyphics turned out by electronic gear into plain old-fashioned arithmetic and English such as that turned out by business machines.

What is needed is a bridge between the two devices, one that need not be monitored by human hands. Suitable component parts are already known in many cases, and the span has actually been completed in a few highly specialized robots. But the problem still lies largely ahead.

Building this bridge may very well be the next great job for engineers.

**Poetry** normally leaves us cold, but we do like the piece entitled:

PANORAMA WITH SIGNS AND SYMBOLS

By Harold Willard Gleason

Where brackets' jealous fingers  
About black surds entwine,  
The shy mantissa lingers  
By tangents of the sine;  
Binomials brood there bleakly  
In corollary trees,  
As minuends munch meekly  
Cubed "x"s, "y"s, and "z"s.

There sigma curves assemble,  
Prime radii outspread,  
And variants, atremble,  
By radicals are bled,  
Sage scientists ecstatic  
With grieved ease construe such;  
But we, non-mathematical,  
Would rather root than view such!

Reprinted by permission and Copyright 1949 by *The New Yorker Magazine, Inc.*, this little poem comes to mind whenever we read





**New!**

**20 PIN PLUG-IN  
HERMETIC TERMINAL**

TERMINAL ILLUSTRATED  
IS #232OHTO



The advantages of the octal type key plug-in terminal are now extended to include applications calling for as high as 20 pins. Many additional types of relays and other electrical components may now employ this simple fool-proof combination of hermetic sealing and plug-in connection. Sockets are available. All Fusite Hermetic Terminals are an interfusion of steel and inorganic glass. Write Dept. E for specifications and complete information.

**THE FUSITE CORPORATION**

CARTHAGE AT HANNAFORD, NORWOOD, CINCINNATI 12, OHIO

# SHOCK AND VIBRATION NEWS

There's a BARRYMOUNT for each of your needs!



## AIRCRAFT MOUNTING BASES

Standard bases with dimensions to government specifications. Special bases to customers' exact requirements.



## AIRCRAFT VIBRATION ISOLATORS

Unit isolators designed to meet Army, Navy, and CAA requirements. Stock mountings — 1/4 pound to 45 pound load range. Others on order.

## SHOCK MOUNTINGS

For mobile, railroad, and shipboard electronic and electrical equipment. Also for isolation above 2000 c.p.m., and for general sound isolation.

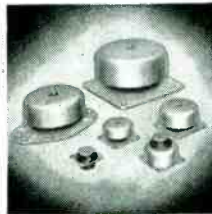

## INSTRUMENT MOUNTINGS

For electronic components, tiny fractional H.P. motors, record changers, dictating machines, and other lightweight apparatus.

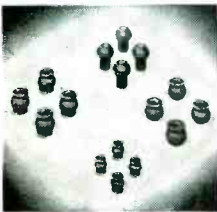

## INDUSTRIAL MOUNTINGS

For fans, motor generator sets, transformers, presses, other heavy industrial equipment.

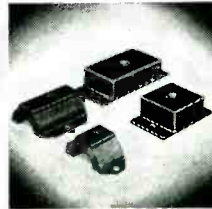

**Free Catalogs** give dimensions and load ratings of stock BARRYMOUNTS. Catalog 502 covers aircraft applications. Catalog 504 covers industrial and general-purpose mountings. **WRITE TODAY to**

THE **BARRY** CORP.

Main Office 177 Sidney St.

Cambridge 39 Massachusetts

New York    Rochester    Philadelphia    Washington    Cleveland    Dayton

Chicago    Minneapolis    St. Louis    Los Angeles    Toronto

a technical paper with the mathematics symbolized up.

Licensed Radio Stations totaled 152,974 as of December 31, 1949, broken down as follows:

Broadcast	
Standard (a-m)	2,234
Frequency-modulation	788
Remote pickup	649
Television	111
Television (experimental)	215
Educational	72
International	37
Facsimile	0
Other	39
Nonbroadcast	
Aeronautical	25,513
Marine	22,390
Public Safety	6,242
Industrial	5,167
Land Transportation	3,497
Amateur	84,394
Miscellaneous	1,626

Licensed operators totaled 589,706, broken down as follows:

Commercial	393,470
Special Aircraft	113,028
Amateur	83,208

We've Been Watching the new-product announcements of manufacturers who put out thousands of radios equipped with television jacks for some sign of a unit that would utilize these unused little apertures. So far we've seen nothing, and begin to grow suspicious.

Still Harping on the same string—the need for more reliable small industrial tubes—we predict that if some established tube makers refrain from designing types the customer wants much longer, for economic or any other reasons, companies that have never lighted a gas flame or pulled a vacuum will take a whirl at it.

Incidentally, just the other day we heard about a new line of tubes now in production for use in aircraft that have the following characteristics:

- Solid ceramic insulation
- Improved heater welds
- Oversize cathodes
- Eight-wire circular stems
- Mica eyelets welded to side rods
- Larger grid side rods
- Increased electrode spacings
- Increased getter capacity
- Getter-splash micas
- Gold-plated grid wires
- Higher vacuum
- Pretest burn-ins

There are ten types in all, and they have been in process of design for two years.

One Of Our Readers has just applied for a patent on a combination timer and rotary switch. Built

into a radio, it not only turns the set on and off at desired intervals but also permits any one of several tuned circuits, and therefore stations, to be preselected.

The design seems fairly simple, and appears to lend itself to assembly by relatively unskilled workers. Printed-circuit technique could also be used. We'll be glad to pass inquiries from interested manufacturers along.

Admiral Telfair Knight of the U. S. Maritime Service says that insurance premiums covering Alaskan shipping are reduced as much as 50 percent when radar navigation equipment is installed. Scuttlebutt tells us that the average ship plying in these waters spends \$11,000 per year for insurance.

Spencer-Kennedy of Boston had a rep in Europe all last Summer and reports that American laboratory electronic equipment is in very high regard indeed. Export drawback has been lack of dollars, but an ECA grant to Italy in December may be the forerunner of other similar grants.

After One Year of experience, a poll of bus and trolley drivers operating 1,000 vehicles in St. Louis indicates that 75 percent like radio programs supplied by Transit Radio through KXOK-FM, 15 percent are neutral on the subject and 10 percent object to the idea.

Magnetic Tape of the oxide-in type is specified by 78 percent of the makers of recording machines, according to C. J. LeBel of Audio Devices. Red oxide is preferred by 74 percent, black by 17, and 9 percent recommend both. Plastic-base material is specified by 69 percent, paper by 17, and either plastic or paper by 14 percent.

When Bad Engineers Die their first assignment in the hereafter is to tune up five and ten-watt marine radiophone transmitters. By the time they have learned how to adjust the four to nine interacting tank and antenna-coil taps for proper loading and resonance they know precisely what hell is.

# SIGMA

## *Sensitive Relays*

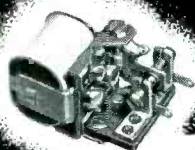

SERIES 4

SPDT GENERAL PURPOSE SENSITIVE D. C. RELAY. Inexpensive. Balanced armature for vibration resistance on aircraft at 50 milliwatt adjustment. Sensitive enough for V-T operated relay circuits; can be set to operate down to 10 milliwatts. Precision adjustments for pull-on and drop-out. 2 amp. nominal contact rating. Coil resistance up to 14,000 ohms.



SERIES 5

SPDT VERY SENSITIVE D. C. RELAY. Balanced armature and magnetic efficiency resist aircraft vibration on inputs as low as 6 milliwatts. Withstands 500g shock without damage. Precision adjustments. 2 amp. nominal contact rating. Coil resistance up to 16,000 ohms. Special adaptations: Built-in rectifier, two-coil differential operation, constant voltage temperature compensation.

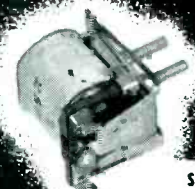

SERIES 41

SPDT SENSITIVE RELAY AC-DC-KEYING. Unusual characteristics at low cost. Same D. C. sensitivity as Series 4 but less flexibility of adjustment. Available with long life and bounce-free contacts, it is suited to high speed counting and keying. Mechanical life exceeds 10<sup>9</sup> operations. Good for plate circuits needing moderate precision and vibration immunity. Contact ratings up to 5 amps. Coil resistance to 14,000 ohms. A. C. sensitivity exceeds 0.1 V. A. at 60 cps. Serviceable on frequencies from 16-400 cps. Protects delicate thermostat or instrument contacts.

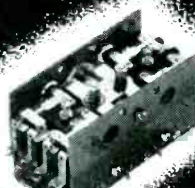

SERIES 6

MULTICIRCUIT POLARIZED SENSITIVE RELAY. Single or double (differential) windings. Resistance up to 25000 ohms total. Contacts up to 4PDT, 5 amp. nominal rating. Balanced armature for strong vibration resistance. FORM X—Three Position or Null Seeking. For automatic positioning or 2-Way process control. Sensitivity (depending on contact complexity) from 10 to 100 milliwatts. FORM Y—Biased (Spring Return). Use as an ordinary sensitive relay if a complex contact combination is needed. Combines function of pilot relay and contactor. Sensitivity same as Form X. Responds only to one polarity. FORM Z—Latching (permanent magnetic). Replaces mechanical latch electrical reset relays, where longer life and greater vibration resistance is required. Sensitivity from 100 to 250 milliwatts.



SERIES 7

SPDT SENSITIVE HIGH SPEED POLARIZED RELAY. Single or multiple windings up to 14,000 ohms (single). Balanced armature. Nominal contact rating 2 amps. For repeating telegraphic signals at speeds up to 250 W.P.M. Small in size and weight. Hermetically sealed. Mechanical life exceeds 10<sup>9</sup> operations. FORMS X, Y and Z (see Type 6 above) available in Series 7. Sensitivities from less than 1 to 10 milliwatts depending on form and requirements. Form X is useful as the detecting element in positioning bridge circuits.



### VARIETY OF ENCLOSURES

In addition to the open styles shown, SIGMA Relays are available with dust-proof or hermetically-sealed enclosures. Most types are available for either plug-in or permanent solder-lug connections.



WRITE FOR FULLY DESCRIPTIVE CATALOG

# SIGMA Instruments, Inc.

SENSITIVE RELAYS

62 Ceylon Street Boston, Mass.

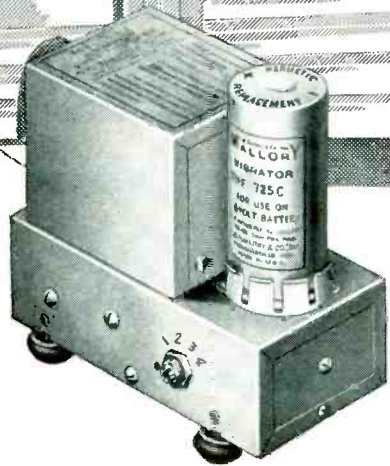
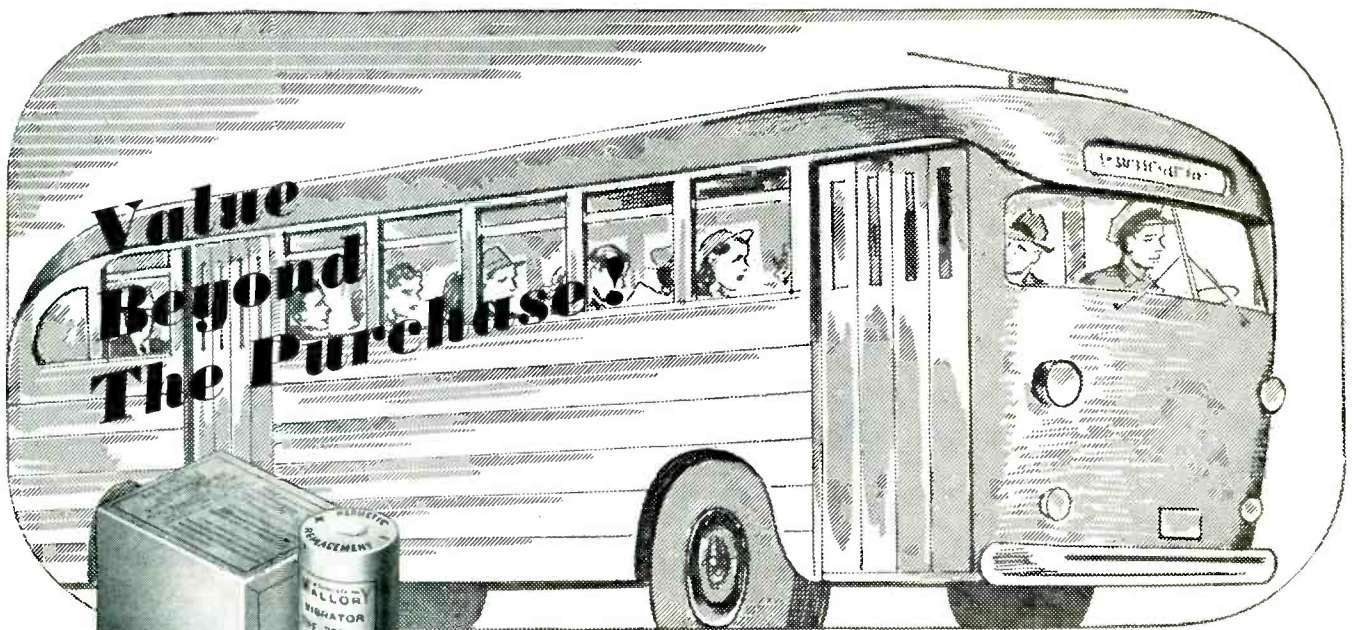

## MALLORY VIBRATORS

Mallory Vibrators and Vibrapack power supplies are based on exclusive design and manufacturing methods that assure long, trouble-free service. Send the details of your application. Get Mallory's recommendation on the Vibrator or Vibrapack power supply best suited to your needs.

## Mallory Vibrapacks\* Replace Costly Power Supply System *Effect Tremendous Savings!*

In one typical case, a simple and inexpensive circuit modification, developed by Mallory, made it possible for a manufacturer of mobile radio receivers to substitute Vibrapacks for a costly and less efficient power supply system. The conversion saved this Mallory customer \$40,000 in the first year! In addition, thousands of dollars are being saved in maintenance costs. Servicing the old system required hours of labor . . . the new one requires only occasional replacement of the vibrator.

When you buy Mallory vibrator equipment you benefit by a winning combination of dependability, economical performance and creative engineering.

*That's value beyond the purchase!*

And whether your problem is electronic or metallurgical, what Mallory has done for others can be done for you!

### Vibrators and Vibrapack Power Supplies

**P. R. MALLORY & CO., Inc.**  
**MALLORY**

P. R. MALLORY & CO., Inc., INDIANAPOLIS 6, INDIANA

#### SERVING INDUSTRY WITH

Capacitors	Contacts
Controls	Resistors
Rectifiers	Vibrators
Special	Power
Switches	Supplies
Resistance	Welding Materials

\*Reg. U.S. Pat. Off.



## CROSS TALK

### ►WHITE ON CYBERNETICS . . .

W. C. White, having recently read Wiener's "Cybernetics", writes:

"I have been convinced for some time of two things. First, cybernetics is one of the most important, if not the most important, science of the second half of the century as regards the many detailed changes it may make in our way of life. In the second place, electronics is unquestionably the most important single factor in this science. Not only does it furnish elements and techniques for the 'brain' but even more important it furnishes the unique devices that simulate many of the human senses and thus furnishes what Wiener terms the 'impressions' or 'signals.' I refer to the microphone (ear), loudspeaker (voice), phototube (vision), each necessarily associated with electronic amplifiers and control. There are also other electronic devices that excel the human senses in response to delicacy of touch, temperature change, motion and sense of smell for certain odors.

"This whole science has crept up on us from many directions and through many channels without our fully grasping its full significance. It seems to me that Wiener's chief contribution is putting it together as a whole and naming it. Most of us, I believe, have not seen clearly that the ship's steering engine, the household thermostat with its anticipatory heat coil, as well as the memory tube, the computer and the optical contour follower control for

machine tools are all parts of this newly defined science.

"I will predict that in not too many years the pages of *ELECTRONICS* could, if you so desired, be dominated by the electronic aspects of this new science and there would be an eager host of readers."

These words have the persuasive air of ordained prophecy. In furtherance of the program in the last paragraph, we are happy to report the receipt of a definitive manuscript on electronic correlation by Professors Wiesner and Lee of MIT. We doubt such subjects will dominate our pages, for the next few years at least, but they will surely have a prominent place.

►QUIZ . . . For some months we have been amazed and baffled by a series of "electrical essays" appearing in *Electrical Engineering* from the pens of Joseph Slepian, Walther Richter and others. These are impressive little problems, couched in deceptively simple language, which require a fundamental knowledge of electrical theory plus considerable ingenuity. Their purpose is partly entertainment, partly stimulation to better understanding of the art. We have had little success with them, but the answers are printed in succeeding issues, and the denouement is worth it in every case. Those unfamiliar with the essays are advised to look them up.

All of which brings up the question of whether a similar series of

purely electronic problems, demanding less erudition, might not be welcomed by the readers of this magazine. We will go searching for a series of poor man's electronic essays, on the following conditions: that five readers (about 1/60th percent of the readership) will write us expressing interest in the same, and that one reader will send us an acceptable essay, and its solution, to start the thing off. After the prudent fashion of our esteemed colleagues in the AIEE, no prizes will be offered for correct solutions.

►LAMP TVI . . . Speaking of problems, we seek further explanation concerning a most puzzling type of television interference, first reported in *ELECTRONICS* in the December 1949 issue, p 132. This is produced by incandescent lamps in good working order, notably from old-type Mazda B bulbs having a single filament wire draped zig-zag fashion on a glass post. The interference appears most strongly in the 50 to 80-mc region. W. C. White wrote to say that 30-mc radiation from such lamps had been detected about 20 years ago, and the cause had been ascribed to Barkhausen-Kurz oscillations. It was found to occur only in draped-filament lamps. But other readers report the same type of interference from modern coiled-coil filament lamps. Can this be a manifestation of the worthy Drs. Barkhausen and Kurz also? In any case, what is the mechanism? Anyone in Nela Park got any ideas?

# 20-YEAR GROWTH OF THE ELECTRONICS INDUSTRY

(IN AT-FACTORY VALUES FIGURES IN MILLIONS OF DOLLARS)

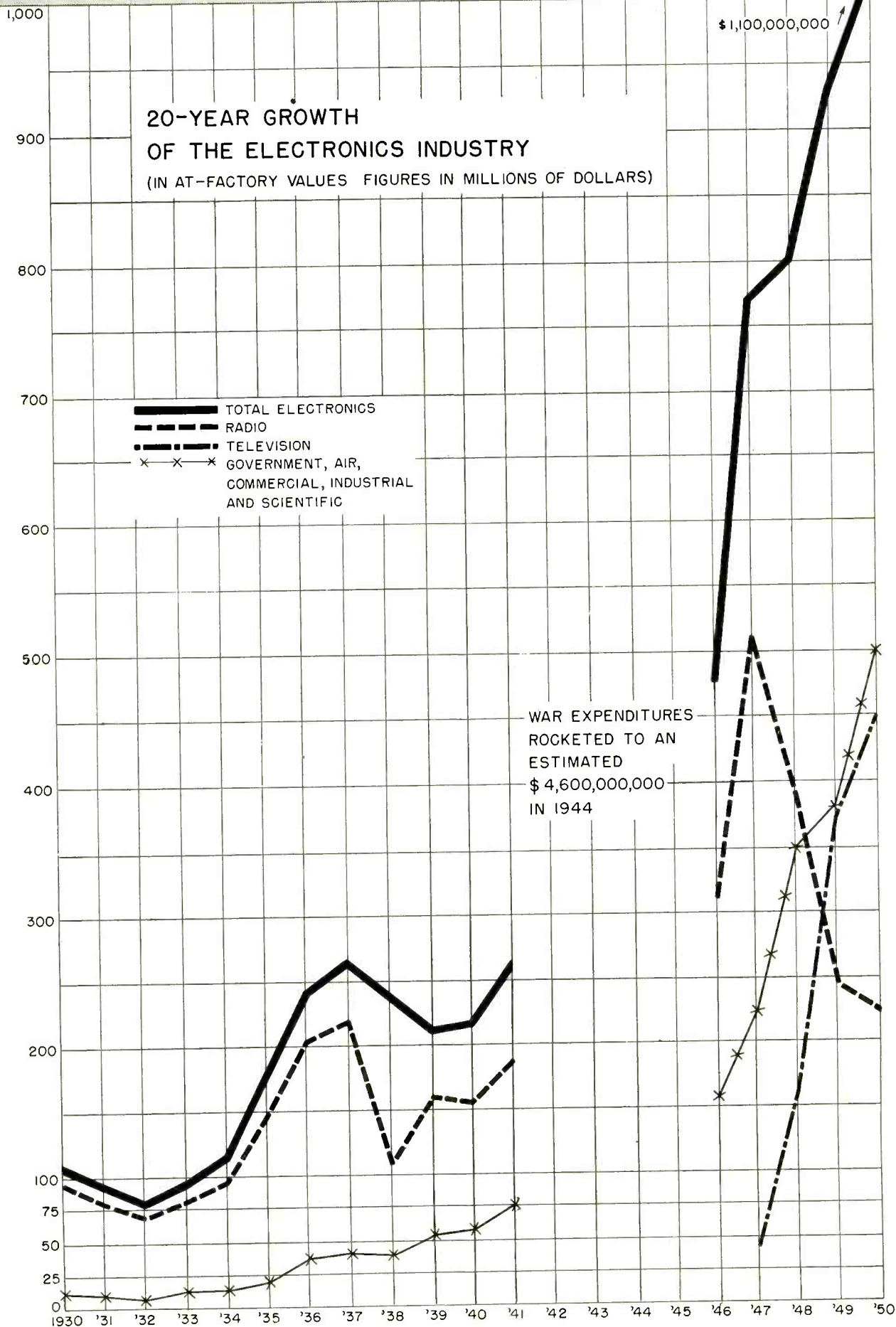

# Our Business in 1950

---

Until 1940, dollars revolved largely around radio. The next ten years included the war years, in which the influence of the tube made itself felt in military circles and throughout industry as well as in communications. In 1950 television may dominate, but radio production should continue to be substantial and other electronic applications will really begin carrying the ball

By **WALLACE B. BLOOD**

*Manager, ELECTRONICS*

**F**IGURES show that the electronics industry has increased ten and a half times in dollars from 1930 to the estimated volume for 1950. In round numbers this is \$103,500,000 to \$1,100,000,000. For the first time, peacetime electronics will cross the billion-dollar-at-factory-value mark, although it was well over four times that amount at the peak of the war.

You who are in the field today benefit by a metamorphosis unique in industrial history. The war, television, and industrial electronics have brought about tremendous growth, while radio has continued to rank in importance with other major electrical appliances. Estimated radio-receiver dollars for 1950 are two and a half times more than they were 20 years ago—a matter of \$92,500,000 in 1930 against \$225,000,000 in 1950. The percentage of radio-receiver manufacturing to the whole in 1930 was roughly 90 percent. The figure for 1950 is about 20 percent.

In the figures for the first decade dollars merely doubled, as the country dug out of the depression. But in the second decade, boosted vastly by the war but also in spite of it, much greater gains were made and the radio receiver has ceased to be king. Electronics is a broadly

applied art, the scope of which few realize.

Readers of *ELECTRONICS* who were a part of the industry in 1930 when this magazine was first published (our anniversary is next month) are now fortyish and up. The average subscriber today is well below that age, so the figures herein revealed may be quite new, and certainly should be inspiring.

### **First Ten Years**

When our April 1930 issue went into the mail, it started to serve a radio industry then about nine years old. Prior to that date, battery sets had given way to plug-ins, the speaker had been put into the cabinet and a pretty fair noise came out as the end result.

Applications of tubes to industrial uses were largely gleams in the eyes of a mere handful. There was no conception of radar, little of aerial navigation, certainly none of guided missiles. Oscillate a tube

at 100 megacycles? You're crazy! It was just consoles, tabletop jobs and a trickle of phono combinations, a meager market in marine, and amateur equipment, and some playing around with this new gadget radio by police, forestry people and the like.

The ten years prior to 1940 were not conducive to rapid expansion. With the depression and subsequent 1938 recession making things tough, manufacturers had few dollars with which to dabble in new markets. Industrial applications began to creep in, although in no great dollar volume. The cathode-ray tube permitted the timid introduction of all-electronic television. The "electric eye" began to look at more and more things industrial-wise. Welding began to be electronically controlled. High-frequency power was creeping in as a heating agent. But, at the end of that decade, electronics other than communications was of such little moment that the big companies had not even departmentalized it. A great majority of electronic developments other than communications were conceived by individuals—independent engineers and consultants—but they had a gruesome time trying to sell their brain children to industry. Electronic de-

---

### **"Readers of *ELECTRONICS***

who were part of the industry in 1930 are now fortyish and up . . . the average subscriber today is well below that age . . . so the figures herein revealed may be quite new, and certainly should be inspiring"

---

vices were looked upon as tricky things, unreliable, delicate and mysterious.

The industry did, however, double itself in that ten years, mostly because of radio, with its progressing needs for replacement parts. But many other industries came out of the depression with similar rapidity. December 1941 shot the starting gun of electronics as it is today.

### **The Next Ten**

It is not for this nontechnical observer to describe the progress in electronics brought about by the necessities of war, the opening up of the usable spectrum from a narrow hallway to a path the breadth of which has not yet been measured. It is easily said that the war propelled our industry ahead ten years—twenty years. Those are just numbers. But the practical side of it is that private industry could not have gathered up the billions which went into technological research and practical applications that we had to have to win. It is paradoxical that war inevitably accelerates progress with fantastic speed, because we are able to beat the swords into plowshares.

The year 1946 presented the industry with the greatest problem it had ever faced—a quick slide-down from a war business of more than four billions. We are far enough along in history now to know that the retreat was orderly. Beset by shortages, quotas, black-markets and a carpetbagging type of coniving which tried men's souls, there were surprisingly few mortalities, and are to this day. Only a few remembered prewar company names disappeared. A few more merged. But the test of management—and that is what it was—was largely met.

The huge backlog for radio receivers was heavily cut into by colossal production in 1947. True, the sets were mostly of prewar design and were sometimes thrown together with haywire and binding twine, but the public got its clamored-for radio and didn't kick.

The year 1948 was the year of redesign. With the pressure eased for radio sets, smart management saw gruelling competition rearing

its head. They redesigned with war know-how. Also, to the complete surprise of practically everyone, the infant television bounced into long pants like no prodigy ever seen before. Components, forced to quality by JAN, began to shrink in size. It was recognized with astonishment that one television set ate up three to ten times as many components as did one radio set, with only a few exceptions. Make 'em good, make 'em smaller, make everything simpler—here we go, boys, in a new entertainment field which the public wants like all-get out. Make 'em good, but get the price down for the workman with a family. The war years taught how to do it.

So, 1949 became the year of production. The quality has so far been kept up, but innovations in simplification, in production efficiency (taught, too, by the war) are bringing 1950 television sets into the homes of people whom the most enthusiastic thought could not be reached on a price basis for several years.

### **Dollars Versus Units**

When you have scanned the accompanying graph covering twenty years of our business you will note that the electronics industry is ten and one half times greater than 20 years ago, five times greater than in 1940. It is—in dollars. But it is not in units—nor in prewar dollars.

---

### **The ELECTRONICS INDUSTRY . . .**

- Will do 10½ times as much business in 1950 as it did in 1930.
  - Sales, at factory prices, should top the billion-dollar mark.
  - The Government is in the market for about \$300,000,000 worth of gear.
  - Television production is expected to reach 3,700,000 units.
  - Radio should hold up above 8,000,000 sets.
  - Industrial applications will achieve more substantial dollar totals.
- 

In units there are many variables. For instance, resistor-unit totals for 1950 will probably be six times the 1940 figure. But another essential component, the speaker, will be one third less in manufacture than prewar. As Dorman Israel points out in his article in January *ELECTRONICS*, "In three years, tv has taken over the resistor business, but not all traditional suppliers of radio-set components have fared so well. Those on the wrong side of the ratio sign include the makers of fancy dials, who have converted to picture-masks, and the variable-capacitor people who are wrestling with head-end tuners, many of which do not even use variable capacitors. And lo! The poor loudspeaker manufacturer. Loudspeaker plants find it necessary to convert to ion traps, focus assemblies and other debased items employing permanent magnets."

Well, automobiles have shed many things, including Prestolite tanks, and now even the clutch pedal is on the way out. Yet the automobile business is still very good indeed in spite of the changes that have taken place.

We have so far stressed progress in dollars. But a 1950 dollar is not a 1940 dollar—it is 60 cents of a 1940 dollar. So, on a dollar basis, 1950 total business of \$1,100,000,000 would represent a 1940 dollar business of \$663,000,000. Wholesale commodity prices are up 115 percent above prewar. Radio receivers are up about 200 percent, the cost of living is up 75 percent and consumer purchasing power is up 113 percent. You figure from that hodgepodge whether we are five times bigger than prewar or only two and one half times. It's a job for an economist.

The doubling up of radio receiver costs has in it more than increases in material and labor expense. If there are 639 separate taxes in the cost of a house, 151 in a loaf of bread, and 150 in an Easter hat, it is logical to assume that a complex radio or more complex television set loaded with taxed materials made by scores of taxed manufacturers bears an extraordinarily heavy load. Certainly a good share of the excises collected at manufacturers' level must be passed on



to the consumer. "So varied are the invisible taxes which impinge on the innocent taxpayer that experts are unable to determine, with any degree of exactness, how much these levies cost him over the year or what percentage of his total taxes they represent," wrote Robert S. Bird in the *New York Herald Tribune*.

Yet, with the burden of taxes comparatively nonexistent in 1930, with prices and labor costs more than doubled since then, a householder can buy a good television set with a 1950 dollar today for about what he paid for a good radio with a 1930 dollar in that period of twenty years ago. It is a great tribute to technology that such a thing can be accomplished.

### Predictions for 1950

In its emergence from the war the industry has resumed a sales cycle which is not unlike that of prewar. It becomes apparent that television will be bought by the public in about the same ratio by months as has been radio. It is even possible that the spring-to-summer dip will be steeper because of the lack of "portable" appeal—though, heaven knows, we may get portable battery-type television some day soon.

Comparative curves showing shipment of components, production of television and radio, and set shipment to retailers in 1949 are shown in the second chart. This is not an entirely normal chart because few parts makers anticipated the Fall cry for television, and eased off too much in the summer months. Probably the components curve is most indicative of the normal seasonal curve.

When television goes on a buyers' market, the retail-shipment curve will surely sag deeper in May and June. However, the chart presents a study which should serve to stifle the gripe about poor business in warm months. It always has been low, always will be low, and the manufacturer who accepts such a curve and plans for it will really enjoy his golf or summer cruise.

In April 1949 we printed this: "The economists (Department of Commerce) estimate that 2,000,000 tv sets will be produced in 1949,

worth \$600,000,000 (retail). We get optimistic and say 2,500,000 at \$750,000,000." Lately published figures (2,750,000) showed we did all right.

We also called the turn on 8,000,000 radio sets against the Commerce figure of 10,000,000, and it was a pleasure to be one of the few who about hit it. So, with no little trepidation we try again, for 1950, this time sticking to the 8,000,000 radios and going up to 3,700,000 on tv. Before us are tv predictions ranging from 3 to 5 million, and that's quite a lot of latitude.

If you predicate your business on three-seven for tv, we have a feeling you won't have to dump in the distress markets or watch your competitors grab business because

of your own underproduction. If you do, you'll find us somewhere around Lake Athabaska.

Government, in 1950, is good for about \$300,000,000 in electronic gear. It may go up. Depends on Joe. Radio and tv also depend on Joe and such luminaries as John L. Lewis.

Industrialwise, electronics is approaching the point where it must be used for a majority of control and measuring operations or a manufacturer will have to bow out to his competitors. It is getting that good in doing those things which cannot be as efficiently and accurately done by any other means. This control business will be the next number-one market for the electron tube.

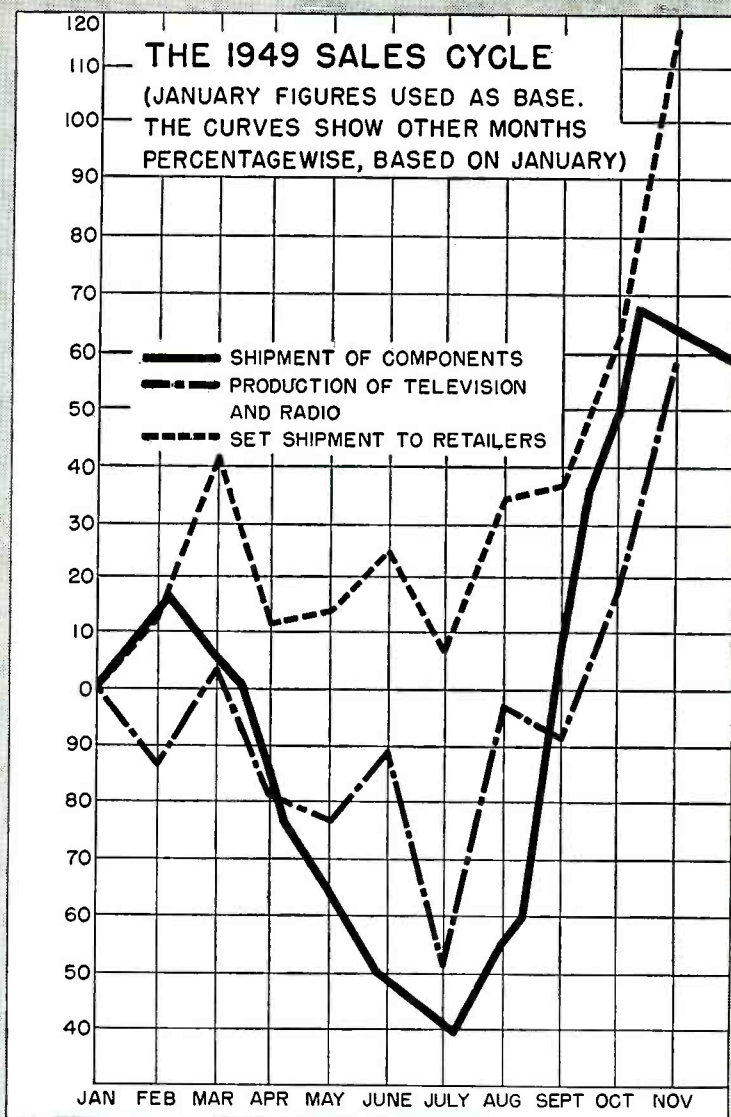

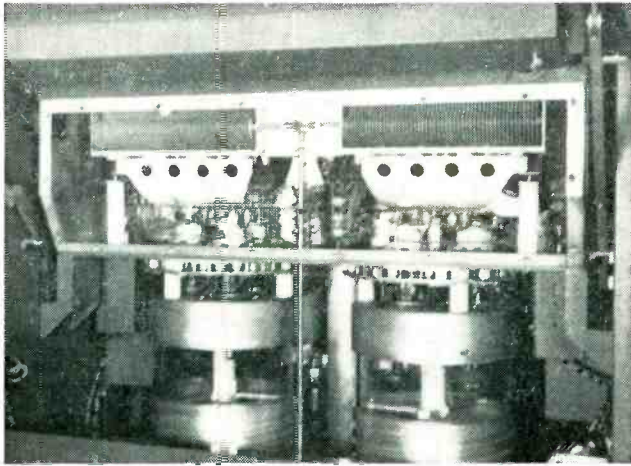

Cooling air for final amplifier tubes is brought up through two large glass cylinders. Perforated sheets form connections between tube cathodes and input tuning capacitors

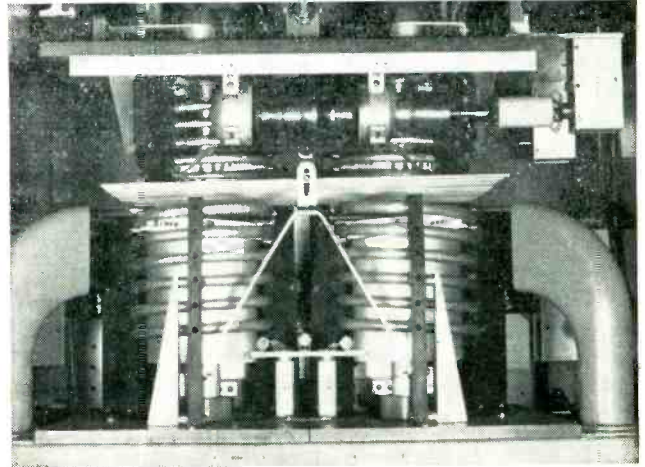

Intermediate plate tank and its output coupler are separated by a Faraday shield to minimize transfer of harmonics. Funnels on either side deliver cooling air

# CONTINUOUSLY-TUNED

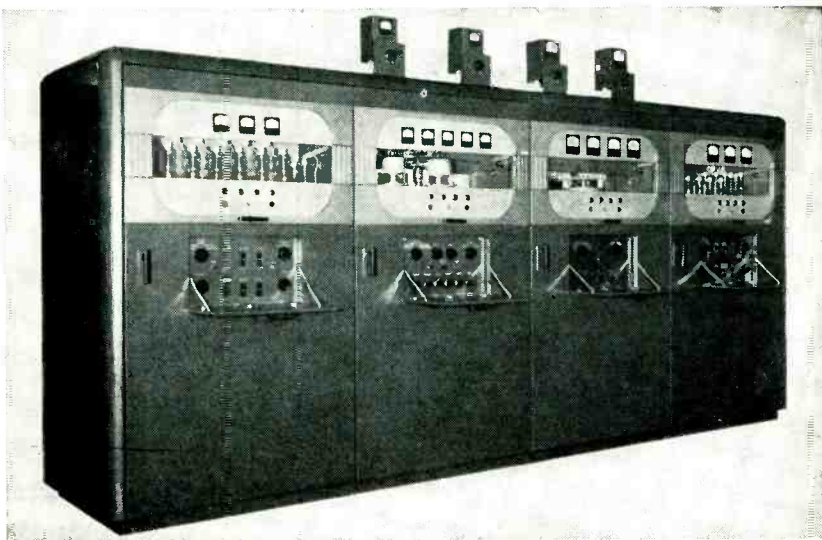

Nine adjustments required for frequency changing are located on front of two r-f bays (center). Meters on top are r-f line meters. Two left-hand meters are only used when driver is used as independent 15-kw transmitter

By **JAMES L. HOLLIS**

*Engineer  
Collins Radio Company  
Cedar Rapids, Iowa*

**S**INCE THE OPTIMUM FREQUENCY for transmission over a given path varies annually, monthly, daily, and even hourly, and since the optimum frequency for one path length may be different from that for another, frequency changing is a big factor in high-frequency radio communications. Either several pretuned transmitters or a single easily shifted transmitter must be used for reliable high-frequency service.

Multiple transmitters unquestionably provide for the most rapid frequency shift. Initial cost and

space requirements are usually prohibitive, however, especially when power outputs of 10 kw or more are required.

The transmitter to be described (Navy type AN/FRT-5 and AN/FRT-6) has been developed for use at key points in high-speed radiotelegraph circuits where dependability, versatility, and rapid frequency changeability are of great importance. It provides continuous coverage over a frequency range of 4 to 26 megacycles with an overall efficiency (output/primary power input) varying from 55 to 60 per-

cent. Several features new to transmitters of this power and frequency range are incorporated. Paralleled medium-power tubes, servo-positioned tuning, complete air cooling, relatively low d-c anode voltage, and low-voltage rectifier tubes are among these features.

Frequency changing of this 50-kilowatt transmitter is accomplished entirely from the front panel by means of nine control knobs and a crystal selector. These controls may be set initially from individual frequency calibration charts or from a setup chart if the equipment has been previously tuned to the frequency and dial readings recorded. All circuits are motor-driven and the maximum time for travel from one frequency limit to the opposite is one minute. This means that the resonant circuits can be set quite closely to any chosen frequency within one minute. After the voltages are applied, only three of these controls need be checked to make certain that they are exactly resonant and operation can be resumed on the

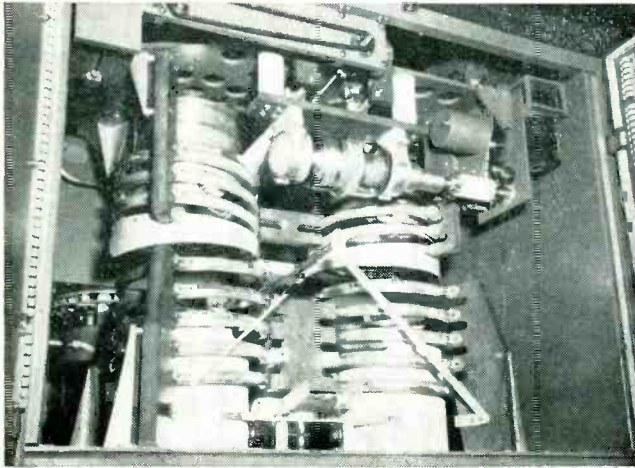

To decrease coupling to 50-kw plate tank (bottom), resonant output coupler (top) is moved forward by means of chain drive and lead-screw arrangement

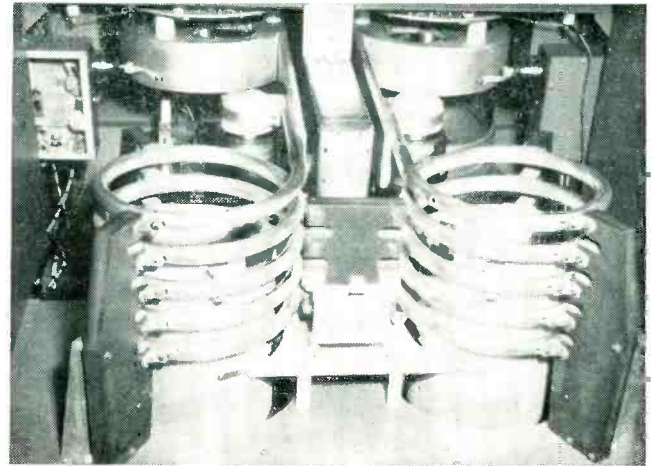

Plate tank circuit with output coupler removed to show variable vacuum capacitors and amplifier-tube anode assemblies. Sheet-metal box between plate lines distributes cooling air

# 50-KW TRANSMITTER

High-efficiency operation on any frequency from 4 to 26 mc is possible without tank-circuit switching. Stages are individually tuned by motor-driven servo-positioned units which may be preset for desired frequency in less than a minute

new frequency. An experienced operator can make this change in less than two minutes without hurrying.

## The Transmitter

The transmitter consists of a grounded-grid power amplifier stage using six 3X2500A3 tubes in push-pull parallel driven by an intermediate power amplifier using

two more 3X2500A3's in push-pull. The intermediate amplifier is driven by a single 4-400A tetrode which is preceded by a two-stage frequency multiplier and an untuned buffer. Oscillator output is fed to the buffer through a 50-ohm transmission line.

The 3X2500A3 tubes were chosen for the final and driver because of their high perveance, which insures

high plate efficiency; their compact structure, which minimizes stray inductances; their low plate voltage requirement, which reduces the cost and complexity of the tank circuits as well as the power supplies; and their low filament-power requirements. All power amplifier tank and output circuits use all-copper variable vacuum capacitors with 20-to-1 capacitance ranges. A

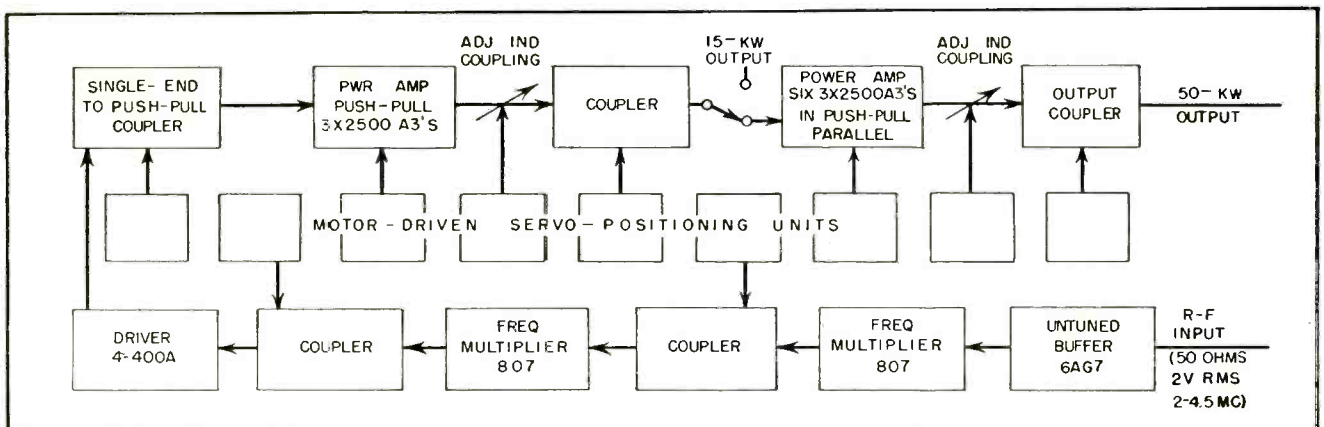

Motor-driven servo-positioned adjustments are controlled from front panel. Seven of these adjust continuously variable resonant circuits; the other two adjust output coupling of the final and driver

block diagram, presented on the preceding page, illustrates the functions of the nine motor-driven servo-positioned adjustments. Seven of these adjustments are continuously-variable resonant circuits. These circuits are mechanically driven by small low-inertia two-phase reversible motors geared so that approximately 2,000 revolutions of the motor will carry the circuit through its complete range. The motors are controlled by relays through a servo-positioning system to be described.

Probably the most interesting circuit and definitely the most difficult to develop, is the 50-kilowatt plate tank and output coupler.

The plate tank circuit consists of two 25 to 500- $\mu\text{f}$  variable vacuum capacitors (Jennings Type UXC), two oppositely wound variable inductors mounted with their axes parallel and vertical, the output capacitance of the amplifier tubes, and the connecting lead inductance. The amplifier tubes themselves are mounted in two groups of three paralleled tubes each to form a push-pull circuit. Three tubes are mounted in a common 11-inch diameter anode housing which in turn is connected to one vacuum capacitor and one inductor by a wide conductor. In order to minimize the self-inductance of this connector, and at the same time obtain reasonable mechanical spacing between components, a grounded box structure was placed between the two conductors while the conductors were made as wide as practical. The effect was to form a very low impedance transmission line section between the tubes and the inductors. By this expedient it was possible to transfer a sufficiently large portion of the required in-

ductance at 26 mc to the tank inductors where it could serve a useful purpose for coupling to the output network. This box structure also provided a very convenient means of distributing cooling air to the tank circuit components.

The coils remain stationary and the drum-supported contact assembly is rotated. Three sliding contacts are mounted on the top edge of the drum and arranged to match the pitch of the copper coil. These contacts have a small amount of vertical and lateral freedom and are spring-and-cam loaded so they maintain balanced downward and outward pressure with the weight of the drum providing the loading force. The drums are centerless except for the driving spline at the bottom. A second set of contacts is mounted on a cross-connecting plate to tie the drums of the contacts of the two coils together. The drums and cross-connecting plate are made as large as practical to reduce the stray inductance in the cross-connecting path.

The contacts themselves are hardened beryllium copper clips heavily chrome plated and may be easily removed for replacement. A hard contact surface was found to be necessary to prevent chattering and burning which always occurred when softer materials were used against the copper coil.

### R-F Amplifiers

Since this is a grounded-grid amplifier, the input voltage is applied between cathode and ground or, because it is a balanced push-pull circuit, between the common cathode terminals of the two groups of three tubes. The input impedance is quite low being in the order of 100 ohms balanced. Effective r-f isolation of the filament terminals from ground is provided by a composite r-f choke consisting of six filament wires inside of a copper tube which in turn is formed into a helix. One such choke is used for each group of three tubes. The six filament wires provide three individual circuits so that each tube may be independently metered and protected. In each three-tube group all filament terminals are capacitively coupled to the r-f input terminal. The

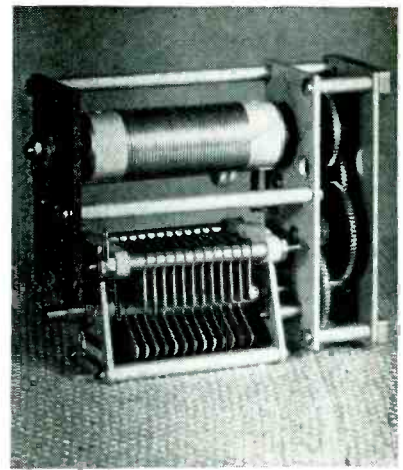

Rotating coil and variable capacitor of frequency multiplier tank circuit are adjusted by gear train at right

output coupling network of the intermediate amplifier is then coupled through a short transmission line to these input terminals.

The intermediate amplifier output may be coupled directly to a 600-ohm antenna transmission line and the first two units operated as an independent 15-kw transmitter.

The intermediate amplifier plate tank and output coupling circuit is very similar to, although physically smaller than, the 50-kw amplifier plate tank. It is this output coupler which supplies the input voltage for the power amplifier. It was not practical to design this output coupler with the midpoint of its capacitance branch grounded, therefore, a pair of variable air capacitors is connected from each amplifier input terminal to ground to provide the necessary low impedance path to ground for the power amplifier plate current pulse. This variable capacitor assembly is directly connected to a front panel control and is set to produce an approximately constant shunt reactance as the frequency is varied. It is set up directly from a frequency chart and is not adjusted as part of the tuning procedure.

Very low inductance connectors are required from the variable capacitors to the common filament terminals to push the natural resonance of the circuit thus formed above 52 mc, the second harmonic of the highest operating frequency. Several other places in this coupling circuit required carefully de-

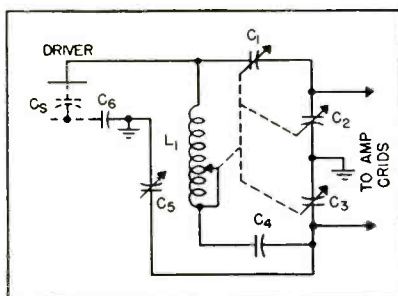

Single-ended to push-pull coupler used between driver and intermediate power amplifier uses two identical capacitors in a capacitance voltage divider

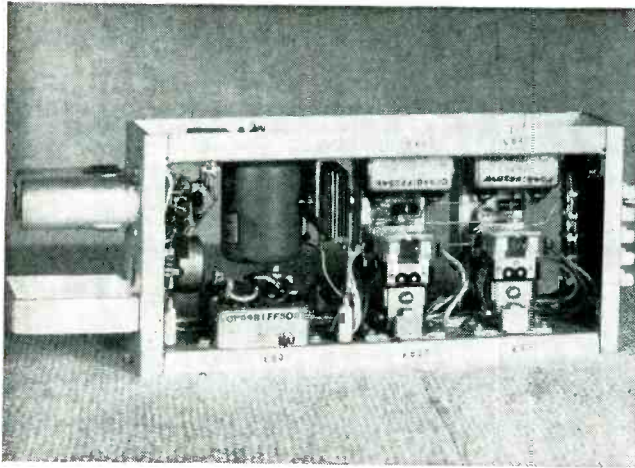

Nine of these servo control amplifiers and relay units enable operator to make all adjustments at front panel of transmitter when changing frequency

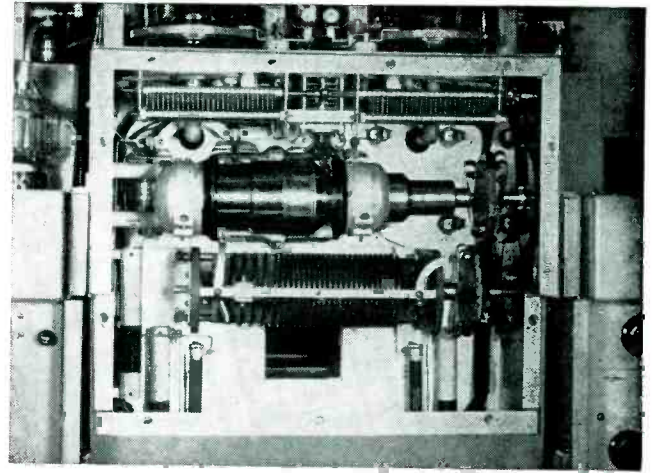

Variable inductor, two variable air capacitors and one vacuum capacitor are coupled together and driven through gear assembly visible at right

vised arrangements to prevent such resonances.

The most unique coupling circuit in this equipment is the one between the 4-400A single-ended driver and the push-pull intermediate power amplifier. This is a single circuit which simultaneously provides the single-end to push-pull conversion, a five to one impedance change, and a resonant tank for the driver stage.

The circuit of this coupler shows  $L_1$ ,  $C_1$ ,  $C_2$  and  $C_3$  to be variable elements mechanically coupled together to form a continuously-variable resonant circuit. Capacitor  $C_1$  is a d-c blocking capacitor only. The ratio  $C_2/C_1$  is maintained at approximately 5, which is the required ratio between driver plate voltage and amplifier grid voltage. Since  $C_3$  is identical to  $C_2$ , the grid voltages will be 180 degrees out of phase and identical in value when  $C_1$  is adjusted to pass all of the current that flows in  $C_2$ , the stray tube and wiring capacitance.

### Servo-Positioning System

Each of the variable circuits is motor driven and controlled from the front panel through a simple servo-positioning system. The motors themselves are small, high-torque, low-inertia, two-phase units operated by two sensitive relays. The positioning system is an a-c bridge type in which the front panel control is a voltage-dividing potentiometer which constitutes two of the arms while a second identical potentiometer coupled to the driven

circuit constitutes the remaining bridge arms. Identical voltages are applied across the potentiometers so that any difference in position between the manually-set front-panel control and the driven circuit results in a voltage difference between the movable arms of the potentiometers. Since this is an a-c bridge the output voltage will have a 180-degree phase difference between unbalance in one direction and unbalance in the opposite direction and thus provide a sense to the system.

This voltage could be coupled through a transformer to the grids of a pair of control tubes whose plate circuits each contain a relay—one for forward and the other for reverse operation of the motor. If these tubes are operated with a common a-c plate voltage of the same frequency and phase as the applied bridge voltage then only that tube which has a positive grid voltage swing while the plates are positive will conduct and close its relay.

In the actual equipment a voltage amplifier is inserted between the bridge output and the control tubes to increase the setting accuracy. This voltage amplifier, the control tubes, the relays and their associated components are assembled on a small chassis and arranged as a plug-in unit.

Operating efficiency and ease of tuning have been very gratifying. Overall efficiency (a-c power input to r-f power output) varies from 55 to 60 percent at 50-kw output.

The apparent efficiency of the grounded-grid power amplifier measures 95 percent, at the low-frequency end, down to 89 percent at the high-frequency limit. The intermediate amplifier operating independently will deliver 16 to 18 kw at efficiencies ranging from 77 to 83 percent over this same range. The combined efficiency of the intermediate and the power amplifier varies from 74 to 71 percent over the frequency range. The efficiency figures at the low-frequency end are very nearly the calculated maximum tube efficiencies for the operating conditions. The drop off in efficiency at the high-frequency end is to a large extent the result of tank and output coupler losses. This means that these losses amount to approximately 3 kw at 26 mc.

### Operation

Changing operating frequency does not involve the mad scramble to change shorting straps, plug-in capacitors, neutralizing circuits, or complete inductance assemblies so familiar to operators of this class of equipment. The control dials are simply rotated to the set-up figures corresponding to the new operating frequency, power is applied, and plate circuit resonances checked. The tune-up procedure for new uncharted frequencies is almost as simple. The control dials are set to the approximate dial reading selected from the tuning curves and a simple straightforward tuning procedure is followed.

# Versatile X-Ray Intensity

This practical device permits rapid exploratory measurements, continuous monitoring or work involving a large number of readings within a short time. Detector probe may be carried by hand for portable applications or permanently mounted for gaging thin materials during production

**A** DIRECT-READING x-ray intensity meter was desired that would be sufficiently sensitive to indicate the leakage radiation from lead-protected production-line "ray-proof" housings. This implies a sensitivity of the order of 0.2 roentgen (r) per hour, about 5 milliroentgens per minute, at one meter from the target of an x-ray housing.

It was also desirable to measure the full r output from a beryllium window x-ray tube, previously described by Rogers' as a high-energy source of long-wavelength x-rays. At 10 centimeters from the tube target, the intensity of the Machlett OEG-50T tube of this type is about 58,000 r per minute. A reasonable calibration was required to be maintained over the wide range of x-rays from about 0.05 angstrom unit (260,000-volt deep-therapy tube) to about 5 angstrom units (thin beryllium window tube operating at 3,000 to 5,000 volts).

After passing through several development stages, the direct-reading r meter described herein was evolved. It consists of an electrometer tube and a triode d-c amplifier, a power supply, and a pair of ionization chambers, one for high-intensity work with direct radiation, and one for low-intensity work involving measurement of scattered or leakage radiation.

## Circuit Operation

Referring to the circuit of Fig. 1, a beam of x-rays entering the ionization chamber through one of its

windows partially ionizes the air in the chamber in proportion to the amount of the radiation absorbed in the air. Since a potential difference is maintained across the chamber by the B supply, a current flows through load resistor *R*, this current being proportional to the number of ion pairs produced in the chamber, assuming that all are collected. This, in turn, is proportional to the chamber volume.

The signal voltage appearing at the 959 No. 3 grid (which is its signal grid in this application) is proportional to the amount of the x-ray beam absorbed per unit volume, to the chamber volume, and to the load resistor *R*, provided that the effective resistance of the chamber while measuring the beam intensity remains high enough so that it, and not the load resistor *R*, determines the current through *R*. Since the International Roentgen Unit (r) is defined in terms of the amount of energy absorbed in one

cubic centimeter of air at certain standard conditions, the chamber must be so designed (or calibrated) that its indications may be interpreted in terms of international r units.

The high voltage is supplied from a conventional full-wave rectifier regulated by VR-105 tubes, and supplied from the a-c line through a Sola constant-voltage transformer. This double regulation has been found to remove all traces of line-voltage fluctuation from the B supply. The 6J4 heater is supplied from a winding of the same transformer, and is therefore also regulated. The 959 filament voltage was initially supplied from a well-filtered rectifier system but this was not found to be satisfactory in that a rapid and random fluctuation was observed. Operation of this tube on a-c is precluded by the hum voltage introduced, and so a battery supply was added for this tube alone. Provision was made for adjusting the filament voltage to a predetermined value, which may be checked as often as required on the panel meter by a push-to-calibrate button.

## Electrometer Probe

The x-ray detector head consists of the ionization chamber with the electrometer stage in a lead-shielded compartment. This head is carried by hand in probing for x-ray leaks. The voltage developed by the chamber is detected by the electrometer tube and is supplied to the 6J4 d-c amplifier.

Since resistor *R* is of the order

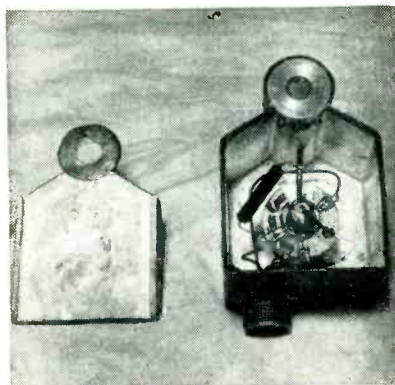

Detector probe contains a one-cubic-centimeter ionization chamber and an acorn preamplifier

# Meter

By **WILLIAM B. LURIE**

*Machlett Laboratories, Inc.  
Springdale, Connecticut*

of  $10^8$  to  $10^{11}$  ohms (100 to 100,000 megohms), each chamber must be so constructed that the leakage path between electrodes provides a leakage resistance large compared with these values. Likewise, the 959 tube must be operated at electrode voltages such that its signal grid current is small compared with the  $10^{-12}$  ampere or so of ionization current which flows. The electrometer tube is operated with about 0.7 volt across its filament, conventional control grid tied to filament (positive end), screen grid at about 7 volts positive, suppressor grid (acting as signal grid) at about 5 volts negative bias, and about 7 volts positive on the plate.

Since stock 959 tubes are used, with no special selection, different tubes must be operated at different voltages to produce the same plate current. It is necessary, in changing tubes, to keep the plate current the same in order to keep the same operating bias on the 6J4 tube.

In practice, each chamber has its own preamplifier permanently attached to it, to avoid making and breaking, even with low-leakage connectors, the very highly insulated chamber collecting electrode connection. To adjust the 959 plate current to the desired point, its filament voltage is adjusted to bring the 6J4 bias, and therefore plate current, into the range which can be handled by the zero set. This has been found to be preferable to either using the same preamplifier with all chambers, or disturbing several of the 959 and 6J4 electrode voltages by resetting them for each

chamber at the time of change.

The 959 plate is returned through 3.9 megohms to ground, giving it effectively 200 volts as plate supply, since its filament is maintained at about 200 volts below ground. The change in voltage across this resistor with signal is applied directly to the 6J4 grid, this tube type having been chosen for the d-c amplifier because of its extremely high transconductance at reasonable plate voltages. The 6J4 steady-state plate current is bucked out, and its change is read on the d-c microammeter in its plate circuit as an indication of the x-ray intensity.

## Indicator

The limit of sensitivity of the d-c microammeter is imposed by the stability of its needle in x-ray-free regions. The 6J4 plate current is adjusted to 10 milliamperes, at which operating point the tube has a transconductance of about 12,000 microhms, or 12 ma per volt. A millivolt appearing at its grid, due to a sudden thermal or electrostatic

change, or even random r-f pickup, produces a  $12\text{-}\mu\text{a}$  displacement of the zero position of the meter.

The complete instrument has been found to be quite stable after warmup even when operated in the same room as, and from the same power line as, a 280,000-volt 15-ma constant potential x-ray generator with an exposed aerial system.

To change the full-scale sensitivity of the instrument, the microammeter may be shunted to, say, 200, 500, 1,000 and 2,000  $\mu\text{a}$  full scale, provided that the chamber is not permitted to saturate (produce more ion pairs than can be collected in its volume at the operating voltage), and provided the 959 and 6J4 tubes are not operated beyond their regions of linearity. Beyond these limits, the chamber volume and voltage must be suitably adjusted.

Since the small one-cubic centimeter chamber does not saturate up to a very high x-ray intensity, the chamber load resistor may also be changed to vary the full-scale sensitivity of the instrument. Resistors of 100 megohms, 1,050, 10,-

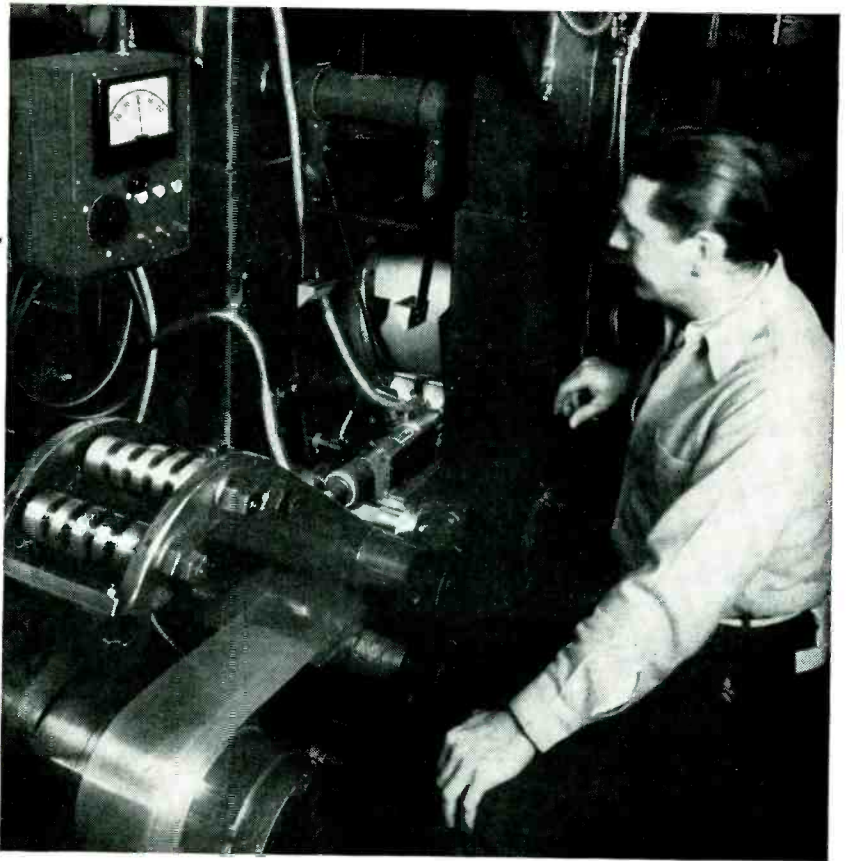

Typical installation of x-ray gaging equipment in a rolling mill, to measure the thickness of brass being rolled. The instrument described in the text can be used in similar applications by mounting the detector probe under the moving strip

500, 55,000, and 185,000 megohms have been used with the chambers and amplifiers described. Thus, without changing the chamber volume or voltage, by shunting the meter and changing load resistors the full-scale sensitivity is varied over a range of 37,000 to one.

### Meter Circuit

The meter shunt circuit is somewhat novel, in that its requirements are that the resistance inserted into the 6J4 plate circuit by the meter and its shunts must be the same on any range, and that the meter not be damped by plain resistance shunting. This is achieved by using a 100- $\mu$ a, 360-ohm movement as a millivoltmeter. A voltage drop of 50 millivolts from the 6J4 plate to the main voltage divider will produce 100  $\mu$ a of current (full scale) through the meter and its lowest series resistor, the total resistance being 500 ohms. On the next range, ( $\times 2$ ) the total resistance is still 500 ohms, with 100  $\mu$ a through the meter and its multiplier resistor, totalling 1,000 ohms, or 100 millivolts drop, and 100  $\mu$ a through the 1,000-ohm shunt. In this manner, no low-ohmage resistances are placed directly across the meter, and the movement remains essentially undamped.

With the 1-cc chamber used for direct radiation measurements, the full-scale sensitivities in r units per

minute are as follows:

Chamber load resistor (megohms)	Microammeter range			
	0-100	0-200	0-500	0-2,000
100	53	106	265	1,060
1,050	5.02	10.04	25.1	100.4
10,500	0.5	1.0	2.5	10.0
55,000	0.095	0.19	0.48	1.9
185,000	0.028	0.057	0.14	0.57

The full-scale sensitivity with this size chamber is then variable between 1,000 or more r per minute and about 1/40 r per minute (1.7 r per hour) full scale. When used with a 200-cc chamber, for detection of leakage radiation, the sensitivity with the 55,000-megohm load resistor is about 30 milliroentgens per hour, and, though less stable, is still quite usable for detection and estimation of the leakage from "rayproof" housings.

### Chamber Construction

Each chamber and preamplifier compartment is shielded from x-rays except where the primary x-ray beam passes through. This is accomplished by covering the entire assembly with sufficient lead to reduce the intensity in undesired places to a negligible value for the hardest (highest voltage) x-rays for which the chamber is used.

To permit simple interchangeability of load resistors, the interior of the preamplifier compartment is made accessible. The cover of the box can be taken off by removing four machine screws

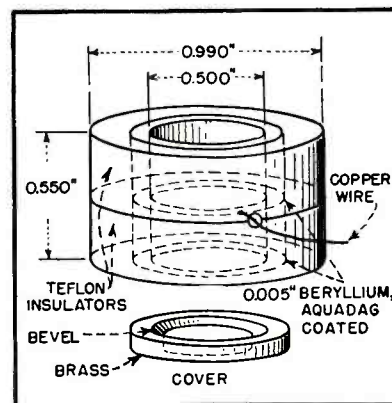

FIG. 2—Construction of ionization chamber. This assembly fits into a one-inch brass cylinder with top and bottom covers

tapped from the side so that the lead top of the box remains integral.

The chamber electrodes are beryllium disks 0.005-inch thick, beryllium being the most workable conductor of low atomic number and therefore low x-ray absorption. The center or collecting electrode is sandwiched between two annular rings of teflon, which in turn are sandwiched between the top and bottom covers of a brass pill-box, the whole assembly (other than the top and bottom) being lead covered. A hole is cut in the side of each piece of teflon, through which a lead is brought for the application of voltage to the center electrode. To this lead a brass sleeve is soldered

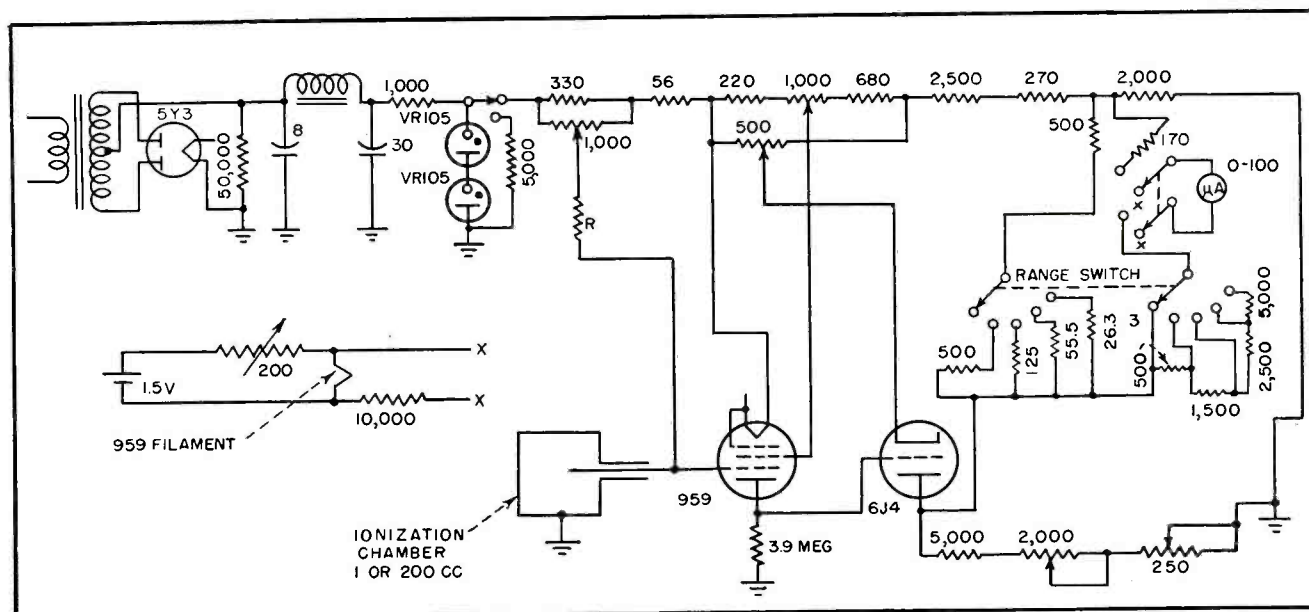

FIG. 1—Complete circuit of meter includes an ionization chamber, electrometer tube, sensitive d-c amplifier and inverted power supply



which fits over the suppressor-grid pin of the 959 tube. The leakage path to ground from this point is over the surface of, and through, the 959 tube, over the surface of the load resistor which is soldered to the brass sleeve, and over the surface of the teflon insulators in the ionization chamber.

A steatite socket with the  $g_3$  region cut off is used for the electrometer tube. This eliminates the socket as a source of leakage. The load resistor is placed inside the preamplifier compartment, so that it is shielded from hum pickup and capacitive leakage. The plate load resistor of the electrometer stage is mounted on the amplifier chassis, since at its level hum pickup and leakage are less likely; it is still shielded by the amplifier cabinet, chassis, and bottom plate.

In its present state, the equipment has been used for over a year, with no modifications or repairs other than battery replacement. During this period it has been used for a variety of tasks. The direct output of a new very-low voltage beryllium window tube for Grenz-Ray therapy was measured at only 3,000 volts anode voltage, and was found to be about 0.03 r per minute per milliamperere of tube current, at a distance of 10 centimeters from the tube target. The same tube was used at 25,000 volts, at which point the total x-ray output was 1,010 r per minute per milliamperere, as measured with the same ionization chamber.

Shockproof and "rayproof" housings were also tested, with the leakage radiation at 50 centimeters from the x-ray tube target known to be about 0.1 r per hour. In this case, it was of interest to probe around, to locate the regions on the housing from which the radiation was emanating, and to determine its direction of emergence. The 200-cc chamber served well for this purpose.

Since this detection method is quite sensitive to long-wavelength x-rays, which are readily absorbed by even thin layers of matter, and since compact, rugged sources of these x-rays are now available in the form of beryllium-window tubes, the combination may be used for thickness gaging of very thin sheets of material such as metal,

plastics, paper and coatings.

At present, a high-voltage x-ray tube (the OEG-50) is used for continuous, non-contacting gaging of the thickness of steel plate, brass, copper, and aluminum while being rolled in a rolling mill at thousands of feet per minute. The roll pressure is continuously adjusted to maintain the plate at uniform thickness while the operator observes the thickness deviation on a large zero-center meter. The accuracy of this method of gaging has been quoted as being within one percent (within 0.0002 inch, for example, on 0.020-inch sheet brass).

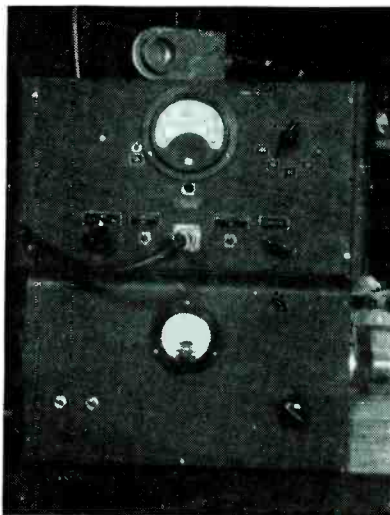

Complete x-ray intensity meter with power supply at bottom and 200-cc probe unit on top of case

By using the newly developed EG-25 x-ray tube, the thickness or freedom from tears of rolled paper may be checked, or of cellophane, or of aluminum foil 0.0005-inch thick, or thinner, of plastic sheet, of paper coating or even of paint or lacquer thickness. The same or better accuracy should be obtainable with the r meter described, since even a slight variation of the thickness of the material will produce a pertinent change in the x-rays transmitted, provided the total intensity of x-rays at the detector is sufficient to be measured. The use of an x-ray tube as a source in such a gage is further advantageous in that the voltage and therefore penetrating power may be adjusted to the optimum value for the material being gaged,

the tube current and therefore total intensity of radiation may be adjusted to the level necessary for the thickness of material being gaged and the intensity level is high enough for simple, stable, fast-acting detector systems.

### Calibration Method

In calibrating any x-ray measuring instrument, some reference standard is necessary. In this case, the standard was a Victoreen 250-r nylon chamber, which has been calibrated by the National Bureau of Standards (Research Paper 1926) at voltages as low as 10 kilovolts. The direct-reading r meter was calibrated directly against the Victoreen r meter for voltages down to 10 kv. Below this voltage, the 10-kv calibration factor was used, with an added correction applied for absorption in the chamber window (0.005-inch beryllium) and in the center electrode of the same material. This factor becomes rather large at long wavelengths, being about 2 at 4 angstrom units and 4 at 5.3 angstroms.

No satisfactory standard exists against which to calibrate at these wavelengths, and so the exact calibration for every long wavelength is only approximate. The instrument is still usable, however, even for voltages as low as 3 kilovolts (4 angstroms and longer) for comparisons between tubes, between tube types, for thickness gaging and for filter and radiation quality determinations.

The instrument is easily carried about by one person, and maintains its calibration over long periods of time. The only apparent disadvantages it possesses are a rather long warm-up and stabilization time, for about the first quarter-hour of operation, and a rather long time constant when the 185,000-megohm and larger load resistors are used. Neither of these, however, is objectionable.

The author wishes to express his appreciation to Machlett Laboratories, Incorporated, for permission to publish this report on its engineering development.

### REFERENCE

- (1) T. H. Rogers, High-Intensity Source of Long Wavelength X-Rays, *Industrial Radiography*, 4, p 35, Winter 1945-6.

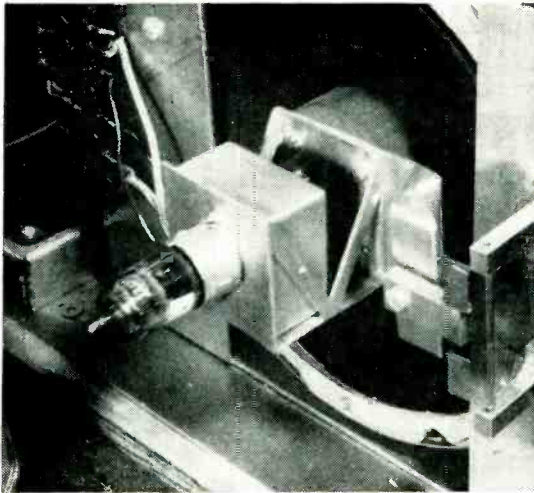

Vibration is imparted by a loudspeaker cone. Tube may be rotated ninety degrees for sidewise vibration

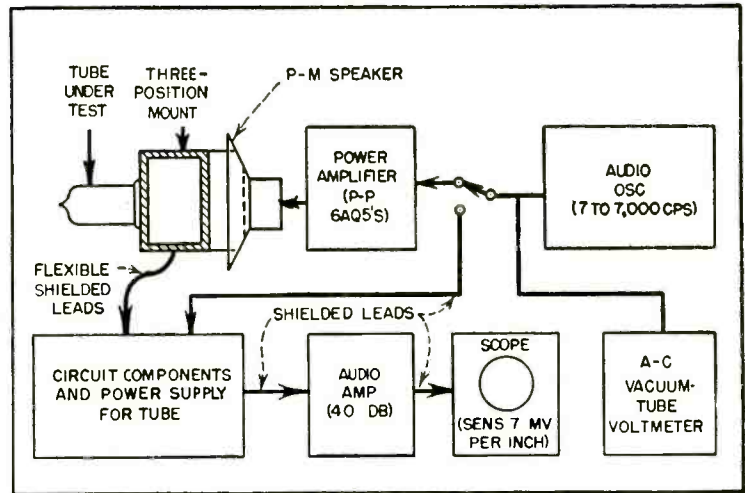

FIG. 1—Vacuum-tube voltmeter measures oscillator voltage required to match microphonic output (with no signal input) of tube under vibration

# Microphonics Tester

Convenient setup for quantitative determination of the effects of varying degrees of mechanical vibration on vacuum-tube operating characteristics. Components used are practically all standard laboratory equipment. A p-m loudspeaker imparts vibration

By **NORMAN ALPERT**

*Servo Corporation of America  
New Hyde Park, N. Y.*

**M**ICROPHONICS are inherent in all types of vacuum tubes. Their existence presents a formidable problem when it is necessary to measure or detect signals which are of the order of 1 to 10 microvolts. The equipment described here was designed to obtain quantitative information about various tube types and the effects of varying degrees of mechanical vibration on their operating characteristics. The setup is made up of standard laboratory parts, with the exception of a few special, but simple, jigs and fixtures.

Figure 1 is the block diagram of the complete microphonic test apparatus. The tube under test can

be vibrated sinusoidally in any plane parallel or perpendicular to its base by means of a mounting bracket which is connected to the cone of a loudspeaker. This bracket is shown in the close-up photograph of a tube being vibrated.

## Procedure

The test procedure is as follows: The tube to be tested is connected to the speaker-driven bracket, and the output of the audio oscillator is fed into a push-pull 6AQ5 audio amplifier (Fig. 4) which drives the speaker. The oscillator frequency can be varied from 7 to 7,000 cps.

With no input to the tube under test, any output measured by the cathode-ray oscilloscope will be the result of microphonics caused by the vibration imparted by the speaker. The magnitude of this

microphonic output is noted. The oscilloscope used has a sensitivity of 7 mv rms per inch with its associated 40-db audio amplifier.

As seen in the circuit diagram of Fig. 2, the resistive component of the grid circuit impedance of the tube under test is about 10 ohms. Johnson noise is therefore virtually eliminated in the grid cir-

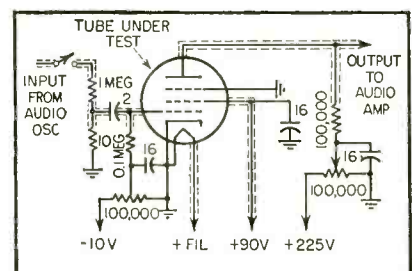

FIG. 2—Tube voltages are furnished by batteries through shielded flexible leads

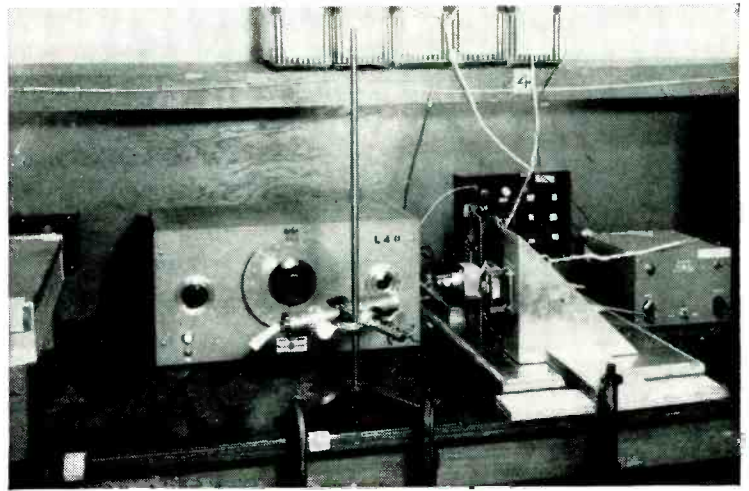
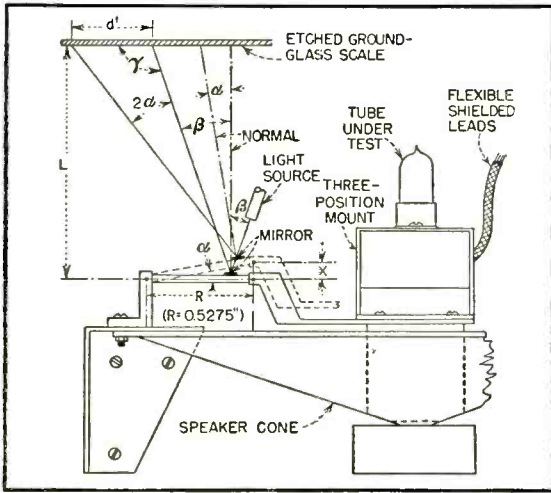

FIG. 3—Optical lever system with dimensions exaggerated for clarity. In actual test setup,  $L$  is four feet

Distance tube moves during vibration is determined by width of light band reflected onto etched glass scale visible at extreme left of photograph

# for Vacuum Tubes

cuit. The d-c grid bias and plate voltage can be adjusted for suitable quiescent conditions.

After the amplitude of the microphonic output of the tube has been noted, the audio oscillator is removed from the speaker-driving amplifier and applied to the grid of the tube under test (attenuated 100 db). The oscillator output is adjusted to give the same output on the oscilloscope as was noted with the tube being vibrated with no signal input. The magnitude of the audio oscillator output is then measured with a vacuum-tube voltmeter and recorded as the effective microphonic noise referred to the grid.

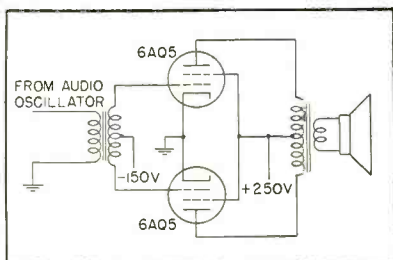

FIG. 4—The speaker is driven at various frequencies by a pair of 6AQ5's

The acceleration imparted to the tube is calculated by noting the frequency and measuring the amplitude of vibration by means of an optical lever system similar to that used with standard wall-type galvanometers. The light source is composed of a condenser and a projector lens in conjunction with a reticle which allows light to pass through a tiny 0.00625 by 0.025-inch rectangular opening. Light is focused on a small mirror which is cemented to a linkage plate that rotates when a lever arm moves in and out with the speaker cone assembly. The light is reflected from the mirror and is observed as a band of light through an etched glass scale placed four feet away.

From the expression for sinusoidal motion, the acceleration  $a$  is given by

$$a = \omega^2 x = 0.1 f^2 X$$

where  $a$  is the acceleration in G's,  $f$  the frequency of vibration in cps, and  $X$  the displacement from center or neutral position in inches.

If  $\alpha$ , as shown in Fig. 3, is small, the rays of reflected light can be considered to emanate from the same point on the mirror. Also,

with  $\beta \cong 12$  deg and  $L = 4$  feet, the error in assuming  $\tau$  is a right angle is less than 5 percent. Hence on this assumption

$$\tan \alpha = \frac{X}{R}$$

$$\tan 2\alpha = 2 \tan \alpha = \frac{d'}{L}$$

$$X = \frac{Rd'}{2L}$$

where  $d$  is the peak-to-peak deflection on the scale in cm ( $d' = d/2$ ), then

$$X = \frac{0.5275 \times d}{2 \times 2L \times 2.54} = \frac{0.052 d}{L}$$

where  $L$  is the distance between scale and mirror, and  $X$  is the displacement of the tube in inches as required in the acceleration formula.

Since the amplitude of vibration for frequencies above a few hundred cycles is extremely small, the acceleration for frequencies above about 200 cps can only be roughly determined.

The optical lever system is capable of measuring displacements as small as 0.001 inch with good accuracy.

# The ELECTRON COUPLER

## A Spiral-Beam UHF Modulator

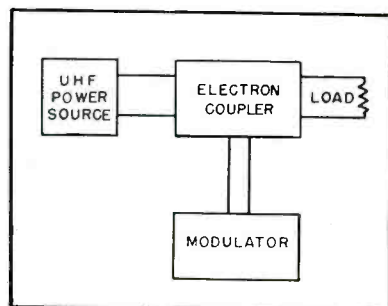

FIG. 1—Basic electron coupler circuit

By **C. L. CUCCIA**  
and **J. S. DONAL, Jr.**

Research Department  
RCA Laboratories  
Princeton, New Jersey

**T**HE ELECTRON COUPLER is a developmental tube which utilizes several new principles for the amplitude modulation of high power at the ultra high frequencies. These new principles arise from the use of spiral electron beams to transfer uhf power from an input system to an output system. This is a true energy transfer device since conversion from direct-current energy to alternating-current energy is not involved, only the input uhf power being available to the output system. Control factors based on the behavior of the electron beam during the power transfer may be used to control the transfer.

At low frequencies, modulation and control of power is obtained by using triodes and multigridd vacuum tubes. High power outputs are usually obtained by starting with a lower power oscillator whose frequency is carefully controlled and then building up to high power using a cascaded set of power amplifiers. Used in this manner, the

tubes are unilateral control impedances in that, in addition to amplifying, they prevent variations in the output circuit from being transmitted back to the input. Such unilateral characteristics are extremely important since the primary oscillator should not be pulled in frequency during a modulation cycle as this causes distortion. In the uhf region, power is obtained in a different manner. Compact high efficiency generators, such as magnetrons, contain virtually the entire oscillator circuit within their envelopes.

Such uhf tubes are capable of working at very high power levels, and may be frequency stabilized during continuous-wave or pulse transmission by using spiral electron beams<sup>1, 2, 3</sup> or external stabilizing cavities for frequency control.<sup>4</sup> Since high power is readily available, power amplification is a factor which is not as important as control of the power. Magnetrons, for example, are difficult to amplitude modulate without attendant frequency modulation. It is for the

purpose of providing a means of electronically controlling this uhf high power that the electron coupler was developed. The tube, a two-cavity device with one electron beam, has the characteristics of a nonamplifying unilateral control impedance.

### Physical Characteristics

The electron coupler is a spiral-electron-beam tube consisting essentially of two adjacent cavities which are coupled by an electron beam. The input cavity is connected to the generator and the output cavity is connected to the load, as shown in Fig. 1. A basic configuration using suitable resonant cavities is pictured in Fig. 2 where the arrangement is seen to include a collector and a magnetic field parallel to the axis of the cavities. It is assumed that there is no electromagnetic coupling between the input and output cavities. Power is absorbed by the electron beam in the form of spiral or rotational energy in the first cavity. The rotational energy is in addition to the

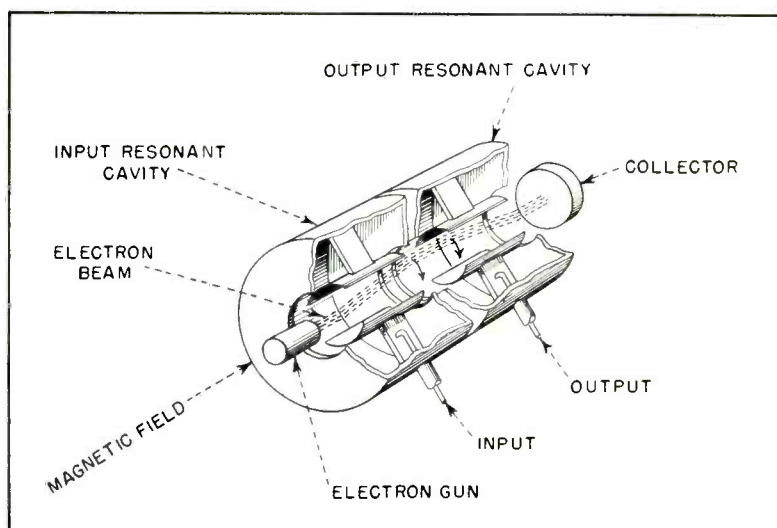

FIG. 2—Internal structure of electron coupler tube

Based on a paper presented at the 1949 National IRE Convention in New York.

A two-cavity tube, consisting of an electron gun, two axially mounted cavities and a collector, is used to modulate uhf power. Placed between r-f generator and load, the r-f energy is imparted to the beam in the form of rotational energy with a transfer efficiency of 70 percent

energy due to a direct-current beam potential which transports the electrons through the tube and determines their transit time.

### Resonance Characteristics

The resonant frequencies of the input and output cavities and the frequency of the input power are adjusted to the cyclotron frequency. This frequency is

$$f_c = 2.794H \times 10^6 \quad (1)$$

where  $H$  is the magnetic field intensity in Gauss and  $f_c$  is the frequency in cycles per second.

The resonant cavities which are used in the electron coupler have the particular property of introducing an alternating electric field whose direction is transverse to the path of the electrons through the cavity. Each of the cavities pictured in Fig. 2 has this property and consists essentially of a pair of capacitance plates which are connected to an inductance loop. This cavity design is particularly useful because it is simple and tunable. In the electron coupler, which uses two of

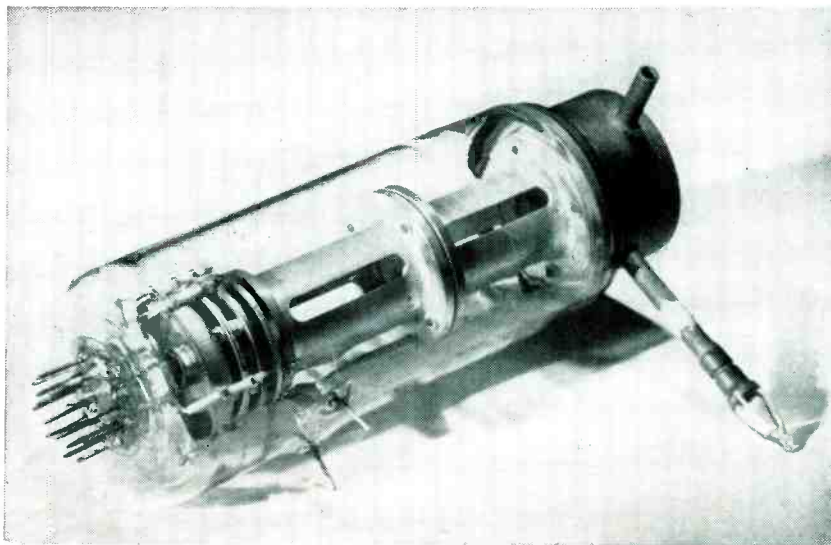

FIG. 4—Experimental tube simulating beam region of the electron coupler

such cavities, complete decoupling may be achieved by rotating one cavity to a position so that transverse electric field in one cavity is in quadrature with the transverse electric field in the other. In addition, such cavities may be designed to be short compared to the wavelength of operation. This is an im-

portant practical consideration since a magnetic field must pass through the tube thereby necessitating the use of an electromagnet or a solenoid.

### Input Cavity Action

In Fig. 3A, 3B and 3C, it is seen that the electron trajectories in the input cavity are all the same. The major function of the cavity is the absorption by the electron beam of the uhf power. As the electrons pass through the input cavity, the frequency of the input power being equal to the cyclotron frequency, an absorption of energy by the beam takes place in increments of increasing magnitude as the electrons progress through the tube. Since this continued absorption can only take place if the electrons, regardless of where they may be in the cavity, see an accelerating electric field at all times, all electrons will lie on the line-directrix of a cone as shown.

The beam spins with angular velocity  $\omega = 2\pi f_c$  and is phased with respect to the transverse electric field. When this field is a maximum

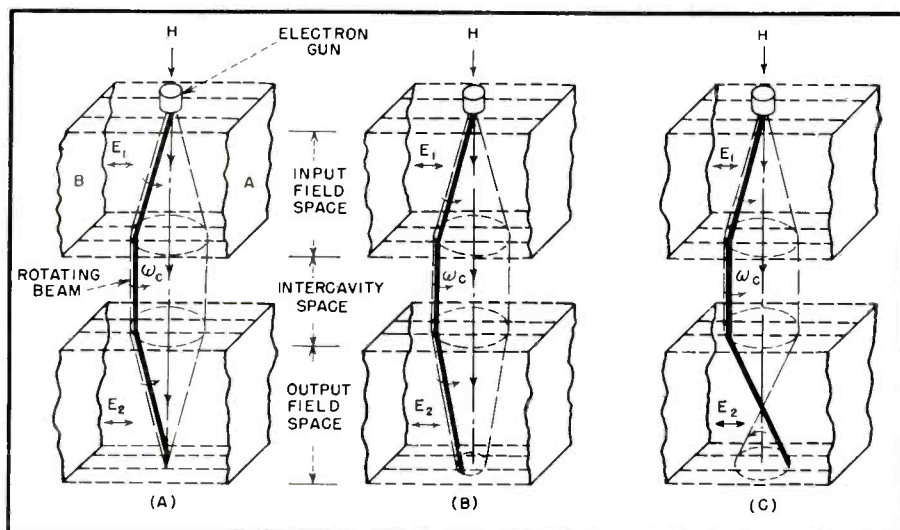

FIG. 3—Beam configuration in the tube for three different values of transit time or loading

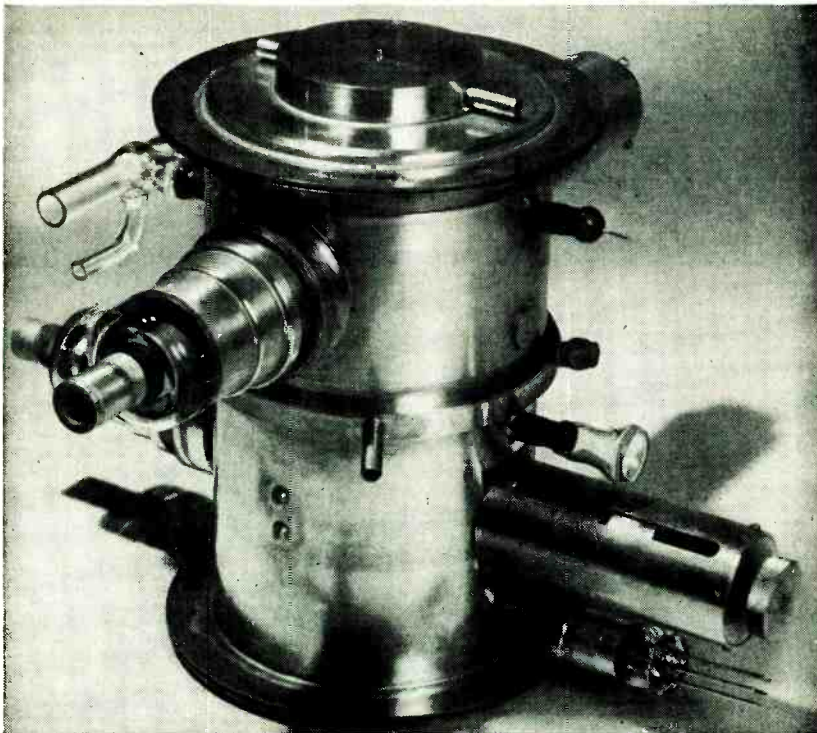

FIG. 5—Experimental electron coupler, showing both input and output sections

and when, for example, its gradient is positive from poleface *A* to poleface *B*, the electron beam will be midway between the polefaces and rotating in the direction from poleface *B* to poleface *A*. A quarter cycle later, when the transverse field amplitude is equal to zero, the electron beam is passing in closest proximity to poleface *A*. The electron beam continues to rotate between the polefaces with an ever widening radius. When the electrons leave the cavity, they will have attained a maximum spiral radius which will correspond to a certain amount of rotational energy.

As the electrons pass through the intercavity space after emerging from the input cavity, no energy is imparted to or extracted from the electrons since no transverse electric fields are present here (in an ideal tube). Each electron pursues a helical path through the region at a transit velocity prescribed by the beam potential and for a beam of vanishingly small cross section, all the electrons form a cylinder-directrix extension of the cone directrix beam as shown in Fig. 3. The electrons enter the output cavity with the same spiral radius which they

had when they emerged from the input cavity.

#### Output Cavity Behavior

As the rotating electron beam passes through the output cavity, by virtue of the fact that these electrons represent an oscillating space charge with periodicity  $f_c$  between the pole faces, an induced current is produced in the load of the output system. In general, the incremental current induced between a pair of parallel-plane boundaries due to an oscillating charge,  $dq$ , between them is, for an incremental length of travel through these boundaries,

$$dIe^{j\omega t} = \frac{dq}{d} \times v_t \quad (2)$$

where  $d$  is the spacing between the boundaries and  $v_t$  is the transversely directed velocity. The total induced current is

$$i = \int_{\tau=0}^{\tau=\tau_2} dIe^{j\omega t} \quad (3)$$

where the integration is carried out for the total transit time,  $\tau_2$ , in the output cavity. If  $e_1$  is the voltage across the input cavity pole faces and if  $e_2$  is the voltage across the output load, the electric field strength,  $E_2$ , in the output cavity due to the induced current flowing

through  $R_o$  is determined by<sup>5</sup>

$$E_2 = \frac{e_2}{d_2} = e_1 \times 2 \frac{l_1}{d_1} \sqrt{\frac{V_{b2}}{V_{b1}}} \times \frac{d_2 R_o I_o l_2}{[8 V_{b2} d_2^2 + R_o I_o l_2^2]} \quad (4)$$

where  $I_o$  is the beam current in amperes,  $R_o$  is the output load in ohms,  $V_{b1}$  and  $V_{b2}$  are the beam voltages in the first and second cavities respectively in volts and  $l_1$ ,  $d_1$ , and  $l_2$ ,  $d_2$  are the lengths and distances between pole faces of the input and output cavities, respectively, in centimeters.

Equation 4 shows that there are two methods available for controlling the power output of the basic electron coupler<sup>6</sup>: beam-current variation and variation of the beam potential,  $V_{b2}$ , which will control the transit time in the output cavity. The transit time control is an important means of producing amplitude modulation since no reaction back to the input cavity is produced—the driving generator sees a constant impedance at all times.

#### Transit Time Characteristics

A discussion of the nature of the beam configuration in the output cavity as a function of transit time is particularly illuminating since it yields insight into the overall operation of the electron coupler. Consider the case when the transit time,  $\tau_2$ ,  $V_{b2}$ , and  $R_o$  are such that the voltage,  $e_2$ , across the pole faces of the output cavity is equal in magnitude but 180 deg out of phase with respect to  $e_1$ . If  $l_1 = l_2$  and  $d_1 = d_2$ , the beam configuration in the output cavity will be an exact image of the beam configuration in the input cavity. This configuration resembles a cone whose apex is at the exit of the cavity, representing a complete extraction of rotational energy from the coupling beam by the transverse electric fields of the output cavity. This case is pictured in Fig. 3A and represents a 100-percent transfer of power to the output load—only the energy due to the beam voltage  $V_{b2}$  remains with the electrons as they reach the collector.

If the transit time  $\tau_2$  is decreased, the electrons will not remain in the output cavity long enough to give up all of their rotational energy and a truncated-cone beam, similar to

that in Fig. 3B, will result. The rotational energy represented by the part of the cone which does not occur between the pole faces, is, of course, lost to the output cavity and goes to the collector. Since the power represented by a certain cone-directrix beam radius will be seen to be proportional to a square of the radius, see Eq. 5, a decrease in radius to one-half represents an absorption of 75 percent of the rotational power in the beam by the output cavity load—the remaining 25 percent going to the collector. For zero power into the output load, the beam radius must not change in the output cavity; all of the input power, goes to the collector. It can be shown that an increase in loading will produce the same effect on the beam configuration as the decrease in transit time.

If the transit time  $\tau_2$  is increased, the electrons will remain in the output cavity longer. The cone directrix beam will converge to zero before the end of the cavity is reached, as shown in Fig. 3C, and the electrons will start to spiral outward again, reabsorbing energy from the cavity field. This reabsorbed energy goes to the collector. However, the convergence point cannot recede into the output cavity beam space more than one-half of the length of the cavity since no more energy can be reabsorbed by the rotating beam than is made available by the entering electrons. A decrease in output cavity loading

may be shown to have the same effect on the beam configuration as the increase in transit time.

Two cases based on the preceding discussion, which represent zero power into the load as a result of transit time variation become important in considerations of output modulation in which the output power or voltage is varied within certain maximum and minimum values in accordance with the rate and swing of the modulating signal. The first is that which takes place when the transit time is decreased, by raising the magnitude of  $V_{b2}$  to such an extent that the electron beam is passed through the output cavity before it can set up a transverse electric field. The other case occurs when  $V_{b2}$  is reduced to such a value that the electrons reabsorb all of the rotational energy from the output cavity field. This latter method is actually not practical because of space charge limitations which will be discussed.

#### Power and Grazing Consideration

The attainment of a certain spiral radius  $x$  by a cone-directrix beam in the input cavity corresponds to an absorption of power in watts which is described by the equation

$$P = 1.122 \times 10^{-2} f_c^2 I_0 x^2 \quad (5)$$

where  $f_c$  is the frequency in megacycles,  $I_0$  is the beam current in amperes and  $x$  is the maximum cone-directrix beam radius in centi-

meters. The spiral radius is related to the parameters of the first cavity by

$$x = 2.36 \frac{E_1 l_1}{V_{b1}^{1/2} f_c} \quad (6)$$

where  $E_1$  is the peak value of the transverse electric field in volts per centimeter,  $l_1$  is the distance which has been transversed by the electron beam in the input cavity and  $V_{b1}$  is the direct-current beam voltage in volts. For the cavity previously described, using a coupling beam of  $\frac{3}{8}$ -inch diameter and 90 milliamperes at 800 megacycles, if  $x = 1.25$ , the value of power which can be absorbed in the input cavity of the electron coupler is

$$P = \frac{1.122 \times 10^{-2} \times 800^2 \times 0.090 \times 1.25^2}{1.010} = 1,010 \text{ watts}$$

This is not a maximum value but is one which is safely within the grazing limits. The cavity pole faces are 6 centimeters long; the beam potential necessary to yield the deflection of 1.25 cm when for example,  $E_1 = 2,000$  volts per centimeter, is found from Eq. 6 to be

$$V_{b1} = \left[ \frac{2.36 \times E_1 l_1}{x f_c} \right]^2 = \left[ \frac{2.36 \times 2,000 \times 6}{1.25 \times 800} \right]^2 = 804 \text{ volts}$$

#### Space Charge Considerations

It is seen from Eq. 5, that the power which can be absorbed by the electron beam in the first cavity is proportional to the beam current. Therefore space charge limitations will have an important bearing on

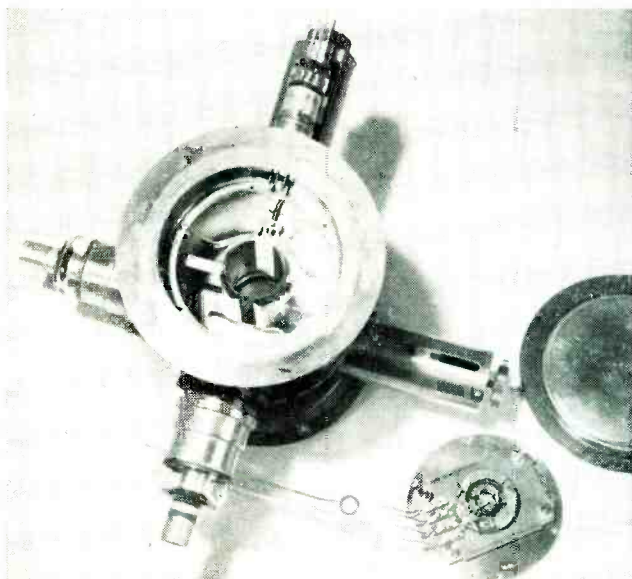

FIG. 6—Internal details of the input cavity

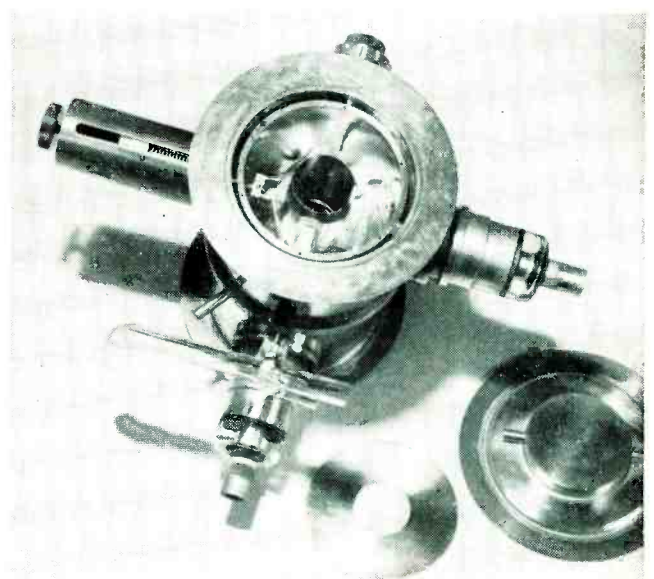

FIG. 7—Internal details of the output cavity

the power handling capabilities of the tube.

If space charge is introduced into a region in which an electrostatic potential exists, this potential will be depressed in the region of the charge. For a particular tube geometry and potential (which is a function of the boundary voltage) there will be a corresponding maximum amount of charge which can be sustained.<sup>6,7</sup> Beyond this amount the potential in the vicinity of the charge will drop to zero and some of the charge will turn back, causing instability.

This maximum value of current corresponds to a particular beam voltage which governs the transit time through the tube and is connected with the power limitations arising from grazing at the pole faces. Even at a stable maximum value of beam current, considerable depression of the space potential takes place. Hence, electrons in various parts of an electron beam of the cross-section determined by the electron gun have different transit times and, because of the direct-current transverse electric field components arising from the potential depression, undergo some translation in position. Therefore, beam dispersion, which will be detrimental to the power transfer efficiency, may occur.

For a cylindrical beam,  $\frac{3}{8}$ -inch diameter and concentric with respect to cylindrical boundaries of  $1\frac{1}{2}$ -inch diameter (which are closely approx-

imated by the arcuate pole faces in the experimental tubes), a current of 150 milliamperes could be sustained with a beam voltage of 750 volts.<sup>7</sup> In an experimental tube, shown in Fig. 4, which accurately simulated the region transversed by the beam in the final tube, the predicted value was confirmed; 155 milliamperes was realized before instability was encountered. In the actual operating electron coupler, an increase of beam current to about 175 milliamperes could possibly occur at the same beam voltage, because of the increased proximity of the spiralling electrons to the pole faces and some spreading of the beam.

#### Details of Construction

Figure 5 pictures an experimental electron coupler showing the glass press for the electron gun, the input and output load line seals, the tuners, and the water-cooled collector at the top. The top part of the tube is the output section and the lower part, the input section. The tube is made of copper with monel lids which were atomic-hydrogen welded to monel rings. These rings in turn were silver-brazed to each end of the body of the tube.

Figure 6 shows the details of the input resonant cavity, coupling loop and tuner with the top lid of the tube removed. The electron gun is shown mounted on ceramics on the lid of the input cavity.

Figure 7 shows the output section with its pole faces and a belows-controlled capacitance tuner capable of tuning from 750 to 825 megacycles. The details of the output resonant cavity, coupling loop, and tuner are identical with those of the input cavity with the exception that the entire output cavity is mounted on ceramic supports. Thus its potential can be varied independently of the potential of the rest of the tube. The connection to vary the potential of this cavity is made by a single lead which is near the top of the tube, opposite the glass exhaust lead, see Fig. 5. The output cavity was water-cooled in subsequent tubes to prevent the continual evolution of gas from this cavity when it gets hot during actual operation.

#### Experimental Results

An experimental set-up in the laboratory, using an electron coupler of the design shown in Fig. 5, is pictured in Fig. 8. To the left is seen the driving magnetron which is capable of a 1-kilowatt output and which can be tuned through the tuning range of the electron coupler. A transmission line connects this magnetron to the electron coupler in the center of the picture; the output of the coupler goes to a water-cooled resistance-load system as shown. A standing-wave indicator is included in the transmission line between the magnetron and the electron coupler so that the combination of voltages and currents at which the input cavity presents a matched termination to the transmission line can be measured. This information, when used with the tube magnetron-Reike-diagram and the measured input power, is useful for making measurements on the power input to the beam.

The method for operating the magnetron—electron coupler system is relatively simple. The coupling beam voltage and current are first adjusted to arbitrary values. The driving magnetron is turned on and tuned to the predetermined resonant frequency of the input cavity of the coupler. The coupler magnetic field is then adjusted until power is indicated in the output circuit. Each parameter, including the

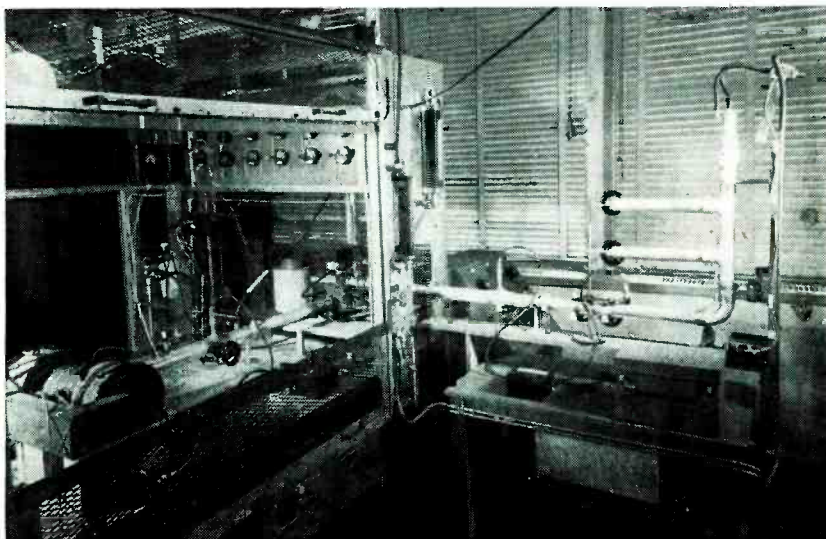

FIG. 8—The electron coupler in operation between magnetron transmission lines and load



output cavity tuner, is then successively readjusted until the output power is maximized, assuming that the output load is properly matched to the output cavity of the electron coupler.

The power transfer efficiency of the electron coupler was measured at several power levels by using a specially designed T-network in the input circuit for a more accurate measurement of the input power. Power-transfer efficiencies up to 70 percent were obtained at output power levels of up to several hundred watts. More power output was unobtainable because of the power limitations of the driving magnetron which supplied both the coupler and another load in the T-network. This power transfer efficiency was acceptable since many factors were present which served to cause a deterioration in the power output. These were beam dispersion owing to the fringe fields at each end of the cavities, differing transit times of the electrons affected by the variations in beam potential over the cross section of the beam caused by space charge effects, and translational electric field components leading to grazing by outer electrons. This grazing, if present, takes place in the input cavity, since negligible current is measured to the output cavity which is independently maintained at a suitable voltage.

Beam-current control of the output power is the most complete type of control possible in the electron coupler since when no beam passes through the tube, no power appears in the output. However, as the beam current is reduced from some value equal to or greater than that which matches the line, the beam resistance is reduced and the driving magnetron will see a change in impedance which will be a function of the line length connecting it to the electron coupler. This impedance change may either decouple the magnetron shifting its operation to a low-efficiency portion of the Rieke diagram, or it may load the magnetron further and possibly cause spectrum failure or instability. Either effect will cause frequency and amplitude distortion during modulation if not actually causing the driving magnetron to suffer damage. The situation may be

partially redeemed by adjusting the line lengths and by using a shunt load, as was done by J. S. Donal, Jr. and R. R. Bush<sup>8</sup>, to make the frequency variation during modulation nearly negligible. Some power is lost in this shunt load however, which will reduce the overall efficiency of the system.

Transit-time control of the output power of the basic electron coupler is a useful and practical method of control since it permits the tube to function as a nonamplifying unilateral control impedance. Variations in the output are not reflected back to the input and the input impedance of the electron coupler therefore remains constant. Once the voltage of the secondary cavity is adjusted for maximum power output, the output power may be theoretically reduced by either raising or lowering the cavity voltage. Actually, the only practical direction is an increase in cavity voltage, since reducing the cavity voltage will soon cause a space-charge instability in the cavity and some of the beam current will turn back.

Figure 9 shows a representative curve of r-f output voltage across a 52-ohm load, as a function of output-cavity voltage, for a beam current of 50 milliamperes, a frequency of 775 megacycles, and an input cavity and collector voltage of 650 volts. It is seen that the r-f output voltage is variable from a maximum value at  $E_0 = 520$  volts to virtually zero at an output-cavity voltage of 1,700 volts. A representative sinusoidal modulating wave and its output counterpart are included in Fig. 9. The characteristic curve pictured in Fig. 9 is a function of the tube parameters and the peak-to-peak voltage necessary for 100-percent amplitude modulation may be altered by suitable changes in cavity design. Although a large peak-to-peak voltage may be necessary for the amplitude modulation of the electron coupler to a satisfactory level, it must be remembered that no electrons are collected by the secondary cavity and the impedance of the output cavity as seen by the modulator is a capacitive reactance. If very wide-band amplitude modulation is desired, then the modulator must be designed so that its output into this

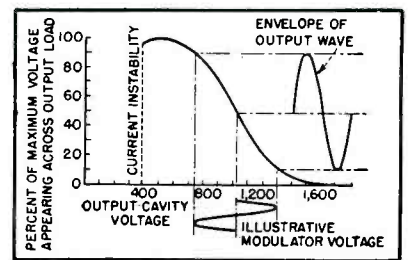

FIG. 9—Operating characteristic curve of the electron coupler with input cavity beam potential of 650 volts

capacitive load is commensurate with the requirements of the modulation rate.

### Higher Frequency Operation

As the frequency of operation increases, the tube will become smaller and smaller due to the decrease in size of the resonant cavities. However, the power handling capabilities of the electron beam do not necessarily suffer from the change in tube size and may improve. As is seen in Eq. 5, the absorbed power varies as the square of both the frequency and the maximum spiral radius. An increase in frequency from 800 to 3,000 megacycles, for example, would require a spiral radius of only 0.427 centimeter and a current of 50 milliamperes for the absorption of 1,000 watts by the beam. With an interaction space in the input cavity, 2.5 centimeters long, and an r-f field strength of 1,500 volts per centimeter, the electron coupler would require, see Eq. 6, an input cavity beam voltage of 48.4 volts.

### REFERENCES

- (1) Lloyd P. Smith and Carl I. Shulman, Frequency Modulation and Control by Electron Beams, *Proc. IRE*, 35, p 644, July 1947.
- (2) G. R. Kilgore, C. I. Shulman, and J. Kurshan, A Frequency Modulated Magnetron for Super-High Frequencies, *Proc. IRE*, 35, p 657, July 1947.
- (3) J. S. Donal, Jr., R. R. Bush, C. L. Cuccia, and H. R. Hegbar, A 1-Kilowatt Frequency-Modulated Magnetron for 900 Megacycles, *Proc. IRE*, 35, p 664, July 1947.
- (4) J. S. Donal, Jr., C. L. Cuccia, B. B. Brown, C. P. Vogel, and W. J. Dodds, Stabilized Magnetron for Beacon Service, *RCA Review*, VIII, No. 2, p 352, June 1947.
- (5) C. L. Cuccia, The Electron Coupler—A Developmental Tube for Amplitude Modulation and Power Control at the Ultra-High Frequencies, Part I, The Physical Theory, *RCA Review*, X, No. 2, p 270, June 1949.
- (6) A. V. Haeff, Space-charge effects in electron beams, *Proc. IRE*, 27, p 586, Sept. 1939.
- (7) L. P. Smith and P. L. Hartman, Formation and Maintenance of Electron and Ion Beams, *Journal of Applied Physics*, 11, p 220, March 1940.
- (8) J. S. Donal, Jr., and R. R. Bush, A Spiral-Beam Method for the Amplitude Modulation of Magnetrons, *Proc. IRE*, 37, p 375, April 1949.

By **NORMAN FULMER**

Research Department, Lamp Division  
Westinghouse Electric Corporation  
Bloomfield, New Jersey

**T**HE COMMONLY USED technique of photographically recording cathode-ray traces is to place a hood around the c-r screen and camera to exclude all external light. The resulting photographs show only the trace against a plain black background.

To keep account of each photograph, information must be kept on file concerning sweeps, calibrations and test conditions. Later, if prints are made, it is necessary to include a copy of the test information with each print.

Considerable time, effort, and chance for error can be eliminated if the required information is recorded along with the c-r trace on each photograph taken. This may be accomplished by using an external light source to illuminate the area around the tube face sufficiently for it to show in the picture. The lighting must be evenly distributed and not so bright as to interfere with the clarity of the c-r trace. The illuminated area is used for calibration data and other pertinent notations.

### Calibrated Screen

Oscilloscopes are customarily equipped with a celluloid scale having dark calibration lines. With proper external illumination, these lines will show in a photograph. Normally, three shades of gray must then be recorded on the film: the light gray of the electron-beam trace, the medium gray background, and the dark gray (black) calibration lines.

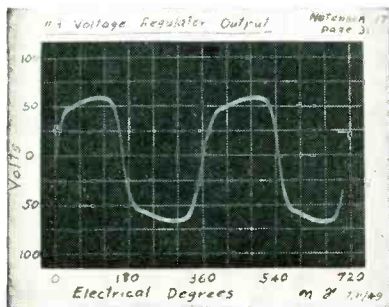

Unretouched photograph of c-r tube screen and data made by the technique described

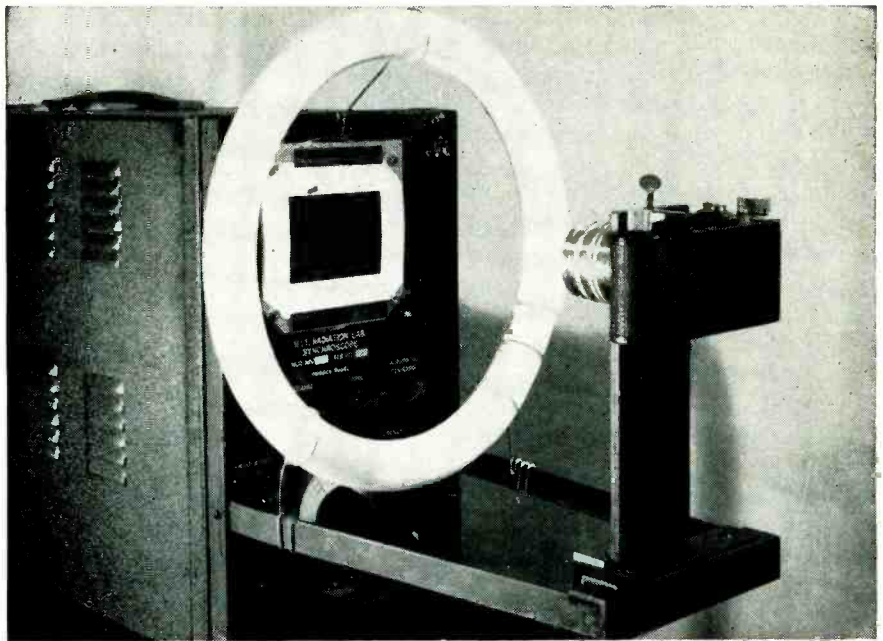

Only one photograph need be taken when calibration lines and notations are illuminated by the circular fluorescent lamp and recorded on film simultaneously with the c-r tube trace

# Improved C-R Photographs

Extreme care with lighting is needed to properly balance the three shades of gray. It is difficult to obtain a picture showing clearly the light trace and dark calibration lines against the gray background. This difficulty is overcome by providing for only two shades: light-colored trace and light calibration lines against a dark background. Thus, legibility is increased since only two tones are required in the picture, white and black.

A calibrated screen having light-colored calibration lines can be made by spot welding or soldering fine, shiny wires in a criss-cross pattern on a metal frame. The external illumination reflects on the curved wire surfaces and appears on the film as white calibration lines.

A suitable screen can be made with 0.010-inch diameter tungsten

wire spot-welded to a steel frame. A frame having a rectangular cut-out  $2\frac{1}{2} \times 3\frac{1}{2}$  inches is suitable for a five-inch c-r tube. The frame is held by screws and bushings in front of the c-r tube face.

For a tube having a green phosphor, a green plastic filter is placed between the calibrated screen and the c-r tube face to provide a darker background by filtering out all light except the green trace. A suitable green filter can be made of  $\frac{1}{8}$ -inch thick DuPont Plastacele C11872.

White paper masks having rectangular cut-outs the same size as the calibration frame are provided. The mask is lightly stuck to the tube with dabs of glue and notations written on it concerning sweep speeds, trace height calibration, date, title of test or notebook reference page. If two or more

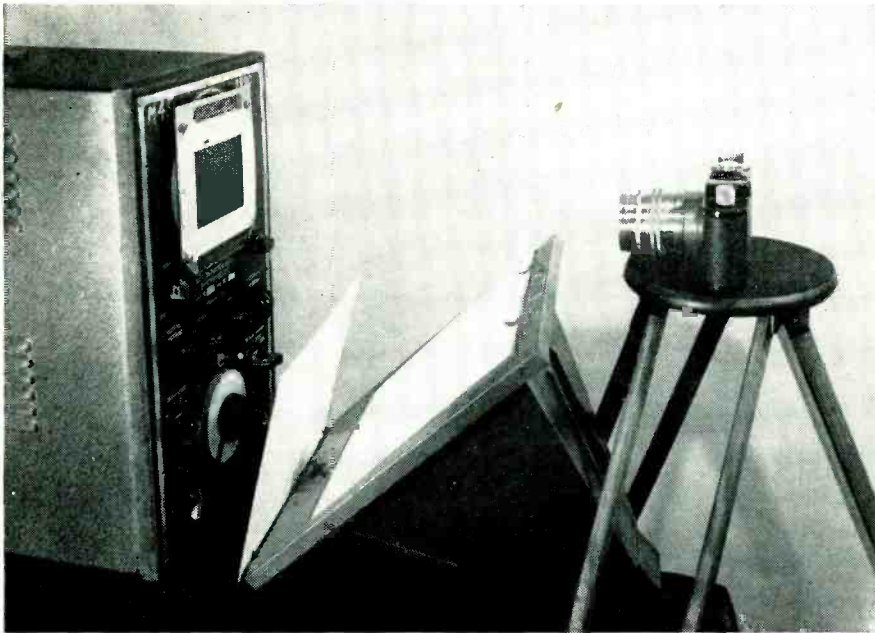

Alternative method of lighting the calibrated screen area, using a ground-glass diffused light source and baffle to distribute light evenly on the tube screen and on the surrounding area

Single picture shows clearly both the trace desired and associated data such as a calibrated screen, test conditions and other file notes. Evenly distributed light from either of two light sources provides two picture tones for high legibility of information

vertical scales are to be used frequently, it is convenient to show both scales on the mask and provide a black paper arrow that can be adjusted to indicate the scale in use.

### **Illumination**

The best source of illumination was found to be a 32-watt circular fluorescent lamp, mounted on a frame. The lamp must be close enough to the tube screen to avoid reflections in the picture from the c-r tube glass. A spacing of four inches between lamp and screen is satisfactory.

To record both the trace and scale in a single exposure, it was found desirable to lower the illumination by operating the lamp at about 10 milliamperes from a 150-volt d-c source with about 5,000 ohms resistance in series with the lamp. Other means for reducing lamp in-

tensity are by painting or covering the lamp with translucent material such as nail-polish, lightweight paper, or colored cellophane, or by winding a spiral of opaque tape around the bulb in a spaced toroidal manner.

An alternative device for producing even, diffused illumination is an 8×10-inch ground-glass diffuser (Eastman x-ray illuminator, model D) placed to illuminate the c-r screen at an angle. Since the amount of illumination reaching a point of the tube screen from the diffused source is approximately inversely proportional to the square of the distance of the point from the light source, means must be taken to reduce the amount of light reaching the bottom (nearer) part of the tube. A cardboard baffle was placed to distribute the light intensity so that the top and bottom

of the screen receive equal illumination.

Proper lighting was obtained by operating the 50-watt incandescent lamp of the diffused light source at 80 volts.

For accurate control of illumination and to prevent reflections on the c-r tube glass from room lights or windows, an opaque cloth is placed around the camera and oscilloscope when making exposures.

### **Camera Installation**

When extreme detail is required in a photograph, a double-extension view camera may be used; a 4×5-inch film will record a 3 or 5-inch c-r tube almost actual size. The camera may be mounted on a tripod set on the floor, or on a support set on a table with the cro.

A 35-mm camera is convenient to use and the film cost is low. A spacing of nine inches between the camera and cro enables most cameras to cover the screen properly. A frame to support the camera and circular lamp may be fastened to the cro with machine screws. To enable the camera to focus at a distance of nine inches, a bushing must be inserted between its lens and body. A suitable bushing for a Leica camera is  $\frac{1}{2}$  inch thick for a lens having a focal length of five cm. This particular camera was mounted in the support frame by inserting the lens and bushing through a hole in a camera bracket. A thumb screw tightens against the bushing to hold the camera securely.

### **Exposure**

Correct exposure for the scale when illuminated by the circular lamp operating at normal current is less than the exposure required for a typical cro trace. For example, in one instance correct exposure for the c-r trace was 0.1 second at f:3.5, and correct exposure for the illuminated scale was 0.1 second at f:11. If only a few pictures are to be taken, a single film may be exposed twice—for the trace with illumination off, then for the scale with illumination on.

### **BIBLIOGRAPHY**

Rudolph Feldt, Photographing Patterns on Cathode-Ray Tubes, *ELECTRONICS*, p 130, Feb. 1944.

# Folded Sideband Modulation

Basic principles of a proposed system of radio communication in which several kilocycles of information bandwidth are transmitted in sequence in a narrow band on one side of a carrier, and interfering heterodynes are eliminated by shifting them to the unused side of the carrier

**A**N IMPORTANT CHARACTERISTIC of any communication system is its effectiveness in the face of interference. So far the effect of interference on proposed narrow-band systems has received scant attention.

Present communication systems are affected differently by interfering signals. We have, for example, heterodyne beatnote interference in a-m, capture effects experienced in f-m, and tvi in television. In wired communication where channel separation can be controlled, there is no serious problem, but in wireless communication, particularly over long distances, interference is always possible. Therefore the measure of the worth of any communication system not only should include the efficiency of modulation versus bandwidth and noise, but also the system's effectiveness in rejecting interference. Stated another way, a theoretical communication system will anticipate the factor of interference and will do something about it.

## Interference Problem

The fallacy of reducing the transmitted bandwidth alone to reduce interference can be illustrated as follows. In the case of a single-sideband amplitude-modulated signal, the removal of a heterodyne beatnote caused by a carrier lying within this band can only be achieved by rejecting a portion of

this band either by filters or phase-shifting networks requiring critical adjustments. In a double-sideband system, the interference can be removed more rapidly by simply rejecting the whole sideband containing the interfering carrier.<sup>1</sup>

In other words, greater actual selectivity or signal separating ability is achieved in the latter case by using a transmitted bandwidth twice that of the former. That the reduction of bandwidth alone is not the solution of heterodyne elimination can further be proved by c-w operation. Such a system of communication can be reduced to a bandwidth of but a few cycles. Despite this reduction in bandwidth, serious heterodyne interference prevails when an interfering carrier falls within this reduced band.

Interference will affect narrow-band systems in various ways. One

example is illustrated in Fig. 1. The block diagram illustrates a communication system with a bandwidth required for the r-f emissions of but 1 kc to transmit 4 kc of information. This system is essentially a simple single-sideband a-m transmitter, with suppressed carrier (replaced at the receiver by local oscillator). Sequential modulation is achieved by shifting the carrier in 1-kc steps. Such a communication system should prove useful where channel separation is effectively controlled. But its narrowband usefulness will be impaired seriously should heterodyne interference be present. If the interfering carrier is 51 kc, a beatnote of 1 kc will appear when information of 200 to 1,200 cycles is being transmitted. There would be another of 2 kc in an information band of 1,200 to 2,200 cycles, 3 kc

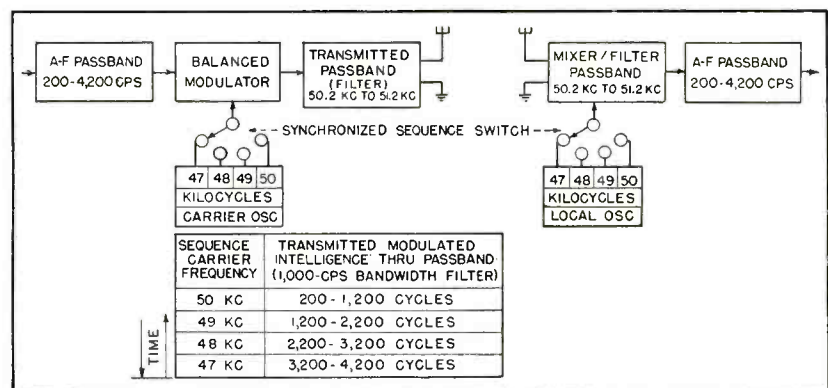

FIG. 1—Block diagram of sequence modulation. The received demodulated intelligence is the same as that transmitted for each synchronized sequence

By **J. L. A. McLAUGHLIN**  
*La Jolla, California*

in the band 2,200 to 3,200 cycles and a fourth beatnote of 4 kc in the band of 3,200 to 4,200 cycles. The above illustrates simply one of the possible types of interference characteristics of narrowband systems.

### Basic System

A communication system will be described with a spectrum space less than the message information and means for eliminating heterodyne beatnotes produced by carriers falling within this band. The basic principle of this new system is illustrated by a series of steps in Fig. 2.

At A is illustrated a conventional amplitude-modulated car-

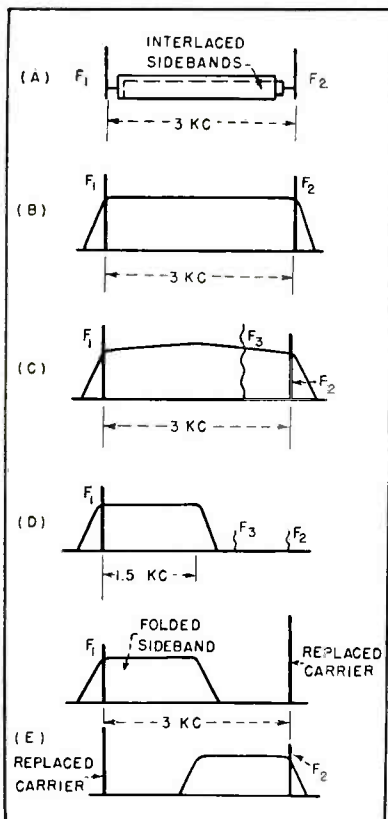

FIG. 2—Steps illustrating the basic method of eliminating two interfering carriers

rier,  $F_1$ , in the presence of a second carrier,  $F_2$ , also amplitude modulated, which causes interference in the form of a heterodyne or beatnote.

The interference takes the form of a continuous whistle of 3,000 cycles since this is the frequency separation between carriers. If this heterodyne whistle is eliminated the audible interference remaining (demodulation of the desired carrier with the undesired signal's sideband) will be small. This whistle or beatnote can be reduced or eliminated by a selective circuit in the i-f or audio amplifiers.

If the two carriers are present with respect to frequency in an i-f amplifier with passband characteristics as shown in Fig. 2B, and the 3,000-cycle heterodyne whistle has been removed by one of the aforementioned schemes, both signals will be intelligible to somewhat the same extent as listening to two people talking at the same time.

The next step is to assume the modulation in the sidebands of the two transmitters to be identical. The heterodyne whistle has been eliminated and only one intelligence is now being received. The audible interference of the interlaced sidebands is present, but small, compared to the interference caused by the heterodyne whistle.

Figure 2C shows a new interfer-

ing carrier,  $F_3$ , and Fig. 2D illustrates its elimination by increasing the selectivity of the i-f passband as shown.

### Folded Sideband

In eliminating the undesired carrier  $F_2$ , we have also eliminated carrier  $F_2$ . If  $F_2$  is replaced in the detector by a local oscillator of the same frequency, demodulation of the full information band of 3,000 cycles will be recovered despite the reduced bandpass of the i-f which as shown is but 1,500 cycles. Carrier  $F_1$  demodulates the lower half of its 3,000-cycle band (0 to 1,500 kc). The replaced carrier for  $F_2$  demodulates the upper portion (1,500 to 3,000 kc) for  $F_2$  sideband which falls in the same spectrum as the lower frequency half of the sideband associated with carrier  $F_1$ .

The narrowed bandpass thus contains a completely folded sideband containing all the information, one half of which belongs to carrier  $F_1$  and the other half to  $F_2$ . Should the interfering carrier  $F_3$  fall within the spectrum of the passband, the process can be reversed since the total transmitted spectrum of 3 kc contains two folded sidebands of information, as illustrated in Fig. 2E. If carriers  $F_1$  and  $F_2$  are alternately transmitted the monkey-chatter interference will automatically be removed and

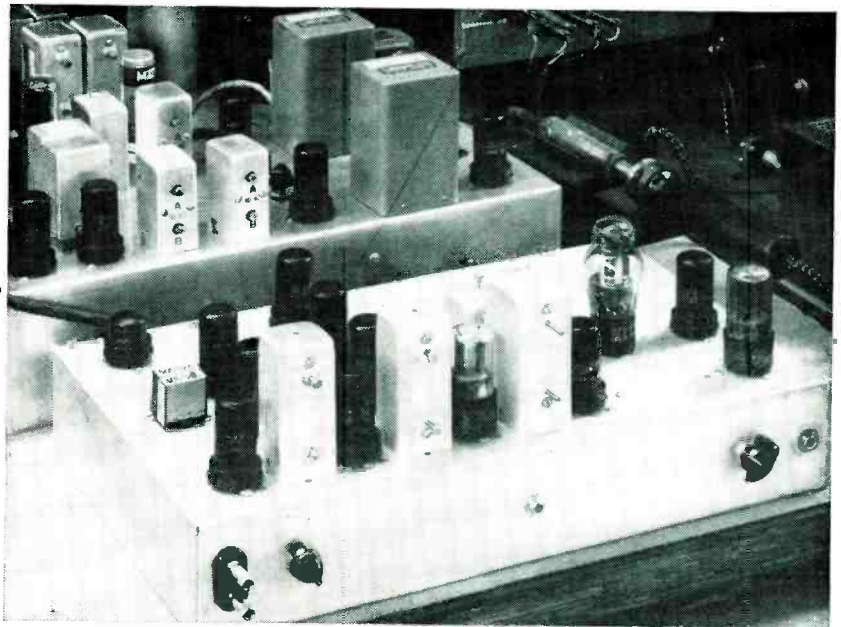

An r-f exciter unit for folded sideband transmitter appears in the foreground and behind it is an adaptor for a receiver

a normal-sounding signal will result.

This is a simplified explanation of FSM. The above case illustrated requires a transmitted bandwidth equal to the information, and with means at the receiver to achieve sophisticated selectivity such as to eliminate a heterodyne falling within any portion of this band since but half of the transmitted spectrum contains all the information.

### Heterodyne Rejection

In a more elaborate form of the system the transmitted spectrum space can be reduced to but a few hundred cycles and still retain at the receiver the ability to reject heterodyne beatnotes, as in the above case. A system suitable for transmitting an information bandwidth of 4 kc in a spectrum space of 2 kc is illustrated in Fig. 3. Four carriers (suppressed or transmitted) are employed.

Carrier  $F_1$  provides information from 0 to 2 kc. Carrier  $F_2$  provides the same information in the same spectrum space but in an inverted numerical order. Carrier  $F_3$  handles the information of from 2 kc to 4 kc. Carrier  $F_4$  contains the same information but in inverted numerical order similar to that of the first two carriers. Carrier  $F_5$  indicates an undesirable carrier falling within the transmitted spectrum. The shaded area of the sideband indicates the system's halfband selectivity sufficient to reject beatnotes which would be produced by  $F_5$ , the undesired carrier, beating with each of the system's carriers.

The passband of 1 kc at the receiver contains all the transmitted information, for in sequence A 0 to 1 kc will be demodulated, in sequence B 1 to 2 kc, in sequence C 2 to 3 kc, and in sequence D 3 to 4 kc. Should the interference appear in the shaded portion, instead of as shown, the system can be inverted since the other half also contains the full band of information.

### Use of Filters

In order that a FSM system effectively reject interference lying close in frequency to the edge of

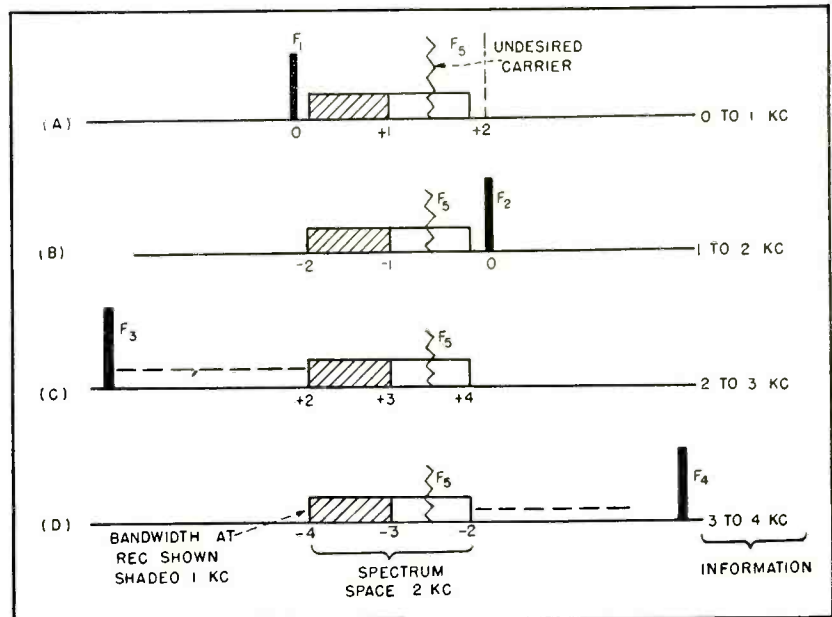

FIG. 3—Operation of four-carrier folded sideband system

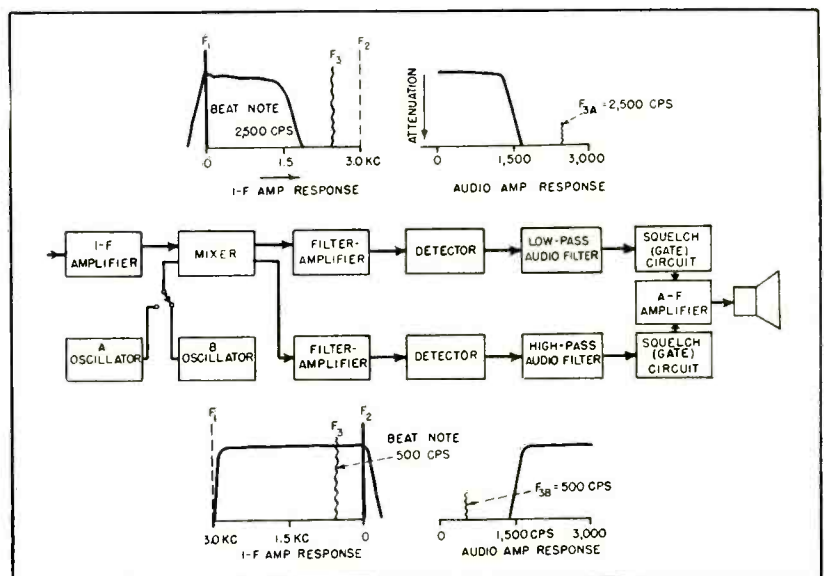

FIG. 4—Stages required in the receiver for a two-carrier system

the system's acceptance spectrum, a high degree of selectivity is required. If this selectivity is to be achieved in the i-f amplifier the required filters would be quite expensive. However, most of the system's heterodyne elimination selectivity takes place after detection, where it can be accomplished less expensively. This is illustrated in Fig. 4.

For the sake of simplicity, the system illustrated is of the two-carrier type, in this case both being transmitted alternately. The signal is converted to a low frequency

i-f of say 50 kc and is split into two i-f filters with response curves as indicated. The upper i-f accepts carrier  $F_1$  and has a bandpass of roughly 1.5 kc. The carrier  $F_2$  and the undesired carrier  $F_3$  will receive attenuation. At the output of this filter's detector, a lowpass filter supplies the necessary high degree of selectivity for the attenuation of beatnotes above 1,500 cycles. Since the beatnote between the system's carrier and interference is 2,500 cycles it will not be heard due to the high selectivity of the lowpass filter, plus the additional selectivity

of the i-f filter system.

In the lower case, where carrier  $F_2$  and its sideband information is shown, the beatnote will be 500 cycles, but at the output of this detector a highpass audio filter is used with high attenuation below 1,500 cycles, sufficient for attenuation of the beatnote and all others below the cutoff frequency.

In FSM systems employing more than two carriers, audio bandpass filters equal to the information of each sequence are used in the same manner as in the above two-carrier system.

Figure 5 illustrates more fully the transmitted spectrum with the system's two carriers at either edge

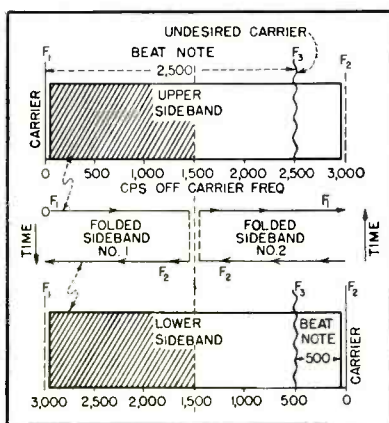

FIG. 5—Frequency spectrum handled by the receiver of Fig. 4

of it, together with an undesired carrier falling in the unused half of the system's bandwidth. The used portion is shown shaded. The terms upper and lower sideband may cause some confusion as the system is essentially a single-sideband one. The terms refer only to the relation of the information to each carrier with respect to the numerical frequency order. The shaded area marked upper sideband for carrier  $F_1$  transmits information from 0 to 1,500 cycles, whereas this same half spectrum in the lower case contains information from 1,500 to 3,000 cycles.

### Frequency Inversion

In Fig. 4 two oscillators are indicated. The condition shows  $B$  in operation. This oscillator-mixer circuit is of the off-frequency inverter type.<sup>1</sup> The frequencies of the oscillators are such that in one case the oscillator's frequency is the first i-f plus the second i-f frequency. In the second case, the oscillator's frequency is the first i-f minus the second intermediate frequency. In FSM the second i-f will be the mean frequency of the system between the two carriers. Switching from one oscillator to the other inverts all frequencies around the mean. The principle of this system is illustrated in Fig. 6.

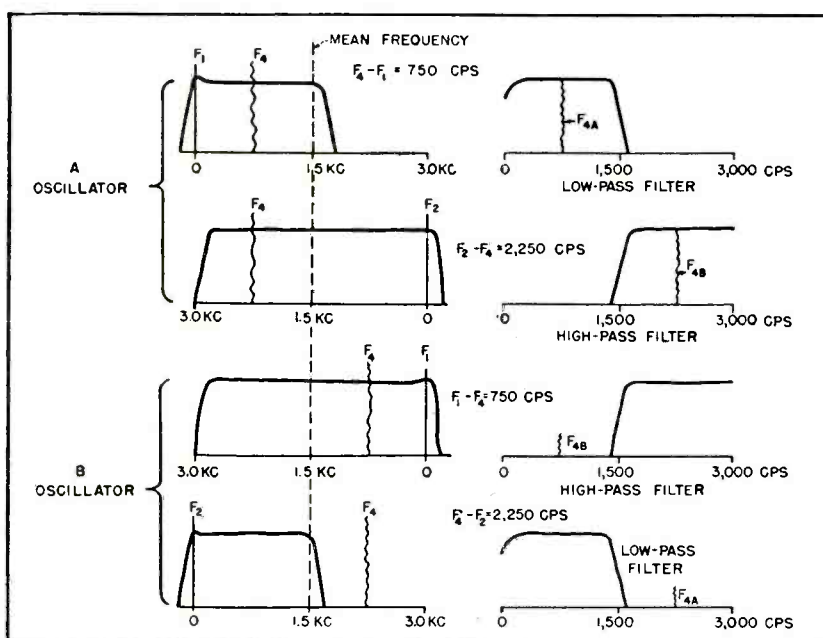

FIG. 6—Choice of oscillator provides frequency inversion to take advantage of the proper filter characteristics in eliminating heterodynes

A marked improvement in signal-to-noise ratio is achieved by the squelch or gating circuits following the audio filters (Fig. 4). Without these circuits, when the carrier handling the lower half of the sideband is on, high-frequency noise would be passed by the highpass filter. The reverse is true for the carrier handling the upper half of the sideband frequencies. These squelch circuits are normally open and are only closed by the desired carrier frequency.

The signal-to-noise ratio can be improved further by making the squelch circuits such that they remain open until the carrier is on plus a certain percentage of modulation. In other words, the gates are closed only when information sufficient for intelligibility is present, rather than alternately and cyclically in time sequence. This is an important point because many times a carrier may be on without having any information to transmit in its time sequence.

Still greater refinements along these lines can be achieved in the transmitter by information amplitude sequence time instead of cyclic time sequence. By these and other refinements the information efficiency can be raised to a greater degree than by conventional amplitude modulation means alone. Other FSM systems employ narrowband information sequence instead of carrier sequence switching. In the case of suppressed carriers this reduces synchronization problems since the reintroduced carriers at the receiver can be on at all times. One interesting FSM variation, suitable for aircraft and mobile use, permits two separate voice frequencies and one c-w signal to occupy a spectrum space of but 3 kc.

This article has been restricted to the discussion of amplitude-modulated systems suitable for speech frequencies but any band of information, modulated by more efficient pulse systems, can be converted to narrowband operation by the heterodyning principles of FSM outlined.

### REFERENCE

- (1) J. L. A. McLaughlin, Heterodyne Eliminator, *ELECTRONICS*, p 83, March 1949.

# Simplified Multistation

Requires only two wires and ground for complete privacy between any two stations among a maximum of eight stations. The pulse-generating system used for automatic switching can be adapted to remote control by wire, carrier or radio, when power lines are synchronized at transmitters and receivers

By **ANDREW W. VINCENT**

*Consultant  
Rochester, N. Y.*

**I**N CONVENTIONAL intercommunication systems that do not employ centralized switching the desired talking-circuit path is set up at the calling station when a manually operated selector switch completes a direct-wire connection to the called station. An intercom

employing centralized switching ordinarily requires that a circuit first be established to the switching apparatus; after this the circuit path to the desired station is remotely set up by a manual switch at the calling station.

The cost of the direct-wire sys-



Station for automatic call selection by means of three-position switches. Extreme right switch controls talk, listen and release

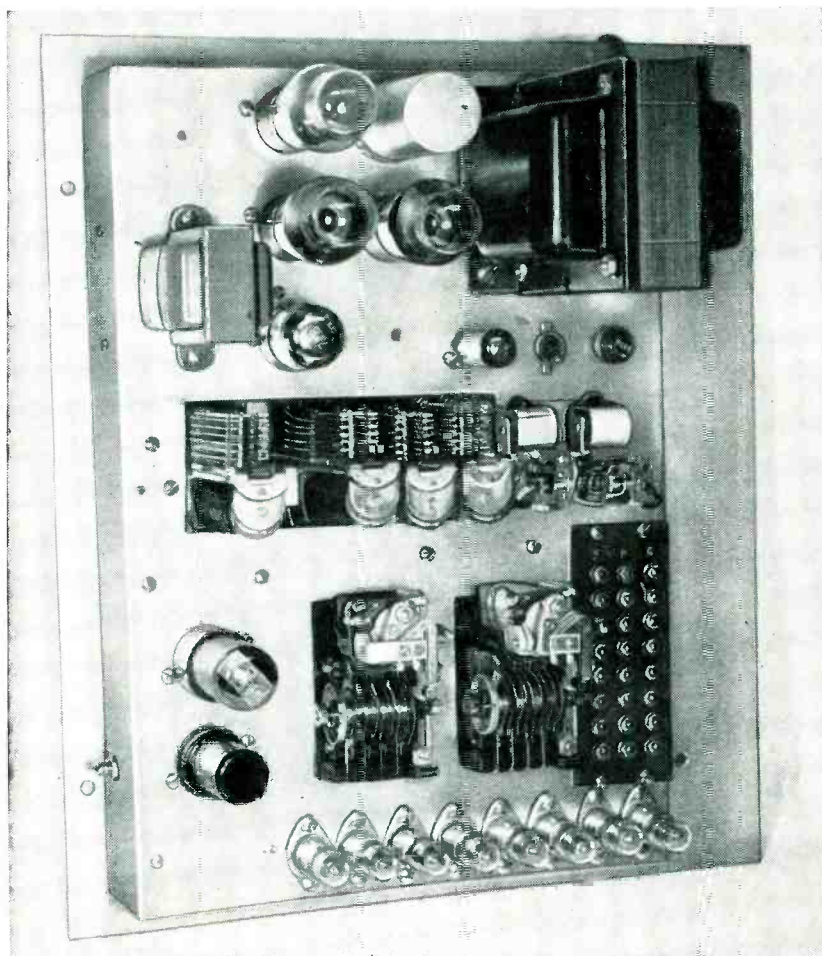

Central switching unit of the intercom, showing two rotary stepping switches and neon glow lamps along lower edge of chassis

tem increases rapidly as the service area increases because the multiplicity of wires between stations makes installation, relocation and servicing difficult. In addition, the extensive wire network increases noise pickup. Central switching, although it eliminates individual station amplifiers and reduces the number of interconnecting wires, usually requires complex central equipment to perform the remotely controlled functions of call, talk, listen and release.

## **New Central System**

The centralized system to be described uses a finder circuit with no line relays, a pulse system for station selection, one audio amplifier, and simple three-position switches at each station. The pulse system employs an inductor and eight different half-wave rectifier



# Intercom System

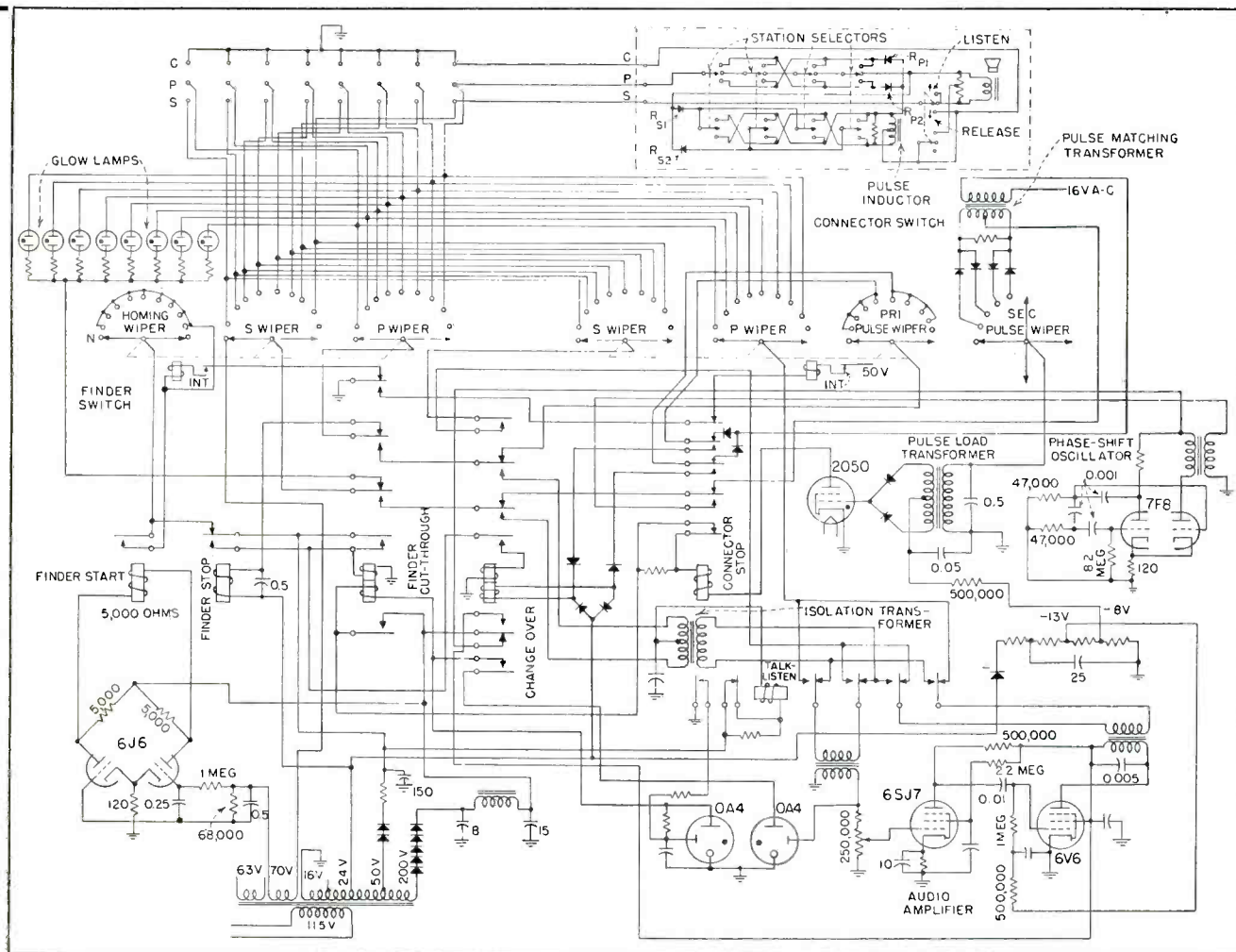

FIG. 1—Wiring diagram of the central station, with connections shown for one substation in dashed box

combinations to select eight unique positive or negative voltage impulses from a 60-cycle supply.

Up to eight stations can be used. Each station is connected directly to the central unit by three wires, a balanced talking pair and ground. The station units house a p-m speaker, small selenium rectifiers, resistors, a pulse inductor and keys that set up eight different pulse-circuit conditions for station selection and control the talk-listen and release functions. The keys are three-position lever type with spring return to center.

When a call is made the desired station-selection key is operated and held until a completion tone is heard in the speaker to indicate that the system is not in use. The

switching is completed and the key may be released. The release of the station-selector key completes the connections to the amplifier and the calling station is ready to carry the message in the direction of the called station. Operation of the listen key reverses the talking direction, allowing a reply. Operation of the release key releases the system for subsequent calls.

### Line Finder Circuit

The glow lamps in Fig. 1 are connected to the *P* wires of each of the balanced pairs extending to each of the speaker stations. The common connection to the glow lamps is in a circuit traceable to ground through the 70-volt transformer winding and the grid circuit

of one of the tubes in the bridge circuit.

When the system is idle, the relay contacts complete this circuit in which the 70 volts a-c of the transformer winding is impressed upon each of the *P* station leads through the glow lamps. Since the glow lamp breaks down at and maintains a voltage of about 65 volts d-c, the voltage appearing across the remainder of this circuit will consist of sine-wave tops or pulses as shown in Fig. 2A having effective voltages in these peaks of about 25 volts.

When the station-selector keys are in the normal position, the station speaker voice coil is connected across the balanced pair *P* and *S*. Therefore the line capacitance of

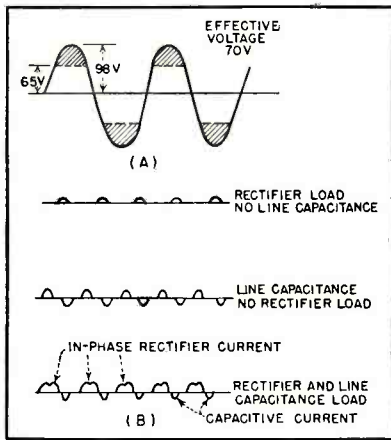

FIG. 2—Voltage and current waveforms available for switching

both the *P* and *S* wires to the ground control wire is presented at each of the lines as a capacitance load between the glow lamp and ground, since the speaker impedance is small in relation to the reactance of the line capacitance.

This capacitive load causes symmetrical current pulses to flow in the load capacitor. The time constant of the R-C network in the grid circuit is purposely made long enough so that the d-c grid potential is unaffected and thereby maintains a balance within the bridge circuit.

When the station-selector key is operated at a calling station the speaker is disconnected from the *P* wire and the load circuit through the rectifier  $R_{P_1}$  or  $R_{P_2}$  and the pulse inductor to ground is presented to the glow lamp of the calling line. The effect of the rectifier load causes current pulses to flow in the direction in which the rectifier conducts. These rectified pulses cause the R-C circuit at the grid to charge either positively or negatively, thereby unbalancing the bridge circuit which operates the finder start relay and the finder switch. The finder switch, stepping on its own self-interrupting contacts, hunts over the station lines.

Because the rectifier constitutes a resistance load, the rectified current pulses are in phase with the voltage and therefore lag the capacitive current pulses. The connection of the rectifier load on the one calling line controls the bridge circuit even while being shunted by the low-shunt-reactance combination of the

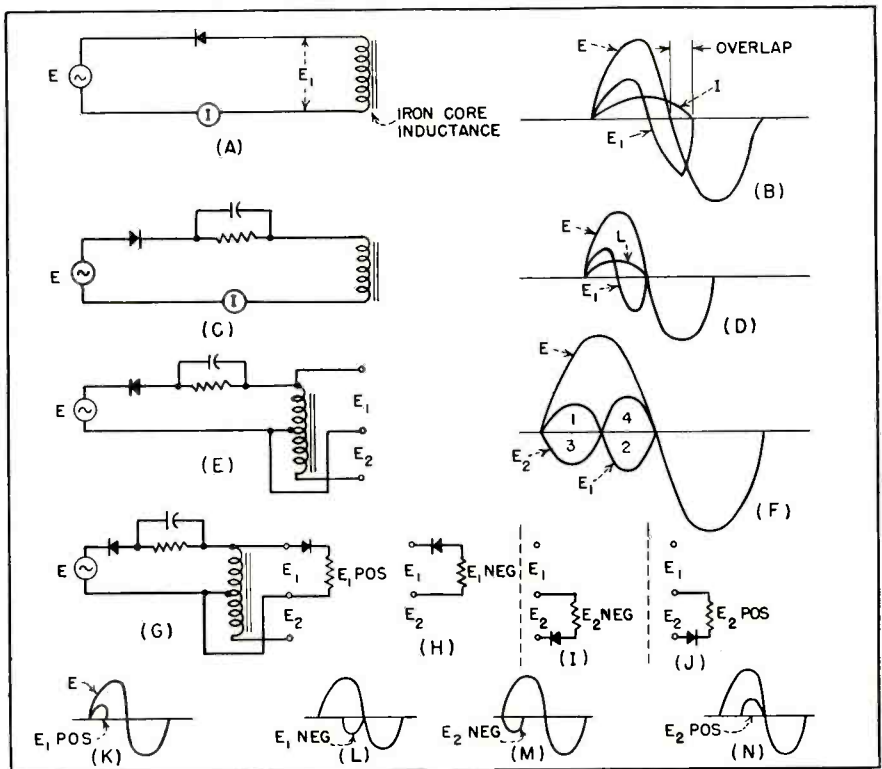

FIG. 3—Combinations of rectifier and inductance connections and their waveforms

other seven line capacitances because the rectifier current component is displaced from the capacitive current component as shown in Fig. 2B.

The finder stop relay is connected between the *P* wiper of the finder switch and the 24-volt tap of the power transformer. As the finder switch hunts over the lines, the *P* wiper momentarily connects the finder stop relay to each of the *P* line wires. When connection is made to the *P* wire of the calling line, the rectifier load to ground operates the finder stop relay which stops the finder switch and operates the finder cut-through relay which locks up on its own contacts, thereby seizing the link.

The movement of the *S* wiper from the home position disconnects the 70-volt transformer winding from the glow lamps, thereby disconnecting, by the removal of a sufficient breakdown voltage, the common connection established by the glow lamps to the *P* line wires. This locks out the other stations from the link by preventing the operation of the finder start relay and also disconnects the unbalanced load on the *P* line wires, thereby bringing the lines into the

balanced condition in readiness for the talking circuits.

### Station Selection

The operation of the finder cut-through relay starts the connector switch and connects the *P* and *S* wires coming from the calling station, where they are connected to a pulse circuit already set up by the operation of the station-selector key, to the associated central pulse-matching circuit which will stop the connector switch on the contacts of the called line.

The principle of circuit selection utilizes an inductance and selenium rectifiers to break down the 60-cycle power supply voltage into pulses that allow 8 selections. The pulse signals are individual, thereby obviating reliance upon combinations of pulses and eliminating testing before the selection is determined.

If an alternating voltage *E* is fed into an iron-core inductance through a half-wave rectifier, a current *I* will flow and the voltage  $E_1$  produced across the inductance is the distorted sine wave shown in Fig. 3B. Because of the effect of the inductance in the circuit, the current *I* and the voltage  $E_1$  is partly carried over into the next

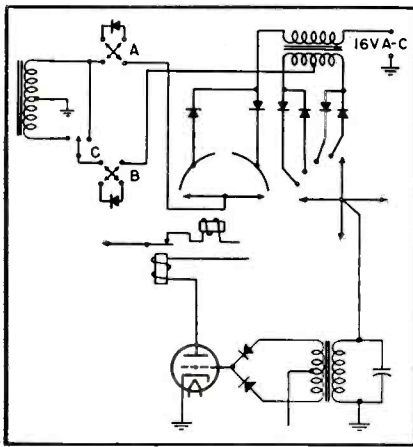

FIG. 4—Talk-listen and release switching circuits

half cycle. This overlap of current and voltage can be brought back to occupy all or any part of the first half cycle by inserting a parallel resistance and capacitance in series as shown in Fig. 3C. When current flows in the circuit, the voltage charge built up across the capacitor cancels the voltage of the inductance and causes voltage across the rectifier to reverse sooner, thereby reducing the duration of the current in relation to the applied voltage  $E$ .

If a center tapped inductance is used as in Fig. 3E it is possible to reverse the phase of the  $E$ , voltage, thereby producing  $E_2$ . If a secondary rectifier is added it is possible to segregate any one of the four half cycles of  $E_1$  and  $E_2$ . These circuit combinations and their accompanying waveforms are shown in Fig. 3G through N. By reversing the polarity of the primary circuit rectifier, the current flows during the negative half of the cycle and in the same manner as described above, four more pulses can be generated, occurring during the last half-cycle of the applied voltage  $E$ . This pulse-generating circuit can be used for remote-control service over a single pair of wires or to modulate a radio or wire-carrier wave to set up eight different circuit selections, assuming that the same synchronized power source is available at both ends of the connection.

### Control Circuits

In the system described, a 3-wire system is necessary for the remote

control of the talk-listen and release functions. The three-wire selection circuit used, shown in Fig. 4, is a modification of the basic selection system. The a-c voltage is supplied at the central unit only, thereby making a power connection unnecessary at the speaker station. The diagram shows a simplified circuit of the station switching which, by the operation of the two rectifier reversing switches  $A$  and  $B$  and the phase-reversing switch  $C$  into their eight possible combinations, sets up the eight pulse circuit conditions. The wipers of the stepping switch set up the equivalent pulse circuits at the central unit. When the pulses are matched, current flows in the pulse-load transformer which fires the thyatron, operates the connector-stop relay, and stops the connector switch on the called line.

The operation of the connector-stop relay sets up completion tone and changeover relay circuits on the calling line. The output of the 700-cps phase-shift completion-tone oscillator is connected over the  $S$  wire to the calling station, speaker voice coil to ground through the rectifier  $R_{s1}$  or  $R_{s2}$  and the pulse inductor. The completion tone indicates that the connector switch has stopped on the calling line and that the station selector key may be released immediately.

The release of the selector key operates the changeover relay over the circuit traceable from the 24-volt power transformer winding through the rectifier bridge circuit and changeover relay winding, the primary pulse wiper of the connector switch, the  $P$  wire, the speaker voice coil, back on the  $S$  wire and through the output winding of the completion tone oscillator to ground. The bridge circuit prevents the reversal of flux in the changeover relay to allow lock-up operation and introduces into the circuit a rectifier which bucks the station rectifier and thereby prevents operation of the changeover relay before the selector key is released.

The changeover relay disconnects the plate voltage from the tone oscillator, connects it to the audio amplifier and connects the input and output of the audio amplifier to the calling and called lines respectively,

thereby completing the talking circuit.

### Talk-Listen Circuit

The operation of the listen key at the calling station grounds the talking pair  $P$  and  $S$  through the bridging center-tapped resistance, thereby operating the talk-listen relay which reverses the amplifier connections to allow a reply from the called station. The current interruptions to the talk-listen relay cause very little disturbance in the amplifier because of the balanced center-tapped connections at the line terminations. The isolation transformer keeps the talk-listen relay current out of the talk-listen switching contacts, thereby preventing switching transients that would be caused by the normal deviations from simultaneous contact closure in a relay with standard adjustment.

### Release Circuit

The operation of the release key disconnects the  $S$  wire from the speaker voice coil and connects it to ground. The talk-listen relay circuit is completed as in the listen function but the unbalanced current in the isolation transformer causes a transient voltage surge which goes through the input transformer and fires the type OA4 cold-cathode release tube. The OA4 tube supplies current through a differential winding to knock down the cut-through relay which returns the finder switch to the home position on its homing wiper, and interrupts the holding current to the finder-stop and changeover relays, thereby releasing the system.

The R-C timing circuit fires the other OA4 release tube at a predetermined time after the finder cut-through relay operates unless the talk-listen relay is operated which discharges the capacitor and extends the timing cycle. This feature releases the system when the calling station is abandoned by the calling party without releasing the system or when there is a circuit failure following the operation of the finder cut-through relay. When a station calls its own line the system is automatically released by the amplifier feedback voltage which fires the OA4 tube.

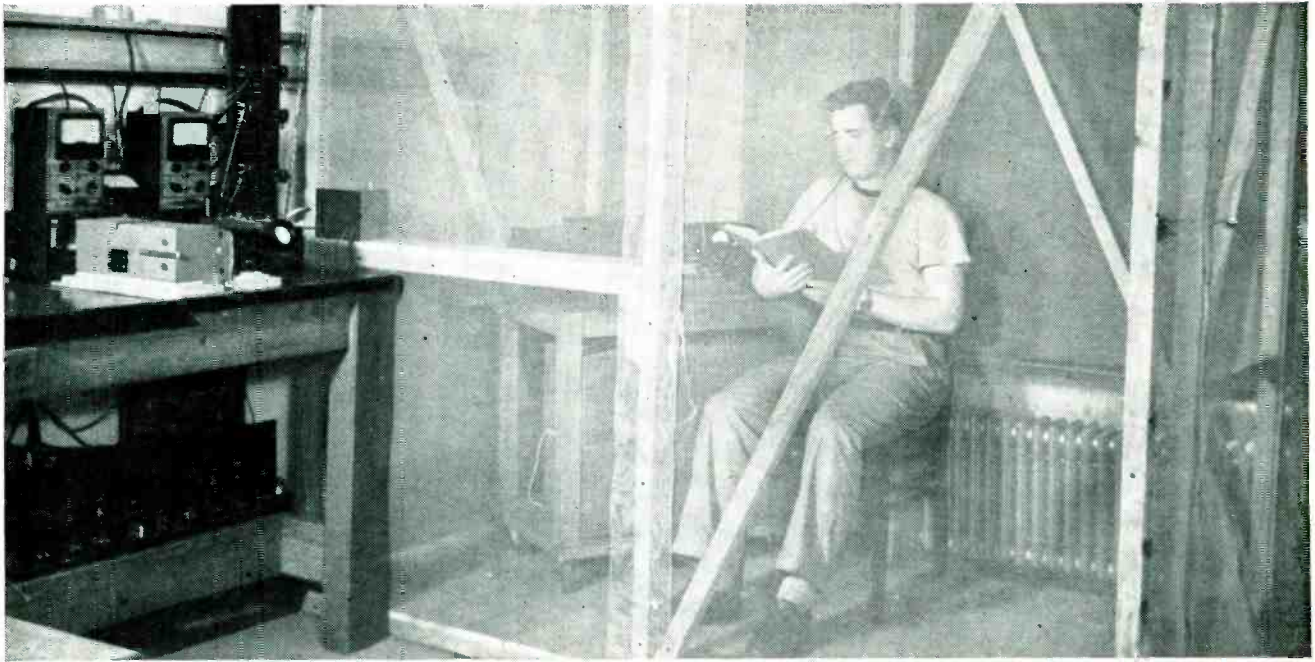

As subject reads book in shielded cage, equipment measures voltage between electrodes on temples as it varies with eye position. Resulting traces on recorder chart show variations in force exerted by extrinsic ocular muscles. These data are useful as criteria of fatigue or other cause of muscular weakness

# Testing Eye Muscles

Progress of muscle-impairing disease such as poliomyelitis can be determined electronically by recording second derivative of eyeball potentials measured between electrodes on opposite temples. Technique also evaluates fatigue in physiological research

By **EDWARD R. POWSNER\***  
and **KURT S. LION**

*Department of Biology  
Massachusetts Institute of Technology  
Cambridge, Mass.*

**T**HE MEASUREMENT of muscular strength is an important problem in physiological research and clinical medicine. The force of certain muscles and muscle groups varies with the progress of a

disease such as poliomyelitis, with fatigue, and even depends upon psychological circumstances. Such measurements are usually made with ergometers. These instruments measure and record the output of a subject working against a load. A well known example is the bicycle ergometer which is frequently used in physical medicine and in rehabilitation service.

Certain muscles or muscle groups are not accessible to these kinds of ergometric measurements, such as the extrinsic ocular muscles, which move the eyeball left and right, and up and down. The eye has one outstanding characteristic, however,

which makes it possible to measure the force of these muscles electronically. It was found by Mowrer, Ruch and Miller<sup>1</sup> that the eyeball is polarized. The eyeball may be represented by a sphere with a positive and a negative pole. This polarized sphere, turning in the semiconducting medium of the head, acts very much like a spherical potentiometer. Two electrodes, placed on opposite temples to record the eye potentials, serve with the intervening media to act like sliding contacts. Fenn and Hursh<sup>2</sup> found that the potential thus measured depends on the angular position of the eyeball in its socket. In

\* Now at Yale University School of Medicine, New Haven, Connecticut.

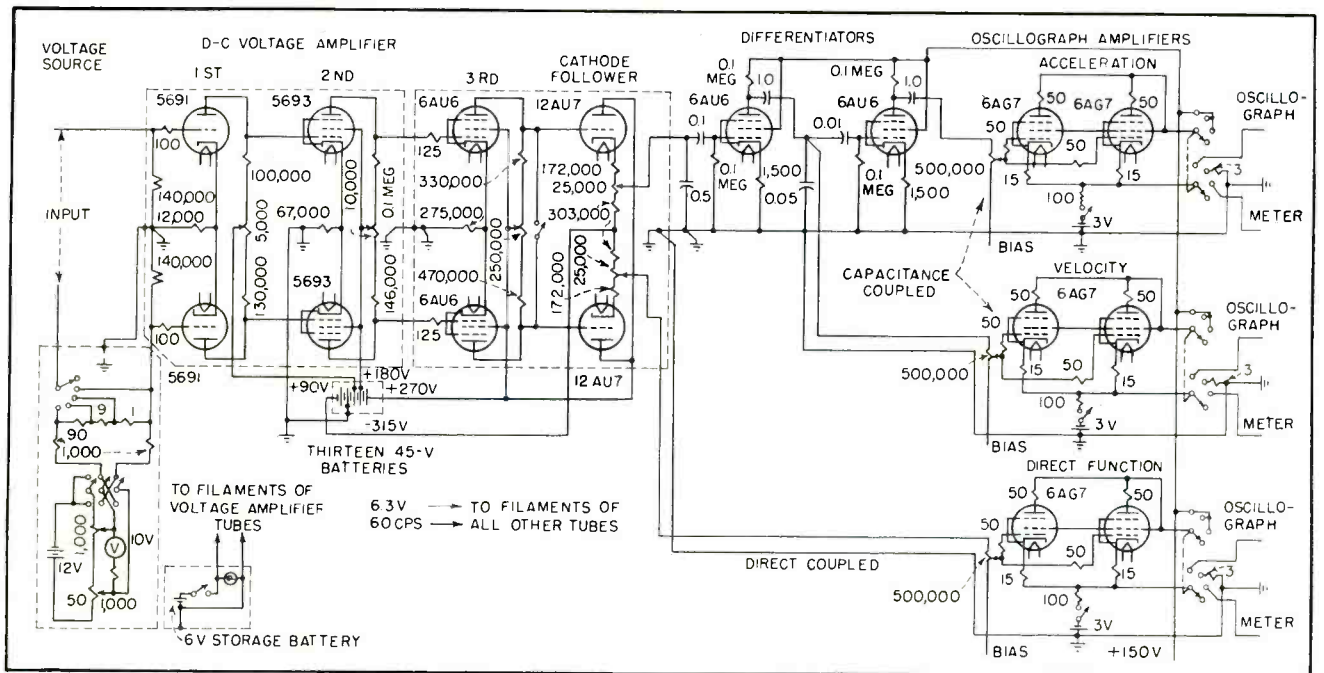
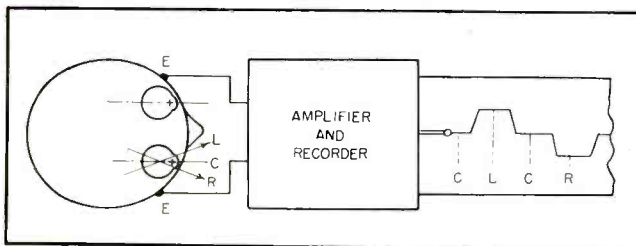
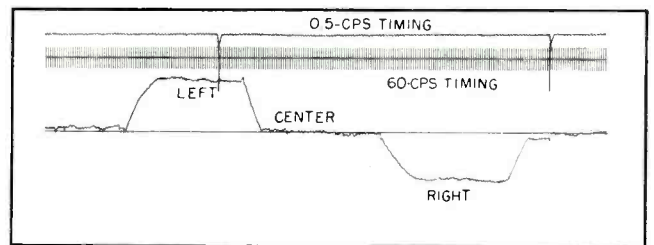

FIG. 1—Direct-coupled amplifier arrangement used to provide overall gain of 99 db, with circuit noise level of only about 3 microvolts, for recording eyeball potentials and their derivatives. Uppermost output stage handles second derivative, which is proportional to force of extrinsic ocular muscles that move eyeballs right and left and up and down



Arrangement used for recording position of eyeballs, with chart trace at right



Sample of calibration record for 45-degree eye motion left and right of center

any one subject the relation of potential to position shows little change from day to day.

This eyeball potential, if recorded, furnishes a graph which indicates the angular position of the eyeball as a function of time,  $\theta(t)$ . Differentiation of this voltage therefore indicates the velocity,  $\omega = d\theta(t)/dt$ , of the eyeball movement. A second differentiation furnishes the angular acceleration,  $a = d^2\theta(t)/dt^2$ , of the eyeball.

Once the acceleration of the eyeball is known, the force causing it can be found easily from Newton's law. For translational movement, force is equal to mass times accel-

eration. For the rotational movement of the eye this law has to be modified into  $T = aI$  where  $T$  is the torque,  $a$  is angular acceleration and  $I$  is the polar moment of inertia of the eyeball. With some simplification one can say that the torque  $T$  is the result of the muscular force  $f$  acting at a radius  $r$  from the center of rotation, so that  $T = fr$ . The muscular force can therefore be found from

$$f = \frac{T}{r} = \frac{aI}{r} = \frac{d^2\theta(t)}{dt^2} \frac{I}{r} \quad (1)$$

It can be shown<sup>8</sup> that the output voltage  $e$  from the subject is proportional to the angular position of

the eyeball, so that

$$e = k \frac{d^2\theta}{dt^2} \frac{I}{r} \quad (2)$$

The force of the extrinsic ocular muscles is proportional, therefore, to the second derivative of the output voltage arising between the electrodes attached to the patient's temples. In this equation  $k$ ,  $I$  and  $r$  are constants; their values need not be known for comparative measurements. For absolute measurements  $I$  and  $r$  can be approximated with reasonable accuracy from anatomical data. The constant  $k$  is the overall calibration constant and includes the subject,

the gain of the amplifiers, the constant of the differentiators and the sensitivity of the recorder, all of which can be measured.

### D-C Amplifier Design

The first and most important step in the present experiments is the amplification of the eye potentials so as to permit their recording and differentiation. The smallest important signals are of the order of 25 microvolts. The slowest potential has a period of 2 seconds. At the other end of the frequency response it is desired to have the cutoff high enough to permit accurate reproduction of the most rapid rise times. Since it is desired to record the output graphically, the amplifier is designed with a slightly higher cutoff than that of the best available recording galvanometer, which is about 5,000 cps. It was felt that these requirements could best be met by a direct-coupled amplifier.

The high gain required, about 100 db, and the necessity of maintaining the drift at a fairly low level call for special techniques. Batteries are used as the power supply for all but the output stage. Tubes and other components are likewise selected for stability and low noise. Double-shock-mounted "red" tubes and wirewound resistors are used in the first two stages.

As shown in Fig. 1, the amplifier consists of three stages with a gain of 83,000 or 99 db. The stages are direct coupled. Because of the com-

mon cathode resistors, the amplifier is comparatively insensitive to equal voltage variation of the two input terminals. A Beckman Helipot in the plate circuit of the first stage permits balancing of the amplifier during operation when necessary.

The high zero-signal voltage of the third stage, which results from the direct coupling between the individual stages, is reduced to zero by the use of a cathode follower stage. There is, of course, an inherent loss of gain in this arrangement, but this is minimized by making the negative voltage large compared to the zero-signal plate voltage of the preceding stage. For the values used in this case, the gain factor is 0.63. This results in an overall amplifier voltage gain of 54,000 or 95 db.

The fact that the oscillograph galvanometers and, consequently, the oscillograph amplifiers are single-ended means that only half of the gain of the amplifier can be employed. Rather than employ an additional stage to convert the balanced output to a single-ended input, the output is simply taken from one half of the amplifier. While this solution is simpler and requires fewer tubes, it is necessary to adjust the operating points of the two tubes of the final amplifier stage so both would be capable of handling either positive or negative signals within the linear portion of their characteristic. This adjustment is made by selecting the cathode resistor to give the proper

value of bias. Centering of this stage is achieved as in previous stages by adjustment of load resistors.

The basic consideration in the design of the differentiators is the time constant of the R-C network, which was arrived at experimentally. The time constant of the first differentiator is chosen at 0.01 second; that of the second, where the additional stage of gain permits, is decreased to 0.001 second.

The other important design consideration is the degree of smoothing. In general, the high-frequency components present in the noise are such that their derivative will tend to mask the derivative of the function. To avoid this difficulty, the higher-frequency components are removed from the signal to be differentiated with a shunt capacitor that acts in conjunction with the input impedance of the stage as a low-pass filter. For this purpose a 0.5-microfarad capacitor is used at the input to the first differentiator and a 0.05-microfarad capacitor is used at the input of the second differentiator. Mathematical computation, confirmed by visual comparison of the filtered and the unfiltered waveforms, has shown that the smoothing does not appreciably change the waveform, but simply removes the noise component of the signal. Both differentiators were calibrated by means of triangular waves of known rise time.

### Oscillograph Amplifiers

The amplifier for the oscillograph galvanometer used for the recording of the function itself is direct coupled, while the amplifiers employed for the two differentiated functions are capacitance-coupled. The major requirement for this stage is high transconductance, a current rating of 100 milliamperes and a fairly low drift. The two parallel 6AG7 tubes with a small amount of cathode feedback meet these requirements. In parallel their total transconductance is 20,000 micromhos. A single-ended arrangement was chosen. A balanced stage could have been designed, but when used with galvanometers having no centertap it would have required twice the

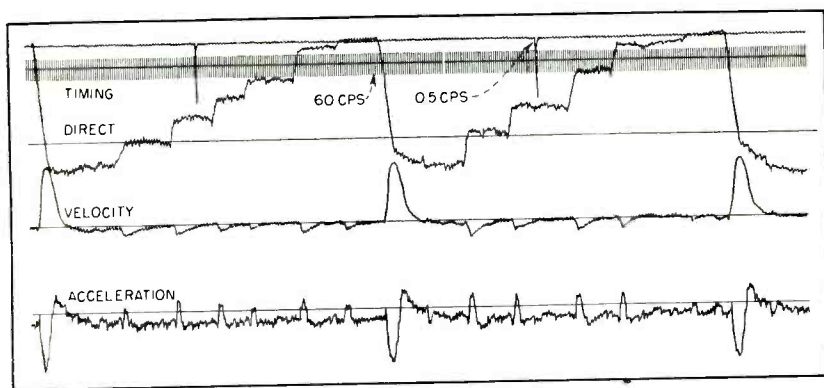

FIG. 2—Example of pattern obtained while subject reads line of print. Direct trace shows eye position during reading. Eye velocity is first derivative of eye position potential. Eye acceleration trace is second derivative, corresponding to muscular forces that move eyeballs from side to side and up and down

power supply capacity now used.

Centering was provided by the use of a variable current to oppose the tube current. This centering current was obtained from a 3-volt battery and a variable resistance. A gain control and an output selector were also provided. The latter permitted a meter or a shunt resistor to be switched into the circuit in place of the galvanometer.

Bias for the two capacitance-coupled amplifiers is provided from the power supply through the grid resistor. For the direct-coupled amplifier it is adjusted by varying the output voltage level of the cathode follower stage. The amplifier is operated with a zero-signal current of 50 milliamperes in either direction. With galvanometers of highest sensitivity (1.7 milliamperes per millimeter) this is equivalent to about 3 centimeters deflection to either side of center.

A modified General Electric miniature oscillograph PM17 is used for recording. For these experiments it is equipped with galvanometers having a frequency response of less than 1,000 cycles per second.

The electrodes were made from a head band taken from a set of earphones. Brass holders were machined to fit in place of the earphone assembly. The electrode itself consists of a cup-shaped silver button, about  $\frac{1}{8}$  inch in diameter, supported by a straight silver wire which fits through a hole in the plastic mounting. A sponge-rubber washer assures even pressure. Both the position and the pressure of the electrodes can be adjusted by use of set screws.

Whenever two electrodes are brought into contact with a human skin, a polarization voltage up to one volt may occur. Usually this voltage is not constant, and therefore introduces a slow drift. A low-impedance voltage source that is reversible in polarity and continuously variable over several ranges is used to balance out this contact polarization. A meter makes it possible to record the magnitude of the polarization if desired.

The subject is seated inside a shielded and grounded cage. The three voltage-amplifier stages and the cathode follower, all battery-

operated, are placed on a small carriage. The three output terminals of the amplifier are connected to the corresponding terminals in a shielded terminal box in the side of the cage. From there connections are made to the oscillograph amplifier and to the differentiators.

### Calibrating Procedure

Prior to making a test, the amplifier is allowed to warm up for 15 to 30 minutes. The subject is seated against the center of the far wall of the cage, facing a point on the near wall midway between two signal lights. The area under the electrodes is cleaned and the head piece put in place. The amplifiers and associated equipment are then adjusted and a series of calibration tests made to check the relation between the eye position and the measured eye potential. Calibration involves having the subject hold his head fixed and move his eyes to look at numbered marks on the opposite wall of the cage corresponding to a certain angular position to each side of a central point. The movement itself starts quite abruptly; preceding each movement there is a small spike of about 10 microvolts in the negative direction. This either corresponds to an eye motion through about two degrees or may represent a muscle twitch connected with the eye movement.

After the calibration test the subject is given a reading task, while the output voltage and its derivatives are recorded. As described by previous workers<sup>4</sup>, when reading a line of print the eye does not move continuously, but in jumps (saccades). The position of the eye is fixed towards a certain group of letters or words, and then moves to a new group. Occasionally, as when the reader does not grasp the meaning of a word, regression occurs, wherein the eye jumps a step back and then continues the usual pattern.

A record of a reading pattern is shown in Fig. 2. The first derivative pattern shows that the velocity of the return sweep is considerably higher than that of the saccades. The time required for the saccades is almost the same as that needed for the much larger angular deflection of the return sweep. The

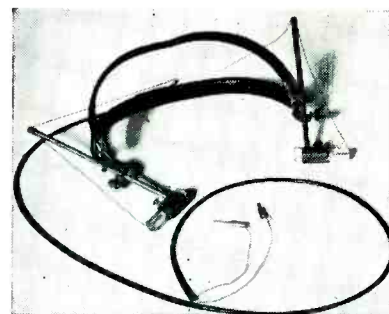

Electrode arrangement used on temples of subject to pick up eyeball potentials

muscular forces expended for the saccades as well as for the return sweeps are surprisingly constant for any one subject. The forces needed for the return sweep are from two to three times higher than the ones needed for the saccades.

The noise level in these records is of the order of five to seven microvolts. Inasmuch as the noise level of the amplifier with an equivalent resistor substituted for the human subject is about three microvolts or less, it may be assumed that the noise is biological in origin. Jaw motion, neck motion and blinking, as well as other muscular involvements, are the most important sources of this noise.

The record of the forces exercised by the extrinsic ocular muscles may be of considerable help in physiological investigations or for medical diagnosis. It is also expected to be of particular importance in the study of visual fatigue. The method is applicable, of course, to other muscles or muscle groups if their action can be converted into an equivalent voltage or current.

The authors wish to express their thanks to the Illuminating Engineering Society Research Fund for sponsoring this research.

### REFERENCES

- (1) O. H. Mowrer, T. G. Ruch and N. E. Miller, The Corneo-Retinal Potential Difference as the Basis of the Galvanometric Method of Recording Eye Movements, *American Journal of Physiology*, 114, p 423, 1928.
- (2) W. O. Fenn and J. B. Hursh, Movements of the Eyes When the Lids are Closed, *American Journal of Physiology*, 118, p 8, 1937.
- (3) To be published in the *American Journal of Physiology*.
- (4) L. Carmichael and W. F. Dearborn, "Reading and Visual Fatigue," Cambridge: Houghton Mifflin Company, 1947; M. Luckiesh and F. K. Moss, Reading a Line of Print, *School and Society*, Vol. 53, p 612, May 1941; "Reading as a Visual Task", D. Van Nostrand Co., 1942, N. Y.; "The Science of Seeing", D. Van Nostrand Co., 1937 (1943), N. Y.

# CURVE TRACER with

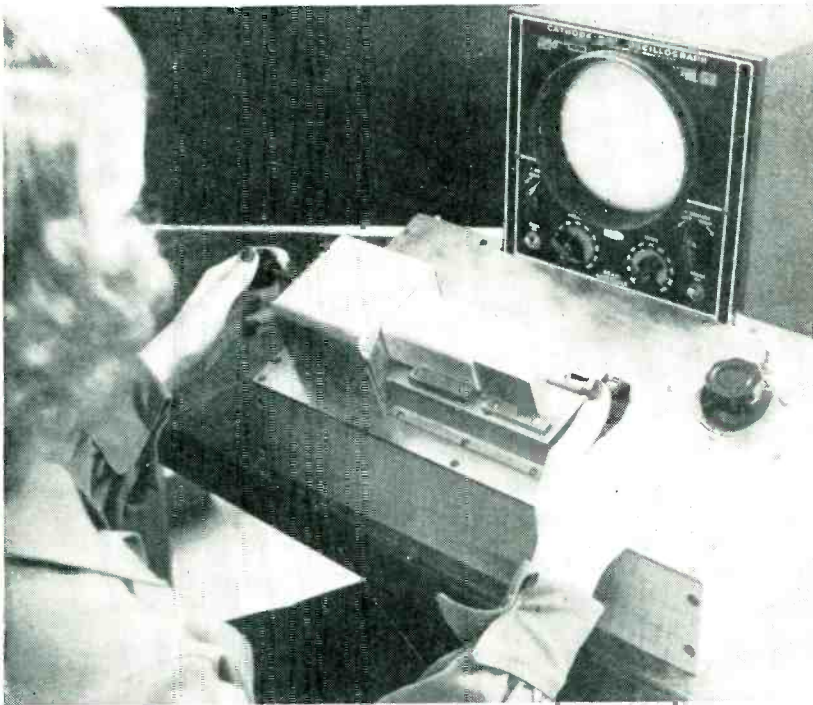

Unskilled operator using curve tracer can achieve higher production rates at lower test cost per unit than was previously obtainable with point-by-point production testing of band-pass filters. Resulting response curve is also smoother and more symmetrical. Operator merely adjusts captive screwdrivers to make band-pass peaks come within proper electronically produced limit lines on cathode-ray screen

**By J. W. BALDE, J. C. BREGAR and K. L. CHAPMAN**

*Engineering Staff, Western Electric Radio Shops  
Winston-Salem, North Carolina*

**I**N RECENT YEARS, the cathode-ray oscilloscope and frequency-sweep generator have been adapted to display the frequency-amplitude characteristics of apparatus under test. Results of tuning or coupling adjustments are instantly shown qualitatively on the cathode-ray tube screen.

To adapt this setup for quantitative measurements, a method of calibrating the cathode-ray display is necessary. This problem has been solved in numerous ways, one of which is to have displayed on the oscilloscope not only the curve of the response of the apparatus under test, but also a high limit and low limit curve. This has been done both mechanically and electronically, the former by fastening a graph of the high and low limit

curves on the face of the cathode-ray tube and the latter by electronically switching in high and low limit standards. The mechanical arrangement has proved useful but requires constant calibration due to amplifier drifts, frequency drifts and other uncontrolled variables. The electronic method eliminates errors due to these uncontrolled variables; however, if a large variety of apparatus is to be tested, the number of standards required becomes a major problem.

Recently, a program of filter production was started which required testing many different types of filters at various frequencies, for use in rural power line carrier telephone apparatus. With the high and low limit method, an excessive number of reference standards

McGraw-Hill Publications

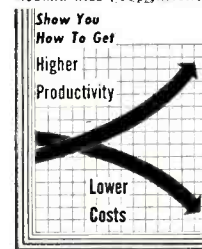

would have to be made, adjusted, carefully checked, and maintained with known recorded values for each filter. Therefore, a program was undertaken to develop a more universal type curve tracer which presents a graph-paper type of display electronically on the oscilloscope screen and requires no standard high-low limit units. In effect, what was desired was a flexible frequency scale and attenuation scale which produced a graph effect on the face of the oscilloscope. The response curve of the apparatus under test would then be read against these graph lines.

## **Nature of Display**

The curve-tracer display obtained is shown in Fig. 1. It includes the envelope of the gain characteristic of a filter under test and three horizontal lines. Each of the lines is obtained from the same input voltage that is applied to the filter. This input voltage is either applied directly to the detector circuit, producing a zero loss-zero gain reference line, or is passed through attenuators, producing a line at any specified attenuation level. Three such lines were decided upon, although any number of lines could be displayed. Such lines spaced equally in attenuation or vertical displacement form the vertical scale of graph lines.

The horizontal frequency scale is marked by negative intensity markers. Normally, only two frequency points are indicated, each appearing as a dark vertical line cutting all curves. The frequency interval between the two marker lines is controlled by key selection of crystals



# Electronic Graph Lines

Production testing and adjustment of band-pass filters, amplifiers and discriminators is speeded up by making electron beam trace calibrated graph lines on c-r screen along with response curve. Setup can be changed for different type of product in few minutes

which generate the lines. Here again, any number of vertical frequency marker lines could be displayed at the same time if desired, forming a horizontal scale, but only two were deemed necessary for the present application. The vertical lines can be set for any frequency interval in steps determined by the crystals available. Since the marker frequencies can be changed by key selection without disturbing any adjustments, intermediate frequency points may be identified at will.

The absolute frequency through which the apparatus under test is being swept is controlled by a separate tuning control which shifts the frequency until it is set at the desired point. Once set correctly, the frequency markers are used to produce the scale of frequency differences. Such setting of frequency markers is made to indicate absolute frequency by momentarily inserting some high-Q resonant circuit of known frequency into the transmission path in place of the apparatus under test. The output frequency is then adjusted till one of the relative markers coincides with the sharp pip displayed. This effectively locates the frequency markers with respect to absolute frequency, while the difference between the markers is determined with the accuracy of the crystals generating the markers.

## Technique of Use

What is needed for production testing is a display which can utilize the go-no go gage technique. Such a display should indicate the filter limits for center frequency,

bandwidth and gain. Only two frequency marks are needed, with the interval between the marks set to the bandwidth limit of the filter. The filter is tuned for the desired symmetrical curve, then shifted in frequency till the curve is visually centered between the markers. Once centered by the filter tuning adjustments, the gain and band-

width factors are ready to be measured or checked.

The gain check is performed by placing two attenuators in series with the signal from the test circuit. One attenuator, mounted on a remotely located control rack, is set to the value of nominal filter gain. The second attenuator, on the test console, is a small-range

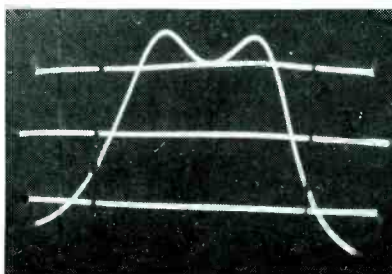

FIG. 1—Example of presentation incorporating three horizontal and two vertical graph lines along with response curve. More lines can be produced by the same electronic technique if needed, each representing a known value

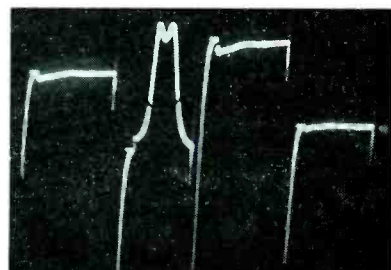

FIG. 3—Detector output waveform as applied to vertical deflection plates of c-r tube. Repeating this pattern 60 times per second with 240-cycle sawtooth sweep on horizontal deflection plates serves to superimpose the four traces

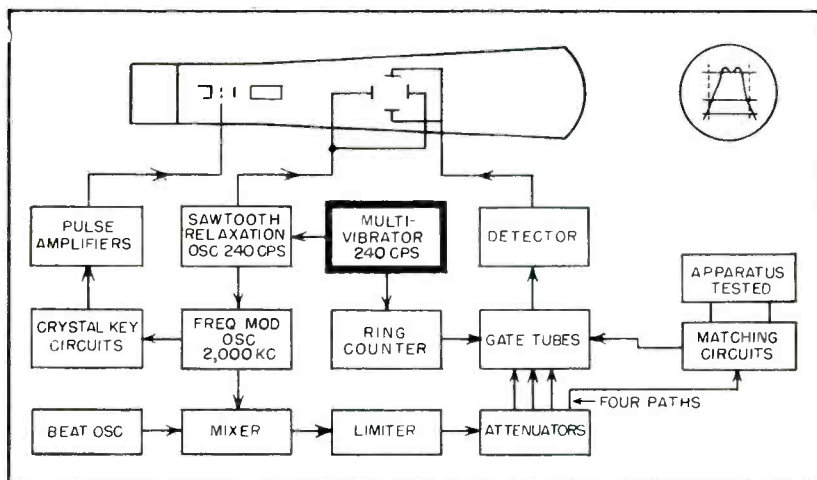

FIG. 2—A 240-cps multivibrator is the master control that makes the c-r beam trace in sequence the response curve and the horizontal graph lines, with Z-axis modulation producing the dark vertical lines

attenuator with a locking device. This locking device is set to limit the range of this attenuator to the permissible range of deviation from nominal gain of the filters. When a filter has been tuned to center frequency this small-gain-variation attenuator is adjusted by the test operator until the voltage level of the filter characteristic curve response at center frequency coincides with a zero reference line. If such coincidence cannot be accomplished within the available variation of the small-gain attenuator, the filter is known to be outside normal gain variation limits, and is rejected.

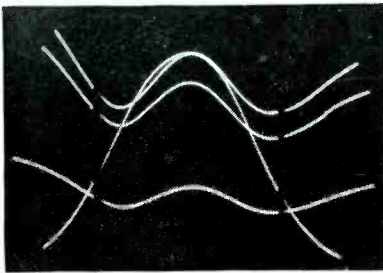

FIG. 4—Presentation obtained when input impedance of filter under test varies appreciably over range of frequencies employed. The three horizontal graph lines are now curved, but their relationship to the response curve is still a correct measure of gain or loss

With the filter centered between the frequency limits and the gain check made, the other two horizontal lines come into play. These lines are so set that they indicate the limits of filter loss at the nominal frequency bandwidth limits. The high limit line is set for 2 db, the wide limit of that filter. A filter narrower than the limit value will produce a curve which will cross the frequency marker line at a loss level greater than 2 db.

A wide filter will not have sufficient attenuation at the limit frequency (+25 kc for one particular filter) and its response curve will cross the marker line at a point above the 2-db line and be rejected.

In a similar manner, the low limit line is set for the narrow bandwidth limit (6 db) at the nominal width frequency. Excessively narrow filters having too great a loss at the specified bandwidth frequency will

show on the oscilloscope as crossing below the low limit line. A satisfactory filter curve will cross the marker lines between the two limit lines.

### Principle of Operation

In Fig. 2 is an overall block diagram of the complete curve tracer apparatus. The sawtooth relaxation oscillator operates at a frequency of 240 cps, driving a reactance tube which frequency-modulates an oscillator operating nominally at 2,000 kc. A beat oscillator signal is mixed with this frequency-modulated signal to shift the output frequency to the range desired for the apparatus under test. The mixer output is amplified and limited to guarantee uniform amplitude of signal over the frequency range being swept.

The frequency marker circuits are excited by a sample of the 2,000-kc frequency-modulated signal before mixing. The signal is fed to crystals in the 2,000 to 2,100-kc range serving as crystal filters. At the output side of the crystal, there is an increase in transmitted voltage at the resonant frequency of the crystal. This increase is not immediately usable to produce a marker signal because of the rounding of such increase due to the Q of the crystal.

The transient effect at the frequency of the crystal is sharpened by a positive-feedback pulse amplifier circuit. The amount of feedback, the capacitance across the crystals, and the time constant of the circuits are adjusted so a sharp, clear, steady pulse is produced from the crystal disturbance.

Operation of two crystal keys produces two steep, narrow pulses which sharply intensity-modulate an oscilloscope trace. The two notches or dark spots thus produced are separated along the horizontal (frequency) scale of the oscilloscope by a value determined by the differences of the absolute frequencies of the crystals involved. The distance separation is therefore a function of the frequency bandsweep of the f-m signal. The crystals can be selected as close together as 2 kc and the

markers will be usable and steady.

Such frequency markers provide a scale of relative frequency as accurate in frequency spacing as are the crystals. The frequency markers could be actuated by the output f-m frequency (after mixing), producing absolute frequency markers. The flexibility of the set with regard to changing frequency would be seriously inhibited, however, since new marker crystals would have to be provided for even the smallest change in frequency.

By actuating the markers from crystals operating at the high f-m frequency and changing the output frequency by heterodyning action with a beat oscillator, the markers become relative. Such relative markers can be located in relation to the absolute value of the output frequency by coinciding any one of the markers with the transmission output characteristic curve of any calibrated resonant circuit. The combination of relative markers and variable calibrated resonant circuit is far more flexible than absolute markers would be.

The gate tubes that serve as an electronic switch receive the frequency-modulated signal from the mixer through four separate paths, each having an attenuator. One of the paths has zero attenuation. The apparatus under test is normally inserted in another of these paths. The signal from all four paths is combined at the detector by sequence-switching the input of the detector to the signal from each of



Unified test position, with electronic circuitry and electrical matching networks for filters located under console. Operator's test jig clamps to front of scope, masking all scope controls except centering, focusing and intensity

the paths in rotation. This composite detected signal is applied to the vertical input of the oscilloscope. The signal is a series of four pictures, each a frequency response of the transmission characteristics of the path involved.

A 240-cycle multivibrator synchronized with 60 cycles is used as the basic pulse generator for actuating the ring counter used to switch the gate tubes of the electronic switch and for synchronizing the saw-tooth sweep generator. Since there are four paths, the basic switching rate of 240 causes each path to be repeated 60 times per second, a value satisfactory to avoid flicker on a cathode-ray oscilloscope with a P-1 phosphor.

The waveform of the output of the detector is as shown in Fig. 3, with the four images in sequence. These four images are superimposed on the face of the oscilloscope of the curve tracer by driving the horizontal sweep of the oscilloscope with the 240-cycle sweep of the relaxation oscillator. This sweep, being the same as the frequency sweep rate, causes all paths to be displayed with the same horizontal location for equal frequencies, and persistence of vision combines them into one picture.

### Production Test Procedure

The circuits connected directly to the filter under test are selected to supply the appropriate voltages and terminal impedances to the filter. The circuits may take any form necessary to provide a transmission path through the apparatus under test, terminated in the proper impedances both to the curve tracer circuits and the filter. Since the circuits will vary with the filters to be tested, little can be said here as to what form such circuits will take. They must be stable, linear elements arranged so that the transmission through the entire circuit is affected by the portion under test alone.

Connections to the filter circuits have been made low-impedance. For production line testing, it is convenient to have the test position placed right on the assembly line, especially if conveyor belt operation

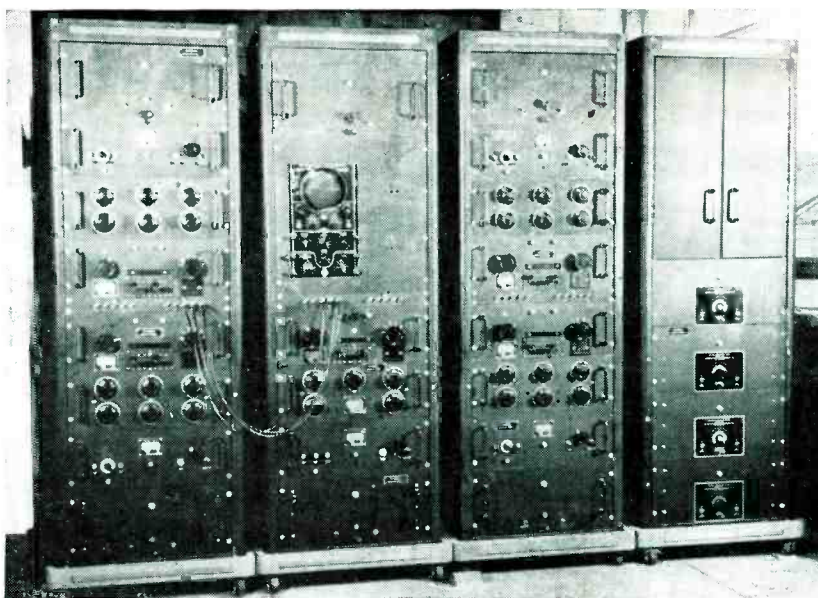

Rack-mounted electronic circuitry serving installation of five curve tracers. Monitor oscilloscope facilitates checking operation of test sets on production line. Locating controls remotely from operators minimizes accidental shifting of adjustments and simplifies maintenance

is planned. By connecting to the filter circuits with low-impedance cables, the rack-mounted electronic circuit items of the curve tracer proper can be located up to 40 feet away without undue pickup due to long lines. The filter circuits can be combined with the oscilloscope into a test console of small, convenient size. When there is a group of such console work positions, the curve tracer components can be located together with a monitor oscilloscope to facilitate observation of the operation of the sets.

When testing filter circuits over a range of frequencies, the effect of varying input impedance on input voltage can be eliminated by producing the horizontal attenuation lines from a sample of the input voltage to the filter. The horizontal graph lines are then pulled down along with input voltage as the filter impedance drops, and the relationship between them remains a correct measure of the transmission loss or gain of the filter. Figure 4 illustrates such a curve of a filter with input impedance variation.

When using the curve tracer with a filter whose input impedance varies, the variation in input impedance can be used as a tuning aid. The primary of the filter when

tuned will produce a dip or drop in voltage at its resonant point. The filter therefore can be tuned to center frequency by observing the db reference lines only. For three or four-section filters where the output voltage is negligible till all tuning adjustments have been made, this becomes very important.

### Conclusions

The curve tracer described here, while initially designed because of a particular need of one project, is essentially a flexible tool. The present model can test any apparatus with a band spread from 10 to 70 kc at center frequencies of 100 to 700 kc. Such a curve tracer could be constructed for any necessary frequency and bandwidth. The electronic graph paper method can be used to observe and test many different types of apparatus, including amplifiers, receivers and discriminators.

The design of the present curve tracer apparatus was carried on under the immediate supervision of D. K. Briggs, F. E. Burley, and D. R. Barney, department chiefs of test engineering. The authors wish at this time to express appreciation for their encouragement and assistance during the development period.

# D-C AMPLIFIER Using

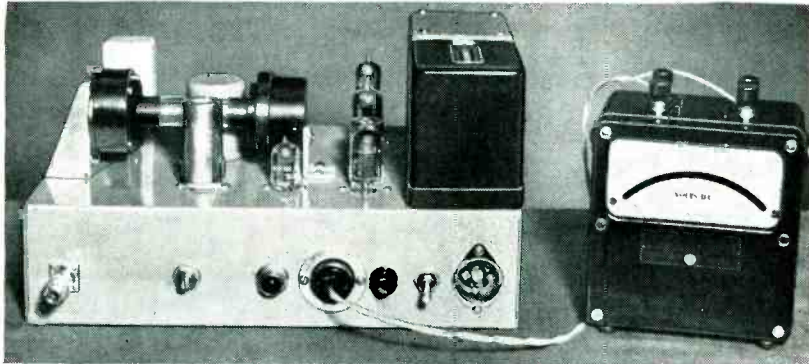

By **CURTISS R. SCHAFER**

*Member, Technical Staff  
C. G. S. Laboratories, Inc.  
Stamford, Conn.*

Complete amplifier is nonmicrophonic and rugged enough to withstand use in truck over rough terrain. All internal ground leads are brought to lugs under mounting screws of UG-290/U input receptacle at left. Air-coupled chopper is on top of chassis. During development, voltmeter at right was used instead of a recording galvanometer

the output of the choke may be assumed to have a certain value of direct current upon which there is superimposed a nonsinusoidal alternating current. During the positive peaks the grid of the 5610 is driven in a positive direction, the plate current increases, and the plate resistance of the tube is lowered so that these positive peaks are actually absorbed in the tube. The reverse action takes place during that part of the cycle when the grid is driven more negative. The 2,000-ohm variable resistor is adjusted for maximum control (or filtering), and locked. Variations in line voltage from 90 to 130 volts rms produce a change of only 0.02 percent in ripple voltage at the output of this filter, and this variation

**U**SE of air coupling between the exciting coil and the moving contacts of this new d-c/a-c modulator, or chopper, gives two advantages over conventional choppers used for breaking up a d-c signal to permit amplification in a high-gain a-c amplifier. First, the exciting voltage for the reed is kept entirely out of the field around the contacts, so that no local noise is generated except the thermal noise due to contact friction. Second, the modulating frequency may range from 20 to 2,000 cycles per second. A high carrier frequency has definite advantages when it comes to the reduction of hum in an amplifier.

The new modulator consists of two units, shown in Fig. 1. The driver is a miniature loudspeaker of the moving-coil type, with a phenolic diaphragm which is air-coupled to the chopper diaphragm through a flexible plastic tube. This driver is excited at a frequency of 1,000 cycles per second (in the present design) by the amplified output of a stabilized Colpitts oscillator, which also supplies the reference voltage to the discriminator.

The driver unit may be mounted anywhere on the chassis, even in a region of strong magnetic fields, and the chopper may be placed right at the input stage.

The amplifier, oscillator and polarity discriminator circuits used

with the air-coupled modulator to provide d-c amplification are shown in Fig. 2. One unique circuit feature here is the electronic ripple filter for the plate voltage supply.

Electronic filtering gives smoothing action equal to a standard filter section consisting of two 40- $\mu$ f electrolytic capacitors and one 30-henry choke. With its use, only small values of paper capacitors are required, chiefly for bypassing.

The partially filtered voltage at

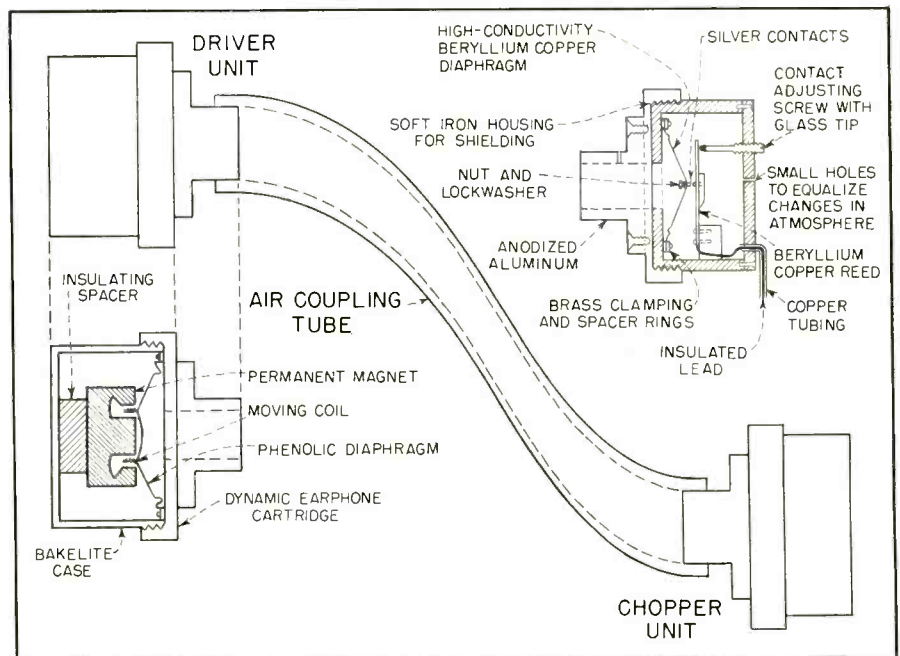

FIG. 1—Flexible plastic tubing with diaphragm at each end provides air coupling between driver and chopper that breaks up weak direct current to permit amplification in high-gain a-c stages. Locating driver remotely keeps its stray field away from chopper contacts, reducing noise



# Combining Positive

By JOHN M. MILLER, Jr.

Broadcast Receiver and Television  
Engineering Dept.  
Bendix Radio Division  
Baltimore, Maryland

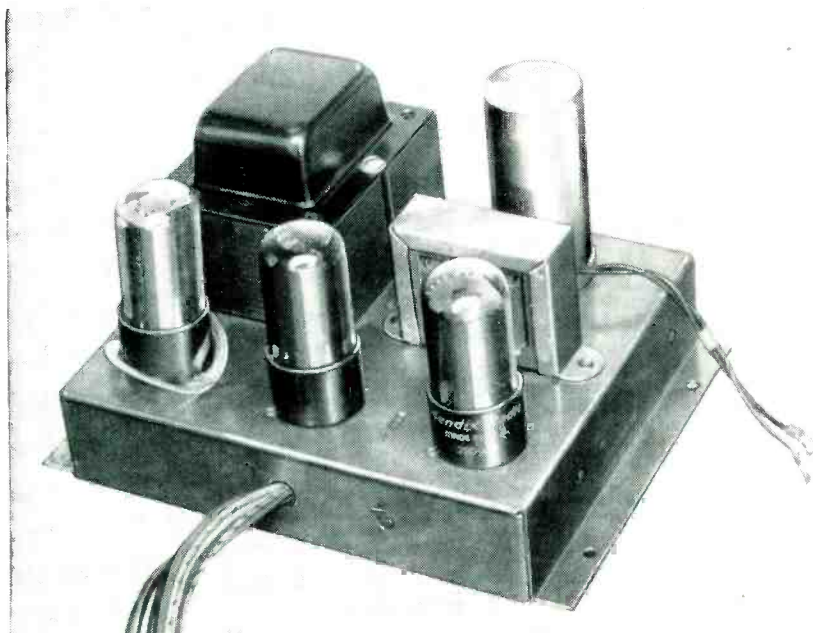

Experimental output-stage chassis. Unit is capable of 5 watts output with 0.5-percent harmonic distortion at 400-cps. Note small output transformer

IT HAS BEEN PROVED that the ear can detect as little as 0.5 percent of pentode distortion.<sup>1</sup> To achieve this low degree of distortion in typical pentode amplifiers, approximately 25 db of negative feedback is required. This sacrifice in gain, and the solution of the oscillation problem outside the passband, involve considerable added cost.

It is possible in a two-stage amplifier to approximate the results that would be obtained in a conventional amplifier with 25 db of negative feedback, by using a combination of local positive feedback in the first stage, and a moderate amount of overall negative feedback. The positive feedback has the effect of increasing the gain of the first stage. The general principle of combined feedback has been known for some time.<sup>2</sup>

The block diagram of a two-stage amplifier with combined feedback is shown in Fig. 1. The inherent voltage gains, with no feedback, of the first and second stages, are represented by  $A_1$  and  $A_2$  respectively, for very small signals;  $B_1$  is the feedback ratio of the feedback around the first stage, and  $B_2$  is the overall feedback ratio, for very

small signals. The feedback ratio is defined as the ratio of the voltage fed back to the voltage existing at the point from which the feedback is obtained. These are all complex vector quantities, although their phase angles are likely to be very small in the vicinity of the amplifier band center. In the ideal case where there are no phase shifts,  $A_1$  and  $A_2$  are conventionally considered to be positive, and a feedback ratio is positive when the voltage fed back is in phase with the input.

## Feedback Equations

The voltage gain is

$$A = \frac{A_1 A_2}{1 - A_1 B_1 - A_1 A_2 B_2} = \frac{A_1 A_2}{N} \quad (1)$$

$N$  is the vector quantity by which the gain without feedback,  $A_1 A_2$ , is divided. If  $B_1$  is positive (which would be the case for positive feedback), it has the effect of increasing the gain  $A$ ; and  $B_2$ , if negative, tends to decrease the gain.

A term such as  $A_1 B_1$  or  $A_1 A_2 B_2$  is known as a feedback factor. In the ideal case it will be a pure positive or negative quantity, but in the practical case, it will have a phase angle that is the sum of the phase angles of the factors involved.

When there is no phase shift in the feedback network itself, the feedback ratio is considered to be a real quantity, and the phase angle of the feedback factor is equal to the sum of the phase angles of the  $A$ 's involved.

The output impedance  $Z_2$  is

$$Z_2 = Z_L \frac{(1 - A_1 B_1)}{N(1 + Z_L/Z_{p2}) - (1 - A_1 B_1)} \quad (2)$$

where  $Z_L$  and  $Z_{p2}$  are the load impedance and inherent output impedance of the output stage. It is seen in the above expression that when the product  $A_1 B_1$  is positive, a decrease in the output impedance can result.

The expression for distortion and gain stability is

$$D = \frac{D_1}{N} + D_2 \left( \frac{1 - A_1 B_1}{N} \right) + D_1 D_2 \left( \frac{1 - A_1 B_1}{N} \right) \quad (3)$$

The inherent gain increments  $D_1$  and  $D_2$  in the first and second stages are caused, for example, by a change in applied static or instantaneous signal electrode voltages, or aging of the tube, and  $D$  is the resulting overall gain increment. The parameters  $D$ ,  $D_1$ , and  $D_2$  are each expressed as a fraction of  $A$ ,  $A_1$ , and  $A_2$ . Equation 3 also holds if  $D_1$ ,  $D_2$ , and  $D$  represent nonlinear distortion.

## Regeneration and Distortion

For most purposes, optimum performance is obtained by designing so that the product  $A_1 B_1$  over the useful range of frequencies is approximately equal to unity. (If the negative feedback were temporarily removed, the first stage would be in a state of critical regeneration, with a gain approaching infinity.)

# and Negative Feedback

Development of simple two-stage audio amplifier using a combination of local positive feedback in first stage and a moderate amount of overall negative feedback to approximate the results obtainable from conventional amplifier with 25 db negative feedback

From Eq. 2, we now obtain zero output impedance, and from Eq. 3 we find that the distortion and gain variation contributed by the final stage, including the output transformer, are reduced to zero. From Eq. 1, the gain becomes  $1/-B_2$ . In an amplifier using negative feedback only, it would be necessary to provide an infinite amount of feedback gain reduction to obtain these results.<sup>3</sup> Very good results can be obtained even when  $A_1B_1$  departs from unity by  $\pm 20$  percent.

It will be seen from Eq. 3 that if  $A_1B_1$  exceeds 2, the distortion introduced by the output stage will actually be greater than that which would be produced by omitting the positive feedback entirely. This

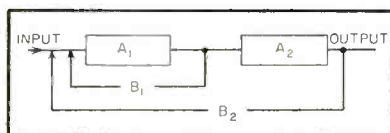

FIG. 1—Notation used for a two-stage amplifier showing two feedback paths

shows the unsoundness with large feedback factors of the balanced feedback principle, in which  $A_1B_1$  is made equal to  $-A_1A_2B_2$ , ( $N$  equals unity), since the distortion and gain variation are greater, though reversed in sign, than if no feedback at all were used.

### Oscillation

It is apparent from Eq. 1 that the quantity  $(A_1B_1 + A_1A_2B_2)$  is analogous to the feedback factor  $AB$  in a conventional feedback amplifier, and may be considered to be the effective feedback factor in determining the possibility of oscillation. Thus we can use Nyquist's<sup>4</sup> and

Bode's<sup>5</sup> criteria in analyzing any particular case. If, because of phase reversal in the feedback factor, a positive value of unity is assumed at some frequency, Eq. 1 gives a gain value of infinity, indicating oscillation. If the feedback factor is positive and greater than unity, oscillation will usually result, although there are exceptional cases, known as conditional stability<sup>6</sup>, where oscillation does not result. However, in good practice it is customary to design so that the feedback factor never assumes a positive value greater than, say, 0.5.

Since the effective feedback factor  $(A_1B_1 + A_1A_2B_2)$  must be held to a value less than plus unity at all frequencies to avoid oscillation, then if  $A_1B_1$  equals plus unity, the negative feedback factor  $A_1A_2B_2$  must never become zero or positive. This requirement cannot

be met; in fact, the asymptotic phase shift in a loop containing a two-stage resistance-coupled amplifier and the primary and secondary of an output transformer is at least 270 degrees at very high frequencies with a resistance load. Thus it becomes necessary to cause  $A_1B_1$  to assume a value other than unity at frequencies where  $A_1A_2B_2$  is positive. A phase shift must be introduced into the feedback transmission network which, in conjunction with the phase shift in  $A_1$ , actually reverses the phase of  $A_1B_1$  at very high and very low frequencies, so that it becomes negative feedback, although its amplitude is then very small. The local feedback factor  $A_1B_1$  may now tend to oppose rather than aid oscillation at extreme frequencies where  $A_1A_2B_2$  is positive, although  $A_1B_1$  is still essentially positive and nearly unity

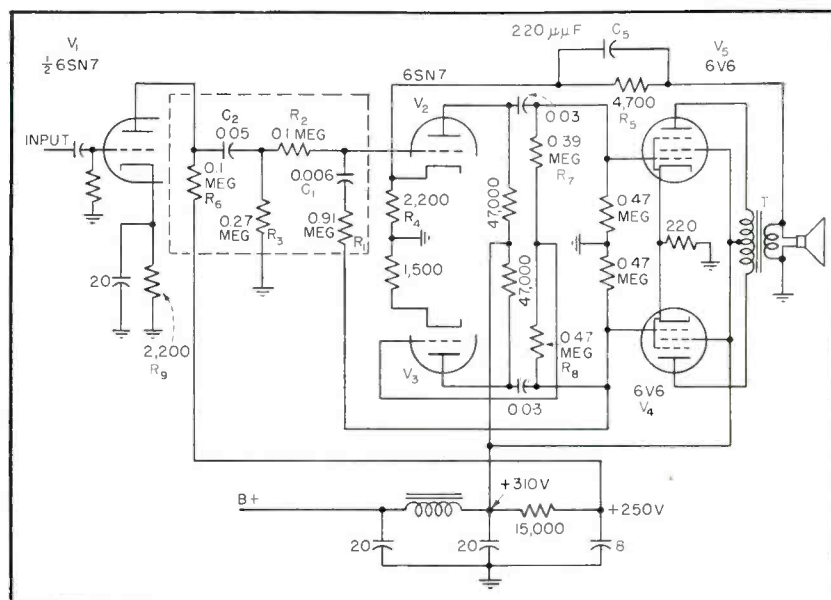

FIG. 2—Two-stage amplifier using combination feedback circuits

**Table I—Distortion Figures for Various Combinations of Operating Conditions**

Harmonic Distortion—8 watts into 3.9-ohm speaker load						
Harmonic	Frequency in Cps					
	100		400		1,000	
	%	Db	%	Db	%	Db
2	0.12	58	0.2	54	0.17	55
3	0.09	61	0.24	52	0.32	50
4	0.04	68	0.045	67	0.036	69
5	0.034	69	0.017	75	0.04	68
6	0.002	94	0.003	90	0.02	74
7	<0.001	—	<0.001	—	0.006	84
8	—	—	—	—	0.006	84
9	—	—	—	—	<0.001	—
10	—	—	—	—	0.012	78
11	—	—	—	—	<0.001	—

Harmonic Distortion—3.9-ohm load				
Harmonic	50 Cps, 5 watts		2 Kc, 1 watt	
	%	Db	%	Db
2	0.7	43	0.1	60
3	0.88	41	0.23	53
4	0.03	70	0.006	84
5	0.08	62	0.02	74
6	0.01	80	0.002	94
7	0.02	74	0.008	82
8	0.004	88	—	—
9	0.002	94	—	—
10	0.002	94	—	—

Percent Harmonic Distortion—8 watts into 3.9 ohms at 100 cps			
Harmonic	No feedback	Negative feedback	Pos-neg feedback
2	0.6	0.07	0.12
3	6.0	2.2	0.094
4	0.15	0.01	0.04
5	0.6	0.08	0.034
6	0.2	0.08	0.002
7	0.2	0.04	<0.001

Percent Harmonic Distortion—8 watts into 3.9 ohms at 400 cps			
Harmonic	No feedback	Negative feedback	Pos-neg feedback
2	1.4	0.3	0.2
3	7.0	2.4	0.24
4	0.6	0.1	0.045
5	1.2	0.08	0.017
6	0.14	0.02	<0.001
7	0.27	0.02	<0.001

Percent Intermodulation Distortion—8 watts into 3.9 ohms, 4 to 1 voltage ratio at 60 and 100 cps			
Frequency	No feedback	Negative feedback	Pos-neg feedback
2 kc	—	—	1.4
7 kc	40	8.0	1.9
12 kc	—	—	2.2
100 Cps			
2 kc	—	6.6	0.52
7 kc	—	5.8	0.84
12 kc	—	6.1	1.0

throughout the band of useful frequencies.

The amplifier of Fig. 2 incorporates positive and negative feedback. It is otherwise conventional, using self-bias throughout, and a highly degenerative self-balancing phase inverter. The output transformer is small, having a  $\frac{3}{4} \times \frac{3}{4}$ -inch stack. The copper efficiency is about 80 percent.

The overall negative feedback is obtained from the secondary of the output transformer  $T$ , and is fed through  $R_5$  to the cathode of  $V_2$ . Shunt capacitor  $C_5$  affords some feedback phase correction at very high frequencies. The feedback gain reduction is 9 db, and becomes 11 db with the positive feedback disconnected.

The positive feedback is obtained from the grid of  $V_4$ , and is fed through  $R_1$  and  $C_1$  to the grid of tube  $V_2$ . The positive feedback voltage is developed primarily across  $R_2$  and  $C_2$ , since the plate resistance of  $V_1$  is relatively small, and the input resistance of the grid of  $V_2$  is high. The positive feedback is designed so that, with the negative feedback disconnected,  $V_2$  will be near oscillation or oscillating weakly. Since the voltage gain of the stage  $V_2$  is approximately 10, about one-tenth of the voltage on the grid of  $V_1$  is fed back to the grid of  $V_2$ . The resistance of  $R_1$  is therefore made about nine times that of  $R_2$ , and  $C_2$  has about nine times the capacitance of  $C_1$ . Thus the phase and amplitude of the positive feedback is maintained flat over the range of audio frequencies. Because of the highly degenerative nature of the phase inverter, the balance is not appreciably affected by the additional load of the positive feedback network.

Some phase shift in the positive feedback is obtained at extreme frequencies in the stages  $V_2$  and  $V_3$  due to electrode and stray capacitances, and due to the blocking capacitors. The input capacitance of the grid of  $V_2$  causes a further phase shift, so that the polarity of the product  $A_1B_1$  reverses from positive to negative at extremely high frequencies. The input capacitance of  $V_2$  is primarily dynamic, due to feedback through its grid-plate capacitance<sup>6</sup>, at very high fre-

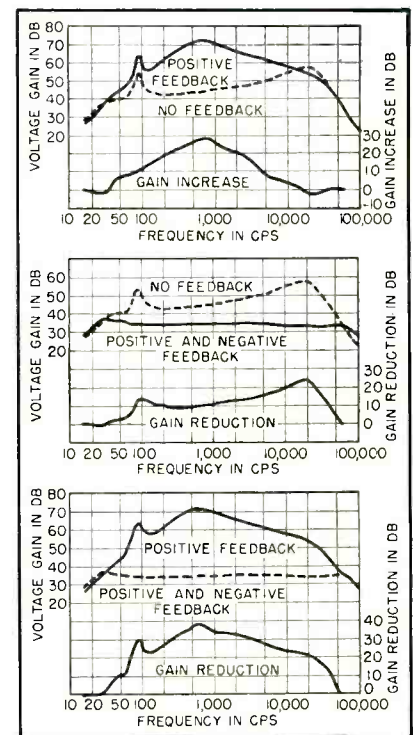

**FIG. 3—Amplifier response curves for various types of feedback with 0.5-watt input to a 3.9-ohm loudspeaker load**

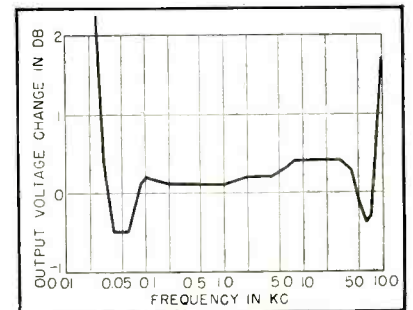

**FIG. 4—Voltage regulation in db with 1-volt output into 3.9-ohm loudspeaker load**

quencies where the overall feedback is positive or small.

In some designs, it may be necessary to connect a small capacitor from the grid of  $V_2$  to ground, or to use a more elaborate phase-shift network to obtain a sufficiently rapid phase turnover in the local feedback.

At extremely low frequencies most of the local feedback current flows through  $R_3$  instead of through  $C_2$ , so that a phase shift is obtained, which together with the phase-shifting action of the 0.03- $\mu$ f blocking capacitors in stages  $V_2$  and  $V_3$ , is sufficient to cause the desired phase reversal. In practice, the phase reversal frequencies are



placed as far outside the desired pass band as good stability permits.

### Performance Measurements

Figure 3 permits the determination of the quantities  $(1-A_1B_1)$ ,  $(1-A_1B_1-A_1A_2B_2)$ , or  $N$ , and ratio  $(1-A_1B_1-A_1A_2B_2)/(-A_1B_1)$ .

Figure 4 indicates a negligibly small output impedance, since the output voltage varies only slightly when the speaker load is disconnected. The regulation of 0.1 db at 400 cycles may be compared with the regulation of 2.7 db that is obtained with the positive feedback disconnected (11 db of negative feedback remaining) or the regulation of 19 db that is obtained with no feedback.

The distortion indicated in Table I would presumably be inaudible even with a wide-range loudspeaker. The intermodulation distortion averages three or four times as much as the harmonic distortion, as would be expected. The table shows that the positive feedback causes a great reduction in distortion.

### Design Improvements

The amplifier of Fig. 2 is not represented as being the ultimate in design of a positive-negative feedback amplifier, although it seems probable that most major improvements would involve cost increases.

If the negative feedback could be

made uniform over a wider frequency range, the local positive feedback could also be made effective over a wider range. A wide-band output transformer would be helpful. Reducing  $R_1$ ,  $R_2$ ,  $R_3$  and  $R_6$  and  $R_8$ , and increasing  $C_2$  and  $C_1$ , will also be helpful. The grid-plate capacitance of  $V_2$  could be largely neutralized by shunting  $R_1$  with a small capacitor of, say, 3 micro-microfarads. The last two measures would reduce the high-frequency phase shift in the overall feedback that is caused by the Miller effect in  $V_2$ . Also,  $R_7$  could be shunted with a small capacitor to reduce the phase shift caused by the grid-plate capacitance of  $V_3$ . It would also be desirable to replace  $R_1$  by a network having a rapid phase turnover at ultrasonic frequencies and a small phase shift at audio frequencies.

### Low-Cost Amplifier

Figure 5 shows the circuit of an economical amplifier. Type 6K6GT output tubes are used, and the current drain is so low that a 5Y3 rectifier is used at less than its rated operating conditions, and with resistance filtering only. The hum is almost inaudible even in a quiet room, being 67 db below maximum level. In production, the output regulation rarely exceeds  $\pm 0.2$  db, and the response is flat over the useful range of fre-

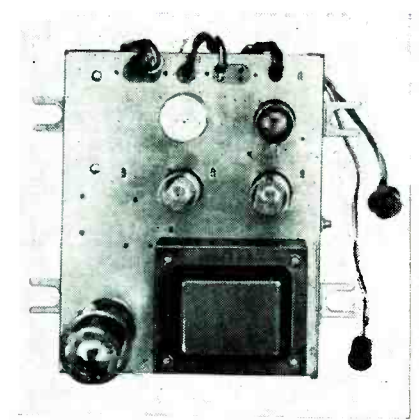

Top view of complete low-cost audio amplifier. Output transformer is mounted beneath the chassis

quencies. No production difficulties have arisen, although many many thousands of units have been manufactured, and no special selection of tubes or components has been made. Numerous production units selected at random for test had an average harmonic distortion at 400 cycles of 0.5 percent with 5 watts output. With a shock impulse at the amplifier input, the transient output across the loudspeaker voice coil is negligibly small after the first cycle.

The photograph of this amplifier shows the output transformer to be small. However, the harmonic distortion in the 60-cps output at five watts is only one percent. The 6SN7GT driver-phase inverter is not shown, as it is located on the tuner chassis of the receiver.

### Conclusions

In conclusion, it appears that combined positive and negative feedback offers considerable possibility for improved performance in pentode audio power amplifiers, particularly where cost is an important consideration, and when conventional mass-production techniques are used.

### REFERENCES

- (1) H. F. Olson, "Elements of Acoustical Engineering," Second Edition, D. Van Nostrand Co., Inc., New York, p 488.
- (2) F. E. Terman, "Radio Engineers' Handbook," McGraw-Hill Book Co., Inc., New York, First Edition, sec. 5, par. 11.
- (3) H. S. Black, "Stabilized Feedback Amplifiers," *B.S.T.J.*, Jan. 1934.
- (4) H. Nyquist, "Regeneration Theory," *B.S.T.J.*, July 1932.
- (5) H. W. Bode, "Relations between Attenuation and Phase in Feedback Amplifier Design," *B.S.T.J.*, July 1940.
- (6) J. M. Miller, "Dependence of the Input Impedance of a Three Element Vacuum Tube upon the Load in the Plate Circuit," *NBS Scientific Paper* 351.

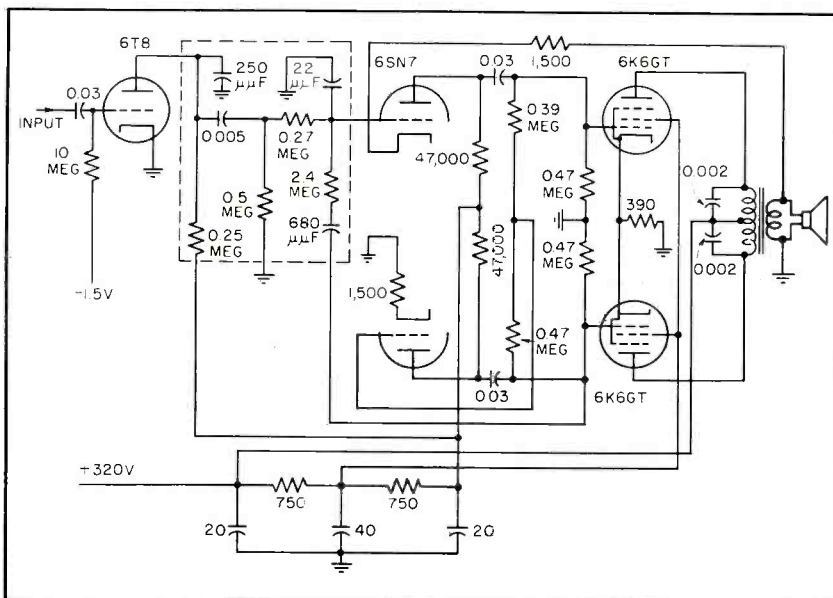
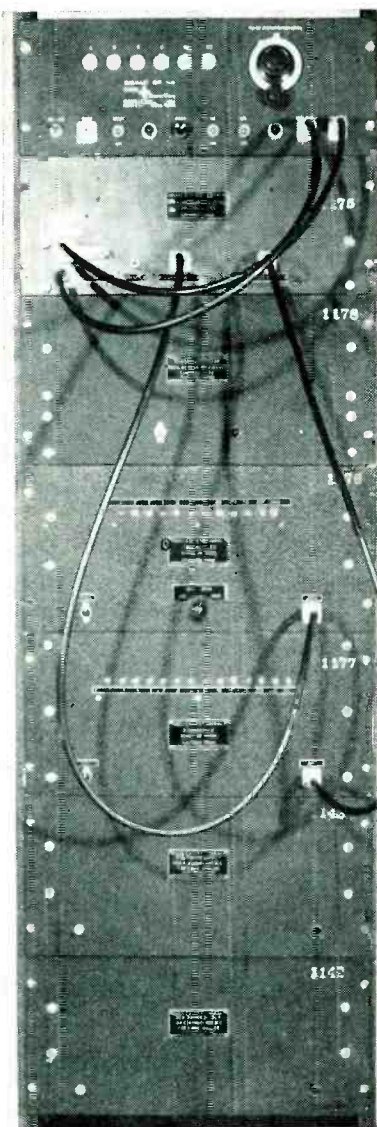

FIG. 5—Complete schematic of a low-cost audio amplifier using combination feedback

# Measuring

By R. L. CHASE

Brookhaven National Laboratory  
Associated Universities, Inc.  
Upton, N. Y.



The complete frequency measuring system does not quite fill a standard rack

**T**HE equipment to be described measures radio frequencies in the range between 100 kc and 5 mc to an accuracy of 0.1 percent in an interval as short as 200 microseconds. The method used is to count the number of cycles from a 5-mc standard oscillator that occur in a time interval corresponding to a selected integral number of cycles of the unknown frequency. The precision of the measurement increases linearly with the duration of this time interval.

The system is particularly useful for measuring instantaneous values of frequency from a variable-frequency source, when a measurement of short time duration is essential. The instrument was constructed in order to make precise measurements of the frequency of the r-f oscillator in a frequency-modulated particle accelerator, but circuits of this speed and precision should find many other applica-

tions. The gate and scaling circuits, for example, might be used in a high-speed counter-chronograph for the measurement of projectile velocities or for the measurement of short life times in radioactive decay schemes.

The details of operation may best be understood by reference to the block diagram, Fig. 1. The unknown frequency (sine-wave or other simple periodic wave shape) is converted by a pulse shaper into sharp pips synchronized with the unknown frequency in a definite and constant phase relationship. The pulse shaper shown in Fig. 2 is a trigger circuit of the Schmitt type capable of operating at frequencies up to 5 mc. It is followed by a short differentiating time constant of 0.15 microsecond. The measurement is initiated by a starting pulse derived from an external source. This starting pulse triggers gate-control flip-flop 1 to its other stable state, opening gate 1. The gate-control flip-flops are fast-acting trigger circuits of the Eccles-Jordan type, capable of passing from one stable state to another in less than 0.05 microsecond. The gates are type 6AS6 pentodes with high suppressor-plate transconductance. The gate-control signals are impressed on the suppressor grids and the signals to be gated are impressed on the control grids as shown in Fig. 3.

When gate 1 opens, the pulses from the pulse shaper pass through the gate and associated amplifier into scaler 1. The first of these pulses triggers gate-control flip-flop 2 to its other stable state, opening gate 2 which passes a 5-mc signal from the crystal oscillator to scaler 2. The scaling circuits shown in Fig. 4 are composites of

Table I—Results of Frequency Measurements

Nominal Frequency	Scaler 1 Reading A	Scaler 2 Reading B	5 (A-1)/B
5 mc	528	530	4.9717 mc
	1,017	1,053	4.9668
	2,079	2,092	4.9665
	4,135	4,162	4.9664
1 mc	515	2,614	0.98317 mc
	1,028	5,223	0.98315
	2,054	10,441	0.98314
	4,103	20,861	0.98317
200 kc	513	12,804	199.938 kc
	1,025	25,606	199.950
	2,050	51,239	199.945
	4,098	102,454	199.943

# a Varying Frequency

Instantaneous measurement of slowly changing or fixed frequency between 100 kc and 5 mc is made to an accuracy of 0.1 percent in only 200 microseconds. Designed to test synchrotron controls, the circuits can be adapted to measurement of projectile velocities or short-life radioactive decay

designs by Fitch<sup>2</sup> and Higinbotham<sup>3</sup>, which, in this arrangement, run reliably at pulse repetition frequencies up to 5 mc.

This cascaded-gate arrangement starts the measurement of time within less than one cycle at 5 mc (0.2 microsecond) after a pip from the pulse shaper. This 0.2-microsecond uncertainty is the controlling error of the system. It can be reduced by going to higher master oscillator frequencies, but this presents serious scaler design problems.

Provision is made to stop the timing interval in synchronism with another input pip. In this way no additional error is introduced at the end of the timing intervals. The problem is somewhat complicated by the fact that a pulse is delayed considerably in passing through the scaling circuits. For example, in the 12-stage scaler used (scale of 4,096) a signal is delayed approximately 7.8 microseconds. In addition to being rather long, this delay time is not entirely constant but varies somewhat as tubes age.

For these reasons a coincidence mechanism is used to close the gates. Scaler 1 is set to produce a trigger pulse as it records the last of a predetermined number of counts. This trigger pulse is impressed and maintained for several microseconds on the suppressor grids of the type 6AS6 coincidence trigger tubes. The control grids of these tubes are continually supplied with the shaped input pulses to scaler 1. The first of these input pulses following the initiation of the trigger pulse from scaler 1 triggers both gate-control flip-flops and turns off both gates.

Because the delay time through scaler 1 may correspond to a num-

ber of cycles of the measured frequency, this scaler, as well as scaler 2, is built with interpolating lights. These record the number of counts arriving during the total counting interval, the preset number of

counts plus those which arrive in the delay interval.

As an illustration, consider the measurement of a radio frequency in the neighborhood of 2 mc. Assume that an accuracy of 0.1 per-

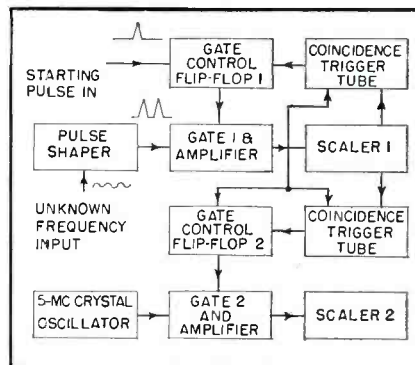

FIG. 1—Block diagram of main circuits

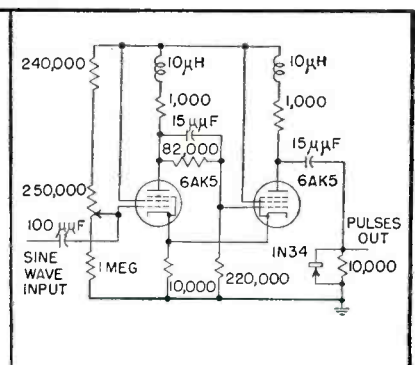

FIG. 2—Pulse shaping circuit used to change sine into triangular waves

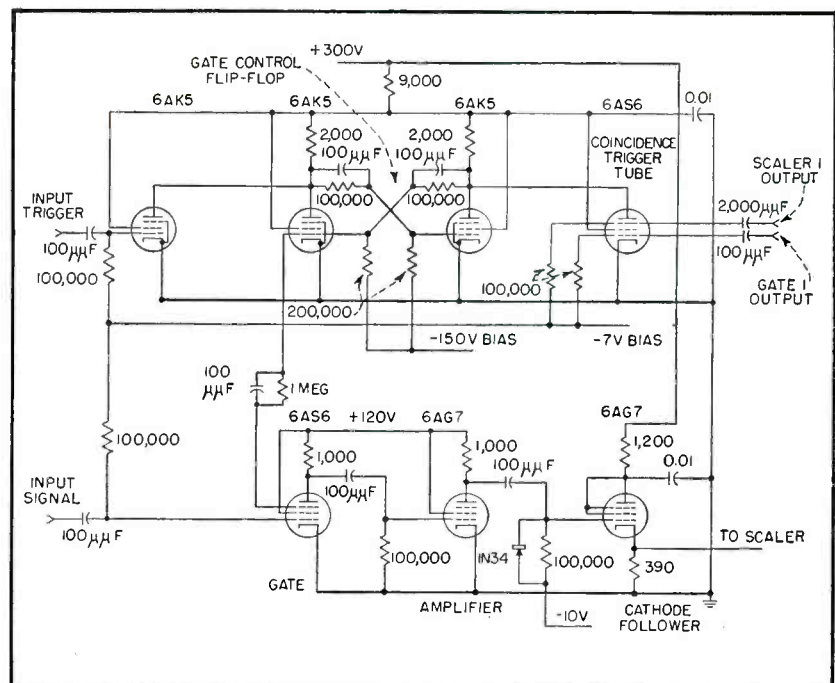

FIG. 3—Coincidence trigger, gate control, gate and amplifier circuits

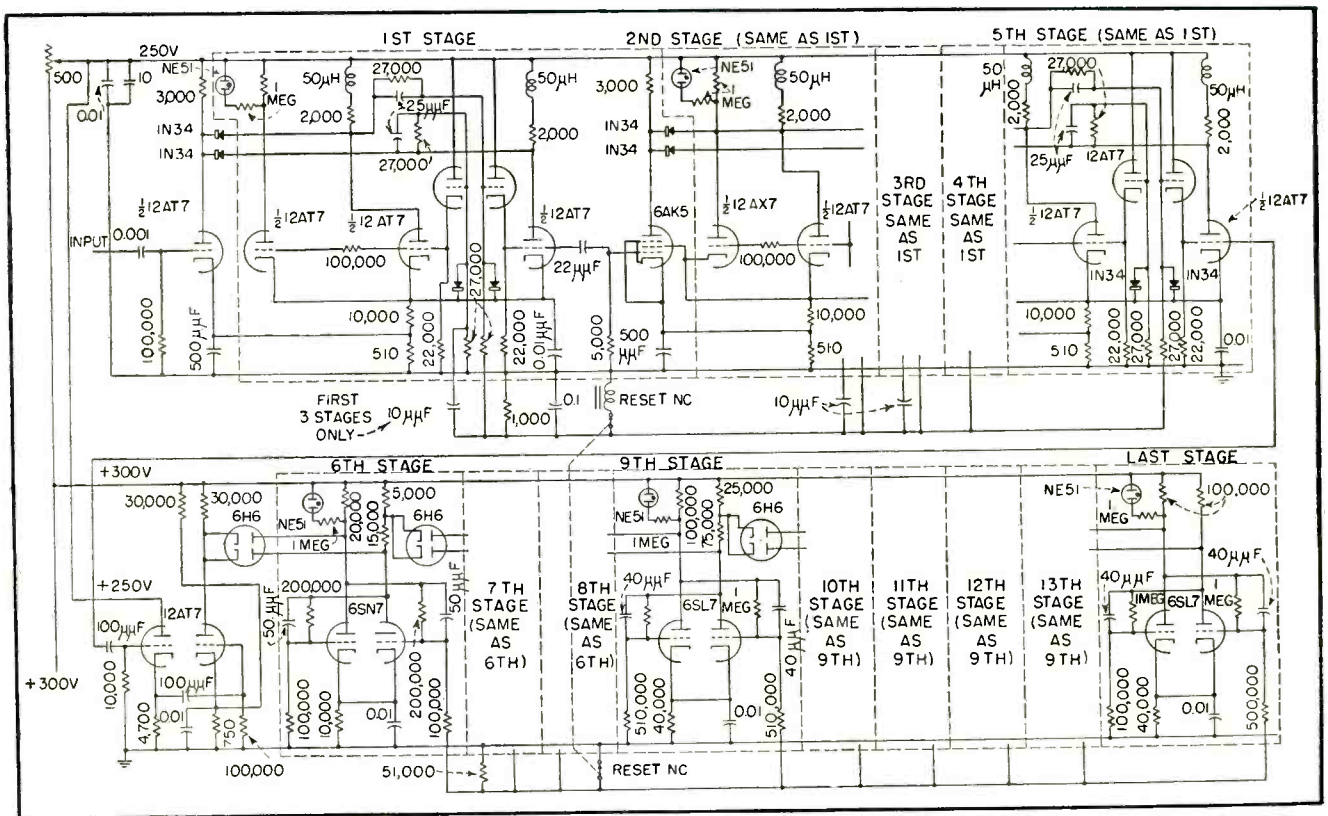

FIG. 4—Circuit diagram of the fast scaler

cent is required. This means that the counting interval must include at least 1,000 cycles of the standard 5-mc oscillator, which corresponds to approximately 400 cycles of the frequency to be measured. It is therefore necessary to preset scaler 1 to 512 cycles (the first integral power of 2 greater than 400), clear the scalers by pressing the reset buttons, and initiate the measurement with a starting pulse. After the measuring interval scaler 1 might read 517. This condition would mean that 4 additional pulses had passed through gate 1 during the time that the 512th was passing through the scaler. The next pulse (517th) turned off the gates. Gate 2 would then have been open during  $517 - 1$  or 516 cycles of the measured frequency, since the number of intervals bounded by  $n$  pulses is  $n-1$ . If scaler 2 had recorded 1,299 counts, then the input frequency would have been

$$5.000 \text{ mc} \times (516)/(1,299) = 1.9861 \pm 0.0015 \text{ mc}$$

Figure 5 shows a typical series of waveforms encountered in the measurement of a frequency in the neighborhood of 2 mc. It is seen that despite the delay in the scal-

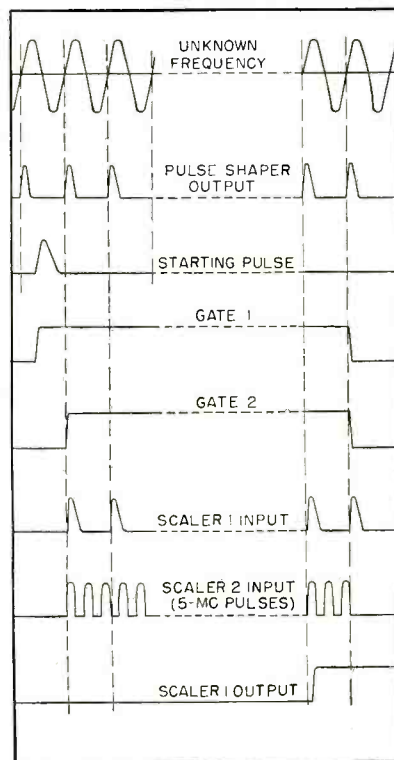

FIG. 5—Waveforms appearing at indicated circuits

ers, both scalers count cycles over intervals that differ in duration by less than 0.2 microsecond.

Table I shows the results of some frequency measurements. Each

measurement was made with four different preselected values for the count in scaler 1 in order to test the consistency of the system. At each frequency the four preselected counts were 512, 1,024, 2,048 and 4,096. Even in as short a measuring interval as 106 microseconds, the error is only slightly greater than 0.1 percent.

### Synchrotron Control Problem

In the 3-billion volt proton synchrotron, the r-f master oscillator will be frequency-modulated from 200 kc to 4.2 mc in one second.

The author wishes to express his gratitude to J. B. H. Kuper and W. A. Higinbotham of the Electronics Division of the Brookhaven National Laboratory for their advice and technical assistance, and to R. V. Dvorak and L. O. Davis for their help in layout and construction. This work was done under the auspices of the Atomic Energy Commission.

### REFERENCES

- (1) O. H. Schmitt, *J. Sci. Inst.*, **15**, p 24, 1938.
- (2) Val Fitch, Columbia University Report No. CUD-35.
- (3) W. A. Higinbotham, J. Gallagher and M. Sands, *Rev. Sci. Inst.*, **18**, p 706, 1947.

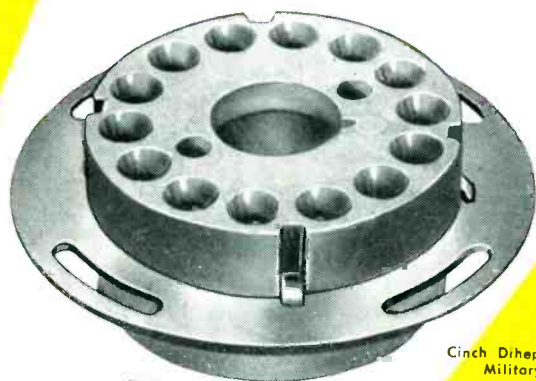

Cinch Diheptal Socket  
Military Type

**"The job to be done  
may vary..but never  
the performance"**

— that is the consensus of opinion of leading electronics manufacturers, as the records will show, an opinion which they back up by the consistent selection of Cinch parts . . . for their constant use. So that today in Electronics —



Cinch Sub-Miniature  
Sockets for Printed Circuit  
and Regular Type  
Wiring

**Cinch**  
**ELECTRONIC**  
**COMPONENTS**

**— are standard**

Available at leading Electronic jobbers — everywhere



**Cinch**  
**ELECTRONIC**  
**COMPONENTS**

**CINCH MANUFACTURING CORPORATION**

CHICAGO 24, ILLINOIS

Subsidiary of United-Carr Fastener Corporation - Cambridge 42, Massachusetts

# Noise Figure Chart

Gives noise figure directly in decibels from value of noise-generator diode current required to double the noise power output of an amplifier from its no-input value. The input impedance of the unit under test is the other parameter

By **EUGENE D. JAREMA**

*Thermionics Branch  
Evans Signal Laboratory  
Belmar, New Jersey*

**T**HE NOISE FIGURE of a receiver or amplifier is the factor, expressed in decibels, by which the signal-to-noise ratio existing in a resistive source is

degraded in passing through the receiver or amplifier, the bandwidth remaining constant. The signal-to-noise ratio is measured at 20 deg C before the source is connected to the receiver.

The most common method for determining noise figures is by using a temperature-limited di-

ode noise generator. Such a noise generator is self-calibrating. No correction factor is necessary, providing the limiting frequencies are considerably less than the self resonance of the noise diode and the electron transit angle is less than 90 degrees. The load of the diode generator must also be matched to the input impedance  $R$  of the receiver or amplifier under test.

The accompanying chart eliminates the computations usually involved in obtaining a noise figure by the noise-generator method. The noise generator in its off position is connected to the input of the amplifier under test, and the noise power level of the amplifier is noted on an output meter. The generator is then turned on and adjusted until the amplifier noise power output reading is doubled. The noise-generator diode current  $I_A$  is then noted.

The amplifier noise figure, in decibels, will be represented on the chart by the diagonal line which crosses the intersection of the appropriate  $I_A$  and  $R$  lines. For example, let  $R = 300$  ohms and  $I_A = 1.0$  ma; the noise figure will be 7.8 db.

The chart is based on the fact that the noise figure is equal to  $20I_A R$ , where  $I_A$  is in amperes and  $R$  in ohms.

Occasion may arise when  $R$  may be larger than 1,000 ohms or  $I_A$  may be less than 0.1 ma. For every cycle change in either  $R$  or  $I_A$  the reference level will change 10 db in the same direction.

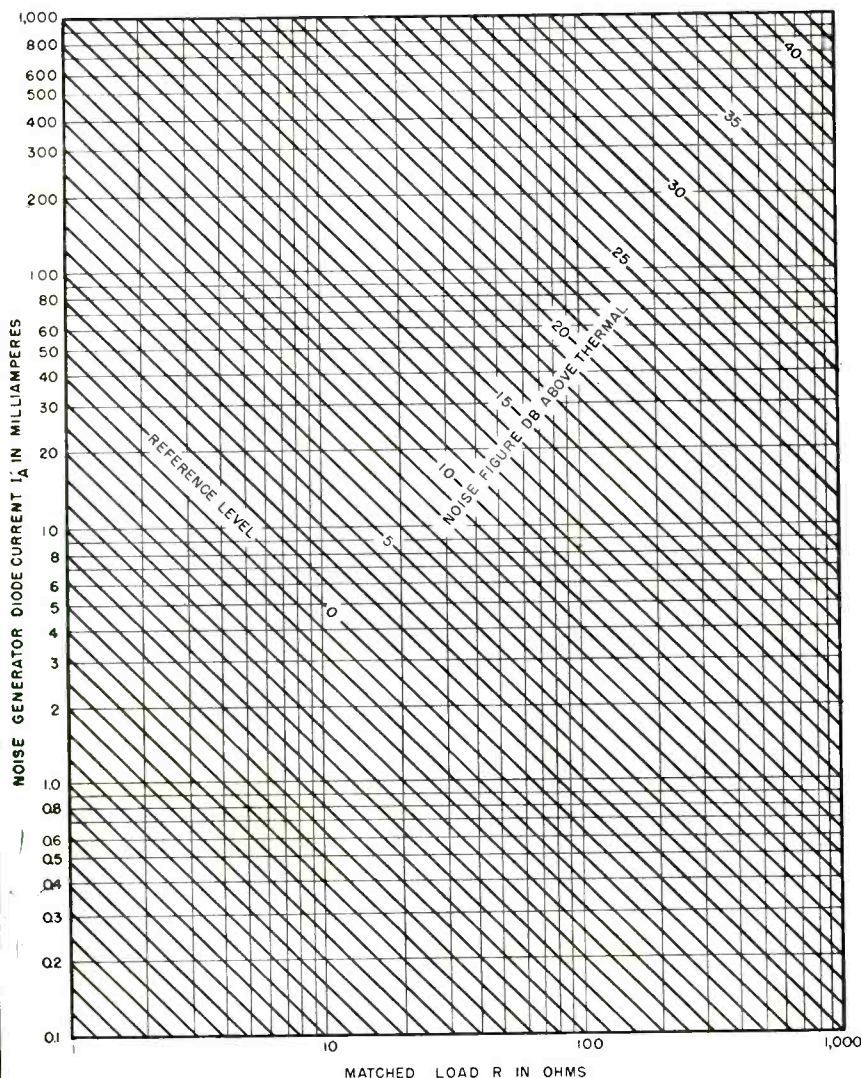

**Service  
Beyond  
The Sale!**

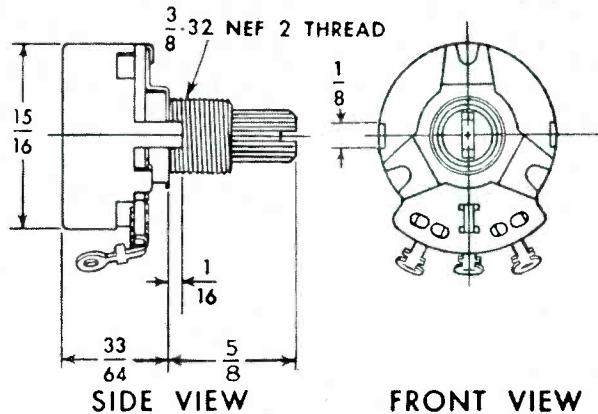
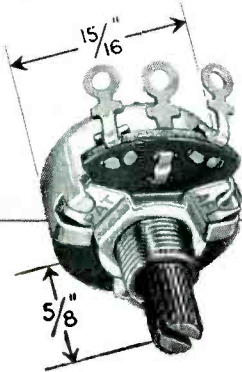

**15/16" MALLORY  
MIDGETROL**

Electrical characteristics specially designed for critical applications in television, radio and other circuits. Insulated shafts are knurled for ease in adjustment. Shaft and current-carrying parts provide 1500 volt insulation . . . 15/16" diameter saves space . . . phenolic material eliminates mechanical noise. Precision-controlled carbon element provides smooth tapers, quiet operation, accurate resistance values, less drift in television applications.

**Design Standardization  
By Mallory**  
*effects real customer savings!*

Mallory goes beyond the basic research and development work which results in totally new products . . . and utilizes every opportunity to pass on to customers the savings effected by product standardization.

Such is the case with the well known Mallory Midgetrol. Standardizing its diameter and shaft design resulted in cost reductions for radio and television manufacturers. The standard molded phenolic shaft provides a combination hand knurl and screwdriver slot adjustment at no extra cost . . . and it is available with either 1/4" or 3/8" bushing length. In addition, the Mallory Midgetrol occupies less space than larger controls, with no sacrifice in wattage rating.

*That's service beyond the sale!*

Mallory's electronic component know-how is at your disposal. What Mallory has done for others can be done for you!

Television Tuners, Special Switches, Controls and Resistors

**P. R. MALLORY & CO., Inc.**  
**MALLORY**

**P. R. MALLORY & CO., Inc., INDIANAPOLIS 6, INDIANA**

**SERVING INDUSTRY WITH**

Capacitors	Contacts
Controls	Resistors
Rectifiers	Vibrators
Special Switches	Power Supplies
Resistance Welding Materials	

# TUBES AT WORK

Including INDUSTRIAL CONTROL

Edited by VIN ZELUFF

Stable Instrument Amplifier.....	116
Miniature Equipment for Army.....	116
Radio-Controlled Toy Auto.....	118
High-Resistance Measurement.....	118
Egg Processing Equipment.....	132
Telemetering Ocean Current Information.....	148
Horological Stroboscopes.....	158
Prospecting Unit for Fluorescing Minerals.....	166

## Stable Instrument Amplifier

BY PETER G. SULZER

*Engineering Experiment Station  
The Pennsylvania State College  
State College, Pennsylvania*

IN MAKING direct-voltage measurements of high-impedance sources such as vacuum-tube circuits or electrolytic cells, it is frequently desirable to place a low-gain amplifier ahead of the indicating instrument in order to obtain high current sensitivity. Such an amplifier<sup>1</sup> usually requires that both terminals of the indicating instrument be above ground, a condition that is not desirable when overload protection is to be obtained with biased diodes, or when special scale characteristics are to be obtained with non-linear circuit elements.

The circuit of Fig. 1 shows a simple amplifier which permits grounding of both the input and the output terminals; it has the additional features of low grid current,  $10^{-12}$  ampere, low output im-

pedance of 200 ohms and excellent linearity over the input-voltage range of  $\pm 5$  volts.

The amplifier is stabilized by the use of series-balanced bridge circuits<sup>2</sup>. The output stage consists of  $V_2$ , a cathode follower, connected in series with  $V_3$ , a dummy tube constituting the other arm of the bridge.

The plate circuit of  $V_3$  presents a very high incremental impedance to the cathode circuit of  $V_2$ ; consequently the cathode-follower gain is almost unity, and is practically independent of tube characteristics. This condition holds provided that the resistance of the indicating instrument is much higher than 200 ohms, which is normally true.

To correct for drift resulting from heater voltage variations,

provision is made, by means of  $R_1$ , for the differential adjustment of the heater voltages of  $V_2$  and  $V_3$ .

The first stage of the amplifier, consisting of  $V_{1A}$  and  $V_{1B}$ , also employs the series-balanced circuit. The tubes are operated with the low plate supply of 20 volts, and a heater supply of 3 volts to obtain low grid current. The use of a high cathode-bias resistor helps to maintain the grid bias at the most favorable point for low grid current.

A number of measurements have shown the amplifier characteristics to be as follows: A linearity of 2 percent is maintained over the input-voltage range of  $\pm 5$  volts. The grid current, determined by the method given by Strong<sup>3</sup>, varies considerably over this range, it being  $10^{-12}$  ampere at zero input,  $5 \times 10^{-12}$  ampere at an input of  $\pm 0.2$  volt, and  $10^{-10}$  ampere at an input of  $\pm 5$  volts. The zero drift was found to be about 10 millivolts for a 10-percent change in heater-supply voltage.

With a stabilized heater supply, a drift of less than one millivolt per hour was noted. This measurement was made with a grid-circuit resistance of 500 megohms. The overall voltage gain of the amplifier under open-circuit conditions is approximately 0.9. Tube changes or heater-supply voltage changes of  $-10$  percent did not alter the gain by more than 5 percent. It should be noted that selected tubes were not used during these tests.

### REFERENCES

- (1) J. N. Thurston, *ELECTRONICS*, 16, p 102, Oct. 1943.
- (2) Maurice Artzt, *ELECTRONICS*, 18, p 112, Aug. 1945.
- (3) John Strong, "Procedures in Experimental Physics," Prentice-Hall, Inc., N. Y. 1945.

## Miniature Equipment for Army

MINIATURIZED products for the Signal Corps include a crystal rectifier the size of a match head, a field switchboard that weighs but 22 pounds and a portable teleprinter weighing 45 pounds. Developed through Signal Corps research projects, the field switchboard designed by the Army may be used for both wire and radio

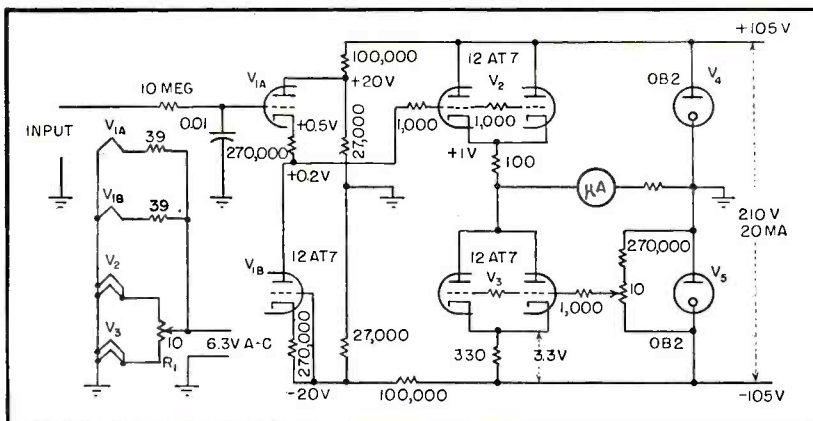

FIG. 1—Both stages of the amplifier employ series-balanced bridge circuits





*The finest solder made  
for all television and radio  
work . . . Everything Electrical*

# Kester Solder

# Uniform

# Efficient

Kester Plastic Rosin-Core and Kester "Resin-Five" Core Solders are recognized by the trade as outstanding for the finest type of radio, television and electrical work.

Kester Solders are made only from newly mined grade A tin and virgin lead. Fluxes chemically correct.

Only highly skilled craftsmen are employed by the Kester Solder Company. Flux formulas and specifications are rigidly adhered to for perfect uniformity.

Making Kester Solder is an exact science from the raw material to the finished product. Everyone knows and prefers Kester because it can be relied upon to do the job right every time, even under the most difficult soldering conditions.

WRITE FOR FREE COPY "SOLDER AND SOLDERING TECHNIQUE"



Be sure to get your free copy of Kester's Technical Manual filled with valuable information regarding the most advanced and efficient industrial solders and fluxes.

Kester...Standard for the TV and Radio Fields

**KESTER SOLDER COMPANY**

4204 Wrightwood Avenue, Chicago 39, Illinois  
Newark, N. J. • Brantford, Canada

EASIER TO USE  
MADE FROM VIRGIN METALS  
FASTER  
ELIMINATES REJECTS  
DEPENDABLE  
SAVES TIME



circuits. Its weight of 22 pounds compares with a 72-pound switchboard currently in use. The new board takes up four-tenths of a cubic foot as compared with two cubic feet for the older type. Three switchboards, each with a capacity of 12 lines, can be connected to provide switching for 36 circuits.

The new portable teleprinter, having a weight of 45 pounds, will eventually replace equipment weighing 225 pounds. The newly developed teleprinter is considered faster and stronger than its predecessor.

During the war, field wire used by the Army weighed 132 pounds a mile. Recent research has resulted in development of wire which weighs only 48 pounds per mile. The lighter wire has a talking range, when wet, of 12 miles, as

compared with a 10-mile range of field wire currently in use.

Miniature tubes take only 15 percent of the space of older types, while subminiatures in turn are only about 10 percent the size of the miniatures. Resistors are a tenth of their wartime size, while capacitors today take less than 25 percent of the space they required in equipment used in World War II.

The Signal Corps has found 400-cycle a-c permits the use of smaller and lighter components in much of its electronics equipment. Also, 400-cycle generators themselves could be made smaller and lighter than 60-cycle equipment, for the same power output. Engineers have developed a generator weighing but 85 pounds that puts out as much power as an older piece of equipment weighing 120 pounds.

## Radio-Controlled Toy Auto

**SIMPLIFIED** to just about the ultimate degree, a radio-controlled toy automobile has been invented that employs one electronic tube in the car and another in the transmitter.

As shown in the accompanying illustration, the toy consists of a plastic car powered by batteries. The tonneau contains the receiving tube and two relays. These are covered by a transparent plastic top

for protection against rough treatment by the user.

The control box contains the transmitter which feeds an antenna lead that can be arranged in a circle of 50 feet in diameter. The car operates within the circle and from four to six feet beyond it. Designed by John and Andrew Yeiser of Berkeley, California, the toy will sell for 25 to 30 dollars.

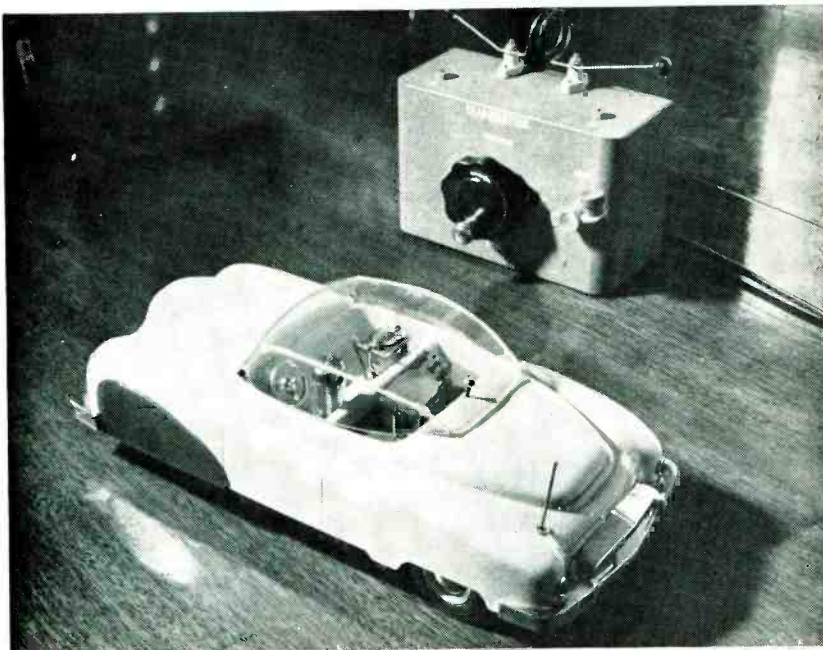

Operated by radio control, this toy automobile covers a fifty-foot circle

## High-Resistance Measurement

BY W. G. SHEPARD  
Physical Research Dept.  
Boeing Airplane Co.  
Seattle, Washington

ACCURATE measurement of resistance below about one megohm is usually made by means of a Wheatstone bridge using a galvanometer for the null indicator. Above this value the resistance of a galvanometer is too low to properly match the high-resistance arms of the bridge and insufficient indication results. A vacuum-tube amplifier connected to the output of the bridge, however, offers a much higher impedance and is quite effective since the voltage output of a high-resistance bridge is comparatively high.

Figure 1 shows a bridge and amplifier for the purpose. The

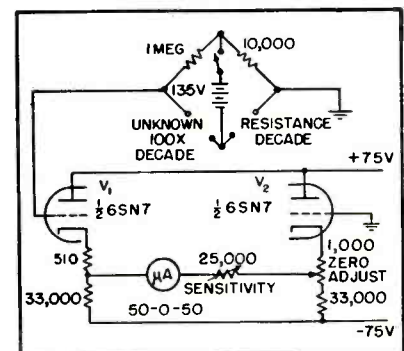
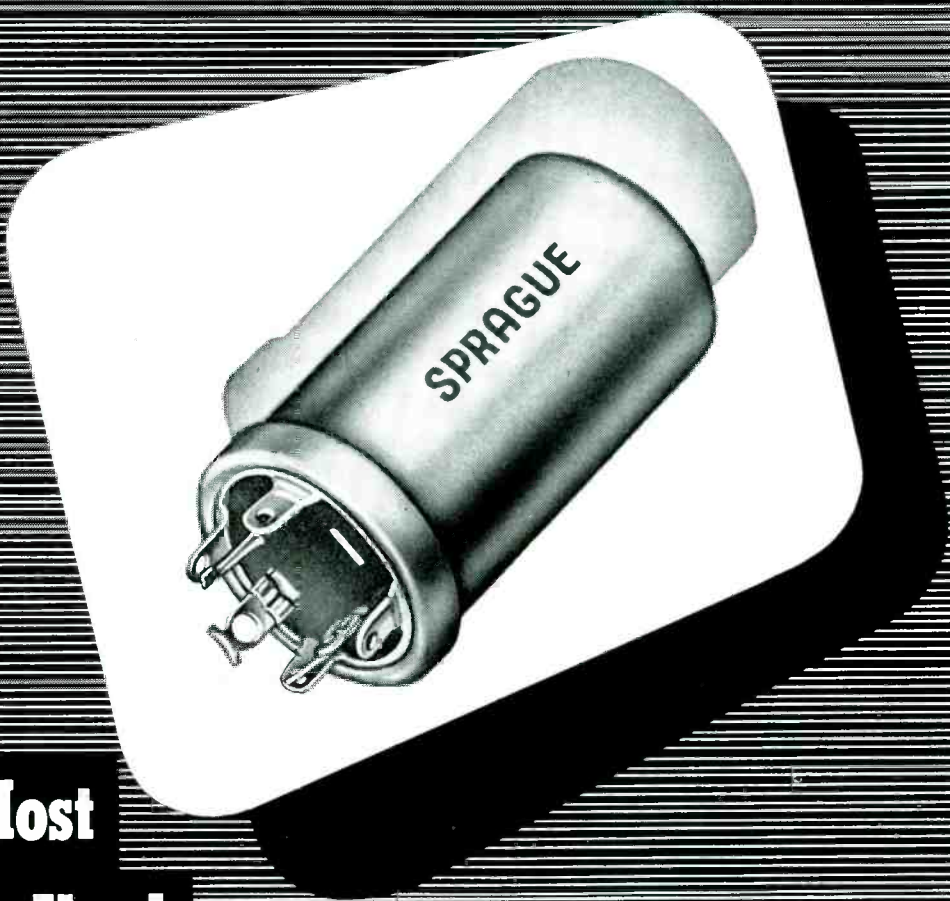

FIG. 1—Circuit of high-resistance bridge and amplifier for convenient measurements up to 100 megohms

bridge consists of precision ratio arms, a variable standard, which may be a laboratory-type resistance decade, and the unknown. Since the ratio is 100 to 1, a 1-megohm decade may be used for measurements up to 100 megohms. The accuracy of laboratory decades is usually 0.1 percent or greater, and the ratio arms, if not already this accurate, may be adjusted by putting a 0.1-percent resistor across the unknown terminals of the bridge and a 0.1-percent resistor of 1/100 the value across the decade terminals and then correcting the ratio arms until the bridge balances. The meter-amplifier circuit indicates to much closer than 0.1 percent except when measuring extremely high resistances, so the

(Continued on p 132)



*The Most*  
**Widely Used**

**Electrolytics in  
TV Receivers Today**

- . . . . Television set makers are turning to Sprague as their major source for electrolytic capacitors.
- . . . . Stability under maximum operating conditions plus outstandingly l-o-n-g service life are the reasons for this preference.
- . . . . And expanded facilities, now being completed, permit Sprague to accept a larger portion of your requirements.

**SPRAGUE**

**SPRAGUE ELECTRIC COMPANY**  
North Adams, Massachusetts

**PIONEERS IN**

**ELECTRIC AND ELECTRONIC DEVELOPMENT**

# THE ELECTRON ART

Edited by JAMES D. FAHNESTOCK

Synthetic Mica.....	120
Television Demonstration.....	120
Atom-Smashing Analysis of Minute Samples.....	122
Printed Iron Core Coils.....	122
Intra-Ocular Tachistoscope.....	178
Single-Frame TV Photography.....	184
Wide-Range Voltage Regulator.....	192
X-Ray Microscope.....	196
Thyratron Thermoregulator.....	200
Operating Small Thyratrons in Parallel.....	202
A New Ceramic Material with Unusual Properties.....	204
Survey of New Techniques.....	206

## Synthetic Mica— $K_4Mg_{12}Al_3Si_{12}O_{40}F_8$

SYNTHETIC MICA has been crystallized by scientists of the National Bureau of Standards. The synthetic substance is said to have all the desirable properties of its natural version, with improved heat-resisting characteristics.

The ingredients used are similar to raw materials often used in making glass: quartz, magnesite, bauxite, and a fluorosilicate compound. The fluorosilicate is the crystallizing agent.

### Process

After the initial mixing, the quartz, magnesite and bauxite are placed in a ceramic crucible and heated for more than an hour at a temperature of 1,000 C. This calcining operation drives off carbon dioxide and water which would interfere with the formation of good crystals of synthetic mica. The cal-

ined ingredients are ground together with potassium fluorosilicate, and the resulting mixture is then packed into a platinum crucible and melted in a special electric furnace at 1,400 C. As the furnace cools, mica crystals form at the bottom of the crucible.

The most satisfactory synthetic mica developed thus far has the chemical formula  $K_4Mg_{12}Al_3Si_{12}O_{40}F_8$ . This is equivalent to a form of natural mica in which the hydroxyl radical has been replaced by fluorine.

Impurities may occur in the synthetic mica in the form of milky films parallel to the individual layer or white patches between crystals. Crystals free of impurities are clear and transparent, and thin flakes are easily split away along the planes of natural cleavage. The synthetic form has physical properties which compare favorably with natural mica. Electrical measurements on several clear flakes,  $\frac{3}{4}$  inch square by  $\frac{1}{8}$  inch thick, indicate a dielectric constant of about 6.3. The largest crystals grown so far at the National Bureau of Standards have a surface area of 4 square inches.

Satisfactory mica synthesis depends to a large extent on the materials used in the crucible lining. Ceramic linings are badly corroded by a fluorine-bearing melt. Carbon and silicon carbide crucibles are somewhat better, but fluoride gases escape through the relatively porous walls, and fine carbon particles become imbedded throughout the synthe-



Flakes of synthetic mica are examined under a binocular microscope for structural defects, such as impurities, gas bubbles, faulty orientation and incomplete crystallization

sized mica. Crucibles lined with platinum foil give the best results. They do not react with the melt and are able to withstand high temperatures for long periods. Although initial cost is high, the platinum linings may be melted down and re-formed.

The shape of the crucible is also important in mica synthesis. Flat-bottomed crucibles are undesirable because they offer a large surface for the formation of many seed crystals which grow independently in different directions and thus limit the development of single large crystals. Mica has a sheet-like structure and grows faster in a direction parallel to its cleavage plane than in any other direction. Consequently, if a crucible with a cone-shaped bottom is used, the number of seed crystals is reduced and the direction of growth tends to be upward. Experiments are now in progress to find ways of predetermining crystal growth even more completely in order to grow large parallel sheets.

## Television Demonstration

HOW TELEVISION WORKS can be vividly demonstrated by the experimental setup shown in the accompanying diagram. Two cathode-ray oscilloscopes, a sensitive phototube unit and a lense comprise the equipment. The oscilloscopes furnish their own sweep voltages. The internal sweep generator of the viewing oscilloscope is operated at



Ingredients for synthetic mica are melted in a special electric furnace at 1,400 C. Crystals form at bottom of platinum-lined crucible on cooling

# Laboratory Instruments for TELEVISION

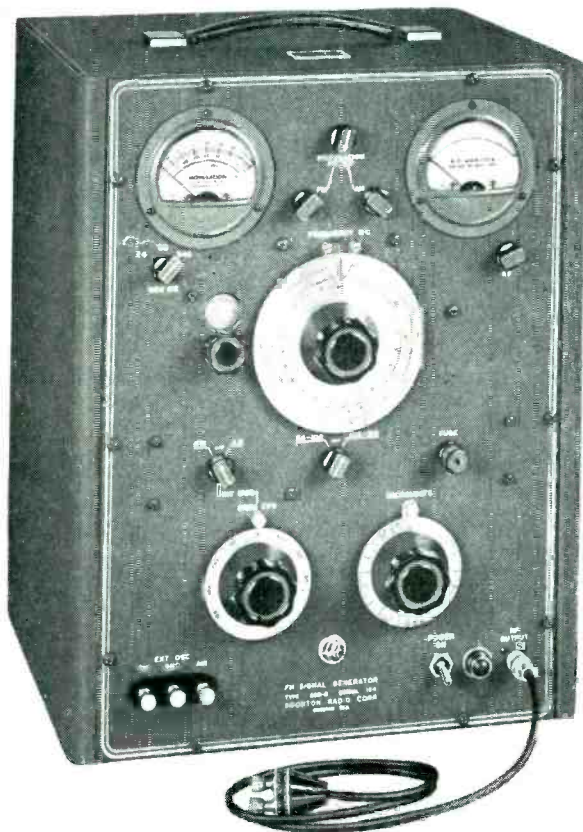

## FM SIGNAL GENERATOR Type 202-B

The Type 202-B FM Signal Generator is specifically designed to meet the exacting requirements of television and FM engineers working in the frequency range of 54 megacycles to 216 megacycles. Following are some of the outstanding features of this versatile instrument:

**RF RANGES:** 54-108, 108-216 mc.  $\pm$  0.5% accuracy. Also covers 0.4 mc. to 25 mc. with accessory 203-B Univerter.

**VERNIER DIAL:** 24:1 gear ratio with main frequency dial.

**FREQUENCY DEVIATION RANGES:** 0-24 kc., 0-80 kc., 0-240 kc.

**AMPLITUDE MODULATION:** Continuously variable 0-50%, calibrated at 30% and 50% points.

**MODULATING OSCILLATOR:** Eight internal modulating frequencies from 50 cycles to 15 kc. available for FM, AM.

**RF OUTPUT VOLTAGE:** 0.2 volt to 0.1 microvolt. Output impedance 26.5 ohms.

**FM DISTORTION:** Less than 2% at 75 kc. deviation.

**SPURIOUS RF OUTPUT:** All spurious RF voltages 30 db or more below fundamental.

If you have an FM or television instrument requirement, let us acquaint you with full particulars and technical data concerning the Type 202-B FM Signal Generator and Type 203-B Univerter.

DESIGNERS AND MANUFACTURERS OF THE Q METER · QX CHECKER  
FREQUENCY MODULATED SIGNAL GENERATOR · BEAT FREQUENCY  
GENERATOR AND OTHER DIRECT READING INSTRUMENTS

## Type 202-B FM SIGNAL GENERATOR

Frequency Range  
54-216 mc.

Additional coverage from  
0.4 to 25 mc. with accessory  
UNIVERTER Type 203-B



## UNIVERTER Type 203-B

AVAILABLE AS AN ACCESSORY is the 203-B Univerter, a unity gain frequency converter which, in combination with the 202-B instrument, provides the additional coverage of commonly used intermediate and radio frequencies.

**R. F. RANGE:** 0.4 mc. to 25 mc. (0.1 mc. to 25 mc. with no carrier deviation).

**R. F. INCREMENT DIAL:**  $\pm$  250 kc. in 10 kc. increments

**R. F. OUTPUT:** 0.1 microvolt to 0.1 volt,  $\pm$  1 db. Also approximately 2 volts maximum (uncalibrated).

**OUTPUT IMPEDANCE:** Approximately 60 ohms at 0.1 volt jack, 470 ohms at 2 volt pin jack.

**BOONTON RADIO**  
BOONTON · N · J · U · S · A · Corporation

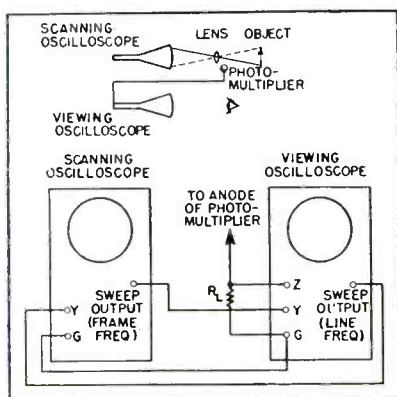

Wiring diagram for a simple but effective television demonstration using only two oscilloscopes and a photomultiplier unit

line-scanning frequency and is connected to the vertical amplifier of the scanning oscilloscope, while the internal oscillator of the scanning oscilloscope is adjusted for frame frequency and also furnishes vertical scanning for the viewing oscilloscope.

The rasters thus generated are automatically synchronized. The

scanning oscilloscope raster is focused, by a lens, onto the object to be viewed. The light reflected by the object is picked up by a photomultiplier unit. The resulting photomultiplier-tube signal is used to intensity-modulate the beam of the viewing oscilloscope which reproduces the image of the scanned object.

The hook-up shown rotates the viewing raster ninety degrees on the oscilloscope screen. For erect viewing, the scanned object may be laid on its side.

For best results, the frame frequency should be set just high enough to eliminate flicker—about 30 cps. Line frequency can be adjusted to the point where the limited resolution of the system becomes objectionable—about 3,000 cps, or 100 lines per frame. This ingenious system was presented by Robert E. Benn of the Franklin Institute Laboratories in the October, 1949 issue of the *American Journal of Physics*.

## Atom-Smashing Analysis of Minute Samples

ANALYSIS of minute quantities of matter, as little as a billionth of an ounce, has been made possible by a recent Stanford Research Institute development. The new technique, which was developed for the purpose of analyzing smog particles, is capable of determining the constituents of layers of material no more than one molecule in thickness.

In operation, specimens of the substance to be analyzed are bombarded by a stream of ions which are scattered in a characteristic way when they come in contact with the substance. Ion detectors determine the nature of the scattering. By comparing the unknown's scattering characteristics with those of known elements, the elements in the unknown can be detected.

This work was described by Sylvan Rubin, staff physicist at the California Institute of Technology, in a paper presented before a national meeting of the American Physical Society at Stanford University. The photograph shows Dr.

Rubin beside the half-million volt Van de Graff generator which is used to accelerate the ions that bombard the sample of the material being analyzed.

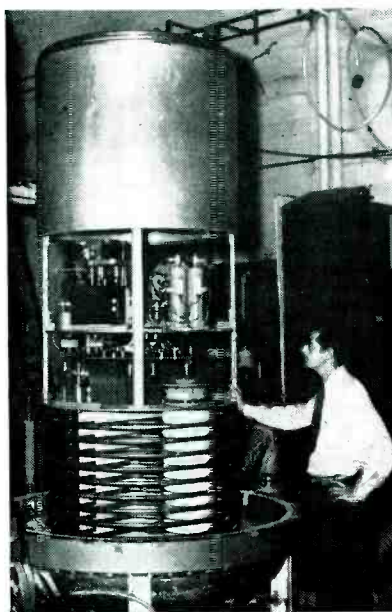

Half-million volt ion accelerator makes possible the sub-microchemical analysis of atmospheric pollutants by bombarding them with a stream of protons

## Printed Iron Core Coils

BY MARTIN RUDERFER  
Brooklyn, N. Y.

A METHOD of coil construction is presented here whereby the printing technique, with its adaptability to mass production and miniaturization, may be applied to iron-core coils. The basic construction shown in Fig. 1A consists of a thin insulating wafer on both sides of which are printed spiral coils, the center end *H* of each coil being automati-

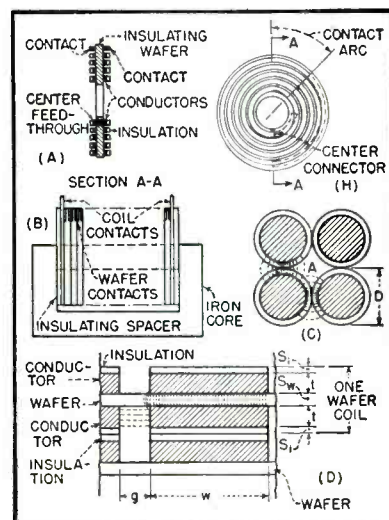

FIG. 1—Spiral coils, printed on insulating wafers, are connected in series simply by bringing two wafers together under slight pressure

cally connected in manufacture through the wafer base. The outer ends terminate in two slightly raised contacts, one on each side. Both sides are insulated except for the contact surfaces.

A complete coil is obtained by assembling any number of wafers so that the contacts register, thereby connecting all turns in series as shown in Fig. 1B. The core is inserted through the central hole; wafer contacts, insulative spacer and a jacket (not shown) exert pressure to maintain contact between wafers. Several methods are available for printing the conductor<sup>1,2</sup>, including electroplating or stamping for high conductivity, spraying or painting.

### Space Requirements

The space occupied by the wafer base is offset by the elimination of

(Continued on p 172)

**LOOK AT IT**

**FOR SPECIAL APPLICATIONS . . .**

**SUCH AS THIS ONE**

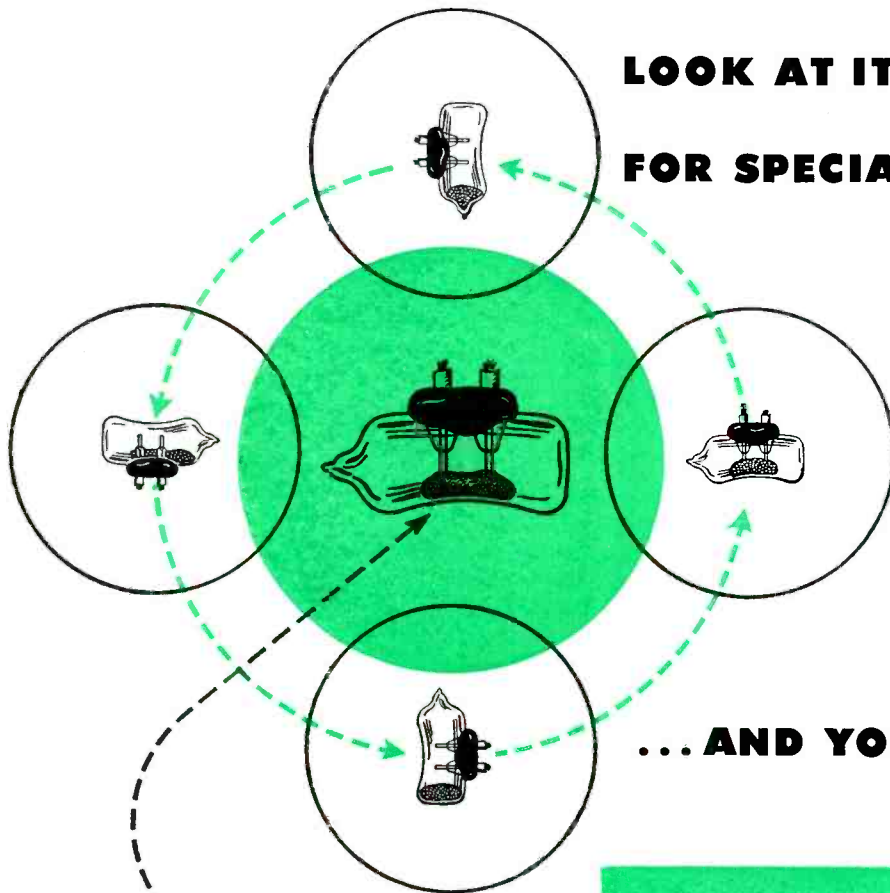

This Honeywell Mercury Switch (Type AS702B) is standard in the line . . . was found to be ideal for a manufacturer who requires momentary switching action only once in every 360° revolution of a shaft. The glass sleeves around the electrodes prevent contact at any other time.

**... AND YOU'LL PICK THE**

**HONEYWELL**

*Mercury Switch*

THE specific application is a mighty important thing to consider when selecting a mercury switch.

The complete line of Honeywell Mercury Switches gives you an extremely wide selection . . . permits you to pick the one that exactly suits your need.

Honeywell Mercury Switches are tiny and compact . . . are adaptable to unusual mountings. They operate at low angles . . . have no moving parts . . . are sealed against dust, gas and corrosion. Fouled contact points cannot occur.

The complete line is at your command . . . affording greater latitude in product design, with improved performance and trouble-free operation. Write for a copy of new Catalog 1343 for down-to-earth information . . . or call in your local Honeywell engineer for a detailed discussion of a particular application.



MINNEAPOLIS-HONEYWELL REGULATOR CO.  
BROWN INSTRUMENTS DIVISION

4428 Wayne Avenue, Philadelphia 44, Pa.

Offices in 73 principal cities of the United States, Canada and throughout the world

FOR {

- POSITIVE ACTION
- LOW ANGULARITY
- LONGER LIFE
- WIDE SELECTION

} SPECIFY **HONEYWELL**  
*Mercury Switches*



*Mercury Switches*

FOR POSITIVE ACTION



# NEW PRODUCTS

EDITED by WILLIAM P. O'BRIEN

**Increased Activity in Nuclear Field Steps Up Production of Radiation Detector Equipment . . . Time and Labor Savings in Labs and Plants Augmented By New Testing Devices On The Market . . . Products of Fifty-Seven Companies Are Described**

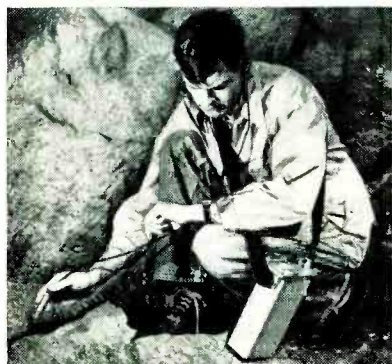

## Ore Detector

TRACERLAB INC., 130 High St., Boston 10, Mass. The SU-7 detector is designed for rugged field use in prospecting for all types of radioactive ores. It is unaffected by humidity or moisture. When radiation enters the small Geiger tube contained in the probe, a clicking noise can be heard through the earphones. The small size of the probe, mounted at the end of a flexible 30-in. cable, permits exploration of crevices and small bore holes.

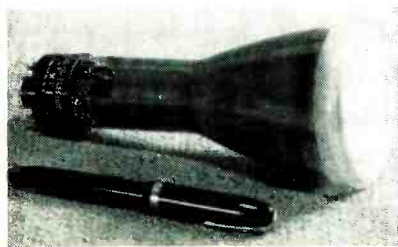

## Three-Inch C-R Tube

GENERAL ELECTRIC Co., Schenectady, N. Y. The 3MP1 three-inch electrostatic c-r tube was originally designed for use in small industrial oscilloscopes. However, the new tube is expected to find numerous applications for tv servicing and for testing apparatus such as weld-

ers, amplifiers and electronic timing devices. Maximum ratings include an anode No. 1 d-c voltage of 1,000 volts and an anode No. 2 d-c voltage of 2,500 volts. Maximum negative-bias value is 200 volts d-c, and positive-bias value is 2 volts d-c.

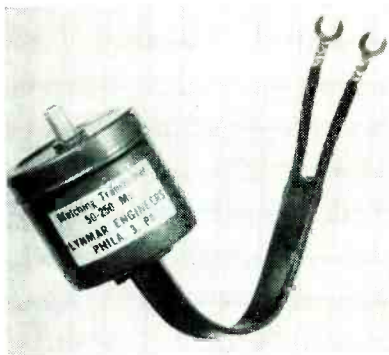

## Matching Transformer

LYNMAR ENGINEERS, 1721 Delancey St., Philadelphia 3, Pa. The impedance matching transformer illustrated is designed to give improved tv reception by minimizing noise pickup and ghosts due to feed-line reflections. It is made to match a 70 to 95-ohm coaxial line to the 300-ohm input of any television receiver.

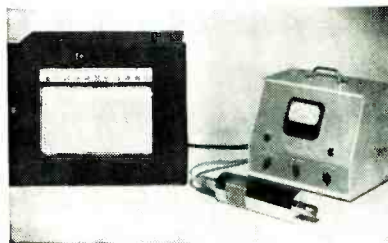

## Recording Vacuum Gage

NATIONAL RESEARCH CORP., 70 Memorial Drive, Cambridge 42,

Mass. The Alphatron cold-emission ionization gage connected to a recorder provides means for recording total pressure in three separate ranges from one micron to 10 mm of mercury. Control of an external circuit can be provided at option by a mercury switch on the recorder which can be set to open or close as the pressure rises above or falls below a given value, with an accuracy of  $\pm 2$  percent of the full-scale value.

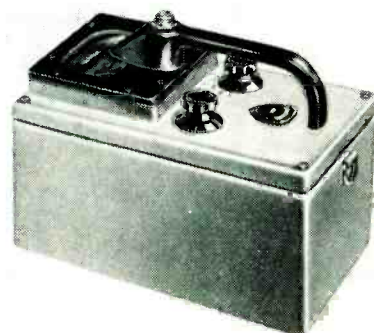

## Gamma Survey Meter

THE KELLEY-KOETT MFG. CO., 12 E. 6th St., Covington, Ky. Model K-350 five-range ionization-chamber gamma survey meter covers the range from 0 to 5 milliroentgens per hour to 0 to 50,000 mr per hr. The instrument features a hermetically sealed ion chamber, is non-microphonic and has a  $\pm 10$ -percent accuracy over an operating range from  $-10$  to 125 F.



## Electrical Reset Register

ATOMIC INSTRUMENT Co., 160 Charles St., Boston, Mass. Model 1238 electrical reset register is designed for use with all types of nuclear and industrial equipment. Accurate counting from 1 to 999,999 at up to 12 counts per second is possible. Reliable register actu-



WHY THE WHOLE INDUSTRY  
IS TURNING TO...

**RAYTHEON**

**GERMANIUM  
CRYSTAL  
DIODES**

CK707, for example, has high back resistance even at elevated temperatures.

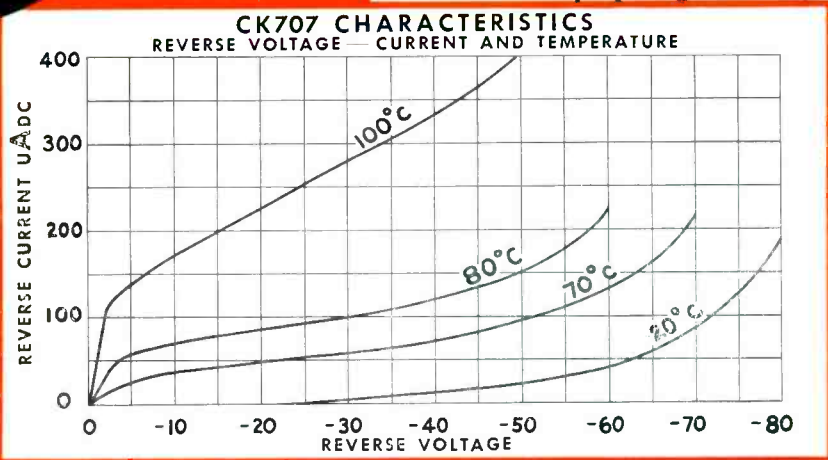
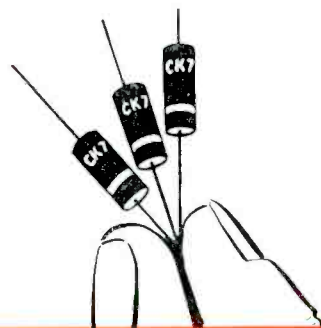

Other features that mean better, more dependable performance include:

1. Superior humidity characteristics\*
2. No wax or filler to affect operation even up to 100°C.
3. Extremely small change in forward resistance with temperature
4. Small size — 9/64" diameter, 25/64" length
5. Distinctive color coding
6. Smaller, more flexible leads for easier wiring

**7. Completely insulated body for compact assembly**

\* Repeated eight hour temperature-humidity cycles (20°C and 70°C at 95% humidity) indicate an increase of about 10% in forward resistance. In this respect Raytheon CK707 Germanium Crystals are similar to copper oxide, selenium and other dry contact rectifiers. About 85% of the crystals show little or no change in reverse resistance characteristics after 10 of the above cycles. About 10% of the crystals decrease in reverse resistance to approximately half of the 25°C limits after 10 cycles. A small portion of the crystals become inoperative except for low impedance circuits such as video detectors, after 10 temperature-humidity cycles.

The following types are available in production quantities at Newton and Chicago, and in smaller quantities at our 310 Special Tube Distributors.

	CK705 General Purpose	CK706 Video Detector	CK707 50 Volt D.C. Restorer	CK708 100 Volt D.C. Restorer
<b>MAXIMUM RATINGS (at 25°C.)</b>				
DC Inverse Voltage (volts)	60	40	80	100
Average Rectified Current (ma.)	50	35	35	35
Peak Rectified Current (ma.)	150	125	100	100
Surge Current (for 1 sec.) (ma.)	500	300	500	500
Ambient Temperature for all types	-50 to +100°C			
<b>CHARACTERISTICS (at 25°C.)</b>				
Max. Inverse Current at -5 volts (ma.)			0.005	
Max. Inverse Current at -10 volts (ma.)	0.05	0.2		
Max. Inverse Current at -50 volts (ma.)	0.8		0.05	
Max. Inverse Current at -100 volts (ma.)				0.625
Min. Forward Current at +1 volt (ma.)	5.0		4.0	3.0
Min. DC Reverse Voltage for Zero Dynamic Resistance (volts)	70	50	100	120
Shunt Capacitance (uuf)	1.0	1.0	1.0	1.0
Rectification Efficiency at 54 mc (approx. %)		60		

Other types are available for special applications.

**RAYTHEON MANUFACTURING COMPANY**

SPECIAL TUBE SECTION • Newton 58, Massachusetts

SUBMINIATURE TUBES • GERMANIUM DIODES and TRIODES • RADIATION COUNTER TUBES • RUGGED, LONG LIFE TUBES

**RAYTHEON**

*Excellence in Electronics*

ation is obtained with as little as 10 ma at 50 v or with external contacts using the built-in d-c supply. The unit operates on 105 or 125 v, 50 or 60 cycle a-c, and draws 5 watts during normal operation, 30 watts maximum during resetting.

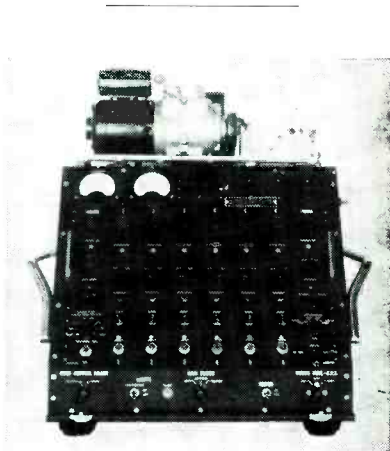

### Six-Trace C-R Oscillograph

MARYLAND ELECTRONIC MFG. CORP., 5009 Calvert Rd., College Park, Md. The instrument illustrated uses eight 2-in. c-r tubes as indicating elements for recording on a moving strip of 35-mm film. Six channels are available with associated amplifiers providing an input impedance of 0.1 megohm, a frequency response flat from 0 to 40,000 cps dropping 6 db at 100,000 cps, and gain sufficient to give 1½-in. deflection for 0.01 volt rms input. The two additional c-r tubes are used for recording timing signals which are produced internally.



### Radiation Meter

RADIO CORP. OF AMERICA, Camden, N. J. Type EMA-6 count-rate meter indicates the average number of

pulses per unit of time produced by a G-M counter or other suitable detector in the presence of nuclear radiations. It may be used as a testing and safety device in laboratories, as an assaying device or to study the rate of decay and the decay scheme of radioactive isotopes. The meter is self-calibrating and operates from a 115-volt, 60-cycle a-c power line. The output from its h-v power supply system is a filtered d-c which can be varied over a range of 0 to 2,500 volts by means of a panel-mounted potentiometer.

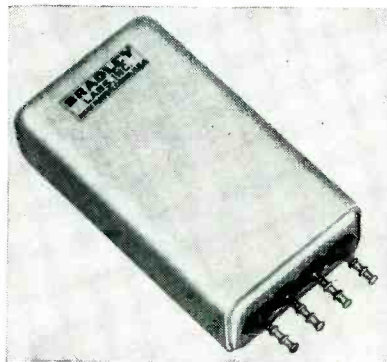

### Aircraft Radio Rectifier

BRADLEY LABORATORIES, INC., New Haven, Conn., has developed a special hermetically sealed version of its SE-8L rectifier for use in aircraft radio receivers. Its function is to demodulate an f-m signal which provides navigation information in the new omnirange system. The unit can operate continuously within limits at 95-percent relative humidity.

### Tele Picture Tube

RAYTHEON MFG. Co., 55 Chapel St., Newton 58, Mass. Type 16LP4 tube is a 16-in. glass envelope, direct-view picture tube for use in tv receivers. It employs magnetic deflection and focus and has an electron gun designed to be used with an external ion-trap magnet to prevent ion-spot blemishes. Its screen coating and practically flat face provide high-quality pictures and good contrast even under high ambient-light conditions.



### Safeguard for Atomic Workers

RADIO CORP. OF AMERICA, Camden, N. J. The EMA-2B hand and foot monitor is a radiation counter for routine checking of personnel who work with radioactive substances in laboratories and plants. The unit consists of a platform, two posts containing indicator lights and a control cabinet which may be installed in any out-of-the-way space that is free from contamination and excessive vibration. It operates on a 115-volt, a-c, 50 or 60-cycle, 250-watt power supply.

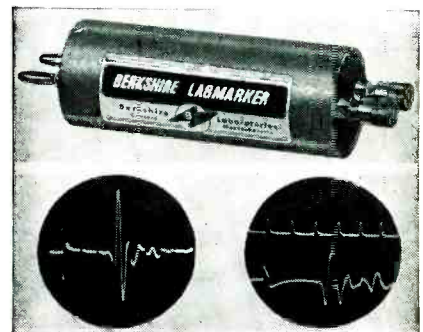

### Wave-Shaping Device

BERKSHIRE LABORATORIES, P. O. Box 70, Concord, Mass. The Labmarker is a wave-shaping device for producing time marks in c-r oscillography. It converts a sinusoidal input of 30 volts rms maximum into a series of sharp unidirectional pulses. The pulses may be displayed directly on the face of a c-r tube by connecting the Labmarker's output to the vertical input. Timing marks consisting of short breaks in the oscillograph trace are obtained by connecting

(Continued on p 208)

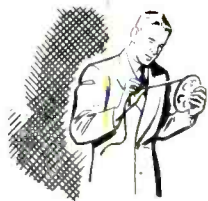

# What to look for

when you buy recording tape!

THESE  
PHYSICAL  
PROPERTIES

THESE  
MAGNETIC  
PROPERTIES

AND  
THESE  
BOXES

**Straight-Line Slitting** that makes the tape track and wind absolutely flat

**Freedom From Curl** so that the tape will ride flat over the heads with minimum tension.

**Smooth, Non-Absorbent Surface** that permits the tape to unwind freely, without any tendency to stick layer to layer.

**Maximum Signal-to-Noise Ratio**, for utmost clarity of reproduction, especially on soft musical passages.

**Wide Bias Range**, with minimum sensitivity to possible fluctuations in amplitude of the machine bias.

**Excellent High-Frequency Response**, for maximum fidelity where full tonal range is desired.

**Uniform Dispersion of Oxide Particles**, with freedom from "clumping" which causes high noise level.

**Low Surface Friction** which results in reduced wear of the magnetic heads.

**Strong Adherence** of the oxide to the base, so that the coating will not chip or peel off.

**Low Distortion**, for more life-like reproduction of either voice or music.

**Freedom From Audible Low-Frequency Modulation Noise**. This avoids the rasping hum that is often blamed on the recording machine.

**Uniformity of Output**, within the reel and from reel to reel—without the frequently-encountered magnetic "weak spots."

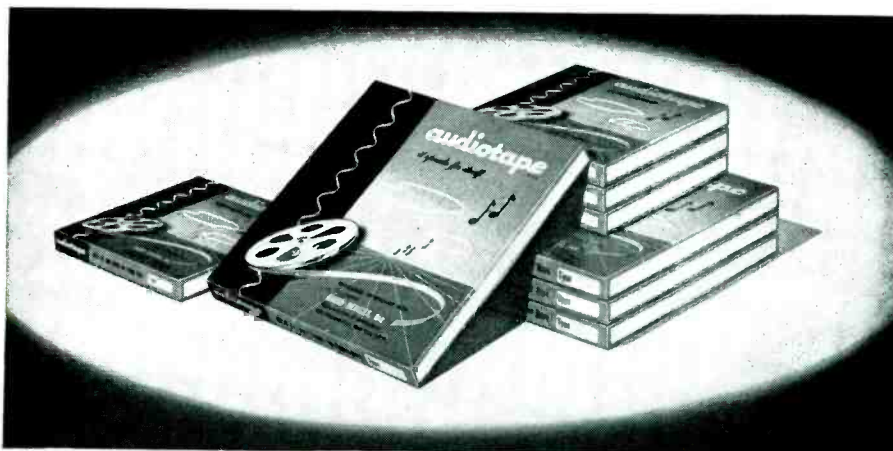

Yes, when you look for these distinctive red and blue boxes you can be *sure* that you're getting all the physical and magnetic properties that are so important for truly fine recording and reproduction. Audiotape is made in our own plant—under our own constant supervision and control. It is manufactured to the same exacting standards of quality and uniformity that have characterized Audiodiscs for the past decade. And *every foot* of Audiotape is monitored for output, distortion, and uniformity—your assurance of the finest, professional-quality tape available anywhere.

## PLASTIC-BASE audiotape\*

(In the Red Box)

- A plasticized cellulose acetate base with a perfectly smooth surface, permits maximum uniformity of coating thickness, with resulting minimum noise level. Will not stretch or break even at *many times* the maximum tension encountered in service.

TYPE NO.		COATING	WOUND ON REEL WITH
1250 Foot Reel	600 Foot Reel		
1240	640	Black Oxide	Oxide Out
1241	641	Black Oxide	Oxide In
1250	650	Red Oxide	Oxide Out
1251	651	Red Oxide	Oxide In

## PAPER-BASE audiotape\*

(In the Blue Box)

- The base especially developed for Audiotape, is a strong, durable, supercalendered kraft paper which provides the necessary smoothness of texture without the use of any fillers, which either tend to come out or stiffen the paper.

TYPE NO.		COATING	WOUND ON REEL WITH
1250 Foot Reel	600 Foot Reel		
1200	600	Black Oxide	Oxide Out
1201	601	Black Oxide	Oxide In
1220	620	Red Oxide	Oxide Out
1221	621	Red Oxide	Oxide In

NOTE: Audiotape is also available on larger reels. Write for information.

## AUDIO DEVICES, INC.

444 MADISON AVE., NEW YORK 22, N. Y.

Export Dept.: ROCKE INTERNATIONAL, 13 East 40th St., New York 16, N. Y.

\* Trade Mark



# NEWS OF THE INDUSTRY

Edited by WILLIAM P. O'BRIEN

## First Circular Lens Antenna Used for Omnirange

A NEW precision omnirange operating on a frequency near 5,000 megacycles, developed by Sperry engineers for the Air Force, uses a circular lens antenna to reduce ground reflections. Accuracies of a half degree have been demonstrated in experiments at New York's La Guardia Airport.

Statistical studies show that delays in the handling of air traffic, both for civil and military craft, increase rapidly if the working rate becomes much greater than 70 percent of the maximum capacity. Therefore, the maximum capacity must be set as high as practicable. However, this capacity depends upon accuracy of the system. A navigation system accurate to one-tenth degree for aircraft flying at 120 mph and landing at a rate of 120 per hour would cause errors in position of 250 feet, and it could also give rise to scheduling and ground speed errors of three seconds and 2.4 miles per hour. These errors added to position error could permit aircraft, supposedly one

mile apart, to fly as close as 3,000 feet from each other.

The conventional omnirange (VOR) now being installed for civil aviation operates in the frequency region between 112 and 118 mc and employs a heart-shaped beam that sweeps through 360 degrees in the manner of an airport searchlight. A basic improvement to the accuracy of the new 5,000-mc omnirange is the addition of eleven lobes or scallops to the heart-shaped pattern. When the receiving equipment is made responsive to both the large pattern and the lobes a high degree of accuracy results.

## Technical Institute Education Award

THE JAMES H. MCGRAW AWARD in Technical Institute Education will be presented for the first time at the Seattle meeting of the American Society for Engineering Education in June on the University of

Washington campus. Consisting of an annual prize of \$500 in cash and an appropriately engraved certificate, the award is sponsored by the McGraw-Hill Book Co. in memory of James H. McGraw, Sr., and is given in recognition and encouragement of outstanding contributions to technical institute education in the U. S.

Thorndike Saville, dean of engineering, N. Y. U., president of the American Society for Engineering Education, has appointed the following committee to select the recipient of the 1950 award: E. E. Booher of the McGraw-Hill Book Co.; J. T. Faig of Ohio Mechanics Institute; C. J. Freund of the University of Detroit; K. L. Holderman of Pennsylvania State College; L. V. Johnson of Southern Technical Institute; C. S. Jones of the Academy of Aeronautics; and H. P. Rodes of the University of Calif., chairman.

Nomination forms, which may be obtained from any member of the committee or from A. B. Bronwell of Northwestern University, must be mailed or delivered by March 15, 1950, to H. P. Rodes, James H. McGraw Award Committee, 130 Administration Bldg., University of California, Los Angeles 24, Calif. Any persons other than members of the award committee or employees of the McGraw-Hill Book or Publishing Companies may make nominations.



Circular lens antenna for shf consists of metal slats that direct 6-cm waves toward horizon, avoiding ground reflections. Supporting tower is 75 feet high

## IRE Awards

SIX major awards and thirty fellowships will be conferred by the IRE at its annual convention in New York, March 6 to 9. The Browder J. Thompson Memorial Prize will be awarded to Joseph F. Hull and Arthur W. Randals for their paper entitled "High-Power Interdigital Magnetrons." Winner of the Editor's Award is E. J. Barlow, for his paper "Doppler Radar." Otto H. Schade is recipient of the Morris Liebmann Memorial Prize, for outstanding contributions to the analysis, measurement technique and system development in the field of television and related optics. The Harry Diamond Memorial Award goes to Andrew

AS EXHIBITED AT THE RADIO ENGINEERING SHOW



SPOTLIGHT  
THE

NEW  
IMPROVED



## LAVOIE C. I. METER

*Now . . . top, unequalled performance in a Crystal Impedance Meter that definitely provides:*

- ★ GREATER ACCURACY of setting of load capacitance.
- ★ EASIER TUNING of fine frequency control.
- ★ GREATER RANGE of crystal activity — both high and low.
- ★ INFORMATION and INSTRUCTIONS to more easily obtain data relative to crystal activity level.
- ★ COARSE FREQUENCY SETTINGS recalibrated to improve operation.
- ★ GREATER SENSITIVITY available at higher crystal resistance values.

Booth Nos. 87, 88, 89

★ FOR THESE AND OTHER FEATURES, SEE THE LAVOIE C. I. METER AT THE SHOW, OR WRITE FOR BULLETIN LA-51A FOR FULL, DETAILED INFORMATION.

*Lavoie Laboratories*

RADIO ENGINEERS AND MANUFACTURERS  
MORGANVILLE, N. J.

**Specialists in the Development and Manufacture of UHF Equipment**

V. Haeff, for his work in the field of h-f radio analysis, the traveling-wave tube and memory storage devices. Frederick E. Terman will receive the Medal of Honor for his many contributions to the radio and electronics industry as teacher, author, scientist and administrator.

Members raised to the rank of fellow and their citations are as follows:

A. L. Albert—"For his contribution to electronics as a teacher and writer."

R. R. Batcher—"For his pioneer work with c-r instruments and more recently for his development of precision variable-frequency standards and meters."

A. V. Bedford—"For his many contributions to sound recording and the development of many circuits of basic importance to present-day television."

R. Bennett—"For his contributions in programming, guiding and developing sonar systems for military use and his contribution to the administration of military electronics laboratories."

F. J. Bingley—"In recognition of his contributions in the field of television broadcast engineering."

K. H. Blomberg—"In recognition of his many contributions to development and engineering in the field of communications in Sweden."

J. F. Byrne—"For his development of a system of polyphase broadcasting and for effective engineering administration in connection with radar countermeasures during the war."

W. G. Dow—"For outstanding contributions to the teaching and understanding of electronics through the organization of educational material and the stimulation of students and others to critical thought."

D. E. Foster—"For his contributions and technical direction of work leading to better radio receiver design."

G. W. Gilman—"For his contributions to the communication art and for his direction of important developments in the field of radio transmission systems."

G. L. Haller—"For his work on aircraft antennas and for his diversified radio effort during the war."

A. G. Hill—"For his work in the utilization of electronics to research in physics and his contribution in the conversion of wartime development laboratories to peacetime fundamental research."

E. S. Howes—"For his contributions as a teacher in the field of communication engineering."

H. A. Iams—"For the development of electronic apparatus for converting images formed by electromagnetic waves to electrical signals, first in the television field, and later, using new principles, in the realm of short radio waves."

W. Jackson—"For his services as an educator and his many contributions to the literature in both the radio and electrical fields."

R. Kompfner—"For his research in electron tube theory and particularly for his original contributions to the concepts of the traveling-wave amplifier."

H. B. Marvin—"For his outstanding contributions to the measurements art and pioneering work in f-m, television and allied fields."

P. Mertz—"In recognition of his important contributions to the fundamental concepts of television transmission and reception."

J. H. Miller—"For his long activity and many contributions in the field of electrical metering and measuring technique."

G. Mountjoy—"For his contributions to the design of radio and television broadcast receivers."

E. R. Piore—"For his many contributions in the fields of engineering and physical sciences, and for outstanding service in enhancing the national effort in basic research."

J. R. Poppele—"For his long and continued leadership in the broadcasting field and in particular for his recent contributions to television broadcasting."

S. Ramo—"For his many contributions to the analysis of electromagnetic phenomena and for his leadership in research."

C. E. Shannon—"For his contributions to the philosophy of new pulse methods

## MEETINGS

FEB. 27-MARCH 3: ASTM Committee Week and Spring Meeting, Hotel William Penn, Pittsburgh, Pa.

MARCH 1-2: Cathode Committee Meeting, ASTM headquarters, 1916 Race St., Philadelphia, Pa.

MARCH 6-9: IRE Convention and Radio Engineering Show, Hotel Commodore and Grand Central Palace, New York City.

APRIL 19-22: Annual Meeting of the Electrochemical Society, Hotel Statler, Cleveland, Ohio.

APRIL 26-28: Fourth annual meeting of the Armed Forces Communications Association, Astoria, New York City, and Fort Monmouth, N. J.

MAY 3-5: 1950 Dayton IRE Technical Conference, Dayton Biltmore Hotel, Dayton, Ohio.

MAY 9-11: Conference on Improved Quality Electronic Components, 1317 F Street N W, Washington, D.C.

MAY 22-25: Parts Distributors Show, Hotel Stevens, Chicago, Ill.

JUNE 26-30: Annual Meeting and 9th Exhibit of Testing Apparatus and Related Equipment, Hotel Chalfonte-Haddon Hall, Atlantic City, N. J.

AUG. 23-26: AIEE Pacific General Meeting, Fairmont Hotel, San Francisco, Calif.

AUG. 28-31: APCO National Conference, Hotel Hollenden, Cleveland, Ohio.

SEPT. 13-15: Sixth Annual Pacific Electronic Exhibit, Municipal Auditorium, Long Beach, Calif.

SEPT. 18-22: Fifth National Instrument Conference and Exhibit, Memorial Auditorium, Buffalo, N. Y.

SEPT. 25-27: National Electronics Conference, Edgewater Beach Hotel, Chicago, Ill.

OCT. 17-21: AIEE Midwest General Meeting, Netherland Plaza Hotel, Cincinnati, Ohio.

and to the basic theory of communications."

W. A. Steel—"For his contributions in Canada in advancing development of military radio, broadcasting and international communication."

J. R. Steen—"For his work in the introduction and development of statistical quality control techniques in electron tube manufacturing."

G. R. Town—"For his contributions in radio receiver engineering and research."

D. Ulrey—"For pioneering research and for administrative and technical contributions to the development of special purpose and power tubes."

R. R. Warnecke—"For his engineering and research contributions to vacuum tube theory and design in France."

H. A. Zahl—"For his guidance of the Army Signal Corps research program in the transition from war to peace and for his contribution to radar in its early development stages."

## Bridgeport UHF Television Station

IN ORDER to obtain data on the propagation characteristics of ultrahigh frequencies in the region around 530 mc, the Radio Corporation of America has established an experimental television transmitter in the town of Stratford, 2 miles from the center of Bridgeport, Conn. About 50 uhf receivers are being installed in the vicinity and mobile recording equipment is also used for measuring field strengths.

The transmitter building and tower are located on Success Hill,

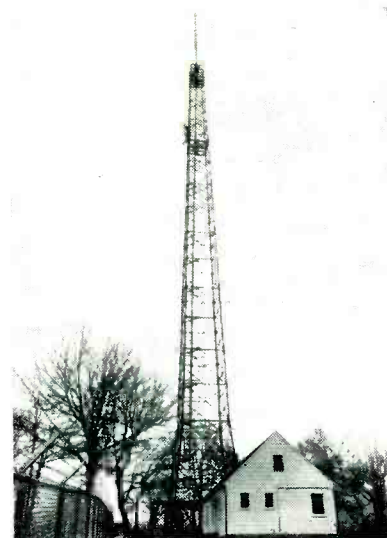

Building housing uhf equipment and tower that supports high-gain slot antenna at top and receiving dish at 160-foot level

190 feet above sea level. The fabricated tower that supports the 40-foot multiple-slot transmitting antenna is 210 feet high. At the 160-foot level is located the directive receiving antenna that picks up programs from WNBT in New York City, 53 miles distant.

A modification of the type

(continued on page 246)

# Just 3 plug-in coils cover 100-300 mc range in McMurdo Silver's "Grid Dip" adapter

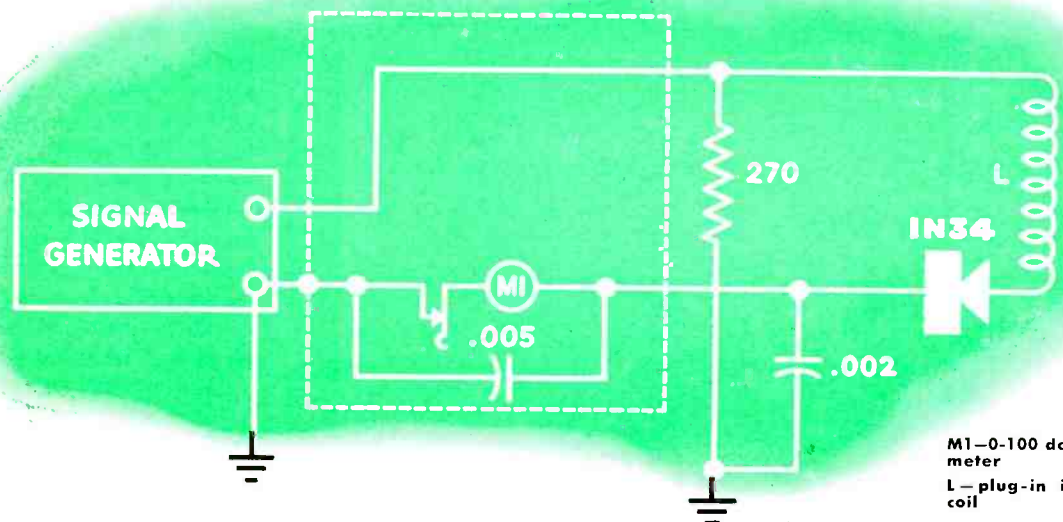

M1—0-100 dc microammeter  
L—plug-in inductance coil

## THE SYLVANIA IN34 GERMANIUM DIODE MAKES THIS SIMPLIFIED CIRCUIT DESIGN POSSIBLE!

"In our Model 915 Tubeless 'Grid Dip' Adapter, the extremely low shunt capacitance of the Sylvania IN34 Germanium Diode made possible the design of a series tuned circuit with only 3 plug-in coils to cover the range from 100 to 300 mc," reports D. H. Carpenter, Chief Engineer of McMurdo Silver Co., Inc., Hartford, Conn. "Other advantages are compact probe design, savings in production costs and assurance of a positive zero set."

Many manufacturers have found that Sylvania Germanium Diodes contribute to circuit improvement and design simplification. Have you investigated the possibilities of these compact, lightweight, heaterless components?

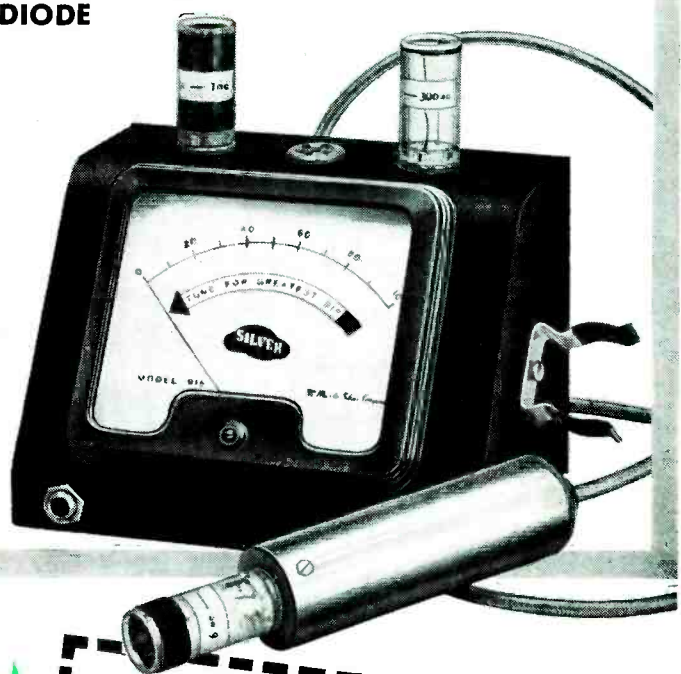

MAIL COUPON FOR LITERATURE  
ON SYLVANIA GERMANIUM DIODES

# SYLVANIA ELECTRIC

ELECTRONICS DIVISION  
500 FIFTH AVENUE, NEW YORK 18, N. Y.

Sylvania Electric Products Inc.  
Electronics Division, Dept. E-1003  
500 Fifth Avenue, New York 18, N. Y.

Gentlemen:  
Please send me full information on your Germanium Diodes.

Name \_\_\_\_\_  
Company \_\_\_\_\_  
Address \_\_\_\_\_  
City \_\_\_\_\_ Zone \_\_\_\_\_ State \_\_\_\_\_

ELECTRONIC DEVICES; RADIO TUBES; CATHODE RAY TUBES; PHOTOLAMPS; FLUORESCENT LAMPS, FIXTURES, WIRING DEVICES, SIGN TUBING; LIGHT BULBS

## TUBES AT WORK

(continued from page 118)

overall accuracy is perhaps 0.2 to 0.3 percent.

### *Circuit*

The amplifier is a conventional vtvm type in which two triodes are balanced against each other to cancel drift. Any drift that remains may cause a slight shift in the zero position of the meter, but, by using a momentary switch which must be pressed to make the measurement, the circuit is automatically placed in the zeroing position before and after every measurement and any shift in zero is immediately apparent. Since a sensitive meter is used, no voltage amplification is necessary.

Grid current flowing through the bridge causes a potential to appear at the grid of  $V_1$ , but since the circuit is arranged with the same resistance in the grid circuit in both the zeroing and measuring positions, no error is introduced. It is advisable, however, to keep the grid current at a minimum by applying proper voltages to the tubes.

Because of the high resistances involved, some points in the bridge circuit not connected to the chassis must be carefully insulated from it and from each other, as a slight leakage may cause serious errors in measurement. Although the instrument has been described as a high-resistance measuring device, it can also be used equally well for any resistance down to about 100 ohms simply by reversing the position of the decade and the unknown resistance in the bridge circuit.

### Egg Processing Equipment

By S. M. MILANOWSKI  
*Consulting Engineer*  
Los Angeles, California

TO IMPROVE efficiency and to lower the cost of candling and handling eggs, Industrial Electronic Engineers of Los Angeles have developed an automatic egg processing line based on principles that could possibly be applied to other phases of the food-products industry.

The setup eliminates the need for the human handling of eggs from the time a farmer places them in crates until they are actually consumed. The components can be

**RF and AN CONNECTORS**

**COAXIAL and  
MULTI-WIRE CABLES**

**COMPLETE ASSEMBLIES**

**- from the leading source of  
Radio-Electronic Components**

Write Department 17 for data-sheets or subjects of  
particular interest . . .

**AMPHENOL CORPORATION**  
1830 S. 54TH AVENUE • CHICAGO 50 ILLINOIS.

**AMPHENOL**



View of Magnet Assembly: Top bar Crucible Alnico; lower bar (replacing former 2nd magnet) provides return path and reinforces assembly.

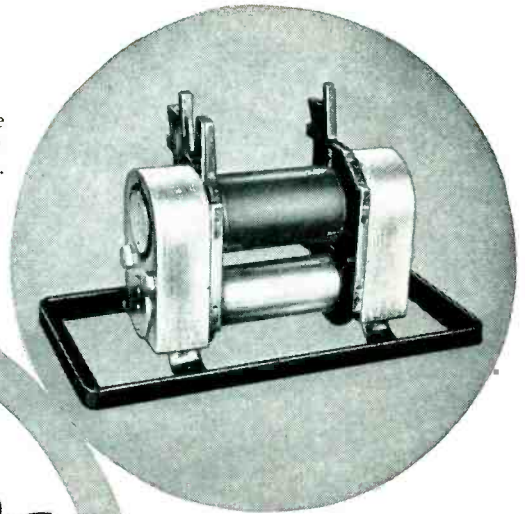

Crucible  
cuts magnet  
costs in  
half!



TelAutograph Corporation, New York, N. Y., designs and manufactures the TelAutograph teleprinter, an instrument that transmits handwritten messages over wire to one or many remotely located receivers.

Receiver operation is similar to a d-c voltmeter: the motion and position of the recording pen is determined by the force developed in a coil that is free to move in a fixed magnetic field. Originally this field was produced by current through a wound coil, but this generated heat and reduced the field strength. Permanent magnets were substituted for the coil. But here a problem arose:

Two permanent magnets were required to match the electromagnetic field. This made assembly time and unit costs excessive. Crucible Magnet Specialists were called in, and in short order developed one permanent magnet to replace the two. This resulted in a 50% magnet cost cut, improved mechanical construction and a general reduction in assembly cost . . . plus increased unit efficiency.

That's how TelAutograph Corporation made good use of Crucible's half-century of specialty steel experience. Your problems will be given the same careful attention. Please state your permanent magnet application when you write.

CRUCIBLE STEEL COMPANY OF AMERICA  
405 LEXINGTON AVE., NEW YORK 17, N. Y.  
*Branches: Warehouses and Distributors in Principal Cities*

**CRUCIBLE**

first name in special purpose steels

## PERMANENT ALNICO MAGNETS

STAINLESS • HIGH SPEED • TOOL • ALLOY • MACHINERY • SPECIAL PURPOSE • STEELS  
ELECTRONICS — March, 1950



## A NEW SOLUTION TO OLD PROBLEMS

**AEROCOM'S NEW ARTIFICIAL ANTENNA, SIMULATING ACTUAL OPERATING CONDITIONS, SAVES TIME ON TRANSMITTER AND RECEIVER TUNING**

It is no longer necessary to final tune transmitters or receivers aboard aircraft. With the new Artificial Antenna (Model DA200) you can precisely simulate, electrically, any normal aircraft antenna. All this without leaving the test bench. This equipment will accept any transmitter power up to 200 watts -- coaxial fitting provides direct 52 ohm metered load. Sturdily constructed for hard usage, can be mounted in standard rack cabinet or used on bench top.

*A letter or wire from you will bring descriptive literature*

CONSULTANTS, DESIGNERS AND MANUFACTURERS OF STANDARD OR SPECIAL ELECTRONIC, METEOROLOGICAL AND COMMUNICATIONS EQUIPMENT.

**AER-O-COM**  
Reg. U. S. Pat. Off.

**AERONAUTICAL COMMUNICATIONS EQUIPMENT, INC.**  
3090 Douglas Road, Miami 33, Florida

DEALERS: Equipelero Ltda., Caixa Postal 1924, Rio de Janeiro, Brasil \* Henry Newman Jr., Apartado Aereo 138, Barranquilla, Colombia \* Radelec, Reconquista 46, Buenos Aires, Argentina

### Build YOUR OWN *Heathkit* TEST EQUIPMENT

**Heathkit AUDIO GEN. KIT**  
\$34.50

**Heathkit TUBE CHECKER KIT**  
\$29.50

**Heathkit TELEVISION GENERATOR KIT**  
\$39.50

**Heathkit 5" OSCILLOSCOPE KIT**  
\$39.50

**Heathkit SIGNAL TRACER KIT**  
\$19.50

**Heathkit BATTERY ELIMINATOR KIT**  
\$22.50

**Heathkit CONDENSER CHECKER KIT**  
\$19.50

**Heathkit ELECTRONIC SWITCH KIT**  
\$34.50

**Heathkit NEW IMPEDANCE BRIDGE SET**  
\$69.50

**Heathkit R.F. SIGNAL GEN. KIT**  
\$19.50

**Heathkit VACUUM TUBE VOLTMETER KIT**  
\$24.50

**Heathkit HANDITESTER KIT**  
\$13.50

Heathkits are beautiful factory-engineered quality service instruments supplied unassembled. The builder not only saves the assembly labor cost but learns a great deal about the construction and features of the instrument. This knowledge aids materially in the use and maintenance of the equipment. Heathkits are ideal for and used by leading universities and schools throughout the United States. Each kit is complete with cabinet, 110V 60 cycle transformer (except Handi-Tester), all tubes, coils assembled and calibrated, panel already printed, chassis all punched, formed and plated, every part supplied. Each kit is provided with detailed instruction manual for assembly and use. Heathkits provide the perfect solution to the problem of affording complete service equipment on a limited budget. Write for complete catalog.

**HEATH COMPANY**  
BENTON HARBOR, 14 MICHIGAN

EXPORT DEPARTMENT  
13 EAST 40th STREET  
NEW YORK 16, N.Y.  
CABLE - ARLAB - N.Y.

# SOLVE your hi-fidelity problems with *University* TWEETERS

WIDEST SELECTION • BEST VALUE • HIGHEST QUALITY

### SINGLE UNIT TWEETERS

**MODELS 4408, 4409—600 CYCLE TWEETERS:** Recommended for highest quality reproduction systems requiring a low crossover frequency. Cobra shaped horn results in perfect wide angle distribution. Frequency response 600 to 15,000 cycles. Model 4408 handles 6 watts and 4409 25 watts.



**MODEL 4407 ADAPTER MOUNTS 4401 TWEETER IN ANY 12" CONE UNIT:** Converts any 12" cone speaker into a wide-range coaxial reproducer in a few minutes. Installation is extremely simple and results in a dual speaker occupying little more space than the original cone speaker. Complete with 4401 tweeter.



**MODEL 4401—2000 CYCLE TWEETER:** An economical 6 watt unit for converting any good 10-15" cone speaker for extended response to 15,000 cycles. Wide Angle horn, compact design and low price bring excellent high fidelity well within the popular price range.



### DUAL TWEETERS



**MODEL 4402, MODEL 4404:** Model 4402 reproduces to 15,000 cycles. Crossover at 2000 cps. Horizontal dispersion 100°, Vertical 50°. Handles 12 watts. Compact design mounts in any radio, phono, or speaker cabinet. Model 4404 incorporates 4402 tweeter in handsome walnut cabinet complete with high-pass filter and high frequency volume control. Anyone can install.

### CROSSOVER NETWORKS



**MODEL 4405 HIGH PASS FILTER:** An effective and economical unit for preventing lows reaching the tweeter unit. Contains high frequency control to balance highs and lows. Cutoff frequency 2000 cycles.



**MODEL 4410, 4420 LC CROSSOVER NETWORK:** Genuine LC frequency dividers for segregating highs and lows. Not to be confused with ordinary high-pass filters. Crossover frequencies: Model 4410 600 cycles, Model 4420 2000 cycles. Attenuator controls included and wired.

Write for illustrated Catalog Today  
Address Inquiries to Department E

*University*  
**LOUDSPEAKERS • INC**

80 SO. KENSICO AV., WHITE PLAINS, N.Y.

**SOMETHING BRAND NEW IN  
HOOK-UP WIRE—**

**TURBOTHERM REL 16-A  
INSULATED WIRE**

**105°C  
CONTINUOUS  
OPERATION**

**...now you need stock  
but one wire for every  
hook-up and lead  
requirement!**

**TINNED  
COPPER WIRE  
FOR FAST  
SOLDERING**

**NON-  
DETERIORATING  
VINYL DIELECTRIC  
FOR PERMANENT  
SAFETY**

**Braided  
Lacquered Glass  
Jacket 90° C with  
Cotton or  
Rayon**

**OPERATING  
RANGE —10  
TO 105°C**

- NON-POROUS, NON-FRAYING
- FREE STRIPPING INSULATION
- FLEXIBLE
- AVAILABLE FOR 300 AND 600 V.
- NON-DETERIORATING VINYL DIELECTRIC
- WITHSTANDS POTTING TEMPERATURES



... IT'S  
APPROVED BY  
UNDERWRITERS  
LABORATORIES

IT REDUCES  
WIRE  
INVENTORY, IT  
SPEEDS WIRING



... IT'S  
AVAILABLE IN  
ALL SIZES  
12 TO 30 AWG



TURBO REL-16A Insulated Wire is the biggest news in hook-up wire to be announced in recent years. Its unusual characteristics make it possible for the first time, to stock one single type of wire for all requirements—point-to-point wiring, cabling, equipment and component leads.

REL-16A is a free stripping insulated wire composed of a tinned copper conductor, covered with a layer of non-deteriorating vinyl plastic, overlaid with a close-woven lacquered glass jacket. The

combination of free stripping and the tinned conductor enormously speed production. The vinyl dielectric gives permanent electrical protection, and the lacquered glass woven outer layer insures the utmost mechanical protection.

The overall qualities of REL-16A are so thoroughly outstanding that this is the first thermoplastic wire to earn Underwriters' approval recognition for 105° C continuous operation. Check the advantages—write for free sample today.

**WILLIAM BRAND & COMPANY**  
276 FOURTH AVE., NEW YORK 10, N. Y. • 325 W. HURON ST., CHICAGO 10, ILL.



# Ballantine's PEAK to PEAK Electronic VOLTMETER

Designed for  
PULSE AMPLITUDE  
MEASUREMENTS



MODEL 305

The outstanding characteristic of the Model 305 Electronic Voltmeter is its ability to provide absolute indication of transient or pulse voltages of short duration. Reliable indication of pulses a few microseconds wide repeated only 10 times per second is readily obtained with this instrument. The Voltmeter is pre-calibrated, compact, easy to operate and observe. Positive and negative peaks are registered over the range of .001 volt to 1000 volts, peak to peak. Decade ranges and a logarithmic scale output meter are characteristic features, along with a separately available high gain, wide-band amplifier.

Send for Bulletin No. 12

## BALLANTINE LABORATORIES, INC.

BOONTON, NEW JERSEY, U. S. A.

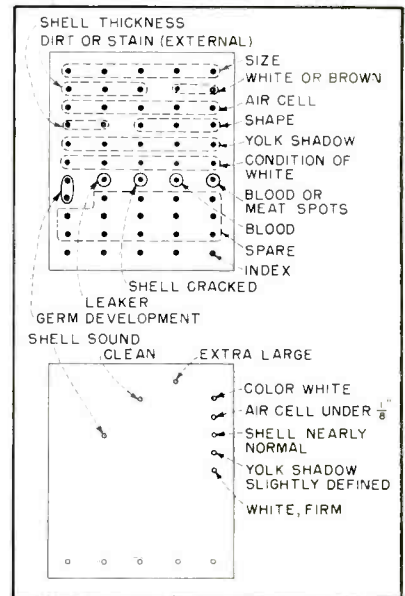

FIG. 1—Inspection data are recorded magnetically in the form of dots corresponding to each egg's characteristics. Bottom is a drawing of a typical egg card

arranged in many ways to meet different production requirements.

The automatic equipment takes over as soon as the egg crates reach the inspection station. Racks of rubber-fingered hangers reach into the crates and remove eggs a layer at a time. Between each layer an arm removes the packing pad which separates the layers of eggs. The emptied crates are moved to a storage area by another conveyor.

The rubber-fingered hangers carry the eggs to an egg-conveyor belt which consists of a series of foamed-rubber cups on which the eggs ride from one inspection operation to the next.

### Magnetic Recording

As the eggs speed through their inspection stations, data describing the size and quality of each egg is magnetically recorded on a rust-proof magnetic card which is attached to each foamed-rubber conveyor cup. Details of the magnetic card are shown in Fig. 1. Each dot denotes some characteristics of the egg as determined by inspection data.

A collector unit scans the magnetic card for each egg after it leaves the final inspection station, and transmits the data on the card to a control unit which energizes various circuits in accordance with

33<sup>1/3</sup> RPM

78 RPM

45 RPM

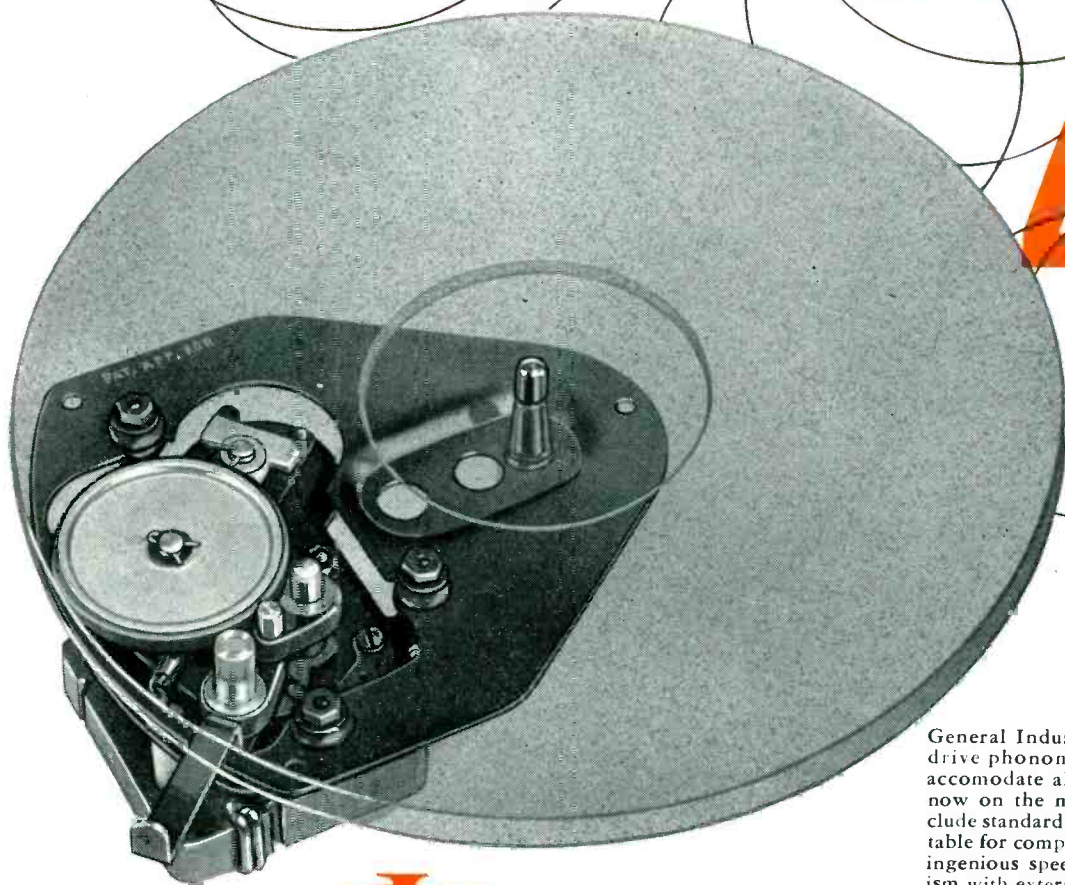

This model for manual operation. Many variations are available to record-changer manufacturers.

General Industries' newest rim-drive phonomotor, designed to accommodate all types of records now on the market. Features include standard narrow-flange turntable for compact installation, and ingenious speed-change mechanism with external shift lever.



## MODEL TS (ALL THREE SPEEDS)

Here's the turntable that puts you right in the middle of the profitable market for consoles, table models and portable phonographs that will play all three types of records. Simple and fool-proof in operation, the Model TS incorporates all of the advanced engineering features which have long distinguished GI's *complete* line of Smooth Power phonomotors, recorders and record-changer recorders.

Quantity price quotations, specifications and blueprints mailed immediately upon request. Write today to:



**The GENERAL INDUSTRIES Co.**

DEPARTMENT B • ELYRIA, OHIO

*It's easy to fit all TV circuits with*

**GRACOIL**

"One Good Turn or a Million"

**TELEVISION**

*Transformers*



Vertical and Horizontal Blocking Oscillator. Below Chassis mounting

★ Order these Gracoil TV Transformers and get identical physical and electrical duplicates of original units used in all popular receivers. Used and endorsed by leading TV set manufacturers. Dependable. Trouble-free. We invite your inquiry. Write.



Vertical and Horizontal Blocking Oscillator. Above Chassis mounting

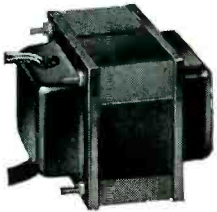
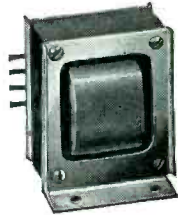

Plate and Filament Transformer with and without Magnetic Shielding



Vertical Deflection Output Transformer



Filter Choke

**THE GRAMER COMPANY**

*Electrical Coils and Transformers*

2734 N. PULASKI ROAD

CHICAGO 39, ILL., U.S.A.

ESTABLISHED IN 1935

**V.L.F.!**  
*Very Low Frequencies!*

CONFORMS TO ALL REQUIREMENTS OF C63.2 RADIO NOISE METER SPECIFICATION ADOPTED BY AMERICAN STANDARDS ASSOCIATION, OCTOBER 26, 1949



**STODDART NM-10A RADIO INTERFERENCE AND FIELD INTENSITY METER**

- MEASURES radiated and conducted signals
- RANGE—14 kc to 250 kc.
- SENSITIVITY — Field strength using rod antennas one microvolt-per-meter to 2 volts-per-meter. Field strength using shielded loop antennas 10 microvolts-per-meter to 100 volts-per-meter.
- READS directly in microvolts and db.
- A.C. POWER SUPPLY 105 to 125 volts or 210 to 250 volts, 50 CPS AND 1600 CPS. No shock hazard.

Write for complete technical data

**STODDART AIRCRAFT RADIO CO.**

Main office and plant:

6644 SANTA MONICA BLVD., HOLLYWOOD 38, CALIF., Phone: Hillside 9294

skilled springmakers...  
**AND** practical,  
experienced engineers,  
**SPECIALISTS**  
in spring design  
and manufacture

*Accurate*



IT takes people to make springs. Ours are specialized, highly trained, long-experienced people—well qualified to give you the finest in spring craftsmanship.

Our engineers too, are an important reason why you'll like Accurate Spring Service. They're old hands at spring-making... they've developed manufacturing systems and procedures that enable us to handle your jobs with the greatest speed and efficiency. These Accurate engineers are at your service on spring design problems. You will benefit from their practical assistance in designing exactly the right spring for your application.

Why not try Accurate on your next job?



**A dependable source of supply!**

**ACCURATE SPRING MFG. CO.**

3830 W. Lake St. • Chicago 24, Ill.

*Springs, Wire Forms, Stampings*

**MITCHELL-RAND** announces...

# 1766EX

## CAPACITOR END FILLER

### FOR SEALING OIL, WAX AND ELECTROLYTIC PAPER TUBE CAPACITORS

*it's new • it's better • it's low cost*

Once again Mitchell-Rand demonstrates the effectiveness and value of its research and development... produces 1766EX, a resin base thermoplastic having high cold flow, solid adhesion, inflexible oil resistance, absolute sealing and low-cost characteristics, all superior to any like product now available. 1766EX is the product long required by manufacturers of paper tube capacitors that must be guaranteed for operating temperatures to 105°C.

Yes, once again Mitchell-Rand gives point to its repute as "Headquarters for Everything in Electrical Insulation"...

1766EX adds another to Mitchell-Rand's more than 3500 compound and wax formulas that resist high voltage breakdown, salt spray atmosphere, humidity, cracking or flaking, acids and alkalis... with excellent flexibility and adhesive qualities, high cold flow and good thermal conductivity... waxes that penetrate fibre, floss, bakelite, paper and cloth and with low viscosity, high surface tension and good electrical characteristics... Mitchell-Rand has the compound or wax to meet your specific requirements and should the need arise for a special formula to meet a particular condition, then Mitchell-Rand will create the compound embodying every quality required.

#### SPECIFICATIONS

<b>COLD FLOW (M-R)</b>	— 250/255 F
<b>S.P. (B&amp;R)</b>	— 255/260 F
<b>POURING TEMPERATURE</b>	— 350/400 F
<b>COLOR</b>	— Brown
<b>ADHESION</b>	— Good
<b>PENETRATION 77/100/5</b>	— 0
<b>CHLORIDE CONTENT</b>	— *Negative
<b>SPECIFIC GRAVITY</b>	— 1.59
<b>FLASH POINT</b>	— 490 F
<b>MINERAL OIL RESISTANCE</b>	— Good

Write for your laboratory test sample... free upon request.

M-R THE ELECTRICAL INSULATION HEADQUARTERS FOR 60 YEARS.



#### FEATURES

##### ADHESION TO WAX IMPREGNATED TUBES:

In developing 1766EX every effort was made to assure good bonding properties to wax impregnated tubes without sacrificing hardness at high temperatures (100°C).

##### MINERAL OIL RESISTANCE:

Since penetration of mineral oil from oil impregnated and oil cooled capacitor sections tend to soften end fill compositions, 1766EX was formulated to resist mineral oils.

##### LOW COST:

In order that its adaptability be extended to almost every end sealing application, attractive low cost was included as a prime factor in the development of 1766EX and without the sacrifice of any quality feature.

##### COLD FLOW:

The high cold flow temperature of #1766EX permits its use for paper tube capacitors which are guaranteed for operating temperatures up to 105°C. Employing the standard container specified for the standard M-R Cold Flow test (2" in diameter by 1 3/8" high filled to depth of 1") 1766EX will resist cold flow at 115°C for more than 24 hours.

##### APPLICATION CHARACTERISTICS:

Sealing of capacitors with 1766EX is facilitated by the low pouring viscosity and good bubble release which this seal exhibits. The relatively sharp melting point and special filler combination of 1766EX permit easy pinhole repair. These properties make 1766EX particularly well suited for sealing electrolytic units.

\*Less than 4 parts per million.

## MITCHELL-RAND INSULATION CO. Inc.

51 MURRAY STREET • CORtlandt 7-9264 • NEW YORK 7, N. Y.

A PARTIAL LIST OF M-R PRODUCTS: FIBERGLAS VARNISHED TUBING, TAPE AND CLOTH • INSULATING PAPERS AND TWINES • CABLE FILLING AND POTHEAD COMPOUNDS • FRICTION TAPE AND SPLICE • TRANSFORMER COMPOUNDS • FIBERGLAS SATURATED SLEEVING • ASBESTOS SLEEVING AND TAPE • VARNISHED CAMBRIC CLOTH AND TAPE • MICA PLATE, TAPE, PAPER, CLOTH, TUBING • FIBERGLAS BRAIDED SLEEVING • COTTON TAPES, WEBBINGS AND SLEEVINGS • IMPREGNATED VARNISH TUBING • INSULATED VARNISHES OF ALL TYPES • EXTRUDED PLASTIC TUBING

# NEW SAFETY INTERLOCK



**RED TOP  
ENGINEERED TO  
"CHEAT" CHANCE**

## A NEW UNIMAX DESIGN

gives new, foolproof protection for high voltage equipment . . . the "cheater-release" lets you reclose the circuit manually for test or service work . . . automatically restores protection when the door of the safety enclosure is shut . . . eliminates the hazard of a tied down, blocked, or "jumped out" circuit.

## "CHEATS" FOR SAFETY

1. The leaf-spring actuator holds the circuit "ON" — until the door is opened as little as  $\frac{1}{8}$  inch.
2. The push-button-operated slide cam, mounted above the actuator, permits manual reclosing of the circuit.
3. The slide cam and interlock immediately spring back to "safety" when the door is closed on the leaf actuator.

For complete information — dimensions, performance specifications, ratings — write for Interlock Data Sheet MXM.



**UNIMAX SWITCH**  
DIVISION OF THE W. L. MAXSON CORPORATION  
460 WEST 33rd ST., NEW YORK 1, N. Y.

TUBES AT WORK

(continue)

the quality of the particular egg. The energized circuits have two functions: (1) Marking a second magnetic card on a pickup and removal hanger, so that each will be shunted off to a predetermined accumulator line; (2) Adding to the totalizers in an electronic control unit, so that the quantity and quality of eggs from each producer will be constantly and accurately indicated.

After the eggs are unloaded, the empty conveyor cups and magnetic cards are passed through a demagnetizing field, to erase the previously recorded data. The cups are then washed and dried before reuse.

Automatic book keeping is achieved through the use of markers on crates during the initial unloading process. These markers are plastic code plates that actuate a sensing switch so that the eggs in each different case will be accredited to the source from which they were purchased. The sensing switch enables a printer unit to record data with regard to quality and quantity for each producer.

### Inspecting Line

In all, there are five separate inspection stations, as follows:

Station No. 1 is an egg-sizing unit, as shown in Fig. 2. It is operated on the basis of the resonant-string principle with a tungsten wire serving as the string. A temperature-compensating mounting is provided, and the wire is electro-magnetically excited to a pitch or frequency which can be amplified and fed into a discriminator which is preset to measure frequency in terms of egg sizes.

At station No. 2, the color and shape of the egg are determined. First a prism-photocell setup is used to determine shell color by means

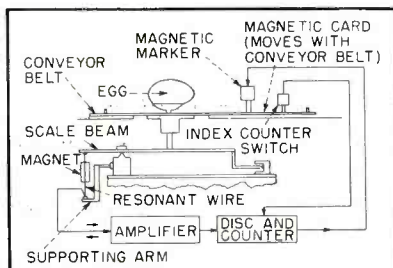

FIG. 2—Weight of egg is measured by the resonant-wire frequency-discriminator scale system shown

this complex shape is being made at low cost by ...



actual size

## Cold Heading

This special steel stud, used in heavy duty power transmission equipment, combines two different shapes with four diameters.

Some of the steps involved in cold heading this part from a length of steel wire. (Shown one-half actual size.)

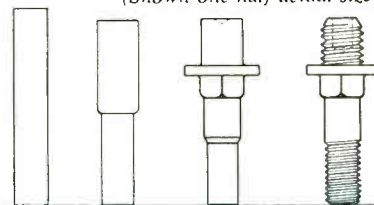

Production of this steel part by ordinary methods would involve the use of high cost machines, plus other costly operations. Cold heading not only provides economy and speed of production, but also produces a much stronger part.

Possibly this special technique can help you with your fastener problems. Send your sample or blueprint to Scovill first.

"Guide to the Profitable Use of Cold Heading"—Bulletin No. 2 describes the advantages and limitations of this process. It's free for the asking.

A PRODUCT OF

Recessed Head Screws • Sems  
Tapping Screws • Standard  
Machine Screws • Special Cold  
Headed Parts

**SCOVILL** FASTENERS AND SPECIAL PARTS

Industrial Fastener Sales, Waterville Division  
Scovill Manufacturing Co., Waterville 14, Conn.

New York • Detroit • Wheaton, Ill.  
Los Angeles • Cleveland • San Francisco



# NEW



# ACCURACY

Designed for the engineer and technician who wants laboratory accuracy. Achieved in Model 630-A by more accurate components and hand-drawn scales that compensate for the average individual characteristic of each instrument. Also includes knife-edge pointer and mirror scale to eliminate parallax.

Model  
**630-A**

**ONLY \$47.50 AT YOUR DISTRIBUTOR**

- 1/2% RESISTORS**
- COMPENSATED OHMMETER CIRCUIT**
- LONG HAND-DRAWN MIRRORED SCALES**

FOR THE MAN WHO TAKES PRIDE IN HIS WORK

# Triplet

TRIPLET ELECTRICAL INSTRUMENT COMPANY - BLUFFTON, OHIO, U.S.A.

# Easy on the Ears...



## TELEX Monoset\*—Under Chin Headset

Stethoscope design of the Telex *Monoset* eliminates tiresome pressure—instrument swings lightly under the chin. Wear it for hours without fatigue!

## TELEX Earset\*—Slips onto the Ear

Weighing only 1/2 oz., *Earset's* flat plastic frame slips onto the ear, holds the sensitive receiver securely in place. User's other ear is always free for phone calls or conversation.



## TELEX Twinset\*—Nothing Need Touch Ears!

Lightest twin-receiver headset made—weighs only 1.6 oz. Adjust to any head. Flexible, slips into pocket.



Write for Colorful FREE Specifications Folder Today!

**TELEX** DEPT. B-20-3, TELEX PARK  
MINNEAPOLIS, MINNESOTA  
In Canada, Atlas Radio Corp., Toronto



# WIND more COILS faster

WITH YOUR PRESENT COIL-WINDING MACHINE!

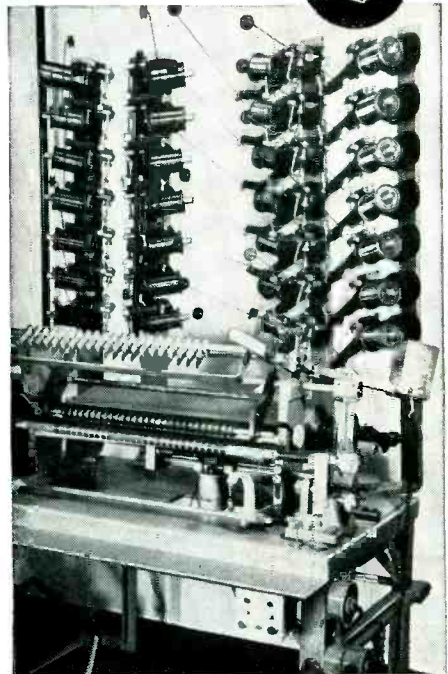

— use **PAMARCO** Wire DeReeling Tensions for PERFECT COILS

Installation of these inexpensive PAMARCO tensions lowers winding costs because each machine will accommodate more coils at higher winding speeds. In addition to increased production, PAMARCO tensions raise production quality. Free-running action practically eliminates wire breakage and shorted turns. Simple thumb screw setting quickly adjusts for any wire gauge. No tools or special skill are needed for operation. For complete data call or write.

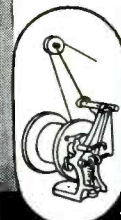

**PAPER MACHINERY & RESEARCH, INC.**

1014 OAK STREET  
ROSELLE, NEW JERSEY

## Permanent Magnet Problems Can Be Simple... If You Have:

- ✓ Quality Magnets
- ✓ Prompt Delivery
- ✓ Complete Engineering Service
- ✓ Low Unit Cost

For 49 years Thomas & Skinner has geared its facilities to provide the answer to all permanent magnet problems. Why not let Thomas & Skinner engineers work with you in the design and production of the *right* permanent magnet for your application? Write or call us today.

**THOMAS & SKINNER** — Specialists in magnetics: permanent magnets and laminated cores

**THOMAS & SKINNER Steel Products Company**  
1120 East 23rd Street • Indianapolis, Indiana

ANCEP  
**NATVAR**  
*in*

GERM  
**SWITZERLAND**

This 3125 KVA generator, 5750 volt, 3 phase, is typical of the large generating equipment built by Brown Boveri & Cie., A.G., in Baden, Switzerland. Natvar varnished cambric and varnished cambric tape were used in its manufacture.



### Natvar Products

- Varnished cambric—straight cut and bias
- Varnished cable tape
- Varnished canvas
- Varnished duck
- Varnished silk
- Varnished special rayon
- Varnished Fiberglas cloth
- Silicone coated Fiberglas
- Varnished papers
- Slot insulation
- Varnished tubings and sleeveings
- Varnished identification markers
- Lacquered tubings and sleeveings
- Extruded vinyl tubing and tape
- Extruded vinyl identification markers

Ask for Catalog No. 21

Continued demand for a product in a free market is strong proof of its value. Where the demand persists in spite of economic difficulties, it is also evidence of superior quality. In Switzerland, and other markets throughout the world, preference for Natvar insulating materials is steadily increasing.

Natvar insulations give dependable performance because they are skillfully made of the best materials available. They are always the same no matter when or where purchased.

Delivery can be promptly made either from conveniently located wholesaler's stock, or direct from our own.

**THE NATIONAL VARNISHED PRODUCTS**

TELEPHONE  
RAHWAY 7-8800

CABLE ADDRESS  
NATVAR: RAHWAY, N. J.

*Corporation*

201 RANDOLPH AVENUE ★ WOODBRIDGE, NEW JERSEY

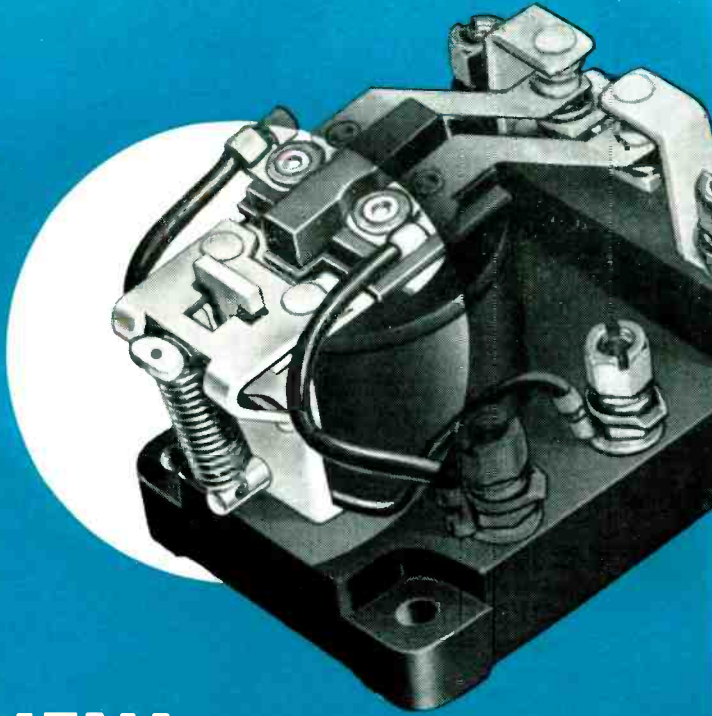

## NEW— a Mighty Midget Built for Millions of Operations

### semi-knife-edge bearing reduces frictional wear

This is Ward Leonard's new Bulletin 110 Midget Relay for long, trouble-free service, particularly in equipments subject to vibration.

Exceptionally good vibration characteristics are due to proper proportioning of contact masses and springing combined with heavy pressures on both normally open and normally closed contacts.

Higher contact ratings than most midgets. Available up to 3-pole, double throw. Contact finger leads are insulated with the new, impregnated glass-fiber tubing.

Write for Bulletin 110. Ward Leonard Electric Co., 31 South Street, Mount Vernon, N. Y. Offices in principal cities of U. S. and Canada.

**WARD LEONARD  
ELECTRIC COMPANY**  
*Result-Engineered Controls*

RESISTORS • RHEOSTATS • RELAYS • CONTROL DEVICES



of light reflected from each egg-shell. A second photocell makes use of transmitted light to ascertain the internal color of the egg; and, a pair of flying-spot television-type scanners provide indications as to whether the shape of the egg is essentially normal, slightly abnormal, or abnormal. The scanners are respectively focused on each egg and a diagram for a perfect egg shape so that the latter indications are obtained by comparison.

Station No. 3 is a unit for measuring shell thickness, air-cell depth, and yoke centers. Thickness is checked in terms of electrical capacitance by means of a sensing head comprising a  $\frac{1}{4}$ -in. square block with two thin plated-metal strips which can contact a shell without damage to determine the distance from an outer shell surface to the white of each egg. Air-cell depth is measured by means of a quartz crystal which induces a very short pulse into an egg from an overhead position so as to produce wave reflections as illustrated in Fig. 3. The echo time can be computed in terms of air-cell depth (elapsed time normally being in the order of 20 microseconds). Yoke centering is determined by simultaneously applying two crystal units to an egg in the horizontal plane (with 90-deg spacing) so that three pulses will be produced and reflected for three-dimensional measurements, much the same as one pulse is used to indicate air-cell depth.

Station No. 4 is a unit for determining the condition of each egg-shell with reference to cleanliness, cracks, roughness, and leaks. This involves the use of a phototube set-

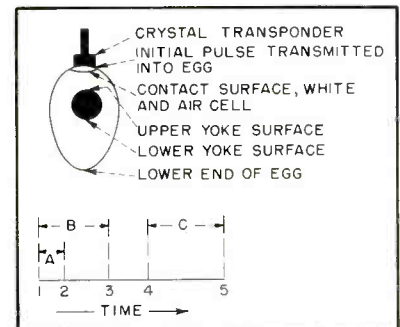

FIG. 3—Pulses shown in lower portion of diagram represent (1) initial pulse, (2) beginning of egg white (air-cell depth), (3) top of yoke, (4) bottom of yoke, and (5) bottom of egg



# OF THE *Cathode-Ray* TUBE!

## The HAYDU Electron Gun

Efficient mass production of today's cathode-ray picture tubes has been one of the outstanding contributors to the phenomenal growth of this new American industry. But no amount of production skill could have made this possible without the precise standardization of tube components such as the gun mount.

Haydu Brothers has made its contribution through the manufacture of more than ONE-THIRD MILLION electron guns, those all-important precision components which are the key to the cathode-ray picture tube — the heart of the television industry.

Look for the rugged, 3-pillar construction, and the imprint, "HB," the identifying mark of superior electron guns.

A few of our many satisfied customers include:  
Capehart-Farnsworth Corp. . . . . Ft. Wayne  
Tel-O-Tube Corp. . . . . Paterson  
Thomas Electronics, Inc. . . . . Passaic  
National Video Corp. . . . . Chicago

Be sure to see our exhibit at  
**I. R. E. SHOW**  
**BOOTH 318**  
**Grand Central Palace**  
**March 6-9**

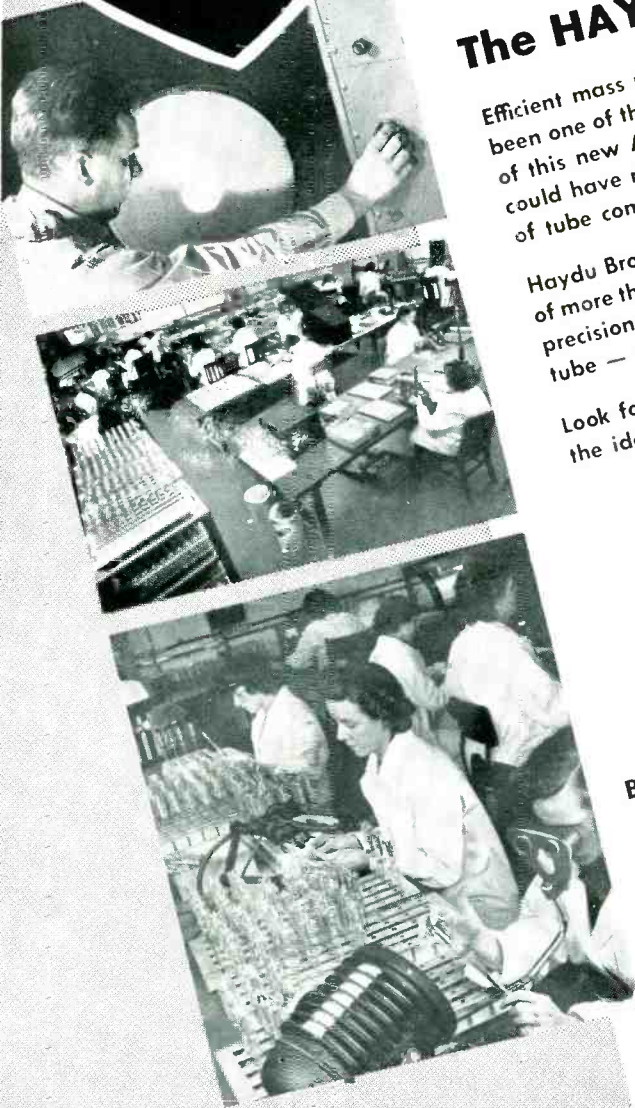
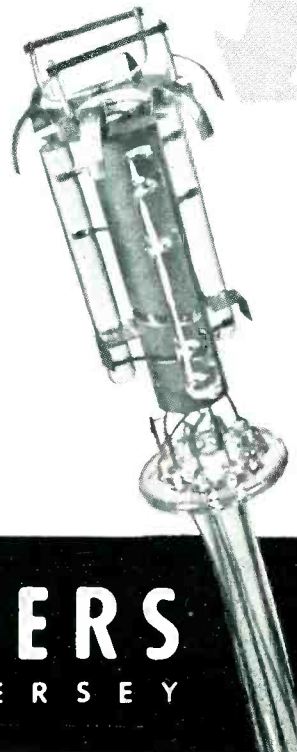

# HAYDU BROTHERS

PLAINFIELD • NEW JERSEY

# DO YOU KNOW?

— that a **PILOT LIGHT**  
CAN IMPROVE YOUR PRODUCT

... add attraction — safety — service?

Ask



- what lamp to use
- how to use it
- what it will do
- what it will cost

**THIS MAY BE THE ONE**  
Designed for low cost NE-51 Neon

- Built-in Resistor • Patented
- U/L Listed • Rugged

Catalogue Number 521308 — 997  
for 110 or 220 volts.

**SAMPLES**  
for design purpose  
**NO CHARGE**

**NEW!** Write for the  
"HANDBOOK OF PILOT LIGHTS."

Write us on your design problems.



**The DIAL LIGHT COMPANY of AMERICA**

Foremost Manufacturer of Pilot Lights.

900 BROADWAY, NEW YORK 3, N. Y. TELEPHONE SPRING 7-1300

## 2 KW VACUUM TUBE BOMBARDER OR INDUCTION HEATING UNIT



For Only **\$650.**

Never before a value like this new 2-KW bench model "Bombarder" or high frequency induction heater... for saving time and money in surface hardening, brazing, soldering, annealing and many other heat treating operations.

Simple... Easy to Operate...  
Economic Standardization of  
Unit Makes This New Low Price  
Possible

This compact induction heater saves space, yet performs with high efficiency. Operates from 220-volt line. Complete with foot switch and one heating coil made to customer's requirements. Send samples of work wanted. We will advise time cycle required for your particular job. Cost, complete, only \$650. Immediate delivery from stock.

Scientific Electric Electronic Heaters are made in the following range of Power: 1-2-3½-5-7½-10-12½-15-18-25-40-60-80-100-250KW.

*Scientific  
Electric*

Division of

"S" CORRUGATED QUENCHED GAP CO.

107 Monroe St., Garfield, N. J.

## CO-AX AIR-SPACED ARTICULATED R.F. CABLES

**4mm/ft**  
LOWEST EVER  
CAPACITANCE &  
ATTENUATION

LOW ATTEN. TYPES	IMPED. OHMS	ATTEN. db/100ft	LOADING Kw at 100 Mc/s	O.D. "
A.1	74	1.7	0.11	0.36
A.2	74	1.3	0.24	0.44
A.34	73	0.6	1.5	0.85

FOR RADIO FREQUENCIES

LOW CAPAC. TYPES	CAPAC. mmf/ft	IMPED. OHMS	ATTEN. db/100ft	O.D. "
C.1	7.3	150	2.5	0.36
P.C.1	10.2	132	3.1	0.36
C.11	6.3	173	3.2	0.36
C.2	6.3	171	2.15	0.44
C.22	5.5	184	2.8	0.44
C.3	5.4	197	1.9	0.64
C.33	4.8	220	2.4	0.64
C.44	4.1	252	2.1	1.03

FOR VIDEO and SPECIAL APPLICATIONS

We are specially organized to handle direct enquiries from overseas and can give IMMEDIATE DELIVERIES to U.S.A.

\* Cable your rush order for delivery by air. Settlement in dollars by check on your own bank. Transaction as simple as any local purchase and delivery just as quick.

HIGH POWER FLEXIBLE

PHOTOCELL CABLE

VERY LOW CAPACITANCE CABLES

**TRANSRADIO LTD**  
CONTRACTORS TO H.M. GOVERNMENT.

138A CROMWELL ROAD  
LONDON. S.W.7-ENGLAND.

CABLES: TRANSRAD · LONDON

YOU CAN BE **SURE**.. IF IT'S  
**Westinghouse**

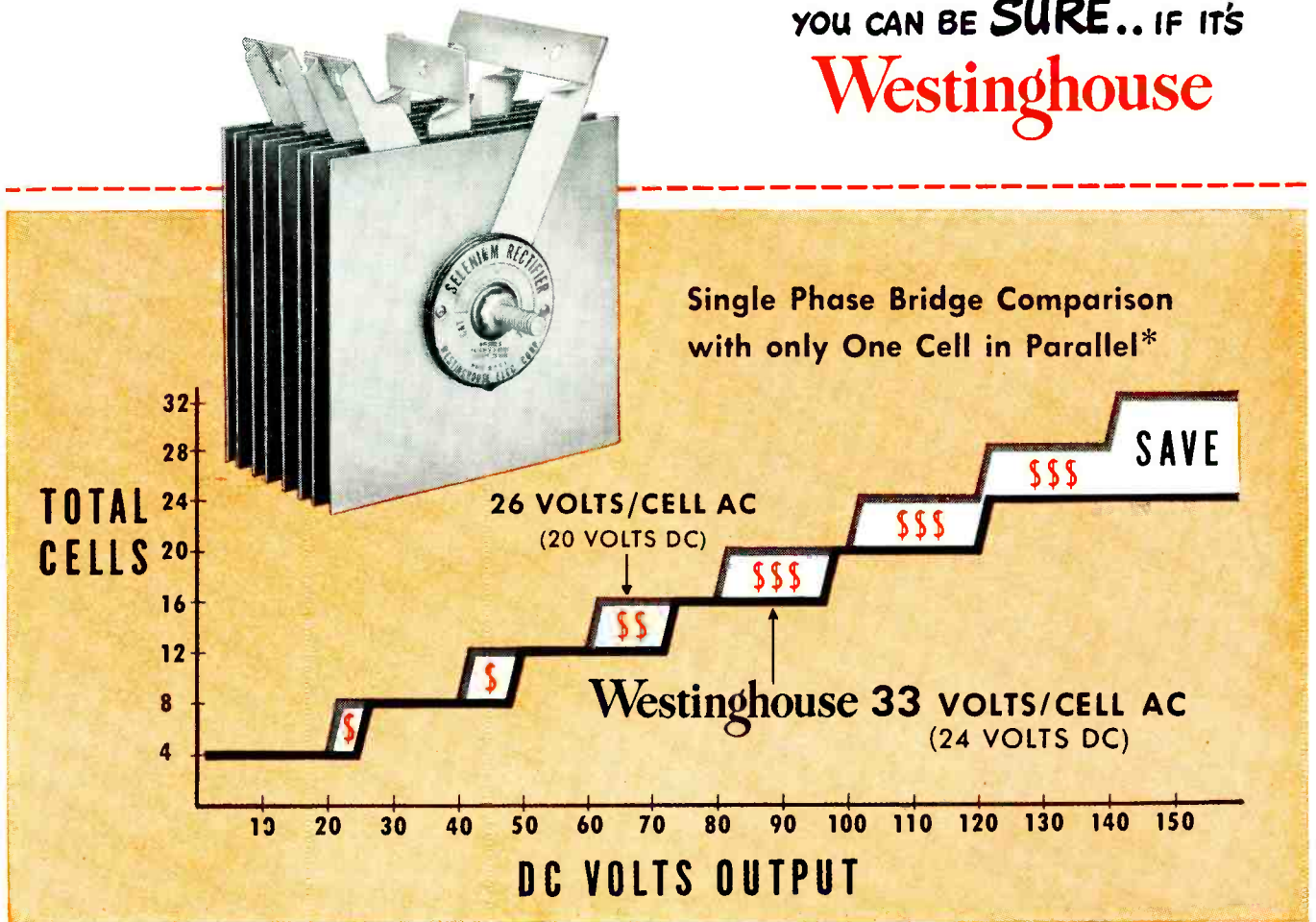

## SAVE THE DIFFERENCE

*with Rectox Selenium Rectifiers*

The above graph shows, strikingly, the dollars and cents savings possible with Rectox Selenium Rectifiers.

*The reasons?*

High-voltage cells—24-volt d-c; 33-volt RMS compared to conventional 20-volt d-c; 26-volt RMS—mean fewer cells per watt output. And since each plate stands more voltage, smaller, lighter stacks result.

An exclusive Westinghouse process of manufacture assures lowest rate of forward aging and constant, uniform cell performance.

Test the Rectox under your own conditions. Try a sample. Figure your own savings—in space . . . in weight . . . in dollars. Phone or write your local Westinghouse office for details. Westinghouse Electric Corporation, P. O. Box 868, Pittsburgh 30, Pennsylvania. J-21591

\*  
In a bridge circuit, total savings are the product of: the cells saved in series (due to 24 volts d-c per cell) times 4 (the number of arms in the bridge) times the number of cells in parallel in each bridge arm. For example: A 4-5-3 connection cut to 4-4-3 by use of one fewer cell in series per arm means 1 saved x 4 x 3 or 12 total cells saved.



**Westinghouse**  
*Rectox*  
Rectifiers & Chargers for  
**ALL INDUSTRIES**

# H IS FOR HORNET

## CLASS H

### HIGH VOLTAGE

#### KNOW HOW

##### AND THEY MAKE AN H OF A DIFFERENCE

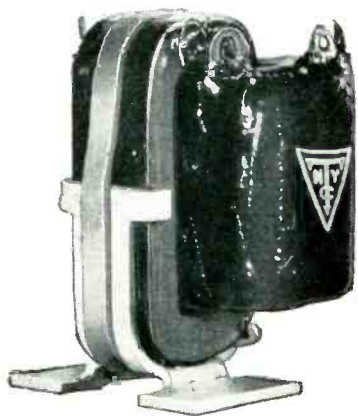

HORNET Transformers provide minimum size, maximum efficiency and greatest life expectancy in transformers for portable and airborne equipment.

Because they are manufactured of newly developed Class H materials — silicones, fiberglass and special steels — HORNET miniature transformers can be operated at temperatures far in excess of the so-called "normal range."

#### Compare These Typical Volume and Weight Figures

PLATE TRANSFORMER: Primary 115V., 380/1600cps. Secondary 860V. C.T. 70 MA-RMS, 60 V.A. (85 deg.C. ambient, 50,000 ft. alt.)					
	Max. Oper. Temp. Deg.C.	Volume Cu. Ins.	Relative Volume Percent	Weight Pounds	Relative Weight Percent
Hermetically Sealed (Class A insulation)	105	21.3	100	2.0	100
Open Construction (Class A insulation)	105	11.0	54.2	1.2	60
<b>HORNET</b> (Class H insulation)	200	6.5	30.5	.33	16.5

The HORNET represents a combination of ingenious design, modern materials, and radically different manufacturing techniques which opens vast new fields in transformer construction and application.



Send for your copy of Bulletin B-300, containing detailed size, weight and rating information on Hornet Transformers and Reactors.



**NEW YORK  
TRANSFORMER CO., INC.**  
ALPHA, NEW JERSEY

up, similar to that at station No. 2, and a surface gage which resembles a phonograph pickup except for the fact that it generates an electrical signal which can be analyzed by comparison of the intensity of the signal in an egg with that of a specimen which is known to be in excellent condition. Two light spring feelers are attached to the surface gage to detect leakers by means of electrical conductivity.

Station No. 5 is a candling unit, employing a television-type scanning device to grade eggs according to the intensities of their yoke shadows as created by electronic signals transmitted through each egg. Shadows are classed as poorly defined, moderately defined, well defined and plainly visible.

All mechanical movements of the fully-automatic egg processing set-up are regulated by means of potentiometers and limit switches through a master board, control panel and electronic control unit. The control panel provides manual dials for operations at different or indifferent circumstances, and has signal lights to indicate the operating condition of all components. Standard vacuum tubes in the control unit coordinate the accumulations of inspection data and mechanical operations in accordance with dial settings of the control panel and impulses from the potentiometers and limit switches.

An average crew of three workers can operate the largest processing setup, and in such circumstances it is estimated that a fully-automatic production line can save approximately \$20,000 per month when operated on a constant 24-hour schedule, at which rate the initial cost of the equipment can be fully amortized in three or four months.

Savings can be attributed to higher rates of production in less space, reduced labor costs, less damage due to breakage, and optimum precision with reference to inspections.

#### Telemetering Ocean Current Information

To FACILITATE the navigation of seagoing vessels by providing continuously-accurate data regarding the velocity and direction of ocean currents along the West Coast, an



Kodak

## Because photography is accurate to the last detail

The magic of photography turns hours of costly drafting room time into a minute-quick job of utmost accuracy.

Correcting an engineering drawing—or restoring a dimmed one—used to take long, tiresome hours. But not today. For photography with its ability to record detail in a flick of time has been put to work, and the most intricate drawing is copied accurately, inexpensively, and with lasting quality.

Using the new Kodagraph Auto-positive Paper, you can get sharp positive prints directly from originals of every type, even from worn or weak tracings—get them with regular blueprint or direct process equipment—in ordinary room light, without negatives.

Using the new Kodagraph Contact Paper (with conventional photo-copying equipment and negative step) you can produce sharp, clear, legible pho-

tographic prints of letters, specification sheets, forms, drawings.

Using the new Kodagraph Projection Papers, you can enlarge small-scale negatives of drawings and documents to original size or larger... get high contrast reproductions.

With Kodagraph or Recordak Micro-File Equipment, you can reproduce the most detailed drawings, charts, etc.—“de-bulk” them 98%... and protect your valuable originals.

This same ability to reproduce detail exactly, completely, lastingly... even to improve its quality... gives photography a multitude of uses in your plant. It can help make your designs faster, your production methods smoother, and get your product to the dealer's sooner.

Eastman Kodak Co., Rochester 4, N. Y.

Advancing industrial technics—**Functional Photography**

# The new S.S. WHITE 80X HIGH VOLTAGE RESISTOR

(1/2 Actual Size)

4 watts • 100 to 100,000 megohms

Developed for use as potential dividers in high voltage electrostatic generators, S.S. White 80X Resistors have many characteristics—particularly negative temperature and voltage coefficients—which make them suitable for other high voltage applications.

They are constructed of a mixture of conducting material and

binder made by a process which assures adequate mechanical strength and durability. This material is non-hygroscopic and, therefore, moisture-resistant. The resistors are also coated with General Electric Dri-film which further protects them against humidity and also stabilizes the resistors.

## WRITE FOR BULLETIN 4906

It gives complete information on S.S. White resistors. A free copy and price list will be sent on request.



**S.S. WHITE INDUSTRIAL** DIVISION  
THE S. S. WHITE DENTAL MFG. CO. DEPT. R 10 EAST 40th ST., NEW YORK 16, N. Y.



FLEXIBLE SHAFTS AND ACCESSORIES  
MOLDED PLASTICS PRODUCTS—MOLDED RESISTORS

One of America's AAAA Industrial Enterprises

## NOW! Get this MIDGET CONDENSER MICROPHONE

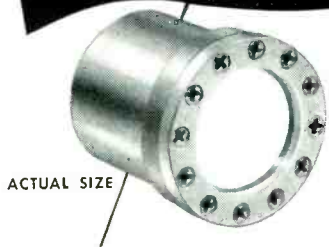

ACTUAL SIZE

## for PRECISION SOUND MEASUREMENTS

- Rugged Construction
- Exceptional Calibration Stability
- Unaffected by Variations in Humidity

Kellogg Midget Condenser Microphones are used regularly for sound measurement in Kellogg's own laboratories . . . several having been in service for over 10 years without exhibiting de-

tectable drift, although in frequent use, and without the use of dessicators. Users include government laboratories, universities, audio development laboratories and industrial plants manufacturing sound equipment.

### • PRINCIPAL CHARACTERISTICS:

**RESPONSE**—Using a cathode follower preamplifier the response is approximately -59db referred to 1 volt/dyne/cm<sup>2</sup>. The response is flat to within 1db from 100 to 7000cps and to within 3db from 60 to 10,000 cps. **MATERIAL**—Diaphragm—.001" ST-17 aluminum alloy. All other major components are brass. External surfaces are bright gold plated and lacquered. **CAPACITY**—Approximately 40mmf. **INSULATION RESISTANCE**—100,000 megohms minimum measured at 250 volts. **POLARIZING VOLTAGE**—150-300 volts recommended.

Send for full specifications today. Write, wire or call:

**KELLOGG** SWITCHBOARD AND SUPPLY COMPANY

Established 1897

MIDGET CONDENSER MICROPHONE

6650 SOUTH CICERO AVENUE • CHICAGO



FOR THE ELECTRONICS & ELECTRICAL INDUSTRIES

### TUNGSTEN

Wire ● Rod for Contacts  
Rod for Valve Seals and Supports  
Electrodes for Therapeutic Apparatus  
Atomic Hydrogen Arc Welding Rods  
Rod and Wire for Metal Volatilization processes ● Hammered Slabs  
Sheet, Strip and Foil

### MOLYBDENUM

Rod for Contacts ● Valve Stems  
Grid and Mandrel Wire  
Support Wires and Rods  
Wire for Furnace Windings  
Hammered Slabs  
Sheet, Strip and Foil for all Purposes  
Sheet for Furnace Boats

We also supply Tungsten, Molybdenum and Tantalum Metal Powders, Titanium Hydride, Zirconium Hydride and many other metallurgical products.

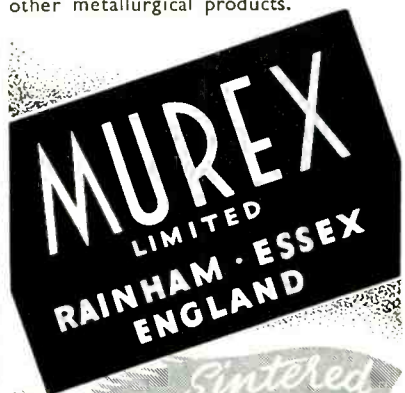

Sintered Permanent Magnets  
ALNICO · ALCOMAX · HYCOMAX

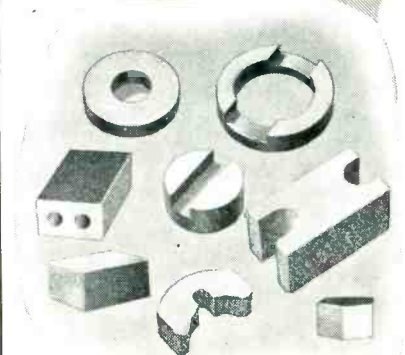

Small physical size and high efficiency. Available in a wide range of sizes and shapes for the Electronics Industry.

Don't say we didn't tell you!

This is the 5th and final message in a series designed to alert manufacturers to the value, use and need of the symbol that will earmark the 10th annual issue of the ELECTRONICS Buyers' Guide.

the symbol...



...that means...

greater value for Users and Manufacturers

This symbol, only much smaller, will appear after certain products listed in the 1950 GUIDE.

# in the 10<sup>th</sup> Annual **electronics BUYERS' GUIDE**

## CLOSING DATES

### For Product Listings...

The product questionnaire which has recently been mailed you should be properly filled out according to regulations, signed and returned not later than...

**March 15, 1950**

### For Advertising...

#### COMPLETE PLATES

**May 1, 1950**

#### COPY TO SET

**April 1, 1950**

#### INSERTS

Inserts should be planned for a run of 35,000. Paper stock must not exceed 80 lbs. They should be delivered to Williams Press, 129 North Broadway, Albany, N. Y. not later than...

**May 25, 1950**

For complete information on any of the above items, contact your district manager or write to our New York office.

## WHAT IT MEANS TO MANUFACTURERS...

When product listings have this symbol tied in with them, those listings are of far greater significance to the subscriber-users of the GUIDE. The symbol will indicate to them a more accurate source of supply than is possible with the unverified, non-symbolized listings. For these symbols will indicate (1) current production, (2) availability, (3) unrestricted use. This information is vital to potential buyers and will encourage far wider use of products so indicated. As a direct result, inquiries and sales of those products will show a marked increase.

## HOW TO GET THIS SYMBOL WITH PRODUCT LISTINGS...

Although there is no charge for product listings or the use of this identification, it takes more than a request to obtain it. Manufacturers must first prove that the products are in actual production, or in stock, available in a reasonable time: and that there are no restrictions, governmental or other, on the use of the product. Clear indication of what proof is necessary is described in the product questionnaire which is mailed to every presently known manufacturer. Those regulations must be rigidly followed. The manufacturers should read them carefully to assure that they will have the right to the symbol.

## VALUE OF SYMBOL TO USERS OF THE GUIDE...

Anyone using the GUIDE as a where-to-buy-it book will be greatly helped by the additional information this symbol identification provides. Buyers must know more than just who makes a product. They want to be sure they can get it — without unnecessary delay — and equally sure that its use, for their purpose, is unrestricted. The symbol will guide buyers directly to the products they need and prevent time wasted in a fruitless search as well as in unnecessary correspondence on the part of both buyer and manufacturer.



**ELECTRONICS BUYERS' GUIDE**



The 13th issue of electronics — a bonus to all subscribers

A MCGRAW-HILL PUBLICATION

330 WEST 42nd STREET, NEW YORK 18, N. Y.

ELECTRONICS — March, 1950

151

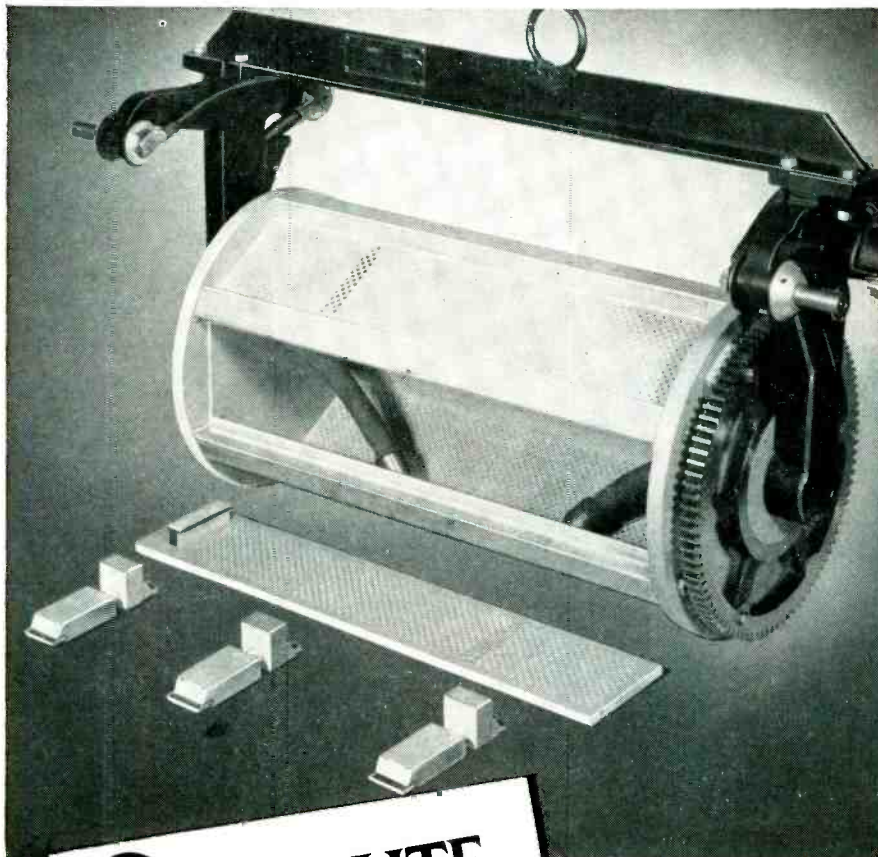

Photo—Courtesy  
The Udylite Corporation—Detroit

**PHENOLITE**  
Laminated PLASTIC

**The ideal material for plating barrels where high resistance to corrosion is a "must."**

In the electroplating of metals, plating barrels must have high resistance to corrosion from the strong chemical solutions for efficient low-cost operation. In this role, Melamine Fabric Base Phenolite has proved to be very effective because of its exceptional resistance to chemical corrosion.

Phenolite, in addition to these important qualities, is light in weight, with high impact strength, excellent electrical insulating properties and one of the strongest materials per unit weight known. Phenolite has broad use in 'most every industry because of its remarkable combination of properties. Available in a broad group of grades—in Sheets, Rods, Tubes and Special Shapes.

*National Service Engineers will, without obligation, assist you in utilizing Phenolite, National Vulcanized Fibre and Peerless Insulation to your best advantage.*

**NATIONAL VULCANIZED FIBRE CO.**

WILMINGTON

Offices in



DELAWARE

Principal Cities

Since 1873

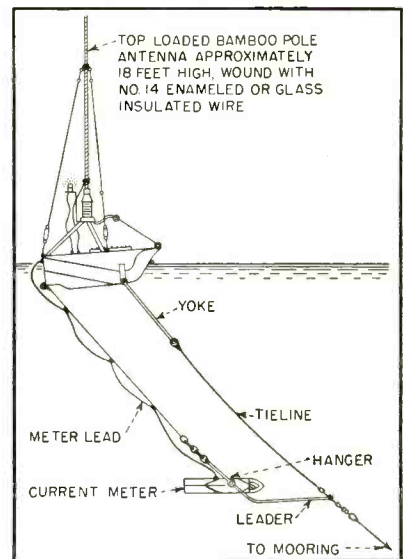

Setup for electronic ocean current meter

electronic current meter has been developed for the U. S. Coast and Geodetic Survey.

It comprises a pontoon-type buoy with radio-transmitter equipment for relaying speed and compass instrument indications to a shore-based receiving station. It is economically advantageous in that it eliminates many of the maintenance costs required to provide survey vessels at strategic locations for visual observation of ocean currents.

Battery power is used to operate the equipment, and firm anchorage to the ocean floor assures satisfactory alignment of the buoy with currents which must be measured. Signals produced within a streamlined cylinder suspended beneath the buoy, are sent to the radio transmitter within the buoy.

#### Detecting Devices

Directional instrumentation comprises two sets of contact points, arranged for proper relationship to the vertical axis of a compass. One set is mounted on the compass for constant orientation to magnetic north. The other set is oriented in the direction imposed on the cylindrical housing by an ocean current. Comparative impulses or signals can be relayed to the transmitter by means of a revolving contactor.

The revolving contactor is driven by an impeller, so that velocity data can be computed from the time intervals between directional signals by means of a calibrated

# QUALITY

*You Can See!*

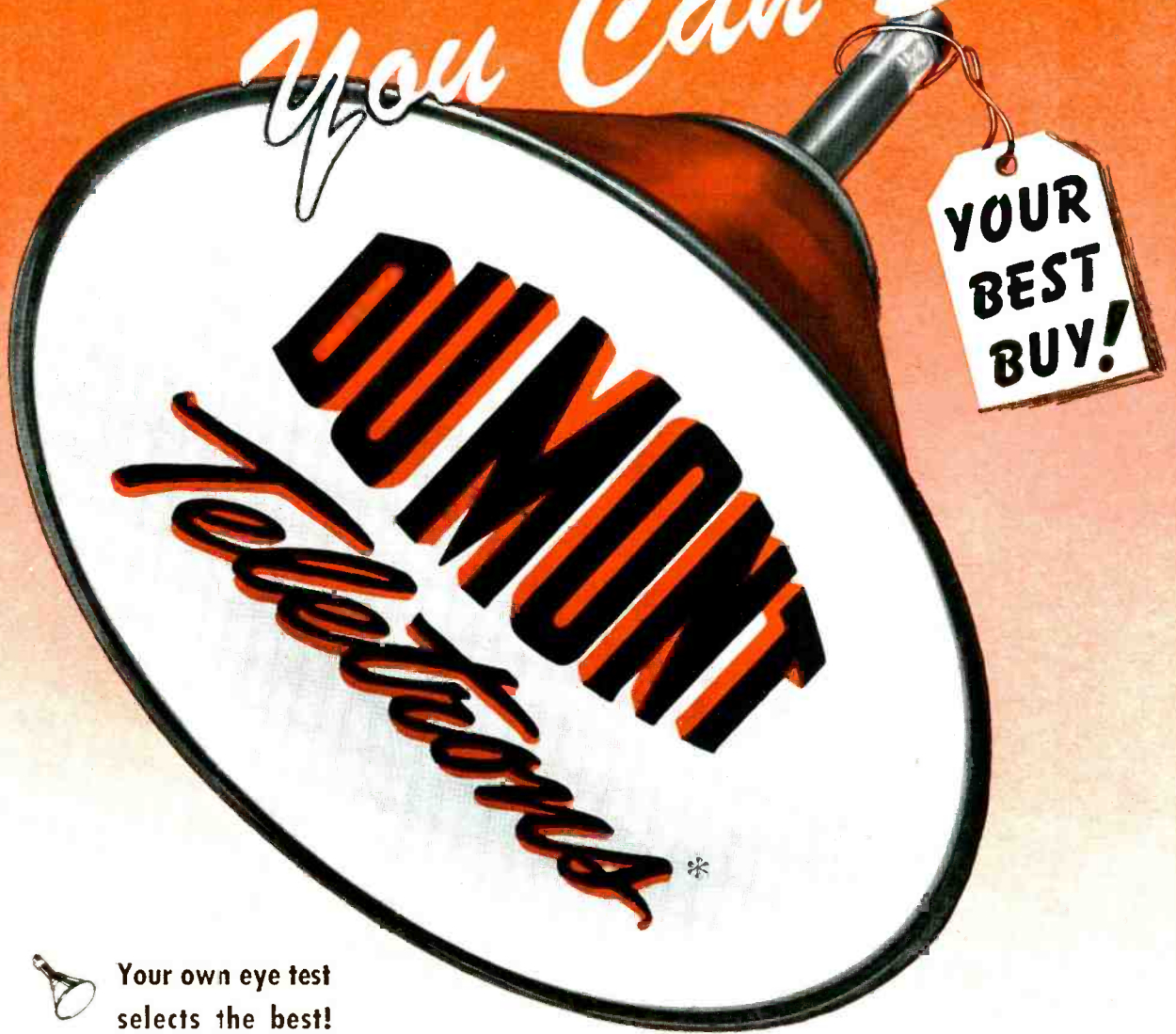

Your own eye test  
selects the best!

Literature and Quotations on Request

© ALLEN B. DU MONT LABORATORIES, INC.

\*Trade-mark.

# DUMONT

FIRST WITH THE FINEST IN T-V TUBES

*Teletrons*

ALLEN B. DU MONT LABORATORIES, INC. • TUBE DIVISION, CLIFTON, N. J. • PLANTS AT ALLWOOD AND PASSAIC, N. J.

# GET **KOBZY** QUALITY

into your quality products

## LAMINATIONS

STANDARD OR SPECIAL TYPES

• You'll find that this organization produces the quality that is so important to you. We meet your definite specifications in specially designed parts. Get the benefits that come from an experienced, modernly equipped organization that has worked closely with engineers and designers in the radio and electronic industries for years.

We are equipped to make immediate delivery from stock and give you fast service on special laminations.

We also make:

Covers, Channel Frames  
Housings  
Metal Stamping Parts

Keep a copy of the KOBZY Catalog handy for reference. If you don't have one send for your copy.

**K O B Z Y**  
TOOL COMPANY  
1539 DAYTON ST. CHICAGO 22, ILL.

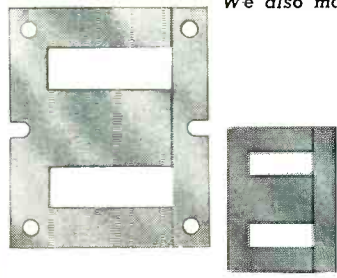
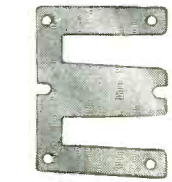

## THREE DECADES OF RADIO-TELEVISION "KNOW-HOW"

an **insuline** cabinet or chassis for every need



Hundreds of styles and sizes for relay racks, transmitters, amplifiers, speakers, meters, etc., many with decorative chrome trim.

All sizes of steel and aluminum standard chassis bases and bottom plates as well as the necessary accessories and hardware for complete assembly work.

Custom built cabinets, racks and panels of any type made in quantity to specifications.

WRITE DEPT. E FOR LATEST CATALOG



**insuline** CORPORATION OF AMERICA  
INSULINE BUILDING • 36-02 35th AVENUE • LONG ISLAND CITY, N. Y.  
West Coast Branch and Warehouse: 1335 South Flower Street, Los Angeles, Calif.  
Exclusive Canadian Sales Agents: CANADIAN MARCONI COMPANY, Montreal



TWO  
NEW  
COIL  
FORMS  
by

**CAMBRIDGE THERMIONIC**

These two new slug tuned coil forms by Cambridge Thermionic Corporation are designed to give you top performance while fitting easily into small or hard-to-reach places. Illustrations are actual size.

Both have silicone impregnated ceramic bodies, grade L-5, JAN-I-10 for high resistance to moisture and fungi. Ring terminals are adjustable. Both sizes are provided with a spring lock for the slug, and the mounting stud is cadmium plated to withstand severe service conditions.

The LS-5 and LS-6 are available with high, medium or low frequency slugs. Mounting hardware is supplied.

Ask for CTC's new Catalog #300 describing our complete line of *Guaranteed Components*.

See us at Booth 287 at the IRE Exposition, Grand Central Palace, March 6-9. Our representatives will be glad to discuss problems concerning electronic components with you.

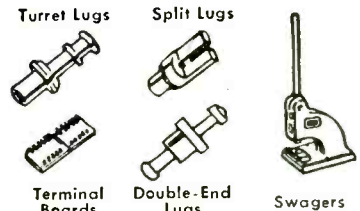

Custom or Standard  
**The Guaranteed Components**

**CAMBRIDGE THERMIONIC CORP.**  
437 Concord Ave., Cambridge 38, Mass.

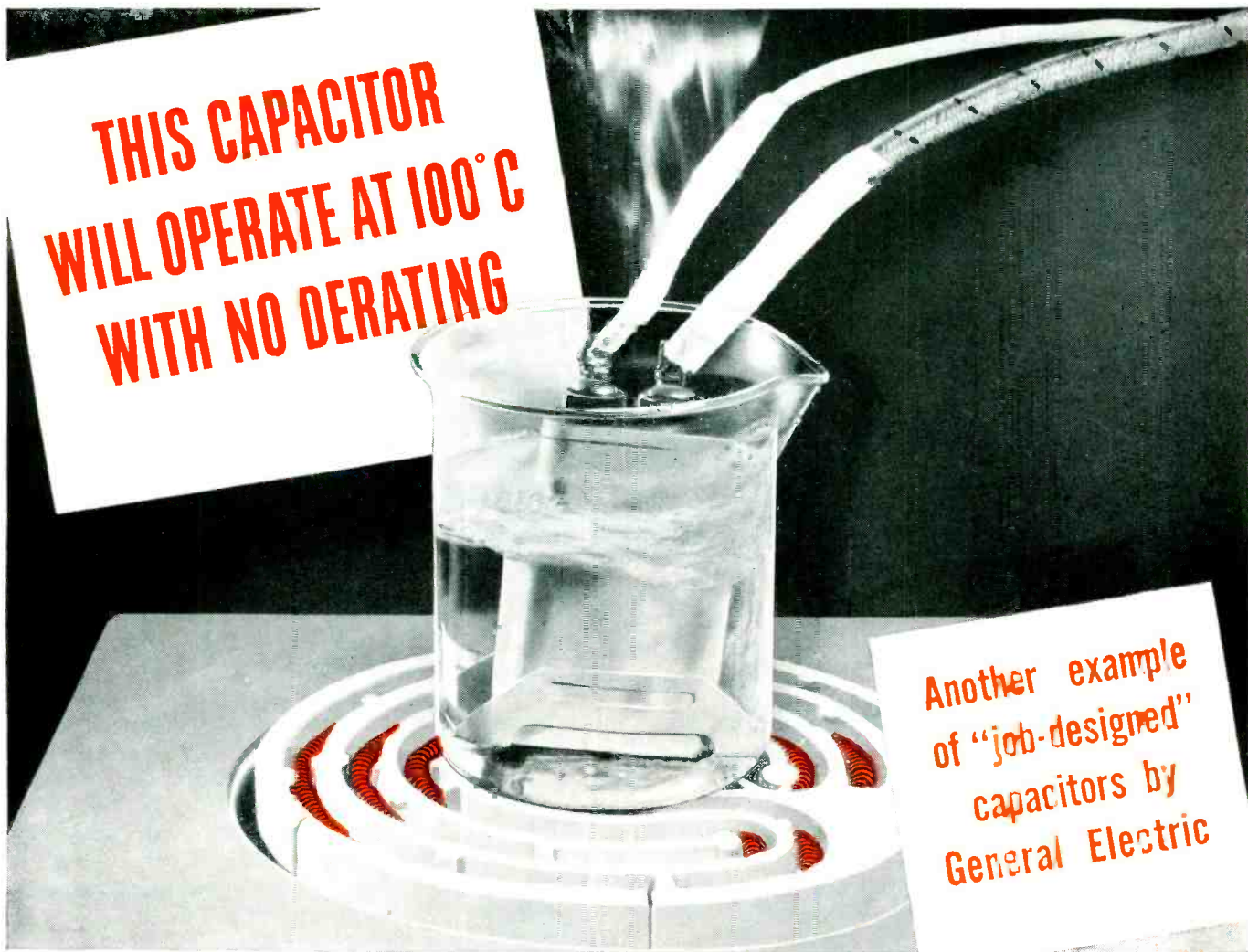

Here's a line of capacitors *specifically developed for operation at high ambient temperatures.* These G-E units require no derating at temperatures up to 100°C; can be used, up to 125°C. Similar in construction to other General Electric d-c paper-dielectric capacitors, these Permafil units are treated with a compound which retains its electrical stability at high operating temperatures.

Permafil capacitors, now part of G-E's standard line, are available in case styles 61, 63, 65 and 70, as covered by specifications JAN-C-25, in ratings

of .10 to 10.0 muf; and 600-, 1000- and 1500-volts. All have metallic containers which are sealed with G-E's new long-life all-silicone bushings.

When continual operation at ambient temperatures above 85°C is indicated, consider the special characteristics of these G-E capacitors. Their "custom-made" qualities may go hand-in-glove with your product designs.

For further information, on these or on capacitors for other applications, write Capacitor Sales Div., General Electric Co., Pittsfield, Mass.

*Apparatus Department, General Electric Company, Schenectady 5, N. Y.*

# GENERAL ELECTRIC

407-167

*Specialty Capacitors*

FOR

Motors  
Luminous-tube transformers  
Fluorescent lamp ballasts

Industrial control  
Radio filters  
Radar  
Electronic equipment  
Communication systems  
Capacitor discharge welding

Flash photography  
Stroboscopic equipment  
Television  
Dust precipitators  
Radio interference suppression  
Impulse generators

AND MANY OTHER APPLICATIONS



# MOSINEE

*"More than Paper"*



In the field of electronics and the electrical goods industry, MOSINEE is known for its *dependable uniformity*, and its scientifically controlled physical and chemical properties, such as:

Good dielectric strength . . .  
proper softness or stiffness . . .  
high tensile or tear strength . . .  
creped with controlled stretch or flexibility . . .  
specified pH for maximum-minimum acidity or alkalinity . . .  
accurate caliper, density, liquid repellency or absorbency.

If you have a fabricating or processing problem involving paper, a discussion with MOSINEE technicians might prove helpful. Please write Dept. E.



MOSINEE PAPER MILLS COMPANY, MOSINEE, WIS.

*"Essential Paper Manufacturers"*

chart at the receiving station.

Impeller bearings are carried by struts at the forward end of the subsurface cylinder, and motion is consequently provided for the revolving contactor by means of a magnetic drive. Differences in pressures within the cylinder are minimized by means of an aft expansion chamber.

Water-exposed parts of the subsurface cylinder are made from materials with low relative electrolytic potentials to reduce corrosion. Internal parts are protected with light petroleum oil seals.

### *The Transmitter*

The transmitter circuit comprises a type 1T5 beam-power Pierce oscillator coupled to a 1Q5 beam-power amplifier by means of an untuned impedance, and the amplifier is coupled to the antenna by means of a simple pi-section network wherein coupling capacitors are the only variable elements (these being adjustable for operation in the 80-meter band frequencies). The antenna is a wire-wound bamboo pole, extending some 18 feet above the buoy.

Instantaneous value of transmitted radiations amounts to about 10 watts, which is sufficient for good reception for considerable distances over open water.

Signals are recorded at the receiving station by means of a receiver with a preselector stage, amplifier, chronograph, chronometer (with break circuit attachment to provide a time reference on the chronograph tape), and related accessories—including two independently-operated styli for the simultaneous recording of buoy signals and seconds of time.

When the flow of a current is in perfect alignment with magnetic north, directional signals are simultaneous and indistinguishable on the recording tape. However, velocities can still be computed in conformity with the time intervals between the overlapping signals.

In special circumstances, where transmitted signals were below the noise level and could not be clearly recorded, it has been found that the signals can be detected by ear (via earphones or a loudspeaker) and recorded by manually tripping the



# Microline\* CROSS-GUIDE DIRECTIONAL COUPLERS

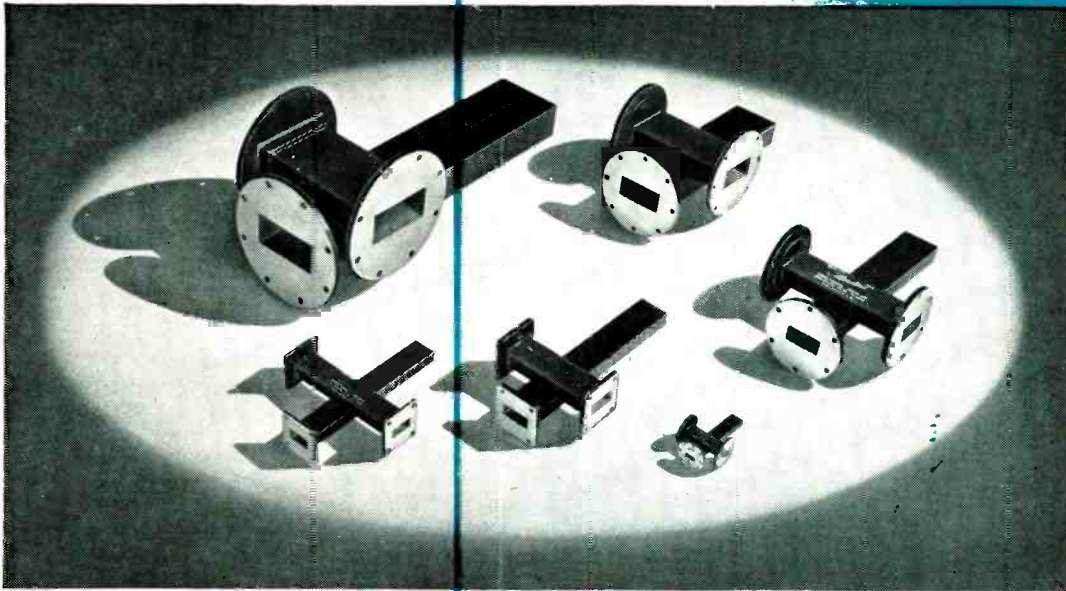

■ Sperry has a complete line of Cross-Guide Directional Couplers for all frequencies ranging from 2600 to 40,000 mc. These couplers are superior to other types of directional couplers in high directivity and unusually uniform coupling characteristics.

■ The coupling varies less than 3 db over the entire useful frequency band of the waveguide transmission line, whereas other types of couplers have attenuation which varies rapidly with frequency. Calibration accuracy on these instruments is  $\pm 0.5$  db through the quoted range. Operating temperature range is from  $-40^\circ$  to  $+55^\circ$  C and humidity effects are negligible.

■ Cross-Guide Directional Couplers, part of Sperry's MICROLINE\*, are versatile, precision instruments well adapted for general laboratory and pro-

duction test work. They differ in appearance only in their external dimensions. Each consists of two rectangular waveguides, a primary and secondary guide, joined perpendicularly to each other. Coupling is provided by slots cut in the common wall between the waveguides. One end of the secondary waveguide is terminated in a matched load.

■ In addition to the superior electrical properties of the Cross-Guide Directional Couplers, they are also physically constructed for convenient assembly into a waveguide system. Our Industrial Department will be glad to give you additional information on these as well as other MICROLINE instruments.

ELECTRICAL CHARACTERISTICS			LINE AND CONNECTOR TYPES		
Model No.	Frequency Range (Kmc)	Nominal Coupling (Db)	Waveguide		Connectors Both Arms AN Type
			AN Type	Size (in.-O.D.)	
306	2.6-4.0	30	RG-58/U	3x1½x.080	UG-214/U
233	4.0-6.0	24	RG-49/U	2x1x.064	UG-149A/U
321	4.0-6.0	30			
322	4.0-6.0	40			
209	5.3-8.1	24	RG-50/U	1½x¾x.064	UG-344/U
237	5.3-8.1	30			
235	8.1-12.4	20	RG-52/U	1x½x.050	UG-39/U
236	8.1-12.4	24			
234	8.1-12.4	40			
388	12.4-17.0	20	RG-91/U	.702x.391x.040	UG-419/U
413	18.0-26.5	20	RG-53/U	½x¼x.040	UG-425/U
415	18.0-26.5	40			
405	26.5-36.0	20	RG-96/U	.360x.220x.040	UG-381/U

\*TRADE MARK

# SPERRY

## GYROSCOPE COMPANY

DIVISION OF THE SPERRY CORPORATION, GREAT NECK, NEW YORK · NEW YORK · CLEVELAND · NEW ORLEANS · LOS ANGELES · SAN FRANCISCO · SEATTLE

# AIR ASSOCIATES

## POSITIVE POSITIONING ACTUATORS

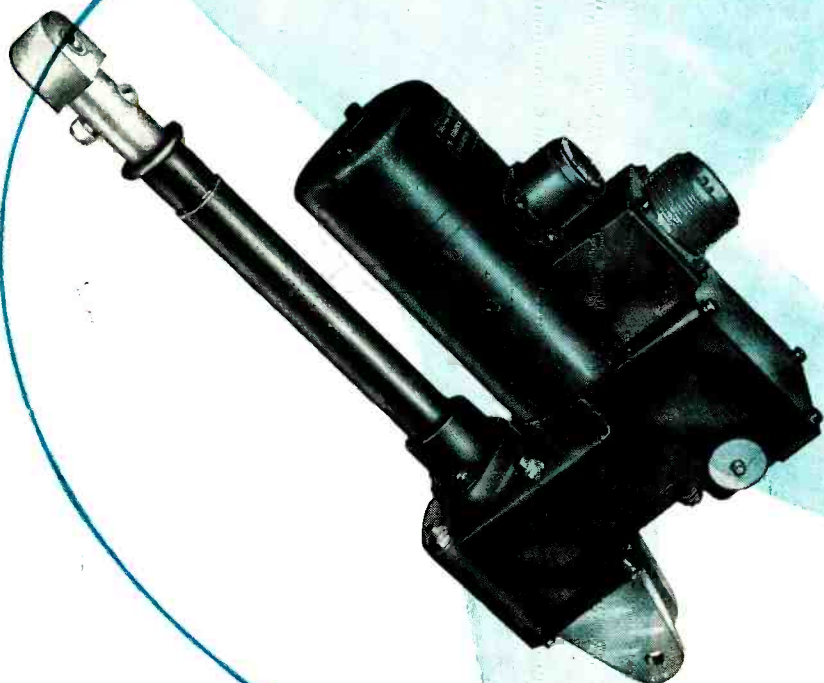

Positive positioning control is assured in Air Associates actuators by using internal load-limiting switches. The back-pressure exerted adjusts the actuators automatically. This counteracts backlash and eliminates surface flutter as well as switch adjustments at installation and in service. Air Associates non-jamming actuators meet, or exceed, applicable AN specifications.

Air Associates designs and manufactures *electronic, hydraulic, electro-mechanical, pneumatic and miscellaneous* devices.

Also, twenty-two years' experience supplying the needs of manufacturers, airlines and airport operators has established Air Associates as the leading distributor of aircraft supplies.

Write For **ENGINEERING CATALOG**



## AIR ASSOCIATES

INCORPORATED

Teterboro, New Jersey

DALLAS, TEXAS • CHICAGO, ILLINOIS • GLENDALE, CALIF.  
EXPORT DEPARTMENT • CABLE ADDRESS 'AIRSOC.TETERBORO'

*Serving the Nation in Aviation*

TUBES AT WORK

(continued)

stylus for buoy signals. Such manual records are not as accurate as fully-automatic recordings, but appear to be more than sufficient for the maintenance of safety in coastal navigation.

### Horological Stroboscopes

BY RONALD L. IVES

*Department of Geography  
Indiana University  
Bloomington, Indiana*

REPAIR of electric clocks and similar timing mechanisms by horologists, who are skilled in all mechanical phases of the work, has been inhibited by lack of a simple and inexpensive instrument for determining when the clock rotor is turning at synchronous speed.

Exact synchronism of rotor speed with line frequency is of prime importance for, assuming correct line frequency, an electric clock with its rotor making only 3,590 of the requisite 3,600 revolutions per minute loses four minutes per day, or about one hour each two weeks. This relatively minor slippage (10 rpm, or 1/360) can be detected most easily by stroboscopic methods, but the cost of a standard stroboscope is beyond the financial reach of most horologists.

Several horologists, working independently, have found that a small neon bulb (such as NE-30, 1 watt), painted so that the light from one electrode dominates the visual field, would function as a crude stroboscope<sup>1</sup>, but the improvisation causes a great deal of eye strain, which is already a serious problem among workers with small mechanisms.

Needed, for solution of this specific problem, is a simple and inexpensive one-flash-per-cycle stroboscope which can be used and maintained by the average horologist.

Available for more than a decade is the basic circuit for such a device—the Germeshausen-Edgerton one-flash-per-cycle circuit<sup>2</sup>, using a 631-P1 Strobotron. This circuit, shown in Fig. 1, performs well under a variety of conditions.

A working model was constructed, with the rectifier and controls housed in a small utility case, and the Strobotron in a fiber tube, supported by a conventional labora-



# TOP TEAM ON TOTEM POLE...



## SANGAMO PAPER CAPACITORS

Sangamo hermetically sealed paper capacitors prove "tops" for dependable performance... *Tops* for quality - *Tops* for small size - *Tops* for stability! They are fully described in Sangamo's new Paper Capacitor Catalog No. 832. Write for your copy.



### Electrolytic Replacement Types

(TYPE 40 SERIES)

For compact high-voltage power supply filter applications in industrial electronic, radio receiving, and radio transmitting equipment. They assure long life and high efficiency through an extremely wide operating range of temperatures.

### Bathtub Types

(TYPE 50 SERIES)

Unusually small, exceptionally stable bypass capacitors for applications where high temperature operation is important. They are available in single, double, and triple section units and have excellent life and voltage characteristics.



### Small Drawn Can Types

(TYPE 60 SERIES)

Best for use where exceptionally small filter capacitors are needed. Ideal for aircraft, guided missile work, or commercial applications. Seamless drawn steel, or non-magnetic cases are smaller than JAN-C-25, CP 60 Series specifications.



### Large Fabricated Can Types

(TYPE 70 SERIES)

These compact units are designed for use in broadcast and aircraft transmitters, industrial applications, and in many other high-voltage circuits. They give highly satisfactory performance, even under the most severe conditions.

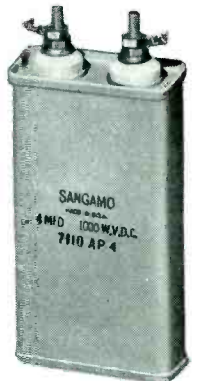

Your Assurance of

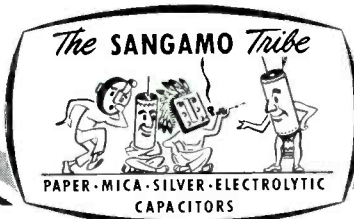

Dependable Performance

## SANGAMO ELECTRIC COMPANY

SPRINGFIELD, ILLINOIS

IN CANADA: SANGAMO COMPANY LIMITED, LEASIDE, ONTARIO

SC50-5

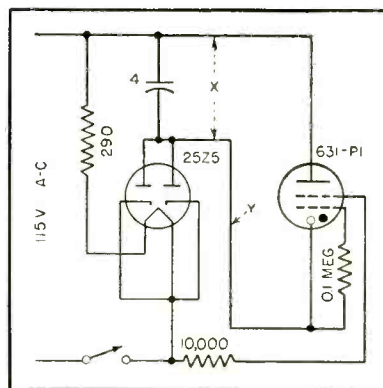

FIG. 1—Germeshausen-Edgerton one-flash-per-cycle circuit

tory stand. Power consumption is about 30 watts, component depreciation is estimated at one cent per hour, and first cost (retail) is about \$20.00.

In-service tests of the unit showed that it supplies too much light for horological working distances, so that eye strain, headaches and bright green after-images result. In addition, the heat radiated by the control box, due to power dissipated in the 25Z5 filament and its dropping resistor, was found to be annoying. Reduction of the illumination was accomplished by insertion of a shunt resistor at X of Fig. 1 and later by a series resistor at Y. These resistors lowered the intensity of the ignition flash, and slowed the release of the energy stored in the capacitor.

When light intensity was reduced to about  $\frac{1}{3}$  that originally produced, the after-images disappeared, and much of the eye-strain was eliminated. Tests of illumination produced under optimum working values indicated that the Strobotron output was about equal to  $2\frac{1}{2}$  watts of ordinary neon illumination.

*Neon Circuit*

Experiments with several combinations of a rectifier and a neon bulb resulted in the circuit shown in Fig. 2, in which the intensity of the illumination can be varied by means of a series resistor, and its duration by means of a potentiometer across the line, taking advantage of the potential variations inherent in the supply cycle.

Tests showed that this is a nice

*Specify*

**MOLDITE  
IRON  
CORES**

*because*

- They're precision-mixed, precision-made, precision-controlled for every electronic use
- Only our own exclusive formulas are used
- Our engineers are specialists in every iron core application
- Specially designed powder-mixing equipment assures uniformity and dependability
- Improved production, test and inspection facilities guarantee high quality performance

**NATIONAL  
MOLDITE  
COMPANY**  
1410 CHESTNUT AVE., HILLSIDE 5, N. J.

Samples promptly submitted upon request for design, pre-production, and test purposes.

SEND FOR CATALOG 106

Jerry Golten Co.  
2750 W. North Ave.  
Chicago 22, Ill.

Perlmuth-Colman & Associates  
1335 South Flower  
Los Angeles, Cal.

(Northern N. Y.)  
Martin P. Andrews  
Garden City, N. Y.

Jose Luis Pontet  
Cordoba 1472  
Buenos Aires

# For Vital Control Circuits in Curtiss Electric Propellers

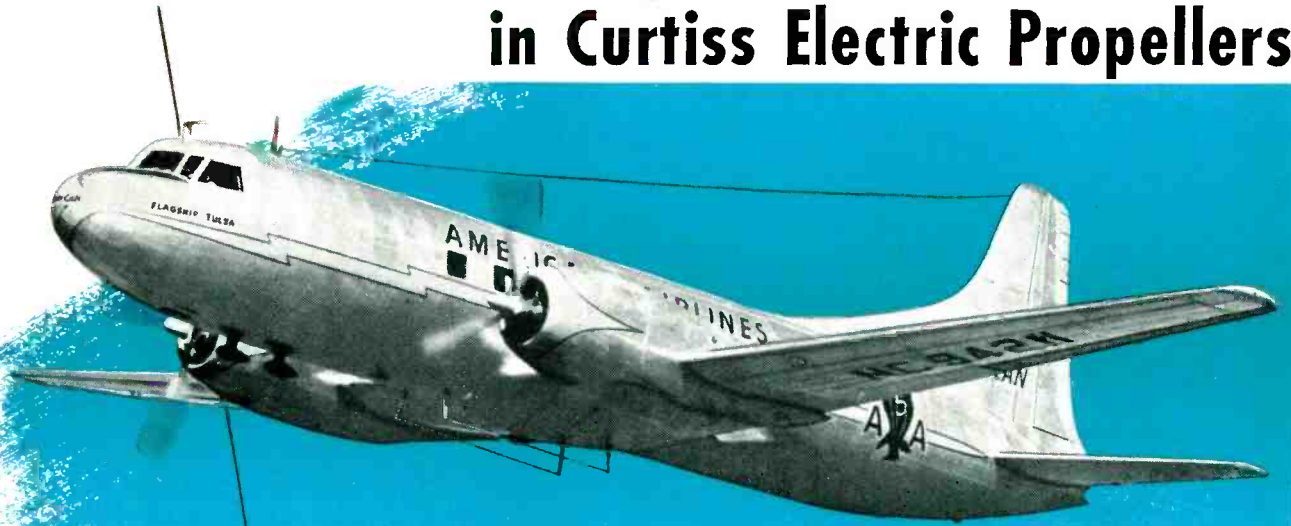

American Airlines' Convair Flagship equipped with CURTISS ELECTRIC propellers

## IT'S BENDIX-SCINTILLA ELECTRICAL CONNECTORS

... THE FINEST MONEY CAN BUY



### CHECK THESE ADVANTAGES

- Moisture-proof
- Radio Quiet
- Single-piece Inserts
- Vibration-proof
- Lightweight
- High Insulation Resistance
- Easy Assembly and Disassembly
- Fewer Parts than any other Connector
- No additional solder required



Unfailing dependability is the standard set by Curtiss propellers and American Air Lines in their selection of equipment.

Bendix-Scintilla is therefore the logical choice for the electrical connectors in the Curtiss Electric propellers on American Flagships.

In fact, wherever circuits must be arranged to connect and disconnect with ease and certainty Bendix-Scintilla is the choice.

Remember whenever there is no compromise with quality—it pays to specify Bendix-Scintilla electrical connectors—the *finest* money can buy.

*Write our Sales Department for detailed information.*

**BENDIX  
SCINTILLA**

SCINTILLA MAGNETO DIVISION OF  
SIDNEY, NEW YORK



Export Sales: Bendix International Division, 72 Fifth Avenue, New York 11, New York

not only pioneers in design,  
 development and production,  
 but also largest suppliers of  
 electric connectors for  
 the aircraft industry

# CANNON PLUGS



Battery Disconnects



Standard "AN"



Standard and Firewall  
"K" and "RK"



Firewall "AN"



Rack and Panel "DP"



New "AF"



Glass Sealed

Douglas Aircraft, Lockheed, Boeing, Convair, Rohr, North American, Martin, Chase, Curtiss-Wright, Northrop, Fairchild, Ryan, McDonnell, Beech, Chance Vought, Republic, Sikorsky, Piasecki, Bell, United Helicopter, Wright Aero, Texas Engr., Hamilton Prop., Edo, Radio Plane, Grumman, etc., etc.

Cannon Electric leads in both volume and variety of electric connectors and d. c. solenoids, lamp sockets and pushbuttons for the aircraft industry and the related equipment installed in aircraft. Shown here is only a partial list of types. In addition, there are "RS," "RTC," Buffet Plugs, Hot Cup Receptacles, D. C. Solenoids, "XL," and other miscellany. Write for catalog covering particular type series or contact our nearest representative.

Address Cannon Electric Development Co., Division of Cannon Manufacturing Corporation, 3209 Humboldt St., Los Angeles 31, Calif. Canadian office & plant: Toronto, Ontario. World export: Frazar & Hansen, San Francisco, New York.

SINCE 1915  
**CANNON ELECTRIC**  
 DIVISION OF CANNON MANUFACTURING CORP.

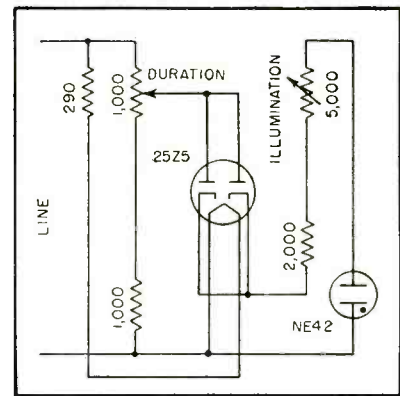

FIG. 2—Neon-tube stroboscope circuit with adjustable flash intensity and duration

laboratory instrument, ideal for classroom demonstrations, and that its optical qualities are satisfactory for testing electric clock motors for slip.

Chief objections to this neon-tube stroboscope are that it takes up about 100 square inches of bench space; that the controls require re-setting; that it requires about 45 seconds to warm up for a 10-second test and that it contains about \$20.00 worth of parts.

In-service tests also disclosed that as long as the duration of each individual flash was less than about 7.5 milliseconds, the rotor of an electric clock turning at synchronous speed appeared to stand still (desired appearance). Thus, it is possible to eliminate the duration control entirely, as the duration of the flash, with a reasonably sinusoidal wave form in the supply circuit, is only about 4.9 milliseconds, at 115 volts of 60-cycle a-c. Although this value will be changed by tube variations, line voltage fluctuations, and variations in wave form, the flash duration will remain below the critical value (about 7.5 milliseconds) under almost any circumstances likely to be encountered.

The circuit of the final one-flash-per-cycle neon tube stroboscope is shown in Fig. 3. Standard control components require only about three cubic inches of space, radiate a negligible amount of heat, and cost less than 5 dollars, including case and bulb.

### Final Model

Because of the small bulk of this simplified stroboscope, it appeared reasonable and economical to put

# for COMPLETE r-f *COVER*AGE

— from VHF to SHF

it's **PRD**

If you are in need of accurate test equipment why not consult with PRD? You'll no doubt find we have just the item you require. Consider, for example, the versatile new instruments illustrated on this page which embody the carefully thought out design features characteristic of all of PRD's precision test equipment. These and many other new instruments are now being offered to fulfill your VHF, UHF, and microwave requirements.



#### TYPE 650 UNIVERSAL POWER BRIDGE —

This direct-reading bridge may be used with either positive or negative temperature co-efficient bolometers for the accurate determination of r-f power. Full scale ranges of 0.1, 1.0, 10, and 100 milliwatts permit measurement over a wide range of power levels.



#### TYPE 904 VHF-UHF NOISE GENERATOR —

This calibrated broadband noise source permits direct measurement of noise factors as high as 20 db for r-f amplifiers and receivers operating in the range from 10 to 1000 mc/sec.

For complete information and a copy of our latest catalog, write to Department E-7, or see these instruments at Booth 271 at the forthcoming I.R.E. Show.

#### TYPES 902 and 903 BROADBAND MICRO-WAVE SIGNAL GENERATORS —

These new instruments furnish c-w, pulsed, or frequency modulated r-f signals for the 3650-7300 and 6800-10,900 mc/sec. bands. Direct reading frequency dials and automatic made tracking are employed, together with a 0-120 db cutoff attenuator calibrated directly in -dbm.



*Polytechnic* **RESEARCH**  
& DEVELOPMENT COMPANY, Inc.

202 TILLARY STREET, BROOKLYN 1, NEW YORK



# Contractor saves penalty of \$500 — by investing \$3.84 in Air Express

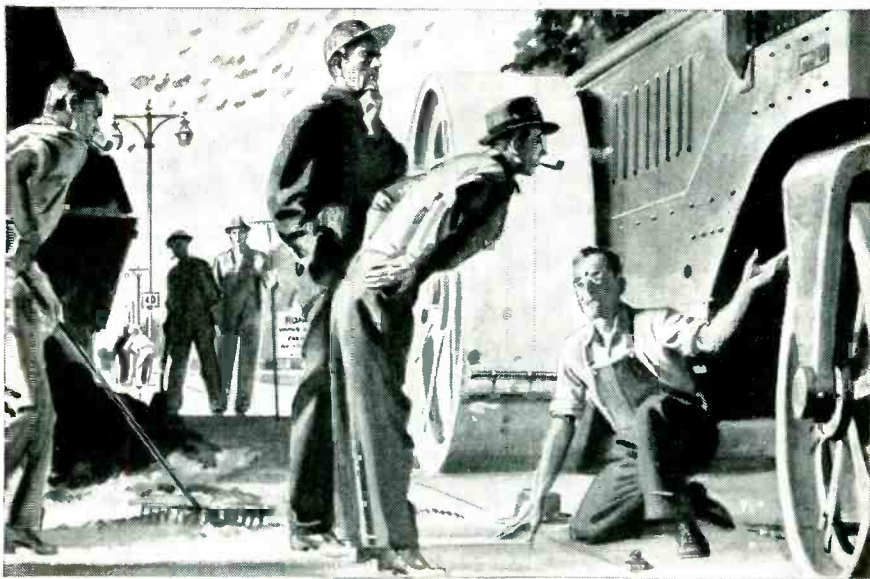

**Time clause** in housing project paving contract stood good chance of being invoked when equipment broke down at 5 P.M. So 10-lb. carton of replacement parts was Air Expressed from 1200 miles away. Delivered in just 8 hours. The Air Express charge was only \$3.84—and contractor completed job on time.

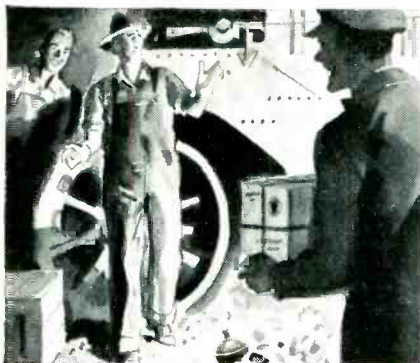

**\$3.84 is small** indeed, since it covers door-to-door service. Anytime delivery, 7 days a week. Makes the world's fastest shipping service the most convenient.



**Air Express** goes by Scheduled Airlines; extra dependability, *experienced* handling. Shipments keep moving. Regular use keeps *any* business moving.

## Only Air Express gives you all these advantages

**World's fastest** shipping service.

**Special door-to-door service** at no extra cost.

**One-carrier responsibility** all the way.

**1150 cities** served direct by air; air-rail to 22,000 off-airline offices.

**Experienced Air Express** has handled over 25 million shipments.

Because of these advantages, regular use of Air Express pays. It's your best air shipping buy. For fastest shipping action, phone Air Express Division, Railway Express Agency. (Many low commodity rates in effect. Investigate.)

# AIR EXPRESS

GETS THERE FIRST



Rates include pick-up and delivery door to door in all principal towns and cities

A service of  
Railway Express Agency and the

## SCHEDULED AIRLINES of the U.S.

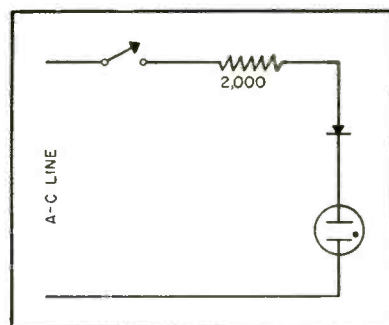

FIG. 3—Final circuit of simplified horological stroboscope

all components in a flashlight case. The original switch of the flashlight is used as the actuating lever of the internal switch. Use of the integral switch, without modification, is undesirable because of danger of shock.

All components are mounted on a metal bracket, which is firmly attached to the case by one screw. The reversed switch arm of the flashlight engages the switching mechanism of the instrument when assembled.

Bench tests of this simplified model show that it does the required job satisfactorily, conveniently, and cheaply. Power consumption is about 3 watts, depreciation is a small fraction of a cent an hour, and first cost, including construction time at \$2.00 an hour, is less than \$10.00.

Two minor difficulties were encountered. When a new bulb is inserted, the lower (inside) plate of the neon lamp is sometimes illuminated instead of the upper. This is corrected by taking the bulb out of the socket, rotating the base 180 degrees about the long axis, and replacing it. The second difficulty is bulb breakage due to screw-

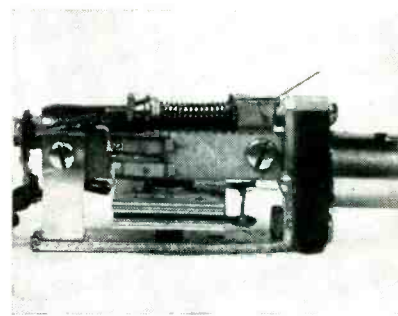

In the final model, the reversed switch arm of the flashlight engages the switching mechanism of the instrument at arrow. Upper surface of socket base is flattened to clear switch arm



THERMOPLASTIC INSULATED WIRE IN ALL SIZES

★ RESISTS SHRINK-BACK WHEN SOLDERED

105°C  
PERFORMANCE  
UL APPROVED!

★ RESISTS DEFORMATION

*...and More Megohms!*



★ MEETS JAN C76 LOW TEMPERATURE REQUIREMENTS

*Surprenant*



MFG. CO.

199 Washington St., Boston 8, Mass.

# SLASH FILM PRODUCTION COSTS with the Fairchild PIC-SYNC\* Tape Recorder

\*Pic-Sync means "in sync" with picture camera regardless of tape stretch.

Each time you retake a sound track, film production costs go up. The waste of film stock and the time delay for processing increase operating costs immeasurably. You *eliminate* these extra costs with the Fairchild PIC-SYNC Tape Recorder. Play back the sound at once . . . check it . . . erase the track . . . retake the sound *before the talent, the set and crew are disbanded.*



## Now Use 1/4" Tape For All Original Sound Tracks

Fairchild's development of the PIC-SYNC feature makes possible the use of 1/4" tape. Sprocket driven magnetic tape is costly.

- 1/4" tape costs 80% less than 16 mm magnetic tape.
- 1/4" tape requires 50% less storage space.
- 1/4" tape is easier to handle.
- 1/4" tape assures more intimate contact with the heads.
- 1/4" tape has more uniform coating—less amplitude flutter.
- 1/4" tape eliminates roughness of tone caused by sprocket drive.

*Bulletin fully describes the new PIC-SYNC Tape Recorder. Send for your copy today.*

### TELEVISION SAFETY SOUND TRACK RECORDING

CBS-TV saves \$24.00 per hour by making safety sound tracks of television recordings with the Fairchild PIC-SYNC Tape Recorder.

FR-110



154TH ST. AND 7TH AVE.

WHITESTONE, L. I., N. Y.

TUBES AT WORK

(continued)

ing down the lens retaining ring of the flashlight too tight. Surrounding the bulb with a cone of white blotting paper, which also serves as a reflector, eliminates this difficulty.

Although each instrument constructed offered a practical solution to the problem and all performed fairly well, there was an 8 to 1 variation in power need; a 4 to 1 variation in construction cost; and a 20 to 1 variation in bulk. Interestingly, the cheapest and smallest of the devices tried also performed the requisite task most satisfactorily.

### REFERENCES

- (1) J. E. Coleman, Clockwise and Otherwise, *Amer. Horologist and Jeweler*, p 89, Aug. 1949.
- (2) E. J. Gerneshausen and H. E. Edgerton, The Strobotron, *ELECTRONICS*, p 12, Feb. 1937; John Markus and Vin Zelnoff, "Handbook of Industrial Electronic Circuits," McGraw-Hill Book Co., N. Y., 1948, p 215.

## Prospecting Unit for Fluorescing Minerals

By RONALD C. WALKER  
Reading, England

MANY naturally occurring minerals show characteristic fluorescence to ultraviolet rays and a few of them exhibit phosphorescence. In most cases, the response is relatively high to long-wave ultraviolet of the 300 to 400 m $\mu$  range and feeble or nonexistent to the short-wave region below 300 m $\mu$ .

Fluorescence is known to be associated with crystal structure and is agreed to be due to the presence of minute quantities of heavy impurities such as silver, copper or manganese in the crystal lattice. In fact, the whole development of phosphors for cathode-ray tube screens has been associated with the study of activators and the enormous influence that small quantities of such substances exert on the screen characteristics. In most cases, fluorescence in mineral deposits is not universal in different samples of the same substance and appears only in those deposits which have crystallized in the presence of such activators.

Scheelite (calcium tungstate) and powellite (calcium molybdate) are apparently exceptions to the general behavior of mineral de-

PRODUCED BY THE MILLIONS

The Hi-Q Ceramic  
Laboratory



BC Tubular Capacitors

*- by the top specialists in the ceramic field*

# Hi-Q COMPONENTS

Capacitors  
Trimmers • Choke Coils  
Wire Wound Resistors

## BETTER 4 WAYS

- ✓ PRECISION
- ✓ UNIFORMITY
- ✓ DEPENDABILITY
- ✓ MINIATURIZATION

• **Hi-Q** BC Tubular Ceramic Capacitors for bypassing, coupling and filtering are available with any of three types of insulations:—clear non-hydroscopic styrene coating (CN) . . . Durez impregnated with low loss microcrystalline wax (SI) . . . or a ceramic (steatite) cover tube sealed with a specially developed end seal (CI). The **Hi-Q** trade mark is your assurance that like all **Hi-Q** Components, they rigidly meet specifications and are uniformly dependable in every respect. As leading specialists in the ceramic field, **Hi-Q** has come to be regarded by producers of radio, television, communications and electronic equipment as their best source of technical assistance in developing components to meet the needs of any circuit.

JOBBERS — Address: 740 Belleville Ave., New Bedford, Mass.

# Hi-Q

## Electrical Reactance Corp.

FRANKLINVILLE, N. Y.

SALES OFFICES: New York, Philadelphia,  
Detroit, Chicago, Los Angeles

PLANTS: Franklinville, N. Y., Jessup, Pa.,  
Myrtle Beach, S. C.

EXPORT DEPARTMENT: 41 EAST 42nd ST., NEW YORK 17, N. Y.

# Microphones BY TURNER

## TURNER MODEL 99 DYNAMIC

Response: 40—9000 c.p.s.  
Level: 52 db below 1 volt/dyne/sq.cm. at high impedance.

\* "Best all-purpose mike ever used"  
"Very satisfied—excellent results—ruggedness an asset."

\*  
**SOUND PERFORMANCE**  
as verified by letters in our files

## TURNER MODEL 22X-22D

22X Crystal—50-9000 c.p.s.,  
52 db below 1 volt/dyne/sq.cm.  
22D Dynamic—50-9000 c.p.s.,  
54 db below 1 volt/dyne/sq.cm.  
at high impedance.

\* "Good tonal quality and smart design."  
"Does an excellent job on wire recording."

## TURNER MODEL 33X-33D

33X Crystal—50-9000 c.p.s.,  
52 db below 1 volt/dyne/sq.cm.  
33D Dynamic—30-9000 c.p.s.,  
54 db below 1 volt/dyne/sq.cm.  
at high impedance.

\* "Like small size and neat appearance."  
"Higher percentage of contacts."

## TURNER MODEL U9S DYNAMIC

4 impedances at your fingertips  
Response: 40—9000 c.p.s.  
Level: 52 db below 1 volt/dyne/sq.cm. at high impedance.

\* "Excellent fidelity."  
"Like variable impedance."  
"Good response—rugged—good output."

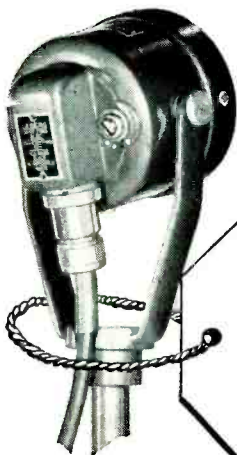
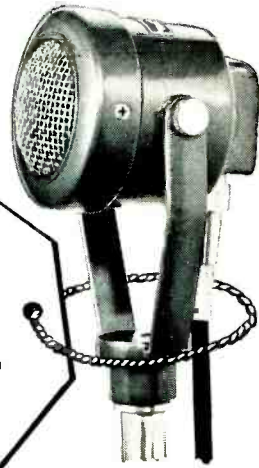

TUBES AT WORK

(continued)

posits in that they show brilliant fluorescence in the short ultraviolet region and are invariable in this respect. Scheelite, in particular, exhibits the same blue fluorescence characteristic of synthetic calcium tungstate which, unlike so many of the synthetically prepared phosphors, requires no activator to cause fluorescence.

Tungsten and molybdenum are very valuable metals in industry, not so much for their intrinsic worth as their characteristic properties of high melting point, hardness and resistance to corrosion for which there are no adequate substitutes. As a result of their characteristic response to short ultraviolet radiation, the mercury-vapor lamp provides a reliable means of

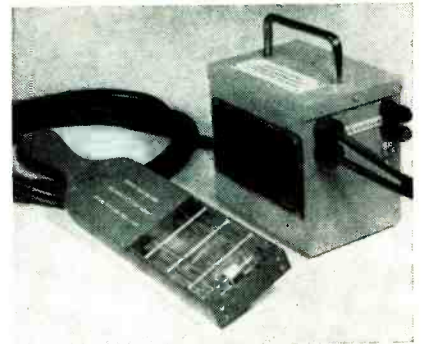

Portable mercury-vapor discharge lamp and high-voltage power supply for examining rock faces for minerals

prospecting, particularly for scheelite which is not usually visibly distinguishable from the rocks in which it is found.

The prospecting outfit shown in the accompanying illustration incorporates a low-pressure cold-cathode mercury-vapor discharge lamp in a quartz bulb. This is fitted into a holder designed to facilitate the tube being held near vertical or horizontal rock faces, and a 15-foot high-voltage cable connects this holder to the converter, which in turn is cable-connected to a 12-volt battery as the power source.

The discharge lamp is U-shaped and requires a starting voltage of 700 with a steady running current of 35 ma at 350 volts. About 60 percent of the ultraviolet radiation is in the shortwave region around 2,537 Å.

Although a good deal of visible

Write for Complete Microphone Literature

**THE TURNER COMPANY**

905 17th Street N. E., Cedar Rapids, Iowa

IN CANADA: Canadian Marconi Co., Ltd., Montreal, P. Q., and branches

EXPORT: Ad. Auriema, 89 Broad Street, New York 4, N. Y.



Licensed under U. S. patents of the American Telephone and Telegraph Company, and Western Electric Company, Incorporated. Crystals licensed under patents of the Brush Development Company.

# If you manufacture Electronic Equipment...

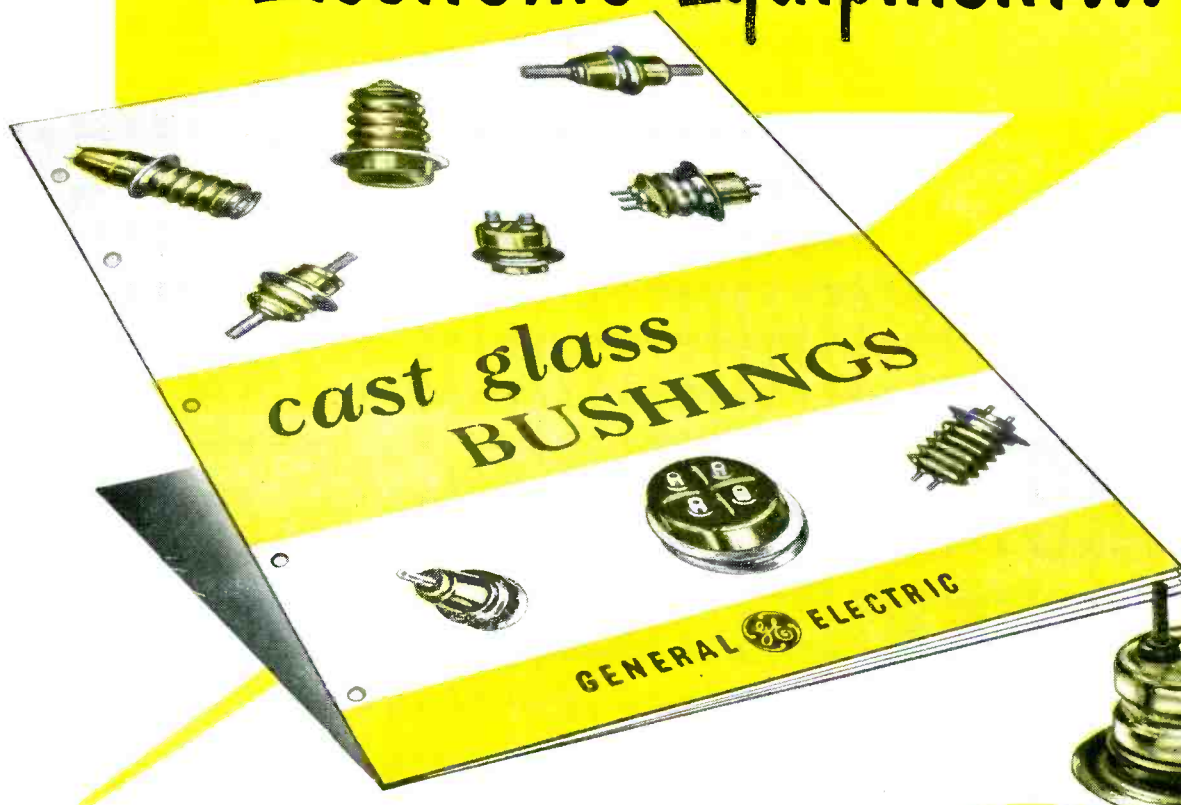

## you'll want this bulletin on glass bushings

General Electric is now offering to other manufacturers the cast glass bushings it has used so successfully on many types of electrical equipment.

These bushings are cast of a stable, low-expansion glass. Metal hardware is a special nickel-alloy steel, fused to the glass in casting. Bushings can be attached directly to the apparatus without gaskets—by soldering, welding or brazing.

The resulting joint between bushing and equipment is permanent, vacuum-tight, and of high mechanical strength. It is especially desirable for equipment subject to vibration, shock, attack by fungus growth or severe changes in temperature. It eliminates moisture problems and often permits more compact, light-weight design of equipment.

Our bulletin, GEA-5093, contains a complete listing of standard designs now available—giving withstand voltages, current ratings and physical dimensions. A copy of this bulletin is yours for the asking. Just write *Apparatus Department, General Electric Company, Schenectady 5, New York.*

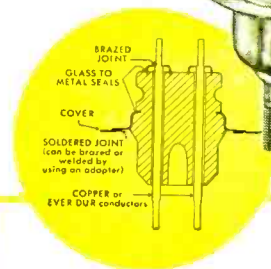

Glass bushings are currently available to meet dry, 60-cycle, flashover values of from 10 to 50 kv, and in current ratings of 25 and 50 amperes (large sizes up to 800 amperes). They may be single or multi-conductor and can be provided with a top flange to permit mounting tube sockets directly on the bushings. Diameters range from 1 3/8 to 3 3/8 inches and weight from 2 1/2 oz. to 4 lb.

**GENERAL**  **ELECTRIC**

401-57

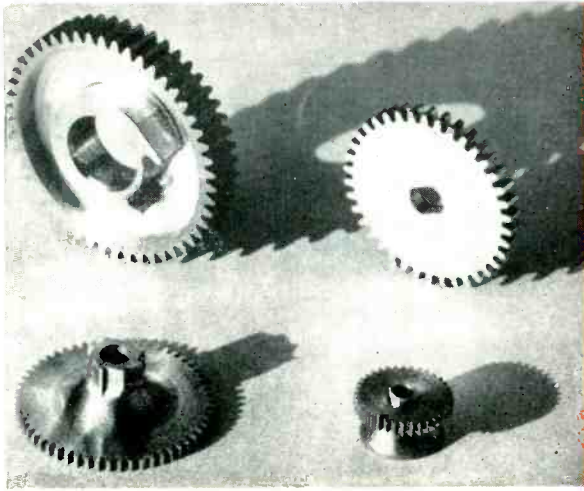

# GEARS WITH SHAPES

Special Shapes and Features? . . . Tolerances within .0005" . . . Let our experience in supplying precision small and medium sized gears with such features solve these production problems for you . . . Ask for quotation on your job specifications. Circular on Request.

MEMBER OF



## Beaver Gear Works Inc.

1021 PARMELE STREET, ROCKFORD, ILLINOIS

- SPUR
- WORM
- SPLINE
- HELICAL
- SPROCKET
- STRAIGHT BEVEL
- GROUND THREADS

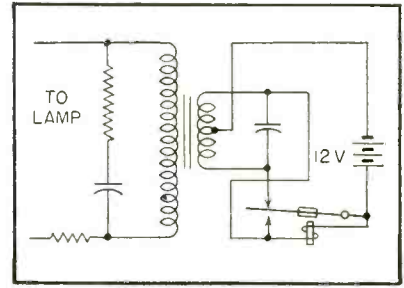

FIG. 1—Circuit of high-voltage power supply for the discharge tube

radiation is also present and can be removed by filters, no advantage is thereby secured, since there is practically no increase in contrast of the fluorescing mineral against its surroundings and some visible light is also an advantage in examining a rock face.

The circuit of the high-voltage converter is shown in Fig. 1. This is a vibrating-reed type. The high-voltage secondary is connected through a stabilizing resistance to the lamp. Spark and radio interference suppressors are included in the circuit. The total weight of the lamp and converter is 15 pounds.

The operator must wear glass goggles with side shields since the quartz bulb of the lamp passes radiation dangerous to eyesight. It is only necessary to scrub the rock face thoroughly with water before starting an examination and the operator is soon able to judge from experience whether the fluorescence is that of a low grade ore or one of workable value suitable for a preliminary assay.

Another use for this prospecting unit is the detection of mercury ores. Mercury vapor absorbs ultraviolet radiation of 2,537 Å region so that if a prepared willemite screen is excited to fluorescence by the lamp and a sample of the ore heated so that the vapor given off passes between the lamp and the screen, black shadows will be seen on the screen due to the absorption of the ultraviolet radiation by the mercury vapor.

The prospecting unit has also found some application in the examination of oil-bearing strata since crude petroleum is fluorescent to both long and short ultraviolet.

# KENYON Fits Your Production To A "T"

**KENYON "T's"**—high quality, uniform transformers, are your best bet for development, production and experimental work. For over 20 years, the KENYON "K" has been a sign of skillful engineering, progressive design and sound construction.

Now—reduce inventory problems, improve deliveries, maintain your quality—specify KENYON "T's," the finest transformer line for all high quality equipment applications.

**New Catalog Edition! Write Today!**

**KENYON** new modified edition tells the complete story about specific ratings on all transformers. Our standard line saves you time and expense.

Send for your copy of our latest catalog edition now!

**KENYON TRANSFORMER CO., Inc.**  
840 BARRY STREET · NEW YORK 59, N. Y.

*Ward Aerials Give Radio-  
Equipped Taxicabs the  
Best Service*



- Regardless of the make of transmitter and receiver, Ward aerials assure the best performance on radio equipped taxicabs.
- The Model SPP-18 Roof Top Mount for intercommunication on the 140-165 megacycle band is ruggedly constructed to withstand corrosive atmospheric conditions such as ice, snow, sleet, rain, and fog.
- Equipped with a twelve foot coaxial lead cable, the Ward Model SPP-18 is easily installed *without cutting the car upholstery.*



*Ward is the largest and oldest  
exclusive maker of auto radio  
and television aerials.*

**WARD PRODUCTS CORPORATION**  
1523 E. 45TH STREET • CLEVELAND, OHIO  
*Division of the Gabriel Company*

# SYNTHETIC SAPPHIRE *for*



## Resistance to Wear

Outlasting hardened steel and cemented carbides 2 to 5,000 times.



## Resistance to Friction

Affording very low friction surfaces due to hardness and surface continuity.



## Resistance to Heat Distortion

Retention of form at temperatures up to 1,000°C.

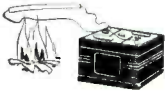

## Retention of Insulating Properties

Excellent dielectric properties over a wide range of temperatures.

LINDE Synthetic Sapphire is available in a variety of forms. It can be polished by flame or ordinary diamond polishing; it can be formed and bent by flame. Polished sapphire surfaces keep free of dirt, and in many anti-friction applications, need not be lubricated.

The experience that LINDE engineers have in applying sapphire to industrial processes may be of help to you. Call or write the LINDE office nearest you. Get your copy of the "Synthetic Sapphire Data Sheet", and the "Synthetic Crystal Stock List" of forms available.

*Linde*  
Trade-Mark

## THE LINDE AIR PRODUCTS COMPANY

Unit of Union Carbide and Carbon Corporation

30 East 42nd St., New York 17, N.Y. Offices in Other Principal Cities

In Canada: DOMINION OXYGEN COMPANY, LIMITED, Toronto

The term "Linde" is a trade-mark of The Linde Air Products Company.

## THE ELECTRON ART

(continued from p 122)

the space lost in round wire coils (A in Fig. 1C). The relative conductor volume (RCV), defined as the ratio of volume of conductor to volume occupied, is for the printed conductor

$$RCV = 1/(1 + k_t)(1 + k_w)$$

where  $k_w$  is the ratio of gap  $g$  between turns to width  $w$  of conductor, and  $k_t$  is the ratio of half the thickness of wafer base  $s_w$  plus thickness of outer insulation  $s_i$ , all divided by the conductor thickness  $t$ . RCV is plotted in Fig. 2.

For a No. 18 conductor,  $w$  and  $t$  may be 200 and 6.38 mils respectively,  $g$  10 mils, and  $s_i$  0.75 mils, so that  $RCV = 77.1$  percent. For a No. 40 conductor,  $w$  and  $t$  may be 15.5 and 0.5 mils respectively,  $g$  1.5 mils, and  $s_i$  0.07 mils, so that  $RCV = 63.4$  percent. Assuming a linear relationship for other wire sizes, this is plotted in Fig. 2 and compared to round wire.

The maximum internal voltage

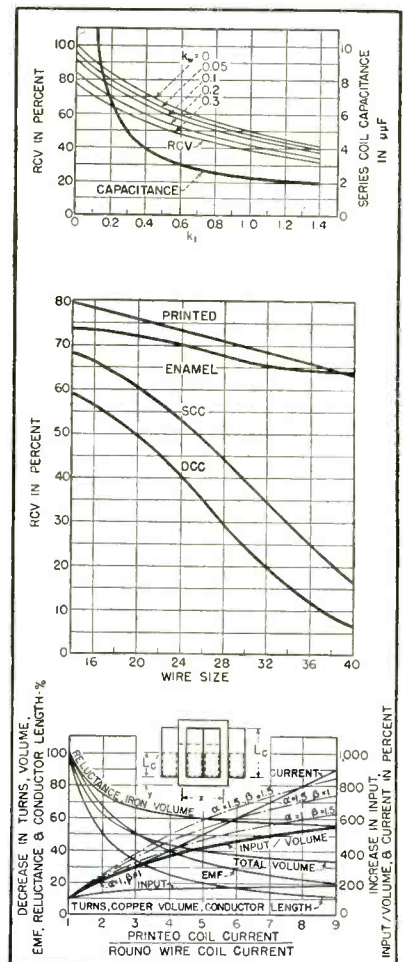

FIG. 2—Printed coil construction offers numerous advantages, as evidenced by these curves. RCV stands for Relative Conductor Volume



# Announcing the

## **SIE** MODEL "M" OSCILLATOR

✓ **LOW DISTORTION**

✓ **HIGH STABILITY**

✓ **HIGH ACCURACY**



### THE FIRST IN A NEW LINE OF WIDE RANGE, LOW DISTORTION OSCILLATORS

#### **ABRIDGED SPECIFICATIONS**

**RANGE:** 1 cps to 120,000 cps continuously variable in five overlapping ranges. Two positions on range selector switch provide for use of fixed frequency plug-in units\* from .25 cps to 120,000 cps.

**OVERALL DISTORTION:** Less than .2% in the audio range. Less than 1% over the entire range.

**ELECTRONICALLY REGULATED POWER SUPPLY:** Maintains HUM LEVEL 80 db below signal level, at any signal amplitude. Eliminates transients in output due to power line surges.

**CALIBRATION:** (1½% plus .1 cps).

**POWER FREQUENCY COMPARATOR:** For quick check of dial calibration.

**OUTPUT:** 20 volts or 20 milliamps. 1 volt at 250 ohms constant impedance.

\*These units available at slight extra cost.

The full range of .25 cps to 120,000 cps is made possible by the use of the unique SIE oscillator circuit which has no lower limit to its possible frequency of oscillation. The low frequency coverage makes the Model "M" a valuable research tool, especially in Medicine, Geophysics, and Ordnance. It provides a versatile source of power suitable for both experimental and production uses.

Quality components are used throughout. Deposited carbon resistors, considered to be the most stable resistors obtainable for this purpose, are used in the frequency-determining networks to assure good short and long time stability.

Write today for your free copy of the illustrated booklet which gives full specifications and prices on this outstanding oscillator . . . the first in a new line of wide range low distortion oscillators to be announced by SIE.

A limited number of excellent territories are still available, and inquiries are invited from Engineering Sales Agents.

**SOUTHWESTERN  
INDUSTRIAL ELECTRONIC CO.**  
2831 POST OAK ROAD - HOUSTON 19, TEXAS

between any two adjacent turns in a round wire coil compared to that in a printed coil of the same dimensions is very nearly  $E_r E_p = 1.13 \sqrt{r L_c/T}$  where  $r$  is  $w/t$ ,  $L_c$  is coil length, and  $T$  is coil thickness ( $\frac{1}{2}$  difference of inner and outer diameters). The ratio  $L_c/T$  is rarely less than 1, and usually 3 or more; while  $r$  may be about 50. Thus, printed construction ordinarily results in over 20 times reduction in maximum internal potential, compared to a round wire coil of same size, same applied voltage, and same number of turns.

*Properties*

Thermal properties are improved by increased thermal conductivity due to elimination of space  $A$ , even distribution of thermal stress on conductor surface (compare dotted lines of Fig. 1C and 1D) and increased conductor area for a given cross-section, resulting in a cooler conductor surface.

Electrical properties are improved by even distribution of electrical stress, better current distribution, decreased eddy currents in conductor and decreased proximity effect. The combined thermal and electrical gain may be represented by an increase in current in the printed conductor. For equivalent coils of same conductor cross-section and ampere-turns, the printed coil would thus require less turns, and hence decreased coil length, iron and copper volumes, and emf, producing an increase in power input per unit volume. The latter, which determines miniaturization, turns out to be

$$\frac{P'/V'}{P/V} = \frac{(\alpha + 1)^2 (\beta + 1) p^2}{(\alpha + p) (\beta + \alpha \beta + \alpha + p)}$$

where  $P'/V'$  and  $P/V$  are printed and round wire input-to-volume ratios respectively,  $\alpha = L_c/(x + y)$ ,  $\beta$  is ratio of copper to iron volume in round wire coil, and  $p$  is the ratio of current in printed coil to that in round wire coil. Miniaturization increases with  $p$  as shown in Fig. 2. If the advantages of the printed construction are assumed to be equivalent to double-cotton insulation,  $p$  would be 3, allowing a volume reduction of  $\frac{1}{3}$ , for  $\alpha = \beta = 1$ .

Capacitance of the printed coil is reduced in two ways: capacitance

Thinking of Stainless?

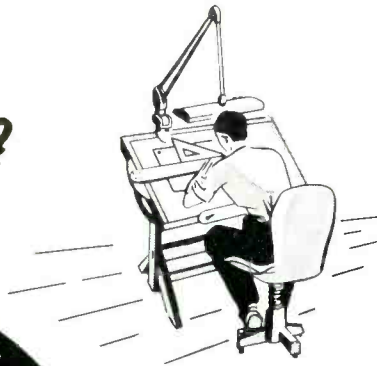

Think of ALLMETAL

for the finest in STAINLESS STEEL FASTENERS

**MADE RIGHT —**

By specialists in stainless steel since 1929.

**PRICED RIGHT —**

Because ALLMETAL uses modern equipment—including cold-heading machines—devoted solely to stainless.

**RIGHT COMBINATION**

For solving fastening problems quickly, economically.

Allmetal has the fasteners you want. Stock items, including Government and "AN" specs, shipped immediately. Prompt delivery on various types of Phillips Recessed Head screws and specials. Switch to Allmetal Stainless Fasteners when you switch to Stainless!



Use our "Rush Order" direct wire service—Send telegrams to "Allmetal Screw Products—WUX—New York."—that's all—



WRITE FOR CATALOG 49C

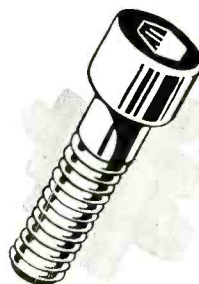

MANUFACTURERS SINCE 1929

**ALLMETAL**

*Screw Products Co., Inc.*

33 GREENE STREET, NEW YORK 13, N. Y.

a  
“live  
wire”  
for



hot

spots

**Vitrotex\* Magnet Wire** with Glass Fiber Insulation  
withstands temperatures of 130°C.

**Highly Flexible . . . Amazing Space Factor** — made possible by insulation of alkali-free glass, the insulation that's soft as silk and strong as steel!

**High Dielectric Strength and Smooth Surface . . .** resists moisture, acids, oils and corrosive vapors!

**Vitrotex Windings Give Tighter, Safer Coils** — for operation in confined spaces under high heat!

*Ask the Anaconda Sales Office nearest you for complete information on the entire ANACONDA Magnet Wire Line. Anaconda Wire & Cable Company, 25 Broadway, New York 4, N. Y., or 20 N. Wacker Drive, Chicago 6, Ill.*

\* Reg. U. S. Pat. Off.

50322

The right wire for the job **ANACONDA**<sup>®</sup>  
**WIRE AND CABLE**

# Leach RELAYS

## ARE PERFORMANCE PROVED!

### INDUSTRIAL RELAYS

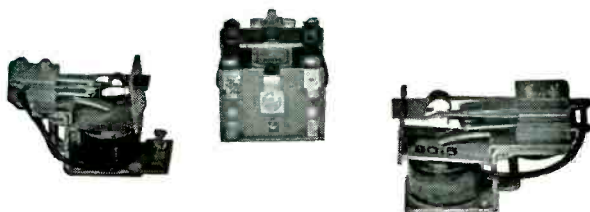

### AIRCRAFT RELAYS

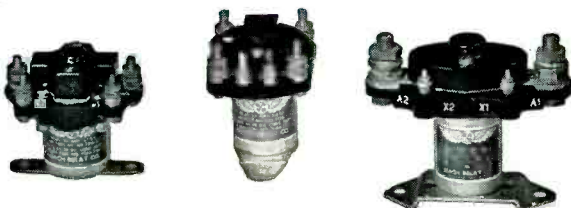

### SPECIAL RELAYS



You get better service from LEACH RELAYS because thousands of types of relays for thousands of applications have been proved-in-use for over 30 years.

LEACH RELAYS are designed with an exceptionally high factor of safety for *extra* dependability. Simplicity of designs makes installation quick, easy and inexpensive. Get *all* the facts and make your own comparisons. LEACH RELAYS' outstanding performance, reliability, sturdiness and economy have been *proved-in-use*.

Highest standards of engineering, materials and workmanship assure long, safe, efficient, trouble-free service.

FOR BETTER CONTROLS THROUGH BETTER RELAYS—CONTACT LEACH



# LEACH RELAY CO.

5915 AVALON BOULEVARD. ★ LOS ANGELES 3, CALIF.

Representatives in Principal Cities of U. S. and Canada

between spirals is in series, and turn-to-turn capacitance is decreased considerably by use of thin conductors and relatively large gap  $g$ . Assuming the conductor area on the surface of each wafer is the plate of a capacitor, total series capacitance in  $\mu\text{mf}$  becomes

$$C = \left[ \frac{0.2244 K_w K_o (1+b)}{b K_w + K_o} \right] \left[ \frac{A}{L_c} \right] \left[ \frac{1+k_t}{k_t} \right]$$

where  $K_w$  and  $K_o$  are the dielectric constants of wafer base and outer insulation coating respectively,  $b = 2s_t/s_w$ ,  $A$  is the conductor area on the wafer in sq in., and  $L_c$  is coil length in inches. This is plotted in Fig. 2 against  $k_t$  for a coil having  $A/L_c = 1$  in.,  $K_w = K_o = 5$ , and  $b = 0.6$ .

The turn-to-turn capacitance, which is distributive, may be represented for the printed coil by

$$\frac{C_s'}{C_d'} = r \left[ \frac{g}{s_w} \right] \left[ \frac{b K_w + K_o}{2 b K_o} \right]$$

where  $C_s'$  is total spiral-to-spiral (series) capacitance per unit conductor length,  $C_d'$  is total turn-to-turn capacitance per unit conductor length, and  $K_o$  is the dielectric constant in gap  $g$ . For a round wire coil  $C_s/C_d$  is of the order of unity. The comparison of round wire to printed conductor is then

$$\frac{C_d}{C_d'} = \frac{(C_s + C_d) (C_s'/C_d' + 1)}{(C_s' + C_d') (C_s/C_d + 1)}$$

The ratio  $(C_s + C_d)/(C_s' + C_d')$  is approximately 0.1 for equal cross-sections and equivalent insulations. For  $r = 50$ ,  $g/s_w = 5$ ,  $b = 0.6$ ,  $K_w = K_o = K_o$ , the turn-to-turn capacitance is approximately 250 times less in a printed coil compared to an equivalent round wire coil of the same size and conductor cross-section.

#### Disadvantage

An inherent disadvantage in the proposed construction is the large number of contacts in series. Methods for reducing this contact resistance include longitudinal pressure along the axis of contact, large contact area, plating contacts with silver, and permanently fusing contacts with suitable binder by r-f heating or equivalent tech-

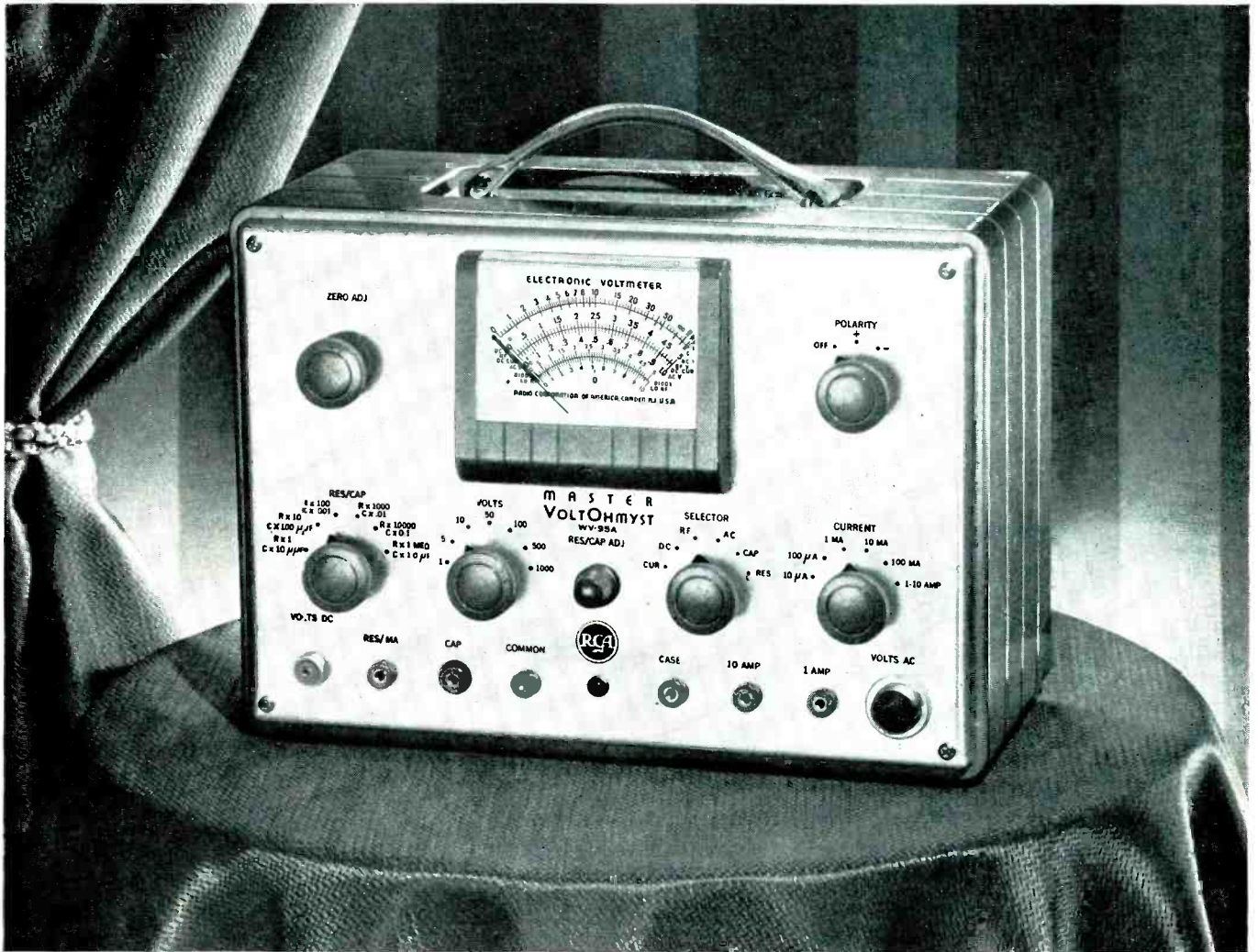

# Only RCA Makes the VoltOhmyst\*

The **Master VoltOhmyst** . . . the most versatile instrument of its kind. The WV-95A has no equal for fast and accurate test and measuring applications in the plant and laboratory. It is especially convenient because it measures capacitance, as well as voltage, current, and resistance. Measures ac and dc potentials to 1000 volts, dc current from 1 microampere to 10 amperes, capacitance from 4 mmf to 1000 mf. The microampere current scale makes the instrument useful as an electronic galvanometer.

When used with the WG-275 accessory diode probe, the WV-95A will measure rf voltages in communication equipment or in coaxial lines, and peak-to-peak voltages of recurrent pulses in sync signal generators, television receivers, radar units, and computing devices.

For full details, ask your RCA Test Equipment Distributor for Bulletin 2F721—or write RCA, Commercial Engineering, Section C42Y, Harrison, N. J.

\*Reg. Trade Mark, U.S. Pat. Off.

The WV-95A, 195A, and WV-75A can be used with the WG-289 accessory high-voltage probe to measure up to 50,000 dc volts.

The **Standard VoltOhmyst** . . . the workhorse of electronic meters. The RCA Type 195A measures ac and dc voltages to 1000 volts, resistance to 1000 megohms, in six ranges. Reads db at all audio frequencies. Has zero-center scale for discriminator alignment. Its 10-megohm dc input resistance provides accurate measurements in high-impedance circuits. WG-263 accessory crystal probe permits rf voltage measurements to 100 Mc.



The **Advanced VoltOhmyst** . . . for all high-frequency measurements. The WV-75A is ideal for TV and HF measurements. Reads flat to 250 Mc. Measures peak-to-peak voltages. Measures ac and dc potentials to 1000 volts. Resistance readings to 1000 megohms. Supplied complete with WG-275 diode probe.

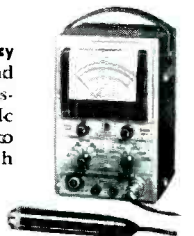

Available from your RCA Test Equipment Distributor



**RADIO CORPORATION of AMERICA**  
TEST EQUIPMENT  
HARRISON, N. J.



*That's* what you'll say when you try the new Astatic "AC" Crystal Cartridge—perfection of performance entirely unrelated to its tiny size. Weighs only five grams, is approximately 15/16" thick, 1/2" high and 1-1/2" long, not including pins. Yet, frequency response, particularly in the high frequencies, is amazingly excellent. A new low measure of inertia of the mechanical drive system is chiefly responsible for full wide range response and excellent tracking characteristics. Also assures low needle talk and long life for needle and records.

The "AC" employs Astatic's exclusive Taper-Lock Needle, easily changeable without tools. Molded Bakelite housing, with metal mounting brackets (fit standard 1/2" mounting) and needle guards. Available in four models: AC-78 with 3-mil stylus tip, precious metal or sapphire; AC, with 1-mil stylus tip, precious metal or sapphire; AC-AG with new Astatic "ALL-GROOVE" stylus; ACD turnover type, with both 1 and 3-mil point needles. Write for complete details.

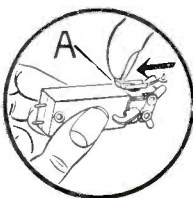

**Changing the Taper-Lock Needle**

Placing thumbnail against stub at rear of needle (A), simply push in direction of arrow to remove. To insert, fold card, on which new needle comes, along scored line; place narrow end of needle shank in wide end of metal cartridge groove (B) and pull card in direction of arrow.

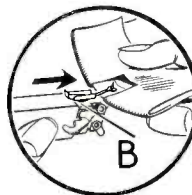

**THE HOME OF  
ASTATIC PRODUCTS**

**THE Astatic CORPORATION**  
CONNEAUT, OHIO

IN CANADA: CANADIAN ASTATIC LTD., TORONTO, ONTARIO

**83,196 SQ. FEET OF FLOOR SPACE**

*Astatic Crystal Devices manufactured under Brush Development Co. patents*

nique. For most electronic applications this contact resistance is secondary. Other advantages include ease in providing taps, repairability, flexibility in adding and balancing secondaries, adaptability to mass production, and the possibility of using superior insulations unsuitable for wire.

**REFERENCES**

- (1) National Bureau of Standards, "Printed Circuit Techniques," Circular 468.
- (2) National Bureau of Standards, "New Advances in Printed Circuits," Miscellaneous Publ. M192.

**Intra-Ocular Tachistoscope**

By **LELAND L. ANTES**  
Bureau of Engineering Research  
The University of Texas  
and

**B. H. DEATHERAGE**  
Department of Psychology  
The University of Texas  
Austin, Texas

PROBLEMS have arisen in psychology for which answers cannot be derived using commercially available tachistoscopes. The commercial tachistoscope is designed to present a single image for a very brief period of time, or two or three images successively, either monocularly or binocularly. An instrument was needed which would furnish inter-ocular stimuli and continued stimulation to the eyes.

In the model built for the Department of Psychology at the Univer-

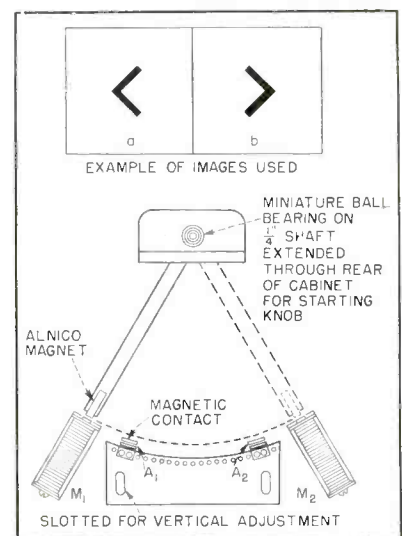

FIG. 1—Method of flashing two blue fluorescent lamps alternately to give square-wave light output, adjustable durations and flashing rates that can be adjusted by varying air gaps of armatures A<sub>1</sub> and A<sub>2</sub> and their positions along arc of pendulum

# This is *IT* for Stainless Steel Fastenings

## Over 7,000 Varieties and Sizes of Stainless Fastenings **IN STOCK**

Virtually every standard stainless fastening you might require is on hand in our stock bins and listed in the big, 80-page Anti-Corrosive Reference Catalog . . . called by many the "Bible of the Stainless Steel Fastening Industry."

## Fingertip Index Makes Items Easy to Find; Prices Are Figured **INSTANTLY**

Separate sections are devoted to stainless steel machine screws, nuts, caps and bolts, wood and sheet metal screws, rivets, set screws, washers, pins and nails. In addition, each page shows list prices for all items and a quantity discount chart which makes cost estimating a simple task!

## Supplementary List of Hard-to-Get Items **IN STOCK**; Special Alloy Section

Thousands of odd sizes and varieties in stock are found in the supplementary stock list. In addition, special sections are devoted to type 316 and other special alloys. Other items can be obtained rapidly through our special order service.

**If YOU Use Stainless Steel Fastenings This Catalogue is a *MUST* for Your Files!**

Whatever application you have for stainless fastenings, this comprehensive and authoritative reference will save you time, effort and expense. Send for your copy **NOW!**

**Simply Fill Out the Coupon Below and Mail Today for Your *FREE* Copy of This Catalog**

**ANTI-CORROSIVE METAL PRODUCTS CO., INC.**  
Castleton-on-Hudson, New York

Please rush my **FREE** copy of your 80-page reference catalog on stainless steel fastenings.

Name \_\_\_\_\_

Title \_\_\_\_\_ Firm \_\_\_\_\_

Address \_\_\_\_\_

City \_\_\_\_\_ State \_\_\_\_\_

**Anti-Corrosive** SINCE 1927  
Metal Products Co., Inc.  
**Manufacturers of STAINLESS STEEL FASTENINGS**  
CASTLETON-ON HUDSON, NEW YORK

# Timing Ideas

## AT YOUR COMMAND



More and more manufacturers interested in maintaining a reputation for precise efficiency are looking to Haydon® at Torrington for dependable timing. Our entire engineering staff and production facilities are devoted exclusively to the design and manufacture of timing motors and devices including time delay relays, elapsed time indicators, repeat cycle and interval timers. At your command are the complete resources of Timing Headquarters, where timing is the only interest. The products illustrated below are examples of many shown in our new catalogs.

### THE 4400 SLOW SPEED SERIES

A very slow speed unit — for low cost installations where space is at a premium. Offers speeds from 6 hours to 7 days per revolution.



4400 SERIES

### INTERVAL TIMER WITH BUZZER

This timer features an optional buzzer; demands attention by sounding continuously after completion of cycle until manually turned off. Unusually compact, for use where space is limited; offered in a wide range of intervals.

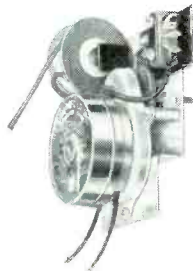

8010 SERIES  
INTERVAL TIMER  
WITH BUZZER

### SUPERIORITY FEATURES OF HAYDON MOTORS

Slow 450 rpm rotor speed. Very small size. Totally enclosed. Separate rotor and gear lubrication systems. Operation in any position. Simple, secure, inexpensive assembly.

© TRADE MARK REG. U.S. PAT. OFF.

### NEW CATALOGS TO MEET EVERY NEED

For complete design and engineering specifications, write for catalog: Timing Motors No. 322 — Timers No. 323 — Clock Movements No. 324. Yours without obligation.



sity of Texas, the presentation of the images continues, one image after another, for as long as desired. It will present two images, *a* and *b*, alternately to the two eyes; *a* to the left eye only, *b* to the right eye only, in the sequence *ababab* . . . for as long as desired. A pair of prisms, of six prism diopters power, serves to resolve the separate images into a single visual image in a single visual field, much as a stereoscope does. The timing of presentations may be changed rapidly and continuously from succession through optimal movement to simultaneity.

The images are made visible by consecutive square-wave flashes of illumination on the backs of two 3-inch square opal glass windows. The timing of the two flashes and the interval between them is necessarily adjustable, each flash being on the order of 0.010 second and the interval between flashes being roughly 0.060 second for optimum psychological results. Two consecutive flashes may constitute a complete operation. The order of the flashes can be reversed and the operations can be controlled remotely by means of pushbuttons. For other purposes continuous repetition of pulses can be had.

### Lamps

Chief requirements for a light source are square-wave output and an economical power supply, using standard radio components. The 15-watt T-8 blue fluorescent lamp proved highly satisfactory. It has a very high flicker factor and low persistence of its cadmium sulfate phosphor. With d-c voltage applied and with one cathode heated, this

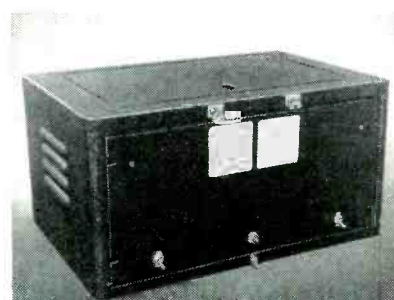

Completed tachistoscope. Fluorescent lamps are behind opal glass screens, with half of each lamp blacked out so each screen is illuminated by only one lamp. In use, hood with prisms and two eyepieces is usually attached to hinges over screens to resolve separate images into single visual image

**HAYDON**  
AT TORRINGTON  
HEADQUARTERS FOR  
**TIMING**

**HAYDON Manufacturing Co., Inc.**  
2427 ELM STREET  
TORRINGTON, CONNECTICUT  
SUBSIDIARY OF GENERAL TIME CORPORATION



# The Right Switches... at the Right Price...

to modernize your product and  
to enhance its "saleability"

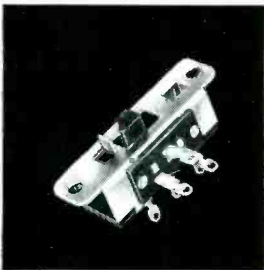
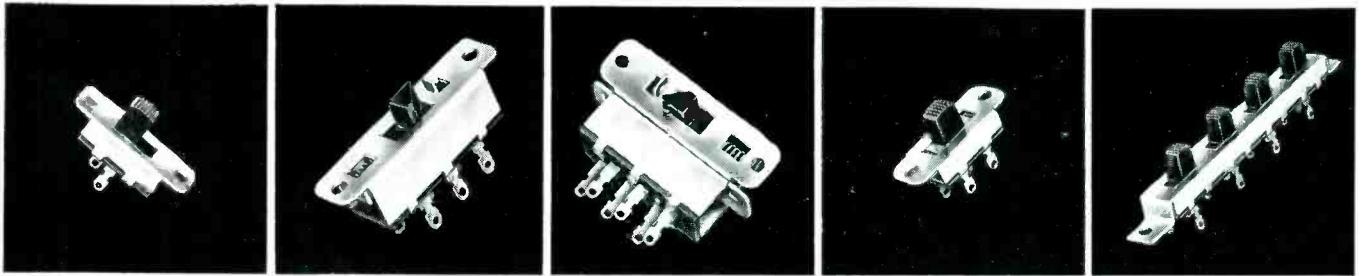

**NEW!**  
Two slide switches rated  
1 ampere at 125 volts DC  
3 amperes  
at 125 volts AC

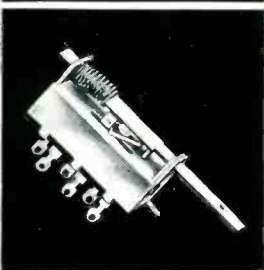

These sturdy little switches are  
ideal for appliances, toys and  
electrical equipment requiring  
3-ampere switch contact carry-  
ing capacity. Both are Un-  
derwriters approved. Write  
for SS-26 Switch Bulletin.

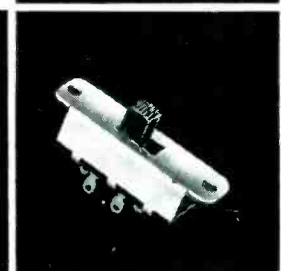
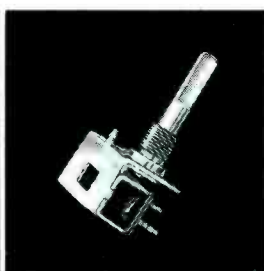
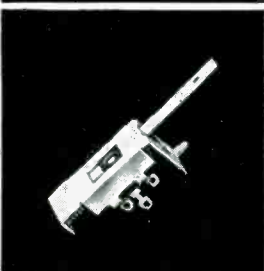
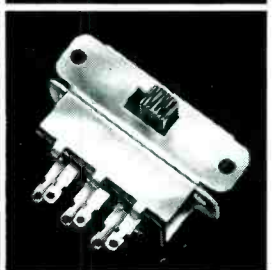
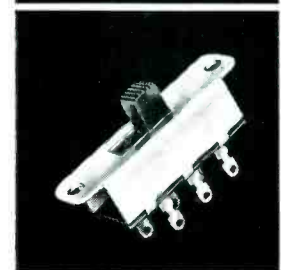

**LINE OR SLIDE ACTION**  
*Dozens of Contact Arrangements*

Inexpensive types are available for practically any switching  
requirement and at prices that will please you. Samples to speci-  
fications on request to quantity users. Write for Stackpole  
Bulletin RC7C.

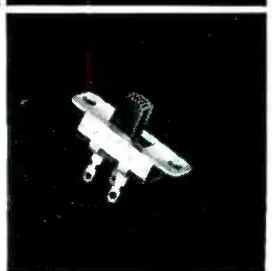

Fixed and Variable Resistors  
Iron Cores • Alnico II Perma-  
nent Magnets ...

ELECTRONIC COMPONENTS DIVISION,  
**STACKPOLE CARBON CO. St. Marys, Pa.**

...and hundreds of molded  
iron powder, metal, carbon  
and graphite products.

# STACKPOLE

lamp will start with a voltage of 400 to 450 at ordinary temperatures, but more than this should be applied for reliable operation. Sufficient series ballast resistance must be provided to limit the current to the desired value. Normal operating current is 254 ma, but considerably larger or smaller currents may be utilized when efficiency and lamp life are not important factors.

Vacuum tubes switch the fluorescent lamps on and off without having to break the lamp current directly. When connected in series with the lamps the 6L6 tubes give perfect control with 700 to 750 volts in the plate circuit and a grid voltage ranging from 0 to -150 volts.

*Timer*

Since only off-and-on control is desired, a mechanical means of grounding the grids, as shown in Fig. 1, is all that is required. The one-cycle timer is a pendulum which carries a small permanent magnet at its extremity. Electromagnet coils  $M_1$  and  $M_2$ , mounted as in Fig. 2, maintain the swinging. The coils are connected in series with a 25,000-ohm bleeder resistance across the power supply, and are normally energized to hold the pendulum in either extreme position of its swing. Pressing control button  $L$  will short-circuit  $M_1$  and allow the pendulum to swing across to  $M_2$ . Holding  $L$  closed during this operation

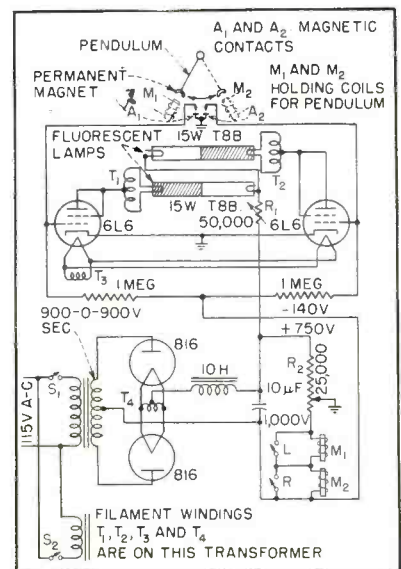

FIG. 2—Magnetically controlled pendulum used as mechanical timer in intraocular tachistoscope developed for psychological tests

AVOID LOSSES FROM  
**"BLOBBING"**  
 Not being an extruded plastic,  
 it eliminates the costly  
 "blobbing" of insulations under  
 heat of soldering irons

specify



**"NOFLAME-COR"**  
 the TELEVISION hookup wire

APPROVED BY  
 UNDERWRITERS  
 LABORATORIES AT

**90°** CENTIGRADE **600** VOLTS

Proven BEST, and specified regularly, by leading manufacturers of television, F-M, quality radio and all exacting electronic equipment. For maximum output and minimum rejects. Available in all sizes, solid and stranded. Over 200 color combinations.

PRODUCTION ENGINEERS: Specify "NOFLAME-COR" for absolute uniformity of diameter, permitting clean stripping of insulation without damage to the copper conductor...

NO NICKING OF CONDUCTORS  
NO CONSTANT RESETTING OF BLADES

RUBBER	_____	75°
PLASTIC	_____	80°
<b>"NOFLAME-COR"</b>		<b>90°</b>

- Flame Resistant
- High Insulation Resistance
- Heat Resistant
- Facilitates Positive Soldering
- High Dielectric
- Easy Stripping
- Also unaffected by the heat of impregnation — therefore, ideal for coil and transformer leads

COMPLETE DATA AND SAMPLES ON REQUEST

*"made by engineers for engineers"*

**CORNISH WIRE COMPANY, Inc.**

605 North Michigan Avenue,  
 Chicago 11

15 Park Row, New York 7, N. Y.

1237 Public Ledger Bldg.,  
 Philadelphia 6

MANUFACTURERS OF QUALITY WIRES AND CABLES FOR THE ELECTRICAL AND ELECTRONIC INDUSTRIES

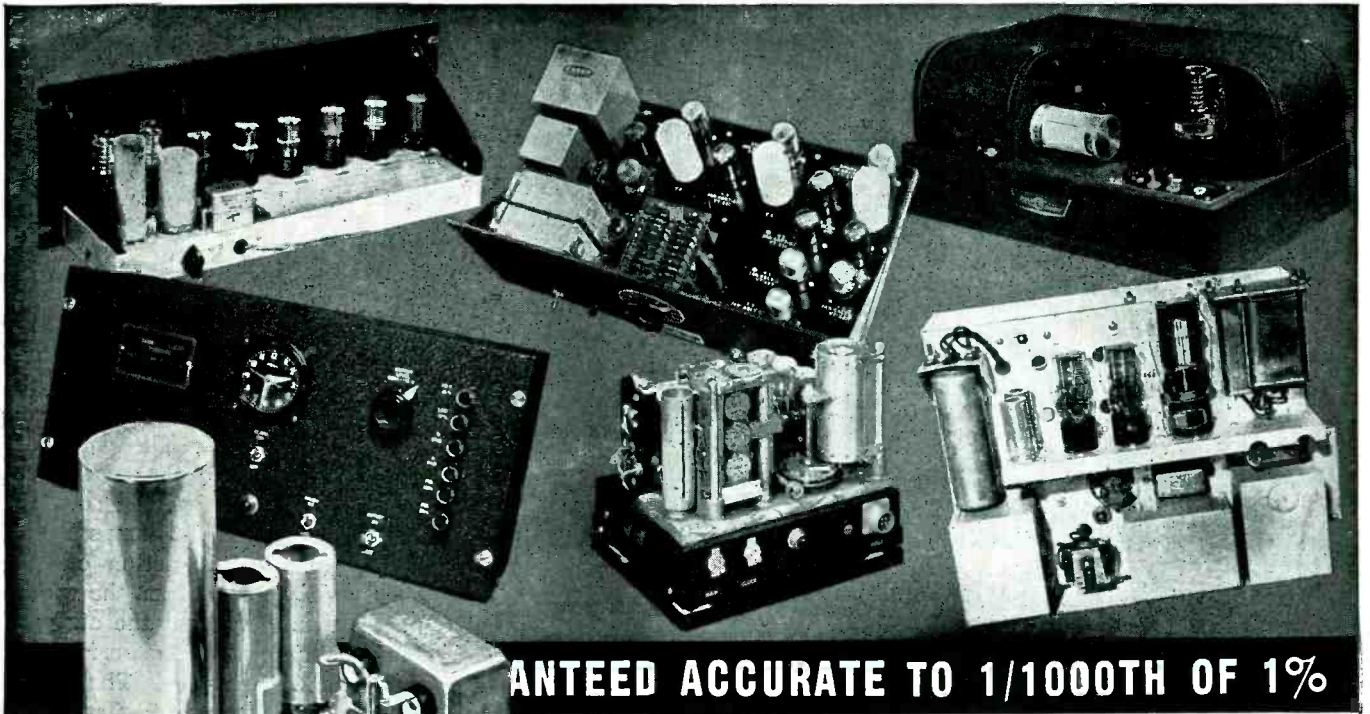

## **ELECTRONIC FREQUENCY STANDARDS AND GENERATORS**

*The basic unit of the frequency standards and generators presented here is an electrically driven tuning fork,—temperature-compensated and hermetically sealed against changes of humidity and barometric pressure. Through its use any frequency or multi-frequencies between 40 and 10,000, fractional or otherwise, are obtainable.*

*Any Frequency  
from 40 to 10,000  
in fractions or otherwise*

**F**OR plant operations, for product development, for timing studies, wherever frequency generation or interval measurement is required, these instruments provide accuracy to 1 part in 100,000.

Their reliability and stability have been proven through the years here and abroad in Government Departments, aviation, industry and laboratories where precision is imperative.

The instruments with which the basic frequency standard unit is integrated are adaptable to an infinite number of uses. If you have a precision timing or frequency problem, we will be pleased to suggest a solution.

# **American Time Products, Inc.**

**580 Fifth Avenue**

**New York 19, N. Y.**

OPERATING UNDER PATENTS OF THE WESTERN ELECTRIC COMPANY

**NOW... the best lines for industry and research are all under ONE roof!**

**ONE call  
gets  
them  
All!**

**MILO**

**SIMPSON ELECTRIC  
STANDARD TRANSFORMER • BURGESS  
CORNELL-DUBILIER • A. B. DUMONT • ERIE  
AMPHENOL • HAMMARLUND • NATIONAL COMPANY  
CINCH-JONES • JAMES MILLEN • SYLVANIA • BUD  
HICKOK • IRC • OHMITE • ATR • UTC • etc.**

Only Milo now answers your call for the specialized products of every outstanding manufacturer of electronic parts, tubes and equipment—for all your production, research and industrial needs.

**STREAMLINED ONE-SOURCE PURCHASING  
SAVES YOU MONEY, TIME AND EFFORT!**

Only Milo gives you these exclusive buying advantages:

- ★ **QUICK, EASY, SIMPLIFIED PURCHASING** — One constant, dependable source for all your procurement. No wasteful hunting around. No hazardous, costly guessing.
- ★ **COMPLETE NEWEST STOCKS** — Up to specified quantities, you get the identical price the factories would give you.
- ★ **SAME-DAY SHIPMENT** — Assures you of fast, on-time delivery — prevents costly delays.
- ★ **TECHNICAL KNOW-HOW AND KNOW-WHAT** — The up-to-the-minute, right, fast answers you need, by men with decades of experience in industrial electronics requirements.
- ★ **PERSONAL ATTENTION AND ADVICE** — Whether your order is large or small, Milo's large staff of Industrial Salesmen is ready to help you with the latest information and personal consultation, at your office if you so desire.

**The Newest Products of the Best Manufacturers are always at MILO**

Here are just a handful of the latest products of major interest to you now available from Milo's great warehouse of complete stocks:

**AMPEREX**—New inexpensive Geiger tubes, types 75N and 75NB, priced at \$10.00 each. New type PL-105 mercury vapor thyratron tube.\*

**ALLEN B. DUMONT LABORATORIES**—New oscilloscopes, superseding the famous 208B. Type 304, \$308.00 each. Type 304H, \$328.00 each.

**ERIE\*** — New button-style capacitors, GP ceramicons, tubular trimmers, ceramicon trimmers, etc.

**IRC\***—New type DCH and DCF precision resistors. BTS, BTA, BT2 and BW resistors, in all tolerances and values. New CLA and CL-1 insulated chokes, readily identified with RMA color coding in microhenries.

**SOLA ELECTRIC\***—Constant voltage transformers.

**SYLVANIA\***—All types of germanium crystals, new glow modulators, gas pressure tubes, TR and ATR tubes, strobotrons, thyratrons, flash tubes.

**TUNG-SOL**—New type 5687 miniature twin triode tube, \$7.25 each.

**ALLEN BRADLEY\***—Potentiometers, and EB, GB, HB resistors in all tolerances and values.

\*Prices and literature on these products available on written request on your letterhead.

To get it right, to get it fast, to get it at the factory price— Call Milo's INDUSTRIAL SALES DIVISION today. Ask for Mr. Lee. Or write on your letterhead for free latest Catalog E.

**MILO**

PHONE  
**BEekman 3-2980**

**Radio & Electronics Corp.**

200 Greenwich Street, New York 7, N. Y.

Cable Address: MILOELECTRO

The ONE source for ALL your electronic needs

allows above-normal current to flow in  $M_2$ , giving double assurance that the pendulum will be held at the end of its swing by  $M_2$ .

*Adjustments*

In swinging from  $M_1$  to  $M_2$ , the permanent magnet on the end of the pendulum passes successively above silicon steel armatures  $A_1$  and  $A_2$ . As these armatures rise momentarily, contacts are closed which ground the grids of the control tubes in succession. The length of time during which the grids are grounded is the period during which the fluorescent lamps flash. This period is a function of the velocity of the pendulum, the width of the armatures, and the air gap distance between the permanent magnet and armatures. The interval between successive flashes is determined by the velocity of the pendulum and the separation of the armatures. Means are provided for varying the air gap of the armatures and their position along the arc of the pendulum. The magnitude of swing of the pendulum, and hence its velocity behavior, is fixed.

*Circuit Details*

Window illumination is varied by  $R$ , in series with the lamps. The cathodes of the fluorescent lamps are heated by individual 7.5-volt filament transformers. Switch  $S_2$  should be closed first, to allow the tube cathodes to heat before the high voltage is applied by closing  $S_1$ .

Any set of external contacts actuated by the most minute stimulating forces may be caused to operate the flasher, since the control grid current of the switching tubes is almost negligible. Several types of electron tube control and amplifying circuits will suggest themselves as alternate means of controlling the flasher.

**Single-Frame TV  
Photography**

BY MAURICE DISTEL AND ALAN GROSS

*Signal Corps Engineering Laboratories  
Fort Monmouth, New Jersey*

IN ENDEAVORING to record a remotely situated, random, short-duration visual phenomenon, an experimental closed-circuit television system was arranged to transmit

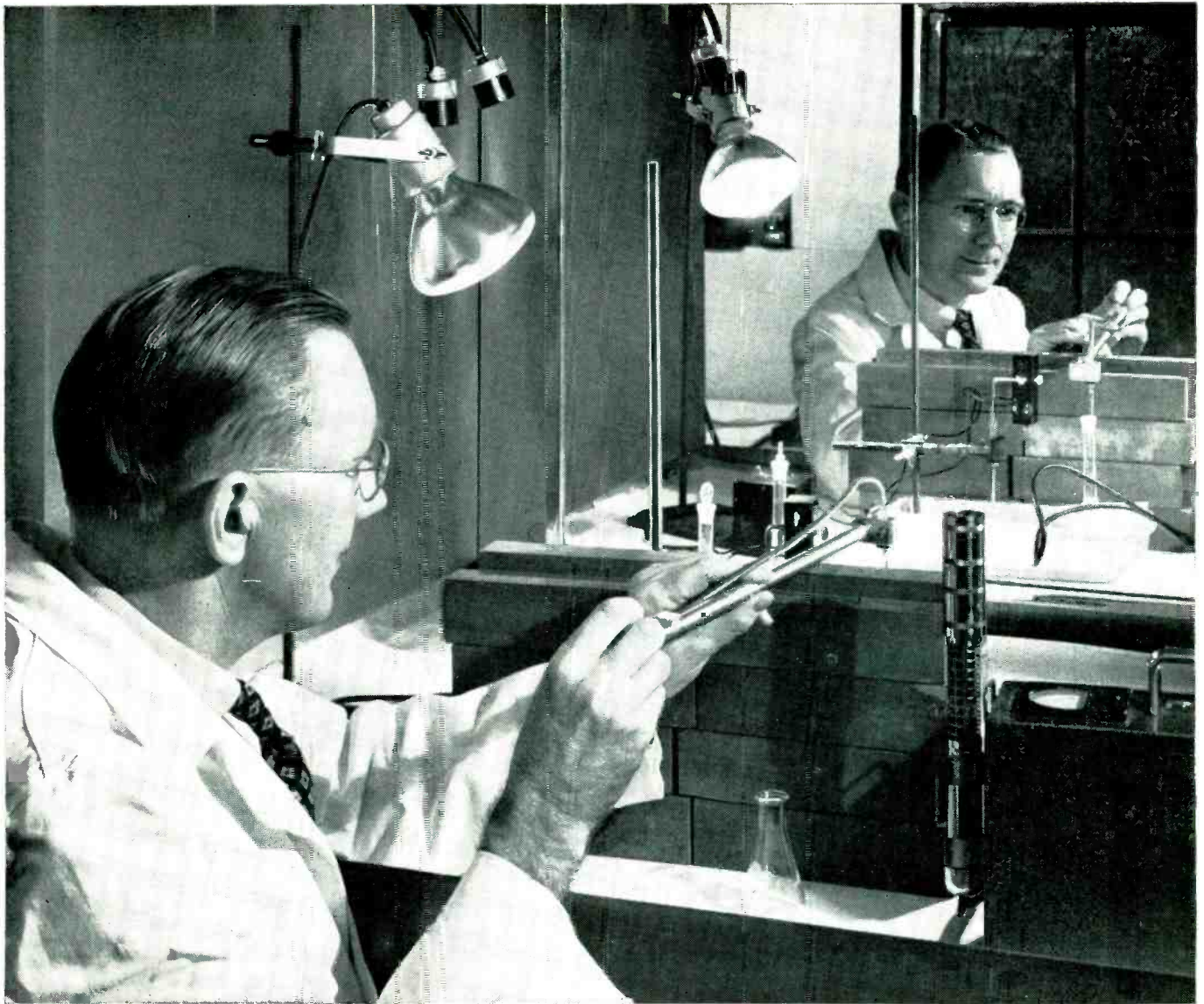

# IT'S **DONE WITH MIRRORS!**

Protected by a wall of lead bricks and using a mirror to guide his instruments, this Bell Laboratories scientist is preparing a solution of a radioactive isotope, for use as a tracer to study materials for your telephone system.

Bombardment by neutrons turns some atoms of many chemical elements into their "radioactive isotopes"; these are unstable and give off radiation which can be detected by a Geiger counter. Chemically a "radioactive isotope" behaves exactly like the original element. Mix the two in a solution or an alloy and they will stay together; when the Geiger counter shows up an isotope, its inactive brother will be there too. Minute amounts beyond the reach of ordinary chemical methods can be detected — often as little as one part in a billion.

The method is used to study the effect of composition on the performance of newly developed germanium transistors — tiny amplifiers which may one day perform many functions which now require vacuum tubes.

It enables Bell scientists to observe the behavior of microscopic impurities which affect the emission of electrons from vacuum tube cathodes. It is of great help in observing wear on relay contacts. And it may develop into a useful tool for measuring the distribution and penetration of preservatives in wood.

Thus, one of science's newest techniques is adopted by Bell Laboratories to make your telephone serve you better today and better still tomorrow.



**BELL TELEPHONE LABORATORIES**

EXPLORING AND INVENTING, DEVISING AND PERFECTING, FOR CONTINUED IMPROVEMENTS AND ECONOMIES IN TELEPHONE SERVICE.

**Introducing**  
 THE NEW No. 5841  
 Subminiature  
**CORONA REGULATOR**

★  
**CHARACTERISTICS**

D.C. Starting Voltage.....(max.) 930 Volts  
 D.C. Regulating Voltage..... 900 ±15 Volts  
 Regulated Current Range..... 2-50 μa  
 Voltage Regulation (2-50 μa)...(max.) 1.5%  
 Life.....(min.) 1000 hrs.

**RATINGS**

Regulator Current.....(max.) 50 μa  
 Relative Humidity.....(max.) 100%  
 Ambient Temperatures..... -65°C to 100°C.



The 5841 sub-miniature corona regulator now in production is another Victoreen component developed to make fine instrumentation finer. This regulator supplements other specially designed electron tubes required in radiation measurement and in the broader field of laboratory instruments.

... subminiature  
**ELECTRON TUBES**

Tube Type	Typical Service	Volts $E_{c1}$	Volts $E_{c2}$	Volts $E_b$	μa $I_b$	μ	μmhos $G_m$	Grid current Signal grid
*5800	** Electrometer Tetrode	+3.4	***-3	+4.5	12	1	15	$3 \times 10^{-15}$
*5803	Electrometer & D.C. Amp.	-1.7	----	+7.5	100	2.0	150	$10^{-14}$
*5828	D.C. Amp.	-1.0	----	45	250	17.5	450	$10^{-9}$

— — — and a complete line of counter tubes including the universally used 1B85, the 1B67 end window mica window tube, gamma ray counters, and sub-miniature counter tubes — — — not forgetting Victoreen hi-meg resistors vacuum sealed in glass, values 100—10,000,000 megohms.

Write for data sheets



**THE VICTOREEN INSTRUMENT CO.**  
 5806 HOUGH AVENUE CLEVELAND, OHIO

the scene to the picture tube where it could be photographically recorded. Since the time of occurrence of the event was not predictable, an electronic triggering scheme was tried which would enable the film camera to monitor the screen continuously. The camera shutter was opened and the screen maintained dark except when triggered to brightness by the event itself, thus capturing the image on film. The alternative to this, of course, would be the obviously less economical method of operating a motion picture camera continuously in anticipation of the event.

*Trigger System*

The effectiveness of the electronic triggering scheme depended upon a number of things. The camera and television receiver had to be in a light-tight enclosure to prevent fogging of the exposed film. Triggering the kinescope picture on and off had to be accomplished by sequential application of the proper bias voltages to the kinescope control grid. In trial, a single-shot multivibrator, triggered by the event by means of an auxiliary photocell in the television camera, generated a square pulse of duration equal to the average television frame period. This pulse was used to gate the cathode-ray beam.

It was found that the vertical oscillator of the 40-frame-per-second television scanning system would, over a period of days and under changing temperature conditions, vary approximately within one cycle per second about a frequency in the range 39 to 46 cycles per second. Rather than modify the television synchronization generator system to remedy this difficulty, it was decided to control the timing circuit which gates the kinescope cathode-ray beam. It

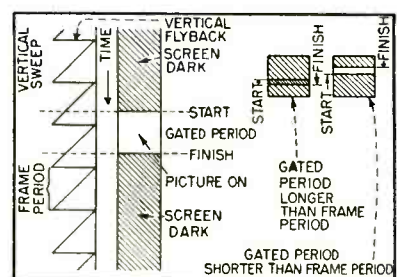

FIG. 1—Samples of banding occurring in single-frame television photography

# Brown - Brockmeyer solves tough insulating problem *with*

## ROGERS DUROID PART



Rogers ability to fabricate this complex component in one piece saved the customer the problem of redesigning the part and complicating assembly with five individual pieces of insulation.

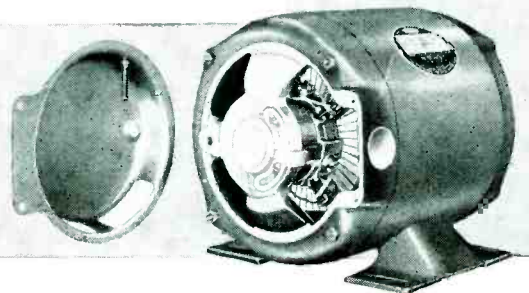

BROWN-BROCKMEYER required a deep drawn and shaped fibrous insulating part. It had been designed to cover a steel support housing for a commutator. The steel housing is used to hold a radial molded commutator for the newly designed "Dyna-Line" brush-lifting motor.

The problem was to find a material with the required electrical and physical characteristics and a fabricator capable of forming and shaping the part to design requirements. Rogers filled the bill on both counts. DUROID, a new Rogers material similar in electrical properties to vulcanized fibre, made the part possible. It could be drawn to the required depth—a virtual impossibility with any other fibrous sheet material. Our Fabricating Division's skill and experience met the challenge of producing this intricate piece with economy and speed.

You can apply this same high order of fabricating efficiency to your requirements for fibrous or laminated phenolic parts. Our range of high quality materials, our specialized knowledge, skills and facilities will **SAVE YOU MONEY — AND GET THE JOB DONE.**

Write for catalog describing Rogers Corporation's complete fabricating services.

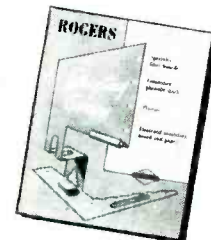

FABRICATING DIVISION, DEPT. E  
**ROGERS CORPORATION**  
GOODYEAR, CONNECTICUT



SPECIALTY FIBRE PRODUCTS  
ELECTRICAL INSULATING BOARDS AND PAPERS  
DUROIDS • SHOE PRODUCTS

MOLDING AND LAMINATING PLASTICS  
Boards • Blanks • Pre-shaped Preforms  
High Strength Molding Compounds  
Laminated Phenolics

COMPLETE FABRICATING SERVICES  
ON FIBROUS MATERIALS AND  
LAMINATED PHENOLICS

EDA HIGH GAIN DC AMPLIFIER. DC to 100,000 cps. Gain 25,000 times.

**THE ACCURATE, FLEXIBLE SOLUTION TO YOUR TOUGHEST JOBS!**

H-41 FOUR CHANNEL OSCILLOSCOPE. 2 AC and 2 DC amplifiers. DC to 800,000 cps.

H-43 FOUR CHANNEL OSCILLOSCOPE. Designed to record through continuous strip cameras similar to Fairchild F 246 A.

MULTI-GUN CATHODE RAY TUBES. Two, four, six, eight, and ten gun tubes, potentiometer and radio deflection tubes.

H-21 DUAL CHANNEL OSCILLOSCOPE. Sensitivity better than 0.036 V rms per inch.

CA-1 DC PRE-AMPLIFIER. For strain gage applications. Gain 150 times.

Men in work similar to yours have successfully applied our Cathode Ray tubes, oscilloscopes and scope amplifiers in testing production and research capacities where such equipment was never practical before.

In other instances our products have replaced less satisfactory equipment, doing the job with greater speed and accuracy than was possible previously.

You can benefit from our development program which is leading industry to new products new refinements in existing products, new research methods and techniques.

Drop us a line. We'll be glad to send you full information or talk over your specific needs. If you are planning to attend the IRE Convention in New York, drop in to see us at booths #274 and 275.

All scopes illustrated employ five inch flat-face tubes.

*electronic tube corporation*  
PHILADELPHIA 12, PENNSYLVANIA



was necessary to find some solution since, within a few hours after adjustment, the photographs taken would invariably cover slightly more or slightly less than the single frame required, resulting in undesirable banding as illustrated in Fig. 1. To overcome this defect in the photograph it is necessary that the on period of the picture, initiated at any time during a given frame, extend to exactly the equivalent point in the succeeding frame.

*Circuit Details*

The circuit, which was evolved from various designs and selected as the simplest satisfactory solution, comprises a single-shot multivibrator whose pulse width is a function of grid bias, and an analog counter circuit whose output voltage is proportional to the input frequency, in this case the television frame frequency. Figure 2 shows a block diagram of the system.

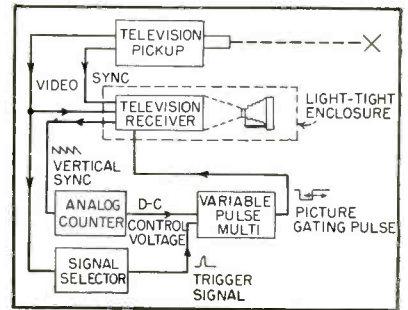

FIG. 2—System for gating one frame of a television receiver whose vertical scanning frequency is not constant

The television pickup feeds both video and sync signals to the receiver. The signal selector is used to derive a trigger pip from the event which is fed to the variable-pulse multivibrator where it initiates the picture gating pulse. The analog counter is the control circuit for the multivibrator, and makes the multivibrator pulse vary in width to compensate for the drift of the frame frequency of the television system.

Figure 3 shows the complete schematic of the multivibrator and counter. To the counter circuit is fed a portion of the output of the vertical oscillator. The counter produces a voltage proportional to the frequency of the vertical oscillator. A negative counter was used in this



# MYCALEX 410

## COMMUTATORS IN CONTINUOUS OPERATION For 600 HOURS

Sets astonishing high operational record for telemetering commutator used on aeronautical research projects . . . MYCALEX 410 only insulation to fill exacting requirements.

To December 2, 1949 more than 600 hours of maintenance free, high speed, clean signal telemetering commutator performance has been logged on MYCALEX 410 Units . . . Experience indicated four hours was optimistic . . . specifications hoped for ten hours . . . and the challenging problem was solved by MYCALEX 410 molded insulation.

### SPECIFICATIONS TO BE MET IN PRODUCING MYCALEX 410 MOLDED INSULATION COMMUTATORS FOR TELEMETERING

O.D. 2.996" + .000 - .002 • Location of 3 slip rings and the 3 contact arrays from the center has a total tolerance of  $\pm .001$ . • Contact spacing 6° apart  $\pm 1$  minute. • Parting line thicknesses on insulation body are + .002 - .000. • Concentricity between ball bearing bushing and O.D. .0015. • Assembly height from face of slip rings and contacts to Mycalex 410 has tolerance of + .002 - .000. • Every contact must be tested from its neighbor contact for infinity on a 500 volt megger • Plate ambient - 20° C. to + 100° C. • Plate to operate at 95% humidity must not warp, crack, change in dielectric constant or resistivity • Contacts to resist high temperatures and must not loosen when repeatedly heated by soldering • Soldering required to withstand and operate under a 50 G acceleration.

**SPECIFY MYCALEX 410 for Low Dielectric loss. . . High Dielectric strength. . . High Arc Resistance. . . Stability over wide Humidity and Temperature Changes. . . Resistance to High Temperatures. . . Mechanical Precision. . . Mechanical Strength. . . Metal Inserts Molded in Place. . . Minimum Service Expense. . . Cooperation of MYCALEX Engineering Staff.**

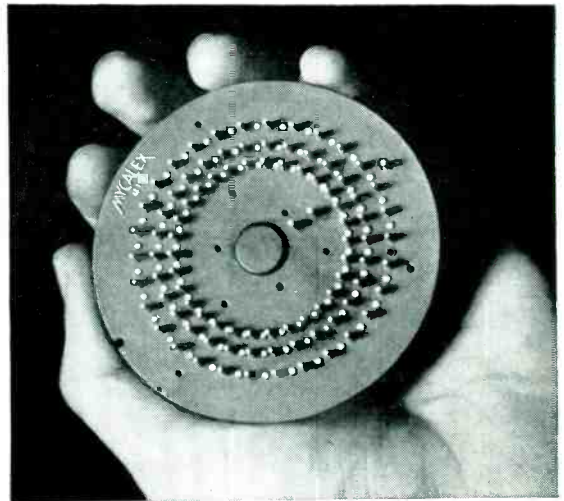

Illustrated are top and bottom views of the MYCALEX 410 molded insulation commutators manufactured to the specifications of Raymond Rosen Engineering Products, Inc., for Air Material Command, Navy telemetering projects, and other government agencies. These commutators are precision injection molded with 108 or 180 contacts and 3 slip rings all of coin silver.

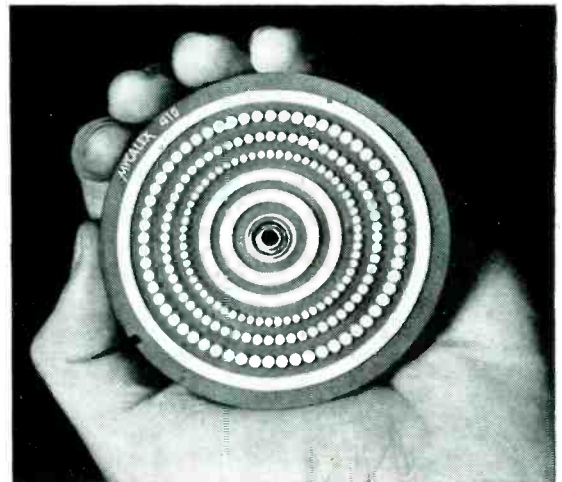

MYCALEX 410 molded insulation is designed to meet the most exacting requirements of all types of high frequency circuits. Difficult, involved and less complicated insulation problems are being solved by MYCALEX 410 molded insulation . . . the exclusive formulation of MYCALEX CORP. OF AMERICA . . . our engineering staff is at your service.



## MYCALEX CORP. OF AMERICA

"Owners of 'MYCALEX' Patents"

Plant and General Offices, CLIFTON, N. J.

Executive Offices, 30 ROCKEFELLER PLAZA, NEW YORK 20, N. Y.

Visit the Mycalex exhibit at the 1950 IRE SHOW, Booth 82.

# New di-acro POWERSHEAR

OFFERS

CONTINUOUS ACTION

Plus VARIABLE SPEED

from 30 to 200  
strokes per minute

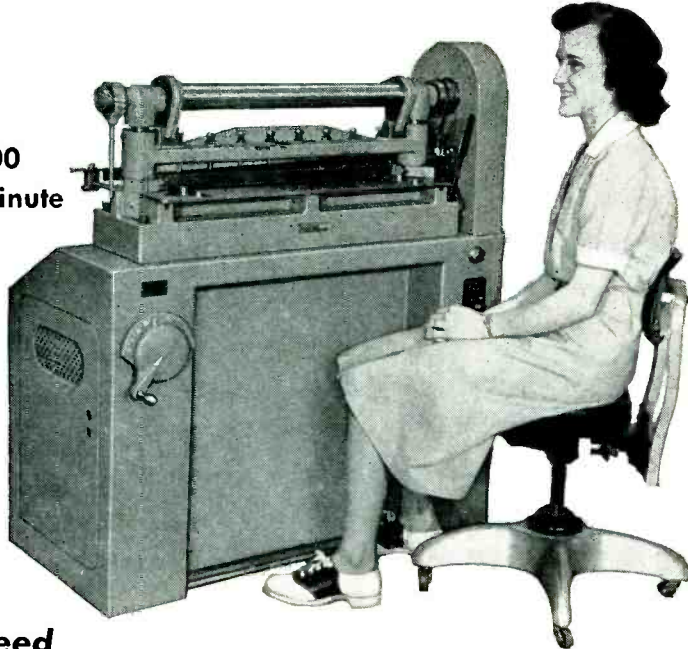

for high speed

## "DIE-LESS DUPLICATING"

DOES PRECISION  
WORK ON ALL  
SHEARABLE  
MATERIALS:

MICA  
PLASTICS  
BIMETALS  
FIBRE  
LEATHER  
SILVER  
MAGNESIUM  
COPPER  
ALUMINUM  
SILICON STEEL  
CHROME MOLY  
LEADED BRASS  
STAINLESS STEEL  
and many  
other materials

When you see the remarkable speed and accuracy of the new Di-Acro POWERSHEAR in the production of small parts and pieces, you will join the mounting chorus of approval this versatile unit is receiving. Consider these points:

- 1. CONTINUOUS SHEARING ACTION**—no clutch to engage—a marvelous time-saver! Feeding speed determines shearing speed.
- 2. VARIABLE SPEED**—cutting cycle quickly set at speed of maximum efficiency for each shearing operation.
- 3. EASE OF OPERATION**—with correct cutting speed on each job, fatigue is reduced, accuracy increases, production soars.
- 4. SINGLE STROKE SHEARING**—non-repeating safety clutch allows "single stroke" operation for jobs that do not lend themselves to continuous shearing.

Regardless of larger capacity shears which may now be in use, any plant doing high speed precision shearing on smaller parts cannot afford to be without the DI-ACRO POWERSHEAR. This precision machine is available in 12" and 24" shearing widths with capacity for 16 gauge sheet steel. Also offered in standard model with single speed.

Send for 40 page "DIE-LESS DUPLICATING" catalog giving full details on Di-Acro Powershears, also other Di-Acro Precision Machines as illustrated below and offered in a wide range of sizes.

Pronounced "DIE-ACKRO"



O'NEIL-IRWIN MFG. CO. 321 EIGHTH AVE., LAKE CITY, MINN.

Manufacturers of DI-ACRO

PUNCHES

BENDERS

SHEARS

BRAKES

NOTCHERS

ROD PARTERS

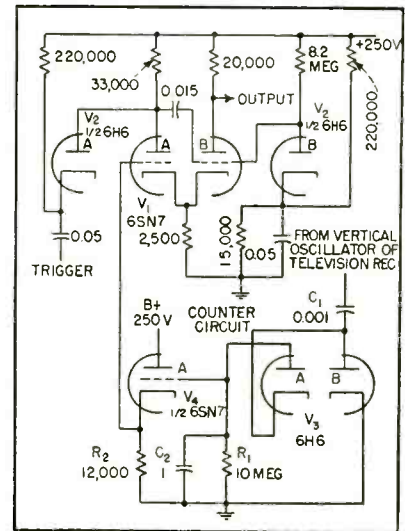

FIG. 3—Vertical scanning frequency variation from 39 to 46 cps will give a voltage change of -2.5 volts for controlling gating time

case so that an increase in frequency causes a drop in average plate current of  $V_1$ . Thus the output voltage drops with an increase in frequency. For the type of controllable multivibrator selected, this effect was necessary so that the pulse width would decrease with an increase in frequency. For cases where an increase in frequency must give a wider output pulse, a positive counter circuit may be used.

### Counter Design

In the design of the counter circuit, whether positive or negative, the time constant  $R_1 C_2 \gg 1/f$  where  $f$  is the frequency to be measured, and  $C_2 \gg C_1$  with  $C_1$  being kept very small.

The d-c output voltage of the counter is equal to:

$$\frac{E_a f R_1 C_1}{1 + f R_1 C_1} \left( 1 - \frac{1}{2 f R_1 C_2} \right)$$

where  $E_a$  is the peak applied voltage and  $f$  the frequency, and  $R_1, C_1$  and  $C_2$  are as shown in the schematic of Fig. 3.

For the values shown in Fig. 3 a variation from 39 cycles per second to 46 cps will give a voltage change of 2.5 volts.

The multivibrator was so designed that for a change of -2.5 volts on the control grid the output pulse of the multivibrator decreases from 25,380 microseconds to 21,300 microseconds. This compares fairly well with the requirement of 25,640 microseconds for 39 cps, and 21,740

# It PAYS to work with an MB Vibration Exciter



You can save time, eliminate tedious calculations, and improve your product with the help of an MB electromagnetic shaker. Note how these benefits add up in the following typical applications—just three of many uses for this quality-control and research “tool.”



**MODEL 5A VIBRATION EXCITER** Delivers 5 pounds force from 20 to 1,000 c.p.s., usable to 20,000 c.p.s.

**INDEFATIGABLE FATIGUE TESTER**—Here is the endurance tester to show up *quickly* those faults which often result in failures under dynamic stresses. Why risk trouble reports? You can shake such parts as axles, brackets, complete assemblies, housings, castings and make improvements *before* full scale production—*before* the remedy becomes costly.

**NOISE LOCATER**—Operating silently, the MB Exciter reveals sources of noise in equipment of all types. Because you can “scan” a product’s operating frequency range, you can put your finger right on resonant

trouble areas. Less noise means more customer satisfaction.

**SHAKE OUT THE “BUGS”**—Electrical and sensitive components can be checked for ability to withstand severe vibratory service conditions. Reproduce the effect of years of vibration on your product within *hours!*

You’ll find MB Vibration Exciters at work for many leading companies recognized for the quality of their engineering. Would you like to know how to apply one to your *own* problems? An MB engineer will be glad to show you—without obligation.

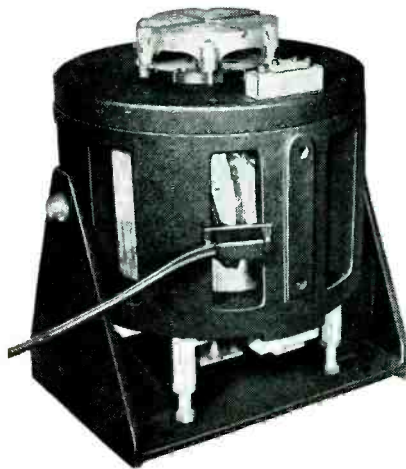

**MODEL 53 VIBRATION EXCITER** Delivers controlled force up to 200 pounds, in frequency range of 3 to 500 c.p.s.

Testing of small turbine blades (encircled) mounted on an MB Model C-1 Exciter which delivers 25 pounds force in range of 4 to 500 c.p.s. (and higher). Using stroboscopic lighting, resonances and deflections are studied visually—and any need for corrections determined quickly. A stronger, stiffer blade is sure to result.

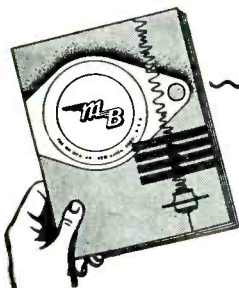
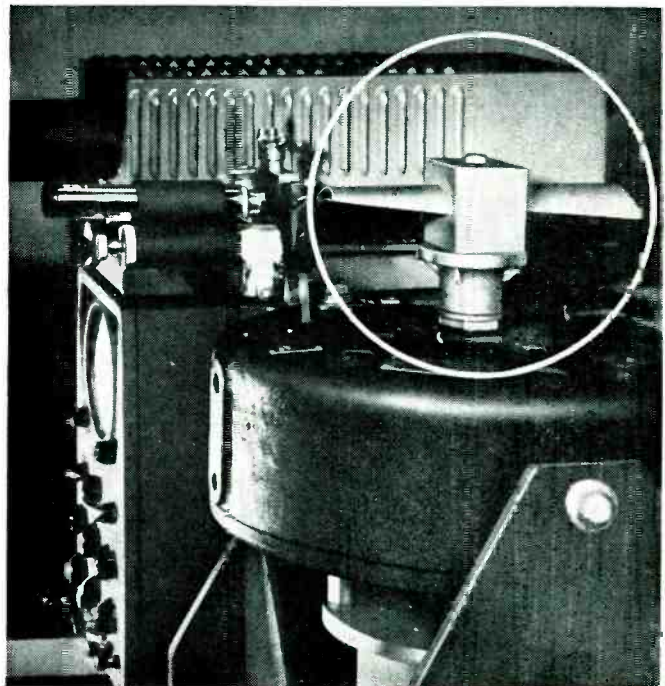

## DO YOU HAVE OUR NEW BULLETIN ON FILE?

It contains helpful design data on vibration control, plus more information on the line of MB Exciters. Write for your copy today. Ask for bulletin No. 410-G5.

**THE  
MB  
MANUFACTURING COMPANY, Inc.**  
1060 State St., New Haven 11, Conn.

# What's New in TELEVISION COILS?



DEPEND ON LEWIS SPRING ENGINEERS to keep abreast of the latest developments in television coil design and application. New and improved types including double coils with four leads, units with coils cemented to ceramic resistors and other choke, contact, band-tuning and channel coils such as shown above are being mass-produced by Lewis for leading TV manufacturers.

Take advantage of the up-to-the-minute know-how, experience and facilities of Lewis to help design and produce television coils to your specifications. You'll appreciate the efficiency, prompt delivery and economy in which Lewis will satisfy your demands.

There is a Lewis Engineer near you who will welcome the opportunity to check your requirements and quote delivery and price. Call or write us today without obligation.

LEWIS SPRING & MANUFACTURING COMPANY  
2656 West North Avenue, Chicago 47, Illinois

**Lewis** PRECISION  
**SPRINGS**  
THE FINEST LIGHT SPRINGS AND WIREFORMS OF EVERY TYPE AND MATERIAL

microseconds for 46 cps.

Since the counter is sensitive to amplitude as well as frequency, it is important that the input to the counter be limited to constant amplitude signals. Where amplitude variation is anticipated, a limiter stage should be placed ahead of the counter.

## Wide-Range Voltage Regulator

BY CHARLES E. GREEN

U. S. Navy Electronics Laboratory  
San Diego, California

A REGULATED POWER SUPPLY has been designed with a continuously variable voltage output over the range from 3.5 to 300 volts at full rated current of 300 ma, up to 500 volts with limited current.

A standard full-wave rectifier using two 5V4's with capacitor input supplies 480 volts to the four 807's in parallel that serve as the control tube. These four tubes limit the voltage obtained in the output. A single 6AC7 operated below ground serves as a d-c amplifier that is capable of swinging the grid of the control tube over the wide range required to maintain constant output voltage.

### Control Tube Requirements

The amount of energy the control tube must dissipate is important in

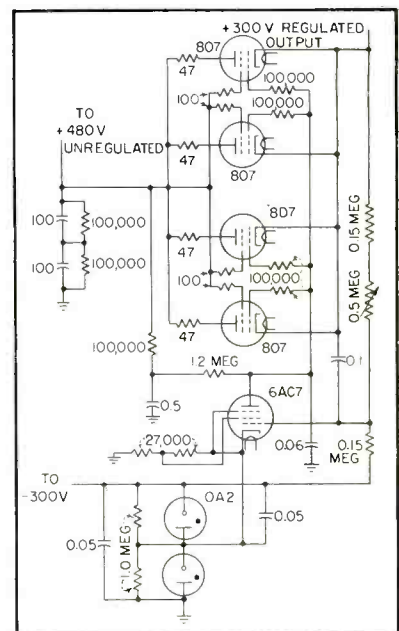

FIG. 1—Schematic diagram of voltage regulator capable of providing voltages from 3.5 to as high as 500 volts. Unregulated voltage is supplied by standard circuits, not shown

# CHATHAM

## ELECTRONIC TUBES and EQUIPMENT

Chatham also designs, develops and manufactures Electronic Equipment to exact customer specifications. Inquiries regarding this service are invited.

LOOK FOR US AT THE IRE SHOW  
BOOTHS 120 and 121

### CHATHAM 2D21 THYRATRON



A Xenon filled shield grid thyatron for grid controlled rectifier service. Permits use of high resistance in the grid circuit. Heater 6.3 volts .6 amp. . . . Inverse peak plate voltage 1300 volts, 100 ma. average plate current.

### CHATHAM 5594 THYRATRON



Xenon filled thyatron. Operates through ambient temperatures from  $-55^{\circ}\text{C}$  to  $+90^{\circ}\text{C}$  without auxiliary equipment to maintain bulb temperature. Fil. 2.5 volts, 5.0 amperes. . . . Peak inverse 5000 volts; anode current 0.5 amps. average, 2.0 amps. peak.

### CHATHAM 884 THYRATRON



An Argon filled thyatron for use as a sweep circuit oscillator in cathode ray tube circuits. Stable oscillator. Heater 6.3 volts, 0.6 amp. . . . Peak forward plate voltage 300 volts, 75 ma. average plate current.

### CHATHAM 1B46 REGULATOR



A cold cathode glow discharge tube designed for voltage stability. D.C. operating voltage 82 volts —operating current range 1 to 2 mA dc.

### CHATHAM 4B32 RECTIFIER



A rugged half wave Xenon filled rectifier. Operates in any position throughout an ambient temperature range of  $-75^{\circ}\text{C}$  to  $+90^{\circ}\text{C}$  Fil. 5 volts, 7.5 amp. . . . Inverse peak anode voltage 10,000 volts, 1.25 amp. average anode current.

### CHATHAM 866-A RECTIFIER



A rugged half wave Mercury Vapor rectifier to withstand high peak inverse voltages. Heavy duty filament. Fil. 2.5 volts, 5.0 amp. . . . Peak inverse anode voltage 10,000 volts, .25 amp. average anode current.

### CHATHAM 1B3GT RECTIFIER



High voltage vacuum rectifier for Television and similar applications. Low filament power permits efficient operation from R.F. supply. Filament 1.25 volts, 200 ma. . . . Inverse peak plate voltage 30,000 volts, 2 ma. average plate current, 17 ma. maximum plate current.

### CHATHAM 3B28 RECTIFIER



This rugged half wave Xenon filled rectifier will operate in any position and throughout an ambient temperature range of  $-75^{\circ}\text{C}$  to  $+90^{\circ}\text{C}$  Fil. 2.5 volts, 5.0 amp. . . . Inverse peak anode voltage 10,000 volts, .25 amp. average anode current.

### CHATHAM 1Z2 RECTIFIER



A small bulb high voltage vacuum rectifier. Low cathode heating power and low dielectric losses make tube suitable for radio frequency supply circuits. Fil. 1.25 volts, .265 amp. . . . Inverse peak plate voltage 15,000 volts, 2 ma. average plate current, 10 ma. peak plate current.

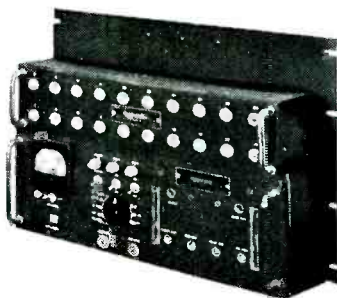

• Pulse life test equipment built by CHATHAM checks receiver type tubes under pulse operating conditions.

## CUSTOM BUILT ELECTRONIC EQUIPMENT

CHATHAM specializes in the development, design, and construction of custom-built electronic equipment to exactly meet customers' requirements. Our capable staff of engineers will furnish prompt estimates or, if desired, will call to discuss your problem personally. Call or write today for complete information.

Write today for the informative CHATHAM catalog. For free copy address requests on company letterhead — no obligation.

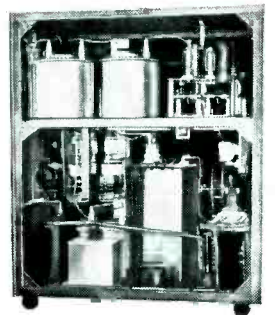

• 5 Megawatts radar modulator built by CHATHAM to rigid government standards.



# CHATHAM ELECTRONICS • INC

475 WASHINGTON STREET, NEWARK 2, NEW JERSEY

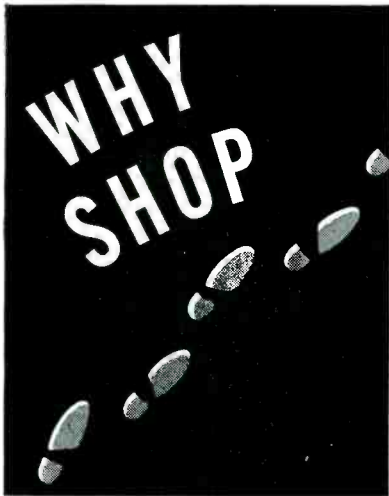

FOR  
VOLTAGE  
REGULATORS

## THE SUPERIOR ELECTRIC COMPANY HAS A STABILINE FOR YOUR NEEDS

If you're looking for dependable automatic voltage regulation, investigate STABILINE first. You'll save time and money — you'll get longer service through better design and construction — you'll get performance and operating characteristics as advertised.

### AVAILABLE IN 2 TYPES

STABILINE Type IE is instantaneous and completely electronic in action. Keeps output voltage to within  $\pm 0.1\%$  of preset value regardless of wide line variations; to within  $\pm 0.15\%$  regardless of load current or power factor changes. Waveform distortion *never* exceeds 3%. STABILINE Type IE is available in cabinet or rack mounting models — in numerous ratings.



TYPE IE  
PORTABLE

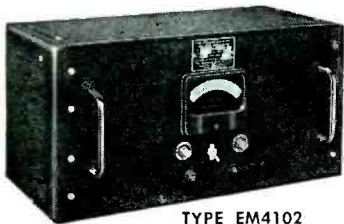

TYPE EM4102

STABILINE Type EM (Electromechanical) features zero waveform distortion, insensitivity to magnitude and power factor of load, no effect on system power factor; no critical adjustments. It is available in output ratings up to 100 KVA — for single and for 3 phase operation.

STABILINE Types IE and EM perform "as advertised". Each and every STABILINE Automatic Voltage Regulator is inspected and tested to the most rigid specifications. If — after you purchase a model of either type — you would like a copy of the inspection and test report, write us and a full report will be sent promptly.

WRITE US TODAY FOR FURTHER DETAILS ON THE STABILINES

403 Meadow St.,  
BRISTOL,  
CONN.

THE SUPERIOR ELECTRIC CO.  
BRISTOL, CONNECTICUT



POWERSTAT VARIABLE TRANSFORMERS • VOLTBOX A-C POWER SUPPLIES • STABILINE VOLTAGE REGULATORS

obtaining low-voltage, high-current operation. It is calculated by using the highest voltage drop and the largest current through the tube. In this particular supply the largest voltage drop used is about 470 volts and the greatest current is 0.3 amp. The four 807 tubes must therefore dissipate approximately 140 watts.

Since the highest output voltage occurs when the tube voltage drop is lowest, the internal resistance must be kept a minimum. The double requirements of high heat dissipation and low internal resistance are most economically met by using tubes in parallel rather than by using one large tube having sufficiently low internal resistance. The 807 tube was chosen because it will dissipate 35 watts without overheating. Four 807's in parallel will handle the required 140 watts and will have only one-fourth the resistance of a single tube.

To obtain cut-off on the control tube, the regulating tube acting as a d-c amplifier is operated somewhat below ground. A negative potential for the d-c amplifier is obtained from a power transformer and half-wave rectifier and regulated with the VR tubes. The operating voltages for the cathode and screen of the 6AC7 are taken from this bias supply, and plate voltage is obtained from the unregulated main positive supply. The control grid is made variable from  $-3$  to  $-5$  volts with respect to its cathode by operating on a bleeder from the regulated output voltage to the negative supply voltage. The grid potential of the 6AC7 decreases with increasing load on the power supply, thereby cutting off the plate current and raising the plate potential. Since the plate of the 6AC7 and the grids of the 807's are connected together, the 807 grids become more positive and build up the output voltage again.

### High Voltage Limit

The maximum output voltage of this type of supply is the same as the safe maximum voltage that may be used on the control tubes, since at low output voltage nearly all of the potential drop in the system is across these tubes. If it is desired to obtain a higher output voltage than the 480-volt example all that

**USERS SAY**  
**G.E.'S 9574 ALL-PURPOSE\***  
**INSULATING VARNISH**

**"is tops!"**



J. L. Hughes

How do users like General Electric's new all-purpose insulating varnish G-E 9574?

Here's a statement from J. L. Hughes, owner of the J. L. Hughes Electric Company, Columbus, Ohio.

*"We have found from test and practical experience that General Electric general-purpose varnish 9574 is tops for our work."*

Mr. Hughes knows what he is talking about. He has been in the business of motor repair and rewinding in Columbus for thirty-three years.

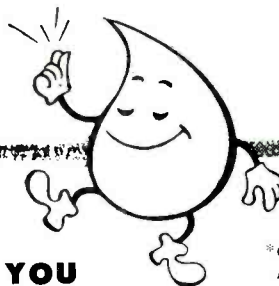

**YES, G-E 9574 OFFERS YOU**

**One** varnish you can depend on for ALL\* jobs.

**A Combination** of electrical, chemical and mechanical properties formerly found only in special-purpose varnishes.

**Easier Handling:** Low baking temperature; deep penetration; simple thinning with petroleum spirits.

*\*G-E 9574 gives excellent results on all types of coils except extra-high-speed armatures. It is one of G. E.'s complete line of electrical insulating materials, including adhesives, wedges, cements, compounds, cords and twines, sleeving, wire enamels, mica, papers and fibers, permafils, tapes, tubing, varnished cloths, and varnishes.*

**SEND FOR BULLETIN!** If you haven't yet tried G-E 9574, get in touch with your local G-E Distributor, or write for our new bulletin to Section K1, Chemical Department, General Electric Company, Pittsfield, Massachusetts.

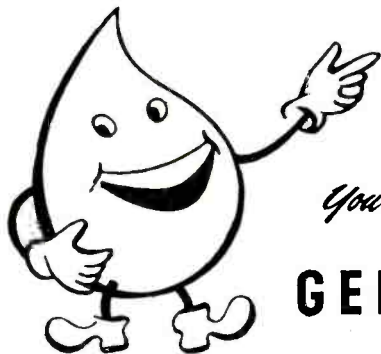

*You can put your confidence in*

**GENERAL  ELECTRIC**

CD50-K1

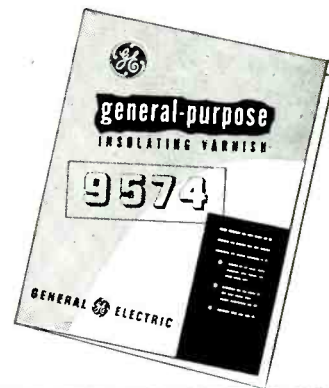

# MODERN ELECTRONIC DESIGN MEANS PLUG-IN UNIT CONSTRUCTION

With basic elements as units—that plug-in, slide-in, lock-in, break away easily—so that electronic equipment is instantly accessible—ready for rapid checks, servicing, and unit replacement.

More and more engineers are finding that plug-in unit construction is the type of design that makes many of the new complex electronic projects feasible to operate and maintain. It's also recognized that plug-in, unit principles make present electronic equipment much more practical for wider general use.

Up to now there has been no one place where components specifically designed for plug-in, unit construction were available. To get this type of construction—it has been necessary for engineers to design and have parts custom made or improvise with standard components in make shift arrangements.

Here at Alden's we are designing and manufacturing components for plug-in unit construction. We are setting up to work with manufacturers on as many of these problems as possible. Very frankly, much of our work is still in the pilot run stage—but, in every instance—proven in use. If you don't see the answer to your problems here—let us work it out with you.

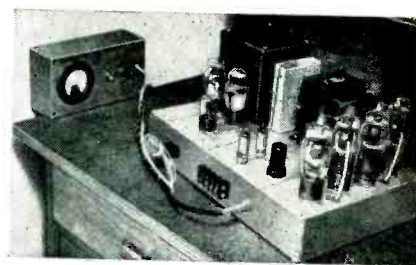
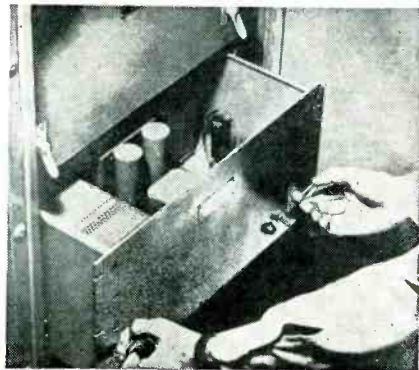

FIG. 2—Voltage regulator chassis and remote control panel (left) showing four 807 control tubes, 6AC7 regulator tube and two miniature OA2 regulators for the negative 6AC7 supply

is required is an adequate supply transformer. If a higher current is desired, another tube may be inserted in parallel, providing the transformer and choke have the required ratings.

Under pulse conditions it is advantageous to know the internal impedance of the power supply and to determine variation in the supply voltage. This supply has a measured internal impedance of 8 ohms for loads requiring less than 300 volts at 300 ma, and reaches a maximum of 12 ohms for higher voltages and less current. This low impedance results from the use of the high-gain d-c amplifier stage.

## Remote Control

To facilitate the use of the instrument, the voltage control and switches can be placed in a shielded container remote from the unit. The B+ and grid wires of the d-c amplifier that run to the control panel must be shielded to prevent pickup and amplification of signals.

Few parts are required in addition to those employed in standard regulated power supplies. Many conventional regulated power supplies can be altered without much difficulty to extend their lower limit in this way. The author wishes to acknowledge the assistance of G. A. Coates of this laboratory, who constructed the first model and whose experimentation developed optimum operating conditions for this unit.

## X-Ray Microscope

X-RAY IMAGES have been magnified by 100 diameters (10 diameters by electron optics, and 10 by photographic means) in a microscope announced recently by the General Electric Company. The resulting enlargements, produced under lab-

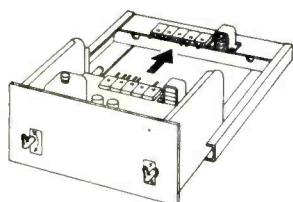

**Back connected chassis**—become instantly accessible. Half twist of handles brings chassis into place or ejects—no matter how heavy. Built for racks or as separate units—miniature and standard sizes.

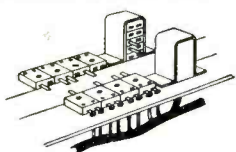

**Rugged color coded back connectors**—make and break circuits—provide rapid circuit checks. Wide mating tolerances compensate for any chassis misalignment. Miniature and heavy duty sizes.



**Top operated clamps** for tubes and plug-in units. Take minimum of space. Can be operated in cramped locations. Free floating—orients unit to socket without straining or bending pins.

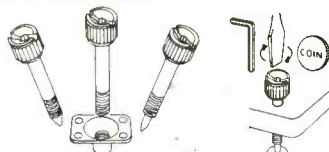

**Alden Cap Captive Convenience Screws**—Hold miniature chassis, heavy plug-in cans or detachable mechanical units securely. Assemble easily in production by power tools—yet any tool or coin services in field.

**At last—a base specifically designed for plug-in units.**  
No more broken bosses, bent pins, "shorted" circuits.

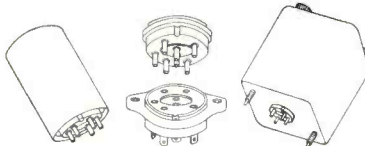

More and more engineers have been unitizing the basic elements of their circuits into compact, easily replaceable plug-in units. Since the conventional octal and tube socket bases have been the only component readily available, they have been constantly plagued by the broken bosses, bent pins, and "shorted" circuits caused by these bases.

This suggested an entirely new approach was necessary, so we went to work with some of these engineers. Out of this work the Alden-Noninterchangeable plug-in base was developed.

Pins have been made strong and stubby—for long, rugged use. The boss is eliminated entirely. Slight lead of center pins and locating rings with marker in the socket allow quick lining up of plug-in units. Further, this base is supplied with 2 to 11 contacts—in variable pin patterns—so that even where the same number of contacts are used, the pin layout may be varied so only the correct unit will mount in its proper socket. Pin patterns can even be selected to isolate critical voltages or signals.

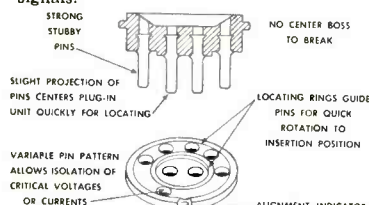

Write today for literature and samples. Let Alden work with you on your components for plug-in, unit construction.

Write for new booklet on "Components for Plug-in Unit Construction"

Visit us at Booth R at the I.R.E. Show, March 6-9

**ALDEN PRODUCTS CO.** 117 NORTH MAIN ST. BROCKTON 64, MASS.



# Label it permanently and attractively...

## with **MONEL** name plates

**Y**OUR name plate may be essential to your product, or merely decorative... but it is never unimportant.

If it is to be worth the cost of affixing it, your name plate should stay legible and attractive for the useful life of your product. For it is, after all, your company's *signature*... as important as your letterhead or your trade mark design.

That is why so many leading concerns are making their name plates of MONEL\*. This gleaming, silvery INCO Nickel alloy is rustproof, corrosion resistant, with strength and hardness exceeding that of structural steel.

MONEL takes a mirror polish, and because of its superior hardness, has excellent resistance to abrasion. MONEL's high resistance to oxidation and corrosion recommends it particularly where heat, moisture, and corrosive atmospheres are anticipated.

In addition to its other desirable properties, MONEL is easy to etch with the proper solution... gives fine definition, deep and sharp.

For further information about MONEL name plates, including sources of supply, write directly to INCO. Our Technical Service Department will gladly furnish full instructions for etching INCO Nickel alloys.

*Free*

**SAMPLE MONEL NAME PLATE**

To help you visualize your own name plate in MONEL, a sample will be sent free upon request.

**THE INTERNATIONAL NICKEL COMPANY, INC.**  
67 Wall Street, New York 5, N. Y.

\*Reg. U. S. Pat. Off.

# MONEL...for Minimum Maintenance

ELECTRONICS — March, 1950



EMBLEM OF SERVICE  
**INCO**  
TRADE MARK

# A Complete Line of PRODUCTION TEST EQUIPMENT for TV Manufacturers

Tel-Instrument has designed and provided the production test equipment for many of the major TV manufacturers. A complete line of instruments designed to be unusually critical in the testing of TV receivers is available. They are the result of the wide practical experience of Tel-Instrument engineers plus a complete understanding of the production problems of TV manufacturing.

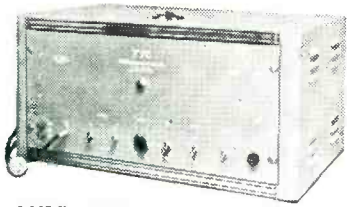

**TYPE 2120**  
R.F. PICTURE SIGNAL GENERATOR

Provides picture and sound carrier. Modulated by standard R.M.A. composite picture signal. Sound carrier stability suitable for testing Inter Carrier type receivers. Internal 400 cycle FM and External audio with 75 microsecond pre-emphasis. Output max. 0.1v p-p across 75 ohm line. Available channels 2-13.



**TYPE 1200**  
12 CHANNEL  
R.F. SWEEP GENERATOR

Intended for precise adjustment of R.F. head oscillator coils and R.F. band pass circuits. Pulse type markers at picture and sound carrier frequencies extend to zero signal reference base line. Accuracy of markers 0.02% of carrier frequency. 12 to 15 MC. sweep on all channels. Max. 1.V peak output across a 75 ohm line. Provisions for balanced input receivers. Instant selection by push button.



**TYPE 1900**  
CRYSTAL CONTROLLED  
MULTI-FREQUENCY GENERATOR

A 10 frequency, 400 cps. modulated crystal controlled oscillator, ideal for production line adjustment of stagger tuned I.F. amplifiers. Available with crystals ranging from 4.5 to 40 M.C. Output frequency accurate to 0.02%. Immediate push button selection of frequency. Output attenuator range .5V to 500 microvolts. Self contained regulated power supply.



**TYPE 1500**  
I.F. WOBBLATOR

A two band sweeping generator covering the range of 4.5 to 50 M.C. Capable of a band width of approximately  $\pm 25\%$  on either band. Five pulse type crystal generated markers to specified frequencies available for each band. Accuracy of markers .05%. Zero signal reference base line, with markers extending to base line. 1.V. output max. intc 75 ohms. A saw sweep available for "X" axis of scope.

Write for Detailed Engineering Data Sheets

## Tel-Instrument Co. Inc.

52 PATERSON AVENUE • EAST RUTHERFORD, N. J.



Cylinder at far right houses x-ray source for x-ray microscope capable of magnifications up to 100 diameters

oratory conditions, are clear and sharp, and no serious loss of detail has been experienced.

The device uses the electron microscope principle, but the samples under study need not be in a high vacuum, as required by the regular electron microscope. This presents the possibility of studying living materials at much higher magnifications than ever before.

Objects studied to date have been fine mesh screens. Purpose of the studies have been to test the instrument's ability to reveal small details, and the results have been excellent.

### Operating Principle

The microscope operates on the principle that x-rays can be reflected from polished surfaces, as can visible light, provided they strike the surfaces at an angle less than one-half degree, after passing through the sample. The mirrors, acting like a convex lens, bend the rays in such a manner as to form a magnified x-ray image of the sample on a photographic plate.

The mirrors are platinum-plated slabs of fused quartz which are as nearly flat as surfaces can be made. They are curved by mechanical pressure which can be adjusted. This method makes it possible to change the curvature of the mirrors to effect focusing.

In passing through the entire system, the x-ray beam travels about a foot from tube to photographic plate. The setup shown in

# Floating Rotor Prevents Motor Lag or Slippage

Specially designed light-weight rotor virtually floats in a rotating magnetic field. Rotor shaft rotates on a film of oil . . . no metal to metal contact with its bearing. These features, together with capillary oiling system, account for the fact that *All Telechron Timing Motors Are Instantly, Constantly Synchronous.*

That is why so many designers concerned with split-second timing or control of light-weight moving parts specify Telechron motors.

If you have such a problem, why not turn it over to a Telechron Application Engineer? Drawing on the experience that makes all electric timing possible (virtually all frequency-controlling master clocks in power stations are made by Telechron), he can probably show you how a standard Telechron motor can do your job, too. Consult him early in your planning for big savings in time and money. Use handy coupon below for complete data. TELECHRON INC. A General Electric Affiliate.

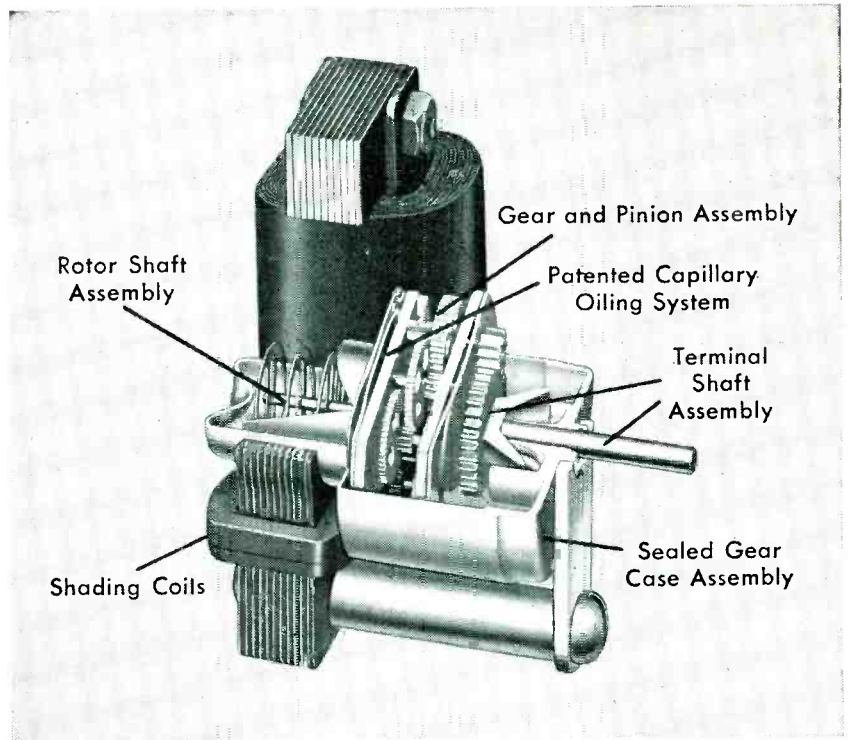

Telechron Type B Synchronous Motor. For medium duty purposes such as switches, recording-controlling mechanisms and other control equipment. Other models with lower or higher torque for light or heavy duty applications.

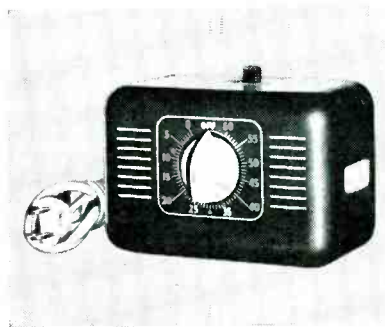

Typical of Telechron Type H3 light duty motor applications is this 60-minute timer, the purpose of which is to operate a switch or signal at the end of a pre-selected period.



Practically all time-stamps and recorders employ Telechron Type B motors to operate their timing mechanisms. Obviously a motor that is instantly, constantly synchronous is needed for such applications.

# Telechron<sup>®</sup>

ALL TELECHRON TIMING MOTORS ARE

INSTANTLY...CONSTANTLY SYNCHRONOUS

**TELECHRON INC.**  
40 Union Street  
Ashland, Massachusetts

Please send me information on sizes and types of Telechron Synchronous Motors. My possible application is:

- |                                     |                          |  |                          |
|-------------------------------------|--------------------------|--|--------------------------|
| Instruments                         | <input type="checkbox"/> | Communications Equipment                         | <input type="checkbox"/> |
| Timers                              | <input type="checkbox"/> | Other (please fill in)                           | <input type="checkbox"/> |
| Electric Appliances                 | <input type="checkbox"/> | .....  |                          |
| Cost Recorders                      | <input type="checkbox"/> | .....  |                          |
| Advertising, Display Items          | <input type="checkbox"/> | .....  |                          |
| Juke Boxes                          | <input type="checkbox"/> | .....  |                          |
| Air Conditioning & Heating Controls | <input type="checkbox"/> | <input type="checkbox"/> Please send new Catalog |                          |

NAME.....  
COMPANY.....  
ADDRESS.....  
CITY..... ZONE.....  
STATE.....



# Protected Performance!

with



## MOUNTINGS

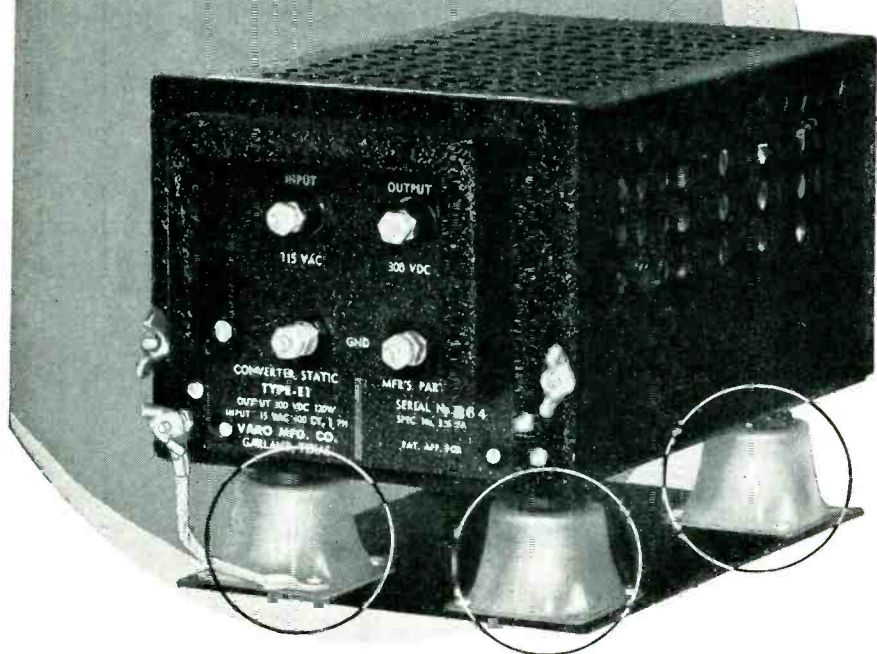

Varo Static Converters change alternating to direct current for aircraft use with *less than 1% voltage ripple*. LORD Mountings protect such precision against shock and vibration, thus insuring the user long and dependable service.

More and more manufacturers of sensitive equipment appreciate the customer satisfaction which LORD Vibration-Control Mountings add to their products. Builders of heavier mechanical equipment use them to provide smoother, quieter operation . . . greater sales appeal. If you are interested in product improvement, investigate LORD Mountings now.

# LORD Vibration Control

LORD MANUFACTURING COMPANY • ERIE, PA.

Canadian Representative: Railway & Power Engineering Corp. Ltd.

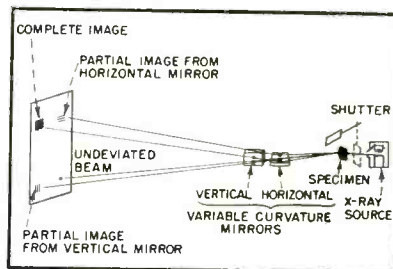

Curvature of x-ray microscope reflecting surfaces can be varied by a mechanical adjustment for focusing

the photograph is purely an experimental model with sliding mechanisms for adjustment of the distances between components of the optical system. The instrument was described by Charlys M. Lucht, shown in the photograph, at the recent Philadelphia meeting of the American Society for X-ray and Electron Diffraction.

### Stanford Version

Since the General Electric announcement, Stanford University published a similar report describing the work done recently by the inventor of the x-ray microscope, Paul H. Kirkpatrick. The Stanford instrument operates on the same principle as the GE version shown in the accompanying diagram, that of bouncing electrons off optically perfect mirrored surfaces.

The Stanford laboratory model is capable of magnifications of between 50 and 100 diameters, without the aid of photographic enlargement, according to a paper delivered before the American Physical Society at Stanford.

### Thyratron Thermoregulator

A SIMPLE but effective circuit for on-off temperature control has been described by D. F. Swinehart of the University of Oregon in the December, 1949, issue of *Analytical Chemistry*. The circuit is entirely a-c operated and is shown in the accompanying diagram. Current through the thermoregulator is limited to 3 or 4 microamperes, which is low enough to prevent appreciable corrosion of the mercury contacts.

The filament voltage supplies the grid signal. The connection of the

# TWO-WAY RADIO COMMUNICATION FOR MOTORCYCLES

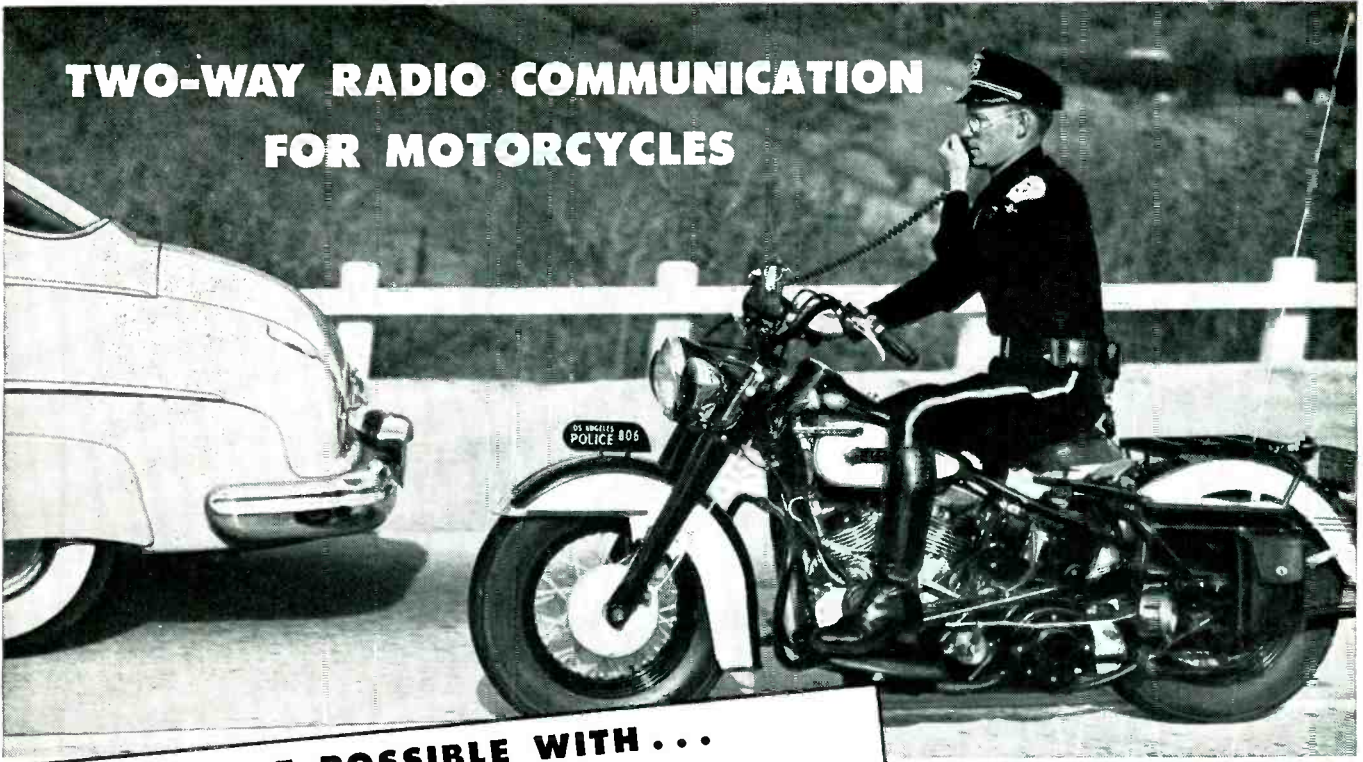

**MADE POSSIBLE WITH . . .**

**Equipment by**



**Tubes by**



**Link Radio and VETRIC** | **SYLVANIA-ELECTRIC**

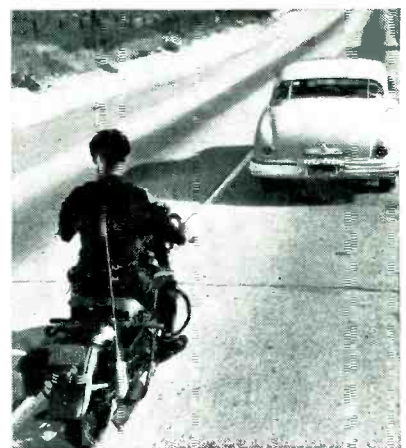

Highway bumps and rutted by-ways often have to be taken at high-speed. Sylvania tubes defy sudden shock, constant vibration. Maintenance work cut to a minimum.

The long arm of the Law is just that much longer through the combined skill of Link-Vetric and Sylvania. In designing this compact two-way radio for the Los Angeles Motorcycle Police, one quality was paramount . . . faultless performance under the toughest conditions. Nothing must fail when the call comes through!

Link-Vetric uses Sylvania low-drain miniature tubes because every step in their manufacture is quality controlled, ensuring longer life under the most adverse conditions. From Regular Glass Tubes to the famous Lock-ins . . . from Miniatures to tiny Sub-Miniatures, Sylvania tubes give the perfection that can really take punishment. Sylvania Electric Products Inc., Emporium, Pa.



Neatly installed either side of the rear fender, the two-way radio keeps patrolmen in constant touch with headquarters. All police calls are urgent calls . . . absolute reliability is essential. Sylvania tubes are chosen wherever necessity demands the highest standards.

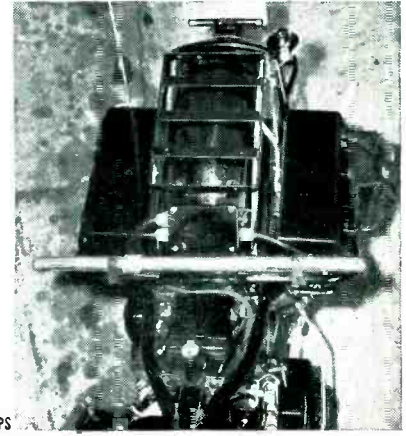

# SYLVANIA ELECTRIC



RADIO TUBES; CATHODE RAY TUBES; ELECTRONIC DEVICES; FLUORESCENT LAMPS; FIXTURES, SIGN TUBING, WIRING DEVICES; LIGHT BULBS; PHOTOLAMPS

**AIRCRAFT  
RADIO  
CORPORATION**



**Type H-12  
SIGNAL GENERATOR  
900-2100 MEGACYCLES**



**-Simplified  
-Compact  
-Portable**

- 900-2100 megacycles, single band
- Directly calibrated, single dial frequency control
- Directly calibrated attenuator, 0 to -120 dbm
- CW or AM pulse modulation
- Internal pulse generator with controls for width, delay, and rate. Provision for external pulsing
- Controls planned and grouped for ease of operation
- Weight: 42 lbs. Easily portable—ideal for airborne installations
- Immediate delivery



*Built to  
Navy Specifications  
for research  
and production  
testing*

*Write for specifications—investigate the advantages of this outstanding new instrument.*

DEPENDABLE ELECTRONIC EQUIPMENT SINCE 1928

**Aircraft Radio Corporation**  
BOONTON, New Jersey

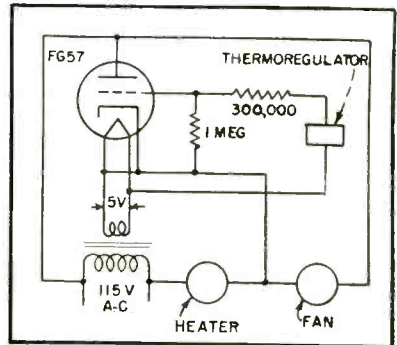

Thyratron thermoregulator circuit. If circuit fails to effect control, filament transformer connections should be reversed

grid circuit to the filament transformer secondary must be in the proper polarity for the circuit to operate.

*Operation*

The impedance of the fan is inherently much larger than that of the heater. When the tube is non-conducting, the fan runs by means of the current through the heater. This current is very small and produces negligible heat in the heater. When the tube fires, the fan is effectively shorted by the tube, the fan stops running, and the heater is activated.

The circuit shown has the advantage of furnishing accurate control with almost negligible current through the thermoregulator unit. It was designed for controlling (and has controlled, for over a year) two 40-gallon water thermostats. The fan is directed at the water surface of the thermostat and serves to cool it. By this means, the thermostat may be operated several degrees below room temperature.

**Operating Small Thyratrons in Parallel**

SUBSTANTIALLY simultaneous firing of parallel-operated thyratrons is insured by the accompanying circuit, developed by Paul G. Hansel of Servo Corp. of America for discharging a large capacitor through the primary of a high-voltage transformer to produce a high-voltage trigger for a flashing light source. When the input trigger is applied to the parallel-connected control

For the Answer to Your Insulation Problem

# Look Through *this* Line...



● Can't guarantee that the Varflex Line will solve every insulation problem. But ... Many's the problem—large, small, unusual—that Varflex Electrical Sleeving or Tubing has solved. The Varflex range of application is vast—chances are you'll find the solution to your Electrical insulating problem somewhere in the Varflex line.

- **VARGLAS SILICONE.** That's the insulating sleeving and tubing—pioneered by Varflex—that takes temperatures ranging from 500° F above to 85° F below in its efficient, resistant stride. Lead wire and treated cord too.
- **VARGLAS TUBING IMPREGNATED WITH GENERAL ELECTRIC PERMAFIL.** Tough, flexible, heat-resistant—available in coils. Premium tubing at a reasonable price.
- **VARGLAS SLEEVING AND TUBING.** Numerous types and grades—including synthetic treated, varnished, lacquered, saturated, litewall and others.
- **VARGLAS NON-FRAY SLEEVING.** Three types—may be subjected to temperatures up to 1200° F—for applications where dielectric requirements are not primary.
- **VARFLO TUBING AND SLEEVING.** New, low-priced — for applications where unusually high temperatures are not a factor. A real economy line, this.
- **VARFLEX COTTON TUBING AND SLEEVING.** Varnish or lacquer impregnants — for applications where Fiberglas products are not required.
- **SYNTHOLVAR EXTRUDED PLASTIC TUBING.** Low temperature flexibility—high dielectric and tensile strength—made from a standard formulation of vinyl polymers.

**SAMPLES?** All you want with our compliments. For free folder of our complete line, just clip and mail this coupon.



**VARFLEX  
CORPORATION**

**MAKERS OF ELECTRICAL INSULATING  
TUBING AND SLEEVING**

**VARFLEX Corporation, 309 Jay St., Rome, N. Y.**

Please send me information as well as free samples of your electrical Sleeving and Tubing.

I am particularly interested in samples suitable for.....

Name.....

Company.....

Street.....

City..... Zone..... State.....

The little **SHURE** cartridges

that fill the Big need

for High Fidelity

Phonograph Reproduction . .

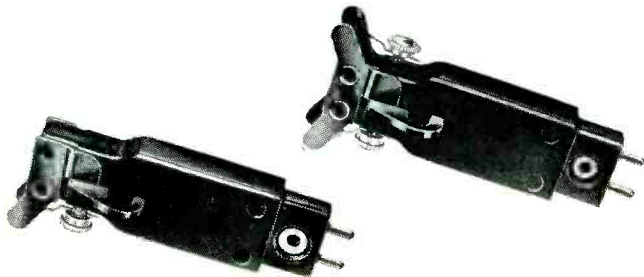

THE  
NEW SHURE "VERTICAL  
DRIVE"

CRYSTAL PICKUP CARTRIDGES

Big things often come in little packages . . . So it is with the superlative new Shure "Vertical Drive" Crystal Cartridges. They reproduce *all* the recorded music on the new fine-groove recordings—a reproduction that meets the strict requirements of high compliance and full fidelity. The "Vertical Drive" cartridges are requisite for the critical listener—the lover of fine music. They are especially recommended for those applications where *true fidelity* is essential.

**SINGLE MODELS:**  
W23A for standard width-groove records.  
W21A for fine-groove records.

**TURNOVER MODELS:**  
W22A and W22AB for both standard and fine-groove recordings.

Unusually highly compliant, these "Vertical Drive" Cartridges will faithfully track standard records with a force of only 6 grams—micro-groove records with a force of only 5 grams (an added protection for treasured recordings). Will fit standard or special mountings. Have more than adequate output for the average audio stage.



**SHURE BROTHERS, INC.**

Microphones and Acoustic Devices

225 WEST HURON STREET, CHICAGO 10, ILL. • CABLE ADDRESS: SHUREMICRO

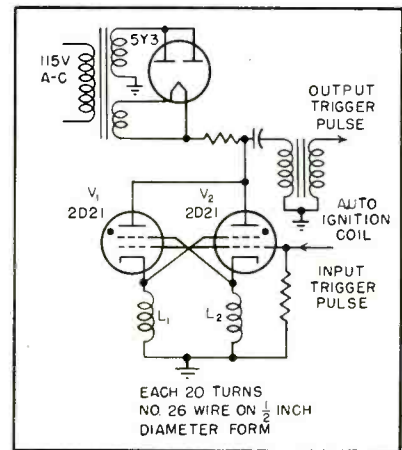

No matter which tube fires first, pulse across its cathode inductance acts on shield grid of other tube to make it fire

grids, one tube may fire first. If for example it is  $V_1$ , then the resulting surge of current through the small inductance  $L_1$  in its cathode lead results in a positive pulse across  $L_1$  that is applied to the shield grid of  $V_2$ , thereby causing that tube to fire. The firing delay can be made very small by proper choice of values for  $L_1$  and  $L_2$ .

Conventional parallel operation of two thyratrons ordinarily fails to prevent overloading because of the tendency of one tube to fire first, thereby reducing the anode voltage on the second tube and preventing it from firing.

**A New Ceramic Material With Unusual Properties**

STUPALITH, a ceramic material which apparently defies most accepted laws by contracting when heated and expanding when cooled, is being produced by the Stupakoff Ceramic and Manufacturing Co. of Latrobe, Pennsylvania.

Engineers who are evaluating Stupalith's properties for possible use in radomes and jet and rocket engines claim that materials including the new substance can be produced with linear coefficients of thermal expansion below that of any other material known. It is believed that the material will find wide application in housing electronic instruments on airborne missiles since it will withstand a thermal shock of at least 2,000 F. Its electrical properties make it



# from crystal set to television

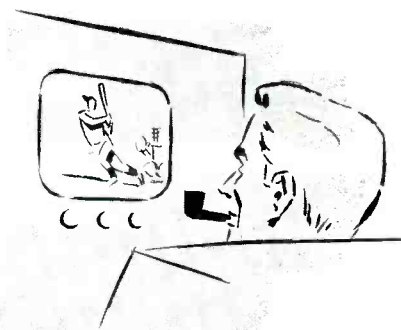

## LENZ has served the radio industry!

When the radio industry first appeared on the American scene 25 years or more ago, the Lenz Electric Manufacturing Co. was ready with the facilities required for the production of needed wires.

These facilities have grown with the industry, all through the days of the crystal set, right down to the present boom in Television equipment, Lenz Wires and Cables, have been used in the production of millions of elec-

tronic units of all kinds and their component parts.

Lenz will continue to be a leading source for properly engineered underwriters approved Plastic and Textile Hook-Up, Wires, Cables, Shielded Lead-Ins, and Harnesses for all types of electronic equipment, A.M., F.M., Television and Communications. Consult Lenz, now as always your source for engineered wires and cables designed for the job.



**LENZ ELECTRIC  
MANUFACTURING CO.**

1751 N. Western Ave.

Chicago 47, Illinois

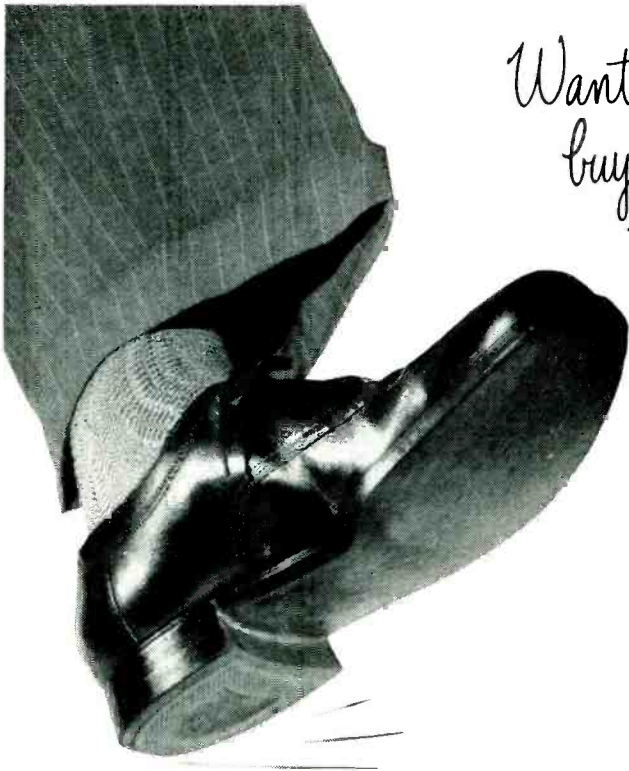

*Want to stop a  
buyer in his  
tracks?*

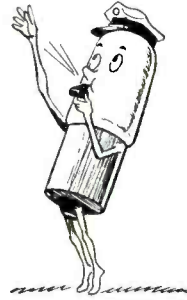

## Little lamps add extra features that win attention . . . make sales!

**L**IGHTS on electronic products are often the stop signs that make the passer *buy*. They flash a message of extra convenience, novelty and value!

You'll find dozens of uses for General Electric lamps—both filament and neon glow, in all types and sizes. Use them to indicate whether the current is on or off, or to check the operation of individual circuits. Let them light up instrument dials and controls. Use them to brighten your product design, add novelty and give extra appeal.

There's nothing like light to catch a customer's eye—and with General Electric lamps you know you can be sure of quality and long service.

For assistance in selecting the proper type, consult your nearest G-E lamp district office. Or write General Electric, Nela Park, Cleveland 12, Ohio.



*You can put your confidence in—*

**GENERAL  ELECTRIC**

suitable for use as insulation in electronic and radio circuits.

Unlike most metals, which conduct heat rapidly and attain uniformity of temperature quickly, most currently-used ceramics are poor thermal conductors. Pronounced temperature gradients within a body result in expansion differentials which may exceed the strain point. As a result of the discovery of the new material, its producers believe that the breaking of ceramics caused by sudden exposure to high or low temperatures may soon become a thing of the past.

### SURVEY OF NEW TECHNIQUES

INSTANTANEOUS PROCESSING of photofluorographic films, using techniques worked out by the Army for rapid processing of radar photographs in combat operations, is being investigated at Johns Hopkins University under supervision of R. H. Morgan. The process has potential value in rapid examination of individuals for early gastric cancer. A special optical system in the camera has ten times the efficiency of any previous photofluorographic unit, permitting sharp pictures of the relatively dim image on the screen.

X-RAY MOVIES involving exposures of 10 millionths of a second on film moving at 150 frames per second were obtained in Westinghouse Research Laboratories by using a special radar-type pulse transformer to provide power pulses exceeding five million watts for flashing an electronic tube at 150,000 volts.

LIGHT OUTPUT of a television viewing tube screen is charted accurately in 48 seconds by a recording spectroradiometer built in the Research Laboratories of Sylvania Electric. The instrument measures and records the degree of output of all visible light wavelengths progressively and automatically. Speed of operation permits prompt correction of chemical mixtures used for c-r screens, since minute changes seriously affect the actual color of the light from white screens.

*What's Your*  
**PANEL INSTRUMENT**  
*Problem?*

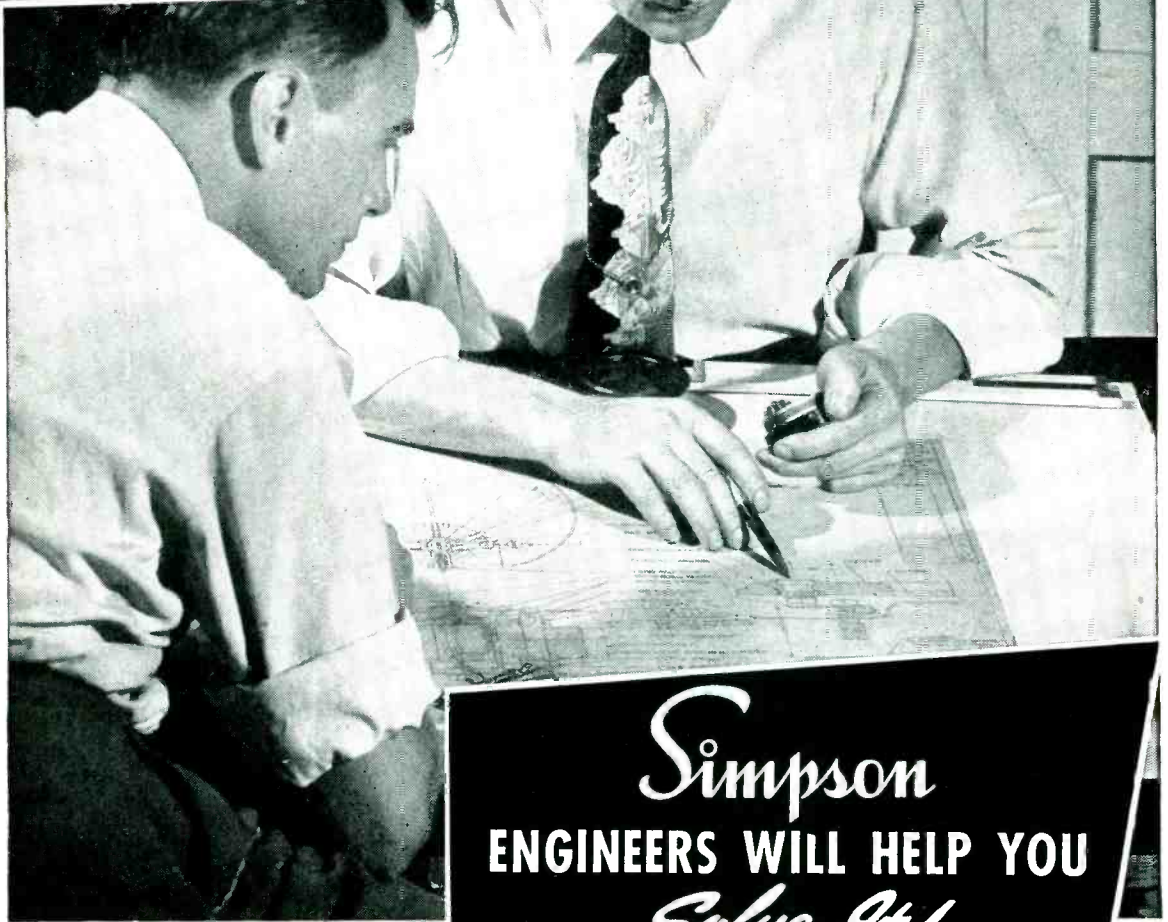

*Simpson*  
**ENGINEERS WILL HELP YOU**  
*Solve It!*

*No matter what your panel instrument problem is, Simpson Electric Company engineers will be glad to help you solve it. Every day they are confronted with individual design problems.*

Behind every Simpson instrument is a world-wide reputation for quality. Simpson movements have greater ruggedness and accuracy, because of the full bridge-type construction and soft iron pole pieces.

When Simpson helps you with your problem, you benefit from this world-wide reputation and the years of experience of Simpson engineers.

Let Simpson engineers help you with your next instrument problem and for your standard instrument requirements take advantage of our large stock, available for immediate delivery.

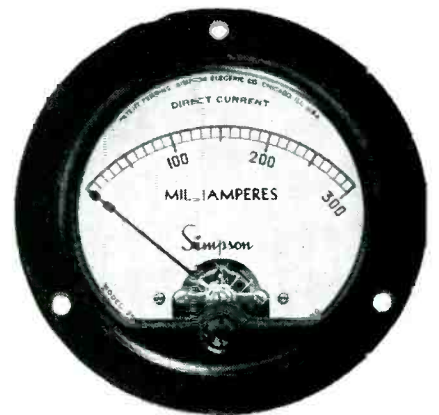

**SIMPSON ELECTRIC COMPANY**

5200-18 WEST KINZIE STREET, CHICAGO 44, ILLINOIS  
IN CANADA: BACH-SIMPSON, LTD., LONDON, ONTARIO

THERE'S A  
**VICKERS**  
*Standard*  
**MAGNETIC  
 AMPLIFIER  
 TO FIT YOUR  
 CONTROL  
 NEEDS**



NOW — for the first time — you can select a standard magnetic amplifier — to serve your 60-cycle control application. Vickers supplies from stock 28 styles — pre-engineered and laboratory tested with a choice of d-c or a-c output. Power (output) levels range from milliwatt to 108 watts maximum (d-c output).

Comprehensive application data sheets are furnished to help you select the Vickers magnetic amplifier for your control needs.

**A FEW OF THE MANY APPLICATIONS**

• Line-to-line Voltage Regulators • Hydraulic Transmission Controls • A-c and D-c Generator Voltage Regulators • Controls Relays • Speed and Frequency Regulators • Lamp and Furnace Controls • Temperature Regulators • Time Delay Devices

**READY NOW—THE VICKERS EDUCATIONAL MAGNETIC AMPLIFIER**

Designed for school and industrial laboratory use, it permits study of all basic single-phase self-saturating circuits. Complete with Laboratory Experiment Manual and Magnetic Amplifier Design Handbook.

• Write today for complete information on the Vickers Educational Magnetic Amplifier and for your copy of the Vickers Magnetic Amplifier Design Handbook which specifies characteristics and illustrates circuits. Please make request on your letterhead.



**VICKERS ELECTRIC DIVISION**

**VICKERS Inc.**

1801 LOCUST STREET • ST. LOUIS 3, MISSOURI

**NEW PRODUCTS**

(continued from p 126)

the output to the Z-input terminals of the oscilloscope. Both methods are illustrated.



**Utility Tester**

SUPERIOR INSTRUMENTS Co., 227 Fulton St., New York, N. Y. The new pocket-size tester can measure the actual current consumption of any appliance or utility either a-c or d-c while the unit under test is in operation. The appliance is plugged into the front panel receptacle and registers a reading in amperes. A special pair of insulated clip-ends is supplied for motors. The unit measures 3½ in. × 5½ in. × 2¼ in.



**Miniature Triode**

SYLVANIA ELECTRIC PRODUCTS INC., 500 Fifth Ave., New York 18, N. Y. Type 6AB4 miniature triode is suitable for use as a grounded-grid r-f amplifier, frequency converter,

# COPPER ALLOY BULLETIN

## PRODUCT IMPROVEMENT EDITION

REPORTING NEWS AND TECHNICAL DEVELOPMENTS OF COPPER AND COPPER-BASE ALLOYS

Prepared Each Month by Bridgeport Brass Co. "Bridgeport" Headquarters for BRASS, BRONZE and COPPER

### Phosphor Bronze for Longer Life

#### Overcoming Corrosion in a Mixing Valve

The automatic tempering valve illustrated is used to provide water at any temperature within the range of the thermostat. The mixture of hot and cold water passes over the thermal element. If the mixture is too cold, the bellows gradually contracts and partially closes the cold water port and opens the hot water port wider. If the mixture is too hot, the reverse occurs.

Obviously, the efficiency of the valve depends primarily on the reliable operation of the metal bellows. Bridgeport Phosphor Bronze, which provides an excellent combination of corrosion resistance and resilience under repeated flexing, is excellent for the manufacture of bellows of this type, which may be in constant contact with hot water and other corrosive fluids.

#### Excellent Corrosion Resistance

Phosphor Bronze is more corrosion resisting than most metals. Steam, hot water, sea water, and similar corrosive liquids and gases used in industrial and processing plants for heating, cooling and refrigeration come in direct, intimate contact with the parts of valves, pressure and temperature gauges and controls made from Phosphor Bronze. Long experience has shown that this metal will stand up under these conditions and give dependable service so necessary for the operation of automatic instruments and controls.

From an engineering standpoint, only the best available metals should be used since the function of the instrument or control depends upon the action of the component — bellows, diaphragms, Bourdon tubing, springs, or electrical and mechanical contacts.

Bellows for Automatic Tempering Valve made of Bridgeport Phosphor Bronze — Courtesy Fulton-Sylphon Division, Robertshaw-Fulton Controls Co., Knoxville, Tenn.

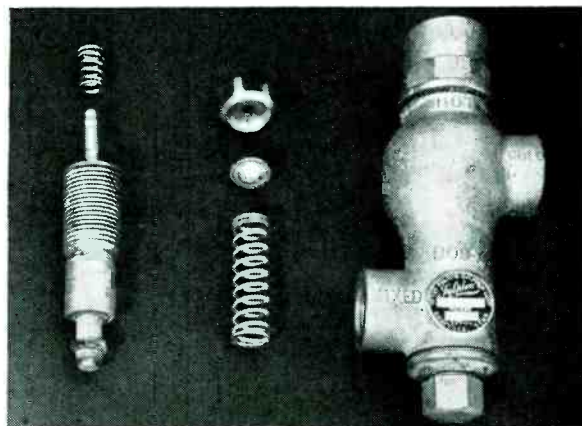

#### Vacuum Cleaner Switch—Wanted Reliable Spring Action

Contact springs in the vacuum cleaner motor switch illustrated are a good example of parts which are small and insignificant in appearance, but vital to the operation of the equipment. This motor switch is manufactured by Electrolux Corporation, Old Greenwich, Connecticut. The springs made from Bridgeport's Phosphor Bronze must maintain constant pressure and provide dependable contact at all times.

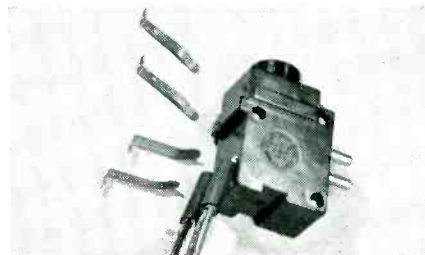

Motor switch connector terminals made from Bridgeport's Phosphor Bronze — Courtesy Electrolux Corporation, Old Greenwich, Connecticut.

High fatigue resistance and dependable spring properties are developed in Bridgeport's Phosphor Bronze through close laboratory control of composition and careful processing in the mill with powerful modern equipment.

#### Thermostat Reset Lever—Dependable Spring Quality

Safety in operating electrical and mechanical equipment often depends upon the reliability of a few tiny spring parts. Thermo-O-Disc Protective Thermostat employs Phosphor Bronze for the reset lever because of fine spring properties and dependability.

Phosphor Bronze provides an excellent combination of properties for electrical and mechanical spring applications. Its resilience and high fatigue resistance mean good spring action and dependability through many thousands of flexing cycles. Its high corrosion resistance reduces failure from the attack of corrosive atmospheres. Phosphor Bronze is also unusually tough and resistant to wear and abrasion, insuring continued good mechanical and electrical contact.

The unique properties of phosphor bronze depend not only on alloy composition but also upon improved melting practice, casting techniques and processing methods.

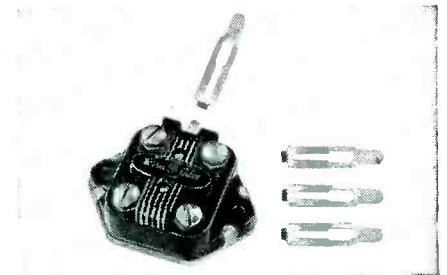

Thermo-O-Disc Protective Thermostat employs reset lever made of Bridgeport's Improved Phosphor Bronze. Courtesy Therm-O-Disc, Inc., Mansfield, Ohio.

#### Other Applications

Bridgeport Phosphor Bronze offers special advantages where good spring qualities are desired—in such parts as snap switches, diaphragms, current collectors, spring contacts, and parts for radios and appliances. Because of its resistance to corrosion and wear, it is also widely used in packless valves, steam traps, lock washers.

Much information on Phosphor Bronze and other spring alloys is published in Bridgeport's 128-page Technical Handbook. This also contains the latest data on various brasses in strip, rod, wire and tubing used in the manufacture of electrical devices, appliances, and electronic instruments.

Contact the nearest Bridgeport office for technical help in selecting the alloy and temper best suited for economical fabrication.

BRASS • BRONZE • COPPER • DURONZE — STRIP • ROD • WIRE • TUBING

MILLS IN  
BRIDGEPORT, CONNECTICUT  
INDIANAPOLIS, INDIANA

In Canada:  
Noranda Copper and Brass Limited,  
Montreal



BRIDGEPORT BRASS COMPANY  
BRIDGEPORT 2, CONNECTICUT

Established 1865  
District Offices and Warehouses in Principal Cities

# HOT ASSIGNMENT

*for this PROGRESSIVE fastener*

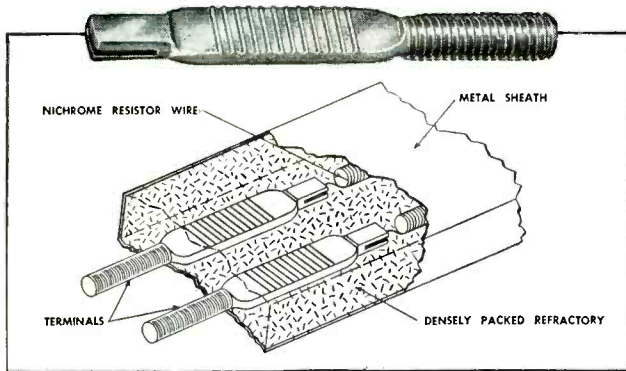

Edwin L. Wiegand Company uses this terminal pin on their versatile Chromalox seamless blade-type immersion heaters, which operate as high as 750°F. It is one of many special fasteners made by Progressive.

The design provides for electrical clearance between the pin and the metal heating blade casing — for secure fastening of the pin in the refractory — and for attaching electrical wiring connections.

Progressive is equipped to handle special fastener production with speed, precision and economy. Do what many leading manufacturers do — IF IT'S SPECIAL, see PROGRESSIVE.



WRITE FOR OUR CATALOG  
IT MAY SAVE YOU MONEY

*Other typical PROGRESSIVE "Specials"*



**THE PROGRESSIVE  
MANUFACTURING COMPANY**

50 NORWOOD ST., TORRINGTON, CONN.

SALES OFFICES: SAN FRANCISCO, LOS ANGELES,  
PORTLAND, DETROIT, PHILADELPHIA, CLEVELAND,  
SEATTLE, BOSTON, SYRACUSE, ST. LOUIS, CHICAGO.

or oscillator at frequencies below 300 mc. Its frequency range makes it applicable for use in currently allocated tv bands. It is supplied with a 6.3-volt, 150-ma heater.



## Rectifier Power Supply

P. R. MALLORY & Co., INC., 3029 E. Washington St., Indianapolis 6, Ind. The new portable rectifier power supply provides a dependable source of d-c power for the designing, building, testing and repairing of radio, electronic and electrical equipment for electrolytic processes and for taper charging of batteries. It will operate from either 208 to 230 or 460-volt, 3-phase input and will provide a nominal 6, 12 or 24-volt output.



## Survey Meter

RADIOACTIVE PRODUCTS, INC., 3201 E. Woodbridge St., Detroit 7, Mich. Model D-1 radiation hazard survey

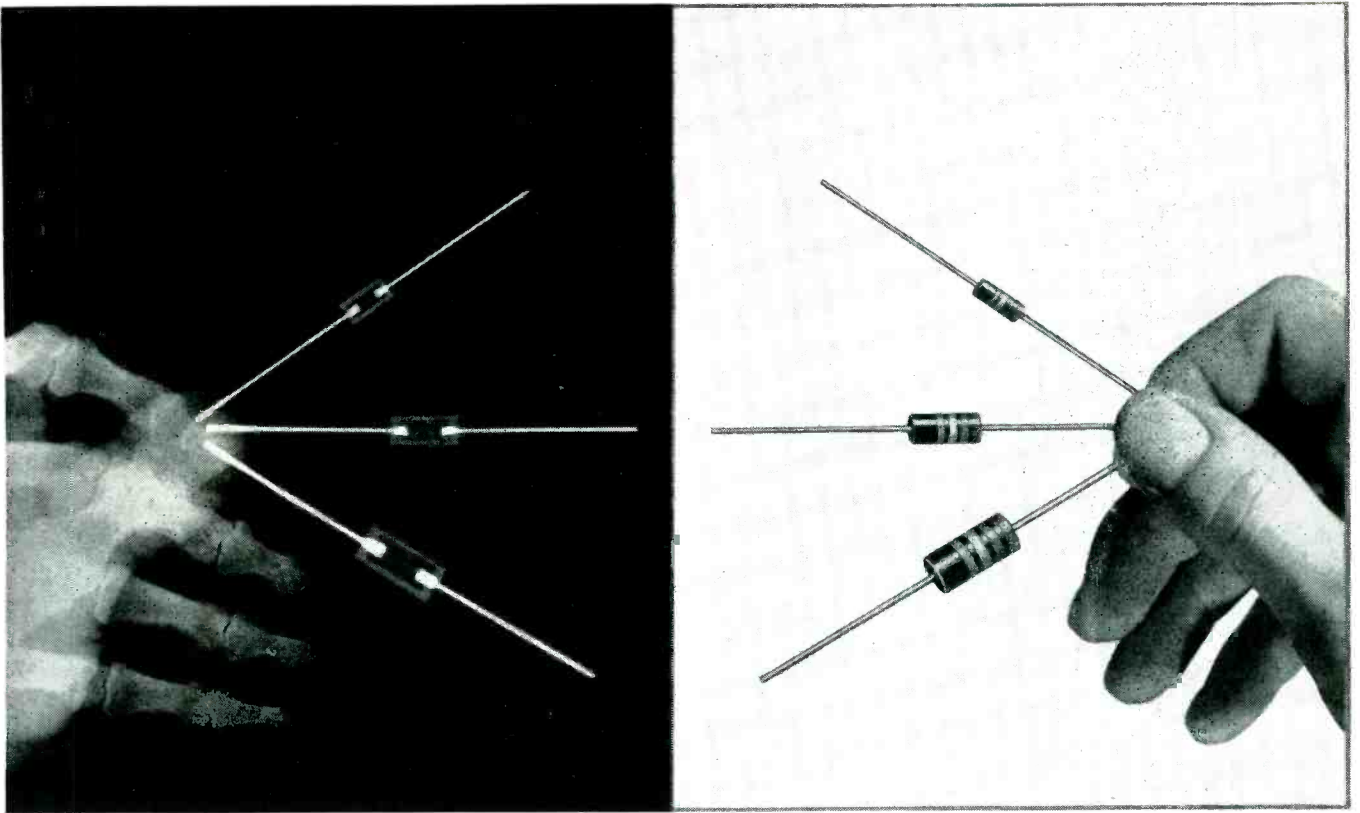

## X-ray reveals solid molded construction of Allen-Bradley Fixed Resistors

These unusual photographs tell a convincing story . . . about Bradleyunit resistors!

Solid molded . . . through and through . . . their leads are imbedded in the densely compacted body of the resistors.

This construction assures unbeatable performance . . . stability . . . and long life. Heat, humidity, and high load do not affect Bradleyunits, which are available in all standard R.M.A. values in  $\frac{1}{2}$  and 2 watt ratings from 10 ohms to 22 megohms; 1 watt from 2.7 ohms to 22 megohms.

Fixed resistors are usually rated at ambient temperatures of 40 C. Bradleyunits are rated at 70 C. At this high temperature they will operate at full rating for 1000 hours with less than 5% resistance change.

Bradleyunits need no wax impregnation to pass salt water immersion tests. They have high mechanical strength. The leads are differentially tempered to prevent sharp bends near the resistor. Let us send you a complete Allen-Bradley resistor chart.

Allen-Bradley Co., 110 W. Greenfield Ave., Milwaukee 4, Wis.



## DIRECT WRITING RECORDERS

Records are produced by a heated writing stylus in contact with heat sensitive paper. The paper is pulled over a sharp edge in the paper drive mechanism (standard speed 25 mm/sec., slower available) and the stylus wipes along this edge as it swings, thus producing records in *true rectangular coordinates*. The writing arm is driven by a D'Arsonval moving coil Galvanometer with an extremely high torque movement (200,000 dyne cms per cm deflection).

This recorder assembly may be obtained in bare chassis form, as illustrated (51-600) with or without built-in timer; or, with the addition of a stylus heating transformer, temperature controls, and control panel (127); or, with the entire assembly, controls and control panel enclosed in a mahogany carrying case (127C). Complete catalog available, see below.

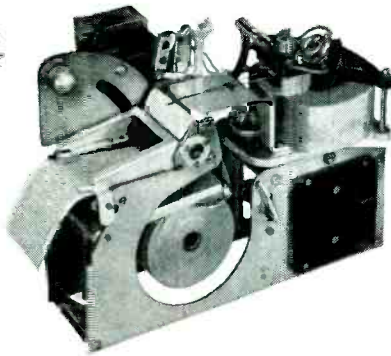

**SINGLE CHANNEL**

**NO INK  
RECTANGULAR  
COORDINATES  
PERMANENT RECORDS**

## INSTRUMENT AMPLIFIERS

A general purpose, A.C. operated driver amplifier for use with model 127 Recorder, comprising three direct coupled push-pull stages. Maximum sensitivity 50 mv. per cm., minimum sensitivity 50 volts per cm., with four intermediate ranges. Balanced input terminals available with impedances of 5 megohms to ground. Complete information in catalog shown below.

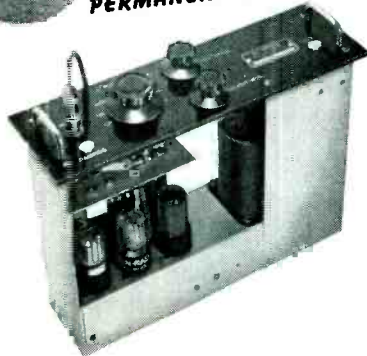

## AMPLIFIER-RECORDERS

Model shown at right is a single channel unit comprising above Amplifier 126 and Recorder 127, contained in one mahogany carrying case, and designed for use in the industrial field as a direct writing vacuum tube recording voltmeter capable of reproducing any electrical phenomena from the order of a few millivolts to more than 200 volts. More complete data in catalog shown below.

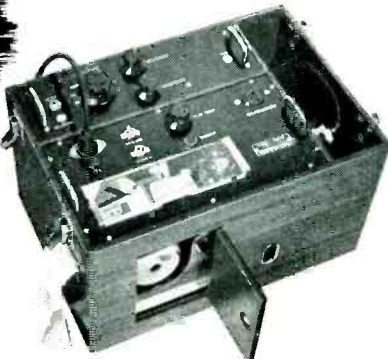

**MULTI-CHANNEL**

**NO INK  
RECTANGULAR  
COORDINATES  
PERMANENT RECORDS**

At lower right is a typical "Poly-Viso" multiple channel direct writing Recorder and Amplifier in console. Numerous combinations of this recording equipment and associated amplifiers and accessories are available. The Multi-channel Recorder (Model 165) provides for the simultaneous registration of up to four input phenomena, using the same principles and method as for the Recorder Assembly above. In addition, the "Poly-Viso" Recorder provides a selection of eight paper speeds: 50, 25, 10, 5, 2.5, 1.0, 0.5 and 0.25 mm/sec., and for the use of 4, 2, or 1 channel recording Permapaper. The Amplifier equipment is housed in a rack which has space for four individual driver amplifiers (electrically identical to model 126, above) and one 4-channel preamplifier.



For complete catalog giving tables of constants, sizes and weights, illustrations, general description, and prices, address:

**SANBORN COMPANY**  
*Industrial Division*  
**CAMBRIDGE 39, MASS.**

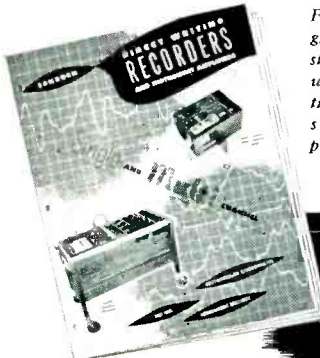

meter is an ionization type battery-operated, pistol-grip instrument. The ion chamber is approximately 600 cubic cm in volume. Three radiation intensity ranges of 0 to 50, 0 to 500, and 0 to 5,000 milliroentgens per hour are provided. The instrument is calibrated against a radium gamma ray source and is accurate to within 10 percent of full scale on all scales.

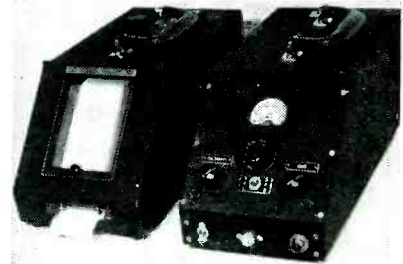

## Recording Oscillograph

PHOTRON INSTRUMENT Co., 6516 Detroit Ave., Cleveland 2, Ohio, offers instantaneous recording on strip chart at frequencies up to 120 cps. The complete instrument includes amplifier and single or double-channel recorder. However, amplifier or recorder may be used separately. Chart speed is variable from zero to maximum speed.



## Hi-Fi Mike

ELECTRO-VOICE, INC., Buchanan, Mich. The TV655 versatile microphone has ultrawide range and high-fidelity dynamic performance

Sanborn Recorders and Amplifiers have evolved from those originally designed by Sanborn Company for use in electrocardiographs, and have, by actual practice, proven to have wide applications in the industrial field as well.





# QUALITY COIL FORMS

*Ensure Satisfaction!*

## CLEVELAND . . .

COSMALITE\* spirally laminated paper base phenolic tubes are engineered and produced for those who must have quality performance with attractive prices and quick deliveries.

The outstanding choice in the industry for coil forms in all standard broadcast receiving sets and for permeability tuners . . . Cleveland Cosmalite is backed by over 25 years experience.

Consult us about our kindred products for both new and established needs in the electronic and electrical fields. For the best . . . "Call CLEVELAND!"

\*Reg. U. S. Pat. Off.

See our Exhibit No. 207  
at the I.R.E.  
Radio Engineering Show

*The* **CLEVELAND CONTAINER Co.**  
6201 BARBERTON AVE. CLEVELAND 2, OHIO

PLANTS AND SALES OFFICES at Plymouth, Wisc., Chicago, Detroit, Ogdensburg, N.Y., Jamesburg, N.J.  
ABRASIVE DIVISION at Cleveland, Ohio  
CANADIAN PLANT: The Cleveland Container, Canada, Ltd., Prescott, Ontario

**REPRESENTATIVES**

CANADA METROPOLITAN NEW YORK NEW ENGLAND	WM. T. BARRON, EIGHTH LINE, RR #1, OAKVILLE, ONTARIO R. T. MURRAY, 614 CENTRAL AVE., EAST ORANGE, N.J. E. P. PACK AND ASSOCIATES, 968 FARMINGTON AVE. WEST HARTFORD, CONN.
---	---



# 3 CLEAN-CUT ADVANTAGES

OF  
*Seamless*  
[PATENTED]  
RADIO PINS

- 1 Extreme Uniformity
- 2 Superior Staking Qualities  
...ends will roll without splitting
- 3 Better for Molded Parts  
...closed end keeps compound out

If you use pins for vacuum tubes, adapters, fluorescent lamps, plugs, or electrical equipment of any kind, the chances are you'll save time, money and rejections by using these super-smooth, *seamless*, patented Radio Pins. They are available in a wide variety of styles and sizes, with staking end either closed or open. For a quotation, simply send a sketch, sample or description and state the quantity and finish you need.

#### SHEET METAL STAMPINGS?

In addition to Radio Pins, we produce large quantities of top caps, base shells and adapter shells for vacuum tubes; also a wide variety of other metal products, including deep-drawn shells and cups, blanks and stampings, ferrules, grommets, washers, vents, fasteners—and, for almost every manufacturing requirement, the world's largest assortment of eyelets.

We invite your inquiry to the Waterbury Brass Goods Branch of The American Brass Company, Waterbury 20, Connecticut.

49407

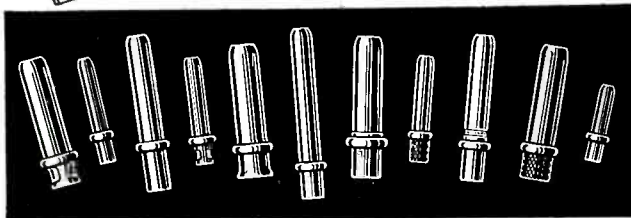

FOR QUALITY BRASS GOODS— **ANACONDA**

and utility. It is omnidirectional and features peak-free response from 40 to 15,000 cps, plus or minus 2.5 db. Impedance is 250 ohms. The microphone without swivel is  $8\frac{3}{4}$  in. long; diameter is  $1\frac{1}{8}$  in.

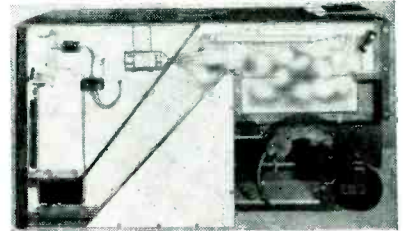

#### Rat Trap

ELECTRONIC RAT TRAPS, INC., 80 W. Main St., Rochester 4, N. Y., has incorporated a new automatic insecticide device on each trap to eradicate the dreaded disease-bearing fleas and ticks from the rats' bodies while they are electrocuted in the electronic rat trap. As the electrically-charged death plate clamps down upon the rat, a single mechanism releases a jet-spray of insecticide into the corpse. Both rat and germs are dead when the body is released from the trap.



#### F-M Signal Generator

BOONTON RADIO CORP., Boonton, N. J. Type 202-D signal generator is designed for use with telemetering receiver equipment and in other associated applications. It covers the 175 to 250-mc range and is provided with three continuously adjustable deviation ranges: 0 to 24 kc, 0 to 80 kc and 0 to 240 kc. The internal audio oscillator provides

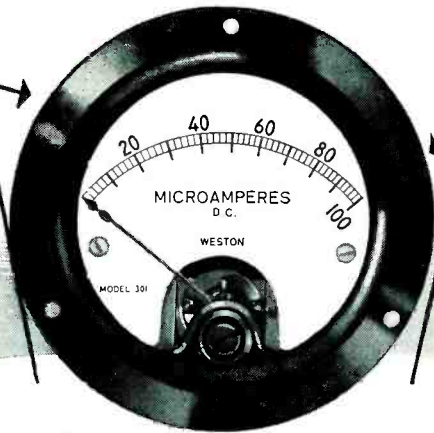

*"Built-in"* OPERATING ASSURANCE

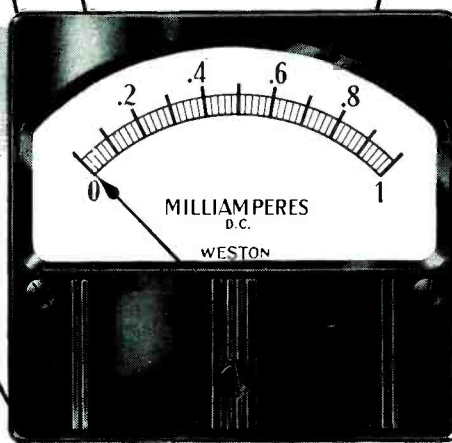

**FOR BUILDERS OF ELECTRIFIED EQUIPMENT!**



Nowhere does WESTON dependability and value pay bigger returns than on the panels or controls of electrical equipment. By consistently *telling the truth*, they help assure efficient performance of the equipment in users' hands . . . where *so much* depends on instrument performance. Moreover, the name WESTON on a panel instrument gains instant recognition . . . helps build buyer acceptance for the products on which they are installed. Available in types, sizes, ranges and styles for all needs. Ask your nearest WESTON representative for all the facts, or write for bulletin A-7-B. WESTON Electrical Instrument Corporation, 618 Frelinghuysen Avenue, Newark 5, New Jersey.

**WESTON**  
*Panel Instruments*

Albany • Atlanta • Boston • Buffalo • Charlotte • Chicago • Cincinnati • Cleveland • Dallas • Denver • Detroit • Houston • Jacksonville • Knoxville  
Little Rock • Los Angeles • Meriden • Minneapolis • Newark • New Orleans • New York • Orlando • Philadelphia • Phoenix • Pittsburgh • Rochester  
San Francisco • Seattle • St. Louis • Syracuse • Tulsa • Washington, D. C. • In Canada, Northern Electric Company, Ltd., Powerlite Devices, Ltd.

**KAY**

**SEE THESE  
NEW INSTRUMENTS  
at BOOTH 22, I.R.E. CONVENTION**

**AN ACCURATE TV RF PIX  
AND SOUND CARRIER MARKER**



**THE DUAL MEGA-MARKER SR.**

**New Features**

- Provides both sound and picture RF markers on each TV channel (crystal controlled).
- Markers available at high level for use with TV tuners or receivers.
- Tone modulation may be switched on to sound carrier.
- 4.5 mc signal (crystal controlled) available at separate connector.
- Sound Carrier may be switched on or off.
- Attenuators available for RF and 4.5 mc signal.
- Frequency accuracy on Picture RF and 4.5 mc signal .01%. Picture and Sound Carrier Separation 4.5 mc  $\pm$ 500 cps.

PRICE: \$350.00 F.O.B. Factory.

**THE MOST ACCURATE ELECTRONIC INDICATOR OF  
INSTANTANEOUS SHAFT SPEED VS. TIME**



**THE ROTALYZER**

**New Features**

- Displays instantaneous shaft speed variations vs time on oscilloscope screen.
- Covers very wide range of shaft rpm.
- Reads average and instantaneous shaft speeds to very high accuracy.
- Indicates shaft speed variations which occur rapidly.
- Indicates very small variations in shaft speed.
- Accuracy of speed indication better than .1%. .01% at selected speeds.

PRICE: Pickup and Amplifier Analyzer \$825.00 F.O.B. Factory. Special Companion Oscilloscope \$328.00 F.O.B. Factory.

Prices slightly higher outside U. S. A. and Canada.

eight fixed frequencies between 50 cycles and 15 kc. Deviation sensitivity of the f-m system is within  $\pm$  0.5 db from d-c to 200 kc. The a-m system is substantially flat from 30 cycles to well above 100 kc. The instrument is designed for use on 115 volts, 60 cycles.

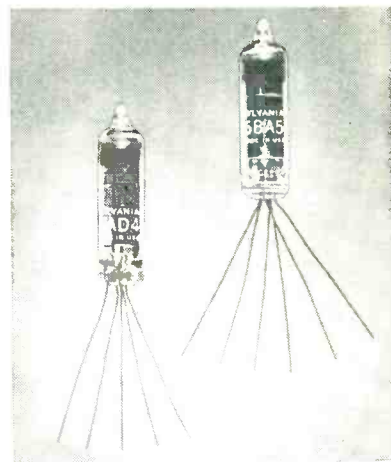

**Subminiature Amplifier  
Tubes**

SYLVANIA ELECTRIC PRODUCTS INC., 500 Fifth Ave., New York, N. Y. Two new subminiature tubes have been designed for use as Class A a-f amplifiers or resistance-coupled

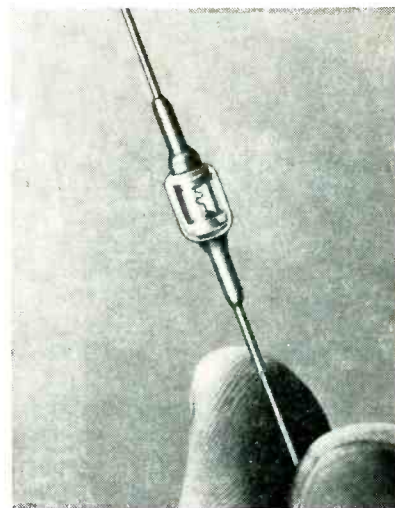

**GLASS-SEALED CARTRIDGES** for germanium diodes are proof against moisture and dust. Another wrinkle, apparent from the unit shown above, is the method of bringing out connection leads so that several units can be mounted side by side without danger of shorting. Sylvania Electric Products Inc., 500 Fifth Ave., New York, N. Y.

**ELECTRIC**

**KAY**

**COMPANY**

25 Maple Avenue

Phone CAldwell 6-4000

Pine Brook, N. J.

# A BRADLEY CASE HISTORY

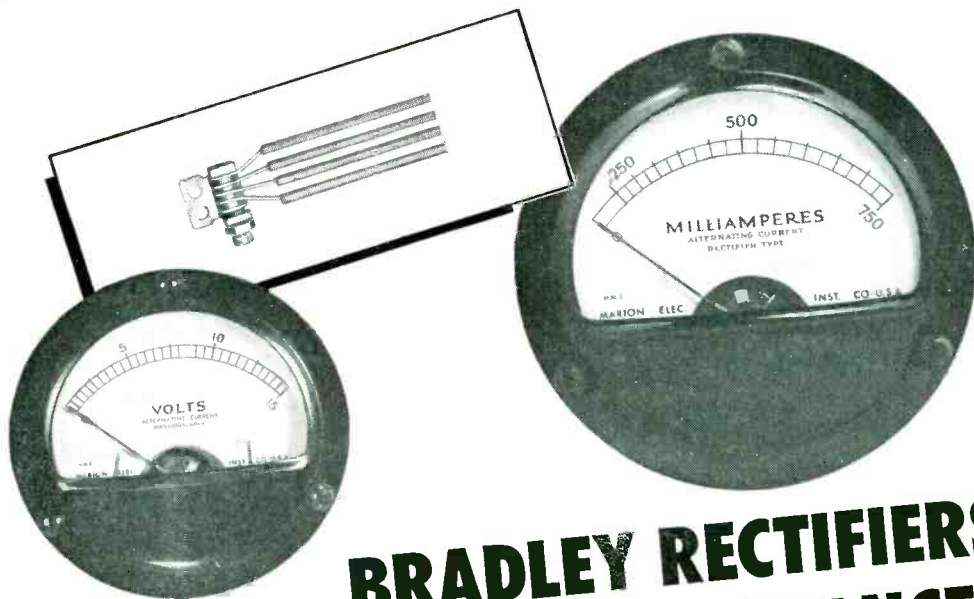

## BRADLEY RECTIFIERS APPLY CORSET TO TOLERANCES

Lace a corset around something and you narrow down its digressions. Use Bradley vacuum processed rectifiers and much the same thing—in a stricter sense—happens to your power conversion requirements. Product performance improves, as it did for Marion Electrical Instrument Co. voltmeters and milliammeters.

"In this particular application," reports Marion, "your rectifiers (Coprox Model CX2E4F) were of great assistance in supplying rectified type AC milliammeters which could be held, under varying temperature requirements, to much closer than normal tolerances."

That statement points up strongly the fact that the Bradley vacuum process produces rectifiers that contribute to performance. We just don't talk about uniformity in rating, predictable operating characteristics—our unique and exclusive vacuum process assures them.

For power conversion that is consistently and reliably true to rating, specify Bradley vacuum-processed selenium or copper oxide rectifiers. Our engineers are always available for consultation. Specify Bradley—your product will act better.

### THE BRADLEY LINE

SELENIUM RECTIFIERS

COPPER OXIDE RECTIFIERS

SELF-GENERATING PHOTOCELLS



COPROX CX2E4F

### SPECIFICATION DATA

Coprox CX2E Series — These instrument rectifiers are rated up to 4.5 volts A.C., 3 volts D.C., 5 milliamperes D.C. Available for all conventional circuits and for special current control applications. Size 7/16" x 1/4" x 3/8", 4 flexible leads. Two 7/64" diameter mounting holes.

# BRADLEY LABORATORIES, INC.

82 MEADOW STREET  
NEW HAVEN 10, CONN.

here's your answer to problems in

## OSCILLOSCOPE RECORDING!

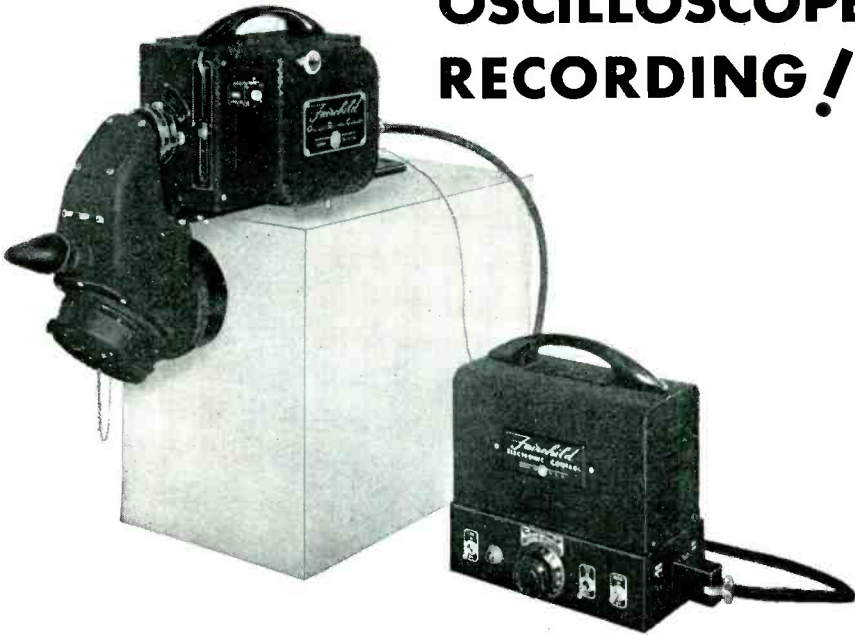

### FAIRCHILD *Oscillo-Record* CAMERA

This new engineering tool is finding more and more use in—

1. Recording of electronic circuit performance.
2. Comparison of performance after changes have been made.
3. Study of complex high-frequency signals.
4. Comparison of two or more simultaneous phenomena.
5. Telemetering.
6. Analysis of high-speed transients.
7. Monitoring of random transients.
8. Maintenance of laboratory records.

A remote control connection plus dynamic braking makes it possible to start and stop the camera automatically by the signal itself, thereby making a complete record of irregularly occurring phenomena without wasting film and without any attention on the part of the operator. Other features include:

a) Sharp, clearly defined images on inexpensive 35mm film or paper; b) writing speeds up to 270 inches per microsecond; 20 seconds to 20 hours of recording on 100-ft. rolls of film, or 3½ minutes to 8½ days of recording on 1000-ft. rolls; d) no obstruction of oscilloscope controls; e) permits viewing of 'scope while photographing phenomena.

The Oscillo-Record Camera, designed by Fairchild in close cooperation with leading users and manufacturers of cathode-ray oscilloscopes, is the product of the world's foremost manufacturer of precision specialty camera equipment. It can be adapted to practically all 3-in. and 5-in. oscilloscopes.

Complete details may be obtained by writing to Dept. WS, Fairchild Camera and Instrument Corporation, 88-06 Van Wyck Boulevard, Jamaica 1, N. Y.



a-f amplifiers. Type 6AD4 triode has a mutual conductance of 2,700 micromhos; the 6BA5 pentode rating is 3,300 microhos. Both are enclosed in T-3 envelopes and are supplied with 6.3-v, 150-ma heaters.

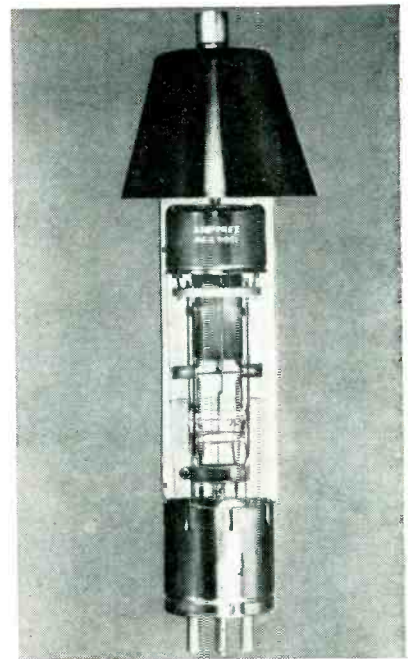

### Mercury Vapor Rectifier

AMPEREX ELECTRONIC CORP., 25 Washington St., Brooklyn 1, N. Y. Type AGR-9951 grid-controlled mercury vapor rectifier tube has a maximum peak anode voltage of 21,000 volts. Filament heating time is two minutes. In a single-phase full-wave rectifier it can deliver an average current of 5 amperes.



### Resistance Percentage Bridge

SPECIALTIES, INC., Skunks Misery Rd., Syosset, L. I., N. Y. Designed for testing and calibrating precision potentiometers, the bridge illus-

# Compare!

## Here's the Helipot Principle that is Revolutionizing Potentiometer Control in Today's Electronic Circuits

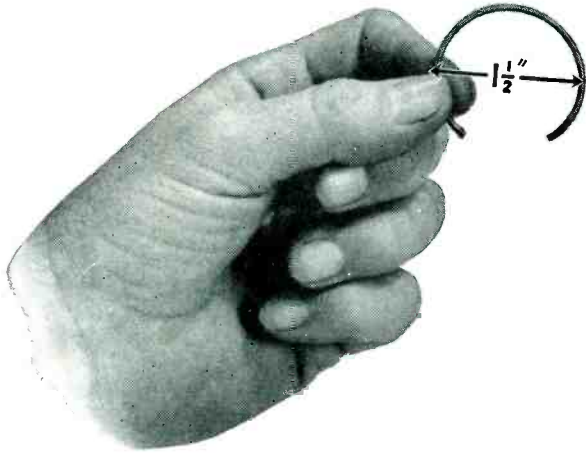

**CONVENTIONAL POTENTIOMETERS** have a coil diameter of approximately 1½" and provide only 4" (about 300°) of potentiometer slide wire control.



**THE BECKMAN HELIPOT** has the same coil diameter, yet gives up to 46" (3600°)\* of potentiometer slide wire control—nearly TWELVE times as much!

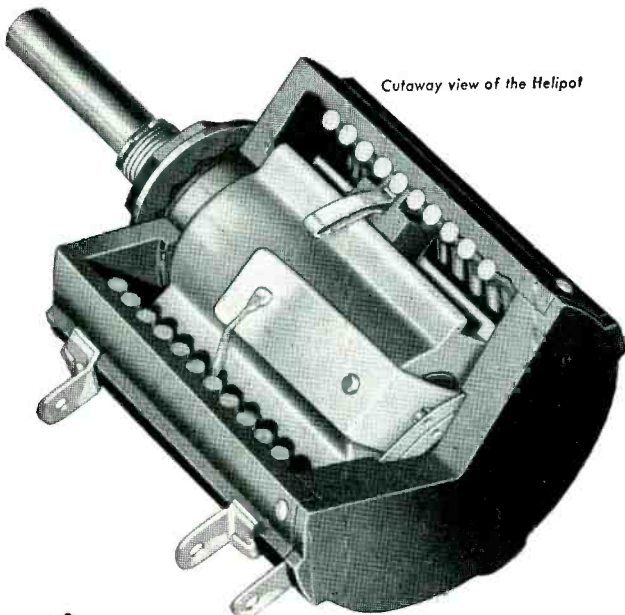

Cutaway view of the Helipot

### Some of the multiple Helipot advantages

**E**XTENSIVELY used on precision electronic equipment during the war, the Helipot is now being widely adopted by manufacturers of quality electronic equipment to increase the accuracy, convenience and utility of their instruments. The Helipot permits much finer adjustment of circuits and greater accuracy in resistance control. It permits simplifying controls and eliminating extra knobs. Its low-torque characteristics (only one inch-ounce starting torque\*, running torque even less) make the Helipot ideal for power-driven operations, Servo mechanisms, etc.

*And one of the most important Helipot advantages is its unusually accurate linearity. The Helipot tolerance for deviations from true linearity is normally held to within  $\pm 0.5\%$ , while precision units are available with tolerances held to 0.1%, .05%, and even less—an accuracy heretofore obtainable only in costly and delicate laboratory apparatus.*

The Helipot is available in a wide range of types and resistances to meet the requirements of many applications, and its versatile design permits ready adaptation of a variety of special features, as may be called for in meeting new problems of resistance control. Let us study your potentiometer-rheostat problem and make recommendations on the application of Helipot advantages to your equipment. No obligation of course. Write today.

\* Data is for Model A unit



#### HELIPOTS ARE AVAILABLE IN MANY SIZES:

**MODEL A**—5 watts, incorporating 10 helical turns and a slide wire length of 46 inches, case diameter 1¾", is available with resistance values from 10 ohms to 300,000 ohms.

**MODEL B**—10 watts, with 15 helical turns and 140" slide wire, case diameter 3¼", is available with resistance values from 50 ohms to 500,000 ohms.

**MODEL C**—2 watts, with 3 helical turns and 13¼" slide wire, case diameter 1¾", available in resistances from 5 ohms to 50,000 ohms.

**MODEL D**—15 watts, with 25 helical turns and 234" slide wire, case diameter 3¼", available in resistances from 100 ohms to 750,000 ohms.

**MODEL E**—20 watts, with 40 helical turns and 373" slide wire, case diameter 3¼", is available with resistance values from 200 ohms to 1,000,000 ohms.

Other types and designs of Potentiometers available.

Send for the New Helipot Booklet!



# THE Helipot CORPORATION, SOUTH PASADENA 2, CALIFORNIA

## NEW HIGHS IN RESOLUTION

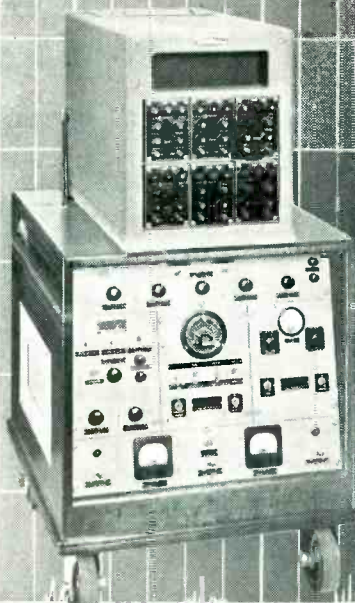

### THE HATHAWAY SC-16A SIX ELEMENT RECORDING CATHODE-RAY OSCILLOGRAPH

NEW HIGHS IN RESOLUTION are obtained by this new oscillograph because of its unusually HIGH FREQUENCY RESPONSE and HIGH CHART SPEED...designed for recording fast transients and continuous phenomena.

**FREQUENCY RESPONSE** 0 to 200,000 cycles per second  
**RECORDS** up to 1000 ft. long at speeds up to 600 inches per second  
**RECORDS** up to 10 ft. long as speeds up to 6000 inches per second  
**WRITING SPEED** above 100,000 inches per second

#### Note these additional unusual features.

- SIX ELEMENTS with convenient interchangeable lens stages for 1, 2, 3, or 6 traces on full width of chart.
- INTERCHANGEABLE RECORD MAGAZINES for CONTINUOUS RECORDING on strip chart, either 6 inches or 35mm in width up to 1000 feet in length, DRUM RECORDING for short, high-speed records, and STATIONARY CHART for very short transients.
- PRECISION TIMING EQUIPMENT, tuning fork controlled, for 1-millisecond or 10-millisecond time lines.
- Crystal-controlled Z-AXIS MODULATION for 1/10 millisecond time marks.
- QUICK-CHANGE TRANSMISSION for instantaneous selection of 16 record speeds over a range of 120 to 1.
- AUTOMATIC INTENSITY CONTROL.
- CONTINUOUS SWEEP OSCILLATOR which permits viewing as well as recording.
- Single-pulse LINEAR OSCILLATOR for recording transients on stationary film. The record can initiate the transient to be recorded, or the transient can initiate the record.

Each recording element is a complete unit, fully housed, which can be instantly inserted or removed. Recording element contains high-intensity cathode-ray tube, and both AC and DC amplifiers. Control panel is located on outside end.

FOR FURTHER INFORMATION, WRITE FOR  
BULLETIN 2 GTG

*Hathaway*  
INSTRUMENT COMPANY  
1315 SO. CLARKSON STREET • DENVER 20, COLORADO

trated measures the percentage of total potentiometer resistance tapped in at any mechanical setting of the potentiometer wiper arm. Accuracy is better than 0.01 percent at all settings from 0 to 100 percent of total resistance. The unit incorporates a modified Wheatstone bridge circuit and operates from 110-volt, a-c power or from a low-voltage d-c source.

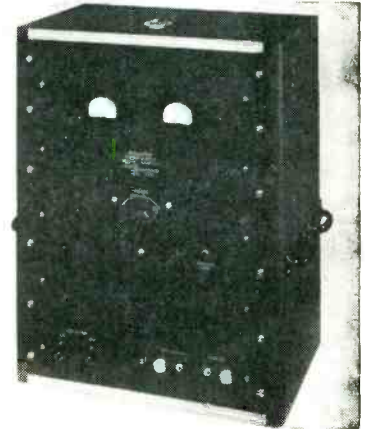

#### Regulated Power Source

FURST ELECTRONICS, 12 S. Jefferson St., Chicago 6, Ill. Models 1110 and 1110-A power supplies were designed for laboratories, test-stations on production lines and similar applications. They produce d-c power at constant output voltages, independent of variations of power-line voltage and of currents drawn by the load. Output is 0.5 kw maximum. Power consumption is about 1,500 watts at full load from a 115-volt (nominal), 50 or 60-cycle single-phase a-c power line.



#### Dental Radiography Tube

AMPEREX ELECTRONIC CORP., 25 Washington St., Brooklyn 1, N. Y., has announced the Mini-X 045A



# And which Metallic Rectifier Is Best?

No one type is "best." Each type of rectifier has characteristics which make it a "natural" for a particular application. For every application there is usually one best type. The correct choice depends upon the application. Here are general recommendations!

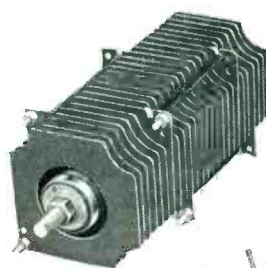

copper-oxide



low-voltage selenium

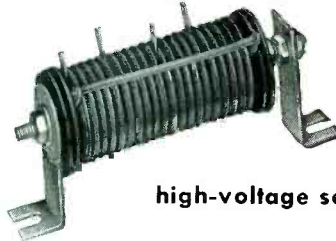

high-voltage selenium

## GENERAL RECOMMENDATIONS

Where you want	Use	Because
Small size	High-Voltage Selenium	Except for 12 volts and below, fewer high-voltage selenium cells are needed.
Light Weight	High-Voltage Selenium	Selenium-on-aluminum cells are much lighter than copper-oxide.
High Power for a few seconds	Copper-Oxide	Both types will withstand high short-time current overloads but only copper-oxide will withstand the higher a-c voltage necessary to deliver short-time high power output.
High current with Low Voltage	Fan Cooled Copper-Oxide	While with fan cooling, selenium can operate at higher current densities than copper-oxide, efficiency will be lower. Copper-oxide aging remains stable.
High Voltage	High-Voltage Selenium	Fewer selenium cells are required.
Low Current at 6 volts or less	Copper-Oxide	Cell for cell, copper-oxide costs less than selenium. Where the minimum number of cells of either type is required, copper-oxide will be cheaper.
Long life with unchanged output	Copper-Oxide	While both types appear to have unlimited life. Characteristics of copper-oxide do not change after the first 6 to 12 months of continuous operation. Selenium continues to age—to build up internal resistance with time and particularly with high current densities.
Blocking in D-C Circuits	Copper-Oxide	Selenium tends to "uniform" when used as a check valve in d-c circuits or when idle for a period of time (though it reforms quickly when reverse voltage is impressed).
Resistance to Corrosive Atmosphere	Oil-Filled Selenium	Stacks are hermetically sealed in oil, protected against fumes, dirt and dust.

Low-voltage selenium is generally recommended as a compromise between copper-oxide and high-voltage selenium. Where some of the features of both high-voltage selenium and long life copper-oxide are desired, low-voltage selenium would be a logical choice.

To fully meet your needs General Electric makes all three types. If you have a rectifier problem, bring it to us. As we make all three types, we play no "favorites." You can expect an impartial recommendation. Contact your G-E Apparatus Agent or write Apparatus Dept., General Electric Company, Schenectady 5, New York.



# UHF OSCILLATOR

FREQUENCY RANGE:

300 Mc. to 1000 Mc.

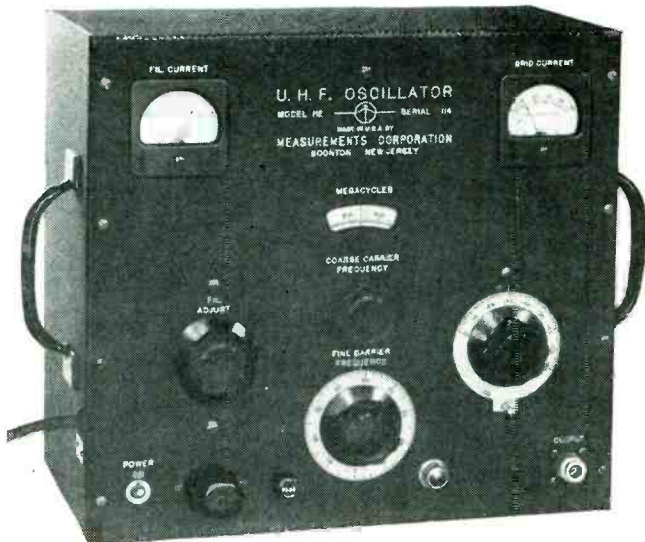

## MODEL 112

THIS oscillator was designed for the many applications in ultra-high frequency engineering that require a high degree of frequency accuracy and stability. The direct-reading frequency dial is individually calibrated to an accuracy of  $\pm 0.5\%$ .

An output dial, calibrated in decibels, permits relative voltage measurements within a ratio of 100 to 1.

**FREQUENCY RANGE:** 300 to 1000 Megacycles  
**FREQUENCY CALIBRATION ACCURACY:**  $\pm 0.5\%$   
**OUTPUT VOLTAGE:** Maximum varies with frequency between 0.3 volt and 2 volts. Adjustable over 40 db range  
**OUTPUT IMPEDANCE:** 50 ohms  
**POWER SUPPLY:** 117 volts; 50-60 cycles; 60 watts  
**DIMENSIONS:** 12½" x 13½" x 8". Weight 22 lbs.

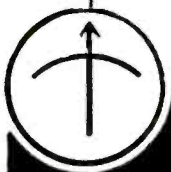

# MEASUREMENTS CORPORATION

BOONTON

NEW JERSEY

tiny x-ray tube for use in dental radiography. It measures 2¼ in. in length (including the pins), has a diameter of 1½ in. and a focal spot of 0.8 square mm. It operates at 45 kv and 7 ma.



## Horizontal Linearity Control

RADIO CORP. OF AMERICA, Harrison, N. J. Type 207R1 variable inductor is designed for adjusting horizontal linearity of the picture on 10 and 12-inch kinescopes. Utilizing a powdered-iron core, it is intended for operation with the 217T1 horizontal-deflection-output and high-voltage transformer and the 205D1 deflecting yoke. Ratings, characteristics and dimensional outline are given in a single-page bulletin.



## Regulated Power Supply

OREGON ELECTRONIC MFG. CO., 206 SW Washington St., Portland 4, Oregon. Model A3 regulated power supply features flexible continuously variable d-c voltage output from 0 to 400 with 0.5-percent reg-

THIS MAN WOULDN'T NEGLECT

A MACHINE IN HIS PLANT

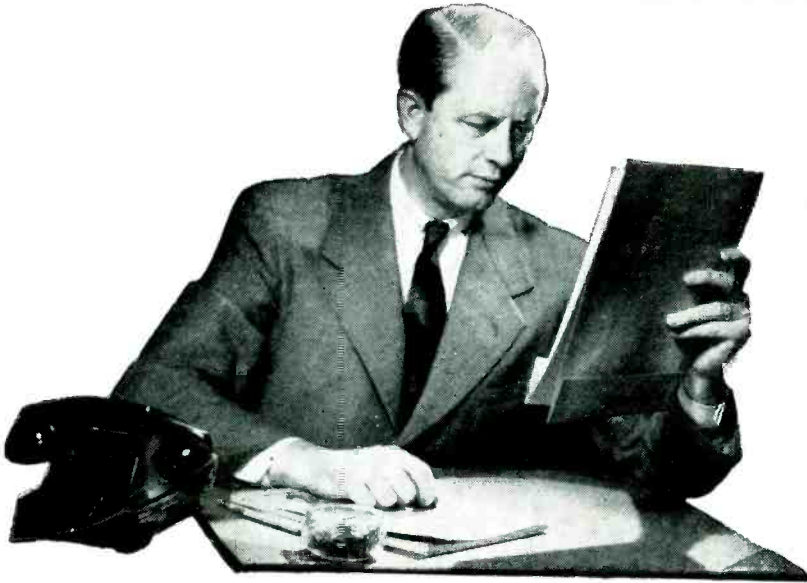

...yet he hasn't  
had a Chest  
X-Ray!

**H**e checks every piece of mechanical equipment he owns for wear, lubrication, efficiency.

Yet he fails to take the simple precaution of a Chest X-Ray to make sure he does not have tuberculosis. *Not because he's opposed to the X-Ray. Simply because he is not sufficiently informed—or just hasn't taken the time and trouble, or does not realize the seriousness of the problem.*

A Chest X-Ray is the first step toward detecting tuberculosis in its early stages. And in its early stages it can be cured with the least loss of time from work.

So, if you're the man above, that one simple reason should make you get your Chest X-Ray—*today*. But listen, see how serious this really is:

Between the ages of 15 and 34, tuberculosis leads all other diseases as a cause of death—although at no age are you safe from TB. Yet, if everyone does his part by getting a Chest X-Ray periodically, and the majority of cases thus discovered are followed up, we can eliminate TB entirely as a public health hazard!

Will you do your part today? Get a Chest X-Ray. It may mean your life!



*Published in the public interest by:*

**McGRAW-HILL PUBLICATIONS**

# PANORAMIC RADIO PRODUCTS, Inc.

Cordially invites you to attend dynamic demonstrations of panoramic spectrum analyzers at the I. R. E. National Convention, Booth Z, March 6th-9th.

Long recognized as being unexcelled for laboratory, research and production applications requiring spectrum or waveform analysis, these instruments help collect data more quickly, simply and accurately.

Spectral components are graphically visualized on a cathode-ray tube as vertical deflections distributed horizontally in order of frequency. Deflection height directly indicates signal level.

Whether your problem is investigating the characteristics of AM, FM or pulsed signals, spurious oscillations or modulation, cross modulation, etc., or monitoring many frequency channels simultaneously, it will pay you to see these panoramic analyzers in actual operation.

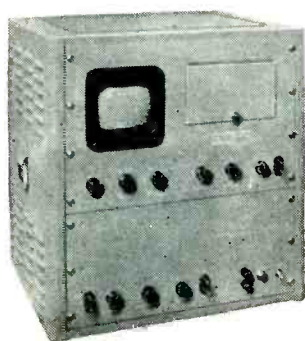

## PANORAMIC SONIC ANALYZER, MODEL AP-1 Automatic Waveform Analysis in Only 1 Second

Accepted as the practical answer for truly simple high speed analysis of vibrations, noises, harmonics, intermodulation and acoustics, the AP-1 automatically separates and measures the frequency and magnitude of complex wave components.

Frequency Range: 40-20,000cps, log scale  
Input Voltage Range: 500uv-500V  
Voltage Scale: Linear and two decade log  
Direct Reading and Simple operation

Can be calibrated to determine sound level of components. Presentations easily photographed or recorded.

## PANORAMIC ULTRASONIC ANALYZER, MODEL SB-7 A New Direct Reading Spectrum Analyzer

An invaluable new instrument for monitoring, telemetering, and for investigating ultra audible noises and vibrations, the SB-7 allows overall observation of a 200KC wide band or highly detailed examination of selected narrow segments in the ultrasonic region.

Frequency Range: 2KC-300KC, linear scale  
Scanning Width: Continuously variable from 200KC to Zero  
Amplitude Scale: Linear and two decade log  
Input Voltage Range: 1mv-50V  
Scanning Rate: 6.7cps (approx.)



## PANADAPTOR SA-3, SA-6 PANALYZOR SB-3, SB-6 For General RF Spectrum Analysis

Recognized as the fastest and simplest means of investigating and solving such RF problems as frequency stability, modulation characteristics, oscillations, parasites and monitoring under static or dynamic conditions, these models are available in over a dozen different types, designed to meet your particular application.

Panadaptor units operate with superheterodyne receivers which tune in the spectrum segment to be observed.

Panalyzers use an external signal generator for this purpose and have a flat response for determining relative levels of signals.



## PANADAPTOR, SA-8 PANALYZOR SB-8 For RF Spectrum Analysis where Maximum Resolution is a "Must"

Available in several types with maximum scanning widths ranging from 200KC to 20MC, both the SA-8 and SB-8 feature.

- Continuously Variable Resolution from 250KC to 100cps
- Synchronous and Non-synchronous Scanning
- Long Persistence Displays plus Intensity Grid Modulation for Analysis of Pulsed RF Signals
- Continuously Variable Scanning Width from maximum to Zero

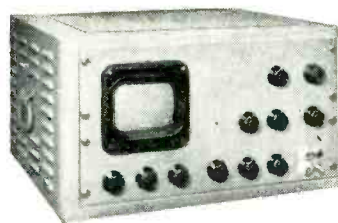

Write Dept. E3 for complete specifications and prices.

**PANORAMIC**  **RADIO PRODUCTS Inc.**  
10 SOUTH SECOND AVE. MOUNT VERNON, N. Y.

ulation at loads from 0 to 200 ma. Other outputs are: 400 v d-c unregulated, 0 to -150 v d-c variable and stabilized, and 6.3 v a-c at 5 amp. Output ripple voltage is less than 10 mv. A 40- $\mu$ f capacitor may be switched across the regulated output to accommodate large peak-current loads.



## Pencil-Type Iron

ELECTRIC SOLDERING IRON Co., Inc., Deep River, Conn. The new No. 61 pencil iron is 7 in. long and weighs 2.5 ounces exclusive of cord. Handle temperature at the point where held in fingers is no higher than body temperature. A plug-type tip is held in place with a set screw. The iron is regularly wound to 25 watts at 105 to 120 volts.

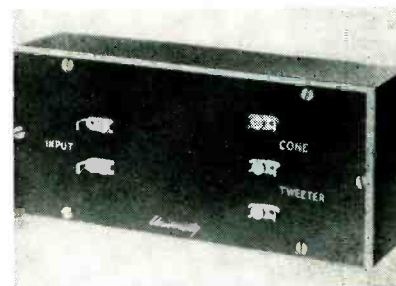

## Filter Network

UNIVERSITY LOUDSPEAKERS, INC., 80 South Kensico Ave., White Plains, N. Y. Model 4410 filter network, for use with coaxial or duplex loudspeaker systems, provides a proper attenuation rate at a crossover of 600 cycles. It was designed primarily for use with the new h-f tweeter and is especially recom-

# KOTRON

THE NAME TO REMEMBER IN  
SELENIUM METALLIC RECTIFIERS

**KOTRON** Multi-volt cells are the only industrial rectifiers blocking 40 volts rms per cell with the same current density as ordinary 26 volt cells — They save weight, size and cost and have higher efficiency.

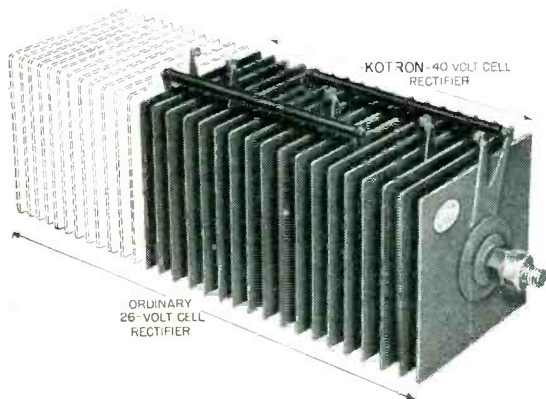

**KOTRON'S** amazingly new capillary stop-gap current collector . . . perfect protection against moisture. No center contact — no slotted petal contact.

**KOTRON** 3-phase high voltage rectifier. 3 cells in series per arm block 120 volts rms 0.5 Amp. per sq. in. of actual rectifying area. Keyed square cells deliver 20% more current in the same space occupied by round cells.

The **KOTRON** recti-graph tells the story

**KOTRON** blocking 40 volts rms per cell has the same current density as ordinary 26 volt cells.

**KOTRON** blocking 26 volts rms per cell has 1.6 times current density of ordinary 26 volt cells.

**KOTRON** blocking 20 volts and downward has 2.2 times the current density of ordinary 26 volt cells. High or low voltage, **KOTRON** sets new standards.

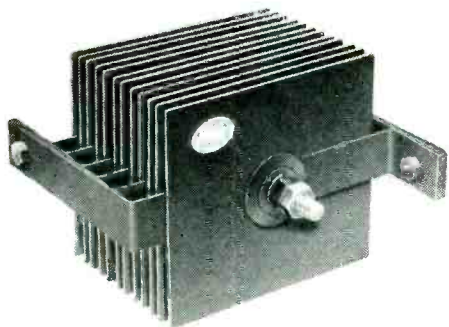
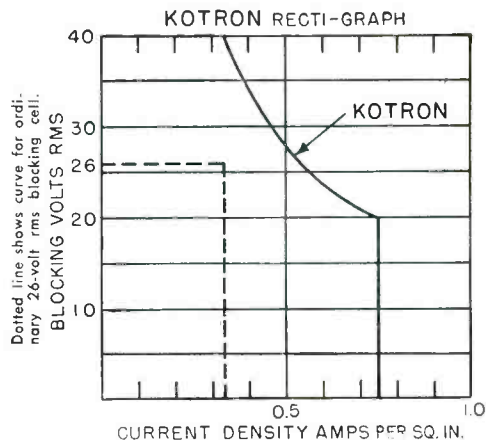

**KOTRON** high current selenium rectifier. 3-phase, half-wave rectifier stack. Occupies but 90 cu. in. volume. Delivers 12 volts at 500 amps fan cooled or 2.2 times the current density of ordinary 26 volt cell rectifier having 180 cu. in. volume. Echelon terminal structure eliminates soldered, riveted or screw connections.

**KOTRON** specialized engineering consulting service available to help you with your rectifier problems. Details on request.

FREE—technical bulletins, data and literature available for design engineers and manufacturing executives requesting same on Company stationery.

Telephone HUmboldt 2-2400



## KOTRON RECTIFIER CORP.

AN AFFILIATE OF STANDARD ARCTURUS CORPORATION

54 CLARK STREET

NEWARK 4, N. J.

Another  
**PRECISION  
PRODUCT**

**Burlington**

## RUNNING TIME METER

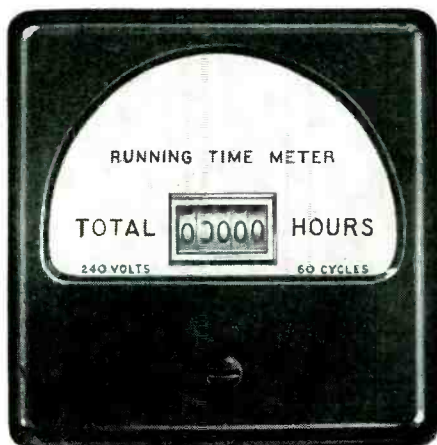

- Designed for use on AC lines where successful servicing of electronic or electrical equipment depends upon the regular servicing of such equipment based on actual operating (or idle) time. Unit has a range of 9999.9 hours and resets automatically at 10,000 hours. Can be supplied for either 120 or 240 volts. 60 cycle operation and has operating temperature of  $-55$  to  $+55^{\circ}$  C.

- The Running Time Meter is housed in Burlington's attractive, black bakelite 3" square or 3 1/2" round case.

- 9999.9 hour range
- 10,000 hour automatic reset
- $-55$  to  $+55^{\circ}$  C operating temperature

Write Dept. F 30 for further details.

**BURLINGTON INSTRUMENT COMPANY**  
BURLINGTON, IOWA

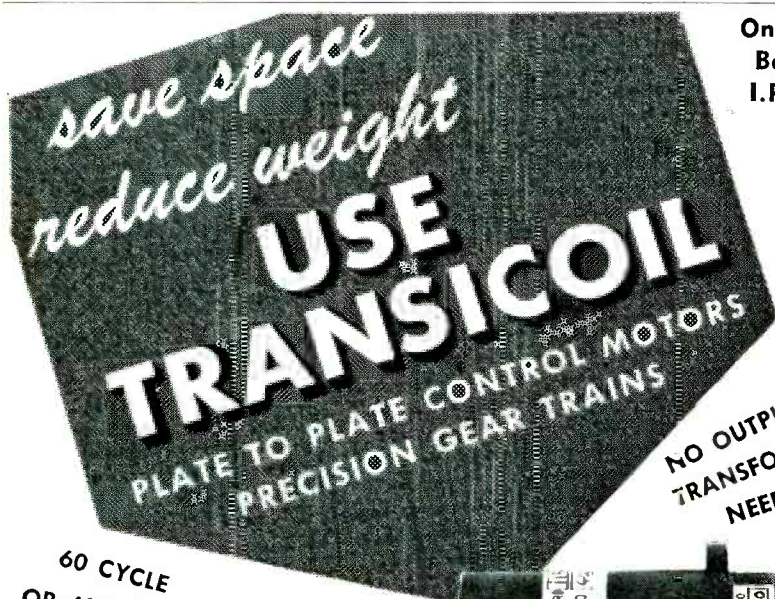

60 CYCLE  
OR 400 CYCLE

There Is A Transicil Unit Designed To Meet the Requirements Of Your Particular Application

Complete Technical Data Available Upon Request

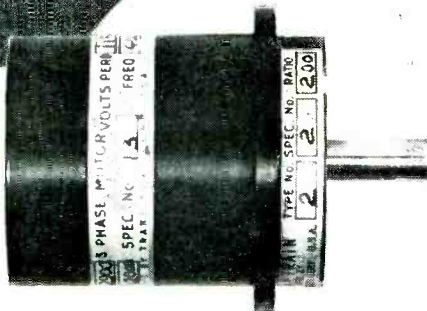

On Display:  
Booth 263  
I.R.E. Show

**TRANSICOIL CORPORATION**

114 Worth St.,  
New York 13, N. Y.

## ELECTRON-TUBE CIRCUITS

1. Timely new book discusses different classes of circuits which have widespread application in radar, television, pulse communication, and general electronic control. Shows how to combine circuits of various types to achieve

one or a number of operations. Treats power rectifiers, filters, regulators, amplitude modulation, oscillators, etc. By S. Seely, Prof. of Electr. Eng., Syracuse U. 529 pages, \$6.00

Maintenance  
Manual of  
**ELECTRONIC  
CONTROL**



MAINTENANCE  
MANUAL OF

## ELECTRONIC CONTROL

2. Covers installation, servicing and troubleshooting of timing relays—time delay relays—photoelectric relays—furnace temperature control—and mercury arc rectifiers. Goes from the most basic electrical circuit to advanced circuits of electronic motor control and welding control. Edited by R. E. Miller, Sales Mgr., Weller Mfg. Co. 304 pages, \$4.50

## ULTRASONICS

3. A complete engineering consideration of the ultrasonic field. Reviews electronic considerations and outlines of circuits. Explains mechanical and electrical design and construction techniques... from the design consideration of ultrasonic crystals to the measurement of ultrasonic waves. Includes data on instruments, applications, developments, etc. By B. Carlin, formerly with Sperry Prods. 264 pages, \$5.00



## APPLIED MATHEMATICS

for Radio and  
Communication Engineers

4. A complete course in mathematics, from arithmetic through calculus designed for home study. Each theory is built up from the basic fundamentals to elaborate detailed concepts. Practical exercise problems help build a working knowledge of trigonometry, vector addition, etc. By C. Smith, Smith Pract. Radio Instit. 336 pages, \$3.50.

Examine one or all 10 days FREE

McGraw-Hill Book Co.  
330 W. 42d St., N.Y.C. 18, N. Y.

Send me book(s) corresponding to numbers encircled below for 10 days' examination on approval. In 10 days I will remit for book(s) I keep, plus few cents for delivery, and return unwanted book(s) postpaid. (We pay for delivery if you remit with this coupon; same return privilege.)

1 2 3 4

Name.....

Address.....

City..... Zone..... State.....

Company.....

Position..... L-3-50

This offer applies to U. S. only

mended for the exacting needs of concert halls or theatres.

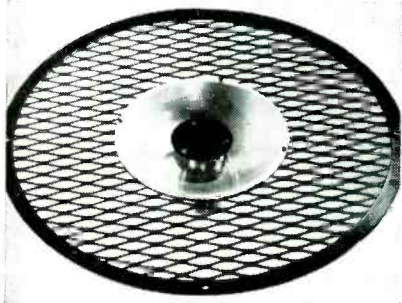

**High-Frequency Tweeter**

MARK SIMPSON MFG. CO., INC., 32-28 49th St., Long Island City 3, N. Y. The Masco HFT-100 high-frequency tweeter is designed for use with the average cone speaker in order to obtain an overall response up to 15,000 cycles. In operation, the existing cone speaker is demounted, the screen with the high-frequency speaker is put into place and the two speakers are then connected in series.

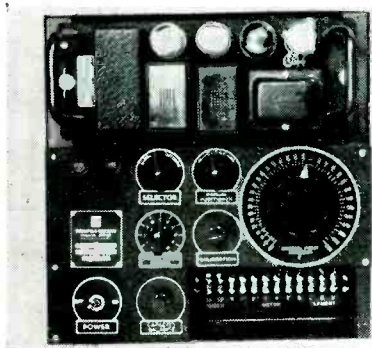

**Temperature Controller**

BROWN INSTRUMENTS DIVISION, MINNEAPOLIS-HONEYWELL REGULATOR Co., 2753 Fourth Ave., S., Minneapolis, Minn. Model 077 electronic control instrument will control industrial processing temperatures in which the temperature range is between 20 deg below zero and 300 deg above. It contains a sensing element which forms one leg of a Wheatstone bridge circuit so that any minute change in temperature causes the bridge to become unbalanced and permits current to flow. Electrical unbalance of the bridge is imposed on an

**End "SQUINT-SQUAT" TV Tuning with S.S. WHITE FLEXIBLE SHAFTS**

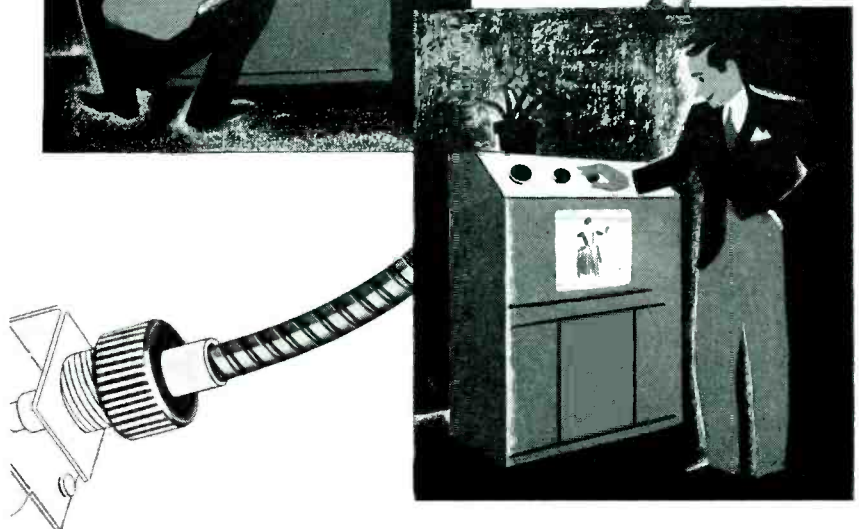
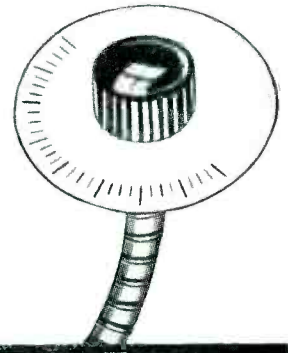

Make your TV sets easy to tune. Eliminate the squatting and squinting that is necessary when dials are mounted in the dark below the picture tube. Mount the dials where they're easy to see and comfortable to operate.

You can do it readily by using S.S.White remote control flexible shafts to connect the dials to the circuit elements they tune. These shafts were developed just for this kind of duty and have the right characteristics for the job.



BULLETIN 4501 will give you full details about the shafts. Write for a copy today.



**S.S. WHITE INDUSTRIAL**  
 THE S. S. WHITE DENTAL MFG. CO. DEPT. E 10 EAST 40th ST., NEW YORK 16, N. Y.



FLEXIBLE SHAFTS AND ACCESSORIES  
 MOLDED PLASTICS PRODUCTS—MOLDED RESISTORS

*One of America's AAAA Industrial Enterprises*

# INSULATION

FORMVAR • FORMEX • ENAMEL

## STRIPPED CLEAN IN SECONDS

with **X-VAR**

IN



1. DIP WIRE in X-VAR for 3 seconds.

OUT



2. WITHDRAW and watch coating disintegrate.

WIPE

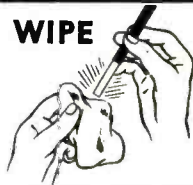

3. WIPE CLEAN. Operation completed in seconds.

X-VAR is non-corrosive, non-creeping — leaves wire ready for soldering. Now in use by leading manufacturers of electrical products. Write for **FREE SAMPLE** for testing.

**FIDELITY CHEMICAL PRODUCTS CORP.**

472 Frelinghuysen Avenue, Newark 5, New Jersey

# KEEP IN STEP!

- ★ Series 37, linear and tapered resistance of 1000 ohms min. to 5 meg. max.
- ★ Series 43, 10,000 ohms max., linear.
- ★ Resistance values within 10% plus/minus, standard, on Type 43. Within 20% on Type 37 under 100,000 ohms; 30% over 100,000 ohms (RMA Standard).

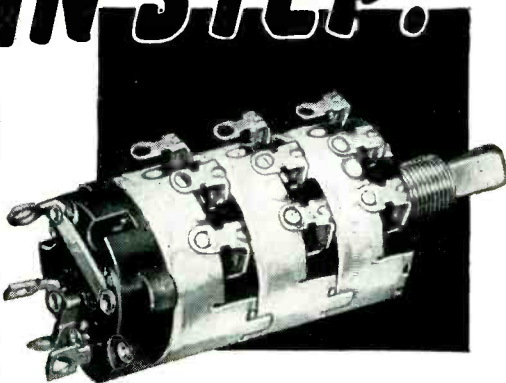

## DUAL AND TRIPLE CONTROLS

- ★ Two or three Clarostat Series 37 (composition-element) or Series 43 (wire-wound) controls in tandem. With or without switch. One-knob simultaneous control of two or three circuits. Neatest mechanical job yet. And most efficient, electrically. Only 1 1/8" dia.

WRITE FOR BULLETINS 112 AND 116. LET US QUOTE!

CLAROSTAT



*Controls and Resistors*

CLAROSTAT MFG. CO., INC. • DOVER, NEW HAMPSHIRE • In Canada: CANADIAN MARCONI CO., LTD. Montreal, P. Q., and branches.

## POSITIONS OPEN

For

### SENIOR RESEARCH

### ENGINEERS

And

### PHYSICISTS

Established Electronic and Control Laboratory in the Los Angeles, California area, offers exceptional opportunities for Senior Engineers and Physicists having outstanding academic background and experience in the fields of

- Microwave Techniques
- Moving Target Indication
- Servomechanisms
- Applied Physics
- Gyroscopic Equipment
- Optical Equipment
- Computers
- Pulse Techniques
- Radar
- Fire Control
- Circuit Analysis
- Autopilot Design
- Applied Mathematics
- Electronic Subminiaturization
- Instrument Design
- Automatic Production Equipment
- Test Equipment
- Electronic Design
- Flight Test Instrumentation

Salaries commensurate with ability, experience and background. Working conditions and opportunities for advancement are excellent. Send information as to age, education, experience and work preference to:

**NORTH AMERICAN AVIATION, INC.**

*Aerophysics Laboratory*

Box No. K3

12214 South Lakewood Blvd.

Downey, California



electronic amplifier which amplifies and detects the direction of unbalance to operate either of two output relays according to the direction of temperature change.

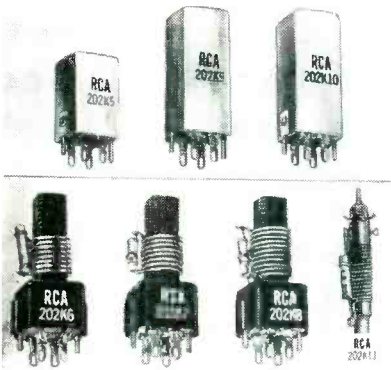

**Picture I-F Components**

RADIO CORP. OF AMERICA, Harrison, N. J. New picture i-f components giving improved sensitivity, selectivity and response are as follows: the 202K5 converter transformer; 202K6, 202K7, 202K8, 202K9 and 202K10 picture i-f transformers; and 202K11 cathode-circuit trap. These units, tuned by conveniently adjustable cores are designed for a sound i-f carrier of 21.25 mc and a picture i-f carrier of 25.75 mc.

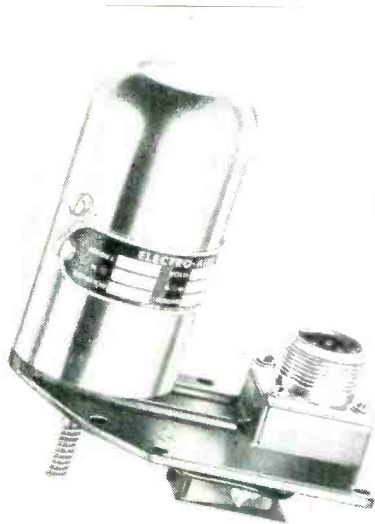

**Small D-C Motor**

ELECTRO-AIRE, INC., 11439 Vanowen St., North Hollywood, Calif. Model 1301 Highspeed, reversible, 1/100 h-p, d-c motor has a built-in electrical mechanical brake. Running torque is 1.1 inch-ounce at 19,000 rpm at 28 volts d-c; and the

# RCA TUBES ...

the complete line for industry...



FREE—New 20-page RCA Tube Booklet\*

**FOR ALL YOUR ELECTRON TUBE NEEDS...phone your local RCA Tube Distributor**

Your local RCA Tube Distributor carries adequate stocks of dependable RCA Electron Tubes to meet virtually every industrial and laboratory requirement. For prompt service on all your electron tube needs... look to your RCA Distributor.

\* Contains complete data on 159 RCA Vacuum Power Tubes, Rectifier Tubes, Thyratrons, Glow Discharge Tubes, and Ignitrons. Ask

your RCA Distributor for Bulletin PG-101A or write Commercial Engineering, RCA, Section E66T, Harrison, N. J.



**RADIO CORPORATION of AMERICA**  
ELECTRON TUBES HARRISON, N. J.

YOU CAN DO IT BETTER WITH **FORMICA**

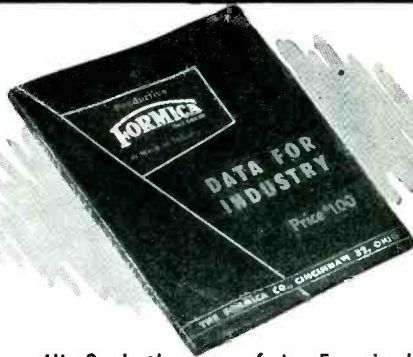

and you'll find the proof in Formica's new "DATA FOR INDUSTRY" . . . the most comprehensive technical handbook on laminated plastics ever produced. Properties and performance characteristics for every grade are at your fingertips in this 96-page, durably bound reference volume. Send \$1.00 today for your own personal, numbered copy. Learn how Formica can serve you, whatever your requirements.

**FORMICA**  
4640 SPRING GROVE AVE.,  
CINCINNATI 32, OHIO

Productive  
**FORMICA**  
at Work in Industry

**FORMICA**  
makes a grade that "Makes The Grade"



MODERN  
ELECTRONIC  
ENGINEERING  
GIVES  
PRECISE

# FINGERTIP SPEED CONTROL

- TACHOMETER PROPORTIONING
- TENSION OR POSITION CONTROL
- MOTOR INTEGRATORS
- BI-DIRECTIONAL
- DYNAMIC BRAKING
- SERVO CONTROL

**Servo-Tek**  
products co.  
4 Godwin Ave. Paterson, N. J.

# MICROPOT

PRECISION TEN-TURN POTENTIOMETER

1. You get permanent accuracy because the resistance wire is locked in place. It is precision positioned and moulded integrally with the housing.
2. You get permanently accurate settings, smooth action and low uniform torque provided by the stainless steel, precision ground, double thread lead screw guiding the moving contact.
3. You get precise positioning of the moving contact because of the two bearings supporting the rotor assembly.
4. You get good rigid terminals because they are moulded integrally with the housing.
5. Terminals soldered to ends of resistance element before moulding. Entire resistance circuit is an integral part of the housing.
6. You get accurate setting and re-setting due to anti-backlash spring in contact guide.
7. You get a fine resolution because of the  $43\frac{1}{2}$ " length of resistance wire in the spiral element.
8. You get a resistance output directly proportional to shaft rotation within  $\pm 0.1\%$  of the total resistance. Every potentiometer is automatically machine tested for linearity at 101 points.

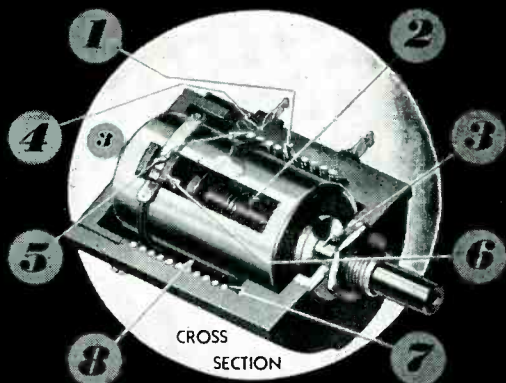

**LINEARITY  
ACCURACY  $\pm 0.1\%$**

Units for immediate shipment:  
1,000 to 30,000 ohm range.  
Special resistance values made to order.

WRITE TODAY FOR  
ENGINEERING INFORMATION



GIBBS DIVISION  
**THE GEORGE W. BORG CORPORATION**  
DELANA • WISCONSIN

brake operates within the 18 to 30-volt range. Dimensions (excluding worm gear) are 3.5 × 1.75 in. diameter, and weight is slightly over 1 pound.

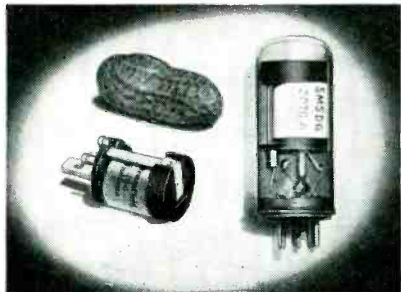

**Subminiature Relay**

POTTER AND BRUMFIELD, 549 W. Washington Blvd., Chicago 6, Ill. Model SM subminiature relay is available with windings as high as 8,000 ohms and adjustment for current operation to pull in as low as 3 ma, with coil consumption of 75 mw minimum. The standard model, wound for d-c voltage actuation, draws approximately 0.5 watt, but the coil size will permit a maximum dissipation of 1.75 watts at 83 deg C rise. It is available in either the open type or hermetically sealed in a miniature glass tube envelope with a 7-prong base.



**H-V Power Supply**

RADIO CORP. OF AMERICA, Camden, N. J. Type EME-2 regulated d-c power supply is designed for applications requiring a voltage between 10 and 50 kv with a maximum current requirement of 2 ma. An ideal accelerating supply for c-r tubes in experimental equipment or as a permanent set-up for testing these tubes, the driver and rectifier units pictured above are also designed for

**An Envious Record of Performance and Dependability!**

The INDUSTRIAL and TELEVISION

**POCKETSCOPE**

BY WATERMAN



Model S-11-A

A "standard" and a "must" wherever a dependable, versatile, portable AC-DC oscilloscope is required for electronic measuring or testing.

AND NOW . . . new companion products in keeping with the rigid Waterman standards of engineering excellence . . . THREE NEW POCKETSCOPES will be unveiled in a premiere showing at the IRE Radio Engineering Exposition . . .

*See the Performance of these*  
**3 BIG FEATURES**  
*Plus Extra Added Attractions!*  
 AT THE RADIO ENGINEERING SHOW  
 BOOTH NO. 27  MARCH 6 to 9

**NEW** ★  
**NEW** ★  
**NEW** ★

**A SIMULTANEOUS DUAL-TRACE POCKETSCOPE**

*An Electronic Milestone You Must See!*

**A WIDE BAND POCKETSCOPE!**

*To Fill a Multitude of Engineering Needs!*

**A HIGH GAIN INDUSTRIAL POCKETSCOPE**

*More Versatile . . . Greater Utility!*

Proudly bearing the heritage of the famed S-11-A POCKETSCOPE, these new instruments include such features as 10-times more sensitivity . . . non-frequency discriminating volume controls . . . trigger sweep . . . and many other important added features. You must see these wonderful new instruments IN ACTION—at the show—to truly appreciate them!



**WATERMAN PRODUCTS CO., INC.**  
 PHILADELPHIA 25, PA.

MANUFACTURERS OF

**POCKETSCOPES . . . RACKSCOPES . . . D. C. AMPLIFIERS**  
**RAYONIC TUBES AND OTHER ELECTRONIC TECHNICAL EQUIPMENT**

Make Your Circuits "Slip-Proof"

with

**CURTIS TYPE "K"**

Lock-In

**TERMINAL  
BLOCKS**

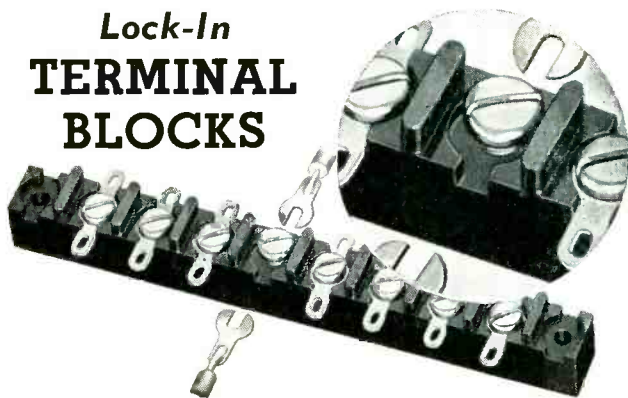

Write for  
your copy  
of Bulletin  
DS-114

There's no chance of terminals pulling out or dropping out of position when you use Curtis Type "K" Terminal Blocks. Solder-type spade lugs are securely held in position when binder screws are drawn up, but any terminal can be quickly and easily removed when desired. The solid base, a Curtis feature, insures maximum insulation.

**CURTIS**

**DEVELOPMENT & MFG. CO.**

Terminal Block Sales  
4522 West Madison St., Chicago 24, Ill.  
Factory—Milwaukee 10, Wisconsin

**The Shape and  
Size YOU need!**

**PARAMOUNT  
SPIRAL  
WOUND PAPER TUBES**

All Sizes in

**Square and Rectangular Tubes**

Leading manufacturers rely on the quality and exactness of PARAMOUNT paper tubes for coil forms and other uses. Here you have the advantage of long, specialized experience in producing the exact shapes and sizes for a great many applications. *Hi-Dielectric, Hi-Strength.* Kraft, Fish Paper, Red Rope, or any combination. Wound on automatic machines. Tolerances plus or minus .002". Made to your specifications or engineered for YOU.

**SEND FOR ARBOR LIST  
OF OVER 1000 SIZES**

Inside Perimeters from  
.592" to 19.0"  
Convenient. Helpful. Lists  
great variety of stock ar-  
bors and tube sizes. In-  
cludes many odd sizes.  
Write for Arbor List today.

**PARAMOUNT PAPER TUBE CORP.**

616 LAFAYETTE ST., FORT WAYNE 2, IND.

Manufacturers of Paper Tubing for the Electrical Industry



The Triad high-fidelity output transformers listed below afford a standard of performance exceeded only by the Triad "HS" Series outputs. Embodying a simplified, inexpensive construction through the use of mass production die-stamped cases and flexible leads, costs on these transformers are held to a minimum without affecting performance.

These transformers are designed with plenty of the highest quality core material and with interleaved windings of low resistance. These coils have a frequency response linear within 1 db. from 30-15,000 cycles and will deliver their full rated output within 3 db. over this entire range of frequencies. Their high open circuit reactance and low leakage reactance will permit their use within feedback loops employing as high as 30 db. of negative feedback.

*Compare these  
Specifications and Prices*

Type No.	Primary Impedance	Secondary Impedance	Output Watts	List Price
S-31A	8000 C.T.	4-8-16	15	\$8.75
S-33A	3000 C.T.	4-8-16	15	8.75
S-35A	5000 C.T.	4-8-16	18	9.50
S-38A	9000 C.T.	4-8-16	25	12.50
S-40A	2500 C.T.	4-8-16	30	12.50
S-42A	4500 C.T.	4-8-16	50	17.50
S-45Z	4000/2000/ 1000/500	4-8	10	4.75
S-46A	2000/1000/ 500/250	4-8-16	20	11.00

Circuit diagrams for the most effective use of these transformers, plus data and prices on the entire Triad line, are shown in Catalog TR-49-A, free on request.



2254 Sepulveda Blvd.  
Los Angeles 64, Calif.

use in nucleonics and the operation of laboratory test equipment for general use.

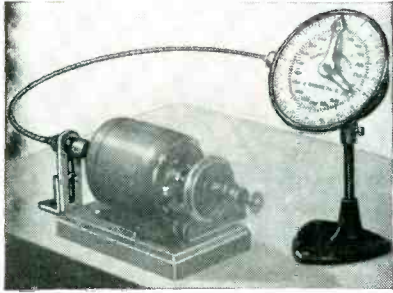

### Coil Winding Counter

PRODUCTION INSTRUMENT Co., 710 W. Jackson Blvd., Chicago 6, Ill. The Clipper quarter-turn coil winding counter will count to speeds of 10,000 turns per minute. Equipped with a 6-inch dial which indicates 2,500 turns and repeats, it automatically deducts turns taken off the coil in case of overrun.

### Miniature Tubes

GENERAL ELECTRIC Co., Schenectady, N. Y. Two new miniature tubes have been developed for use in altimeters, radio compasses, radio control equipment and h-f aircraft radio receivers and transmitters. The GL-5814 is a heater-cathode type medium-mu twin triode with a heater voltage of 6.3 volts at 0.35 ampere for parallel operation and 12.6 volts at 0.175 ampere for series operation. Its maximum plate voltage is 330 volts and plate dissipation is 3.03 watts. The GL-5751 is a high-mu twin triode with the same cathode heater and maximum plate voltages. Its plate dissipation is 1.1 watts.

### Bench Power Supply

P. R. MALLORY & Co., INC., 3029 E. Washington St., Indianapolis 6, Ind. Model 6RS10 portable d-c power supply was designed for such use as testing and demonstrating automobile radios and electrical equipment, operation of telephone systems, laboratory equipment,

# LOCKSEAM\* NICKEL CATHODES

*right for*

## TELEVISION

Lockseam\* Cathodes, a patented product of the Superior Tube Company's Electronic Division, has "earned its spurs" by producing quality cathodes for the expanding field of television. By this unique method, special machinery turns out cathodes directly from thin strip stock.

Correct performance characteristics are assured by a combination of exacting production procedures, constant metallurgical and chemical laboratory control and continuous testing both in our Electronics Laboratory and in actual service.

Superior Lockseam\* cathodes are available in round, oval and rectangular shapes, plain or beaded as required.

Write for full information on types of materials, dimensional range and tolerances of these revolutionary Lockseam\* cathodes.

For Electronic products for export, contact Driver-Harris Company, Harrison, New Jersey. Harrison 6-4800.

\*Superior Tube Company Patents

# Superior

THE BIG NAME IN SMALL TUBING

All analyses .010" to 3/8" O.D.  
Certain analyses (.035" max. wall) up to 1 1/8" O.D.

**SUPERIOR TUBE COMPANY**  
2500 Germantown Ave., Norristown, Pa.  
**ELECTRONICS DIVISION**

188,000 SQ. FT. PRODUCING METAL TUBING

# PRECISION



**POTENTIOMETER  
PERFORMANCE  
THAT EXCEEDS  
SPECIFICATIONS**

In potentiometers, "Fairchild" and "Precision" are synonymous. Because in Fairchild Potentiometers, close-tolerance machining of all parts goes hand-in-hand with the careful selection of the right contact materials and the right resistance wire. This, plus painstaking assembly by skilled craftsmen and the exact adjustment of wiper arm pressure, adds up to potentiometer performance that assures sustained accuracy over a service life far exceeding the guaranteed 1,000,000 cycles of operation.

Fairchild engineers will be glad to help in the selection of both linear and non-linear potentiometers to meet your particular needs. Address: Dept. L, 88-06 Van Wyck Boulevard, Jamaica 1, New York.



*Unless the Dry Battery You Need  
Is Listed in This Free Manual...*



**BURGESS ENGINEERS WILL  
DESIGN A NEW BATTERY TO  
MEET YOUR SPECIFICATIONS**

It's all part of the Burgess Service! This complete Engineering Manual lists *hundreds* of battery types developed by Burgess Engineers to meet new requirements. If the specific battery you need is not among them, the complete Burgess facilities, design, production, and engineering will be placed at your disposal to build the battery you need in any quantity—large or small!

**Write for ENGINEERING MANUAL and CHECK SHEET**

No obligation. By return mail you will receive the FREE Engineering Manual listing the complete line of Burgess Batteries together with specifications; also the Burgess "Check Sheet" on which you may outline your requirements in the event that the battery you need has not already been developed. Address:



**BURGESS BATTERY COMPANY**  
(DEPT. E1) FREEPORT, ILLINOIS

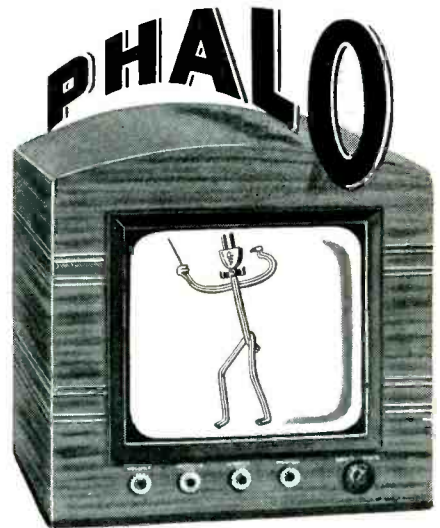

**Very Much in the  
T. V. PICTURE!**



**300 OHM Shielded, Jacketed Cable**



(Cat. No. 12506)

**Coaxial Cable**

72 OHM coaxial cable. Construction equivalent to RG59/U



(Cat. No. 22007, 22007-A, 22007-B, 22007-C, 22007-D)

**300 Ohm Parallel  
Twin Construction Line Cables**



**T. V. Power Supply Cords**



(Cat. No. 42007-42008 4-Conductor)  
(Cat. No. 52008 5-Conductor)

**Four and Five Conductor Leads  
For Rotating Antenna Controls**

**PHALO Single Conductor  
And Hook-Up Wire**

Phalo is fully equipped to assemble special harness or assembly requirements for almost all Television and Radio applications. Send for your copy of the 22 page PHALO Catalog NOW!

**PHALO**  
*Plastics Corporation*

Corner of Commercial Street  
WORCESTER, MASS.

Manufacturers of Thermoplastic insulated wire, cables, cord sets and tubing

solenoids, relays and motors. With a d-c voltage continuously variable from 0 to 8 v, the unit may be safely operated continuously at 10 amperes and intermittently at 20 amperes. Filtered d-c output with less than 1-volt ripple is 6 volts, 10 amperes. Power supply has a 0 to 20-amp d-c ammeter and a 0 to 10-v d-c voltmeter.

### Ultrasonic Soldering Iron

MULLARD ELECTRONIC PRODUCTS LTD., Shaftesbury Ave., London WC2, England, has developed the type E7587 ultrasonic soldering iron for soldering aluminum and other light metals and alloys. It consists essentially of a removable copper soldering bit and a magnetostriction transducer. The soldering bit, heated by means of a conventional resistance winding, is secured to a brass block held in firm contact with the nickel core of the transducer. The ultrasonic power necessary to drive the transducer is supplied by an electronic amplifier comprising the power supply unit.

### Literature

**Video Oscilloscope.** Federal Telecommunication Laboratories, Inc., 500 Washington Ave., Nutley 10, N. J. A well-illustrated description of the FTL-32A video oscilloscope is given in a recent four-page folder. Special features of the unit treated are a vertical amplifier bandwidth of 10 cps to 50 mc, and a horizontal amplifier bandwidth of 10 cps to 10 mc. Full technical characteristics are given.

**Audio Instruments.** Audio Instrument Co., 1947 Broadway, New York 23, N. Y. A recent one-page bulletin illustrates and describes the following audio instruments: Model 100 bridge, model 121 logger, model 140 disc-noise meter and models 12 and 14 miniature preamplifiers for use with the 640 AA condenser microphone.

**Tube Base Connections.** Tung-Sol Lamp Works, Inc., 95 Eighth Ave.,

# TOROIDS

by

**B&W**

...to your **SPECIFICATIONS**

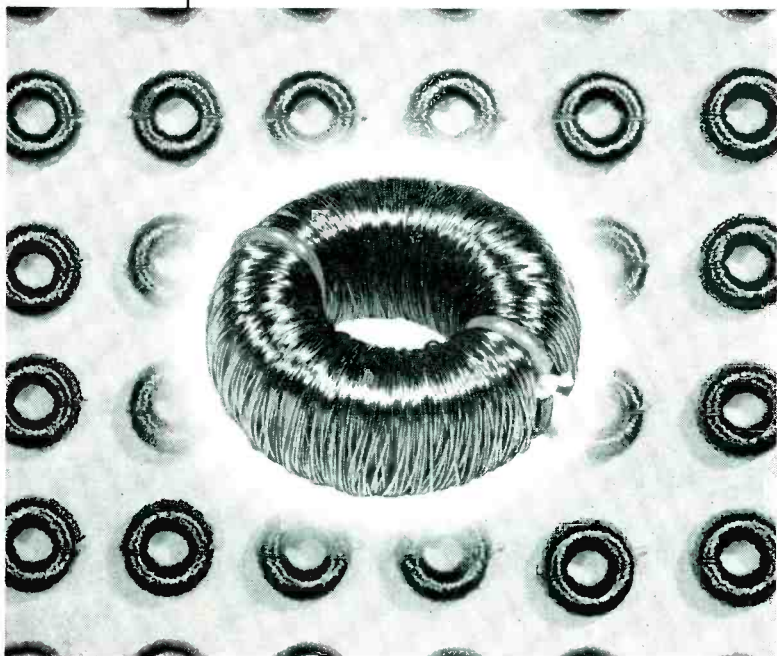

Development of stabilized, high permeability cores of various types and grades, has greatly increased the applications of toroid coils in the low frequency range from 500 cycles to 200 KC. B&W toroids feature high inductance and high Q within a minimum of space and confined electrical field. These features assure the highest performance in many types of filters or networks.

Over fifteen years background in coil design and manufacture, plus the latest toroidal coil winding equipment, provides a combination that makes it possible for B&W to meet your most exacting requirements. B&W Toroidal Coils are available in open types, shielded, potted or hermetically sealed units in addition to complete filters or networks for specific applications. Our Engineering Department is ready to assist you with your problems in the application of toroids.

Write to Dept. EL-30

**BARKER & WILLIAMSON, Inc.**

237 Fairfield Avenue

Upper Darby, Pa.

SEE US AT BOOTH C, I.R.E. SHOW

# Performance Plus!

with the Peerless hi-quality 18 watt TRIODE output amplifier kit. Heart of this kit is the Peerless S-240-Q output transformer, conclusively proved superior to all competition in square wave tests. Amplifier's response is flat from 20 to 20,000 cps for radio input. Phono input is equalized for variable reluctance pickup. Simple modification adapts amplifier for use with microphone. Kit contains all basic components and instructions for assembly.



10722  
Triode  
Amplifier  
Kit

 **PEERLESS**  
Electrical Products  
Division

1161 N. VINE ST., HOLLYWOOD 38, CALIF.  
161 SIXTH AVE., NEW YORK 13, NEW YORK



# Titeflex

**FLEXIBLE WAVEGUIDES**  
*Save Money*  
**IN VIDEO TRANSMISSION**

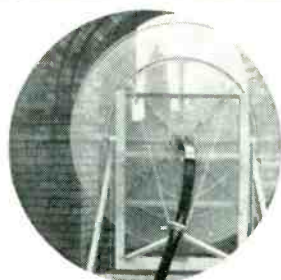

Titeflex Waveflex Waveguides used in television transmission. Assembled lengths of Waveflex over 30 feet long connect movable antenna with transmitter inside building. Antenna is directed at Empire State Bldg. faintly visible in background.

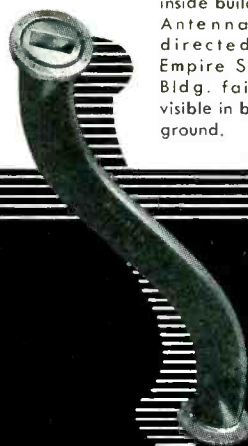

Titeflex Waveflex Waveguides give you all the advantages of rigid waveguides plus the additional feature of flexibility. Complicated bends and twists can be made with virtually no change in electrical properties . . . installation costs are lowered . . . design problems are simplified. Waveflex Waveguides are made in many standard types to Army-Navy specifications—or our engineers will develop special styles for you.

Write for  
**COMPLETE WAVEFLEX CATALOG**

## TITEFLEX, INC.

500 Frelinghuysen Ave., Newark 5, N. J.



**HEAT RESISTANT WIRES FOR EVERY APPLICATION . . .**

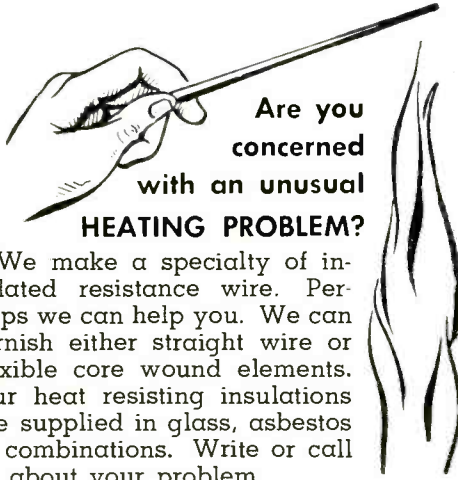

**Are you concerned with an unusual HEATING PROBLEM?**

We make a specialty of insulated resistance wire. Perhaps we can help you. We can furnish either straight wire or flexible core wound elements. Our heat resisting insulations are supplied in glass, asbestos or combinations. Write or call us about your problem.

*Send your electronic control, communications or appliance wiring specifications for a recommended solution by our engineers.*

FOR A TRIAL ORDER OR A CARLOAD consult

**HEATING UNITS**

**HEATING ELEMENT**

**RESISTANCE LINE CORD**

**THERMOCOUPLE WIRE**

**ASBESTOS LEAD & FIXTURE WIRE**

**INSULATED RESISTANCE WIRE**

**FIBERGLAS INSULATED WIRE**

**WIRE TO ANY SPECIFICATIONS**



**THE LEWIS ENGINEERING CO.**

*Wire Division*

**NAUGATUCK CONNECTICUT**



Newark 4, N. J., has published a 3 x 3-in. book containing 301 base diagrams of nearly 800 different electron tubes. Its convenient size and form enable the radio-tv serviceman to manipulate it in the palm of one hand with the pages always lying flat. Price is 50 cents.

**Self-Locking Nuts.** The Palnut Co., 77 Cordier St., Irvington 11, N. J. A new four-page folder gives details of construction savings and assembly with washer-type self-locking nuts on sheet metal products and components. It outlines assembly procedures and shows many typical applications on electrical equipment, radio and television.

**Multiple Power Supply.** Kepco Laboratories, Inc., 149-14 41st Ave., Flushing, N. Y. A single-sheet bulletin treats of the model 103 multiple power supply. Chief features, specifications and principles of operation, as well as an illustration of the unit are given. The instrument described is particularly designed for laboratory tests and experiments.

**Polystyrene.** Plax Corporation Division, Hartford-Empire Co., P. O. Box 1019, Hartford 1, Conn., has published a pocket-size booklet summarizing recommended techniques for machining and working with polystyrene. It covers the use of coolants, sawing, turning, milling, drilling, threading, tapping, grinding, annealing, polishing, forming, cementing, die-cutting and checking for stresses.

**Tele Relay Link.** Federal Telecommunication Laboratories, Inc., 500 Washington Ave., Nutley 10, N. J. The FTL-27-A television uhf radio relay link, intended as an stl, intercity relay, or a portable remote pickup system, is fully treated in a four-page folder. Each of the parts is illustrated and technically described. The system covered operates in the 1,990 to 2,110-mc band.

**Spectrophotometry.** National Bureau of Standards, Washington 25, D. C. Circular 484 is a 48-page illustrated booklet written to help users of spectrophotometers to

# New!!

a MEPCO "FIRST"

## MOLDED\* lead terminal PRECISION RESISTORS

- Positive Connection between Winding and Terminal.
- Eliminates all Soldered Joints in Resistor
- NO FLUX USED — All Connections Non-corrosive
- Cannot "OPEN" due to Flexing of Lead Terminals
- Same construction as our JAN R-93 Lug Terminal Types

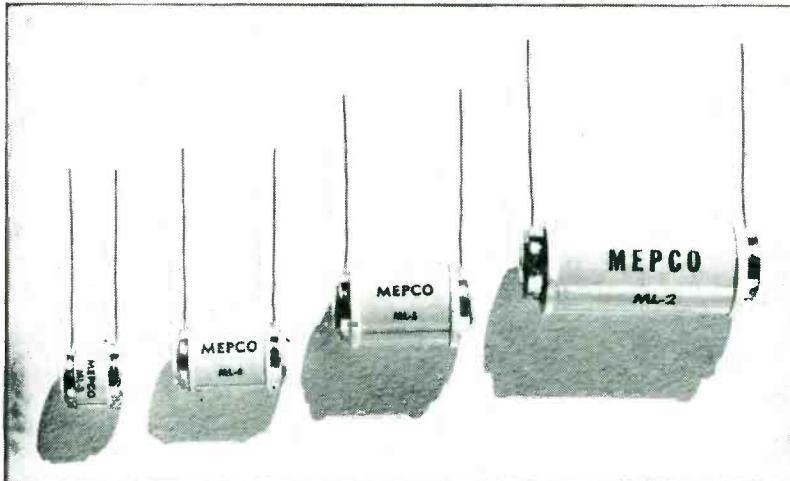

MEPCO-TYPE	ML-3	ML-4	ML-5	ML-2
WATTAGE	.25	.5	1	2
RESISTANCE	.1 OHMS 300 K	.1 OHMS 1 Meg.	.1 OHMS 1.5 Meg.	.1 OHMS 4 Meg.

**IRE National Convention**  
 GRAND CENTRAL PALACE  
 and  
 HOTEL COMMODORE  
 New York

**RADIO ENGINEERING SHOW**  
 March 6-9 1950

Booth  
**MEPCO**  
 248

\* The terminal and the end of the winding are imbedded together by the metal molding process, assuring a positive electrical and mechanical connection.

IMMEDIATE DELIVERY

All inquiries will receive our immediate attention.

**MEPCO, INC.** 37 Abbett Avenue  
 Morristown, N. J.  
 Telephone: Morristown 4-5777

Manufacturer's tests confirm superiority of **PALINEY\* #7** for brushes on new Rectilinear Potentiometer . . .

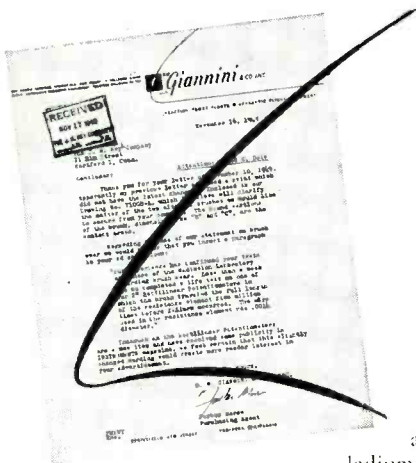

"Our experience has confirmed your tests and those of the Radiation Laboratory regarding brush wear. Less than a week ago we completed a life test on one of our 2" Rectilinear Potentiometers in which the brush traveled the full length of the resistance element five million times before failure occurred. The wire used in the resistance element was .0014 diameter."

**PALINEY\* #7** . . . a precious metal alloy containing gold, platinum and palladium . . . is giving outstanding service as the sliding contact in many types of potentiometers where long life, low noise and maintained linearity are essential. This and other Tested NEY Precious Metal Alloys are also being used successfully in numerous precision contact and slip ring applications requiring controlled wear resistance, high conductivity and freedom from tarnish and corrosion. Write or call our Research Department for additional technical data, outlining your problem if possible.

**THE J. M. NEY COMPANY** 179 ELM ST., HARTFORD, CONN.  
SPECIALISTS IN PRECIOUS METAL METALLURGY SINCE 1812

G. M. GIANNINI & CO., INC.  
697 Morris Turnpike  
Springfield, New Jersey

\* Reg. T.M. J. M. Ney Co.

# EISLER Television Tube MACHINERY

- ECONOMICAL
- MODERN DESIGN
- PRODUCTION ENHANCING

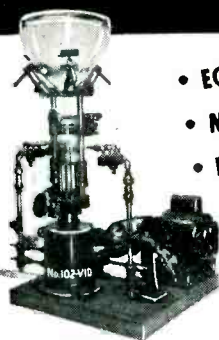

No. 102-VID



No. 57-VID

EISLER'S Electronic Equipment is especially Designed and Built to your exact requirements.  
From 5" to huge 24" Television Tube

EISLER specializes in GLASS WORKING MACHINERY for the manufacture of: Cathode Ray; Radio Tubes (Standard, Miniature, Sub Miniature); Fluorescent Lamps; Glass Ampoules; Vials; Incandescent Lamps.

- Consultation without any obligation on your part is cordially invited.

**EISLER ENGINEERING CO., INC.**  
751 SOUTH 13th ST. • NEWARK 3, NEW JERSEY

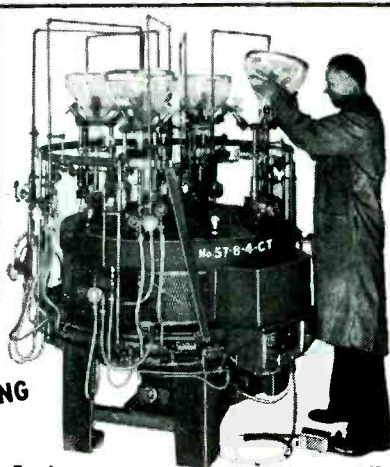

No. 57-B-4-CT



RESISTANCE WELDERS

• 1/4 to 300 KVA



EISLER TRANSFORMERS  
STANDARD • SPECIAL  
Air, Oil or Water Cooled

• Sizes From 1/4 to 500 KVA



# NATIONAL

- **P**roven
- **D**ependable
- **Q**uality

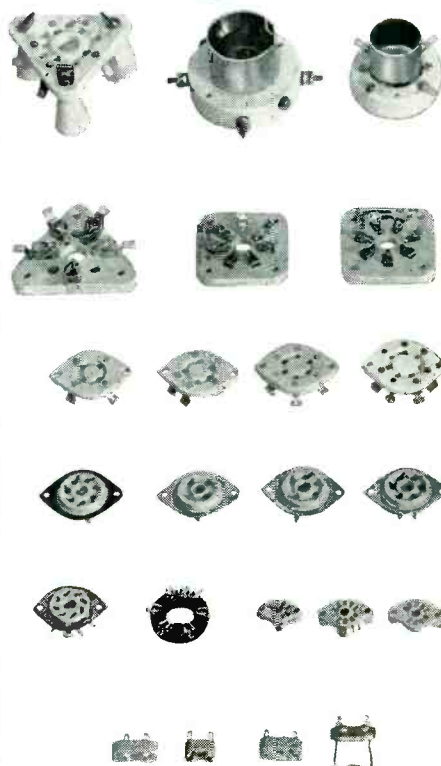

... A SOCKET FOR EVERY PURPOSE

Write for general catalog.  
Address export inquiries to Dept. E-350

**National**  
EST. 1914  
**NATIONAL COMPANY, Inc.**  
MALDEN, MASSACHUSETTS

better understand their instruments, calibrate and maintain them in the proper operating condition, and guard against the numerous errors common in such work. Instruments and methods for use in the ultraviolet, visible and near-infrared spectral regions are considered, including photographic, visual and photoelectric methods. The booklet is available from the Superintendent of Documents, U. S. Government Printing Office, Washington 25, D. C., at 25 cents a copy (do not send stamps).

**Two-Way Radios.** Communications Co., Inc., Coral Gables, Miami 34, Florida. A recent folder illustrates and describes a line of vhf f-m low-drain two-way radios. Among the units covered is the small model for mounting under the dash or seat of a taxicab or other vehicle.

**Transformer Catalog.** Peerless Electrical Products Division, Altec Lansing Corp., 161 Sixth Ave., New York 13, N. Y. Catalog 1950-1 contains new models as well as a complete line of transformers for broadcasting and other professional applications, for amplifier constructors, audio enthusiasts, the replacement field and hams.

**Filter Information.** Cinema Engineering Co., 1510 West Verdugo Ave., Burbank, Calif., has issued catalog 12-E, an 8-page supplement to its general catalog 11-A. It is primarily a case study showing the use of equalizers and filters, and includes the use of fixed and variable high and low-pass filters for use in recording and reproducing lateral cut discs.

**Selenium Rectifiers for Industry.** Radio Receptor Co., Inc., Seletron Rectifier Division, 251 W. 19th St., New York 11, N. Y., has prepared a 4-page folder showing industrial applications of a line of selenium rectifiers in units up to 75-kw. Illustrated and described are typical installations used in theatres, electroplating and similar processes, elevator motor supplies and power packs for d-c motors.

**Adjustable Speed.** General Electric Co., Schenectady 5, N. Y. A 24-page, two-color booklet (GEA-

# TIC

## INSTRUMENTS THAT BELONG IN *Your* LABORATORY

### TIC Type 310-A Z-Angle Meter — 30 to 20,000 c.p.s.

Measures impedance directly in polar coordinates as an *impedance magnitude* in ohms and *phase angle* in degrees  $Z \angle \pm \ominus$ . Measures, with equal ease, pure resistance, inductance, capacitance or complex impedances comprised of most any RLC combinations. Range: Impedance (Z), 0.5 to 100,000 ohms; Phase Angle ( $\ominus$ ),  $+90^\circ$  (X<sub>L</sub>) through  $0^\circ$  (R) to  $-90^\circ$  (X<sub>C</sub>). Accuracy: Within  $\pm 1\%$  for impedance and  $\pm 2^\circ$  for phase angle. Price: \$425.00.

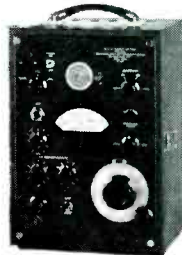
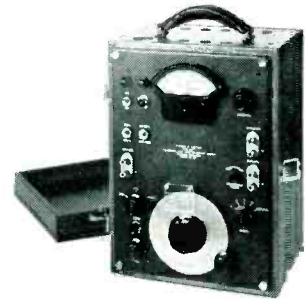

### TIC Type 311-A R-F Z-Angle Meter for radio frequencies — 100 kc to 2 mc.

Simplifies laboratory and field *impedance* and *phase angle* measurements. Ideal for checking impedance of coils, transformers, coupling networks, lines, filters, antennas, etc. Direct-reading Impedance Range: 10 to 5,000 ohms up to 200 kc, and 10 to 1,000 ohms at 1 mc. Phase Angle:  $+90^\circ$  (X<sub>L</sub>) through  $0^\circ$  (R) to  $-90^\circ$  (X<sub>C</sub>). Accuracy: Impedance to within  $\pm 3\%$ , and phase angle  $\pm 4^\circ$ . Price: \$350.00.

### TIC Type 410-A R-F Oscillator — 100 kc to 10 mc. (Special models 46.5 kc to 4.65 mc available.)

Power oscillator for use as bridge driver and general laboratory measurements. Features: High stability, high output (approximate 30 volts), 50-60  $\Omega$  output impedance, expanded frequency scale, direct reading output voltmeter, compact design. Price: \$350.00.

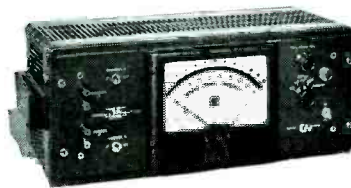
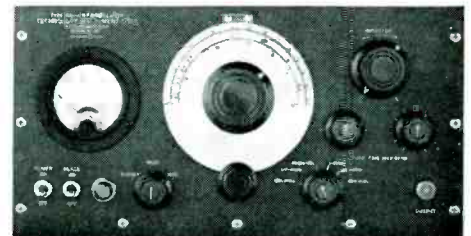

### TIC Type 320-A Phase Meter — frequency range 20 cycles to 100 kc.

The *first* commercially available all-electronic instrument that directly measures the phase angle between two voltages in a *simple* operation. Ideally suited to applications in such fields as audio facilities, ultrasonics, servomechanisms, geophysics, vibrations, acoustics and many others.

Phase angle readings made directly without balancing . . . stable at frequencies as low as 2 to 3 cycles. Voltage range: 1 to 170 peak volts. Terminals for recorder . . . choice of relay-rack or cabinet mounting. Price \$475.00. Cabinet \$20.00.

### TIC Type 110 Slide-Wire Resistance Box

Convenient combination consisting of precision decade resistor and continuously adjustable slide-wire which provides smooth, continuous variation of resistance between decade steps (permits adjustment of resistance to one part in 10,000). For most applications, eliminates need for more elaborate multi-dial decade boxes. Ideal for student and general laboratory use. Decade resistance cards adjusted to within  $\pm 0.1\%$  of nominal values, and slide-wire resistors direct-reading to within 1% of their maximum values. Cast aluminum cabinet. All resistance elements completely enclosed. Suitable for use at audio and ultrasonic frequencies. Type 110-A, range 0-11,000 ohms: \$42.50. Type 110-B, range 0-110,000 ohms: \$45.00.



See us at Booth 101 at the Show

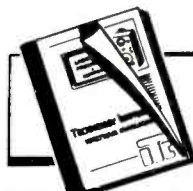

**Technical Catalog** — yours for the asking. Contains detailed information on all TIC Instruments, Potentiometers and other equipment. Get your copy without obligation — write today.

# TIC TECHNOLOGY INSTRUMENT CORP.

1058 Main Street, Waltham 54, Massachusetts  
Engineering Representatives — Cleveland, Ohio PRospect 6171

Chicago, Ill.—UPtown 8-1141 Dallas, Tex.—LOgan 6-5097 Rochester, N.Y.—Charlotte 3193-J  
Cambridge, Mass.—ELiot 4-1751 Canaan, Conn.—Canaan 649 Hollywood, Cal.—Hollywood 9-6305

# ELECTRONIC RESEARCH DESIGN • PRODUCTION

of

Microwave Transmission Lines and  
Associated Components  
Radar, Racon, and Missile Equipment  
Special Test Apparatus

## TWENTY YEARS OF EXPERIENCE IN THE FIELD OF ELECTRONIC DEVELOPMENT

Completely equipped research laboratory, full time design and research staff, facilities for maintaining full security, competent understanding of government contract procedures.

For details of our specialized production facilities write or phone us, or consult us at

**Booth 312A**  
at the **IRE Show**

•  
**L. H. TERPENING COMPANY**

16 West 61st Street New York 23, N. Y.

Circle 6-4760

NEW PRODUCTS

(continued)

5334) presents a concise summary of the specific benefits which various branches of modern industry can expect from properly applied adjustable speed. It provides a check list of points to consider in selecting an adjustable speed drive and gives a clear picture of various packaged units, their range of application and performance features.

**Voltage Regulators.** Sorensen and Co., Inc., 375 Fairfield Ave., Stamford, Conn. Catalog A-1049 contains complete specifications and description of the many standard voltage regulators for the control of a-c power, including new sizes and types not previously listed. Number B-1049 lists and describes the line of d-c power sources and supplies, also listing many new instruments not previously shown. Basic circuits and performance curves are included.

**Instrument Transformers.** Westinghouse Electric Corp., P. O. Box 2099, Pittsburgh 30, Pa. Booklet B-4319 describes construction features of a full line of instrument transformers. Methods of insulating current and potential transformers using oil, plastic, or dry-type construction are explained for all voltage classes. Illustrations show how impulse levels are coordinated and built up to provide a high degree of protection against surges.

**Subcarrier Discriminator.** Electro-Mechanical Research, Inc., Ridgefield, Conn., has issued a single-sheet bulletin on a discriminator which converts frequency-modulated signals to intelligence signals suitable for actuation of recording galvanometers or other devices matching the output impedance of 330 ohms. With the instrument described, by means of suitable plug-in units, any center frequency from 400 cps to 70 kc may be employed, the modulation or intelligence frequency ranging from d-c to several percent of the carrier frequency.

**Pulse Transformers.** Raytheon Mfg. Co., Waltham, 54, Mass., offers a chart giving complete data on a line of pulse transformers

# BIRTCHEr

STAINLESS STEEL - LOCKING TYPE

## TUBE CLAMPS

Stainless Steel      Corrosion Proof



**83 VARIATIONS**

Where vibration is a problem, Birtcher Locking TUBE CLAMPS offer a foolproof, practical solution. Recommended for all types of tubes and similar plug-in components.

**More than three million of these clamps in use.**

**FREE CATALOG**

Send for samples of Birtcher stainless steel tube clamps and our standard catalog listing tube base types, recommended clamp designs, and price list.

**THE BIRTCHEr CORPORATION**  
5087 HUNTINGTON DR.      LOS ANGELES 32

## NEW EDUCATIONAL MAGNETIC AMPLIFIER by VICKERS Inc.

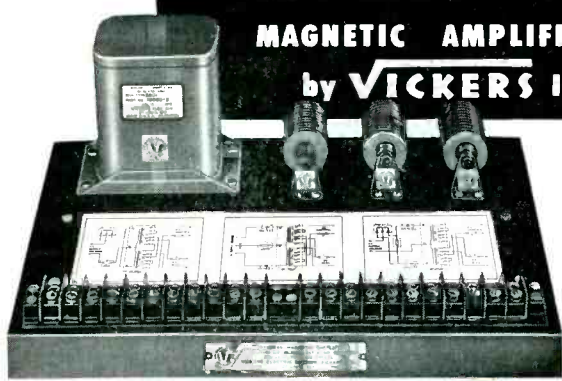

### for School and Industrial Laboratories

- A unit designed by Vickers Electric Division to help students and industrial personnel obtain a wider knowledge of the characteristics and applications of high-performance self-saturating magnetic amplifiers.
- All three basic single-phase self-saturating circuits may be studied, and the educational unit can actually be used in operating controls circuits. Gives d-c or a-c output, uses d-c or a-c control power.
- Magnetic Amplifier Laboratory Manuals and Magnetic Amplifier Design Bulletins included with each educational unit.

Write for information and price.



**VICKERS ELECTRIC DIVISION**

VICKERS Inc.  
1801. LOCUST STREET • ST. LOUIS 3, MISSOURI

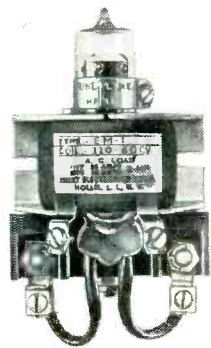

### Plunger Type MERCURY RELAYS



★ **POSITIVE**—Hermetically sealed mercury-mercury contact assures silent flickerless operation . . . no pitting, no sticking!

★ **DEPENDABLE**— Hermetically sealed . . . no dust, no dirt, no oxidation . . . means no servicing, no cleaning!

### They ALWAYS Work

Available in single, double and triple groups operated by one coil. Coil ratings for every application. Contacts rated conservatively at 35 Amp. 115 V. AC; 25 Amp. 220 V. AC. Available normally open or normally closed.

Write for Catalog

**EBERT ELECTRONICS CORP.**  
185-09 Jamaica Avenue, Hollis 7b, L. I., N. Y.

Specify **GLASS JEWEL BEARINGS**  
for . . . Low Cost  
. . . Long Life

Glass Jewel Bearings by Bird are highly accurate and surprisingly inexpensive. They're ideal for use in ammeters, volt meters, timing instruments, compasses and other instruments where large volume production and low cost must be maintained.

Of special interest to instrument manufacturers is Bird's method of mounting jewels. There's a minimum of stress and strain on the bearing itself as a result of Bird's special mounting technique. It is this special mounting feature which adds so materially to the useful life of Bird Jewel Bearings.

Whenever there's a need for jewel bearings — whether in glass or in sapphire — Bird can supply the right bearing to your specifications. Write today for more information and a quotation.

*Sapphire Bearings available in all jewel styles and mountings*

**Richard H. Bird & Co., Inc.**  
1 Spruce Street  
Waltham 54, Mass.  
*"Serving Industry with Fine Jewels Since 1913"*

DO YOU HAVE THE  
*Lafayette Radio*  
1950 CATALOG?

All famous makes at lowest prevailing prices: Television and Radio Parts—High Fidelity Equipment—P. A. Systems—Tools—Test Equipment, etc.

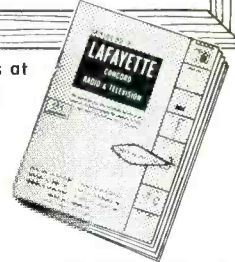

A valuable 164-page reference book no engineer should be without. Send for your FREE copy today.

**INTERESTED IN HIGH FIDELITY?**

Check the coupon, and we'll also send you the new "High Fidelity Music Guide" prepared by David Randolph, noted musicologist and music consultant to Lafayette Radio.

### Lafayette Radio

100 Sixth Avenue, New York 13, N. Y.  
901 W. Jackson Blvd., Chicago 7, Ill.

LAFAYETTE RADIO, Dept. EC-50  
100 6th Avenue, New York 13, N. Y.  
or 901 W. Jackson Blvd., Chicago 7, Ill.  
Rush me FREE copy of  
 1950 Lafayette Catalog (Please do not request if you have already received a copy.)  
 David Randolph's "High Fidelity Music Guide"

Name .....  
Address .....  
City ..... Zone . . . State . . .  
PASTE ON PENNY POSTCARD

*Designed for*



*Application*

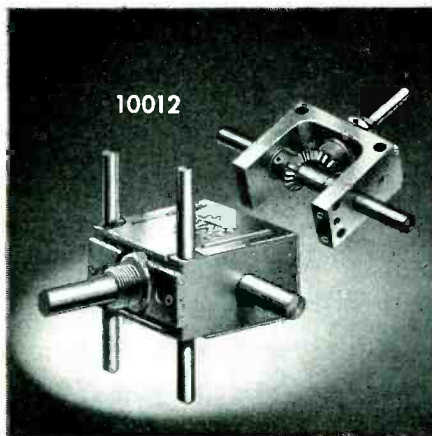

10012

**The No. 10012  
RIGHT ANGLE DRIVE**

"Designed for Application." Extremely compact. Case size is only 1½" x 1½" x ¾". Uses bevel gears. Mounts on adjustable "standoff rods," single hole panel bushing or tapped holes in frame. Ideal for operating switches, potentiometers, etc., that must be located, for short leads, in remote parts of chassis.

**JAMES MILLEN  
MFG. CO., INC.**

MAIN OFFICE AND FACTORY  
**MALDEN  
MASSACHUSETTS**



NEW PRODUCTS

(continued)

suitable for use in driver circuits as blocking oscillator or interstage units. Write for chart DL-K-315.

**Electro-Optical Instruments.** The Perkin-Elmer Corp., Glenbrook, Conn. The first issue of a quarterly publication on modern electro-optical instruments in industry was recently released. An article in this issue on improvements in the d-c amplifier is of particular interest.

**Hermetic Seals.** Hermetic Seal Products Co., 29-37 S. Sixth St., Newark 7, N. J. A 16-page catalog presents information on many types of hermetic seals. It should be of interest to manufacturers or users of relays, transformers, capacitors, filters, or any components in which hermetic seals are used.

**Special Transformers.** Nothel'ier Winding Laboratories, 111 Albermarle Ave., Trenton, N. J. An 8-page bulletin with 34 illustrations shows a wide range of special transformers from 10 volt-amperes to 300 kva, ranging from 20 to 400 cycles, and up to 60 kv. The units covered are designed for industrial, electronic and research use.

**Recording Oscillographs.** Consolidated Engineering Corp., 620 No. Lake Ave., Pasadena 4, Calif. Applications, operations and features of multichannel recording oscillographs are discussed in a 48-page catalog. Sample records of actual applications are presented along with detailed assembly drawings.

**Geophysical Transformers.** Triad Transformer Mfg. Co., 2254 Sepulveda Blvd., Los Angeles 64, Calif., has released Catalog GP-49, a four-page bulletin illustrating, describing and pricing a line of geophysical transformers. The units covered, intended for geophysical exploration equipment, are hermetically sealed and magnetically shielded.

**Medium-Mu Triode.** Eitel-McCullough, Inc., San Bruno, Calif. Model 450 TL medium-mu triode, intended for use as an amplifier, oscillator and modulator, is cov-

**put an  
added**

*Selling Factor*  
**into your  
COIL WINDINGS**

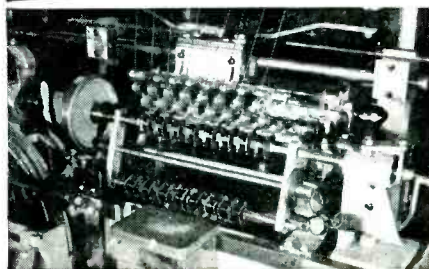

**PRECISION  
BOBBINS**

by

**PERFORMANCE,  
PUBLICITY,  
Precision Quality**

has the outstanding reputation for superior Coil Bases thruout the electrical field.



*Some of the reasons:*

Tubes spirally wound of finest dielectric materials for greatest strength—better heat dissipation—less moisture absorption—vulcanized fibre flanges—swaged tube ends for secure locking—entire assembly impregnated—perfect seal—meeting Underwriters' requirements.



Send today for samples to your specifications. Round, square, rectangular. **LOW COST.** Any quantity. Phone, wire or write

**PRECISION PAPER TUBE CO.**

Also Precision paper tubes.  
Ask for new Mandrel List. Over 1,000 sizes.

2041 W. Charleston St. Chicago 47, Ill.  
Plant No. Two, 79 Chapel St. Hartford, Conn.

March, 1950 — ELECTRONICS

# COSSOR for QUALITY

MODEL 1049

## Industrial OSCILLOSCOPE

Meets research and industry requirements for measurements of zero or low frequency signals up to 100 Kc/s.

Unique Cossor twin beam tube permits accurate time and voltage comparisons of two independent signals with single locked time base.

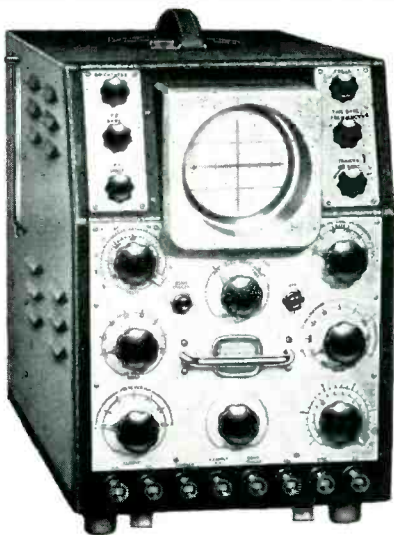

\$589 f.o.b. Halifax  
\$795 f.o.b. New York

Amplifiers flat 0-100 Kc/s  $\pm$  1.5 db.  
0.2V/in. deflection at full gain.

Direct volts measurement from .01 to 1000 volts. Stabilized throughout for HT, EHT and filament supply variations.

4" flat face twin beam CRT operates at 2 or 4 KV depending on writing speed.

Direct time readings on repetitive or triggered time base. Intensity mod. zero to 80 Kc/s.

Write for bulletin and details of camera and motor drives.

SEE US AT BOOTH 251 IRE CONVENTION

**COSSOR (CANADA) LIMITED**

Windsor St., Halifax, Nova Scotia



**BEAM INSTRUMENTS CORP.**

Room 208, 55 W. 42nd Street,  
New York 18, N. Y.

# WIRE

Made to Your Order

- Here are (1) Engineering and research facilities to work on your particular wire problems; (2) Production geared to any quality and quantity desired; (3) Unsurpassed craftsmanship; and (4) Wire that's made right
- Let us quote!

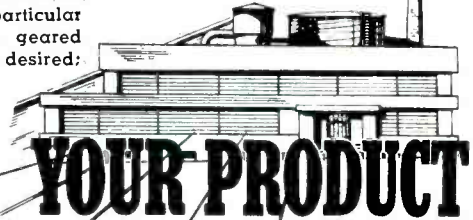

HUDSON WIRE



Partial List of Products...

Bare Wire (Hudson Wire Division):  
Copper. Brass. Bronze. Zinc. Silver-plated. Tin. Phosphor-bronze. Nickel. Silver. Cadmium.  
Specialty Wires.

Insulated Wire (Winsted Division):  
Enamelled. Litz. Cement-coated. Enamelled. Cotton. Silk. Celanese. Glass-fibre. Enamelled Aluminum. Formvar. Loop Wire. Etc.

One of the Oldest Fine Wire Companies in America

## HUDSON WIRE COMPANY

GENERAL OFFICES: OSSINING, N. Y. • WINSTED DIVISION: WINSTED, CONN.



when you need resistors—

IT WILL PAY YOU TO CONSULT THE NEW

## IN-RES-CO CATALOG

Included are complete descriptions and specifications on wire wound resistors of all types and sizes. Each is precision wound to close tolerance, and many feature special moisture-proofing to assure proper functioning under severest climatic conditions. INRESCO Resistors —available for IMMEDIATE DELIVERY—are supplied in standard or custom types to meet the most unusual design or operational requirements, and are offered at prices that benefit from mass production facilities. A copy of the new INRESCO catalog will be helpful; write for it today. Prices, samples and estimates promptly on other than standard resistors.

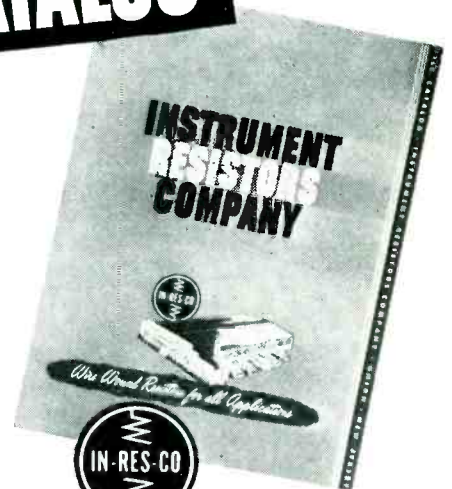

**INSTRUMENT RESISTORS COMPANY**

1036 COMMERCE AVE., UNION, N. J.

Wire Wound Resistors for Every Use in Electronics and Instrumentation

# PLAY SAFE WITH A LEADER-

in the Radio, Electronic and  
Television Industries



## Glaser LECTRON ROSIN CORE SOLDER

Acclaimed by manufacturers across the country, in the radio, electronic, and television industries as the "best"\* activated rosin core solder for speeding soldering operations on the production line.

Made with an exclusive activated rosin flux, **Glaser Lectron Rosin Core Solder** is more efficient and faster than plain rosin core solder. Bonds copper, brass, nickel, chrome, and other metals *perfectly* and *permanently*—yet is non-corrosive and non-conductive. Available in any tin-lead alloy and wire gauge.

*\*Satisfied users of Glaser Lectron Rosin Core Solder report gains of 15% or better in soldering speed on their production lines.*

### GLASER ROSIN CORE SOLDER

Both Glaser Lectron Rosin Core and Glaser Rosin Core Solders are made from the purest virgin tin and lead, and perfect flux. They take hold instantly — forming a permanent solder bond.

**For greater economy in your soldering operations  
specify Glaser's Core Solders.**

### OTHER GLASER PRODUCTS

Glaser Solder Pre-forms, Glaser Bar, Solid Wire, or Ingot Solder, Glaser Fluxes for every purpose.

*Our Engineering Department will gladly assist you with any soldering or flux problem, without any obligation. Free solder or flux sample upon request.*

**GLASER LEAD CO., INC.**

21-31 Wyckoff Avenue, Brooklyn 27, N. Y.



OUR 28TH YEAR OF DEPENDABLE SERVICE TO AMERICAN INDUSTRIES

### NEW PRODUCTS

(continued)

ered in a recent folder. General characteristics, applications, dimensional drawings and several charts are given.

**Machine Speed Regulation.** General Electric Co., Schenectady 5, N. Y. Bulletin GEA-5336 gives an 8-page treatment of the electronic Speed Variator, a packaged adjustable-voltage d-c drive operating from a-c power, and closely regulated by an electronic brain. Complete descriptive and application data including features, advantages, operating characteristics and ratings are given.

**Leak Detector.** Consolidated Engineering Corp., 620 N. Lake Ave., Pasadena 4, Calif. A new 16-page two-color catalog describes the model 24-101A leak detector. Applications and leak detection methods used in both vacuum and pressure systems are discussed and examples of both probe and envelope techniques are given.

**Coax Cable.** Andrew Corp., 363 E. 75th St., Chicago 19, Ill. Bulletin 29-A covers the type 83 coaxial cable which is  $\frac{3}{8}$  in. in diameter and semi-flexible. Characteristics, a table of efficiency vs frequency and a list of accessories are included.

**TV Component Replacements.** Standard Transformer Corp., Elston, Kedzie and Addison Sts., Chicago 18, Ill. A 20-page booklet, form DD338C, lists replacement transformers for 215 tv receivers and chassis made by 43 manufacturers. Replacement part numbers are listed together with manufacturers' part numbers for positive identification.

**Handling of Radioactive Isotopes.** National Bureau of Standards, U. S. Dept. of Commerce, Washington 25, D. C. Recommendations for the safe handling of artificially-produced radioactive isotopes in the typical laboratory or small industrial operation are concisely set forth in a new handbook, "Safe Handling of Radioactive Isotopes." Designated as handbook H42, the 29-page publication is available from the Supt. of Documents, U. S. Government Printing Office, Washington 25, D. C., at 15 cents a copy.



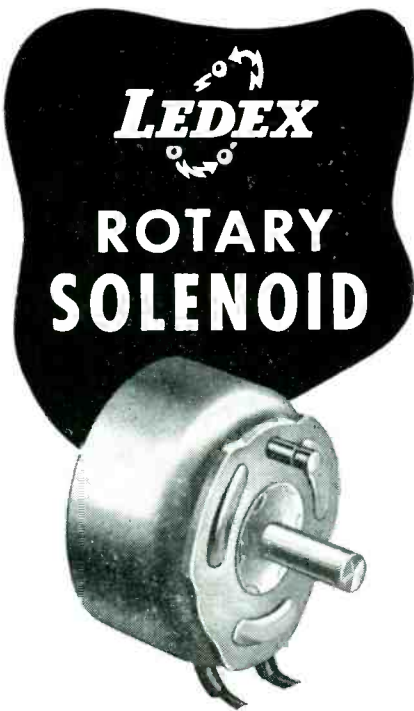

**SOLVES MANY REMOTE CONTROL PROBLEMS**

The many production applications of Ledex Rotary Solenoids vary from the dependable, snap-action tripping of airborne bomb releases to the actuation of rugged, hydraulic valves in heavy duty materials handling equipment.

Five Ledex Rotary Solenoid models are manufactured. Diameters range from 1 1/8 to 3 3/8 inches. Predetermined rotation up to 95° can be engineered to suit your product's requirements. Starting torques for 45° stroke range from 1/4 pound-inches to 50 pound-inches.

We supply to quantity users and solicit the opportunity to be of assistance in engineering a Ledex Rotary Solenoid to meet your product's requirements.

MODEL NO.	2	5	6	7	8
Diameter	1 1/8"	1 7/8"	2 1/4"	2 3/4"	3 3/8"
Torque lb./inches	1/4	5	10	25	50
Weight lbs.	1/8	1/2	1	2 1/4	4 1/4

Magnetic action moves the armature along the solenoid axis. This action is converted into a rotary motion by means of ball bearings on inclined races.

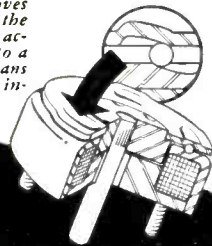

WRITE DIRECT TO

**G.H. Leland INC.**

118 WEBSTER STREET

DAYTON 2, OHIO

**FREE!**

**"MUSTS" in Your "KNOW-HOW" Library...**

← Monthly Mailer packed full with up-to-the-minute radio - electronic product ideas.

← "Audio Equipment" — a gold mine of practical dope on high-fidelity sound.

• Sun Radio MONTHLY MAILER keeps you posted on timely radio-electronic parts, accessories, assemblies, tubes, instruments. Real technical dope. We tell you everything we know about the products—pictures, descriptions, specs, prices. But no high-pressure selling. You do your own deciding—and buying, if you wish.

If you're interested in superlative sound reproduction, there's our 68-page manual-catalog "Audio Equipment". It's chock full of practical, economical, hard-to-find data.

Both "musts" ABSOLUTELY FREE! Nothing to buy! No strings!

**Sun Radio & ELECTRONICS CO. INC.**  
122-E DUANE ST. • NEW YORK 7, N.Y.  
2 Blocks North of Chambers St.  
BARCLAY 7-1840

**Portable Precision for the Field Engineer!**

**CONFORMS TO ALL REQUIREMENTS OF C63.2 RADIO NOISE METER SPECIFICATION ADOPTED BY AMERICAN STANDARDS ASSOCIATION, OCTOBER 26, 1949**

**STODDART NM-20A RADIO INTERFERENCE AND FIELD INTENSITY METER**

- A portable unit that you can **DEPEND** upon!
- Measures **FIELD INTENSITIES** of radio signals and r.f. disturbances using either a rod antenna or a rotatable loop antenna.
- **CONTINUOUS RANGE** 150 kc to 25 mc.
- **ONE MICROVOLT SENSITIVITY** as a two-terminal voltmeter; 2 microvolts-per-meter using rod antenna.
- Operates from self-contained dry batteries or external A.C. power unit.

Write for complete technical data  
**STODDART AIRCRAFT RADIO CO.**

Main office and plant:  
6644 SANTA MONICA BLVD., HOLLYWOOD 38, CALIF., Phone: Hillside 9294

Functionally  
**PACKAGED**  
 Electronics

the *mecha*  
**MINI-CHOPPER**  
PATENT PENDING

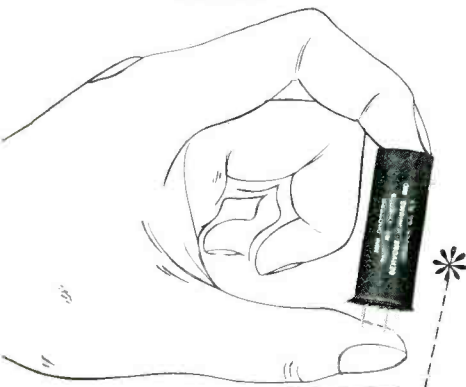

Servomechanisms, Inc.  
 Announces the  
**MINI-CHOPPER**

- A precision miniature device for use in  
 Modulation . . .  
 Demodulation . . .  
 Rectification . . .  
 Inversion . . .  
 The ultimate in miniature functional packaging combining the maximum in  
 Performance . . .  
 Stability . . .  
 Dependability . . .

INFORMATION FOR SPECIFIC APPLICATIONS ON REQUEST.

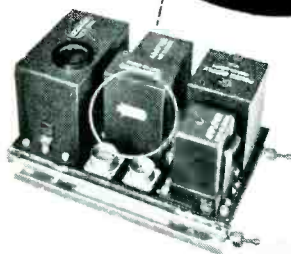

Designers and Producers of precision electronic devices for military and commercial application.

Old Country & Glen Cove Roads  
**MINEOLA, N. Y.**  
 Garden City 7-0754-5-6

**SERVOMECHANISMS**  
 inc.

**NEWS OF THE INDUSTRY**  
 (continued from page 130)

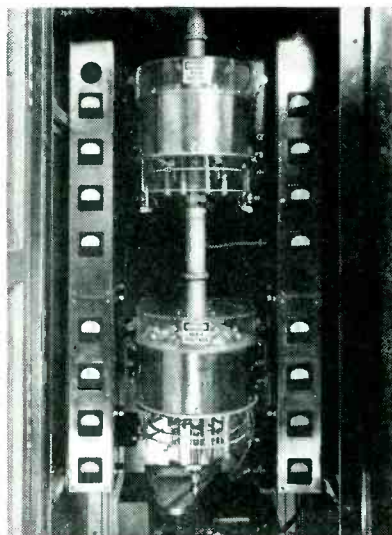

Tripler (lower section) and power amplifier (above) of the Bridgeport uhf picture transmitter. Eight type 4X150 tubes are paralleled in each stage

TT500B transmitter, styled the type TTU1A, employs a tripler power amplifier and special cavity output stage in both the picture and sound sections to give power outputs of 1 kw (peak) and 500 watts respectively at 530.25 and 534.75 mc. Eight type 4X150A tetrodes operate in parallel in a single cavity for both tripler and final service although the arrangement of components and tuning methods differ somewhat.

Another feature of the transmitting equipment is the use of a single frequency-control unit comprising a crystal oscillator for the picture channel and another crystal reference that maintains the center frequency of the sound channel 4.5 mc above. Separation between the two carriers is thus held accurate to within 450 cycles.

The high-gain antenna is a ten-inch diameter conductor with twenty-two groups of slots. Each one is a half wavelength long with a vertical separation of an electrical half wavelength. The slots are energized by a special coaxial feed. A notch diplexer combines output from the picture and sound transmitters in the antenna feed without interaction.

A special uhf television tuner covering the range from 500 to 700 mc has been designed to feed into the i-f of any conventional television receiver. These equipments will be used on a limited basis for

**ACE**  
*Ready-Built*  
*"Unit Cell"*  
**SCREEN ROOMS**

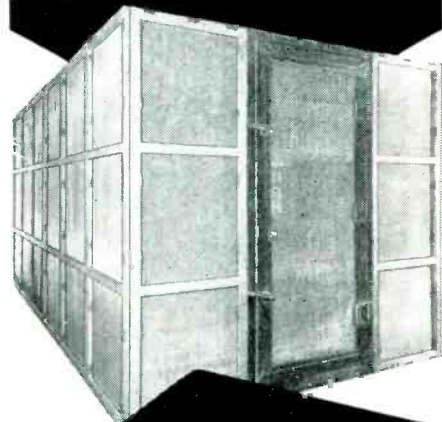

**MINIMUM**  
**of 100 DB.**  
 from 0.15 to 1000 mc.

- ✓ *More efficient*
- ✓ *Easily installed*  
by 2 men in less than 8 hours—no soldering necessary
- ✓ *Quickly moved or enlarged*
- ✓ *Low priced*
- ✓ *Available in various sizes*
- ✓ *Approved and used by leading laboratories and plants*

WRITE, WIRE OR PHONE FOR DETAILS

SEE THEM AT THE SHOW  
 Visit Booth 351 at the I.R.E. show for demonstrations of the remarkable filtering efficiency of ACE SCREEN ROOMS.

**ACE ENGINEERING AND MACHINE CO.**  
 3642 N. Lawrence Street  
 PHILADELPHIA 40, PA. REgent 9-1019

**IRE National Convention**  
**GRAND CENTRAL PALACE**  
 and  
**HOTEL COMMODORE**  
 New York

**RADIO ENGINEERING SHOW**  
 March 6-9 1950

**247 Exhibits**

**COME AGAIN**  
**Electronic Men!**

"Spotlight is on the New" in 247 Electronic Exhibits for you to see. Hear the latest developments given in 175 technical papers organized into 28 sessions and symposiums covering every field of electronics. Last March 15,710 attended. The registration (4 days) is \$3.00, for electronic industry people. Not open to general public.

THE INSTITUTE OF RADIO ENGINEERS  
 1 East 79th St. New York 21, N. Y.



**KESTER SOLDER**  
**PREFORMS**

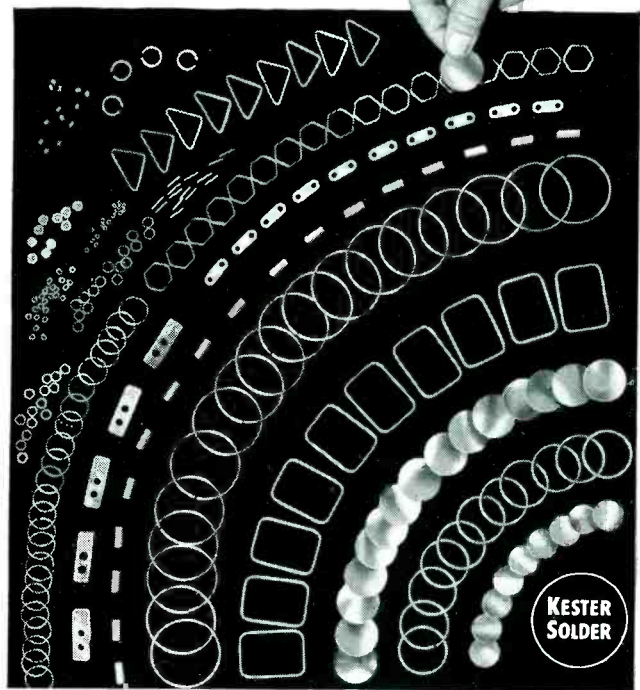

Use Kester Soft Solder Preforms for flame, oven, and induction soldering. Write today for samples and complete information.

**KESTER SOLDER COMPANY**

4204 Wrightwood Ave., Chicago 39 • Newark, N. J. • Brantford, Canada

**KNOBS**  
**FROM STOCK MOLDS**



"No Tool Charge"  
 —Saves You Money

No Tooling-Up Time  
 —Fast Delivery

Wide variety of shapes, sizes, colors. Available from stock molds. Supplied without tool charge. Immediate delivery. Can be branded to specifications. Precision made of quality materials. Save time, trouble and money . . . get your next knobs from Rogan.

SEND FOR FREE CATALOG

**ROGAN BROTHERS**

2504 IRVING PARK BLVD.  
 CHICAGO 18, ILLINOIS

Compression Molders and Branders

**ATTENTION**  
**MOBILE RADIO OPERATORS**

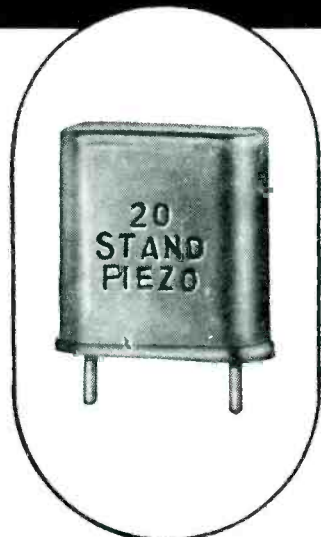

Replacement crystals can be supplied for ALL types of mobile communication equipment.

**STANDARD** crystals assure  
 Precision  
 Dependability  
 Quality

We have supplied large operators of mobile equipment with replacement crystals to their complete satisfaction for many years.

Visit Booth 307 at the I.R.E. Show, March 6-9, 1950, New York

Write for New Catalog on Mobile Crystals  
 Your orders will be given prompt attention

**Standard Piezo Company**

CARLISLE, PA.



# NOTHELPER

## Special TRANSFORMERS

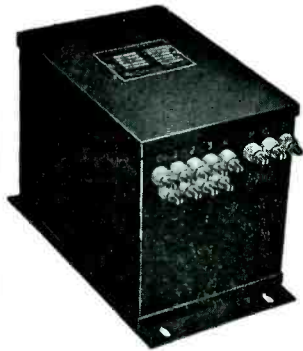

Proven by  
Past  
Performance

Over 25 years' experience in the manufacture of special transformers to meet individual requirements. Built in quality proved by years of actual use.

From 10 VA to 300 KVA Dry-Type only. Both Open and Encased. 1, 2, and 3 Phase. 15 to 400 cycles.

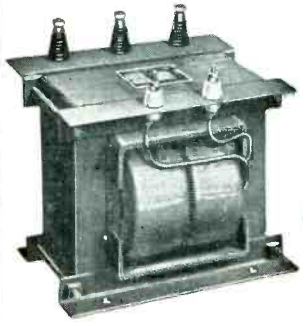
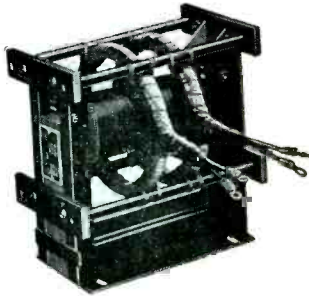

Send for NEW 8 page BULLETIN



## NOTHELPER

WINDING LABORATORIES

9 ALBEMARLE AVE., TRENTON 3, N. J.



the field tests of KC2XAK (Bridgeport station).

The Radio and Allocations Engineering Group of NBC under Raymond F. Guy constructed the station and will collect and analyze the field strength data.

### Revised Technical Broadcast Services

A NEW series of technical radio broadcast services over radio stations WWV, Beltsville, Md., and WWVH, Maui, Territory of Hawaii, were inaugurated on January 1, 1950. Except in certain details, these services of the National Bureau of Standards do not differ greatly from those given in the past.

The revised services from WWV include (1) standard radio frequencies of 2.5, 5, 10, 15, 20, 25, 30, and 35 mc, (2) time announcements at 5-minute intervals by voice and International Morse Code, (3) standard time intervals of 1 second and 1, 4 and 5 minutes, (4) standard audio frequencies of 440 cycles (the standard musical pitch A above middle C) and 600 cycles, (5) radio propagation disturbance warnings by International Morse code consisting of the letters W, U or N, indicating warning, unstable conditions, or normal, respectively.

The audio frequencies are interrupted at precisely one minute before the hour and are resumed precisely on the hour and each five minutes thereafter. Code announcements are in Universal Time using the 24-hour system beginning with 0000 at midnight; voice announcements are in Eastern Standard Time. The audio frequencies are transmitted alternately. The 600-cycle tone starts precisely on the hour and every 10 minutes thereafter, continuing for 4 minutes; the 440-cycle tone starts precisely five minutes after the hour and every 10 minutes thereafter, continuing for 4 minutes. Each carrier frequency is modulated by a seconds pulse which is heard as a faint tick; the pulse at the beginning of the last second of each minute is omitted.

Further information on the tech-

# PRECISION

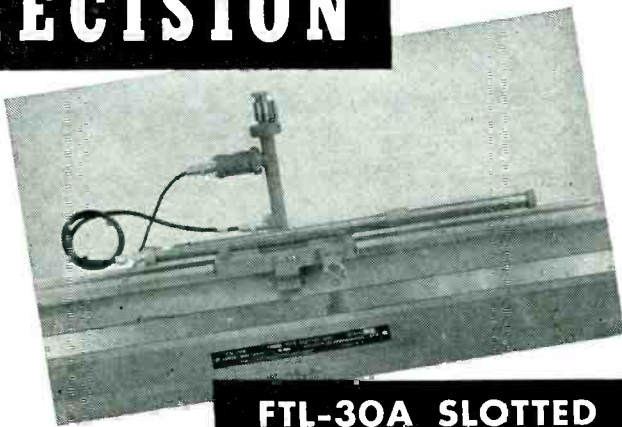

## FTL-30A SLOTTED LINE

On display at Booths 31-34  
1950 I.R.E. Radio Engineering Show

Designed for making impedance, standing wave ratio, and wavelength measurements in the range of 60 to 1000 megacycles per second.

Careful design and precision manufacture enable highly accurate measurements to be made with the line.

High sensitivity and selectivity due to efficient probe tuning.

End connectors adapted to use of Type N or similar fittings for solid dielectric cables are supplied with the line. End connectors for adapting 7/8, 1 1/8 and 3 1/8 inch air lines are available on special order.

Write for complete  
FTL-32A Brochure

**Federal Telecommunication Laboratories, Inc.**

500 WASHINGTON AVENUE

NUTLEY 10, NEW JERSEY



*Engraving*

## PROFILING VERTICAL MILLING

Here is the most versatile machine... So simple to operate by unskilled labor.

**NEW HERMES**  
*Engraving*

This heavy duty bench type model covers a larger engraving area than any other machine of its kind.

Send for illustrated booklet H



**NEW HERMES, Inc.**  
Dept. 29  
13-19 UNIVERSITY PL. • NEW YORK 3  
World's Largest Manufacturer  
of Portable Engraving Machines

**Dies**  
**Displays**  
**Signs**  
**Panels**  
**Name Plates**



**SAVE SPACE!  
SMALLER — FITS CURRENT  
MINIATURIZATION TREND**

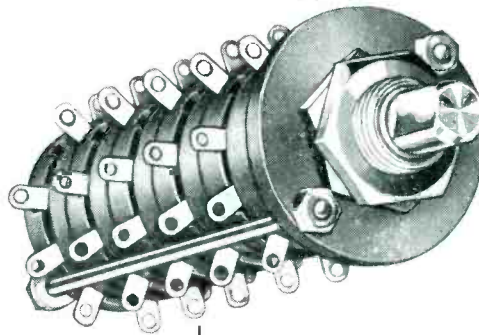

## GRAYHILL Series 5000 MINIATURE MULTI-DECK TAP SWITCH

Ask for  
information on  
Series 5000 MD

Overall diameter is only 1 3/32". Behind panel dimension for one deck is 13/16" . . . each additional deck adds 13/32". There's space available for 2 to 10 contacts on each deck. A real space saver—and dependable too! Rated to break 1 amp at 115 volts AC . . . carries 5 amps at 115 volts AC.

*Grayhill*

4522 WEST MADISON STREET  
CHICAGO 24, ILLINOIS

## Lavite STEATITE GERAMIC

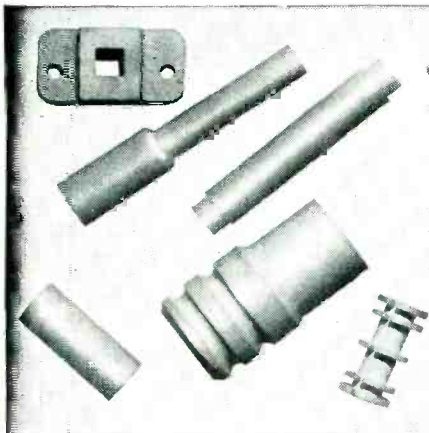

Design engineers and manufacturers in the radio, electrical and electronic fields are finding in LAVITE the precise qualities called for in their specifications . . . high compressive and dielectric strength, low moisture absorption and resistance to rot, fumes, acids, and high heat. The exceedingly low loss-factor of LAVITE plus its excellent workability makes it ideal for all high frequency applications.

Complete details on request

**D. M. STEWARD MFG. COMPANY**

Main Office & Works: Chattanooga, Tenn.  
Needham, Mass. • Chicago • Los Angeles  
New York • Philadelphia

## ACCURATE OBSERVATION OF WAVEFORMS FROM 10 CYCLES TO 50 MC PER SECOND

### 50 MC WIDEBAND VIDEO OSCILLOSCOPE FTL-32A

- Vertical amplifier bandwidth of 10 cps to 50 mc.
- High deflection sensitivity over the entire bandwidth.
- Low-capacity probe maintaining high sensitivity.
- Sweep time as fast as one tenth microsecond per inch.

On display at Booths 31-31  
1950 I.R.E. Radio Engineering Show

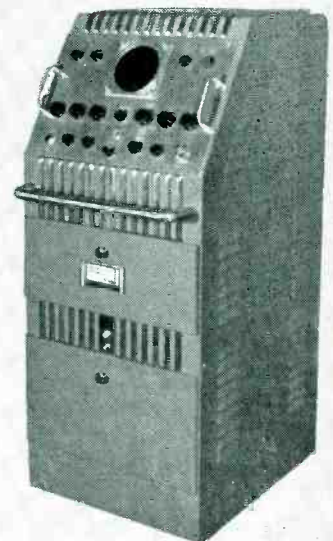

Write for complete  
FTL-32A Brochure



**Federal Telecommunication Laboratories, Inc.**

500 WASHINGTON AVENUE, NUTLEY 10, NEW JERSEY



DO  
BOTH  
WITH

## New 250-watt WELLER GUN

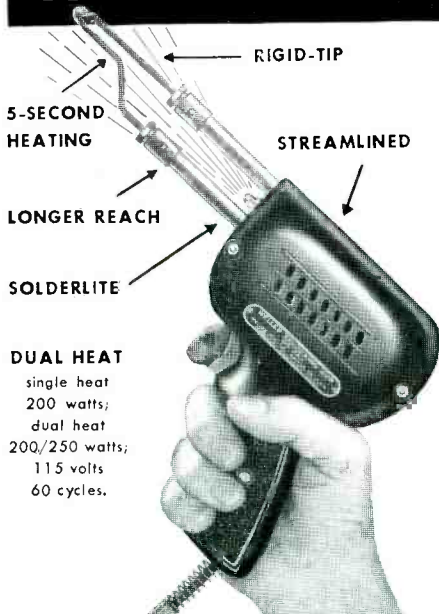

**DUAL HEAT**  
single heat  
200 watts;  
dual heat  
200/250 watts;  
115 volts  
60 cycles.

You'll save on tools and time with the new Weller Soldering Gun WD-250. Whether the job is rugged or delicate, your Weller Gun does it with the same ease and efficiency. Chisel-shaped RIGID-TIP provides more soldering area for faster heat transfer. New "over-and-under" terminal design gives bracing action to tip. Your Weller Gun is light-weight and compact, gets into the tightest spots.

Weller Guns actually pay for themselves in a few months. Fast 5-second heating saves time on every job. Trigger-switch control saves power—no need to unplug gun between jobs. Prefocused spotlight and longer length mean easy soldering, even when the job's buried deep. No other soldering tool gives you so many time-and-money-saving features. Order your new 250-watt Weller Gun from your distributor today, or write for bulletin direct.

**SOLDERING GUIDE** Get your copy of "SOLDERING TIPS"—new fully illustrated 20 page booklet of practical soldering suggestions. Price 10c at your distributor's or order direct.



**WELLER**  
MANUFACTURING COMPANY  
806 Packer Street, Easton, Pa.

nical radio broadcast services may be obtained on request from the National Bureau of Standards, Washington 25, D. C. Reports on reception are welcomed; forms on which to submit such reports may also be obtained on request.

### Air-Sea Rescue Radio

THE AIR MATERIEL Command's Communication and Navigation Laboratory, Electronics Subdivision, Wright Field, Dayton, Ohio, has designed and developed a new air-sea rescue transmitter-receiver. The new equipment is a miniaturized battery-operated unit which will in time become standard equipment for every USAF pilot and airman.

Up to now, men leaving a ditched or sinking airplane for a life raft have had to resort to the "Gibson Girl," a rescue set weighing about 40 pounds and operating on medium frequencies necessitating yards of antenna launched by means of a kite or balloon. The new set, known as the URC-4, is not much larger than a ration kit and can be held in one hand. Its mercury-type battery is a separate unit with a rubberized cable connection.

The entire unit is completely impervious to salt water and is designed to withstand temperature extremes ranging from 160F to -50F. Tests at Seal Beach, Calif., have proven that a message can be picked up by a search plane rang-



J. S. Horrigan, USAF's Air Materiel Command project engineer on the URC-4, demonstrates how the battery of the midget air-sea rescue transmitter-receiver can be slipped into the pocket of an ordinary flying suit

## GET THE FACTS ON *Potter* HIGH SPEED ELECTRONIC PREDETERMINED COUNTERS

For these applications:

- AUTOMATIC MACHINE CONTROL
- PACKAGING BY PREDETERMINED COUNT
- LINEAL MEASUREMENTS
- FREQUENCY MEASUREMENTS
- TIME INTERVAL CONTROL



The ONLY counter  
with ALL these features!

- COUNTS AT RATES UP TO  
60,000 PER MINUTE
- ABSOLUTE ACCURACY
- INSTANTANEOUS AUTOMATIC RESET
- NO MOVING PARTS,  
FRICTION OR INERTIA
- SIMPLE DIAL SELECTION OF COUNT

Potter Predetermined Electronic Counters extend the field of automatic counting and control far beyond the scope and capabilities of existing mechanical and electromechanical devices. There are no moving parts, therefore, wear, slippage and inertial effects are eliminated.

Although the standard models count at rates up to 60,000 per minute, counters capable of counting at higher rates are available.

A complete line of photoelectric and electromagnetic detectors, for counting any material or action, can be supplied.

The instruments are easily applied to any problem requiring the precise measurement or control of QUANTITY, LENGTH, TIME, FREQUENCY, REVOLUTION or CAM SEQUENCE. Absolute accuracy of count is guaranteed.

Write today for an accurate appraisal of your counting, timing or control problem to Department 6-N.

**POTTER**  
INSTRUMENT CO.  
INCORPORATED  
136-56 ROOSEVELT AVE., FLUSHING, N. Y.



over  
**50,000**  
references  
to pertinent  
electronic and  
allied engineering  
articles published  
from 1925 to  
the present time . . .  
including

foreign and domestic magazines,  
journals, proceedings, government  
reports, technical house-organs, U. S.  
patents and texts.

### THE ELECTRONIC ENGINEERING MASTER INDEX

is an absolutely indispensable refer-  
ence in every electronic and indus-  
trial laboratory, library and Patent  
Attorney's office.

Visit our Booth No. 310 at the IRE Show

Write today for full descriptive literature

**Electronics Research Publishing Co.,  
INC.**

Dept. 33, 480 Canal St. New York 13, N. Y.

## Try Remler for Service-Tested "Hard-to-Get" Components

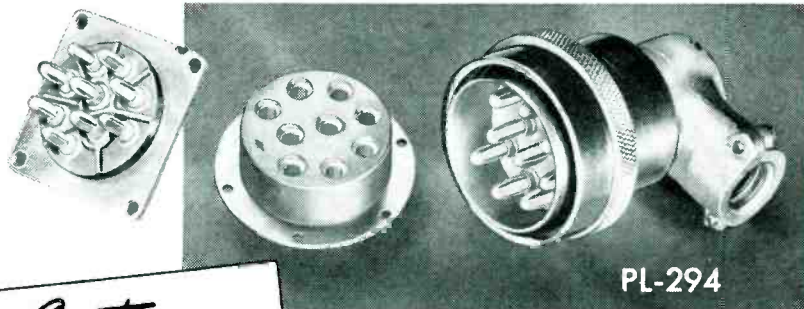

### Custom Components

Metal-plastic components  
designed and manufactured  
to order. Write for quota-  
tions specifying electrical  
and mechanical character-  
istics. Describe application.  
No obligation.

## PLUGS & CONNECTORS BANANA PIN TYPES...JAN SPECIFICATIONS

Multi-contact connectors and mating chassis counterparts. Melamine or alkyd insulation; steel or brass nickel-plated shells. Banana springs are heat treated beryllium copper. Unexcelled low resistance contact. Highest quality . . . good for thousands of connects and disconnects.

**Special Connectors to Order**—Miniatures; water tight and pressure proof types to JAN specifications.

Remler Company Ltd. 2101 Bryant St. San Francisco 10, Calif.

# Remler

Since 1918

PIONEERS IN ELECTRONICS AND PLASTICS



## SPECIALTY DRY BATTERIES are Laboratory Built

We custom make dry batteries of unusual sizes and capacities to give most effective service in industrial and laboratory work of all kinds. We will specially design batteries to your individual needs.

### Promptly Supplied

We are specially equipped to produce and ship even the smallest orders of hard-to-get batteries without delay.

### FREE Helpful Catalog

Gives complete description of hard-to-get industrial, laboratory, and radio batteries quickly available from Specialty. Write today.

## SPECIALTY BATTERY COMPANY

A RAY-O-VAC SUBSIDIARY

**RAY-O-VAC**

MADISON 3, WISCONSIN

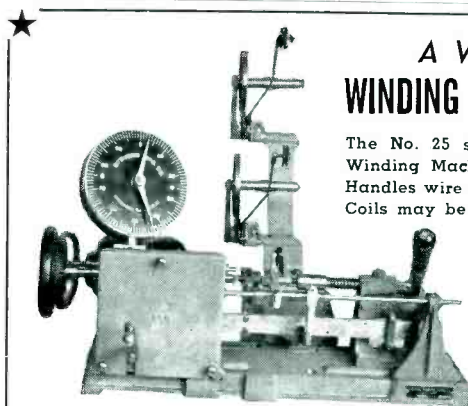

## A VERSATILE FINE-WIRE WINDING MACHINE BY GEO. STEVENS

The No. 25 shown is a combination of the Universal Winding Machine and the 6" Space Winding Machine. Handles wire from 24 to 40 gauge. Progressive Universal Coils may be up to 3½ inches in length.

- Other models for winding Coils, Transformers, Resistors, and Solenoids
- Dial Counters also available separately
- We welcome the opportunity to consult with you on your needs and would like you to have our latest catalog . . . write!

**GEO. STEVENS MFG. CO.**

6022 N. ROGERS AVE.  
PULASKI & PETERSON  
CHICAGO 30, ILLINOIS

# FOR ORIGINALITY

LOOK TO **XCELITE**

### Only \$9.95 for This COMPLETE

Nut Driving, Screwdriving, Reaming Kit!

The big XCELITE handle fits the detachable blades—gives you 12 QUALITY TOOLS. 9 chrome plated nut drivers, 3/16" 1/2" sizes, two screwdriver sizes, one reamer, indurable roll kit! NOW AVAILABLE—#1 and #2 Phillips points on ONE blade! Order No. 99-82 blade. List price \$1.05. (P.S. We left a space for it in both 99 kits) ASK YOUR SUPPLIER OR WRITE:



**PARK METALWARE CO., INC.**

Dept. C Orchard Park, N. Y.

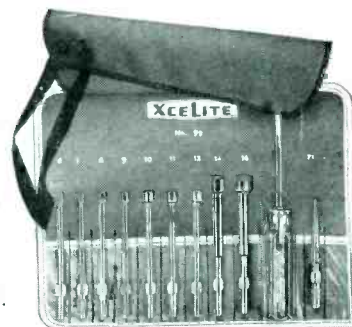

Canadians Send Orders Direct to: Chas. W. Pointon, Canadian Warehouse Distributor, 1926 Gerrard St., Toronto, Ont.

# QUANTITATIVE MEASUREMENT

The **Tektronix Type 512** Cathode Ray Oscilloscope is particularly well adapted for use in the detailed examination of complex waveforms.

The calibration accuracy of **5%** in time and amplitude; the **direct coupled** amplifiers; the **wide band pass** and **extended sweep range** will permit your research and development staff to better evaluate and measure the performance of electronic circuitry.



\$950.00  
f.o.b. Portland, Ore.

**DC - 2MC** 5 Millivolt sensitivity, **DC or AC**  
Sweeps 3 Sec. to 30 MSec.



**TEKTRONIX, INC.**

Cables, Tektronix  
712 S.E. Hawthorne Blvd. Portland 14, Ore.

## New Type 2A TAP SWITCHES

HAVE A CONSTANT CONTACT RESISTANCE OF  
**ONLY 1 or 2 MILLIOHMS!**

**T**hese high quality switches with up to 24 contacts were specifically developed to meet the need for rugged precision instrument switches that have longer operating life and are economical components in competitively priced electronic instruments and military equipment.

Write for Technical  
Bulletin No. 28.

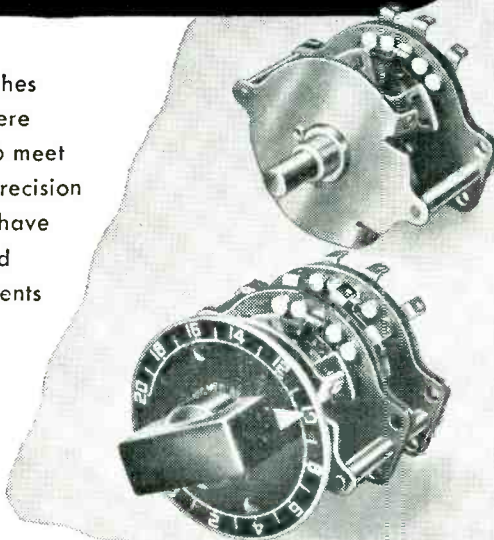

**TECH LABORATORIES** PALISADES PARK  
NEW JERSEY

ing as far as 80 miles from a crash survivor in life raft.

### Etta Kappa Nu Awards

OUTSTANDING young electrical engineers were recognized and presented awards by Eta Kappa Nu in New York City on January 30, 1950, during the week of the Winter General Meeting of the AIEE. Robert C. Cheek of Westinghouse Electric Corp. was the winner. Recipients of honorable mentions were Lester M. Field of Stanford University and Louis G. Gitzendanner of General Electric Co.

To qualify for this annual award the candidate must be not older than 35 years nor be out of college for more than 10 years by May 1 of the year for which he is cited. After qualifying on these two counts the candidate is judged on the basis of accomplishment in professional, social and cultural fields. Final selection of candidates is made by a jury of awards composed of well known engineers from industry and educational institutions.

### BUSINESS NEWS

THE A. W. HAYDON Co., manufacturer of timing motors, has moved

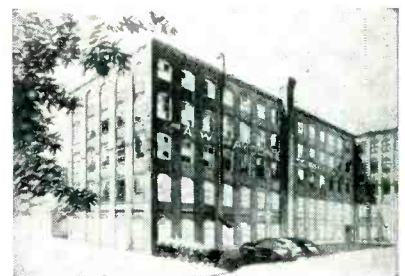

A. W. Haydon Co.'s new plant

to new and larger quarters at 232 North Elm St., Waterbury 20, Conn.

THE ATOMIC ENERGY COMMISSION recently transferred its radiation instruments branch from Oak Ridge, Tenn., to Washington, D. C.

STEVENS MFG. Co., INC. has transferred operations to a new plant at 69 South Walnut St., Mansfield, Ohio, to concentrate production of precision bi-metal thermostats for



# The New STAVER MINI-SHIELD

TRADE MARK REG. AND PAT. PEND.

The shield  
that fits all  
Miniature  
Tubes



A flexible shield that snugly fits all miniature tubes because it compensates for all variations in tube dimensions. Mini-Shields are made for both T5 1/2 and T6 1/2 bulb tubes. Send for catalog sheet.



## HERE'S BIG HELP IN TERMINAL WIRING!

### The New JONES FANNING STRIP

Connections are made through Fanning Strip, on bench or anywhere apart from barrier strip, and quickly slipped into assembly.

Use with Jones Barrier Terminal Strips, Nos. 141 and 142, for 1 to 20 terminals.

Simplifies soldering. Insures correct connections. Saves time. Ideal for harness or cable assembly. Brass terminals, cadmium plated. Bakelite mounting. Send for complete data.

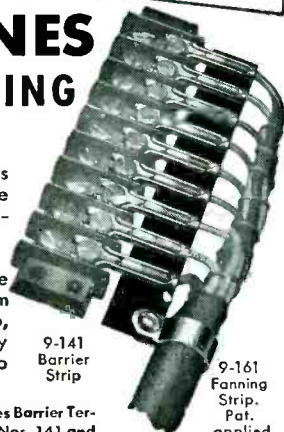

9-141  
Barrier  
Strip

9-161  
Fanning  
Strip.  
Pat.  
applied  
for.

The correct wire to  
correct terminal  
every time!

**Jones** HOWARD B. JONES DIVISION  
CINCH MANUFACTURING CORPORATION  
CHICAGO 24, ILLINOIS  
SUBSIDIARY OF UNITED-CARR-FASTENER CORP.



## REMEMBER THIS SIGN!

It identifies the finest, most stable resistor on the market.

HIGH STABILITY Carbon resistors are 1% stable, noise free, and cost less, even in small quantities, than five percent composition resistors of questionable stability. Welwyn resistors are selected and stable to  $\pm 1\%$ .

Investigate the advantages of this outstanding development.

### WELWYN ELECTRONIC COMPONENTS INC.

234 East 46th Street

New York 17, N. Y.

Murray Hill 2-2535

## ELECTRONIC COMPUTER CORPORATION

Dr. Samuel Lubkin, *President*

announces

The Opening of Offices and Plant  
at

265 Butler St., Brooklyn 17, N. Y.

CONSULTATION • RESEARCH • MANUFACTURE  
Electronic Digital Computers • Allied Applications

## For Precision Washers... For Precision Stampings...

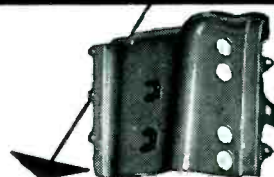

## WHITEHEAD STAMPING CO.

A preferred source of precision-made WASHERS and STAMPINGS. 46 years of experience and up-to-the-minute facilities, assure highest quality and service.



EST.  
1903

**WHITEHEAD STAMPING CO.**

1691 W. Lafayette Blvd.

Detroit 16, Michigan

**it's FALSTROM for**  
**metal forming-**

Falstrom Cubicles can be supplied wired to your specifications.

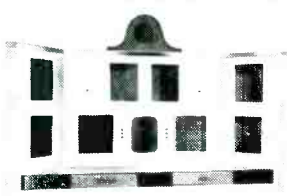

Control Centers can be designed to meet any requirement.

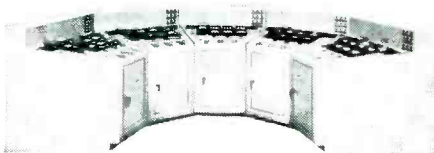

1. CONTROL CENTERS
2. ENCLOSURES
3. PANELS
4. BOXES



**FALSTROM** service is fast, competent, complete. It includes forming, punching, welding and finishing. Piping, wiring and accessories can be built in when desired. Falstrom engineers will even procure and install your instruments to your specifications. All work performed by Falstrom is done by engineers and technicians thoroughly familiar with each phase of production. Mechanics skilled in working with steel, aluminum and stainless steels assure finest workmanship. Falstrom installations are in service throughout the electrical, chemical and petroleum industries — have been an accepted standard of excellence since 1870. For a practical, economical solution to your metal forming problems, go to Falstrom!

TO GET ALL THE FACTS, FILL OUT AND MAIL THE HANDY COUPON BELOW

**FALSTROM COMPANY**

93 FALSTROM COURT • PASSAIC, N. J.

Gentlemen:  
 Please send full information at once. I am interested in Nos. \_\_\_\_\_  
 NAME \_\_\_\_\_  
 TITLE \_\_\_\_\_  
 COMPANY \_\_\_\_\_  
 STREET \_\_\_\_\_  
 CITY \_\_\_\_\_ ZONE \_\_\_\_\_ STATE \_\_\_\_\_

use in appliances, industrial and electronic equipment.

THE SOCIETY OF MOTION PICTURE ENGINEERS recently changed its name to the Society of Motion Picture and Television Engineers.

RADIO CORP. OF AMERICA AND TWENTIETH CENTURY-FOX FILM CORP. recently signed a contract for cooperative research looking toward further advancement of the applications of large-screen television in the motion picture industry.

FAIRCHILD GUIDED MISSILES DIVISION is the new name of the Pilotless Planes Division of the Fairchild Engine and Airplane Corp., Farmingdale, N. Y.

ILLINOIS INSTITUTE OF TECHNOLOGY chapter was recently given the Eta Kappa Nu Achievement Award for 1948-49. It was the second straight year this chapter has been so honored.

HYTRON RADIO & ELECTRONICS CORP. recently opened a new plant in Newburyport, Mass., for the mass production of television picture tubes.

GENERAL ELECTRIC X-RAY CORP., Milwaukee, Wis., is constructing a two-million-volt x-ray machine for installation in New York City's new

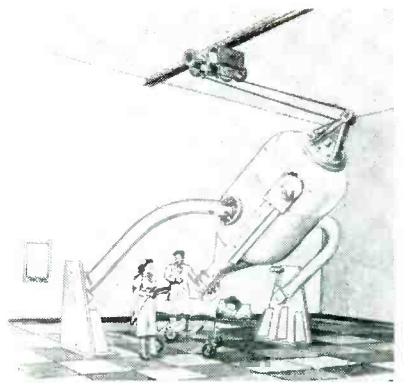

Artist's sketch of 2,000,000-volt x-ray therapy machine recently purchased by New York City from GE X-Ray Corp. for Francis Delafield Hospital

Francis Delafield Hospital to combat cancer.

ELECTRONIC COMPUTER CORP., 265 Butler St., Brooklyn, N. Y., is a new company formed to manufac-

*Etched*  
**TUNGSTEN WIRE**



FROM .0004" TO .00015" AND EVEN SMALLER



Accurate, uniform and smooth

Also available in Molybdenum and other metals

Write for details and List of Products

**SIGMUND COHN CORP.**  
 44 GOLD ST. NEW YORK



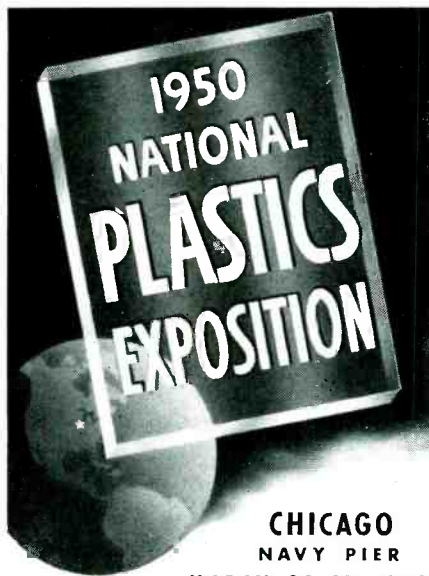

**CHICAGO  
NAVY PIER  
MARCH 28-31, 1950**

For designers, production men, sales executives, merchandise men and buyers in all industries and businesses. See all the latest advances in the world of plastics. See how to use plastics in all forms, old and new — to stimulate the sale of *your* products. Over 100 exhibits — materials, machines, finished products. Consult with the experts — they'll be there!

**Guest Tickets:** Exposition not open to public. Free guest tickets are available by writing (on your company letterhead) to

**THE SOCIETY OF THE  
PLASTICS INDUSTRY, INC.  
295 MADISON AVENUE, NEW YORK 17, N. Y.**



... hitch your product  
to a star

The A. W. Haydon Company's newly developed Chronometric DC Governed Motors are finding applications requiring precision timing to Mean Sidereal Time — the time of the stars — for navigational computations. These Chronometric Governed Timers can be supplied for Sidereal or Solar time as motors alone — or incorporated into any of the A. W. Haydon Company's line of timers and time delay relays. They are furnished in various types of housings to rigid specifications including hermetic sealing for aircraft, guided missiles, etc., as well as for industrial applications.

When you want the latest and best in timing, either AC or DC, hitch your product to a star with the A. W. Haydon Company's motors and timers.

Write for the latest catalog.



Visit us at the I.R.E. Convention, Grand Central Palace,  
New York, March 6 - 9, 1950 at Booth Number 136

**Stop listening to  
DISTORTED  
MUSIC**

The connoisseur of music listening wants to recognize the clear brilliance of symphonic sound and

**BROOK  
All Triode High Quality  
AUDIO AMPLIFIER  
Gives It To Him**

(illus. Model 10C3-30 watts)  
Also available: Model 12A3-10 watts  
**with**

- Distortion and intermodulation at a new low.
- Reduction of listening fatigue.
- Brilliant, clear tone.
- Separate controls-stepped-for Bass and Treble.
- Extremely low volume without any loss of quality.

Write TODAY for FREE Technical Bulletin and Detailed Distortion Analysis

**BROOK ELECTRONICS, Inc.**  
Sales Agent  
Dept. BC-O, 34 DeHart Place, Elizabeth, N. J.

**Little thought-of facts about capacitors**

The short time breakdown voltage of a well-made D.C. capacitor is not less than 5 to 6 times the actual working voltage at 20° —

$$E = 5 \times e \text{ min.}$$

E = Breakdown voltage  
e = Rated d.c. working voltage

**INDUSTRIAL CAPACITORS** are unvaryingly held to this formula.

Designed for maximum safety factor and the smallest possible volume, **INDUSTRIAL CAPACITORS** are the most widely used capacitor in industrial applications.

**WRITE TODAY FOR DETAILED CATALOG**

**INDUSTRIAL CONDENSER CORP.**

Watch this space for other capacitor facts that will help you.

Sales Offices in All Principal Cities  
3243 N. California Ave.  
Chicago 18, Illinois

**SMALL PARTS**

Filaments, anodes, supports, springs, etc. for electronic tubes. Small wire and flat metal formed parts to your prints for your assemblies. Double pointed pins. Wire straightened and cut diameter up to 1/8-inch. Any length up to 12 feet.

LUXON fishing tackle accessories.

Inquiries will receive prompt attention.

**ART WIRE AND STAMPING CO.**

227 High St. Newark 2, N. J.

## SERVICE . . . a grossly misused word, but...

a bonafide policy with Lectrohm. You get the required resistors when you want them and as you want them. Bring your stock up to date with Lectrohm Resistors now and eliminate all resistor worries.

### Order from stock



Pigtail Resistors—1, 5 and 10 Watt  
Fixed " —20 to 200 Watt  
Adjustable " —10 to 200 Watt

### Also Special



Non-Inductive Vitreous Enameled  
Close Tolerance Resistors (1% ±)  
Ferrule Terminal Resistors—13 to  
190 Watt  
Rib-on-edge Resistors — 155 - 420  
Watt  
Plate and R F Chokes  
Solder Pots  
Brackets and Accessories

Ask for sample giving detailed specifications of your application! Write for catalog!



5903 Archer Avenue Chicago 38, Illinois  
Division of  
National Lock Washer Co., Newark, N. J.

ture electronic digital computers for industrial uses.

RAYPAR, INC., radio and television parts manufacturers, have purchased a new 59,000-sq ft factory at 7810 West Addison St., Chicago, Ill.

### PERSONNEL

DELMAN E. ROWE, former head of the electronics development division of the Naval Aviation Ordnance Test Station, Chincoteague, Va., has been appointed senior test director in the guided missiles research laboratory of the National Bureau of Standards, Washington, D. C.



D. E. Rowe



N. L. Harvey

NORMAN L. HARVEY, formerly head of the Applied Research Branch of the Physics Laboratory of Sylvania Electric Products Inc., Bayside, N. Y., has been appointed director of engineering of Colonial Radio Corp., a wholly-owned subsidiary of Sylvania Electric.

VANNEVAR BUSH, president of the Carnegie Institution of Washington, has been made an honorary life member of the AIEE.

IRVIN GUTTMAN, previously associated with the U. S. Signal Corps Laboratories, is now chief electronics project engineer and sales engineer with Telrex, Inc., Asbury Park, N. J.

CLIFF GARDNER, formerly with Raytheon Mfg. Co. as engineering department head in charge of klystron development, has joined Varian Associates, San Carlos, Calif., as an engineering staff member to continue in klystron development work.

# SYNTHESIS

IS A HIGH CLASS WORD  
FOR DESIGNING  
SERVO MECHANISMS

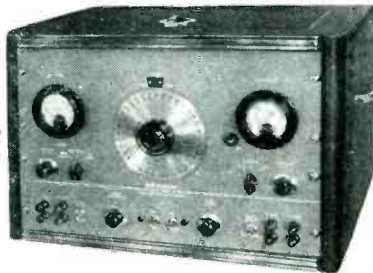

## ...SERVOSCOPE IS A HIGH CLASS INSTRUMENT FOR SERVO SYNTHESIS!

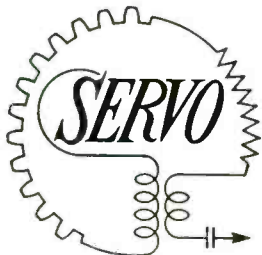

SEE BOOTH 352  
Radio Engineering Show

**MEASURES** amplitude & phase vs. frequency  
**CARRIERS** accepted, 50 to 800 cps  
**MODULATES** chosen carrier, 0.1 to 20 cps  
**ANALYZES** D.C. or A.C. automatic controls  
**SUB-AUDIO** sine generator, 0.1 to 20 cps  
**SQUARE WAVE** generator, 0.1 to 20 cps  
**PHASE READING** to 1° accuracy, 2 methods  
**LINEAR SWEEP** for external use, 0.1 to 20 cps

# SERVO CORP. OF AMERICA

## NEW HYDE PARK, N. Y.

# New ARBOR

TECHNIQUE

Saves  
MONEY

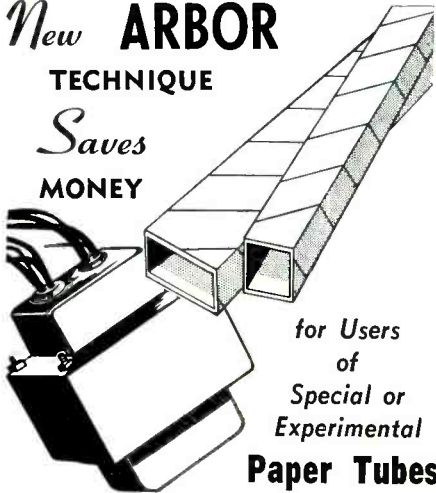

for Users  
of  
Special or  
Experimental  
Paper Tubes

With our new arbor technique we can provide you with any number of square or rectangular tubes, for experimental purposes, to whatever specifications you need up to 6" x 6", AT NO ARBOR COST.

We maintain an inventory on standard size tubes from 3/8" x 3/8" up, of dielectric Kraft paper tubes in 25" lengths in the most popular sizes and wall thicknesses.

Write, phone or wire today for free sample kit—also prices on any size and quantity of tube you desire.

## ACCURATE PAPER TUBE CO.

Square and Rectangular Paper Tubes  
for Coil Winding

852 N. Noble St. Chicago 22, Ill.



ONLY \$215\* FOR  
THE GREEN  
ENGRAVER  
... yet it's fast, versatile  
and rugged enough  
for die steel

The Green Engraver offers great speed and convenience. Quickly cuts up to four lines of letters from 3/64" to 1" on curved or flat surfaces whether made of metal, plastics or wood... operates by merely tracing master copy — anyone can do an expert job. Special attachments and engineering service available for production work. Just the thing for radio, electronic apparatus and instrument manufacturers.

See Us  
at the  
I. R. E. Show  
Booth 337

For quality engraving on  
• Panels • Name Plates • Scales  
• Dials • Lenses • Molds • Instruments  
... also does routing, profiling and three dimensional modeling.  
\*Price does not include master type and special work holding fixtures.

GREEN INSTRUMENT CO.

363 Putnam Ave.  
Cambridge, Mass.

# NEW! THE CB COIL CHECKER

For measurement of:

COIL INDUCTANCE      CAPACITY OF MICA CONDENSERS  
DISTRIBUTED CAPACITY OF COILS      Q OF COILS

Combines an amplifier circuit, a calibrated variable capacitor with dial accuracy of 1% + IMM, and a highly stable VTVM into a single unit. Any R.F. Oscillator may be used as an external source.



CB MODEL 301A

IDEAL FOR PRODUCTION COIL TESTING  
MODERATELY PRICED

For complete construction details and performance data write for Bulletin 27C.



## The CLOUGH BRENGLE CO.

6012 Broadway

Chicago 40, Ill.

Pioneer in Radio Engineering Instruction Since 1927

# CAPITOL RADIO ENGINEERING INSTITUTE

An Accredited Technical Institute

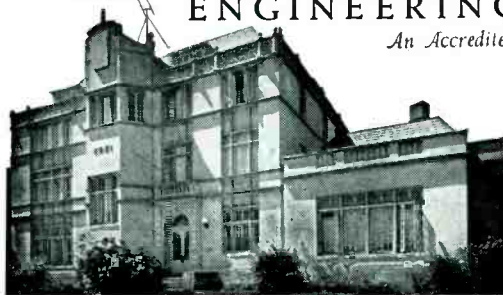

ADVANCED HOME STUDY  
AND RESIDENCE COURSES IN  
PRACTICAL RADIO-ELECTRONICS  
AND TELEVISION ENGINEERING

Request your free home study or  
resident school catalog by writing to:

DEPT. 283B

16th and PARK ROAD, N.W.  
WASHINGTON 10, D.C.

Approved for Veteran Training

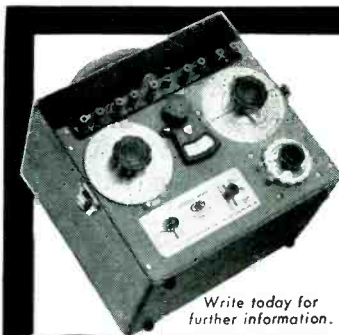

## NEW EXTENDED RANGE Model 250-B IMPEDANCE BRIDGE

TEN TIMES THE RANGE

Resistance: 1 milliohm to 11 megohms.  
Capacitance: 1 mfd. to 1100 mfd.  
Inductance: 1 microhenry to 1100 henrys.

TWICE THE ACCURACY

Better than 1/2% on most measurements.

MANY TIMES THE CONVENIENCE

Simplified switching — Colored indexed dials — Unique direct reading LRC dial — No AC power connection required — Lightweight, 15 lbs. — Compact, 9 1/2" x 10 1/2" x 10 1/2". Accessory null amplifiers available.

Of Previous Instruments In Its Price Range



BROWN ELECTRO-MEASUREMENT CORPORATION

Successor to Brown Engineering Co.

4635-37 S. E. HAWTHORNE BOULEVARD

PORTLAND 15, OREGON

FOR  
DEMONSTRATING  
& TESTING AUTO RADIOS  
from AC LINES



**ATR**

**"A" BATTERY  
ELIMINATORS**

I. R. E. SHOW  
BOOTH 202 MARCH 6-9



**for DEMONSTRATING AND  
TESTING AUTO RADIOS**

New Models . . . Designed for testing D. C. Electrical Apparatus on Regular A. C. Lines. Equipped with Full-Wave Dry Disc Type Rectifier, Assuring Noiseless, Interference-Free Operation and Extreme Long Life and Reliability.



**AUTO RADIO VIBRATORS**

A Complete Line of Vibrators . . . Designed for Use in Standard Vibrator-Operated Auto Radio Receivers. Built with Precision Construction, featuring Ceramic Stack Spacers for Longer Lasting Life.

NEW MODELS ✓ NEW DESIGNS ✓  
NEW LITERATURE ✓  
ATR "A" Battery Eliminator, DC-AC Inverters, Auto Radio Vibrators

See your dealer or write factory

**AMERICAN TELEVISION & RADIO Co.**  
Quality Products Since 1931  
SAINT PAUL 1, MINNESOTA-U. S. A.

**NEW BOOKS**

**Acoustic Measurements**

BY LEO L. BERANEK. *John Wiley & Sons., Inc., New York, 1949, 914 pages, \$7.00.*

THE NEED for this book has long been felt by engineers and physicists working with acoustical apparatus. It is written by a man who is fully equipped with the theoretical and practical knowledge required to accomplish the difficult task of correlating theory with practice.

The book, because of the nature of the subject material, takes the form of a series of essays on various acoustical subjects. It includes a brief and fact-packed history of acoustical measurements which holds enormous interest for anyone working in or around the field of sound. There is a long list of definitions of acoustical terms which seems to be quite complete, although some of the definitions are a bit terse. Then follows a discussion of liquids and gases as sound-transmitting media, the most useful part of which is a series of charts and tables which never before have been gathered together in any one place. This section is aimed primarily at the physicist, although the practicing engineer can derive much benefit from it. The sections on diffraction and reflection of sound waves includes data on the effects of the human body which is of considerable practical use.

The section on absolute calibration of microphones includes a discussion on reciprocity which is most complete and understandable. It seems to be a compilation of information heretofore available only from many disconnected sources. The practical side of microphone calibration is well taken care of by detailed dimensioned drawings of test cavities, and circuits for measurement are completely detailed.

There are detailed discussions on sound sources, practical microphones (including the ear), and very excellent sections on measurements of basic quantities in acoustics, including frequency, intensity, and impedance. The section on random noise is possibly the most complete collection of usable informa-

how can  
**YOU use this  
unique Edison  
Thermal Relay?**

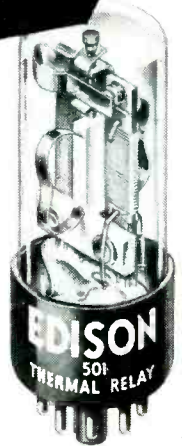

- For cathode protection
- —overload protection
- —holdovers
- —pulse integration
- —motor starting
- —or other control functions?

If you are designing circuits requiring a time delay element, or a reliable relay where a short operating interval can be tolerated, it might be to your advantage to consider the Edison 501 Thermal Relay.

**Here are 7 good reasons why:**

1. **Vibration and shock resistant** — Guaranteed to withstand continuous vibration of 1/16" over-all amplitude at 55 cps., and impact shock of 50 g.
2. **Chatter-proof** — Pre-loaded spring provides 50-gram pressure almost instantaneously, for sure, positive operation.
3. **Non-position sensitive** — Characteristics not affected by mounting angle — operates satisfactorily in any position. Standard intermediate octal base.
4. **Ambient compensated** — Automatically compensated for ± 60° C. ambient range by extra unheated bimetal. Will operate from -60° C. to +100° C.
5. **Non-arcng** — Sealed-in-glass. Operates in its own arc-suppressing atmosphere. Withstands substantial currents and voltages without arc-pitting.
6. **Explosion-proof** — Hermetically sealed. You can specify it for safe use in corrosive or hazardous fumes and dusts. Tamper-proof, too.
7. **Fungus-resistant** — Available with fungus and salt-spray resistant micanol base.

**GENERAL SPECIFICATIONS—STANDARD TYPES**

Operating Time—5 to 300 sec. in 14 standard intervals, pre-set at factory.	Heater—5 watts, 117 v., 26.5 v., 6.3 v., dc. or ac to 2400 cps
Contacts—Silver, SPST, normally open.	Size—1.275" max. dia., 3.250" max. seated height (standard T-9 envelope).
Contact Rating—Types 5 sec. to 75 sec., 3 amp. 150 vdc or 250 vac; Types 90 to 300 sec., 3 amp. 450 v. ac/dc.	Weight—1½; to 2½ ounces.
Other than standard types can be made up on special order to meet requirements for other heater voltages, higher currents, etc.	

**LITERATURE AVAILABLE**

Free illustrated Bulletin 3007A gives full details. Write today for a copy. 293 Lakeside Ave., West Orange, N. J.



# KEEPING PACE with ELECTRONIC NEEDS

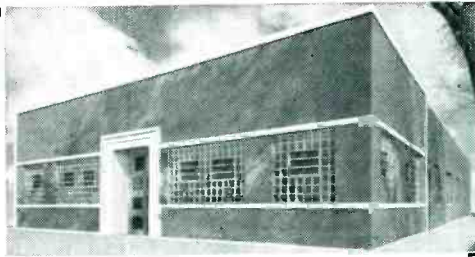

... Our New Plant's Expanded Manufacturing, Technical Facilities

Now we can serve you even better . . . faster. A modern equipped plant and laboratory; latest production methods, and trained technicians provide a more systematized and complete operation. Products are constantly being created and tested to offer you the latest and best in electronic equipment.

**New Model "B" Supplies 1 to 20 Amps 6 Volts DC, Continuous Duty  
3 to 9 Volts at Other Ratings**

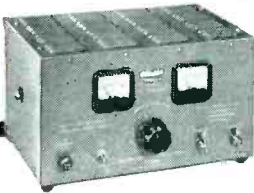

#### APPLICATIONS

Tests or operates any 6 volt radio, relays, telephone circuits, laboratory instruments and many other low voltage requirements.

New conduction cooling method increases rectifier power rating 1½ times, providing lower cost per ampere output over any other type. The Electro "B" gives you highest efficiency, offering ample power to operate two auto radios simultaneously. Peak instantaneous current rating of 35 amperes (from 50 to 60 cycle 115 volt power source).

#### FEATURES

Less than 3% AC ripple or hum. Damped volt and ammeters (no wiggling) voltmeter 3% accuracy. Heavy duty selenium rectifiers, switch, transformer and choke. 6000 mfd. filter condenser.

Send for Folder on  
Complete Line



Pioneer Manufacturers

of Battery Eliminators

ELECTRO PRODUCTS LABORATORIES 4513 N. RAVENSWOOD AVE., CHICAGO 40, ILL.

## STANDARD (RMA) RESISTANCE BOX

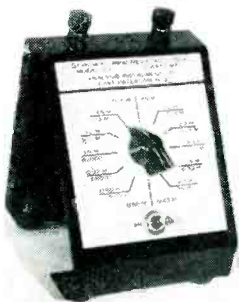

A handy resistor "decade" for electronic production and development use.

#### FEATURES:

1. Each step an RMA value.
2. Wide range of resistances.

#### ADVANTAGES:

1. Eliminates the potentiometer-ohmmeter method of first approximation of circuit values.
2. Reduces the number of resistors drawn from supply for trial in circuit.
3. Can not "run out" of standard resistor values for test when these boxes are available.

#### SPECIFICATIONS:

MODEL 101. All RMA 10% resistances from 47,000 ohms to 2.7 meg., ½ watt, 10% acc.	} \$6.90 ea.
MODEL 102. All RMA 10% resistances from 680 to 39,000 ohms, ½ watt, 10% accuracy.	
MODEL 101A. Same as 101, but with 5% resistor accuracy.	} \$7.50 ea.
MODEL 102A. Same as 102, but with 5% resistor accuracy.	

ANALYSIS INSTRUMENT CO.

P. O. Box 231 East Paterson, N. J.

Telephone: Fairlawn 6-5208

## For Stability CONTINENTAL "NOBLELOY" RESISTORS



- Engineered Performance
- Metal Film
- Range ½ ohm to 30 megohm
- Ratings, ½, 1, 2 & 5 Watt
- Tolerance ½%, 1% & 5%

The "Nobleloy" type X resistors assure dependable operating characteristics for many critical applications at economical savings.

Write for further details

CONTINENTAL CARBON INC. CLEVELAND 11, OHIO

Where the  
Requirements  
are Extreme...

## Use SILVER GRAPHALLOY\*

For extraordinary  
electrical performance



THE SUPREME BRUSH  
AND CONTACT MATERIAL

in BRUSHES

- for high current density
- minimum wear
- low contact drop
- low electrical noise
- self-lubrication

in CONTACTS

- for low resistance
- non-welding character

\* SILVER GRAPHALLOY is a special silver-impregnated graphite

Accumulated design experience counts — call on us!

## GRAPHITE METALLIZING CORPORATION

1055 NEPPERHAN AVENUE, YONKERS 3, NEW YORK

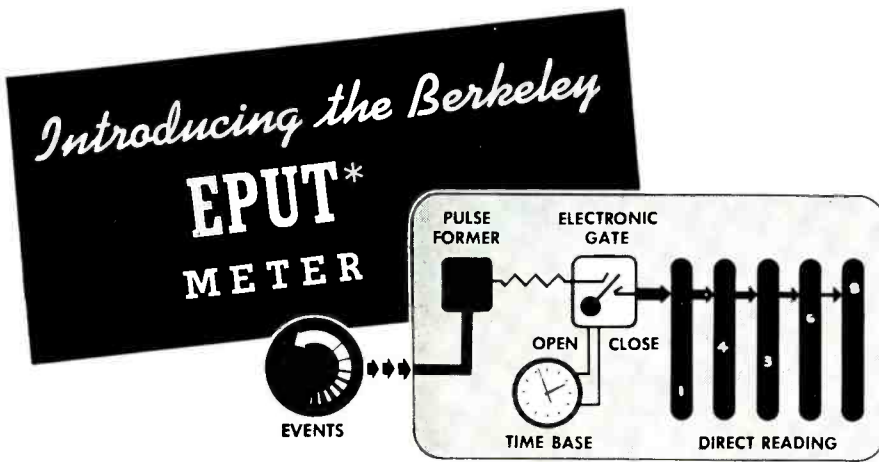

Any physical, optical or electrical events which can be translated into changing voltages can be counted for a specific time interval by this new Berkeley \*Events-per-Unit-Time-Meter.

Signals of unknown occurrence rate are amplified, properly shaped by the input circuit and admitted through the time base controlled electronic gate to the Decimal Counting Units. The instrument then reads directly in Events-Per-Unit Time.

Send for bulletin for full, detailed description.

Booth 333 I. R. E. Show, N. Y. C. March 6-9

# Berkeley Scientific Company

SIXTH AND NEVIN AVENUE • RICHMOND, CALIF.

## Cross it Out!

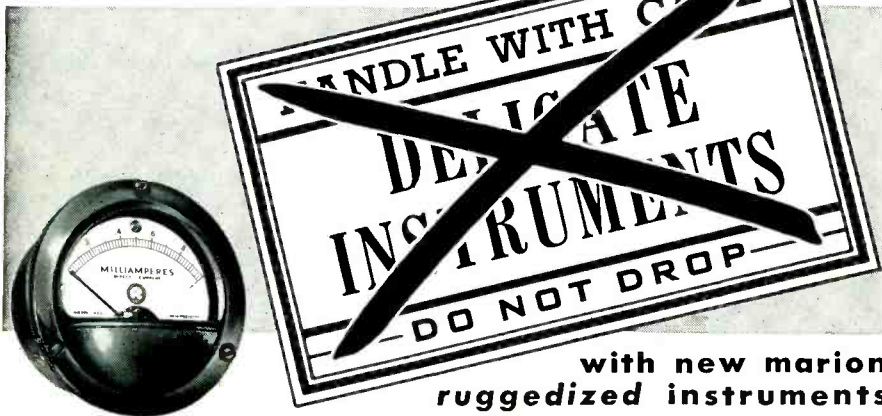

with new marion  
ruggedized instruments

The new Marion Ruggedized meters (Hermetically Sealed) now give you an exceptionally accurate and sensitive means for electrical measurement and indication — under extreme conditions of Shock, Vibration, Mechanical Stress, Strain, Weather Conditions and Climate. This whole new family of Ruggedized Panel instruments gives you new freedom of application. You can use them where you have never before dared use "delicate instruments." What's more, they meet the dimensional requirements of JAN 1-6 and are completely interchangeable with

existing standard JAN 2½" and 3½" types.

When you need ruggedized meters for rugged applications; when you need special meters for special applications; when you need *better* meters for *any* application . . . call on Marion — the name that means the *most* in meters.

Send for your free copy of our booklet on the New Marion Ruggedized Instruments today.



Marion means  
the most in meters

Marion Electrical Instrument Co., Manchester, New Hampshire

Makers of Hermetically Sealed Meters Since 1944



# marion meters

tion on this subject which exists in the literature today. The discussions and illustrations of transient response help to fill the void which has existed because of lack of factual information on the response of acoustical systems to transient phenomena.

The section on indicating instruments should be thoroughly read and understood by anyone who encounters the problem of estimating sound power levels on audio programs. This is a problem the magnitude of which is not generally appreciated.

The test procedures outlined for loudspeakers and earphones present the problem in such a way that it becomes possible for the user of such equipment to interpret the results of measurements as they will affect actual use.

This book should become the standard reference on the subject of acoustical measurements for many years to come. It is to be hoped that college courses based on this subject matter become generally available within a short time, to help make acoustics and acoustic measurements a powerful tool for the practising engineer.—N. C. PICKERING, *Pickering & Co., Inc., Oceanside, N. Y.*

### Modern Oscilloscopes and Their Uses

By JACOB H. RUITER, Jr. *Murray Hill Books, Inc., New York, 1949, 326 pages. \$6.00.*

IT HASN'T been many years since few persons outside research and development laboratories knew what a cathode-ray oscilloscope was, or what could be done with one. Today, however, the situation is quite different. A scope is very helpful in servicing f-m receivers, and is an absolute necessity in television work. For those who must quickly learn basic oscilloscope fundamentals and operating techniques, this book is required reading.

In twenty well-written chapters, the author treats three basic phases of the subject: fundamentals, operating techniques, and practical applications. The first three



# CERAMIC

**SUBMINIATURE CAPACITORS**  
of High K Material  
for  
**Temperature Compensation Filter and Bypass uses**  
in  
**HEARING AIDS RADIO TELEVISION PRINTED CIRCUITS**  
and  
**SUBMINIATURE ASSEMBLIES**

Standard Capacities and sizes available or special designs made to manufacturers' specifications.

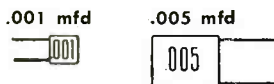

ACTUAL SIZE

.150 x .150 max. .270 x .350 max.  
x .070 in. thick x .070 in. thick  
600 VDC

## GLENCO CORP.

METUCHEN, N. J.

Telephone: Metuchen 6-0661

## ELECTRONICALLY REGULATED LABORATORY POWER SUPPLIES



BENCH MODEL 25

- STABLE
- DEPENDABLE
- MODERATELY PRICED
- 

- **INPUT:** 105 to 125 VAC, 50-60 cy
- **OUTPUT #1:** 200 to 325 Volts DC at 100 ma regulated
- **OUTPUT #2:** 6.3 Volts AC CT at 3A unregulated
- **RIPPLE OUTPUT:** Less than 10 millivolts rms

WIDTH 14"  
DEPTH 6"  
HEIGHT 8"  
WT: 17 LBS.

For complete information write for Bulletin E



**LAMBDA ELECTRONICS CORPORATION**  
CORONA NEW YORK

# Kahle

specialists in custom-built, ultra-precision  
**ELECTRON TUBE MACHINERY**

KAHLE CUSTOM-BUILDS machines to make the exact tubes you require—from big 20-inchers to tiny sub-miniature—from laboratory types to those for high-speed production. Kahle puts each unit through exhaustive trial runs in our plant to assure trouble-free operation in yours.

#1405 Cathode Ray Tube Sealing Machine

16 heads for sealing up to 12½ inch tubes; 12 heads for sealing up to 16 inch tubes. Adaptors for these sizes instantly interchangeable.

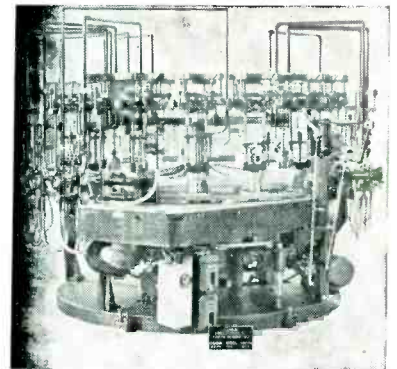

We specialize in cost-cutting, production-boosting, labor-saving equipment for complete manufacture of cathode ray tubes, standard, miniature and sub-miniature radio tubes, sub-miniature tubes, fluorescent lamps, photocells, x-ray tubes, glass products.

Consultations invited  
Send for our new catalog

# Kahle ENGINEERING CO.

1309 Seventh Street, North Bergen, New Jersey

## MANUFACTURERS

MOLDED AND FABRICATED  
INDUSTRIAL RUBBER PRODUCTS

- BUMPERS • BUSHINGS • EXTRUSIONS
  - GASKETS • GROMMETS • MOLDS • RINGS
  - ROLLS • SHEET • SLAB • SPRING • SPONGE
  - TIRES • TUBING • VACUUM CUPS • WASHERS
- ALL PHONES: HARRISON 7-8290

THOUSANDS OF  
ITEMS IN STOCK  
SINCE 1919

INDUSTRIAL  
RUBBER  
PRODUCTS

**ATLANTIC INDIA RUBBER WORKS, INC.**  
571 WEST POLK STREET • CHICAGO 7, ILLINOIS.

WRITE FOR COMPLETE CATALOG #44

## Winner and Still Coil Champion DANO

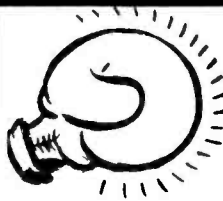

True champions because they stand up to every test, Dano coils are the wide odd favorites of experienced engineers who seek coil perfection.

Dano is completely set up to handle all your electrical coil winding problems including specially treated coils. Every coil made to your exact specifications.

ALSO TRANSFORMERS MADE TO ORDER

- Form Wound
- Paper Section
- Acetate Bobbin
- Bakelite Bobbin
- Cotton Interweave
- Coils for High Temperature Applications



**THE DANO ELECTRIC CO.**  
MAIN ST., WINSTED, CONN.

MODEL—245

**VOLTAGE  
REGULATED  
POWER  
SUPPLY . . .**



**OUTPUT VOLTAGE DC:** 200-500 volts.  
**OUTPUT CURRENT DC:** 0-200 milliamperes.  
**REGULATION:** Less than 1/2% for both line fluctuation from 105 to 125 volts and load variation from minimum to maximum current.  
**OUTPUT IMPEDANCE:** Less than 2 ohms.  
**RIPPLE VOLTAGE:** Less than 5 millivolts.  
**OUTPUT AC:** 6.3 volts 6 amperes unregulated.



Write for specifications bulletin #245

**KEPCO LABORATORIES, Inc.**

149-14 41 Avenue

FLUSHING, NEW YORK

# "Scratch-PROOFED" for High Fidelity Reproduction

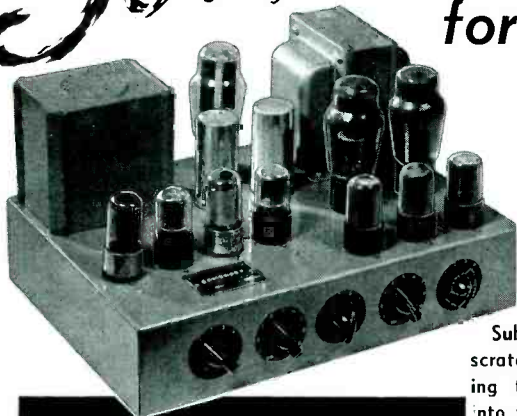

Multiple feedback with beam tetrodes for exceptional output circuit damping and high sound definition, substantially eliminates effect of loudspeaker resonances, makes load impedance non-critical, and reduces distortion and noise to negligible values.

A 12 watt amplifier with 32 db of feedback that has the famous SOMERSET DYNAMIC NOISE SUPPRESSOR built in.

Substantially all high frequency scratch noises are eliminated by feeding the high frequency components into the first stage out of phase with the input signal so that they cancel themselves out to an extent depending upon the volume of the middle and high frequency notes. This action is dynamic — continuous — automatic — avoiding sharp cut-off and giving natural "scratch-proofed" reproduction without loss of tone color.

PRICE \$159.50

NET F.O.B. UNION CITY, N. J.

**Somerset LABORATORIES, INC.**

1701 PALISADE AVENUE, UNION CITY, N. J.

chapters serve as a general introduction, and present a brief history of the development of the oscillograph and the cathode-ray tube. The six chapters that follow discuss the fundamental principles of cathode-ray tube operation, details of the modern cathode-ray tube, general-purpose oscilloscopes, and power-supply, amplifier, attenuator, positioning, and time-base circuits. Wherever a schematic or pictorial diagram, photograph, table or chart, or reproduction of an actual oscilloscope trace will serve to illustrate the points brought out in the text, they have been wisely chosen and generously used.

To make the sections devoted to the operation and specific applications of a scope of the greatest practical value, the author has included numerous step-by-step procedures. For continuity, the text is based on the DuMont model 208B general-purpose oscilloscope. For those who do not have access to this particular instrument, a table which gives a list of the exact names of comparable controls as they appear on the front panels of other oscilloscopes is included to extend the usefulness of the step-by-step procedures. In the chapters devoted to operating techniques, the author treats such basic procedures as adjusting and reading the frequency controls, proper display of the pattern on the screen, and interpreting the figures obtained, to name only a few.

The greater portion of the book is devoted to specific applications of the general-purpose oscilloscope, and this is as it should be in a practical textbook of this kind. Individual chapters are devoted to the use of a scope in servicing a-m, f-m, and television receivers. Also included in separate chapters are the use of a scope in audio circuits, at a radio transmitter, in teaching basic radio fundamentals, and in various industrial applications.

The book closes with a chapter on photographing cathode-ray patterns, and an eight-page glossary of terms. The illustrations are clear and appropriate throughout, and the text is sufficiently clear so that no difficulty should be experienced by the average technician. The

*Specify...* 

D'ARSONVAL PORTABLE  
**GALVANOMETERS**  
AND MOVEMENTS...

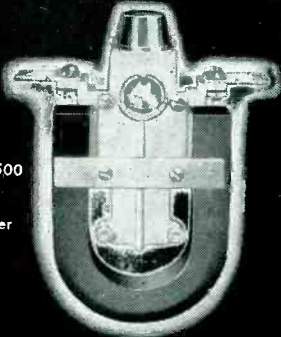

Series 570-500  
Mirror-Type  
D.C.  
Galvanometer

Ideal as a built-in component of other instruments—with the sensitivity and ruggedness that is especially desirable for Colorimetry, Densitometry, and various other measurements. Unit includes mirror movement, magnet and zero correction knob. Choice of 4 standard models.

*Write us about your application and requirements*



**LABORATORIES, INC.**

4314 N. Knox Ave. Chicago 41, Ill.

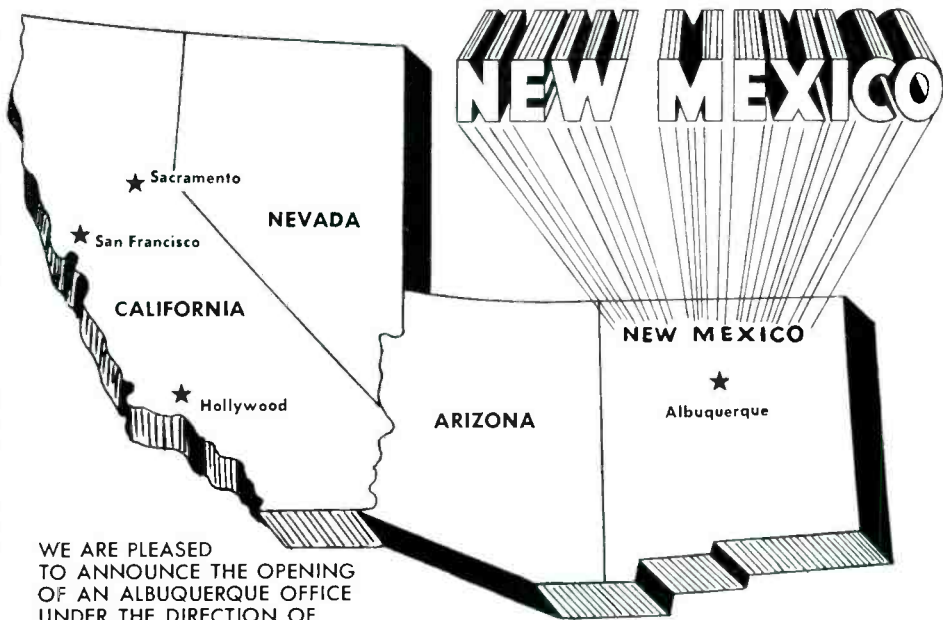

WE ARE PLEASED TO ANNOUNCE THE OPENING OF AN ALBUQUERQUE OFFICE UNDER THE DIRECTION OF L. E. FRENCH AT

302½ W. CENTRAL AVENUE  
ALBUQUERQUE, NEW MEXICO  
TO SERVE THE NEW MEXICO TERRITORY.

**NEELY ENTERPRISES**  
ELECTRONIC MANUFACTURERS REPRESENTATIVES  
7422 MELROSE AVENUE  
HOLLYWOOD 46, CALIFORNIA  
SAN FRANCISCO — SACRAMENTO

REPRESENTING THE FOLLOWING INSTRUMENT MANUFACTURERS:

BIRD ELECTRONIC CORP.  
BOONTON RADIO CORP.  
BROWN ELECTRO-MEA. CORP.  
CONTINENTAL CARBON, INC.  
JOHN FLUXE ENGINEERING CO.  
HEWLETT-PACKARD CO.  
KAY ELECTRIC CO.  
SENSITIVE RESEARCH INSTR. CORP.  
SORENSEN & CO.  
TEKTRONIX, INC.  
VARIAN ASSOCIATES



**HARD-TO-BEAT VALUES!**  
Exceptionally Low Prices, Limited Quantities!

**QUIET BLOWERS**

Electric motor driven blowers for a multitude of uses; cooling instruments and tubes; exhausting heat from cabinets; supplying fresh air; exhausting warm air, fumes and odors. Useful in laboratories, workshops, television and electronics work, lavatories, home use, etc.

**GENERAL SPECIFICATIONS:**  
**MOTOR:** AC-60 Cycle, 110V, single phase.  
**ROTOR:** Multivane **HOUSING:** sheet metal.  
**MOUNTING:** By bolting housing or metal strips around motor.

**BLOWER:** With 6" dia. rotor, directly connected to 1/20 HP 1550 RPM Redmond totally enclosed motor. 410 CFM free air, 360 CFM @ .2" S.P. (NAFM Rating). **\$18.50**

**BLOWER:** with 4¾" dia. rotor, directly connected to 1/25 HP, 1550 RPM Redmond totally enclosed motor. 175 CFM free air, 155 CFM @ .1 inch S.P. (NAFM Rating). **\$15.50**

**BLOWER:** with 3" dia. rotor, 90 CFM free air, 82 CFM @ 1 inch S.P. (NAFM Rating). Motor speed—2800 RPM. **\$6.95**

**VACUUM PUMPS—LIMITED QUANTITY**  
10 CFM—15" Vacuum. Gast Mfg. Co. pump, belt-driven by Kingston-Connelly, ½ HP ball-bearing, capacitor motor; AC, 110/220 V, 60 Cycle, 1 Phase. Mounted on 2¾" x 9¼" base. In original cartons. **\$50.00**

All equipment new, offered subject to prior sale.  
**TERMS:** net cash 25% with order, balance C.O.D., except to rated firms. F.O.B. our warehouse.

**ELECTRIC TRADING CO.**  
Dept. EA, 313 Canal St. New York, N. Y.

**COMPOUNDS**

Scientifically compounded for specific applications from waxes, resins, asphalts, pitches, oils, and minerals. Available in wide range of melting points and hardnesses. Special potting compounds are heat conducting and crack resistant at extremely low temperatures. Recommendations, specific data, and samples will be furnished on request.

*for*

<b>IMPREGNATING</b> radio coils transformer coils ignition coils wire coverings paper tubes and forms porous ceramics	<b>SEALING</b> condensers batteries switch base terminals socket terminals light fixtures
<b>DIPPING</b> Coils Transformers Condensers	<b>POTTING</b> Radio Transformers Light Units Loading Coils Condensers



**BIWAX CORPORATION** 3445 HOWARD STREET  
SKOKIE, ILLINOIS

**MACDONALD ELECTRONIC MICROAMMETER**



THIS instrument is designed to replace high-sensitivity galvanometers in many applications. Due to its ruggedness, freedom from burnout, and relative insensitivity to shock, it is an ideal instrument for use in balancing resistance bridges, measuring crystal rectifier output, photo-cell, strain-gage, thermocouple, and lead-sulphide cell currents, etc. The instrument may also be used as a DC pre-amplifier for recorders. When used in this manner, current amplification of 1,000 is available.

**SPECIFICATIONS:**

Sensitivity • 1 microampere full scale 50 microvolts full scale	Permissible overload — ¼ ampere Accuracy — ±3% full scale Time constant — about 6 seconds Power supply — 110 — 125 V, 60 C. P. S. Dimensions — 7" x 8" x 9½"
Ranges • 1, 3, 10, 30, 100 microamperes	

PRICE — \$250.00 F.O.B. CAMBRIDGE, MASS.

**W. S. MACDONALD CO., INC.** 33 UNIVERSITY ROAD  
CAMBRIDGE 38, MASSACHUSETTS

TI 401  
Signal Generator



## INTERMODULATION

### TESTS

### MADE EASY!

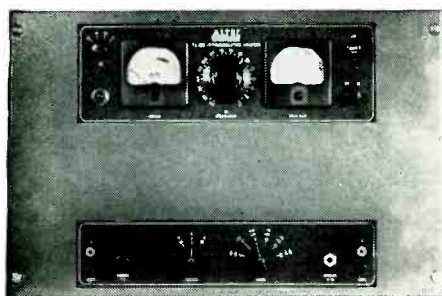

TI 402—Intermodulation Analyzer

An ideal tool for the design, maintenance and testing of audio devices, Altec's Intermodulation Analyzer offers distinct advantages over single-frequency "harmonic" methods of distortion measurement. Distortion products resulting from the interaction of double test frequencies are measured and read directly for any given power level. Analyzer includes VTVM, making residual noise and signal-to-noise ratio determinations possible without extra equipment. Instrument is a reliable performance index for FM and AM transmitters and receivers, all audio amplifier, disc, tape and film recording equipment.

1161 N. VINE ST., HOLLYWOOD 38, CALIF.  
161 SIXTH AVE., NEW YORK 13, NEW YORK

# ALTEC

LANSING CORPORATION

## wave guide & coaxial assemblies

- RAPID INSTALLATION
- HIGH EFFICIENCY
- UNIFORM IMPEDANCE
- COMPLETE LINE OF FITTINGS

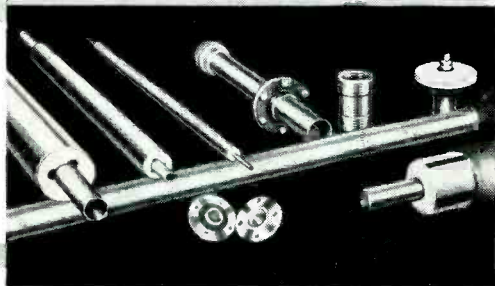

### Transmission line in all types including standard RMA sizes for FM and TV

GENERAL CERAMICS Transmission Lines are available in sizes to meet any installation requirement. All lines are of the bead supported type, in standard lengths. Fabrication to close tolerance assures highest efficiency. Special "clover leaf" spacer beads effectively reduce capacity effects and

arcng. Carefully designed end seals assure permanently gas-tight terminations. Pressurizing equipment, including gauges, valves, etc., impedance matching units, wave guide and coaxial assemblies for antennae and R.F. sections are supplied to exact requirements.

Our engineers are always pleased to check any project and furnish quotations.

## General CERAMICS and STEATITE CORP.

GENERAL OFFICES and PLANT: 22 CROW'S MILL ROAD, KEASBEY, N. J.

MAKERS OF STEATITE, FERRAMIC ZIRCON PORCELAIN,  
LIGHT DUTY REFRACTORIES AND CHEMICAL EQUIPMENT

book is a welcome and much needed addition to the how-to-do-it literature for the radio and television fields.—R. H. SCHAAF, *National Radio Institute, Washington, D. C.*

### Learning Electricity and Electronics Experimentally

BY LEONARD R. CROW. *Universal Scientific Co., Inc., Vincennes, Indiana, 1949, 525 pages.*

IMPORTANT principles of electricity and magnetism are covered on a qualitative basis by 75 experiments requiring only simple, inexpensive material. Most of the experiments provide attention-getting action, such as by shooting aluminum rings into the air, magnetizing with a single-turn loop carrying alternating current as in soldering guns, and spinning an aluminum ball as a demonstration of phase splitting. A 300-page advanced section gives nonmathematical theory of alternating current, reactance, resonance, d-c controlled saturable-core reactors, magnetic frequency-multiplying apparatus, peaking transformers, electric arcs, dry-disc rectifiers, electronic tubes and electronic circuits along with 59 additional experiments. Specially taken photographs illustrate experimental setups and greatly increase the practical usefulness of the book.

—J.M.

### Isotopic Tracers and Nuclear Radiations with Applications to Biology and Medicine

BY WILLIAM S. SIRI. *McGraw-Hill Book Co., New York, 1949, 653 pages, \$12.50.*

DESPITE the title, this book offers much to readers of ELECTRONICS. The entire 260 pages of Part I, dealing with isotopes and nuclear radiations, is applicable to the electronic physicist. The compilations of reference tables in this section alone can justify a place for this book in any fundamental research library.

Part II, dealing with methods and instruments, gives 240 pages of engineering descriptions for the electronic engineer in design and pro-

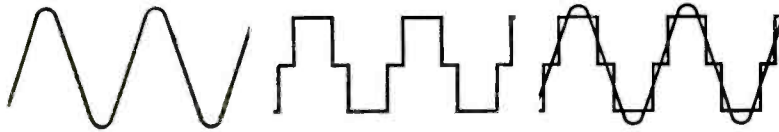

## AN SPEC CHOPPERS

- Reliability . . .
- Precision . . .
- And long life

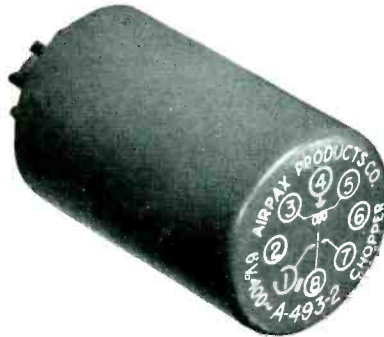

Life of 1000 hours and over, stable, precise, reliable operation can be expected from these hermetically sealed choppers, used in DC amplifiers and servo systems. Choppers may operate directly from 120 volts 400 cycles, are relatively unaffected by great extremes of temperature, vibration, acceleration, shock, altitude or humidity, can be corrected to 0° phase angle.



1024 GREENMOUNT AVE. BALTIMORE 2, MARYLAND

## NEW! 10 MC BANDWIDTH HIGH GAIN OSCILLOSCOPE

TOP PERFORMANCE FOR \$279.50

Laboratories—Industry—Broadcasters . . .

**AT LAST!** an engineer's scope built by engineers for you.

- ★ Y-AXIS: 10 mv rms/in; 10 cps, 10% tilt; —3 db at 10 MC.
- ★ SWEEPS: 10 cps to 50 KC; recurrent and driven, expansion 5x full scale.
- ★ SUP1—Int. Calibrator—Int. 60° Phase Shifter—40 lbs. —13 x 8 x 17".

Write **TODAY** for full data. See it at Booth 330-IRE Show.



**TELEVISION EQUIPMENT CORP.**  
238 WILLIAM ST. • NEW YORK 7, N. Y.

IN CANADA: The Ahearn & Soper Co., Ltd., Ottawa

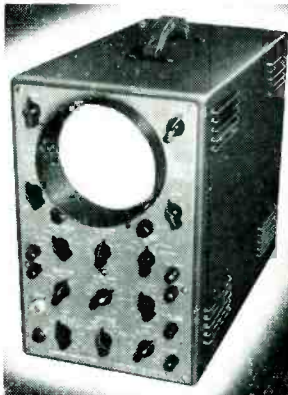

## VARIABLE HIGH VOLTAGE RF POWER SUPPLY

1 TO 40KV NEGATIVE OR POSITIVE OUTPUT

Low range—1000—12,000 Volts D.C.  
High range—12,000—40,000 Volts D.C.

**APPLICATIONS**—Industrial users and Research Engineers recognize the advantages of this unit for precipitators, electrostatic painting, nuclear and physics research, projection television, insulation testing, etc.

**CONTROLS:** AC stand-by switch—green High-Low output switch  
High Voltage switch—red Focusing voltage control  
Variable voltage control knob

**SIZE:** 17x13x9", Chassis and cover constructed of sheet aluminum throughout to provide maximum protection from dust and dirt. (Unit shown above without dust cover.)

**TUBES:** 1—5U4, 1—6L6, 1—1625, 3—1B3's

Write for complete information.  
**INDUCTOGRAPH PRODUCTS**  
Dept. A

236 W. 55 St. New York City



**THIS CATALOG NOW  
CAN SAVE YOU  
TIME & MONEY  
LATER**

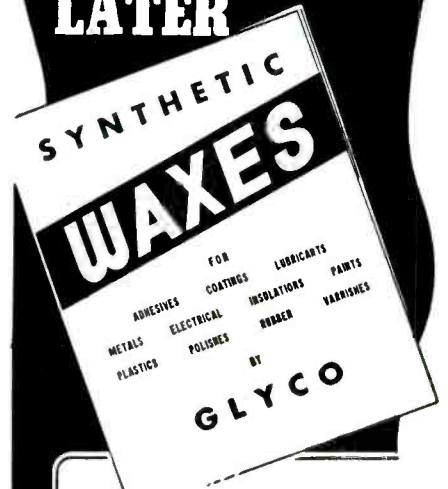

Just off the press, this new Glyco catalog may contain just the answers you want to some of your problems. It describes our synthetic waxes and gives chemical, physical and application information. It gives many suggestions for lowering costs.

**SYNTHETIC WAXES**—18-page catalog on high or low m.p., hard or plastic, waxes used in a wide range of industries. Complete physical and use data included.

free for the asking



GLYCO PRODUCTS CO., Inc.  
Dept. T-12, 26 Court St.  
Brooklyn 2, New York

Send me a free copy of the catalog:  
"Synthetic Waxes" by Glyco (18 pages)

NAME \_\_\_\_\_  
COMPANY \_\_\_\_\_  
AND \_\_\_\_\_  
TITLE \_\_\_\_\_

STREET \_\_\_\_\_

CITY \_\_\_\_\_ ZONE \_\_\_\_\_  
STATE \_\_\_\_\_

TYPE OF BUSINESS \_\_\_\_\_

## STABLE D. C. AMPLIFICATION

with flat frequency response to 40 K.C.

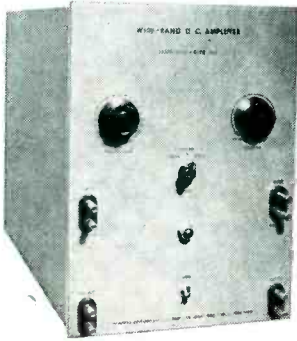

down 1% at 50 K.C.  
and 12% at 200 K.C.

INPUT — 20,000 ohms, single ended.  
OUTPUT — about 1,000 ohms, resistive,  
single ended. POWER SUPPLY — 100 V.  
to 125 V. A.C. 175 Watts. HEIGHT — 14",  
WIDTH — 10", DEPTH — 22", WEIGHT —  
45 lbs., FINISH — Navy gray crackle.

The Hanover Type 105 is designed for use as a preamplifier to provide  
**D.C. SENSITIVITY OF 5.0 MV. PER INCH**  
with an oscillograph such as the DuMont Type 279 or Type 250  
(Oscillograph synchronizing circuits and focus are not disturbed)

**STABILITY WITHIN 0.5 MV. EQUIVALENT SIGNAL**  
with a line voltage variation from 100 volts to 125 volts.

**NO BLOCKING WITH A 75 VOLT SIGNAL**  
with the amplifier at full gain. This is made possible by the avoid-  
ance of reactive compensation. This feature also accounts for the

**EXCELLENT SQUARE WAVE RESPONSE**

Requirements for many special applications may be met without extensive modifications.

### HANOVER DEVELOPMENTS

401 E. 74 ST.  
NEW YORK 21, N.Y.

duction fields. Subjects covered here include: Mass Spectrographs; Geiger-Muller Counters; Proportional Counters; Ionization Chambers; Standardization of Radioactive Samples; Radioautograph; Tracer Methods; Safety Precautions; Electrostatic Generator; Cyclotron; Betatron; Synchrotron.

Only the 50-page concluding section on biological and medical applications of isotopes is really pertinent to the title of the book and hence of little interest electronics-wise. The 90-page bibliography in the concluding chapter is universally useful to all who deal with radiations and related subjects—J.M.

### Microwaves and Radar Electronics

BY ERNEST C. POLLARD AND JULIAN M. STURTEVANT. *John Wiley & Sons, Inc., New York, 1949, 426 pages, \$5.00.*

THIS BOOK could be called the pocket edition of the 27-volume Radiation Laboratory Series. It is a well-written introduction to the multitude of subjects that are covered by the title. The authors, a physicist and a chemist, have presented this book in the hope that the information and knowledge gained during and after the war on microwaves and associated circuits will be useful in the various fields of science. To those who have not been associated with microwaves or radar, this introduction to the art should provide them with many new tools for their work.

A short introductory chapter outlines the special knowledge of electromagnetic fields that is necessary to an understanding of microwaves. In general, an understanding of the book requires no special knowledge not present in the usual student background of physics or electrical engineering. References are included to direct the reader to detailed information.

The three major sections into which the book is divided are microwaves, radar circuits, and radar systems together with an analysis of microwaves being used in physical research. The first four chapters deal with microwaves. This group starts with a detailed description

*Completely new in every detail!*

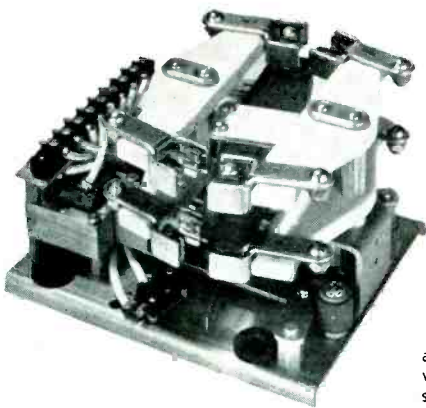

## JOHNSON RF CONTACTORS

Series 145-100  
145-200

Rugged and compact with fast, snappy action, these new JOHNSON contactors were designed primarily for high voltage RF switching and are suitable for many other applications. The toggle actuated balanced rotary armature permits mounting in any position. Positive contact is maintained even under conditions of extremely heavy vibration. Entirely new wiping contacts, mounted on low-loss insulation, stay aligned.

These JOHNSON contactors are available in two sizes with voltage ratings of 17KV and 22KV peak. Current rating of both is 25 amperes per contact. Either contactor model is available with SPDT or DPDT contact arrangement with or without two auxiliary single pole switches. Solenoids are wired in series for 230 volt operation but may be connected in parallel for 115 volt operation. No holding current is required.

For complete description and prices write for the new "RF CONTACTOR" data sheet.



**JOHNSON** . . . a famous name in Radio  
E. F. JOHNSON CO. WASECA, MINNESOTA

and review of electromagnetic fields from which the actions of coaxial lines, waveguides, and cavities are explained. A discussion on the production of microwaves, using both klystrons and magnetrons, is followed by a discussion of methods of measurement and detection. A short section deals with impedance measurement and the various components necessary to deal with microwaves including waveguide, rotating joint, antenna, T-R box and magic T.

The elements of various radar circuits are covered in the second section consisting of the next seven chapters. Included here are discussions on various pulsing techniques such as generating, delay and timing circuits. Separate chapters are devoted to cathode-ray tubes and their associated sweep and indicator circuits, amplifiers, amplification of very weak signals, servomechanisms and computers, and miscellaneous circuits including regulated power supplies, cathode followers, multivibrators, clamping and counting circuits.

The last three chapters deal with a brief discussion of the overall properties of several typical radar sets now in use. Four different fields of physical research are described in the concluding chapter and thus serve to remind us that the purpose of this book is to help in furthering the use of this knowledge gained in the development of radar.—JAMES A. KENNY, *Airborne Instruments Laboratory, Inc., Mineola, N. Y.*

### Pulse Generators

*Volume 5 of the MIT Radiation Laboratory Series.* EDITED BY G. N. GLASOE AND J. V. LEBACQZ. McGraw-Hill Book Company, New York, 1948, 741 pages, \$9.00.

TECHNIQUES for pulse generation developed during the war at the Radiation Laboratory are treated in this volume. Although these techniques were developed for radar applications, the material in the book will interest engineers and physicists who are concerned with the general problem of pulse generation. The treatment is alternately theoretical and descriptive;

# Big Tower Reliability

in an

## INEXPENSIVE LIGHT WEIGHT MAST



It is a problem to combine the engineering features of a big radio broadcast tower in a lightweight, inexpensive mast... But TRYLON has done just that! Triangular in shape, 6-1/2 inches across each face, and weighing only 2 pounds per foot, the new TRYLON Antenna Mast provides tower characteristics of dependable modern design:

- Light in weight, yet sturdy enough for easy climbing and high loads.
- Low wind resistance resulting in minimum down load.
- Double-welded at bracing points under rigid electronic controls.
- Hot dip galvanized after fabrication.
- Easy to install and maintain.
- Low cost per lineal foot.

There are a host of antenna support applications for such a mast in heights up to 60 ft. These include television receiving, mobile communications, wire type antennas (rhombics, dipoles, etc.), amateur, and many others.

Write today for detailed specifications of the TRYLON Antenna Mast... designed and fabricated by a long established tower manufacturer.

**WIND TURBINE CO.**  
West Chester  
Pennsylvania

SEE US AT BOOTH 42, I. R. E. SHOW

## CONTINUOUSLY VARIABLE REGULATED DC SUPPLY

### ✓ FEATURES

- ✓ Continuously variable, 0 to 350 volts.
- ✓ Ripple voltages less than 10 millivolts.
- ✓ Regulation better than .5%.
- ✓ Maximum current 200 milliamperes.
- ✓ Stabilized variable bias supply.
- ✓ 6.3 volts AC at 5 amperes.
- ✓ Reasonably priced.



### MODEL A3 POWER SUPPLY

*A Precision Instrument Used by Leading Laboratories*

REQUEST BULLETIN NO. 52 FOR DETAILED SPECIFICATIONS

**Oregon ELECTRONICS**  
MFG. CO.  
206 S.W. WASHINGTON ST., PORTLAND 4, ORE., U.S.A.



**RESISTORS  
DESIGNED  
FOR TV  
HIGH VOLTAGE  
CIRCUITS**

**MEET YOUR  
MOST EXACTING  
REQUIREMENTS**

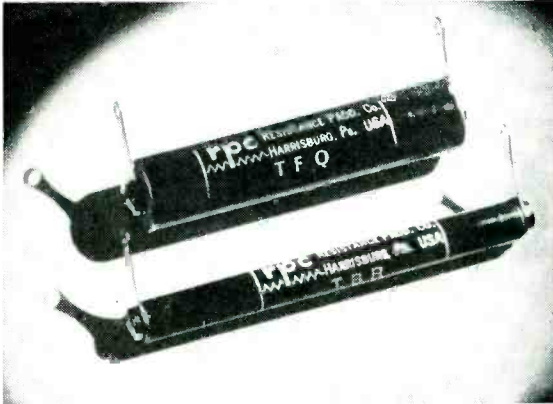

Also Manufacturers of a Complete Line of

- Precision Wire Wound Resistors
- High Voltage Resistors
- High Frequency Resistors
- High Megohm Resistors

Write for Complete Catalog

**Eliminate TV Resistor failures in High Voltage circuits!**

RPC Type T Resistors are built to stand up under severe circuit and pulse voltage conditions in TV voltage doublers.

They are now being used by leading manufacturers.

**WRITE FOR ENGINEERING DATA!**

**RESISTANCE  
PRODUCTS CO.  
714 RACE STREET  
HARRISBURG  
PENNSYLVANIA**

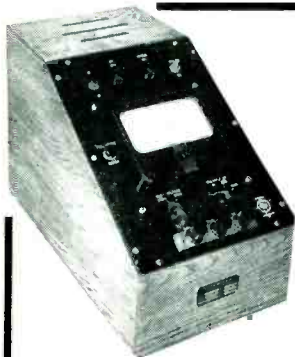

**NOW YOU KNOW  
THAT THE SPECIFIED  
VOLTAGE IS THE  
APPLIED VOLTAGE  
WHEN YOU USE  
THE NEW**

## **SERIES L MEGOHM METERS**

### **FEATURES**

- Designed for production use as well as laboratory.
- Charging terminals provided for pre-test condenser charging.
- Internal checking standard enables operator to check and adjust calibration at any time.
- Broad-scale meter dial has wider spacing at high end.
- Circuit thoroughly guarded to reduce effects of high humidity.
- Balanced tube circuit and voltage regulators in internal power supply assure stability.
- Low internal resistance assures constant voltage on test.
- **WRITE FOR BULLETIN**

• The circuit design of the Series L Megohm Meters assures the user that the specified voltage is the voltage being applied to test as long as the resistance being measured is within range of the meter. Complete line covers large range of measurements as well as available voltage sources. Excellent workmanship and design. Encased in hardwood case with inclined front panel.

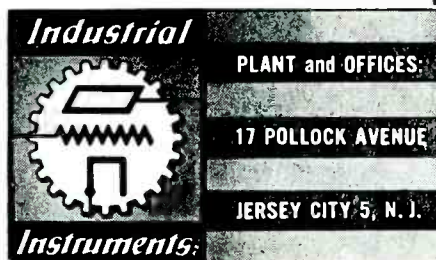

rather complete descriptions of several specific systems are included. A knowledge of the Laplace-transform method of circuit analysis is assumed.

Necessary terms are defined in the introduction, and the various types of pulse generator are briefly described and compared. The remainder of the book is divided into three parts. Part I deals with hard-tube pulsers, in which the pulse is formed in a lumped-constant network and a vacuum tube is used as a switch. Consideration is given to charging and discharging circuits, impedance matching, and required tube characteristics.

Part II is a treatment of line-type pulsers, in which the pulse is formed in a transmission line or equivalent network, and the switch may be a spark gap or hydrogen thyratron. Charging from both a-c and d-c sources is discussed. Pulse transformers are covered in detail in Part III, attention being given to design, construction and performance. An appendix describes oscillographic and metering techniques, and discusses the equivalence of various pulse shapes.

A commendable feature of the book is the large number of oscillographs and illustrations of actual equipment. Some readers may be disappointed by the emphasis on power pulse generators, with the resultant concentration on low impedance and magnetron loads.—T. M. STOUT, *Department of Electrical Engineering, University of Washington.*

### **Physical Aspects of Color**

By DR. P. J. BOUMA, *Philips Research Laboratories, Eindhoven. Published by N. V. Philips Gloeilampenfabrieken, Eindhoven, The Netherlands, 1949, 312 pages.*

THE CLOSER color television comes to being a commercial reality, the more electronic engineers become interested in color. This book, like W. D. Wright's "The Perception of Light" (Blackie & Sons, London, 1938), provides a bridge between physics and physiology.

A resume of the contents of the book will indicate its nature and scope. The introductory chapter sets the stage. The five following



## LOGARITHMIC AC VOLTMETER WIDE BAND AMPLIFIER

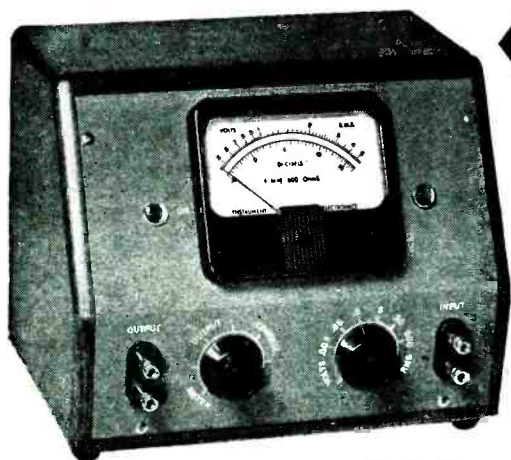

Advanced Design  
give you a sensitivity  
and frequency response  
never before obtained.

### Also MODEL 47 AUDIO FREQUENCY VOLTMETER

40 Microvolts to  
500 Volts  
15 Cycles to 30 Kc.  
Amplifier Gain 40000

#### MODEL 45

No other Voltmeter offers all these advantages

- Range .0005 to 500 volts
- Frequency 5 CPS to 1.6 MC.
- Logarithmic voltage scale
- Input 2 Megohm 15 MMF
- Accuracy  $\pm 2\%$
- Stability  $\pm 1\%$  105 to 125V.
- Linear DB scale

Ideal for Audio, Supersonic, Lowers Radio Frequency Spectrum.  
Measures Stage Gain, RF and IF Amplifiers on Broadcast Receivers.

Write for Complete Information

### INSTRUMENT ELECTRONICS CORP.

45-17 Glenwood Street

Little Neck, L. I., N. Y.

## CML ELECTRONIC PRODUCTS

Outstanding for  
RESEARCH - PRODUCTION

#### VARIABLE FREQUENCY GENERATORS

**MODEL 1430**  
50-5000 Cycles  
1400 Watts Output Power  
0-140 V Output Voltage  
Frequency Stability  $\pm 2\%$   
Distortion (Full-load) Under 10%

**MODEL 1420**  
50-6000 Cycles  
250 Watts Output Power  
80-270 V Output Voltage

#### STROBOSCOPE

**MODEL 1210 B**  
480-60-000 RPM (8-1000 CPS)  
A Must for Motion Studies

#### ROTOBRIDGE

**MODEL 1010**  
Automatic circuit inspector checks one  
circuit per second to predetermined  
tolerances.

#### REGULATED POWER SUPPLIES

Write for Complete Literature

#### COMMUNICATION MEASUREMENTS

#### LABORATORY, INC.

120 Greenwich Street New York City

AT LAST... A Unified Account of the  
Whole Field of Microwaves Including  
Particle Accelerators and the  
Traveling-wave Amplifier

## MICROWAVE ELECTRONICS

By John C. Slater, Ph.D., Sc.D.  
Head of the Department of Physics,  
Massachusetts Institute of Technology

In this broad treatment of microwave theory, both wartime and post-war developments are included. Based upon Dr. Slater's extensive work at Bell Telephone Laboratories and M.I.T. Radiation Laboratory on magnetron research and the general theory of microwaves, this comprehensive account also treats the theory of the linear accelerator, the cyclotron and the synchrotron.

Grounded in the most rigorous mathematical approach so far attempted, yet fully intelligible to the reader of only moderate mathematical training, this truly fundamental work has the widest usefulness for physicists, electrical engineers and research workers as a reference and practical handbook.

See for yourself how valuable this book can be to you. Examine it for ten days without obligation.

#### MAIL THIS COUPON

D. Van Nostrand Company, Inc. Publishers  
250 Fourth Ave., New York 3, N. Y. Since 1818  
Please send me a copy of "Microwave Electronics". After ten days I will either return the book or send you \$6.00, plus a few cents postage.

Name .....

Address .....

City ..... Zone ..... State .....

EL-350



Shown above in actual size is our  
newest end-on lead sulfide cell—  
the CE-705—Write, phone or  
wire for complete information.



## CONTINENTAL ELECTRIC CO.

America's Leader in Quality  
Electronic Tube Manufacture

GENEVA, ILLINOIS

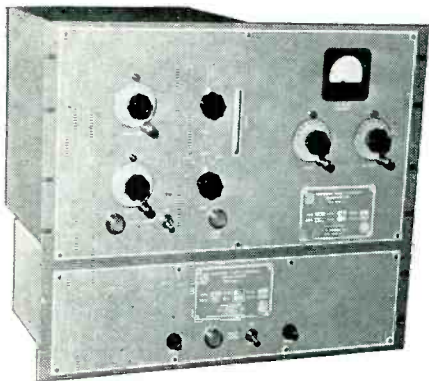

# NEW

## FREQUENCY SHIFT KEYSER

Type 105 Model 4

- To more than meet the new ICAO recommendations.
- See this unit at IRE Convention Booth #131.

• Compare these new and novel features with other available keyers.

1. Frequency shift dial adjusts "mark" and "space" frequencies equally above and below the carrier position, which remains fixed.
2. Simplified frequency setting permits only the upper side band tuning indication to be visible on the meter over substantially all of tuning range.
3. Direct reading frequency calibration of shift from 0 to 1000 cps.
4. Direct reading frequency calibration of mixer and output tuning dials from 2.5 to 6.7 mc.
5. Direct reading of calibration of output frequency vernier  $\pm 600$  cps.
6. Pulse shaping circuit to permit operation within assigned bandwidth with no adjacent channel radiation.
7. Highly stable temperature controlled oven with temperature control of  $\pm 0.1^\circ\text{C}$  at  $60^\circ$  with heaters on 4 sides of inner oven.
8. Component ratings according to JAN specs provide greater assurance of trouble-free operation.

• For more complete line of frequency shift equipment, see our advertisement in *Electronics Buyers Guide*, pages 153, 154, 155.

**NORTHERN RADIO COMPANY**

Incorporated

143-145 West 22nd St.,

New York 11, N. Y.

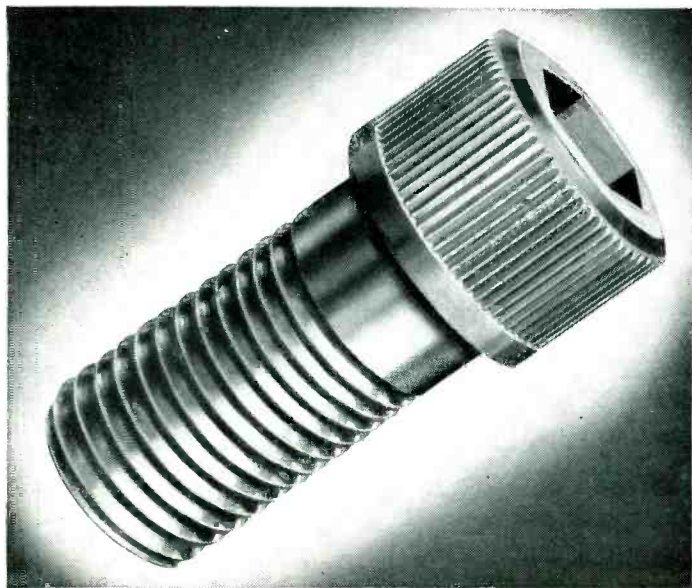

The **UNBRAKO** Socket Head Cap Screw

... is specified by designers and production men everywhere because of its time-saving knurled head and its uniformly high quality.

SOCKET **UNBRAKO** SCREWS

See us at Booths 128 to 138 inclusive. A.S.T.E. Exposition, April 10-14, Convention Hall, Phila.

**SPS**

STANDARD PRESSED STEEL CO.

JENKINTOWN 10, PENNSYLVANIA

chapters present the scientific background of the subject: brightness, the color triangle, the representation of color in space, the CIE coordinates, and calculations based on the CIE system. Three chapters are devoted to colorimetry. They deal with light sources, objective measurements, and subjective methods. Four following chapters present the biological aspects of color, defective color visions, the development of the science (which chapter constitutes a convenient introduction for those making a first acquaintance with this subject), color discrimination, and the chromatic adaptation of the eye. The concluding chapter reviews the practical applications of color phenomena. The book contains an appendix with an extensive bibliography.

As the author states in his preface to the Dutch edition, the reader is assumed to be acquainted with mathematics and physics as taught in secondary schools "and to possess a certain amount of zeal!" W. de Groot translated the book into English in the expectation that the author's "clear exposition and his simple style" would prove useful to the English-speaking reader.—  
F. H. ROCKETT, JR., *Airborne Instruments Laboratory, Inc., Mineola, N. Y.*

• • •

### Books Received for Review

TELEVISION PICT-O-GUIDE, Vol. II. By John Meagher. RCA Tube Department; available only from RCA tube distributors. Loose-leaf booklet containing 84 photos taken from face of kinescope to show effects of various operating troubles on the image, for quick isolation of the defective stage in a television receiver. Each picture is accompanied by troubleshooting suggestions.

ENGINEERS' DICTIONARY — Spanish-English and English-Spanish. By Louis A. Robb. John Wiley & Sons, Inc., New York. Second Edition, 664 pages. \$12.50. Enlargement of 450-page first edition to cover electrical and mechanical engineering more thoroughly. Important radio and television terms are now included, along with those of other new engineering fields. Definitions are not included, except in default of a satisfactory equivalent or to avoid ambiguity. English trade names have been translated into Spanish whenever they are in good technical usage.

THE OSCILLOGRAPH IN MODERN AM, FM AND TV SERVICE. By Walter Weiss. The Hickock Electrical Instrument Co., Cleveland, Ohio, 47 pages, paper-covered, \$1.00. Consists chiefly of diagrams of wave shapes normally encountered at various points in each stage in an a-m superheterodyne radio receiver, plus chapters on f-m and television receiver alignment with a scope.

**NOT JUST  
A PRODUCT\***



**FREQUENCY RANGE**  
1-10 MC

WITHOUT TEMPERATURE CONTROL, 2HG CRYSTAL UNITS (SHOWN IN RHANCM) CAN BE BUILT TO STABILIZE WITHIN  $\pm 0.025\%$  FROM  $-55^{\circ}$  TO  $+90^{\circ}$ . WITH TEMPERATURE CONTROL, INSTALLED IN TYPE TCO-1 OVENS, STABILITY CAN BE  $\pm 0.01\%$  IF DESIRED. IT PAYS TO CONSIDER THE RATIO OF COST TO IMPROVED STABILITY.

**B**UT... A COMPLETE APPRECIATION OF END USE COST FACTORS, AS APPLIED TO FREQUENCY STABILITY.

Always Specify Bliley!

**Bliley  
CRYSTALS**

BLILEY ELECTRIC COMPANY  
UNION STATION BUILDING  
ERIE, PA.

## Backtalk

This department is operated as an open forum where our readers may discuss problems of the electronics industry or comment upon articles which **ELECTRONICS** has published.

### Mice and Men

DEAR SIR:  
HAVING BEEN A LOYAL SUBSCRIBER and also contributor to **ELECTRONICS** for quite a few years, I know you will not take amiss this suggestion for the improvement of your otherwise excellent publication.

My copies of **ELECTRONICS** are filed in a bookcase in my office along with *Proceedings of the IRE*. Recently I have noted that the glued edge of **ELECTRONICS** which contains the Vol., No. and date seemed to be missing from quite a few issues. Subsequent investigation proved that mice were responsible. Since not a single issue of the *Proceedings* has been so treated I can only surmise one of two things:

- (1) **ELECTRONICS** is more readily digested and assimilated than the *Proceedings*, or
- (2) The glue used in **ELECTRONICS** is more palatable to mice than that used in the *Proceedings*.

After considerable thought and deliberation I am forced to the conclusion that, although the first of these surmises is undoubtedly as true as the second, the best procedure would be to change the glue.

I trust this suggestion will receive the consideration it merits.

FRED SCHUMANN  
Professor of Electrical Engineering  
Box 115, Vanderbilt University  
Nashville, Tennessee

### Why Not Covat?

DEAR SIR:  
ON MANY OCCASIONS, we have noted that your organization has taken an active interest in the terminol-



**MANUFACTURERS OF FRACTIONAL POWER MOTORS (1/1000 HP to 1/2 HP) • AXIAL AND CENTRIFUGAL BLOWERS (6 TO 750 CFM) • ALTERNATORS AND TACHOMETERS • GEAR MOTORS • AND OTHER SPECIAL ROTATING DEVICES.**

This new line of motor-driven blowers may be used for Commercial or Military applications. They are available with either sleeve bearings or ball bearings and can be designed for various single frequencies or variable frequency operation. These blowers can be easily modified to meet high temperature operational requirements and our Military type blowers meet all critical JAN specifications.

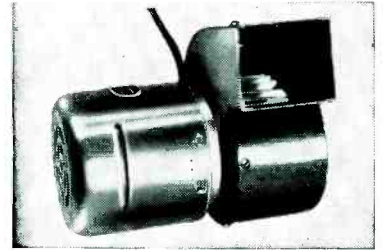

Type No. BE 10LC - Actual Size 6 $\frac{5}{8}$ " x 5 $\frac{3}{4}$ "

100 CFM at .5" static pressure (NAFM), 1/30 HP Capacitor Induction Motor, 120 Volts, single phase, 60 Cycles, 3300 RPM, clockwise or counter-clockwise rotation.

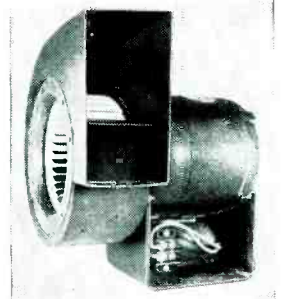

Type No. BF 94DDL-2 - Actual Size 8 $\frac{3}{8}$ " x 9 $\frac{5}{8}$ "

250 CFM at .5" static pressure (NAFM), 1/6 HP Capacitor Induction Motor, 120 Volts, single phase, 60 Cycles, 3200 RPM, clockwise or counter-clockwise rotation, rigid base.

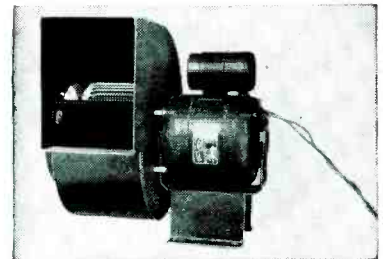

Type No. BE 92FEK-2 - Actual Size 11 $\frac{3}{8}$ " x 10 $\frac{7}{8}$ "

300 CFM at .25" static pressure (NAFM), 1/12 HP Capacitor Induction Motor, 230 Volts, 1625 RPM, single phase, 50/60 Cycles, clockwise or counter-clockwise rotation, special base.

WE ALSO MANUFACTURE A COMPLETE LINE OF AXIAL FLOW BLOWER UNITS RANGING IN CAPACITY FROM 100 CFM TO 750 CFM.

We Invite Inquiry

For additional data send us your Engineering specifications.

**EASTERN AIR DEVICES, INC.**  
585 DEAN ST., BROOKLYN 17, N.Y.

# CONTACTS

FOR THE FIELD OF ELECTRONICS

BACKTALK

(continued)

ogy relevant to electronics. May we inquire as to whether any serious consideration has been given to the nomenclature with regard to continuously adjustable auto-transformers? Our organization manufactures variable-output d-c power supplies. We are finding it occasionally embarrassing to call the voltage control units "variacs" or "power-stats." These names, as you know, are both trade names. On occasion, we have even had to use "transstat."

In our instruction manuals and on our circuit diagrams, and also on the nameplates that are used on the control panels, we occasionally have to inscribe "variac" or "powerstat." We, naturally, prefer to have a single term to reduce costs of name plates. Also, the single term would be preferred where we have to use both of the manufacturers' products in one power supply, in order to achieve the optimum design and minimum cost.

If such a suggestion has never been made, would it be feasible for us to introduce the term "Covatt" or something similar as a contraction of COntinuously Variable Auto Transformer? If this term is adopted throughout the electrical industry, we can eliminate the use of the terms "variac" and "powerstat", which will not only prove convenient but will eliminate embarrassment.

VICTOR WOUK  
Beta Electric Corp.  
New York, N. Y.

## Same System

DEAR SIRs:

I NOTE WITH INTEREST the timer described by Sidney Wald in the August, 1948, issue of ELECTRONICS, in which the timing action is independent of the supply voltage.

During the war, I employed the same principle to make an artificial bottom for use in an echo sounder. A servo system kept this artificial bottom equal to the real bottom and so gave a sounding record that was independent of the excessively variable marine power supplies.

A. A. FOSTER  
Duke University  
Durham, North Carolina



## EISLER—Manufactures Complete Equipment for:

SPOT WELDERS, Electric, for 1/4 to 250 KVA.  
A.C. ARC WELDERS from 100 to 400 Amps.  
TRANSFORMERS, Special and Standard Types.  
INCANDESCENT LAMP Manufacturing Equipment.  
FLUORESCENT TUBE Manufacturing Equipment.  
NEON SIGN MAKERS EQUIPMENT.  
ELECTRONIC EQUIPMENT, Vacuum Pumps, etc.  
WET GLASS SLICING and Cutting machines for Laboratory use.  
EISLER ENGINEERING CO., INC., 774 So. 13th St., Newark 3, N. J.



**FINE RIBBONS OF TUNGSTEN and Molybdenum**

Quality and accuracy in our fabrication of Tungsten & Molybdenum Ribbons have characterized our service to the Electronic industry.

A development of  
**H. CROSS Co.**  
15 Beekman St., New York 7, N. Y.

## CEMENT'S FOR THE RADIO INDUSTRY

NITROCELLULOSE  
SYNTHETIC  
MOISTURE RESISTANT  
THERMO PLASTIC  
THERMO SETTING  
VINYL IN COLOR  
COIL VARNISH

**BARRETT VARNISH CO.**  
1532 South 50th Court  
Cicero 50, Ill.

Write Us for Additional Information

**MICROMETER FREQUENCY METER**

will monitor any number of frequencies, FM or AM, 100 KC to 175 MC

**LAMPKIN LABORATORIES, INC.**  
Bradenton, Fla., U. S. A.

**FLUXES SODERING BRAZING & WELDING**

L. B. ALLEN CO. INC. Chicago 31, Ill.  
6751 BRYN MAWR AVE.

**POWER SUPPLY PROBLEM?**

If you can't find the commercial power supply with range and capacity you need we'll design one and build it for you.

**BUCK ENGINEERING CO.**  
37-39 Marcy St. Freehold, N. J.

**SUB-MINIATURE PRINTED ELECTRONIC CIRCUITS**

produced from your schematics or existing electronic equipment. Circuits fired on ceramics or air dried on plastics and paper bases. Confidential service.

**PLASTICS & ELECTRONICS CO.**  
272 Northland Ave., Buffalo 8, New York

**EL-TRONICS, INC.**

Research, development, and manufacture of electronic equipment—a single model to large quantities.

Specialists in Geiger-Muller equipment

2647-67 N. Howard St., Phila. 33, Pa.  
Garfield 5-2026

**PRINTED CELLOPHANE**

Colorful - Self Adhesive - Cellophane, processed in Rolls. Easy to buy - Easy to apply - used for Packaging - Point of Sale advertising - Parts marking and Aircraft Wire terminal identification.

**TOPFLIGHT TAPE - YORK, PA.**

**SILICONE DC 4 COMPOUND**

THE NON-MELTING SILICONE INSULATING AND WATERPROOFING COMPOUND FOR IGNITION SYSTEMS AND ELECTRONIC EQUIPMENT.

MEETS ALL REQUIREMENTS OF AN-C-128a.

STABLE AT TEMPERATURES FROM -70° to +400°F.

For more data on DC 4 Silicone compound write Dept. J

**Dow Corning**  
FIRST IN SILICONES

**DOW CORNING CORPORATION**  
MIDLAND, MICHIGAN

Atlanta • Chicago • Cleveland • Dallas  
Los Angeles • New York  
Canada: Fiberglas Canada, Ltd., Toronto  
Great Britain: Albright and Wilson, Ltd., London

MPB makes more than 50 different types & sizes

Miniature ball bearings for application in precision mechanisms minimize friction and wear. High load capacity. Least weight and space. Special designs and complete engineering service for your application. Write for catalog E.

**MPB MINIATURE Precision BEARINGS**  
INCORPORATED  
KEENE, NEW HAMPSHIRE, U.S.A.

**ATOMIC ENERGY NEWSLETTER**

The business paper of the atomic energy industry For suppliers & contractors to the atomic energy program—and for those who want to participate—Atomic Energy Newsletters furnish an unexcelled source of up-to-the-minute, primary market data on the atomic energy industry.

Use these specialized, bi-weekly Newsletters to keep abreast all nuclear energy work & development.

\$18.00 a year, U. S. & Canada  
**ATOMIC ENERGY NEWS, INC.**  
509 5th Ave. New York 19

# PROFESSIONAL SERVICES

Consulting—Patents—Design—Development—Measurement

in

Radio, Audio, Industrial Electronic Appliances

## AMPLIFIER CORP. of AMERICA

*Research, Design, Development and Manufacturing Engineers*  
Specializing since 1936 in All Phases of  
MAGNETIC TAPE RECORDING FOR  
ALL APPLICATIONS

Precision Regulated Power Supplies  
A. C. Shaney, Chief Engineer  
398-7 Broadway New York 13, N. Y.

When  
time  
is  
short . . .

put the solution of your problems up to a specialized Consultant whose professional card appears on this page. His broad experience may save you months of costly experimentation.

## ELECTRONICS

330 West 42nd St., New York 18, N. Y.

## ALBERT PREISMAN

*Consulting Engineer*

Television, Pulse Techniques, Video  
Amplifiers, Phasing Networks,  
Industrial Appliances

Affiliated with  
MANAGEMENT-TRAINING ASSOCIATES  
3308-14th St., N.W. Washington 10, D. C.

## CROSBY LABORATORIES

*Murray G. Crosby & Staff*

FM, Communications, TV,  
Industrial Electronics,  
High-Frequency Heating

Offices, Laboratory & Model Shop at:  
126 Herricks Rd., Mineola, N. Y.  
Garden City 7-0284

## BERNARD SACHS, B.E.E., M.S.

*Registered Patent Agent*

Specialist in electronic cases

1033 E. 12th St. Brooklyn 30, N. Y.  
Cloverdale 2-6382

## EDGERTON, GERMESHAUSEN & GRIER, INC.

*Consulting Engineers*

Research, Development and Manufacture  
of Electronic and Stroboscopic Equipment  
Specialists in High-Speed Photography

160 Brookline Avenue, Boston 15, Mass.

## KENT LABORATORIES, INC.

*Model Work in Metal & Plastics*

Electro - Mechanical  
Design - Development - Manufacture  
Precision Mechanical Specialists

230 Warburton Ave. Hawthorne, N. J.  
Telephone HA wthorne 7-6777

## SERVO CORPORATION OF AMERICA

*Consultants on*

Electronic Control Problems

for Industry

New Hyde Park Long Island, N. Y.

## ELECTRO-MECHANICAL RESEARCH INC.

*Specialized Research and Manufacture*

High and Low Frequency Circuit Development  
Electronic Measuring and Test Equipment  
Optical and Infra-Red Studies  
Special Geophysical Equipment  
Automatic Inspection Devices

Ridgefield, Conn.

## MEASUREMENTS CORP.

*Research & Manufacturing Engineers*

Specialists in the Design and  
Development of Electronic Test Instruments  
Boonton, N. J.

## SERVO-TEK PRODUCTS CO., INC.

*Servo-Systems • Position Recorders  
Motor-Integrator Systems*

Specialists in Electronic Motor Speed Control

4 Godwin Avenue Paterson, N. J.  
Tel. ARmory 4-3366 Teletype PAT 199

## ELECTRONIC ENGINEERING CO. of CALIFORNIA

Radio and Electronic Consulting and  
Designing.

180 S. Alvarado Los Angeles  
DUmkirk 7-8323 California

## MICROCIRCUITS COMPANY

*Consultation-Development-Manufacture*

PRINTED CIRCUIT  
APPLICATIONS and PAINTS

Conducting, Resistance, and Magnetic  
Paints, Pastes, and Hot Melts  
for Experimentation and Production

New Buffalo Michigan

## A. F. SMUCKLER & CO., INC.

*Electronic and Communication*

Engineers and Manufacturers

202-208 Tillary Street Brooklyn 1, N. Y.  
ULster 5-5141

## ERCO RADIO LABORATORIES, INC.

*Radio Communications Equipment*

Engineering - Design - Development - Production  
Pioneers in Frequency Shift Telegraph  
Garden City • Long Island • New York

## Eugene Mittelman, E.E., Ph.D.

*Consulting Engineer & Physicist*

High Frequency Heating — Industrial Electronics  
Applied Physics and Mathematics

549 W. Washington Blvd. Chicago 6, ILL.  
State 2-8021

## TECHNICAL MATERIEL CORPORATION

*Communications Consultants*

RADIO TELETYPE • FREQUENCY SHIFT  
INK SLIP RECORDING  
TELETYPE NETWORKS

453 West 47th Street New York 19, N. Y.

## PAUL GODLEY CO.

*Consulting Radio Engineers*

GREAT NOTCH, N. J.

Est. 1926 Little Falls 4-1000

## NIAGARA ELECTRON LABORATORIES

CONSULTATION - DESIGN - CONSTRUCTION  
MFG. THE THERMOCAP RELAY

Specializing in solution of problems of electronic  
and electro-physical instrumentation for the  
research or analytical laboratory. Industrial plant  
problems also invited.

Andover, New York Cable Address: NIATRONLAB

## ANDREW W. VINCENT

CONSULTANT

*Development and Models*

Electromagnetic relays & devices Audio and inter-  
communication equip. Remote control selection  
circuits, Telephone equipment.  
300 W. High Terrace Rochester, N. Y.  
Genesee 2648

## HANSON-GORRILL-BRIAN INC.

*Product & Mfg. Development*

ELECTRICAL - ELECTRONIC  
HYDRAULIC - MECHANICAL

One Continental Hill Glen Cove, N. Y.  
Glen Cove 4-1922

## PICKARD AND BURNS, INC.

*Consulting Electronic Engineers*

Analysis and Evaluation  
of Radio Systems  
Research, Development & Design  
of Special Electronic Equipment

240 Highland Ave., Needham 94, Mass.

## YARDENY LABORATORIES, INC.

*Research and Development*

Remote Controls and Electro Chemical  
Generators of Energy

105 Chambers Street WO 2-3534, 35  
New York, N. Y.

## NATIONAL UNION RESEARCH DIVISION

There are several desirable openings for experienced

## PHYSICISTS and ENGINEERS

capable of handling the design and development of electron tubes and circuits.

Our growing organization can offer excellent prospects for security and advancement to qualified personnel.

Interested applicants are invited to send their resume to:

Divisional Personnel Manager  
National Union Research Division  
350 Scotland Road, Orange, N. J.

REPLIES (Box No.): Address to office nearest you  
NEW YORK: 330 W. 42nd St. (18)  
CHICAGO: 520 N. Michigan Ave. (11)  
SAN FRANCISCO: 68 Post St. (4)

### POSITION VACANT

ENGINEER, EXPERIENCED circuit design. Special-purpose amplifiers, electronic gages, oscilloscopes. Write: Industrial Electronics, Inc., 2457 Woodward Avenue, Detroit 1, Michigan.

### SELLING OPPORTUNITY OFFERED

REPRESENTATIVE—PROCURE work for machine shop and stamping shop 8000 square feet with modern equipment, accustomed quality aircraft and instrument components and small assemblies. Capable billing quarter million annually. 27 years experience contract manufacturing. RW-2052, Electronics.

### EMPLOYMENT SERVICE

SALARIED PERSONNEL, \$3,000-\$25,000. This confidential service, established 1927, is geared to needs of high grade men who seek a change of connection under conditions assuring, if employed, full protection to present position. Send name and address only for details. Personal consultation invited. Jira Thayer Jennings, Dept. L, 241 Orange St., New Haven, Conn.

### POSITIONS WANTED

YOUNG MAN, 33, with engineering education and experience wants opportunity to understand a buyer of electronic or electrical equipment. Will relocate. PW-2047, Electronics.

COMMUNICATIONS TECHNICIAN 14 yrs. exp. all phases. Design & Mfr. Comm. & Electronic eqpt. Patents. Traveled Europe & SA. 9 yrs. Brazil. PW-2220, Electronics.

CHIEF ENGINEER Available. 20 years experience in the development and production of electronic equipment. Qualified in all phases of government contracts. PW-2258, Electronics.

### SALES MANAGERS' ATTENTION

Are you satisfied with your sales volume within 100 miles of New York City?

ELECTRONICS SALES ENGINEER, with years of experience as manufacturer's representative selling to research laboratories and industrial concerns in this area, seeks line of high quality electronic instruments, equipment or components. Can offer exceptional good coverage.

SA-2277, Electronics  
330 W. 42nd St., New York 18, N. Y.

## ELECTRONIC MUSIC

Electronic engineers, young, sales and service engineering, electronic organs. Some musical ability. Some travel. Send resume and salary requirements.

ALLEN ORGAN COMPANY, INC.  
ALLENTOWN, PENNSYLVANIA

## TECHNICAL WRITER

As Collaborator in the writing of a Practical Radio-Television Home Study course. State experience fully.

P-2196, Electronics  
330 W. 42nd St., New York 18, N. Y.

### POSITIONS WANTED

ELECTRONICS ENGINEER, 16 years factory and field experience in design, construction, and management of broadcast stations and communications systems. Also, laboratory design of electronic equipment, direction of technical personnel, and the engineering side of international broadcasting. I.E. degree, cost conscious, capable. Noted for ingenuity. Resume on request. PW-2107, Electronics.

TELEVISION BROADCAST Engineer, age 32. Good background. Presently employed. Interested joining new station as Technical Supervisor. Midwest or west. PW-2122, Electronics.

ELECTRONIC/Broadcast Engineer, B.E.E. degree. 1 yr. television design and other lab. work in mfg. 2 yrs. Merchant Marine Radio Officer, Ham, 1st class radiotelephone, 2nd class radiotelegraph licenses. Desires lab. engineering position or one with broadcasting station. Salary secondary. Relocate. PW-2102, Electronics.

ELECTRICAL ENGINEER, recent graduate, desires trainee position: research or development field with progressive company. Former R.T. single, 23. Will relocate. PW-2202, Electronics.

COMMUNICATIONS OFFICER, nine years USAF, age 34, married, car, experienced airborne and ground signal supply and maintenance, needs position radio-electronics sales or apprentice design. Discharged January, 1950. PW-1731, Electronics.

ELECTRONIC ENGINEER, experience in Circuit Development, Instrumentation, U. H. F. Interested Industrial, Development or Sales. Will relocate, prefer Midwest. PW-2283, Electronics.

E.E.—15 years experience in the electron tube industry as chief engineer, design engineer, project and product engineer, and process engineer. Thoroughly familiar with every phase of tube manufacturing. Administrative ability, aggressive, and initiative. Currently in the cathode ray tube industry. Wishes position as plant manager, or chief engineer. PW-2295, Electronics.

### BUSINESS OPPORTUNITY

Exclusive rights  
to valuable cathode-ray tube patents available. Basic claims involved. Inventor ownership. BO-2027, Electronics.

## WANTED

Typewriters complete, components or parts. Any quantity and condition.

W-6654, Electronics  
330 West 42nd Street, New York 18, N. Y.

### FOR SALE

## ELECTRONICS LABORATORY

Entire floor 9000 square feet in concrete building in Boston. Well equipped for electronics laboratory and photo-process research. Also excellent for manufacturing. Portion of space now air conditioned.

BO-2290, Electronics  
330 W. 42nd Street, New York 18, N. Y.

## Positions Open for PHYSICISTS

## SR. ELECTRONIC ENGINEERS

Familiar with ultra high frequency and micro wave technique.

Experience with electronic digital and/or analog, computer research and development program.

Salaries commensurate with experience and ability. Excellent opportunities for qualified personnel.

Contact  
C. G. Jones, Personnel Department  
GOODYEAR AIRCRAFT CORPORATION  
Akron 15, Ohio

## CONTRACT

## ENGINEERING—MANUFACTURING

electronic and electro-mechanical devices  
● developed to meet your specifications  
● manufactured per sample or drawings

TELETRONICS LABORATORY, Inc.  
Westbury, L. I., N. Y.—Westbury 7-1028

Time is money. Save it by referring to our  
ACCUMULATIVE INDEX FOR  
ELECTRONICS BIBLIOGRAPHY

Simple and Dependable

Write for descriptive literature

TECHNICAL INDEX SERVICE  
Box 632 Asbury Park, New Jersey

### WANTED

## AS/27A RAMS HORN ANTENNAS

(no substitutes) state quantity, price, condition and location.

W-2216, Electronics  
330 West 42nd Street, New York 18, N. Y.

### WANTED

## WESTERN ELECTRIC VACUUM TUBES

Types 101F, 102F, 272A, 274A or B, 310A or B, 311A, 313C, 323A, 328A, 329A, 348A, 349A, 352A, 373A, 374A, 393A, 394A, 121A Ballast Lamps.

W-6641, Electronics  
330 West 42nd St., New York 18, N. Y.

### WANTED

## TEST EQUIPMENT

state asking price, age and condition in first letter.

W-1150, Electronics  
330 W. 42nd St., New York 18, N. Y.

## HIGHEST CASH PRICES

Offered for your

## LABORATORY QUALITY TEST EQUIPMENT

Send list and description to

W-2281, Electronics  
330 W. 42nd St., New York 18, N. Y.

### WANTED

## TYPE #48 VACUUM TUBES

New—In any quantities. Write stating quantity, price, manufacturer.

W-2302, Electronics  
330 W. 42nd St., New York 18, N. Y.

### WANTED

## JUNCTION BOX JB70

as used with

## Halicrafters BC610 SCR 399

State Condition, Quantity & Price

W2252, Electronics  
330 W. 42nd St., New York 18, N. Y.

(Additional Wanted ad on page 305)

## SENIOR ELECTRONIC CIRCUIT PHYSICISTS

for  
*Advanced Research  
and Development*

### MINIMUM REQUIREMENTS:

1. M.S. or Ph.D. in Physics or E.E.
2. Not less than five years experience in advanced electronic circuit development with a record of accomplishment giving evidence of an unusual degree of ingenuity and ability in the field.
3. Minimum age 28 years.

### Hughes Aircraft Company

Attention: Mr. Jack Harwood  
CULVER CITY, CALIFORNIA

### RADAR ENGINEER-PHYSICIST WANTED

Must have heavy experience in basic study and research on new radar systems and similar electronic equipment.

Excellent opportunity for Senior man. Juniors please do not apply.

State full particulars. Replies confidential.

Write: A. Hoffsommer

### W. L. MAXSON

CORPORATION  
460 W. 34th St., New York 1, N. Y.

### SEVERAL ENGINEERS

needed by contractor for work at Naval Air Missile Test Center, 50 miles northwest of Los Angeles. College degree and several years experience essential. Radar, computer, or telemetering experience preferable.

ELECTRONIC ENGINEERING CO.  
OF CALIFORNIA  
2008 West Seventh Street  
Los Angeles 5, California

### SCIENTISTS AND ENGINEERS

Wanted for interesting and professionally challenging research and advanced development in the fields of microwaves, radar, gyroscopes, servomechanisms, instrumentation, computers and general electronics. Scientific or engineering degree or extensive technical experience required. Salary commensurate with experience and ability. Direct inquiries to Mr., Engineering Personnel, Bell Aircraft Corporation, P. O. Box 1, Buffalo 5, N. Y.

## RCA VICTOR Camden, N. J.

### Requires Experienced Electronics Engineers

RCA's steady growth in the field of electronics results in attractive opportunities for electrical and mechanical engineers and physicists. Experienced engineers are finding the "right position" in the wide scope of RCA's activities. Equipment is being developed for the following applications: communications and navigational equipment for the aviation industry, mobile transmitters, microwave relay links, radar systems and components, and ultra high frequency test equipment.

These requirements represent permanent expansion in RCA Victor's Engineering Division at Camden, which will provide excellent opportunities for men of high caliber with appropriate training and experience.

If you meet these specifications, and if you are looking for a career which will open wide the door to the complete expression of your talents in the fields of electronics, write, giving full details to:

National Recruiting Division  
Box 300, RCA Victor Division  
Radio Corporation of America  
Camden, New Jersey

## TELEVISION ENGINEERS

Wanted by Chicago area manufacturer of leading, nationally known television and radio receivers.

### CHIEF TELEVISION ENGINEER

To assume full responsibility of large scale research and development program.

Requirements: EE graduate with minimum of 10 years in industry in similar capacity, a record of eminent results demonstrating aggressive leadership, a thorough knowledge of production requirements and consumer problems.

### TELEVISION PROJECT ENGINEERS

EE graduates with minimum of 5 years experience in television design and development for production. Capable of new design and full utilization of conventional circuits in all phases of television receivers.

Well equipped laboratories in modern high speed plant.

Send resume to

P-2066, Electronics  
520 No. Michigan Ave., Chicago, Ill.

## RADAR, COMMUNICATIONS and SONAR TECHNICIANS

# WANTED

For Overseas Assignments

### Technical Qualifications:

1. At least 3 years' practical experience in installation and maintenance.
2. Navy veterans ETM 1/c or higher.
3. Army veterans TECH/SGT or higher.

### Personal Qualifications:

1. Age, over 22—must pass physical examination.
2. Ability to assume responsibility.
3. Must stand thorough character investigation.
4. Willing to go overseas for 1 year.

Base pay, bonus, living allowance, vacation add up to \$7,000.00 per year. Permanent connection with company possible.

Apply by Writing to  
A-1, P. O. Box 3414  
Philadelphia 22, Pa.

Men qualified in RADAR, COMMUNICATIONS or SONAR give complete history. Interview will be arranged for successful applicants.

# DESIGN ENGINEERS

- RADIO
- TELEVISION
- FM

Hoffman Radio Corporation has positions open for junior and senior radio and television design engineers. Write Engineering Department, giving education, experience and salary desired.

HOFFMAN RADIO  
CORPORATION  
3761 SOUTH HILL STREET,  
LOS ANGELES 7, CALIF.

**IMMEDIATE DELIVERY**

**LOW PRICES**

**FULLY GUARANTEED**

**AC-SERVO MOTORS**

**Pioneer Type CK-2.**  
26 v. 400 cycles fixed phase, var. phase 49 v. max. 1.05 in/oz. Stall torque. Rotor moment of inertia 7 gm/cm: With 40:1 gear reduction.  
Stock #SA-97A. Price \$6.50 each. Also available less gear train as Stock #SA-97. Price \$4.25 each

**MINNEAPOLIS-HONEYWELL**

Type G303AY2CA4  
115 v. 400 cycles. Built in gear reduction. 50 in/lb. torque. Stock #SA-268. Price \$8.50 each.

**KOLLSMAN 776-01**

400 cycle. 2 Phase drag cup type. Fixed phase 29 v., variable phase 35 v. max. 5840 rpm. 0.471 in/oz. stall torque. Spline shaft. Stock #SA-56. Price \$12.50 each.

**PIONEER CK-17**

400 cycle 2 phase. 26 v. fixed phase. 45 v. max. variable phase. Built in gear reduction. Output shaft speed approx. 4 rpm. Stock #SA-287. Price \$12.50 each.

**MERCURY CONTACT RELAY**

W.E. D-168479  
Millisecond switching at up to 60 cycles per sec. Ideal for servo amplifiers of relay type. 4 page brochure on request. Stock #SA-259. Price \$4.75 each.

**INVERTER SPECIALS**

General Electric PE-218 D—Input 28 v. d-c @ 92 amps. Output 115 v. 400 cycles @ 1500 va. Power factor 0.90. Shipping wt. 100 lbs. New—Original Cartons. Stock #SA-112. Price \$39.50 each.

Leland or Russell PE-218 E or PE-20.8H. Similar to PE-218D. Stock #SA-112A. Special Price \$29.50 each.

Leland SD-93—(10285)—Input 28 volts DC at 60 amps. Output 115 volts three phase 400 cycles at 750 va. 0.90 P.F. Second output voltage of 26 volts 400 cycles at 50 V.A. Voltage and frequency regulated. Designed for use with various autopilots. Stock #SA-209. Price \$79.50 each

Holtzer Cabot MG-149H—Similar to MG-149F but draws 44 amps DC at 28 v. Output ratings are at 0.90 P.F. Equipped with high altitude brushes. Stock #SA-4. Price \$34.50 each

General Electric 5D21NJ3A — Input 28 volts DC at 35 amps. Output 110 volts 400 cycles. 485 V.A. at 0.90 P.F. Weight 15 lbs. Stock #SA-41. Price \$9.95 each

General Electric 5AS131NJ3 — Input 26 volts DC at 100 amps. Output 115 volts 400 cycles. 1500 V.A. 0.8 P.F. Stock #SA-286. Price \$19.50 each

**DC SERVO MOTORS**

C-1 Autopilot Servo Unit—28 v. d-c Shunt motor. 2250 rpm. 2 magnetic clutches, reduction gear, differential and 2 magnetic brakes. Output shaft 15 rpm. Torque 225 in/lbs.  
Stock #SA-180 Price \$19.50 each

Elenco B-64 DC Servo Unit—armature voltage, 80 v d-c max. 27.5 v. field 1/165 hp 3100 rpm. Field current 200 ma. Armature current 200 ma. at normal torque.  
Stock #SA-211 Price \$12.50 each

John Oster A-21E-12R — Split field series reversible motor. W.E. KS-5996-LO-4. 28 v. d-c at 0.4 amps. 2 watts output. 1 1/2" diam. x 2 1/2" lg. Ideal for relay or thyatron servos. Stock #SA-282. Price \$6.75 each.

G.E. 5PS56HC18 — Split field series reversible motor. 60 v. d-c at 1.4 amperes. 5500 rpm. 3" diam. x 5" lg. Ideal for servo applications. Stock #SA-273. Price \$8.75 each.

**SAWTOOTH POTENTIOMETER**

W.E. KS-15138  
Type RL-E-R. 100 ohm element. Non linear ring gives linear output with CRT deflection coil load. Cont. rotation. 2 brushes 180 degrees opposed. 2 taps 180 degrees opposed. Stock #SA-288. Price \$5.50 each.

**LP-21-LM Compass Loops**

Motor driven loop enclosed in graphited zepelin housing includes Autosyn transmitter.  
New \$9.50 each

**Remote Position Indicating System**

6-12 v. 60 cycles 5 inch indicator with 0 to 360° dial. Heavy duty transmitter. Stock #SA-115. Price \$9.95 per system

AC Motor Special Eastern Air Devices J-33 115 V. 400 cy. 3 phase synchronous. 8000 RPM. Stock #SA-59. Price \$8.00 each

Autosyn Indicator I-82F Compass Indicator. 0-360°-5 in. dial. 26 v 400 cy. 8-12 v. 60 cy. Ideal position indicator. Stock #SA-284. Price \$6.50 each

**MINIATURE DC SELSYN INDICATOR**

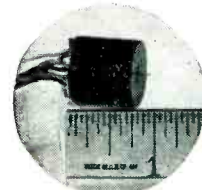

Miniature indicator, 24 v. d-c operation with G.E. Position Transmitter or with Ohmite 360° type potentiometer. Has iron plug for zero dial adjustment. Stock #SA-248. Price \$6.75 each.

**G.E. POSITION TRANSMITTER**

Type 8TJ9—continuously rotatable 360 wound potentiometer. Taps every 120 degrees. Two 180° opposed sliders. 24 v. d-c operation with indicator described above. Stock #SA-13. Price \$4.75 each.

**SYNCHROS**

Navy Types



1G, 1F, 1CT, 5G, 5F, 5CT, 5DG, 5HCT, 5SF, 5HSF, 5SDG, 6DG, 6G, 6DG, 7G, etc.

Prices on Request

**D.C. MOTORS**

Universal Electric DC W.E. KS-5603-1-02, 28 v. d-c 0.6 amps. 1/100 hp. 4 lead shunt. Stock #SA-233. Price \$2.95 ea. plus 15¢ p.p.

**OSTER PM MOTOR**  
Alenco Field  
27.5 v. D-C 10,000 RPM. Can also be used as rate or tachometer generator. Stock #SA-281. Price \$3.75 each

**DELCO CONSTANT SPEED MOTOR A-7155**  
1/30 hp. 27.5 v d-c 3600 rpm. Cont. duty. 2 1/2" diam. x 5 1/2" lg. 7/8" shaft extension, 5/32" diam. 4 hole base mounting. Stock #SA-94. Price \$4.75

Delco 5069625 Constant Speed DC Motor, 27 v. d-c 120 rpm. Governor controlled. Stock #SA-249. Price \$3.95 each.

General Electric 2 RPM Motor. Type 5BA10FJ228, 27 v. d-c @ 0.6 amps. 10 lb/in torque at 2 rpm. Shunt wound. L-C noise filter. Stock #SA-274. Price \$6.75 each.

**AC DC GENERATOR Homelite 18A120D28-1**

Self excited. Output 115 v. 400 cycles single phase at 39 amperes and second output 28 v. d-c at 17.9 amps. Required speed 4000 rpm. SPECIAL PRICE \$175.00.

Prices F.O.B. Paterson  
Phone ARmory 4-3366  
Teletype PAT. 199

WRITE FOR LISTING

**Servo-Tek products co.**  
4 Godwin Ave. Paterson, N. J.

**SPECIALISTS IN FRACTIONAL HORSE POWER MOTOR SPEED CONTROL**



# R. F. COMPONENTS - MICROWAVE - TEST EQUIPMENT

10 cm. horn and rotating joint assembly, gold plated ..... \$65.00 ea.  
**ROTARY JOINT** choke to choke ..... \$17.50  
**ROTARY JOINT** choke to choke with deck mounting ..... \$17.50

**BC 987A PPI, 12" Indicator Console w/additional, A Scope IC 986B Compl/w all Pwr Sply Osc. Control Unit, desk shelf. .... \$350.00**  
 12 GPT Tubes for above. .... \$14.95

**TR-ATR Section** for above with 724 ATR cavity. .... \$8.50  
**TR-ATR Section, APS 15, for IB24, with 724 ATR cavity with IB24 and 724 tubes. Complete. \$21.00**  
**TR CAVITY** for 724 A Tube \$3.50

### RADAR BEACONS

CPN-3 10 cm. Used. .... \$1500.00  
 CPN-8 10 cm. Used. .... 1500.00  
 CXBR (3 cm) CPN-6 Prototype. .... 1500.00

**APS-31 mixer section** for mounting two 2K25's. Beacon reference cavity IB24 TR tube. New and complete with attenuating slugs. .... \$42.50 ea.  
**DUPLEXER SECT.** for IB24 \$10.00

### AIRBORNE RADAR

APS-4 3 cm Compl. Write  
 APS-15 All Major Components. .... \$500.00  
 APS-3 New & Complete. .... \$750.00

3 cm 180° bend with pressurizing nipple \$6.00 ea.  
 3 cm. 90 bend, 14" long 90° twist with pressurizing nipple. \$6.00 ea.

**THERMISTOR BRIDGE:** Power meter 1-205-A, 10 cm. inf. WVE complete with mercury interpolation chart, portable carrying case. \$72.50

**12" SECTION** 45 deg twist 90 deg bend ..... \$6.00  
**15 DEG BEND** 10" choke to cover ..... \$4.50

### PULSE EQUIPMENT

**MIT. MOD. 3 HARD TUBE PULSER:** Output Pulse Power: 114 KW 12 KV at 12 amp. Duty Ratio: .001 max. Pulse duration: 1.0 2.0 microsec. input voltage: 115 v. 400 to 2400 cps. Uses 1-715-B, 1-820-B, 3-72's, 1-73 New ..... \$110.00

AT-48 Horn Silver Plate, "N" Inpt. New \$6.50  
 AT-68 Horn, Sperry, "N" Inpt. New \$6.50  
 TS-235 UP, Dummy Load, New. .... \$87.50

**I.F.F.** KW Pulsed output Pkg. Tunable 154-186 mc. adj. modulating pulses 4-10 micro sec. comp. 115v 60 cy ac pwr. supply. Video output monitor. New w/ tubes. .... \$350.00  
 Wavemeter for above. .... \$75.00  
 Dipole Array for above. .... \$65.00

**RIGHT ANGLE BEND,** with flexible coax output pickup loop. .... \$8.00  
**STUB-SUPPORTED RIGID COAX,** gold plated 3" lengths. Per length. .... \$5.00

**100CM ECHO BOX CABY HARA-1** of ORU-3, 2890 Mc to 3170 MCS direct reading micrometer head. Ring prediction scale plus 90° to minus 90°. Type "N" input. Resonance indicator meter. New and Comp. w/access. Box and 10 CM Directional Coupler ..... \$350.00

**TRANSITION** 1 x 1/2 to 1 1/4 x 3/8, 14 in. \$8.00  
 723 A/B Klystron mixer section with crystal mount, choke flange and iris flange output. .... \$22.50  
 3 cm. right angle bends, "E" plane 18" long cover to cover. .... \$6.50 each

### APS 4 AIRBORNE RADAR

Complete sets and various components available.

**WAVEGUIDE TO 7/8" RIGID COAX "DOORKNOB" ADAPTER, CHOKE FLANGE, SILVER PLATED BROAD BAND** ..... \$37.50  
**WAVEGUIDE DIRECTIONAL COUPLER,** 2/ db. Navy type CABV-47AAN, with in. slotted section ..... \$32.50

## SCR 584

SPARE PARTS AVAILABLE

Magnetron Cplg. 3/8 rigid coax, 3/8 I.C. .... \$7.50  
 3/8" rigid coaxial tuning stubs with vernier stub adjustment. Gold Plated. .... \$17.50

**WRITE FOR FLYERS OF DEMORNAV BUDD PLUMBING. WE PURCHASED 80% OF THE N. Y. INVENTORY TO BE SOLD AT SURPLUS PRICES**

### 3 CENTIMETER

Choke Flanges UG40/U ..... \$ .85  
 Cover Flanges UG39/U ..... \$ .65  
 Uni-Directional Couplers CU105 APS-31, Type "N" Terminated 25DB ..... \$10.00  
 Uni-Directional Couplers Cover Flange Terminated 20 DB ..... \$9.50  
 "E" Plane Bends 2 1/2" Radius CH. to CUR. .... \$10.00  
 12" Straight Sections Square CH. to CUR S. P. \$3.00  
 "H" Plane Bends 2 1/2" Radius CH. to CUR. .... \$10.00  
 Crystal Mount ..... \$9.00  
 Bi-Directional Coupler Type "N" Terminated ..... \$15.00  
 Bi-Directional Coupler Type "N" Terminated. Broad Band ..... \$15.00  
 EG-176/AP Dir. Coupler 20DB Nominal "N" Terminated ..... \$15.00  
 Xa Band Mitted Elbows ..... \$9.00  
 Fullhead Feed-Thru ..... \$10.00  
 Press Test Sections Ch to CUR W/15 db. gauge ..... \$9.00  
 Mitted Elbows ..... \$9.00  
 Adapter UG39 U to UG40 U ..... \$3.50

### "K" BAND

90 Deg Bend Sq. CH. to CUR. .... \$ 5.00  
 90 Deg Bend Sq. CH. to CH. .... 5.00  
 90 Deg Bend Sq. CUR. to CUR. .... 5.00  
 Bi-Directional Couplers 20DB P/O APS-34 ..... 49.50  
 Uni-Directional Couplers ..... 39.50  
 Rotary Joints P/O APS 34 ..... 49.50  
 Straight Sections CH. to CUR. 6" ..... 3.00

### "C" BAND

RT Angle Bends Circ CH to CIRC CUR Unplated ..... \$3.50  
 CIRC CHOKE FLANGES (?) Mitted Elbows CIRC CH. to CIRC CUR ..... \$16.50

### TEST EQUIPMENT

"L" Band Standard Line with Probe and Carriage and "N" Terminated Directional Coupler ..... \$300.00  
 "C" Band Flap Attenuator, Gold Plated ..... \$90.00  
 7/8 Rigid Coax 3/8" Bullet Directional Couplers 20DB ..... \$17.50  
 7/8 Rigid Coax 3/8" Bullet To Type "N" Adapter ..... \$10.00  
 10 CM Horn P/O APS-20 ..... \$100.00  
 C9176 AT Dir Cplg 20 DB Nominal ..... \$15.00

### WILCOX CS390

#### CONTROL EQUIPMENT

**FOR AIRPORT CONTROL GROUND STATION** — Standard relay rack housing, monitor loudspeaker, dual channel receiver amplifier, Type 100-A control panel, microphone speech amplifier, etc., spare parts, new and complete ..... \$750.00 each

HV. Rect. Full Wave Sin. Phase Rect. utilizing 2-705A tubes. Input 115v 60 cy AC. Output 1800v 45 ma. at v. primary secondary. 12000v DC at output term. New \$125.00 w/tubes.

### SEE YOU AT THE

**IRE SHOW**  
**BOOTH L, 2ND FLOOR**  
**MARCH 6 TO 9TH INCL.**

### MARK IV RADAR CONSOLE

Compl. "L" band pkg. Operating fr. 115 v 60 cy. w/o Pulser. Rec. 709A Mag. Osc. Pwr. Sply. w/ most tubes ..... \$750.00  
 Individ. Chassis avail. separately

3 cm. wavemeter. Ordinance type micrometer head. New. Absorption type. Sections 9000-9500 MCS X Missn type. \$92.50

### H.V. PWR. SUPPLY

15000v 50 ma. DC Bridge Rect. Pwr Sply. Oper. FM. 115v 60 cy ..... \$115.00

3 cm 90° twist 6" ch. to cover \$8.00

**DEHYDRATOR UNIT.** CPD 10137. Automatic Cycling. Compressor to 50 lbs. Compl for Radar XSMN. Line. New ..... \$425.00

**SWR MEAS. SECTION,** with 2 type "N" output probes MITD full wave apart. Bell sizes given. Silver plated. .... \$10.00

### 200 MC COAXIAL PLUMBING

Right Angle Bend ..... \$35.00  
 T Section ..... \$55.00  
 T Section with Adapter to 7/8" in rigid coax. \$65.00  
 Running Ftg. .... \$5 per Ft.

Rotating joint, with deck mount ..... \$15.00  
**RIGID COAX** slotted section ..... \$15.00  
 CU 60/AP ..... \$5.00

**AN/APS-15A "X" Band** compl. RF head and mod. 725-A magnetron two 723A/B IB24, TR, rev. amp. driver. HV supply, blower. Peak Pwr Out: 45 KW apx. Input: 115, 400 cy. Mod. pulse dur. .5 to 2 micro-sec. apx. 13 KV Pk Pulse. Compl. with all tubes incl. 715-B, 820B, 8KR 73, two 72's. New ..... \$210.00

10 cm Wavemeter. WVE type B 435-490  
 Transmission type. Type N Fittings. Veeder Root Micrometer dial. Gold Plated W/Calib. Chart. P/o Freq. Meter X66404A. New \$99.50



### SURFACE SEARCH RADAR

S.E. 10 cm 115 VDC New ..... \$1200.00  
 SQ-4 10 cm. 115 VDC 1 used ..... \$1200.00  
 SF-4 10 cm. 115 VDC New w/spares ..... \$2800.00

**TR/ATR SECTION** choke to cover \$4.00  
**MITRED ELBOW** and S sections choke to cover ..... \$4.50

UG 65/U 10CM Hoses. .... \$6.75 each  
 UG 53/U Cover ..... 4.00 each  
 UG 54/U Choke ..... 4.50 each

**"K" BAND FEEDBACK TO PARABOLA HORN.** with pressurized window. .... \$30.00  
**MITRED-ELBOW** cover to cover \$4.00  
**FLEXIBLE SECTION** 1" choke to choke ..... \$5.00  
**WAVEGUIDE** 1/2 x 3/4 per ft. .... \$1.00

**ASI4A/AP**—10cm Pick up Dipole with "N" Cables ..... \$4.50

**TWIST** 45 deg., 6" long ..... \$8.00  
 90 degree twist, 6 inches long. .... \$8.00  
**TWIST** 90 deg. 5" choke to Cover w/press nipple ..... \$6.50

**RL 26.** Gas driven reversible engine, for laying & picking up field tel. wire. .... \$125.00  
**WIRE PIKES** ..... \$1.50

**ADAPTER,** rd. cover to sq. cover. .... \$5.00

**APS-2 10CM RF HEAD COMPLETE WITH HARD TUBE** (715A) Pulser, 714 Magnetron 417A Mixer all 7/8" rigid coax. incl. rev. front end ..... \$210.00

### MAGNETRONS

QK 61 2975-3200 mc. .... \$65.00  
 QK 60 2800-3025 mc. .... \$65.00  
 QK 62 3150-3375 mc. .... \$65.00  
 QK 59 2075-2900 mc. .... \$65.00

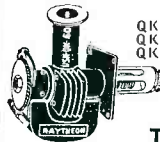

### FILAMENT TRANSFORMER

for above 115V/60 cy Pri: four 6.3V/4 Sec. 5000VT ..... \$27.50  
 Magnetron Kit of four QK's 2975-3375 inc. w/trans special ..... \$250.00

### BRAND NEW ORIG. PACKED GUARANTEED GOOD

2J31	2J38	3J31	
2J21-A	2J39	5J30	
2J22	2J40	714AY-A	
2J26	2J49	718DY	
2J27	2J61	720BY	
2J32	QK915	720CY	
2J34		725-A	
2J37		730-A	
723AY, BY, CY, DY, EY, FY, GY			
700-A, B, C, D			
706-A, Y, BY, DY, EY, FY, GY			
Klystrons: 723A, B 707B W, Cavity 417A 2K41			

**WRITE FOR QUANTITY & PRICE**

Electromagnets for magnetrons 700A \$24.50 ea.  
 GE Magnet type M765115. GI distance between pole face variable from 2 1/16" (19.0 gauge to 1 1/2" (2200 gauge). Pole dia. 1 3/8" P/O SCR 686. New ..... \$34.50

**RT32/APS 6A RF HEAD.** Compl. with 725A Magnetron magnet pulse filter. TRCA-ATR. 723 A/B local use and beacon MT. Preamp. Used but excellent. .... \$97.50

### MAGNETRON MAGNETS

Gauss	Pole Diam.	Spacing	Price
4850	3/4 in.	5/8 in.	\$12.50
4200	21/32 in.	3/4 in.	\$15.50
1500	1 5/8 in.	1 5/16 in.	\$12.50
1860	1 5/8 in.	1 1/2 in.	\$14.50



**TS 89/AP Voltage Divider.** Ranges 100: 1/2 for 2000 to 20000v. 10:1 for 200 to 2000v. Input Z 2000 ohms. Output Z 4 meg ohms flat response 150 cy to 5 meg cy. .... \$42.50

All merchandise guaranteed. Mail orders promptly filled. All prices, F.O.B. New York City. Send Money Order or Check. Only shipping charges sent C.O.D. Rated Concerns send P.O.

# COMMUNICATIONS EQUIPMENT CO.

131 Liberty St., New York, N. Y. Dept. E3 Phone: Digby 9-4124 Att. Mr. Paul Plishner

CHOKES  
INVERTERS

TRANSFORMERS

THERMISTORS  
VARISTORS

Power Transformers—115V/50-60 cps input

Volts Out	Am p	Filaments	Each
770V	.0025	2.5V/3A	\$1.98
550VCT	.050	6.3V/5, 2.5VCT/1.75	2.49
2 x 110VCT	.01	6.3V/10, 2.5VCT/7	2.75
2 v 110V	.010	6.3/2.5, 2 x 2.5VCT/7	3.45
550VCT	.100	6.3V/1.8, 6.3/6	2.29
580VCT	.040	5VCT/3A	2.49
100VCT	.017	5VCT/3A	2.25
2300V	.004	2.5/2A	7.49
100VCT, 65V	.100	6.3VCT/10, 40V/1, 18VCT/1, 18-6/1 6.3/1	3.49
1500V	.160	2.5VCT/12, 30V/.01	6.95
1100V, 400V	.250	6.3V/6A	6.95
78V	.300	6.3V/2A	1.79
800VCT	.150	5V, 3A, 2.5V/2	3.98
2 x 300V	.042	55V/125, 45/3.5	3.95
585	.086	5V, 3, 6.3V/6	3.95
1080VCT	.055	6.3V/1.2, 6.3/1.2	5.95
600VCT	.155	6.3VCT/5, 5VCT/3	3.95
1120V	.600	2 x 5VCT/6-2A, 6.3VCT/3, 6.3/300	14.95

Plate Transformers—115V/50-60 cps input

Volts Out	Amp.	Each	Volts Out	Amp.	Each
65V	.500	1.49	70V	1	\$1.95
500VCT	.150	3.00	100V	3	1.95
650VCT	.015	4.25	126V	1.5	2.25
2 x 150V	2 x .940	4.25	126V	1.5	2.25
600VCT	.0165	2.49	690V	.450	4.95
250VCT	.077	1.470VCT	1.2	24.00	

Filament Transformers—115V/50-60 cps input

Rating	Each	Rating	Each
2.5V/5A, HV Ins.	\$1.79	30VCT/330	\$1.95
6.3V/2A, 78/300	1.79	34VCT/380	3.25
36V/1.11	1.49	6.3V/2.5, 2 x 2.5/7	3.25
5VCT/20A	5.49	2 x 2.5VCT/6.5A	3.25
4V/16A, 2.5V/1.75	4.75	2.5V/1.75, 5V/3A, HV Ins	3.85
5V/15A	12.95	6.5/5A, 6.5V/7	
7.2V/6.4/10, 6.4/2, 2 x 26.2/2.5, 16V/1	5.95	10VCT/13A, 5CVCT/13.5	6.95
6.3VCT/20, 6.3V/21.8, 6.3V/6	5.25	2 x 5VCT/6.75, 1.3V/0.091KVA	2.95
6.3VCT/1, 6.3VCT/7	2.75	6.3VCT/6A, 5V/2A	1.85
6.3/5m 6.3/1A	2.25	6.3VCT/2A, 5.3VCT/2A	2.45
6.3VCT/3.2	2.25	6.3V/1A, 6.3V/1A	1.95
6.3VCT/1	2.25	6.3/2.5/7, 6.3VCT/1A, 5V/2A	3.25
5V/6A	1.10	6V/3A	

SPECIAL TYPES

Input	Output	Each
6, 12, 24 or 115VDC or 230V AC	420VCT/85Ma, 6.3V/1.9, Univ Vibrator Xtmr	\$2.39
230V 60 cy	230V/.05A	1.10
115V 60 cy	115V/78V-410A/.600MA	1.59
110, 115/120 125	13.5V/1.11A	1.49
210, 220/230 230V 60 cy	2.5VCT/4A	1.49
230V 60 cy	2.5V/6.5A	2.95
220 440V	300V/20A, 4 x 6.3/900A	2.95
220V 60 cy	286VCT/290MA	2.95
200V 60 cy	260V.03, 100/1.6/3/4.2	2.95
200V 60 cy	700VCT/.75, 40VCT/.71A 15/10/15V/1A	2.39
45/78/90 220V 60 cy	Tapped 1V to 10V 2 x 40V/.05, 2 x 5V/6A, 12.6V/1A	2.95
220V 60 cy	24V/6A, 5V/3, 2 x 6.3/1A	2.29
43/78/90/115/180/230 110/115/120/125	2.5V/6.5A, 2.5/6.5, 6.3/4A	3.95
230V 60 cy	6/12/18/24/75/100/115V/150A	2.49
200V 60 cy	5V/9A MV INS 700VCT/.08A, 110VCT/.08A	4.25
230V 60 cy	24V/.08, 6.3V/3, 6.3VCT/1.5V/3A, 5V/2A, 2.7V/6A	4.25
50V 60 cy	400V/.03, 100V/.03A, 5/2.5 5V/2.5A, W-2-866 Sockets	4.25
6V & 12V	2 x 750V/.901A 84V.009, 51V/.003, 1.4V/500 Vibrator Transformer	1.95
230V 60 cy	250V/1A, 5V/2A, 6V/9A	4.95
220-440 230V-115V	3 x 2.5V/5A, 2.5V/15A 5VCT/7.5, 5V/7.5, 5VCT/15A	5.95
440V/60 cy 3PH	220V 30W 3 phase or 220V & 6V 1 phase 60 cy	10.95
230V 60 cy	110V/200, 33V/200, 5V/10A, 2.5-14/10A, 1500V/160	5.95
95-130V 60 cy	115V/3.6A, 40.9V/3.3A	7.95
220/440V	115V/6.52A	10.95
220-440V	115V/110/105-7A	12.95

PRECISION CAPACITORS

D-163707: 0.4 mfd @ 1500 vdc. —50 to plus 85 deg C	\$4.50
D-163035: 0.1 mfd @ 600 vdc, 0 to plus 85 deg C	\$2.00
D-170908: 0.152 mfd, 300 v, 400 cy. —50 to plus 85 deg C	\$2.50
D-164960: 2.04 mfd @ 200 vdc, 0 to plus 55 deg C	\$2.50
D-168344: 2.16 mfd @ 200 vdc, 0 to plus 55 deg C	\$3.00
D-161555: 5 mfd @ 400 vdc. —50 to plus 85 deg C	\$3.00
D-161270: 1 mfd @ 200 vdc, temp comp 40 to plus 65 deg C	\$12.50

INVERTERS



PE 218-E: Input: 25 28 vdc, 92 amp. Output: 115 v, 350-500 cy 1500 volt-amps. Dim: 17"x6 1/2"x10" New (as shown) \$29.50

PE 218-H: Same as above except size: 16 1/2" x 6" x 10". New \$29.50

PE 218H, used, good cond. \$22.00

PE 208: Input: 28 vdc, 38 amps. Output: 30 v, 800 cy, 500 volt-amps. Dim: 13" x 5 1/2" x 10 1/2". New \$12.50

GE 502IN/3A: Input: 28 vdc, 35 amp. Output: 115 v, 400 cy, 485 volt-amps. Dim: 9" x 4 1/2" diam. New \$49.95

MOTOR GENERATOR SETS

GF Generator 5BC76A/B109 Type BC, KW.75 DC 12.5A 1725 RPM AC motor Type AM, 3 HP 440V-250V 60 Cy 3 PH 3.6A DC. 1725 RPM. Used Good. \$250.00

Marconi Motor Generator. 1KW Type #CB232A 125V 500 Cy Crocker Wheeler Generator 120V/14A, 250V/10A 2000 RPM 1.7 HP. Used. \$75.00

Cont Elect Motor Generator for TBL Equip., Gen. 1.4 KW 2000V, 7 Amp 1780 RPM. Motor 3.5 HP 115V 27A 1780 RPM. \$300.00

Marathon Elect. Motor Gen. 115VDC 1 HP 3600 RPM. Type DP Gen. 115VAC .5KVA 60 Cy 4.54A Model DE 753 \$98.00

Elect Spec BFR54. AC Motor 440V 3 Phase 60 Cy 5.8A 1750 RPM. DC Gen. 97517 Type FA4, 120-75V 1.7-7 Amp. DC Gen. BFR55 1500-600V 1-1.5A 1750 RPM. \$375.00

COAX CABLE

RG 9/U. 52 ohms \$24/Ft.

RG 17/U. 52 ohms imp. \$48/Ft.

RG 57/U. Twin Cond. 95 ohms. \$55/Ft.

RG 18/U. 52 ohms in. armored. \$51/Ft.

RG 53/U. twin coax. 125 ohm imp. armored. \$50/Ft.

RG 28/U. 50 ohm imp. pulse cable Corona min. starting voltage 17 KV. \$50/Ft.

RG 35/U. 70 ohm imp. armored. \$50/Ft.

Many other Cables & Wire in stock. Write.

SEE YOU AT THE  
IRE SHOW

BOOTH L, 2nd FLOOR  
MARCH 6 TO 9th INCL.

POWER EQUIPMENT

- Fil. Trans. 110v 60 cy in., 5vct/30A out. \$8.95
- In 110v 60 cy out 6.3vct/20A, 6.3V/1.8A, 6.3V/600MA \$4.95
- In 110v 60 cy out 2x5vct 6.75A, 5vct/13.5A. 3500 Test. \$6.95
- In 110v 60 cy out 10 vct/13A, 10vct/6.5A, 6.3vct/2A \$7.95
- In 115v 60 cy out 760vct/500MA, 800vct/40MA \$10.95
- In 110v 60 cy out 690vct/400MA. \$6.95
- Tapped in. 107 to 127v out 160 to 200v/700MA 12 Taps \$12.95
- In 110v 60 cy out 4V/16A, 2.5V/7.5A. \$4.75
- In 110v 60 cy out 17000V/144MA, w/choke 26" x 29" x 13" oil immersed \$65.00
- In 115v 60 cy out 2x5/5.5A 29kv ins. \$24.50
- 115V 60 Cy to 10800 V or 21000 V Dblr. PHICB. \$19.95

FILTER CHOKES

5HY 40 MA. 3 for. \$ .99	20 HY 50 MA. \$ .79
30 HY 25 MA. .79	11.5 HY 90 MA. 1.39
25 HY .065A. 1.00	6 HY 150 MA. .99
Dual: 1.52 HY 167A 1.95	25 HY 75 MA. 1.25
Dual: 120 HY 17 MA 2.49	.030 HY 2A. 1.39
Dual: 10 HY 200 MA3.50	5 HY 150 MA. 1.45
3.5 HY 500 MA. 4.95	Dual 7 HY 75 MA, 11 HY 60 MA. 1.39
10 HY 500 MA. 12.95	75 HY 225 MA. 2.25
6 HY 175 MA. 1.50	HY 400 MA. 1.75
116 HY 150 MA. 4.25	100 HY 1.4A. 1.95
35 HY 30 MA. 7.25	333 HY 1.12A. 2.29
	1 HY 1 Amp. 3.95
	20 HY 300 MA. 7.95
	10 HY 450 MA. 12.95
	MA. 14.95
	3.5 HY 130 MA. 1.25
	.01 HY 2.5A. 1.45
	5 Hy 200 MA. 1.45

RADIO PARTS DIV. ATT. MR. ROSEN

400 CYCLE TRANSFORMERS

Input	Output	Price Each
115V	6.3V/1.8A P/O APG2	\$1.49
57.5V	2x57.5V/.0001 A. P/O APG2	1.95
115V	2x145V/.000145A.	1.49
115V	780V, 27V/4.3, 6.3V/2.9, 1.25V/20A	3.95
115V	6.4V/11 Amp. P/O APQ7	2.25
115V	2x63V/1.25A, P/O APQ13	1.95
80v	6.3V/1A, 2.5V/2A P/O 1PE172A.	3.95
115V	15.35VCT/1A	1.95
115V	59.2V/118, 63V/8.1, 5V/2A, P/O APQ13	3.95
118V	6.3/9, 6/3V/.65V/6, 640/200 MA.	4.95
115V	2x14CV/00014A, 12GV/000012A, P/O APG2	1.95
115V	3460V/400 Ma. P/O APT 4	7.95
115V	23.5V Tapped 22V/47 MA.	1.95
115V	600VCT/36 Ma	1.95
115V	408VCT/11a, 120VCT/.250a, 6.3V/6.15, 5V/2A, 45V Tapped 28V/8 and 3a	4.95
115-80V	6.4V/2.5, 400VCT/35Ma, 6.4/150a.	3.95
115V	6.4V/7.5, 6.4/3.8, 6.4/2.5A 780V/. 27V/4.7, 6.3/2.9, 1.25/2a	2.49
115V	6.4V/8a, 6.4V/1A	1.95
115V	6.3V/5.35A, 6.3VCT/6.5a	2.49
115V	5V/2a, 6.3V/2a, 5V/2a, 6.3/5A 5V/15A, 5000V Ins.	3.99
80-115V	6.3/2.7, 6.3/66 6.3VCT/21A	2.95
115V	760V, 6.3V, 6.3V, 5V, 320V, 6.3V/20A	5.95
110V	220V	
110V	3V	
55V	20V/20V	1.49
115V	6.4/7.5, 6.4/3.8 6.4/2.5	2.95
115V	592V/118MA, 6.3/8.1a, 5V/2 V/E	4.95
115V	6.3V/9.1, 6.3VCT/.65a	
115V	2x2.5V/3.5A	2.95
115V	6VCT.00006 KVA	.98
115V	6.4/8a, 6.4V/1a	1.49
115V	1034 VCT/111a, 6.9V/10, 2x6.3V/1, 5V/2, 6.3/2, 63/1	6.49
115-80V	526VCT/50a, 6.3VCT/2a, 5VCT/29.	3.49
80-15V	400VCT/35Ma, 6.4/2.5, 6.4/15a	3.25
115V	2300VCT Large Qty	1.49
115-v	600VCT/36Ma	1.49
80-115V	2.5V/1.75, 5V/3A, 6.5V/6.5, 6.5/2A. For SCR729.	3.95
115V	640V/500MA, 2.5V/1.75A P/O APS 15B	2.95
80-115V	360VCT/20Ma, 1500V/1Ma, 2.5V, 6.3/2.5 6.3V/.6a. P/O 729A.	3.95
115V	2x2.5V/5A, 2.5V/10A. P/O APT 4	4.95
118V	2x2.5V/2.5a, 6.3V/2.25a 1200V Tap 1000V-750V P/O AN/AP5-15.	4.95
115V	742.5V/50 MA, 709V 47 MA, 671V/45MA	2.95
115V	600VCT/36 MA, 2 3/4x2 1/4 x3 1/4	
115V	1150-1150, 2 3/4x2 1/4x3 1/4, 640 VCT/250 MA, 6.3V/.9	
115V	6.3V/6, 5V/6A.	3.95
115V	6.3V/9.1a 2.5V/3.5A 6.3VCT/.65a 2.5V/3.5a	3.25
115V	9800V or 8600V/32MA.	12.50
115V	592 VCT/120 MA, 6.3V/ 8a, 5V/2A	3.50
115V	4540VCT/250 MA.	7.50
115V	5V/3A, 6.3V/2a.	1.75
115V	70 to 111V @ 247-622VA.	1.35
115V	5000V/290 MA, 5V/10A.	12.50
115V	2200V/350	5.45
115V	2.5V/6, E200V/2 MA.	14.95
115V	13.5 KV/3.5 MA.	11.50
115V	734 VCT/.177a, 1710VCT/.177a.	6.95
115V	6.3V/9A, 7.7V/.365A	2.79
100, 110 120, 130	2.5/20A.	4.85
115V	6.3V/12a, 6.3V/2a, 6.3V/1a P/O AN/APQ-5	5.85
115V	6.4VCT/7.5, 6.4VCT/3.8, 6.4VCT/2.5a	4.35
115V	6.3V/2.7, 6.3V/66A, 6.3VCT/21A	2.95
115V	6.5V/12A, 250V/100 MA, 5V/2a P/O AN/AP5-15.	3.50
115V	400VCT/35 MA, 6.4V/15a, 6.4V/2.5a.	2.25
80-115V	650VCT/50 MA, 6.3VCT/2A, 5VCT/2a P/O R58/ARQ8	2.45
115V	2400CT/5MA, 640V/5MA, 2.5V/1.75A	3.85

THERMISTORS VARISTORS

D-167332 (tube) . . . \$ .95	D-170225 . . . \$1.25
D-170396 (head) . . . \$ .95	D-167176 . . . \$ .95
D-67613 (button) . . . \$ .95	D-168087 . . . \$ .95
D-104690 for MTG in "X" band Guide \$2.50	D-171812 . . . \$ .95
D-167618 (tube) . . . \$ .95	D-171828 . . . \$ .95
	D-168549 . . . \$ .95
	D-168442 . . . \$3.00
	D-163293 . . . \$1.25
	D-98428 . . . \$2.00
	D-16187A . . . \$2.85
	D-171812 . . . \$ .95
	SA (12-43) . . . \$1.50
	D-167620 . . . \$3.00
	D-105598 . . . \$2.25

WRITE FOR  
C.E.C. MICRO-  
WAVE CATALOG  
NOW AVAILABLE

COMMUNICATIONS EQUIPMENT COMPANY  
CABLE ADDRESS: COMSUPO  
PHONE DIGBY 9, 4124  
131 LIBERTY ST. DEPT. E  
NEW YORK 7, N.Y.  
C.E.C. MONEY BACK GUARANTEE, \$3 MIN. ORDER.  
F.O.B. N.Y.C. SEND MONEY ORDER OR CHECK, ONLY SHIPPING CHARGES SENT C.O.D.

RADAR TELEVISION ELECTRONICS  
ELECTRONICS  
MICROWAVE SONAR

**SHOCK MOUNTS**

- No. 1 Square
  - No. 2 Square & Diamond
  - No. 4 Square & Diamond
  - No. 6 Square
  - No. 8 Square & Holder
  - No. 12 Square & Holder
  - No. 15 Square & Holder
  - No. 20 Square & Holder
  - No. 33 Square & Holder
  - No. 85 Square & Holder
  - No. 10 Square & Holder
  - No. 25 Square & Holder
  - No. 45 Holder
  - No. 65 Holder
- Write for More Data



Universal  
Output  
Transformer

Amertran Silcor.  
P11- 20,000/16,000/  
5000/4000 ohms. Sect.  
500/15/7.5/5/3.75/  
1.25 flats. 30 db.  
contin. flat. to 17,000  
CY. w/Diag. & Inst.  
for 6 watt amplifier  
\$4.75

**LOOK at these  
BIG VALUES!**

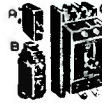

Heineman  
Ckt. Hkrs.  
for 400VDC  
Operation  
Amperes  
0.10, 3, 7,  
10, 50, 80,  
100, 150,  
Ea. \$1.10  
Klixon 25A ..... 75c  
Dual 8 & 25 Amp. .... \$2.25

**VEEDER  
Counter**

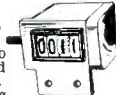

Counts to  
9999 and  
repeats.  
Many uses  
1/2" shaft. Front meas.  
1 1/2" x 1 1/2" ..... 98c



**VFD  
Capacitor**

High grade  
unit con-  
sists of 3  
gang cap.  
420 MMF  
per sect.  
ceramic ins. low drift,  
w/volts reduction gear  
120:1 w/ext. shaft and 4  
digit Veeder counter \$3.95

**BC-223 TRANSMITTER**

30 Watt Transmitter with  
crystal oscillator control on  
four preselected channels —  
also master oscillator. Fre-  
quency coverage 2000 KC.  
to 5250 KC. by use of  
three plug in coils. Five  
tube operation, 801 oscilla-  
tor, 801 power amplifier,  
two 40 modulators and one  
40 speed oscillator. Price  
with TU18 Tuning Unit  
3000-4500 KC ..... \$19.95

**OIL CONDENSERS  
FAMOUS MAKES  
BRAND NEW**

Mfd.	Volt	Price
15	220AC	\$2.00
.5	400	.45
1	600	.45
6	600	.98
7	800	1.05
.5	750AC	1.69
809		1.20
7.5	1K	.69
1.5	1K	.75
2	1K	.99
4	1K	.98
10	1K	1.95
15	1K	2.20
1.25	1.5K	1.05
1	1.5K	.89
1.5	1.5K	.95
2	1.5K	1.05
6	1.5K	2.25
1	2K	.90
1	2.5K	1.20
.15	4K	2.95
1.1	4.8K	2.95
.4	5K	2.95
1	6K	2.79
.15	15K	3.95
1.5	15K	7.95
1.1	17K	3.39
1	7.5K	2.95
1	7.5K	12.95
.15	8K	4.95
1	10K	14.95
.0016	15K	7.95
1	15K	30.95
.015	16K	6.95
.25	20K	16.95
.5	25K	36.95
1	25K	83.95
4	50	.25
1	100	.15
2.5	100	.23
2x.1	2ST	.15
2x.1	3TF	.15
2x.1	4ST	.16
2x.1	2ST	.15
.5	2TT	.15
.5	2ST	.15
2x.25	3ST	.21
2x.1	3ST	.21
2x.1	2TT	.20
3x.1	3ST	.25
1	2TT	.19
.5	1TT	.19
1	2ST	.23
1	2ST	.26
1	2TT	.20
.1	2ST	.21
2x.1	3ST	.27
2x.1	3BT	.25
2x.1	2ST	.26
3x.1	3ST	.28
2x.25	3ST	.23
.25	2TT	.20
1	2ST	.30
2x1	3ST	.35
2	2ST	.40
2	2BT	.39
2	2BT	.39
1000VDC		.45
1	2ST	.45
BT	Bot. Term.	
ST	Site Term.	
TT	Top Term.	
BT-Top Term.		



**INSULATORS**

**STAND OFFS**

w/alum base 1 1/4x3"	\$1.25
w/alum base 1 1/4x3"	.98c
w/alum base 1 1/4x3"	.98c
w/alum base 1x4"	.70c
w/alum base 1 3/4x3 3/8"	1.69
w/alum base 1 5/8x3"	1.00
IN84, x81, 2 1/4"	.90c
IN81 feed support 1 1/2"	.8c
IN82 feed support 3"	1.6c

Stand off 3"x1 1/2" ..... 20c  
Stand off 6 3/4x1 1/2" ..... 40c  
Spreader 2 1/8x5/8 Sq. .... 8c  
Spreader 2 1 1/16x7 1/16" d. .... 10c  
Thru panel 1 1/4x3/4" ..... 15c  
Rowl thru x53, 6 3/4x3" d. 1.10  
Antenna IN86 ..... 15c

Send your re-  
quirements for all  
types of Rotary  
Switches.

Mossman  
Type  
4PDT  
\$1.79



**UPRIGHT OIL CAPACITORS**

Fig.	Mfd.	Voltage	Terminals	Price
B	1	600VDC	2	35c
E	.25	400VDC	2	39c
E	.5	600VDC	2	39c
D	2 x .5	600VDC	3	49c
D	3 x .1	600VDC	3	55c
B	.25	400VDC	2	39c
B	.5	600VDC	2	39c
E	1	400VDC	2	35c
B	.1	400VDC	2	40c
D	.4	600VDC	2	39c
D	2 x .1	600VDC	2	50c
D	1	750VDC	2	35c
D	3 x .1	600VDC	2	55c
D	2 x .5	600VDC	3	49c
A	.1	600VDC	2	45c
A	.1	600VDC	2	45c
D	.1	500VDC	2	45c
A	.1	500VDC	2	45c
B	.1	600VDC	2	45c



Private Tele-  
phone for  
Home or Of-  
fice. Consists of  
Hangar, Buzzer,  
Pushbutton,  
Mount, Handset,  
50 Ft. Wire,  
Batteries. Complete set of two  
phones wired ready to operate.  
\$14.95



**Sound Power  
FIELD PHONES**

EE-108. Talking  
range 9 to 12 miles  
without batteries or  
current. Has crank  
and generator for  
signaling. In fine  
leather case. Weighs  
1 1/2 lbs. Brand  
New. A wonderful  
buy. 2 units as fig.  
above ..... \$37.50

**AN-GSC-TI  
(Code Train-  
ing Set)**

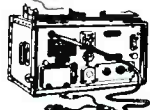

Operates on  
6V - 12V -  
24V - 115V  
DC 115V -  
230V AC with  
10 keys. Contains a blinker  
system and frequency adjustment.  
A real buy for Boy Scouts and  
students. Enclosed in trunk.  
Brand New. Complete ... \$23.95  
TG5 Telegraph Set includes Key,  
Buzzer, Ringer Bell in compact  
metal or wooden box. To learn  
code ..... \$2.95

**BC-605  
Interphone  
Amplifier**

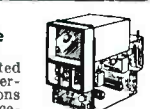

Easily converted  
to an ideal inter-  
com muni-  
cations  
set for office-  
home or factory. Original. New  
\$4.75

**Birtcher  
Tube Clamps**

- 926C
- 926-16
- 926-B1
- 926-B2
- 926-B8
- 926-C-13
- 926H
- 926C-19
- 926B-16
- 926A-14
- 926A
- 926C1
- 926A11
- Each 15¢
- 10 \$1.40
- 100 \$12.00

**ROTARY  
BEAM  
COUPLER**

RF Coupler  
360° rota-  
tion 1  
turn cou-  
pling link. Easily  
adapt 200 to 300 Mc.  
Plastic case mount  
on side. Price \$2.95

**MOUNTINGS**

- MT-5/ARR2
- MT-7/ARR2
- MT-17A/U
- MT-17A/U
- 3PDT 24-28 vdc 280 Allied DDX-3 1.50
- SPST 24-28 vdc 2400 GM 12917-1 75c
- DPDT 24 vdc 280 Allied BOG635 1.00
- 26 vdc 280 Allied BS 1.10
- (10A) DPDT 28 vdc 280 Allied BO 1.00
- 6D35 Allied KS 85c
- 5862
- DPDT 20-30 vdc Onnce 50XB 1.00
- DPDT 10-14 vdc Onnce 100AB 1.00
- DPDT 24-28 vdc PB21C057-A 1.00
- 3PDT 24-28 vdc GECR2791 1.50
- SPDT 24-28 vdc GECR2791 1.00
- DPDT 12 vdc Onnce 1.49
- DPDT 10-12 vdc 125 Onnce 1.49
- DPDT 27.5 vdc 400 Allied 1.10
- DPDT 9-14 vdc Allied 1.10
- DPDT 24v60cy 50 Allied 1.40

**RF CHOKES**

- 1Mhy/125Ma .23
- 1.9-2MchY .10
- 2.5Mhy/500Ma .39
- 3.2MchY .10
- 3.3MchY .10
- 3.6MchY .10
- 5.2Mhy/200Ma .39
- 5.5Mhy/500Ma .98
- 6.4MchY .10
- 10Mhy/350Ma .39
- 20MchY .18
- 94Mhy .10
- 100MchY .10
- 115Mhy/150Ma .39
- 185MchY .10
- 220MchY .18

Write for  
Flyers of  
Items Req.

If You Don't  
See It Write  
For It.

**Ceramicons**

Mmt	25
1	27
3	30
3.1	33
4	37
5	47
6	50
7	57
8.5	58
11	69
12	67
20	67
24	70
79	220
115	240
125	250
150	350
180	1000
200	200
100 for	\$7.50

**Feed**

40	100	50
180	200	500
175	500	470
185		

100 for \$9.50



**SELSYN MOTORS**  
115 V.A.C. 60 cycle #C-78248.  
Can be used to turn small anten-  
nas or as indicators. Size 3 1/2" x  
5 1/2". Price per pair ..... \$6.95

**Soldering  
Iron 200W**

121-130V Iron  
% removable  
copper tip.  
Heats in a min-  
ute. Complete  
with cord &  
plug. New with  
stand ... \$3.95

**ANTENNA MAST**

Are you in a dead spot. If you  
can't get a good T. V. Picture.  
Here is a Sig. Corp. Ant. mast  
30' high of rugged plywood con-  
struction to solve your prob-  
lem. It telescopes into 3 ten ft.  
sect. for easy storage. Easy to  
Mnt. Comp. with stakes &  
rods. Ea. \$19.95.

**SCR 183 REC. TUNING UNITS**

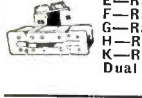

D-Range 850-1330 Kc  
E-Range 1330-2040 Kc  
F-Range 2.04-3 Mc  
G-Range 3.4-5 Mc  
H-Range 4-6 Mc  
K-Range 9.05-13.5 Mc  
Dual Range 400-600 Kc 6-9 Mc  
\$1.95 EACH

**SCR 183 TRANS TUNING UNITS**

1-1.2 Mc	\$1.49	5-6.2 Mc	1.49
1.2-1.5 Mc	1.49	4-5 Mc w/4495Kc	2.95
3.2-4 Mc	1.49	X.TAL.	2.95

Many Others

**WHOLESALE ONLY**

Phone or Write  
for Quantity & Price  
Digby 9-4124

ATT. MR. C. ROSEN

- 4,000,000 Mic.
- 300,000 Sil. Mic.
- 100,000 Oil Cond.
- 4,000,000 Resistors
- 400,000 Electrolytics
- 400,000 H.V. Mic.
- 5,000 K.V. Cond.
- 150,000 Prec. Resis.
- 500,000 Tube Clamps
- 1,000,000 An. Connec-  
tors
- 50,000 Dynamotors
- 20,000 Power Xfrms
- 20,000 Chokes
- 100,000 Antennas
- 50,000 Audio Xfrms
- 100,000 400 CyXfrms
- 100,000 Shock Mts.
- 25,000 Magnetrans
- 5,000 Magnets
- 50,000 Pulse Xfrms
- 50,000 Control Boxes
- 500,000 Tubes
- 300,000 Relays
- 500,000 Pats.
- 35,000 Vibrators
- 200,000 UG Connec-  
tors

**ARC 3 MINIATURE RELAYS**

Can SPDT 5 Prong. GECR2791C104 1.95  
SPDT 28 vdc 300 RBM55342 35c  
6 PST 22-28 vdc 300 RBM55528 35c  
SPST 22-28 vdc 300 RBM55251 35c  
DPDT 22-28 vdc 300 RBM55531 35c  
DPDT 22-28 vdc 300 RBM55526 35c

**Tons of Nuts & Bolts,  
Screws, Etc.**

- 1,000 Gibson Girls
- 500 BC 375 New and Complete
- 500,000 Insulators
- 150,000 Bind Posts
- 200,000 W a f e r  
Switches
- 500,000 Ceramicons
- 500,000 Ferrule Resis.
- 50,000 PL 64
- 25,000 JK 16



**RELAYS**

Con- tacts	Rating	Coil Ohms	Mfg.	Price
DPDT	24-28V	170	GECR2791B	75c
(8A)			100F3	
SPDT	28vdc	175	GECR2791B	75c
3PDT	24-28 vdc	175	GECR2791B	75c
4PST	24 vdc	180	GECR2791G	75c
DPDT	12 vdc	44	Leach 1067-	1.25
SPST			490	
DPDT	22-28 vdc	160	Leach	1.25
SPST	28 vdc	250	Allied BO48	75c
DPST	14 vdc	85	Price X20-A	65c
3PDT	24-28 vdc	280	Allied DDX-3	1.50
SPST	24-28 vdc	2400	GM 12917-1	75c
DPDT	24 vdc	280	Allied BOG635	1.00
26 vdc	280	Allied BS	1.10	
(10A) DPDT	28 vdc	280	Allied BO	1.00
6D35			Allied KS	85c
5862				
DPDT	20-30 vdc	Onnce	50XB	1.00
DPDT	10-14 vdc	Onnce	100AB	1.00
DPDT	24-28 vdc	PB21C057-A		1.00
3PDT	24-28 vdc	GECR2791		1.50
SPDT	24-28 vdc	GECR2791		1.00
DPDT	12 vdc	Onnce		1.49
DPDT	10-12 vdc	125	Onnce	1.49
DPDT	27.5 vdc	400	Allied	1.10
DPDT	9-14 vdc	Allied		1.10
DPDT	24v60cy	50	Allied	1.40

**ARC 3 MINIATURE RELAYS**

Can SPDT 5 Prong. GECR2791C104 1.95  
SPDT 28 vdc 300 RBM55342 35c  
6 PST 22-28 vdc 300 RBM55528 35c  
SPST 22-28 vdc 300 RBM55251 35c  
DPDT 22-28 vdc 300 RBM55531 35c  
DPDT 22-28 vdc 300 RBM55526 35c

Solenoid Aircraft Relay. 4PST High  
Amp Cutler Hammer 24VDC. \$3.95

Solenoid Aircraft Relay SPST High  
Amp double break 24 volt Leach  
7220-24. Many Others

**COMMUNICATIONS EQUIPMENT COMPANY**  
CABLE ADDRESS: COMSUPO  
PHONE DIGBY 9, 4124  
131 LIBERTY ST. DEP'T. E  
NEW YORK 7, N.Y.  
C.E.C. MONEY BACK GUARANTEE, 13 MIN. ORDER.  
P.O. B. N.Y.C. SEND MONEY ORDER OR CHECK, ONLY SHIPPING CHARGES SENT C.O.D.

**FULLY GUARANTEED BRAND NEW SURPLUS OFFERED BY A LEADING**

**A.C. MOTORS**

- 5071930**, Delco, 115 V., 60 Cycle, 7000 r.p.m. **Price \$4.50 each net.**
- 36938-2**, Haydon Timing Motor, 110 V., 60 cycle, 2.2 w.; 4/5 r.p.m. **Price \$3.00 ea. net.**
- Type 1600** Haydon Timing Motor—110 V., 60 cycle, 3.2 w., 4 r.p.m., with brake **Price \$4.00 each net**
- Type 1600** Haydon Timing Motor—110 V., 60 cycle, 2.2 w., 1/240 r.p.m. **Price \$3.00 each net.**
- Type 1600** Haydon Timing Motor 110 V., 60 cycle, 2.3 w., 1 r.p.m. **Price \$2.70 each net.**
- Type 1600** Haydon Timing Motor, 110 V., 60 cycle, 2.2 w., 1 1/5 r.p.m. **Price \$2.70 each net.**
- Type 1600** Haydon Timing Motor 110 V., 60 cycle, 3.5 w., 1 r.p.m. With shift unit for automatic engaging and disengaging of gear. **Price \$3.30 ea. net.**
- Type 1600** Haydon Timing Motor, 110 V., 60 cycle, 2.2 w., 1/60 r.p.m. **Price \$3.00 each net.**
- Eastern Air Devices** Type J33 Synchronous Motor 115 V., 400 cycle, 3 phase, 8,000 r.p.m. **Price \$8.50 each net.**
- Telechron Synchronous Motor**, Type B3, 115 V., 60 cycle, 2 r.p.m., 4 w. **Price \$5.00 each net.**

**SERVO MOTORS**

- CK 1**, Pioneer, 2 phase, 400 cycle. **Price \$10.00 each net.**
- CK 2**, Pioneer, 2 phase, 400 cycle. **Price \$4.25 each net.**
- 10047-2-A** Pioneer 2 phase, 400 cycle, with 40:1 reduction gear. **Price \$7.25 each net.**
- FPE-49-6** Diehl, Low-Inertia, 115 V., 60 cycle, 2 phase, .3 amps., 10 watt, output. **Price \$34.50 each net.**
- FPE-25-16** Diehl Low Inertia 20 V., 60 cycle, 2 phase, 1600 r.p.m., .85 amps. **Price \$10.00 ea. net.**
- FP 25-3** Diehl, Low Inertia, 20 V., 60 cycle, 2 phase, .50 amps., 3200 r.p.m. **Price \$10.00 each net.**
- CK2**, Pioneer, 2 phase, 400 cycle, with 40:1 reduction gear. **Price \$6.50 each net.**
- MINNEAPOLIS-HONEYWELL TYPE B** Part No. G303AY, 115 V., 400 Cycle, 2 phase, built-in gear reduction, 50 lbs. in torque. **Price \$8.50 each net.**

**AMPLIFIER**

- Pioneer Gyro Flux Gate Amplifier**, Type 12076-1-A. **Price \$17.50 ea. net, with tubes.**

**REMOTE INDICATING MAGNESYN COMPASS SET**

**Pioneer Type AN5730-2** Indicator and AN5730-3 Transmitter 26 V., 400 cycle. **Price \$40.00 per set new sealed boxes.**



**Kollsman Remote Indicating Compass Set** Transmitter part No. 679-01, indicator part No. 680k-03, 26 V., 400 cycle. **Price \$12.50 each net.**

**GYROS**

**Schwein Free & Rate Gyro** type 45600. Consists of two 28 V. D.C. constant speed gyros. Size 8" x 4.25" x 4.25". **Price \$10.00 ea. net.**



**Schwein Free & Rate Gyro**, type 46800. Same as above except later design. **Price \$15.00 each net.**



**Sperry A5 Directional Gyro**, Part No. 656029, 115 volts, 400 cycle, 3 phase. **Price \$17.50 each net.**

**Sperry A5 Vertical Gyro**, Part No. 644841, 115 V., 400 cycle, 3 phase. **Price \$20.00 each net.**

**Sperry A5 Amplifier Rack** Part No. 644890. Contains Weston Frequency Meter. 350 to 450 cycle and 400 cycle, 0 to 130 voltmeter. **Price \$10.00 each net.**

**Sperry A5 Control Unit** Part No. 644836. **Price \$7.50 each net.**

**Sperry A5 Azimuth Follow-Up Amplifier** Part No. 656030. With tube. **Price \$5.50 each net.**

**Pioneer Type 12800-1-D Gyro Servo Unit**. 115 V., 400 cycle, 3 phase. **Price \$10.00 each net.**

**Norden Type M7 Vertical Gyro**. 26 V., D.C. **Price \$19.00 each net.**

**Norden Type M7 Servo Motor**. 26 V., D.C. **Price \$20.00 each net.**

**Allen Calculator**, Type C1 Bank and Turn Indicator, Part No. 21500, 28 V. D.C. Contains 28 V. D.C. constant speed gyro. **Price \$10.00 each net.**

**COMPLETE LINE OF AIRCRAFT THERMOCOUPLES**

**D.C. MOTORS**



**5069625**, Delco Constant Speed, 27 V., 120 r.p.m. Built-in reduction gears and governor. **Price \$3.90 each net.**

**A-7155**, Delco Constant Speed Shunt Motor, 27 V., 2.4 amps., 3600 r.p.m., 1/30 h.p. Built-in governor. **Price \$6.25 each net.**

**C-28P-1A**, John Oster Shunt Motor, 27 V., 0.7 amps., 7000 r.p.m., 1/100 h.p. **Price \$3.75 each net.**

**Jaeger Watch Co.** Type 44-K-2 Contactor Motor, Operates on 3 to 4.5 volts D.C. Makes one contact per second. **Price \$2.00 each net.**

**General Electric** Type 5BA10AJ52C, 27 V. D. C., 0.65 amps., 14 oz. in. torque, 145 r.p.m. Shunt Wound, 4 lead reversible. **Price \$5.00 each net.**

**General Electric** Type 5BA10AJ37C, 27 V. D. C., .5 amps., 8 oz., in. torque, 250 r.p.m. Shunt Wound, 4 leads reversible. **Price \$6.50 each net.**

**D.C. ALNICO FIELD MOTORS**

**5067043** Delco 12 volts, 10,000 rpm. **Price \$5.50 each net.**

**5069600**, Delco, 27 V., 250 r.p.m. **Price \$5.00 each net.**

**5069466**, Delco, 27 V., 10,000 r.p.m. **Price \$3.50 each net.**

**5069370**, Delco, 27 V., 10,000 r.p.m. **Price \$5.00 each net.**

**S. S. FD6-16**, Diehl, 27 V., 10,000 r.p.m. **Price \$4.00 each net.**

**S. S. FD6-18**, Diehl, 27 V., 10,000 r.p.m. **Price \$4.00 each net.**

**S. S. FD6-21**, Diehl, 27 V., 10,000 r.p.m. **Price \$4.00 each net.**

**Sampsel Time Control Inc.** Alnico Field Motor, 27 V. D.C. Overall length 3 5/16" by 1 3/8". Shaft 5/8" long by 3/16", 10,000 r.p.m. **Price \$4.50 each net**

**GENERAL ELECTRIC D. C. SELSYNS**

**8TJ9-PDN** Transmitter, 24 V. **Price \$3.75 each net.**

**8DJ11-PCY** Indicator, 24 V. Dial marked—10° to +65°. **Price \$4.50 each net.**

**8DJ11-PCY** Indicator, 24 V. Dial Marked 0 to 360°. **Price \$7.50 each net.**

**RELAYS**

**Type B4** 28 volts D.C., 200 amps. continuous duty. Electric Auto-Lite Co. Part no. WSN4001. **Price \$2.50 each net.**

**Type B5B**, 28 volts D.C., 50 amps., continuous duty Hart Mfg. Co. Part no. 692R. **Price \$1.85 each net.**

**Type B8**, 28 volts D. C., 250 amps., intermittent duty Cutler-Hammer. Part no. 6041H139A **Price \$2.50 each net.**

**INSTRUMENT ASSOCIATES**

**37 EAST BAYVIEW AVE., GREAT NECK, N. Y. Telephone IMperial 7-1147**

**Write for Catalog NE100**

U. S. Export License-2140

March, 1950 — ELECTRONICS

**SUPPLIER OF ELECTRONIC & AIRCRAFT EQUIPMENT****IMMEDIATE  
DELIVERY****INVERTERS**

**Wincharger Corp.** Dynamotor Unit. PE-101-C. Input 13, V.D.C. or 26 V.D.C. D.C. AT, 12.6 or 6.3 amps. Output 400 V.D.C. AT. .135 amps., 800 V.D.C. AT. .02 amps., 9 V.A.C. 80 cycle at 1.12 amps.

Price \$10.00 each net.

**153F, Holtzer Cabot**, Input, 24 V.D.C. Output 115 V., 400 cycle, 3 phase, 750 V.A. and 26 V., 400 cycle, 1 phase, 250 V.A.

Voltage and frequency regulated also built in radio filter.

Price \$115.00 each net.

**149H, Holtzer Cabot.** Input 28 V. at 44 amps. Output 26 V. at 250 V.A., 400 cycle and 115 V. at 500 V.A. 400 cycle.

Price \$40.00 each net.

**149F, Holtzer Cabot.** Input 28 V. at 36 amps. Output 26 V. at 250 V.A., 400 cycle and 115 V. at 500 V.A., 400 cycle.

Price \$40.00 each net.

**12117, Pioneer.** Input 12 V.D.C. Output 26 V., 400 cycle, 6 V.A.

Price \$22.50 each net.

**12117-2 Pioneer.** Input 24 V.D.C. Output 26 V. 400 cycle, 6 V.A.

Price \$20.00 each net.

**12116-2-A Pioneer.** Input 24 volts D.C., 5 amps. Output 115 volts 400 cycle single phase 45 watts.

Price \$100 each net.

**5D21NJ3A General Electric.** Input 24 V.D.C. Output 115 V., 400 cycle at 485 V.A.

Price \$12.00 each net.

**PE218, Ballentine.** Input 28 V.D.C. at 90 amps. Output 115 V., 400 cycle at 1.5 K.V.A.

Price \$50.00 each net.

**METERS**

**Weston Frequency Meter.** Model 637, 350 to 450 cycles, 115 volts.

Price \$10.00 each net.

**Weston Voltmeter.** Model 833, 0 to 130 volts, 400 cycle.

Price \$4.00 each net.

**Weston Voltmeter.** Model 606, Type 204 P, 0 to 30 volts D. C.

Price \$4.25 each net.

**Weston Ammeter.** Model 506, Type S-61209, 20-0-100 amps. D. C.

Price \$7.50 each net with ext. shunt.

**Weston Ammeter.** Type F1, Dwg. No. 116465, 0 to 150 amps. D. C.

Price \$6.00 each net.

With ext. shunt \$9.00 each net.

**Westinghouse Ammeter.** Type 1090-D120, 120-0-120 amps. D. C.

Price \$4.50 each net.

**Weston Model 545.** Type 82PE Indicator. Calibrated 0 to 3000 RPM. 2 3/4" size. Has built-in rectifier, 270° meter movement.

Price \$15.00 each net.

**VIBRATOR**

**Rauland Corp.** vibrator non-synchros type Stock No. 3H6694-11; 6, 12 or 24 V.D.C., Input. Frequency 200 cycle.

\$3.50 each net.

**Sperry Phase Adapter.** Part No. 661102.

Used for operating three-phase equipment from a single phase source. 115 volts 400 cycle. Maximum load 50 watts.

Price \$15.00 each net.

**PIONEER AUTOSYNS**

AY1, 26 V., 400 cycle.

Price \$5.50 each net.

AY14D, 26 V., 400 cycle, new with calibration curve.

Price \$15.00 each net.

AY20, 26 V., 400 cycle.

Price \$7.50 each net.



AY31, 26 V., 400 cycle. Shaft extends from both ends.

Price \$10.00 ea. net.

AY38, 26 V., 400 cycle. Shaft extends from both ends.

Price \$10.00 each net.

**PIONEER PRECISION AUTOSYNS**

AY101D, new with calibration curve.

PRICE—WRITE OR CALL FOR SPECIAL QUANTITY PRICES

AY131D, new with calibration curve.

Price \$35.00 each net.

AY130D, new.

Price \$35.00 each net.

**PIONEER AUTOSYN POSITION INDICATORS**

Type 5907-17. Dial graduated 0 to 360°, 26 V., 400 cycle.

Price \$15.50 each net.

Type 6007-39, Dual, Dial graduated 0 to 360°, 26 V., 400 cycle.

Price \$30.00 each net.

**PIONEER TORQUE UNIT**

Type 12602-1-A.

Price \$40.00

each net.

Type 12604-3-A.

Price \$40.00 each net.

Type 12606-1-A. Price \$40.00 each net.

Type 12627-1-A. Price \$80.00 each net.

**MAGNETIC AMPLIFIER ASSEMBLY**

**Pioneer Magnetic Amplifier Assembly** Saturable Reactor type output transformer. Designed to supply one phase at 400 cycle servo motor.

Price \$8.50 each net.

**PIONEER TORQUE UNIT AMPLIFIER**

Type 12073-1-A, 5 tube amplifier, Mag-nesyne input, 115 V., 400 cycle.

Price \$17.50 each net with tubes.

**BLOWER ASSEMBLY MX-215/APG**

**John Oster,** 28 V.D.C., 7000 r.p.m. 1/100 h.p.

**Westinghouse** Type FL Blower, 115 V., 400 cycle, 67000 r.p.m., Airflow 17 C.F.M.

Price \$3.70 each net.

**RATE GENERATORS**

**PM2, Electric Indicator Co.,** .0175 V. per r.p.m.

Price \$8.25 each net.

**F16, Electric Indicator Co.,** two-phase, 22 V. per phase at 1800 r.p.m.

Price \$12.00 each net.

**J36A, Eastern Air Devices,** .02 V. per r.p.m.

Price \$9.00 each net.

**B-68, Electric Indicator Co.,** Rotation Indicator, 110 V., 60 cycle, 1 phase.

Price \$14.00 each net.

**Weston Tachometer Generator** (aircraft type) model 752-J4 single phase. A.C. output.

Price \$17.50 each net.

**SINE-COSINE GENERATORS**

(Resolvers)

**FPE 43-1, Diehl,** 115 V., 400 cycle.

Price \$20.00 each net.

**SYNCHROS**

**1F Special Repeater,** 115 V., 400 cycle. Will operate on 60 cycle at reduced voltage.



Price \$15.00 each net.

**7G Generator,** 115 V., 60 cycle.

Price \$30.00 each net.

**2J1F3 Selsyn Generator** 115 volts, 400 cycle.

Price \$5.50 each net.

**2J1M1 Control Transformer** 105/63 V., 60 cycle.

Price \$20.00 each net.

**2J1G1 Control Transformer,** 57.5/57.5 V., 400 cycle.

Price \$1.90 each net.

**2J1H1 Selsyn Differential Generator,** 57.5/57.5 V., 400 cycle.

Price \$3.25 each net.

**W. E. KS-5950-L2, Size 5 Generator,** 115 V., 400 cycle.

Price \$4.50 each net.

**5G Generator** 115 volts, 60 cycle.

Price \$50.00 each net.

**5G Special, Generator** 115/90 V., 400 cycle.

Price \$15.50 each net.

**5SF Repeater,** 115/90 V., 400 cycle.

Price \$19.00 each net.

**2J1F1 Selsyn Generator,** 115 V., 400 cycle.

Price \$3.50 each net.

**5SDG Differential Generator** 90/90 V., 400 cycle.

Price \$12.00 each net.

**1CT Control Transformer.** 90/55 volts, 60 cycle.

Price \$40.00 each net.

**INSTRUMENT  
ASSOCIATES**

ALL PRICES, F.O.B. GREAT NECK, N. Y.

37 EAST BAYVIEW AVE., GREAT NECK, N. Y.  
Telephone Imperial 7-1147

Write for Catalog NE100

Western Union address:  
WUX Great Neck, N. Y.

first time in RHS history!  
Special Purchase

# SALE!

while quantities last!

Transmitting—Cathode Ray—Special Purpose

# TUBES

Brand New! Standard Brands! No Seconds!

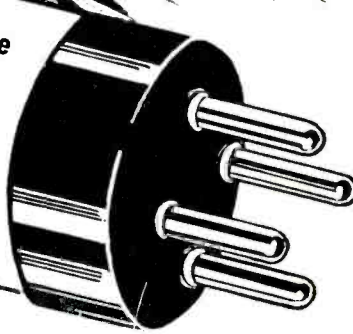

We made a once-in-a-lifetime purchase—and now you can benefit by the terrific savings. No need to tell you these are the most sensational values in our history! Just look at the listing below... compare the prices... you'll know what we mean when we say that you may never again come across a real savings opportunity like this!

**DIODE GAS RECTIFIERS**

4B26	\$ 3.49	866JR	\$ .98
249C	1.49	869B	26.50
575A	11.95	872A	1.12
816	.99	RX21	2.39
866A	1.05	RX120	8.95

**PENTODES**

307A/RK75	\$3.89	837	\$1.19
713A	.79	1613	.49
717A	.79	1619	.15
603	2.95	1851	.69
804	7.95	EF50	.39
807	1.09	HY115/145	.59

**UHF TRIODES**

2C40	\$2.95	703A/368AS	\$1.89
2C43	7.95	708A	3.59
2C44	.98	826	.39
2C46	6.95	8012	.89
3C24/24G	.35	GL434A	2.69
388A	.47	HY615	.19
885	5.95	VT127A/100TS	1.95

**THYRATRONS**

2D21	\$.89	2051	\$.39
3C23	2.19	COJ	3.65
3C31/C1B	.169	FG17	2.69
3C45	12.95	FG27A	6.95
884	1.19	FG81A	3.29
885	1.19	FG105	8.95
2050	1.19	FG172	13.95

**VOLTAGE REGULATORS**

OA3/VR75	\$.93	OD3/VR105	\$.69
OB3/VR90	.65	OD3/VR150	.49
	874		.39

**ACORNS**

954	\$.16	958	\$.22
955	.25	959	.35
956	.25	900A	.24
957	.22	9005	1.39

**TRIODES**

2C22/7193	\$.15	811	\$1.98
2C26A	.15	812	2.15
3C22	39.50	814	1.98
6J4	4.49	833A	33.95
10Y	.19	838	1.98
30 spec	.19	841	.29
45 spec	.19	843	.29
75TL	3.89	845	3.85
100TH	10.49	851	12.95
211	.25	1626	.25
250TH	18.75	8005	4.75
304TH	3.49	8011/WL538	.25
304TL	1.29	8011	22.50
316A	.29	8025	3.69
450TH	16.95	F123A	7.95
710A	.25	F127A	15.95
800	1.49	F128A	69.50
801A	.19	F862A	397.50
805	3.69	HYE1148	.29
808	.99	ML101/GL605	49.50
809/3C30	1.89	WL530	12.95
810	7.95		

**DIODE VACUUM RECTIFIERS**

3B24	\$1.49	8013	\$1.39
3B26	1.49	F660/WL562	49.50
15R	.49	RK72	.59
100R/8020	.89	RK73	.59
GL151	.89	VU11	.49
250R	5.95	WL531	1.75
371A	.39	WL616	37.50
371B	.49	KC4	37.50
705A	.69	ML100	37.50
1616	.49	F606	37.50

**MINIATURES**

9001	\$.32	9003	\$.33
9002	.25	9006	.15

**CATHODE RAY TUBES**

2AP1	\$3.89	5CP1	\$1.29
3AP1	4.59	5CP7	2.95
3BP1	2.39	5FP7	1.19
3CP1	1.39	5GP1	2.98
3DP1	1.79	5JP1	29.95
3FP1-S2A	2.79	5JP2	8.95
	.97	5LP1	12.95
3CP1	5.95	7BP7	3.49
4AP10	2.98	8LP7	1.98
5AP1	2.95	902	3.39
5AP4	2.95	905	2.49
5BP1	1.85	908/3API	4.95

**CRYSTAL RECTIFIERS**

IN21	\$.49	IN23A	\$.79
IN21A	.89	IN23B	1.89
IN21B	.89	IN27	.89
IN23	.59	IN34	.82

**KLYSTRONS**

2K25/723AB	\$23.50	723A/B	\$12.95
2K28	24.95	726A	6.75
417A	3.95	726B	29.50
707B	14.95	726C	49.50

**TWIN PENTODES**

3E29	\$8.95	829UH	\$7.45
815HF	1.59	832A	4.89

**TETRODES**

3D21A	\$.98	715A	\$5.49
4-65A	14.21	715B	6.59
4-125A	24.03	715C	19.95
4-250A	34.25	813	6.85
E27	12.45	850	14.95
257B	12.45	861	9.49
5D21	24.45	885	.79
350B	1.39	1614	1.35

**GAS SWITCHING TUBES**

1B24 TR	\$.59	532A	\$1.89
1B26 TR	2.79	1B36 anti TR	3.95
1B27 TR	7.95	721A anti TR	1.98
1B29 TR	.79	724B anti TR	2.49
1B32	1.89	1960/SB36 diode	.89

**PHOTOTUBES**

1P24	\$.59	930	\$.98
1P36	2.98	931A	2.39

**TWIN TRIODES**

2C21/RK33	\$.24	2C34/RK34	\$.22
1612	.24	RK59	1.69

**MAGNETRONS**

2J21A	\$.79	2J48	\$12.75
2J22	.79	2J51B	22.50
2J25	6.95	5J29	11.95
2J27	12.75	850	17.50
2J31	8.49	714AY	3.59
2J32	12.95	725A	6.45

**DUO-DIODE GAS RECTIFIERS**

3B22/EL1C	\$.98	CK1005	\$.09
4B24/EL3C	1.98	CK1006	.85

**SPECIALS**

23D4 ballast	\$.29	1625 beam amp	\$.19
26D7 beam amp	.29	1629 tuning eye	.98
559 UHF diode	.98	1631 beam amp	.98
876 ballast	.29	1636 beam amp	.98
1624 beam amp	.67	REL21 spark gap	.98

1630 orbital beam hexode. \$ .49  
RK60/1641 duodiode vac rect. .42

**RECEIVING TUBES**

OA2	\$1.29	6B8G	\$.69	12AT7	\$.79
OA4G	.89	6BA6	.55	12AU6	.57
OB2	1.67	6BF6	.52	12AU7	.67
OZ4	.57	6BF6	.57	12AV6	.54
OA3	.44	6BG6G	1.47	12BA6	.55
1A3	1.09	6BH6	.59	12BE6	.49
1A4	.97	6C4	.19	2C8	.34
1A4P	.97	6C4	.19	12F5GT	.58
1A5GT	.49	6C5	.47	12H6	.27
1A6	.79	6C6	.57	12J5GT	.34
1A7GT	.67	6C8G	.69	12J7GT	.67
1AB5	.59	6D8	.44	12K7GT	.52
1B3/8016	1.15	8D8G	.47	12L8	.59
1B4	1.19	6E5	.69	12Q7	.49
1B5 25S	.89	6E5	.47	12SA7	.57
1C5GT	.59	6F6	.57	12SC7	.54
1C6	.89	6F6GT	.57	12SF5	.59
1C7G	.89	6F7	.69	12SF7	.54
1D5GP	.97	6F8G	.57	12SG7	.52
1D7G	.89	6G6G	.69	12SH7	.35
1D8GT	.95	6H6	.39	12SJ7	.47
1F4	.75	6H6GT	.37	12SK7	.57
1F5G	.75	6J5	.47	12SL7	.59
1G4GT	.65	6J5GT	.39	12SN7	.52
1G6GT	.65	6J6	.77	12SQ7	.49
1E7G	1.15	6J7	.47	12SR7	.49
1H4G	.55	6J7GT	.65	12Z3	.69
1H5GT	.54	6K5GT	.79	14A4	.79
1H6GT	.87	6K6GT	.44	14A7	.52
1J0G	.75	6K7	.49	14B6	.67
1L4	.48	6K8	.79	14F7	.69
1L4A	.79	8I5GT	.87	14F8	.79
1LA6	.89	6L6	1.05	14H7	.59
1LB4	.89	6L6G	.99	14J7	.87
1LC5	.69	6L6GA	.85	14N7	.85
1LD5	.79	6L7	.79	14Q7	.53
1LE3	.69	6L7G	.87	14R7	.67
1L5	.79	6Q7	.75	19	.69
1LH4	.79	6R7	.64	24A	.49
1LN5	.67	6S7G	.79	25L6GT	.53
1M4	.59	6S8GT	.77	25Z6GT	.49
1P5GT	.67	6SA7	.44	26	.49
1Q5GT	.67	6SC7	.79	28	.42
1R4	.59	6SD7GT	.44	28D7	.35
1R5	.69	6SF5	.49	30	.37
1S1	.59	6SF7	.59	31	.59
1S5	.49	6SG7	.59	32	.85
1T4	.53	6SH7	.37	32L7GT	.89
1T5GT	.69	6S7	.44	33	.69
1U4	.59	6SK7GT	.44	34	.37
1V	.57	6SL7GT	.59	35/51	.57
2A3	.87	6SN6GT	.97	35A5	.63
2A4G	1.07	6SN7GT	.54	35B5	.25
2A5	.69	6SR7	.44	35C5	.59
2A6	.79	6SR7GT	.52	35L6	.52
2A7	.79	6SS7	.49	35W4	.39
2V3G	.69	6ST7	.72	35Y4	.49
2N2	.37	6SU7GT	.25	35Z3	.57
3A2A	.34	6SV7	.79	35Z4	.39
3A3	.34	6T7G	.69	35Z5	.44
3A5	.79	6T5G	.65	36	.67
3A8	1.59	6U6GT	.63	37	.35
3B7/1291	.29	6U7G	.49	38	.37
3D6/1299	.29	6V6	.89	39/44	.27
3LP1	.79	6V6GT	.57	41	.49
3Q5GT	.47	6W4	.63	42	.49
3S4	.67	6W7G	.77	43	.49
3S4	.57	6X4	.57	45	.52
3V4	.67	6X5GT	.47	45Z3	.57
5R4GY	1.09	6Y6G	.67	45Z5	.65
5T4	.49	6C7G	.98	46	.52
5U4G	.49	6ZV5G	.59	47	.69
5V4G	.87	7A4/XXL	.49	49	.85
5W4	.67	7A6	.59	50	1.39
5X4G	.57	7A7	.53	50A5	.69
5Y3GT	.39	7AG7	.72	50B5	.53
5Y4G	.49	7B1	.53	50L6GT	.52
5Z4	.77	7B6	.67	50Y6	.57
6A3	.92	7B7	.59	56	.45
6A4LA	1.09	7C4	.34	57	.45
6A6	.79	7C5	.48	58	.49
6A7	.69	7C7	.59	59	.89
6A8	.75	7E5	.67	70L7	.99
6AB7	.79	7F6	.54	71A	.59
6AC7	.74	7E7	.62	75	.53
6AD7G	1.09	7F7	.59	76	.44
6AF6G	.79	7H7	.59	77	.43
6AG5	.69	7K7	.89	78	.44
6AG7	.98	7L7	.69	80	.37
6AH6	1.29	7N7	.67	81	.15
6AJ5	.79	7O7	.59	82	.84
6AK5	.85	7R7	.69	83	.75
6AL6	.79	7V7	.87	83V	.89
6AK5	.59	7W7	.79	84/6Z4	.56
6AQ5	.49	7X7	.75	85	.69
6AQ6	.59	7Y4	.47	80Y	.35
6AR5	.52	7Z4	.57	117L7	.79
6AT6	.44	12A	.57	M7	1.19
6AU6	.59	12A6	.17	117N7	1.19
6AV6	.47	12A7	.89	117P7	1.19
6B4G	.89	12ASGT	.49	12ASGT	.49
6B6G	.79	12AH7G	.80	11	

# RHS Warehouse Clearance SALE!

Profit by these spectacular values! We're clearing our warehouse to make room for incoming stock! Everything goes!

## TRANSFORMERS—115v 60 cyc

### OIL CONDENSERS—DC RATINGS

3x1	mfd	600v	\$4.9	15	mfd	2000v	\$4.95
25	mfd	600v	.25	.1	mfd	2500v	1.19
1	mfd	600v	.25	.25	mfd	2500v	1.29
1	mfd	600v	.25	.5	mfd	2500v	1.98
2x2	mfd	600v	.57	.01	mfd	3000v	1.07
4	mfd	600v	.57	.05	mfd	3000v	1.19
6	mfd	600v	.97	.1	mfd	3000v	1.39
8	mfd	600v	1.05	.25	mfd	3000v	1.49
10	mfd	600v	1.15	.5	mfd	3000v	1.69
3x1	mfd	1000v	.59	1	mfd	3000v	2.19
25	mfd	1000v	.29	.2	mfd	3000v	3.47
.5	mfd	1000v	.39	4	mfd	3000v	4.45
1	mfd	1000v	.49	12	mfd	3000v	4.65
2	mfd	1000v	.69	1	mfd	3600v	2.39
4	mfd	1000v	1.29	.25	mfd	4000v	1.98
8	mfd	1000v	1.89	.5	mfd	4000v	2.49
10	mfd	1000v	2.07	1	mfd	4000v	2.79
20	mfd	1000v	3.29	2	mfd	4000v	3.10
.5	mfd	1500v	.77	3	mfd	4000v	4.95
1	mfd	1500v	.97	.1	mfd	5000v	1.98
2	mfd	1500v	1.19	.25	mfd	5000v	2.29
4	mfd	1500v	1.98	1	mfd	5800v	2.98
24	mfd	1500v	4.98	1	mfd	7000v	1.49
1	mfd	2000v	.69	.01	mfd	7500v	1.79
.25	mfd	2000v	.89	.02	mfd	7500v	1.79
.5	mfd	2000v	.97	.03	mfd	7500v	1.79
1	mfd	2000v	1.29	.05	mfd	7500v	1.79
2	mfd	2000v	1.98	1	mfd	7500v	1.79
4	mfd	2000v	3.89	2x.1	mfd	7500v	4.95
8	mfd	2000v	4.95	.02	mfd	12000v	9.95

### HIGH CAPACITY CONDENSERS

2x3500	mfd	25v	\$3.47	100	mfd	50v	.45
2500	mfd	3v	3.35	4000	mfd	18v	1.95
3000	mfd	25v	2.45	4000	mfd	30v	3.25
650	mfd	80v	1.29	2350	mfd	24v	2.25
1000	mfd	15v	.98	10000	mfd	25v	4.57
200	mfd	35v	\$.57				

1000KC crystal BT cut	\$3.95
3" scope shield	\$1.29
2 sp. dial dr. for 1/4" shaft ratios 5 to 1-1 to 1	\$.49

### SELENIUM RECTIFIERS FULL WAVE BRIDGE TYPE

Input: 0-18v AC Type #	Output: 0-14.5v DC Max. DC Current	Price
18D1	1.2	\$2.59
18E1	2.4	3.49
18F1	6.4	4.95
18K1	13.0	8.95
18J1	17.5	11.95
18K2	26.0	17.95
18K3	39.0	24.95
18K4	52.0	29.95
18K5	65.0	35.95

Input: 0-40v AC Type #	Output: 0-34v DC Current	Price
40D1	0.6	\$2.95
40E1	1.2	3.49
40F1	3.2	5.79
40K1	6.0	9.95
40J1	9.0	12.95
40K2	12.0	18.95
40J2	18.0	22.45
40K4	24.0	32.50
40K5	30.0	37.95
40J4	36.0	42.50

Input: 0-120v AC Type #	Output: 0-100v DC Max. DC Current	Price
40D1	.6	\$7.85
40E1	1.2	10.76
40F1	3.2	16.65
40K1	6.0	27.47
40J1	9.0	34.35

### SINGLE PHASE FULL WAVE—Center Tapped

Input: 10-0-10v AC Type #	Output 8v DC Max. DC Current	Price
20D1	1.2	\$1.89
20E1	2.4	2.29
20F1	6.4	3.87
20K1	12.0	4.95
20D1	18.0	7.95
20K2	24.0	11.95
20K3	30.0	14.95
20K4	48.0	17.95
20K5	60.0	22.49
20K6	72.0	25.57
20K7	84.0	27.95
20K8	96.0	32.50
20K10	120.0	36.50

### THREE PHASE FULL WAVE—Bridge Rectifiers

Input: 120v AC Type #	Output: 150v DC Max. DC Current	Price
40D31	.9	\$16.52
40E31	1.8	19.87
40F31	4.75	27.95
40K31	9.0	32.50
40J31	12.0	54.69

Input: 240v DC Type #	Output: 0-300v DC Max. DC Current	Price
40J61	.9	27.45
40F61	1.8	33.65
40E61	4.75	49.95
40K61	9.0	92.76
40J61	12.0	98.75

Current ratings can be increased 2 to 2 1/2 times by fan cooling

### HS—Herm. Sealed OF—Open Frame

SECONDARIES:	Wgt	Ht	W	D	Price
HS 6350v @ .025 arms (16KV ins)	33 1/2	5	7 1/2	8	\$11.95
OF 6250v or 3850v or 2600v @ .050 arms	37	12	8	4	13.95
HS 2500v @ 4 ma; 340-350v @ 150 ma; 6.3v @ 9A	13	5	4 1/2	4	3.49
HS 1600v @ 5 ma; 340-340v @ 300 ma	9 1/2	5	4	4	4.45
HS 1540v @ 5 ma; 340-340v @ 300 ma	16	5	5	4	4.35
FS 1120-0-1120v @ 500 ma; 12v CT @ 14A; 2.5v @ 10A; 17v @ 2.5A; 32v @ 25 ma	45	7 1/2	10	7 1/2	27.00
HS 115/230 pri.					
HS 925v @ 10 ma; 525-0-525v @ 60 ma; 2x5v @ 3A; 6.3v CT @ 3.6A; 6.3v @ 2A;	14 1/2	5	4 1/2	4 1/2	5.55
FE 700-0-700v @ 300 ma	34	5	11 1/2	4 1/2	7.55
FE 500-0-500v @ 175 ma	16	5	5 1/2	4 1/2	4.55
FS 430-0-430v @ 340 ma; 6.3v CT @ 6.3A; 5v @ 6A	14	5	4 1/2	4 1/2	4.85
HS 425-0-425v @ 75 ma; 6.3v @ 1.5A; 5v @ 3A	8	5	3 1/2	3 1/2	3.65
FE 415-0-415v @ 60 ma; 5v CT @ 2A 115/230 dual pri	7 1/2	4 1/2	3 1/2	3 1/2	4.97
HS 405-0-405v @ 150 ma; 6.3v CT @ 2A; 5v @ 3A; 2.5v CT @ 5A	18	6 1/2	4 1/2	4 1/2	4.75
HS 400-315-0-100-315v @ 200 ma; 2x6.3v @ 9A; 5v @ 3A; 2.5v @ 2A	12 1/2	5 1/2	4 1/2	4 1/2	5.35
HS 500-385-0-385v @ 200 ma; 3x6.3v @ 6A; 5v @ 3A; 2.5v @ 2A	15	6 1/2	4 1/2	4 1/2	4.75
HS 325-0-325v @ 12 ma; 255-0-255v @ 240 ma	18	5 1/2	4 1/2	4 1/2	4.25
HS 300-0-300v @ 65 ma; 6.3v @ 2.5A; 6.3v @ 1A; 2x5v @ 2A	6	3 1/2	2 1/2	2 1/2	3.25
HS 120-0-120v @ 50 ma	3	4 1/2	3 1/2	3 1/2	2.95
HS 80-4-80v @ 225 ma; 5v @ 2A; 5v @ 4A	3	4 1/2	3 1/2	3 1/2	2.97
FE 0-17.4-21.6/25.8v @ 400 ma; 6.4v @ 5A; 2.6v CT @ 2.5A pri 115/230.	7	5	5	3	3.85

### SECONDARIES

SECONDARIES:	Wgt	Ht	W	D	Price
OF 18 or 36v @ 15A	16	6 1/2	6	3 1/2	\$8.75
FS 25.5v CT @ 2.25A	5 1/2	4 1/2	3 1/2	3	2.17
FS 12.6v CT @ 10.1v 11v CT @ 6.5A	12 1/2	6 1/2	5 1/2	3 1/2	6.35
FE 3x10.3v CT @ 7A	17 1/2	4 1/2	7	5 1/2	6.95
HS 6.5v @ 12A; 6.3v @ 2A; 115v @ 1A	9	5 1/2	4 1/2	3 1/2	3.50
HS 6.4v @ 10A; 6.3v @ 6A; 7 1/2	5 1/2	4 1/2	3 1/2	2	2.77
OP 6.5v @ 8A; 6.5v @ 6A; 2.5v @ 1.75A @ 6A	9	4 1/2	4 1/2	3 1/2	4.17

### TRANSFORMERS—220v 60 CYC

SECONDARIES:	Wgt	Ht	W	D	Price
FE 512.5-0-512.5 @ 427 ma.	24 1/2	6 1/2	6 1/2	4 1/2	5.35
FE 385v @ 6A; 4 @ 25A	10	5 1/2	4	4	2.95
FE 3x8.3v CT @ 3A; 6.3v CT @ 1.6A	9 1/2	5 1/2	4	3 1/2	2.95
FE 10v CT @ 6.5A; 6.3v CT @ 2.5A; 6.3v CT @ 1.8A 220/440 pri.	13	5 1/2	5 1/2	4 1/2	3.95

### FILTER CHOKES—HI V INS

SECONDARIES:	Wgt	Ht	W	D	Price
FE 14/3.5 hy @ 40/400 ma	17	4 1/2	6	6 1/2	\$6.95
FE 3 hy @ 50 ma/300 ohms	1 1/2	1 1/2	1 1/2	1 1/2	3.33
FE 2 hy @ 175 ma/60 ohms	1	2	1	1 1/2	1.49
FE 5 hy @ 70 ma/100 ohms 2 dual @ 350 ma/6 ohms	5	3	4	3	2.39
HS 1.1 hy @ 5A	12	6	4	3	6.97
FE .065 hy @ 2.5A	9	4	4	3	2.49
HS .05 hy @ 15A	11	6	4	3	7.97

### COMPONENTS

50 mmfd ceramic condensers	\$.29
50 mmfd button condensers	.07
55 mmfd ceramicon feed thru	.08
4-30 mmfd ceramicon trimmers	.29
25, 50 mmfd air trimmers screwdriver	.29
100, 140 mmfd air trimmers screwdriver	.39
50 mmfd 5KV GE vacuum condensers	1.49
1 mid 600v donut condenser (152 in box)	1.98
TMC-300 national variable 300 mmfd	1.29
Single gang variable 33-435 mmfd	.69
Five gang variable 11.5-30 mmfd per section	.98
Three megacycle IF coil (double slug)	.29
Thirty megacycle IF coil	.19
80 meter osc. coil for ARC5	.29
80 meter PA final coil for ARC5	.29
0-1 MA meter Weston 506	2.95
-10+5 decibel meter Weston 301	9.95
2v, 6v, 12v vibrators	.98
Circuit breaker 15 amp	.69
137 key	.69
200 watt power supply kit, complete	17.95
400 watt modulation xformer 803, 813, 100th	19.95
Output xformer UTC pri: 8500 ohms, sec: 0.8-125-500	.69
500 watt 12.5 ohm Rheostat	3.49
Driver unit WE 35 watt	4.95
Horn throat for above	.39
Rotary switch GE Mycalex, 2 deck SP3T	.49
Plate caps ceramic, 2x2, 807, etc	.19
Plate caps ceramic, 866A, 813, etc	.29
Couplings ceramic 1/4" to 3/8"	.29
Couplings ceramic 3/8" to 1/2"	.29
Couplings ceramic 1/2" to 3/4"	.29
Couplings ceramic 3/4" to 1"	.29
Crystal socket ceramic 2 prong 5/32"	.14

### SOCKETS

Angle octal	\$.19
Margit	.59
Dihedral	.59
Safety recessed	.39
Mycalex for 813	.59
Ceramic for 5D21	\$.89
Ceramic for 832	.69
826, 829	.69
Mycalex for VT127A	.59
Ceramic acorn	.29
Ceramic for 866A	.59

### EQUIPMENT

APN-1 altimeter transceiver	New	\$7.95	
ATR inverter 12v DC in 110v AC 100w out	New	16.95	
AN/CRW-2 UHF receiver	New	5.95	
BC 1016 tape recorder	New	139.50	
HC 950A-121 xmitter 100-156 mc, modulated	New	49.50	
HC 778 Gibson Girl Shellworm	New	3.95	
RC3755 xmitter, 7 tuning units, dynamotor	Like New	69.50	
IC-AL229 receiver	Used	2.95	
BC 733 receiver	Used	6.95	
BC 456 modulator	Used	24.95	
BC 434A control box/SCR269	Used	2.45	
BC 996T1 interphone amplifier Like New	6.95		
BC 602A control box/SCR522	Used	2.49	
BK-22 relay for SCR269	New	2.95	
RK-22 relay for SCR269	Used	1.95	
CP1 Navy unit w/200 KC crystal	New	14.95	
Constant Voltage transformer, sola	100/260-60c in 115v-17A out	New	16.95
DM19 dynamotor 12v DC in 200 ma cont out	Good	5.95	
FE8 foundation unit	Good	4.95	
1-135E test set for handy talkie	Good	7.95	
KM1203 wire recorder GE, complete	Good	97.50	
LM7 or 10 frequency meter	Good	37.50	
MN26C compass receiver	Good	24.95	
M110 dynamic chest mike	New	4.95	
MT28 mounting rack ARN5	New	4.98	
PE34 dynamotor/SCR22	Good	1.98	
PE37A vibrator power supply	New	4.95	
R89/ARN5 receiver	New	7.95	
SCR158 altimeter, complete	New	29.95	
T17B carbon mike	Good	.98	
T21B field microphone radiossode	Good	19.95	
TU25 tuning unit/BC223	New	1.79	

### PHONE DIGBY 9-0347

Write for quantity prices  
Prices subject to change without notice

All Merchandise Guaranteed

F.O.B. N.Y.C. Minimum Order \$10.

20% Deposit Required

# RADIO HAM SHACK Inc.

189 GREENWICH STREET . NEW YORK, N. Y.



# SPECIAL SURPLUS BROADCAST OF OUR SUPER SPECIALS!!!

## Amertran "TRANSTATS" Voltage Regulator



11.5 KVA 50-60 cy. Commutator range 0-115 V. Max. Amps. 100. Reconnection diagram available for 230 V. 50 A operation. BRAND NEW. Factory Cases \$100.00

## TRANSTAT VOLTAGE REGULATOR



Amertran type RIF. Input: 115 V, 400 cy. 0.5 KVA, 5.5 max. amps. Output: 92-115V. 5 1/2 x 4 1/2 x 3 1/2. \$1.95

25 KVA Fixed winding 115/160. Commutator range 103-126 V. 2.17 Max. Amps. \$9.45

## DECK ENTRANCE INSULATORS (Bowl and Flange Type)



Mfd. by Ohio Brass Co. Heavy galv. metal flange 10 1/2" D. Pure bowl set in rubber gaskets. Top bell 7 1/2" D. Brass feed thru 10 1/2" L. Insul. dist. between top bell and flange 6 1/2". \$3.50

## DYNAMOTOR GENERATOR



Model 3975-1. Electric Spray Co., part of "Gibson Girl". Input 28 VDC @ 1.75 amps. Output 200 VDC @ 0.10 amps. 7" L. 3 1/2" D. \$1.00 ea.

## SELECTOR SWITCHES



Heavy duty. E. S. Control any type of multi-circuit devices. Removable contacts enabling any comb. of closed and open circuit. The following available: 5 section-10 pole or 10 section-20 pole. \$1.50 ea. Case lots of (8) \$8.00 or (5) cases, special... \$32.50

## MINE DETECTOR SCR 625



Detects metallic objects (ferrous or non-ferrous) to a depth of approx. 6 ft. Find outboard motors on the bottom of lakes, locate underground piping, treasure, metallic fragments in lumber, etc. New, complete with inst. book, \$65.00. Used but like new... \$45.00

## B. C. 604 F. M. TRANSMITTER



Wide or narrow band FM. 30 watt power output. Excellent possibility for ten or eleven meter exciter. Freq. 20-27.9 MC. Working space permits modification. W/ tubes but less power supply and xtals. LN \$11.50. Complete with Crystal, \$25.00

## NEW SWITCH INTERLOCKS



Cory Type B857. Single Key Oper. Interlocking of doors, vaults, reactor or resistor-enclosures, oil circuit breakers, etc. \$1.98  
Cory Type B936. Single Key Oper. SPST SW w/ Yale Cyl Lock 60A tumbler lock. \$2.49  
Cory Type B1536. Supervisory Oper. 2 key type. \$2.95

## DELCO CONSTANT SPEED MOTOR



Type A-7155, 27 VDC, 2.4 A. 1.30 HP, 3600 RPM. 2 1/2" Diam. x 5 3/4" L. 7/8" Sh. Ext. Cont. Duty. Base mounted. \$4.25 ea.

## VIBRATOR POWER SUPPLY (PE 204A)



Used with Telephone Repeater BE-99A. Input 12 VDC. Output 2 windings @ 4.3 VDC @ 50 MA; 2 @ 45 VDC @ 5 MA; 2 @ 85 VDC @ 5 MA. Loaded with parts. New \$1.95

**YJ RADIO EQUIPMENT.** Two Channel, automatic responding Radar Beacon or Beacon. Designed for shore installation. Automatically transmits coded signals in reply to interrogating signals from craft equipped with radar or IFF equipment. Replies to interrogating signals in the (A) Band 176 MC, (B) Band, 515 MC. Rectifier power unit; A and B Band transponders, transmitter and receiver complete with 30 tubes, 11 1/2" x 36" L. 18" H. 17" W. Wgt. 270 lbs. LN. Project Model Cased. \$80.00  
\$4.95: 5 CPT @ \$3.50; 3 EP1 @ \$2.95.

**HOT SPECIALS—CONDENSERS—Standard Brands**  
2550 MFD @ 150 WVDC TUBULAR @ 50¢  
40 MFD @ 200 WVDC TUBULAR @ 35¢  
16 MFD @ 500 WVDC TUBULAR @ 20¢  
1 MFD @ 600 WVDC TUBULAR @ ea. 15¢  
25 MFD @ 600 WVDC OIL IMPREG TUBULAR (CAW 481074 17¢ ea.; 10 for \$1.50)  
Same as above but 400 volt 15¢ ea.; 10 for \$1.35  
501 MFD @ WVDC PAPER TUBULAR HERALD SPECIAL 10¢ ea.; 10 for \$1.50

**RAYTHEON DEFLECTION COILS.** #18820 for 4CT5 CRT. Metal Cased. \$1.85  
**COMMAND SET EQUIVALENT—BC 450.** Excellent VFO using 2 Type 45's and 2 Type 10 tubes. 40 WATTS CW with one coil. (COIL RANGES: 2 - 2.5, 2.5 - 3.2, 3 - 3.6, 3.6 - 4.3, 4 - 4.8, 6 - 7.3, and 7.3 - 9 MC. Your choice of coils. \$6.95  
**COMM. BAND TRANSMITTERS** 2 - 3 MC. LN \$7.95, 3 - 4 MC. LN \$12.95, 4 - 5 MC. LN \$7.95, 5.8 - 7 MC. LN \$7.95.

**SCR 178 TRANSMITTER RECEIVER, 2400-3700 KCS 10 W OUTPUT w/spare parts PHONE, AND CW opt.** \$45.00  
**RL-42B ANTENNA REEL—w/MOTOR AND GEAR BOX.** Perforated Beam rotator. 4 lbs. magnetic clutch. Reversible with SPST switch. \$3.95

**"BEAM INDICATOR" SELSYNS GE model 2116.** Operates from 37.5-57.5 V. 400 cy w/wiring diagram for 110 V 60 cy oper. \$2.50 pair. Also available GE Model 211P1 115-57.5 V 100 cy pair \$3.00

**SELSYNS—Dihel/BENDIX SYNCHRO TRANSMITTERS.** 115 V 60 cy. \$4.35 ea. pair \$7.95  
**ANTENNA CHANGE OVER SWITCH "SP100"** Instantly operated. Heavy duty. Isolating insulation. 25¢

**HEAVY DUTY AIR COOLED RESISTORS.** 32 ohms or 10 ohms 100W. Your choice. \$1.00  
**REMOTE CONTROLS.** RM21A Telephone Units, no ext. power nec. Good up to 50 miles. self contained Magnet. \$2.95

**CALROID HEATERS GE.** #5A760 115V 200W. \$1.50  
GE. 5A699 65W 57.5V .75  
**G.E. FUSE HOLDERS TYPE EL-1.** Neon lamp indicating Midget size = 6328723G1, 15A. 69¢  
G. E. 6227889G1, 60A \$1.95

**TRANSMITTER AND RELAY RACK CABINETS** Chrome decorated hinged door on top and back with catch Amateur or W.E. notched. Black cracked 28 1/2" H., 18" D Panel space 26 1/2" LN \$15 ea.; 2 for \$27.00  
**WESTERN ELECTRIC PRECISION CRYSTALS** 40 Motor Band 7270 KC 95¢ ea. 2 for \$1.75

**25' EXTENSION LIGHT** heavy duty cord. Switch on handle. Metal bulb protector. \$1.95  
**HEINEMAN CIRCUIT BREAKERS.** 21 VDC @ .22 A., SPST 95¢ ea.; 0311 M-10, 24 VDC @ 10 A., SPST \$1.45, 0322M-10-24 VDC @ 15 A. D.P.D.T. \$2.25  
**GUYWIRE** 1/16" Dia. Galv Per Steel. Excellent elasticity. Rust proof. Ideal for TV antenna installations. 1000 ft. roll. \$3.00/roll

**FRACTIONAL HORSE POWER MOTORS** 08T13M 27.5 VDC 1/20 HP 3600 RPM SHUNT Wound. \$7.55  
**UNIVERSAL ELECTRIC 115 VDC. 12 AMPS .003 HP 5000 RPM** \$4.50  
**OSTER 6 VDC 1.8 AMPS 5000 RPM.** 6 oz./in. torque W/BLOWER Size 1 1/2" AND IMPPELLER. \$4.50  
**EMC 110 VAC 60 cy. 1/40 HP 1725 RPM. LN.** \$4.50  
**OSTER 27.5 VDC/100 HP.** Series 7000 RPM. \$2.50  
**UNIVERSAL ELECTRIC 28 VDC. 0.6 AMPS 5000 RPM. 1/100 HP.** \$2.50

**EMERSON 24 VDC 24 AMPS.** Series wound. 100 RPM 160 OZ. FT torque. \$7.95  
**GE 27VDC 5 AMPS 250 RPM 8 OZ/IN LN.** \$2.50  
**PHONO MOTORS—GENERAL.** JND 115 V 60 cy. 5 A., 80 RPM Minus turntable. \$2.50

**CHOKES** 2.5 H @ 700 MILS., 14 OHMS. \$5.95  
20 HENRIES @ 45 MILS., 500 OHMS. 60¢  
40 HENRIES @ 20 MILS. 80¢  
150 HENRIES @ 1 MIL., 7,000 OHMS. 45¢

**THORBARSON (G0162)** 350-0-350 145 MILS.; 5 V @ 3 A., 6.3 VDC @ 4.5A. \$1.25  
**JEFFERSON FIL.**—20 Volts @ 10 A. \$3.95  
**OPEN CORE POWER.** 18 V @ 6 A. \$2.95

**AMPLIDYNE MG SET** Motor 110/220, 60 C.A. C.

Mtd. by G.E. Generator Type V-5875677, motor 73AB58; Navy type CG21ABU, generator delivers 250 VDC 375 W. Motor 115/230V, 1 ph., 60 cy. 3/4 HP RPM-1725. PRICE, EACH—NEW \$58.00

## VDC SERVO MOTORS



White Rodgers Elec. Co. (6905X-46). 24 VDC @ 1.65 Amps Torque 50 in./lbs. 1/2 RPM reversible comp. w/limit switch, relays and selenium rectifier on top of motor, to keep AC out of motor. 5X5A1 \$8.95  
600-4X 27, 24 VDC @ 1 Amp., 150 in./lbs. torque, 2 1/2" RPM reversible. Complete w/limit switch, relays and selenium rectifiers same as above. \$9.95

## DICTOGRAPH INTER-COMMUNICATION SETS

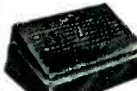

Designed to bring to homes and offices the convenience of two-way, convers. w/ the use of telephone, household elec. circuit, or radio. Efficient to 800 ft off flashlight batteries. New. Pair... \$9.95

## DAVEN SOUND ATTENUATORS



Type 350-A. Network, ladder, linear imped. 30/30 ohms. 20dB attenuation. 10 W dissipation. Brand new... \$3.95

## Standard Brand RHEOSTATS



High shock rheostats, four 1 1/2" plates, 100 ohms 8-2A, 175-345 V connected in series. Assembled for back of board mg. or by reversing the supporting brackets for floor or table oper. New... \$19.75

## RETARD CHOKE COILS



Amertran. Disc Type Line voltage 15,000; ripple freq. 120. Oil-filled. 620A 1DC @ 200H @ 18¢ ripple. 52A DC @ 251 @ 48¢ ripple. 173172297 w term. 10" alt base. 40°C temp. rise. \$34.00

## MILLIAMMETERS



150-0-150 MA DC. Accuracy 1/2 of 1%. Scale length 4 1/2". Wt. 3 1/2 lbs. 4" x 2 1/2" x 4 3/4". Like New \$2.50

## SPERRY A-5 VERTICAL GYRO UNIT



#644841. 115 V. 400 CY 3 phase. Contains gyro assembly, erection motor, erection relay assembly, pick-off assembly, elevator and altimeter limit switches, and roll axes. 15 x 12 x 9. New \$27.50

## New Submarine Signal QBE-1 Underwater Sound Equipment



Type BC 55681 Indicator Unit—Ranges 0-1000 yds. and 0-5000 yds. Visual & Audio Indication Synchronous motor driven, input 115/160. 20 x 16 x 8 1/2 \$25.00

## BATTERY CHARGER



Ideal for your car, for the serviceman and home. Selenium transformer type. 7 1/2" x 4 1/2" x 4 1/2". Portable metal container. Input 115. VAC output 6.5 V @ 2 amps. \$7.25

## FITCH CRYSTAL DUPLICATOR



Calibrates crystal plate of unknown freq. against standard plate of desired freq. Consists of standard and test oscillators whose outputs are mixed to produce an amplified beat note; the freq. is shown on 500, 5000, 50,000 cycle meter. Metal cabinet w/ hinged cover. 9" H. x 15" W. x 19" L. Comp. w/4" sq. activity and frequency meter. \$29.50

## DIEHL MOTORS



Normally 110V, 60 cy. 3 ph. units. Will operate satisfactorily on 110V 60 cy. 1 Ph. by addition of capacitors across one of the other phases. 1/10 HP. cont. duty. 3450 RPM. 1 3/4" x 5/8" D Shaft. Motor dimensions: 4" H x 5" W x 5" D. Wgt. 10 lbs. \$5.50

## AMERTRAN HEAVY DUTY TRANSFORMERS



Pri 115/230 VAC 60 cy. Sec. 4730/2365. KVA 1.66 RMS 12 KV. Wgt. 150# 11" x 11" x 9" Brand New \$37.50

ALL PRICES F.O.B. BOSTON. ORDERS ACCEPTED FROM RATED CONCERNS ON OPEN ACCOUNTS NET 30 DAYS. MINIMUM ORDER \$3.00



399-405 ATLANTIC AVENUE Dept. E-3 BOSTON 10, MASSACHUSETTS LIBERTY 2-7890



**LINE VOLTAGE STABILIZERS**

**RAYTHEON**—Navy Type, CRP-301407. Input: 92-138V., 57,763 CPS., 1 PH. Output: 115V., 0.82 KVA., 1% Reg., 0.96 PF. Weight 385 lbs. Overall size—36" high x 20" wide x 12 1/2" deep. Enclosed in Navy Grey Ventilated Cabinet for Wall Mounting.  
**Brand New \$97.50**

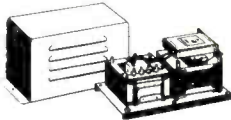

**RAYTHEON** A41, input tap, 95-130V., 60 cy., 1 Ph. Output: 115V., 60 Watts, 1/2 of 1% Reg. Wt. 20 lbs. 6 1/2" H x 8 1/4" L x 4 3/8" W. Overload protected. Sturdily constructed. Tropicalized. Special..... **\$12.50**

**TRANSFORMERS**  
**1.5 KVA Stepdown**

General Electric Cat. No. T60173. Input: 115 or 230 Volts, 60 cycles. Output: 23 or 11.5 volts at 1.5KVA. Either high voltage connection may be used with either low voltage connection. Weight 50 lbs.  
**Brand new \$23.95**

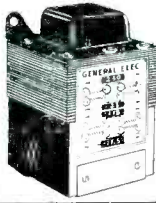

**FILAMENT TRANSFORMER**



Raytheon Hypersil core. Primary: 115V., 60 cycles. Sec: 6.3 at 22A., 6.3 @ 2.4A., 6.3 @ 2.25A., 6.3 @ 0.6A., 1700V. INS.  
**Brand New \$3.95**

**For type B66 tubes**

Input: 115 volts. Output: 2.5 volts center tapped, at 10 amps. Glazed porcelain standoff insulated for high voltage breakdown. Mfgd. by Kenyon.  
**Brand New \$3.95**



**AUTO TRANSFORMER**  
G.E. 400 cy. Cat. No. S04184 K.V.A. 9158—5201 Volts 460/345/230/115 New..... **\$4.50**

**FILAMENT TRANS.**  
**400/2600 cy.**

Input: 0/75/80/85/105/115/125V. Output: 5V2A, 5V3A, 5V3A, 5V3A, 5V6A, 5V6A, 6.5V6A, 6.5V5A  
**\$3.95**

**THYRATRON POWER TRANS.**

Raytheon UX8876. 400/1600 cy. PRI: 115V., 1 PH SEC: 50-050V at 0.5A, 6.3V 1.2A Test r.m.s. 1750  
**\$2.75**

**Pulse, Input Trigger Inverting**

Westinghouse #145 EWP Fosterized..... **\$4.95**

**PULSE**

Utah No. 9350..... **\$1.25**



**BLOCKING, OSC**

Westinghouse #132 AMP Fosterized **\$4.95**

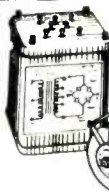

**12 and 24 Volt POWER KIT**

Consists of Power Trans. and full wave bridge selenium rectifier. Input: 115/230 A.C. Output: 12/24V D.C. at 1.1 amps. Fine for operating relays, small motors, dynamos, or for low voltage D.C. source in laboratories, etc.  
**Brand New \$7.95**

**SWEEP GENERATOR CAPACITOR**

High speed ball bearings. Split start-silver plated coaxial type. 5/10 mmfd. Brand new. **\$1.00**



**FULL WAVE BRIDGE TYPE SELENIUM RECTIFIER**

Input up to 35V A.C. Output up to 28V D.C. Fed. Tel. & Tel. Co. 1.1 amps. 8 plates 2 1/2" diameter.  
**Brand New \$2.75**

**MICROWAVE RECEIVERS**

APR-1, APR-4, APR-5A. Tuning Units for APR-1 or APR-4, TN-16 (38-95 mc.), TN-17 (74-320 mc.), TN-18 (300-1400mc.) These front ends may be used with any 30 mc. IF amplifier or as converters into receivers tuned to 30 mc.

**MODEL AN/ APA 10 PANORAMIC ADAPTER**

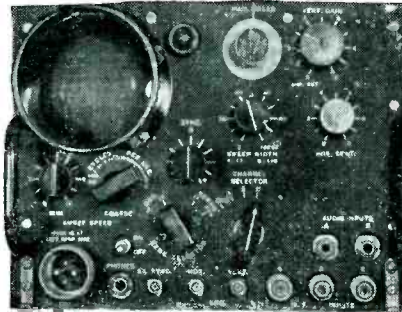

Provides 4 Types of Presentation:  
(1) Panoramic (2) Aural  
(3) Oscillographic (4) Oscilloscopic

Designed for use with receiving equipment AN/ARR-7, AN/ARR-5, AN/APR-1, SCR-587 or any receiver with I.F. of 455kc, 5.2mc, or 30mc. With 21 tubes including 3" scope tube. Converted for operation on 115 V., 60 cycle source.  
**Includes 80 page T. M. \$195.00**



**Micro-Wave Lavoie Freq. Meter**  
**375 to 725 MCS**

Model TS-127-U is a compact, self-contained, battery powered, precision (± 1 Mc) frequency meter which provides quick, accurate readings. Requires a standard 1.5V "A" and 45V "B" battery. Has 0.5 MIN. time switch. Contains sturdily constructed "H-Q" resonator with average "Q" of 3000 working directly into detector tube. Uses 957, LS6 and 384 Tubes. Complete, new with inst. books, probe and spare kit of tubes. Less batteries  
**\$69.50**

Full data on request.

**PARABOLOIDS**

Spin Magnesium dishes 17 1/2" dia., 4" deep. Mounting brackets for elevation and azimuth control on rear. 1 1/2" x 1 1/2" opening in center for di-  
**Brand new per pair \$8.75**



**Synchro Differential**

90/90 volts, 400 cycles. Brand new in sealed containers. Ford Inst. type 58DG. Brand new, **\$12.50**

**MOTOR GENERATORS**

Allis Chalmers 115V. D.C. to 120V. 60 cy. 1 Ph. 1.25 K.V.A., P.F. 80 Centrifugal starter. Fully enclosed.  
**New \$97.50**

Same as above but for 250V. D.C. **\$125.00**

Spare Parts Kit for either machine..... **\$15.00**

Dieht 120V. D.C. to 120V. A.C., 60 cy., 1 Ph., 2.5 K.V.A., P.F. 80. Complete with magnetic controller, 2 field rheostats and full set of spare parts including spare armatures for generator and motor.  
**New \$185.00**

O'Keefe and Merritt, 115V. D.C. to 120V. A.C. 50 cycles, 2 K.V.A., P.F. 80 Idles as a 3 phase synchronous motor on 208V. 50 cy.  
**New \$165.00**

Electrolux dynamotor 105/150V. D.C. at 6 amps. to 26 or 13V. D.C. at 20 amps or 40 amps. respectively. Fully filtered for radio use and complete with Square "D" lineswitch. Navy type CA30-21144.  
**New \$74.50**

**MERCURY CONTACT VACUUM RELAYS**  
**WE Type D-165479**



Glass sealed, mercury-wetted contact switches surrounded by operating coils encased in metal housings on octal tube base. S.P.D.T. contacts, 2 coils, 700 and 3300 ohms. Operating current coils seriesed 6.6 MA releasing at 5.2MA. Operating life 1000 hrs. at 60 operations per sec. Use for: High speed logging • Tabulating • sorting and computing machines • Relay amplifiers • Vibrator supplies • Servo Mechanisms, etc.  
**\$4.75 ea. Brand New**

Send for 4 page data sheet



**THERMOSTATIC TIME DELAY RELAY**

Ameritec type 115 No. 45 Heater voltage 115V. Normally open SPST contacts .45 sec. delay. Contact rating 115V. 3A., A.C. for 410V. A.C. 2A) max. voltage on contacts—1000 max voltage bet. contacts and heater—1500. Size 3 1/2 x 3 1/2 overall. Made for U. S. Navy..... **\$1.10**

**CRYSTAL DIODE**

Sylvania 1N21B. Individually boxed and packed in leaded foil. Brand new **\$1.00**

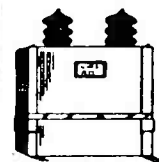

**High Voltage Capacitors Oil Filled**

.25 MFD., 20KV..... **\$15.75**  
.5 MFD., 25KV..... **\$23.50**  
1 MFD., 15KV..... **\$16.50**  
1 MFD., 7.5KV..... **\$5.95**

All brand new. Made by prominent manufacturers.



**MP22 Mast Base Insulator**

Ideal for marine, mobile vertical whip antennas. Complete new with mounting plate and hardware..... **\$2.75**

3CM Antenna Horn For receiving or transmitting Type AT-48/U1 with cone receipt. Brand new **\$4.75**

**LINE FILTER**

Elimostat 20 amp. 117 volts A.C. or 600 D.C.  
**Brand new \$1.75**



**PILOT LAMP**

Aircraft "grain of wheat" 3V Mazda G.E. 32  
**Brand New 10c ea.**

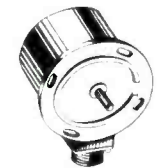

**LINEAR SAWTOOTH POTENTIOMETER**  
**No. KS 15138**

Has continuous resistance winding to which 24 volts D.C. is tied to two fixed taps 180° apart. Two rotating brushes 180° apart take off linear sawtooth wave voltage at output. Size approximately 3 1/2" dia. x 3" deep x 4 3/8" long. Enclosed in die cast alum. frame with AN connector socket.  
**\$5.75 Brand New**

**U. S. NAVY SOUND POWERED BATTLE PHONES**

Western Electric No. D173312, Type O, Combination headset and chest microphone as illustrated. Brand new including 20 ft. of rubber covered cable..... **\$19.50**



Automatic Elec. Co. No. G1242A0. Similar to above but including throat microphone in addition to chest microphone. Brand new with 20 ft. rubber covered cable. **\$19.50**



**SYNCHRO GENERATORS**

Brand new—Gov't. sealed and inspected. Packed in overseas cans. Synchro Transmitters 115V., 60 cy. operation. Precision accuracy made for gun fire control. Cost Gov't. \$90.00 each. Wgt. 5 lbs. Dimensions: 3 1/2" L x 3 1/4" W. Brand New **\$14.75 Per Pair**

All prices indicated are F O B Tuckahoe, New York. Shipments will be made via Railway Express unless other instructions issued.

**ELECTRONICRAFT**

INC.

**5 WAVERLY PLACE TUCKAHOE 7, N. Y. PHONE: TUCKAHOE 3-0044**

All merchandise guaranteed. Immediate delivery, subject to prior sale.

**All Prices Subject to Change Without Notice**

# SELENIUM RECTIFIERS

and

## ELECTRONIC COMPONENTS

### THREE PHASE FULL WAVE BRIDGE RECTIFIERS

Input 0-234VAC	Output 0-250*VDC	Price
Type #	Current	
3B13-1	1 AMP.	\$22.00
3B13-2	2 AMP.	32.00
3B13-4	4 AMP.	56.00
3B13-6	6 AMP.	81.50
3B13-10	10 AMP.	105.00
3B13-15	15 AMP.	120.00

### CENTER TAPPED RECTIFIERS SINGLE PHASE FULL WAVE

Input 10-0-10VAC	Output 0-8*VDC	Price
Type #	Current	
C1-10	10 AMP.	\$6.95
C1-20	20 AMP.	10.95
C1-30	30 AMP.	14.95
C1-40	40 AMP.	17.95
C1-50	50 AMP.	20.95

### RECTIFIER MOUNTING BRACKETS

For Types B1 through B6, and Type C1.....\$ .35 per set  
For Types B13......70 per set  
For Types 3B..... 1.05 per set

### SINGLE PHASE FULL WAVE BRIDGE RECTIFIERS

Input 0-18VAC	Current	Output 0-12*VDC	Price
Type #			
B1-250	250 MA.		\$ .98
B1-1	1 AMP.		2.49
B1-1X5	1.5 AMP.		2.95
B1-3X5	3.5 AMP.		4.50
B1-5	5 AMP.		5.95
B1-10	10 AMP.		9.95
B1-20	20 AMP.		15.95
B1-30	30 AMP.		24.95
B1-40	40 AMP.		27.95
B1-50	50 AMP.		32.95

Input 0-36VAC	Current	Output 0-26*VDC	Price
Type #			
B2-150	150 MA.		\$ .98
B2-250	250 MA.		1.25
B2-300	300 MA.		1.50
B2-2	2 AMP.		4.95
B2-3X5	3.5 AMP.		6.95
B2-5	5 AMP.		9.95
B2-10	10 AMP.		15.95
B2-20	20 AMP.		27.95
B2-30	30 AMP.		36.95
B2-40	40 AMP.		44.95

Input 0-115VAC	Current	Output 0-90*VDC	Price
Type #			
B6-250	250 MA.		\$2.95
B6-600	600 MA.		5.95
B6-750	750 MA.		6.95
B6-1X5	1.5 AMP.		10.95
B6-3X5	3.5 AMP.		18.95
B6-5	5 AMP.		24.95
B6-10	10 AMP.		36.95
B6-15	15 AMP.		54.95

**CUSTOM DC POWER SUPPLIES**  
Built to your specifications  
We will be pleased to quote on your requirements. Kindly send for our specification form.

### RECTIFIER CAPACITORS

CF-14	3000 MFD	12VDC	\$1.69
CF-15	6000 MFD	12VDC	2.95
CF-1	1000 MFD	15VDC	.98
CF-2	2000 MFD	15VDC	1.69
CF-20	2500 MFD	15VDC	1.95
CF-3	1000 MFD	25VDC	1.25
CF-4	2X3500 MFD	25VDC	3.45
CF-5	1500 MFD	30VDC	2.49
CF-6	4000 MFD	30VDC	3.25
CF-7	3000 MFD	35VDC	3.25
CF-8	100 MFD	50VDC	.98
CF-19	500 MFD	50VDC	1.95
CF-16	2000 MFD	50VDC	3.25
CF-21	1200 MFD	90VDC	3.25
CF-9	200 MFD	150VDC	1.69
CF-10	500 MFD	200VDC	3.25
CF-12	125 MFD	350VDC	2.49

Mounting clamps for above capacitors...15¢ each

### RECTIFIER TRANSFORMERS

All Primaries 115 VAC 50/60 Cycles

Type #	Volts	Amps	Shpg. Wt.	Price
XF15-12	15	12	7 lbs	\$3.95
TXF36-2	36	2	6	3.95
TXF36-5	36	5	8	4.95
TXF36-10	36	10	12	7.95
TXF36-15	36	15	20	11.95
TXF36-20	36	20	30	17.95
XFC18-14	18 VCT	14	10	5.95

All TXF Types are Tapped to Deliver 32, 34, 36 Volts. XFC type is tapped to deliver 16, 17, 18 Volts Center-Tapped.

### RECTIFIER CHOKES

Type No.	Hy.	Amps.	D.C. Res.	Price
HY5	.02	5	.25	\$3.25
HY5A	.028	5	.20	3.95
HY10	.02	10	.30	9.95
HY10A	.014	10	.04	7.95
HY15	.015	15	.30	13.95
HY20A	.007	20	.02	12.95

Type "A" low resistance chokes are specially suited to circuits requiring excellent voltage regulation.

ADDITIONAL SELENIUM RECTIFIER TYPES AND GENERAL INFORMATION MAY BE FOUND IN OUR CATALOG No. 719

### VACUUM CAPACITORS

Standard Brands



50 Mmfd.	20 Kv	\$4.95
1 Cmfd.	32Kv	5.95

Overall length: 6 1/2". Diam: 2-3/16". Terminal Diam: 3/8". Shpg Wt 2 lbs.

**EDISON THERMO TIME DELAY RELAY**  
Heater voltage 115 V. Norm. open SPST contacts, 15-30 sec. delay. Contact rating 115 V. 3A., 440 V. 2A. Size 3 1/4" x 1 1/2" diam. Standard 4 prong tube base..... **98c ea.**

### OIL CONDENSERS

2X.1 Mfd 600VDC Bathub.....	.39
6 Mfd 600VDC w/mtg. Clamp.....	.79
8 Mfd 660VAC/2000VDC w/Brkts. 3.50	
15-.15 Mfd 8000VDC Voltage Doubler	
Type 26F381 w/Brkts.....	3.95

### KLIXON 40 SECOND DELAY SWITCH

Heater operates on 115 VAC or DC. Contacts SPST—rated at 30 A., 115V., or 20 A. 220 V. plus auxiliary contacts for lighter loads. Each.....**\$2.40**

### PILOT LIGHT ASSEMBLIES



Aircraft type, panel mounting, amber jewel only. Knurled rim, controls "Dim-Bright." Bakelite and aluminum construction. Bulb replaceable from front panel. For single contact bayonet bulbs. T-3 1/4" or G-3 1/2" size. Dimensions: 2 1/4" overall length, 3 1/4" diameter, 5/8" panel mtg. hole.  
**IMMEDIATE DELIVERY — 500 to carton, nested, \$50.00 per carton. Prices on larger quantities on request.**

### SILVER CERAMIC TRIMMERS

820-Z 5-20 Mmfd Zero Temp.....	24c
822-N 5-20 Mmfd Neg. 300.....	21c
822-AZ 4.5-25 Mmfd Zero Temp.....	24c
823-AN 20-125 Mmfd Neg. 650.....	33c

### ATTENTION!!!

Bulletin #713, listing various government and commercial surplus items, is now available upon request.

### DC POWER SUPPLY

Limited quantity — Gov't Surplus — Output to operate. Full wave bridge copper-oxide rectifier, heavy duty multi-tapped transformer.

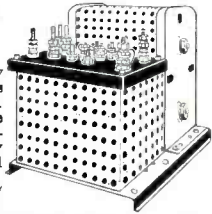

Input: 85/95/105/115 VAC/50/60cps  
Output: 2.5/24/28/32/36 VDC at 5 amperes unfiltered  
For wall or bench mounting. Overall dimen. 9" x 8 1/4" x 8 1/2" high. Shpg. wt. 30 lbs. Tested and guaranteed...**\$36.00**  
Filter Kit, 2% ripple..... **6.65**



### DIEHL MOTOR

Fan duty, brushless induction type (no TV interference). For 115 VAC 60 cycles 46 watts, 1800 RPM. Shaft 1/4" diam. 1" long. Noiseless ball-bearings—heavy cast construction. Brand new.....**\$4.50**

### RECTIFIER KIT #612-10

6 and 12 VDC at 10 Amps  
This unit will deliver unfiltered direct current for operation of motors, dynamos, solenoids, electroplating, battery charging and similar equipment. The two output voltages may be used simultaneously, and varied above and below their nominal ranges. Complete with schematic diagrams and instructions, shpg. wt., 12 lbs. **\$15.95**

### Filter Kits For #612-10

1 Section choke input, 10% ripple...**\$9.64**  
2 Section choke input, 2% ripple...**19.28**

### D-C PANEL METERS

Attractive, rugged, and reasonably priced. Moving vane solenoid type with accuracy within 5%.  
0-6 Amperes D-C Any range  
0-12 Amperes D-C **\$2.49** each  
0-15 Volts D-C

Minimum order \$3.00. No C.O.D.'s. Add 10% for Prepaid Parcel Post and Handling. Terms: Net 10 days in the presence of approved credit.

All prices subject to change without notice. Prices and Delivery F.O.B. our NYC Warehouse. All merchandise subject to prior sale.

### WESTERN ELECTRIC BLOWER

#KS5881 — Brand New — Heavy Duty Sirocco type blower, capacitor start, 1/40 H.P. 3400 RPM 115 VAC 60 cycles. Displaces 84 C.F.M. Extremely quiet operation. Opening 2 1/4", overall size 7 1/2" long, 6" diam. Moisture and fungus resistant. With capacitor. Shpg. Wt. 15 lbs. Quantity limited. **\$19.95**



### DIEHL BLOWER

Sirocco type, displaces 100 C.F.M. 115 VAC 60 cps. Moisture and fungus resistant. Flange diameter 4". Overall size 7 1/2" x 6 1/2". Removed from equipment. Tested and guaranteed. **\$9.95**

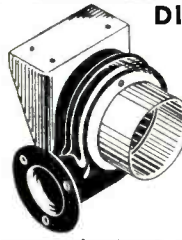

Adjustable right angle aluminum extension tube to fit flange.....**\$8.98**

### WESTINGHOUSE AIRCRAFT MOTOR

Brand new—24 VDC or AC, reversible on both. 1/50 H.P. 4800 RPM continuous duty. Length of leads 18". Dimensions 3 1/2" x 2 1/4" shaft 1/4" diam. by 3/8" long. Price.....**\$2.95**  
Reversing switch with "off" position Each.....**79c**



# OPAD-GREEN COMPANY

71 Warren St.  
New York 7, N. Y.

Phone: BEekman 3-7385-6



# ORDER from ARROW!

## BC-605 INTERPHONE AMPLIFIER

Easily converted to an ideal intercommunication set for office—home—or factory **\$4.95**  
 Original—New .....  
 Like ..... **3.95**  
 New .....  
 (With schematic)

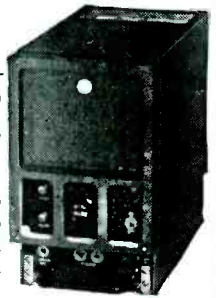

All necessary parts and instructions to convert the above to AC operation with one remote station. \$8.25 additional.

### Miscellaneous SPECIALS

	Used	New
ID 6/APN 4 Scope, Excellent	29.50	—
ID 57/APQ 7 Scope	9.95	—
ID 2/APS-5FP7 Assembly	—	6.95
R 7/AP2 2 Receiver-Indicator	—	79.50
R 78/APS-15 Receiver-Indicator	34.50	—
BC 1287 A Scope	75.00	—
ASB 7 Indicator Scope	12.95	—
ARB Receiver, 200 to 9000 KC.	19.95	—
SCR 522 Transceiver 100 to 150 MC.	34.95	75.00
BC 1206 Receiver, 200 to 400 KC.	3.95	5.95
MN 26 C or Y Receiver	17.50	24.95
RA 10 DA Receiver	17.50	24.95
T 85/APT 5 Transmitter	—	69.50
T 39/APQ 9 Transmitter	7.95	—
T 26/APT 2 Transmitter	8.95	—
BC 457 Transmitter—as is—fair condition—as they come, some with some less tubes and Xtal	1.95	—
BC 458 Transmitter—as is—fair condition—as they come, some with some less tubes and Xtal	1.95	—
R 89 Receiver chassis less tubes and side covers	1.95	—
RT 7/APN 1 Transceiver	7.95	9.95
APN 1 Complete	—	34.50
BD 71 6 Pos. Switchboard	9.95	12.95
EE 8 Field Phones	7.95	—
BC 347 Interphone Amplifier	—	2.95
I-70 Tuning Meter	—	.89
AM 61 Indicator Amplifier	—	9.50
SCR 625 Mine Detector	—	39.50
PE 237 Power Supply	—	12.95
BC 461 Veeder Root Counter	—	.59
BC 442 Less Condenser	1.49	1.95
BC 306 Antenna TU for BC 375	—	1.50
A 27 Phantom Antenna	—	.98
APS 13 UHF Antenna, Pair	—	.98
Manual for BC 312 & 342 J	—	1.00
Manual for SCR 269 G	—	2.50
FL 8 Filter	—	2.95
I-97 Bias Meter	—	2.95
RM 29 Remote Telephone Control	—	7.95
BC 602 Control Box	—	.98
B C 639 Receiver with RA 42 Rectifier	—	—
RTA 1B Transceiver	—	—
TA 2J24 Transmitter and MP 10G Power Pack	—	—
SCR 269 Compass Installation	—	—
R 5/ARN 7 Compass Installation	—	—
MN 26 Compass Installation	—	—
I.L.S. Installation (R 89-BC 733)	—	—
SCR 584 Components	—	—

Information and prices on request

### HERMETICALLY SEALED CHOKES

10 H. 100 M.A.	59c
59 H. 100 M.A.	95c
3.7 H. 145 M.A.	59c
10 H. 20 M.A.	39c

### RECEIVER

Easily Converted for Use in Citizens Band

Crystal Controlled Local Oscillator. Broad Band Pass—20.7 MC I.F.'s. Complete with 7-8AJ5, 1—12SR7, 2—12SN7, 1—28D7, relays, crystals. Schematic furnished. Used **\$7.95**

### CONDENSERS

	Each
2 mfd. 4000 VDC Oil-Filled	\$2.95
4 for	\$10.00
2 mfd. 5000 VDC Oil-Filled	3.95
3 for	10.00
1 mfd. 6000 VDC	1.98
.25 mfd. 15000 VDC	4.93
.00025 mfd. 25000 VDC	2.95
.4 mfd. 1500 VDC	.29
10 for	2.49

### TUBES

All Brand New  
 Drastically Reduced from 10 to 50%

#### Nationally Advertised Brands

Type	Net Price	Type	Net Price	Type	Net Price
1A4P	\$.024	6R7	\$.034	39 44	\$.024
1A6	.19	6SF5GT	.34	49	.39
1B5/25S	.24	688GT	.59	50	.39
1B22	1.49	68F7	.39	56	.24
1B26	2.29	6SJ7	.69	57	.24
1B29	.39	6T7G	.39	76	.24
1B32-532A	2.29	6U7G	.29	77	.24
1C6	.19	6Z7G	.39	211 Vt4L	.29
1C7G	.19	6ZY5G	.29	316A	.34
1D5GP	.24	7C4/1203A	.24	371B	.34
1D7G	.19	7E5/1201	.39	703A	1.49
1H4	.24	10YV125A	.19	705A	.79
1F5G	.24	12A6	.34	714AY	5.95
1H4G	.24	12A6GT	.34	724B	4.95
1J6G	.24	12A7	.34	801A	.39
1J6GT	.24	12A8GT	.19	836	.95
1N5GT	.24	12C8Y	.29	837	1.49
1F5GT	.24	12F5GT	.24	841	.29
1V	.24	12H6	.29	864	.29
2A6	.39	12J5GT	.24	872A	.98
2A7	.24	12J7GT	.24	954	.19
2C26A	.19	12K8GT	.24	955	.34
2V3G	.49	12Q7GT	.24	957	.34
2K2/379	.25	12SF5	.24	1625	.19
3FF7	.98	12SF5GT	.24	1626	.24
4AP10	.98	12SF7	.24	1629	.24
5BP1	1.95	12SH7	.24	1630	.29
5BP4	2.95	12SR7	.24	1636	2.95
5CP1	2.95	12SR7GT	.29	1638	.69
5D21	9.95	12T3	.29	1642	.29
5J23	5.95	15R	.19	2050	.89
5T4	.49	19	.59	2051	.49
5W4	.49	2J22	.24	7193	.19
5Z4	.49	28D7	.34	9002	.35
6B8	.59	30SPEC	.39	9003	.39
6C4	.29	(Vt67)	.59	9006	.29
6D8G	.59	30	.24	GL4A2I	.29
6F5GT	.39	32L7GT	.39	Amperite	.29
6H6	.29	33	.24	10T1	.29
6J6	.89	34	.24	Jan CRP72	.98
6J7GT	.39	35/51	.24	WE331A	.89
6K6G	.59	36	.24	REL36	.69
6L5G	.39	37	.24	VR150	.39
6L7G	.39	38	.24	VR105	.69

WRITE FOR QUANTITY PRICES

### BEAM INDICATORS

I 82-57	New	\$4.95
Transmitter selsyn for above	Used	2.45
I 81-37	both for	7.00
Transmitter Selsyn for above	New	3.45
I 81	both for	5.25
	Used	2.45

### SURPRISE PACKAGE

20 lbs. Ass't radio parts. A \$25.00 value for only **\$1.95**

### PP 12A/APS-3 RECTIFIER POWER SUPPLY

110 VAC—800 to 2400 CPS input. Used to supply many voltages for APS 3 equipment. Contains four VR105; Three 5U4G; 2x2; 6AC7; 6Y6-G; VR 150; 6X5GT-G condensers, chokes, etc. Parts alone worth more **\$6.95** than

### OUTPUT TRANSFORMER

Hi-Fil used in Scott Manufactured Navy receiver. Fully potted. Pri. 5000 ohms; output secondary 600 ohms C.T.—inverse feedback secondary CT-60 ohms. New **\$1.45**

### NEW CATALOG

listing many surplus values, write for your **FREE** copy TODAY.

All shipments FOB Chicago. 20% Deposit required on all orders. Minimum order accepted—\$5.00. Illinois residents, please add regular sales tax to your remittance

## ARROW SALES, Inc.

Dept. E5  
 1712-14 S. Michigan Ave., Chicago 16, Ill.  
 PHONE: HARRISON 7-9374

### BC-604 TRANSMITTER FM 20-28 MC

11 and 15 meters. Can be operated on 10 meters—10 channel push button crystal. With all tubes and meter but less dynamotor. Excellent Condition **\$12.95**  
 Crystals—Set of 80. **14.95**

### COMMAND (SCR 274 N) EQUIPMENT

	Used	New
BC-453	\$12.95	—
BC-454	4.95	\$6.95
BC-455	7.95	—
BC-456	1.95	2.95
BC-457	5.95	—
BC-458	5.95	7.95
BC-459 (or T22)	9.95	—
BC-696 (or T19)	11.95	24.95
ARC5 Transm 2.1-3MC	9.95	—
BC-450-3 Receiver Remote Control	.89	1.95
BC-442	—	2.95
3 Receiver Rack	1.95	—
2 Transmitter Rack	1.50	—
Complete Command set as removed from aircraft—3 receivers—2 transmitters—Relay unit—control boxes—mounting racks—plugs—modulator and dynamotors—crated. Set	—	<b>\$34.50</b>

### DYNAMOTORS

DM-28—For BC-348 with Mount and Filter	New	\$6.95
	Used	3.95
DY-12—For ART-13 less filter and base	New	6.95
DM-36	Used	.95
	New	1.95
BD-77	New	5.95
PE-206	New	6.95
	Used	2.75
PE-101	New	2.75
PE-73	New	3.95
DM-53	New	3.95
	Used .95	(3 for \$2.00)
DM-32	New	1.95
	Used .95	(3 for \$2.00)

### MIKES—HEADSETS

HS-23 Hi Imp.	New	\$2.95
HS-33 Lo Imp.	New	2.95
HS-30 Hi Imp.	New	1.50
	Used	.79
T-17D Carbon Mike	New	2.75
T-24 Hi Imp. Carbon Mike	New	1.19
T-30 Throat Mike	New	.98
T-45 (or Navy) Lip Mike	New	.98
CD-307 Extension Cord for Headsets	New	.59

### BC 620

Receiver-Transmitter—2 crystal channels—20 to 27.8 MC FM—13 tubes. Metered, Plate and Filament **New \$14.95**  
 Used 9.95

PE 97 Power Supply for above 6-12 volt vibrator type.  
 Used—complete **\$6.95**  
 Used less tubes, vib. & cond. **2.95**

FT 250 Mount for both BC 620 and PE 97 **New \$1.50**

### BC 223

Brand new Transmitter with all three tuning units, two tuning unit cases, spare tube carrying case, shock mount and brace; but less tubes at new low price of **\$19.95**

Tuning units are available separately at **Ea. \$2.50**  
 Cases at **Ea. .95**  
 PE 125—12-volt Vibrator Pack **New \$12.95**  
 Used **8.95**

# GUARANTEED BRAND NEW ELECTRONIC RESEARCH TUBE SPECIALS STANDARD BRANDS ONLY

<b>RECEIVING TUBES</b>	5Z4 .79	6S8GT .95	12AU7 .86	50L6GT .57	<b>Thyratrons</b>	3J31 39.25	WE-283A 1.27	814 3.79
OZ4 .59	6A6 .87	6SA7GT .52	12AX7 .86	50A4 .95	OA4G .95	SN-4/631- 3.77	WE-293A 3.36	815 1.72
OZ4G .59	6A7 .72	6SB7Y .79	12BA6 .64	55 .55	EL-C1A 3.35	P1 3.77	304TH 3.86	816 1.97
1A3 .45	6AB7/1853 .99	6SC7 .66	12BA7 .86	L55B .18	2A4G 1.15	4A1 .58	304TL 1.25	826 .57
1ASGT .69	6AC5GT .94	6SD7GT .79	12BE6 .61	56 .56	2D21 1.09	4B22/EL- 5.20	WE-310A 7.50	829 4.91
1AB5 .73	6AC7W 1.45	6SF5 .59	12C8 .59	57 .72	3C23 3.20	4B24/EL- 2.44	316A .66	829B 6.20
1B3GT/ 8016 1.18	6AD6G .79	6SF5GT .59	12F5GT .65	58 .72	3C31/EL- 1.24	3C 3.35	350B 1.95	832 3.95
1B4P 1.15	6AD7G 1.13	6SF7 .72	12J5GT .49	70L7G1 1.24	4C35 19.77	EL-C5B 8.95	354C 19.50	832A 4.91
1B5/25S 1.16	6AF6G .72	6S7 .69	12K8 .69	75 .59	6F1 4.44	6C5 8.70	WE-356B 4.45	836 .89
1C5GT 1.04	6AG5 .96	6SH7 .44	12O7GT .59	76 .59	FG-17 2.89	4C28 8.85	361A 4.75	837 1.38
1C6 .94	6AG7 1.19	6SJ7 .59	12SA7GT .59	77 .59	FG-33 11.95	5D21 26.50	371B 2.93	838 2.93
1D5GP 1.04	6AJ5 .89	6SJ7GT .59	12SF5 .65	79 .77	FG-67/ 1904 8.85	5J23 14.20	417A 10.65	841 .49
1D8GT 1.04	6AK5 .89	6SK7 .59	12SF7 .65	80 .45	1904 8.85	5J29 14.20	434A 3.65	851 27.50
1E5GP 1.16	6AK6 1.35	6SL7GT .69	12SG7 .69	81 1.41	FG-81A 4.95	5R4G1 1.05	446A .79	852 6.40
1E7G .76	6AK6 1.35	6SN7GT .64	12SH7 .49	82 .92	FG-105 9.95	6C21 19.88	450TH 19.70	860 4.50
1G6GT .79	6AL5 .69	6SN7GT .64	12SJ7 .49	83 .95	FG-172 14.50	6A 5.20	471A 2.75	861 17.70
1H4G .69	6AO5 .72	6SN7W 1.45	12SJ7GT .49	83V 1.15	WE355A 14.15	10T1 .58	503A X 1.47	864 .19
1H5GT .59	6AO6 .55	6SO7GT .53	12SK7 .59	84/6Z4 .65	394A 3.77	10Y .19	506A X 1.47	866A .95
1J6G 1.04	6AT6 .64	6S7GT .59	12SK7GT .59	89Y .55	KU-610 6.35	15R .75	507A X 1.47	869B 27.00
1L4 .66	6AU6 .72	6S7 .65	12SL7GT .69	117L7GT 1.24	KU-634 17.20	REL-21 3.25	527 9.75	872A 1.88
1L4A .94	6AV6 .55	6S7 .65	12SN7GT .79	117N7GT 1.24	WL-652/ 38.00	24G .44	530 17.20	874 1.65
1L8A .94	6B4G .94	6T7G 1.15	12SO7GT .79	117P7GT 1.24	657 1.35	RK-25 2.11	531 17.80	876 .39
1L8 .94	6B8 .79	6T8 1.04	12SR7 .69	117Z3 .54	884 .54	FG-32 4.25	532A 3.15	878 1.85
1LC5 .73	6B8G .79	6U5/6G5 .72	12X3 .88	117Z6GT .87	885 .88	RK-34 .28	559 .95	884 .39
1LC6 .94	6BA6 .65	6U7G .65	14A7/12B7 .79	14B6 .79	885 .88	UV199 .52	561 1.45	955 .39
1LD5 .94	6BA7 .86	6V6G 1.07	14B7 .79	14B7 .79	885 .88	FM-1000 .97	579B 5.85	956 .49
1LE3 .73	6BF6 .65	6V6G .59	14J7 .79	2AP1 3.65	885 .88	1904 8.85	EF-50 .45	957 .49
1LNS .88	6BG6G 1.72	6V6GT .59	14K7 .79	2AP5 5.95	2050 .83	2051 .49	HY615 .29	958A .49
1NSGT .69	6BJ6 .72	6W7G .79	14J7 .79	3AP1 4.63	2051 .49	53A 3.82	631-P1 3.77	958A .49
1N6G .72	6C4 .21	6X4 .59	14N7 .89	3AP4 1.32	2051 .49	53A 3.82	631-P1 3.77	958A .49
1P5GT .59	6C5 .65	6X5GT .59	14N7 .89	906P4 5.94	2051 .49	53A 3.82	631-P1 3.77	958A .49
1Q5GT .94	6C6 .69	6X7G 1.09	14N7 .89	3BP1 2.59	2051 .49	53A 3.82	631-P1 3.77	958A .49
1R4 .69	6C8G .89	6Z7G .79	19T8 1.04	3CP1 1.87	2051 .49	53A 3.82	631-P1 3.77	958A .49
1R5 .69	6D6 .59	6Z75G .79	19T8 1.04	3DPA 5.75	2051 .49	53A 3.82	631-P1 3.77	958A .49
1S4 .86	6D8G .87	7A4 XXL .65	22 .65	3EP1 2.92	2051 .49	53A 3.82	631-P1 3.77	958A .49
1S5 .64	6E5 .60	7A6 .65	24A .65	3HP7 4.91	2051 .49	53A 3.82	631-P1 3.77	958A .49
1T4 .64	6E5 .60	7A7 .65	25L6GT .59	3HP7 4.91	2051 .49	53A 3.82	631-P1 3.77	958A .49
1TSGT .94	6F5GT .69	7AD7 .65	25L6GT .59	4A1P10 5.35	2051 .49	53A 3.82	631-P1 3.77	958A .49
1U4 .72	6F6 .69	7AG7 .79	25Z6GT .59	5AP1 3.75	2051 .49	53A 3.82	631-P1 3.77	958A .49
1V .69	6F7 .62	7AR .65	26 .65	5AP4 4.75	2051 .49	53A 3.82	631-P1 3.77	958A .49
2A3 .89	6F8G .89	7B4 .65	27 .65	5BP1 2.40	2051 .49	53A 3.82	631-P1 3.77	958A .49
2A5 .79	6G6G .88	7B6 .64	28D7 .61	5CP1 2.87	2051 .49	53A 3.82	631-P1 3.77	958A .49
2A7 .89	6H6 .48	7C4 .19	30 Spec. .64	5CP7 3.76	2051 .49	53A 3.82	631-P1 3.77	958A .49
2B7 .79	6H6GT .48	7C4 .19	30 Spec. .64	5CP7 3.76	2051 .49	53A 3.82	631-P1 3.77	958A .49
2E5 .94	6J5 .49	7C7 .65	32 .65	5HP4 3.35	2051 .49	53A 3.82	631-P1 3.77	958A .49
2X2/879 .79	6J5GT .48	7E5 .29	33 .29	5JP4 9.55	2051 .49	53A 3.82	631-P1 3.77	958A .49
2X2A .79	6J5GT .48	7E6 .64	34 .64	5LP1 13.95	2051 .49	53A 3.82	631-P1 3.77	958A .49
3A4 .61	6J6 .72	7F7 .79	35/51 .75	5MP1 10.65	2051 .49	53A 3.82	631-P1 3.77	958A .49
3A5 .96	6J7 .72	7F8 .92	35A5 .65	5MP5 10.65	2051 .49	53A 3.82	631-P1 3.77	958A .49
3B7/1291 .15	6J7GT .71	7H7 .72	35L6GT .59	7B11 12.87	2051 .49	53A 3.82	631-P1 3.77	958A .49
3C6(XXB) .29	6J8G .96	7K7 .75	35W4 .45	7BP7 4.95	2051 .49	53A 3.82	631-P1 3.77	958A .49
3D6/1299 .29	6K6GT .86	7L7 .79	35Y4 .65	7BP14 14.95	2051 .49	53A 3.82	631-P1 3.77	958A .49
3O4 .69	6K7 .52	7N7 .79	35Z3 .65	9GP7 9.85	2051 .49	53A 3.82	631-P1 3.77	958A .49
3Q5GT .79	6K7G .54	7O7 .79	35Z5GT .45	9LP7 3.88	2051 .49	53A 3.82	631-P1 3.77	958A .49
3S4 .61	6K7G .54	7S7 .96	36 .37	10BP4 24.66	2051 .49	53A 3.82	631-P1 3.77	958A .49
3V4 .48	6N7 .83	7T7 .96	37 .96	10FP4 28.88	2051 .49	53A 3.82	631-P1 3.77	958A .49
5A24 .702	6N7GT .87	7W7 .96	38 .96	12DP7 12.85	2051 .49	53A 3.82	631-P1 3.77	958A .49
5R4GY 1.05	6L6A 1.22	7Y4 .65	39/44 .65	12GP7 12.85	2051 .49	53A 3.82	631-P1 3.77	958A .49
5T4 .89	6L6A .87	10Y .19	42 .19	905 4.47	2051 .49	53A 3.82	631-P1 3.77	958A .49
5U4G .59	6L7 .87	12A6 .24	43 .24	913 4.90	2051 .49	53A 3.82	631-P1 3.77	958A .49
5V4G .84	6N7 .87	12A7 .59	45 .59	CE-1C/918 .88	2051 .49	53A 3.82	631-P1 3.77	958A .49
5W4 .76	6P7GT .87	12A8GT .72	45Z5GT .65	1P24 .46	2051 .49	53A 3.82	631-P1 3.77	958A .49
5X4G .59	6O7 .89	12A8GT .72	45Z5GT .65	1P24 .46	2051 .49	53A 3.82	631-P1 3.77	958A .49
5Y3GT .59	6O7 .89	12A8GT .72	45Z5GT .65	1P24 .46	2051 .49	53A 3.82	631-P1 3.77	958A .49
5Y4G .44	6R7 .89	12A7 .59	45Z5GT .65	1P24 .46	2051 .49	53A 3.82	631-P1 3.77	958A .49
5Z3 .65	6S7G 1.02	12AU6 .72	50B5 .69	1645 1.67	2051 .49	53A 3.82	631-P1 3.77	958A .49

### WESTINGHOUSE HYPERSIL TRANSFORMER

PRI-115V. 60CY 3/4 KVA  
 SEC #1 - 240V - 1.56A  
 SEC #2 - 240V - 1.56A  
 WT. 30 LBS.

**\$175 EACH**

**\$100 ea. Lots of 10**

### ASB YAGI ANTENNA

5 ELEMENT ROTATABLE ARRAY—  
 450 TO 560 MC **\$7.00**

SAME EXCEPT DOUBLE STACKED  
 6 ELEMENT 450 TO 560  
 MC **\$12.70**

Same Except Double Stacked  
 6 Element 370 to 430 MC **\$29.40**

### RCA HI-VOLTAGE TRANSFORMER

Pri—115/230V. 60CY  
 Sec—6000V—80 MA

**\$11.80**

Insulated for  
 Voltage Doubler Use

Antennas for AN/APR-4 Receivers  
 AT-38A/APT—(70 to 400 MC).....\$13.70  
 AT-49/APR-4—(300 to 3300 MC).....\$13.70

### KOLLSMAN INSTRUMENT LOW INERTIA SERVO MOTOR

Freq. Cycles	100	Res.—Phase 1	306 Ω
Volts—Phase 1	85	Res.—Phase 2	776 Ω
Volts—Phase 2	68	No. of Poles	4
Current—Phase 1	110MA	Speed—RPM	2650
Current—Phase 2	40MA	Weight—Oz.	6.5
Input Watts—No Load	2650 RPM CW		5.8
Input Watts—Stalled			5.0
Torque Stalled—(Oz. In.)			.80
Temp. Rise (°C)—2650 RPM—No Load			54
Temp. Rise (°C)—Stalled			54
Reversing Time—(Seconds)			0.1
Moment of Inertia (G. CM. <sup>2</sup> )			6.7

Will Operate Satisfactorily at 60 Cycles  
 Original Price \$34.50—Our Price—\$8.22 ea.  
**\$7.50 EACH—Lots of 10**

### COAXIAL CONNECTORS

83-1AC .42	UG-12/U .63	UG-86/U 1.22
83-1AP .09	UG-21/U .67	UG-87/U .68
83-1F 1.12	UG-22/U .86	UG-171/U 1.33
83-1H .10	UG-23/U .63	UG-175/U .15
83-1J .80	UG-24/U .67	UG-176/U .15
83-1R .28	UG-27/U .68	UG-180A/U3.82
83-1RTY .45	UG-29/U .83	UG-191/AP .57
83-1SP .28	UG-30/U .94	MX-195/U .41
83-1SPN .28	UG-33/U 14.80	UG-197/U 1.33
83-1T 1.12	UG-34/U 12.80	UG-206/U .58
83-22AP .85	UG-36/U 12.80	UG-254/U .88
83-22F .88	UG-37/U 12.80	UG-255/U .82
83-22R .48	UG-58/U .57	UG-264/U 1.74
83-22SP .48	UG-85/U .62	MX-367/U .15

Full Line of JAN Approved Coaxial Connectors In Stock. Send us your inquiries.

### GENERAL ELECTRIC AMPLIDYNE Motor-Generator

Consists of G.E. 1HP 115V 1 ph 60 cy 11.5A 3450 RPM continuous duty motor coupled to G.E. model 5AM65FB31 250V DC 2A 0.5KW 3450 RPM Amplidyne generator.

**Brand New \$97.50**

RADIATION COUNTER TUBES  
 1B98 GAMMA COUNTER.....\$9.87  
 AMPEREX 75N & 75NB (Beta & Gamma).....\$9.90  
 Full Line of Amperex Radiation Counters in Stock

### AMERTRAN HIGH CURRENT TRANSFORMER

Suitable for Welding Use  
 Pri—115 Volt, 60 cy.  
 Sec—5 Volt—190 Amp.  
 35 KV. Insul.

**\$1950**

### RAYTHEON SUB-MINIATURE PENTODE OUTPUT TUBES

CK-503AX ANY TYPE	\$1.47 EA.
CK-506AX Lots of 10	\$1.30 EA.
CK-507AX Lots of 100	\$1.00 EA.

### AT-48/UP 3 CM HORN ANT. \$3.95

\$3.50 each (Lots of 10)  
 Type N Plug to connect to probe.....67¢

### GENERAL ELECTRIC FG-32 TUBES \$4.25

\$3.75 Ea. - Lots of 10  
 Brand New Original Cartons

# ELECTRONIC RESEARCH LABORATORIES

1021-23 CALLOWHILL ST. PHILA. 23, PA.  
 Telephones - MARKET 7-6590 and 6591



RESISTORS  
EB 1/2, GB1 and HB2

LIFE OFFERS THE MOST COMPLETE INVENTORY OF 1/2, 1 and 2 WATT RESISTORS IN 5% and 10% TOLERANCES IN THE COUNTRY

PRICE SCHEDULE

Wattage	Tol.	Quantity per Type 500 or over
EB 1/2 1/2 Watt	10%	.06 .04 .025
EB 1/2 1 Watt	5%	.12 .08 .05
GB1 1 Watt	10%	.09 .06 .045
GB1 1 Watt	5%	.18 .12 .09
HB2 2 Watt	10%	.15 .10 .075
HB2 2 Watt	5%	.30 .20 .15

Prices shown are per size. Resistors may not be assorted for quantity price.

THE FOLLOWING VALUES ARE AVAILABLE IN 10% TOLERANCE:

Ohms	Ohms	Ohms	Ohms	Megs	Megs	Megs
10	100	1000	10000	1	1.0	10.0
12	120	1200	12000	1.2	1.2	12.0
15	150	1500	15000	1.5	1.5	15.0
18	180	1800	18000	1.8	1.8	18.0
22	220	2200	22000	2.2	2.2	22.0
27	270	2700	27000	2.7	2.7	27.0
33	330	3300	33000	3.3	3.3	33.0
39	390	3900	39000	3.9	3.9	39.0
47	470	4700	47000	4.7	4.7	47.0
56	560	5600	56000	5.6	5.6	56.0
68	680	6800	68000	6.8	6.8	68.0
82	820	8200	82000	8.2	8.2	82.0

THE FOLLOWING VALUES ARE AVAILABLE IN 5% TOLERANCES:

Ohms	Ohms	Ohms	Ohms	Megs	Megs	Megs
10	68	470	3300	22000	0.15	1.0
11	75	510	3600	24000	0.16	1.1
12	82	560	3900	27000	0.18	1.2
13	91	620	4300	30000	0.20	1.2
15	100	680	4700	33000	0.22	1.5
16	110	750	5100	36000	0.24	1.8
18	120	820	5600	39000	0.27	2.0
20	130	910	6200	43000	0.30	2.2
22	150	1000	6800	47000	0.33	2.2
24	160	1100	7500	51000	0.36	2.4
27	180	1200	8200	56000	0.39	2.7
30	200	1300	9100	62000	0.43	3.0
33	220	1500	10000	68000	0.47	3.3
36	240	1600	11000	75000	0.51	3.6
39	270	1800	12000	82000	0.56	3.9
43	300	2000	13000	91000	0.62	4.3
47	330	2200	15000	0.1	0.68	4.7
51	360	2400	15000	0.11	0.75	5.1
56	390	2700	18000	0.12	0.82	5.6
62	430	3000	20000	0.13	0.91	6.2

TYPE "J" POTENTIOMETERS



Available in screw-driver and regular shafts locking and non-locking type bushings.

When ordering locking type bushing potentiometers, locking nuts are available at \$.05 each.

Specify whether regular or screw-driver shaft is required.

DUAL POTENTIOMETERS TYPE "JJ"

PRICE SCHEDULE

Single Pots.....	\$.50
Dual Pots.....	1.50
Triple Pots.....	2.50

Ohms	Ohms
60/60	10,000/25,000
100/100	20,000/35,000
500/500	20,000/700,000
600/600	25,000/25,000
1800/1800	50,000/50,000
2500/2500	75,000/75,000
3000/3000	100,000/100,000
5000/5000	200,000/200,000
7500/7500	500,000/500,000
10,000	1 Meg/1 Meg
10,000	5 Meg/5 Meg

SINGLE POTENTIOMETERS TYPE "J" AND "JL"

Ohms	Ohms	Ohms	Ohms
50	1300	20,000	200,000
60	1500	25,000	250,000
150	2000	30,000	500,000
200	2500	35,000	600,000
250	3000	50,000	750,000
400	5000	60,000	1.0Meg
500	6500	75,000	2.0Meg
			2.5Meg
600	10,000	100,000	3.0Meg
1,000	15,000	150,000	4.0Meg
			500,000/500,000/500,000

Send for Free A.B. Bulletin

SILICON DIODES

Type	Design Freq. (mc)	Price each
IN21	3,000	\$.50
IN21B	3,000	1.00
IN23	10,000	1.25
IN23A	10,000	1.50
IN23B	10,000	2.00

GERMANIUM DIODES

Type	Price each
IN34	\$.85
IN35	2.00

MICA CAPACITORS

Regular and Silvered

Capacity MMFD	Regular Mica	Silvered Mica	Capacity MMFD	Regular Mica	Silvered Mica	Capacity MMFD	Regular Mica	Silvered Mica
5	\$.07	\$.12	130	\$.06	\$.14	1100	\$.12	\$.33
10	.07	.12	150	.06	.14	1200	.12	.36
12	.07	.12	160	.06	.14	1300	.12	.42
15	.07	.12	180	.06	.14	1500	.12	.45
18	.07	.12	200	.06	.14	1600	.15	.48
20	.07	.12	220	.07	.14	1800	.15	.51
24	.07	.12	240	.07	.16	2000	.15	.54
27	.07	.12	250	.07	.16	2200	.15	.54
30	.07	.12	270	.07	.16	2400	.15	.54
33	.06	.12	300	.07	.16	2700	.15	.60
36	.06	.12	330	.07	.16	3000	.15	.63
39	.06	.12	360	.07	.16	3600	.15	.63
43	.06	.12	390	.07	.19	3900	.17	.63
47	.06	.12	430	.07	.19	4300	.17	.63
50	.06	.12	470	.07	.21	4700	.17	.63
51	.06	.12	500	.07	.21	5000	.18	.66
56	.06	.12	510	.07	.21	5100	.18	.66
62	.06	.12	560	.07	.23	5600	.18	.75
68	.06	.12	620	.09	.25	6200	.20	.81
75	.06	.12	680	.09	.25	6800	.22	.90
82	.06	.12	750	.09	.27	7500	.24	.96
91	.06	.12	820	.09	.27	8200	.30	1.05
100	.06	.12	910	.10	.30	9100	.30	1.12
110	.06	.14	1000	.10	.30	10000	.36	1.20
						15000	.51	1.50

"UHF" COAXIAL CABLE CONNECTORS



No.	AN No.	Description	1-99	100-500 or over
83-1SP	PL250	Plug	.35	.28 .24
83-16S	UG176U	Adapter	.15	.12 .11
83-18S	UG175U	Adapter	.15	.13 .12
83-1SPN	PL250A	Plug	.35	.28 .24
83-776	UG203U	Plug	.61	.55 .53
83-1R	SO239	Receptacle	.35	.28 .24
83-1R7Y	SO239	Receptacle	.50	.45 .40
83-1H	UG106U	Hood	.12	.10 .09
83-1HP	UG106U	Hood	.27	.24 .21
83-765	UG177U	Hood	.31	.25 .22
83-1AC	.....	Cap and chain	.61	.50 .45
83-1BC	.....	Cap and chain	.38	.34 .31
83-1T	M358	"T" connector	1.12	.98 .90
83-1AP	M359A	Angle adapter	.35	.28 .24
83-1J	PL258	Junction	.85	.70 .65
83-1F	PL274	Feed thru	1.12	.98 .90
83-2SP	UG102U	Twin plug	.75	.68 .62
83-22R	UG103U	Twin recept	.50	.40 .36
83-22AP	UG104U	Twin ang. adapt.	.98	.80 .72
83-22T	UG105U	Twin junction	1.25	1.12 1.05
83-22F	UG196U	Twin "T"	1.65	1.50 1.35
83-22P	PL275	Twin feed thru	1.50	1.35 1.25
83-2SP	PL295	Lge twin plug	1.94	1.75 1.55
83-2R	SO265	Lge twin recept.	1.44	1.30 1.18
83-2H	M365	Lge Hood	.24	.22 .20
83-2AC	.....	Lge CAP and chain	.61	.55 .50
83-2AP	PL325	Lge Twin angle adpt.	2.08	1.88 1.68
83-2J	PL305	Lge twin junction	1.45	1.30 1.18

COAXIAL CABLES



BRAND NEW!!!  
JAN APPROVED!!!

RG No.	Impedance	Price per Thousand Ft.
RG5U	52.5 ohms	\$70.00
RG6U	76.0 ohms	150.00
RG7U	97.5 ohms	70.00
RG8U	152.0 ohms	60.00
RG9U	51.0 ohms	135.00
RG9AU	51.0 ohms	125.00
RG10U	52.0 ohms	125.00
RG11U	75.0 ohms	100.00
RG12U	75.0 ohms	190.00
RG13U	75.0 ohms	125.00
RG18U	52.0 ohms	450.00
RG19U	52.0 ohms	350.00
RG20U	52.0 ohms	450.00
RG22U	95.0 ohms	120.00
RG24U	125.0 ohms	240.00
RG25U	48.0 ohms	575.00
RG27U	18.0 ohms	290.00
RG29U	53.5 ohms	50.00
RG31U	71.0 ohms	175.00
RG33U	32.5 ohms	400.00
RG39U	72.5 ohms	180.00
RG41U	67.5 ohms	575.00
RG45U	58.0 ohms	65.00
RG45AU	58.0 ohms	75.00
RG57U	95.0 ohms	100.00
RG58U	53.5 ohms	50.00
RG59U	73.0 ohms	40.00
RG62U	93.0 ohms	50.00
RG65U	95.0 ohms	250.00
RG71U	93.0 ohms	175.00
RG74U	52.0 ohms	250.00
RG78U	48.0 ohms	80.00

Prices based on a minimum quantity of 500 ft. For cut lengths add 50% to prices shown.

BRAND NEW!!! UG TYPE CONNECTORS JAN APPROVED!!!



UG 30/U	UG 88/U	UG 290/U	UG 306/U	UG 352/U
AN No. Price ea.	AN No. Price ea.	AN No. Price ea.	AN No. Price ea.	AN No. Price ea.
UG9/U... 1.56	UG23BU... 1.29	UG88U... 1.17	UG146U... 2.25	UG235U... 28.50
UG10/U... 1.45	UG27AU... 2.25	UG89U... .95	UG155U... .40	UG236U... 11.75
UG11/U... 1.45	UG28U... 2.34	UG90U... 1.05	UG154U... 5.35	UG241U... 2.20
UG12/U... .95	UG29U... 1.22	UG91U... 1.25	UG156U... 4.25	UG242U... 2.50
UG13/U... 1.56	UG29AU... 1.36	UG91AU... 1.05	UG157U... 4.25	UG243U... 2.75
UG14U... 1.45	UG30U... 1.75	UG92U... 1.10	UG160U... 1.90	UG244U... 2.50
UG15/U... .95	UG33U... 1.75	UG92AU... 1.35	UG160AU... 1.55	UG245U... 1.25
UG16U... 1.56	UG37U... 20.00	UG93U... 1.25	UG167U... 3.00	UG246U... 1.45
UG17U... .95	UG38U... 20.00	UG93AU... 1.45	UG173U... .30	UG252U... 4.50
UG18U... .99	UG34U... 17.50	UG94U... 1.25	UG174U... 16.00	UG254U... 1.82
UG18AU... 1.05	UG35AU... 16.00	UG94AU... 1.05	UG188U... .95	UG255U... 1.85
UG19BU... 1.09	UG36			

# Reliance Specials

POSTAGE STAMP MICAS					CAPACITORS					OIL FILLED		
MMF	MMF	MMF	MMF	MFD	SILVER MICA	MMF	MMF	MMF	MFD	MFD	V.D.C.	Price
8.2	60	250	600	0015	10	100	360	680	.0027	375@	16,000 (and)	
10	62	300	620	.002	24	110	370	700	.003	.75@	8,000 (dual)	\$6.95
15	70	350	650	.0026	25	120	390	820	.0039	5	7,500	23.95
20	75	370	680	.0027	30	125	400		.0039	1	7,500	1.55
22	82	390	750	.003	40	150	430	MFD	.004	1	7,000	1.55
24	90	400	820	.0033	47	180	466	.001	.0047	1	7,000	1.50
25	100	430	910	.0039	60	200	488	.0013	.005	1	6,000	8.50
39	110	470	MFD	.004	62	208	500	.0015	.0051	1	6,000	1.45
40	150	500	.001	.005	66	240	510	.002	.006	2	4,000	4.50
47	160	510	.0012	.0068	68	250	560	.0022	.0082	2	3,000	1.95
50	220	560	.0013	.0075	75	300	600	.0024	.01	1	2,000	.95
51	240	580	.00136	.0082						4	1,000	.90
56				.01						3	1,000	.80
										2	1,000	.65
										10	600	1.00
										4	600	.69
										2	600	.39

**SELSYNS**  
115 V., 60 Cyc.  
#C78248  
3 3/8" dia. x 5 1/8" long  
**\$7.95 pair**

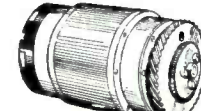

Mounting Brackets — (Bakelite) for selsyns, and differentials shown above .....25¢ pair

**DIFFERENTIAL**  
115 V., 60 Cyc.  
#C78249  
3 3/8" dia. x 5 1/8" long  
**\$2.25 ea.**



Used between two #C78248's as dampener. Can be converted to 3600 RPM Motor in 10 minutes. Conversion sheet supplied.

**WW PRECISION RESISTORS, 1% OR BETTER**

1/4 WATT—25c				1 WATT—30c			
6.68Ω	12.32Ω	16.37Ω	123.8Ω	1.01Ω	5.21Ω	1.250Ω	9,000Ω
10.48	13.02	20	147.5	2.58	10.1	3,300	18,000
10.84	13.52	62.54	220.4	3.39	10.9	7,000	55,000
11.25	13.89	79.81	301.8	5.05	270		70,000
11.74	14.98	105.8	366.6				

1/2 WATT—25c				1 WATT—40c			
.250Ω	11.1Ω	210Ω	3,427Ω	100,000Ω	128,600Ω	180,000Ω	522,000Ω
.334	13.15	235	4,000	120,000	130,000	220,000	600,000
.502	46	260	4,451	125,000	160,000	470,000	700,000
.557	62	270	5,000				
.627	55.1	208.3	5,900				
.76	75	400	6,500				
1.01	97.8	723.1	7,000				
1.53	125	2,500	7,500				
2.04	180	2,850	8,000				

**UNIVERSAL JOINT**  
3/16" hole x 3/8" O.D.  
1 1/8" long  
Steel or Aluminum  
**50¢**



**TOGGLE SWITCHES**  
Bat Handle, S.P.S.T. 6A, 125 V. Off-On plate.....20c  
Ball Handle, S.P.D.T. 6, 125 V.....24c  
Bat Handle D. P. S. T. 6A, 125V.....29c

**DRY DISK RECTIFIER**  
117 V.A.C. in, 110 V.D.C. out @ 100 Ma.....72c

**ALLEN SET SCREWS**  
4-40 x 1/4 8-32 x 1/4 8-32 x 5/16  
4-40 x 3/16 8-32 x 3/16 8-32 x 3/8  
ALL SIZES (Cup Point) .....\$1.50 per 100

**GLYPTAL CEMENT** 1 qt.....75¢ 1 gal.....\$2.50

**Wrapped—BALL BEARINGS—New**

Mfg.	ID	OD	Width	Price
Fafnir 33K5	3/16"	1/2"	5/32"	.25
N.D. 38	5/16"	7/8"	9/32"	.45
Fafnir K8A	1/2"	1 1/8"	5/16"	.60
N.D. 5202C13M	1/2"	1 3/8"	1/8"	1.00
Fafnir 7308W	1 37/64"	3 9/16"	5/16"	2.00
SKF 466430	0"	8"	1"	5.80
SKF 170645	3 11/32"	4 1/8"	7/16"	1.50
Fafnir 545	2 1/16"	2 5/8"	15/32"	1.00

**NEEDLE BEARINGS**  
B108 1/2" wide 5/8" 13/16" 30¢  
GB34X 1/4" wide 3/16" 11/32" 25¢

**SOUND POWERED HANDSET**  
Brand New! TS-10  
Includes 6 ft. cord & spring clips  
\$8.92 ea. — \$17.60 pr.



**WALL HANGER**—Navy type, for Sound Powered Phones (Shown above).....\$1.00 each

**HAYDON TIMING MOTORS**  
2/3 It.P.M., 115V., 60 Cyc. Two motors connected on one shaft to make unit reversible. Only.....\$1.95  
4 R.P.M., 115V., 60 Cycle.....1.79

**POWER RHEOSTATS**  
STANDARD BRANDS

25 WATT	25 WATT	90Ω 1/2"	79¢
Resist. Shaft	3,000Ω 1/4"	123 1/2"	79
10Ω 1/4"	3,500 1/4"	1,250 1/2"	89
15 1/4"	5,000 S.D.* 69	2,000 1/2"	89
25 1/4"		3,500 1/2"	89
145 1/2"			
with switch	2Ω 1/4"	79¢	
200 59	8Ω S.D.* 79	8Ω 1/2"	\$1.99
250 59	12 1/4"	75 1/4"	1.99
370 1/2"	20 1/4"	79	*S.D. Screw Driver Slot

**FILAMENT TRANSFORMER**  
Amertran Type WS  
For High Voltage Rectifiers.  
PRI. 115V., 50/60 Cycle.  
SEC. 5V., C/T @ 10 Amp.  
35 KV R.M.S. Test 12 KV D.C.  
Operating. Uses 872A Tube  
(See our tube list).  
**NEW OVERSEAS PACKED \$10.95**

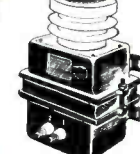

**RANGE UNIT**  
From AN/APS-15. Contains 11 Utah X 124-T2 (9262) Pulse Transformers, 12 Prec. Resistors, 28 V.D.C. Blower, metal cabinet and other useful parts **SPECIAL \$10.95**

**PRECISION CONTROLS**

6 WATT	4 WATT	12 WATT
20,000 Muter 314A \$1.70	500Ω Centralab 48-501 \$9.90	10,000 Muter 471A \$2.00
20,000Ω GR 314A 2.50	50 De jur 292 .75	10,000Ω De jur 271T 2.00
6,000 De jur 260 1.70	50 GR 301 1.10	5,000 De jur 271T 2.00
6,000 Muter 314A 1.70	25 GR 301 1.10	
5,000 Muter 314A 2.50	20 De jur 292 .75	
5,000 GR 214A 1.40	12 GR 301 1.10	
2,000 De jur 260 1.70		
100K GR 433A \$4.95		

**DC AMMETER**  
0-15A BASIC MOVE 12 Ma. 5" x 4" METAL CASE MIRROR SCALE  
Lots of 10—\$34 **\$3.85 ea.**



**CHOKE**  
400 MA 12 Hy. 90 OHM 6,000 V. D. C. TEST  
Lots of 10 for \$34.00 **\$3.85**



**METERS**

0-7.5 V.A.C. 3 1/2" Westinghouse.....	\$3.49
0-15 V.A.C. 3 1/2" Westinghouse.....	3.49
0-8 Amps. R.F. 3 1/2" Weston.....	3.29
00-0-60 Amps. D.C. 2" Westinghouse.....	1.29

## RG 8/U 52 OHM

**\$50.00 per 1,000 feet OTHER COAXIAL CABLE**

RG 7/U 97 OHM.....	per 1,000 ft.	\$60.00
RG 9/U 51 OHM.....	per 1,000 ft.	125.00
RG 22/U 95 OHM (2 cond.).....	per 1,000 ft.	100.00
RG 58/U 53 OHM.....	per 1,000 ft.	50.00
RG 69/U 78 OHM.....	per 1,000 ft.	40.00
RG 62/U 93 OHM.....	per 1,000 ft.	50.00

## COAXIAL CABLE CONNECTORS



Angle-Adapter	Plug	Socket	Hood
15c	28c	9c	9c
M-359	PL-259A	SO-239	83-1H
83-1AP	83-1SPN	83-1R	

Adapter for PL-259 A for use on small coax.  
12¢ each .....\$10.00 for 100

83-1SP	\$28	83-22SP	.48	UG 27/U	.60
83-1J	.80	83-22J	1.50	UG 59/U	.60
83-1T	1.12	UG 13/U	.60	UG 61/U	.60
83-1F	1.12	UG 21/U	.60	UG 85/U	.60
83-22AP	.85	UG 22/U	.60	UG 87/U	.50
83-22J	.85	UG 24/U	.60	UG 167/U	2.00
83-22R	.48	UG 25/U	.60	UG 281/U	.60

## CARBON RESISTOR ASSORTMENT

Color coded, insulated.....100 only \$1.19

**PULSE TRANSFORMERS**  
X 124 T2, UTAH, marked 9262 or 9280, Small gray case. Ratio 1:1:1, hypsilyl core.....\$1.50  
D161310, 50 Kc to 4 Mc. 1 1/4" dia. x 1 1/2" high, 120 to 230 ohms.....\$1.50  
352-7178—Spec. 10, 111 Chicago Trans. equivalent to 9262 (above).....\$1.00  
D166638 W.E. Permalloy core. Semi-toroidal windings \$1.25  
KS9800, Ratio, 1:1:1, 2:1, Freq. range 380 to 520 C.P.S.....\$3.50  
D106173, W.E. Freq. resp. 10KC to 2 MC.....\$9.80  
300 KVA GE K 2468B, 50 ohm pulse cable connection; 3,850 V. in., 17,300 V. out (250 KVA @ 1/4 microsecond).....\$13.75  
800 KVA G.E. K2731, 28000 Volt pk. output; Bifilar; one-microsecond pulse width.....\$14.50

**TUBE SPECIAL—New—Guaranteed**

2J26	\$8.29	6AL5	\$7.72	6X5 GT	\$5.57
2X2/879	.44	6SN7	.65	6Y5	.84
3C24	.49	6SN7 GT	.65	872A	1.88
6AC7	.79	6SQ7 GT	.47	C5B	6.98
6AK5	.84	6V6 GT	.59		

**DELAY NETWORK—ALL 1400 Ω**  
T 113—Approx. 1.2 micro sec. delay.....85¢  
T 114—Approx. 2.2 micro sec. delay.....85¢  
T 115—Similar to T 114 with tap brought out.....85¢

**TIME DELAY RELAY**  
Raytheon CPX 24166 KS 10193-60 Sec.  
• 115 V. 60 Cycle  
• Adj. 50-70 Seconds  
• 2 1/2 seconds recycling time. spring return  
• Micro Switch Contact, 10A  
• Holds On as long as power is applied. Fully Cased  
**ONLY.....\$6.50**



**JONES BARRIER STRIPS**

Type	Price	Type	Price	Type	Price
2-140Y	\$ .05	4-141 1/2 W	\$ .22	9-141 1/2 W	\$ .47
2-140 1/2 W	.10	4-141 Y	.20	10-141 1/2 W	.52
3-140 1/2 W	.13	5-141 Y	.27	12-141 Y	.67
4-140	.13	5-141 Y	.27	17-141 Y	.87
8-140	.23	5-141 1/2 W	.27	17-141 Y	.87
8-140 W	.33	6-141	.23	3-142	.15
10-140 1/2 W	.40	7-141	.27	5-142	.24
13-140 1/2 W	.37	7-141 1/2 W	.37	6-142	.28
3-141 W	.17	7-141 Y	.37	9-142	.41
3-141 Y	.17	8-141	.30	10-142 1/2 W	.64
4-141 W	.22	8-141 1/2 W	.42	2-150	.28
				4-150	.52

7 Terminal Bakelite Tie Point.....35 for \$1.00

**VERNIER DIAL**  
(From BC-221)  
2 5/8" Dia. 0-100 in 360°. Black with silver marks. Has thumblock.....85¢

**HARDWARE ASSORTMENT** (mostly brass — screws, nuts, washers, rivets).....3 lbs., \$1.00

**Gear Assortment.....\$6.50**  
Experimenters dream, 100 pieces, many stainless steel.

3AG	FUSES	3AG
1/4 Amp \$4.00 per 100	100	2 Amp \$2.50 per 100
3/4 4.00	100	3 2.50
1 4.00	100	4 2.75
1 1/2 2.50	100	10 3.00
	100	15 3.00

Fuse Holder—Littlefuse for 4AG fuse.....18¢  
Minimum Orders \$3 ..... All orders f.o.b. PHILA, PA.

# RELIANCE MERCHANDIZING CO.

Arch St. Cor. Croskey Phila. 3, Pa. Telephone RIttenhouse 6-4927

# A ONCE-IN-A-LIFETIME SURPLUS SALE

## EXCLUSIVE! AMPERE DEMAND INDICATOR

Made by STEWART-WARNER, ONLY \$2.49!

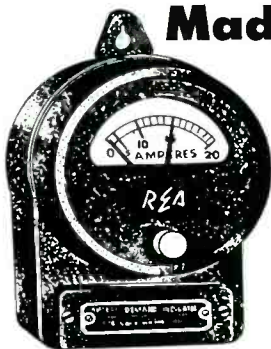

SPECIAL PRICE IS 5-10 TIMES LOWER THAN REPLACEMENT COST!

THERMALLY OPERATED — 2 WIRE — 20 AMP RANGE — 600 V OR LESS

CUT current costs, INCREASE equipment life with 20 amp range Stewart-Warner Model 748A (Type RD) demand indicators for 600 volts or less. These 2-wire instruments are a "must" for Electrical Contractors, production lines, labs, colleges, electric sub stations. Accurately check transformer loading, load distribution! Determine proper current distribution! Meter consumes

only 6 watts at full indication. Red pointer indicates demand at time of reading; black pointer shows maximum registered demand; front panel knob zeros pointers. Weather-proof gray crackle-finish metal case 4 1/2" W, 5 1/2" H, 2 3/4" D. Provision for wall mounting. Weight 1 1/2 lbs. Brand NEW! Individually packed in original carton, with complete technical data. Only \$2.49 each!

### New! Not War Surplus! Heavy Duty POWER TRANSFORMERS SEE THE LIST PRICE ON EACH!

Brand new power transformers in battleship gray enamelled potted metal cases, with porcelain high voltage terminals. Conservatively rated — will handle much larger than stated capacities. Mount upright or inverted. Excellent for ham rig, experimenters, broadcast stations. Available in two ranges, both with input of 115/1/60:

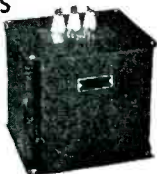

2650-0-2650 AC at 550 ma (ICAS) — size 7 3/4 x 7 3/4 x 8 1/2". Weight 50 lbs. LIST Price \$150. OUR PRICE ONLY \$29.95  
1750-0-1750 AC at 550 ma (ICAS) — size 6 3/4 x 8 x 7 1/2". Weight 37 lbs. LIST Price \$100. OUR PRICE ONLY \$18.95  
NOTE: add 50c ea. for wooden crating of above transformers.

### \$48 PRICE CUT ON RCA VOLTOHMYST! NOW \$39.50 WAS \$87.50



ONLY A LIMITED QUANTITY REMAINS of this sensational battery-operated V.T.V.M. at a price LESS THAN HALF of RCA's original net price! WV-65A is a fully self-contained portable vacuum tube voltmeter-ohmmeter requiring no external power. Among its many features are: zero grid current, controlled inverse feedback, 1 meg shielded signal-tracing probe, polarity reversing switch. Has scores of TV, FM, shop, lab and field uses. RANGES: 0-3/10/30/100/300/1000 volts DC, constant input resistance 11 meg all ranges; 0-10/30/100/300/1000 volts AC at 1000 ohms/volt; 0-1000/10,000/100,000/1 meg/10 megs/1000 megs; 0-3/10/30/100/300 milliamps DC; 0-10 amps DC. Gray metal case 9 1/2 x 6 1/2 x 5 1/2". Only \$39.50. Battery kit \$2.52 extra.

### BRAND NEW! MADE BY GENERAL MOTORS!

## HUGE SURPLUS SALE of DELCO DUAL BLOWERS!



ONLY

\$14.85 Ea. lots of 1-9  
\$13.95 Ea. lots of 10-49  
\$12.75 Ea. lots of 50-99

New and in original shipping cartons! Way, way, way below regular price! Built by Delco division of General Motors. Million household, commercial and marine uses: photo darkrooms, cooling xmtr tubes, furnace draft boosting, machinery suction unit, humidifiers, hair dryers, kitchen ventilation, etc. No brushes to cause radio interference. Quiet, continuous duty 115 V 60 cycle Delco shaded-pole motor with skewed squirrel-cage type rotor. Two multi-blade squirrel-cage type fans and pressed-steel welded 2-piece snail type housing. Die cast alloy case and housings. Operates at 2800 rpm; 2750 fpm velocity, 120 cfm free volume air delivery. 62 watts input. Black lacquer finish. Weight 11 lbs. Over-all 10 21/32" by 5 27/32" by 6 7/32", with universal mounting brackets. It's the blower-buy of all time!

MANUFACTURERS! EXPORTERS!

Write for discount on lots exceeding 100 blowers.

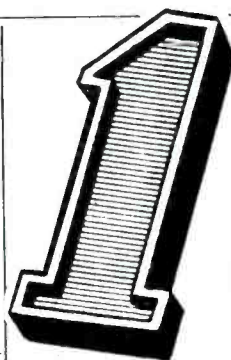

## 1¢ TUBE SALE

minimum order \$2

BUY ONE TUBE at our regular low price . . . get ANOTHER FOR ONLY 1c. EXTRA!

THE RADIO SHACK again honors the forgotten penny and the penny-wise gentleman who uses tubes! LIMIT is two tubes per type. Penny-sale ENDS March 24. All tubes brand new, standard makes. Tubes will be shipped by Railway Express only, for your protection. Inspected for mechanical breakage by us before shipping.

TYPE	EACH	SALE PRICE
1A3	.39	2 for .40
2X2	.40	2 for .41
2E22	1.50	2 for 1.51
3A4	.39	2 for .40
3FP7	2.25	2 for 2.25
6AK6	.89	2 for .90
7C4	.35	2 for .36
7E5	.75	2 for .76
12A6	.23	2 for .24
125F7	.69	2 for .70
15R	.98	2 for .99
15R	3.50	2 for 3.51
227A	4.50	2 for 4.51
304TH	1.70	2 for 1.71
724B	4.25	2 for 4.26
805	2.95	2 for 2.96
814	1.95	2 for 1.96
815	4.26	2 for 4.27
826	.49	2 for .50
830B	3.50	2 for 3.51

TYPE	EACH	SALE PRICE
838	2.95	2 for 2.96
872A	1.15	2 for 1.16
957	.25	2 for .26
1616	.60	2 for .61
1626	.37	2 for .38
9001	.40	2 for .41
9004	.30	2 for .31
9006	.42	2 for .43
FG27A	5.45	2 for 5.46
KR72	.75	2 for .76
RV150	.60	2 for .61

### MORE PENNY BUYS!

TRANSFORMER — 115VAC 60 cy, Sec. 9V at 1A, Order No. R-0132. Each 75c 2 for 76c  
2-GANG SELECTOR SWITCH — SP7/POS, 2PDT. Each 25c 2 for 26c  
10 MFD 600V OIL CONDENSER — 2 x 5 mfd, rect., Tobe. Each 75c 2 for \$1.11

### HURRY!

EVEREADY 600 AMP STORAGE BATTERY REG. \$9.50, ONLY \$1.95



Eveready T-1600 "Aircell", 1.25 volts at 600 amp-hour capacity at maximum drain. Perfect for telephone, railroad, industrial and other applications where current drain is of utmost importance. Bakelite cased. Shipped dry. 10" x 5" x 6 1/2". BRAND NEW, individually packed. Order No. R-734A. Only \$1.95 each, 3 for \$5.50

### REDUCED!

650 MFD AT 80 VDC RECTIFIER CONDENSER REG. \$6.50, ONLY \$1.75



Ideal for heavy duty low-voltage supplies! C.D. type 48952. Isolate pillar terminals, base mounted through angle brackets. 6 x 6 x 3". Unused! Order No. R-379. Only \$1.75.

ORDERS FILLED PROMPTLY

TERMS - cash or 20% deposit, balance C.O.D.

RADIO SHACK  
152-PAGE  
1950 CATALOG  
NOW BEING MAILED!

The RADIO SHACK Corp.  
167E WASHINGTON ST., BOSTON, MASS., U.S.A.

# Engineering-Hand Selected-Government Surplus

EVERY ITEM PERSONALLY SELECTED BY OUR ENGINEERS

Unconditionally guaranteed.

## UHF & MICROWAVE EQUIPMENT

### FREQUENCY METERS

**Field Strength-Frequency Meter.** 1-95BM 100 to 15% Mc. Cavity Type-Battery Operated. Now being used by GAA and Airlines. Complete in case—New... \$21.50  
**Wave Meter-BC906D.** 160 to 220 Mc. Absorption type consisting of coaxial wave meter, diode rectifier, amplifier and individual calibration charts. Complete in black cradle case with antenna... \$29.50  
**Loavoie Frequency Meter.** 375 to 725 Mc. Model 105SM. 0.1% accuracy. Covers new citizen band, Aircraft, Amateur, New Television band, Government bands. Precision Equipment. Individually calibrated. Complete with instruction manual and cable. New... \$59.50. Case scratched but otherwise perfect... \$49.50  
**Resonance Cavity "S" Band Wavemeter** Manf. by Western Electric. Type 1B435. 430 Transmission type ca. ty. Coaxial input and output loops. Rotary calibrated inductor and calibration charts... \$49.95

### MAGNETRONS

**Magnetron—2132.** 2780 to 2820 Mc. Fil. Voltage—6.3V at 1.5 Amps. Pulse Voltage—18-22 Kilovolts. Average Ma. 12.5-25. Average Power Out—280 Watts. Peak Power Out—285 KW. Band Width—2.5 Mc. Duty Cycle 1000/1. New JAN boxed Crystal Diodes... \$19.95

### CRYSTAL DIODES

1N21... \$75 1N23A... \$1.25 1N22... \$1.00  
 New—Jan Inspected—Boxed

### BAND PASS FILTER 1000 CPS

Band Pass at 3 db: ± 150 cycles. Center Frequency adjustable: ± 10 cycles. Input 23,000—Output 225,000—Triple allow. Shielded. Mfd. by UTC. Size 1 1/2 x 1 1/2 x 2" each... \$3.95

### FILTER CHOKES

10 Hy. 75 Ma. 260 Ohms Herm. sealed in 100 lots... \$ .47  
 single unit... .70  
 4/20 Hy. 100 Ma. 120 Ohms Herm. sealed... 1.10  
 10 Hy. 100 Ma. 260 Ohms Herm. sealed... 1.40  
 5 Hy. 130 Ma. 100 Ohms Herm. sealed... 1.20  
 10/14 Hy. 145-200 Ma. 100 Ohms... 1.95  
 5 Hy. 200 Ma. 70 Ohms... 1.95  
 3-5 Hy. 200 Ma. 60 Ohms Herm. sealed... 2.50  
 16 Hy. 450 Ma. 112 Ohms Herm. sealed... 9.95  
 8 Hy. 500 Ma. 80 Ohms... 8.50  
 5/20 Hy. 500 Ma. 80 Ohms... 8.50  
 8 Hy. 700 Ma. 60 Ohms... 12.75  
 3/20 Hy. 700 Ma. 60 Ohms... 12.75  
 4 Hy. 900 Ma. 28 Ohms Herm. sealed... 15.50

### OIL CAPACITORS

2 MFD 600 volts... \$ .35  
 4 MFD 600 volts... .60  
 6 MFD 600 volts... .80  
 7 MFD 600 volts... .80  
 10 MFD 600 volts... 1.20  
 2 MFD 1000 volts... .80  
 4 MFD 1000 volts... 1.10  
 10 MFD 1000 volts... 2.25  
 1 MFD 3600 volts... 3.50  
 25 MFD 4000 volts... 3.50  
 1 MFD 5000 volts... 4.95  
 2 MFD 5500 volts... 6.95  
 1 MFD 7500 volts... 5.95  
 .02 MFD 20,000 volts... 7.95  
 All made by prominent manufacturers.

### RELAYS-CONTACTORS

Type Coil Contacts Price  
 CH Contactor 115V AC 4PST-30 Amps \$7.95  
 West gl. encl 115V AC 4PST-20 Amps \$7.50  
 Allied Bo. 6 V DC DPDT-10 Amps \$1.00  
 G. E. PJC Adj. overload 4-12A ac/dc \$12.50  
 G. E. PJC Adj. overload 2-8A ac/dc \$12.50  
 G. E. PJC Adj. overload 0.5-1.5A ac/dc \$12.50  
 AB Solinoid 115V AC DPST 20 Amps \$3.95

We carry large stocks of all types Resistors, Variable & Fixed Condensers, Potentiometers, Rheostats, Connectors, Tubes, Transformers ETC. Send your needs for quotation. We also manufacture electronic equipment to your specifications.

**GRID DIP OSCILLATOR.** See August Issue Electronics Pg. 176. "New Products". An all around Laboratory instrument for measurement of resonant frequency. Circuits Q, RF, voltages, antenna and many other purposes. 3 MC. to 250 Mc. or other extended ranges. Compact and complete in kit form. Instruction book and application book sent free on request. Complete Kit... \$21.50

**BIRD WATTMETER.** 5 to 500 watts of R.F. Measures MF, HF, VHF and UHF. Write for full description. Only one used unit left... \$75.00 each

**DAVEN ATTENUATION BOX Model HA-740** 110 DB attenuation in 1 Db steps 600/600 ohm input and output. New. Three left... \$59.00 each

**TETRAD FREQUENCY STANDARD.** Self contained, dual 100/1000 KC XTL, Multivibrator and Harmonic Amp. Calibrate with WWV or Broadcast for high accuracy. 100 to 45,000 KC check points every 100/1000 KC. Now... \$29.50

### MULTI CONDUCTOR CABLE MILLION FEET AVAILABLE

**9 CONDUCTOR**—#20 str. plastic, 2 vinyl jacket. Shield 1/2" G.E. Reel Lengths .09/ft. 100 ft. .14/ft.  
**10 CONDUCTOR**—#20 Solid, Plastic vinyl jacket. 1/2" dia. On steel reels. Reel lengths .08/ft. 100 ft. .10/ft.  
**28 CONDUCTOR**—#20 stranded plastic vinyl jacket 3/8" dia. Reel lengths. 20/ft. 100 ft. .24/ft.  
**4 CONDUCTOR.** Each cond. 1/4" dia. Double plastic Ins. Heavy Duty Power Cable—Extremely flexible. 1-1/2" Dia. Reel lengths Approximately 250 ft. .26/ft.  
**3 CONDUCTOR**—#18. Shield Jacket. .05/ft.  
**2 CONDUCTOR**—#20 Shield Jacket. .04/ft.

### WIRE

Underwriters Laboratory Approved Wire—Ideal for Television—8 colors—Plastic Insulation—Solid #22 Voltage Insulation 3000 Volts  
 5000' reel lengths—\$5.75 per 1000' 1000' lengths... \$6.00 per M  
 #20 HV str. White plastic... \$4.95/M  
 #20 str. white, red and green plastic... \$3.95/M  
 3/16" magnet DC/rect. Reel lengths .35/lb.  
 #30 SSE magnet. Reel lengths .60/lb.

### MICA CONDENSERS

Largest stock in the country at 90% Discount.  
 Types—FIL, XR, etc.  

Cap. Wk.Vo. Pr.	Cap. Wk.Vo. Pr.
750 5,000 .75	200 3,000 .70
560 5,000 .75	100 3,000 .55
375 5,000 .75	90 3,000 .50
001 4,500 1.10	50 3,000 .50
002 3,500 .95	.025 2,500 1.10
003 3,000 .95	.006 2,500 .75
700 3,000 .60	30 2,000 .40
500 3,000 .70	015 1,500 .75
400 3,000 .55	.12 500 1.15

Type H-A2  

Cap. Wk.Vo. Pr.	Cap. Wk.Vo. Pr.
.002 3500#9 .60	350 2500#9 .35
.005 2500#4 .45	.002 1000#4 .25
400 2500#4 .30	

 Also complete stock of ceramics—2.2 to 300 MMFD Button capacitors 40 to 2400 MMFD—500 to 1250 Volts

### VOLTAGE REGULATOR

Manf. guaranteed 1% regulation. Primary 92-138V 57-63 cycles. 1 Phase Secondary 115V 1% regulation 96 LF Navy Gray Cabinet. Shipping wt. 250 lb. Size 36x20x12. Limited quantity... \$97.50

### STEPDOWN TRANSFORMERS

440 to 220 to 110-5 KVA. Complete enclosed G.E. Explo. Proof. Can be used as 4:1 or 2:ratio step-up or down. 60 cps. Size 20x11x10. Weight 255 lbs. Navy Gray finish. Integral junction box and mounting frame... \$75.00  
 440 to 220 to 110-2 KVA. Same specifications as above except 2 KVA. Size 12x11x10. Wt. 93 lbs. Only 5 units left... \$35.50

### BROADCAST MODULATION TRANSFORMER

R.C.A. 833'As to pair 833'As, as used in R.C.A. Commercial 1 K.W. Broadcast Transmitters. Transformer being used in U.S. Broadcast stations. New fully guaranteed. Primary 15,000 ohms Secondary 5,030 ohms. .86 KVA Audio. Size 12x10x13. Wt. uncrated 153 lbs. Limited Qty. available... \$75.00

### POWER TRANSFORMER

440/220 3 Phase. A bushy brute for induction heating. Primary 440/220 3 phase Secondary. Each phase 1365V at .67 Amps. Manf. by Raytheon. This transformer and a pair of 304's will give 2.5 KW output at a total cost of less than \$50.00. Special—while they last—Only... \$42.50

### SPECIAL TRANSFORMER

440 or 220 1 phase Filament transformer 440/220 Pri. Secondary 5.0 at 30 Amp 1500 volt insulation. Herm. Sealed Navy Specs... \$7.95  
 Plate Transformer. 200/220/240 Pri. Secondary 1400V Ct. at 350 ma. Gray Hermetically sealed... \$6.70  
 Filament Transformer 200/220/240 Pri. Secondary 6.3V at 2.7 Aps. Matched unit for above... \$2.45

### POWER TRANSFORMERS

**115V A.C. 60 cycles Primary**  
 110 volts A.C. 60 cycles Primary  
 3700-0-3700 at 500 Ma. (Delivers 3000 volts D.C. full load) \$59.00  
 2500-0-2500 at 700 Ma. (Delivers 2000 volts D.C. full load) \$45.00  
 2500-0-2500 at 500 Ma. (Delivers 2000 volts D.C. full load) \$39.50  
 1800-0-1800 at 350 Ma. (Delivers 1500 volts D.C. full load) \$19.50  
 1500-0-1500 at 350 Ma. (Delivers 1250 volts D.C. full load) \$17.50  
 575-0-575 at 220 Ma. (Delivers 500 volts D.C. full load) \$7.95  
 The above transformers not Surplus but made by a large transformer manufacturer especially for ELDIACO  
 740-0-740 at 1.2 Amps... \$17.50  
 430-0-430 at 325 Ma. and filaments \$4.95  
 400-0-400 at 300 Ma. and filaments \$5.95

### SCOPE & TELEVISION TRANSFORMERS

**115 Volts A.C. Primary**  
 4500 Volts at 4.5 Ma. 5 V at 3 Amps... \$7.95  
 3750 Volts at 2 Ma... 4.50  
 1100 Volts at 10 Ma. & Filaments... 2.75

### FILAMENT TRANSFORMERS

**115V A.C. 60 cycles Primary**  
 36 Volts at 10 Amps... 5.95  
 24 Volts at 10 Amps... 4.95  
 12.6 Volts at 7 Amps... 3.95  
 11.5 Volts at 11.5 Amps. (10 Volts at 20 Amps.)... 4.95  
 10 Volts at 6 Amps... 3.50  
 10 Volts at 6 Amps. 6.3V at 11A. 5.0V at 3A... 5.50  
 6.3 Volts at 10 Amps... 2.95  
 5 Volts at 10 Amps. 15KV Ins (For 872A's)... \$5.75  
 2.5 Volts at 10 Amps. 10KV Ins. (For 868A's)... 3.75

### ALL MATERIAL NEW AND GUARANTEED

10% Discount on order over \$100.00. Large quantities available. Quotes on request.

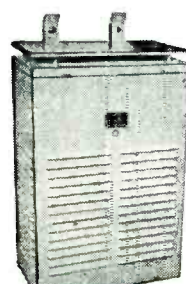
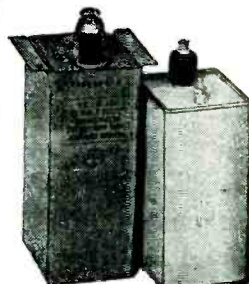
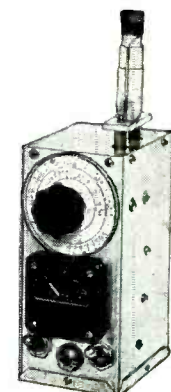

# ELDICO OF NEW YORK, INC.

44-31 DOUGLSTON PKWAY., DOUGLSTON, L.I., N.Y., U.S.A. Cable Address. ELDIKOINC  
 BAYSIDE 9-8686



**SPECIAL METERS**

**SENSITROL RELAY.** 0-50 microampere sensitivity, Weston 705 type 5, Single fixed contact with 110 volt A.C. solenoid reset and adjustable index to indicate operating point. Has two scales, one for setting index, the other for reading pointer position. Contact closes on decreasing value and has a capacity of 5 Watts at 110 volts.  
List Price \$68.50, Your Cost ONLY \$27.50

**FREQUENCY METER.** JET 30-F, Dual Range covers Co. type MF-11 Platinum vibrating reed type, 11 needs, 100 to 150 volt operation, 3 1/2" round flush bakelite case. \$7.50

**FREQUENCY METER.** JET 30-F, Dual Range covers frequency ranges from 48-52 cycles and 58-62 cycles; Dual element, vibrating reed type 115 volt, 3 1/2" rd flush metal case. \$5.95

**DECIBEL METER.** Weston 301 type 61, minus 10 to plus 6 dB, 3 1/2" rd fl bakelite case, 6 MW 600 ohms. High speed type, with 3 external wire wound multipliers to extend range. \$11.50

**AIRCRAFT METERS**

All aircraft meters listed are 2 1/2" type with black scales unless noted otherwise.

0-30 Volt, Westinghouse AX-33 \$4.50  
0-30 Ampere, Westinghouse AX (1'SN C-30) \$5.60  
0-240 Ampere, Westinghouse AX 33 W/ext shunt \$6.50  
0-300 Ampere, Westinghouse, E-1, 3 1/2" \$7.50  
30 Volt 60 Amp. G.E. W/ext shunt, AN Conn. type \$5.50  
30 Volt 120 Amp. General Electric W/ext shunt, AN Conn. type \$5.50  
30 Volt 240 Amp. Westinghouse AX-33 W/ext shunt \$7.50

**A.C. VOLTMETERS**

0-15 G.E. AO-22, 3" R-B bl se, MR35HO15ACVV \$3.00  
0-40 W.H. NA-33, 2" R-B bl se, Cal for 60 cycle \$3.95  
0-40 W.H. NA-33, 2" R-B 400 cycles. \$3.50  
0-75 Weston 517, 2" R-M ring mt'd. \$2.95  
0-150 Weston 517, 3" R-B, MR21W150ACVV. \$4.50  
0-150 G.E. AO-25, 3" R-B, MR21W150ACVV. \$5.50  
0-150 Triplett 331-JP, 3" R-B. \$4.50  
0-150 Triplett 331-JP, 3" R-B W/resistor for 300 volts \$5.50  
0-300 Triplett 232-C, 2" R-M. \$6.00

**A.C. AMMETERS**

0-10 G.E. AO-25, 3" S-B, expanded between 4 & 7 Amps. Scale calibrated 0-100 Amps for Direct Reading divide scale reading by 10. \$4.95  
0-30 Triplett 331-JP, 3" R-B. \$4.00  
0-60/120 Burl 32XC, 3" R-B W/ext Transformer \$7.50  
0-150 G.E. AO-22, 3" R-B, 5 Amp mt'l, W/ext trans. \$7.50

**R.F. AMMETERS**

0-500 M.A. R.F. Weston 425, 3" R-B W/ext thermo-couple \$12.50  
0-1 G.E. DW-44, 2" R-B bl se. \$2.95  
0-1 G.E. DO-41, 3" R-B. \$11.00  
0-1 Weston 425, 3" R-B. \$11.00  
0-1.5 Weston 425, 3" R-B. \$8.25  
0-2 Simpson 135, 2" R-B. \$3.50  
0-2.5 Simpson 35, 3" R-B. \$4.95  
0-2.5 Weston 425, 3" R-B. \$8.50  
0-3 Weston 507, 2" R-B bl se. \$3.95  
0-3 Weston 425, 3" R-B W/ext couple. \$9.50  
0-5 G.E. DO-41, 3" R-B. \$7.50  
0-8 Weston 424, 3" R-B. \$10.50  
0-30 Triplett 0347-A, 3" S-B W/ext couple. \$8.00

**D.C. MICROAMMETERS**

0-100, Weston 506, 2" R-M, Bl. Sc. cal 300 Volts & 30 M.A. \$3.95  
0-200, W.H. NX-35, 3" R-B MR35W200DCMA \$8.50  
0-200, Superior 4" x 4 1/2" P-B. \$7.50  
0-400, Triumph 4" x 4 1/2" P-B. \$5.50  
0-500, Delur Amisco 210, 2" R-B. \$3.00

**D.C. MILLIAMMETERS**

0-1 G.E. DO-41, 3" R-B se cal 0-50 M.A. \$4.50  
0-1 W.H. NX-35, 3" R-B MR35W010DCMA. \$7.50  
0-2 W.H. NX-35, 3" R-B MR35W020DCMA. \$5.50  
0-5 Westinghouse RX-33, 2" S-B red mark for 3 Volts. \$3.50  
5-0.5 Western Electric 3" R-B, concentric style \$3.00  
0-15 Simpson 26, 3" R-B MR25W015DCMA. \$4.95  
0-20 W.H. NX-35, 3" R-B MR35W020DCMA. \$4.95  
0-50 G.E. DO-41, 3" R-B. \$4.00  
0-80 G.E. DO-41, 3" R-B. \$3.75  
0-150 Gruen 508, 2" R-B. \$3.00  
0-200 Gruen GV 511, 2" R-B MR25W200DCMA \$3.00  
0-200 G.E. DO-41, 3" R-B. \$4.50  
0-200 Simpson 26, 3" R-B MR35W200DCMA. \$4.95  
300-0-300 G.E. DO-40, 3" R-B, ring mt'd non-ranged case. \$3.00  
0-500 W.H. NX-33, 2" R-B. \$3.95  
0-500 Delur 312, 3" S-B. \$4.50

**PORTABLE TACHOMETERS**

0-20,000 RPM Range Jaeger #43 A-6 Chronometric type \$24.50  
300-1200, 1000-4000, 3000-12000 RPM. Jones Motorola Co., Multiple Range, Continuous Indicating \$24.50  
300-1500, 1000-5000, 3000-15000 RPM. Jones Motorola Co., Multiple Range, Continuous Indicating \$25.50

**CURRENT TRANSFORMER.** Weston 461-4 5 Amp Secondary, Primary 50/100/200/250/500/1000 Amps., 15 V. A. Capacity. Your Cost Only \$35.00  
List Price \$98.00

**POTENTIAL TRANSFORMER.** Weston 311 Potential ratio of 1500 & 750 to 150 volts, 15 V. Capacity. List Price \$247.50 Your Cost Only \$90.00

ALL ITEMS ARE BRAND NEW-SURPLUS-GUARANTEED UNLESS SPECIFIED OTHERWISE. All materials shipped from stock same day as order received, subject to prior sale. Orders accepted from rated concerns, public institutions and agencies on open account, others please send 25% deposit, balance C.O.D. or check with order. All prices FOB our warehouse, N.Y.C.

**D.C. VOLTMETERS**

0-5 W.H. NX-35, 3" R-B 200 I.V.A. \$3.50  
0-10 Sun 2AP458, 2" R-B 100 I.V.A. \$2.50  
0-30 Delur Amisco 210, 2" R-B. \$2.50  
0-10 Sun 3AP459, 3" R-B, 100 I.V.A. \$4.95  
0-150 Weston 301, 3" R-B surf mt'd 200 I.V.A. \$1.50

**D.C. KILOVOLT METERS**

0-1.5 W.H. NX-35, 3" R-B W ext resistor. \$7.50  
0-3 Weston 301, 3" S-B W ext resistor. \$10.50  
0-3.5 W.H. NX-35, 3" R-B 1 MA W/ext resistor. \$9.00

0-5 W.H. NX-35, 3" R-B, 1 MA mvt, W/ext resistor. \$11.00  
0-7.5 Weston 301, 3" R-B, 1 MA mvt W/ext resistor. \$14.50  
0-15 W.H. NX-35, 3" R-B 1 MA mvt, less resistor. \$4.95

0-20 G.E. DO-41, 3" R-B, 1 MA mvt W/ext resistor. \$19.50  
0-33 W.H. NX-35, 3" R-B, 1 MA mvt less resistor. \$4.95



**Weston 433 PORTABLE A.C. VOLTMETER**  
FREQUENCY RANGE 25 to 2400 CYCLES 0-150 Volts, Weston 433, Accuracy within 1/2% of 1 1/2% on A.C. from 25 to 1400 Cycles and within 1 1/2% up to 2400 Cycles. Knife edge pointer; hand calibrated mirror scale; shielded moving iron vane movement; Resistance approximately 2800 Ohms. Scale length 4.04", in case 5" x 6" x 3 1/2". Similar to illustration. Your Cost Only \$35.00

**SOCKET SELECTOR SET WESTON 666 TYPE IC**

Designed for purpose of taking readings of currents, voltages and resistance and other electrical measurements in a vacuum tube circuit. It can be used with many Western Analyzers or other make multirange volt-ohm-milliammeters. To test a tube circuit the tube is plugged into the appropriate adapter and the test plug inserted in the tube socket. This brings all currents and voltages out through a cable where they may be measured with an analyzer.  
Complete with Tube Base Data Connections and Chart 15 Adapters, pin leads and test block.  
List Price \$30.00 Your Cost \$9.50

**COMBINATION OFFER**

150 VOLT A.C. METER 30 AMP A.C. METER  
Triplett 331-JP, 3 1/2" Triplett 331-JP, 3 1/2"  
Rd flush case Rd flush case  
Both meters for \$7.95

**CURRENT TRANSFORMER.** Weston 461-4 5 Amp Secondary, Primary 50/100/200/250/500/1000 Amps., 15 V. A. Capacity. Your Cost Only \$35.00  
List Price \$98.00

**POTENTIAL TRANSFORMER.** Weston 311 Potential ratio of 1500 & 750 to 150 volts, 15 V. Capacity. List Price \$247.50 Your Cost Only \$90.00

**GASOLINE HEATER—MOTOROLA MODEL GN-3-24**

An internal combustion type heater which will give 15,000 B.T.U. of heat per hour. Ideally suited for use with equipment, farms, boats, bungalows, cabins, trailers, work sheds, darkrooms, mobile equipment, transmitter stations, etc., and any place where a quick heat is required in volume. Very economical in operation—tank holds one gallon of gasoline which is sufficient for 6 hours operation. Uses any grade gasoline.

This unit is designed primarily for aircraft installation, 24-28 volts d.c., but it can be readily adapted for a 115 or 230 volt 60 cycle power supply by use of a transformer and rectifier. Simple circuit diagram for adaption to 115 or 230 volts 60 cycle use supplied with each unit. Can be used on 32 volt farm or boat systems as is without the installation of additional transformers, etc. Power consumption approximately 75 to 100 watts. Approximately 12" long x 9 1/2" high x 9 1/2" wide. Complete with technical manual and parts list. Made by Galvin (Motorola) Mfg. Co. Your Cost Only \$22.50

**MINIATURE MILLIAMMETERS**

BULOVA WATCH CO., type G-1, 1.25 M.A. 500 M.V. movement, 1/4" square flush bakelite case, 1 7/16" barrel diameter, 1 3/16" overall depth behind flange \$4.50

**ROLLER-SMITH, Type G-1**

1.25 M.A., 500 M.V. movement, 1 3/4" square flush bakelite case, 1 1/2" Barrel Diameter, 1 3/8" overall @ \$4.50

**TERMINAL BOARDS**

Barrier type, 6 pairs, 12 connections, General Electric = 16 KING 2 1/2" L x 2" W x 1 1/4" H. Minimum order 10 pieces. @ \$ .60

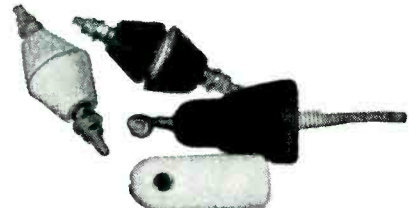

**INSULATORS**

32,200—Glazed, white, 2 cones, 1 1/2" L x 1 1/4" base diameter with stud. Signal Corps # 3G584.  
5,000—Same as above except brown.  
31,800—Stand-off type, 3" long, glazed with mtg. Signal Corps # 3G582. (Signal type not available) LOT PRICE \$800.00

**INSULATORS**

5,100—Stand-off type, Navy stock # CHO-81174B. Over all height 3", brass base and cap, brown glazed porcelain, (some with hardware), Individually cartoned. LOT PRICE \$600.00

**STRIP HEATERS**

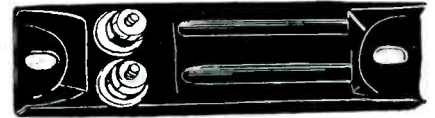

50 Watt, 115 Volt, 250 Ohms, 1 1/2" x 1/2" x 6" G.E. Catalog No. 2A301, Minimum order 10 pieces at 60c each.

**PORTABLE TACHOMETER**

**Multiple Range Continuous Indicating**

This unit is of the centrifugal mechanical type and is designed to show INSTANTANEOUSLY and CONTINUOUSLY the speed or change in speed of any revolving shaft or surface. No stop watch or other mechanism required.

- Three ranges in R.P.M. and three in F.P.M. Low Range 300-1,200 (Each division equals 10 R.P.M.) Medium Range 1,000-4,000 (Each division equals 10 R.P.M.) High Range 3,000-12,000 (Each division equals 100 R.P.M.)
- Large open dial 4" diameter.
- Ruggedly constructed for heavy duty service.
- Ball bearing and oilless bearings—require no lubrication whatsoever.
- Readily portable—Fits neatly into hand.
- Gear shift for selecting low, med., high ranges.
- Made by Jones Motorola, Stamford, Connecticut.
- Comes complete in blue velvet lined carrying case: 7 1/2" L x 4" H x 5" W. Your cost \$24.50

**PORTABLE (CHRONOMETRIC) TACHOMETER**

**Jaeger Watch Co. Model #43A-6**

- Can be used for speeds up to 20,000 R.P.M.
- Can be used for lineal speed measurements to 10,000 F.P.M.
- Ideally suited for testing the speeds of motors, particularly of fractional horse power, generators, turbines, centrifugals, fans, etc.
- Very small Torque—requires practically no power to drive.
- Unequaled Readability 2" Open face dial—each division on large dial equals 10 R.P.M.; each division on small dial equals 1,000 R.P.M.
- Greatest Accuracy—meets Navy specifications—guaranteed to be within 1/2% of 1%.
- Results of test reading remain on dial until next test taken.
- Push button for automatic resetting.
- Complete with the following accessories.
  - 1—Large pointed rubber tip
  - 1—Large hollow rubber tip
  - 1—6" circumference Wheel tip
  - 1—Operating instructions
  - 1—Temperature Correction chart.

The combination of the above features will give accurately, within a few seconds, by direct reading, the R.P.M. of shafts or the lineal speeds of surfaces without any accessories or timing of any kind. Each unit comes complete in a red velvet lined carrying case 5 1/2" x 3 1/2" x 1 1/2". Net List Price \$70.00 Your Cost \$24.50

**TESTED NEW PANEL METERS**

EACH METER TESTED BEFORE SHIPMENT. CALIBRATIONS ARE FOR NON-MAGNETIC PANELS. IF METERS ARE FOR USE ON MAGNETIC PANELS SPECIFY PANEL THICKNESS AND WE WILL CALIBRATE ACCORDINGLY AT NO EXTRA CHARGE. All meters have white scale and are flush mounted unless specified otherwise.

S—Square M—Metal sc—scale  
R—Round r/x—Ohms per volt surf—surface  
B—Bakelite bl—Black mounted

**MARITIME SWITCHBOARD**  
338 CANAL STREET  
NEW YORK, 13, N. Y.

Worth 4-8217

# TEST EQUIPMENT

- APR-1 or APR-4 RADAR SEARCH RECEIVER, 30 mc I. F., 2 mc wide.
- TUNING UNITS FOR APR-1 or APR-4 RECEIVERS (can be used with any 30 mc amplifier):
- TN-19, range 1000 to 2000 mc.....\$150.00
- TN-54, range 2000 to 4000 mc.....\$150.00
- 30 MC I. F. STRIP AND 110 VOLT 60 cps POWER SUPPLY, bandwidth 10 mc, complete, new (part of APR-5 Receiver).....\$65.00
- TS-45A/APM-3 SIGNAL GENERATOR, 9200-9600 mc, 110 V, 60-800 cps
- TS-155B/UP S BAND SIGNAL GENERATOR, pulsed, calibrated output, 110 V, 60 cy., NEW
- TS-155A/UP S BAND SIGNAL GENERATOR, pulsed, calibrated output, 110 V, 60 cy., NEW
- TS-56/AP SLOTTED LINE, slot length 16", tuned probe and meter.....\$100.00
- TS-35/AP X BAND SIGNAL GENERATOR, pulsed, calibrated power meter, frequency meter, 8700-9500 mc
- TS-13/AP X BAND SIGNAL GENERATOR, pulsed, calibrated output, 110 V, 60 cycles
- TS-120/AP X BAND SIGNAL GENERATOR, pulsed, calibrated output
- WAVEMETER CAVITY, 8500-9600 mc, Transmission Type.....\$35.00
- TPS-51PB/20 S BAND 20 db PAD.....\$20.00
- X BAND PICK-UP HORN.....\$10.00
- X BAND VSWR TEST SET TS-12/AP, complete with linear amplifier, direct reading VSWR meter, slotted waveguide with gear driven traveling probe, matched termination and various adapters, with carrying case, NEW. UNITS I AND II are available separately or together as a test set.
- S BAND SIGNAL GENERATOR CAVITY WITH CUT-OFF ATTENUATOR, 2300-2950 mc, 2C49 tube, with modulator chassis.....\$30.00
- HIGH PASS FILTER F-29/SPR-2, cuts off at 1000 mc and below; used for receivers above 1000 mc.....\$12.00
- UPN-1 S BAND BEACON RECEIVER-TRANSMITTER.....\$75.00
- S BAND TEST LOAD TPS-55P/BT, 50 ohms \$8.00
- X BAND TEST LOAD TS-108/AP, 150 watts, accessories.....\$35.00
- 250 WATT X BAND TEST LOAD, VSWR less than 1.15 between 7 and 10 KMC.....\$150.00
- LAE-2 SIGNAL GENERATOR, 520-1400 mc, CW & pulse modulation, calibrated output 110 V, 60 cps, used, good condition
- LAF-1 SIGNAL GENERATOR, 100-600 mc, CW & pulse modulation, calibrated output, good condition, 110 v, 60 cps operation
- GENERAL RADIO SIGNAL GENERATOR MODEL 522, 250-1000 mc, good operating condition.
- GENERAL RADIO POWER OUTPUT METER MODEL 583-A.....\$45.00
- GENERAL RADIO VACUUM TUBE VOLTMETER MODEL 726, good working order.....\$120.00
- GENERAL RADIO PRECISION WAVEMETER TYPE 724A, range 19 kc to 50 mc, 0.25% accuracy, V.T.V.M. resonance indicator, complete with accessories & carrying case NEW.....\$175.00
- GENERAL RADIO SIGNAL GENERATOR 605-B, good working order.....\$300.00
- GENERAL RADIO VACUUM TUBE BRIDGE, Model 561D.....\$275.00
- GENERAL RADIO FREQUENCY METER AND CALIBRATOR, Model 620AM, 300 kc to 300 mc \$340.00
- FEDERAL RADIO 605-CS, 9 kc to 50 mc SIGNAL GENERATOR (JAN version of G. R. 605 \$350.00
- HEWLETT-PACKARD AUDIO SIGNAL GENERATOR 205A.....\$230.00
- HEWLETT-PACKARD DISTORTION ANALYZER MODEL 325B.....\$200.00
- OBU-2 S BAND ECHO BOX.....\$100.00
- TBN-3EV THERMISTOR BRIDGE
- S BAND THERMISTOR BRIDGE CU-60 ABU, Part of LZ Radar.....\$60.00
- RADIO RECEIVER BC-967T2, 18-160 mc, 3 bands, FM/AM, 110 V, 60 cps.....\$200.00
- RADIO RECEIVER BC-969B, 15-150 kc....\$150.00
- MEASUREMENTS 78E, 50-75 mc, calibrated output.....\$100.00
- FERRIS MODEL 22A SIGNAL GENERATOR, 85 kc to 25 mc, Output 2 microvolts to 1 volt, modulation variable, good working order \$175.00
- FERRIS MODEL 10B SIGNAL GENERATOR, 85 kc to 25 mc, calibrated output, good working order.....\$100.00
- FERRIS 18 C SIGNAL GENERATOR, 5-175 mc, calibrated output, good working order....\$250.00
- STANDARD SIGNAL GENERATOR MEASUREMENTS 65B, 100 kc to 30 mc, 1-2,000,000 microvolts, good working order.....\$400.00
- LABORATORY RECTIFIER, SYLVANIA 541-A, 3500 volts at 2 amperes DC output.
- LB-3 LIMIT BRIDGE, Industrial Products \$60.00
- P-4 SYNCHROSCOPES, made by Sylvania or Browning Lab.....\$175.00
- SIGNAL GENERATOR 1-72-K, 100 kc to 32 mc, output not calibrated, 110 V, 60 cps.....\$35.00
- AUDIO OSCILLATOR, HICKOK 198, RC tuned, 20-20000 cps.....\$45.00
- TEST SET TS-278/AP FOR AN/APS-13, synchronized, delayed pulse signal generator, 400-430 mc, calibrated waveguide below cutoff attenuator, synchronized marker generator, 115 V, 60 cps, NEW, COMPLETE.....\$160.00
- RCA SCOPE 5" MODEL 160B, NEW, export packed \$125.00
- CLOUGH BRENGLE RESISTANCE CAPACITY BRIDGE, model 230A, new.....\$50.00
- FIXED ATTENUATOR PADS, 20 db + 0 - 2 db, DC-1200 mc, 50 ohms, VSWP 1.3 or less, 2 watts average power.....\$30.00
- WAVEGUIDE BELOW CUT-OFF ATTENUATOR, type N connectors, rack and pinion drive, attenuation variable 120 decibels, calibrated 20-120 db, frequency range 300-2000 mc.....\$32.00
- WAVEGUIDE BELOW CUT-OFF ATTENUATOR, similar to above except upper frequency limit is 3300 mc.....\$32.00
- WAVEGUIDE BELOW CUT-OFF ATTENUATOR, same as above except input is matched in range of 2200-3300 mc, VSWR less than 1.2.....\$54.00
- CERAMIC FEED-THRU CAPACITORS:
- 300 mmf.....10 for \$2.00
- 55 mmf.....10 for \$1.00
- PULSE INPUT TRANSFORMER, permalloy core, 50 to 4000 kc impedance ratio 120 to 2350 ohms \$3.00
- PULSE TRANSFORMER, UTAH 9280.....\$1.50
- PULSE TRANSFORMER, 132-AWP.....\$6.00
- PULSE TRANSFORMER, GE 68G, 823G-1...\$5.00
- TS-10/AP CALIBRATED DELAY FOR APN-1.....\$25.00
- TS-203/AP CALIBRATED SELSYN.....\$10.00
- UG-27/U TYPE N RIGHT ANGLE ADAPTERS 10 for \$5.00; 1000 for \$250.00
- U.H.F. RIGHT ANGLE ADAPTER 83-1AP 10 for \$2.50; 1000 for \$125.00
- SD-3 SHIPBOARD RADAR, New and complete with test equipment.....\$1050.00
- SQ RADAR, used but in good working order, complete with antenna, control unit.....\$650.00
- SN RADAR, used, good working order, complete.....\$550.00
- HYPERMIL CORE CHOKE, 1 Henry, Westinghouse L-422031 or L-422032.....\$3.00
- PULSE FORMING NETWORK, 20 kv, .02 microsecond, 50 ohms, 800 p.p.s.....\$40.00
- ANCHOR SCREWS from AB20CR Mast Equipment.....\$2.00 each

## ELECTRO IMPULSE LABORATORY

P. O. Box 250      Eatontown 3-0768      Red Bank, N. J.

## DEPENDABLE & GUARANTEED

equipment for  
communications

★ ★ ★

### TRANSMITTERS—PHONE

BC-610 HF 450 Watts  
WE-34A HF 350 Watts  
BC-365 LF 350 Watts  
BC-325 HF 400 W. CW  
TDE LF/HF 125 Watts  
TCE LF/HF 125 Watts  
ET-8019 HF 300 W. CW

### RECEIVER-TRANSMITTERS

Mobile, Field, Aircraft, Marine

JT-350A HF 75 Watts  
SCR-508 VHF 35 Watts  
SCR-528 VHF 35 Watts  
SCR-608 VHF 35 Watts  
SCR-628 VHF 35 Watts  
SCR-298 VHF 35 Watts  
TCS HF 20/40 W.  
AVI/R/A MF 6/10 W.

JT-52 Ship-to-Shore radiotelephone, for 6 volts DC BRAND NEW & COMPLETE. Large stock available.

### RADAR

LABS! MANUFACTURERS! SCHOOLS!

Here is a radar search receiver covering the range of 80 to 3000 MCS which is excellent for general signal detection or for use as a precision frequency meter.

### AN/ARD-2

Made for US NAVY, it incorporates built in pulse analyzer. Has a PRR of 50 to 8000 cps, 110 V.A.C power supply (60-2600 cycles), Amplifier, Detector, 2 Antennas, Tubes, Cables, Spares, Manuals & Test Oscillator.

BRAND NEW! ORIGINAL CASES!  
Price...\$175.00

SN Mfgd. by Gen. Elect. Co., portable, 0 to 25 mile ranging, unused, complete with spares.

### WALKIE-TALKIES HANDY TALKIES

Of every description, new, complete and guaranteed. Quotations on request.

Complete bulletins on above and  
other stock items on request.

## COMMUNICATION DEVICES CO.

Cable:                      Tel:  
Communidev              AD-4-6174, 5  
2331 Twelfth Avenue      New York 27, N. Y.

# SAVE on Miniature and Toggle Switches at WELLS

## Miniature Switches

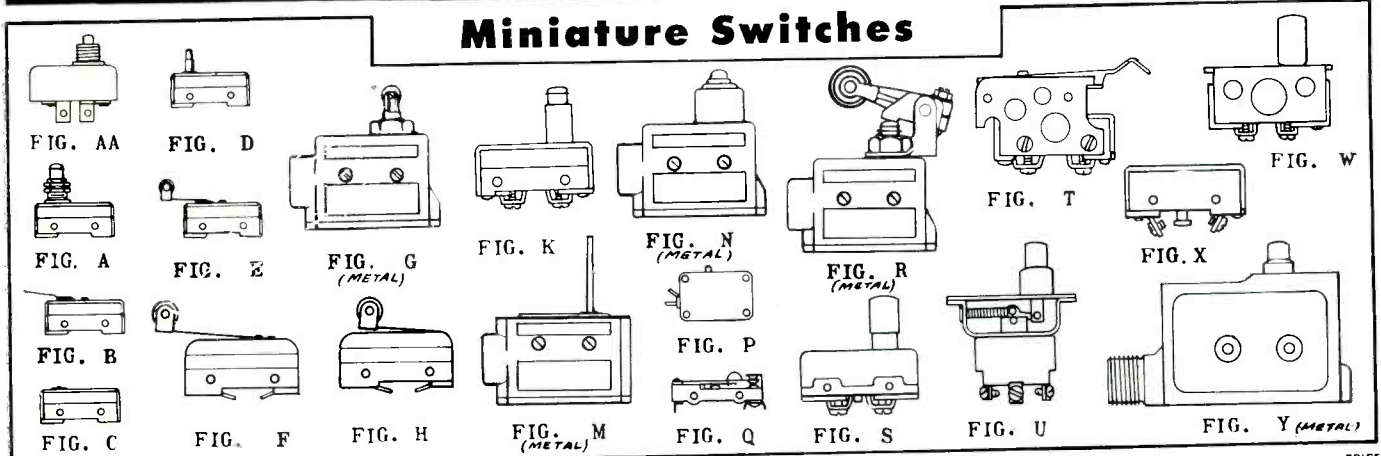

STOCK NUMBER	MANUFACTURER	MFR. TYPE NO.	CONTACTS	ILLUSTRATION	PRICE EACH	STOCK NUMBER	MANUFACTURER	MFR. TYPE NO.	CONTACTS	ILLUSTRATION	PRICE EACH
305-10	Microswitch	WP3M5	N.C.	FIG. AA	\$0.40	311-116	Microswitch	SW0186	N.C.	FIG. D	.63
305-160	Microswitch	WP-5M3	N.C.	FIG. AA	.40	303-49	Microswitch	YZ2YST	SPDT	FIG. D	.68
307-210	Microswitch	YP3A	N.O.	FIG. AA	.50	309-93	Microswitch	BRS36	SPDT	FIG. D	.68
L309-75	Microswitch	YZ7RQ1	N.O.	FIG. A	.92	370-17	MU-Switch	QRS	SPDT	FIG. D	.75
303-67	Microswitch	YZ7RA6	N.O.	FIG. A	.71	PH-112	MU-Switch	MBW	SPDT	FIG. E	.72
PH-100	Acro	R01P2T	N.O.	FIG. A	.71	305-64	Microswitch	WZR12	N.C.	FIG. E	.65
301-46	MU-Switch	MLB-321	SPDT	FIG. B	.85	311-25	Microswitch	CUN24155	N.C.	FIG. E	.85
301-93	Microswitch	YZ-2YLTC1	SPDT	FIG. B	1.01	370-10	MU-Switch	R02M12T	N.O.	FIG. E	.70
301-30	MU-Switch	R02M	SPDT	FIG. B	.95	303-32	Acro	YZ-3RW2T	N.O.	FIG. F	.65
301-78	MU-Switch	Green Dot	SPDT	FIG. B	.75	306-10	Microswitch	BZE-2RQ9T1M	SPDT	FIG. G	2.48
303-79	Microswitch	BZ-RL32	SPDT	FIG. B	.75	309-101	Microswitch	BZ-2FW22L	SPDT	FIG. H	.95
303-85	MU-Switch	MLB329	SPDT	FIG. B	.67	PH-113	Microswitch	RZBQT	SPDT	FIG. K	.58
305-154	Acro	XD4-5L	SPDT	FIG. B	.78	L306-1010	Acro	RD7-8586	N.O.	FIG. K	.55
311-130	Acro	---	SPDT	FIG. B	.70	370-18	Acro	HRO71P2TSF1	N.O.	FIG. K	.60
PH-101	Microswitch	BRL18	SPDT	FIG. B	.78	370-19	Microswitch	YZRQ41	N.O.	FIG. K	.65
PH-102	Microswitch	YZRL812	N.O.	FIG. B	.65	370-40	Cutter Hammer	---	N.O.	FIG. K	.75
PH-103	MU-Switch	Blue Dot	SPDT	FIG. B	.68	370-8	Microswitch	RN-11-H03	SPDT	FIG. M	1.50
PH-104	Microswitch	YZ3RLTC2	N.O.	FIG. B	.64	309-157	MU-Switch	---	N.C.	FIG. N	1.15
PH-105	Microswitch	YZR31	N.O.	FIG. C	.53	370-15	MU-Switch	AHB203	SPDT	FIG. N	1.25
PH-106	Microswitch	R-R36	N.C.	FIG. C	.50	370-7	Microswitch	WZE-7RQTN	N.C.	FIG. N	1.35
PH-107	Microswitch	G-R36	N.C.	FIG. C	.53	305-11	Acro	2M031A	N.O.	FIG. P	.37
PH-108	Microswitch	WZ-2RT	N.C.	FIG. C	.50	305-71	Acro	2M041A	SPDT	FIG. P	.37
305-161	Microswitch	YZ3R3	N.D.	FIG. C	.71	305-50	Microswitch	Open Type	SPDT	FIG. Q	.35
311-115	Microswitch	WZR31	N.C.	FIG. C	.71	370-28	Microswitch	YZE-RQ22	N.O.	FIG. R	2.75
311-123	Microswitch	WZ-7R	N.C.	FIG. C	.60	303-84	Acro	HRO7-4PST	N.O.	FIG. S	.50
311-126	Acro	HRR07.1A	N.C.	FIG. C	.50	303-83	Microswitch	YZ-RQ4	N.O.	FIG. S	.50
311-125	Acro	HRR07.1A	N.O.	FIG. C	.53	PH-114	Microswitch	WZR-31	N.C.	FIG. T	.65
311-121	Microswitch	WZ7RTC	N.C.	FIG. C	.50	PH-115	Cutter Hammer	8905K564	DPDT	FIG. U	.65
311-128B	Microswitch	YZ	N.O.	FIG. C	.53	PH-116	Microswitch	WZRQ41	N.O.	FIG. U	.60
370-6	Microswitch	X757	N.C.	FIG. C	.45	PH-118	Microswitch	BZRQ41	SPDT	FIG. W	.60
PH-109	Microswitch	RRS13	N.C.	FIG. D	.45	311-128A	Microswitch	YZ-RTX1	N.O.	FIG. X	.90
PH-110	Microswitch	BRS36	SPDT	FIG. D	.53	PH-117	MU-Switch	Z	N.C.	FIG. Y	1.35
PH-111	Microswitch	GRS	N.O.	FIG. D	.49						

## Toggle and Push Switches

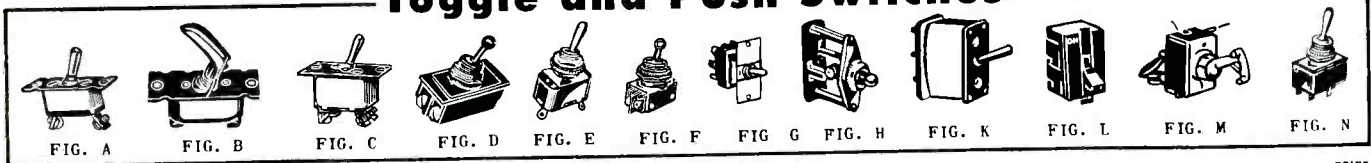

STOCK NUMBER	FIG.	CONTACT ARRANGEMENT	MANUFACTURER & NUMBER	PRICE EACH	STOCK NUMBER	FIG.	CONTACT ARRANGEMENT	MANUFACTURER & NUMBER	PRICE EACH
PH-500	A	SPDT	B1B	.35	305-174	C	DPDT CENTER OFF MOM 1 SIDE	AN 3023-5	.50
PH-501	A	SPDT	AN3022-3B	.35	305-177	C	DPDT CENTER OFF MOM EACH SIDE	C-3	.50
PH-502	A	SPST MOMENTARY	B10	.30	305-176	C	DPDT CENTER OFF MDM EACH SIDE	AN-3023-7	.50
PH-503	A	SPDT CENTER OFF MOM EACH SIDE	B11	.32	305-173	C	DPDT	8710K3	.55
PH-504	A	SPDT CENTER OFF	B14	.35	305-175	C	DPDT CENTER OFF MOM EACH SIOE	3712K3	.50
PH-505	A	SPDT MOMENTARY	B21	.30	305-179	C	DPDT CENTER OFF MOM EACH SIDE	8732-K2	.55
PH-505	A	SPST	AN-3022-2B	.30	309-163	C	DPDT CENTER OFF MOMENTARY	CH C-11	.45
PH-506	A	SPDT CENTER OFF	AN-3022-1	.35	309-162	C	DPST	CH C-1	.40
PH-507	A	SPDT CENTER OFF MOM EACH SIDE	AN-3022-7B	.32	309-164	C	DPST MOMENTARY	CH 8711K3	.45
PH-508	A	SPST MOMENTARY	AN-3022-8	.28	370-31	C	DPDT	CH C-1B	.55
PH-513	A	SPDT CENTER OFF	CH AN-3022-1B	.38	305-87	D	1 SIDE DPST MOM 1 SIDE SPST	AH & H	.95
PH-514	A	SPST	CH B-5 A	.35	305-111	E	SPST MOMENTARY	CH 8817K2	.28
LT-104	A	SPDT 1 SIDE MOMENTARY	CH 8905K568	.35	305-153	E	SPDT CENTER OFF	CH AN-3021-1B	.35
309-168	A	SPST	168553	.35	LT-100	F	SPST	CH	.22
309-171	A	SPDT CENTER OFF MDM 1 SIDE	CH 8209K5	.35	LT-101	F	SPST MOMENTARY	AH & H w/LEADS	.20
370-1	A	SPST MOMENTARY	CH AN-3022-8B	.25	301-51	G	DPDT MOMENTARY	CH 8905K12	.75
370-4	A	SPDT CENTER OFF	CH B-9A	.35	305-140	H	DT NO MAKE EACH SIDE	OPEN FRAME	.25
370-14	A	SPDT CENTER OFF 1 SIDE MOM.	CH B-7A	.30	309-161	K	SPST	CH 8781K3	1.95
370-25	A	SPST MOMENTARY	CH B-6B	.25	305-76	L	DPST	AH & H OPEN FRAME	.75
305-171	A	SPDT CENTER OFF MOM 1 SIDE	8209K5	.32	311-77	L	DPST	AH & H	1.25
309-169	B	SPST MOMENTARY	CH B-19	.45	301-12	M	DPST	AH & H SPECIAL FOR HANDY	.40
PH-509	C	DPST	AN-3023-2B	.50	LT-107	N	DPST	AH & H TALKIE	.25
PH-510	C	DPDT MOMENTARY	CH 8715K2	.50					
PH-511	C	DPDT MOMENTARY	CH 8715K3	.50					
PH-512	C	DPST CENTER OFF	CH 8720K1	.55					
303-65	C	DPST	CH AN-3023-2	.45					

Distributors: Our standard distributor arrangement applies on these items.

Many More Types in Stock. Send Us Your Requirements.

JUST OUT: CATALOG H500 Manufacturers, Distributors and Amateurs write for the brand new Wells Electronic Catalog H500. Full of tremendous values in highest quality components.



Order directly from this ad or through your local parts jobber—

320 N. LA SALLE ST. DEPT. SL, CHICAGO 10, ILL.

# BEFORE YOU ORDER

any electronic tubes or equipment and after comparing all other prices—check NIAGARA for the **LOWEST PRICE OF ALL!**

Huge complete stocks on hand to meet the needs of schools, manufacturers, aircraft and marine operators and export and import companies.

Our prices and quality are always in your favor. "Promptness and courtesy" is our motto and your fullest assurance of satisfaction. Send us your quotation requests **TODAY.**

## NIAGARA RADIO SUPPLY CORP.

160-A Greenwich Street

New York 6, N. Y.

Phone DIgby 9-1134

### BARGAINS!

#### NEW RA-38 RECTIFIERS

115 v., 60 cy. 1 phase input, output 0-15,000 v. d-c @ 500 ma. Write for detailed information.

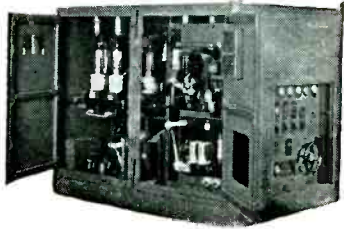

#### ASD RADAR TRANSMITTER & MODULATOR

3 centimeter; complete with 725A magnetron, cavity, two 723A/B Klystrons, one RKR73, four 72's, one 715B, one 820B, two 724B's, two 6AC7's, one 1N23 crystal diode, high voltage supply, two cooling blowers, etc. Input: 115 v. 400 c. N-2 condition ..... \$39.50  
Preamp assembly; includes plumbing (2) 723 A/B's, (2) 6AC7's, (2) 724B's, 1N23, etc ..... \$17.50

931A PHOTOMULTIPLIER TUBE, new R.C.A., original cartons. \$2.00 each, 10 for \$15.00.

TRANSTAT, 115/220 v. 50/60 c., 0-260 v. 2 1/2 amp. cont., 5 amp. max. output. New. Original packing. List \$43.00. \$17.50 each, 2 for \$30.00.

### BARGAINS!

#### TUBES:

1N22	\$4.25
1N23	50
21N23	37.50
3B22	2.50
3C23	2.25
4B28	2.75
15E	1.25
127A	2.25
250TL	19.50
304TL	.95
316A	.35
388A	2.75
700A	9.75
701A	3.50
702A	2.75
703A	2.75
704A	1.00
706BY	12.50
706EY	12.50
707A	12.50
707B	2.75
708A	2.75
713A	.75
714AY	3.75
715A	7.50
715B	6.50
719A	9.50
721A	2.75
722A	7.50
723A/B	8.50
724B	2.50
725A	8.50
730A	10.50
750TL	45.00
829B	3.50
846	47.50
872A	1.75
C5B	7.75
C8	8.25
C6J	4.75
FG81A	3.75
WE-203A	8.75
VT98 (Br)	12.50

### BARGAINS!

#### Filament Transformer



HIGH VOLTAGE FILAMENT TRANSFORMERS: Amertran Type W.S. .050 KVA, 50/60 c., 1 phase; 35 KV test, 12 KV d-c operating; sec. 5 v. c-t @ 10 amps. Has socket that takes 872A, 250T, 371, 5563 etc., rectifiers. Net Wt. 16 lbs. \$12.50 each, 2 for \$22.50, 4 for \$40.00.

METER, 3" Roller-Smith, 1 ma. f.s., calibrated 0-4 KV d-c; and 4 Weston precision 1 mg. meter multipliers. \$3.75 each, 3 for \$10.00.

CAPACITOR, 4 mfd. 1000 wv d-c, new, original boxes. \$6.60 each, 4 for \$22.00.

SELENIUM RECTIFIER, 6.5 v. a-c., FWCT, 2.2 v d-c @ 3 amps., new, original boxes. \$7.75 each, 4 for \$22.00.

More Values In Our Surplus Bulletin—Send For Yours Today.

## EPCO

1527 E. SEVENTH ST.  
Los Angeles 21, Calif.

### GRAIN OF WHEAT LAMPS



Used for illuminating meters, compass dials, airplane instruments, etc. Soldering iron removes lamp from base to use in models, doll houses, miniature trains, Xmas trees, etc.

Mazda G.E. 323 3V. 19.A doz. \$1.50



#### MARKTIME 5 HOUR SWITCH

A 10 amp. timing device. Pointer moves back to zero after time elapses. Ideal for shutting off radios and TV sets when you go to bed. Limited supply at this special PRICE.... \$3.90

Also available in 15 min.-30 min.-1 hr. at \$8.50

#### ISOLATION TRANSFORMER

Nat. known Mfgs. 50 watt 2 windings, 115 V. to 115 V. 60 cy. Ideal to prevent shocks from small radios and medical and electronic devices. Shipping Weight 5 lbs. Other sizes and 220-110 in stock.

\$1.95

Kilowatt Demand Meter Totalizer containing heavy-duty TELECHRON B-7, 1 R.P.M. motor and hundreds of watch size gears, clutches, springs, etc. Shipping weight 2 lbs.

5 for \$10.00 \$2.50

RADAR MAGNETS ..... \$5.00 to \$17.50 Write for Sizes and Weights.

RCA 930 PHOTO TUBE ..... \$1.25 5 for \$5.00.

HOLTZER-CABOT MOTOR 110V A.C. 50 R.P.M. Inst. Revers. .... \$17.50

SMALL 12V. DC 40 OHM RELAY ..... \$ for \$1.00 Sample 50¢

ANT. KNIFE SWITCH S.P.D.T. 30 AMP. .... 95¢

ALLIANCE OR RUSSELL 110V AC MOTOR. \$1.85; 3 for \$5.00

## GONIOMETER CFT-47263 CFT-47372

We are Authorized Wholesalers for Micro Switch Corp. and carry the largest stock of Allen-Bradley Solenoids, Potter & Broomfield Relays, Guardian Electric Co. Solenoids and Relays and Hayden Clock Motors in all speeds. Electric Counters.

EST. 1923 **BLAN** EST. 1923

Experimenters and Inventors Supplies  
64 Dey St., New York 7, N. Y.

### 2 x 5 MFD. 400-600V. OIL CAPACITORS—57¢ EACH

Famous make 2x5 mfd. oil capacitor, packed 24 to a carton weighing 42 lbs., offered at fraction of cost. New Glyptal sprayed units measuring 3 5/16 x 2 x 3 25/32 overall with 4 #13 mtg. holes spaced 3/4 x 1 7/16 on centers. Capacity tolerance +14 -6%, tested 1800VDC. Good at 600V up to 40° C, at 400V up to 72° C. Sample forwarded for \$1.00 postpaid. Discounts for larger quantities.

WESTON LABORATORIES, Weston, Massachusetts

**Finest of Surplus PEAK ELECTRONICS CO. Fraction of Cost**



**HIGH CURRENT PLATE TRANSFORMER**  
820 Volts CT at 775 MA. Pri. 110/220 Volts 60 Cycles. Wt. 36 lbs. Fully Cased. . . . \$5.95

**HIGH VOLTAGE VACUUM CONDENSERS**  
50 MMF 32 Kilovolts . . . . . 5.50 ea.

**SILVER MICAS**  
MMF: 10, 17, 50, 60, 240, 750, 780, 1000, any type . . . . . .06 ea.

**MIDGET VARIABLE CONDENSERS**  
Stearite Insulation  
15 MMF (HF 15) . . . . . .39  
Dual 15 MMF (HF 15 D) . . . . . .69  
250 MMF (MC 250 S) . . . . . .69  
325 MMF . . . . . .79

**U. H. F. COAX. CONNECTORS**  
831AP-UG12U, UG-11U-831, R831SP. . . . . 35 ea.

Precision 15 Meg. 1% Accuracy Resistor, Non-inductive, 1 watt, hermetically sealed in glass .25 ea. 10 for . . . . . \$1.90

Thermal Time Delay Relay. 15 to 30 seconds, plugs into 4 Prong Tube Socket Glass Enclosed. 250 V. . . . . 95 ea.

Mallory Vibropack Kit. 6 Volt Input. Output 300 Volts at 100 MA. Transformer & Vibrator. . . . . \$5.95 for both

**30 WATT WIRE WOUND RESISTORS**  
Ohms: 100-150-2500-3k-4k-4500-5k-5300-10k-15k-18k . . . . . .15 ea. 8 for .99

**ADJUSTABLE RESISTORS**  
20 Watt: 1, 5, 50 Ohms . . . . . .25  
50 Watt: 500 Ohms . . . . . .35  
75 Watt: 40, 100, 150, 200 Ohms . . . . . .39  
100 Watt: 20, 75, 120, 180 Ohms . . . . . .49  
150 Watt: 50, 100 Ohms . . . . . .59

**WIRE WOUND RESISTORS**  
5 Watt type AA, 20-25-50-200-470-2500-4000 ohms . . . . . \$ .09 ea.  
10 watt type AB, 25-40-84-400-470-1325-1000-2000-4000 ohms . . . . . .15 ea.  
20 watt type DG, 50-70-100-150-300-750-1000-1500-2500-2700-5000-7500-10000-16000-20000-30000 ohms . . . . . .20 ea.

**SCOPE AND FIL. TRANSFORMER**  
Pri. 115 volts, 60 cycles. Sec. 4400 volts RMS 4.5 MA., 5 volts CT 3 amps. Fil. Ins. 15 KV RMS test. Hermetically sealed. Has insulated plate cap for rectifier. Made by Raytheon, 4 1/2 x 5 x 5 1/2 . . . . . Only \$4.95  
5 for 22.50

**SCOPE TRANSFORMERS**  
Pri 110V 60CY — Hermetically Sealed  
2500 V @ 12MA . . . . . \$2.95  
1050V @ 20MA, 20V 4.5A, 2.5V 5A . . . . . 4.75

50 megohm 35 watt Resistor with mount. . . \$1.49 each; 10 for \$9.90  
10 Meg 10 Watts. . . . .49; 2 Meg 5 Watt . . . . . 35

UTC type PA 5000 ohm plate to 500 ohm line and 6 ohm voice coil. 10 watts. 60 to 10,000 cps+1 DB. GREAT VALUE . . . . . ea. \$2.75

**MISCELLANEOUS BARGAINS**  
.02-400 volt dc tunblers . . . . . 15 for .99  
G.E. 2mfd 250 volts ac oil cond. . . . . 6 for .99  
10 meg 10 watt resistor . . . . . 2 for .99  
Heineman 15 amp 110 volt ac ckt breaker . . . . . 1.19  
Heineman 25 amp 110 volt ac ckt breaker . . . . . 1.99  
Ceramicon .0005 mfd . . . . . 20 for .99  
.01 600 volt dc pigtail micas . . . . . 10 for .99  
.001 600 volt dc pigtail micas . . . . . 15 for .99  
.006 600 volt dc pigtail micas . . . . . 12 for .99  
Butterfly cond. 2 to 11 mmf ball brngs. . . . . 3 for .99  
CD type 4 micas .011 600vdc . . . . . 10 for .99  
25 mmf variable cond (mc250s) . . . . . .59  
CRL 10,000 ohm potentiometers . . . . . 6 for .99  
5 meg potentiometers . . . . . 5 for .99  
Trim "Commercial" Headphones . . . . . 3.75 ea.  
CD 16 mfd 450 volt electrolytic (EB9160) . . . . . 3 for .99  
Hammarlund cond. 150 mmf .07 spacing. . . . . 2 for .99  
Variable ceramicon 20 to 125mmf type 823. . . . . 5 for .99  
Western Electric silver variable 5 to 2.5 mmf 8 for .99  
G.E. weatherproof switch DPDT 20amp 120vac .99 ea.  
CRL steatite switch 3 section—2 pole 5 positions per section, model 2521 centralab. . . . . 2 for .99

Tremendous stocks on hand. Please send requests for quotes. Special quantity discounts. Price f.o.b. N. Y. 20% with order unless rated, balance C. O. D. Minimum order \$5.00.



**MOSSMAN SWITCHES**  
4 Pole Single Throw . . . . . 1.10  
3 PDT, plus 6 PST. . . . . 1.75



**MINIATURE HEADPHONES**  
250 ohms imp. Can be used for sound power Telephones, etc.  
Type HS 30 . . . . . .69 ea.  
10 For . . . . . 4.99  
Hi Imp Transf. for above . . . . . 45

**GENERAL PURPOSE TRANSFORMERS**  
Ideal for Bias, Filament, Isolation, Standdown, etc.  
2 isolated 110V Pri. Sec. 110V at 900 ma plus 6.3 @ 2 amps. Fully cased. . . . . Now \$1.49 ea.

**1% PRECISION RESISTOS W. W.**  
2000-2500-5000-8500 ohms . . . . . ea. 25  
50000-95000 ohms 750,000 . . . . . ea. 29  
1 meg . . . . . ea. 69

**GENERAL ELECTRIC SELENIUM RECTIFIER**  
32 Volts input. 28 Volts Output at 2 Amps. Full Wave . . . . . 3.75

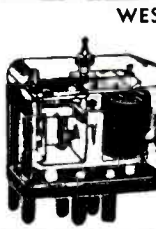

**WESTINGHOUSE OVERCURRENT RELAY**  
Type MN Overcurrent Relay. Adjustable from 250 ma. to 1 amp. External Push Button Reset. Enclosed in glass case. Hand calibrated adjustments, only \$5.95

**GENERAL ELECTRIC Type PBC Instantaneous Overcurrent Relay.** Adjustable from 100 to 200 MA. Electrical and Manual Reset. 4 PDT. Reset 110 Volts 60 Cycles . . . . . 7.95

**General Electric Overload Relay. Electrical Reset 110 Volts 60 Cycle**  
Breaks at 640 Milliamps but easily adjustable for other currents. Terrific value at only . . . . . 2.95  
10 for 25.00

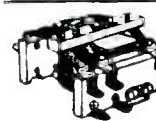

**ADVANCE D.P.D.T. ANTENNA RELAY**  
110 V. 60 cycle coil Steatite Insulation. Only \$1.95 each.



**ALLEN BRADLEY SOLENOID**  
115 Volt 60 Cycle Coil D.P.S.T. 25 Amp Contacts. Model 702 . . . . . 3.75  
3 for 9.90

**FILAMENT TRANSFORMERS**  
110 V 60 CY Pri. Fully Cased.  
5 Volt 15 Amp . . . . . \$2.75  
6.3 Volt 12 Amp . . . . . 1.69  
2.5 Volt 10 amp . . . . . 3.49  
2.5 Volt CT 21 Amp . . . . . 4.75  
5 1/2 V CT 21A, 7.5V 6A, 7.5V 6A . . . . . 4.95  
5 Volt 4A, 6.3V, 3A . . . . . 2.45  
2.5V CT 20A, 2.5V CT 20A . . . . . 6.95

**CHOKE BARGAINS**  
6 Henry 50 ma 3 0 ohms . . . . . 3 for \$0.99  
6 Henry 80 ma 220 ohms . . . . . 2 for .99  
6 Henry 160 ma 140 ohms . . . . . .99  
1.5 Henry 250 ma 72 ohms . . . . . .59  
6 Henry 300 ma 65 ohms . . . . . 3.75  
Swing 1.6/12 Henry 1 Amp/100 ma 15 ohm. . . . . 19.95

**W. W. POWER RHEOSTATS**  
100 Ohms 100 Watt . . . . . .89  
150 Ohms 50 Watt . . . . . .59  
250 Ohms 50 Watt . . . . . .59  
300 Ohms 50 Watt . . . . . .59  
Dual 200 Ohms 50 Watt . . . . . .79



**STANDARD BRAND RHEOSTATS**  
25 Ohms. 675 Watts Max. with Knob and Hardware . . . . . 3.95  
10 for 29.50

**PANEL METERS—BRAND NEW**

2" WESTON 0-1 Ma DC 26 ohms res. . . . . \$3.50  
2" G.E. 0-1 Ma DC (volt scale) . . . . . 2.95  
2" G.E. 0-5 Ma DC (amp scale) . . . . . 1.95  
2" G.E. 0-30 Volts DC 1000 ohm/v. . . . . 2.50  
2" G.E. 0-30 Amps DC . . . . . 2.45  
2" G.E. 0-1 Amp RF (Internal Thermo) . . . . . 2.45  
3" WESTINGHOUSE 0-2 Ma DC . . . . . 3.95  
3" WESTERN ELECTRIC 0-80 Ma DC . . . . . 2.95  
3" DEJUR 0-100 Ma DC . . . . . 2.95  
3" GE 0-200 Ma DC . . . . . 3.95  
3" WESTON 0-50 Amps AC . . . . . 4.95  
3" TRIPLETT 75 Amps AC . . . . . 2.95  
3" WESTINGHOUSE 0-20 Ma DC . . . . . 3.95  
2" TRIPLETT 0-300 VAC . . . . . 2.95  
3" WESTON 0-200 Micro Amp. Mod 301 . . . . . 8.75

**SENSITIVE RELAY TYPE G2**  
S.P.D.T., Breaks at 3 Milliamps. Beautifully Constructed, Delicately Pivoted and Balanced. Approx. 2000 ohms resistance. Sealed in aluminum container. Plugs into standard 5 prong socket. . . . . Only \$1.50 ea.

**PLUG IN CAPACITOR**  
8 x 8 Mfd 600 volts DC. Oil filled. Plugs into standard 4 prong socket. 3 3/4 h x 3 1/4 w x 1 1/8 d. . . . . \$1.99



**Heavy Duty Tap Switch, Ohmite Model 412**  
Single Pole 6 Positions. Non-Shorting. 50 amp. contacts. Vitreous Enamel case . . . . . Only \$2.95

**CERAMICONS**  
MMF: 1.5, 2, 3, 8, 10, 20, any type . . . . . .05 ea.

**BAKELITE CASED MICA**

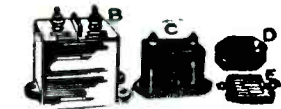

MMF	VDC	Price	MMF	VDC	Price
D .001	600	\$ .18	D .005	3 KV	\$ .70
E .01	600	.26	C .005	3 KV	1.24
D .02	600	.26	C .006	3 KV	1.50
E .027	600	.26	D .002	3 KV	.70
C .01	1 KV	.45	C .001	5 KV	.70
C .056	1 KV	.50	C .005	5 KV	.85
C .07	1 KV	.55	C .0015	5 KV	1.60
C .024	1500	.65	C .003	5 KV	1.90
C .033	1500	.75	C .005	5 KV	2.50
C .015	2 KV	.80	B .007	5 KV	2.75
C .02	2 KV	.90	B .003	6 KV	3.75
D .002	2500	.45	B .006	6 KV	4.25
E .005	2500	.55	B .0005	8 KV	2.90
C .025	2500	1.25	B .0012	8 KV	3.25
C .001	3KV	.90	B .004	8 KV	5.59
C .002	3 KV	.95			

**HIGH CURRENT MICAS**  
Type G4 Ceramic Case 5 3/4" High, 5" Diameter Tolerance 5% or Better

CAP MFD	Amps 1 Mc	Amps 300 Kc	KV DC	Price Each
.08	80	42	4	\$27.50
.1	70	50	4	29.50
.05	60	42	5	24.50
.037	45	35	6	26.50
.02	40	30	9	29.50
.02	55	38	10	31.50
.0117	40	27	14	24.50
.0075	39	27	15	24.50
.009	40	26	15	29.50
.00978	40	25	15	29.50
.01	43	28	15	31.50
.0025	23	15	20	29.50
.00315	26	18	20	30.50
.004	30	20	22	33.50
.0033	25	16	25	35.50
.00982	14	8	30	27.50
.00153	12	13	30	33.50

**TYPE G3 4" High 5" DIAMETER**  
0013 15 9 15 14.50  
**TYPE G2**  
00057 8 5 10 7.95  
**G1 2 1/2" High 2-1/16 DIAMETER**  
004 16 11 6 4.95  
00024 4 2 6 3.95

**OIL CONDENSERS**  
1 mfd 600 vdc—29 10 mfd 2000 vdc—6.95  
2 mfd 600 vdc—39 2 mfd 1000 vdc—4.95  
4 mfd 600 vdc—59 1 mfd 5000 vdc—4.50  
6 mfd 600 vdc—79 1/1 mfd 7000 vdc—2.25  
3 3/3 mfd 600 vdc—79 1 mfd 7500 vdc—1.95  
10 mfd 600 vdc—89 1 mfd 7500 vdc—9.25  
20 mfd 600 vdc—1.99 .02 .01 mfd 12 kv—5.75  
4 mfd 1000 vdc—95  
6 mfd 1000 vdc—1.19 .005/.01 mfd 12 kv dc—5.50  
5 mfd 1000 vdc—1.09  
2 mfd 1500 vdc—1.25 65 mfd 12,500 vdc—5.50  
4 mfd 1500 vdc—2.25 75 35mfd8 16kv—7.95  
6 mfd 1500 vdc—2.95 2 mfd 18 kv dc—49.55  
2 mfd 2000 vdc—1.45 2 mfd 15 kv dc—15.95  
2 mfd 2000 vdc—2.25 1 mfd 15 kv dc—15.95  
8 mfd 2000 vdc—5.95

**PEAK ELECTRONICS CO. Phone CO 7-6486 188 Washington St., New York 7, N. Y. DEPARTMENT EA**

# NEW YORK'S RADIO TUBE EXCHANGE

TYPE	PRICE	TYPE	PRICE	TYPE	PRICE	TYPE	PRICE	TYPE	PRICE
OA4G	\$7.72	4C35	19.95	249C	3.75	720BY	45.00	879	.55
CI1B	3.95	4J31	95.00	250TH	19.25	720DY	45.00	884	1.70
IA3	2.95	4J32	95.00	250TL	15.00	721A	2.40	885	1.25
1B22	2.95	4J35	195.00	250R	5.95	722A	3.95	931A	3.95
1B23	8.95	4J38	95.00	HK253	6.95	723A	9.95	955	.45
1B24	4.95	4J40	195.00	274B	1.75	723A/B	10.95	956	.45
1B26	2.95	4J44	195.00	287A	3.95	724A	2.95	957	.25
1B38	32.50	4J52	350.00	GE303	3.95	724B	3.95	958A	.55
IN21	.95	51P1	2.75	304TH	3.95	725A	12.95	959	.75
IN21A	.95	51P4	3.95	304TL	1.25	726A	19.95	975A	12.50
IN21B	1.50	5C30	9.95	307A	4.25	726B	36.00	991	.25
IN23	.85	5CP1	1.95	310A	4.50	726C	45.00	CK1005	.35
IN23A	.95	5D21	24.95	316A	.69	728AY	.69	CK1006	.99
IS21	3.75	CSB	9.95	350A	2.40	801A	4.50	1280	.59
2AP1	3.50	5P7	1.95	350B	1.80	802	4.50	WE1378X	2.95
2C23	.75	5J1P	45.00	368AS	2.40	804	4.95	1602	1.50
2C33	1.95	5J2P	10.95	371B	.89	805	1.35	1611	1.10
2C34	.59	5J4P	25.00	388A	1.80	807	2.75	1616	1.10
2C39	18.00	C6A	7.95	393A	4.95	808	2.75	1619	.50
2C40	5.75	6A07	.90	394A	4.95	809	7.50	1624	.99
2C43	12.50	6AC7W	1.75	417A	12.95	810	2.50	1625	.45
2C44	1.25	6AK5 (JHN)	1.16	434A	3.50	811	2.50	1626	.45
2C51	7.50	6C21	19.95	450TH	17.50	812	7.95	1629	.45
2D21	1.08	6F4	5.95	450TL	37.50	814	2.95	1635	1.35
2J21	9.95	6J4	4.95	446A	.90	813	2.50	1641	1.00
2J22	9.95	6-8	4.95	446B	1.80	815	.59	1851	1.10
2J26	8.75	6O5G	1.75	WL468	5.95	816	90.00	1852	.99
2J27	9.75	6SU/GTY	1.25	WL469	2.75	827R	7.50	1853	.99
2J31	9.75	7BP7	4.95	WL525	2.75	829B	3.95	1984	2.75
2J32	12.95	7DP4	12.50	527	7.95	832	1.10	8011	1.25
2J36	105.00	10Y	.59	WL530	12.95	834	1.95	8012A	3.95
2J38	7.95	15E	1.25	WL531	7.95	837	3.75	8013A	2.75
2J40	25.00	15R	1.00	WL532	2.95	838	4.50	8014A	25.00
2J42	150.00	15R1	1.25	WL533	39.95	845	4.50	8016	1.25
2J49	24.50	5C22	45.00	WL535	7.75	849	19.95	8019	1.75
2J50	24.50	CV35	35.00	WL538	1.25	851	19.95	8020	2.95
2J55	55.00	CK72	.95	GL570	1.25	852	9.95	8021	1.75
2J61	45.00	CK73	.95	575A	12.50	861	19.95	8025	1.00
2J62	45.00	OK77	249.00	579B	5.95	869B	29.95	9001	.55
2K25	19.95	OK70	55.00	653B	45	872A	2.75	9002	.35
2K28	19.95	OK61	49.50	700A to B	19.50	874	1.95	9003	.55
2K29	24.95	RK39	2.25	701A	3.95	876	.75	9004	.45
2X2A	.69	RK49	2.40	703A	2.40	878	2.25	9006	.25
2V3G	.99	VK59	.45	705A	.75	350A	is a long life WE807		
3A4	.75	NR74	.45	707A	6.95	350B	is a long life WE6LG		
3A5	.95	VR90	.79	707B	9.95	WE701A	can be used for a Super 813		
3AP1	4.95	VR95	.45	710A	1.25				
3BP1	3.95	100TH	10.95	714AY	7.95				
3B24	1.50	VR105	.79	715A	6.95				
3C23	3.95	PI23A	8.95	715B	9.95				
3C24	.95	VR150	.63	715C	24.95				
3C31	3.95	VT90	.63	717A	3.95				
3C45	13.95	VT98	39.95	720AY	45.00				
3DPIA	3.25	X99	.75						
3E29	6.75	203A	3.95						
3J31	59.95	211	.75						
4A1	.95	212C	6.95						
4B30	1.95	CE220	.95						
4C21	1.25	RX232	.95						
4C27	29.95	RX233	1.95						
4C30	1.25	242C	7.50						

## LIST OF TEST EQUIPMENT

Equipment	Price
Micro-Wave Test Equipment	
X Band TS148/UP X Band Spectr Analyzer	
X Band Signal Generator Type TS-146/UP 115 V. 50-1200 Cycle TAA 16 Twin T Amplifier	
X Band Sig Gen Type TS263A TP/10 115 V. 50-1200 Cy	
TS 12/AP Unit 1 SWWR meter	
TS 12/AP Unit 2 Plumbing for unit 1	
TV N7 Pulse Gen for microwave sig gen (Browning Labs Inc.)	
TBN-3EV High Freq Thermistor Meter Radiation Labs	
MIT	
SVWR Meter TAA-11BL Browning Labs	
High Power Klystron Sig Gen S Band, Polarad Mod PE 102	
BC 1287A Scope for Radar, up to 1,000,000 cycles, CW-60ABP made by Western Electric	
BC 1277A/60AQ-1 Signal Generator and Freq. Meter 2700-3400 MC S Band Western Electric	
TS3A/AP Freq and Power meter 2400-3400 MC WE 1017-1 Pulse and Sweep Gen by Hazeltine Corp. I-203A Power Meter	
X-Band Magic T	
X-Band Precision Calibrated Load	
X-Band Tunable Crystal Mounts	
X-Band TS 13 Signal Generator	
X-Band TS 35 Signal Generator	
X-Band TS 45 Signal Generator	
TS 34 Oscilloscope	
Standard Broadcast and Short Wave Equipment	
Model 20B Ferris Microvoltage	
Rider Channelist 162C	
BC 1277A/60AQ-1 Signal Generator and Freq. Meter	
Hewlett Packard Model 2000	
RCA Audio Channelist	
65 B Signal Generator	
160 A Q Meter	
Meters	
TS 15/AP Gauss Meter	
General Radio Tube Voltmeter Type 728A to 3000 volt	
Airradio Millivolt 0-2 Millivolt	
Model 617-F Shallcross Percent Limit Bridge	
Model 40 Pyrometer, Elematic Equipment Co.	
Light Spot Galvanometers, General Scientific Co.	
Microammeter Rollers 0-10 Micramp.	
Radar Sets	
APS3 Complete and Parts	SCR 284
APS4 Complete and Parts	



LIBERTY ELECTRONICS, INC.

PHONE WORTH 4-8262

135 LIBERTY ST., NEW YORK 6, N.Y.

ATTENTION! PURCHASING AGENTS SCHOOLS, MFRS, ETC. We buy your Surplus Inventories for CASH in Tubes, Parts and Test Equipment.

### WHIP ANTENNA EQUIPMENT

**MAST BASES—INSULATED:**

MP-132—1" heavy coil spring, 2" insulator. Overall length: 11 1/2". Weight: 2 3/4 lbs. Price: \$3.95

MP-22 Spring action direction of bracket. 4" x 6" mounting. Price: \$2.95

MP-57—2" heavy coil spring, 5" insulator. Price: \$3.95

MP-48—2" heavy coil spring, 3" insulator. Price: \$2.95

MP-37—2" heavy coil spring, 8" insulator. Price: \$3.95

MP-47—2" heavy coil spring, 9" insulator. Price: \$5.95

**MAST SECTIONS FOR ABOVE BASES:**

Tubular steel, copper coated, painted, 3 foot sections, screw-in type. MS-53 can be used to make any length, with MS-52-51-50-49 for taper. Price, per section: 50¢

BAG BG-56 for carrying above 5 mast sections. 50¢ ea.

### DYNAMOTORS:

Input	Output	Stock No.	Price
12 V. DC	680 V. 210 MA.		
@ 6 V. DC	300 V. 150 MA.	DM-680	\$7.95
9 V. DC	450 V. 60 MA.	DM-9450	
@ 6 V. DC	275 V. 20 MA. w/Blower		3.95
12/24 V. DC	440 V. 200 MA.		
18 V. DC	220 V. 100 MA.	D-104	9.95
12 V. DC	450 V. 60 MA.	DM-175	2.95
12 V. DC	600 V. 300 MA.	BD-86	7.95

**PERMANENT MAGNET FILLED DYNAMOTORS:**

12/24 V. DC 275 V. 110 MA. USA/0516 3.95

12/24 V. DC 500 V. 50 MA. USA/0515 2.95

**PM FIELD DYNAMOTOR POWER SUPPL.**—Completely filtered. Has two PM Dynamotors as listed directly above. Price: \$5.00

**WRITE TODAY FOR QUOTATION ON OTHER DYNAMOTOR OR INVERTER NEEDS!**

**ALNICO FIELD MOTOR**—24 VDC. 3/4" x 1 1/2". Shaft 3/8" x 3/16" w/10,000 RPM. Design No. 63662C. Price: \$3.75

**ALNICO MIDGET DC VOLTAGE GENERATOR**—Type PM-2 Electric Indicator Co. 0.175 V. per RPM. 3/4" x 2 1/2". Shaft 1/2" x 5/32". Price: \$6.95

**ALNICO FIELD MOTOR**—24 VDC. 3-5/16" x 2". Shaft: 9/16" x 1/4" knurled. 10,000 RPM. Type P-11212. Price: \$3.75

## FAIR RADIO SALES

132 SOUTH MAIN ST. LIMA, OHIO

### CONDENSER ASSEMBLIES:

**5 GANG**—with vernier tuning 25 MMFD to 450 MMFD each section. Size: 7 1/2" x 3 1/2" x 3 1/2". Price: \$2.95

**3 GANG**—25 MMFD to 450 MMFD each section. Size: 6" x 3 1/4" x 3". Price: \$1.95

### SELENIUM RECTIFIER UNITS

**HEAVY DUTY—30 VOLT DC OUTPUT:**

115/200 V. Three Phase 400 Cycle input:

TYPE 143 w/Transformer & VIT 100 amp. \$89.50

TYPE 3FS-5 w/Trans., VIT, & Blower 200 amp. \$99.50

TYPE 52A-11 Rectifier only, Cased 200 amp. \$49.50

TYPE AI Rectifier only, Cased 300 amp. \$59.50

TYPE RE-60 Rectifier only, Cased 400 amp. \$69.50

### GEARED MOTOR

Ideal reversible motor for rotating antennas, displays, etc. (Similar to illustration) Weight: 4 lbs. Overall size: 7" long, less shaft. Gear Box size: 3 1/2" x 3 1/2". Motor size 4" x 2 1/2". Shaft size: 3/8" x 1 1/2" threaded. Operates from 24 volt DC. 2.9 A. 9 RPM or 36 volt AC at 75 lbs. torque per inch. Price: \$5.95

36 Volt Transformer: \$2.95

### SYNCHRONOUS MOTOR

26 V. 60 cycle 60 RPM. Size: 1 1/2" x 2 1/4". Shaft 1" x 1/16". Type 1147, with 26 V. Transformer: \$2.95

### AUTOMATIC CODER-TIMER

complete with 110 Volt 60 cycle motor, 7.2 Watts at 4 RPM. Micro switch and adjusting discs. \$12.95

Address Dept. E. • • • All Prices Are F.O.B., Lima, O. • 25% Deposit on C.O.D. Orders

## WILL SELL

Write for Prices

TS-10B/APN	IE-21A
TS-16/APN	I-122
TS-23/APN	I-126
TS-33/AP	I-145
TS-34/AP	I-152C IND.
TS-35/AP	I-196B
TS-36/AP	I-222
TS-61/AP	BC-376-H
TS-62/AP	BC-689A
TS-74/UPM	BC-754A
TS-92/AP	BC-906D
TS-110/AP	BC-929A
TS-118/AP	BC-949A
TS-126/AP	BC-1061A
TS-131/AP	BC-1066B
TS-143/CPM-1	BC-1155A
TS-192/CPM-4	BC-1203A
TS-204/AP	BC-1255A
TS-BE-67	
T9-APQ2	SN7A/APQ-13
T28-APT-1	R78-APS-15A
T85-APT-5	R18-APS-3
ID57/APQ-7	RA-60A
PP72/APQ-7	CQ-164-U (24")
	AN/CRN-2

**WRITE FOR PRICES**

## Alvaradio

Dept. L-2, 341 S. Vermont  
Los Angeles 5, California  
DUnkirk 8-2211

# GUARANTEED GOVT SURPLUS

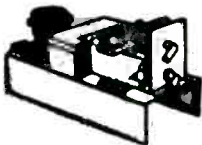

## 420—750 MC OSCILLATOR

Compact, beautifully built line oscillator employing two W. E. 368AS (703A) "door-knob" tubes in push-pull. Exceptionally stable. 5W output at 420mc. 2W at 700mc. Independent grid and plate tuning. Adjustable output coupling and tuning assembly. Coaxial output connection. Built-in blower may be operated from 110VAC. Power requirements: 300VDC/150ma, 1.2V/4A, 1.2V/4A. 5 1/4"x6 1/2"x1 1/2". 7 lb. Supplied complete with tubes. Ideal for 420mc amateur operation or for use in the 460-470mc citizens radio band. **Stock No. AYO-66... \$8.95** Spare 368AS/703A tubes... **\$1.69 ea.**

**WE CARRY A LARGE AND VARIED INVENTORY WHICH INCLUDES:**

- AMPLIFIERS
- AN CONNECTORS
- CABLE
- CAPACITORS
- CHOKES
- CIRCUIT BREAKERS
- COAX-CONNECTORS
- COILS
- CORDS
- CRYSTALS
- DELAY LINES
- FILTERS
- FUSES
- HANDSETS

### JAN TUBES

BRAND NEW IN ORIGINAL CARTONS  
(Except as specified with \*)

1P24	\$4.75	1KCR-73	\$0.95	954	\$0.39
2C44	1.75	304TH	3.95	955	.39
2I21	1.19	304TL	1.95	956	.49
2J38	14.95	417A	19.95	957	.39
2J48	14.95	705A	1.95	958A	.39
2K28	24.95	715B	9.95	959	.39
2X2A	0.89	715C	24.95	991/NE16	.79
3D21A	1.95	725A/B	14.95	2050	1.49
5I4GY	1.09	724B	4.75	5013	.39
6AC7*	.79	725A	7.50	9001	.39
6AG7	1.19	805	3.95	9002	.39
6AK5	1.09	811	1.95	9003	.39
6AL5	.75	814	3.95	9004	.39
6J6	.95	815	1.95	9006	.39
6SL7GT	.69	829B	4.75	OB3/VR90	.89
6SU7GT/Y	1.29	872A	1.69	OC3/VR105	.89
6Y6G	.88	902A	3.95	OD3/VR150	.69
72/3B24	.95	931A*	3.95		

Specify JAN tubes when ordering.  
\* Manufacturers bulk pack JAN.

## Wide Range Butterfly Wavemeter & Oscillator Elements



Precision wide range butterfly circuit elements. Sturdily constructed. Mounted in bull bearings. Suitable for motor drive. Ideal for use as wavemeters and oscillators (See description below.)

Stock No.	Freq. (mc.)	Notes *	Unit Price
TN-20	105-330	1.3	\$4.95
TN2A	75-300	1.4	4.95
TN-30	135-485	2.3	5.95
TN3A	300-1000	2.5	6.95

Brand, new, in original packing.

- NOTES: 1) Aluminum construction  
2) Silver-plated brass  
3) Designed as oscillator element (955 acorn triode)  
4) Has diode socket mounted on unit (955 as diode)  
5) Has crystal diode mount for 1N21 crystal

Immediate delivery from stock (subj. to prior sale). Open acct. to rated organizations, others 20% with order balance COD. Prices FOB Corona, N. Y. and subject to change without notice.

A PENNY POST-CARD WILL PUT YOUR NAME ON YOUR MAILING LIST.

# DUBIN ELECTRONICS CO. Inc.

TELEPHONES: HICKORY 6-3066-7-8

Dept. E-350

103-02 NORTHERN BLVD., CORONA, N. Y.

### TUBES

1N21	\$0.95	803	\$8.95	902	\$3.95
1N21B	1.25	804	12.95	5R4GY	1.25
1N23	1.25	805	5.95	5U4G	.79
1N23A	1.90	810	8.95	5X4	.79
1N23B	2.49	811	2.49	5Y3GT	.55
1N23C	37.50	813	8.95	5Z3	.69
1N34	.85	814	3.95	6C3	.25
1N35	2.05	816	.95	80	.49
1N48	1.35	829B	7.95	83	.79
2J36	115.00	830B	5.25	2050	1.10
2J21A	12.95	832A	4.95	2051	.95
2K25	24.60	836A	1.75	OA2	1.55
715B	24.95	837	2.50	OB2	1.75
715C	24.95	845W	4.85	VR75	.89
723AB	9.95	866A	1.15	VR105	.89
725A	9.95	872A	2.10	VR150	.69

### 3" METERS

0-50 ua DC WH	\$17.50	0-15 VAC WH	\$3.95
0-50 ua DC RS	13.50	-10+6 DB WEST 301	8.95
0-200 ua DC WH	10.50	0-150 VAC TRIP	5.95
0-500 ua DC 4" SQ	5.95	0-150 VAC WH	6.95
0-1 MA DC WH	7.50	0-30 AMP AC TRIP	5.95
0-1 MA DC S scale	3.95	0-75 AMP AC TRIP	5.95
1-0-1 MA Sp Sele.	2.95	FRAHM Freq. Mtr.	7.50
0-2 MA DC WH	5.95	60 cy	
0-2 MA DC SIMP	4.95		
0-5 MA Sp Scale	3.45		

### 2" METERS

0-15 MA DC GE SQ	3.45	0-1 MA GE	3.95
0-20 MA DC WH	3.45	0-1.5 MA WEST 506	4.50
0-100 MA DC DEJ	3.45	0-3 VDC GRUEN	3.50
0-200 MA DC GE	3.45	0-30 VDC GE	3.50
0-1000 MA DC DEJ	3.95	0-1 AMP RF GE	3.50
0-2 AMP DC SIMP	5.95	0-9 AMP RF WH	3.50
0-300 VDC WH	7.95	0-30 AMP DC GE	3.50
0-500 VDC WH	7.95	0-10 VAC GE	3.50
0-8 VAC WEST 476	3.95	0-300 VAC TRIP	5.95

### CHOKES

8 HY 50 MA 90 ohm	\$0.39	6 HY 250 MA 90 ohm	2.95
10 HY 80 MA 240 ohm	.75	5 HY 300 MA 75 ohm	3.50
10 HY 150 MA 140 ohm	1.10	200 HY 6 MA 620 ohm	.99

### OIL CAPACITORS

2 MF 600V	.69	2 MF 1500V	1.75
4 MF 600V	.79	1 MF 2000V	1.45
6 MF 600V	.89	2 MF 2000V	2.49
10 MF 600V	1.10	.25 MF 3000V	1.95
10 MF 1000V	2.49	1 MF 15,000V	19.50

**LABORATORY POWER SOURCE & SQUARE WAVE MODULATOR** (for klystrons such as 2K22, 2K25, 2K26, 2K50 etc. Complete kit of high quality parts... \$149.50 Completely wired ready to use... \$175.00)

**INDUSTRIAL heavy duty portable extension outlet box, for LAB or SHOP** Four HUBBELL 15A receptacles, 10 ft. SUPER SERVICE rubber cable with armored plug... \$3.95  
25% Deposit with order, balance C.O.D. Send for "POLY-GRAM"

**POLY-TECH N. Y.**  
919 Dawson Street, New York 59, New York

## ACORN

**SERVES SCHOOLS, LABS INDUSTRIALS—SAME DAY SERVICE**

### OIL CONDENSERS

10 MFD, 330 v. A.C., 1,000 v. D.C. Standard Brand \$1.49  
Other sizes in stock. Write us your requirements.

### RELAYS

SPDT. Sensitive. Operates on 1 ma., 8,000 ohm coil. \$2.95 each  
D.P.D.T. 115 v. A.C. Latching type, manual reset. Allied—AHLX-1... \$1.69

### 6V6 OUTPUT TRANSFORMERS

8000 ohm plate-to-plate 15 w. output. Universal voice coil 4, 8, 15, 250 & 500 ohms. Upright mount. Shielded. \$1.99

### ATLAS PAGING AND TALK-BACK SPEAKER

Model HU-15V  
Alnico V Magnet. Complete with unbreakable super-efficient driver unit. Power 12 watts, impedance 8 ohms. Length 11", diameter 3 1/2", air column 15". List \$29.75.  
OUR PRICE \$13.95

### WESTON METER 506

2 1/2" 0 to 500 microamp basic. Scale 0 to 15v. and 0 to 600 v. \$3.49

### VARIABLE AIR TRIMMERS

50 MMFD each section. 1/2" slotted shaft. Length 2", width 1", height 1 1/2". Bakelite insulation. Each... 89¢  
10 for... \$7.90  
100 for... \$74.00

APC Trimmer, 100 MMFD, screw driver shaft. National W 100. Each... 49¢  
10 for... \$4.50  
100 for... \$39.00

Dual 35 MMFD Screw driver shaft. Length 3", width 1", height 1 1/2". Ceramic insulation. Each... 95¢  
10 for... \$8.70  
100 for... \$79.00

### FILAMENT TRANSFORMER

Cased. Input, pri. 210, 220, 230, 60 cy. Secondary Output:  
#1—7 1/2 v. @ 4 amps c.t.  
#2—7 1/2 v. @ 4 amps c.t.  
#3—2 1/2 v. @ 5 amps c.t.  
#4—7 1/2 v. @ 8 amps c.t.  
#5—6.3 v. @ 4 amps

**\$3.95**

**PHONE WORTH 4-3270**

**ACORN ELECTRONICS CORP.**  
76 Vesey St., Dept. E-3, New York 7, N. Y.

TERMS: 20% cash with order. Balance C.O.D. unless rated. All prices F.O.B. our warehouse in New York City. No orders under \$2.50.

# COMMUNICATION EQUIPMENT

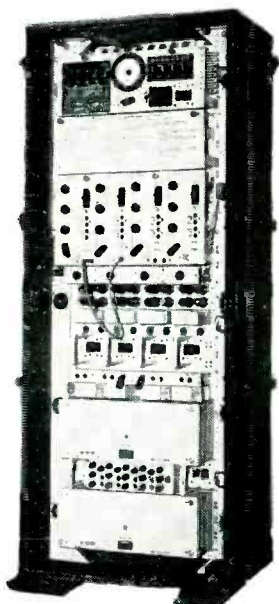

W. E. Co. type CF-2B; 4 Channel V. F. Telegraph Carrier Terminal.

Teletype Model 19—Page—Sending—Receiving & Tape Perforating Set.



Teletype Model 14—Sending—Receiving Typing Reperforator Set.

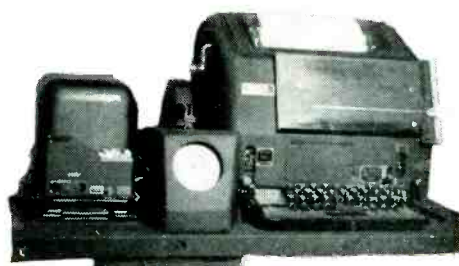

W. E. Co. Type 506B Cordless Monitor Telephone Switchboard.



- TELEPHONE CARRIER ● TELETYPEWRITERS
- TELEGRAPH CARRIER ● TELEPHONE SWITCHBOARDS
- SPEECH PLUS DUPLEX TELEGRAPH TERMINALS

CABLE - MASTELRAD

## MASPETH TELEPHONE & RADIO CORPORATION

142 ASHLAND PLACE

BROOKLYN 1, NEW YORK

MAIN 4-2982 — TWX: N. Y. 2-1123

### VACUUM PUMP SALE!

CENCO MEGAVAC PUMPS—\$79.00 each  
CENCO HYPERVAC PUMPS—\$159.00 each.  
Slightly used, guaranteed perfect operating condition. White or Gull.

AMERICAN ELECTRICAL SALES CO.  
67 E. 8th St. New York 3, N. Y.

### We Buy & Sell TUBULARS—BATHTUBS CERAMICONS—RESISTORS

Trimmers, Spkrs., Pots, Micas, etc.

GOULD GREEN  
252 GREENWICH ST. N. Y. C. 7

### LINE VOLTAGE STABILIZERS

All New Material: Discontinued Models  
95-130 V Input 60 Cycle, 115 V Output, Unity P.F.  
Model VH 621—35 watts; each \$11.00 net  
Model VH 622—70 watts; each \$15.50 net

Subject to Prior Sale  
RAYTHEON MANUFACTURING CO.  
Waltham 54, Mass.

## SQUARE WAVE AUDIO OSC. & HI FREQUENCY SIGNAL GEN.

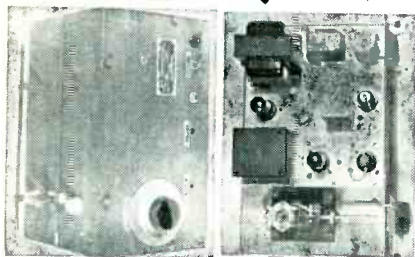

channels with the audio of 1100 cycles square wave for the audio section of the tel. set.

This makes an ideal test unit for lining and Etc. no changes are needed to use this unit for the above purpose, you can however put a tapped switch with several values of capacity across the audio tank circuit coil 167 D for any audio freq. desired for example .18 MFD equals 440 cycles, .1 equals 555 cycles and etc.

If you want to use this unit for a reg. sine wave can be done by changing the value of cap. 29 or use a gain control in the first audio stage this gives a sine wave instead of a square wave in the output stage, as the unit is the first stage is overdriven this gives square wave output.

The output transformer is an Amertran 3871 30 DB gain response flat to 17000 cycles universal tapped Pri. 24 M 16 M 4 M 1 M Sec. 500 15 7.5 3.75 1.25 ohms has Therman power trans. and choke W.F. audio circuit National Venet Dial on the R-F oscillator. Once you calibrate this national dial you have a stable variable osc. for approx. 125 to 210 mcs. and an audio osc. with a square or sine wave 4100 cycles or tapped at various frequencies.

These units also make perfect speech amplifiers transmitters and receivers a unit you do not want to miss. The original print is with each unit we furnish other into plus a print of the taps on the output modulation trans.

These Units Sold Only on a Money Back Guarantee a Fraction of original Cost New \$16.95

### RECEIVERS

RC-106 and RC-406A 190 to 210 megacycles with self contained 115 VAC 60 cycle 150 mil supply with 4 section filtering 150 mil choke and 8-8 mic cond. in ea. section, has 2 R-F and 4 I-F stages, 15 tubes as follows: 5-954 1-955 4-68K7 2-68J7 2-6N7 1-5Y4. This receiver is ideal for converting to the 420 meg. band and perfect for 2-6-10 meters, we furnish a print and instructions for converting to 2 meters, this receiver will also make a television picture receiver only difference in the 406 and 406A is the 406A is a latter model and has a 115 VAC motor for var. tuning this motor has 75 ounce inches of torque speed .65 RPM, Super Her circuit.

Converts to 2-6-10 meters and 420 meg. band. We give conversions for 2 meters and the 6 page CQ FEB. '46 10 meter conversion free. All perfect—like new.

McCONNELL'S

3834 Germantown Ave.,  
Phila., Penna. RA5-6033

XTALS 500KC

standards 2 pin holder  
CR-2B/U brand new \$1.50

### CLARE STEPPING SWITCHES



Type SD-14, 20 steps, 6 levels. Coil 12V, DC. Lists at \$40.26; our low price \$13.00. Brand new in original boxes—not war surplus. Quantities of four or more, \$12.25 each. Satisfaction guaranteed or money refunded.

NEOMATIC, INC.

879 Wellesley Ave., Los Angeles 49, Cal.  
Arizona 3-4897

## NEW BENDIX PLATE TRANSFORMERS

A limited supply of original packed high quality plate transformers are offered for sale. Operating from 200/220/240—If 50-60 cycle lines, these fine units deliver 2903VCT • 4KVA. Insulation tested at 9000v and weighing 220 lbs. each, they represent a \$500.00 list value. Specially priced at \$94.00 each FOB.

WESTON LABORATORIES  
WESTON 93, MASS.



# Columbia Electronics, Ltd.

**MODEL  
ET-8023-D1  
TRANSMITTER**

High frequency radio telegraph transmitter. Continuous frequency range of 2 to 24 Mcs., with A1 or A2 emission. Xmitter can be converted to A3 by slight modification of audio amplifier. 225-watts output. Input power 115-VDC. Has center section for Receiver housing. Xtal or M.O. control, with or without Receiver.

**\$325<sup>00</sup>** Less Receiver

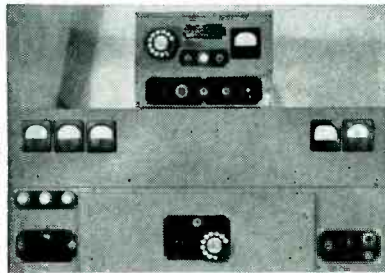
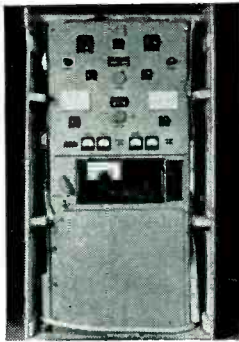

**1100-A  
FOUR TRANSMITTERS IN ONE**

Can be present on 4 bands. Has BFO or xtal on each from 1.5 to 10 mcs. Oscillators are all between 1.5 and 5 mcs. 6L6 osc. VR-150 regulator, buffer or doubler is a 6L6 into 3-807's in parallel. 125 watts on phone and 125 watts on c.w. modulator has 4-6L6's in push-pull parallel. Rig has telephone dial on front for selecting any one of 4 transmitters, selecting phone, CW, turning heaters on, plate current, or turning everything off. Also has remote control unit for **\$225<sup>00</sup>** remote operation. Used, but in excellent condition. **With Remote**

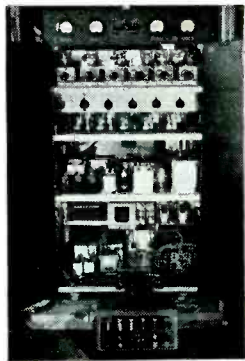

**TCR  
TRANSMITTER**

w / remote control, 6-channel, pre-set frequencies in 2 to Mc. 125-Watts output with A2 or A3 emission. Input 105 to 125, or 210 to 250 volts at 60-cycle (50-60 cy)

**\$275<sup>00</sup>**



**RAYTHEON  
RECTICHARGER  
W-3155**

Supply current at a constant voltage and supplies current to a storage battery, providing an automatic AC-DC power system; No moving parts; No adjustments; Life of the battery increases as much as 40%; Eliminates voltage variations. 11/12 cells, 22-24 volts at 3 amp. output; Input 95-130 volts, 60 cy- **\$45<sup>00</sup>** cles; Weight 180 pounds.

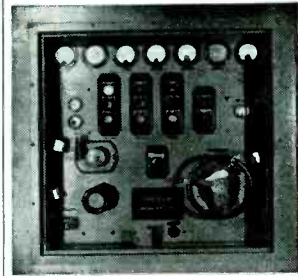

**RA-38  
RECTIFIER**

115 V. 60 cycles, single phase input, output 0-15,000 VDC at 500 ma.

Near New **\$275<sup>00</sup>**

APR-1 RECEIVER, used, excellent condition.  
APR-4 RECEIVER, used, excellent condition.  
TUNING UNITS for above, used, excellent condition.

APR-5 RECEIVERS, used, excellent condition.  
SCR-610 TRANSCEIVER: Complete with power supply and crystal. New.  
MG-149H INVERTER: \$24.50.

BC-611 HANDY-TALKIES.  
APS-4 COMPONENTS: Indicators, control boxes, junction boxes, 800-1C inverters, amplifier boxes, cords and plugs.  
PU-7 INVERTERS: New. \$27.50.

BROADCAST EQUIPMENT: Write in for information regarding broadcast consoles, control and amplifiers.

SCR-528 FM RECEIVER & TRANSMITTER: complete with 80 xtals for operation in the 20 to 27.9 Mc. Powered by 12 or 24 VDC. A light, portable set for mobile or fixed operation.  
VARIAC TRANSAT AMERTRAN: Input 0-115 V. 50-60 cycle; output 115 V 100 amps. 11.5 Kva. \$75.00.

1-222-A RF SIGNAL GENERATOR: 2 bands cover from 8.15 mcs. and 150-230 mcs. Can use up to the 3-harmonic. 110 V. 60 cycle built-in power supply. New. \$125.00.

## COLUMBIA ELECTRONICS LTD.

524 S. San Pedro St.  
Los Angeles 13, Calif.  
Cable Address: COLELECT  
25% deposit with order. Balance C.O.D.  
All items subject to prior sale

### BY POPULAR DEMAND

**MIRROR** — front surface aluminized on optical glass 1 3/16" diameter 3/32" thick ..... **\$1.50**

**PRECISION LEVEL** — interior ground tube level with 4 adjusting screws. Overall length 1 3/4" diam. 15/32". One end with shoulder 1/2" diam. **\$1.85**

**DELCO BLOWER** — sirocco type D.C. Flange diameter 3 1/2" blade 3-3/16" RPM @ 12 volts 3400 RPM @ 6 volts 1600 ..... **\$3.95**

**SELENIUM RECTIFIERS** — G.E. model 6RS 5FB3 maximum A.C. volts 56 D.C. amps. 0.150..... **\$1.35**

**CIRCUIT BREAKER** — 10 amp 30 volt D.C. C-H. Cat. #8751K4... **\$1.10**

**GLASS VIAL** — to use as a permanent level on equipment ..... **\$1.00**

**RELAYS** — G.E. Type CR2791-B109M3 Res. 170 OHMS 24 Volts D.C. SPDP... \$ .69  
Cutler Hammer #506 Relay Bull. #6001 SPNO ..... **\$1.75**

**TELECHRON B-3** — 1 watt Synchronour Motors 5/6 RPM on 50 cycle 1 RPM on 60 cycles ..... **\$3.50**

**DETROIT THERMOSTATIC EXPANSION VALVES** #674-494 2-5/8" Inlet: 1-2" S A E Outlet; 7-32" Orifice for use with FREON, Maximum Operation 55 lbs. **\$4.50**

**WATTHOUR METER SINGLE PHASE** — G.E. type I-16 two wire 5 amp. 115 volt 60 cycle ..... **\$5.75**

SEND FOR FREE BULLETIN

TELEPHONE BEEKMAN 3-8623  
**A. Cottone & COMPANY** ELECTRONIC MECHANICAL & OPTICAL COMPONENTS  
336-340 CANAL ST., NEW YORK 10, N.Y.

# SENSATIONAL PRICE CUT

## TEST OSCILLATOR WR-67A



The WR-67A provides speed, accuracy, convenience, and over-all dependability in signal injection and alignment work. A range switch allows the quick selection of three fixed frequencies of 1500, 600, and 455 kc...band-spread dial provides continuously variable fundamental frequencies from 100 kc to 30 Mc, plus useful harmonics out to 90 Mc. Add to this—a temperature compensated oscillator...special signal-injection probe...both step and vernier attenuators...double shielding...six-band drum dial with easy-to-read, four-foot scale spread...scale accuracy of ±2%, adjustable modulation level on internal and external modulation positions...power-line filter to minimize rf leakage...and 400-cycle signal source—More features than can be found in most signal generators. Shipping weight, 20 lbs.

Frequency Range: Continuous from 100 kc to 30 Mc  
Band A: 100-260 kc; Band B: 260-650 kc; Band C: 635-1600 kc; Band D: 1.6-4.7 Mc; Band E: 4.4-12.8 Mc; Band F: 10.5-30 Mc  
Scale Accuracy: ±2%  
Fixed Frequencies: 455, 600, 1500 kc  
Output Voltage (RMS): Continuously variable, 5 μv to 1 volt  
Internal Modulation: 400 cps; adjustable from 0% to 50%  
External Modulation: 2 RMS volts req. for 30% mod.  
Audio Output: 25 max. RMS volts across 100,000 ohms  
RF Output Impedance: 10-1000 ohms (Varies with attenuator setting)  
Dimensions: 10" x 13 1/2" x 7 1/2"

Regularly **89.50**  
NOW ONLY **49.50**

**HURRY — LIMITED QUANTITY!**

**ORDER BY MAIL,  
ORDER TODAY!**

# The RADIO SHACK Corp.

167 WASHINGTON ST., BOSTON, MASS., U.S.A.

# PULSE TRANSFORMERS

Tube base plug in type

Here are precision made, high quality compact pulse transformers wound on hypersil cores. They are built in octal bakelite tube bases and can be adapted to many uses. Kindly distribute this data to key personnel in your Electrical Engineering Department, to your Technical Library, to your Electronic Equipment Buyers and to any person who should have knowledge of this item.

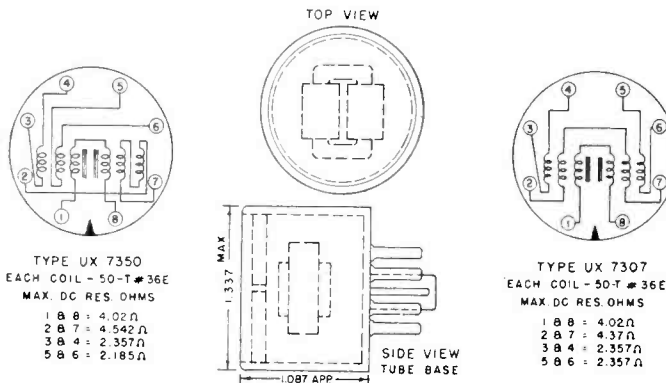

**TYPE UX 7350**  
EACH COIL - 50-T #36E  
MAX DC RES OHMS  
1 8 8 = 4.02Ω  
2 8 7 = 4.542Ω  
3 8 4 = 2.357Ω  
5 8 6 = 2.185Ω

**TYPE UX 7307**  
EACH COIL - 50-T #36E  
MAX DC RES OHMS  
1 8 8 = 4.02Ω  
2 8 7 = 4.37Ω  
3 8 4 = 2.357Ω  
5 8 6 = 2.357Ω

### OTHER DATA

- \*—Completely impregnated and sealed.
- \*—Physically small, measuring only 1.377" dia. x 1.087" high.
- \*—Convenient to use—merely plug into an octal socket—simplifies production.
- \*—The two types UX7350 and UX7307 differ only by placement and termination of windings.
- \*—Schematic of winding sequence and connections pressed into disc covering top of tube base. Schematic designates socket connections.
- \*—The coils are wound on high-grade tested hypersil cores.
- \*—Used in some of the Navy's modern and highly accurate Radar and Direction Finding Equipment.
- \*—Standard types—manufactured by Raytheon Manufacturing Company.
- \*—Quantities available—immediate delivery.

### SUGGESTED USES

- \*—Blocking Oscillator, Multivibrator and Scope Circuits.
- \*—Wherever Accurate Timing and Triggering are necessary.
- \*—Unexcelled in circuit applications for generating low power and low voltage pulses.
- \*—Can be used in circuits utilizing repetition rates from 0 to well over 1 MC and pulse widths ranging from .05 Microsecond up.

**PRICE \$3.95 EACH**

## HATRY and YOUNG

THE *Elect* IN ELECTRONICS

42-44 Cornhill, Boston 10, Mass.  
Lafayette 3-2546

# SPOT SURPLUS! SPECIALS!

**DIEHL or DELCO MOTORS**  
Norm. 110v 60 cy. 3 PH 3450 R.P.M. 1/40 H.P. Supplied with M.F.D. 150 V. AC oil filled condensed to run on single phase ..... **\$4.45**

**I.F. CONVERTER STRIP**  
Part of AN/APS series equipment. FREQ. 30 MC. Uses 8-6AC7, 1-884, 1-6AG7, 1-6SL7, 1-6HG, 1-2050. New, with tubes... **\$17.95**

**AMERTRAN TRANSFORMER**  
5 VOLT, 190 Amp. Pri. 105-125 V. 25 KV Ins. Sig. Corp. 2C6383A/13 ..... **\$15.95**

### COMPLETE KITS • ALL NEW • SPECIAL!

**100 INSULATED RESISTORS**  
RMA color coded, 1/4, 1/2, 1, 2 watt. Contains over 50 values. Complete kit ..... **\$1.75**

**100 CARBON NON-INS. RESISTORS**  
RMA color coded. Well known makes, 1/2-2 watts. Cont. over 25 values. Complete Kit ..... **\$0.95**

**50 RF CHOKE COILS**  
All sizes for plate, grid, filament circuits. Includes popular 2.5 MH chokes. For Trans., T.V. osc., etc. Complete Kit ..... **\$1.45**

**50 MICA CONDENSERS**  
Over 20 values, inc. silver mica types. Complete Kit ..... **\$1.75**

**25 PRECISION WIRE WOUND RESISTORS**  
Well known brands, Inc. over 20 values. Complete Kit ..... **\$1.95**

**VOLUME CONTROL KIT**  
15 types, inc. carbon and wire wound S.D. and shaft types, some w/switch. Complete Kit ..... **\$1.95**

**50 CERAMIC CONDENSERS**  
Over 30 values  
CODED ..... **\$1.95**

**50 BY-PASS CONDENSERS**  
Tubular, Bakelite molded, etc. Popular values. For all purposes. GUARANTEED ..... **\$1.75**

**20 ELECTROLYTIC CONDENSERS**  
Tubular with leads, FP types, ONLY upright mount. All popular numbers. GUARANTEED ..... **\$2.25**  
Check this terrific buy!

Prices F.O.B. Phila.—Check or M.O., no C.O.D.'S. Please incl. postage. Balance promptly refunded.

**THE ELECTRIC SPOT**  
132 S. 11th St. PE 5-9146 Phila. 7, Pa.

## CLOSE OUT SPECIALS

**PHOTO-CELL AMPLIFIER**  
110V. 60 cy. Drawer type. Has milliammeter on front panel. Complete with tubes—6V6, 6J7, 45, 80 and VR105.  
With Tubes ..... **\$9.35**  
Less Tubes ..... **\$7.25**

**PARABOLIC REFLECTORS**  
15" spun aluminum. Alzak, fin. for 1200 Mc. Up. Pair ..... **\$2.75**  
Special quantity discounts to schools and colleges.

**SCHOOLS-COLLEGES-MANUFACTURERS**  
Please contact us if you have any surplus parts or materials that you no longer use.

Write for our catalog.  
**AMERICAN SALES CO.**  
1811 W. 47th St. Chicago 9, Ill.

Write for Flyers pulse transformers, co-ax fittings, etc.

**AN CONNECTORS**  
756 Different Types in Stock  
**HAROLD H. POWELL**  
632 Arch St. Phone MA. 7-5650  
Phila. 6, Pa.

Over 100,000 Relays In Our



### VAST STOCK

GUARANTEED—IMMEDIATE DELIVERY

Write us your needs for our quote

### AN CONNECTORS

- AN 3106-40-9s 69¢ ea
- AN 3108-36-15s 69¢ ea
- AN 3108-18-1P 39¢ ea
- AN-3108-12S-3S 25¢ ea
- AN-3102-10S-2P 20¢ ea
- AN-3106-10S-2S 18¢ ea

And many others.

### H-F TIE POST



(pictured actual size)  
4-40 Thread

LOW-LOSS  
BAKELITE  
INSULATION

\$7.50/C \$67.00/M

### PULSE XFMR'S

T151 and T94 are 3 winding Pulse Input xfmr's with hypersil core. 1000 ohm windings carefully balanced for operation in series with filament. Pulse modulation fed to low impedance winding.  
W.E. type KS9798 50 to 1000 to 1000 15KV. #T94 \$3.95 ea.  
W.E. type KS9565 40 to 1000 to 1000 7.5 KV. #T151 \$2.95 ea.  
DONGAN TR 1043-A461 Ratio 1:1 high power pulse modulation driver xfmr for final. Pa. winding approx. 8 ohms d-c; 200 mh; 260T #30 wire #T152 ..... \$2.95  
W.E. (coreless type) A quasi differentiating xfmr. Pri. when tuned with a .01 mfd resonates at 5630 cps. Split wound secondary terminates into 10000 ohms Army SC# 2C2270/T2 ..... \$1.95 ea.  
W.E. — KS9562 3 windings Blocking Osc. xfmr. \$1.49 ea.  
W.E. KS9564 1:1 ratio—high repetition rate ..... .95 ea.  
FREED #12524 2:1 ratio—high repetition rate. \$1.35 ea.



### SOLENOIDS

G. E. CR9533K100A2 240 ohm 24 VDC DPST N.C. & SPST n.o. 2 switchettes. Extra Long throw. #R132 ..... \$8.40  
HART M569A CAT # 694R19 75 ohm 24 VDC 200 amp. cont. SPST n.o. #R127A ..... \$1.75  
SINE-COSINE SQUARE-WAVE POTENTIOMETER W.E. CO# D169100 For very low freq. sweep circuits \$9.95 ea.  
S.S. WHITE DENTAL LAB RESISTORS 1K, 4K, 60K, 100K, 500K. All 1 Watt \$7.50/C



### LARGE STOCKS OF

- APC'S BINDING POSTS
- CABLE CAPACITORS
- CERAMICONS
- CERAMICS
- CHOKES
- CIRCUIT BREAKERS
- COILS
- CONTROLS
- CRYSTALS
- FILTERS
- FUSES
- HARDWARE
- KNOB
- RELAYS
- RESISTORS
- SHOCK
- MOUNTS
- SOCKETS
- SPAGHETTI SWITCHES
- TRANSFORMERS
- TUBES

Write Us Your Needs for Immediate Quote

Min. Order \$2.50

**Universal General Corp.** Prices Not FOB Our Plant  
365 Canal St., New York 13, N. Y. Walker 5-9642

**BRAND NEW  
RADAR SPECIALS**

APS-4 Radomes	\$25.00 ea
J-84/APS-4 Junction Box	\$25.00 ea
AT-38A/APT Antenna for APR-4	\$8.50 ea
AT-49/APR-4 Antenna	\$8.50 ea

**AIRCRAFT RADIO  
EQUIPMENT and TEST  
SETS**

1-96 UHF Sig. Gen. (Recond.)	\$200.00
AN/ARM-1 Test Set for ARC-3	150.00 set
BC-376-H 75-MC OSC.	\$95.00
A-58 Phantom Antenna 100 w, 200 kc— 12mc.	15.00 ea
A-98 Phantom Antenna with special R-F Meter, for testing Gibson Girls	15.00 ea
1-100 Test Set for ARN-7 or 269 Comp.	850.00 set
BE-67 Test Ind.	\$15.00
1-139 Test Motor for SCR-522	12.00 ea
IE-19 Test Set for SCR-522 complete	200.00 set
TS-10A/APN Altimeter Delay Line	40.00 set
TS-16/APN Altimeter Test Set 24-v AN/ APN-1	125.00 set
TS-16X/APN Altimeter Test 12-v AN/APN-1	150.00 set
TS-80/U Test Meter for AN-ARC-1	12.00 ea
1-86 Test Set	95.00
RC-54 Test Set for ARC-5 or 274-N Receivers	150.00 set
RC-55 Test Set for ARC-5 or 274-N Trans- mitters	250.00 set
1-95 UHF Field Strength Ind. (100-150 MC)	35.00
BC-906 Freq. Meter	\$49.00
Model GP-7 Transmitter, complete. Brand new, all tuning units.	\$100.00
W. E. Type 27B Marker Receivers 12-v (complete and reconditioned)	150.00 set
Bendix RTA-1B Transmitter only (recond. L. N.)	500.00 ea

Some of the above Test Sets are one of a kind in stock.

Also in stock: AN/ARC-1, AN/ARC-3, AN/ART-13, BC-348, AN/ARN-7, MN-26, SCR-269-G, RL-41, RL-42, RC-103, ARN-5, 522, 274-N, ARC-5.

**LARGEST DYNAMOTOR LIST  
AT LOWEST PRICES**

DM-32 (24V)	\$ 2.00	DM-18 (MN-26 12V)	\$10.00
DY-2/ARR-1 (24V)	3.00	DY-21/ARC-3	10.00
DM-33 (24V)	12.00	DY-22/ARC-3	7.00
DM-33 (24V)	5.00	DM-53-A (24V) ea.	5.00
DY-8/ARC-5 (24V)	5.00	DM-53-AZ (12V) ea.	12.00
DM-28 w/flt	8.50	PE-86 w/flt (24V)	3.00
DM-28 less flt	5.00	PE-86-AZ w/flt (12V)	12.00
DM-24 w/flt (12V)	10.00	DY-12/ART-13 w/flt	50.00
DM-24 less flt	8.00	DY-12/ART-13 1/flt	15.00
PE-73 (24V)	10.00	BD-77 (12V)	10.00
D-101 (APN-24V) ea.	5.00	PE-109 Inverter (12V)	50.00
D-101 (APN-1 12V)	10.00	MG-149-H Inverter (24V)	39.00
PE-94-C (522 24V)	5.00	DA-1F BENDIX	20.00
PE-98 (522 12V)	20.00		
DA-7A (Bendix TA-21)	25.00		
DA-1A (MN-26 24V)	10.00		
DA-1B (MN-26 12V)	10.00		

ABOVE MATERIAL ALL BRAND NEW IN MANUFACTURERS ORIGINAL BOXES. DELIVERY STOCK, SUBJECT TO OMISSIONS, CORRECTIONS, PRIOR SALE.

LARGE INVENTORY "AN", CANNON, "ARC" AND BREEZE CONNECTORS—SEND US YOUR REQUIREMENTS FOR FAST QUOTATIONS.

**AIRCRAFT RADIO  
INDUSTRIES**

780 State Street, New Haven, Conn.  
N.Y.C. Office—274 Madison Ave.  
Phone LExington 2-6254

**BRAND NEW U. S. GOV'T. SURPLUS GUARANTEED**

**POWER RHEOSTATS**



Ohms watt ea.	Ohms watt ea.
2 225 \$4.95	150 150 \$3.50
3 100 2.90	200 25 .98
3 225 4.95	200 150 3.50
4 225 4.95	225 50 1.24
5 50 1.24	250 25 .98
5 100 2.90	350 25 .98
5 150 3.50	350 100 2.70
6 25 .98	378 150 3.50
6 50 1.24	400 25 .98
7 25 .98	500 25 .98
8 50 1.24	500 75 2.49
10 25 .98	585 150 3.50
10 100 2.70	750 25 .98
12 25 .98	750 150 3.50
15 25 .98	1000 25 .98
16 50 1.24	1200 225 4.95
22 50 1.24	1250 50 1.24
25 25 .98	1250 150 3.50
32 300 5.25	1500 50 1.24
50 25 .98	2000 25 .98
50 50 1.24	2000 50 1.24
50 750 17.95	2500 100 2.90
60 25 .98	3000 25 .98
75 150 3.50	3000 100 2.90
80 50 1.24	3500 50 1.24
80 500 7.60	5000 25 .98
100 25 .98	5000 50 1.49
100 50 1.24	7500 50 1.63
100 225 2.70	7500 100 3.30
125 25 .98	10000 50 1.63
125 500 7.60	10000 100 3.30
150 50 1.24	20000 150 5.26

\* Specify whether shaft required is for knob or screwdriver adjust. (Discount to Quantity Users.)

**BIRTCHEUR TUBE CLAMPS**

#926-A	#926-B22
#926-A1	#926-C
#926-B	#926-C1
#926-B1	#926-C5
#926-B2	#926-C10
#926-B7	#926-C24

**18c ea.**

**SELECTOR SWITCHES**

Pole	Pos	Deck	Type	Ea.
1	5	1	bakelite	\$ .29
1	6	1	bakelite	.31
1	12	1	ceramic	.55
1	21	3	bakelite	.69
2	2	1	ceramic	.39
2	2	3	bakelite	.49
2	8	2	bakelite	.54
2	11	2	bakelite	.60
4	4	2	ceramic	.54
5	3	2	ceramic	.56
6	11	6	bakelite	1.98
10	5	3	ceramic	1.49
12	2	3	bakelite	1.75
16	2	4	bakelite	.98
18	5	9	ceramic	1.90

**"AN" CONNECTORS**



LARGE VARIETY AVAILABLE AT GREAT SAVINGS  
Send your specs and let us quote

**OIL CONDENSERS**

Mfd.	Volt.	Each
.25	3000	\$0.75
.25	2000	.95
.1	600	.35
.25	3000	1.10
.25	3500	1.35
1	600	.28
1	600	.35
1	2000	1.95
2	400	.35
2	600	.39
4	600	.69
6	400	.75
6	600	.79
10	600	.98
14	600	1.75
15	600	1.98
15	1000	3.25
2x.1	7000	3.95
3x4	400	1.49

**BATHTUBS**

mfd	vdw	each
.033	400	.17
.05	200	.17
.05	400	.19
.05	400	.21
.1	600	.22
.1	1000	.32
.15	600	.22
.25	200	.19
.25	600	.23
.35	400	.22
.5	400	.23
.5	600	.25
.5	1000	.35
1	200	.29
1	600	.35
2	400	.44
2	600	.49
4	50	.25
4	500	.59
25	50	.28
25	75	.30
40	25	.27
50	25	.28
200	12	.35
300	6	.39
.05-.05	600	.29
.05-.05	1500	.45
1-.05	200	.25
1-.1	400	.26
1-.1	600	.28
1-.16	600	.28
2-.2	600	.29
2-.25	600	.30
3-.5	600	.35
1.0-1	300	.29
200-200	9	.49
3 x .05	600	.40
3 x 1	400	.42
3 x 1	600	.45
3 x .25	600	.50
3 x 1.0	100	.40

**"UG" Connectors**

UG-12/U	\$ .89
UG-13/U	1.49
UG-18/U	.89
UG-19/U	1.15
UG-21/U	.89
UG-22/U	.98
UG-24/U	.95
UG-25/U	1.15
UG-27/U	1.75
UG-57/U	.89
UG-58/U	.65

**ALWAYS BUY**

**TYPE "J" 50c ea.**

ohms shaft bush.	ohms shaft bush.
60 1/8" 1/2"	10K 1/8" 1/2"
100 1/8" 1/2"	10K 3/8" 3/8"
150 1/8" 3/8"	11K 1/4" 1/4"
300 3/8" 1/4"	12K 3/8" 3/8"
400 1/8" 1/2"	15K 1/8" 1/4"
500 3/8" 1/4"	15K 1/8" 3/8"
500 1/2" 1/2"	16K 1/4" 1/4"
600 1/2" 1/2"	20K 1/8" 1/2"
1000 1/8" 1/2"	20K 3/8" 3/8"
1000 5/8" 1/2"	25K 1/8" 1/2"
1200 1/4" 1/4"	25K 1-1/8 1/2"
1400 1-1/8 1/4"	30K 1/4" 3/8"
1500 1/8" 1/2"	50K 1/8" 1/2"
1500 1/2" 1/4"	50K 3/8" 3/8"
2000 1/8" 3/8"	75K 5/16" 7/16"
2000 1/2" 1/2"	80K 1/2" 1/4"
2100 1/8" 1/2"	100K 1/8" 1/2"
2200 1/8" 3/8"	100K 9/16" 3/8"
2200 1-1/8 3/8"	200K 1/8" 1/2"
4000 1-1/8 3/8"	200K 3/8" 3/8"
4700 3/8" 1/2"	250K 7/16" 1/2"
5000 1/8" 1/2"	300K 1/8" 1/2"
5000 1/2" 1/4"	1meg 1/8" 1/2"
5000 5/8" 1/2"	1meg 3/8" 1/4"

**TYPE "JJ" \$1.25 ea.**

ohms shaft	ohms shaft
100/100 1/8"	100K/100K 1/8"
200/200 1/2"	100K/100K 1/2"
500/500 1/8"	130K/130K 1/4"
500/500 2-1/8"	150K/150K 3/8"
600/600 1-1/2"	200K/200K 3/8"
1500/1500 2-1/8"	250K/250K 1/2"
2000/2000 1/8"	300K/300K 1/2"
2000/2000 2-1/8"	350K/500K 3/8"
5000/5000 2-1/8"	350K/250K 5/16"
10K/10K 3/8"	500K/500K 2-1/8"
20K/20K 3/8"	800K/75K 1/2"
25K/10K 2-3/4"	1meg 1meg 3/8"
35K/5000 3/8"	4meg 4meg 3/8"
50K/50K 1-1/4"	5meg 1/2"

**TYPE "JJJ" \$2.25 ea.**

ohms shaft	ohms shaft
20K/200K 20K	3/8"
45K/27K 2500	1/4"
700K/700K 700K	3/4"
750K/750K 750K	1-3/8"
800K/800K 800K	1-3/8"
1 meg/1 meg/1 meg	3/4"

\*screwdriver slot. † Locking bushing

**"UHF" Coax Cable Connectors**



Cat. No.	Army No.	Type	Ea.	Per/C
83-IAP	M-359	Plug	.35	.28
83-ID	PL-271	Adap	1.25	1.00
83-IF	PL-274	Feed	1.10	.90
83-IR	SO-239	Rec.	.35	.28
83-ISPN	PL-259A	Plug	.35	.28
83-22R	SO-264	Rec.	.50	.40
83-22SP	UG-102/U	Plug	.45	.40

Open Accounts to Rated Concerns  
Prices net FOB our w/ho NYC.  
Send for our Catalog

**ALEXANDER MOGULL CO., INC.**  
161 Washington St., N. Y. 6, N. Y. WOrth 4-0865

**Brand New - Original Crate & Carton**  
**\$1500.00 G. E. No. 910 Projection T. V. Receiver**  
**with FM-AM and short wave radio**

- 43 Tubes:—540-1620 KC Standard  
9.4-12.1 MC, S.W.—2 bands  
42-108 MC, F.M.—2 bands
- Screen Size: 18"x24"
  - Schmidt Optical System
  - 5TP4 Picture Tube
  - Complete with AM & FM Antenna, & Connecting Cables
  - Includes 2 G.E. 12" P.M. Speakers
  - 25 Watts Max. Audio Output

Price only  
**\$395.00**

Just the Thing for Custom Installation  
FS-2259, Electronics  
330 W. 42nd St., New York 18, N. Y.

# COMET RECORD SMASHING VALUES!

## EXTRA SPECIAL VALUES

### LECTURE TYPE GALVANOMETER

- DC Galvano-Volt-Ammeter ● Scale 5-0-5
  - Complete with shunts
  - DIMENSIONS: 15" Lg. x 14 1/2" H x 7 1/2" W
- Mfg'r Centre #82145  
**BRAND NEW—SPECIAL \$68.00**

Esterline-Angus Twin Chart Graph Recorder Model AWT-N Twin Flush Graph D.C. Milliammeter feeds hourly - 3/4" - 1 1/2" - 3" - 6" - 12"

Minute 3/4" - 1 1/2" - 3" - 6" Scale Range 2.5-0-2.5 MA Writing Door—Synchronous Clock on each meter—Chronograph pen on each meter. Complete with Pens, Filler, Graphic Meter, Ink Charts, etc.  
**Brand New \$450.00**

### Synchro Amplifier for GENERAL RADAR USE

- Syn. Amp. CM 211103-A Input 115V, 1 phase, 60 cy Synchro 5CT @ 1 and 36 speed.
  - Output Syn. Equiv. 3-7G @ 1 speed, equiv. 2-7G @ 36 speed.
  - Amplifier CM-50131-A (6 tubes)
  - Spare parts.
- Brand New \$129.00**

### 10 CM ECHO BOX

10 CM Echo Box CABV-14-ABA-1 of ORL-3 2590 MC to 3170 MCS direct reading micro-meter head. Ring prediction scale plus 9% type "N" input. Resonance indicator meter, complete with accessories and spares and 10CM directional coupler.  
**Brand New \$120.00**

### AMERICAN BLOWER AND MOTOR

1/2 HP GE motor 115V 1 phase 60 cycle, 1725 RPM CW rotation—Assembly is 10 1/4" wide, 12" high—Air intake 6" dia.—Air output 4 3/4" x 1 3/4".  
**Brand New \$19.95**

### ALUMINUM MAST

76 feet telescopic aluminum mast fully collapsed only 11 ft. Dia. at base 7" tapers to 3 3/4" at top—with guys, erection poles and lights.  
**\$175.00**

**10 CM ROTATING ANTENNA**  
24" parabola in turret 300° span at 12 RPM. DC motor control.  
**New \$74.00**

### TOWER LIGHTING POWER TRANS.

115/230V 50/60V secondary 115V 3 3/4 amps. 60 KV insulation—Oil filled ceramic case w/galv. malleable iron end bells. Lightning gap and rain shield.  
**New \$89.50**

### SPECIALS

- 80.86 KC crystal with holder \$1.50
- NE-2 Neon lamp .05
- Battery tester 0-10V, 0-35A .85
- 33 mmf—440 mmf variable condenser 1750V test .69
- 24-750 mmf tapered rotor plates .90
- 7-100 mmf 1000 V peak var. cond. .69
- 50 watt tube socket 872, 211 1.19

**TERMS** Minimum order \$5.00—mail orders promptly filled—all prices F.O.B. Boston, Mass. Send M.O. or check Shipping charges sent C.O.D. 25% deposit required on all C.O.D. orders.

INQUIRIES FROM DEALERS, SCHOOLS AND INDUSTRIAL FIRMS INVITED

### SPECIALS TRANSMITTING MICA AEROVOX

0012 MFD 20,000 VDC  
**Brand New \$10.95**

### TIME DELAY LINE

1 micro second 15 KVA 400 cycle  
50 ohm Brand New \$4.95

### DE-ION LINE STARTER

DPST 115V 60 cy 15A 1 H.P. rating Westinghouse New \$3.25

### WESTON #666 SOCKET SELECTOR UNIT

Measures current, voltage, resistance, etc. in a vacuum tube circuit.  
**Brand New \$9.95**

### INERTEEN CAPACITOR

1.0 MFD 7500 VDC  
**Brand new \$5.25 ea/2 for \$4.45 ea**

### FILTER REACTORS

4 HY 4.5 amp DC 3 ohms 1230 RMS to ground test GE  
**Brand New \$39.00**

1.7 HY with .02 amp DC and not less than 0.3 HY with 2 amp DC ripple. 3000 V DC circuit GE Y3494A  
**Brand New \$75.00**

### CHOKES

.25 HY 4 amp .5 ohm DC resistance. 20,000 V test GE  
**Brand New \$21.95**

1HY 3.2 amp DC 3.5 ohm GE 69G459  
**Brand New \$34.95**

### GENERATOR VOLTAGE REGULATOR

115 volt 400 cycle GE CBA 20C  
**New \$10.95**

### CRYSTAL ANALYSIS UNIT

Consists of X-ray diffraction equipment with goniometer and collimator ray protective—Adj. scales—crystal blank holder  
**Write for Special Price**

### RELAYS

- 12 VDC DPST Box 32 .65
- 24 VDC Solenoid operates two Switchlets 1.25
- 110 VAC DPDT RF antenna change-over 3.50
- 110 VAC DPDT 2.95
- 110 VAC DPST S-D CXA 1970 2.45
- 115 VAC DPST S-D CXA 2997 2.45
- 220 VDC DPST S-D CX 2122 3.02
- 230 VAC DPDT GE 12HG11A 3.20
- enc. in bakelite case 4.25

### SENSATIONAL VALUES

- TCS-12 Transceiver Freq. Range 1.5 to 12MCS. Brand new with 110VAC power supply, operating accessories, complete spares for transceiver and power supply. Original export packing. **\$450.00**
- TBL-13 Transmitter and spares. Brand new. Export packed. **\$450.00**
- BC-325 Transmitter. Brand New **\$750.00**
- PPI Receiver Indicator Console includes: BC-988A Calibrator. BC-981A Receiver. BC-986 Oscilloscope. PE-138A Power Supply. Export Packed. **\$350.00**

### SOUND ON FILM

Harttron Recorder-Reproucer-Records up to 4 hours on a 62 foot loop of film—Plays back immediately—No processing of film required. Brand New. **\$150.00**

### ROUND PANEL METERS

0-1 RF Amps GE	2"	\$3.95
0-5 RF Amps Weston	3 1/2"	4.50
0-300 MA DC Simpson	2 1/2"	3.75
0-300 MA DC Weston	2 1/2"	3.75
5-0-5 MA DC Weston	3 1/2"	4.25
with 50 MA shunt	3 1/2"	4.25
0-5 Amps DC McChn	2 1/2"	1.95
0-50 Amps DC Weston	3"	4.75
0-100 Amps DC Hoyt	3"	3.00
0-15 Volts AC GE	3"	4.94
0-3 Volts DC Sun	2 1/2"	1.95
0-2500 Volts DC Simpson	3 1/2"	4.95
with 2500 Volt Multiplier	3 1/2"	4.95
0-5 KV DC 0-10 MA DC	3"	5.75
0-150 Volts DC Hoyt	3"	3.95
10-0+6 DB Weston	2"	4.50

### PORTABLE METERS

0-10 Amps DC Weston	480	7.50
0-3-6-30 Volts DC Weston	280	17.50
0-25 Amps AC Weston	433	23.95
0-150 Volts AC Weston	433	25.95
0-1-5-6 Volts AC Output meter	Weston	571 10.95

### NAVY RDF RECEIVER

Fixed tuned freq. range 200-550 KC operates on 110 VAC. Brand new w/ speaker and spares. **\$39.95**

### TIME DELAY SWITCHES

1 minute 115 VAC 60 cy Ene. in waterproof metal case New \$2.95  
3 micro switches make contact at 40-11-42 sec. time delay 110 VAC motor New \$4.00  
30-40 Sec. mercury time delay relay 110 VAC New \$5.95  
Thermo switch 50°P to 500°P, 115VAC @ 6A, 230VAC @ 5A Breaks contact with increase in temperature New .95

### TUBES

2C34	.25	CK-1005	.20
2X2A	.55	CK-1007	.90
2X2 879	.35	1628	.25
3C24	.38	1629	.25
7C4 1203A	.35	2051	.40
10Y	.45	7193	.20
15E	1.20	8011	2.00
15R	.60	9002	.30
39 44	.25	9003	.35
45 80cc	.28	9006	.25
11K54	1.65	C5B	6.90
211	.40	CEQ72	1.30
713A	.90	CK-70	3.50
717A	.55	E-1148	.35
801A	.25	HY615	.70
803	4.00	RK-73	.75
801	8.50	VT-127A	2.25
805	3.65	VF-1	.50
826	.40	3BP1	2.50
861	.35	3CP1	1.95
869B	25.00	5BP4	2.90
872A	1.45	6FP7	1.00

### FOR SALE

Stem and Sealing Machines, vacuum pumps, Button Stem, flare and exhaust machines. Many others.

**HAYDU BROTHERS**  
PLAINFIELD, N. J.

### PATCH CORDS

6 foot rubber covered, two conductor, tinsel with Western Electric Type 241A plug at each end. Price \$4.30 each.

Western Electric 241A plugs. Price \$2.00 each.  
**MASPETH TELEPHONE & RADIO CORPORATION**  
112 Ashland Place Brooklyn 1, N. Y.

## A. C. POWER ANYWHERE

with Katolight Plants and Generators

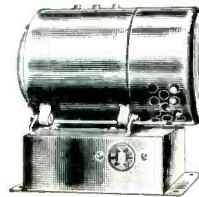

### CONVERTERS

One 350 Watt, 115 Volt D.C. input, 115 Volt A.C. output ... \$52.00  
Three 2.5 KW, 230 Volt D.C. input, 115 Volt A.C. output, 60 cycle, \$160.00 each

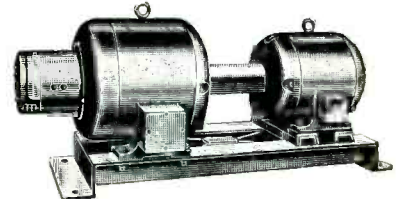

### MOTOR GENERATOR SETS

One 2000 Watt, 120 Volt D.C. output, driven by a single phase, A.C. 115/230 Volt Motor... \$240.00  
One 1000 Watt, 110 Volt A.C. Generator, driven by a 110 Volt, D.C. Motor... \$220.00

### LIGHTING PLANTS

Three 2500 Watt, 115 Volt, 60 cycle, A.C. \$250.00 each.

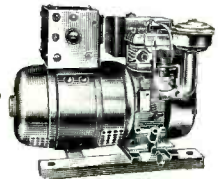

All offered subject to prior sale  
Manufacturers of electrical machinery since 1928

**KATO ENGINEERING COMPANY**  
105 Maxfield Avenue  
Mankato, Minnesota

## SOUNDTRONICS SPECIALS

### NAT'L BRAND MANUFACTURERS

6V. @ 12 AMP. TRANSFORMER 115 V. @ 60 Cy. Imp. open frame 2 1/2" x 3" x 1 1/2" \$1.65

1 MFD 400 V. OIL CONDENSER 14c ea. Upright Mtg. & 2 lugs, 1 3/4" x 1 3/4" x 5/8"

STD. WIREWOUND CONTROLS 1 K, 5 K, 20 K, 75 K, Ohms 1/2" or longer shafts... 24c ea.

PANEL FUSE MTG. FOR 3AG & 4AG Fuses 16c ea.

14 PIN T. V. SOCKET For 3BP1, 7MP4, etc. Black Bakelite 18c  
Mica Filled 28c

REMOTE CONTROL M2-AMPLIFIER 115 V. 60 Cy. Input 2 channels of Class B. Amp. Used for Servo Control. Less Tubes... \$8.75

CONTROLLED FREQ. UNIT BENDIX #Cal 11100 w/tubes \$45.00

T.G. 10 KEYS W/TUBES \$24.95

POP. BRAND BALLAST TUBES CRC-876, BK42B, K12E, K55C, 185R, NB8, NB7, 49A2, 55B2. Many others... 25c ea.

Send for free flyer.

Minimum order \$3.00 plus postage

**SOUNDTRONICS LABS.**  
632 Arch St., Phila. 6, Pa. MA 7-2775

### COMPUTER CONDENSERS

Precision Polystyrene D161270, Low Retentivity, Low Temp. Coef. 1.0 M.F., 200 V. D.C.

FS-1711, Electronics  
330 West 42nd St., New York 18, N. Y.

### D.C. MICROAMMETERS

- 0-200 ua 3" sq. G.E. DO 50 \$ 8.00
- 0-100 ua 3" sq. G.E. DO 50 10.00
- 0-50 ua 3" sq. G.E. DO 50 12.00

### R.F. MILLIAMMETERS

- 0-115 Ma 3 1/2" Weston 425 \$12.00
- 0-100 Ma 3 1/2" Weston 425 12.00

### PRECISION

### PORTABLE INSTRUMENTS

Single or multi-range  
D.C. Microammeters, from 5 ua full scale. Thermo-couple Millimeters, from 1.5 Ma. Thermo-couple voltmeters.

**Precision Electrical Instrument Co.**  
146 Grand Street New York 13, N. Y.

### RADAR EQUIPMENT

SCR-717B AFS-3 AFS-4 SO-9 Search Radars Complete  
 APR-1 and APR-4 Receivers with Tuning Units  
 DP-12 Direction Finder  
 TS-51/APG-4 Test Set

W. E. COMPUTER POTENTIOMETERS  
 D-170541 D-170542 D-170543 D-170545 D-170546  
 D-170548 @ \$10.00  
 2J36 Magnetrons @ \$75.00

Arc Connectors @ .25  
 6963-18 Contact Female  
 55916-18 Contact Male Chassis  
 9488-3 Contact Female  
 55915-3 Contact Male Chassis

Write for listings of other surplus bargains

**LERU LABORATORIES, INC.**  
 360 Bleecker St. New York 14  
 OR 5-3525

### WESTINGHOUSE HIPERSIL CORES

OVER 40,000 UNITS IN 20 DIMENSIONS, SEVERAL GAUGES; UP TO 16,000 UNITS IN SOME SIZES. AVAILABLE FOR IMMEDIATE DELIVERY. SEND FOR LIST WITH COMPLETE DESCRIPTIONS.

**RAYTHEON MFG. CO.**  
 Surplus Sales Dept., Waltham, Mass.  
 Tel. Waltham 5-5860—Ext. 2

### IRESSCO ELECTRONIC & ELECTRICAL SUPPLIERS

LABORATORY & INDUSTRIAL  
 AMPHENOL Connectors & Tube Sockets  
 APIEZON High Vacuum Oils & Greases  
 BIDDLE Meggers & Instruments  
 CAPACITORS Standard Brand  
 CUTLER-HAMMER Devices  
 GENERAL ELECTRIC Products  
 HARVEY HUBBELL Wiring Devices  
 JONES Fittings & Plugs  
 MICROSWITCH Switches  
 SENSITIVE RESEARCH Lab. Instr.  
 SUPERIOR Powerstats  
 WESTINGHOUSE Instruments, Devices.  
 Send For Latest Bulletin

**INDUSTRIAL RADIO ENGINEERING SUPPLY & SERVICE CO.**  
 253 East 32 Street New York 16, N. Y.

### SIGNAL GENERATORS

Surplus to our needs  
 GENERAL RADIO 805 C \$990.00  
 Guaranteed like new condition  
 GENERAL RADIO 603 A 100.00  
 Perfect operating condition  
 BOONTON 150 A 85.00  
 Like new except needs alignment  
 PEER, INCORPORATED, Benton Harbor, Mich.

### I-208 FM SIGNAL GENERATORS FOR SALE—Guaranteed

For Particulars Write to  
 FS-2282, Electronics  
 330 W. 42nd St., New York 18, N. Y.

### MINE DETECTORS

SCR 625, NEW, EXPORT PACKED  
 With Spare Parts, Instruction Books Etc.  
 100 Available F.O.B. New York \$44 ea.  
 FS-2242, Electronics  
 330 W. 42nd Street, New York 18, N. Y.

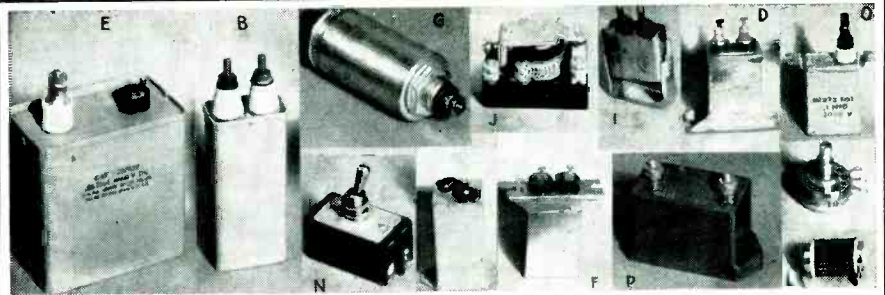

### BATHTUB CONDENSERS Leading Makes

Capacity	Voltage	Terminals	Price	Capacity	Voltage	Terminals	Price
2x .01 mfd.	600	TT	.12	.25 mfd.	600	Matchbox	.12
2x .02 mfd.	600	TT	.12	.25 mfd.	1000	ST	.22
.02 mfd.	1500	TT	.25	2x .25 mfd.	400	ST	.18
.025 mfd.	600	TT	.12	2x .25 mfd.	600	ST	.20
2x .025 mfd.	600	TT	.12	2x .25 mfd.	1000	ST	.24
2x .04 mfd.	600	TT	.12	.3 mfd.	400	ST	.12
.05 mfd.	600	TT	.15	.5 mfd.	400	TT	.15
.05 mfd.	600	TT	.15	.5 mfd.	400	TT	.15
.05 mfd.	1000	TT	.18	.5 mfd.	600	TT	.22
.05 mfd.	1400	TT	.25	.5 mfd.	600	TT	.21
2x .05 mfd.	600	TT	.12	.5 mfd.	1000	ST	.24
2x .08 mfd.	600	TT	.12	2x .5 mfd.	400	ST	.21
.1 mfd.	400	TT	.12	2x .5 mfd.	600	ST	.24
.1 mfd.	1000	TT	.17	1 mfd.	100	ST	.10
.1 mfd.	1200	TT	.19	1 mfd.	300	ST	.15
2x .1 mfd.	400	TT	.10	1 mfd.	100	ST	.20
2x .1 mfd.	400	BT	.10	1 mfd.	600	BT	.25
2x .1 mfd.	600	TT	.19	1 mfd.	600	BT	.25
2x .1 mfd.	600	BT	.19	1 mfd.	1000	ST	.40
2x .1 mfd.	600	TT	.22	1 mfd.	400	ST	.34
2x .1 mfd.	1000	TT	.24	2 mfd.	200	ST	.14
3x .1 mfd.	400	TT	.19	2 mfd.	600	ST	.39
3x .1 mfd.	600	TT	.23	4 mfd.	50	ST	.17
3x .1 mfd.	600	BT	.23	1 mfd.	100	ST	.19
25 mfd.	300	ST	.10	25 mfd.	25	ST	.10
25 mfd.	600	ST	.20				

### OIL CONDENSERS

Symbol	Cap.	Voltage	Price
"E"	.1 mfd.	—2500vdc	\$ .40
"F"	.25 mfd.	—600vdc	1.25
"D"	.5 mfd.	—400vdc	.12
"B"	.5 mfd.	—2000vdc	.75
"B"	.5 mfd.	—3000vdc	1.10
"D"	1 mfd.	—500vdc	.16
"B"	2 mfd.	—2500vdc, Bkts	2.15
"B"	1 mfd.	—600vdc	.59
"B"	10 mfd.	—600vdc	.89
"B"	15 mfd.	—1000vdc, Bkts	2.15

See Feb. issue for other types

### MICA CONDENSERS

10, 20, 30, 50, 100, 150, 200, 250, 300, 350, 400, 500, 1000, 1250, 1500, 1500, 2200, 3000, 3800, 4700, 5000, 6000 and 10,000 mfd @ 500 vdc. \$3.50 per "C". Kit of 100 @ \$2.95.

### SILVER MICA CONDENSERS

10, 20, 30, 50, 100, 120, 150, 200, 240, 270, 300, 345, 400, 500, 670, 1000, 1500, 2000 and 2700 mfd @ 500 vdc \$7.00 per "C". Kit of 100 @ \$5.95.



### SPECIAL—5-5 MFD 400 VDC OIL COND.

3 terms bot. mtg. flanged type. Dim. 3 3/4 x 3 1/4 x 2. Tested at 1500v.d.c. Meets commercial specs. for 600v. operation. Ideal for power factor correction. Carton of 24 \$3.99

### MONMOUTH RADIO LABORATORIES

BOX 159 OAKHURST, N. J.

## WILL BUY

Any quantities of new or used Electronic Surplus Equipment:

APN-9, RTA-1B, TS-67, TS-170  
 ARC-1, ARC-3, ART-13, BC-221,  
 BC-348, SCR-522, etc.

State Condition and Best Price

W-1476, Electronics  
 330 W. 42nd St., New York 18, N. Y.

### "SNOOPERSCOPE" TUBE

Intra-Red Image Converter Tube (British) to make "Snooperscopes," "Sniperscopes," and other devices that see in the dark. Has many useful industrial applications. Operates with invisible infra-red rays, without scanning or amplifiers. See article in November "ELECTRONICS" and October "RADIO CRAFT." Supplied with technical data and diagrams. Every tube guaranteed!

\$5.00 each 6 FOR \$25.00

### TELEMARINE

COMMUNICATION COMPANY  
 280 Ninth Ave. N. Y. 1, N. Y.  
 Ph: LOnagrac 4-4490-1

### G. E. SENSITIVE RELAYS



COIL - 2000 ohm. Pulls in on 18 milliwatts DC (3 MA)  
 CONTACTS - SPDT, 1/8" diameter, pure silver.  
 Center pivot armature, meter type spring. Sealed in inert gas filled, 2 1/8" diameter, aluminum case. Standard five pin base. Original sealed boxes. Send \$2.00 for postpaid sample.

HARRISON RADIO CORPORATION - Industrial Sales Dept.  
 10 West Broadway, New York 7, New York - BARclay 7-7777

99¢

Each in M Lots  
 \$1.19 Each  
 In 100 Lots  
 Item RL-6

TAB for NEW TUBES TESTED and GUARANTEED

Table listing various vacuum tubes with their part numbers and prices. Columns include tube types like 6AF6G, 6U5, 6X5, etc., and prices ranging from a few cents to over \$100.

Infrad Sniperscope \$7.90
Kit 866A's Xformer, Sockets \$5.95
Kit 872A's Xformer, Sockets \$12.95
Seisyn 2161-GE w/data 2 for \$1.49
Circular Slide Rule 1 1/2" Radius .95c
6" Parallel Rules BRITANNIA .39c
Microwave Equipment Bargains!
Xmit-Receive Lighthouse 2,500 Mc \$29.95
3 Cm X-Band Wave-Meter \$16.95
589/AP UHF Freq Mtr New \$59.95

CONSTANT VOLTAGE REGULATORS
SOLA Const V'Reg USN Csd Inpt 95 to 190V/50-60 cyc; Output:115V/2K/W/1.4A Const Dty. 1% Reg LN \$130; Same w/our USN Cost \$689. Yours for \$162.00
GEN ELEC Const V'Reg Inpt 95 to 190V/50-60 cyc; Output:115/115/117V .78KVA at .80PF \$63.00
GEN ELEC Const V'Reg Inpt 115/220V/50-60 cyc; Output:115V/380 Watts \$39.95
RAYTHEON Const V'Reg Inpt-198 to 248V 50-60 cyc; Output:220V/500 Watt/951PF 0.5% RegIn Rack mtg. \$36.00
VARIAC-General Radio 200C 860 Watts, 0-135 Volts, SPECIAL \$15.98
High Fidelity Output Transformers
20 Watts PP6L6/2A3/6AS5 etc Pri 5000 ohms ct; Sec 7 taps 2.5 to 600 ohms PLUS feedback winding \$4.98
30 Watts UTC High Fidelity Output PP 6L6/2A3/6A5G etc Pri 4000 ohm CT; Sec 5 taps 2.5 to 250 ohms \$5.98
MODULATION & AUDIO XFOMERS
MODULATION STANCOR USN H'Sid PP parallel 807's To P1807's RF/2000 ohm Load 2400 Watts Pwr \$6.95
P1807's to 829RCA 5500 to 2600 ohms \$4.50
American USN 3600 or 900 to 30 or 60 Ohms/300 Watts \$12.95
UTAH 12W UnvOutput 5999 Any Tube Any Voice Coil \$1.39
WE output 300W PP805 to 90ohm VC HIFI \$12.98
UTC LVM-11 LineAutoformer 30W \$3.49

Xformers-115V 60 cyc Inpt
1000vct/45ma, 79vct/80ma & 360vct/55ma, 3x5V/3A, 6.3vct/1A, 6.3vct/3A Csd \$4.95
900vct/35ma, 2x2.5v/2A Csd HiVins. \$3.98
700vct/2ma, 115v/100ma, 2x8.3v/1A, 5V/1.87A Csd \$2.98
180vct/120ma, 3V/1.9a. Also Impts 6-12, 24 & 115vdc & 230 vac. \$1.98; 10/16/98 22V/50ma, 5V/6.5a, 6.3v/2a, 6.3v/1a \$2.39
7500v or 15000V Dblcr/.035A Csd. \$18.95
2x330vct/10 ma (or 660vct/10ma) Csd 98c
2x5V/7.5A, Pa, Wndg (for 8.7A's) \$7.95
12.0vct/125A Csd HiVins \$1.49
7.5vct/12A Csd Raytheon \$3.29
6.3vct/4A (rud 6.5A) Csd HiVins \$1.69
6.3vct/0.6A Csd HiVins \$1.39
OIL CONDENSER SPECIALS
2x5 mfd (10mfd) OIL MITE to V.E. spec KR897.6 100Vdc-65 to 65°C. Gtd Usable 600Vdc \$2.00
2x0.1 mfd/2000Vdc ROBE Mfr Common OIP Gnd \$1.08; 2 for \$2.00
300 Wvdc 600 Wvdc
1.0 mfd .7 for \$1
400 Wvdc .5 mfd .8 for \$1
1 mfd .12 for \$1
2 mfd .5 for \$1
4 mfd .3 for \$1
6 mfd .1 for \$1
2x1 mfd .12 for \$1
3x1 mfd .10 for \$1
500 Wvdc 0.5 mfd .10 for \$1
1 mfd .8 for \$1

PRECISION RESISTORS
Over 2 1/2 Million
We Ship Types in Stock 0.1 to 95000 ohms. Ea. 25c; 10 for \$1.98
100K to 950K ohms. Ea. 35c; 10 for \$2.98
1 to 15 Megohms Ea. 70c; 10 for \$5.98
Vacuum Precision Hi Volt Resistors
Megohms \$12.25/8"/.75"/.89"/1.1"/1.5"/2.3"/3.75"/ 1/2" 25V/EA. \$1; 10/\$7.50
Hi Volt Hi Freq Resistors
MVT 2 1/2 Meg/5W/7.5Kv. \$1.08; 10/\$8.98
MVP 5, or 10 Meg/10W/10KV \$1.49; 8/\$10
12 Meg/10W/10KV \$1.49; 8/\$10
MVZ 30 Meg/20W/25KV \$1.98; 6/\$10
MVE 50 Meg/20W/40KV \$1.98; 6/\$10
Hiv Hi Freq Precision Resistor
MFC105 1 Mex/1Kv/1/2" \$1.98; 6/\$10
VWV 20 Mex/20KV/3/4" \$1.95
Daven & IRC Attenuators
IRC 100000 ohms/20 pos \$2.98
Rheostat 20 ohm/50W/Knob & plate 89c
Rheostats 25 Watts Slotted 350/500/1500/5000 ohms \$3 for 98¢
"Williamson" 15 Watts Hi Fi K 1000 10 cycle to 20Kc with case. To 1 Mc. For Experimenters & other applications. Less Output Xformer. Write For Data. \$19.95

"TAB" - Specialists in Industrial Electronic Equipment. Tell Us Your Needs. Write for Your Free "Tabogram".

THAT'S "TAB" THAT'S A BUY
DEPT. 3E SIX CHURCH ST. NEW YORK 6, N.Y., U.S.A. CORNER CHURCH & LIBERTY STS. ROOM 200

TAB MONEY BACK GUARANTEE
\$3 MIN. ORDER F.O.B. N.Y.C.
ADD SHIPPING CHARGES AND 25% DEPOSIT. PHONE WO. 2-7230



when you use  
the **Audax**



**POLYPHASE...**

**ONE** single unit  
plays **ALL**  
your records  
**SUPERBLY...**

and at less  
than the cost  
of ordinary  
magnetic pick-ups

Microgroove,  
78 r.p.m., etc.

Only **\$11.70**  
net cost to you—  
believe it or not!

This one single high grade pick-up yields such quality performance as you'd expect from two or more high grade magnetic units, each made expressly for a given type of recording.

Not only does Audax POLYPHASE accomplish just this - exciting admiration when you hear it, and performing vital functions in a way no other pick-up does - but it refutes the traditional idea that because Audax is so GOOD it costs more.

Not since the advent of the electric pick-up in 1926 has there been such astonished praise and acceptance of a new reproducer; musically and functionally.

Wide range performance with ANY type disc; sapphire or diamond, individually replaceable by you as easy as you changed needles. Low needle radiation. Ear quality *par excellence*.

**Radio Stations** — We have POLYPHASE models for you too, Lateral-Vertical included.

See it at your local dealer

We are right around the corner from the I.R.E. Show! Visit us.

Write for Editorial  
Reprint on  
**POLYPHASE Principles**  
to Dept. 2

**AUDAX COMPANY**  
500 5th Ave., New York 18  
*Fine Electro-Acoustical Units. Since 1915*

Murex, Ltd.	150	Vickers Electric Div., Vickers, Inc.	208, 241
Mycalex Corp. of America	180	Victoreen Instrument Co.	186
National Company, Inc.	238	Ward Leonard Electric Co.	144
National Mulfite Co.	160	Ward Products Corp.	171
National Research Corp.	34	Waterman Products Co., Inc.	231
National Varished Products Corp.	143	Weller Manufacturing Co.	250
National Vulcanized Fibre Co.	152	Welwyn Electronic Components, Inc.	253
Neely Enterprises	263	Westinghouse Electric Corp.	22, 23, 147
New Hermes, Inc.	249	Weston Electrical Instrument Corp.	215
New York Transformer Co.	148	White Dental Mfg. Co., S. S.	150, 227
Ney Company, J. M.	238	Whitehead Stamping Co.	253
North American Aviation, Inc.	228	Wind Turbine Co.	267
Northern Radio Co., Inc.	270		
Northell Winding Laboratories	248		
		PROFESSIONAL SERVICES	273
O'Neil-Irwin Mfg. Co.	190		
Oregon Electronics Mfg. Co.	267		
		SEARCHLIGHT SECTION	
		(Classified Advertising)	
Panoramic Radio Products, Inc.	224	EMPLOYMENT	
Paper Machinery & Research, Inc.	142	Positions Vacant	274, 275
Paramount Paper Tube Corp.	232	Selling Opportunities Offered	274, 275
Park Metalware Co., Inc.	251	Positions Wanted	274
Peerless Electrical Products Div., Altec Lansing Corp.	236	Selling Opportunities Wanted	274
Phalo Plastics Corp.	234	Employment Services	274
Plastics & Electronics Co.	272		
Polarad Electronics Co.	54	SPECIAL SERVICES	
Polytechnic Research & Development Co., Inc.	163	Contract Work	274
Potter Instrument Co., Inc.	250	BUSINESS OPPORTUNITIES	
Precision Apparatus Co., Inc.	307	Offered	274
Precision Paper Tube Co.	242	EQUIPMENT	
Presto Recording Corp.	46	(Used or Surplus New)	
Progressive Mfg. Co.	210	For Sale	276-306
Pyramid Electric Co.	60	WANTED	
		Equipment	274-305
Radio Corp. of America	177, 229	ADVERTISERS INDEX	
	Fourth Cover	Acorn Electronics Corp.	299
Radio Receptor Co., Inc.	26	Aircraft Radio Industries Co.	303
Railway Express Co., Air Express Div.	164	Allen Organ Co., Inc.	274
Raytheon Manufacturing Co.	125	Alvarado Supply Co.	298
Remler Co., Ltd.	251	American Electrical Sales Co., Inc.	300
Resistance Products Co.	268	American Sales Co.	302
Revere Copper & Brass, Inc.	18	Arrow Sales, Inc.	287
Rogan Brothers	217	Bell Aircraft Corp.	275
Rogers Corporation	187	Blair	296
		Columbia Electronics, Ltd.	301
Sanborn Company	212	Comet Electronic Sales Co.	304
Sangamo Electric Co.	159	Communications Devices Co.	294
Scientific Electric, Div. of "S"	116	Communications Equip. Co.	277, 278, 279
Corrugated Quenched Gap Co.	116	Cottone & Co., A.	301
Scintilla Magneto Div.	161	Dubin Electronics Co., Inc.	299
Bendix Aviation Corp.	140	Electric Spot, The	302
Scovill Mfg. Co.	256	Electro Impulse Laboratory	294
Servo Corp. of America	246	Electro Sales Co.	284
Servomechanisms, Inc.	230	Electronic Engineering Co. of Calif.	275
Servo-Tek Products Co.	204	Electronicraft, Inc.	285
Shure Brothers, Inc.	63	Eldico of New York	292
Sigma Instruments, Inc.	207	ELPCO	296
Simpson Electric Co.	255	Fair Radio Sales	298
Society of the Plastics Industry, Inc.	242	Goodyear Aircraft Corp.	274
Somerset Laboratories	42	Green, Gould	300
Sorenson & Co., Inc.	173	Harrison Radio Corp.	305
Southwestern Industrial Electronic Co.	251	Hatry & Young	302
Specialty Battery Co.	157	Haydu Brothers	304
Sperry Gyroscope Co.	119	Hoffman Radio Corp.	275
Sprague Electric Co.	181	Hughes Aircraft Co.	275
Stackpole Carbon Co.	252	Industrial Radio Engrg. Supply & Service Co.	305
Standard Coil Products Co., Inc.	247	Instrument Associates	280, 281
Standard Piezo Co.	270	Kato Engineering Co.	304
Standard Pressed Steel Co.	253	Lectronic Research Laboratories	288
Staver Company	249	Lera Laboratories, Inc.	305
Stevens Mfg. Co., Gro.	138, 245	Liberty Electronics, Inc.	298
Steward Mfg. Co., D. M.	245	Life Electronic Sales	289
Stoddart Aircraft Radio Co.	194	Maritime Switchboard	293
Stoddart Aircraft Radio Co.	233	Maspeth Telephone & Radio Corp.	300, 304
Sun Radio & Electronics Co., Inc.	165	Maxson Corp., W. L.	275
Superior Electric Co.	131, 201	McConnell's	300
Superior Tube Co.	44, 45	Mogull Co., Inc., Alexander	303
Suprenant Mfg. Co.	252	Monmouth Radio Laboratories	305
Sylvania Electric Products, Inc.	239	National Union Radio Corp.	274
Synthane Corporation	252	Neomatic Inc.	300
		Niagara Radio Supply Corp.	296
Tech Laboratories, Inc.	198	Opal-Green Co.	286
Technology Instrument Corp.	199	Peak Electronics Co.	297
Tektroix, Inc.	265	Peer Inc.	305
T&L Instrument Co., Inc.	112	Poly-Tech N. Y.	299
Telechron, Inc.	340	Powell, Harold H.	302
Telex, Inc.	142	Precision Electrical Instrument Co.	304
Terpening Co., L. H.	24	Radio Corp. of America	275
Thomas & Skinner Steel Products Co.	236	Radio Ham Shack, Inc.	282, 283
Titanium Alloy Mfg. Div.	272	Radio Shack Corp.	291, 301
National Lead Co.	226	Raytheon Mfg. Co.	300, 305
Titelflex, Inc.	146	Reliance Merchandizing Co.	290
Topflight Tape	232	Servo-Tek Products Co., Inc.	276
Toplight Corp.	141	Soundtronics Laboratories	304
Transcoil Corp.	168	TAB	306
Transradio, Ltd.		Technical Index Service	274
Triad Transformer Mfg. Co.		Teletronics Laboratory, Inc.	274
Triplett Electrical Instrument Co.		Telemarine Communication Co.	305
Turner Company		Universal General Corp.	302
		Wells Sales, Inc.	295
Unimax Switch Corp., Div. of the W. L. Maxson Corp.	140	Weston Laboratories	296, 300
Union Carbide & Carbon Corp.	172		
The Linde Air Products Co.	Second Cover		
United Transformer Co.	134		
University Loudspeakers, Inc.			
Van Nostrand Co., Inc., D.	269		
Vareflex Corporation	203		