

OCTOBER · 1949

electronics

A MCGRAW-HILL PUBLICATION

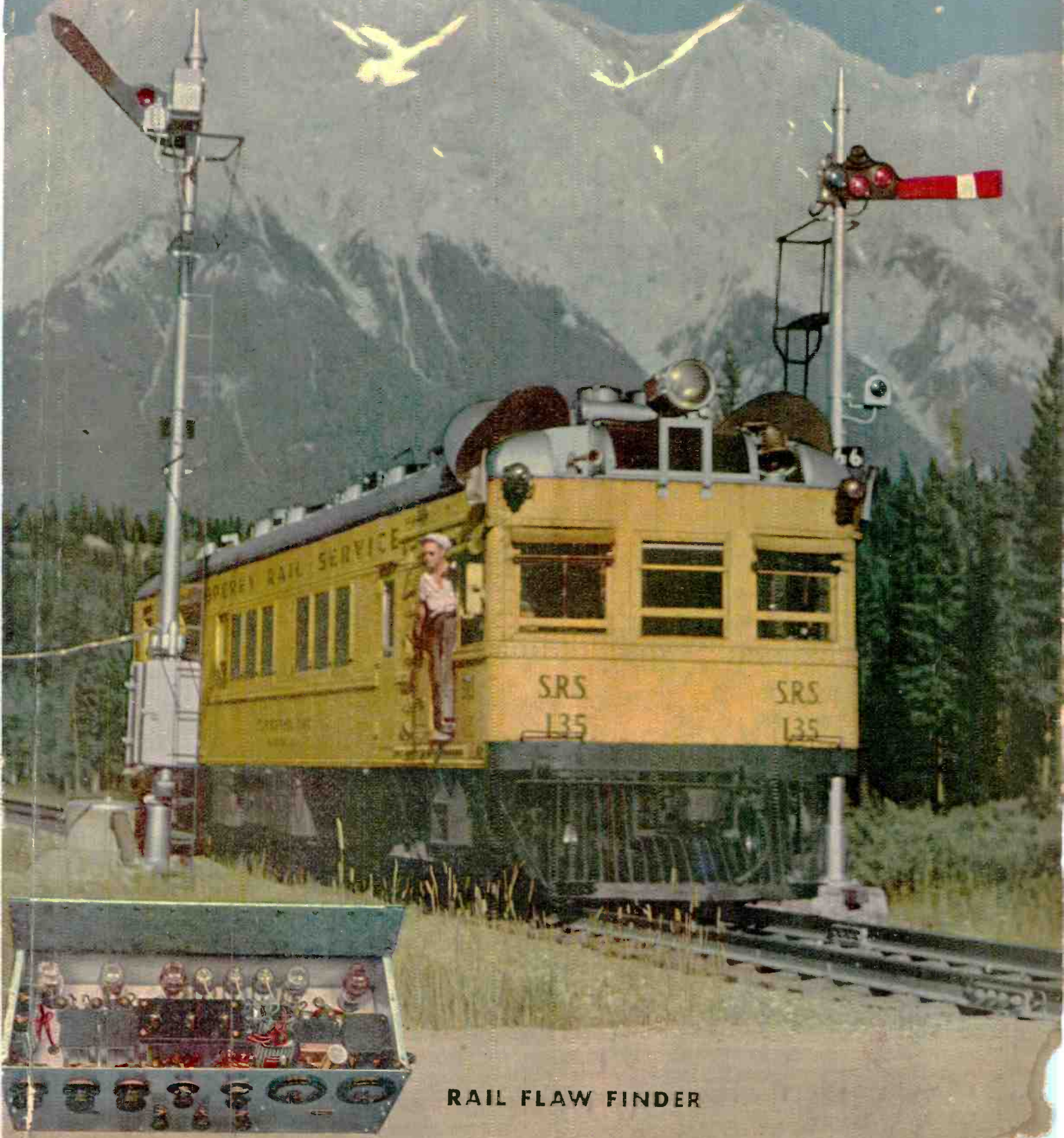

RAIL FLAW FINDER



FOR COMPACT HIGH FIDELITY EQUIPMENT

Ultra compact, lightweight, these UTC audio units are ideal for remote control amplifier and similar small equipment. New design methods provide high fidelity in all individual units, the frequency response being ± 2 DB from 30 to 20,000 cycles. There is no need to resonate one unit in an amplifier to compensate for the drop of another unit. All units, except those carrying DC in Primary, employ a true hum balancing coil structure which, combined with a high conductivity outer case, effects good inductive shielding. Maximum operating level + 10 DB. Weight—8 ounces. Dimensions— $1\frac{1}{2}$ " wide x $1\frac{1}{2}$ " deep x 2" high.

Unit shown is actual size. 6V6 tube shown for comparison only.

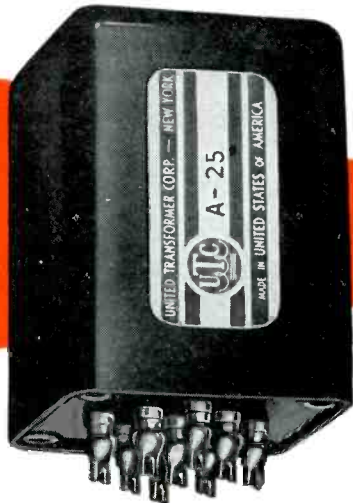

HERMETICALLY SEALED

On special order, we can supply any of the Ultra Compacts hermetically sealed per Jan T-27 Grade 1 Class A in our RC 50 case as illustrated. Dimensions: Height $2\frac{1}{4}$ ", Base $1\frac{9}{16}$ " x $1\frac{9}{16}$ ".



ULTRA COMPACT HIGH FIDELITY AUDIO UNITS

| Type No. | Application | Primary Impedance | Secondary Impedance | ± 2 DB from | List Price |
|----------|---|---|---|--|------------|
| A-10 | Low impedance mike, pickup, or multiple line to grid | 50, 125/150, 200/250, 333, 500/600 ohms | 50,000 ohms | 30-20,000 | \$15.00 |
| A-11 | Low impedance mike, pickup, or line to 1 or 2 grids | 50, 200, 500 ohms | 50,000 ohms | 50-10,000 multiple alloy shield for extremely low hum pickup | 16.00 |
| A-12 | Low impedance mike, pickup, or multiple line to push pull grids | 50, 125/150, 200/250, 333, 500/600 ohms | 80,000 ohms overall in two sections | 30-20,000 | 15.00 |
| A-18 | Single plate to two grids split primary | 8,000 to 15,000 ohms | 80,000 ohms overall, 2.3:1 turn ratio overall | 30-20,000 | 14.00 |
| A-19 | Single plate to two grids 8 MA unbalanced D.C. | 15,000 ohms | 80,000 ohms overall, 2.3:1 turn ratio overall | 50-20,000 | 18.00 |
| A-24 | Single plate to multiple line | 8,000 to 15,000 ohms | 50, 125/150, 200/250, 333, 500/600 ohms | 30-20,000 | 15.00 |
| A-25 | Single plate to multiple line 8 MA unbalanced D.C. | 8,000 to 15,000 ohms | 50, 125/150, 200/250, 333, 500/600 ohms | 50-12,000 | 14.00 |
| A-26 | Push pull low level plates to multiple line | 8,000 to 15,000 ohms each side | 50, 125/150, 200/250, 333, 500/600 ohms | 50-20,000 | 15.00 |
| A-30 | Audio choke, 300 henrys with no D.C. 450 henrys @ 2 MA | 6000 ohms D.C., 75 henrys @ 4 MA | 1500 ohms D.C., inductance | | 10.00 |

The above listing includes only a few of the many Ultra Compact Audio Units available . . . Write for our new catalog.

United Transformer Co.
 NEW YORK 13, N. Y.
 150 VARICK STREET
 EXPORT DIVISION: 13 EAST 40th STREET, NEW YORK 16, N. Y. CABLES: "ARLAB"

electronics

A McGRAW-HILL
PUBLICATION



OCTOBER • 1949

| | |
|---|--------------|
| RAIL FLAW FINDER | Cover |
| Invisible defects within rails are located electronically by this Sperry Products detector car, pictured on Canadian Pacific line in the Rockies. Inset shows amplifier (see page 66) | |
| RAILROAD TRACK INSPECTION CAR , by Robert D. Walker, Jr. | 66 |
| Mobile laboratory tests tracks at the rate of 12 miles per hour | |
| PROGRESS TOWARD INTERNATIONAL TV STANDARDS , by Donald G. Fink | 69 |
| Agreement reached on aspect ratio, interlace and desirability of power-line independence | |
| PLANNING FOR AUTOMATIC PROCESS CONTROL | 72 |
| Factors to consider when choosing from among the many electronic, electrical and other units now available | |
| CRYSTAL TETRODE MIXER , by Rowland W. Haegele | 80 |
| Provides high conversion-transconductance and low interaction between input circuits | |
| TECHNIQUE FOR TV FIELD SURVEYS , by John F. Dreyer, Jr. | 82 |
| Traverse as well as radial measurements are suggested | |
| REDUCING COSTS IN RECEIVER MANUFACTURING , by Spencer A. Tucker | 86 |
| Procedure for setting up a cost-reduction program, and case histories of money-saving ideas | |
| COMPLIANCE METER FOR PICKUPS , by A. M. Wiggins | 94 |
| Placing pickup stylus on vibrating reed provides reading on v/vm in centimeters per dyne | |
| PROPERTIES OF CONDUCTIVE PLASTICS , by M. A. Coler | 96 |
| Electrical resistivity approaches that of mercury while other properties compare with ordinary phenolics | |
| VHF DUMMY ANTENNAS , by B. E. Parker | 100 |
| Three types accommodate transmitters from 25 to 5,000 watts | |
| ANASTIGMATIC YOKES FOR PICTURE TUBES , by Kurt Schlesinger | 102 |
| Nonuniform deflecting fields correct spot deflection and improve picture corners | |
| PHOTOTUBE AMPLIFIER WITH LOW OUTPUT IMPEDANCE , by Norman Alpert | 108 |
| Amplification and low-impedance output are obtained from a cathode-loaded stage | |
| RADIOACTIVE THICKNESS GAGE FOR MOVING MATERIALS , by J. R. Carlin | 110 |
| Absorption of beta rays from radioisotope, varying with thickness of material, is measured with ion chamber | |
| MEASURING PHASE AT AUDIO AND ULTRASONIC FREQUENCIES , by Ernest R. Kretzmer | 114 |
| A new type of laboratory and test device can be used for audio and radio-frequency measurements | |
| RECEIVER NOISE NOMOGRAPH , by Chester W. Young | 120 |
| Gives over-all noise figure of radio or radar receiver quickly when checking suitability of components | |

| | |
|------------------------------|------------|
| BUSINESS BRIEFS | 60 |
| CROSSTALK | 65 |
| TUBES AT WORK | 122 |

| | |
|-----------------------------------|------------|
| ELECTRON ART | 126 |
| NEW PRODUCTS | 130 |
| NEWS OF THE INDUSTRY | 134 |

| | |
|-----------------------------------|--|
| NEW BOOKS | |
| BACKTALK | |
| INDEX TO ADVERTISERS | |

DONALD G. FINK, Editor; **W. W. MacDONALD**, Managing Editor; John Markus, Vin Zeluff, A. A. McKenzie, Associate Editors; William P. O'Brien, James D. Fahnestock, Assistant Editors; Hal Adams Burleson, Ann Mastropolo, Editorial Assistants; Gladys T. Montgomery, Washington Editor; Harry Phillips, Art Director; Eleanor Luke, Art Assistant

KEITH HENNEY, Consulting Editor

H. W. MATEER, Publisher; **WALLACE B. BLOOD**, Manager; R. S. Quint, Directory Manager; D. H. Miller, H. R. Denmead, Jr., New York; Wm. S. Hodgkinson, New England; Warren W. Shew, Philadelphia; C. D. Wardner, Chicago; J. L. Phillips, Cleveland; J. W. Otterson, San Francisco; Carl W. Dysinger, Los Angeles; Ralph C. Maultsby, Atlanta; Bernard H. Butler, London, England

Contents Copyright 1949, by McGraw-Hill Publishing Company, Inc. All Rights Reserved. McGRAW-HILL PUBLISHING COMPANY, INCORPORATED, JAMES H. McGRAW (1860-1948), Founder • PUBLICATION OFFICE, 99-129 North Broadway, Albany 1, N. Y., U. S. A. EDITORIAL AND EXECUTIVE OFFICES, 330 West 42nd St., New York 18, N. Y., U. S. A.—Member A. B. P., Member A. B. C.

James H. McGraw, Jr., President; Curtis W. McGraw, Vice-President and Treasurer; Eugene Duffield, Senior Vice-President, Publications Division; Nelson Bond, Vice-President and Director of Advertising; J. E. Blackburn, Jr., Vice-President and Director of Circulation; James A. Gerardi, Secretary; Dexter Keezer, Director Economic Department; Russell F. Anderson, Editor, World News.
ELECTRONICS, October, 1949, Vol. 22, No. 10. Published monthly, with an additional issue in June, price 75c a copy for U. S. and possessions, and Canada; \$1.50 for Latin America; \$2.00 for all other foreign countries. Directory issue \$2.00. Allow at least ten days for change of address. All communications about subscriptions should be addressed to the Director of Circulation. Subscription rates—United States and possessions, \$6.00 a year, \$9.00 for two years, \$12.00 for three years. Canada (Canadian funds accepted), \$7.00 a year, \$11.00 for two years, \$14.00 for three years. Latin American countries \$15.00 for one year, \$25.00 for two years, \$30.00 for three years. All other countries \$20.00 for one year, \$30.00 for two years, \$40.00 for three years. Please indicate position and company connections on all subscription orders. Entered as Second Class matter August 29, 1936, at Post Office, Albany, New York, under the Act of March 3, 1879. BRANCH OFFICES: 520 North Michigan Avenue, Chicago 11, Ill.; 68 Post Street, San Francisco 1; Aldwych House, Aldwych, London, W. C. 2; Washington, D. C. 4; Philadelphia 3; Cleveland 15; Detroit 26; St. Louis 8; Boston 16; Atlanta 3, Ga.; 621 So. Hope St., Los Angeles 14; 738-9 Oliver Building, Pittsburgh 22. **ELECTRONICS** is indexed regularly in The Engineering Index.

Let **MARION** help you . . .

... seal components *hermetically*
... speed up sub-assemblies



**Marion portable,
bench-type induction
soldering unit**

- SMALL
- COMPACT
- ADAPTABLE
- EFFICIENT
- ECONOMICAL
- EASY-TO-USE

A PRODUCTION TOOL This unit was designed to simplify and improve both the quality and quantity of production of many different assemblies in the electronic and electrical fields. It has been used successfully for many years in the manufacture of Marion hermetically sealed instruments. Assembly applications include magnet assemblies, relay armatures, connectors, capacitors and transformer cans and germanium diode assemblies; also jewelry, watches, toys, automotive parts, household fixtures, etc.

HERMETICALLY SEALED COMPONENTS Because of the present intense interest in hermetically sealed components, Marion offers the benefit of its experience in true glass-to-metal hermetic sealing with the Marion Induction Soldering Unit and Marion metalized (platinum film) glass. Marion platinum film base glass has been developed to permit higher sealing temperatures, greater thermal shock range and resoldering if necessary.

PROFIT FROM EXPERIENCE Investigate now. Submit your requirements. We will be glad to supply samples and quotations. Ask for bulletin.



MANUFACTURERS OF
HERMETICALLY
SEALED METERS
SINCE 1944



MARION ELECTRICAL INSTRUMENT COMPANY

M A N C H E S T E R , N E W H A M P S H I R E

Export Division, 458 Broadway, New York 13, U. S. A., Cables MORHANEX

IN CANADA: THE ASTRAL ELECTRIC COMPANY, SCARBORO BLUFFS, ONTARIO

WHY NOT HAVE A DOZEN

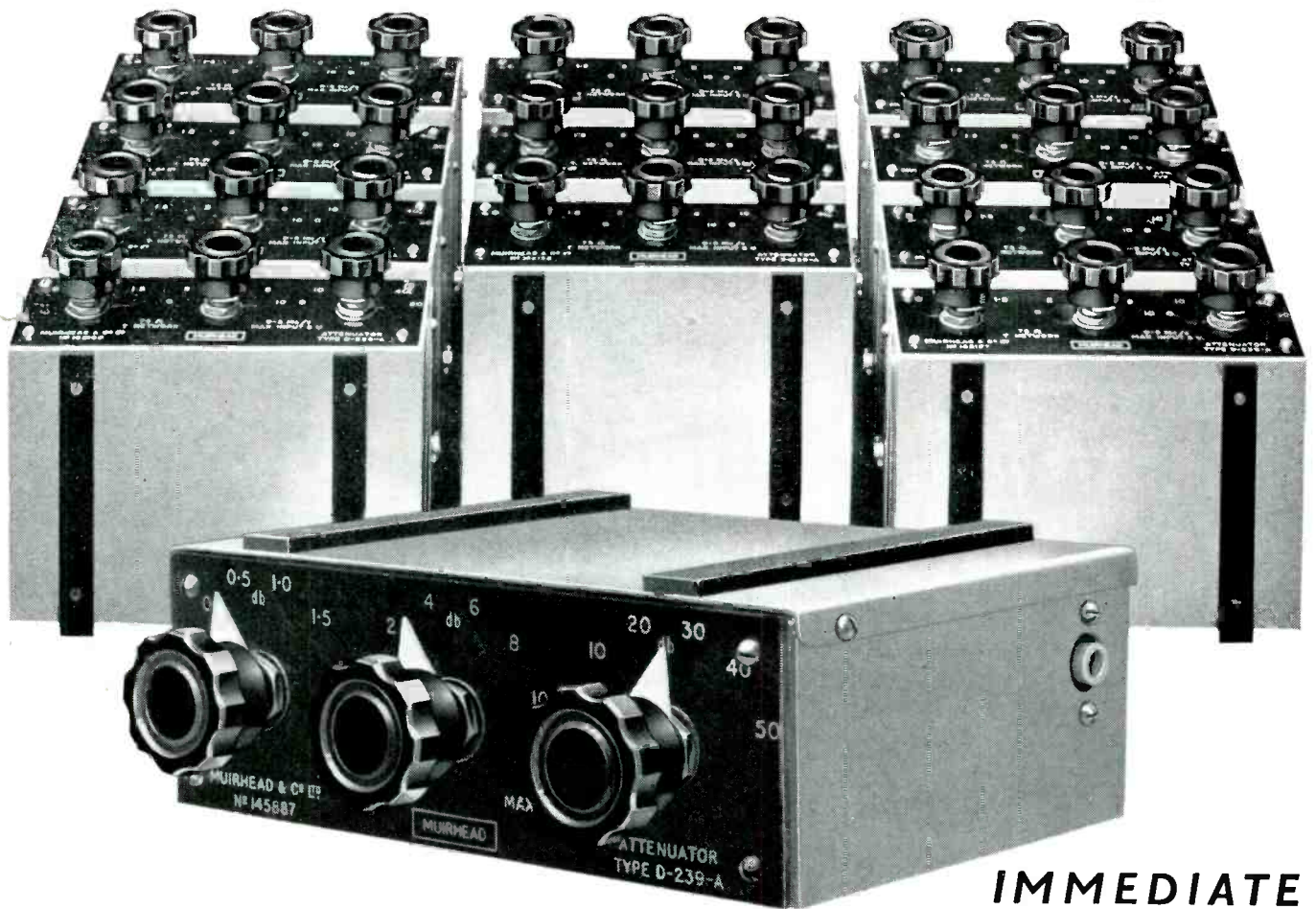

R. F. ATTENUATOR TYPE D-239

**IMMEDIATE
DELIVERY**

DESIGNED for work on coaxial cables and for testing at video frequencies — arranged to work between finite impedances — conventional gain and loss measuring technique may be used up to 20 Mc.

UNLIKE MOST PRECISION INSTRUMENTS, IF YOU WANT A DOZEN, THE COST NEED NOT DETER YOU

SPECIFICATION

| | | | |
|-----------------------------|--|------------------------|--|
| NETWORK : | "T" Section | MAXIMUM INPUT : | 3 volts |
| ATTENUATION RANGE : | D-239-A 61.5 db in 0.5 db steps D-239-B 80 db in 1 db steps | DIMENSIONS : | 6½" x 2¾" x 5½" (16.5 cm x 6 cm x 13.5 cm) |
| TERMINAL IMPEDANCE : | Both Types 75 ohms | WEIGHT : | 2½ lbs. (1.13 kg) |
| TERMINATIONS : | Coaxial Connectors | MOUNTING : | Equally suitable for bench or panel use |
| ACCURACY : | Better than 0.5 db at 10 Mc | PRICE : | \$50.00 |

YOU MAY REMIT TO US BY YOUR OWN DOLLAR CHECK

MUIRHEAD & Co. LTD.
PRECISION ELECTRICAL INSTRUMENT MAKERS
BECKENHAM · KENT · ENGLAND

Telegrams and Cables: MUIRHEADS ELMERS-END

PRECISION
MUIRHEAD
ELECTRICAL INSTRUMENTS

M.U.

You pipe the Tune!

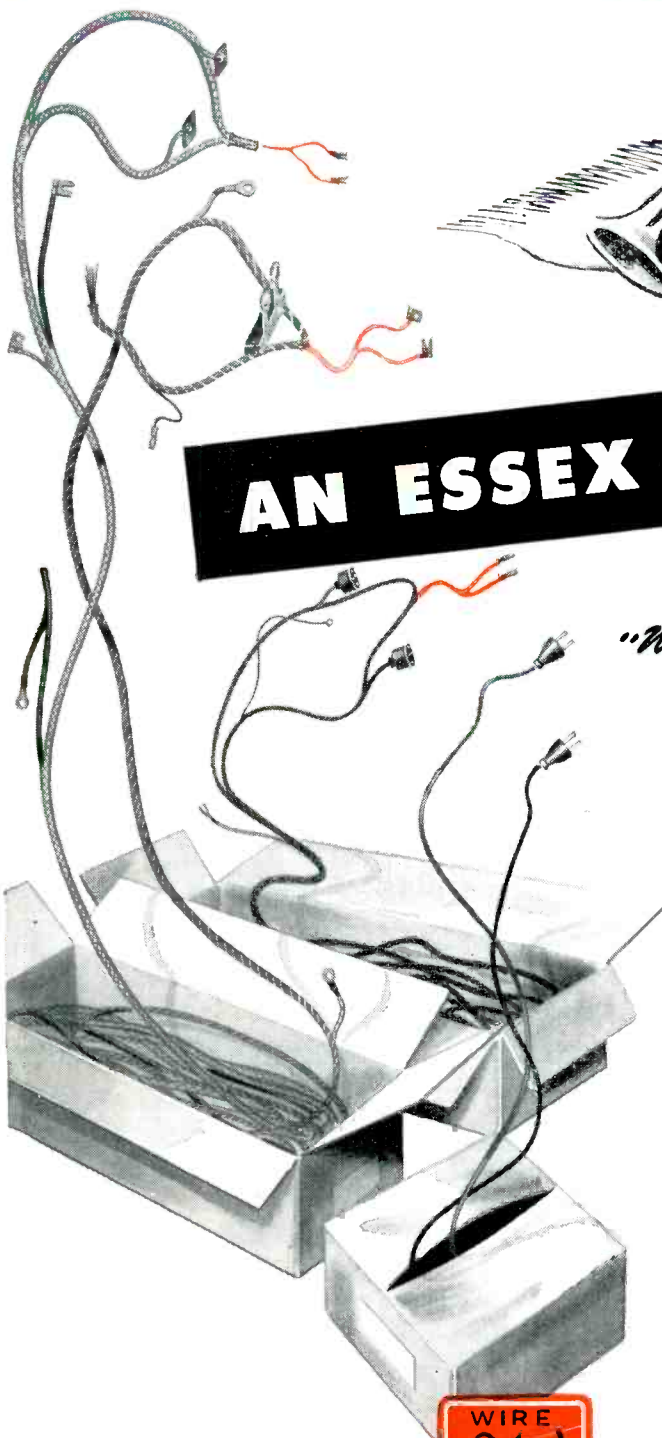

AN ESSEX NERVE SYSTEM

...will give a Great Performance

Regardless of the song you sing, from Opera to Bop—cord set to automotive harness—the most economical, dependable and uniform performers have repeatedly proved to be ESSEX WIRE ASSEMBLIES.

No matter how complex your harness problem, Essex experts can solve it and save you time and trouble. The Essex Wire combined staffs of specialists completely engineer and outfit your assemblies with all of their electrical components, making a *completely* integrated unit to Essex high standards.

The Essex network of 20 plants develops, manufactures and controls these custom-tailored assemblies from wire bar to your appliance. Because of Essex intense specialization, complete control of overall operation and long experience (dating back to the days of the early automobiles) you are safeguarded against an electrical failure that can turn your "masterpiece" into a dead duck.

One sample of an assembly built to your specifications will prove why Essex leads. Ask for one. Call our representative today, or send your specifications to the factory.

BUILT TO PERFECTION

WIRE ASSEMBLY AND



PROVED BY INDUSTRY

CORD SET DIVISION

ESSEX WIRE CORPORATION MONTICELLO, INDIANA

October, 1949 — ELECTRONICS

Do you know

HOW THESE 9 FACTORS AFFECT THE QUALITY OF DISC REPRODUCTION?

| | | | |
|--|---|--|---|
| <p>1 INTERMODULATION DISTORTION ?</p> | <p>Intermodulation distortion—present in many types of record reproducers to a far greater degree than suspected—causes “fuzziness” in reproduction, particularly at the higher frequencies. Low intermodulation distortion is essential for <i>clean</i> reproduction.</p> | <p>7 FREQUENCY COMPENSATION ?</p> | <p>The reproducing equipment must provide the correct frequency compensation for the recording characteristics most commonly used. Since different recording companies use widely varying characteristics, a correspondingly wide choice of equalization characteristics must be available.</p> |
| <p>2 TRANSLATION LOSS ?</p> | <p>When record groove velocity decreases (as the stylus moves closer to the center pin) a loss in high frequency reproduction occurs. To keep this “translation loss” to a minimum, stylus tip radius, stylus force and mechanical reactance must be in correct balance.</p> | <p>8 SCRATCH EQUALIZATION ?</p> | <p>A choice of scratch equalization is also necessary to meet the surface noise conditions of all records. “Rolloff” of reproducing curves must permit maximum scratch reduction while retaining as much as possible of the original material on the record.</p> |
| <p>3 STYLUS FORCE ?</p> | <p>While low stylus force is desirable to lengthen life of records, <i>too</i> low a force frequently results in inability of the reproducer to track properly at high frequencies. This, in turn, produces high intermodulation distortion. Stylus force should be kept to the lowest value consistent with proper tracking.</p> | <p>9 NOISE PICK-UP ?</p> | <p>The signal-to-noise ratio must not be impaired by induced noise pick-up in the reproducer or equalizing circuits. Design of the equalizer and repeating coil should minimize hum pick-up from motor fields or other sources.</p> |
| <p>4 MECHANICAL IMPEDANCE ?</p> | <p>For a given stylus force, low mechanical impedance in the reproducer stylus improves tracking at both low and high frequencies. Both ends of the recorded spectrum are therefore reproduced with less distortion.</p> | <p>How does the 109 Type Group stack up against these reproducer requirements?</p> <p>Western Electric has just issued a 12-page bulletin explaining in greater detail the importance of these nine factors in high-quality reproduction—and showing just <i>why</i> the design of the 109 Type Reproducer Group results in outstanding performance. You'll want to have all these facts when you select reproducing equipment!</p> <p>CALL YOUR LOCAL GRAYBAR REPRESENTATIVE FOR A COPY OF THIS NEW BULLETIN—OR MAIL COUPON BELOW ➔</p>  | |
| <p>5 UNWANTED OUTPUT ?</p> | <p>On lateral recordings, the pick-up unit should not reproduce the unwanted vertical output which can result from surface irregularities, turntable vibrations and riding up of stylus on groove walls. Conversely, on vertical recordings, the pick-up unit should not reproduce the unwanted output caused by lateral stylus motion.</p> | | |
| <p>6 ARM RESONANCE ?</p> | <p>The reproducer arm should not have resonant points within the spectrum of frequencies normally reproduced. If the resonant frequency of the arm is within the range of frequencies on the transcription or record, the resonant vibration of the arm will cause a spurious response.</p> | | |

Western Electric

— QUALITY COUNTS —



DISTRIBUTORS: IN THE U.S.A.—Graybar Electric Co.
IN CANADA—Northern Electric Company, Ltd.

Graybar Electric Co.
420 Lexington Avenue,
New York 17, N. Y.

Gentlemen: Please send me a copy of Bulletin T2551, "109 Reproducer Group."

Name _____
Title _____
Company _____
Street Address _____
City _____ State _____

Pin point accuracy is

for resistors too!

And IRC provides it. Witness leading manufacturers who specify IRC resistors for advanced electronic circuits. In instrumentation and industrial applications, IRC resistors excel in every important characteristic.

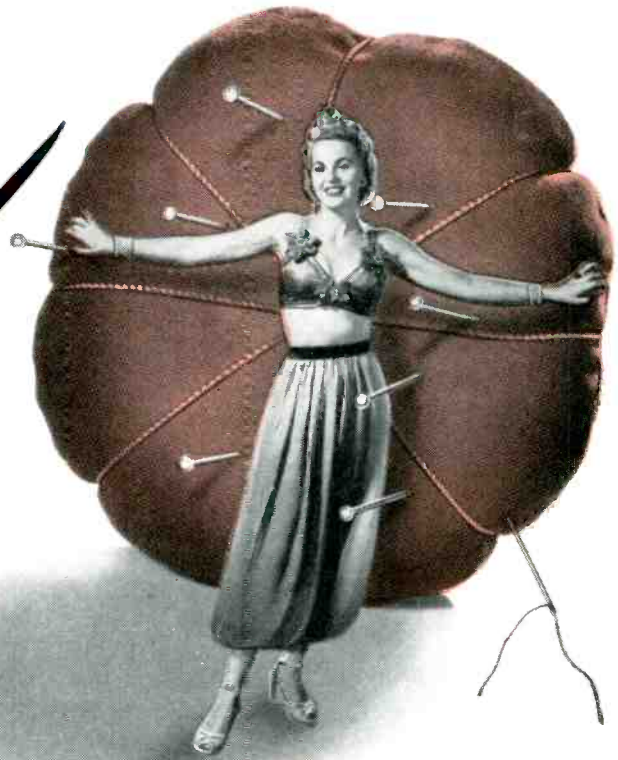

IN CRITICAL INSTRUMENTATION, IRC Precision Wire Wounds offer a fine balance of accuracy and dependability. Tolerances of 1% are standard, but 1/2%, 1/4% and 1/10% are available. IRC Precisions also afford maximum temperature coefficient of .002% per °C. at no extra cost. And in addition, their design and construction assure stability—even where recurring surges are encountered. Labels are acetate. May we send you complete technical data? Just check the coupon.

essential



SEALED PRECISION Voltmeter Multipliers find many critical applications such as are encountered in marine service because of absolute dependability under the most severe humidity conditions. Type MF's are compact, rugged, stable, fully moisture proof and easy to install. They consist of individual wire wound precision resistors, mounted, interconnected and encased in glazed ceramic tubes—and these may be either inductive or non-inductive, for use on AC as well as DC. Send coupon for technical data bulletin.



ACCURACY AND ECONOMY in close tolerance applications make IRC Deposited Carbon PRECISTORS ideal for television and similar circuits. They are outstanding in their ability to provide dependable performance in circuits where the characteristics of carbon composition resistors are unsuitable and wire-wound precisions too expensive. Manufactured in two sizes, 200 ohms to 20 megohms in 1%, 2% and 5% tolerance. Coupon brings full details.

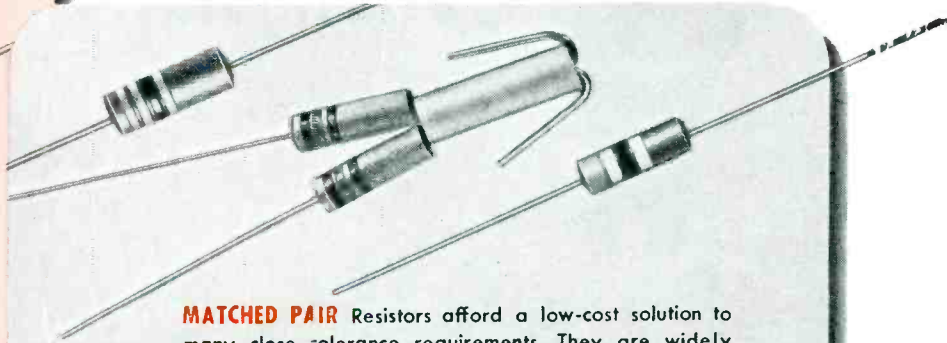

MATCHED PAIR Resistors afford a low-cost solution to many close tolerance requirements. They are widely used as dependable meter multipliers. Two insulated IRC resistors are matched in series or parallel to as close as 1% initial accuracy. Both JAN-R-11 approved Advanced BT resistors and low-range BW insulated wire wounds are available in Matched Pairs. Use the coupon to send for Bulletin B-3.

For fast, local service on standard IRC resistors, simply phone your IRC Distributor. IRC's Industrial Service Plan keeps him well supplied with the most popular types and ranges—enables him to give you prompt, round-the-corner delivery. We'll be glad to send you his name and address.



Wherever the Circuit Says

Power Resistors • Voltmeter Multipliers
 • Insulated Composition Resistors • Low
 Wattage Wire Wounds • Controls
 • Rheostats • Voltage Dividers •
 Precisions • Deposited Carbon
 Precisors • HF and High Voltage
 Resistors • Insulated Chokes

**INTERNATIONAL
 RESISTANCE COMPANY**

401 N. Broad Street, Philadelphia 8, Pa.

In Canada: International Resistance Co., Ltd., Toronto, Licensee

INTERNATIONAL RESISTANCE CO.
 403 N. BROAD ST., PHILADELPHIA 8, PA.

Please send me complete information on the items checked below:

- Precision Wire Wounds Deposited Carbon Precisors
 Wire Wound Controls Voltmeter Multipliers
 Matched Pair Resistors Name of Local IRC Distributor

NAME

TITLE

COMPANY

ADDRESS

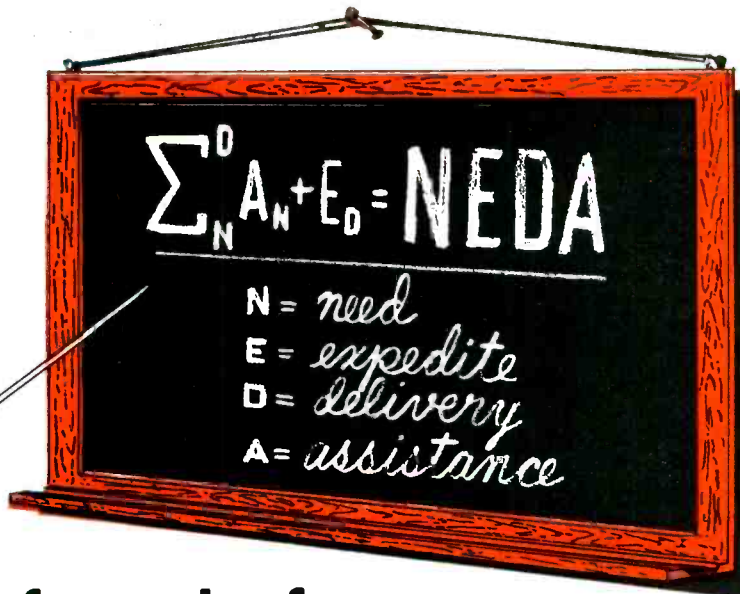

a formula for *electronic* needs...

Let us start by saying that there *may* be a price advantage to you in ordering electronic parts or equipment directly from the manufacturer. Against this, however, weigh these advantages of working with your local NEDA Distributor:

1. You avoid costly, time-consuming delays when, for example, you schedule a pilot run or production samples and have your NEDA Distributor expedite delivery of your electronic needs.

2. You get additional assistance through the NEDA Distributor's experience and knowledge.

3. You have your choice of more than one manufacturer's line in ordering for experimental needs and determining what is best.

You can add a valuable "extension" to your own engineering and research facilities by giving your NEDA Distributor the opportunity to develop as a service depot for you. *Look into it!* You'll find that both top management and the purchasing department will agree, when they compare small savings on small quantity orders with the NEDA formula for better research and production.

Call on your **NEDA** Distributor

PRONOUNCED NEED A

Consult the list of NEDA members on the opposite page.



NATIONAL ELECTRONIC DISTRIBUTORS ASSOCIATION
INCORPORATED

2214 LaSALLE-WACKER BUILDING, 221 N. LaSALLE ST., CHICAGO 1, ILLINOIS



WHEN YOU NEED A DISTRIBUTOR—CONSULT THIS **NEDA** LIST

ALABAMA

BIRMINGHAM
James W. Clary Co.
MOBILE
Nelson Radio & Supply Co.
TUSCALOOSA
Allen & Jerimison Co.

ARIZONA

PHOENIX
Radio Parts of Arizona
ARKANSAS
FORT SMITH
Wise Radio Supply
LITTLE ROCK
Southern Radio Supply
TEXARKANA
Lavender Radio Supply Co.

CALIFORNIA

GLENDALE
R. V. Weatherford Co.
LONG BEACH
Scott Radio Supply
LOS ANGELES
Radio Products Sales, Inc.
Universal Radio Supply Co.
OAKLAND
W. D. Brill Co.
Electric Supply Co.
Wave Miller & Co.
E. C. Wenger Co.
SAN BERNADINO
Inland Electronic Supply
SAN DIEGO
Coast Electric Co.
Electronic Equipment Distr.
SAN FRANCISCO
Associated Radio Distributors
C. C. Brown Co.
Kaemper-Barrett Dealers
Supply Co.
San Francisco Radio &
Supply Co.
Wholesale Radio & Electric
Supply Co.
Zack Radio Supply Co.
SAN JOSE
Frank Quement, Inc.
STOCKTON
Carter W. Dunlap Wholesale
Radio Co.

COLORADO

PUEBLO
L. B. Walker Radio Co.

CONNECTICUT

BRIDGEPORT
Hatry & Young
HARTFORD
Hatry & Young, Inc.
NEW BRITAIN
United Radio Supply
NEW HAVEN
Hatry & Young
Thomas H. Brown Co.
NEW LONDON
Hatry & Young
STAMFORD
Hatry & Young
WATERBURY
Hatry & Young
The Bond Radio Supply

DISTRICT OF COLUMBIA

WASHINGTON
Kenyon Radio Supply Co.
Rucker Radio Wholesalers
Silberne Radio & Elec. Co.

FLORIDA

MIAMI
Herman Radio Supply Co.
Walder Radio & Appliance

GEORGIA

AUGUSTA
Prestwood Electronics Co.
COLUMBUS
Radio Sales & Service Co.

IDAHO

BOISE
Craddock's Radio Supply
Kopke Electronics Co.

ILLINOIS

BELLEVILLE
Lurtz Electric Co.
BLOOMINGTON
Alverson Sales Co.
CHICAGO
Allied Radio Corp.
J. G. Bowman & Co.
Chauncey's, Inc.
The Lukko Sales Corp.

CHICAGO
Pilgrim Distributing Co.
Radio Parts Co.
Walker-Jimison, Inc.
MOLINE
Lofgren Distributing Co.
PEORIA
Herberger Radio Supply
ROCK ISLAND
Tri-City Radio Supply
SPRINGFIELD
Wilson Supply Co.

INDIANA

CROWN POINT
Hub Appliance & Supply Co.
FORT WAYNE
Pemberton Laboratories
INDIANAPOLIS
Van Sickle Radio Supply Co.

IOWA

COUNCIL BLUFFS
World Radio Laboratories
DAVENPORT
Midwest-Timmerman Co.
DES MOINES
Gifford-Brown, Inc.
Iowa Radio Corp.
Radio Trade Supply Co.
DUBUQUE
Boe Distributing Co.
FORT DODGE
Ken-Els Radio Supply Co.
SIOUX CITY
Duke's Radio Co.
WATERLOO
Ray-Mac Radio Supply

KANSAS

TOPEKA
The Overtone Electric Co.
WICHITA
Excel Distributors
Interstate Distributors, Inc.

KENTUCKY

LEXINGTON
Radio Equipment Co.
LOUISVILLE
Peerless Electronic
Equipment Co.
Universal Radio Supply Co.

LOUISIANA

ALEXANDRIA
Central Radio Supply
LAFAYETTE
Radio Electronic Supply
LAKE PROVIDENCE
F. H. Schneider & Sons
MONROE
Hale & McNeil
NEW ORLEANS
Wm. B. Allen Supply Co.
Columbia Radio & Supply Co.
Shuler Supply Co.
Southern Radio Supply Co.
SHREVEPORT
Koelemay Sales Co.

MAINE

AUBURN
Radio Supply Co., Inc.
PORTLAND
Maine Electronic Supply

MARYLAND

BALTIMORE
Kann-Ellert Electronics, Inc.
Radio Electric Service Co.
Wholesale Radio Parts
HAGERSTOWN
Zimmerman Wholesalers

MASSACHUSETTS

BOSTON
De Mambro Radio Supply Co.
Hatry & Young of Mass., Inc.
A. W. Mayer Co.
The Radio Shack Corp.
BROCKTON
Ware Radio Supply Co.
CAMBRIDGE
Electrical Supply Corp.
LAWRENCE
Hatry & Young
MELROSE
Melrose Sales Co.
NATICK
Willett Radio Supply, Inc.
NEW BEDFORD
C. E. Beckman Co.
PITTSFIELD
Pittsfield Radio Co.
ROXBURY
Gerber Radio Supply Co.

SPRINGFIELD
Hatry & Young
T. F. Cushing
Springfield Radio Co., Inc.
Springfield Sound Co.
WORCESTER
Radio Electronic Sales Co.
Radio Maintenance Supply

MICHIGAN

ANN ARBOR
Wedemeyer Electronic
Supply Co.
BATTLE CREEK
Electronic Supply Corp.
DETROIT
M. N. Duffy & Co.
Ferguson Radio Supply Co.
K-L-A Laboratories
of Detroit
Radio Electronic Supply Co.
Radio Specialties
FLINT
Lifsey Distributing Co.
Radio Tube Merchandising
Shand Radio Specialties
JACKSON
Fulton Radio Supply Co.
LANSING
Electric Products Sales Co.
Offenhauer Co.
LAURIAM
Northwest Radio of Michigan
MUSKEGON
Industrial Electric Supply
PONTIAC
Electronic Supply Co.

MINNESOTA

DULUTH
Northwest Radio
MINNEAPOLIS
Bauman Company
Lew Bonn Co.
Northwest Radio &
Electronic Supply Co.
Radio Maintenance Co.
The Stark Radio Supply Co.
ST. PAUL
Electronic Distributing Co.
Hall Electric Co.

MISSISSIPPI

JACKSON
Cabell Electric Co.

MISSOURI

CAPE GIRARDEAU
Suedekum Electronic
Supply Co.
JEFFERSON CITY
Central Missouri Distrib.
JOPLIN
M. Brotherson
Four State Radio & Supply
KANSAS CITY
Burstein-Aplebee
Manhattan Radio &
Equipment, Inc.
McGee Radio Co.
ST. LOUIS
Walter Ashe Radio Co.
Ebinger Radio & Supply Co.
Interstate Supply Co.
Radonics
Van Sickle Radio Co.
SPRINGFIELD
Harry Reed Radio & Supply

NEBRASKA

LINCOLN
Hicks Radio Co.
Leuck Radio Supply Co.
OMAHA
J. B. Distributing Co.
Radio Equipment Co.

NEW HAMPSHIRE

CONCORD
Evans Radio
DOVER
American Radio Corp.
MANCHESTER
Radio Service Laboratory

NEW JERSEY

BRIDGETON
Joe's Radio Shop
NEWARK
Continental Sales Co.
Krich-Radisco, Inc.
Aaron Lippman & Co.
PHILLIPSBURG
Carl B. Williams Co.

NEW YORK

ALBANY
Fort Orange Radio
Distributing Co.
E. E. Taylor Co.
AMSTERDAM
Adironack Radio Supply
AUBURN
Dare's Radio Service
BINGHAMTON
Federal Radio Supply Co.
BROOKLYN
Green Radio Distributors
National Radio
Parts Distributing Co.
BUFFALO
Dymac, Inc.
Genesee Radio & Parts Co.
ELMIRA
Fred C. Harrison
GLEN FALLS
Ray Distributing Co.
HEMPSTEAD
Davis Electronics Corp.
Standard Parts Corp.
ITHACA
Stallman of Ithaca
JAMAICA
Chanrose Radio Stores, Inc.
Norman Radio Distributors, Inc.
KINGSTON
Arace Brothers
MOUNT VERNON
Davis Radio Distributing Co.
NEW YORK
Arrow Electronics, Inc.
Bruno-New York, Inc.
H. L. Dalis, Inc.
Federated Purchaser, Inc.
Fischer Distributing Co., Inc.
Milo Radio & Electronics
National Radio Distributors
O & W Radio Co.
Powell Radio Supply
Sanford Electronics Corp.
Slate & Co.
Stan-Burn Radio &
Electronics Co.
Sylvan-Wellington Co.
Terminal Radio Corp.
United Radio & Electric Co.
Wilco Radio Distributors
POUGHKEEPSIE
Chief Electronics
ROCHESTER
Rochester Radio Supply Co.
SCHENECTADY
Electric City Radio Supply
SYRACUSE
Roberts & O'Brien
Stewart W. Smith, Inc.
Syracuse Radio Supply, Inc.
TROY
Trojan Radio Co., Inc.
UTICA
Beacon Electronics, Inc.
Electronic Laboratories &
Supply Co.
WHITE PLAINS
Westchester Electronic
Supply Co.

NORTH CAROLINA

ASHEVILLE
Freck Radio & Supply Co.
Long's Distributing Co.
CHARLOTTE
Radiotronic Distr., Inc.
GREENSBORO
Johannesson Electric Co., Inc.
GOLDSBORO
Signal Radio Supply
RALEIGH
Carolina Radio Equipment
Southeastern Radio Supply
WILMINGTON
French Radio Co.
WINSTON-SALEM
Dalton-Hege Radio Supply
Lambeth Electronic Supply Co.

NORTH DAKOTA

FARGO
Dakota Electric Supply Co.

OHIO

AKRON
The Sun Radio Co.
ASHTABULA
Morrison's Radio Supply
CINCINNATI
Chambers Electronic Supply
Herrlinger Distributing Co.
Radio & Refrigeration
Supply Co.
The Schuster Electric Co.
Steinberg's, Inc.
United Radio, Inc.

CLEVELAND
Radio & Electronic
Parts Corp.
Winteradio, Inc.
COLUMBUS
Electronic Supply Co.
Hughes-Peters, Inc.
Thompson Radio Supplies
Whitehead Radio Co.
DAYTON
Srepro, Inc.
LIMA
Lima Radio Parts Co.
TOLEDO
Toledo Radio Specialties
Warren Radio Co.
YOUNGSTOWN
Ross Radio Co.

OKLAHOMA

OKLAHOMA CITY
Miller Jackson Co., Inc.
Radio Supply, Inc.
TULSA
Patterson Radio Supply Co.
Radio, Inc.
S & S Radio Supply

OREGON

EUGENE
Carlson, Hatton & Hay, Inc.
MEDFORD
Verl G. Walker Co.
PORTLAND
Appliance Wholesalers
Bargett Supply
Portland Radio Supply Co.
Stubbs Electric Co.
Tracey & Co., Inc.
United Radio Supply, Inc.

PENNSYLVANIA

ALTOONA
Hollenback's Radio Supply
BETHLEHEM
Buss Electric Supply
ERIE
J. V. Duncombe Co.
Jordan Electronic Co.
Warren Radio, Inc.
HARRISBURG
Radio Distributing Co.
JOHNSTOWN
Canbria Equipment Co.
PHILADELPHIA
A. C. Radio Supply Co.
Allied Electric Appliance
Parts, Inc.
Almo Radio Co.
Barnett Brothers Radio Co.
Consolidated Radio Co.
Emerson Radio of Pa., Inc.
Herbach & Rademan, Inc.
Nat Lazar Radio Co.
M & H Sporting Goods Co.
Radio Electric Service Co.
of Pa., Inc.
Raymond Rosen & Co.
Albert Steinberg & Co.
Eugene G. Wile
PITTSBURGH
Cameradio Co.
John Marshall Co.
Radio Parts Co.
Tydings Co.
ST. MARYS
B & R Electric Co.
SCRANTON
Scranton Radio & Television
WILLIAMSPORT
Williamsport Radio Supply
YORK
J. R. S. Distributors
York Radio &
Refrigeration Parts

SOUTH CAROLINA

COLUMBIA
Dixie Radio Supply Co.

SOUTH DAKOTA

SIOUX FALLS
Power City Radio Co.
Warren Radio Supply
WATERTOWN
Burghardt Radio Supply

TENNESSEE

CHATTANOOGA
Curle Radio Supply
JACKSON
L. K. Rush Co.
KNOXVILLE
Chemcity Radio & Electric
Roden Electrical Supply Co.

MEMPHIS
Bluff City Distr. Co., Inc
Boyd Electronic Supply
NASHVILLE
Electra Distributing Co.

TEXAS

ABILENE
R & R Electronic Co.
AMARILLO
R & R Electronic Co.
West Texas Radio Supply
AUSTIN
The Hargis Co.
BEAUMONT
Montague Radio Distr. Co.
CORPUS CHRISTI
Electronic Equipment &
Eng. Co.
Wicks-DeVilbiss Co.
DALLAS
All-State Distributing Co.
Crabtree's Wholesale Radio
Ra-Tel, Inc.
Wilkinson Brothers
FORT WORTH
Electronic Equipment Co.
Fort Worth Radio Supply Co.
"Scooter's" Radio Supply
Bill Sutton's
Wholesale Electronics
HOUSTON
R. C. & L. F. Hall, Inc.
Sterling Radio Products Co.
LUBBOCK
R. & R. Supply Co., Inc.
SAN ANTONIO
Mission Radio, Inc.
WACO
The Hargis Co., Inc.
WICHITA FALLS
Clark & Gose Radio Supply
Mooney Radio Supply Co.

VIRGINIA

DANVILLE
Womack Electric & Supply
NORFOLK
Ashman Distributing Co.
Radio Equipment Co.
Radio Parts Distributing Co.
Radio Supply Co.
RICHMOND
Johnston-Gasser Co.
Radio Supply Co.
Winfree Supply Co.
ROANOKE
H. C. Baker Sales Co., Inc.
Leonard Electronic
Supply Co.

WASHINGTON

SEATTLE
General Radio Inc.
Harper-Meggee, Inc.
Seattle Radio Supply, Inc.
Herb E. Zobrist Co.
TACOMA
C & G Radio Supply Co.
Wible Radio Supply Co.

WEST VIRGINIA

BLUEFIELD
Whitehead Radio Co., Inc.
CHARLESTON
Chemcity Radio & Electric
HUNTINGTON
Electronic Supply, Inc.
King & Irwin, Inc.
PARKERSBURG
Randle & Hornbrook

WISCONSIN

GREEN BAY
Northern Electrical Dist.
MADISON
Radio Distributors
Satterfield Radio Supply
MANITOWOC
Harris Radio Corp.
MILWAUKEE
Acme Radio Supply Corp.
Central Radio Parts Co.
Electro-Pliance Distrib.
Marsh Radio Supply Co.
Radio Parts Co., Inc.
RACINE
Standard Radio Parts Co.
WAUSAU
Radio Service & Supply

WYOMING

CHEYENNE
Houge Radio & Supply

Now you can work with **REMALLOY**

Permanent Magnet Material
(Manufactured under license from Western Electric Company)

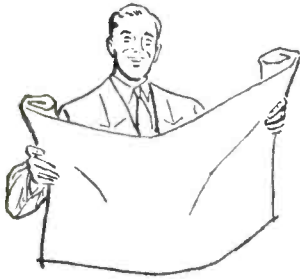

*It's fully available
for the first time*

*How you
can
get it!*

ARNOLD can supply **REMALLOY**
in the form of **BARS** and **CASTINGS**
or **SINTERED TO SPECIAL SHAPES**

*How you
can
use it!*

REMALLOY generally may be used
instead of **36-41% Cobalt Permanent
Magnet Steel**—replacing it without
design changes, and at a cost saving.

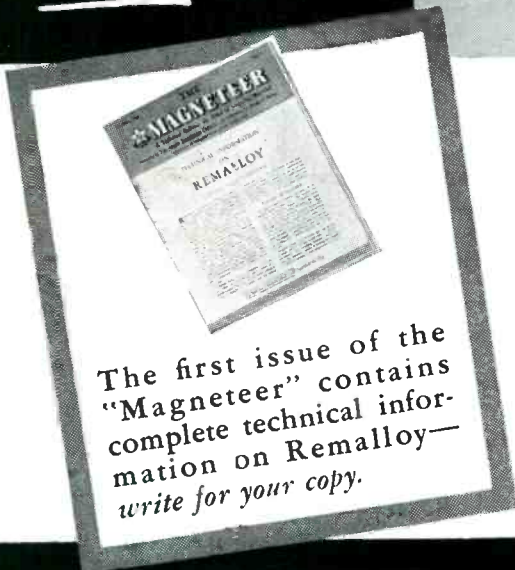

The first issue of the
"Magneteeer" contains
complete technical infor-
mation on Remalloy—
write for your copy.

In addition to our customary production of all types of ALNICO and other permanent magnet materials, we now produce REMALLOY. The various forms in which it is available—bars, castings or sintered shapes—are all produced under the Arnold methods of 100% quality-control; and can be supplied to you either in rough or semi-finished condition, or as completely finished units ready for assembly. ● Let us help you secure the cost-saving advantages of REMALLOY in your designs. Call or write for further data, or for engineering assistance.

THE ARNOLD ENGINEERING COMPANY

SUBSIDIARY OF ALLEGHENY LUDIUM STEEL CORPORATION
147 EAST ONTARIO STREET, CHICAGO 11, ILLINOIS



ARNOLD





















SPECIALISTS AND LEADERS IN THE DESIGN, ENGINEERING AND MANUFACTURE OF

PERMANENT MAGNETS

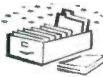
ADVENTURES IN ELECTRONIC DESIGN

TORTURE TESTS PROVE SWITCH PERFORMANCE



Turn it on.  Turn it off.  Do this 25,000 times or more and you'll get a good idea of the terrific punishment  Centrallab  switches  must be able to withstand. Day  and night,  skilled CRL engineers  and specially designed testing machines put Centrallab  switches  through torture tests  no switch  is ever asked to undergo in ordinary operation. What does this mean to you?  Just this. You can be sure that Centrallab  gives you the smooth operation , positive indexing  and accurate positioning  you want in the switches  you buy. What's more, you can be sure CRL  switches  will continue to provide these advantages for a long, long time. 



Constant checking makes sure CRL switches give you desirable uniform low contact resistance. Here an engineer tests resistance by running 1 ampere through contacts.

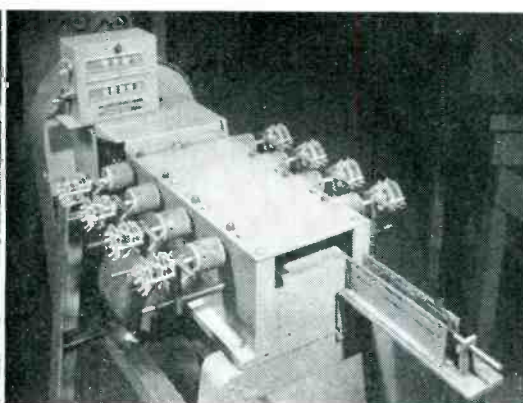

Accelerated life test machine rotates through fixed number of positions at 1000 cycles per hour . . . proves switch springs, clips and contacts stand up under long, hard use.



Resistance of switch insulation to atmospheric change is tested in controlled temperature and humidity chamber. Test helps avoid breakdown or leakage.

Centralab — DEVELOPMENTS THAT CAN HELP YOU 

Division of GLOBE-UNION INC. • Milwaukee

Centralab reports to

OCTOBER 1949

Check
the outstanding
Features
of these two
Great CRL
Switches!

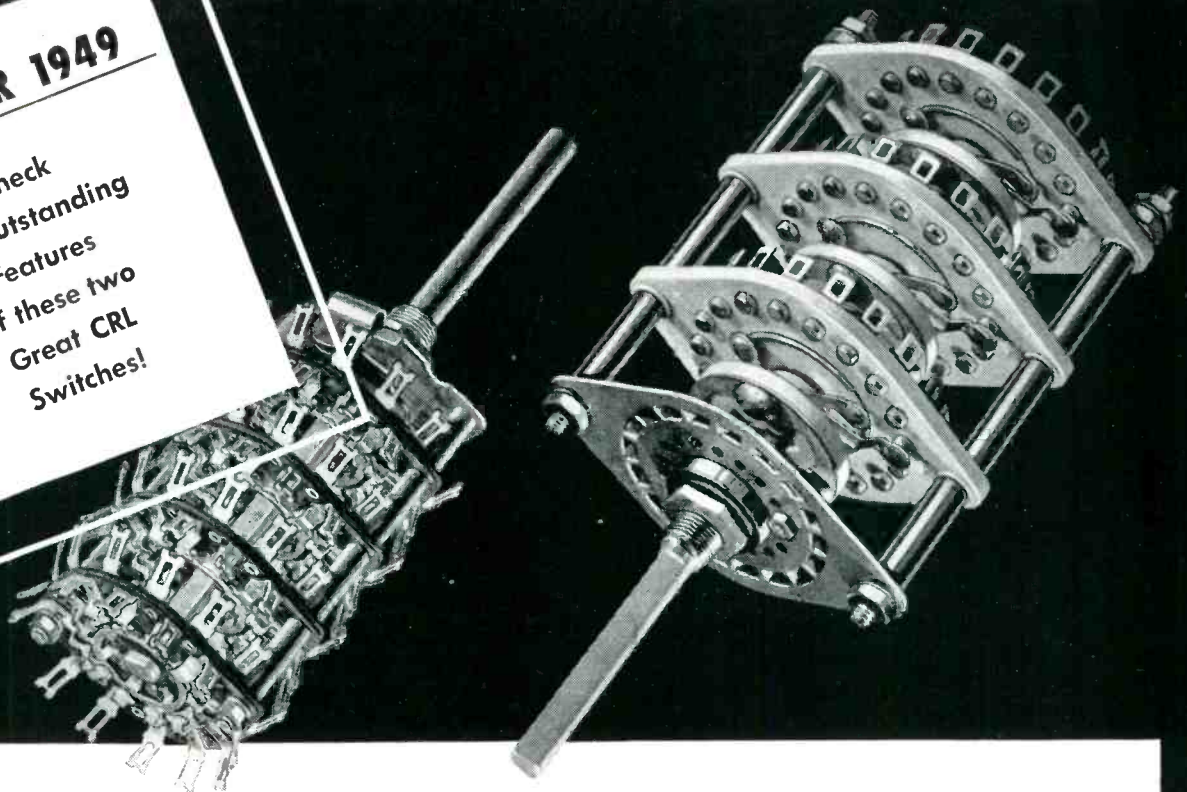

1 • Up to 24 insulated clips on each section — an exclusive CRL feature — assures great variety of switching combinations ... cuts size and cost of units. • No rotor rivets used. Where it's not necessary to connect contacts on opposite side of rotor, contacts are held by legs formed on contact. • Stator and rotor constructed in only the highest grades of laminated phenolic ... clips are of silver-plated brass or silver alloy for better contact. • Offset inter-element construction in both rotating contacts and back-to-back terminals provides lower electrostatic capacities. • Choose from many types in this double-wipe style switch. One or more sections—a versatile multiple-section switch built to your specifications. • Ratings: 7½ amperes at 115 volts. Used up to 20 megacycles.

• Up to 18 insulated clips on each section cuts unit size and cost. • Snug-fitting square rotor shaft plus individually aligned and adjusted contacts assure accurate positioning. • Multiple-gang design provides variety of switching combinations. Torque adjustable to suit individual needs. • Twenty-degree roller indexing, solid silver contacts, and Grade L-5 steatite stator and rotor give 25,000 cycles or more of positive indexing without contact failure. • Lug-type terminals assure strong solid electrical-mechanical connections; single-hole bushing facilitates mounting. • One or more sections — a versatile multiple-section switch built to your specifications. • Ratings: 7½ amperes at 115 volts, 60 cycles. Voltage breakdown to ground, 3000 volts RMS 60 cycles.

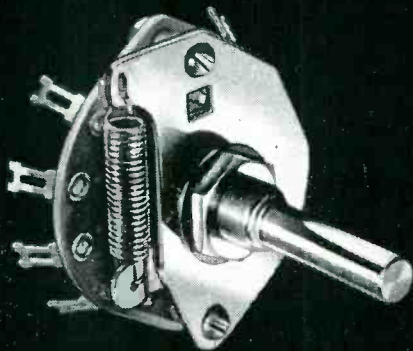

2 Great step forward in switching is CRL's New Rotary. Coil, Spring and Cam Index Switch. It gives you smoother action, longer life.

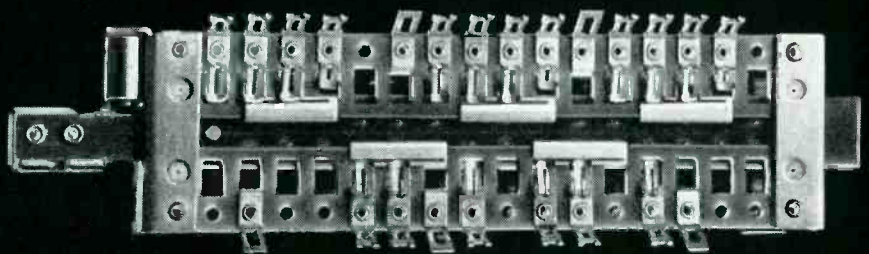

3 Centralab's development of a revolutionary, new *Slide Switch* vastly facilitates AM and FM set design! Flat, horizontal design saves valuable space, allows short leads, convenient location to coils, reduced lead inductances for increased efficiency in low and high frequencies. CRL *Slide Switches* are rugged and dependable.

Electronic Industry

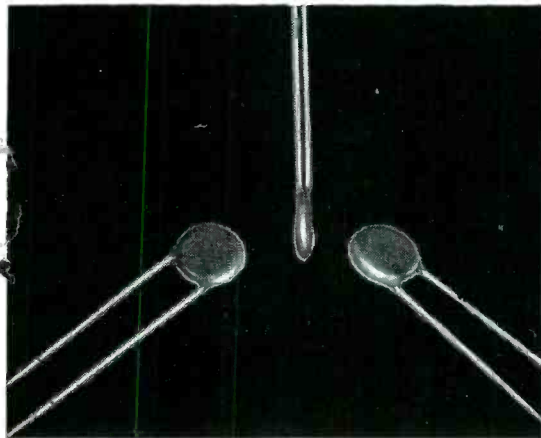

4 For by-pass or coupling applications, check Centralab's original line of ceramic disc *Hi-Kaps*. Disc *Hi-Kaps* are smaller than a dime.

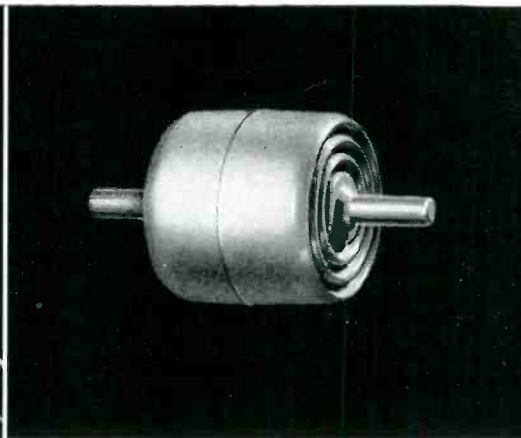

5 *Hi-Vo-Kaps* are filter and by-pass capacitors combining high voltage, small size and variety of terminal connections to fit most TV needs.

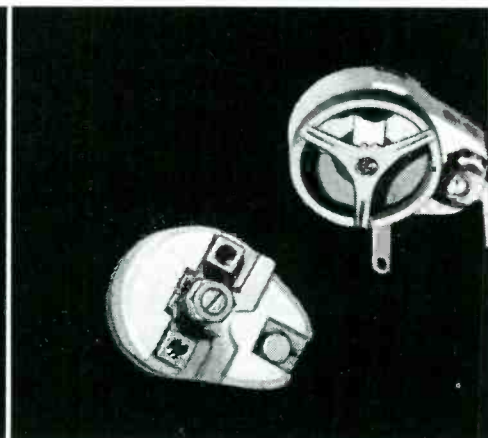

6 Ceramic *Trimmers* are made in five basic types. Full capacity change within 180° rotation. Spring pressure maintains constant rotor balance.



7 CRL's new high quality Model 2 *Radiobm* Controls specifically designed for TV, radio, other electronic equipment. Lower noise level, longer life.

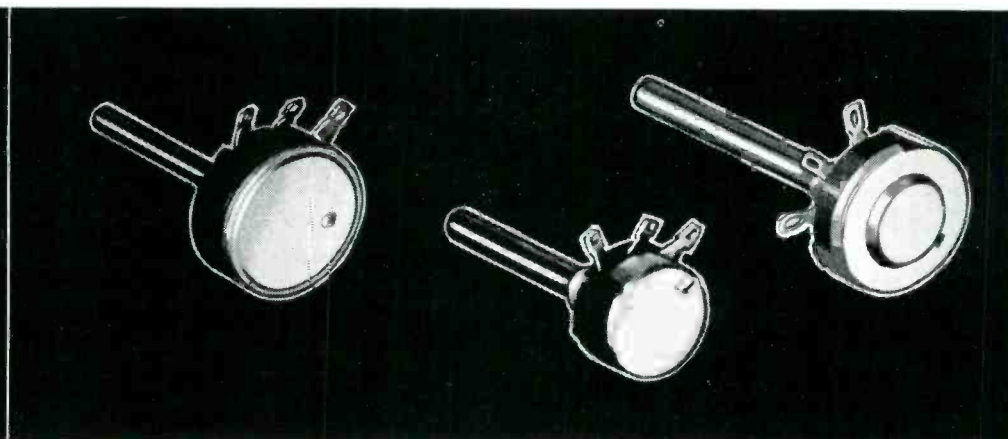

8 Let Centralab's complete *Radiobm* line take care of your special needs. Wide range of variations: *Model "R"* — wire wound, 3 watts; or composition type, 1 watt. *Model "E"* — composition type, 1/4 watt. Direct contact, 6 resistance tapers. *Model "M"* — composition type, 1/2 watt.

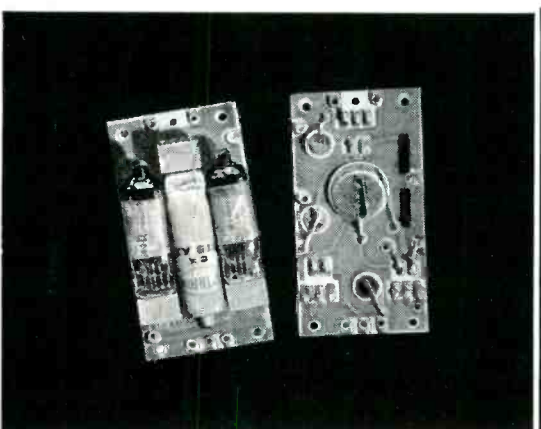

9 Centralab's *Ampec*, above, is an integral assembly of tube sockets, capacitors, resistors and wiring combined into one miniature amplifier unit.

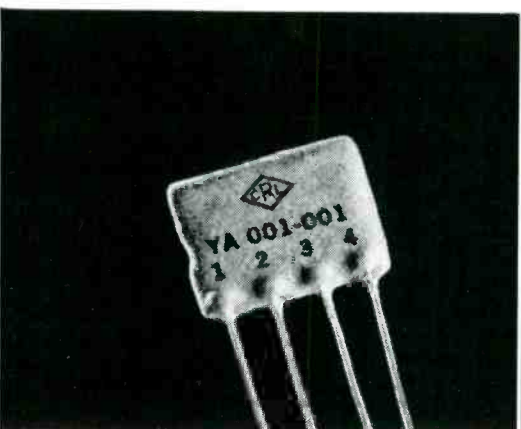

10 *Couplate* consists of plate and grid resistors, plate by-pass and coupling capacitors. Minimum soldered connections speed production.

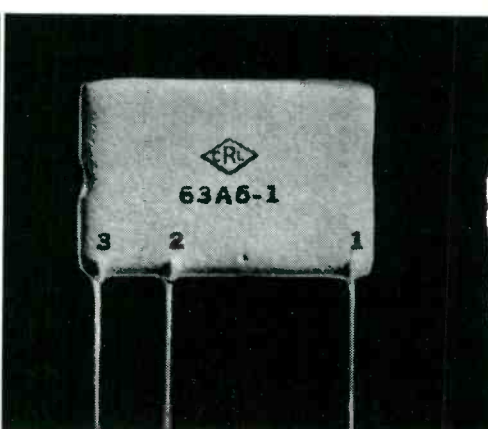

11 This is the new CRL *Vertical Integrator Network* used in TV sets. Variations of this Centralab *Network* are available on special order.

IMPORTANT BULLETINS FOR YOUR TECHNICAL LIBRARY!

They're factual!



THEY'RE FREE!

Choose From This List!

Centralab Printed Electronic Circuits

- 973 — AMPEC — three-tube P. E. C. amplifier.
- 42-6 — COUPLATE — P. E. C. interstage coupling plate.
- 999 — PENTODE COUPLATE — specialized P. E. C. coupling plate.
- 42-9 — FILPEC — Printed Electronic Circuit filter.

Centralab Capacitors

- 42-3 — BC TUBULAR HI-KAPS — capacitors for use where temperature compensation is unimportant.
- 42-4 — BC DISC HI-KAPS — miniature ceramic BC capacitors.
- 42-10 — HI-VO-KAPS — high voltage capacitors for TV application.
- 695 — CERAMIC TRIMMERS — CRL trimmer catalog.
- 981 — HI-VO-KAPS — capacitors for TV application. For jobbers.
- 42-18 — TC CAPACITORS — temperature compensating capacitors.
- 814 — CAPACITORS — high-voltage capacitors.
- 975 — FT HI-KAPS — feed-thru capacitors.

Centralab Switches

- 953 — SLIDE SWITCH — applies to AM and FM switching circuits.
- 970 — LEVER SWITCH — shows indexing combinations.
- 995 — ROTARY SWITCH — schematic application diagrams.
- 722 — SWITCH CATALOG — facts on CRL's complete line of switches.

Centralab Controls

- 42-7 — MODEL "1" RADIOHM — world's smallest commercially produced control.
- 697 — VARIABLE RESISTORS — full facts on CRL Variable Resistors.

Centralab Ceramics

- 967 — CERAMIC CAPACITOR DIELECTRIC MATERIALS.
- 720 — CERAMIC CATALOG — CRL steatite, ceramic products.

General

- 26 — GENERAL CATALOG — Combines Centralab's line of products for jobber, ham, experimenter, serviceman or industrial user.

Look to CENTRALAB in 1949! First in component research that means lower costs for the electronic industry. If you're planning new equipment, let Centralab's sales and engineering service work with you. For complete information on all CRL products, get in touch with your Centralab Representative. Or write direct.

CENTRALAB
Division of Globe-Union Inc.
900 East Keefe Avenue, Milwaukee, Wisconsin

203

Yes—I would like to have the CRL bulletins, checked below, for my technical library!

- | | | | | | | |
|-------------------------------|-------------------------------|--------------------------------|------------------------------|--------------------------------|-------------------------------|------------------------------|
| <input type="checkbox"/> 973 | <input type="checkbox"/> 42-9 | <input type="checkbox"/> 42-18 | <input type="checkbox"/> 953 | <input type="checkbox"/> 42-10 | <input type="checkbox"/> 722 | <input type="checkbox"/> 720 |
| <input type="checkbox"/> 42-6 | <input type="checkbox"/> 42-3 | <input type="checkbox"/> 695 | <input type="checkbox"/> 814 | <input type="checkbox"/> 970 | <input type="checkbox"/> 42-7 | <input type="checkbox"/> 26 |
| <input type="checkbox"/> 999 | <input type="checkbox"/> 42-4 | <input type="checkbox"/> 981 | <input type="checkbox"/> 975 | <input type="checkbox"/> 995 | <input type="checkbox"/> 697 | <input type="checkbox"/> 967 |

Name.....

Address.....

City..... State.....

TEAR OUT COUPON

← for the Bulletins you want

Centralab

Division of GLOBE-UNION INC. • Milwaukee



YOU GET A SQUARE DEAL AT OUR ROUND TABLE

When you bring your sheet metal fabrication problems to KARP, you immediately set in motion a "round table" board of experts whose combined specialized skill and experience is without an equal in the field. This group includes the president, chief engineer, chief draftsman-designer, chief toolmaker, plant superintendent, production manager and cost accountant.

These men make a detailed study of your special requirements. They plan, design and engineer the job with your needs and uses in mind. They determine the best manner of producing it, utilizing KARP'S superior equipment and facilities to your greatest advantage.

When your job is finished, it will be correctly designed for its application, handsome, rugged and built for long service life. You will have no costly problem of assembly . . . no need to spend additional time and labor on finishing touches. The job will be COMPLETE, ready for the installation of your electrical or mechanical operating parts with ease and simplicity. No matter how many units you order, every last detail will be absolutely uniform.

This custom service not only gives your product added value, but under KARP methods may often save you money.

Consult us for cabinets, housings, chassis, racks, boxes, enclosures or any type of sheet metal fabrication.



Karp

METAL PRODUCTS CO., INC.

Custom Craftsmen in Sheet Metal

215 - 63rd STREET, BROOKLYN 20, N. Y.

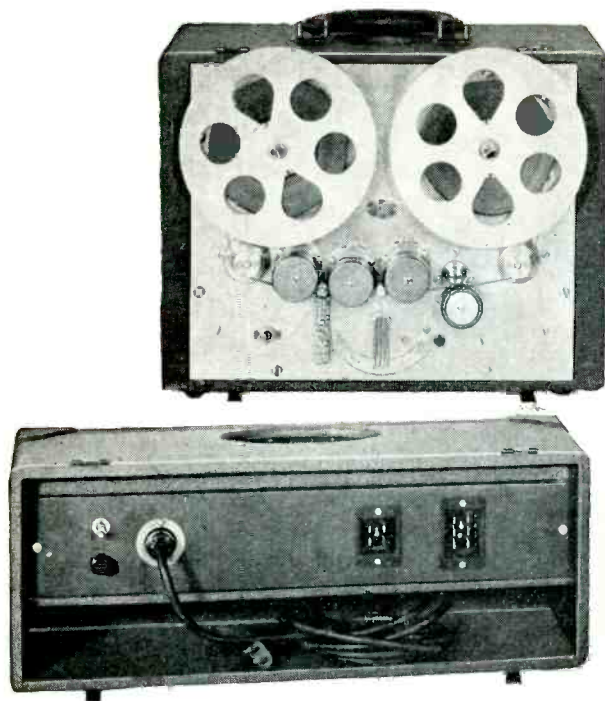

Ready Now!
 for immediate delivery

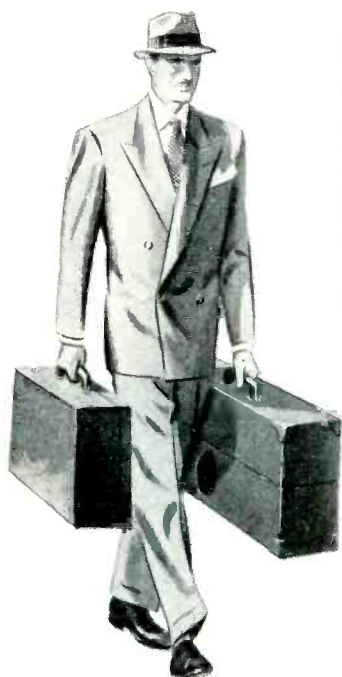

NEW PRESTO

Portable Tape Recorder PT-900

Complete in two easily portable cases—
 one containing the recorder, the other
 the amplifying equipment.

MANY OUTSTANDING FEATURES:

- Three separate heads for superior performance (and for monitoring direct from tape). One head each to erase, record and play back.
- 3 microphone channels with master gain control in recording amplifier.
- Large V.U. meter with illuminated dial to indicate recording level, playback output level, bias current and erase current, and level for telephone line.
- 2-speed, single motor drive system. Toggle switch to change tape speeds from 7½" to 15" per second.

Don't choose your tape recorder until you see the *new* Presto Portable Tape Recorder. Write for complete details today.

Write today to be put on our mailing list for "The Presto Recorder," new house organ of practical ideas for anyone in the recording and broadcasting field.

PRESTO

RECORDING CORPORATION
 Paramus, New Jersey

Mailing Address: P. O. Box 500, Hackensack, N. J.

In Canada: WALTER P. DOWNS, Ltd., Dominion Square Building, Montreal

WORLD'S LARGEST MANUFACTURER OF INSTANTANEOUS SOUND RECORDING EQUIPMENT AND DISCS

DUMONT

presents

The Successor to the World-Famous Type 208...

The New TYPE 304 and TYPE 304-H Cathode-ray OSCILLOGRAPHS



Allen B. Du Mont Laboratories, Inc.
Instrument Division



See Reverse Side
For Details

Turner Model 25 Microphones Widely Accepted

Since its introduction in April, the Turner Model 25 Microphone has received wide acceptance as an outstanding dollar for dollar value. In six months time it has become one of the most wanted microphones in the entire Turner line. This new unit was designed for general sound work, amateur communications, paging and call systems, and also for commercial broadcast work.



Tait Cummins, sports director of Radio Station WMT, using a Turner Model 25D Dynamic.

Tait Cummins, sports director of WMT, is a familiar and popular personality in every cross roads, village and town in Eastern Iowa. His pipe, his grin in a round face topped with a straggling forelock are trademarks of "The Taiter". At any affair the prospect of Tait and his microphone are sure fire drawing cards. As a speaker or master of ceremonies he spices his remarks with the sports lore he has accumulated during more years than he cares to remember as a newsman and sportscaster.

Exceptionally rugged

Radio Station WMT, CBS outlet for eastern Iowa, has been using the Turner Model 25D Dynamic in remote recording and broadcast work. Many of these programs originate out in the country, in barns, feed lots, fields, and at fair grounds. The microphone is proving exceptionally rugged in being able to take unusually rough treatment and still give faithful service. The unit is easily handled in interview type programs and its small size does not hide the faces of persons being interviewed.

Two-tone gray or deluxe chrome finish

The microphone case is of two-piece construction with front section finished in deep gray and the rear body in a lighter shade of gray. The grille is chrome plated and blends with the two-tone gray of the case to produce a pleasing over-all effect. A deluxe model is offered completely finished in satin chrome. Complete information on the Model 25 Microphones may be obtained by writing to The Turner Company, 905 17th Street N. E., Cedar Rapids, Iowa.

Advertisement

Microphones BY TURNER

EASY ON THE EYES

MODERATELY PRICED

CONVENIENT—DEPENDABLE

HIGH OUTPUT LEVEL

WIDE RANGE RESPONSE

THE *New* TURNER MODEL 25X—25D CRYSTAL OR DYNAMIC

PRACTICAL FOR ALL SOUND APPLICATIONS

If you need a microphone for studio or recording work, call system, public address, or amateur communications—you want a Turner Model 25X—25D. It's an all around unit for all around performance. You'll praise its smooth, wide range response and high output level. And you'll like the full 90 degree tilting head and convenient removable cable set. Finished in two tone umber gray with chrome plated grill or bright chrome at slight additional cost. Turner Engineers went all out in designing the 25X—25D. See it at your dealer.

Write for Complete Microphone Literature

THE TURNER COMPANY
905 17th Street N. E. Cedar Rapids, Iowa

IN CANADA
Canadian Marconi Co., Ltd.
Montreal, P. Q., and branches

EXPORT
Ad. Auriema, Inc.
89 Broad St., New York 4, N. Y.

25X CRYSTAL

52 db below 1 volt/dyne/sq.cm.
Flat from 50—9,000 c.p.s.
List price \$27.50

25D DYNAMIC

54 db below 1 volt/dyne/sq.cm.
at high impedance
Flat from 50—10,000 c.p.s.
30, 200, 500 ohms—wired for balanced line
List price \$40.00
High impedance—wired single ended
List price \$40.00

All models in bright chrome finish at \$2.50 List additional.
Push-to-talk switch, \$2.50 List additional.



Licensed under U.S. patents of the American Telephone and Telegraph Company, and Western Electric Company, Incorporated. Crystals licensed under patents of the Brush Development Company.

Translucent LAMICOID dials mean clear, accurate tuning on Dumont Television Sets. Lighted from behind, numerals stand out sharply without glare.

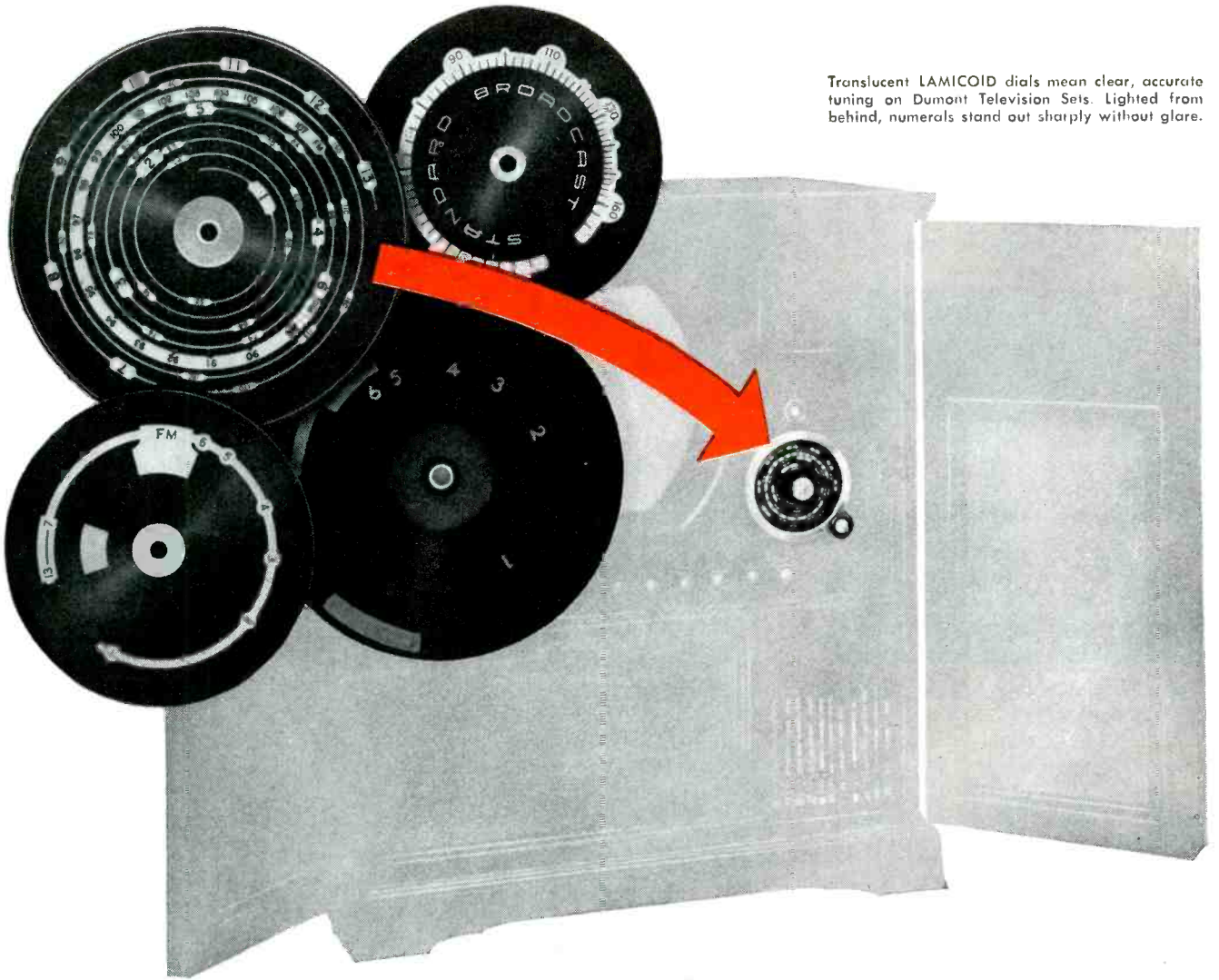

ON Translucent Lamicoid^{*} DIALS all channels are clear!

The tuning "channel" on Translucent LAMICOID dials for TV is always highly legible. Lighted from behind, its printed numerals stand out bright and clear without glare.

Translucent LAMICOID won't "brown out" or warp. This thermosetting laminated plastic is tough, stable, moisture-resistant, attractive, colorful, easy to clean, economical to fabricate—all the things you want in a material for dials, signs,

charts, nameplates or similar products.

For visual devices of all kinds, you have a choice of three different grades of Decorative LAMICOID—Graphic, Translucent or Engraving. In addition, we offer a complete line of electrical insulating materials—perfected through our experience of more than a half century. Contact our nearest branch office or fabricator for further information.

^{*}Registered Trade Mark



MICA *Insulator* **COMPANY**

Schenectady 1, New York

Offices in Principal Cities

TOWERS

above all others!

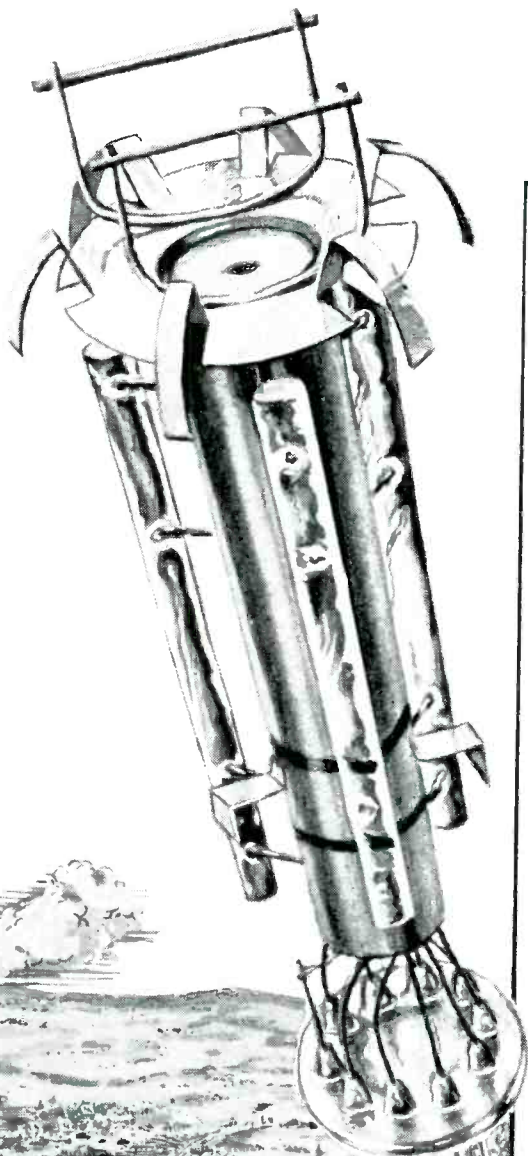

The HAYDU Electron Gun

For C. R. T. Tubes

Because no television picture tube can be better than the electron gun which goes into it, more and more tube manufacturers are turning to the Haydu gun to do the job for them — and rightly so!

For Haydu Brothers' experience in the successful manufacture of thousands upon thousands of electron guns (as well as millions of other precision electronic components) is a solid guarantee of complete dependability under all conditions! Rugged three-pillar construction coupled with rigidly controlled production processes mean a greatly prolonged life of the gun, at higher over-all efficiency.

In this way, Haydu Brothers has established its reputation throughout the industry—by building good business, good will, and component parts upon which many reputations depend. The Haydu electron gun is one of those parts.

We also make complete glassworking equipment.

See the Haydu Brothers display at the Electronics Show, Sept. 26-29, Booth 59, Edgewater Beach Hotel, Chicago, Illinois

HAYDU BROTHERS
PLAINFIELD NEW JERSEY



It took nearly SEVEN years for this job to materialize!

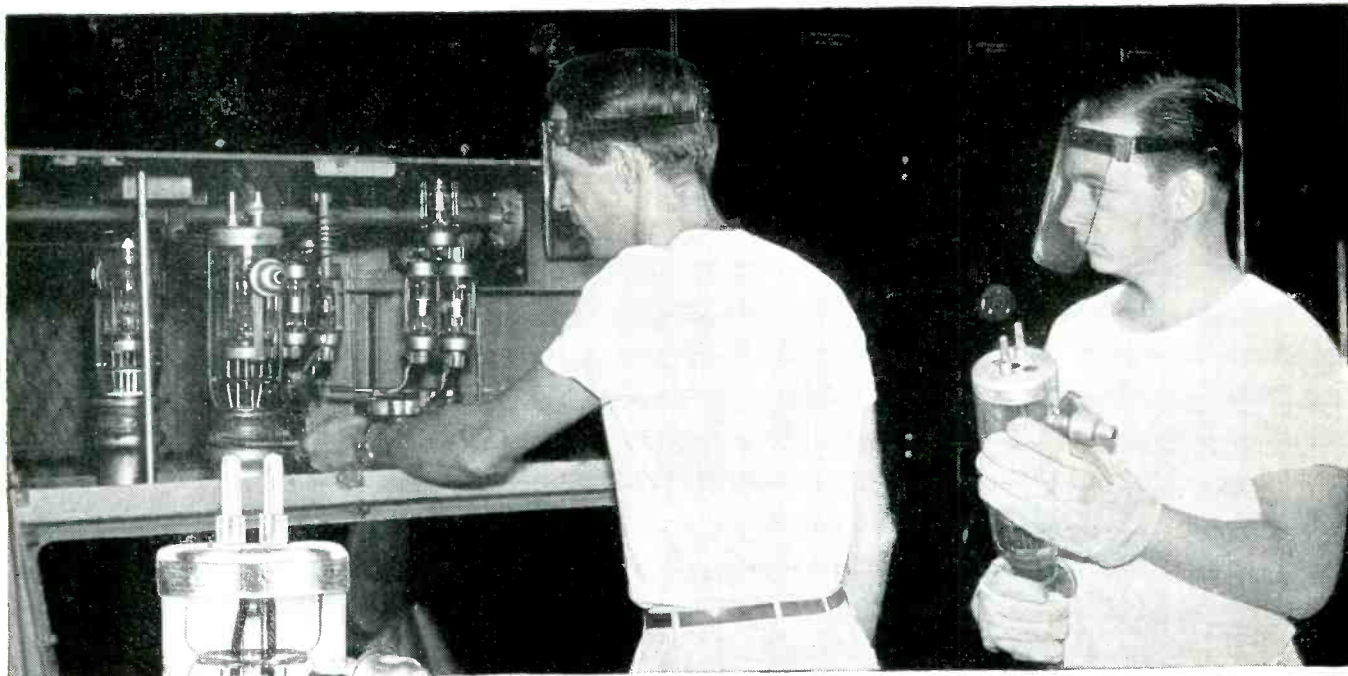

Station engineers at WLW, Cincinnati, replacing two Federal F-342-A tubes after more than 50,000 hours service in the RF driver stage of WLW's redesigned 50-KW transmitter.

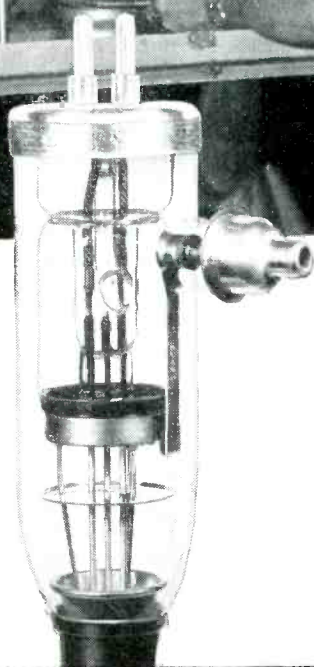

WLW retires two Federal F-342-A tubes AFTER MORE THAN 50,000 HOURS OF OUTSTANDING PERFORMANCE

See what can happen when you use the finest tubes available . . . in properly engineered transmitter circuits.

"It is obvious," says R. J. Rockwell, Vice President in charge of Engineering, Station WLW, Cincinnati, "that properly coordinated tube and circuit engineering definitely pays off. These two Federal tubes were placed in operation almost seven years ago, and performed very satisfactorily for over 50,000 hours each. We expect to obtain approximately 15 years service from the two sets of tubes (one operating, one spare) now on hand."

WLW is no stranger to the phenomenal life of Federal tubes. Mr. Rockwell reports similar outstanding service life from Federal tubes in WLW's shortwave transmitters operating in excess of 200 KW.

Federal tubes . . . backed by 39 years of development and manufacture . . . are precision-made, checked and double checked for mechanical perfection and finest electrical performance. For information write to Dept. K-313.

FROM THE WLW LOG BOOK:

| | Life | Cause of Failure |
|---|-------------|------------------|
| Federal Tube #21,473 | 54,665 hrs. | Open Filament |
| Federal Tube #21,277 | 57,083 hrs. | Open Filament |
| Cost per hour per tube . . . less than one cent! | | |

Federal Telephone and Radio Corporation

100 KINGSLAND ROAD, CLIFTON, NEW JERSEY

In Canada: Federal Electric Manufacturing Company, Ltd., Montreal, P. Q.
Export Distributors: International Standard Electric Corp., 67 Broad St., N. Y.



FEDERAL TELECOMMUNICATION LABORATORIES, Nutley, N. J. . . . a unit of I.T. & T.'s world-wide research and engineering organization.

REDESIGN TRIMS LENGTH 5¼ INCHES, CUTS UNIT COST \$5.70

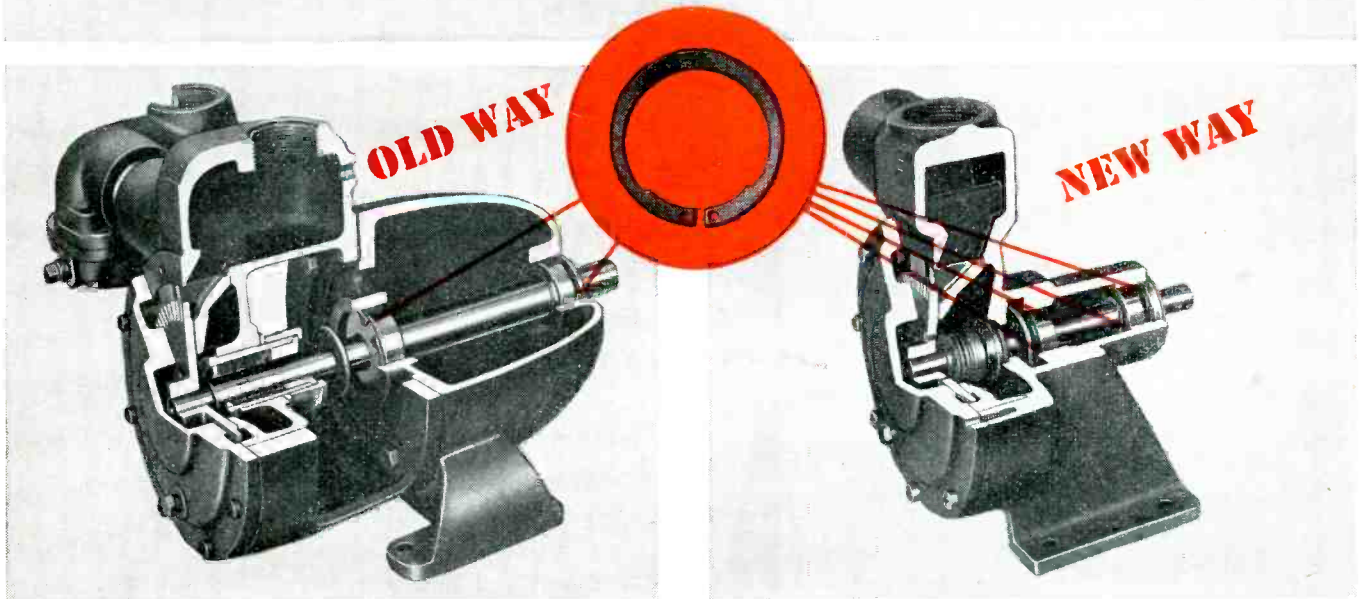

Series D Wayne water pump uses machined shoulders to position bearings on shaft. 2 Truarc rings hold bearings in housing. Locknut holds screw-type stuffing box that requires periodic tightening.

New design uses 4 Truarc Inverted rings (2 external, 2 internal) to position shaft, retain bearings. Inverted rings provide shoulders of uniform section height. 1 Standard ring secures maintenance-free mechanical seal.

Redesign with Truarc Rings helps save \$5.70 per unit for Wayne Home Equipment Company, Inc., Fort Wayne, Ind. It gives them a more compact product, eliminates a separate bearing pedestal and a skilled-labor grinding operation. It facilitates use of maintenance-free mechanical seal instead of old type stuffing box.

Redesign with Truarc Rings and you too will cut costs. Wherever you use machined shoulders, nuts, bolts, snap rings, cotter pins, there's a Truarc Ring that does a better job of holding parts together.

Truarc Rings are precision engineered. Quick and easy to assemble, disassemble. Always circular to give a never-failing grip. They can be used over and over again.

Find out what Truarc Rings can do for you. Send your blueprints to Waldes Truarc engineers for individual attention, without obligation.

REDESIGN WITH 5 TRUARC RINGS GIVES THESE BIG SAVINGS

- Cuts length 5¼ inches
- Cuts total labor 15.3%
- Eliminates skilled-labor grinding operation
- Saves 38.3% materials
- Allows use of stock-size shaft, smaller bearings
- Eliminates separate bearing pedestal

TOTAL UNIT SAVING ... \$5.70

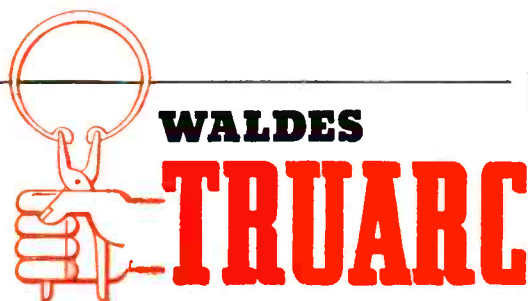

REG. U. S. PAT. OFF.

RETAINING RINGS

WALDES KOHINOOR, INC., LONG ISLAND CITY 1, NEW YORK

WALDES TRUARC RETAINING RINGS ARE PROTECTED BY U. S. PATS. 2,302,948; 2,026,454; 2,416,852 AND OTHER PATS. PEND.



Waldes Kohinoor, Inc., 47-16 Austel Place
Long Island City 1, N. Y.

E-101

Please send 28-page Data Book on Waldes Truarc Retaining Rings.

Name _____

Title _____

Company _____

Business Address _____

City _____ Zone _____ State _____ ★

Divides a second
into 1,600,000 parts—

1.6 MEGACYCLE COUNTER- CHRONOGRAPH



FEATURES:

- High Resolution and Accuracy—1/1,600,000 second.
- Direct Indication of intervals up to one second — recycling of counter can be observed or recorded for longer intervals.
- Retains Indication of measurement until reset.
- Easy to actuate — pulses from common or separate sources can be used.
- Dependable and stable — no adjustments required.
- Accepted standard in practically all government proving grounds.

APPLICATIONS:

PROJECTILE VELOCITY MEASUREMENTS
CAMERA SHUTTER TIMING
FREQUENCY MEASUREMENTS
PRECISION TACHOMETER
RELAY CONTACT TIMING
GEOPHYSICAL MEASUREMENTS*
GAS TUBE MEASUREMENTS

PRINCIPLE OF OPERATION:

A quartz crystal, continuously oscillating at 1.6 mc is used as a time base. During the time interval to be measured the cycles are gated into four binary counting stages having a capacity of 16 counts. The neon indicator lights of these stages are numbered 1/16, 2/16, 4/16, and 8/16 (sixteenths of 10 microseconds or 0.625 microsecond). Following the binary stages are five decade counting units having a capacity of 100,000 counts. Each count entering the decades from the binary stages represents 10 microseconds. Therefore, the time interval between 10 microseconds and 1 second is registered in the decades and the remainder is registered in the binary stages. For instance a time interval of .5374825 second would be indicated as follows: .53748 on the decade indicators plus 4/16 (of 10 microseconds) on the binary indicators.

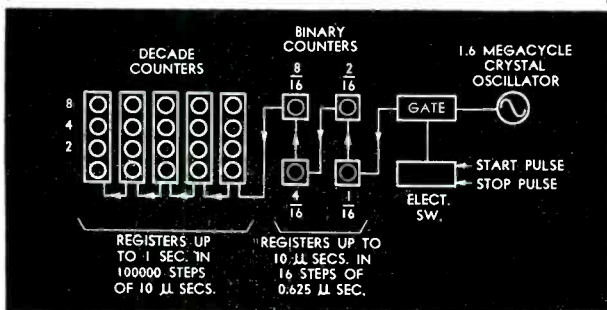

HIGH SPEED ELECTRONIC COUNTERS, COMPUTERS AND PRECISION INTERVAL TIMERS FOR ALL APPLICATIONS—ADDRESS INQUIRIES TO DEPT. 6-H

POTTER INSTRUMENT COMPANY
INCORPORATED
136-56 ROOSEVELT AVENUE • FLUSHING • NEW YORK



High wire artist praises...

H. I. Walker says, "I no longer get shocked when lightning strikes my high wire. G-E Textolite shoe soles give me complete protection."

GENERAL  ELECTRIC
TEXTOLITE* LAMINATED
Plastics
*REG. U. S. PAT. OFF.



● If you haven't as yet used nonmetallic G-E Textolite laminated plastics in your products, you should give it a try. Versatile General Electric Textolite may be your solution to lower costs and product improvement . . . it has excellent electrical properties. Then too, its mechanical, thermal, and chemical characteristics are outstanding.

Although the story about the aerial artist may be a slight exaggeration, it does point up an important fact—G-E Textolite is continually solving difficult problems. Why not fully investigate this proven material. You'll profit. Plastics Division, Chemical Department, General Electric Company, One Plastics Avenue, Pittsfield, Mass.

It's the excellent electrical properties that enable G-E Textolite to perform this insulating feat. If it weren't for General Electric Textolite, high-wire artistry would be mighty uncomfortable . . . even deadly during electrical storms.

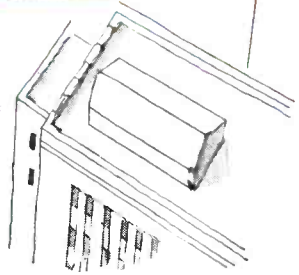

G-E TEXTOLITE LAMINATED PLASTICS IS SUPPLIED IN:

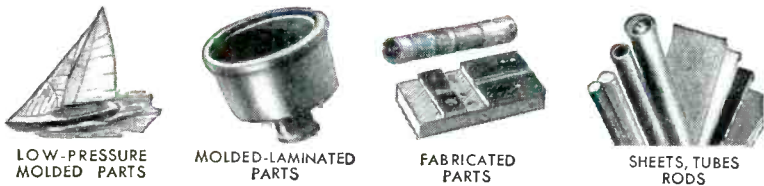

LOW-PRESSURE MOLDED PARTS

MOLDED-LAMINATED PARTS

FABRICATED PARTS

SHEETS, TUBES RODS

SEND FOR THIS HELPFUL BULLETIN TODAY— IT'S FREE

Write for your copy of "G-E Textolite Laminated Plastics." It lists grades, properties, fabricating instructions, and detailed information about Textolite industrial laminates.



**General Electric Company
 Chemical Department (9-10)
 One Plastics Ave.,
 Pittsfield, Mass.**

Please send me the new G-E Textolite laminated plastics bulletin

Name

Firm

Address

City State

GENERAL  ELECTRIC
CD49-J3

RADIO CORES, INC.
FORMERLY MOLDED METALS CORPORATION

PHONE OAK LAWN 2993

9540 TULLY AVENUE
OAK LAWN, ILLINOIS

August 25, 1949

Mr. T. R. Moore, Jr.
Sales Manager, Antara Products
Div. of General Aniline & Film Corp.
444 Madison Avenue
New York 22, N. Y.

Gentlemen:

Under the pressure of business, too often, we are prone to accept without acknowledgment a job well done. Carbonyl Iron Powders have been a major factor in the success of our Company, and at this time we want to commend you on the excellent quality of your product and thank you for your splendid cooperation.

Experience has taught us that the manufacture of quality cores requires the use of the best in magnetic materials. Your various powders, when used in their particular fields of application, excel in uniformity, density, ease of fabrication, and electrical properties. The electrical properties in particular are unparalleled in that they permit the design of high stability cores with superior Q, or permeability, or a combination of both.

Many components in common use today in radio and television equipment would not be practical without the use of cores made with G.A.F. Carbonyl Iron Powders.

Very truly yours,
RADIO CORES, INC.
Lester M. Becker
Lester M. Becker,
Secretary-Chief Engr.

LMB:s

"...a major

G.A.&F* Carbonyl

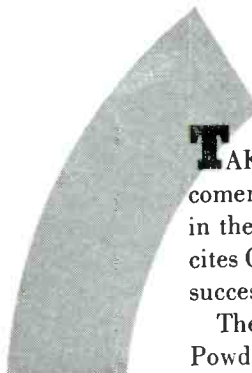

TAKE the case of Radio Cores, Inc., a relative newcomer among manufacturers of quality cores. Already in the top rank of its field, this Illinois core maker cites Carbonyl Iron Powders as "a major factor in the success of our Company."

There's a reason for the success of Carbonyl Iron Powder cores made by Radio Cores, Inc., just as

factor in the success of our Company"

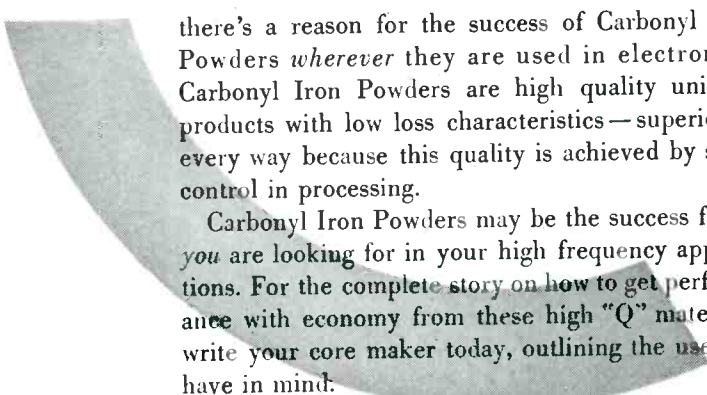

there's a reason for the success of Carbonyl Iron Powders *wherever* they are used in electronics. Carbonyl Iron Powders are high quality uniform products with low loss characteristics — superior in every way because this quality is achieved by strict control in processing.

Carbonyl Iron Powders may be the success factor you are looking for in your high frequency applications. For the complete story on how to get performance with economy from these high "Q" materials, write your core maker today, outlining the use you have in mind.



ANTARA* PRODUCTS

**GENERAL
ANILINE & FILM CORPORATION**

444 MADISON AVENUE
NEW YORK 22, N. Y.

*®



Iron Powders



Typical of the C-D line of capacitors with built-in quality characteristics is the

TYPE UP
for TV applications

Tested and proved in thousands of television receivers, the type UP electrolytic capacitors are available in capacities from 4 mfd. to 2,000 mfd. in any capacity combination. Voltages range from 6 volts to 500 volts. Standard ambient temperature range is -25°C to $+85^{\circ}\text{C}$. Special, exclusive C-D design and construction assures maximum capacity stability in operation. A better capacitor for more difficult TV applications.

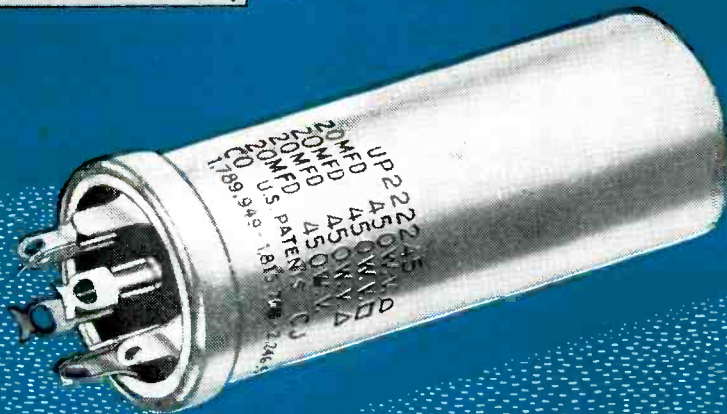

ARE THEY ALIKE?

or do they only look alike?

Cornell-Dubilier capacitors might look like others... but differ where it counts!

That there's more than meets the eye—when it comes to capacitors—is a fact well known to radio engineers for many years. Anyone who knows his way around in the industry, as you do, is not fooled for a moment by external appearance. It's what's *inside* that counts—which is why you can count on Cornell-Dubilier.

Engineers specify C-D because over a period of 40 years they have learned they can count on C-D capacitors for complete dependability, for long years of trouble-free performance, for really genuine economy. Perhaps that's why an impressive percentage make it a point to specify C-D's. Inquiries cordially invited. Catalog available on request.

Cornell-Dubilier Electric Corporation, South Plainfield New Jersey, Dept. K109. Other plants in New Bedford, Brookline and Worcester, Mass.; Providence, R. I.; Indianapolis, Ind., and subsidiary, The Radiart Corp., Cleveland, Ohio.

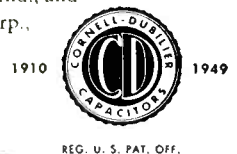

REG. U. S. PAT. OFF.



C-D Best by Field Test!



*music
comes to
life!*

with New
Jensen Genuine *Wide Range* Loudspeakers

- 16 COMPLETELY NEW MODELS
- 3 15-inch Coaxials, 1 12-inch Coaxial
- 11 5-inch to 15-inch Single Radiator models

Now music can come to life for everyone — for in the new Jensen Genuine Wide Range loudspeaker series, there is a choice of cost, size and degree of performance to meet every requirement for thrilling realistic reproduction. Whether it be a 5" loudspeaker at \$8 list . . . a 12" Coaxial at \$33.40 list . . . or a 15" Coaxial with the new Jensen Wide-Angle Acoustic Lens listing at \$135 . . . you will find totally new concepts of performance, way ahead of conventional speaker reproduction, brilliantly engineered and painstakingly constructed in these new products.

Write now for Data Sheet No. 52 describing all the new loudspeakers in the Jensen Genuine Wide-Range series, and booklet "Let Music Come to Life!"

NEW — WIDE ANGLE ACOUSTIC LENS

Typical of Jensen leadership in loudspeaker engineering is the acoustic diverging lens used on the H-510 Coaxial illustrated above. Adapting optical principles to acoustics, this lens acts in conjunction with the h-f horn to distribute h-f radiation uniformly over a wide angle . . . insures constant balance and high quality reproduction throughout the whole room.

This trademark identifies an advanced design loudspeaker . . . with performance to meet today's exacting requirements for faithful music reproduction . . . achieved through the most modern applications of acoustics.

JENSEN MFG. CO. CHICAGO

Jensen

WIDE RANGE

MADE IN U.S.A.

Division of the Muter Company

6607 SOUTH LARAMIE AVENUE • CHICAGO 38, ILLINOIS

In Canada: Copper Wire Products, Ltd., 351 Carlaw Avenue, Toronto

Z

ZIRCON

Zirconium Silicate— 67% ZrO₂ + 33% SiO₂

FOR HIGH MELTING POINT,
HEAT SHOCK RESISTANCE,
LOW THERMAL EXPANSION,
ACID AND CORROSION RESISTANCE,
HIGH MECHANICAL STRENGTH,
GOOD ELECTRICAL RESISTIVITY.

MECHANICAL, THERMAL, CHEMICAL AND PHYSICAL PROPERTIES

| | | |
|--|----------------------------|--------------------|
| Crystal Structure | Tetragonal | |
| Bulk Density — | | |
| Granular Zircon | 180 lbs./cu. ft. | 0.104 lbs./cu. in. |
| Milled Zircon | 102 lbs./cu. ft. | 0.059 lbs./cu. in. |
| Fired Rammed Body | 216 lbs./cu. ft. | 0.125 lbs./cu. in. |
| Fired Slip Cast Body | 250 lbs./cu. ft. | 0.139 lbs./cu. in. |
| Thermal Conductivity cal/°C/sec/cm/cm (Up to 700°F = 0.031 BTU/°F/sec/in./sq. ft.) | = 0.0258 | |
| Mean Specific Heat | (21-51°C) | 0.132 cal/gram/°C |
| Softening Point | 3452°F (1900°C) | |
| Cold Modulus of Rupture | Rammed Body— | 1600-2600 psi |
| | Slip Cast Body— | 7000-8000 psi |
| | (2200-2260°C) | 4000-4100°F |
| Melting Point | 4000-4100°F | |
| Thermal Expansion (mean reversible 20°-1000°C) | 4.5 x 10 ⁻⁶ /°C | |
| | 2.5 x 10 ⁻⁶ /°F | |
| Insoluble in aqueous alkaline solutions and in all acids | | |

ELECTRICAL PROPERTIES

| | | |
|---|--------|-----|
| Dielectric Constant E | 12 ± 1 | |
| Resistivity at °F in Megohms/in. ³ | 1100° | 170 |
| | 1200° | 120 |
| | 1300° | 70 |
| | 1400° | 25 |
| | 1500° | 7 |
| | 1600° | 2.5 |

IN HIGH TEMPERATURE APPLICATIONS

Such as pyrometer tubes—gas turbine combustion chambers—cyanamide processing containers—aluminum resmelting—phosphate, sulphuric acid and silica gel processing furnaces, Zircon offers definite advantages. Its properties make it an ideal body constituent in certain electrical porcelains. As a mold and core wash ingredient, it is in increasing demand and is receiving considerable attention as a mold material in precision alloy casting.

Granular and milled zircon of various purities are available also in addition to zircon refractories, ramming mixes and cements. During years of research and practical experience, a fund of information on the properties, applications and potentials of zircon compounds has been built up.

Specific data and practical suggestions may be obtained through our field engineers or by writing our New York office direct.

TAM

TAM is a registered trademark.

Registered U. S. Pat. Off.

TITANIUM ALLOY MFG. DIVISION NATIONAL LEAD COMPANY

Executive and Sales Offices: 111 BROADWAY, NEW YORK, N. Y. • General Offices and Works: NIAGARA FALLS, N. Y.

BUILT BY THE DESIGN LEADER!



BROAD-BAND MICROWAVE GAS SWITCHING TUBES

TR, ATR, and PRE-TR types



GL-1B63-A



GL-1B44 and GL-1B56



GL-1B38

GENERAL ELECTRIC COMPANY pioneered the broad-band gas switching tube for microwave applications. From G-E research laboratories and drawing-boards came the original plans for these r-f "traffic sentinels" whose instant and automatic operation makes possible modern radar for military purposes—for electronic navigation in fog and darkness—for airway scanning, airport traffic control, and cloud and weather study.

Now G.E. offers to equipment designers and users a group of highly developed TR, ATR, and PRE-TR types which reflect intensive effort to achieve still

more efficient tube-switching in microwave work.

Key ratings are given below. Complete characteristics and performance data gladly will be supplied at your request, covering any or all of the tubes listed. Announcement of still other types later, may be expected in view of General Electric's continuing program in the field.

For information, prices, and the help of specialist tube engineers who gladly will cooperate in choosing the right tubes for your microwave circuits, wire or write *General Electric Company, Electronics Department, Schenectady 5, New York.*

RATINGS

| Group | Type No. | Freq. range | Max peak power | Leakage power | Recovery time, max |
|--------|-----------|--------------|----------------|---------------|--------------------------------|
| TR | GL-1B63-A | 8490-9578 mc | 250 kw | 30 mw max | 4 mu sec at -3 db |
| ATR | GL-1B35 | 9000-9600 mc | 250 kw | 5 kw | Loaded Q, typical 4 |
| | GL-1B37 | 8500-9000 mc | 250 kw | 5 kw | |
| | GL-1B44 | 2680-2830 mc | 1000 kw | 20 kw | |
| | GL-1B56 | 2783-2922 mc | 1000 kw | 20 kw | |
| PRE-TR | GL-1B38 | 2700-2910 mc | 1000 kw | 100 kw | Leakage energy .0002 joules |

GENERAL ELECTRIC

180-H6

FIRST AND GREATEST NAME IN ELECTRONICS

To be sure of
more dependable performance
 from wire-wound components

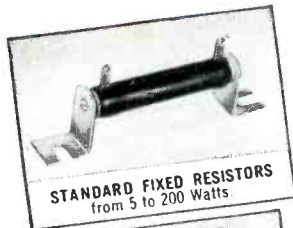

STANDARD FIXED RESISTORS
 from 5 to 200 Watts



ADJUSTABLE RESISTORS
 from 10 to 200 Watts.



OVAL RESISTORS
 for limited space requirements
 — from 30 to 75 Watts.

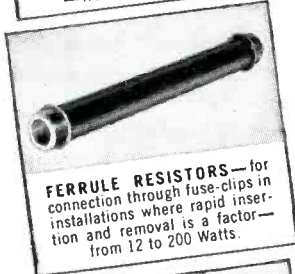

FERRULE RESISTORS — for
 connection through fuse-clips in
 installations where rapid inser-
 tion and removal is a factor —
 from 12 to 200 Watts.



RESISTORS FOR SPECIAL
 APPLICATIONS made to order.
 I-T-E Power Resistors are made
 with a normal tolerance of 10%.
 Tolerances of 5% and less are
 made to order.

● Now you can secure modern electronic products, specially designed to meet the exacting and changing needs of the electronics industry. All I-T-E wire-wound components are *engineered for quality* — given the same thought in design, the same care in fabrication that the most complicated I-T-E Switchgear devices receive.

Whatever your wire-wound needs, it will pay you to investigate I-T-E *precision-built* products. For complete information on any of these products — or for information on special wire-wound fabrications — write us specifying your needs.

I-T-E STANDARD AND OVAL POWER RESISTORS

All I-T-E Standard and Oval Power Resistors are ruggedly constructed, fully capable of meeting the most critical conditions of heavy usage. Bases are made of best, non-hygroscopic ceramics. Terminals are tinned, double-leaf tabs, securely fastened to ceramic base tube. Resistance wires are purest obtainable; and are uniformly wound, mechanically tied, and silver-soldered for permanent, solid connections. The glazed, moisture-repellent surface is made of blue-black vitreous enamel or organic coating, if specially ordered, which locks and insulates the wire winding, and provides fast heat dissipation.



PRECISION-BUILT

I-T-E CIRCUIT BREAKER COMPANY

RESISTOR DIVISION, 19th & HAMILTON STS. - PHILADELPHIA 30, PA.

I-T-E

Precision Built **RESISTORS • DEFLECTION YOKES FOCUS COILS**

I-T-E "METCLADS" (Metal-Clad Resistors)

These precision built metal-clad resistors are made of high grade resistance wire, wound on a special heat resistant bakelite strip, insulated by special phenolic insulation. The resistance element is completely enclosed in a metal case of either brass or zinc plated steel to provide an efficient path to dissipate heat to the chassis. The brass terminals are securely anchored to the wire wound bakelite strip and are tinned for easy soldering. I-T-E "Metclad" resistors are available in length from 2" to 12"; in wattage from 7 to 42. They may be had in various mountings to customer's specifications.

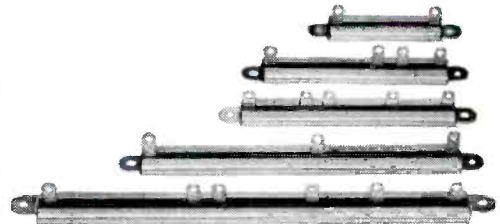

I-T-E DEFLECTION YOKES

Deflection yokes are built with uniform characteristics; wire size and quality is constantly checked. The coils are impregnated in a special moisture resistant thermo plastic material properly cured to insure a firm coil with the minimum of losses. Deflection yokes may be obtained complete with wire leads, resistors and capacitors to customer's specifications.



I-T-E FOCUS COILS

I-T-E Focus Coils are available in two types: The first type utilizes an electro-magnet. The second type combines a permanent magnet with an adjustable electro-magnet. Both are wound of finest enameled uniform-cross-section copper wire. Leads are securely anchored, and the entire wound assembly is enclosed in a pressed-steel case, which is zinc-plated to resist corrosion. PM-EM construction makes possible the use of smaller and less expensive power supply, retains proper focusing longer, and minimizes temperature rise. I-T-E Focus Coils are made for use with tubes 10", 12", and 16" in size. Information required to manufacture: Type of tube; second anode voltage; focusing current. Mountings and leads are made to specifications.

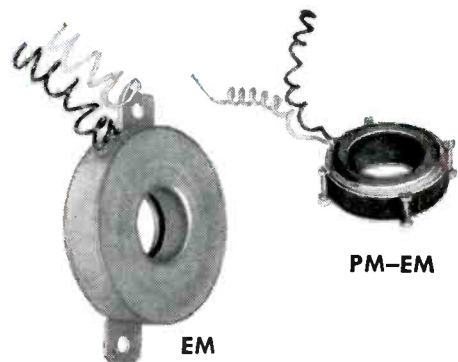

WIRE WOUND PRODUCTS

**SWITCHGEAR • UNIT SUBSTATIONS • ISOLATED PHASE BUS STRUCTURES
AUTOMATIC RECLOSING CIRCUIT BREAKERS • RESISTORS • SPECIAL PRODUCTS**



INSUROK
By
RICHARDSON

DEPENDABLE NAMES IN PLASTICS

A RECORD OF SERVICE—The Richardson Company is proud of the contribution Laminated and Molded INSUROK have made to industrial progress.

INSUROK has become a symbol of quality wherever plastics are used, and Richardson laboratory, engineering and production skills have written important chapters in the development of many products, both for military and peace-time use.

We mention past accomplishments only because they may help you understand that Richardson can offer experienced help in every phase of the planning and production of plastics parts.

Why not send us specifications today . . . and learn how Richardson experience and facilities can work for you?

The **RICHARDSON COMPANY**

GENERAL OFFICES: LOCKLAND, OHIO FOUNDED IN 1858

Sales Headquarters: MELROSE PARK, ILLINOIS

TUNG-SOL

5A6



A MINIATURE-3 WATT-FILAMENTARY

TYPE-PENTODE RF POWER AMPLIFIER

a high
frequency
transmitter tube
with all the
advantages of
miniature
construction

25 mc
50 mc
72 mc
76 mc

see other side for additional information

TUNG-SOL

5A6



1 Instant heating—no standby power required.

2 Full input to 100 megacycles.

3 No neutralization required in class C amplifiers.

THE TUNG-SOL 5A6 was designed to fill a definite void in the transmitter tube range. It is a medium power tube engineered to operate at low supply voltages. This tube is ideal for equipment in the 25-50 and 72-75 megacycle bands, now permanently assigned for mobile units by the FCC. Laboratory conditions surround every step in the manufacture of 5A6. Through the succession of individual inspections, tests and assembly operations, the highest standards are maintained to assure uniformity and dependability.

DIRECT INTERELECTRODE CAPACITANCES

| | With Shield | Without Shield | |
|--|-------------|----------------|-----|
| Grid to plate: (G ₁ to p) max. | 0.10 | 0.15 | μμf |
| Input: G ₁ to (F+G ₂ +G ₃) | 8.5 | 8.5 | μμf |
| Output: P to (F+G ₂ +G ₃) | 9.5 | 6 | μμf |

RATINGS

Interpreted According to RMA Standard M8-210

CLASS B OR CLASS C AMPLIFIER

| | 2.5 | 5.0 | |
|---|------|-----|-------|
| Filament Voltage (±15%) | | | VOLTS |
| Maximum Plate Voltage | 150 | | VOLTS |
| Maximum Grid #3 Voltage | 0 | | VOLTS |
| Maximum Grid #2 Voltage | 150 | | VOLTS |
| Maximum Negative Grid #1 Voltage | -7.5 | | VOLTS |
| Maximum Plate Dissipation | 5 | | WATTS |
| Maximum Grid #2 Power Input | 2 | | WATTS |
| Maximum Plate Current | 40 | | MA. |
| Maximum Grid #1 Current | 3 | | MA. |
| Maximum Frequency for Maximum Plate Input Power | 100 | | MC |

CHARACTERISTICS

Typical Operating Conditions and Characteristics

RF AMPLIFIER AT 70 MC

| | CLASS B | | CLASS C | | |
|--------------------------------------|---------|-----|---------|-----|-------|
| | 2.5 | 5.0 | 2.5 | 5.0 | |
| Filament Voltage | 2.5 | 5.0 | 2.5 | 5.0 | VOLTS |
| Filament Current | 460 | 230 | 460 | 230 | MA. |
| DC Plate Voltage | 150 | | 150 | | VOLTS |
| Grid #3 Voltage | 0 | | 0 | | VOLTS |
| DC Grid #2 Voltage | 150 | | 150 | | VOLTS |
| DC Grid #1 Voltage | -15 | | -24 | | VOLTS |
| Peak RF Grid #1 Voltage | 23 | | 35 | | VOLTS |
| Grid #2 Resistor | 1500 | | 0 | | OHMS |
| Grid #1 Resistor | 5000 | | 20000 | | OHMS |
| DC Plate Current | 40 | | 40 | | MA. |
| DC Grid #2 Current | 7 | | 11 | | MA. |
| DC Grid #1 Current | 1 | | 1.2 | | MA. |
| Grid #1 Driving Power (Approx.) | 60 | | 100 | | MW. |
| Useful Power Output | 2.8 | | 3.1 | | WATTS |
| Triode Amplification Factor | | | | | |
| (Approx. at I _b = 30 ma.) | | | | | 6.8 |



TUNG-SOL

ELECTRON TUBES

TUNG-SOL LAMP WORKS INC., NEWARK 4, NEW JERSEY

SALES OFFICES: ATLANTA • CHICAGO • DALLAS • DENVER • DETROIT • LOS ANGELES • NEWARK
 Also Mfrs. of: RECEIVING TUBES, MINIATURE INCANDESCENT LAMPS, ALL-GLASS SEALED BEAM HEADLIGHT LAMPS and CURRENT INTERMITTORS

For more complete information about the 5A6 write for these bulletins.

TUNG-SOL engineers are constantly at work on a multitude of special electron tube developments for industry. Many exceptionally efficient general and special purpose tubes have resulted. For information about types in which you are interested write to Tung-Sol, Commercial Engineering Department. Let us know your specific requirements.



SUBMINIATURE PAPER CAPACITORS Hermetically Sealed in Metal Cases

Sprague Subminiature Paper Capacitors represent the latest development in the trend toward smaller components with characteristics that are at least equal and often superior to their larger counterparts.

The unusually small size of these paper capacitors is a direct result of new techniques, materials and processes developed through painstaking research.

Sprague Subminiature Paper Capacitors give trouble-free performance under the most exacting electrical, temperature and humidity conditions.

Glass-to-metal solder-sealed terminals assure positive hermetic closure with maximum arc-over clearance to metal cases. Subminiature capacitors are available with either grounded or insulated sections using various capacitor impregnants, so as to best meet *your* individual circuit requirements for physical size, insulation resistance, operating temperature and other factors.

Complete details of Sprague Subminiature Paper Capacitors are given in Bulletin No. 213. Please write for your copy on company letterhead.

SPRAGUE

PIONEERS IN

SPRAGUE ELECTRIC COMPANY

North Adams, Massachusetts

ELECTRIC AND ELECTRONIC DEVELOPMENT

"dag" Colloidal Graphite in Television

The NEW "dag" CRT Interior Wall Coating, a colloidal graphite dispersion, is widely used to improve the performance of television viewing tubes.

Specifically developed by Acheson Colloids engineers for CRT interior surface coating, this dispersion provides a colloidal graphite film which serves as a final high voltage anode, and improves screen contrast by absorbing reflected light.

"dag" CRT Wall Coating sticks fast to all types of glass. A simple adjustable applicator gives a uniform coating from tube face to tube neck while the envelope is turned in a lathe.

Electrical and electronic manufacturers use "dag" colloidal graphite because it is opaque, electrically conductive, chemically inactive, diamagnetic, resistant to electron bombardment, low in photoelectric sensitivity and a gas adsorbent. Can this unique combination of properties be helpful to you? Mail coupon TODAY for more information.



ACHESON COLLOIDS CORPORATION
PORT HURON, MICHIGAN

_____ Send me more information on "dag" colloidal graphite in electronics.

_____ Send an Acheson Colloids engineer at my convenience.

Name _____

Company Name _____

Address _____

City _____ Zone _____ State _____

K-5

ACHESON
COLLOIDS
CORPORATION

Port Huron,
Michigan

dag
REG. U. S. PAT. OFF.
COLLOIDS

It PAYS to work with an MB Vibration Exciter



You can save time, eliminate tedious calculations, and improve your product with the help of an MB electromagnetic shaker. Note how these benefits add up in the following typical applications — just three of many uses for this quality-control and research “tool.”

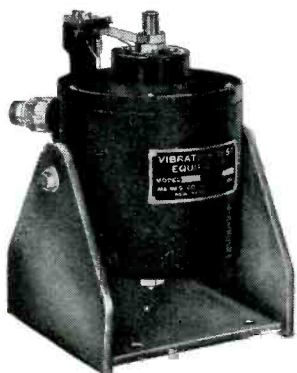

MODEL SA VIBRATION EXCITER Delivers 3 pounds force from 20 to 1,000 c.p.s., usable to 20,000 c.p.s.

INDEFATIGABLE FATIGUE TESTER — Here is the endurance tester to show up *quickly* those faults which often result in failures under dynamic stresses. Why risk trouble reports? You can shake such parts as axles, brackets, complete assemblies, housings, castings and make improvements *before* full scale production — *before* the remedy becomes costly.

NOISE LOCATER — Operating silently, the MB Exciter reveals sources of noise in equipment of all types. Because you can “scan” a product’s operating frequency range, you can put your finger right on resonant

trouble areas. Less noise means more customer satisfaction.

SHAKE OUT THE “BUGS” — Electrical and sensitive components can be checked for ability to withstand severe vibratory service conditions. Reproduce the effect of years of vibration on your product within *hours!*

You’ll find MB Vibration Exciters at work for many leading companies recognized for the quality of their engineering. Would you like to know how to apply one to your *own* problems? An MB engineer will be glad to show you — without obligation.

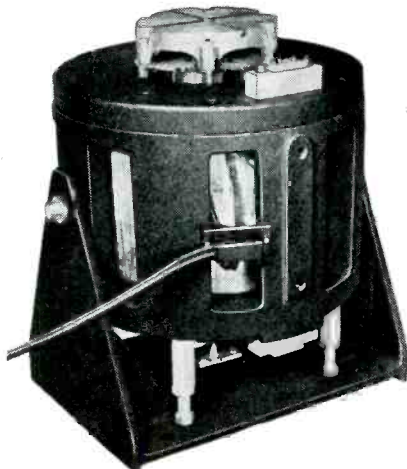

MODEL S3 VIBRATION EXCITER Delivers controlled force up to 200 pounds, in frequency range of 3 to 500 c.p.s.

Testing of small turbine blades (encircled) mounted on an MB Model C-1 Exciter which delivers 25 pounds force in range of 4 to 500 c.p.s. (and higher). Using stroboscopic lighting, resonances and deflections are studied visually — and any need for corrections determined quickly. A stronger, stiffer blade is sure to result.

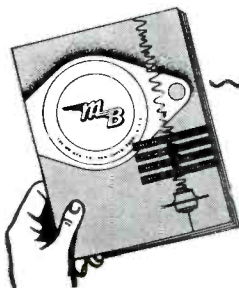
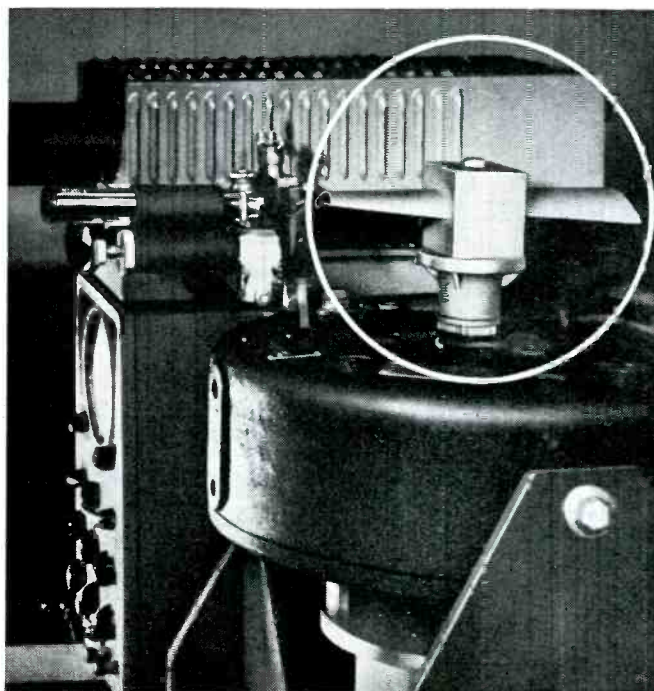

DO YOU HAVE OUR NEW BULLETIN ON FILE?

It contains helpful design data on vibration control, plus more information on the line of MB Exciters. Write for your copy today. Ask for bulletin No. 410-G5.

**THE
MB
MANUFACTURING COMPANY, Inc.**
1060 State St., New Haven 11, Conn.

AMERICAN PHILLIPS SCREWS

Play "close harmony" with musical instrument makers in both these vital ways...



1. "Sweet Music" in Production: Never a "sour note" of spoilage, delay or accident where these automatically straight-driving American Phillips Screws are used in assembly. Costly materials and hours of skilled workmanship are never wasted or lost. To the contrary, American Phillips Screws combine speed with precision so that *fastening time is cut 50%*, even on the fussiest work.

2. "Sweet Music" in Promotion: American Phillips Screws are "grace notes" in their clean, modern appearance on musical instruments and all other products... a signature of quality on the surface that certifies the quality within. Wherever you find American Phillips Screws, you find a product that sells well *and stays sold*. Write.

AMERICAN SCREW COMPANY, PROVIDENCE 1, RHODE ISLAND
 Chicago 11: 589 E. Illinois St. Norristown, Pa. Detroit 2: 502 Stephenson Building

4-WINGED DRIVER CAN'T SLIP OUT OF PHILLIPS TAPERED RECESS

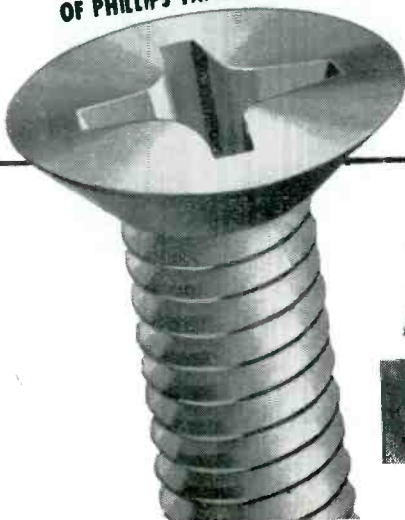

AMERICAN PHILLIPS Screws



ALL TYPES
 ALL METALS: Steel, Brass, Bronze, Stainless Steel, Aluminum, Monel, Everdur (silicon bronze)

If it's a problem calling for **PRECISION POTENTIOMETERS**

Bring it to Helipot

For many years The HELIPOT Corporation has been a leader in the development of advanced types of potentiometers. It pioneered the *helical* potentiometer—the potentiometer now so widely used in computer circuits, radar equipment, aviation devices and other military and industrial applications. It pioneered the *DUODIAL*—the turns-indicating dial that greatly simplifies the control of multiple-turn potentiometers and other similar devices. And it has also pioneered in the development of many other unique potentiometric advancements where highest skill coupled with ability to mass-produce to close tolerances have been imperative.

In order to meet rigid government specifications on these developments—and at the same time produce them economically—HELIPOT® has perfected unique manufacturing facilities, including high speed machines capable of winding extreme lengths of resistance elements employing wire even less than .001" diameter. These winding machines are further supplemented by special testing facilities and potentiometer "know-how" unsurpassed in the industry.

So if you have a problem requiring *precision potentiometers* your best bet is to bring it to The HELIPOT Corporation. A call or letter outlining your problem will receive immediate attention!

*Trade Marks Registered

In this panel are illustrated standard models of HELIPOT multi-turn and single-turn precision potentiometers—available in a wide range of resistances and accuracies to fulfill the needs of nearly any potentiometer application. The Beckman DUODIAL is furnished in two designs and four turns-ratios, to add to the usefulness of the HELIPOT by permitting easy and rapid reading or adjustment.

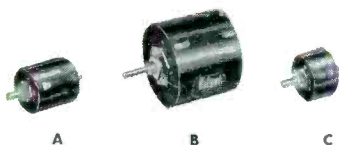

MODELS A, B, & C HELIPOTS
 A—10 turns, 46" coil, 1-13/16" dia., 5 watts—resistances from 10 to 300,000 ohms.
 B—15 turns, 140" coil, 3-5/16" dia., 10 watts—resistances from 50 to 500,000 ohms.
 C—3 turns, 13-1/2" coil, 1-13/16" dia., 3 watts—resistances from 5 to 50,000 ohms.
 — Ask for Bulletin 104 —



MODELS D AND E HELIPOTS
 Provide extreme accuracy of control and adjustment, with 9,000 and 14,400 degrees of shaft rotation.
 D—25 turns, 234" coil, 3-5/16" dia., 15 watts—resistances from 100 to 750,000 ohms.
 E—40 turns, 373" coil, 3-5/16" dia., 20 watts—resistances from 200 ohms to one megohm.
 — Ask for Bulletin 104 —



MODELS F AND G PRECISION SINGLE-TURN POTENTIOMETERS
 Feature both continuous and limited mechanical rotation, with maximum effective electrical rotation. Versatility of designs permit a wide variety of special features.
 F—3-5/16" dia., 5 watts, electrical rotation 359°—resistances 10 to 100,000 ohms.
 G—1-5/16" dia., 2 watts, electrical rotation 356°—resistances 5 to 20,000 ohms.
 — Ask for Bulletin 105 —

LABORATORY MODEL HELIPOT

The ideal resistance unit for use in laboratory and experimental applications. Also helpful in calibrating and checking test equipment. Combines high accuracy and wide range of 10-turn HELIPOT with precision adjustability of DUODIAL. Available in eight stock resistance values from 100 to 100,000 ohms, and other values on special order.
 — Ask for Bulletin 106 —



MODELS R AND W DUODIALS
 Each model available in standard turns-ratios of 10, 15, 25 and 40 to 1. Inner scale indicates angular position of HELIPOT sliding contact, and outer scale the helical turn on which it is located. Can be driven from knob or shaft end.
 R—2" diameter, exclusive of index.
 W—4-3/4" diameter, exclusive of index. Features finger hole in knob to speed rotation.
 — Ask for Bulletins 104 and 114 —

The versatility of the potentiometer designs illustrated above permit a wide variety of modifications and features, including double shaft extensions, ganged assemblies, the addition of a multiplicity of taps, variation of both electrical and mechanical rotation, special shafts and mounting bushings, high and low temperature operation, and close tolerances on both resistance and linearity. Examples of potentiometers modified for unusual applications are pictured at right.



3-GANGED MODEL A HELIPOT AND DOUBLE SHAFT MODEL C HELIPOT
 All HELIPOTS, and the Model F Potentiometer, can be furnished with shaft extensions and mounting bushings at each end to facilitate coupling to other equipment.
 The Model F, and the A, B, and C HELIPOTS are available in multiple assemblies, ganged at the factory on common shafts, for the control of associated circuits.

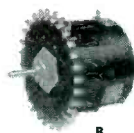

MULTITAPPED MODEL B HELIPOT AND 4-GANGED TAPPED MODEL F
 This Model B HELIPOT contains 28 taps, placed as required at specified points on coil. The Four-Gang Model F Potentiometer contains 12 taps on each section. Such taps permit use of padding resistors to create desired non-linear potentiometer functions, with advantage of flexibility, in that curves can be altered as required.

THE **Helipot** CORPORATION, SOUTH PASADENA 2, CALIFORNIA

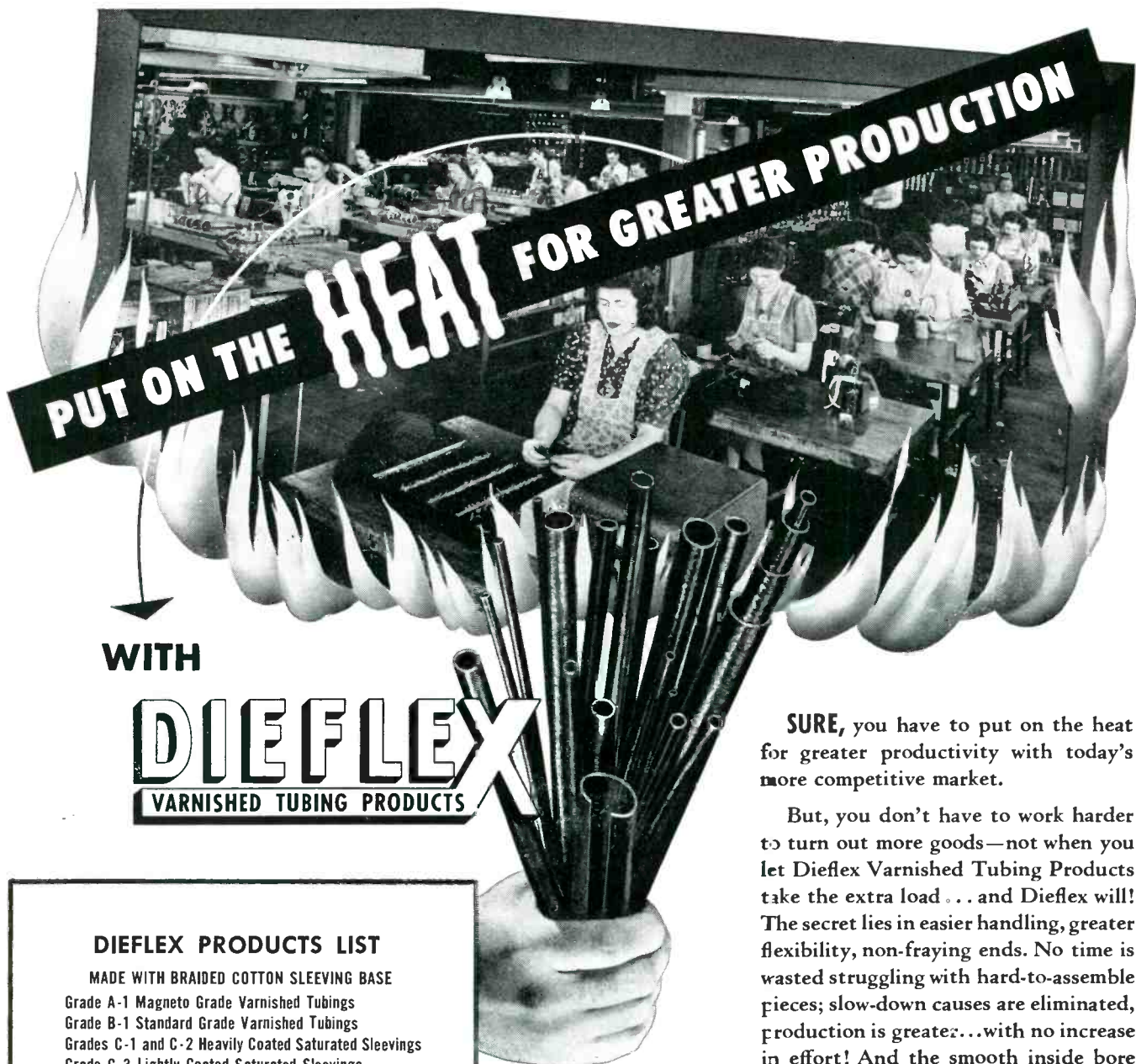

WITH

DIEFLEX

VARNISHED TUBING PRODUCTS

SURE, you have to put on the heat for greater productivity with today's more competitive market.

But, you don't have to work harder to turn out more goods—not when you let Dieflex Varnished Tubing Products take the extra load... and Dieflex will! The secret lies in easier handling, greater flexibility, non-fraying ends. No time is wasted struggling with hard-to-assemble pieces; slow-down causes are eliminated, production is greater... with no increase in effort! And the smooth inside bore of Dieflex prevents snagging, guarantees a rapid, even flow of production.

Arrange now to get test-run samples and prove to your own satisfaction that Dieflex increases production. Contact your nearest Dieflex sales office, today.

DIEFLEX PRODUCTS LIST

MADE WITH BRAIDED COTTON SLEEVING BASE

- Grade A-1 Magneto Grade Varnished Tubings
- Grade B-1 Standard Grade Varnished Tubings
- Grades C-1 and C-2 Heavily Coated Saturated Sleeveings
- Grade C-3 Lightly Coated Saturated Sleeveings
- Heavy Wall Varnished Tubings and Saturated Sleeveings

MADE WITH BRAIDED GLASS SLEEVING BASE

- Grade A-1 Magneto Grade Varnished Glass Tubings
- Grade C-1 Extra Heavily Saturated Glass Sleeveings
- Grade C-2 Heavily Saturated Glass Sleeveings
- Grade C-3 Lightly Saturated Glass Sleeveings
- Silicone-Treated Glass Varnished Tubings and Sleeveings

FREE TECHNICAL LITERATURE

Send for your free copy of the Dieflex technical folder which describes the different types and grades of Dieflex Varnished Tubings and Saturated Sleeveings. Easy-to-read charts help you to select the right tubing or sleeveing for your particular application.

INSULATION MANUFACTURERS CORPORATION

Chicago 6 • 565 W, Washington Blvd.

MILWAUKEE 2
312 E. Wisconsin Ave.

DETROIT 2
15 Lawrence Ave.

CLEVELAND 14
1231 Superior Ave., N. E.

DAYTON 2
120 W. Second St.

IMC Representatives
W. C. JOHNSON—PEORIA 5—101 Heinz Court
H. A. HOLDEN—MINNEAPOLIS 3—1208 Harmon Place
H. R. BRETHERN—DETROIT 2—15 Lawrence Ave.

Authorized Distributors
INSULATION and WIRES INCORPORATED
St. Louis 3, Mo. • Atlanta, Ga. • Boston 20, Mass.
Detroit 2, Mich. • Houston 2, Tex. • Hillside, N. J.
and other cities.

TRI-STATE SUPPLY CORPORATIONS
Los Angeles 13, Cal. • San Francisco 7, Cal. • Seattle 4, Wash.

SUFLEX CORPORATION
33-11—57th St., Woodside, N. Y.



NEW!

SO LA "CVE"*

CONSTANT VOLTAGE POWER SUPPLY TRANSFORMER

The SOLA "CVE" Transformer delivers filament and plate voltages regulated within $\pm 3\%$ or less, with line voltage variations of 100-130 volts. (See chart for typical regulation curve.)



MADE UNDER ONE OR MORE OF THE FOLLOWING PATENTS NO'S 2,143,748 - 2,112,199 - 2,346,621 AND PATENTS PENDING.

SOLA CONSTANT VOLTAGE TRANSFORMER—

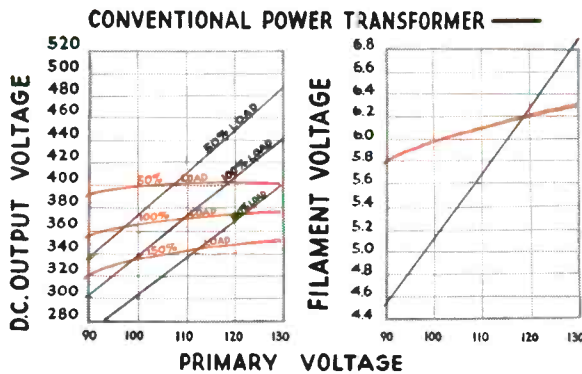

Now you can enjoy the benefits of a constant voltage power supply transformer at lower costs with the SOLA "CVE". This modification of the famous SOLA "CV" precision constant voltage transformer provides a compact regulated source of plate and filament windings on the same core.

Your local electronic distributor has each of the three sizes in stock, or can readily supply you with them. We welcome any inquiries you may have concerning the SOLA "CVE" and its specific application to your requirements.

Write if you would like to receive mailings of the latest technical data on the many SOLA developments.

SO LA *Constant Voltage* TRANSFORMERS

"CV" for high precision voltage regulation. "CVE" for regulated electronic power supplies. "CVA" for constant voltage appliance application.

Schematic of the "CVE"

*Catalog #7105
275 volts D.C. @ 50 M.A. input to filter
6.3 volts C.T. @ 2.5 amps.
5.0 volts, 2.0 amps.
Capacity 42 V.A.
Height—4-13/16"
Width—3-1/8"
Depth—3-3/16"

*Catalog #7106
385 volts D.C. @ 110 M.A. input to filter
6.3 volts C.T. @ 3.0 amps.
5.0 volts, 2.0 amps.
Capacity 75 V.A.
Height—4-13/16"
Width—3-1/8"
Depth—3-15/16"

*Catalog #7107
380 volts D.C. @ 250 M.A. input to filter
6.3 volts @ 8.0 amps. unregulated
6.3 volts @ 4.0 amps.
5.0 volts @ 3.0 amps.
Capacity 210 V.A.
Height—7"
Width—4-1/2"
Depth—4-1/2"

*Nominal values. Voltage regulated unless otherwise specified.

Transformers for: Constant Voltage • Cold Cathode Lighting • Airport Lighting • Series Lighting • Fluorescent Lighting • Luminous Tube Signs
Oil Burner Ignition • X-Ray • Power • Controls • Signal System • etc. • SOLA ELECTRIC COMPANY, 4633 W. 16th Street, Chicago 50, Illinois

Manufactured under license by: ADVANCE COMPONENTS LTD., Walthamstow, E., England ENDURANCE ELECTRIC CO., Concord West, N. S. W., Australia
M. C. B. & VERITABLE ALTER, Courbevoic (Seine), France UCOA RADIO S.A., Buenos Aires, Argentina

MITCHELL-RAND



the one dependable source
of supply for everything in
electrical insulation

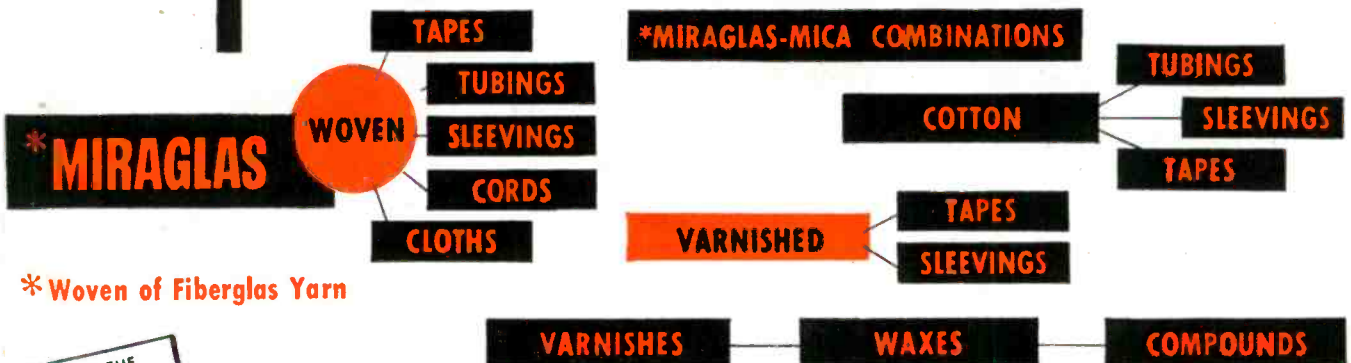

* Woven of Fiberglas Yarn

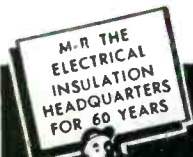

MITCHELL-RAND INSULATION CO. Inc.

51 MURRAY STREET · Cortlandt 7-9264 · NEW YORK 7, N. Y.

A PARTIAL LIST OF M-R PRODUCTS: FIBERGLAS VARNISHED TUBING, TAPE AND CLOTH · INSULATING PAPERS AND TWINES · CABLE FILLING AND POTHEAD COMPOUNDS · FRICTION TAPE AND SPLICE · TRANSFORMER COMPOUNDS · FIBERGLAS SATURATED SLEEVING · ASBESTOS SLEEVING AND TAPE · VARNISHED CAMBRIC CLOTH AND TAPE · MICA PLATE, TAPE, PAPER, CLOTH, TUBING · FIBERGLAS BRAIDED SLEEVING · COTTON TAPES, WEBBINGS AND SLEEVINGS · IMPREGNATED VARNISH TUBING · INSULATED VARNISHES OF ALL TYPES · EXTRUDED PLASTIC TUBING

Follow the Leaders to

Eimac
TUBES

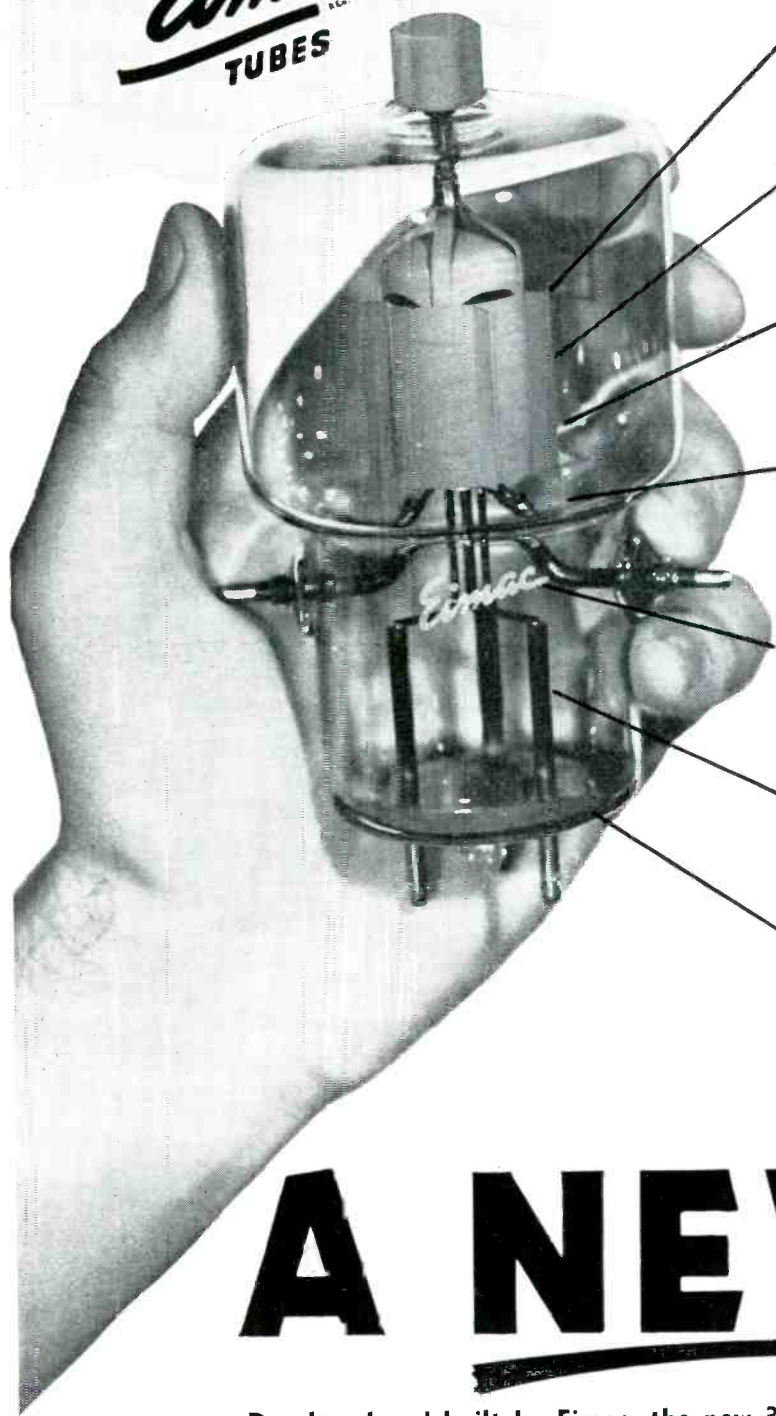

★ Pyrovac plate . . . for long life and to withstand momentary overloads.

★ Eimac non-emitting grid . . . for stability of operation.

★ Component materials are chemically stable . . . insuring long filament life.

★ Mechanical design of internal structures produces a high degree of rigidity and resistance to physical abuse.

★ Trade-marked "Eimac" . . . your assurance of superior performance and continuing service.

★ Tungsten leads . . . for low R-F resistance.

★ Eimac moulded glass base and precision aligned base pins.

A NEW 592

Developed and built by Eimac, the new 3-200A3/592 is directly interchangeable with existing tubes marked 592 without equipment modification.

The structural features indicated above impart to this new triode a long life span and rugged construction customarily associated with Eimac tubes.

Further information may be had by writing the Application Engineering Department of:

EITEL-McCULLOUGH, INC. SAN BRUNO, CALIFORNIA

Export Agents: Frazier & Hansen, 301 Clay St., San Francisco, California

MUCH ELECTRICAL MANUFACTURING MAGIC BEGINS HERE

● One of the best known manufacturers of air circuit breakers in the country is the I-T-E Circuit Breaker Company, located at 19th and Hamilton Streets in Philadelphia. From its inception the company has displayed unusual receptiveness to new ideas, whether from within or without; hence it has done its share of pioneering, and perhaps more. Revere is proud to play a part in its progress, through close collaboration with I-T-E engineers, production men, and the purchasing department. The extensive use of Revere Extruded Shapes is but one result of our mutual attack upon I-T-E problems, which the company is good enough to say has saved a great deal of money, as well as made possible a better product . . . Perhaps similar results would be obtained if you gave us the opportunity to place our knowledge as well as our metals at your disposal. Why not inquire?

REVERE

COPPER AND BRASS INCORPORATED

Founded by Paul Revere in 1801

230 Park Avenue, New York 17, N. Y.

Mills: Baltimore, Md.; Chicago, Ill.;
Detroit, Mich.; Los Angeles and Riverside, Calif.;
New Bedford, Mass.; Rome, N. Y.—
Sales Offices in Principal Cities,
Distributors Everywhere.

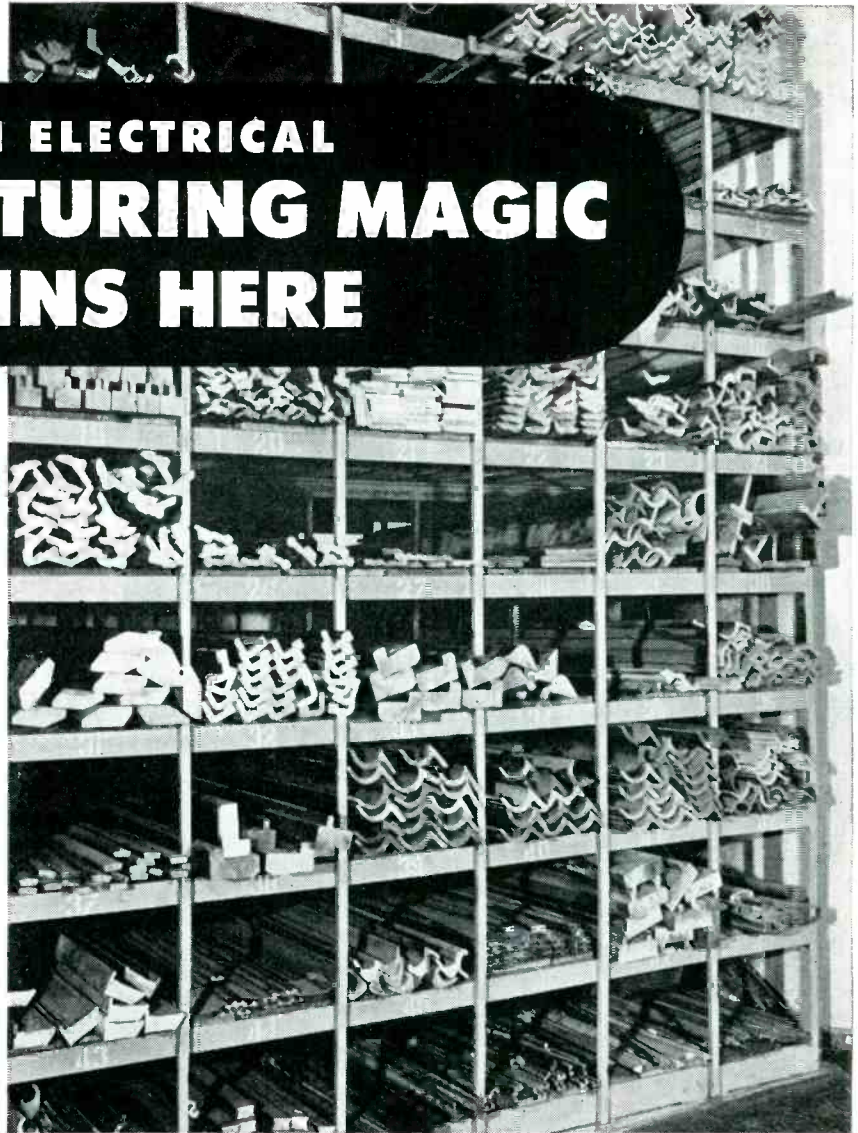

This is but a part of the I-T-E Stock of Revere Extruded Shapes in copper, brass, manganese bronze, and aluminum. I-T-E is a great advocate of extruded shapes, from long experience finding them markedly superior, in uniformity, strength, and economy due to the fact that a great deal of machining is avoided.

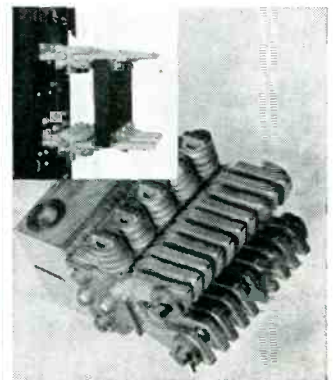
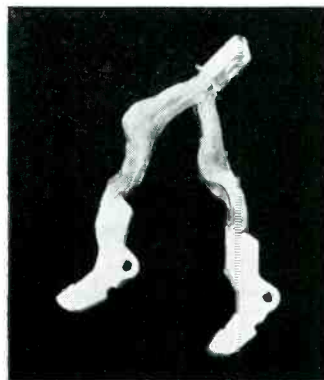
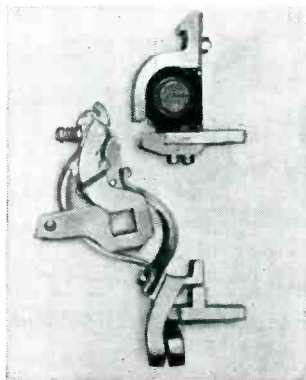
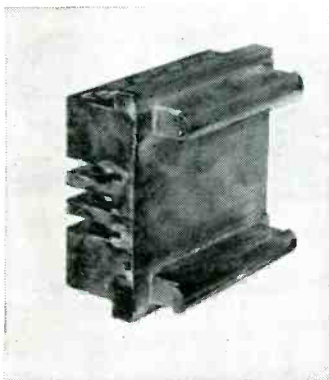

(Left) I-T-E Contact Block made from an extruded shape. This was formerly extruded in electrolytic copper; changing to Revere Free-Cutting Copper resulted in a saving of 30% in machining time. (Right) I-T-E "K" Breaker, Main Contact Assembly in open position. This is an especially interesting assembly, since it shows no less than eight extruded shapes in copper and bronze. Use of these shapes makes the assembly more compact, stronger, lighter, and considerably more economical to produce. The contacts are silver alloy, and the unit is silver plated. . . . In addition to supplying I-T-E with extruded shapes, and strip, Revere furnishes rolls, bar, rod, sheets, in a wide range of non-ferrous alloys, and seamless brass tube.

(Left) Main movable Contacts and Flexible Connectors in an I-T-E "K" Type Circuit Breaker. The two contacts are made from Revere Extruded Shapes. Revere and I-T-E collaborated closely on the specifications for the thin-gauge copper strip for the pigtails, working out the correct gauge and temper to avoid notch effects and cracking of the connection at the braze. (Right) Main Separable Contacts from an I-T-E Type "LG" Circuit Breaker. These are stamped from Revere Copper Strip with the temper specially controlled to eliminate a de-burring operation previously found necessary to obtain edge surface suitable for electrical contacts. (Inset) Back view of "K" type Breaker showing a similar type of contact.

**HOW TO
GET A**

*Steady
115 Volts*

**REGARDLESS
OF LINE
FLUCTUATION**

Here's a small automatic voltage stabilizer—small enough to be built into most products—accurate enough to take the uncertainty out of voltage-sensitive relays, controls, and electronic tubes and circuits. By permitting the simplification of circuits, it will usually save far more than it costs. In photographic-printing and other equipment that needs a light source of constant intensity, it provides definite sales advantages.

This particular stabilizer is rated 50 volt-amperes. Others are available in 15- to 5000-va ratings. All will deliver 115 volts output (within ± 1 percent for fixed, unity power-factor loads) with input voltage varying from 95 to 130. Operation is practically instantaneous (recovery time: less than 3 cycles), and entirely automatic. The stabilizers have no moving parts, will operate continuously at no load or short circuit without damage to themselves, and will limit short-circuit current to approximately 200 percent of rated full-load current.

For general information on these automatic voltage stabilizers, ask your nearest G-E Apparatus Office for Bulletin GEA-3634B. Or address Apparatus Department, General Electric Company, Schenectady 5, N. Y.

Inquiries invited on special units. Requests should include data and description of circuit and load. Address Specialty Transformer Sales Division, General Electric Co., 1635 Broadway, Fort Wayne, Indiana.



GENERAL  ELECTRIC

411-66

NEW Miniature Telephone Type Relay

NEW LK RELAY

MOUNTING: End mounting for back of panel or under-chassis wiring. Interchangeable with standard "Strowger" type mounting.

COIL POWER: From 40 milliwatts to 7 watts D.C.

CONTACTS: Standard 2 amperes, special up to 5 amperes. 2 amperes up to 6 P.D.T. 5 ampere contacts (low voltage) up to 4 P.D.T. Special 20 ampere power contacts S.P.S.T., normally open, paralleled.

DIMENSIONS:

1 $\frac{5}{8}$ " HIGH, 2 $\frac{7}{32}$ " LONG,
1 $\frac{3}{32}$ " WIDE

*These are the dimensions
for the 6 pole relay.*

*Will meet Army and Navy
aircraft specifications
as a component unit.*

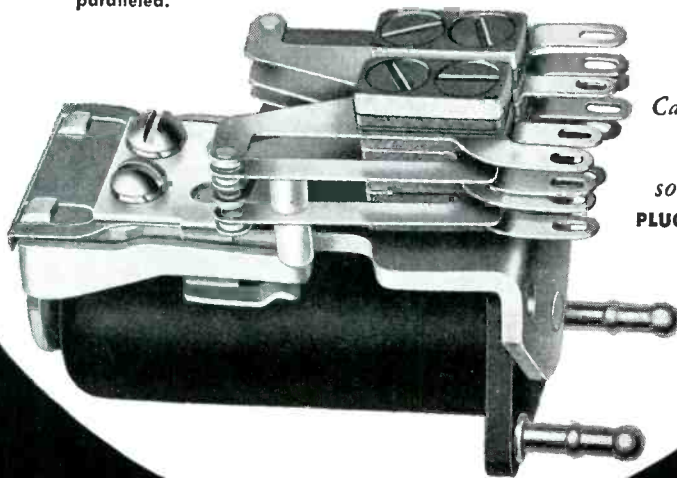

*Can be furnished
hermetically
sealed with
solder terminals.*
**PLUG-IN MOUNTING-
SPECIAL.**

SK RELAY

MOUNTING: Front of panel mounting and wiring.

COIL POWER: From 100 milliwatts to 4.5 watts D.C.

CONTACTS: Same as "LK".

DIMENSIONS: 1 $\frac{1}{2}$ " HIGH, 1 $\frac{1}{16}$ " LONG, 3 $\frac{1}{32}$ " WIDE.

*These are the dimensions
for the 4 pole relay.*

*Will meet Army and Navy
aircraft specifications
as a component unit.*

**CAN ALSO BE FURNISHED
HERMETICALLY SEALED
WITH SOLDER TERMINALS.
PLUG-IN—SPECIAL.**

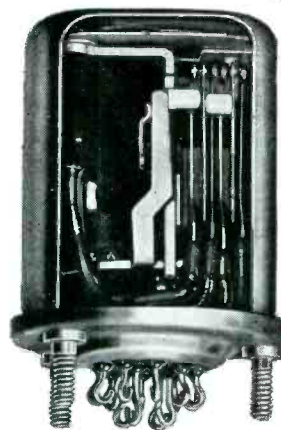

SK, HERMETICALLY SEALED

AL-132



ALLIED CONTROL CO. INC. 2 EAST END AVE., NEW YORK 21, N. Y.

NEW **hp** 460A WIDE BAND AMPLIFIER

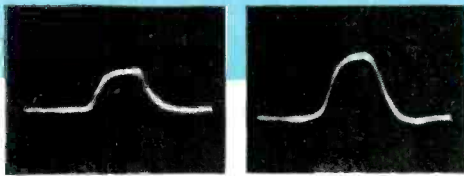

Figure 1

Actual photo of oscillograph trace showing .01 μ sec pulse (left) applied direct to CRT plates; (right) through -hp- 460A.

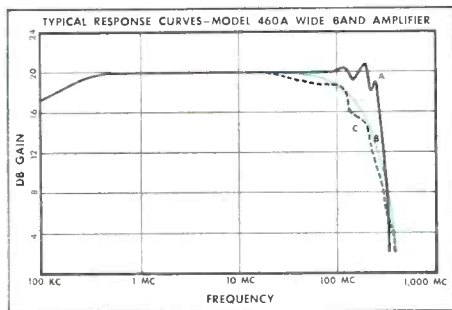

Figure 2

Typical response curves. Line A, with -hp- 410A VTVM. Line B, into 200 ohm load. Line C, Gaussian curve.

SPECIFICATIONS

Frequency Response: *High frequency*—closely matches Gaussian curve when operating into a 200 ohm resistive load. 3 db point is 140 mc.

Low frequency—when operating from a 200 ohm source and .01 blocking condenser, response off 3 db at 3 kc into an open circuit or succeeding amplifier. When operating into a 200 ohm load, off 3 db at 100 kc.

With -hp- 410A VTVM: ± 1 db, 200 kc to 200 mc.

Gain: Approx. 20 db into 200 ohm load, with tubes of G_m 5,000 micromhos. (When operating into 200 ohm load.) Gain control has range of 6 db. 5 or more amplifiers may be cascaded.

Output: Approx. 8 v. peak open circuit. Output impedance, 330 ohms.

Input Impedance: 200 ohms.

Delay Characteristics: Approx. .012 μ sec.

Rise Time: Approximately .0026 μ sec (10% to 90% amplitude). No appreciable overshoot.

Mounting: Relay rack, 5 $\frac{1}{2}$ " x 19" x 6" deep.

Power Supply: 115 v. 50/60 cps, self-contained.

Data subject to change without notice.

SETTING A NEW STANDARD FOR FAITHFUL PULSE AMPLIFICATION!

True amplification of very short pulses. Rise time .0026 microseconds; 20 db gain; can be cascaded. For oscilloscope, TV, UHF, nuclear or general laboratory work. Increases voltmeter sensitivity 10 times over 200 mc band.

The new -hp- 460A Wide Band Amplifier is the first instrument of its kind to offer you *faithful amplification* of very short pulses without objectionable ringing or overshoot. The rise time of the amplifier itself is only .0026 microseconds; and its response matches the Gaussian curve (transmission ideal) more closely than any other instrument yet offered.

The exactness with which the new -hp- 460A amplifies very short pulses can be seen in Fig. 1. Left: shows a .01 μ sec pulse applied direct to plates of a 5XP11A cathode ray tube. Right: same pulse after passing through the -hp- 460A. Note the very short rise time and the absence of ringing or overshoot. Fig. 2, illustrates how closely the -hp- 460A conforms to the Gaussian ideal. As many as 5 amplifiers can be cascaded when high gain is necessary.

GENERAL AMPLIFIER

Fig. 2 also illustrates the wide fre-

quency response of this instrument. It offers flat response up to 200 mc when used with the -hp- 410A Vacuum Tube Voltmeter. Sensitivity is increased 10 times. The -hp- 460A may also be used as a general purpose laboratory amplifier.

ACCESSORIES

Since the -hp- 460A Amplifier operates best at impedances of 200 ohms, -hp- has designed a 200 ohm coaxial system of connectors and cables. These accessories include leads with fittings, panel jacks and plugs, adapters to connect into a 50 ohm Type N system; and a special adapter for use with the -hp- 410A Voltmeter.

Get complete information now! See your nearest -hp- representative or write to factory.

HEWLETT-PACKARD CO.

1936-A Page Mill Road, Palo Alto, California

Export: FRAZAR & HANSEN, LTD.

301 Clay Street, San Francisco, Calif., U. S. A.
Offices: New York, N. Y.; Los Angeles, Calif.

hp laboratory instruments
FOR SPEED AND ACCURACY

Crucible Magnet Assembly
saves space • saves weight
without sacrificing field strength

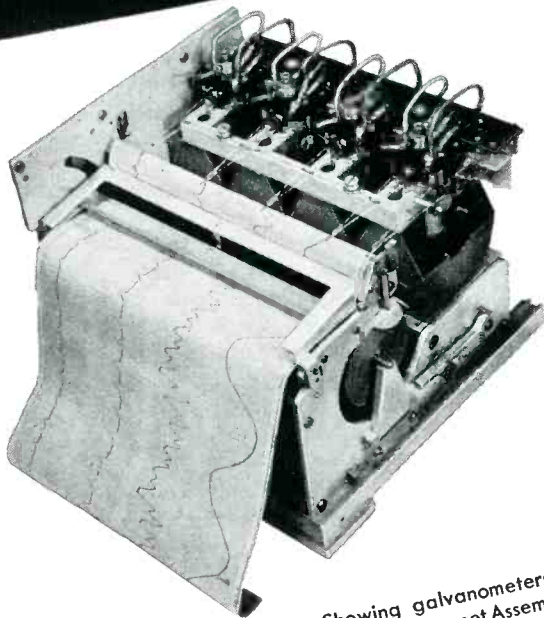

Recording unit exposed. Showing galvanometers in action. Note compactness of Crucible Magnet Assembly.



Complete console unit. Recording assembly is to the left.

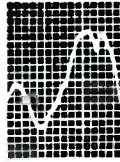
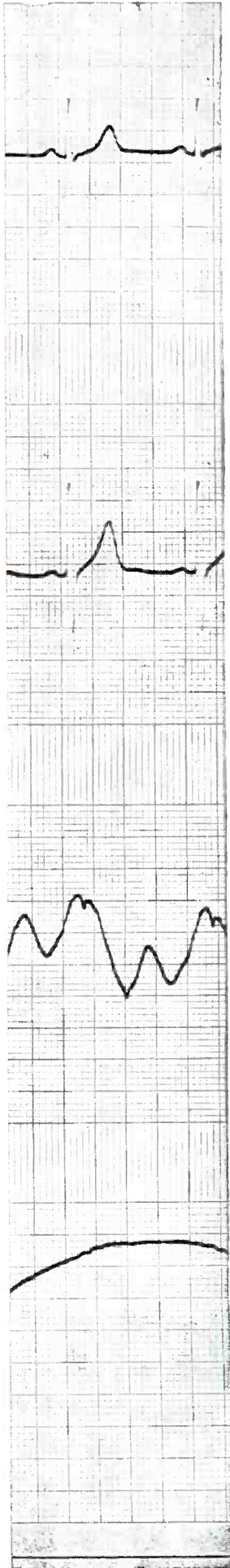

WHEN Sanborn Company of Cambridge, Massachusetts, big name in recording equipment, first started working on the design and construction of their new "Poly-Viso" Recorder, they ran into a magnet problem:

This recorder makes available permanent simultaneous tracings on one piece of paper of four different kinds of information which, for the first time, are directly written, in rectangular coordinates. That meant that Sanborn needed four separate but compact galvanometers. Crucible was called in, and here's the way Crucible magnet specialists solved the problem:

After careful study of the limits of the equipment, a master magnet was designed that consisted of four pairs of magnetic poles cast on a single base. This eliminated the need for bolting four magnets together, and reduced the amount of space required by the galvanometer assembly. An added feature of this special magnet assembly is a unique and exclusive Crucible method of strengthening the pole pieces of the individual magnets so as to retain maximum field strength. This also adds to the sensitivity of the galvanometer assembly.

The Sanborn "Poly-Viso" Recorder is used in both the biophysical and industrial fields for the measurement of pressure, flow, temperature, strain, values of AC or DC voltage or current, and the like. Because such quantities are directly recorded, immediate analysis can be made of many problems. Also, records can be run at any one of eight selectable speeds.

Crucible's part in Sanborn's far-reaching development is but one example why Crucible has maintained, for half a century, a position of leadership in the specialty steel field. Your permanent magnet problem will receive the same experienced consideration from Crucible's unsurpassed staff of metallurgists and production specialists. Please give full details.

CRUCIBLE STEEL COMPANY OF AMERICA

Chrysler Building, New York 17, N. Y.

Branches, Warehouses and Distributors in Principal Cities

CRUCIBLE

first name in special purpose steels

PERMANENT ALNICO MAGNETS

STAINLESS • HIGH SPEED • TOOL • ALLOY • MACHINERY • SPECIAL PURPOSE • STEELS

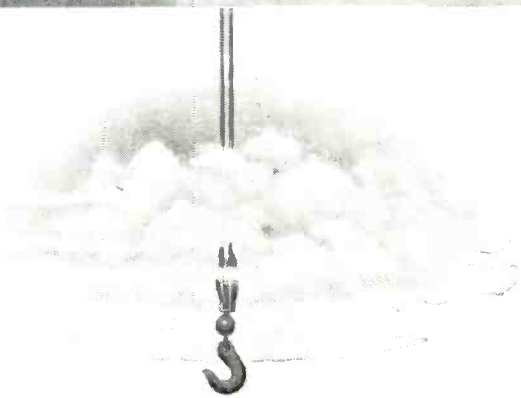

**NEXT BEST THING
TO A
"SKY-HOOK!"**

"Sky-hooks" being expensive and somewhat impractical, why not start from the ground up with a Blaw-Knox tower to obtain support for your high-riding FM and TV antennas?

Blaw-Knox, having built towers since spark-gap days, makes available to electronic engineers a degree of practical experience unequalled in this field. So, when you want the next best thing to a sky-hook, call Blaw-Knox.

[Shown here is a Blaw-Knox special 417 ft. Type H-40 Heavy Duty tower for Station WHIO, Dayton, Ohio. This tower was designed to support an RCA combination 4-section pylon, plus a 6-section TV antenna and station call letters.]

**BLAW-KNOX DIVISION
OF BLAW-KNOX COMPANY**

2077 FARMERS BANK BUILDING • PITTSBURGH 22, PA.



**BLAW-KNOX
ANTENNA
TOWERS**

Smooth

CLOSE CONTROL



WITH OHMITE RHEOSTATS

The unmatched smoothness of action you feel when turning the knob of an Ohmite Rheostat indicates more than good operating characteristics. It means you have the kind of *close, evenly graduated* control once associated only with special laboratory-type rheostats. And it means your Ohmite Rheostat has been engineered and built to give years and years of trouble-free service.

No wonder more Ohmite Power Rheostats are purchased than all other makes combined. Manufacturers have found they can easily select the exact rheostat for their needs from Ohmite's extensive series of ten sizes ranging from 25 to 1000 watts. They have found Ohmite Rheostats can be depended on for unflinching performance under the toughest operating conditions.

That's why Ohmite is first among industrial buyers . . . and why it pays you to standardize on Ohmite Rheostats for your products.

THESE COMPONENTS CONTRIBUTE TO THE GLIDING SMOOTHNESS OF OHMITE RHEOSTATS

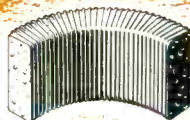

Even, Uniform Windings wound on a solid ceramic core, are locked against shifting by special vitreous enamel.



Floating Brush of metal-graphite, has a pivoted action that constantly keeps it in flush contact with windings.



Tempered Steel Contact Arm forms a long steel spring which assures uniform contact pressure at all times.



Brass Bushing provides a wear-resistant, wobble-free bearing for effortless shaft rotation.



Be Right with . . .

OHMITE

Reg. U. S. Pat. Off.

RHEOSTATS

RESISTORS

TAP SWITCHES

OHMITE RESISTORS

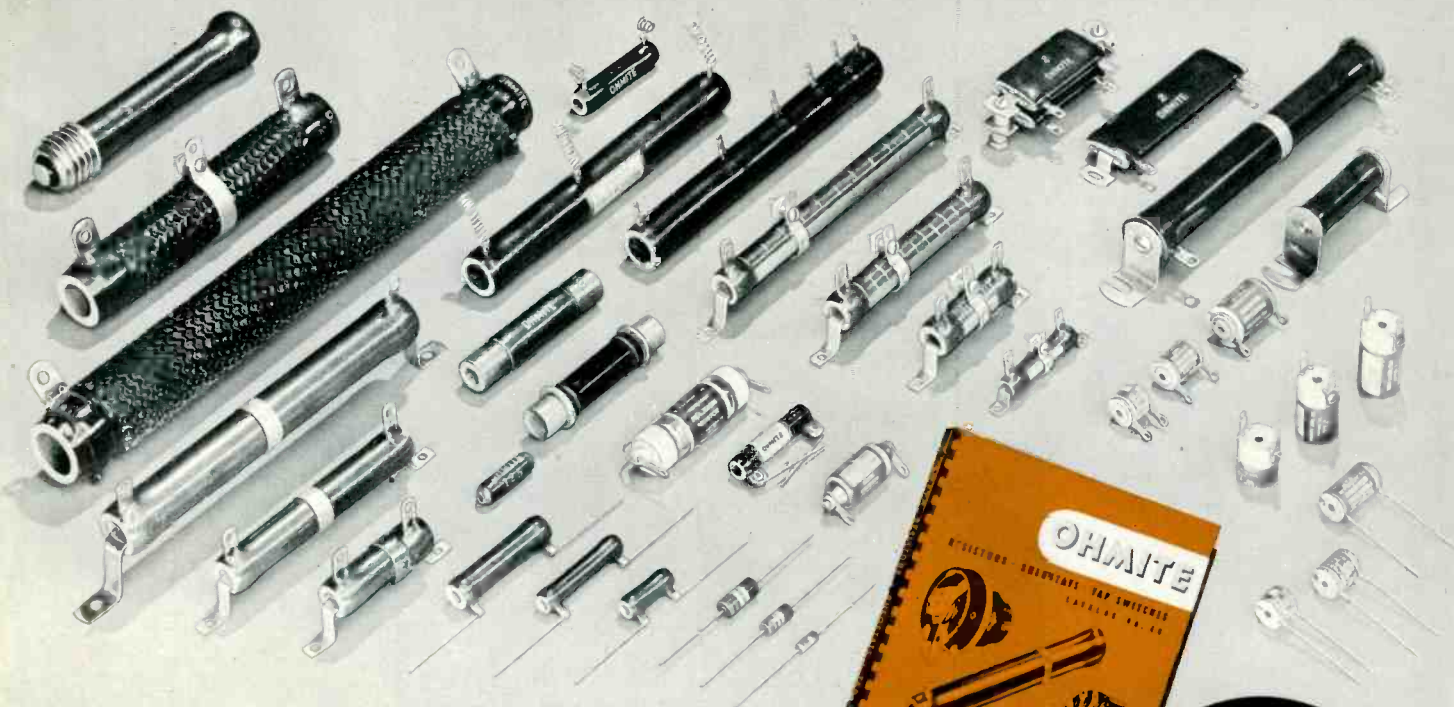

Write on
Company
Letterhead
for Catalog
40

Standard Types and Sizes To Meet Every Need



The extensive range of Ohmite types and sizes makes possible an almost endless variety of standard Ohmite resistors to meet each individual need. Ohmite offers resistors in more than 60 core sizes, in a wide range of wattage and resistance values. There are also 18 types of resistor terminals available. Included in the Ohmite line are fixed, adjustable, tapped, non-inductive, and precision units.

These rugged resistors have proved their worth under the toughest operating conditions. Specially developed vitreous enamel holds the winding rigidly in place and protects it from mechanical damage, shock, vibration, cold, heat, fumes, and humidity—providing years of unflinching performance. Ohmite engineers will be pleased to help you in selecting the right resistors for your job.

OHMITE MANUFACTURING COMPANY

4817 Flournoy St., Chicago 44, Ill.

Be Right with...

OHMITE

Reg. U.S. Pat. Off.

RHEOSTATS • RESISTORS • TAP SWITCHES

Industry's First Choice

Announcing a superior Fiberglas Insulation at a price comparable to Cotton

BH

"649"

Here is a new Fiberglas Tubing and Sleeving with superior physical and dielectric properties *at a price comparable to ordinary cotton-base or rayon-base insulations.*

BH "649" is non-burning, non-fraying, non-stiffening . . . but above all it's the toughest insulation we have ever made. No varnish to crack or flake off. Toughened against the rough treatment encountered in assembly or product use. It is no longer necessary to specify an insulation grade with a rated dielectric strength substantially in excess of voltage requirements to insure against expected dielectric loss in assembly and service. Test the ability of BH "649" to maintain its rated dielectric strength and save the extra cost.

Production samples in any size, grade or color are available on request. Use coupon below.

BENTLEY, HARRIS MANUFACTURING CO., CONSHOHOCKEN, PA.

BH Fiberglas* SLEEVINGS



KNOT IT . . . Take a length of BH "649". Knot it. Pull it as tight as you can. Twist it. Then loosen the knot. There is no cracking. No change in the dielectric strength.

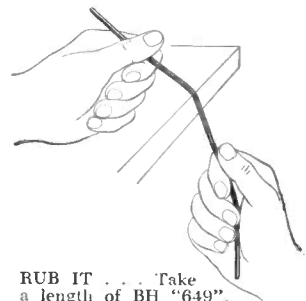

RUB IT . . . Take a length of BH "649". Hold the ends firmly. Then rub the sample up and down briskly in a sawing motion against the edge of a desk or chair. See how difficult it is to damage the coating.

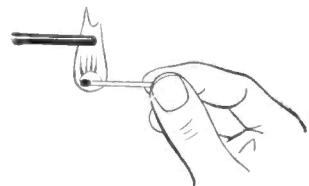

HOLD A MATCH UNDER IT . . . Take a length of BH "649". Hold a lighted match under it. BH "649" will not support combustion.

C O U P O N

Bentley, Harris Mfg. Co., Dept. E-36, Conshohocken, Pa.

I am interested in BH "649" Fiberglas Tubing and Sleeving. Send samples for production testing of Grade _____ in sizes as follows _____ for _____ operating at temperatures of _____ °F. at _____ volts.
(size or I.D.) (product)

NAME _____

ADDRESS _____

Send samples, pamphlets and prices on other BH Products as follows:

- Cotton or Rayon-base Sleeving and Tubing
- BH non-fraying Fiberglas Sleeving

IRVINGTON lowers costs

with
NEW
VARNISHED
FIBERGLAS*
Style OW Insulation



Here's a new Irvington insulating material that's important to investigate now. Important because it makes possible the use of Fiberglas (Class B Insulation) at a cost substantially lower than formerly. Important because it provides in a standard product the combination of higher dielectric strength, greater flexibility and high mechanical strength desired in many specific applications.

In making Varnished Fiberglas Style OW, Irvington employs base cloth woven by a new principle that permits the woven fiberglas to carry more insulating varnish. Not only test results, but actual applications have proved its advantages in such services as core wrappings, field coils and punchings. It is available in black or yellow, in thicknesses of .007", .010", .012"; in rolls 25 and 50 yards long; approximately 36" wide; tape in widths from 1/2" up. Write today for test reports, further details, and samples.

*T.M. Reg. U.S. Pat. Off. by Owens-Corning Fiberglas Corp.



IRVINGTON *Varnish & Insulator Company*

Irvington 11, New Jersey

Authorized distributors in Atlanta; Baltimore; Berkeley; Bluefield, W. Va.; Boston; Charlotte; Chicago; Cleveland; Dallas; Denver; Detroit; Los Angeles; Milwaukee; Minneapolis; New Hartford, N.Y.; New Orleans; Philadelphia; Pittsburgh; Portland, Ore.; St. Louis; Seattle; Hamilton, Ont., Canada.

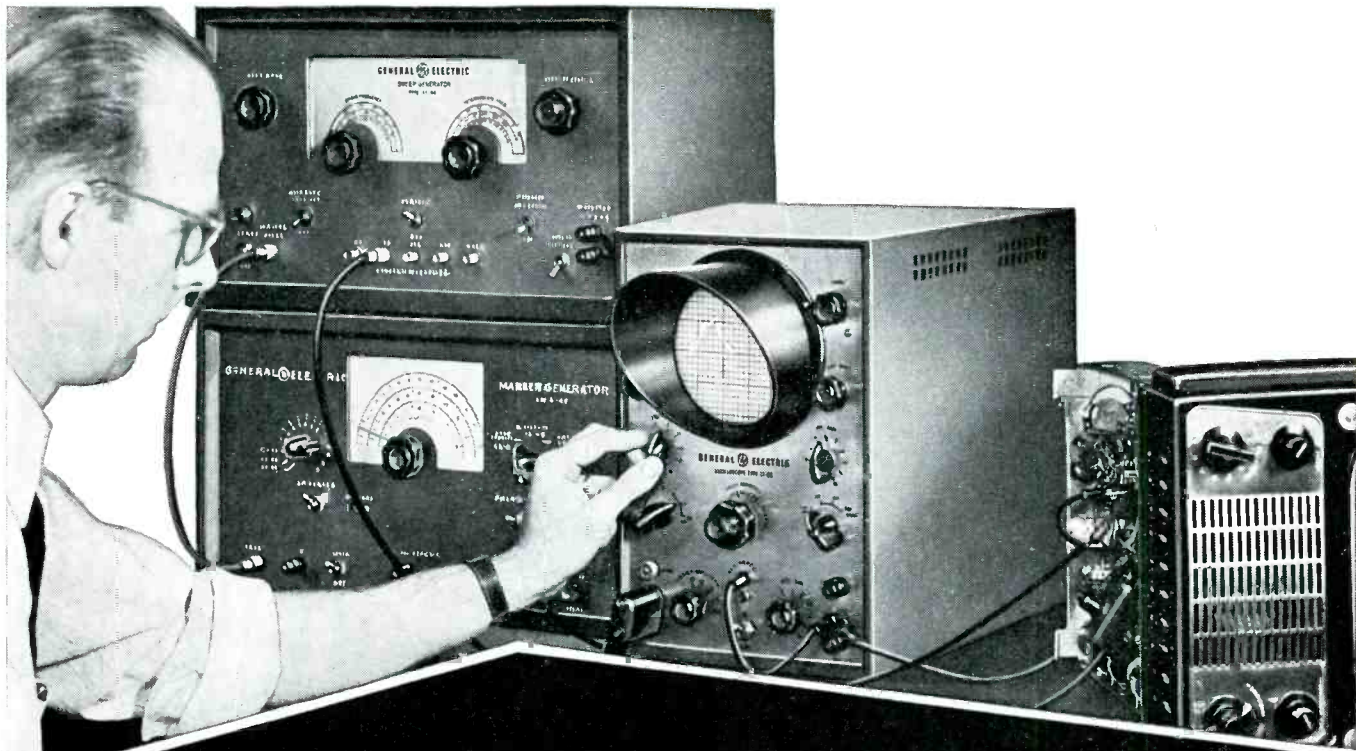

3 *New Time-Saving, Profit-Building* G-E TELEVISION SERVICE INSTRUMENTS



Now — with this new G-E equipment — you can check TV receivers under conditions varying from fringe areas to "under the tower" and predict operation of the sets anywhere in the service area — at a glance!

VARIABLE Permeability Sweep Generator! Crystal Controlled Marker Generator! Cathode Ray Oscilloscope! Put them all together in one group and you have what manufacturers and servicing dealers have acclaimed the fastest, most accurate answer to television receiver testing problems ever offered!

Here's why—

- Variable Permeability Sweep Generator can be set quickly to any desired frequency, supplying high output and exceptionally wide linear sweep—

- Because of low leakage, complete over-all response from antenna terminals to picture detector can be viewed with contrast at maximum settings.
- All desired markers for complete alignment are obtained by one initial setting of the master dial on the marker generator.
- High quality general purpose oscilloscope presents accurate picture of wide range of phenomena from response curves to composite signal.



GET THE FACTS TODAY!

Specialty Division — Room 107
Electronics Park
Syracuse, New York

Send me specifications, pictures, and prices on the new G-E Television Test Equipment Package.

NAME _____
ADDRESS _____
CITY _____ STATE _____

You can put your confidence in—

GENERAL  ELECTRIC

What's Your
PANEL INSTRUMENT
Problem?

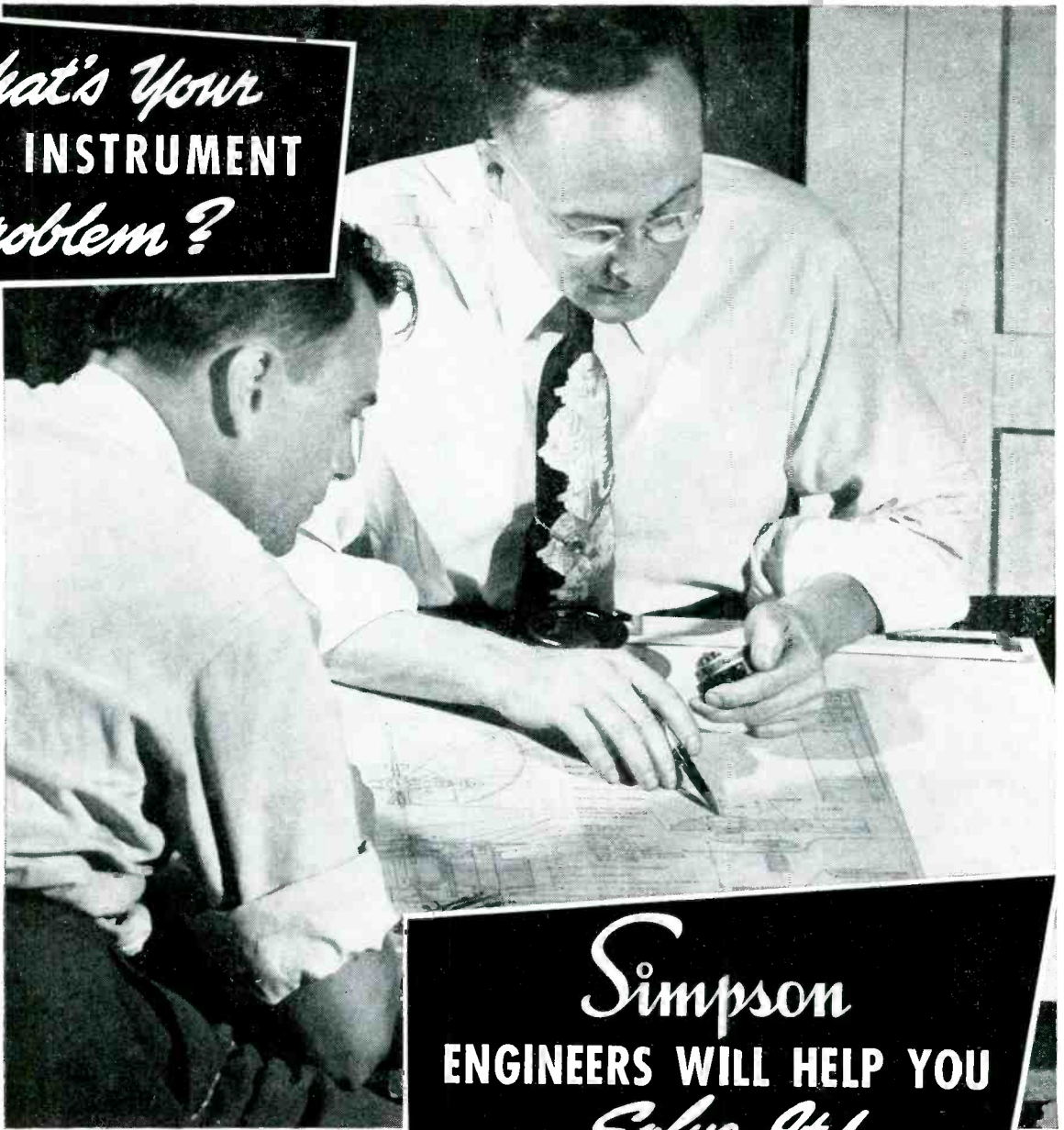

Simpson
ENGINEERS WILL HELP YOU
Solve It!

No matter what your panel instrument problem is, Simpson Electric Company engineers will be glad to help you solve it. Every day they are confronted with individual design problems.

Behind every Simpson instrument is a world-wide reputation for quality. Simpson movements have greater ruggedness and accuracy, because of the full bridge-type construction and soft iron pole pieces.

When Simpson helps you with your problem, you benefit from this world-wide reputation and the years of experience of Simpson engineers.

Let Simpson engineers help you with your next instrument problem and for your standard instrument requirements take advantage of our large stock, available for immediate delivery.

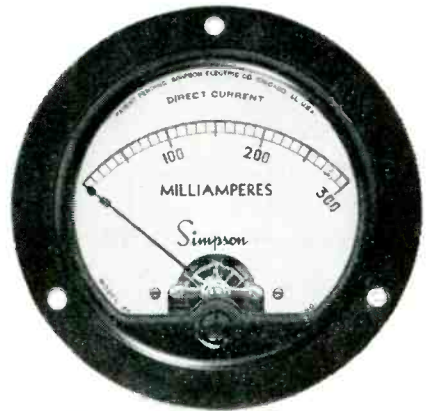

SIMPSON ELECTRIC COMPANY 5200-18 WEST KINZIE STREET, CHICAGO 44, ILLINOIS
IN CANADA: BACH-SIMPSON, LTD., LONDON, ONTARIO

Specify **Hi-Q** COMPONENTS for **PRINTED CIRCUITS**

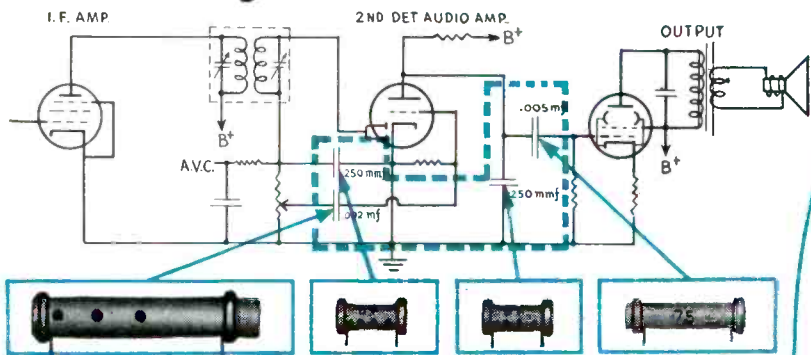

...THE PROBLEM
Hi-Q engineers were recently asked to design a component which would replace the 4 standard components called for in the schematic drawing illustrated at left. The problem was one of space saving without affecting the operation of the circuit.

HERE IS HOW Hi-Q SOLVED THE PROBLEM OF SPACE SAVING AND REDUCED COST

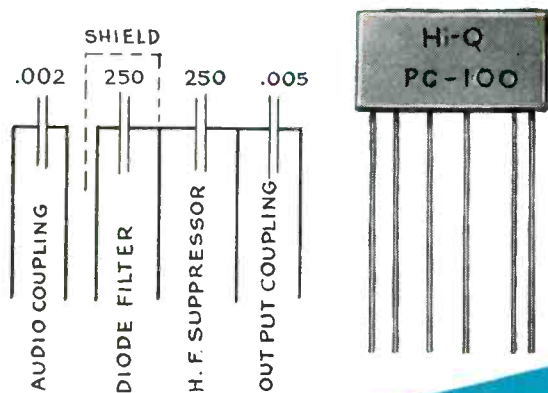

THE SOLUTION

Hi-Q engineers designed a printed circuit known as the **Hi-Q P. C. 100**. This component replaced all 4 of the standard sized units formerly used, thus reducing the physical proportions of the space formerly required. In addition, this new component eliminated 25% of soldering time as well as eliminating 75% of the unit handling cost. The result of this customer's foresight in placing his problem before Hi-Q engineers is that a new component was designed which saved our customer space, labor and time.

WHAT'S YOUR PROBLEM?

Our engineering department will gladly work with you on any problems you might have. Consult with us and ask for our suggestions regarding your specifications before your design has gone too far. Perhaps we can work out savings in space, time and labor for you.

WRITE FOR FREE CATALOG

JOBBERS—ADDRESS: ROOM 1332, 101 Park Ave., New York, N. Y.

Hi-Q COMPONENTS
BETTER 4 WAYS

PRECISION Tested step by step from raw material to finished product. Accuracy guaranteed to your specified tolerance.

UNIFORMITY Constancy of quality is maintained over entire production through continuous manufacturing controls.

DEPENDABILITY Interpret this factor in terms of your customers' satisfaction . . . Year after year of trouble-free performance. Our Hi-Q makes your product better.

MINIATURIZATION The smallest **BIG VALUE** components in the business make possible space saving factors which reduce your production costs . . . increase your profits.

Hi-Q

Electrical Reactance Corp.

FRANKLINVILLE, N. Y.

Plants: Franklinville, N. Y.—Jessup, Pa.—Myrtle Beach, S. C.
Sales Offices: New York, Philadelphia, Detroit, Chicago, Los Angeles

Beat *the* Heat

specify

"NOFLAME-COR"

the TELEVISION hookup wire

APPROVED
BY
UNDERWRITERS
LABORATORIES
AT

by



90°

CENTIGRADE _____ **600** VOLTS

Preferred more and more by particular manufacturers of television, F-M, quality radio and all exacting electronic equipment. Available in all sizes, solid and stranded; over 200 color combinations.

PRODUCTION ENGINEERS: Specify "NOFLAME-COR" for maximum output and minimum rejects. This is not an extruded plastic and therefore losses from "blobbing" under heat of soldering iron are avoided.

- ✓ Flame Resistant
- ✓ High Dielectric
- ✓ High Insulation Resistance
- ✓ Facilitates Positive Soldering
- ✓ Heat Resistant
- ✓ Easy Stripping

✓ Also unaffected by the heat of impregnation—
therefore, ideal for coil and transformer leads

RUBBER _____ 75°

PLASTIC _____ 80°

"NOFLAME-COR" _____ 90°

"made by engineers for engineers"

CORNISH WIRE COMPANY, Inc.

605 North Michigan Avenue,
Chicago 11

15 Park Row, New York 7, N. Y.

1237 Public Ledger Bldg.,
Philadelphia 6

MANUFACTURERS OF QUALITY WIRES AND CABLES FOR THE ELECTRICAL AND ELECTRONIC INDUSTRIES

2 new metal "Big Picture" tubes by Rauland!

AVAILABLE WITH NEW HIGH-CONTRAST LUXIDE SCREEN

Gives 60% greater contrast! Reduces glare! Gives sharper, easier-to-view pictures!

50% LIGHTER WEIGHT

Can be safely shipped installed in sets, reducing field installation costs.

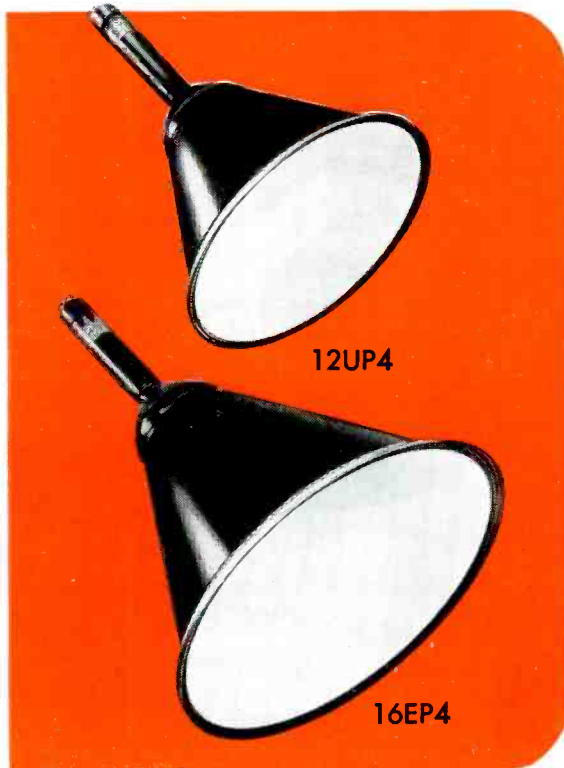

LARGER SCREEN

105 square inches useful screen area

LOWER PRICE

Lower bulb cost permits lower prices

BETTER FACE QUALITY

Optical quality of metal tube faces is superior to the pressed faces of all-glass tubes.

.....

SHORTER LENGTH

2 $\frac{5}{8}$ " shorter than the 16AP4

USES AVAILABLE OPERATING COMPONENTS

Same focus and deflection coils as used with the 16AP4

ALLOWS IMPROVED CABINET DESIGN AND LOWER CABINET COST

Because of reduced cabinet depth requirement

Other Available Types—10BP4, 10FP4, 12LP4, 12KP4, 16AP4

WRITE FOR TECHNICAL BULLETINS

"Perfection through Research"

THE **Rauland** CORPORATION

4245 N. Knox Avenue • Chicago 41, Illinois

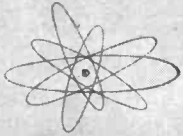

Designers

Now..higher voltage
 from
GENERAL ELECTRIC
SELENIUM STACKS

using new 18-volt (D-C) cells



New process for depositing selenium gives rectifier stacks greater uniformity, higher efficiency and longer useful life.

Here's real news for rectifier users. G.E.'s new 18-volt selenium cells, made by a special evaporation process which deposits selenium on the aluminum base with greater uniformity than otherwise possible, give you these advantages:

GREATER OUTPUT—With 50% more output than the standard 12-volt cells, the new design can be used for any application except those few which demand 24-hour, year-around service.

HIGHER EFFICIENCY—Not only is the initial efficiency higher, but more uniform coating keeps it high during the life of the stack.

SAVING IN SPACE—About one-quarter less space is required for the same output.

LOWER COST—Depending on the voltage across the stack, the 18-volt cells can save 25% in cost compared to standard 12-volt cells.

Selenium stacks are available in several standard sizes. Output in d-c voltage ranges from 18 to 126; applied a-c voltage, from 26 to 161. Bulletin GEA-5258 will give you detailed information. Send for it today!

STYLED FOR READABILITY
 BUILT FOR RELIABILITY

This brand-new line of 2½-inch thin panel instruments has streamlined features which will give your panels a "new look." Arc lines have been eliminated,

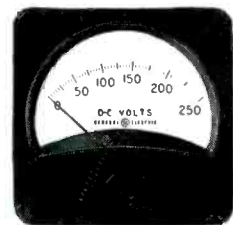

GENERAL  ELECTRIC

Digest

TIMELY HIGHLIGHTS ON G-E COMPONENTS

leaving only the upright scale divisions. New tapered pointer helps eye focus only on the reading. All but essential markings are masked by attractive case.

Internal mechanism is designed for extra reliability. High coercive Alnico magnet assures proper alignment, even under severe operating conditions. Large air gap reduces danger of stickiness caused by foreign particles. A variety of types and ratings in round or square cases are available for use in radio, television or testing equipment. Get complete details from Bulletin GEC-368.

DESIGNED FOR YOUR REQUIREMENTS

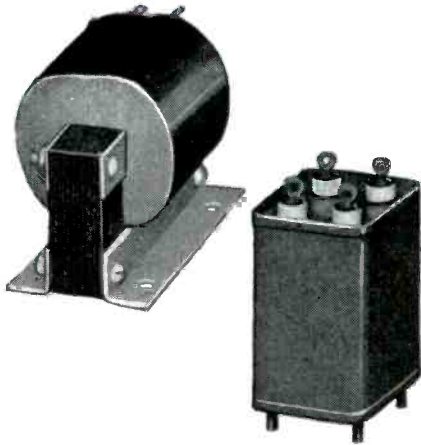

General Electric pulse transformers for radar and associated applications are designed to perform dependably in extremes of operating conditions. Many ratings in current production are of a special nature—designed to keep pace with rapidly changing requirements of the industry. However, for certain applications, they can be built to the specifications of electronic equipment manufacturers. Types available include interstage transformers, blocking oscillator transformers, charging chokes, current transformers, and pulse thyatron grid transformers. For a listing of available designs and ratings, send for bulletin GEC-481.

THEY'RE SMALL BUT THEY CAN TAKE IT

Cast-glass bushings with sealed-in nickel-steel hardware can be readily welded, soldered, or brazed directly to the apparatus, thus eliminating gaskets and providing a better seal. Small, compact structure often makes possible reduction of over-all size and weight of equipment. Practically unaffected by weathering, micro-organisms, and thermal shock, they're particularly well suited for use in electronic equipment and in installations where operating conditions are severe. Available in ratings up to 8.6 kv and for currents to 1200 amperes. Check Bul. GEA-5093.

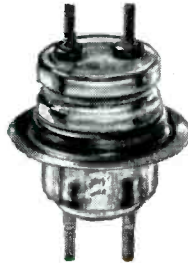

RELY ON THESE FOR STABILITY

Fixed paper-dielectric capacitors are manufactured in accordance with joint Army-Navy specification JAN-C-25. They're constructed with thin Kraft paper, oil or Pyranol* impregnated, for stable characteristics and high dielectric strength. Plates are aluminum foil; special bushing construction provides for short internal leads, prevents possible grounds and short circuits. Cases have permanent hermetic seal.

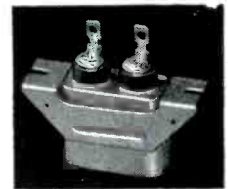

Case style CP 63 (shown above) is rated 0.1–0.1 muf and 1000 volts. Other ratings range from .01 muf to 15 muf and from 100 to 12,500 volts. Write for detailed description and operating data in bulletin GEA-4357A. *Reg. U.S. Pat. Off.

DOES A BIG JOB IN CLOSE QUARTERS

G.E.'s midget soldering iron can do a big job with only one-fourth the wattage usually used. This handy 6-volt, 25-watt iron is only 8 inches long with 1/8" or 1/4" tips and weighs but 1 3/4 ounces. Designed for close-quarter, pinpoint precision soldering, the "midget" offers you all these advantages: low cost soldering; "finger-tip" operation; quick, continuous heat; easy renewal; long life; low maintenance. A real aid in designing radios, instruments, meters, electric appliances, and many other products requiring precision soldering. Available from stock. Check bulletin GEA-4519.

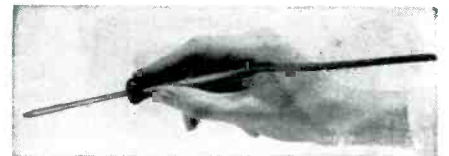

General Electric Company, Section J667-2
Apparatus Department, Schenectady, N. Y.

Please send me the following bulletins:

- GEA-4357A D-C Capacitors GEC-481 Pulse Transformers
 GEA-4519 Midget Soldering Iron
 GEA-5093 Glass Bushings
 GEA-5258 Selenium Stacks
 GEC-368 Panel Instruments

NAME

COMPANY

ADDRESS

CITY STATE

Standardize on Dependability

AUTOMATIC  ELECTRIC

CHICAGO

RELAYS

In Automatic Electric's complete line of relays, there are over forty basic types—offering spring and coil combinations in almost infinite number. They are dependable and proved products of an organization that has made electrical remote control its business for more than fifty years.

New Class "B" Relays

The newest and most outstanding member of Automatic Electric's relay family is the Class "B"—even better than the widely used, *widely copied* Class "A" Relay. Designed for ordinary relay service—opening, closing or switching circuits—and for extremely high-speed operation. Independently operating twin contacts assure perfect contact operation. Contact points are dome-shaped to maintain uniformly low contact resistance. May be arranged in one or two pileups with maximum of 16 contacts on 13 springs in each pile.

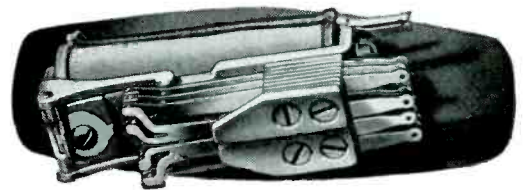

Hermetic Sealing Available To Maintain Automatic Electric Quality

All Automatic Electric Relays can be obtained in hermetically sealed housings to maintain the high quality for which these relays are famed. The "sealed-in" controlled atmosphere protects them from electrical or mechanical failure resulting from varying conditions of temperature, dust, humidity, acid, fungus or air pressure—and makes them completely tamper-proof.

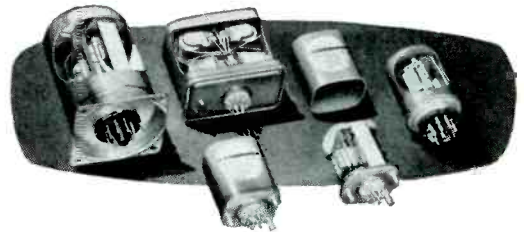

SWITCHES

Automatic Electric Stepping Switches are designed and built to assure exceptionally long life. A complete range of Automatic Electric Switches is available for all remote control applications.

The New Type 45 Switch

Here, for example, is a rotary switch that's new and better! *Faster* . . . 70 steps a second. *Greater capacity* . . . up to 10 (or more) 25-point bank levels, with single-ended wipers available for 50-point operation. *Simpler* . . . only one field adjustment.

Compact rotary and re-set type switches are also available with 10-point bank levels and speeds of 35 steps a second for automatic or remote-control operations.

And there's the famous "Two-Motion Switch" that selects one circuit from among two hundred in just 2 seconds or less. It's a re-set type switch adaptable to either automatic or remote control.

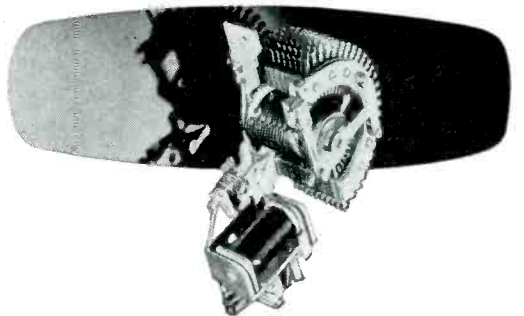

For help in the field of remote control, call in an Automatic Electric field engineer. Meanwhile, send for helpful literature. Address AUTOMATIC ELECTRIC SALES CORPORATION, Chicago 7, Ill. In Canada: Automatic Electric (Canada) Ltd., Toronto.

RELAYS

SWITCHES

AUTOMATIC  ELECTRIC

CHICAGO

NEWEST LAB

FURNACE!

HEAT-POWERED WITH NICHROME*V

New Model 051 Hevi Duty Muffle Furnace

Standard for use on 115 v. or 230 v., 50 to 60 cycles, A.C. Input: 1150 watts. Maximum operating temperature: 1850°F. 36-step control down to approximately 900°F. Heating elements: 22 gauge Nichrome V wire.

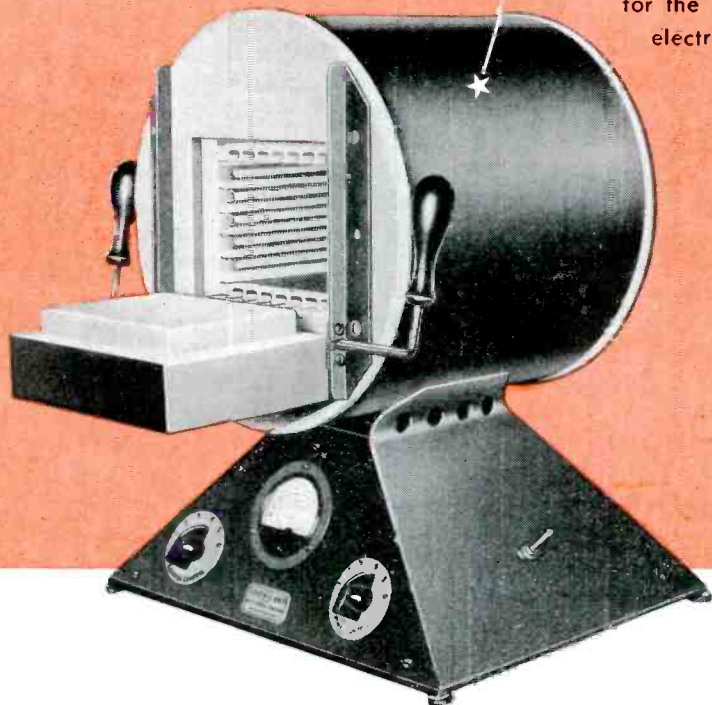

Hevi Duty Electric Company has introduced a revolutionary new development in laboratory furnace equipment—for requirements such as drying of precipitates, ash determinations, fusions, ignitions, heat treating, enameling and ceramic firing, and general laboratory work.

Housed in a cylindrical shell, the furnace is mounted with practically line contact on a base containing instruments and controls—a type of construction that permits the base to remain at almost room temperature, with instruments and controls easily accessible at all times.

Operating temperatures from 900°F. to 1850°F. are obtainable—precisely controlled by means of a manually operated 36-step, tap-changing transformer.

Outstanding characteristics of this new type furnace are rapid heating (about 85 minutes from cold to maximum temperature), and quick response to demand for temperature change.

To assure heating elements that will "stand the gaff" and give top-level performance under such punishing conditions, Hevi Duty Electric Company uses high heat- and corrosion-resistant Nichrome V.

The absolute uniformity of this superior alloy assures even heat distribution; its retention of physical and electrical properties at high temperatures, enables critical adjustments to be made and maintained; its resistance to thermal shock assures long life, completely dependable and economical service.

Whatever your electrical resistance problem, consult with us. In addition to world-famous Nichrome V and Nichrome, we make over 80 alloys for the electrical and electronic industries—the most complete line of electrical resistance alloys in the world.

Heating units, top and bottom, are interchangeable; likewise, the two side units. All units are easily replaceable and reversible (permitting the coiled Nichrome V wire to be exposed or muffled).

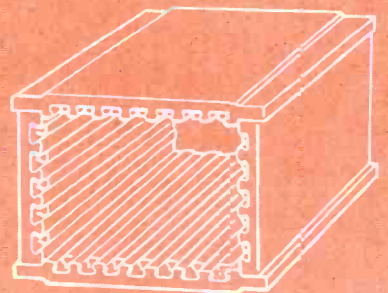

NOTE: Nichrome V elements are also used in standard model, industrial Hevi Duty furnaces designed for operation up to 2000° F.

*Nichrome is manufactured only by

Driver-Harris Company

HARRISON, NEW JERSEY

BRANCHES: Chicago, Detroit, Cleveland, Los Angeles, San Francisco, Seattle
Manufactured and sold in Canada by
The B. GREENING WIRE COMPANY, LTD., Hamilton, Ontario, Canada



*T. M. Reg. U. S. Pat. Off.

BUSINESS BRIEFS

By W. W. MacDONALD

You'll Get the **MOST FOR YOUR MONEY** by specifying **PYRAMID Capacitors**

WRITE FOR COMPLETE LITERATURE

Representatives and Distributors Throughout the U.S.A. and Canada

PYRAMID CAPACITORS

PYRAMID ELECTRIC COMPANY
155 Oxford Street
Paterson, N. J., U.S.A.
TELEGRAMS: WUX Paterson, N. J.
CABLE ADDRESS: Pyramidusa

We Should Be Able to interpret Citizens Radio Band regulations and answer in simple unequivocal language such inquiries as "Do I have to have approved equipment before applying for a license?" and "Is a converted BC-645 approved?" but we can't. Nor do we think local FCC offices can do it.

Because the Commission is overloaded with work, or because Citizens Radio regulations have not been worked out in detail, or both, the best advice we can give prospective applicants at the moment is to write to Washington and then keep writing until all necessary details are cleaned up.

Survey among 78 members of the Association of Electronic Parts and Equipment Manufacturers indicated the following prevailing terms of sale as of early this year:

| | Job-ber | In-dus-trial | For-eign |
|----------------------------|---------|--------------|----------|
| 2% 10th & 25th net 30 days | 15 | 12 | 1 |
| 2% 10 days net 30 days | 14 | 5 | 4 |
| 1% 10 days net 30 days | 11 | 16 | 5 |
| 1% 10th & 25th net 30 days | 11 | 12 | 3 |
| 2% 10th prox. | 10 | 1 | .. |
| Sight draft | 5 | .. | .. |
| Net 30 days | 4 | 6 | 4 |
| 1% 10th prox. | 2 | 2 | 1 |
| Net 10 days | 1 | 2 | 1 |
| C.O.D. | 1 | .. | .. |
| Cash in advance | 1 | .. | .. |
| 1/4% 10th prox. | .. | 1 | .. |
| 2% 15th & E.O.M. | .. | 1 | .. |
| Letter of credit | 1 | .. | .. |
| 5% 10th & 25th prox | 1 | .. | .. |
| 3% 10 days net 30 days | 1 | .. | .. |

Of the manufacturers reporting, 55 said they strictly enforced discount dates.

Tit-Tat-Toe Machine designed by Bob Haufe of Cal Tech exhibits a nice understanding of human nature. It lets its human opponent start the game. It beats him or draws every game, but is equipped with a switch that permits a really skilful player to win. And Bob has held the machine's speed down to five seconds per move so that the relative slowness of its opponent's mind is not made too obvious.

President LeBel of the Audio Engineering Society, speaking informally to the press at a party

held to give the society's Audio Fair (see p 136) a sendoff, made a very refreshing remark. He said that all exhibited audio apparatus would be in operation and that for him "it would have to sound right to be right, regardless of what any instruments said."

Latest Data compiled by NBC indicates that there were 2,010,000 television receivers in use in the country as of July 1, and almost 20 million families within a 40-mile radius of the 72 stations then on the air.

By Focussing attention on the living room as the center of family life and hospitality, television affords the furniture industry an opportunity to stimulate markets which can be made to yield millions of additional dollars worth of new and replacement furniture sales, thinks Joseph B. Elliott of RCA.

Two Months Ago We Said (p 60 August) that too many companies were counting on development contracts in general and government business in particular to support their still war-expanded facilities. Exception to the rule is a large West Coast plant that asks us to keep an eye open for promising electronic products they might manufacture, with particular emphasis upon sequence-control, industrial-control, measurements and industrial television apparatus.

Subscriber Bill Stewart of Philadelphia notes that picture i-f's of many television receivers are essentially the same, wonders why some components manufacturer doesn't put them out as a standard, pre-tuned package for sale to set makers.

Most Mail this column has received since its inception resulted from an item in June noting that we knew a man who had developed an electronic converter having

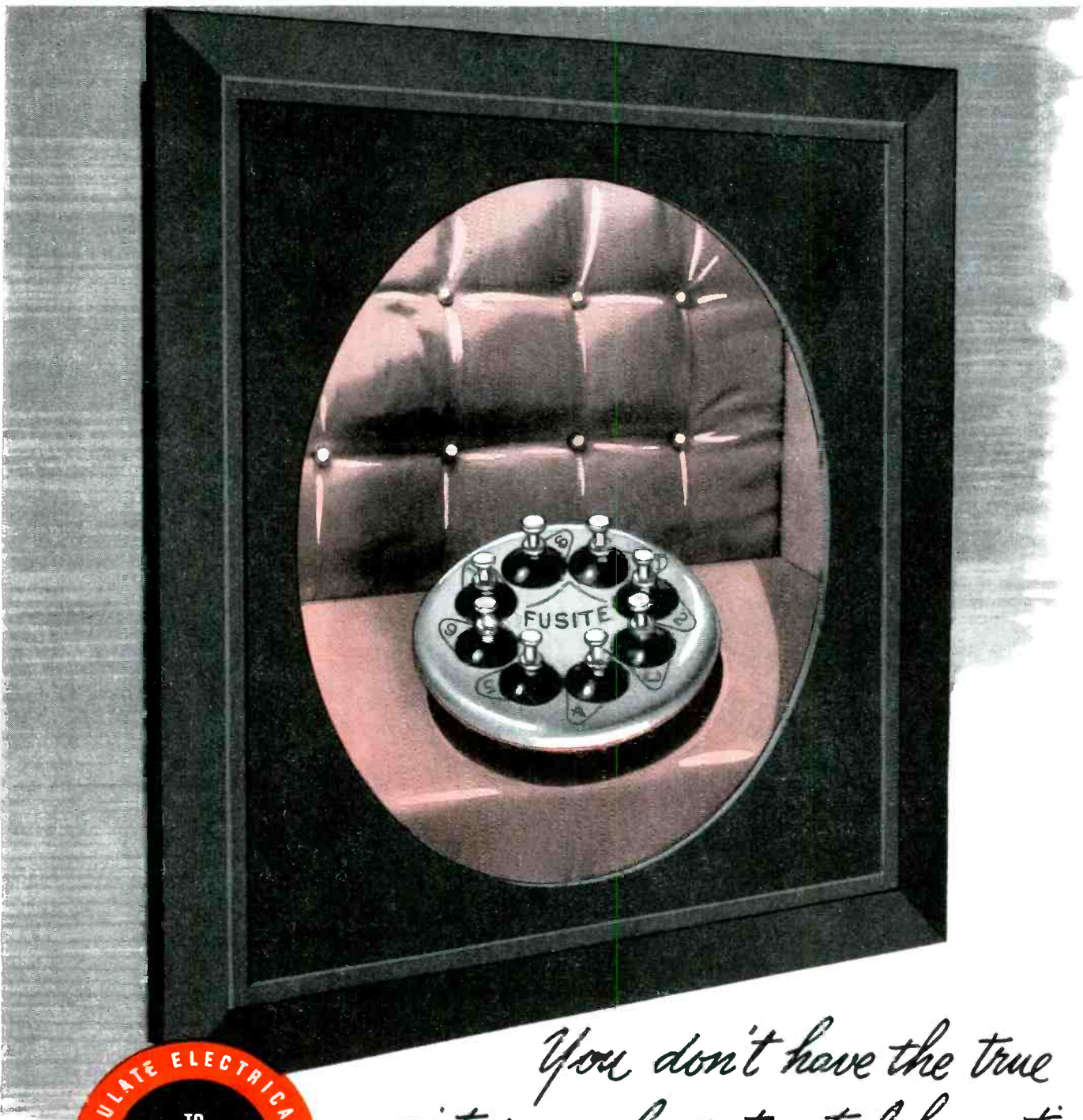

*You don't have the true picture on glass-to-steel hermetic terminals unless you've tried **Fusite!***

TERMINAL ILLUSTRATED: 908TH
Typical of turret head series. Available in 2 to 9 electrodes.
Numbering identification standard feature.

THE FUSITE CORPORATION

CARTHAGE AT HANNAFORD, NORWOOD, CINCINNATI 12, OHIO

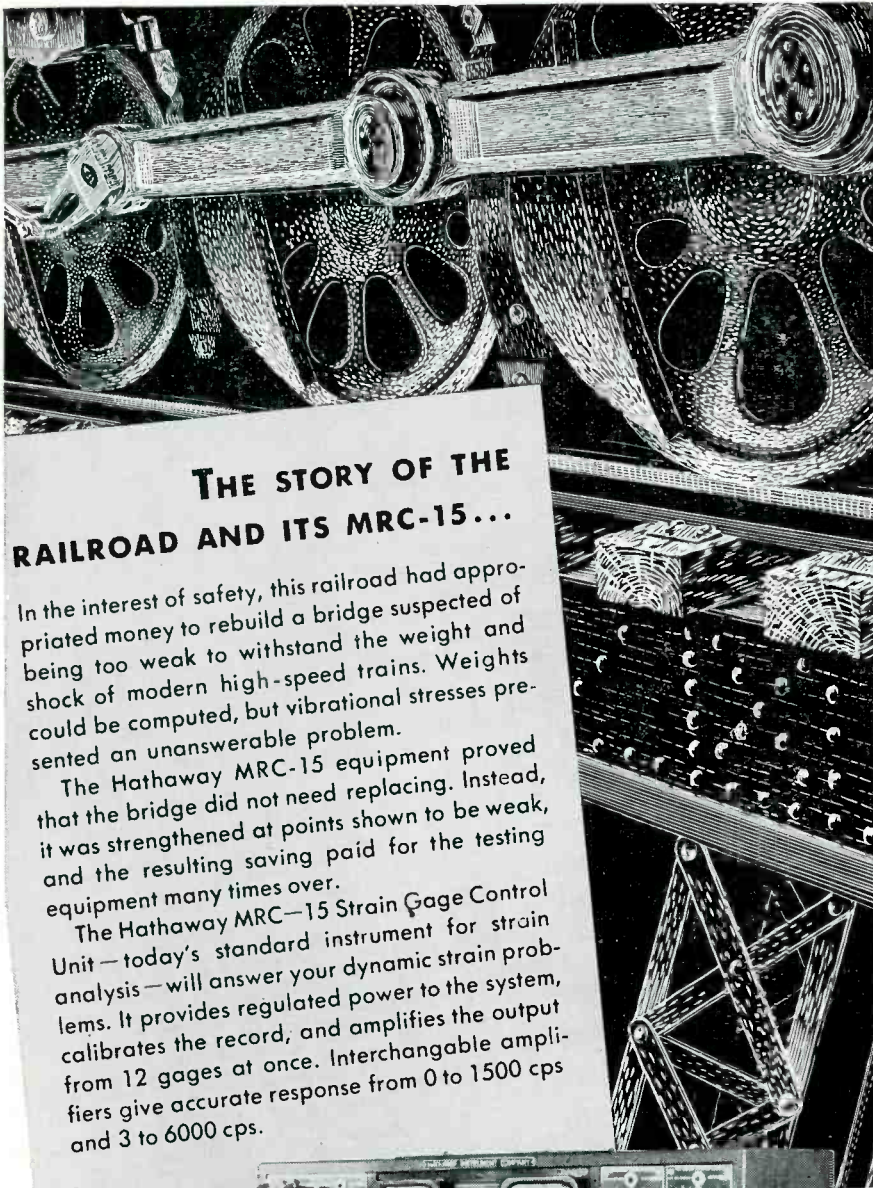

THE STORY OF THE RAILROAD AND ITS MRC-15...

In the interest of safety, this railroad had appropriated money to rebuild a bridge suspected of being too weak to withstand the weight and shock of modern high-speed trains. Weights could be computed, but vibrational stresses presented an unanswerable problem.

The Hathaway MRC-15 equipment proved that the bridge did not need replacing. Instead, it was strengthened at points shown to be weak, and the resulting saving paid for the testing equipment many times over.

The Hathaway MRC-15 Strain Gage Control Unit—today's standard instrument for strain analysis—will answer your dynamic strain problems. It provides regulated power to the system, calibrates the record, and amplifies the output from 12 gages at once. Interchangeable amplifiers give accurate response from 0 to 1500 cps and 3 to 6000 cps.

The Hathaway Type MRC-15 Strain Gage Control Unit

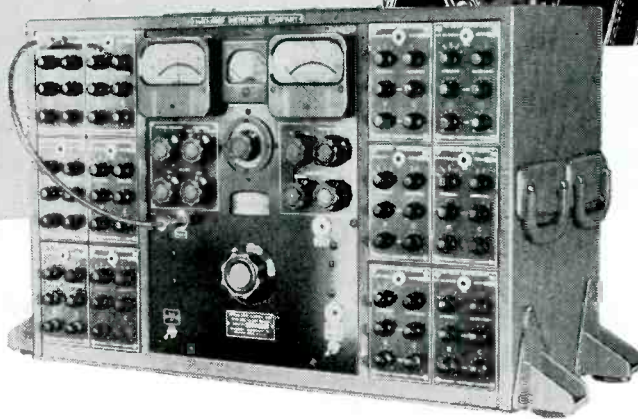

WRITE FOR TECHNICAL BULLETIN SP-195R

Hathaway
INSTRUMENT COMPANY
1315 SO. CLARKSON STREET • DENVER 10, COLORADO

no moving parts and useful as a power source for such things as aircraft, mobile and portable radios. Scads of manufacturers asked to be placed in touch with him, and we relayed their requests along.

Association of American Railroads reports the following percentage increases in radio-station authorizations from May 1948 to May 1949:

| | |
|-------------------------------------|------|
| Train (base) | 184% |
| Train (mobile) | 94 |
| Yard, terminal and utility (base) | 47 |
| Yard, terminal and utility (mobile) | 78 |

In the same period inductive-carrier equipment installations by railroads increased:

| | |
|-------------------------|------|
| Train (base) | 2.8% |
| Train (mobile) | 23.6 |
| Yard, terminal (base) | 4.8 |
| Yard, terminal (mobile) | 12.5 |

Exhibiting Our Ignorance concerning double-entry bookkeeping, we are always intrigued by the nice balance of assets and liabilities in reports to stockholders that come across our desk. Take one totalling \$28,824,677 for example. We find patents and trademarks listed under assets at \$3 and can't for the life of us see where its balancing counterpart is fitted in on the liabilities side of the ledger. Also, we wonder what the patents and trademarks are that are worth only \$3.

Marine Radar is used by about 187 ships operating on the Great Lakes. Most of them are ore carriers. The Lakes have about 266 ore carriers and 334 bulk carriers.

Quote: "In 20 years your radio cabinet will be as obsolete as a wood-burning cook-stove" says Howard C. Hardy of Illinois Tech. You won't have to wait that long, judging from some of them we have seen for the past 20.

Dr. Hardy thinks most radio equipment will be built into walls of homes in the future. We don't.

Reading Our Own Ads, we notice that:

Many manufacturers are selling their engineering service just as hard as their products.

Technical bulletins and/or sam-

ples are offered by a preponderance of advertisers.

Random-noise-source instruments are being made by more and more companies (imagine paying for noise in the old days!).

Toroids seem to be experiencing a renaissance.

Screws now come like bullets on a machine-gun belt, and soldering lugs are available in continuous strips.

Transformer makers now offer types for communications, for industrial applications and a third, rock-bottom-price variety for amateur and similar use.

It took us, incidentally, just three hours to read quickly through the September ads. And it was worth it in product-knowledge that was gained.

1950 Census questionnaires have already been drawn up and funds for tabulation allocated. So it will not be easy to throw in an additional question at this late date. We have it on good authority, however, that the number of television receivers in use in the country, as well as the number of radios, will be checked if the Bureau can swing the extra work within its budget.

Television Designers have done an effective job of getting receiver prices down without sacrificing picture quality. They have, however, permitted the sound quality to drop off and we are receiving reports from the field that the public is aware of it. Newsstand radio magazines are beginning to run articles telling owners of sets how to improve tv-set audio response.

Nostalgic Note: Editor Fink spent his vacation with the Henney's in New Hampshire, the writer sailed a sloop to Block Island, Markus went home to Minn-e-sota, Zeluff went to Bermuda to duck the heat, McKenzie broke ground for a summer shack in the White Mountains, O'Brien worried the crabs on the south shore of Long Island and Fahnestock took in the Cleveland Air Races.

SIGMA SENSITIVE RELAYS AS POWER AMPLIFIERS

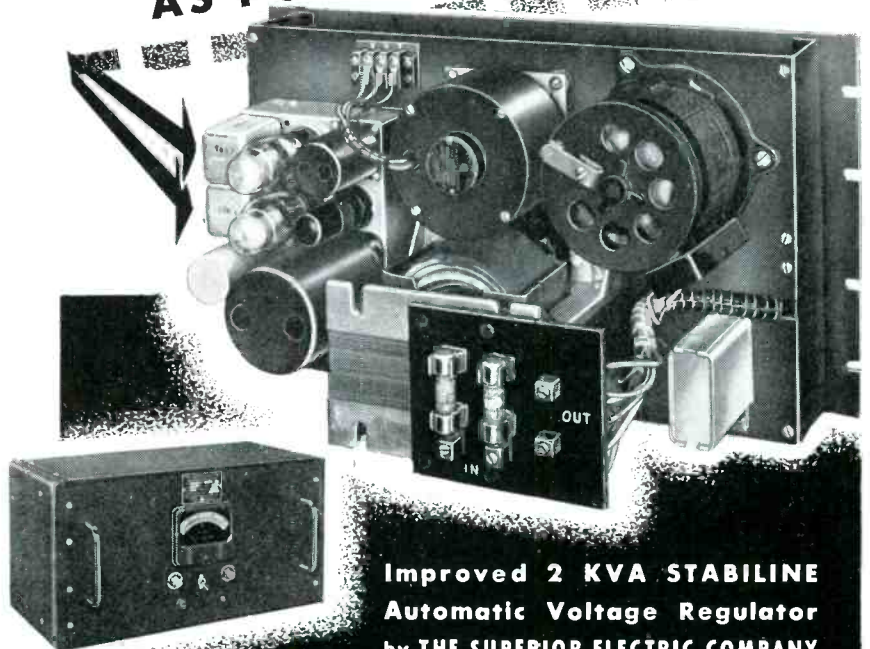

**Improved 2 KVA STABILINE
Automatic Voltage Regulator
by THE SUPERIOR ELECTRIC COMPANY
BRISTOL, CONNECTICUT**

In this compact regulated A.C. supply an electronic circuit monitors the output voltage and makes corrections by motor control of a variable autotransformer. It has the advantages of relative simplicity, zero waveform distortion, and response time fast enough for most purposes.

Assisting in achievement of fast response is the high power gain supplied between the electronic circuit and the motor by means of two fast, long life SIGMA relays, adaptations of the standard type 41R.

Within certain limitations of frequency response, the use of relays as amplifiers or power modulators gives tremendous gain, and performance otherwise achievable only with much more expensive and high powered electronic components.

Two-way positioning may be achieved, as in this equipment, by a pair of fast single pole relays, one in each plate circuit of a push pull output stage. SIGMA Type 41 relays are excellent in this service. Where variation in the total plate current of the push pull stage cannot be controlled, the relay stage must respond only to differential plate current. Here a 3 position or null seeking differential relay is usually necessary.

Two such types are made by SIGMA. Both are polarized, both have positive detent centering. Series 6 operates at sensitivities from 5 to 100 milliwatts differential power, switching up to 4 poles. Series 7, faster and more sensitive, is single pole and operates in the range of 2 to 10 milliwatts differential power.

See more complete description of these relays given in bulletins available on request.



Sigma Instruments, Inc.
Sensitive RELAYS

62 CEYLON ST., BOSTON 21, MASS.

The Spotlight's On

P. R. MALLORY & CO. Inc. MALLORY Midgetrol

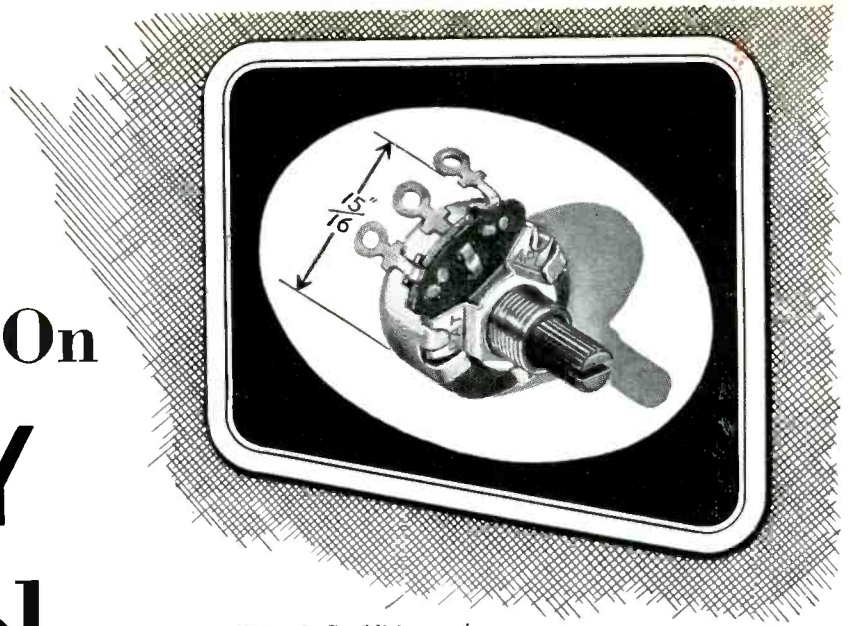

*The little BIG addition to the
Mallory Line of Television Controls.*

Mallory has done it again. Here is an all-new, revolutionary control that is perfect for television application. Only $\frac{15}{16}$ " in diameter, it is Mallory's answer to the designer's cry for smaller and smaller controls.

Don't be deceived by its compact size. It's all Mallory through and through. For instance: Shaft is completely insulated from chassis. Good for higher voltage applications—can't get a shock. The insulated shaft is knurled for easy adjustment—has screw-driver slot for back panel applications. Thoroughly tested, the Mallory Midgetrol has come through with flying colors for television applications.

The Mallory Midgetrol is typical of Mallory superiority in controls. Today, Mallory has a control, carbon or wire-wound, required for any specific usage, for every television application.

The dependability of today's television receivers which is responsible for the great public demand has as one of its bases the precision performance built into Mallory controls by special skills, long experience and devotion to quality ideals.

And with all this superiority, Mallory offers service—quick delivery for both standard and special applications—and low price.

**MALLORY CONTROLS
FOR
TELEVISION APPLICATION**

1. For volume
2. For focusing
3. For height of picture
4. For linearity
5. For centering picture on tube, horizontal or vertical
6. For contrast or brightness
7. For horizontal and vertical "hold" controls
8. For audio tone control

***You Expect More
And Get More
From Mallory***

Precision Electronic Parts—Switches, Controls, Resistors

**P. R. MALLORY & CO. Inc.
MALLORY**

P. R. MALLORY & CO., Inc., INDIANAPOLIS 6, INDIANA

SERVING INDUSTRY WITH

| | |
|------------------------------|------------|
| Capacitors | Rectifiers |
| Contacts | Switches |
| Controls | Vibrators |
| Power Supplies | |
| Resistance Welding Materials | |



CROSS TALK

McGRAW-HILL PUBLICATIONS

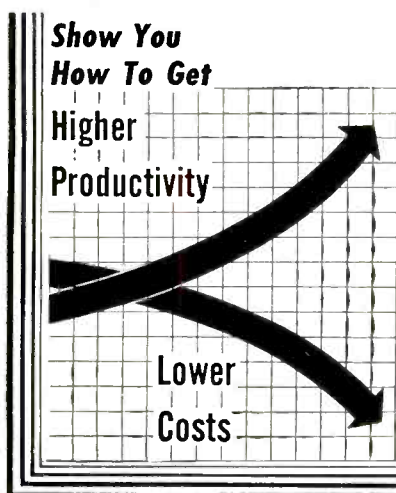

► **CAMPAIGN** . . . It is always gratifying when the parent takes up the cudgel where the child has fought. We speak of our parent, the McGraw-Hill Publishing Company, which is undertaking in some thirty publications a campaign to promote techniques for keeping production costs down while maintaining and improving the quality and quantity of the product. This is the vineyard in which *ELECTRONICS* has been laboring for nigh unto twenty years.

This magazine has published more than 15,000 pages of editorial material since 1930, nearly 4,000 of which have dealt with industrial applications of vacuum tubes to process controls, automatic measurements, and protection of property and personnel. In this issue we present 16 more pages, two articles dealing with plans for

process control, and costs in radio receiver manufacture.

Our participation in the higher-productivity, lower-cost campaign involves no fanfare. But we can hardly fail to underscore its importance. If our half of the world doesn't adopt techniques to get costs down and push productivity up, we shall surely run into a stone wall, as the other half of the world so freely predicts.

► **STANDARD I-F** . . . JTAC, in a report made to the FCC August 26th, recommends that the Commission arrange for the adoption of standard television intermediate frequencies (41.25 and 45.75 mc for sound and picture respectively). Time was when the radio manufacturing industry would have screamed that receiver design was no part of the government's responsibility; and the FCC would have agreed. But the climate seems to have changed. The problems of the tv spectrum and the control of oscillation radiation interference loom so large that government-coordinated standardization is actively sought by a joint committee of the RMA and the IRE. Coordination between channel allocations and receiver design has always been a good idea. But the legal foundation for enforcement has been lacking, or so the lawyer said. We hope the Commission will accept the responsibility and that the industry will cooperate wholeheartedly.

► **PICKUP** . . . Readers will recall that the FCC has set up a channel centering on 27.12 mc for the exclusive use of medical diathermy and similar electronic heating equipment. The rules pertaining to this allocation provide that any interference caused by such equipment to authorized radio services shall be remedied forthwith. Subsequent to the making of this rule it was realized that the picture i-f passband of the majority of television receivers includes or borders on the 27.12-mc frequency. Moreover, it was soon found that most tv receivers of current design display an alarming susceptibility to direct pickup of interference at intermediate frequencies. The question then arose whether diathermy and other heating-equipment manufacturers were required to ameliorate such interference. We are happy to report that the FCC proposes no such thing. The Commission proposes, in fact, to exempt the diathermy equipment manufacturers from such responsibility, when the interference is caused by direct i-f pickup. This puts the shoe on the foot of the tv designer, where it belongs. There are plenty of forms of interference from which the television service must be protected by regulation, but direct i-f pickup is surely not one of them. The cure lies in proper shielding of i-f components. The alternative is to shut down all radio transmissions of substantial power in the range from 20 to 30 mc.

RAILROAD TRACK



Rail flaw detector car inspects track at a rate of about 12 mph. Detector coils and current-carrying brushes are mounted on rear carriage

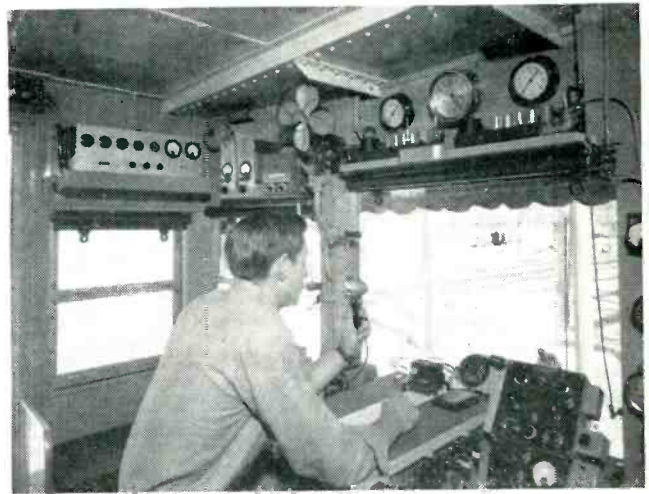

Operator, sitting at rear of car, directs engineer by means of intercom system. Operators work in one-hour shifts to avoid fatigue

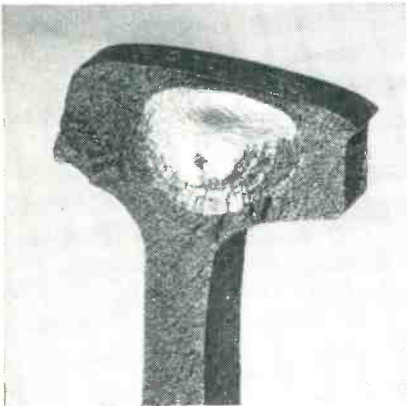

Transverse rail fracture of the type which is now prevented by early detection

By **ROBERT D. WALKER, Jr.**

*Sperry Rail Service Division
Sperry Products, Inc.
Danbury, Connecticut*

ELIMINATION of accidents caused by shortcomings of track construction or upkeep depends largely on the operating railroad's ability to locate rails which have become potentially unsafe through the development of internal fissures. Known to metallurgists as submolecular disintegration within the steel, these fissures are attributed to fatigue failure of the steel forming the head of the rail.

The transverse fissure, potentially the most dangerous of the various types of defects, generally grows slowly in a plane normal to the length of the rail and spreads outward from a nucleus until it attains

a size sufficient to weaken the effective strength of the rail and cause complete rupture. The rate of growth of such defects is unpredictable. Large or small, a transverse fissure is always a potential danger since it may grow suddenly to a size which will cause the rail to break under load as easily as a brittle iron casting.

Detection Methods

Years ago railroads relied upon track-walkers to inspect the track visually for signs of defective rails. This method was successful in detecting some of the defects which had grown large enough to break through the surface of the rail, or to cause an external deformation of the rail head. It was completely useless in the detection of defects which were wholly internal.

In 1911 the United States Bureau of Standards conducted a series of experiments culminating in the development of the magnetic system of rail testing. The principle appeared to be sound in theory and was successful in laboratory tests, but in actual trials on track it was found that the equipment was unable to differentiate between dangerous true defects and the strains caused by slipping locomotive wheels, surface irregularities, cold working by car wheels, and residual magnetic spots.

An electric contact method was tried but soon abandoned when it was found that rust, dirt or surface irregularities on the running surface of the rail prevented good contact and resulted in more false than true indications.

The method developed by E. A. Sperry proved to be the solution to the problem. The testing car passes a heavy low-voltage current through the rail, thereby setting up a strong magnetic field around the head of the rail. A series of searching coils suspended at a constant distance above the head of the rail detects any deflection or variation in the magnetic field caused by the presence of fissures within the railhead. A defect in the rail deflects the current in the rail head at the location of the defect and thus causes a corresponding distortion of the magnetic field at the defect. When the searching coils are passed through the distorted magnetic field, a voltage is induced within them. This voltage is used to actuate the indicating components of the detection equipment aboard the car.

Detector Details

Since the detector car tests both rails of the track simultaneously, it is necessary to have two complete sets of testing equipment on each car, one for each rail of the track. The main rail current system con-

INSPECTION CAR



Testing rail by hand with more sensitive equipment. A paint spot near the operator's hand marks a flaw detected by the moving car

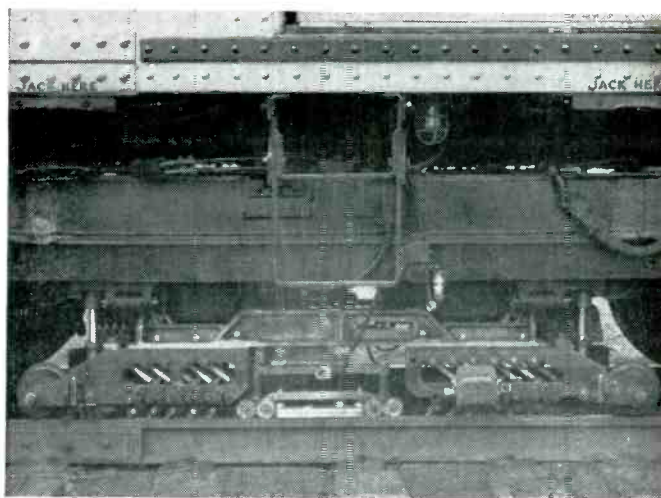

Closeup view of rail flaw-detecting system, showing pick-up coil assembly at center and brushes contacting rail on each side

Self-propelled mobile laboratory permits nondestructive inspection of railroad tracks. Special generator passes large currents through rails, and search coils detect internal flaws which are accompanied by nonuniformities in the magnetic field surrounding the railhead

sists of a homopolar generator with a rated output of 8,000 amperes at 1.8 volts, to provide non-fluctuating direct current, the associated controls, and the main brush carriages.

The output of the generator is introduced to the rail through a cluster of alloy brushes at the rear end of the main brush carriage. The current flows forward to the brushes at the front end of the carriage to complete the circuit. In this manner a strong, constant magnetic field is set up around the portion of the rail between the front and the rear brush clusters of the main brush carriage. The strength of the field can be adjusted by the operator through rheostats wired in series with the field windings of the homopolar generator.

The searching unit, containing a number of variously wound and spaced pairs of coils, is suspended in a constant-position carriage midway between the front and rear brush clusters of the brush carriage. In this position it is moving through a magnetic field of constant strength and is not affected by variations in the transmission of

current from the brushes to the railhead. Each of the various sets of coils consists of a pair of coils wound with opposing outputs. This arrangement prevents the generation of a signal due to fluctuations in the rail current which affect the entire field around the rail. The spacing of each pair is such that a local variation in field strength due to a defect will affect each coil of the pair unequally and thus generate the signal needed for indication.

A pre-energizing current, supplied by a twin generator, is passed into the rail, prior to the passage of the searching unit, through the forward brushes of the main brush carriage and through the brushes of the pre-energizing brush carriage which is mounted on the rear end of the drive truck of the car. The function of this current is to provide improved detection by better energizing of the rail.

The signal amplifiers are designed to respond to the unusual characteristic signal generated in the presence of a rail defect. They incorporate several novel features such as resonant circuit elements

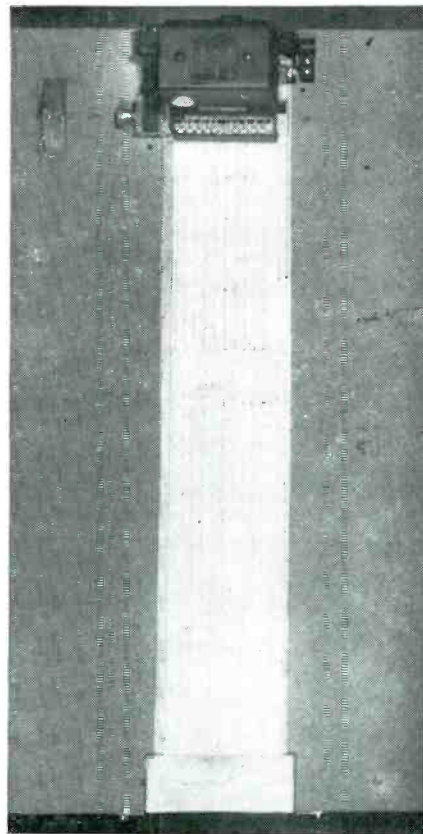

Tape printer and puller are mounted so the tape moves across the table toward the inspecting operator

which serve to peak the signal for maximum defect detection efficiency, high inherent stability to maintain critical calibration, and unusual interlocking connections with other equipment to present immediate tape and meter indications of any malfunctioning equipment. The power supply for the amplifier is regulated to prevent any serious drift which might occur between calibration periods.

Indicating System

The output of each amplifier controls the action of one or more pens at the pen unit, plus one paint-gun relay. A defect in the rail will cause the appropriate recording pen to deflect momentarily from the normal line on the recording tape. Simultaneously the paint gun will fire a spot of paint onto the rail web at the precise location of the defect.

The magnitude of the signal induced in the searching unit coils is proportional to the size of the causative defect. In order to control the minimum size of the defect detected, the sensitivity of each amplification channel is adjusted so that it will react only to signals above a predetermined level. To maintain the amplifiers at the proper sensitivity level, a signal-generator calibrator is employed. By switching this calibrator into the lines leading from each searching unit channel and sending a standard signal to the amplifier channel, the unit can be calibrated to the desired value. This value, which is based on

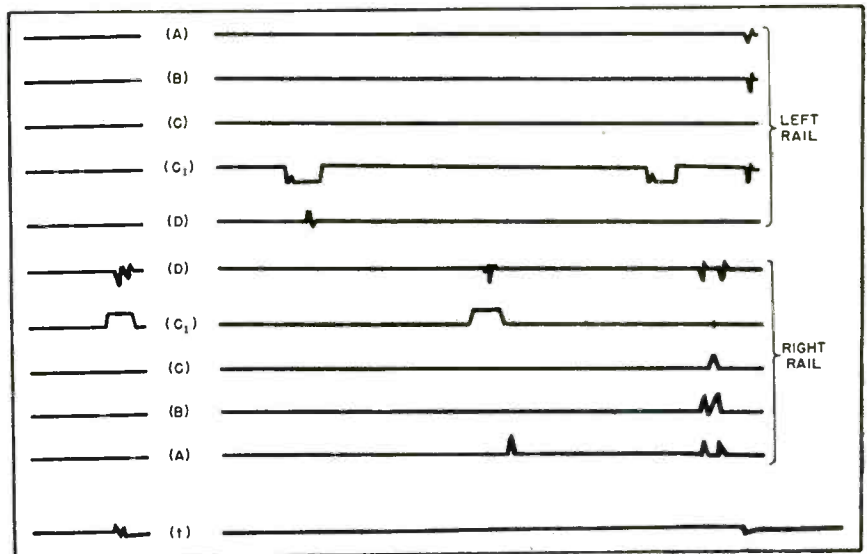

Double pips on A and B (right rail) of the recording tape indicate a rail flaw. The channels are: A, coil on field side of rail; B, coil on gage side of rail; C, center of rail; C₁, insensitive range for C coils for extra large flaws; D, rail burns and transverse defects; and t showing five-second timing intervals and landmarks which are recorded by pressing a button at the operating position. Actual tape is 3¼ inches wide

percent size of the minimum defects to be detected, will vary with different weights and types of rail.

The record drawn on the tape by the recording pens is not in itself sufficient for complete determination of the type and size of the defect. The operator may verify a defect by identifying the characteristic deformation or discoloration of the railhead. If the visual examination does not permit classification of the defect, a hand test is made.

In hand testing, the running surface of the rail is thoroughly cleaned with abrasives and a heavy current passed through the suspect length of rail. A hand contactor

consisting of two spaced metal contacts connected to a sensitive millivoltmeter is then slid along the rail. If a defect exists, when the two contacts are spanning the defect, it will be visually indicated by a measurement of potential drop on the millivoltmeter. In the case of transverse defects, the potential drop is a measure of the area size of the separation within the rail.

Car Details

The detector cars operated by Sperry Rail Service are self-propelled, utilizing a gasoline-electric drive system.

Complete living quarters are supplied for the operating crew. A bedroom contains four bunks with adequate storage space for clothing and personal effects. A complete dining salon, with a separate galley, is used for meals and for after hour recreation. A steward is employed on each car for cooking and maintenance of the living quarters.

A fleet of twenty detector cars tests almost 200,000 track miles annually (at a rate of about 12 mph), this mileage including the majority of the main line trackage in the country. Track submitted to exceptionally heavy service may be tested as often as six times yearly in order to make fully certain that no transverse defect is given a chance to grow to dangerous size before detection and removal of the rail.

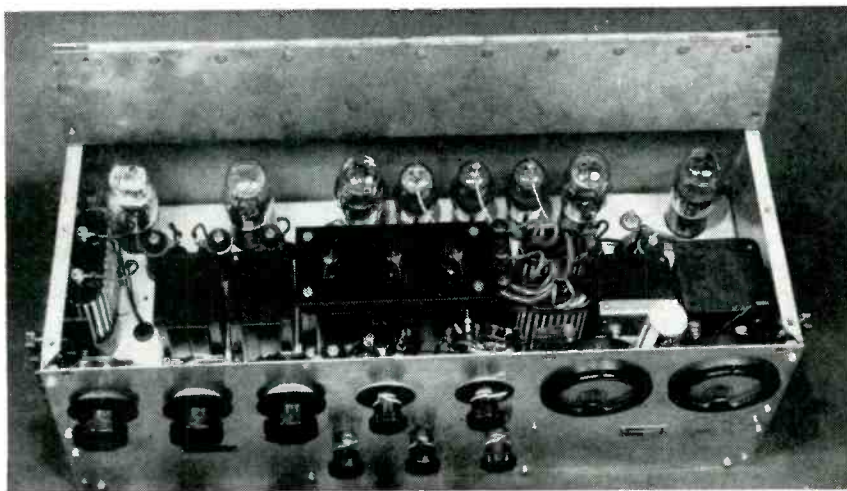

Three-channel amplifier of the type used in the flaw detector car for amplifying the signals picked up by the search coils so they may be used to actuate recording pen and paint-gun relays

Progress Toward INTERNATIONAL TV STANDARDS

First meeting of Eleventh Study Group of C.C.I.R. at Zurich comes to agreement on aspect ratio, interlace, and power frequency independence. Nations favoring 405, 525 and 625 lines agree to conduct further study looking toward eventual regional or worldwide standards

TO EXPLORE the possibility of international agreement on television standards, representatives of 11 nations met in Zurich, Switzerland, July 4th to 14th, 1949. The conference was called by the International Radio Consultative Committee following instructions issued by the C.C.I.R. at Stockholm last year.

A Study Group (number 11 in the C.C.I.R. roster) was set up and requested to formulate recommendations on standards which might be acted upon by the C.C.I.R. Plenary Session scheduled to meet in Prague in 1951. The study was instituted by Dr. Balthasar van der Pol, Director of the C.C.I.R., who sent a questionnaire to all the nations and organizations connected with the C.C.I.R. This questionnaire asked that preferences be stated on nine points:

(1) *Should standards be agreed upon regionally or on a worldwide basis.*

(2) *Should a television system operate independently of the frequency of the power system.*

(3) *The optimum number of frames per second.*

(4) *Optimum number of lines per frame.*

(5) *The aspect ratio.*

(6) *Interlace and interlace ratio.*

(7) *Positive or negative modulation.*

By DONALD G. FINK

Editor, ELECTRONICS; Technical Adviser to U. S. Delegation, C. C. I. R. Television Study Conference

(8) *Horizontal or vertical polarization, and*

(9) *F-M or a-m for sound transmission.*

The answers to these questions, as of the conclusion of the conference, are given in Table I.

Agreements Reached

As Table I shows, substantially unanimous agreement was reached on three points. In the first place, the aspect ratio (question 5) was adopted as 4 units horizontally to 3 units vertically. This conforms to the U.S.A. standard. At present the British standard is 5 by 4 units, but the BBC plans to change to the 4 by 3 ratio in the near future. The basis of the choice was the fact that the aspect ratio of commercial 35-mm and 16-mm films is very close to the 4 by 3 value.

The second agreement was on interlacing (question 6). It was agreed that interlacing should be adopted, using the 2-to-1 odd-line method.

The third point of agreement was on the independence of vertical scanning and the power-system frequency (question 2). When the conference opened, the vote was 6 in favor of independent operation

to 5 against it. At the conclusion of the meeting the vote had changed to 12 to 1 in favor of the independent method. This change of opinion represented one of the important accomplishments of the meeting.

Most television stations operate with the vertical synchronizing pulses rigidly synchronized with the a-c power source to which the station is connected. This is done to minimize the effect of a-c hum in the filament and B-supply voltages within the transmitter and to permit motion-picture projectors to be synchronized simply with the scanning process. Similar advantages accrue at the receiver, provided the power system supplying the receiver is rigidly tied in with that supplying the transmitter. But if the two power systems are not tied together, stray fields and hum components in the system make themselves evident as geometric or tonal distortions in the received image.

In voting affirmatively on question 2, the conference put itself on record that transmitters and receivers should be so designed that distortions would not be evident, whether or not the two power systems were synchronized. Two reasons lay behind this decision. First, it was recognized that the power system of various countries would not usually be interconnected. Thus

the interchange of programs between nations would be facilitated by the independent type of operation. Moreover, power systems serving different cities in the same country are often not connected and the advantage in such countries would apply to domestic as well as to international programs.

In the second place, independence of the vertical scanning frequency from the power-system frequency would permit changes in the vertical scanning rate to be made at some future date, should such a change be desired. The European nations favor a vertical scanning rate of 50 fields per second as against the American value of 60. These nations argue that this value is high enough to avoid flicker and allows additional horizontal resolu-

tion for a given bandwidth. The American delegation pointed out that the 60-field rate allows the received picture to be 5 to 10 times as bright, without visible flicker, and that this additional brightness might be demanded by the public at a future date. If this demand should arise, the scanning rate might be changed, provided only that the scanning system were set up, initially, independent of the power-system frequency. It was recognized that additional costs would be incurred in the independent method of operation, and studies of the costs of various methods were to be undertaken prior to the next meeting of the conference.

One further agreement was reached concerning the polarization

of the radiated waves. The conference decided that it was not necessary to standardize on this point.

Controversial Issues

No agreement was reached on the remaining items of the questionnaire.

In the final vote, negative modulation (question 7) was supported by 5 votes and positive by 3, the remaining nations showing no distinct preference. F-M sound was favored by 8 groups (question 9), against 2 for a-m. These two questions were actively discussed in relation to the intercarrier method of sound reception, which requires f-m for the sound and has thus far been used only with negative modulation. The British delegation pointed out that the intercarrier system could be used with positive modulation if the synchronizing pulses were prevented from reaching the zero-carrier level. It was stated that the sync pulses in the British transmissions do not, in fact, reach zero carrier. The British delegates stated they intended to experiment with the intercarrier system, using positive modulation, and would report the results at the next meeting of the Study Group.

The principal subject of controversy had to do with the scanning standards, that is, the number of lines per picture (question 4) and the number of frames and fields per second (question 3). Three camps of opinion appeared: the Americans favored the 525-line, 30-frame, 60-field values. The Anglo-French coalition supported 405 lines at 25 frames, 50 fields, for channels in the 41 to 68-mc band. The remaining nations constituted a 625-line bloc, favoring 625-line images at 25 frames, 50 fields.

The arguments behind these positions were as follows: The United States delegation stated that the 30-frame value was necessary, regardless of the power-system frequency, to allow picture brightness higher than 20 foot-lamberts without objectionable flicker, and that the six-megacycle channel is the optimum compromise between picture quality and spectrum economy. Finally, 525 is the proper number of lines for a 30-frame image and a 6-mc channel.

Table I—Summary of Answers to Questionnaire (July 14, 1949)

| Question (see text) | 1 ^a | 2 | 3 | 4 ^c | 5 | 6 | 7 | 8 | 9 |
|--------------------------|----------------|------------------|-------|---|----------------------------|------------|--|--|-----|
| Austria | — | — | — | — | — | yes 2/1 | negative if a-m sound positive if f-m sound | horizontal | f-m |
| Belgium | — | — | — | — | — | — | — | — | — |
| Czechoslovakia | — | yes | 25/50 | 625 | 4/3 | yes 2/1 | negative | horizontal | f-m |
| Denmark | — | yes | 25/50 | 625 | 4/3 | yes 2/1 | positive | — | f-m |
| France | — | yes ^d | 25/50 | 405 ^e and 819 | 4/3 | yes 2/1 | positive | horizontal but not important | a-m |
| Hungary | — | yes | 25/50 | 625 | not im- port- ant | yes 2/1 | negative | horizontal | f-m |
| Italy | — | yes | 25/50 | — | 4/3 | yes 2/1 | — | horizontal | f-m |
| Netherlands | — | yes | 25/50 | 625 | 4/3 | yes 2/1 | negative | vertical but not import- ant | f-m |
| Sweden | — | yes | 25/50 | 625 | 4/3 | yes 2/1 | — | — | — |
| Switzerland | — | yes | 25/50 | 625 | 4/3 | yes | — | — | — |
| United Kingdom | — | yes ^d | 25/50 | 405 ^e and 819 ^f | 4/3 | yes 2/1 | positive | vertical but not neces- sary to standardize | a-m |
| United States of America | — | yes ^d | 30/60 | 525 ^b | 4/3 | yes 2/1 | negative | horizontal | f-m |
| Comp. Gen. de T. S. F. | — | no | 25/50 | 405 ^e and 819 | — | — | — | — | — |
| L. M. Ericsson | — | yes | 25/50 | 625 | 4/3 | yes 2/1 | — | — | — |
| R. C. A. | — | yes | 30/60 | 525 ^b | 4/3 | yes 2/1 | negative | horizontal | -m |

^a Deferred to a later meeting.

^b The figures 30 and 525 are compatible with 25 and 625 if question 2 is answered affirmatively.

^c 405 is intended for frequency band 41 to 68 mc, higher frequency bands to be used for 819 lines or for color.

^d Provided the price of receivers is not increased and the picture quality is not deteriorated in any case.

^e To avoid misunderstanding on the significance of the answers listed under question 4 it is necessary to point out that the number of lines only is not sufficient to define the quality of any television system. The number of picture elements, the bandwidth effectively used and the fidelity of transmission provided within this bandwidth should also be indicated.

^f It is to be noted that the band of frequencies from 174–216 mc is not available for broadcasting in the United Kingdom and there is no intention at present of starting a television service on 819 lines on these or higher frequencies.

The British position, to which the French agreed during the course of the meeting, was that 405 lines and 25 frames provided an adequate service and occupied a channel only 5 mc wide (using vestigial-sideband transmission, the standard in Great Britain for all new stations). The British government is committed to providing service on these standards for a number of years. Therefore, if neighboring European nations desire to exchange programs with Great Britain, they must necessarily employ the 405-line standard.

The other nations stated that they did not desire to start a new public service on as low a number of lines as 405. Moreover, they believed that the 30-frame rate of the U.S.A. system was unnecessarily high and that even if the system were divorced from the European 50-cps power rate the 25-frame rate should be retained because it allows about 20 percent additional resolution for the same bandwidth. These nations believed that a channel width between 6 and 7 megacycles is optimum and that the proper number of lines for such a channel, at 25 frames, is 625.

During the discussion of these points, the American delegation pointed out that the 525-30 standard and the 625-25 standard had an interesting relationship, namely that the line scanning frequencies of the two systems are the same within one percent (see line 6 in Table II). Moreover, substantially all receivers in service have sufficient range in the vertical hold control that either 25 or 30 frames can be accommodated. It is thus possible that a receiver designed to operate at 525 lines and 30 frames would operate equally well on 625 lines and 25 frames. If the synchronizing signals were not synchronized with the power-system frequency a receiver designed for one set of standards could receive, without degradation, programs transmitted for the other set. This would, however, be possible only if the polarity of modulation, type of sound modulation and carrier spacings were the same in both systems. Such a system of operation offers a possibility of world-wide

Table II—Comparative Specifications and Performance of American, British and Proposed Television Standards

| | American | British | Proposed |
|--|-----------------|----------------|----------------|
| 1. Lines per frame (total) | 525 | 405 | 625 |
| 2. Active lines per frame (93.5 percent or 95 percent of 1) | 490 | 385 | 583 |
| 3. Vertical resolution (72 percent of 2) | 353 lines | 277 lines | 420 lines |
| 4. Frames per second | 30 | 25 | 25 |
| 5. Picture bandwidth | 4.25 mc | 2.75 mc | 4.75 mc |
| 6. Line scanning frequency (product of 1 and 4) | 15,750 cps | 10,125 cps | 15,625 cps |
| 7. Line scan time (total) (inverse of 6) | 63.5 μ sec | 98.7 μ sec | 64.0 μ sec |
| 8. Active line scan time (7 less approx, 10 μ sec) | 52.8 μ sec | 88.8 μ sec | 53.1 μ sec |
| 9. Picture elements per line (twice 5 times 8) | 449 | 488 | 505 |
| 10. Horizontal resolution (3/4th or 4/5ths 9) | 336 lines | 390 lines | 379 lines |
| 11. Picture elements per frame (product of 3 and 9) | 158,000 | 130,000 | 212,000 |
| 12. Resolution ratio (ratio of 10 to 3) | 0.95 | 1.40 | 0.9 |
| 13. Aspect ratio | 4/3 | 5/4 | 4/3 |
| 14. Screen area utilized (percent of circumscribed circular area) | 61 percent | 62 percent | 61 percent |
| 15. Maximum highlight brightness for flicker-free images | 100 ft-lamberts | 20 ft-lamberts | 20 ft-lamberts |
| 16. Peak power output, at maximum power output, of transmitter (anode-dissipation limit) | 5 kw | 3.7 kw | 5 kw |
| 17. Channel width | 6.0 mc | 5.0 mc | 6.75 mc |
| 18. Modulation polarity | negative | positive | negative |
| 19. Sound Modulation | F-M | A-M | F-M |

agreement on dual standards which would embrace both systems.

Proposals

Table II provides a comparison between the proposals made by the Americans and the British, together with a third group of proposed standards representing the majority opinions in the replies to the questionnaire. This table was prepared by the U. S. delegation.

The principal differences in performance appear in connection with vertical resolution, horizontal resolution, picture elements per frame, maximum highlight brightness and channel width. The 625-25 system exceeds the others in vertical resolution and in total number of picture elements per frame. Its horizontal resolution is intermediate to the American and British systems. The 25-frame systems (British and proposed) are limited in brightness. Finally, the 625-line system occupies the widest channel width.

The conference concluded that several important questions required further study by the various delegations before agreement could be reached on controversial

points. The first study would inquire into the methods and costs of divorcing the vertical scanning rate from dependence on the power-system frequency. A second study would deal with the relative flicker-free picture brightnesses obtainable at 50 and 60 fields per second. Two other studies would investigate the resolving power required in television systems and would compare television image quality with that of motion pictures. Positive and negative modulation would be studied with particular reference to the effect of noise on synchronization and picture quality, and its relation to agc and intercarrier systems. Geographic separation between stations as a means of controlling interference was also to be examined. Finally, the standardization of motion-picture films for television transcriptions was to be studied.

The next meeting of the Study Group, scheduled for the fall of 1949 or the spring of 1950, may consist of a tour of the television systems of the world. Invitations to view the various systems were extended by the American, British, French and Dutch governments.

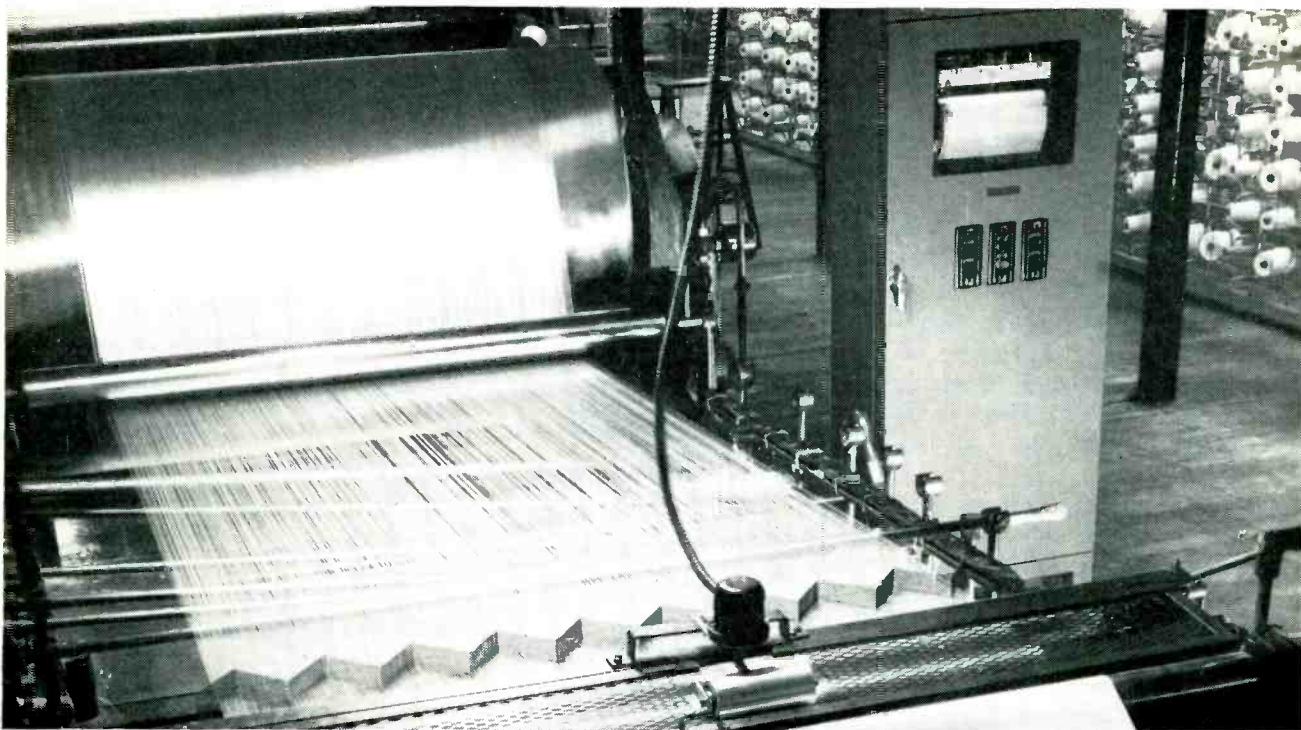

TEXTILE INDUSTRY Amount of moisture in yarn is measured and recorded continuously with resistance-type detector roll on top of yarn and associated Brown electronic

measuring and recording instrument in cabinet at right. Instrumentation like this often pays for itself in a few months. Addition of automatic control promises still further economies

Planning for AUTOMATIC

Factors to consider when adding modern electronic, electrical or other instrumentation to a machine or process, starting with the error-sensing element and going on through available ready-to-use types of recorders and controllers to the final correcting device

McGRAW-HILL PUBLICATIONS

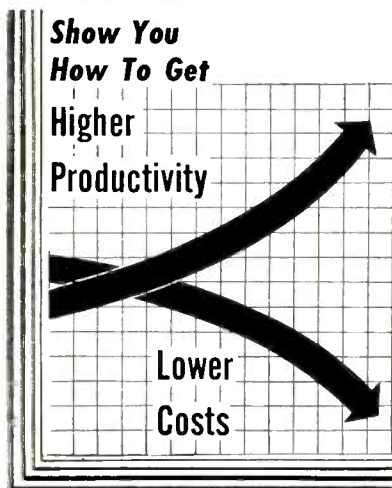

IN THE BEGINNING of industrial processing as it is known today, control was crude. The human senses of the operator, varying widely with mood and health, were the only indicators used to monitor the process. In hundreds of plants these human indicators are still in use, controlling processes involving hundreds of thousands of dollars worth of materials a day.

The indicator era for industrial processing begins when a mercury-in-glass thermometer is installed to show temperature, a meter is hooked up to indicate an electrical quantity, or some other mechanical or electrical device is put in to replace fickle human senses. An im-

mediate improvement in product quality is obtained.

In one instance, installation of a moisture indicator on a drying machine in a textile factory revealed extreme overdrying. Operation according to indicator readings reduced drying power consumption and speeded up the machine, giving lower production cost and several hundred percent increase in output.

There is much of a sameness to the stories of early indicator installations in plants. After an appropriate period of showing off results to top brass, the plant engineer explains the indicator to the machine operator and considers his job done. Passing by the machine a few

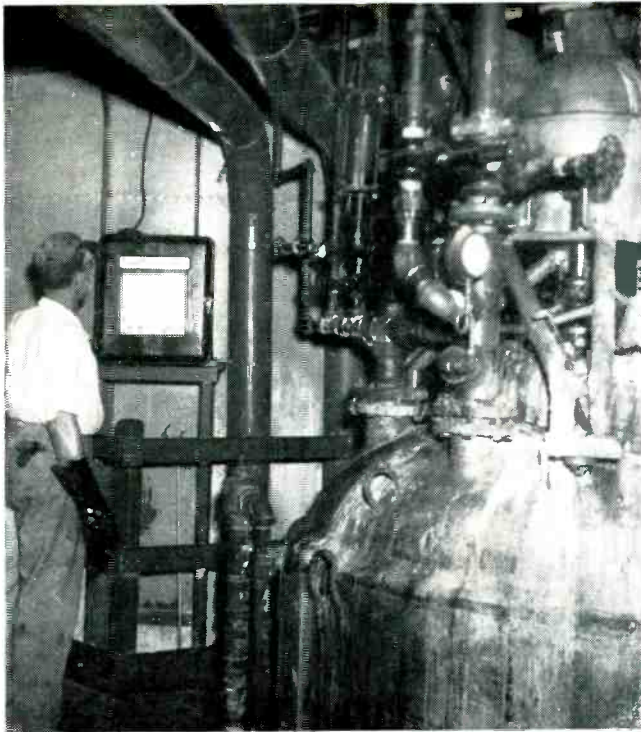

CHEMICAL INDUSTRY Temperature of synthetic resin in processing vessel at right is automatically maintained by Leeds and Northrup controller on storage tank

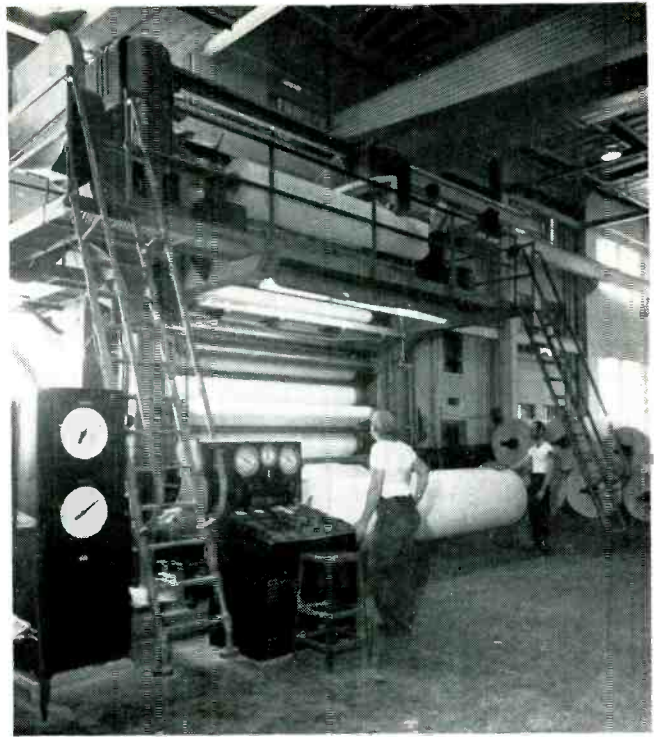

PAPER INDUSTRY Measuring gloss of finished paper output of calender stack. Phototube unit for sensing gloss, near man on balcony, feeds circular-chart recorder

PROCESS CONTROL

weeks later, he all too often finds the new indicator covered with dust or even disconnected, with the operator controlling by guess and by golly just as he always did. The reason—man is inherently opposed to change.

Thus is created a need for recorders, to show exactly how well an operator maintains required conditions over periods of hours, days or weeks. Modern units are available with either circular or strip charts, for producing permanent printed or inked records of up to 16 different variables per chart. When the operator of a machine is feeling uncooperative, however, the odds are that even the recorder will be ignored. The next logical step technologically, then, is to complete the path of action from the recorder to the controlled element in such a way that corrections are made automatically.

Despite man's shortcomings, it

takes a heap of thinking and designing to build a device that will replace him. Using the textile drying application again, there are admittedly a few men who can keep moisture content within half a percent of a predetermined value just by feeling the dried cloth occasionally with the fingers and varying the speed of the machine accordingly. These men seem able to anticipate changes and make corrections in advance so deviations do

not occur. Automatic controllers must do this also, even though the process has long time lags between correction and result.

Automatic Controllers

Practically anything that can be measured today can be controlled. Some idea of the great variety of sensing elements now available commercially for measuring process variables is given by the first column in Table 1. Controllers and

TRENDS

- Productivity per man-day is being increased significantly, in many industries using continuous or batch processing, by changeover to automatic control
- Elimination of the costly human element from quality control is lowering production costs as required by buyer attitudes in today's market
- Electronic measuring circuits are expanding the list of measurable variables clear across the board, to include even such elusive quality factors as chemical composition
- The ratio of electronic to other types of controllers is increasing in monthly reports of new installations

TABLE I—Equipment Available Commercially for Automatic Process Control

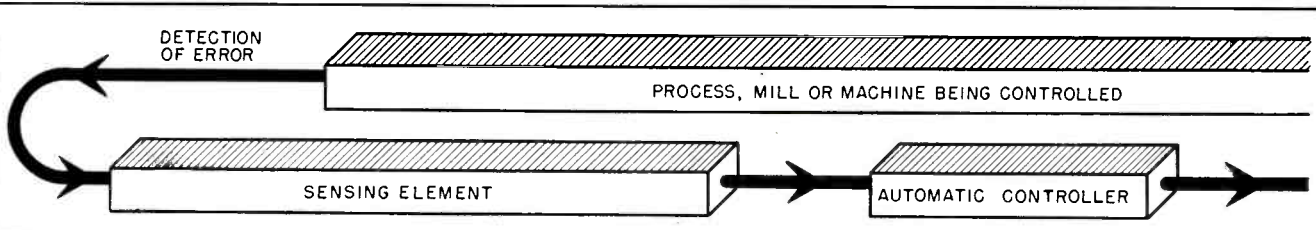

Representative Types of Sensing and Measuring Elements

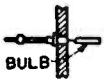

Thermometer — Bulb filled with mercury, connected to pneumatic controller with capillary tubing. Range—minus 40 to 1,000 F. Other liquids and gas also used



Thermocouple—Heat at junction of two dissimilar metal wires produces voltage proportional to difference in temperature between junction and free ends of the wires. Fast response when exposed to heat source, slower when enclosed in protecting well. Copper-Constantan used for —300 to 600 F; iron-Constantan up to 1,600 F; Chromel-Alumel up to 2,100 F; platinum-platinum rhodium for higher ranges

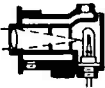

Radiation pyrometer — Lens focuses heat rays on thermocouples or thermopile. Range—75 to 3,200 F. Gives temperature inside furnace or of hot moving objects

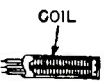

Resistance thermometer — Depends on change in resistance of coil of pure nickel wire with temperature. Slower in response than bare thermocouple. Generally in protecting well. Range—20 to 300 F

Photocell or phototube — Resistance varies with intensity of light given off by hot body. Range—850 to 3,000 F

Electric hygrometer — Conductivity of moisture-sensitive compound on dual wire winding varies with moisture absorbed



Bourdon-tube gage—Arc of thin-walled tubing straightens out when pressure is applied to open end, moving pointer through linkage. For 30 to 10,000 psi

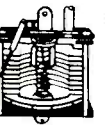

Spring-opposed bellows gage — Pressure being measured acts on outside of bellows enclosed in shell, compressing it against spring action to move pen or pointer linkage. Range 15 psi down to vacuum

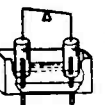

Inverted bell gage—Inverted bell suspended in oil from balance. Pressure to be measured is applied to inside of bell so increasing pressure raises bell. Other end of balance beam may have counterweight or another inverted bell for measuring difference in pressure between two sources



Differential pressure or head meter — Constricting orifice plate, venturi tube or flow nozzle in flow line creates artificial pressure drop related to rate of flow, and measured with U-tube manometer. In electric version, soft iron armature attached to float in manometer moves through two coils to unbalance a-c bridge circuit

Area-type flow meter—Piston lifted by upstream pressure varies size of orifice in line to maintain constant differential pressure. Armature attached to piston actuates induction-bridge transmitter



Air purge liquid level method—Air line is immersed in liquid below minimum level and regulated to give slow bubbling when vessel is filled. Pressure in air line, equal to back pressure exerted by head of liquid, is then measured

Mercury manometer liquid level method—One end of mercury-filled U-tube goes below minimum level of open vessel, other is open to air. Level of float on mercury, proportional to head of liquid, is transmitted electrically or pneumatically to controller

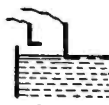

Electrodes—For control of liquid level at one specific point. Uses electrical conductivity of solution. Two electrodes give stability in turbulent liquids

pH—Glass electrodes immersed in process liquor form electrolytic cell with output voltage proportional to hydrogen-ion concentration



Moisture—With resistance-type detector, fabric or other material passes between metal detector roll and grounded metal idler roll on machine. Resistance between two rolls, varying with moisture content, is connected into one leg of self-balancing Wheatstone bridge in controller. With capacitance-type detector, material moves between metal-plate electrodes, and change in dielectric constant of material with moisture is measured with special electronic bridge circuit

Chemical composition—Gas analyzer using sensitized filament measures concentration of any combustible gas within lower explosive limits. Gas analyzer using thermal conductivity measures concentration of inert gases when controlling purity or proportioning one gas to another

Automatic Controllers



Two-position—Places control element in either high or low position, which may be on and off. Electric version uses movement of galvanometer pointer to actuate output relay; galvanometer pointer is periodically clamped to determine its position

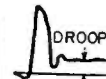

Proportional — Produces definite position of control element for variable being controlled. Throttling range adjustment determines amount of error that will move valve or other control element through entire operating range. Recognizes amount, direction and speed of change in variable and provides continuous corrective action

Typical electric version has null-balance Wheatstone bridge circuit to provide intermediate positioning of control motor. Controller has slidewire resistor over which contact moves in direct relation to pen. Electric motor on control valve drives similar contact over its own slidewire. Balancing relay detects unbalance in bridge containing both slidewires and closes proper motor winding to maintain balance of bridge resistances or voltages

Typical electronic version uses vibrating-reed converter to change sensing element output to a-c for amplification to drive two-phase balancing motor that rebalances slidewire bridge

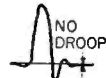

Proportional-reset—Same as proportional except returns pen to control point after each correction, so there is no droop or permanent drift in value being maintained. Can handle all combinations of process characteristics, even the most unfavorable, except for a few special types requiring rate action

Floating—Final control element is moved gradually at constant rate toward open or closed position in response to sensing element, and floats or remains stationary at position it has when variable gets back into neutral zone around desired control point. Similar to two-position control except for slower movement of control element and intermediate positioning. Ideal for processes that respond very fast to corrections, such as speed control. Electric only

Proportional-reset plus rate action—For any amount of process capacitance, transfer lag or dead time and process load changes. Used when it takes a process longer than two minutes or so to respond to a correction

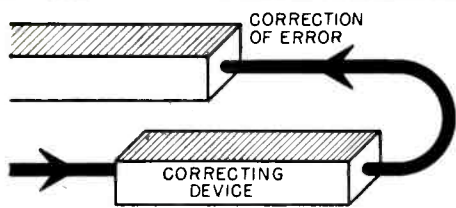

Correcting Devices

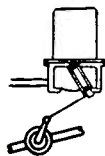

Geared electric motors—For operating valves, dampers and other mechanical control elements. Two-position operation is obtained directly from contacts. Positioning action is obtained with balancing potentiometers



Solenoid electric power units—Used with two-position electric controllers for operating sliding-stem control valves in smaller sizes. Has only two positions, full-open or full-closed

Stalled-motor electric control valve—Used chiefly for low-pressure gas lines. Motor opens valve by driving gear train. At full-open position, mechanical stop stalls motor and gears. When power is cut off, spring action drives gear train and motor backward to close valve



Pneumatic diaphragm motor—Air pressure from pneumatic controller (2 to 15 psi) is applied to one side of diaphragm and spring pushes other side, so diaphragm position varies with air pressure for driving valve or damper directly or through lever. Fast-acting for two-position control. For proportional control, generally used with valve positioner to overcome friction and get closer control

Valve positioner—Auxiliary air pilot system using separate 15 or 30 psi air supply applies full air pressure on diaphragm or exhausts air until stem of valve is at exact position called for by controller output air pressure

Springless pneumatic diaphragm motor—Fixed air pressure used in place of spring on valve side of diaphragm. Positioning is by differential air pressure on either side of diaphragm. Provides greater forces for sensitive positioning of heavy dampers, louvers and large control valves

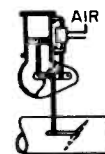

Pneumatic power cylinder—Gives more power and longer stroke than diaphragm motor, as required for dampers and special control elements. Air power is used in both directions of travel. Intermediate positioning obtained with device similar to valve positioner. Available with strokes up to 32 inches and internal diameters up to 12 inches to give forces up to 11,000 lb

process-correcting devices are also listed, to give a birds-eye view of the entire field of modern instrumentation.

The number of possible combinations of existing manufactured elements for controllers is not quite infinite, but nearly so. At least one manufacturer can produce from standard design items over 2 million distinctly different models and ranges of controllers for industrial use.

Practically all controllers have some form of pointer-type indicator for telling the operator what is going on. Many have recorders, for checking on operators and control equipment, providing data for cost accounting, providing clues to production difficulties, and providing a means of reproducing quality from batch to batch.

Automatic control does more than improve quality and lower costs—it increases the output of a given plant. For example, a petroleum plant built today may appear no larger than one erected fifteen years ago, yet have a capacity many times that of the older unit. This is achieved largely by stepping up the velocity of fluid throughout and reducing the amount of stored liquid capacity, all because every stage of the process is under rigid automatic control.

By bringing down percentage of rejects, automatic controllers keep production costs at the absolute minimum. An excellent example of this is the plastics molding business. When molds are too cold the plastic does not flow to all extremities and a reject drops out. When molds are too hot the required cooling time goes up and the press slows down. Automatic temperature control of the dies on injection and compression-molding machines is thus becoming a must for those in the business.

Types of Control Systems

The four basic types of control systems are two-position, proportional, proportional-reset and floating. The first three are available in both electric and pneumatic forms, while the lesser-used floating system is available only for electric operation. Under comparable conditions, performance characteristics

of a controller are the same regardless of whether it operates from electric power or from a compressed air line.

The choice between electric and pneumatic controllers is governed by the availability of an air supply, the existence of explosive or inflammable conditions that preclude electric operation, and the nature of the final device to be controlled. Electric switches and relays are best controlled electrically, while valves are easier to control with air-actuated diaphragms.

Personal preference of plant engineers in various fields also enters into the final choice. Chemical, petroleum and rubber industries favor pneumatic controllers since they are used to handling piping and generally have air supplies available.

The choice of the basic type of control depends upon the nature of the process and the required accuracy of control. For some processes the simple and relatively inexpensive two-position controller will perform just as well as the more complex types. For other processes the controller must have capabilities approaching those of a mind reader. Here the past experience of instrument engineers with similar problems becomes highly essential to the planning of a successful installation.

The characteristics of each basic type of controller will now be taken up in turn, with advantages and drawbacks of each, as a starting point for planning an industrial process control system.

Two-Position Controller

The two-position controller moves the final control device back and forth between two fixed positions of travel in response to changes detected by the sensing element. These two positions may correspond to open and shut or on-off action or to partly open and partly shut settings of the valve, damper, or other controlling means.

Two-position control is popular because of its simplicity, and is generally satisfactory for processes that respond quickly to the valve or other control device. It is not perfect when there are large or sudden changes in the load being controlled, as it permits considerable



FOOD INDUSTRY Banana-ripening temperature is regulated by electronic controller on back wall, using vacuum-tube action to position steam valves accurately. This type of device indicates but does not record



DRUG INDUSTRY Oven temperature of machine for applying and baking decoration onto collapsible metal tubes is controlled electronically by unit in center. Blank tubes enter on conveyor at lower left

deviation before settling down to even cycling. It is ideally suited, however, for such applications as temperature control of a cooking kettle, where the only load is that of maintaining a heat balance against radiation losses.

Proportional Controllers

When the position of the valve or other final control element varies proportionally with the position of the indicating pointer or pen, we have a proportional controller. This is sometimes called a throttling controller, because the valve or damper is throttled continuously and smoothly over its range as required to maintain the desired constant conditions. Corrective action for an error is provided almost immediately, with a rate and magnitude directly proportioned to the error. A triode vacuum tube providing linear amplification of the input signal is a perfect analogy for this proportioning action.

Proportional control is ideally suited for pneumatic installations, because air-actuated motors are available in a wide variety of sizes and designs to move valves and dampers smoothly between their limits of travel and provide intermediate positioning of these control elements. Electric applications of proportional controllers require more costly installations of revers-

ing geared-down electric motors to provide this same gradual and closely controlled positioning of a valve.

Proportional controllers have a throttling range adjustment which determines how much the control valve will move for a given change in the measured variable. For example, on a temperature controller for a highly critical whiskey distillation process a one-degree change in temperature could be so serious that full-open action of a valve would be called for. In monitoring a bath of molten glass at several thousand degrees F, however, this same one-degree drift would be negligible and the throttling range would therefore be set so it caused very little movement of the control valve.

The taste of blended whiskey is actually being controlled by some manufacturers today through use of proportional controllers on the stills. This instrumentation permits duplicating a given taste from year to year without reliance on the tongues of tasters.

In normal operation a proportional controller develops a certain amount of droop or permanent drift from the control point. As a result, the value that should presumably be held constant is slowly drifting around either above or below the desired condition. For some applica-

tions this is permissible, but in others it must be eliminated by automatically resetting the control to the correct point after each correction.

Proportional-Reset Controllers

The proportional controller may be equipped with an automatic reset feature that returns the indicator or pen to the control point after each and every load change. The resulting instrument is more complex since its throttling and reset actions occur simultaneously, but is used when precise control under the most adverse conditions is essential.

As the representative applications in Tables II and III indicate, proportional-reset controllers are used more than any other type in continuous industrial process control. This is natural, because most processes require the maintaining of a fixed temperature or other condition rather than a rough elimination of wide fluctuations in conditions.

Floating Controllers

Floating control is like two-position control except that the final control device moves gradually rather than suddenly between its open and closed positions whenever the controlled variable gets outside the neutral zone. When the variable

TABLE II—Examples of Process-Control Applications in Four Major Heavy-Industry Markets

| Market | Process | Factor Controlled | Type of Equipment | Typical Installations | |
|--|---|---|---|-----------------------|--|
| CHEMICAL | Oxidation of sulphur to sulphur dioxide in burner for manufacturing sulphuric acid | Process reaction heat, by varying air input to burner | Thermocouple in combustion chamber outlet; proportional-reset controller with diaphragm motor for damper in air intake | | |
| | Cooking of synthetic resins for varnishes | Temperature and pressure of batch in kettle | Thermocouple in bottom of kettle; proportional-reset controller; diaphragm-operated valves in cooling water line and air lines to gas burners; burner flame-failure detector | | |
| | Sewage sludge digester | Temperature of heating water, by varying ratio of warm to cool water | Thermocouple; proportional controller; diaphragm-operated valve | | |
| | Purification of water | pH | pH electrodes in raw water; pH amplifier with reset action; proportional controller; electronic motor control; feed motor for dry corrective chemical | | |
| | Fractional precipitation of blood plasma | Temperature of processing room | Resistance thermometer; proportional-reset controller; diaphragm-operated mixing valve in refrigerant supply line | | |
| | Electroplating | Temperature of heating water flowing through jacket around plating tank | Mercury-filled stainless-steel thermal system; proportional pneumatic controller; diaphragm-operated valves in steam and cold water lines | | |
| PETROLEUM | Operation of sludge screen cleaning rakes in sewerage treatment plant | Differential in liquid level on upstream and downstream size of clogged stream | Air purge type differential liquid level detector; two-position controller; rake motor | | |
| | Fractional distillation of crude petroleum in refineries | Rate of feed of crude oil into fractionating column | Orifice-type flowmeter; proportional controller; diaphragm-operated valve in feed line | | |
| | | Composition of overhead product withdrawn, by varying withdrawal rate | Thermocouple in top of column (temperature is direct measure of composition); proportional-reset controller; diaphragm-operated valve in product line | | |
| | | Level of bottom product in kettle section of column | Liquid level detector in bottom liquid; proportional controller; diaphragm-operated valve in pumping-out line | | |
| | Partial vaporization of fluid by adding heat in tube still | Gas pressure in reflux condenser | Pressure-sensitive element near top of column; proportional-reset controller; diaphragm-operated vent valve | | |
| | | Outlet temperature of processed fluid, by varying fuel to burner | Thermometer bulb at still outlet; proportional-reset controller; diaphragm-operated valve in gas or oil fuel line | | |
| Use of catalysts for conversion of heavy petroleum fractions into gasoline | | Temperature of catalysts, by control of circulating molten salt | Thermocouple in salt inlet line to catalyst cases; proportional-reset suppressed-range controller; diaphragm-operated valve in salt by-pass line | | |
| METALS | Manufacture of aviation gasoline and butadiene | Product composition, by controlling intensity of infrared radiation at a fixed wavelength | Infrared spectrophotometer with output product flowing through absorption cell; controller; diaphragm-operated valves at appropriate corrective locations | | |
| | Storage of explosive or inflammable liquids in tanks | Liquid level, by monitoring gamma radiation from radium-bearing float inside | Geiger-Muller tube; gamma ray counter; controller; diaphragm-operated valve in tank inlet line | | |
| | Conversion of prepared latex to crumb form of synthetic rubber | pH value, by controlling addition of acid to coagulation tank | pH electrodes; proportional controller; diaphragm-actuated valve in acid feed line | | |
| METALS | Hot-dip tinning of sheet steel | Quality of tin plate, by maintaining constant temperature of molten tin and palm oil in gas-fired pots through which steel sheets are run | Thermocouple in tin bath; proportional controller; electric motorized throttling valve in fuel line to burner. Thermocouple in oil; two-position controller; electric motor driving pump that circulates oil from pot through water-cooled heat exchanger | | |
| | Gas carburizing of steel in electrically heated furnaces | Temperature of each heating zone | Thermocouple; two-position controller; relay and contactor for each zone | | |
| | Open-hearth furnace for melting metal | Roof temperature and rate of fuel flow | Radiant heat-sensing element in furnace roof and flowmeter in fuel line; two interlocked proportional controllers, arranged so roof-temperature controller takes over control of fuel valve only when roof temperature approaches preset safe maximum; electric-pneumatic relay feeding diaphragm-operated fuel valve | | |
| | Blast furnace for producing pig iron | Temperature of hot blast, by varying ratio of hot and cold air | Thermocouple in hot blast line near bustle pipe; controller; air-actuated power cylinder linked with mixing valve in cold blast line | | |
| | Gas-fired soaking pits for bringing ingots to correct temperature for rolling mills | Temperature of soaking pit, by varying air-fuel ratio and input to furnace | Thermocouple in pit; proportional-reset controller; electric drive unit for gas valve in fuel line | | |
| | Heat treating of steel products in continuous gas-fired furnace | Temperature of furnace, by varying air-fuel ratio to burners | For pre-heat zone: thermocouple in furnace; proportional controller; diaphragm-operated mixer valve in air line. For final zone, same except proportional-reset controller | | |
| METALS | Lubrication of electrolytic tin strip with oil fog | Amount of oil on strip, by varying oil volume with speed of mill | Tachometer coupled to mill; proportional controller; electric drive unit for oil valve | | |
| | | | | | |

TABLE III—Examples of Process-Control Applications in Five Major Light-Industry Markets

| Market | Process | Factor Controlled | Type of Equipment | Typical Installations |
|----------|--|---|---|-----------------------|
| PAPER | Drying of paper with steamheated cylinders | Moisture in sheet, by controlling steam flow to dryer | Resistance-type moisture detector roll; proportional-reset controller; diaphragm-operated steam valve | |
| | Preparation of bleach liquor for pulp making | pH of liquor, by adjusting input of liquid chlorine | pH electrode assembly in bleach storage tank; amplifier; proportional-reset controller; diaphragm-operated valve in chlorine input line | |
| | Reclamation of turpentine from digester relief gases of alkaline pulp mill | Flow of cooling water to condensers | Temperature-sensitive bulb in condenser water output line; proportional controller; diaphragm-operated valve in cooling water input line | |
| | | Flow of heating steam to turpentine still | Temperature-sensitive bulb in turpentine vapor output line of still; proportional-reset controller; diaphragm-operated steam valve | |
| | Digesting of pulp | Amounts of black and white liquor used to charge digester, by controlling liquid levels in measuring tanks | Two of each, for white and black liquor measuring tanks respectively; air purge type liquid level detector; two-position controller; electric motor driving pump | |
| | Applying uniform coating to paper | Level of coating mixture in supply pan | Two stainless steel electrodes spaced about 1/2 inch vertically in mixture; conductivity-detecting relay; electrical-pneumatic relay; diaphragm-operated valve in mixture supply line | |
| | | Viscosity of coating mixture, by holding temperature constant | Mercury-filled thermometer bulb in mixture; proportional controller; diaphragm-operated valve in steam valve to heating coils of coating pan | |
| FOOD | Recovery of chemicals by disc evaporator in sulfate mill | Liquid level in evaporator | Thermometer bulb at desired liquid level so bulb is uncovered and senses decrease in temperature when level of hot black liquor drops; proportional controller; diaphragm-operated valve in black liquor input line | |
| | Recovery of lime in soda or sulfate water | Baume of lime mud leaving storage tanks, by diluting lime mud at rotary filter | Baume measuring element at storage tank output; proportional controller; dilution valve in lime mud line of rotary filter | |
| | Batch cooking of jams and jellies | Temperature of batch, by varying steam input | Thermocouple immersed in batch; two-position controller; solenoid valve in steam line | |
| FOOD | Flash pasteurizing of fruit juices | Sterilizing temperature of juice, by varying steam input | Thermocouple in juice output line; proportional-reset controller; diaphragm-operated valve in steam input line; steam pressure controller | |
| | Retort cooking of small cans of foods | Cooking time and temperature, by varying steam input and blowing retort at end of cycle | Thermometer bulb in retort; proportional controller with built-in timer; air-actuated throttling valve in steam input line; diaphragm-operated on-off valve in drain line | |
| | Baking of soda crackers and cookies on traveling mesh in tunnel oven | Baking temperature in oven, by regulating gas flow to burners | Thermometer bulb in oven; proportional controller; diaphragm-operated gas valve | |
| | Blanching of fruit and vegetables for deactivation of enzymes | Temperature of water in rotary blancher, by regulating steam input | Thermometer bulb in hot water; on-off controller; solenoid valve in steam line | |
| TEXTILE | Application of size solution to yarn before weaving | Level of solution, to give uniform yarn immersing time | Two level-sensing electrodes; electric relay; electric-pneumatic relay; diaphragm-operated valve in size solution inlet line | |
| | Continuous bleaching of cloth | Temperature of cloth as it enters storage chamber | Thermocouple pressing against moving cloth; proportional-reset controller; diaphragm-operated steam valve in input line to J-box | |
| | Dyeing of piece goods | Temperature of dye liquor and time schedule, by controlling steam input | Thermometer bulb in dyeing machine; proportional controller; time-pattern transmitter using scissor-cut aluminum cam; diaphragm-operated valve in steam input line | |
| | Warp sizing operation on cotton slasher | Percent regain of moisture in sized warp, by adjusting speed of slasher | Resistance-type moisture detector roll bearing against yarn at delivery end; proportional controller; speed-changing mechanism | |
| | Neutralizing of wool | pH of neutralizing solution, to hold it neutral by adding dilute alkali | pH electrodes; controller; air-actuated valve in alkali line | |
| CERAMIC | Firing of vitrified clay pipe in kiln | Kiln temperature, by adjusting oil flow to burner | Thermocouple in kiln; proportional controller; air-actuated valve in oil line to burner | |
| | Melting of glass for automatic glass-blowing machines | Temperature of molten glass in feeder | Thermocouple immersed in molten glass; proportional controller; diaphragm-operated valve in air or gas line to burner | |
| | Melting of refractory materials and fluxes in smelter to produce enamel frit | Melt temperature, by varying combustion air to burners | Radiation pyrometer aimed at bath; proportional controller; diaphragm-operated valve in combustion air line to burner | |
| | High-temperature 24-hour curing of concrete blocks | Kiln temperature during steaming period by varying steam input and during hot-air drying by adjusting dampers | Thermometer bulb; proportioning controller; diaphragm-operated steam valve; two diaphragm-operated dampers | |
| Plastics | Injection molding of polystyrene | Temperature of die, by varying water feed to die block | Thermocouple inserted in drilled hole in die; on-off controllers; solenoid valve in water feed line to die block | |

enters the neutral zone again, the valve stays put or floats at whatever position it happens to have then.

Floating control is relatively little used except for fast-acting processes such as those involving speed control, because it is applicable only to processes having limited time lags and is available only as an electric controller. Any appreciable time lag in the process causes excessive overshooting and wide cycling.

Other Types of Control Action

A number of special modes of control are also available, for less common applications that generally call for consulting services of experienced instrument application engineers. As an example, ratio action might be added to a proportional or proportional-reset controller when a process takes several minutes to respond to a corrective action. Ratio action provides a correction based on how fast the process is drifting away from the control point, on the theory that a fast drift calls for a bigger correction.

Final Process-Correcting Device

The valve, damper, motor or other device that makes the required correction on a process or machine is just as important to the success of an automatic control system as the sensing element and the controller.

Valves of all types are generally

operated by pneumatic rather than electric power units. Diaphragm motors and variations thereof are the most common type of pneumatic power unit for valves. A diaphragm motor has a flexible diaphragm with a pressure-type chamber on one side to which the air output line of the pneumatic controller is connected. On the other side of the diaphragm is a compression spring and a rigidly fastened rod that is directly attached to the valve stem or lever. Air pressure applied to the top of the diaphragm moves it down, compressing the spring further until a balance is reached between air pressure and spring pressure. Each change in air pressure results in a new position of the diaphragm, hence the diaphragm motor is a sensitive means for intermediate positioning of the final control element.

Diaphragm motors are also used for two-position control. Here the control air pressure from the controller is either maximum or minimum, to position the valve in either of its two extremes of travel.

Electric process-correcting devices employ either electric motors or solenoids as power units. The motors are geared down, and generally use either a lever arm or cam for converting the final rotary motion to the required linear motion for operation of valves, dampers and the like. In a few instances,

CYBERNETICS vs CONTROL

"The first industrial revolution devalued human labor. No pick-and-shovel ditchdigger can sell his services at any price in competition with a steamshovel. The second industrial revolution of electronic robots is here. The completely automatic factory without a human operator is on its way.

"We already have something very close to it in the electric power plants and the chemical industries, where gauges not only report the condition of the process but take executive action to keep it going right and check up to see that their orders have been carried out. Such machines will make it very difficult for the human being to sell a service that consists of making routine, stereotyped decisions. The electronic brain will make these logical decisions more cheaply, more reliably, and, of course, more quickly."

Dr. Norbert Weiner,
N. Y. Times, Apr. 10, 1949

direct drives are used for rotary valves. The motors are invariably reversible, and have built-in limit switches.

Looking Ahead

The trend in instrumentation and control today is definitely toward electronics. Already machines and processes are being controlled with gamma-ray and x-ray equipment that is monitoring specific gravity, density, thickness and other factors related to selective absorption of radiation. Already Geiger-Muller tubes and their associated electronic counters are permitting precise control of inaccessible processes through thick steel walls, monitoring chemical composition to new degrees of accuracy through their response to radioactive isotopes, and doing a host of other still-secret control jobs in connection with the processing of U-235. In addition, electronics has made possible the use of dropping-mercury electrodes, hygrometers, and infrared and ultraviolet spectrometers as sensing elements for process control.

But the trend is not a landslide. There are still, and will be for countless years, simple control jobs that can be done more cheaply and just as well with simpler instrumentation.—J.M.

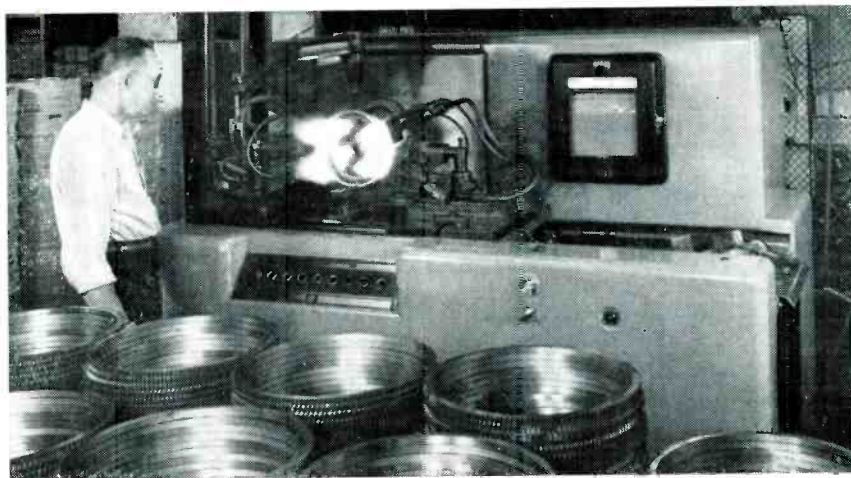

METALS INDUSTRY Newest application of electronic control in this major market for instrumentation maintains surface temperature of gears accurately to within 5 degrees F of required red-heat temperature, for selective surface hardening in Cincinnati Flamatic hardening machine. Sensitive radiation thermopile in overhead housing is focused onto work

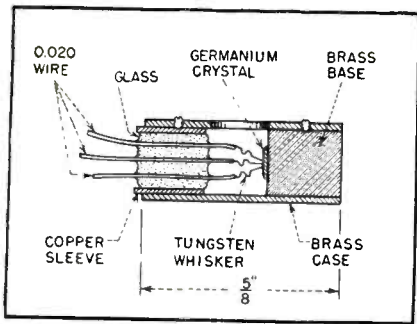

FIG. 1—Construction details of crystal tetrode suitable for use as a mixer

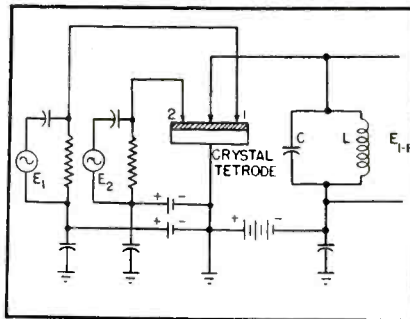

FIG. 2—Input voltages are applied to the emitter electrodes as shown

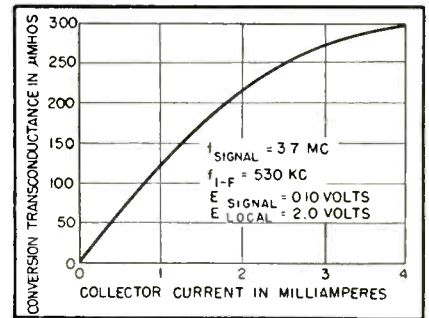

FIG. 3—Curve of conversion transconductance with respect to collector current

Crystal-Tetrode Mixer

By **ROWLAND W. HAEGELE**

*Physics Laboratories
Sylvania Electric Products, Inc.
Bayside, New York*

CRYSTAL DEVICES have been used for many years as demodulators and mixers. Of more recent interest¹ is the crystal-triode amplifier or transistor employing two closely-spaced whiskers and a germanium crystal. This device can also be used as a mixer and will show a conversion gain in a manner analogous to that of the thermionic triode.

A crystal mixer using three whiskers offers certain advantages over the crystal diode or triode mixer, though the use of such a tetrode is by no means limited to mixers. The crystal-tetrode mixer provides the advantages of good conversion gain with accompanying high conversion transconductance, low interaction between input circuits and usefulness at input frequencies which are much higher than can be amplified in the germanium triode.

The construction of a crystal tetrode suitable for use as a mixer

is shown in Fig. 1. This construction is particularly adaptable to experimental use since either the whiskers or the crystal semiconductor can readily be changed, though a simpler construction might be more suitable for production. The three whiskers are arranged in a triangle spaced about 0.002 inch. In most of the tetrodes thus far made in the laboratory, germanium crystals of the type commonly used in 1N34 diodes were used. These are given the same processing as crystals used in triodes.

Performance

The input voltages are applied to the emitter electrodes 1 and 2 in the manner indicated in Fig. 2. Usually, emitter 1 connected to the local oscillator requires no bias since, by adjusting the local oscillator voltage to the proper level, a self-biasing action can be obtained. A resonant circuit tuned to the intermediate frequency, or a frequency equal to $f_2 - f_1$, is used for a load in the collector circuit.

One of the usual ways for describing the effectiveness of a mixer is by the conversion transconductance. The range of conversion

transconductance obtainable from vacuum-tube mixers is from 200 to 600 μmhos . As an example for comparison with the crystal mixer, a 6SA7 pentagrid converter has a g_c of 425 μmhos at a plate voltage of 100 volts and a cathode current of 12.3 ma. Typical operating values of the crystal mixer include a collector voltage of 30 volts, a collector current of 2 ma and a value of g_c of 300 μmhos . Values as high as 1,100 μmhos and conversion power gain of +1 db have been observed.

Typical of the manner in which g_c varies with collector current in the crystal mixer is the curve shown in Fig. 3. For voltages and currents below those required for vacuum-tube mixers, the crystal-tetrode mixer gives a conversion transconductance quite comparable to that from common tube types.

An important feature of the crystal tetrode is the degree of isolation that can be achieved between the emitter circuits. From inspection of Fig. 4 it is evident that excellent signal isolation can be obtained so that the signal impressed on each emitter does not tend to be transmitted to the other to a great extent nor does the heterodyne fre-

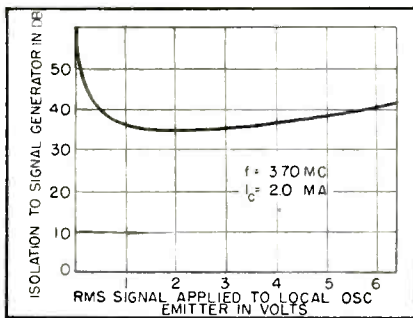

FIG. 4—Curve shows excellent signal isolation obtained with crystal tetrode

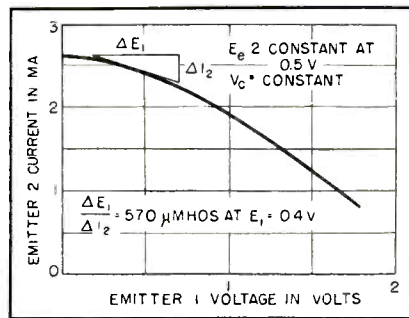

FIG. 5—Typical crystal-tetrode interaction transconductance characteristic

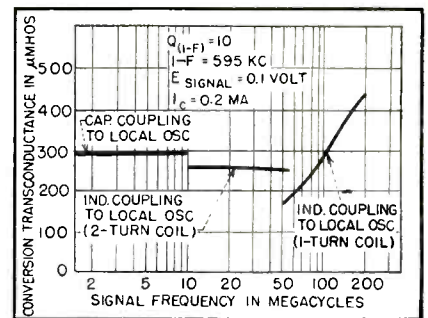

FIG. 6—Crystal-tetrode frequency characteristic for several coupling methods

Provides good conversion gain, high conversion transconductance and low interaction between input circuits. Useful at input frequencies higher than those that can be amplified in the germanium triode

quency appear in large measure in either emitter circuit.

Further evidence that there is good isolation between emitters can be found in the static interaction transconductance curve in Fig. 5, which shows the dependence of current in one emitter on the voltage applied to the other. A typical operating point indicated on the curve has an interaction transconductance of 570 μ mhos. When compared to the usual input conductance of either emitter, which is of the order of 10^4 μ mhos, it is evident that signal interaction will be small.

Another important feature of the crystal-tetrode mixer is the frequency range over which it may be used. The crystal triode as an amplifier is ordinarily limited to frequencies less than about 5 mc, usually because of transit-time losses. The same is true for the tetrode when either emitter is used with the collector to form an amplifier circuit. However, if the i-f frequency used in the mixer is kept within the useful range of the device as an amplifier, the two input frequencies can be extended far beyond the 5-mc limit with no loss in conversion efficiency. Crystal tetrodes have been operated at an i-f of 500 kc and

input signals beyond 100 mc with conversion transconductance actually higher than that obtained at much lower frequencies. As an example, a typical mixer with an i-f of 600 kc showed a conversion voltage gain of 2.5 and a corresponding conversion transconductance of 430 μ mhos at a frequency of 150 mc. Figure 6 shows more completely the frequency characteristic of the crystal-tetrode mixer.

Experiments indicate that the noise in the collector circuit is at least no greater than in the crystal triode. By way of example, the signal and noise outputs in some units were about equal with the input signal reduced to 2 microvolts.

Conclusion

It should be mentioned that the crystal triode gives good results as a mixer at some frequencies with somewhat higher values of g_c than have been obtained with the tetrode. However, due to the complete lack of isolation between the signal and local-oscillator circuits, and the difficulty of matching two signals in the same low impedance, the crystal tetrode offers considerable advantage over the triode as a mixer.

A device as new as the crystal-tetrode mixer cannot be fully evaluated in one short paper. Such important details as an equivalent-circuit analysis, a more thorough study of its frequency characteristic and a measure of its noise figure are necessary before the complete picture of its usefulness can be known. However, the fact that it has a conversion transconductance equal to that of ordinary tube mixers but requires less power, is physically very small, and operated with input signals at least up to 200 mc, should make further investigation very much worth while.

The excellent isolation of the input circuits is an important advantage over diode or triode mixers. The maximum intermediate frequency at which it may be used seems to be about the same as the maximum frequency for crystal-triode amplifier operation, which is to say that the input frequencies may be much higher.

The writer wishes to acknowledge the experimental help given by E. W. Burke and Frieda A. Stahl.

REFERENCES

- (1) Bardeen & Brattain, Letters to Editor, *Phys. Rev.*, 74, July 15, 1948.

Technique for

Data taken in the New York area indicate that field strengths measured on radials at 10-foot antenna height are not truly representative of actual service rendered. Traverse measurements are suggested and measured height factors reported

WHEN a field-strength survey of a television station is made, two purposes are usually in mind. The first is to satisfy the FCC that the station performs in accordance with the specifications of the construction permit, the second to assure the management of the station that a satisfactory signal is available to the majority of the population lying within the service area.

These two purposes are not necessarily served by the same set of measurements. In fact, the purpose of this article is to point out that measurements made along radials in accordance with FCC standard proof-of-performance pro-

cedure may give too optimistic a picture of coverage.

Standard survey procedure has recently been described in detail¹. Briefly, the procedure is as follows: At least eight radials are drawn from the station, either at 45-degree intervals, or following roads at approximately 45-degree intervals. Profile graphs are drawn along these radials and the average elevation over the 8-mile distance from 2 to 10 miles is calculated. The height of the transmitting antenna above this elevation is taken as a reference and the expected field strength, for the given value of radiated power, is computed by reference to FCC coverage charts.

Contours are drawn through the 500-microvolt points on the radials. It is presumed that the 500-microvolt signal is available throughout the area enclosed by this contour.

After the station is in operation, measurements of actual field strength must be made, and the values shown to agree within reasonable limits, with the predicted values. The FCC recommends that mobile measuring equipment be used, with an omnidirectional receiving antenna about 10 feet above the ground. The field values so measured must be corrected to represent the actual field strength 30 feet above the ground, the latter value being the nominal height of antennas installed in homes. Simple theory, acceptable to the Commission for this purpose, states that the field strength should increase linearly with height. Thus, if field-strength measurements are made at 10 feet the stated values for 30 feet would be three times as great.

When the terrain between the station and the point of reception is flat and free from obstructions the measured and predicted values are usually found to be in reasonable agreement. But when rough terrain or massive obstructions are encountered, two discrepancies appear. First, the field increases at a rate less than proportional to the antenna height. Second, the values

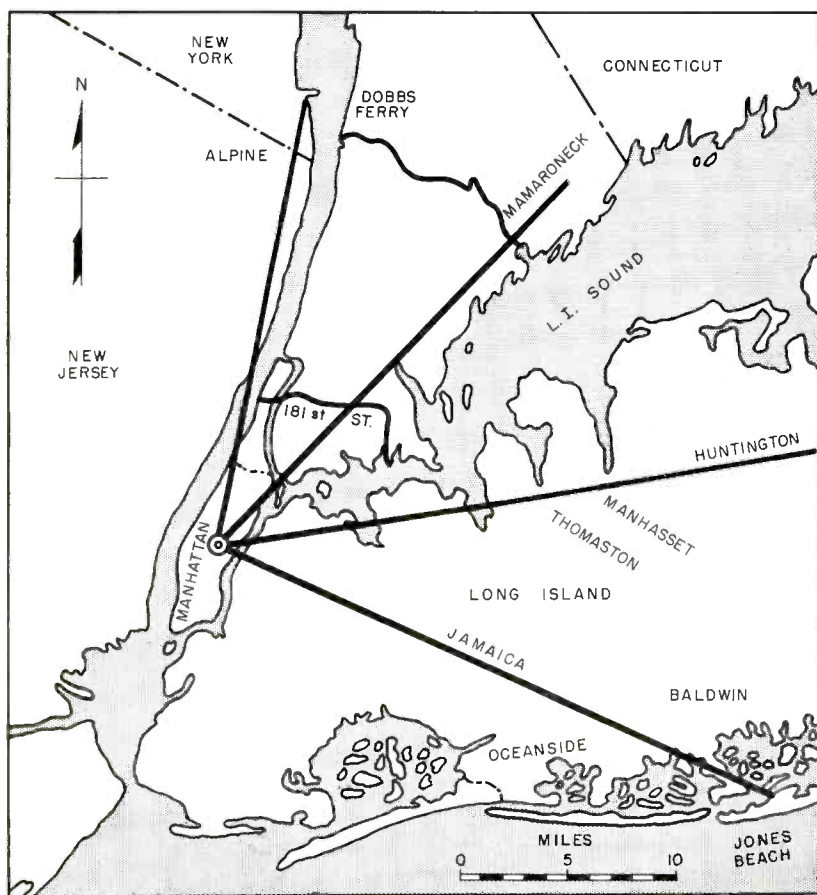

FIG. 1—Four radials and two traverses employed in making the measurements for the survey

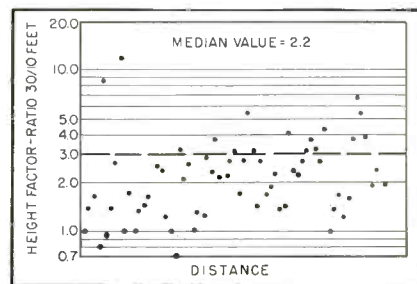

FIG. 2—Height factors on channels 7 and 11, along Jamaica and Huntington radials

TV Field Surveys

By JOHN F. DREYER, Jr.

*Crosby Laboratories
Mineola, N. Y.*

of field strength measured along the radials are generally higher than those measured at locations between the radials. The latter effect probably is accounted for by the fact that roads along radials generally follow the gaps and valleys in the terrain, hence the obstructions between the station and the points of measurement on radials are generally smaller than those at other points.

Figure 1 is a map of a portion of the New York metropolitan area. Five television stations in Manhattan lie within the center circle. Station WATV, on channel 13, is located just off the map, 16 miles west of the center point. Four radials are shown and are referred to as the Jamaica radial, the Huntington radial, the Mamaroneck radial and the Alpine radial.

At the FCC hearing held in Washington Dec. 1, 1948, the writer submitted an analysis of 66 measurements made on the two Long Island radials. These measurements were made on channels 7 and 11 by the cluster method². At each point, the signals at 10 ft and 30 ft were observed. The ratio of the signal strengths at these heights are plotted in Fig. 2. The ratios cover a wide range. At one point, the signal at 30 ft was 0.7 of that at 10 ft while at the other extreme, the 30-ft signal exceeded the 10-ft value by 12 to 1. When analyzed on probability paper, the distribution seems to be random, with a median value of 2.2.

Very Flat Country

In an attempt to arrive at a more comprehensive understanding of the height factor several other areas were investigated by a similar method, namely readings of signals recorded on tape in a moving vehicle. In a given area, a re-



Survey car, showing antennas at 10 and 30 feet

ording was made while the vehicle moved slowly around a closed course with the antenna at 10 ft. This procedure was then immediately repeated with the antenna at 30 ft.

A section of the Meadowbrook Causeway, about 2,500 feet long, was selected. Referring to Fig. 1, this location is near the end of the Jamaica radial in the center of a coastal marsh with no hills, houses or overhead wires, located $22\frac{1}{2}$ miles from a transmitter operating on channel 11. The car was operated at approximately 2 miles per hour, or 3 feet per second. The time constant of the recording system was 3.5 seconds.

Checks were made at the beginning and end of each run to determine if the station output had changed appreciably. Most measurements were made on the sound signal of the station in question,

since the picture signal is apparently subject to variation when cameras are switched. Otherwise, the behavior of the sound and picture signals is very similar.

The recording tape was divided into 20 sections and the average value of each section plotted, as shown in Fig. 3. Twenty-one signal ratios were calculated. It was found that 50 percent of these ratios exceeded 2.94 (the median value). This is in very close agreement with the theoretical value of 3.0. With the car stationary, at the center of the run, measurements were made of the signal at 15, 20, 25 and 30 ft, on channels 4 and 11. (The results are plotted in Fig. 6A.) It is interesting to note how precisely linear is the height factor for this flat type of terrain. Another height vs signal measurement was made in very similar ter-

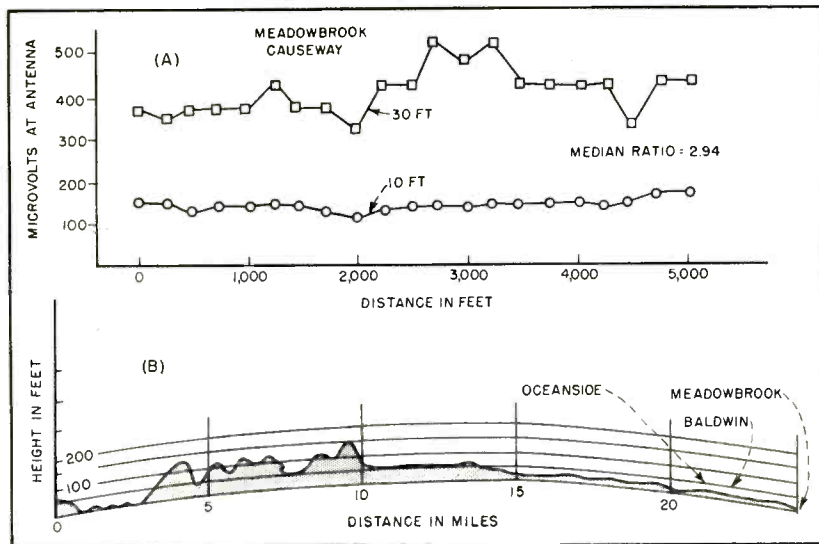

FIG. 3—Average signal levels at 10 and 30 feet at Meadowbrook Causeway (A) and profile (B) of the Jamaica radial. The median ratio between signal levels at 30 and 10 feet is 2.94, close to the theoretical value

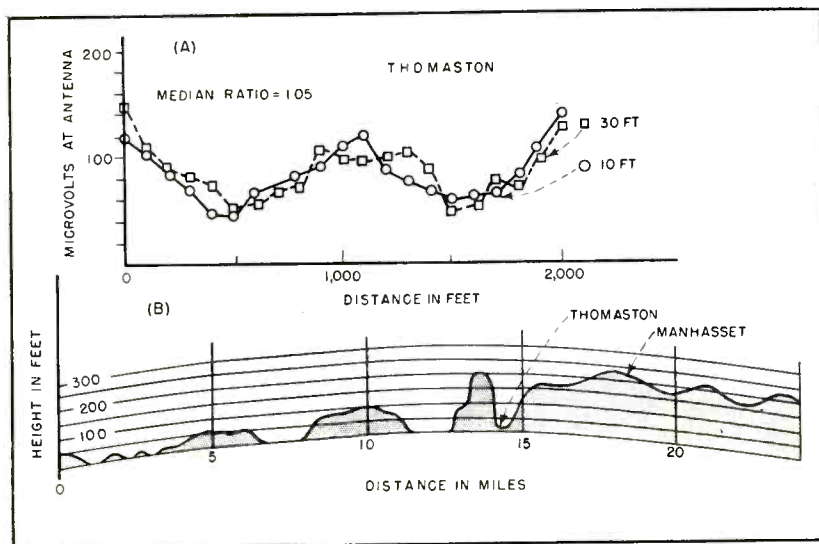

FIG. 4—Average signal levels (A) and profile (B) of the Huntington radial. The median value of the 30/10 ratio is only 1.05 in this case, reflecting the fact that the observation point (Thomaston) is well shadowed

rain at Heckscher Park, 30 miles further east. The distance of over 50 miles puts the Manhattan stations well below the horizon. These measurements (Fig. 6B) would indicate that the height factor is determined principally by the terrain in the vicinity of the receiver.

The same procedure was followed at Thomaston, 14 miles out on the Huntington radial. As may be seen from the contour, Fig. 4, this region is at the bottom of a fairly deep valley. It is, however, not an "impossible" region, since many television installations could be seen on nearby buildings.

A run of 500 ft was obtainable free of overhead wires. To obtain a better average, a complete closed

circuit was made twice, giving a total travel of 2,000 ft. The tape was divided into 20 sections and the values plotted. The signals in this case at 30 ft were hardly different from those at 10 ft, the median value of the ratio being 1.05.

Observation of the signals on the video channel was made on a receiver and no special multipath conditions were noted. The signal quality was good except for noise and ignition interference. The direction of arrival was noted to be very closely the azimuth of the transmitter. The signal path apparently was one of refraction over the top of the hill.

Measurements were also made in a cluster with the car stationary

and antenna heights of 10, 15, 20, 25 and 30 ft on channels 4 and 11. (One typical location is illustrated in Fig. 6C.)

Another location, 18 miles out in a residential part of Manhasset was checked. This point lies on relatively high ground but the terrain is covered with trees (no foliage at the time) and detached frame dwelling of approximately 30 ft height.

No recorder run was possible because of overhead branches and wires but the cluster measurements indicated conditions not very different from those in the valley. (A typical position is illustrated in Fig. 6D).

Residential Flat Country

On the Jamaica radial at 22 miles, a residential development in Baldwin was investigated. This seemed representative of suburban communities. The streets are winding, lined on both sides with two-story frame dwellings, with trees of about 25-ft height (no foliage when the measurements were made.) A recorder run around a closed circuit of 3,000 ft without overhead obstructions was feasible. When the recordings were analyzed, the median value of the ratio was 2.4, as shown in Fig. 5.

A recorder run of about 100 ft length was made in the vicinity of Oceanside. This is only about 1½ miles from the Baldwin location and the neighborhood is very much the same. The 30 to 10 ft ratio was 2.25.

Figures 6E and 6F illustrate the signal-versus-height factor at the Oceanside location on New York stations (peak video signals were used in this case).

Radial vs. Peripheral Measurements

During the course of several surveys in the New York area during

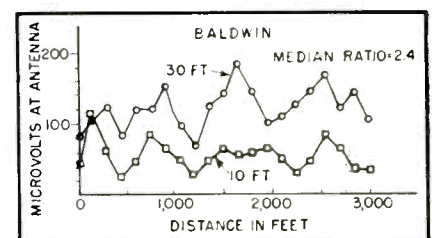

FIG. 5—At Baldwin, on the Jamaica radial, the median signal ratio was 2.4 (see position on profile in Fig. 3B)

the past year, it has been observed that, in built-up regions, the signal on radial avenues is much greater than on cross streets. It seemed likely that this condition might also occur in hilly rural areas, because vehicle surveys following radial roads naturally follow valleys, rivers, and notches in hills. To investigate this possibility, measurements were made on portions of the Alpine and Mamaroneck radials straddling the Bronx, nearby New Jersey and Westchester regions (See Fig. 1).

The Alpine radial (principally along route US 9W) lies on top of the Palisades and has a clear signal path. The Mamaroneck radial traverses flat country in the Bronx and follows the Boston Post Road fairly close to Long Island Sound. It en-

counters some hills at its outer end. Recorder measurements taken on these radials are presented in Fig. 7. The readings are given as μV per m at 10 ft in db above $100 \mu\text{V}$ per m.

For comparison, portions of two traverses (peripheral paths) were measured, one on roads approximating an arc at 9 miles radius and the other at about 19 miles radius. The measurements on the traverses are presented in Fig. 8. In this figure, the straight lines represent the signal level as judged from the values on the two radials.

On the Mamaroneck-Dobbs Ferry traverse, through the center of suburban Westchester, the measured signals fell substantially below those predicted by the radials by 12 to 18 db, rising only on high ground near the center of the

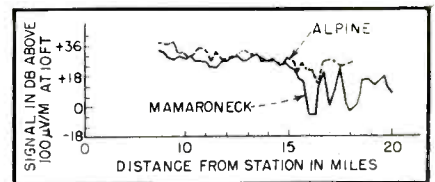

FIG. 7—Average signal levels along Mamaroneck and Alpine radials

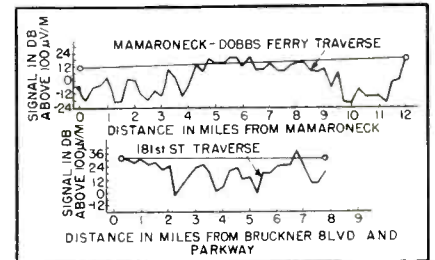

FIG. 8—Average signal levels along Dobbs Ferry-Mamaroneck and 181st Street traverses. The median signal values are 12 db and 9 db, respectively, lower than the radial values

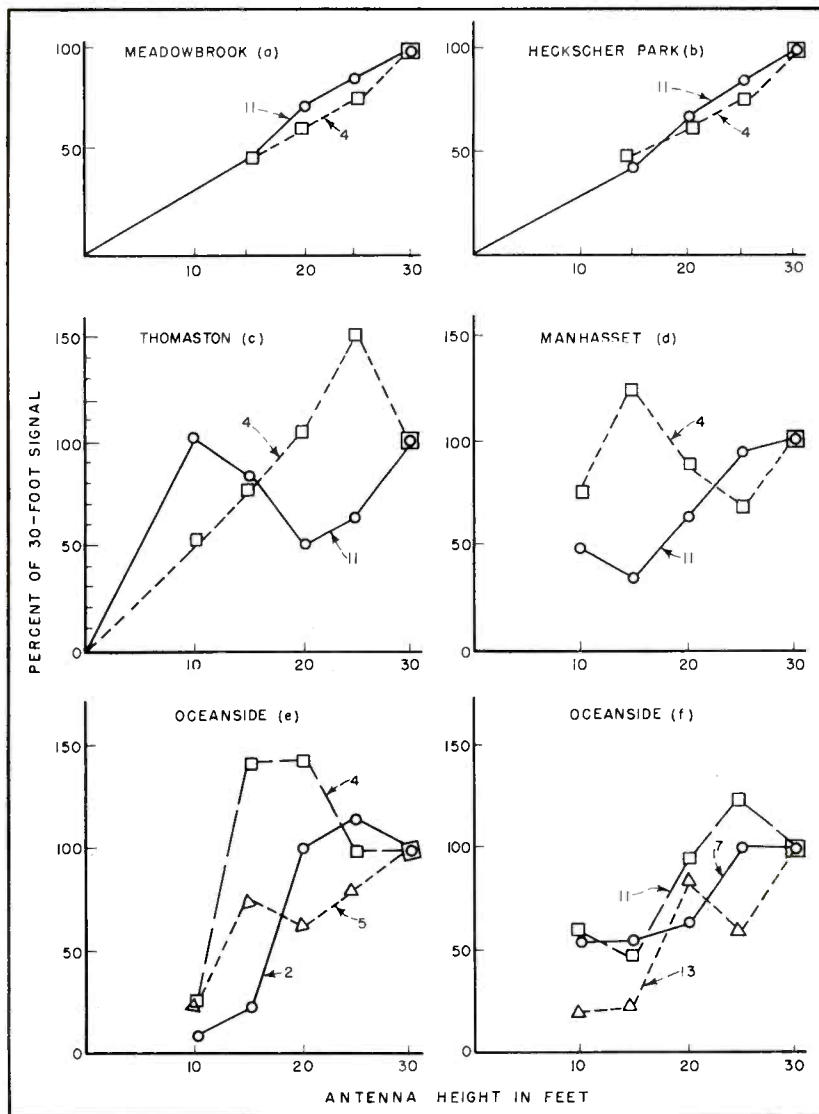

FIG. 6—Variation of signal with height at various locations, on channels 4 and 11 (a-d) and on all New York channels (E-F)

county. The same is true of the 181st St traverse. The signal rises to the predicted line only on a high bridge across the Harlem River.

The writer favors use of a moving vehicle with 10-ft antenna height. For the high-band television channels (7-13), the height factors to change readings made at 10 feet to the value at 30 feet, should probably be as follows: 3.0 in very flat country with no houses, trees or other obstructions; 2.3 in very flat country occupied by small buildings and trees; 1.1 in regions deeply shadowed by hills; intermediate values between 1.1 and 2.3 for hilly country occupied by buildings.

To investigate off-radial coverage, it is suggested that two peripherals be run, one at approximately 7 miles, the other at 20 miles, and that the recorder tapes be analyzed in the arcs between radials. These analyses should be used in correcting the signal values obtained on the radials.

The survey car should include a collapsible 30-ft. antenna for spot checks of the height factor. Multipath transmission should be investigated photographically at appropriate points on the peripherals.

REFERENCES

- (1) J. B. Epperson, Television Field Intensity Measurements, *ELECTRONICS*, p 78, March 1949.
- (2) Goldsmith, Wakeman and O'Neill, A Field Survey of Television Channel 5 Propagation of New York Metropolitan Area, *Proc. IRE*, p 556, May 1949.

Reducing Costs in

McGRAW-HILL PUBLICATIONS

Show You
How To Get

Higher
Productivity

Lower
Costs

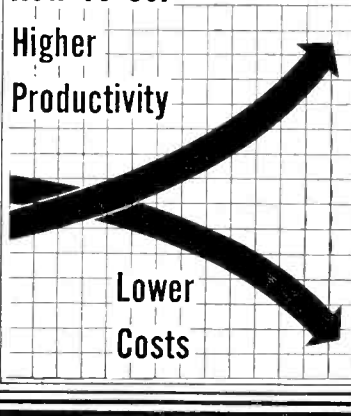

By **SPENCER A. TUCKER**

*Chief Engineer
Tucker & Co., Management Engineers
New York, N. Y.*

THE ELECTRONIC INDUSTRY, especially that branch which serves the consumer levels, has recently experienced a transition from a seller's to a buyer's market.

Many companies, operating without the benefit of accurately determined costs and with no plans for reducing costs, have found the transition difficult. Others attacked the problem with vigor, installed wage incentives, reorganized, analyzed the market for new products, and maintained the positions they had earned during the war.

Increase of productivity, along with reduction of costs, is essential for most companies at this time, and it is to help such companies solve this twin problem that this article has been written.

A sound cost-reduction program should be all-inclusive, with each function of the company contributing its share. This includes the sales and financial functions as well as the engineering and production ends of the company.

Cost reduction is accomplished by many methods and manifests itself in many ways, each effective within its own sphere of influence. The twelve basic elements of a cost-reduction program are given in Table I.

Incentive Plans

A wage incentive plan, if properly installed, is highly effective and equitable. By paying off directly on the basis of productivity it virtually

puts each worker in business for himself.

In most electronic plants on day work it is believed that productivity averages 65 percent of a full day's work at this writing. A good incentive plan requires that 100 percent must be reached before incentive payoffs commence. After 100 percent, the plan should pay off about a 1-percent increase in wages for each 1-percent increase in productivity.

In upgrading workers from 65 percent to 100 percent a productivity increase of 48 percent has taken place, which is a direct labor cost reduction. After 100 percent, direct-labor costs remain fixed but direct-overhead costs reduce as productivity increases.

In most cases it is difficult to effect the upgrade from the daywork 65 percent to the 100-percent standard for incentives. Upgrading slowly by paying minor incentives before 100 percent appears to be the most effective way. A plan may be used which asks the worker to increase productivity to 80 percent, at which point management starts paying off. The payoff between 80 percent and 100 percent is about one-half for one; after 100 percent the one-for-one payoffs are resumed, as indicated in Fig. 1.

In one radio plant, girl solderers were producing an average of 300 soldered joints per hour. Three weeks after an incentive plan was installed, they were producing 430 an hour. After a month, with the assurance that rates would not be cut and that they alone were mas-



Receiver Manufacturing

Suggestions for setting up a comprehensive cost-reduction program include sales and management as well as production ideas. Case histories of successful applications of the methods and fixtures recommended for assembling radio equipment are given

ters of their payroll check, average productivity rose to 120 percent, or 520 joints per hour. After methods improvements, to be discussed later, productivity rose to 900 joints per hour.

Reducing labor costs by methods improvements in operations can be

executed by simple expedients. In many instances in the electronic industry jigs and fixtures can sharply cut costs by increasing productivity. These simple tools eliminate unnecessary handling and positioning yet do not require costly new equipment or expensive changes in existing

equipment in most radio plants.

It is usually much more effective economically to concentrate efforts upon plant hourly-productive-potential and use existing plant equipment. Sometimes by a change in the operation sequence, equipment may be used as is. In other cases it may



Production lines in a typical receiver assembly plant, illustrating use of over-head trolley-duct wiring, rail-guided chassis cradle, soldering-iron fixture and other cost-reducing methods and fixtures described in this article

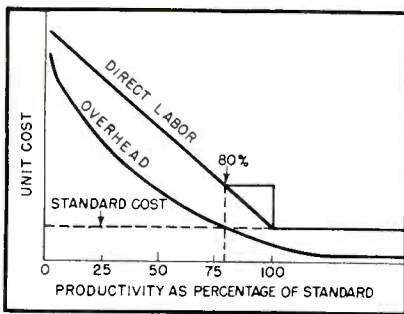

FIG. 1—Effect of incentive pay on unit cost when payoff is started at 80 percent of standard output

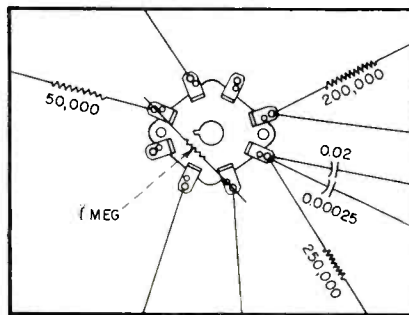

FIG. 2—Example of parts that can be assembled on feeder line before riveting socket to chassis

sometimes miss the boat on ideas that threaten the security of their ivory towers of tradition. They cling to the concept of operation efficiency based purely on the experience factor: "We and the entire industry have done it this way for twenty years and have made money. Why should we change it now?"

Savings from Specialization

This same assembly-line project was continued further, effecting large direct-labor savings without any expenditure.

After relocation of mechanical operations on the receiver line under discussion, the degree of specialization present at each operation was analyzed. It was discovered that similar specialties such as wiring-in wires and components and soldering were widely scattered along the line, making the element of repetition important. It was reasoned that if a wireman had nothing to do but wire, just using long-nose pliers and diagonal cutters, and if a solderer did nothing but solder, a higher productivity would result due to the greater skills which could develop from constant repetition. Actually, however,

be necessary to make a simple change or addition to produce greater operational productivity.

The allocation of funds for expensive machinery, elaborate jigs and tools should be reduced to a minimum, except in cases where the sales order covers such cost or the plant equipment has deteriorated to such an extent as to make purchase of the items mandatory.

On the other hand, simple devices made in the toolroom are frequently justified in terms of the savings they create and by the high rate of amortization.

Process Studies

The following example proves that it doesn't always take money to make savings in the direct-labor cost. A Brooklyn manufacturer of home radios was thinking of designing a new riveting machine to rivet five sockets to the chassis at one time, instead of riveting them separately. The scheme was originally promoted on the basis that when five were riveted at once the cost should be less than five times the cost of the single riveting operation.

Upon analysis it was revealed that the cost to rivet the five at once was more than five times the single riveting cost, in addition to the cost of constructing the jig and machine. The excessive cost was due to the delicate positioning required and the dropping out of some of the rivets in clamping the jig.

Statistically, the jig and machine did five sockets at the cost of doing seven individually. Methods analysis here produced a negative saving since it served to spot and

negate a cost-provoking device.

While on this project, management was questioned as to why they would want to place five sockets on the chassis at the same time, or why they had to assemble all of anything at the same time. They put on five sockets at the beginning of the line, then the variable capacitor assembly, dial bracket, i-f transformers and volume control. But when were these items actually needed in the assembly sequence? One was wired one-quarter of the way up the line, some half-way up, and others almost at the end of the line. Why weren't these parts assembled into the chassis at the point at which they were to be used?

The advantages are obvious: Under the conventional sequence, each person on the line was working with the chassis at its maximum weight, since wire, solder and small components hardly affect weight. However, by changing the sequence slightly to accommodate this new theory, the maximum weight was apparent only toward the end of the line. The handling of 1,000 such units per day, on a half-minute cycle, definitely makes the fatigue element important. By restudy and allocation of a lower fatigue allowance, the direct labor cost dropped 7 percent, at no cash disbursement.

A questioning attitude is a tool of methods improvement. Equally important is the ability to remain objective and open-minded in the light of what analysis reveals. Here is where many inquiring minds fail to function fully.

While many managements are objective and advanced in terms of a new piece of equipment, they

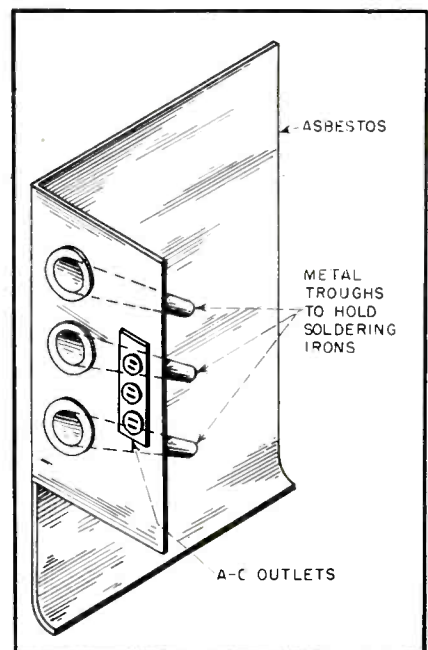

FIG. 3—Three-iron apron for a soldering position, allowing workers to change irons quickly when they cool during maximum production periods

Table I—Elements of an Effective Industrial Cost-Reduction Program

(A) Reducing Direct Labor and Direct Overhead Costs

1. By wage incentives that increase hourly productivity, thus reducing unit labor cost until standard is reached, and constantly reducing unit overhead cost proportionately as productivity increases.

2. By improving and redesigning existing manufacturing methods and processes, and by the use of more modern equipment.

(B) Reducing Factory Overhead Costs

1. By budgeted cost systems, and through incentives to foremen and supervisors, in order to maintain an economical ratio between department direct and indirect costs.

2. By control of indirect expenses through an analysis of cost of such items as repairs, scrap and reprocessed parts, and by replacement of cost-provoking equipment.

(C) Reducing Materials Cost

1. By installing statistical quality-control plans to minimize scrap, rejection and reprocessing losses.

2. By substituting less costly materials, fabricated differently.

(D) Reducing Plant Space and Process Costs

1. By proper plant layout to minimize manufacturing-cycle time and linear travel of all parts.

2. By proper scheduling to minimize floor space by reducing work-in-process, thereby releasing space.

3. By designing a flexible layout which is easily adaptable to changes in sales requirements and current consumer demands.

(E) Reducing Non-Operational Labor Costs

1. By making transportation or movement of parts machine-performed instead of man-performed, and handling materials by conveyors, trucks or bins.

2. By eliminating labor duplication through proper raw parts feeding to the line, and by using proper preparation techniques.

(F) Reducing Inventory Loss Costs

1. By proper stock control, purchasing and production control, keyed to sales forecasts and requirements.

2. By considering financial position of company in terms of working-capital ratios. Selected level of inventory should reflect capital position as well as current market and overall business conditions.

(G) Reducing Administrative Overhead Costs

1. By relating administrative labor to some yardstick in production such as units shipped or direct factory hours.

2. By designing entire organization to act as an accordion having the flexibility to expand and retrench in accordance with any given economic condition.

(H) Reducing Personnel Training Costs

1. By installing a personnel evaluation and selection plan. This includes aptitude and psychological testing for higher levels.

(I) Reducing Mortality Rate of Bids

1. By an accurate determination of all costs to allow consistent bidding. This eliminates bids which are overestimated for safety and those which try to make up for a guessed previous underbid.

(J) Reducing Engineering Costs

1. By complete and thorough liaison between all engineers and the production department for cost-conscious and cost-economic design.

2. By scheduling and planning individual engineering assignments and posting cumulative time to each job for control purposes.

3. By reducing quantity of equipment stocked and purchased by department, limiting purchases to necessary items.

(K) Reducing Selling Costs

1. By selecting salesmen on a scientific basis to ascertain their sales aptitudes.

2. By selective selling through determination of most profitable items and paying higher commissions for them, while restricting rewards on least profitable lines.

(L) Reducing Money Costs

1. By limiting borrowing of working capital by a proper alignment among the elements of market potentials, sales forecasts, production budget and purchasing policies.

the wireman had to take a component not already in the set, such as a paper or mica capacitor or a resistor, and bend and cut its leads to size before wiring it into the set. Having other people prepare leads of parts in advance helped a great deal, but this was not the final answer.

On the theory that wiremen should wire and solderers should solder, feeder lines were established near each major wiring position. On these lines, components were wired and soldered to loose sockets, as illustrated in Fig. 2. Then, instead of riveting an empty socket into the chassis, a socket assembly

consisting of the socket with previously wired and soldered components was riveted.

Wiremen on the main line never put down their pliers. They did nothing but complete wiring connections within the set, never having to locate and fuss with outside component parts. In addition to

cutting wiring costs, this procedure decreased over-all soldering time. Where formerly a joint consisting of five wire ends required two passes with the iron, at different stages in the sequence, it now required just one pass. Concern over parts falling out in transport had necessitated a first pass with the iron before.

All in all, feeder lines and specialization cut direct-labor costs another 28 percent. It worked in practice as well as in theory, even including the somewhat inflated time of the riveter because of the extra positioning element due to components hanging from the sockets he had to handle.

Soldering Iron Techniques

In another plant, solderers on incentive were working like wildfire, doing 800 joints per hour under

iron were blamed. One remedy tried was to provide 200-watt irons. This did not help since the heavier iron contributed to fatigue and lowered productivity. Management in the plant felt the problem was insoluble. They were attempting to solve it in terms of what other radio manufacturers did, however, instead of opening their minds to possible new solutions.

After much wrangling, it was decided to let outside engineers use an unprejudiced and fresh approach to the problem. The result was the design of a soldering "apron" made of asbestos and sheet metal, mounted to the right and below each soldering operator. The apron consisted of three metal troughs to accommodate three irons, as shown in Fig. 3. The asbestos was used to prevent burning the operator's leg. On the front of each apron next to

agement a reduction of 63 percent in labor and unit overhead costs.

With the bottleneck eliminated that had previously prevented full productivity from operations following soldering, production per hour practically doubled.

Cabinet Bottlenecks

In the plant of a prominent manufacturer there was a huge pile-up of radio cabinets all over the final assembly area, occupying almost 400 square feet. A casual look could convince the most skeptical that something was wrong and could be improved, yet the foreman and others would trip over the mess every day with little or no reaction.

These cabinets were empty, being rejected from the line because of scratches, dents and other defects. The situation was costing this plant about \$7,000 a year because of plant space the rejects were occupying, additional time used by the final assembly operator to reject a cabinet, and full time of two stock hands carrying the cabinets back to the stockroom.

Starting with the last point first, any simple materials handling expedient such as a hand-lift truck could be used to return the rejects to the stockroom. While that would be some help, it wouldn't remedy the first two points.

The method finally adopted solved all three problems. It consisted of an overhead conveyor running from inside the stockroom over the fencing to the terminus of the assembly line. No plant space had to be provided or wasted for rejects, since inspection was made in the stockroom and only good cabinets were placed on the conveyor for delivery to the line. The final assembly-operator's time was completely devoted to his job and nothing else, which increased his continuity of work and consequently his productivity. The two stock hands were not needed.

The conveyor was a motor-driven cleated-belt type which paced the main assembly line by delivering a good cabinet to the final position at the same time that a completed chassis arrived there. The conveyor and its relation to the rest of the assembly floor are shown in Fig. 4.

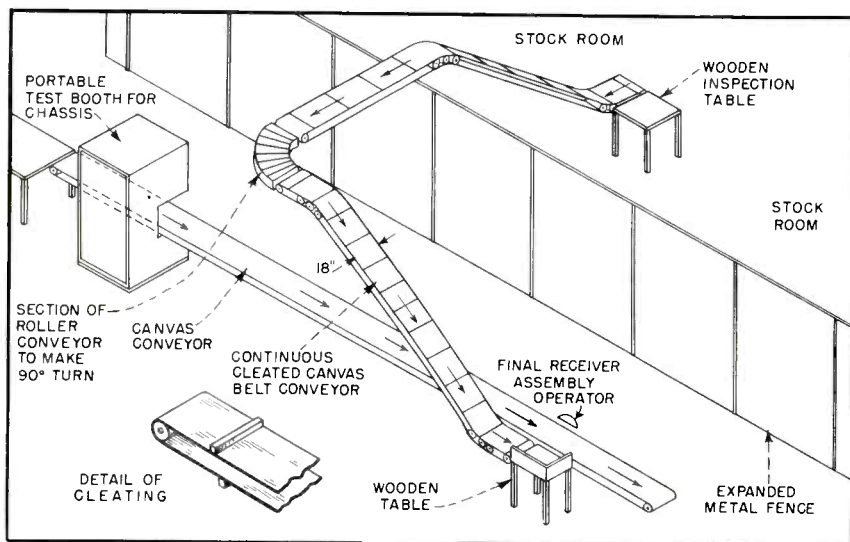

FIG. 4—Use of conveyor to speed moving of cabinets from stockroom to receiver production line

certain conditions, then dropping back severely due to "some trouble with the irons". The only trouble with the irons was that as the girls approached 800 joints per hour, more heat was pulled out of the iron than the heating element could replace. This insufficient heat melted the solder slowly, with a consequent decrease in the number of joints per hour.

The high production was always evident during the first hour or so in the morning, so that the operator's fatigue and the quality of the

each trough were three plugs into which all three irons were plugged at all times. A soldering girl took one iron and used it until it was too cold, then replaced it in the trough and used another iron for awhile. Lighter irons were used, which minimized operator fatigue and lowered power consumption.

With three irons per girl, production increased and remained at a constant average of 900 joints per hour. The savings amortized the inexpensive soldering aprons in a matter of weeks, then gave to man-

The cost of the entire installation was amortized within four months.

Trolley Ducts Give Flexibility

In this same project a new plant had to be laid out. The items to be manufactured were the usual table model a-c/d-c radios and larger a-m, f-m and television sets. Before proceeding, it was agreed that the layout should be as flexible as possible to permit inexpensive changes in set-up wherever style, design or sales trends demanded.

At the time of this layout, small sets were at the height of their demand. This management decided to make 1,000 five-tube sets per day and 500 seven-tube sets daily. However, they realized that this ratio could be changed overnight. Flexibility and minimum investment in fixed items were therefore paramount.

The largest items of expense in this plant were the lighting and electrical installation. Fixed lighting was undesirable since it limited the location of assembly lines to the fixed lights. Fixed electrical installations, such as overhead or underfloor conduit, also limited flexibility of assembly.

The most practical solution was the use of trolley-duct electrical installation throughout for both lighting and power. This type of duct is shown in Fig. 5. It was installed in parallel lines 10 feet apart over the entire assembly floor, so that industrial fluorescent fixtures could either be hung on a duct parallel and below it, or at right angles between two ducts. In that way, every inch of the 16,000-sq-ft assembly area received an average illumination of 45 foot-candles.

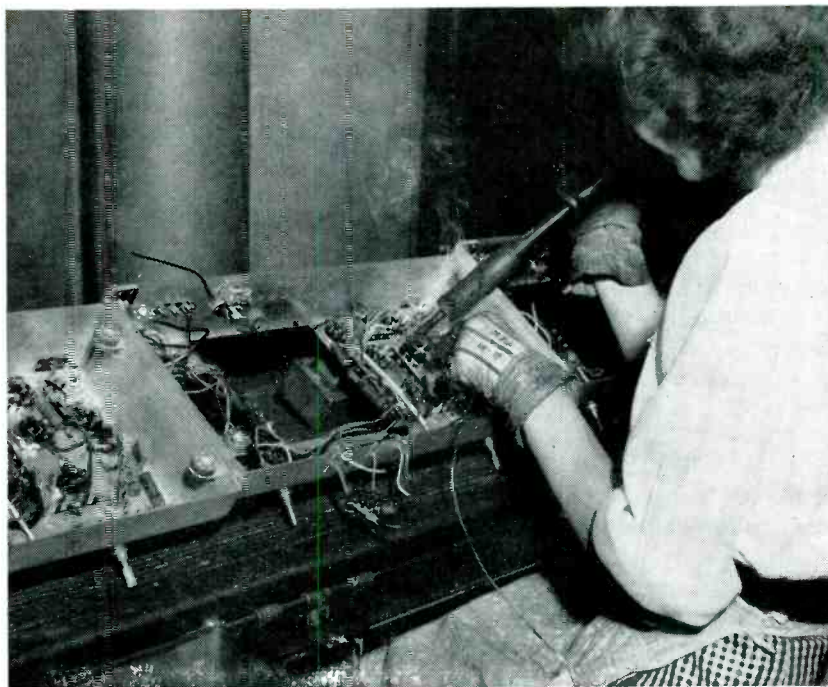

Avoiding assembly operations at soldering positions is one example of specialization that cuts costs

The cost of the trolley-duct installation was one-third that of a permanent installation. The end cost was even less, for when the manufacturer left this plant after realizing his market potential, he took the trolley system out with him and sold it for a large percentage of the original cost.

Portable Test Booths

For flexibility, in receiver production lines, each r-f and i-f alignment booth should be movable, should permit a belt conveyor to run through, and should be small enough so other lines can be set up parallel to it. Technical requirements were double copper-mesh shielding plus room for a signal generator and output meter.

An inexpensive portable test booth design meeting these requirements is shown in Fig. 6. It was built on a single-faced wooden pallet which makes it easy to move by hand lift truck. Side openings admit the belt conveyor which runs through the booth. In use, the operator takes a chassis off the conveyor and places it on the small shelf before him for alignment, then returns the chassis to the conveyor.

Instead of equipping each booth with individual signal generators, a master signal-generating source fed to strategic points throughout the plant could be used. Coaxial cable tapped by T coax connectors would provide ready plug-in points for booths. The same cable could be used for carrying more than one

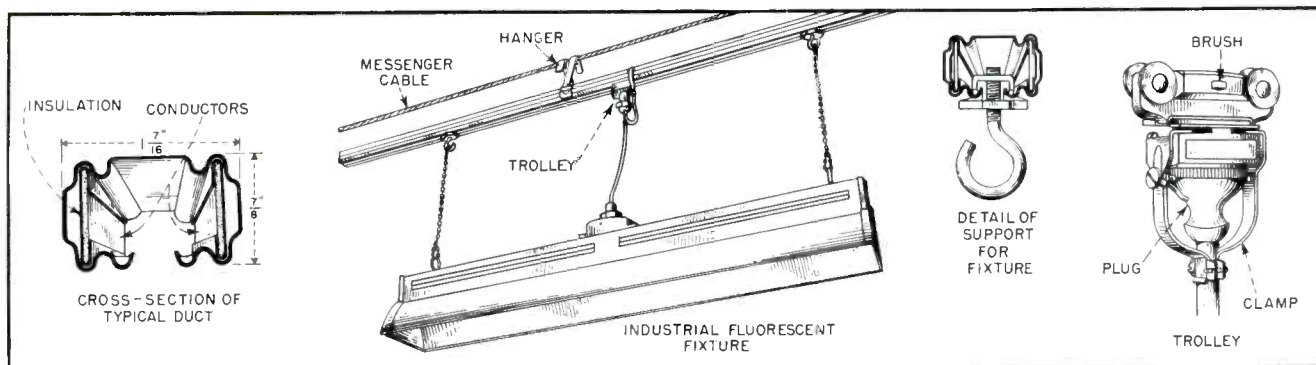

FIG. 5—Details of trolley-duct wiring system used in receiver-assembly department to give complete flexibility for any required rearrangement of production lines

signal at a time, by proper filtering. With i-f signals of 455 kc and 10.7 mc, filtering would not be mandatory at the booth, since the Q of both circuits and the harmonic attenuation of the 455-kc signal would be sufficient to prevent difficulties. In very large plants where many people would be using the same frequency at the same time, r-f equalization of the line would be needed at all the used frequencies to prevent interaction due to lowered line impedance.

Chassis Cradle

Some method of easily moving a chassis from one position to the next on the line is highly desirable in receiver assembly. Push-along methods generally involve too much friction, since up to five chassis units are usually found between operators to cushion against waiting for work or being overburdened.

A solution is found in the bench and chassis cradle design of Fig. 7, where the cradle rides on an angle-iron rail. The cradle is constructed from sheet metal. By a simple stud and spring arrangement the chassis can be rotated and indexed at any position for maximum accessibility. Four wheels on the cradle are roller or ball bearing.

At the rear of each cradle is a lever which is gravity operated and which automatically engages in a notch at each operating position. When an operator finishes a certain set she depresses the lever, disengaging the cradle from the stop, and rolls the cradle toward the next operator.

The cost of the cradle was about \$4.00. At the operation prior to the insertion of the tubes for heater test, a cradle-return system provides for return of empty cradles to the starting point, while the completed chassis is placed on a belt conveyor which goes through the portable test booth and on to the end of the line.

Besides savings in fatigue, operational time was considerably reduced, which increased productivity. The cost of the cradle system was amortized in about two months. Direct labor savings amounted to 43 percent of an already lowered total cost.

For larger sets the cradle was made larger, but the rails on which the cradle traveled were the same. This made the workbenches highly flexible and standardized at the same time.

The soldering iron apron and the rail are easily moved by loosening a

few screws, when benches are moved to other positions.

Custom Building

One unending discussion in radio and television assembly plants concerns custom building larger sets versus specialization and breakdown of operations. Those in favor of custom building claim better technical accuracy as regards such things as critical lead dress, plus the advantage of being able to fix responsibility, which may yield fewer rejects. Advocates of specialization claim increased productivity because of the higher skills acquired on repetitive jobs.

There are elements of validity in both arguments. It is possible to combine the advantages of both methods by preparing and cabling a large group of wires beforehand, using a wooden jig with nails as pegs. The cabling operation is done on a feeder line by operators who develop great skills in this operation. A large set may have two or three cable assemblies. Only non-critical leads are selected for cabling. In a plant making 12 and 15-tube sets, cabling doubled custom productivity. Including the cost of external cabling, direct labor was cut 40 percent.

Telescoping Stud Jig

In a plant manufacturing intercommunicating equipment, considerable direct labor was being used in testing the completed units, especially in the switching circuits from the master station to each call position. The wiring at the multi-connection terminal strip in the rear of the unit had to correspond with the station markings on the front of the master station and had to work at each station.

The method of testing was to connect 42 spade lugs to each of the 42 terminals by unscrewing each and then tightening each connection and feeding it into a mock-up for visual check of output at each position. In connecting the spade lugs, care had to be exercised to prevent the lugs from touching and shorting out a circuit. It took about 15 minutes to test each unit, and that operation became the bottleneck of the plant.

A new method solved the prob-

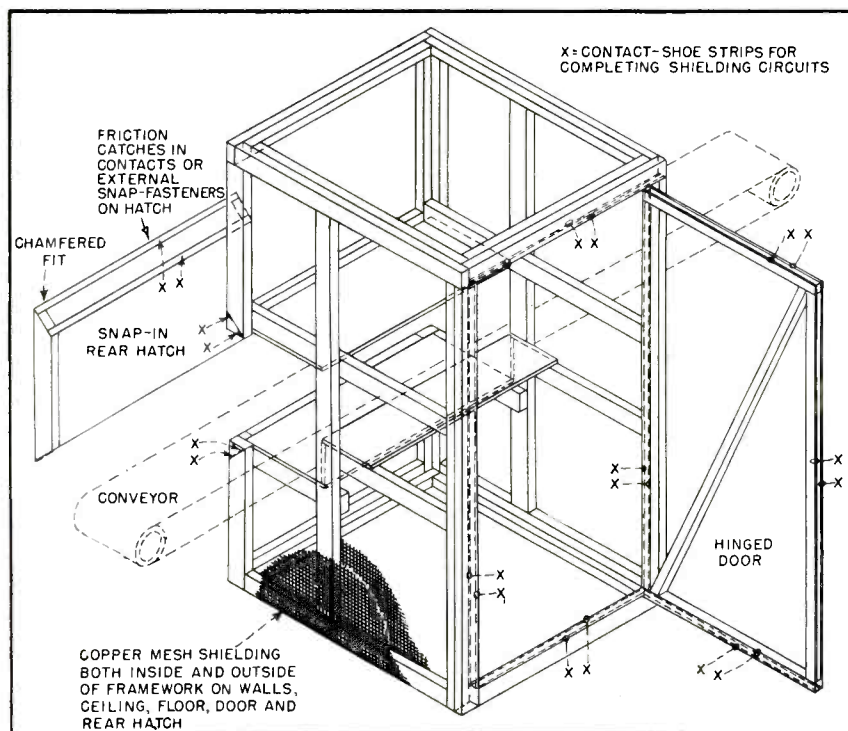

FIG. 6—Portable shielded test-booth for chassis conveyor. It can be moved to any production line in a few minutes with a hand-lift truck

lem. A jig containing 42 spring telescoping studs, simulating the same mechanical layout of the terminal strip, was built. The terminal strip of the unit was placed in this jig and clamped so that each of the studs made contact with each of the terminal screws on the strip. The springs compensated for screws which were not screwed all in.

The studs were connected to an external selector switch that fed each station in turn into the master unit. The station's dynamic speaker, used as a microphone, was placed in front of the master station speaker, and the external selector switch was rotated through each of the individual station positions. If the wiring was OK, acoustic feedback was heard at each position. This insured communication from individual stations back to the master. To insure communication from the master station to each of the individual stations, the master station speaker was switched to use as a microphone, and the selector switch was rotated back through each of the positions. If the same feedback was heard, the entire system was functioning.

The entire new procedure took approximately one minute.

Quantity Amortization

In making small metal parts for electronic devices, methods-conscious managements often look for the most modern and fastest methods of fabrication without duly considering their real cost in terms of quantity amortization.

In making small flat chassis pieces and brackets, most progressive factories think of stamping dies and neglect simpler, less expensive methods on the basis that they are old-fashioned. For small-run production, the lower labor cost induced by the dies, for example, may still not be truly representative of the end cost, since it takes a certain minimum amount of production to pay for the die. If there is no possibility of reaching this minimum, which is high for dies, then management had better use a cheaper first-cost tool, even though it means higher direct-labor cost.

In other words, management should not use direct labor cost as

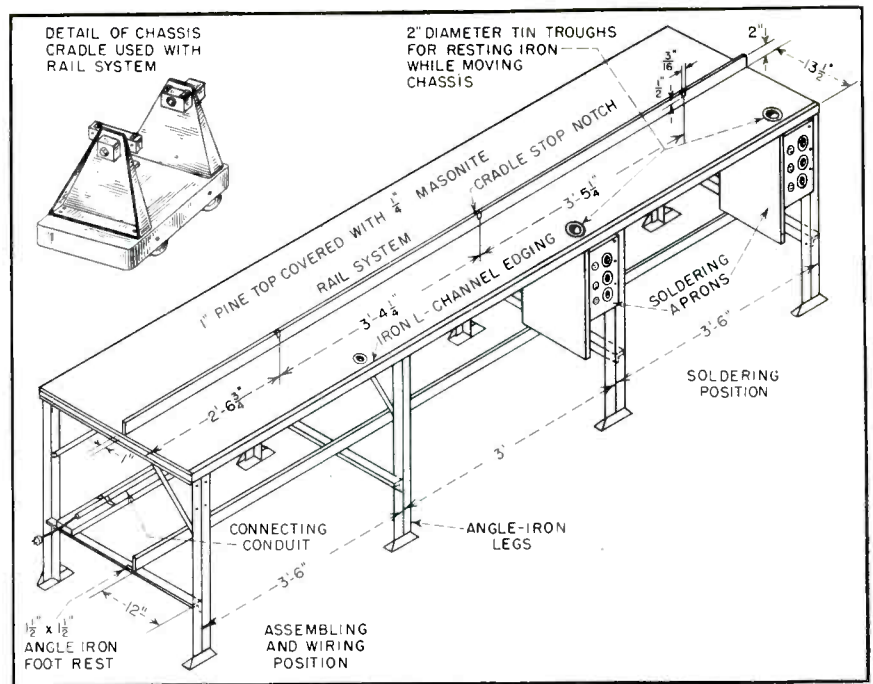

FIG. 7—Design of standard workbench for receiver assembly, and details of chassis cradle that rolls along bench guided by rail in center. Back of bench is used for storage of parts and for preparatory operations like cutting and bending wires

the sole criterion. Before a new piece of equipment is purchased, a comparison of both methods should be made by plotting the information on a break-even chart to show the amortizing quantity required for the proposed new machine or process. The data to make such a chart is taken from a tabulation like the following:

| SAWING vs. STAMPING | Present Method | Proposed Method |
|--------------------------------|----------------|-----------------|
| Cost per M | | |
| (1) Labor | \$3.72 | \$.94 |
| (2) Power | .08 | .19 |
| (3) Maintenance and repairs | .11 | .41 |
| (4) General plant expense | .04 | .07 |
| (5) General overhead | .03 | .02 |
| (6) Supervision | .28 | .12 |
| (7) Scrap cost | .42 | .02 |
| (8) Cost of new equipment | 0.00 | 3,500.00 |
| Total cost, first 1,000 pieces | \$4.68 | \$3,501.77 |

Where this sort of tabulation is not made, the decision to buy generally hinges on the labor item, which here is clearly favorable for the proposed method. But the cost for the first 1,000 pieces is out of line for the new method, if 1,000 is the total expected production. From a break-even chart it can be seen that the new equipment is feasible only when the expected production exceeds 1,202,700 pieces.

If management uses or will use up pieces at the rate of 100,000 per year, then the proposed method will

pay for itself in 12 years. This may be a poor financial policy since it ties up working capital for a long period. Therefore, another factor should be used in evaluating a new proposal—the loss to the firm from a lowered working capital. This can be done by estimating interest charges on loans which ordinarily might not be required.

Capital equipment changes cannot be decided unilaterally. The sales department must be involved for market and sales forecasts. The financial functions must state and fix financial policies, and the operating departments must evaluate direct savings.

In this same situation, even if the past and expected production was better than one million pieces per year, making the amortization period one year instead of twelve, the capital and operating characteristics of the company may veto the proposal. If a company is undercapitalized any large expenditure jeopardizes the meeting of weekly payrolls and immediate material purchases.

The only answer to this problem and all the others brought up in this article is the ability to remain objective, to think and to have an open mind.

Compliance Meter

By **A. M. WIGGINS**

Engineering Director
Electro-Voice Inc.
Buchanan, Michigan

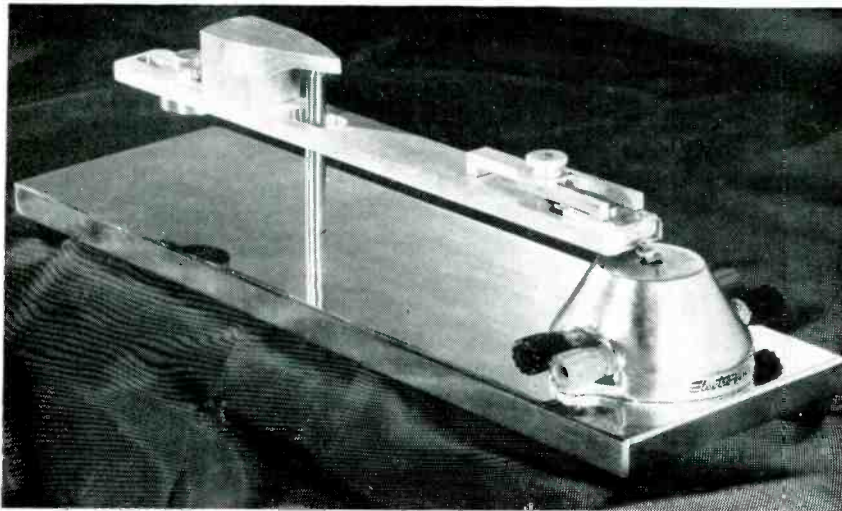

Compliance meter with a universal tone arm

SINCE THE ADVENT of the one-mil stylus, and the low needle force required to prevent excessive wear on stylus point and record groove, it has been necessary to design pickups with greater compliance than was heretofore necessary. There have been several types of compliance meters¹ and mechanical impedance bridges² used which have been very useful for determining the value of the compliance of a phonograph pickup. Some of the instruments used in the past, however, have been strictly laboratory instruments and involve time-consuming labor to make a measurement or to calculate the compliance.

The compliance meter illustrated is simple to construct and easy to use. The compliance in centimeters per dyne may be read directly from a specially calibrated vacuum-tube voltmeter by merely placing the stylus of the pickup on the vibrating element.

The effective mass of a tone arm may also be determined from the data obtained.

The vibrating system of the compliance meter is composed of a cantilever reed which serves as the armature of a magnetic driving system. A piezoelectric ceramic slab is cemented to this reed in such a manner that a voltage is developed which is proportional to the displacement of the reed. Machined into the top of the reed are V slots to facilitate the application of the

stylus point to the reed. A schematic drawing of the vibrating system is shown in Fig. 1.

When an alternating force is applied to the reed by sending a current through the driving coil, the reed will vibrate with a velocity of

$$v = f/Z_m \quad (1)$$

where v is the velocity in centimeters per second, f the force in dynes and Z_m the mechanical impedance in mechanical ohms.

The mechanical circuit of such a system is simply a series circuit composed of the mass M of the reed, the compliance C_R of the reed, and the mechanical resistance R of the reed, as shown in Fig. 2. The force required to overcome the reactance of the compliance is f_c .

When a lateral stiffness load such as the stylus of a phonograph pickup is applied to the reed as shown in Fig. 1, the stiffness at the stylus point will be added to the stiffness of the reed, and the reed will vibrate with a different amplitude due to the added stiffness of the stylus. The mechanical circuit of the system is shown in Fig. 3. The resistance of the system is neglected as it is quite small.

When the system is vibrating with no load applied, the compliance to be measured, C_x , is shorted in the circuit diagram. When the load is applied the short is removed from C_x . From the mechanical circuit

$$f_c = \frac{f \frac{1}{j\omega C_R}}{j\omega M + \frac{1}{j\omega C_R}} \quad (2)$$

where f_c is the force required to overcome the stiffness of the reed under no-load conditions, C_R is the compliance of the reed, M is the equivalent mass of the reed, and $\omega = 2\pi f$ (where f is the frequency). Under loaded conditions

$$f_c' = \frac{f \frac{1}{j\omega C_R}}{j\omega M + \frac{1}{j\omega C_R} + \frac{1}{j\omega C_x}} \quad (3)$$

where f_c' is the force required to overcome the stiffness of the reed under loaded conditions. Combining these two equations,

$$\frac{1}{j\omega C_x} = \left[j\omega M + \frac{1}{j\omega C_R} \right] \frac{f_c - f_c'}{f_c'} \quad (4)$$

$$C_x = \frac{f_c'}{f_c - f_c'} \left[\frac{C_R}{1 - \omega^2 MC} \right] \quad (5)$$

For frequencies well below the resonant frequency

$$1 \gg \omega^2 MC \quad (6)$$

and the equation reduces to

$$C_x = \frac{f_c' C_R}{f_c - f_c'} \quad (7)$$

The ceramic generates a voltage proportional to the displacement, and the displacement is proportional to f_c and f_c' .

$$e_0 \propto f_c \text{ and } e_L \propto f_c' \quad (8)$$

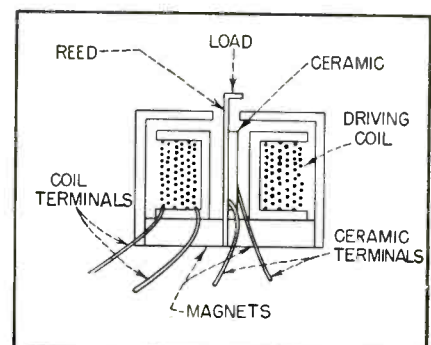

FIG. 1—Components of the vibrating system

For Pickups

Stylus point is placed on a vibrating reed on which is cemented a piezoelectric ceramic slab whose output voltage is indicated on a vacuum-tube voltmeter that may be calibrated in centimeters per dyne of compliance

where e_0 is the voltage generated under no-load conditions and e_L is the voltage generated under loaded conditions. The unknown compliance C_x may now be written as

$$C_x = \frac{e_L C_R}{e_0 - e_L} \quad (9)$$

The compliance C_R of the reed may be determined by applying a known compliance such as a cantilever reed as a load. The compliance of a cantilever reed may be calculated by

$$C = \frac{4 L^3}{E b c^3} \quad (10)$$

where C is the compliance in centimeters per dyne, L is the length in centimeters, b is the width in centimeters, c is the thickness in centimeters, and E is the modulus. The compliance C_R of the reed can now be determined by

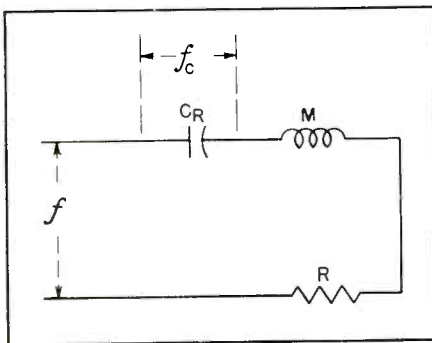

FIG. 2—Mechanical circuit of the vibrating system

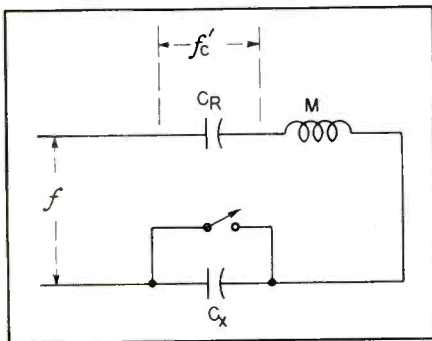

FIG. 3—Stiffness load added to the mechanical circuit

$$C_R = C \left[\frac{e_0 - e_L}{e_L} \right] \quad (11)$$

To measure compliance, the driving coil of the compliance meter is connected to an oscillator. The measurement should be made at a frequency above the tone arm resonance of the pickup and well below the resonance of the vibrating reed of the compliance meter.

The terminals of the piezoelectric ceramic are connected across a vacuum-tube voltmeter of at least 0.5-megohm input impedance. The output of the oscillator may be set so that the vacuum-tube voltmeter reads full scale when no load is applied.

When a stiffness load is applied the meter will read less than full scale by an amount depending on the ratio of the stiffness of the load to the stiffness of the reed. By the use of Eq. 9 the meter may be calibrated in centimeters per dyne.

When a measurement is desired at a frequency above about one third the resonant frequency of the reed, the mass of the reed must be considered and Eq. 5 used. A measurement should never be made at a frequency within 100 cycles of the resonance of the reed, as the resistance of the system would then have to be considered.

The effective mass of a tone arm

may be determined by placing the tone arm on the vibrating system so that the point of contact is at the same position as the stylus would be and measuring the resonant frequency of the system by observing the voltage maximum on the meter. The effective mass of the tone arm may then be calculated from

$$M = \frac{1}{4\pi^2 f_0^2 C_R} \quad (12)$$

where M is the effective mass of the tone arm and f_0 is the resonant frequency of the system.

Care should be taken that the vibrating reed is parallel to the axis of the pickup cartridge when a measurement is made. The reed should not be driven at a displacement high enough to produce rattles or too great nonlinear distortion.

The tone arm should be quite rigid and massive enough to have a low tone arm resonance with the lowest-compliance cartridge to be measured.

In the compliance meter illustrated the resonance of the reed was 800 cycles per second with a compliance of 0.32×10^{-6} centimeter per dyne. The no-load voltage output of the ceramic slab is set at 0.1 volt without producing appreciable nonlinear distortion.

A chart of compliance versus the loaded voltage output of the ceramic slab, when the no-load voltage is set at 0.1 volt, is shown in Fig. 4. For rapid measurements, the calibration of a vacuum-tube voltmeter to read in centimeters per dyne with a full-scale setting of the no-load voltage is recommended over the use of a chart.

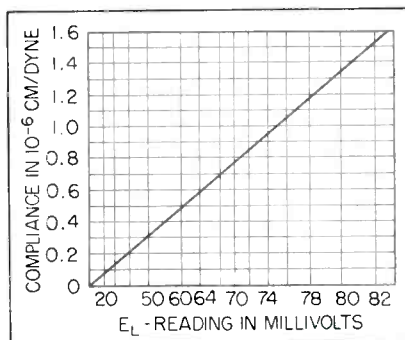

FIG. 4—Typical chart of compliance versus loaded voltage

REFERENCES

- (1) B. B. Bauer, Measurement of Mechanical Compliance and Damping of Phonograph Pickups, *J. Acous. Soc. Amer.*, 19, p 319, March 1947.
- (2) A. M. Wiggins, Mechanical Impedance Bridge, *J. Acous. Soc. Amer.*, 15, p 50, July 1943.

Properties of CONDUCTIVE PLASTICS

New conductive materials can be molded like ordinary plastics yet have electrical resistivities approaching that of mercury. Many can be soldered or electroplated directly. Promising applications include shielding, molded circuits, resistors and commutators

AN INCREASING NUMBER of engineering problems require for their solution structural assemblies having selected properties of both metals and plastics.

Efforts to secure desired combinations of metallic and plastic properties usually depend upon such methods as incorporating metal inserts in plastic bodies at the time of molding, coating formed metal parts with plastic insulator materials and metal-cladding molded plastic objects. The most exten-

sively employed method of metallizing plastics is electroplating. However, since all ordinary plastics are good insulators, it is necessary to first render the surface conductive in order that plating can take place. This is accomplished by such means as applying a conductive undercoat such as a silver mirror deposit, graphite-wax layers or conductive bronzing lacquers.

For many purposes, the above procedures are partially or wholly unsatisfactory. Thus, metal-to-plastic bonds may be subject to severe stresses and may fail at extremes of temperature due to the great disparity in thermal expansion coefficients of the two materials. Similarly, the use of a conductive undercoat as a base for metal plating introduces other processing operations with attendant expenses and sources of rejects; deep recesses and isolated flat areas involve special difficulties.

Electrically conductive materials

which can be molded like ordinary plastics and can be directly plated offer a solution to many of these problems. Quite apart from serving as a base for electroplating, the materials have other useful and unique applications as engineering materials. Thermosetting, thermoplastic and elastomeric variants have been produced, many of which exhibit enhanced thermal conductivity and heat stability.

As indicated in Fig. 1, Markite conductive plastics have been prepared which encompass a fairly extensive range of resistivity values. Appearances vary from dark, opaque, semimetallic-looking materials to completely transparent ones. Most of these materials may be classified as organic plastics and seem to depend chiefly on high polymeric carbon-carbon chains and networks for their plastic structure.

Current costs are of the order of several dollars per pound. Since the molding operations are normally

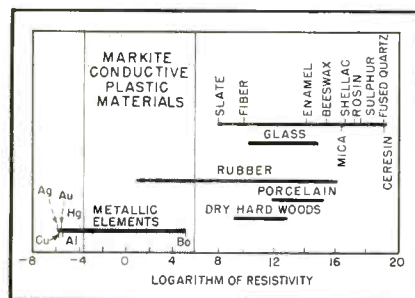

FIG. 1—Resistivity spectrum, showing range covered by new conductive plastic materials

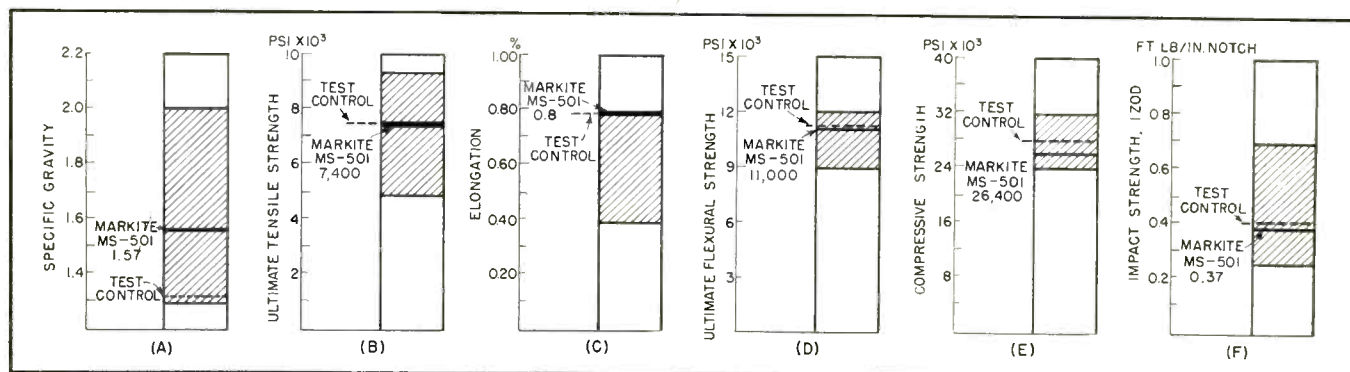
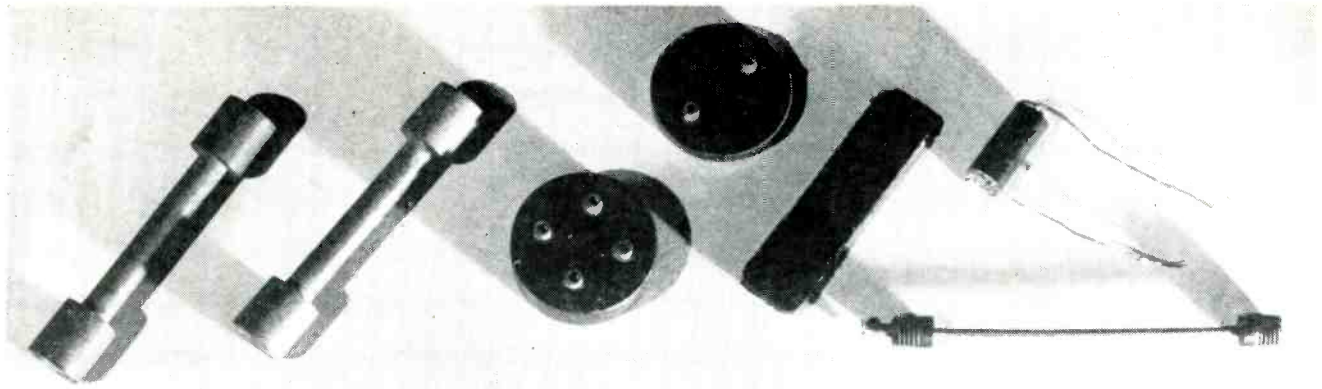

FIG. 2—Twelve properties of MS-501, a representative conductive plastic material, shown in relation to corresponding properties of general-purpose phenolics (shaded areas). Speci-

mens of one typical general-purpose phenolic were used as test controls. In general, conductive properties are obtained in the new materials with no sacrifice of other desirable prop-



Samples of typical thermosetting, thermoplastic and elastomeric conductive plastics. Rods at left have less than 1 ohm resistance between ends. Leads are soldered directly to ends of

resistor section at right. Disc sample with four terminals was used to check homogeneity of material, by measuring resistance between various pairs of terminals in turn

not conventional and special precautions must be observed, present arrangements are designed to furnish parts molded to the user's specifications rather than molding powders.

More detailed properties of a representative conductive plastic are indicated in the bar graphs of Fig. 2, which also provide a reference comparison with the familiar general-purpose phenolics. In order to have a more specific yardstick and a cross-check on the test methods, specimens of a single typical general-purpose phenolic were included as test controls. Control samples were molded, stored and tested under the same conditions as the conductive plastic samples.

Mechanical Properties

Test observations and comparisons with respect to specific gravity, ultimate tensile strength, elongation, tensile modulus of elasticity, ultimate flexural strength, compres-

sive strength, impact strength and hardness show that the new conductive material behaves like the reference phenolics with respect to all of the general and mechanical properties examined, as indicated in Fig. 2A, B, C, D, E, F and G. Accelerated weathering tests showed substantially the same weathering resistance as the general-purpose phenolic control, with both exhibiting little or no deterioration of these mechanical properties under the conditions of test. Incidentally, in most applications involving use as an electrical conductor, insulator coatings or envelopes would probably be employed for electrical purposes; bare specimens were employed in the above tests without benefit of such supplemental protection.

Thermal Properties

The specific heat (Fig. 2H) falls in the range of the typical plastic materials. The heat distortion

temperature (Fig. 2I) is distinctly on the high side of the general-purpose range. Irrespective of the electrical properties, a high heat distortion temperature is definitely advantageous when a molded part is to serve as a structural member at elevated temperature.

The enhanced heat distortion resistance may be at least in part a result of the comparatively high thermal conductivity, shown in Fig. 2J as being approximately four times that of the average general-purpose phenolic. High thermal conductivity favors more even curing of large masses.

Many applications require composite structures made up of insulators and conductors. Conductive metallic inserts mounted in non-conductive plastic masses are extensively used in the electrical industries. Difficulties often arise due to the differences in thermal expansion coefficients; thus, general-purpose phenolics have coefficients

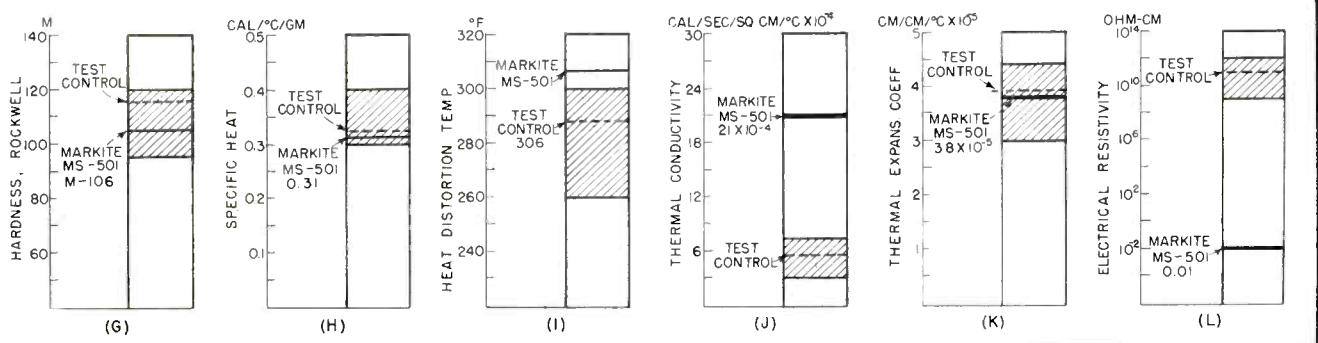

erties of ordinary plastics. Material MS-501 is thermosetting, black in color, and can be fabricated by compression molding, machining and grinding. Water absorption (gain) is 0.55 per-

cent; moisture vapor transmission is 44 g/100 sq in./24 hr/mil; flexural modulus of elasticity is 11×10^5 psi; tensile modulus of elasticity is 13×10^5 psi

of the order of 2.5 times that of copper. These difficulties are naturally accentuated at extreme temperatures and may result in loose-fitting parts or splitting and deformation on shrinkage.

The thermal expansion coefficient (Fig. 2K) of the conductive plastic is squarely in the range of the general-purpose materials, permitting the combining of the two particular plastic materials (which happen to be comoldable) without shrinkage difficulties. The thermal expansion of both materials is the same over a temperature range extending from below -50 to 80 C (-60 to 180 F). Comoldings of both materials exhibit good integral bonding characteristics.

Electrical Properties

Conductivity (Fig. 2L) is of the order of a trillion times that of the reference general-purpose plastics, and definitely in the range of the substantial electrical conductors. However, low resistivity is in itself of little value for most electrical applications unless reasonable predictability and reproducibility of behavior with respect to the chief operating variables can be expected. Important variables include temperature, current density, duration of loading and frequency.

The resistivity increases in a simple and essentially linear manner with increasing temperature as indicated in Fig. 3. The temperature coefficient of resistivity of approximately $+ 0.2$ percent per degree C is, for many purposes, desirably low. The value is roughly one half that of the most familiar conductor materials—copper, silver and aluminum.

The effect of current density on resistivity is indicated in Fig. 4. For current densities up to about 16 amp/cm², the resistivity is independent of the current density and the material follows the simple Ohm's Law relation. In the neighborhood of 30 amp/cm² destructive pyrolysis appears to take place. At lower current densities the behavior is reversible and resistivity values check on repeated testing cycles. The increase of resistivity in the 10 - 30 amp/cm² band is primarily a temperature effect.

At moderate and low current

densities, the resistivity is stable and apparently exhibits no tendency to drift or vary significantly after an appreciable number of hours of continuous loading.

For the range from d-c to 40 mc, resistivity appears to be independent of frequency.

A number of these conductive plastics are compatible with each other and can also be blended with certain conventional insulator plastics to yield materials of intermediate resistivities. Predictable and reproducible variations can also be secured, within limits, by the incorporation of different fillers and plasticizers and modifications of the processing methods. It is thus possible to produce plastics of preassigned resistivities over a substantially continuous range of values. The extent of this range has been indicated in Fig. 1.

Future Possibilities

Roughly summarized, it is feasible to design materials having any desired resistivity from approximately one megohm-cm to less than one milliohm-cm. There is evidence that the range may be extended upward to at least $1,000,000$ megohms and probably may be extended downward to values approaching 10 microhms. The present conductive plastic materials have resistivities which span the range of the moderate and semiconducting metals and the high-conductivity rubbers. This range includes all of the common aqueous solutions of electrolytes such as acids, bases and salts. The present band is approximately bracketed between multiply-distilled water and mercury.

Resistivity values for a number of specific conductive materials are given in Fig. 5. Of those listed, MP-401-8, MP-401-11, E-473 and M-485 are thermoplastic; the others are thermosetting. Lower-resistivity thermosetting and higher-resistivity thermoplastic materials have also been produced.

A unique member of the series is E-473, which has distinct rubberlike properties. Strips of this elastomeric material have been reversibly bent and twisted through arcs of more than 180 degrees without undergoing major changes in conductivity during or subsequent to

deformation. This material has over $1,000$ times the conductivity of the highly conductive rubbers.

Applications

In many applications, such as devices intended for aircraft use, a special premium is placed on low total weight. Similarly, low density is often desired of parts which are to be rotated at high speeds in order to minimize centrifugal stresses. The favorable conductivity-weight ratios of a number of conductive plastics commend them for such purposes. The strength-weight ratios also compare favorably with those of the metals.

The wide range of resistivities available and the desirable loading and temperature characteristics naturally suggest the use of these materials as resistors. There appears to be a serious need for relatively inexpensive low ohmic value (0.5 - 0.01) resistors suitable for a frequency range in the neighborhood of 100 mc. The present materials are promising for such purposes.

For a given material, a wide range of resistances may be secured by merely varying the path length and cross-section. It is intrinsically just as easy to mold a tapered resistor or the key member of a tangent potentiometer as it is to mold a plain uniform linear resistor. Cooling fins can be molded integrally.

Many devices such as certain wave guide auxiliaries, attenuators and pads require high surface conductivity; the conductivity of the interior structural material may not

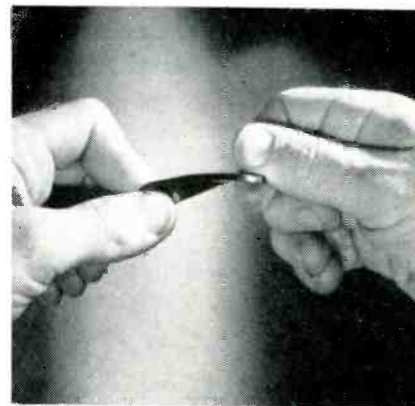

Sample of true elastomeric conductive plastic, being twisted

be as important. Often, intricate shapes are involved which demand elaborate machining and close tolerances. Conductive plastic parts precisely molded and directly plated with silver are inherently promising for such applications.

Protective devices which depend upon destructive action of predetermined overload currents may be directly molded.

There is evidence that wide but controllable variations of resistivity with temperature may be designed into these conductive plastic materials.

Irrespective of electrical functions, it is often desirable to have parts which can be fabricated with the ease and speed of ordinary plastics but which possess higher heat distortion temperatures and greater flame resistances. Several of these conductive plastics are superior in these respects, partly because of their relatively higher thermal conductivities.

Static electricity is a frequent source of annoyance. In the handling of explosives and in surgical procedures involving the use of anaesthetics, it has been a cause of many recorded deaths. Storage containers, casters, handles, funnels and laboratory appliances, in general, molded from conductive plastic materials will not build up undesirable static charges.

Cabinets, instrument cases and related members may be simultaneously furnished with shielding properties at the time that they are being molded on a mass-production basis. In addition, the enhanced thermal conductivity will tend to minimize overheating effects.

Molded Circuits

By comolding compatible conductive and ordinary plastics of matched temperature coefficients, composite assemblies may be fabricated in which the joints and interfaces are liquid-tight and gas-tight and will remain so over a wide temperature range.

Two and three-dimensional electric circuits can also be molded. Instead of requiring a panel on which to mount wires and terminal equipment (or to print a circuit with conductive ink) the wiring itself may be molded, threaded, tapped

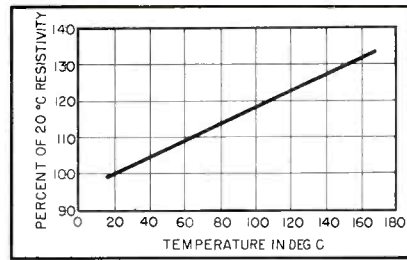

FIG. 3—Effect of temperature on resistivity of type MS-501 conductive plastic

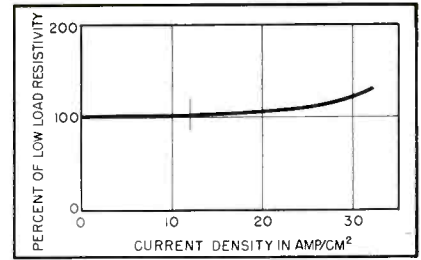

FIG. 4—Effect of current density on resistivity of MS-501 conductive plastic

and heat-bonded to provide a compact and adequate support for tubes, capacitors and other parts. Soldered connections and awkward lead wires may often be reduced in number or eliminated completely. Certain conductive plastics may be soldered to directly.

Such molded circuits may be used by themselves or in cooperation with printed and other circuits. In common with printed circuits, they would possess the inherent advantages of mass-producibility and lend themselves to uniform and comparatively foolproof manufacture since the correctness of most connections would be fixed by the master dies. Stocks of many miscellaneous parts and supplies would be replaced by a few molding powders and corresponding molded sections.

Three-dimensional configurations will permit the utilization of corners and other irregular, inconvenient and frequently wasted regions, thus further favoring miniaturization of equipment and allowing more space for other items such as batteries.

Plastic commutators are special examples of molded three-dimensional circuits. Apart from simplified fabricating procedures, possible advantages include the natural tendency for matched plastic conductors and plastic insulators to wear down together more uniformly. By similar matching of thermal expansion coefficients, close relative dimensional tolerances may be preserved over a wide temperature range.

Elements may be made to develop heat by both ordinary resistance and induction effects. Rubber-like as well as rigid types may be fabricated to form jackets, panels and immersion units. Complex curved

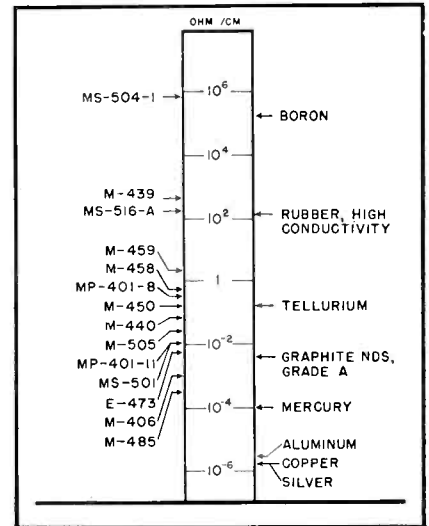

FIG. 5—Representative resistivity values of various Markite conductive plastics, compared with familiar conductors

shapes which will conform to preassigned contours may be built up in sections and often as a single unit.

It is implied in the above examples that no one type or grade of conductive plastic can be expected to serve all purposes efficiently. However, there is a fair chance of satisfying almost any reasonable specification.

Acknowledgments

A substantial amount of the technical information contained herein is based on a paper by Myron A. Coler, F. Robert Barnet, Albert Lightbody and H. A. Perry, Jr. Dr. Lightbody is Chief of the Plastics Division of the Naval Ordnance Laboratory. Mr. Perry is Chief of the Research Sub-Division and Mr. Barnet, Plastics Measurements Section Head of the Plastics Division. Dr. Coler has been a Consultant to the Naval Ordnance Laboratory and is Technical Director of Markite Co., 155 Waverly Place, New York 14, N. Y.

VHF Dummy Antennas

By B. E. PARKER

Engineering Head
F-M Department
Gates Radio Company
Quincy, Illinois

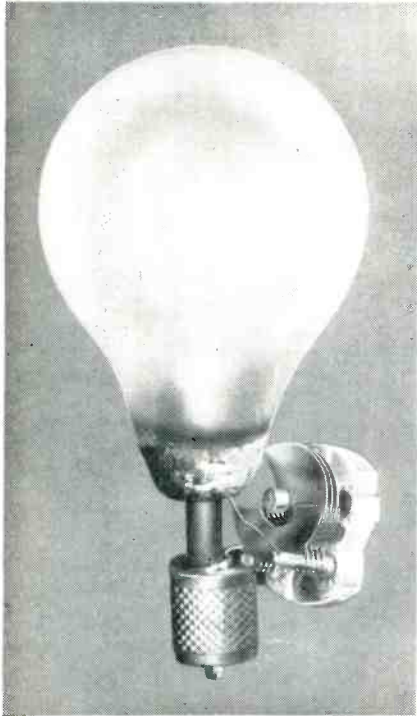

FIG. 1—Low-power dummy antenna consists of a debased 32-volt bulb and a variable capacitor

THE INCREASING NUMBER of vhf stations has accented the need for revision of test techniques and equipment designed for operation on the lower frequencies.

At 100 megacycles, a load used as a dummy antenna on the low frequencies may have a reactance several times its d-c resistance, with consequent introduction of a high standing-wave ratio. Standing-wave ratios which do not exceed a ratio of 1:1.5 are generally considered acceptable in the industry and the three dummy antennas illustrated meet this requirement.

The 25-watt unit shown in Fig. 1 handles 25 watts up to 160 mc with a standing-wave ratio under 1:1.3 when properly adjusted.

The 1,000-watt unit, Fig. 2, handles slightly over 1,000 watts at any frequency in the f-m broadcast band with a standing-wave ratio

which does not exceed 1:1.3 after the initial adjustment. With reasonable care in building and adjustment it may be adjusted to give a standing-wave ratio under 1:1.1 at any given frequency in the f-m band.

The 5,000-watt unit is illustrated in Fig. 3. It presents a nonreactive resistive load well beyond 160 mc. Standing-wave ratios under 1:1.1 will be obtained up to 160 mc without any kind of adjustment. This is a marked advantage in laboratory applications and in factories for testing high-power transmitters.

Each of the dummy loads described has been used by the final test engineers in our f-m department. For 10-watt f-m campus transmitters and communications transmitters, the 25-watt load has proven popular, due largely to compactness and ease in connecting to the transmitter under test.

25-Watt Load

The only parts required for construction of the 25-watt dummy load are a 25-watt, 32-volt light bulb, an Amphenol type 83-1SP plug, and a Hammarlund type APC25, 25- μ f capacitor. The 32-volt light bulb is of the popular rural-lighting-system type and is readily available from electrical supply houses in most localities.

The base of the bulb must be removed. A hacksaw, a soldering iron and a pair of diagonal cutters will do the job nicely without breaking off the two wires. One side of the bulb is soldered directly to the center conductor of the plug. The capacitor is soldered in series with the plug shell and the remaining bulb wire. The rotor connection of the capacitor should connect to the shell. The 25-watt dummy load shown in Fig. 1 has a one-inch length of polyethylene dielectric pushed over the center lead to make the bulb self-supporting. The poly-

ethylene was obtained from a piece of RG8/U coaxial cable.

1,000-Watt Load

The 1,000-watt dummy load has been of real value in field-engineering use and should prove popular because of its portability to stations that experience difficulty in the transmission system from the transmitter up to and including the antenna. When excessive standing-wave ratios are experienced in the transmission-line system, the transmission line may be pulled apart and terminated with the dummy, thus isolating the difficulty to the antenna, isolating unit, or section of coax causing the difficulty.

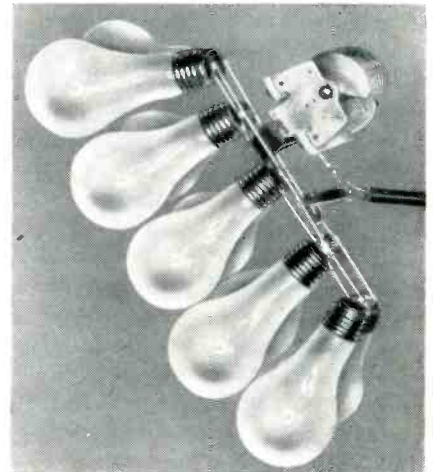

FIG. 2—Ten 100-watt bulbs and a variable capacitor form the 1,000-watt load

While the dissipation or power-handling capabilities of this particular dummy load is limited to a little over 1,000 watts, this does not limit its uses to stations of 1,000 watts or less. Most 3-kw f-m transmitters can be reduced in power to a kilowatt by means of transformer taps for the isolation procedure.

To make the 1,000 watt dummy load, ten 100-watt, 120-volt Sylvania light bulbs are connected in parallel by means of three twelve-inch lengths of No. 8 or No. 10 tinned

Three dummy loads for transmitter powers ranging from 25 to 5,000 watts and frequencies up to 160 megacycles are easily constructed. Voltage standing wave ratios are well under 1:1.5 for all types described

copper bus wire. The bulb shells are all soldered to the middle length, with five on each side. The second length of bus is laid across the bulb center-contact point of one row of bulbs and soldered, joining the five bulbs together. The remaining length of bus is laid across the center contacts of the other row of bulbs and likewise soldered.

The two outer rows of bus are joined by a short length of copper strap at least $\frac{1}{2}$ inch wide. This copper strap serves as the connection point for the inner conductor of the coax. A Cardwell variable capacitor is connected, by means of a copper strap, in series with the shells of the bulbs and the outer conductor of the coax. It is paramount that connections be kept short.

The 1,000-watt dummy shown in Fig. 2 has a ten-foot length of RG8/U coax with various adapters attached to assist in connecting to different types of fittings.

5,000-Watt Load

The materials for the 5,000-watt unit are an IRC type LP 51.5-ohm dummy resistor unit and a short length (approximately 14 inches) of $3\frac{1}{8}$ -inch coaxial cable with end flange attached. Cooling is done by a filtered water flow of five gallons per minute. A rubber hose for carrying the water and the necessary hose fittings and clamps for attaching it to the dummy and the water supply are also required as shown in Fig. 3.

The type LP resistor slides down into the $3\frac{1}{8}$ -inch coax with the flange fingers gripping the outer conductor. The lower end of the resistance element is attached to the inner conductor of the coax by means of a 10-32 screw.

The hose carrying the incoming filtered water is connected to the resistor fitting marked INLET. The outgoing heated water is carried

off by an additional length of hose to the plumbing drainage system. A fine-screen wire filter unit may be obtained from a plumbing supply house for insertion in the intake line. The filter prevents abrasive material, practically always present in water mains, from wearing away the thin carbon film constituting the resistive element. Cost of the element is around \$70 and the completed dummy should be under \$100.

This type dummy load may be increased to 10 kw by using a 3-inch T plumbing fitting and paralleling two 103-ohm type LP units.

Bulb Loads

It would appear that the number of bulbs could be reduced by using bulbs of greater wattage but this has not been found practical. The larger-wattage bulbs develop hot spots on the filament, destroying it before it can be brought up to brilliance. Also, a type of fluorescence occurs, often accompanied by internal arcing.

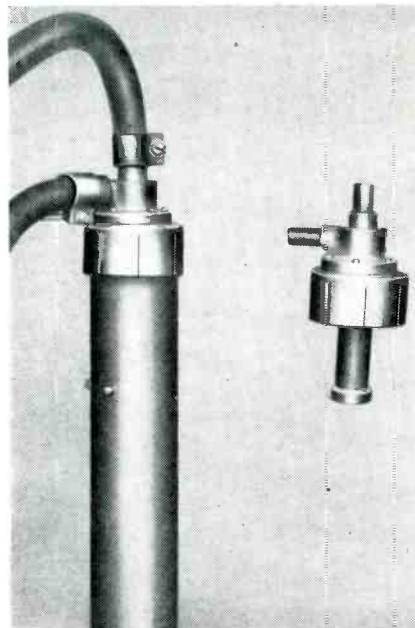

FIG. 3—Complete 5,000-watt dummy antenna is shown at left. The resistive element is at right

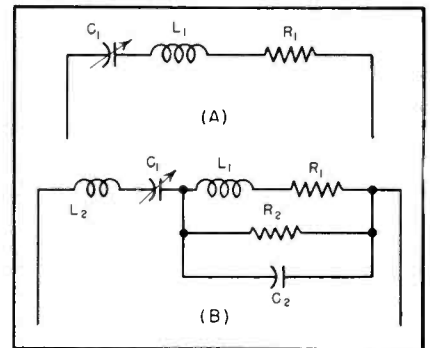

FIG. 4—Basic representation of R , L and C is shown at A. Complexities created by bulb shell and mount are shown at B

The d-c resistance of the bulbs when paralleled and operating at full brilliance figures out to be 14.4 ohms. This is far from the 51.5 ohms desired. Apparently the actual resistance is raised to 51.5 ohms at vhf due to the predominance of skin effect.

Figure 4A is an over-simplified schematic representation of the complex inductance, capacitance and resistance present in bulb-type dummy loads. Resistance R_1 represents the 51.5-ohm resistance in which we are primarily interested; L_1 represents the series inductance due to the filament structure and length; C_1 is the external capacitance added to series-resonate L_1 to the operating frequency and make the load appear purely resistive.

In practice, the complex reactances are more nearly represented by Fig. 4B. Capacitance C_2 represents the shell and lead capacitance in the base of the bulb; R_2 represents the insulating material used in the base of the bulb as well as the losses of the glass filament-supporting structure due to the high lead content used in the glass; L_2 represents the inherent inductance present in even the short external lead lengths used as connections as well as unavoidable inductance present in the capacitor construction.

Anastigmatic Yoke

Loss of picture detail in the corners of large tubes is caused primarily by spot or deflection refocusing and can be corrected by means of a deflection yoke that provides nonuniform deflecting fields that restore the spot to its proper size

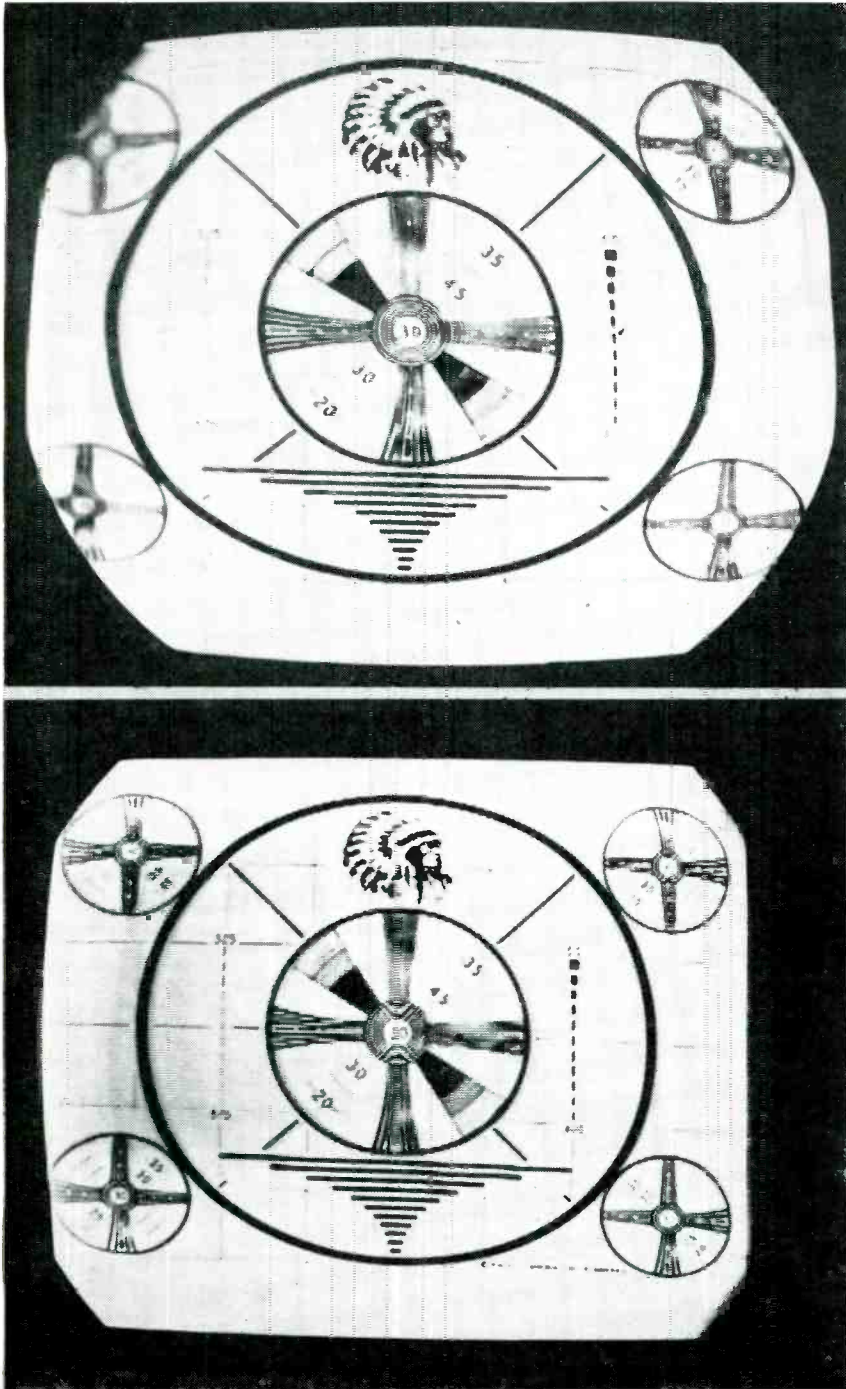

FIG. 1—Top pattern obtained with uncorrected yoke and bottom pattern with anastigmatic yoke

TWO TYPES OF DISTORTION frequently encountered in television pictures are pattern distortion and spot distortion.

Pattern distortion is a deviation from the desired rectangular frame and appears in the form of barrel or pin-cushion geometry. Non-linearity of the scanning presentation is a by-product of these geometric distortions.

Spot distortion, also known as deflection defocusing, causes a loss of picture detail in the corners of the picture. This effect has passed almost unnoticed in the smaller picture tubes. However, with the advent of large screens, such as the 16-inch tube, deflection defocusing becomes quite noticeable since these tubes are subject to viewing at relatively close range.

In Fig. 1, the top photo shows a picture exhibiting deflection distortion, giving an idea of the magnitude of the defects involved. This picture was obtained from a local monoscope generator, using a standard commercial deflection yoke and a 16-inch tube. The bottom photo shows the same picture taken with an anastigmatic yoke in use.

Spot defocusing can be compensated by the use of nonuniform deflecting fields which have a suitable and controlled amount of inherent field distortion. In so doing, a slight amount of pattern distortion is traded for spot defocusing and the deflected spot is restored to its original size. A deflection yoke with this quality has been tentatively termed anastigmatic yoke.

Practical tests with commercial picture tubes have shown that the

Presented at IRE National Convention, New York, March 1949.

for Picture Tubes

By **K. SCHLESINGER**

Motorola Inc.
Chicago, Illinois

pattern distortion introduced by an anastigmatic yoke is so small that it may not be noticed, whereas the original deflection defocusing is easily detected. It is further found that the adjustment of the yoke for minimum astigmatism often coincides with good rectangular geometry. One reason for this may be that the field distortion in the yoke as required for focus correction is of a type which, by itself, would produce barrel distortion on the screen. On the other hand, magnetic deflection from an undistorted sawtooth current tends to project, on a flat-face screen, a pattern of pin-cushion geometry. Both effects are small and of opposite sign, so that they tend to cancel.

Astigmatism of Electron Beam

It is widely believed that a uniform field of deflection is all that is needed to maintain proper focus, even on a flat screen.¹ However, this holds only for very small angles. It may be shown, and has been confirmed by experiment, that magnetic deflection is inherently astigmatic even in a uniform field. This is due to the circular nature of electron trajectories in a magnetic deflection field.

Figure 2 illustrates this in a somewhat simplified manner. It shows a pencil of cathode rays, represented by an axial ray 1 and a meridial ray 2. Both rays are brought to a point focus on the axis at P . If a magnetic field H_x is applied over a region L , both rays will describe circles of radii r_a and r_b , in the field, and leave it in the direction of the tangents at B_1 and B_2 , with no change in velocity along their path. The sagittal² focus P will therefore move in a circle with

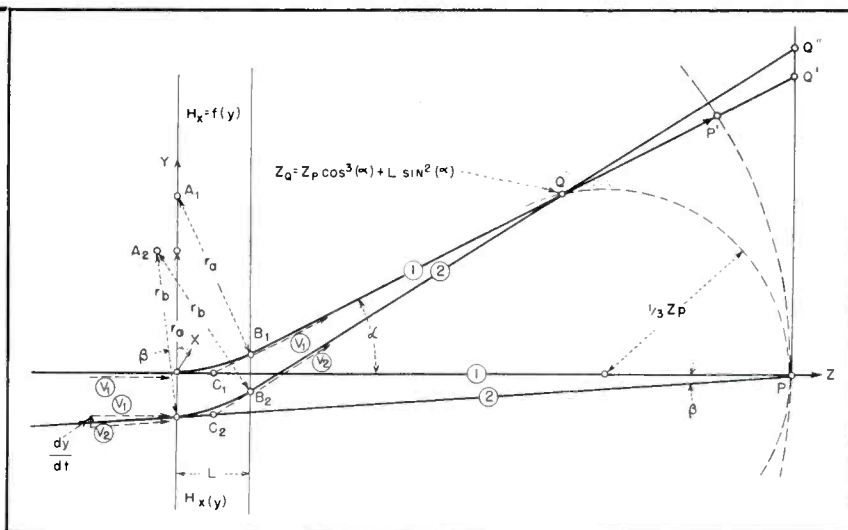

FIG. 2—Astigmatism of a focused beam with magnetic deflection

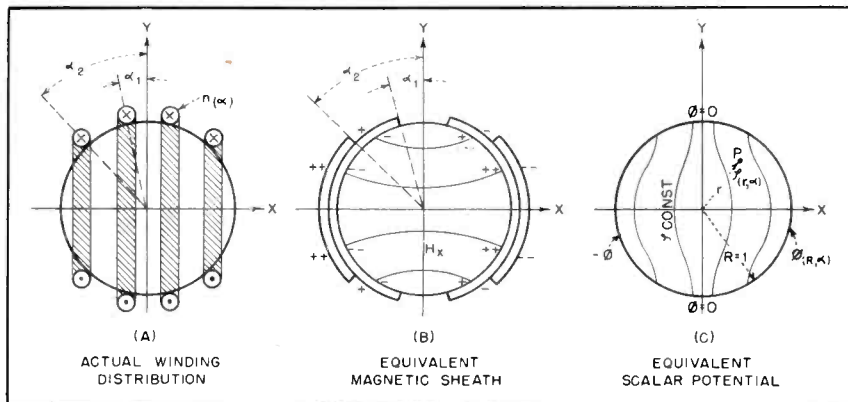

FIG. 3—Two-dimensional theory of deflection coils

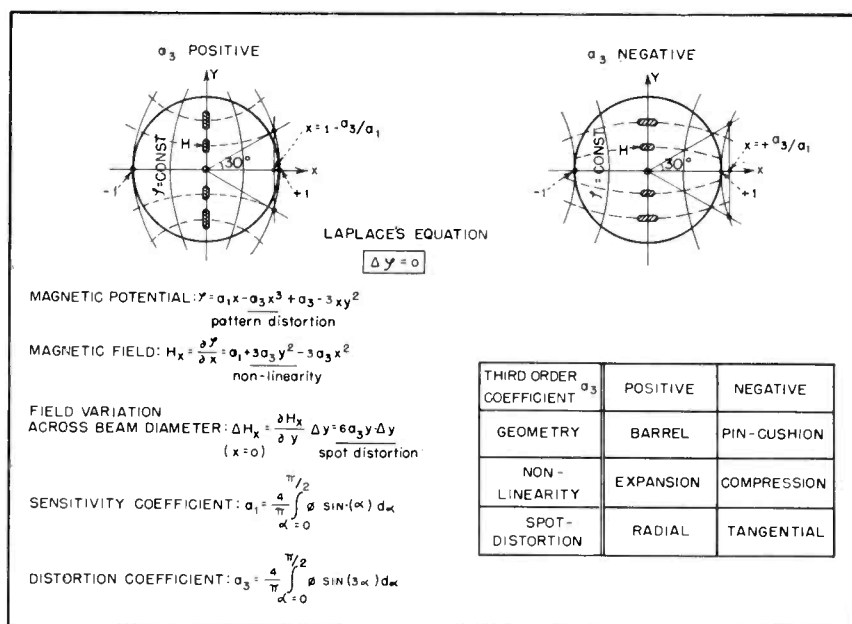

FIG. 4—Relationship between third-order term of winding distribution and spot and pattern distortion

radius $C_1 - P$ around a center of deflection C_1 which coincides very closely with the center of the magnetic field. (The deviation is less than 10 percent for angles up to ± 30 degrees). The meridial ray 2, however, is deflected too much, so that the meridial focus Q moves inward along ray 1. Simple analysis shows that the focus Q for meridial rays 2 moves on a surface whose curvature at the apex P is three times that for the sagittal rays 1. Accordingly, a spot focus at P will be distorted, by deflection, into a line focus $Q'Q''$, and produce radial astigmatism.

This condition cannot be corrected by variations of the axial focusing system. It can be cured, however, by introducing a controlled amount of nonuniformity into the deflecting field. What is needed is a change of the field intensity H_z in the direction of deflection and in such a way that the field becomes stronger with increasing distance off axis. This will then deflect beam 1 more and beam 2 less than shown in Fig. 2. Such a field introduces some degree of barrel distortion, but it restores the spot to its original shape and size at wide angles of deflection.

Theoretically, the spot in Fig. 2 would stay focused on a plane screen through P if the trajectories were parabolas rather than circles. This seems to suggest that electrostatic deflection is in a more favorable position than magnetic deflection as far as astigmatism is con-

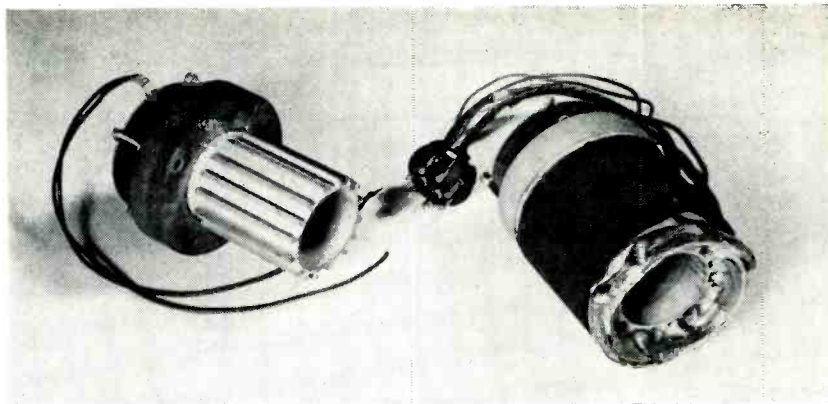

FIG. 6—Eight-coil yoke with mount and focus coil

cerned. Unfortunately, this is not so in practice since the idealized setup of Fig. 2 cannot be realized with electrostatic deflectors without introducing troublesome chromatic aberration due to electron acceleration in the fringe fields.

In practice, electrostatic deflection lends itself less well to wide-angle operation than magnetic deflection.³ It is practical only for angles below 30 degrees, while magnetic deflection handles almost twice that angle.

For a given angle of deflection, the magnitude of astigmatism on the screen depends on the beam diameter within the field. Present tubes like the 16LP4 have a measured beam spread of only about two degrees, which means a beam diameter of approximately $\frac{1}{8}$ inch inside the yoke. The astigmatic aberration is less than half of that value, or about two lines. This is tolerable, and hence it follows that astigma-

tism in a uniform field is only partly responsible for the much greater aberrations observed in practice. The main cause for deflection defocusing lies in the nonuniformity of the deflecting fields themselves.

Astigmatism of Deflection Coils

We have considered the inherent astigmatism of the electron beam in a uniform magnetic field of deflection. This astigmatism of the beam may be corrected by some controlled nonuniformity of the field.

We are, therefore, interested in a simple and workable theory of nonuniform fields inside the deflection yokes. Such a theory should demonstrate the relationship between field distortion and ampere-turn distribution, so that it may be possible to control the one by the other. The following theoretical approach is based on a number of simplifying assumptions. The problem is considered as two-dimensional and the effects of fringe fields are neglected. The results of the theory apply therefore only to cylindrical deflection coils of the parallel-wire type. However, those coils yield the highest deflection sensitivity for given volume.⁴

As a further simplification, the electron trajectories through the yoke have not been calculated. Instead, characteristics of deflection are predicted from the field configuration in the plane of reference, which is a cross section through the center of the yoke. This procedure is permissible as long as the yoke may be considered thin as compared to the total pencil length. This, and the other simplifications,

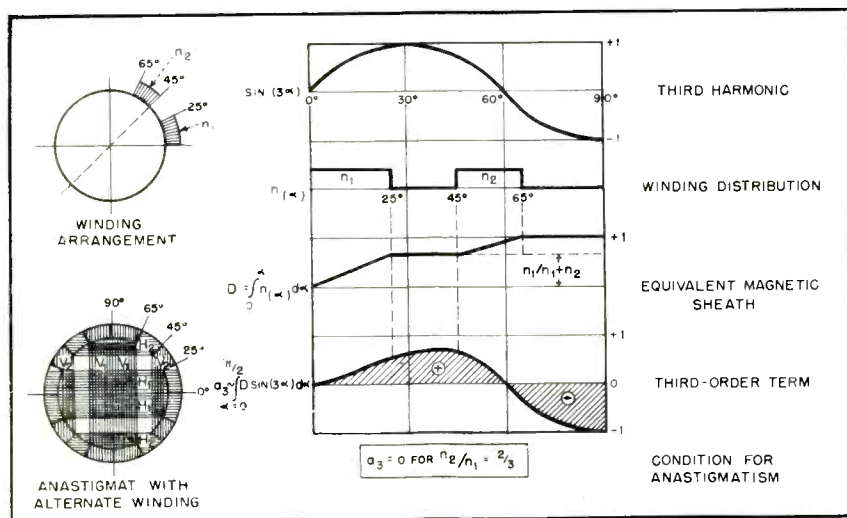

FIG. 5—Anastigmatic deflection yoke with alternate winding

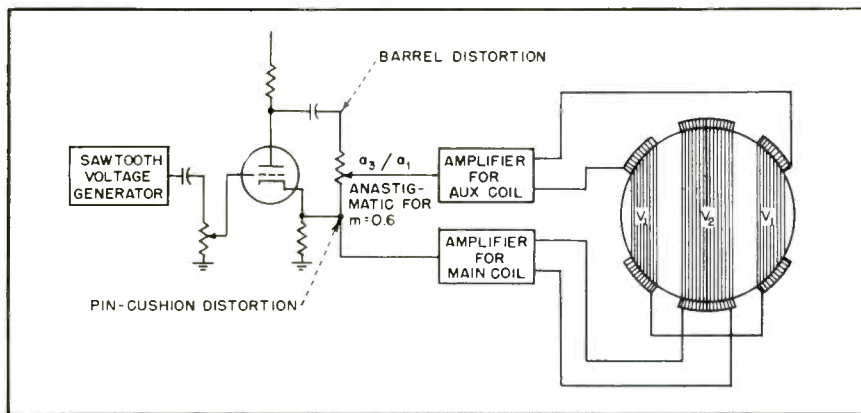

FIG. 7—Arrangement of test equipment for control of deflection distortion and defocusing

are best justified by the success of the theory in its practical applications.

Figure 3 shows the theoretical procedure used to study the field problem in yokes. Figure 3A shows some arbitrary distribution of wires on the surface of the cylinder, all being energized by the same current. Fig. 3B shows the application, to this problem, of Ampere's theorem of the equivalent magnetic sheath. The rule states that the magnetic field inside the cylinder may as well stem from a magnetic double layer on the surface, with a specific dipole moment, per unit area, of I/c . Here, I is the current bounding the surface element in question. Since the double layers are piling up on top of each other, the equivalent dipole moment at any point on the surface is proportional to the sum total of ampere-turns between this point of reference and the nearest pole ($\alpha = 0$).

By the next step (Fig. 3C), the problem becomes very similar to an equivalent boundary problem of electrostatics. The magnetic field inside the cylinder may be considered as the gradient of a scalar magnetic potential $\phi(r, \alpha)$ which in turn is uniquely determined by a potential distribution $\phi(R, \alpha)$ at the surface. The latter follows from the magnetic double layer and is, to a good approximation, proportional to its dipole-moment, the enclosed ampere-turns.

$$\phi \sim \int_{\alpha=0}^{\alpha} n(\alpha) d\alpha$$

Considering the conditions of symmetry in our problem, the magnetic potential then appears in the

following form

$$\phi = a_1 r \sin \alpha + a_3 r^3 \sin(3\alpha) + a_5 r^5 \sin(5\alpha) + \dots \quad (1)$$

The coefficients a_k in this form are actually the Fourier coefficients of the potential distribution $\phi(r, \alpha)$ on the boundary

$$a_k = \frac{4}{\pi} \int_0^{\pi/2} \phi \cdot \sin(k\alpha) d\alpha \quad (2)$$

Hence, we have control over the coefficients a_k in Eq. 1, by controlling the ampere-turn distribution on the surface. One well-known arrangement is the deflection coil with cosine distribution

$$n(\alpha) = \cos \alpha \quad \phi(\alpha) = \sin \alpha \quad (3)$$

Within such a coil, the field is entirely uniform:

$$\frac{\phi(r, \alpha)}{a_3} = \frac{a_1 r \sin \alpha}{a_3} = \dots = 0 \quad (4)$$

All terms of higher order than the first cancel out.

In practice, the ideal cosine distribution has been approximated by the so-called semi-distributed type of windings, which consists of several sections, usually from three to six in number. Such yokes are expensive to make and are worth while only in cases where beams of very large cross section are to be handled, such as in the orthicon, the image dissector tube, and the like.

We have found that for ordinary television picture tubes it is unnecessary to use field correction of higher than the third order. Mathematically speaking, it is necessary and sufficient to cancel the third-order coefficient a_3 in Eq. 2, but none of the higher terms. In practice, this does not require a distrib-

uted winding, but may be accomplished by simpler means as will be shown below (Fig. 5 and 10).

Figure 4 shows the results of the theory if terms of higher order than the third are neglected. Listed are expressions for potential, field intensity, and the force differential across the beam diameter. It is apparent that the third-order coefficient a_3 is equally responsible for pattern distortion, nonlinearity of deflection and spot distortion. The diagrams of Fig. 4 and the table show more specifically how these aberrations are correlated.

The shape of the equipotential lines is indicative of the picture distortion, since they are at right angles to both the flux lines and the beam and hence coincident with the lines of force of magnetic deflection. On the basis of Fig. 4, we expect barrel distortion to be associated with radial astigmatism, while pin-cushion distortion brings with it tangential astigmatism.

If the third order term is made to vanish, rectangular geometry obtains over most of the field. How-

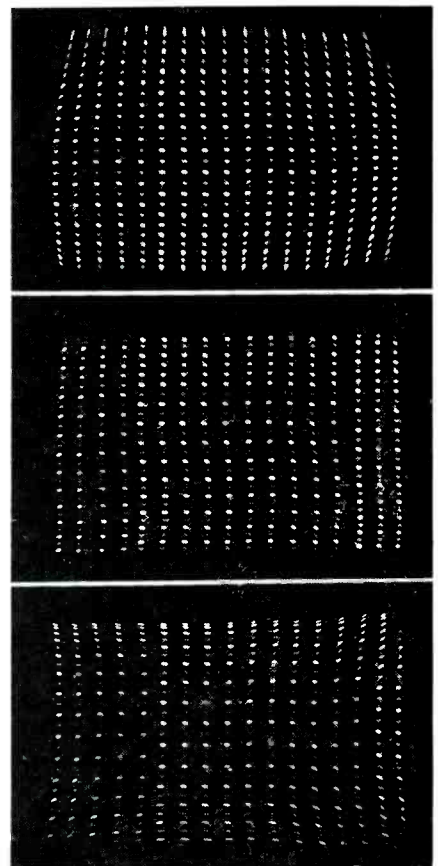

FIG. 8—Relationship between pattern and spot distortion. Anastigmatic adjustment is shown in center

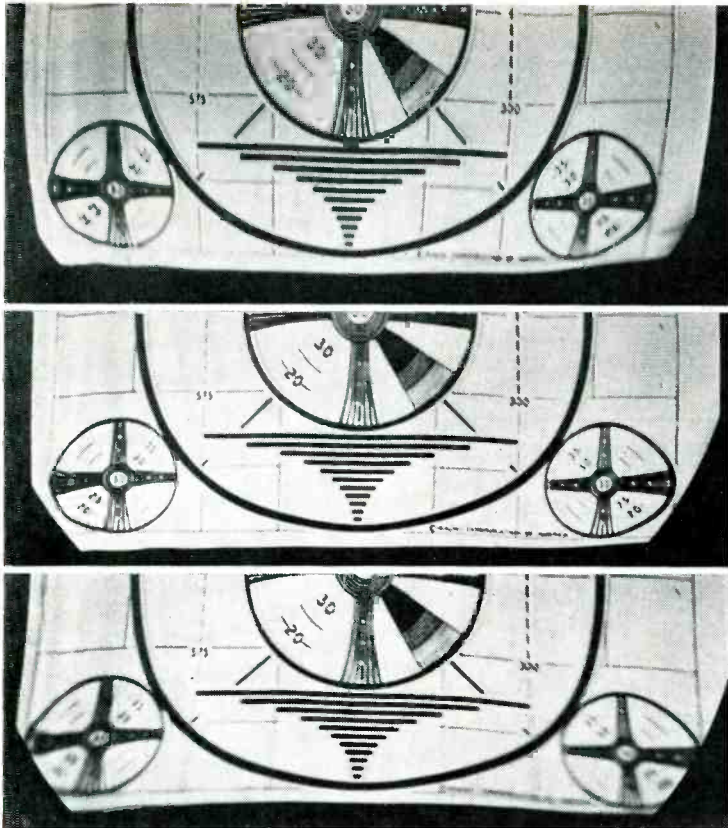

FIG. 9—Detail at wide angles for various stages of yoke correction

ever, the inherent astigmatism of the beam (Fig. 2) requires for its correction some slight radial defocusing. This may be brought about by allowing a slight degree of barrel distortion to remain in the yoke (a_3 slightly positive). The absence of serious defocusing in some commercial yokes is probably due to the fact that many of them exhibit some degree of barrel distortion, which has helped, more or less accidentally, to correct for the astigmatism of the beam.

Alternate Winding

On the basis of the above theory, it has been possible to develop successfully some special arrangements of windings suitable for obtaining anastigmatic deflection. One such form is shown in Fig. 5. This is an alternate winding. Each component of deflection consists of two pairs of coils, so that there is a total of eight coils on the yoke. Each pair of coils is composed of one main or field coil, and one auxiliary or corrector coil. Hence the surface of the cylinder is alternately, and completely, covered with vertical and horizontal coils.

Figure 6 shows the appearance of this yoke complete with focus coil in a common mounting.

To make this system anastigmatic, it is necessary to adjust a critical ampere-turn ratio for each pair of field and corrector coils. The design procedure for the yoke is based on the preceding theory and is indicated (Fig. 5) in several steps. The winding distribution $n(\alpha)$ is plotted for the first quadrant

of the cylinder, and is integrated to obtain the equivalent surface-potential function. This is then multiplied by the third harmonic of the angle and the product is integrated.

The yoke will become anastigmatic if this integral vanishes, that is, if the shaded areas above and below the axis are equal. This condition obtains if the main coil provides 58 percent of the total mmf of the pair. The turns ratio of both coils in series connection then comes close to 1/1.5.

To prove this theory an experimental test was set up as shown in Fig. 7. Corrector and field windings were separated and each was fed sawtooth current from a separate amplifier. The ratio of these current amplitudes and the sign of the corrector current could be controlled along a potentiometer included in the circuit.

The resulting pattern and spot distortion is shown in Fig. 8. On top and bottom are the two extreme cases of barrel and pin-cushion distortion, while the anastigmatic correction is shown at the center. The results confirm the above theory; radial defocusing occurs along with barrel geometry, and tangential defocusing with pin-cushion geometry. The anastigmatic adjustment, for which there is no noticeable spot-distortion, is found to be also remarkably free from pattern distortions. This condition occurs at an ampere-turn ratio of 0.60, in good agreement with the calculated ratio of 0.58.

Figure 1 shows the picture im-

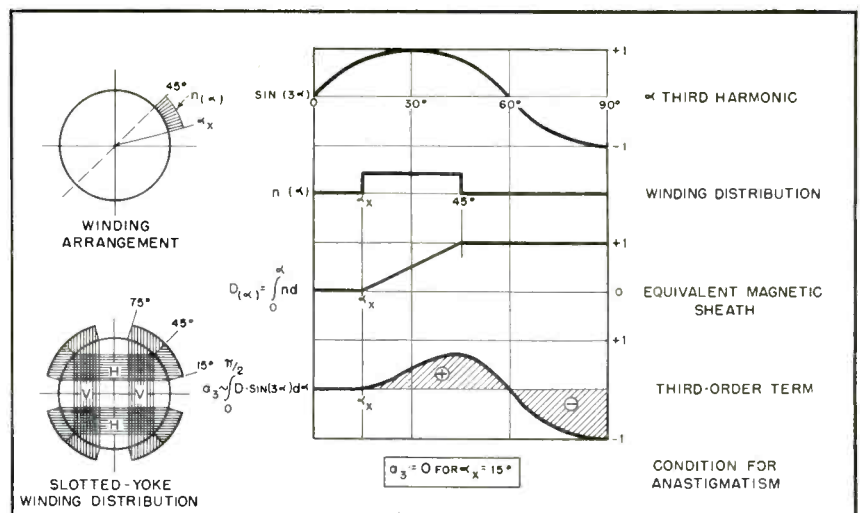

FIG. 10—Design procedure for a slotted-yoke winding

provement obtained with this type of yoke. The upper part was done with a conventional 4-coil yoke. The bottom picture was obtained with the anastigmatic yoke. Note the slight residual barrel distortion, and the improvement of detail at wide angles of deflection.

In Fig. 9, a portion of the pictures shown in Fig. 1 have been repeated. The center view shows more clearly the improvement in definition as obtained by the anastigmatic correction. The two companion pictures show how barrel distortion (bottom) impairs vertical definition, while horizontal definition (top view) is reduced by pin-cushion distortion. The anastigmatic yoke preserves full definition for deflection angles of more than 50 degrees.

The 8-coil yoke is remarkably sensitive, due to the absence of dead-angles of winding. Its power-efficiency lies between 25 and 30 percent.⁵ It is more expensive than the standard four-coil yoke, but its higher sensitivity makes it possible to use simple circuits so that the total cost of a receiver using this yoke is not prohibitive.

Slotted Winding

There is still another way to obtain third-order correction in a cylindrical deflection coil. This alternative method has only 4 coils, but it makes use of their angular position to obtain anastigmatic correction.

Figure 10 shows the structure and design of a slotted yoke. This is a one-layer, four-coil arrangement, which differs from the conventional deflection yoke by the existence of four dead-angles, or slots around the poles. By proper design of these slots, it is possible to make this yoke anastigmatic.

The procedure for finding the critical slot width is similar to that used on the alternate winding. The angle α_c for the start of each coil is left variable and its value is determined by the condition that the third-order term should cancel. It is found that this happens if the coil extends from 15 to 45 degrees. The slots then subtend an angle of 30 degrees at the center. At this setting we get pattern correction.

To obtain spot correction it is

necessary, as outlined above, to move somewhat further in the direction toward barrel distortion. This requires the slots to be narrowed down to about 20 degrees. At this point wide-angle definition is practically restored. If the slots are narrowed down still further, excessive barrel distortion results and the astigmatism returns.

Figure 11 shows the coil form for a slotted winding, complete with focus coil. Figure 12 is a dot pattern, taken from an experimental yoke of this kind, which had slot correction at the vertical poles but no slots at the horizontal poles. The picture shows strong radial astigmatism in the horizontal direction but practically no defocusing with vertical deflection. The slotted winding is somewhat less sensitive than the alternate winding, since only two thirds of the available winding space is used. This slight disadvantage may be outweighed, however, by its greater simplicity and lower cost. The electron-optical performance of the two types of yokes is equally good. The slotted yoke of Fig. 10 is employed in one of the latest television receivers produced by this company.

Circuit Technique

The high deflection sensitivity of the anastigmatic yokes, especially of the eight-coil type, has made it possible to use relatively simple deflection circuits. No sweep transformers are necessary for either

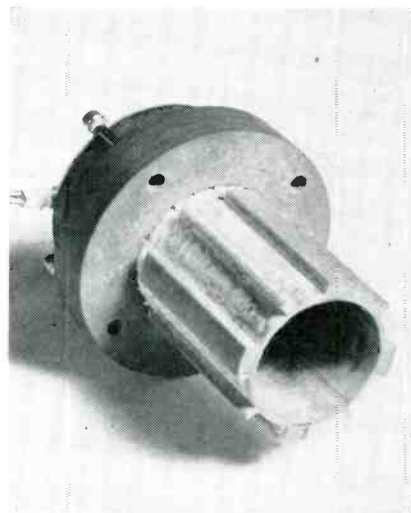

FIG. 11—Winding form for a slotted yoke

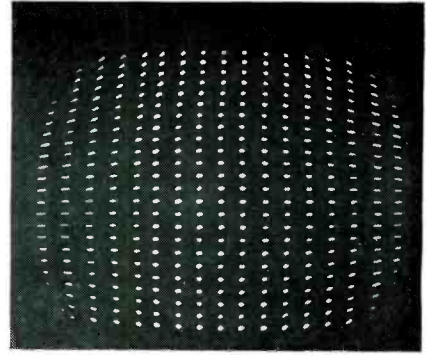

FIG. 12—Slotted-yoke pattern with vertical deflection corrected and horizontal deflection uncorrected

direction, which more than makes up for the cost of the yokes. In addition, it was found practical to use the flyback energy of the yoke to operate, through a rectifier, the focus coil of the picture tube. This method may be developed to a point where the focus stays fixed over a wide voltage range.

In a sweep-focus circuit of this type the focus coil is removed from its customary connection in series with the B-supply. This avoids a considerable voltage drop and makes it possible to operate the receiver from a low-voltage power supply, using, for example, a simple voltage doubler directly off the power line but no power transformer. A receiver of this type combines the benefits of anastigmatic deflection with economy of cost and operation.

The author is grateful to D. E. Noble, vice-president and director of research at Motorola, whose interest and encouragement made this work possible. He is also indebted to V. Graziano, for his work on pulse equipment to test the yokes, and to Messrs. Costello and Grigg, who built them.

REFERENCES

- (1) George Wendt, Astigmatism in Electron-Optics, *Die Telefunken Roehre*, 15, p 100, April 1939. (in German)
- R. G. E. Hutter, Electron Beam Deflection, *Jour. Applied Physics*, 18, p 740, Aug. 1947; 18, p 797, Sept. 1947.
- (2) A. C. Hardy and F. H. Perrin, Astigmatism in Light Optics, "The Principles of Optics," p 99, McGraw-Hill Book Co., New York, 1932.
- (3) K. Schlesinger, Electrostatic Wide Angle Deflection, U. S. Patent 2 227 036, filed July 23, 1938, patented Dec. 31, 1940.
- (4) M. Knoll, Elliptical Deflection Coil, *Telefunken Hansmitteilungen*, 20, No. 81, p 72, Berlin, July 1939. (in German)
- (5) W. T. Cocking, Deflector Coil Efficiency, *Wireless World*, p 460, Dec. 1947.
- R. W. Dressel, Deflection Coils, ch. 8, Vol. 22, MIT Radiation Lab. Series, McGraw-Hill Book Co., New York, 1948.

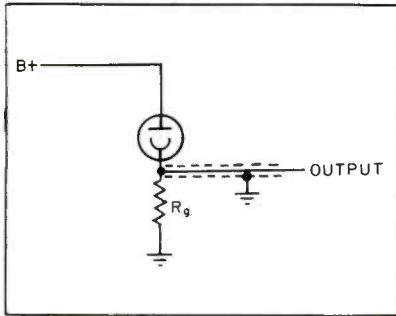

FIG. 1—Conventional phototube circuit using shielded cable

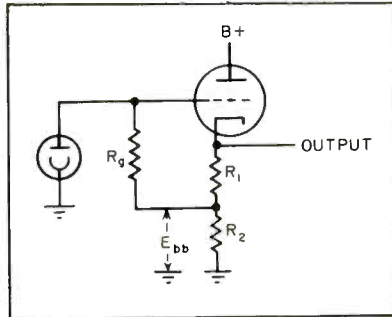

FIG. 2—Low-output-impedance phototube amplifier

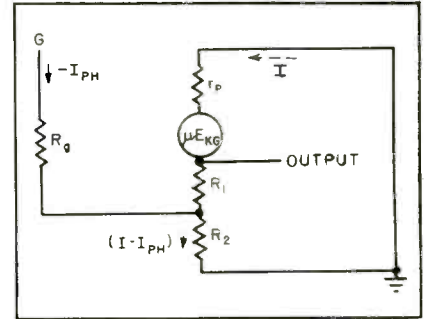

FIG. 3—Equivalent circuit of Fig. 2 for voltage analysis

Phototube Amplifier With

Both amplification and low-impedance output are obtained from a single-stage cathode-loaded phototube amplifier. Circuit analysis and development are given to show advantages over a conventional cathode follower

By **NORMAN ALPERT***

Senior Development Engineer
Hillyer Instrument Company
New York, N. Y.

THE PROBLEM of coupling to a remotely located phototube has been solved in the past by employing several feet of low-loss shielded cable in a circuit such as that in Fig. 1.

To obtain a low output impedance and at the same time amplification of signal, the circuit of Fig. 2 has been successfully employed. The phototube is considered to be a constant-current device since it has a very high internal impedance (of the order of 100 megohms). This is a valid assumption for a vacuum phototube like the 934 when the plate voltage is kept between 50 and

250 volts. Under these conditions, the phototube current I_{PH} can be expressed as follows:

$$I_{PH} = KF \quad (1)$$

where F = light flux in lumens
 K = proportionality constant
(30 μ a per lumen for the 934)

Voltage Gain

The equivalent circuit of Fig. 2 is shown in Fig. 3. By Kirchhoff's Voltage Law,

$$-\mu E_{KG} + I R_1 + (I - I_{PH}) R_2 + I r_p = 0 \quad (2)$$

$$E_{KG} = -I R_1 - I_{PH} R_2 \quad (3)$$

Combining Eq. 2 and 3 and rearranging,

$$I = \frac{-I_{PH} (\mu R_0 - R_2)}{\mu R_1 + R_1 + R_2 + r_p} \quad (4)$$

The output voltage drop will be defined as

$$V_o = -I (R_1 + R_2)$$

The input voltage drop is

$$V_i = I_{PH} R_0$$

Thus, the voltage gain G can be written as

$$G = \frac{V_o}{V_i} = -\frac{I (R_1 + R_2)}{I_{PH} R_0} \quad (5)$$

Combining Eq. 4 and 5 produces

$$G = \frac{\mu R_0 - R_2}{\left(\frac{R_1 + R_2}{\mu R_0} + 1 + \frac{r_p}{R_1 + R_2}\right) R_0} \quad (6)$$

Usually μR_0 is much greater than R_2 and Eq. 6 becomes

$$G = \frac{\mu}{\frac{\mu R_1 + r_p}{R_K} + 1} \quad (7)$$

where

$$R_K = R_1 + R_2$$

This result could also be obtained by considering the triode as a feedback amplifier where

$$\beta = \text{feedback factor} = \frac{R_1}{R_1 + R_2}$$

$$G_o = \text{gain without feedback} =$$

$$\frac{\mu (R_1 + R_2)}{r_p + R_1 + R_2}$$

* Now with Servo Corp. of America, New Hyde Park, N. Y.

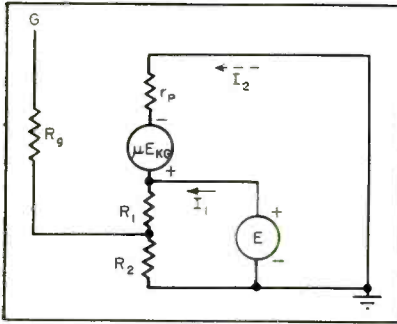

FIG. 4—Equivalent circuit for determining output impedance

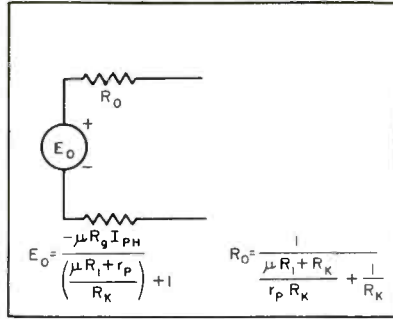

FIG. 5—Output voltage and impedance for circuit of Fig. 2

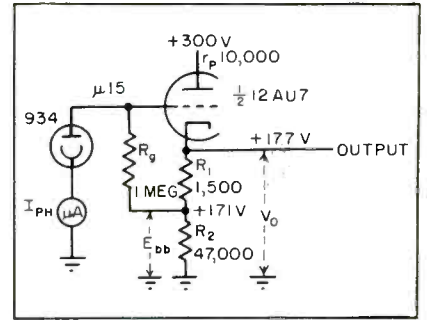

FIG. 6—Practical circuit developed from that shown in Fig. 2

Low Output Impedance

Hence $G =$

$$G_o = \frac{\mu(R_1 + R_2)}{r_p + R_1 + R_2} \times \frac{R_1}{R_1 + R_2} = \frac{\mu}{\frac{\mu R_1 + r_p}{R_1} + 1} \quad (8)$$

This result is the same as Eq. 7.

Output Impedance

To calculate the output impedance of the circuit of Fig. 2, impress a voltage E across the output and set I_{PH} equal to zero as shown in Fig. 4. By Kirchhoff's Voltage Law,

$$-E + (I_1 + I_2)(R_1 + R_2) = 0 \quad (9)$$

$$-\mu E_{KG} + E + I_2 r_p = 0 \quad (10)$$

$$E_{KG} = -(I_1 + I_2) R_1 \quad (11)$$

From Eq. 9, 10 and 11,

$$\frac{E}{I_1} = \frac{r_p R_K}{\mu R_1 + R_K + r_p}$$

The output impedance is therefore

$$Z_o = \frac{E}{I_1} = \frac{r_p R_K}{\mu R_1 + R_K + r_p} = \frac{1}{\frac{\mu R_1 + R_K}{r_p R_K} + \frac{1}{R_K}} \quad (12)$$

The circuit of Fig. 2 can thus be replaced by a box as shown in Fig. 5, where the minus sign in the expression for E_o indicates that E_o decreases as I_{PH} increases.

It should be noted that although the output impedance is larger than that obtained from a conventional cathode follower, it is considerably smaller than that obtained from a one-stage conventional degenerative amplifier. In addition, while the gain of a cathode follower is always less than unity, the gain of the circuit of Fig. 2 is of the order of μ , the amplification factor of the tube. This is due to the fact that R_g is not grounded, and the input voltage is not considered from grid to ground, but as that across R_p .

The circuit may also be considered as a device for effectively increasing the phototube load resis-

tance R_o to a value GR_g , thus giving a higher output voltage and at the same time presenting an output impedance which is very much smaller than R_p .

Experimental Results

The circuit of Fig. 6 is a practical illustration of Fig. 2. Resistors R_1 and R_2 were chosen on the basis of linearity and favorable operating point considerations. By means of Eq. 8 and 12, the gain was calculated to be 9 and the output resistance was 7,500 ohms. The voltages listed on the diagram were those for $I_{PH} = 0$. Noise measurements indicated that this circuit (all resistors were carbon type) had approximately 100 microvolts rms of noise.

Figure 7 is a plot of the output voltage variations V_o as a function of phototube current I_{PH} and it may be seen that the curve is quite linear and is in close agreement with the theoretical curve.

If it is desired to pass high-frequency signals a pentode could be used instead of a triode. By this means, advantage is taken of the inherently low grid-to-plate inter-electrode capacitance of the pentode tube.

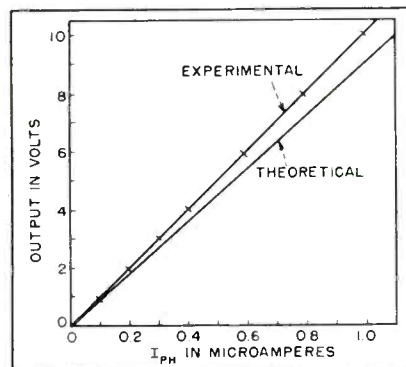

FIG. 7—Plot of output voltage versus phototube current

Radioactive Thickness Gage

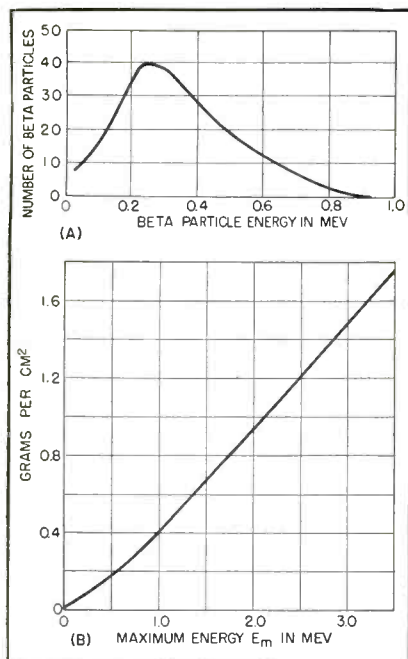

FIG. 1—Energy spectrum of beta-ray particles (A), showing significance of maximum energy rating, and material density required to stop beta rays with various maximum energies (B). Absorption of beta rays by a material is dependent only on density, hence is independent of the nature of the material

By J. R. CARLIN

Tracerlab, Inc.
Boston, Mass.

MANY MANUFACTURING processes require a method of continuously measuring the thickness of material in one or more stages of production. It is usually preferable to accomplish the measurement without physically contacting the specimen, in order not to interfere with production or cause material damage. The advantages derived from the utilization of such a thickness gage are improved quality control, elimination of material wastes, time savings and the removal of manufacturing uncertainties.

Several methods of thickness measurement have been proposed which have achieved varying degrees of success. One arrangement is to have the material under investigation flow between the plates of a capacitor, whose capacitance is affected by the mass and nature of the dielectric between the plates. A simple relation, however, between thickness and capacitance is hardly possible because the contribution

to capacitance made by some materials is completely out of proportion to their concentration in the specimen. Consider, for example, the inaccuracies introduced by the presence of water of dielectric constant 81 in paper of dielectric constant 2.0 to 2.5.

Other methods involve the measurement of absorption, reflection or scattering of a radiation by the material being measured. When the specimen is accessible from two sides the absorption method is usually employed because of the gross and easily measured changes occurring in the radiation upon penetration of matter.

Thickness-measuring instruments employing x-rays have been used successfully for some time. They are limited, however, by their inability to measure thin materials accurately because of the penetrating nature of the radiation. Even very low energy x-rays suffer little or no change upon transmission through thin sheets of plastic, fabric or paper. The high cost of x-ray equipment and the appreciable replacement cost of an x-ray tube, whose useful life rarely exceeds one thousand hours, have reduced the applicability of this type of radiation.

Nuclear radiations, on the other hand, have become readily available with various energy and penetrating characteristics from an imposing list of pile-produced radioisotopes, some at almost nominal cost. Their applicability has been proved and a line of thickness gages employing radioisotopes is now commercially available. These instruments are based on the principle that radiations from radioactive substances undergo reductions in intensity upon penetration of matter. The degree of absorption of a

nuclear radiation is a function of the total mass between the radiation source and detector.

Geiger counter tubes and ionization chambers are at present the only radiation-sensitive devices that appear to be suitably reliable for commercial application. The stability of Geiger tubes is frequently questionable and their life is inherently short, hence ionization chambers were chosen as the radiation-sensitive elements.

An ion chamber is simply a cavity containing some ionizable medium, in this case air at atmospheric pressure. Contained within the medium are two electrodes across which a voltage is applied. Upon irradiation, the ions drift to the collecting electrodes, establishing a small current which can be measured directly by an electrometer or amplified and used to operate a current meter or recorder.

Choice of Radiation

Consider now several important aspects of nuclear radiations. Alpha particles, or positively charged helium nuclei, ionize profusely and are stopped completely by only several milligrams per sq cm of absorber. For practical use, however,

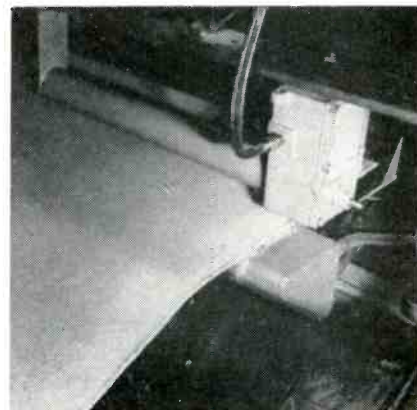

Gaging thickness of paper at Continental Paper Co., Ridgefield Park, N. J.

Material moving between ionization chamber and radioisotope source absorbs beta or gamma radiation in proportion to thickness. Meter in basic electrometer amplifier circuit can be calibrated to read thickness directly. Recorder is easily added

for Moving Materials

alpha particles possess too limited a range and are applicable only to very thin thickness measurements which can be accomplished with low-energy beta radiation.

Beta rays are composed of high-energy electrons originating in the nuclei of atoms undergoing radioactive transformation. The wide range of beta-ray energies provided by available emitters makes possible thickness measurements from 0.000015 in. aluminum to approximately 0.1 in. steel, corresponding to a density range of 0.0001 to 2 gm per sq cm.

Gamma rays, which are electromagnetic in nature like light or x-rays, are far more penetrating and are suitable to the measurement of considerably more ponderous masses or thicknesses up to several inches of steel or concrete.

Radioisotopes are obtainable which emit beta or gamma rays only of one or more energies, or any combination of the two. Where there is a choice between a beta and gamma emitter, the beta-ray isotope is usually more desirable because its greater ionizing ability requires less activity for equal chamber response.

Beta rays emerging from a radio-

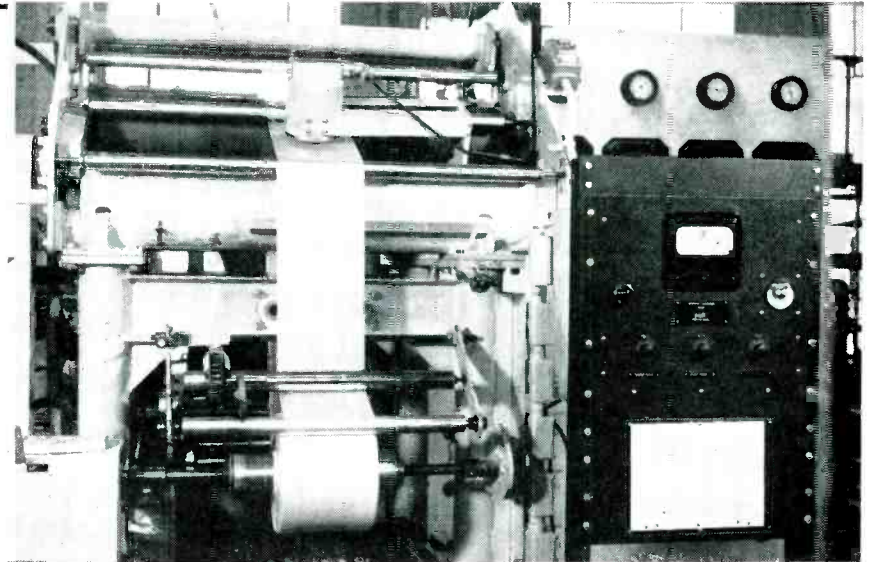

Installation of indicating radioactive thickness gage on machine producing thin plastic sheets at Dewey-Almy Chemical Co. plant in Lockport, New York. Ionization chamber is over plastic sheet at top of machine and radioisotope housing is directly under it beneath moving sheet material. Calibration chart is on rack at right, below indicating meter

active source are not monoenergetic but rather possess a continuous spectrum of energies, as shown in Fig. 1A. In describing the beta rays from a source, the maximum energy usually is stated; the average beta particle energy is appreciably less than this maximum. Figure 1B provides an indication of the total weight per unit area of absorber material required to stop completely the beta radiation whose maximum

energy is plotted as abscissa. The range of weights indicated represents a wide variety of industrial thickness measuring applications of beta-ray absorption, such as paper, cardboard, textiles, plastic films and metallic sheets.

The process of absorption of beta rays by matter is due to the electrostatic interaction between the high-velocity electron and the electrons present in the absorber. The beta

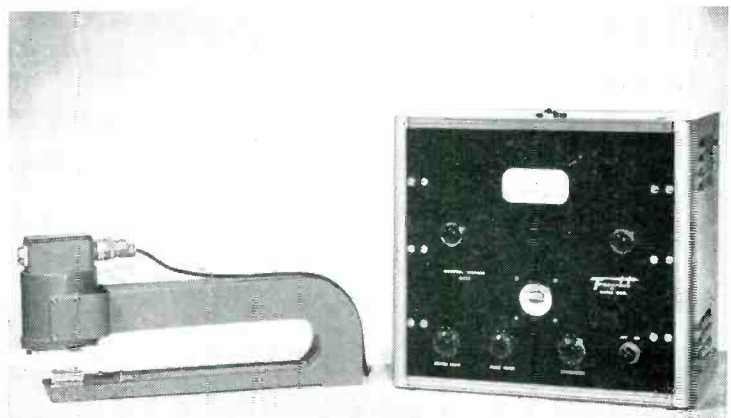
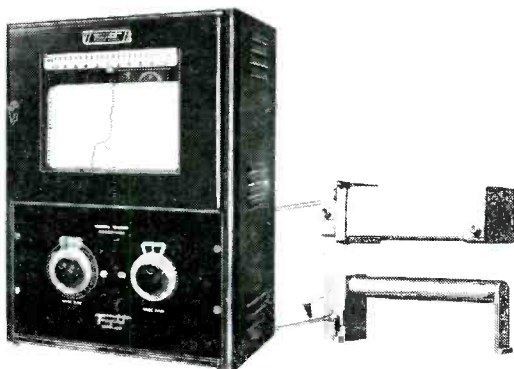

Fully automatic recorder-type radioactive thickness gage (left) and model providing meter indication only. Both models are for continuous production measurements

particle imparts its initial energy to residual electrons during inelastic collisions with absorber atoms. The thickness of absorber required to stop completely a beta ray depends obviously upon its energy at incidence and upon the density of electrons present in the absorber. If the weight per unit area instead of thickness of absorber is considered the mass required to stop a beta ray is independent of the nature of the absorber since the number of electrons in a specific mass of material is substantially independent of the nature of the material.

For each particular application the choice of isotope depends primarily upon the maximum weight per area to be measured by the instrument, remembering that the most ideal isotope is that which generates greatest ionization in the chamber and provides the steepest and most linear section of its absorption characteristic over the range of weight per area to be covered. In addition, cost consideration and convenience require that the radioisotope be reasonably long lived.

Circuit Details

A complete instrument design including a basic electrometer amplifier arrangement is shown in Fig. 2. The small direct ionization currents developed in the chamber produce a measurable voltage drop across a high-value resistor R_p in the grid circuit of the amplifier tube. The Raytheon CK571AX electrometer tube used has a grid current of the order of 10^{-11} ampere and a transconductance of approximately 120 μ mhos. A high-impedance circuit of this type necessitates careful shielding and good insulation technique. These difficulties can be reduced by increasing the magnitude of the chamber current by raising the level of radiation to which the chamber is exposed.

The maximum amount of activity which can be incorporated in the source is of course limited by the associated health hazard. One millicurie of a beta emitter like Sr^{90} can be, with relative ease, safely shielded to prevent any likelihood of overexposure to nearby personnel

and yet will produce in a chamber 5 liters in volume a current of the order of magnitude of 10^{-10} ampere. The exact value of ionization current developed is dependent on the solid angle subtended by the chamber at the source and the percentage of the total path lengths of the primary beta rays spent in the chamber volume.

The zero-signal plate current is balanced to zero in the meter by the auxiliary circuit loop containing E_s and R_s . One method of calibrating such a thickness gage is to allow the source S to irradiate the chamber after first inserting a standard absorber A between the two. The meter in this case is true zero centered, and the voltage impressed across R_p by the chamber current is counterbalanced by potentiometer R_i to provide a zero meter reading. Any subsequent changes in the weight per unit area of A will produce a positive or negative meter deviation from zero.

To establish a scale range of, for example, ± 10 percent, the meter is first zero-adjusted by R_i with A interposed between the source and chamber. Absorber A is then replaced by another A' , differing from A within the limits ± 10 percent. The meter shunt rheostat R_s is then adjusted so that the deviation $100(A' - A)/A$ appears as the meter reading whose scale ends are ± 10 percent of the value represented by the meter zero at center scale, in this case, A .

Calibration of Instrument

A complete calibration chart can be provided giving settings of R_i and R_s for various values of weight per area represented by center scale. It is necessary for the meter sensitivity to be altered by adjustments of R_s for different center scale values to compensate for the changing slope of the absorption characteristics at various values of absorber weight per area.

The calibration chart need not be repeated once carried out. When the specific gravity of a particular material is known, the calibration can be put in terms of units of thickness instead of weight per unit area. The operator, after consulting the calibration chart, adjusts the settings of R_i and R_s for a par-



Radioactive thickness gage as designed for single measurements in laboratories

ticular thickness of material being produced. If exactly that thickness of material passes between the source and chamber, the meter reading will indicate zero deviation. Subsequent changes in thickness from this value will be evidenced by changes in meter reading up to ± 10 percent or almost any other desirable limits. If only one material is used and one thickness range is adequate, the meter may be calibrated to read thickness directly.

By locating the absorber closer to the detector than to the source, the effect of flutter associated with moving absorber materials can be diminished. If the flutter is so great that fluctuations in the output meter are still observable, an integrating circuit is necessary to provide a smoothing action. The averaging effect of such an integrating circuit is advantageous when measuring nonuniform or inhomogeneous materials in motion.

Laboratory Test Model

A small laboratory model gage has been used for measuring thin sheets of mica in a Geiger tube production plant. The ionization chamber and source of radiation are contained within the instrument cabinet. The samples are placed on a slide that is moved manually to introduce the specimen into measuring position within the cabinet. Profiles of a wide sheet of material can be studied by cutting off a strip along the width of a sheet and running the strip at a constant speed through the instrument. This instrument is also suitable for laboratory measurements of sheet mate-

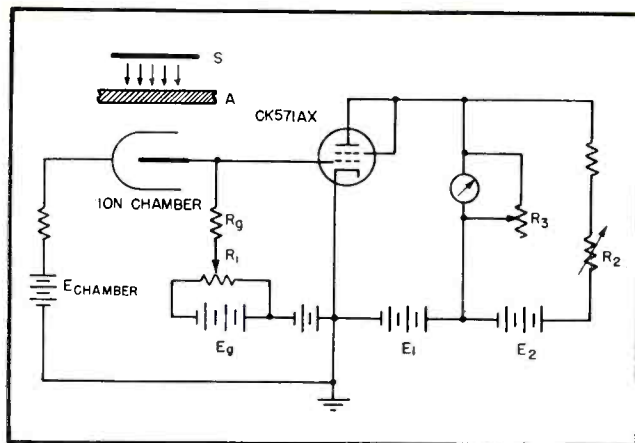

FIG. 2—Basic electrometer circuit used with indicating type radioactive thickness gage

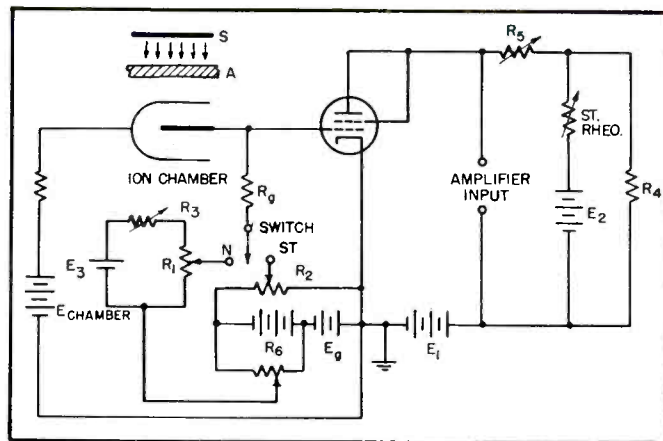

FIG. 3—Electrometer circuit with automatic standardization, for use with selfbalancing potentiometer-type recorder

materials like paper, plastic film, metal foil, mica and textile yarn roving.

Gage for Moving Materials

Another form of the gage, designed for continuous production measurements, employs the circuit shown in Fig. 3. The ionization chamber and source are supported on a U-shaped bracket which in turn is mounted on or near a machine engaged in sheet production. The material under study flows between the source and chamber and the desired information appears on a large front-panel meter which can be set several hundred feet away from the pick-up head. Tolerance limits can be set on a supersensitive relay so that a flashing red or green light will appear if thickness tolerances are exceeded. Terminals are also provided for accommodating any auxiliary warning or control equipment.

In most industrial installations of thickness gages for measuring moving sheets of materials it is desirable to have the results appear on a recorder chart. In addition, the use of a self-balancing potentiometer-type recorder makes possible a method of automatic standardization, suggested by W. C. Peacock. The recorders should be equipped with the feature for automatically standardizing slide wire potentials.

In normal operation a portion of the potentiometer voltage opposes the input voltage signal. When these two voltages are equal their sum is zero and the potentiometer contactor is at the balance position. The contactor is coupled to a pointer which indicates the magnitude of

the applied potential. If the two voltages are not equal the instrument determines the magnitude and direction of the unbalance and adjusts the position of the potentiometer contactor to rebalance the system.

The balancing operation is frequently accomplished by converting the d-c signal voltage to a-c and after amplification applying the voltage to two poles of a four-pole induction motor. Since the other two poles are actuated by line voltage, the phase relationship between the two alternating voltages determines the direction in which the balancing motor rotates to re-establish balance.

In application, the potentiometer voltage R_1 in Fig. 3 is placed in series with the voltage developed by the current from the ion chamber flowing across the grid resistor R_g of the first amplifier stage. The input to the recorder amplifier is in the plate circuit of the electrometer amplifier tube whose zero-signal plate current is balanced to zero by the auxiliary bucking loop. Variations in ion current change the voltage developed across R_g and upset the null condition between the recorder amplifier's input terminals in the plate circuit. The potentiometer readjusts itself so that it develops a voltage to equalize the new potential across R_g . In normal operation the switch SW is in position N.

When standardizing, the main radiation source S becomes momentarily blocked by a heavy absorber so that it cannot affect the ionization chamber. At the same time, a

small standard source, identical in nature to S , is automatically permitted to energize the chamber from within. Simultaneous with this operation SW is switched from the normal position N to the standardized position ST. Potentiometer R_2 is initially adjusted so that the voltage developed across R_g , due to the irradiation of the chamber by the standard source, is equalized by the R_2 voltage. The null condition between recorder amplifier input terminals remains unaffected. Any deviation from the null condition will upset this balance and the standardizing rheostat, which during standardization becomes coupled to the balancing motor, rotates to restore the null condition at the amplifier input. By this operation, which occurs approximately once every half hour for a period of several seconds, the instrument automatically corrects for variations in battery voltage, source strength and electronic components.

The ionization chamber, situated above the source mount, is equipped with a flag indicating the presence of radiation. In order to exceed radiation tolerance limits, it would be necessary for a man to stay within six inches of the source for 8 hours per day.

BIBLIOGRAPHY

- L. E. Glendenin, Determination of the Energy of Beta Particles and Photons by Absorption, *Nucleonics*, January 1948.
- A. P. Schreiber, Radioisotopes for Industry, *ELECTRONICS*, January 1949.
- H. A. Bethe, "Elementary Nuclear Theory", J. Wiley & Sons, Inc., New York, 1947.
- Rutherford, Chadwick and Ellis, "Radiations from Radioactive Substances", The Macmillan Co., New York, 1930.
- "Radioisotopes", distributed by Isotopes Branch, U. S. Atomic Energy Commission, Oak Ridge, 1947.

MEASURING PHASE at Audio and

PERIODIC SIGNALS are characterized by the parameters of amplitude, frequency and phase relative to some time reference.

Measurement of amplitude and frequency, at audio and ultrasonic frequencies, can be carried out rather easily, but accurate measurement of phase has proved much more difficult and has consequently been neglected in many applications where it could provide useful information. In contrast to amplitude and frequency, phase is a relative concept—that is, one is generally interested in the phase difference between two periodic signals.

A variety of methods has been used to measure phase difference. The most familiar of these is the display of Lissajous figures on the screen of a cathode-ray oscilloscope. These patterns, obtained by applying one signal to the horizontal deflection plates, the other to the vertical deflection plates of the cro, indicate the phase difference between the two signals; for example, a straight line indicates 0 or 180 degrees, while a circle indicates 90 deg. Another method, also using a cro as an indicating device, employs an electronic switch to produce a

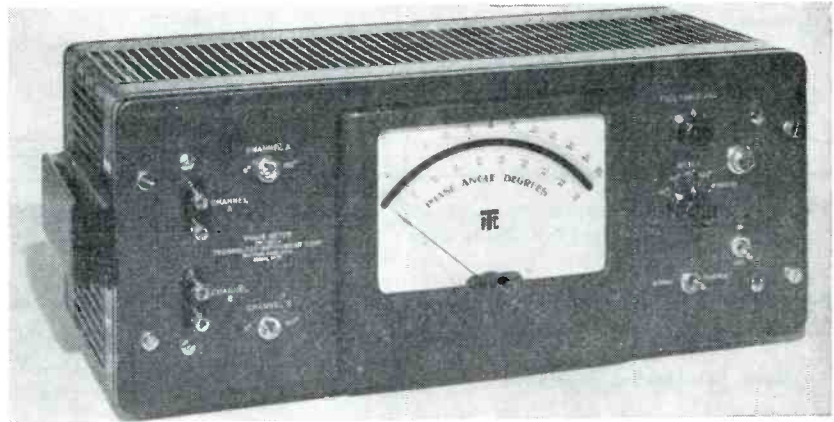

A commercial phase meter embodying the circuits shown in Fig. 5

superposition of the two signals on the screen, so that the phase difference can be scaled off directly.

Other cro methods, not so widely known but capable of greater accuracy, make use of a circular sweep derived from one of the two signals. One such scheme, devised by K. S. Lion¹, is illustrated. The circular sweep, ordinarily of very small diameter, is expanded momentarily by each of the two signals being compared; the geometrical angle between the two spikes thus produced is the unknown phase angle. More than two signals can have their relative phases displayed simultaneously.

Schemes not requiring a cathode-ray oscilloscope fall into two classifications: null methods, requiring a balancing operation, and direct-reading methods that produce a direct phase-angle indication on a meter. As an example of the former, amplitude and phase of one of the two signals can be changed until it completely cancels the other. The required phase shift is then read from a calibrated dial. The use of ordinary phase-shift networks would render the calibration frequency-sensitive, but by adding a quadrature component to one of the signals it is possible to obtain the necessary phase shift independently

* Now with Bell Telephone Laboratories, Murray Hill, N. J.

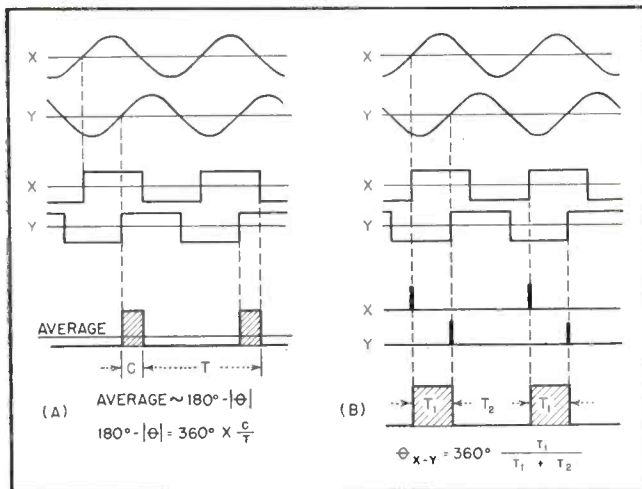

FIG. 1—Direct-reading methods of phase measurement

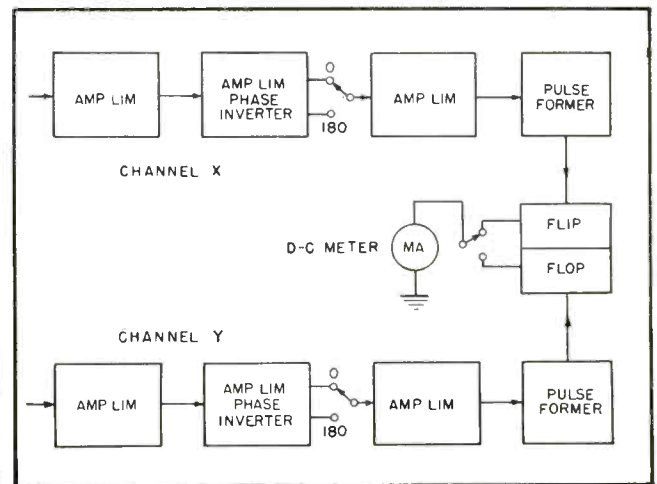

FIG. 2—Block diagram of direct-reading flip-flop meter

Ultrasonic Frequencies

By ERNEST R. KRETZMER*

*Research Laboratory of Electronics
Massachusetts Institute of Technology
Cambridge, Massachusetts*

Phase difference between two periodic signals is compared in a flip-flop circuit. The average current is read directly in degrees of phase on a calibrated meter. Possible applications include measurement of phase shift in feedback amplifiers, from screen-grid degeneration in a pentode stage, and in simulated antenna arrays

of frequency, over a finite frequency range.² Apart from the inconvenience of the balancing operation, this null method has the disadvantage of requiring sinusoidal signals.

Two practical methods that give direct meter indications of the phase difference between two signals X and Y are illustrated in Fig. 1. The signals (which need not have sinusoidal waveforms or equal magnitudes) are converted to square waves whose edges coincide with the zero-axis crossings of the original signals. In Fig. 1A, these two square waves are fed to a gate tube that produces a current proportional to the fractional overlap of the positive portions of the square waves. Similarly, the overlap between the positive portions of square wave x and the negative por-

tions of square wave y , or vice versa, can be measured by means of a diode and a d-c meter. In any case, the meter reading is proportional to the magnitude of the phase difference, or its supplement, and is ambiguous to the extent that one cannot distinguish between the angles θ and $360 - \theta$.

The ambiguity of the overlap method is avoided in the case of the flip-flop method, illustrated in Fig. 1B. Here, the two square waves X and Y are used to form pulse trains X and Y , respectively. Each X pulse triggers a flip-flop circuit into the flip position, for a time interval T_1 until the next Y pulse arrives and triggers the circuit into the flop position, for a period T_2 , and so on. It is clear that the angle by which signal X leads signal Y is directly proportional to the fraction

$T_1/(T_1 + T_2)$, and hence to the average current through the X side of the trigger circuit. Conversely, the angle by which Y leads X corresponds to the fraction $T_2/(T_1 + T_2)$ and hence to the average current through the Y side of the trigger circuit. The remainder of this paper will be devoted to this flip-flop method. It was patented in 1945³, and other workers have since experimented with this as well as

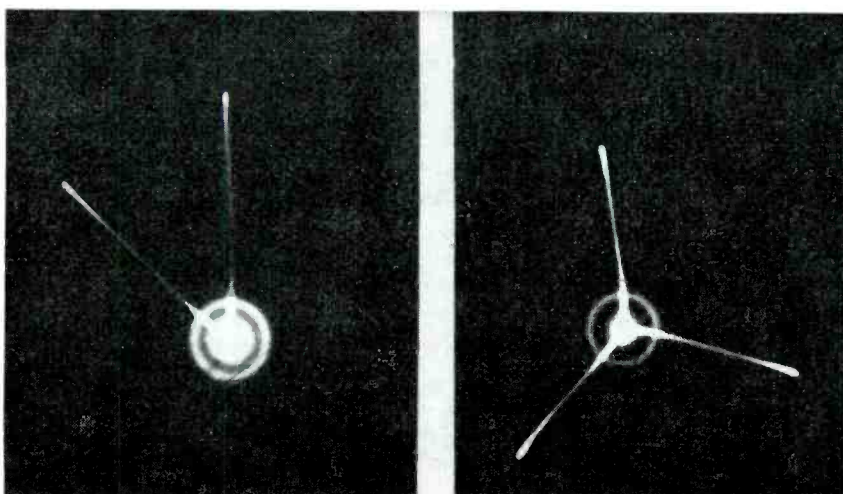

Oscillograms showing a method of phase measurement employing a circular sweep

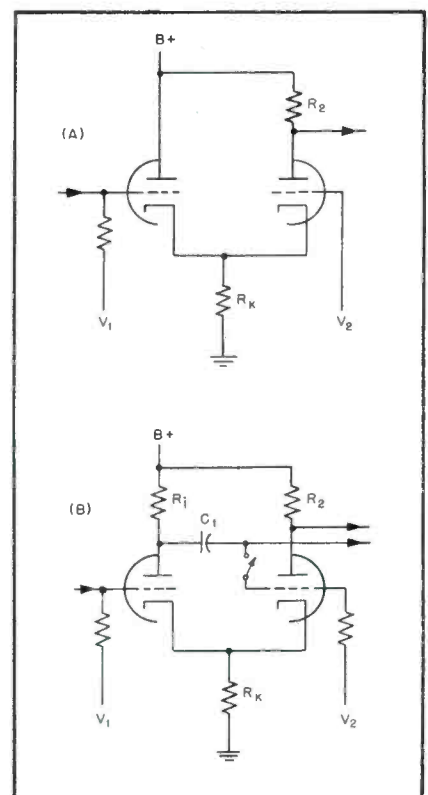

FIG. 3—Cathode-coupled clipper circuits

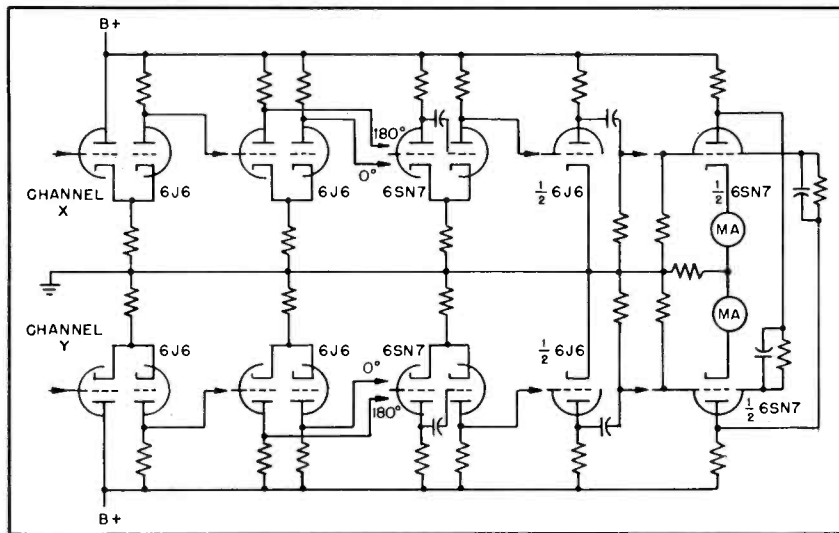

FIG. 4—Simplified circuit diagram of the direct-reading phase meter

with the overlap method.^{4,5}

The Flip-Flop Method

Figure 2 shows a block diagram of an instrument employing the flip-flop method for measuring the phase difference between two periodic voltages. Two identical channels, X and Y, handle the two signals, X and Y, respectively. The principal operation performed in each channel is the limiting-amplifying process by which the signals are converted into square waves. The first three stages serve this purpose. The second stage is, in addition, a phase inverter that makes it possible to reverse the signal polarity. If the signal has evenly spaced zero-axis crossings, such a reversal represents a phase shift of 180 degrees. The square wave in each channel is fed to a pulse former, which, in effect, differentiates the positive-going edges. The resulting pips are fed to a flip-flop circuit. A d-c meter measures the average current through either side of the circuit, allowing the meter to read either the angle θ or the angle $360 - \theta$. This switching arrangement, together with the phase-reversing switches, permits any angle to be transposed into the first quadrant (0 to 90 deg), so that the meter scale can be expanded by a factor of four if increased meter sensitivity is desired.

Although the block diagram of Fig. 2 appears straightforward, severe problems are encountered in the design of an instrument com-

bining simplicity with accurate readings that are independent of input amplitude and frequency over wide ranges.

Square-Wave Generation

The most difficult operation is the formation of square waves from the original signals, since the square-wave edges must coincide exactly with the zero-axis crossings, regardless of signal amplitude and frequency. Most instruments constructed in the past have made use of cascaded pentode-diode combinations. Such extensive amplifier-limiter stages are neither simple, nor do they answer the requirements of wide frequency band and large amplitude range as well as might be expected. A circuit that appears better suited for the present application is the cathode-coupled clipper,⁶ the basic form of which is shown in Fig. 3A. The grid of the right-hand triode is returned to a fixed positive voltage, V_2 . The signal is applied to the grid of the left-hand triode that is also returned through a high resistance to a fixed positive voltage, V_1 . For small input signals, the circuit acts as a linear amplifier. However, if the instantaneous signal voltage goes below a certain value (a few volts below V_1), the left-hand triode cuts off, and above a certain value (a few volts above V_1), the right-hand triode cuts off. Thus, both the positive and negative limiting results from one or the

other tube's being cut off, and very good limiting symmetry can therefore be attained. Like a cathode follower, the cathode-coupled circuit has high input impedance and can handle a large range of input voltages without drawing grid current. It has other useful advantages, illustrated in Fig. 3B. First, by inserting the resistor R_1 in the plate line of the input triode, one obtains a phase inverter, the usefulness of which was pointed out in the discussion of the block diagram (Fig. 2). The limiting action at the plate of the input triode is not exactly the same as at the plate of the output triode, but by means of a type IN34 germanium crystal diode it can be made very nearly the same. A second useful modification is obtained by connecting a capacitor C_1 as shown. This addition makes the circuit regenerative without destroying its controllability and results in an output square wave with edges of short rise and decay times limited only by stray capacitance.

Elementary Circuit

A simplified circuit diagram of a complete phase meter in Fig. 4 shows close correspondence to the block diagram. Three cascaded limiter-amplifier stages are cathode-coupled types, the first stage being in the basic form, the second modified to provide phase reversal if desired, and the third stage being regenerative so as to insure very steep square-wave edges. The fourth stage in each channel is a triode followed by an r-c differentiator. The triode has a high load resistance but a low plate resistance, so that it reacts rapidly only to the positive going square-wave edges—producing large negative pulses of 0.5- μ sec duration at the differentiator output.

These pulses mark the positive-going zero-axis crossings of the original signal (either channel X or channel Y), unless the phase-reversing switch is in the 180-degree position—in which case the pulses mark the negative crossings. The flip-flop circuit, triggered alternately by pulses from channels X and Y, is an Eccles-Jordan type. The average current through either half of the circuit is measured in

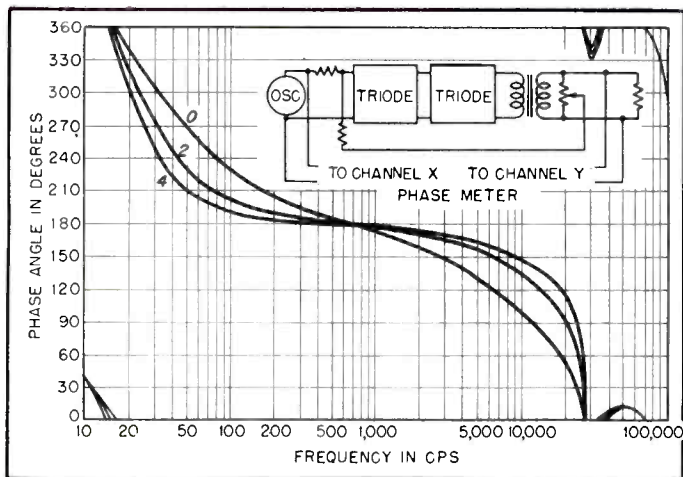

FIG. 6—Phase shift of an amplifier for various degrees of inverse feedback over a wide band of frequencies

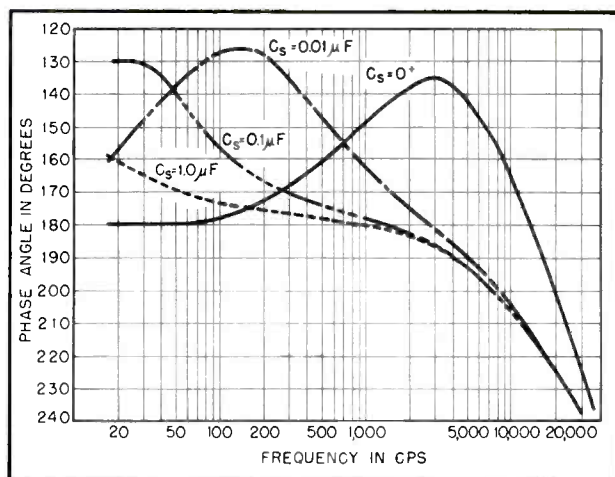

FIG. 7—Phase shift in a pentode stage with various degrees of screen bypassing when screen resistor is 240,000 ohms

square-wave generators are generally unequal. The phase meter can readily be used to determine the duty factor of a train of pulses as well as the time delay between two pulse trains, provided that the repetition rate is not too high and the pulses are not too short.

R-F Phase Measurements

All methods of audio-frequency phase measurement can be used to measure the phase difference between radio-frequency signals, as in the testing of broadcast antennas, by taking advantage of the heterodyne principle. If both signals are heterodyned into the audio frequency band by means of a common heat oscillator, their phase difference will be preserved. The required converter stage could be added to each of the two channels with relatively little complication. A preferable solution may be to precede the phase meter with a separate unit containing heterodyne stages and amplifiers. Both audio and r-f phase measurements can then be made at low (millivolt) input levels.

Applying the Phase Meter

A typical problem in which the direct-reading phase meter finds a useful application is that of phase shift in feedback amplifiers. Figure 6 shows plots of phase shift versus frequency (from 10 cps to 100 kc) obtained in approximately ten minutes by means of the phase meter described. The three curves are for various degrees of feedback, ranging from zero to critical feedback. The amplifier tested contains

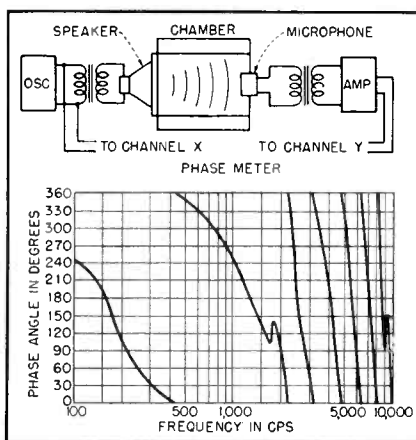

FIG. 8—Phase shift versus frequency for an electroacoustical system used in testing loudspeakers

two triode stages and a transformer, resonance in the transformer being responsible for the peculiar phase variation at 30 kc

Another example is the measurement of phase shift resulting from screen-grid degeneration in a single pentode stage. Accurate computation of this phase shift, even with a good knowledge of the tube characteristics, is not a simple matter, although the phase meter affords an easy way of measuring it. The phase shift plotted versus frequency, for various degrees of screen-grid bypassing, is shown in Fig. 7. Both the magnitude and phase angle of the gain can also be plotted on polar coordinates.

A most interesting and important application of the direct-reading phase meter occurs in acoustics. Arrays of phased loudspeakers, used to simulate directive antenna arrays, contain hundreds of small

speakers whose phase characteristic must be within certain tolerances over a wide band of audio frequencies. The test setup for these loudspeakers is shown in Fig. 8, together with a plot of phase shift versus frequency. It contains the speaker, an anechoic chamber, a dynamic microphone, and two transformers whose resonances are evident in the plot. A linearly increasing component of phase shift results from the chamber whose length, expressed in wavelengths, is directly proportional to frequency. Practice has shown that, by cros methods, only 3 to 5 speakers can be tested in one day, while up to 60 can be tested per day by means of a direct-reading phase meter. Some applications require the testing of hundreds of speakers, so that, several months' work is reduced to a week's work.

Acknowledgment

The phase meter described was developed for the Technology Instrument Corporation, Waltham, Massachusetts. The writer wishes to express his appreciation to Mr. L. E. Packard of that company for his help in the development.

REFERENCES

- (1) J. Goodman, unpublished BS thesis, Electrical Engineering Dept., MIT, 1943.
- (2) J. R. Ragazzini and L. A. Zadeh, A Wide-Band Audio Phasemeter, National Convention, IRE, 1949.
- (3) J. E. Shepherd, U. S. Pat. 2,370,692.
- (4) Harold Goldberg, Direct Reading Phasemeter, *Bendix Radio Engineer*, p 4, April 1946.
- (5) E. F. Florman and A. Tait, An Electronic Phasemeter, *Proc. IRE*, p 207, February 1949.
- (6) L. A. Goldmuntz and H. L. Krauss, The Cathode-Coupled Clipper Circuit, *Proc. IRE*, p 1172, Sept. 1943.

new!

MOLDED CONNECTOR SOCKET

for higher voltage application
when used with *integral
metal clad plug*



No. 60U 13970



No. 60M 13969



No. 54A 13967



No. 15M 13631

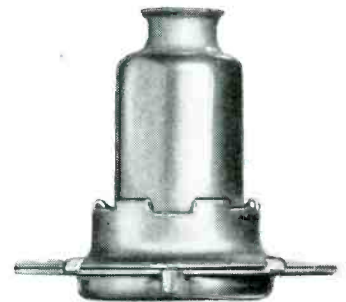

... the new **molded** connector socket which, when used with integral metal saddle laminated plug ... the shell and integral spring provide connector plug for shielded grounded circuit. Higher voltage capacity provided is attributed to the feature, the molded insulator developed by Cinch Engineering. Molded plug reinforced with metal shell with extruded neck, providing shoulder for soldering shielding braid; inside shell bakelite insulator. Three prong laminated plug shown; available in maximum of four, polarized.

Write for samples and further details.



Cinch
IS THE
STANDARD

AVAILABLE AT LEADING ELECTRONIC JOBBERS ... everywhere

CINCH MANUFACTURING CORPORATION

Subsidiary of United-Carr Fastener Corporation, Cambridge 42, Mass.

1026 South Homan Avenue
CHICAGO 24, ILLINOIS

Receiver Noise Nomograph

Over-all noise figure of radio or radar receiver is quickly found when noise factors of first two sections and gain or loss of first section are known

IN THE DESIGN of radio and radar receivers, it is often advantageous to determine quickly the feasibility of using components at hand. The following nomograph was developed for this purpose, and is based on two well-known formulas^{1,2}

$$\overline{NF}_{(1+2)} = \overline{NF}_1 + \frac{\overline{NF}_2 - 1}{W_1} \quad (1)$$

$$\overline{NF}_{\text{mix}} = Lt \quad (2)$$

where $\overline{NF}_{(1+2)}$ is noise factor (in power) of overall receiver, \overline{NF}_1 is noise factor of first network, \overline{NF}_2 is noise factor of second network, $\overline{NF}_{\text{mix}}$ is noise factor of mixer, W_1 is gain (or loss) of first network, L is loss of mixer and t is noise temperature (ratio) of mixer.

The nomograph can be used with either a mixer followed by an i-f amplifier as the second network or

By CHESTER W. YOUNG

*Electronic Engineering Designer
Consolidated Vultee Aircraft Corp.
San Diego, Calif.*

with an r-f amplifier followed by a mixer-i-f amplifier combination whose overall noise factor can be worked prior to adding the r-f amplifier. Scale A is used if the first network has a gain (or loss) less than one and Scale B is used if it has a gain greater than one.

How to Use Nomograph

Place a straightedge on desired values on A and B scales to locate turning point on AB scale. Using this turning point and value on A scale (or B scale), read final value on adjacent A scale (or B Scale; use A scales together or B scales together). The L and t scales are used to determine noise factor of the mixer.

Example: If required range for

system with a given transmitted power requires over-all noise figure to be 13.65 db (noise factor of 23.2), what is minimum noise figure which crystal mixer can have if it has a loss of 13 db, and can this be used with an existing 3-db i-f amplifier?

Starting on left side of nomograph, align straightedge with noise temperature of 1.0 and mixer loss of 20, and read $\overline{NF}_{\text{mix}}$ as 20. Using this and overall $\overline{NF}_{\text{receiver}}$ value of 23.2, find turning point on AB. Using turning point and 13-db (mixer gain of 0.05) loss point on slant A scale, read 0.65 db for \overline{NF}_2 on vertical A scale, as maximum permissible noise figure.

REFERENCES

- (1) S. N. Van Voorhis, "Microwave Receivers," Vol. 23 of MIT Radiation Lab Series, p 2.
- (2) Torrey and Whitmer, "Crystal Rectifiers," Vol. 15 of MIT Radiation Lab Series, p 30.

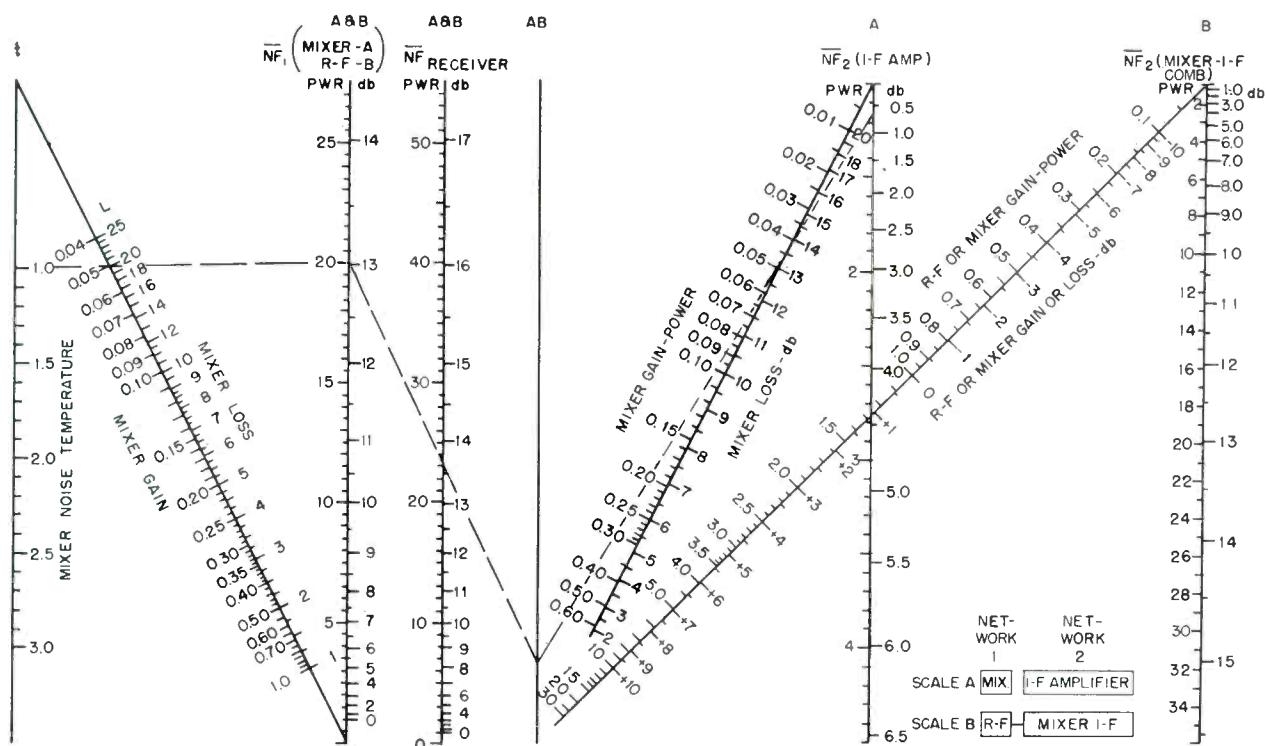

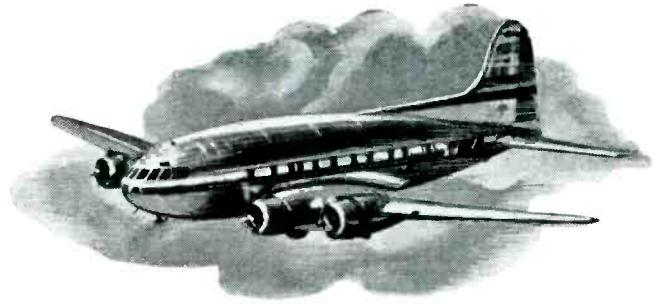

On Land, Sea, and Air

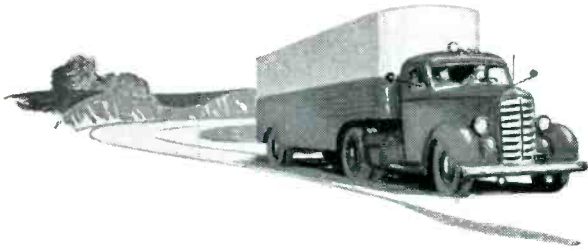

Mallory Vibrators Are Relied Upon For Complete Dependability

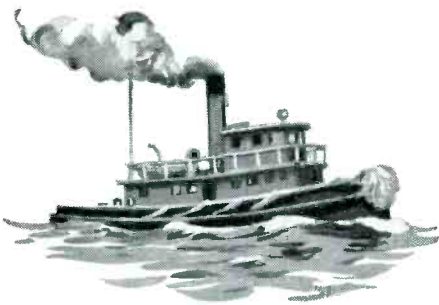

Whatever your vibrator application, the odds are that a standard Mallory Vibrator already is performing a similar job. The illustrations on this page are only a few of many examples where Mallory Vibrators are giving dependable service.

Mallory engineering skill, long experience, and complete adherence to quality ideals mean that Mallory Vibrators will give you longer life and less trouble.

More Mallory Vibrators are used in original equipment than all other makes combined. Why take a chance on anything less than this standard of excellence?



Send complete technical details of your problem. Mallory will supply the answer.

Vibrators and Vibrapack* Power Supplies

P. R. MALLORY & CO., Inc.
MALLORY

P. R. MALLORY & CO., Inc., INDIANAPOLIS 6, INDIANA

SERVING INDUSTRY WITH

| | |
|----------------|------------|
| Capacitors | Rectifiers |
| Contacts | Switches |
| Controls | Vibrators |
| Power Supplies | |

Resistance Welding Materials

*Reg. U. S. Pat. Off.

TUBES AT WORK

Including INDUSTRIAL CONTROL

Edited by VIN ZELUFF

| | |
|---|-----|
| Built-in Picture Tube Filter..... | 122 |
| Leak Detector Tests Welded Tanks..... | 122 |
| Edsac..... | 124 |
| Microwave TV Remote..... | 124 |
| A Voltage-Controlled Multivibrator..... | 144 |
| Two-Way Radio in Industry..... | 158 |
| Oxide-Coated Cathodes..... | 164 |
| Twin Oscillator..... | 170 |

Built-in Picture Tube Filter

A CONTRAST RATIO of approximately 35 to 1, highlight to darkest shade, is provided for picture tubes by a new glass called Teleglas when used as the tube face.

Developed primarily as the tube face for metal-coned tubes, the glass is practically colorless. Certain metallic oxides are added to the glass in manufacture to produce uniform attenuation throughout the visible light range. The coefficient of expansion of the treated glass is the same as that of clear glass suitable for sealing to the metal of metal-glass picture tubes. Light transmission of the treated glass is about 65 to 70 percent. Clear glass is about 90 percent.

Teleglas was developed in the Creighton Research Laboratories of the Pittsburgh Plate Glass Company and tubes containing face plates of the material are featured in the Zenith television receiver

line. It is being used in 12 and 16-inch metal tubes. Its use in all-glass tubes would be predicated upon agreement between all of the picture tube manufacturers.

Under normal conditions, clear-glass picture tubes have a contrast ratio of about 35 to 1 only when operated in an otherwise dark room. Use of external room light falling on the tube face then causes the dark picture areas to appear lighter in tone or grey. To minimize this condition, many viewers have installed the commercially available filters. These attenuate the external light, which has to pass twice through the filter; and although they attenuate light from the phosphor as well, this passes only once through the filter, and the contrast ratio between the two is increased.

The new glass operates in the same manner to reduce the effect of ambient light, and in addition it

also helps reduce halation from the phosphor. In clear-glass tubes, light from bright picture areas of the phosphor that strikes the exterior tube face surface at angles greater than 48 degrees is completely reflected over into the dark picture areas, reducing its apparent blackness. Teleglas attenuates this light both before and after reflection from the front surface so that the dark picture areas seem blacker.

Leak Detector Tests Welded Tanks

WELDED FUEL TANKS for use in large transportation trucks have capacities ranging from 85 to 150 gallons. To make certain there are no possible places for gasoline to

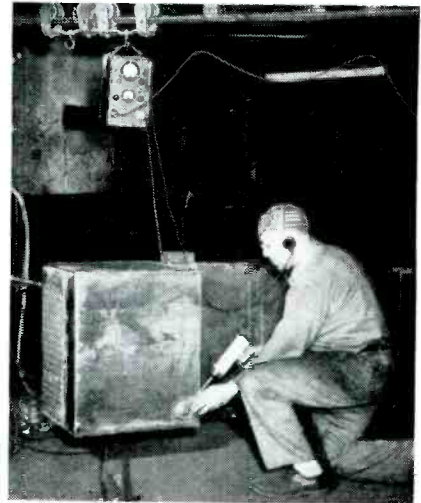

Pistol-shaped pickup is passed along a welded seam in a fuel tank. Gas leaking through weld is indicated visually on the General Electric leak detector on trolley hook and audibly to inspector via headphones

seep out, all welds are checked by a portable leak detector before the finished tanks pass from the assembly line at Lintern Corp., Berea, Ohio.

Six welders and one inspector armed with the leak detector can turn out about 18 tanks in the average day. Fabrication is in six stages. The tanks are placed on iron rails rather than positioners so that they can be pushed from one welding booth to another as they move along the assembly line.

The top plates of the tanks are made of mild steel deck plate; the bottoms and ends are 12-gage sheet steel. First the inner baffles and

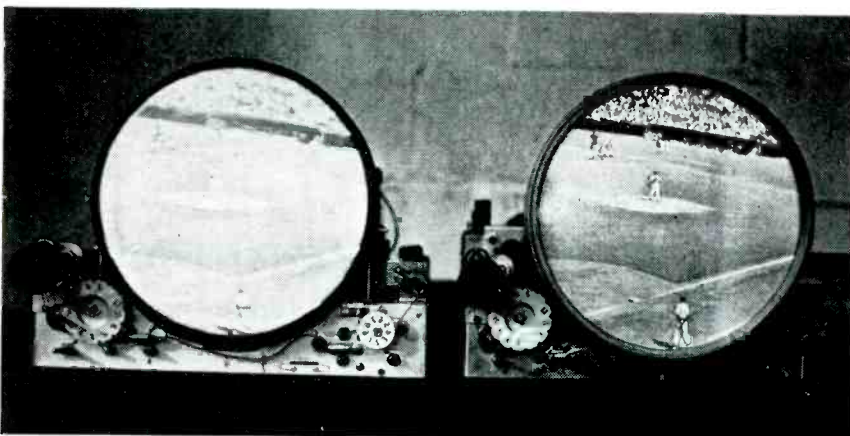

Picture tube at left has clear glass face that, although it transmits 90 percent of light from phosphor, has low contrast ratio because of room lighting and reflection of light from phosphor from front surface into dark areas. Tube at right has Teleglas face that transmits about 65 percent of light but shows contrast ratio of 35 to 1

SOLDERING TIPS

DIP SOLDERING

Container—The Solder Pot should be made of fine grained non-porous cast iron or steel; free from defects.

Size—The size of the solder pot is determined by the overall size of the articles to be tinned and the depth to which they are to be submerged.

The introduction of a large mass of cold metal into a solder pot causes a decided drop in the solder bath temperature and thought should be given to the size of the pot so that an adequate reserve of heat will be maintained.

Excessive chilling due to the addition of masses of solder may be avoided by continuously feeding solder wire into the pot or by frequent addition of small lumps of solder.

Temperature—The temperature of the solder bath will fall as each article is dipped into the solder so that it is necessary to keep the solder bath well above the liquefaction point of the alloy being used. Generally from 150° F. to 300° F. above the liquefaction point of the solder, before the immersion of the article, is satisfactory. For 50% tin 50% lead solder this would be from 564° F. to 714° F.

Too high temperatures will be inefficient due to excessive and rapid forming of oxides over the solder bath.

Contamination—Solder baths will gradually become contaminated due to the affinity between tin and copper, resulting in the formation of sludge at the bottom of the pot and the gradual diminishing of the tin content. Frequent stirrings will help to keep the alloy normal and as the solder bath becomes increasingly contaminated, the entire mixture should be changed.

Adding new solder to a badly contaminated solder bath is false economy and the use of floor sweepings should never be considered as they frequently contain metal filings. Use the correct flux, this will enable you to do a quicker, easier tinning job. Eliminate all doubts about the quality of your solder by purchasing virgin metal solder from a reliable manufacturer.

If you are in doubt about the corrosive qualities of the flux you are now using, send a sample assembly/or soldered parts to the Kester Solder Company, 4204 Wrightwood Avenue, Chicago 39, Illinois, and an accelerated humidity test as outlined in Army-Navy Aeronautical Specifications will be made and you will be informed of the results. The test itself requires 72 hours, and since facilities are naturally limited, please allow plenty of time for your tests to be made. Of course, there is no charge. "Soldering Tips" will be pleased to answer all inquiries pertaining to solder, soldering fluxes, and soldering technique. Merely address "Soldering Tips," Kester Solder Co., 4204 Wrightwood Ave., Chicago 39, Ill.

NOW AVAILABLE . . . The New Manual —"SOLDER and Soldering Technique"!

Send for this complete analysis of the properties of soft solder alloys and soldering fluxes . . . a comprehensive reference book that you will want to retain. It's yours for the asking . . . request it NOW!

ADVERTISEMENT

ELECTRONICS — October, 1949

KESTER SOLDER

partner in

Electronics

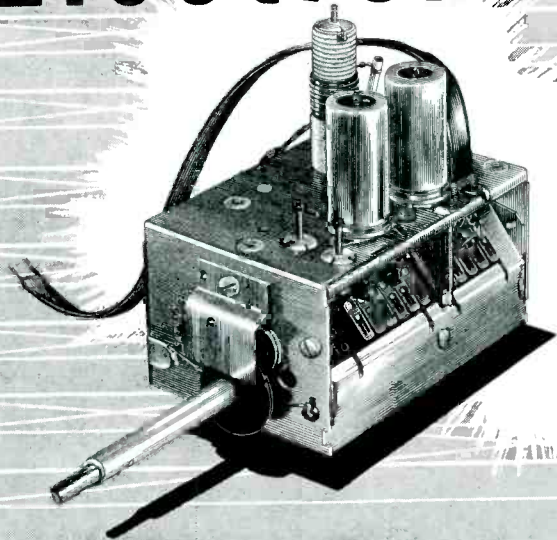

Kester "Resin-Five" Core Solder is more active, more efficient, and faster than any rosin flux—yet is absolutely non-corrosive and non-conductive. The finest flux-core solder made for all television and radio work. Available in diameters as small as .010" . . . 5 different core openings for each diameter . . . all practical alloys.

The TV tuner pictured above, manufactured by Standard Coil Products Company, contains 210 soldered connections, all made with Kester "Resin-Five" Core Solder.

Call in a Kester Technical Engineer today and have him show you how "Resin-Five" Core Solder in the proper size and alloy will increase your soldering efficiency.

FREE—TECHNICAL MANUAL

Send for Kester's new manual, "SOLDER and Soldering Technique"—a complete analysis of the application and properties of soft solder alloys and soldering fluxes.



KESTER SOLDER COMPANY

4204 Wrightwood Avenue, Chicago 39, Illinois

Factories also at Newark, New Jersey • Brantford, Canada

**KESTER
SOLDER**

braces and the bottom sections are tacked together, the side panels are then tacked on, and final weldments are made after all the parts are assembled. Sixty feet of welding electrode goes into each tank.

An inspector checks all welded seams in finished tanks with the Type H leak detector. This electronic instrument can detect leaks small enough to release only one ounce of gas per 100 years. Previous leak-testing methods uncovered only the large leaks.

Edsac

CAPABLE of working out 15,000 operations in one minute, Edsac is the Electronic Delay Storage Automatic Calculator installed at the Mathematical Laboratory, Cambridge University, England.

Problems are coded on ticker tape and fed into the brain which stores them and shows their presence on a cathode-ray tube. The instrument

can store 512 numbers of ten figures each. The intricate operations are carried out by 3,500 tubes mounted on 120 panels in twelve racks.

Maintenance requirements are almost negligible and are met by one man working part time. Power consumption is about 10,000 watts.

Circuits are provided that check the answers obtained. The machine takes only 0.005 second to multiply two ten-figure numbers but it can be fooled. When set to multiply a series of numbers by zero it continues to try until it is turned off or a tube ceases to function.

Microwave TV Remote

IN BRINGING a special broadcast from Winchester, Va. to Washington, the WMAL-TV engineering department employed its own microwave relay facilities to cover a course of approximately 74 miles.

Two problems were encountered

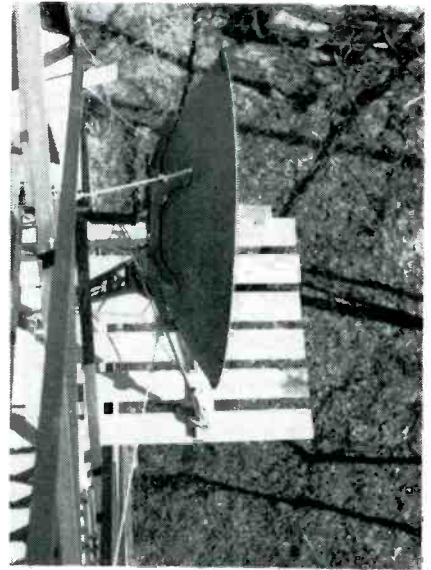

View of 2,000-mc four-foot reflector mounted on a scaffold below the cabin of the fire tower

in setting up the relay. First, line-of-sight does not exist between these two points, and second, the distance involved is considerably greater than can normally be spanned by a single microwave link.

A convenient intermediate relay point was established atop Signal Mountain along the Blue Ridge near Linden. This point is 17 miles line-of-sight from the point of program origination in Winchester, and is 57 miles line-of-sight to the WMAL-TV transmitter tower in Washington. A conventional 100-milliwatt 7,000-mc relay was used for the first leg of the circuit, and a 50-watt 2,000-mc relay was used over the 57-mile course.

The transmitting and receiving equipment proper was housed in the cabin atop the fire tower, while the antennas were mounted on a specially constructed scaffold approximately 20 feet below. A six-foot dish was on the receiving circuit from Winchester, while a four-foot reflector was used on the transmitting circuit to Washington. Power was provided by a gasoline-driven motor-generator set.

The receiving point in Washington is shown in one of the illustrations. An eight-foot parabolic reflector is mounted on a platform at the 225-foot level of the WMAL-TV tower at American University campus. The antenna and reflector assembly is oriented from the ground by a station-constructed

(Continued on p 140)

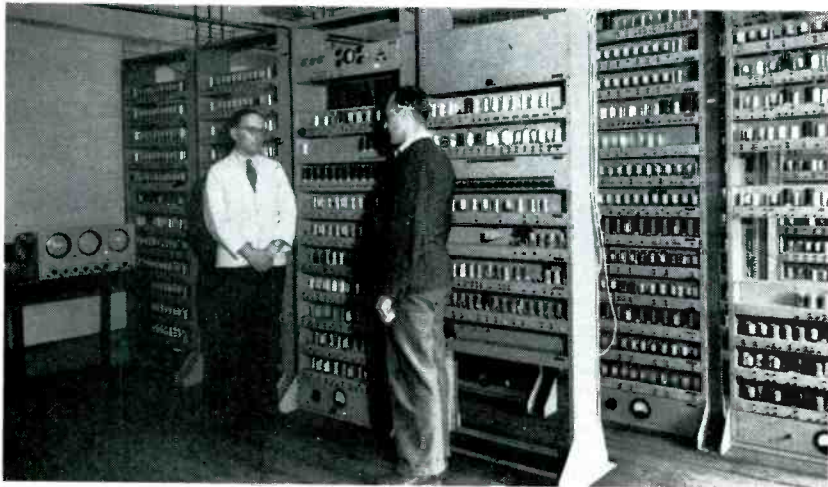

Convenience in replacing tubes is provided in the Edsac by its designers M. V. Wilkes and W. Renwick

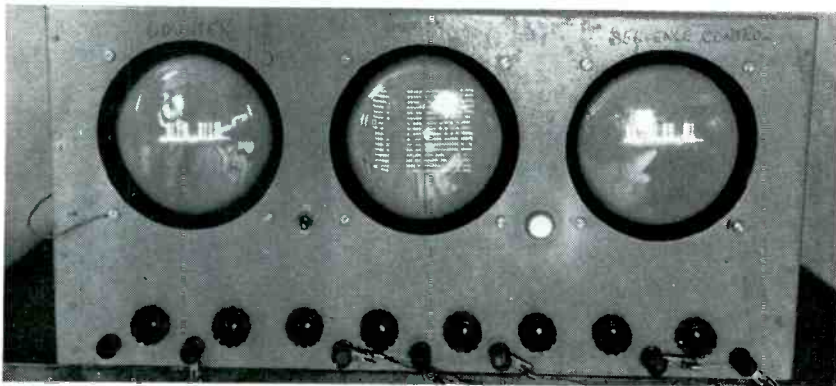

Timing monitor or counter tube, memory tube and sequence control tube are cathode-ray tubes in the Edsac

THESE CURVES TELL A STRAIGHT STORY...

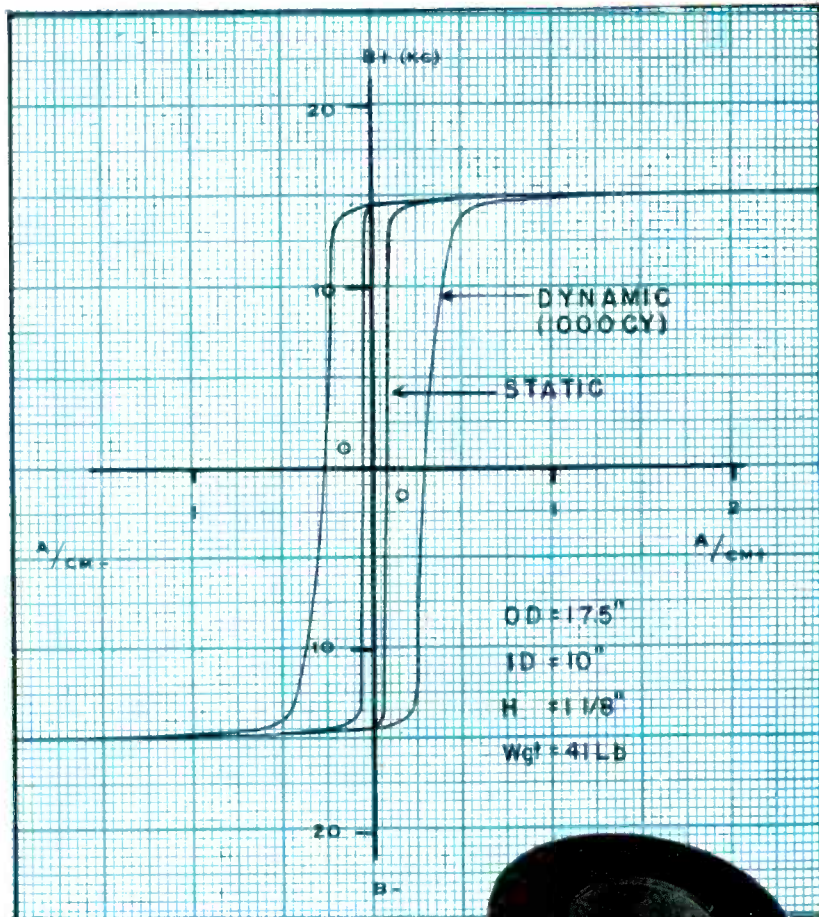

... the story of PERMERON— I-T-E's new magnetic core material

The curves on this performance chart show the static and dynamic (1000 cycle) magnetization characteristics of Permeron — I-T-E's new development in magnetic alloys.

Examine the dynamic curve particularly, to see how Permeron acts under typical operating conditions. Note how magnetic saturation is achieved with only the slightest change in magnetizing current — how the knees of the saturation curve are consistently sharp — even at higher frequencies.

These characteristics of Permeron open up entirely new possibilities in the design and manufacture of core and coil assemblies. For instance, they make it possible to build smaller magnetic amplifiers of extreme reliability.

And all Permeron cores have identical magnetization characteristics. With Permeron, you can predict performance accurately and positively!

Permeron cores are available now in widths of 20 mm. and 30 mm., in any specified inside and outside diameters. The cores are delivered heat-treated and insulated, in housings specially designed to protect the magnetic material against deformation.

For complete information on Permeron, write Rectifier Division, I-T-E, or ask your local I-T-E Representative.



Permeron... another new product of I-T-E—where better designs and better equipment are developed first.

I-T-E PERMERON

A product of Rectifier Division, I-T-E CIRCUIT BREAKER COMPANY,
19th & Hamilton Streets, Philadelphia 30, Pa.

SWITCHGEAR • UNIT SUBSTATIONS • ISOLATED PHASE BUS STRUCTURES • MECHANICAL RECTIFIERS • RESISTORS • SPECIAL PRODUCTS

THE ELECTRON ART

Edited by JOHN MARKUS

| | |
|---|-----|
| Tropospheric Measurements | 126 |
| Carrier-Type D-C Amplifier For Biological Research..... | 128 |
| Deposited-Carbon Resistors | 182 |
| Microwave Secondary-Emission Switch..... | 186 |
| Oxide Cathode Theory..... | 190 |
| Survey of New Techniques..... | 198 |

Tropospheric Measurements

BY PETER HARBURY
*Cruft Laboratory, Harvard University
 Cambridge, Massachusetts*

THEORETICAL STUDIES indicate that vertical incidence transmissions near 100 mc are likely to produce measurable reflections from air mass boundaries in the troposphere. It is expected that data obtained from these transmissions will yield valuable information regarding meteorological phenomena. In addition, it is expected that the use of a sharp beam will yield new information regarding meteoric ionization at higher elevations.

The antenna and recording system described herein are part of a tropospheric research project carried on at the Harvard University Field Station in Concord, Massachusetts, under the auspices of the

Armed Forces. It is a continuation and extension of work done at microwave frequencies by A. W. Friend at Harvard University.

The Antenna System

The antenna system consists of a driven dipole with a disc-type parasitic reflector spaced $\lambda/4$ and the entire assembly placed at the focus of a large parabolic reflector. The reflector recently completed is shown in the accompanying photograph.

In order to minimize back radiation, as well as side lobes caused by currents flowing along the vertical stay wires, a series of wires is soldered to the vertical stays a quar-

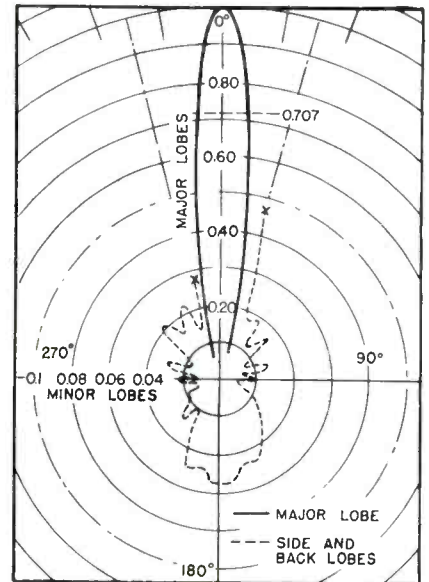
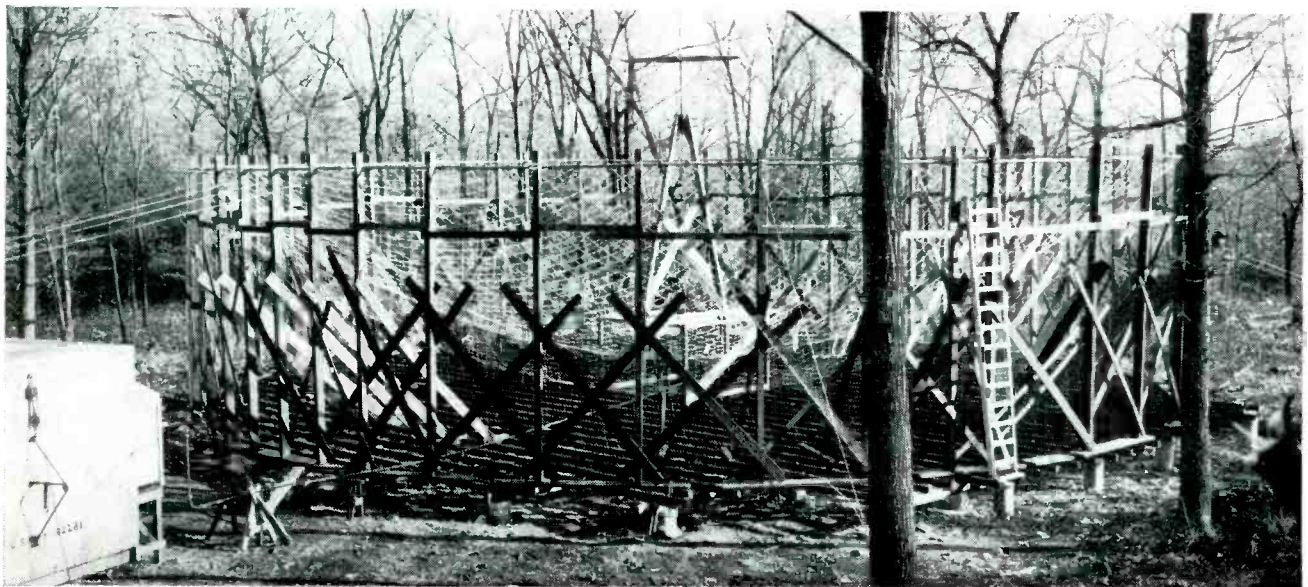

FIG. 1—E-Plane field pattern using dipole and disc reflector in a scale model parallel-wire paraboloid at a frequency of 1.325 mc. The H-plane pattern is similar except for slightly larger minor lobes

ter-wavelength down from the surface of the parabola. A high impedance is accordingly presented to currents tending to flow along these vertical stays.

Maximum gain and minimum side lobes are obtained for a focal length of 0.30 to 0.35 D (depending upon the type of radiating element used). A disc type of reflector was selected as a result of field pattern measurements of various scale-models.

The E-plane field pattern shown in Fig. 1 is for a scale-model radi-



The parabolic reflector shown is 62 feet in diameter and 13 feet deep. It has a power gain of 24 db over an isotropic radiator. Beam widths between half-power points are 12 and 11 degrees for the E and H planes respectively

Laboratory Instruments for TELEVISION

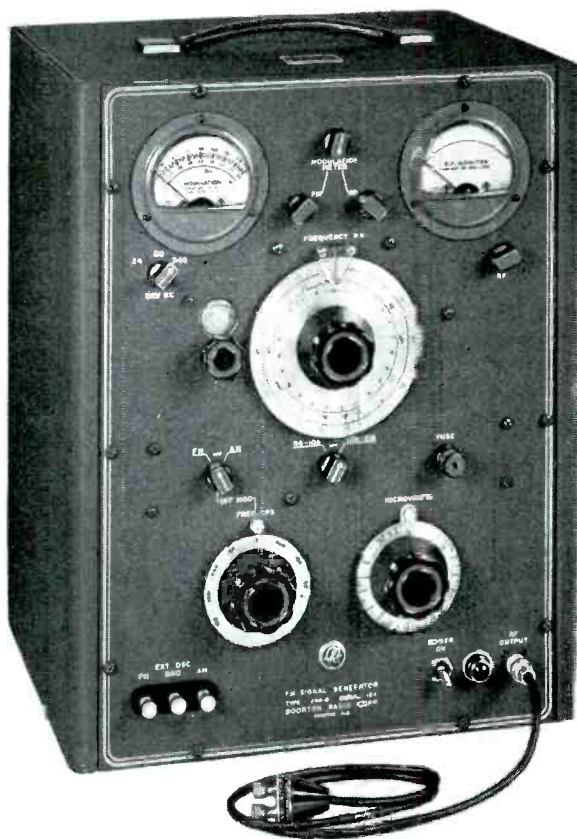

FM SIGNAL GENERATOR Type 202-B

The Type 202-B FM Signal Generator is specifically designed to meet the exacting requirements of television and FM engineers working in the frequency range of 54 megacycles to 216 megacycles. Following are some of the outstanding features of this versatile instrument:

RF RANGES: 54-108, 108-216 mc. \pm 0.5% accuracy. Also covers 0.4 mc. to 25 mc. with accessory 203-B Univerter.

VERNIER DIAL: 24:1 gear ratio with main frequency dial. **FREQUENCY DEVIATION RANGES:** 0-24 kc., 0-80 kc., 0-24G kc.

AMPLITUDE MODULATION: Continuously variable 0-50%, calibrated at 30% and 50% points.

MODULATING OSCILLATOR: Eight internal modulating frequencies from 50 cycles to 15 kc. available for FM, AM.

RF OUTPUT VOLTAGE: 0.2 volt to 0.1 microvolt. Output impedance 26.5 ohms.

FM DISTORTION: Less than 2% at 75 kc. deviation.

SPURIOUS RF OUTPUT: All spurious RF voltages 30 db or more below fundamental.

If you have an FM or television instrument requirement, let us acquaint you with full particulars and technical data concerning the Type 202-B FM Signal Generator and Type 203-B Univerter.

DESIGNERS AND MANUFACTURERS OF THE Q METER - QX CHECKER
FREQUENCY MODULATED SIGNAL GENERATOR - BEAT FREQUENCY
GENERATOR AND OTHER DIRECT READING INSTRUMENTS

Type 202-B FM SIGNAL GENERATOR

Frequency Range
54-216 mc.

Additional coverage from
0.4 to 25 mc. with accessory
UNIVERTER Type 203-B

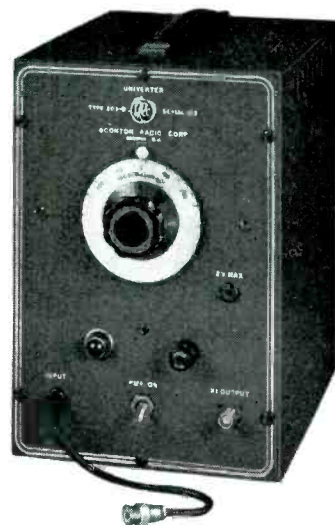

UNIVERTER Type 203-B

AVAILABLE AS AN ACCESSORY is the 203-B Univerter, a unity gain frequency converter which, in combination with the 202-B instrument, provides the additional coverage of commonly used intermediate and radio frequencies.

R. F. RANGE: 0.4 mc. to 25 mc. (0.1 mc. to 25 mc. with no carrier deviation).

R. F. INCREMENT DIAL: \pm 250 kc. in 10 kc. increments.

R. F. OUTPUT: 0.1 microvolt to 0.1 volt, \pm 1 db. Also approximately 2 volts maximum (uncalibrated).

OUTPUT IMPEDANCE: Approximately 60 ohms at 0.1 volt jack, 470 ohms at 2 volt pin jack.

BOONTON RADIO

BOONTON · N.J. · U.S.A. *Corporation*



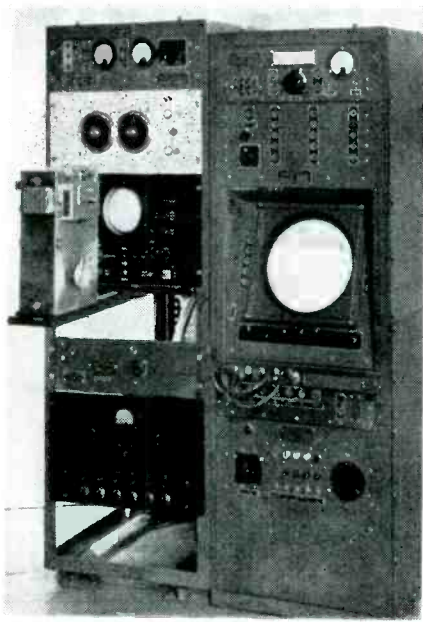

Tropospheric receiving and recording equipment provides a wide variety of sweep ranges and range markers

ator consisting of a half-wavelength dipole and a disc reflector spaced a quarter-wavelength above the driven element.

Transmitter and Recorder

The transmitter consists of SCR-270 radar having a peak power of 100 kw operating at 106 mc with a pulse repetition frequency of between 300 and 400 cps. The pulse width is of the order of 10 μ sec.

The original 12-inch A-scope, which is a part of the equipment, together with the associated sweep and marker circuit provides sweeps up to 200 miles, with five-mile markers injected when desired. However, since the area of interest

for tropospheric measurements lies between the earth's surface and approximately 15 km, sweeps of much shorter duration and of greater accuracy must be employed.

The recorder for this project, a block diagram of which is shown in Fig. 2, was adapted from similar recorders used by the Wave Propagation group located at Cruft Laboratory.

Two types of presentation are possible. The first permits intensity modulation of the baseline by the echo signal; the second is a regular A-scope presentation for wave-form analysis. There is a choice of five sweep ranges, between 0-4 km and 0-220 km, with range markers spaced at 2 or 10-kw intervals, as desired.

The recording camera, which photographs the crt face, makes use of a continuously-moving strip of photographic paper capable of moving at speeds of 36, 24, 12, 6 and 4 cm per hour. Single time-reference markers may be injected automatically every ten minutes and a double marker every hour; or, if desired, reference markers may be injected manually. This is done by brightening the baseline of the cathode-ray tube momentarily which results in the recording of a black line on the photographic paper.

The research program described in this paper was made possible through the support extended Cruft Laboratory jointly by the Navy Department Office of Naval Research and the Signal Corps, U. S. Army, under contract N5ori-76.

Carrier-Type D-C Amplifier For Biological Research

BY C. R. MADUELL, JR.
Electronic Engineer
Delta Electronic Equipment Co., Inc.
New Orleans, La.

AND H. MALCOLM OWEN
Special Biologist
Louisiana Dept. of Wildlife & Fisheries
New Orleans, La.

THE CONTINUOUS recording of small, slow, mechanical motions (below 0.1 min and 20 cps) has usually been done with mechanical

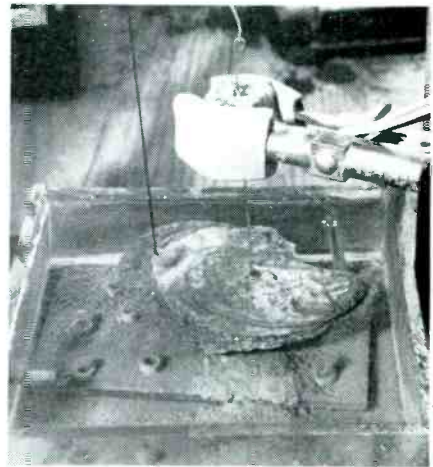

Pickup mechanism of instrument as positioned for observing the heart beat of an oyster that is slowly dying in a salt-water environment simulating that produced by industrial pollution. Coils are held by clamp. For this usage, the instrument has been named an astredynamometer

amplifiers of motion and a clock-driven drum. At best, the system is far from being friction free, and usually contains quite a bit of inertia and mass which use up con-

(continued on page 176)

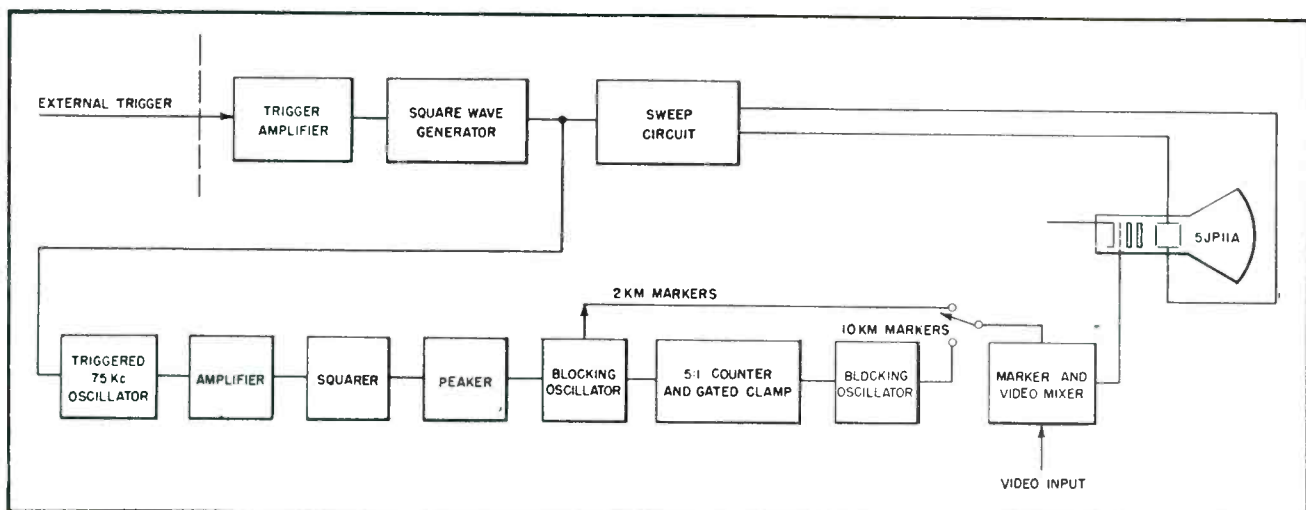

FIG. 2—Block diagram of recorder used in conjunction with parabolic antenna for tropospheric measurements

New

ELECTRICAL TUBING

gives

Better Performance

5-WAYS

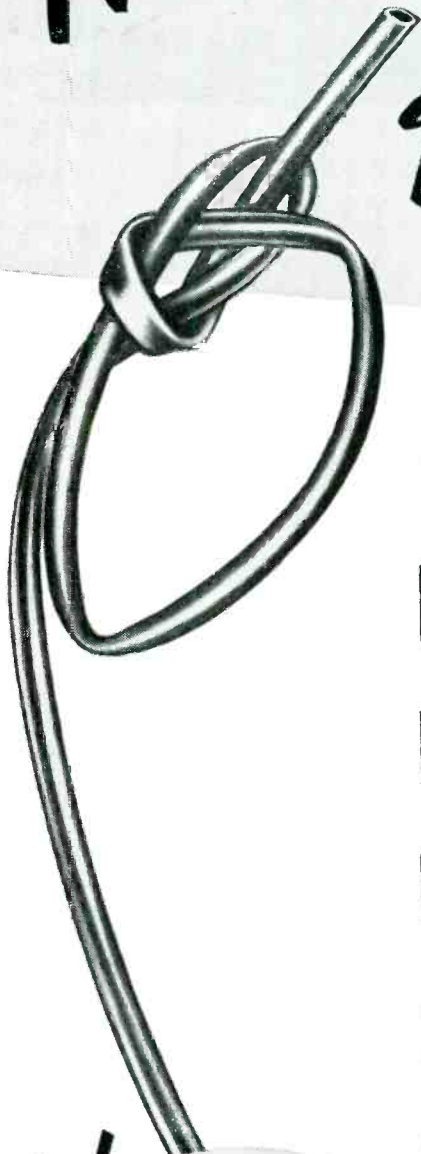

Here's why...

VARGLAS Tubing is now impregnated with G. E. PERMAFIL

Here's how...

1 BETTER DIELECTRIC RETENTION

... 7,000 volts — and keeps its high dielectric value under toughest service conditions.

2 BETTER FLEXIBILITY

... twist it — tie it — bend it — wrap it! No crack — no peel — no dielectric loss.

3 BETTER HEAT RESISTANCE

... withstands more than 2,000 hours at 105° to 110° C — 1,000 hours at 125° C — extensive periods even at 150° C.

4 AVAILABLE IN COILS

... so that you can cut the length you need — no more, no less, no waste. Standard colors — wide range of sizes — meets or exceeds all A.S.T.M. specifications.

5 CAN BE AFTER-TREATED

... in baking and varnishing operations. Reacts better than most oleoresinous materials and other synthetic coated tubings.

Varflex

CORPORATION

Makers of
Electrical Insulating
Tubing and Sleeving

Send for
FREE
Sample—
Full
Information

VARFLEX Corporation, 308 Jay St., Rome, N. Y.

Please send me full information as well as a free sample of your new Varglas Tubing impregnated with General Electric Permafil. I am particularly interested in samples suitable for.....

Name.....

Company.....

Street.....

City..... Zone..... State.....

NEW PRODUCTS

Edited by WILLIAM P. O'BRIEN

Cross-Hatch Generator

THE HICKOK ELECTRONIC INSTRUMENT Co., Cleveland, Ohio, has developed the Model 620 cross-hatch generator which provides a stable video pattern at any time for alignment and trouble shooting. The

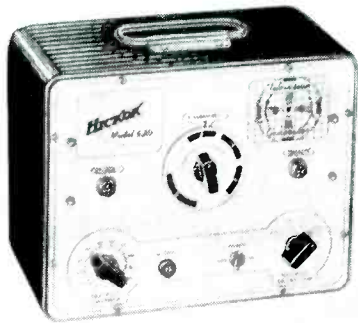

instrument has output frequencies for 4 channels—2 through 5 inclusive; output voltage is 50 to 5,000 μ v, with all modulating frequencies crystal controlled. The unit operates on 105-125 volts, 60 cycle a-c.

Wideband Amplifier

U. S. Electronic Co., 262 Canner St., New Haven 11, Conn. Model 100 wideband amplifier is designed for application in the field of nuclear research or for general problems involving the study of transients.

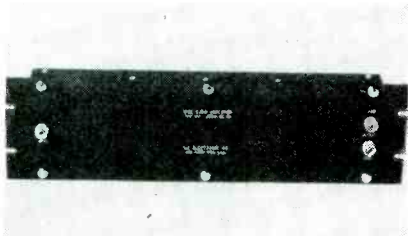

Bandwidth extends from 4,000 cycles to 22 mc. Voltage gain is 520 on the high-impedance output connection and response is uniform within 3 db.

Transmission Measuring Set

THE DAVEN Co., Newark, N. J., Type 11A transmission measuring set is a single-meter instrument designed for specific use in checking

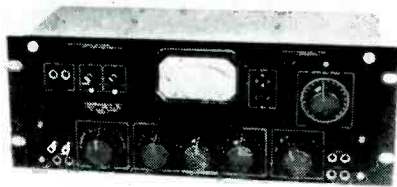

frequency response, impedance matching characteristics and gain and loss measurements. The unit features a 1.0-percent accuracy and a frequency range from 20 to 20,000 cycles. Attenuation measurements can be made to 111 db in 0.1-db steps. This instrument is applicable in telephone transmission work and as test equipment in audio laboratories and broadcast stations.

Pocket VOM

ELECTRONIC MEASUREMENTS CORP., 423 Broome St., New York 13, N. Y. Model 102, a light-weight 1,000 ohms-per-volt meter, features a 3-in. square meter. Exact specifica-



tions, which include 5 a-c and 5 d-c voltage ranges, 4 d-c and 3 a-c current ranges and 2 resistance ranges, can be had by writing directly to the manufacturer.

Disc Ceramic Capacitors

SPRAGUE ELECTRIC Co., North Adams, Mass. The new wafer-thin capacitors consist of a half-dime or dime-sized ceramic plate of very high dielectric constant with silvered electrodes fired on both faces

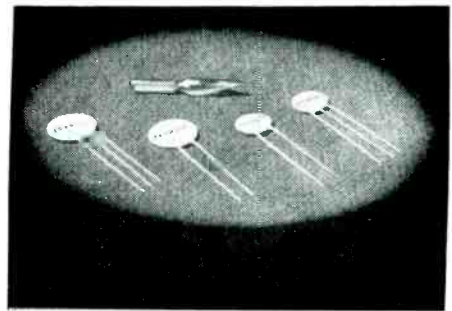

of the disc. Unidirectional leads are soldered to the silvering and the capacitors are coated with a moisture-resistant insulating resin. The units fit across miniature tube sockets, and can be used for bypassing at high-frequencies. They are available in ratings up to 0.01 or $2 \times 0.004 \mu$ f., 500 volts d-c working.

Aircraft Inverter

EICOR, INC., Chicago, Ill., is producing an aircraft inverter which electronically controls output voltage within ± 1.0 percent and output frequency within a 1.5-percent range.

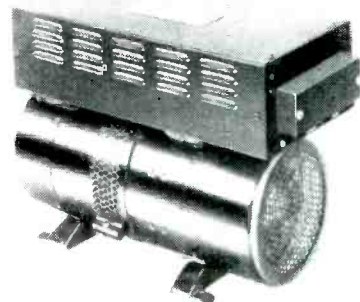

It has a 26 to 29 volt d-c input, 115-volt 400-cycle output, rated at 1,500 to 2,500 volt-amperes.

Stable Audio Oscillator

C. G. S. LABORATORIES, INC., 36 Ludlow St., Stamford, Conn. The model 50 stable audio oscillator is intended for use as a secondary frequency standard for low-frequency

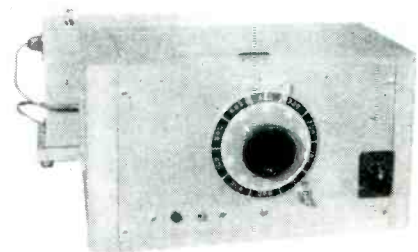

Raytheon presents this NEW GERMANIUM CRYSTAL DIODE

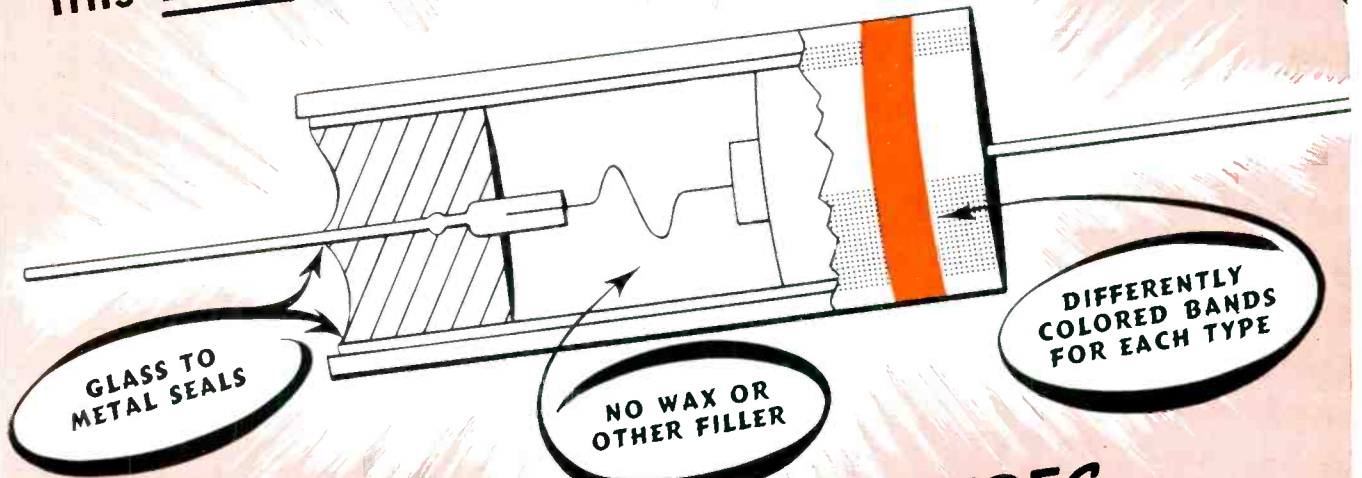

with these NEW FEATURES

- 1 VACUUM-TIGHT SEALS
- 2 NO WAX OR FILLER PERMITS OPERATION UP TO 100°C
- 3 DISTINCTIVE MARKING
- 4 EXTREMELY SMALL CHANGE IN FORWARD RESISTANCE WITH TEMPERATURE
- 5 SMALL SIZE — 9/64" diameter, 25/64" long
- 6 SMALLER, MORE FLEXIBLE LEADS, FOR EASIER WIRING
- 7 COMPLETELY INSULATED BODY FOR COMPACT ASSEMBLY



The following types are now available in production quantities at Newton and Chicago, and in smaller quantities at our 310 Special Tube Distributors.

DC CHARACTERISTICS (25°C)

| | CK705 | CK707 | CK708 |
|--|-------------|------------|------------|
| Maximum inverse current at -10 volts (ma) | 0.05 | — | — |
| Maximum inverse current at -50 volts (ma) | 0.8 | 0.05 | — |
| Maximum inverse current at -100 volts (ma) | — | — | 0.625 |
| Forward current at plus 1 volt (ma) | 5.0 to 10.0 | 4.0 (min.) | 3.0 (min.) |
| Shunt capacitance (mmf) | 1.0 | 1.0 | 1.0 |

Other types are available for special applications. We will be glad to discuss your requirements with you.



Excellence in Electronics

RAYTHEON MANUFACTURING COMPANY

SPECIAL TUBE SECTION - Newton 58, Massachusetts
SUBMINIATURE TUBES · SPECIAL PURPOSE TUBES · MICROWAVE TUBES · CATHODE RAY TUBES · RECEIVING TUBES

applications. It covers the 2,500 to 25,000-cycle range. Guaranteed accuracy is ± 0.1 percent. Tube change and ± 10 -percent line voltage change affect the frequency by less than ± 0.03 percent. Temperature coefficient is of the order of 0.002 percent per degree C.

Cable Fault Detector

CENTURY GEOPHYSICAL CORP., 1333 North Utica, Tulsa, Oklahoma. The cable fault detector may be used for pin-point location of open or shorted circuits in all types of unshielded

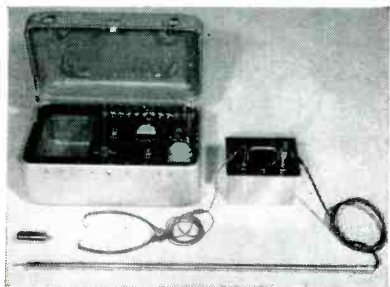

multiconductor cables. It is self-contained, complete with a double carrier, vacuum-tube oscillators, meter continuity test, detachable locating receiver and batteries.

Portable Engine Analyzer

SPERRY GYROSCOPE CO., Great Neck, N. Y., has developed a portable version of the airborne engine analyzer for use by ground crews servicing fleets not equipped with the flying model. It is applicable to engine test stands and engine and fuel research projects. The unit detects vibration and detonation troubles as well as ignition troubles. Power re-

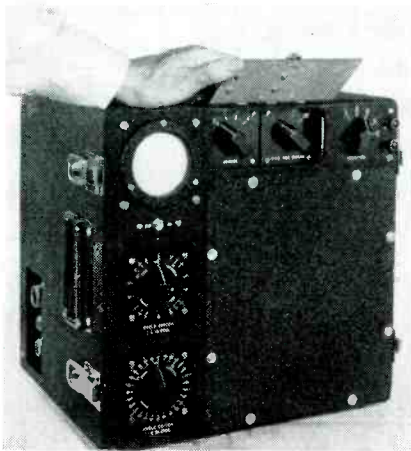

quirements are 1 ampere, 115 volts, 400 cycles, single-phase. Frequency range is 340 to 440 cps. Voltage range is from 105 to 126.5 volts.

Vacuum Control

THE SKANEATELES MFG. CO., INC., Dickerson and Clinton Sts., Syracuse 2, N. Y. Model SM-3 Skana-scope electronic vacuum control incorporates automatic line voltage regulation, a meter to give an indication of trend while the system is

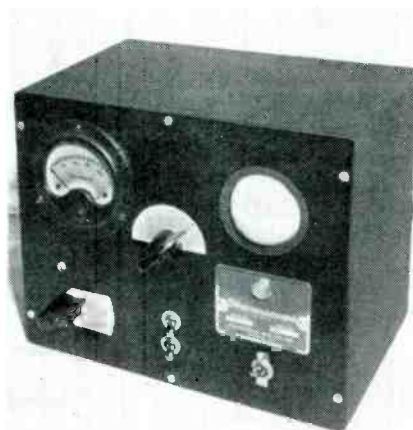

activated. It will accommodate one, two or three variable sensing tubes. Range is from 100 mm absolute to 60 microns on stock model sensing tubes and down to 0.1 micron on special tube applications.

X-Ray Measuring Device

THE VICTOREEN INSTRUMENT CO., 5806 Hough Ave., Cleveland 3, Ohio. The new Integron IV for x-ray dosage measurement has a meter



scale calibrated from 0 to 500 roentgens and a portable floor pedestal. It solves the problem of leakage caused by dirt, lint or humidity by use of an ionization chamber tube that is hermetically sealed. The instrument also incorporates electronic principles which eliminate rotating or moving components.

Capacitor Assembly

THE COMPTON CO., Bethesda, Md. The Capaci-Ring is a capacitor assembly designed to simplify the problem of socket terminal r-f bypassing. It combines in a compact unit four separate mica capacitors

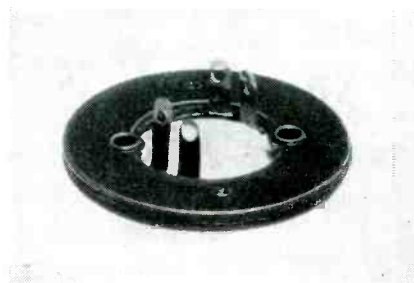

isolated from one another. Each of the four sections of the standard unit, type 6MA, has the nominal capacitance of 500 $\mu\mu\text{f}$. The unit is designed for application to a standard 7-pin miniature tube socket.

Klystron Power Supply

POLYTECHNIC RESEARCH & DEVELOPMENT CO., INC., 202 Tillary St., Brooklyn 1, N. Y. Type 801 universal klystron power supply provides for c-w, square wave, saw-

(Continued on p 202)

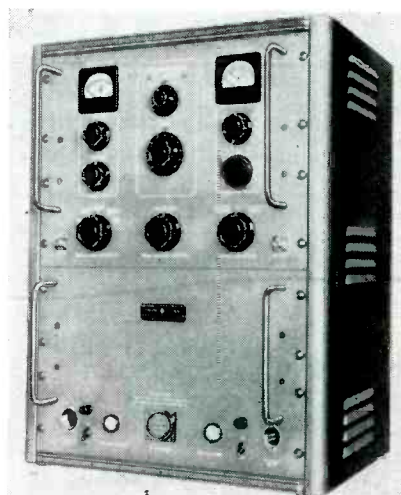

New Polyphase Reproducer System*

Incorporating principles which provide a simple and logical solution of today's problem of high quality reproduction of different types of records and transcriptions
—at incredibly low cost

DESIRE for music springs from the pleasure it can afford. However, one could hardly expect much pleasure from a record that can be played only after changing and shifting of apparatus, back and forth.

To enjoy today's discs (micro, 78 rpm, etc.) requires a single pickup unit capable of delivering such quality performance as would be delivered by two or more separate high grade magnetic reproducers—each designed expressly for a given type of recording.

The new AUDAX Reproducer,—

presented herewith,—*will do just that.*

This new AUDAX is perhaps the most important and revolutionary advance since the advent of the electronic pickup itself,—back in 1926. Yet,—remember,—its cost to you is *less than the cost of ordinary pickups.*

Your admiration will be aroused when you see and hear the way this remarkable instrument works.

You will know,—this new AUDAX performs important functions that no other unit does.

You will know,—this new AUDAX

is the very type of instrument you so long wanted, but thought impossible of development.

You will know,—this new AUDAX constitutes the complete answer to your reproducer problem.

You will know,—this is the logical instrument for YOU—whether you play one type or several types of discs.

When you learn that, with all its unprecedented accomplishments, this new AUDAX costs less than ordinary pickups,—you too will say, "*Yes, this is IT!*"

Wide range performance with any type disc • Point pressure about 7 grams • Genuine sapphire styli; (or diamonds if desired) • Replaceable individually by the user himself • Output about 30. m.v. • High or low impedance • Needle radiation very, very low • Ear quality *par excellence*

Write for complimentary EDITORIAL REPRINT describing polyphase principles

There is an AUDAX model to suit every purpose

Also available for Radio Stations:—

This is the answer for which you waited so long. This remarkable reproducer, —one single unit,—will play ALL your discs,—superbly!

There is no substitute for experience. When you are buying a motor car, washing machine or refrigerator, almost instinctively you evaluate the experience of the manufacturer behind the product. Has he the all-important KNOW-HOW to justify your implicit confidence? In no other field is this KNOW-HOW more important than in the field of Electronic Sound Apparatus, where AUDAX has set the pace for more than twenty-five years.

* Pats. Pend.

Visit us at the N. Y. Audio Fair, Oct. 27-28-29

AUDAX COMPANY

500 Fifth Avenue

New York 18, N. Y.

"Creators of Fine Electro-Acoustical Apparatus Since 1915"

NEWS OF THE INDUSTRY

Edited by WILLIAM P. O'BRIEN

NEC Program

THE NATIONAL ELECTRONICS CONFERENCE, an annual forum on electronic research, development and application, is being held at the Edgewater Beach Hotel, Chicago, on September 26, 27 and 28. The technical program is as follows:

Monday, Sept. 26

10:00 A. M.—Electronic Instrumentation I:

Radio Link Telemetry for Recording during High Acceleration Phenomena, by Sidney Himmelstein of Naval Ordnance Laboratory.

Closed Cycle Recording Oscillographs, by Ben Ciseel and Roman Ruhland of Minneapolis-Honeywell Regulator Co.

D-C Amplifier Techniques in Oscillography, by M. Maron of Allen B. DuMont Laboratories, Inc.

Solid State Studies I:

Neutron Irradiated Rectifiers, by K. Lark-Horowitz of Purdue Univ., W. E. Johnson and J. C. Pigg of Oak Ridge National Laboratory.

Low Frequency Noise in Transistors, by Howard T. Mooers of Univ. of Minnesota.

Experimental Examination of Rectifier Theory as Applied to the Selenium Rectifier, by Herbert W. Henkels of Univ. of Pennsylvania.

Field Effects in Germanium and Their Relation to the Transistor Problem, by Ralph Bray of Purdue Univ.

Computer Session I:

The Photoformer in Anacom Calculations, by H. W. Schultz and J. P. Calvert of Northwestern Univ.

Linear Electronic Analog Computer Design, by C. A. Meneley and C. D. Morrill of Goodyear Aircraft Corp.

Bone Density Computing Machine, by Walter N. Brown, Jr. of The Pennsylvania State College.

2:00 P. M.—Electronic Instrumentation II:

A Pulse Length Sorter and Counter, by Robert J. Parent and Robert W. Schumann of University of Wisconsin.

Thickness Gage for Non-Magnetic Materials, by Irving W. Rozian and Stephen V. Hart of Industrial Electronics Inc.

Multiple Channel Cathode Ray Instrumentation of Non-Electrical Quantities, by G. F. Warnke of Armour Research Foundation of Illinois Institute of Technology.

Computer Session II:

A Computer for Solving Secular Equations, by John F. Storm of Univ. of Minnesota.

Coordinate Tubes for Use with Electrostatic Storage Tubes, by R. S. Julian and A. L. Samuel of Univ. of Illinois.

Electronic Analogue for Heating System Analysis, by Ralph T. Squier, Ben Ciseel and Kinball C. Cummings of Minneapolis-Honeywell Regulator Co.

Television:

A Universal-Application Cathode Ray Sweep Transformer with Ceramic Iron Core, by Charles E. Torsch of General Electric Co.

Two New Image Orthicons, by R. B. Janes, R. E. Johnson and R. R. Handel, of RCA.

Design of Printed-Circuit Television Tuner, by D. Mackey and E. J. Sass of RCA.

Two New Television Tuners, by Myron F. Melvin of P. R. Mallory and Co. Inc.

Tuesday, Sept. 27

9:00 A. M.—Antennas I:

End Loaded and Expanding Axial Mode Helices as Broadband Circularly Polarized Radiators, by Paul W. Springer of Wright-Patterson Air Force Base.

Impedance and Radiation Characteristics of Slotted Cylinder Antennas, by Robert E. Beam and Harold D. Ross, Jr., of Northwestern Univ.

A Combination Slot Antenna and Resonant Tank Circuit, by Norman L. Harvey of Sylvania Electric Products Inc.

The Channel Guide Antenna, by Walter Rotman of Cambridge Field Station, USAF.

Measurements I:

Theoretical Limit to Time Difference Measurements, by Donald Richman of Hazeltine Electronics Corp.

Electronic Contour Mapping, by Richard C. Raymond of Haller, Raymond and Brown Inc.

Waveguide Attenuation Measurement by a Cavity Decrement Method, by Warren A. Tyrrell of Bell Telephone Laboratories.

Automatic Calibration of Oscillator Scales, by W. J. Means and J. Slonczewski of Bell Telephone Labs.

Magnetic Amplifiers:

Magnetic Amplifier Studies on the Analog Computer, by E. L. Harder, W. H. Hamilton, D. F. Aldrich, J. T. Carleton and F. N. McClure of Westinghouse Electric Corp.

On the Theory of Magnetic Amplifiers, by M. Liwchitz-Garik, E. Weber and E. J. Smith of Polytechnic Institute of Brooklyn.

Audio Transformer with Frequency Range Extending below One Cycle Per Second, by Donald W. Kuester of Naval Ordnance Lab.

2:00 P. M.—Research Management For the Government, by R. D. Bennet of Naval Ordnance Lab.

For the Research Foundation, by H. A. Leedy of Armour Research Foundation of Illinois Institute of Technology.

For the Universities, by F. A. Rohrman of Univ. of Colorado.

For Industry, by Dudley E. Chambers of General Electric Co.

Antennas II:

An Automatic Built-In Antenna for Television Receivers, by K. Schlesinger of Motorola Inc.

The Electronically Driven Ripple-Tank as an Aide to Phase-Front Visualization, by Allen H. Schooley of Naval Research Lab.

The Electromagnetic Field in the Vicinity of a Linear Conductor, by Paul H. Nelson of University of Florida.

Correction of Spherical Aberration by a Phased Line Source, by Roy C. Spencer, Carl J. Sletten, and John E. Walsh of Cambridge Field Station, USAF.

Theory of Communications:

Application of Statistical Theory in Communications, by Jerome B. Wiesner of Massachusetts Institute of Technology.

Statistical Prediction of Noise, by Y. W. Lee and C. A. Stutt of Massachusetts Institute of Technology.

Traffic Handling Capacity of Paired-Pulse Coding for 100 Channel Distance Measuring Equipment (DME), by Charles J. Hirsch of Hazeltine Electronics Corp.

Wednesday, Sept. 28

9:00 A. M.—Vacuum Tubes I:

The High Frequency Response of Cylindrical Diodes, by Edward H. Gamble of Curtiss-Wright Corp.

Radial-Beam, Velocity-Modulated Microwave Tube, by Chester G. Lob, of Univ. of Illinois.

The 6BN6 Gated Beam Tube, by Robert Adler of Zenith Radio Corp., and A. P. Haase of General Electric Co.

Volume Deionization Processes at Ionospheric Pressures, by O. T. Fundingsland and G. E. Austin of Cambridge Field Station, USAF.

Electromagnetics:

Electromagnetic Waves in Circular Wave Guides Filled with Dielectrics, by

Robert Teasdale of Illinois Institute of Technology, and Thomas J. Higgins of Univ. of Wisconsin.

Small Surface Microwave Diffraction, by A. Applebaum and P. C. Fritsch of Naval Ordnance Lab.

The Magnetic Cross Valve, by Harold J. McCreary of Automatic Electric Co.

Coupling between Two Degenerate Cavity Modes through Slots cut in the Cavity Walls, by H. C. Hu of Univ. of Illinois.

Supersonics:

Application of Supersonic Energy to High Speed Electronic Recording, by Homer J. Dana and James L. Van Meter of State College of Washington.

Supersonic Control of a Lantern Slide Projector, by S. G. Lutz and George Rand of New York University.

Variable Resonant Frequency Crystal Systems, by William J. Fry and Wayne L. Hall of Univ. of Illinois.

2:00 P. M.—Vacuum Tubes II:

A New Rectifier Tube for Extremely High Power and Voltage Levels, by T. H. Rogers of Machlett Laboratories Inc.

A Progress Report on Development of the Travelling Wave Tube as a Power Amplifier, by Stanley E. Webber of General Electric Co.

Efficiency of Reflex Klystrons, by William G. Shepherd of Univ. of Minnesota.

Design Features and Some Applications of a New Photocell, by J. H. Crow and V. C. Rideout of Univ. of Wisconsin.

Circuits:

A Versatile Crystal Controlled Source of Angle Modulation, by James F. Gordon of Bendix Aviation Corp.

The "D-C Transformer" as a Component in Electronic Circuits, by Otto H. Schmitt of Univ. of Minnesota.

Transient Response of Filters, by M. S. Corrington of RCA.

Audio Frequency:

Continuously Adjustable Low and High-Pass Filters for Audio Frequencies, by Arnold Peterson of General Radio Co.

A Variable Speed Turntable and Its Use in the Calibration of Disk Reproducing Pickups, by H. E. Haynes and H. E. Roys of RCA.

Methods and Instruments for the Visual Analysis of Complex Audio Waveforms, by H. R. Foster and E. E. Crump of Kay Electric Co.

Devices for Speech Analysis and Compression, by Dr. Ing. habil Friedrich Vilbig of Cambridge Field Station, USAF.

New Operator Classification

EFFECTIVE January 3, 1950, FCC will require that each aircraft radiotelegraph operator pass an additional examination. (At present, radiotelegraph second or first class licenses suffice.) Exceptions to the new ruling are those who have acted as chief or sole radio operator of an aircraft employing radiotelegraph prior to that date.

If the applicant does not hold a radiotelegraph first-class license, he must pass a code test of 20 code groups and 25 words of plain language per minute. In addition, he must be at least 18 years old.

A written examination containing 100 questions of the multiple choice type covers FCC Rules and Regulations, Civil Air Regulations, and ICAO procedures. Also included are questions on theory and

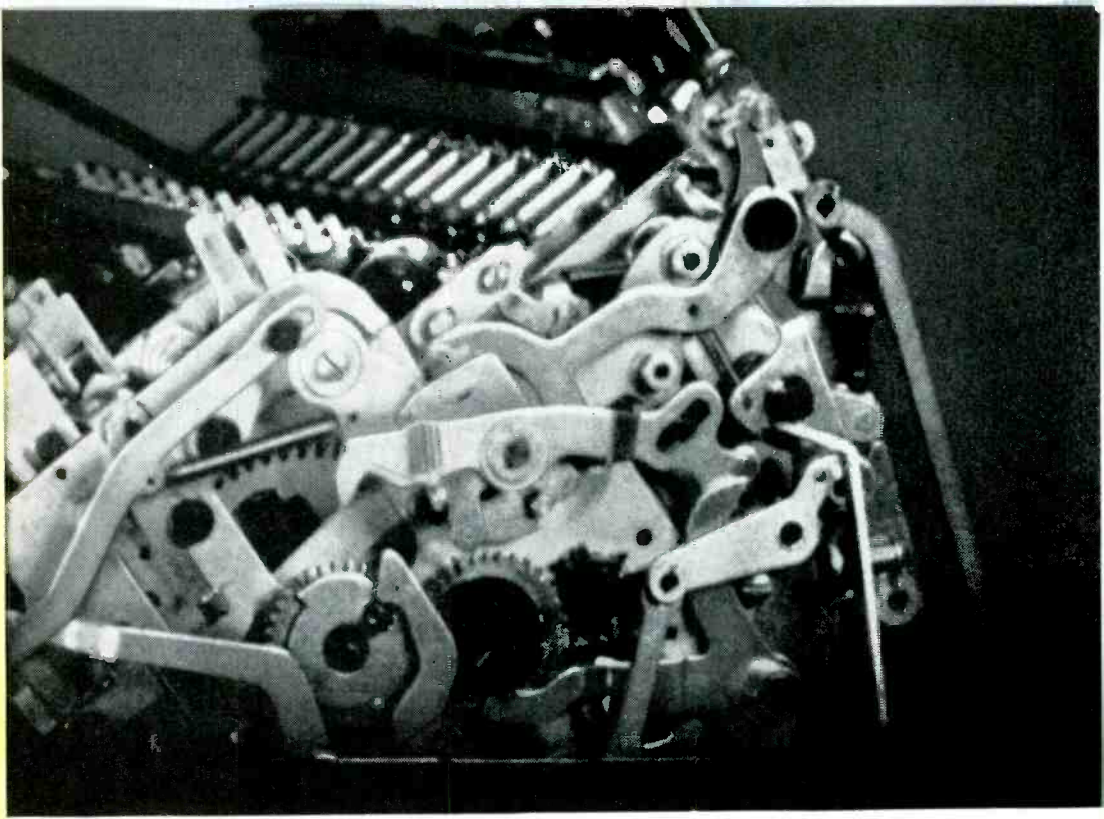

Frames of movie film, taken with Kodak High Speed Camera, show a desk-type calculating machine performing automatically at five hundred r.p.m.

Now high speed movies with good depth of field

TODAY high speed movies provide the research scientist with more detailed information than ever. For with the Kodak High Speed Camera, these pictures are sharp and clear and in addition have remarkably good depth of field.

This is due both to the high intensity lighting now available and to the high-quality optical system which employs a rotating, accurately plane-parallel glass plate behind the lens to sweep the image in synchronism with the traveling film.

In the example illustrated, the camera was operating at 2000 frames per second with a lens aperture of $f/8$. Illumination of 7 to 15 times the intensity of sunlight on a bright day was provided by the new General Electric 750R Reflector Photographic Lamp.*

If you would like more information about the Kodak High Speed Camera, just mail the coupon. Eastman Kodak Co., Rochester 4, N. Y.

*This lamp may be ordered from your local Kodak dealer.

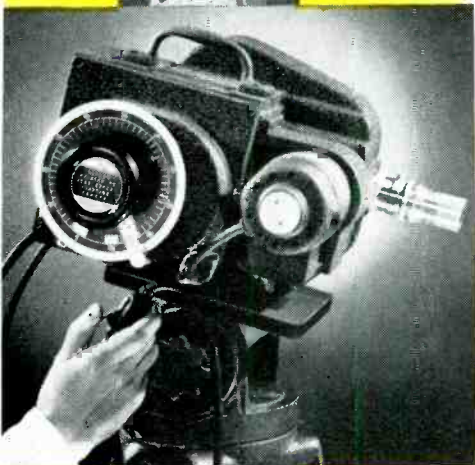

the Kodak High Speed Camera

magnifying time

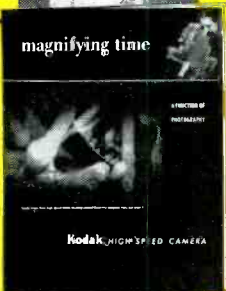

EASTMAN KODAK COMPANY, Rochester 4, N. Y.

Gentlemen:

Please send me: your folder "Magnifying Time" which describes the High Speed Camera; a 16mm. sample reel of high speed motion study which I may borrow.

Name _____ Firm _____

Address _____

City _____ State _____

48

Kodak
TRADE-MARK

operation of radio communication and navigational systems, aircraft radio operating procedures, and radio navigation of aircraft.

The Commission has issued Supplement 5 to its "Study Guide and reference Material for Commercial Radio Operator Examinations" which is available without cost at field examination offices of the FCC. The Study Guide is available from the Superintendent of Documents, U. S. Government Printing Office, Washington 25, D. C., at a cost of 25¢.

The new Supplement 5 comprises the entire new Element VII, 266 questions that require not only a good grounding in electronic principles but also those of navigation.

Audio Exhibit Scheduled

THE AUDIO ENGINEERING SOCIETY will sponsor the nation's first "Audio Fair" at the Hotel New Yorker, New York City, on October 27, 28 and 29. Rooms and suites comprising the entire sixth floor of the hotel have been reserved for exhibitors, assuring those in attendance an opportunity to see and hear new products and developments with a minimum of interference.

In association with the exhibit, the Society will hold technical sessions on each day of the meeting. Expected to be covered by exhibits and papers during the three-day meeting will be recording and reproduction on tape, disc and film. Microphones, loudspeakers and amplifying equipment will also be demonstrated and discussed.

RMA Membership Committee Named

AN EIGHT-MAN committee representing all phases of the radio manufacturing industry was recently named by RMA president R. C. Cosgrove to serve on the Association's Membership Committee. The complete committee membership for the 1949-50 term is as follows:

J. J. Kahn of Standard Transformer Corp., chairman; Virgil M. Graham of Sylvania Electric Prod-

MEETINGS

SEPT. 26-28: National Electronics Conference, Edgewater Beach Hotel, Chicago, Ill.

SEPT. 27-29: Twenty-sixth Annual Session of the Communications Section, Association of American Railroads, Wentworth Hotel, Portsmouth, N. H.

SEPT. 28-OCT. 8: 16th National Radio Exhibition (Radiolympia), Olympia Exhibition Hall, London, England.

OCT. 8-9: Annual Midwest ARRL Convention, Fontenelle Hotel, Omaha, Nebraska.

OCT. 10-14: ASTM 1949 West Coast Meeting, Fairmount Hotel, San Francisco, Calif.

OCT. 10-14: SMPE 66th Semi-annual Convention, Hollywood-Roosevelt Hotel, Hollywood, Calif.

OCT. 12-15: Ninety-Sixth Convention of The Electrochemical Society, LaSalle Hotel, Chicago, Ill.

OCT. 17-21: Annual Meeting of the Society for Non-Destructive Testing, Public Auditorium, Cleveland, Ohio.

OCT. 27-29: Audio Engineering Society's "Audio Fair," Hotel New Yorker, New York City.

OCT. 31-Nov. 2: Second annual Conference on Electronic Instrumentation in Nucleonics and Medicine, Hotel Commodore, New York City.

OCT. 31-Nov. 2: 1949 Radio Fall Meeting of IRE and RMA engineering department, Hotel Syracuse, Syracuse, N. Y.

OCT. 31-Nov. 2: Fall Meeting of the URSI and IRE, National Academy of Sciences and State Dept. Bldg., Washington, D. C.

Nov. 14-18: 23rd NEMA Annual Meeting, Haddon Hall Hotel, Atlantic City, N. J.

ucts Inc.; H. L. Hoffman of Hoffman Radio Corp.; George Lewis of Federal Telephone and Radio Corp.; A. Liberman of Talk-A-Phone Co.; Harry G. Sparks of the Sparks-Withington Co.; R. L. Triplett of Triplett Electrical Instrument Co.; and Thomas A. White of Jensen Mfg. Co.

Radio Fall Meeting

MEMBERS of the RMA Engineering Department and the IRE will hold their Radio Fall Meeting at the Hotel Syracuse, Syracuse, N. Y., on October 31, November 1 and 2, 1949. Scheduled technical sessions are as follows:

Monday, Oct. 31

10:00 A. M.—R. H. Williamson, Chairman
Measurement of Transient Response of Television Receivers, by J. Van Dwyne of Allen B. DuMont Laboratories, Inc.

Television Transient Response Measurement, by Jerry Minter of Measurements Corp.

Underwriters' Requirements for Television Receivers, by K. S. Geiges of Underwriters' Laboratories, Inc.

2:00 P. M.—J. R. Steen, Chairman
Quality Control from the Producer and Consumer Viewpoints, by A. B. Mundel of Sonotone Corp.

Quality Control Gets a Job in Television Manufacturing, by L. Lutzger of Allen B. DuMont Laboratories, Inc.

8:00 P. M.—Joint Session with Technology Club of Syracuse sponsored by the Syracuse Section of IRE.

The Atomic Bomb and National Security, by R. E. Lapp.

Tuesday, Nov. 1

9:30 A. M.—R. A. Hackbusch, Chairman
An Intercarrier Sound System for Tele-

vision Receivers Using the 6BN6, by Walter Stroh of Zenith Radio Corp.

Simplification of Television Receivers, by W. B. Whalley of Sylvania Electric Products Inc.

Came the Television Revolution, by Dorman D. Israel of Emerson Radio & Phonograph Corp.

2:00 P. M.—J. E. Brown, Chairman
Universal Application—Cathode Ray Sweep Transformer with Ceramic Iron Core, by C. E. Torsch of General Electric Co.

Characteristics of High-Efficiency Deflection and High-Voltage Supply Systems for Kinescopes, by O. H. Schade of RCA.

6:30 P. M.—Radio Fall Meeting Dinner
The Engineering Aspects of Sin, by Kenneth W. Jarvis.

Wednesday, Nov. 2

9:30 A. M.—A. N. Curtiss, Chairman
Pickup Tracking, by H. E. Roys of RCA Victor.

New Audio Amplifier Circuit, by Frank H. MacIntosh, consulting engineer.

The Safety-Vox, A Novel Continuous Tape Magnetic Recorder-Reproducer for Industrial Purposes, by R. A. York of General Electric Co.

A New Type of Dual-Cone Loudspeaker, by Harry F. Olson and John Preston of RCA Laboratories, and D. H. Cunningham of RCA Victor.

2:00 P. M.—H. C. Shreve, Chairman
Design and Application of a New Miniature High-Frequency Transmitting Pentode, by Robert M. Cohen and George F. Elston of RCA.

A VHF Remotely Tunable Receiver, by Leonard A. Mayberry of The Hallcrafters Co.

The Advantages of Toroidal Transformers in Communication Systems, by H. W. Lamson of General Radio Co.

Munitions Board's Coordinating Program

THE MUNITIONS Board has reestablished its Communications and Electronics Equipment Committee to

(Continued on p 240)

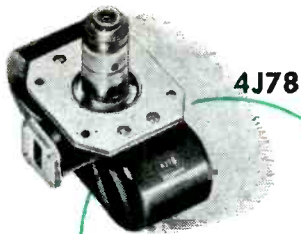

4J78

FOR SUPER-HIGH FREQUENCIES...

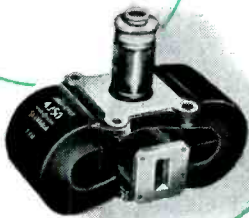

4J50

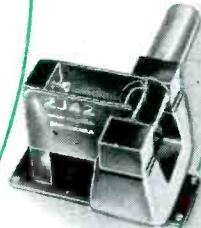

2J42

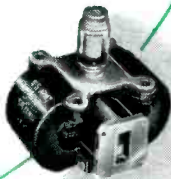

4J52

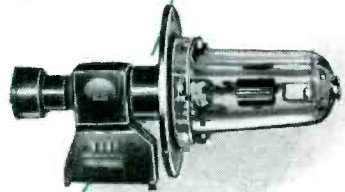

3J31



2J42A

SYLVANIA MAGNETRONS

Sylvania Electric now offers a family of fixed-frequency cavity magnetrons, including both "package" and external magnet types. All are designed to operate in the microwave region above 9,000 mc. Peak power outputs range from 7 to 300 kw. ¶ Sylvania Magnetrons are primarily designed for radar use, but also have potential applications as pulsed transmitting oscillators in other types of microwave equipment. ¶ New catalog includes section on magnetron operating theory; complete characteristics and ratings, presented both in tabular form and graphically; and general operating precautions and observations.



*Mail Coupon
for
New Bulletin*

Sylvania Electric Products Inc.
Electronics Division, Dept. E-2910
500 Fifth Avenue, New York 18, N. Y.

Gentlemen:

Please send me your new catalog on magnetrons and your new catalog index and technical digest of Sylvania electronic products.

Name.....

Position.....

Company.....

Street Address.....

City..... State.....

SYLVANIA ELECTRIC

Electronic Division, 500 Fifth Avenue
New York 18, N. Y.

ELECTRONIC DEVICES: RADIO TUBES; CATHODE RAY TUBES; PHOTOLAMPS; FLUORESCENT LAMPS, FIXTURES, WIRING DEVICES, SIGN TUBING; LIGHT BULBS.



PICTURE OF A COMPLETE YEAR'S

ADVERTISING CAMPAIGN IN . . .

FOR MANUFACTURERS OF ELECTRONIC AND

The 12 monthly issues of electronics and the

Editorially, the 12 monthly issues of **ELECTRONICS** bring to its more than 30,000 subscribers authentic and complete reviews of technical developments and applications vital to all whose interests lie in any phase of the vast aspects of the electronic industry. Because this technical coverage is so complete and timely — because **ELECTRONICS** has been outstanding in its field for better than a decade and a half, design engineers of all types, and management, consider it essential to their work.

Manufacturers have learned, either by observation or through conversation with their own engineers, of the industry-wide acceptance and coverage of **ELECTRONICS**. To them, as well as to engineers, its leadership has been, and is an accepted, proven fact.

It follows, therefore, that there is no better place for a manufacturer to tell his product story — each month — than in the publication read by users of his products. Manufacturers are certain of reaching old customers and prospects or developing new ones. Inquiries from **ELECTRONICS'** advertising develop new applications and new markets in industries other than are presently utilizing a manufacturer's products. Advertising is certain of careful readership — where it will do the most good in terms of eventual sales. The reason, therefore, that more manufacturers names, both big and small, are regularly seen in the advertising pages of **ELECTRONICS**.



electronics — *First in* **RECOGNITION** —

A MCGRAW-HILL PUBLICATION 330 WEST 42nd ST. NEW YORK 18, NEW YORK



electronics

INDUSTRIAL CONTROL EQUIPMENT

Mid-June issue of the **BUYERS' GUIDE**

Budget **NOW**

FOR THE 1950

13

ISSUES OF

electronics

The Buyers' Guide serves several distinctly different functions than those of the monthly issues of **ELECTRONICS**. First: It is accepted and used as the only complete reference book in the industry. Secondly: It includes a "where-to-buy-it" function in the carefully compiled Directory Section. Thirdly: Its catalogue-type of advertising provides design engineers with technical data on **ALL** of the manufacturers' products. In this respect it serves as a condensed summary of the advertising in the 12 monthly issues and permits a manufacturer to catalogue his entire line in one issue. Lastly: It saves valuable time for the busy engineer in locating data on a particular component he is designing into some equipment.

These are only a few of the many exclusive features of this recognized reference book. They are, however, the basic reasons for the long and important list of Buyers' Guide advertisers and its wide use by both management and engineers.

Plan now to use it in any campaign designed to sell electronic and industrial control equipment manufacturers. Keep in mind that this one issue is used throughout the year — that it is the only complete reference book on product data and product source. As conclusive proof a manufacturer can quickly determine its wide and valuable use by simply questioning his own engineering staff.

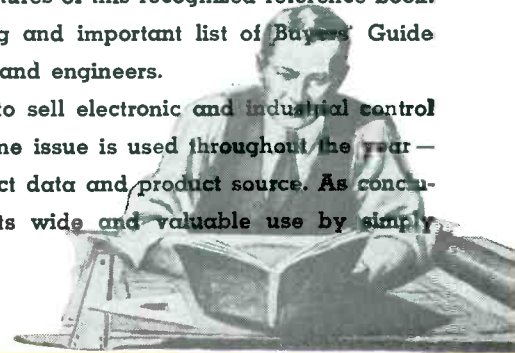

First in IMPORTANCE — First in PREFERENCE



HERE'S HOW TO *Save* ON Special Selector Switches!

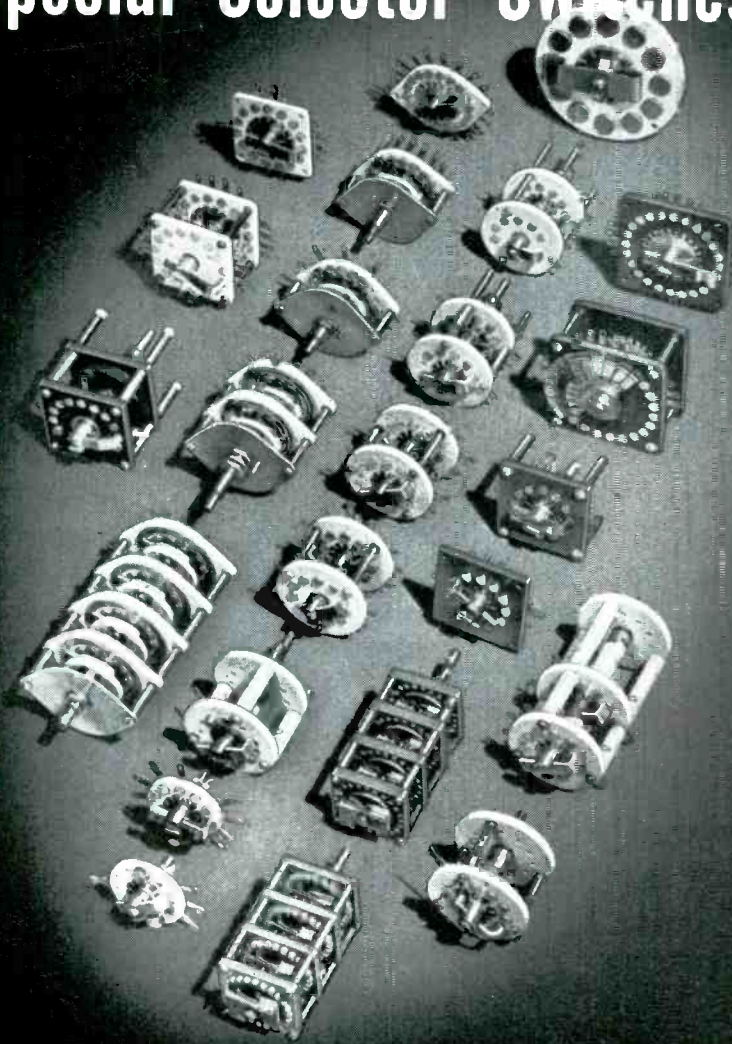

Shallcross

Shallcross can supply exactly the right precision-made selector switch for your application—at lower cost than you might expect for a “tailored” job.

Hundreds of Shallcross selector switch types permit inexpensive adaptations for specific needs. And back of these are many years of precision switch “know how” that have enabled Shallcross engineers to meet unusual and exacting requirements in hundreds of widely diverse applications.

SHALLCROSS MFG. CO.

Dept. E-109

Collingdale, Pa.

RESISTORS • INSTRUMENTS • SWITCHES • ATTENUATORS

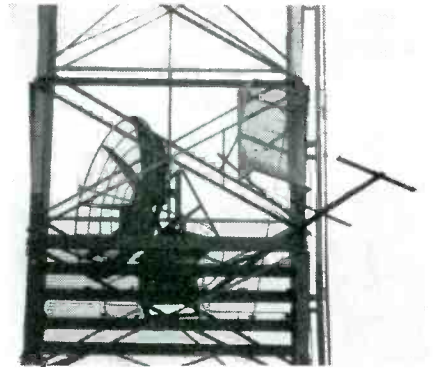

An eight-foot parabola was mounted on a platform of the WMAL-TV tower in Washington

drive mechanism allowing full 360-degree rotation. The signal from the antenna is carried to the receiver on the ground by means of a gas-filled 1½-inch transmission line.

Television broadcasters may be interested in a resume of the operation schedule followed in setting up the project. A preliminary test was made several weeks in advance of the actual broadcast in order that no doubt would exist as to the ability of the equipment to perform in a satisfactory manner.

Two men took the relay equipment to Signal Mountain two days in advance of the scheduled program. The platform was constructed, equipment was set up in the cabin, and communication over the 57-mile leg of the circuit was established the first day. An off-the-air receiver was used to feed the WMAL-TV test pattern back through the system to check its performance under actual signal conditions. On the second day the same team set up the shorter leg of the system and tested through the complete circuit from Winchester to Washington.

On the third day, the mobile unit and crew came up from Washington to do the actual pickup of the parade of the Shenandoah Apple Blossom Festival. The installation and operation of the microwave relay equipment for this broadcast was under the supervision of Earl D. Hilburn, Assistant Chief Engineer of the Evening Star Stations; and Frank W. Harvey, Chief Engineer, directed the broadcast operation.

A picture signal was transmitted over the 57-mile leg of the circuit

TORCOFILTOWN

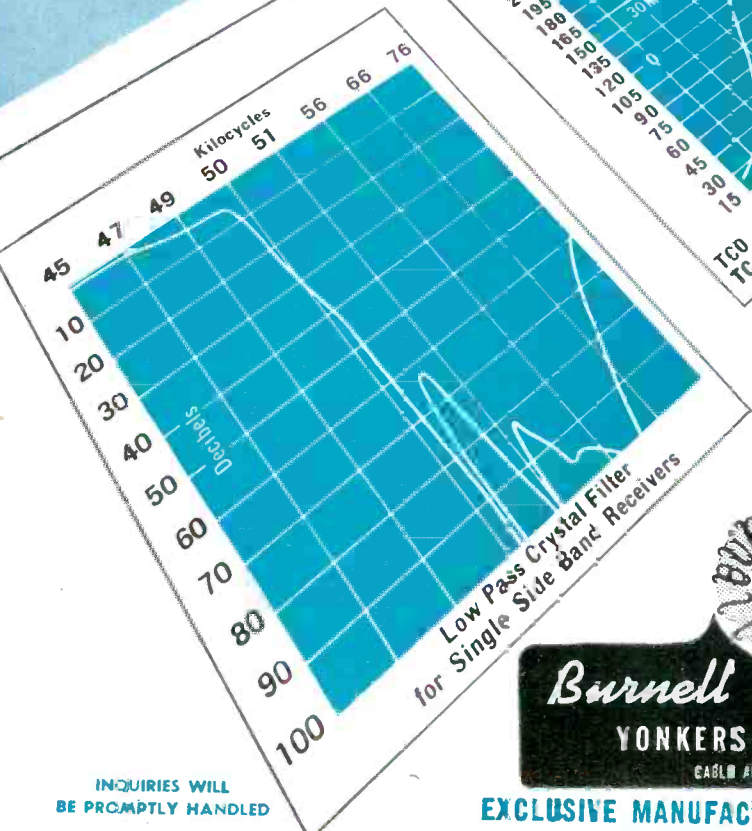
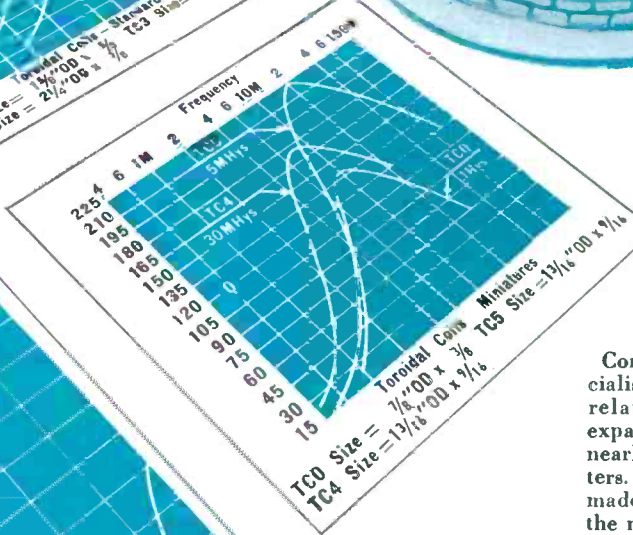
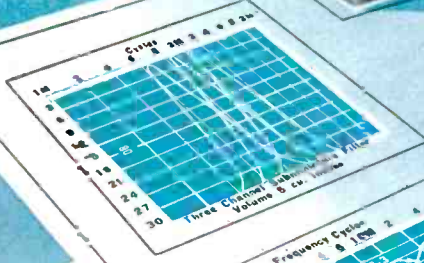
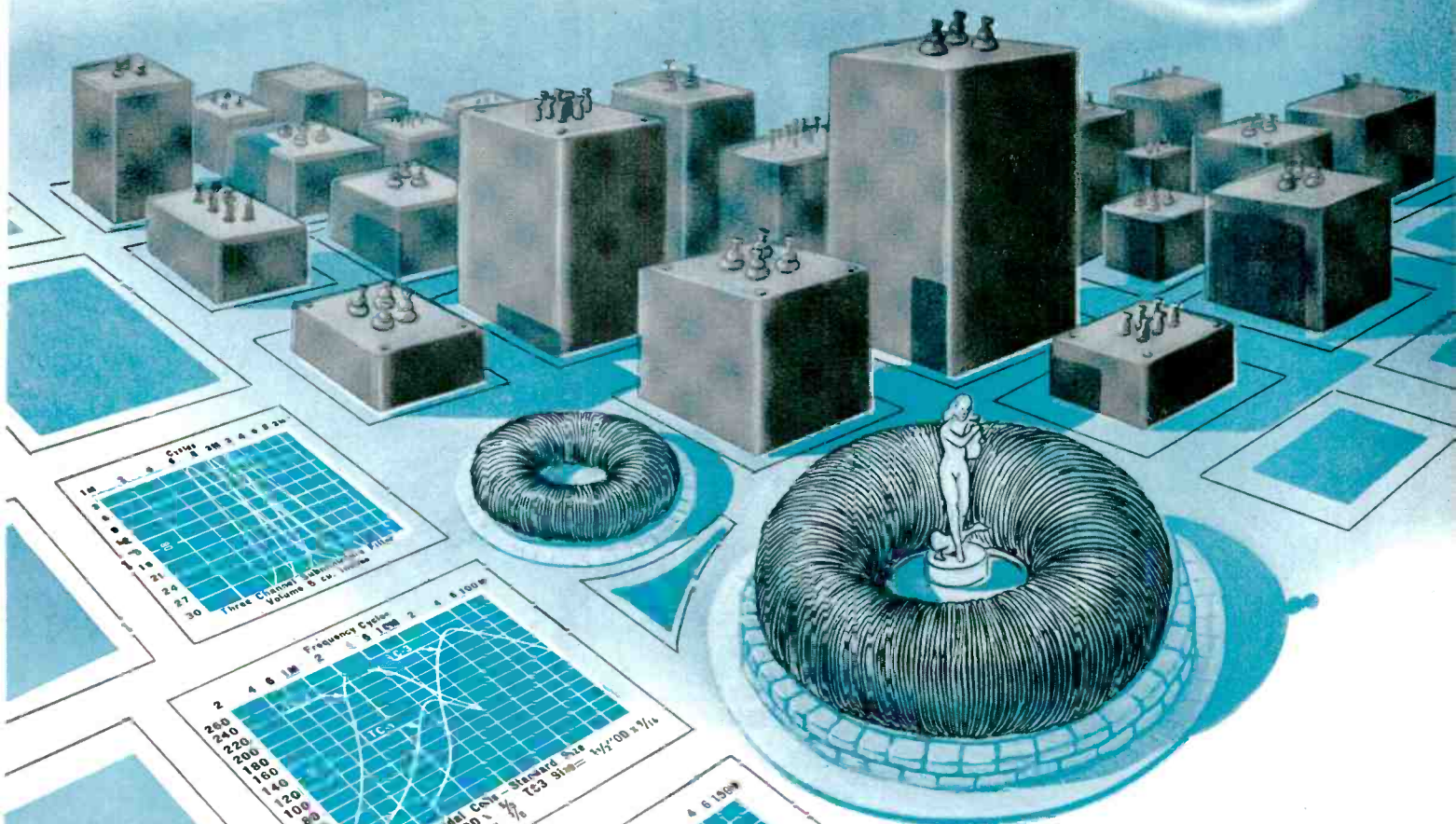

***TORCOFILTOWN**, Tor-coil'-town - - n. Toroidal Coils and Filters of Outstanding Quality and Performance as produced by Burnell & Co., Exclusive Manufacturers of Communication Network Components.

Consistent with our claim that we are specialists in the field of audio filters and related networks, we are continually expanding our range of products to satisfy nearly every application that requires filters. Our intense development program has made it possible for us to lead the way in the manufacture of sub-miniature types as well as many others up to and including crystal filters. We have made great strides toward simplifying the design and manufacturing problems of crystal filters which have formerly been the primary cause for their high cost. This has made them more readily available for applications which could not formerly afford them.

We take pride in the assistance we have been able to render our customers in solution of their problems and can assure you that your inquiries will receive the same prompt and detailed attention as do your orders.

INQUIRIES WILL BE PROMPTLY HANDLED

Burnell & Company
YONKERS 2, NEW YORK
CABLE ADDRESS "BURNELL"

ALL TYPES ARE AVAILABLE HERMETICALLY SEALED

EXCLUSIVE MANUFACTURERS OF COMMUNICATIONS NETWORK COMPONENTS

VULCAN FAT MELTER

110 - 125
OR
230 - 250
VOLTS
60 CYCLES A C
WITH OR
WITHOUT
THERMOSTAT
CONTROL.



An electric immersion heater designed specifically for melting fats, greases, waxes and similar compounds.

Can be set at the top of a 55 gallon drum and so arranged that it will sink into the mass as the melting progresses, right down to the bottom.

MADE TO ORDER ONLY

Give complete details—material to be melted, size of drum, etc.

VULCAN ELECTRIC COMPANY
DANVERS, 10, MASS.

By the expert makers of Vulcan Tubular, Cartridge, Flat, Immersion Band and Strip Electric Heating Elements, including the new Vulcan 900 series: Electric Soldering Tools: Electric Glue Pots and Solder Pots: and Electric Branding Irons.



NATIONAL

- **P**roven
- **D**ependable
- **Q**uality

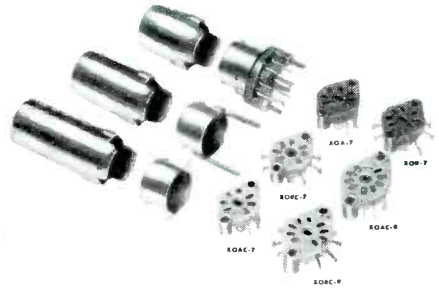

MINIATURE SOCKETS AND SHIELDS

National's 7 and 9 pin miniature tube sockets. Designed to meet rugged government and commercial requirements. Also tube shields for both 7 and 9 pin sockets. Bases for shields available with either spade bolts or holes for flush mounting.

MICA FILLED BAKELITE

XOA-7 @ .50 XOR-7 @ .50

CERAMIC

XOAC-7 @ .50 XORC-7 @ .50
XOAC-9 @ .57 XORC-9 @ .57

SHIELDS 7-pin SOCKETS

XOS-1 fit 1 3/16" tube body @ .48
XOS-2 fit 1 1/2" tube body @ .48
XOS-3 fit 2" tube body @ .48

SHIELDS 9-pin SOCKETS

XOS-4 fit 1 3/16" tube body @ .51
XOS-5 fit 1 1/2" tube body @ .51
XOS-6 fit 2" tube body @ .51



"Feathers are all right on birds and even on Indians — on them they look good and serve a useful purpose. But feathers don't even look good on tracing cloth, and what's more they don't belong either. Thanks to my unique fibre surface, I am always free from feathers despite repeated erasures. Yes, sir, work is faster and cleaner when you're working on MICRO-WEAVE."

MICRO-WEAVE exceeds all specifications in minute perfection of weave — in transparency — in better blueprints — in longer life. Test MICRO-WEAVE on your drawing board. Send for generous sample.



THE HOLLISTON MILLS, INC.
NORWOOD, MASS.

NEW YORK PHILADELPHIA CHICAGO

★ MICRO-WEAVE is backed by Holliston's 50 years of leadership and experience in developing special cloths for industry.

National



EST. 1914

NATIONAL COMPANY, Inc.
MALDEN, MASSACHUSETTS

another C-D development . . .

a strong, lightweight, **LOW-COST** tubing
for your electrical applications

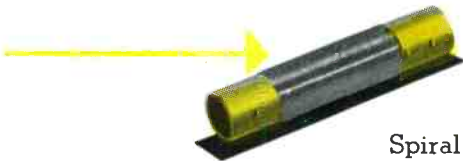
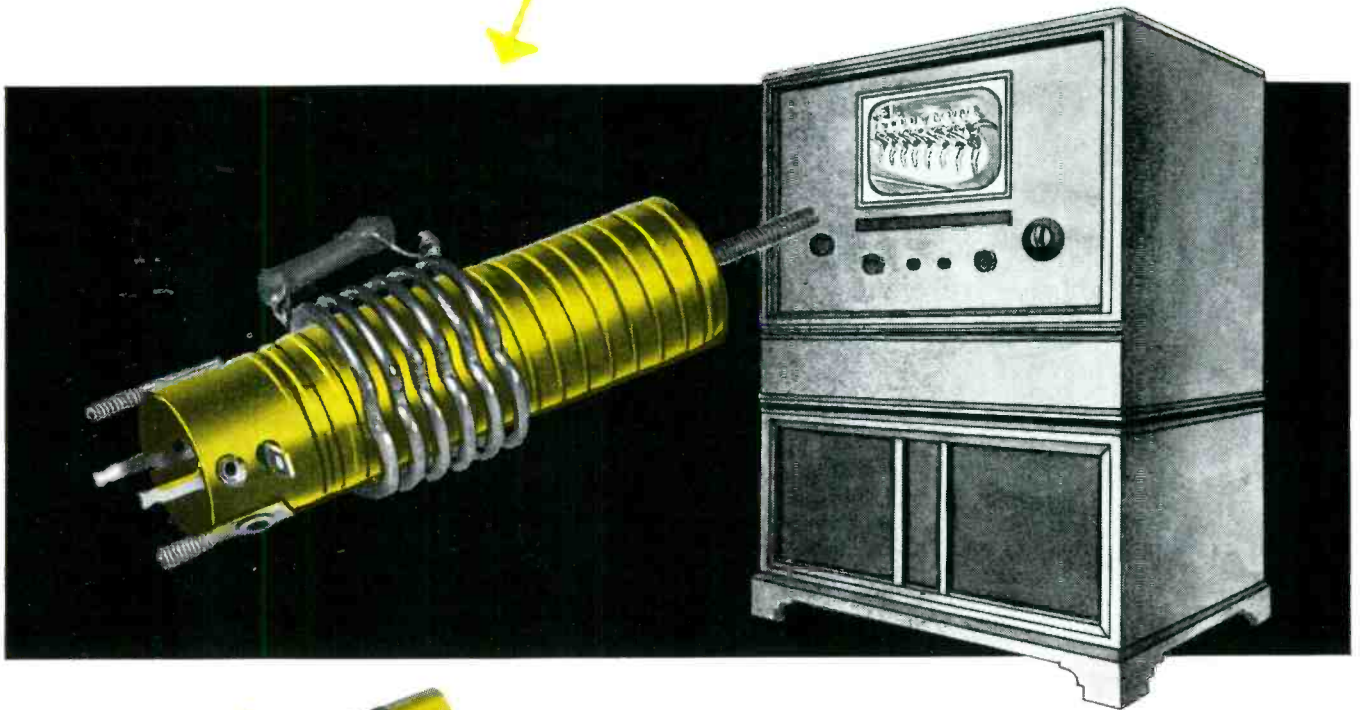

Spiral Tubing—one of the many developments that have helped bring television into the mass market. Recently introduced by Continental-Diamond laboratories, it is ideal for electrical, radio, and television applications where a good dielectric tubing with high strength and lightweight is needed. It is available in a variety of sizes and grades to meet requirements for low moisture absorption, forming, riveting, drilling, tapping, etc.

It is another example of why it pays to see C-D first in your search for the right plastic. C-D Plastics provide *practical* combinations of mechanical, electrical, and chemical properties—structural strength, lightweight, moisture, heat and corrosion resistance. For fast delivery, or help with material selection problems, call your nearest C-D office, any time.

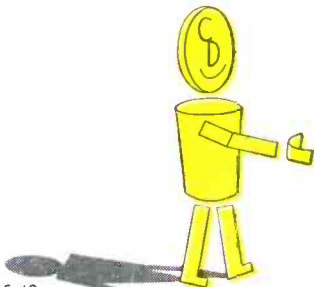

your partner in producing better products

DE-5-49

BRANCH OFFICES: NEW YORK 17 • CLEVELAND 14 • CHICAGO 11 • SPARTANBURG, S. C. • SALES OFFICES IN PRINCIPAL CITIES.
WEST COAST REPRESENTATIVE: MARWOOD LTD., SAN FRANCISCO 3 • IN CANADA: DIAMOND STATE FIBRE CO. OF CANADA, LTD., TORONTO 8

Continental - Diamond FIBRE COMPANY

Established 1895..Manufacturers of Laminated Plastics since 1911—NEWARK 16 • DELAWARE

NOW! A Dual-Channel Oscilloscope



**THAT BEATS MANY SINGLE SCOPES
IN WEIGHT . . . SIZE . . . COST**

Plus **THESE ADDITIONAL FEATURES**

- HIGH SENSITIVITY ON X OR Y AXIS
- DIFFERENTIAL OR SINGLE-ENDED INPUT
- INTERCHANGEABLE DEFLECTION CHANNELS
- TRIGGERED AND CONTINUOUS SWEEPS
2 cps to 50 kc
- CONTINUOUS CALIBRATION VOLTAGE
INDICATED ON PANEL VOLTMETER

The new H21 *Dual-Channel Oscilloscope* enables you to observe two independent signals simultaneously . . . without the frequency limitations of electronic switching or costly optical systems. Containing two complete electron guns in a single tube, it enables you to compare speed and vibration, input and output signals of amplifiers, or even a complete signal with an expanded portion of the signal. Vertical sensitivity is better than 0.1Vdc/in. Weight with cabinet 65 lbs.; for rack mounting 75 lbs. Dimensions: 14¼" wide, 16¾" high, 21" deep.

The new H21 *Dual-Channel Oscilloscope* is the result of years of experience E.T.C. has had as the pioneer manufacturer of multi-gun tubes and multi-channel oscilloscopes. If you have a problem which can be solved by utilizing 2, 4, 6, 8, or even 10 gun tubes, you'll find us ready, willing, and able to help. Write for full details.

E. T. C. — THE ORIGINAL MANUFACTURER OF MULTI-GUN TUBES

electronic tube corporation **ETC**
PHILADELPHIA 18, PENNSYLVANIA

TUBES AT WORK

(continued)

for three days and at no time was any fading observed. Careful comparisons of the transmitted and the received test patterns showed no deterioration of the picture in any regard. The signal at the receiver was approximately five times that required for a minimum usable signal.

A Voltage-Controlled Multivibrator

JULIAN M. STURTEVANT

*Yale University
New Haven, Conn.*

REGENERATIVE FEEDBACK, which has been employed previously in improving the linearity of sawtooth generators, may be applied to multivibrators and blocking oscillators to give frequency characteristics showing linear dependence of frequency on the first or second power of an input direct voltage.

The frequency of a free-running multivibrator is determined by the time constants in the grid circuits and the voltages to which the grid resistors are returned. If we represent by E_{min} the minimum voltage reached by the grid of V_1 (Fig. 1A), by E_c the cutoff voltage of V_1 , and

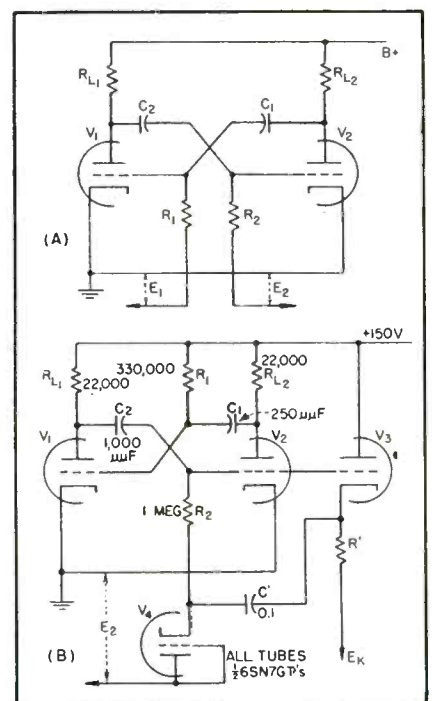

FIG. 1—Schematic diagrams of ordinary (A) multivibrator, and one having a frequency which varies with a direct voltage E_2 .

Definitely in the Picture

FOR TELEVISION



ERIE RESISTOR *Components*

THE special problems inherent in television receivers have been given careful attention by Erie Resistor engineers in designing condensers for these applications.

The components illustrated above have been correctly designed for efficient operation at high frequencies. The condensers have low series inductance and incorporate specially designed terminals and mounting arrangements. Of special interest is the high voltage Erie Double Cup condenser for power supply

filtering circuits. Rated at 15 KV and having a capacity of .0005 mfd. these units are unusually compact and economical. Plastic coil and transformer forms are custom injection molded to customer's specifications.

We will be glad to send you technical data and samples on any of the condensers shown above. Our engineers are at your service to develop special ceramic or mica condensers for television applications.

*"Ceramic" is a registered trade name and refers to ceramic dielectric condensers manufactured by Erie Resistor Corp.



Electronics Division
ERIE RESISTOR CORP., ERIE, PA.
LONDON, ENGLAND . . . TORONTO, CANADA

FORMVAR — FORMEX — ENAMEL INSULATION STRIPPED CLEAN IN SECONDS!

with **X-VAR**

1. Dip wire in X-VAR for 3 seconds, then withdraw.
2. Expose to air and watch coating disintegrate.
3. Wipe wire clean. Whole operation takes a matter of seconds.

X-VAR is non-corrosive and does not creep. Now in use by leading manufacturers of electrical products. Write for **FREE SAMPLE** for testing.

FIDELITY CHEMICAL PRODUCTS CORP.
472 FRELINGHUYSEN AVE. NEWARK, 5, N. J.

REDUCE ASSEMBLY REJECTS WITH...

TINNED STEATITE HERMETICALLY SEALED TERMINALS



- ... THAT WITHSTAND HIGH SOLDERING TEMPERATURES
- ... ARE IMMUNE TO ROUGH SHOP HANDLING
- ... HAVE TINNED SHOULDER FOR RAPID ASSEMBLY
- ... FOR 200°C SERVICE ON SPECIAL ORDER

A tinned surface, permanently bonded to the glazed body of these terminals permits rapid soldering to any metal enclosure. Exceptional strength of the steatite body practically eliminates assembly rejects that frequently result when other types of terminals are subjected to soldering temperatures or rough handling. Leads are brought out through an axial hole in the center of the bushing and terminated on the tinned lug. A drop of solder on the hole effects a complete hermetic seal. For complete information concerning tinned steatite terminals, call or write today.

General CERAMICS and STEATITE CORP.
OFFICES and PLANT: CROW'S MILL ROAD, KEASBEY, N. J.

MAKERS OF STEATITE, TITANATES, ZIRCON PORCELAIN, ALUMINA, LIGHT-DUTY REFRACTORIES, CHEMICAL STONWARE

3 GREAT NEW TITONES meet changing pickup needs!

NOW a full line of Titone's amazing ceramic pick ups—made by famous Sonotone! All with these great basic features: Full frequency (response from 50 to 10,000 cycles.) Bell-like supertone makes new or old players thrilling. Climate-proof, moisture-proof, fungus-proof! Lightest pressure saves needle wear, revives worn records. NO needle talk! NO crystals, magnets, filaments to fall. NO pre-amplifiers. Performs perfectly for years!

3 NEWEST! TITONE MICROGROOVE PICKUP

For all 45 and 33 1/3 rpm players. Highest compliance and 5 to 6 grams needle pressure give minimum wear on record and needle! Aluminum case—1-mil permanent sapphire needle.
Order # W 7530 \$7.95 list

2 NEWER! TITONE 3-MIL PICKUP

New superlight aluminum pickup complements famous original Titone pickup below. 15 grams needle pressure gives unparalleled reproduction, low-est wear!
Order # W 7540 \$7.95 list

1 NEW! ORIGINAL CERAMIC TITONE

Within a few scant months in widest use from coast to coast! Plays at 20 grams needle pressure. Used instead of the newer aluminum Titone above for changers requiring over 15 grams pressure to "flip" records.
Order # 7500 \$7.50 list

NO TONE LIKE TITONE



Call your Jobber or write to
SONOTONE, Box 5, Elmsford, N. Y.

Outstanding POWER CONVERSION UNITS...

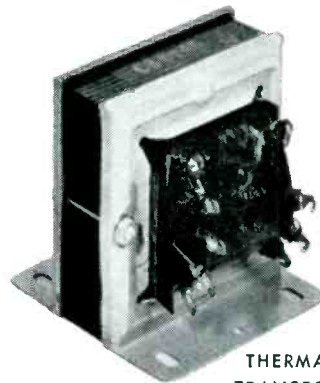

THERMADOR
TRANSFORMER

for any Voltage and Amperage Rating



VICKERS
SELENIUM
RECTIFIER

R.P.S. Power Conversion Units specially designed to convert any d-c Receiver, Transmitter, etc., into a-c use. No rewiring necessary; simple, easy, quick installation. No Tubes! Instant Warm-up! Cool Operation! No Maintenance! Low Cost!

Installation Diagram with each unit.

When ordering—be sure the input rating of your dynamotor does not exceed the d-c output rating of the rectifier. For example, 12 V. 2 amp. dynamotors require Rectifier No. S-295A and Transformer RPS-8883.

Weights listed—contact freight agent for cheapest means of shipment and include charge with remittance.

All prices F.O.B. Los Angeles (California purchasers add 2½% sales tax). Include 25% with orders—balance on delivery. Foreign orders cash. Address correspondence Dept. Q-7.

| ALL NEW—FULL WAVE VICKERS SELENIUM RECTIFIERS | | | | | ALL NEW—THERMADOR TRANSFORMERS 50/60 Cyc—117 Volt Primary Rating (For Taps, see Note A) | | | | |
|--|---------------------|-------|----------------|---------------------|---|--------------------|-------|----------------|---------------------|
| Code No. Rectifier | d-c Output Volts | Amps. | Ship. Wt. Lbs. | Amateurs Net Pr. | Code No. Transformer | Secondary Volts | Amps. | Ship. Wt. Lbs. | Amateurs Net Pr. |
| S-295A | 14 | 2 | 1.25 | \$ 6.95 | RPS-8883 | 18 | 3 | 3.5 | \$ 3.75 |
| S-458A | 14 | 4.5 | 1.75 | 7.25 | RPS-8884 | 18 | 5.2 | 5.5 | 4.25 |
| S-167A | 14 | 10 | 3.75 | 10.95 | RPS-8885 | 18 | 12 | 12 | 6.15 |
| S-292A | 14 | 40 | 12 | 29.95 | RPS-8886 | 18 | 46 | 35 | 19.65 |
| S-296A | 28 | 1.8 | 1.25 | 5.75 | RPS-8888 | 36 | 2 | 5 | 4.15 |
| S-344A | 28 | 5 | 5.75 | 11.50 | RPS-8889 | 36 | 6 | 12 | 6.75 |
| S-172A | 28 | 10 | 6 | 16.50 | RPS-8892 | 36 | 12 | 25 | 11.65 |
| S-291A | 28 | 20 | 12 | 29.95 | RPS-8890 | 36 | 23 | 32 | 19.25 |
| S-297A | 28 | 40 | 23 | 52.25 | RPS-8891 | 36 | 46 | 78 | 51.25 |

NOTE A: All transformers have 3 extra taps—for example: 20, 19, 18, 17, volts and 38, 37, 36, 35 volts.



Distributed Nationally by

RADIO PRODUCTS SALES, INC.

1501 SOUTH HILL STREET • LOS ANGELES 15, CALIFORNIA • PHONE PROSPECT 7471

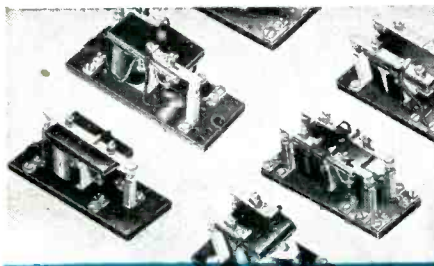

WARD LEONARD RELAYS

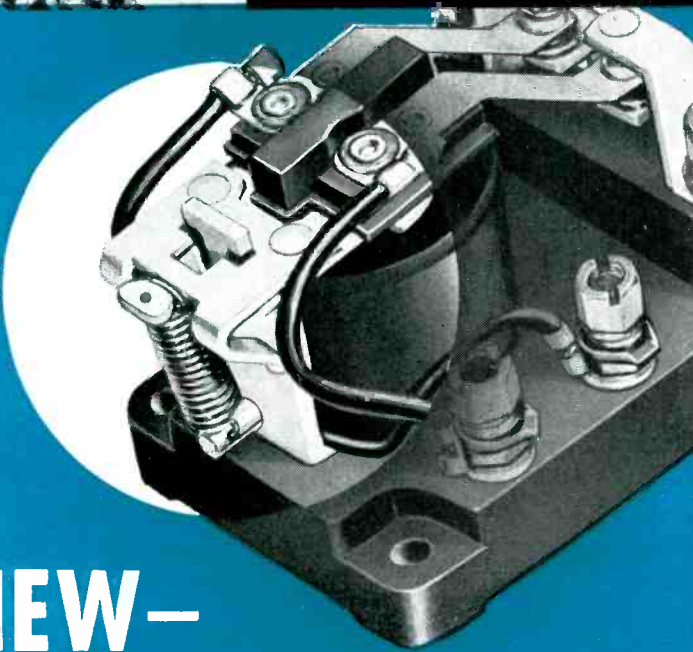

NEW—
**a Mighty Midget Built for
Millions of Operations**

**semi-knife-edge bearing
reduces frictional wear**

This is Ward Leonard's new Bulletin 110 Midget Relay for long, trouble-free service, particularly in equipments subject to vibration.

Exceptionally good vibration characteristics are due to proper proportioning of contact masses and springing combined with heavy pressures on both normally open and normally closed contacts.

Higher contact ratings than most midgets. Available up to 3-pole, double throw. Contact finger leads are insulated with the new, impregnated glass-fiber tubing.

Write for Bulletin 110. Ward Leonard Electric Co., 31 South Street, Mount Vernon, N. Y. Offices in principal cities of U. S. and Canada.

**WARD LEONARD
ELECTRIC COMPANY**

Result-Engineered Controls

RESISTORS • RHEOSTATS • RELAYS • CONTROL DEVICES

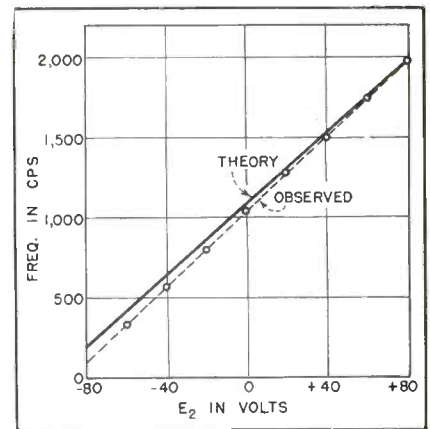

FIG. 2—Curve showing frequency variation of multivibrator of Fig. 1B as a function of voltage E_2 .

by E_1 the voltage to which R_1 is returned, then the recovery of the grid of V_1 follows the exponential curve given by

$$e_1 = E_1 - (E_1 - E_{1_{min}}) e^{-\frac{t}{R_1 C_1}} \quad (1)$$

provided $R_1 \gg R_{1i}$, and the off time of this tube is

$$t_1 = R_1 C_1 \ln \frac{E_1 - E_{1_{min}}}{E_1 - E_{1_{\infty}}} \quad (2)$$

Similar expressions hold for V_2 . It is evident that the frequency of the multivibrator, given by

$$f = \frac{1}{t_1 + t_2}, \quad (3)$$

can be varied by varying E_1 and E_2 .

The logarithmic dependence of f on E_1 and E_2 can be changed to a linear variation by employing regenerative feedback to convert the grid recovery curves to straight lines. This type of feedback has been very successfully employed in the design of accurately linear sawtooth generators.

In the circuit of Fig. 1B, the current which charges C_2 during the recovery of the grid of V_2 is held nearly constant by employing feedback from the cathode follower V_3 to maintain a constant voltage drop across R_2 . The analysis of this circuit is very simple if the impedances of the source of E_2 , the diode V_1 and the cathode follower are small enough so that the coupling capacitor C' can be charged to the required voltage in a time short compared to the off time of V_2 . If this condition is fulfilled, the initial voltage across R_2 will be $E_2 - E_{2_{min}}$. This voltage will be maintained if



TYPE 1001-A

Standard-Signal Generator

- MODERATE COST THROUGH SIMPLIFIED DESIGN
- UNUSUALLY LOW LEAKAGE

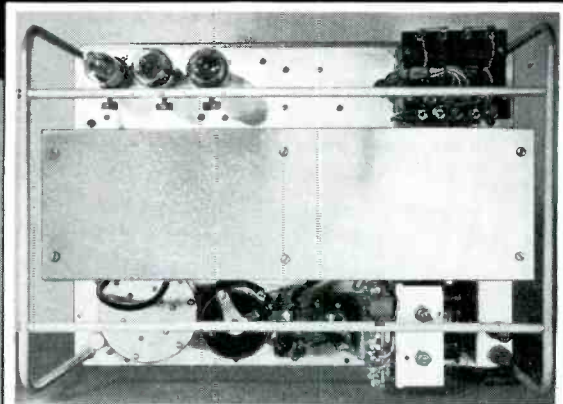

Rear view, removed from metal cabinet. Semi-unit construction with power supply along top, completely enclosed shielded and filtered carrier oscillator in center, and attenuator, carrier control, audio oscillator and modulation control at bottom.

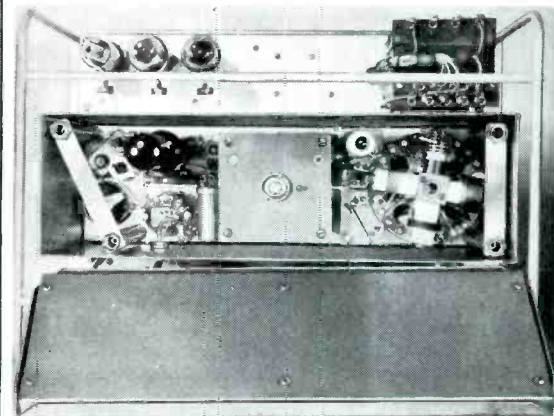

Cover removed from oscillator compartment. Note two-piece construction of cover, each being insulated from the other and making contact with both surfaces of the metal box housing the oscillator. All leads to this box are carefully filtered to prevent leakage.

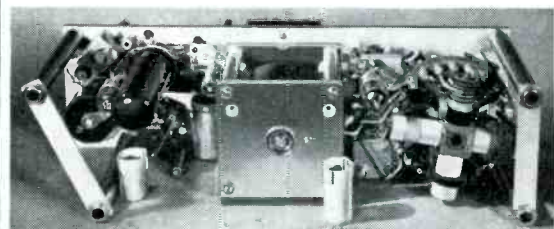

The complete oscillator plugs in and out of the metal box shown above, making testing and servicing particularly easy. The oscillator can be operated when removed from its shielding box. Extra precautions have been taken to insure excellent contact between the pre-loaded contact springs and the cylindrical contacts on the oscillator coil turret shown at extreme right.

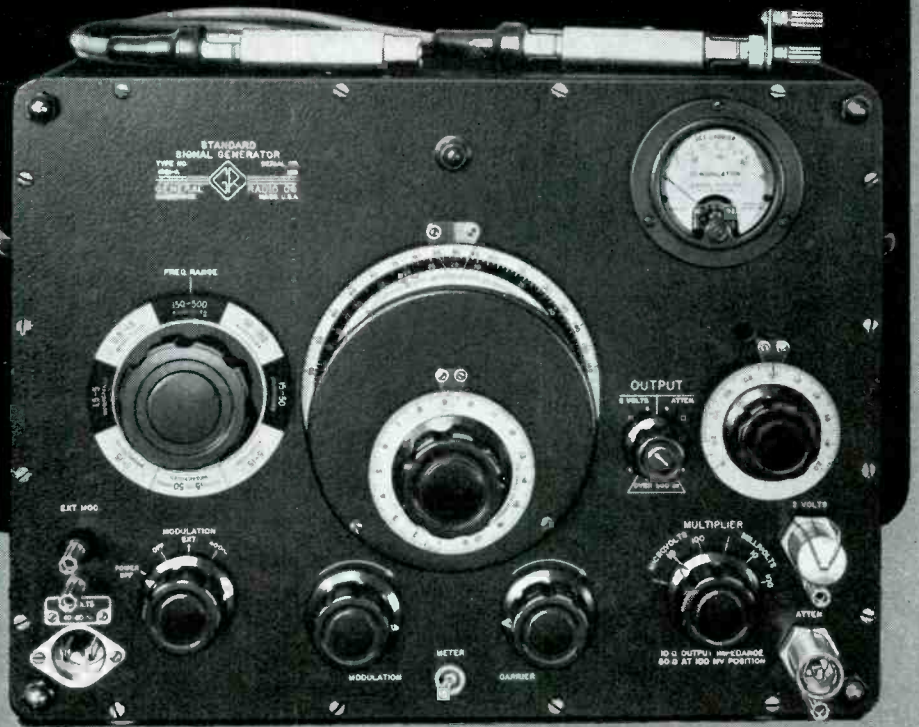

With many mechanical and electrical improvements, the Type 1001-A Standard-Signal Generator replaces the once-popular Type 605.

Ruggedly designed, with unique mechanical construction and simplified circuits, this generator has exceptionally low leakage. Through the elimination of a number of circuit frills it has been possible to keep its cost to a moderate figure.

ABRIDGED SPECIFICATIONS

CARRIER-FREQUENCY RANGE: 5 kc to 50 Mc in eight logarithmic, direct-reading ranges.

FREQUENCY CALIBRATION: accurate to $\pm 1\%$.

INCREMENTAL-FREQUENCY DIAL: indicates increments of 0.1 per cent of frequency per division up to 15 Mc.

OUTPUT VOLTAGE: open-circuit voltage adjustable from less than 0.1 microvolt to 200 millivolts. Two-volts output available from a second jack.

AMPLITUDE MODULATION: adjustable from 0 to 80% either with 400-cycle built-in source, or over 20 to 15,000 cycles from an external source.

LEAKAGE: stray fields are substantially less than 1 microvolt per meter two feet from the generator.

INCIDENTAL FREQUENCY MODULATION: varies from 10 to 100 parts per million, at 80% a.m., over each range except 15-50 Mc where it may be three times this amount.

ENVELOPE DISTORTION: about 6% at 80% modulation.

NOISE LEVEL: carrier noise level corresponds to about 0.1% modulation.

Fully 90 per cent of the needs for a standard-signal generator for general laboratory use are adequately met in this carefully designed G-R instrument, where the ultimate in accuracy and stability is not required.

TYPE 1001-A STANDARD-SIGNAL GENERATOR.....\$595.00

GENERAL RADIO COMPANY

Cambridge 39, Massachusetts

NEW YORK

CHICAGO

LOS ANGELES

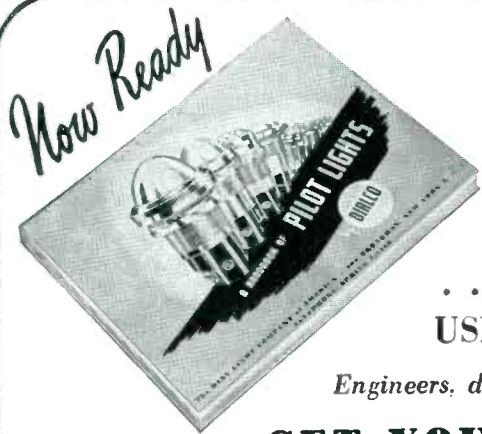

The **NEW** **DIALCO** **HANDBOOK**

... 192 PAGES of
USEFUL INFORMATION

Engineers, designers, purchasing agents —

GET YOUR COPY

You will find complete data on the lamps used in pilot lights.
And illustrations - all full size - of hundreds of items you will use.
There is a table of resistors for operation of lamps on all voltages.
Complete dimensional data on each unit.
More than 2,000 Underwriters' Listed Assemblies.

The **DIAL LIGHT COMPANY** of AMERICA

Foremost Manufacturer of Pilot Lights.

900 BROADWAY, NEW YORK 3, N. Y. TELEPHONE SPRING 7-1300

Write for Handbook D-149



DC Silicone (Life-time) Lubrication Pays Dividends

The more progressive manufacturers of electrical equipment have found that DC Silicone (life-time) lubrication gives their customers long term, trouble-free service. That's true in motors ranging from industrial units to the "flea-power" synchronous motors used in the kilowatt demand meters and time switches made for electric utility companies by Sangamo. These devices must give several years of continuous and absolutely accurate service whether they're installed in the North where temperatures drop to -40°F. or in the South where internal temperatures reach 180°F.

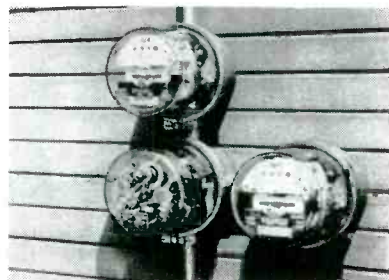

PHOTO COURTESY SANGAMO ELECTRIC COMPANY

DC 33 Silicone Grease retains its consistency to permit timing motors in demand meters and time switches to operate at constant speed in spite of varying climatic conditions.

Sangamo engineers specified DC 33 Silicone Grease for the bronze sleeve bearings of these small synchronous motors after extensive comparative testing. Their tests proved that DC 33 was superior to any other lubricant for this application because it is practically non-volatile, heat-stable, and because it has low torque at low temperatures. Final proof is the fact that thousands of these little motors have given faultless service ever since Sangamo started to use DC 33 Silicone Grease over 3 years ago.

In oven and toaster timers, parking meters, wind velocity indicators and in the permanently sealed bearings of industrial motors, Dow Corning Silicone Oils and Greases have made permanent lubrication a practical reality. You can obtain more information about Dow Corning Silicone Greases from our nearest branch office or by writing for data sheet No. Q-10.

DOW CORNING CORPORATION MIDLAND, MICHIGAN

Atlanta • Chicago • Cleveland • Dallas
Los Angeles • New York

In Canada: Fiberglas Canada, Ltd., Toronto
In England: Albright and Wilson, Ltd., London



ZOPHAR Waxes, Compounds and Emulsions

Materials for potting, dipping or impregnating all types of radio components or all kinds of electrical units. • Tropicalized fungus proofing waxes. • Waterproofing finishes for wire jackets. • Rubber finishes. • Inquiries and problems invited by our engineering and development laboratories.



Zophar Mills, Inc. has been known for its dependable service and uniformity of product since 1846.

ZOPHAR MILLS, Inc.

ESTABLISHED 1846

117 26th STREET, BROOKLYN 32, N. Y.

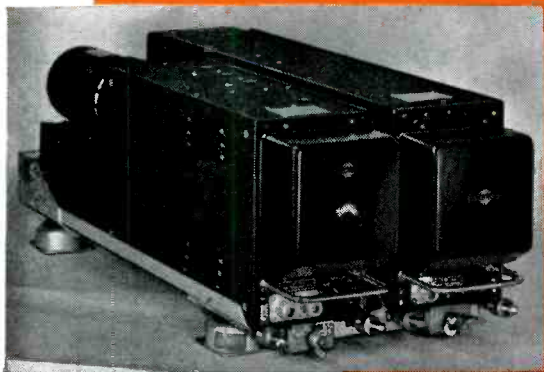
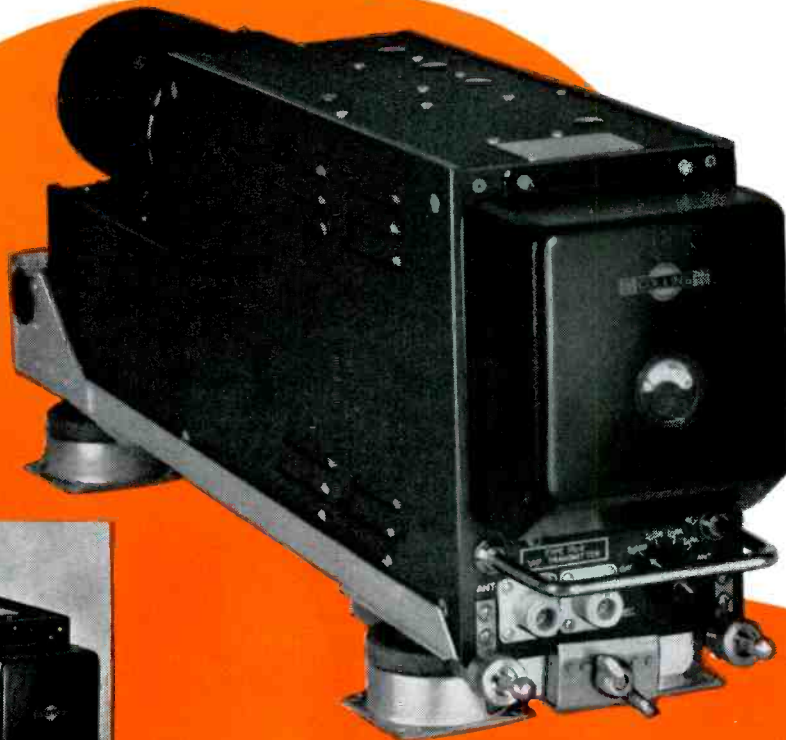

Collins 17L-2 vhf transmitter and 51R-2 vhf navigation-communication receiver in dual shock-mount.

Presenting the Collins 17L-2 vhf aircraft transmitter

Development of a full line of navigation and communication equipment for aircraft use in the vhf and uhf bands is a continuing, first-line project at Collins Radio Company. The purpose is to make available to the aviation industry complete, integrated radio facilities fulfilling all requirements for navigation and communications over the Federal Airways. This program is closely meshed with, and will progress with, the interim and long-range programs of the Radio Technical Commission for Aeronautics.

The new Collins 17L-2 shown above is a product of this Collins project. It provides transmitting facilities on all channels reserved for aircraft communications in the vhf band.

The 17L-2 transmitter is intended as a companion equipment for either the Collins 51U vhf communication receiver, or the Collins 51R vhf navigation receiver now in almost universal use by the leading airlines of the United States.

17L-2 Specifications

Power Output: Eight watts or better into a 52 ohm load.
Modulation Capability: Up to 90% on voice from a carbon microphone or on a 1000 cps tone for MCW.
Modulation Fidelity: Within 3 db from 300 to 4000 cps. Distortion at 1000 cps, 90% modulation, less than 10%.
Stability: 0.007% under all service conditions; i.e., from 0-95% humidity; from -55 to +72 degrees C; and with supply voltage variations of $\pm 10\%$.
Side Tone: Side tone output 100 milliwatts into a 500 ohm audio circuit. Side tone is derived from modulated r-f carrier providing complete check on operation.
Spurious Responses: All undesired signals radiated by the transmitter are at least 80 db below the r-f carrier.
Power Requirements: Standby, transmitter only, 1.0 amps. at 26.5 v d-c or 2.0 amps. at 13.5 v d-c. Transmitting, 7.5 amps. at 26.5 v d-c or 15.0 amps. at 13.0 v d-c.
Mechanical: The transmitter is housed in a standard $\frac{1}{2}$ ATR size case (JAN A-1-d). All power and control connections are made through a rear mounted multi contact plug. Coaxial connectors for antenna and companion receiver connection are mounted on the front panel. Weight of the transmitter is 19 pounds.
 We shall be glad to send you more complete information about the Collins 17L-2 transmitter on request.

IN RADIO COMMUNICATIONS, IT'S . . .



COLLINS RADIO COMPANY, Cedar Rapids, Iowa

11 W. 42nd St.
NEW YORK 18

2700 West Olive Ave.
BURBANK

M & W Tower
DALLAS 1

Fountain City Bank Bldg.
KNOXVILLE

*

FOR

**SAFETY
ECONOMY
CAPACITY**

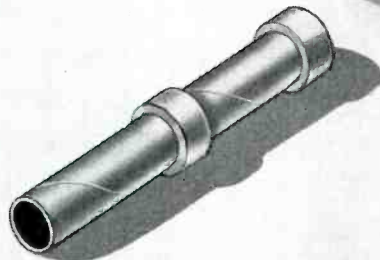
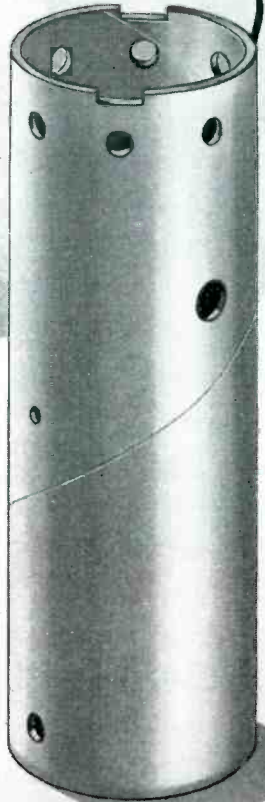

SPECIFY....

COSMALITE*

(left)

For high voltage power supply circuits of television receivers, specify our #102 COSMALITE COIL FORM. Note the sturdy, heavy-wall construction . . . the clean-cut, accurate, punched holes and notches. Ask about the many other advantages of these outstanding Cosmalite Coil Forms.

(right)

COSMALITE COIL FORMS WITH COLLARS, made from our #96 Cosmalite, are a fibre base phenolic tubing, also of the highest quality at the lowest production cost. Specify that the collars be included and positioned on the core and thus secure a snug fit and an electrically stronger assembly.

COSMALITE is a proven product backed by over 25 years of experience.

*Reg. U.S.Pat.Off.

The **CLEVELAND CONTAINER Co.**
6201 BARBERTON AVE. CLEVELAND 2, OHIO

PLANTS AND SALES OFFICES at Plymouth, Wis., Chicago, Detroit, Ogdensburg, N.Y., Jamesburg, N.J.
ABRASIVE DIVISION at Cleveland, Ohio
CANADIAN PLANT: The Cleveland Container, Canada, Ltd., Prescott, Ontario

REPRESENTATIVES

| | |
|--------------------------|--|
| CANADA | WM. T. BARRON, EIGHTH LINE, RR #1, OAKVILLE, ONTARIO |
| METROPOLITAN NEW YORK | R. T. MURRAY, 614 CENTRAL AVE., EAST ORANGE, N.J. |
| NEW ENGLAND | E. P. PACK AND ASSOCIATES, 968 FARMINGTON AVE. WEST HARTFORD, CONN. |

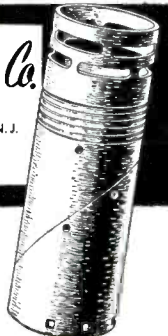

$C' \gg C_2$, and the slope of the grid recovery line will then be $(E_2 - E_{2min})/R_2C_2$. Thus the off time of V_2 is given by

$$t_2 = R_2C_2 \frac{E_{2co} - E_{2min}}{E_2 - E_{2min}} \quad (4)$$

If $R_1C_1 \ll R_2C_2$, so that the off time of V_1 is negligible compared to that of V_2 , the frequency is very nearly

$$f = \frac{1}{R_2C_2} \frac{E_2 - E_{2min}}{E_{2co} - E_{2min}} \quad (5)$$

Obviously E_K must be less than E_{2min} to have the cathode follower function properly.

The data plotted in Fig. 2 were obtained using the circuit parameters indicated. The off time of V_1 was about 40 microseconds. The solid line is calculated using the characteristics of 6SN7 tubes given

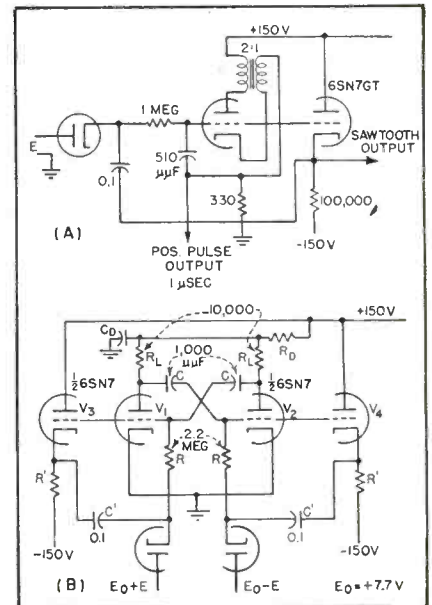
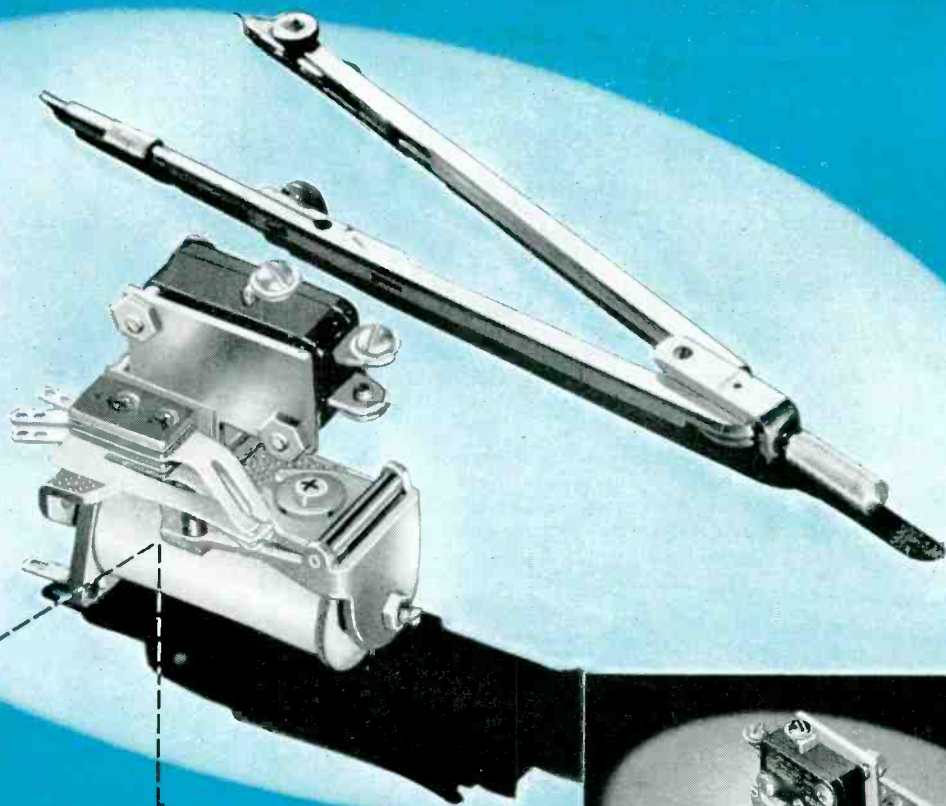
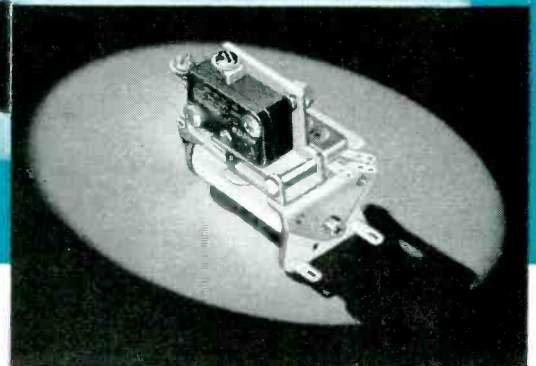

FIG. 3—Blocking oscillator with feedback to provide linear frequency change with voltage change is shown in B. The circuit in A shows how regenerative feedback on both multivibrator grids gives a frequency varying as the square of direct voltage E

in the tube manual; the circles are frequencies measured by using the sawtooth waveform at the cathode of V_2 as sweep voltage for an oscilloscope on the vertical plates of which the output of a Hewlett-Packard audio oscillator was impressed. The frequency-voltage relation is linear within an average deviation of ± 4 cycles over a 20-fold range of frequency, and agrees



CLARE Type "JMS" Relay with single arm armature, equipped with one snap-action switch.



Showing mounting of snap-action switch on CLARE Type "JMS" Relay with single armature.

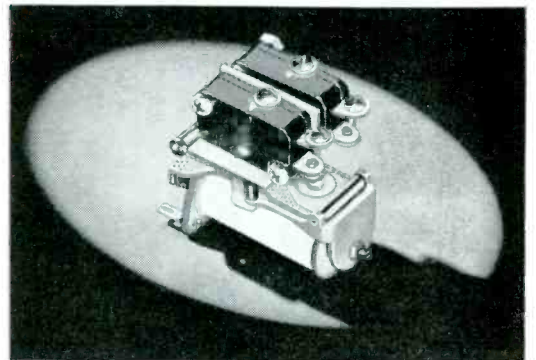

CLARE Type "JMS" Relay provided with double armature and two snap-action switches.

THIS SMALL, COMPACT **CLARE RELAY**

WILL SWITCH 1250 WATTS WITH AN INPUT OF 1 WATT!

This new CLARE Type "JMS" Relay is a sensitive relay for switching heavy a-c loads with small d-c controlling currents . . . as high as 1250 watts can be switched with a 1-watt input.

It combines the outstanding features of the larger CLARE Type "CMS" Relay with the small size and light weight of the CLARE Type "J" Relay and employs a new-type Micro precision switch of unusual efficiency and compact design.

The CLARE Type "JMS" Relay is especially suitable to locations subject to sudden jolts, constant vibration or tilting. It may be provided with either one or two Micro snap-action switches, or with one switch and a pileup of twin-contact springs. For installations where quick removal or replacement may be desirable, it may be fitted and wired to a standard radio type plug.

This new relay is a development of CLARE's unceasing effort to keep pace with every industrial relay requirement. Our engineers and sales representatives are constantly at your service to provide just the relay to meet your specific need.

For full information on the CLARE Type "JMS" Relay, look up the CLARE office in your classified telephone directory . . . or write for Bulletin 102 to C. P. Clare, 4719 West Sunnyside Avenue, Chicago 30, Illinois. In Canada: Canadian Line Materials Ltd., Toronto 13. Cable Address CLARELAY.

STANDARD SPECIFICATIONS

Contacts: Snap-action, enclosed. Varying capacity: 10 amperes at 125 volts; 5 amperes at 250 volts.

Residual: Lock Screw (Adjustable).

Mounting: May be mounted on relay bases or strips as well as mounting bars or individual mounting brackets.

Dimensions: Overall length: 2 1/4"; width: 1 1/8"; height: 2".

Weight: Net: 4 oz. (approx.); Shipping: 1/2 lb. (approx.)

Write for Clare BULLETIN 102

CLARE RELAYS

First in the Industrial Field



**WANT TRUE
ECONOMY IN
MOLDED PLASTICS?**



There are so many plastics, so many design factors, so many angles involved in choosing from among the different molding methods that it pays to get the best, most experienced help with your custom molding jobs.

This help is available from the Watertown man virtually on your doorstep. He's backed by our 34 years experience and complete facilities, including a laboratory second to none in the industry, to develop, produce and test your part or product to your satisfaction . . . and your customers'.

If you have a custom molded plastics job on blueprints . . . or merely in mind . . . phone your nearest Watertown man today . . . or phone or write us directly. Here are the Watertown men . . .

New York—H. A. Rankow, 175 Fifth Ave.
Chicago—National Insulations Co.,
2808 W. Lake St.

G. W. Glaescher R. C. Farquhar
J. P. Bonnamy J. R. Kallaher

Detroit—J. P. Greener from Chicago
Cleveland—Carl F. Linn, 866 Hanna Bldg.

Milwaukee—Roger L. Miller, 729 N. Broadway

Seattle—John W. Witherow,
National Vulcanized Fibre Co.
1927 First Ave., South

San Francisco—G. W. Harmsen,
National Vulcanized Fibre Co.
273 Seventh Ave.

Los Angeles—Fred M. Foley,
National Vulcanized Fibre Co.
2325 East Eighth St.

THE WATERTOWN MANUFACTURING CO.
777 ECHO LAKE RD., WATERTOWN, CONN.

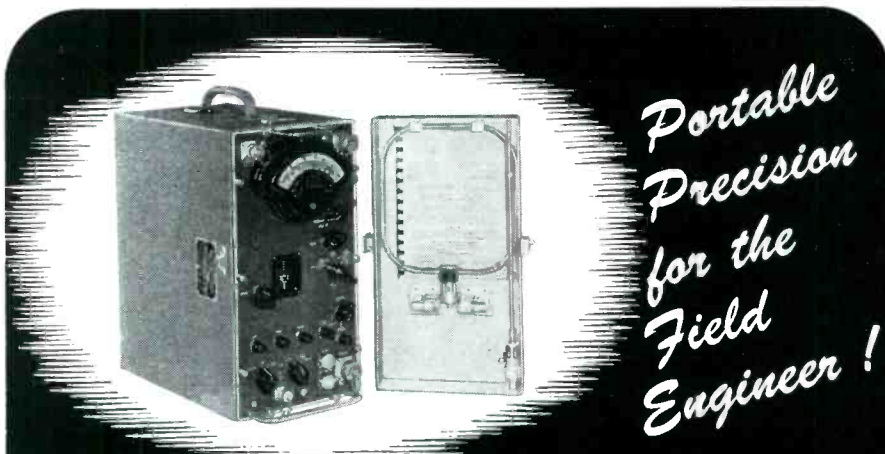

*Portable
Precision
for the
Field
Engineer!*

STODDART NM-20A RADIO INTERFERENCE AND FIELD INTENSITY METER

- A portable unit that you can **DEPEND** upon! Designed especially to withstand the rigors of all-weather field operation and yet provide reliable performance.
- Measures **FIELD INTENSITIES** of radio signals and **r.f.** disturbances using either a rod antenna or a rotatable loop antenna.
- May be used as a two-terminal **r.f.**

voltmeter (balanced or unbalanced), frequency selective over the **CONTINUOUS RANGE** 150 kc to 25 mc.

- **ONE MICROVOLT SENSITIVITY** as a two-terminal voltmeter; 2 microvolts-per-meter using rod antenna.
- Operates from self-contained dry batteries or external A.C. power unit providing well-regulated filament and plate supplies.

Write for complete technical data

STODDART AIRCRAFT RADIO CO.

Main office and plant:
6644 Santa Monica Blvd.
Hollywood 38, Calif.
Phone: Hillside 9294

8-247 General Motors Bldg.
Detroit 2, Michigan
Phone: Trinity 1-9260

1346 Connecticut Ave.
duPont Circle Bldg.
Washington 6, D. C.
Phone: Hudson 7313

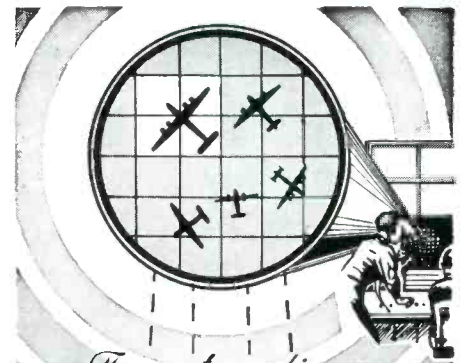

*For extraordinary
electrical performance*

**Use SILVER
GRAPHALLOY**



THE SUPREME CONTACT MATERIAL

BRUSHES



CONTACTS

in BRUSHES

for high current density minimum wear low contact drop low electrical noise self-lubrication

in CONTACTS

for low resistance non-welding character

GRAPHALLOY works where others won't! Specify GRAPHALLOY with confidence.

*A special silver-impregnated graphite

**GRAPHITE METALLIZING
CORPORATION**

1055 NEPPERHAN AVENUE, YONKERS 3, NEW YORK

High Vacuum FURNACES

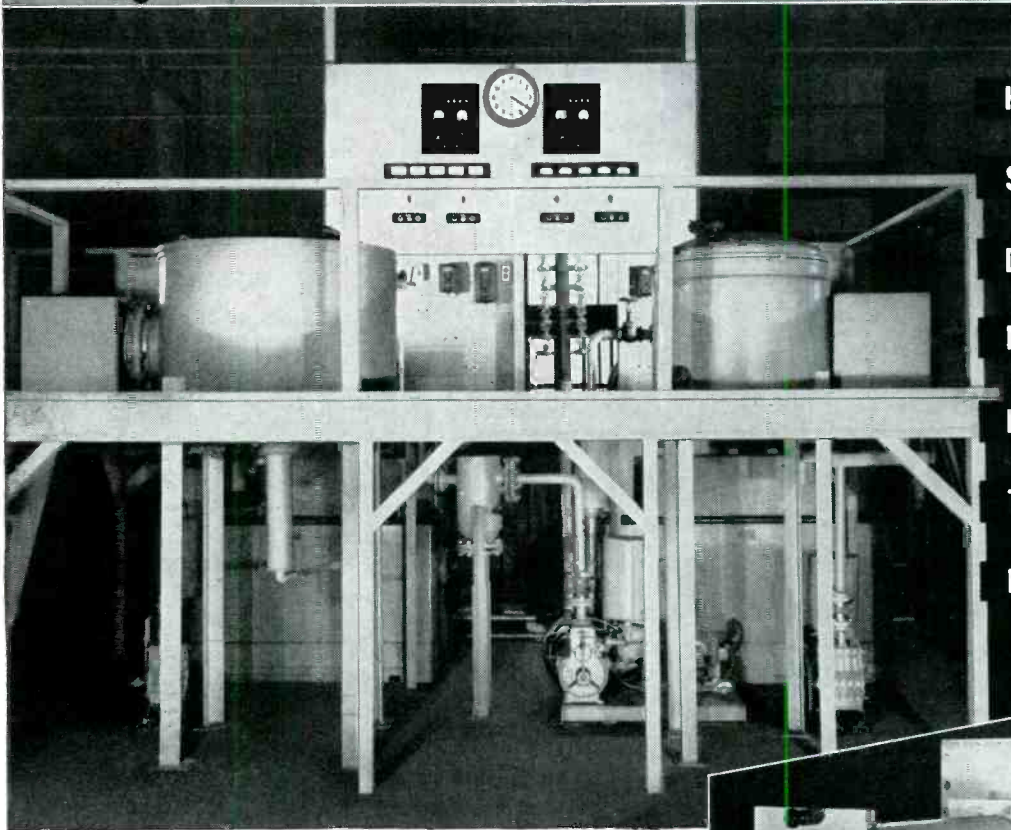

PRODUCTION FURNACES — MELTING AND CASTING

High Vacuum Metallurgy is not new as laboratory technique. It *is* new as a practical industrial operation.

For the first time, National Research Corporation offers its services to design and build, to your requirements, furnaces which operate in the micron pressure range. Pressures run as low as 10^{-4} mm. Hg. absolute.

Six years' experience in the engineering and construction of High Vacuum metallurgical equipment is at your disposal. Write National Research Corporation.

HEAT TREATING

SINTERING

DEGASSING

BRIGHT SOLDERING

METAL DISTILLATION

THERMAL REDUCTION

MELTING and CASTING

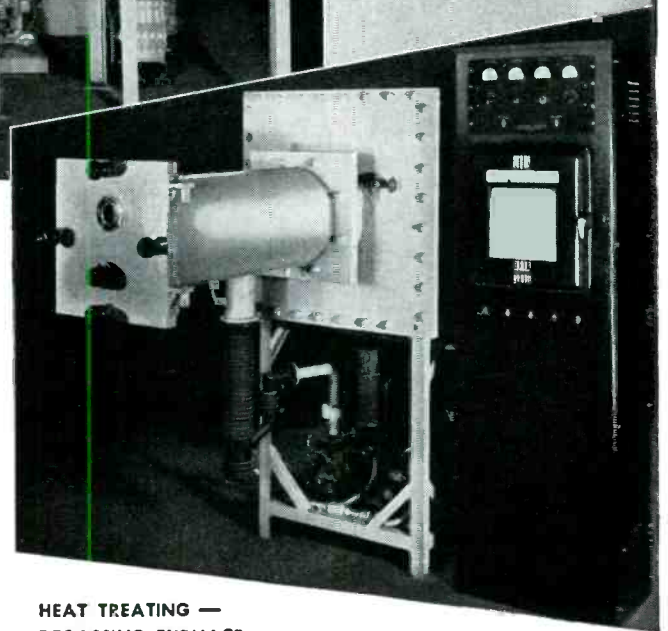

HEAT TREATING —
DEGASSING FURNACE

Write to { VACUUM ENGINEERING DIVISION,
National Research Corporation,
Cambridge 42, Massachusetts

We supply a complete line of diffusion pumps, vacuum gauges, valves, seals, coating equipment, dehydration equipment and special high vacuum apparatus.

HIGH VACUUM FOR INDUSTRY
NATIONAL RESEARCH CORPORATION
Vacuum ENGINEERING DIVISION

MOSINEE

"More than Paper"

If you have a fabricating or processing problem involving paper . . . if you require definite technical characteristics and, above all, *dependable uniformity*, it may be worthwhile for you and MOSINEE technicians to get together. MOSINEE is not interested so much in terms of volume production as in our ability to render helpful service to manufacturers in the field of electronics and in the electrical goods industry. Our "paperologists" are at your service for consultation. Please write Dept. E.



MOSINEE PAPER MILLS COMPANY • MOSINEE, WIS.
Essential Paper Manufacturers

well with that predicted by Eq. 5.

The circuit of Fig. 1B can be modified to serve as a moderately linear delay circuit by using direct coupling through a suitable resistive divider from the plate of V_2 to the grid of V_1 , the grid resistor of V_1 being returned to E_c . A positive trigger applied to the grid of V_1 , or a negative trigger to the plate, will

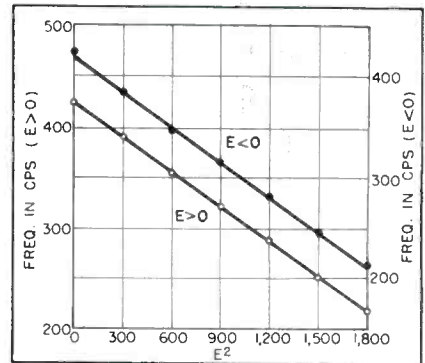

FIG. 4—Frequency of multivibrator shown in Fig. 3B as a function of the square of the voltage E

initiate one cycle of operation. A delayed trigger, with delay time controlled by E_c , can then be developed in the usual way by differentiating the plate signal of V_2 and inverting the negative pip, or by the use of a blocking oscillator.

Regenerative feedback may be applied in a similar manner to a blocking oscillator, although, as might be expected, there is considerably more short time fluctuation, or jitter, than found with the multivibrator circuit. A typical schematic diagram is given in Fig. 3A. The observed frequency of this circuit fits the equation $f = 2,030 + 34.4 E$ with an average deviation of about ± 16 cycles for E between -60 and $+80$ volts (frequency between 2 and 4,800 cycles).

A multivibrator whose frequency is linearly dependent on the square of a direct voltage is obtained by applying regenerative feedback to both grids. If the circuit is completely symmetrical as shown in Fig. 3B, and $E_1 = E_0 + E$, $E_2 = E_0 - E$, the frequency is given by

$$f = \frac{1}{t_1 + t_2} = \frac{(E_0 - E_{\min})^2 - E^2}{2RC(E_{co} - E_{\min})(E_0 - E_{\min})} \quad (6)$$

The control voltages can be supplied by a differential direct-coupled

FREED

Instruments & Components "PRODUCTS OF EXTENSIVE RESEARCH"

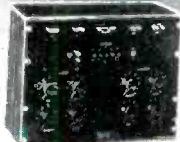

NO. 110 INCREMENTAL INDUCTANCE BRIDGE
Inductance range from 1 MHY to 1000 H. Frequency range from 40 to 1000 cycles. D.C. range from .5MA to 1 Amp.



STEPDOWN TRANSFORMERS
High efficiency Auto Transformer— can be used as either Step Up or Step Down transformer equipped with standard receptacle and line cord.



HIGH FIDELITY OUTPUT TRANSFORMER
High quality output transformer combines unusually wide frequency range together with very low phase shift and harmonic distortion. Frequency range 1/2 DB 20-30,000 cycles.



DISCRIMINATORS
For telemetering and remote control application using audio and super-sonic frequency sub-carriers.



NO. 1010 COMPARISON BRIDGE
For precision laboratory adjustment and incoming inspection of resistors, capacitors and inductors. Entirely self contained, A.C. operated and includes a three frequency oscillator, an A.C. bridge and a null detector.



NO. 1020 DIRECT READING MEGOHMMETER
Measures insulation resistances up to 2,000,000 megohms. 500 volts D.C. potential included in the instrument. Entirely self contained and A.C. operated.



NO. 1140 NULL DETECTOR
High gain Null Detector for Bridge measurements. Contains selective circuits for 60-400-1000 cycles. Frequency range 30-20,000 cycles.



FILTERS
Narrow band pass filters for remote control and telemetering applications. High pass, low pass, band pass and band elimination filters for communication and carrier systems.



NO. 1030 "Q" INDICATOR
Frequency range from 20 cycles to 50 kilocycles. "Q" range from .5 to 500. "Q" of inductors can be measured with up to 50 volts across the coil.



HI-Q MINIATURE TOROIDAL INDUCTORS
Size 7/8" D. x 3/4" — weight 3/4 ounce. Type TI-5 Frequency range 1000 cycles - 15,000 cycles. Type TI-7 Frequency range 10,000 cycles - 100,000 cycles. Wound on molybdenum permalloy dust cores. Available in hermetically sealed cans, potted and cased or open units.

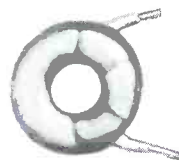

TOROIDAL INDUCTORS
Hi Q toroidal coils wound on powdered molybdenum permalloy. Can be supplied for frequencies from 200 cycles to 200 KC Available in hermetically sealed construction potted and cased or open type units.

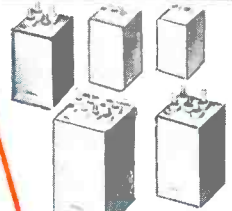

HERMETICALLY SEALED COMPONENTS
Class A Grade I components to meet JAN-T-27 specifications. Made to customer requirements where temperature and humidity are factors.



NO. 1150 UNIVERSAL BRIDGE
For measurement of inductors, capacitors, and determination of resistive and reactive components of impedances. Frequency range 20 cycles - 20,000 cycles 1% accuracy.



NO. 1210 NULL DETECTOR & VACUUM TUBE VOLTMETER
Vacuum Tube Voltmeter: Sensitivity .1, 1, 10, 100 volts. Input impedance 50 megohms shunted by 20 mmfd. Frequency range 20 cycles - 20,000 cycles. NULL DETECTOR: Gain 94 DB. Selective circuits for 60, 400, 1000 cycles. Frequency range 20-30,000 cycles.



NO. 1060 VACUUM TUBE VOLTMETER
For use at audio, super-sonic and radio frequencies. Frequency range from 10 cycles to 1.6 megacycles. Input impedance 50 megohms, input capacity 15 MMF. Voltage range from .001 to 100 volts. Frequency range from 10 cycles to 2 megacycles.



NO. 1180 A.C. POWER SUPPLY
A valuable laboratory instrument with continuous variable output from .1 volt to 100 volts @ 60 cycles.

FREED TRANSFORMER CO., Inc.

DEPT. E O 1718-36 WEIRFIELD ST., (RIDGEWOOD) BROOKLYN 27, NEW YORK

How ALLEN HEAD precision fastenings apply to...

RADIO • TELEVISION • INSTRUMENT AND GENERAL ELECTRICAL MANUFACTURING



For greater strength: Allen \odot Head Screws permit the use of smaller sizes. For instance a No. 6 Allen \odot Head Cap Screw is equivalent to a No. 8 conventional screw.



For space economy: Allen \odot Head Screws permit closer spacing of screws, eliminate projecting heads.



For greater holding power: Allen \odot Head Screws are insurance against avoidable costly service operations.

In hard-to-reach places: Allen \odot Head Screws, plus Allen Hex Keys and Drivers start screws easily and save awkward "fingering in."



For fine adjustments, close, snug fit between key and screw permits delicate adjustments that stay put.



For tamper-proof settings in gauges and instruments, Allen \odot Head Screws can be set below surface and wax sealed.



If vibration is a factor, the precise Class 3 fit of Allen \odot Head Screws will build longer trouble-free life into the product.



For a ready-made threaded hole, the new Allenut offers greater holding power and positive anchor in soft metals.

Allen \odot Head Screws are available as standard items in a wide range of sizes ranging upward from No. 4 x 1/8". NC and NF threads. Popular sizes also available in 18-8 non-magnetic stainless steel. Set screws stocked in cup, oval, flat cone and half dog points (full dog, special).

Sold only through leading distributors. Write the factory for technical information or regarding any special requirement.

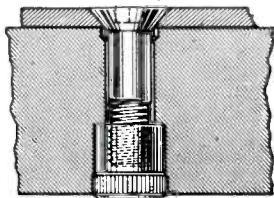

Allenut and Allen Flat Head Cap Screw used to hold thin metal plate to metal base. Allenut has been pressed into counterbored hole. Will not fall out or turn against driving action.

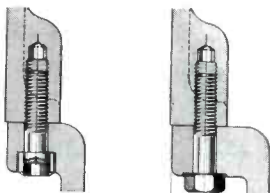

Allen \odot Head Cap Screws contribute to compact designing. Can be countersunk without allowing for wrench clearance.

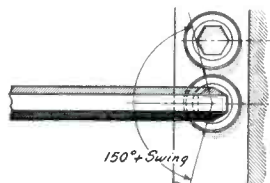

Allen \odot Heads permit close spacing impossible with conventional heads.

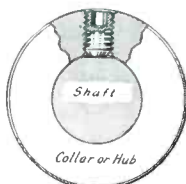

Firm grip without the use of weak slots or projecting heads.



ALLEN ALLEN HEAD
MANUFACTURING COMPANY
Hartford 2, Connecticut, U. S. A.
NEW YORK, CLEVELAND, DETROIT, CHICAGO, LOS ANGELES

FOR 40 YEARS THE BUY-WORD FOR SOCKET SCREWS

amplifier having cathode-follower outputs.

The behavior of this circuit is illustrated by the data plotted in Fig. 4. For both $E > 0$ and $E < 0$, the square law relation

$$f = 424 - 0.1153 E^2 \quad (7)$$

holds with an average deviation of ± 3 cycles.

Stability of Circuits

The short time stability of the multivibrator circuits is quite good, there being very little observable jitter. However the stability with respect to supply voltages is such as to indicate that well-regulated power supplies should be used. Over the larger part of the frequency ranges in the data reported above, the frequency of either multivibrator circuit changes by less than 3 percent for a 10-percent change in tube heater voltage; however, at the lower frequencies, where the grid voltages pass cutoff with relatively small slope, a frequency change of as much as 10 percent may result from a 10-percent change in heater voltage.

Two-Way Radio in Industry

WHEN AN industrial aid can be made to pay for itself in a short time, it is considered to be a worthwhile investment. Such has been the case with two-way radio systems which have been adopted in so many phases of industry.

According to reports from the



Superintendent in charge of construction of Medicine Creek Dam, George Stiers uses two-way radio in his car to call for reinforcements

The Tracerlab BETA GAUGE

For PAPER . . . PLASTICS
SHEET METAL . . . TEXTILES

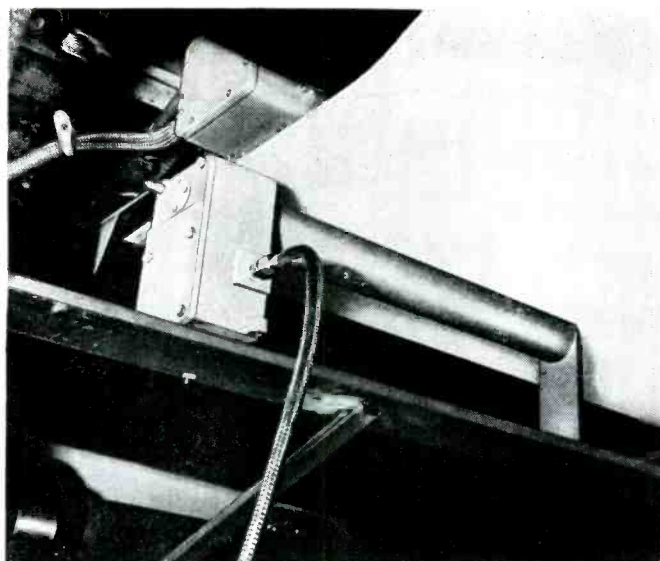

A Tracerlab Beta Gauge installation for measuring paper board at Continental Paper Co., Ridgefield Park, New Jersey.

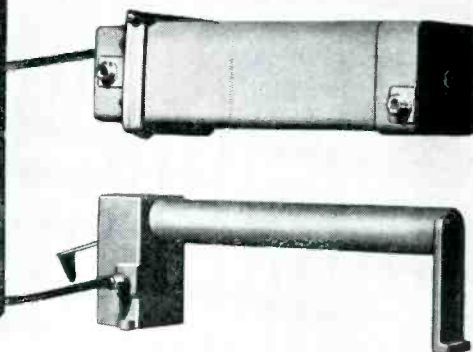

A FEW TYPICAL USES

Measuring weight per unit area or thickness of the following:

VINYL PLASTIC FILM
SHEET RUBBER
CELLOPHANE
PHOTOGRAPHIC FILM
BASE
COATED TEXTILES
WAX COATED PAPER
GLASSINE PAPER
CONDENSER PAPER
CARDBOARD
TEXTILE YARN AND
ROVING
ALUMINUM FOIL
AUTOMOBILE BODY
STEEL
TINPLATE
BRASS SHEET

NON-CONTACTING THICKNESS GAUGE • AUTOMATIC STANDARDIZING FEATURES • EXTREMELY HIGH ACCURACY AND SENSITIVITY • UNAFFECTED BY SHEET COMPOSITION • REGULATED POWER SUPPLY UNNECESSARY • REQUIRES A MINIMUM OF MAINTENANCE

The Tracerlab Beta Gauge is a completely new and unique instrument for measuring and recording weight per unit area or thickness of various materials directly on the production line. It uses beta radiation from Oak Ridge produced radioisotopes to achieve a high degree of accuracy and sensitivity and is unaffected by variations in chemical composition of the material being measured. This is a non-contacting type of gauge designed for the severe operating conditions usually encountered in production operations. In addition to the recording type, a non-recording industrial model and a laboratory model of the Tracerlab Beta Gauge are also available.

Let us know your gauging problems and we will gladly advise you how the Tracerlab Beta Gauge can help you.

Write for Beta Gauge Bulletin 20.

Tracerlab

TRACERLAB INC., 130 HIGH STREET, BOSTON 10, MASS.

Western Division
2295 San Pablo Ave., Berkeley 2, California
New York Office
General Motors Building, 1775 Broadway, New York 19
Midwest Office
LaSalle-Wacker Bldg., 221 N. LaSalle St., Chicago, Ill.

There's a True Thrift Lesson in—

The Case of the Canceled Check



Office Manager: Guess I've thrown away a canceled check I need badly to prove payment of a bill!

Draftsman: We have similar trouble. Instead of using permanent Arkwright Tracing Cloth for every drawing, we use temporary tracing paper. Then — when we happen to need it again, it has been discarded or has become brittle, opaque and useless in the file!

If a drawing is worth keeping — it is worth making on dependable Arkwright Tracing Cloth. The trifling extra cost insures years of permanence — no chance of becoming dogeared and torn by use nor opaque and illegible by age, as perishable tracing paper is apt to do. Arkwright is woven, bonded and processed for enduring transparency. It is real economy — good business — to use Arkwright, always!

Send for generous working samples of Arkwright and judge its superiority over any substitute. Arkwright is sold by leading drawing material dealers everywhere. Arkwright Finishing Co., Providence, R. I.

The Big Six Reasons Why Arkwright Tracing Cloths Excel

1. Erasures re-ink without feathering.
2. Prints are always sharp and clean.
3. Tracings never discolor or go brittle.
4. No surface oils, soaps or waxes to dry out.
5. No pinholes or thick threads.
6. Mechanical processing creates permanent transparency.



ARKWRIGHT

TRACING CLOTHS

AMERICA'S STANDARD FOR OVER 25 YEARS

TUBES AT WORK

(continued)

Timken Roller Bearing Company's Steel and Tube Division at Canton, Ohio, many operating hours a month are saved by the use of two-way radio between a central station and three dispatcher units—two in material-carrying straddle trucks, and one in a station ambulance. After the first 30 days of operation, two trucks handled 354 more bales than did three previously.

Figures, according to plant officials, fail to tell the whole story about savings introduced by the adoption of two-way radio. In many cases customers' orders may be speeded by as much as five days by the efficient movement of materials and finished products. The prompt arrival of a truck at the right time and place eliminates piling up of work, keeps machines operating by providing materials when needed.

Effective coordination between overhead cranes and material trucks is made possible through the use of two-way radio communications, and the result has been seen in the noticeable increase in smoothness of flow as materials and products pass systematically between buildings and machines.

The central station in the Timken installation is a 30-watt Motorola transmitter-receiver combination, while the dispatcher trucks employ 10-watt units.

Pipe Line Communication

The Buckeye Pipe Line Company has also found two-way radio to be



At maintenance, of construction job, Patty Campbell takes the superintendent's call and relays it to other via G-E two-way radio equipment

NEW!

small

d-c capacitors for use
in ambient temperatures
up to 125°C

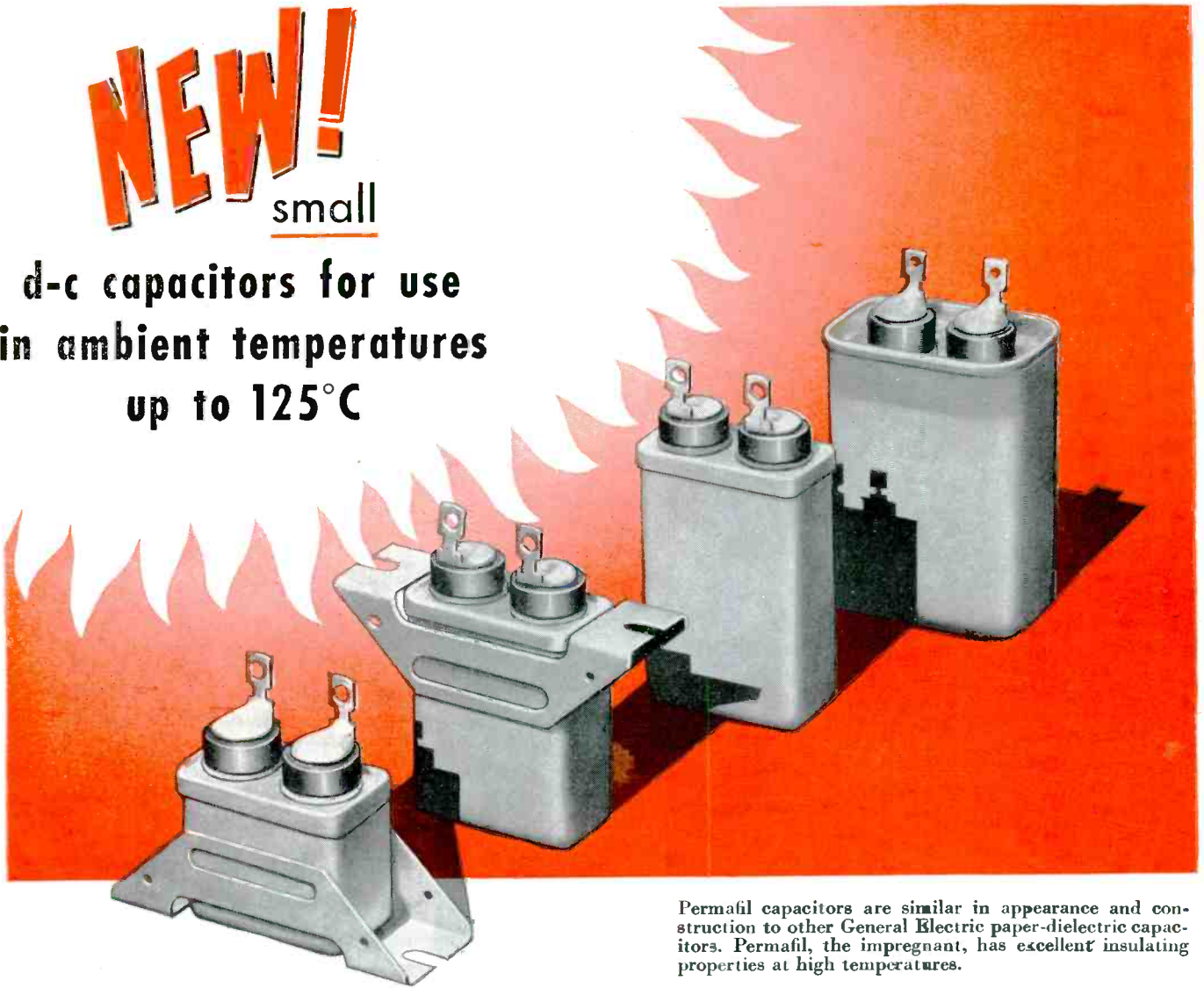

Permafil capacitors are similar in appearance and construction to other General Electric paper-dielectric capacitors. Permafil, the impregnant, has excellent insulating properties at high temperatures.

General Electric announces a new line of Permafil d-c paper-dielectric capacitors designed especially for operation in high ambient temperatures. They require no derating for temperatures up to 100°C and can be used up to 125°C.

Hermetically sealed in metallic containers, these new units are available in case styles 61, 63, 65 and 70, as covered by Joint Army-Navy Specifications JAN-25-C, in ratings of 0.10 to 4.0 muf 600-, 1000- and 1500-volts. Permanent-

ly sealed silicone bushings are provided on all types.

Permafil capacitors were developed to provide suitable components for the many new applications involving continual operation at ambient temperatures above 85°C—another example of capacitors "designed for the job" by G-E engineers. For further information on these or on capacitors for other applications, write *Capacitor Sales Division, General Electric Company, Pittsfield, Mass.*

GENERAL ELECTRIC

Specialty Capacitors

FOR

Motors
Luminous-tube
transformers
Fluorescent lamp
ballasts

Industrial control
Radio filters
Radar
Electronic equipment
Communication
systems
Capacitor discharge
welding

Flash photography
Stroboscopic
equipment
Television
Dust precipitators
Radio interference
suppression
Impulse generators

AND MANY OTHER APPLICATIONS

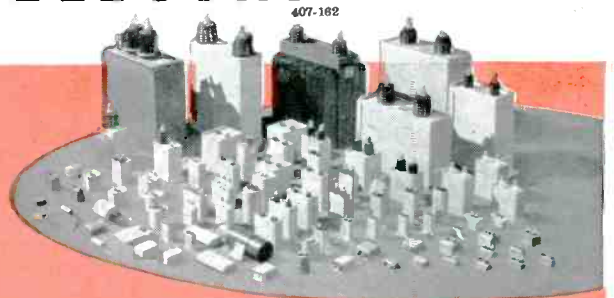

an asset, if not a necessity. Previously, communication along the pipe lines was maintained by telephone and telegraph, but interruptions due to ice and wind storms made radio communication a vital necessity in an operation where interruptions increased the hazards of transmitting crude oil under extremely high pressures.

To cover the long distances and mountainous terrain involved, the Buckeye system employs frequencies in the 30 to 40-mc band. As a beginning, 100 company vehicles will be Motorola equipped. In some instances central stations will be as far as 100 miles apart. Ultimately, two-way radio will cover the entire line. The company also expects the system to be invaluable in future line construction operations.

In practically all large cities, the sight of mobile transmitting antennas is already commonplace, with public utility trucks, police cars, fire department vehicles and taxicabs equipped with two-way

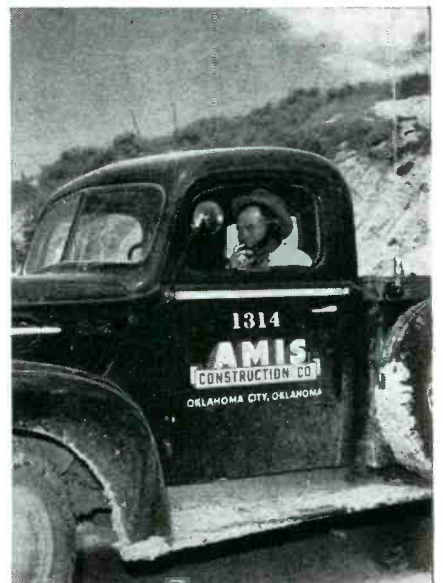
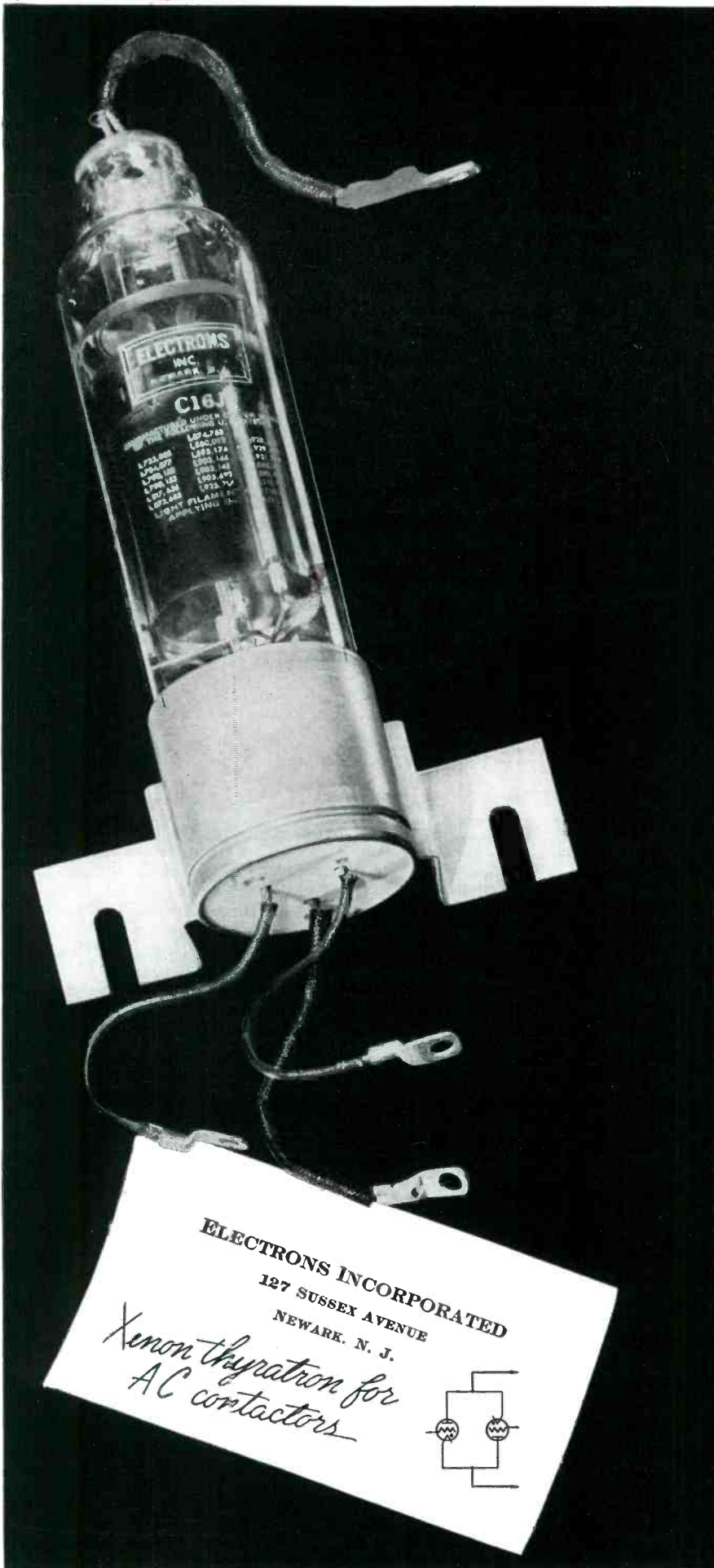

The shift boss receives the call from headquarters over the G-E radiophone in his truck and prepares to call his crew into action

radio equipment. The use of smaller units similar to the wartime walkie talkie is becoming more and more common among construction gangs and maintenance crews of all kinds.

Loss of equipment which would have set back materially construction of the Medicine Creek Dam

a simplified, outstandingly dependable LINE SWITCH for Stackpole Controls

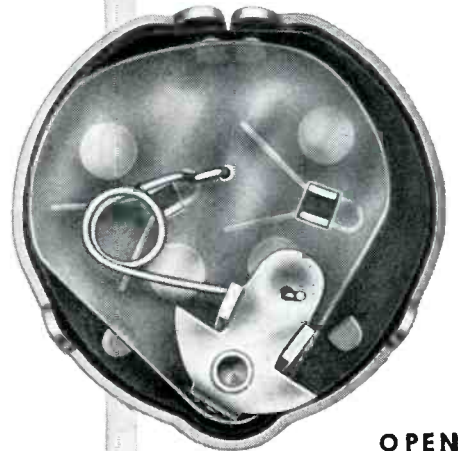

OPEN

*(Interior views approximately
2½ times actual size of switch)*

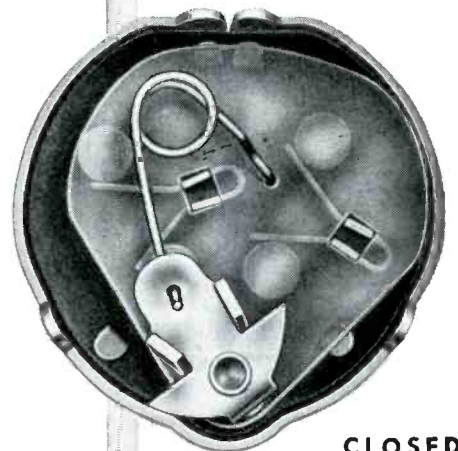

CLOSED



Only .888" in diameter by .312" thick, this Type A-10 double-pole, single-throw line switch fits even the smallest Stackpole controls. Rated 1 ampere at 250 volts AC-DC or 3 amperes at 125 volts AC-DC, it combines outstanding ruggedness of design with ample-sized contacts and positive contact wiping action. Stationary contacts are

mounted on a fiber surfaced Bakelite base to reduce arc tracing. The base is held securely in the can. Throughout, the switch is constructed for long, trouble-free service and in suitable ratings for portable and auto radios and numerous other applications. A similar single-pole design (Type A-11) with dummy terminal is also available.

Write for Stackpole Bulletin RC-7

ELECTRONIC COMPONENTS DIVISION
STACKPOLE CARBON COMPANY, ST. MARYS, PA.

STACKPOLE

VARIABLE RESISTORS FOR MODERN RADIO AND TELEVISION NEEDS



Do you recognize these HOLTITE fastenings?
Guess what industry uses each of them.
Check yourself by the list below.

CONTINENTAL makes them all and thousands more

Of all the 400,000 varieties of fastenings that literally hold our industries together, Continental makes a large proportion marketed under the famous HOLTITE trade name. Most of them are standard — screws, nuts, and bolts for every use in every industry. Others like the well-known HOLTITE-Sems and HOLTITE-Phillips screws are patented specialties and the famous HOLTITE-Thredlock, Lockite and Tap screws were first designed and produced by Continental. Sometimes a fastening engineered by HOLTITE for one industry finds an unexpected use in another. Often a HOLTITE-Engineered fastening will replace several parts that a manufacturer is using. Why not discuss your fastening requirements with a Continental Sales-Engineer. He will focus on your requirements all the broad industrial-fastening experience and ingenuity of Continental. Remember Continental is constantly improving HOLTITE products, lowering their cost and broadening service.

ENGINEERED FASTENINGS FOR PRODUCT ENGINEERS

A. A typical flat head HOLTITE steel woodscrew. Continental makes a complete range of sizes with either slotted or Phillips heads.

B. Special Phillips "HOLTITE-Thredlock" door hinge screw eliminates lock washers and other locking devices giving improved performance when subjected to vibration.

C. Dial adjusting screw specially designed for bathroom scales. Screw inserted in frame is swaged against square shoulder under head. Completed part engages scale leveling mechanism to allow screw driver adjustment.

D. Beater drive shaft for a home electric mixer. Continental engineered this unusual part and produced it economically by cold heading process. Head end is welded to the beater unit. Knurled section provides grip for motor chuck.

This Trademark
HOLTITE
T. M. REG. U. S. PAT. OFF.
means made by —

CONTINENTAL SCREW COMPANY

1904

NEW BEDFORD, MASS., U.S.A.

1949

of the U. S. Bureau of Reclamation's Missouri Valley Authority on the Republican River in Nebraska, has been prevented by two-way radio. When a flash flood occurred, radio was used to direct emergency crews to vulnerable points in the temporary cofferdams and to move equipment when water came up to within 18 inches of the top of the cofferdams.

One mobile unit was moved into a nearby town to keep residents there informed of the situation during the high-water period. Last year 13 residents of the town were drowned during a flash flood. The system consists of eight GE units located in the main office, general superintendent's car, excavation superintendent's pick-up, the concrete superintendent's pick-up, in the field mechanic's truck, the service shop, at the quarry, and in the shift supervisor's pickups.

Oxide-Coated Cathodes

BY WILLIAM COUCH
Machlett Laboratories, Inc.
Springdale, Connecticut

THE IMPORTANCE of oxide-coated cathodes is probably not generally appreciated. All modern receiver tubes, except ballast and regulator tubes, have this type of cathode. Mercury vapor rectifiers and cathode-ray tubes have oxide-coated cathodes exclusively. In addition, they are used in many low-power transmitting tubes such as the 2C-39.

The choice of this type cathode over thoriated tungsten and pure tungsten is based on its high emission efficiency and the fact that it is the only practical indirectly heated cathode. Cathodes of this type operate around temperatures of 825 C, giving an emission of 0.7 ampere per square centimeter cathode area at an emission efficiency of 100 ma per watt filament heating power.

Pure tungsten filaments, which are used in the large power tubes because of their greater resistance to destruction by arcs and liberated gases, operate around temperatures of 2,250 C, giving emissions of 0.1 ampere per square centimeter of cathode area at emission efficiencies

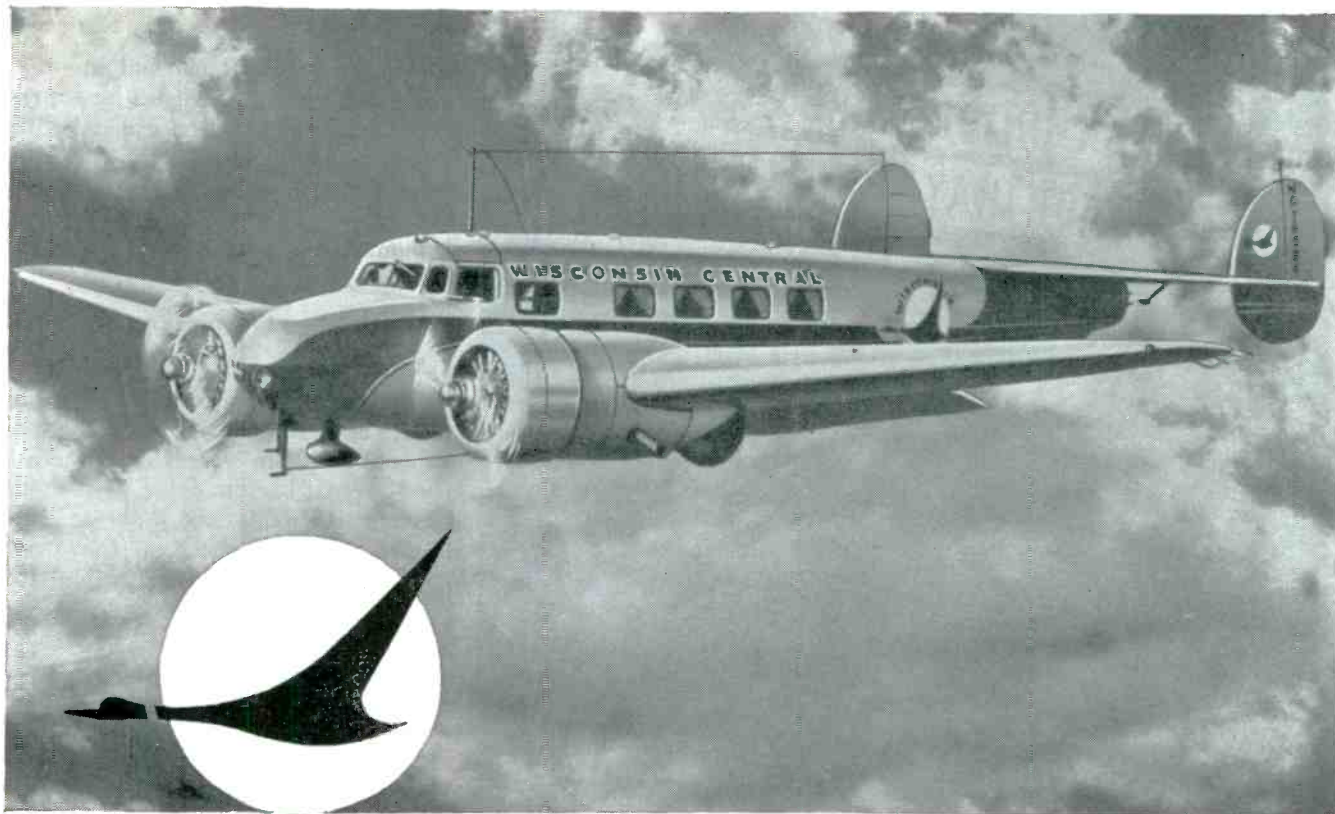

WILCOX

...First Choice

of WISCONSIN CENTRAL AIRLINES

**WIS completely equips all ground stations
and aircraft with WILCOX radio**

VHF AIR-BORNE COMMUNICATIONS

WILCOX TYPE 361A—50 watt transmitter, high sensitivity receiver, and compact power supply—each contained in a separate ½ ATR chassis. Receiver and transmitter contain frequency selector with provisions for 70 channels...ample for both present and future needs.

VHF GROUND STATION PACKAGED RADIO

WILCOX TYPE 378A—Complete with Type 364A, 50 watt transmitter, 305A Receiver, common antenna, telephone handset and loudspeaker, desk front, message rack and typewriter well. Type 411A LF Transmitter may be installed in the same cabinet for radiobeacon facilities.

MULTI-FREQUENCY GROUND STATION TRANSMITTER

WILCOX TYPE 99A—Provides simultaneous transmission on LF, MHF, and VHF, frequencies. Housed in a single steel cabinet, the rectifier, modulator, remote control, and 4 transmitting channels combine to make the most compact multi-frequency transmitter in the 400 watt field.

WRITE TODAY...for complete information on all types of point-to-point, air-borne, ground station, or shore-to-ship communications equipment.



WILCOX ELECTRIC COMPANY

KANSAS CITY

MISSOURI

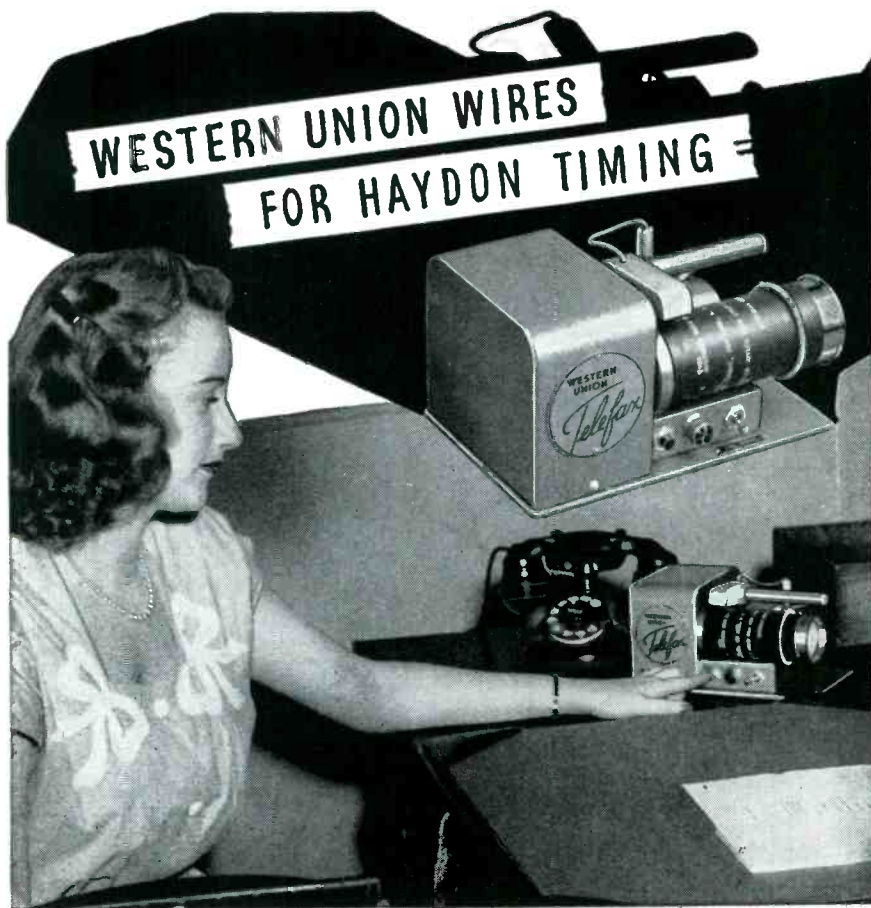

Western Union's new Telefax Receiver, the Desk-Fax model, is a compact facsimile telegraph sending and receiving system for desk use. Accurate timing is one of the fundamentals of its ingenious operation and the new device is wired for dependable Haydon timing. A #1600 series motor is used to drive the scanning stylus from left to right by means of a drum and cord. The synchronous motor operation permits constant speed stylus movement and both sending and receiving units run at the same speed.

Western Union pioneers in communications, Haydon in the science of timing . . . developing devices and motors which make possible progress in all fields of industry. In addition to producing timing motors and a wide range of standard timers, Haydon also specializes in design engineering and production of custom-built timing devices for specific volume applications. Wherever timing is important, Haydon is ready to assist.

Wire or write for a Haydon representative to call. If it's time for timing, it's time for Haydon. An Engineering Data Catalog is available. For quick reference, see Haydon Catalog, Sweet's File.

WRITE 2422 ELM STREET, TORRINGTON, CONNECTICUT

HAYDON

MANUFACTURING COMPANY, INC.

TORRINGTON

CONNECTICUT

HARNESS TIME TO



YOUR PRODUCTS

SUBSIDIARY OF GENERAL TIME INSTRUMENTS CORPORATION

TUBES AT WORK

(continued)

of 5 ma per watt filament input.

Oxide-coated cathodes are prepared by coating a base metal with the emitter material in the carbonate form. The carbonates are converted to oxides on the vacuum pumps, and are then activated to high emission capabilities.

Processing

The nitrates of barium, strontium, and calcium are mixed in the dry crystalline form in such proportions as to give approximately 60-percent barium oxide, 37-percent strontium oxide, and 3-percent calcium oxide in the final converted state. Barium is the best emitter of the three, and calcium the poorest. It has been found that a mixture is more successful in tube manufacture than any one oxide alone since a strontium oxide plus barium oxide mixture adheres better to the core metal.

The nitrates are dissolved in distilled water and then mixed with a water solution of sodium or ammonium carbonate. The rate at which these two solutions are poured together and the temperatures at which they are maintained during the mixing are very critical in controlling the particle size. The two solutions react and form barium, strontium and calcium carbonates (which are insoluble in water), and sodium or ammonium nitrate (which is water soluble).

The carbonates are filtered out and carefully washed, then mixed in a liquid organic medium. To this mixture is added nitrocellulose which acts as a binder, holding the material on the core metal until the cathodes are converted.

Addition of diethyl oxalate reduces the rate at which the material dries on the core metal, and increases its spreading properties so that a level coating may be obtained. Before applying the coating material to the core metal it is thoroughly mixed so that the carbonates and binder are uniformly distributed throughout the liquid.

The emitter material may be coated on the core metal in a number of ways, such as by spraying, dipping or electrolytic deposition (cataphoresis). Filamentary or directly heated cathodes are usually coated by repeatedly dragging the



From this tiny 2½-inch tube

Norelco PROTELGRAM now offers



Life-Size
MORE
Life-Like
Television

... in a choice of picture sizes!

Now, for the first time, NORELCO PROTELGRAM makes possible a variety of picture sizes from 130 square inches to 12 square feet . . . from the same basic PROTELGRAM unit!

Many of America's progressive TV manufacturers are already featuring the popular 192-square-inch picture (16" x 12", 20" diagonal, square corners). Soon they will introduce two companion sizes—130 square inches with 16" diagonal and rounded corners, and 234 square inches with 20" diagonal and rounded corners.

The newest development of PROTELGRAM television, which projects a giant 3' x 4' picture on a home-movie screen, has already been announced by several well-known makers of quality television receivers.

PROTELGRAM provides *life-size*, more *life-like* television that is big, clear, bright, sharp, flicker-free, reflectionless, easier on the eyes . . . at the lowest cost per square inch of viewing area. And the compactness of the PROTELGRAM unit makes possible a variety of cabinet designs to fit every home requirement.

PROTELGRAM has been chosen by leading TV manufacturers because it is the answer to the demand for bigger, better, more true-to-life television. PROTELGRAM is available to all interested manufacturers. Its profit potentialities are unlimited. For further information, write today to North American Philips Company, Inc., Dpt. PA-10, 100 East 42nd Street, New York 17, N. Y.



PROTELGRAM

An exclusive development of
NORTH AMERICAN PHILIPS

"Here's a new way to end yoke spitting"



SPITTING BY DEFLECTION YOKES on television tubes stops for good with this simple application of "SCOTCH" No. 33 Electrical Tape. Putting this thin, tough plastic tape on the television tube itself instead of on the yoke gives excellent results, eliminates expensive yoke replacements. And that's only one of the many

ways in which "SCOTCH" No. 33 Electrical Tape saves time—gives perfect results. From antenna to set, it protects connections and wiring from moisture, corrosion and abrasion.

TRY IT AT OUR EXPENSE—a free trial roll and complete details are yours for the asking. Address Dept. ES10.

Quick Facts About "SCOTCH" No. 33 Electrical Tape

- **TOUGH**—plastic backing is abrasion resistant, unaffected by water or weather.
- **STRETCHY**—conforms snugly to uneven surfaces, odd shapes.
- **HIGH DIELECTRIC**—over 7,000 volts.
- **THIN CALIPER**—only .007 in. thick, insures neater work.
- **QUICK**—pressure-sensitive adhesive holds at a touch. Only *one tape* and *one operation* needed for all common electrical jobs.
- **P.S.** For high-heat insulation use "SCOTCH" Electrical Tape No. 27 with Glass Cloth Backing—Thermo-setting adhesive.



REG. U.S. PAT. OFF.
SCOTCH
BRAND
No. 33
Electrical Tape

ANOTHER **3M** COMPANY PRODUCT

MADE IN U. S. A. BY

MINNESOTA MINING & MFG. CO., ST. PAUL 6, MINN.,

also makers of other "SCOTCH" Brand Pressure-Sensitive Tapes, "UNDERSEAL" Rubberized Coating, "SCOTCHLITE" Reflective Sheeting, "SAFETY-WALK" Non-Slip Surfacing, "3M" Abrasives, "3M" Adhesives.

General Export: DUREX ABRASIVES CORP., New Rochelle, N. Y.
In Canada: CANADIAN DUREX ABRASIVES LTD., Branford, Ontario

wire through a bath of the material, thence through an infrared drying oven until the coating has been built up to the specified thickness. Indirectly heated cathodes such as that in the 2C39 are usually coated by spraying the material on with an air gun.

If the cathodes are too light or thin (below 6 milligrams per square centimeter cathode area), short life can be expected, as well as lower emission. If the cathodes are coated too heavily (above 15 milligrams per square centimeter), there is greater tendency for sparking and poor adhesion of the material to the core metal. The coating should dry with a smooth surface that is not coarse in texture and should be evenly distributed over the face of the core.

Alloy Cores

The core metal which supports the coating and reacts chemically with it to produce high emission is formed of a wide variety of metals. The choice is usually nickel alloy or tungsten alloy wire for filamentary cathodes, and nickel for indirectly heated cathodes. The core metal must not contain materials with low vapor pressures since the cathodes may run at temperatures above 900 C and it must have sufficient mechanical strength at these temperatures to maintain the electrode structure. It must chemically reduce the oxide coating, reacting with it to free metallic barium or strontium and, to a certain degree, match the expansion characteristics of the coating so that the bond between the two is not disrupted.

Extreme care is maintained to avoid contaminating the core metal before the emitter material is coated on. A degreasing and chemical cleaning is usually followed by hydrogen firing to prepare a surface entirely free of impurities.

Any volatile material driven off other metal parts while the tube is being pumped or operated is liable to poison the cathode so that the emission is seriously reduced. It is probably true that most emission troubles are caused by contamination from parts of the tube other than the cathode itself such as oil left on them from machining or drawing, or acid salts remaining



NACA Photo

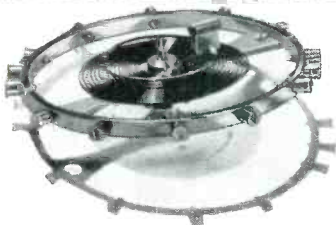

Hair Springs and Jet Engines

... IMPROVED BY HIGH VACUUM

AT several famous watch factories hair springs and main springs emerge from the vacuum annealing furnace with a bright finish. Thus, cleaning operations that are costly to the manufacturer and tend to weaken the springs are eliminated.

Jet engines impose terrific heats and stresses which quickly would melt or tear apart ordinary metals. The high vacuum furnace with its freedom from oxygen and other air gases is the invaluable tool of the metallurgist to produce the metals which help make possible the harnessing of jet power.

Uses for high vacuum seem unlimited. New high vacuum techniques are constantly finding their

way from the laboratory into science and industry.

Lenses, insulating paper, plastic forms, metal castings are beautifully, uniformly, and inexpensively coated by vaporizing gold, silver, chromium; and other metals in high vacuum chambers.

Substances once thought undistillable are fractionated in high vacuum stills.

Precious biological cultures are dehydrated under high vacuum to

multiply four-fold the length of time they keep their potency in storage.

Manufacturers of refrigerators produce more dependable products by employing high vacuum. Electronic tubes last longer the higher the vacuum achieved in them.

It may pay you to look into high vacuum techniques. The experience of DPI research men and engineers and the DPI line of high vacuum equipment are available to all industries. We invite inquiry.

DISTILLATION PRODUCTS, INC.

Subsidiary of Eastman Kodak Company

727 RIDGE ROAD WEST, ROCHESTER 13, N. Y.

Distillers of Oil-Soluble Vitamins and Other Concentrates for Science and Industry; Manufacturers of High-Vacuum Equipment.

WEBSTER ELECTRIC Featheride

CRYSTAL CARTRIDGES
that meet the requirements for
33 1/3, 45 and 78 RPM Records

MODEL F-16

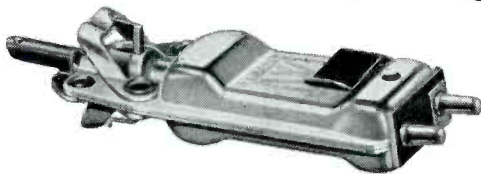

The model F16 is an all-purpose crystal cartridge employing two separate needles to permit playing both fine-cut and standard records . . . with a single tone arm and three-speed turntable. The cartridge can be rotated 180° in the arm to bring the proper needle into playing position. The model F16 is a quality cartridge with ideal response characteristics.

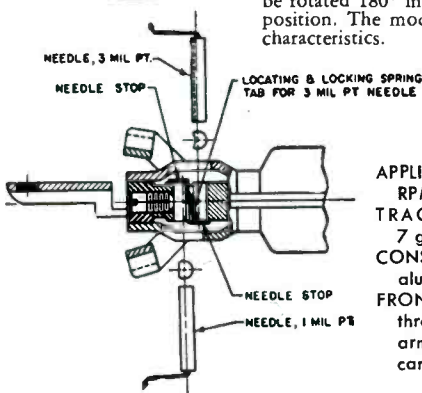

SPECIFICATIONS

APPLICATION: 33 1/3 RPM, 45 RPM and 78 RPM.

TRACKING PRESSURE: 7 grams for all speeds.

CONSTRUCTION: Stamped aluminum half-shells.

FRONT BRACKET: Extends through front of pick-up arm to permit rotating cartridge 180°.

STYLE: Osmium-tipped, replaceable. 1-mil point for 33 1/3 and 45 RPM, 3-mil point for standard 78 RPM.

TERMINALS: Pin type, grounded or ungrounded.

OUTPUT: 8 volt for 33 1/3 and 45 RPM, 1.2 volts for standard 78 RPM.

MODEL A-1

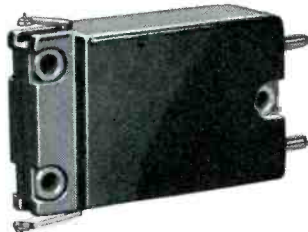

The Model A-1 crystal cartridge is newly developed . . . miniature in size and ideally adapted for tone arms of modern styling and function. It mounts either a 1-mil or 3-mil point stylus or both, making it applicable to all types of recordings in use today. Tracking pressure is only 7 grams . . . meeting the requirements of 33 1/3 and 45 RPM as well as the standard 78 RPM records. Adaptor brackets supplied for mounting in arms originally designed for standard cartridges.

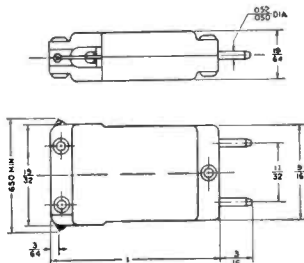

SPECIFICATIONS

APPLICATION: 33 1/3, 45 and 78 RPM recordings.

CONSTRUCTION: Bakelite housing.

TERMINALS: Pin type.

STYLUS: Osmium- or Sapphire-tipped.

TRACKING PRESSURE: 7 grams.

OUTPUT: 1 volt at 1000 cps.

WEBSTER ELECTRIC
RACINE WISCONSIN

Established 1909
Export Dept.: 13 E. 40th Street, New York (16), N. Y. Cable Address
"ARLAB" New York City

"Where Quality is a Responsibility and Fair Dealing
an Obligation"

after the cleaning operation.

One serious source of trouble is caused by oxides left on the metal parts when they are heated during glassing or soldering operations. If they are not completely removed by acid cleaning or broken down on the pumps, during operation of the tube oxygen may be liberated, the slightest trace of which will destroy the emission.

After spraying the cathode and assembling it into a tube, the next step in the process is conversion and activation on the exhaust pumps. When a sufficiently low vacuum is reached, the nitrocellulose binder is burned off by passing a current through the filament until the temperature of the cathode is raised to approximately 500 C. The carbonate mixture is then converted to the oxides of Ba, Sr and Ca, by slowly raising the temperature of the cathode to around 1,110 C, the carbon dioxide being removed by the pump.

The electron emission is still low at this point and the actual activation takes place by prolonged heating of the cathode (1/2 to 1 hour), and the application of gradually increasing anode voltage until the cathode emission is in the order of 300 ma per square centimeter cathode surface.

Twin Oscillator

By TY KIRBY
Radio Supervisor
Detroit Street Railways
Detroit, Michigan

THE TWIN OSCILLATOR described here was designed primarily as a stable oscillator which would be variable over a narrow band of frequencies. The theory of the twin is simple. Two oscillators are built on the same chassis using identical parts. The physical arrangement is made such that both oscillators are subjected to identical variations in voltage, temperature, humidity and other conditions. Then if there is any drift both oscillators should drift the same amount in the same direction.

One of these oscillators is padded with zero temperature coefficient capacitors to operate on a frequency slightly lower than the other. The feedback is then adjusted so both tubes operate on the same part of

GENERAL ELECTRIC

NOW BRINGS YOU

2

OUTSTANDING IMPROVEMENTS IN PERMANENT MAGNET MATERIALS

ALNICO 5 DG

Now—the G-E Alnico 5 DG permanent magnet offers manufacturers greater available energy than ever before! Results of the continuing program of G-E research and development—a change in the manufacturing process which aligns the crystal structure of the magnet in the direction of magnetization—have been incorporated in the product of Alnico 5 DG.

Available in cast form, Alnico 5 DG now offers manufacturers additional advantages: Use of smaller magnets to do the same job; reduction in the size of magnetic frame, with a corresponding reduction in costs; reduction in equipment weight—opening new design possibilities and production savings.

Available from production, cast Alnico 5 DG is ready to provide manufacturers of radio speakers, magnetic separators, meters, instruments, and other industrial products with the greatest external energy and residual induction of any permanent magnetic material known today.

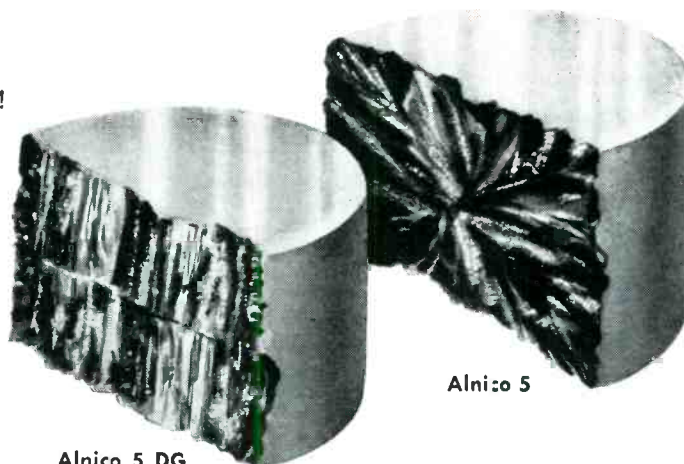

Alnico 5 DG

Alnico 5

Considerably smaller, this Alnico 5 DG permanent magnet has the same energy value as the Alnico 5. Note the directional grain growth which gives a higher energy value than can be obtained in the same size, random-crystal structure Alnico 5.

AND NEW ALNICO 7

Here is a new permanent magnet specifically developed by G. E. for applications where a high demagnetization force is present. In such applications as motors, generators, and variable air gap devices, new Alnico 7 shows a higher coercive force than any other grade of Alnico.

For more information on these magnets, and others in the G-E permanent magnet line, please write on your company letterhead to Section 14-10, Chemical Department, General Electric Co., Pittsfield, Mass.

You can put your confidence in

GENERAL ELECTRIC

Watch

CHICAGO

for the

BIG NEWS in TRANSFORMERS

New

Full Frequency Range INPUT and OUTPUT TRANSFORMERS

Freq. Response, ± 0.5 db, 20 to 20,000 Cycles



Catalog No.
BI-7

BI-7 INPUT: low impedance mike, pickup, or multiple line to grid(s). Pri: 50/150/250/600 ohms. Sec: 50,000 ohms CT. Unique in the field—has continuous, tapped primary winding that needs no series-parallel connections. Impedance changes are simple with rotary switch. Oper. level, +15 dbm. Hum reduction, -70 dbm. Sealed in compact, drawn steel case, $2\frac{1}{8}'' \times 2\frac{1}{4}'' \times 2\frac{1}{8}''$ List price, \$23.00

BO-9 OUTPUT: P-P plates to line or voice coil. Pri: 5000/3000 ohms CT. Sec: 600/150/16/8/4 ohms. Ideal for use with 6AS7-G, 6B4G's, 2A3's, etc. Stated freq. response measured at operating level of +40 dbm. In drawn steel case, $4\frac{3}{8}'' \times 3\frac{1}{4}'' \times 3\frac{3}{8}''$. List Price. \$22.00

Get details on the whole CHICAGO New Equipment Line

New

LOW PASS FILTER AND SPLATTER CHOKES

For limiting band width in low/high level speech applications



Catalog No.
SR-300

LPF-1 FILTER, for attenuating frequencies above 3000 cycles in low level speech amplifiers for aircraft, police, amateur, and other communications use. Operates from a 15,000-ohm source (plate of 6C5, 6J5, or triode 6SJ7) to a 100,000-ohm grid (step-up ratio, 2.6 to 1) or to a 500-ohm line. Has extremely sharp cut-off characteristics and negligible insertion loss. Operates efficiently at signal levels up to -8 db. A complete, self-contained filter in a compact, drawn steel case only $2\frac{3}{8}'' \times 2\frac{1}{4}'' \times 2\frac{1}{8}''$. List Price. \$10.00

SR-300. SR-500. SPLATTER CHOKES, for use in high level "clipper" filters to reduce the band width of AM signals, while permitting heavier modulation and greater effective, radiated power in speech transmitters. Windings are tapped for an inductance range of .02 to 1.5 hys. at relatively constant Q. Adequately insulated to withstand high peak voltages when heavy modulation is employed. Mounted in drawn steel cases with bushing-insulated terminals.

SR-300, 300 ma. d-c, size $5\frac{3}{8}'' \times 5\frac{1}{4}'' \times 4\frac{3}{8}''$ List price, \$17.00
SR-500, 500 ma. d-c, size $6\frac{1}{8}'' \times 5\frac{7}{8}'' \times 5\frac{3}{8}''$ List price, \$22.00

New

Catalog Line of HERMETICALLY SEALED TRANSFORMERS

. . . Meet All JAN-T-27 Requirements!



A complete range of power, bias, and filament transformers, and filter reactors, that meet all Grade I "JAN" tests for Class A operation. Famous CHICAGO "Sealed in Steel" constructions with bushing-gasket terminal seals. If you are in military research or development work, be sure to get complete details at once on this advanced line of hermetically sealed transformers.

5 NEW CATALOGS NOW AVAILABLE

- CHICAGO New Equipment Transformers
- CHICAGO Vibrator Transformers
- CHICAGO Replacement Transformers
- CHICAGO Television Transformers
- CHICAGO Hermetically Sealed Transformers

Ask for Them at Your Jobber, or Write Us Direct

CHICAGO TRANSFORMER

DIVISION OF ESSEX WIRE CORPORATION

3501 ADDISON STREET • CHICAGO 18, ILLINOIS



their curves and drift the same amount under varying conditions. The outputs of the two oscillators are combined and the difference between them used as our output frequency. Thus although any oscillator will drift slightly, as long as its twin drifts the same amount in the same direction at the same time, the output frequency is constant.

It was decided to build a twin whose harmonics would cover the amateur bands. The two halves of a 6SN7 were used in Clapp circuits for the twin oscillators, followed by a 6SN7 mixer and a 6SJ7 doubler. The unit was adjusted for balance in the center of its range and a series of one hour runs made to determine the amount of drift. The resulting drifts after one hour:

Low end of band, 16 cps per mc (negative); center of band, 0 cps per mc; and at the high end of band, 15 cps per mc (positive). The band in this case was 2 mc to 1.75 mc. Tests were run over a period of several weeks to determine at which frequency the drift would be the least. This was found to be 1.850 mc. The oscillator was set at this frequency on Friday at 10 p.m. and left running until the following Monday at 8 p.m. at which time the frequency was measured and the drift found to be 12 cycles (6 cps per mc approximate).

The unit was built on a 10 × 14

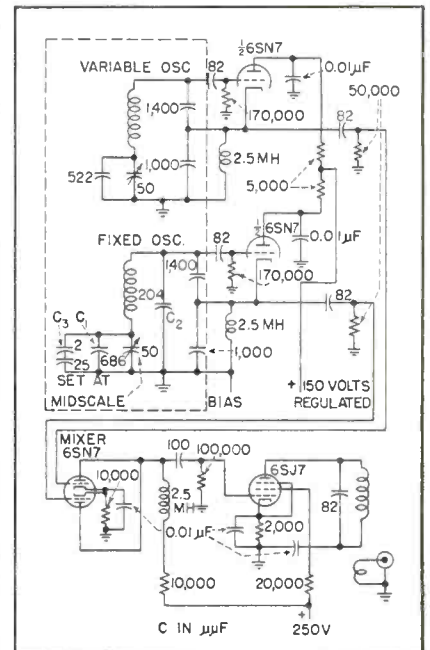

Schematic diagram of highly stable twin oscillator with output from 1.75 to 2 mc

WHERE ACCURACY IS ESSENTIAL

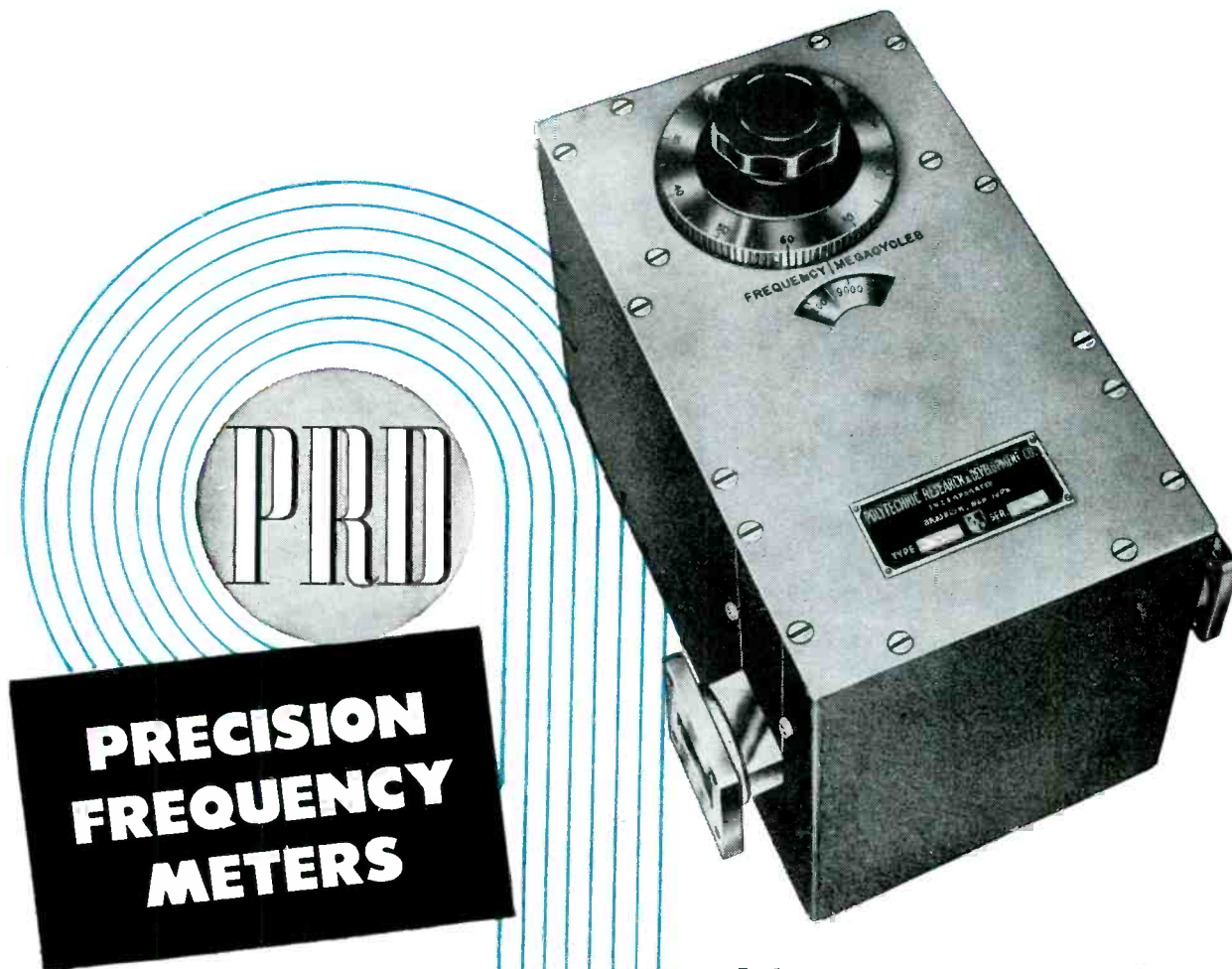

PRECISION FREQUENCY METERS

Features:

- DIRECT READING DIAL
- HIGH Q, TE_{011} MODE CAVITY
- LINEAR DRIVE
- TEMPERATURE COMPENSATION
- HERMETIC SEALING
- REACTION OR TRANSMISSION COUPLING

202 TILLARY ST.
BROOKLYN 1, N. Y.

In keeping with the increasing demand for greater precision in microwave frequency measurement, PRD now offers a complete new line of cavity type frequency meters, covering the spectrum from 3950 to 39,000 megacycles per second. These instruments feature for the first time direct reading dials of precisely linear frequency calibration, hermetic sealing to eliminate humidity effects, and the use of low temperature coefficient alloys to provide maximum accuracy over a wide range of temperature.

All units are calibrated by means of crystal controlled frequency standards to afford maximum precision for use in the fields of military and communications research as well as in the important new science of microwave spectroscopy. Write to Dept. E-4 for your copy of the new 95-page catalog describing PRD's complete line of microwave test equipment.



Polytechnic **RESEARCH
& DEVELOPMENT COMPANY, Inc.**

FOR

Cathode Ray Tube

PRODUCTION

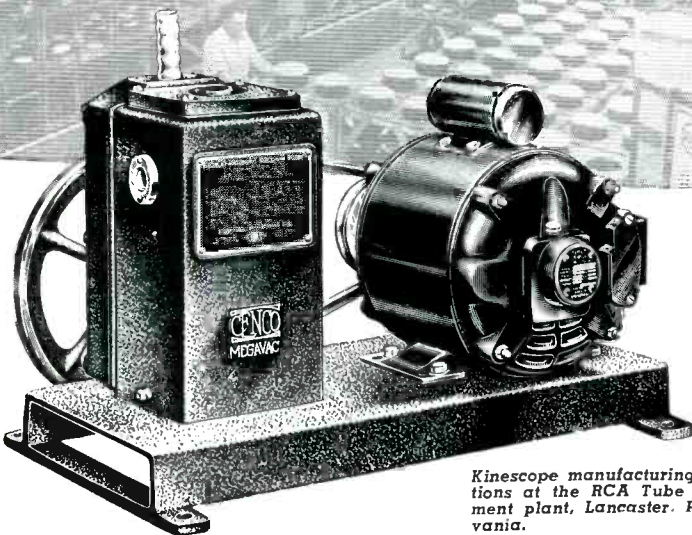

Kinescope manufacturing operations at the RCA Tube Department plant, Lancaster, Pennsylvania.

THE CENCO-MEGAVAC PUMP

is an excellent mechanical unit for high speed evacuating in cathode-ray and television tube production. This pump is proved for fast initial evacuation and dependable and trouble-free service. Makes an ideal unit for backing glass or metal diffusion pumps. Speed at 1 micron, 375 ml; vacuum, 0.1 micron or better. Specify No. 92015A Cenco-Megavac Pump mounted with base and motor for 115 volt, 60 cycle operation.....\$195.00

Also available with motors for other voltages and frequencies.

Write Dept. B. I. for engineering Bulletin 10A "High Vacuum Equipment".



CENTRAL SCIENTIFIC COMPANY

Scientific Apparatus • Instruments • Chemicals

1700 IRVING PARK ROAD, CHICAGO 13

NEW YORK BOSTON SAN FRANCISCO NEWARK LOS ANGELES TORONTO MONTREAL

TUBES AT WORK

(continued)

× 3 chassis with the power supply on a separate chassis to keep away unnecessary heat. The coils and variable capacitors were taken from surplus TU-10-B tuning units and used without alterations. All fixed capacitors used were zero temperature coefficient or silver mica types.

The coils are mounted on feed-through insulators above the chassis and a shield measuring 10 × 8 × 6 inches covers both coils. The outside of this shield is covered with asbestos to keep external heat away from the coils and the inside cover of the shield is covered with asbestos to aid in keeping the temperature on both coils the same.

The variable oscillator was padded to operate from 6.375 to 6.5 mc. The fixed oscillator is padded to operate at 5.5 mc. Since padding the variable capacitor changes the feedback in this Clapp circuit, part of the padding was done from the grid end of the coil to ground (C_2 in diagram) and these padding capacitors (C_1 and C_2) so proportioned that the plate current of the two oscillators was the same.

Because one oscillator operates at a different frequency than the other and tends to drift the same percentage rather than the same amount (in cycles), a 25- μmf silver mica capacitor (0.002 positive drift) was connected in series with a 2- μmf zero temperature coefficient capacitor and placed in the fixed oscillator circuit (C_3 in diagram). This brought the drift to zero in the center of the band chosen.

If the twin is to be used as a VFO in a CW transmitter the mixer circuit should be keyed. Since the oscillators are not on the output frequency and not keyed there is neither backwave nor chirp.

Although Clapp circuits were used for the twin oscillators any stable oscillator circuit would work. The less drift the individual oscillator circuits have the easier it is to compensate for the difference in drifts due to the difference in frequencies. Standard parts were used but parts which were used in both oscillators were individually matched since commercial tolerances are not close enough to serve the purpose.

DO YOUR MARKET RESEARCH...

in thousands of laboratories where

ENGINEERS DESIGN NEW APPLICATIONS FOR YOUR PRODUCTS

As the designs of existing equipment are simplified or improved for better end performance — as new equipment for tomorrow's production line is developed, design engineers find new, varied and strange uses for standard components, materials and allied products.

Yes, it is the design engineers in countless laboratories throughout the world's manufacturing centers that develop new applications and new markets for old line products. They also create, by their new design requirements, the need for new products... new tubes, components, new types of nuts or bolts; chemicals, metals and literally hundreds of others.

How to gather that market information

You can reach those design engineers through the advertising pages of **ELECTRONICS** — reach and influence their open and creative minds. And it will repay you ten-fold, for their creative talents will uncover unknown and profitable applications to enlarge the use and market for your products. They, more than 30,000 of them, through their own needs, will do a market research job for you in both known and heretofore unknown fields, provided you tell them your product story. Their inquiries and requests will provide the fundamental basis for your market research and product development.

Why advertise in electronics?

Because it is the one publication that design and control engineers whose work is concerned with the development of electronic and sensitive control gear must read for the information that is vital to successful designing. It is the only publication in which manufacturers can be sure to reach the greatest number of them.

electronics

A MCGRAW-HILL PUBLICATION



330 WEST 42nd STREET
NEW YORK 18, N. Y.



NEW 2½" INSTRUMENTS

easier to read!

more reliable!

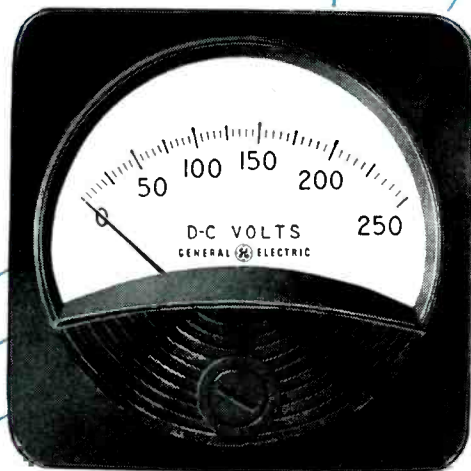

Here's a new 2½-inch instrument—styled to match the recently announced 3½-inch line—and specially designed for quick, easy reading.

Arc lines have been eliminated, leaving only the upright scale divisions, marked with legible vertical numerals.

A new type of tapered pointer helps focus the eye directly on the reading being taken.

And, the attractively styled case masks the lower part of the scale, covering all markings except those essential for reading.

IMPROVED INTERNAL DESIGN—The mechanism is a single, self-contained unit, all parts of which are supported by a high-coercive Alnico magnet. This assures permanent alignment even under severe operating conditions.

The high-strength Alnico magnet permits the use of a large air gap. This reduces the danger of foreign particles causing stickiness. The higher torque to weight ratio gives improved performance and better damping. The high torque also permits the use of large-radius pivots which can withstand greater vibration.

All these features contribute to the reliability and sustained accuracy of these instruments (2 per cent of full scale, except rectifier types, which are ± 5 per cent). Plan to incorporate these instruments in your radio, testing, or television equipment. They're available (in round or square case) as d-c ammeters, milliammeters, microammeters, voltmeters, thermocouple ammeters, and rectifier microammeters, milliammeters, and voltmeters; also a-c milliammeters, ammeters, and voltmeters. Complete details are given in Bulletin GEC-368. Write for your copy today. Apparatus Dept., General Electric Company, Schenectady 5, N. Y.

GENERAL ELECTRIC

602-162

THE ELECTRON ART (continued from p 128)

siderable energy from the entity being measured.

In biological applications the motions of small, soft membranes and tissues cannot exert much force, as undue strain would cause rupture as well as inaccuracy of measurements. The instrument described here was an attempt to keep this energy draw from biological entities at an absolute minimum. The mechanical motion is made to change the a-c impedance of two coils connected in a conventional Wheatstone bridge circuit, as shown in Fig. 1. Resulting variations in 1,000-cycle bridge output current are amplified and rectified for actuating a recorder. This instrument is now being used to study kinetic activities of bivalve mollusks. For the first time the encumbrances of the shell have been circumvented, permitting biological investigations under natural environmental conditions.

Probe Design

A small, light probe of nonmagnetic material rests on the tissue being studied so that a movement of the membrane in an upward direction exerts a very small force against a very light weight. Upon relaxation in the downward direction, gravity or surface tensions cause the probe to remain in contact with the tissue. Attached to the probe is a small piece of silicon steel of length equal to the cross-section thickness of one coil. Two coils are placed one atop the other and connected in a Wheatstone bridge circuit. The coils are adjusted so that the steel fragment lies halfway between them. A sim-

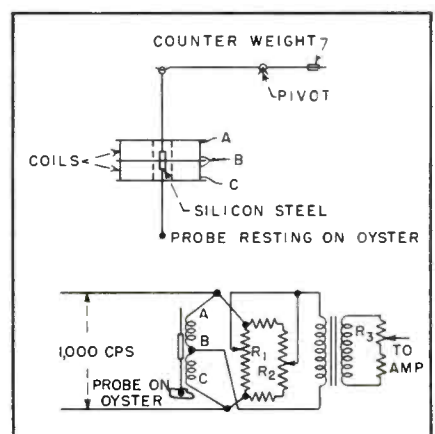
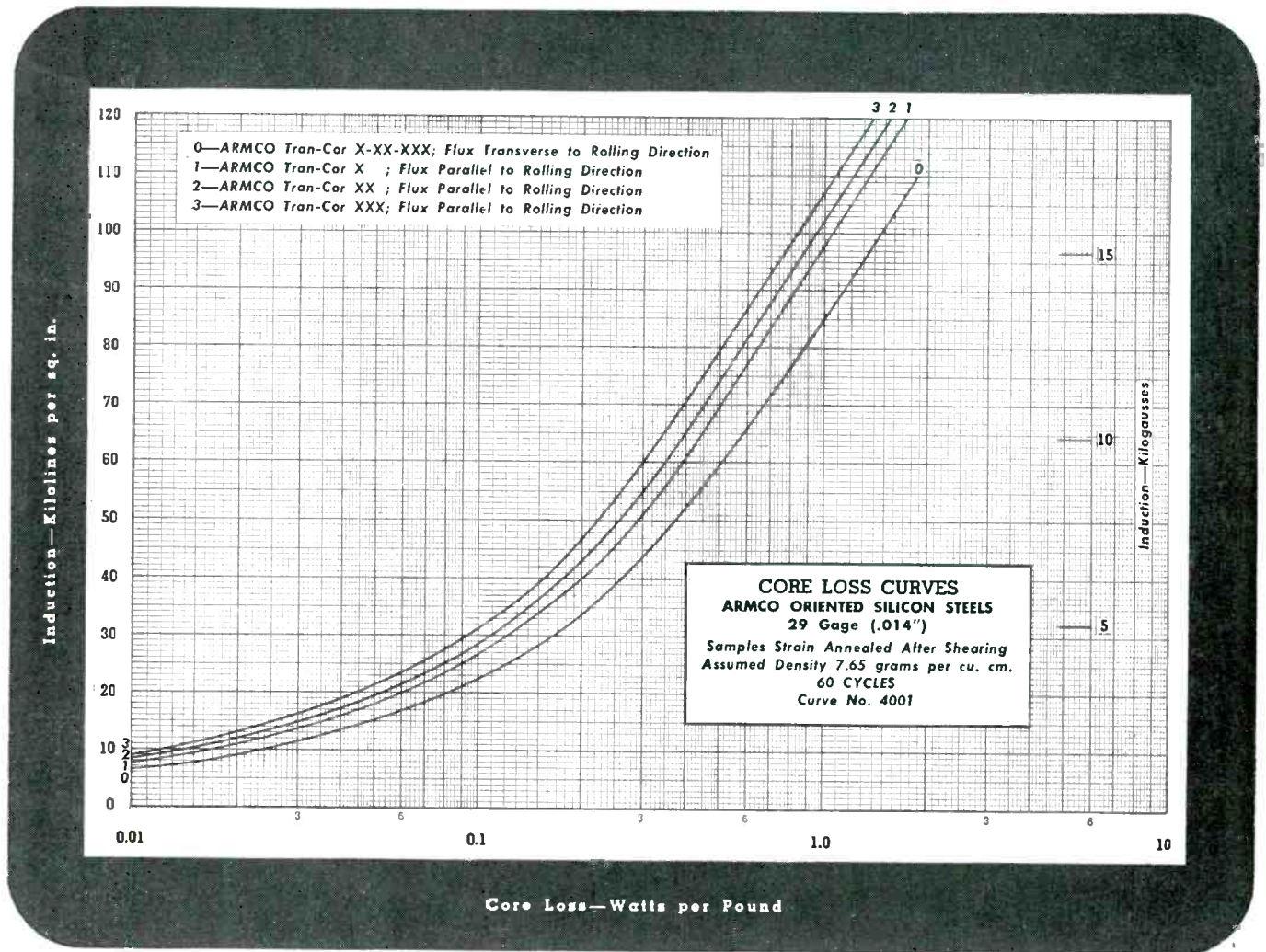

FIG. 1—Details of probe coils and detecting bridge

TYPICAL CORE LOSS CURVES FOR ARMCO ORIENTED SILICON STEELS



Want lower core loss with higher permeability?

These are the advantages you get when you specify Armco Oriented Electrical Steels for transformer cores:

1. Lower core loss in the rolling direction.
2. Higher permeability in the rolling direction.
3. Smaller cores that can be operated at higher inductions.
4. Permanent insulation on both sides of strip.
5. Improved ductility.

Armco Oriented Steels were the first fully annealed cold-reduced grades of oriented steels on the market. They are known as Armco TRAN-COR X, XX and XXX.

The high permeability of Armco Oriented Steels is fully utilized in wound cores, where the magnetic flux

is parallel to rolling direction of the sheet or coil. In stacked cores, any flux passage not in the rolling direction should be limited to small sections.

Magnetic qualities of these grades are fully developed at the mill by a special high-temperature heat treatment. However, it usually is advisable to give the laminations or wound cores a moderate-temperature stress-relieving anneal after fabricating.

If a study of the core loss chart on this page interests you, write us for the booklet titled, "ARMCO Oriented Electrical Steels." With the data in this booklet, you can determine suitable shapes and dimensions for wound cores of highest efficiency. Just write Armco Steel Corporation, 3359 Curtis Street, Middletown, Ohio.

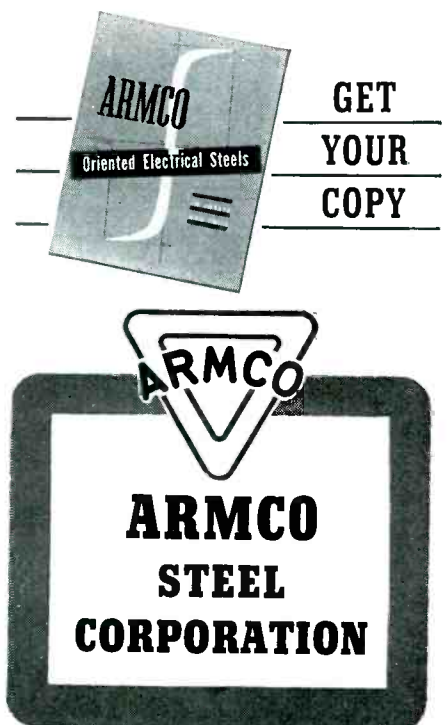

STANDARD A-N AIRCRAFT CONDUIT FITTINGS



AN3053 RIGID CONDUIT FERRULE is used with AN3054 Coupling Nut to couple a rigid conduit to straight and angle couplings.

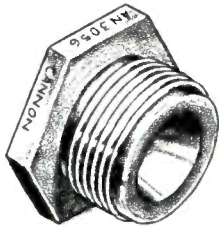

AN3056 CONDUIT COUPLING is used to connect rigid aluminum conduit to flexible aluminum conduit.

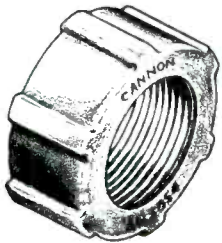

AN3054 CONDUIT COUPLING NUT is used for holding ferrules to connectors or fittings.



AN3064 BOX CONNECTOR is used with AN3066 Conduit Coupling Locknut to form a termination inside conduit boxes or panel.

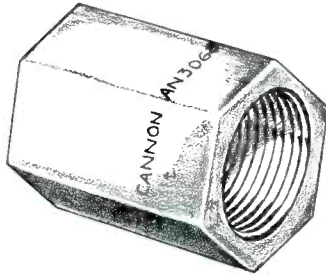

AN3068 CONDUIT COUPLING ADAPTER is used to make a coupling between any two male threaded conduit fittings.

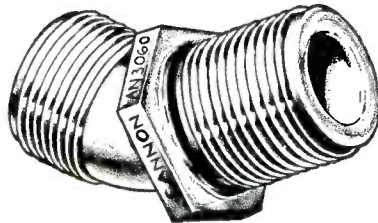

AN3060 ANGLE 45° CONDUIT COUPLING is used for connecting either flexible or rigid aluminum, brass or other conduit.



AN3058 STRAIGHT CONDUIT COUPLING is used with rigid conduit, flexible aluminum conduit, cable or loose wiring as a junction or with AN3066 Locknut as a feed-thru for panel or bulkhead.

Other available Conduit Fittings: AN3055 Adapter; AN3062 Angle 90° Conduit Coupling; AN3063 Conduit Coupling for 90° terminations; AN3066 Conduit Coupling Locknut.

For descriptive Bulletin AN-C, address Department J-120. Prices and delivery will be quoted by factory.

Cannon Electric Development Company, Division of Cannon Manufacturing Corporation, 3209 Humboldt St., Los Angeles 31, Calif. Canadian offices and plant: Toronto, Ontario. World Export (excepting British Empire) Frazer & Hansen, San Francisco, Los Angeles and New York.

SINCE 1915
CANNON ELECTRIC



REG. U. S. PAT. OFF.

ilar device could be designed to measure horizontal movements.

As the probe moves upward, the upper coil will have a corresponding increase in impedance, and at the same time the lower coil will decrease in impedance. Any coil changes due to temperature or to proximity of other objects affect both coils equally and cancel at the amplifier terminals.

Detecting Bridge

The bridge is operated in a slightly unbalanced state so that if the probe moves down, the bridge is moved further toward an electrical balance. Conversely, if the probe moves up, the bridge is further away from electrical balance. The balanced condition is to be avoided, since a passage through balance would result first in a voltage decrease, then an increase. Since the coils contain a steel fragment, the frequency of the oscillator must be stable. A change in frequency could result in a corresponding change in amplitude at the detector due to the change in impedance of the coils, transformers, and other circuit elements of the amplifier system.

A conventional 1,000-cycle Wein bridge oscillator is used as a source for the detecting bridge. This oscillator has good frequency and amplitude stability, and its frequency is sufficiently high to act as a carrier for the low frequencies to be detected.

Amplifier Circuit

As the system was designed to make two measurements and comparisons are often necessary, a buffer amplifier is used to decouple the bridges in each system from the oscillator. The circuit of this

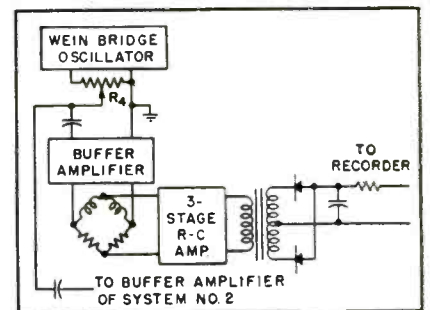

FIG. 2—Block diagram of complete carrier-type d-c amplifier system

Federated ROSIN CORE SOLDER

Look for the orange package . . . the universally popular solder for use in electrical applications where bonding must be secure and free from corrosion.

The flux is in the solder . . . all you need is heat! Federated Rosin Core Solder is available in 1, 5, and 20-pound sizes.



Federated makes every commercial solder . . .

Asarco Body Filler Metal, acid-core, solid wire, spray-gun, and bar . . . purity and composition guaranteed by the world's leading supplier of solder.

Federated METALS

Division of AMERICAN SMELTING AND REFINING COMPANY

120 Broadway, New York 5, N. Y.

OFFICES IN PRINCIPAL CITIES ACROSS THE NATION



arrangement is shown in Fig. 2. The gain of the two systems is equalized by a potentiometer when making comparative measurements. An oscillator voltage control is adjustable for sensitivity purposes. The amplifier is a conventional three-stage high-gain pentode system utilizing an 11-step degenerative feedback control for gain. The steps utilize selected resistors so that the feedback in both amplifiers is identical at the same setting of the control.

Since the amplifier is of very high gain, a well-regulated power supply is essential. Although the complete system using both amplifiers draws only 85 ma at 285 volts, the transformer, rectifier and filter are capable of delivering 450 volts at 250 ma. By using such a high voltage at the input of the voltage regulator, stability of the output at a 285-volt level is assured with the input varying between limits of 90 and 135 volts.

Operational Data

Using two 9,000-ohm coils (d-c resistance) in the detector system, a movement of 0.05 mm gave a deflection of 17 mm on recorders having a sensitivity of 1 ma for 6 inches (at 2 volts).

In operation, the probe and coils are adjusted to fit the individual oyster. The probe is adjusted so that the balance is slightly in favor of that part resting on the membranes of the oyster. The lower portion of the probe is thinly coated with a cellulose nitrate plastic and treated with a wetting agent prior to its immersion in the running salt water of the aquarium.

The pens of the recorders can be controlled by the balance units on the amplifiers. In this manner, a base line can be set in any position on the recorder. The amplitude of the recording can be regulated by varying the feedback in the amplifier or by varying the milliamperage range of the recorder.

The instrument can be set and the internal kinetic activities of the oyster determined for indefinite periods without the constant observations of the operator.

Other Applications

The carrier-type d-c amplifier system described here can be used

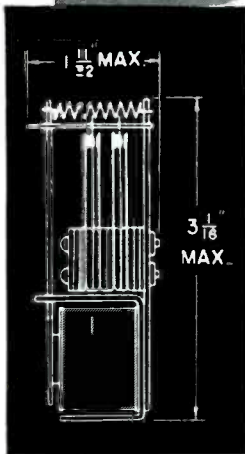
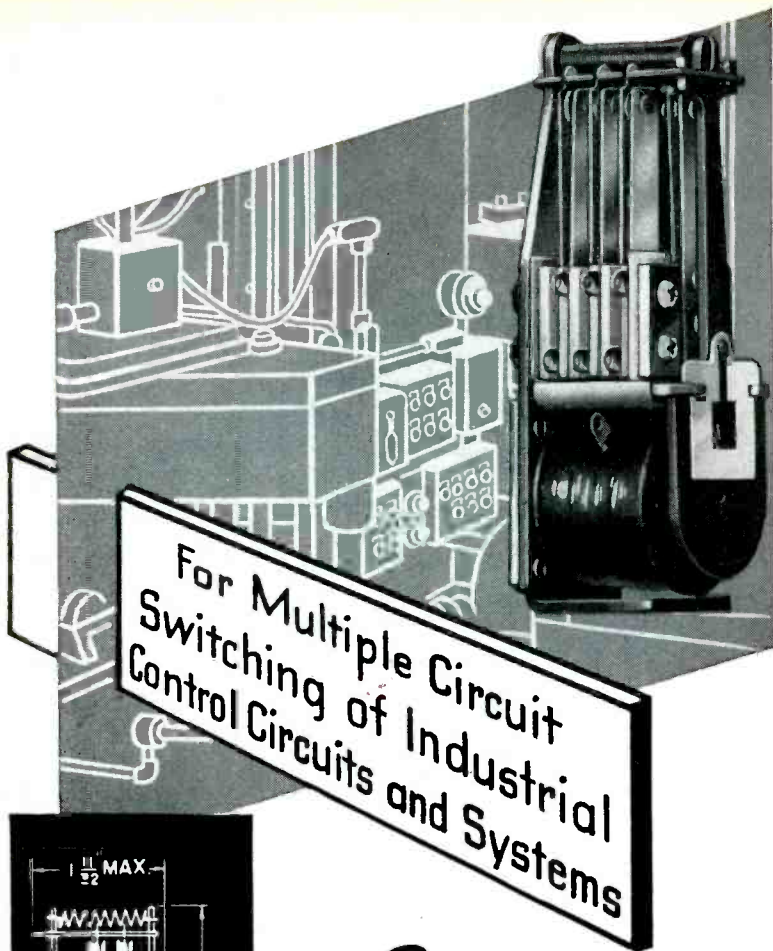

Sensitive MULTIPLE ARM RELAYS

Designed to give reliable service under the varying conditions encountered in industrial applications.

Compact for minimum space. Small power consumption.

Multiple contact arrangements utilizing up to 18 arms, requiring no extra space.

Available for surface mounting . . . in hermetically sealed containers, or with octal plug-in base and cover.

Contacts of silver or palladium, or special alloys, according to requirements.

WRITE FOR BULLETIN No. 50—6

SIGNAL ENGINEERING
and MANUFACTURING COMPANY
154 WEST 14th ST. • NEW YORK 11, N. Y.



Crash prevention

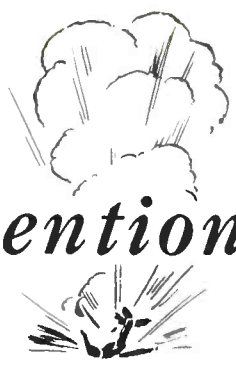

... WITH AN
ASSIST FROM
TELECHRON TIMING MOTORS

Preventing aircraft failures tomorrow depends on knowing exactly what causes them today. That's why so many modern planes carry a sure-to-survive witness that tells what mechanical malfunction betrayed the pilot's skill. It's the amazing new Flight Recorder that charts a continuous log of the variables that might cause a crash.

THE FLIGHT RECORDER MUST STAY ON TIME

The heart of this pilot's loyal supporter is a Telechron Timing Motor . . . *instantly, constantly synchronous*. Only such an accurate, trouble-free motor could be trusted to time the chart that shows the aircraft industry's planners how to add ever-increasing safety to the age of flight.

IS YOUR TIMING OFF?

You, too, can control or record your variable factors with the ultimate in accuracy. Just call in a Telechron application engineer. Drawing on the broadest experience in the industry, he can probably show you how a standard Telechron motor can do your job. Consult him early in your planning for big savings in time and money. TELECHRON INC. A General Electric Affiliate.

Telechron[®]

ALL TELECHRON TIMING MOTORS ARE

INSTANTLY...CONSTANTLY SYNCHRONOUS

TELECHRON INC
40 Union Street
Ashland, Massachusetts

Please send me information on sizes and types of Telechron Synchronous Motors. My possible application is:

- | | | | |
|-------------------------------------|--------------------------|--|--------------------------|
| Instruments | <input type="checkbox"/> | Communications Equipment | <input type="checkbox"/> |
| Timers | <input type="checkbox"/> | Other (please fill in) | |
| Electric Appliances | <input type="checkbox"/> | | |
| Cost Recorders | <input type="checkbox"/> | | |
| Advertising, Display Items | <input type="checkbox"/> | | |
| Juke Boxes | <input type="checkbox"/> | | |
| Air Conditioning & Heating Controls | <input type="checkbox"/> | <input type="checkbox"/> Please send new Catalog | |

NAME

COMPANY

ADDRESS

CITY..... ZONE.....

STATE



Put 'em on Pillows!

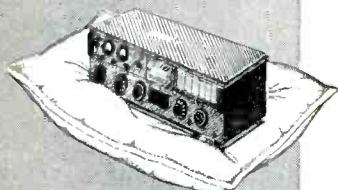
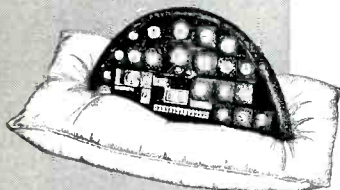
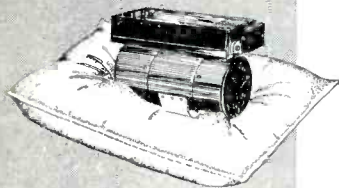

Regardless of the size, bulk or weight of units, mechanisms, instrument assemblies or electronic equipment, VIBRASHOCK mounts will safeguard them from the costly ravages of vibration and shock.

Experienced engineers, in all phases of manufacturing, have learned that when VIBRASHOCK equipment and Robinson experienced consulting services are used, the menace of vibration and shock is reduced to an absolute minimum.

VIBRASHOCK mounting systems are now available with MET-L-FLEX, the new all-steel resilient material, impervious to extremes of temperature. (VIBRASHOCK MET-L-FLEX mounts have been awarded the coveted "Yellow Dot" Approval for low temperature use by the Air Materiel Command.)

These mounts are available in many forms and sizes, including standard form factors. Special designs are available to meet a wide variety of applications.

VIBRASHOCK mounts insure new high standards of performance, durability and load tolerance. Send for detailed literature and performance curves, or write us regarding your requirements.

Vibrashock

MET-L-FLEX

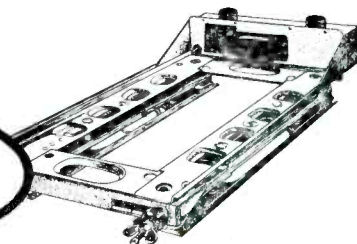

ROBINSON AVIATION, INC.

TETERBORO, NEW JERSEY

VIBRATION CONTROL ENGINEERS

for many other types of measurements involving very small movements, biological or otherwise. Strain gage measurements are just one example. The only requirement is that it be possible to convert the variable into a change in impedance of some circuit element.

Deposited-Carbon Resistors

PRECISION deposited-carbon resistors, born of necessity during the war as a substitute for the bulky and then unobtainable wire-wound units, have the advantages of high accuracy and stability accompanied by smaller size and lower costs. These resistors, developed by Bell Telephone Laboratories, are improved versions of similar products made in Europe prior to the war.

Pyrolytic carbon, which is carbon obtained by the thermal decomposition of gaseous hydrocarbons at high temperatures, is deposited in the form of a thin film on the surface of ceramic cores of varying length and diameter in a process resembling that which deposits undesired carbon in internal combustion engines. Films as thin as 1×10^{-4} to 5×10^{-8} inches can be deposited, the lower limit being set by the thickness of the average crystallites of which the films are composed.

By grinding helical grooves through the carbon film, the resistance of carbon deposited resistors can be increased from several thousands of ohms to a range of from about four to almost ten thousand times that value.

After the carbon has been deposited on a typical resistor, and the resistance-increasing spiral ground, graphitic or special metallic paint

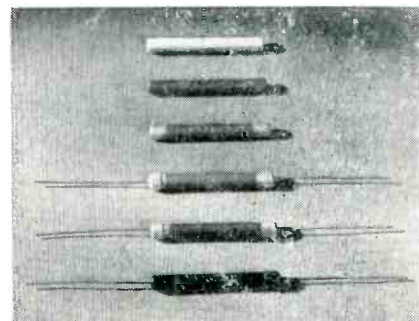

Deposited carbon resistors in various stages of completion

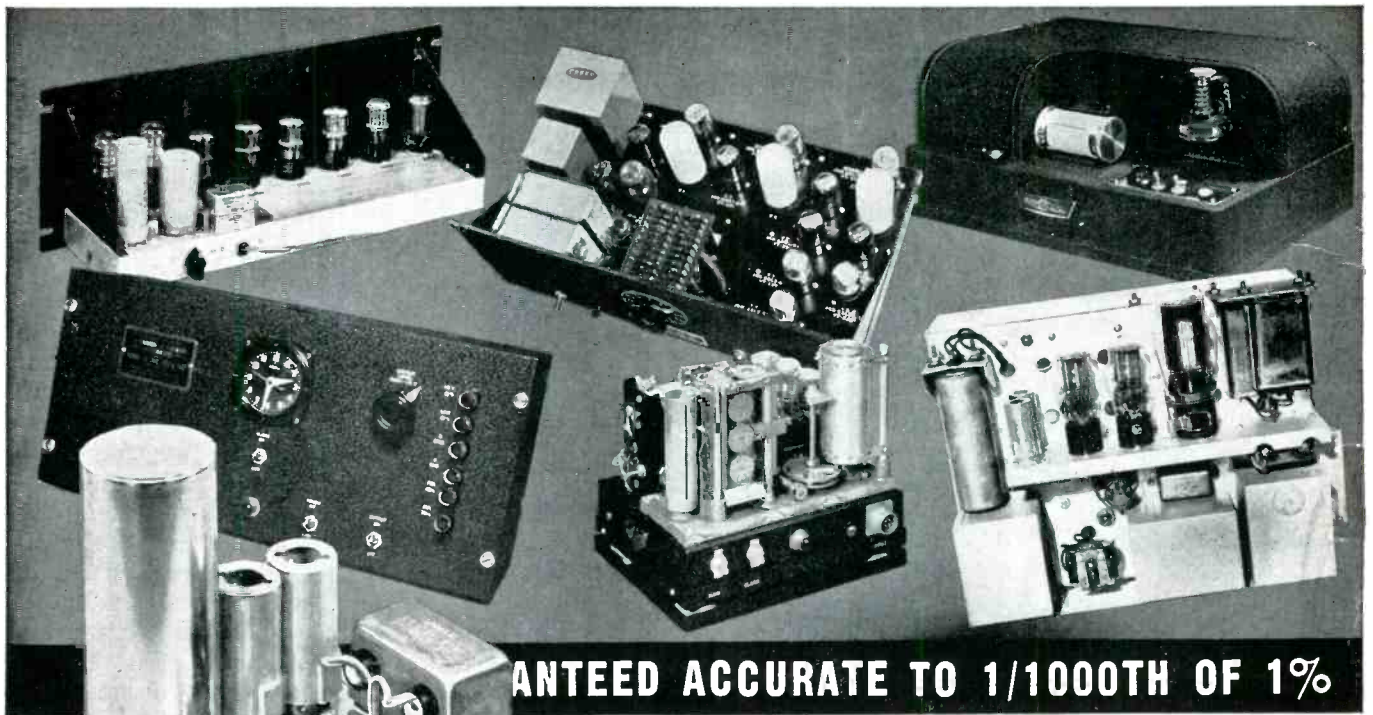

GUARANTEED ACCURATE TO 1/1000TH OF 1%

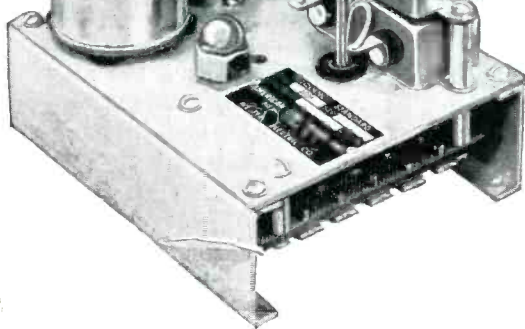

ELECTRONIC FREQUENCY STANDARDS AND GENERATORS

The basic unit of the frequency standards and generators presented here is an electrically driven tuning fork,—temperature-compensated and hermetically sealed against changes of humidity and barometric pressure. Through its use any frequency or multi-frequencies between 40 and 10,000, fractional or otherwise, are obtainable.

*Any Frequency
from 40 to 10,000
in fractions or otherwise*

FOR plant operations, for product development, for timing studies, wherever frequency generation or interval measurement is required, these instruments provide accuracy to 1 part in 100,000.

Their reliability and stability have been proven through the years here and abroad in Government Departments, aviation, industry and laboratories where precision is imperative.

The instruments with which the basic frequency standard unit is integrated are adaptable to an infinite number of uses. If you have a precision timing or frequency problem, we will be pleased to suggest a solution.

American Time Products, Inc.
580 Fifth Avenue New York 19, N. Y.

OPERATING UNDER PATENTS OF THE WESTERN ELECTRIC COMPANY

THESE THREE
NEW DEVELOPMENTS
ARE
Keeping
ASTATIC
Out in Front
IN THE
MANUFACTURE OF
**PICKUP
CARTRIDGES**

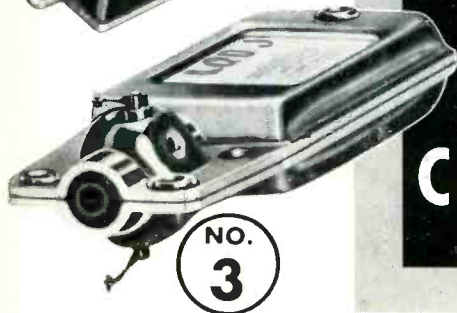
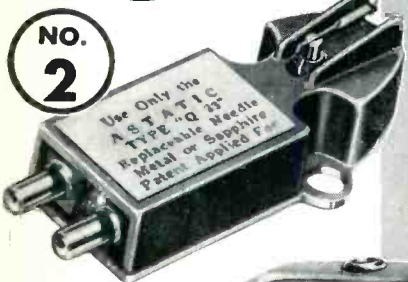
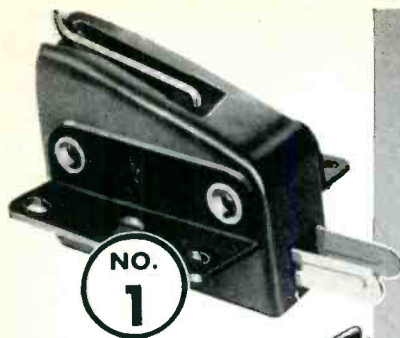

1 GC CERAMIC CARTRIDGE

First major engineering stride in phonograph pickup cartridges employing ceramic elements since Astatic pioneered in this type unit last year. The GC is the first cartridge of its kind with replaceable needle. Takes the special new Astatic "Type G" needle—with either one or three-mil tip radius, precious metal or sapphire—which slips from its rubber chuck with a quarter turn sideways. Resistance of the ceramic element to high temperatures and humidity is not the only additional advantage of this new development. Output has been increased over that of any ceramic cartridge available. Its light weight and low minimum needle pressure make it ideal for a great variety of modern applications.

2 CQ CRYSTAL CARTRIDGE

An entirely new Astatic design, featuring miniature size and five-gram weight. Model CQ-J fits standard 1/2" mounting and RCA 45 RPM record changers. Model CQ-IJ fits RMA No. 2 Specifications for top mounting .453" mounting centers. Needle pressure five grams. Output 0.7 volts at 1,000 c.p.s. Employs one-mil tip radius, Q-33 needle. Cast aluminum housing.

3 LQD Double-Needle Crystal Cartridge

The LQD Cartridge—for 45, 33-1/3 and 78 RPM Records—quickly became the first choice of many of the nation's largest users, on the basis of comparative listening tests, and is, today, the PROVED TOP PERFORMER for turnover type pickups. Outstanding for excellence of frequency response, particularly at low frequencies. A gentle pry with penknife removes ONE needle for replacement . . . without disturbing the other needle, without removing cartridge from tone arm. Gentle pressure snaps new needle into place. Available with or without needle guards. Stamped aluminum housing.

is applied to the ends as electrodes, connecting wires are attached, and the unit is treated with a coating of baking varnish. Several of the different stages of completion are shown in the accompanying photograph.

High-Frequency Applications

Resistors of this type have been found to be highly suitable for many high-frequency applications. The usual fluctuations of effective resistance at high frequencies are minimized because of the small inductance and capacitance of the units. Skin effects are also minimized because of the thinness of the films used. In fact, computations for the thickness of films on large-diameter cores show that the relative contribution of skin effect to resistance is negligible.

Spiralling changes the distributed capacitance only slightly, and it has been found that the alteration in high-frequency behavior of a resistor which is spiralled to a high-resistance value is largely that associated with the resistance increase alone. The inductance of a spiralled resistor is readily calculated by simple formulas.

Greatest constancy of effective resistance at high frequencies is obtainable when a glass envelope is placed around the resistor instead of the usual organic protective coating. This substitution reduces the effective distributed capacitance, which is a principal contributing factor in high frequency performance of any component.

Power-Handling Aspects

In power rating these components, the usual precautions must be observed since carbon tends to oxidize at temperatures above 160 degrees C. Even so, a unit with a suitable protective coating 1/8-inch in diameter and 3/4-inch long is capable of dissipating one watt continuously.

Many different forms of deposited-carbon resistors have been experimented with, including special forms of tee and pi attenuators of relatively small reactance. Laboratory tests show them to be reasonably constant to frequencies as high as 100 mc.

The power-dissipating ability of a given size of deposited-carbon re-

THE **Astatic**
CORPORATION
ASTATIC
CONNEAUT, OHIO
IN CANADA CANADIAN ASTATIC LTD TORONTO ONTARIO

Astatic
Crystal
Devices
manufactured
under
Brush
Development
Co. patents

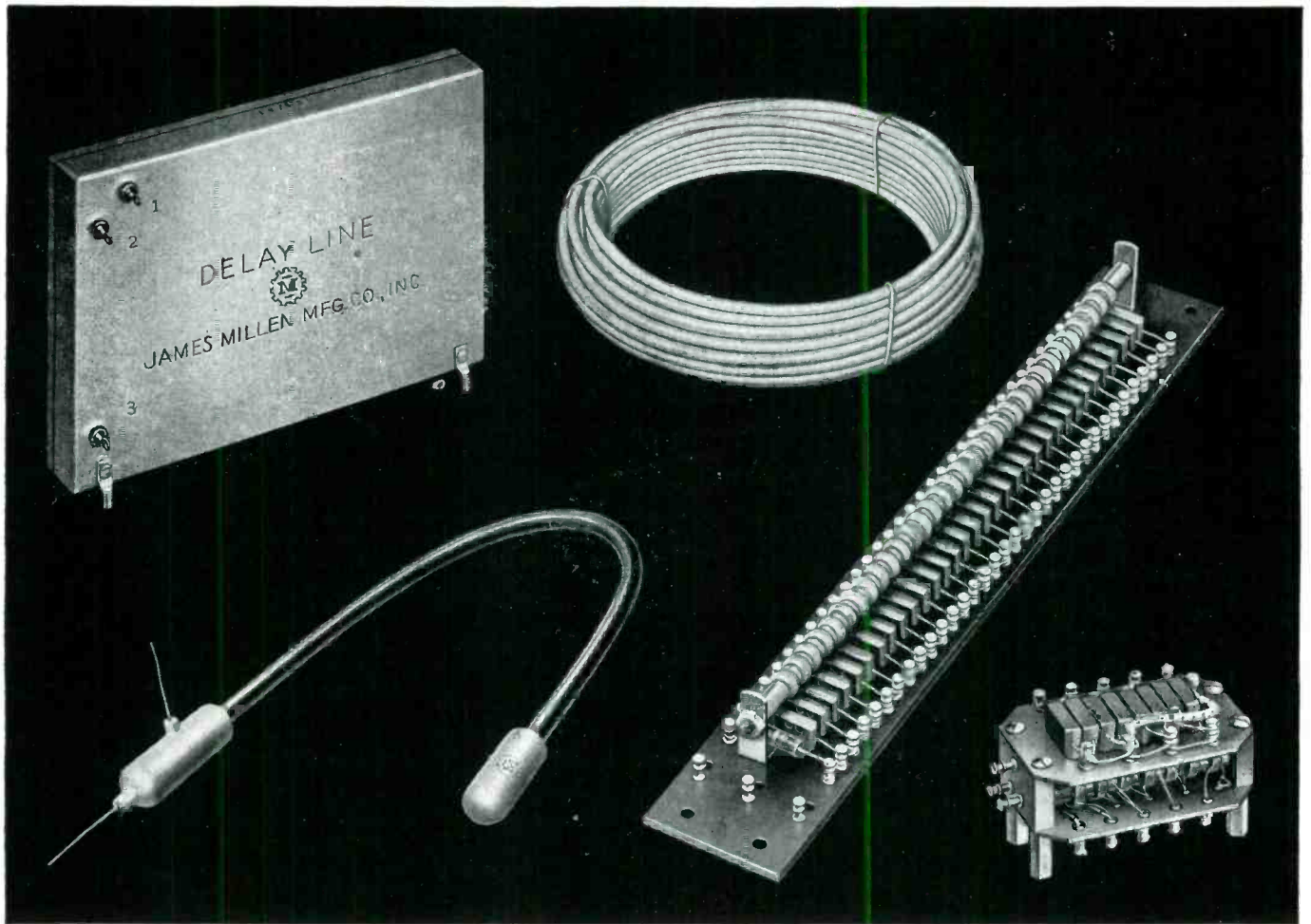

"Designed for Application"

DELAY LINES and NETWORKS

The James Millen Mfg. Co., Inc., has been producing continuous delay lines and lump constant delay networks since the origination of the demand for these components in pulse formation and other circuits requiring time delay. The most modern of these is the distributed constant delay line designed to comply with the most stringent electrical and mechanical requirements for military, commercial and laboratory equipment.

Millen distributed constant line is available as bulk line for laboratory use and in either flexible or metallic hermetically sealed units adjusted to exact time delay for use in production equipment. Lump constant delay networks may be preferred for some specialized applications and can be furnished in open or hermetically sealed construction. The above illustrates several typical lines of both types. Our engineers are available to assist you in your delay line problems.

Millen delay lines are illustrated and described in the new printing of our Laboratory Equipment catalogue, a copy of which will be sent upon request.

JAMES MILLEN

MAIN OFFICE

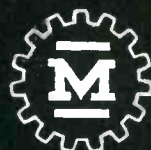

MFG. CO., INC.

AND FACTORY

MALDEN, MASSACHUSETTS, U. S. A.

NEW STEVENS THERMOSTAT

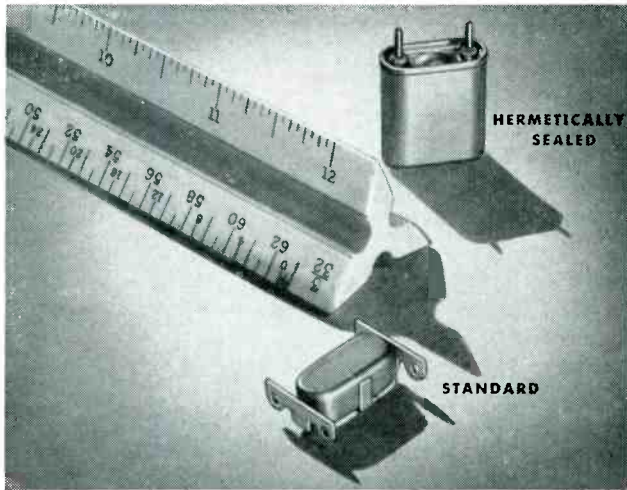

- close temperature control
- clean make and break
- fast response

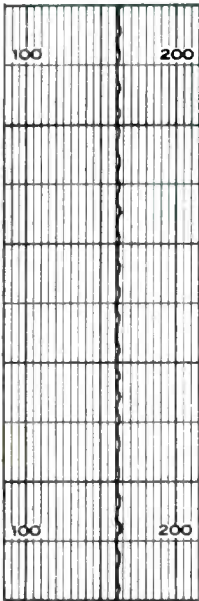

Compactly designed for use in communications equipment, electronic devices and apparatus demanding a high degree of temperature stability, Stevens Type C* thermostats feature an electrically independent bi-metal that responds *only to heat from controlled device.*

Typical temperature curve at left shows how this construction completely eliminates artificial cycling or life-shortening "jitters." Current flows readily through stainless steel or alloy contact spring . . . does not pass through high resistance bi-metal. Contacts open only when bi-metal overcomes spring pressure and friction of bi-metal strip against contact spring surface—for a clean, positive break.

Components are permanently riveted to dimensionally stable Alsimag base to further insure against erratic operation. Heavy-duty silver contacts assure long life.

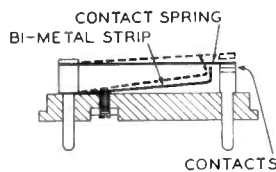

Standard and hermetically sealed Stevens Type C thermostats are carefully pre-calibrated in pots simulating actual service conditions; spot life-tests assure quality control. Specify Stevens Type C thermostats for closer temperature control—*longer life.*

A-2299

* PATENT APPLIED FOR

STEVENS manufacturing company, inc.
MANSFIELD, OHIO

sistor can be multiplied ten-fold by sealing the resistive element in a glass envelope containing a neutral gas. At their rated capacities, these units may be operated at red heat, the first limitation being imposed by the softening temperature of the glass envelope, if not otherwise limited by external conditions.

Another method which has been tried in an effort to increase the power handling capacity of deposited-carbon resistors makes use of water cooling. Because the water is brought into direct contact with the carbon resistance element, only a-c can be used with this type of cooling device since anodic oxidation of the carbon film will occur if d-c is used.

Microwave Secondary-Emission Switch

USE OF SECONDARY EMISSION in a microwave cavity to give a high-speed, high-frequency switch has been proposed by B. D. Steinberg of the Research Laboratory of Electronics at MIT.

A 10-cm cavity has been designed and constructed as shown in Fig. 1. The gap distance, d , is nominally 0.03 inch and may be varied from 0.015 inch to 0.045 inch by raising and lowering the diaphragm. The opposite faces of the gap consist of beryllium copper, a material whose secondary-emission ratio is approximately 3.5. The remainder of the cavity is copper. The shunt resistance of the cavity is on the order of 500,000 ohms, and the unloaded Q is about 3,000.

The cavity is interposed between a QK-61 magnetron and a matched load. It is operated on a vacuum

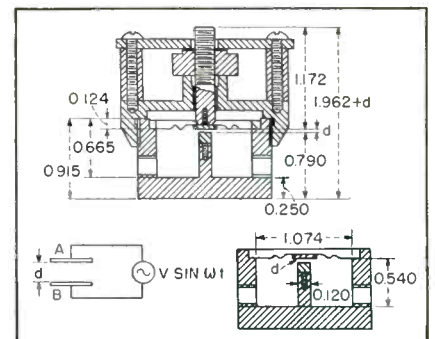

FIG. 1—Cross-sections of cavity and basic representation of secondary-emission switch



A NEW SOLUTION TO OLD PROBLEMS

**Aerocom's New Artificial Antenna,
Simulating Actual Operating Conditions,
Saves Time On Transmitter And Receiver Tuning**

It is no longer necessary to final tune transmitters or receivers aboard aircraft. With the new Artificial Antenna (Model DA200) you can precisely simulate, electrically, any normal aircraft antenna. All this without leaving the test bench. This equipment will accept any transmitter power up to 200 watts -- coaxial fitting provides direct 52 ohm metered load. Sturdily constructed for hard usage, can be mounted in standard rack cabinet or used on bench top.



**Keeping Your Radio Beacon
Signal "On The Air" Is Simple With
Aerocom's Automatic Transfer**

The problem of transmitter failure in radio beacons is very serious. The safety of crew and passengers depends on the continuous operation of this navigational aid.

Aerocom's Automatic Transfer provides the means of placing your standby transmitter "On the Air" should the main transmitter fail for any reason except loss of powerline voltage. It can be set to function either on abnormally low carrier power or abnormally low level of keyed tone identification signals.

A letter or wire from you will bring descriptive literature

**CONSULTANTS, DESIGNERS AND MANUFACTURERS OF STANDARD OR SPECIAL
ELECTRONIC, METEOROLOGICAL AND COMMUNICATIONS EQUIPMENT.**

AER - O - COM
Reg. U. S. Pat. Off.

AERONAUTICAL COMMUNICATIONS EQUIPMENT, INC.
3090 Douglas Road, Miami 33, Florida

DEALERS: Equipeleto Ltda., Caixa Postal 1925, Rio de Janeiro, Brasil ★ Henry Newman Jr.,
Apartado Aereo 138, Barranquilla, Colombia ★ Radelec, Reconquista 46, Buenos Aires, Argentina

Cut Polishing Time Improve Surface Quality

with "LINDE" FINE ALUMINA POWDERS

Now, you can choose the type of finish you want, free from microscopic pits and scratches, on metallic and non-metallic surfaces. And you can get these superior results in a fraction of the usual polishing time by using ultra-fine LINDE abrasive powders.

Because of extremely uniform particle size and form, smaller amounts of LINDE Fine Alumina Powders go further. You can use them directly from the container without expensive preparatory steps—or compound them with waxes and other vehicles to suit your need.

Two types are available. Type A is a quick-acting powder of hexagonal structure and sapphire hardness. Type B produces a still finer polish, almost as quickly.

LINDE Fine Alumina Powders may be the answer to your polishing problems. They have already gained acceptance in polishing metallographic specimens, gemstones, and other materials. Call or write any LINDE office to find out how these powders can be used to advantage in your particular polishing applications.

The term "Linde" is a trade-mark of The Linde Air Products Company

| | Type A | Type B |
|---|-----------------|----------------------|
| Chemical Composition | Alpha Al_2O_3 | Gamma Al_2O_3 |
| Particle Size (approximate) | 0.3 Micron | Less than 0.1 Micron |
| Hardness (Mohs) (Equivalent to crystalline material) | 9 | 8 |
| Crystalline Structure | Hexagonal | Cubic |

THE LINDE AIR PRODUCTS COMPANY

Unit of Union Carbide and Carbon Corporation

30 East 42nd St., New York 17, N. Y.  Offices in Other Principal Cities

In Canada: DOMINION OXYGEN COMPANY, LIMITED, Toronto

pump at a pressure of 5×10^{-5} mm Hg. The actual pressure is probably not significant so long as it is below a value at which the mean-free-electron path is several times greater than the gap distance.

If R is the secondary-emission ratio and n is the number of successive emissions, the gain, or ratio of final current to initial current, is R^n . In electrostatic secondary-emission multipliers, n is the number of emitting surfaces. However, if alternating fields are used, such that the electron stream returns m times to each of p surfaces, then $n = m \times p$.

With only two surfaces, designated A and B in Fig. 1, the gap distance d , the peak amplitude of the generator voltage V , and the frequency $f = \omega/2\pi$ are so adjusted that an electron leaving one plate at time $t = 0$ with a small or zero initial velocity strikes the opposite plate in $\omega t = \pi$ radians (as the field goes through zero). The secondaries produced by this electron will in turn be accelerated to the first plate, and will strike it approximately π radians later. These electrons will liberate secondaries which also will be directed by the field to the opposite plate. Hence, if the secondary-emission ratio is greater than unity, the current density in the space between the electrodes will increase.

The conductance of the gap is defined as the ratio of the current in the gap to the gap voltage. Being linearly related to the current the conductance will increase as the current increases.

Since electrons will successively strike the plates in $\omega t \approx \pi$ radians, the time per interval is π/ω , which

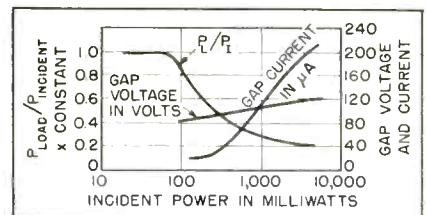

FIG. 2—Operating characteristics of cavity, showing the electron current in the gap, the gap voltage and the ratio of power transmitted to the load as functions of the incident power upon the cavity as functions of the incident power

Sorensen — The most *ECONOMICAL* line of Electronic Voltage Regulators



AC REGULATORS



GENERAL APPLICATION

Model NOS. 150S 250S 500S
Load-Range (VA) 0-150 0-250 0-500

MEDIUM CAPACITY

Model NOS. 1000S 2000S 3000S
Load-Range (VA) 0-1000 0-2000 0-3000

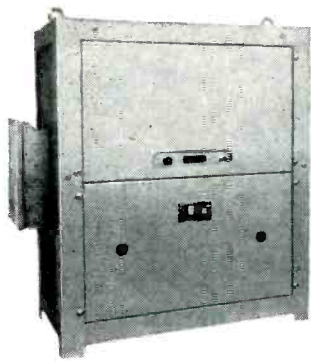

HEAVY DUTY UNITS

Model NOS. 5000S 10000S 15000S
Load-Range [VA] 0-5000 0-10000 0-15000

STANDARD AC SPECIFICATIONS

| MODEL IN VA CAPACITY | 150S 500S | 250S 1000S | 2,000S 3,000S | 5,000S 10,000S 15,000S |
|----------------------|--|---------------|------------------|------------------------------|
| Harmonic Distortion | 3% max. | 2% max. | 3% max. | 3% max. |
| Regulation Accuracy | ±0.1% against line or load | | | |
| Input Voltage | 95-130 VAC; also available for 190-260 VAC Single Phase 50-60 cycles | | | |
| Output Voltage | Adjustable between 110-120; 220-240 in 230 VAC models. | | | |
| Load Range | 0 to full load | | | |
| P. F. Range | Down to 0.7 P. F. All models temperature compensated. | | | |

NOTE: REGULATORS CAN BE HERMETICALLY SEALED

SORENSEN ELECTRONIC VOLTAGE REGULATORS are designed to meet the need for rugged, economical, low-maintenance-cost units. There is no need to buy extras — no need to buy more than you require when you purchase a SORENSEN regulator. Depend on SORENSEN — the FIRST line of STANDARD electronic voltage regulators.

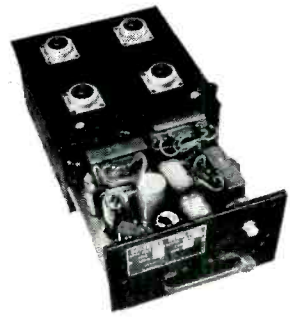

400 CYCLE LINE

Model NOS. D 100, D 500, D 1200, D 2000
Load-Range (VA) 0-100, 0-500, 0-1200, 0-2000
Accuracy ± 0.5% against line and load.
Maximum distortion 5%
Frequency Range 400 cycles ± 10%

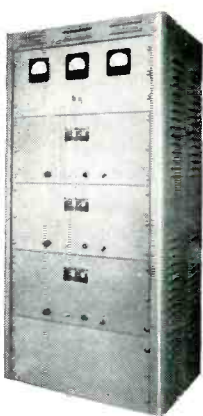

3 — PHASE REGULATION

All types of three-phase systems effectively handled. Sorensen Engineers available to review your particular problems.
Load range 450 VA to 15 KVA

DC REGULATORS

The SORENSEN NOBATRON (DC REGULATION) in effect eliminates the need for Batteries without losing any battery features. It maintains a constant voltage output against load variations, can be over compensated against line drop. It is a clean and self-sustaining source of DC power.

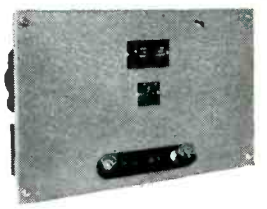

STANDARD DC SPECIFICATIONS

| *Output Voltage | 6 | 12 | 28 | 48 | 125 |
|----------------------------|--|---------|---------|----|------|
| **Load in Amperes | 5-15-40-100 | 5-15-50 | 5-10-30 | 15 | 5-10 |
| Input Voltage | 95-130 VAC single phase 50-60 cycles; adapter available for 230 VAC operation. | | | | |
| Regulation Accuracy | 0.2% from 0.1 to full load. | | | | |
| Ripple Voltage RMS Maximum | 1%. | | | | |
| Recovery Time | 0.2 seconds-value includes charging time of filter circuit for the most severe change in load or input conditions. | | | | |

*Adjustable ± 10% — 25%.
**Individual models identified by indicating output voltage first then amperes.
Example: E-6-5 = 6 VDC @ 5 amperes.

WRITE for FREE COPY of the "SORENSEN REGULATOR PERFORMANCE CHART"
Copyright 1949

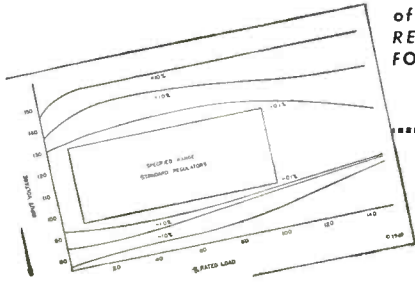

SPECIAL REQUIREMENTS can be met by employing the ORIGINAL SORENSEN CIRCUIT. Engineering Consultation available without cost.
JAN SPECIFICATIONS met by all AC models.

Sorensen and Company, Inc.
375 Fairfield Ave., Stamford, Connecticut

ADC *Yeoman* TRANSFORMERS

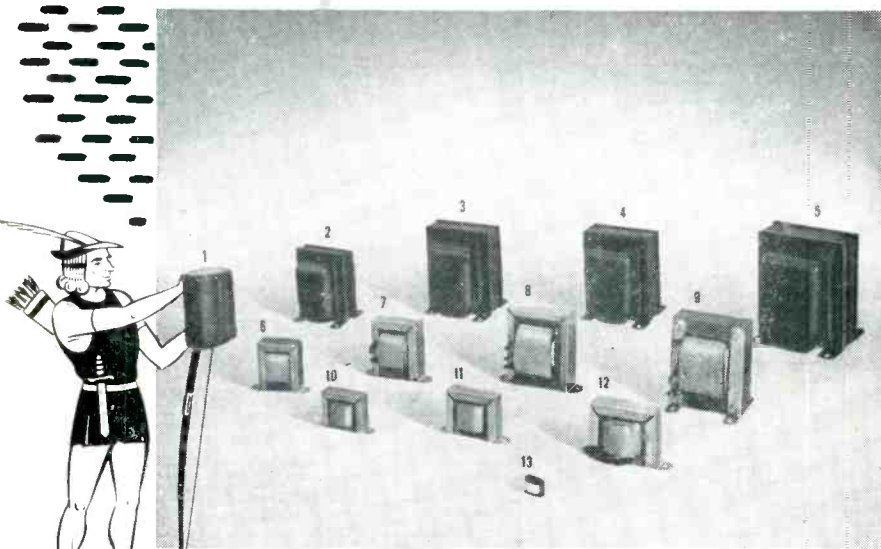

Quality AT LOW COST

High quality, low cost transformers for a wide range of applications are provided by ADC in its new Yeoman transformer line.

Many features of the ADC Quality Plus and Industrial series . . . widely known for their unvarying high standard of performance . . . are incorporated in the Yeoman line.

The low prices of the new Yeoman line are made possible by improved production engineering methods, simplified types of construction and standardization of parts.

Engineers, experimenters and amateurs will find in the Yeoman series the transformers for their needs.

**VISIT US AT
THE AUDIO FAIR**

Recent developments in new equipment will be displayed by Audio Development Co. at the Audio Engineering Society's "Audio Fair" in Hotel New Yorker, Oct. 27, 28 and 29. Walter E. Lehnert, noted design engineer and ADC vice president, will be there prepared to discuss special transformer design problems with you.

PICTURED ITEMS

| Type | Description |
|----------------------------|---|
| (1) 708A Band Pass Filter: | 200-3000 cps |
| (2) 517D Power: | Pri. 38 VA Sec. #1, 240-0-240 @ 40 ma DC Sec. #2, 5 V @ 2 amp Sec. #3, 6.3 V @ 1.6 amp |
| (3) 517H Power: | Pri. 104 VA Sec. #1, 300-0-300 @ 125 ma DC Sec. #2, 5 V @ 3 amp Sec. #3, 6.3 V @ 4.5 amp |
| (4) 517J Power: | Pri. 109 VA Sec. #1, 350-0-350 @ 125 ma DC Sec. #2, 5 V @ 3 amp Sec. #3, 6.3 V @ 4.5 amp |
| (5) 517N Power: | Pri. 174 VA Sec. #1, 400-0-400 @ 200 ma DC Sec. #2, 5 V @ 3 amp Sec. #3, 6.3 V @ 5.5 amp |
| (6) 516E Filament: | Pri. 9 VA Sec. 6.3 V CT @ 1 amp |
| (7) 516C Filament: | Pri. 19 VA Sec. 5.0 V CT @ 3 amp |
| (8) 516B Filament: | Pri. 31 VA Sec. 2.5 V CT @ 10 amp |
| (9) 517A Filament: | Pri. 72 VA Sec. 6.3 V CT @ 10 amp |
| (10) 416C Choke: | 8.5 hy @ 50 ma DC |
| (11) 416G Choke: | 8.0 hy @ 85 ma DC |
| (12) 516F Filament: | Pri. 24 VA Sec. 6.3 V CT @ 3 amp |
| (13) 208F Input: | Microphone Pri. 50/200 Sec. 62500/250000 |

New

The new ADC catalog will be a convenience in selecting almost any transformer you may need. Send for your copy today.



decreases as the frequency is raised. Thus, at high frequencies only a relatively short time will be required to effect a large change in gap conductance, and the tube may operate as a high-speed high-frequency switch.

Figure 2 shows the gap voltage, gap current, and ratio of load power to incident power as functions of the incident power; qualitatively, it shows that the ratio of load power to incident power decreases by a factor of five as the incident power is raised from 0 milliwatts to 3 watts. In the absence of an electron current in the gap, the ratio would remain constant. Of further interest is the voltage-current characteristic of the gap, which is determined from standing-wave measurements at the input to the cavity.

Measurements so far have been qualitative; techniques have yet to be refined before data will be reliable. However, it is fairly certain that the observed behavior of the cavity is due to secondary-electron current in the gap. When conclusive data is obtained at the present power levels, it is proposed to make measurements at higher power by replacing the present power source with a pulsed magnetron.

Oxide Cathode Theory

By WILLIAM COUCH

*Machlett Laboratories
Springdale, Conn.*

AUTHORITIES disagree widely on the exact mechanism by which an oxide-coated cathode is activated. The following theory seems to have the widest acceptance:^{1,2}

Metallic Ba, Sr, and Ca are liberated from the oxide by chemical reaction due to the reducing agents in the core metal, by positive ion bombardment of the cathode by residual gas which has become ionized by the electron flow, and by electrolysis caused by ion and electron flow through the body of the coating.

Due to these processes, a layer of free barium accumulates on the cathode surface, its low work function accounting for the copious supply of electrons at the relative low temperature. There is no absolute evidence that a monomolecular layer



Audio DEVELOPMENT CO.

"Audio Develops the Finest"

2847 13th Ave. South, Minneapolis 7, Minn.

He finds trouble by ear

As this cableman runs his pickup coil along the cable, his ear tells him when he has hit the *exact spot* where unseen trouble is interfering with somebody's telephone service.

Trouble develops when water enters a cable sheath cracked perhaps by a bullet or a flying stone. With insulation damaged, currents stray from one wire to another or to the sheath. At the telephone office, electrical tests on the faulty wires tell a repairman approximately where to look for the damage.

A special "tracer" current, sent over the faulty wires, generates a magnetic field. Held against the sheath, an exploring coil picks up the distinctive tracer signal and sends it through an amplifier on the man's belt to headphones. A change in signal strength along the cable tells the exact location of the "fault."

Compact, light, simple to use, this test set makes it easier for repairmen to keep your line in order. It is another example of how Bell Laboratories research helps make Bell Telephone service the most dependable in the world.

BELL TELEPHONE LABORATORIES

Exploring and inventing, devising and perfecting, for continued improvements and economies in telephone service.



How SPEED helped catch "bugs" in the lacquer



Final finish on pianos mysteriously going "sour." Production halted. Lab needed X-ray diffraction camera to identify impurity. At 9 A.M., 10-lb. camera Air Expressed from 1100 miles away, delivered by 4 P.M. same day. Cost, only \$3.58. Company uses Air Express as routine method to get supplies fast, keep inventory low.



That low \$3.58 figure was total cost for Air Express and included door-to-door service. That makes the world's fastest shipping method exceptionally convenient, complete, and easy to use.

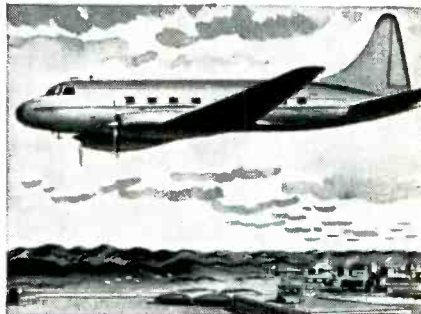

Scheduled Airlines carry Air Express on every flight. Speeds up to 5 miles a minute! Direct by air to 1300 cities; air-rail for 22,000 off-airline offices. Serves many foreign countries, too.

FACTS on low Air Express rates

Package of blueprints (4 lbs.) goes 800 miles for \$1.54.
Special tools (21 lbs.) go 600 miles for \$3.87.
(Every kind of business finds Air Express pays.)

Only Air Express gives you all these advantages: Special pick-up and delivery at no extra cost. You get a receipt for every shipment and delivery is proved by signature of consignee. One-carrier responsibility. Assured protection, too—valuation coverage up to \$50 without extra charge. Practically no limitation on size or weight. For fast shipping action, phone Air Express Division, Railway Express Agency. And specify "Air Express delivery" on orders.

SPECIFY AIR EXPRESS

GETS THERE FIRST

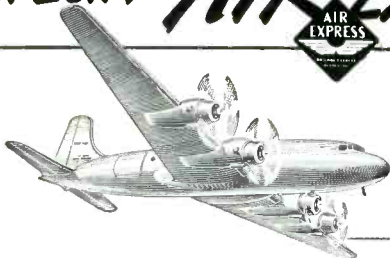

Rates include pick-up and delivery door to door in all principal towns and cities



AIR EXPRESS, A SERVICE OF RAILWAY EXPRESS AGENCY AND THE
SCHEDULED AIRLINES OF THE U.S.

of pure barium is formed but x-ray diffraction analysis indicates that a thin layer of strontium oxide is in the surface region, and that there is an absence of barium oxide.³ The argument for the barium layer is based on the facts that a small amount of oxygen in the tube will poison the cathode emission, presumably due to its reaction with the pure barium surface, and when metallic barium is deposited on an oxide-coated surface, the coating is activated.

The x-ray diffraction analysis spoken of above also indicates that complicated compounds are formed at the core metal-oxide interface.

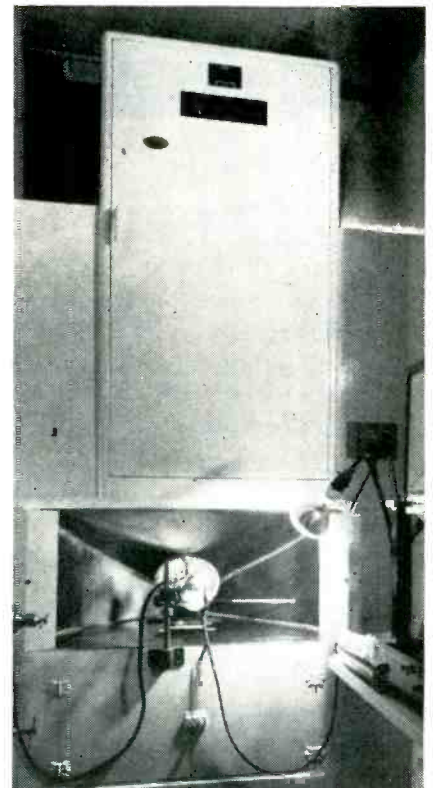

Constant speed rotating work table insures uniform deposits, and Raytheon electrostatic precipitator above table removes air-borne particles

That this plays an important part in pulsed emission phenomena will be discussed later. That it is not the source of the copious emission has been shown by removing the body of the coating by means of mechanical shock, leaving only the interface. A recheck shows little or no emission remaining. In summary, the present state of the theory leaves us with a layer structure for

THE ADLAKE MIGHTY MIDGET RELAY (No. 1110)

IS IDEAL FOR

Flasher Service

**IT IS DEPENDABLE—
REQUIRES NO MAINTENANCE**

The Adlake No. 1110 Relay is small enough to fit in one hand, yet it makes and breaks 30 amps. easily, and with low operating current.

Like all Adlake Relays, No. 1110 is hermetically sealed against dust, dirt, moisture and oxidation; mercury-to-mercury contact prevents burning, pitting and sticking. It's absolutely safe, *requires no maintenance*, and is cushioned against impact and vibration.

These qualities make the Adlake "Mighty Midget" ideal for use with flasher installations—as well as in power circuits, motor and heater controls, traffic signals and a host of other uses.

WRITE TODAY for FREE illustrated catalog, with details on No. 1110 and other new Adlake Relays. The Adams & Westlake Company, 1107 N. Michigan, Elkhart, Indiana.

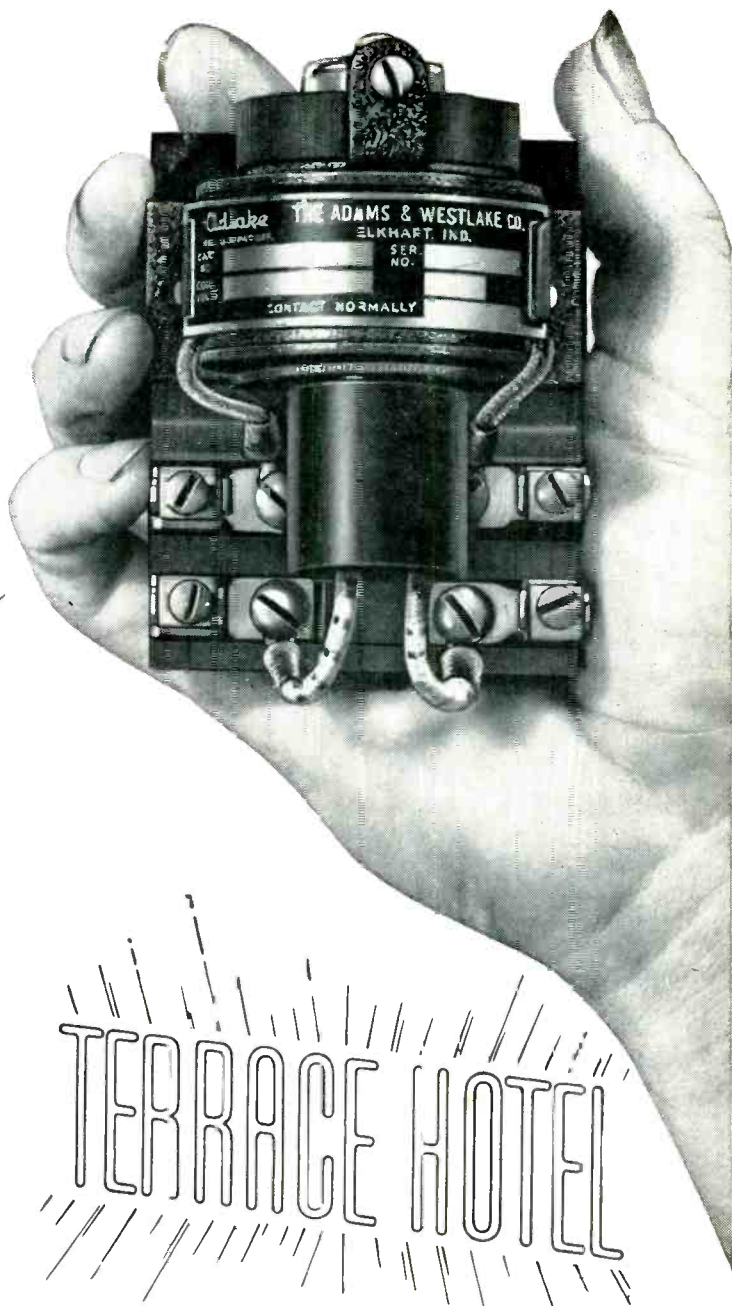

The Adlake Mighty Midget Relay gives you long, trouble-free service on outdoor installations. It's weatherproof, shockproof and absolutely dependable! Silent and chatterless! Equipped with compression-type terminals to simplify installations.



THE Adams & Westlake COMPANY

Established 1857 • ELKHART, INDIANA • New York • Chicago

Manufacturers of Adlake Hermetically Sealed Mercury Relays for Timing, Load and Control Circuits

that
big question of
**GOOD
INSULATION**

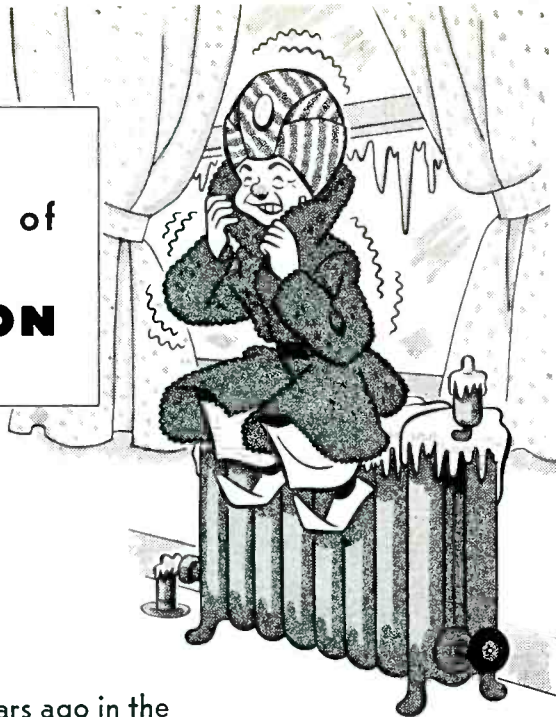

... was settled many years ago in the mica field, when engineers, specification writers and purchasing executives began to connect the name MACALLEN with MICA that was supreme in the qualities that made this extraordinary insulation material do an even better job than nature intended. Qualities such as variety and adaptability of shape, uniform thickness, flexibility, dielectric or other wanted characteristics. So — to product planners who realize that the importance of good mica is way out of proportion to its low cost in an assembly, mica has to mean MACALLEN MICA not some of the time, but all of the time.

DEPENDABILITY

is just another reason why MACALLEN MICA is way out ahead . . . you save time and trouble because of uniformity, cut assembly costs, increase profits.

MACALLEN MICA

ALL FORMS, ALL QUANTITIES — ALL DEPENDABLE

when you think of MICA, think of MACALLEN



THE MACALLEN COMPANY • 16 MACALLEN ST., BOSTON 27, MASS.

CHICAGO: 565 W. WASHINGTON BLVD • CLEVELAND: 1231 SUPERIOR AVE.

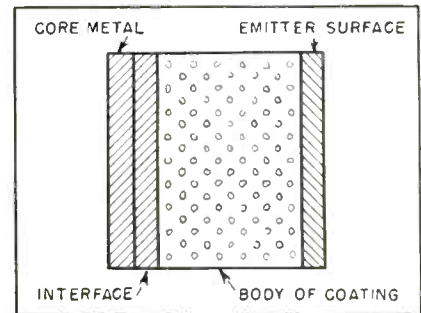

FIG. 1—Theoretical layer structure of an oxide-coated cathode installation for spraying oxide coatings on cathodes

the oxide-coated cathode, as pictured in Fig. 1.

Peak Emission Properties

During the war a great amount of study went into the properties of these cathodes due to their importance in pulse applications. Electrodes incapable of withstanding continuous dissipations of powers required could stand intermittent high peak powers providing cathodes could be made which would deliver the required peak currents at relatively low emission efficiencies. Classical emission laws of Richardson and Schottky yield information of little value to the engineer studying the peak emission properties of oxide cathodes due to various phenomena such as patch emission, cathode temperature rise and sparking which will be discussed. However, constants for Richardson's equation have been determined and are more or less agreed upon as $A = 0.01$ ampere per square centimeter per degree Kelvin squared, and $b = 11,605$ degrees Kelvin (since the work function is about 1 volt), giving an emission equation

$$I = 0.01 T^2 e^{-12,005/T} \text{ ampere per sq cm}$$

Use of this formula is practically vitiated by the following difficulties and phenomena:

(1) Inability to accurately determine T , since the thermal emissivity of cathodes varies a great deal among different ones as well as over the surface of any one.

(2) Inability to determine the emitting area since microscopically the surface of the material is very rough and since it appears that emission occurs preferentially in

Where cables can't go



TIME SHARING MULTIPLEX *can*

Natural hazards are no longer obstacles to the telephone engineer. Standard Time-sharing Multiplex can provide a thoroughly reliable trunk system which is easy to install and maintain in the most difficult terrain.

Each equipment deals with up to 24 channels, handling any kind of A.F. traffic in the 300-3400 c/s range, including teleprinter and automatic telephone signals. Time-sharing Multiplex ensures low crosstalk and noise levels, and fading does not affect speech levels.

A UHF carrier is used, and the normal line-of-sight range can be extended by automatic repeaters.

Complete terminal equipment occupies a double cabinet 7' wide x 2'4" deep x 6'6" high, and aerials may be up to 100' from the main equipment.

Write for Bulletin No. 511 which gives further facts and figures.

Standard Telephones and Cables Limited Radio Division

Associates of the International Telephone and Telegraph Corporation

OAKLEIGH ROAD, NEW SOUTHGATE, LONDON, N.11, ENGLAND
R.D.6.

HARDWICK, HINDLE

Tubular Rheostats

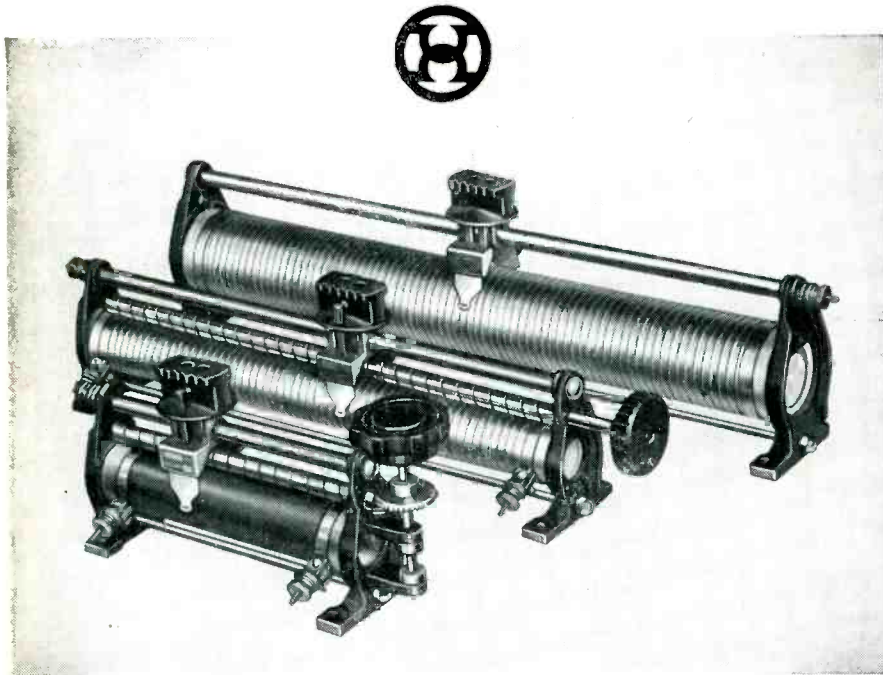

THESE FINE SLIDING contact rheostats are widely used in laboratories. They serve as rheostats or potentiometers;—portable, easily mounted, with fine gradations of adjustment.

These sturdy, improved tubular rheostats are used for accurate adjustment of voltage or current in meter-checking laboratories;—as field rheostats for generator and motor control;—as filament and plate control in radio and audio transmitting and amplifying apparatus;—for control of illumination and heat control in electric furnaces and ovens; as well as in general laboratory use.

Available in 3 sizes: 200, 400 and 750 watts with any one of 3 types of control.

Hardwick, Hindle resistors and rheostats offer many exclusive advantages. We ask you to give our engineers an opportunity to discuss your specific requirements.

HARDWICK, HINDLE, INC.

Rheostats and Resistors

Subsidiary of

THE NATIONAL LOCK WASHER COMPANY

NEWARK 5, N. J. Established 1886 U. S. A.

varying patches over the cathode surface.

(3) When current pulses are drawn at relatively high repetition rates there is a large rise in the cathode temperature due to the I^2R losses at the interface and within the body of the material.

(4) As the anode voltage is increased, the emission does not saturate, but the cathode will spark, transferring particles of oxide coating from the cathode to the anode. One or several such sparks will pit the emitting surface so that sparking will subsequently take place at lower voltages. Early in the life of the cathode this sparking occurs while the voltage is still in the space charge region on the straight portion of an I vs $E^{3/2}$ curve. Sparking is dependent on pulse width, occurring at lower voltages for greater pulse widths. It is also dependent on the nature of the cathode and the general condition of the tube, smooth cathodes and high vacuums having less tendency to spark. Other causes are incomplete activation, cathode misalignment, lint and burrs on the electrodes.

(5) For increased pulse widths it has been found that there is a tendency for emission decay, giving high emission on the leading edge of the pulse and low emission on the trailing edge. This phenomenon substantiates the theory of the blocking layer at the interface.³ However, recognition of the instantaneous dissipation in the anode at high peak currents leads to consideration of liberated gases which would temporarily poison the emission, be gettered, and the cathode become reactivated in time for the next pulse.

From this brief discussion it can be gathered that there is little correlation between the operation of a cathode in a receiving tube under normal continuous emission and the operation of a cathode in a pulse transmitting tube.

Life of Tubes

The life that can be expected from an oxide-coated cathode depends, of course, on the service it gets. For low-power receiver tubes 10,000 hours life is not unusual, as many home radio owners can attest. For pulsed emission tubes

SAVE TIME AND SKILLED LABOR

Discover the Efficiency

of BOWSER

SUB ZERO

TEMPERATURES

**In Laboratory Research . . . Testing . . . Standardization
AND PRODUCTION OF
Plastics, Liquids, Metals, Instruments, Chemicals, Etc.**



Bowser refrigeration units, producing temperatures as low as minus-150° f., are designed to meet the rigid requirements of modern industry in testing, processing and laboratory procedure. They are the result of many years of research and development . . . and are available in a number of standard models. Experienced Bowser engineers will design special units to meet specific requirements.

- 1. LABORATORY UNITS** . . . for the user who requires varying conditions of temperature, altitude and relative humidity. A typical application . . . complete testing of aircraft instruments under various conditions of flight.
- 2. RELATIVE HUMIDITY UNITS** . . . for the user whose products are not affected by low temperature or high altitude, but by moisture only. A typical application . . . testing for the moisture content of paper as it is being processed.
- 3. INDUSTRIAL UNITS** . . . for the user whose requirements do not call for conditions of

high altitude or relative humidity, but low temperatures only. A typical application . . . the expansion fitting of bushings.

- 4. UTILITY UNITS** . . . for the user who does not require the accuracy of our Laboratory Units. A typical application . . . production line spot checking of radio components.
- 5. ALTITUDE — VACUUM UNITS** . . . for the user whose products or testing requirements are not affected by temperature or humidity, but who is primarily interested in noting the effect of varying atmospheric pressures. A typical application . . . testing and proving the advantages or limits of vacuum packaging, as well as standard aircraft testing.

BOWSER, INC. REFRIGERATION DIVISION — 420 LEXINGTON AVE., N. Y. C.

IN CANADA, S. F. BOWSER CO., LTD., 344 SHERMAN AVE., HAMILTON, ONTARIO

YOU CAN BE SURE.. IF IT'S

Westinghouse

THE ELECTRON ART

(continued)

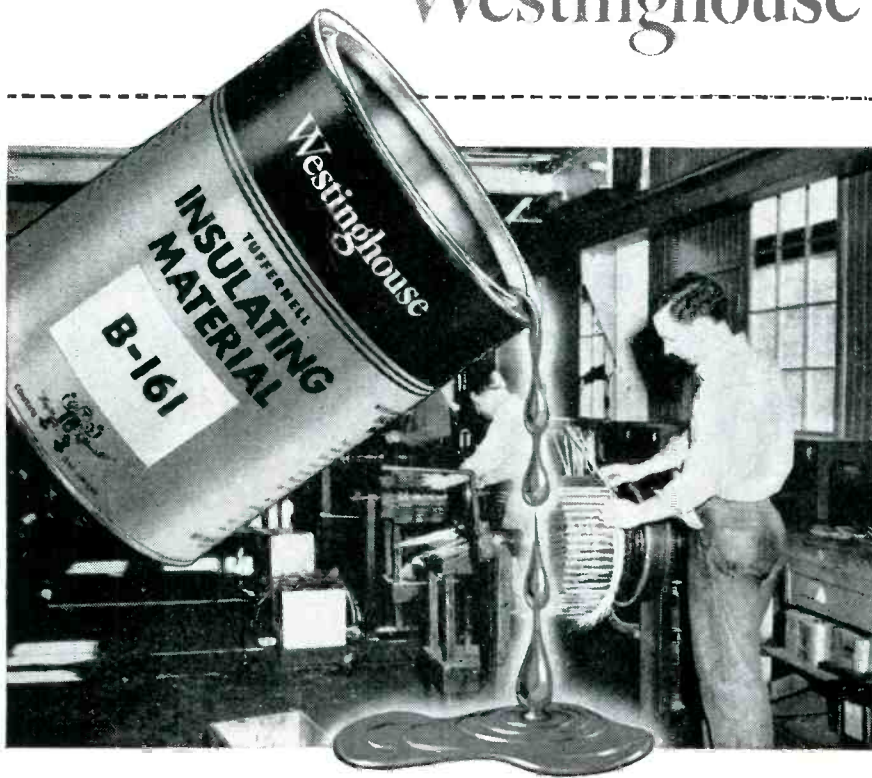

4-WAY PROTECTION FOR LONG ELECTRICAL LIFE

Give electrical apparatus the benefit of Tuffernell 4-Way Protection:

1. High dielectric strength
2. Long life at Class B operating temperatures
3. Excellent resistance to moisture, oil, acids and alkali
4. High bonding strength

These qualities are characteristic of the new Tuffernell Thermo-setting Varnishes. For example, Tuffernell B-161 is already a favorite with many users. It provides the *extra* protection needed for dependable operation under conditions where ordinary varnishes break down.

A good illustration is the growing use of Tuffernell for mine electrical equipment. Below ground, and above, the service is unusually severe. Many progressive mine operators now use Tuffernell exclusively when rebuilding apparatus.

Such proof of performance is assurance of dependability for your equipment, too. For data on the complete Tuffernell line, call your nearby Westinghouse office. Ask for Bulletins 65-120 and 65-130. Or write Westinghouse Electric Corporation, Dept. 39, P. O. Box 868, Pittsburgh 30, Pennsylvania. J-06433

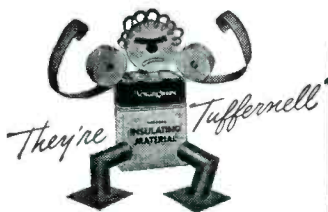

Westinghouse
TUFFERNELL INSULATING VARNISHES
— for every electrical need

with cathodes operated at higher temperatures, such as tubes used in radar transmitters, the life is considerably shorter since the rate of evaporation of barium from the coating determines the life. For some pulsed operations 500 hours life may be all that is realized. Cathode heater ratings should be closely adhered to, both from the standpoint of overheating and resultant foreshortening of life and the standpoint of underheating resulting in reduced emission and tendency for cathode sparking.

In summary, the chief troubles with oxide-coated cathodes are: (1) Poisoning of the emission by liberation of gases from within the tube, or from contamination of the coating by impurities such as chemical salts; (2) disrupting the coating-core metal bond by overheating the cathode or too rapid evolution of gases during conversion on the pumps; (3) sparking of the cathode due to excessive voltage, rough coating material, incomplete conversion, and scores of other reasons.

REFERENCES

- (1) J. P. Blewett, Properties of Oxide-Coated Cathodes, *Jour. Appl. Physics*, Oct. 1939 and Dec. 1939.
- (2) L. R. Koller, "Physics of Electron Tubes," McGraw-Hill Book Co., p 41-51.
- (3) A. Eisenstein, A Study of Oxide Cathodes by X-ray Diffraction Methods, *Jour. Appl. Physics*, June 1946 and July 1946.
- (4) E. A. Coomes, The Pulsed Properties of Oxide Cathodes, *Jour. Appl. Physics*, p 647, 1946.

SURVEY OF NEW TECHNIQUES

IN THE MANUFACTURE of fluorescent lamps of uniform quality it is desirable to be able to control the thickness of the powder coating on the inside of the glass tube. A recently developed instrument, which quickly measures the light transmission of powders, permits rapid determination of the thickness of the powder layer, through the use of calibration curves derived from appropriate transmission factors. A collimated beam of light from a filament lamp is passed down a narrow tube and directed onto a light-sensitive tube by means of a prism. The coated glass to be measured is passed between the prism and the phototube. By this arrangement the entire coated sur-



UNDER SEVERE CONDITIONS

Three years ago Sangamo successfully pioneered the FIRST molded tubular capacitor. The experience gained in these three years is now applied by new effective manufacturing methods, and proven by special exhaustive tests which invariably exceed the requirements of actual service conditions. Thus, the Type 30 you purchase today offers positive promise of exceptional long life under severe conditions.

- 85° C Performance:** Excellent. Trouble-free long-life operation in spite of the high temperatures encountered in auto radios, television receivers, or any other application where high temperatures cause trouble.
- Humidity Resistance:** Excellent. Results show insulation resistance practically unchanged under severe conditions of humidity.
- Immersion Resistance:** Excellent. Far surpasses any existing specification requirements. Insulation resistance not impaired.
- Exposure Resistance:** Excellent. Accelerated exposure test comparable to prolonged field exposure, but more severe, results in no change in performance ability.
- Mechanical Strength:** Excellent. Leads resist breaking or pulling out, even when handling is extremely rough.

Remember this about Sangamo Type 30 Tubulars: They are molded at *low* pressure. This means their elements are undamaged in fabrication. It also means longer life, greater dependability, and the absence of "hot spots." A trial of Sangamo Molded Tubulars will convince you!

Your Assurance of

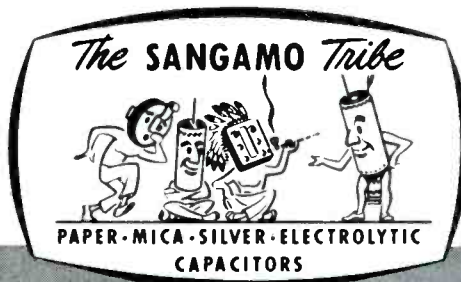

Dependable Performance

SANGAMO ELECTRIC COMPANY

SPRINGFIELD · ILLINOIS

IN CANADA: SANGAMO COMPANY LIMITED, LEASIDE, ONT.

SC4911

ALL THIS!

...in the **IMPROVED**

E-V
Cardyne

**CARDIOID DYNAMIC
MICROPHONE**



**It Means: Better Performance!
Finer Quality! Greater Value!**

Recessed Impedance Selector
Dual-Type External Shock Mount
Non-metallic Acoustalloy Diaphragm
Built-in Cannon XL-3 Connector
E-V Mechanophase* Cardioid
High Output Level
—50 db, Model 731 —53 db, Model 726
Smooth Wide Range Response
30—12,000 cps, Model 731
40—10,000 cps, Model 726
Enclosed Magnetic Assembly
With or Without "On-Off" Switch
Wider Stand Mounting Stud
Highest Purity Cast Case
Satin Chromium Finish

Model 731. Broadcast Cardyne II
List Price \$80.00

Model 726. Cardyne I. With MC-3
connector and without external
shock mount. List Price . \$59.50

Try the Cardyne now! Send for Bulletin No. 139

ELECTRO-VOICE, INC., BUCHANAN, MICH.

Export: 13 East 40th St., New York 16, U.S.A.

Cables: Arlab

NO FINER CHOICE THAN

Electro-Voice

*Patent Pend.

face can be explored. Output from the phototube is measured on a meter scaled to show 100-percent transmission when a clear glass tube is tested.

EXCESSIVE SOLAR ENERGY outbursts in the radio-frequency range are closely correlated with relay chatter in electric power distributing systems, according to reports from a group of interested public utilities. A year's study of solar radiation intensity in the radio-frequency range indicates a slight degree of polarization in received signals. This information is considered to be of possible significance in interpreting the structure of the earth's upper atmosphere.

EXPERIMENTS HAVE SHOWN that the starting voltage of low-pressure positive-column discharge lamps is dependent on ambient atmospheric humidity, even though the lamps are completely sealed. Under humid conditions the necessary starting voltage for a mercury-argon-filled fluorescent lamp may rise by as much as 50 percent. It is believed that the phenomenon may be due to distortion of the electric field in the lamp caused by locally-charged areas on the wall of the glass tube. A cure for the abnormally high starting voltage is a narrow ground strip attached to the glass tube.

RADIOACTIVE PHOSPHORUS mixed with the other components of fertilizer enables agriculturists to determine how much fertilizer a plant will use, how close to the plant the fertilizer should be placed and when it should be applied for maximum yield. A Geiger counter is used to determine the assimilation.



Special clothing protects technician engaged in experiments with radioactive fertilizers

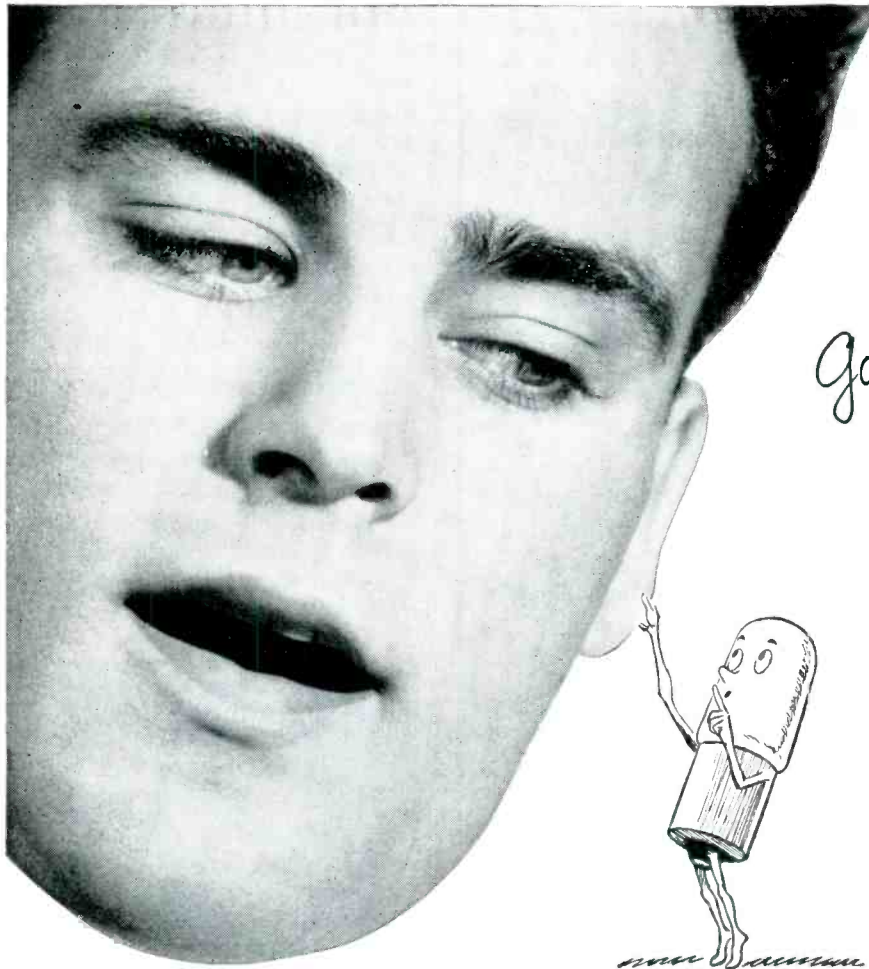

*P-s-s-s-t!
Got a need for me in
your product?*

Little lamps bring new sales appeal -add extra features that make sales!

WHEN the choice is between your product and a competitor's, it's often a little thing that swings the sale!

Little lamps that warn when the current is on or off. "Tell-tale" lamps that check the operation of individual circuits. Built-in lamps to light up dark spots or to help in quick reading of instrument dials.

General Electric miniature lamps have dozens of valuable appli-

cations in electronic products. There's a type and size for every use—all voltages and wattages, filament or neon glow. And every General Electric miniature lamp is made to the same high standards as its bigger brothers.

For assistance in selecting the proper type for your particular problems or applications, consult your nearest G-E lamp district office. Or write General Electric, Nela Park, Cleveland 12, Ohio.

Whatever lamps you need—



makes 'em all!



G-E LAMPS
GENERAL  **ELECTRIC**

Take the headaches out of Fall production rush

Get trouble-free performance — smooth assembly — fast delivery

Today's engineering goes beyond just getting something that will work. In the hectic days ahead—days of volume production and extremely short delivery schedules on component parts—**COMPONENTS MUST BE TROUBLE-FREE OR PRODUCTION LINES WILL STOP.**

Alden hasn't been publication advertising recently, but has built up a whole series of products that are **UNMATCHED for TROUBLE-FREE PERFORMANCE and QUICK DELIVERY.** It holds a dominant position in kinescope socket assemblies. Its engineering has anticipated economic price trends. It is giving trouble-free performance on all kinds of speaker, hi-voltage, terminal and other connectors due primarily to the high standards of design calling for forward connected contacts that are trouble-free in production and service.

Go down through the list of items here—items unmatched for engineering, fast delivery and trouble-free performance.

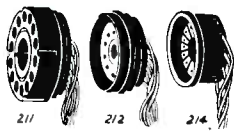

211, 212, 214 — Full line of cathode ray tube connectors — magnal, duo decal, di-heptal—meet highest standards for instrument work.

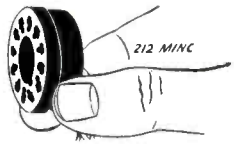

212MINC—Miniature duo-decal that incorporates forward connected contacts. Individual strain relief for each lead—hi-voltage breakdown and 100% insulation for each lead.

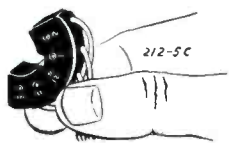

212-5C—Segment duo-decal with same high engineering standards makes material and space savings.



212-5MINC — Miniature duo-decal segment absolute minimum of material and yet has complete safety—forward connected contacts give each lead individual strain relief and 100% insulation of leads.

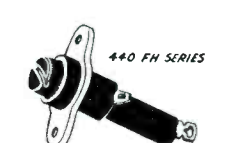

440FH—Complete line of fuseholders—provide for noiseless fused circuits—quick fuse ejection. Uses standard production tools—rivets, eyelets or spot welds to chassis. New improvements — coin slot knobs—miniaturized indicator fuseholders.

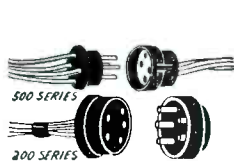

200-500 — Engineers, production men and purchasing agents are now realizing that in our 200-500 series connectors they've got the only forward connected contacts that provide long protective insulation within the molding for each lead—that snubs the wire tip for insulation — and mechanically holds wire tips so it cannot be imperfectly soldered.

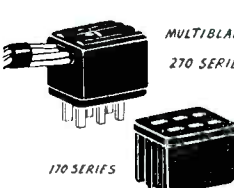

— and our very latest development:

ALDEN MULTIBLADE CONNECTOR

provides for first time multiblades with forward connected contacts—which give long protective molded insulation around each lead—strain relief for each individual lead. Completely housed in compact cover, attractive colors.

Write, wire or phone for an immediate, thought-through response on any connector need.

ALDEN PRODUCTS COMPANY
BROCKTON 64E, MASS.

402AC — Convenience outlets with absolutely dependable contacts—that rivet or eyelet to chassis with no possibility of breakage—and using an absolute minimum of space below panel.

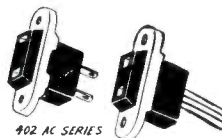

202FRAC — Detachable line cords with sure grip plug—dependable snap-in connectors that take the smallest possible mounting space both above and below panel.



Non-int. 100, 200, 400 — Whole series of plugs and non-interchangeable bases for cables or plug in units (relays, coils, condensers, etc.). Strong stubby pins—no center boss to break—cannot be mistakenly plugged in tube socket—mate only with proper socket.

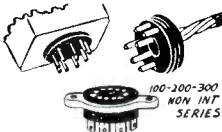

90 Series—Every conceivable type of tube cap. Engineered to meet any requirements.



201M & F, 8101M & F — Hi-voltage disconnects. 2000 VDC operating rating—bakelite housing—forward connected contacts. 15000 VDC operating rating—low loss polyethylene with leads.

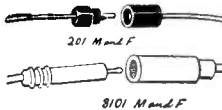

110BCS — Completely insulated pin jack providing easy constant checking point for circuits or tubes.



81L—Pilot light sockets—Rugged, dependable construction with the very minimum of parts and labor. Uses special Alden "center file" contacts — provides strain relief for each lead.



tooth, or external modulation of a wide variety of klystron oscillators. Beam supply is continuously variable in two steps from -800 to -1,500 volts at 65 ma or -1,500 to -3,600 volts at 25 ma. Repeller voltage may be continuously adjusted over the range from -20 to -750 volts.

Fiberglas Insulation

BENTLEY, HARRIS MFG. CO., Conshohocken, Pa., has announced BH649 braided Fiberglas tubing and sleeving insulation. It can withstand potting temperatures of 450 F up to 60 minutes and exposure to 220 F for 96 hours with little physical

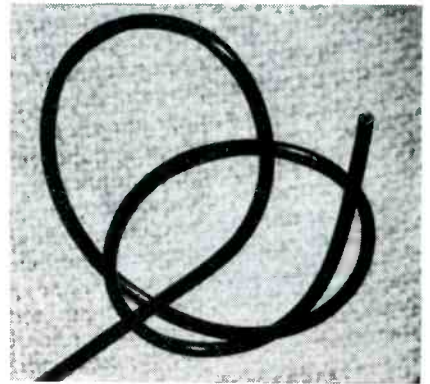

change or less dielectric strength. Resistance is 50,000 megohms when dry; 10,000 when wet. Sizes range from No. 20 to 3/4 in. inclusive.

Industrial Rectifier Tube

NATIONAL ELECTRONICS, INC., Geneva, Ill., has developed the NL-618P, a quick-heating xenon-filled rectifier tube with a 6.4-ampere output current rating, for industrial rectifier and control applications. It may be used at any ambient temper-

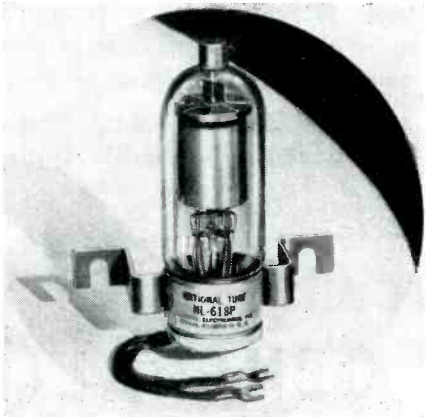

THEY BOTH HAVE IT

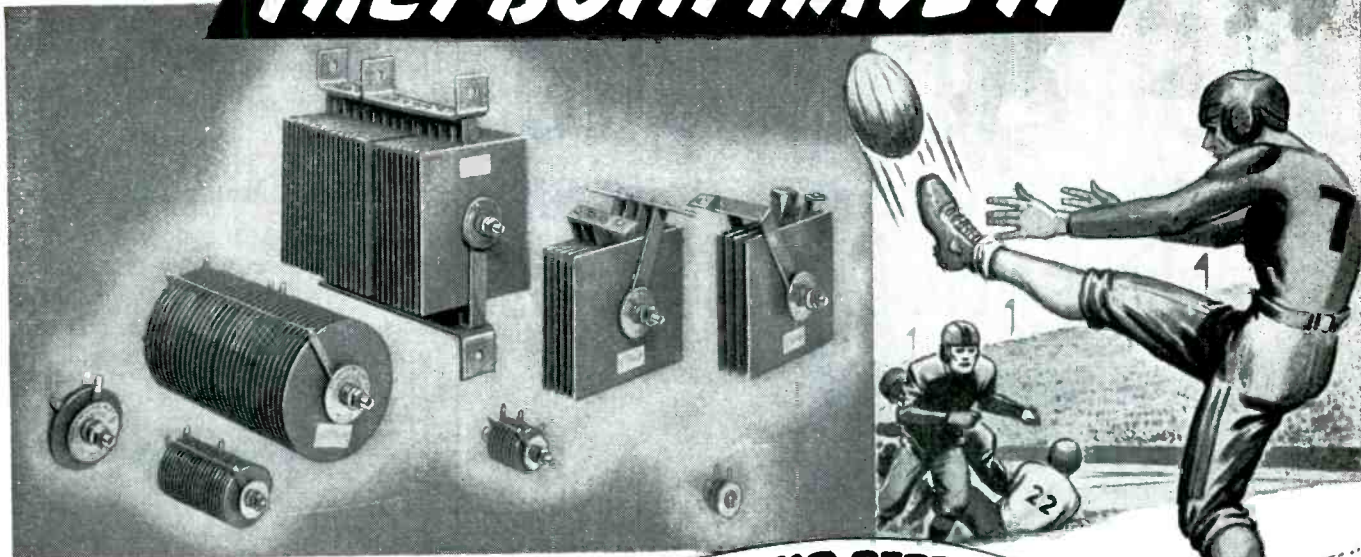

The EXTRA SOMETHING that spells TOP PERFORMANCE



Built on Aluminum

THE football star who eludes the players of the rival team and sends the pigskin hurtling down the field to a goal has "the extra something that spells top performance."

For outstanding service in every rectifier application specify Seletron Selenium Rectifiers. They have the "extra something" that spells top performance.

From the large power stacks to the miniature units for radio and television, Seletron uniformity and precision methods of manufacture insures user satisfaction. Efficient—dependable, durable under the severest service conditions.

Furnished in a wide variety of voltages and currents to meet the individual requirements.

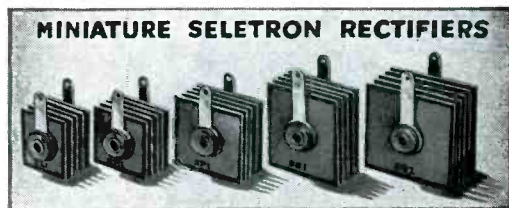

**SPECIFY SELETRON
MINIATURE SELENIUM RECTIFIERS
FOR RADIO AND TELEVISION APPLICATIONS**

The complete family of miniature Seletron Rectifiers is designed for use on a nominal 115 A-C line, to provide direct current for radio, television sets, amplifiers, and other low power applications. Instant starting, small size, long life and simplicity of installation are a few of many features of the Seletron Family.

| CODE NUMBER | 5L1 | 5M1 | 5P1 | 5R1 | 5Q1 |
|----------------|--------|---------|---------|---------|---------|
| Current Rating | 75 ma. | 100 ma. | 150 ma. | 200 ma. | 250 ma. |
| Plate Height | 1" | 1" | 1 1/8" | 1 1/2" | 1 1/2" |
| Plate Width | 7/8" | 1" | 1 1/8" | 1 1/4" | 1 1/2" |

Write today for catalog. Address Dept. ES-22

SELETRON DIVISION
RR RADIO RECEPTOR COMPANY, INC. RR
Since 1922 in Radio and Electronics
 251 WEST 19TH STREET, NEW YORK 11, N. Y.

INSTANTANEOUS

recordings from D.C. to 100 cps!

Accurate recordings of voltages, pressures, strains, vibrations and countless other phenomena.

Permanent ink on paper recordings by Brush Oscillographs make their use almost unlimited.

Either A. C. or D. C. signals can be measured. Whenever desired, recordings may be stopped for notations on chart-paper,

• Investigate Brush measuring devices before you buy... they offer more for your money.. Why not have a Brush field engineer call? At no obligation, of course. Just call or write.. today.. you will find it worth a few seconds' time!



THE **Brush**
DEVELOPMENT CO.

Canadian Representatives: A. C. Wickman, (Canada) Ltd., P. O. Box 9, Station N, Toronto 14

3405 Perkins Avenue • Cleveland 14, Ohio, U. S. A.

MAGNETIC RECORDING DIV. • ACOUSTIC PRODUCTS DIV.

INDUSTRIAL INSTRUMENTS DIV. • CRYSTAL DIVISION

NEW PRODUCTS

(continued)

ature between -55 and $+70\text{C}$. Filament voltage is 2.5 volts; filament current, 17 amperes; peak inverse voltage, 750 volts; d-c current output, 6.4 amperes.

Disc-Noise Meter

AUDIO INSTRUMENT Co., 1947 Broadway, New York 23, N. Y. Model 140 Disc-noise Meter checks noise level of lacquer discs and test pressings. It consists of high-gain

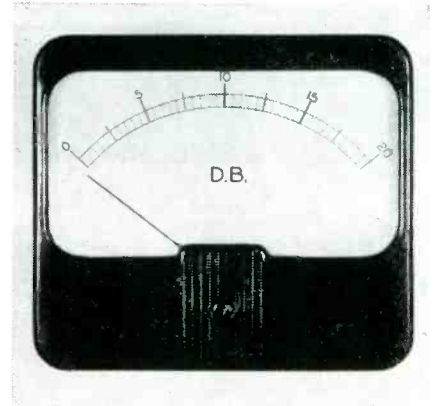

preamplifier, monitor amplifier, new logarithmic circuit and vacuum-tube voltmeter. Due to use of new inherently logarithmic material, the meter is overload proof and has a scale completely linear to 20 db.

High-Voltage Resistor

S. S. WHITE INDUSTRIAL DIVISION, 10 E. 40th St., New York 16, N. Y. The 80X high-voltage resistor, rated at 4 watts, is offered in values

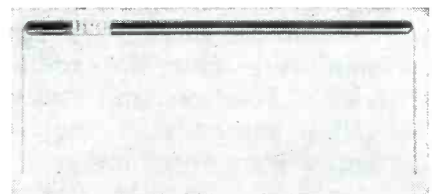

from 100 to 100,000 megohms, established at 10,000 volts d-c at 75 F and 50-percent relative humidity. Standard tolerance is ± 10 percent. Full details are contained in bulletin 4906.

H-V Rectifier Cells

GENERAL ELECTRIC Co., Schenectady 5, N. Y. The new high-voltage selenium rectifier cell is designed

SYLVANIA *Quality* **LIKE**

COLONIAL *Safety* **IS NO ACCIDENT!**

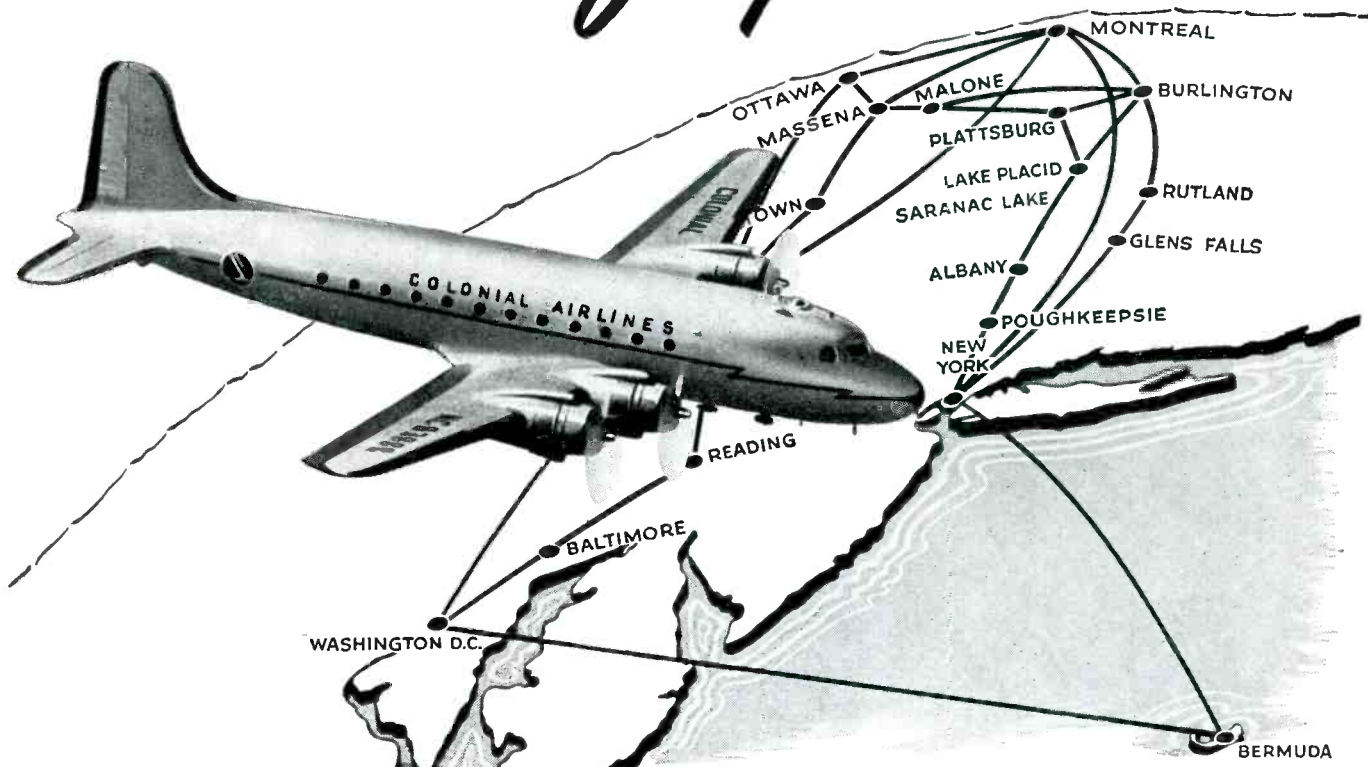

COLONIAL AIRLINES is now in its 20th year with a record of over 250,000,000 passenger miles without a single passenger or crew fatality—a result of the finest personnel and equipment.

Colonial uses Sylvania Tubes in its communication system.

There's not much that can be added to those two statements. On the one hand you have a wonderful safety record by one of America's outstanding airlines. On the other you have this airline's entire communication system—a paramount factor in air safety—using Sylvania high quality tubes . . . from the new miniatures to the famous Lock-Ins.

Yes, like the *safety* of Colonial Airlines, Sylvania *quality* is no accident. We, too, insist on the best equipment—to make the finest small parts that go into Sylvania tubes. We, too, select our personnel with great care—for workmanship that is unsurpassed.

If you wish full information on our complete tube lines, write *Sylvania Electric Products Inc., Department R-1110, Emporium, Pa.*



Colonial's pilot and navigator are in constant communication with landing field over extensive radio equipment.

Sylvania miniature tubes play prominent part in Glide Path Receiver that assists pilot in safe landing by instruments alone.

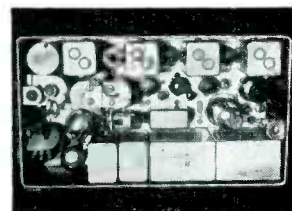

SYLVANIA
ELECTRIC

RADIO TUBES; CATHODE RAY TUBES; ELECTRONIC DEVICES; FLUORESCENT LAMPS, FIXTURES, WIRING DEVICES, SIGN TUBING; LIGHT BULBS, PHOTOLAMPS

SPECIFY

AMPHENOL

"AN" CONNECTORS

On sizes 20 and up, Amphenol provides 70% thicker inserts . . . stranger to withstand roughest handling.

Contacts are selected high conductivity bronze alloys, silver plated and with pockets pre-tinned for soldering.

Both coupling rings and assembly screws are cross-drilled for safety wiring in accordance with Army-Navy specifications.

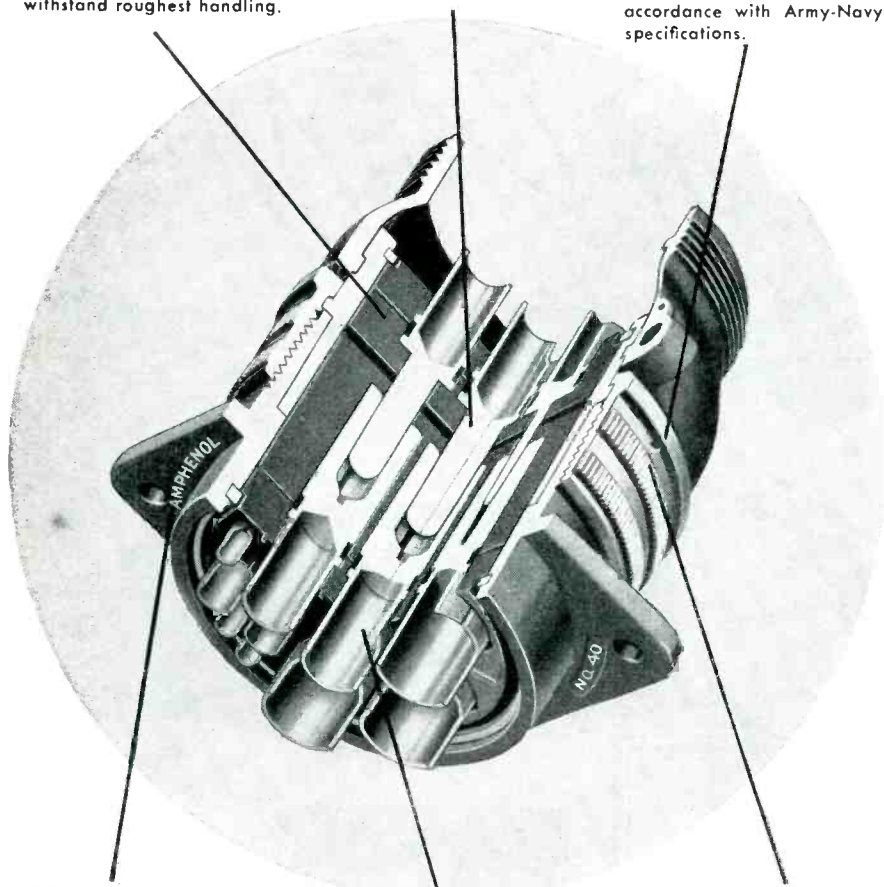

AMPHENOL — the assurance of absolutely dependable, weatherproof, vibration-proof service.

Non-rotating contacts with solder cups are uniformly aligned . . . saves 40% in assembling time, lowers cost.

Coupling rings are a screw machine part made from solid aluminum bar stock providing 80% greater tensile strength.

FOR POWER, SIGNAL and CONTROL CIRCUITS in AIRCRAFT and ELECTRONIC EQUIPMENT

Amphenol engineers and technicians are available without obligation to assist in specifying the right type of "AN" connector for application in instrument, power and control problems. Amphenol "AN" Connectors are available in five major shell designs, each accommodating over 200 styles of contact inserts.

COMPLETE LISTINGS OF "AN" CONNECTORS
Write for your copy of Amphenol's comprehensive and illustrated catalog on "AN" and "97" Connectors. Please send request on company letterhead.



AMERICAN PHENOLIC CORPORATION

1830 SO. 54TH AVENUE • CHICAGO 50, ILLINOIS

NEW PRODUCTS

(continued)

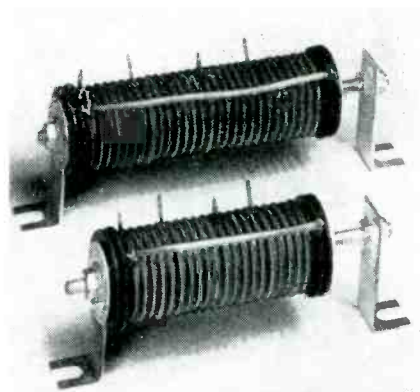

to permit use of a smaller stack to achieve the same wattage output. Illustrated here are two selenium rectifier stacks, the top one assembled from low-voltage cells (12 volts each), and the bottom one assembled from the new high-voltage cells (18 volts each). Both provide 90-volt output.

Audio Amplifier

THORDARSON, 500 West Huron, Chicago 10, Ill. The T-32W10 audio amplifier has a frequency response from 20 to 20,000 cycles. Hum level is -70 db below rated output. Output is 10 watts at less than 2-percent distortion. The unit features

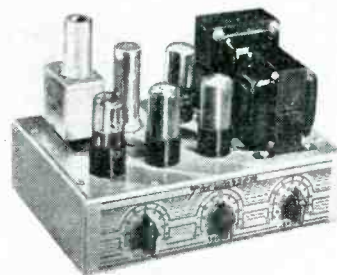

adequate gain to obtain full output from the ordinary high-impedance pickup or tuner. It is available with or without a plug-in preamplifier.

Four-Beam C-R Indicator

ALLEN B. DUMONT LABORATORIES, INC., 1000 Main Ave., Clifton, N. J. The new cathode-ray indicator is capable of displaying simultaneously four related or unrelated independent phenomena on a single crt screen. Equipped with the K1027-P11 c-r tube containing four independent electron guns, the unit incorporates its own power supply

KAY ELECTRIC COMPANY

PREPARE FOR UHF TESTING

WITH SWEEPING OSCILLATORS . . .
SCANNING REFLECTED ENERGY METERS . . .
VISUAL VOLTMETERS and SPECTRUM ANALYZERS

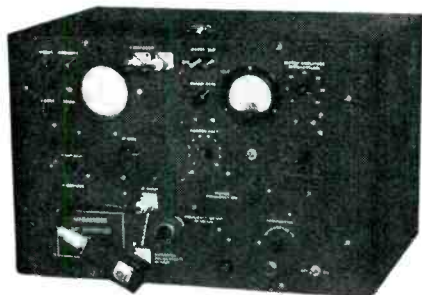

The UHF MEGALYZER

The UHF MEGALYZER now incorporates increased sensitivity, broadened frequency range, and improved linearity. The frequency range now extends from 30 to 500 mc and is useful to 1000 mc. The maximum sensitivity for linear operation is 100 microvolts. The equivalent noise input is approximately 20 microvolts. The frequency response from 30 to 500 mc is within 4 db. The flatness of the frequency response and sensitivity are only slightly deteriorated between 500 and 1000 mc. The frequency resolution is still 100 kc. The UHF MEGALYZER contains a sweeping oscillator, (The MEGA-SWEEP) and an oscilloscope, both of which can be used separately.

The UHF MEGALYZER contains a wavemeter for identifying the frequency of unknown signals. By use of an auxiliary calibrated signal generator, the level of any unknown signal may be determined.

Price: \$895.00 F. O. B. Factory



The MEGALYZER JR.

The MEGALYZER JR. is an accessory device for use with a MEGA-SWEEP sweeping oscillator and a standard oscilloscope. These three devices, when used together, comprise a Visual Voltmeter and Spectrum Analyzer system. The specifications of the system are the same as those for the MEGALYZER. Either the MEGALYZER JR. system or the MEGALYZER can be used for tuning circuits intended for selecting crystal harmonics, studying the spurious output of transmitters or generators, measuring C.W. oscillator radiation, observing the modulation on a carrier and many other applications at VHF or UHF.

Price: \$250.00 F. O. B. Factory



THE UHF MEGA-MATCH

The UHF MEGA-MATCH is an improved design of the widely used MEGA-MATCH which increases the useful frequency range from 10-250 mc up to 10 to 1000 mc. (VHF MEGA-MATCH still available.) The UHF MEGA-MATCH rapidly indicates reflected energy over a swept band width up to 30 mc through the VHF and UHF ranges. MEGA-MATCH units now in customers' hands may be converted to cover the wider frequency range at a price of \$200.00.

Price: VHF MEGA-MATCH—\$695.00 F. O. B. Factory

UHF MEGA-MATCH—\$895.00 F. O. B. Factory



THE CALIBRATED MEGA-SWEEP

The CALIBRATED MEGA-SWEEP provides single dial tuning over the entire frequency range of the instrument. A calibrated dial is included which indicates the center frequency of the swept output to sufficient accuracy to place the wanted frequency within the swept range. After warm-up and one check of operation the CALIBRATED MEGA-SWEEP can be used for very long periods over a wide continuous frequency range (50 kc to 1000 mc) by varying only the single tuning knob. Sweep widths up to 30 mc.

MEGA-SWEEPS now in customers' hands can be changed to the CALIBRATED MEGA-SWEEP Model for \$75.00.

Price: \$425.00 F. O. B. Factory

The MEGA-NODE SR.—A NEW INSTRUMENT. Watch our next advertisement announcing specifications and details on the MEGA-NODE SR., a UHF and Microwave Random Noise Source—Frequency Range 100-3000 mc, Read Noise Figures to 20 db—Output impedance 50 ohms unbalanced, no tuning necessary. Price \$895.00 F. O. B. Factory

Prices outside U. S. A. and Canada 10% higher.

FOR FURTHER DETAILS WRITE

KAY ELECTRIC CO., 25 MAPLE AVE., PINE BROOK, N. J.
Telephone CAldwell 6-4000

Manufacturers of: Mega-Match, Mega-Node, Megaligner, Mega-Pulsar, Sonalater, Sona-Graph, Microwave Mega-Match, Micro-Pulsar.

FILEWORTHY FACTS on Superior Nickel & Nickel Alloy Tubing

(.010" to 5/8" O.D. MAX.)

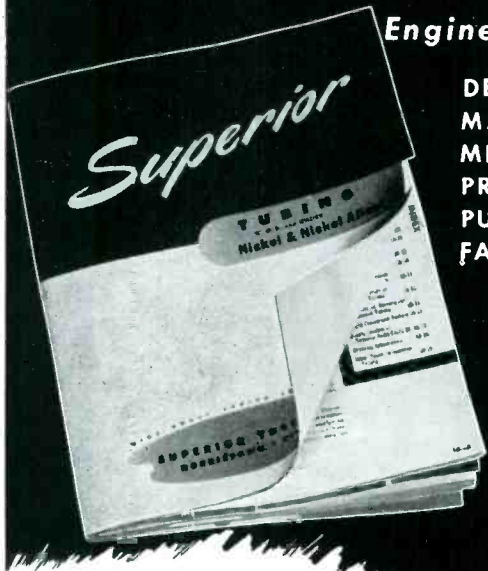

The Most Complete Catalog On Small Nickel and Nickel Alloy Tubing Available.

Engineering Data for the—

DESIGNER
MATERIALS ENGINEER
METALLURGIST
PRODUCTION MAN
PURCHASING AGENT
FABRICATOR

ON

NICKEL
MONEL†
INCONEL†
"K" MONEL†
30% CUPRO-NICKEL
36% NICKEL IRON (INVAR)
42% NICKEL IRON
52% NICKEL IRON

Information on Nickel and Nickel Alloy Tubing conveniently arranged for quick, accurate reference:

- Comparative Physical and Chemical Properties
- Selection and Application
- Tolerance, Temper and Weight Data
- Design and "Use" Information
- Types of Superior Tubing (Seamless and WELDRAWN*)
- Time-Saving Ordering and Specification Data

FOR YOUR COPY, WRITE TODAY ON YOUR COMPANY LETTERHEAD.

*Reg. U. S. Trademark. Superior Tube Company
†Reg. U. S. Trademark. The International Nickel Co.

Superior

THE BIG NAME IN SMALL TUBING (.010" TO 5/8" O.D. MAX.)

SUPERIOR TUBE COMPANY
2500 Germantown Ave., Norristown, Pa.

See our tubing display booth #2527 at the 31st National Metal Exposition, October 17th to 21st, Cleveland, Ohio.

For Superior Tubing on the West Coast, call PACIFIC TUBE CO., 5710 Smithway St., Los Angeles 22, Cal. • ANGELES 2-2151

NEW PRODUCTS

(continued)

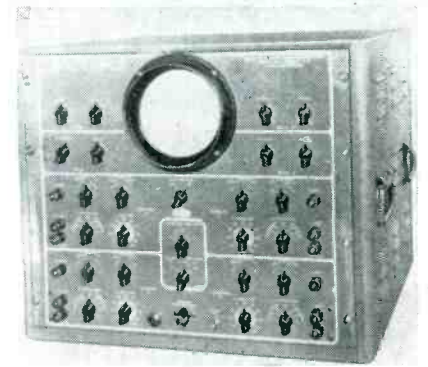

and a horizontal amplifier for each of the four channels. The instrument is intended for use with an oscillograph-record camera of the moving-film type.

Silicone Resin

GENERAL ELECTRIC Co., Pittsfield, Mass. The new Silicone resin No. 9989-1 designed to enable electrical equipment to operate at temperatures as high as 180 C, can be used for impregnating spun glass and asbestos wire coverings and for binding coils, windings, and other motor, generator and transformer parts.

H-F Amplifier Kit

SUN RADIO AND ELECTRONICS Co., INC., 122-124 Duane St., New York 7, N. Y. Model CR-10 all-triode, high-fidelity amplifier kit is a 10-watt 7-tube unit boasting flat fre-



quency response (± 1 db) from 20 to 15,000 cycles. Distortion is less than 2.5 percent; gain is 75 db on radio, and 97 db on phono. The unit is also available completely wired and tested.

Disc Thermostat

STEVENS MFG. Co., INC., Mansfield, Ohio. Type M midget thermostat features close temperature control of electronic devices, appliances and

Predetermined Counters

POTTER INSTRUMENT CO.,
INC. 138-56 Roosevelt Ave.,
Flushing, N. Y. The Potter
Predetermined Electronic

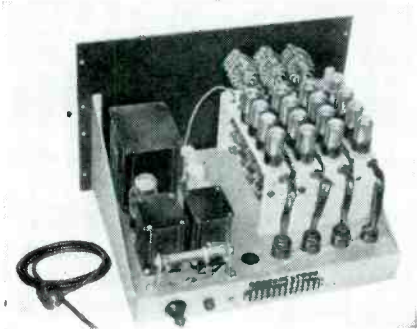

Counters have a counting rate up to 20,000 per second and a control rate up to 15,000 per minute. Input-sharp negative pulses, 30 to 80 volts amplitude, pulse rise time 10 micro-seconds maximum.

The Potter Predetermined Counter for high speed counting, batching, sorting, packaging and for many other industrial uses, is typical of the varied applications KENYON "T" Line Transformers are called upon for rugged, dependable service.

Leading manufacturers and engineers in all fields, specify KENYON "T" Line Transformers for many industrial, communication and electronic applications.

For more than 20 years, the KENYON organization has been producing "specials" to specification, and size needs of individual applications, at cost approaching catalog items.

The Potter Instrument Co., too, looks to KENYON for high quality, economy transformers!

Advertisement

Here's the "Q" in Transformers

It's **KENYON** Quality

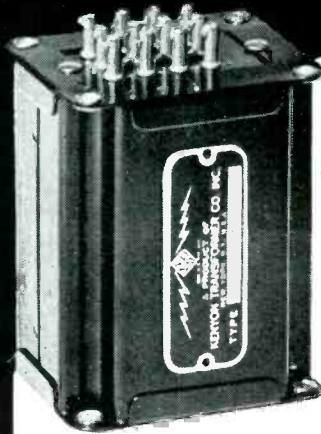

*Custom-built
to your
Specifications*

KENYON one of the oldest names in transformers, offers you high quality specification transformers custom-built to your requirements — *practically at catalog prices!* For over 20 years the KENYON "K" has been a sign of skillful engineering, progressive design and sound construction.

KENYON "Specials" Are Designed For:

- | | |
|----------------------|---------------------------|
| JAN APPLICATIONS | AUTOMATIC CONTROLS |
| BROADCAST | AUDIO AMPLIFIERS |
| INDUSTRIAL MACHINERY | EXPERIMENTAL LABORATORIES |
| RADAR | ATOMIC ENERGY EQUIPMENT |

Among many others

Consult our engineering staff on any of your "special" problems at no obligation to you. Call or write now for our representative.

KENYON "T's"— famous line of high quality, uniform transformers are ready for immediate delivery from stock. Our standard line can save you much time and expense. For a complete story about specific ratings on all transformers, send for your copy of the latest KENYON Catalog edition now!

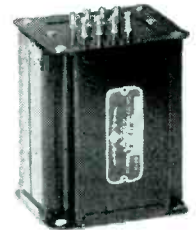

KENYON TRANSFORMER CO., Inc.

840 BARRY STREET

NEW YORK 59, N. Y.

SEND FOR LATEST CATALOG NOW!

KENYON Transformer Co., Inc.

840 Barry Street, New York 59, N. Y.

Send me the latest edition of your new catalog without obligation.

Name..... Address.....

Position..... City..... Zone.....

Company..... State.....

We need "special" transformers —

Please have your representative call

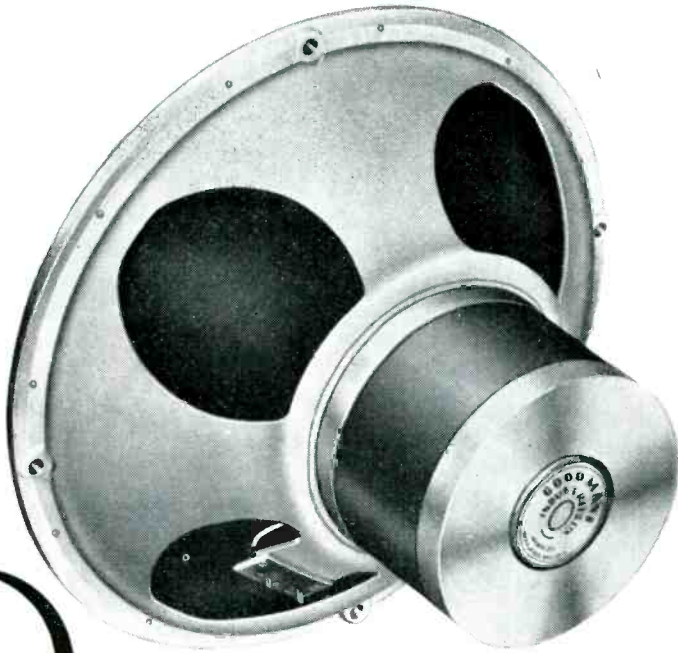

Big *in POWER* PERFORMANCE STAMINA

This high-power version of Goodmans famous 12" T.2. is available as a Bass Unit for multi-speaker systems or general Public Address use. The last word in reliability, design and performance.

SPECIFICATIONS:

R22/1205/15

| | |
|------------------------|-----------------------|
| Overall Diameter | 12.5/16" |
| Overall Depth | 7" |
| Fundamental Resonance | 75 c.p.s. |
| Voice Coil Impedance | 15 ohms at 400 c.p.s. |
| Maximum Power Capacity | 20 watts Peak A/C |
| Total Flux | 195000 Lines |
| Nett Weight | 18 lbs. 4 ozs. |

R22/1206/15

| | |
|------------------------|-----------------------|
| Overall Diameter | 12.5/16" |
| Overall Depth | 7" |
| Fundamental Resonance | 55 c.p.s. |
| Voice Coil Impedance | 15 ohms at 400 c.p.s. |
| Maximum Power Capacity | 20 watts Peak A/C |
| Total Flux | 195000 Lines |
| Nett Weight | 18 lbs. 4 ozs. |



GOODMANS

R22 *20-WATT* *12" P.M. FULLY DUSTPROOF* Loudspeaker

GOODMANS INDUSTRIES LIMITED

Lancelot Road, WEMBLEY, Middlesex, ENGLAND

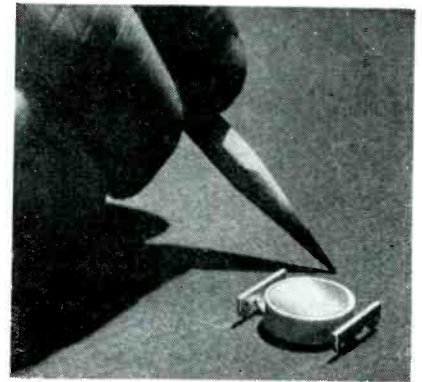

industrial apparatus. It employs a bi-metal thermal element of disc construction. Maximum operating temperature is 600 F; minimum, -60 C. The unit may be had with standard closure for normal operation; hermetically sealed for special applications.

Plate-to-Plate Servo

THE TRANSICOIL CORP., 114 W. Worth St., New York 13, N. Y. Savings of weight and space in industrial and military control systems is made possible by servo motors featuring plate-to-plate operation. Use of an output trans-

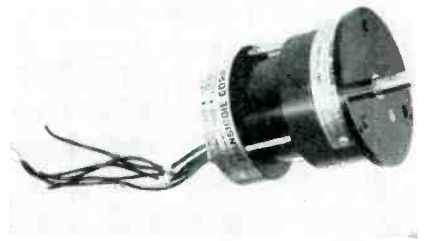

former in the servo-amplifier is eliminated through direct winding. Complete technical data is available on request.

High-Fidelity Speaker

UNIVERSITY LOUDSPEAKERS, INC., 80 S. Kensico Ave., White Plains, N. Y. Model 6201 lightweight, high-fidelity speaker covers a 50 to 15,000-

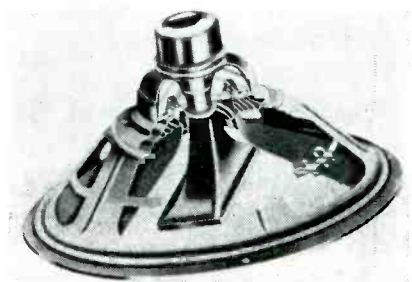

Smaller

METALLIZED-PAPER CAPACITORS

Here's a 150 volt 5 mfd. Aerolite[®] metal-cased unit contrasted with the usual paper-and-foil capacitor of equivalent rating. Its Aerolite[®] hermetically-sealed metallized-paper section means smaller size, lighter weight, performance reliability, plus the unique self-healing characteristic. Aerovox application engineering assures satisfactory usage.

Smaller

BANTAM[®] ELECTROLYTICS

Type SRE Bantams[®] are the smallest electrolytics yet! Especially suitable for cathode by-pass applications, screen filter circuits and similar functions. Improved processing and materials combined with more efficient space utilization, means smaller size and no reduction in life.



Smaller

METALLIZED-PAPER TUBULARS

Aerolite[®] Type P'82 (front) and Type '84 usual tubulars are further examples of Aerovox's long line of size reductions. These miniature paper tubulars provide the maximum in performance, life, operating ranges and stability.

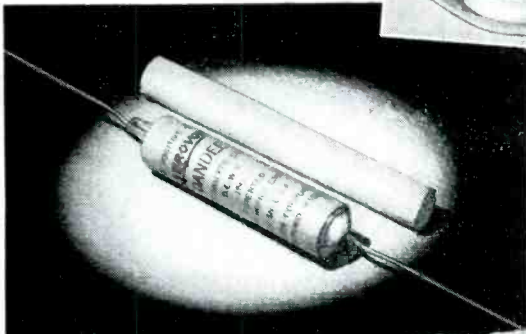

SMALL... SMALLER... Smallest

AEROVOX

Capacitors

WE MUST KNOW...

- 1 Life
- 2 Operating Voltage
- 3 Maximum Surge Voltage
- 4 Maximum Ambient Temperature ?
- 5 Duty Cycle
- 6 Humidity
- 7 Altitude
- 8 Shock
- 9 Terminals
- 10 Mounting

● How small is *small*? The radio-electronic miniaturization trend poses the question. And here's the Aerovox answer:

Small in capacitors means the *minimum size* required to meet *actual performance requirements*. There must be no secrets as to the operating conditions. To give you a true miniature capacitor, we must know the facts called for by the accompanying questions.

How small is *small*? Let Aerovox engineers, with their latest techniques and production processes, give you the *practical* answer.

● *Submit your miniaturization or other capacitance requirements for engineering collaboration and quotations.*

*Trade-marks



FOR RADIO-ELECTRONIC AND INDUSTRIAL APPLICATIONS

AEROVOX CORPORATION, NEW BEDFORD, MASS., U.S.A.

SALES OFFICES IN ALL PRINCIPAL CITIES • Export: 13 E. 40th St., NEW YORK 16, N. Y.

Cable: 'ARLAB' • In Canada: AEROVOX CANADA LTD., HAMILTON, ONT.

CHIEF ENGINEER FLEXY SAYS:

**HERE'S WHERE IT PAYS
TO CONSIDER S.S. WHITE
Flexible SHAFTS**

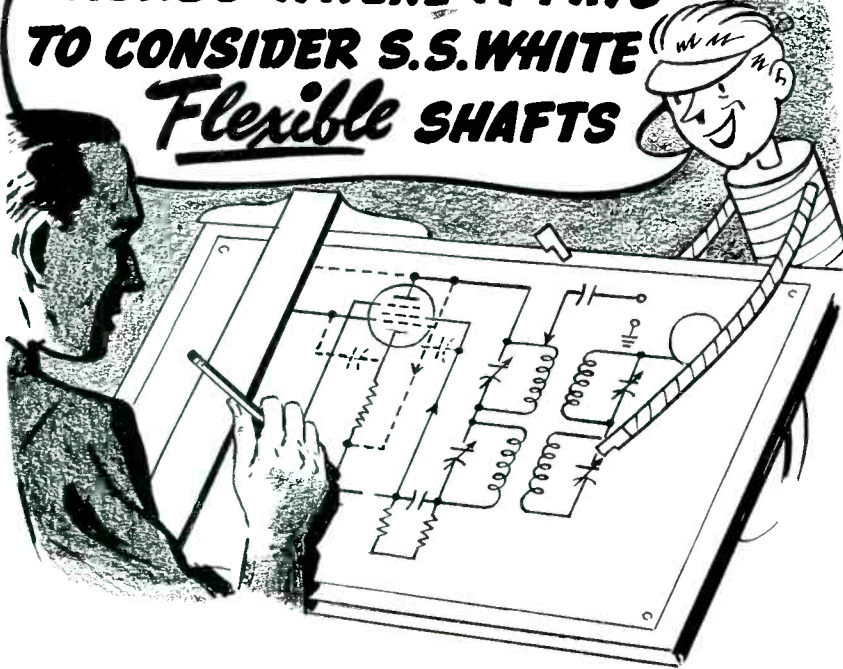

"I'm referring, of course, to circuit elements—like this variable condenser—which have to be regulated during the operation of your equipment. When you use S.S. White flexible shafts to connect these parts to their control knobs you gain several important advantages.

"First, you can develop chassis and cabinet designs to the maximum. You can locate the elements in any position, at any angle to meet space assembly or wiring requirements. You can group the controls as desired for full operating convenience and to suit the needs of any cabinet design. You can do this, because S.S. White flexible shafts readily transmit control between any two parts regardless of their relative positions.

"Second, S.S. White remote control flexible shafts provide a smooth turning, slip-proof method of control that maintains its sensitivity for the life of the equipment. Since they are especially built for this service, S.S. White shafts have minimum deflection underload and practically equal deflection in either direction of rotation.

"Start planning for S.S. White flexible shafts while your equipment is still in the drawing board stage. Ask S.S. White engineers for recommendations. Their cooperation is yours without obligation."

FREE—FLEXIBLE SHAFT HANDBOOK

This valuable flexible shaft handbook is full of useful information and data about how to select and apply flexible shafts. Copy sent free if you request it on your business letterhead and mention your position.



S.S. WHITE INDUSTRIAL DIVISION
THE S. S. WHITE DENTAL MFG. CO. DEPT. E 10 EAST 40th ST., NEW YORK 16, N. Y.



FLEXIBLE SHAFTS AND ACCESSORIES
MOLDED PLASTICS PRODUCTS—MOLDED RESISTORS

One of America's AAAA Industrial Enterprises

NEW PRODUCTS

(continued)

cycle range, and has a built-in cobra-shaped tweeter for high-frequency which is installed coaxially with the cone. Input impedance is 6 to 10 ohms; power, 20 watts; dimensions, 12-in. diameter × 7½-in. depth; weight, 5 pounds.

Sealed-Plunger Switch

UNIMAX SWITCH DIVISION OF THE W. L. MAXSON CORP., 460 W. 34th St., New York 1, N. Y. Entrance of moisture or dust to the plunger mechanism of model KMXN-2A precision switch is stopped by a neoprene boot sealed to the actuating plunger. The neoprene compound,

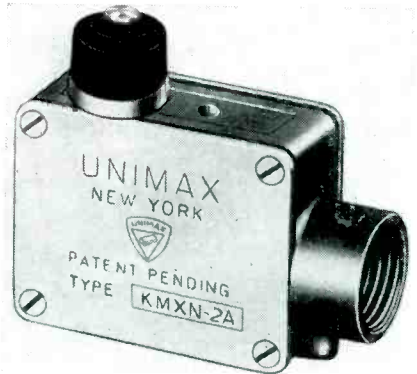

besides being oil resistant, retains its flexibility at all temperatures from -65 to +160 F. Information on the suitability of the switch to specific services will be furnished on inquiry.

TV and F-M Sweep Generator

THE TRIPLETT ELECTRICAL INSTRUMENT Co., Bluffton, Ohio. Model 3434 television and f-m sweep generator has two built-in markers: a 19.5 to 40-mc marker frequency for i-f; 57 to 240 mc for r-f and oscillator. Continuous tuning is provided over all tv and f-m bands. Sweep width is 0 to 12 mc, continu-

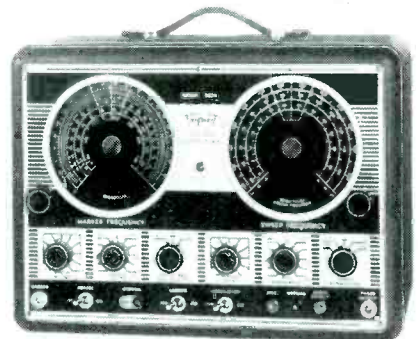

COMPARE FACTS!

| UP-TO-DATE FEATURE | YOUR CAMERA | DU MONT |
|--|-------------|---------|
| Dual Purpose Equipment (Studio or remote) | | ✓ |
| Electronic View Finder | | ✓ |
| Tube Interchangeability | | ✓ |
| Turret Lens Plate with Remote Iris Control | | ✓ |
| Breakaway Chassis for Accessibility | | ✓ |
| Automatic Lap Dissolve and Fade | | ✓ |
| Single-Unit Sync Generator | | ✓ |
| Single Jiffy Connectors | | ✓ |
| White Peak Limiter | | ✓ |
| Fingertip Controls | | ✓ |
| Adequate Cooling | | ✓ |
| Panhandle Focus | | ✓ |

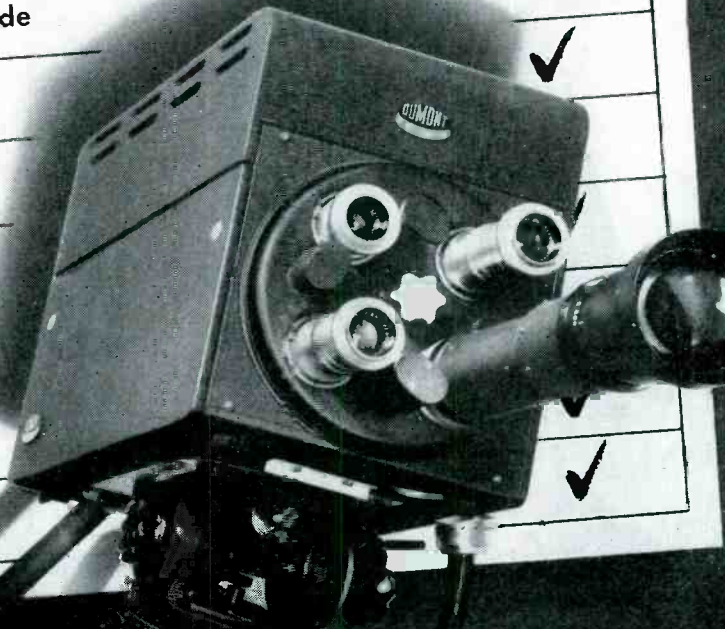

Are your cameras up-to-date?

© A. L. E. N. B. DU MONT LABORATORIES, INC.

DU MONT *First with the Finest in Television*

DU MONT LABORATORIES, INC. • TELEVISION EQUIPMENT DIVISION, 42 HARDING AVE., CLIFTON, N. J. • DU MONT NETWORK AND WABD, 515 MADISON AVE., NEW YORK 22, N. Y. • DU MONT'S JOHN WANAMAKER TELEVISION STUDIOS, NEW YORK 3, N. Y. • WTTG, WASHINGTON, D. C. • STATION WDTV, PITTSBURGH, PA. • HOME OFFICES AND PLANTS, PASSAIC AND EAST PATERSON, N. J.

*finer components
provide the margin for
finer instruments*

5841



5841
REGULATOR

Regulated voltage 900 volts
Starting voltage 930 volts
Current 2 to 50 ua
Regulation 1.5%

1B87



1B87
THYRODE

Operating voltage 900 volts
Plateau length 100 volts
Max. slope 10%/100 V
Wall (glass) 200 mg/cm²

1B88



1B88
THYRODE

Operating voltage 300 volts
Plateau length 50 volts
Max. slope 30%/50 V
Wall (glass) 200 mg/cm²

5799



5799
RECTIFIER

Filament current 10 ma
Filament voltage 1.25 volts
Inverse peak 3000 volts
Insulation 10¹⁴ ohms

5828



5828
AMPLIFIER

Filament current 10 ma
Filament voltage 1.25 volts
Amplification 18
Transconductance 450 umho

1B85

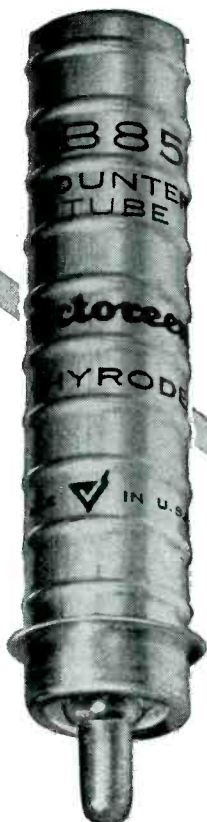

1B85
THYRODE

Operating voltage 900 volts
Plateau length 200 volts
Max. slope 3%/100 V
Wall (aluminum) 30 mg/cm²

THE VICTOREEN INSTRUMENT CO.
5806 HOUGH AVENUE
CLEVELAND 3, OHIO

ously variable. The unit also has crystal marker provision up to 216 mc.

High-Gain L-F Amplifier

ELECTRO-MECHANICAL RESEARCH, INC., Ridgefield, Conn. Model 33A high-gain narrow-band amplifier is designed for operation at or near a frequency of 10 cycles. It is intended for use with photocells, thermistors, or other high imped-



ance devices. A full-scale sensitivity of 1 microvolt makes it possible to work close to theoretical thermal noise levels. A calibrated attenuator permits the gain to be changed in convenient steps by a factor of up to 1,000.

VU Multiplier

SHALLCROSS MFG. Co., Collingdale, Pa. A new unit provides five-step straight-T performance in a control size normally limited to ladder and potentiometer circuits. A pair of extra terminals increases the utility of the unit because in the off position the vu multiplier network is automatically disconnected from the line which it normally bridges, and the vu meter, completely isolating both. Two standard attenuation ranges are available: 0 (1 milli-

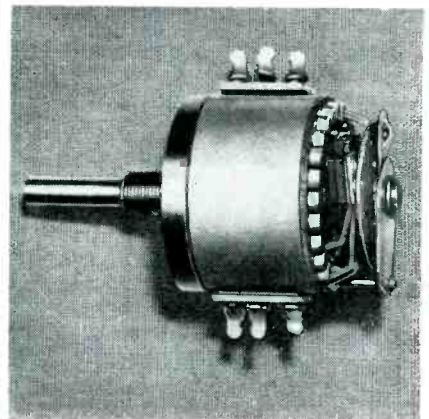



(actual size)

PLASTICON RF Transmitting CAPACITORS

Superior to mica capacitors because:

- Greater safety factor
(3500 VDC Operating; 7500 VDC Test)
- Lower RF Losses
(See current rating below)
- More conveniently mounted
- Less chassis space
- Smaller overall volume
- Impervious to moisture (The GLASSMIKE construction is 100% sealed)
- Silicone-fluid filled
- Can be operated at 75° C ambient

The above advantages are possible by the use of the Type L film dielectric which has lower losses than mica.

• • •

TYPE LSG—PLASTICON GLASSMIKES 3500 VDC Operating—7500 VDC Test

| Cat. No. | Cap. Mfd. | Dimensions OD Length | Current Rating in RF Amperes | | | |
|----------|-----------|-------------------------|------------------------------|--------|------|------|
| | | | 100 Kc | 300 Kc | 1 Mc | 3 Mc |
| LSG500 | .00005 | 19/32" x 1-3/16" | .02 | .05 | .16 | .47 |
| LSG101 | .0001 | 19/32" x 1-3/16" | .03 | .09 | .31 | .94 |
| LSG251 | .00025 | 19/32" x 1-3/16" | .05 | .25 | .5 | 2.2 |
| LSG501 | .0005 | 19/32" x 1-3/16" | .15 | .5 | 1.6 | 3.0 |
| LSG102 | .001 | 19/32" x 1-9/16" | .31 | .94 | 2.5 | 4.5 |
| LSG202 | .002 | 3/4" x 1-9/16" | .62 | 1.9 | 4.5 | 7.0 |
| LSG502 | .005 | 3/4" x 1-3/4" | 1.6 | 3.1 | 6.0 | 7.0 |
| LSG602 | .006 | 29/32" x 1-9/16" | 1.9 | 3.5 | 6.2 | 7.0 |
| LSG103 | .01 | 29/32" x 1-3/4" | 3.1 | 5.0 | 7.0 | 7.0 |



Condenser Products Company

1375 NORTH BRANCH STREET • CHICAGO 22, ILLINOIS

Manufacturers of Plasticon Capacitors; Pulse Forming Network and Hi Volt Power Supplies

OSCILLOSYNCHROSCOPE
Model OL-15B

Designed for maximum usefulness in laboratories doing a variety of research work, this instrument is suited to radar, television, communication, facsimile, and applications involving extremely short pulses or transients. It provides a variety of time bases, triggers, phasing and delay circuits, and extended-range amplifiers in combination with all standard oscilloscope functions.

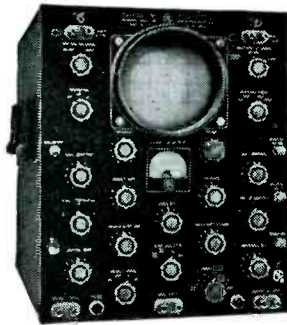

THESE FEATURES ARE IMPORTANT TO YOU

- Extended-range amplifiers: vertical, flat within 3 db 5 cycles to 6 megacycles, full tube deflection; horizontal, flat within 1 db 5 cycles to 1 megacycle.
- High sensitivity: vertical, 0.05 RMS volts per inch; horizontal 0.1 RMS volts per inch.
- Single-sweep triggered time base permits observation of transients or irregularly recurring phenomena.
- Variable delay circuit usable with external or internal trigger or separate from scope.
- Sawtooth sweep range covers 5 cycles to 500 kilocycles per second.
- 4,000-volt acceleration gives superior intensity and definition.

For complete data, request Bulletin MO-910

SWEEP CALIBRATOR



Model GL-22 A

This versatile source of timing markers provides these requisites for accurate time and frequency measurements with an oscilloscope:

- Positive and negative markers at 0.1, 1.0, 10, and 100 micro-seconds.
 - Marker amplitude variable to 50 volts.
 - Gate having variable width and amplitude for blanking or timing.
 - Trigger generator with positive and negative outputs.
- Further details are given in Bulletin MC-910.

**SQUARE-WAVE MODULATOR
AND POWER SUPPLY**



Model TVN-7

Here is the heart of a super high frequency signal generator with square-wave, FM, or pulse modulation. Provides for grid pulse modulation to 60 volts, reflector pulse modulation to 100 volts, square-wave modulation from 600 to 2,500 cycles. Voltage-regulated power supply continuously variable 280-480 or 180-300 volts dc. For additional data and application notes, see Bulletin MM-910.

STANDING WAVE RATIO METER AND HIGH GAIN AUDIO AMPLIFIER

Model TAA-16



Ask for your FREE copy of our Brochure illustrating and describing all Browning Products.

- Standing wave voltage ratios are read directly on the panel meter of this sensitive, accurate measuring instrument.
- Frequency range 500 to 5,000 cycles per second.
- Two input channels with separate gain control for each.
- "Wide-band" sensitivity 15 microvolts full scale.
- "Selective" sensitivity 10 microvolts full scale.
- Bolometer/crystal switch adjusts input circuit to signal source.

Write for Bulletin MA-910 containing full details of this useful instrument.

In Canada, address Measurement Engineering Ltd., Arnprior, Ontario.

EXPORT SALES
9 ROCKEFELLER PLAZA
Rm. 1422, New York 20, N.Y.



BROWNING
Laboratories, Inc.
Winchester, Mass.

ENGINEERED FOR ENGINEERS

watt) to plus 16 and off in 4-vu steps; plus 5 to plus 20 vu and off in 4-vu steps. Spacing between adjacent positions is 30 degrees.

R-F Power Supply

SPELLMAN TELEVISION Co., INC., 130 W. 24th St., New York 11, N. Y., has available a 30-kv r-f power supply suitable for application in dust precipitation, electrostatic painting and insulation breakdown tests, as well as projection television. Power up to 500 μ a may be

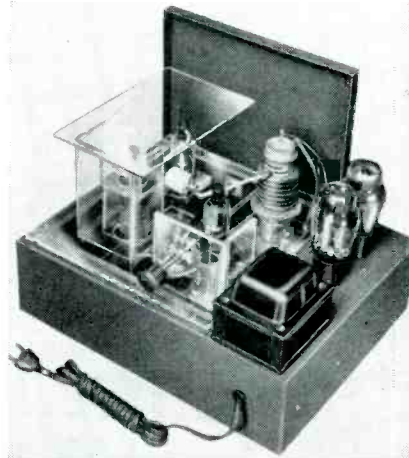

drawn with good regulation. Voltage is variable from 15 kv to 30 kv through a control on the front panel.

H-V-Coupler Controls

CLAROSTAT MFG. Co., INC., Dover, N.H. Type 56-125 high-voltage coupler, for controls used in tv, oscillograph and other h-v circuits, uses a plastic straight-through shaft in place of the previous insulating strip joining separate sections of the metal shaft. This eliminates backlash, providing more critical settings where necessary. An insulating tube isolates the con-

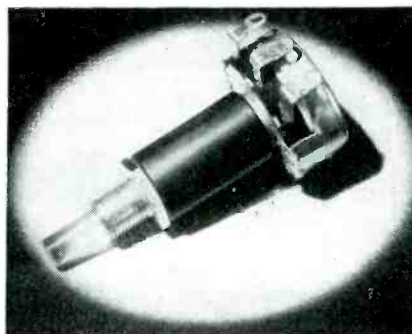

Why you and your advertising manager are partners

FROM WHERE YOU SIT, advertising may look like the "glamour department" of your company—necessary, of course, but pretty far removed from the hard-headed realities of the production line.

But take a closer look. In one respect, the advertising manager's job bears a striking resemblance to your own.

You're production-minded. You're concerned with anything that will improve plant procedures, speed up assembly time, prevent waste, and reduce the manufacturing cost per unit.

And that is precisely where you walk arm-in-arm with your advertising manager. Because he thinks the same way about the *manufacture of a sale*.

The whole process of selling and distribution are his assembly line. And every time he can reduce the unit cost of a sale by so much as a few cents, he increases your company's chance to show a profit.

Ask him for a definition of advertising, and he will probably tell you that it is simply *mechanized selling*, a machine that multiplies the productive capacity of the sales force — seeking out prospects, arousing their interest, creating a preference for the things your company makes.

And when it is concentrated among the hand-picked readers of business papers, advertising becomes the most efficient machine this partner of yours has found for lowering the cost of producing a sale.

What are the ten ways to measure the results of your business paper advertising? You'll find the answers in a recent ABP folder, which we'll be glad to send you on request. Also, if you'd like reprints of this advertisement (or the entire series) to show to others in your organization, you may have them for the asking.



THE ASSOCIATED BUSINESS PAPERS
205 East 42nd Street, New York 17, N. Y.

CO-AX AIR-SPACED ARTICULATED R.F. CABLES

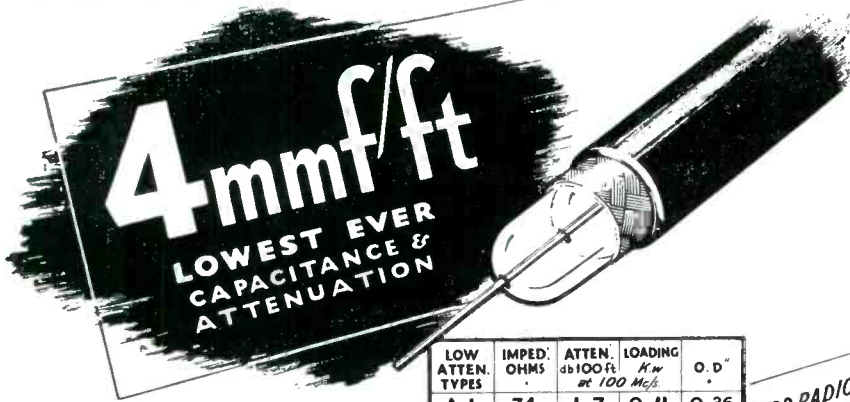

We are specially organized to handle direct enquiries from overseas and can give IMMEDIATE DELIVERIES to U.S.A.

Cable your rush order for delivery by air. Settlement in dollars by check on your own bank. Transaction as simple as any local purchase and delivery just as quick.

HIGH POWER FLEXIBLE

| LOW ATTEN. TYPES | IMPED. OHMS | ATTEN. db/100 ft at 100 Mc/s | LOADING Kw | O.D. " |
|------------------|-------------|------------------------------|------------|--------|
| A.1 | 74 | 1.7 | 0.11 | 0.36 |
| A.2 | 74 | 1.3 | 0.24 | 0.44 |
| A.34 | 73 | 0.6 | 1.5 | 0.85 |

FOR RADIO FREQUENCIES

PHOTOCELL CABLE

| LOW CAPAC. TYPES | CAPAC. mmf/ft | IMPED. OHMS | ATTEN. db/100 ft 100 Mc/s | O.D. " |
|------------------|---------------|-------------|---------------------------|--------|
| C.1 | 7.3 | 150 | 2.5 | 0.36 |
| P.C.1 | 10.2 | 132 | 3.1 | 0.36 |
| C.11 | 6.3 | 173 | 3.2 | 0.36 |
| C.2 | 6.3 | 171 | 2.15 | 0.44 |
| C.22 | 5.5 | 184 | 2.8 | 0.44 |
| C.3 | 5.4 | 197 | 1.9 | 0.64 |
| C.33 | 4.8 | 220 | 2.4 | 0.64 |
| C.44 | 4.1 | 252 | 2.1 | 1.03 |

FOR VIDEO and SPECIAL APPLICATIONS

VERY LOW CAPACITANCE CABLES

TRANSRADIO LTD

CONTRACTORS TO H.M. GOVERNMENT

138A CROMWELL ROAD

LONDON, SW7 ENGLAND

CABLES: TRANSRAD · LONDON

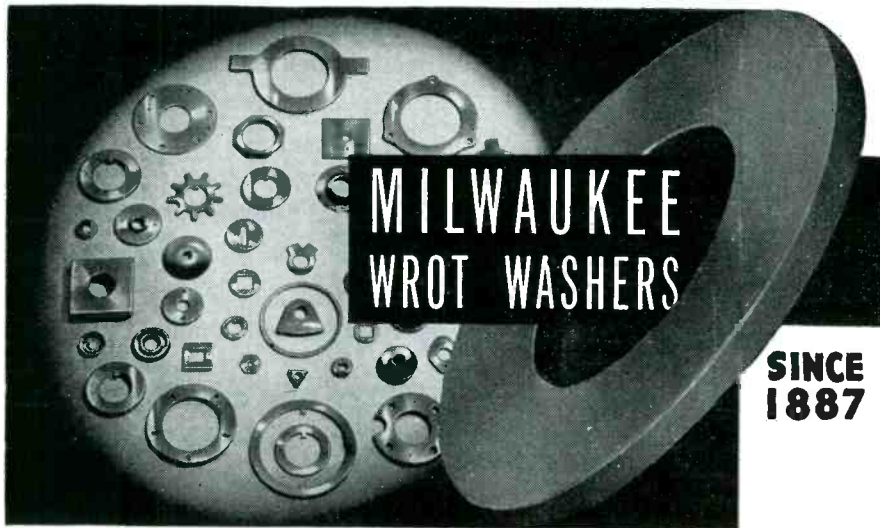

MILWAUKEE WROUGHT WASHERS

SINCE 1887

The SYMBOL of QUALITY for 62 YEARS

WASHERS . . . Standard and Special, Every Type, Material, Purpose, Finish . . . STAMPINGS of every Description . . . Blanking, Forming, Drawing, Extruding.

Your most dependable source of supply — the world's largest manufacturer of Washers, serving Industry since 1887. Over 22,000 sets of Dies. Submit your blueprints and quantity requirements for estimates.

WROUGHT WASHER MANUFACTURING CO.

The World's Largest Producer of Washers

2118 S. BAY ST., MILWAUKEE 7, WIS



3½ KW VACUUM TUBE BOMBARDER or INDUCTION HEATING UNIT



Only \$975

Never before a value like this 3½ KW bombarder or high frequency induction heater . . . for saving time and money in surface hardening, brazing, soldering, annealing and many other heat treating operations. Is

Portable . . . mounted on four rubber coasters. Width 14½"; depth 27"; height 42½"; weight 300#.

Operates from 220 volt line. Complete with foot switch and one heating coil made to customer's requirements. Send samples of work wanted. We will advise time cycle required for your particular job. Cost, complete, only \$975. Immediate delivery.

Scientific Electric Electronic Heaters are made in the following ranges of power: 1-2-3-5-7½-10-12½-15-18-25-40-60-80-100-250. KW.

Scientific Electric

Division of

"S" CORRUGATED QUENCHED GAP CO.

105 - 119 Monroe St., Garfield, N. J.

trol proper from its mounting bushing and protects the plastic shaft. Control-to-ground breakdown rating is better than 10,000 volts.

Vibration Pickup

TELECOMPUTING CORP., 2901 Hollywood Way, Burbank, Calif. The Vibratab is a vibration frequency pickup only $\frac{3}{16}$ in. in diameter, weighing less than a gram. The instrument's light weight permits accurate testing of highly sensitive test structures without danger of influencing vibration characteristics.

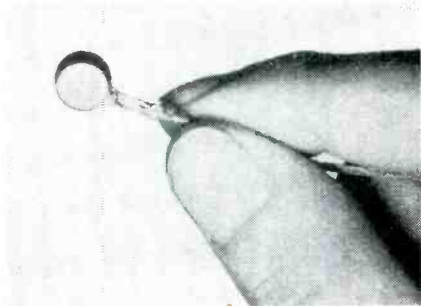

It has a life expectancy of 100 to 300 hours and will respond to acceleration frequencies from 3 to over 2,000 cps.

Transmitter Capacitors

CORNELL-DUBILIER ELECTRIC CORP., South Plainfield, N. J. The Faradon NF series of transmitter mica capacitors with universal mountings are intended for use in low-power transmitters for plate or grid coupling, filament, and plate bypass applications. Dimensions are $1\frac{1}{8} \times \frac{3}{8} \times 1\frac{1}{8}$ in. overall. Rating range is from 0.00005 μ f with 2,500 d-c working volts to 0.03 μ f with 600 d-c working volts.

Oscillograph Tube

RADIO CORP. OF AMERICA, Harrison, N. J. A new, 3-inch, oscillograph tube 3KP11 is intended particularly



Anti-Corrosive STAINLESS STEEL FASTENINGS

DO THE JOB *Better*

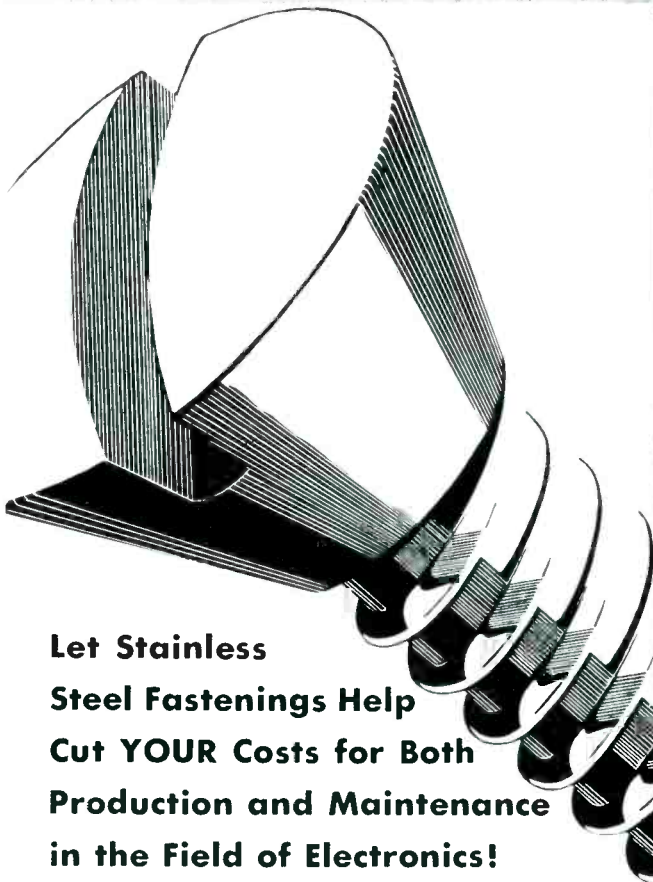

Let Stainless Steel Fastenings Help Cut YOUR Costs for Both Production and Maintenance in the Field of Electronics!

Every day, the electronics industry is discovering more specific ways in which stainless fastenings *do the job better!* They not only resist corrosion, vibration and changes in temperature, but also give you added strength, fine appearance, ease in cleaning or reuse and non-magnetic quality. Stainless gives you a *lower ultimate cost* through longer life and elimination of production interruptions.

7000 ITEMS IN STOCK

- Nuts
-
- Bolts
-
- Cap Screws
-
- Machine Screws
-
- Nails
-
- Set Screws
-
- Pins
-
- Rivets
-
- Sheet Metal Screws
-
- Washers
-
- Wood Screws
-
- Aircraft Fastenings to A-N & Govt. Specifications

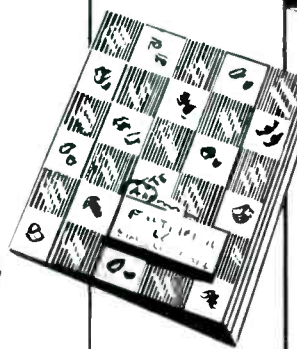

A Note on Your Letterhead Brings YOU This Outstanding Reference Catalog

Called by many users the "Bible of the Stainless Steel Fastening Industry", Anti-Corrosive's new catalog gives a complete listing of more than 7,000 items IN STOCK! Send us a note on your letterhead requesting Catalog 49C.

Anti-Corrosive
 Metal Products Co., Inc.
Manufacturers of STAINLESS STEEL FASTENINGS
 CASTLETON-ON-HUDSON, NEW YORK

*Now Terminals Can Be
ATTACHED & SOLDERED
in ONE Automatic Operation!*

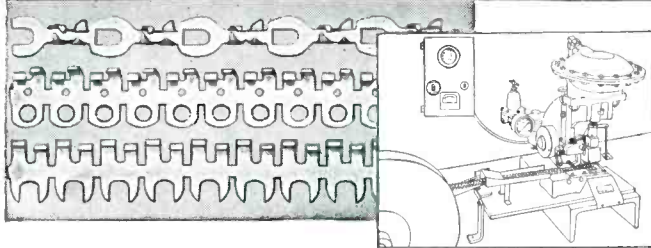

New Terminal Attaching Machine—

attaches and solders various sizes and types of pre-soldered tandem terminals (supplied on reels) at rates up to 1200 per hour. Machine cuts off, clinches and solders terminals in one instantaneous operation. Eliminates handling of loose terminals, solder and flux to increase production and lower costs on long runs. Standard types available. Strong, perfectly soldered joints are assured, as absolute control of heat is maintained. Send for detailed information, enclose sample of wire and terminal now used. Address Dept. F.

For ordinary runs in moderate quantity we continue to produce
SEPARATE TERMINALS for ELECTRIC WIRES

We also make **SMALL METAL STAMPINGS**, exact to Customer's Prints. Modern Plant, Equipment and Methods. Precision Work. Moderate Die Charges. Prompt, Dependable Service.

PATTON-MacGUYER COMPANY
17 Virginia Avenue, Providence, R.I.

IN · RES · CO
Wire Wound
RESISTORS
meet all instrumentation needs

TOLERANCE TO ± 0.1%

.01 OHM TO 1.0 MEGOHM

HIGH OR LOW WATTAGE

HERMETIC SEALED TYPES

A L TYPES OF MOUNTING

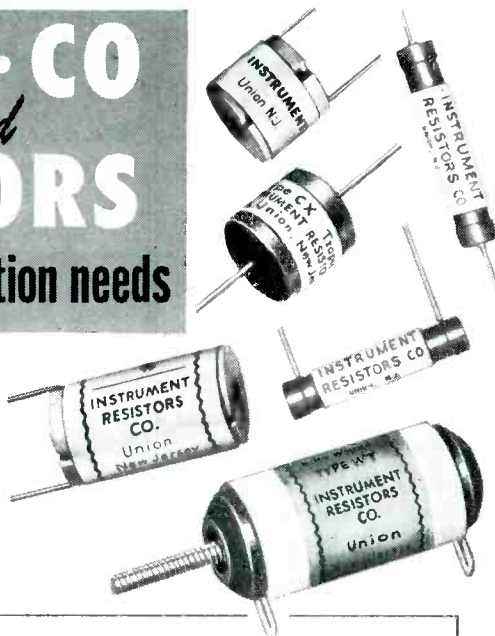

INRESCO Resistors are a product of high-speed winding techniques that introduce a new measure of economy in precision wire wound resistors.

They are available for IMMEDIATE DELIVERY, in diversified types that meet practically every circuit requirement of load, ohmic value, size, shape, and operating condition.

When planning a new circuit design, investigate the advantage of INRESCO resistors for economy, dependability and permanently fixed characteristics. For complete details, call or write today for your copy of the INRESCO catalog.

Manufacturers and designers of wire wound resistors—exclusively. Estimates on custom built resistors furnished.



INSTRUMENT RESISTORS COMPANY
1036 COMMERCE AVENUE, UNION, NEW JERSEY

POLARAD
TELEVISION Equipment

for studio • laboratory • manufacturer

SYNCHRONIZING GENERATOR

Model PT 101—Television

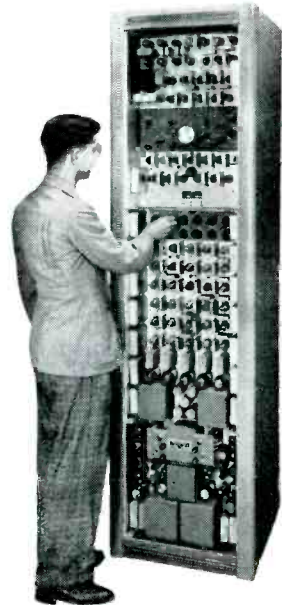

FEATURES

- Built-in 3" oscilloscope with synchronized sweeps for viewing Timing and Video Output pulse wave forms.
- Synchronized marker system for checking pulse width and rise time.
- Extreme stability, insured by deriving all pulses from leading edge of master oscillator pulse.
- Means for checking synchronizing pulses in odd and even fields.

SPECIFICATIONS

525 line, interlaced, 60 fields, 30 frames, RMA Synchronizing pulses held to tolerance specified in the NRTPB report of 1945. Output Pulses: Synchronizing, Video Blanking, Camera Blanking, Horizontal Driving, Vertical Driving Pulses. 5 volts across 100 ohm termination. Dual output jacks. 115 volts 50/60 cps. Complete with tubes.

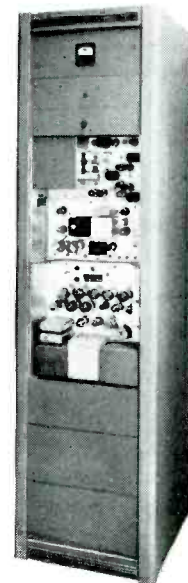

TELEVISION MONOSCOPE SIGNAL SOURCE

Model PT 102

- Composite Video Signal
- Wide Band Video Amplifier, 6 DB down at 10MC
- Dual outputs for feeding two 75 or 100 lines
- Black positive or Black negative output
- Resolution greater than 600 lines

INPUT: Vertical and Horizontal Driving pulses. Camera and Kinescope Blanking Pulses.

OUTPUT: Composite Video Signal, 3 volts, 100 ohm line 115 volts 50/60 cps. Complete with tubes and including high and low voltage power units.

9 FERRY STREET
NEW YORK 7, N. Y.

Polarad
Electronics Company

Television engineers and consultants to the nation's great television stations.

for photographic recording of electrical phenomena. The blue radiation of its fluorescent screen is highly actinic and has sufficiently short persistence for moving-film recording without blurring except where the film moves at high speed. The tube has electrostatic focus, electrostatic deflection, high deflection sensitivity, and a zero current-to-first anode gun.

D-C Timing Motor

THE A. W. HAYDON Co., Waterbury, Conn., is producing series 5500 and 5700 d-c motors with a specially designed marine-type clock escapement governor for uniform time drive on d-c. They will maintain an accuracy of 1 percent and 0.1 percent respectively under variations

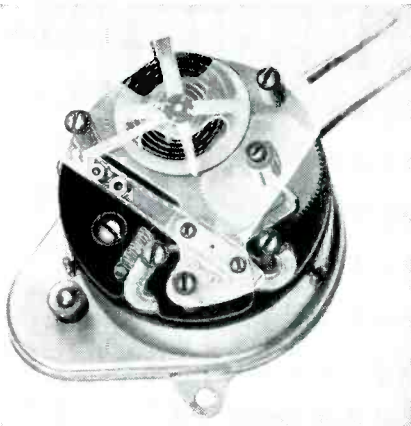

of input voltage of ± 20 percent, load variations from 0 to 30 inch ounces (based on a 1-rpm speed) and over a temperature range of -50 F to $+150$ F.

D-C Microammeter

W. S. MACDONALD Co., Inc., 33 University Road, Cambridge 38, Mass. Type 100 microammeter is designed for measuring very small direct

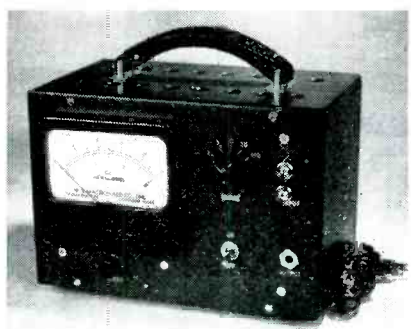

Cut "Breadboard" Time 50% with UNICHASSIS

THE ELECTRONIC CONSTRUCTION SET

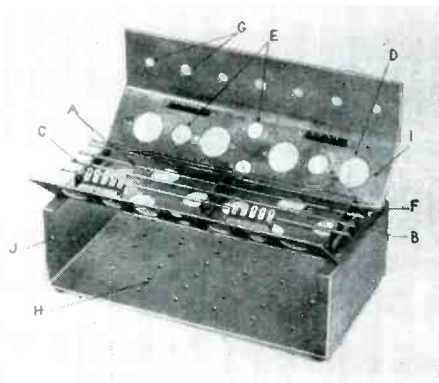

First advertised in the July 1949 issue of *ELECTRONICS*, the UNICHASSIS has been purchased by mail by hundreds of manufacturers, laboratories and schools. It has been found that, properly used, laboratory time for construction of experimental circuits can be cut in half. Thousands of different circuits have been created and tested on this device. Once completed the circuit can be stored, used as permanent equipment, or broken down for re-use. Complex circuits have been created using UNICHASSIS in gangs.

HERE'S HOW IT'S MADE

- | | |
|---|---|
| <p>A. Brass trough busbar partly filled with solder. Stick wire in groove and touch with iron.</p> <p>B. Connector pins to plug in input or output.</p> <p>C. Ends of busbars fit UNILEADS—simply plug in.</p> <p>D. Socket holes take regular, snap-rim or lip mount sockets. Miniature adapters also furnished for up to 16 tubes total.</p> <p>E. Four 7-pin socket holes and four 9-pin socket holes, plus miniature adapters shown here.</p> | <p>F. Access holes for grid cap leads and leads from components on lower shelf.</p> <p>G. Mounting holes for pots, switches, jacks, fuses, lights, condensers, etc.</p> <p>H. Lower shelf drilled for fixed mounting of heavier components.</p> <p>I. Tube-socket mounting holes tapped for screws.</p> <p>J. Holes for connection to two or more UNICHASSIS. Overall dimensions 11" x 7" x 8 1/4".</p> |
|---|---|

UNILEAD SET

Consisting of fittings and leads which plug into each other, allowing endless combination of short-proof connections. Assorted lengths of flexible, insulated conductors with terminals at each end.

COMPLETE KIT

UNICHASSIS plus 22 UNILEADS and 96 UNILEAD attachments consisting of probes, alligator clips, banana plugs, phone-tip plugs, Pee Wee Clips, spade lugs, large and small grid caps, Fahenstock clips and ample 1" and 1/2" connectors, solder-stub connectors, tee and X connectors.

Everything Ready to go, on a "Breadboard"
that can be used again and again

SMALL CROSS-SECTION OF PURCHASERS

Armour Research Foundation — Bell Telephone Labs. — E. I. DuPont — Douglas Aircraft — GE — Johns Hopkins — Monsanto — N.Y.U. — Bureau of Standards — University of Pennsylvania — Shell Oil — Fisher Pierce — Kimberly Clark — Brookhaven National Laboratory — Geophysical Service, Inc. — Federal Telecommunication Labs. — and practically every government laboratory.

PRICE **\$22.50** f.o.b. Washington. See your local jobber or send your order complete direct to us. We pay postage if money order or check is advanced.

UNI-PRODUCTS, INC.

1048 POTOMAC STREET, N.W. • WASHINGTON 7, D. C.

**IF IT'S
SPECIAL
SEE
PROGRESSIVE**



KEEP YOUR COSTS DOWN

Progressive specializes in manufacturing special heads, threads and finishes on any metal or alloy adapted to cold upset. Please write for catalog showing many Progressive specials. Catalog includes purchasing and engineering helps.

The **PROGRESSIVE
MANUFACTURING CO.**

50 NORWOOD ST.
TORRINGTON, CONNECTICUT



ENLARGED VIEW

Sterling INDUSTRIAL RELAYS

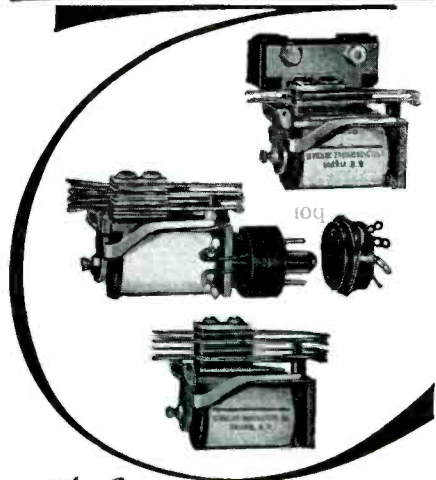

are
ADAPTABLE
and
DEPENDABLE

Adaptability and dependability are two of the most outstanding features in **STERLING INDUSTRIAL RELAYS.**

STERLING RELAYS have won general acceptance as standard equipment by many users throughout industry. Among these satisfied customers are manufacturers, military and naval services along with industrial and private laboratories.

STERLING will engineer and design relays for your particular needs or requirements.

TYPE GS illustrated.

TYPE KS - for Aircraft, Long Form Telephone type Relays are standard manufacture at Sterling.

Write today for your copy of **BULLETIN 110** on relays for industry.

**Sterling
Engineering Co.**
LACONIA
NEW HAMPSHIRE



STANDARDIZED READY-TO-USE METAL EQUIPMENT

ADAPTABLE FOR EVERY REQUIREMENT

Par-Metal Equipment offers many features, including functional streamlined design, rugged construction, beautiful finish . . . plus **ADAPTABILITY.** Eliminate need for special made-to-order units on many jobs.



Engineers and manufacturers will effect economies with Par-Metal Products, which are available for every type of job from a small receiver to a deluxe broadcast transmitter.

Professional techniques and years of specialization are reflected in the high quality of Par-Metal. . .

**CABINETS • CHASSIS
PANELS • RACKS**

Write for Catalog

**PAR-METAL
PRODUCTS CORPORATION**
32-62 - 49th STREET
LONG ISLAND CITY 3, NEW YORK
Export Dept. - Rocke International Corp
13 East 40 Street, New York 16

currents. Input resistance is 50 ohms and sensitivity is 1 μ a full scale. An output jack is provided so that the instrument can be used as a high-sensitivity d-c amplifier, and as such it will actuate a 1-ma, 1400-ohm recorder directly.

Terminal Structure

VECTOR ELECTRONIC Co., 1101 Riverside Drive, Los Angeles 31, Calif. The Socket-Turret is a new terminal structure on which the circuit components associated with a vacuum tube may be neatly connected directly at the socket. The

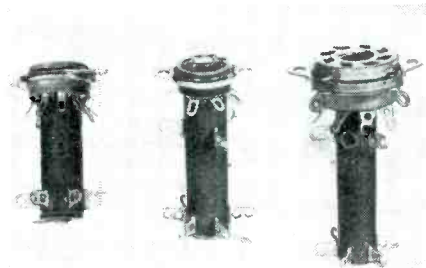

method is applicable to almost any electronic assembly whether for large or small production or for experimental work. Various mountings available are described and illustrated in a recent bulletin.

Impedance Measuring Unit

ELECTRODYNE Co., 899 Boylston St., Boston 15, Mass. Facilitating the measurement of impedances from 0.1 to 100,000 ohms through a wide range of frequencies, the Impedometer, used in conjunction with a suitable oscillator and vtvm, provides means for comparing the voltage drop across a resistive standard when the same current is flowing in both circuits. The unit uses stand-

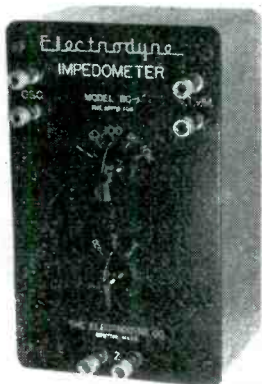

Introducing the TL-40C COMPASS LOCATOR TRANSMITTER

by

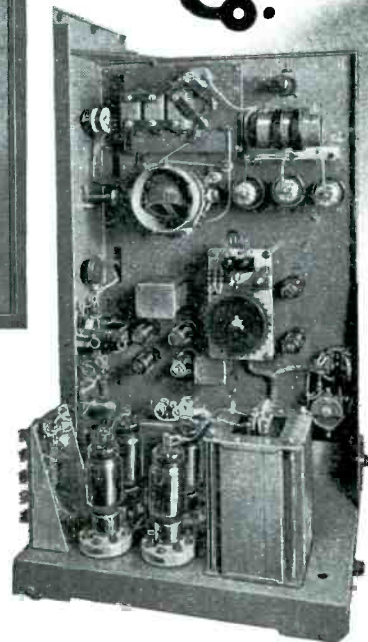

...for instrument landing systems and short range navigation.

SPECIALLY designed for the standard CAA and ICAO instrument landing systems. Enables the pilot to navigate to the ILS and line himself up on the localizer. Also suitable for installation in any location where a low powered homing facility is required. Can be used to locate fan markers and other important reference points.

This transmitter is built for maximum accessibility. A feature of the equipment is simplified tuning, only two controls being required to tune the transmitter to the crystal frequency. Entire unit mounted on ball bearing wheels; can be rolled out of its cabinet on self-contained tracks. May be serviced from the front while in operation.

A separate antenna tuning unit is supplied with the transmitter. It is contained in a totally enclosed aluminum housing; designed for mounting on any vertical surface. Includes an antenna tuning control and a current meter on the front panel. 25 feet of Transmission line is supplied to connect the tuning unit to the transmitter.

Write for our New bulletin on the TL-40C
Address Dept. ES-9

Communications Division



RADIO RECEPTOR COMPANY, INC.



Since 1922 in Radio and Electronics

251 WEST 19TH STREET

NEW YORK 11, N. Y.



Volume users
of
Special Fasteners
and allied devices
turn first to
UNITED-CARR
for cost-cutting
design engineering
service

Send us your specifications or requirements. Address Dept. 14

UNITED-CARR FASTENER CORP.

Cambridge 42, Mass.

MAKERS OF **DOT** FASTENERS



INKLESS

RECTILINEAR

Direct Writing

RECORDERS



— with extremely high torque movement (200,000 dyne cms), ruggedly built and producing clear, permanent records.

Sanborn Direct Writing Recorders offer these advantages, plus performance characteristics (see table below) that make them outstandingly useful in a wide variety of industrial recording applications.

Whenever a phenomenon or action lends itself to transformation to an electrical quantity, and whether the variation is steady or of a pulse type, these Recorders (with associated amplifiers) can be used for immediate, direct, continuous registration.

Typical applications, actual and potential, include: temperature changes, automotive noise and vibration, varied output of strain gages and bridges, lightning and earthquake recording, pressure variations, audio frequency response, and many others.

Recording paper (Sanborn Permapaper) is heat sensitive — eliminating ink — yet clear and permanent. Trace is rectilinear — no curvature, no negative time intervals — yet with totally negligible tangent error.

Sanborn Recorders are available in self-contained, portable recording outfits, complete with cases and controls, or in component form for integration with existing equipment. Associated amplifiers are also available.

TABLE OF CONSTANTS

| | |
|---|--|
| Sensitivity | 10 ma/1 cm. |
| Coil resistance | 3,000 ohms, center tapped for push-pull operation. |
| Critical damping resistance | 500 ohms. |
| Undamped fundamental frequency | 45 cycles/sec. |
| Stylus heater requires from external source | 1.25 volts, 3.5 amps, AC or DC. |
| Maximum undistorted deflection | 2.5 cm. each way from center. |
| Marker requires from external source | 1.25 volts, at 1.5 amps, AC or DC. |
| Paper speed | 25 mm/sec. |
| Chart ruling | 1 mm intervals. |

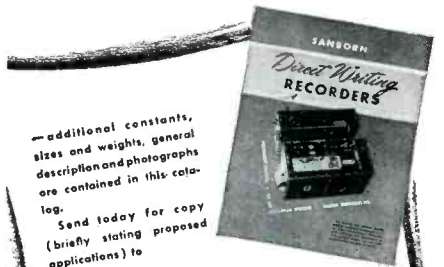

— additional constants, sizes and weights, general description and photographs are contained in this catalog. Send today for copy (briefly stating proposed applications) to

INDUSTRIAL DIVISION
Sanborn Company
CAMBRIDGE 39, MASSACHUSETTS

MICROPOT

PRECISION TEN-TURN POTENTIOMETER

1. You get permanent accuracy because the resistance wire is locked in place. It is precision positioned and moulded integrally with the housing.
2. You get permanently accurate settings, smooth action and low uniform torque provided by the stainless steel, precision ground, double thread lead screw guiding the moving contact.
3. You get precise positioning of the moving contact because of the two bearings supporting the rotor assembly.
4. You get good rigid terminals because they are moulded integrally with the housing.
5. Terminals soldered to ends of resistance element before moulding. Entire resistance circuit is an integral part of the housing.
6. You get accurate setting and re-setting due to anti-backlash spring in contact guide.
7. You get a fine resolution because of the $4\frac{3}{8}$ " length of resistance wire in the spiral element.
8. You get a resistance output directly proportional to shaft rotation within $\pm 0.1\%$ of the total resistance. Every potentiometer is automatically machine tested for linearity at 101 points.

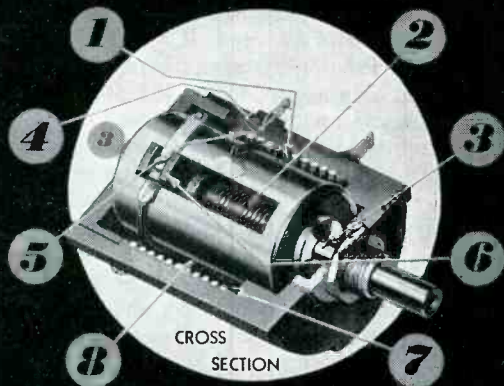

LINEARITY ACCURACY $\pm 0.1\%$

Units for immediate shipment:
1,000 to 30,000 ohm range.
Special resistance values made to order.

WRITE TODAY FOR ENGINEERING INFORMATION



GIBBS DIVISION
THE GEORGE W. BORG CORPORATION
DELANA • WISCONSIN

ard resistors accurate to 1 percent. No batteries are used. A descriptive bulletin with complete specifications and application data is available on request.

Crystal Microphone

ELECTRO-VOICE, INC., Buchanan, Michigan. Model 911 Mercury microphone is a general-purpose crystal type with a frequency response which is substantially flat from 50 to 8,000 cps. Output level



is -48 db. It is available with either 8 or 20-ft cable. Further details may be found in bulletin 154.

Ultrasonic Analyzer

PANORAMIC RADIO PRODUCTS, INC., 10 South Second Ave., Mt. Vernon, N. Y. Typical uses of the SB-7 ultrasonic analyzer include analysis of ultrasonic vibrations, monitoring telemetering subcarriers and communications carrier systems, and

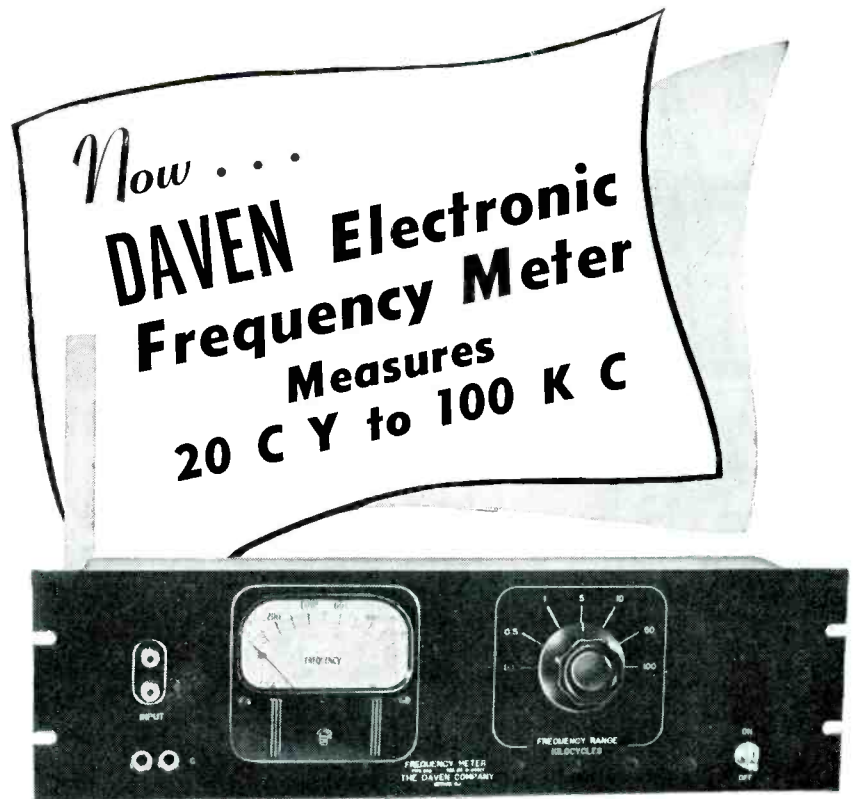
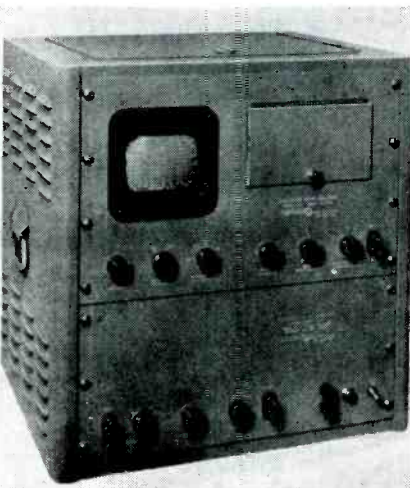

The Type 838 Frequency Meter is a direct reading instrument designed to measure audio and supersonic frequencies from 20 to 100,000 cycles per second. The instrument has great laboratory and industrial utility in applications requiring either occasional or continuous frequency measurement in the above spectrum. A jack connection has been provided on the back of the instrument for the use of an external recording milliammeter for applications where a continuous graphic frequency record is required.

—Features—

- Frequency range from 20 cycles to 100 KC.
- Seven ranges available with an accuracy of 2% of full scale on all ranges.
- Can operate on input voltage as low as ½ volt.
- Large easy-to-read meter with illuminated dial.
- Built-in voltage regulated power supply.
- Indication on meter is substantially independent of input wave form.
- May be used with an indicating recorder to make permanent records of frequency runs.
- Mounted on standard 5¼" relay rack panel.

Write for additional information
Dept. E-2

THE **DAVEN** CO.
191 CENTRAL AVENUE
NEWARK 4, NEW JERSEY

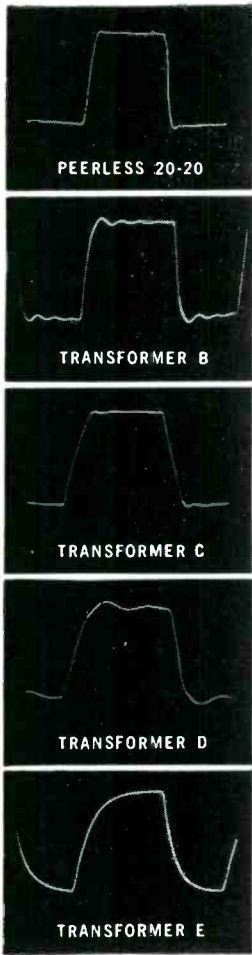

AGAIN! PEERLESS DEMONSTRATES SUPERIORITY OF ITS TRANSFORMERS BY SQUARE WAVE TEST AT WCEMA SHOW AND WEST COAST I.R.E. CONVENTION IN SAN FRANCISCO

*Photos show square wave response with
11,000 cycle fundamental frequency*

Square waves provide the most rigorous test of an audio system and give indisputable evidence on transformer performance. These square wave tests were made under conditions simulating actual transformer operation, that is, square waves were fed from a balanced generator through resistors equivalent to the plate load of the tubes. A non-inductive resistance load was used on the secondary. All transformers were demonstrated under identical conditions. No compensation of any kind was used. A switching mechanism was arranged to give an A-B comparison between any of the transformer. All competitive transformers (as well as the Peerless transformer used) were selected from jobber stock items of leading transformer manufacturers. Only the highest priced "high quality" transformer of each manufacturer was chosen. Equally decisive comparative results were obtained at all other frequencies from 20,000 down to 20 cycles. Let Peerless figure on all of YOUR transformer requirements.

PEERLESS ELECTRICAL PRODUCTS DIVISION

1161 N. Vine St., Hollywood 38, Cal.
161 Sixth Avenue, New York 13, N. Y.



Frazar & Hansen Ltd., 301 Clay St., San Francisco 11, Cal.
Exclusive Export Agent

*Have you examined
these volumes
in the*

M.I.T. RADIATION LABORATORY SERIES

COMPONENTS HANDBOOK

Vol. 17. Edited by John F. Blackburn, M.I.T.
613 pages, illustrated, \$8.00

This book codifies information on the properties and characteristics of most electronic components. The first part lists fixed components such as wires, cables, resistors, etc. The second deals with electro-mechanical devices and the third section is devoted to vacuum tubes and cathode ray tubes.

VACUUM TUBE AMPLIFIERS

Vol. 18. Edited by George E. Valley, Jr., M.I.T.; and Henry Wallman, M.I.T. 733 pages, illustrated, \$10.00

Here is a complete analysis of important types of amplifiers together with their design principles and constructional techniques. The amplifiers discussed provide special characteristics such as very high gain, large bandwidth, or precise response.

WAVEFORMS

Vol. 19. Edited by Britton Chance, E. F. MacNichol, University of Penn.; F. C. Williams, Manchester University; V. W. Hughes, Columbia University; and D. Sayre, Alabama Polytechnic Institute. 776 pages, illustrated, \$10.00

A detailed description of the generation and use of precisely controlled voltages and currents, introducing methods of wave shaping by linear circuit elements and negative feedback amplifiers. The properties of vacuum tubes as non-linear circuit elements and their application to waveform manipulation are presented in detail.

ELECTRONIC TIME MEASUREMENTS

Vol. 20. Edited by Britton Chance and E. F. MacNichol, University of Penn.; and R. I. Hulsizer, M.I.T. 528 pages, \$7.00

This book opens with a survey of precision ranging circuits depending upon both manual and automatic control. The second part deals with circuits using supersonic delay elements for cancellation of recurrent waveforms, and the third section presents precision methods for data transmission employing pulse timing techniques.

SEE THEM 10 DAYS FREE

----- MAIL COUPON TODAY -----

McGraw-Hill Book Co., Inc.,
330 W. 42nd St., N. Y. C. 18

Send me the volumes of the M.I.T. RADIATION LABORATORY SERIES indicated by the numbers encircled below for 10 days' examination on approval. In 10 days I will remit the price of the books I keep, plus a few cents for delivery, and return unwanted books postpaid. We pay for delivery if you remit with this coupon; same return privilege.)

| | | | | |
|----------------|------------|-------------|----|---------|
| | 17 | 18 | 19 | 20 |
| Name | | | | |
| Address | | | | |
| City | Zone | State | | |
| Company | | | | |
| Position | | | | L-10-49 |

This offer applies to U. S. only.

do you know what PAPER can do for you?



Central Engineered Electrical Papers are among the most versatile of materials. They can be accurately controlled in thickness, porosity, Ph, weight and many other characteristics. Central Electrical Papers can also be made with anti-rust and anti-tarnish properties . . . they can be creped for easier wrapping around corners . . . they can be juted for extra strength . . . they can be water-proofed . . . or almost any combination of these properties and special treatments may be had.

The Central Paper Engineer knows his papers and is backed by laboratory facilities second to none in the industry.

CENTRAL PAPER COMPANY INC.

2446 LAKESHORE DRIVE



MUSKEGON, MICHIGAN

other investigations requiring overall observation of the ultrasonic spectrum. Frequency range is from 2 to 300 kc. The unit also features a continuously variable scanning width from a 200-kc maximum to zero, full scale deflections for input voltages between 1 mv and 50 volts. Signal amplitude ratios as high as 300 to 1 are measurable.

Ultrasonic Generator

GENERAL ELECTRIC Co., Schenectady 5, N. Y., announces a new ultrasonic generator for use in research laboratories to study the effect of ultrasonic energy on various materials and processes. It converts h-f electrical power into h-f mechanical vibrations in the form of sound waves pitched much higher than the range

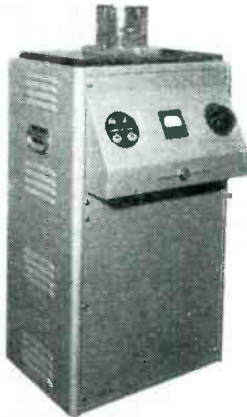

of human hearing. Four vibration frequencies are provided: 300, 500, 750 and 1,000 kc. Power input is 500 watts at 115 volts, 50 cycles, while power output is 200 to 250 acoustical watts.

Fuse Holder

HUGH H. EBY, INC., 4703 Stenton Ave., Philadelphia, Pa. Using the principle of a tube socket contact of proper diameter, a new fuse holder has been developed for in-the-line service in electrical and electronic equipment. Positive contact is as-

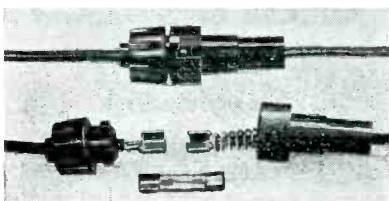

T PRECISION Transformers

**FOR TODAY'S
MORE EXACTING
REQUIREMENTS**

**POWER -- AUDIO
CHOKES -- FILTERS**

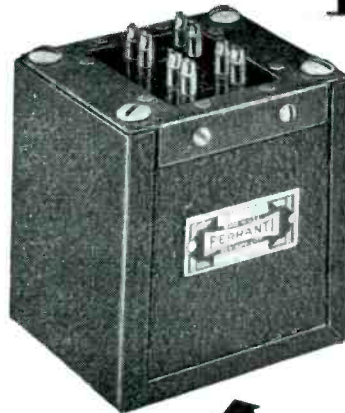

ENCLOSED CASE, compound filled, for high moisture resistance. Standard cases up to 500 VA. Wide range of standard audio transformer units.

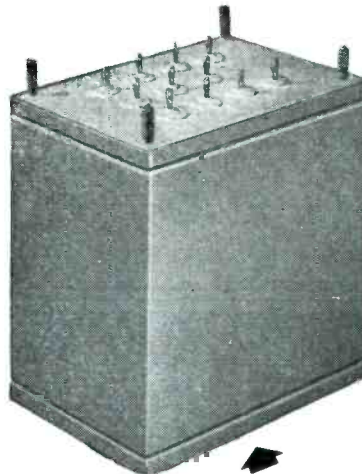

HERMETICALLY SEALED and compound filled cases. Glass or ceramic sealed terminals. Designed to meet JAN salt water immersion tests.

For Television and all other applications where specifications are precise and the emphasis is on quality and performance, famous FERRANTI transformers offer superior value.

Into each unit goes long years of specialized experience, plus up-to-the-minute knowledge of today's improved practices and latest materials. Our large and varied stock of patterns, tools, and dies often permits us to supply "custom" requirements from standard parts, effecting worthwhile savings. We invite your inquiries.

FERRANTI

OPEN FRAME TYPE for mass production, minimum cost and weight for enclosed equipment.



**FERRANTI
ELECTRIC, INC.**
30 ROCKEFELLER PLAZA
New York 20, N. Y.



*Trade Mark

MINIATURE ELECTRICAL TRANSMITTERS

- Fully temperature compensated
- The most RELIABLE precision instruments employing strain gage elements ever constructed for industrial and aircraft applications

- CUSTOM INSTRUMENTATION
- ACCELEROMETERS
- ALTIMETERS
- AIRSPEED TRANSMITTERS
- PRESSURE TRANSMITTERS

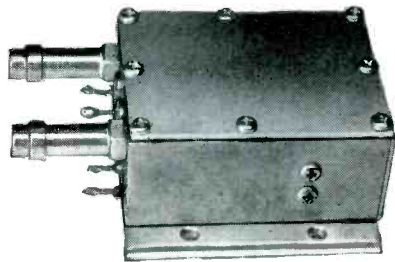
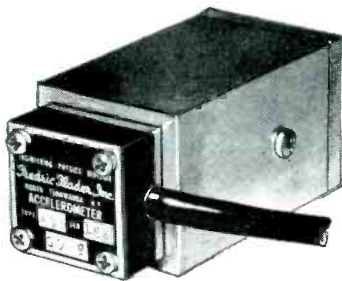

Specify Teleflight Instruments

Write for descriptive bulletin

ENGINEERING PHYSICS DIVISION

Fredric Flader, Inc.

North Tonawanda, New York, U. S. A.

COVERING THE ENTIRE RANGE OF COMPONENTS...

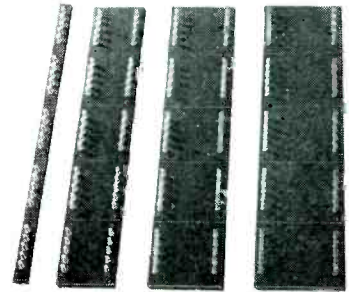

CTC ALL-SET Boards Speed Up Work On Assembly Lines And In Laboratories

CTC ALL-SET Boards are designed to save time and cut costs over a wide range of standard assembly operations.

Boards with Type 1724 Turret Lugs come in four widths: $\frac{1}{2}$ ", 2", $2\frac{1}{2}$ ", 3"; and in thicknesses of $\frac{3}{32}$ ", $\frac{1}{8}$ ", $\frac{3}{16}$ ". A Board with Type 1558 Turret Lugs, for miniature components, is $1\frac{1}{16}$ " wide, with thicknesses of $\frac{1}{16}$ " and $\frac{3}{32}$ " only (Type X1401E). This new miniature Board completes the CTC ALL-SET group.

Boards are all of laminated phenolic, in five-section units scribed for easy separation. Each section is drilled for 14 lugs, with 10 mounted, except X1401A ($\frac{1}{2}$ " wide), which is drilled for 7 lugs per section, with 5 mounted. All lugs are solidly and precisely swaged, and each whole board is ready for assembly.

Custom-Built Boards

are an important specialty at CTC. Avail yourself of our long experience in handling the widest range of materials and jobs — many of them requiring special tools — and in all types of work to commercial or government specifications.

CTC ALL-SET Terminal Boards, Custom-Built Boards and many other CTC *Guaranteed Components* are described and illustrated in our big new catalog #300. Send for your copy today.

Build YOUR OWN TEST EQUIPMENT

Heathkit

Heathkit AUDIO GEN. KIT \$34.50

Heathkit TELEVISION GENERATOR KIT \$39.50

Heathkit CONDENSER CHECKER KIT \$19.50

NEW Heathkit IMPEDANCE BRIDGE SET \$69.50

Heathkit HANDITESTER KIT \$13.50

Heathkit TUBE CHECKER KIT \$29.50

Heathkit 5" OSCILLOSCOPE KIT \$39.50

Heathkit BATTERY ELIMINATOR KIT \$22.50

Heathkit ELECTRONIC SWITCH KIT \$34.50

Heathkit R.F. SIGNAL GEN. KIT \$19.50

Heathkit VACUUM TUBE VOLTMETER KIT \$24.50

Heathkits are beautiful factory engineered quality service instruments supplied un assembled. The builder not only saves the assembly labor cost but learns a great deal about the construction and features of the instrument. This knowledge aids materially in the use and maintenance of the equipment. Heathkits are ideal for and used by leading universities and schools throughout the United States. Each kit is complete with cabinet, 110V 60 cycle transformer (except Handitester), all tubes, coils assembled and calibrated, panel already printed, chassis all punched, ferried and plated, every part supplied. Each kit is provided with detailed instruction manual for assembly and use. Heathkits provide the perfect solution to the problem of affording complete service equipment on a limited budget. The basic three instruments — an Oscilloscope, Vacuum Tube Voltmeter and Signal Generator can be purchased in Heathkits for \$83.50, about the cost of a factory built VTVM alone. Write for complete catalog.

HEATH COMPANY

BENTON HARBOR, 14 MICHIGAN

EXPORT DEPARTMENT
13 EAST 40TH STREET
NEW YORK 16, N. Y.
CABLE — ARLAB — N. Y.



Turret Lugs



Split Lugs



Terminal Boards



Double-End Lugs



Swagers

Custom or Standard The Guaranteed Components

CAMBRIDGE THERMIONIC CORP.
437 Concord Ave., Cambridge 38, Mass.

sured by attaching the wire lead to the socket-type contact by a solderless crimp connection. After three insertions of a 0.253-inch diameter pin there is a maximum voltage drop of 5-mv at 20 amperes when measured with a 0.247-inch silver-plated copper pin.

Video-Circuit Trap

RADIO CORP. OF AMERICA, Harrison, N. J., has developed the type 203L5 video-circuit trap, designed for use in the plate circuit of the first video amplifier of television receivers to

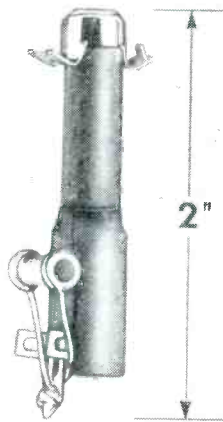

attenuate the 4.5-mc intercarrier beat frequency. Its design uses a fixed, ceramic capacitor shunting a low-Q inductance tuned by an adjustable iron core.

Servo Analyzer

FLIGHT RESEARCH ENGINEERING CORP., P. O. Box 1-F, Richmond, Va. Type 6 servo analyzer is a portable instrument for measuring the dynamic characteristics of servos or control systems employing 60 or 400-cycle electrical error measuring



MICROSEN D. C. AMPLIFIER

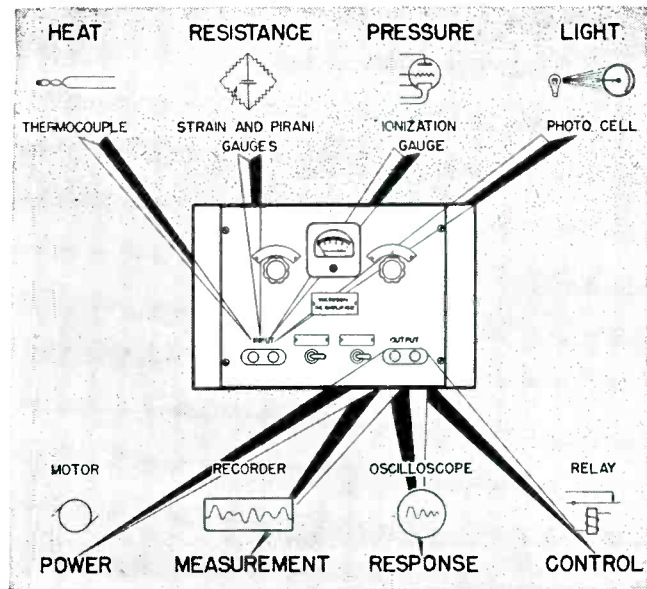

Performance plus Versatility

THE Microsen D. C. Amplifier provides stable and accurate amplification that is simple in operation, compact in design, moderate in cost. Particularly adaptable to laboratory and field work, the Microsen Balance principle assures the advantages of high gain with stability and fast response. The versatility and scope of this electronic instrument opens new fields in engineering research and process development work.

Line voltage variations of 15 per cent cause output changes of less than .5 per cent. There are no mechanical rectifiers or choppers. Tubes are standard. Time constant from .001 to .2 seconds. Drift less than 5 microvolts per day.

Models available include Voltage, Current and Potentiometer Type Amplifiers, Direct Current Converters, Direct Current Transformers and engineered designs to meet special requirements.

For complete data including operation, applications, advantages and specifications—write for the Microsen D.C. Amplifier Bulletin.



MICROSEN D. C. AMPLIFIER

A Product of
MANNING, MAXWELL & MOORE, INC.
STRATFORD, CONNECTICUT

Makers of 'Microsen' Electrical and 'American' Industrial Instruments, 'Hancock' Valves, 'Ashcroft' Gauges, 'Consolidated' Safety and Relief Valves. Builders of 'Shaw-Box' Cranes, 'Budgit' and 'Load Lifter' Hoists and other lifting specialties.

the inside story of an

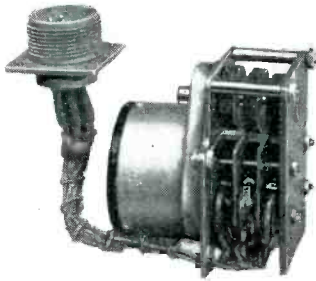

COMPACT
Size 2 1/2" x 2 1/2" x 2 1/8"
Series 3602

A. W. HAYDON

*Custom
Designed
Timer*

This compact unit illustrates the internal mechanism of a custom designed D. C. Repeat Cycle Timer. Photo shows the extreme simplicity and compactness of a three-circuit sequence timer with aircraft type connection for mounting in housing (not shown).

Let Haydon apply more than 18 years' experience and knowledge to the solution of your electrical timing and control problems. Write:



The
A. W. HAYDON
COMPANY
NORTH ELM STREET
WATERBURY 32, CONNECTICUT
Design and Manufacture of Electrical Timing Devices

AMPERITE

Thermostatic Metal Type

Delay Relays



PROVIDE DELAYS RANGING FROM 1 TO 120 SECONDS

FEATURES: — Compensated for ambient temperature changes from -40° to 110° F . . . Hermetically sealed; not affected by altitude, moisture or other climate changes . . . Explosion-proof . . . Octal radio base . . . Compact, light, rugged, inexpensive . . . Circuits available: SPST Normally Open; SPST Normally Closed.

PROBLEM? Send for "Special Problem Sheet"

Regulators

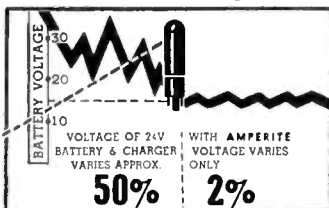

Amperite regulators are the simplest, lightest, cheapest, and most compact method of obtaining current or voltage regulation . . . For currents of .060 to 6 Amps. . . Hermetically sealed; not affected by altitude, ambient temperature, humidity.

Write for 4-page Illustrated Bulletin.

AMPERITE CO., Inc., 561 Broadway, New York 12, N. Y.

In Canada: Atlas Radio Corp., Ltd., 560 King St., W. Toronto

American Beauty

ELECTRIC SOLDERING IRONS

are sturdily built for the hard usage of industrial service. Have plug type tips and are constructed on the unit system with each vital part, such as heating element, easily removable and replaceable. In 5 sizes, from 50 watts to 550 watts.



TEMPERATURE REGULATING STAND

This is a thermostatically controlled device for the regulation of the temperature of an electric soldering iron. When placed on and connected to this stand, iron may be maintained at working temperature or through adjustment on bottom of stand at low or warm temperatures.

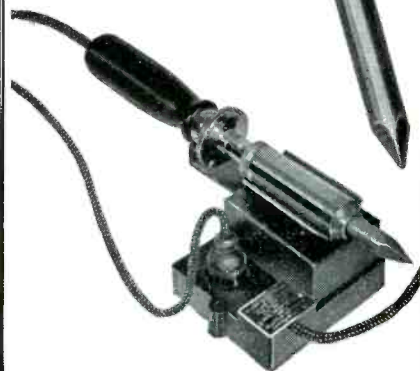

For descriptive literature write

110-1

AMERICAN ELECTRICAL HEATER COMPANY
DETROIT 2, MICH., U. S. A.

devices, at frequencies from 0.2 to 30 cps. It is designed for measurement accuracy of better than 5 percent in amplitude ratio and 2 deg in envelope phase.

Pulse Generator

POTTER INSTRUMENT Co., INC., 136-56 Roosevelt Ave., Flushing, N. Y., announces a 1,000-cycle pulse generator for exposing 0.001-second timing marks on film in the high-speed Fastax cameras. The timing marks are precisely controlled from a built-in 100,000-cps crystal oscilla-



tor. Output frequency is obtained by dividing the 100-kc frequency down to 1,000 cycles through the use of two counter decades. The power supply will operate from 50, 60 and 400 cycles at 110 volts.

Compact Kilovoltmeter

THE HICKOK ELECTRICAL INSTRUMENT Co., 10527 Dupont Ave., Cleveland 8, Ohio, has available a portable size d-c kilovoltmeter with a double range of 0 to 15,000 and 0 to 30,000 volts d-c. The S44A meter is an aid in installing and servicing h-f induction heating equipment, and other h-f uses including lab testing. Sensitivity is

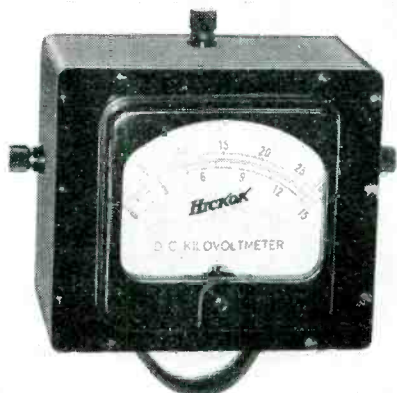

Listen for the words "Transcribed by AMPEX" after the great shows in radio

Here's why...the new series 300

AMPEX

MAGNETIC TAPE RECORDER answers industry need!

*Designed by
engineers who had
your engineering
needs in mind!*



Console Model 300* \$1,573.75

Portable Model 300 \$1,594.41

Rack Mounted \$1,491.75

*Meter panel extra

F. O. B. Factory. San Carlos, Calif.

★ You can depend on Ampex

Read what Frank Marx, Vice President in charge of Engineering, American Broadcasting Company, says: "For the past two years A.B.C. has successfully used magnetic tape for rebroadcast purposes... A.B.C. recorded on AMPEX in Chicago... 17 hours per day. For 2618 hours of playback time, the air time lost was less than 3 minutes: a truly remarkable record."

★ Original program quality preserved

Use of independent reproduction facilities allows instantaneous monitoring and makes possible the most stringent comparisons between recordings and originals.

SPECIFICATIONS

FREQUENCY RESPONSE:

At 15" ± 2 db. 50—15,000 cycles

At 7.5" ± 2 db. 50— 7,500 cycles

FLUTTER AND WOW: At 15 inches per second, well under 0.1% r.m.s., measuring all flutter components from 0 to 300 cycles, using a tone of 3000 cycles. At 7.5 inches, under .2%.

SIGNAL-TO-NOISE RATIO:

The overall unweighted system noise is 70 db. below tape saturation, and over 60 db. below 3% total harmonic distortion at 400 cycles.

STARTING TIME:

Instantaneous. (When starting in the Normal Play mode of operation, the tape is up to full speed in less than .1 second.)

Manufactured by Ampex Electric Corporation, San Carlos, Calif.

DISTRIBUTED BY

BING CROSBY ENTERPRISES

★ GRAYBAR ELECTRIC CO. Inc.

9028 Sunset Blvd., Hollywood 46, Calif.

420 Lexington Ave., New York 17, N. Y.

AUDIO & VIDEO PRODUCTS CORPORATION

1650 Broadway, New York, New York

MULTUM in PARVO —or, how to cut Space Requirements

This narrow-band filter for a carrier telephone system was cut in size to less than half by the use of Lenkurt Toroidal Coils as inductors. At the same time, performance capability was increased by 30 per cent.

For you, Lenkurt Toroidal Coils may help by saving space, permitting closer mounting of parts, improving Q, simplifying shielding. Write:

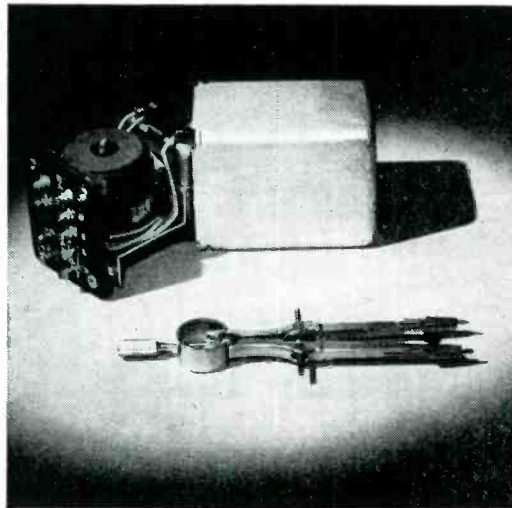

Lenkurt knows how



LENKURT ELECTRIC CO.
SAN CARLOS • CALIFORNIA

STANDARD...



Stands for Quality

Low Frequency Crystal Units

A special process has been developed to overcome fragility and give sturdiness to this STANDARD unit. Range—200 to 1200 kc. CT and DT cut. Hermetically sealed and filled with dry nitrogen. Good stability over wide temperature range. Meets government specifications. Write or wire for additional information.

We are in a position to make prompt delivery.



Standard Piezo Company
CARLISLE, PA.



CONSTANT POWER ZONE

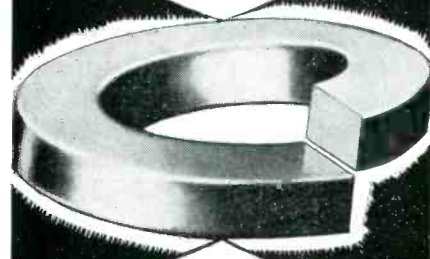

DIAMOND G SPRING LOCK WASHERS

Assure Longer Lasting Assemblies

The life of the assembly is usually determined by the length of the Power Zone of the fastening device. Diamond G Spring Lock Washers have been designed, developed and torture-tested to provide the maximum Constant Power Zone . . . longer positive holding power.

WASHER FOR EVERY NEED

Whatever your needs in spring lock washers, there's a Diamond G to answer it—high carbon steel, bronze, aluminum, stainless steel and monel metal spring lock washers finished or plated with cadmium, nickel, brass, copper or other finishes . . . plus the new Diamond G Aluminum Spring Lock Washer that combines lightness of aluminum with the strength and durability of steel.

Garrett also manufactures a complete line of flat washers, spring washers, springs, stampings, hose clamps, snap and retainer rings.



Write for your free copy of the technical booklet "Small Parts For Better Production."

DIAMOND G PRODUCTS

Manufactured by
GEORGE K. GARRETT CO., INC.
Philadelphia, Pa.

GARRETT

MANUFACTURERS OF SMALL PARTS

10,000 ohms per volt; current drain, 100 microamperes, full-scale deflection.

Isolation Transformers

CHICAGO TRANSFORMER DIV., ESSEX WIRE CORP., 3501 W. Addison St., Chicago 18, Ill. Three new isolation transformers with 50, 150, and 250-kva capacities have recently been announced for adjusting high or low line voltages, elimination of chassis grounds from line grounds, and reduction of shock hazard.



Secondaries will supply 105, 115, or 125 volts with 115 input to the primary.

Literature

Plugs and Switches. Switchcraft Inc., 1328-30 N. Halsted St., Chicago 22, Ill. Catalog S49 contains valuable engineering data and complete listing on many new products including jacks, plugs and switches for low-power applications. Schematic circuits, detailed line drawings and prices are given.

Electrical Measuring Instruments. Simpson Electric Co., 5200-18 West Kinzie St., Chicago 44, Ill., recently issued catalog No. 16, a 50-page spiral-bound publication in color, dealing with a line of electrical measuring instruments. Several new products are listed including the model 480 f-m/tv Genescope, which provides all of the necessary signal sources for aligning and servicing receivers. Pro-

**AIRCRAFT
RADIO
CORPORATION**



Type H-12 SIGNAL GENERATOR

900-2100 MEGACYCLES



**-Simplified
-Compact
-Portable**

- 900-2100 megacycles, single band
- Directly calibrated, single dial frequency control
- Directly calibrated attenuator, 0 to -120 dbm
- CW or AM pulse modulation
- Internal pulse generator with controls for width, delay, and rate. Provision for external pulsing
- Controls planned and grouped for ease of operation
- Weight: 42 lbs. Easily portable—ideal for airborne installations
- Immediate delivery

Built to
Navy Specifications
for research
and production
testing

Write for specifications—investigate the advantages of this outstanding new instrument.

DEPENDABLE ELECTRONIC EQUIPMENT SINCE 1928

Aircraft Radio Corporation
BOONTON, New Jersey



CUSTOM-BUILT

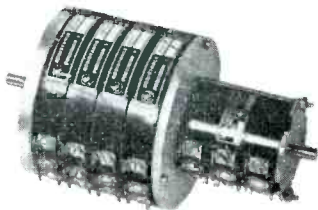

FAIRCHILD PRECISION POTENTIOMETERS

Typical of the solutions to special precision potentiometer problems submitted to Fairchild engineers by our customers is this custom-built combination of standard parts. It combines the extremely high resolution, fine linearity, and large electrical angle of the 4-gang Type 748 linear windings (left) with the flexibility, high accuracy, and small size of the 3-gang Type 736 non-linear potentiometer.

Through our policy of custom-manufacturing these instruments to your order, the services of our Potentiometer Sample Laboratory engineers are available for the analysis of all special precision potentiometer applications submitted to us. Sample deliveries are currently on a 3-week basis. Send us your precision potentiometer problems. For descriptive literature address: Dept. M, E8-06 Van Wyck Boulevard, Jamaica 1, New York.



**"DIE-FORMED TO GIVE
YOU BETTER, MORE
DEPENDABLE COILS!"**

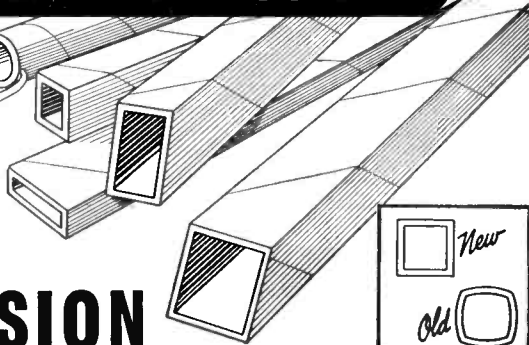

PRECISION PAPER TUBES . . .

Precision gives you the plus . . . coil bases formed under heat and pressure. The result, a coil base of less weight—greater strength—more thorough insulation—more effective resistance to moisture, oil and heat. All at the very minimum of cost. *It's a better coil that has a Precision base.*

Precision Paper Tubes are available in the best quality, dielectric Kraft, Fish Paper, Cellulose Acetate, Asbestos or combinations. Round, square or rectangular.

TODAY—WRITE FOR FREE SAMPLE
AND COMPLETE MANDREL LIST OF OVER 1,000 SIZES.

LOOK AT THESE FEATURES:

- * No need for coil, forming after winding.
- * Automatic stacking.
- * Wire saved by closer engineering of coil.
- * No side bow.

PRECISION PAPER TUBE CO.

2041 West Charleston St.
Chicago 47, Ill.
Plant No. 2, 79 Chapel St.
Hartford, Conn.



STANDARD AND HEAVY DUTY INVERTERS



For Inverting D. C. to A. C.

Specially Designed for operating A. C. Radios, Television Sets, Amplifiers, Address Systems, and Radio Test Equipment from D. C. Voltages in Vehicles, Ships, Trains, Planes and in D. C. Districts.

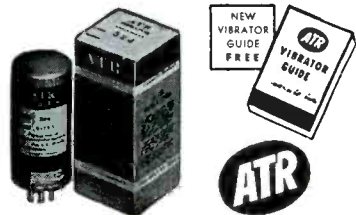

AUTO RADIO VIBRATORS

A Complete Line of Vibrators . . .

Designed for Use in Standard Vibrator-Operated Auto Radio Receivers. Built with Precision Construction, featuring Ceramic Stack Spacers for Longer Lasting Life.

NEW MODELS ✓ NEW DESIGNS
NEW LITERATURE ✓
ATR "A" Battery Eliminator, DC-AC Inverters, Auto Radio Vibrators
See your folder or write factory

AMERICAN TELEVISION & RADIO CO.
Quality Products Since 1931
SAINT PAUL, MINNESOTA—U. S. A.

duction methods are also described with many illustrations.

Wide-Range Oscillator. Southwestern Industrial Electronic Co., 2831 Post Oak Road, Houston 19, Texas. A four-page folder for insertion in a looseleaf catalog covers the model M oscillator which was designed as a source of power covering the frequency range of 0.25 to 120,000 cps. Description, specifications and circuit diagram of the low distortion unit are included.

Soldering Guns. Weller Mfg. Co., 808 Packer St., Easton, Pa., has released a catalog bulletin describing a line of soldering guns, featuring the new model WD-250 which is designed for heavy duty with a 250-watt handling capacity. Specifications, characteristics, tip types and prices for each model are included.

Technical Information. Radio Corp. of America, Harrison, N. J., recently published three new bulletins of technical information. Items covered comprise the 3KP1 and 3KP11, three-inch oscillograph tubes for photographic recording; the 203L5, a 4.5-mc video-circuit trap; and the 203R2 horizontal blocking oscillator coil and frequency-stabilizing coil.

Selenium Rectifier Brochure. The International Rectifier Corp., 6809 South Victoria Ave., Los Angeles 43, Calif., has announced a new 6-page brochure, identified as C-349-848, dealing with a line of selenium rectifiers. Included in the booklet are operating characteristics, applications, circuit diagrams and design data. Price information on a standard line of full-wave, single-phase, bridge rectifiers is also given.

Bi-Metal Disc Thermostats. Stevens Mfg. Co., Inc., Mansfield, Ohio. Stressing the quick make and break operation of type M bi-metal disc thermostats, bulletin F-2001 reproduces a schematic of thermostat operation, a typical response curve and construction data. It

Ballantine's PEAK to PEAK Electronic VOLTMETER

Designed for
PULSE AMPLITUDE
MEASUREMENTS

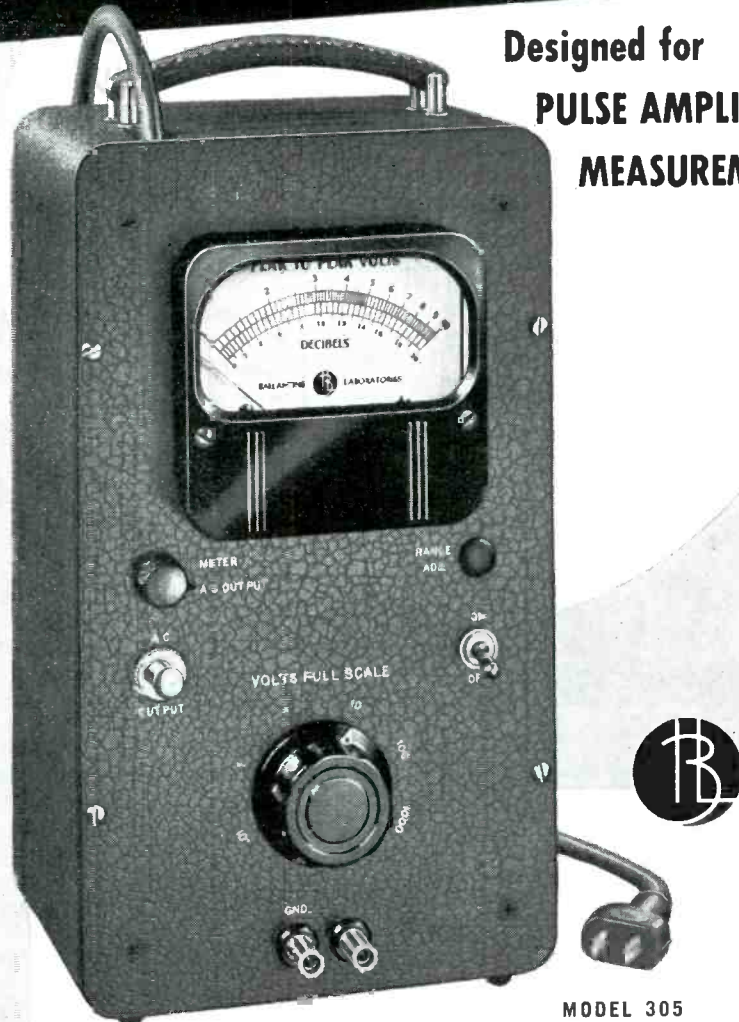

MODEL 305

The outstanding characteristic of the Model 305 Electronic Voltmeter is its ability to provide absolute indication of transient or pulse voltages of short duration. Reliable indication of pulses a few microseconds wide repeated only 10 times per second is readily obtained with this instrument. The Voltmeter is pre-calibrated, compact, easy to operate and observe. Positive and negative peaks are registered over the range of .001 volt to 1000 volts, peak to peak. Decade ranges and a logarithmic scale output meter are characteristic features, along with a separately available high gain, wide-band amplifier.

Send for Bulletin No. 12

BALLANTINE LABORATORIES, INC.

BOONTON, NEW JERSEY, U. S. A.

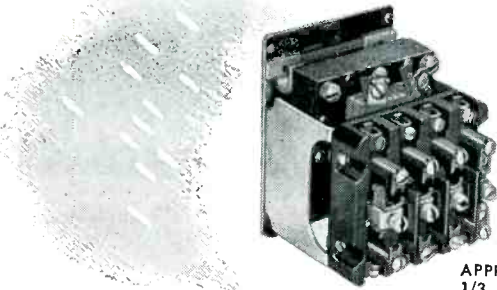

APPROX.
1/3 SIZE

**WHERE SPACE IS A FACTOR
and Accessibility a Must—
USE R-B-M INDUSTRIAL CONTACTORS**

R-B-M Industrial Contactors, with interchangeable normally open and normally closed contacts, can be mounted in minimum space without sacrificing accessibility. You will also find that the initial low cost of R-B-M, plus long and dependable performance, will save you money.

Available in 10 and 15 ampere sizes, 600 volt A.C., 2 to 8 pole non-reversing—2 to 4 pole reversing. Open and enclosed types. Write for Bulletin and Price List on your company letterhead.

Dept. D-10, R-B-M DIVISION OF ESSEX WIRE CORP.
Logansport, Indiana



MANUAL AND MAGNETIC ELECTRIC CONTROLS
— FOR AUTOMOTIVE, INDUSTRIAL, COMMUNICATION AND ELECTRONIC USE

**NEW! THE CB AUTOMATIC
AUDIO SWEEP GENERATOR**

25 CYCLES TO 32,000 CYCLES IN ONE CONTINUOUS RANGE—WAVE FORM DISTORTION .005 (1/2%) OR LESS — MANUAL OR AUTOMATIC OPERATION

Automatic Range adjustable from a minimum spread of 500 cycles to a maximum spread of 10,000 cycles. Sweep calibration is LINEAR and is adjustable from 2 to 10 sweeps per second.

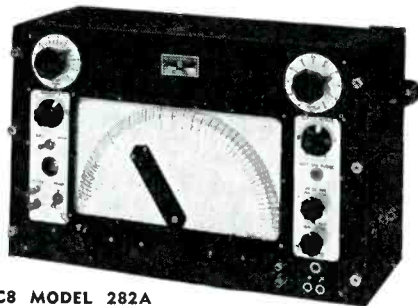

CB MODEL 282A

The new CB Model 282A is built to highest precision instrument standards and has a wide application range. For complete construction details and performance data, write for Bulletin 22A.



The CLOUGH BRENGLE CO.

6012 Broadway

Chicago 40, Ill.

WANTED

**ELECTRICAL
ENGINEER**

for

DEAN

of

ELECTRICAL SCHOOL

of a

SMALL

MID-WESTERN

COLLEGE

- An interesting and challenging appointment is available to a man having the desire and experience to enter or broaden his opportunities in the field of Education.

- The locality and facilities are the finest with good housing available on the campus and the position is one which can be permanent and satisfy a desire for personal achievement.

- In applying for this appointment outline in complete detail — teaching and administrative experience, scope of research work, educational background, degrees. Experience in electronics will be given extra consideration.

- An interview can be expedited if you will include personal information such as family status, and salary desired. Our faculty knows of this staff opening and your reply will be held in full confidence.

Write care

Box 9937

ELECTRONICS

520 N. MICHIGAN AVE.

CHICAGO 11, ILL.

also shows a variety of terminal arrangements available on regular or hermetically sealed models.

Torque Controllers. Duncan & Bayley Inc., 785 Hertel Ave., Buffalo 7, N. Y. Design features, installation and performance data, and history of fluid magnetic torque controllers are contained in a recent brochure. Limitations of the fluid magnetic clutch are shown so that misapplication may be kept to a minimum.

Radiation Counter Tubes. Ampere Electronic Corp., 25 Washington St., Brooklyn 1, N. Y. An 8-page folder describes and illustrates 14 types of self-quenching radiation counter tubes for research and industry. The tubes covered feature unlimited life, low operating voltage, uniform characteristics, small size and thin mica windows.

Heterodyne Eliminator. J. L. A. McLaughlin, P. O. Box 529, La Jolla, Calif. The MCL-4 Signal Splitter, an asymmetrical off-frequency inverter type heterodyne eliminator, is fully treated in a 4-page reprint and also outlined briefly in a recent folder. Diagrams, response curves and specifications are given.

Low-Voltage Controls. Square D Co., Los Angeles, Calif. Bulletin 1008R-1 is a 16-page well-illustrated manual treating of the low-voltage control system for electrical installations. Technical data, wiring diagrams and working advantages are shown. The booklet introduces a new selector switch control and a redesigned master control contactor for use with the 24-volt system.

Electrolytic Listings. Aerovox Corp., New Bedford, Mass. Because of the wide range of capacitance and voltage values, particularly in dual and triple units, additional listings in the type AF or twist-prong-base metal-can electrolytics have been published. The added listings, as well as listings of other types of capacitors, are

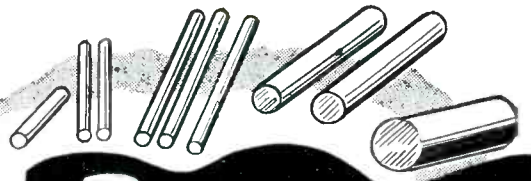
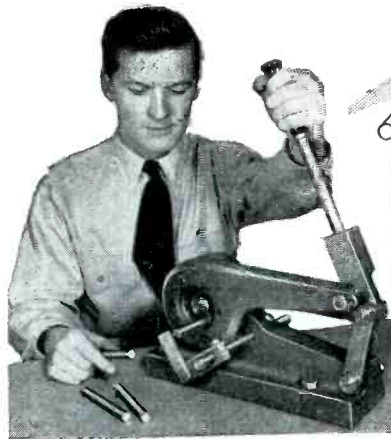

Precision Rod Cutting at High Speed

with the New DI-ACRO ROD PARTER

The DI-ACRO Rod Parter further increases the applications of "DIE-LESS DUPLICATING" as a cost-cutting, time-saving production technique so well established by DI-ACRO Precision Benders, Brakes and Shears.

Do you require precision?—The DI-ACRO Rod Parter holds tolerance to .001" on duplicated cuts. The ends are square, and roundness is maintained.

Do you want speed?—The Rod Parter exceeds output of other methods with equal accuracy, on rods and bars up to 5/8". Torrington Roller Bearings incorporated in an exclusive multiple leverage arrangement provide remarkable ease of operation in both heavy and light materials.

GET "DIE-LESS DUPLICATING" CATALOG

Shows parts produced without die expense by DI-ACRO Benders, Brakes, Shears, Rod Parters, Notchers, Punches. Send for your free copy.

Pronounced "DIE-ACK-RO"



"PARTS OFF" MANY MATERIALS

All hot and cold rolled rods
Stainless steel
Chrome Molybdenum
Aluminum Brass
Copper Bi-metals
Many types of plastics
Fibre Rubber
Wood



O'NEIL-IRWIN MFG. CO.

321 EIGHTH AVENUE • LAKE CITY, MINNESOTA

Measure Time **ACCURATELY**

10 MICROSECONDS TO 1 SECOND

**THE AMERICAN
HIGH SPEED CHRONOSCOPE**

Simple, Accurate and Reliable, the Chronoscope indicates significant time intervals directly in milliseconds. Operation is completely automatic and the time indicator does not drift. A few of the varied applications include—relay, contactor and fuse testing, shutter speed and flash lamp timing, automatic system development and human reaction studies. PRICE: \$375. Write for Bulletin 100A.

When time is your problem—Consult us.

AMERICAN CHRONOSCOPE CORPORATION
316 WEST FIRST STREET MOUNT VERNON, N. Y.
TELEPHONE: MOUNT VERNON 4-2030

NOTHELFER

Custom Built
TRANSFORMERS

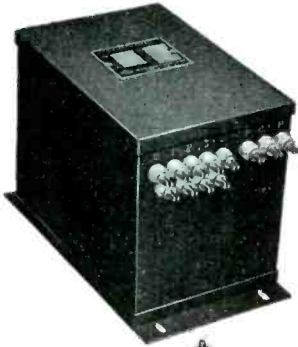

Proved by
Past
Performance

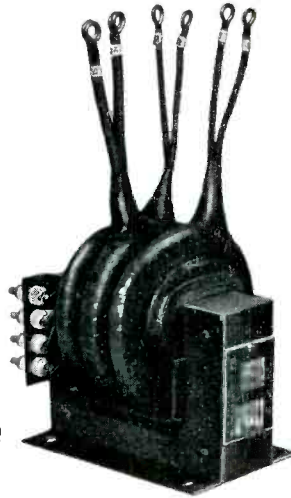

Over 25 years' experience in the manufacture of specials at cost that compares favorably with standard types. Built in quality proved by years of actual use.

From 10VA to 300 KVA Dry-Type only. Both Open and Encased. 1, 2, and 3 Phase. 15 to 400 Cycles.

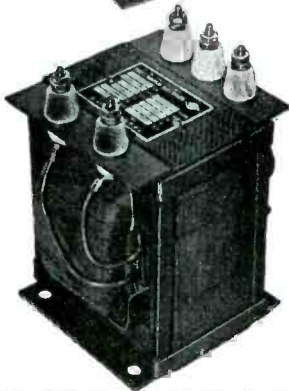

NOTHELFER
WINDING LABORATORIES

9 ALBEMARLE AVE., TRENTON 3, N. J.

contained in the new condensed supplement, Form SC-549.

Vibration Testing and Control. The MB Mfg. Co., Inc., 1060 State St., New Haven 11, Conn. A new 12-page catalog presents data on vibration isolators and testing equipment. It features a chart for use by designers in locating the points on their products at which mountings provide the greatest degree of vibration isolation. Detailed example shows how to use the chart.

C-R Oscilloscope Application. Sylvania Electric Products Inc., Radio Division, 500 Fifth Ave., New York 18, N. Y., has published a 72-page booklet entitled "How to Service Radios with an Oscilloscope," designed as a practical reference for radio, television and amplifier servicemen, radio operators, students and electronic technicians. The publication contains more than 90 diagrams, tables and schematic circuits including many waveform patterns as they appear on the face of an oscilloscope in actual service application. Price is one dollar per copy.

Instruments Bulletin. Reiner Electronics Co., Inc., 152 W. 25th St., New York 1, N. Y., has issued a four-page folder illustrating and describing technically the following instruments: the model 508 five-inch oscilloscope; model 524 high-frequency oscilloscope; model 456 comprehensive master tester; model 530 square-wave generator; model 451 vtvm and model 101 amplifier. Price for each unit is given.

Rotating Anode X-Ray Tube. Amperex Electronic Corp., 25 Washington St., Brooklyn 1, N. Y., announces availability of a kit containing complete information and calculation charts for the new oil-immersed rotating-anode x-ray tube for all diagnostic applications, such as mass chest radiography, rapid-sequence exposure, heavy intermittent loadings and sustained operation for fluoroscopy.

NEW! R&S AUTOMATIC LOCKING Midget EVER-LOK

PLUGS, RECEPTACLES & CORD CONNECTORS

FOR SAFE, DEPENDABLE PERFORMANCE

DUPLEX RECEPTACLE—
FITS SINGLE GANG BOX

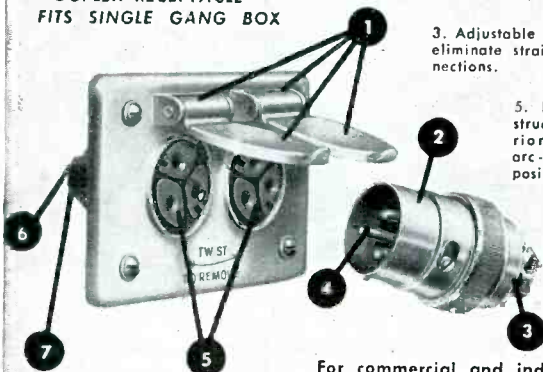

1. Spring hinged, gasketed covers close receptacle when not in use.
2. Plated steel housings fully protect the contacts.
3. Adjustable Cord Grips eliminate strain on connections.
4. Contacts are precision-made, self-wiping, and self aligning.
5. Rigidly constructed, all interiors of molded arc-resisting composition.
6. Heat-treated beryllium copper contacts and terminals — an advanced EVER-LOK feature.
7. Compact design provides ample capacity, yet allows for easy wiring.

For commercial and industrial applications.

10 ampere
125 or 250 V.
A.C. or D.C.

All units are steel clad, fully grounded and are complete with the R&S Ever-Lok automatic feature that positively eliminates strain on contacts or connections.

Sold Through Electric Wholesalers
SALES OFFICES IN PRINCIPAL CITIES

Full details
in catalog
EL49-6

83



RUSSELL & STOLL COMPANY, INC.
Precision-Built Electrical Equipment

125 BARCLAY STREET, NEW YORK 7, N. Y.

**Etched
TUNGSTEN
WIRE**

From .0004"
to .00015"
diameter and
even smaller

Accurate, uniform
and smooth
Also available in
Molybdenum and
other metals.

Write for
Details and
List of
Products

SIGMUND COHN CORP.
44 GOLD ST. NEW YORK

SINCE  1901

Kahle specialists in custom-built, ultra-precision
ELECTRON TUBE MACHINERY

KAHLE CUSTOM-BUILDS machines to make the exact tubes you require—from big 20-inchers to tiny sub-miniature—from laboratory types to those for high-speed production. Kahle puts each unit through exhaustive trial runs in our plant to assure trouble-free operation in yours.

#1405 Cathode Ray Tube Sealing Machine

16 heads for sealing up to 12½ inch tubes; 12 heads for sealing up to 16 inch tubes. Adaptors for these sizes instantly interchangeable.

We specialize in cost-cutting, production-boosting, labor-saving equipment for complete manufacture of cathode ray tubes, standard, miniature and sub-miniature radio tubes, sub-miniature tubes, fluorescent lamps, photocells, x-ray tubes, glass products.

Kahle ENGINEERING CO.

1309 Seventh Street, North Bergen, New Jersey

Consultations invited
Send for our new catalog

SAFE at 10,000V!

- ★ Factory-fitted to most Clarostat carbon and wire-wound controls.
- ★ Control-to-ground breakdown rating better than 10,000 v.
- ★ New design eliminates troublesome backlash. Permits more critical settings.

IMPROVED HIGH-VOLTAGE CONTROLS

Improved design high-voltage controls for TV sets, oscillographs and other high-voltage electronic assemblies. Safe operation up to 10,000 v.

Straight-through plastic shaft simplifies and improves operation. No back-lash to throw off critical adjustments. Cheaper. Better. Simpler.

Ask for Bulletin No. 120.
Let us quote on your needs.

CLAROSTAT

Controls and Resistors

CLAROSTAT MFG. CO., INC. • DOVER, NEW HAMPSHIRE • In Canada: CANADIAN MARCONI CO., LTD. Montreal, P. Q. and branches

1949
15
TV
YEAR

- On
- Off
- Select
- Transfer

PUSH-BUTTON is the way to do it

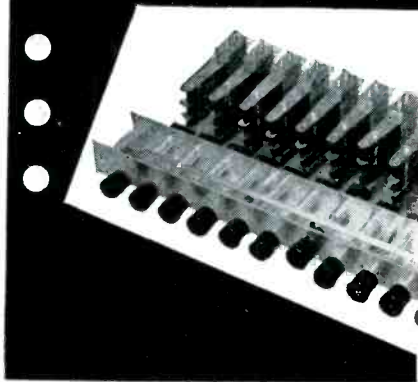

- Modern design means push-button switching . . . placing at your fingertips incomparable ease and versatility of control . . . with accurate selection and ever-visible indication of each selected function. Thus you gain functional appearance and added product acceptance. No other switching method will do it.
- MODEL MPB switches offer many advantages to the manufacturer who desires the modern features of push-button switching for electrical and electronic circuit control.

How do these specifications fit your design?

- Handles five amperes non-inductive load at 125 volts a-c.
- Two to 12 push-buttons.
- Up to six circuits per button.
- Four actions: lock, non-lock, release-lock, accumulative lock with single-button release.
- Corrosion resistant.
- Phenolic insulation.
- Fine silver contacts riveted to nicked phosphor bronze spring blades.
- Buttons on 3/4" centers; mounting holes 3/4" from each end button.
- Depth behind panel, 4 7/16".
- Thickness (SPDT contacts) 1/16".



**GENERAL
CONTROL
COMPANY**

1202 SOLDIERS FIELD ROAD
BOSTON 34, MASSACHUSETTS

NEWS OF THE INDUSTRY (continued from page 136)

take over military aspects of mobilization planning in electronics. The committee will work closely with the Munitions Board's Communications and Electronics Equipment Advisory Committee composed of 30 representative manufacturers and headed by Fred Lack, vice-president of Western Electric Company. The new Electronics Committee is headed by Major General Patrick W. Timberlake, U.S.A.F., Director for Military Programs, Munitions Board. One member and one alternate of general or flag rank will be designated by each of the three Military Departments, and the committee will have the assistance of a full-time staff of military and civilian personnel.

One of the most important features of the new committee is the continuing secretariat. In the previous setup, which was under the Office of Production Planning of the Munitions Board, the chairman took over the burden of the work. Under the present plan, the secretariat will be headed by a \$10,000-a-year man, preferably with industry and government experience.

Various subcommittees of the committee will be: (a) Equipment Subcommittee under five panels: airborne, shipborne, and ground electronics, wire communications and special electronic devices. (b) Components Parts Subcommittee with three panels: Common components, special components, parts and vacuum tubes. (c) Material Subcommittee composed of two panels: Common materials and special materials.

Since the formation of the first committee, there has been a heated controversy between some industry representatives and government representatives on the plan for mobilizing the electronics industry. (See *ELECTRONICS*, May 1949, p 60). This boils down to two plans known as the RMA and the Greenbook or government plan, both of which have been up for consideration since last April. The Industry Advisory Committee, at its last meeting in February, proposed a compromise industrial mobilization plan which was a softer version of the RMA plan and worded in such a way that it allowed the Electronics

WIND more COILS faster

WITH YOUR
PRESENT
COIL-WINDING
MACHINE!

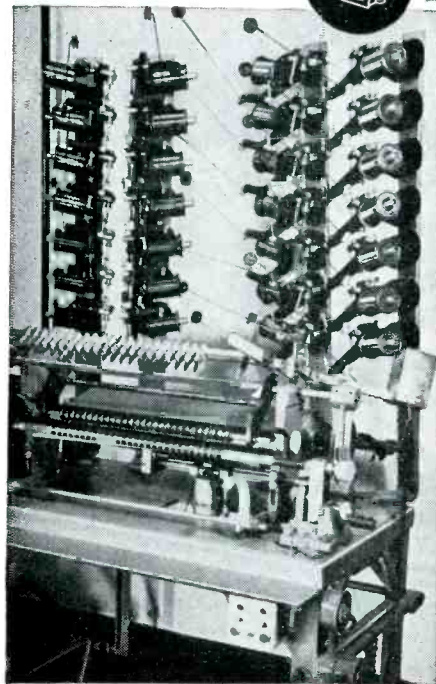

— use
PAMARCO
Wire DeReeling Tensions
for PERFECT COILS

Installation of these inexpensive PAMARCO tensions lowers winding costs because each machine will accommodate more coils at higher winding speeds. In addition to increased production, PAMARCO tensions raise production quality. Free-running action practically eliminates wire breakage and shorted turns. Simple thumb screw setting quickly adjusts for any wire gauge. No tools or special skill are needed for operation. For complete data call or write.



**PAPER MACHINERY
& RESEARCH, INC.**

1014 OAK STREET
ROSELLE, NEW JERSEY

LINKING FUNCTION
to design
with
ADVANCE RELAYS



Engineers and Designers who insist on dependable components have adapted **ADVANCE RELAYS** into their control circuits. They are specifying **ADVANCE** products, and are submitting their relay problems to us. Our expanded engineering and plant facilities, plus the recognized dependability of **ADVANCE RELAYS**, make it possible for us to offer the most complete line of relays for light, intermediate and heavy duty applications. Proved and Improved relay performance through **ENGINEERED** adaptability.

Follow the Engineers
to **ADVANCE**



ADVANCE ELECTRIC & RELAY CO.
1200 WEST SECOND STREET • LOS ANGELES 26, CALIFORNIA

DUMONT
TYPE **P6M**

World's Finest
Moulded Paper
CAPACITORS

NOW USED IN

World's Largest
and Best Selling
Television Sets

Send for samples
and literature.

FOR DEPENDABILITY
ALWAYS SPECIFY **DUMONT**

DUMONT
ELECTRIC CORP.

MFR'S OF
CAPACITORS FOR EVERY REQUIREMENT
308 DYCKMAN ST., NEW YORK, N. Y.

*Worth a
Second Look*



Since '26, **MINES** has specialized in designing and manufacturing Molded Rubber Connectors to meet individual as well as standard electrical power requirements. During this period, thousands of styles and shapes ranging from "cartridge size" models to the mammoth Biguns used in marine, mining and construction work have been developed. No question about it—this wealth of experience and know how deserves a "second look". Write now for full details on your needs.

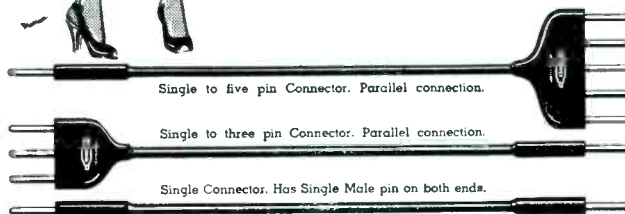

Single to five pin Connector. Parallel connection.

Single to three pin Connector. Parallel connection.

Single Connector. Has Single Male pin on both ends.

Illustrated are three "cartridge size" Molded Rubber Connectors developed recently by **MINES** for business machinery. Overall length twelve inches. Pins are 3/32" in diameter.

MINES EQUIPMENT COMPANY

4265 CLAYTON AVE. **MINES** ST. LOUIS 10, MO.



There is a
SPECIALTY BATTERY
For Your
Special
Needs



**Custom Built Dry Batteries Built to Exacting
Industrial and Electronic Requirements**

If you need a battery that's completely new, one you've never heard of, or that's no longer available through normal channels, call on Specialty Battery Company. Specialty supplies hard-to-get batteries for every purpose, designs and manufactures dry batteries to your specifications.

Send For This Free Catalog

Gives complete specifications for industrial, laboratory, instrument and ignition batteries for every possible dry battery requirement.

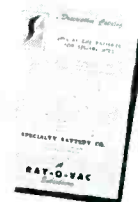

SPECIALTY BATTERY COMPANY

A SUBSIDIARY OF THE **RAY-O-VAC** RAY-O-VAC COMPANY
MADISON 3, WISCONSIN

NOW! Modern, Comprehensive TV "Staging" plus NEW TV REVENUE from Pattern Time

NEWS OF THE INDUSTRY

(continued)

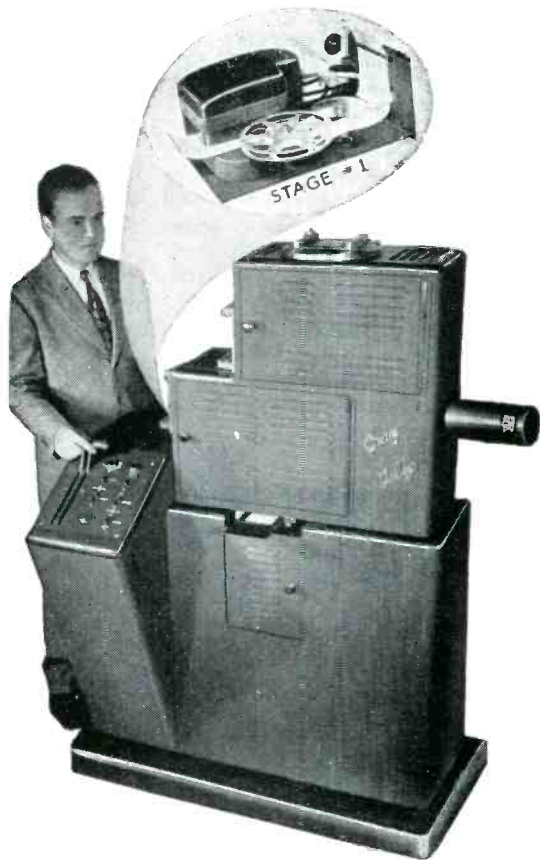

with the **GRAY TELOP**

This most versatile telecasting optical projector enables dual projection with any desired optical dissolve under exact control.

The accessory STAGE NUMBER 1 adds three functions separately or simultaneously: a) teletype news strip, b) vertical roll strip and c) revolving stage for small objects.

The TELOP, used with TV film cameras, permits instant fading of one object to another, change by lap dissolve or by superimposing. Widest latitude is given program directors for maximum visual interest and increased TV station income.

For full details write for Bulletin T-101

**GRAY RESEARCH
and Development Co., Inc.**
16 Arbor St., Hartford 1, Conn.

Committee to write in its own procedures to implement the industry plan. The RMA plan would place contracts with ten major companies who, in turn, could take on the other companies by specially arranged contracts.

Government advisors claim that this arrangement was primarily for peacetime contracts and there was no justification for limiting the field to ten companies.

Among the announced assigned tasks for the new committee are the coordination of current peacetime procurement programs with plans for mobilization in an emergency; and also the development of combined requirements of the three military departments for end items, components and parts.

BUSINESS NEWS

SPEER CARBON Co., St. Mary's Pa., manufacturer of carbon and graphite products, has acquired sole ownership of both the Speer Resistor Corp., of St. Mary's and Angelica, N. Y., and Jeffers Electronics, Inc., with plants at Dubois and Driftwood, Pa.

ALTEC LANSING CORP., Hollywood, Calif., manufacturers of audio equipment, recently entered the field of television receiver production.

NATIONAL ELECTRONICS, INC., Geneva, Ill., has purchased the high-capacity resistance welding equipment formerly used by Liquid Carbonic Corp., at Morrison, Ill. The equipment will be used in the production of industrial rectifier, thyatron and mercury pool tubes.

GENERAL ELECTRIC Co., Schenectady, N. Y., is building a 70-million volt x-ray synchrotron which will be placed in operation at the University of California Medical School in San Francisco for research on high-energy radiation in the treatment of cancer.

GERTSCH PRODUCTS INC., Los Angeles, Calif., is a recently organized group in the electronic and

V. L. F.!

Very Low Frequencies covered by the...

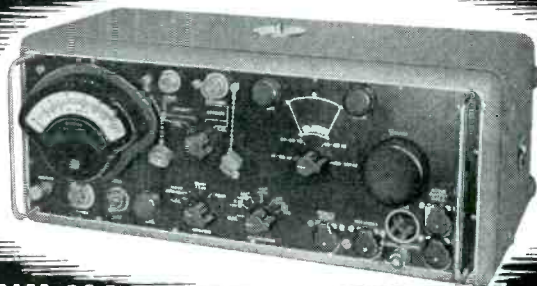

STODDART NM-10A RADIO INTERFERENCE AND FIELD INTENSITY METER

- MEASURES radiated and conducted signals, including pulse or random interference.
- RANGE—14 kc to 250 kc.
- SENSITIVITY — Field strength using rod antennas one microvolt-per-meter to 2 volts-per-meter. Field strength using shielded loop antennas 10 microvolts-per-meter to 100 volts-per-meter. As a two-terminal voltmeter, either balanced or unbalanced, one microvolt to one volt.
- READS directly in microvolts and db.
- A.C. POWER SUPPLY REQUIREMENTS 105 to 125 volts or 210 to 250 volts A.C. Single phase source may be ANY FREQUENCY BETWEEN 50 CPS AND 1600 CPS. No shock hazard.
- GRAPHIC RECORDER included with versatile complement of accessories.

Write for complete technical data

STODDART AIRCRAFT RADIO CO.

Main office and plant:
6644 Santa Monica Blvd.
Hollywood 38, Calif.
Phone: Hillside 9294

8-347 General Motors Bldg.
Detroit 2, Michigan
Phone: Trinity 1-9260

1346 Connecticut Ave.
duPont Circle Bldg.
Washington 6, D. C.
Phone: Hudson 7313

Here's a career opportunity for
Mechanical and Electrical

ENGINEERS

Dalmo Victor, one of America's foremost manufacturers of airborne radar equipment, has openings on the staff for engineers experienced in design of intricate mechanisms and microwave transmission lines.

If you are an electrical or mechanical engineer with high qualifications, interested in associating yourself with a team of top-flight engineers and physicists, then here's a career opportunity you should investigate.

Mail details of education and technical background to WILLIAM F. GATES, Chief Engineer

DALMO VICTOR

Manufacturers of Airborne Radar
Antennas
SAN CARLOS, CALIFORNIA

Flexible Shafts

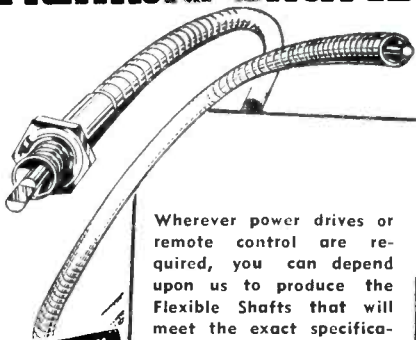

Wherever power drives or remote control are required, you can depend upon us to produce the Flexible Shafts that will meet the exact specifications. We have years of experience in manufacturing flexible shafting for all types of industry. If we do not have what you require in stock, we can make shafts to your specifications. Our engineers will be glad to work out your problems without obligation.

WRITE FOR MANUAL D



F. W. STEWART MFG. CORP.

4311-13 RAVENSWOOD AVE.
CHICAGO 13, ILL.

WEST COAST BRANCH:

431 VENICE BLVD.

LOS ANGELES 15, CAL.

UNBRAKO

SOCKET CAP SCREW WITH KNURLED HEAD

- ... SLIP PROOF HEADS
- ... EXTRA STRONG
- ... MADE TO CLOSE TOLERANCES

There is a definite saving of assembly time when you use "UNBRAKO" Socket Head Cap Screws with Knurled Heads. The exclusive knurled heads perform a triple duty: (1) the knurling provides a sure, slip-proof grip; (2) the knurling permits positive locking—a feature so often essential where there is excessive impact or vibration; (3) the knurling speeds assembly, because it enables the "UNBRAKO" to be screwed in easier, faster, and further with the fingers—handiest of all wrenches—before a "key" becomes necessary.

As Always, the name "UNBRAKO" signifies extra strength and precision manufacture to close tolerances.

"UNBRAKO" Knurled Socket Head Cap Screws are available in sizes from #4 to 1 1/2" diameter, and in a full range of lengths. Write for your free copy of the "UNBRAKO" Catalog and the name of your nearest "UNBRAKO" Distributor.

Knurling of Socket
Screws originated with
"UnbraKO" years ago.

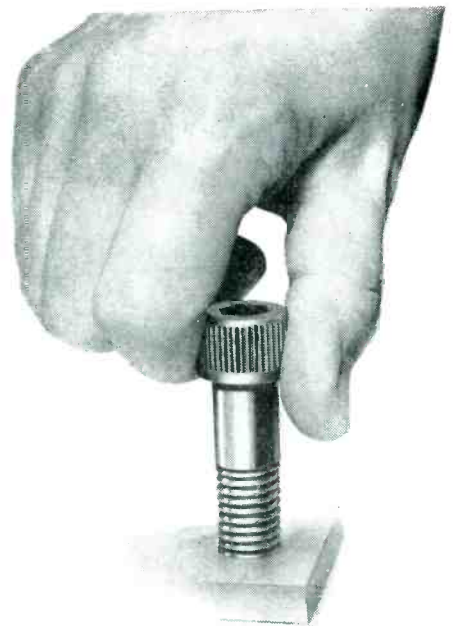

Other "UNBRAKO" Products include:
Socket Set Screws with Knurled Cup Points,
Socket Set Screws with Knurled Threads,
Square Head Set Screws with Knurled Cup
Points—all patented, self-locking screws
that won't shake loose! Socket Head
Stripper Bolts. Precision-Ground Dowel
Pins. Fully-Formed Pressure Plugs.

SPS

STANDARD PRESSED STEEL CO.

BOX 596 JENKINTOWN, PENNSYLVANIA

"Serving Industry continuously since 1903 through Industrial Distributors"

Large or Small SQUARE, ROUND OR RECTANGULAR PAPER TUBES

FOR COIL WINDING



SEND FOR ARBOR LIST
OF OVER 1000 SIZES

Inside Perimeters from .592" to 19"

With specialized experience and automatic equipment, PARAMOUNT produces a wide range of spiral wound paper tubes to meet every need... from 1/2' to 30' long, from .592" to 19" inside perimeter, including many odd sizes of square and rectangular tubes. Used by leading manufacturers. Hi-Dielectric, Hi-Strength. Kraft, Fish Paper, Red Rope, or any combination, wound on automatic machines. Tolerances plus or minus .002". Made to your specifications or engineered for YOU.

Paramount PAPER TUBE CORP.

616 LAFAYETTE ST., FORT WAYNE 2, IND.

Manufacturers of Paper Tubing for the Electrical Industry

**INCREASED
COVERAGE...
at a LOWER
ANTENNA
SUPPORT
COST...**

**with the
TRYLON**



**ANTENNA
MAST #650**

At a surprisingly low cost per lineal foot, you can raise your present antenna height to 60 ft. with the new TRYLON #650 Antenna Mast. It weighs only 2 lbs. per foot, comes in handy 10 ft. sections and is easy to erect and climb. It is double-welded for added safety and hot dip galvanized after fabrication.

All sections are standard. Base plates and top fittings for mounting antenna support tube are available from stock.

Write for complete details and specifications.

Tower and Antenna Division

WIND TURBINE CO.
WEST CHESTER, PENNA.

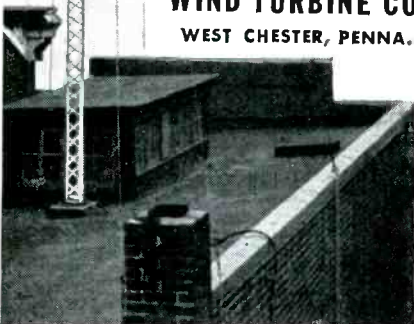
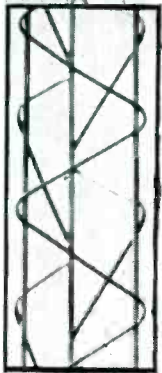

NEWS OF THE INDUSTRY

(continued)

engineering manufacturing field. The new firm has purchased the assets of Kappler Engineering and Mfg. Corp. and has expanded into a new modern building with some 5,000 sq ft of floor space.

THE ATOMIC ENERGY COMMISSION and General Electric Co. have invited bids for construction of the first units of the experimental atomic power plant to be erected on a 4,000-acre tract about 18 miles north of Schenectady, N. Y. The new plant will form part of the Knolls Atomic Power Laboratory.

MOTOROLA, INC., Chicago, Ill. recently expanded its manufacturing plant to permit a 40-percent increase in television set production.

PERSONNEL

NEAL MCNAUGHTEN has been appointed director of the NAB engineering department. He was previously assistant director of the department and prior to that had been with the FCC for seven years.

J. W. HEAD, president and founder of Electronics Institute, Inc., Detroit, Mich., was recently elected president of the Detroit Section of the Instrument Society of America.

JOHN REINARTZ, designer of the Reinartz tuner, has joined the field engineering department of Eitel-McCullough, Inc., San Bruno, Calif., to assist in directing the application of tubes for amateur use.



J. Reinartz



L. M. Hershey

LLOYD M. HERSHEY, previously assistant to the chief engineer at the Hallicrafters Co., was recently appointed director of research for General Instrument Corp., Elizabeth, N. J.

ALFRED H. MASSALLEK, formerly design engineer for the Stewart-

**SHOCK AND
VIBRATION NEWS
BY BARRY**



uses

**AIR-DAMPED
BARRYMOUNTS**
to protect their new

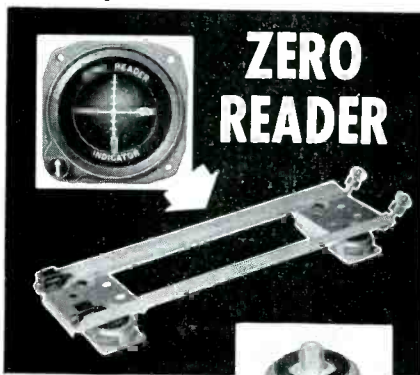

... the new Sperry flight control instrument which has stirred the air-craft world is mounted on air-damped BARRYMOUNTS.

Literally a super-instrument, the ZERO READER promises to revolutionize instrument flying in that it presents, on a simple two-element indicator, information which is ordinarily supplied by five separate instruments, and directly tells the pilot how to move his controls. Its two coordinating cross-lines dictate the pre-set plan of flight to the pilot who merely acts as the "muscles" at the controls.

To protect this sensitive electronic "nerve center" from aircraft shock and vibration, Sperry Gyroscope Company mounts the ZERO READER on a base equipped with air-damped BARRYMOUNTS.

BARRY bases permit virtually instant installation and removal of the instruments they hold. Unit air-damped BARRYMOUNTS are also available for direct installation to airborne instruments.

Whatever your shock or vibration problem, Barry experience and consulting engineering facilities offer a sure solution. Write for our free catalog listing stock BARRYMOUNTS; for special information, call our nearest office or write to

THE BARRY CORP

MAIN OFFICE
177 SIDNEY ST.

CAMBRIDGE 39,
MASSACHUSETTS

New York Rochester Philadelphia Washington
Cleveland Dayton Chicago Minneapolis
St. Louis Los Angeles

THIS FEATHERWEIGHT WILL
LICK SOLDERING FATIGUE!



THE NEW
HEXA CON BANTAM
--- MODEL 30H ---

Weight—5½ Ounces • Watts—40 or 60 • Tip Dia.—Both ⅛" and ¼" Tips
Furnished with Each Iron • Price—\$5.00

So light its weight is hardly noticeable. Outperforms any iron of equal size. Hatchet design makes it more comfortable and practical to use than a pencil iron. No transformer required. Write for complete catalog.



HEXA CON ELECTRIC CO.
130 WEST CLAY AVE., ROSELLE PARK, N. J.



THE NEW
BERKELEY
MODEL 700
DECIMAL COUNTING UNIT

This unique packaged component is easily built into your apparatus. It has true decimal reading, and simple binary circuit with reliable automatic interpolation. Miniature size. Moderate price. Immediate shipment.

Send for Bulletin DCU-115

Berkeley Scientific Company
SIXTH AND NEVIN AVE - RICHMOND, CALIFORNIA

It's easy to fit all TV circuits with

GRACOIL TELEVISION Transformers

"One Good Turn or a Million"

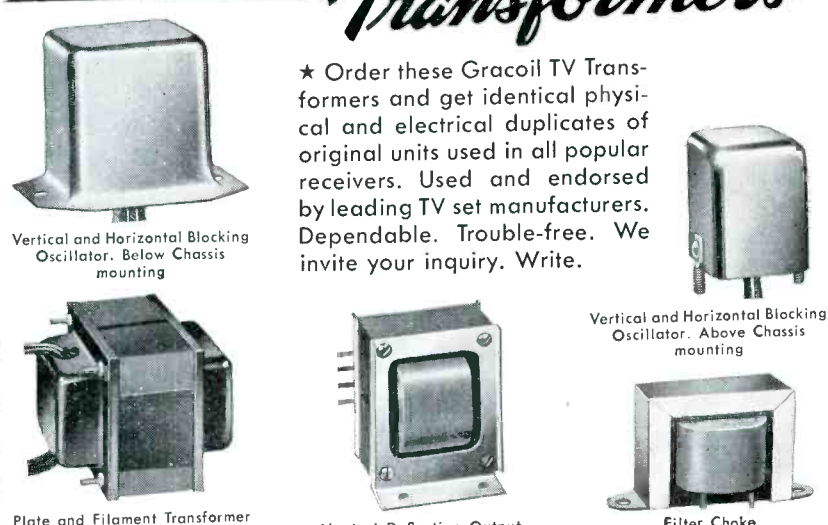

★ Order these Gracoil TV Transformers and get identical physical and electrical duplicates of original units used in all popular receivers. Used and endorsed by leading TV set manufacturers. Dependable. Trouble-free. We invite your inquiry. Write.

Vertical and Horizontal Blocking Oscillator. Below Chassis mounting

Vertical and Horizontal Blocking Oscillator. Above Chassis mounting

Plate and Filament Transformer with and without Magnetic Shielding

Vertical Deflection Output Transformer

Filter Choke

THE GRAMER COMPANY
Electrical Coils and Transformers
2734 N. PULASKI ROAD CHICAGO 39, ILL., U.S.A.
ESTABLISHED IN 1935

New **WIDE-RANGE POWER OSCILLATOR**

Designed for measurements and tests in the 300 to 2500 mc range. The AIL Type 124A Power Oscillator unit consists of a grid separation coaxial oscillator employing a 2C38 disc seal triode, an audio oscillator and modulator section, and a self-contained power supply for operation from 115 volts at 50-60 cps.

POWER OUTPUT { 300 mc - 10 w
600 mc - 20 w
1200 mc - 10 w
2500 mc - 2.5 w



AIL TYPE 124A

SEND FOR COMPLETE DATA

Airborne Instruments Laboratory, INC.
160 OLD COUNTRY ROAD • MINEOLA, N.Y.

TEKTRONIX DIRECT COUPLED OSCILLOSCOPE

The Tektronix Type 512 is a completely new direct coupled cathode ray oscilloscope which provides the sensitivity; band pass; sweep ranges; flexibility and dependability so necessary for precision applications.

* * *

Present users throughout the world—leading universities; industrial organizations; branches of armed services; physiologists; geophysicists; etc.—have come to consider the Type 512 an indispensable instrument by virtue of its full complement of outstanding characteristics.

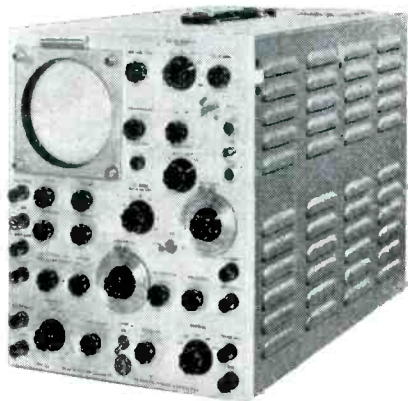

DC-2 mc. SWEEPS 3 sec-30 microsec. 5 Millivolt Sensitivity DC or AC



Cables, TEKTRONIX

712 S. E. HAWTHORNE BLVD. PORTLAND 14, OREGON

Detailed Specifications on request.

\$950.00
f. o. b. Portland,
Oregon

200 MC BAND WIDTH AMPLIFIERS

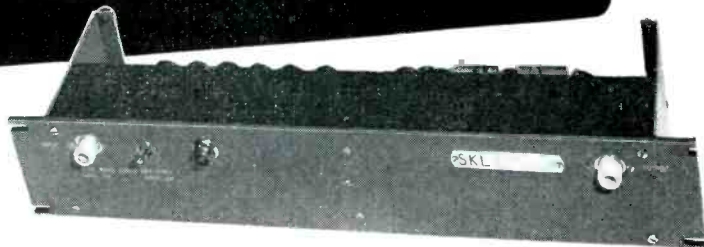

MODEL 202 WIDE BAND CHAIN AMPLIFIER

Band Width: 100 KC to 200 MC. Gain: 20 db.

Impedance: 200 ohms. Rise time: less than .003 usec.

With the Model 202: very fast pulses, transients and other high frequency voltages can now be amplified.

With the Model 202: vacuum tube voltmeters and oscilloscopes are ten times more sensitive.

With the Model 202: the output voltage of signal, sweep and pulse generators is ten times greater.

Other Wide Band Chain Amplifiers available:

Model 200A — 10 db Gain. Model 204 — 40 db Gain.

Makers of chain amplifiers, temperature controls, variable electronic filters and power supplies.

SKL SPENCER-KENNEDY LABORATORIES, INC.
187 MASSACHUSETTS AVE., CAMBRIDGE 39, MASS.

Warner Corp., has been appointed executive design engineer for Shure Bros., Inc., Chicago, Ill., manufacturers of microphones, phonograph pickups and acoustic devices.

H. B. FANCHER, formerly assistant section engineer in charge of television equipment, was recently named section engineer of broadcast studio equipment for the transmitter division of General Electric Co., Syracuse, N. Y.



H. B. Fancher



K. F. Kellerman

KARL F. KELLERMAN has left the post of executive director of the Research and Development Board's committee on guided missiles to join The Brush Development Co., electronic designers and manufacturers, as head of their recently opened Washington, D. C., office.

JOHN RANKIN, formerly chief engineer for Belmont Radio, Chicago, and six years with the RCA License Laboratory in New York, has been appointed chief engineer of Hoffman Radio Corp., Los Angeles, Calif.

CHEN TO TAI of Harvard's Cruft Laboratory has been appointed senior research physicist in Stanford Research Institute's department of electrical engineering to head the theoretical section of the Aircraft Radio Systems Laboratory.

H. P. CORWITH, formerly director of research, has been appointed vice-president in charge of development and research of the Western Union Telegraph Co., New York City.

LOUIS G. PACENT, president and technical director of Pacent Engineering Corp., New York City, has been appointed consulting engineer by the Plessey International Ltd. of Ilford Essex, England.

MICO ENGRAVER

Model 253 For LARGE PANELS

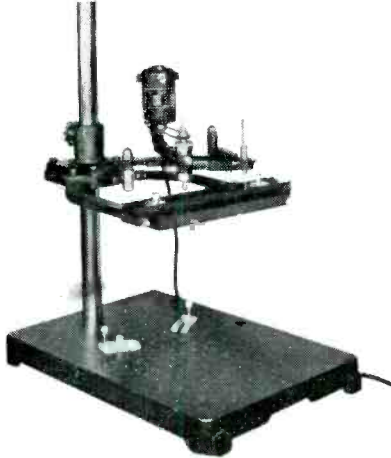

A further adaptation of the already proven model 252 Mico Engraver. Permits accurate engraving on metal or plastic panels up to 19 inches wide and of unlimited length. Maximum height of work above table, 19 inches. Micrometer spindle and four reduction ratios are standard equipment.

MICO INSTRUMENT CO.

76 E TROWBRIDGE STREET DEPT. I
CAMBRIDGE 38, MASS.

Specify **GLASS JEWEL BEARINGS**
for . . . Low Cost
. . . Long Life

Glass Jewel Bearings by Bird are highly accurate and surprisingly inexpensive. They're ideal for use in ammeters, volt meters, timing instruments, compasses and other instruments where large volume production and low cost must be maintained.

Of special interest to instrument manufacturers is Bird's method of mounting jewels. There's a minimum of stress and strain on the bearing itself as a result of Bird's special mounting technique. It is this special mounting feature which adds so materially to the useful life of Bird Jewel Bearings.

Whenever there's a need for jewel bearings — whether in glass or in sapphire — Bird can supply the right bearing to your specifications. Write today for more information and a quotation.

Sapphire Bearings available in all jewel styles and mountings

Richard H. Bird & Co., Inc.

1 Spruce Street
Waltham 54, Mass.

"Serving Industry with Fine Jewels Since 1913"

S.S. White MOLDED RESISTORS

The "All-Weather" Resistors

Of particular interest to all who need resistors with inherent low noise level and good stability in all climates

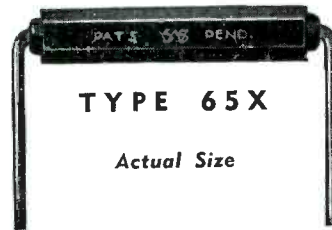

TYPE 65X

Actual Size

STANDARD RANGE

1000 OHMS TO 9 MEGOHMS

Used extensively in commercial equipment including radio, telephone, telegraph, sound pictures, television, etc. Also in a variety of U. S. Navy equipment.

HIGH VALUE RANGE

10 to 10,000,000 MEGOHMS

This unusual range of high value resistors was developed to meet the needs of scientific and industrial control, measuring and laboratory equipment—and of high voltage applications.

SEND FOR
BULLETIN 4906

It gives details of both the Standard and High Value resistors, including construction, characteristics, dimensions, etc. Copy with Price List mailed on request.

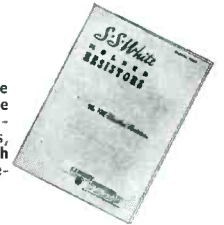

S.S. WHITE INDUSTRIAL DIVISION
THE S. S. WHITE DENTAL MFG. CO. DEPT. R. 10 EAST 40th ST., NEW YORK 16, N. Y.



FLEXIBLE SHAFTS AND ACCESSORIES
MOLDED PLASTICS PRODUCTS—MOLDED RESISTORS

One of America's AAAA Industrial Enterprises

You Are Invited To Attend The First Annual AUDIO FAIR

Hotel New Yorker, New York City, October 27, 28, 29

An event of utmost importance to Broadcast Engineers, Recordists, Sound-on-Film Men, Public Address Men, Audio Hobbyists and Distributors and Dealers.

Presenting for the first time, under one roof, an industry-wide display of audio equipment, components and accessories.



SPONSORED BY THE AUDIO ENGINEERING SOCIETY

DANO COILS
DANO COILS
DANO COILS
DANO COILS
DANO COILS
DANO COILS
DANO COILS
DANO COILS
DANO COILS
DANO COILS

It's DANO for Specially Treated Coils

DANO is completely set up to produce specially treated coils. If your requirements demand coils that are deeply impregnated with wax or varnish in vacuum impregnation tanks and cured in heat controlled ovens, get in touch with DANO-makers of specially treated coils to YOUR specifications.

- Form Wound
- Paper Section
- Acetate Bobbin
- Bakelite Bobbin
- Cotton Interweave
- Coils for High Temperature Applications

ALSO TRANSFORMERS MADE TO ORDER



THE DANO ELECTRIC CO.

MAIN ST., WINSTED, CONN.

Tungsten and Molybdenum Metals

FOR THE ELECTRONICS & ELECTRICAL INDUSTRIES

TUNGSTEN

Wire • Rod for Contacts
 Rod for Valve Seals and Supports
 Electrodes for Therapeutic Apparatus
 Atomic Hydrogen Arc Welding Rods
 Rod and Wire for Metal Volatilization processes • Hammered Slabs
 Sheet, Strip and Foil

MOLYBDENUM

Rod for Contacts • Valve Stems
 Grid and Mandrel Wire
 Support Wires and Rods
 Wire for Furnace Windings
 Hammered Slabs
 Sheet, Strip and Foil for all Purposes
 Sheet for Furnace Boats

We also supply Tungsten, Molybdenum and Tantalum Metal Powders, Titanium Hydride, Zirconium Hydride and many other metallurgical products.

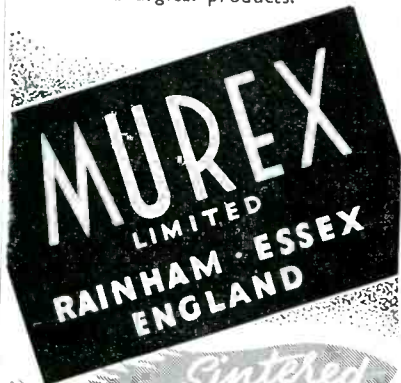

Sintered Permanent Magnets
 ALNICO · ALCOMAX · NYCOMAX

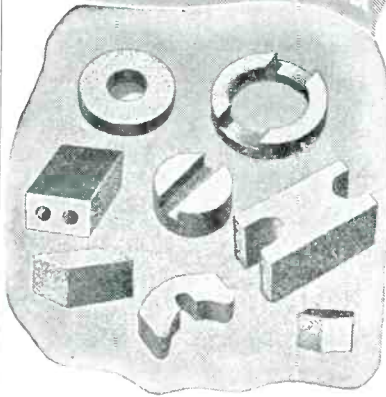

Small physical size and high efficiency. Available in a wide range of sizes and shapes for the Electronics Industry.

NEW BOOKS

Magnetic Recording

BY S. J. BEGUN, *Murray Hill Books, Inc., New York, 1949, 242 pages, \$5.00.*

THE RAPID progress and increasing importance of magnetic recording during the last decade almost demanded that someone write a book that would review the subject up to date, separate the chaff from the wheat in the literature and present an authoritative discussion of the art. Mr. Begun has accomplished this and considerably more in an unusually readable and well organized text. Of particular interest is the excellent bibliography presented at the end of each chapter and the glossary defining magnetic recording terminology. The development of the information, through basic theory to a discussion of specific equipment, applications, problems and instrumentation for their study, is logically ordered and clearly presented with a wealth of illustrations.

It is always a difficult compromise to write a book intended to aid the "technically interested amateur" that will be worthwhile reading for the engineer. Mr. Begun has recognized this and coped with it in an unusually successful manner. The first few sentences of the preface express the problem involved in writing a book during an active period in a dynamically expanding art. The interval between the time of writing and the date of publication has indeed produced a number of new and interesting developments. However, this simply means that a revised edition will be necessary in the future and certainly should in no way deter current interest in the book.

In many instances the author has recognized the logical path of research and development and prophesied the course that it would take. As an example of this he says, ". . . . fortunately it seems quite feasible to make a multitude of copies from one master recording at the same time A good deal of engineering ingenuity will have to go into the development of such equipment. None of the equipment is available today." Now, in the July 1949 issue of *ELECTRONICS*,

Satisfaction is guaranteed

when you use

ATLAS

**SPEAKERS
 MIKE STANDS
 ACCESSORIES**

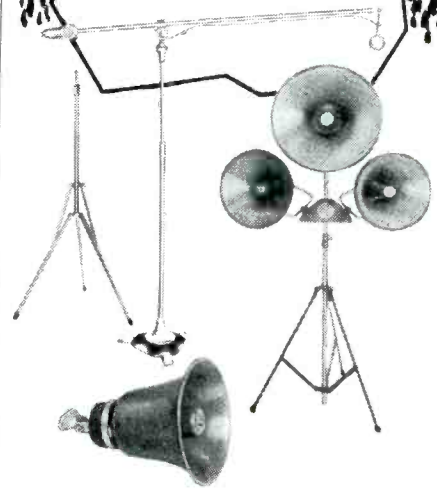

From professional microphone boom supports to a small microphone fitting, the Atlas line is complete. Atlas is your guarantee of quality engineering. Precision Built—Pre-tested ATLAS SOUND products are of the finest quality and give complete and lasting satisfaction.

Specialists know that it is often the one little "finnigan pin" which holds up the final completion of a well engineered and constructed sound system.

Atlas produces not only a complete line of speakers and accessories but also fittings, adaptors, parts and gadgets. Atlas stocks these small items for your convenience. This is just part of the "all around" service to users of ATLAS SOUND EQUIPMENT.

Write for our new catalog today.



ATLAS SOUND CORP.
 1450 39th Street
 Brooklyn 18, New York



here's help for HIGH VACUUM problems

Beach-Russ Type RP
Single Stage Vacuum
Pump. Capacity—17
to 845 c.f.m.

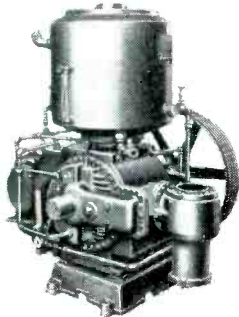

For vacuum exhausting and processing at low pressures in electronic or electrical operations, these pumps offer the advantages of positive rotary, automatically lubricated, noiseless operation. They are "tops" for producing high vacuum or for backing diffusion pumps. Test to absolute pressures as low as 4 microns.

BEACH-RUSS
high vacuum
PUMPS

Write
for
Catalog
No. 84

BEACH-RUSS COMPANY
52 Church St. New York 7, N. Y.

how to keep your PLUG-INS plugged in

THE TOP HAT RETAINER

Four standard sizes fit most tubes and components. Special types also available.

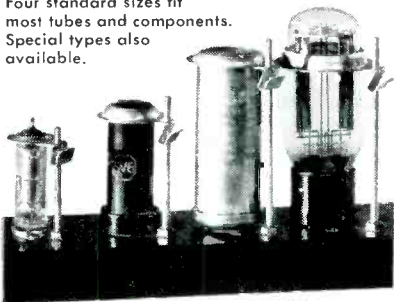

New stainless steel clamp for plug-in units subject to vibration. Materials and finishes comply with Armed Forces specifications. Recommended for use in military electronic equipment.

Please state in your inquiry the type of tube or component to which the retainer is to be applied, or supply sample or outline drawings with pertinent dimensions.

TIMES FACSIMILE CORPORATION
A Subsidiary of The New York Times Company
229 West 43 St., New York 18, N. Y.

DETECT RF TROUBLE and its CAUSES

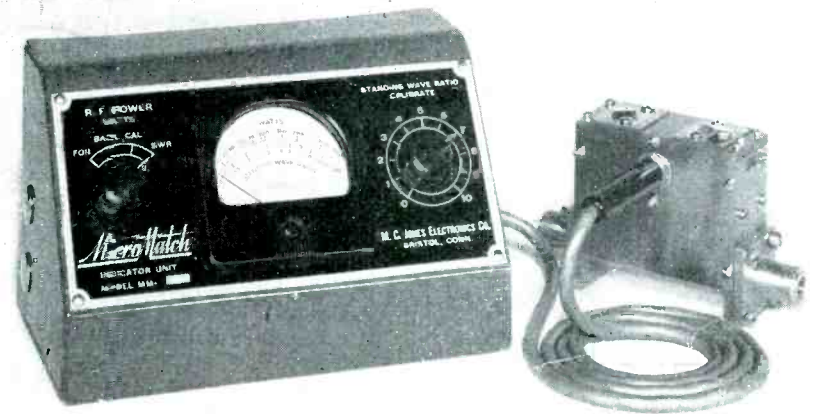

SPECIFICATIONS

Frequency Range 50 to over 500 MCS
Impedance 51.5 ohms
Connectors Standard connectors supplied are type N to accept UG-21/U attached to RG-8/U and RG-9/U cable. The instrument is supplied on request, with UHF type connectors to accept 82-1SP attached to RG-8/U and RG-9/U cable. Adapters are available for attaching to 7/8 inch 51.5 ohm coaxial line.
Power Ranges:
Model MM 565 0 to 4 watts
MM 560 0 to 12 watts
MM 561 0 to 40 watts
MM 562 0 to 120 watts
MM 563 0 to 400 watts
MM 564 0 to 1200 watts
Accuracy Plus or minus 5% of full scale for RF power. Plus or minus 10% for V.S.W.R.
Reflection Coefficient Less than 0.01.

Distributed outside of Continental U.S.A. by RCA International Div., Radio Corporation of America

MM 560 SERIES

This new MicroMatch provides direct reading of incident power, reflected power, net power to load, and VSWR of load—without reversing coupler. You can detect trouble wherever it may be in the transmitter, transmission line or antenna system. \$97.00 complete.

M. C. JONES ELECTRONICS CO.
BRISTOL, CONNECTICUT

STOCK MOLDED KNOBS

For Every Requirement

Rogan offers a large selection of knobs from stock molds, supplied without tool charge. Wide variety of sizes, shapes and colors. Knobs can be branded to specifications. Low cost, fast delivery.

Write For Free Catalog

ROGAN BROTHERS
2504 W. IRVING PK. BLVD.
CHICAGO 18, ILLINOIS

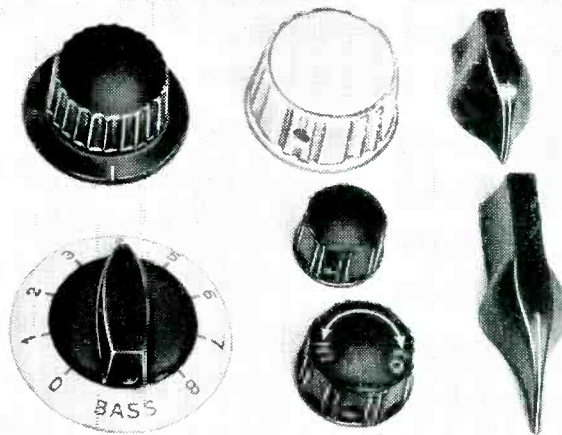

Pioneer in Radio Engineering Instruction Since 1927

CAPITOL RADIO ENGINEERING INSTITUTE

An Accredited Technical Institute

ADVANCED HOME STUDY AND RESIDENCE
COURSES IN PRACTICAL RADIO-ELECTRONICS
AND TELEVISION ENGINEERING

Request your free home study or residence school catalog by writing to:

REGISTRAR
16TH AND PARK ROAD, N.W.
WASHINGTON 10, D. C.

Approved for Veteran Training

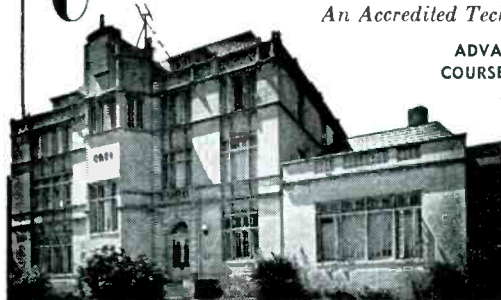

VERSATILE VIBRATOR

OPERATING COIL 2 to 120
volts AC

FREQUENCY 0 to 450 cycles

POWER HANDLING CAPAC-
ITY 0 to 30 WATTS

NOISE LEVEL LESS THAN 1
mv

VERY LONG LIFE

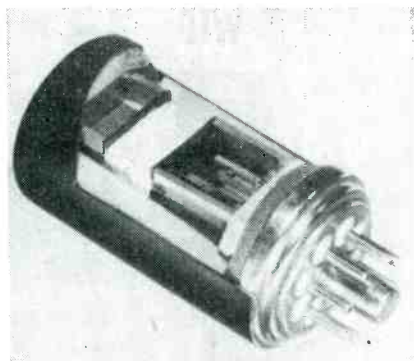

These features make this "Chopper" Vibrator a "must"! Extremely versatile, its application is the amplification of minute d-c potentials such as the output of a thermocouple. Acting as a self-driven vibrator, the unit can generate its own control signal or provide a signal for another chopper. Used to convert small d-c values to a-c, it can rectify the amplified signal to produce d-c again whose polarity and level vary directly as the source.

WRITE TODAY
FOR
FULL DETAILS

AIRPAX PRODUCTS CO.

1024 Greenmount Ave., Baltimore 2, Md.

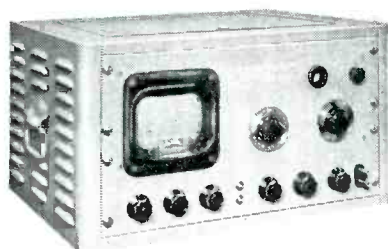

USES

- Ultrasonic Vibration Measurements
- Harmonic Analysis
- Cross Modulation Studies
- Noise Investigations
- Determining Transmission Characteristics of Lines and Filters
- Monitoring Communications Carrier Systems
- Checking Interference, Spurious Modulation, Parasitics, Effects of load changes, shock, humidity, component variations, etc. upon frequency stability
- Telemetering

SPECIFICATIONS

Frequency Range: 2KC—300KC, stabilized linear scale
Scanning Width: Continuously variable from 200KC to zero
Four Input Voltage Ranges: 0.05V. to 50V. Full scale readings from 1 millivolt to 50 volts
Amplitude Scale: Linear and two decade log
Amplitude Accuracy: Within 1db. Residual harmonics suppressed by at least 50db.
Resolution: Continuously variable. 2KC at maximum scanning width, 500c.p.s. for scanning widths below 8KC.

WRITE NOW For Complete Information, Price and Delivery

Available Now!

Easy, Fast
Ultrasonic Spectrum Analysis

WITH

MODEL SB-7

**PANORAMIC
ULTRASONIC ANALYZER**

An invaluable new direct reading instrument for simplifying ultrasonic investigations, the SB-7 provides continuous high speed panoramic displays of the frequency, amplitude and characteristics of signals between 2KC and 300KC. The SB-7 allows simultaneous observation of many signals within a band up to 200KC wide. Special control features enable selection and highly detailed examination of narrower bands which may contain signals separated by less than 500c.p.s. The instrument is unique in that it provides rapid indications of random changes in energy distribution.



the article describing the multiple magnetic tape recorder developed by Reynolds Marchant in the laboratories of Minnesota Mining and Manufacturing Co. announces that this feat has already been accomplished in practical form.

It may be worthy of comment that introductory material relating to the general subjects of acoustics, hearing and fundamental electronic components is endlessly repetitive from one book to the next and represents a never completely successful effort to condense a thorough education in audio engineering in the space of a few pages. Although in this instance the author has done well with limited space, it is a moot question whether it would be better to eliminate the chapter on "Acoustic Factors" or to expand it. As it stands a good portion seems either inadequate or unnecessary, depending upon the status of the reader.

Certainly it is true that the novice in the field will gain greatly through the reading of this book, and there are few engineers, even among those active in magnetic recording work, who will not profit from reviewing the information and using this presentation as a means for collating their concepts. The book should be read, at least in part, by everyone in the industry.—JOHN D. GOODELL, *The Minnesota Electronics Corp., St. Paul, Minn.*

Photoelectricity and Its Applications

By V. K. ZWORYKIN AND E. G. RAMBERG, *John Wiley & Sons Inc., New York, 1949, 494 pages, \$7.50.*

THIS BOOK covers virtually the entire field of photoelectricity from its historic beginning to its recent application in Ultrafax. The various photoelectric phenomena are described individually and the histories of their development presented along with the general theories and characteristics of light-sensitive devices.

A portion of the book is devoted to a detailed study of the different kinds of photosensitive surfaces, including advantages and disadvantages of using particular surfaces for certain applications. Each chap-

BIRTCHEr

STAINLESS STEEL - LOCKING TYPE

TUBE CLAMPS

Stainless Steel

Corrosion Proof



83 VARIATIONS

Where vibration is a problem, Birtcher Locking TUBE CLAMPS offer a foolproof, practical solution. Recommended for all types of tubes and similar plug-in components.

More than three million of these clamps in use.

FREE CATALOG

Send for samples of Birtcher stainless steel tube clamps and our standard catalog listing tube base types, recommended clamp designs, and price list.

THE BIRTCHEr CORPORATION
5087 HUNTINGTON DR. LOS ANGELES 32

LOGARITHMIC AC VOLTMETER

WIDE BAND AMPLIFIER

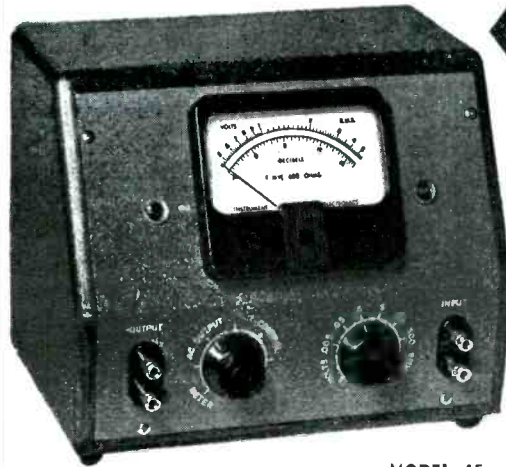

MODEL 45

Advanced Design gives you a sensitivity and frequency response never before obtained.

Also MODEL 47

AUDIO FREQUENCY

VOLTMETER

40 Microvolts to 500 Volts
15 Cycles to 30 Kc.
Amplifier Gain 40000

No other Voltmeter offers all these advantages

- Range .0005 to 500 volts
- Frequency 5 CPS to 1.6 MC
- Logarithmic voltage scale
- Input 2 Megohm 15 MMF
- Accuracy $\pm 2\%$
- Stability $\pm 1\%$ 105 to 125V.
- Linear DB scale

Ideal for Audio, Supersonics, Lower Radio Frequency Spectrum.
Measures Stage Gain, RF and IF Amplifiers on Broadcast Receivers.

Write for Complete Information

INSTRUMENT ELECTRONICS CORP.
45-17 Glenwood Street Little Neck, L. I., N. Y.

RAHM



DIRECT WRITING

MULTI-CHANNEL

OSCILLOGRAPHs

- INSTANT DIRECT RECORDS WITHOUT INK
- HIGH GAIN COMBINATION AC-DC AMPLIFIERS
- CONSTANT MESH MULTI-SPEED CHART DRIVE
- CUSTOM QUALITY AT MODERATE PRICE
- UNEQUALLED SENSITIVITY
- 1-2-4-6 CHANNELS

Write for Information

RAHM INSTRUMENTS, INC.
12 West Broadway New York 7, N. Y.

A VERSATILE FINE-WIRE

WINDING MACHINE BY GEO. STEVENS

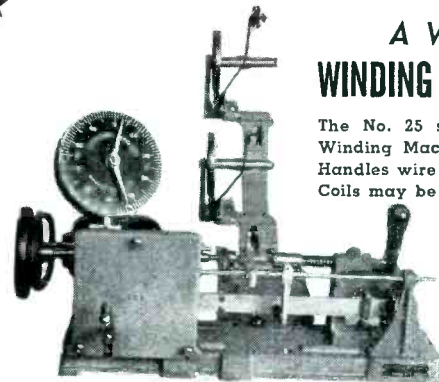

The No. 25 shown is a combination of the Universal Winding Machine and the 6" Space Winding Machine. Handles wire from 24 to 40 gauge. Progressive Universal Coils may be up to 3½ inches in length.

- Other models for winding Coils, Transformers, Resistors, and Solenoids
- Dial Counters also available separately
- We welcome the opportunity to consult with you on your needs and would like you to have our latest catalog . . . write!

GEO. STEVENS MFG. CO.

6022 N. ROGERS AVE.
PULASKI & PETERSON
CHICAGO 30, ILLINOIS

If You Are Having Difficulty

Maintaining Your Mailing Lists . . .



Probably no other organization is as well equipped as McGraw-Hill to solve the complicated problem of list maintenance during this period of unparalleled change in industrial personnel.

McGraw-Hill Mailing Lists cover most major industries. They are compiled from exclusive sources, and are based on hundreds of thousands of mail questionnaires and the reports of a nation-wide field staff. All names are guaranteed accurate within 2%.

When planning your direct mail advertising and sales promotion, consider this unique and economical service in relation to your product. Details on request.

McGraw-Hill Publishing Co., Inc.
DIRECT MAIL DIVISION
330 West 42nd Street New York, 18, New York

REGULAR
FLEXLOC

ONE-PIECE SELF-LOCKING NUTS

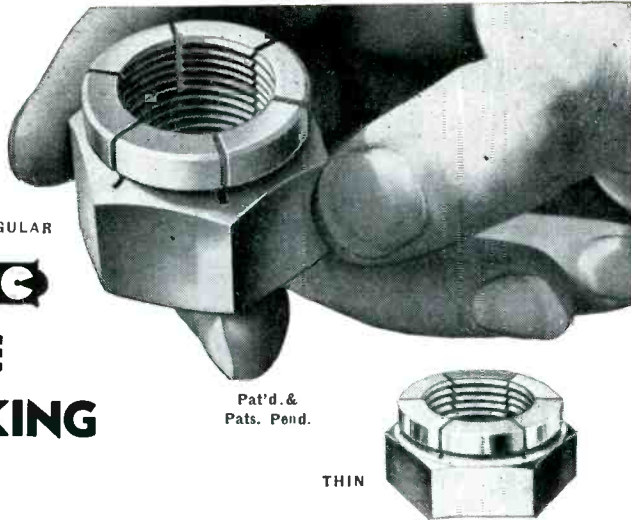

Pat'd. &
Pats. Pend.

THIN

. . . Won't Shake Loose . . . Reduce Maintenance

Invariably, when nuts loosen, they cause shutdowns, loss of production, and bad tempers all around. All this can readily be eliminated by installing the one-piece, self-locking "FLEXLOC", because it positively will not shake loose and positively cuts cost of maintenance.

The all-metal, one-piece resilient "FLEXLOC" is becoming increasingly popular, because it is processed to have an exceptionally uniform torque and, because it packs a stop, lock and plain nut all in one. "FLEXLOC" accommodates itself to a wide range of thread tolerances and can be used over and over again without losing much of its torque. And, being a stop nut, it stays locked in any position on a threaded member. It is not affected by temperatures commonly met within the industrial field of Mechanical Engineering.

Available in "thin" and "regular" types—in sizes from #6 to 2" in diameter—in NC and NF thread series. Write for your copy of the "FLEXLOC" Catalog.

OVER 46 YEARS IN BUSINESS

SPS

STANDARD PRESSED STEEL CO.

BOX 596 JENKINTOWN, PENNSYLVANIA

"Serving Industry continuously since 1903 through Industrial Distributors"

*All in One
Instrument*

MODEL
TFR



TWIN CHANNEL GRAPHIC RECORDER

in RUGGED CASE
for portable and
bench use.

And for RACK
MOUNTING

•
VERSATILE

•
COMPACT

•
ECONOMICAL

THIS RECTANGULAR COORDINATE RECORDER
features:

- TWO independent recording channels
- SERVO-CONTROLLED writing Systems
- INTERCHANGEABLE range potentiometers
- ALL operating controls on Front Panel
- SYNCHRONOUS, reversible and changeable chart drive for oscillator, analyzer and selsyn drives
- CALIBRATED charts available for general and specific purposes
- DEPENDABLE trouble-free operation

Engineering Skill and Years of Experience have produced this RECORDER which is truly unexcelled in combining Simplicity, Compactness, Versatility and Ease of Operation.

Descriptive literature mailed upon request.

Designers and Manufacturers of Graphic Recorders

SOUND APPARATUS COMPANY STIRLING, N. J.
Instruments Engineered for Individual Requirements

ter concludes with a complete list of references.

The materials and apparatus used in the manufacture of phototubes are discussed in detail, and separate chapters are devoted to descriptions of the vacuum, gas-filled and multiplier phototube principles and characteristics. Photoconductive and photovoltaic cells are each presented in individual chapters.

The last half of the book deals in specific applications for photoelectric devices. Numerous industrial circuits are shown. Photosensitive television camera tubes are discussed individually, and the complete electronic television system is studied in detail.

The application portion of the book is completely illustrated with circuit diagrams, and wherever practical, design data are included. A complete appendix of material pertaining to photoelectric devices is furnished.—J. F.

• • •

Books Received for Review

AUTOMATIC RECORD CHANGER SERVICE MANUAL, Vol. 2, 1948. Howard W. Sams & Co., Inc., Indianapolis, Ind., 1949, 432 pages, \$6.75. Covers 45 models of standard, LP, dual-speed record changers plus wire and tape recorders. Exploded diagrams show each individual part in approximately correct relationship to other parts, to speed identification of any part.

THE CATHODE-RAY OSCILLOSCOPE. By George Zwick. Raderaft Publications, Inc., New York, 1949, 112 pages, paper-covered, \$0.75. Simple fundamentals of scopes and measuring techniques, for those lacking engineering training.

ELECTRON TUBES. Vol. I—1935-1941; Vol. II—1942-1948. Published by RCA Review, Radio Corporation of America, Princeton, N. J., 1949, 475 and 454 pages respectively, \$2.50 each. Collected papers published by RCA authors, arranged in four sections in each volume: general; transmitting; receiving; special. Each book includes an electron tube bibliography for the period covered.

ELECTRIC AND MAGNETIC FIELDS. By Stephen S. Attwood, Prof. of E. E., Univ. of Mich. John Wiley & Sons, Inc., New York, 1949, Third Edition, 475 pages, \$5.50. Advanced electrical engineering text for colleges, arranged in four parts to cover separately the electric field, magnetic field, ferromagnetic field, and interactions of electric and magnetic fields. Moderate revision of 1941 edition, with all formulas recast to units of official mks system.

A PROFESSIONAL GUIDE FOR JUNIOR ENGINEERS. By W. E. Wickenden; Edited and Collated by G. Ross Henninger. Engineers' Council for Professional Development, 29 W. 39th St., New York, N. Y., 56 pages, paper cover, \$1.00. Presentation of philosophy and engineering ethics for young engineers. Beginnings of engineering societies are traced, and engineering is evaluated as a career. Appendix includes a self-appraisal questionnaire.

For Precision Washers... For Precision Stampings...

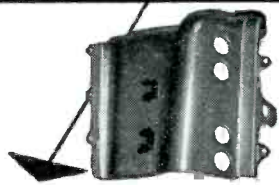
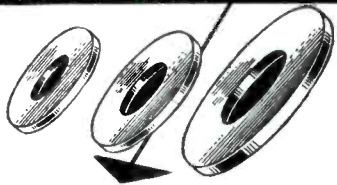

WHITEHEAD STAMPING CO.

A preferred source of precision-made WASHERS and STAMPINGS. 46 years of experience and up-to-the-minute facilities, assure highest quality and service.



EST. 1903

WHITEHEAD STAMPING CO.

1691 W. Lafayette Blvd.

Detroit 16, Michigan

Little thought-of facts about capacitors

The short time breakdown voltage of a well-made D.C. capacitor is not less than 5 to 6 times the actual working voltage at 20°—

- E = 5 × e min
- E = Breakdown voltage
- e = Rated d.c. working voltage

INDUSTRIAL CAPACITORS are unvaryingly held to this formula.

Designed for maximum safety factor and the smallest possible volume, INDUSTRIAL CAPACITORS are the most widely used capacitor in industrial applications.

WRITE TODAY FOR DETAILED CATALOG

INDUSTRIAL CONDENSER CORP.

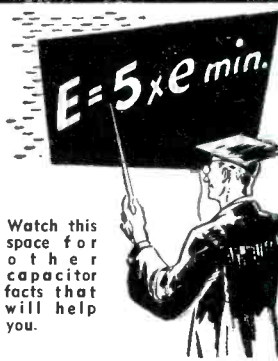

Watch this space for other capacitor facts that will help you.

Sales Offices in All Principal Cities
3243 N. California Ave.
Chicago 18, Illinois

PHOTOVOLT VIDEO

Brightness Tester
MOD. 205



A photoelectric instrument for measuring the brightness of television tubes and screens in foot-lamberts.

Price, \$68.

Write for literature to
PHOTOVOLT CORP.

95 Madison Ave. New York 16, N. Y.
Photoelectric and
Electronic Measuring Instruments

FREE! Send for it NOW!

ALLIED'S NEW 1950 CATALOG!

196 PAGES—
Everything in
Radio and
Electronics



GET RADIO'S LEADING BUYING GUIDE

Service Technicians and Engineers: ALLIED's 1950 Buying Guide brings you all the new releases and money-saving values—from the world's largest stocks of test instruments, amplifiers, P.A. systems and equipment, tubes, parts, tools, books and accessories—ready for instant expert shipment. Send today for your FREE new 196-page ALLIED Catalog.

ALLIED RADIO CORP., DEPT. 11-K-9
833 W. Jackson Blvd., Chicago 7, Ill.

Send FREE New ALLIED Catalog.

FREE

Name.....

Address.....

City..... Zone..... State.....

ALLIED RADIO

Now Best TV servicing practices

HERE is an up-to-the-minute A-to-Z manual for everyone concerned with TV receiver installations and optimum signal output. It tells how the video and audio signals originate... how they are transmitted... how they are received. It gives a balanced and detailed picture of both AM and FM circuits, operation and servicing.

Covered in detail are such topics as oscilloscope operation, the ratio detector system and intercarrier sound receivers, deflection circuits, automatic synchronizing control and the synchroguide system, projection systems, sequential and simultaneous color television, etc. Simplified diagrams, complete schematics and photographs supplement the text matter.

A quick-reference chart gives you every important characteristic of all picture tubes in common use, from the 3NP4 to the 16AP4 and the 20BP4. Elaborate trouble-shooting charts show symptoms, causes and cures for more than 50 typical receiver problems.

Just Published!

BASIC TELEVISION Principles and Servicing

By **BERNARD GROB**

Instructor, RCA Institutes, Inc.

592 pages • 6 x 9 • Over 400 Tables, charts, illustrations • \$6.50

CONTENTS

The Television System—
Camera Tubes — The Electron Scanning Beam — Scanning and Synchronizing — The Composite Video Signal — The Picture Carrier Signal — Frequency Modulation — Television Receivers — Picture Tubes—Power Supplies — Video Amplification — Practical Design of Video Amplifiers — Brightness Control and D-C Reinsertion—Video Detector and Automatic Gain Control — Separation of the Synchronizing Signals—Deflection Generators — Deflection Circuits — Picture I-F Stages—The R-F Tuning Section — Antennas and Transmission Lines — The Associated Sound Signal and FM Receivers—Receiver Servicing —Television Broadcasting—Color Television—Light — Appendices: Standards of Good Engineering Practice Concerning TV Broadcast Stations, etc.

This new book combines well-rounded self instruction in basic television principles with practical, ready-reference receiver troubleshooting guidance.

Full and careful explanations of every basic point like these are given—phase inversion, automatic volume control, rectifier circuits, modulation and condenser action in a circuit.

Each block of circuits in the receiver is given a separate chapter to cover details fully. Other chapters are devoted to camera tubes, scanning and synchronizing, power supplies, antennas and transmission lines and color television.

This new manual gives you more than enough material to qualify for the FCC's added FM and TV requirements for the 1st class license test. It also gives you the necessary background of theory to understand new TV developments, and work with them easily.

Accept This Offer Now

You can examine this book for 10 full days free of charge. Fill out and mail the free-examination coupon below now, while this magazine is handy.

10 DAYS' FREE EXAMINATION

McGraw-Hill Book Co., 330 W. 42nd St., N.Y.C. 18
Send me Grob's Basic Television Principles & Servicing for 10 days' examination on approval. In 10 days I will remit \$6.50, plus few cents for delivery, or return book. (We pay for delivery if you remit with this coupon; same return privilege.)

Name.....

Address.....

City..... Zone..... State.....

Company.....

Position..... F.L-10-49

WHERE TO BUY IT

WHOLESALE RADIO

of Baltimore

New G.E. Television LAB INSTRUMENTS

5" OSCILLOSCOPE

Wide frequency response for T.V. Circuit work.

\$279.50

- High sensitivity
- Exceptional stability
- DC Amplifiers
- Excellent linearity
- Low capacity input probe
- 2 Axis input
- Calibrated voltages provided
- Regulated Power supply
- 105-125 volts AC
- 50 - 60 cycles
- 100 watts
- Type ST-2A.

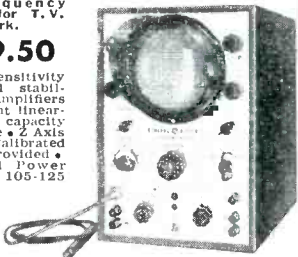

MARKER GENERATOR

For Television Applications

\$395.00

All desired markers for complete alignment are obtained by one initial setting of the master dial on the marker generator. Separate crystal for each TV channel selected by rotary switch. Picture and audio carrier marker available simultaneously. I.F. ranges continuously variable in three ranges from 10 to 50 mc. Power supply — 105 to 125 volts, 50-60 cycles. 60 watts. Power transformer has double primary and can be connected to 210-250 v. Type ST-5A.

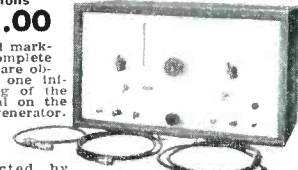

SWEEP GENERATOR

Wide linear sweep for Television Servicing.

\$379.50

Covers all broadcast TV channels, TV and FM — IF bands. Good attenuation and extremely low leakage. Entirely electronic. Frequency range continuously variable from 4 to 110 mc and 170 to 220 mc. Sweep width linear from 500 kc to greater than 15 mc. Output voltage — greater than 0.1 from 4 to 110 mc. Greater than 0.5 volts from 170 to 220 mc. Same power requirements as marker generator. Marker generator and sweep generator are adequately shielded and have front panels slotted for standard 19" relay rack mounting.



WRITE FOR FULL DETAILS, PICTURES AND SPECIFICATIONS

EL-TRONICS

Gelger Muller

RADIATION SURVEY INSTRUMENT

A complete, lightweight, portable, battery operated instrument for the measurement of radiation intensities. For: Locating radium, uranium and other radio active ores; geological survey work; measuring radiation intensity in plants, hospitals, laboratories. The instrument has three full scale ranges of .2, 2.0 and 20 milli-roentgens per hr. Reading directly from scale of indicating meter located on top of instrument. **\$225** Model SM3.



MILLEN GRID DIP METER

Accurate & Dependable. Compact and completely self-contained. AC power supply is of the transformer type. The drum dial has 7 calibrated uniform length scales from 1.5 to 270 mc with generous overlaps plus an arbitrary scale for use with special application inductors. Internal terminal strip permits battery operation for antenna measurement. **\$55** Order Millen 90651.



WRITE FOR FREE MONTHLY "FYI" BULLETIN Phone MULberry 2134 Address Orders to Dept. QR 90

WHOLESALE RADIO PARTS CO., Inc.
311 W. Baltimore St.
BALTIMORE 1, MD.

Distributors for—Ohmite • Centralab • Millen • Amphe-nol • Tripplitt • Sola • Superior • Aerovox and many other famous makes.

Backtalk

This department is operated as an open forum where our readers may discuss problems of the electronics industry or comment upon articles which **ELECTRONICS** has published.

Packaged Precision

DEAR SIRs:

READING THROUGH a series of your publication, **ELECTRONICS**, to which journal we have subscribed for many years, I have been interested to note the number of times the term "packaged" or "packeted" occurs when some concern wishes to draw attention to the size or quality of a product.

Size and quality do not always blend but when they do so, extensive advertisement is hardly necessary, the goods will usually sell themselves.

One of the drawbacks of electronics, so we have been told over a period of years, is the instability of such units when compared with mechanical units to perform the same office. We are told of a comparator using the usual lever magnifying mechanism which is stable for weeks on end whilst the electronic comparator can't possibly remain as stable owing to the variations in tubes, coils, capacitors, resistors and what not. On the face of it, this argument appears sound. There is nothing in the electronic circuit which can give confidence to the mechanically minded engineer insofar as stability is concerned. As he says, he has to adjust his radio after it has been switched on for about ten minutes or it wanders off the station.

I should be very interested to know the parallel condition in America where it would appear the engineer is much more electronic minded; or is he?

As an example may I quote the following:

We were requested to supply on approval a dimensional comparator

Lavite STEATITE CERAMIC

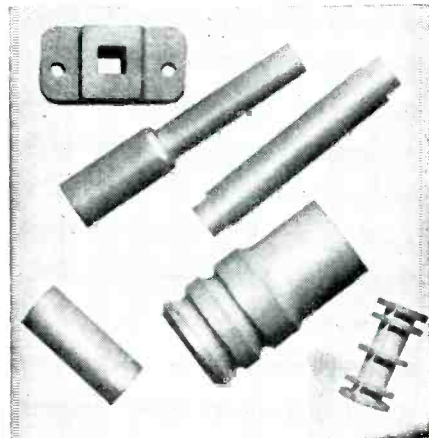

Design engineers and manufacturers in the radio, electrical and electronic fields are finding in LAVITE the precise qualities called for in their specifications . . . high compressive and dielectric strength, low moisture absorption and resistance to rot, fumes, acids, and high heat. The exceedingly low loss-factor of LAVITE plus its excellent workability makes it ideal for all high frequency applications.

Complete details on request

D. M. STEWARD MFG. COMPANY

Main Office & Works: Chattanooga, Tenn.
Needham, Mass. • Chicago • Los Angeles
New York • Philadelphia

RAWSON ELECTROSTATIC VOLTMETERS

Type 518



Now available to 35,000 VOLTS

Measure true R.M.S. values on A.C., no waveform or frequency errors.

NO POWER CONSUMPTION

Leakage resistance greater than one million megohms. These meters may be used to measure

STATIC ELECTRICITY

Ideal for measuring high voltage power supplies with zero current drain. Rugged, well-damped movement. All elements surrounded by metal shielding for accuracy and safety.

Write for new bulletin

RAWSON ELECTRICAL INSTRUMENT COMPANY

111 POTTER ST. CAMBRIDGE, Mass. Representatives

Chicago

Los Angeles

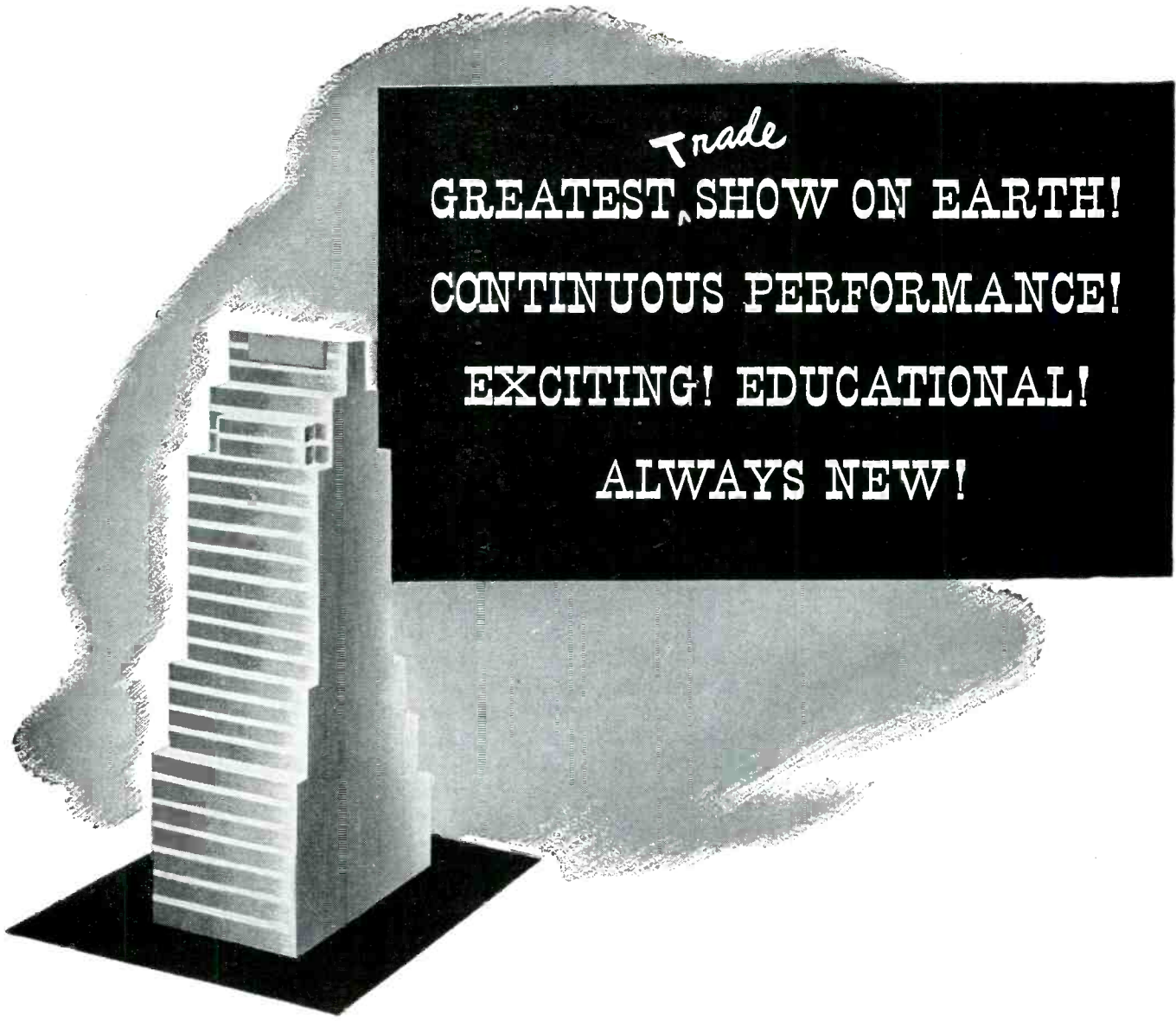

Trade
GREATEST SHOW ON EARTH!
CONTINUOUS PERFORMANCE!
EXCITING! EDUCATIONAL!
ALWAYS NEW!

If you are interested in new products . . . new services . . . new industrial developments . . . you'll follow the parade of advertising pages that marches through each issue of all McGraw-Hill magazines.

Alert executives and technical men eagerly scan these advertisements for information essential to their business. Few buyers feel that they can afford to miss them. Read-

ing these pages regularly is a sure way of keeping right up-to-the-minute on the developments in your field.

Add this fact to the wealth of news and information provided by McGraw-Hill's staff of over two hundred editors and over four hundred field correspondents, and you know why men say: **FOR THE FACTS OF INDUSTRIAL LIFE, TURN TO McGRAW-HILL.**

McGRAW-HILL

Publishing Company, Inc., 330 West 42nd Street, New York 18, N. Y.

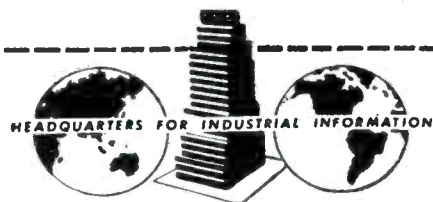

The McGraw-Hill Network of Industrial Communication: American Machinist • Air Transport • Aviation • Aviation News • Bus Transportation • Business Week • Coal Age • Chemical Engineering • Construction Methods • Electrical Contracting • Electrical Merchandising • Electrical West • Electrical Wholesaling • Electrical World • Electronics • Engineering & Mining Journal • E. & M. J. Metal and Mineral Markets • Engineering News-Record • Factory Management & Maintenance • Food Industries • McGraw-Hill Digest • Mill Supplies • Power • Product Engineering • Science Illustrated • Textile World • The Welding Engineer.

ANALYZE COMPLEX IMPEDANCES

WITH THE
Z-ANGLE
METER

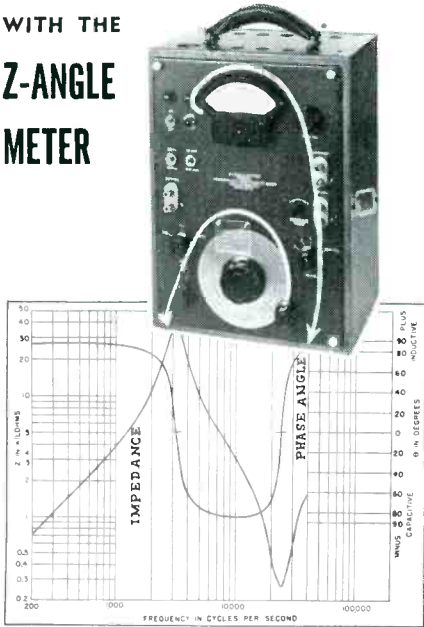

APPLICATIONS...

- Loudspeakers
- Microphones
- Transmission Lines
- Filters
- Amplifier Inputs and Outputs
- Resonant Circuits—series or parallel
- Transformers
- General Laboratory Measurements

FOR MEASUREMENTS OF...

- Impedance (Z)
0.5 to 100,000 ohms
- Phase Angle (θ)
+90° (X_L) thru
0° (R) to -90° (X_C)
D.....0.1 to 10
Q.....10 .. 0.1
- Frequency...30 to 20,000 c.p.s.

PRICE \$425.00

Write today for bulletins on other T.I.C. products: R.F. Z-Angle Meter . . . R-F Power Oscillator . . . Translatory Variable Resistors . . . Slide Wire Resistance Boxes . . . Phase Angle Meter.

TECHNOLOGY INSTRUMENT CORP.

1058 Main Street, Waltham 54, Mass.



Engineering Representatives
Chicago, Ill.—State 2-7444
Dallas, Tex.—L Ogan 6-5097
Cambridge, Mass.—Eliot 4-151
Canaan, Conn.—Canaan 649
Rochester, N. Y.—Charlotte 3193-J
Hollywood, Cal.—Hollywood, 9-6305

BACKTALK

(continued)

with a full scale deflection (4-in. indicator movement) equal to 0.0001 inch at the stylus.

The movement over the scale was to be linear and guaranteed to be within 1 percent of the full scale value at any position. The movement was to provide accuracy to within 2 percent of the full scale value at any temperature between 50 and 72 degrees F with the proviso that both work and instrument had been soaked at that temperature for the normal ten hours necessary for temperature stabilization.

The instrument was delivered and with the guarantee as above.

It was then forwarded by the purchaser to the national Laboratory for checking.

On return with Laboratory O.K. certificate it was put into service.

After six months use without one minute of trouble, the works superintendent still complains that *he's not quite certain of it* but he doesn't know why.

This instrument is crystal controlled, with an accuracy stability of two parts in one million. It repeats consistently to inside one millionth part of one inch 200 times every hour. On the static test the meter deviation is less than 0.000-001 inch over 720 hours at any temperature.

And he's not quite certain of it.
Can you believe it?

JAMES R. CORNELIUS

Cornelius Electronic Instruments Ltd.
Coventry, England

Electronic Organ

DEAR SIRs:

MESSRS. GOODELL AND SWEDIEN presented an interesting description of their pipeless organ in the August issue of ELECTRONICS. I was sorry to notice, however, that they made no reference to the original electric organ based on the use of tooth and pole generators. More than 40 years ago, Thaddeus Cahill designed and built such a machine. About the year 1906, I well remember its furnishing music for an electrical show in old Madison Square Garden in New York City. At that time, of course, loudspeakers were unknown. Instead, hundreds of old-fashioned telephone

**LARGE CAPACITY
SMALLEST SIZE**

1500
and
1000
 μmf

5000
 μmf

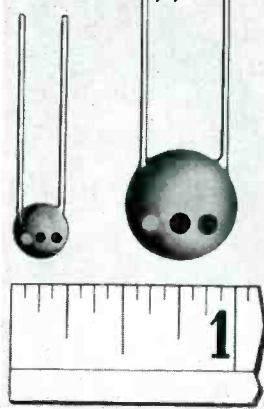

**R.M.C.
DISCAPS**
•
**Leading TV
Makers
Depend
On
Them**

Type CC Miniature Ceramic High Frequency By Pass Series

1000 mmf and 1500 mmf DISCAPS measure only 1/4" in diameter; 5000 mmf only 7/16" and 10,000 mmf 9/16". 600 V.D.C. working voltage—1200 V.D.C. test—3500 to 5000 V.D.C. breakdown.

LOW LEAKAGE • LOW SELF INDUCTANCE
Type CC DISCAPS are impervious to moisture, have a low temperature coefficient and good power factor. DISCAPS are definitely better.

SEND FOR DETAILS AND TEST SAMPLES

Radio Materials Corporation
1708 BELMONT AVE. CHICAGO 13, ILL.

**For HEAVY DUTY
WORK!** Severest Electrical
Services!



P-506-CE
Plug with Cap



S-506-DB
Socket with
deep Bracket

**JONES
PLUGS &
SOCKETS**

500 SERIES

*Proven
Quality*

**For 5,000 Volts,
25 Amperes per
Contact Alter-
able by circuit
Characteristics.**

Socket contacts phosphor bronze, knife-switch type, cadmium plated. Plug contacts hard brass, cadmium plated. 2, 4, 6, 8, 10, and 12 contacts. Plugs and sockets polarized. Long leakage path from terminal, and terminal to ground. Caps and brackets, steel parkerized (*rust-proofed*). Plug and socket blocks interchangeable in caps and brackets. Terminal connections most accessible. Cap insulated with canvas bakelite.

Write for Jones BULLETIN 500 for full details on line.

HOWARD B. JONES DIVISION
Cinch Mfg. Corp.
1026 SOUTH HOMAN AVE. CHICAGO 24, ILL.

CONTACTS

FOR THE FIELD OF ELECTRONICS

ALLEN BRADLEY RESISTORS
 Immediate delivery



RESISTORS
INCORPORATED

5%—10%
 1/2 W., 1W., 2W.

Write for Price Bulletin E-10

RESISTORS, INCORPORATED
 71 MURRAY ST., NEW YORK 7, N. Y.
 TEL.: WORTH 2-7862

EL-TRONICS, INC.
 Research, development, and manufacture of electronic equipment—a single model to large quantities.
 Specialists in Geiger-Muller equipment
 2647-67 N. Howard St., Phila. 33, Pa.
 Garfield 5-2026

PRINTED CELLOPHANE
 Colorful - Self Adhesive - Cellophane, processed in Rolls. Easy to buy - Easy to apply - used for Packaging - Point of Sale advertising - Parts marking and Aircraft Wire terminal identification.
TOPFLIGHT TAPE - YORK, PA.

This

CONTACTS

Section

supplements other advertising in this issue with these additional announcements of products essential to efficient and economical production and maintenance. Make a habit of checking this page, each issue

Classified Advertising Division

ELECTRONICS



FINE RIBBONS OF TUNGSTEN and MOLYBDENUM
 Quality and accuracy in our fabrication of Tungsten & Molybdenum Ribbons have characterized our service to the Electronic industry.
 A development of
H. CROSS Co.
 15 Beekman St., New York 7, N. Y.

MICROMETER FREQUENCY METER will monitor any number of frequencies, FM or AM, 100 KC to 175 MC

LAMPKIN LABORATORIES, INC.
 Bradenton, Fla., U. S. A.

ELECTRONICS COMPANIES USE STENCILS . . .
 for marking stock bins, plant equipment, parts, as well as Shipping Containers. For sample stencil, Shippers' Handbook, prices, pin this ad to business letterhead with your name.

MARSH STENCIL MACHINE CO.
 46 Marsh Bldg. • Belleville Ill., U. S. A.



MARSH STENCIL MARKING

PROBLEMS IN MANUFACTURING VACUUM TUBES?
 We build any and all kinds of equipment to your specification and design for the manufacture of tubes or associated products.

BUCK ENGINEERING CO.
 37-39 Marcy St. Freehold, N. J.



FLUXES
 SODERING BRAZING & WELDING
 L. B. ALLEN CO. INC. Chicago 31, Ill.
 6751 Bryn Mawr Ave.

EISLER
 SPECIALIZES IN EQUIPMENT FOR THE COMPLETE MANUFACTURE OF

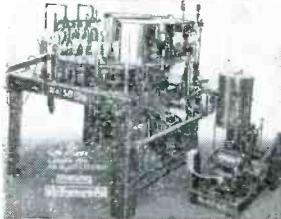

Incandescent and Fluorescent Lamps, Luminous Neon Signs, Radio, Cathode Ray, Television and Electronic Tubes of All Sizes

36-Head Radio Tube Exhausting Machine.

Transformers of All Types
 IN SIZES FROM 1/4 TO 300 KVA

For Lighting Power Welding Phase Changing Auto Testing



Special Transformers For Electronic Devices

EISLER ENGINEERING CO. Inc.
 751 So. 13th St. Newark 3, N. J.

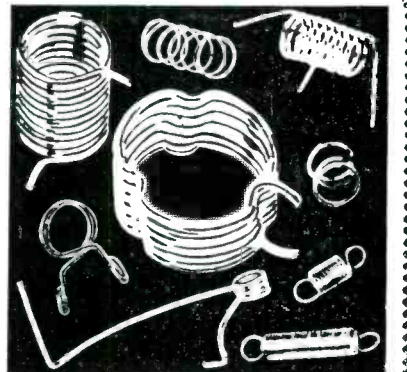



Antenna Coils, Grid Clips, Dial Cord Springs and Precision Springs of all types pertaining to Radio and Television.

Your Inquiries Invited

WEBSTER SPRING CORPORATION
 176 Johnson St., UL ster 5-3196-7-8, Brooklyn 1, N. Y.

EISLER — Manufactures Complete Equipment for:

SPOT WELDERS, Electric, for 1/4 to 250 KVA.
 A.C. ARC WELDERS from 100 to 400 Amps.
 TRANSFORMERS, Special and Standard Types.
 INCANDESCENT LAMP Manufacturing Equipment.
 FLUORESCENT TUBE Manufacturing Equipment.
 NEON SIGN MAKERS EQUIPMENT.
 ELECTRONIC EQUIPMENT, Vacuum Pumps, etc.
 WET GLASS SLICING and Cutting machines for Laboratory use.
 EISLER ENGINEERING CO., INC. 751 So. 13th St., Newark 3, N. J.

IN THE PROFESSION, AN HONORED NAME

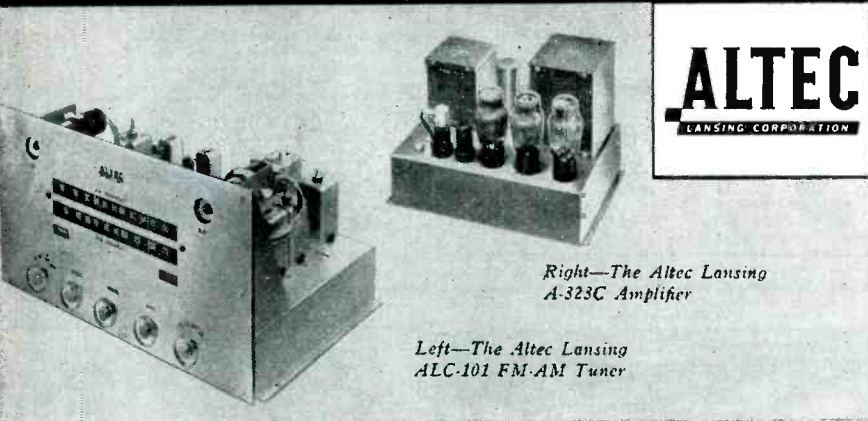

ALTEC
LANSING CORPORATION

Right—The Altec Lansing A-323C Amplifier

Left—The Altec Lansing ALC-101 FM-AM Tuner

ENGINEERED FOR THE HIGHEST POSSIBLE PERFORMANCE REGARDLESS OF COST

This superb two-unit Altec Lansing combination was designed in accordance with a single directive: "They are to be the finest. No component, no circuit, is to be chosen with price in mind. They must be able to realize the full resources of the finest AM and FM programs; they must be capable of receiving and delivering these resources undisturbed to the finest loudspeaker in the world,

the Altec Lansing 604B Duplex." The AM section is an improved tuned radio frequency circuit recognized as the best for high quality reception. The distortion-free circuits of the FM section re-create all of the life-like reproduction possible with FM. The A-323C Amplifier transmits to the loudspeaker the signal delivered by the tuner, changed only in power level. This two-unit com-

bination is available with special accessories to permit rack mounting for professional monitoring. Phonograph and television inputs and required switching are provided.

Technical folder describing ALC-101 Tuner and A-323C Amplifier sent on request. Write Altec Lansing Corporation, 1161 North Vine Street, Hollywood 38, Calif., 161 Sixth Avenue, New York 13, N. Y.

BACKTALK (continued)

receivers equipped with horns were used. The effect was quite impressive, for those days.

Cahill was years ahead of his time. His voluminous patents indicate that he had an excellent knowledge of the fundamentals and problems involved in electrical musical instruments.

To the best of my knowledge, he did not report his work in any technical publication, but popular types of articles were written. In the November, 1936, issue of the *IRE Proceedings*, B. F. Miessner devoted several pages to Cahill's work and showed pictures of parts of his equipment. One of the pictures shown was a pitch-wheel assembly bearing a striking resemblance to that in your August issue, but having a length of about four feet and weighing hundreds of pounds.

W. C. WHITE
Schenectady, New York

Electrocardiographs

DEAR SIRS: I SHOULD LIKE to call your attention to some errors that were made in the February issue of *ELECTRONICS* in reporting on a paper I presented at the AIEE-IRE Conference on Electronic Instrumentation in Medicine and Nucleonics. The paper in question is "Engineering Aspects of Biological Recorder Design."

In outline, my paper presented some short general remarks about end instruments for general biological recorders. The remainder of the paper concerned itself with a special type of biological recorder, the electrocardiograph, as an example of the problems encountered in typical instrumentation for biology. All remarks as to frequency bandwidth, phase measurements and so on, were concerned with the electrocardiograph.

The summary given in *ELECTRONICS* made no mention at all of the electrocardiograph but gave the erroneous impression that the entire paper was concerned with general biological recorders. It is fairly well known that recorders having only a 200-cps bandwidth, as stated in the summary, could not have satisfied the requirements of all biological recording.

In addition, figures quoted for

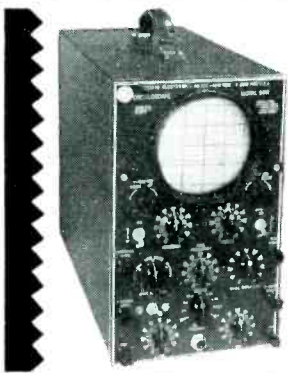

Reiner OSCILLOSCOPE

MODEL 508

A highly desirable 5 inch oscilloscope that meets the requirements of industry for its laboratory operation as well as for production testing. A 5 inch economically replaceable type of cathode ray tube with four free deflection plates is used. This operates at a high accelerating potential. Deflection sensitivity is high so that low potential input signals can be satisfactorily observed. The focus can be adjusted for a very sharp trace and there is no distortion introduced by the oscilloscope circuits.

Net \$265⁰⁰

SPECIFICATIONS

Sweep Circuit—Continuously Variable from 2 to 50,000 cps.
Vertical Deflection Sensitivity 10 miv. r.m.s. per in. max.; direct connection 21 volts r.m.s. per in.
Horizontal Deflection Sensitivity—500 miv. r.m.s. per in.; direct connection 22 volts r.m.s. per in.
Frequency Range—2 cps to 100,000 cps sinusoidal for both horizontal and vertical.
Input Impedance—5 megohms, 25 micromicrofarads for horizontal amplifier—2 megohms, 30 micromicrofarads for vertical amplifier.
Finish: Black Hammer-tone tube hood and panel with characters, black wrinkle finish steel case with carrying handles. Size 15 3/4" high x 8 3/4" wide x 20 1/4" deep. Weight 53 lbs.

square wave generator

MODEL 530—Designed to meet the demand for a square wave generator suitable for production and general testing.
Outstanding features of this model include: hand-calibrated frequency scale, 4-step decade multiplier, synchronization with any standard generator, output voltage in steps or continuously variable.
RANGES: Frequency Ranges: 10 cycles to 100 kilocycles. Each instrument is individually hand calibrated.
Output Voltage: The maximum variable output voltage available is 20 volts peak to peak.
Output Impedance: 100-200-400-600-1,000-1,500-2,000 ohms in fixed steps, 0-200 ohms by means of variable voltage potentiometer.
NET \$90⁰⁰

VACUUM TUBE VOLTMETER

MODEL 451

Model 451, when used alone has flat frequency characteristics up to 700 megacycles.

Both AC and DC voltage ranges can be easily read on a single long, linear scale.
Ranges: 0-2.5-10-25-100-250-1000 volts AC and DC.

A unique feature in an instrument of this type is a multirange millimeter.
Ranges: 0-2.5-10-25-100-250-1000 milliamperes DC.

There is also a 6 range ohmmeter 0-1000-10,000-100,000-1 megohm-10 megohms-1000 megohms. A reading of 0.1 ohm can readily be made on the low range with center of scale 10 ohms.



Net \$115.00

THE MODEL 101 AMPLIFIER

This unit together with the above instrument gives full scale deflection at 25 millivolts.

Net \$45.00

Reiner ELECTRONICS CO., Inc.

152 WEST 25th STREET • NEW YORK 1, N. Y.

PROFESSIONAL SERVICES

Consulting—Patents—Design—Development—Measurement

in

Radio, Audio, Industrial Electronic Appliances

THE BARRY CORPORATION

Specialist in the Control of
VIBRATION IMPACT NOISE

*Engineering Development
Manufacturing*

185 Sidney Street Cambridge, Mass.
Telephone: ELIot 0861-0140

ERCO RADIO LABORATORIES, INC.

Radio Communications Equipment

Engineering - Design - Development - Production
Pioneers in Frequency Shift Telegraph

Garden City • Long Island • New York

NIAGARA ELECTRON LABORATORIES
CONSULTATION - DESIGN - CONSTRUCTION
MFG. - THE THERMOCAP RELAY

Specializing in solution of problems of electronic
and electro-physical instrumentation for the re-
search or analytical laboratory. Industrial plant
problems also invited.

Andover, New York Cable Address: NIATRONLAB

S. BERTRAND BARNARD, LL.B., M.E.

REGISTERED PATENT ATTORNEY

Mechanical, Electronic,

Automotive and Aircraft Patents.

PATENT ANALYSES and INVESTIGATION

29-28 41st Avenue Stillwell 4-5428
Long Island City 1, N. Y.

PAUL GODLEY CO.

Consulting Radio Engineers

GREAT NOTCH, N. J.

Est. 1926 Little Falls 4-1000

PICKARD AND BURNS, INC.

Consulting Electronic Engineers

Analysis and Evaluation
of Radio Systems
Research, Development & Design
of Special Electronic Equipment

240 Highland Ave., Needham 94, Mass.

CROSBY LABORATORIES

Murray G. Crosby & Staff

FM, Communications, TV,
Industrial Electronics,
High-Frequency Heating

Offices, Laboratory & Model Shop at:
126 Old Country Rd., Mineola, N. Y.
Garden City 7-0284

HANSON-GORRILL-BRIAN INC.

Product & Mfg. Development

ELECTRICAL - ELECTRONIC
HYDRAULIC - MECHANICAL

One Continental Hill Glen Cove, N. Y.
Glen Cove 1922

ALBERT PREISMAN

Consulting Engineer

Television, Pulse Techniques, Video
Amplifiers, Phasing Networks,
Industrial Appliances

Affiliated with
MANAGEMENT-TRAINING ASSOCIATES
3308-14th St., N.W. Washington 10, D.C.

EDGERTON, GERMESHAUSEN & GRIER, Inc.

Consulting Engineers

Research, Development and Manufacture
of Electronic and Stroboscopic Equipment
Specialists in High-Speed Photography

160 Brookline Avenue, Boston 15, Mass.

MEASUREMENTS CORP.

*Research & Manufacturing
Engineers*

Specialists in the Design and
Development of Electronic Test Instruments
Boonton, N. J.

BERNARD SACHS, B.E.E., M.S.

Registered Patent Agent

Specialist in electronic cases

1033 E 12th St. Brooklyn 30, N. Y.
Cloverdale 2-6382

ELECTRO IMPULSE LABORATORY

Consulting Physicists

Radio Interference and Noise Meters; Interference
Suppression Methods for Ignition Systems and
Electrical Devices.

P. O. Box 250 Red Bank, New Jersey
Red Bank 6-4247

MEASUREMENT ENGINEERING LIMITED

Consultants on Special Equipment for measurements
and production tests, communications and audio
systems.

Head Office and Plant
Atnprior Canada

60 Front Street West Montreal
Toronto, Canada, Canada

A. F. SMUCKLER & CO., INC.

Electronic and Communication

Engineers and Manufacturers

202-208 Tillary Street Brooklyn 1, N. Y.
ULster 5-5141

ELECTRO-MECHANICAL RESEARCH INC.

Specialized Research and Manufacture

High and Low Frequency Circuit Development
Electronic Measuring and Test Equipment
Optical and Infra-Red Studies
Special Geophysical Equipment
Automatic Inspection Devices

Ridgefield, Conn.

Eugene Mittelman, E.E., Ph.D.

Consulting Engineer & Physicist

High Frequency Heating — Industrial Electronics
Applied Physics and Mathematics

549 W. Washington Blvd. Chicago 6, Ill.
State 2-8021

TECHNICAL MATERIEL CORPORATION

Communications Consultants

RADIOTELETYPE • FREQUENT SHIFT
INK SLIP RECORDING
TELETYPE NETWORKS

453 West 47th Street New York 19, N. Y.

ELECTRONIC ENGINEERING CO. of CALIFORNIA

Radio and Electronic Consulting and
Designing.

2008 W. Seventh St. Los Angeles
DItexel 8323 California

NEWTON ENGINEERING SERVICE

Transformers for Electronics

Designs, prototypes and production quantities to
individual requirements. We offer a highly per-
sonal service and fast delivery on "Breadboard
models".

84 Linden Park Street Highlands 2-1310
Boston 20, Mass. Nights—Holidays LA Salle 7-4959

YARDENY LABORATORIES, INC.

Research and Development

Remote Controls and Electro Chemical
Generators of Energy

105 Chambers Street WO 2-3534, 35
New York, N. Y.

THE
REAL
VALUE

*of placing your unusual problem in the hands of a competent con-
sultant is that it eliminates the elements of chance and uncertainty
from the problem and provides real facts upon which to base decisions.*

SEARCHLIGHT SECTION

EMPLOYMENT • BUSINESS • OPPORTUNITIES • EQUIPMENT—USED or RESALE

UNDISPLAYED RATE:

\$1.20 a line, minimum 4 lines to figure advance payment count 5 average words as a line.
INDIVIDUAL EMPLOYMENT WANTED undisplayed advertising rate is one-half of above rate, payable in advance.
PROPOSALS \$1.20 a line an insertion.

INFORMATION:

BOX NUMBERS in care of any of our New York, Chicago or San Francisco offices count 1 line additional in undisplayed ads.
DISCOUNT of 10% if full payment is made in advance for four consecutive insertions of undisplayed ads (not including proposals).

DISPLAYED—RATE PER INCH

The advertising rate is \$10.25 per inch for all advertising appearing on other than a contract basis. Contract rates quoted on request.
AN ADVERTISING INCH is measured $\frac{7}{8}$ inch vertically on one column, 3 columns—30 inches—to a page.
 ELECT.

NEW ADVERTISEMENTS received by September 29th will appear in the November issue, subject to limitation of space available.

REPLIES (Box No.): Address to office nearest you
 NEW YORK: 330 W. 42nd St., (18)
 CHICAGO: 520 N. Michigan Ave. (11)
 SAN FRANCISCO: 68 Post St. (4)

POSITION VACANT

(Additional Positions Vacant ads on page 262)

WANTED: ELECTRICAL or Electronic engineers with experience in magnetic recording techniques and/or systems, preferably in the computer field. P-9932, Electronics.

EMPLOYMENT SERVICES

SALARIED POSITIONS \$3,500-\$35,000. If you are considering a new connection communicate with the undersigned. We offer the original personal employment service (39 years recognized standing and reputation). The procedure, of highest ethical standards, is individualized to your personal requirements and develops overtures without initiative on your part. Your identity covered and present position protected. Send only name and address for details. R. W. Bixby Inc., 278 Dun Bldg., Buffalo 2, N. Y.

POSITIONS WANTED

APPLIED MATHEMATICIAN and Physicist MS recent Graduate desires permanent industrial research position. PW-9872, Electronics.

SALES ENGINEER (B. S.)—Experienced in industrial market analysis and sales to electronic and aircraft trade on eastern seaboard. Design background in electronic equipment. PW-9754, Electronics.

PRACTICAL ELECTRONIC engineer desires position where know-how and initiative are essential. 7 years field engineer aircraft electronics, interest and experience in audio systems and industrial electronics. Personable, aggressive and resourceful. PW-9670, Electronics.

WANTED

ANYTHING within reason that is wanted in the field served by Electronics can be quickly located through bringing it to the attention of thousands of men whose interest is assured because this is the business paper they read.

ELECTRICAL ENGINEER

with recognized accomplishments in the electro-acoustic, electronic, and electrical branches, can bring ability and experience to a serious-minded organization, in which his qualifications can be mutually advantageous. Professional experience of 24 years, including 10 years responsible charge planning, directing, estimating for engineering and manufacture.

Accomplishments include origination, development, design for manufacture, a variety of successful apparatus and systems incorporating electronic amplification and control, electro-magnetic devices, acoustical instruments, film recording equipment, switching and timing devices, etc., both for commercial and government specifications. Accustomed to contract analysis and project breakdowns. Broad acquaintance in the industry and considerable contact government technical bureaus.

Licensed P.E., engineering societies; patents; technical articles. Age over 45, sincere, principled, creative, tenacious. Wholesome hobbies. Home in N. Y. area.

Your organization may require just this type of background and personality to direct practical and effective technical effort. This man will assume such responsibility in a position offering permanency. Please reply:

PW-9873, Electronics

330 W. 42nd St., New York 18, N. Y.

MANUFACTURERS REPRESENTATIVE

Established firm with valuable experience in the electronics field interested in securing sales representation for responsible manufacturer. Fully acquainted with the industry in New York and New Jersey areas. Can give complete engineering sales service.

RA-9878, Electronics

330 W. 42nd St., New York 18, N. Y.

WANTED

New Electronic Ideas Company with capital and manufacturing facilities is seeking new electronic products, inventions, or ideas to expand commercial business. Liberal arrangements with inventors.

BO-9843, Electronics

330 W. 42nd Street, New York 18, N. Y.

CONTRACT ENGINEERING—MANUFACTURING

electronic and electro-mechanical devices
 • developed to meet your specifications
 • manufactured per sample or drawings

TELETRONICS LABORATORY, Inc.
 Westbury, L. I., N. Y.—Westbury 7-1028

Time is money. Save it by referring to our
**ACCUMULATIVE INDEX FOR
 ELECTRONICS BIBLIOGRAPHY**

Simple and dependable

Write for descriptive literature

TECHNICAL INDEX SERVICE

Box 632

Asbury Park, New Jersey

WANTED

(Additional Wanted ads on page 284)

WANT TO BUY

MARINE and AIRCRAFT Receivers,
 Transmitters, Radar and Test
 Equipment

All types and models, including
 SO-, SA-, SF-, SG-, SK-, SL-, SJ-, SN-, SQ-, etc.
 MARINE RADAR, DIRECTION FINDERS,
 RADIOTELEPHONES
 AIRCRAFT—All AN/ARC-, AN/APN-, AN/APS-,
 AN/TPS-, AN/APR-, etc.

TUBES—Magnetrans, klystrons, transmitting and special purpose. NEW, UNUSED, ONLY
 Send full details to

AMBER COMPANY

467 Greenwich St. New York, N. Y.

WANTED

Any Western Electric Parts: Relays, Cable
 Aircraft Radios, Radar Equip, Micro Wave
 Sonar Equip., Amphenol Plugs, Sockets, Tubes
 H.V. Mica Condensers, Transformers
 We are interested in all types of Radio and Electronic Equipment. State Quantity, Condition and Best Price.

World Wide Packing and Shipping Co.

350 Pearl St. Brooklyn, N. Y.

WANTED, AIRCRAFT RADIOS

AN/ART-13, BC-348, RTA-1B, AN/APN-9, R5A/
 ARN-7, AN/ARC-1, AN/ARC-3, BC-788-C, 1-152,
 MN-26, Test Sets with TS- or I- prefix, Dyna-
 motors, Control Boxes, Transmitters, Receivers,
 Power Supplies, etc. State quantity, condition and best price first letter.

HI-MU ELECTRONICS

Box 105, New Haven, Conn.

WANTED

WESTERN ELECTRIC VACUUM TUBES

Types 101F, 102F, 272A, 274A or B, 310A
 or B, 311A, 313C, 323A, 328A, 329A, 348A,
 349A, 352A, 373A, 374A, 393A, 394A, 121A
 Ballast Lamps.

W-6641, Electronics

330 West 42nd St., New York 18, N. Y.

OWNERS: Let factory-trained experts treat your ailing receiver

HALLICRAFTERS, HAMMARLUND, COLLINS, NATIONAL, PIERSON, RME

Communication and television receivers and transmitters

- Complete realignment
- Bandspeed Calibration
- Sensitivity Measurements
- Image Rejection Ratios
- S Meter Calibration
- Rebuilding to factory standards



Authorized Service Center
RADIO LABORATORY

11 WARREN STREET NEW YORK 7, N. Y. WO rth 2-7955

MANUFACTURERS WHOLESALER'S DEALERS

A service to save you TIME and MONEY by locating your "HARD TO FIND" items and selling your "non-movable" surplus.

Please write on company stationery, TELLING us your needs—SELL US YOUR SURPLUS.

ELECTRONIC SURPLUS BROKERS

3232 Broadway, N. Y. C. 27

RADAR, COMMUNICATIONS and SONAR TECHNICIANS WANTED

For Overseas Assignments

Technical Qualifications:

1. At least 3 years' practical experience in installation and maintenance.
2. Navy veterans ETM 1/c or higher.
3. Army veterans TECH/SGT or higher.

Personal Qualifications:

1. Age, over 22—must pass physical examination.
2. Ability to assume responsibility.
3. Must stand thorough character investigation.
4. Willing to go overseas for 1 year.

Base pay, bonus, living allowance, vacation add up to \$7,000.00 per year. Permanent connection with company possible.

Apply by Writing to
A-1, P. O. Box 3414
Philadelphia 22, Pa.

Men qualified in RADAR, COMMUNICATIONS or SONAR give complete history. Interview will be arranged for successful applicants.

ELECTRONIC ENGINEERS and PHYSICISTS

Canada's leading manufacturer of radio and electronic equipment has openings for the following experienced personnel in an expanding research and development laboratory in Montreal, Quebec:

- (1) Engineer or Physicist, preferably with post-graduate degree, at least 5 years' experience advanced development or research on electrical circuits. Pulse experience preferred. Able to plan and direct an engineering group.
- (2) Graduates in electrical engineering or Physics with at least 3 years' design and manufacturing experience on radio transmitters or radar equipment. Non-graduates having at least 6 years' similar practical experience will be considered also.
- (3) Graduate in mechanical engineering with at least three years' experience or non-graduate with at least six years' experience in mechanical design of radio transmitting or similar electrical equipment.

Furnish particulars, age, education, experience, salary requirements to

Personnel Manager,
RCA Victor Company, Ltd.,
Montreal, Quebec

ELECTRONIC ENGINEERS PHYSICISTS

"A leading Electronics Company in Los Angeles, California offers permanent employment to persons experienced in advanced research and development. State qualifications fully."

P 6606 Electronics
68 Post St., San Francisco 4, Calif.

WESTINGHOUSE RESEARCH in TELEVISION PHYSICISTS • ENGINEERS

Specialists in OPTICS, ELECTRON-OPTICS, PHOSPHORS, PHOTO SURFACES, SYSTEMS and CIRCUITS are needed for an expanding program at the Westinghouse Research Laboratories, in East Pittsburgh, Pennsylvania.

For Information Write:

Manager, Technical Empl.
Westinghouse Elec. Corp.
306 4th Ave., Pittsburgh, Pa.

Lockheed AIRCRAFT CORPORATION has positions available for RESEARCH ENGINEERS in PHYSICS and ELECTRONICS

These openings are for men who have achieved advance status as researchers in either of these fields and who possess the following qualifications:

1. Advanced degree (preferably Ph.D.);
2. 7-10 years industrial or graduate research experience;
3. Ability to perform mathematical analysis in field of specialization.

Lockheed's research and development facilities are among the most advanced in the aircraft field. The accomplishments of Lockheed's research staff have resulted in the acquisition of new far-reaching scientific studies.

Immediate openings available. Salary commensurate with ability.

If you are interested, and meet the qualifications listed above, send a resume of your training and experience to—

LOCKHEED AIRCRAFT CORPORATION

Employment Manager, Post Office Box 551
BURBANK, CALIFORNIA

Electronic Engineers

PROJECT ENGINEERS

Five or more years experience in the design and development, for production, of major components in radio and radar equipment.

ASSISTANT PROJECT ENGINEERS

Two or more years experience in the development, for production, of components in radio and radar equipment.

Well equipped laboratories in modern radio plant . . . Excellent opportunity . . . advancement on individual merit.

Baltimore Has Adequate Housing

Send resume to Mr. John Siena:

BENDIX RADIO DIVISION
BENDIX AVIATION CORPORATION
Baltimore 4, Maryland

WANTED FOR NUCLEAR INSTRUMENTATION FIELD

Location, New York City

Development engineers—all grades with degrees and experience in the design and development of high quality instruments for research in physics, chemistry, etc. Applicant will be required to design and develop electrical, electronic, and mechanical instruments for the nuclear field. Salary commensurate with ability to produce a final working model from the idea stage.

Electronic technicians—for work in laboratory, assembling, wiring and testing of precision electronic design models. Applicants must have at least three years of similar experience, and must be capable of producing the highest quality work.

Submit resume to:

P-9793, Electronics
330 W. 42nd Street, New York 18, N. Y.

Positions Open for PHYSICISTS SR. ELECTRONIC ENGINEERS

Familiar with ultra high frequency and micro wave technique. Experience with electronic digital and/or analog, computer research and development program.

Salaries commensurate with experience and ability. Excellent opportunities for qualified personnel.

Contact:
C. G. JONES, Personnel Department
GOODYEAR AIRCRAFT CORPORATION
Akron 15 Ohio

SCIENTISTS AND ENGINEERS

Wanted for interesting and professionally challenging research and advanced development in the fields of microwaves, radar, gyroscopes, servomechanisms, instrumentation, computers and general electronics. Scientific or engineering degrees or extensive technical experience required. Salary commensurate with experience and ability. Direct inquiries to Mgr., Engineering Personnel, Bell Aircraft Corporation, P. O. Box 1, Buffalo 5, N. Y.

ELECTRONIC-PHYSICIST

A leading radiochemical instrument manufacturer requires departmental head. Experienced electronic-physicist, PhD or equivalent required.

RADIATION COUNTER LABORATORIES,
Inc.
1844 West 21st St., Chicago 8, Illinois

REPRESENTATIVES WANTED

Manufacturer of Electronic Heating Equipment desires representation on commission basis in several open territories. Experience in electronic heating desirable. Write full details.

RW-9792, Electronics
330 W. 42nd St., New York 18, N. Y.

TOP TRANSFORMER BUYS!

Power Transformers—115V/50-60 cps input

Table listing power transformer specifications including Volts Out, Amp, Filaments, and Each price.

Plate Transformers—115V/50-60 cps input

Table listing plate transformer specifications including Volts Out, Amp, and Each price.

Filament Transformers—115V/50-60 cps input

Table listing filament transformer specifications including Rating, Each price, and various transformer models.

SPECIAL TYPES

Table listing special transformer types with input/output specifications and prices.

- List of special transformer types with prices, including 440V/60 cy 3PH, 230V 60 cy, and T.V. Transformer.

COMMUNICATIONS EQUIPMENT COMPANY for your needs

SPECIALS

FLCTROLYTIC CONDENSERS D.Y. TYPE TUBULAR, PRONG MOUNT, LUG TERM. 18c ea. 10 For \$1.75

Table listing electrolytic condenser specifications including Mfd., Volt, and Price.

29c each. 10 For \$2.75

Table listing various electronic components including Mfd., Volt, Price, and specific part numbers.

MINICAPS PIGTAIL

Table listing minicap specifications including Mfd., Volt, Price, and various part numbers.

DS Y TYPE CARDBOARD w/ LONG PIGTAILS

Table listing DS Y type cardboard specifications including Mfd., Volt, Price, and part numbers.

AN CONNECTORS AT 80% OFF LIST

Table listing AN connector specifications including size, quantity, and price.

TRANSTAT AMERTRON

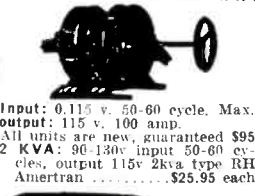

Input: 0.115 v. 50-60 cycle. Max. output: 115 v. 100 amp.

KITS POWER SUPPLY

- List of power supply kits including Basic TV 5" & 7" Pwr Supply, Basic TV 3" & 5" Pwr Supply, and 3" Oscilloscope Kit.

Advertisement for Potentiometers with 'FREE' offers and contact information.

Table listing potentiometer specifications including Ohms, Shaft, Dia., and Price.

SHOCK MOUNTS

- List of shock mounts with part numbers and prices.

BIRTCHEE TUBE CLAMPS

- List of Birtchee tube clamps with part numbers and prices.

CERAMICONS

- List of ceramicons with MMF. values and prices.

DIAL LIGHTS

- List of dial lights with specifications and prices.

POWER EQUIPMENT

- List of power equipment with specifications and prices.

T.V. TRANSFORMER

- List of TV transformers with specifications and prices.

FILTER CHOKES

- List of filter chokes with specifications and prices.

COMMUNICATIONS EQUIPMENT COMPANY logo and address information.

R. F. COMPONENTS—MICROWAVE—TEST EQUIPMENT



10 CENTIMETER

WAVEGUIDE TO 7/8" RIGID COAX "DOOR-KNOB" ADAPTER, CHOKE FLANGE, SILVER PLATED, BROAD BAND, 49.50 EACH
WAVEGUIDE DIRECTIONAL COUPLER, 27 db. Navy type CABV-17AAN, with 4 in. slotted section. \$42.50
SO. FLANGE to rd choke adapter 18 in. long OA 1 1/2 in. x 3 in. guide, type "N" output sampling probe. \$32.00
Crystal Mixer with tunable output TR pickup loop, Type "N" connectors. Type 62ABH. \$14.50
Slotted line probe. Probe depth adjustable. Sperry connector, type CR-14AA. \$9.50
Coaxial slotted section, 5/8" rigid coax with carriage and probe \$25.00
Waveguide Transition from 1 1/2" x 3" to 2" x 1" \$45.00
Right Angle Bend 6" radius E or H plain. \$27.50
Right Angle Bend 3" radius E or H plain—Circular flanges. \$17.50
AN/APR5A 10 cm antenna equipment consisting of two 10 CM waveguide sections, each polarized, 45 degrees \$75.00 per set
APN-7 McNally Cavity for 707B, with tuning slugs \$5.50 each
PICKUP LOOP, Type "N" Output. \$2.75
TR BOX Pickup Loop \$1.25
POWER SPLITTER: 726 Klystron input dual "N" output \$5.00
MAGNETRON TO WAVEGUIDE coupler with 721-A duplexer cavity, gold plated \$27.50
10 CM WAVEGUIDE SWITCHING UNIT, switches 1" input to any of 3 outputs. Standard 1 1/2" x 3" guide with square flanges. Complete with 115 vac or dc arranged switching motor. Mfg. Raytheon. CRP-24AAS. New and complete \$150.00
10 CM END-FIRE ARRAY POLYRODS. \$1.75 ea.
"S" BAND Mixer Assembly, with crystal mount, pickup loop, tunable output. \$3.00
721-A TR CAVITY WITH TUBE. Complete with tuning plungers. \$12.50
10 CM McNally CAVITY Type SG. \$3.50
10 CM OSC. PICKUP LOOP, with male Homebell output \$2.00
10 CM DIPOLE WITH REFLECTOR in lucite ball, with type "N" or Sperry fittings. \$3.00
10 CM FEEDBACK DIPOLE ANTENNA in lucite ball, for use with parabola 7/8" Rigid Coax Input. \$8.00
PHASE SHIFTER, 10 CM WAVEGUIDE. WE TYPE ES-683816. E PLANE TO H PLANE. MATCHING SLUGS. MARK 8 RADAR. \$35.00 ea.
721A TR cavities. Heavy silver plated, 1" x 3" x 10 cm, horn and rotating joint assembly, gold plated \$65.00 ea.

7/8" RIGID COAX—3/8" I.C.

7/8" rigid coaxial tuning stubs with vernier stub adjustment—Gold Plated \$17.50
7/8" RIGID COAX ROTARY JOINT. Pressurized. Sperry #810613. Gold Plated. \$27.50
Dipole assembly. Part of SCR-584. \$25.00 ea.
Rotary joint. Part of SCR-584. \$35.00 ea.
RIGHT ANGLE BEND, with flexible coax output pickup loop \$8.00
SHORT RIGHT ANGLE BEND, with pressurizing nipple \$3.00
RIGID COAX to flex coax connector \$3.50
STUB-SUPPORTED RIGID COAX, gold plated 5' lengths. Per length. \$5.00
RT. ANGLES for above. \$2.50
RT. ANGLE BEND 15" L. OA. \$3.50
FLEXIBLE SECTION, 15" L. Male to female \$4.25
MAGNETRON COUPLINGS to 7/8" rigid coax, with TR pickup loop, gold plated \$7.50
FLEX COAX SECT. Approx. 30 ft. \$16.50
CG 54/U—4 foot flexible section 7/8" I.C. pressurized \$15.00
7/8" RIGID COAX Bend Supported, per ft. \$1.20
SHORT RIGHT ANGLE BEND. \$2.50
Rotating joint, with deck mounting. \$15.00
RIGID COAX slotted section CU-60/AP. \$5.00

WAVEGUIDE

1 1/2" x 1 1/2" ID. \$1.00 per foot
1 1/2" x 1 1/2" OD. 1.50 per foot
1 1/2" x 1 1/2" OD Aluminum. .75 per foot
1 1/2" x 3" OD. 3.00 per foot
1 1/2" x 3" OD. 3.50 per foot
1 1/2" x 3" OD Flexible. 4.00 per foot
1 1/2" x 3/4" OD Flexible. 1.20 per foot
7/8" rigid coax 7/8" I.C. (Available in 10' to 15 ft. lengths or smaller.) \$4.00 per foot
UG 65/U 10CM flanges. \$8.50 each
UG 53/U Cover 4.00 each
UG 54/U Choke 4.50 each

MISCELLANEOUS

Type "N" patching cord UG11/U female to UG9/U using RGS/U cable 12' long. \$2.25 ea.
AN/TFS-1B flanged nipple and insert assembly for rotary coupling. \$3.75 ea.
Pulse connector Navy type 49579. \$1.50 ea.
Transmission line pressure gauge, 2" 15 lbs. \$1.85 ea.
Pulse cable assembly Western Electric type D163262, 10 feet long. \$4.50 ea.
Holmdel Jack Western Electric BO-12962-1 D. E. =J-102X. \$3.75 ea.
Adapter type "N" RGS/U to RG17/U or 18/U cable \$4.50 ea.
ADAPTER TYPE "N" TO RG-71/U CONNECTOR \$5.50
F-29/SPR-2 HIGH PASS FILTER P/O AN/APR-5AX. TYPE "N" CONNECTORS. \$12.50
Magnetron coupling to 7/8" rigid coax. \$5.00 ea.
Hand pumps for pressurizing transmission line with humidity indicator \$12.50 ea.

200 MC COAXIAL PLUMBING

Right Angle Bend \$35.00
T Section \$55.00
T Section with Adapter to 7/8" in rigid coax. \$65.00

1.25 CENTIMETER

"K" BAND DIRECTIONAL COUPLER CU104/APR-34 20 DB. \$49.50 ea.
"K" BAND FEEDBACK TO PARABOLA HORN, with pressurizing window. \$30.00
MITRED ELBOW cover to cover. \$4.00
TR/ATR SECTION choke to cover. \$4.00
FLEXIBLE SECTION 1" choke to choke. \$5.00
ADAPTER, rd. cover to sq cover. \$5.00
MITRED ELBOW and S sections choke to cover \$4.50
WAVE GUIDE 1/2 x 1/4 per ft. \$1.00
K BAND CIRCULAR FLANGES. \$50c
3J31 "K" BAND MAGNETRON. \$55.00

3 CENTIMETER

(STD. 1" x 1/2" GUIDE UNLESS OTHERWISE SPECIFIED)

723 A/B Klystron mixer section with crystal mount, choke flange and Iris flange output. \$22.50
TR-ATR Section for above with 724 ATR Cavity \$8.50
90 degree twist, 6 inches long. \$8.00
723 AB Mixer—Beacon Dual Oscillator Mount with crystal holder \$12.00
2 Way directional coupler, type N fitting 1 3/4 x 5/8 guide 26DB. \$18.50
CG 98B/APQ 13, 12" flexible section 1 3/4" x 5/8" OD. \$10.00
TR-ATR Section, APS 15, for 1B24, with 724 ATR Cavity with 1B24 and 724 tubes. Complete \$21.00
Crystal mount \$17.50
Stabilizer Cavity with bellows. \$21.50
3 cm. 180° bend with pressurizing nipple. \$6.00 ea.
3 cm. 90° bend, 14" long 90° twist with pressurizing nipple \$6.00 ea.
3 cm. "S" curve 18" long. \$5.50 ea.
3 cm. "S" curve 9" long. \$5.50 ea.
3 cm. right angle bends. "E" plane 18" long cover to cover. \$6.50 ea.
3 cm. Cutler feed dipole. 11" from parabola mount to feed back. \$8.50 ea.
APS-31 mixer section for mounting two 2K25's Beacon, reference cavity 1B24 TR tube. New and complete with attenuating slugs. \$42.50 ea.
DUPLEXER SECTION for 1B24 \$10.00
CIRCULAR CHOKE FLANGES, solid brass. .55
SQ. FLANGES, FLAT BRASS. .55
APS-10 TR/ATR DUPLEXER section with additional Iris flange \$10.00
FLEX. WAVEGUIDE 1 1/2" x 1 1/2" x 5/8" 14 in. L. \$6.00
2" x 1/2" BAND PREAMPLIFIER, consisting of 2-723 A/B local oscillator beacon feeding waveguide and TR/ATR Duplexer sect. incl. 60 pic IF amp \$67.50
Random Lengths waveged, 6" to 18" Lg. \$1.10/Ft.
WAVEGUIDE RUN, 1 1/4" x 1 1/2" guide, consisting of 4 ft. section with Rt. angle bend on one end, 45 deg bend other end. \$3.50 ea.
"X" BAND PRESSURIZING gauge section w/15 lbs. gauge & Pressurizing Nipple. \$18.50
45 DEG. TWIST 6" Long. \$10.00
12" SECTION 45 deg twist, 90 deg bend. \$6.00
15 DEG BEND 10" choke to cover. \$4.50
5 FT. SECTIONS choke to cover Silver Plated \$14.50
18" FLEXIBLE SECTION \$17.50
"E" PLANE BENDS \$12.50
BULKHEAD FEED THRU \$15.00
"X" BAND WAVEGUIDE 1 1/4" x 5/8" OD 1/16" wall Aluminum Per Foot \$ 7.75
WAVEGUIDE 1" x 1 1/2" I.D. Per Foot \$ 1.50
TR CAVITY, 724 A TR Tube \$3.50
3" FLEX SECT. sq. flange to Circ. Flange Adapt \$7.50
724 TR TUBE (41 TR 1) \$2.50
SWR MEAS. SECTION, with 2 type "N" output probes MTD full wave part. Bell size guide. Silver plated. \$10.00
ROTARY JOINT with slotted section and type "N" output pickup \$17.50
WAVEGUIDE SECTION, 12" long choke to cover 45 deg. twist & 2 1/2" radius, 90 deg. bend. \$4.50
SLUG TUNER/ATTENUATOR, W. E. guide, gold plated \$6.50
TWIST 90 deg. 5" choke to cover w/pressurizing nipple \$6.50
WAVEGUIDE SECTIONS 2 1/2 ft. long silver plated with choke flange \$5.75
ROTARY JOINT choke to choke. \$17.50
ROTARY JOINT choke to choke with deck mounting \$17.50
3 cm. nitred elbow "E" plane unplated \$6.50 ea.
2 Way Directional Coupler 26 DB TO Type N. 1 1/4 x 5/8 Guide \$17.50
12" Flexible Section, 1 1/4" x 5/8" \$8.75

THERMISTORS VARISTORS

| | | | |
|---------------------|--------|-----------|--------|
| D-167332 (tube) | \$.95 | D-170225 | \$1.25 |
| D-170396 (head) | \$.95 | D-167176 | \$.95 |
| D-167613 (button) | \$.95 | D-168687 | \$.95 |
| D-164699 for MTC in | \$.95 | D-171812 | \$.95 |
| "X" band Guide | \$2.50 | D-171528 | \$.95 |
| D-167018 (tube) | \$.95 | D-168549 | \$.95 |
| | | D-162482 | \$3.00 |
| | | D-163298 | \$1.25 |
| | | D-99428 | \$2.00 |
| | | D-161871A | \$2.85 |
| | | D-171121 | \$3.95 |
| | | DA(12-43) | \$1.50 |
| | | D-167020 | \$3.00 |

WRITE FOR C.E.C. MICRO-WAVE CATALOG NOW AVAILABLE

ALL MERCHANDISE GUARANTEED. MAIL ORDERS PROMPTLY FILLED. ALL PRICES F.O.B. NEW YORK CITY. SEND MONEY ORDER OR CHECK ONLY. SHIPPING CHARGES SENT C.O.D. RATED CONCERNS SEND P. O. MERCHANDISE SUBJECT TO PRIOR SALE

COMMUNICATIONS EQUIPMENT CO.

131 "E10" Liberty St., New York, N. Y. At: P. J. Plisher Cable "Comsupo" Ph. Digby 9-4124

TEST EQUIPMENT

TS-117/GP 10 CM WAVEMETER TEST SET. Mfg. "Sperry" 2400-3400 MC. Micrometer Adj. Coaxial Cavity. Freq. Meas. by absorption or transmission method. Mounts Crystal Current Meter & Calib. Chart. \$175.00
SWR AMPLIFIER TS-12/AP Unit 1, 3 stages of Amplif. and Diode Rectifier w/direct VSWR, reading on meter. 115 volts 60 cyc. AC power w/Inst. BK and CCT diag. New. \$285.00
SLOTTED LINE PROBE and Matched Termination includ'g Accessories TS-12/AP Unit 2 incl. UG81/U, CG92/U, CG91/U, CG89/U, UG70/U, CG87/U, MX1-58/U, CG88/U, CG90/U, UG80/U plus Tools. New. \$200.00
COMPLETE TS-12/AP UNITS 1 AND 2 \$150.00
3 CM Wave Meter, Ordnance Type, Micrometer Head. New. Absorption Type \$85.00
Transmission Type \$92.50



MODEL TS-268/U

Test set designed to provide a means of rapid checking of crystal diodes IN21, IN21A, IN21B, IN23, IN23A, IN23B. Operates on 1/2 volt dry cell battery. 3x6x7. New. \$35.00

ICCM ECHO BOX CABV 14ABA-1 of OBU-3. 2890 MC to 3170 MCS. direct reading micrometer head. Ring prediction scale plus 9% to minus 9%. Type "N" input. Resonance indicator meter. New and Comp. w/access. Box and 10 CM Directional Coupler. \$35.00
3 CM RECEIVER, SO-3. Complete with W.C. Mixer Assy. 723-A/B, Reg. Fil. Power Supply 60 Flanges (6ACT) \$99.50
10 cm horn assembly consisting of two 5" dishes with dipoles feeding single type "N" output. Includes UG28/U type "N" junction and type "N" pickup probe. Mfg. cable. New. \$5.56 ea.
10 cm. cavity type wavemeters 6 deep, 6 1/2" in diameter. Coax. output. Silver plated \$64.50 ea.
10 cm. echo box part of 5 ft radar w/140 volt AC tuning Motor sub sig 118A. \$47.50
THERMISTOR BRIDGE: Power meter 1-203-A 10cm. wfg. W.E. Complete with meter, interpolation chart, portable carrying case. \$59.50
W.E. I 138. Signal generator 2700 to 2900 Mc. range. Lighthouse tube oscillator with attenuator & output meter. 115 VAC input. 2 pr. supply. With circuit diagram. \$50.00
3 cm. stabilizer cavity, transmission type. \$20.00
TS-108A/P DUMMY LOAD. \$65.00
3 CM. HORN AT-48/UP model 710. Type "N" input. Iiv. silver plated. \$6.50
AT-68/UP 3 CM Horn with type N fitting. \$5.00
SA-1, 200 Mc Bedson Eng Antenna with pedestal. \$45.00
FLAME PKGD. "CW" MAGNETRONS
QK 61 2975-3200 mc. QK 62 3150-3375 mc. QK 60 2800-3025 mc. QK 59 2675-2900 mc. QK 915 Raytheon \$150.00
New Guaranteed Each \$65.00



MODULATOR UNIT BC 1203-B
 Provides 200-4,000 PPS Sweeptime: 100 to 2,500 microsec. in 4 steps. fixed mod. pulse, suppression pulse, sliding modulated, sliding modulating voltage, marker pulse, sweep voltages, calibration voltages, fil. voltages. Operates 115 vac. 50-60 cy. Provides various types of voltage pulse outputs for the modulation of a signal generator such as General Radio #801B or #804C used in depot bench testing of SCR 695, SCR 595, and SCR 535. New as shown. \$125.00



MASTER OSCILLATOR UNITS

M. O. units designed for oper. 2-18 mc TBK. Flexible plug in units using type S60 tube in ECO circuit. Tunes 2000 to 4565 kc in 6 bands. Freq. Determining elements are enclosed in shock mounted oven assembly and has frequency monitor PU link coupled to output. Net Wt: 138 Lbs. Dim. 21 in. d x 14 1/2 in. W x 2 1/2 in. H. New (with tube) \$100.00

SUPER SONICS

QCU Magneto striction head RCA type CR 278225—New \$75.00
Stainless Steel streamlining housings for above \$18.50
QCB Driver Amplifier. New \$200.00
QCU Magneto striction head coil plate assembly \$14.50
QCC-2/QCB Magneto striction head coil plate assembly \$14.50

MAGNETRONS - RADAR - PULSE EQUIPMENT

SA SC SD SE SF SG SL SN SO1 SO3 SO8 SO9 SO13 SQ SU TAJ TBK TBL TBM APG5 APR APS2 APS3 APS4 APS6 APS10 APS15 ABA QBF QBG QCC QEA RAK CPN3 CPN6 DAB ECI45 ECI48 YD ZA

MAGNETRONS

Table with columns: Tube, Freq. Range, Pk. Pwr. Out, Price. Lists various magnetron models and their specifications.

MAGNETRON MAGNETS

Table with columns: Gauss, Pole Diam., Spacing, Price. Lists magnetron magnet specifications.

R. F. EQUIPMENT

LHT. LIGHTHOUSE ASSEMBLY. Part of RT-30/APG-5 & APG-15. Receiver and Transmitter Lighthouse Cavities with Assoc. RF Cavity and Type X CTR. To Rcvr. Uses 2C40, 2C43, 11B27. Tuneable APX 2400-2700 MCS. Silver plated. \$49.50

IKW-FM STATION

General Electric Kilowatt Amplifier Model 4B22A1 Type BT2A Serial RC 25. General Electric 250 Watt Exciter Model 4B11A1 Type 2T1A Serial CC833. General Electric Station Monitor Model 4B11A1 Type BM1A Serial WC268.



INVERTERS PE 218-E: Input: 25 28vdc. 92 amp. Output: 115 v. 350-500 cy 1500 volt amperes. Dim: 17 5/8" x 10". New (as shown) \$49.95

MARINE RADAR

SO-1 AND SO-8 RADAR SETS. Complete, in Used but Excellent Condition. 10 CM Surface Search using 2126 or 2127 Memotron. 707B Mixer. PPI Indicator. Input 115VDC. Used on Merchant Ships throughout the world. Guaranteed \$1250.00

SF-1 RADAR

10 CM surface search using PPI and "A" Scope. 115 VDC input, complete with spares. 14 cases \$2800.00

MICROWAVE ANTENNAS

SO-3 RADAR 3 CM. SURFACE SEARCH ANTENNA. Complete with 24 "DC" Drive Motor, Selsin Gear Mechanism, "X" Band Slotted "Peel" Reflector. Less Plumbing \$135.00

AP-15 Antennas. New \$99.50 APS-10 MFG-1 Antenna. Rotary feed type high speed scanner antenna assembly, including horn parabolic reflector. Less internal mechanisms. 10 deg. sector scan. Approx. 12' L x 4' W x 3' H. Unused. (Gov't Cost - \$4500.00) \$250.00

AN/TPS3. Parabolic dish type reflector approx. 10' diam. Extremely lightweight construction New in 3 carrying cases. \$89.50

RELAY SYSTEM PARABOLIC REFLECTORS: approx. range: 2000 to 600 mc. Dimensions: 4 1/2' x 3' rectangle, new \$85.00

TDY "JAM" RADAR ROTATING ANTENNA. 10 cm. 30 deg. beam. 115 v.a.c. drive. New. \$100.00 SO 13 ANTENNA, 24" dish with feedback dipole 300 deg. rotation, complete with drive motor and selsin. New \$128.00

CPN-6 3CM RADAR BEACON EQUIPMENT

Complete sets available in unused condition. Write for price and information.

VOLTAGE REGULATORS

Mfg. Raytheon: Navy CRP-301107; Pri: 92-138 v. 15 amps. 57 to 63 cy. 1 phase. Sec: 115 v. 7.15 amp. 62 KVA. 96 PF. Contains the following components:

REGULATOR TRANSFORMER: Raytheon 1X-9545. Pri: 92-138 v. 60 cy. 1 PH. Sec: 200/580 v. 5.5/5.26 amps. 4000 v. rms test. FILTER REACTOR: 150 hz. 5 amps. 4000 v. test Raytheon 1X-9547. TRANSFORMER: Pri: 186 v. 5 amps. Sec: 115 v. 7.2 amps. Size 12" x 20" x 29". Net Wt. approx. 250 lbs. Entire unit enclosed in grey metal cabinet with mounting facilities. New, as shown \$99.50

WILCOX CS390 CONTROL EQUIPMENT FOR AIRPORT CONTROL GROUND STATION

Standard relay rack housing, monitor loud speaker, dual channel receiver amplifier. Type 100 A control panel, microphone speech amplifier, etc. spare parts, new and complete \$750.00 each

TEST SET 159 TPX

Measures frequency between 150 & 200 mc. by heterodyne method. Power of Xmitr can be directly measured. Measures DV voltages up to 500 Volts. Original Operation on 110 V. 400 cy. but conversion kit makes it operable on 110 V. 60 cy. nwc, and complete with tubes, crystal, cal. chart, antenna, meter \$29.95

AIRCRAFT AUXILIARY POWER PLANT

Navy take 1A, Lawrence Model 30 D, 10 horsepower, 2 cylinder, 4 Strokes cycle air cooled engine, for use with 1.71 KWDC and 1.22 KWAC aircraft generator, new, in original cellophane packing \$425.00

CROSS POINTER INDICATOR

ID 24-ARN-9 Dual 0-200 microamp. movement in 37 case. Each movement brought out to 6-term receptacle at rear. Originally used in ILS equipment. New \$3.95

ALL MERCHANDISE GUARANTEED. MAIL ORDERS PROMPTLY FILLED. ALL PRICES F.O.B. NEW YORK CITY. SEND MONEY ORDER OR CHECK ONLY. SHIPPING CHARGES SENT C.O.D. RATED CONCERNS SEND P. O. MERCHANDISE SUBJECT TO PRIOR SALE COMMUNICATIONS EQUIPMENT 131 "E10" Liberty St., New York, N.Y. ATT: P. J. Plishner Cable "Comsupp" Ph. Digby 9-4124

**FULLY
GUARANTEED**

BRAND NEW SURPLUS OFFERED BY A LEADING

A.C. MOTORS

5071930, Delco, 115 V., 60 Cycle, 7000 r.p.m. **Price \$4.50 each net**
 36938-2, Haydon Timing Motor, 110 V., 60 cycle, 2.2 w.; 4/5 r.p.m.



Price \$3.00 ea. net.
Haydon Timing Motor—110 V., 60 cycle, 3.2 w., 4 r.p.m., with brake. **Price \$4.00 each net.**
45629R Haydon Timing Motor, 110 V., 60 cycle, 2.2w., 1/240 r.p.m. **Price \$3.00 each net.**
1600 Haydon Timing Motor 110 V. 60 cycle 2.3 W. 1 r.p.m. **Price \$2.70 each net.**
36938-3, Haydon Timing Motor, 110-V., 60 cycle, 2.2 w., 1 1/5 r.p.m. **Price \$2.70 each net.**
36228 Haydon Timing Motor, 110 V., 60 cycle, 2.2 w., 1/60 r.p.m. **Price \$2.70 each net.**
Eastern Air Devices Type J33 Synchronous Motor 115 V., 400 cycle, 3 phase, 8,000 r.p.m. **Price \$8.50 each net.**
Telechron Synchronous Motor, Type B3, 115 V., 60 cycle, 2 r.p.m., 4 w. **Price \$5.00 each net.**

SERVO MOTORS

CK 1, Pioneer, 2 phase, 400 cycle. **Price \$10.00 each net.**
CK2, Pioneer, 2 phase, 400 cycle. **Price \$4.50 each net.**
10047-2-A Pioneer 2 phase, 400 cycle, with 40:1 reduction gear. **Price \$7.25 each net.**
FPE-25-11, Diehl, Low-Inertia, 75 to 115 V., 60 cycle, 2 phase. **Price \$16.00 each net.**
FPE-49-7 Diehl, Low-Inertia, 115 V., 60 cycle, 2 phase, 3.0 amps., 10 w., output. **Price \$34.50 each net.**
FP-25-2, Diehl, Low-Inertia, 20 V., 60 cycle, 2 phase. **Price \$9.00 each net.**
FP-25-3, Diehl, Low-Inertia, 20 V., 60 cycle, 2 phase. **Price \$9.00 each net.**
CK2, Pioneer, 2 phase, 400 cycle, with 40:1 reduction gear. **Price \$6.70 each net.**
MINNEAPOLIS-HONEYWELL TYPE B Part No. G303AY, 115 V., 400 cycle, 2 phase, built-in gear reduction, 50 in. lbs. torque. **Price \$7.50 each net.**



**REMOTE INDICATING
MAGNESYN COMPASS SET**

Pioneer Type AN5730-2 Indicator and cator part No. 680k-03, 26 V., 400 cycle.
Price \$40.00 per set new sealed boxes
Kollsman Remote Indicating Compass Set Transmitter part No. 679-01, indicator part No. 680k-03, 26 V., 400 cycle **Price \$12.50 each net.**

GYROS

Schwein Free & Rate Gyro type 45600. Consists of two 28 V. D.C. constant speed gyros. Size 8" x 4.25" x 4.25". **Price \$10.00 ea. net.**
Schwein Free & Rate Gyro, type 46800. Same as above except later design. **Price \$11.00 each net.**
Sperry A5 Directional Gyro, Part No. 656029, 115 volts, 400 cycle, 3 phase. **Price \$17.50 each net.**



Sperry A5 Vertical Gyro, Part No. 644841, 115 V., 400 cycle, 3 phase. **Price \$20.00 each net.**
Sperry A5 Amplifier Rack Part No. 644890. Contains Weston Frequency Meter. 350 to 450 cycle and 400 cycle, 0 to 130 voltmeter. **Price \$10.00 each net.**
Sperry A5 Control Unit Part No. 644836. **Price \$7.50 each net.**
Sperry A5 Azimuth Follow-Up Amplifier Part No. 656030. With tube. **Price \$5.50 each net.**
Pioneer Type 12800-1-D Gyro Servo Unit. 115 V., 400 cycle, 3 phase. **Price \$8.00 each net.**
Norden Type M7 Vertical Gyro. 26 V., D.C. **Price \$19.00 each net.**
Norden Type M7 Servo Motor. 26 V., D.C. **Price \$20.00 each net.**
Allen Calculator, Type C10 Bank and Turn Indicator, Part No. 21500, 28 V. D.C. Contains 28 V. D.C. constant speed gyro. **Price \$10.00 each net.**

D.C. MOTORS

Jaeger Watch Co. Type 44-K-2 Contact Motor, Operates on 3 to 4.5 volts D.C. Makes one contact per second. **Price \$2.00 each net.**
General Electric Type 5BA10AJ52C, 27 V. D. C., 0.65 amps., 14 oz. in. torque, 145 r.p.m. Shunt Wound, 4 lead reversible. **Price \$4.70 each net.**
General Electric Type 5BA10AJ37C, 27 V. D. C., .5 amps., 8 oz., in. torque, 250 r.p.m. Shunt Wound, 4 leads reversible. **Price \$6.50 each net.**

D.C. MOTORS



5069625, Delco Constant Speed, 27 V., 120 r.p.m. Built-in reduction gears and governor. **Price \$3.90 each net.**
A-7155, Delco Constant Speed Shunt Motor, 27 V., 2.4 amps., 3600 r.p.m., 1/30 h.p. Built-in governor. **Price \$6.25 each net.**
C-28P-1A, John Oster Shunt Motor, 27 V., 0.7 amps., 7000 r.p.m., 1/100 h.p. **Price \$3.75 each net.**

D.C. ALNICO FIELD MOTORS

5069456, Delco, 27.5 V., 10,000 r.p.m. **Price \$4.70 each net.**
5069600, Delco, 27 V., 250 r.p.m. **Price \$5.00 each net.**
5069466, Delco, 27 V., 10,000 r.p.m. **Price \$3.50 each net.**
5069370, Delco, 27 V., 10,000 r.p.m. **Price \$4.70 each net.**
5069230, Delco, 27 V., 145 r.p.m. **Price \$5.00 each net.**
S. S. FD6-16, Diehl, 27 V., 10,000 r.p.m. **Price \$3.75 each net.**
S. S. FD6-18, Diehl, 27 V., 10,000 r.p.m. **Price \$3.75 each net.**
S. S. FD6-21, Diehl, 27 V., 10,000 r.p.m. **Price \$3.75**



Sampsel Time Control Inc. Alnico Field Motor, 27 V. D.C. Overall length 3 5/16" by 1 3/8". Shaft 5/8" long by 3/16", 10,000 r.p.m. **Price \$4.50 each net.**

GENERAL ELECTRIC D. C. SELSYNS



8TJ9-PDN Transmitter, 24 V. **Price \$3.75 each net.**
8DJ11-PCY Indicator, 24 V. Dial marked —10° to +65°. **Price \$4.50 each net.**
8DJ11-PCY Indicator, 24 V. Dial Marked 0 to 360°. **Price \$7.50 each net.**

AMPLIFIER

Pioneer Gyro Flux Gate Amplifier, Type 12076-1-A. **Price \$17.50 ea. net, with tubes.**

**COMPLETE LINE OF
AIRCRAFT THERMOCOUPLES**

**INSTRUMENT
ASSOCIATES**

**37 EAST BAYVIEW AVE., GREAT NECK, N. Y.
Telephone Imperial 7-1147**

Write for Complete Listings

U. S. Export License-2140

SUPPLIER OF ELECTRONIC & AIRCRAFT EQUIPMENT**IMMEDIATE
DELIVERY****INVERTERS**

Wincharger Corp. Dynamotor Unit. PE-101-C. input 13, V.D.C. or 26 V.D.C. D.C. AT. 12.6 or 6.3 amps. Output 400 V.D.C. AT. .135 amps., 800 V.D.C. AT. .02 amps., 9 V.A.C. 80 cycle at 1.12 amps. **Price \$10.00 each net.**

153F, Holtzer Cabot. Input, 24 V.D.C. Output 115 V., 400 cycle, 3 phase, 750 V.A. and 26 V., 400 cycle, 1 phase, 250 V.A. Voltage and frequency regulated also built in radio filter.

Price \$115.00 each net.

149H, Holtzer Cabot. Input 28 V. at 44 amps. Output 26 V. at 250 V.A., 400 cycle and 115 V. at 500 V.A. 400 cycle. **Price \$39.00 each net.**

149F, Holtzer Cabot. Input 28 V. at 36 amps. Output 26 V. at 250 V.A., 400 cycle and 115 V. at 500 V.A. 400 cycle. **Price \$35.00 each net.**

12117, Pioneer. Input 12 V.D.C. Output 26 V., 400 cycle, 6 V.A. **Price \$22.50 each net.**

12117, Pioneer. Input 24 V.D.C. Output 26 V. 400 cycle, 6 V.A. **Price \$20.00 each net.**

5D21NJ3A General Electric. Input 24 V.D.C. Output 115 V., 400 cycle at 485 V.A. **Price \$12.00 each net.**

PE218, Ballentine. Input 28 V.D.C. at 90 amps. Output 115 V., 400 cycle at 1.5 K.V.A. **Price \$45.00 each net.**

**WESTON FREQUENCY
METER**

Model 637, 350-450 cycle, 115 V.
Price \$10.00 each net.

WESTON VOLTMETER

Model 833, 0 to 130 V. 400 cycle.
Price \$4.00 each net.

VIBRATOR

Rauland Corp. vibrator non-synchros type Stock No. 3H6694-11; 6, 12 or 24 V.D.C., input frequency 200 cycle. **\$3.25 each net.**

PIONEER AUTOSYNS

AY1, 26 V., 400 cycle.
Price \$5.50 each net.

AY14D, 26 V., 400 cycle, new with calibration curve.
Price \$15.00 each net.

AY20, 26 V., 400 cycle.
Price \$7.50 each net.

AY31, 26 V., 400 cycle. Shaft extends from both ends.
Price \$10.00 ea. net.

AY38, 26 V., 400 cycle. Shaft extends from both ends. **Price \$10.00 each net.**

**PIONEER PRECISION
AUTOSYNS**

AY101D, new with calibration curve.

PRICE—WRITE OR CALL FOR
SPECIAL QUANTITY PRICES

AY131D, new with calibration curve.
Price \$35.00 each net.

AY130D, new. **Price \$35.00 each net.**

**PIONEER AUTOSYN
POSITION INDICATORS**

Type 5907-17. Dial graduated 0 to 360°, 26 V., 400 cycle.

Price \$15.50 each net.

Type 6007-39, Dual, Dial graduated 0 to 360°, 26 V., 400 cycle.

Price \$30.00 each net.**PIONEER TORQUE UNIT**

Type 12602-1-A.
Price \$30.00 each net.

Type 12604-3-A.
Price \$30.00 each net.

Type 12606-1-A. **Price \$40.00 each net.**
Type 12627-1-A. **Price \$80.00 each net.**

**MAGNETIC AMPLIFIER
ASSEMBLY**

Pioneer Magnetic Amplifier Assembly Saturable Reactor type output transformer. Designed to supply one phase of 400 cycle servo motor.

Price \$8.50 each net.**PIONEER TORQUE UNIT
AMPLIFIER**

Type 12073-1-A, 5 tube amplifier, Mag-
nesyn input, 115 V., 400 cycle.

Price \$17.50 each net with tubes.

Type 12077-1-A, single tube Amplifier,
autosyn input, 115 V., 400 cycle.

Price \$49.50 each net, with tube.**BLOWER ASSEMBLY
MX-215/APG**

John Oster, 28 V.D.C., 7000 r.p.m.
1/100 h.p. Price \$2.90 each net.

Westinghouse Type FL Blower, 115 V.,
400 cycle, 67000 r.p.m., Airflow 17
C.F.M. Price \$4.50 each net.

RATE GENERATORS

PM2, Electric Indicator Co., 0175 V.
per r.p.m. Price \$8.25 each net.

F16, Electric Indicator Co., two-phase,
22 V. per phase at 1800 r.p.m.
Price \$12.00 each net.

J36A, Eastern Air Devices, .02 V. per
r.p.m. Price \$9.00 each net.

B-68, Electric Indicator Co., Rotation
Indicator, 110 V., 60 cycle, 1 phase.
Price \$14.00 each net.

Weston Tachometer Generator (aircraft
type) model 752-J4 single phase. A.C.
output. Price \$17.50 each net.

**SINE-COSINE GENERATORS
(Resolvers)**

FPE 43-1, Diehl, 115 V., 400 cycle.
Price \$20.00 each net.

FJE-43-9, Diehl, 115 V., 400 cycle.
Price \$20.00 each net.

SYNCHROS

1F Special Repeater,
115 V., 400 cycle. Will operate on 60
cycle at reduced
voltage.

**Price \$15.00 each net.**

7G Generator, 115 V., 60 cycle.
Price \$30.00 each net.

6DG Differential Generator, 90-90 V.,
60 cycle. Price \$15.00 each net.

2J1M1 Control Transformer 105/63 V.,
60 cycle. Price \$20.00 each net.

2J1G1 Control Transformer, 57.5/57.5
V., 400 cycle. Price \$1.90 each net.

2J1H1 Selsyn Differential Generator,
57.5/57.5 V., 400 cycle.
Price \$3.25 each net.

W. E. KS-5950-L2, Size 5 Generator,
115 V., 400 cycle.
Price \$3.50 each net.

5G Special, Generator 115/90 V., 400
cycle. Price \$15.50 each net.

5SF Repeater, 115/90 V., 400 cycle.
Price \$19.00 each net.

2J1F1 Selsyn Generator, 115 V., 400
cycle. Price \$3.50 each net.

5SDG Differential Generator 90/90 V.,
400 cycle. Price \$15.30 each net.

ALL PRICES, F.O.B. GREAT NECK, N. Y.

**INSTRUMENT
ASSOCIATES****37 EAST BAYVIEW AVE., GREAT NECK, N. Y.**
Telephone IMperial 7-1147*Write for complete listings*Western Union address:
WUX Great Neck, N. Y.

MORE TUBES - LOWER PRICES!

| ALL BRAND NEW - STANDARD BRAND | | ALL BRAND NEW - STANDARD BRAND | | ALL BRAND NEW - STANDARD BRAND | | ALL BRAND NEW - STANDARD BRAND | | ALL BRAND NEW - STANDARD BRAND | |
|--------------------------------|--------|--------------------------------|-------|--------------------------------|--------|--------------------------------|--------|--------------------------------|-------|
| Type | Price | Type | Price | Type | Price | Type | Price | Type | Price |
| 1B22 | \$4.95 | 24G | .98 | 841 | .69 | GL559 | 5.35 | 1Q5GT | 1.06 |
| 1B23 | 9.50 | 35T | 4.95 | 843 | .69 | GL673 | 11.50 | 1R4 | 1.06 |
| 1B24 | 4.95 | 45SPEC | .49 | 845 W | 4.95 | GL697 | 150.00 | 1R5 | .80 |
| 1B25A | 4.95 | 53A | 24.95 | 849A H | 69.50 | HF100 | 3.95 | 1S4 | .96 |
| 1B26 | 7.95 | 75TL | 3.95 | 850 | 22.50 | HF200 | 17.95 | 1S5 | .72 |
| 1B27 | 4.95 | 100TH | 12.95 | 851 | 75.00 | HF210 | 17.95 | 1T4 | .60 |
| 1B29 | 4.89 | 100TS | 3.00 | 860 | 3.00 | HF300 | 17.50 | 1T5GT | 1.06 |
| 1B32 | 4.95 | 101F | 4.95 | 861 | 49.95 | HK254 | 19.95 | 1U4 | .80 |
| 1B38 | 49.50 | 114A | .69 | 864 | .69 | HV18 | 12.95 | 1U5 | .72 |
| 1B40 | 4.95 | 114B | 1.25 | 865 | 2.98 | HY615 | 1.25 | 1V | .88 |
| 1B59 | 12.95 | 120 | 5.95 | 866A | .99 | HYE1148 | .48 | 2A3 | 1.28 |
| 1B60 | 4.95 | 121A | 2.65 | 866JR | 1.19 | KR23 | 15.05 | 2A4G | 1.28 |
| 1N21 | 1.00 | 203A | 16.95 | 872A | 2.95 | U610 | 9.95 | 2A5 | .88 |
| 1N23 | 1.00 | 205B | 4.50 | 874 | 2.49 | MI101 | 150.00 | 2A6 | 1.06 |
| 1P23 | 1.95 | 205F | 4.50 | 876 | 2.50 | MX408U | .49 | 2A7 | 1.06 |
| 2A1P1 | 3.95 | 211 | .98 | 878 | 2.49 | PJ23 | 1.35 | 2B7 | .88 |
| 2C4 | 1.18 | 215A | 3.00 | 884 | 1.49 | RL100 | 3.75 | 2V3G | 1.98 |
| 2C21 | 7.95 | 218 | 49.50 | 885 | .98 | R200 | 7.95 | 2X2A | 1.25 |
| 2C22 | 3.95 | 221A | 2.95 | 889R | 140.00 | RL130 | 12.95 | 2Y4 | .59 |
| 2C26A | .28 | 231D | 1.49 | 891 | 110.00 | RK20A | 7.50 | 3A5 | 1.49 |
| 2C34 | .59 | 249C | 3.49 | 892 | 115.00 | REL36 | .98 | 3A8GT | 1.98 |
| 2C40 | 3.98 | 250R | 7.95 | 902P1 | 7.95 | RK22 | 4.95 | 3B7 | .36 |
| 2C43 | 9.50 | 250TH | 19.50 | 905 | 11.95 | RK23 | 4.95 | 3D6 | .36 |
| 2C44 | 1.75 | 252A | 4.95 | 907 | 11.95 | RK331 | 3.95 | 3L F4 | 1.28 |
| 2C46 | 7.50 | 259A | 4.95 | 913 | 4.95 | RL201 | .98 | 3M | .88 |
| 2C51 | 6.50 | 262A B | 3.50 | 917 | 1.50 | RK34 | .59 | 3O5GT | .96 |
| 2D21 | 1.18 | 274B | 1.25 | 918 | 1.59 | RK39 | 1.75 | 3S4 | .80 |
| 2E22 | 1.50 | 275A | 7.95 | 922 | 1.00 | RK51 | 3.95 | 3V4 | .80 |
| 2E24 | 4.95 | 282A B | 9.95 | 923 | .98 | RK52 | 4.50 | 5A Z4 | .50 |
| 2E25A | 4.25 | 283A | 10.95 | 925 | 1.40 | RK59 | 5.95 | 5R4GY | 1.15 |
| 2E26 | 3.95 | 286A | 10.95 | 930 | 1.00 | RL60 | 7.95 | 6A4 | 1.28 |
| 2E30 | 2.39 | 290A | 4.95 | 931A | 4.95 | RK62 | 1.98 | 5U4G | .60 |
| 2J21A | 12.95 | 291A | 4.95 | 934GT | 1.50 | RK63 | 12.95 | 5V4G | .96 |
| 2J26 | 8.95 | 294A | 4.95 | 949A | 0.95 | RK65 | 24.95 | 5W4 | 1.06 |
| 2J27 | 14.95 | 300A | 3.95 | 950 | .98 | RK72 | 1.95 | 5W4GT | .66 |
| 2J30 | 19.95 | 301A | 6.95 | 954 | .75 | RK73 | 3.95 | 5X4G | .72 |
| 2J31 | 19.95 | 304B | 9.95 | 955 | .75 | RK81 | 3.95 | 5Y3GT | .42 |
| 2J32 | 24.95 | 304TH | 6.95 | 956 | .75 | RK120 | 10.00 | 5Z3 | .60 |
| 2J33 | 24.95 | 304TL | 1.49 | 957 | .75 | T21 | 1.50 | 5Z3 | .72 |
| 2J36 | 75.00 | 307A | 4.95 | 958A | .75 | T21 | 1.75 | 5Z4 | 1.06 |
| 2J37 | 24.95 | 310A | 7.95 | 959 | 2.95 | T55 | 3.95 | 6A3 | 1.28 |
| 2J38 | 24.95 | 315A | 6.95 | 966A | .99 | T200 | 10.95 | 6A6 | 1.06 |
| 2J49 | 24.95 | 316A | 4.95 | 972A | 6.95 | T20 | 2.85 | 6A7 | .80 |
| 2JB51 | 4.95 | 327A | 4.95 | 975 | 1.95 | TZ40 | 2.95 | 6A8 | .80 |
| 2J54B | 24.95 | 338A | 4.93 | 991 | .75 | UH50 | 5.95 | 6A8GT | .80 |
| 2K23 | 24.95 | 348A | 5.95 | 1613 | .75 | UX200 | .75 | 6B5 6N5 | .88 |
| 2K25 | 24.95 | 350A B | 2.95 | 1614 | 1.75 | V70D | 7.50 | 6B7 1853 | 1.06 |
| 2K28 | 24.95 | 354C D | 19.95 | 1616 | 1.39 | VR75 | .98 | 6AC5GT | 1.16 |
| 3AP1 | 4.95 | 357B | 49.50 | 1619 | .75 | VR75 | .98 | 6AC7 1852 | 1.16 |
| 3B22 | 4.95 | 368A S | 4.93 | 1620 | 4.95 | VR90 | .75 | 6A D | .75 |
| 3B23 | 4.95 | 371A B | 8.99 | 1621 | .98 | VR91 | 1.49 | 6AD7G | 1.25 |
| 3B24 | 1.98 | 374A | 2.50 | 1622 | 1.75 | VR105 | .98 | 6AF6 | 1.28 |
| 3B24W | 2.95 | 393A | 7.95 | 1624 | 1.75 | VR150 | .75 | 6AG5 | 1.06 |
| 3B26 | 1.89 | 394A | 7.50 | 1625 | .49 | VT127A | 3.00 | 6AG7 | 1.28 |
| 3B28 | 5.95 | 399A | 2.50 | 1626 | .49 | W111 | 1.19 | 6AH6 | 1.56 |
| 3BP1 | 3.95 | 400A | 3.25 | 1628 | 4.95 | WL440 | 14.95 | 6AJ5 | .80 |
| 3C23 | 4.95 | 401A | 1.95 | 1629 | 6.99 | WL468 | 14.95 | 6AK5 | 1.56 |
| 3C24 | .69 | 403A B | 1.75 | 1631 | 1.50 | WL532A | .49 | 6AK6 | .96 |
| 3C30 | 1.50 | 417A | 24.95 | 1633 | .89 | WL562 | 150.00 | 6A1 5 | .80 |
| 3C31 | 4.95 | 434A | 7.95 | 1634 | .79 | WL616 | 105.00 | 6AL7GT | 1.06 |
| 3CP1 | 3.00 | 446A B | 24.95 | 1636 | 5.95 | Z255 | 1.06 | 6AO5 | .80 |
| 3DP1-A | 3.95 | 450TH | 24.95 | 1638 | .98 | ZB120 | 6.95 | 6AO6 | .72 |
| 3EP1 | 3.95 | 450TL | 45.00 | 1641 | .79 | ZB320 | 150.00 | 6AO7GT | .88 |
| 3E29 | 4.95 | 464A | 9.50 | 1642 | .98 | ZP477 12DP8 | 14.95 | 6AR5 | .66 |
| 3FP7 | 3.95 | 527 | 12.95 | 1644 | 1.49 | 0A2 | 1.69 | 6AS7G | 4.95 |
| 3GP1 | 4.95 | 531 | 24.50 | 1645 | 1.98 | 0A3 VR75 | 1.98 | 6AT6 | .60 |
| 3JP7 | 9.95 | 532A | 4.95 | 1649 | 1.25 | 0AC | 1.06 | 6AU6 | .80 |
| 4-65A | 14.50 | 531P1 | 4.95 | 1645 | 1.98 | 0B2 | 2.05 | 6AV6 | .60 |
| 4-125A | 27.50 | 700B D | 49.50 | 1851 | 1.25 | 0B3 VR90 | .75 | 6B4G | 1.28 |
| 4-250A | 37.50 | 701A | 4.95 | 1852 | 1.06 | 0C3 VR105 | .98 | 6B5 | 1.56 |
| 4A1 | .98 | 703A | 4.95 | 1853 | 1.06 | 0D3 VR150 | .75 | 6B6G | .88 |
| 4AP10 | 4.95 | 705A | 2.95 | 1960 | .95 | 0Y4 | .88 | 6B7 | 1.28 |
| 4C35 | 19.95 | 706AY | 49.50 | 2050 | 1.19 | 0Y4 | .88 | 6B8 | 1.28 |
| 4J26 | 100.00 | 706CY | 18.95 | 2951 | .98 | OZ4G | .88 | 6B8G | 1.28 |
| 5AP1 | 4.95 | 706G | 49.50 | 5514 | 4.95 | O1A | .80 | 6BA6 | .80 |
| 5AP4 | 4.95 | 707A B | 24.95 | 5516 | 5.95 | IA3 | .72 | 6BE6 | .72 |
| 5BP1 | 2.95 | 708A | 7.95 | 5562 | 14.00 | IA4 | 1.28 | 6BG6G | 1.92 |
| 5BP4 | 4.95 | 710A | 2.95 | 7193 | .39 | IA9P | 1.56 | 6BH6 | .80 |
| 5C22 | 49.50 | 713A | 1.65 | 8005 | 4.95 | IA8GT | 1.06 | 6BJ6 | .72 |
| 5CP1 | 3.95 | 714Y | 8.91 | 8011 | 2.95 | IA6 | 1.28 | 6B | .39 |
| 5CP1A | 9.95 | 715A B | 9.95 | 8012A | 4.95 | IA7GT | .80 | 6C5 | .66 |
| 5D21 | 29.95 | 715C | 24.95 | 8013A | 2.95 | IB3GT | 1.49 | 6C5GT | .66 |
| 5FP7 | 3.95 | 717A | .99 | 8014A | 24.95 | IB4 | 1.56 | 6C6 | .80 |
| 5GP1 | 9.95 | 720DY | 34.95 | 8016 | 1.49 | IB5 25S | 1.28 | 6C7 | 1.28 |
| 5HP4 | 9.95 | 721A B | 4.35 | 8020 | 3.95 | IB6GT | 1.06 | 6C8G | 1.06 |
| 5J23 | 100.00 | 723A B | 7.95 | 8025A | 7.95 | IC5GT | .88 | 6D6 | .66 |
| 5P29 | 100.00 | 724A B | 4.95 | 8026 | 12.95 | IC6 | 1.28 | 6D8G | 1.28 |
| 5JP2 | 11.95 | 725A | 9.95 | BR | 2.50 | IC7G | 1.28 | 6E5 | .85 |
| 5LP1 | 11.95 | 726A B/C | 23.50 | BH | 4.95 | ID5GP | 1.55 | 6E6 | 1.06 |
| 5MP1 | 4.95 | 728GY | 24.95 | C1A | 4.95 | ID7G | 1.28 | 6F5 | .66 |
| 5NP1 | 1.98 | 730A | 24.95 | C1B | .88 | ID8GT | 1.38 | 6F5GT | .66 |
| 6AF6G | 24.95 | 750TL | 49.50 | C5B | 49.50 | IE8GT | 1.38 | 6F6 | .80 |
| 6C21 | 24.95 | 800 | 2.25 | C6A | 9.95 | IE7G | 1.56 | 6F6GT | .66 |
| 6F4 | 5.95 | 801A | 8.95 | C6J | 12.95 | IF4 | 1.06 | 6F7 | 1.06 |
| 6J4 | 4.95 | 802 | 4.25 | CK1005 | .35 | IF5G | 1.06 | 6F8G | 1.28 |
| 7BP1 | 4.95 | 803 | 8.95 | CK1006 | .69 | IF6 | 1.56 | 6G6G | 1.06 |
| 7BP7 | 4.95 | 804 | 12.95 | CK1099 | 4.95 | IF7G | 1.56 | 6H6 | .80 |
| 7C23 | 75.00 | 805A | 8.95 | EL50 | .99 | IG4GT | 1.06 | 6H6GT | .69 |
| 7C24 | 80.00 | 807 | 1.25 | EL1C | 4.95 | IG6GT | 1.06 | 6J5 | .54 |
| 7C25 | 90.00 | 808 | 1.89 | FL3C | 4.95 | IH4G | .88 | 6J5GT | .54 |
| 7DP4 | 17.95 | 809 | 2.93 | FL23A | 12.95 | IH5GT | .66 | 6I6 | 1.16 |
| 9C23 | 250.00 | 810 | 7.95 | FL6G | 79.50 | IH6G | 1.28 | 6J7 | .80 |
| 9GP7 | 15.00 | 811 | 2.45 | F160 | 150.00 | IH6GT | 1.28 | 6J7GT | .80 |
| 9JP1 | 7.95 | 812 | 2.95 | FG17 | 3.25 | IJ6GT | 1.28 | 6J8G | 1.28 |
| 9LP7 | 15.00 | 812H | 6.90 | FG27A | 9.95 | IL4 | .80 | 6K5GT | .96 |
| 9NP1 | 7.95 | 813 | 8.95 | FG32 | 5.95 | IL4A | 1.06 | 6K6GT | .60 |
| 10Y | .69 | 814 | 3.95 | FG33 | 8.95 | IL6A | 1.06 | 6K7 | .66 |
| 10SPEC | .69 | 815 | 2.95 | FG81A | 6.95 | ILB4 | 1.06 | 6K7GT | .66 |
| 10BP4 | 24.50 | 816 | 3.19 | FG95 | 9.95 | ILC5 | 1.06 | 6K8 | .80 |
| 12DP7 | 14.95 | 829A B | 7.95 | FG105 | 19.95 | ILC6 | 1.06 | 6K8GT | .96 |
| 12DP8 | 14.95 | 829B 3E29 | 4.95 | FG172A | 32.50 | ILD5 | 1.06 | 6L5G | 1.06 |
| 12FP7 | 14.95 | 830 | 2.95 | FG238B | 59.50 | ILF3 | 1.06 | 6L6 | 1.42 |
| 12GP7 | 14.95 | 830B | 5.25 | GL146 | 11.00 | ILH4 | 1.06 | 6L6G | 1.16 |
| 12HP7 | 14.95 | 832A | 4.95 | GL473 | 65.00 | ILH5 | 1.06 | 6L6GA | 1.16 |
| 12KPA | 49.50 | 834 | 34.50 | GL502A | 1.98 | INS5GT | .80 | 6L7G | 1.16 |
| 12LP4 | 49.50 | 834 | 5.95 | GL530 | 49.50 | IPS5GT | 1.06 | 6N6G | 1.56 |
| 15E | 1.50 | 836 | | | | | | | |

BUY NOW! BUY NIAGARA!



POWER TRANSFORMERS ALL 117V. 60 CYCLE PRI.

| | | |
|----------|---|--|
| T-47177 | 40VDC @ 250 ma. 5V @ 3A. 1600 V. ins. herm. sealed | |
| SP-105 | 725-0.725V. @ 60 ma., 5V @ 3A. 6.3V. @ 1.2A | |
| 511-T2 | 350V C.T. @ 150 ma. 6.3V @ 8A herm. sealed | |
| 475-T301 | 245-0.245 @ 70 ma., 6.3V @ 6.2A, 1600V. ins. herm. sealed | |
| 466-T1R | 110-0.110 @ 225 ma. 5V. @ 3A herm. sealed | |
| PC-110 | 600V. C.T. @ 125 ma. 6.3V @ 3.8A, 5V @ 3A. 1600V. ins. herm. sealed | |

PLATE TRANSFORMERS

| | | |
|----------|------------------------------------|--|
| T-47168 | 540-0-540V. @ 650 ma. Herm. sealed | |
| 475-T302 | 2350-0-2350V. @ 300 ma. | |
| 69125 | 2100V. C.T. @ 500 ma. | |

FILAMENT TRANSFORMERS

| | | |
|----------|--|--|
| T-47164 | 6.4V. @ 8A. 1600V. ins. herm. sealed | |
| T-47167 | 5V. @ 9A. 3500V. ins. herm. sealed | |
| SP-100 | 24V. @ 10A. | |
| 0161917 | 6.3V. @ 3A., 2.5V. @ 2A., herm. sealed | |
| 510-T4 | 6.4V. @ 10A., 6.3V. @ 5A., 1200V ins. herm. sealed | |
| 475-T201 | 5V C.T. @ 15A., 1600V ins. herm. sealed | |

MISCELLANEOUS TRANSFORMERS

All 117V 60 cycle unless otherwise indicated

| | | |
|---------|---|--|
| 15266 | Audio: pri: 600 ohm. C.T. balanced to 600 ohm sec. Response. 1 db from 100 to 400 cps elect. shield, herm. sealed | |
| T-46255 | Mod. output: pri: P.P. par. 6XT class B. to 8000 ohms, herm. sealed | |
| 616 | output: 6V6 to 8 or 600 ohms unbal. line | |
| T-47369 | mike to line: 30 ohm mike to 600 ohm. C.T. bal. line, herm. sealed | |
| T-47368 | Audio input: 600 ohm. C.T. to 300 ohm mike or unbal. line, herm. sealed | |
| T-47171 | modulation: class "A B" 807 plates (2800 ohms. P to P) to Class "C". 425V. @ 240 ma. radio 145 to 1.3800 VDC ins. herm. sealed | |
| T-47165 | Bias. Rectifier and filament: 5V. @ 3A.C.T., 5 V. @ 3A.C.T. 55V. DC @ 250 ma. DC. herm. sealed | |
| 510-T6 | modulation: P.P. 809. to 2400 ohms at 240 ma. DC., herm. sealed | |
| 32332 | Power: Pri. 115V. or 80V—400 to 1200 cycle Sec. 6.4V. @ 2.5A., 6.4V. @ 150 ma., 400V.C.T. @ 35 ma. DC. herm. sealed | |
| I-930 | Plate: P11. 30 VAC—1020 cycles Sec. 600 V.C.T. @ 25 ma. DC. herm. sealed | |
| 573 | Comb. Rectifier plate: 300-0-330 bridge rectifier for 500V.D.C. @ 600 ma. or (but not simultaneously) full wave rectifier for 250V.D.C. @ 200 ma., 2000V. insul. herm. sealed | |

CHOKES - REACTORS

| | Cap. | Current | Res. | Insul. | |
|-----------|--------|-----------|------|----------|--------|
| L-143 | 1.72 | 4A. | | 10,000V | \$8.95 |
| L-554 | 20 | 125ma. | 300 | | *4.95 |
| 475-CH301 | 3.8 | 75 ma. | 160 | 1600V. | *4.15 |
| 475-CH302 | 10 | 300ma. | 100 | 7500V. | *5.25 |
| 14010 | 15 | 200ma. | 150 | 2000V. | *5.25 |
| 15406 | 12 | 225ma. | 200 | | *5.25 |
| 510-X2 | 15 | 200ma. | 145 | | 5.25 |
| S-16886 | 2.5-24 | 50/400ma. | 53 | 10,000V. | 8.95 |
| S-16885 | .875 | 400ma. | 45 | 10,000V. | 8.95 |
| RC-72 | 15 | 125ma. | 250 | 1,600V. | *4.15 |
| L-218 | 45 | 90 | | | 2.75 |
| T-46256A | 12 | 210ma. | | | 5.25 |

*Herm. Sealed

MINIMUM ORDER \$5
QUANTITY PRICES ON REQUEST

All tube types in stock now—subject to prior sale. Prices subject to change without notice. 20% DEPOSIT WITH ORDERS, UNLESS RATED. All Prices F.O.B. N.Y.C.

BARGAINS IN NEW METERS

| | | |
|-------|---|--------|
| N-197 | 2" Rd. G.E. 0-10 D.C. Amps. | \$1.96 |
| N-198 | 3" Rd. G.E. 0-10 D.C. Amps. (Adapt. Planged) | 2.25 |
| N-199 | 3" Rd. Weston 0-800 Ma. D.C. | 3.95 |
| N-200 | 3" Rd. Asst'd brands 0-1 KV. D.C. | 1.96 |
| N-231 | 2" Rd. Asst'd brands 0-1 R.F. Amps. | 1.96 |
| N-232 | 4" Rd. W.E. 50-0-50 Yds. per sec. (0-1 ma) | 3.95 |
| N-233 | 3" Rd. G.E. 0-30 KV. D.C. | 2.65 |
| N-234 | 3" Rd. —6 to +100 DB. (0-1 ma. basic). Illum. | 4.95 |
| N-235 | 3" Rd. McClintock 0-2.5 R.F. Amps. | 1.96 |
| N-236 | 3" Rd. McClintock 0-1 Ma. D.C. | 3.45 |

*N-230 Shunt available at \$1.00 each



SELENIUM RECTIFIERS

| No. | Volts In | Volts Out | Current | Price |
|-------|----------|-----------|---------|--------|
| N-241 | 18 | 14 | 2 Amps. | \$2.49 |
| N-242 | 18 | 14 | 200 Ma. | .89 |
| N-243 | 10 | 8 | 200 Ma. | .89 |
| N-244 | 125* | 117 | 100 Ma | .65 |

* Half wave.
All others full wave.

OUTPUT TRANSFORMER



Quality output transformer made by DONGAN, 6V6 to 2-4-8 ohm voice coil. Fully enclosed channel mounted, 2" between hole centers.
CAT. NO. N-245
SPECIAL \$.49

| | | | | | |
|------|-------|------|-----|---------|--------|
| 2.49 | N-241 | 18 | 14 | 2 Amps. | \$2.49 |
| 2.75 | N-242 | 18 | 14 | 200 Ma. | .89 |
| 4.95 | N-243 | 10 | 8 | 200 Ma. | .89 |
| 1.95 | N-244 | 125* | 117 | 100 Ma | .65 |

* Half wave.
All others full wave.



2.5 Mhy. R.F. CHOKES

2.5 microhenry Radio Frequency Chokes. Pie wound on ceramic bases. Pigtailed leads. Excellent for receiver or low power transmitter.
CAT. NO. N-100
SPECIAL \$.15
10 for \$1.25

NATIONAL 450-550 KC I.F. TRANSFORMER

Niagara does it again! Genuine National 450-550 KC I.F. transformers. Ideal for ham, experimenter or serviceman. Unit consists of air padder condensers isolated from each other by an internal aluminum shield. Litz wound coils on moisture proofed ceramic base. Fully enclosed in shield can 1 1/2 x 2 3/8 x 2. Fungus proofed and anti-corrosion treated.
CAT. NO. N-130
SPECIALLY PRICED AT \$1.49
3 for \$3.95



12 V. D.C. KEYING RELAY

DPDT high speed keying relay. 300 ohm coil, in grey vacuum sealed metal shield, mounted on octal base. Will follow 100 words per minute. Made by BETT & BETT. Brand new in original boxes.
Cat. No. N-201
Your Cost \$2.00

RCA 630 T.S. Power Transformer

Exact Replacement Transformer for the RCA 210T6, both physically and electrically. Primary 115 V. 60 cy.
Sec. = 1 325-0-325 V. @ 400 ma.
Sec. = 2 5 V. @ 3 amps.
Sec. = 3 12.6 V. CT @ 10 amps.
Sec. = 4 6.3 V. @ 7 amps.
List price \$40.00. Weight 18 lbs. Cat. No. N-229.
Your cost — Special \$13.95



CONDENSERS



| Cat. No. | Cap. | Voltage | Each |
|----------|-----------|---------|--------|
| N-146 | 500 | 12 | \$.59 |
| N-147 | 1000-1000 | 15 | 1.95 |
| N-148 | 1000 | 25 | .98 |
| N-149 | 6x.3 | 600 | .89 |
| N-150 | 4 | 450 | |
| | 8 | 300 | .79 |
| N-151 | 16-16 | 150 | |
| | 10 | 25 | .49 |
| N-152 | 3x.25 | 600 | .71 |
| N-153 | 1 | 3500 | .98 |
| N-154 | 2x.6 | 25 | .98 |
| N-155 | 2 | 330AC | .69 |
| N-156 | 1 | 140AC | .69 |
| N-157 | 2 | 440AC | .69 |
| N-158 | 4 | 140 | .95 |
| N-159 | 1 | 7500 | 3.95 |
| N-160 | 2 | 600 | .89 |
| N-161 | 1 | 1000 | 1.19 |
| N-162 | 4 | 600 | .95 |
| N-163 | .25 | 600 | .98 |
| N-164 | 6 | 4000 | 3.95 |
| N-165 | 2-4-8 | 330AC | .75 |
| N-166 | 10 | 400 | .98 |
| N-167 | 2 | 1000 | .98 |
| N-168 | 4 | 1000 | 1.95 |
| N-169 | 4 | 1500 | 2.10 |
| N-170 | 6 | 1500 | 2.89 |
| N-171 | 1 | 2500 | 2.25 |
| N-172 | .5 | 3000 | 1.75 |
| N-173 | 1 | 3500 | 2.25 |
| N-174 | .2 | 5000 | 2.95 |

BEAT FREQ. OSCILLATOR

Imagine! A completely prefabricated BFO, built to rigid government standards, using close tolerance components, ceramic tube sockets, color coded wiring (including co-ax grid lead to prevent interstage coupling). Fully enclosed in metal box, with mounting brackets, all hardware, adjustable pitch control, circ. diagram and 6J5GT/G tube. Easily adapted to 456KC or any beat freq. desired. Originally built as additional equipment for the RC669, will fit any receiver. Measures 2 1/2 X 3 X 4 1/2. Brand new in original cartons.
CAT. NO. N-102
YOUR COST with tube \$2.39
CAT. NO. N-103
YOUR COST less tube \$2.00

OVERLOAD RELAY

Westinghouse overload relay. Adjustable from 250 ma. to 1 amp. D.C. Manual reset, heavy construction, coil and contacts fully enclosed in 3/4" glass shield.
WORTH PLENTY.
CAT. NO. N-122
YOUR COST \$12.95

SPST 6 V.D.C. RELAY

Completely encased in compact round can 6 V.D.C. field. SPST contacts will take up to 50 amps.
CAT. NO. N-120
YOUR COST \$.98

COPPER BRUSH

Perfect Replacement copper brush for transtat or heavy duty motor 1/4x3/4x3/4 long. "L" shaped holder, 1 1/4" phosphor bronze flexible pigtail with spade lug attached.
CAT. NO. N-117
EXTRA SPECIAL \$.10
12 for \$1.00
Quantity Prices Upon Request

PATCH CORD

Don't be caught short! Niagara's shelves are bursting with U. S. Navy 2 conductor, neoprene jacketed headset extension cords 5 feet long, equipped with PL55 plug and JK26 Jack. Fully moisture and fungus proofed. In original overseas pack.
CAT. NO. N-115
YOUR COST \$.69

PLAQUE RESISTOR

1000 ohms, 25 watt wire non inductive.
CAT. NO. N-108
YOUR COST \$.59
each

Niagara Radio Supply Corp.

DEPT. E109 160 Greenwich Street, New York 6, N. Y.

Phone
Dlgbly 9-
1132-3-4

RADIO-ELECTRONIC Components by the Thousands!

6 OUTSTANDING VALUES FROM WELLS' FAMOUS STOCK



Heavy Duty Blower

Centrifugal type blower for cooling your transmitter or dark room. Adjustable air control. Capacity 200 CFM. 115 VAC. Price only \$12.95.

Junior Centrifugal Blower with 75 CFM capacity—\$6.95.

S Meter

Add an S meter to your receiver at low cost. High grade 5 mil movement. 2 inch barrel. Only \$1.25.

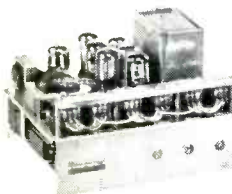

Servo Amplifier

Beautiful 7 tube amplifier complete with 6 relays for servo system operation. Parts alone worth several times our low price. New in original packing—only \$11.95.

Fractional H. P. Motor

Perfectly built, silent running motor originally built for ART/13 tuner. 3900 RPM. 1/20 HP. Instructions for operating on 115 VAC. Makes a fine sewing machine motor. Priced very low at \$7.95.



Circuit Breaker

25 Ampere circuit breaker protects your equipment in case of overload. Ideal for replacing household fuse boxes. Price only \$1.95.



Relay for Electronic Keyer

Sensitive type relay, 3500 ohms, SPDT contact for use in electronic keyer described in QST October 1948. Our stock No. 110. Price only \$1.50 each or \$2.75 per pair.



WELLS

TUBE DEPARTMENT

Brand new, standard make tubes by the thousands are ready for immediate delivery at the lowest prices in our history. Check this list for exceptional values.

| Type | Price | Type | Price | Type | Price |
|-----------------|--------|----------------|--------|----------------------|---------|
| O1A | \$0.45 | 10Y/VT-25 | \$0.45 | 707B | \$23.25 |
| 1B22 | 4.35 | 12A6 | .25 | 710A | 2.15 |
| 1N21 Xtal Diode | .65 | 12K8 | .65 | 713A | 1.55 |
| 1N21B " | .. | 12SF7 | .70 | 714AY | 9.95 |
| 1N23 " | .. | 12SH7 | .40 | RK715B | 7.95 |
| 1N23A " | .. | 12SK7 | .60 | 717A | .60 |
| 1N27 " | .. | 12SL7/GT | .70 | 721A | 3.95 |
| 1R4/1294 | .65 | 12SR7 | .40 | 724A | 4.65 |
| 1R5 | .95 | 12:825 2 amp. | 2.25 | 724B | 4.25 |
| 1S5 | .95 | 13-4 Ballast | .35 | 725A | 19.95 |
| 1S21 | 1.10 | 15R | 1.40 | 726A | 19.95 |
| 1T4 | .95 | FG-17 | 2.85 | 730A | 11.95 |
| 2C26 | .35 | REL-21 | 3.25 | 801 | .60 |
| 2C26A | .45 | 23D4 Ballast | .45 | 801A | .75 |
| 2C34 | .55 | 25Z6/GT | .55 | 803 | 6.95 |
| 2J21A | 11.45 | 28D7 | .40 | 804 | 9.95 |
| 2J22 | 9.85 | 30/VT-67 | .75 | 805 | 5.45 |
| 2J26 | 8.45 | 33/VT-33 | .75 | 808 | 1.75 |
| 2J27 | 14.45 | RK-34 | .45 | 809 | 2.75 |
| 2J31 | 9.95 | 34 | .35 | 810 | 7.95 |
| 2J32 | 14.85 | 39/44 | .35 | 811 | 2.35 |
| 2J33 | 19.95 | 45 Spec. | .55 | 813 | 7.85 |
| 2J37 | 13.85 | 46 | .80 | 814 | 3.75 |
| 2J38 | 12.95 | EF50/VT250 | .45 | 815 | 2.85 |
| 2J48 | 14.95 | CEQ 72 | 1.50 | 826 | .49 |
| 2X2/879 | .65 | 72/3624 | 1.75 | 829 | 3.25 |
| 3A4 | .35 | VR-75 | .90 | 830B | 3.95 |
| 3A5 | 1.05 | 76 | .55 | 837 | 1.75 |
| 3AP1 CRT | 3.85 | VR-78 | .65 | 838 | 3.25 |
| 3B22 | 2.95 | 80 | .45 | 841 | .55 |
| 3B24 | 1.75 | FG-81-A | 3.95 | 843 | .55 |
| 3BP1 CRT | 3.75 | 83 | .85 | 851 | 39.50 |
| 3CP1-S1 | 1.95 | 83V | .95 | WL-860 | 2.55 |
| 3C24/24G | .47 | 89Y | .40 | 861 | 32.50 |
| 3D6/1299 | .65 | VR-90 | .70 | 864 | .55 |
| 3FP7 CRT | 2.95 | VR-92 | .65 | 865 | 2.55 |
| 3HP7 CRT | 2.95 | 100R | 3.25 | 866A | 1.30 |
| 3GP1 CRT | 3.75 | FG-105 | 9.95 | 869 | 26.50 |
| 3Q5 | .90 | VR-105 | .85 | 869B | 28.95 |
| REL-5 | 17.95 | VU-111 | .65 | 872A | \$2.45 |
| 5AP1 CRT | 3.95 | 117Z3 | .55 | 874 | 2.15 |
| 5BP1 CRT | 2.95 | VT-127 English | .25 | 878 | 2.15 |
| 5CP1 CRT | 3.85 | VT-127A | 2.95 | 930 | 2.20 |
| 5GP1 CRT | 6.55 | VR-150 | .55 | 954 | .50 |
| 5J23 | 14.25 | VT-158 | 9.85 | 955 | .55 |
| 5J29 | 14.25 | FG-172 | 29.50 | 956 | .55 |
| 5Y3G | .40 | 205B | 1.95 | 957 | .55 |
| 6A6 | .90 | 211 (VT-4-C) | .65 | 991 (NE-16) | .30 |
| 6AB7 | .95 | 215A | 1.95 | 1005 | .35 |
| 6AC7 | .90 | 231D | 1.30 | 1148 | .40 |
| 6AK6 | .80 | 282B | 4.25 | 1201 | .75 |
| 6B7 | .95 | 304TH | 5.95 | 1616 | 1.25 |
| 6BE6 | .65 | 304TL | 1.75 | 1619 | .55 |
| 6C4 | .45 | 307A | 4.25 | 1624 | 1.25 |
| 6C6 | .75 | 316A | .75 | 1625 | .45 |
| 6C21 | 19.75 | 350B | 2.55 | 1626 | .45 |
| 6D6 | .60 | 371B | .85 | 1629 | .45 |
| 6E5 | .70 | 388A | 4.95 | 1635 | .95 |
| 6H6 | .50 | 417A | 19.95 | 2051 | .95 |
| 6J5/GT | .50 | 434A | 7.45 | 7193 | .35 |
| 6J6 | .90 | 446A | 1.55 | 8011 | 2.55 |
| 6N7/GT | .80 | 450TH | 19.95 | 8012 | 4.25 |
| 6R7G | .80 | GL-471A | 2.75 | 8020 | 3.35 |
| 6SF5 | .65 | 527 | 11.25 | 8025 | 7.50 |
| 6SG7 | .70 | WL-530 | 17.50 | 9001 | .70 |
| 6SH7 | .40 | WL-531 | 17.50 | 9002 | .45 |
| 6SJ7/GT | .65 | 532A/1B32 | 3.55 | 9003 | .65 |
| 6SK7/GT | .65 | GL-559 | 3.75 | 9004 | .45 |
| 6SL7/GT | .65 | KU-610 | 7.45 | 9006 | .45 |
| 6SN7/GT | .80 | HY-615 | 1.20 | | |
| 6SQ7/GT | .60 | 700B | 9.95 | NEON BULBS FOR RADIO | |
| 7A4 | .65 | 700C | 9.95 | NE-2 | \$0.06 |
| 7A7 | .65 | 700D | 9.95 | NE-15 | .06 |
| 7C4/1203 | .40 | 702A | 2.95 | NE-16 | .24 |
| 7C7 | .65 | 703A | 4.85 | NE-20 | .06 |
| 7E6 | .65 | 705A | 2.65 | NE-21 | .24 |
| 7F7 | .75 | 707A | 19.50 | NE-48 | .24 |
| 7H7 | .75 | | | NE-51 | .06 |
| 7N7 | .75 | | | | |
| 7Q7 | .65 | | | | |
| 10/VT-25A | .40 | | | | |

Distributors: Our standard distributor arrangement applies on these items.

Brand new, complete catalogs for Manufacturers, Distributors and Amateurs now ready. Write for your copy today.



Order directly from this ad or through your local Parts Jobber.

320 N. LA SALLE ST., DEPT. SL, CHICAGO 10, ILL.

PERMALLOY SHIELDS
for CATHODE RAY TUBES
3" Shield \$1.47
5" Shield 1.97



NOW AVAILABLE
1000 KC Crystal..... \$2.97
Socket07

TUBES!! BRAND NEW! STANDARD BRANDS! NO SECONDS! COMPARE! TUBES!!

| | | | | | | | | | | | | | | | | | |
|-------|--------|----------|--------|------------|---------|--------|---------|---------|--------|---------|--------|--------|--------|---------|--------|---------|--------|
| 1B21 | \$2.87 | 3FP1 | \$2.87 | 305A | \$12.95 | 843 | \$ 3.39 | C100D | \$1.95 | O1A | \$2.25 | 6A6 | \$.89 | 6U5 | \$.65 | 19 | \$.98 |
| 1B22 | 3.95 | 3E29 | 1.75 | 307A | 3.95 | 843W | 4.25 | CK507AX | 1.95 | 1A3 | .57 | 6A7 | .69 | 6U7G | .55 | 24A | .53 |
| 1B23 | 8.95 | 3FP7 | 1.75 | 308A | 3.54 | 851 | 15.95 | CK1005 | .19 | 1A4 | .97 | 6A8 | .79 | 6V6 | .79 | 251L | .53 |
| 1B24 | 4.69 | 3GP1 | 6.75 | 327A | 2.75 | 860 | 2.49 | CK1208 | .98 | 1A5GT | 1.09 | 6A17 | .79 | 6V6GT | .65 | 2525 | .49 |
| 1B26 | 4.57 | 4-65A | 14.49 | 338A | 3.95 | 861 | 16.95 | CK1090 | 2.95 | 1A6 | .67 | 6AC7 | .77 | 6Z6 | .59 | 2576 | .49 |
| 1B27 | 8.95 | 4-125A | 27.45 | 350A | 1.25 | 864 | .49 | EF50 | .45 | 1A6 | .79 | 6AF6G | .79 | 6X5GT | .49 | 26 | .57 |
| 1B36 | 3.49 | 4-250A | 37.45 | 350B | 1.89 | 865 | 2.95 | FI23A | 12.95 | 1A7GT | .67 | 6AG5 | .77 | 6Y6G | .67 | 27 | .47 |
| 1B38 | 47.50 | 4B24 | 3.95 | 353A | 2.95 | 866A | 1.05 | FI25A | 14.95 | 1AB5 | .49 | 6AG7 | .98 | 6Z7G | 1.15 | 28D7 | .35 |
| 1D21 | 5.75 | 4C35 | 19.50 | 362A | 1.95 | 866JR | 1.10 | FI27A | 27.50 | 1B4 | 1.19 | 6AH6 | 1.29 | 6ZY5G | .69 | 30 | .57 |
| 1N21 | .95 | 4E27 | 12.75 | 368AS | 3.95 | 869B | 27.95 | FI402 | 85.00 | 1B5/25B | .89 | 6AJ5 | .79 | 7A4/XXL | .59 | 31 | .89 |
| 1N21B | 1.65 | 4J32 | 97.50 | 371B | .85 | 874 | .57 | FI660 | 125.00 | 1C6 | .89 | 6AK5 | .85 | 7A6 | .67 | 32 | .97 |
| 1N23 | .79 | 5AP1 | 1.95 | 388A | 2.95 | 876 | .98 | FI862A | 450.00 | 1C7G | .89 | 6AL5 | .65 | 7A7 | .57 | 32L7GT | .97 |
| 1N23B | 1.95 | 5AP4 | 1.95 | 393A | 3.85 | 878 | 1.98 | PG17 | 2.89 | 1D5GP | .97 | 6AQ5 | .59 | 7B4 | .57 | 33 | .69 |
| 1N34 | .85 | 5B1P1 | 1.89 | 394A | 3.85 | 884 | 1.39 | PG27A | 9.75 | 1D7G | .89 | 6AQ6 | .59 | 7B6 | .59 | 35/51 | .57 |
| 1P24 | .79 | 5B1P4 | 3.75 | 417A | 14.50 | 885 | 1.39 | VG81A | 3.55 | 1D8GT | .95 | 6AT6 | .47 | 7B7 | .59 | 35A5 | .67 |
| 1S21 | 3.95 | 5CP1 | 1.85 | 434A | 3.50 | 890P21 | 3.85 | VG95 | 17.95 | 1E4 | .75 | 6AT6 | .59 | 7C4 | .37 | 35B5 | .65 |
| 2AP1 | 3.89 | 5CP1A | 9.95 | 446A | 1.25 | 905 | 3.98 | PG105 | 9.95 | 1F5G | .75 | 6AV6 | .47 | 7C5 | .57 | 35C5 | .65 |
| 2C22 | .27 | 5CP2 | 9.95 | 450TH | 17.95 | 907 | 4.95 | PG172 | 19.95 | 1G4CT | .89 | 6B4G | .69 | 7C7 | .59 | 35L6 | .54 |
| 2C22 | .19 | 5C30 | 7.95 | 450TL | 37.50 | 920 | .97 | PT210 | 13.95 | 1G6GT | .69 | 618G | .79 | 7E5 | .67 | 35W4 | .39 |
| 2C26 | .27 | 5E27 | 27.95 | 527 | 9.95 | 923 | .85 | GL146 | 9.95 | 1H4G | .69 | 617 | .89 | 7E6 | .59 | 35Y4 | .49 |
| 2C34 | .19 | 5FP7 | 1.35 | 559 | 1.85 | 931A | 19.95 | GL451 | 3.25 | 1H5GT | .54 | 6B8G | .89 | 7E7 | .69 | 35Z1 | .57 |
| 2C40 | 6.59 | 5GP1 | 5.95 | 575A | 12.95 | 953B | 19.95 | GL502 | 85.00 | 1H6GT | .89 | 61A6 | .55 | 7F7 | .64 | 35Z5 | .39 |
| 2C43 | 8.95 | 5J1 | 24.95 | 700A/B/C/D | 955 | .37 | GL697 | 69.50 | 1J6GT | .89 | 6BF6 | .57 | 7L7 | .69 | 37 | .35 | |
| 2C44 | .67 | 5JP2 | 11.75 | 701A | 34.50 | 956 | .37 | HY115 | .85 | 1L4 | .55 | 6BF6G | 1.47 | 7N7 | .67 | 38 | .29 |
| 2C46 | 8.95 | 5J29 | 17.50 | 702A | 3.60 | 955 | .39 | HY165 | .79 | 1LA4 | .79 | 6B36 | .57 | 7Q7 | .59 | 39/44 | .27 |
| 2C51 | 8.25 | 5K30 | 49.50 | 703A | 3.25 | 957 | .24 | HYE1148 | .39 | 1L6 | .89 | 61H6 | .59 | 7R7 | .59 | 41 | .52 |
| 2D21 | 1.17 | 5LP1 | 13.95 | 705A | 1.10 | 958A | .35 | KC4 | 49.50 | 1L34 | .89 | 6H36 | .59 | 7Q7 | .59 | 42 | .49 |
| 2E22 | 1.29 | 5NP1 | 1.10 | 706 | 1.95 | 958A | .35 | KL610 | 9.75 | 1L35 | .89 | 6H36 | .59 | 7T7 | .59 | 43 | .49 |
| 2E24 | 4.47 | 6C21 | 19.69 | 706CY | 18.75 | 991 | .27 | ML100 | 49.50 | 1L38 | .89 | 61A6 | .55 | 7Y4 | .49 | 44 | .49 |
| 2E26 | 3.89 | 6F4 | 5.59 | 707B | 14.95 | 1603 | 3.95 | ML101 | 139.50 | 1LD5 | .89 | 6C6 | .57 | 7Y4 | .49 | 45 | .52 |
| 2F21A | 10.95 | 6J4 | 5.95 | 708A | 3.95 | 1611 | .97 | ML501 | 69.50 | 1LE3 | .89 | 6C8G | .69 | 7Z4 | .57 | 46 | .49 |
| 2J22 | 8.95 | 7BP7 | 4.65 | 713A | .95 | 1613 | .59 | ML502 | 149.50 | 1L65 | .89 | 6D6 | .47 | 12A | .57 | 45Z3 | .57 |
| 2J26 | 7.95 | 9GP7 | 12.50 | 714A | 12.95 | 1616 | 1.45 | RFEL21 | 2.95 | 1LH4 | .65 | 6D8G | .87 | 12A6 | .19 | 45Z5 | .49 |
| 2J27 | 13.95 | 9JP1 | 6.95 | 714AY | 3.95 | 1616 | .98 | RK21 | .79 | 1LH5 | .65 | 6E5 | .69 | 12A7 | .98 | 46 | .69 |
| 2J30 | 49.50 | 9LP7 | 2.25 | 715C | 24.95 | 1619 | .47 | RK21 | .98 | 1N5GT | .59 | 6F5 | .47 | 12ASGT | .59 | 47 | .69 |
| 2J31 | 9.75 | 10BP1 | 24.95 | 717A | .59 | 1621 | .98 | RK23 | 4.85 | 1P5GT | .67 | 6F6 | .65 | 12AH7GT | .85 | 48 | .69 |
| 2J32 | 8.95 | 10Y | 4.9 | 721A | 2.95 | 1625 | .37 | RK25 | 3.65 | 1Q5GT | .67 | 6F7 | .85 | 12AT6 | .45 | 50A5 | .69 |
| 2J33 | 19.95 | 12BP7 | 14.95 | 723A/B | 24.95 | 1626 | .37 | RK33 | .27 | 1R1 | .69 | 6F8G | .87 | 12AU6 | .67 | 50B5 | .55 |
| 2J34 | 19.95 | 12GP7 | 13.95 | 724A/B | 3.95 | 1629 | 3.99 | RK34 | .27 | 1R5 | .69 | 6G6G | .69 | 12AU7 | .79 | 50L6 | .52 |
| 2J37 | 17.50 | 12HP7 | 13.95 | 725A | 8.95 | 1630 | 3.95 | RK50 | 1.95 | 1S4 | .79 | 6H6 | .47 | 12BA6 | .49 | 50Y6 | .57 |
| 2J38 | 12.95 | 15E | 1.29 | 726A | 14.95 | 1631 | 1.45 | RK63 | 18.95 | 1T4 | .57 | 6J6 | .77 | 12C8 | .49 | 51 | .57 |
| 2J39 | 34.50 | 15R | .79 | 730A | 10.95 | 1632 | .98 | RK65 | 24.95 | 1T4 | .57 | 6J6 | .77 | 12C8 | .49 | 52 | .57 |
| 2J40 | 24.50 | 23D4 | .29 | 730TL | 45.00 | 1633 | .98 | RK72 | .97 | 1T5GT | .79 | 6J7 | .67 | 12F5GT | .58 | 56 | .45 |
| 2J46 | 89.50 | 30A | .47 | 800A | 1.95 | 1636 | 4.75 | RK73 | .97 | 1U1 | .59 | 6K6GT | .45 | 12H6 | .27 | 57 | .38 |
| 2J48 | 39.50 | 30A Spec | .35 | 801A | 1.45 | 1638 | .79 | RN21 | 3.19 | 1V | .69 | 6K7 | .49 | 12J5 | .27 | 58 | .49 |
| 2J49 | 24.95 | 45 Spec | .29 | 802 | 4.25 | 1641 | .69 | RS120 | 8.95 | 2A3 | 2.43 | 6K8 | .79 | 12K7 | .54 | 59 | .39 |
| 2J50 | 42.50 | 75TL | 3.69 | 803 | 4.95 | 1642 | .27 | S836 | 2.95 | 2A4G | 1.07 | 6L5 | .89 | 12L8 | .59 | 60 | .39 |
| 2J53 | 14.95 | 100R | 2.95 | 804 | 8.95 | 1665 | 1.10 | TZ40 | 2.95 | 2A5 | .69 | 6L6 | 1.17 | 12Q7 | .49 | 70L7 | 1.17 |
| 2J54B | 39.50 | 100TH | 11.50 | 805 | 4.95 | 1851 | .97 | V701D | 6.95 | 2A6 | .79 | 6L6GA | .87 | 12SA7 | .57 | 71A | .67 |
| 2J61 | 39.50 | 100TS | 1.95 | 807 | 1.10 | 1960 | 2.95 | VR65A | .98 | 2A7 | .89 | 6L7 | .79 | 12SC7 | .57 | 75 | .53 |
| 2J62 | 39.50 | 204A | 57.50 | 808 | 1.47 | 2050 | .75 | VR75 | .97 | 2V3G | .99 | 6M7 | .79 | 12SF7 | .57 | 76 | .39 |
| 2K25 | 23.95 | 205B | 2.95 | 808 | 1.75 | 2051 | .43 | VR78 | .65 | 2X3G | .39 | 6Q7 | .59 | 12SG7 | .57 | 77 | .43 |
| 2K28 | 14.95 | 211 | .49 | 810 | 6.95 | 7193 | .99 | VR90 | .67 | 2X2A | .69 | 6G7 | .79 | 12SH7 | .35 | 78 | .43 |
| 3AP1 | 4.85 | 215A | .65 | 811 | 2.10 | 8005 | 4.75 | VR105 | .79 | 3A4 | .37 | 6S7 | .89 | 12SJ7 | .49 | 78 | .45 |
| 3B22 | 2.69 | 217C | 9.95 | 812 | 2.79 | 8011 | .69 | VR111 | .55 | 3A5 | .99 | 6SA7 | .44 | 12SK7 | .57 | 80 | .39 |
| 3B23 | 4.85 | 219 | 47.50 | 813 | 7.75 | 8013A | 1.47 | VT127 | 2.25 | 3B7 | .35 | 6SC7 | .59 | 12SL7 | .59 | 81 | 1.29 |
| 3B24 | 4.59 | 221A | 1.95 | 814 | 2.75 | 8014 | 22.50 | VU111 | .59 | 3D5 | .35 | 6SD7GT | .69 | 12SN7 | .52 | 82 | .87 |
| 3B25 | 4.87 | 225 | 8.70 | 814 | 2.75 | 8014A | 22.50 | WL468 | 7.95 | 3Q4 | .59 | 6SE5 | .49 | 12SQ7 | .49 | 83 | .72 |
| 3B26 | 1.79 | 227A | 2.95 | 815 | 2.45 | 8016 | 1.25 | WL530 | 17.50 | 3Q6GT | .67 | 6S7 | .69 | 12SR7 | .49 | 84 | .72 |
| 3B27 | 3.85 | 231D | 1.25 | 816 | 1.10 | 8020 | 3.25 | WL531 | 7.95 | 3S4 | .67 | 6SG7 | .59 | 12Z3 | .79 | 85 | .89 |
| 3B31 | 2.95 | 249B | 2.49 | 826 | .42 | 8025 | 4.95 | WL532 | 3.50 | 5R1GY | 1.10 | 6SH7 | .49 | 14A4 | .79 | 81/6Z4 | .63 |
| 3C21 | 5.21 | 250R | 2.89 | 829B | 7.45 | 9001 | .37 | WL538 | .69 | 5T4 | .89 | 6S7 | .57 | 14A7 | .69 | 85 | .69 |
| 3C22 | 39.50 | 250TH | 18.95 | 832A | 4.25 | 9002 | .34 | WL578 | 1.95 | 5U4G | .89 | 6SK7GT | .55 | 14B6 | .67 | 85 | .39 |
| 3C24 | .45 | 250TL | 18.95 | 833A | 32.50 | 9003 | .37 | WL616 | .97 | 5V4G | .89 | 6S17GT | .65 | 14E7 | .69 | 89Y | .39 |
| 3C30 | .49 | 274B | 1.19 | 834 | 5.75 | 9004 | 1.95 | WL619 | .97 | 5V4G | .89 | 6S2GT | .97 | 14F8 | .89 | 11L7/M7 | 1.29 |
| 3C31 | 3.49 | 282B | 9.75 | 836A | .99 | 9005 | 1.97 | WX3245 | 49.50 | 5X4G | .59 | 6SN7GT | .65 | 14H7 | .65 | 117P7 | 1.37 |
| 3CP1 | 2.67 | 291A | 4.57 | 837 | 1.69 | 9006 | .24 | OA2 | 1.57 | 5Y3GT | .37 | 6SQ7 | .45 | 14X7 | .89 | 117P7 | 1.27 |
| 3D21A | 1.49 | 304TH | 4.95 | 838 | 3.25 | C5B | 7.95 | OA4G | .95 | 5Y4G | .49 | 6SR7GT | .57 | 14Q7 | .57 | 117Z3 | .57 |
| 3DP1 | 1.97 | 304TL | 1.39 | 841 | .49 | C6A | 8.45 | OB2 | 1.75 | 5Z3 | .49 | 6S7 | .59 | 14R7 | .67 | 117Z6 | .65 |
| | | | | | | C6J | 4.95 | OZ4 | .57 | 5Z4 | .49 | 6T7G | .98 | 15 | .89 | | |

OIL CONDENSERS
NATIONALLY ADVERTISED BRANDS
All Ratings D. C.

| | | | |
|---------------|--------|-------------|--------|
| 2x.1mfd. 600v | \$0.37 | 1mfd. 2000v | \$0.97 |
| .25mfd. 600v | .37 | 2mfd. 2000v | 1.27 |
| .5mfd. 600v | .37 | 4mfd. 2000v | 3.77 |
| 1mfd. 600v | .37 | 8mfd. 2000v | 3.47 |
| 2mfd. 600v | .37 | 15mfd. 200v | 4.97 |
| 4mfd. 600v | .57 | 4mfd. 2500v | 3.97 |
| 8mfd. 600v | 1.07 | 2mfd. 2500v | 2.37 |
| 10mfd. 600v | 1.17 | 1mfd. 2500v | |

Finest of Surplus PEAK ELECTRONICS CO. Fraction of Cost



HIGH CURRENT TRANSF. 820 Volts CT at 775 Ma. Pri. 110/220 Volts 60 cycles. Fully Cased. Wt. 36 Lbs. \$5.95

MALLORY TRANSFORMER & 534C Vibrator as used in above. Both for \$5.95

UTC type PA 5000 ohm plate to 500 ohm line and 6 ohm voice coil. 10 watts. 60 to 10,000 cps ±1 DB. GREAT VALUE. ea. \$2.75

THORDARSON PLATE TRANSF. 700 volts CT at 145 MA 5V. 3 Amp. 6.3V. 4.5 Amp. CT Fully shielded 110V. 60 Cy. Price \$2.99 ea.

CHOKO BARGAINS

- 6 Henry 50 ma 300 ohms 3 for \$0.99
- 6 Henry 80 ma 220 ohms 2 for .99
- 8 Henry 160 ma 140 ohms .99
- 1.5 Henry 250 ma 72 ohms .59
- 6 Henry 300 ma 65 ohms 3.75
- 4.3 Henry 620 ma 42 ohms 6.95
- Swing. Choke 1.6/12 Henry 1 Amp/100 ma 15 ohm 17.95

U. H. F. COAX. CONNECTORS

831AP-UG12U, UG-1411-831, R83ISP .35 ea.



FEDERAL ANTI-CAPACITY SWITCH. Double Pole. Double Throw .85c each; 10 for \$7.50

W. W. POWER RHEOSTATS

- 25 Ohms 25 Watt .49
- 150 Ohms 50 Watt .59
- 250 Ohms 50 Watt .59
- 300 Ohms 50 Watt .59
- Dual 200 Ohms 50 Watt .79
- 8 Ohms 150 Watts 1.79

WESTERN ELECTRIC MOTOR

Input 110 volts 60 cycles. 11 watts; Torque 75 oz. in. 0.65 RPM. Ideal for driving H.F. Antenna. Condenser, etc. 3" diam., 3 1/2" long. Complete with capacitor \$3.75 each

HIGH VOLTAGE—CURRENT MICAS



| MMF | VDC | Price | MMF | VDC | Price |
|--------|------|-------|---------|-------|--------|
| D .001 | 600 | .18 | C .006 | 3 KV | \$1.50 |
| E .01 | 600 | .26 | D .002 | 3 KV | .70 |
| E .02 | 600 | .26 | C .0001 | 5 KV | .76 |
| E .027 | 600 | .26 | C .0005 | 5 KV | .85 |
| D .039 | 600 | .39 | C .0015 | 5 KV | 1.60 |
| C .01 | 1 KV | .45 | C .003 | 5 KV | 1.90 |
| C .056 | 1 KV | .55 | C .005 | 5 KV | 2.50 |
| C .07 | 1 KV | .55 | B .007 | 5 KV | 2.75 |
| D .02 | 1200 | .35 | B .002 | 6 KV | 3.50 |
| C .024 | 1500 | .65 | B .003 | 6 KV | 3.75 |
| C .035 | 1500 | .75 | A .004 | 6 KV | 4.95 |
| C .015 | 2 KV | .80 | B .006 | 6 KV | 4.25 |
| C .02 | 2 KV | .90 | B .0005 | 8 KV | 2.90 |
| D .002 | 2500 | .45 | B .001 | 8 KV | 3.25 |
| E .005 | 2500 | .55 | B .002 | 8 KV | 4.00 |
| C .025 | 2500 | 1.25 | B .003 | 8 KV | 4.75 |
| C .001 | 3 KV | .90 | B .004 | 8 KV | 5.59 |
| C .002 | 3 KV | .95 | A .0098 | 15 KV | 32.50 |
| D .005 | 3 KV | .70 | A .0059 | 18 KV | 28.50 |
| C .005 | 3 KV | 1.24 | A .0013 | 30 KV | 36.50 |

OIL CONDENSERS

| | | | | | | | |
|-----|-----|-----------|-------|----------|---------|-------------|----------|
| 20 | mfd | 330 vac. | —1.85 | 6 | mfd | 2000 vdc. | —3.95 |
| 5 | mfd | 150 vac. | —49 | 2 | mfd | 4000 vdc. | —1.95 |
| 1 | mfd | 600 vdc. | —29 | 1 | mfd | 5000 vdc. | —4.50 |
| 2 | mfd | 600 vdc. | —39 | 1 | 1/1 mfd | 7000 vdc. | —2.25 |
| 4 | mfd | 600 vdc. | —59 | 1 | mfd | 7500 vdc. | —1.95 |
| 6 | mfd | 600 vdc. | —79 | 1 | mfd | 7500 vdc. | —9.25 |
| 3/3 | mfd | 600 vdc. | —79 | .01/.01 | mfd | 12 kv | dc—5.75 |
| 10 | mfd | 600 vdc. | —89 | .005/.01 | mfd | 12 kv | dc—5.75 |
| 4 | mfd | 1000 vdc. | —95 | .65 | mfd | 12,500 vdc. | —12.95 |
| 15 | mfd | 1000 vdc. | —2.95 | .75/.35 | mfd | 8/16 kv | —7.95 |
| 2 | mfd | 1500 vdc. | —1.25 | 2 | mfd | 16 kv | dc—39.50 |
| 6 | mfd | 1500 vdc. | —2.95 | | | | |
| 1 | mfd | 2000 vdc. | —1.45 | | | | |
| 2 | mfd | 2000 vdc. | —2.25 | | | | |

Tremendous stocks on hand. Please send requests for quotas. Special quantity discounts. Price f.o.b. N. Y. 20% with order unless rated, balance C. O. D. Minimum order \$5.00.

PANEL METERS—BRAND NEW

- 2" WESTON 0-1 Ma Dc 26 ohms res. \$3.50
- 2" GE 0-1 Ma DC (volt scale) 2.95
- 2" GE 0-5 Ma DC (amp scale) 1.95
- 2" WESTINGHOUSE 0-10 Ma DC 2.45
- 2" GE 0-30 Volts DC 1000 ohm/v 2.50
- 2" WESTON 0-250 Volts DC 2.50
- 2" WESTON 150-0-150 Microamps DC 3.49
- 2" GE 0-30 Amps DC 2.45
- 2" GE 0-1 Amp RF (Internal Thermo) 2.45
- 2" WESTON 0-1 Amps RF (Internal Thermo) 2.00
- 3" WESTINGHOUSE 0-2 Ma DC 3.95
- 3" GE 0-15 Ma DC (Square Case) 3.95
- 3" WESTON ELECTRIC 0-80 Ma DC 2.95
- 3" DEJUR 0-100 Ma DC 2.95
- 3" GE 0-200 Ma DC 3.95
- 3" WESTON 0-50 Amps AC 4.95
- 3" TRIPLETT 75 Amps AC 2.95
- 3" WESTINGHOUSE 0-20 Ma DC 3.95

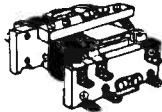

ADVANCE D.P.D. ANTENNA RELAY
110 V. 60 cycle coil Steatite insulation. Only \$1.95 each.

DUNCO RELAY 6 volt 60 cycle coil DPST \$1.39

SCOPE TRANSFORMERS

- Pri 110V 60CY — Hermetically Sealed
- 2500V @ 12Ma \$3.95
- 2300 @ 1 MA, 2.5 Volts @ 2 Amps 4.95
- 1050V @ 20Ma, 20V 4.5A, 2.5V 5A 4.75

PLATE AND FIL. TRANSF. PRI 110 v 60 cy. sec. 1120 volts CT @ 600 ma. 6.3v CT = 3A. 2x5VCT @ 6A Hermetically sealed. \$9.95 ea.

1500, 5000 Ohm 100 Watt Ferrule Resistors.
20,000 Ohm 50 Watt Ferrule Resistors.
Any Types only .10 each. Min. Order 50.



HS 30 HEADPHONES
250 ohms imp. Can be used for sound power Telephones.
Brand new .69 ea.

LARGE QUANTITY AVAILABLE AT REDUCED PRICE



PHASE SHIFT CAPACITOR
J Statior Single Rotor. 0-360 Degrees Rotation Only \$2.95 each

GENERAL PURPOSE TRANSFORMERS

Ideal for Bias, Filament, Isolation, Standup, etc. 2 isolated 110v ac. sec. 110v at 900 ma plus 6.3 @ 2 amps. Fully cased. Now \$1.49 ea.

FILAMENT TRANSFORMERS

- 110V C0CY Pri. Fully Cased.
- 5 Volt 15 Amp \$2.75
- 2.5 Volt 10 Amp 3.49
- 2.5 Volt CT 21 Amp 4.75
- 6.3 Volt 10 Amp 1.89

MULTIPLE SECONDARIES

- 5 1/2 V CT 21A, 7.5V 6A, 7.5V 6A \$4.95
- 6.3V 21 Amp, 6.3V 2A, 2.5V 2A 3.95
- 5 Volt 4A, 6.3V, 3A 2.45
- 2.5V CT 20A, 2.5V CT 20A 6.95
- 2.5V CT 10A, 10V 3A, 5V 3A, 5V 3A 3.95

MEGOHM METER

Industrial Instruments model L2AU 110/220 volts 60 cycle input. Direct reading from 0-100000 megohms on 4" meter can be extended to 500000 megohms with external supply. Stopping hardwood Cabinet 15"x8"x10" Brand new with tubes plus running spare parts including extra tubes. Great value Only \$69.50.



Precision 15 Meg. 1% Accuracy Resistor, Non-inductive, 1 watt, hermetically sealed in glass. 29 ea. 10 for



50 megohm 35 watt Resistor with mount. \$1.95 each; 10 for \$15.00

CONSTANT VOLTAGE TRANSF.

Thordarson. Pri. 95-135/190-270 volts 60 cycles. Output 115 volts. 350 VA. \$29.75 ea.

SCOPE AND FIL. TRANSFORMER

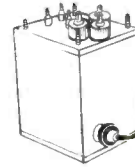

Pri. 115 volts 60 cycles. Sec. 4400 volts RMS, 5 volts CT 3 amps. Insulation 15 KV RMS test. Hermetically sealed. Has insulated plate cap for rectifier. Made by Raytheon. 4 1/2 x 5 x 5 1/2. Only \$6.75

PLUG IN CAPACITOR

8 x 8 Mfd 600 volts DC. Oil filled. Plugs into standard 4 prong socket. 3 3/4 h x 3 3/8 w x 1 7/8 d. \$1.39

ODDS AND ENDS BARGAINS 1000 VDC

- .004 1000 VDC Micas 9 for .99
- .01 600 VDC Mica Cond. 9 for .99
- GE 24V DC Relays 5 for .99
- .02 40 V DC Tubulars 15 for .99
- 1000 MFD Volt Electrolytic 2 for .99
- 25 MFD, 25 Volt Elect. Tubular 6 for .99
- JAN 60V Tubes, New, Boxed 4 for .99
- .05 500V VDC Oil Tubular 10 for .99
- 10 MMF Midget Variable Cond. 4 for .99
- Heineman 5 Amp 110 VAC CKT Breaker .99
- Heineman 25 Amp 110 VAC CKT Breaker 1.49
- 2 MFD 250 VAC Oil Cond. 5 for .99
- Solar .02 600 VDC Dominoes 9 for .99
- Erie .0005 N750D Ceramics 15 for .99
- 1x1 1/2 KV DC Oil Condenser 79
- H&H SPST P.B. Switch N.O. 5 for .99
- 1/40 Amp (25 Ma) Littlefuses 15 for .99
- .25 MFD 600 V. Tubulars 6 for .99
- C.D. 1 MFD 400 V Oil Tubulars 9 for .99
- Butterfly Cond 2-11 MMF Ball Bearings 2 for .99
- 50 MFD 50 Volt Elect. Tubulars 5 for .99
- .0015 5% Silver Micas 9 for .99
- Midget Closed CKT Jacks 7 for .99
- CD Type 4 .001 600 VDC Micas .50 for 4.99



SELSYN MOTORS

115 volts 60 cycles. Large size, high torque. Made by Diehl and Bendix. Ideal for rotating TV beam, etc. Great value at \$6.75 per pair.

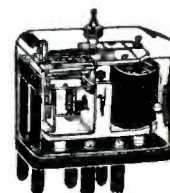

WESTINGHOUSE

Type MN Overcurrent Relay, Adjustable from 250 ma. to 1 amp. External Push Button Reset. Enclosed in glass case. Hand calibrated adjustments, only \$5.95

WIRE WOUND RESISTORS

- 5 Watt type AA, 20-25-50-200-470-2500-4000 ohms .09 each
- 10 watt type AB, 25-40-84-100-170-1325 .15 ea.
- 1000-2000-1000 ohms .15 ea.
- 20 watt type DG, 50-70-100-150-300-750-1000-1500-2500-2700-5000-7500-10000-16000-20000-30000 ohms .20 ea.

30 WATT WIRE WOUND RESISTORS

- Ohms: 100-150-1500-2500-3k-4k-4500-5k-5300-10k-15k-18k-40k .15 ea. 8 for .99



ADJUSTABLE RESISTORS

- 20 Watt: 1, 5, 50 Ohms .25
- 50 Watt: 80, 100, 500 Ohms .35
- 75 Watt: 40, 80, 100, 150, 200 Ohms .39
- 100 Watt: 20, 50, 75, 120, 180 Ohms .49
- 150 Watt: 50, 100 Ohms .59

1% PRECISION RESISTORS

- 2000-2500-5000-8500-10,000 ohms ea. .25
- 50000-95000 ohms ea. .29
- 10000-750000-1 meg ea. .69

PEAK ELECTRONICS CO.
188 Washington St., New York 7, N. Y.

PHONE CO-7-6443
DEPARTMENT EA
SEND FOR BULLETIN

SELENIUM RECTIFIERS

and

ELECTRONIC COMPONENTS

THREE PHASE FULL WAVE BRIDGE RECTIFIERS

| Input 0-126VAC | Current | Output 0-130*VDC | Price |
|-------------------|---------|---------------------|---------|
| Type # 3B7-4 | 4 AMP. | | \$32.95 |
| 3B7-6 | 6 AMP. | | 48.90 |
| 3B7-15 | 15 AMP. | | 70.00 |

| Input 0-234VAC | Current | Output 0-250*VDC | Price |
|-------------------|---------|---------------------|---------|
| Type # 3B13-4 | 4 AMP. | | \$56.00 |
| 3B13-6 | 6 AMP. | | 81.50 |
| 3B13-15 | 15 AMP. | | 120.00 |

SINGLE PHASE FULL WAVE CENTER TAPPED RECTIFIERS

| Input 10-0-10VAC | Current | Output 3-8*VDC | Price |
|---------------------|----------|-------------------|--------|
| Type # C1-10 | 10 AMP. | | \$6.95 |
| C1-20 | 20 AMP. | | 10.95 |
| C1-30 | 30 AMP. | | 14.95 |
| C1-40 | 40 AMP. | | 17.95 |
| C1-50 | 50 AMP. | | 20.95 |
| C1-80 | 80 AMP. | | 28.95 |
| C1-120 | 120 AMP. | | 36.95 |

CUSTOM DC POWER SUPPLIES

Built to your specifications.
For:

- INDUSTRY
- LABORATORIES
- UNIVERSITIES
- GOVERNMENT AGENCIES

We will be pleased to quote on your requirements.

*Select Proper Capacitor to Obtain Higher VDC Than Indicated.

VACUUM CAPACITORS

| Standard Brands | | | |
|-----------------|--------|--|--------|
| 12 Mmfd | 20 Kv. | | \$1.95 |
| 50 Mmfd | 20 Kv. | | 4.95 |
| 50 Mmfd | 32 Kv. | | 5.95 |

OIL CONDENSERS

| | |
|------------------------------------|-------|
| 2 Mfd 200VDC Bathtub | \$.20 |
| .5 Mfd 400VDC telephone type | .20 |
| 2 Mfd 400VDC Bathtub | .30 |
| 2X.1 Mfd 600VDC Bathtub | .39 |
| 6 Mfd 600VDC w/mtg. Clamp | .79 |
| 10 Mfd 440VAC/1500VDC w/Brkts. | 1.55 |
| 8 Mfd 660VAC/2000VDC w/Brkts. | 3.50 |
| 15-.15 Mfd 8000VDC Voltage Doubler | |
| Type 26F381 w/Brkts. | 3.95 |

SYNCHRO MOTORS

| | |
|--|--------|
| Type 1F Special—KS-6949, L1 Western Electric 115/90 VAC—400 Cycles | |
| Brand new, boxed. | \$8.00 |
| Price Each | |

ATTENTION!!!

Bulletin #713, listing various government and commercial surplus items, is now available upon request.

SINGLE PHASE FULL WAVE BRIDGE RECTIFIERS

| Input 0-18VAC | Current | Output 0-12*VDC | Price |
|------------------|----------|--------------------|--------|
| Type # B1-1 | 250 MA. | | \$1.95 |
| B1-50C | 500 MA. | | 2.49 |
| B1-1 | 1 AMP. | | 2.95 |
| B1-1X5 | 1.5 AMP. | | 4.50 |
| B1-3X5 | 3.5 AMP. | | 5.95 |
| B1-5 | 5 AMP. | | 9.95 |
| B1-10 | 10 AMP. | | 13.95 |
| B1-15 | 15 AMP. | | 15.95 |
| B1-20 | 20 AMP. | | 24.95 |
| B1-30 | 30 AMP. | | 27.95 |
| B1-40 | 40 AMP. | | 32.95 |
| B1-50 | 50 AMP. | | 36.95 |
| B1-60 | 60 AMP. | | 44.95 |
| B1-80 | 80 AMP. | | |

| Input 0-36VAC | Current | Output 0-26*VDC | Price |
|------------------|----------|--------------------|--------|
| Type # B2-150 | 150 MA. | | \$1.25 |
| B2-250 | 250 MA. | | 1.50 |
| B2-300 | 300 MA. | | 1.95 |
| B2-450 | 450 MA. | | 3.95 |
| B2-1 | 1 AMP. | | 4.95 |
| B2-2 | 2 AMP. | | 6.95 |
| B2-3x5 | 3.5 AMP. | | 9.95 |
| B2-5 | 5 AMP. | | 15.95 |
| B2-10 | 10 AMP. | | 24.95 |
| B2-15 | 15 AMP. | | 27.95 |
| B2-20 | 20 AMP. | | 36.95 |
| B2-30 | 30 AMP. | | 44.95 |
| B2-40 | 40 AMP. | | |

| Input 0-54VAC | Current | Output 0-38*VDC | Price |
|------------------|---------|--------------------|--------|
| Type # B3-150 | 150 MA. | | \$1.25 |
| B3-250 | 250 MA. | | 1.95 |
| B3-600 | 600 MA. | | 3.25 |
| B3-5 | 5 AMP. | | 13.95 |
| B3-10 | 10 AMP. | | 24.95 |

| Input 0-72VAC | Current | Output 0-50*VDC | Price |
|------------------|---------|--------------------|--------|
| Type # B4-600 | 600 MA. | | \$3.95 |
| B4-3 | 3 AMP. | | 14.95 |
| B4-5 | 5 AMP. | | 17.95 |
| B4-10 | 10 AMP. | | 27.95 |

| Input 0-115VAC | Current | Output 0-90*VDC | Price |
|-------------------|----------|--------------------|--------|
| Type # B6-150 | 150 MA. | | \$1.95 |
| B6-250 | 250 MA. | | 2.95 |
| B6-600 | 600 MA. | | 5.95 |
| B6-750 | 750 MA. | | 6.95 |
| B6-1X5 | 1.5 AMP. | | 10.95 |
| B6-3X5 | 3.5 AMP. | | 18.95 |
| B6-5 | 5 AMP. | | 24.95 |
| B6-10 | 10 AMP. | | 36.95 |
| B6-15 | 15 AMP. | | 54.95 |

| Input 0-234VAC | Current | Output 0-190*VDC | Price |
|-------------------|----------|---------------------|---------|
| Type # B13-600 | 600 MA. | | \$12.95 |
| B13-1X5 | 1.5 AMP. | | 19.95 |
| B13-3 | 3 AMP. | | 35.95 |
| B13-5 | 5 AMP. | | 48.95 |
| B13-10 | 10 AMP. | | 69.95 |

VOLTAGE REGULATORS

These solenoid operated carbon pile regulators will stabilize the output of 12-18 VDC power supplies, simply by connecting the coil leads across the output of the rectifier, and the carbon element leads in series with the load.

Price each \$2.49

D-C POWER SUPPLY FTR 3377-AS

Rating 115 VAC to 115 VDC, .77 Amperes. Operates fans, motors, magnetic chucks, business machines, relays, etc. Descriptive literature available.

Complete, ready to operate.....\$18.50

D-C PANEL METERS

Attractive, rugged, and reasonably priced. Moving vane solenoid type with accuracy within 5%.

9-8 Amperes D-C Any range
 9-12 Amperes D-C \$2.49 each
 3-15 Volts D-C

Minimum order \$3.00. No C.O.D.'s under \$25.00. 25% deposit on C.O.D. Add 10% for Prepaid Parcel Post and Handling. Terms: Net 10 days in the presence of approved credit.

All prices subject to change without notice. Orders Promptly Filled from Our Stocks All Prices F.O.B. our NYC Warehouse

RECTIFIER CAPACITORS

| | | | |
|-------|------------|--------|------|
| CF-14 | 3000 MFD | 12VDC | 1.69 |
| CF-15 | 6000 MFD | 12VDC | 2.95 |
| CF-1 | 1000 MFD | 15VDC | .98 |
| CF-2 | 2000 MFD | 15VDC | 1.69 |
| CF-20 | 2500 MFD | 15VDC | 1.95 |
| CF-3 | 1000 MFD | 25VDC | 1.25 |
| CF-4 | 2X3500 MFD | 25VDC | 3.45 |
| CF-5 | 1500 MFD | 30VDC | 2.49 |
| CF-6 | 4000 MFD | 30VDC | 3.25 |
| CF-7 | 3000 MFD | 35VDC | 3.25 |
| CF-8 | 100 MFD | 50VDC | .98 |
| CF-19 | 500 MFD | 50VDC | 1.95 |
| CF-16 | 2000 MFD | 50VDC | 3.25 |
| CF-21 | 1200 MFD | 90VDC | 3.25 |
| CF-9 | 200 MFD | 150VDC | 1.69 |
| CF-10 | 500 MFD | 200VDC | 3.25 |
| CF-12 | 125 MFD | 350VDC | 2.49 |

RECTIFIER TRANSFORMERS

All Primaries 115VAC 50/60 Cycles

| Type # | Volts | Amps. | Price |
|----------|--------|-------|--------|
| XF15-12 | 15 | 12 | \$3.95 |
| TXF36-2 | 36 | 2 | 3.95 |
| TXF36-5 | 36 | 5 | 4.95 |
| TXF36-10 | 36 | 10 | 7.95 |
| TXF36-15 | 36 | 15 | 11.95 |
| TXF36-20 | 36 | 20 | 17.95 |
| XFC18-14 | 18 VCT | 14 | 5.95 |

All TXF Types are Tapped to Deliver 32, 34, 36 Volts. XFC type is tapped to deliver 16, 17, 18 Volts Center-Tapped.

RECTIFIER CHOKES

| Type | Inductance | Amps. | Price |
|-------|------------|-------|--------|
| HY5 | .02 Hy | 5 | \$3.25 |
| HY8X5 | .02 Hy | 8.5 | 7.95 |
| HY10 | .02 Hy | 10 | 9.95 |
| HY12 | .02 Hy | 12 | 12.95 |
| HY15 | .015 Hy | 15 | 13.95 |

RECTIFIER SURGE PROTECTION

When an inductive DC circuit is opened, a high voltage surge is produced that may damage a rectifier power supply. This danger can be reduced by the application of a non-linear resistance device known as Thyrite. Further information will be found in catalog #719.

RECTIFIER MOUNTING BRACKETS

For Types B1 through B6, and Type C1.....\$.35 per set
 For Types B13......70 per set
 For Types 3B.....1.05 per set

RECTIFIER KIT #612-10

6 and 12 VDC at 10 Amps.

This unit will deliver unfiltered direct current for operation of motors, dynamos, solenoids, electroplating, battery charging and similar equipment.

The following components are supplied:

- 1 ea. Full Wave Bridge Rectifier
- 1 pr. Rectifier Mounting Brackets
- 1 ea. Transformer 115 VAC 50/60 CPS
- 3 ea. Silver-Plated Binding Posts
- 1 ea. 4-position Tap-Switch
- 1 ea. Fuse and Fuse Holder
- 1 ea. Line Cord and Plug
- 1 ea. Pilot Light Assembly and Bulb

The primary of the transformer is multi-tapped permitting adjustment of the DC output voltages.

Complete with schematic diagram; shpg. wt., 12 lbs. \$15.95

Filter Kits For #612-10

- 1 Section choke input, 10% ripple...\$ 9.64
- 2 Section choke input, 2% ripple...19.28

WRITE FOR SELENIUM RECTIFIER CATALOG #719 ON COMPANY LETTERHEAD

OPAD-GREEN COMPANY

71 Warren St.
New York 7, N. Y.

Phone: BEekman 3-7385-6

RADAR TUBES

2J62 Magnetron
2914-3010 mc., 35 K.W. \$49.50
4C35 Thyatron \$22.50
7BP7 Cathode Ray \$7.50

MODEL AN/APA 10 PANORAMIC ADAPTER

Provides 4 Types of Presentation:

(1) Panoramic (2) Aural

(3) Oscillographic (4) Oscilloscopic

Designed for use with receiving equipment AN/ARR-7, AN/ARR-5, AN/APR-4, SCR-587 or any receiver with I.F. of 455kc, 5.2mc, or 30mc. With 21 tubes including 3" scope tube. Converted for operation on 115 V. 60 cycle source. Includes 80 page T. M. \$195.00

AN/APA-10 POWER SUPPLY



Input:
80 or 115 volts,
400 to 2600 cycles

Output:

1200 volts D.C. at 1.5 MA.
400 volts D.C. at 150 MA.
6.4 A.C. volts at 0.8A (ins. for 1500 v. D.C.)
Includes tubes: 1-5B4GY, 1-2x2, 1-6AK5,
cathode ray tube socket, resistance capacitance
filter, two focus controls, an intensity control and
6AK5 reinsertor circuit. \$8.95
Brand new. Complete.

VOLTAGE REGULATOR CHASSIS AN/APA-10



Consists of 3 filter capacitors, choke, 2-7R150 tubes, etc. Can be used to regulate any 300 volt, power supply and provides 300 and 150 volt regulated taps. Complete as shown. Price \$4.95

NAVY MOTOR GENERATORS



Allis Chalmers 115V. D.C. to 120V. 60 cy., 1 Ph. 1.25 K.V.A., P.F., .80 Centrifugal starter. Fully enclosed.

New \$97.50

Same as above but for 230 V. D.C. input
O'Keefe and Merritt, 115V. D.C. to 120V. A.C., 50 cycles, 2 K.V.A., Pf. .9.

New \$165.00

Diehl 120V. D.C. to 120V. A.C., 60 cy., 1 Ph. 2.5 K.V.A. Complete with magnetic controller, 2 field rheostats and full set of spare parts including spare armatures for generator and motor.

New \$185.00

Electrolux Dynamotor 105/130 V. D.C. at 6 amps. to 26 or 13V. D.C. at 20 amps. or 40 amps. respectively. Fully filtered for radio use and complete with Square "D" lineswitch. Navy type CAJO 211444.

New \$74.50

MERCURY CONTACT RELAYS

WESTERN ELECTRIC

TYPE D-168479



These relays are glass sealed, mercury-wetted contact switches surrounded by operating coils and encased in metal housings, mounted on an octal tube base.

TYPICAL APPLICATIONS

- High speed keying
- Tabulating, sorting and computing machines
- Relay Amplifiers
- Vibrator Power Supplies
- Servo-mechanisms

CHARACTERISTICS

- High speed of operation
- Constant operating characteristics
- Freedom from chatter
- High current capacity
- Long, trouble-free service

Single Pole, Double Throw Contacts. Two coils of 700 ohms and 3300 ohms. Operating current with coils connected in series 6.6 ma. Release current 5.2 ma.

When operated under specified conditions this relay has a life expectancy of 1000 hours at 60 operations per second.

Overall length—3-3/8". Overall dia.—1-5/16"

Brand new
Priced at a fraction
of Government cost **\$4.75**

Send for 4 page Technical data

THERMOSTATIC TIME DELAY RELAY

Amperite type 115 No-45.



Heater voltage 115V. Normally open SPST contacts. 45 sec. delay. Contact rating 115V-3A., A.C. (or 440V., A.C. 2A.) max. voltage on contacts—1000. max voltage bet. contacts and heater—1500. Size 3 9/32 x 1 1/4" overall. Made for U. S. Navy.

New Surplus \$1.10

LINEAR SAWTOOTH POTENTIOMETER

W.E. No. KS 15138



Input 24 volts D.C. Output varies in accordance with linear sawtooth wave.

Brand New \$5.75

SELENIUM RECTIFIER

Bridge Type



Input: 36 V. AC
Output: 28 V. DC., 1.1 Amps.

Brand New .. \$2.75

STEPDOWN TRANSFORMERS

Input: 115 V. 60 cycles.
Output: 20 V., at 10 amps.
Also tapped at 6V., for pilot light. Ideal for Selenium Rectifier Applications, etc.



Brand New .. \$2.45

RELAY



Brand New

Clare octal base Relay
No. 30FMX 115V. 60
cy. 0.140 amp. Res. 75
ohms. Makes two breaks
one. \$2.45

SHOCK MOUNTS

Lord #20, 3" x 3" x 13/4"30
U. S. Rubber #5150 C, 2 1/2" x 2 1/2" x 1 1/8"20
Lord 15, 2 1/4" x 2 1/4" x 1 1/8"20
Lord #10, 1 1/4" x 1 1/4" x 5/8"10
Lord #3, 1 1/4" x 1 1/4" x 3/8"10

PARABOLOIDS

17 1/2" diameter, spun magnesium dishes, 4 inches deep. Reinforced perimeter. Two sets of mounting brackets on rear. Opening at apex for waveguide dipole assembly 1 1/2" x 1 1/2".

Brand new, per pair, \$8.75

SOUND POWERED FIELD SETS

TYPE TP-3



No batteries needed. Brand new in Water-proof fabric carrying case with strap.

Per Unit \$29.50

Per Pair 55.00

W. E. CRYSTAL UNITS TYPE CR-1A/R

Available in quantity—following frequencies
5910 - 6350 - 6370 - 6470 - 6510 - 6610
6670 - 6690 - 6940 - 7270 - 7350 - 7380
7390 - 7480 - 7580 - 9720 - Kilocycles

Brand New \$1.00 each

25,000 Volt Inerteen Filled 1/2 MFD. Type FP CAPACITORS



Brand New .. \$23.50

Shipping weight 35 lbs.

SYNCHROS in Stock

Navy Types, 5F, 5DG, 5SF, 5SDG, 6DG

Prices on request

WESTERN ELECTRIC

Type O # D173312

SOUND POWERED CHEST SETS

No Batteries Required

Ideal for television installers, or any antenna measurement work. Leaves hands free to make adjustments. Consists of microphone and headset as illustrated.

Brand New

Each \$19.50

RADAR COMPONENTS

CRP-23AGC Load Dividers for use with S.G. Modernization Kits. New.

CBM-50AFO Navy type Radar Repeater Adapters. New and complete with 14 tubes, coax fittings, installation plans and wiring diagrams.

SO Series Radar P.P.I. Units and accessory Control Panels. New.

Syncho Amplifiers. New.

Type CARD 23AEK Bearing Control Units. New.

Type T.D.Y., SO-1, SO-13, SO-3 Radar Antenna Assemblies. New.

Radar Crystals Raytheon 98.35 KC.

Type SO-11 Radar Modulator.

Type SO-1 and SO-13 Transmitter Receivers.

All prices indicated are F O B Tuckahoe, New York. Shipments will be made via Railway Express unless other instructions issued.

ELECTRONICRAFT

INC.

5 WAVERLY PLACE TUCKAHOE 7, N. Y.
PHONE: TUCKAHOE 3-0044

All merchandise guaranteed. Immediate delivery, subject to prior sale.

All Prices Subject to Change Without Notice

A.C. VOLTMETERS

| | |
|--|--------|
| 0-15 G.E. AW-41, 2" R-B bl sc, Signal Corps IS-122 | \$2.50 |
| 0-15 G.E. AO-22, 3" R-B bl sc | \$3.00 |
| 0-15 Weston 476, 3" R-B | \$4.50 |
| 0-15 W.H. NA-35, 3" R-B | \$3.95 |
| 0-40 Weston 517, 2" R-M 400 cycle | \$3.50 |
| 0-40 W.H. NA-33, 2" R-B 400 cycle | \$3.50 |
| 0-75 Weston 517, 2" R-M ring mid | \$2.95 |
| 0-150 Triplett 332-JP, 3" R-M | \$4.00 |
| 0-150 Triplett 331-JP, 3" R-B | \$4.50 |
| 0-150 Triplett 331-JP, 3" R-B W/Resistor for 300 volts | \$5.50 |
| 0-300 Triplett 232-C, 2" R-M | \$6.00 |
| 0-300 Burlington 22A, 2" R-M | \$6.00 |

A.C. VOLTMETERS

| | |
|---------------------------------------|--------|
| 0-120 MASimpson 25, 3" R-B | \$7.50 |
| 0-1 G.E. DW-44, 2" R-B bl sc | \$2.95 |
| 0-1 G.E. DW-44, 2" R-B | \$3.50 |
| 0-1 G.E. DW-52, 2" R-B | \$3.00 |
| 0-1.5 G.E. DW-52, 2" R-M bl sc | \$2.95 |
| 0-1.5 Weston 507, 2" R-M bl sc | \$2.50 |
| 0-1.5 Weston 425, 3" R-B | \$8.25 |
| 0-2 Simpson 135, 2" R-B | \$3.50 |
| 0-2 Weston 425, 3" R-B | \$8.50 |
| 0-2.5 Weston 507, 2" R-B 400 cycle | \$3.95 |
| 0-2.5 McClintock, 3" R-B S.C. #IS-111 | \$4.50 |
| 0-2.5 Simpson 35, 3" R-B | \$8.50 |
| 0-2.5 Weston 425, 3" R-B | \$8.50 |
| 0-2.5 W.H. NT-35, 3" R-B | \$5.50 |
| 0-3 W.H. NT-35, 3" R-B | \$5.50 |
| 0-3 Weston 425, 3" R-B | \$8.50 |
| 0-3 Weston 425, 3" R-B W/Ext couple | \$9.50 |
| 0-5 G.E. DO-44, 3" R-B W/Ext couple | \$8.50 |
| 0-5 G.E. DO-44, 3" R-B | \$7.50 |
| 0-6 G.E. DW-44, 2" R-B bl sc | \$2.50 |

A.C. AMMETERS

| | |
|---|--------|
| 0-30 Triplett 331-JP, 3" R-B | \$4.00 |
| 0-30 Triplett 332-JP, 3" R-B | \$3.50 |
| 0-50 G.E. AO-22, 3" R-B | \$4.50 |
| 0-50 W.H. NA-35, 3" R-B | \$4.50 |
| 0-60/120 Burl 32XC, 3" R-B W/Ext Transformer | \$7.50 |
| 0-60/120 Burl 32XC, 3" R-B without ext Transformer | \$4.50 |
| 0-150 G.E. AO-22, 3" R-B 5 Amp mvt, with ext Trans. | \$7.50 |

D.C. MICROAMMETER

| | |
|--|--------|
| 0-200 W.H. NX-35, 3" R-B MR 35 W 200 DC IA | \$8.50 |
| 0-500 De Jur Amsec, 2" R-B | \$3.00 |
| 0-500 Simpson 6103, 2" R-B | \$3.50 |
| 0-500 Triplett 0221-T, 2" R-B | \$3.50 |

D.C. MILLIAMMETERS

| | |
|---|--------|
| 0-1 G.E. DO-41, 3" R-B | \$5.50 |
| 0-1 W.H. NX-35, 3" R-B MR 35 W 00 1 DC MA | \$7.50 |
| 0-3 Gruen GW-580, 2" R-B | \$3.50 |
| 5-0-5 W.E. 3" R-B Concentric style | \$3.00 |
| 0-15 Simpson 26, 3" R-B | \$4.50 |
| 0-20 G.E. DW-55, 2" R-B Black Scale | \$3.00 |
| 0-30 G.E. DO-41, 3" R-B | \$3.50 |
| 0-80 G.E. DO-41, 3" R-B | \$3.75 |
| 0-150 Gruen 506, 2" R-B | \$3.00 |
| 0-500 W.H. NX-33 2" R-B | \$3.95 |

D.C. AMMETERS

| | |
|--|--------|
| 0-2 Simpson 25, 3" R-B | \$4.00 |
| 0-5 Gruen 53, 2" R-B | \$3.50 |
| 0-15 Sun AP-381, 3" R-B | \$3.50 |
| 0-15 Triplett 6321-T, 3" R-B | \$4.00 |
| 0-30 Hoyt 123, 2" R-M | \$2.50 |
| 30-0-30 Beede, 2" R-M | \$2.95 |
| 30-0-30 G.E. DW-51, 2" R-M | \$3.50 |
| 0-150 Simpson 425, 3" R-M with shunt | \$5.50 |
| 0-200 Weston 506, 2" R-B with shunt | \$7.50 |
| 200-0-200 Weston 506, 2" S-B W/Ext 50 M.V. shunt | \$7.50 |
| 0-300 G.E. DW-51, 2" R-B with shunt | \$7.50 |
| 0-500 G.E. DW-51, 2" R-B less shunt | \$3.50 |

D.C. VOLTMETERS

| | |
|--|--------|
| 0-3 Simpson 125, 2" R-M ring mid | \$2.00 |
| 0-5 W.H. NX-33, 2" R-B 200 r/v | \$3.50 |
| 0-10 Sun 2AP458, 2" R-B 100 r/v | \$2.50 |
| 0-15 McClintock D-100-R-1, 2" R-B black scale 1000 r/v | \$3.00 |
| 0-30 DeJur Amsec 210, 2" R-B | \$2.50 |
| 0-30 G.E. DW-41, 2" R-B 250 r/v | \$2.95 |
| 0-150 Weston 301, 3" R-B Surf mid 200 r/v | \$4.50 |
| 0-150 G.E. DW-51, 2" R-B Special scale | \$3.95 |
| 0-500 Sun, 3" R-B MR35W500DCVV | \$7.00 |
| 0-1.5 KV W.H. NX-35, 3" R-B 1 MA mvt, with resistor | \$7.50 |

FREQUENCY METER, 55 to 65 cycles, James Biddle Co., type MF-11. Fralin vibrating reed type, 11 reeds, 100 to 150 volt operation, 3 1/2" round flush bakelite case. \$7.50

FREQUENCY METER, JBT 30-F. Dual Range covers frequency ranges from 48-52 cycles and 58-62 cycles; Dual element, vibrating reed type, 115 volt, 3 1/2" rd flush metal case. \$5.95

FREQUENCY METER, Range 350 to 450 cycles, 115 volt A.C. Iron core dynamometer type movement, 5 cycles per scale division, black scale luminous markings, Weston Model 637 3 1/2" Aircraft style. \$4.95

DECIBEL METER, Weston 301 type 61, minus 10 to plus 6, 3 1/2" rd fl bake case, 6 MW 600 ohms, Zero DB equals 1.9 volt. High speed type 29-35 Seconds to final reading. Only 2-6% overthrow, 5000 ohms at Zero DB, 16-50 Damping factor. Complete with external wire wound precision resistors to extend the range to any or all of the following ranges:

- 20 to plus 16 DB
- 30 to plus 26 DB
- 40 to plus 36 DB

Ideal for sound and broadcasting applications. Total List Price \$37.50 Your Cost Only \$11.50

DECIBEL METER, Weston 506, minus 10 to plus 6 DB 2 1/4" round flush bakelite case, Black scale, luminous markings. \$4.50

SIGNAL STRENGTH ("S") METER, 5 M.A. 6 ohms Zero right movement. Scale calibrated minus 6 to plus 100 DB above 1 microvolt, illuminated scale. \$4.50

PORTABLE A.C. AMMETER 0-3 and 0-15 Amps A.C., Weston Model 528. Complete with leather carrying case and test leads. \$12.50

PORTABLE D.C. MILLIAMMETER, Dual Range, 0-25 and 0-250 M.A., Weston Model 264, mounted on vertical stand with test cord, Scale approximately 4 1/4" long. \$9.00

PORTABLE D.C. VOLTMETER, 0-10 Volts, Weston Model 489, 125 ohms per volt, similar to Model 528 meters. \$9.50

COMBINATION OFFER

30 Amp A.C. Meter—150 Volt A.C. Meter—Triplett 331-JP 3" rd fl bake case.

BOTH METERS FOR \$7.95

BC-1161-A RADIO RECEIVER

150 to 210 Megacycles. Operates off 115 volt 60 cycle Power supply. Inductance tuning for R. F. Antenna detector and oscillator. With a few modifications this unit makes an ideal F.M. Receiver. Each set complete with circuit diagram and the following tubes: 1-6SN7 Cathode Follower; 1-6H6 second Detector; 2-6SH7 1st and 2nd I.F. Amp; 1-6SH7 Video Amp; 3-6AC1/1852 1st, 2nd, 3rd IF Amp; 2-6AB7/1853 4th, 5th IF Amp; 1-9006 Mod.; 1-6J5 Osc.; 1-5U4G Rect.; 1-6E5 Tuning Indicator.

Complete in a metal cabinet 10" high 16 1/2" wide and 15" deep \$34.50

BC-1160-A TRANSMITTER

157 to 187 Megacycles. Operates off 117 volt 60 cycle. Contains 115 volt, 1525 R.P.M. Blower. General Radio 200 B 1.5 Amp. Variac 10 tubes, 0-5 Kilovolt 3 1/2" meter transformers, relays, circuit breakers to numerous to list. Complete in metal cabinet 17 1/2" x 18 1/2" x 18" with circuit diagram \$29.50

THERMAL CIRCUIT BREAKER, D.P.S.T. 15 Amp, 120 volt A.C., Curve D. Heineman #0322 \$1.50

TERMINAL BOARD with barrier strips, 6 Terminals with 2 connection points each 4 1/2" long x 2" w x 1 1/2" H, minimum order 10 pieces 5.60 each

STRIP HEATERS, 50 Watt, 115 volt, 250 ohms, 1 1/2" x 1/2" x 6" G.E. Catalog #2A301, minimum order 10 pieces \$6.00 each

GENERATOR VOLTAGE REGULATOR, Eclipse Pioneer Dwg #1317-2-A sets at 117 volt, Carbon pile regulator complete with selenium rectifier unit \$4.50

CARBON PILE D.C. VOLTAGE REGULATOR, 20 Amps max, 110 load volts max, 140 line volts max, Mfd. by Safety Car Heating & Lighting Co. Catalog No. 29540, Type S700 E—16 1/16" W x 16 3/8" H x 10" D \$65.00

A.C.-D.C. VOLTMETER



WESTON 341

0-150 Volts, Electrodynamometer type, 1/4 of 1% Accuracy on D.C. AND A.C. FROM 25 to 1200 CYCLES. Indicates true r m s voltage. Shielded movement, 3.9 V.A. power consumption. Complete in mahogany carrying case with cover. Even though these instruments are Brand New Surplus, we had Weston check each and every unit and furnish a NEW Certificate to guarantee the accuracy of each instrument. Ideal for use in conjunction with Model 311 Potential Transformer to extend the range to 750 & 1500 volts.

New in original manufacturers boxes. List Price \$226.50 Your Cost Only \$115.00

PORTABLE TACHOMETERS

0-2000 RPM Range, Jaeger #43 A-6 Chronometric type \$24.50

300-1200, 1000-4000, 3000-12000 RPM, Jones Motorola Co., Multiple Range, Continuous Indicating \$24.50

300-1500, 1000-5000, 3000-15000 RPM, Jones Motorola Co., Multiple Range, Continuous Indicating \$25.50

GASOLINE HEATER—MOTOROLA MODEL GN-3-24

An internal combustion type heater which will give 15,000 B.T.U. of heat per hour. Ideally suited for use with equipment, farms, boats, bungalows, cabins, trailers, work sheds, darkrooms, mobile equipment, transmitter stations, etc., and any place where a quick heat is required in volume.

Very economical in operation—tank holds one gallon of gasoline which is sufficient for 6 hours operation. Uses any grade gasoline.

This unit is designed primarily for aircraft installation, 24-28 volts d.c., but it can be readily adapted for a 115 or 230 volt 60 cycle power supply by use of a transformer and rectifier. Simple circuit diagram for adaptation to 115 or 230 volts 60 cycle use supplied with each unit. Can be used on 32 volt farm or boat systems as is without the installation of additional transformers, etc. Power consumption approximately 75 to 100 watts.

Approximately 12" long x 9 1/4" high x 9 1/4" wide. Complete with technical manual and parts list. Made by Galvin (Motorola) Mfg. Co.

Your Cost Only \$22.50

BOWL INSULATORS

Clear Glass, Corning Glass Works No. 67076, Type C (Comprises flanged bowl, 4 3/8" h x 6 15/16" O. D. at base. Center lead-in pin 3/8" dia. Overall dia. 8 3/4". All brass fittings.

S. C. Stock #3G-1830-67076.1 \$6.00

ALL ITEMS ARE BRAND NEW-SURPLUS-GUARANTEED UNLESS SPECIFIED OTHERWISE. Orders accepted from rated concerns, public institutions & agencies on open account, others please send 25% deposit, balance C.O.D. or check with order. All prices FOB our warehouse, N.Y.C.

MARITIME SWITCHBOARD

338 CANAL STREET
NEW YORK, 13, N. Y.

Worth 4-8217

We carry a complete line of surplus new meters suitable for every requirement, such as portable, panel, switchboard, laboratory standard, etc.

Over 50,000 METERS in Stock

We carry a wide assortment of aircraft type electrical meters, precision tubular multipliers and meter shunts. Your inquiries will receive our prompt attention.



NEW YORK

ST. LOUIS

BROOKLYN

BOSTON

CLEVELAND

PHILADELPHIA

Phone-Digby 9-4154-5

"UHF" COAXIAL CABLE CONNECTORS

| No. | AN No. | Description | Price Each |
|---------|--------|------------------|------------|
| 83-1SP | PL259 | Plug | .35 |
| 83-1B8 | UG176U | Adapter | .15 |
| 83-1B5 | UG175U | Adapter | .15 |
| 83-1SPN | PL259A | Plug | .35 |
| 83-776 | UG203U | Plug | .61 |
| 83-1R | SO239 | Receptacle | .35 |
| 83-1RTY | | Receptacle | .50 |
| 83-1H | UG106U | Hood | .12 |
| 83-1HP | | Hood | .27 |
| 83-765 | UG177U | Hood | .31 |
| 83-1AC | | Cap and chain | .61 |
| 83-1BC | | Cap and chain | .38 |
| 83-1T | M358 | "T" connector | 1.12 |
| 83-1AP | M359A | Angle adapter | .35 |
| 83-1J | PL258 | Junction | .85 |
| 83-1F | PL274 | Feed thru | 1.12 |
| 83-22SP | UG102U | Twin plug | .50 |
| 83-22R | UG103U | Twin recept. | .50 |
| 83-22AP | UG104U | Twin ang. adapt. | .98 |
| 83-22J | UG105U | Twin junction | 1.25 |
| 83-22T | UG196U | Twin "T" | 1.65 |
| 83-22F | PL275 | Twin feed thru | 1.50 |

UG TYPE CONNECTORS

| AN No. | Price ea. | AN No. | Price ea. |
|--------|-----------|---------|-----------|
| UG 9/U | 1.56 | UG96AU | 51.45 |
| UG10/U | 1.45 | UG97/U | 3.50 |
| UG11/U | 1.45 | UG98/U | 1.55 |
| UG12/U | .95 | UG100/U | 2.34 |
| UG13/U | 1.56 | UG101/U | 2.95 |
| UG14/U | 1.45 | UG107/U | 2.25 |
| UG15/U | .95 | UG108/U | 1.75 |
| UG16/U | 1.56 | UG109/U | 1.75 |
| UG17/U | 1.45 | UG114/U | 1.50 |
| UG18/U | .99 | UG115/U | 1.33 |
| UG18AU | 1.05 | UG123/U | .45 |
| UG19BU | 1.09 | UG131/U | 6.00 |
| UG19U | 1.28 | UG146/U | 2.25 |
| UG19AU | 1.38 | UG155/U | 2.40 |
| UG19BU | 1.45 | UG154/U | 5.35 |
| UG20/U | 1.17 | UG156/U | 4.25 |
| UG20AU | 1.26 | UG157/U | 4.25 |
| UG20BU | 1.41 | UG160/U | 1.90 |
| UG21/U | .99 | UG160AU | 1.59 |
| UG21AU | 1.05 | UG167/U | 3.00 |
| UG21BU | 1.09 | UG173/U | .30 |
| UG22/U | 1.08 | UG174/U | 16.00 |
| UG22AU | 1.38 | UG188/U | .95 |
| UG22BU | 1.34 | UG195/U | 5.00 |
| UG23/U | .99 | UG212/U | 4.50 |
| UG23AU | 1.26 | UG201/U | 1.83 |
| UG23BU | 1.29 | UG202/U | 2.75 |
| UG27AU | 2.25 | UG204/U | 2.25 |
| UG28/U | 2.34 | UG206/U | 1.02 |
| UG29/U | 1.22 | UG208/U | 28.00 |
| UG29AU | 1.36 | UG212/U | 4.50 |
| UG30/U | 1.75 | UG213/U | 4.50 |
| UG32/U | 20.00 | UG215/U | 3.35 |
| UG33/U | 20.00 | UG216/U | 8.70 |
| UG34/U | 17.50 | UG217/U | 3.10 |
| UG35AU | 16.00 | UG218/U | 6.50 |
| UG36/U | 16.00 | UG222/U | 35.00 |
| UG37/U | 16.00 | UG231/U | 2.00 |
| UG37AU | 16.00 | UG235/U | 28.50 |
| UG57/U | .99 | UG236/U | 11.75 |
| UG58/U | .65 | UG241/U | 2.20 |
| UG59/U | 2.75 | UG242/U | 2.50 |
| UG60/U | 1.70 | UG243/U | 2.75 |
| UG60AU | 1.90 | UG244/U | 2.50 |
| UG61/U | 2.05 | UG245/U | 1.25 |
| UG61AU | 1.80 | UG246/U | 1.45 |
| UG62/U | 28.00 | UG252/U | 4.50 |
| UG63/U | 1.50 | UG254/U | 1.82 |
| UG85/U | 1.65 | UG255/U | 1.85 |
| UG86/U | 1.69 | UG259/U | 4.10 |
| UG87/U | 1.40 | UG260/U | .99 |
| UG88/U | 1.17 | UG261/U | .95 |
| UG89/U | .95 | UG262/U | 1.05 |
| UG90/U | 1.05 | UG269/U | 2.60 |
| UG91/U | 1.25 | UG270/U | 6.50 |
| UG91AU | 1.05 | UG273/U | 1.50 |
| UG92/U | 1.10 | UG274/U | 1.98 |
| UG92AU | 1.35 | UG277/U | 2.40 |
| UG93/U | 1.25 | UG287/U | 5.25 |
| UG94/U | 1.45 | UG290/U | 2.75 |
| UG94U | 1.25 | UG291/U | 1.05 |
| UG94AU | 1.05 | UG306/U | 2.03 |
| UG95/U | 1.10 | UG333/U | 4.70 |
| UG95AU | 1.35 | UG334/U | 5.75 |
| UG96/U | 1.25 | UG352/U | 6.00 |

ALLEN BRADLEY POTENTIOMETERS

No better pot at any price, no source more complete than Life Electronic Sales.

Available in screw-driver and regular shafts locking and non-locking type bushings.

When ordering locking type bushing potentiometers, locking nuts are available at \$.05 each.

Allen Bradley type "L" pots available in the following values from stock.

Specify whether regular or screwdriver shaft is required.

| Single Pots Ohms | Dual Pots. | | | | |
|------------------|------------|-------|--------|--------|--------|
| | 50 | 100 | 10000 | 60000 | 3000 |
| 50 | 100 | 10000 | 60000 | 3000 | 10000 |
| 150 | 1500 | 20000 | 100000 | 25000 | 20000 |
| 200 | 2000 | 22000 | 200000 | 50000 | 50000 |
| 250 | 2500 | 25000 | 250000 | 100000 | 100000 |
| 400 | 3000 | 30000 | 500000 | 500000 | 500000 |
| 500 | 5000 | 50000 | 600000 | 1 Meg. | 1 Meg. |
| 600 | 6500 | 50000 | 1 Meg. | 5 Meg. | 5 Meg. |

Price each
Single Pots \$.50 Dual Pots \$1.50

RESISTORS

| Ohms | Ohms | Ohms | Ohms | Megs | Megs | Megs |
|------|------|------|-------|------|------|------|
| 10 | 100 | 1000 | 10000 | 0.1 | 1.0 | 10.0 |
| 11 | 110 | 1100 | 11000 | 0.11 | 1.1 | 11.0 |
| 12 | 120 | 1200 | 12000 | 0.12 | 1.2 | 12.0 |
| 13 | 130 | 1300 | 13000 | 0.13 | 1.3 | 13.0 |
| 15 | 150 | 1500 | 15000 | 0.15 | 1.5 | 15.0 |
| 16 | 160 | 1600 | 16000 | 0.16 | 1.6 | 16.0 |
| 18 | 180 | 1800 | 18000 | 0.18 | 1.8 | 18.0 |
| 20 | 200 | 2000 | 20000 | 0.20 | 2.2 | 20.0 |
| 22 | 220 | 2200 | 22000 | 0.22 | 2.2 | 22.0 |
| 24 | 240 | 2400 | 24000 | 0.24 | 2.4 | 24.0 |
| 27 | 270 | 2700 | 27000 | 0.27 | 2.7 | 27.0 |
| 30 | 300 | 3000 | 30000 | 0.30 | 3.0 | 30.0 |
| 33 | 330 | 3300 | 33000 | 0.33 | 3.3 | 33.0 |
| 36 | 360 | 3600 | 36000 | 0.36 | 3.6 | 36.0 |
| 39 | 390 | 3900 | 39000 | 0.39 | 3.9 | 39.0 |
| 43 | 430 | 4300 | 43000 | 0.43 | 4.3 | 43.0 |
| 47 | 470 | 4700 | 47000 | 0.47 | 4.7 | 47.0 |
| 51 | 510 | 5100 | 51000 | 0.51 | 5.1 | 51.0 |
| 56 | 560 | 5600 | 56000 | 0.56 | 5.6 | 56.0 |
| 62 | 620 | 6200 | 62000 | 0.62 | 6.2 | 62.0 |
| 68 | 680 | 6800 | 68000 | 0.68 | 6.8 | 68.0 |
| 75 | 750 | 7500 | 75000 | 0.75 | 7.5 | 75.0 |
| 82 | 820 | 8200 | 82000 | 0.82 | 8.2 | 82.0 |
| 91 | 910 | 9100 | 91000 | 0.91 | 9.1 | 91.0 |

Life Electronic Sales is the leading source of "hard to get" industrial electronic components, has available from stock a complete line of standard brand 1/4, 1 and 2 Watt resistors in 5% and 10% tolerances. These resistors meet the following Jan specs:

| RC20-1/2 Watt | RC30-1 Watt | RC40-2 Watt | 100 or more |
|------------------|---------------|---------------|---------------|
| 1/2 Watt 10% .06 | 1 Watt 5% .12 | 2 Watt 5% .18 | 5 Watt 5% .30 |

Prices shown are "Per Value"

CRYSTAL DIODES SILICON DIODES

| Type | Design Freq. (mc) | Max. Conv. Loss (db) | Max. Output Noise Ratio | Burnout Test | I. F. Imp. (ohms) | Price each |
|-------|-------------------|----------------------|-------------------------|-------------------------|-------------------|------------|
| IN21 | 3,000 | 8.5 | 4.0 | B _s =0.3 erg | 200-800 | \$.50 |
| IN21B | 3,000 | 6.5 | 3.0 | B _s =2.0 erg | 200-800 | 1.00 |
| IN23 | 10,000 | 10.0 | 3.0 | B _s =0.3 erg | 150-600 | 1.25 |
| IN23A | 10,000 | 8.0 | 2.7 | B _s =1.0 erg | 150-600 | 1.50 |
| IN23B | 10,000 | 6.5 | 2.7 | B _s =0.3 erg | 150-600 | 2.00 |

GERMANIUM DIODES

| Type | Cont. Reverse Working Voltage | Peak Back Volt- age* | Fwd. Curr. at + Iv (ma min.) | Av. Anode Current (ma max.) | Recurrent Peak Anode Current (µa max.) | Reverse Current (µa max.) | Price each |
|------|-------------------------------|----------------------|------------------------------|-----------------------------|--|---------------------------|------------|
| IN34 | 60v max. | 75v min. | 5.0 | 40 | 150 | 50 @ -10v 800 @ -50v | \$.85 |
| IN35 | 50v max. | 75v min. | 7.5 | 22.5 | 60 | 10 @ -10v | 2.00 |

COAXIAL CABLES

| RG No. | Impedance | Price per Thousand Ft. | RG No. | Impedance | Price per Thousand Ft. |
|--------|------------|------------------------|--------|-----------|------------------------|
| RG5U | 52.5 ohms | \$70.00 | RG25U | 48.0 ohms | \$75.00 |
| RG6U | 76.0 ohms | 150.00 | RG27U | 48.0 ohms | 290.00 |
| RG7U | 97.5 ohms | 70.00 | RG29U | 53.5 ohms | 50.00 |
| RG8U | 52.0 ohms | 55.00 | RG34U | 71.0 ohms | 175.00 |
| RG9U | 51.0 ohms | 135.00 | RG39U | 72.5 ohms | 180.00 |
| RG9AU | 51.0 ohms | 125.00 | RG41U | 67.5 ohms | 575.00 |
| RG10U | 52.0 ohms | 125.00 | RG54U | 58.0 ohms | 65.00 |
| RG11U | 75.0 ohms | 100.00 | RG57U | 95.0 ohms | 100.00 |
| RG12U | 75.0 ohms | 190.00 | RG58U | 53.5 ohms | 50.00 |
| RG13U | 75.0 ohms | 450.00 | RG59U | 73.0 ohms | 45.00 |
| RG18U | 52.0 ohms | 350.00 | RG62U | 93.0 ohms | 50.00 |
| RG19U | 52.0 ohms | 450.00 | RG71U | 93.0 ohms | 175.00 |
| RG20U | 52.0 ohms | 120.00 | RG74U | 52.0 ohms | 250.00 |
| RG22U | 95.0 ohms | 450.00 | | | |
| RG24U | 125.0 ohms | \$240.00 | | | |

Prices based on a minimum quantity of 500 ft. For cut lengths add 50% to prices shown.

← CALL

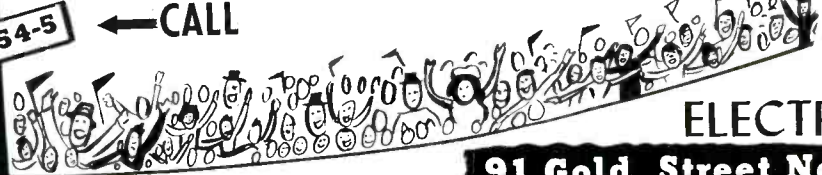

LIFE ELECTRONIC SALES
91 Gold Street New York 7, N.Y.

Send for FREE bulletin J-700

IMMEDIATE DELIVERY

• LOW PRICES •

FULLY GUARANTEED

REMOTE INDICATING

Compass System

Type AN5730-2 Indicator and AN5730-3 Transmitter 26 volts, 400 cycle.

Stock =S-22
Special Price \$6.95 each

SPECIAL

Pioneer Compass System with 12 V. D-C Inverter, all cables, waterproof housing, ETC. Ready for Marine Installation. Price \$19.50 Stock #SA-174

D. C. MOTORS

DELCO CONSTANT SPEED MOTOR A-7155

1/30 hp. 3600 rpm. Cont. duty. 2 1/2" diam. x 5 1/2" lg. 3/8" shaft extension. 5/32" diam. 4 hole base mounting. Stock #SA-94. Price 4.75 each.

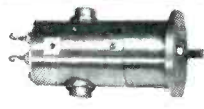
12V D. C. Motor John Oster B-9-2
1.4 amps.
5600 rpm.

1 1/4" Diam. x 3 3/4" Lg. Spline shaft. C. W. rotation. Stock #SA-46. Price \$1.95 each.



General Electric 2 RPM Motor. Type 5BA10FJ228. 27 v. D-C @ 0.6 amps. 10 lb/in torque at 2 rpm. Shunt wound. I-C noise filter. Stock #SA-272. Price 6.75 each.

General Electric 1/2 HP D-C Motor. Type 5BA50LJ66. Armature voltage 60 v. max. field 27 v. Armature current 9.25 amps. field 2.3 amps. 4600 rpm. 7" lg. x 4 1/2" diam. with 3 1/2" worm gear shaft 5/8" diam. Stock #SA-270. Price \$8.50 each.

Universal Electric DC
W.E. KS-5603-L-02, 28 v. DC
0.6 amps. 1/100 hp. 4 lead
shunt. Stock #SA-233.
Price \$1.95 ea. plus 15¢ p.p.

SERVO MOTORS

Pioneer Type CK-2.

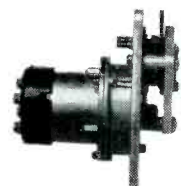
26 v. 400 cycles fixed phase, var. phase 49 v. max. 1.05 in/oz. Stall torque. Rotor moment of inertia 7 gm/cm². With 40:1 gear reduction.

Stock #SA-97A. Price \$6.50 each. Also available less gear train as Stock #SA-97. Price 4.25 each.

BLOWER ASSEMBLY

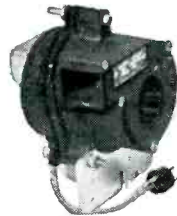

WESTINGHOUSE FL BLOWER

115 v. 400cy. 17 c.f.m. Includes capacitor. Stock #SA-144. Price \$3.75 each.

MINIATURE DC SELSYN



INDICATOR

Miniature indicator. 24 v. d-c operation. Use with G.E. Position Transmitter or with Ohmite 360° type potentiometer. Has iron

plug for zero dial adjustment. Stock #SA-248. Price \$6.75 each.

INVERTER SPECIALS

General Electric PE-218 D—Input 28 v. d-c @ 92 amps. Output 115 v. 400 cycles @ 1500 va. Power factor 0.90. Shipping wt. 100 lbs. New—Original Cartons. Stock #SA-112. Price \$29.50 each.

Leland or Russel PE-218 E or PE-20.5H. Similar to PE-218D. Stock #SA-112A. Special Price \$19.50 each.

800 Cycle Inverter—Navy Type CRV-21AAR. G.E. 5AS121LJ2. Input 27 v. d-c @ 45 amps. Output 120 v. 800 cycles @ 750 va. Power factor 0.90. Net. wt. 22.5 lbs. Stock #SA-192. Price \$39.50 each.



G. E. 5D 21NJ3A.

Input 24 V. D-C.
Output 115 V. 400 cycles 3/4 485 V.A.

New in Original Cartons Stock #SA-41 Price \$9.95 each.

DC SERVO MOTORS

C-1 Autopilot Servo Unit—28 v. DC Shunt motor. 2550 rpm. 2 magnetic clutches, reduction gear, differential and 2 magnetic brakes. Output shaft 15 rpm. Torque 225 in/lbs. Stock #SA-180. Price \$19.50 each

Elinco B-61 DC Servo Unit—80 v. DC max. armature voltage. 27.5 v. field. 1/165 h.p. 3100 rpm. Field current 200 ma. Armature current 200 ma. at normal torque. Stock #SA-211. Price \$12.50 each

Synchro Cable—5 wire plastic jacket cable for synchro interconnection. Made especially for Servo-Tek. Price \$4.00 per 50 feet.

GYROS

Schwein Free & Rate Gyro type 45600. Consists of two 28 volt D. C. constant speed gyros. Size 8" x 4.25" x 4.25". Stock No. SA-146



Price \$8.75 each net.

Pioneer Type 12800-1-D Gyro Servo Unit. 115 volts, 400 cycle, 3 phase. Price \$6.95 each net.

ALSO IN STOCK

Sperry A5 Vertical Gyro. Part No. 644841, 115 volts, 400 cycle, 3 phase.

Sperry A5 Directional Gyro Part No. 656029, 115 volts, 400 cycle, 3 phase.

MICROWAVE ANTENNA

AS-217 APG 15B, 12 Cm dipole and 13 inch Parabola housed in weatherproof Radome 16" dia. 24 v. DC spinner motor for conic scan. Stock #SA-95. Shipping wt. 70 lbs.



Price \$6.95 ea.



Remote Position Indicating System



6-12 v. 60 cycles 5 inch indicator with 0 to 360 dial. Heavy duty transmitter. Stock #SA-115. Price \$9.95 per system

SELSYN SPECIAL



Type XXI 115 V. 60 cycle repeater. 2 1/2" diam. x 2 1/2" lg. Use as transmitter or repeater. Stock #SA-42. Price \$4.75 each

DC GENERATOR



Ford Instrument Co. Compound Wound. Bu. of Ordnance d.w.g. 223128. 115 v. d-c @ 0.75 amperes. Cont. duty. Ideal for laboratory use. Special low price \$2.95 ea. Stock #SA-258.

ELECTRONIC
DESIGNING & MANUFACTURING
FOR INDUSTRYPrices F.O.B. Paterson
Phone ARmory 4-3366
Teletype PAT. 199Servo-Tek
products co.

4 Godwin Ave. Paterson, N. J.

WRITE FOR LISTING

SPECIALISTS IN FRACTIONAL HORSE POWER MOTOR SPEED CONTROL

BE A "FORTY-NINER" IN '49

THE "FORTY-NINER" GEIGER COUNTER

- Light weight uranium detector.
- Detects beta and gamma rays.
- Equipped with 36 inch search probe.
- Contains two 67½ volt Minimax batteries in the well-known type of relaxation oscillator supply. Weight 4½ lbs. complete; size 4"x5"x6". Beautifully finished case with handle.

\$8950

Complete with four tubes, including Geiger tube, batteries, search probe and ear-phone.

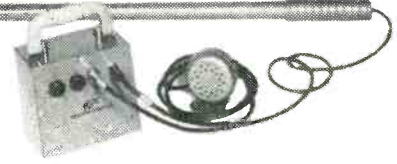

ALL-PURPOSE CHASSIS

Contains 3 plugs, 2 vol. controls, 1 25 wt. resistor 2600 ohms, 250,000 ohms 10 wt. resistors, 13,500 ohms, 10 wt. resistors, 3 ½ mmfids, 3 bath-tub condensers 600V, 3 sockets, 4 shock mounts and many other parts in a blank top chassis.



95c



304TL 75¢

Just the tube for that 1KW final — typical operation 2500 volts at 400 MA. An ideal tube for that induction heater or dielectric heater. Efficient operation at 1500V. to 3000V.

TUBES

| | | | | | | | |
|------|--------|-------|-------|-------|-------|-------|--------|
| 815 | \$1.95 | VR150 | .69 | 9006 | .44 | RK60 | \$.95 |
| 3BP1 | 1.95 | 955 | .65 | 5035 | .89 | 1T4 | .44 |
| 5FP7 | .95 | 9002 | .44 | 35W4 | .69 | 3Q4 | .44 |
| 7BP7 | 1.49 | 12X3 | .44 | 872A | 1.95 | 3S4 | .44 |
| 9LP7 | 2.95 | 9004 | \$.44 | 1H5 | \$.69 | 1N5 | .69 |
| | | | | 3Q5 | .69 | VT25 | |
| | | | | 6L5GA | .95 | (210) | \$.44 |
| | | | | 5U4G | .44 | 5W4 | .44 |
| | | | | 6SA7 | .44 | 2X2 | .95 |

COAXIAL FITTINGS

| | | | |
|------|---------------------------|--------------------------|--------------------------------------|
| | | | |
| 5c | 25c | 35c | 20c |
| HOOD | SOCKET 50-239 83-1R | PLUG PL-259 83-1SP | ANGLE- ADAPTER M-359 83-1AD |



T-17 Carbon Mike
Like New **79c**



30 MC-1F Silver Slugg'd
35c

Exide Aircraft Battery

AN3151-24V 17AH at 5HR. rate. Brand new in original cartons.
Wt. 52 lbs. Filled **\$4950**



MICA CAPACITOR
.002 MFD 3000 MVDC **69c**



NEW BC 223 AX TRANSMITTER
901 Oscillators and 801 power amplifiers. 2-46 modulators and 1-46 speech amplifier. 4 Xtal frequencies and master oscillator on selector switch. 30 Watts output. Tone voice or C.W. Mod. Ideal for 1/2 meter band. Comes with 3 coils TU 17A 2000-3000 Kc. TU 25 3500-5250 Kc. Black crackle case. Includes two separate cases to store extra coils. Frequencies chart and tubes included, packed in original cases. Less crystals at this low price. **\$39.95**

TEST OSCILLATOR

12 or 24 V DC. Vibrators, switches and many other parts used in 2A Equipment. **95c**

A-5 AUTOMATIC PILOT
Servel—100 pounds max. to use as a steering device, or compass control on ships. **\$9.95**

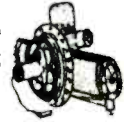

CD501A

Cord and plug set used with BC654 between PE 103 Dynamotor and Transmitter. **\$1.95**



Butterfly Condensers
Oscillator assembly 76 to 300 MC with acorn tube socket mounted on condenser \$3.95
Type B Frequency range 300-1000 megacycles 2.95
BC4 Antenna condenser 105-330 MC. 3.95
Oscillator 105-330 M.C. 3.95

INDUSTRIAL PAPER OIL CAPACITATORS

| | |
|----------------|---------------|
| 1. MFD 5000 V. | \$2.95 |
| 1. MFD 6000 V. | \$4.95 |
| 2. MFD 6000 V. | \$8.95 |

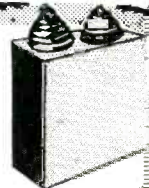

Complete!

INTER-OFFICE COMMUNICATION SYSTEM

\$2995

Inter-Phone amplifier BC367 complete with cables 2BC 422 box, BC 369 Box, 3C 370 Box, mounted on board complete with screws, clamps and everything needed for a Inter-Phone communication system.

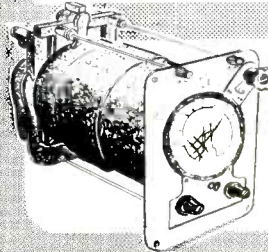

BANK-CLIMB GYRO CONTROL

For Mark 4 automatic pilot

\$995

DIRECTIONAL GYRO

M-1

A-5 Automatic pilot Mfd. by A. C. Spark Plug under license of Sperry Gyroscope Co., Inc.

\$995



HERSHEL RADIO CO.

DEPT. E. 40

5249 GRAND RIVER
DETROIT 8, MICHIGAN

Write for Free Catalogue

All orders F.O.B. Detroit—Minimum order \$2.00—Michigan customers add 3% sales tax—20% payment must accompany all orders.

RELIANCE SPECIALS

COAXIAL CABLES RG 8/U 52 OHM

10,000 ft. & over... \$47.50 per M
 1,000 ft. to 9,999 ft... 50.00 per M
 Smaller quantities... 6¢ per ft.
 RG 22/U 95 OHM (2 cond.) per 1,000 ft. \$120.00
 RG 62/U 93 OHM per 1,000 ft. \$40.00

COAXIAL CABLE CONNECTORS



| Angle Adapter | Plug | Socket | Hood |
|--|---------|---------|-------|
| 15c | 28c | 28c | 9c |
| M-359 | PL-259A | SO-239 | 83-1H |
| 83-IAP | 83-I5PN | 83-IR | |
| Adaptor for PL-259 A for use on small coax. \$10.00 per 100 12¢ each | | | |
| 83-I5P | \$.28 | UG 21/U | .60 |
| 83-1J | .80 | UG 22/U | .60 |
| 83-1T | 1.12 | UG 24/U | .60 |
| 83-22AP | .85 | UG 25/U | .60 |
| 83-22J | .85 | UG 27/U | .60 |
| 83-2I | 1.50 | UG 28/U | 2.00 |
| UG 13/U | \$.60 | UG 59/U | .60 |

"AB"

CARBON RESISTORS

| 1/2 Watt | | 1/2 Watt | | 1/2 Watt | | 1 Watt | |
|----------|------|----------|------|--------------|------|--------------|------|
| Resist. | Tol. | Resist. | Tol. | Resist. | Tol. | Resist. | Tol. |
| 3,600 | 10 | 150K | 10 | 3 meg. | 10% | 3,300Ω | 10% |
| 12K | 10 | 300K | 5 | \$3.00 Per C | | 18K | 10 |
| 30K | 10 | 390K | 10 | 1 Watt | | \$4.00 Per C | |
| 39KΩ | 10% | 1.3 meg. | 10 | 27Ω | 10 | 2 Watt | |
| 75K | 10 | | | 43 | 5 | 6.8 meg. | 10 |
| | | | | 560 | 5 | \$5.00 Per C | |

POWER RHEOSTATS

| 25 WATT | | | | 50 WATT | | | |
|---------|-------------|------------------|-----|---------|--------------|------|-----|
| Resist. | Mfg. | Shaft | Pr. | 10 | Ohmite | 1/8" | .69 |
| 10Ω | Clarostat | 1/8" | .49 | 12 | Ohmite | 1/8" | .69 |
| 15Ω | Ohmite | 1/8" | .59 | 20 | Ohmite | 1/8" | .69 |
| 25 | IRC | S.D. | .49 | 50 | Ohmite | 1/8" | .69 |
| 35 | Ohmite | 1/8" | .59 | 90Ω | Clarostat | 1/8" | .59 |
| 50 | Clarostat | 1/2" | .49 | 123 | IRC | 1/2" | .59 |
| 145 | Grimes Mfg. | 1/2" with switch | .49 | 1,250 | Ohmite | 1/2" | .79 |
| 200 | IRC | 1/2" | .49 | 2,000 | Ward Leonard | 1/2" | .79 |
| 250 | Ohmite | 1/2" | .59 | 3,500 | Ohmite | 1/2" | .59 |
| 370 | IRC | 1/2" | .49 | | | | |
| 1,500 | Clarostat | 1/2" | .49 | | | | |
| 2,000 | Ohmite | S.D. | .69 | 2Ω | Ohmite | 1/2" | .59 |
| 2,500 | Ohmite | S.D. | .69 | 10,000 | Ohmite | S.D. | .79 |
| 3,500 | Ohmite | S.D. | .69 | | | | |
| 5,000 | Ohmite | S.D. | .69 | | | | |

WW PRECISION RESISTORS 1% OR BETTER

| 1/4 WATT-25c | | | | | | | |
|--------------|--------|--------|--------|--------|--|--|--|
| 6.68Ω | 12.32Ω | 16.37Ω | 123.8Ω | 414.3Ω | | | |
| 10.48 | 13.02 | 20 | 147.5 | 705 | | | |
| 10.84 | 13.52 | 62.54 | 220.4 | 2193 | | | |
| 11.25 | 13.89 | 79.81 | 301.8 | 10,000 | | | |
| 11.74 | 14.98 | 105.8 | 366.6 | 59,148 | | | |

1 Megohm-1 Watt 1¢-65¢; 50%-40¢
 Orders for 100 pieces-10% off;
 Orders for 1,000 pieces-20% off.

BC-1072-A TRANSMITTER

115V., 60 Cyc., 150-200mc. Power supply gives 0-5,000 V.D.C. (Variac control) .312 and 700 V.D.C., 6.3 V.A.C. also contains blower 115 V.A.C., 5 KV meter, condensers, tubes, relays and many other useful parts. Shipping Wt., 245 lb. ONLY \$22.50

CAPACITORS

| POSTAGE STAMP MICAS | | | | |
|---------------------|-------|--------|--------|---------|
| 8.2mmf | 47mmf | 350mmf | 650mmf | 0026mfd |
| 10 | 50 | 370 | 680 | 0027 |
| 18 | 55 | 400 | 001mfd | 003 |
| 20 | 60 | 470 | 0012 | 0039 |
| 22 | 68 | 500 | 0013 | 005 |
| 25 | 100 | 510 | 00135 | 008 |
| 39 | 150 | 560 | 002 | 01 |
| 40 | 160 | 600 | | 0015 |

SILVER MICAS

| PRICE SCHEDULE | | | | |
|----------------|--------|--------|--------|---------|
| 10mmf | 150mmf | 400mmf | 665mmf | 0024mfd |
| 39 | 180 | 430 | 680 | 0025 |
| 50 | 200 | 460 | 700 | 0027 |
| 62 | 240 | 470 | 750 | 003 |
| 66 | 250 | 488 | 820 | 0033 |
| 100 | 300 | 500 | 001mfd | 0039 |
| 110 | 330 | 510 | 0012 | 004 |
| 110 | 360 | 525 | 0013 | 005 |
| 125 | 370 | 560 | 0015 | 0051 |
| | 390 | 600 | 002 | 01 |

| OIL FILLED | | | MFD V.D.C. | | |
|---------------------|--------|---------|--------------|--------|--------|
| MFD | V.D.C. | Price | MFD | V.D.C. | Price |
| .1 | 25,000 | \$14.95 | 1 | 7,000 | \$1.95 |
| .03 | 16,000 | 4.50 | .1 | 7,000 | 1.75 |
| (\$375 @ 16,000 and | | | .02 | 7,000 | 1.65 |
| 7.5 @ 8,000 (total) | | | 1 | 6,000 | 8.54 |
| .5 | 7,500 | 23.95 | 1 | 6,000 | 1.75 |
| .1 | 7,500 | 1.85 | .03 | 6,000 | 1.65 |
| | | | .2 | 4,000 | 4.50 |
| | | | .25 | 3,000 | 1.75 |
| | | | 2,750 V.A.C. | | |
| | | | 1 | 2,000 | .39 |
| | | | 2 | 1,000 | .90 |
| | | | 3 | 1,000 | .80 |
| | | | 2 | 1,000 | .65 |
| | | | 1 | 800 | .40 |
| | | | 10 | 600 | 1.00 |
| | | | 2 | 600 | .69 |
| | | | 2 | 600 | .39 |

Wrapped-BALL BEARINGS-New

| Mfg. | ID | OD | Width | Price |
|---------------|----------|---------|--------|-------|
| Fafnir 33K5 | 3/16" | 1/2" | 5/32" | .25 |
| N.D. 38 | 5/16" | 7/8" | 9/32" | .45 |
| Fafnir K8A | 1/2" | 1 1/8" | 5/16" | .60 |
| N.D. 3201 | 15/32" | 1 1/4" | 3/8" | .60 |
| N.D. 5202C13M | 1 1/2" | 1 3/8" | 1/8" | 1.00 |
| Fafnir 7304W | 1 3/4" | 3 1/8" | 1 1/8" | 2.00 |
| SKF 466430 | 6" | 8 1/8" | 1 1/2" | 5.00 |
| SKF 170645 | 3 11/32" | 4 1/8" | 7/16" | 1.50 |
| Fafnir K37B | 2 5/16" | 3 1/16" | 11/32" | 1.00 |
| Fafnir 545 | 2 1/16" | 2 5/8" | 15/32" | 1.00 |

NEEDLE BEARINGS

| | | | |
|-----------------|-------|--------|-----|
| B108 1/2" wide | 5/8" | 13/16" | 30¢ |
| GB34X 1/4" wide | 3/16" | 11/32" | 25¢ |

TIME DELAY RELAY

| Raytheon CPX 24166 | |
|--------------------|------|
| KS 10193-60 | Sec. |

- 115 V., 60 Cycle
- Adj. 50-70 Seconds
- 2 1/2 seconds recycling time, spring return
- Micro Switch Contact, 10A
- Holds On as long as power is applied. Fully Cased

ONLY \$6.50

UNIVERSAL JOINT

ALUMINUM
 1 1/8" long x 1/2" O. D. 1/4" ID
 ONLY 40c

| PRECISION POTENTIOMETERS | | | | | |
|--------------------------|------------|--------|---------|------------------|--------|
| 6 WATT | | 4 WATT | | | |
| 20,000Ω | Muter 314A | \$1.70 | 500Ω | Centralab 48-501 | \$9.00 |
| 20,000Ω | GR 314A | 2.50 | 50 | De jur 292 | .75 |
| 6,000Ω | GR 314A | 2.50 | 50 | GR 301 | 1.10 |
| 6,000Ω | De jur 260 | 1.70 | 25 | GR 301 | 1.10 |
| 6,000Ω | Muter 314A | 1.70 | 20 | De jur 292 | .75 |
| 5,000Ω | Muter 314A | 2.50 | 20 | GR 301 | 1.10 |
| 5,000Ω | GR 314A | 2.50 | 12 | GR 301 | 1.10 |
| 5,000Ω | GR 214A | 1.40 | | | |
| 2,000Ω | De jur 260 | 1.70 | | | |
| 600Ω | GR 314A | 2.25 | 10,000Ω | GR 471-AS15 | 3.50 |
| 200Ω | Muter 314A | 1.40 | 10,000Ω | De jur 271T | 2.00 |
| 40Ω | GR 214A | 1.40 | 5,000Ω | De jur 271T | 2.00 |

CARBON RESISTOR ASSORTMENT

Color coded, insulated... 100 only \$1.19

WE'RE BACK AT THE OLD STAND!-ARCH ST., COR. CROSKY KEY.

JONES BARRIER STRIPS

| Type | Price | 15-140Y | .59 | 4-142 | .19 |
|---------|-------|--------------|-----|--------------|-----|
| 2-140Y | \$.05 | 4-141 | .16 | 5-142 | .21 |
| 3-140 | .10 | 5-141 | .19 | 7-142 | .32 |
| 3-140 | .12 | 5-141 1/4 W | .27 | 8-142 | .39 |
| 4-140 | .13 | 5-141Y | .25 | 9-142 | .41 |
| 4-140Y | .17 | 6-141 | .23 | 10-142 | .45 |
| 5-140Y | .21 | 7-141Y | .37 | 11-142 | .48 |
| 6-140 | .18 | 8-141 1/4 W | .38 | 11-142 1/4 W | .57 |
| 6-140Y | .25 | 9-141 | .37 | 12-142 | .53 |
| 7-140 | .21 | 9-141Y | .42 | 13-142 | .57 |
| 8-140 | .23 | 10-141 1/4 W | .47 | 13-142 1/4 W | .82 |
| 10-140 | .43 | 11-141 | .40 | 14-142 | .61 |
| 10-140Y | .49 | 12-141 | .43 | 15-142 1/4 W | .94 |
| 11-140 | .36 | 17-141Y | .78 | 17-142Y | .97 |

Any order for 100 pieces-10% off

HAYDIN TIMING MOTOR

110V., 60 Cyc., 2/3 R.P.M. Two motors connected on one shaft to make the unit reversible. **ONLY \$1.95**

CHOKE

400 MA
 12 H
 90 OHM
 6,000 V. D. C. TEST
\$3.85

10 FOR \$34.00

PULSE TRANSFORMERS

X 124 T2, UTAH, marked 9262 or 9280, small gray case 1 1/2" high x 1 1/4" x 1/2" with two 6-32 mtg. studs. Ratio 1:1:1, hypersil core... \$1.50

D161810, 50 Kc to 4 Mc, 1 3/4" dia. v 1 1/4" high, 120 to 2500 ohms... \$3.00

352-7178-Spec. 10, 111 Chicago Trans. equivalent to 9262 (above)... \$1.50

TR 1018, Dinton Coil Co... \$1.25

TR 10 9, Dinton Coil Co... \$1.25

352-7250-2A, cased 16 1/2" dia. x 1 3/4" high, DC 10 ohm, 3 1/2 ohm, 140 cy. to 175 KC \$1.25

352-7251-2A, similar-shorter pulses... \$1.25

KS9800, Ratio, 1:1:1, 2:1, Freq. range 380 to 650 C.P.S. \$3.50

D40617B, W. E. Freq. response 10KC to 2 MC \$9.80

300 KVA GE 7557296, 50 ohm pulse cable connection; 3,850 V. in., 17,300 V. out. (250 KVA @ 1/4 microsecond) \$11.75

800 KVA G.E. K3731, 28,000 Volt pk. output; Bifilar, pulse width; one-microsecond \$9.50

SELSYNS

115 V., 60 Cyc.
 3 1/2" dia. x 4 1/2" body
#C78248
\$7.25 pair

DIFFERENTIAL

115 V., 60 Cyc.
#C78249
\$2.25 ea.

Used between two #C78248's as dampener. Can be converted to a 3600 RPM Motor in 10 Minutes. Conversion sheet supplied. Mounting Brackets--(Bakelite) for selsyns, and differentials shown above 25¢ pair

GLYPTEL CEMENT, 5 gal. \$11.00, 1 gal. \$2.50, 1 qt. 75¢

HARDWARE ASST. (Mostly Brass) screws, nuts, washers, rivets... 3 lb. \$1.00

SPAGHETTI SLEEVING-Asst. sizes & colors, 3 ft. lengths, 95 ft. ONLY \$1.00

POWER TRANSFORMER. Pri. 110/220/440; 60 Cyc., 2 Sec. Windings each 300V., 4 Amp **SPECIAL \$9.95**

ALLEN SET SCREWS

| | | |
|-------------|------------|-------------|
| 4-40 x 1/8 | 6-32 x 1/8 | 8-32 x 5/16 |
| 4-40 x 3/16 | 8-32 x 1/8 | 8-32 x 3/8 |

ALL SIZES (Cup Point) \$1.50 per 100

GEAR ASSORTMENT

Experimenters' dream. Approx. 100 pieces, many stainless... \$6.50

FUSES

| | |
|---------------------------|-----------------------|
| 3AG | 3AG |
| 1 1/4 Amp. \$4.00 per 100 | 3 Amp. \$2.50 per 100 |
| 1 1/2 | 2 |
| 1 3/4 | 3 |
| 2 | 4 |
| 3 | 5 |
| 4 | 10 |
| 5 | 3.00 |

RANGE UNIT

From AN/APS-15. Contains 11 Utah X-124-T2 (9280) Pulse Transformers, 12 Prec. Resistors, 28 V.D.C. Blower, metal cabinet, and other useful parts... **SPECIAL \$10.95**

Minimum Orders \$3. All orders f.o.b. PHILA., PA.

RELIANCE MERCHANDIZING CO.

Arch St. Cor. Croskey Phila. 3, Pa. Telephone Rittenhouse 6-4927

TEST EQUIPMENT

X BAND SIGNAL GENERATOR, 8500-9600 mc, calibrated wavemeter, power meter and attenuator, for 110 V 60 c.p.s. operation.

X BAND WAVEMETER CAVITY, TRANSMISSION TYPE 9200-11000 mc \$15.00

WAVEMETER CAVITY, 8500-9600 mc, TRANSMISSION TYPE \$35.00

TS-155B/UP S BAND SIGNAL GENERATOR, pulsed, calibrated output, 110 V, 60 cy. NEW

X BAND PICK-UP HORN \$10.00

TS-62/AP ECHO BOX FOR X BAND

TGS-5BL S BAND SIGNAL GENERATOR, 2600-3400 mc, pulsed, calibrated output 110 V, 60 cps.

S BAND STANDARD REFERENCE CAVITY, Type N input connector, crystal holder \$15.00

APR-1 RADAR SEARCH RECEIVER, complete with tuning units for range of 38-4000 mc, 30 mc I.F., 2 mc wide.

TUNING UNITS for APR-1 or APR-4 RECEIVERS (can be used with any 30 mc amplifier):

- TN-16, range 30-90 mc
- TN-17, range 80-300 mc
- TN-19, range 1000-2000 mc
- TN-54, range 2000-4000 mc

X BAND VSWR TEST SET TS-12/AP, complete with linear amplifier, direct reading VSWR meter, slotted wave guide with gear drive traveling probe.

matched termination and various adapters, with carrying case. NEW. UNITS I AND II are available separately, or together as a test set.

S BAND SIGNAL GENERATOR CAVITY with cut-off attenuator, 2300-2950 mc. 2C49 tube, with modulator chassis \$30.00

UPN-1 S BAND BEACON RECEIVER TRANSMITTER \$75.00

S BAND TEST LOAD, TPS-55P/BT, 50 ohms \$8.00

X BAND TEST LOAD, TS-108/AP, 150 watts accessories \$35.00

LAF-2 SIGNAL GENERATOR, 520-1400 mc, CW & pulse modulation, calibrated output 110 V, 60 cps, used, good condition.

LAF-1 SIGNAL GENERATOR, 100-600 mc, CW & pulse modulation, calibrated output, good condition, 110 V, 60 cps operation

GENERAL RADIO SIGNAL GENERATOR MODEL 522, 250-1000 mc, good operating condition.

FEDERAL RADIO SIGNAL GENERATOR MODEL 804C, 7.5-330 mc, good operating condition.

MEASUREMENTS 78E, 50-75 mc, calibrated output \$100.00

AUDIO OSCILLATOR, HICKOK 198, RC tuned, 20-20000 cps. \$45.00

RCA SCOPE, 5", MODEL 160B, NEW, export packed \$125.00

CLOUGH BREngle RESISTANCE CAPACITY BRIDGE, model 230A, new \$50.00

FIXED ATTENUATOR PADS, 20 db ± 0 — 2 db, DC—1000 mc, 50 ohms, VSWR 1.3 or less, 2 watts average power \$30.00

MUTUAL INDUCTANCE ATTENUATOR, Calibrated; frequency range 1 to 1000 mc by means of plug-in coils, attenuation range 120 db. \$100.00

MUTUAL INDUCTANCE OR PISTON TYPE ATTENUATOR, type N connector's rack and pinion drive, attenuation variable 120 decibels, calibrated 20-120 db, frequency range 300-2000 mc \$32.00

MUTUAL INDUCTANCE OR PISTON TYPE ATTENUATOR, similar to above, except upper frequency limit is 3300 mc \$32.00

LOSSY LINE ATTENUATOR, consisting of RG-21/U cable rolled in metal box with UG-10/U connectors, furnished in any attenuation up to 20 db at 3000 mc \$15.00

CONNECTORS:

| | | | |
|-----------------|------|-------------------|------|
| UG-10/U | .80 | UG-190/U | 1.00 |
| UG-12/U | .80 | UG-201/U | 2.00 |
| UG-21/U | .80 | UG-245/U | .60 |
| UG-22/U | .80 | SO-239 | .28 |
| UG-24/U | .80 | PL-259 | .28 |
| UG-25/U | .80 | (for small cable) | |
| UG-27/U | .50 | M-359 | .28 |
| UG-29/U | 1.00 | UG-266 | 1.00 |
| UG-30/U | 1.00 | | |
| UG-30/U special | 1.00 | | |
| UG-58/U | .60 | PL 54 | .10 |
| UG-5 /U | 1.00 | PL | .50 |
| UG-83/U | 1.00 | AN-3102-14S-5P | .25 |
| UG-86/U | 1.00 | AN-3102-14S-2P | .25 |
| UG-167/U | 2.00 | RC-10066-20-1P | .50 |

METERS:

0-350 VOLTS, WESTINGHOUSE NX-35 METER, 1000 ohms per volt, 3 1/2" \$1.50

0-8 AMPS R.F. SIMPSON 1S-89, 2% to 10 mc \$4.50

0-10 AMPERES, TRIPLETT 327-A, 3" square \$4.00

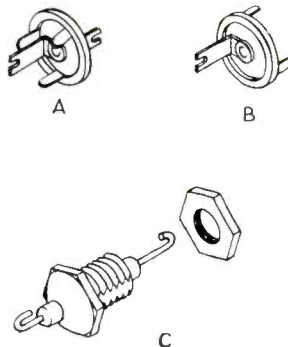

CERAMIC FEED-THRU CAPACITORS

Type A..... 300 mmf..... 10 for \$2.00
Type B..... 300 mmf..... 10 for \$2.00
Type C..... 55 mmf..... 10 for \$1.00

DM-43 DYNAMOTOR, G.E., 24 V, 515/1030/2/8 volts at 250/280 ma, new, export packed \$5.00

LOOP MN-20 E for MN-26, D.F., new \$7.00

TRANSFORMERS, 115 volts, 60 cps primaries:

1. 6250, 3250 and 2000 volts, tapped primary, voltage doubler, 12.5 kv ins \$14.00

2. 6250 volts 80 ma, ungrounded, G.E. voltage doubler, 12.5 kv ins. \$12.00

3. 2 secondaries at 500 volts 5 amps each, wt 210 pounds. \$50.00

PULSE INPUT TRANSFORMER, permalloy core, 50 to 4000 kc impedance ratio 120 to 2350 ohms. \$3.00

PULSE TRANSFORMER, UTAH 9280 \$1.50

PULSE TRANSFORMER 132-AWP. \$6.00

PULSE TRANSFORMER, GE 68G, 828G-1 \$5.00

PULSE TRANSFORMER, Westinghouse 145-EWP \$10.00

PULSE TRANSFORMER G.E. TYPE K-2176, 1 microsecond pulse, 350 pps, 28.5 KV peak, impedance ratio 450/50 ohms \$25.00

TRANSMITTING OIL-FILLED CAPACITORS:

2 MFD 600 WVDC ROUND CAN 10 for \$2.100 for \$10.00

2 Mfd..... 1000 WV..... 1.00
1 mfd..... 2500 WV..... 1.50
.15 mfd..... 4000 WV..... 5.00

2 mfd..... 7000 WV..... 2.00
.1 — .1 mfd..... 7000 WV..... 2.00
.075 — .075 mfd 8000 WV..... 2.00

1 mfd..... 15000 WV..... 25.00
.2 mfd..... 10000 WV..... 5.00
W. E. EQUALIZER D162118..... \$5.00

HYPERSIL CORE CHOKES, 1 Henry, Westinghouse L-422031 or L-422032 \$3.00

PULSE FORMING NETWORK, 20 kv, .92 microsecond, 50 ohms, 800 p.p.s. \$40.00

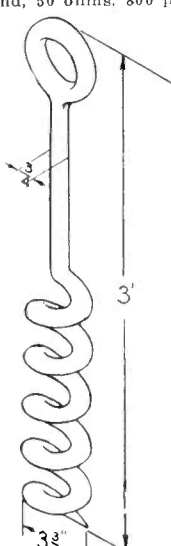

ANCHOR SCREWS from AB26CR Mast Equipment \$2.00 each

ELECTRO IMPULSE LABORATORY

P. O. Box 250 Red Bank, N. J.
Eatontown 3-0768

TEST EQUIPMENT

A Select Offering Of Desirable Test Equipment, Each Unit Fully Guaranteed.

GENERAL RADIO

Wave Analyzer Type 736-A; freq. range 20-16,000 cycles; 110 to 220 volt operation, 40 to 60 cycles.

Standard Signal Generator 605-B 9.5 K.C. to 30 M.C. 115 to 230 v. operation, 40 to 60 cycles.

Impedance Bridge 650-A.

Inductance Bridge 667-A.

Megohm Bridge 544-B; battery operated. Range .1 megohm to 1 million megohms.

Frequency Standard in 7 foot rack cabinet; consisting of the following:

- A) Synchronometer G.R. 693-B.
- B) Heterodyne Detector G.R. 619-E.
- C) Coil Drawer G.R. 619-P-1; for the heterodyne detector; contains 21 coils covering the frequency range from 25 K.C. to 25 M.C.
- D) Coupling Panel G.R. 612-K.
- E) Multivibrator G.R. 692-B. 1-K.C.
- F) Multivibrator G.R. 692-B. 10 K.C.
- G) Multivibrator G.R. 692-B. 50 K.C.
- H) Piezo-electric Oscillator G.R. 675-N.
- I) Heterodyne Freq. Meter G.R. 616-D.

Standard Resistors ± 1% accuracy
G.R. type 663-B 2 ohms
G.R. type 663-C 5 ohms
G.R. type 663-D 10 ohms
G.R. type 663-E 20 ohms
G.R. type 663-F 50 ohms

Recording Voltmeter, Esterline Angus Model AW, 0-10 volts d.c. meter & recorder, 1,000 ohms per volt. Drive motor 110 volts AC 60 cycles.

Q) Meter, Bounton Radio type 170-A; freq. range 30 M.C. to 200 M.C. 110 to 240 volts, 50 to 60 cycles.

Audio Oscillator Hewlett-Packard type 205-A, 20 to 20,000 cps Out. imp. 50-200-500-5,000 ohms.

Signal Generator, Ferris type 22-A, Range 85 K.C. to 25 M.C. in 6 bands.

Standard Signal Generator, Measurements Corp. Model 78-FM, Freq. range 86 M.C. to 108 M.C. Accuracy ± .5%.

Output voltage 1 to 100,000 uv. Modulation 0 to 300 K.C. 117 volts, 50 to 60 cycles.

Analyzer Weston Model 779, Sensitive volt/milliammeter/output meter. In oak carrying case. Brand New \$87.50

Tube Checker-Analyzer Weston 798 type 3, mutual conductance type, in metal carrying case. Brand New \$191.50

Industrial Circuit Tester Weston 785 50 micro-amp. movement, in oak carrying case. Brand new \$94.50

Tube & Set Tester Supreme 599-A, Brand new \$49.50

Tube & Battery Tester, Supreme 589-A, Brand new \$39.95

Set Tester Supreme 592 40 micro-amp movement. Brand new \$46.75

Tube & Set Tester Supreme 504-B, BRAND new \$75.00

Audio Oscillator, Supreme 563 30-15,000 cps. Brand new \$49.95

Signal Generator R.F. Supreme 576 65 K.C. to 20.5 K.C. Brand new \$57.50

Also available from stock a substantial selection of 3" round and square panel meters of standard manufacture. Send for list.

Terms: 20% with order, balance C.O.D. unless satisfactorily rated.

SHIPMENTS: from stock, subject to prior sale via Railway Express only, F.O.B. Ozone Park, N. Y.

ATLANTIC INDUSTRIAL CO.

101-38 91st St.,
Ozone Park, L. I., N. Y.

Virginia 9-5051

GUARANTEED BRAND NEW

ELECTRONIC RESEARCH TUBE SPECIALS

STANDARD BRANDS ONLY

Table listing various vacuum tubes (RECEIVING TUBES, PHOTO CELLS, THYRATRONS, etc.) with their specifications and prices.

ALLEN - BRADLEY TYPE "J" POTENTIOMETERS

Table listing potentiometer models (100, 500, 1000, 6500 SS) and their specifications.

COAXIAL CONNECTORS

Table listing various coaxial connector models (83-IAP, 83-IH, etc.) and their specifications.

Advertisement for RCA HI-VOLTAGE TRANSFORMER with image and pricing details.

Advertisement for GENERAL ELECTRIC FG-172 THYRATRONS with pricing and availability information.

ASB YAGI ANTENNA

Advertisement for ASB YAGI ANTENNA featuring an image and detailed specifications for 5 and 6 element arrays.

Advertisement for WESTINGHOUSE HYPERSIL TRANSFORMER with image and technical specifications.

FILTER CHOKES

Table listing filter choke models (10H, 9H, 15H, etc.) and their electrical characteristics.

FILAMENT TRANSFORMERS

Table listing filament transformer models (UTC, UTC, Raytheon) and their specifications.

Advertisement for G. E. LIQUID LEVEL TRANSMITTER with image and pricing details.

LECTRONIC RESEARCH LABORATORIES 1021-23 CALLOWHILL ST. PHILA. 23, PA. Telephones - MARKET 7-6590 and 6591

RADIO SHACK OCTOBER BARGAINS!

Save 1/2

ON BRAND NEW

SUPREME

MINIMETERS!

Boston's bargain-loving RADIO SHACK slashes dealer-net prices IN HALF with a special purchase of genuine SUPREME Minimizers, new (not surplus) and in original cartons! Save \$\$\$—and—¢¢¢ on voltmeters, millimeters, microammeters and ohmmeters! Servicemen, hams, experimental, school and industrial users like their small size — 2 1/4 x 3 3/8 x 1 1/2" — only slightly larger than ordinary meter movements alone! These precision-built test instruments have solid alnico sintered pole pieces and the same rugged SUPREME movement featured in all SUPREME testing equipment! Shipping wt. 1 lb. **Order NOW!** No more at THESE prices when our supply is gone!

- Model 402, DC volts: 0-5-50-500 . \$5.95
- Model 403, DC volts: 0-10-100-1000 6.95
- Model 404, DC volts: 0-2.5-25-250 4.95
- Model 410, DC mils: 0-25-250-2500 4.95
- Model 411, DC mils: 0-50-500-5000 4.95
- Model 420, DC amps: 0-.1, 0-1, 0-10 5.95
- Model 430, DC microamps: 50-0-50, 500-0-500, 5000-0-5000, designed esp. for alignment of FM receivers 7.95
- Model 440, DC ohms: 0-2000-20000-200000, center scale low range 25 ohms, complete with battery 6.95

WAREHOUSE TUBE SALE!

| Type | Net Each |
|----------|----------|
| 3C24/24G | 25c |
| RK72 | 75c |
| 12A6 | 23c |
| 1616 | 60c |
| 1625 | 15c |
| 872A | \$1.15 |
| ELC5B | \$7.50 |
| FG27A | \$5.45 |
| 3B24 | 85c |

SUPER-SPECIAL!
FG27A
THYRATRON
In lots of 100 \$4.45 each
In lots of 50 \$4.95 each

Write for quantity discounts on above and other tubes you require. Radio Shack prices are generally 10-50% lower than industry average. All tubes inspected for mechanical breakage before shipment.

SOLA CONSTANT VOLTAGE TRANSFORMER

Type 30864
Stock No. RS-721
only \$17.50



Designed to maintain their output voltage constant to within less than plus or minus 1% for a total primary variation of 30%. Input — 190-260 VAC. Output — 115VAC @ 1.7 amps. 15x8x6". Net 30 lbs.

SENSATIONAL SPECIAL on TOBE CONDENSERS!

ONLY \$1.10 each
\$24.00 per carton

Dual 5 mfd @ 400 WVDC — GUARANTEED FOR 600V OPERATION. A recent special-purchase of these solidly built TOBE Type RAL-300 rect. metal can oil condensers enables us to offer them at rock-bottom prices in almost unlimited quantities. Bottom mtg. through four 3/16" dia. holes. Size 3 1/4 x 3 3/4 x 2". Lug terminals. Packed 24 to carton. (Write for special discount on lots of 500 to 1000)



SAVE \$80.50 NOW on STEPHENS TRU-SONIC HIGH FREQUENCY SPEAKER with electro-dynamic driver!

List Price \$110.00
\$29.50 net

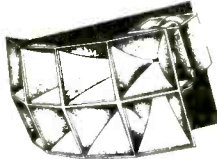

Modernize PM or dynamic speakers into 800 cycle cut-off (flat to 15,000 cps) dual tweeter-woofer systems of incomparable fidelity! True-Sonic horn #824H has 8 cells, each 4 x 4 x 11". True-Sonic 20-watt electro-dynamic driver unit E15 has 11-ohm aluminum voice coil; 3 lb. 150-ohm copper field coil; field dissipation 15 watts. Shipping wt. 26 lbs. Perfect for hi-fi enthusiasts, small theatres, schools, labs, sound studios, WRITE, PHONE or WIRE your order today, because bargain-hunters will immediately recognize this as the most unusual audio "buy" since the war! New (not surplus)! Limited quantity!



Lowest Price in the U.S.A. on Brand New TACHOMETER GENERATORS

ROTATION GENERATOR (Elinco B-68), operates from 110V 60 cy source to provide constant frequency output whose amplitude varies linear with speed. Use up to 6600 RPM. Voltage output at 1000 RPM is minimum of 1.2V. Size 2 1/2 x 3".

AC RATE GENERATOR (Elinco F-16), 2 phase AC, 1.3V per 100 RPM. 60 cy output at 1800 RPM. Size 2 1/2 x 3".

Stock No. RS-904 ONLY \$9.50
Stock No. RS-905 ONLY \$8.95

10 CENTIMETER RADAR SCOPE R7/AP5-2 SPECIAL AT \$49.50

Here's a NEW 10 centimeter radar receiver scope for the price of the 42 tubes alone! 5P7 and 2A1 scope tubes included. Complete with 60 mc i.f. strips, two 115V 400 cy power supplies, meters, DC blower, hundreds of small radio components. Originally called "PPI" unit. New in export packing. Limited quantity!

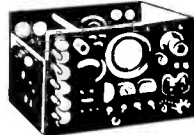

Industrial and Laboratory Heavy Duty OIL CONDENSERS



1 mfd @ 15,000 WVDC. Famous make. Type 14F63, and priced at a FRACTION of original cost. Brand new, individually packed. Overall 16" H, 12" W, 4" D. Net 36 lbs. Originally part of RA-38 rectifier, these giant capacitors have scores of applications: capacitor - discharge spot welders, power-factor correctors, etc. Stock No. RS-703 ONLY \$22.00

1 mfd @ 10,000 WVDC, Type 10D20 (Famous Make!) Overall 14x8x4". Net 27 lbs. Stock No. RS704 ONLY \$15.00
25 mfd @ 20,000 WVDC, Type 20Q20-25. Famous Maker. Overall 15 3/4 x 8 1/2". Net 28 lbs. Stock No. TA-601 ONLY \$15.00

BC-906D FREQUENCY METER

RADIO SHACK SPECIAL AT \$29.95

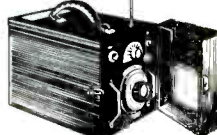

Absorption-type, originally intended for use with BC-1066B radio rcvr and sig. gen. I-196B utilizing dip of a 2 1/2" round 0-500 DC microammeter for frequency indication. Range 150-225 mc. Uses type 185 vac. tube. Power requirements: 2 batts., 1.5V and 45V, which are placed in box within meter. Uses friction-type vernier dial for freq. variation. Black wrinkle-finish metal cabinet fitted with door. NEW, in original boxes, and complete with tube, freq. charts, instruction book. 12 1/2 x 8 3/4 x 6 1/2". Net 18 lbs.

The RADIO SHACK Corp.
167E WASHINGTON ST., BOSTON, MASS., U.S.A.

GRAIN of WHEAT LAMPS



Used for illuminating meters, compass dials, airplane instruments, etc. Soldering iron removes lamp from base to use in models, doll houses, miniature trains, Xmas trees, etc.

Mazda G.E. 323 3V .19 A Mazda G.E. 328 6V .2 A

Photo actual size. Glass Bulb 1/4" x 3/8" Either type doz. \$1.50 75.00 per M.



MARKTIME 5 HOUR SWITCH

A 10 amp. timing device. Pointer moves back to zero after time elapses. Ideal for shutting off radio and TV sets when you go to bed. Limited supply at this special PRICE..... \$3.90

Also available in 15 min.-30 min.-1 hr. at \$6.55

ISOLATION TRANSFORMER

Nat. known Mfrs. 50 watt 2 windings, 115 V. to 115 V. 60 cy. Ideal to prevent shocks from small radios and medical and electronic devices. Shipping Weight 5 lbs. Other sizes and 220-110 in stock.

\$1.95

D.P.S.T. LEACH RELAY Split coil 12 or 24 V.D.C. 10 amp. 45c each, 3 for \$1.00, 7 for \$2.00, 15 for \$4.00. Min. shipment, \$1.00

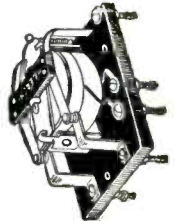

GONIOMETER

CFT-47263
CFT-47372

Kilowatt Demand Meter Totalizer containing heavy-duty TELECHRON B-7, 1 RPM motor and hundreds of watch size gears, clutches, springs, etc. Shipping weight 2 lbs. 5 for \$10.00 \$2.50

WE are Authorized Wholesalers for Micro Switch Corporation and carry the largest stock of Allen-Bradley Solenoids Potter and Broomfield Relays Guardian Electric Co. Solenoids and Relays Haydon Clock Motors in all speeds

EST. 1923

BLAN

EST. 1923

Experimenters and Inventors Supplies

64 E Dey St., New York 7, N. Y.

CLARE STEPPING SWITCHES

Type SD-14 20 steps, 6 levels. Coil 12V, D.C. Lists at \$40.26; our low price \$13.07. All brand new in original boxes, not war surplus.

NEOMATIC, INC.

879 Wellesley Ave. Los Angeles 24, Cal. Phone: Arizona 3-4897

SALE

Telechron timing motor

1 RPM, 115 V. 60 cy. Sale price \$2.50

Push button SPNO

H & H #3391 Sale price 12c ea.

Jones Plugs

| Part # | Terminal | Price |
|-----------|----------|---------|
| P-308-CCT | 8 | 11c ea. |
| S-308-AB | 8 | 9c ea. |
| 2-142-Y | 2 | 9c ea. |
| 7-142-Y | 7 | 25c ea. |
| 17-142-Y | 17 | 55c ea. |

HALLICRAFTER TRANSMITTERS

BC-610 LIKE NEW

also HT-9s in stock.

VAN SICKLE RADIO SUPPLY CO. New Larger Location 102 So. Penn. St. Indianapolis, Ind.

Surplus Prices Slashed!

DYNAMOTOR D-2



D-2 Converts to 110 V AC in ten minutes, diagram included, contains integral gear box having four 1/4 in. drive shafts turning simultaneously at the following speeds:

4000 RPM—Grinders, buffers, flexible shaft tools, etc.
150 RPM—Wrapping fishing rods, slow speed tools.
25 RPM—Dev. tray rocker for photo darkroom.
5 RPM—Turning barbecue spits. Adv. Disp. Beams.
A Thousand Other uses Around the Work Shop. **\$5.95**

DYNAMOTOR D-1

D-1 Converts to 110 V AC in ten minutes, diagram included, has shaft with squirrel cage blower, also gear reducer with 2 shafts and pulleys at the other end, 1001 uses. **ONLY \$4.95**

RM-29 PORTABLE FIELD TELEPHONE

An ideal portable field telephone. Complete in a rugged steel case for years of wear. Ringer circuit included. No leather case to deteriorate. Compact 5"x6"x9"—also used as remote control on SCR-284. Simple two wire operation. 15 miles distance and upwards. Can be used for television installation, intercom system, construction companies outside and inside work, etc. Light weight, 13 lbs. Excellent condition. **\$9.95**



SPECIAL LOW PRICE EACH... 2 for \$18.95

PLUGS AND CONNECTORS

YOUR CHOICE for only each 49c

- For the SCR-522 PLQ-167, PL-172
- For the BC-348 PLQ-103
- For the BC-733 PLQ-254
- For 269-F Radio Compass Inverter. PL-3108-22-48
- For the SCR-274-N
PL-147, 148, 151, 152, 153, 154A, 156, 258
- For the BC-375 PL-59-PL-81-PL-64
- For the ART-13 U-8U, U-10U, U-16U
- For the ARC-1 U-15U, U-16U
- MC-203A coupling Coax Fittings—
PL-259A (83-13P)-UG-21U-UG-22U
M-359 U-11U
- PL-164
- AN-3108-28-19P } Combination Male and
- AN-3108-12S } Female
- AN-3100-12S-33 } SO-44 PL-62
- PL-63 } SO-86
- PL-56 }

BC-733 D

A 10-tube superhet receiver for lateral blind landing guidance (CAA type certificate) TC-1045. Excellent condition 108-110 MC. Tube complement: 1-2S9Q7, 2-12SR7, 1-12A6, 1-12AH7GT, 2-12SG7, 3-117R—tubes alone worth more than this low price. **\$4.95**

SCHMATIC FURNISHED. Each \$4.95

AN/CRW-2 V.H.F. RECEIVER

6 tubes: 3-6SL7, 1-6SN7, 1-6SG7, 1-6J5 Dynamotor, plug-in coils and sensitive relays. This was one of the Army's "Secret" V.H.F. remote control receivers Operating at about 110 MC. A thousand and one uses. Like new in a metal case. **\$4.95**

COMPLETE BEAM ROTATOR ASSEMBLY LP-21A AND 1-82A

A large 5" indicator 1-82A, brand new and an LP-21 loop (removed from aircraft). A complete perfect beam rotator system with indicator. Loop is low impedance—contains selsyn transmitter, etc. **\$7.95**

Loop alone.....\$5.95. Indicator alone.....\$4.25

FILAMENT TRANSFORMERS

Fully shielded Pri. 100 V. Sec. (#1 winding 10.2 V @ 5 A. C. T. #2 winding 10.2 V @ 10 A. C. T.) Secondary winding can be connected in series to supply 25 V. with a line Voltage of 115 Volts—60 Cyc. **\$2.49**

6 VOLT MOTOR

A real beauty, removed from aircraft. Type used for auto fan. **\$1.29**

BC-433G

15-tube superhet radio compass receiver 200 to 1750 Kc.; CW-tone-voice. Like new. Similar to R5/ARNT. **Only \$19.95**

TUBES

1625.....3 for \$1.10 5B1P Scope tubes @ \$1.95
6V6.....@ .49 5Y4 Scope tubes @ \$2.50
3D6.....@ .49 3Z5 @ .59

6" PM SPEAKER

Beautiful New Stock, Alnico Magnet—each **\$1.95**

COMMAND SETS

BC-454—Receiver 3-6 M.C. Used. Good condition. **\$5.95**

DM—53A DYNAMOTOR

24V. in., 220V-80 M.A. Out. Used, good condition **\$1.39**

WRITE FOR NEW CATALOG.

Minimum order \$2.00, F. O. B. Chicago. 20% deposit required on all C. O. D. orders.

NECORP Electronics, Dept. E
2635 W. Grand Ave., Chicago 12, Ill.

WORTHWHILE SAVINGS TO YOU:

INDUSTRIAL POWER SUPPLY EQUIPMENT



T-102 — Filament Transformer. American Transformer Co. Spec. 29106. Type WS .050 KVA 50/60 cyc. Single phase. 35 KVA test, 12 KV D.C. operating. Primary 115 V., secondary 5 V., 10 amps with integral standoff insulator and socket for 250 T, 371, 872 and 5563, etc. rectifier tubes \$12.50. Net Wt. 15 3/4 lbs. Dim. 6 1/2" W x 6" D x 12" H.O.A.

MOTOR GENERATORS

G.E. type CC-21991 Input 115 v d-c. @ 5.7 amps. Output 115 v a-c 60 cycle, single phase 350 VA @ 85% P.F. **\$58.00**
G.E. Type CC-21990 Input 32 v d-c @ 22 amps. Output 115 v a-c 60 cycle, single phase, 350 VA @ 85% P.F. **\$63.00**
Leand Type CLL-21985 Input 115 v d-c 5.7 amps. Output 115 v a-c 60 cycle, single phase, 240 VA @ 86% P.F. **\$47.00**

ASD 3cm Radar Transmitter & Modulator, N2 cond. **\$110.00**
Also parts; details & prices on request.

NEW CAPACITORS

2 mfd 600 v. d-c tubular. \$30: 10 for \$2.50; \$20.00 per C.
3.5/.5 mfd 1,000 v. d-c. \$90: 4 for \$3.00.
3 x 1.0 mfd 1,200 v. d-c wk: isolated sections @ \$1.20
1.25/1.25 mfd 7.5 kv d-c or .625 mfd 15 kv d-c. Pyranol. **\$12.50**
.25/25 mfd 7.5 kv d-c or .125 mfd 12 kv d-c **\$3.75**
1.0 mfd 25 kv d-c. Pyranol. **\$36.00**
500 mfd 200 wv d-c electrolytic; insulated terminals **.95**
.001 mfd 25 kv d-c mica; 25 A. @ 3,000 kc, 18 A. @ 1,000 kc, 11 A. @ 300 kc. **\$25.00**
50 mmfd 32 kv d-c tubular vacuum. **\$4.95**
3.12 mfd 1265 v a-c. 4000 v d-c. New. G.E. Pyranol **\$17.00**

METERS

Weston or Westinghouse

3" 0-120 a-c amps, w/current transf. \$ 8.50
3" 0-20 kv d-c w/precision multiplier 18.00
3" 0-4 kv d-c w/precision multiplier 9.50

SPECIALS

Westinghouse Meter Multiplier: 1 meg. 3/4% tol. w.w. noninductive. **\$1.25**
Filament Transformer: Constant current; 110/220 v., 50/60 c; sec. 21.5 v. 40.5 A. **\$17.50**
Tube W/L 386/MH-3W; 125 KV X-ray oil immersion rect.; 10 v. 11.6 A. fil. **\$32.00**
CRAMER Time Delay Relay: TD2 120S; 0-120 sec., 15 v. 60 c. syn. motor-driven; 10 A., 115 v., S.P.N.O. contact **\$4.95**
Motor: 27 v. d-c. 0.7 A., 110 R.P.M. 1/2 oz./ft. torque **\$3.50**
Solenoids: 115 v., 60 c; continuous, w. 5 1/2 lbs. **\$2.75**
Intermittent, wt. 9 lbs. **\$2.75**
Indicator: 1-81-A Radio Compass. New **\$3.85**
Indicator: ID-14/APN-1 Radio Altimeter. New **\$4.50**
Loop: MN 206, for MN-26 direction finder. New **\$10.00**
Computer: CP-14/APS-15A. New. **\$10.00**

CONSTANT VOLTAGE TRANSFORMERS

95 to 125 volt 50 cycle single phase input: 115 volt output:
60 va.....\$ 8.40 380 va.....\$27.00
120 va.....13.20 500 va.....34.00
190 to 250 volt input: 220 volt output: 60 va.....\$8.40

RAYTHEON

198 to 242 volts 50/60 cycle single phase input: 220 volt 500 watt output. **\$38.00**

All merchandise in "as new" condition. Add approx. 20% to net weights for estimated shipping weights. Terms are 30% with order, balance C. O. D. All prices f.o.b. Los Angeles Warehouse. Write for additional detail information on any of the above items and for special quantity discounts. Telephone MADison 6-5391.

NEW RA-38 RECTIFIERS

115 v., 60 cy. 1 phase input, output 0-15,000 v. d-c @ 300 ma. Write for detailed information.

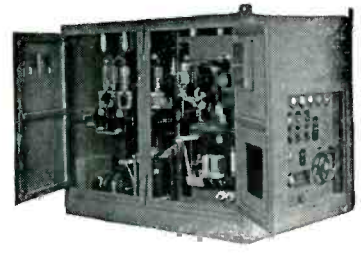

TUBES

All Tubes are New, of Standard Mfg. in original boxes.

| Type | Price |
|-----------|--------|
| 1B22 | \$5.75 |
| 1B23 | 9.75 |
| 2B22 | 47.50 |
| 3B22 | 2.75 |
| 3B24 | 1.75 |
| 3C23 | 3.75 |
| 4B28 | 2.75 |
| 15E | 1.25 |
| VT127A | 2.95 |
| 4507H | 7.50 |
| 2501L | 19.50 |
| *304TL | 7.50 |
| 307A/RK75 | 4.50 |
| 316A | .75 |
| 371B | 2.75 |
| 388A | 2.75 |
| 4507H | 22.50 |
| 700A | 37.50 |
| 701A | 4.75 |
| 702A | 3.75 |
| 703A | 4.75 |
| 704A | 2.25 |
| 705A | 2.25 |
| 706EY | 17.50 |
| 707A | 14.75 |
| 707B | 16.50 |
| 703A | 4.75 |
| 713A | 1.25 |
| 714AY | 5.75 |
| 715A | 3.50 |
| 717A | .75 |
| 719A | 11.75 |
| 721A | 2.75 |
| 722A | 13.75 |
| 725A | 17.50 |
| 730A | 19.50 |
| 7507L | 47.50 |
| 811 | 1.75 |
| 830B | 4.75 |
| 872A | 2.25 |
| 921 | 1.25 |
| 931A | 2.75 |
| C5B | 6.50 |
| C6A | 8.50 |
| C6J | 9.50 |
| F681A | 4.75 |
| WE-203A | 4.75 |
| WL-531 | 17.50 |
| WL-533 | 17.50 |

Includes 115 v 60 c H. V. fil. trans. & socket.

TRANSTATS, AMERTRAN

115 v. 50/60 c; 0-115 v. 100 amp. output **\$95.00**
115 v. 50/60 c; 0-150 v. 10 amp. output **\$24.50**
115 v. 60 c; 103-126 v. 2.17 amp. output **\$9.50**
115/230 v. 50/60 c; 0-260 v. 2.5 amp. output **\$21.50**

TRANSFORMERS

115 v. 60c. primaries
Amertran: 17,600 v. @ 10.4 K. V. A. cont. **\$65.00**
Amertran: 8,800-0-8,800 v. @ 10.4 K. V. A. cont. **\$75.00**
Westinghouse: 18,400-0-18,400 v. @ 9 K.V.A. cont., plus 2 WL-531 rect. tubes, fil. transf. & 50 h 575 ma choke **\$160.00**
24 v. @ 1 amp. unceased **\$16.00**

RELAYS

Westinghouse: Type SC-M Overcurrent relay. 2 to 1 A., 8 A. cont. rating 20-40% drop out ratio. **\$12.95**
A-B 810 Overload Relay. 6.3-18.1 A., 600 v. max. **\$7.95**

CHOKES

Amertron: Swinging, 900 h @ 16 ma. 25 h @ 525 ma, 35,000 v. test. **\$42.00**
Kenyon: 20 h @ 300 ma, 15,000 v. test **\$12.00**

CONTACTORS

I.T.E.: 115 v. 60 c. coil, Single pole 115 A. 600 v. with barriers, adj. time delay & remote contact control trip **\$10.95**
A-B #10-3301: 115 v. 60 c. coil. D.P.S.T. 15 amp contactor **\$4.95**
Monitor: 115 v. 60 c. coil. N.O.D.P. contactor, 100 A. 600 v. N. O. 15,000 v. 1.0A. contact. One N. O. & one N. C. interlock w/150 A & 30 A. removable fuses **\$8.95**

RESISTORS

200 watt wire wound resistors, ferrule ends. 160,000 ohm, 5,000 ohm, or 1,000 ohm **\$1.00**

AUTO-DRYAIR

Model-2200, for pressurizing high altitude equipment **\$160.00**

APR-4 RECEIVER: 115 or 80 v a-c, 60 to 2600 c., includes:

TN-17 tuning unit, 74 to 320 mc, plus
TN-18 tuning unit, 300 to 1,000 mc, plus
TN-19 tuning unit, 850 to 2,200 mc.
Frequency is calibrated to 1% accuracy. Service conditions are:
Temperature range, -67° to 162°F. Altitude range, 0 to 50,000 ft. Humidity range, 0 to 95%. N1 cond. **\$475.00**

EPCO

1527 E. SEVENTH ST.

LOS ANGELES 21, CALIF.

ACORN



IT'S FREE!
OUR BIG NEW CATALOGUE!

Indispensable to Purchasing Agents, Industrials, Schools, Labs. SEND FOR IT TODAY!

U.G. TYPE CONNECTORS

In Orders of 50 or More—Deduct 10%

| | | |
|----------------|----------------|----------------|
| UG 10/U—\$1.56 | UG 26/U—\$1.25 | UG 88/U—\$1.17 |
| UG 11/U—1.45 | UG 27/U—1.75 | UG 89/U—95 |
| UG 12/U—1.14 | UG 28/U—2.25 | UG 90/U—1.05 |
| UG 13/U—1.56 | UG 29/U—1.22 | UG 116/U—1.35 |
| UG 18/U—1.25 | UG 30/U—1.75 | UG 171/U—90 |
| UG 19/U—1.28 | UG 31/U—34.00 | UG 175/U—15 |
| UG 21/U—99 | UG 58/U—63 | UG 176/U—15 |
| UG 22/U—1.08 | UG 85/U—1.65 | UG 206/U—1.02 |
| UG 23/U—99 | UG 86/U—1.69 | UG 245/U—1.25 |
| UG 24/U—1.15 | UG 87/U—1.40 | UG 255/U—1.85 |
| | | UG 273/U—1.50 |

HIGH GAIN • WIDE BAND ★ 5" SCOPE

- Nationally Advertised
This scope is comparable to instruments selling at two to three times the price.
- D e c a d e Attenuators (Frequency Compensated)
 - Push-Pull Deflection
 - Identical Vertical and Horizontal Amplifiers
 - Sensitivity .15 RMS Volts/inch
 - Bandwidth 2 cycles to 450 KC.
 - Z Axis Input Calibration Test Signal

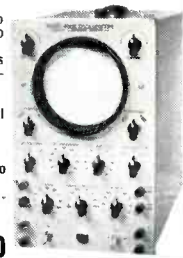

List \$119.50
Our Price **\$99.50**

ALLEN-BRADLEY CONTROLS

| Ohmage | Shaft | Bushing |
|-----------|--------------|-----------|
| 50 | 5/8" reg. | 3/8" L.B. |
| 300 | 3/8" s.s. | 1/4" |
| 500 | 1/4" s.s. | 3/8" |
| 1000 | 3/8" | 3/8" |
| 1000 | 3/16" s.s. | 1/2" L.B. |
| 2000 | 1/8" mill | 1/4" |
| 2500 | 3/8" reg. | 3/8" |
| 3000 | 1/2" mill | 1/4" |
| 5000 | 2 13/16" | 1/2" |
| 5000 | 1/8" s.s. | 1/4" |
| 6500 | 1/8" s.s. | 1/4" |
| 10,000 | 1/8" s.s. | 1/2" L.B. |
| 15,000 | 1/8" s.s. | 1/4" |
| 20,000 | 1/8" s.s. | 1/2" L.B. |
| 25,000 | 1/2" mill | 1/2" L.B. |
| 40,000 | 1/8" s.s. | 1/2" L.B. |
| 50,000 | 5/8" reg. | 1/2" L.B. |
| 50,000 | 1/8" s.s. | 1/2" L.B. |
| 50,000 | 1 3/16" mill | 3/8" |
| 50,000 | 3/8" reg. | 1/4" |
| 60,000 | 1/2" mill | 1/4" |
| 100K | 1/8" s.s. | 1/2" |
| 250K | 1/8" s.s. | 1/4" |
| 500K | 1/4" | 1/2" |
| 500K | 1/2" | 1/4" |
| 1 meg. | 1/8" s.s. | 3/8" |
| 1 meg. | 1/8" s.s. | 1/2" |
| 6.25 meg. | 3/8" | 1/4" |

50c each

RADAR EQUIPMENT

SCR-717B 10cm search radar
APS-3 & APS-4 3cm search sets complete
SO-12 complete w/trailer & gas driven supply
SO-9 10cm shipborne search set compl. w/spares

| | |
|--|----------|
| APR-1 receivers | \$750.00 |
| QBF Sonar sets | 15.00 |
| SO-9 pulse networks 1 microsec. 15 Kwatt | 15.00 |
| SO-9 pulse transformers | 30.00 |
| AY-101D Autosyn w/calibration | 2.00 |
| 2J1G1 Selsyn motor | 1.20 |
| Selenium rectifier, full-wave 115v, AC 250 ma DC | 9.50 |
| BD-77 Dynamotor | |

TRANSFORMERS

| | |
|--|-------|
| T-100 115v-400 cy 4580v. 2 ma 2.5v 5 amperes | 4.00 |
| T-118 G.E. K. 2745 pulse transformer. | 30.00 |
| T-117 UX-9202A pulse transformer | 30.00 |

Write for listings of other surplus bargains.

LERU LABORATORIES, INC.

360 Bleecker St. New York 14, New York

Large Quantity of CE-393A Grid Controlled Rectifier Tubes, Mercury Vapor and Gas Filled. These Tubes Available for Immediate Shipment at Special Low Price of Only \$4.00 each.

FS-9893, Electronics

520 N. Michigan Ave., Chicago 11, Ill.

DYNAMOTOR DM-28-R

For BC 348's **\$3.50**

Brand New Original Pack U. S. A. postpaid

DRILLICK SALES CO.

5453 Virginia Ave. Los Angeles, Calif.

WANTED

WANTED

TN-18-APR-4

or TN-3-APR-1

TUNING UNITS
RANGE 300 TO 1000 MC.

IN ANY CONDITION

W-8301, Electronics

330 West 42nd St., New York 18, N. Y.

WANTED

Teletypewriters complete, components or parts. Any quantity and condition.

W-6654, Electronics

330 West 42nd Street, New York 18, N. Y.

STANDARD BRANDS OIL CONDENSERS

| Cap. | Volt. | Each |
|------|---------|--------|
| 4 | 600 | \$7.79 |
| 5 | 600 | 7.79 |
| 6 | 600 | 8.99 |
| 7 | 600 | 9.99 |
| 2 | 1000 | 7.79 |
| 4 | 1000 | 1.19 |
| 8 | 1000 | 1.59 |
| 8+1 | 1000 | 1.69 |
| 15 | 1000 | 1.95 |
| 10 | 1000 | 2.89 |
| 2x4 | 1500 | 2.25 |
| 4 | 2000 | 2.75 |
| 1.25 | 3000 | 1.19 |
| 1.0 | 3000 | 1.95 |
| 0.1 | 3500 | 1.79 |
| 15 | 4000 | 1.69 |
| 0.5 | 5000 | 2.19 |
| 2 | 5000 | 5.95 |
| 30 | 90v AC | 3.95 |
| | 3 Phase | |

FP CONDENSERS — STANDARD BRANDS

| SINGLE SECTION | | | TRIPLE SECTION | | |
|----------------|-------|--------|----------------|-------------|--------|
| Cap. | Volt. | Each | Cap. | Volt. | Each |
| 2,000 | 15 | \$7.79 | 90-40-20 | 200-200-50 | \$8.99 |
| 1,000 | 25 | .74 | 30-15-10 | 350-300-25 | .59 |
| 10 | 450 | .34 | 10-10-20 | 350-350-25 | .51 |
| 10 | 450 | .39 | 30-15-10 | 350-300-300 | .69 |
| 20 | 475 | .47 | 15-10-10 | 400-400-350 | .62 |
| 30 | 450 | .49 | 15-10-10 | 350-350-250 | .64 |
| | | | 40-40-20 | 400-300-250 | .89 |
| | | | 10-10-20 | 450-450-25 | .69 |
| | | | 15-15-10 | 450-400-350 | .73 |
| | | | 30-10-10 | 450-450-300 | .79 |
| | | | 30-30-10 | 450-450-25 | .89 |
| | | | 60-20-20 | 450-450-400 | 1.19 |

DUAL SECTION

| Cap. | Volt. | Each |
|-------|--------|-------|
| 40-20 | 25 | \$.39 |
| 80-80 | 25 | .54 |
| 20-20 | 350 | .79 |
| 40-40 | 250 | .79 |
| 10-40 | 300-25 | .79 |
| 90-10 | 350 | .69 |
| 40-20 | 450 | .79 |
| 40-40 | 450 | 1.09 |
| 20-20 | 450 | .49 |
| 50-50 | 450 | 1.19 |

PHONE WORTH 4-3270

ACORN ELECTRONICS CORP.

76 Vesey St., Dept. E-10, New York 7, N. Y.

TERMS: 20% cash with order. Balance C.O.D. unless rated. All prices F.O.B. our warehouse in New York City. No orders under \$2.50.

TUBES

BUYING . . . SELLING

COMPARE OUR PRICES

| Type | Price | Type | Price | Type | Price | Type | Price | Type | Price |
|------|--------|-------|-------|-------|-------|--------|-------|------|-------|
| 1A3 | \$0.29 | 4C35 | 19.50 | 217C | 7.95 | 714AY | 4.00 | 809 | 2.75 |
| 1B22 | 3.95 | 5D21 | 24.95 | 304TH | 3.95 | 715A | 6.00 | 810 | 6.95 |
| 1B24 | 4.50 | 5MP1 | 1.95 | 307A | 3.95 | 715C | 24.95 | 811 | 1.75 |
| 1B38 | 39.50 | 6J4 | 4.95 | 3501B | 2.40 | 723A | 7.95 | 813 | 7.95 |
| 1N23 | 3.79 | 6C21 | 19.95 | 371B | .79 | 723A/B | 10.95 | 814 | 2.75 |
| 2C40 | 3.75 | 7B27 | 4.95 | 388A | 1.80 | 725A | 9.95 | 832A | 3.95 |
| 2C44 | 0.75 | 15R | 1.00 | 417A | 19.95 | 730A | 5.95 | 833A | 32.50 |
| 2D21 | 1.08 | 10JTH | 11.95 | 527 | 7.95 | 802 | 3.75 | 834 | 5.75 |
| 2J26 | 8.75 | | | 575A | 12.50 | 803 | 6.95 | 837 | 2.00 |
| 2J27 | 9.75 | | | 703A | 1.80 | 804 | 10.95 | 838 | 2.75 |
| 2J31 | 9.75 | | | | | | | 849 | 29.95 |
| 2J32 | 9.75 | | | | | | | 851 | 29.95 |
| 2J49 | 24.50 | | | | | | | 861 | 29.95 |
| 2J50 | 24.50 | | | | | | | 869B | 29.95 |
| 2K25 | 19.95 | | | | | | | 872A | 2.75 |
| 2K28 | 24.95 | | | | | | | 874 | 0.69 |
| 3C23 | 3.95 | | | | | | | 876 | 0.75 |
| 3J31 | 39.50 | | | | | | | | |

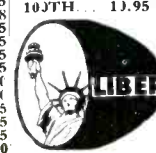

LIBERTY ELECTRONICS, INC.
135 LIBERTY STREET NEW YORK 6, N. Y.
PHONE WORTH 4-8262

THOUSANDS OF OTHERS

Nobody but ARICO has:
"hard-to-get" items—

SPARE PARTS ARE HARD-TO-GET

RADAR AN/APS-2C
or 2E Spares including:

1 ea B-201 Blower Motor, 1 ea B-801 Blower Motor, 1 ea B-802 Blower Motor, 3 ea Crystal IN-21 and the following tubes: 3 ea 6AC7, 2 ea 6H6, 3 ea 6SN7, 2 ea 6L6GA, 2 ea 2AP1, 2 ea 5FP7, 2 ea VR-105-30, 2 ea 5U4G, 2 ea 6X5GT, 2 ea 2X2, 2 ea 829, 2 ea RKR72, 2 ea 715-B, 2 ea 21-22, 2 ea 417-A, 2 ea 721-A, plus misc. fuses, brushes, valve core, dehydrator, etc. Brand new, packed in grey chest with description list. **\$89.00**

AN/ARC-5 or SCR-274-N Spares incl. 53 ea. asst. tubes incl. 12SK7, 12K8, 12SF7, 12SR7, 12A6, 12J5, VR-150, 1625, 1626, 1629, 24 ea. dyn. brushes, 25 ea. asst. capacitors, 8 ea. asst. tube clips, 5 ea. asst. chokes, 2 ea. fuses, 35 lbs asst. resistors and 4 ea. transformers. Brand new, packed in gray hardwood chest with trav. strap, handles and complete parts catalog including part number and electrical ratings. **\$29.00**

AIRCRAFT RADIO EQUIPMENT and TEST SETS

- BC-221-AH Frequency Meter..... 85.00 ea
- AN/ARM-1 Test Set for ARC-3..... 150.00 set
- A-27 Phantom Antenna..... 5.00 ea
- A-58 Phantom Antenna 100 w. 200 kc—12 me 15.00 ea
- A-98 Phantom Antenna with special R-F Meter, for testing Gibson Girls..... 15.00 ea
- I-100 Test Set for ARN-7 or 269 Compass..... 85.00 set
- I-139 Test Meter for SCR-522..... 12.00 ea
- IE-19 Test Set for SCR-522 complete..... 200.00 set
- TS-10A/APN Altimeter Delay Line..... 40.00 set
- TS-16/APN Altimeter Test Set 24-v AN/APN-I 125.00 set
- TS-16X/APN Altimeter Test 12-v AN/APN-I 150.00 set
- TS-80/U Test Meter for AN/ARC-1..... 12.00 ea
- TS-250/U Test Set for APN-I Altimeters..... 150.00 set
- RC-54 Test Set for ARC-5 or 274-N Receivers..... 150.00 set
- RC-55 Test Set for ARC-5 or 274-N Transmitters..... 250.00 set
- RC4 Type = 158 Oscilloscope..... 85.00 ea
- Hallcrafters S-22-R Receiver (reconditioned)..... 40.00 ea
- PP-29/CRN-2 Rectifier Power Supply for SCS-51 ILS Glide Path Xmitter, (used)..... 200.00 ea
- W. E. Type 27B Marker Receivers 12-v (complete and reconditioned)..... 150.00 set
- Bendix RTA-1B Transmitter only (recond. L. N.)..... 500.00 ea

Some of the above Test Sets are one of a kind in stock.

Also in stock: AN/ARC-1, AN/ARC-3, AN/ART-13, BC-348, AN/ARN-7, MN-26, SCR-269-G.

LOWEST PRICE TUBE LIST

| QTY | Part No. | Description | Price |
|-----|----------|-------------|-------|
| 2 | API | 12B7/14A7 | .60 |
| 2 | x 2 | 12J5-GT | .40 |
| | 2J22 | 12K8 | .60 |
| | 2K28 | 12SF7 | .59 |
| | 5FP7 | 12SK7 | .60 |
| | 5U4G | 12SH7 | .35 |
| | 6AC7 | 12SN7 | .75 |
| | 6AG5 | 12SR7 | .40 |
| | 6AK5 | 14B6 | 5.00 |
| | 6AG7 | 28D7 | .40 |
| | 6E5 | 35Y4 | .65 |
| | 6H6 | RKR-72 | 1.50 |
| | 6L6GA | 417A | 14.95 |
| | 6SL7GT | 715-B | 7.50 |
| | 6SN7GT | 717-A | .85 |
| | 6V6GT | 721-A | 3.50 |
| | 6X5GT | 826 | .50 |
| | 12A6 | 811 | 2.25 |
| | | NE-48 | .20 |
| | | 829 | .60 |
| | | 955 | .35 |
| | | 1625 | .35 |
| | | 1626 | .35 |
| | | 1629 | .35 |
| | | 2050 | .70 |
| | | 2051 | .70 |
| | | 3001 | .39 |
| | | 3002 | .39 |
| | | 9003 | .39 |
| | | 9004 | .39 |
| | | 9006 | .39 |
| | | VT-25 | .35 |
| | | VT-52 | .35 |
| | | NE-16 (991) | .29 |
| | | NE-48 | .20 |

AIRCRAFT RADIO INDUSTRIES

780 State Street, New Haven, Conn.
N.Y.C. Office—274 Madison Ave.

Special Transformer Buy

2100 v. each side of center at 1500 ma from 115 or 230 v. 50 - 60 cycle primary. New post-war Westinghouse Hypersil core and coil construction. Absolutely guaranteed. 42 lbs. shipping weight. Net price \$16.00 each f.o.b.

Weston Laboratories
Weston 93, Mass.

APR-4 RECEIVER

good working order, comp. all tuning units, freq. tunable 38-4000 mc.
WILL TRADE for good used Meas. Corp. 84 or equiv. stand. Signal Generator, OR SELL.

JOE'S RADIO SHOP

Bridgeton, N. J. Phone: 251

BRAND NEW U. S. GOV'T. SURPLUS GUARANTEED

MANUFACTURERS - JOBBERS - LABS - SCHOOLS - INDUSTRIALS

MICROSWITCHES



- A-SPST 10a/125vac MS Corp #YZ-RS13 type "S" plunger, metal housing norm open circuit.....49¢
- B-SPDT 10a/125vac MS Corp #B-RS10 type "S" plunger, 2-circ-one norm op & one norm cl.....39¢
- C-DPST 10a/110vac Snap-Action Switchette, GE #CR107—C123—C3, 2-circ: one norm open and one norm closed.....29¢

"UHF" Coax Cable Connectors

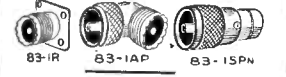

| Cat. No. | Army No. | Type | Price 100 |
|----------|----------|------|-----------|
| 83-1AP | M-359 | Plug | \$.35 .28 |
| 83-1D | PL-271 | Adap | 1.25 1.00 |
| 83-1F | PL-274 | Feed | 1.10 .90 |
| 83-1R | SO 239 | Rec | .35 .28 |
| 83-1SPN | PL-259A | Plug | .35 .28 |
| 83-22SP | UG-102/U | Plug | .45 .40 |
| 83-22R | SO-264 | Rec | .50 .40 |

(Special Prices To Quantity Users)

LEVER SWITCH

DPDT 10-amp. standard heavy duty contact—Mossman #4101 momentary lever action, norm open and norm closed circuits.....\$1.98
Many Other Types Available

AMPHENOL "AN" CONNECTORS



LARGE VARIETY AVAILABLE AT GREAT SAVINGS
Send your specs and let us quote

SELECTOR SWITCHES NATIONALLY KNOWN MFRS.

| Total Poles | Pos. | Total Decks | Type | Price |
|-------------|------|-------------|----------|--------|
| 1 | 12 | 1 | ceramic | \$0.55 |
| 1 | 21 | 3 | bakelite | .55 |
| 2 | 11 | 2 | bakelite | .60 |
| 4 | 11 | 6 | bakelite | 1.17 |
| 6 | 11 | 6 | bakelite | 1.68 |
| 18 | 5 | 9 | ceramic | 1.90 |

OTHER TYPES AVAILABLE

MALLORY PUSH SWITCH

- #2001 S.P. make cont., non/L 29¢
- #2003 S.P.D.T., non-lock..... 32¢
- #2003L S.P.D.T., lock..... 32¢
- #2004 D.P. make 2 non/L..... 36¢
- #2004L D.P. make 2 lock..... 35¢
- #2006 D.P.D.T., non-lock..... 45¢

SHOCK MOUNTS

- 150P 4/4 18¢
- 150P 6/6 24¢
- 204P-112/45¢
- 100P-1/1 10¢
- 100P-2/2 10¢
- 100PR-2/2 10¢
- 100P-3/3 10¢
- 100P-4/4 10¢
- 100P-6/6 13¢
- Barry#5203/7 30¢

ALLEN-BRADLEY potentiometers

| 50 | 1300 | 10000 | 75000 |
|------|------|-------|---------|
| 60 | 1500 | 11000 | 80000 |
| 100 | 2000 | 12000 | 100,000 |
| 150 | 2200 | 15000 | 150,000 |
| 300 | 2500 | 16000 | 200,000 |
| 400 | 4000 | 20000 | 250,000 |
| 500 | 4700 | 22000 | 300,000 |
| 600 | 5000 | 25000 | 350,000 |
| 1000 | 6000 | 30000 | 400,000 |
| 1200 | 6500 | 35000 | 500,000 |

TYPE "JJ" DUALS

| 60-60 | 25K-10K | 200K-200K |
|---------|-----------|-----------|
| 100-100 | 35K-5K | 250K-250K |
| 200-200 | 35K-35K | 300K-300K |
| 500-500 | 40K-7K | 350K-5K |
| 600-600 | 40K-40K | 350K-25K |
| 2K-2K | 50K-50K | 350K-35K |
| 5K-5K | 100K-100K | 400K-100K |
| 10K-10K | 130K-130K | 700K-700K |
| 20K-2K | 150K-150K | 800K-75K |

Price \$1.25 each
5.0 meg/5.0 meg

Price \$1.95 each

Also Available at Surplus, Large Variety of Other Make Controls
TAKE 'EM AWAY!! Dry Electrolytics in Cans

| Mfd | Volt | Price |
|-------|------|---------------|
| 8 | 600 | 1-section .39 |
| 8-16 | 475 | 2-section .43 |
| 8-8 | @350 | |
| 20 | @150 | 3-section .24 |
| 40-40 | @300 | |
| 80 | @50 | 3-section .41 |

JONES CONNECTORS

| | |
|------------------|------------------|
| S 304-CCT \$0.19 | P-324 FHT \$0.55 |
| P 306 AB .12 | P 330 SB .76 |
| S 306 CCT .22 | S 330 SB .80 |
| P 306 CCT-L .25 | P 333-FHT .80 |
| S 306 FHT .17 | P 402 SB .21 |
| S 308 AB .16 | S 494 AB .25 |
| P-308 FHT-L .23 | S-436 CCT .44 |
| S-308-FHT-L .25 | P 408 LAB .21 |
| P-312 AB .17 | S 498 LAB .23 |
| P 312 CCT-L .32 | S 498 CCT .52 |
| P 315 FHT .30 | S 2408 LAB .23 |
| S 315 FHT .34 | S 2408 B .40 |
| P 315 EB .23 | P 508 CE .191 |
| P-315-CCE .36 | P 510 CE .228 |
| S 318 CCE .44 | S 510 CE .228 |
| S 318 CCE .47 | P-510 SB .198 |
| P 321 AB .36 | S 510 S3 .198 |
| P 324 EB .44 | P-512 CE .264 |

(Special Prices to Quantity Users)

JONES BARRIER STRIPS

| Cat. No. | Price | Cat. No. | Price |
|-------------|--------|----------|--------|
| 4-140 Y | \$0.17 | 11-141 Y | \$0.57 |
| 5-140 Y | .21 | 12-141 Y | .43 |
| 10-140 3/4W | .40 | 14-141 Y | .62 |
| 10-240 W | .29 | 13-141 Y | .67 |
| 4-141 | .16 | 14-141 Y | .72 |
| 4-141 3/4W | .22 | 8-142 | .36 |
| 5-141 | .20 | 12-142 | .53 |
| 6-141 Y | .27 | 2-150 | .23 |
| 7-141 | .32 | 2-151 | .51 |
| 7-141 Y | .38 | 4-151 | .98 |
| 7-141 Y | .37 | 5-151 | 1.21 |
| 8-141-3/4W | .42 | 4-152 | 1.42 |

(Special Prices to Quantity Users)

POWER RHEOSTATS (nationally known mfrs)



| ohms | watt ea. | ohms | watt ea. |
|------|----------|--------|----------|
| 5 | 50 | \$1.24 | 378 |
| 5 | 150 | 2.74 | 400 |
| 6 | 25 | .98 | 1250 |
| 6 | 50 | 1.24 | 500 |
| 7 | 25 | .98 | 585 |
| 7.5 | 100 | 2.25 | 750 |
| 8 | 50 | 1.24 | 750 |
| 10 | 25 | .98 | 1000 |
| 12 | 25 | .98 | 1200 |
| 16 | 50 | 1.24 | 1500 |
| 22 | 50 | 1.24 | 1500 |
| 25 | 25 | .98 | 2000 |
| 50 | 25 | .98 | 2000 |
| 50 | 50 | 1.24 | 2500 |
| 60 | 25 | .98 | 3000 |
| 75 | 150 | 2.74 | 3000 |
| 80 | 50 | 1.24 | 3500 |
| 80 | 500 | 4.95 | 5000 |
| 100 | 50 | 1.24 | 5000 |
| 125 | 25 | .98 | 7500 |
| 150 | 50 | 1.24 | 7500 |
| 200 | 25 | .98 | 10000 |
| 250 | 25 | .98 | 10000 |
| 350 | 25 | .98 | 20000 |

BIRTCHESTER TUBE CLAMPS

#926-A
#926-A1
#926-B
#926-B1
#926-B22
#926-C
#926-C5
18¢

OIL CONDENSERS FAMOUS MAKES
most with ceramic pillar insulators.

| | | |
|----------|--|--------|
| .1 Mfd | 3000 vdcw | \$0.75 |
| .25 Mfd | 3500 vdcw | 1.15 |
| 1.0 Mfd | 500 vdcw | .28 |
| 1.0 Mfd | 600 vdcw | .35 |
| 2.0 Mfd | 400 vdcw | .35 |
| 2.0 Mfd | 600 vdcw | .39 |
| 4.0 Mfd | 500 vdcw | .69 |
| 4.0 Mfd | 600 vdcw | .69 |
| 6.0 Mfd | 400 vdcw | .75 |
| 6.0 Mfd | 600 vdcw | .98 |
| 10.0 Mfd | 600 vdcw | 1.00 |
| 14.0 Mfd | 600 vdcw | 1.75 |
| 15.0 Mfd | 600 vdcw | 1.98 |
| 15.0 Mfd | 1000 vdcw | 2.25 |
| 4-4 Mfd | 400 vdcw 3 sep. 4 prong plugs in can 4" high x 3" Dia. | \$1.49 |

BATHTUB CAPACITORS

| Capacity | Price | Capacity | Price |
|-----------|-------|------------|-------|
| .033/400V | .17¢ | 1.0/200V | .29¢ |
| .05/200V | .13¢ | 1.0/600V | .35¢ |
| .05/400V | .13¢ | 2.0/600V | .45¢ |
| .05/600V | .21¢ | 2.0/1500V | .33¢ |
| .1/200V | .17¢ | 2x1/600V | .29¢ |
| .1/400V | .29¢ | 2x1/1000V | .31¢ |
| .1/600V | .22¢ | 2x1/600V | .28¢ |
| .15/600V | .23¢ | 2x.25/600V | .29¢ |
| .25/200V | .13¢ | 2x.5/600V | .34¢ |
| .25/400V | .21¢ | 3x.05/600V | .30¢ |
| .25/600V | .23¢ | 3x.1/600V | .33¢ |
| .5/200V | .29¢ | 3x.25/600V | .30¢ |
| .5/400V | .23¢ | 3x1.0/100V | .35¢ |
| .5/600V | .23¢ | | |
| 4.0/50V | .35¢ | 200/12V | .25¢ |
| 25/25V | .2¢ | 300/6V | .35¢ |
| 25/50V | .25¢ | 2x10/25V | .25¢ |
| 25/75V | .30¢ | 2x200/9V | .49¢ |
| 50/25V | .28¢ | | |

Open Accounts to Rated Companies. Prices net FOB our whose NYC

ALEXANDER MOGULL CO., INC.
161 Washington St., N. Y. 6, N. Y. WOrth 4-0865

ELECTRONIC TUBE-MAKING MACHINERY

For manufacturing radio tubes, electronic tubes, cathode-ray tubes, lamps. New and used. Reasonably priced, satisfaction guaranteed.
AMERICAN ELECTRICAL SALES CO.
67 E. 8th St New York, N. Y.

SHEET METAL MACHINERY

NEW and Used — Brakes — Shears
Forming Rolls — Folders — Punches —
Di-Acro, Pexto, Niagara & Whitney

GUARANTEED GOVT SURPLUS

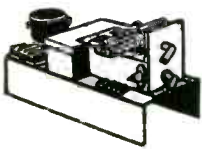

420—750 MC OSCILLATOR

Compact, beautifully built line oscillator employing two W.E. 368AS (703A) "door-knob" tubes in push-pull. Exceptionally stable. 5W output at 420mc, 2W at 700mc. Independent grid and plate tuning. Adjustable output coupling and tuning assembly. Coaxial output connection. Built-in blower may be operated from 110VAC. Power requirements: 300VDC/150ma, 1.2V/4A, 1.2V/4A. 5¼"x6½"x11½". 7 lb. Supplied complete with tubes. Ideal for 420mc amateur operation or for use in the 460-470mc citizens radio band. Stock No. APO-66... \$8.95 Spare 368AS/703A tubes... \$1.69 ea.

WE CARRY A LARGE AND VARIED INVENTORY WHICH INCLUDES:

- AMPLIFIERS
- AN CONNECTORS
- CABLE
- CAPACITORS
- CHOKES
- CIRCUIT-BREAKERS
- COAX-CONNECTORS
- COILS
- CORDS
- CRYSTALS
- DELAY LINES
- FILTERS
- FUSES
- HANDSETS

| JAN TUBES | | | |
|-------------------------------------|--------|---------|--------|
| BRAND NEW IN ORIGINAL CARTONS | | | |
| <i>(Except as specified with *)</i> | | | |
| 1B24 | \$4.75 | 1RKR-73 | \$0.95 |
| 2C44 | 1.75 | 304TH | 3.95 |
| 2D21 | 1.19 | 304TL | 1.95 |
| 2P38 | 14.95 | 117V | 19.95 |
| 2J48 | 14.95 | 705A | 1.95 |
| 2K28 | 24.95 | 715B | 9.95 |
| 2X2A | 0.89 | 715C | 24.95 |
| 3D21A | 1.95 | 723A/B | 14.95 |
| 5R4GY | 1.09 | 724B | 4.75 |
| 6AC7* | 7.79 | 725A | 7.50 |
| 6AG7 | 1.19 | 805 | 3.95 |
| 6AK5 | 1.09 | 811 | 1.95 |
| 6AL5 | .75 | 814 | 3.95 |
| 6J6 | .95 | 815 | 1.95 |
| 6SL7GT | .69 | 829B | 4.75 |
| 6SU7GT/Y | 1.29 | 872A | 1.69 |
| 6Y6G | .88 | 902A | 3.95 |
| 72/3B24 | .95 | 931A* | 3.95 |

Specify JAN tubes when ordering.
* Manufacturers bulk pack JAN.

Wide Range Butterfly Wavemeter & Oscillator Elements



Precision wide range butterfly circuit elements. Sturdily constructed. Mounted in ball bearings. Suitable for motor drive. Ideal for use as wavemeters and oscillators. (See description below.)

| Stock No. | Freq. (mc.) | Notes* | Unit Price |
|-----------|-------------|--------|------------|
| TN-20 | 105-330 | 1, 3 | \$4.95 |
| TN2A | 75-300 | 1, 4 | 4.95 |
| TN-30 | 135-485 | 2, 3 | 5.95 |
| TN3A | 300-1000 | 2, 5 | 6.95 |

Brand new, in original packing.

- * NOTES: 1) Aluminum construction
2) Silver-plated brass
3) Designed as oscillator element (955 acorn triode)
4) Has diode socket mounted on unit (955 as diode)
5) Has crystal diode mount for 1N21 crystal

Immediate delivery from stock (subj. to prior sale). Open acct. to rated organizations, others 20% with order balance COD. Prices FOB Corona, N. Y. and subject to change without notice.

A PENNY POST-CARD WILL PUT YOUR NAME ON OUR MAILING LIST.

DUBIN ELECTRONICS CO. Inc.

TELEPHONES: HICKORY 6-3066-7-8 DEPT. E-10 103-02 NORTHERN BLVD., CORONA, N. Y.

WESTERN ELECTRIC

BELOW MANUFACTURERS COST!

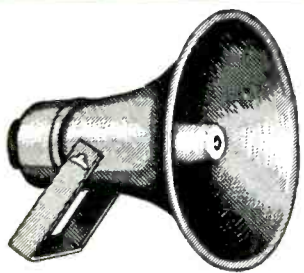

BRAND NEW DRIVER UNIT with REFLEX PROJECTOR

- A Blast-Proof, Blare-Proof Reflex Speaker with a Projector especially designed for use with the famous WESTERN ELECTRIC DRIVER UNIT.
- Heavy Gauge metal construction throughout, including the main trumpet section, gives you peak performance without blaring or blasting.

WILL HANDLE UP TO 50 WATTS WITH NO DISTORTION

EXCELLENT FOR:

- INDUSTRIAL PURPOSES
- CALL SYSTEMS
- CONCESSIONS
- BALL PARKS
- SCHOOLS and
- P. A. WORK

25% Deposit With Order Unless Rated
BALANCE C.O.D.

19⁹⁵
F.O.B. N.Y.C.
4 FOR \$75.00

ANOTHER WESTERN ELECTRIC SPECIAL

A fortunate purchase of genuine Western Electric Voice Coil and Diaphragm Assembly for the above unit at a close-out price.

BRAND NEW IN \$2⁹⁵ SEALED CARTONS

MANUEL KLEIN 76 CORTLANDT ST. NEW YORK 7, N. Y. BEEKMAN 3-9530 RECTOR 2-6608

ONE-HALF MILLION BATHTUB CONDENSERS

- OIL IMPREGNATED -

| | |
|--------------|--------------|
| .1 —400V | .25—600V |
| .1 —600V | .5 —400V |
| 2 x .1 —400V | .5 —600V |
| 2 x .1 —600V | 1.0 —600V |
| 3 x .1 —400V | 4.0 — 50V |
| 3 x .1 —600V | 2 x .25—600V |
| 2 x .05—600V | 2 x .5 —230V |

PRICES ON REQUEST

Many Others Not Listed Above, in Stock Manufacturers Only—Let Us Know Your Needs

SHIRO TRADING CORP.
130 W. 42d St. N. Y. City

D.C. MICROAMMETERS

| | |
|----------------------------|---------|
| 0-200 ua 3" sq. G.E. DO 50 | \$ 8.00 |
| 0-100 ua 3" sq. G.E. DO 50 | 10.00 |
| 0-50 ua 3" sq. G.E. DO 50 | 12.00 |

R.F. MILLIAMMETERS

| | |
|-------------------------|---------|
| 0-115 Ma 3½" Weston 425 | \$12.00 |
| 0-100 Ma 3½" Weston 425 | 12.00 |

PRECISION

PORTABLE INSTRUMENTS

Single or multi-range

D.C. Microammeters, from 5 ua full scale. Thermo-couple Milliammeters, from 1.5 Ma. Thermo-couple voltmeters.

Precision Electrical Instrument Co.
146 Grand Street New York 13, N. Y.

SURPLUS BARGAINS - - NOW ! !

L & N MICROMAX MODELS

REBUILT, RECONDITIONED
ADJUSTED ELECTRICALLY AND
MECHANICALLY



Single Point, Curve Drawing, Continuous Line, One set HIGH, COMMON, LOW Contacts. 110V AC Motor.

RANGES:

- 0-1200° F C/A
- 0-1500° F C/A
- 0-1800° F C/A
- 1000-2000° F C/A
- 1000-3000° F Plat./10%R

PRICE \$210.00

L & N MICROMAX MODEL R

REBUILT, RECONDITIONED
ADJUSTED ELECTRICALLY AND
MECHANICALLY



Single Point, Curve Drawing, Continuous Line. Chart speed—1 RPM/24 hrs. 1 set H.C.L. Contacts. 110V AC Motor.

RANGES:

- 700-1400° F C/A
- 200-2000° F C/A
- 1000-2400° F C/A

PRICE \$135.00

STEP DOWN TRANSFORMERS SPECIAL

Made by GE, heavy duty, considerable over-design, open frame, ideal for rectifier application. size: 3 1/2" x 3 1/2" x 4".
PRI—115 Volts 60 Cycles
SEC—15 V at 12 Amps

\$3.75

GE TRANSFORMER TYPE M Cat. 61G5 ISOLATION TYPE PRI.—230 V. SEC. 115 V

60 Cycles 250 Watts. 8" x 5" x 4 1/2" Net weight—14 lbs. **NEW—\$6.50**

A. T. R. INVERTER

Model RSA Type 12
Input—12V DC. Output—110V AC.
50/60 cycles. 125 W Intermittent,
100 W Cont. 8 1/2" x 8" x 4 1/2" Net 15 lbs.

New, \$16.50

POWERTRON

117 LAFAYETTE STREET

WESTON MODEL 622—NEW!

DC Portables . . . 1/2 of 1% Accuracy

High Sensitivity, Moulded bakelite case

- 0-20 Mics 260 ohms 127.87
- 0-30 Mics 1765 ohms 111.37
- 0-50 Mics 90 ohms 115.50
- 0-100 Mics 37 ohms 115.50
- 0-1.5/3/7.5/15/30/75/150/300/750 Volts 162.11

QUANTITIES LIMITED! ACT NOW!

WESTON MODEL 155—NEW!

AC PORTABLES . . . 1/2 of 1% Accuracy

Hand calibrated mirror scale, black walnut case, leather handle

- 0-50 MA 41.25
- 0-100 MA 41.25
- 0-250 MA 41.25
- 0-500 MA 41.25
- 0-150 Amp FS 5A 28.87
- 0-200 Amp FS 5A 28.87
- 0-300 Amp FS 28.87
- 0-150 Volts 31.76
- 0-300 Volts 31.76

QUANTITIES LIMITED! ACT NOW!

HIGH VOLTAGE CAPACITORS

- 1 MFD 20 KV DC 18"x13 1/2"x5" \$25.00
- 1 MFD 25 KV DC 13"x7"x4" 9.85
- .001 MFD 50 KV DC 5 1/2"x7 1/2"x4" insulators 4" dia. x 7" high 12.50

Cap Mfd. Volts D.C. Height Width Length Price

- 10 1000 5-7/8 x 1-3/4 x 3-7/8" \$1.85
- 4 1000 5-7/8 x 2-3/4 x 1-1/4"85
- 1 1000 3-5/8 x 2" x 1-1/16"50
- 1 500 2" x 1-1/4" x 1-1/16"25
- 25 1000 1-1/2 x 1" x 3/4"15

RACK PANEL CABINET

42" H x 22" W x 16 1/2" D
Heavy Gauge Metal, Black Wrinkle Finish, shipped knocked down, ready to assemble with rear door and hardware. Front Panel not included. Panel size 19 1/8" x 36 3/4". Shipping weight 99 lbs.

NEW! A REAL BUY \$17.50

ALL PRICES FOB OUR WAREHOUSE N.Y. INCLUDE SUFFICIENT FOR POSTAGE

WESTON MODEL 271 Microammeter



Another of the famous Weston fan shaped line. Very large scale 5.8" long. These meters were made by Weston to General Radio specifications, with special mirrored scale and knife edge pointer. Accuracy 1%.

0-600 Microamps 170 M.V.
Coil Res: 250 Ohms
\$22.50

Your Price



WHSE PORTABLE GALVANOMETER

Type PX-12, Movement 7 MA, special scale, solid connecting terminals, contains a 1 Volt internal cell which can be easily removed for conversion to DC AMMETERS & VOLTMETERS, with leather case and canvas carrying strap.

A BUY AT \$4.95

DUMONT Model 164-E 'SCOPE

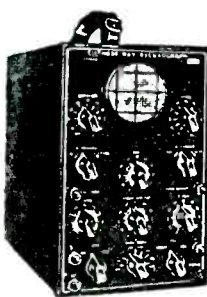

3" CRT operates at accelerating potential of 1100 V—brilliant well-defined trace

Vert amp voltage gain approx 43, horz amp voltage gain approx 55, Freq. range vert. & hor. amp both uniform ±3 DB from 5-100,000 CPS input impedance 1 megohm vert. .8 megohm hor. Operates 115 V, 40-60 cycle.

Price New \$115.00
Your Cost \$77.50

Electrical Equipment Co.

Phone: WOrth 4-8610

NEW YORK 13, N. Y.

SAVE NOW! ON SURPLUS ELECTRONICS LOW PRICES

MIXER ASSY. FOR SG RADAR

W/W.E. 708A Tube \$10.00

CONDENSERS—Standard Brands

- Vitamin Q .05 16000V \$1.49
- 2 x .15 MFD 16000 V \$1.95
- 1 MFD 25000 V \$1.95
- Mica Type 4-4 .0025 MFD 25 KV EFF. \$14.95
- 1 x .1 7000 V \$1.95
- 5-5 MFD 400 WV Tube \$1.95
- 8-8-8 MFD 600 WV \$1.95
- 10 MFD 600 V Oil Filled \$.89
- 1 MFD 10,000 V DC \$9.95

LEACH RELAY #1154 DPST 110 V 60 Cy 10A \$1.25

XTALS 1N 23 and 1N 21 \$.69
Dumont Type 224 Oscilloscope Transformer \$1.95

SIGNAL GENERATOR MOD-78B

Made by Measurements Corp. Calibrated from 1-100,000 Microvolts. 15-25 MC & 190-230 MC, 400 Cy or 820 Cy Mod. Built in Vacuum Tube Volt-Meter for calibration. 110V AC 60 Cy Input. \$42.00

R49/APS-2 INDICATOR RCVR

- With 42 Tubes & 30 MC if strip uses 5P17 & 2AP1 Indicators. Less Case. \$45.00
- LM Freq. Meter New. \$79.50
- Freq. Meter BC-221 AK Modulated \$79.50
- AT-49/APR-4 Ant. New \$4.95
- APG-13A Radar Complete. Brand New. \$250.00
- RT-39/APG-5 Radar Xmitter-RCVR 2500 Meg w/ANT \$55.00
- Indicator ID-93/APG-13A \$25.00
- RC-103 Complete. New. Export Pkcd. \$35.00
- AN/ARN-S Complete. New. Export Pkcd. \$17.50
- SCR-522 Used Excellent \$32.50
- BC-348 Used Excellent \$79.50

APR. 2—RECEIVER

90-1000 MC. Has automatic scanning & recording device. Includes ANT Filter F-3/APR-2, Mounting

- Rack & Inst Book, Brand new \$175.00
- AS-27/APR-2 ANT. New \$4.95
- AS-26/APR-2 ANT. New \$4.95

APR. 5—RECEIVER

1000-3000 MC & 3000-6000 MC continuously by use of interchangeable Tuners. If freq 30 MC. New \$195.00 Used \$125.00

BC-800 RADAR XMITTER RCVR

5 stages RF at 30 MC, 2 stages RF, 160-186 MC. Uses 2-2C26, 19 tubes Total, has Blower. Brand new \$24.95 Used \$12.95

MARK 16 RADAR TEST SCOPE

CW-601BP, Type LZ, 2700-3333 MC. Used, Excellent 110 VAC 60 Cy input \$59.50

LD-4 FREQ. MEASURING UNIT

Type CR-74021, 100-5000 KCS

VARIACS

- 2KVA 0-130 V AC G.R. \$32.50
- 5KVA 0-130 V AC G.R. \$60.00

XFORMERS

- Auto 1KVA 110-220 AC \$12.50
- 11 V 200A \$18.95
- 5 V 60 A New. \$8.00
- 2.5V CT 10A 20KV Insul. \$4.00
- Choke 20 HV 300 MA 20KV Insul. \$9.00
- Pulse Xformer for 725A Magnatron \$4.95

METERS

- 0-10 A DC Tripplett 4 1/2" Mod 422-JR New. \$4.00
- 0-110 V AC 3 1/2" G.E. New. \$3.95
- 0-1 MA 3 1/2" G.E. New. \$4.95
- 0-20 Micro Amps 3 1/2" G.E. New. \$14.00
- 0-110 V AC 2 1/2" Weston. New. \$2.95
- 0-7.5 V AC Square 3" Westinghouse. New. \$2.95
- 0-150 V AC 400 Cye Hickock 2". New. \$2.95

MONROE ADDING CALCULATORS

Model MA-7W 8 column, used, completely overhauled. Guaranteed \$179.00

MAGNETRONS

- 725 A or 2J22 or 2J21 used F11. Checked \$5.95
- 5423 New \$22.00
- 2426 New \$12.00
- British VR-90X Similar to 8011 \$.49
- Magnatron Magnets for 725A, 2422, 2421 \$3.95
- Gen Radio Precision Pot. 100,000 ohm \$4.95
- BC-1073 A Wave Meter Tuner 150-210 MC. Uses cavity tuner w/precision Millen gear drive tuning. Complete with 110V AC 60 cy Power Supply & 19 tubes \$24.50

TUBES

- 5RP1 \$1.95
- 3EP1 1.95
- 12DP7 9.95
- 8364C
- 815 2.95
- 872-A 1.95
- 8020 \$2.9
- 717A 8
- 726 4.00
- 707B 8.00
- 24G \$4.95
- VUT127A 1.95
- 504G49
- 6L689
- 829B 3.55

CONNECTORS

- PT-259 per 100 \$18.00
- M-359 per 100 \$ 9.00
- UG-27U per 50 \$20.00

3 CENTIMETER DUPLEXER, MIXER, DETECTOR OSC ASSY.

Includes 2-723AB LOU OSC, 2-724B Duplexers In 23 Mixer \$14.00

T-28/APT—1 RADIO JAMMER

93-212 MC. Used \$22.50 New \$45.00

MARK—16 FREQ. METER & SIG. GEN.

CW-60ARQ-1 Type LZ-2700-3300MC uses 707-B tube 110VAC 60 c/vc. Used \$69.00

SCR-729-A—ORAZ RADAR

Unit New w/tubes & cables \$190.00

1-139A TEST UNIT

For SCR-522, complete w/cord \$4.95

We manufacture Pulse Forming Networks to your specifications, also Hi Voltage Condensers or Filters

Handie Talkies BC-611 Large Quantity Available. Price on request.



RADIO & ELECTRONICS SUPPLY
DEPT. E-1, 2033-37 W. VENICE BLVD.
LOS ANGELES 6, CALIFORNIA

Send 30% with order or full price. Save C. O. D. charge. Shipments made via Railway Express unless other instructions given. Prices subject to change without notice. Merchandise subject to prior sale. Quantity Prices on Request. WRITE FOR CATALOG.

STEPDOWN

Auto Transformer
220-110V,
 300 W., open frame, \$4.25 ea.
 250 W., open frame, \$3.75 ea.

HI-SPEED KEYING RELAY
 DPDT 24v DC. 300 ohms. Betts & Betts. Vacuum sealed, plug-in type. Fits standard octal socket.
\$1.95

400 CYCLE POWER TRANSFORMER

 Hermetically sealed—400 to 2400 cycle units. Type TX97—2000 v. 4ma: 315-0-315V. 100ma. 115 V pri. with 80 v tap Type 98-1578 ea. \$3.25
 Type TX96-Filament Transformer 2.5v 1.25a; 5v, 3a; 6.3v, 2a; 6.3v, 4a ea. **\$3.25**

EVERYTHING U WANT AT 50% LESS!

CONNECTORS

 RG 8/U Coaxial Cable 50 ft. \$1.79
 AN-3106-40-9s. . 69c ea.
 AN-3108-36-15s. 69c ea.
 AN-3108-18-1P. . 39c ea.

ANTENNA Switching RELAY

 115 V. A.C. DPDT 10 amp contacts, manual release latch 200 ohms. Allied.
98c ea.

6.3V Filament Transformer 8 Amp. 7000 V Insl. G.E. Ship

 Wt. 6 lbs. No. T90 **\$1.95**

Clare Sensitive 3500 ohms 6MA SPDT 3 amp contacts No. 130.

 W.E. 4850 ohms 6MA SPDT 1 amp contacts #R92 **\$1.25 ea.**
 CLARE 2000 ohms 3 PST N.O. 1 amp contacts #R94. **89c ea.**
 W.E. 1300 ohms 20MA SPDT & SPST N.O. 1 amp contacts #R91. **89c ea.**

Universal general corp.
 365 Canal St., New York 13, N. Y. Prices Net FOB Our Plant WALKER 5-9642
 Min. Order \$2.50

SONAR EQUIPMENT

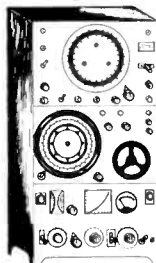
TYPE QCJ-QCO

 Type QCJ-QCO. Consists of indicator, hoist remote control unit and receiver amplifier. Frequency range 13 to 37 KCS. Range 0-1000 yards and 0-5000 yards. Requires 440 volt 3 phase 60 cycle current. OD 52 x 22 x 22", wt. 500 lbs. Good used at **\$195.00**

DRIVER RECTIFIER

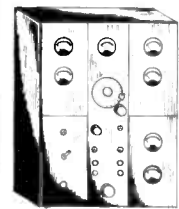
 Driver rectifier. Frequency 17-26 KCS. 600 watts power output. Input 440 volts 3 phase 60 cycles at 3.8 amps. This and above unit mfg. by Submarine Signal Co. OD 52 x 22 x 17", wt. 600 lbs. Good used at **\$195.00**

RECEIVER INDICATOR OSCILLATOR

 Receiver Indicator Oscillator. Type CRV. Consists of receiver indicator oscillator 43013, remote training control unit 25264 and driver amplifier 50093. Frequency range 17-27 KCS. Range 0-1000 yards; 0-3000 yards. Output 200 Watts. Mfg. by RCA. OD 30 x 34 x 48", wt. 500 lbs. Good used at **\$175.00**

DRIVER CONTROL UNIT

 Driver Control Unit. Type CBM. 17-25.5 KCS. Input 220/440 volts 3 phase 60 cycle. Mfg. by Submarine Signal Co. OD 17 x 23 x 34", wt. 350 lbs. Good used at **\$125.00**

200 SURPLUS ELECTRONIC ITEMS on our new list. Rush your name today for the HOTTEST LIST IN THE LAND. Satisfaction Guaranteed or your money back.

DICK ROSE ERECO
 2912 Hewitt Ave. Everett 20, Wash.

TRANSMITTERS
 In all types of emission from low to high power outputs made by Western Electric, RCA, Federal R. & Tel., Westinghouse, Collins. For land, airport & maritime use.

SHIPBOARD EQUIPMENT
 Radio direction finders mfged by RCA and Bludworth for small and large craft. Also motor generators and accessories.

RADAR
 Brand New, complete units made for US Navy in Western Electric & Raytheon Mfg Co. models.
 Our bulletins describing above items and our other stock items sent on request.

Cable: Communidev Tel: AD-4-9277
COMMUNICATION DEVICES CO.
 2331 TWELFTH AVENUE NEW YORK 27, N. Y. Subject to prior sale. FOB: WHSE

F.M. RADIOTELEPHONE
 The demand for the SCR-528 equipment still persists. And now we can supply an AC power supply for stationary installations. Normally, 12 or 24 Volt DC dynamotors are included with a host of accessories, plus a transmitter and receiver, weighing 207 lbs gross export packed. Excellent for telephone input or radio broadcast relay for point-to-point communication.

PORTABLE EQUIPMENT
 Handy-Talkies (SCR-536); Walkie-Talkie (SCR-511 and others) plus test equipment (1-135); Antennas AN-130, AN-131, whips (for SCR-300); portable vibrapacks etc.

PRECISION resistor WIRE
 Advance * Coplo * Cupron
 Copper-nickel alloy—low temp. co-ef. 00004

| Size | Ohms per ft. | Rt. per lb. | Price/lb. |
|----------|------------------|-------------|-----------|
| #22 dcc | .459 (180 alloy) | .515 | \$1.20 |
| #24 dcc | .728 | .820 | 1.35 |
| #25 dcc | .917 | 1.029 | 1.50 |
| #26 dcc | 1.163 | 1.305 | 1.58 |
| #27 dcc | 1.458 | 1.536 | 1.70 |
| #28 dcc | 1.852 | 2.078 | 1.90 |
| #29 dcc | 2.302 | 2.584 | 2.00 |
| #30 dcc | 2.940 | 3.300 | 2.20 |
| #33 dcc | 5.833 | 6.546 | 2.35 |
| #35 dcc | 9.375 | 10.522 | 3.90 |
| #34 S.E. | 7.408 | 8.314 | \$3.25 |
| #35 S.E. | 9.375 | 10.522 | 3.90 |
| #36 S.E. | 11.76 | 13.260 | 4.60 |
| #39 S.E. | 24.00 | 26.930 | 8.50 |
| #40 S.E. | 30.59 | 34.330 | 10.50 |

ORDERING INSTRUCTIONS Unless specified we will ship any of the types advertised above.
 MINIMUM ORDERS D.C.C. #22 to 35, 1 lb.+30%—15%, respooled from original 3 lb. av. spools.
 ENAMELED #34-35-36, min. order 1 lb., ±30%; sizes 39 & 40, 1/2 lb., ±30% min. Enameled wire is spooled on mfr's precision spools. All guar'd.

ATLANTIC INDUSTRIAL CO.
 101-38 91st St. Ozone Park, New York

| | | | |
|--|-------|-------------|------|
| Dynamotor DM-33A: 28 V-5 A: 575V-16A | 1.50 | | |
| Dynamotor AD-2: 14 V-3 A: 220 V-.06A | 2.50 | | |
| Dynamotor RL-24A: 28 V-1.3A: 240 V-.08A | 2.85 | | |
| Drop Line & Relay: WE-D161895B: Tele. | .38 | | |
| BELL RINGERS: MC-131: also 50 115 V. AC | .35 | | |
| BATHTUB COND. 3X.1 mfd-400VDC: also 1X.1 | .14 | | |
| DUAL COIL SET: F-range: 2040-3000 KC: | 1.25 | | |
| N-range 6000-9050 KC: for RU-17 Aircraft | 1.25 | | |
| COIL SET & HAND CHART: 16 steps: | 1.30 | | |
| 2500-3200 KC: for GF Eq. WE-47136 | 1.30 | | |
| FUSES: Bussman 4AG5 (5 amps.) Price per 1000 | 5.00 | | |
| FUSES: Littlefuse, non-renewable Cart.: per M. | 16.00 | | |
| 304-TH | 9LP7 | 371B | .70 |
| 5CP1 | 3DP1 | 371A | .75 |
| 5AP1 | 8013 | 2X2 | .25 |
| 5AP4 | 878 | 800 | .65 |
| 4AP10 | 3B24 | 8013-A | 1.50 |
| \$1.95 | 95¢ | 9GP7 | 3.50 |
| | | 864 per 100 | 4.85 |
| | | 2X2A | .75 |

GOULD GREEN 254 Greenwich St. N. Y. C. 7

LARGE STOCK
AN CONNECTORS
 Priced Right—Immediate Delivery
HAROLD H. POWELL
 632 Arch St. Phila. 6, Pa. Phone MA. 7-5650

FOR SALE—
 Stem & sealing machines
 Vacuum pumps,
 Button Stem, Flare,
 and
 Exhaust machines,
 many others.
HAYDU BROTHERS
 Plainfield New Jersey

FACSIMILE
 For sale, 2 #FRS-140C Finch Duplex Facsimile Machines. New Condition. \$1000.00 Each, FOB Cleveland. Literature upon request.
PERRY-BRIGGS COMPANY
 1220 Huron Rd. Cleveland 15, Ohio

WRITE FOR YOUR FREE "TABOGRAM"

CONDENSER SPECIALS!

Table listing condenser specials with columns for item name, quantity, and price. Includes items like Vacuum 50mmf/7500v, Ceramicon 50mmf Buton Cent Lab, etc.

1000ft Hookup Wire 100ft asstd rolls ONLY \$2.49. Includes items like Mica Cord Sets, Intercom & Spkr Wire, etc.

Heineman Magn Ckt Bkrs for AC/DC Oper. Includes items like Amps .01, .02, .03, .05, .10, .20, .30, .50.

Circular Slide Rule. Equip 12" Only 2 1/2" Radius. LAMINATED - Print Stays on! Mult. Div. Scales & Roots, Log Parallel Rules, Precision Drafting Tool, etc.

Xtal Heater Oven Terrific Buyl! Takes Any FT243 Xtal. Only .98c. Includes items like 525Kc, 375Kc, 350Kc.

2 TO 4 WATT AMPLIFIER BUY! 8-Inch Heavy Duty Speaker. Works 110 Volts AC or DC. Includes 3 Tubes, Volume & Tone Controls, etc.

MOTOR 1/40HP, 100rpm, 115V 60 cy/4500 RPM. GE/Deico/Dohrl w/cnstr Cont Dry 7/39.

MICROSWITCHES Mu. Toggle, Rotary. Includes items like MicroSw Pin Plunger SPDT/10A, MicroSw Plunger SPNO/10A, etc.

FUSES - FUSE HOLDERS. Includes items like 3AG: 1, 1 1/2, 2, 3, 4, 15, 20 Amp. Ea. 3c; 100 for 3.99.

Non-Renewable Ferrule Mtd Fuses. Includes items like 1 1/2x13/32" dia. 0.8, 1.3, 3, 4, 5, 10, 15, 20 Amp. Ea. 5c.

Non-Renewable 35A BUSS AGL Fusetron 35c; 10 for 2.49. Includes items like NonRenew 65, 100A, Knife Blade, etc.

Telephone Grasshopper Fuses-90Volts W.E. 35G/3Amp. Ea. 9c; 10 for 7.5c. Includes items like Renewable 3A Monarch F23/250V, etc.

NonRenew 35A BUSS AGL Fusetron 35c; 10 for 2.49. Includes items like NonRenew 65, 100A, Knife Blade, etc.

3AG-4AG Clip Mtd. Ea. 20c; 6 for 1.00. Includes items like DUAL 2 1/2"x2 1/2" Cartridge Mtg. Ea. 35c; 5 for 1.50.



CRYSTAL DIODES THERMISTORS-VARISTOR

Table listing crystal diodes, thermistors, and varistors with columns for item name, quantity, and price. Includes items like IN21, IN21A, IN21B, etc.



FLASH CONDENSERS 7mtd/250vdc/21.9 u. Includes items like 15mf/330vac/180vdc/INT, 25mf/330vac/180vdc/INT, etc.

SYLVANIA R4330 12 million lumens. Includes items like X-400 Air Corps Lamp, Precision Feeler Gauge, etc.

XTRA SPECIAL - New TV Parts. Includes items like Width Control Sim 201R4, Focus Coil Sim 202D2, etc.

AMPLIFIER KIT-10W HI-FI. Includes items like Self-Balancing, Cathode Poil, Perfect Response Phase Inv, etc.

SUPER HIGH-FIDELITY KIT. Includes items like ALL-ELECTRONIC stage for use with GE/Pickering, etc.

MICROWAVE EQUIPMENT. Includes items like LIGHTHOUSE Xmit-Receive Assy, PARALLEL Tunable Coax Cavity, etc.

METER. Includes items like Mercury Thermo-Reg'lator, Dual Ckt, 105°F & 32°F Ex-Tremely Sensitive & Accurate.

METER SPECIALS - Cased. Includes items like 5Ma Tuning 1/2" GE \$9.98, 1 1/4 Ma DC Miniature, etc.

DC AMMETERS. Includes items like 15A, 2 1/2" Dia. 2.99, 30A, 2 1/2" Wx/Wsg 2.49, etc.

DC VOLTMETERS. Includes items like 30V, 2 1/2" Wx/Wsg 2.49, 100V, 2 1/2" Wx/Wsg 2.99, etc.

AC VOLTMETERS. Includes items like 7 1/4V, 3" Wx/Wsg 3.98, 15V, 3" Sq Wstn 4.95, etc.

Precision Resistors - Over 2,500,000 In Stock

"Tab" - Specialists in Precision Resistors. We Ship Types in Stock - Accuracy up to 0.1 Percent

Large table listing various precision resistor types and values. Columns include resistance value, tolerance, and price. Includes items like 0.116, 0.42, 0.425, etc.

Any Size Above, Each .25c. Ten for \$1.98. Includes items like 100000, 150000, 180000, etc.

Any Size Above, Each .35c. Ten for \$2.98. Includes items like 100000, 150000, 180000, etc.

Any Size Above, Each .70c. Ten for \$5.98. Includes items like Megohms 1.579 2, 2.75, 3.673, etc.

VACUUM RESISTOR HIGHLIGHT RESISTORS

HIGH VOLTAGE PRECISION RESISTORS. Includes items like JAN-1029 MFC105 1MΩ 1K V 1/2% Accy, etc.

High Voltage High Precision Resistors Standard Brands. Includes items like MVT 2Meg/3W/7.5K Vwkg, etc.

RAYDON CLOCK MOTOR & SWITCH. Includes items like Synchronous 6to10VAC/60cy, etc.

POWER PACK KITS. Includes items like 250VDC/50Ma & Filter \$2.98, 350VDC/125Ma & Fil's 4.49, etc.

DAVEN ATTENUATORS. Includes items like 500ohms/20pos \$1.98, 200, 00ohms/20pos 1.98, etc.

RECTIFIERS, BRIDGE. Includes items like 1N 18V 14V 1.35 \$2.49, 18 14V 3.5 3.98, etc.

TAB MONEY BACK GUARANTEE \$3 MIN. ORDER F.O.B. N.Y.C. ADD SHIPPING CHARGES AND 25% DEPOSIT. PHONE WO. 2-7230

THAT'S "TAB" THAT'S A BUY. DEPT. 106 SIX CHURCH ST. NEW YORK 6, N.Y., U.S.A. CORNER CHURCH & LIBERTY STS. ROOM 200

TAB MONEY BACK GUARANTEE \$3 MIN. ORDER F.O.B. N.Y.C. ADD SHIPPING CHARGES AND 25% DEPOSIT. PHONE WO. 2-7230

SPECIALS

Write for Your FREE "Tabogram"

Television Pwr Supply Transformers

HI-VOLTAGE for CR Tubes 5" to 20" & Plate Volts for ALL Tubes & ALL Fil's. Complete w/data for 5000 to 20000 Volt Circuits; also Full Wave Output 300VDC @ 275Ma & 6.1/10.3A 5.4V/8A, 2.5V/3A. Inpt 105-125VAC 50-60cycv Hyper-silCore Oil Impreg. W.E. for USN SPECIAL. \$8.95 1800V 'SCOPE PWR SUPPLY. Ideal CRT Xfmr! 800V DblrCkt; 115V AC Inpt; Output=90V/35Ma, 2x2.5V/2A eaSect 4KVinsSigC Spec, HermSld. Two 2x2tubes&All FltrParts&Data \$5.98



6 VOLT DYNAMOTOR SCOOP! CARTER "MAGMOTORS" PermMagnets 1H1-Edt. Compact 5 1/4 x 3 1/2 x 2 1/2 "Lo-Temp Rise. XMTG "MAGMOTOR" Inpt 5.5VDC; Output 400V/150Ma 5 1/2% Eff. 6500RPM. RCVNG "MAGMOTOR" Inpt 6VDC; Output 250V/100Ma 52% Eff. 1800RPM 4 1/2 lbs. ONLY \$12.49. Bulk Units above SPECIAL. \$12.49 Oil Cndsr Special DUAL 2x0. Infd/2000WV Common Term Off Gnd.TOE Mr. #1.08; 2 for \$2.00 2x5mfd (10-mfd) OILMITE to V.E. specifK8S96 400WVDC 65-to+65°C. GTD Usable600WVDC 2/986

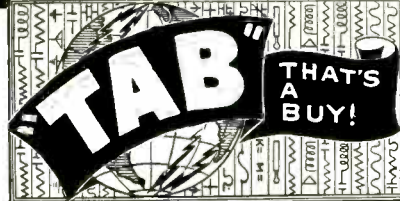

TUBES... "TAB" Tested & Guaranteed

Table listing various vacuum tubes and their prices. Columns include tube type (e.g., OB2, OZ4, CIA), price, and other specifications.

866A Kit. 2Tubes&Xfmr 115v60cyc Output: 2.5vct/100A/10KVins w/Sekts \$5.95 872A Kit Tubes&Sekts & 12KVinsXfmr \$12.95 BLOWERS 40 CFM 28vacdc... 3.49 70 CFM 115V400vac... 4.49 100 CFM 28vacdc... 4.95 100 CFM 115vacdc... 5.95 Xfmr 12 or 28v to 115vacdc 250 CFM 28vacdc... 9.95 250 CFM & 28/115vac Xfmr... 11.95 100 CFM 115vacdc 1/2 Hvy Dty... 7.98 OIL CNDRSR--NEW--Famous Makes MID WVDC Each Mfd WVDC Each .00025 25000 \$4.95 1 4000 \$3.75 .0016 15000 4.98 1 7500 7.98 .002 7000 4.98 1 25000 95.00 .0075 7000 1.29 2 1000 330.00 .02 25000 1.98 2 1500 1.00 .025 1500 5.98 2 2000 1.98 .03 7500 1.98 2 3000 3.98 .05 1500 3.98 2 4000 4.79 .05 4000 1.89 2 5000 9.98 .1 1000 3.98 2 3500 10.99 .1 1500 3.98 2 6000 12.98 2x.1 1500 3.98 2 12500 19.98 1 2000 8.98 3 2000 3.49 1 3000 1.90 4 600 5.49 1 7500 2.89 4 1000 330.00 2 5000 2.25 4 1500 2.00 2.25 1000 .59 4 2000 3.99 2.25 1500 .98 4 3000 5.95 6 4000 16.00 .5 1500 9.98 4 500 6.00 1.99 .5 3000 2.49 5 600 1.99 .65 12500 14.89 5 1000 1.98 1 1000 4.45 5 1500 1.09 5 2000 8.98 1 2000 1.2 8 2000 8.98 1 3000 3.25 8 3000 9.98

XFMRS--115V 60 Cyc Input Plate & Filament Xfms 100V(CT)/200Ma, 6V/5A, 5V/6A, 18V/55A, 90VbiasTapCSD \$6.95 900V/35Ma, 2x2.5V/2A, SigC \$3.98 880VCT/125Ma, 6.3V/1A, 5VCT/2A, 6.3VCT/2A, Csd HVinsHermSld Divrs 250maUSN \$3.98 700VCT/120Ma, 115V/100Ma, 2x6.3V/1A, 5V2A, Csd, HVins \$2.98 650VCT/175Ma, 6.3V/1.2A, 5V/3A, Csd HVins Jett/Stancor \$3.29 500VCT/60Ma, 6.3V/1A, H-Sld/Hri \$1.29 12-24-115VDC&230VAC UnivVibXfmr Csd 2.39 2/4 30. 10/19.98 PLATE TRANSFORMERS 6800VOrVct/1A/17KV104-120Vin \$59.50 3400VOrVct/1A/17KV208-25Vin \$59.50 10800VCT/108Ma, 6.3V/1A, CSD \$1.49 7500r/15000V Dblr/35Ma \$18.95 5000V/10Ma (for2x2) Csd \$7.95 3000V/10Ma Csd HVins \$4.50 1800V/4Ma Csd Altee/GE HV \$3.29 1200VCT/300Ma & 18V/1A Csd \$6.95 2x330VCT/108Ma, 6.3V/1.0A, CSD \$1.49 Filament Transformers 2.5V/1.75A, 4V/16A 20KV ins, Csd \$4.95 2.5V/2A HVins2x2, 6.3V/10 for... \$5.98 5VCT/60A Kenyon HVins \$6.95 5V/115A Kenyon HVins \$12.95 6.3VCT/7A USN, Csd HVins \$1.39 6.3VCT/7A (for6.5A) Csd USN \$1.39 6.4V/12A, 6.4V/10A, 3x5V/10A, 2.5V/1.75A Stancor CsdHVins UsableAsAuto Pormer \$4.98 12.6VCT/2A HVins \$1.49; 2 for \$2.79 1-P XFMRS 150Kc Double Slug Tuned, Shielded Ea. 3pc; 2 for \$1.00 Telev & FM I-F Xfmr 10 to 14Mc Double Slug Tuned Adjustable "Q"

RCA UNIV Output Xfmr 10W to 100C. Matches ANY Line or Spkr w/VG's 3to4or150ohms to ANY Load & TubeIMF bet50&1024ohms. Over1000combinational Acts as EXC BandPassFltr or FreqAttnUnit for DynMike. Cuts HI's or Lows IDEAL. Lazy Q-ActionCwvPhone. 4.95 Gets ONLY Signal youWANT to hear. W/data \$1.39 Hi Gain Dynamic Mike & Xfmr Buy! Comb hi-gain DynMikeXfmr UTC/Super Elec 3wdg,600ohm CTC&4000ohms Tapped 250x150 ohms. FullyShielded. H-Sld P LUS Excelsdlytly DynMike. Both for ONLY \$1.49 Modulation & Audio MODULATION StancorUSN H-Sld PP parallel 807/stoPI807's IF/2000 ohm Load 240WattPeak \$4.95 PP807's to22RCA5500to2600ohms. \$4.50 Amertran USN 3600 or 900 to 30 or 80 ohm/500V \$12.95 UTAH 12W Univ-Output5999 \$1.39 WE 300WattPP805to90ohmVC \$12.98 UTC LVM-11 lineAutoformer 30W \$3.49 UTC O-14"ouncer"50:1Mike orLineTo Grid 200 ohms to 1/2Megohm\$31.15 SPECTRA \$3.98; 10:1 10:835 P U L S E TRANSFORMER Pri:3Sec w/dgs-imped ratio 5:1000 ohms ElectrostaticShield, Permalloy Core,MfrWE Inc 1000V Sec 17500V \$14.98 ANTENNA UHF 12"/30cm ATs/ARRI UsableCltz&HamBand CoaxTerm Instd Insld SlugPICont w/g gask Flang

FILTER CHOKES 13.5H/1Amp/42ohm/1KV \$54.00 15-29H/150Ma Csd \$2.05 13H/300Ma \$1.90 3HY/40Ma 3 for \$1.00 15H/400Maor210H/300Ma/12KV \$7.95 8Hy/150MaNewUTC C'cked T Bd 2/2.25 Const V/Reg New Raytheon Inpt 95-130V/60cyc; Out: 115V/60Wsd510.95 RAYTHEON ConstV/Reg Inpt: 198 to 242V/50-60cyc; Output: 220V/500Watts/0.5% Regln/Track Mfg \$36.00 SOLA ConstV/Reg USN Csd Inpt:95 to 190V/50-60cyc; Output: 115V/21W/1.4A ConstDty %Reg. Ln/In \$130; Same New USN Csd \$369. Yours for... \$162.00 SOLA ConstV/Reg Inpt:92to138V; Out: 115V/26.1A/3KVNew \$185.00 GEN ELEC ConstV/Reg Inpt: 95to130V, 50-60cyc; Output: 113/115/117V 78KV at 80P. Usng Gtd. \$43 NEW. \$63. Sig Corps Dry Batteries--Gtd BRAND New Shelf Dated--Teste! 1A23 7 1/2 6/4 1/2 3/1 Neg Volts... 39c BA35 1 1/2 VsmBURG 4FH 39c BA 36 45.22V BURG5308 89c BA 37 1 1/2 V Walky-Talky... 29c BA 38 105 1/2 V Walky-Talky... 1.49 BA 39 150 1/2 V Burg-FSA 100 1.69 RA40 90 1 1/2 V BurgGB80 1.19 BA41 60/25 1/2 4 1/2 V 89c RA43 90 45/1 1/2 V 98c RA51 67 1/2 V MiniMax 89c BA70 90/60 1 1/2 V 89c BA201 3V Burg F21P 8 for \$1.00 WESTON STANDARD CELL 1.01V Volts Average UnMtd \$3.98 Mast Base MP22 \$3.95 Mast Base MP48 \$3.98

TAB MONEY BACK GUARANTEE 53 MIN. ORDER F.O.B. N.Y.C. ADD SHIPPING CHARGES AND 25% DEPOSIT. PHONE WO. 2-7230 DEPT. 10E SIX CHURCH ST. NEW YORK 6, N.Y., U.S.A. - CORNER CHURCH & LIBERTY STS. ROOM 200 TAB MONEY BACK GUARANTEE 53 MIN. ORDER F.O.B. N.Y.C. ADD SHIPPING CHARGES AND 25% DEPOSIT. PHONE WO. 2-7230

INDEX TO ADVERTISERS

| | | | |
|--|----------------|---|----------------------|
| Acheson Colloids Corp. | 34 | Dumont Electric Corp. | 241 |
| Adams & Westlake Co. | 193 | Du Mont Laboratories, Inc., Allen B. | 16A, 16B, 213 |
| Advance Electric & Relay | 241 | | |
| Aeronautical Communications Equip- ment, Inc. | 187 | Eastman Kodak Co. | 135 |
| Aerovox Corp. | 211 | Eisler Engineering Co., Inc. | 257 |
| Airborne Instruments Laboratory, Inc. | 245 | Eitel-McCullough, Inc. | 41 |
| Aircraft Radio Corp. | 233 | Electrical Reactance Corp. | 53 |
| Airpax Products Co. | 250 | Electronic Tube Corp. | 144 |
| Alden Products Co. | 202 | Electrons, Inc. | 162 |
| Allen Co., Inc., L. B. | 257 | Electro-Voice, Inc. | 200 |
| Allen Mfg. Co. | 158 | El-Tronics, Inc. | 257 |
| Allied Control Co., Inc. | 44 | Erie Resistor Corp. | 145 |
| Allied Radio Corp. | 253 | Essex Wire Corp. | 4 |
| Altec Lansing Corp. | 258 | | |
| American Chronoscope Corp. | 237 | Fairchild Camera & Instrument Corp. | 234 |
| American Electrical Heater Co. | 230 | Federal Telephone & Radio Corp. | 20 |
| American Phenolic Corp. | 206 | Ferranti Electric, Inc. | 227 |
| American Screw Co. | 36 | Fidelity Chemical Products Corp. | 146 |
| American Smelting & Refining Co. | 179 | Flader, Inc., Frederic | 228 |
| American Television and Radio Co. | 234 | Freed Transformer Co., Inc. | 157 |
| American Time Products, Inc. | 183 | Fusite Corporation | 61 |
| Amperex Electronic Corp. | Third Cover | | |
| Amperite Company | 230 | Garrett Co., Inc., Geo. | 232 |
| Ampex Electric Corp. | 231 | General Aniline & Film Corp. | 24, 25 |
| Anti-Corrosive Metal Products Co., Inc. | 219 | General Ceramics & Steatite Corp. | 146 |
| Arkwright Finishing Co. | 160 | General Control Co. | 240 |
| Armo Steel Corp. | 177 | General Electric Co. | |
| Arnold Engineering Co. | 10 | Apparatus Dept. | 43, 56, 57, 161, 176 |
| Astatic Corp. | 184 | Chemical Dept. | 23, 171 |
| Atlas Sound Corp. | 248 | Electronics Dept. | 29, 51 |
| Audak Company | 133 | Lamp Dept. | 201 |
| Audio Development Co. | 190 | General Radio Co. | 149 |
| Audio Engineering Society | 247 | Goodmans Industries, Ltd. | 210 |
| Automatic Electric Sales Corp. | 58 | Gruener Company | 245 |
| | | Graphite Metallizing Corp. | 154 |
| | | Gray Research & Development Co., Inc. | 242 |
| | | | |
| Ballantine Laboratories, Inc. | 235 | Hardwick, Hindle, Inc. | 196 |
| Barry Corporation | 244 | Hathaway Instrument Co. | 62 |
| Beach-Russ Co. | 249 | Haydon Co., A. W. | 230 |
| Bell Telephone Laboratories | 191 | Haydon Mfg. Co., Inc. | 166 |
| Bentley, Harris Mfg. Co. | 49 | Haydu Brothers | 19 |
| Berkeley Scientific Co. | 245 | Heath Company | 228 |
| Bird & Co., Richard H. | 247 | Helipot Corporation | 37 |
| Bircher Corp. | 251 | Hewlett-Packard Co. | 45 |
| Blaw-Knox Co. | 48 | Hexacon Electric Co. | 245 |
| Boonton Radio Corp. | 127 | Holliston Mills, Inc. | 142 |
| Borg Corp., George W. | 224 | | |
| Bowser, Inc. | 197 | Industrial Condenser Corp. | 253 |
| Browning Laboratories, Inc. | 216 | Instrument Electronics Corp. | 251 |
| Brush Development Co. | 204 | Instrument Resistors Co. | 220 |
| Buck Engineering Co., Inc. | 257 | Insulation Manufacturers Corp. | 38 |
| Burnell & Co. | 141 | International Resistance Co. | 6, 7 |
| | | Irrington Varnish & Insulator Co. | 50 |
| Cambridge Thermionic Corp. | 228 | I-T-E Circuit Breaker Co. | 30, 31, 125 |
| Cannon Electric Development Co. | 178 | | |
| Capitol Radio Engineering Institute | 249 | Jelliff Mfg. Corp. | 260 |
| Central Paper Co., Inc. | 226 | Jensen Manufacturing Co. | 27 |
| Central Scientific Co. | 174 | Johnson Co., E. F. | 292 |
| Centralab. Div. Globe Union, Inc. | 11, 12, 13, 14 | Jones Div., Howard B., Cinch Mfg. Corp. | 256 |
| Chicago Transformer, Div. of Essex Wire Corp. | 172 | Jones Electronics Co., M. C. | 249 |
| Cinch Manufacturing Corp. | 119 | | |
| Clare & Co., C. F. | 153 | Kahle Engineering Co. | 239 |
| Clarostat Mfg. Co., Inc. | 239 | Karp Metal Products Co., Inc. | 15 |
| Cleveland Container Co. | 152 | Kay Electric Co. | 207 |
| Clough Brengle Co. | 236 | Kenyon Transformer Co., Inc. | 209 |
| Cohn Corp., Sigmund | 239 | Kester Solder Co. | 123 |
| Collins Radio Co. | 151 | | |
| Condenser Products Co. | 215 | Lumpkin Laboratories, Inc. | 257 |
| Continental-Diamond Fibre Co. | 143 | Lenkurt Electric Co. | 232 |
| Continental Screw Co. | 164 | Linde Air Products Co. | 188 |
| Cornell-Dubilier Electric Corp. | 26 | | |
| Cornish Wire Co., Inc. | 54 | Macallen Company | 194 |
| Cross Company, H. | 257 | Mallory & Co., Inc., P. R. | 61, 121 |
| Crucible Steel Co. of America | 46, 47 | Manning, Maxwell & Moore, Inc. | 229 |
| | | Marion Electrical Instrument Co. | 2 |
| Dalmo Victor | 243 | Marsh Stencil Machine Co. | 257 |
| Dano Electric Co. | 247 | MB Manufacturing Co. | 35 |
| Daven Company | 225 | McGraw-Hill Book Co. | 226, 253 |
| Dial Light Co. of America | 150 | Measurements Corp. | 260 |
| Distillation Products, Inc. | 169 | Mica Insulator Co. | 18 |
| Dow Corning Corp. | 150 | Mico Instrument Co. | 247 |
| Driver-Harris Co. | 59 | Millen Mfg. Co., Inc., James | 185 |

20 Millivolts
Vertical Sensitivity
PRECISION
SERIES ES-500
5" OSCILLOSCOPE



NET PRICE \$149.50

Complete with light shield, calibrating screen and operating manual. Size 8 $\frac{1}{4}$ x 14 $\frac{1}{2}$ x 18".

• • IMPORTANT FEATURES • •

- ★ Wide Range High Sensitivity Vert. Amplifier Response to 1 Megacycle 2 Megohms input resistance
- ★ Vertical Input Step Attenuator, x1, x10, x100. Additional continuous vernier control Cathode follower input circuit
- ★ Extended Range Horizontal Amplifier Response to .5MC. $\frac{1}{2}$ meg. input resistance
- ★ Linear Multi-Vibrator Sweep Circuit 10 cycles to 30 KC. Improved circuits assure unusual linearity thruout range
- ★ Amplitude Controlled Synch. Selection
- ★ "Z" Axis Modulation terminals
- ★ Phasing Control
- ★ Audio Monitoring phone jacks plus direct access to Hor. and Vert. plates
- ★ Light Shield and Calibrating Screen Removable and rotatable
- ★ Tube Complement 1 each type 6J5, 6AK5, 7N7, 6X5, 2X2. 2 each type 7W7, 5CP1/A CR tube.
- ★ Fully Licensed under patents of A.T.&T. & W.E.
- ★ PLUS many "Precision" refinements that must be seen to be appreciated.

See the new Precision 5" Oscilloscope and Series E-400 Sweep Signal Generator on display at leading radio equipment distributors. Write for catalog fully describing the complete line of selected test instruments for all phases of AM, FM, and TV.

PRECISION
APPARATUS CO., Inc.
92-27 Horace Harding Blvd.
Elmhurst 10, N. Y.

Export Division: 458 Broadway, N. Y. City, U. S. A.
Cables: MORHANEX

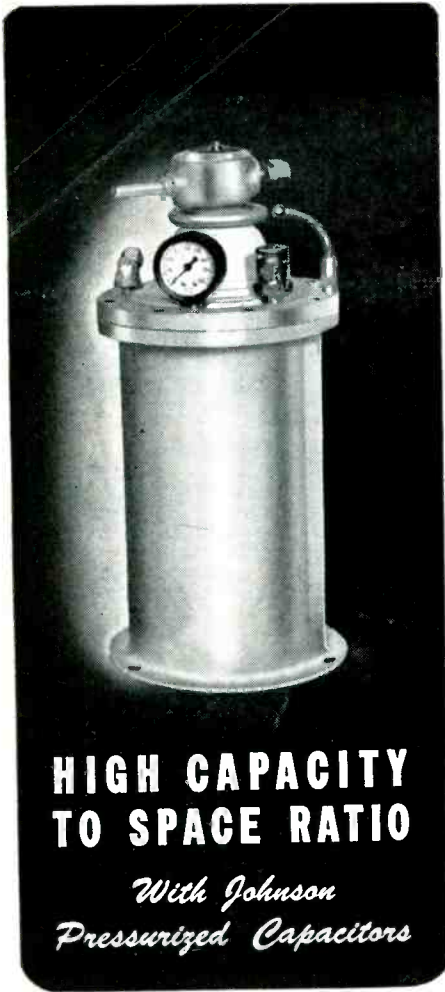

HIGH CAPACITY TO SPACE RATIO

*With Johnson
Pressurized Capacitors*

JOHNSON Pressurized Capacitors are so carefully engineered that they provide the desired capacity and voltage rating with minimum pressure and condenser height. Because of their efficient electrical and mechanical design, they also provide the utmost in stable operating conditions.

Available as "standard" are variable, fixed and fixed-variable units — in a wide variety of capacitance and current rating. In addition, JOHNSON can build any pressure condenser to individual specifications.

FEATURES

- Low Loss
- High KVA Rating
- Shielded From External Electrostatic Fields
- Low Internal Distributed inductance
- Complete Dependability

Write For Illustrated
JOHNSON Catalog and
Prices



JOHNSON

a famous name in Radio!

E. F. JOHNSON CO. WASECA, MINN.

| | | | |
|--|--------------|--|---------------|
| Mines Equipment Co. | 241 | Waldes Robinson, Inc. | 21 |
| Minnesota Mining & Mfg. Co. | 168 | Ward Leonard Electric Co. | 148 |
| Mitchell-Rand Insulation Co., Inc. | 40 | Watertown Mfg. Co. | 154 |
| Mosinee Paper Mills Co. | 156 | Webster Electric Co. | 170 |
| Muirhead & Co., Ltd. | 3 | Webster Spring Corp. | 257 |
| Murex, Ltd. | 218 | Western Electric Co. | 5 |
| National Co., Inc. | 142 | Westinghouse Electric Corp. | 198 |
| National Electronic Distributors Association | 8, 9 | White Dental Mfg. Co., S. S. | 212, 247 |
| National Research Corp. | 155 | Whitehead Stamping Co. | 253 |
| North American Philips Co., Inc. | 167 | Wholesale Radio Parts Co., Inc. | 254 |
| Nothelfer Winding Laboratories. | 238 | Wilcox Electric Co. | 165 |
| Ohmite Manufacturing Co. | 48A, 18B | Wind Turbine Co. | 244 |
| O'Neil-Irwin Mfg. Co. | 237 | Wrought Washer Mfg. Co. | 218 |
| Panoramic Radio Corp. | 250 | Zophar Mills, Inc. | 150 |
| Paper Machinery & Research, Inc. | 240 | | |
| Paramount Paper Tube Corp. | 243 | PROFESSIONAL SERVICES | 259 |
| Par-Metal Products Corp. | 232 | | |
| Patton-MacGuyver Co. | 220 | SEARCHLIGHT SECTION (Classified Advertising) | |
| Peerless Electrical Products Div. Altec Lansing Corp. | 226 | EMPLOYMENT | |
| Photovolt Corp. | 253 | Positions Vacant | 261, 262 |
| Polarad Electronics Co. | 220 | Selling Opportunities Offered. | 262 |
| Polytechnic Research & Development Co., Inc. | 173 | Positions Wanted | 261 |
| Potter Instrument Co., Inc. | 22 | Selling Opportunities Wanted. | 261 |
| Precision Apparatus Co., Inc. | 291 | SPECIAL SERVICES | |
| Precision Paper Tube Co. | 234 | Contract Work | 261 |
| Presto Recording Corp. | 16 | BUSINESS OPPORTUNITIES | |
| Progressive Mfg. Co. | 222 | Offered | 261 |
| Pyramid Electric Co. | 60 | EQUIPMENT (Used or Surplus New) For Sale | 263-270 |
| Radio Corp. of America | Fourth Cover | WANTED Equipment | 261, 284 |
| Radio Materials Corp. | 256 | ADVERTISERS INDEX | |
| Radio Products Sales, Inc. | 147 | Acorn Electronics Corp. | 284 |
| Radio Receptor Co., Inc. | 203, 223 | Aircraft Radio Industries. | 285 |
| Rahm Instruments, Inc. | 251 | Amber Co. | 261 |
| Railway Express Co., Air Express Div. | 192 | American Electrical Sales Co., Inc. | 285 |
| Rauland Corporation | 55 | Atlantic Industrial Co. | 280, 288 |
| Rawson Electrical Instrument Co. | 254 | Bell Aircraft Corp. | 262 |
| Raytheon Manufacturing Co. | 131 | Bendix Aviation Corp., Bendix Radio Div. | 262 |
| R-B-M Div. of Essex Wire Corp. | 236 | Blan. | 282 |
| Reiner Electronics Co., Inc. | 258 | Brooks Inc., R. D. | 285 |
| Resistors, Inc. | 257 | Communication Devices Co. | 288 |
| Revere Copper & Brass, Inc. | 42 | Communications Equipment Co. | 263, 264, 265 |
| Richardson Company | 32 | Drillick Sales Co. | 284 |
| Robinson Aviation, Inc. | 182 | Dubin Electronics Co., Inc. | 286 |
| Rogan Brothers | 249 | Electro Impulse Laboratory. | 280 |
| Russell & Stoll Co., Inc. | 238 | Electronic Surplus Brokers. | 261 |
| Sanborn Company | 224 | Electronicraft, Inc. | 274 |
| Sangamo Electric Co. | 199 | EPCO | 283 |
| Scientific Electric Div. of "S" Corrugated Quenched Gap Co. | 218 | Ereco, Dick Rose. | 288 |
| Shalleross Manufacturing Co. | 140 | Goodyear Aircraft Corp. | 262 |
| Sigma Instruments, Inc. | 63 | Green, Gould | 288 |
| Signal Engineering & Mfg. Co. | 180 | Haydu Brothers | 288 |
| Simpson Electric Co. | 52 | Hershel Radio Co. | 278 |
| Sola Electric Co. | 39 | Hi-Mu Electronics | 261 |
| Sonotone | 146 | Instrument Associates | 266, 267 |
| Sorensen & Co., Inc. | 189 | Joe's Radio Shop. | 285 |
| Sound Apparatus Co. | 252 | Klein, Manuel | 286 |
| Specialty Battery Co. | 241 | Lelectronic Research Laboratories. | 281 |
| Spencer-Kennedy Labs, Inc. | 246 | Leru Laboratories, Inc. | 284 |
| Sprague Electric Co. | 33 | Liberty Electronics, Inc. | 284 |
| Stackpole Carbon Co. | 163 | Life Electronics Sales. | 276 |
| Standard Piezo Co. | 232 | Lockheed Aircraft Corp. | 262 |
| Standard Pressed Steel Co. | 243, 252 | Maritime Switchboard | 275 |
| Standard Telephones & Cables, Ltd. | 195 | Mogull Co., Inc., Alexander. | 285 |
| Sterling Engineering Co. | 222 | Neomatic Inc. | 282 |
| Stevens Mfg. Co., Geo. | 251 | Nescorp Electronics | 283 |
| Stevens Mfg. Co., Inc. | 186 | Niagara Radio Supply Corp. | 268, 269 |
| Steward Manufacturing Co., D. M. | 254 | Opad-Green Co. | 273 |
| Stewart Mfg. Corp., F. W. | 243 | Peak Electronics Co. | 272 |
| Stoddart Aircraft Radio Co. | 154, 242 | Perry-Briggs Co. | 288 |
| Superior Tube Co. | 208 | Powell, Harold H. | 288 |
| Sylvania Electric Products, Inc. | 137, 205 | Powertron Electrical Equipment Co. | 287 |
| Technology Instrument Corp. | 256 | Precision Electrical Instrument Co. | 286 |
| Tektronix, Inc. | 246 | Radiation Counter Laboratories, Inc. | 262 |
| Telechron, Inc. | 181 | Radio Ham Shack, Inc. | 271 |
| Times Facsimile Corp. | 249 | Radio Shack Corp. | 282 |
| Titanium Alloy Mfg. Div., National Lead Co. | 28 | RCA Victor Co., Ltd. | 262 |
| Topflight Tape | 257 | Reliance Merchandising Co. | 279 |
| Tracerlab, Inc. | 159 | Servo-Tek Products Co., Inc. | 277 |
| Transradio, Ltd. | 218 | Shiro Trading Corp. | 286 |
| Tung-Sol Lamp Works, Inc. | 32A, 32B | TAB | 289, 290 |
| Turner Company | 17 | Technical Index Service | 261 |
| Union Carbide & Carbon Corp. | 188 | Teletronics Laboratory Inc. | 261 |
| Uni-Products, Inc. | 221 | Universal General Corp. | 288 |
| United-Carr Fastener Corp. | 224 | Van Sickle Radio Supply Co. | 282 |
| United Transformer Co. | Second Cover | V & H Radio & Electronics Supply. | 287 |
| Varflex Corporation | 129 | Wells Sales, Inc. | 270 |
| Victoreen Instrument Co. | 214 | Westinghouse Electric Corp. | 262 |
| Vulcan Electric Co. | 142 | Weston Laboratories | 285 |
| | | Winters Radio Laboratory. | 261 |
| | | World Wide Packing & Shipping Co. | 261 |

for

HIGH

**frequencies
efficiency**



AX4-125-A
TETRCDE



AX4-250-A
TETRODE



AX-9900
TRIODE



AX-9901
TRIODE



AX-9902
TRIODE

New **AMPEREX** TRANSMITTING TUBES
"ALL-GLASS" types with **MAGNISORB*** ANODES
 for AM, FM, TELEVISION, INDUSTRIAL, and ELECTRO-MEDICAL APPLICATIONS

FEATURES

- **MAGNISORB*** is a graphite base material specially processed by AMPEREX for greatly increased gettering action and heat dissipation characteristics.
- **POWDER GLASS TECHNIQUES** resulting in **STURDY CONSTRUCTION** and **COMPACT SIZE** through the elimination of external bases, make these tubes desirable where space limitations and ruggedness are factors.
- **COOLER TUBE OPERATION** is effected through efficient internal shielding and elimination of the external base.
- **INCREASED ANODE SURFACE AREA** is obtained by virtue of the fact that the heavy walls are deeply milled with circumferential rings.
- **EXCELLENT INTER-ELECTRODE SHIELDING** reduces filament-plate capacity to a minimum in the triodes, for application in grounded grid amplifiers.

TETRODES

Type AX4-125-A and Type AX4-250-A are completely interchangeable, electrically and mechanically, with standard RMA equivalents.

TRIODES
(Electrical Data)

| | AX-9900 | AX-9901 | AX-9902 |
|--|-----------|-----------|---------|
| Filament — Thoriated Tungsten | | | |
| Voltage | 6.3 | 5 | 10 |
| Current (Amps.)..... | 5.4 | 15 | 9.7 |
| Amplification Factor | 25 | 25 | 27 |
| Maximum Ratings — Class "C" Telephony | | | |
| Plate Voltage..... | 2500 | 3000 | 4000 |
| Plate Current (Ma)..... | 200 | 400 | 550 |
| Plate Dissipation (Watts) | 135 | 250 | 450 |
| Frequencies (MC) | 150 200 | 30 120 | 100 |
| Typical Power Output (Watts) | 390 200 | 820 520 | 1450 |
| Inter-electrode Capacitances (mmf) | | | |
| Grid-Plate | 5.5 | 8.0 | 8.0 |
| Grid-Filament | 5.8 | 8.0 | 11.0 |
| Plate-Filament | 0.1 | 0.3 | 0.3 |



re-tube with AMPEREX

Data sheets available on request

AMPEREX ELECTRONIC CORP.
 25 WASHINGTON STREET, BROOKLYN 1, N. Y.
 In Canada and Newfoundland: Rogers Majestic Limited
 11-19 Brentcliffe Road, Leaside, Toronto, Ontario, Canada

RCA PREFERRED-TYPE RECEIVING TUBES

Miniature Types are shown in italics

| RECTIFIERS and DIODE DETECTORS | CONVERTERS | AMPLIFIERS, OSCILLATORS & MIXERS | | | | | | OUTPUT AMPLIFIERS | | KINESCOPIES |
|---|---|----------------------------------|--|-----------------------------------|-----------------------------------|-----------------------------|---|---|---|-------------|
| | | Triodes | | | Pentodes | | | | | |
| | | Single | Twin | With Diodes | Sharp Cutoff | Remote Cutoff | With Diode | 354 | 3V4 | |
| 1B3-GT/8016 5U4-G 5Y3-GT 6AL5 6W4-GT 6X4 12AL5 35W4 117Z3 | 1R5 6BA7 6BE6 12BA7 12BE6 | 6C4 | 6J6 6SC7 6SN7-GT 12AU7 12AX7 | 6AQ6 6AV6 6BF6 12AV6 | 6AG5 6AU6 6SJ7 12AU6 | 1U4 17A 12BA6 | 6A05 6BG6-G 6K6-GT 6L6-G 6V6-GT 35C5 50C5 | 6A05 6BG6-G 6K6-GT 6L6-G 6V6-GT 35C5 50C5 | 51P4 71P4 10BP4 121P4 16AP4 | |

² Projection Type



The new RCA List of Preferred Receiving Tube Types fulfills the major engineering requirements for future receiver designs.

Most likely to succeed...

RCA preferred tube types for AM, FM, and TV receiver designs

WHETHER IT'S GLASS, metal or miniature—RCA *preferred* receiving tube types will serve your major requirements for a long time to come... and RCA preferred types are the tubes you can bank on for your future designs.

These RCA receiving tube types are especially recommended because their widespread application permits production to be concentrated on fewer types. Longer manufacturing runs reduce costs—lead

to improved quality and greater uniformity. These benefits are shared by you and your customers.

RCA *Application Engineers* are ready to suggest the best preferred tube types for your receiver design requirements. Just contact our nearest regional office—or write RCA, Commercial Engineering, Section 42JR, Harrison, New Jersey.

The Fountainhead of Modern Tube Development is RCA



RADIO CORPORATION of AMERICA
ELECTRON TUBES
HARRISON, N. J.