

electronics



JUNE • 1946

CIRCUIT UNDER GLASS	91	COVER	91
Grid and plate lines are within the quadruple-triode VT-158, used in the 600-mc TPS-3 radar transmitter. Final assembly at Evans Signal Laboratory is pictured			
RAILROAD RADIO... FROM FCC TO ICC, by Jeremiah Courtney	92		
Problems for the ICC; now that the FCC has laid down rules and frequencies			
ELECTRONIC NIGHT SIGHT	95		
Infrared light illuminates target and special tube translates reflected light into visible image			
SELECTIVE CALLING SYSTEM, by J. K. Kulansky	96		
Unwanted transmitters are locked off the air when the desired mobile units are dialed			
PHOTOELECTRIC LIGHT FOR SOLAR TELESCOPE, by Walter O. Roberts	100		
Disc masking direct light is automatically centered so that corona photographs can be taken			
REMOTE RECORD-SELECTION SYSTEM, by Fred M. Berry	104		
R-f pulses are transmitted from wall boxes over a coaxial line to record-selecting discriminators			
TORSIONAL MAGNETOSTRICTION PICKUP, by Stanley R. Rich	107		
Operating principle and characteristics of rugged high-fidelity phonograph pickup			
PHOTOELECTRIC CONTROLS FOR COLOR PRINTING, by J. Robins and L. E. Varden	110		
Electronic controls make possible high-speed production of color prints from transparencies			
PULSE-TYPE RADIO ALTIMETER, by Albert Goldman	116		
Details of high-altitude radar-type instrument, employing cathode-ray indicator			
ELECTRONIC CODE TRANSLATOR, by Horace W. Babcock	120		
Code signals are caused to appear as letters and numerals on a moving screen			
REURRENT PENTODE A-F AMPLIFIER, by Robert Adler	123		
Special pentode is operated as two triodes in cascade to give gain of 500 with 45-volt supply			
ULTRASONIC TRAINER CIRCUITS, by Finn J. Larsen	126		
Electronic circuits and a 15-mc ultrasonic beam rotating over underwater map simulate ppi patterns			
TRANSIENT VIDEO ANALYZER, by Clement Moritz	130		
Cathode-ray test set checks performance of wide-band amplifiers used in television equipment			
WAVE GUIDE TRANSMISSION SYSTEMS, by Theodore Moreno	136		
Description of components needed in a microwave plumbing system			
RADAR FOR BLIND BOMBING—PART II, by J. V. Holdam, S. McGrath and A. D. Cole	142		
Modulator, scanner and receiver-indicator circuits of H2X microwave airborne radar			
THEORETICAL SIGNAL-TO-NOISE RATIOS, by J. Ernest Smith	150		
Noise comparison between frequency and amplitude modulation systems			
CROSSTALK	91	ELECTRON ART	214
INDUSTRIAL CONTROL	156	NEW PRODUCTS	236
TUBES AT WORK	192	NEWS OF THE INDUSTRY	286
		NEW BOOKS	316
		BACKTALK	324
		INDEX TO ADVERTISERS	329

KEITH HENNEY, Editor; DONALD G. FINK, Executive Editor; W. W. MacDonald, Managing Editor; John Markus, Vin Zeluff, Associate Editors; Frank Rockett, A. A. McKenzie, Assistant Editors; J. A. Myers, Chicago Editor; Frank Haylock, Los Angeles Editor; Gladys T. Montgomery, Washington Editor; Jeanne M. Heron, Make-up Editor; Jeanne E. Grolimund, Editorial Assistant; Harry Phillips, Art Director; Eleanore Luke, Art Assistant

H. W. MATEER, Publisher; J. E. Blackburn, Jr., Director of Circulation, Electronics; Dexter Keezer, Director, Economics Department; Wallace B. Blood, Manager

D. H. Miller, H. R. Denmead, Jr., New York; Ralph H. Flynn, H. D. Randall, Jr., New England; F. P. Coyle, R. E. Miller, Philadelphia; C. D. Wardner, A. F. Tischer, Chicago; E. J. Smith, Cleveland; J. W. Otterson, San Francisco; Roy N. Phelan, Los Angeles; Ralph C. Maulsby, Atlanta

Contents Copyright, 1946, by McGraw-Hill Publishing Company, Inc. All Rights Reserved

McGRAW-HILL PUBLISHING COMPANY, INCORPORATED
JAMES H. MCGRAW, Founder and Honorary Chairman

PUBLICATION OFFICE 99-129 North Broadway, Albany 1, N. Y., U. S. A.
EDITORIAL AND EXECUTIVE OFFICES 330 West 42nd St., New York 18, N. Y., U. S. A.

Member A. B. P. Member A. B. C.

James H. McGraw, Jr., President; Curtis W. McGraw, Senior Vice-President and Treasurer; Nelson Bond, Director of Advertising; Eugene Dumfield, Editorial Assistant to the President; Joseph A. Gerardi, Secretary; and J. E. Blackburn, Jr., Vice-President (for circulation operations).
ELECTRONICS, June 1946, Vol. 19; No. 6. Published monthly, price 50¢ a copy. Directory issue \$1.00. Allow at least ten days for change of address. All communications about subscriptions should be addressed to the Director of Circulation.
Subscription rates—United States and possessions, \$5.00 a year, \$8.00 for two years, \$10.00 for three years. Canada (Canadian funds accepted) \$6.00 a year, \$10.00 for two years, \$12.00 for three years. Pan American countries \$10.00 for one year, \$16.00 for two years, \$20.00 for three years. All other countries \$15.00 for one year, \$30.00 for three years. Please indicate position and company connection on all subscription orders. Entered as Second Class matter August 29, 1936, at Post Office, Albany, New York, under the Act of March 3, 1879. BRANCH OFFICES: 520 North Michigan Avenue, Chicago 11, Ill.; 68 Post Street, San Francisco 4; Aldwych House, Aldwych, London, W.C. 2; Washington, D. C. 4; Philadelphia 2; Cleveland 15; Detroit 26; St. Louis 8; Boston 16; Atlanta 3, Ga.; 621 So. Hope St., Los Angeles 14; 738-9 Oliver Building, Pittsburgh 22.

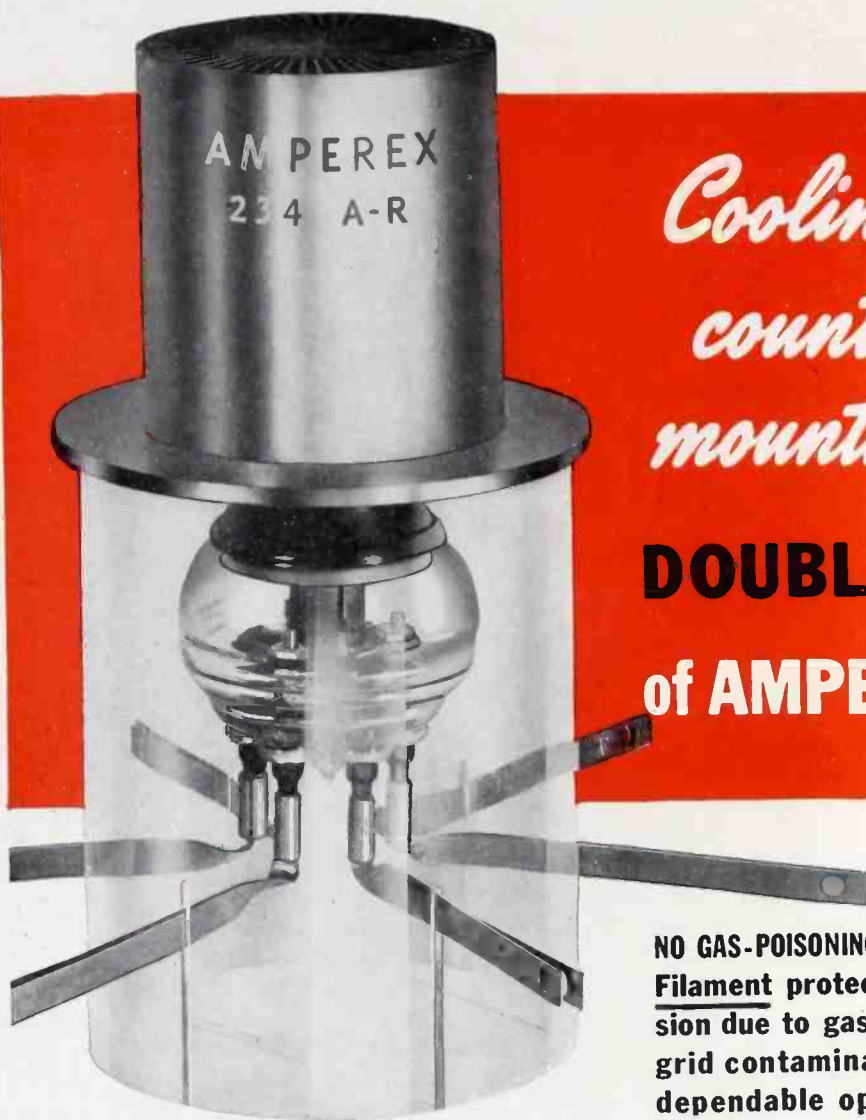

*Cooling where it
counts in new
mounting position*

**DOUBLES OUTPUT
of AMPEREX 234 A-R**

NO GAS-POISONING WORRIES: Pure Tungsten Filament protects against reduced emission due to gas evolution and eliminates grid contamination thus insuring more dependable operation and longer life.

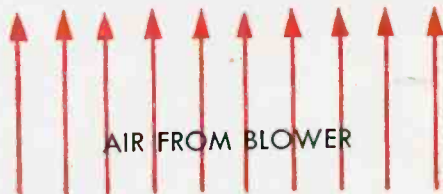

AIR FROM BLOWER

WRITE FOR Detailed Technical Rating and Data Sheets. Industrial and communication engineers are invited to consult with the Amperex Application Engineering Department on all tube, circuit and related problems. Amperex designs and engineers a complete line of power tubes: Communication, Rectification, Industrial, Electro-Medical, Special Purpose.



**AMPEREX
ELECTRONIC CORPORATION**

25 Washington Street, Brooklyn 1, N. Y., Cables: "ARLAB
In Canada and Newfoundland: Rogers Majestic Limited,
622 Fleet Street West, Toronto 28, Canada

MAXIMUM RATINGS AND TYPICAL OPERATING CONDITIONS
R.F. Power Amplifier and Oscillator Class C —
Industrial, FM and Telegraphy

	Maximum Rating		Typical Operation	
	per Tube		One Tube	Two Tubes
Operating Frequency (mc)	110	200	27	110
Filament Voltage	15.0	15.0	15.0	15.0
D.C. Plate Voltage	3500	2000	3500	3500
D.C. Grid Voltage	-450	-250	-330	-275
Peak RF Grid Voltage	—	—	830	675
D.C. Plate Current (amps)	.900	.800	.860	1.43
Plate Input (watts)	3000	1600	3000	5000
Plate Dissipation (watts)*	1000	1000	1000	1700
D.C. Grid Current (ma) (approx.)	200	160	110	220
Driving Power (watts) (approx.)	—	—	87	140
Plate Power Output (watts)	—	—	2000	3300

*Based on air flow data.

POWER TUBE SPECIALISTS SINCE 1925



Foremost Manufacturers of Transformers
to the **ELECTRONIC INDUSTRY**

United Transformer Corp.
150 VARICK STREET • NEW YORK 13, N. Y.
EXPORT DIVISION: 13 EAST 40th STREET, NEW YORK 16, N. Y., CABLES: "ARLAB"

● "The impossible takes a little longer"...this is one way of saying that the draftsman lets no out-worn conceptions restrict his creative ideas. Yet without his specialized technique for expressing ideas on paper, the designs he creates could scarcely be turned into substance. As the draftsman relies on his own hands and eyes, he calls likewise on his drafting instruments to serve him functionally. So integral a part of his technique do they become, they are virtually his partners in creating.

For 78 years Keuffel & Esser drafting equipment and materials have been partners, in this sense, in creating the greatness of America, in making possible our fleets of ships, our skyscrapers, our overwhelming weight of armor on the battlefield... So universally is K & E equipment used, it is self-evident that every engineering project of any magnitude has been completed with the help of K & E. Could you wish any surer guidance than this in the selection of your own "drafting partners"?

Because of their balance, smooth action and responsiveness to your hand, you will find that using MINUSA* Drawing Instruments is almost as natural as breathing. Their legs are round and tapered, without the harsh feel of sharp corners. Joints are firm, snugly fitted, and satin-smooth in operation. Yet these instruments are strong and durable, for their precision will outlast years of continuous use. For complete data on MINUSA* Drawing Instruments, write on your letterhead to Keuffel & Esser Co., Hoboken, N. J.

partners in creating

*REG. U. S. PAT. OFF.

K+E
*Drafting, Reproduction,
 Surveying Equipment
 and Materials.
 Slide Rules,
 Measuring Tapes.*

 ... the world's
 mightiest fleet

 ... speediest
 tanks



 ... tallest
 skyscrapers

KEUFFEL & ESSER CO.
EST. 1867
 NEW YORK • HOBOKEN, N. J.
 CHICAGO • ST. LOUIS • DETROIT • SAN FRANCISCO
 LOS ANGELES • MONTREAL

Why THIS TEAM IS

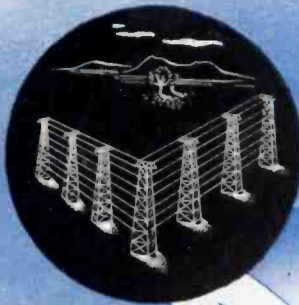

1920 Loop antenna for 400-500 meter ship-to-shore radio telephone receivers. Its design enabled earliest measurements of field strength.



1929 Curtain antennas developed for beaming short-wave radio telephone messages to Europe and South America... Improved commercial service.

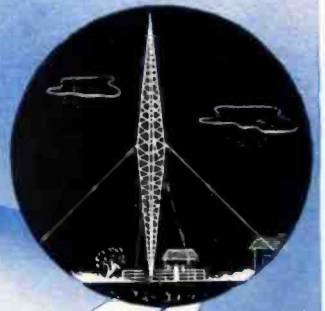

1930 Half-wave vertical radiator, now in general use, was developed into practical form. It greatly improved signal output of broadcast stations.



1934 One of the first directional antenna arrays for broadcasting. Designed for WOR to concentrate signals in service area, eliminate radiation over ocean.



1938 Coaxial antenna for ultra high frequency communications, designed by Bell Laboratories, gave increased signal strength. Widely used in police radio systems.

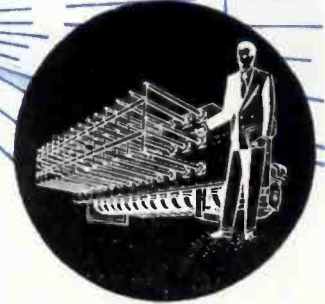

1941 Polyrod radar antenna was an important war contribution... helped sink many Jap ships. Its exceptionally narrow beam and rapid scanning gave high accuracy to big Navy guns.

1946 New 54A CLOVER-LEAF FM broadcast antenna has high efficiency and a circular azimuth pattern; is simple to install and maintain. May be used for any power level up to and including 50 KW.



Up

ON ANTENNAS

As pioneers and leaders in radio, Bell Telephone Laboratories and Western Electric have been vitally concerned with the development of improved antennas for more than 30 years.

From the long-wave days of radio's youth, right through to today with its microwaves, this team has been responsible for much of the progress in antenna design.

Progress based on Research

Following their long-established method of attack, Bell Laboratories scientists are continually observing, investigating and measuring the action of radio waves in space. Their research has covered wave lengths ranging from hundreds of meters to a fraction of a centimeter. In over a quarter-century of intensive study, they have learned how radio waves behave, day and night, under all sorts of weather conditions.

Out of this fundamental research have come such outstanding developments as the rhombic antenna, ~~musa antenna~~, vertical half-wave radiator, curtain antenna, directional array, the polyrod and other improved radar antennas, the metal lens for microwaves and the new CLOVER-LEAF antenna for FM broadcasting.

What this means to YOU

Whether you are interested in AM or FM—equipment for broadcasting, point-to-point, aviation, mobile or marine use—here's the thing to remember. Every item of radio apparatus designed by Bell Laboratories and made by Western Electric is backed by just such thorough scientific research as has been given to antennas. It's designed right and made right to give you years of high quality, efficient, trouble-free service.

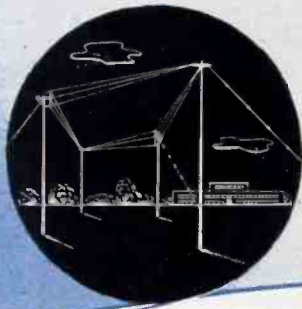

1930 Rhombic (diamond-shaped) antenna for 14-60 meters. It covers wide frequency range without adjustment. Still standard for this band.

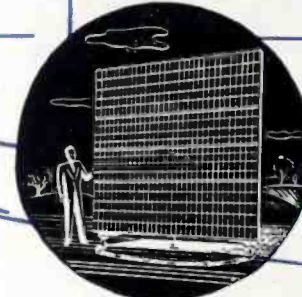

1944 Metal lenses, another Bell Laboratories development, focus microwaves like light. One type has a beam width of only 0.1°—or less than that of a big searchlight.



BELL TELEPHONE LABORATORIES

World's largest organization devoted exclusively to research and development in all phases of electrical communications.

Western Electric

Manufacturing unit of the Bell System and the nation's largest producer of communications equipment.



The Standard of Radio Noise Suppression



FILTERETTES

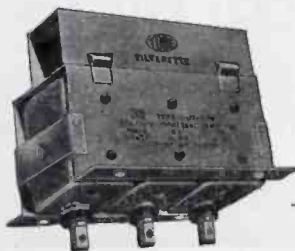

Tobe Filterettes have, for more than twenty years, provided the criterion for judging radio noise suppression devices. In fact, specifications for radio interference eliminating systems were customarily written "shall consist of Tobe Filterette 131, or equivalent." This was common practise until military requirements revealed an imperative need for radio noise suppression systems of greater efficiency, broader frequency coverage, and lower cost than had heretofore been available. Tobe Filterette 1107 was the answer to this demand.

This "mysterious black box" — demonstrated to Signal Corps engineers in early 1940 — set a new standard for efficiency and provided the foundation for the entire vehicular noise suppression program of the United States Army. In a single step, it made obsolete the bulky, costly, and relatively inefficient methods then in use and made practicable the elimination of radio interference in all military vehicles.

Judged by former standards, the performance of Filterette 1107 was impossible. Its voltage drop was so slight as to be negligible; it carried sustained overloads without excessive heating; it successfully withstood direct short-circuiting across a heavy-duty storage battery; and it provided broadband attenuation beyond the ability of existing instruments to determine the amount of interference remaining after the Filterette was installed. The consensus was, "There must be a trick to it."

There was, indeed, a trick — the trick of fully utilizing all properties of every component so that utmost efficiency might be obtained — and the trick of insisting that the Filterette be correctly installed so that its inherent high efficiency might be realized. When the "trick" was revealed as merely good engineering carried to logical extremes, the performance characteristics of Filterette 1107 became the basis of the Signal Corps specifications governing vehicular noise suppression.

The principles first demonstrated in Tobe Filterette 1107 are now embodied in commercial and marine type Filterettes for every requirement. These units make available, at low cost, the efficiency, convenience, and dependability proved under stress of war and guaranteed in time of peace.

TOBE DEUTSCHMANN CORPORATION
CANTON, MASSACHUSETTS

**PIERCE
and
NOTCH
at the
same
time**

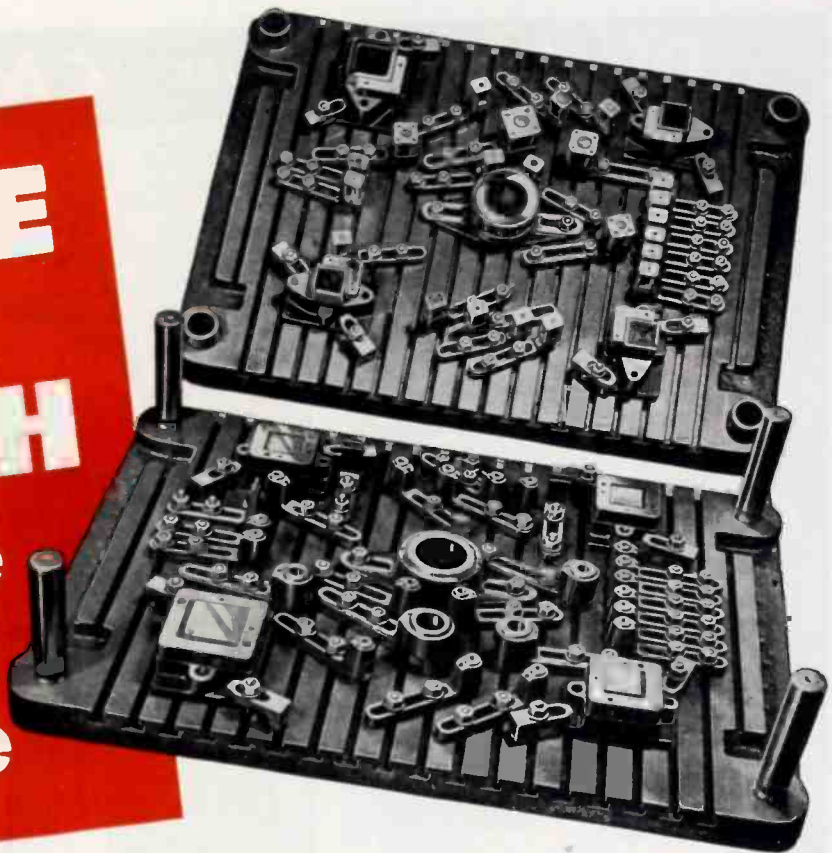

A typical set-up for notching and piercing.

Pierced and notched with Whistler multi-use adjustable dies.

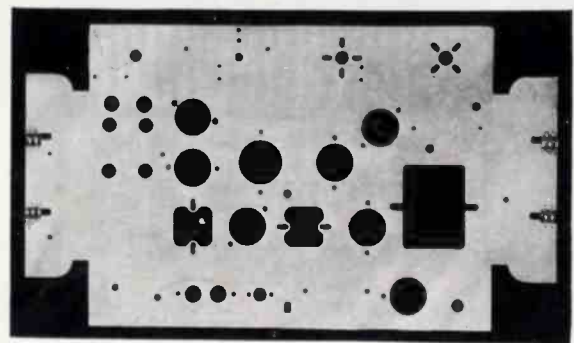

with WHISTLER MULTI-USE Adjustable Dies

You save press time and speed production by combining corner notching dies and group dies in the same set-up with adjustable piercing dies. Press operations are reduced to a minimum. Engineering changes effecting relocation or sizes of holes can be made without delay right on the press.

Whistler multi-use adjustable dies are available from stock... a day or two from your plant... in all standard sizes from 1/32" to 3" diameters... round, square, ovals and rectangles. Notching and group dies to order. In addition to mighty attractive savings in original die costs there



is this important advantage of eliminating weeks of production delay.

Re-arrange Whistler multi-use adjustable dies in as many different set-ups as your production calls for... you actually make up die sets from units in stock and reduce costs per job to an unbelievably low figure. All parts of like size are interchangeable.

Get all the facts on how Whistler adjustable dies can speed *your* production... cut *your* costs. Write today for the Whistler Catalogs.

S. B. WHISTLER & SONS, Inc.
752-756 MILITARY ROAD BUFFALO 17, N. Y.

WHISTLER MULTI-USE ADJUSTABLE PERFORATING DIES

DUMONT

PAPER

CAPACITORS

HEATPROOF

Dumont condenser ends are sealed with bakelite resinoid to withstand 350° F. continuous operation.

SMALL SPACE

1/4" OD x 3/4" LONG
AT 600 VOLTS
Compact . . . solves space problems

MOISTUREPROOF

UP TO 100% HUMIDITY
Sealed under vacuum. No air voids to cause entry of moisture

LONG LIFE

NO HIGH TEMPERATURE
OR HIGH PRESSURE
Used in the manufacture of these condensers . . . thus assuring long life and High Surge Rating to these units.

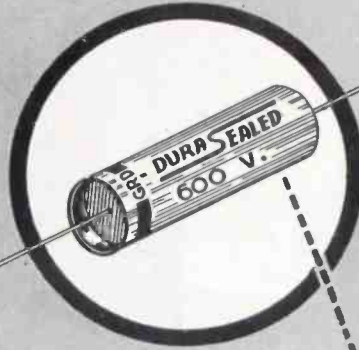

DUMONT
TYPE P6

DUMONT
TYPE P2

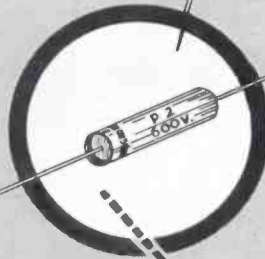

Sealed with DUMONT
BAKELITE RESINOID

DUMONT

ELECTRIC CORP.

MFR'S OF
CAPACITORS FOR EVERY REQUIREMENT
34 HUBERT STREET NEW YORK, N. Y.

NOW—electronic heat right where you want it!



New RCA
15-kw electronic
power generator



New RCA
applicator unit
(or kit of parts)

Separate applicator unit simplifies application to soldering, brazing, welding, hardening, and heat-treating jobs

● With this versatile, easily applied equipment you can quickly realize the economies of time- and money-saving electronic heat. It is medium powered (15 kw, 400 kc) for medium-sized induction heating jobs.

Preliminary adjustments are preset at the generator. The proper time cycle and final power adjustment are selected at the applicator. Output control is stepless; timing is accurate to within 1/30 of a second—thus assuring unvarying heat cycles, uniform work.

The applicator can be set for automatic or manual operation. When on "automatic" a foot switch is used to start the heat cycle; shutoff is automatic. Thus the operator has free use of both hands during this period.

New settings can be rapidly made at the applicator as work pieces change. "ON-OFF" push buttons provide control for manual operation.

This equipment combines sturdiness, ease of operation, and accessibility. Maximum safety to the operator is provided by extensive shielding, interlock switches,

and low voltage output coils. Air-cooled tubes used in the generator contribute to long life and low maintenance. Water is not required at the generator proper.

To take the place of the applicator—for specialized conveyor operations—a complete kit of components with wiring diagrams is available for easy assembly of your own work unit.

Installation supervision and operator training is provided by a staff of experienced laboratory and field engineers at no extra cost to you.



ELECTRONIC HEATING

**RADIO CORPORATION
of AMERICA**

ENGINEERING PRODUCTS DEPARTMENT,

CAMDEN, N. J.

FOR QUICK FACTS USE THE COUPON

Radio Corporation of America
Electronic Apparatus Section
Dept. 30-F, Camden, N. J.

We are interested in the application of money-saving electronic heat for high-speed processing of the following product. Please send me free information on RCA equipment.

Product _____

Name _____

Company _____

Address _____

City _____ Zone _____ State _____

SUPER PRO

Series 400



Less QRM---Phone or CW

When the bands are active it only takes one minute to find that you need Hammarlund's patented variable crystal filter to have a successful QSO—either phone or CW.

Look to the future! When the number of Hams doubles or trebles you will need the crystal filter that weeds-out the QRM . . . If you can't hear 'em, you can't work 'em!

Price (SP-400-X)
\$342.00
Including Speaker



HAMMARLUND

THE HAMMARLUND MFG. CO., INC., 460 W. 34TH ST., NEW YORK 1, N.Y.
MANUFACTURERS OF PRECISION COMMUNICATIONS EQUIPMENT

Need something **SPECIAL** for **VIBRATION CONTROL?**

3 EXAMPLES OF SPECIAL **MB**-ENGINEERED DESIGNS



ISOMODE (passenger seat)



AIRPLANE ENGINE MOUNT



ISOMODE (industrial)

AN IDEAL VIBRATION CONTROL SYSTEM is best prepared in the design stage of your product. But often the problem is one of developing *more* efficient isolation for finished mechanisms. Highly qualified by background and experience, MB vibration specialists can handle any phase for you and come through with uniquely effective designs.

Take the MB passenger seat Isomode, for instance. It was developed for double duty. Loaded, it has one spring rate to isolate passengers from vibratory disturbances . . . unloaded, another to control vibration-induced noises.

Or again, the MB aircraft engine mount, designed to give unusual isolation at *specified mounting points*. High strength-weight ratio, inbuilt damper that *doesn't* reduce isolation, and simplicity—are all MB *extras* of design.

On the other hand, the MB Isomode—a compression-type mount—is specially designed for *positive* vibration control for many applications. It has the same soft spring rate in all directions . . . isolates *all* modes of motion.

Why not find out what MB can do for your vibration troubles? Write for this free 16-page book. It shows you why and how vibration affects a product, and points the way to simpler solutions.



THE MB MANUFACTURING COMPANY, INC.
Vibration Division.

327 EAST STREET, NEW HAVEN 11, CONN.

Please send me a copy of the booklet on vibration.

Name.....Position.....

Company.....

Address.....

THE
MB

MANUFACTURING COMPANY, INC.

Vibration Division

327 East Street, New Haven 11, Conn.



VIBRATION ISOLATOR UNITS AND MOUNTINGS • SPECIAL VIBRATION TEST EQUIPMENT

complete plastic production...

all under one roof

Case History

No. 2

Printloid fabrication of radio dials and windows covers all types of plastic materials. Here are two examples—a silk-screen printed dial of Vinylite and an edge-lit dial engraved from Lucite. Complete supervision by Printloid—of course.

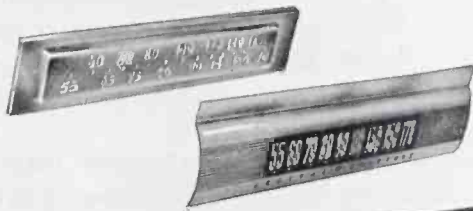

Printloid is a four-in-one outfit that brings you complete plastic fabrication in one plant. Experts handle your job from the initial design through final assembly.

Results? No shopping around, no wasted time. Instead, better design, uniform control and lower costs with Printloid engineering supervision at every step of the job.

FORMING

Radio Dial windows are a Printloid specialty, and we have made millions for the country's largest radio manufacturers. Printloid has worked for every industry, producing finished products as well as sub-assemblies.

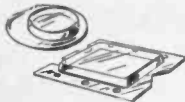

PRINTING AND DIE CUTTING

Limitless possibilities of printing, from line cuts to four color process printing, are yours at Printloid. Die Cutting facilities range from steel rule dies to hydraulic presses for heavy plastic sheets.



MACHINING

Printloid is experienced in precision work to .001" in all machining and finishing operations. Typical of our complete facilities is 2½ inch through spindle lathe capacity for machining.

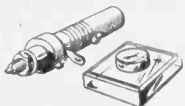

DESIGN AND ASSEMBLY

Printloid experts work to your specifications or execute your original designs. Displays have been created for leading national advertisers. Our engineers invite you to consult them on your problems.



The new Printloid catalog tells the story of complete plastic production under one roof. Includes a useful Plastics Glossary. Write for your copy.

Printloid INC.
PLASTIC FABRICATION

A Name to Remember

Cam-Rotor

variable fluid condenser

- Greatly increases the electrical efficiency . . . virtually eliminates acoustical feedback and contact resistance . . . reduces self-inductance . . . markedly increases signal strength and sensitivity . . . completely shielded.

• A revolution in condenser design . . . at last making attainable many improved efficiencies sought by every quality radio maker. *Study these advanced new features.*

**SINGLE-UNIT
PRESSURE CAST
STATOR
(Actual Size)**

(PATENTS
PENDING)

**COMPLETELY SHIELDED
AND SEALED
by Cover (not shown)**

SPECIAL SYNTHETIC FLUID DIELECTRIC

with an exceptionally high dielectric constant, is introduced into the clearance area between rotors and stator. The fluid remains permanently stable, without breakdown or viscosity change when subjected to temperature extremes and when used throughout a lifetime of service. The fluid dielectric, together with the inherent characteristics of the cam-rotor design, greatly reduce contact resistance and produce an improved electrical efficiency up to nearly twice that of air-gap multiple plate condensers. Strength of signal and sensitivity are correspondingly increased.

PRESSURE CAST SOLID CAM ROTORS

of scientifically-developed areas and contour. Separated from stator by fixed increments of clearance. The relatively large, balanced cam-rotor masses—with only one moving part per stage—and the absence of vibrating plates (present in multiple plate construction), remove the chief causes of acoustical feedback. Self-inductance is minimized. Passage of much higher frequencies and volume is permitted.

LOW-LOSS PLASTIC SHAFT

of calculated rigidity, contributes importantly to the increased efficiency.

SEALED-IN CONSTRUCTION

Dust-proof, moisture-proof, mold-proof. Enclosing a permanent, accurately-positioned lifetime assembly that cannot be damaged or jarred out of adjustment during assembling of the radio set or its transportation.

COMPLETELY INTERCHANGEABLE

Mounting dimensions, shaft location, and overall size conform to RMA standards, making it completely interchangeable with variable air condensers.

NOTICE:

Available now in 420-162 two-stage capacity; other capacities produced to order. Production facilities are being expanded . . . attractive delivery schedules will be possible in the near future. Advance orders will of course receive priority.

TIMING INSTRUMENT CO., INC.

Electric Time Standards
Watch Rate Timers

Timing Switches
Radio and Electronic Devices

106 Spring Street

New York 12, N. Y.

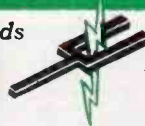

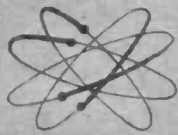

Designer's

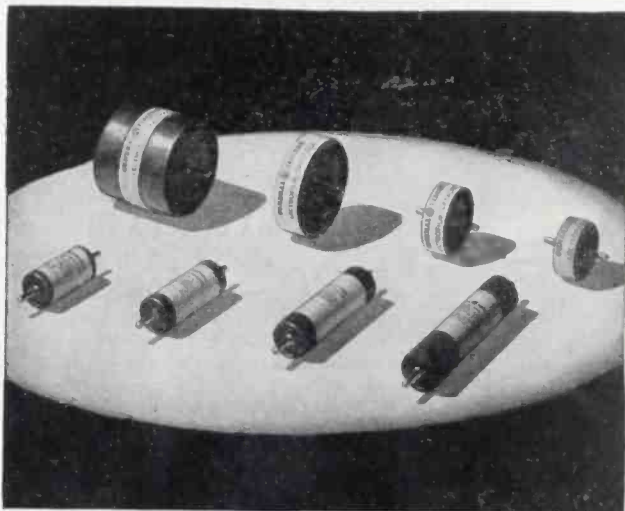

LECTROFILM *at a glance*

Lectrofilm is the name of a new synthetic-resin dielectric developed by General Electric Laboratories which combines a greater number of desirable mechanical and electrical properties than any other single capacitor dielectric material. It is admirably suited for use in dry-type, high-voltage capacitors because it—

1. Withstands high and low ambient temperatures
2. Has low power factor and its power factor decreases as temperature rises
3. Has high dielectric strength and constant
4. Is chemically stable
5. Is strong and flexible
6. Has uniform characteristics
7. Is moisture resistant

New High-Voltage CAPACITORS for TELEVISION Pulse Rectifiers

To smooth out the rectified high-voltage power supply in television and similar electronic applications, G.E. has developed a new line of small, light-weight, high-voltage capacitors. These new components are specially designed to meet the exacting restrictions in size and weight made necessary by the compact design of modern television receivers.

Currently available in two widely usable designs—flat cylindrical and long cylindrical—these Lectrofilm* units are equipped with prong-type terminals, designed to meet the special mounting requirements of modern television receivers.

Constructed of thoroughly tested and proved materials, these new Lectrofilm capacitors make available to the television engineer the high quality and reliability demanded by today's television applications. Write for Bulletin GEA-4558.

G-E Lectrofilm capacitors, for use in television pulse rectifiers, are now available in the ratings given in the following table. (Other ratings and designs will be available on request.)

RATINGS AND DATA

Capacitance ratings: all sizes .0005 Mu-f. Capacitance tolerance; plus 35 per cent, minus 0 per cent.

Peak Working Voltage	Cat. No.	Maximum R-F Current (Milliamperes)			Net Wt. in Oz.	Approx. Dimensions in Inches	
		at frequencies of				Diameter	Length (Inc. terminals)
		20 Kc.	100 Kc.	300 Kc.			
FLAT CYLINDRICAL UNITS, with Terminals on Axls							
5000	29F201	15	50	150	1/2	1 1/8	1 1/8
7500	29F200	20	75	200	3/4	1 1/4	1 1/4
10,000	29F196	25	100	300	1 1/2	2 1/4	1 1/4
16,000	29F206	30	120	350	4 1/2	2 1/4	3 1/2
LONG CYLINDRICAL UNITS, with Terminals on Axls							
5000	29F203	10	40	100	3/4	1 1/4	2 1/2
7500	29F204	10	40	100	1	1 1/4	3
10,000	29F202	10	40	100	1 1/2	1 1/4	4
16,000	29F205	15	50	125	3	1 1/4	5

* General Electric's new synthetic-resin dielectric

GENERAL  ELECTRIC

Digest

TIMELY HIGHLIGHTS ON G-E COMPONENTS



MORE MAGNET *in less space*

G-E alnico magnets are the answer to many a tough problem in design, where coercive force must be large, and the magnet small.

They are formed by the cast as well as the sintered process which makes possible rapid, large-scale, close-tolerance manufacture of both complex and simple shapes. Compact, with uniform flux distribution and great stability, these mighty midgets facilitate the design of small devices of high precision. Write for Bulletin GEA-3682A.

EVER NEED *a non-linear resistance?*

Frequently, electronic designers need a non-linear resistance to protect against voltage surges, to stabilize power voltages or to control voltage-selective circuits. In Thyrite*, General Electric's silicon-carbide resistance material, current varies as a power of the applied voltage. That is, I varies as E^n .

For example, with a Thyrite resistor whose exponent is 4, doubling the voltage multiplies the current by 2^4 or 16, whereas doubling the voltage applied to a wire-wound resistor merely doubles the current.

Thyrite resistors are supplied in discs or rods, in diameters from 0.25 in. to 6.0 in. Write for Bulletin GEA-4138A.

* Trade-mark Reg. U. S. Pat. Off.

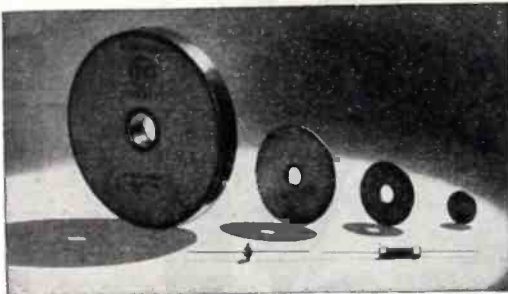
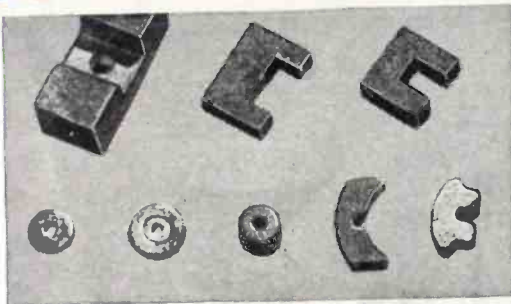

TIGHT, FAST JOINTS

begin with the soldering iron

With the new line of G-E soldering irons, operators can solder just as fast as the nature of the job permits. Tips stay hot during constant use. The Calrod heating element close to the tip gives a short, low-loss heat path to the work.

Sturdy construction prevents work interruptions due to iron failure. Repairs are infrequent, even under severe conditions. Available in five sizes and types, from 75 to 300 watts, 115 volt or 230 volt. Write for Bulletin GEA-4519.



A LOT OF INSTRUMENT

in a little space

These thin, internal-pivot panel instruments have high torque, good damping, and a lightweight moving element that withstands vibration. They respond rapidly and accurately. They give you more instrument in less space, because the internal-pivot construction makes the entire element assembly 20 per cent thinner than most outside-pivoted types. Ask for details of the Type DW voltmeter or ammeter—milli, micro, or radio frequency. Bulletin GEA-4064.



REMOTE CONTROLS *that stay in step*

G-E selsyns *stay* synchronized; that is why they are so widely used for remote control and indication applications with single and multiple receivers.

Three sizes of high-accuracy selsyns give operation to within plus or minus 1 degree. Where plus or minus 5 degrees is close enough, use lower cost general-purpose selsyns.

Accuracy values are for 60 cycle, 110 volt operation. Write for Bulletin GEA-2176A.



General Electric Company, Sec. 642-11
Apparatus Dept., Schenectady 5, N. Y.

Please send me

- | | |
|--|---|
| <input type="checkbox"/> GEA-4558 (Lectrofilm capacitors) | <input type="checkbox"/> GEA-4138A (Thyrite) |
| <input type="checkbox"/> GEA-3682A (Sintered alnico magnets) | <input type="checkbox"/> GEA-4519 (Soldering irons) |
| <input type="checkbox"/> GEA-4064 (Panel Instruments) | <input type="checkbox"/> GEA-2176A (Selsyns) |

NOTE: more data available in Sweets' File for Product Designers

Name

Company

Address

City State

The 3 "most-asked" questions about Carbonyl Iron Powders

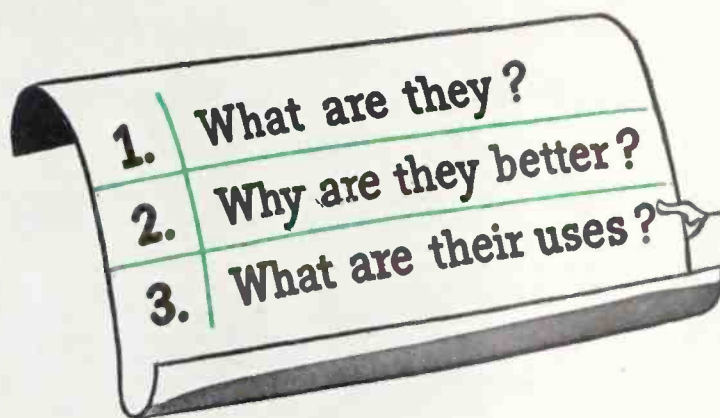

For wartime uses, design engineers asked these three questions.

In peacetime, as design engineers plan for peacetime equipment, the same questions are asked.

"What are they?"

G.A.F. Carbonyl Iron Powders are obtained by thermal decomposition of iron penta-carbonyl. There are five different grades in production, designated as "L," "C," "E," "TH," and "SF" Powder. Each of these five types of iron powder is obtained by special processing methods and has its special field of application.

The particles making up the powders "E," "TH," and "SF" are spherical with a characteristic structure of concentric shells. The particles of "L" and "C" are made up of homogeneous spheres and agglomerates.

Their weight-average diameter, their total iron contents, and their carbon contents are given in the table at upper right.

"Why are they better?"

Carbonyl Iron Powders are better because of their unique spherical shape, shell structure, particle size distribution, high degree of purity and freedom from stress.

Their stability against magnetic shock, temperature changes, and time (aging) is of the highest order.

Permeabilities range up to 70 with low eddy-current losses. Q values are the highest obtainable because of extremely small eddy-current and hysteresis losses.

Carbonyl Iron Powders are better as electromagnetic material over the entire communication frequency spectrum.

A set of relative Q values for the five powder grades is given in the graph on the other page to show the conventional frequency range for each grade.

"What are their uses?"

Carbonyl Iron Powders are used for electromagnetic cores and structures for widely different purposes. Five typical applications are shown on the chart at bottom of other page.

"L" and "C" powders are also used as powder metallurgical material because of their low sintering temperatures, high tensile strengths, and other very desirable qualities. Sintering begins below 500°C and tensile strengths reach 150,000 psi. Compacts can be made having regular pronounced porosity to function as a spongy mass. Compacts can also be made of highest density for excellent magnetic properties.

Further information can be obtained from the Special Products Sales Dept., General Aniline & Film Corporation, 270 Park Avenue, New York 17, N. Y.

Diameters and Chemical Composition of the 5 Carbonyl Iron Powder Grades

Carbonyl Iron Grade	Weight-Average Diameter Microns	Total Fe Content %	Total Carbon Content %
L	20	99.7-99.9	0.005-0.03
C	10	99.5-99.8	0.03 -0.12
E	8	97.9-98.3	0.65 -0.80
TH	5	98.1-98.5	0.5 -0.6
SF	3	98.0-98.3	0.5 -0.6



RELATIVE Q VALUES OF THE 5 CARBONYL IRON POWDER GRADES

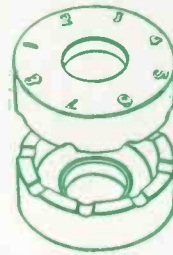
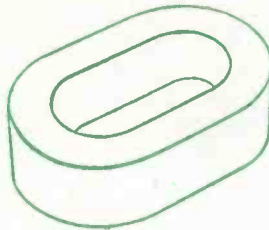
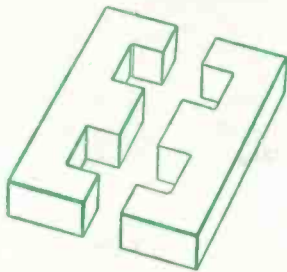
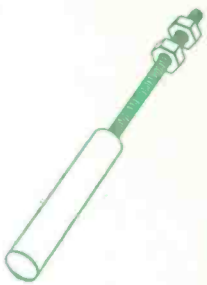
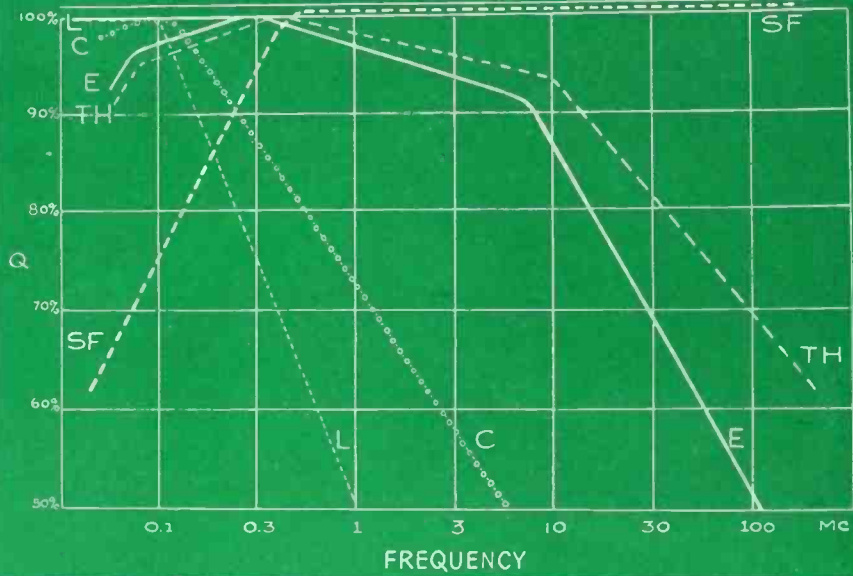

"L" Type Powder used in cores for permeability tuning.

"C" Type Powder for E-cores in filter coils.

For antenna coils, "E" Type Powder used in cores.

"TH" Type Powder is employed for cup shields in coils.

One use of "SF" Type Powder is in high frequency choke cores (with sealed-in leads).

G.A.F. CARBONYL IRON POWDERS

*PLENTY of
Completely Machined
Electrical
Insulating Parts*

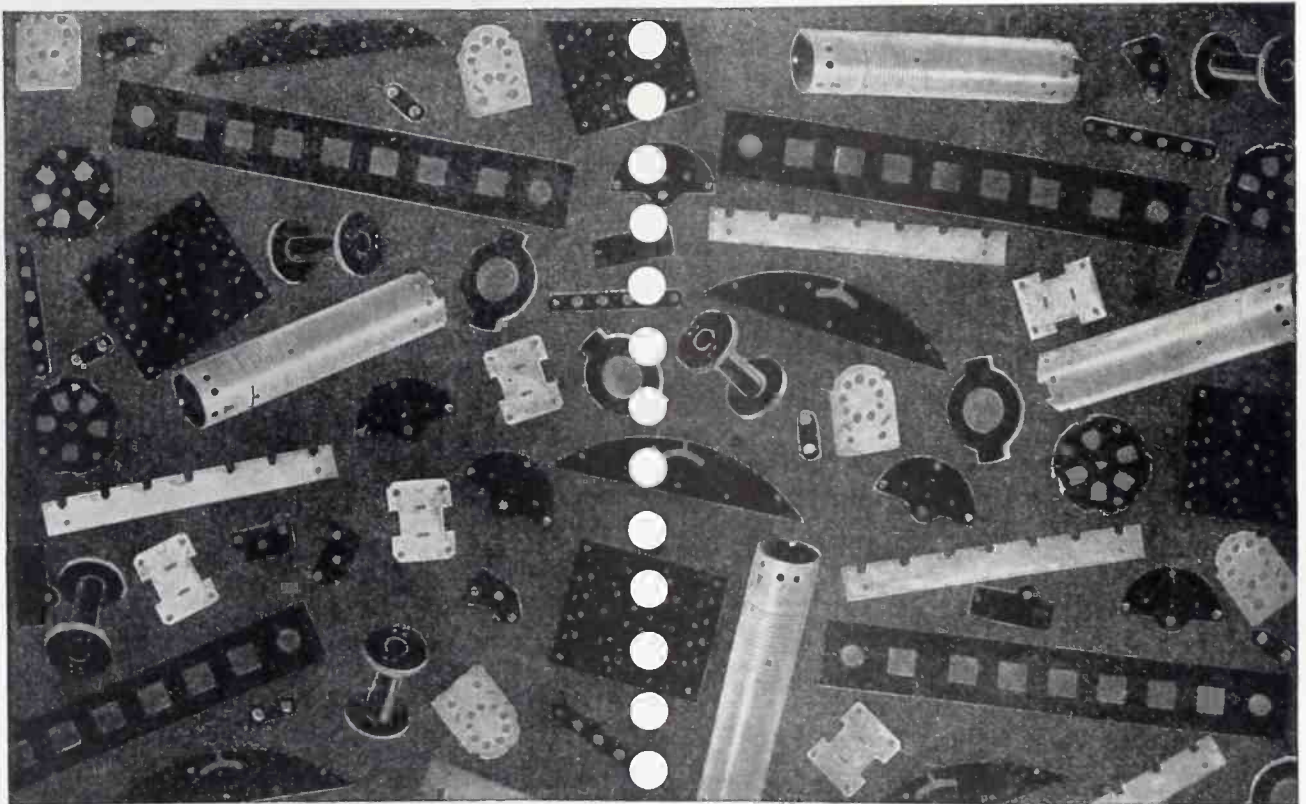

Large increases in machining equipment for Formica electrical parts installed to meet the demands of war, now make it possible for Formica to handle the machining of a much greater volume of parts, and to provide prompt service.

Modern equipment capable of a high level of accuracy and uniformity in the output has raised the quality of Formica machined parts.



If you are interested in a steady flow of high quality laminated plastic insulating parts, send your blue prints for quotations.

The Formica Insulation Co.
4648 Spring Grove Ave.
Cincinnati 32, Ohio

Wire Guides Horsepower



A pent-up river stampedes through the races at Norris Dam . . . a rotor turns . . . and a hundred miles away a happy light twinkles in the window of a lonesome farm house.

Live, snorting steam is corralled and released again to plunge headlong against the whirling blades of a turbine . . . and, silently, a bank of many-colored lights creates a scene from fairyland on a stage on Broadway.

Up on an Aleutian outpost a jeep engine whines in unison with a small generator . . . and a homesick G. I. hears a friendly "Hello" from his girl as she speaks a half a hemisphere away. And on and on.

Magic? No, it is electrical wire that turns the trick. Wire generates and harnesses the wild horsepower. Wire guides it across the miles to make it useful. This "power delivery service" is but one phase of the wiremakers' contribution to industry and better living.

Belden



WIREMAKER FOR INDUSTRY

*PROMPT DELIVERY ASSURED -
ANY QUANTITY ON SHORT NOTICE!*



FOR INDUSTRY...

CHATHAM
HIGH VACUUM • MERCURY VAPOR • INERT GAS
RECTIFIERS

...FOR COMMUNICATIONS

These popular types, like any other CHATHAM rectifiers can be supplied direct from stock to meet immediate needs. Because CHATHAM production is devoted exclusively to producing vacuum, mercury vapor and inert gas rectifiers, these tubes embody many special mechanical and

electrical features that lengthen life and improve performance. As a result of specialized rectifier engineering and production, this plus factor in design and construction involves no price premium. For complete details on CHATHAM rectifiers and thyatrons, call or write today.



CHATHAM ELECTRONICS

475 WASHINGTON STREET, NEWARK 2, NEW JERSEY

WHAT IS CORNING METALLIZING?

NOT THIS — BUT THIS



It isn't like the metallic decoration on tableware . . . an art known even to the ancient Egyptians.



CORNING metallizing is a permanent union of metal to glass so strong it will withstand a pull of 2000 pounds per square inch! This kind of metallizing permits a glass part to be permanently soldered into place. And that means fewer parts, faster assemblies, hermetic seals, better products!

When you think of Corning metallizing, forget about metal that's just painted on—or cemented on—or cast on. This is something entirely different, a development of Corning

Research, which is doing a real job in a dozen different industries. Corning metallized glass parts are available in virtually any shape or size or glass formula. To get the complete story, write today for bulletin EL-Z-Z10. Or if you have an immediate problem you think Corning metallizing might solve, one of our engineers will call at your convenience. Electronics Sales Department E-6, Technical Products Division, Corning Glass Works, Corning, N. Y.

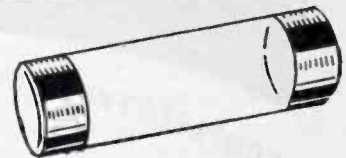

• HOW MUCH DOES IT COST ?

Without knowing exactly what you want, that's hard to say. But this glass tube $\frac{1}{2}$ " in diameter by $1\frac{1}{2}$ " long with $\frac{1}{8}$ " metallized bands on each end, in lots of 100,000 to 1,000,000, costs from 2c to 5c each, depending on the glass and tolerances required.

CORNING
— means —
Research in Glass

Electronic Glassware



"PYREX", "VYCOR" and "CORNING" are registered trade-marks and indicate manufacture by Corning Glass Works, Corning, N. Y.

WATCH FOR IT!

DU MONT'S *new* 5-INCH OSCILLOGRAPH

◆ *The Type 274* ◆

Designed to meet the demand for an
inexpensive general-purpose instrument

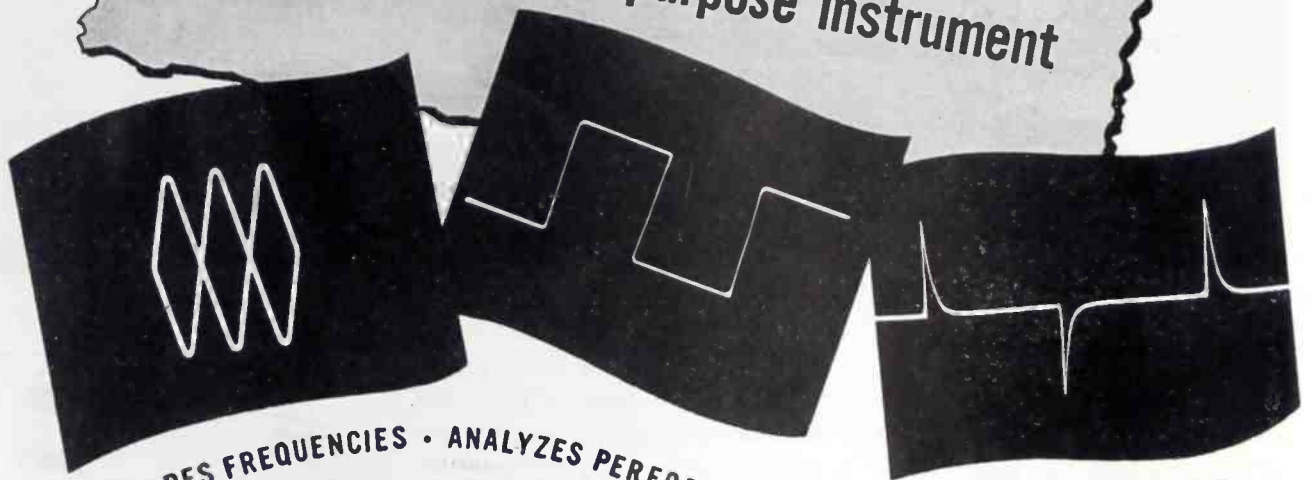

COMPARES FREQUENCIES • ANALYZES PERFORMANCE • SHOWS CIRCUIT FUNCTIONS

◆ In engineering the new Du Mont Type 274 Oscillo-
graph, the emphasis has been on "quality at a price"
—and not price alone. The result: the finest laboratory
instrument ever offered for less than one hundred
dollars. Available soon—and it's worth waiting for!

only
\$99⁵⁰

© ALLEN B. DU MONT LABORATORIES, INC

DUMONT

Precision Electronics & Television

ALLEN B. DUMONT LABORATORIES, INC., PASSAIC, NEW JERSEY • CABLE ADDRESS: ALBEEDU, PASSAIC, N. J., U. S. A.



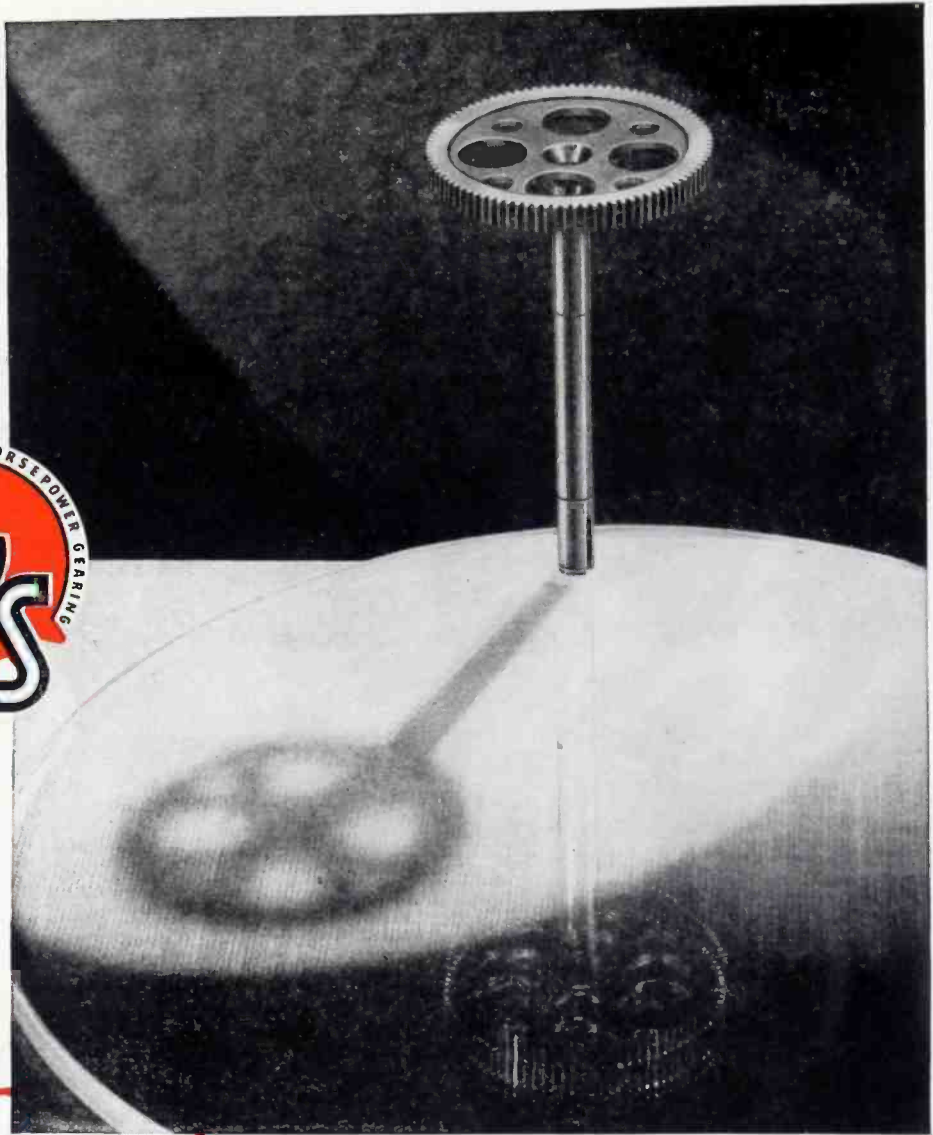

*Precision is Measured
by **Finest** Fractions*

● Every gage or measuring device known to the science of small gear production is employed in the manufacture and inspection of G.S. small gears. In fact, so precise are the manufacturing standards established in our plant, that rejections have been reduced to the vanishing point. Devices and equipment in which G.S. Fractional Horsepower Gears are used function more smoothly, quietly and dependably. If the quantity production of *better, more uniform* custom-made small gears is a matter of interest to you, won't you share your problems with a highly trained specialist in this field . . . a G.S. engineer?



GEAR Specialties

Spurs • Spirals • Helicals • Bevels • Internals • Worm Gearing • Racks • Thread Grinding
2635 WEST MEDILL AVENUE • CHICAGO 47, ILLINOIS

WORLD'S LARGEST EXCLUSIVE MANUFACTURERS OF FRACTIONAL HORSEPOWER GEARS

Superior

CATHODES

SEAMLESS

and

LOCKSEAM

(PATENTED)

SUPERIOR TUBE CO.

NORRISTOWN, PENNSYLVANIA

"THE BIG NAME IN SMALL* TUBING"

*Maximum OD 5/8"



MAKING TUBES IS EASY If YOU KNOW HOW!

HOW THE HYTRON 12SK7GT IS QUALITY CHECKED

Test	100% Production Test	Central Inspection Sampling	Quality Laboratory Sampling	100% Test at Packing
Shorts				
Base shell connection	x			
Heater current		x		
Plate current	x	x		x
Screen current	x	x		
Grid current	x	x	x	
Transconductance	x	x		
Suppressor action	x	x	x	
Emission	x	x	x	
Heater-cathode leakage	x	x	x	
R-f noise	x	x	x	
Transconductance cutoff	x	x	x	
Vibration		x	x	
Insulation resistance			x	
Input capacitance			x	
Output capacitance			x	
Grid-plate capacitance			x	
Grid emission			x	
Immersion (basing cement)			x	
Life			x	
Overall length			x	
Mechanical*	x		x	x
	x	x	x	x

*Mechanical tests are covered by a multipage specification. Typical inspection is conducted visually and/or by gages for the following: pin solder, etching, getter flash, diameter, base-bulb alignment, bent base pins, glass defects, and rigidity of internal elements, bases, and base pins.

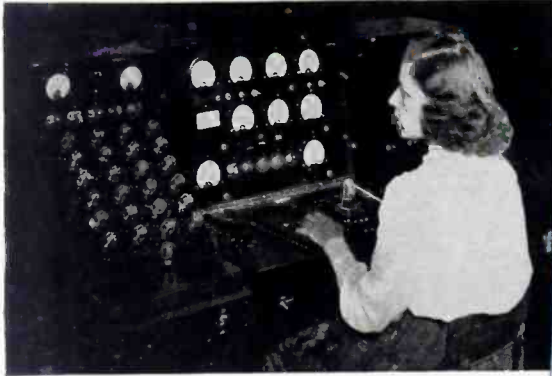

This standardized Hytron production tester is composed of three units: preheater, characteristics tester, noise tester. To permit a better view of the equipment, only one of three operators is shown.

AGAIN HYTRON'S LONG EXPERIENCE

GIVES YOU THE BEST...

FOR your protection Hytron tubes are quadruple-checked. On the production floor, each tube is first tested for significant characteristics. In the central inspection department, a random sampling is next taken for statistical control of the production testing—to assure quality within acceptance limits. Failure at this point demands 100% retest.

Daily a smaller random sampling is subjected to a searching design check of characteristics such as inter-electrode capacitances, grid emission, and transconductance cutoff. These characteristics can be controlled by the smaller sampling, and their testing requires laboratory precision. Simultaneously production tests are again repeated for further statistical control. Again failure to meet acceptance limits demands 100% retest—even for design characteristics not production-tested.



Extreme accuracy and flexibility of this Hytron master test station particularly fit it for quality control.

Finally each tube is once more short-tested and mechanically inspected just before packing.

This painstaking quadruple-checking ensures that specification failures of tubes actually shipped will be a practically irreducible minimum. When you buy a Hytron tube, you can be certain that every ounce of Hytron know-how on quality control—reinforced by wartime experience—has been in there punching to give you only the best.

OLDEST MANUFACTURER SPECIALIZING IN RADIO RECEIVING TUBES



HYTRON

RADIO AND ELECTRONICS CORP.

MAIN OFFICE: SALEM, MASSACHUSETTS



THE MICRO SWITCH

Available In Varied Constructions

Precision Performance Is Based On These Features By Micro Switch

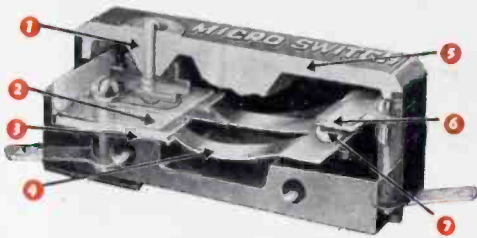

Here Are the Reasons for Micro Switch Precision Performance

- 1** Hard, stainless steel plunger pin. Ground to true diameter with rounded edge: flat area on top.
- 2** Positive stop which limits overtravel of plunger and prevents extra strain on three-blade spring.
- 3** Heavy brass anchor with patented groove in which accurately broached pivot edges of the spring operate, assuring uniform switch performance.
- 4** Perfectly formed and heat treated, three-bladed beryllium alloy spring of high electrical conductivity. Spring bends in normal manner—in same direction as plunger—providing lightning fast action. Lack of reverse bends insures long flexure life.
- 5** Firmly locked-on cover. Carefully checked for size and flatness.
- 6** Heavy, scientifically designed contacts of 99.95% fine silver. Large stationary contact and rivet type movable contact—no overheating, and ample overload capacity.
- 7** Movable contact on spring always moves in same direction as plunger—clean break. Overtravel features hold contacts firm—proof against cross action.

Add to these features scientific manufacturing methods and rigid inspection of finished products and you have further proof of Micro Switch leadership.

• Many manufacturers think of Micro Switch snap-action as a small, precise enclosed switch. This is not literally true, as the Micro Switch principle of precise snap-action can be furnished in a wide variety of constructions as shown. Its use is adaptable to a surprising number of applications.

A characteristic feature of the Micro Switch snap-action principle is precise repeat action, which results in accurate duplication of operating point. It assures high vibration resistance. High contact pressure is maintained, rapid contact separation is achieved irrespective of speed of actuation.

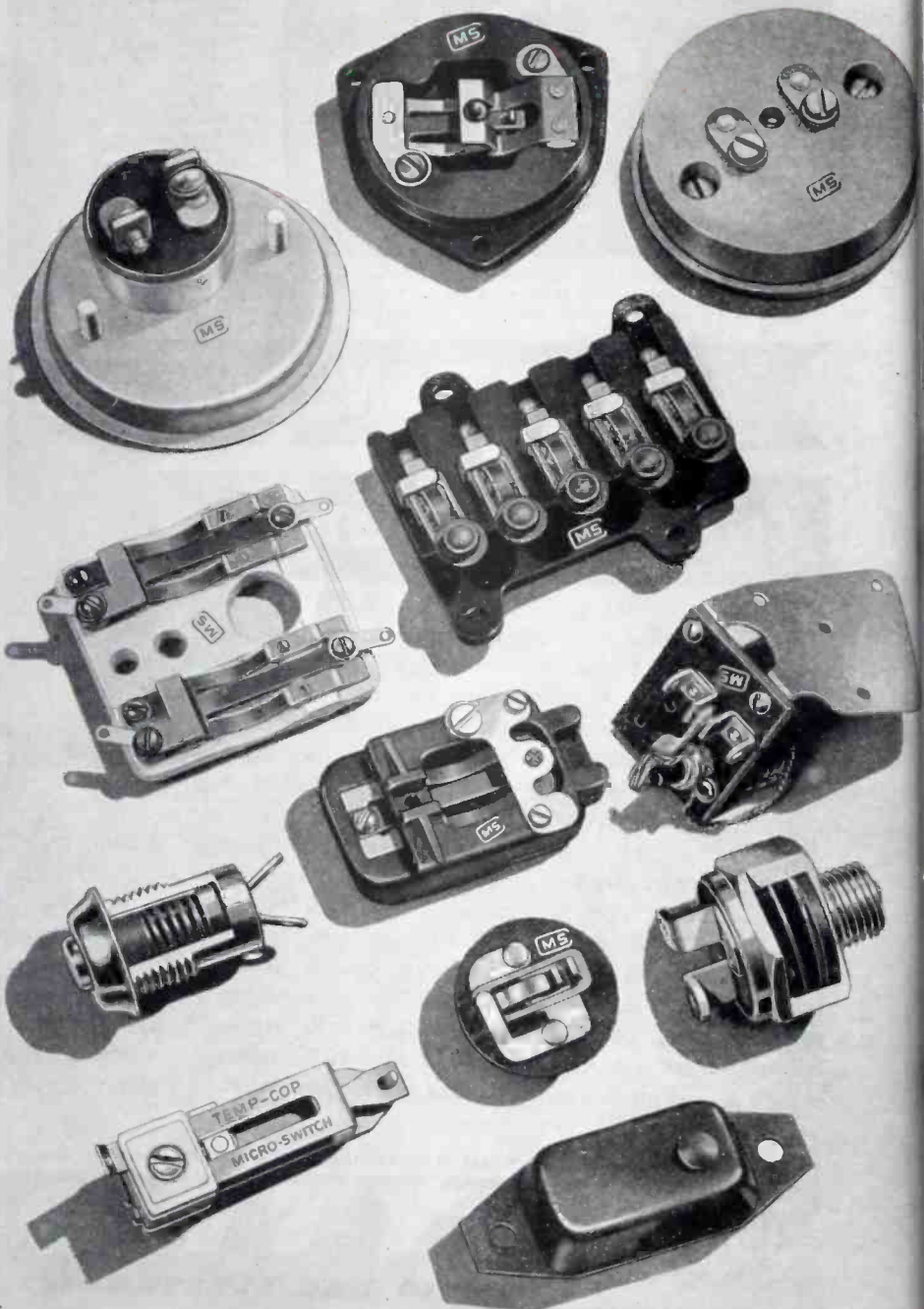

THIS TRADE MARK  IS A SIGN OF GENUINE PRECISION

SNAP-ACTION PRINCIPLE for Many Different Applications

Micro Switch products can be used singly or ganged, and are made with many types of housings and varied actuating arrangements, depending upon the requirements to be met. They have high electrical capacity, long life, and uniformity of characteristics.

View the group of varied constructions shown here, then think in terms of your own products. Let us show you where you can use the Micro Switch snap-action principle in your product.

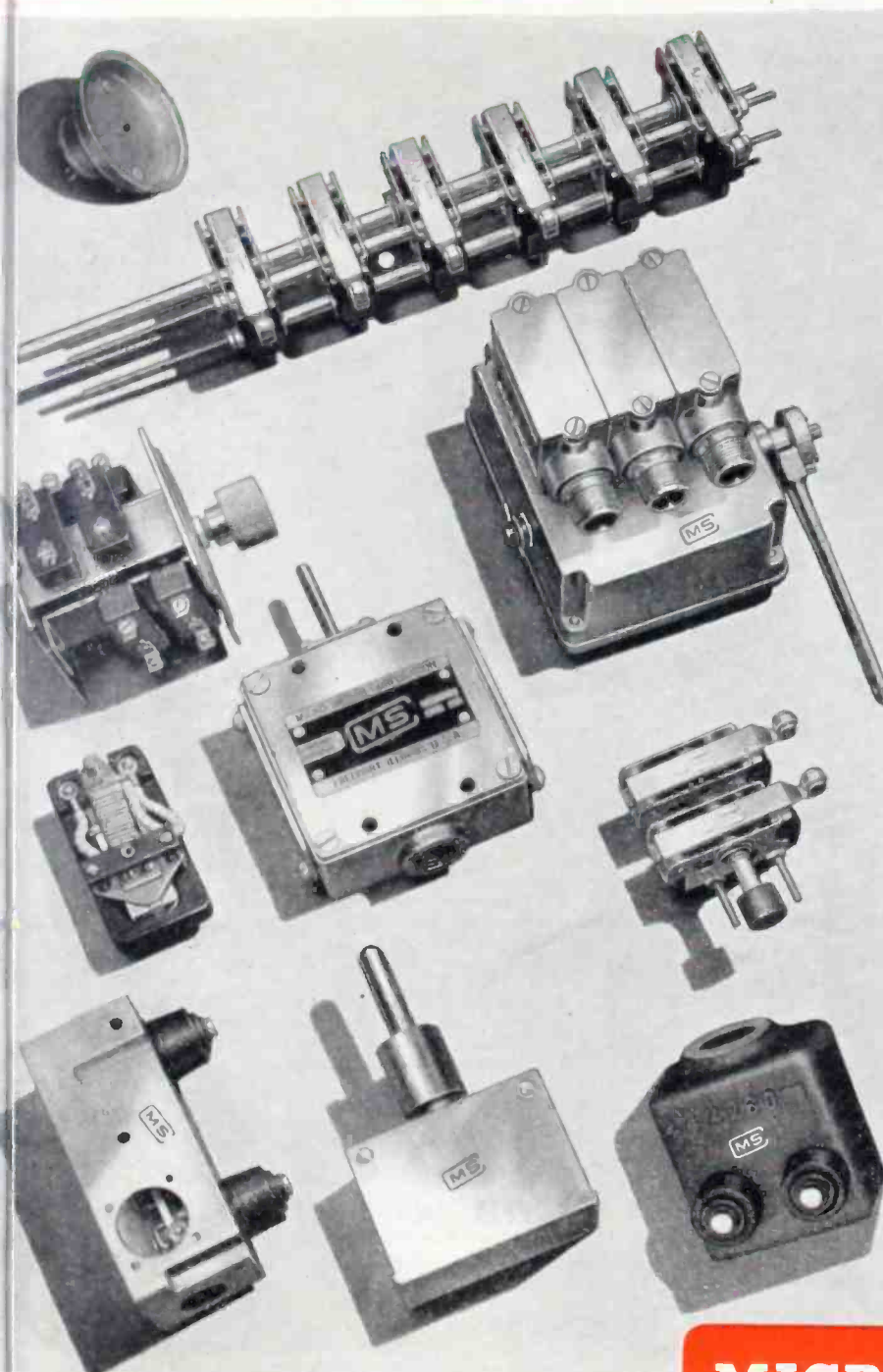

Uses Unlimited

"Uses unlimited" describes, in principle, a few of the wide uses for Micro Switch Snap-Action Switches as incorporated parts in equipment.

PRESSURE ACTUATED



STRAIGHT CAM CONTROL

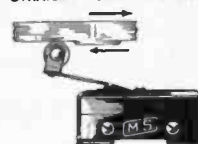

ELECTRO MAGNET RELAY

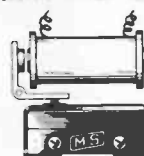

COLN ACTUATED

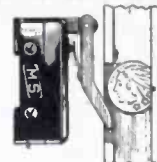

BIMETAL THERMOSTAT



DIAPHRAGM PRESSURE ACTUATED

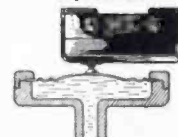

STRAIGHT CAM CONTROL

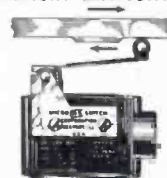

CONTROL OF WEIGHT

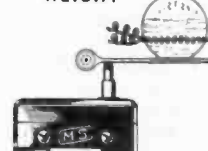

COUNTER FOR ARTICLES ON BELT CONVEYOR



DISC & CAM ACTUATED



©1946, First Industrial Corporation

MICRO MARK
TRADE **MS** SWITCH

A DIVISION OF FIRST INDUSTRIAL CORPORATION

FREEPORT, ILLINOIS, U. S. A.

Sales Offices in Principal Cities

SNAP-ACTION SWITCHES MADE BY

COPPER is the "Metal of Invention"

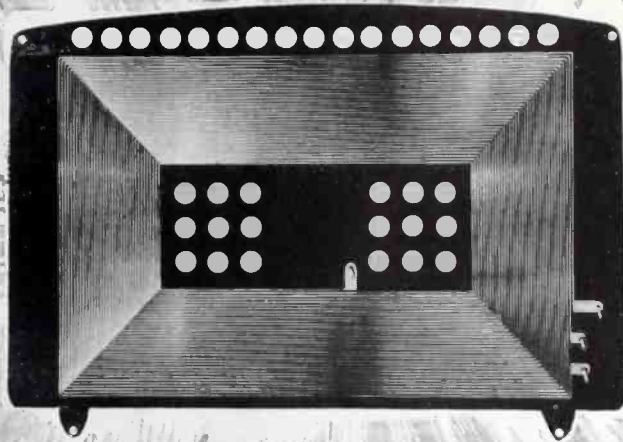

...**SEE REVERE!**

The Franklin Airloop Corp., 175 Varick St., New York 14, N. Y., makes this unique antenna to set manufacturers' specifications.

IT is Revere copper that makes possible the unusual Franklin Airloop antenna. This is die-stamped out of .005" sheet, a single operation on automatic machines forming the loop and locking it into the backboard. The result is superior ruggedness, less distributed capacity, higher "Q," and lower cost.

Thus copper once again proves that its unique qualities make it "The Metal of Invention." Easy workability, high electrical and heat conductivity, corrosion resistance, availability in a variety of tempers and in sheet, strip, plate, bar and rod—copper by Revere serves the radio industry in many different ways.

Revere also offers copper alloys, aluminum and magnesium, and electric welded steel tube. Selection of the proper metal or alloy may at times be a matter for careful study; Revere is always glad to cooperate with engineers, designers and production men in working out the most economical and efficient applications.

REVERE PRODUCTS INCLUDE

Copper and Copper Alloys in sheet and plate, rolls and strip, rod and bar, tube and pipe, extruded shapes, forgings.

Aluminum Alloys in tubing, extruded shapes, forgings.

Magnesium Alloys in sheet and plate, rod and bar, tubing, extruded shapes, forgings.

Electric Welded Steel Tube in straight lengths or semi-fabricated to your designs.

REVERE

COPPER AND BRASS INCORPORATED

Founded by Paul Revere in 1801

230 Park Avenue, New York 17, New York

Mills: Baltimore, Md.; Chicago, Ill.; Detroit, Mich.;
New Bedford, Mass.; Rome, N. Y.

Sales Offices in Principal Cities, Distributors Everywhere.

Listen to *Exploring the Unknown* on the Mutual Network every Sunday evening, 9 to 9:30 p.m., EDST.

DIRECT RESPONSE TO TEMPERATURE CHANGE*

A thermostat should have a short heat transfer path — to provide direct and rapid temperature control. The temperature-sensitive outer shell of FENWAL Thermoswitch expands and contracts with changes in temperature, directly actuating the switch element within. The Thermoswitch does not require heat penetration of an outside barrier, as is common in other types of thermostats.

Chart shows the short heat flow path of the FENWAL Thermoswitch compared to Type 1 and Type 2 thermostats. This means minimal heat gradient effects reducing warming-up and cooling-off time of the thermostat unit.

Short heat transfer path and all the other FENWAL features make the Thermoswitch the ideal thermostat for all applications. Study the *Thermotechnics Booklet* — which includes the Fourteen Facts in Fenwal's Favor. Send for your copy today.



HEAT FLOW PATH



HEX HEAD TYPE THERMOSWITCH

FOURTEEN FACTS IN FENWAL'S FAVOR

- 1.—Fast reaction time
- 2.—Large heat sensitive area, small heat storage
- 3.—Short heat transfer path
- 4.—Small temperature differential
- 5.—Built-in temperature anticipation
- 6.—Enclosed assembly
- 7.—Minimal vibration effects
- 8.—Directly responsive to radiant heat
- 9.—Rugged construction
- 10.—Adjustable over wide temperature range
- 11.—Minimum size
- 12.—Tamper-proof and sealed
- 13.—Uniform sensitivity over adjustable temperature range
- 14.—Readily installed

*#3 of the "Fourteen Facts in Fenwal's Favor".

FENWAL INCORPORATED

43 PLEASANT STREET
ASHLAND MASSACHUSETTS

THERMOTECHNICS FOR COMPLETE TEMPERATURE REGULATION

Fenwal

©1946

NOW! FM

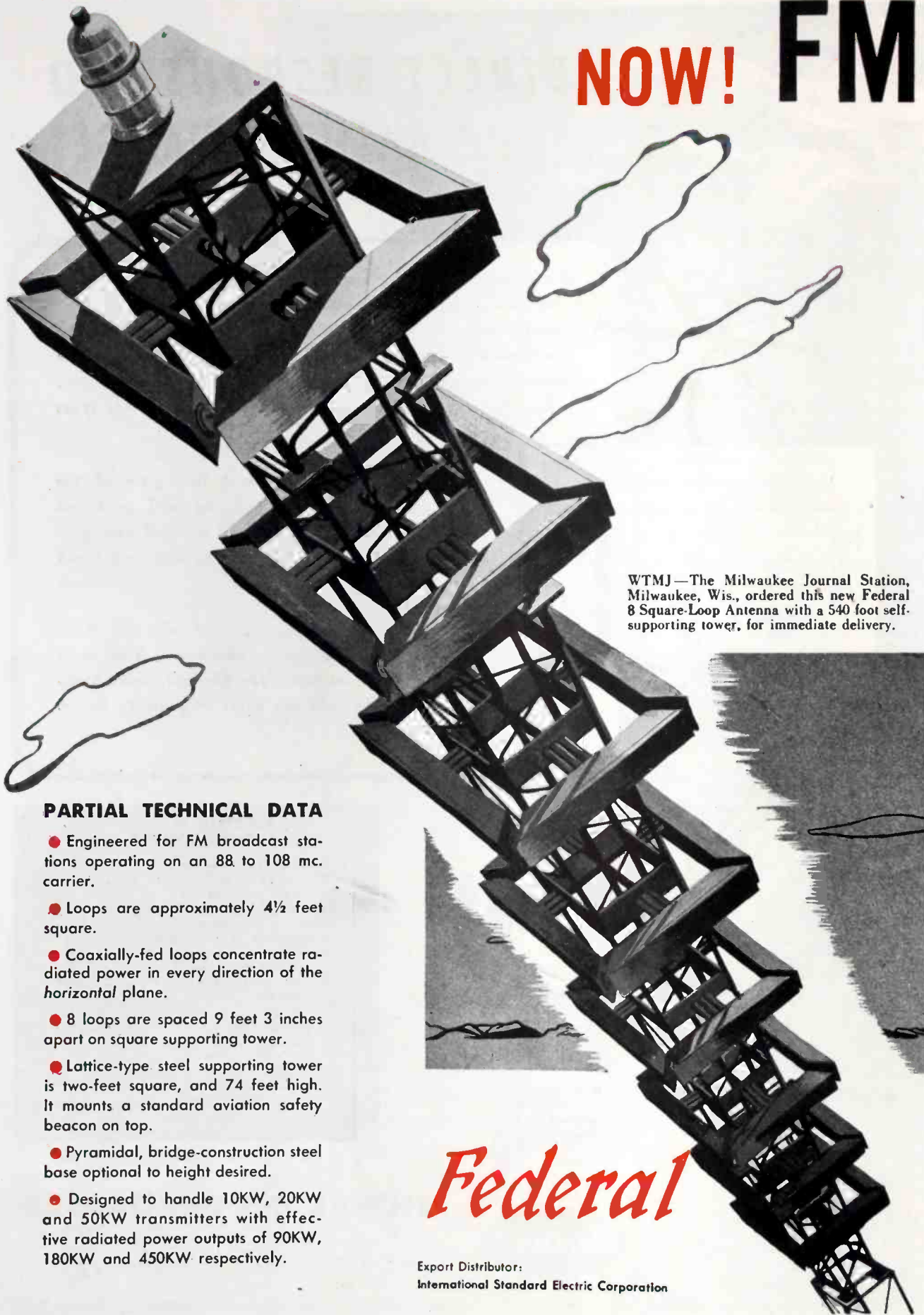

WTMJ—The Milwaukee Journal Station, Milwaukee, Wis., ordered this new Federal 8 Square-Loop Antenna with a 540 foot self-supporting tower, for immediate delivery.

PARTIAL TECHNICAL DATA

- Engineered for FM broadcast stations operating on an 88 to 108 mc. carrier.
- Loops are approximately $4\frac{1}{2}$ feet square.
- Coaxially-fed loops concentrate radiated power in every direction of the horizontal plane.
- 8 loops are spaced 9 feet 3 inches apart on square supporting tower.
- Lattice-type steel supporting tower is two-feet square, and 74 feet high. It mounts a standard aviation safety beacon on top.
- Pyramidal, bridge-construction steel base optional to height desired.
- Designed to handle 10KW, 20KW and 50KW transmitters with effective radiated power outputs of 90KW, 180KW and 450KW respectively.

Export Distributor:
International Standard Electric Corporation

ANTENNA WITH NOMINAL POWER GAIN OF 9!

FEDERAL'S 8 SQUARE-LOOP ANTENNA PROVIDES
90KW EFFECTIVE POWER OUTPUT WITH A 10KW TRANSMITTER...

180KW WITH A 20KW TRANSMITTER... 450KW WITH A 50KW TRANSMITTER!

HERE IS STILL ANOTHER EXAMPLE of Federal's leadership in the entire field of FM... an 8-loop antenna with the highest power gain ever available in the FM broadcast service.

It radiates horizontally polarized waves so highly directive that very little energy is lost to useless ground or sky wave. Thus, with a power gain of 9, you can now get an effective power output of 90KW with a 10KW transmitter; 180KW with a 20KW transmitter and 450KW with a 50KW transmitter! This not only means a great saving on the cost of original equipment, but important economies of operation as well.

Be prepared for future FCC action increasing the effective radiated power!

One antenna is built for use over the entire FM range...

88 to 108 megacycles. Only one predetermined stub adjustment per loop changes it for any frequency in this band. Also, antenna array may be fed in two sections with separate coaxial lines to allow for emergency auxiliary operation.

Structurally, the tower is designed not to disturb the circular pattern of the antenna's radiation... is supported on a rugged, pyramidal base. The entire unit withstands high wind velocities and heavy icing loads.

Coming at a time when the FCC has given the green light to FM station construction, this remarkable new antenna is another contribution to the advancement of FM transmission... part of the "completely packaged service" which Federal now makes available. A Federal engineer will be glad to give you full details.

RADIATION PATTERN
OF FEDERAL FM ANTENNA
*Linear array—8 loops
vertically stacked.*

Shown at right is a square loop antenna in operation at the Federal laboratories. Design is similar to the 8 square-loop antenna.

Telephone and Radio Corporation

Newark 1, New Jersey



THE WILCOX TYPE 255A RECEIVER

A new fixed frequency receiver to meet the present and future requirements of aeronautical ground-air, or point-to-point radio communications.

With increased traffic and new services taxing the already over-crowded 2-20 Mc communication frequencies, the Wilcox Electric Co. Type 255A Receiver has been especially engineered to minimize adjacent channel interference, and to maintain good intelligibility on telephone reception.

The Type 255A occupies only 3½ inches of rack space, making it readily adaptable to the replacement of existing receivers.



- Input Impedance: 70 ohms.
- Output Impedance: 500 ohms, center-tapped.
- Power: 110 V.A.C., 50-60 cycles, 60 watts.
- Output Power: Choice of 50 milliwatts or 1.25 watts.
- Sensitivity: 1 microvolt at 2/1 SN ratio.
- Spurious Frequency Response: 80 D. B.
- A.V. C.: 3 DB variation from 10 microvolts to 1.5 volts.
- Selectivity: 2X—2 Kc. wide.
10X—4 Kc. wide.
100X—7 Kc. wide.
1000X—11 Kc. wide
- Size: 3½" H. x 19" W. x 11½" D.

Detailed information on request.

Use of miniature tubes permits the building of each stage of the receiver complete within its own shield can, which in turn, plugs into an octal tube socket on the chassis.

Thus, each stage is instantly removable for maintenance, and may be checked in a test set similar to those used for vacuum tubes. Maintenance may then be accomplished on the bench, or a spare stage plugged in, and the stage returned to a maintenance base.



**WILCOX ELECTRIC
COMPANY, INC.**

Manufacturers of Radio Equipment
FOURTEENTH AND CHESTNUT
KANSAS CITY, MISSOURI

HERE THEY COME!



**THE NEW
S-38's
4 Bands—540 kc. to 32 Mc.**

\$39.50
ADD 3%
IN
ZONE 2

The Model S-38 meets the demand for a truly competent communications receiver in the low price field. Styled in the post-war Hallicrafters pattern and incorporating many of the features found in more expensive models, the S-38 offers performance and appearance far above anything heretofore available in its class. Four tuning bands, CW pitch control adjustable from the front panel, automatic noise limiter, self-contained PM dynamic speaker and "Airodized" steel grille, all mark the S-38 as the new leader among inexpensive communications receivers.

FEATURES

1. Overall frequency range—540 kilocycles to 32 megacycles in 4 bands.
Band 1—540 to 1650 kc.
Band 2—1.65 to 5 Mc.
Band 3—5 to 14.5 Mc.
Band 4—13.5 to 32 Mc.
Adequate overlap is provided at the ends of all bands.
2. Main tuning dial accurately calibrated.
3. Separate electrical band spread dial.
4. Beat frequency oscillator, pitch adjustable from front panel.
5. AM/CW switch. Also turns on automatic volume control in AM position.
6. Standby/receive switch.
7. Automatic noise limiter.
8. Maximum audio output—1.6 watts.
9. Internal PM dynamic speaker mounted in top.
10. Controls arranged for maximum ease of operation.
11. 105-125 volt AC/DC operation. Resistor line cord for 210-250 volt operation available.
12. Speaker/phones switch.

CONTROLS: SPEAKER/PHONES, AM/CW, NOISE LIMITER, TUNING, CW PITCH, BAND SELECTOR, VOLUME, BAND SPREAD, RECEIVE/STANDBY.

EXTERNAL CONNECTIONS: Antenna terminals for doubler or single wire antenna. Ground terminal. Tip jacks for headphones.

PHYSICAL CHARACTERISTICS: Housed in a sturdy steel cabinet. Speaker grille in top is of airodized steel. Chassis cadmium plated.

SIX TUBES: 1—12SA7 converter; 1—12SK7 IF amplifier; 1—12SQ7 second detector, AVC, first audio amplifier; 1—12SQ7 beat frequency oscillator, automatic noise limiter; 1—35L6GT second audio amplifier; 1—35Z5GT rectifier.

OPERATING DATA: The Model S-38 is designed to operate on 105-125 volts AC or DC. A special external resistance line cord can be supplied for operation on 210 to 250 volts AC or DC. Power consumption on 117 volts is 29 watts.



hallicrafters RADIO

THE HALLICTRAFTERS CO., MANUFACTURERS OF RADIO AND ELECTRONIC EQUIPMENT, CHICAGO 16, U. S. A.

The Record Changer That Gives You Everything!

What do you want in a record changer? Long life
—silent operation—constant speed—freedom
from trouble.

Wire Recorder

Sound on a wire as thin as a hair! The new Seeburg Wire Recorder permits perfect home recording of speeches, plays, music—it takes radio programs off the air. One simple control knob makes anyone a skilled sound technician. A new development everyone will want in tomorrow's phonograph.

*It Will Be Necessary
for radio manufacturers to make
provision in their circuits to ac-
commodate the Seeburg Wire Re-
corder. We invite inquiries from
radio manufacturers.*

The Seeburg Record Changer gives you all these
plus a fine regard for precious discs that makes
friends of phonograph owners. Long recognized
for dependability and simplicity, the newly engi-
neered line of Seeburg Record Changers brings
marked improvements in design and construction.
The finest is now finer still.

Seeburg

RECORD CHANGERS ★ WIRE RECORDERS

J. P. SEEBURG CORPORATION
1500 N. DAYTON ST. • CHICAGO, 22



MINIMUM FRICTION • SILENT • LONG LIFE • CONSTANT SPEED • TROUBLE FREE OPERATION



Newest

v-h-f power triode for FM and TELEVISION



**TYPE
GL-9C24
TRANSMITTING
TUBE**

- Frequency up to 220 megacycles at maximum plate input.
- High power output—see ratings!
- All the electrical characteristics of ultra-modern h-f tube design.
- Sturdy and COMPACT, for close side-by-side tube mounting.
- G-E RING-SEAL construction... gives generous terminal-contact areas.

RATINGS

Filament voltage	6.3 v
Filament current	250 amp
Grid-plate transconductance	11,000 micromhos
Interelectrode capacitances:†	
Grid-filament	23 micromicrofarads
Grid-plate	15 micromicrofarads
Plate-filament	0.7 micromicrofarads
Type of cooling	water and forced air
Plate ratings per tube, Class B r-f power amplifier (video service, synchronizing peak conditions):	
Max voltage	5,000 v
Max current	2 amp
Max input	10 kw
Max dissipation	5 kw
* Useful power output, typical operation (at 4,000 v and 1.7 amp, band width 5mc)	3.4 kw
Plate ratings per tube, Class C r-f power amplifier (key-down conditions without modulation):	
Max voltage	6,500 v
Max current	2 amp
Max input	12 kw
Max dissipation	5 kw
* Useful power output, typical operation (at 6,000 v and 1.3 amp)	6.4 kw
† Includes power transferred from driver to output of grounded-grid amplifier.	

GENERAL ELECTRIC'S great new power tube for FM and television—Type GL-9C24—combines high power output at very-high frequencies with unexcelled advantages of design. *This is the tube you want and need*, for the power amplifier stages of new transmitters now on your drawing-boards!

In FM use, a pair of GL-9C24's, operating conservatively, will put out more than 10 kw of power. In television, broad-band tests prove that a pair easily will deliver in excess of 5 kw at synchronizing peak level.

No neutralization is required when GL-9C24's are employed in a properly designed line or cavity type of

grounded-grid amplifier—the circuit to which this tube is particularly adapted. Other features: . . . Lead inductance is extremely low. All external metal parts are silver-plated, to reduce r-f losses and provide better electrical contact surfaces. Fernico metal-to-glass bonds are used throughout. Ring-seal design gives large terminal-contact areas, with correspondingly improved efficiency.

G-E tube engineers are ready to work closely with you on the application of this new v-h-f tube to your new FM and television transmitters. Phone your nearest G-E office, or write the *Electronics Department, General Electric Company, Schenectady 5, New York.*

GENERAL  ELECTRIC

FIRST AND GREATEST NAME IN ELECTRONICS

FOR VHF CIRCUITS YOU WANT THIS RESISTOR . . .

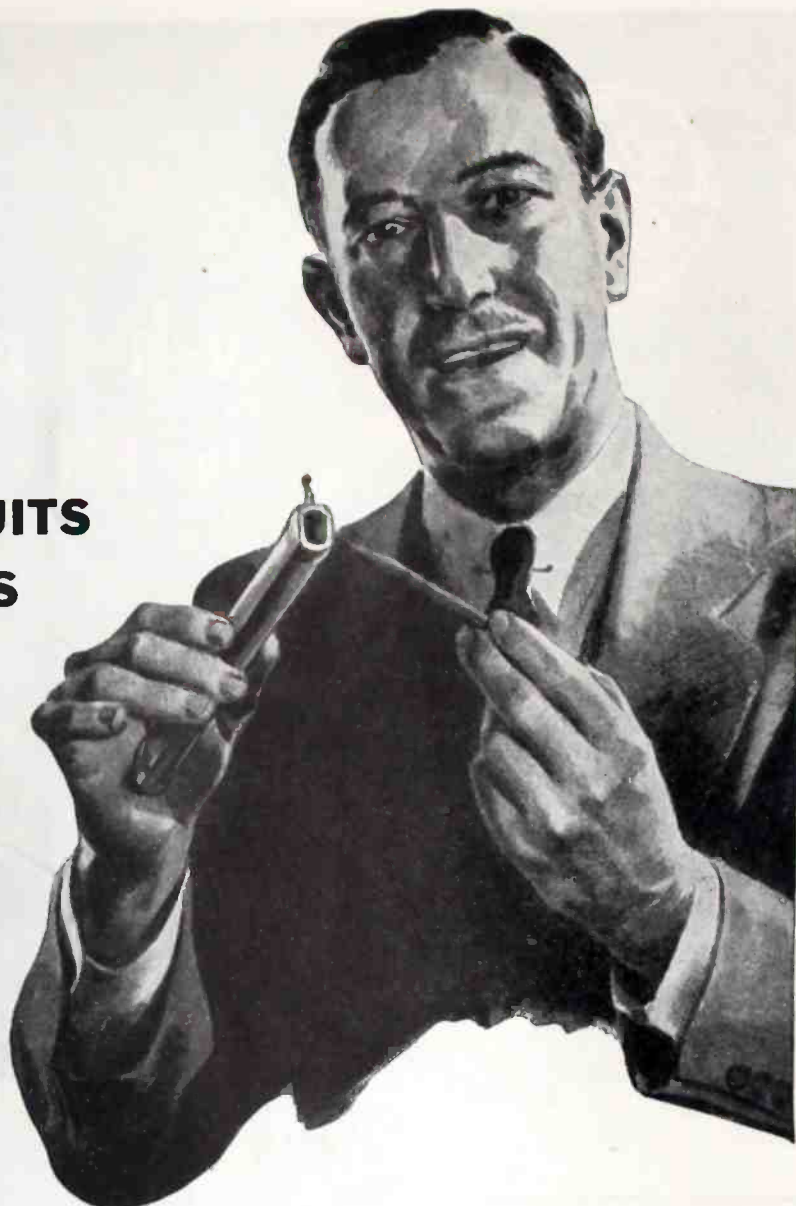
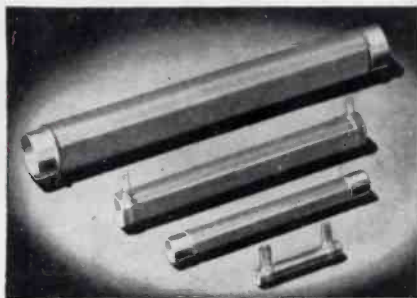

Ward Leonard Non-Inductive Bulletin 21 Resistors were designed especially to meet the exacting requirement of high-frequency applications. The unique design of the Ward Leonard Refractory accurately fixes the points at which the Ayrton Perry Windings cross. This reduces inductance and distributed capacitance to an absolute minimum. Bulletin 21 Resistors are Vitrohm Resistors

with the desirable characteristics of all Ward Leonard Vitrohm Resistors.

* * * *

Available in a wide range of sizes and resistance values, with ferrule or tab terminals. For further information see Bulletin 21.

Write for Bulletin 21 today

WARD LEONARD

RELAYS • RESISTORS • RHEOSTATS

Electric control  devices since 1892

WARD LEONARD ELECTRIC COMPANY
32 SOUTH STREET, MOUNT VERNON, N.Y. • OFFICES IN PRINCIPAL CITIES

featuring
**THE WAR-PROVEN
 BALL-TERMINAL
 SNAP CONNECTOR**



DU MONT'S *New* TELETRON* 10EP4

◆ A new 10-inch magnetic focus and deflection cathode-ray tube suitable for television applications requiring excellent performance at low price. In addition to the ball-terminal snap connector, other outstanding features include ion-trap gun to insure long screen life, new high-efficiency screen, essentially flat face, external conductive coating which can be used for power supply filter capacitor, and new standard duodecal television base.

◆ **NOW AVAILABLE IN PRODUCTION QUANTITIES!**

*Registered trade-mark

TYPICAL OPERATION

Heater voltage	6.3 v.
Anode voltage (Eb)	8,000 v.
Second grid voltage (Ec2)	250 v.
Negative grid voltage (Ec1) for beam cutoff	45 v. (+25, -20 v.)
Grid drive (at Ib-200 μ a.)	38 v. max.

© ALLEN B. DUMONT LABORATORIES, INC.

DUMONT

Precision Electronics & Television

ALLEN B. DUMONT LABORATORIES, INC., PASSAIC, NEW JERSEY • CABLE ADDRESS: ALBEEDU, PASSAIC, N. J., U. S. A.



PERMANENT MAGNETS MAY DO IT BETTER

Characteristics of Permanent Magnet Materials

MATERIALS AND TYPICAL COMPOSITION	Weight (lb.)	Length (in.)	Width (in.)	Thickness (in.)	Volume (cu. in.)	Weight (oz.)	Residual Induction (Gauss)	Remanent Flux Density (Gauss)	Coercive Force (Oersted)	Temperature Coefficient of Induction (%)	Temperature Coefficient of Coercive Force (%)	Temperature Coefficient of Volume (%)	Temperature Coefficient of Resistance (%)	Temperature Coefficient of Permeability (%)	Temperature Coefficient of Retention (%)	Temperature Coefficient of Retention (Hours)	Temperature Coefficient of Retention (Days)	Temperature Coefficient of Retention (Months)	Temperature Coefficient of Retention (Years)
ALNICO I BAR/STRIKES	7,000	440	1.8	3,000	12,300	349	100	100	100	0.197	13.973	11.8	75						
ALNICO II BAR/STRIKES	7,300	350	1.84	3,000	13,300	349	100	100	100	0.197	13.973	11.8	75						
ALNICO III BAR/STRIKES	6,900	370	1.83	3,000	13,300	349	100	100	100	0.197	13.973	11.8	75						
ALNICO IV BAR/STRIKES	6,900	475	1.33	3,000	11,810	349	100	100	100	0.197	13.973	11.8	75						
ALNICO V BAR/STRIKES	3,500	700	1.33	3,000	18,300	349	100	100	100	0.197	13.973	11.8	75						
ALNICO VI BAR/STRIKES	13,500	350	1.8	3,000	11,500	349	100	100	100	0.197	13.973	11.8	75						
ALNICO VII BAR/STRIKES	3,700	1,000	1.8	3,000	11,500	349	100	100	100	0.197	13.973	11.8	75						
ALNICO VIII BAR/STRIKES	8,500	40	30	300	13,500	381	100	100	100	0.197	13.973	11.8	75						
ALNICO IX BAR/STRIKES	8,500	45	30	300	13,500	381	100	100	100	0.197	13.973	11.8	75						
ALNICO X BAR/STRIKES	10,500	60	33	300	13,800	381	100	100	100	0.197	13.973	11.8	75						
ALNICO XI BAR/STRIKES	10,000	240																	
ALNICO XII BAR/STRIKES	8,500	240																	
ALNICO XIII BAR/STRIKES	9,500	150																	
ALNICO XIV BAR/STRIKES	18,500																		
ALNICO XV BAR/STRIKES	1,800																		
ALNICO XVI BAR/STRIKES	7,300																		
ALNICO XVII BAR/STRIKES	3,400																		
ALNICO XVIII BAR/STRIKES	1,800																		
ALNICO XIX BAR/STRIKES	4,500																		
ALNICO XX BAR/STRIKES	14,000																		

MATERIAL CHART CODE

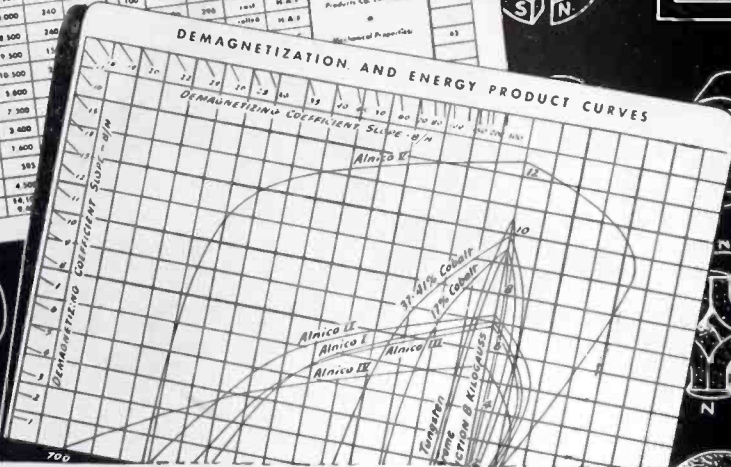

Helpful Reference Data for Use of "PACKAGED ENERGY"

Of special interest to engineers and product designers—here are two helpful reference charts, shown in reduced size above, on the energy product and physical characteristics of permanent magnets featured in the latest "Permanent Magnet Manual", prepared by Indiana Steel Products Company.

This manual contains valuable technical data on uses and applications of permanent magnets; modern materials and methods of fabrication—including complete information on the facilities of the Indiana Steel Products Co., the world's largest producer of "Packaged Energy". Ready for prompt mailing to any firm or individual considering commercial magnet application, this manual is available without cost.

More than 24,000 applications of "Packaged Energy" have been developed by our engineers. They are intimately acquainted with all grades of permanent magnet materials and problems of design and application. You are invited to consult with them without obligation.

Write for your free copy of "Permanent Magnet Manual No. 3" today! Producers of Packaged Energy

*** THE INDIANA STEEL PRODUCTS COMPANY ***

6 NORTH MICHIGAN AVENUE, CHICAGO, 2 ILLINOIS

EST. 1910

Co. 1946, The Indiana Steel Products Co. SPECIALISTS IN PERMANENT MAGNETS SINCE 1910



LABORATORY INSTRUMENTS FOR SPEED AND ACCURACY

BASIC EQUIPMENT FOR AUDIO MEASUREMENTS

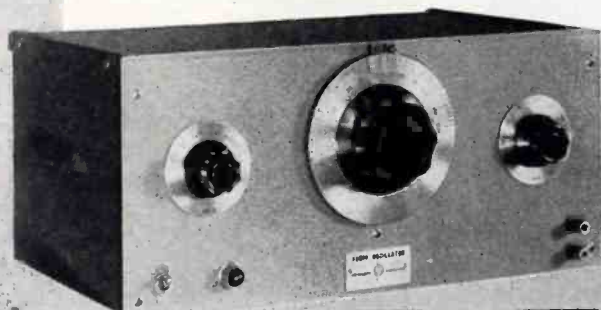

RESISTANCE TUNED OSCILLATORS

Available in 7 models; frequency ranges between 2 cps and 200 kc. No zero setting. Constant output. Low distortion.



VACUUM TUBE VOLTMETER (MODEL 400A)

Full-scale sensitivity from .03 volts to 300 volts in 9 ranges. Input impedance 1 megohm in parallel with 16 mmf. Frequency response—10 cps to 1 mc.



AUDIO SIGNAL GENERATOR (MODEL 205AG)

Frequency range 20 cps to 20 kc. 5 watts output with less than 1% distortion. Output impedances of 50, 200, 500, and 5000 ohms, center-tapped. Output attenuator provides 110 db attenuation in 1 db steps.

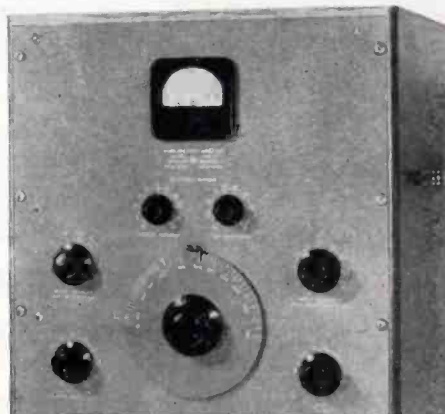

HARMONIC ANALYZER (MODEL 300A)

Measures individual components of a complex wave. Frequency range 30 cps to 16 kc. Variable selectivity. Full-scale sensitivity from 1 millivolt to 500 volts.

Wherever audio-frequency and supersonic measurements are made, whether in an electronics laboratory, a broadcast station, or on a production line, *-hp-* equipment will speed the job and guarantee the accuracy of the results. Measurements of frequency response, gain, power, and voltage level throughout the audio-frequency and supersonic range can be made with *-hp-* Resistance Tuned Oscillators, Audio Signal Generators, and Vacuum Tube Voltmeters. Total distortion, hum, and noise are conveniently measured with *-hp-* Distortion Analyzers, and individual components of complex waves may be studied with the *-hp-* Model 300A Wave Analyzer. Frequency measurements are readily made with the Model 100B Secondary Frequency Standard or the Model 500A Electronic Frequency Meter. For more data on *-hp-* measurement equipment, write direct to factory.

HEWLETT-PACKARD COMPANY

BOX 1222A • STATION A • PALO ALTO, CALIFORNIA

Audio Frequency Oscillators Signal Generators Vacuum Tube Voltmeters

Noise and Distortion Analyzers Wave Analyzers Frequency Meters

Square Wave Generators Frequency Standards Attenuators Electronic Tachometers

AMERTRAN TRANSFORMERS

"Take a Bow" in the New, Compact PRESS WIRELESS TRANSMITTERS

THE new series Press Wireless Transmitters are trim, powerful, and clean as a hound's tooth. This batch is for Naval use (40 to 50 K.W.) built by Press Wireless Manufacturing Corporation at their Hicksville, Long Island factory. As the photos prove, AmerTran transformers and reactors sort of "steal the show" in these units. There's a reason. Press Wireless, Inc., the communications part of the Press Wireless organization, have been using AmerTrans for many years — in the powerful stations they operate for world-wide radio coverage. They like the characteristics and endurance of AmerTrans, and are kind enough to say so.

AmerTran Transformers are designed by authorities in electronic energy transformation. They are built in a plant devoted exclusively to the production of transformers and allied products. The entire AmerTran organization is available to help you get the most up-to-date, efficient performance for your transformer dollar. That is why AmerTran products are built-in components in the best-known communications and industrial-electronic assemblies now in operation.



Bulletin "G" shows the wide scope of AmerTran products. We'll be glad to send you a copy.

AMERICAN TRANSFORMER CO.
178 EMMET ST., NEWARK 5, N. J.



Pioneer Manufacturers of Transformers, Reactors and Rectifiers for Electronics and Power Transmission

AMERTRAN

REG. U. S. PAT. OFF.
MANUFACTURING SINCE 1901 AT NEWARK, N. J.

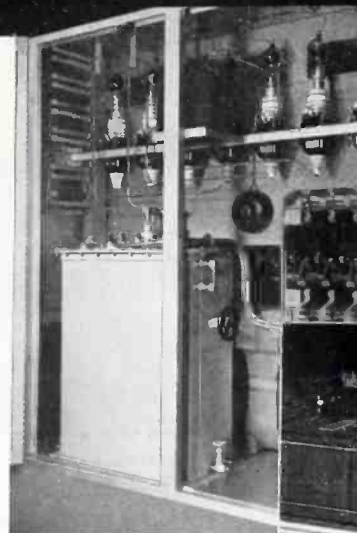

← Rear of 40 KW rectifier section. AmerTran "WS" Filament transformers on upper rack. AmerTran high voltage Plate Transformer in tank at left.

Final amplifier power unit—50 K.W., using AmerTran Transmitter Components throughout.

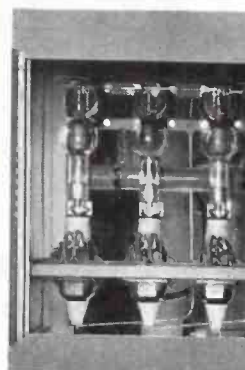
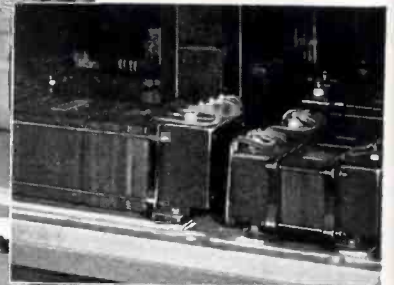

↑ Front panel view, rectifier section, showing AmerTran Filament Transformers.

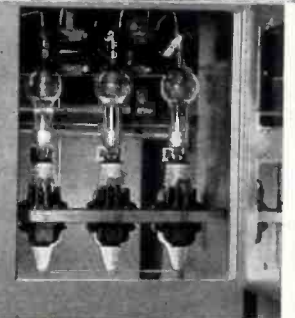

← An Amer-Tran development—The Type "WS" integral filament transformer. Used by leading transmitter manufacturers. Short leads, space-saving design.



↓ AmerTran 8,000 V. Plate Transformer. "WS" Filament Transformers visible at right.

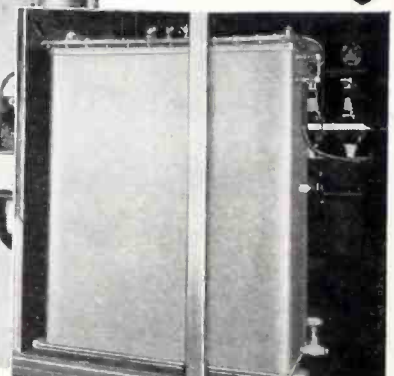



CORDS— that pay their own way

Now you can have them . . . light-weight, flexible cords that are practically non-aging. They're protected with VINYLITE plastic insulation and establish new highs in safety, service life, and long-run economy. Drag and yank these cords over concrete floors—around machines and equipment. Their modern insulation stands the gaff, for it's remarkably tough and abrasion-resistant. Smear them with water, oils, grease, or most common solvents—expose them to alkalis and sunlight—the insulation retains its high dielectric strength. Further, VINYLITE plastics are inherently slow-burning, and non-flammable types are available when desired.

Unsurpassed on cords for portable tools and household appliances, VINYLITE plastic insulation is bringing new ease of installation, new reliability and safety to wires and cables in the public utility, communications, industrial, and construction fields, and for marine, radio, and aircraft applications. Its thin-wall construction permits more wires in existing conduits. It can be made in many colors.

Write Department 18-C for Booklet W-4, "VINYLITE Plastics for Wire and Cable Insulation." And call on Bakelite engineers at any time for help in applying VINYLITE plastic insulation, technically and economically, to your own requirements.

VINYLITE

TRADE-MARK

PLASTICS

BAKELITE CORPORATION, Unit of Union Carbide and Carbon Corporation **UCC** 30 EAST 42ND STREET, NEW YORK 17, NEW YORK

**TRY THORDARSON
MEISSNER
RADIART**
FOR SUPERIOR QUALITY
ELECTRONIC PRODUCTS *PLUS*
FASTER, BETTER — MORE COMPLETE SERVICE

Customers everywhere are applauding the decision of Maguire Industries, Inc. to sell these three groups of outstanding electronic products from a single sales source. They like the convenience, the new high in speedy, reliable service. Try it and you will like it too. For full information, write to the address below . . . today!

**THORDARSON
TRANSFORMERS
TRU-FIDELITY AMPLIFIERS**

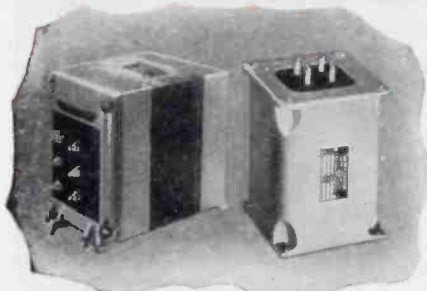

THORDARSON TRANSFORMERS

Precision-built transformers for all requirements . . . replacement, communication, sound amplifier, industrial, experimental and amateur. Tru-Fidelity Amplifiers with all modern features and improvements.

**MEISSNER
COMPONENTS
SERVICE INSTRUMENTS**

High quality components including antenna, R. F. and oscillator coils; standard, plastic and Ferrocart transformers; windings, coils, chokes and accessories. Service Instruments including the famous Meissner Analyst and Meissner Signal Calibrator.

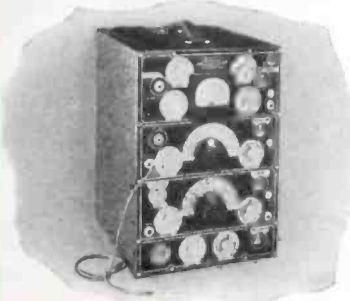

MEISSNER ANALYST

**RADIART
VIBRATORS
VIBRATOR POWER PACKS
RUST-PROOF AERIALS**

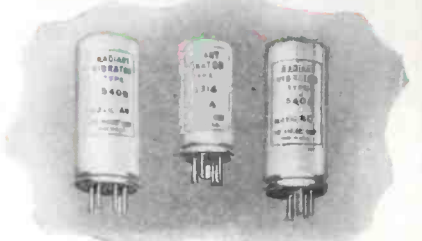

RADIART VIBRATORS

Exact duplicate Vibrators designed for long life, minimum R. F. interference, low noise level and proper starting. Vibrator Power Packs . . . efficient, economical and dependable plate power. Rust-Proof Aerials newly designed to fit all cars; cowl, hood and under hood types.

**ELECTRONIC DISTRIBUTOR AND INDUSTRIAL SALES DEPARTMENT OF
MAGUIRE INDUSTRIES, INCORPORATED
936 NORTH MICHIGAN AVENUE, CHICAGO 11, ILLINOIS
CABLE ADDRESS 'MAGINDUS**

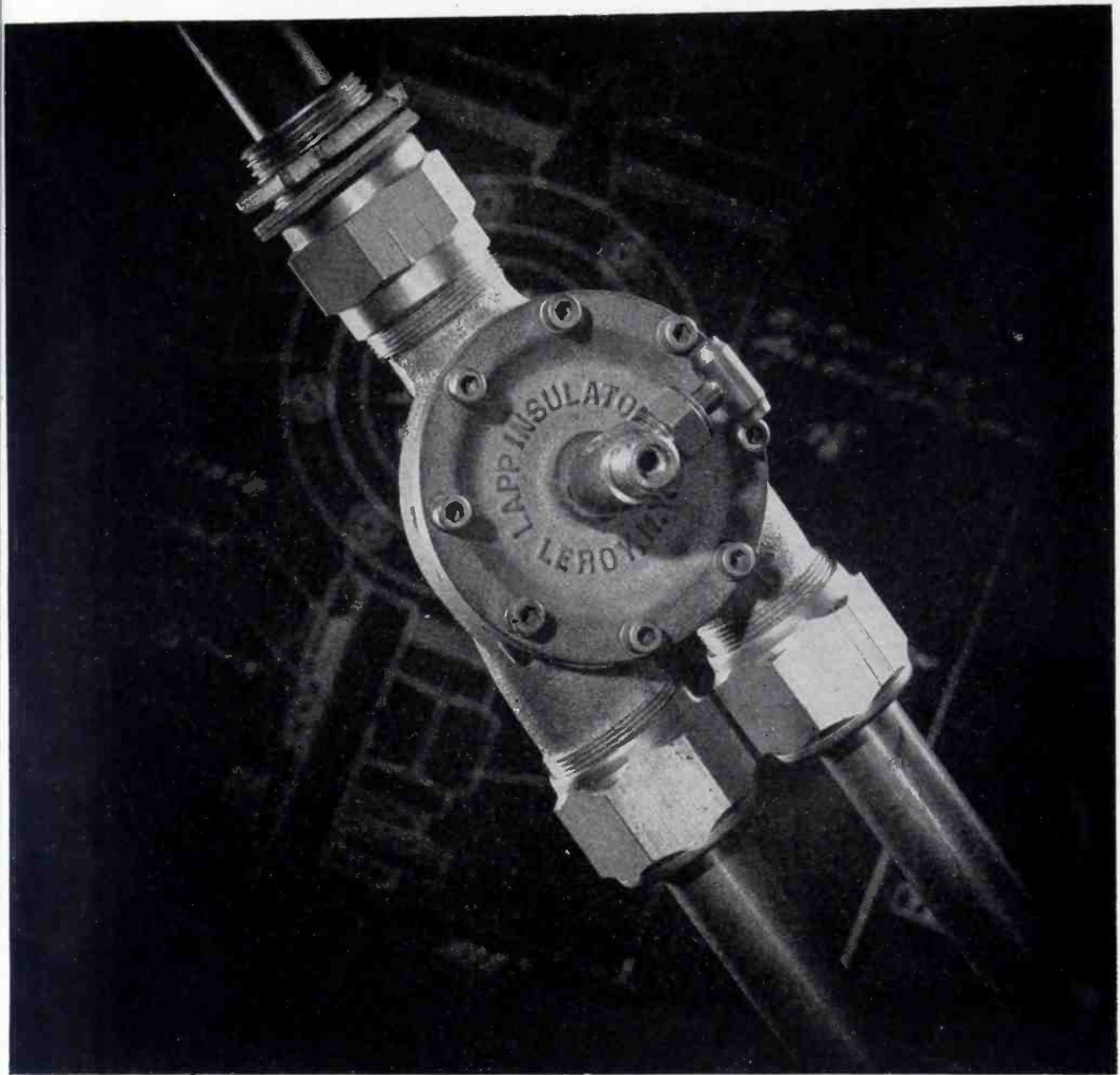

Electronic Parts: ENGINEERING AND PRODUCTION

The gadget above is a junction box for a co-axial gas-filled transmission line. It is one of a series of coupling units, end seals and other fittings for high-frequency transmission—designed and built by Lapp.

To this type of construction, Lapp brings several innovations and improvements. For example, such a line from Lapp parts is genuinely leak-proof. Every gasket is under spring loading, so there's no leakage created by vibration or thermal change.

Whether or not you're interested in gas-filled transmission lines, you ought to know about Lapp. Here is an organization of engineers and manufacturers with broad basic knowledge of ceramics and their application. With experience in hundreds upon hundreds of special-purpose electronic parts, we have been able countless times to improve performance, or reduce costs, or cut production time through

the application of our specialized skills to design and manufacture of parts involving porcelain or steatite and associated metal parts.

For quick and efficient assistance on a war production subcontract—or for the competitive advantage Lapp-designed and Lapp-built parts will give to you in the postwar battle—an inquiry to Lapp now may pay you dividends. *Lapp Insulator Co., Inc., LeRoy, N. Y.*



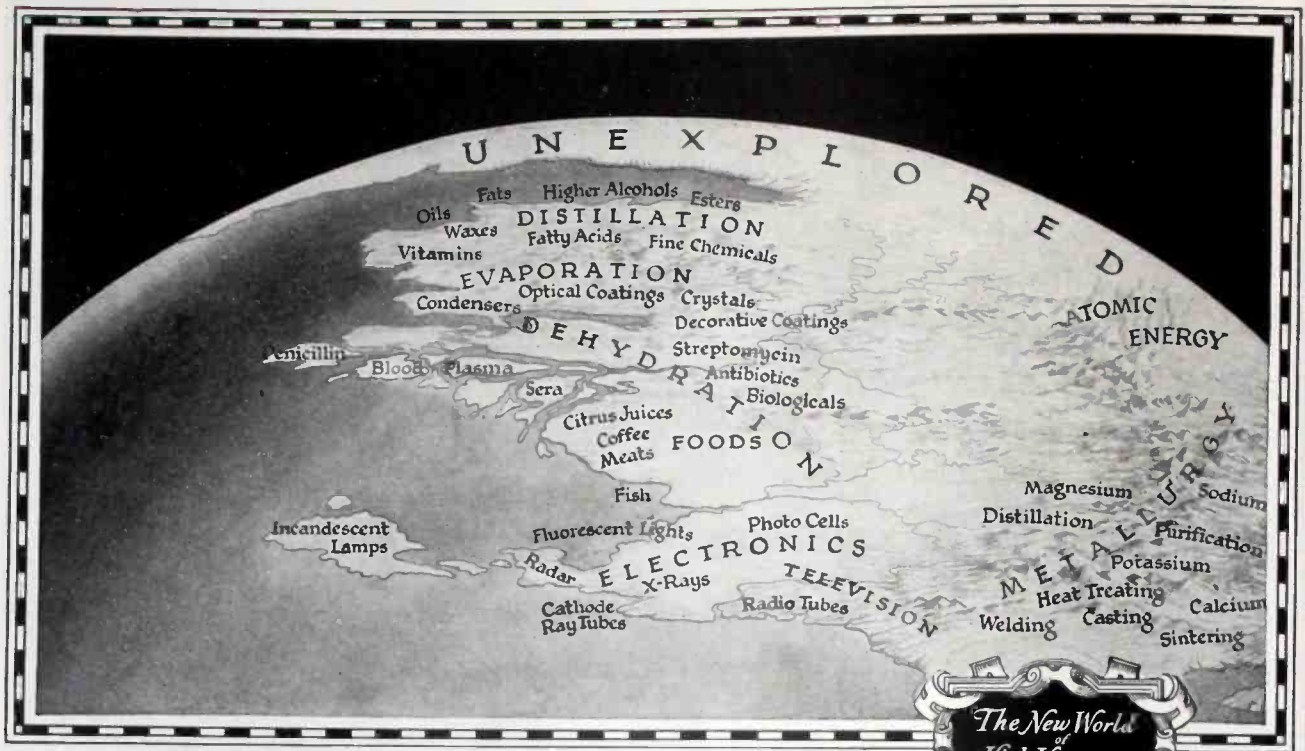

VACUUM COATING - a Field to Explore

The World of High Vacuum is a vast new area. No one knows its extent or its resources. No one can say what opportunities are there for your industry, but National Research Corporation can help you find out as it has helped many others. It can, for instance, give you expert guidance in the new technique of Vacuum Evaporated Coating.

Back in 1892 Dennis Taylor, Englishman, noticed that the light transmission of optical lenses was improved by the tarnish that they acquired with age. Nearly half a century later Cartwright and Turner at M. I. T., John Strong at Cal Tech and Katherine Blodgett of G. E., working independently, put Taylor's discovery on a scientific basis, and the industrial technique of lens coating was born. A considerable amount of publicity followed, and the public added a new term, "invisible glass", to its quasi-scientific vocabulary.

Lens coating is the deposition of a film on the surface of optical glass to improve either transmission or reflection. Dr. Blodgett applied a soap film which, when adjusted to proper refractive index, gave excellent results, but had little durability. The Cartwright and Turner method was to deposit vaporized Calcium Fluoride or Magnesium Fluoride on the glass in a vacuum. There are other methods, but the vacuum deposition of Magnesium Fluoride seems to be the most satisfactory.

Even the most precisely polished optics reflect from 4% to 6% of light per surface. Coating reduces this reflection to as little as one-half of 1%. While this improvement in transmission may be ignored in a single lens, it adds up to an impressive total in optical systems having many components. In fact the

relative improvement in a system of 10 components is about 100% and with 20, as much as 279%.

Commercial lens coating is a high vacuum process, and our specialization in high vacuum technique led us naturally into lens coating during 1940. By 1941 we had ironed out the wrinkles in the process, done the first commercial lens coating and sold our first coating machinery. Then came the War.

World War II was a war of instruments—a war in which the last 1% of advantage in instrumentation was decisive. Six months after Pearl Harbor the call came to us from the Navy. Periscope optics must be coated!

Fortunately we were ready. Two weeks after we received our orders our men and our equipment were coating lenses at Pearl Harbor. Ultimately we built lens coating equipment for Navy repair ships all over the world, and a majority of all the lenses coated for our armed forces were done with NRC equipment.

The coating of optics for both low and high reflection will probably become standard practice. And the other commercial possibilities of vacuum evaporated coating on plastics, fabrics, metals, for protection or ornament, are tremendous. What the process may lead to in your industry we cannot say, but we believe that you should explore the New World of High Vacuum before it becomes crowded, and we believe that you would do well to choose as your guides those who have the experience and knowledge—

theoretical, experimental, and industrial—to help you quickly and economically to your objective. NATIONAL RESEARCH CORPORATION, Boston 15, Mass.

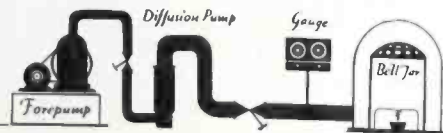

We engineer plant installations and manufacture High Vacuum Gauges, Valves, Seals, Diffusion Pumps, Stills, Furnaces, Coating Equipment and Dehydration Equipment.

HIGH VACUUM FOR INDUSTRY
NATIONAL RESEARCH CORPORATION
 Vacuum ENGINEERING DIVISION



KARP solves peacetime housing problems

All our extensive sheet metal fabricating facilities are now ready to help you speed production of your peacetime products.

Because our specialty in both peace and war years has been a custom-built service at ready-made economy, we have no reconversion worries or delays. We can serve you immediately—whatever your needs may be in sheet metal cabinets, boxes, enclosures or housings . . .

racks, panels, chassis for electrical or mechanical apparatus.

Our vast variety of stock dies is at your service to save your time and money . . . thanks to the fact that our production has never been standardized or restricted to any particular items.

Tell us your needs. Get quotations.

ANY SIZE • ANY FINISH
ANY GAUGE • ANY METAL



KARP METAL PRODUCTS CO., INC.

124-30th Street, Brooklyn 32, N. Y.

Custom Craftsmen in Sheet Metal



FRACTIONAL H.P. MOTORS

BLOWER UNITS

CONTROL COMPONENTS



73 C SERIES

115 Volts—60 cycles... continuous duty. Sleeve Bearing... Fan cooled... totally enclosed. Outside Diam. 3 1/8".

TYPE	H. P.	R. P. M.
Capacitor	1/15, 1/20, 1/30	1600 & 3200
Shaded Pole	1/30, 1/50, 1/100	1500
Synchronous	1/50, 1/100	1800 & 3600



73 SERIES

115 Volts—60 cycles... continuous duty. Sleeve Bearing... totally enclosed. Outside Diam. 3 3/8".

TYPE	H. P.	R. P. M.
Capacitor	1/20*, 1/30*, 1/50	1600 & 3200
Shaded Pole	1/30*, 1/50*, 1/100	1500
Synchronous	1/50*, 1/100, 1/200	1800 & 3600

* Fan Applications

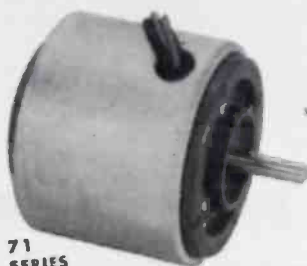

71 SERIES

115 Volts—60 cycles... continuous duty. Sealed Ball Bearing... totally enclosed. Outside Diam. 3 5/16", 3 1/8".

TYPE	H. P.	R. P. M.
Capacitor	1/15, 1/20, 1/30, 1/50, 1/100	1600 & 3200
Shaded Pole	1/30, 1/50, 1/100	1500
Synchronous	1/50, 1/100, 1/200	1800 & 3600

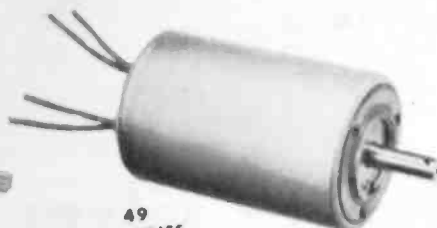

49 SERIES

115 Volts—60 cycles... continuous duty. Ball Bearing... totally enclosed. Outside Diam. 1 3/4".

TYPE	H. P.	R. P. M.
Capacitor	1/100*, 1/250	2800 & 3100
Shaded Pole	1/1000	1400

* Intermittent Duty only

TYPICAL APPLICATIONS

- Cameras and Projectors
- Chart Recorders
- Floor Fans
- Dispensing Machines
- Timing Apparatus
- Turntables
- Air Conditioning

Eastern Air Devices' units embody all of the important advances in design and construction made during the war. Included are such features as: replaceable "capsule" bearings, snap ring construction for easy disassembly, radically improved cooling means, insuring long life with minimum size and weight, etc. Let us fit an E. A. D. unit to your application.

EASTERN AIR DEVICES, INC.

585 DEAN STREET • BROOKLYN 17, N. Y.

An Affiliate of THE FRED GOAT CO., INC., Est. 1893



31 SERIES

115 Volts, 400 cycles, 1/25 to 1/100 H. P. Weight of units 15 oz. Diam. 1 15/16". Length 2 23/32".



36 SERIES

D.C. Voltage Generators for Control and Tachometer applications... 2 Volts per hundred R. P. M. Permanent magnet field weight, 20 oz. Diameter 2 1/4". Length 3".



ALTERNATORS

Special Alternators designed for any application. 20 to 1000 cycles up to 50 watts. Specialists in permanent magnet designs.



AXIAL FLOW BLOWERS

Numerous types for 60 cycle, 400 cycle and D. C. applications. 170 to 800 C.F.M. (NEMA Code) 65 to 300 C.F.M. (NAFM Code). Designed for use in electronic or industrial equipment.



CENTRIFUGAL BLOWERS

Numerous Types for 60 cycle, 400 cycle and D.C. application. 6 to 110 C.F.M. For use in electronic or industrial equipment.



Model A-81 Cabinet

Model A-121 Cabinet

Model A-151 Cabinet

THE FAMOUS

**Bass Reflex*

REPRODUCERS IN NEW,
BETTER-THAN-EVER DESIGNS

True high-fidelity reproducers with the famous and exclusive *Jensen Bass Reflex* principle of design are now available in improved postwar cabinets. *Jensen Bass Reflex* reproducers give crisp, extended range reproduction . . . no back-side radiation . . . full bass with no boom.

Bass Reflex Reproducers are widely used in broadcast monitoring and in recording work. They are ideal for ham shack use and are in much demand for phonographs, FM reception, and general sound reinforcement applications.

Jensen Bass Reflex Reproducers are available in sizes for 8-inch, 12-inch and 15-inch loud speakers and are designed for floor or wall installation. The 15-inch cabinet is designed for both Type J and Type H *Jensen Coaxial Speakers* and for single-radiator 15-inch speakers.

Write for complete literature.

* Trade Mark Registered



Jensen
SPEAKERS
WITH
ALNICO 5

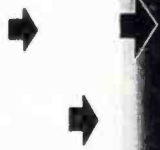

The *Jensen* exhibit will be in Booth 68 at the 1946 Radio Parts Show in Chicago's Stevens Hotel, May 13th through 15th. Old and new friends alike are cordially invited to see the 1946 line of *Jensen* fine acoustic equipment.

JENSEN RADIO MANUFACTURING COMPANY
6607 SOUTH LARAMIE AVENUE • CHICAGO 38, ILLINOIS
In Canada: Copper Wire Products, Ltd., 137 Oxford Street, Guelph, Ontario

Specialists in Design and Manufacture of Fine Acoustic Equipment

skilled hands at Callite

HELP UNITED ELECTRONICS MAKE FINE TUBES...



Callite, pioneer in tungsten metallurgy and in the processing of metallurgical components, keeps pace with the exacting requirements of famous tube-makers like United Electronics Company. The United Type 813 beam power amplifier is only one of many types manufactured by this company with Callite components.

The Type 813 is a four-element tube for which Callite supplies a multiplicity of welds in the base, a Callite weld throughout the top for the plate electrode, a Callite thoriated tungsten fila-

ment and Callite filament tension springs.

Cooperating with leading tube manufacturers, Callite concentrates on assignments calling for high skill and precision in working with metals. If you are striving for new highs in tube performance or developing new types, investigate our specialized abilities and complete facilities for all kinds of metallurgical components. Write Callite Tungsten Corporation, 544 Thirty-ninth Street, Union City, New Jersey. Branch Offices: Chicago, Illinois; Cleveland, Ohio.

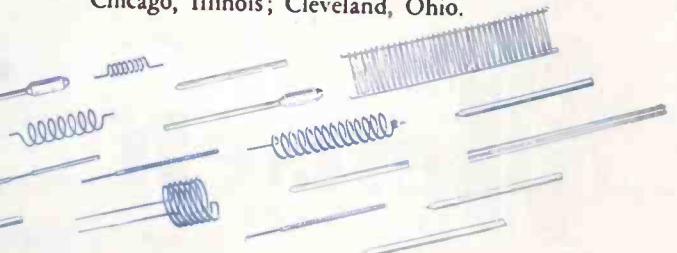

Hard glass leads, welds, tungsten and molybdenum wire, rod and sheet, formed parts and other components for electron tubes and incandescent lamps.





Sweet music—the kind that makes satisfied customers—is yours when Alliance phonomotors drive your turntables, record changers and recorders.

Manufacturers, retailers and service shops everywhere like to "make 'em move" with Alliance. That's because Alliance is the recognized leader when it comes to turning out little motors in large quantities at low cost.

For original equipment or replacement the years have proved that Alliance assures trouble-free performance and long life!

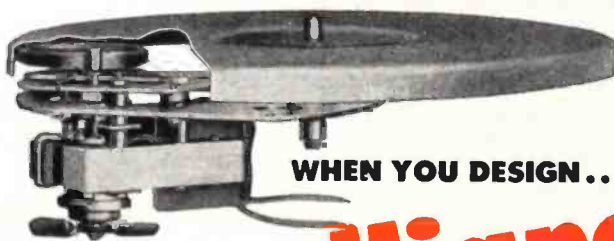

WHEN YOU DESIGN... KEEP

alliance
IN MIND

THE NEW MODEL 80 "Even-speed" phonomotor is smooth, cool running and quiet. Larger bearings with ample oil reservoirs prolong life. New shock mountings almost eliminate vibration of motor and idler plate. Equipped with 60 cycle friction rim-type drive.

NEW USES—For automatic and non-automatic electronic control devices and the power sources to actuate mechanical or push-button controls, Alliance motors offer the most practical engineering economy in advanced designs.

ALLIANCE MANUFACTURING COMPANY • ALLIANCE, OHIO

ALLIANCE TOOL AND MOTOR, LTD., TORONTO 14, CANADA

Your No. 1 rectifier choice for dust-precipitation circuits!

PRECIPITATION PLATES

RECTIFIER (GL-8020's)

A-C SUPPLY

Provides high d-c kilovoltage Economically

GE ELECTRONIC TUBE MADE IN U.S.A.

Type GL-8020 KENOTRON

DESIGNERS of equipment for removing dust and smoke from air by electrical precipitation, look on General Electric's Type GL-8020 as the ideal medium-size rectifier tube, changing a-c power to high-voltage d-c efficiently and economically.

A high-vacuum tube, Type GL-8020 provides greater rectified voltages than do corresponding gas or vapor-filled types. This is a key advantage in electrical precipitation work, where high d-c potentials are necessary in order to ionize the dust or smoke particles.

The GL-8020 kenotron is proved—not alone in industrial use, but as an important component of wartime radio.

Scores of thousands met the test of tough military service in all theatres. Due to high-vacuum design, this tube is not affected by external changes in temperature, which means increased reliability and utility.

General Electric builds kenotrons with peak inverse voltages up to 150,000 v, offering a wide choice to meet your application needs. *G-E tube engineers are glad to work closely with you, to establish and supply the right kenotron or other tube for any circuit.* Telephone your nearest G-E office, or communicate with *Electronics Department, General Electric Company, Schenectady 5, N. Y.*

RATINGS OF TYPE GL-8020 (for rectifier service)

Filament voltage	5 v
Filament current	6 amp
Max anode ratings:	
peak inverse voltage	40,000 v
peak current	750 ma
avg current	100 ma

Since electrical precipitation calls for a relatively high d-c voltage with low current drain, the GL-8020's liberal peak ratings make it practical to use voltage-doubling circuits—thus achieving economy through a minimum tube investment.

GENERAL ELECTRIC

162-EG-6650

FIRST AND GREATEST NAME IN ELECTRONICS



STRAIGHT DOWN THE ALLEY... to your problems!

If the production and maintenance problems of the electronics field were pins on a bowling alley, you'd find many you could topple with one ball—"dag" colloidal graphite. The five above are typical.

Your problems, too, might topple to that unique combination of properties which gives "dag" colloidal graphite such versatility: slippery, finely divided, soft, resistant to high temperatures, chemically inert, pure, opaque, a good

conductor, and capable of permanent adsorption on metal surfaces.

All you need do to probe your possibilities for problem-solving with "dag" colloidal graphite is check below the bulletins which are "down your alley"—or ask for a call from an Acheson technical man.

dag colloidal products

ACHESON COLLOIDS CORPORATION, Port Huron, Michigan

The new literature on "dag" colloidal graphite is yours for the asking:

- 460** A data and reference booklet regarding "dag" colloidal graphite dispersions and their applications. 16 pages profusely illustrated.
- 421** Facts about "dag" colloidal graphite for ASSEMBLING AND BURNING-IN ENGINES AND MACHINERY.
- 422** Facts about "dag" colloidal graphite as a PARTING COMPOUND.
- 423** Facts about "dag" colloidal graphite as a HIGH TEMPERATURE LUBRICANT.
- 431** Facts about "dag" colloidal graphite for IMPREGNATION AND SURFACE COATINGS.
- 432** Facts about "dag" colloidal graphite in the FIELD OF ELECTRONICS.

ACHESON COLLOIDS CORPORATION
PORT HURON, MICHIGAN DEPT. FF-5

JML-A-F 1

Please send me without obligation, a copy of each of the bulletins checked:

NAME _____
 POSITION _____
 FIRM _____
 ADDRESS _____
 ZONE No. _____ STATE _____
 OUR PRESENT OIL SUPPLIER IS _____

(Lubricants containing "dag" colloidal graphite are available from major oil companies.)



The Compact Instrument of Broad Utility

WESTON (MODEL 785) INDUSTRIAL CIRCUIT TESTER

(20,000 Ohms per volt-DC)
(1,000 Ohms per volt-AC)

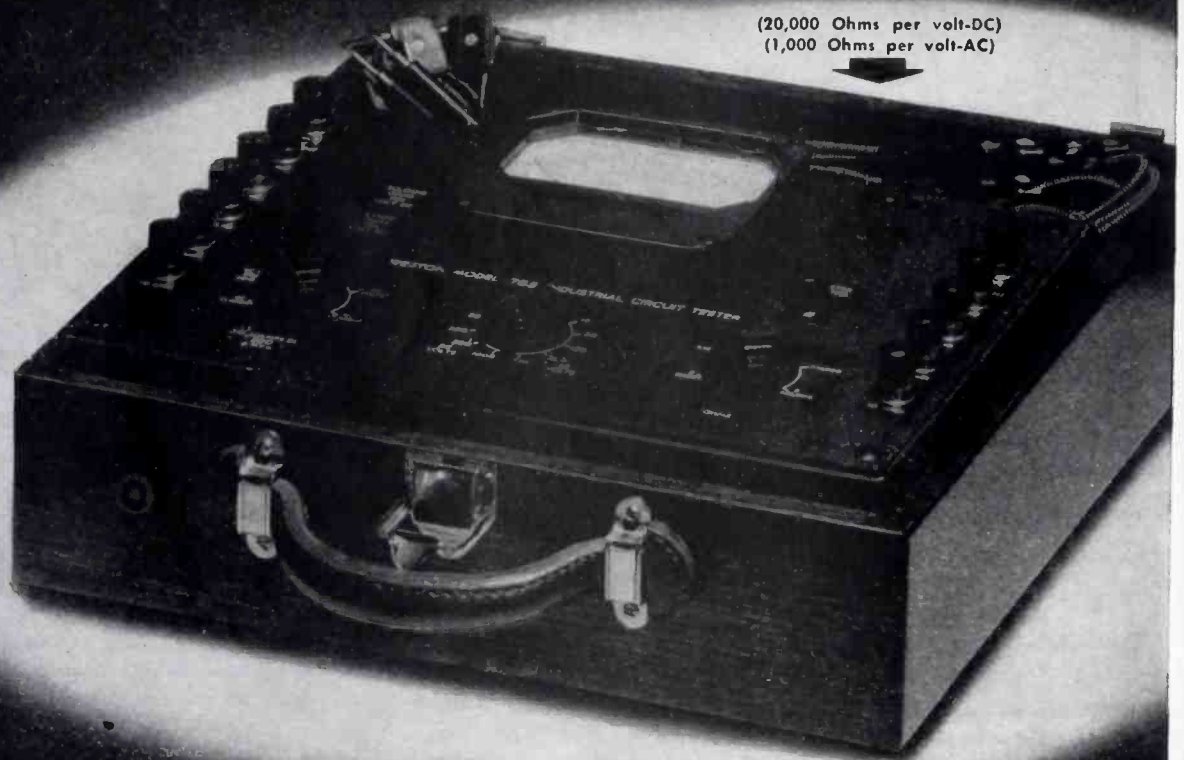

Provides 27 carefully selected AC and DC voltage, current and resistance ranges on long legible scales. A versatile instrument for servicing, plant maintenance or laboratory needs . . . rugged and moderately priced. Details from your local WESTON representative, or direct from . . .

- for measurements in:
Electronic . . . Communication . . .
Sensitive Relay . . . Aircraft . . .
Lighting . . . Motor . . . and Industrial Control Circuits.
- Convenient Accessories:
Weston Socket Selectors, Model 666.
Weston Televerter for 5,000 or 10,000 Volts DC, Model 766

Weston Instruments

Weston Electrical Instrument Corp., 618 Frelinghuysen Ave., Newark 5, New Jersey.

Albany · Atlanta · Boston · Buffalo · Chicago · Cincinnati · Cleveland · Dallas · Denver · Detroit · Jacksonville · Knoxville · Los Angeles · Meriden · Minneapolis · Newark · New Orleans · New York · Philadelphia · Phoenix · Pittsburgh · Rochester · San Francisco · Seattle · St. Louis · Syracuse · In Canada, Northern Electric Co., Ltd., Powerlite Devices, Ltd.

LITTLE COMPONENT*



HUGE SUCCESS



**... THANKS TO
MYCALEX
THE "PERFECT" LOW LOSS INSULATION**

The problem was to mold insulating material of exceptionally low loss factor and high dielectric strength into a closely integrated bond with a metal insert of high conductivity. The difficulty was acute, for both materials had to have virtually the same coefficient of expansion in order to insure an efficient electrical and mechanical seal. High resistance to arcing in the insulator was also imperative. It had to be moisture-proof and heat-resistant.

MYCALEX 410 (Molded Mycalex) proved to be the only solution after many other insulators had been tested and rejected . . . because MYCALEX has the ideal combination of electrical and mechanical

properties for today's high frequency applications.

Have you a problem involving the sealing of highest type insulation with metal? Are your specifications particularly exacting? More than 25 years of leadership in solving the toughest high frequency insulating problems make MYCALEX a "natural" to solve yours. Our engineers will be pleased to cooperate.

*PANEL JACK



MYCALEX CORPORATION OF AMERICA

"Owners of 'MYCALEX' Patents"

Plant and General Offices, CLIFTON, N. J.

Executive Offices, 30 ROCKEFELLER PLAZA, NEW YORK 20, N. Y.

MANY FEATURES IN ONE INSTRUMENT!

The **Q-METER**

TYPE 160-A

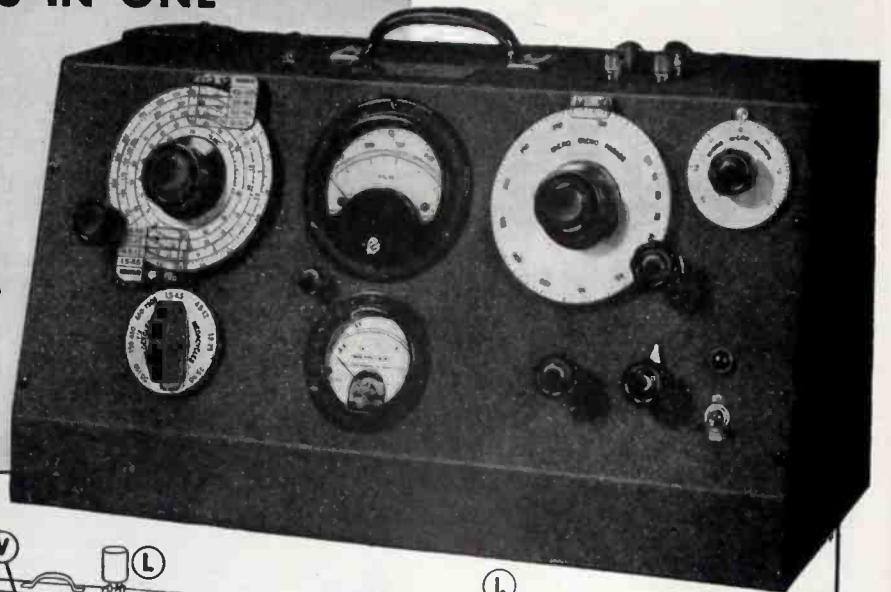

A dependable test and measuring instrument that should be included in your new equipment plans.

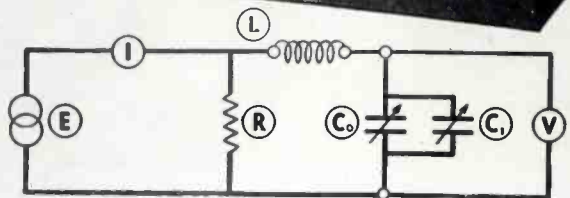
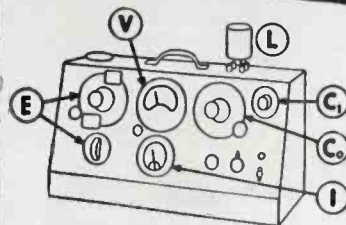

SIMPLIFIED LAYOUT AND SCHEMATIC OF THE 160-A Q-METER

For many years the Q-Meter has been an outstanding contribution to the field of radio frequency measuring equipment. It is an indispensable instrument to engineers, manufacturers, research laboratories and to the whole radio and electronics industry. Because of its simplicity and ease of operation, it replaces many costly pieces of apparatus with which the radio laboratory is customarily equipped. More than one radio engineer has told us that "The Q-Meter is the most valuable instrument that we have in our laboratory".

A FEW USES OF THE 160-A-Q-METER

- Q and inductance measurement of coils.
- Q and capacitance measurement of capacitors.
- Dielectric and power factor measurements of ceramics, plastics and other insulating materials.
- Measurement of circuit losses.
- Interelectrode capacitance measurements.
- Measurement of input impedance of vacuum tubes.
- Measurement of high frequency cable characteristics.
- Measurement of characteristics of small antennae.
- Measurement of coefficient of coupling of R.F. Transformers.
- Measurement of transmission line characteristics.
- The measurement of frequency with negligible loading on circuit under test (50 kc.—75 mc.).

Write for catalog and supplement.



BOONTON RADIO
BOONTON · N · J · U · S · A · Corporation



THE BASIC METHOD OF MEASUREMENT EMPLOYED IN THE 160-A Q-METER

An 8 range R.F. oscillator (E) supplies a heavy current (I) to an extremely low resistance load (R), the value of which is accurately known. The calibrated voltage thus developed across the load resistance (R) is coupled to a series circuit consisting of the inductance under test (L) and a calibrated variable air capacitor (C₀), having a vernier section (C₁). When this series circuit is tuned to resonance by means of the capacitor (C₀ + C₁), the "Q" of the inductance under test is indicated directly by the vacuum tube voltmeter (V). Variations of this basic method of measurement are used to measure inductance, capacitance and resistance.

SPECIFICATIONS

Oscillator Frequency Range: 50 kc. to 75 mc. in 8 ranges.

Oscillator Frequency Accuracy: $\pm 1\%$, 50 kc. — 50 mc.
 $\pm 3\%$, 50 mc. — 75 mc.

Q-Measurement Range: Directly calibrated in Q, 20—250; "Multiply-Q-By" Meter (I) calibrated in tenths from x1 to x2, and also at x2.5; extending Q range to 625.

Q-Measurement Accuracy: Approximately 5% for direct reading measurement, for frequencies up to 30 mc. Accuracy less at higher frequencies.

Capacitance Calibration Range: Main capacitor section (C₀) 30—450 mmf accuracy 1% or 1 mmf whichever is greater. Vernier capacitor section (C₁) ± 3 mmf, zero, —3 mmf, calibrated in 0.1 mmf steps. Accuracy ± 0.1 mmf.

DESIGNERS AND MANUFACTURERS OF THE "Q" METER . . . QX-CHECKER . . . FREQUENCY MODULATED SIGNAL GENERATOR . . . BEAT FREQUENCY GENERATOR . . . AND OTHER DIRECT READING TEST INSTRUMENTS



Your Good Name is "Up for Grabs" Every Time You Specify a Relay

This New Stepping Switch is Typical of Clare's Forward-Looking Design

Times and products change. The need for quality in every component of electrically operated equipment is unchanging. That is why thousands of relay manufacturers among them the top names in American industry... stake their good names on the precise performance and absolute dependability of Clare Relays. You know a Clare Relay will never be a "weak link" in their "chain."

The new Clare Stepping Switch, like all Clare Relays, is built for applications that require... and get... the best relay performance... performance that only the most modern design, careful selection of quality materials and precise manufacturing methods make possible.

The "custom-building" provides a flexibility of construction that gives you a relay exactly fitted to your requirements,

no matter how difficult and unusual they may appear; permits choice of a wide range of contact ratings... innumerable contact arrangements... wide variety of contact materials... coil windings to match the circuit and application.

For the tough job... for relays that must operate reliably even under extreme conditions of temperature, humidity, atmospheric pressure or vibration... join the thousands of design engineers that count on Clare "Custom-Built" Relays.

Clare sales engineers are located in principal cities in order to cooperate with you closely on new and unusual designs. A fine new Clare Engineering Data Book awaits your order. Send for it today. Address: C. P. Clare & Co., 4719 West Sunnyside Avenue, Chicago 30, Illinois. Cable address: CLARELAY.

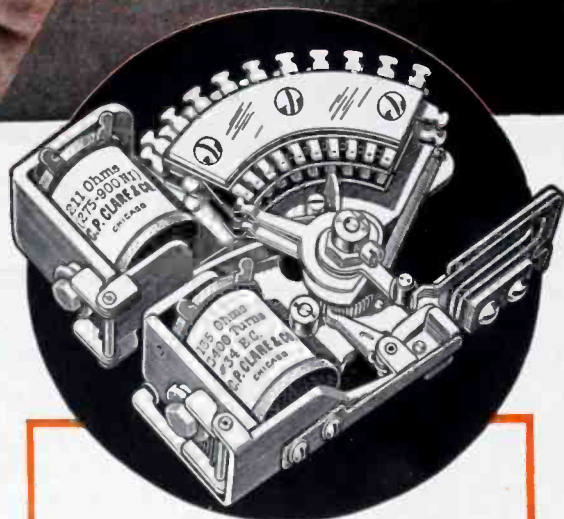

TEN-POINT, DIRECT-DRIVE STEPPING SWITCH WITH RESET MAGNET

A new Clare high speed multiple-contact switch for the selection of any of ten channels for electrical control purposes.

Available with one, two, or three bank levels.

Nominal	Operating Voltage	
		Maximum
6		8
12		16
24		32
48		58

Standard Test Voltage
1000 Volts

Maximum Operating Speed
35 steps per second on 48-volt switch under ideal conditions. Maximum on lower voltages is lower.

Release Time
0.030 second

Dimensions
Overall height 4 1/2"
Width 1 1/2"
Length (from mounting surface) 3 3/8"

Net Weight
13 to 19 ounces, depending upon the number of banks, off-normal springs, coil windings, etc.

Standard Finish
Cadmium

CLARE RELAYS

"Custom-Built" Multiple Contact Relays for Electrical and Industrial Use

USE STANDARD PARTS—SAVE TIME AND MONEY

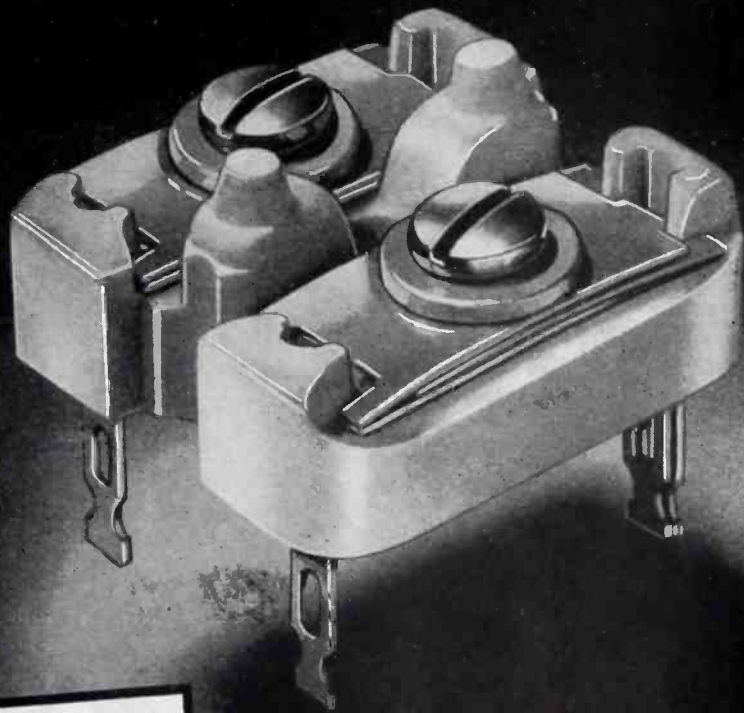

SAVE

*For many years
Automatic has manufactured
Coils and Trimmers for manufacturers.*

*Our mass-production methods
will save you money and headaches.*

*Order your Coils and Trimmers from
people who "know how".*



AUTOMATIC
MANUFACTURING
CORPORATION

MASS PRODUCTION COILS & MICA TRIMMER CONDENSERS

900 PASSAIC AVE.

EAST NEWARK, N. J.

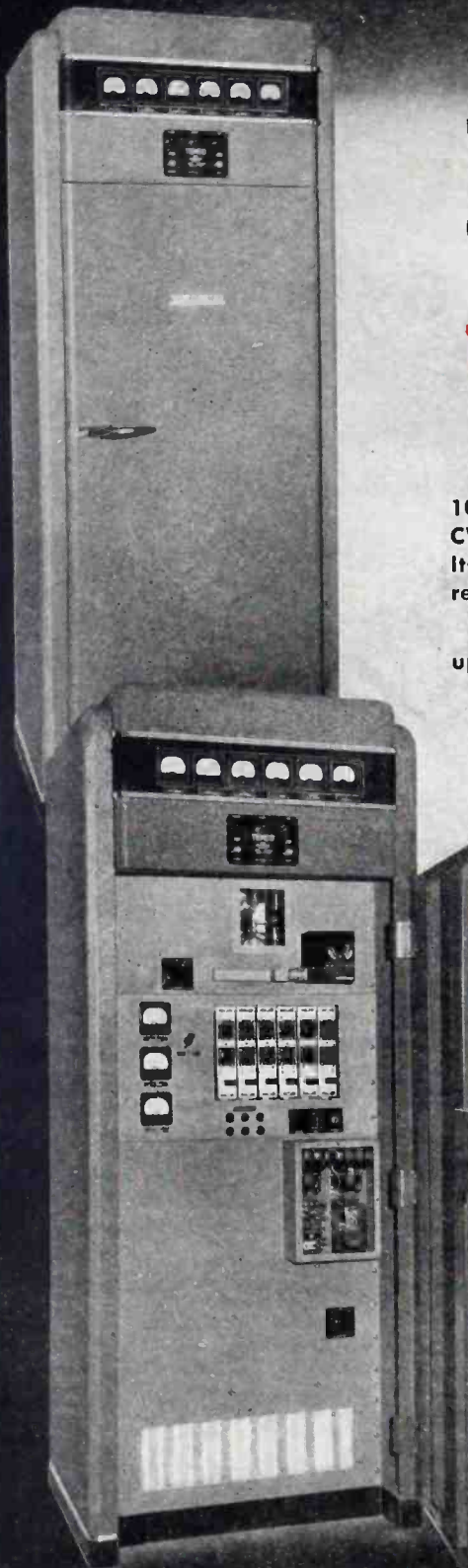

Presenting the 1000-96
LATEST TEMCO 1 K. W.
Communication TRANSMITTER
featuring
TEMCOMATIC Frequency Selection
and **NEWEST TETRODE TUBES**

Designed for point-to-point commercial service the new Temco 1000-J6 is conservatively rated at 1 K.W. output for phone and CW on 6 crystal controlled frequencies from 2 to 20 megacycles. Its most outstanding feature—TEMCOMATIC Frequency Selection representing a major contribution to radio communication.

This new, exclusive Temco system combines and improves upon the best and most desirable features of several earlier automatic frequency selection systems. The operating mechanism is remarkably simple and foolproof in its conception and construction. By turning a selector switch to the pre-set frequency desired, switching is accomplished in a second or two—automatically and dependably. You turn the switch . . . the transmitter does the rest.

Paralleling this long sought for improvement is the use of the latest type tetrode tubes in the power amplifier—2 type 4-250A's. The lower driving power characteristic of these new tubes permits great simplification of the preceding exciter stages.

Servicing, heretofore a serious and objectionable drawback of other systems, has been reduced to a negligible minimum. The handsome, dignified appearance of the 1000-J6 reflects the excellence of its electrical design. Let us tell you more about this finer post-war transmitter that has everything. Write for Bulletin T-6 today.



TEMCO ENGINEERS
COMPLETE INSTALLATIONS
FROM TRANSMITTER TO CONSOLE

TRANSMITTER EQUIPMENT MFG. CO., INC.
345 HUDSON STREET • NEW YORK 14, N. Y.



**SENSITIVITY
CONTACT PRESSURE
DEPENDABILITY
COMPACTNESS
VERSATILITY
LONG LIFE**

this ONE relay has ALL 6 features

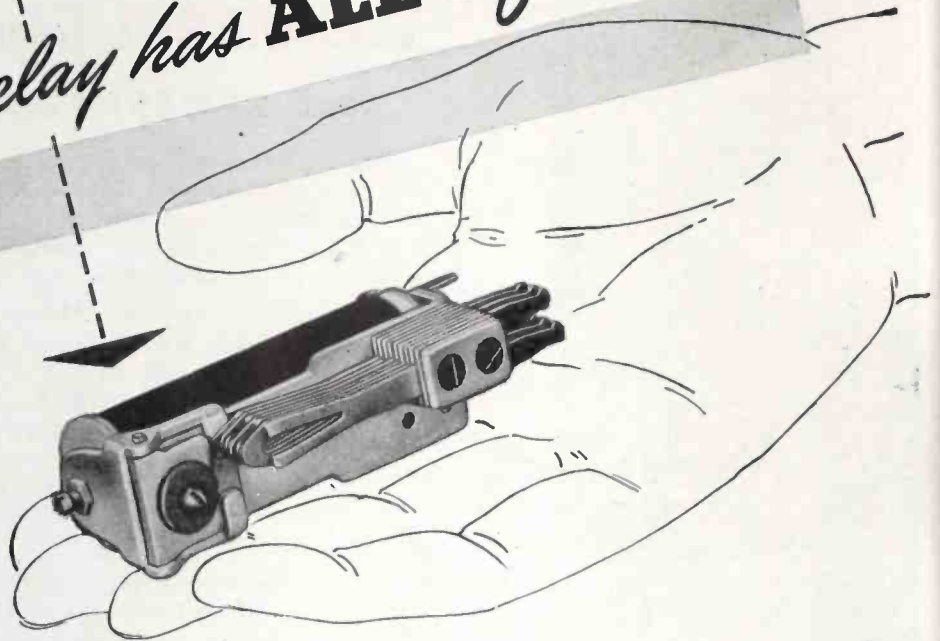

AUTOMATIC ELECTRIC'S CLASS "B" RELAY

Not just 2, 3, or 4—but all 6 features in this one great relay! That's why Automatic's Class "B" relay is the choice of so many experts throughout America. That's why you can buy it with positive assurance that this relay will meet the most exacting requirements.

Due to difficulties over which we have no control, we, like so many other manufacturers, cannot guarantee delivery in terms of our usual schedules. We believe, however, that you will decide to wait for this better relay.

Independent twin contacts for dependable contact closure... efficient magnetic circuit for sensitivity and high contact pressure... unique armature bearing for long wear under severe conditions... compact

design for important savings in space and weight. Made for coil voltages to 300 volts DC and 230 volts AC, with capacities up to 28 springs; also with magnetic-shielding cover, when desired.

The Class "B" relay, and many others, are shown in Catalog 4071. Write today for your copy.

Relays by

AUTOMATIC  ELECTRIC

AUTOMATIC ELECTRIC SALES CORPORATION

1033 WEST VAN BUREN STREET • CHICAGO 7, ILLINOIS

In Canada: AUTOMATIC ELECTRIC (CANADA) LIMITED, TORONTO

PARTS AND ASSEMBLIES FOR EVERY ELECTRICAL CONTROL NEED

Reduce Assembly

Costs with

SHAKEPROOF

SEMS

Pre-Assembled

SHAKEPROOF Lock Washer and Screw

LOCK WASHER
DON'T COME OFF
IT IS FREE TO
VIBRATE!

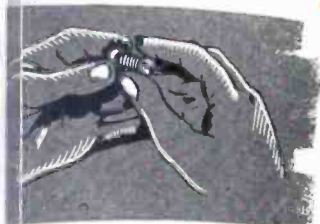

There is no need to waste time and effort putting lock washers on SHAKEPROOF SEMS are pre-assembled!

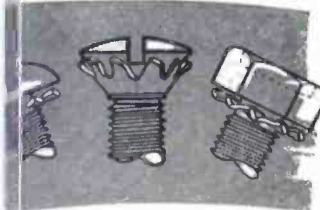

SHAKEPROOF SEMS are available in all standard types and sizes of lock washers and screws. Specials on request.



Write us today and ask for free SHAKEPROOF KIT No. 23! It contains a variety of SHAKEPROOF SEMS for your own testing purposes.



No lock washers are lost or wasted! Inventories stay balanced because lock washers and screws are delivered as a single unit.

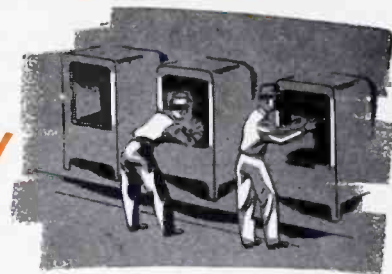

SHAKEPROOF SEMS are easier to handle . . . perfect for hard to reach places. May be power driven . . . no need to hold the lock washer.

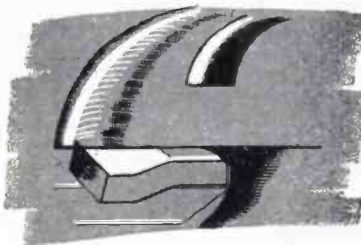

The SHAKEPROOF LOCK WASHER fits close to the screw shank, providing maximum tooth contact and greater locking power.

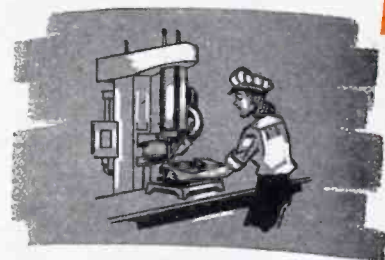

SHAKEPROOF SEMS feed perfectly in hopper fed power drivers. Combine positive vibration protection with high speed production.



SHAKEPROOF inc.

Fastening Headquarters

Division of ILLINOIS TOOL WORKS

2501 North Keeler Avenue, Chicago 39, Illinois

633 South Labrea Ave., Los Angeles 36, Cal.

2895 E. Grand Blvd., Detroit 2, Mich.

Plants at Chicago and Elgin, Illinois • In Canada: Canada Illinois Tools, Ltd., Toronto, Ontario

Centralab



The Mark of QUALITY

THE initials "CRL" in the diamond represent the research-laboratory and technical manufacturing facilities of Centralab . . . a name outstanding for quality, precision and new developments in the field of radio and electronics.

Always Specify Centralab.



Centralab

Division of GLOBE-UNION INC., Milwaukee

PRODUCERS OF



Ceramic Trimmers
Bulletin 695



Variable Resistors
Bulletin 697



Ceramic High Voltage Capacitors
Bulletin 814

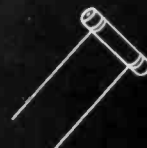

Tubular Ceramic
Capacitors
Bulletins 630 and 586



Selector Switches
Bulletin 722



brazing stainless to stainless

.... in 23 seconds

Figure 1. Work coil for problem 1 (below, left).

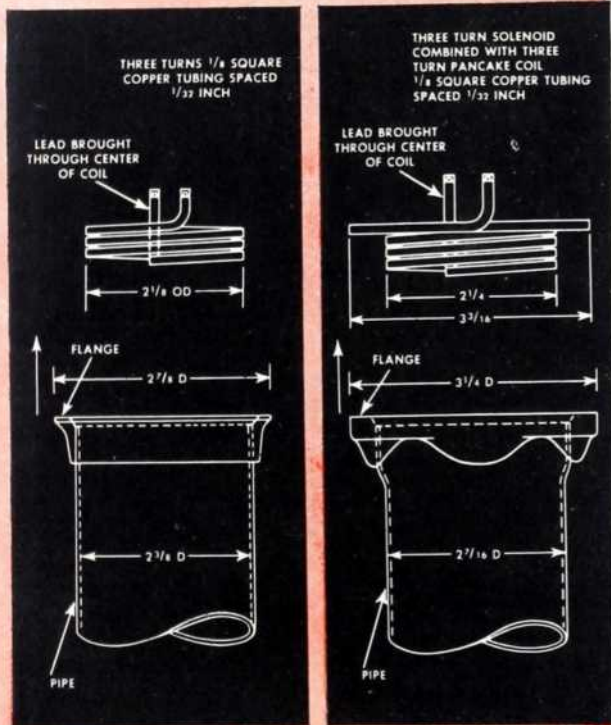

Figure 2. Work coil for problem 2 (above, right).

Your benefits from this unusual application hang directly on the fact that induction heating was able to uniformly heat both stainless steel and copper brazing material simultaneously.

There were two problems:

1. To copper-braze a stainless steel flange to stainless steel pipe (see Figure 1).
2. To copper-braze a cast stainless steel flange to stainless steel pipe (see Figure 2).

The trick in both cases is to find a coil to supply uniform heat. This is easier in the first problem than the second because of the varied thermal capacities of the flange, pipe and brazing material. The answer for problem 1: an internal coil (Figure 1) placed so the temperatures of both steel and copper reached the brazing point together. Actual heating time was only 23 seconds!

The second problem (see Figure 2) was handled similarly by a coil partially in the pipe and pancaked over the end of the flange. Heating time: 30 to 35 seconds. Both were done with a Westinghouse 20 kw r.f. generator.

This profitable use of r.f. heating is just one in the Westinghouse case book of applications for all types of heat-treating . . . sintering, annealing, hardening, soldering, curing, drying and molding. Write today to your nearest Westinghouse office for all the facts. Westinghouse Electric Corporation, P. O. Box 868, Pittsburgh 30, Pa.

J-08162



HERE'S FREE HELPFUL INFORMATION

on both induction and dielectric heating . . . their principles and theories; where to use them; how to select them; actual case histories of their use. Write today for your copy, on your business letterhead, please. Ask for B-3620.



Westinghouse
PLANTS IN 25 CITIES . . . OFFICES EVERYWHERE

Electronics at Work

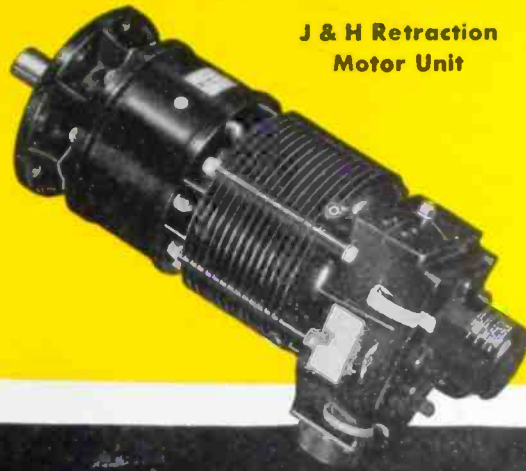

**J & H Retraction
Motor Unit**



**J &
Ball Be**

What's in a Name

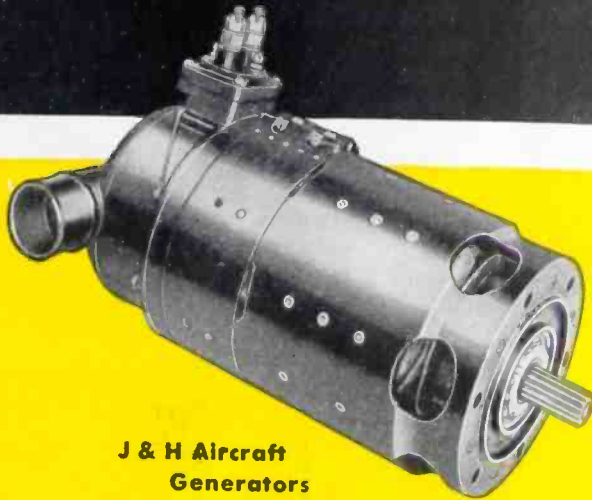

**J & H Aircraft
Generators**



**J & H Fractional
Horsepower Electric Motors**

J & H Electronic Gages



J & H Inverters

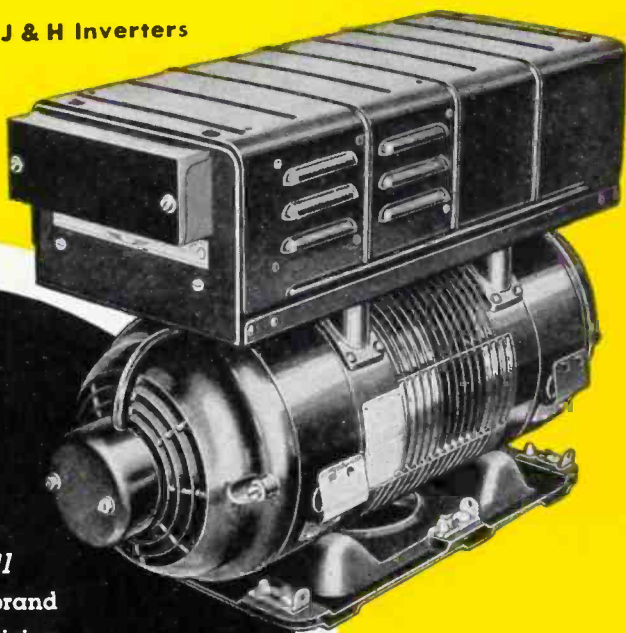

"Precision" is the new word that has been added to our logotype, but *Precision* is not new on our production lines. Our new name had its origin in these production lines where *skill* and *quantity and precision in volume* set brand new standards for the manufacture of high precision production parts.

Now, the word "Precision" is now in our name. "Precision" is guaranteed by the skilled Jack & Heintz associates on our production lines. And you'll find precision performance in all of these Jack & Heintz products...built precisely for the aircraft, automotive, machine tool, home appliance, marine, farm equipment and transportation industries.

J & H Engines

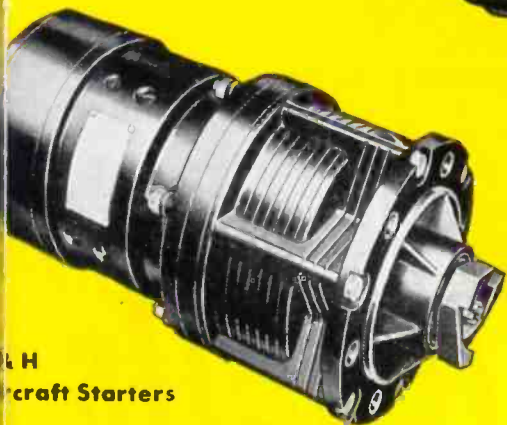
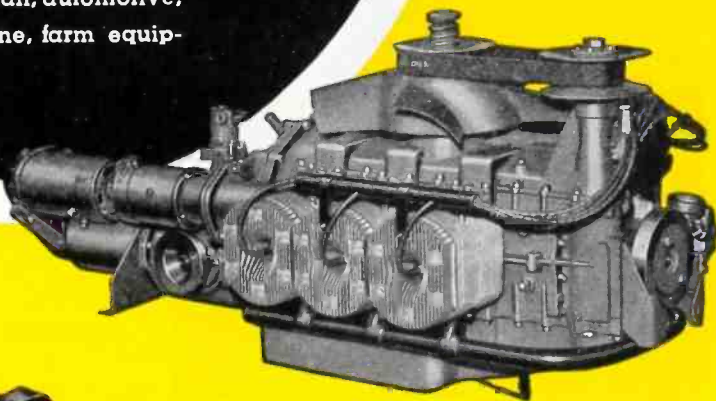

J & H Aircraft Starters

Jack & Heintz
PRECISION INDUSTRIES INC.



Cleveland 1, Ohio

The Ultra-Sensitive HEARING AID MICROPHONE

Another step forward in the fight against deafness — Tibbetts' Industries new *crystal microphone*. Developed especially for hearing aids, this improved unit features an output more than 3 decibels greater than ever before. Half as much again!



The new Diabow Monobar Crystal Unit gives smooth, clear response with low harmonic distortion. Metal clad diabow construction gives superior ruggedness and excellent moisture proofing. It is designed to fit your present hearing aid.

With the trend to compact, low voltage amplifiers and self-contained batteries, this microphone will keep the output level up to requirements.

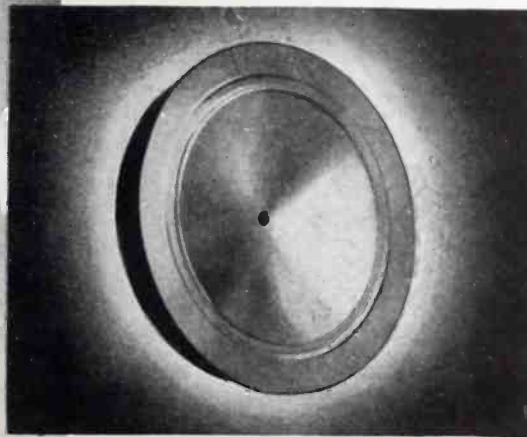

Model HA-24 TIBBETTS Hearing Aid Microphone $1\frac{1}{4}$ " in diameter ($1\frac{3}{8}$ " over flange), $\frac{1}{4}$ " thick.

Not just "another microphone," it represents a gigantic stride forward in the hearing aid field — a truly superior product.

TIBBETTS INDUSTRIES, INC.
CAMDEN, MAINE

MONOBAR
Tibbetts
CRYSTAL

Licensed under Tibbetts Laboratories, Inc. Patents

SLOGANS FOR SALE

Advertising isn't our game—or yours. But both of us know millions are spent to put a name or a slogan across. Million dollar appropriations help! But we know of a surer way—a way that costs a lot less—to sell a name.

THE IDEA IS PRODUCT DEPENDABILITY

Don't pass over those words lightly. It isn't a catch phrase. It gets your product's name repeated, favorably, among housewives and business men—the people who buy. It gets the name repeated frequently, on order pads. It rings up cash registers.

Product dependability starts at the bottom. It starts with the tiniest component. And that dependability is something we sell with every C-D capacitor. Why? Because we've been at it longer. Because we have produced more capacitors. Because we have greater engineering and production facilities than anyone else in the field. Keep that in mind when your plans call for capacitors.

CONSULT WITH OUR ENGINEERS

Your requirements can be handled at C-D with greater efficiency and speed. Cornell-Dubilier Electric Corporation, South Plainfield, New Jersey. Five other plants located in New Bedford, Providence, Brookline and Worcester.



CORNELL-DUBILIER
world's largest manufacturer of
CAPACITORS

MICA • DYKANOL • PAPER • ELECTROLYTICS

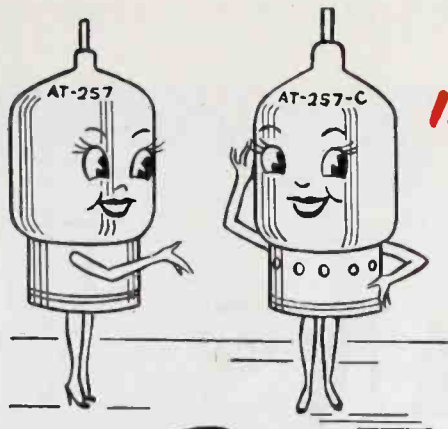

"Meet my Sister"

THE *New* LEWIS
AT257-C

BEAM POWER PENTODE

NOTE TO DESIGN ENGINEERS—With all the advantages of the Lewis AT-257 (4E27) — enormous power gain, great circuit flexibility—the new AT-257C has a "plus" factor you will be interested in. The addition of Zirconium coating to the anode has enabled Lewis Electronics to re-announce this versatile 75 watt beam pentode in the 125 watt class.

By nearly doubling the plate dissipation of the 4E27, the usefulness of this already popular tube is further extended. May we recommend that you consider the use of the Lewis AT-257C in fixed or mobile radio equipment you are now designing? A note to Lewis Electronics, Los Gatos, California, will bring further particulars.

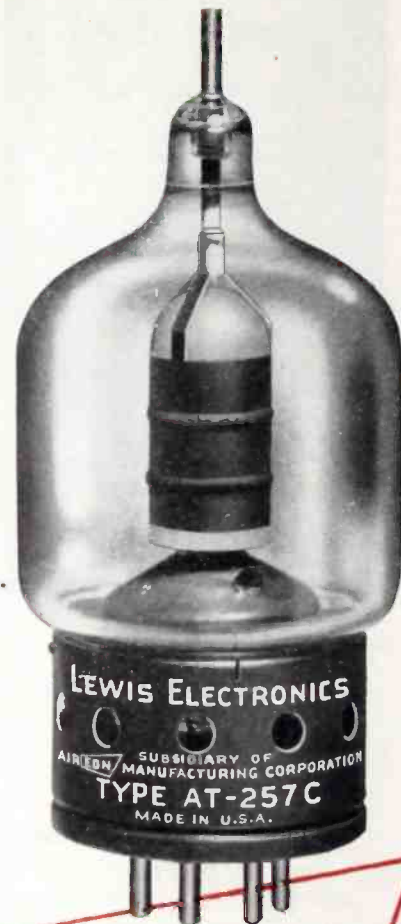

Lewis Electronics at Los Gatos, California, is prepared to build transmitting, rectifying, industrial or special purpose vacuum tubes to your specifications.

Filament Voltage 5 Volts

Plate Dissipation 125 Watts

Filament Current 7.5 Amps.

Jumbo 7-pin Metal Sleeve Bayonet

Lewis Electronics
 LOS GATOS • CALIFORNIA
 Subsidiary of **Aireon** MANUFACTURING CORPORATION

BURNDY

Scrulugs

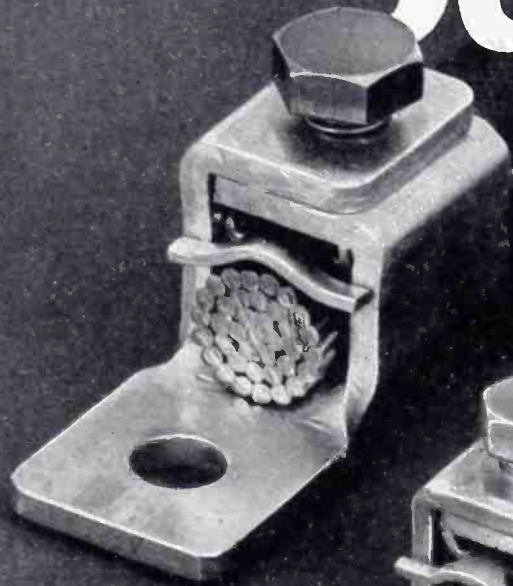

4/0 Str. to 500 Mcm



1/0 Str. to 4/0 Str.



4 Str. to 1/0 Str.



14 Sol. to 4 Str.



14 Sol. to 8 Str.

**NOW AVAILABLE IN
SIZES UP TO 500 MCM**

BURNDY ENGINEERING CO., INC., 107L BRUCKNER BLVD., N. Y. 54, N. Y.

YOU CAN SIT BACK AND RELAX...



... when Adlake Relays are on the job!

YES... with an Adlake Relay handling the control job, you can sit back and relax. Because Adlake Plunger-type Mercury Relays are dependable and tamper-proof!

Control is fully automatic. No servicing or periodic cleaning needed.

Contacts hermetically sealed in metal or glass cylinder—not affected by dust, moisture, or temperature!

Mercury-to-mercury contact—no burning, pitting, or sticking. Positive, noiseless, chatterless, and arcless!

Armored against impact and shock—use for either stationary or moving equipment!

There's an Adlake Plunger-type Mercury Relay for every job! Send today for interesting, free bulletin. All types described in detail. No obligation.

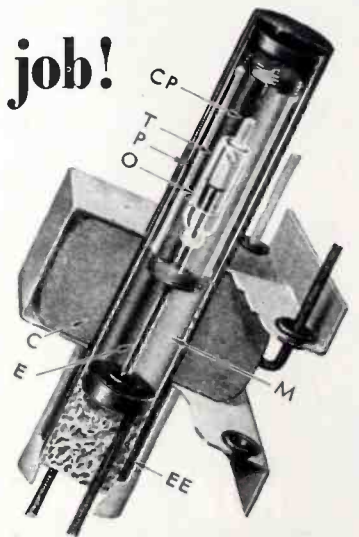

HOW ADLAKE RELAYS WORK

ENERGIZED—Coil C pulls plunger P down into mercury M. Mercury thus displaced enters thimble T through orifice O. Inert gas in thimble gradually escapes through ceramic plug CP.

Mercury now fills thimble T, is completely leveled off and mercury-to-mercury contact established between electrodes E and EE. Degree of porosity of ceramic plug CP determines time delay.



THE ADAMS & WESTLAKE COMPANY

ESTABLISHED IN 1857

ELKHART, INDIANA.

NEW YORK • CHICAGO

Manufacturers of Adlake Hermetically Sealed Mercury Relays for Timing, Load and Control Circuits

**BUILD BETTER PERFORMANCE INTO
ELECTRONIC TUBES WITH**

Driver-Harris
RADIO ALLOYS

For continued success no industry depends more on quality, precision and constancy of metals used, than radio. Small parts perform important functions and if not made of proper alloys that conform to rigid specifications the entire product is affected. Particularly is this true in the manufacture and development of Cathode-Ray Tubes.

Since the inception of radio Driver-Harris metallurgists have pioneered in developing and manufacturing special purpose alloys for this field. Today the leading manufacturers of Cathode-Ray Tubes use D-H alloys to help develop longer life and clearer images.

Driver-Harris makes alloys for every electronic tube requirement—for filaments, grids, plates, grid side rods, glass seals, cathode sleeves, socket prongs, filament support springs and mica straps. In addition there are over 80 other electrical heat and corrosion-resistant D-H alloys available for various electronic applications.

If the alloy you need hasn't already been developed tell us about it. Our engineers with 46 years experience are at your service.

Famous D-H Radio Alloys:

NICHROME* • GRIDNIC* • NICKEL "A", "D", "E", "Z" • FILNIC*
14 ALLOY • 42 ALLOY • 52 ALLOY • NILVAR*

Driver-Harris
COMPANY

Exclusive Manufacturers of Nichrome
HARRISON, N. J.

BRANCHES: Chicago • Cleveland • Detroit • Los Angeles
San Francisco • Seattle

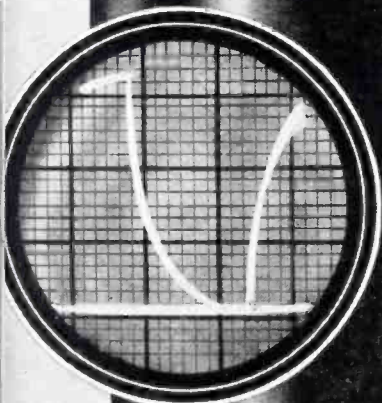

OSCILLOGRAPH



TELEVISION



RADAR

**WHEN ELECTRONIC ASSEMBLIES
NEED REPAIR, WILL YOUR
COMPONENTS CHECK**

"OK?"

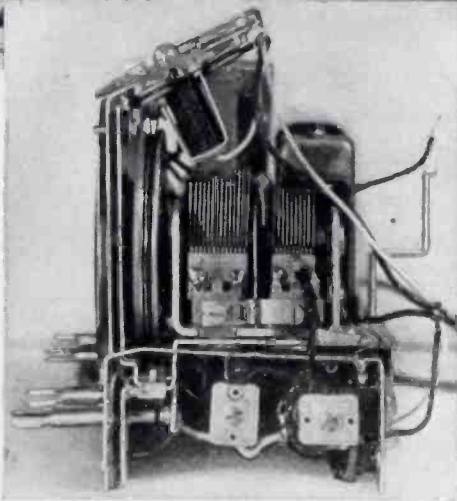

The Emerson Radio and Phonograph Corporation depends on quality insulating materials such as furnished by Mica Insulator Company, for dependable performance of components, and low maintenance.

*You can best insure against premature failures of capacitors, trimmer condensers, spaghetti tubing, laminated plastics for tube socket bases, and precision fabricated spacers for vacuum tubes by specifying the most suitable insulating materials. That is where experience enters in—the kind of experience Mica Insulator Company has gained after years of recommending and supplying insulation for electronic components.

For example, vacuum tube performance depends largely on accurately punched filament, grid and plate spacers. When necessary, hole sizes and spacings can be held to tolerances of ± 0.00025 . This means reduced rejects in manufacture and better, longer performance in the field.

If you are making components that require the insulation to be sealed in, you can be sure that the Mica and Micanite we supply



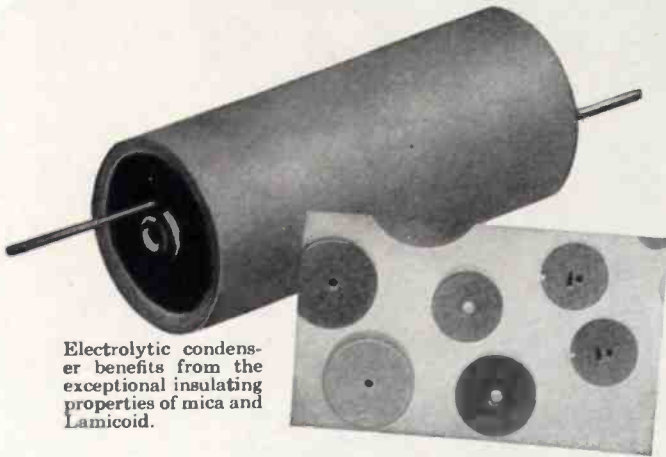

Electrolytic condenser benefits from the exceptional insulating properties of mica and Lamicoid.

Lamicoid combined with various grades of rubber can be supplied for use as end seals on electrolytic capacitors.

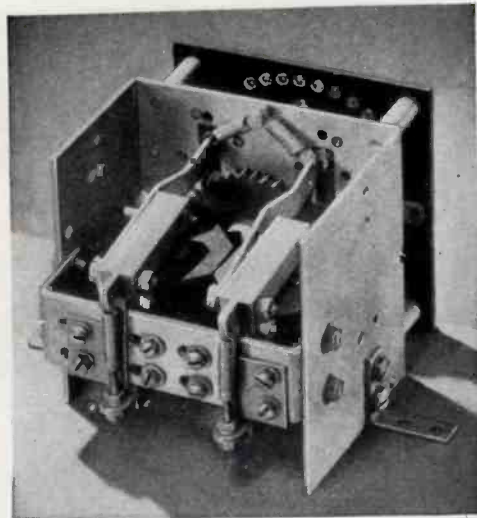

Lamicoid laminated plastic can be used for ratchet gear, contact spacers, and coil ends on such electronic products as this adding and subtracting relay, made by Guardian Electric Mfg. Co.

will be dependable. These materials have high dielectric strength, uniform dielectric constant, and do not readily deteriorate under heat and adverse climatic conditions.

For small terminal boards, tube sockets, ignition systems, switches, coil forms, etc., you can obtain from us Lamicoid laminated plastics of all types. Lamicoid is available in sheet, rod, or tube forms for a wide variety of electrical and mechanical applications. Laminates and rubber combined are also available for end seals on capacitors and similar applications.

You can obtain from us unbiased suggestions for your insulating material requirements because we carry a complete line of all types of materials. Recommendations are based on over 50 years practical experience.

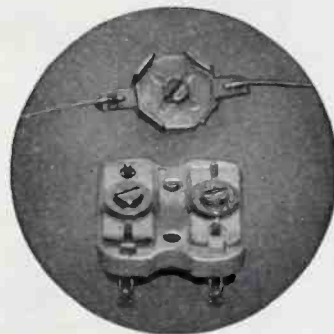

Trimmer condensers made by Underwood Electric Manufacturing Company utilize mica to insure dependable performance of the finished electronic assemblies.

MICA Insulator COMPANY

797 Broadway, Dept. 22, Schenectady 1, N. Y.

SALES OFFICES: Boston: 285 Columbus Avenue • Chicago: 600 West Van Buren Street • Cincinnati: 3403 Hazelwood Avenue • Cleveland: 1276 West 3rd Street • Detroit: Book Building • Houston: Bakoring, Inc., 1020 Houston Avenue • New York: 200 Varick Street • St. Louis: 435 Paul Brown Building • Triangle Pacific Company at Los Angeles: 340 Azusa Street • San Francisco: 1045 Bryant Street

FABRICATORS: Lamicoid Fabricators, Inc., 3600 Potomac Avenue, Chicago, Ill. • Insulating Fabricators, Inc., 69 Grove Street, Watertown, Mass. • Insulating Fabricators, Inc., 12 East 12th Street, New York City • Bakoring, Inc., 1020 Houston Avenue, Houston 10, Texas



JUST OUT

A new four-page bulletin on Micanite and Super Micanite insulation. Contains information on grades and suggested applications. Send coupon for your free copy.

Mica Insulator Company,
797 Broadway, Dept. 22, Schenectady 1, N. Y.

Gentlemen:

- Please rush my copy of your new four-page bulletin on Micanite Insulation.
- Enclose price list.
- Please have your application engineer see me when in my vicinity.

Name _____
 Position _____
 Company _____
 Address _____
 City _____ State _____

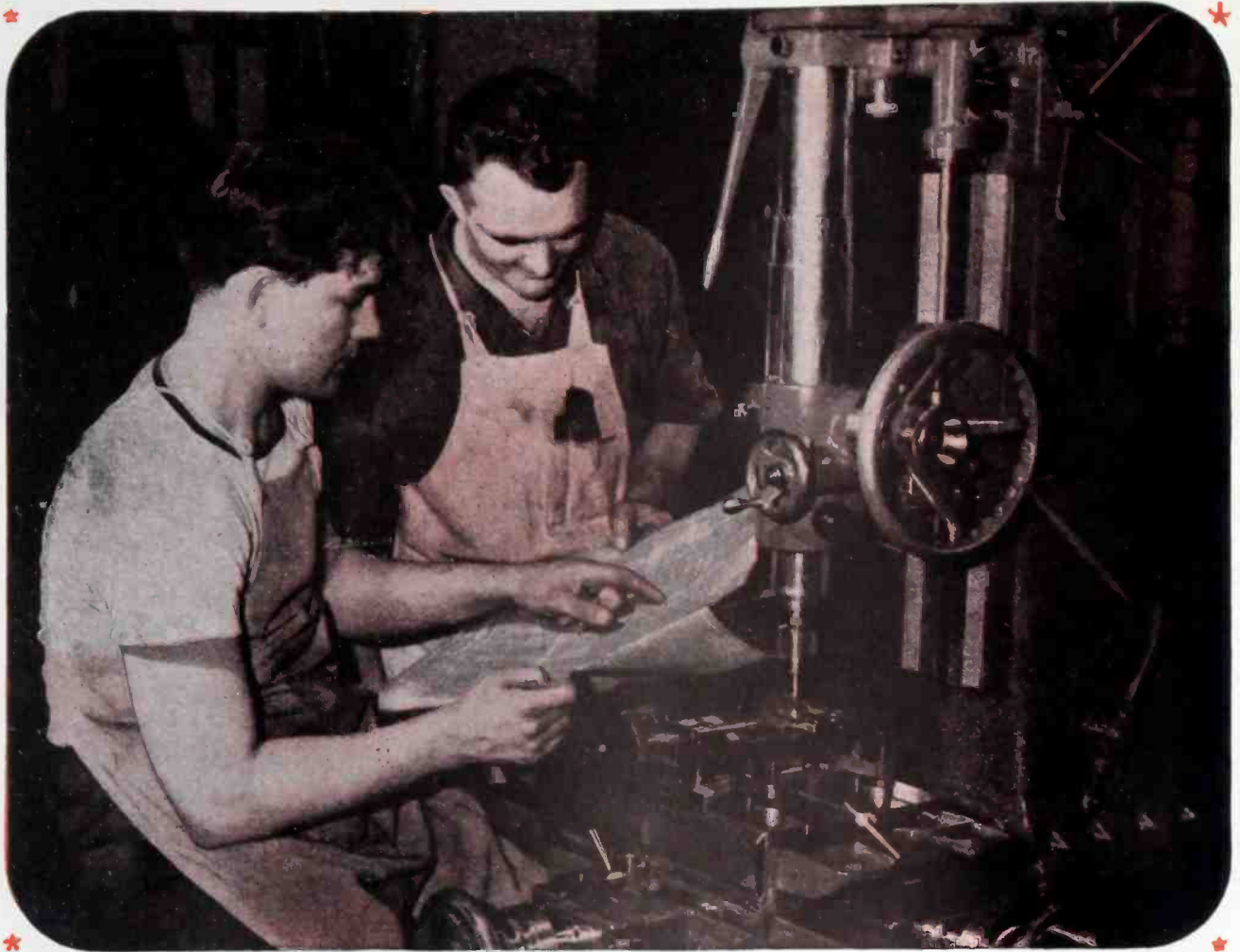

The Men that Know "HOW" *and* "WHY"

PUT OUT MORE PRODUCTION . . . WITH LESS WASTE !

At your Service . . .

ALLEGHENY LUDLUM'S FILM LIBRARY

Instructional films on tool and stainless steels—some in full color, all with sound—available for free showings on request. NEW—"Manufacture of Dies" 16 mm, 400 ft. in length, requiring about 15 minutes to show,—in sound and full color.

FOR DETAILS and BOOKINGS

ADDRESS DEPT. E-42

THE special high-alloy steels take more knowing than ordinary materials, that's sure. But they also give you more—so much more that their uses have taken one of the steepest upward climbs of any class of materials in recent years.

Electric furnace steels are on the march. Our principal special steel products—corrosion and heat-resisting alloys, tool and die steels, electrical, valve and nitriding steels are products which offer you the greatest future promise.

As pioneers and originators in these fields, we have the data your engineers and designers need, and the working information for your

shopmen to handle special steels well and speedily. Let us help you.



ALLEGHENY LUDLUM

STEEL CORPORATION

**General Offices
Pittsburgh 22, Penna.**

W & D 9332 F

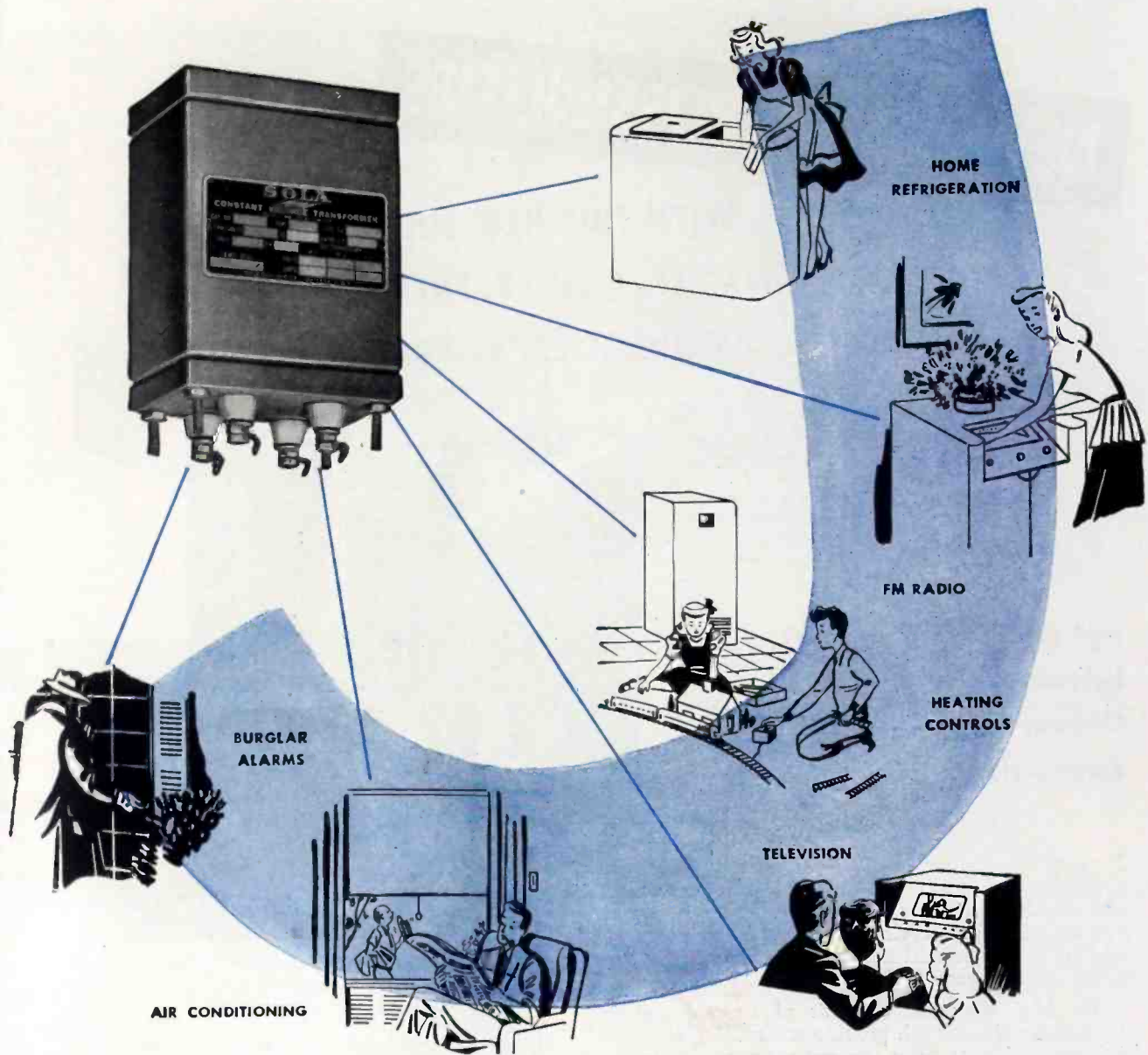

CONSTANT VOLTAGE for home equipment made possible by this low-cost transformer

With this transformer maintaining operating voltage within $\pm 1\%$ of rated requirements, regardless of supply line fluctuations as great as 30%, trouble-free operation of your equipment becomes a reality.

Here is what can be accomplished by building this SOLA Constant Voltage Transformer into your equipment.

1. Increased efficiency.
2. Lowered cost to the user.

3. Reduced maintenance expense.

This Type 11 SOLA Constant Voltage Transformer is designed specifically for such domestic applications as heating and ventilating controls, FM and television receivers, refrigeration and air conditioning controls and other similar products where stable voltages must be maintained. Like all SOLA Constant Voltage Transformers, regardless of size or capacity, it operates automatically,

has no moving parts, and requires no supervision.

Type 11 is just one of 31 standard types in capacities ranging from 10VA to 10,000VA that are available to manufacturers of all types of electrically operated equipment. Special units can be built to your exact specifications. SOLA engineers are available for a discussion of your problems.

Write for new Handbook

A complete treatise on the subject of voltage stabilization. It provides the answer to a problem that confronts every manufacturer or user of electrically operated or electronic equipment.

Ask for Bulletin DCV-102

SOLA

Constant Voltage Transformers

Transformers for: Constant Voltage • Cold Cathode Lighting • Mercury Lamps • Series Lighting • Fluorescent Lighting • X-Ray Equipment • Luminous Tube Signs
Oil Burner Ignition • Radio • Power • Controls • Signal Systems • etc. SOLA ELECTRIC COMPANY, 2525 Clybourn Avenue, Chicago 14, Illinois

NEW DESIGN POSSIBILITIES

... WITH THIS NEW LINE OF
SMALLER, LIGHTER, ENERGY—
STORAGE CAPACITORS

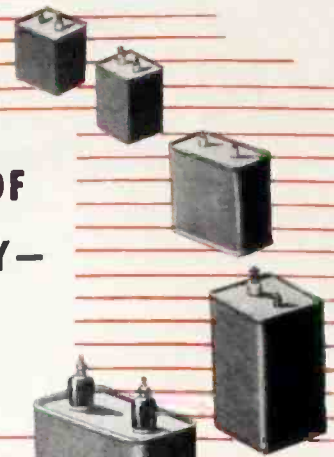

For

High-speed flash photography,
Light-metal welding,
Electronic-timing
devices, etc.

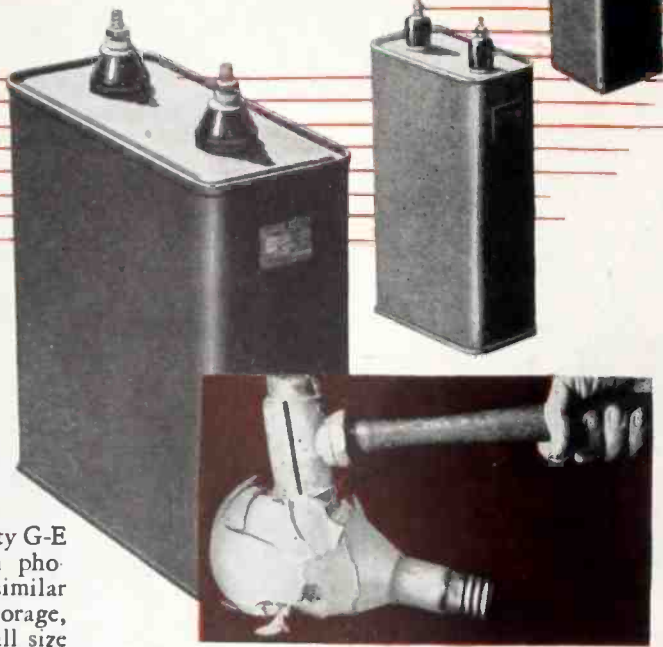

This flash photo was made possible by G-E capacitors.

A complete new line of light-duty G-E Pyranol* capacitors is now available for flash photography apparatus, light-metal welding, and similar applications requiring economical energy storage, fast discharge and service reliability. Their small size and light weight will help designers reduce the size of such equipment.

The high dielectric constant of Pyranol and its high dielectric strength provide outstanding electrical characteristics. Ambient temperature operating limits, at rated voltage, range from 0 to 50 C and the capacitance tolerances, measured at 25 C, are ± 10 per cent. The performance of these compact units has been thoroughly proved by several years of laboratory tests and actual operating experience in the field.

G-E light-duty energy storage capacitors are made in a wide range of ratings to fit practically every requirement of high-speed flash photography as well as

home and industrial welders of light metals. Careful construction, quality materials, and skillful design contribute to long life and efficient operation.

The accompanying table lists preferred ratings which can be promptly shipped. For further information on these ratings or on designs for special operating conditions, advise us of your problem through *Apparatus Dept., General Electric Company, Schenectady 5, N. Y.*

*Pyranol is G.E.'s trade name for askarel, a noninflammable liquid dielectric.



PREFERRED RATINGS									
Max. D-C Volts	Muf	Watt/Sec	Cat. No.	Base	Case Height in In.	Height Over Terminals in In.	No. of Terminals	Net Wt. Lb.	
2000	25	50	25F903	A	4 19/32	5 7/64	2	5.2	
2000	40	80	25F910	A	7	8 1/4	1	7.8	
2500	25.5	80	25F911	A	7	8 1/4	1	7.8	
3000	60	270	14F312	B	13 1/8	15 1/8	2	26	
3350	17.8	100	25F912	A	7	8 1/4	1	7.8	
4000	25/50	200/400	14F309	B	13 1/8	15 1/8	3	26	
4000	100	800	14F311	C	12 7/8	15 1/8	2	56	
4500	10	100	26F872	A	5 1/2	6 3/4	1	6	
5000	25/50	313/625	14F305	D	13 1/8	15 1/8	3	46	
6600	55	1200	14F313	C	12 7/8	16 5/16	2	56	
7000	25	613	14F314	B	13 1/8	16 5/16	2	26	

BASE DIMENSIONS (IN.) A 3 3/4 by 4 9/16 B 4 by 8 C 5 1/8 by 13 1/2 D 4 1/8 by 13 1/2

GENERAL ELECTRIC

407-101-5700

INDEPENDENT INVESTIGATOR FINDS

*Phillips Screws
pay Pullman*

**big money savings for
hundreds of driver skids eliminated!
Hold better ... look better!**

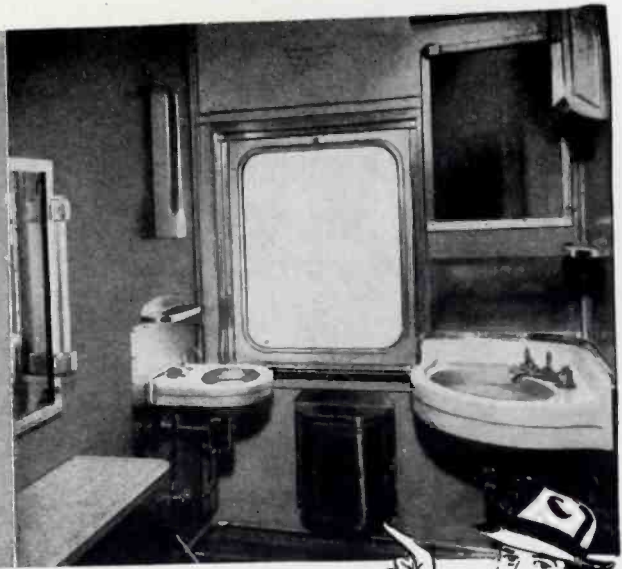

Investigators from James O. Peck Co., industrial research authorities, are visiting a number of representative plants to get authentic FACTS on assembly saving. Get the "INSIDE STORY" of successful assembly practice — read his fact-filled reports!

"When we used slotted screws, we had plenty of trouble with drivers slipping and puncturing the pressed wood panels we use by the thousand for inside trim," a Pullman assembly executive told the investigator. "This meant removing and discarding the panel, replacing and

hand-painting — to the tune of several dollars per skid. Phillips Screws ended driver skids. But that's only one way they pay off.

"Where the heads show in the finish they look better. They don't have to be lined up, like slotted screws, which means they can be set up tighter to resist vibration.

"Railroads like them because they can't be loosened by passengers with coins or nail files like slotted screws — to tear clothes and cause damage claims."

REPORT TELLS MORE PHILLIPS ADVANTAGES

The investigator asked Pullman the same questions you would ask about assembly methods. The report tells you the complete, revealing answers.

It's one of a series of assembly studies covering all types of products — metal, plastics, wood — being made to show how the many Phillips Screw advantages add up big savings you can make in your assemblies.

The reports now ready — and more to come — comprise a practical manual of modern assembly methods — never-before-printed information — inside facts you'd pay good money to get — and you can have them, now, **FREE!**

**PACKED WITH IDEAS FOR
SAVINGS IN YOUR ASSEMBLIES**

Find out how industry's top-flight assemblers licked problems like your own! Get these reports! Don't wait — fill out and mail the coupon **TODAY!**

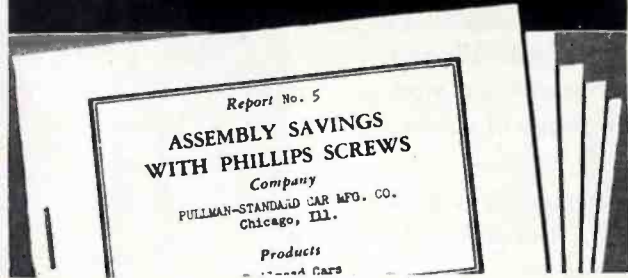

PHILLIPS Recessed Head SCREWS

Wood Screws • Machine Screws • Self-tapping Screws • Stove Bolts

American Screw Co.
Atlantic Screw Works
Atlas Bolt & Screw Co.
Central Screw Co.
Chandler Products Corp.
Continental Screw Co.
Corbin Screw Div. of
American Hdwe. Corp.
The H. M. Harper Co.
International Screw Co.
Lamson & Sessions Co.

26 SOURCES

Manufacturers Screw Products
Milford Rivet and Machine Co.
National Lock Co.
National Screw & Mfg. Co.
New England Screw Co.
Parker-Kalon Corporation

Pawtucket Screw Co.
Pheoll Manufacturing Co.
Reading Screw Co.
Russell Burdall & Ward
Bolt & Nut Co.
Scovill Manufacturing Co.
Shakeproof Inc.
The Southington Hardware Mfg. Co.
The Steel Company of Canada, Ltd.
Sterling Bolt Co.
Wolverine Bolt Company

**PHILLIPS SCREW MFRS.,
c/o Horton-Noyes**

2300 Industrial Trust Bldg., Providence, R. I.

Please send me the reports on Assembly Savings
with Phillips Screws

Name

Company

Address

DeJUR

BUILDS GREAT LITTLE METERS



The DeJur Model 120
Miniature (1 1/2") Meter

The precision-built DeJur 1 1/2" Meters are doing a man-sized job on many applications where space must be conserved.

DeJur EXTERNAL

PIVOT construction gives maximum accuracy — reduces pointer-rocking, and wear on bearing surfaces — greatly lengthening the life of the instrument.

Compact, Trouble-Free Modern Design

External Pivot
(As Used by DeJUR)

Internal Pivot
(Not Used by DeJUR)

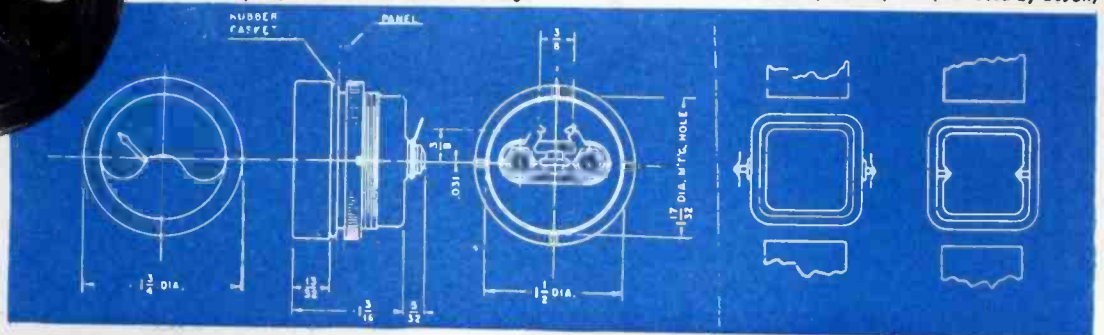

DeJUR RHEOSTAT — POTENTIOMETERS ARE PRECISION BUILT...

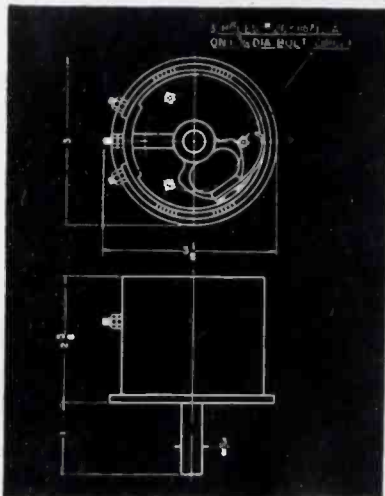

Send details of your requirements to DeJur. Our engineers will gladly advise the correct instrument to meet your needs.

in a wide line of models for many electronic and general electrical applications. They are electrically and mechanically engineered to meet the precise requirements of electrical manufacturers.

The 11 Watt Model 275 (illustrated) is typical of DeJur Potentiometers. Rugged yet light in weight, it is built to give outstanding service under the most severe operating conditions.



WRITE FOR THE LATEST DeJUR CATALOG

DeJUR-AMSCO CORPORATION
LONG ISLAND CITY 1, N. Y.

AMMETERS...VOLTMETERS...POTENTIOMETERS



4,632 Little Bottles

SILENT SENTINELS OF CONTINUOUS RESEARCH

These bottles are but a small portion of the 4,632 which have passed through our laboratory. Each represents a part of a continuous series of chemical research—responsible for attaining and maintaining the quality of Audiodiscs.

★ ★ ★

For the leadership of Audiodiscs is the result of exhaustive experimental work, plus the most exacting quality controls known to the recording industry.

★ ★ ★

Recently, to add still further to our research facilities, we greatly expanded our laboratory. Today, our research engineers are constantly exploring new materials and methods, in order to further improve recording fidelity and broaden the field of sound reproduction.



... they speak for themselves
audiodiscs

Audiodiscs are manufactured in the U.S.A. under Exclusive License from La Soci t  des Vernis Pyrolac—France.

AUDIO DEVICES, INC., 444 Madison Ave., New York 22, N.Y.

STACKPOLE GA MIDGET CAPACITORS

goodbye to gimmicks!

Still twisting insulated wires together to form inefficient, makeshift "gimick" low value capacitors?

Stackpole GA Capacitors cost no more in the long run. Even more important, they bring you outstanding advantages in terms of greater stability, higher Q, better insulation resistance and higher breakdown voltage.

In addition, they are mechanically superior and eliminate the undesirable inductive characteristic common to twisted wires. Sturdily molded, with leads securely anchored and tinned, they are widely used in circuits similar to those illustrated. Standard capacitors include 0.68; 1.0; 1.5; 2.2; 3.3 and 4.7 mmfd. with tolerances of $\pm 20\%$.

Electronic Components Division

STACKPOLE CARBON COMPANY, St. Marys, Pa.

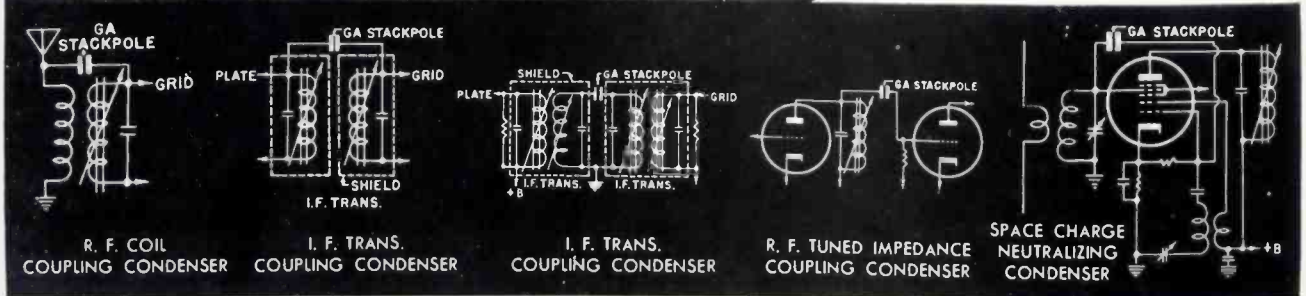
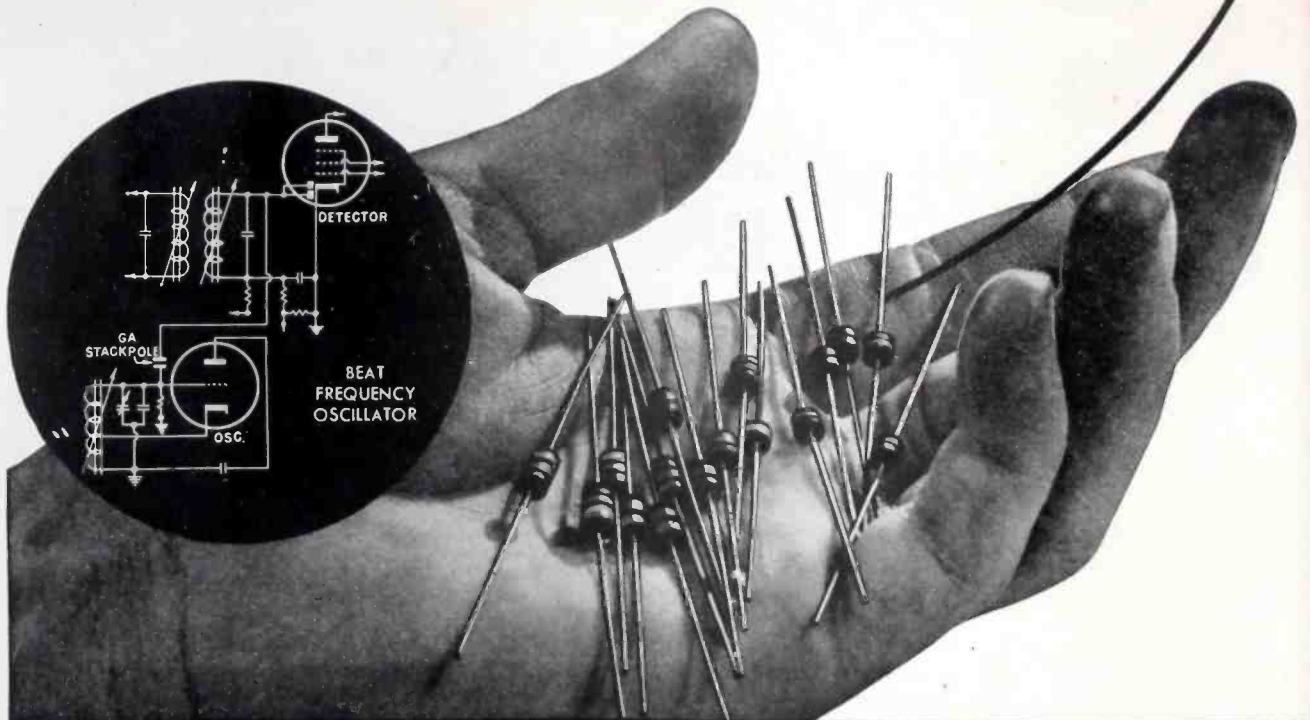

FIXED and VARIABLE RESISTORS • INEXPENSIVE SWITCHES
IRON CORES • COIL FORMS • POWER TUBE ANODES • BRUSHES AND CONTACTS • ALNICO II
RHEOSTAT PLATES and DISCS • ANODES and ELECTRODES, ETC.

Type 710-A
370 to 560 Mc



Type 734-A
1200 to 3750 Mc



RCA Signal Generators for u-h-f jobs

These signal generators may just fill the bill for some of your ultra-high-frequency development work.

The Type 710-A provides an r-f signal of a known frequency and amplitude for easily obtaining the data needed to check the performance of high-frequency devices. This instrument provides smooth and complete attenuation throughout its range, plus precision frequency control.

Output frequency: 370 to 560 megacycles—just right for citizen's radio-telephone and other experimental and

laboratory work within these frequencies. *Output voltage:* 2 microvolts to 0.09 volt. *Amplitude modulation available:* 400 cycles \pm 5 per cent, at modulation of 50 per cent maximum. Controls are provided for adjusting the carrier level, modulation, attenuation, and frequency.

The Type 734-A has been widely used for testing and adjusting radar equipment. It will prove an accurate and handy device for testing any equipment within the following band:

Output frequency: 1200 to 3750 mega-

cycles or 25 to 8 centimeters. *Output voltage:* 1 microvolt to 0.2 volt. *Tube complement:* one 707-B—r-f oscillator, one 6J5—synchronizing amplifier, one 884—pulse-rate oscillator, one 6SN7-GT—multivibrator, one 6AG7 and one 6AC7—pulsers, two 6AC7—voltage controls, one 6J5—shaper, one 6AG7—keyer, two 6X5G and two 5Z4—power rectifiers, four VR-150-30—regulators.

These signal generators are available for immediate shipment—as long as stock lasts.

PLACE YOUR ORDER NOW!



TEST AND MEASURING EQUIPMENT

**RADIO CORPORATION
of AMERICA**

ENGINEERING PRODUCTS DEPARTMENT
CAMDEN, N. J.



Radio Corporation of America
Dept. 30-F, Test & Measuring Equipment Section
Camden, New Jersey

Please reserve (no. of units) Type RCA signal generators pending additional technical and price information from you. We are interested in using these instruments for the following application:

Name _____ Title _____
Company _____
Address _____
City _____ Zone _____ State _____



THE **BIG** DIFFERENCE

is in the Asbestos Insulation

It's the silky but tough fibres of heatproof, fire-proof, age-resistant asbestos that put *performance protection* into Rockbestos wires, cables and cords. They actually *armor* them against baking heat, sub-zero cold, oxidation, rotting fumes, oil, grease, moisture and even flame with an insulation that is *practically indestructible!*

This *permanent* insulation gives you wires that guarantee the dependable operation of your product under any condition it may have to work under. The impregnated non-deteriorating asbestos fibres form a felt-like wall that *prevents* wire-failures because it doesn't become hard or lose flexibility with age. High operating or ambient temperatures won't bake it out or cause it to flow. It won't rot when in contact with oil or grease or when exposed to corrosive fumes. And it eliminates fire-hazard because it won't burn or carry flame.

These *failure-preventing* characteristics are typical of every wire in the Rockbestos line which includes Firewall Hookup wire illustrated above, space-saving multi-conductor cables, switchboard wires, motor lead and power cables and many others. Write for recommendations or a catalog.

ROCKBESTOS PRODUCTS CORP.

436 Nicoll St., New Haven 4, Conn.



NEW YORK BUFFALO CLEVELAND CHICAGO
 PITTSBURGH ST. LOUIS LOS ANGELES SEATTLE
 SAN FRANCISCO PORTLAND, ORE.

<p>WON'T BURN OR SUPPORT FLAME</p>	<p>PERMANENTLY AGE RESISTANT</p>
<p>OIL AND GREASE RESISTANT</p>	<p>RESISTS HEAT AND OXIDATION</p>
<p>REMAINS FLEXIBLE</p>	<p>MOISTURE RESISTANT</p>

ROCKBESTOS

The Wire with Permanent Insulation

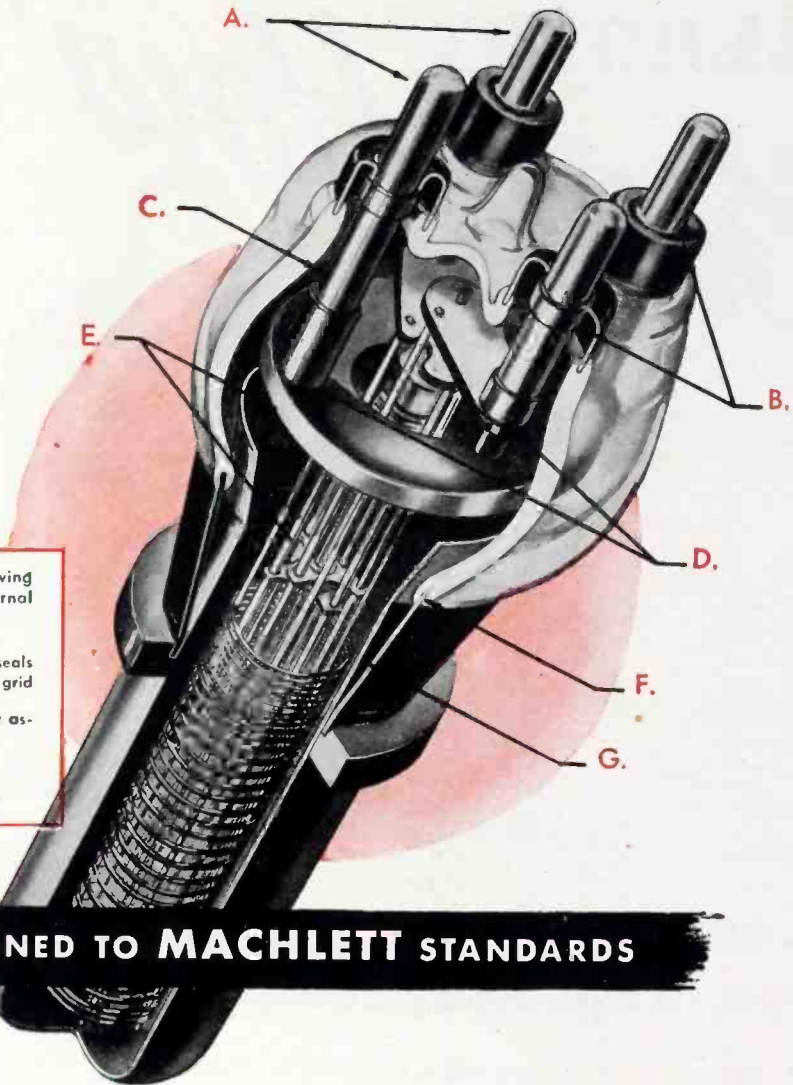

Sectional view of the ML-889-A, showing features typical of Machlett external anode tube construction.

- A. Gold-plated contact surfaces
- B. Rugged Kovar grid and filament seals
- C. One-piece high-conductivity copper grid and filament support leads
- D. Rigidly-supported grid and filament assemblies
- E. Surgically-clean internal parts
- F. Rugged Kovar plate seal
- G. One-piece anode and shield

REDESIGNED TO MACHLETT STANDARDS

For better performance and longer life! ML-892

HERE is another outstanding example of Machlett's ability to apply to the design and manufacture of high-power triodes its unique skills acquired in the manufacture of X-ray tubes. Remember, those skills were developed through almost 50 years of X-ray tube production—and an X-ray tube presents manufacturing problems of the greatest severity in the electron-tube art. Machlett's ability to solve those problems has resulted in making it the largest producer of X-ray tubes in the world. Note these features of the ML-892:

1. Heavy Kovar sections for grid and plate seals, instead of feather-edge copper. Result—greatly increased mechanical strength.
2. Grid assembly supported by heavy Kovar cup, for strength and stable inter-element spacing.
3. Filament assembly greatly strengthened to increase life and preserve correct spacing.
4. All internal parts processed by special

Machlett techniques which prevent contamination by foreign particles, assuring permanent outgassing.

5. Tube pumped by unique Machlett continuous, straight-line, high-voltage process, assuring same high standards maintained in Machlett high-voltage X-ray tubes.

For complete details of this greatly improved tube, write Machlett Laboratories, Inc., Springdale, Connecticut.

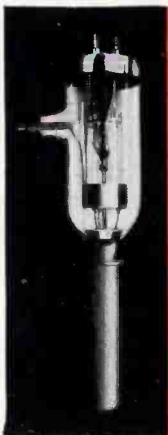

GENERAL CHARACTERISTICS

	ML-892	ML-892-R
Filament Voltage	22	22 volts
Filament Current	60	60 amps.
Amplification Factor	50	50
Maximum frequency for full power	1.6	1.6 mc.
Capacity grid to plate	27	30 uuf
Capacity grid to filament	18	18 uuf
Capacity plate to filament	2	2 uuf
Cooling	Water 3 to 8 G.P.M.	Air 400-700 C.F.M.



APPLIES TO RADIO AND INDUSTRIAL USES
ITS 49 YEARS OF ELECTRON TUBE EXPERIENCE

AEROVOX "Know-How"



Aerovox "Know-How" in action: Chief Engineer Stanley Green (center) with Joseph L. Collins (Electrolytics), Louis Kahn (Assistant Chief Engineer) and Samuel Heyman (Production Manager) working out the capacitance problem of a customer from the application blueprints.

... can save you untold time, expense, trouble

● Ingenuity, imagination, versatility, adaptability, coupled with sound engineering practice, add up to Aerovox "Know-How."

Of course Aerovox has an outstanding line of standard capacitors—paper, oil, electrolytic, mica and low-loss ultra-high-frequency types. A wide range of requirements are met with such a variety of listings. But Aerovox can also meet most extraordinary needs with special types that do not have to be billed at usual special prices. Here's why:

A tremendous variety of cans, terminals, insulators, mountings and production processes at the disposal of Aerovox engineers enables Aerovox to make up special types quickly, readily, inexpensively. So:

Bear in mind Aerovox "Know-How"—and save untold time, expense, trouble.

● Try us on that capacitance problem.

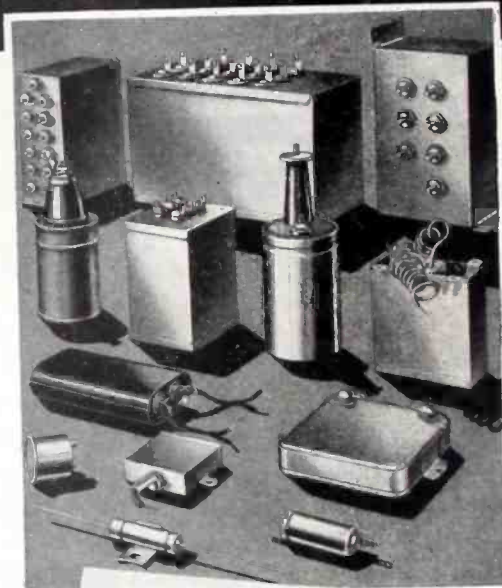

Typical "special" capacitors assembled from standard Aerovox parts, indicating the wide variety of cans, terminals, insulators and mountings.



FOR RADIO-ELECTRONIC AND INDUSTRIAL APPLICATIONS

AEROVOX CORPORATION, NEW BEDFORD, MASS., U.S.A.

SALES OFFICES IN ALL PRINCIPAL CITIES • Export: 13 E. 40th St., NEW YORK 16, N. Y.

Cable: 'ARLAB' • In Canada: AEROVOX CANADA LTD., HAMILTON, ONT.

10... 100... 1,000
 ... 10,000... 100,000...
 1,000,000... 10,000,000

Little
 or
BIG



THIS STANDARD
 SIZE LETTERHEAD
 GIVES YOU AN IDEA
 OF THE SIZE OF
 THESE ALSIMAG
 COIL FORMS

One or one million pieces, big or little, your best bet on technical ceramics is American Lava Corporation. For small quantities the experimental department is geared for prompt service. For large quantities you command special techniques, equipment and experience found

only at American Lava Corporation. Your request will bring property charts which give physical characteristics of the more frequently used AlSiMag compositions. If your requirement demands special or unusual characteristics, the developmental laboratory may find exactly those characteristics in its research records, or develop them quickly for you.

ALSiMAG
 TRADE MARK REGISTERED U.S. PATENT OFFICE

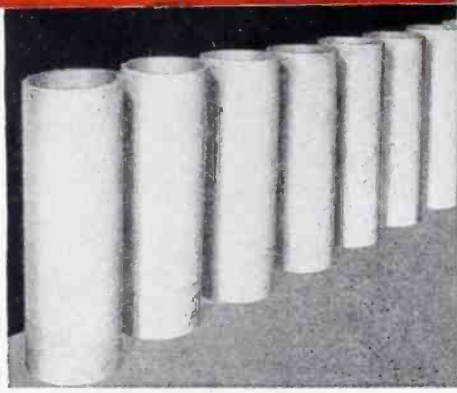

These large, thin walled, coil forms (machined to close tolerances) are an example of American Lava Corporation craftsmanship in technical ceramics.

AMERICAN LAVA CORPORATION
 CHATTANOOGA 5, TENNESSEE
 43RD YEAR OF CERAMIC LEADERSHIP

ENGINEERING SERVICE OFFICES:
 ST. LOUIS, Mo., 1123 Washington Ave., Tel: Garfield 4959 • NEWARK, N. J., 1013 Wiss Bldg., Tel: Mitchell 2-8159
 CAMBRIDGE, Mass., 38-B Brattle St., Tel: Kirkland 4498 • CHICAGO, 9 S. Clinton St., Tel: Central 1721
 SAN FRANCISCO, 163 Second St., Tel: Douglas 2464 • LOS ANGELES, 324 N. San Pedro St., Tel: Mutual 9076



Original Award July 27, 1942
 Second Award February 13, 1943
 Third Award September 25, 1943
 Fourth Award May 27, 1944
 Fifth Award December 2, 1944



WE SPECIALIZE IN "Specials"

FOR NEARLY 20 YEARS, the Kenyon Transformer Company has done an outstanding job of satisfying the demand of large manufacturers for "special units" to fit exactly their most critical needs, with the same care that other manufacturers could provide items of their standard catalog lines.

THIS ACHIEVEMENT is a tribute to the skillful engineering ability of the Kenyon Pioneers who have maintained a leading place in the development of outstanding transformer equipment.

WE INVITE INQUIRIES from manufacturers of electronic and other types of equipment, and from industrial and commercial users of transformers.

KENYON PREDICTS that the small additional cost of "specials" will be more than offset by the superior product—streamlined to fit each manufacturer's requirement.

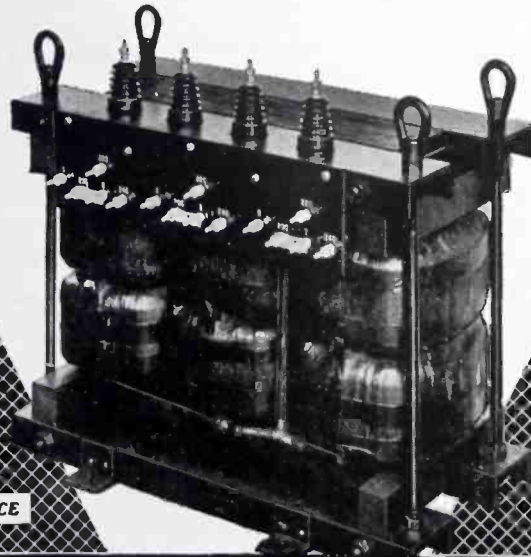

THE MARK OF

EXCELLENCE

KENYON TRANSFORMER CO., Inc. 840 BARRY STREET
NEW YORK, U. S. A.

In Springs

*it's the X-Dimension that saves
tempers, costs, customers*

The sets of Hunter springs you see here force up the bottle platforms of a beverage bottling machine. Lift finder springs used to be single edge wound from flat wire to reduce the possibility of buckling and rubbing on piston and cylinder. It was costlier. It lacked certain needed properties. The nature of design overstressed and broke the spring and the machine had to be held up for time-wasting replacements.

Hunter came up with a spring-

within-a-spring design. Now an inexpensive flat wire inner-spring prevents buckling and takes piston wear. A round music wire compression spring shoulders most of the load. Down went repairs! Up went customer satisfaction.

This is a kind of service you can't blueprint, but it's there in Hunter springs. It's the X-Dimension . . . more than you bargained for . . . in springs. Make sure you and your customers get it for real satisfaction.



HUNTER PRESSED STEEL COMPANY

Lansdale, Pennsylvania

SPRINGS • METAL STAMPINGS • WIRE FORMS
MECHANICAL AND ELECTRICAL ASSEMBLIES

MEMO TO PURCHASING MEN—

• Next time your engineers hand you a tough spring procurement job, let Hunter help you get your money's worth.



This new type potentiometer-rheostat...

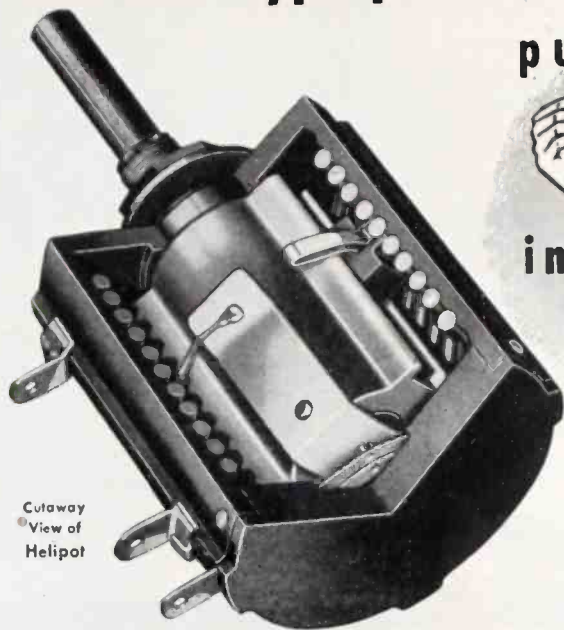

Cutaway
View of
Helipot

puts this much slide wire

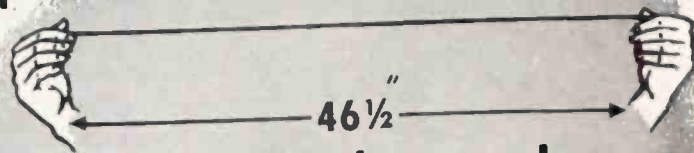

into this much panel space

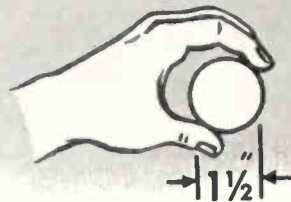

It's the BECKMAN

Helipot

(Trade mark for the HELical POTentiometer)

No matter what type quality electronic instrument you may be manufacturing or preparing to manufacture, be sure to investigate the **multiple advantages** you can build into your product by using Beckman Helipots for resistance control. War-perfected on such ultra-precision electronic equipment as radar, flight control instruments, depth sounding devices, etc., the Beckman Helipot makes possible entirely new standards of accuracy, convenience and compactness in resistance controls.

Unlike conventional potentiometers which consist of a single turn of slide wire, the Helipot has many turns of slide wire helically coiled into a compact case that occupies no more panel space than a conventional single-turn potentiometer. The slider contact is rotated by a knob in the usual manner and a simple device guides the slider contact as the knob is rotated so that the entire helical length of resistance winding can be contacted.

Its advantages are many. Heretofore circuits requiring precise control coupled with wide range have generally required at least two potentiometer units—one for coarse adjustment and the other for fine adjustment. This means two knobs to operate... two controls to waste panel space... two units to complicate installation and wiring. In the

Beckman Helipot both wide range and fine adjustment are combined in the one unit. There is only one knob to operate... one unit to take up panel space... one control to install and wire. You not only save

valuable panel space and assembly time, but you greatly increase the convenience, utility, simplicity and operating efficiency of your electronic instruments. Note these outstanding Helipot features...

High Linearity—As a result of fulfilling wartime requirements for ultra-precision circuit controls, Helipots are mass-produced with linearity tolerances of one tenth of one per cent—and even less!

Precise Settings—Because of the many times longer slide wire, settings can be made with an accuracy impossible with single turn units.

Wide Range—By coiling a long potentiometer slide wire into a helix, the Helipot provides many times the range possible with a single turn unit of comparable diameter and panel space.

Low Torque—Of special interest for power-driven applications—the Helipot has unusually low torque characteristics. The 1 1/2" Helipot—for example—has a torque of only one inch/ounce.

Wide Range of Sizes—Current Helipot production is in two basic sizes, each available in a wide range of ratings. The Type A Helipot is 1 1/2" in diameter and is available in ten or fewer turns of slide wire. The ten turns provide a slide wire 46 1/2" long.

The Type B Helipot is 3" in diameter with 15 turns of slide wire as standard, but is available with either fewer or more turns on order. The 15 turns give a slide wire 140 1/2" long.

Resistance windings can be supplied in virtually any commercially available type of resistance wire for both Type A and Type B so that total resistance values for Type A range from 100 to 30,000 ohms... for Type B from 650 to 100,000 ohms.

SEND US YOUR POTENTIOMETER PROBLEM and our engineering staff will be glad to work with you in applying Helipot advantages to increase the efficiency, accuracy and convenience of your quality electronic instruments.

THE HELIPOT CORPORATION, 1011 MISSION STREET, SOUTH PASADENA 2, CALIFORNIA

ANSWERING THE DEMAND FOR **"Something Better"**



PRESTO

MODEL "L"



A better portable playback—compact, easy to carry, simple to set up. The remarkably clear, wide range of reproduction—far superior to what is ordinarily expected of a portable playback—makes it a favorite with broadcasting stations and advertising agencies who demand top performance in demonstrating recorded programs to prospective clients.

Model L plays 6 to 16" records, 78 or 33 $\frac{1}{3}$ R.P.M., on a 12" rim-driven turntable. Standard equipment includes high quality 16" pickup on a swivel mounting which folds into a case when not in use, four stage amplifier, 8" loudspeaker with 20' extension cable, and a Presto Transcriptone semi-permanent playing needle. For use on 110 volts AC only.

The complete equipment, in an attractive grey carrying case, weighs only 46 lbs.



RECORDING CORPORATION
242 West 55th Street, New York 19, N. Y.
WALTER P. DOWNS, LTD., in Canada

WORLD'S LARGEST MANUFACTURER OF INSTANTANEOUS SOUND RECORDING EQUIPMENT

Franklin QUALITY Sockets

for Personal . . . Broadcast . . . Television Receivers

PERSONAL RECEIVERS

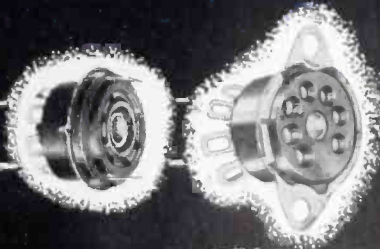

SERIES 55A4 MINIATURE MOLDED

BROADCAST RECEIVERS



SERIES 60 MOLDED OCTAL



TELEVISION
ONE PIECE SOCKETS

DIHEPTAL

MAGNAL

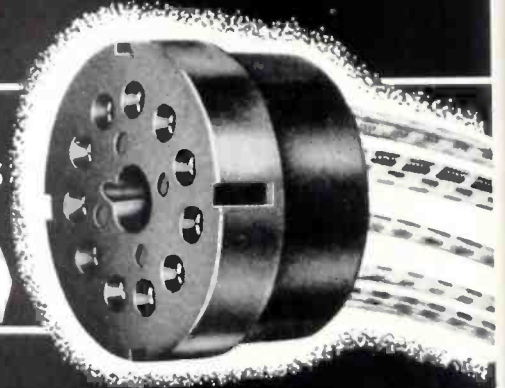

. . . and for general purposes, the Series 39 Socket, with patented bow spring action contacts (with or without a soldering tab to eliminate wiring to ground) is the favorite of all time. Automatically machine made, tens of thousands are being delivered to the radio industry to enable peak production of standard receivers. The millions in use give testimony to its being the favorite socket of pre and post war receivers.



ELECTRONIC
COMPONENTS



A.W. FRANKLIN

MANUFACTURING CORP.

175 VARICK ST., NEW YORK 14, N. Y.

In California: A. W. FRANKLIN Mfg. Corp. of CALIFORNIA, 2216 West 11th St., Los Angeles 6, Calif.

SOCKETS • TERMINAL STRIPS • PLUGS • SWITCHES • PLASTIC FABRICATION • METAL STAMPINGS • ASSEMBLIES

THE LABOR CRISIS

-it's up to Congress

IT HAS remained for John L. Lewis to demonstrate conclusively that, under the sponsorship of the federal government, the power of organized labor has been built up to a point where it can be used to paralyze the economic life of the nation. Therefore, in the elemental interest of self-preservation, the first order of the day is to cut down the power of organized labor to a point where irresponsible leaders no longer have the power to use it to cut down the country.

This will prove an exceedingly complicated job. The federal government, over a dozen years, has developed and buttressed the power of organized labor by many separate steps. They are interlaced in a pattern which cannot easily be unravelled.

Cutting down the power of organized labor to proper proportions will be an operation almost as delicate as brain surgery. To be successful it must impair no basic American political or economic right. It must leave intact the right of workers to organize and bargain collectively through representatives of their own choosing. It must leave intact the right to strike. But it must disassociate from the exercise of these rights opportunities for devastating abuse of the public welfare such as those demonstrated by Mr. Lewis. A meat axe is not the instrument for this operation.

Because of the complexity and delicacy of the operation to be performed it would be helpful if it could be carried out in a tranquil atmosphere. The urgency of the problem is such, however, that no time can be lost in getting at it.

Guiding Principles

However, the dangers that haste or heat will lead to serious blunders can be largely eliminated if the process of bringing the power of organized labor back within safe and reasonable bounds is governed by principles to which all fair minded people can fully subscribe.

The most important of these principles is that it is an abuse of public authority to extend special privileges to organized labor.

When in 1935 Congress passed the Wagner Labor Relations Act, one of the great buttresses of the power of organized labor, it was upon the explicit theory that organized labor was weak and needed coddling by the federal government if it were to survive, let alone grow big and strong. In the policy

section of that act it was stated that "the inequality of bargaining power between employees who do not possess full freedom of association or actual liberty of contract, and employers who are organized in the corporate or other forms of ownership association substantially burdens and affects the flow of commerce . . ."

Regardless of whether or not that was a correct reflection of the situation in 1935, it bears no relation to the situation today. Under the continuous sponsorship of the federal government, the power and bulk of organized labor has waxed until today it is preposterous to regard it as the weak sister in its bargaining with employers. If, after being continuously demonstrated since V-J Day, the proposition that the pendulum of organized power has swung too far over on the side of organized labor needed any final and clinching demonstration, John L. Lewis provided it.

Changes in the Law

Translation of the principle that organized labor is no longer a weakling, requiring a diet of special privileges, into specific legislative enactments is a detailed technical operation beyond the scope of this statement. It is possible, however, to indicate some of the general lines it should follow. Here they are:

1. The duty to bargain collectively, now imposed upon employers by the Wagner Act, should also be imposed upon the leaders of organized labor who are now under no legal compulsion to bargain.

For well over a month Mr. Lewis made a complete mockery of the process of collective bargaining by refusing even to state his demands until the coal operators had approved "in principle" a plan for a miners' "health and welfare" fund which he fancied. In the meantime the country was plunged into an ever deepening crisis.

2. Unions, as well as employers, should be made liable to suit for damages for breaking their collective bargaining agreements.

A degree of responsibility commensurate with their age and power requires that unions be liable, to the extent of union funds but not the funds of individual members, for carrying out their agreements. To have it otherwise is to hold that a collective bargaining agreement is, by defi-

dition, a phoney agreement so far as the union is concerned. Outlaw strikes are the fruit of this lop-sided arrangement.

3. Employers should be given more discretion, in reinstating employees who have gone on strike than is now permitted by the Wagner Act.

The Wagner Act largely eliminates the risks involved in striking because of the requirements it imposes upon employers to take workers back when they have decided to return to work. These requirements make it virtually impossible for the employer to replace workers even if they are engaged in the most unjustifiable of strikes. At the least workers who have smashed up property and stirred up violence in the course of a strike should have no rights under the Wagner Act. How much further the Wagner Act strait-jacket should be loosened at this point should be carefully explored, and excesses encouraged by the Act should be removed.

4. The wedge which the National Labor Relations Board has driven into the orderly conduct of American industry by holding that foremen are covered by the Wagner Act should be eliminated.

The issue involved here is continuously mislabelled and confused as that of the right of foremen to organize. There is no question of the right of foremen to organize any kind of a legal organization they desire. That is their right as American citizens. The issue is whether or not the special privileges accorded by the Wagner Act, which in some circumstances has been so construed as even to prevent employers from talking with their workers, should be extended to foremen who, if American industry is to have a chance to do its duty effectively, must represent management with full loyalty and responsibility.

A member of John L. Lewis' United Mine Workers takes an oath which provides, in part, "that I will not reveal to any employer or boss the name of anyone a member of our union" and will "defend on all occasions and to the extent of my ability the members of our organization." Mr. Lewis insists that the coal operators contract to deal with foremen to be organized in a union where they will take that oath, and where their activities will be separated from the influence of employers by the barriers imposed by the Wagner Act. Such an arrangement undercuts orderly management of American industry.

5. The exemption of labor unions from the federal anti-trust laws, provided when organized labor was presumed to be weak, should be modified to take account of its vastly increased strength, and

the use of this strength to destroy business enterprise and create monopoly.

As matters stand unions can run employers completely out of business by secondary boycotts and run fellow workers out of jobs in the process. An Ohio manufacturer, working with a government-certified C. I. O. union, is put out of business because A. F. of L. workers refuse to handle his products. Still the government, this time in the person of the United States Supreme Court, says that actions of this sort are above the law because Congress exempted unions from the federal anti-trust laws.

To eliminate one of the most devastating forms of restraint of trade, this exemption should be cut down forthwith by subjecting unions imposing secondary boycotts to the same penalties under the federal anti-trust laws as those to which employers doing the same thing are subjected. And the question of further narrowing the obsolete exemption of unions from the federal anti-trust laws should be fully explored.

6. The levying of special sales taxes for the exclusive benefit of unions should be prohibited by law.

As a matter of good government the right to levy consumption taxes should be reserved to the public authorities and used strictly for public purposes. As a matter of good economics, payments to workers or their organizations should be included in the payroll where they can be properly counted as part of the cost of production.

Equality Before the Law

When everything that can conceivably be accomplished by legislation has been accomplished there is no reason to believe that an ideal or even a surely workable system of industrial relations will have been devised. Many of the mainsprings of such a system lie deep in the hearts of men and far beyond the reach of legislation. There is no chance, however, of having such a system, or even a defensible system of democratic government until special privileges which tip the scales of power far on the side of organized labor are withdrawn and there is some measure of equality for employers and organized labor before the law. Though it is hard to believe it at the moment the country may come to be grateful to John L. Lewis for driving that lesson home so ruthlessly.

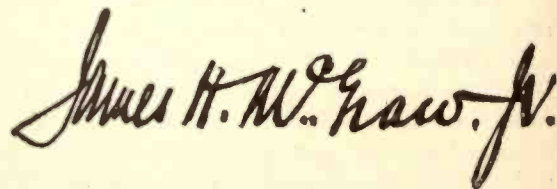

President, McGraw-Hill Publishing Company, Inc.



THE COUNTERSIGN OF DEPENDABILITY IN ANY ELECTRONIC EQUIPMENT

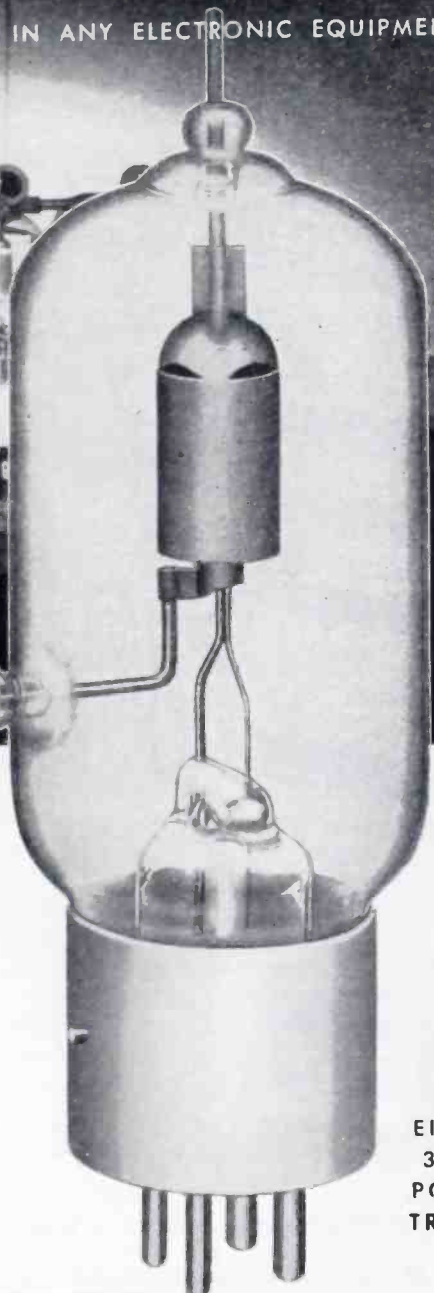
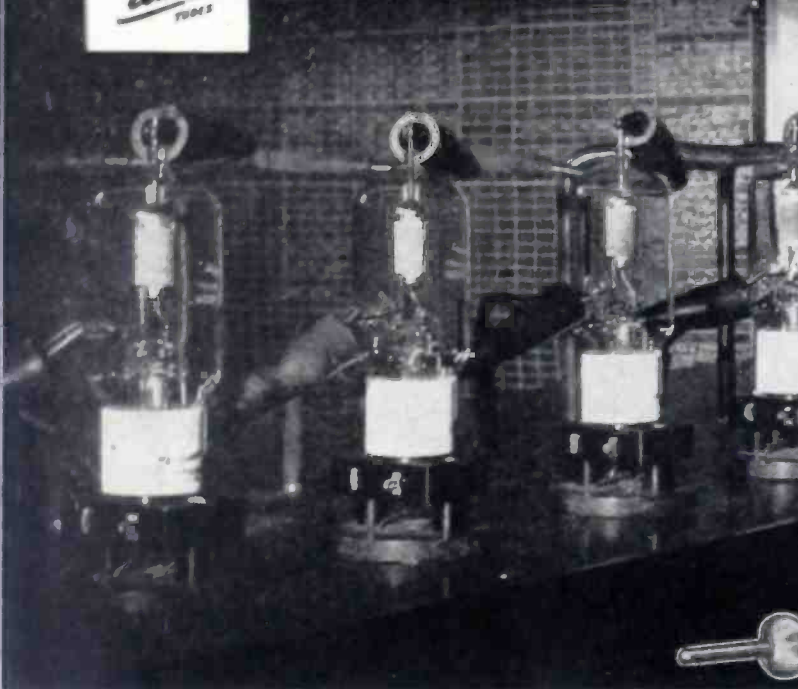

EIMAC
35TG
POWER
TRIODE

A BETTER 35TG

The famous Eimac 35TG VHF tube, with its low inter-electrode capacitances, its logical terminal arrangement, its lack of internal hardware, *is further improved*. It now has a non-emitting grid, an improved filament, and a cooler operating plate. These improved elements, the result of wartime developments in manufacturing technique, are being incorporated in many Eimac tubes and are consistently resulting in vastly increased life.

The 35TG is a power triode of wide applicability. It will function as a Class-C oscillator or amplifier, or as a Class-B audio or supersonic amplifier, and in such service will give excellent performance, due to its stability and low driving-power requirements.

Longer operating life is but one of the many advantages afforded by Eimac tubes. It will pay you to keep informed... see your nearest Eimac representative today, or write direct.

ELECTRICAL CHARACTERISTICS	
Filament: Thoriated tungsten	
Voltage	5.0 volts
Current	4.0 amperes
Amplification Factor (Average)	39
Direct Interelectrode Capacitances (Average)	
Grid-Plate	1.8 uuf
Grid-Filament	2.5 uuf
Plate-Filament	0.4 uuf
Transconductance ($i_b = 100 \text{ ma.}, E_b = 2000 \text{ V.}, E_c = -30 \text{ V.}$)	2850 umhos
Frequency for Maximum Ratings	100 mc

Follow the leaders to



EITEL-McCULLOUGH, INC.
1229E San Mateo Ave., San Bruno, Calif.
Plant located at: San Bruno, California

Export Agents: Frazar and Hansen, 301 Clay Street, San Francisco 11, California, U. S. A

CALL IN AN EIMAC REPRESENTATIVE FOR INFORMATION

- ROYAL J. HIGGINS (W9AIO), 600 S. Michigan Ave., Room 818, Chicago 5, Illinois. Phone: Harrison 5948.
- ADOLPH SCHWARTZ (W2CN), 220 Broadway, Room 2210, New York 7, N. Y. Phone: Carlind 7-0011.
- VERNER O. JENSEN, CO., 2616 Second Ave., Seattle 1, Washington. Phone: Elliott 6871.
- HERB BECKER (W6QD), 1406 S. Grand Ave., Los Angeles 15, California. Phone: Richmond 6191.
- M. B. PATTERSON (WSCI), 1124 Irwin-Keasler Bldg., Dallas 1, Texas. Phone: Central 5764.
- TIM COAKLEY (W1KKP), 11 Beacon Street, Boston 8, Massachusetts. Phone: Capitol 0050.

*Do you know that **MALLORY**
makes all these products?*



MALLORY products cover a wide territory—and so does the Mallory technical information that backs them up. Both are supreme in their field. Both are important to the business you run. If any of the publications listed at the right are not in your Engineering Library, contact your Mallory representative. He'll be glad to make you up a special portfolio.

*... and backs them up with
all this technical data ...*

- Approved Precision Products Catalog
- Electrical Contact Catalog
- Electrical Contact Data Book
- Capacitor Catalog
- AC Capacitor Data Folder
- Grid Bias Cells Data Folder
- Heavy Duty Rectifier Catalog
- RN Resistor Data Folder
- Radio Interference Eliminator Folder
- Radio Service Encyclopedia
- Resistance Welding Catalog
- Resistance Welding Data Book
- RL and RS Switch Data Folders
- Technical Manual
- Replacement Vibrator Guide
- Vibrator Engineering Data Folder
- Vibrator Data Book (in preparation)

P. R. MALLORY & CO., Inc.
**MALLORY APPROVED
PRECISION PRODUCTS**

P. R. MALLORY & CO., Inc., INDIANAPOLIS 6, INDIANA



CROSS TALK

► **SPIRAL** . . . The inflationary spiral in which we are now having a moderately good time is well publicized in the press. It is a phenomenon which can be controlled within the borders of any one country whenever and if the people of that country wish. No one outside the country need be consulted. On a wider basis, of course, international action is required.

There is another spiral in which we are presently engaged which gets no publicity and which is dangerous to stop. This spiral got its start in the last war when it was highly desirable to develop an antidote for each new wartime weapon our enemies might produce. Thus for each new device a counter measure must be provided not only to disrupt a similar device produced by the enemy but to find the holes in our own equipment and plug them before they are discovered by the enemy.

This cycle of developing a new weapon, then a counter means to it, then a new weapon to dodge the counter measure and so on soon develops into a spiral in which the stakes get progressively higher. It is a game in which all nations must play and in which the end point is utter destruction.

This spiral cannot be controlled by any one country lest it be destroyed. Only the highest echelons of command can do anything about such a situation, which requires action on an international basis. Otherwise a great portion of everybody's time and energy and brains will be involved in producing instruments of death and destruction of even greater refinements than existed in the last war.

► **FM** . . . Present day thinking of the broadcast people is indicated by statements made at the FCC hearings on clear channels late in April. CBS President Frank Stanton gave his opinion that f-m would supplant a-m in three years; Mark Woods, president of

ABC, gave 10 years as his guess. The important thing to note is the feeling that f-m will practically put a-m out of business. Mr. Stanton visualized a 200-station f-m network as serving 90 percent of the U. S. population, aided by a few high power (really high power, this time) a-m jobs located at strategic points to cover the places where f-m won't get in. Mr. Stanton also stated that 20 of the Westinghouse stratovision planes might cover over 90 percent of the country with f-m.

This trend, of course, is inevitable—has been so from the beginning and has been evident to all who were not afraid to look. In the meantime the nation's broadcast set manufacturers are hell bent on loading dealers with table models without f-m. In fact, the glut of these small boxes is now so great that you can walk down practically any street in New York or Chicago and find a half dozen stores loaded to the gills with sets of this type. Someone, soon, ought to get consoles ready for those millions of people who want something big and loud, something that will make a real dent in their pocket books and relieve them of that awful feeling of having a big wad of money and no place to spend it except at the races.

And, by the way, is it possible that the programs are somewhat better lately?

► **SURPLUS** . . . Considerable annoyance has been expressed by radio stores, long in business, at one of the large New York department stores which was able to purchase several thousand surplus military transmitter-receivers at around \$40 and promptly unload them by full page ads in the newspapers at around \$80. Dealers claim they would have been glad to turn them over at very small profit to their customers of long standing. The sets, by the way, set the government back some \$1,100.

RAILROAD RADIO

... from FCC

Use of radio in yards and terminals has such obvious advantages that railroads require little urging to adopt it. Employment of radio along main lines, for the promotion of public safety and convenience, needs stimulation. Regulations should be flexible enough to provide it

WHEN THE Federal Communications Commission, on December 31, 1945, made finally effective its rules governing the new railroad radio service, it was tantamount to an announcement that, so far as that agency was concerned, the use of radio by the railroads could henceforth proceed on a regular, non-experimental basis.

The FCC's fundamental responsibilities for encouraging railroad use of radio having largely come to an end with its establishment of the railroad radio service, the problem now passes to the Interstate Commerce Commission. The essential nature of the problems with which the ICC must now deal appears in the following excerpt from Section 25 of the Interstate Commerce Act:

"(b) That the Commission may, after investigation, if found necessary in the public interest, order any carrier within a time specified in the order, to install the block signal system, interlocking, automatic train stop, train control, and/or cab-signal devices, and/or other similar appliances, methods, and systems intended to promote the safety of railroad operation, which comply with specifications and requirements prescribed by the Commission, upon the whole or any part of its railroad such order to be issued and published a reasonable time (as determined by the Commission) in advance of the date for its fulfillment"

The broad, general nature of the language italicized by the author would seem to give the ICC plenary authority to require the installation of train radio systems. Some question might be raised regarding the authority of the ICC to order installations in yard and terminal areas,

* The views expressed in this article are personal to the author.

however. Although such systems indubitably "promote the safety of railroad operation" wherever employed, it might be argued that the yard and terminal radio communication system is not "similar" to the block signal system, train control devices, etc, used in main-line operations and

Table I—Track Mileage of United States Railways

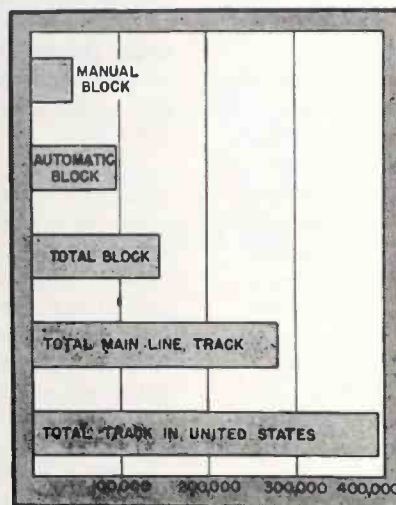

which were specifically mentioned in Section 25 as coming within the ICC's authority. While the exact meaning of the italicized phrase has not been determined by the ICC or the courts, it is believed that a narrow construction would not be put upon the ICC's authority if the question were to arise.

Yard and Terminal Equipment

The ICC's authority to order the installation of train communication systems in yard and terminal, as well

as main-line operations is not likely to be placed in issue, because the present practicability and desirability of using radio for yard and terminal communications has been convincingly demonstrated. The Superintendent of Telegraphs of the Chicago, Burlington and Quincy Railroad recently summarized that road's experience in the use of radio, with one fixed station and several radio-equipped diesel-electric switch engines operating in the Chicago yards, in this way:¹

" We have found the service to be dependable and effective throughout that portion of the Chicago switching district in which we operate, which has a radius of about 18 miles Our operating people, after these many months of actual experience, consider that the productivity of a diesel-electric switch locomotive and the crew operating it is increased from 5 to 6 percent by the application of the radio telephone. The cost of equipping a diesel-electric switching locomotive with radio is only slightly more than 1 percent of the cost of the locomotive itself"

It thus appears that the principal problems confronting the ICC will probably not revolve about yard and terminal installations, the efficacy and advantages of which have been demonstrated. There will, of course, be certain problems incident to fixing the conditions and methods of operation of yard and terminal train communication systems in regular use. But it is not likely that these conditions will materially affect the rapid pace of yard and terminal installations. For reasons to be outlined, this is not true, however, in the case of installations that will be used to control the movement of trains over main-line track outside the yard and

to ICC

By
JEREMIAH COURTNEY*

Chief, Safety and Special Services Div.
Law Department
Federal Communications Commission
Washington, D. C.

terminal areas (and ultimately to provide telephone service for passenger use). In this field, the use of radio holds forth the brightest prospects for improving railroad performance.

Main Line Operations

Unlike yard and terminal installations, the advantages of radio communications in main-line operations are less susceptible of exact evaluation by an experimental program limited in time or area of application. It is therefore of the greatest importance that the conditions and specifications prescribed by the ICC regarding the use of radio communications for the control of main-line train movements shall not unduly restrict the carriers' experimentation with, or adoption of, a tool which holds forth so much promise to the railroad performance of the future.

For purposes of illustrating the foregoing general statement of the major problem now facing the ICC, let us consider a specific question. Should the ICC approve the use of radio for en-route communications control only if the conventional, but expensive, block signal system has first been installed? The importance of this question can be readily perceived when it is realized that on nearly half the main-line track in the United States neither manual nor automatic block systems are in use.² If roads are to be denied the use of radio for en-route communications control purposes until a block signal system has been installed, it will unquestionably seriously retard the wide use of radio in main-line operations.



An engineer out on the main line receives instructions from his dispatcher via radio

This is not to suggest that the radio block system should now supersede the present manual or automatic block signal system on roads employing such systems. The use of radio on such roads supplements the existing system.

Automatic Block and Radio

The testimony of W. R. Triem, General Superintendent of Telegraph of the Pennsylvania Railroad, at the FCC railroad radio hearing, made it abundantly clear that the expense of equipping fixed points and front and rear of trains with radio equipment is entirely warranted, even on roads 100 percent block-controlled.

Even conceding, however, as the ICC once stated, that the conventional block signal system "is the best method known for preventing collisions between trains"³ there is no denying the fact that many thousands of miles of passenger-operated road are still being operated without that best-known method for preventing train collisions. The reason for this situation is quite simple. In the opinion of the railway management concerned, the relatively low-density traffic handled over such non-block sections has not warranted the costs of block installation and maintenance.

That the less expensive radio system, certainly offering a large meas-

ure of added security, may be fully justified in such cases may be seen in the testimony of another railway official. Samuel W. Fordyce, III, Assistant to the President of the Kansas City Southern Railway Company and the Louisiana & Arkansas Railway Company, testified at the FCC railroad radio hearing that a complete installation of radio equipment on all of the road's trains and at all desirable fixed points would require an outlay of \$440,000. Assuming that the equipment would require complete depreciation over only a five year period, his company felt that the outlay was entirely justified because it was estimated that the operating savings possible through the use of radio communications would exceed \$88,000 yearly, without even considering the value of the added safety factors. To equip the road with automatic block protection, however, would cost an estimated \$7,800,000 which, in his opinion, could not be justified on any economic grounds.

Under such circumstances, to condition the use of radio for en-route communications control on the prior installation of a block system is to deny the use of radio. It is not only to deny the use of radio but probably the development of a system which, on roads of low-density traffic, may be found as fully effective for the



Radio communication from end-to-end of a 125-car freight improves performance

prevention of train collisions as the presently better-known manual or automatic block signal controls.

Supplementing Manual Block

The density of traffic that flows over automatic-block protected track will probably justify in most cases the supplementation of such systems with two-way radio, because of the flexibility of control in train movements and the possibilities for preventing traffic tieups if the conductor and train dispatcher can be in instantaneous touch with each other.

In the case of manual block systems, operators at each end of the block control the movement of a train from one block of track to another. Because of the cost of operation of the manual block system, the blocks are quite long, averaging between 12 and 15 miles, as contrasted with between 1 and 2 miles for automatic block systems. The length of these blocks leads to permissive movements, i.e., Train *B* will be allowed to follow Train *A* on the same block; or Trains *A* and *B*, going in opposite directions, may be allowed to occupy the same block for the purpose of meeting at an intermediate point where one may pass the other on a siding.

Thus there is an even greater need for definitizing the position of all

trains on the block in the case of a manual block system, which is readily possible through the instantaneous communication radio permits between fixed control point and moving train, and between trains. Indeed, it may well be that experience with radio en-route communications will prove that type of train control superior to the manual block system of operation with the permissive train movements above described. If so, considerable savings in the costs of operation may be made possible through lengthening of the blocks, for example, or by

expediting the flow of traffic by increasing the number of permissive movements.

The Course Ahead

As it can be seen, the course the ICC must chart in the development of railroad use of radio is not an easy one. Under all three methods of main-line train operations—time-table and train order; time-table, train order and manual block; and time-table, train order and automatic block—the common problem will be the establishment of routines which will, consistent with safety of operation, permit the maximum advantage to be taken of this new tool for improving railroad performance. A sound evaluation of the problems posed by the application of radio to railroad operations cannot be expected if approached with the fixed view that the unchanging basis of all safe operation is to be found only in the block signal system.

The long experience the ICC has had in the railroad field and its continued championing and adoption of other safety devices such as the block system, interlocking switches and automatic cab signals, presages the sound handling of the problems raised by the application of this latest safety measure to railroad main-line operations.

REFERENCES

- (1) Hasselbacker, H. H., Modern Railroad Communication, *The Commercial and Financial Chronicle*, Dec. 20, 1945.
- (2) 59th Annual Report of the Bureau of Safety, ICC, p 98 and p 133, Nov. 1, 1945.
- (3) Report of the Bureau of Safety, ICC, p 14, June 30, 1943.

Table II—Railroad Radio Frequencies

EXCLUSIVE	SHARED	EXPERIMENTAL
158.4 to 162 mc	44 to 50, 54 to 60, 60 to 66, 66 to 72, 76 to 82, 186 to 192, 192 to 198, 198 to 204, 204 to 210, 210 to 216 mc	1375 to 1425, 1750 to 2100, 2450 to 2700, 3700 to 4000, 4200 to 4400, 5650 to 7050, 10500 to 13000, 16000 to 18000, 26000 to 30000 mc
(This provides 60 channels, each 60-ke wide, primarily for end-to-end and fixed-point-to-train communications. Use on a secondary basis for yard and terminal communications permitted)	(Specific channels will be assigned in television channels 1-5 and 9-13 for short-range yard and terminal railroad communications on a mutually non-interfering basis)	(Specific channels will be assigned from fixed and mobile bands for railroad experimental programs in these higher-frequency ranges)

Electronic NIGHT SIGHT



The target is illuminated by infrared light and a combination orthicon and cathode-ray tube with a built-in electron multiplier converts the reflected light into a visible image

The night sight mounted on a 30-calibre carbine, showing the sighting and aiming telescope (receiver) above the barrel, the "near infrared" lightsource (transmitter) below it, and the powerpack on the marksman's back

SIMILAR to a German infrared night sight described in the *Tools at Work* department of this issue of *ELECTRONICS*, a "Sniperscope" demonstrated to the press by Electronic Laboratories, Inc., of Indianapolis is effective up to 60 yards in complete darkness. The marksman switches on a light virtually invisible to the naked eye, sees an image of the target on the screen of a special electronic tube, and squeezes the trigger.

Light produced by a 6-volt 30-watt lamp is sharply focused and directed toward the target through a "near infrared" filter. Light reflected from the target passes through an optical lens system and forms an image on the mosaic of a tube similar to the orthicon type used in television transmitter pickup cameras, except for the fact that it is sensitive in the region between 80,000 and 120,000 Angstrom units. Within this same tube, which employs an electron-multiplier type photoelectric cathode, the infrared image is converted into a visible image by an electrostatically focused cathode-ray section similar to those employed within television receiver picture tubes, and the marksman peers at this image through a magnifying lens system. Resolution, in television terms, is about the equivalent of 600 lines.

The lightsource is operated directly from a rechargeable wet, but non-spillable, battery. The tube obtains 4,500 volts of d-c for the various anodes, control grids, and focusing electrodes from a vibrator. No filament power is required. The battery, operating both the lightsource and the tube, will last for 6 hours on

continuous duty. Total current drain is 36 watts.

In addition to the Sniperscope, designed for mounting on a carbine, a "Snooperscope" intended for detection of infiltrating enemy troops and the reading of maps in darkness was shown. Some 6,000 of these two models using Sylvania and Farnsworth tubes were manufactured and delivered to the military during the war. They were extensively used by the 10th Army based on Hawaii, and by the Marines at Saipan, as early as December 1944. Three other models have also been built, for use in conjunction with anti-aircraft weapons, in night-fighting aircraft, and in tanks. Reporters were told that one model employing a tube containing radium is so sensitive in the "far infrared" region that it can detect a camouflaged tank by engine heat hours after the motors are shut down. This particular model, by vir-

tue of the shorter light wavelength employed, is also quite effective through fog. The models shown were only 30 percent more effective in fog than white light would be.

The Sniperscope sold to the government for about \$750, according to company engineers. Commercial versions, it was said, might eventually be developed for about half this price for police and other law-enforcement agencies, depending to a large extent upon the sales volume attained. Other potential peacetime applications would include use by aircraft to bridge the gap left by most radio and radar blind-landing apparatus in the last 50 feet above ground, safe navigation for shipping at night or in dense fog, and perhaps ultimately fog-piercing apparatus for railroads and even for automobiles. Experimental infrared apparatus has operated effectively at distances up to $\frac{1}{2}$ mile.—W. MACD.

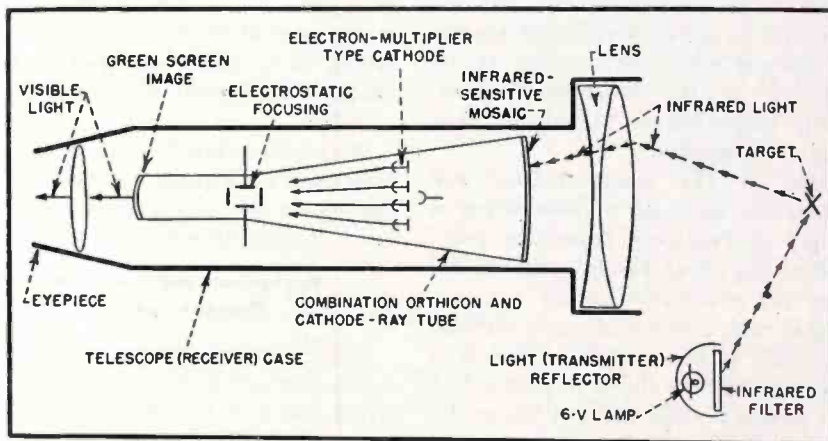

Simplified block diagram of the system, the heart of which is a special television-type tube having a mosaic sensitive in the infrared region between 80,000 and 120,000 Angstroms, a photoelectric cathode of the electron-multiplier type, and an electrostatically focused cathode-ray

RAILROAD RADIO

... from FCC

Use of radio in yards and terminals has such obvious advantages that railroads require little urging to adopt it. Employment of radio along main lines, for the promotion of public safety and convenience, needs stimulation. Regulations should be flexible enough to provide it

WHEN THE Federal Communications Commission, on December 31, 1945, made finally effective its rules governing the new railroad radio service, it was tantamount to an announcement that, so far as that agency was concerned, the use of radio by the railroads could henceforth proceed on a regular, non-experimental basis.

The FCC's fundamental responsibilities for encouraging railroad use of radio having largely come to an end with its establishment of the railroad radio service, the problem now passes to the Interstate Commerce Commission. The essential nature of the problems with which the ICC must now deal appears in the following excerpt from Section 25 of the Interstate Commerce Act:

"(b) That the Commission may, after investigation, if found necessary in the public interest, order any carrier within a time specified in the order, to install the block signal system, interlocking, automatic train stop, train control, and/or cab-signal devices, and/or other similar appliances, methods, and systems intended to promote the safety of railroad operation, which comply with specifications and requirements prescribed by the Commission, upon the whole or any part of its railroad such order to be issued and published a reasonable time (as determined by the Commission) in advance of the date for its fulfillment"

The broad, general nature of the language italicized by the author would seem to give the ICC plenary authority to require the installation of train radio systems. Some question might be raised regarding the authority of the ICC to order installations in yard and terminal areas;

* The views expressed in this article are personal to the author.

however. Although such systems indubitably "promote the safety of railroad operation" wherever employed, it might be argued that the yard and terminal radio communication system is not "similar" to the block signal system, train control devices, etc, used in main-line operations and

Table I—Track Mileage of United States Railways

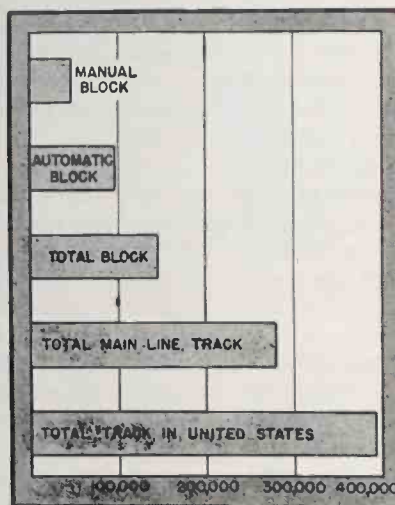

which were specifically mentioned in Section 25 as coming within the ICC's authority. While the exact meaning of the italicized phrase has not been determined by the ICC or the courts, it is believed that a narrow construction would not be put upon the ICC's authority if the question were to arise.

Yard and Terminal Equipment

The ICC's authority to order the installation of train communication systems in yard and terminal, as well

as main-line operations is not likely to be placed in issue, because the present practicability and desirability of using radio for yard and terminal communications has been convincingly demonstrated. The Superintendent of Telegraphs of the Chicago, Burlington and Quincy Railroad recently summarized that road's experience in the use of radio, with one fixed station and several radio-equipped diesel-electric switch engines operating in the Chicago yards, in this way:

" We have found the service to be dependable and effective throughout that portion of the Chicago switching district in which we operate, which has a radius of about 18 miles Our operating people, after these many months of actual experience, consider that the productivity of a diesel-electric switch locomotive and the crew operating it is increased from 5 to 6 percent by the application of the radio telephone. The cost of equipping a diesel-electric switching locomotive with radio is only slightly more than 1 percent of the cost of the locomotive itself"

It thus appears that the principal problems confronting the ICC will probably not revolve about yard and terminal installations, the efficacy and advantages of which have been demonstrated. There will, of course, be certain problems incident to fixing the conditions and methods of operation of yard and terminal train communication systems in regular use. But it is not likely that these conditions will materially affect the rapid pace of yard and terminal installations. For reasons to be outlined, this is not true, however, in the case of installations that will be used to control the movement of trains over main-line track outside the yard and

to ICC

By
JEREMIAH COURTNEY*

*Chief, Safety and Special Services Div.
Law Department
Federal Communications Commission
Washington, D. C.*

terminal areas (and ultimately to provide telephone service for passenger use). In this field, the use of radio holds forth the brightest prospects for improving railroad performance.

Main Line Operations

Unlike yard and terminal installations, the advantages of radio communications in main-line operations are less susceptible of exact evaluation by an experimental program limited in time or area of application. It is therefore of the greatest importance that the conditions and specifications prescribed by the ICC regarding the use of radio communications for the control of main-line train movements shall not unduly restrict the carriers' experimentation with, or adoption of, a tool which holds forth so much promise to the railroad performance of the future.

For purposes of illustrating the foregoing general statement of the major problem now facing the ICC, let us consider a specific question. Should the ICC approve the use of radio for en-route communications control only if the conventional, but expensive, block signal system has first been installed? The importance of this question can be readily perceived when it is realized that on nearly half the main-line track in the United States neither manual nor automatic block systems are in use.² If roads are to be denied the use of radio for en-route communications control purposes until a block signal system has been installed, it will unquestionably seriously retard the wide use of radio in main-line operations.



An engineer out on the main line receives instructions from his dispatcher via radio

This is not to suggest that the radio block system should now supersede the present manual or automatic block signal system on roads employing such systems. The use of radio on such roads supplements the existing system.

Automatic Block and Radio

The testimony of W. R. Triem, General Superintendent of Telegraph of the Pennsylvania Railroad, at the FCC railroad radio hearing, made it abundantly clear that the expense of equipping fixed points and front and rear of trains with radio equipment is entirely warranted, even on roads 100 percent block-controlled.

Even conceding, however, as the ICC once stated, that the conventional block signal system "is the best method known for preventing collisions between trains"³ there is no denying the fact that many thousands of miles of passenger-operated road are still being operated without that best-known method for preventing train collisions. The reason for this situation is quite simple. In the opinion of the railway management concerned, the relatively low-density traffic handled over such non-block sections has not warranted the costs of block installation and maintenance.

That the less expensive radio system, certainly offering a large meas-

ure of added security, may be fully justified in such cases may be seen in the testimony of another railway official. Samuel W. Fordyce, III, Assistant to the President of the Kansas City Southern Railway Company and the Louisiana & Arkansas Railway Company, testified at the FCC railroad radio hearing that a complete installation of radio equipment on all of the road's trains and at all desirable fixed points would require an outlay of \$440,000. Assuming that the equipment would require complete depreciation over only a five year period, his company felt that the outlay was entirely justified because it was estimated that the operating savings possible through the use of radio communications would exceed \$88,000 yearly, without even considering the value of the added safety factors. To equip the road with automatic block protection, however, would cost an estimated \$7,800,000 which, in his opinion, could not be justified on any economic grounds.

Under such circumstances, to condition the use of radio for en-route communications control on the prior installation of a block system is to deny the use of radio. It is not only to deny the use of radio but probably the development of a system which, on roads of low-density traffic, may be found as fully effective for the

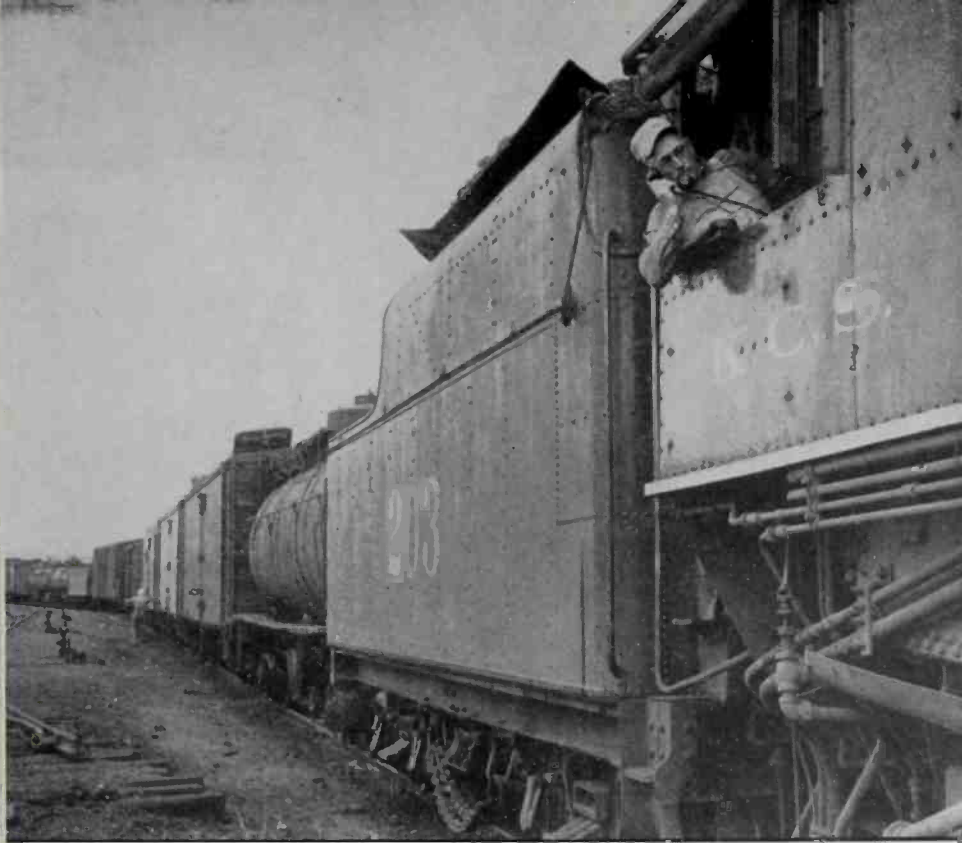

Radio communication from end-to-end of a 125-car freight improves performance

prevention of train collisions as the presently better-known manual or automatic block signal controls.

Supplementing Manual Block

The density of traffic that flows over automatic-block protected track will probably justify in most cases the supplementation of such systems with two-way radio, because of the flexibility of control in train movements and the possibilities for preventing traffic tieups if the conductor and train dispatcher can be in instantaneous touch with each other.

In the case of manual block systems, operators at each end of the block control the movement of a train from one block of track to another. Because of the cost of operation of the manual block system, the blocks are quite long, averaging between 12 and 15 miles, as contrasted with between 1 and 2 miles for automatic block systems. The length of these blocks leads to permissive movements, i.e., Train *B* will be allowed to follow Train *A* on the same block; or Trains *A* and *B*, going in opposite directions, may be allowed to occupy the same block for the purpose of meeting at an intermediate point where one may pass the other on a siding.

Thus there is an even greater need for definitizing the position of all

trains on the block in the case of a manual block system, which is readily possible through the instantaneous communication radio permits between fixed control point and moving train, and between trains. Indeed, it may well be that experience with radio en-route communications will prove that type of train control superior to the manual block system of operation with the permissive train movements above described. If so, considerable savings in the costs of operation may be made possible through lengthening of the blocks, for example, or by

expediting the flow of traffic by increasing the number of permissive movements.

The Course Ahead

As it can be seen, the course the ICC must chart in the development of railroad use of radio is not an easy one. Under all three methods of main-line train operations—time-table and train order; time-table, train order and manual block; and time-table, train order and automatic block—the common problem will be the establishment of routines which will, consistent with safety of operation, permit the maximum advantage to be taken of this new tool for improving railroad performance. A sound evaluation of the problems posed by the application of radio to railroad operations cannot be expected if approached with the fixed view that the unchanging basis of all safe operation is to be found only in the block signal system.

The long experience the ICC has had in the railroad field and its continued championing and adoption of other safety devices such as the block system, interlocking switches and automatic cab signals, presages the sound handling of the problems raised by the application of this latest safety measure to railroad main-line operations.

REFERENCES

- (1) Hasselbacker, H. H., *Modern Railroad Communication, The Commercial and Financial Chronicle*, Dec. 20, 1945.
- (2) 59th Annual Report of the Bureau of Safety, ICC, p 98 and p 133, Nov. 1, 1945.
- (3) Report of the Bureau of Safety, ICC, p 14, June 30, 1943.

Table II—Railroad Radio Frequencies

EXCLUSIVE	SHARED	EXPERIMENTAL
158.4 to 162 mc	44 to 50, 54 to 60, 60 to 66, 66 to 72, 76 to 82, 186 to 192, 192 to 198, 198 to 204, 204 to 210, 210 to 216 mc	1375 to 1425, 1750 to 2100, 2450 to 2700, 3700 to 4000, 4200 to 4400, 5650 to 7050, 10500 to 13000, 16000 to 18000, 26000 to 30000 mc
(This provides 60 channels, each 60-kc wide, primarily for end-to-end and fixed-point-to-train communications. Use on a secondary basis for yard and terminal communications permitted)	(Specific channels will be assigned in television channels 1-5 and 9-13 for short-range yard and terminal railroad communications on a mutually non-interfering basis)	(Specific channels will be assigned from fixed and mobile bands for railroad experimental programs in these higher-frequency ranges)



The night sight mounted on a 30-calibre carbine, showing the sighting and aiming telescope (receiver) above the barrel, the "near infrared" lightsource (transmitter) below it, and the powerpack on the marksman's back

Electronic NIGHT SIGHT

The target is illuminated by infrared light and a combination orthicon and cathode-ray tube with a built-in electron multiplier converts the reflected light into a visible image

SIMILAR to a German infrared night sight described in the *Tubes at Work* department of this issue of **ELECTRONICS**, a "Sniperscope" demonstrated to the press by Electronic Laboratories, Inc., of Indianapolis is effective up to 60 yards in complete darkness. The marksman switches on a light virtually invisible to the naked eye, sees an image of the target on the screen of a special electronic tube, and squeezes the trigger.

Light produced by a 6-volt 30-watt lamp is sharply focused and directed toward the target through a "near infrared" filter. Light reflected from the target passes through an optical lens system and forms an image on the mosaic of a tube similar to the orthicon type used in television transmitter pickup cameras, except for the fact that it is sensitive in the region between 80,000 and 120,000 Angstrom units. Within this same tube, which employs an electron-multiplier type photoelectric cathode, the infrared image is converted into a visible image by an electrostatically focused cathode-ray section similar to those employed within television receiver picture tubes, and the marksman peers at this image through a magnifying lens system. Resolution, in television terms, is about the equivalent of 600 lines.

The lightsource is operated directly from a rechargeable wet, but non-spillable, battery. The tube obtains 4,500 volts of d-c for the various anodes, control grids, and focusing electrodes from a vibrator. No filament power is required. The battery, operating both the lightsource and the tube, will last for 6 hours on

continuous duty. Total current drain is 36 watts.

In addition to the Sniperscope, designed for mounting on a carbine, a "Snooperscope" intended for detection of infiltrating enemy troops and the reading of maps in darkness was shown. Some 6,000 of these two models using Sylvania and Farnsworth tubes were manufactured and delivered to the military during the war. They were extensively used by the 10th Army based on Hawaii, and by the Marines at Saipan, as early as December 1944. Three other models have also been built, for use in conjunction with anti-aircraft weapons, in night-fighting aircraft, and in tanks. Reporters were told that one model employing a tube containing radium is so sensitive in the "far infrared" region that it can detect a camouflaged tank by engine heat hours after the motors are shut down. This particular model, by vir-

tue of the shorter light wavelength employed, is also quite effective through fog. The models shown were only 30 percent more effective in fog than white light would be.

The Sniperscope sold to the government for about \$750, according to company engineers. Commercial versions, it was said, might eventually be developed for about half this price for police and other law-enforcement agencies, depending to a large extent upon the sales volume attained. Other potential peacetime applications would include use by aircraft to bridge the gap left by most radio and radar blind-landing apparatus in the last 50 feet above ground, safe navigation for shipping at night or in dense fog, and perhaps ultimately fog-piercing apparatus for railroads and even for automobiles. Experimental infrared apparatus has operated effectively at distances up to $\frac{1}{2}$ mile.—W. MACD.

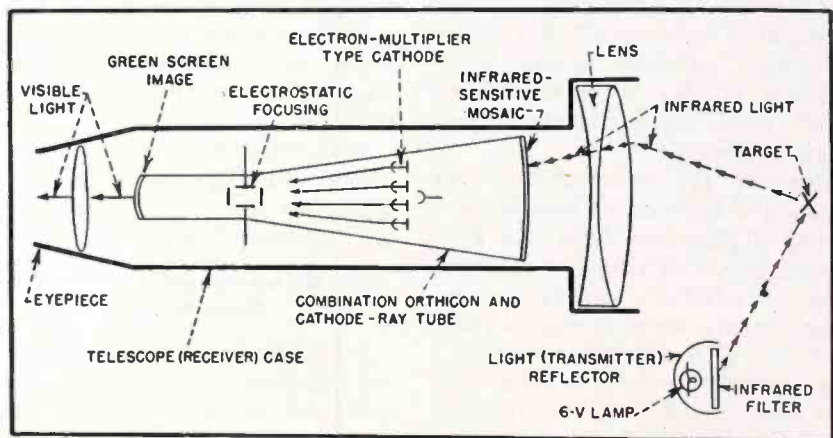

Simplified block diagram of the system, the heart of which is a special television-type tube having a mosaic sensitive in the infrared region between 80,000 and 120,000 Angstroms, a photoelectric cathode of the electron-multiplier type, and an electrostatically focused cathode-ray

Rear view of the central-station unit showing cords connecting microphones or a remote desk set and dial. Besides an audio mixer and automatic restoring-pulse generator the unit includes a power supply

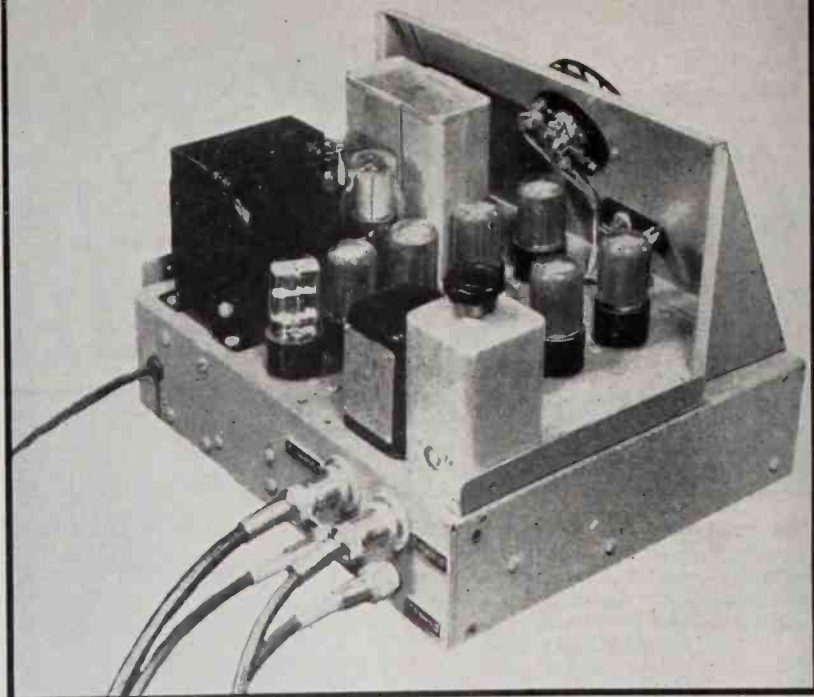

FOR MANY YEARS there have been in existence a number of radio communications systems which were installed primarily as a means of controlling the action of mobile units from a central authority. Police and public utilities systems are the most familiar examples. With the development of new, improved mobile equipment to satisfy a public demand for this type of service a manifold increase may be expected in the use of such systems and this increase will bring with it new problems.

The time-honored announcement "calling all cars" or "calling car X-78", is on the way out. Even in a well-disciplined group represented by police personnel, misunderstanding of verbal signals and the ability of any car to come on the air at will jeopardizes the system. Control of tugboat or taxi fleets in which the operators of the mobile units may forget their call numbers or may unthinkingly break in upon established communications demands a foolproof calling system with lockout of unwanted mobile transmitters. The calling code must be sufficiently distinctive so that receivers will not respond to skywave-reflected signals of distant medium-frequency transmitters or the occasional abnormally long-distance signals on very high frequencies.

One of the most obvious and attractive methods of controlling a group of receivers from one point makes use of an easily operated device for effectively keying a transmitter with a series of coded signals, one for each receiver, in such a manner that an alarm is sounded at the mobile station without the necessity for continuously monitoring the carrier frequency of the central transmitter. A truly satisfactory system of control would be one in

Positive control of remote communications equipment in police, taxi or other mobile fleets. Equipment is applicable to new or existing transmitters and receivers

By J. K. KULANSKY

*Project Engineer
Hammarlund Manufacturing Co., Inc.
New York, N. Y.*

which a "black box" is connected to any of the various types of receivers now in use in order to accomplish the desired effects. By the same token, the signalling device at the transmitter should be a similar self-contained unit, easily attached to any standard equipment with a minimum of effort.

With these objectives in mind, the Hammarlund Manufacturing Co. has designed a fleet-control system which has a number of unique features.

Mechanical and Electrical Characteristics

Moderate-size equipment which can be connected to the speech input circuit of any central-control radio transmitter now in use without adversely affecting the normal audio function is used. The mobile decoder is a small, low-current-drain unit to

be added to equipment already installed in vehicles or craft or for inclusion on the chassis of new receiving equipment.

The code transmitter operates directly into a 500 or 600-ohm audio input at a level of 0-350 millivolts and furnishes an appropriate input circuit for a dynamic or carbon-button microphone or handset in such a manner that there need be no switching between the control and communication function. The receiving equipment is capable of operating reliably with a properly coded signal from the receiver output stage at a level approximately 15 db down from the normal audio signal.

Operational Procedure

The control operator or dispatcher can select any one of 84 different receivers, or all 84 at once, by dialing a



Front view of the central-station selective calling unit. This type of construction is used for older installations where there is no room for another panel in existing equipment

Calling System

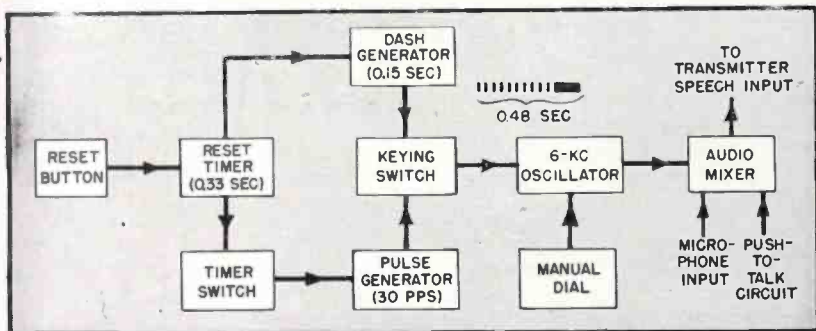

FIG. 1—Block diagram of the central-station coder. The manual telephone dial keys a 6-kc oscillator to signal the mobile units. All the blocks to the left represent circuit elements used in automatically clearing the system for the next call

bur-digit number, such as 2611, the digits of which total 10. At the conclusion of his transmission, he can clear the system quickly in order to initiate further selective calls or to allow the previously locked-out stations to call the master control. The receiving station accepts its coded call and is automatically put into condition to transmit a reply, even with a signal only 3 db above hash-noise applied to the input of the decoder unit. A visual signal light indicates to the operator the condition of the facilities. The receivers not called reject the coded signals, but a warning light shows that the system is busy and unwanted mobile transmitters are locked out of use. Laboratory tests so far indicate that receivers so equipped do not respond to spurious signals of any kind, either voice frequencies, audio tones,

or signals from adjacent systems which utilize the same type or other coded calling systems.

Under certain conditions, when the full 84 mobile stations are not required, the system can be modified to allow a lesser number to be called, one at a time, in any desired sequence. This procedure is effected without releasing the previous calls or calling all stations at once.

Central Station Coder

The central station coder (pictured here) consists of a cabinet 10 x 10 x 12 inches, weighing 22½ pounds. Main power switch, indicating light and primary fuse are located near the lower front edge. The operating controls, a standard telephone dial and a momentary-contact pushbutton, are located on the sloping panel. Microphone and other connections

appear at the rear of the unit (also illustrated). Dial and reset button carry direct current only and so can be remotely located if desired.

A block diagram of the central-station apparatus is shown in Fig. 1. The heart of the transmitting apparatus is the 6-kc tone oscillator which, together with the dialing impulses, furnishes the necessary signal-to-noise discrimination for reliable signalling. Extremely stable oscillations at the desired frequency have been obtained from a kallitron-type oscillator. In this circuit a negative resistance produced by a modified form of multivibrator is used across the primary of an output transformer for the tone oscillator. The dial contacts merely reduce grid bias in such a way as to key the circuit. In actual practice, with the frequency discrimination available at the receiving apparatus, it is possible to use signalling channels about 1,000 cps apart near 6 kc and about 500 cps apart at the lower limit of 3 kc. The tone impulses are fed into a cathode-follower mixer which allows the use of a dynamic microphone or a desk set immediately after the code signal is dialed, without any additional switching. The output of the mixer feeds the regular speech-input circuit of the radio transmitter.

The rest of the blocks to the left of the tone generator represent the circuit elements used to generate the coded pulses necessary to reset all receiving apparatus at the touch of a button.

The reset timer is a normally-off multivibrator, with a period of 0.33 second, from which the bias is removed by closure of the reset button. At the instant the timer turns on, the normally-off timer switch is also

turned on. This electronic switch then connects the +300-v lead to the pulse generator, a multivibrator operating at 30 pps. By this means, exactly 10 pulses are released from the pulse generator and fed to one grid of the keying switch. These impulses act upon the 6-kc oscillator in the same manner as the dial impulses. However, because of the system requirements, a long pulse of about 0.15 second duration must be made to follow the series of ten short pulses.

The first circuit put into operation by depressing the reset button is the reset timer. At the end of its 0.33-second on period, the multivibrator falls back to its normal position and a positive pulse from the normally-off tube is fed to the dash generator, another multivibrator circuit with a period of 0.15 second, which turns on the second grid of the keying switch. The sum total of these operations results in a complex signal pulse lasting approximately half a second, at the end of which time all mobile equipment is released for new calls.

Mobile Code Receiver

The receiving equipment pictured is complex only in the electromechanical sense, in that the received tone pulses are translated into positions

Table I—
Sample Group Calling System

Car Designation	Individual Code Number	Partial Fleet and Group—Control Numbers		
		19	28	37
A	1117	X	X	X
B	1126	X	X	
C	1135	X	X	
D	1144	X	X	
E	1153	X	X	
F	1162	X	X	
G	1171	X	X	
H	1216	X		X
I	1225	X		X
J	1234	X		X
K	1243	X		X
L	1252	X		X
M	1261	X		X

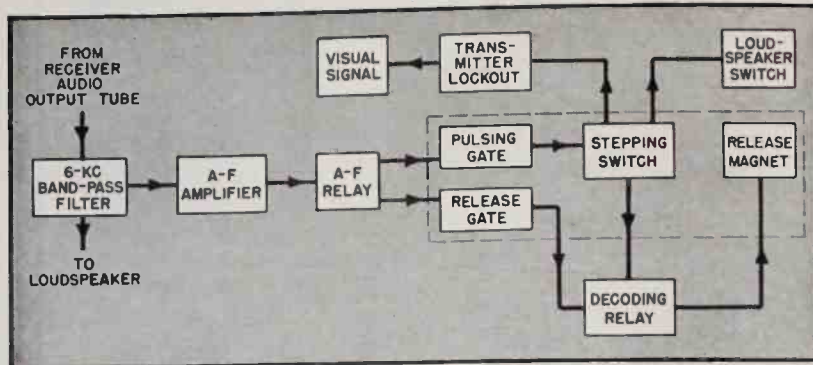

FIG. 2—Simplified block diagram of the mobile decoding equipment. In this device the received 6-kc tone-pulses are converted to the operational sequence positions of a stepping switch or rejected, depending upon the code dialed

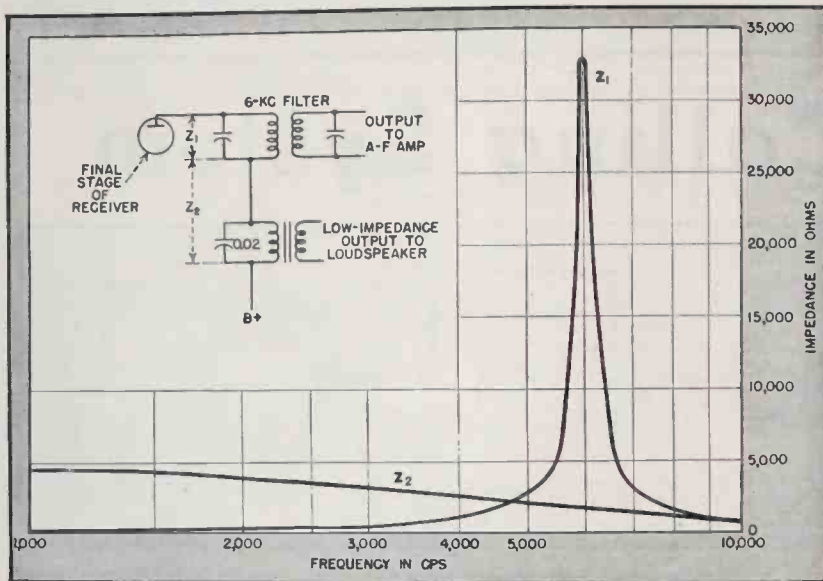

FIG. 3—The mobile decoder is inserted in series with the primary of speaker output transformer in the plate lead of the receiver audio-output tube. The plots of impedance vs frequency across filter and speaker transformer indicate the extreme selectivity of the filter. The speaker response will be down at the signalling frequency, but substantially unaffected in the speech range

of a telephone-type stepping switch. Otherwise, it can easily be connected in the audio output of any receiver, with some additional wiring to provide automatic transmitter lockout and visual indication of a busy system, as shown in the simplified block diagram of Fig. 2.

The 6-kc band-pass filter shown in Fig. 3 is connected in series with the output transformer in the plate lead of the receiver. The transformer is shunted by a relatively low value of capacitance to reduce its impedance to the higher audio frequencies used for calling. The filter primary is sharply tuned to 6 kc, with an input impedance of about 33,000 ohms at that frequency, but it presents a low

impedance of about 200 ohms to voice frequencies. There is therefore no serious speech attenuation by insertion of the coded-calling device.

The first tone impulse passing through the filter turns on the normally-cutoff a-f amplifier which operates a sensitive a-f relay, and locks out the transmitter. At this time, the indicating lamp on the dashboard lights (or a previously lighted lamp dims to half brilliance if this type of system is desired), showing that a call is in progress. Depending upon the wiring of a multiconnector coding plug, the first complete digit dialed either rejects the call or sets up a condition of the switching mechanism for acceptance

further digits. This same form selection takes place upon receipt succeeding digits.

If the received number is correct for the station called, the pulsing rate, which is a part of the stepping relay mechanism, remains open for the duration of each pulse sequence for a digit, until the stepping relay is finally attained its tenth and last step. At this point, the transmitter circuit is unlocked, the visual signal goes out and the loudspeaker is connected to the receiver. If, however, at any point a wrong number for this station comes through, the decoding relay, actuated by the stepping relay and the associated wiring, operates the release magnet of the stepping relay and allows it to fall back to its starting position. The transmitter remains locked out and the indicator lamp remains lighted, showing that it is not possible to operate the mobile transmitter. The loudspeakers on all mobile units are muted during the above sequence to avoid distraction of the mobile operators' attention from other duties.

Calling All Cars

If the central-control operator desires to address all the mobile units at once, he dials zero (actually 10), whereupon all the mobile stepping switches come up to the last position and place the mobile equipments in a condition for two-way operation.

When the dispatcher has concluded communication, he operates the reset button, which causes the transmitter to send out ten short pulses followed by a dash, as described above. All switches, regardless of their previous position, are thereby brought up to the last step and then released by the long dash. The loudspeaker which is normally connected at the moment the stepping switch attains the last contact remains silent during the clearing signal. At the same time, the indicator lamp goes out, showing the mobile operator that the system is again available for use by anyone.

The code number of each vehicle is determined by a multipoint plug which can be quickly inserted or withdrawn from the decoding unit. The plugs are wired according to a definite plan in such a way that all the desired points are tied together. Thus the coding of the vehicle can be changed merely by substituting a

plug differently wired, and stamped with the number to which the equipment will respond.

Physically, the receiving unit is compact, measuring $3\frac{1}{2} \times 3\frac{1}{8} \times 7\frac{1}{8}$ inches above the chassis and extending about 1 inch below. The unit, weighing $3\frac{1}{2}$ pounds, can be replaced in about a minute by loosening four patent fasteners. The coding plug can be quickly shifted from the old to the replacement unit.

Current drain ranges from 3 amperes (at 6 volts) for each pulse during the stepping period, and 0.11 ampere during the transmitter lock-out, down to 0.25 ampere during standby. However, the receiving relays will respond reliably to signals when they are operated from a source of from 5.5 to 7.5 volts, so that there is little danger of the system's becoming inoperative during a period of excessive use or when batteries are being charged.

Possible Variations

Dialing speed is not critical, particularly when faster than normal. The system as basically constituted responds to four-digit numbers, with a limit of 84 stations. If five-digit numbers are permissible, the system can be made to include 126 stations.

In some instances, it may be desired to divide the fleet into several sections and make a general call for each sub-group. Table I illustrates how one section of a fleet, consisting of 13 mobile stations, identified A through M, can be issued a general call by dialing 19 instead of 0 (general call for a whole fleet). In addition, the section can be broken up into two groups, B-G and H-M, with a roving captain represented by A. A general call to the first sub-group can be made by dialing 28, whereas the second sub-group receives a general call when 37 is dialed from the dispatcher's transmitter. It should be noted that in this example station A is included in a general call to either group.

Conclusions

The principles involved in this system can be applied to other remote signalling applications, wire or radio, and variations allow remote control of the transmitting equipment as well as its coded output. The relative simplicity of the equipment is perhaps best attested by its low cost and its variety of uses.

REFERENCE

- (1) Terman, F. E., "Radio Engineers Handbook", McGraw-Hill Book Co., New York, 1943, p 509.

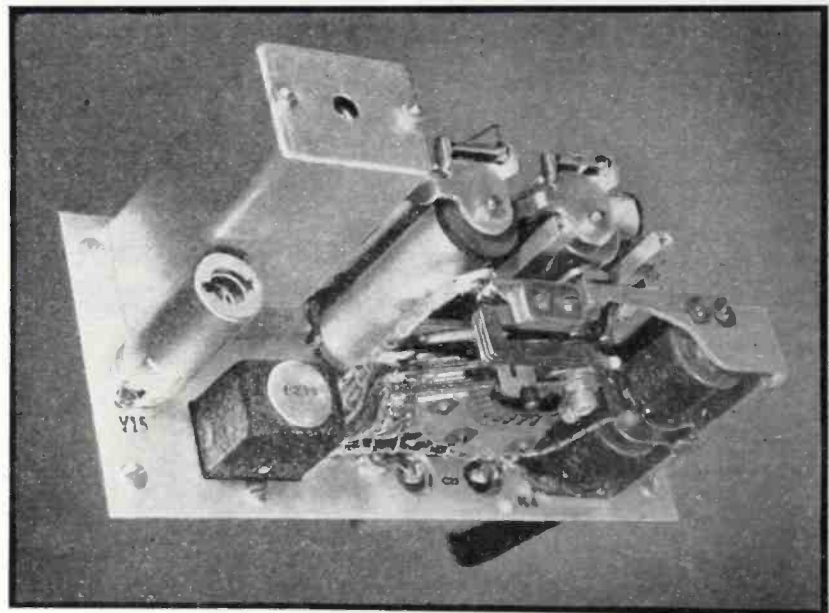

Interior of the mobile decoding unit. The selective filter is enclosed in the can at the left, the stepping and other relays are at the right. A numbered plug (1216) indicates the code to which the unit will respond. This plug can be quickly changed

Photoelectric Sight

Disc masking most of the light radiated by the sun itself is automatically centered within one second of arc so that corona photographs can be taken and radio disturbances forecast

FIG. 1—Photoelectric apparatus is mounted on top of the main telescope. The guiding telescope lens may be seen near the top, with the phototube and amplifier unit below it. A camera is mounted on the near end of the telescope

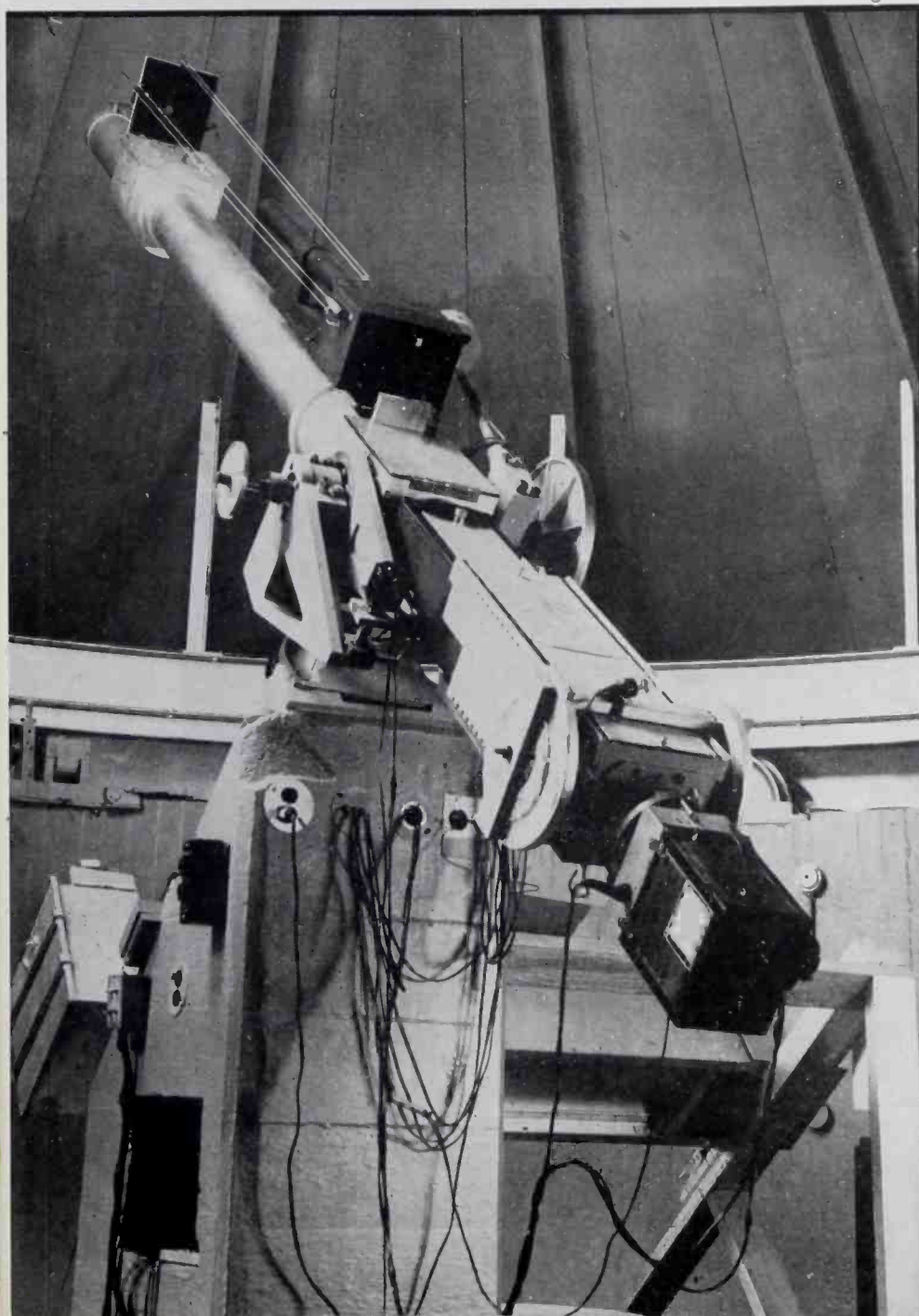

THE DRIVE MECHANISM of the Harvard College Observatory solar coronagraphic telescope located at Climax, Colorado, at an elevation of 11,500 feet above sea level, is photoelectrically controlled.

A solar coronagraph is an astronomical instrument devised in 1930 by Dr. Bernard Lyot of France for the purpose of creating artificial eclipses of the sun's bright disc to permit photography of the prominences and corona of the sun's atmosphere for use in basic astronomical studies and for forecasting radio propagation disturbance. In any such telescope it is of utmost importance that the image of the sun be accurately centered on the artificial moon or eclipsing disc located within the telescope so that none of the intense light from the sun's bright face reaches the camera film and thus obscures the light from the eclipse phenomena under study.

The eclipse phenomena are fainter than the sun itself by a factor ranging up to 600,000. The accuracy required in this telescope-aiming is of the order of one second of arc. In 1940, shortly after the completion of the only coronagraph in the western hemisphere, it was decided that the ideal control system would be entirely automatic, and that the most desirable automatic system would undoubtedly be photoelectrically operated by the sun itself.

Operating Principle

The unusual optical requirements of a coronagraph preclude the possibility of utilizing a partial reflection, prior to the formation of the primary solar image, to form an image on the phototubes so that it was deemed simplest to use a separate guiding telescope mounted rigidly on the

for Solar Telescope

By **WALTER ORR ROBERTS**

Superintendent
Fremont Pass Station
Harvard College Observatory
Climax, Colorado

FIG. 3—(right) Block diagram of the complete automatic sighting system

FIG. 2—(below) When the sun's image is properly centered on the eclipsing disc (A) four phototubes receive equal illumination. When it is not properly centered (B) the phototubes receive unequal illumination and aiming motors operate to restore the desired balance

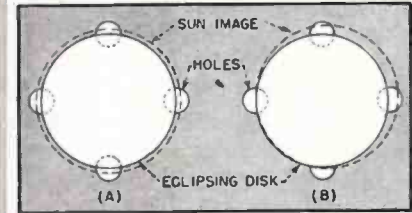
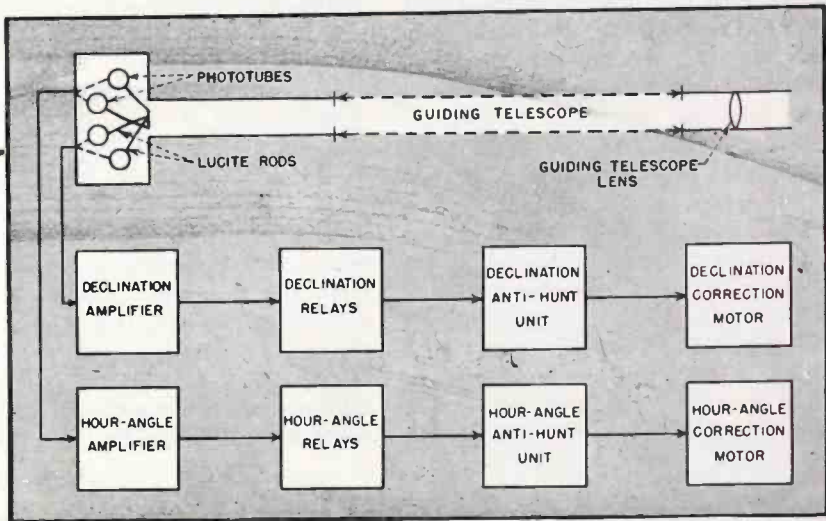

main telescope. The guiding telescope has a lens of small aperture but of the same focal length as the main telescope lens, and is located as near to the main lens as conveniently possible on the exterior of the main telescope. Flexures thus affect both lenses to about the same degree.

The photograph of Fig. 1 shows the coronagraph with the photoelectric aiming telescope mounted upon it. No tubing is used for the guiding telescope for the main portion of its length. A long light-shield near the phototubes serves the purpose without giving rise to the disadvantageous air currents which are set up in a long narrow length of tubing, and which can cause severe unsteadiness in the images of long, thin telescopes.

The image of the sun formed by the guiding telescope falls onto a circular polished metal disc which obscures the bright face of the sun except for a very narrow ring of light at the outer edge, as shown in Fig. 2. Behind the metal disc are located four holes spaced 90 degrees apart, with the line joining one pair

of holes across the diameter of the disc made parallel to an east-west line on the celestial sphere, and the line between the other pair parallel to a north-south line. The amount of light entering the first pair of holes is thus equal when the sun is neither ahead nor behind the telescope along the east-west line. When the second pair of holes admit equal light the telescope is properly aimed in declination. These two coordinates are the motion coordinates of an equatorially mounted telescope, and so it is necessary only to transform the variations of light behind these pairs of holes into impulses to operate the correction motors of the equatorially mounted coronagraph to assure proper aiming.

The light from the east-west pair of holes is made to serve a pair of phototubes operating in a balanced amplifier circuit which electronically couples with the hour-angle drive of the telescope. If the telescope is running too slowly, for example, the sunlight will increase on one phototube and decrease on the other. This will unbalance the circuit and actuate the correction motor through the amplifier, relays, and anti-hunt unit shown in the block diagram of Fig. 3.

Amplifier Details

A novel feature of the photoelectric pickup unit is the use of Lucite

rods to conduct the light from the rods to conduct the light from the holes behind the sun-obscuring disc into the proper phototubes, which are housed in lightproof Bakelite shields as shown in Fig. 4. The ends of the rods at the sun's image were polished smooth, and the ends at the phototube housings fine-ground to diffuse the light smoothly over the photosensitive areas of the phototubes.

The complete electrical circuit of the phototube amplifier and relays is given in Fig. 5. One such circuit is employed for each coordinate. The operation is from standard 115-volt, 60-cycle power mains, with good stability at all ambient temperatures and with convenient control of sensitivity. A 6H6 voltage-doubler rectifier supplies d-c for the phototubes. The phototubes act as loads for each other, and together drive the type 38 amplifier tube which has high input impedance. Gas current to the pentode grid is kept to a minimum by keeping potentials very low. The heater of the 38 is operated at reduced voltage to increase input resistance, and is maintained positive with respect to the grid to reduce emission from heater to grid. The phototubes and the 38 tube were carefully cleaned at installation, and then coated with white ceresin wax. The leads from the top caps of the 917, 919, and 38 were kept to a minimum length, and were supported

only at the tube caps themselves.

When the unit is in balance, the bias on the 6J5 triodes is such that the current flowing through the associated relays is sufficient to close the more sensitive 5,000-ohm relay, but not the less sensitive 2000-ohm relay. In this condition the relays send no impulses to the anti-hunt units, and the telescope correction motors remain at rest. When the light increases on the 917 phototube, and the light decreases on the 919 phototube, the bias on the 6J5's changes so that the current through the relays increases until both are closed. If the light to the 919 increases and that to the 917 decreases, both relays open. Figure 6 shows the relays in the condition produced by excess light to the 917 tube so that both

relays are closed. An impulse is thus sent to the anti-hunt units which send suitable impulses to the correction motors of the telescope to decrease the hour-angle (or the declination) until the 919 once again receives as much light as the 917.

Anti-Hunt Units

The anti-hunt units afford additionally desirable features to the control of the telescope. These units were designed for the purpose of preventing rapid correction-motor response to alternating impulses from the two relays, while at the same time retaining rapid response to repeated impulses from one of the relays. The units have nearly instantaneous response to a consistent telescope error which shows the repeated

need for correction of the same direction. But they have very slow response (eight seconds) to the irregularly distributed aiming errors, generally caused by such factors as fluctuations in atmospheric seeing, which cause the sun's image to dance unsteadily on the disc in front of the phototubes.

The anti-hunt units are simply changeover switches driven by reversible synchronous motors. The synchronous motors have a rotational speed of one revolution per ten seconds, and a cam is fastened to their shafts so that it engages limit switches after operation over adjustable limits (usually set at eight seconds). As the circuit shows, when a synchronous motor reaches one limit it contacts the limit switch, and disengages itself, at the same time changing over the relay circuit to feed directly into the telescope correction motor and to operate this motor in the correct manner. If correction impulses are alternating, but with pulses of one relay sustained longer than pulses of the other, the synchronously driven cam gradually drifts toward the limit of the impulse that is sustained the longer, and eventually produces a suitable impulse to the correction motor itself.

Photographic Technique

As the apparatus is usually adjusted, its overall sensitivity is about one second of arc. Because of the anti-hunt units the telescope will not hunt after errors larger than one second of arc unless they persist for eight seconds of time, or unless, on the average, the fluctuations are greater in magnitude in one direction than in the other, and unless this greater average persists for considerably longer than eight seconds.

The correction motors themselves are simply standard small a-c motors. The hour-angle motor drives a differential gearing unit in the telescope mechanism to add or subtract slightly from the main telescope drive which consists of a synchronously driven worm gear which has been calculated to provide a telescope rate equal to the average rate of apparent motion of the sun through the sky. The correction rate is approximately one-twentieth the constant solar rate. The declination

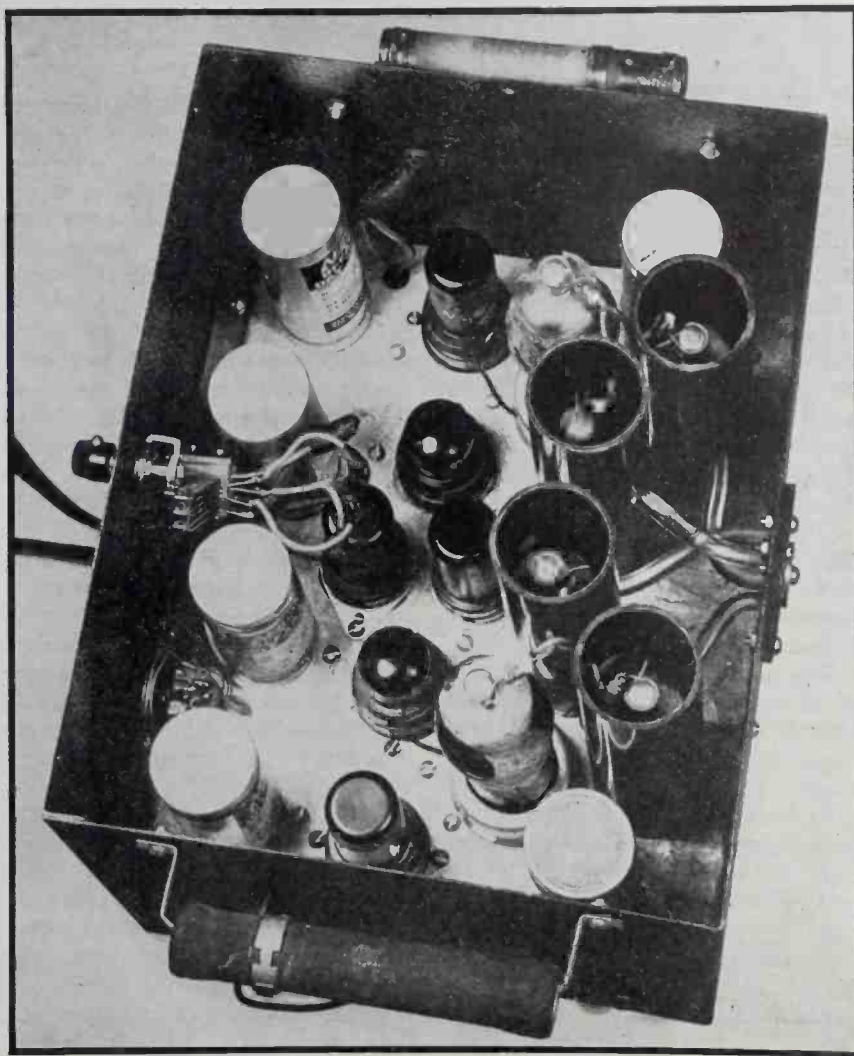

FIG. 4—Harvard coronagraphic telescope phototube and amplifier unit. Relays and anti-hunt units are remotely located

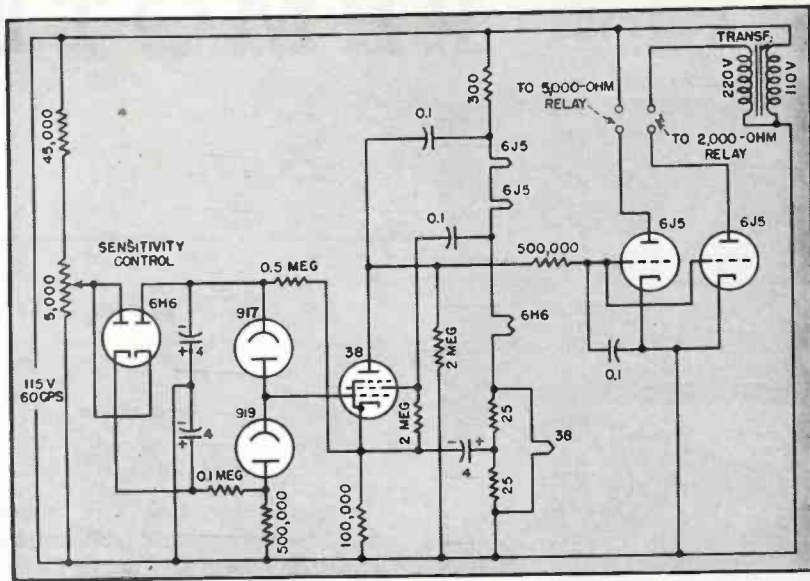

FIG. 5—Circuit diagram of one of the two photoelectrically controlled amplifiers

motor drives directly into a micrometer screw at a rate of 0.7 rpm to produce a rate of correction of the telescope aiming of about two seconds of arc in one second of time.

When this automatic guider is in operation the telescope can be adjusted by positioning the guiding telescope lens properly, at the start of a full-day run, and then left unattended thereafter so far as aiming is concerned. The coronagraph is designed to take rapid-sequence pictures, at 10-second intervals, of the prominences of the sun. With the guider in operation, the aiming of the telescope is uniform from picture to picture, so that the films so obtained can be projected in a motion picture apparatus with good steadiness. Fig. 7 shows a solar prominence photographed with the automatic guider in operation.

Practical Advantages

The present units have been in intermittent service for about three years without need for opening the amplifier case; the phototubes have not even been inspected in two years. We have experienced no difficulties with the operation of the electronic equipment, the relays, or the synchronous motors over this period of time, even with the extreme range of operating temperatures from -20°F to $+65^{\circ}\text{F}$.

Photoelectric control of a solar telescope eliminates the need for

highly accurate constant-drive mechanisms or for costly rate-correction apparatus. In addition, with such a drive we can obtain highly precise telescope aiming without resort to highly precise equatorial mounting of the telescope. It would be entirely possible to provide a portable telescope mounted on a tripod with aiming of this same order of precision.

We believe that considerable advantage can be gained in guiding of the mirrors of fixed horizontal and vertical tower telescopes through the

use of suitably designed photoelectric controls. No efforts have been made to extend any of these principles to the control of stellar telescopes. We have used the sun only, and in this application have been aided by the vast abundance of light available.

The design of the optical and me-

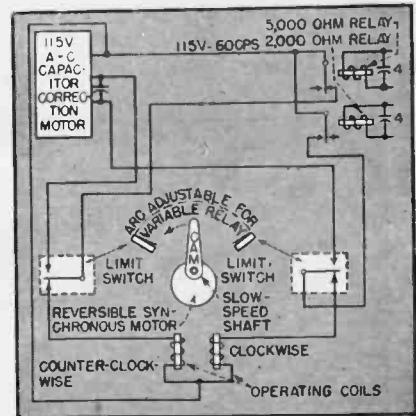
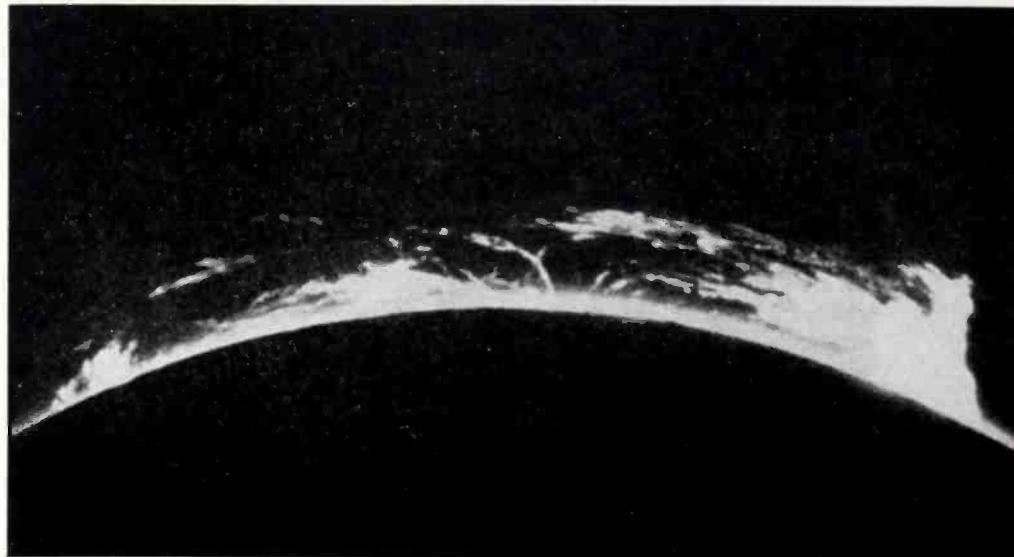

FIG. 6—Relay and anti-hunt unit for one coordinate. As shown, the synchronous motor is in counterclockwise operation toward the left-hand limit switch because excess light on the 917 phototube (Fig. 5) has excited both relays. When the limit is reached the motor will be stopped and then started in the opposite direction

chanical arrangements and of the anti-hunt units is my own; the phototube and amplifier circuits were drawn up by the late James R. Balsley of Stamford, Connecticut.

FIG. 7—Photograph of a solar prominence. The white arc is at the edge of the sun's disc. The cloud of hydrogen comprising the prominence stands out above the sun's limb. If the telescope was not aimed with great position the sun's face might appear above the black arc of the eclipsing disc, completely obscuring the prominence by its overpowering brilliance



REMOTE

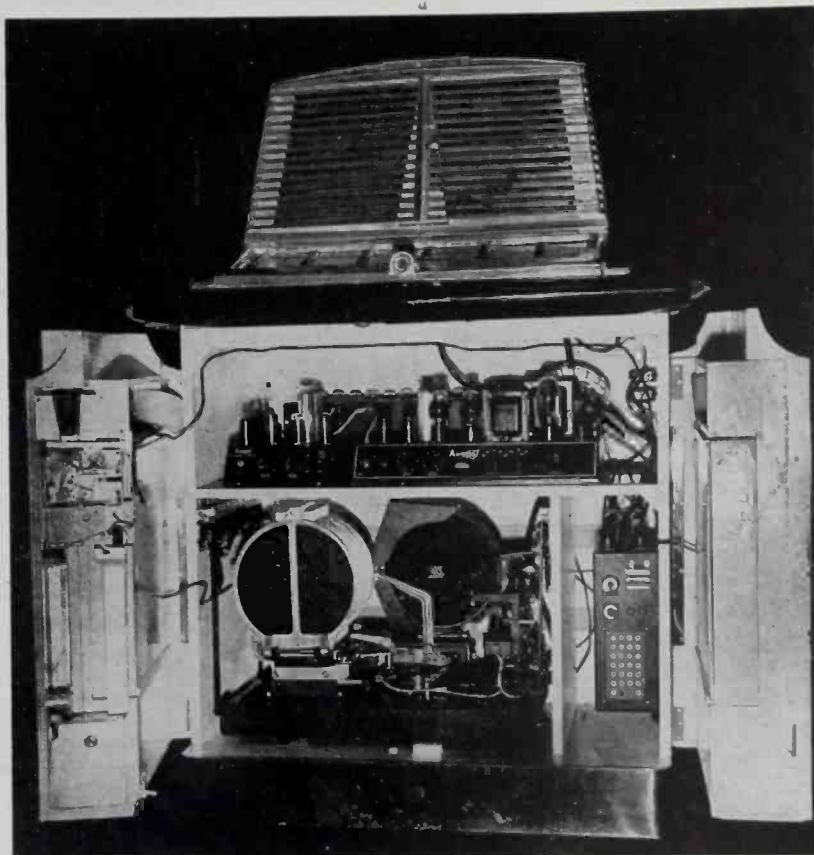

Twenty-four record, coin-operated phonograph in which electronic circuits on the upper shelf actuate the record-changing mechanism when pulses of the proper frequency and phase are received from remote wall boxes

IN THE DESIGN of a remote record-selection system for an automatic phonograph, the method of using independent radio-frequency pulses transmitted over a coaxial cable is believed to have definite advantages over other systems of record selection currently being used.

In the course of our development work, the following systems were analyzed; the 25 to 30-wire cable system, the step or impulse type (both wired and wireless), and the self-balancing potentiometer type. These methods were studied from the point of view of time required to install, replace, and maintain the equipment, mechanical difficulties, interference between two or more wall boxes, and the amount and source of current required to supply power to the wall boxes.

For remote record-selection, it was decided to use radio frequencies transmitted from wall boxes over a

coaxial cable because it became feasible to supply power to the wall-box transmitters and lights and to transmit intelligence over the same single cable. Although it is possible to accomplish this by employing the 115-volt a-c line, this method has several disadvantages. It necessitates a higher r-f output and there is the possibility of interfering with other similar installations. Also, installation of a wall box requires access to a 115-volt outlet.

Low-voltage Line

The system described overcomes all of these problems and at the same time requires considerably less than one volt of r-f over its lines. In addition, it solves the problem of inter-wall-box interference in the event selections are made simultaneously from two different points. By using only 24 volts to power each wall box, it also removes the necessity of en-

By **FRED M. BERRY**

*Aircon Manufacturing Corporation
Kansas City, Kansas*

closing the cable system in conduits.

A block diagram of the complete system is shown in Fig. 1. Each remote selector (wall-box unit) is built around a single 6SN7 tube. One triode of this tube is used in a Colpitts oscillator circuit to generate pulses, and the other triode is used as a loosely coupled isolation amplifier. This amplifier is coupled to the coaxial line by a small capacitance. The circuit of the oscillator and amplifier is given in Fig. 2.

Phase Selection

Twelve frequencies are generated in twelve separate slug-tuned oscillator coils. These are small universal-wound coils mounted on aluminum strips, there being two strips of six coils in each wall box. The twelve frequencies make possible the selection of 24 records by using envelope phase selection in which only one phase of the 60-cycle plate voltage is applied to the oscillator-amplifier. The proper phase is determined by the button pressed.

Each oscillator coil in the box is connected to a pair of pushbuttons. Since the receiver discriminator tubes at the phonograph are powered in the same manner and from the same a-c line, envelope phase selection in the transmitter allows the number of possible record selections to be twice the number of separate frequencies used. The frequency separation of adjacent frequencies is determined on a percentage basis, a factor of approximately 1.07 being used to determine each successively higher frequency.

Figure 2 shows the method of line-phase and oscillator-coil selection.

RECORD-SELECTION SYSTEM

Rapid remote selection of records in a phonograph is provided by employing a carrier-current system in which a wall-box oscillator transmits r-f pulses over its supply line to discriminator circuits in the phonograph cabinet. Twelve carrier frequencies and use of both alternations of the power line permit selection of twenty-four records

Pushing button 1 will select oscillator coil *L* and winding *B* of the high-voltage secondary of the wall box step-up transformer. Pushing button 2 will select the same oscillator coil, but will select winding *A* of the power transformer.

When a pushbutton is pressed, a series of *A* and *B* phase pulses lasting from 0.1 to 0.25 seconds, depending on the time constant of the pushbutton and coin-operated relay, is transmitted over the cable. Pushbuttons are also so interlocked that if more than one is pushed simultaneously at the same wall box, only the numerically lowest button will select a record.

Receiver

Figure 3 shows a functional diagram of the receiver located in the phonograph cabinet. It uses three 6SL7's as amplifiers, twelve 6SN7's as discriminators, a 5Y3 to supply 250 volts of d-c to the plates of the amplifiers, and an 884 which acts as a bias resistor for the discriminator tubes.

The r-f signals from the wall box pass through the input autotransformer to the grids of the 6SL7 dual-triode amplifier tubes. The 6SL7 tubes function as limiters because an r-f voltage to the grids in excess of the bias voltage permits the grids to draw current and allow the charging of a grid capacitor. This swings the bias of the tubes toward cut-off and limits the amplification of the tube. Output voltage of the amplifier tubes is therefore held at a fairly constant level regardless of signal input level.

The six plates of the amplifier tube section are connected individually to

the twelve r-f transformer primaries, two primaries being connected in series in each plate circuit. Plate supply to all amplifier tubes is furnished by the 5Y3 rectifier tube, d-c being applied to these tubes so that they will not discriminate against *A* and *B* phased pulses.

Each r-f transformer consists of two iron-core coils. The frequencies of the two transformers connected in series are purposely staggered as shown in Table I so that no interference is experienced in the tuning of each. The output of each transformer feeds the two paralleled grids

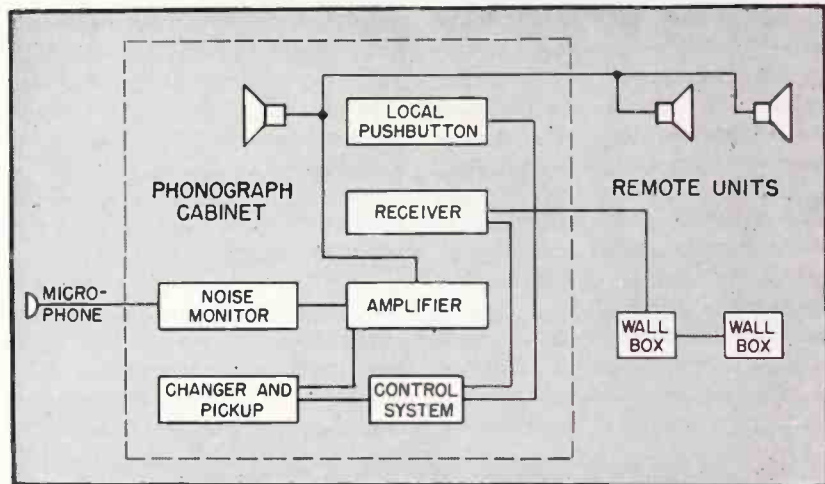

FIG. 1—Stages of the automatic phonograph system are shown in this block diagram

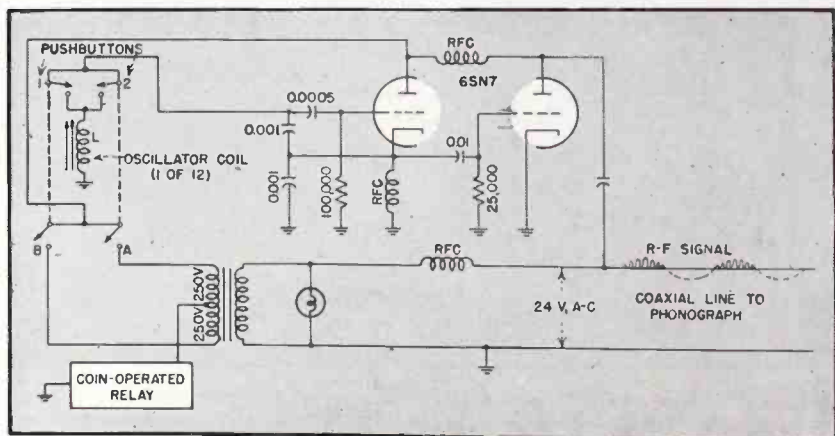

FIG. 2—Complete circuit of one wall box used as a record selector. The Colpitts oscillator and amplifier transmit pulses over a coaxial cable back to the phonograph

of a 6SN7 discriminator tube.

Each discriminator tube functions as a plate rectifier and an r-f voltage appearing on the grids of the tube causes plate current to increase provided the alternating plate voltage is positive at that time. The plate circuits of the 6SN7 tubes are connected through individual relays to the opposite ends of the 500-volt winding on the power transformer, the center tap being at ground potential. Each end of this winding is bypassed to ground for r-f.

Discriminator Action

An r-f signal from the wall box is admitted by all amplifier tubes but eventually coupled into the grids of only one of the 6SN7 tubes. This action is obtained by the frequency discrimination of the filters, the 6SN7 tube being energized depending on the frequency selected at the wall box. If r-f energy is supplied to the two grids of the discriminator tube and d-c potential applied to the plates of this tube, the relays in both plate circuits would be energized. However, because the two plates of the discriminator tube are supplied from opposite sides of the power transformer winding, at the instant that one plate is positive the other plate will be negative. If an r-f signal arrives at the time when the plate is negative, no current will be drawn by its corresponding relay.

Because the signal from the wall box is generated by an r-f oscillator with alternating plate voltage, the r-f energy consists of a series of

Table I—Wall-box Frequencies

Records	Oscillator Coil	Kilocycles
1-2	1	149
3-4	2	212
5-6	3	179
7-8	4	253
9-10	5	159
11-12	6	225
13-14	7	189
15-16	8	269
17-18	9	169
19-20	10	239
21-22	11	200
23-24	12	289

pulses lasting for 1/120 second each and spaced from each other by the same period. These pulses will be in time phase with the plate voltage supplied to one discriminator plate and will be out of phase with the voltage at the opposite plate. The polarity or phase of the a-c is chosen in the wall box by the pushbutton switches, the odd-numbered buttons being of one phase and the even-numbered buttons being of the opposite phase. Thus the selection of the discriminator plate that draws current depends on the phase of the voltage at the wall box.

All discriminator tube cathodes are connected to the plate of an 884 gas tube that acts as a cathode bias resistor. The voltage drop across the 884 tube remains constant regardless of the amount of current flowing and thus remains independent of the number of discriminator tubes drawing current at one time. The action

of the 884 used in this manner is similar to the more commonly used voltage-regulator tubes. The 884 tube, however, has a constant voltage drop of 14 volts which is the correct bias for the discriminator tubes.

Advantages

The principal advantages of this system follow:

Independent and non-interacting selection is made possible from any one of several wall boxes. Though all wall boxes are paralleled on the same coaxial circuit, the amplifier stage in each box effectively isolates each oscillator. No attempt is made to match wall-box output to the line itself as the addition or removal of wall boxes on the circuit would then change the line loading. Because the receiver is quite sensitive, more than sufficient power is sent over the line even though the wall boxes are not exactly matched with the line.

This system is well shielded from external interference and causes no interference with other systems. Since selection can be made with considerably less than one volt of r-f, radiation is held to an absolute minimum.

Mechanical motion and the ensuing possibility of mechanical failure are eliminated because no motors or step relays are necessary. The pushbutton itself is the only moving part in the wall box; the record-selector relay and its accompanying solenoid are the only moving parts at the receiver.

Other Components of the Machine

The record changer holds twenty-four records mounted vertically in the magazine. Mechanical selection of records is automatically made by the record magazine sliding along two parallel glide-rods and positioning the selected record opposite a delivery arm which swings back and places the record in the play ring. The record plane then turns through a 90 degree arc, bringing the record up to the pickup.

Noise monitoring is accomplished by varying bias on the amplifier in accordance with the external ambient noise level as sampled continuously by a microphone placed anywhere in the room. Means are provided to adjust the sensitivity of the pickup amplifier or to disable it completely if circumstances demand.

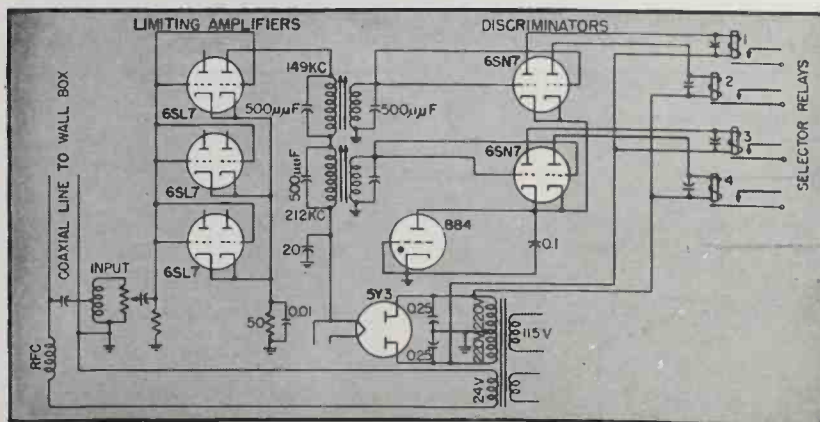

FIG. 3—Simplified receiver circuit in the phonograph. Ten additional 6SN7 tubes (not shown) are fed by the remaining plates of the 6SL7's limiting amplifiers so that each 6SL7 plate actuates four selections. The circuits of the other ten discriminators are similar to those shown here but are tuned to the other frequencies shown in Table I



Parts of torsional magnetostriction pickup fit into small cartridge shown at the left

Torsional Magnetostriction Pickup

Small moving mass, low distortion, wide frequency response, and ruggedness, are obtained in a phonograph pickup operating on leakage flux in a torsional magnetostriction system.

Principle of operation, design, and characteristics of pickup are described

By **STANLEY R. RICH**

*Consultant
Magnetostriction Devices Company
Boston, Mass.*

MAGNETOSTRICTION used in torsion is the basis for a new type of phonograph pickup. This phonograph pickup design permits low needle-point pressures in a unit having inherently wide frequency response and low generating harmonic distortion. The resulting pickup element has substantially uniform characteristics over the frequency range of 30 to 10,000 cycles, except for the normal falling-off in low frequency response below 400 cycles due to the transition from constant velocity to constant amplitude recording of most records below this frequency. The pickup unit itself is extremely

small and has been designed to be contained in a cartridge smaller in size than the standard cartridges surrounding piezo-electric elements.

The new system, applied to phonograph pickup design, results in a unit particularly adaptable to the reproduction expected from f-m broadcasting stations. The pickup has been designed to fall within Standards of Good Engineering Practice Concerning F-M Broadcasting Stations established by the Federal Communication Commission on September 20, 1945. Although Section 8 of these standards does not mention phonograph reproducers specifically, it has

been assumed as obvious that a station system is only as good as its input equipment; the torsional magnetostriction pickup has been designed accordingly. Its frequency response and distortion are such that, with simple compensating networks, these standards are fully satisfied. It is to be noted that most available records and many transcriptions are incapable of utilizing the response capabilities of the pickup but it is hoped that there will be an improvement in record quality to take advantage of the possibilities in low-priced high quality instruments available to the general public as well as to the

professional radio broadcasters.

The torsional magnetostriction phonograph pickup, because there are no discreet ferromagnetic masses moving in flux gaps, is extremely rugged and will withstand considerable abuse in handling. The pickup will also withstand high ambient temperatures and humidities without change in operating characteristics.

Magnetostriction Principle

The principle upon which this pickup is based is the variation of magnetic reluctance in a magnetostrictive wire, rod, or tube, when such a member is subjected to torsional stress in the presence of a magnetic field. When the magnetostrictive wire is twisted about its own axis in a magnetic field, the curve shown in Fig. 1A results. It is to be seen from this curve that as torsional strain is increased in either direction, flux density in the element increases without regard to the sign of the applied stress. It is also to be seen that the total resulting curve of magnetostrictive flux-change as a function of strain resembles a hysteresis curve bent backward upon itself so that the portion normally recorded in the third quadrant appears in the second. It is clear from this discussion that it is necessary under the aforementioned conditions to polarize the mechanical stress in the magnetostriction element if one desires to obtain a linear relationship of electrical output as a function of the mechanical input.

It is interesting to note a modification in the magnetostriction-torsion relationship if one applies tension as well to the magnetostrictive element undergoing torsion. If the magnetostriction element is subjected to static tension, then the very first twisting motion of the torsional element establishes a magnetic polarization in such a way that the resulting relationship between flux density and torsional strain behaves according to the curves shown in Fig. 1B. This figure shows the left-hand or second-quadrant half of the curve beginning to fold down into the third-quadrant under applied tension. Ultimately, a linear relationship results when the tension applied to the wire reaches a critical value, equal to 7.82 kilograms

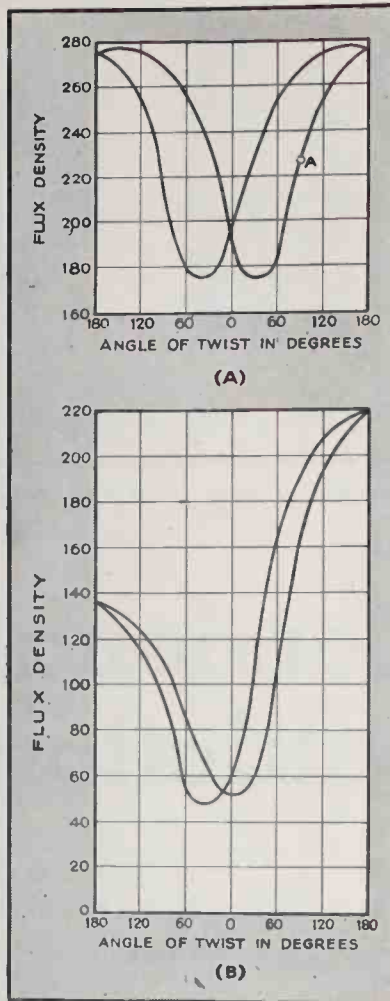

FIG. 1—(A) Flux in magnetic bar changes when it is twisted. (B) If the bar is under tension while being twisted, it becomes magnetically polarized

per square millimeter of cross-section.

Pickup Design

In the design of the torsional magnetostriction pickup, it was decided to use the first mentioned method of operation; namely, torsion in the absence of static tension, but to use static torsion. A magnetostrictive wire, 20-mil nickel, is passed between the two poles of a horseshoe magnet. Two pickup coils consisting of 100 turns each are wound about the two halves of the torsional member. The stylus projects from the nickel wire between the two pickup coils. The wire is given an initial mechanical strain by twisting it within its elastic limits and then fixing it rigidly at the two magnetic poles. Thus, each

element of the nickel wire is subjected to an initial strain.

Figure 2A is a sketch of a torsional member subjected to an initial fixed torsional strain. Each formerly straight-surface element has been twisted to form a space helix due to displacement through an angle θ . This initial strain moves the operating point for the torsional magnetostriction element to the point A shown on the characteristic of Fig. 1A. Any small angle of rotation about the fixed angle will produce a linear variation of flux in the wire. Figure 2B shows the torsional member subjected to an instantaneous strain $d\theta$ at its center such as is produced by a typical stylus mounted in a practical pickup. Any displacement due to stylus motion as shown will further stress those elements to the left of the stylus an additional angle $d\theta$ and will relieve the elements to the right of the stylus by an equal and opposite angle $d\theta$. In the magnetic field, this action is translated into an increase of leakage flux in one-half of the wire at the same time leakage flux is decreased in the other half.

Coil Location

The problem is to use these flux changes to produce the required output from this type of torsional magnetostriction pickup. Mounting two coils upon each of the two halves of the wire in a condition which would normally be described as series opposing produces an addition of voltage due to the above described type of displacement caused by the stylus. Clearly, a displacement in opposite hand will produce equal and opposite effects to those shown in Fig. 2B. The coils are thus connected in such fashion that distortion of the wire common to both coils will cancel. Push-pull connection has the additional virtue of eliminating even-order harmonic distortion. This fact has been found to aid materially in the overall distortion-free character of the pickup.

The nickel wire has its pickup coils integrally wound upon it. The stylus is fixed to its center. The ends of the nickel wire are bent over and so positioned in angle that, when inserted into two parallel slots in the ends of the magnet, an initial torque

produced upon the torsional element. The assembled pickup is then inserted into the Bakelite case to form the finished pickup cartridge.

Figure 3 shows the frequency response characteristic of the pickup. There are no sharp resonances and the curve has the normal form peculiar to all velocity-sensitive elements when played upon RCA test record No. 84522-A.

Pickup Characteristics

It is interesting to observe that this pickup operates upon leakage flux due to flux leaving the magnetostrictive wire in the vicinity of its center, near the stylus. This mode of operation has been found to produce sufficiently high electrical output level and has certain specific advantages compared with other designs. The center space of the magnet is occupied by damping material which serves to critically damp the pickup at its resonant point, which is in the vicinity of 10,000 cycles. With this critical damping of the vibrating member, high frequency response of the unit itself is extended with a loss of about 8 db to 15,000 cycles. A well designed transformer will extend the range of the pickup beyond 15,000 cycles. The writer has not been able to obtain records cut with such frequencies for the purpose of quantitative measurement. It is hoped that such tests can be made in the not too distant future.

The wide frequency response of the

magnetostriction torsion pickup has certain qualitative effects which are worthy of note. Because many phonograph records are recorded with a frequency range far poorer than the capabilities of the pickup, it is desirable to use simple low-pass filters at the output of the coupling transformer when playing poor records. A mechanical high frequency cut-off has not been built into the present pickup because it is the writer's conviction that if one desires a poor frequency response characteristic for a particular condition, it is better to modify temporarily the overall characteristics of a wide frequency re-

of extremely wide frequency response.

One of the features of the present design, due to the fact that the coils are wound integrally upon the torsional member, is its freedom from pickup of hum or other electrical pickup from outside sources. Due to the extremely small diameter of the coils themselves and to the fact that the coils are in series opposition to external fields, pickup of undesired signals is reduced to a minimum, an advantage in low level, low impedance magnetic circuit.

The torsional magnetostriction pickup fills a very definite gap in the

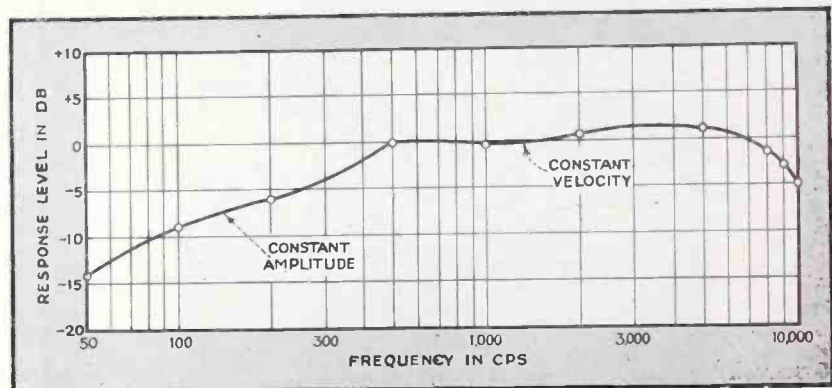

FIG. 3—Pickup response as measured on a test record

sponse pickup than to destroy its characteristics permanently so that very good records cannot be enjoyed to their fullest extent.

Mechanical Features

The needle-point mass of the torsional magnetostriction pickup is extremely low, due to the fact that, except for the stylus itself which is extremely light, all other members move in torsion. The effective mass at the stylus, due to the fact that the torsional element approximates a properly terminated transmission line, is due almost entirely to the stylus itself and in the present case, results in weight at the needle point of 27 grams, for good tracking with even badly warped records. It may be remarked at this time that the torsional member operates as a continuous mechanical network having distributed mass and stiffness, which makes a tractable structure easy to manufacture, and inherently capable

of phonograph field due to its frequency response, ruggedness, freedom from distortion and ability to operate in humid, hot, or noisy locations.

Experiments have been made which demonstrate that the torsional magnetostriction element operates successfully as a recording element as well as a pickup device. In this case, because positive drive is required, a modified construction in which the torsional member is mounted in a bearing attached to a third or middle leg is necessary. Experimental models show considerable promise.

The writer wishes to express his grateful acknowledgement for the invaluable assistance of Edwin E. Turner, Jr., without whose aid a considerable amount of the work done would have been impossible, and to express his gratitude to Tobe Deutschmann, for sponsoring the development program which has led to the production of this pickup.

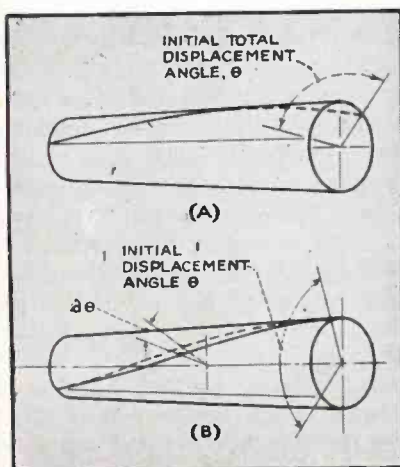
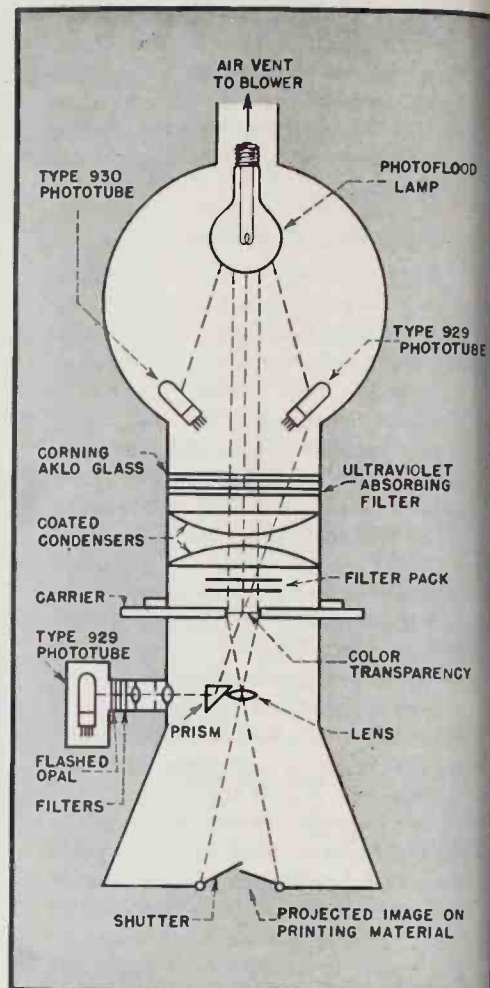
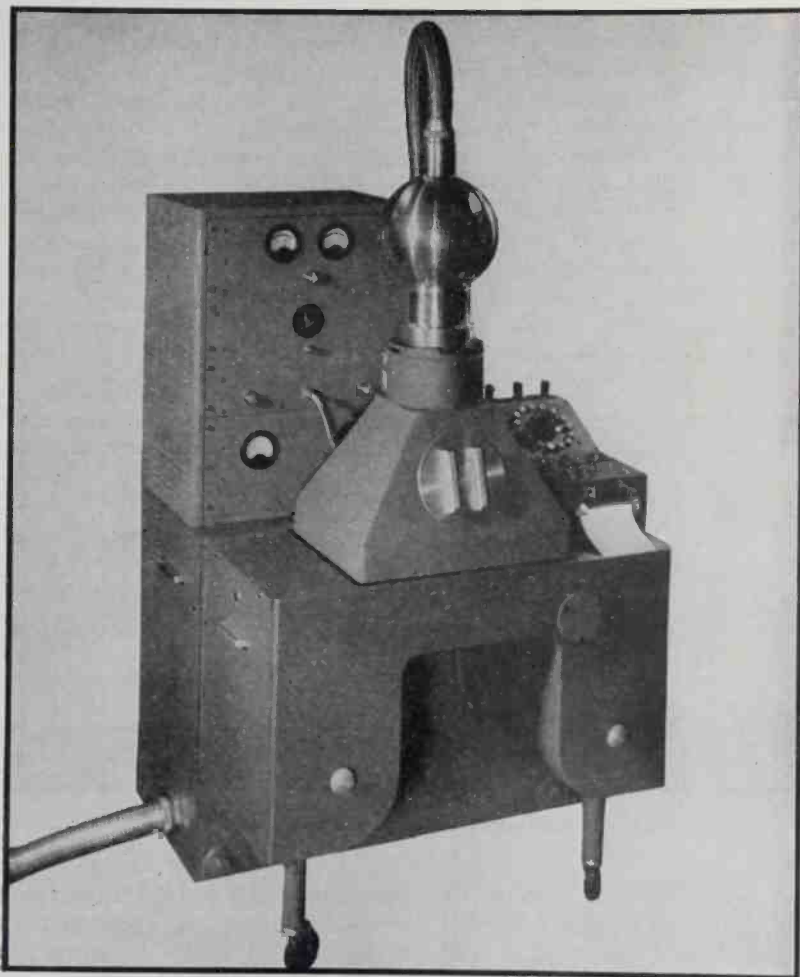

FIG. 2—Magnetostriction bar is given a permanent torque (A) about which the stylus twists it (B)

Photoelectric Controls



Automatic printing machine for making color prints from color transparencies, with diagram identifying essential interior features

THE production of color prints of uniform quality requires exceedingly precise control of every variable. Furthermore, color printing on a low-cost, mass-production basis demands high-speed operating methods.

Proof that many color printing problems can be solved by electronic devices is the fact that our New York plant is able to produce at least 20,000 color prints in a normal working day. Electronic applications permitted the construction of white-light operated printing machines, eliminating the necessity for slow and uncertain darkroom methods customarily employed throughout the industry. Electronic methods assured a high degree of accuracy in various steps of print exposure and

processing, and were completely adaptable to a coordinated system of control operations.

Basic Requirements in Color Printing

In producing direct color prints from positive color transparencies a reversible-type sensitized printing material (Anso Color Printon) is used, and unlike making black-and-white prints from film negatives, only one contrast-grade of material is available. Moreover, mass production requires continuous processing where exposure errors of individual prints cannot be compensated by variations in developing times. These inherent limitations mean that exposure latitude is virtually nonexistent.

The necessity for a high order of exposure accuracy is complicated by

the fact that the color print is a second-generation color reproduction, requiring that the color quality of the exposing source be variable for optimum results in the finished product, but closely controllable at any variation from normal. For a given emulsion, color compensating filters are employed to adjust the normal color quality of the exposing source to the color balance of the material. This establishes conditions for printing all transparencies of visually satisfactory color.

In printing transparencies that appear faulty in color, it is desirable to have a means for rapidly changing the color quality of the exposing source for color correction purposes. Most of the required color quality alterations encountered can be made

for COLOR PRINTING

By J. ROBINS and L. E. VARDEN

Director of Electronics Technical Director
Pavelle Color Incorporated
New York, N. Y.

Analysis of problems involved in turning out high-quality photographic color prints on a mass-production basis. Details of photoelectric circuits used in one large plant to control color temperature and exposure time automatically and to monitor the second exposure

by known changes in lamp color temperature, providing the color temperature is controlled at each level employed. Color correction by this means is entirely reliable for over-bluish or over-yellowish transparencies, and has a significant speed advantage over the use of additional optical filters.

Both a positive silver image and a positive color image are produced simultaneously in a second developer, known as the color developer. For proper color development the sensitized material must be thoroughly second-exposed, but in a continuous processing method the web of sensitized material moves continuously from one solution to the next at a relatively high rate of speed, and it is not desirable to pass the web out of solution for any appreciable distance for giving the second exposure. Therefore, second exposure must be made by means of high-intensity sources during as short a time interval as possible.

Design of Color Printer

Electronic methods made possible the design of a white-light operated color printing machine that is almost completely automatic in operation. The sensitized material has an opaque leader and trailer attached to it and is wound on a flanged metal spool. The spool is loaded into the printer in white light and the opaque

leader is threaded through the machine to a takeup spool. After closing both end doors a motor drive turns the takeup spool, winding up the leader until the sensitized material is brought in position for the first exposure. A switch engages in a notch placed on the leader at the proper spacing to stop the wind-up before any sensitized material is drawn past the exposing position.

The rolls now used are 5 inches wide and 250 feet long, providing for about 950 3x4½-inch prints or 400 4½x6½-inch prints. The printers, however, are made to take widths up to 12 inches.

Operation of Printer

Transparencies are inserted in the carrier, which is manually pushed into position. A numbered card accompanies each order and this is

placed in a slot which, at the proper time during the printing cycle, is illuminated by a small, enclosed lamp. A lens and prism system optically directs the number to the printing material to expose the identifying order number on the outer edge of each print.

A selector dial is manually positioned for the number of prints required from the particular transparency. The selector dial provides for any number of prints up to fifteen. More than fifteen prints can be made by disengaging the stepper relay system and noting the number of prints on an automatic counter.

For making the exposure the operator first presses two switches, one for a predetermined lamp voltage and the other for a predetermined exposure correction. A "start" button is then pressed and the exposure is

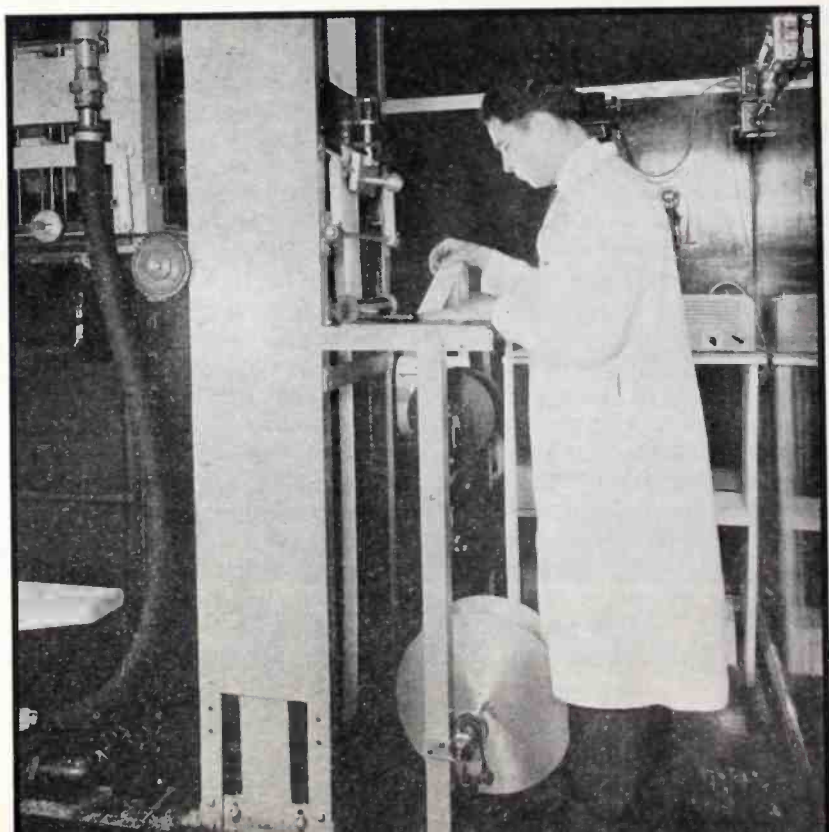

Loading end of developing machine, showing how exposed material is spliced onto the machine leader. Material is first run through a series of black-and-white developing tanks, then given a second exposure, run through another series of tanks for color developing and processing, and finished prints are finally dried by travel between banks of infrared lamps

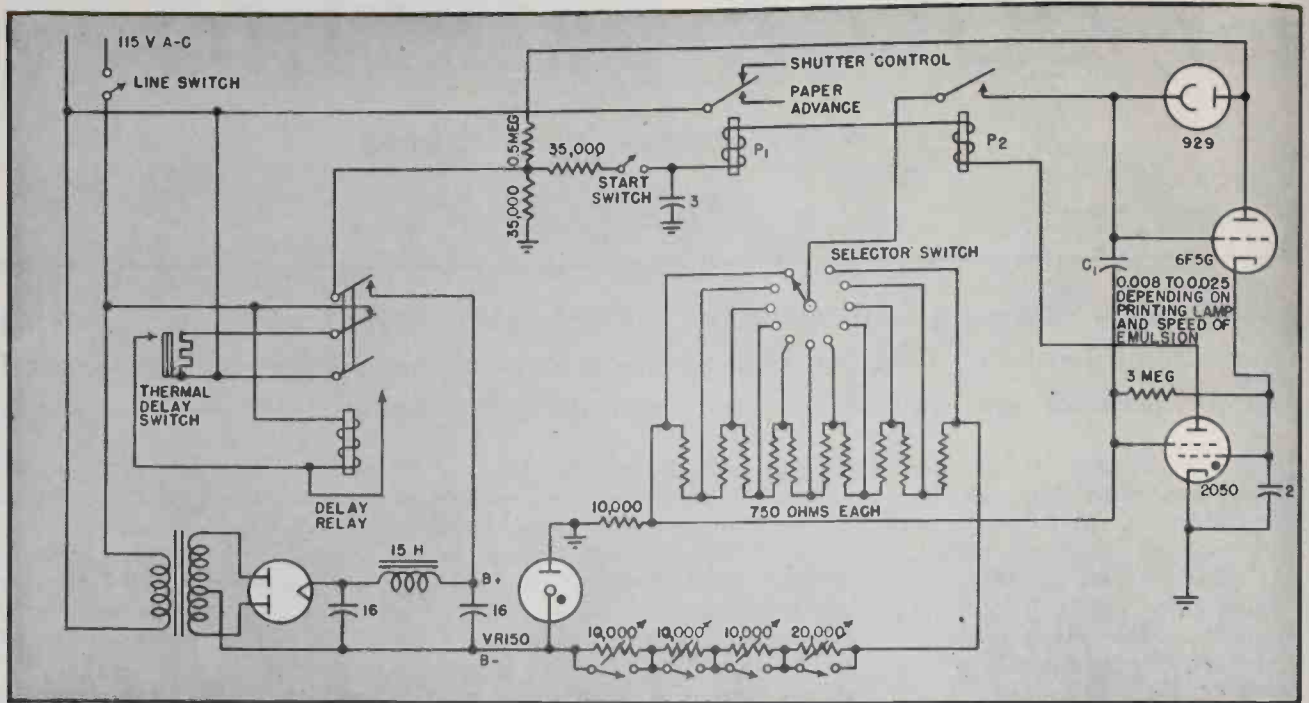

FIG. 1—Circuit of electronic timing system for proper exposure of color printing paper through color transparency. Rectifier tube is type 80

timed, beginning with the opening of a solenoid-operated shutter and ending when proper timing is measured by a phototube system. When the shutter closes, the printing material is automatically transported to the next position, and in the case of a single print from a transparency the carrier is released and automatically returns to its loading position. If the selector dial is set for two or more duplicate prints, the transparency carrier remains in its printing position until after the last print called for by the selector dial is exposed.

At the end of a total printing cycle, when the carrier is released, the control panel automatically clears in readiness for the subsequent transparency to be printed. The control panel can be cleared also by means of a reset button if an error is made by the operator in originally pressing the switches.

When an entire roll of sensitized material has been exposed a switch lever engages in a notch cut in the trailer at the proper spacing, whereupon the motor drive winds the material onto the take-up spool. The wind-up stops before the trailer is pulled completely through the printer, by means of a long-arm switch which rests on the back side of the web at the take-off end. When

the trailer flies loose from the spool the switch arm is no longer held in position by the taut material. The trailer left in the machine is used for attaching the leader of a new roll of material.

Exposure Timing Circuit

The exposure time required to print any given transparency properly is determined electronically during the exposure itself. A small part of the light passing through the transparency is directed onto a type 929 phototube by means of a prism and focusing lens, and the integrated phototube current dissipates a voltage charge across capacitor C_1 in series with the phototube by means of the circuit shown in Fig. 1. The time interval for dissipating this charge depends upon the average density of the transparency and upon the value of the charging voltage applied to the capacitor prior to the start of the timing cycle. The correct charging voltage for each transparency is determined electronically beforehand in an electronic coder that measures the ratio of the density of the most important portion of the transparency to the average over-all density.

In the circuit of Fig. 1, all relays are shown deenergized, as they are when the line switch is open. Closing

this switch energizes the full-wave power pack and the heater circuits of the 2050 thyatron and the 6F5G tube in the phototube system, but no plate voltages are applied because the delay relay is still open. After a delay of about 20 seconds the thermal delay switch closes and operates the delay relay, thereby completing the plate supply circuit. This relay also has its own holding contacts, and an additional pair of contacts to disconnect the thermal switch.

On standby (in between exposures), the starting switch is closed and the 2050 thyatron is conducting, so that relays P_1 and P_2 are energized, the shutter is closed, and capacitor C_1 is being charged through the series resistance determined by the coder to give the correct charging voltage for the next transparency.

When an exposure is to be made, the starting switch is opened momentarily. This opens the two relays, thereby opening the shutter and isolating the phototube circuit from the charging source, and at the same time altering the 2050 bias so it becomes nonconducting and the relays cannot reclose when the starting switch drops back to its closed position. Capacitor C_1 now discharges through the phototube at a rate proportional to illumination and the ini-

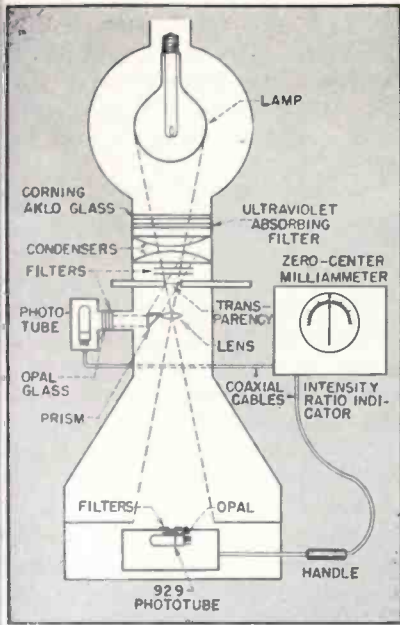

FIG. 2—Cross-section of coder, showing locations of the two phototubes employed to obtain the density ratio required for a satisfactory print. Each transparency is inserted in this coder before it goes to the color printer

ial charging voltage, until C_1 has discharged to the point where the 2050 again becomes conducting. Now the relays pull in, closing the shutter to terminate the exposure, advancing the paper one step, and recharging C_1 in readiness for the next exposure.

The 6F5G tube in the timing circuit is merely a resistance transformer, since it transfers its signal from the high-resistance load of the phototube to the comparatively low-resistance grid circuit of the 2050 tube. Grid emission is reduced by inserting 15 ohms in the heater circuit of the 6F5G, and instead of operating the anode at a low potential, which is commonly done in buffer stages, the anodes of both the 6F5G and 929 tubes are operated at 250 volts to acquire the necessary sensitivity. Over long test periods it has been found that stable characteristics can be maintained even though the anode voltage of the 929 is made as high as 250 volts, providing the 6F5G anode is operated at the same potential as the 929.

To further assure accurate timing it was found necessary to regulate the charging voltage. This is accomplished by a VR-150 which regulates only that portion of the circuit involved in the charging voltage operation.

It is necessary to be able to change the time integral of the circuit for a given amount of light received by the phototube to compensate for variations in emulsion speeds and processing variables. This is accomplished by a selector switch which is used to vary the level of the charging voltages applied on C_1 . For example, when a new emulsion is to be adopted a short test roll is exposed, using a standard transparency, at all eleven positions of the selector switch. Upon development, the proper exposure can be selected and the printer set at that particular tap. If, during continued use of the emulsion, there is a tendency for prints to be lighter or darker than normal, the switch is moved to a new position according to requirements. The effective change in print density in changing from one switch position to the next is made very gradual to permit delicate adjustments.

The value of C_1 is chosen to give an exposure time for an average, normal transparency that is considered convenient for operation. Different rheostats are switched into the B— lead to adjust exposure times on the minus or plus side of normal. The spread in effective exposure change from normal is established by adjusting the rheostats. A $\sqrt{2}$ change in capacitor charging time for each step has been found very satisfactory.

The timing cycle is started by opening a switch because the circuit

is designed for d-c operation and normal changes in grid bias cannot cause a thyratron to stop conducting in a d-c circuit. Therefore, the only satisfactory method of opening the relays to start an exposure is by opening the anode circuit with the starting switch.

Transparency Coder

If all transparencies were of uniform density distribution the same initial voltage charge on the capacitor could always be used. However, many transparencies have relatively large areas that are much darker or much lighter than the density of the important subject matter. Therefore, the integrated light passing through the transparency will not form a satisfactory exposure criterion unless the capacitor charging voltage is increased or decreased as required to time properly the exposure for the most important subject matter. Accordingly, the first step is to determine the ratio between the entire light transmitted by the transparency and the light transmitted by an area of the most important subject matter. This is accomplished in the electronic coder shown in Fig. 2.

The coder consists of a phototube circuit that measures the intensity ratio of the light passing through the entire transparency and of that passing through a small selected area. The phototube that receives the entire transmitted light is sta-

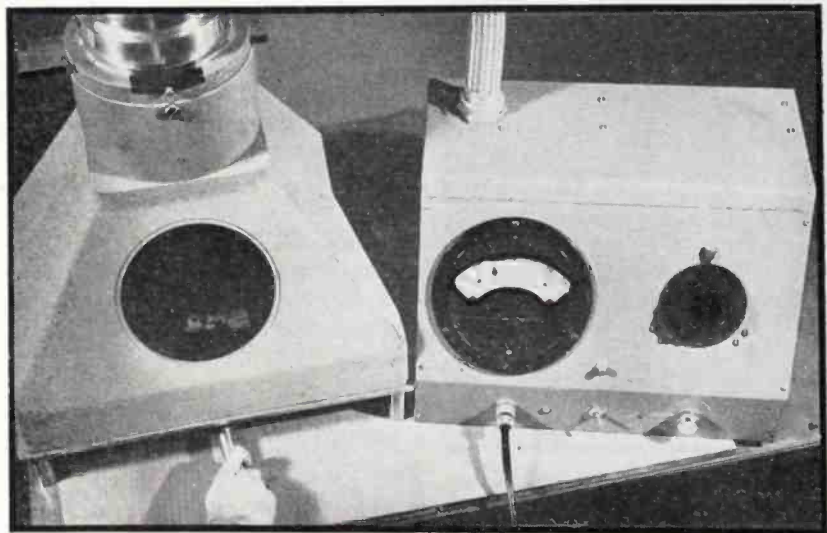

Electronic coder that measures the ratio between the light transmitted by the transparency as a whole and the light through a selected portion, thereby indicating the over-exposure or under-exposure required compared to a normal transparency

tionary, whereas the one that receives the light from the selected area is movable to allow scanning of the projected image area. The circuit is arranged to show a null reading on the milliammeter when a transparency is uniform in density distribution. Such transparencies are termed normal to indicate that the "N" button on the control panel is required to place the proper charge on the capacitor in the timing circuit. If a transparency has appreciable areas of high density surrounding a less dense subject, the milliammeter will be deflected to the left, indicating that a charging voltage lower than normal is necessary to expose properly the transparency. Such transparencies are marked "single minus", "double minus", etc. On the other hand, those transparencies that have appreciable light areas surrounding a more dense subject will cause the meter of the coder to deflect to the right, the extent of which determines the increase in voltage over the normal value required for properly exposing the important subject matter. These transparencies are marked "single plus", "double plus", etc. Once the coding of a transparency is deter-

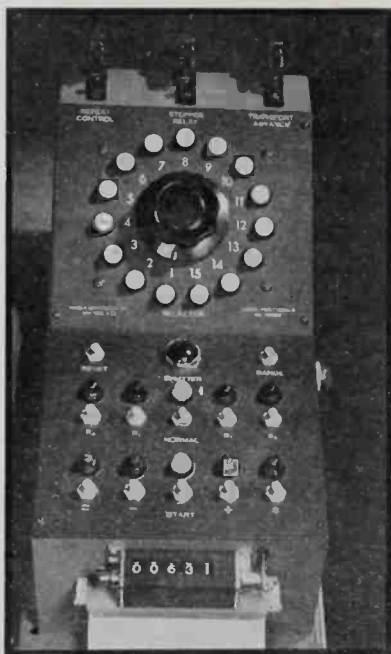

Selector dial for controlling the number of prints from any transparency, and other controls for the printer. The buttons at the bottom provide changes in the color temperature of the exposing lamp and permit control of exposure in relation to the density distribution of the transparency

mined, the timing circuit of the printer will automatically give an accurate print exposure.

Component and Tube Troubles

In designing and constructing the timing circuit, considerable experimental work was necessary to achieve dependable operation. The initial attempt to obtain consistent timing by electronic means was not successful. The results were far too erratic to be acceptable in color printing practice. It was found imperative to use utmost care in selecting component parts for the circuit and in building the equipment.

All components are now pretested over a sufficiently long period of time to determine if their characteristics will remain constant under various conditions. All tubes are bench tested and characteristic curves plotted over a period of fifty hours. Matched sets of selected tubes, namely 6F5G, 2050, 80, VR150, and 929, are placed in a laboratory timing circuit and subjected for forty hours to the same conditions as found in practice. The tubes are then removed and re-checked before being assigned to a printer.

Leakage currents are kept at a minimum by various means. Polystyrene is used wherever possible, ceresin wax is applied to all polystyrene fittings and to the phototube base, and the printing room is carefully air-conditioned. The relative humidity is never permitted to exceed 40 percent.

The spectral response of the 929 phototube is flattened by use of color compensating filters to minimize errors arising from widely varying spectral transmission of color transparencies.

Color Temperature Control

The color temperature of a tungsten lamp varies in practice because of voltage changes and accumulated tungsten deposits on the inside wall of the bulb. It is relatively simple to control the lamp voltage, but to maintain uniform color temperature during lamp darkening is more involved. It so happens that as the lamp darkens its brightness falls as well as its color temperature. By increasing the voltage on the lamp the brightness and color temperature will increase, approximately restor-

ing its normal characteristics.

The phototube circuit shown in Fig. 3 makes possible a lamp brightness control, equivalent to brightness changes arising from ± 1 -volt line variations.

Two phototubes are focused on the portion of the printing lamp that is directed toward the printing material. The phototube of system A is a 930 which has an S1 surface. The phototube of system B is a 929 which has an S4 surface. In system A a drop in illumination will cause the 2050 tube to be conductive since the decrease in phototube current makes the 2050 less negative. Relay P_1 is thereby energized. The contacts of P_1 are connected to one side of a reversible a-c fractional-horsepower motor M , which turns rheostat R_1 in the required direction to increase the illumination of the lamp to the original value, set by R_2 .

In phototube system B an increase in illumination causes its 2050 tube to be conductive, closing relay P_2 , which operates motor M in the direction required to decrease the lamp voltage; therefore, its brightness is restored to the value originally set by R_2 .

A description of the circuit function will make the color temperature control more understandable. A positive voltage is applied to the 2050 anodes and phototube anodes during every other half-cycle, when the upper side of the a-c line is positive. During these half-cycles, negative bias voltage is supplied to the 2050 grid from R_3 . The potential of the grid is made less negative by the IR drop across R_4 , which reduces the negative grid potential, causing the 2050 to conduct and the relay to close.

Excellent stability of both systems is accomplished by use of 1.0-ohm resistors in series with the heaters to reduce slightly the heater voltage and by 7-megohm resistors in the screen grid leads of the thyratrons. Apparently the gas currents within the tube are reduced by operating the screen and heater below the rated values.

Plate relays P_1 and P_2 have a 1,500-ohm resistance to hold the relay current at a safe value.

The anode voltage of the 930 phototube in system A should never exceed 90 volts. Therefore, it is necessary to include a 3,000-ohm resis-

ance, R_5 , to limit the current through the 2050 to a value such that the IR drop across R_2 will not permit the peak voltage of the phototube to exceed 90 volts. Additional limitation is provided by the use of a 1,500-ohm plate relay P_5 . Motor M is a gear reduction motor whose secondary shaft rotates at 1 rpm and is coupled to rheostat R_1 .

The purpose of the Variac is to set the voltage to meet the color balance requirements of the printing material. The permissible tolerances in color temperature for maintaining uniform color balance in finished prints are determined experimentally. These data are then used for the monitoring range of the printing lamp, which is set by positioning the contacts of R_2 and R_3 of systems A and B.

Systems A and B must be isolated from each other to prevent one system from influencing the other. For this reason isolation transformers were used.

Second Exposure Control

The second exposure of the sensitized material is made by two Hanovia DH1 400-watt high-intensity mercury vapor lamps. The lamps are placed above and below the web to assure complete exposure through the emulsion in the short time interval of two seconds. The lamps have the advantage of high light output and low heat, but have the disadvantages of requiring approximately five minutes to reach peak brightness and of requiring a period of about ten minutes for restarting.

Since adequate second exposure of the material is so important, two safety devices are used. One is a phase-changing unit, and the other an electronic means for automatically controlling a bank of tungsten lamps that can be employed for second exposure during relatively short time periods if the Hanovias fail. The tungsten lamps generate excessive heat in the second-exposure cabinet if used longer than 20 or 30 minutes. The two safety devices in combination are referred to as the re-exposure control and phase-changer.

In the operation of the Hanovia lamps, two legs of a three-phase system are utilized as in Fig. 4. When the processing machine is started two phases, energized through a re-

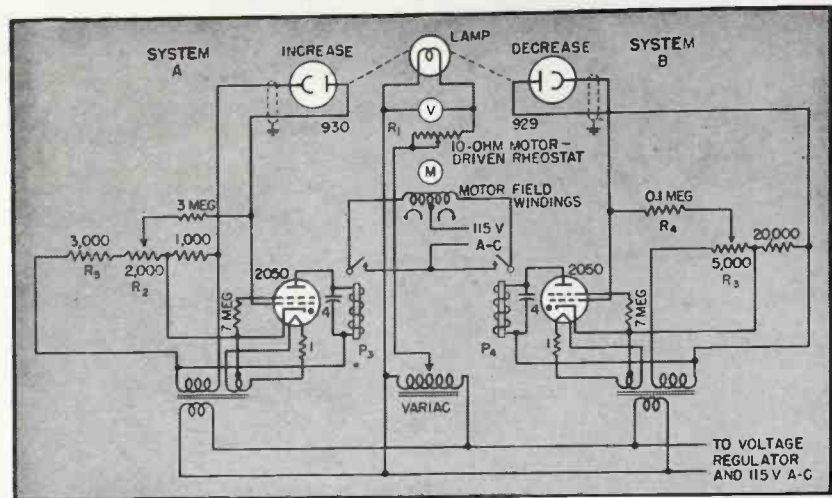

FIG. 3—Circuit for controlling the color temperature of the exposing light source

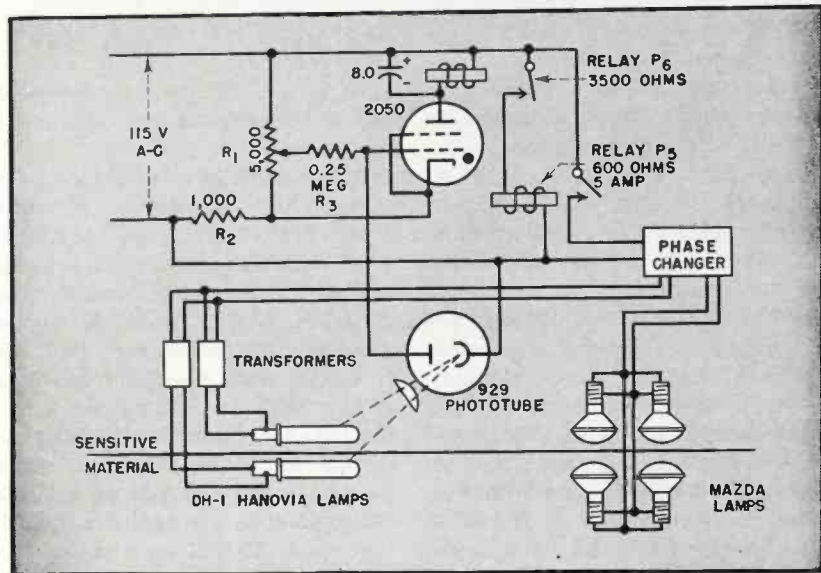

FIG. 4—Photoelectric circuit for monitoring the Hanovia mercury-vapor lamps used for second exposure of color printing paper

mote-control contactor, operate two relays. The lower contacts of one relay carry phase 1, whereas the upper contacts carry phase 2. The contacts of the second relay carry these phases in the reverse order. If for any reason phase 1 should fail, phase 2 becomes effective and vice versa.

The phototube monitoring system controlling the auxiliary tungsten lamps functions through control relay P_5 (Fig. 4) which is energized by plate relay P_6 . The phototube circuit consists of a 2050 and a 929 tube so arranged that as long as the illumination is below a certain level, the 2050 is conductive and energizes plate relay P_6 . Conductivity of the 2050 is lost when the illumination increases to a safe level for complete second exposure. This value was de-

termined experimentally and R_1 was adjusted accordingly.

The operation of the circuit is as follows: Positive voltage is supplied to the anodes of the 2050 and 929 tubes during every half cycle when the upper side of the a-c line is positive. During these half cycles, negative bias voltage is supplied to the 2050 grid from R_2 . The potential of the grid is made less negative by the IR drop resulting from the flow of phototube current through R_3 . A decrease in phototube current makes the 2050 less negative, closing P_6 .

The positioning of the phototube unit in respect to the Hanovia lamps is quite important. The unit must be placed in such a position that the radiation from the two lamps is detected equally.

PULSE-TYPE RADIO ALTIMETER

Technical details of high-altitude altimeter using radar techniques as distinguished from earlier types employing the Doppler effect. Readings on circle-forming cathode-ray indicator are accurate to within 50 feet even above 30,000 feet

DEVELOPMENT of a high-altitude radio altimeter for the Army Air Forces was initiated late in 1930 when the need for an accurate, absolute method of determining terrain clearance for purposes of bombing at altitudes above 20,000 feet became apparent. Five developmental models were constructed by RCA before acceptance of the SCR-518-A, the first pulse-type radio altimeter to go into production. Even while two thousand equipments of this type were being manufactured by the RCA Victor Division and installed in AAF medium and heavy bombers, military requirements necessitated a new design to reduce the weight and size and increase the range and accuracy. For a time it seemed that an answer had been found in the SCR-618-A, which weighed .75 pounds, bulked 2.5 cu ft, and had a range of 40,000 feet, with accuracy main-

By **ALBERT GOLDMAN**

*Chief, Altimeter Unit
Aircraft Radiation Laboratory,
Electronic Subdivision
Air Technical Service Command
Wright Field, Dayton, Ohio*

tained by a crystal-controlled timing oscillator.

Meanwhile, work had already begun on a new light-weight equipment, SCR-718. When Army Air Forces Headquarters was informed of its characteristics, production of SCR-618-A was ordered stopped, after only three had been built, and SCR-718 was given the go-ahead.

The SCR-718-C described here is the latest in the SCR-718 series, and differs from the first two models mainly in the addition of a 50,000-foot scale to the normally-used 5,000-foot scale. This change was made to avoid confusion in reading the altimeter indications. The altimeter it-

self may be likened to a simple, compact, light-weight version of a typical airborne radar search or bombing equipment. Accuracy is stressed, since it is unnecessary to read azimuth, locate targets, solve the bombing problem, or provide automatic tracking. Flights checked against photo-theodolite equipment have nearly always indicated the error to be less than 50 feet, even at altitudes of 30,000 feet and above.

General Description

The two main units of the equipment, the transmitter-receiver and the indicator, are shown in block diagram form in Fig. 1. The timing oscillator is crystal-controlled at 98.356 kc for the 5,000-foot range, and operates as an electron-coupled oscillator at 9.835 kc for the 50,000-foot range.

Part of the sine-wave output of the

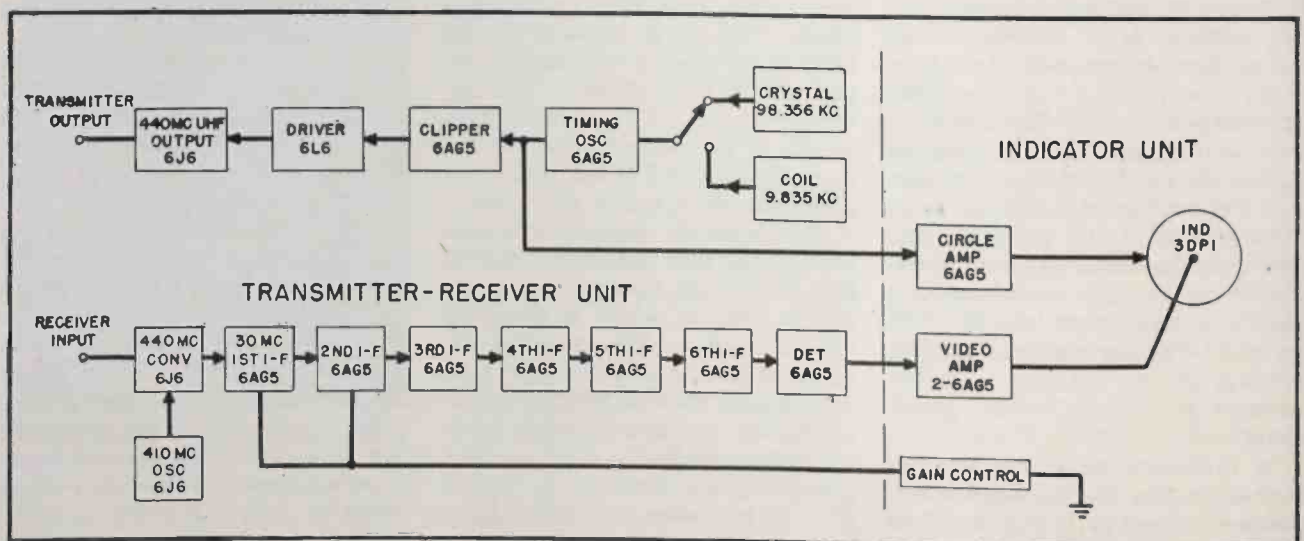
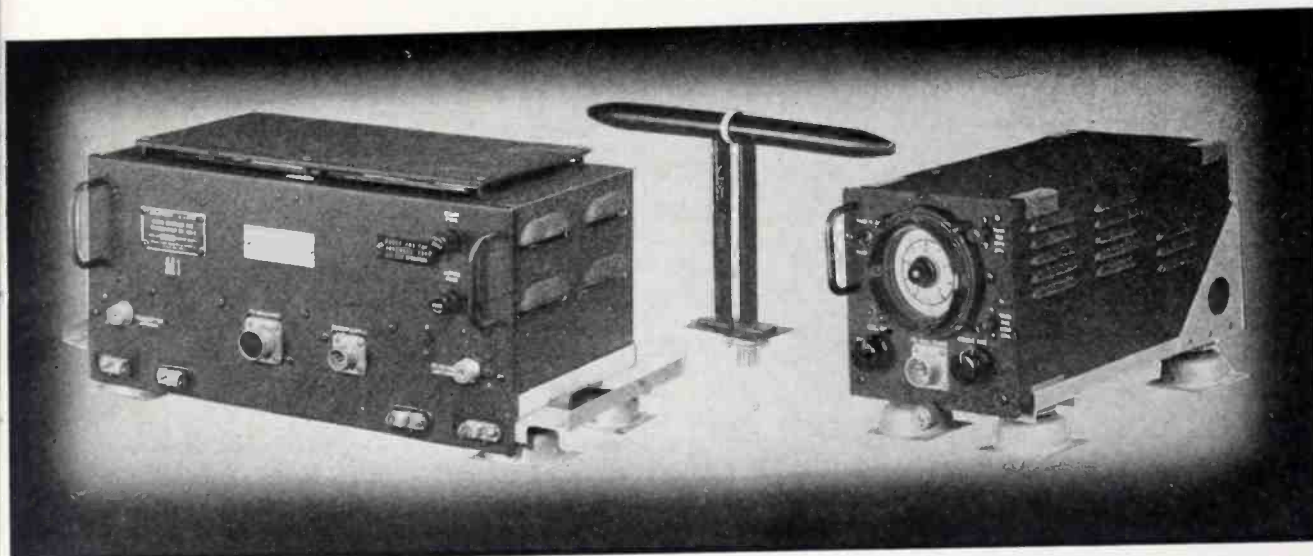

FIG. 1—Block diagram of the SCR-718-C, pulse-type high-altitude radio altimeter



Left to right—transmitter-receiver unit, one of the antennas, and indicator unit

timing oscillator is clipped, differentiated, and amplified in pulse-generating circuits, and the pulses are applied by a 6L6 driver (modulator) to the plates of a 6J6 in the uhf output stage. The pulse repetition frequency is therefore either 98,356 or 9.835 kc. The uhf output circuits are nominally tuned to 440 mc, although it is possible to adjust the frequency over a range of almost ten megacycles. Pulses of 0.25 microsecond length, with a peak power of 5 to 10 watts, are produced.

A small portion of the timing oscillator output is fed through the interconnecting cable to the indicator, where phase-shifting tuned transformers produce voltages 90 degrees out of phase. These voltages are applied to the horizontal and vertical deflecting plates of the cathode-ray tube, generating a circular sweep. The detector output is also fed to the indicator unit, where it is amplified by two 6AG5 tubes in parallel and applied to a radial electrode in the type 3DP1 cathode-ray tube. The negative signal pulse repels the electron beam and causes the circle to be momentarily deflected outward in the shape of a pulse or lobe. There are normally two such lobes on the circle, one at zero representing the outgoing pulse, and the other at a position corresponding to the altitude of the aircraft, representing the pulse reflected by the terrain.

Transmitter-Receiver Circuit

The transmitter-receiver circuit is shown in Fig. 2, and the indicator

circuit in Fig. 3. The frequency of the timing oscillator is changed from 98.356 kc (crystal-controlled) to 9.835 kc (electron coupled) by throwing the scale switch in the indicator from the TIMES ONE position to the TIMES TEN position, which applies voltage to the scale-change relay in the oscillator circuit. Operation of this relay connects the low-frequency section of the oscillator grid coil into the circuit, making the crystal inoperative. This grid coil is paralleled by temperature-compensating capacitors, to insure maximum accuracy over a wide range of ambient temperatures. The high- and low-frequency sections of the coil are wound on the same form, but are tuned separately by powdered iron slugs, one at each end of the coil.

The plate load of the timing oscillator consists of two tuned circuits in series, one for each timing frequency; the coils are permeability tuned. The signal for forming the circular sweep is picked up by an untuned tertiary winding and fed to the circle amplifier in the indicator through a single shielded wire which also carries screen grid currents for the oscillator, clipper, and driver tubes.

The timing oscillator direct output goes to the 6AG5 clipper. The positive peaks are only slightly flattened by grid limiting action. Pulse forming is achieved by the plate load, a coil tuned to about 400 kc and damped so that only the highest positive peak of the clipper output affects the 6L6 driver tube.

The driver plate load is tuned to approximately 900 kc, and the driver output is another damped voltage train, with a peak value of 400 to 450 volts. By means of suitably designed time-constant circuits, the driver output wave shape and amplitude are made relatively independent of the timing oscillator frequency.

The 6J6 uhf oscillator tube is plate modulated by the driver output pulses. The plate lines are silver-plated pipes with outside diameter about $\frac{1}{8}$ inch, $2\frac{1}{2}$ inches long, spaced $\frac{1}{8}$ inch between centers, and tuned by a shorting bar adjustable from the front panel. R-f chokes are small six-turn coils. The antenna coupling loop is mounted directly below the plate lines, and its spacing therefrom is adjustable from the top of the chassis. The loop is series tuned by a small variable air-dielectric capacitor. The entire uhf output assembly is housed in a $1\frac{1}{2} \times 4\frac{1}{2} \times 1\frac{1}{2}$ -inch aluminum can, with heater and driver leads brought into it through ceramic feed-through capacitors.

The uhf converter and oscillator are also housed in an aluminum can, somewhat larger, located at the opposite end of the chassis to reduce direct feed-through. The converter tube plates are connected in parallel, while the grids are connected to parallel lines tuned by a shorting bar as in the uhf output circuits. However, the grid end of the line is shunted (thereby shortening the line to $1\frac{1}{4}$ inches) by a small two-plate variable capacitor, adjustable from the front panel for fine tuning. An-

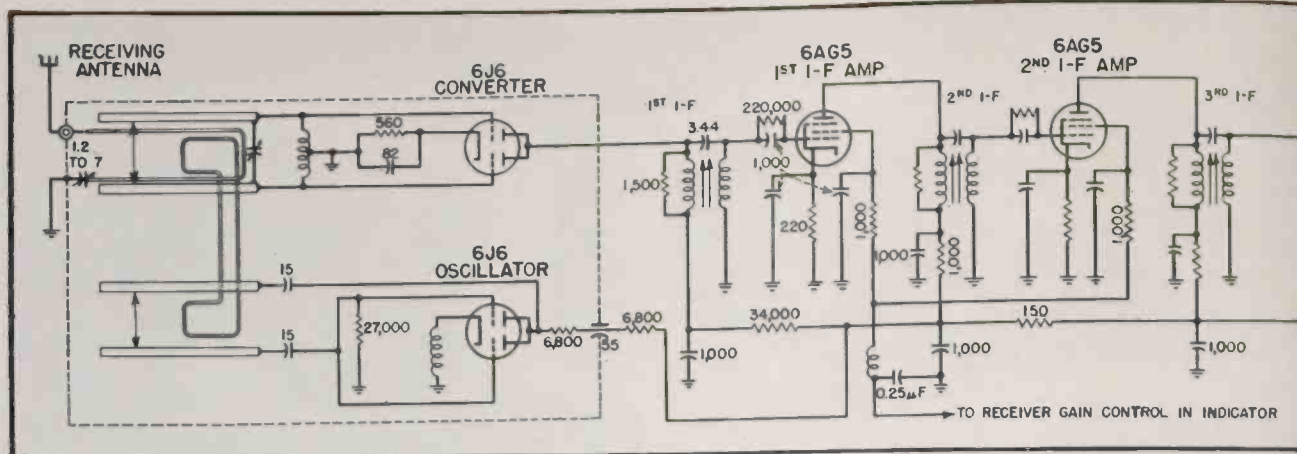

FIG. 2—Transmitter-receiver circuit diagram. All six i-f stages have identical component values as given for the first i-f stage, except where other values are indicated

tenna coupling loop tuning and adjustment are almost identical to that employed in the transmitter assembly.

The 410-mc local oscillator is link-coupled to the converter, the loops being located below the tank lines. The 6J6 oscillator is operated as a single triode, with grids and plates respectively tied together and the element pairs connected to the parallel pipe line through ceramic capacitors. The oscillator frequency is adjusted by means of a shorting bar across the pipe line.

The converter output is coupled to the first of six 30-mc i-f stages. Bandwidth of each i-f transformer is 4.5 mc at 3 db down. The first two stages differ slightly in that the screen grid voltage is variable and controlled by the receiver gain control in the indicator unit. It was found that reducing this voltage to zero did not prevent amplification of the strong signal reflected when the aircraft was on or near the ground; for this reason grid leak bias was added to the first two i-f amplifiers.

The i-f transformers are all capacitance-coupled, double permeability tuned (no capacitance other than stray capacitance being required), and primary loaded. Heaters of the i-f string are isolated for r-f by small chokes, and plate and screen grid supply leads are decoupled by the usual resistor-capacitor networks.

Indicator Amplifier

The output of the 6AG5 detector (Fig. 2) is taken from its cathode

through a simple filter, and fed to the video amplifier in the indicator unit (Fig. 3) through a 75-ohm coaxial line. The video amplifier input is grounded through an 82-ohm resistor, which approximately matches the transmission line impedance. The video output, consisting of negative pulses, is applied to the central electrode of the cathode-ray indicator tube; this electrode is grounded through about 600,000 ohms, so that it does not accumulate a charge.

To minimize interference that might be caused in communications receivers by radiation of these video signals, the central electrode is shielded by a small grounded metal cap. The dial scale is a transparent decalomania applied directly to the face of the cathode-ray tube. A Lucite window protects the tube against accidental damage.

Separate circle-forming circuits are required for the high- and low-frequency timing signals, but the 6AG5 circle amplifier and associated d-c components remain unchanged. Before amplification of the timing signals, they pass through two zero-adjusting transformers, one for each scale; primaries are untuned and connected in series, while secondaries are permeability-tuned. A voltage divider across the secondary of the TIMES ONE transformer permits independent adjustment of the size of the 5,000-foot range circle; the circle size control, at the input to the circle amplifier, controls the size of both circles. The two controls are normally adjusted so that the TIMES

ONE circle is about one-quarter inch smaller. This is done to enable the two scales to be readily distinguished. Before the 50,000-foot scale was added, some confusion was occasioned by the necessity for either counting the number of encirclements made by the reflected pulse or estimating terrain clearance by subtracting terrain height from height above sea-level, the latter determined from conventional barometric altimeter readings.

The circle amplifier plate circuit contains the two circle-forming transformers, one for each sweep frequency; both primaries and secondaries are permeability-tuned, and in addition two variable resistors are provided for circle shape control. Several temperature-compensating ceramic capacitors are associated with the zero-adjusting and circle-forming transformer circuits. Deflection and centering connections are balanced to ground, but otherwise conventional. Focus and brilliance controls are conventional.

Operational Use

This radio altimeter was installed in most medium and heavy bombardment aircraft, but before the war ended it was found to be more valuable as a navigational aid than as a tactical aid in bombing. This resulted on the one hand from the improved accuracy in ranging circuits of radar bombing devices, and on the other from the development and refinement of a method of determining drift by the comparison of radio and barometric altitude readings.

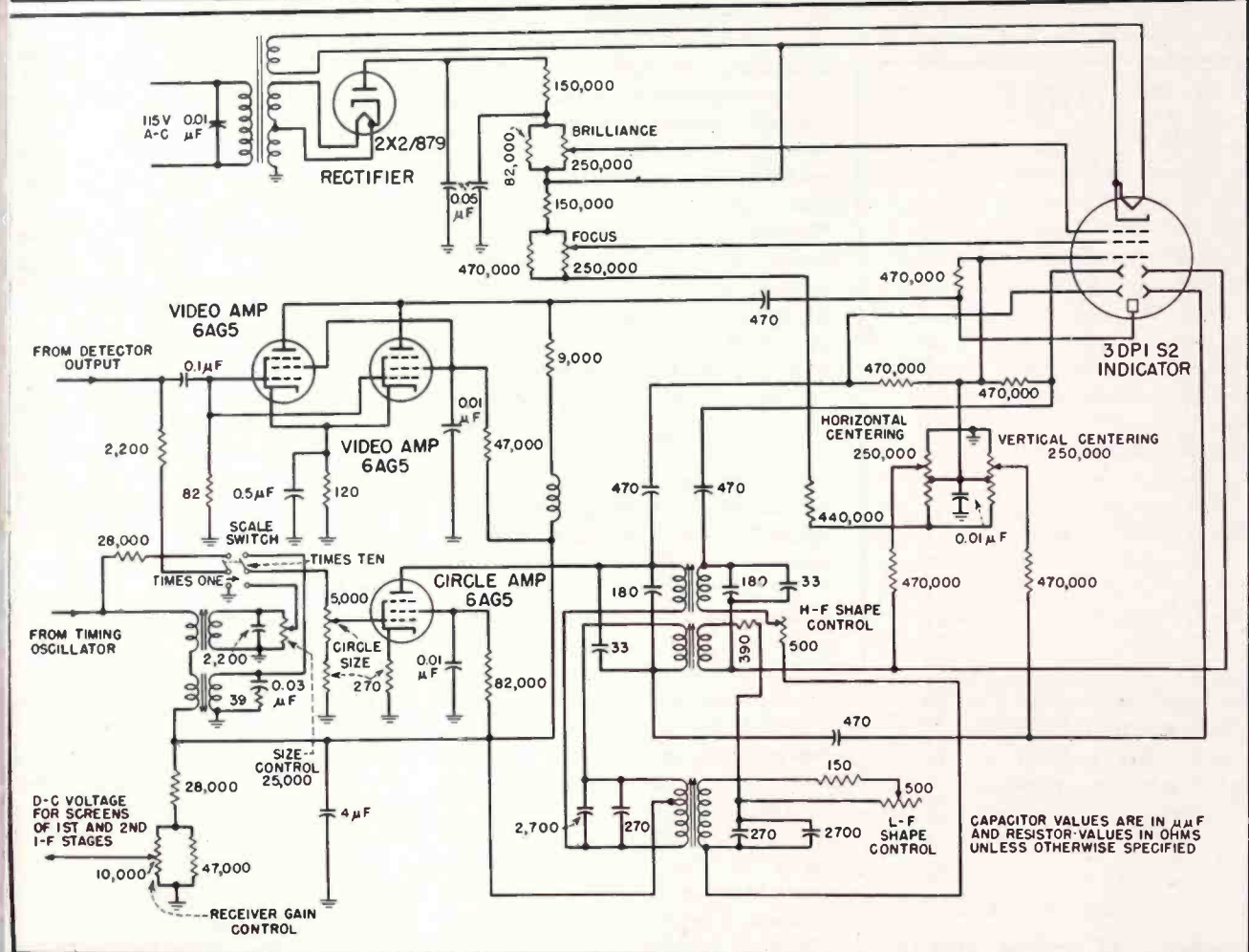
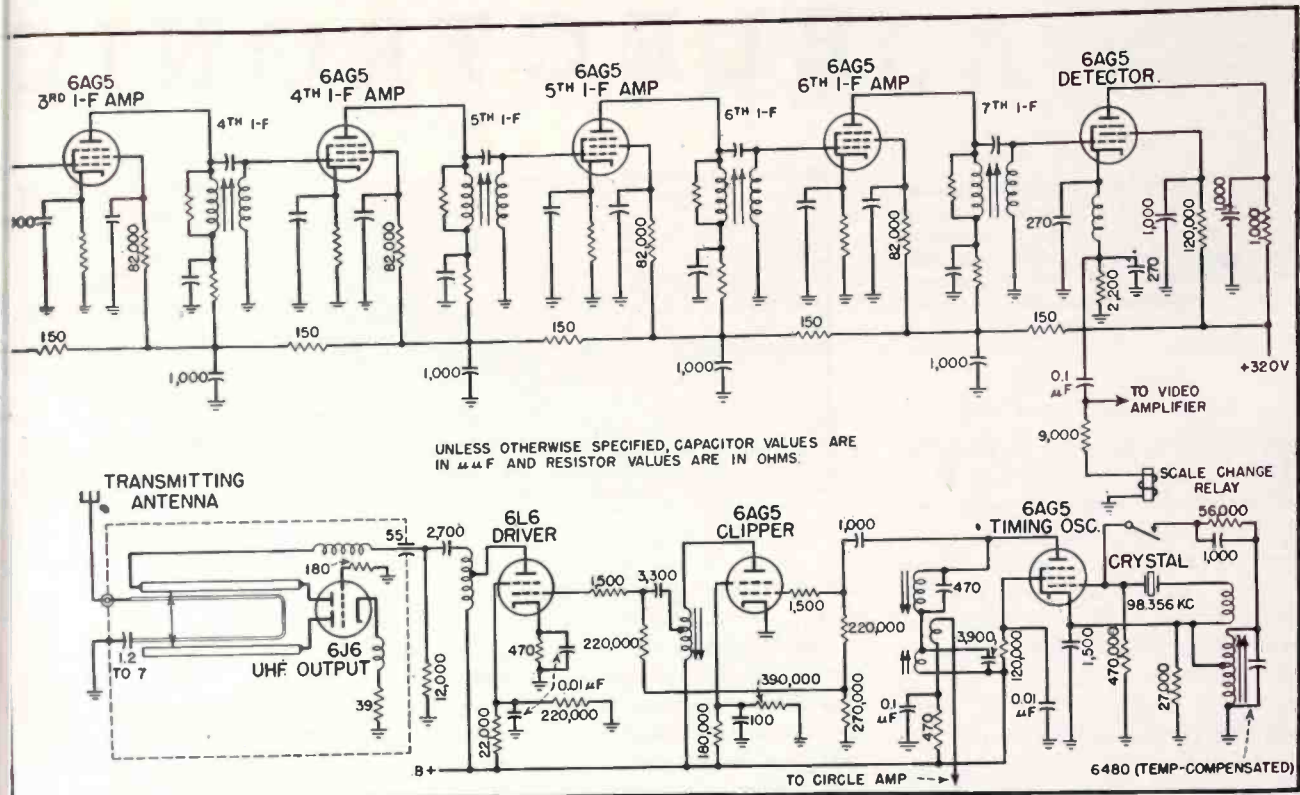

FIG. 3—Indicator circuit diagram. Permeability tuning is used on all r-f coils

ELECTRONIC

Complete translator in which code characters appear as letters on the viewing space of the panel. Four pairs of thyatron tubes were used in this early model. The clock motor mounted on the front of the panel rotates a phosphor-coated disk at a speed of one rpm



THE INSTRUMENT to be described is capable of converting International Morse Code (or any arbitrary code) into visual images of the letters and figures corresponding to the code characters. Since it is designed to be coupled to the output terminals of a radio receiver, it offers the possibility of hearing the code characters and seeing the corresponding letters simultaneously. Alternatively, code can be sent into the translator with a key for code in-

struction, as well as for communications.

The translator consists of two sections: (1) a discriminator, in which five or more pairs of thyatron tubes, employed as reset relays in a scaling circuit, produce after each group of dots and dashes a unique voltage determined by the character received; (2) an indicator, functioning on the stroboscopic principle, that converts the discriminator voltage, at the proper time, into a persistent optical image of the character on a moving phosphorescent screen. Portions of the circuit are gated, so that the thyatron tubes are returned to the ready condition after each character has been presented, and so that the stroboscope is illuminated only at the proper time. The circuits are capable of translating code at any speed that can be followed by a relay.

Weighted Characters

The code characters are analyzed by the discriminator on the following basis. The dots and dashes in a character are considered as numbered 1, 2, 3,, and the numbers are assigned weights in a geometric progression of 1, 2, 4, 8, etc. The total weight of each character is found by adding the weights of the individual unit signals, the individual weight being doubled if the signal is a dash. This rule is illustrated by the schematic system of weights shown in Fig. 1. For example, the weight of the letter "E" (one dot) is 1; of "N" (dash dot) is 4; of "R" (dot dash dot) is 9, etc. Table I gives the weights of all commonly used characters of the International Morse Code.

Thus the various letters and figures have discrete weights, differing in general by unity.

The heart of the discriminator is the array of five (or more) pairs of gas tetrodes (2050's or 2D21's) shown at lower left in the circuit diagram of Fig. 2. These tubes represent the schematic arrangement of weights shown in the block diagram of Fig. 1, the weight being assigned to each tube by specifying its individual plate resistor.

When a given gas tube is turned on by a signal applied to its control grid

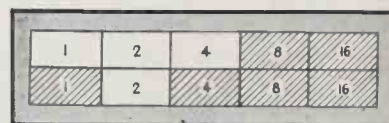

FIG. 1—Weights of unit signals. The upper row is used if the signal is a dot; the upper and lower rows are added if the signal is a dash. The total weight of the dots and dashes in a group is the weight of the character. The unshaded blocks show a total weight of nine for the letter "R"

through the input network, it conducts a current that is nearly inversely proportional to the magnitude of its plate resistor.

The two tubes of each pair have plate resistors of equal value, the values decreasing in geometric progression to the right. Since all the individual plate resistors are coupled to a common point on a voltage divider between R_1 and R_2 , and since the sum of all the tube currents passes through the common resistor R_1 , the voltage drop across this resistor is determined by the particular group of tubes that have been turned

TABLE I		
Letter or Figure	Code Character	Weight
E	.	1
T	..	2
I	...	3
N	..-.	4
A	.-.	5
M	-.-	6
S	...-	7
D	..--.	8
R	.-.-.	9
G	...--.	10
K	..--.-.	11
W	-.--.	12
O	---.	13
H	..-.-.	14
B	...--.-.	15
L	..-..-	16
Z	...--.-.	17
F	...--.-.	18
C	...--.-.	19
P	...--.-.	20
V	...--.-.	21
X	...--.-.	22
Q	...--.-.	23
Y	...--.-.	24
J	...--.-.	25
5	...--.-.	26
6	...--.-.	27
7	...--.-.	28
8	...--.-.	29
9	...--.-.	30
4	...--.-.	31
3	...--.-.	32
2	...--.-.	33
1	...--.-.	34
0	...--.-.	35
()	..-.-.	36
?	...--.-.	37
9	...--.-.	38
4	...--.-.	39
3	...--.-.	40
2	...--.-.	41
1	...--.-.	42
0	...--.-.	43

CODE TRANSLATOR

Code signals from a receiver are fed into a ten-tube discriminator to produce voltages that trigger a gas-filled tube. Illumination from the tube causes corresponding letters and numerals to appear on a moving fluorescent screen

on. Thus, a unique voltage appears at the first grid of tube V_{10} in the indicator circuit, and this voltage corresponds to the particular letter or figure that was sent into the translator.

Circuit Analysis

The method of switching on the various dot and dash tubes of the array may be followed by studying the circuit. The upper tube of each pair in the diagram ($V_1 \dots V_{10}$) is a dot tube, the lower is a dash tube. When a group of dots and dashes is introduced into the circuit, the dot tubes are turned on, in order, at the conclusion of each unit signal, whether it be a dot or a dash. It will be noted that the successive dot tube grids are biased step-wise, and that the whole grid system is raised about three volts per signal by the intermittent charging of capacitor C_1 through the left-hand section of tube V_{10} . (The right-hand section is used to discharge the capacitor when the circuit returns to the cleared condition.)

The problem of ensuring that the dash tube of a pair would go on at the end of a signal only if the signal was a dash was solved by placing two conditions on the ignition of each dash

By HORACE W. BABCOCK

Mount Wilson Observatory
Pasadena, California

tube: (1) The corresponding dot tube must go on, giving a negative pulse to the cathode of the dash tube through capacitance coupling. (After ignition, diode anchor $V_{11}, V_{12} \dots$ prevents the thyatron cathode from rising appreciably in potential); (2) the grid of the dash tube must be at a sufficiently positive potential as determined by an RC circuit (R_2, C_2) that is controlled by the duration of the unit signal, thus discriminating between dots and dashes.

At the conclusion of a group of dots and dashes, another RC circuit permits the indicator to function and then opens a relay (RY_2), cutting off plate potential for all of the thyratrons and so extinguishing them. The circuit is then ready for the reception of the next code character.

The resistance elements (R_3, R_4) of the two timing circuits are ganged on a common control that is set by the operator with the aid of a calibrated dial to the approximate speed of the code being received.

The indicator section of the translator consists of the gate circuit associated with tube V_{10} , a Strobotron or similar triggered-arc illuminating

tube, and a stroboscopic letter disk carried on the rapidly rotating shaft of a 3600-rpm synchronous motor M_1 . The various letters and figures were punched out stencil-fashion around the edge of the disk in the order given in Table I.

The double triode V_{10} is connected in a biased multivibrator circuit* so that normally the left-hand triode is off and the right-hand triode is conducting. The circuit is tripped by a positive pulse on the left-hand grid. This pulse, or trigger, occurs at zero phase of rotation of the stroboscopic disk, upon the closing of a timer contact SW on the motor shaft. The duration of the interval during which the gate remains tripped is determined by the d-c potential on the left-hand grid, and hence by the output voltage of the discriminator.

The Strobotron illuminating tube, V_{10} , is triggered by the return of tube V_{10} to the stable condition, hence the illuminating flash occurs at a phase determined by the discriminator, and the proper letter image appears to the viewer. The indicator tube is independently gated by the relay RY_2 , and hence is always off except for a

* This circuit is a variation of that given on p 59 in Puckle, O. S., "Time Bases," John Wiley & Sons, Inc., 1943.

Tube and shield removed to show the placement of the letter-stenciled disk in relation to the phosphor-coated disk

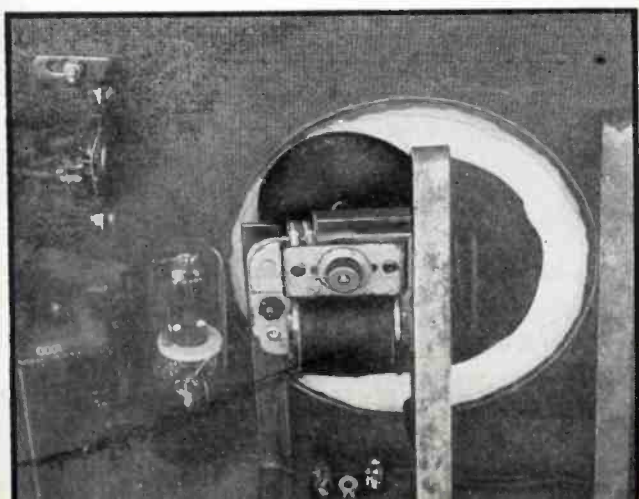

The indicator tube is mounted behind the panel so that flashes shine through an aperture in the metal shield

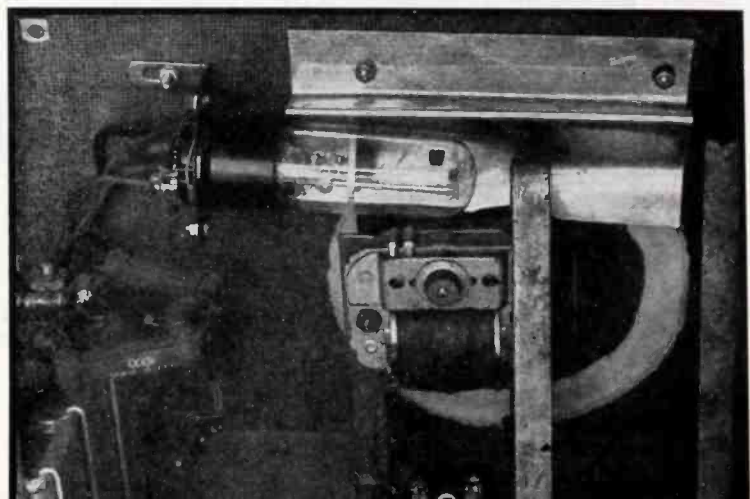

brief interval at the termination of each code character. The gate is open long enough to permit illumination of the letter disk on two or more successive turns (several turns at low code speeds).

To facilitate reading, the illuminated letters are optically transferred from the stroboscopic letter disk to a slowly rotating glass disk, D_2 , that has been coated with a sensitive phosphorescent compound. This viewing disk is rotated by motor M_2 from right to left at a speed of one rpm so that the letters of the message received appear in the proper sequence and their images persist for a number of seconds.

A working model of the translator has been built, and has given results both satisfactory and highly entertaining. The discriminator responds well to ordinary hand sending, and has proved to be not too sensitive to the particular code speed. The ideal source of code is an automatic key-

ing device, but this is not essential for good results. The translator naturally shows up sending that deviates too far from the ideal, in which the dash length is three times the dot length, and in which the interval between dots and dashes in a group is equal to the duration of a dot. If the circuit is to be coupled to a receiver, the whole translator must be adequately shielded to suppress radiation from the relays.

The translator could no doubt be improved in a number of respects. In particular, the timing contact on the shaft of the synchronous motor could be eliminated by triggering the gate circuit from the 60-cycle power wave. An additional tube would be required for squaring up and differentiating the sine wave to produce a suitable trigger, but the gain in dependability and mechanical simplicity would no doubt be worth while. The first model suffered from the fact that the indicator tube lacked suffi-

cient luminous output, especially in the shorter wavelengths of the optical spectrum, to give adequate persistence in the phosphorescent letter images. This feature could be improved by the substitution of a suitable triggered mercury-pool arc tube.¹

Since the time intervals required for the transmission of the various characters are different, the spacing of the letters on the phosphorescent viewing disk is not uniform if the disk rotates at constant speed. Uniformity of spacing could be achieved by causing the rotation to occur in equal steps, one step being made for each action of the relay RY_2 .

Appreciation is expressed to the California Institute of Technology for providing laboratory facilities for part of this work.

REFERENCES

- (1) Edgerton, H. E., and Germeshausen, K. J., *Rev. Sci. Inst.*, 3, p 535, 1932; Edgerton, H. E., *Elec. Eng.*, 50, p 327, 1931; *ELECTRONICS*, p 220, July, 1932; Hitchcock, R. C., *Elec. Jnl.*, 32, p 529, 1935.

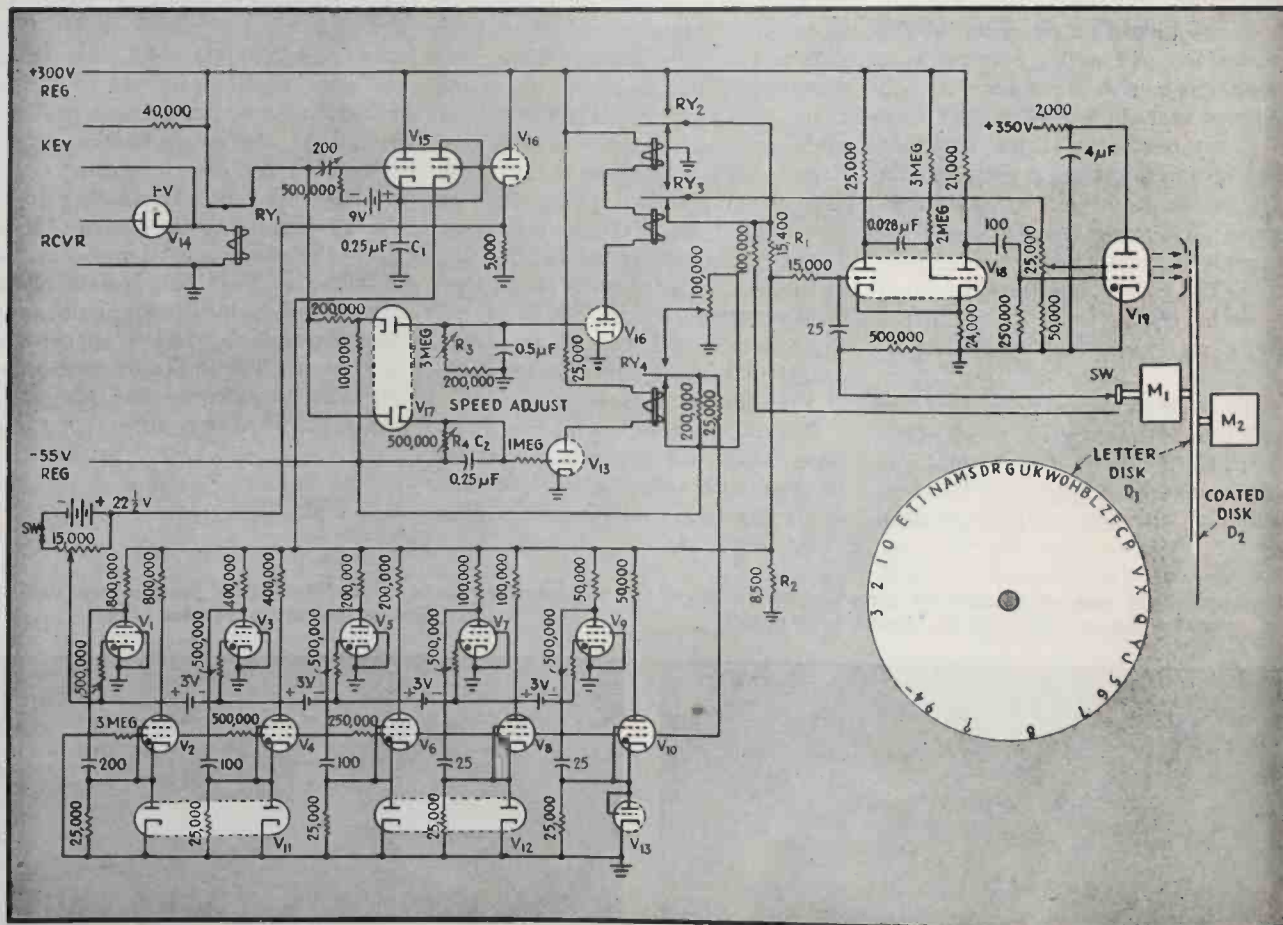

FIG. 2—Complete circuit of the electronic code translator. Tubes lettered V_1 to V_{10} are type 2050; V_{11} , V_{12} , and V_{17} are type 6H6; V_{13} , V_{15} , V_{16} , and V_{18} are type 6SN7; V_{14} is a 1-V and V_{19} is a Strobotron

Reentrant Pentode A-F Amplifier

Special pentode operating as two triodes in cascade gives gains up to 500 with 45-volt plate supply. Grid No. 2 of pentode serves as anode for first triode, while grid No. 3 and plate form second triode system. Factors affecting circuit design are analyzed

By **ROBERT ADLER**

Engineering Department
Zenith Radio Corporation
Chicago, Illinois

PENTODES with sharp cutoff and low plate current are in general use in RC-coupled audio amplifiers where high gain per stage is desirable. With properly chosen screen and plate load resistances, the gain is generally of the same order as the plate supply voltage expressed in volts. This means that with the plate supply of 45 volts or less used in many small portable receivers, the gain per stage is usually limited to 40 or 50 for pentodes in conventional circuits.

The new and unusual circuit to be described permits voltage gains in the order of 300 to 500 and a safe minimum gain of 250 in a single pentode of special design, operating from a 45-volt plate supply.

Two-Stage Amplifier

In the basic two-stage pentode circuit shown in Fig. 1, the first grid, G_1 , is a conventional control grid; the following grid G_2 acts as an anode with respect to G_1 , so that G_1 and G_2 may be considered to act like a triode. Grid G_2 is connected to the plate supply through a load resistor R_2 ,

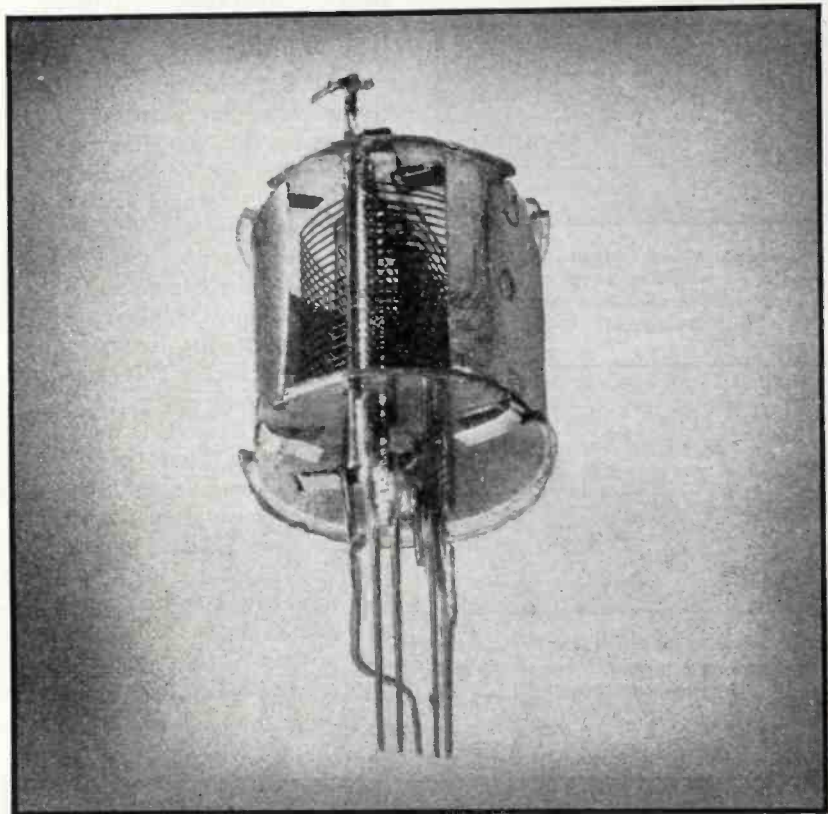

Special experimental pentode tube originally built by Zenith and later manufactured by Raytheon under type number CK511X for reentrant amplifier use

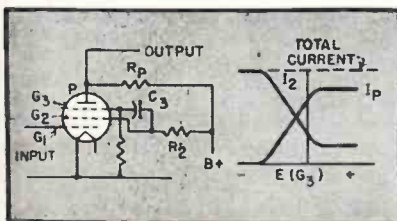

FIG. 1—Basic two-stage circuit for single pentode, with characteristic curves of the two triode systems. Grid 3, ordinarily the suppressor grid, must have a fine mesh

so that amplified audio voltages appear across R_2 . Through coupling capacitor C_3 , these voltages are transferred to the third grid G_3 , which acts as a second control grid. Grid G_3 and the plate P together form a second triode system, amplifying once more the audio signals which finally appear across the plate load resistor R_p .

This simple explanation, which seems to indicate that the circuit should act like two triode stages in cascade, fails to take account of one very important factor—the first triode stage proves to be inherently regenerative, so much so that the circuit will normally oscillate.

To see why this is so, let us assume that the second control grid G_3 is

made a little more negative by some external influence. This will reduce the current which goes through G_2 to the plate, so that those electrons which can no longer reach the plate are forced to return to G_2 , increasing the current I_2 to this grid. The slopes of the two characteristic curves are therefore opposite, as shown in Fig. 1, so that the total current remains substantially constant and independent of the potential on grid G_2 . This grid merely distributes the total available current between G_2 and the plate. It exhibits a normal positive transconductance with respect to the plate, but it also has a negative transconductance with respect to grid G_2 which precedes it. This, in-

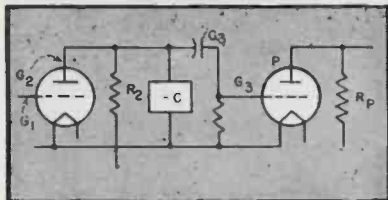

FIG. 2—Equivalent circuit of reentrant pentode a-f amplifier, showing the negative conductance as a new circuit element designated $-C$

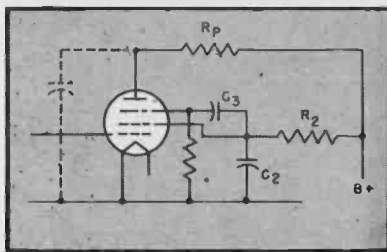

FIG. 3—Method of using shunt capacitor between second grid and ground to suppress oscillation

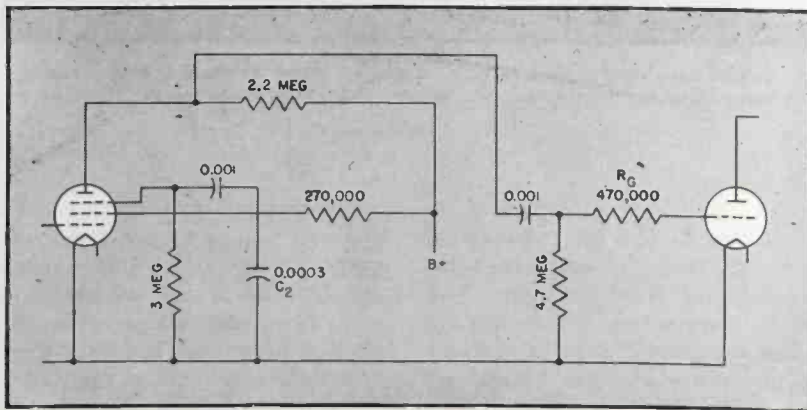

FIG. 4—Complete circuit diagram of a practical two-stage voltage amplifier using a special pentode and feeding into a third triode stage

identally, is a property common to all control grids which follow positive grids or screens, such as the signal grid in pentagrid converters.

Equivalent Circuit

Because G_2 and G_3 are connected together through capacitor C , they represent a single point in the circuit with respect to audio voltages, and the negative transconductance of G_3 with respect to G_2 becomes a negative conductance from these two grids to ground.

In the equivalent circuit of Fig. 2, this negative conductance is introduced as a new circuit element $-C$, and the first triode, the negative conductance and the second triode are shown separately. Actually, of course, all three are functions of a single tube with three grids.

Grid G_2 , considered as the first triode plate, has a certain internal resistance R_{o2} just like any other triode plate. Its load consists of the resistor R_2 in parallel with the negative conductance $-C$. By combining these two elements into a single resistance R_0 , designated as total plate load and equal to $1/[(1/R_2) - C]$, we can compute the triode gain as $\mu R_0 / (R_0 + R_{o2})$. This means that when the numerical value of $-C$ is very small, the gain is normal (less than μ); when C is equal to $1/R_2$, the total plate load is infinitely large, and gain is equal to μ ; when C is larger than $1/R_2$ but less than $(1/R_2) + (1/R_{o2})$, the total plate load is negative and larger than R_{o2} , and gain is more than μ ; when C is larger than $(1/R_2) + (1/R_{o2})$, the total plate load is negative and less

than R_{o2} , and the stage oscillates. Gains far in excess of the normal triode gain are thus obtainable in the first triode section if $-C$ can be properly controlled.

Control of Regeneration

Let us now remember that $-C$ represents the amount of current which is switched from the plate to G_2 when G_2 is made one volt more negative. In practice, some of the electrons which are turned back at G_2 pass the vicinity of the cathode before they finally land on G_2 , thereby increasing the negative space charge around the cathode. The total current, therefore, does not stay constant (as shown in Fig. 1) but drops when G_2 becomes more negative, forcing more electrons to turn back.

If this effect were absent, $-C$ would be numerically equal to the transconductance g_m of G_2 . Actually, it is always somewhat smaller; but—and this is the important point—it is the dynamic transconductance which counts. If, by means of a large plate load resistance R_p , we reduce the dynamic g_m the numerical value of $-C$ will drop correspondingly.

In conventional triodes the gain, which is equal to the product of R_p and dynamic g_m , remains constant over a wide range of plate loads. The dynamic g_m drops as R_p is increased, so without much effect on the gain of the second triode system we can reduce dynamic g_m and, therefore, $-C$ to any value desired by varying the plate load resistance R_p . This gives us a means for adjusting the gain in the first triode system within wide limits.

The following data, taken with an experimental tube and with $R_p = 220,000$ ohms, may serve as an illustration:

R_p meg.	Gain G_1 to G_2	Gain G_2 to P	Overall Gain
3.0	16	9	150
2.0	22	9	200
1.0	50	8	400
0.8	Osc	(8)	Osc

A plate load resistor of 1.5 megohms might be recommended for this tube, with a resulting overall gain of about 250.

Design Precautions

In the practical use of this circuit, certain precautions must be ob-

erved. As explained above, stability is obtained by the use of a plate load resistance R_p , which is sufficiently high to keep the dynamic g_m safely below a critical value. At high frequencies, however, generally above the audible range, the stray capacitance from plate to ground reduces the effective plate load impedance and creates a tendency to oscillate. A simple method for correcting this tendency is shown in Fig. 3. A shunt capacitor C_s provides a low-impedance path from G_2 to ground at those frequencies, counterbalancing the increase of $-C$.

Another precaution may become necessary if the circuit operates as a preamplifier in connection with an audio output stage which does not have sufficient grid bias. High positive signal peaks will then drive the output tube into the grid current region, where a low-impedance path to ground is suddenly produced; this path is effectively in parallel with the plate load and causes a corresponding increase in regeneration. The effect can be suppressed by a current-limiting resistor R_o inserted in series with the grid of the audio output stage.

Practical Circuit

Figure 4 shows the complete circuit diagram, including capacitor C_s and resistor R_o . Figure 5 shows the frequency response curve of such an amplifier, taken with a tube whose first triode system had a μ of 17 so that the gain in normal triode operation might have been about 12. In this circuit, the gain from G_1 to G_2 was 30. The gain in the second triode system—from G_2 to plate—was 10.

There exists considerable prejudice against the use of regeneration in audio circuits, and if conventional circuits are referred to, this attitude is justified. In most such circuits, the regenerative loop includes several load resistors and coupling capacitors, sometimes even transformers, and nearly always two tubes. All these elements exert an influence on the gain and on its variation with frequency, but in this circuit, the amount of regeneration is substantially determined by the ratio of R_p to R_o , and if the ratio of C_s to the capacitance from plate to ground is chosen correctly, the same amount of regeneration exists over the entire audio band.

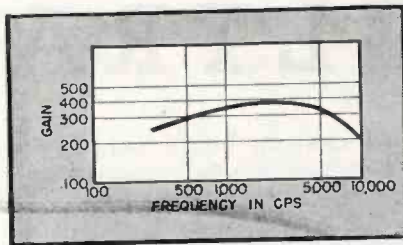

FIG. 5—Frequency response curve of amplifier circuit of Fig. 4

The static transconductance of the tube has little effect on the performance as long as it remains large enough. This is evidenced by the plot of overall gain versus plate supply voltage, shown in Fig. 6. The frequency response curve (shown in Fig. 5) also resembles that of a straight two-stage amplifier and fails to exhibit the peaked character generally associated with regenerative audio amplifiers.

Design of Special Tube

Conventional pentodes will not operate in this circuit because their suppressor grid is not capable of acting as an efficient control grid. In a tube designed for this type of service, G_3 is a fine-mesh grid similar to the signal grid in a pentagrid converter like the 1R5. Grids 1 and 2 are constructed like a conventional control grid and screen grid.

To obtain good gain in the second triode system, it would be desirable to make the μ of this system (G_2 with respect to plate) rather high. On the other hand, the low plate supply voltage at which such a tube is most useful sets a practical limit to the μ at which the second triode system can still operate properly. This limitation made it difficult to obtain gains much in excess of 5 in the second triode system, using a minimum figure of 30 volts for the plate supply voltage, until it was found that the low-voltage performance could be considerably improved by reducing the spacing between G_2 and G_3 . In a tube so constructed, the potential in the gaps between the wires of G_2 is rendered more positive by the closeness of G_3 ; a lower plate voltage is then sufficient to draw the desired amount of plate current through these gaps. The effect is the same as that which enables space charge triodes to operate at low supply voltages.

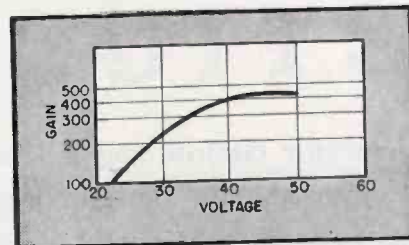

FIG. 6—Variation of gain with plate supply voltage in circuit of Fig. 4

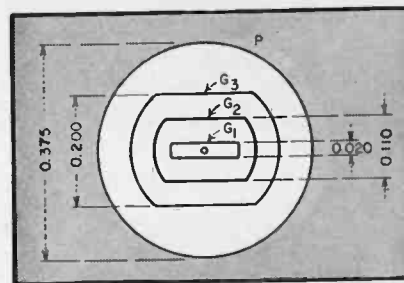

FIG. 7—Cross-section of electrode structure of experimental pentode built for use in reentrant amplifier circuit

Figure 7 shows a cross-section through the electrode structure of an experimental tube which was built at Zenith. A tube with very similar electrode spacings, based on this model, was later manufactured by Raytheon under the type number CK-511X. An amplification factor μ of 17 was selected for both triode systems— G_1 with reference to G_2 , and G_2 with reference to plate. This choice represents a compromise between maximum gain at full plate supply voltage and minimum drop in gain at reduced plate supply voltage. Overall gain (Fig. 6) remains fairly constant down to about 35 volts and is still good at about 30 volts. At lower voltages it drops off sharply. Higher μ would have permitted more gain at 45 volts, but it would not have been possible to maintain satisfactory gain down to 30 volts.

Experience with this tube and circuit indicates that it is possible to maintain a gain figure at least five times in excess of what a conventional pentode circuit would yield at the same plate supply voltage. The reentrant amplifier—to adopt a fairly descriptive term for lack of a better one—does not provide as much gain as two conventional pentode stages, but it will fully replace two triode stages, and wherever that amount of gain is adequate it may find useful application.

ULTRASONIC

Electronic circuits and a 15-mc ultrasonic beam rotating over a special underwater map generate signals that can be fed into a standard Navy radar in a classroom to simulate ppi patterns that would be seen on maneuvers or bombing runs over any desired target

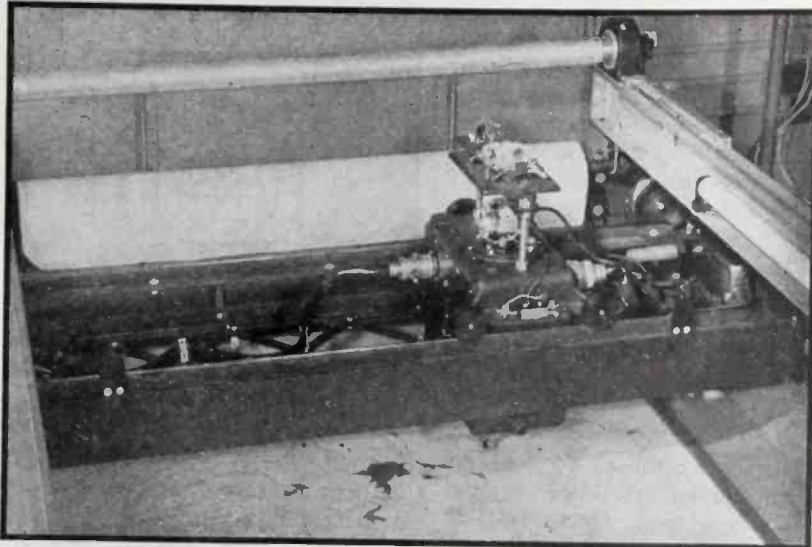

Closeup of trolley that carries crystal cartridge and reflector through the water over the map. Since the map may cover hundreds or even thousands of miles of territory, with trolley moving over map in correct speed relation to throttle setting of a plane flying over actual territory, the trolley moves very slowly during use

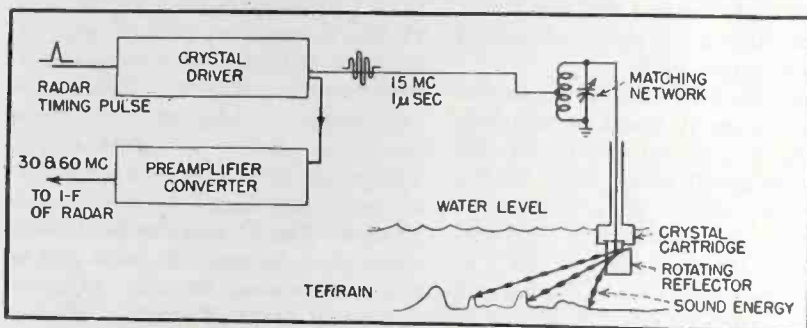

FIG. 1—Use of an ultrasonic beam rotating over a specially prepared map in a pan of water permits compressing into reasonable space in the trainer the identical actions of a radar system used for blind bombing or navigation. The trainer takes a timing pulse from any standard Navy radar, and feeds back into the radar i-f system the signals needed to simulate the ppi pattern desired

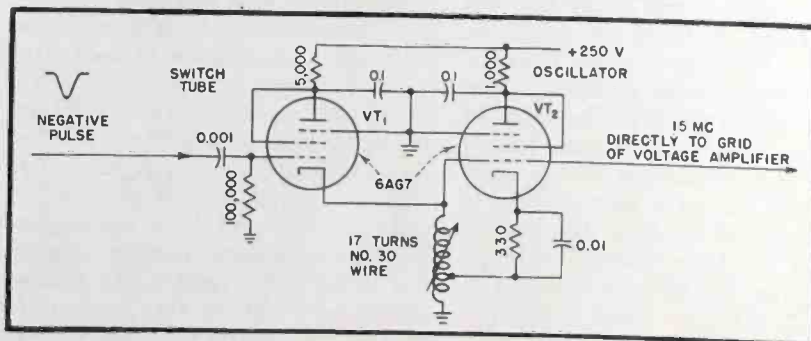

FIG. 2—Circuit of quick-acting switch tube and the Hartley oscillator that it controls

THE ULTRASONIC TRAINER AN/APST-3 was designed and developed by Radiation Laboratories, MIT, and Special Devices Division, ORI, U. S. Navy, to produce on the scope of a stationary radar a pattern identical to that on an airborne radar set in flight. To achieve this simulation the device "flies" a transmitter over a scale-model terrain submerged in an "atmosphere" of water.

When an aircraft radar set is flown over the surface of the earth, short pulses of radio energy are transmitted from the radar antenna. Radio energy is reflected back to the antenna from the terrain below during the period between transmitted pulses. The beam from the antenna scans the surface of the earth as the antenna is rotated in the airplane.

In an analogous manner, the ultrasonic system transmits pulses of high-frequency sound energy which are shaped in a typical beam pattern and, traveling in water, strike the surface of the model below. Exactly as in the radar system, a small amount of energy is reflected back to its source, where it is received and converted to electrical oscillations.

Description of Equipment

The system which controls the flight of the simulated aircraft permits introduction of wind drift as well as a wide range of speeds and aircraft headings. The signal components of the trainer include a crystal driver which when triggered produces a brief 15-mc oscillation, a quartz crystal transducer for sending out the ultrasonic beam, a preamplifier converter, and matching networks, as shown in Fig. 1.

The timing pulse from any of the Navy's recent airborne radar sets may be used to trigger the crystal driver. A blocking oscillator stage forms a sharp (approximately 1

TRAINER CIRCUITS

By FINN J. LARSEN

Lieutenant (jg), U. S. Navy
Project Engineer, Radar Section
Special Devices Division
Navy Department, Washington, D. C.

microsecond) pulse which, by the use of a switch tube, starts and stops the 15-mc oscillator. The amplified 5-mc pulse is conducted through a coaxial line to a matching network, and then to an X-cut quartz crystal transducer that is resonant at 15-mc.

The crystal transducer, mounted in a sealed metal cartridge, has its lower gold-plated surface exposed to the water surrounding the crystal cartridge. The 15-mc sound pulse produced by the vibrating crystal travels to a glass reflector immediately below. This reflector shapes the beam to correspond to that of a particular radar set and reflects it through the water to the terrain below. A carefully constructed model, which duplicates the desired portion of the earth's surface, is placed at the bottom of a tank below the crystal cartridge.

On the model terrain a smooth surface represents sea areas, and mirror reflection occurs, none of the energy returning to the crystal. A land area is simulated by an extremely small-particled rough surface, which reflects a slight amount of sound energy back to the reflector and quartz crystal. As the reflected sound waves strike the crystal transducer, they cause an oscillation which sends electrical impulses back to the crystal driver and preamplifier. Since the crystal driver is not at that time transmitting, its plate output network presents a high impedance to the returning signal which is also applied to the preamplifier converter.

The returning 15-mc signal passes through four stages of amplification before going to a mixer tube which combines the signal with a locally generated 45-mc oscillation. These four stagger-tuned stages are used to bring the mixer signal input up to the same level as that of the 45-mc oscillator. The output of the preamplifier thus provides both 30- and

60-mc signals which will feed the i-f strip of any standard Navy radar gear.

The scanning of the ultrasonic beam is accomplished by rotating the crystal cartridge and reflector around a vertical axis. Since the trainer is adaptable to B-scope radar sets, some of which do a high speed sector scan, as well as the ppi presentation sets, the rotation of the crystal and reflector is controlled by a servo-amplifier system explained in detail later. This system drives the ultrasonic crystal and reflector to a position which is within a fraction of a degree of the direction of the antenna on the operational radar set.

The circuits employed to achieve synthetic radar pictures are in the main conventional with the exception of three now to be considered, which may have general industrial or other applications. These are the switch-tube control circuit, the re-

actance-tube frequency control circuit, and the antihunt circuit for the servo system.

Switch-Tube Control Circuit

In developing the crystal driver for the Ultrasonic Trainer, one of the most serious problems was to start and stop the 15-mc oscillator with the necessary abruptness. This was a requirement since a point target will appear as long in range as the duration of the output pulse. For example, a point object would appear one sixth of a mile long in the range dimension if a two-microsecond pulse were reflected from it. This is true since radio energy requires approximately 12.4 microseconds to travel out and back a distance of one mile.

The stopping and starting of the oscillator is accomplished by means of the switch tube shown in Fig. 2. Here VT_1 is a conventional Hartley

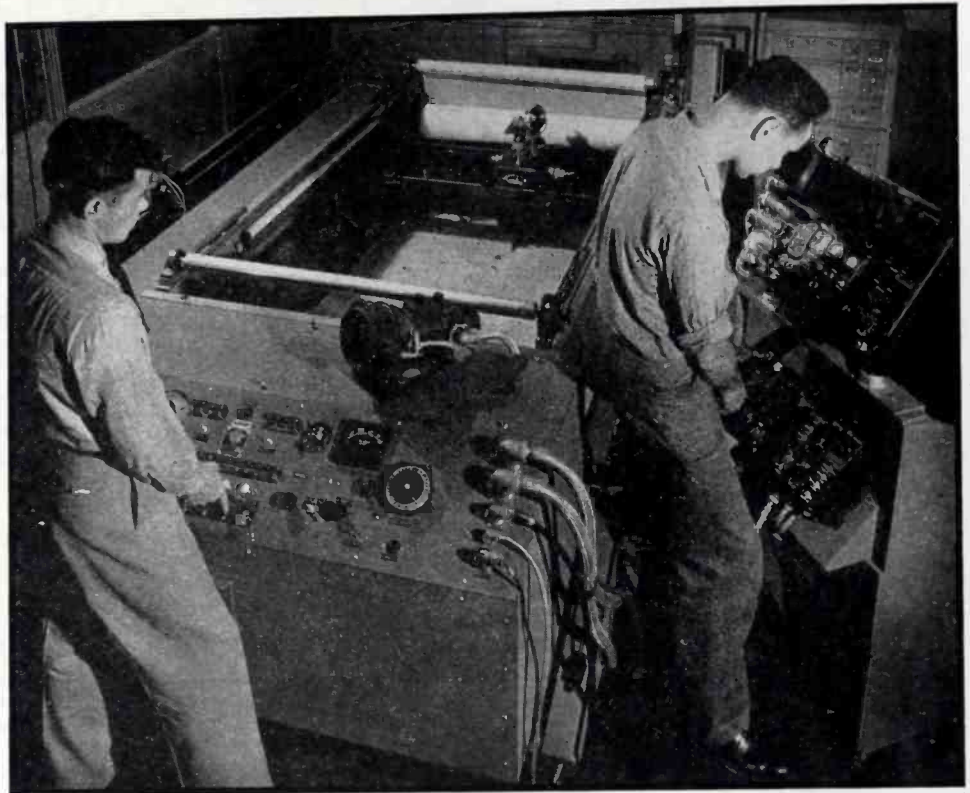

Ultrasonic Trainer APS-T3 in use with APS-15B radar (right). The overhead trolley moves the ultrasonic crystal and rotating reflector through the water covering the map in response to changes in flight controls made by trainees in covered-cockpit mockup that simulates all instrument readings, scope patterns, and sounds of complete flight to an assigned destination and back

oscillator, but the oscillator coil, which is slug-tuned to 15 mc, is in the cathode circuit of VT_1 .

In effect, VT_1 functions as a variable-impedance load which shunts the tank coil of the oscillator. When the switch tube is conducting, the low effective shunt value will prevent sustained oscillations. If this effective shunt value is of such magnitude that it will critically damp the tank coil, oscillations will die out very rapidly as VT_1 begins to conduct.

In operation, a negative pulse is applied to the control grid of the switch tube. At the beginning of the pulse, the sudden decrease in cathode current will shock-excite the oscillator and insure a rapid build-up of oscillation. As the pulse passes, VT_1 begins conducting and quickly damps all oscillation. This circuit is capable of responding not only to a square negative pulse, but will follow the shape of any negative pulse impressed on the grid of the switch tube.

An alternate explanation of the switch tube action can be based on magnetic fields. When the switch tube is conducting, a steady magnetic field around the oscillator coil will prevent oscillation; when the switch tube is cut off, the collapse of the magnetic field will initiate oscillation of VT_1 .

Reactance-Tube Frequency Control

It is desirable that as many of the radar controls operate normally as is possible, and since the radar sets have a discriminator circuit used to control the klystron frequency, it is possible to vary the frequency of the 45-mc local oscillator automatically to simulate afc and manual tuning.

This variation is accomplished by the use of a reactance tube shunted across the tank coil of the oscillator, and a d-c amplifier used to convert various radar repeller voltages to a uniform voltage range for control of the reactance tube, as in Fig. 3.

The d-c amplifier converts the center of a voltage swing from -120 to -180 volts to a swing of approximately 0 to -19 volts. For operation with another radar set having a repeller swing of lower negative voltages, the shorting leads across two resistors are removed, and both cathode and grid operate at less negative voltages.

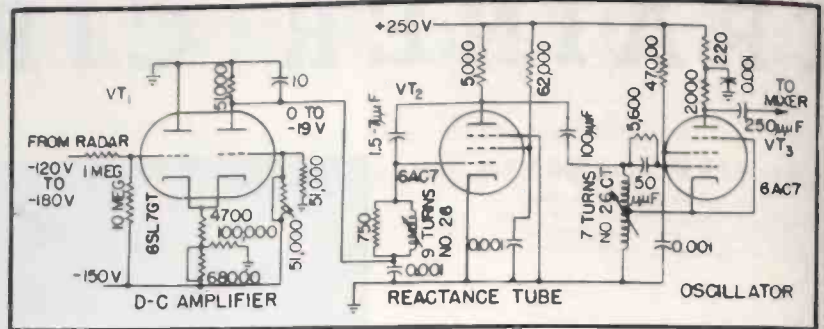

FIG. 3—Circuit of reactance tube used to vary the frequency of a Hartley oscillator in accordance with d-c input voltage variations to simulate afc and manual tuning actions in a radar

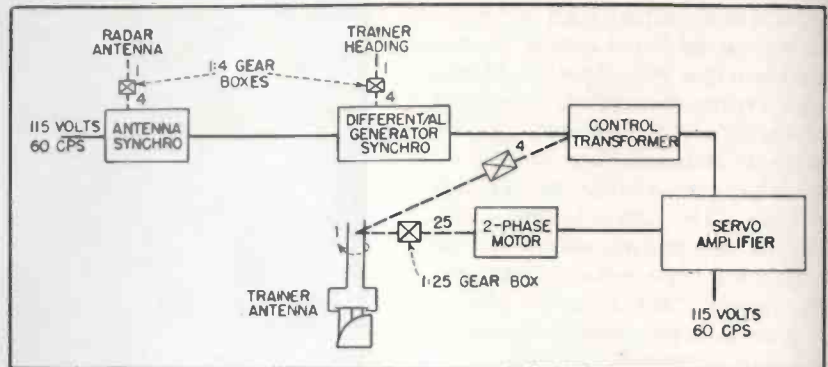

FIG. 4—Arrangement of synchros and servo amplifier in scanning system of ultrasonic trainer

The variable reactance tube VT_2 is connected in parallel with the tank coil of the Hartley oscillator. The reactance tube and its associated circuit behave as a variable capacitor whose capacitance is determined by the mutual conductance of the tube. Since the mutual conductance of a variable- μ tube can be controlled by varying its grid bias, it is possible to change the frequency of the oscillator tank. In practice this oscillator can be easily varied in frequency from approximately 42-mc to 48-mc.

The frequency change which can be obtained by the use of a reactance tube is limited by the resistive load which the variable-reactance tube presents in parallel with the oscillator coil. As the grid voltage of the reactance tube changes, the effective resistive load also changes, and if it becomes too low, the oscillator may stop functioning.

The Scanning System

A servo system, shown in Fig. 4, causes the crystal and reflector to follow the rotation of the radar antenna spinner. A synchro attached to the antenna spinner is connected

through a differential generator synchro to a control transformer. If the rotor of the antenna synchro is turned slightly the magnetic field in the control transformer is also rotated, and a small error voltage is picked up by the transformer rotor and amplified by the servo amplifier. The amplified output feeds one winding of a two-phase motor, the other winding being kept constantly energized at the same phase as the input to the antenna synchro so the motor will restore in the correct direction.

The two-phase motor drives both the control transformer and the vertical sleeve which carries the crystal cartridge and reflector to the correct position. The control transformer operates at four times crystal and reflector speed to obtain greater accuracy; a still higher ratio had too much inertia. The differential generator synchro, when rotated by a change in the simulated airplane heading, feeds the control transformer a displacement which represents the change in heading on the radar scope.

One of the difficulties which arises with a servo amplifier is that of

turning or oscillating of the motor shaft and the mechanical system as these components overshoot their correct position. An interesting filter circuit in this servo gives very positive antihunt control and provides greater than usual accuracy for the servo system.

If an ordinary amplifier is used to drive the motor of a servo system, large torques can only be obtained by allowing a large error since the error voltage input to the amplifier is a direct function of the displacement of the control transformer (in the case under discussion) from its correct position. If, however, a network which gives a derivative or antihunt voltage is part of the amplifier, large output can be obtained from the amplifier at relatively small error voltages, since the derivative voltage is proportional to the velocity of the control transformer error, not the displacement. In other words, a large correcting torque can be applied by the motor in the system, if the error is increasing rapidly, although the error may still be quite small.

Analysis of Error Voltages

An effective study of the requirements of such a network can be made

by assuming an input error voltage consisting of an amplitude-modulated carrier wave. The input error voltage is given, at any time, by

$$e_i = E_1 \cos \omega_0 t [E_2 \cos (\omega_s t + \theta)] \quad (1)$$

$$e_i = \frac{E_1 E_2}{2} \left\{ \cos [(\omega_0 - \omega_s)t - \theta] + \cos [(\omega_0 + \omega_s)t + \theta] \right\} \quad (2)$$

Here E_1 and E_2 are the maximum values of the carrier and modulation voltages respectively, and ω_0 and ω_s are the corresponding frequencies. The two terms in the expanded second equation represent the two sidebands, one lying above and the other below the carrier frequency. The antihunt or derivative voltage which will provide damping is given by

$$e_{a\dot{e}} = E_1 \cos \omega_0 t [E_2 \sin (\omega_s t + \theta)] \quad (3)$$

$$e_{a\dot{e}} = \frac{E_1 E_2}{2} \left\{ -\sin [(\omega_0 - \omega_s)t - \theta] + \sin [(\omega_0 + \omega_s)t + \theta] \right\}$$

The expanded equation for $e_{a\dot{e}}$ indicates the required phase change for the sidebands.

From Fig. 5A and 5B, it may be seen that the antihunt voltage may be at a maximum near the input error voltage minimum, which corresponds to a small displacement error.

Obviously the servo system, in-

cluding both motor and amplifier, should have a wide frequency response. Since the overall frequency response is the product of the responses of the motor and the amplifier (Fig. 5E), the amplifier (Fig. 5D) can compensate for the inherently poor characteristics of the motor (Fig. 5C).

The frequency response curve of the amplifier (Fig. 5D) may be approximated by adding a direct error voltage to the frequency response of a parallel T filter (Fig. 5F). The parallel T filter as used in this servo amplifier is not new, but it has been engineered to give exceedingly good performance in this application.

Servo Antihunt Circuit

In the servo system, Fig. 6, an incoming error voltage is amplified by the input transformer, which is tuned to 60 cps by a capacitor across the secondary. The potentiometer between the input transformer and the triode amplifier serves as a gain control. The output of the triode is fed to both the filter network and a second potentiometer. The amplified error voltage between A and B is applied to the network. If the input is exactly 60 cps, as when the control transformer is following the synchro with a small constant lag, the high impedance of the filter at 60 cps results in zero antihunt voltage.

The direct input voltage between point B and ground is passed to the second triode and amplified. If the control transformer increasingly lags or leads, however, the input voltage (see Eq. 2) will have components higher and lower than 60 cps. Since the parallel T network has a much lower impedance to these frequencies, they will be applied to the second triode and this antihunt voltage will be amplified and used to control the motor. In practice, the second potentiometer is adjusted to give the correct balance of antihunt and direct input voltage. Too large a percentage of antihunt results in a system that falls too far short of its correct position; too little antihunt causes oscillation of the system about the correct point.

This antihunt filter network markedly improves the action of a servo system following any irregular motion, and should have wide application in amplifiers for servo motors.

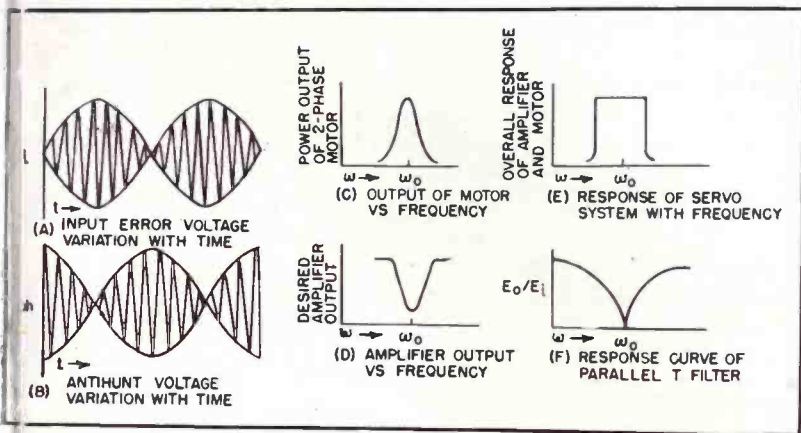

FIG. 5—Curves illustrating action of antihunt circuit used with servo system

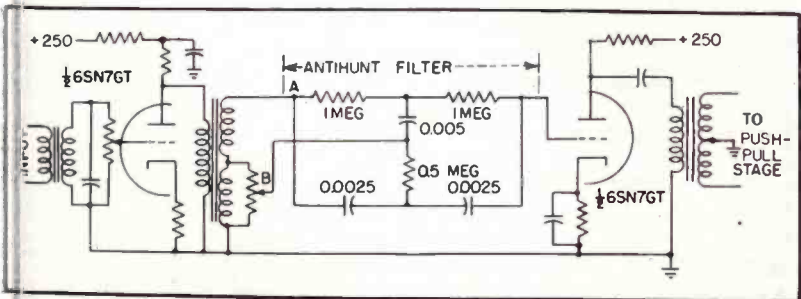

FIG. 6—Antihunt filter circuit used in servo amplifier

TRANSIENT VIDEO ANALYZER

Cathode-ray test set combining a five-signal transient generator with a wide-band oscilloscope, used for checking accuracy of various types of steep waveforms reproduced by wide-band amplifiers used in television and communications equipment

AT present considerable work in the communications field is concerned with systems for the transmission of transient waveforms. Especially in television are the requirements severe as to the accuracy of reproduction of steep waveforms without overshoots or ringing.

Testing and design of such equipment customarily involves laborious use of ordinary steady-state signal generators. Sometimes oscillators with continuously swept frequency are used, but in general such methods have two disadvantages: (1) the shape of the transmission (gain)-vs-frequency characteristic is not singly related to the transient performance which is the real objective; (2) the phase characteristic is ignored by such measurements, and even if it were known, the preceding objection would also apply to it.

A step in the right direction is the use of square waves in conjunction

By **CLEMENT MORITZ**

Research Division
Philco Corporation
Philadelphia, Pa.

with an oscilloscope having excellent transient response and a sweep of adequate speed.^{1, 2} Such systems give a fairly good direct indication of the quality of transient reproduction.

The instrument described in this article is intended to carry forward the same idea. However, in addition

to square waves of certain desirable frequencies, it provides a sharp impulse or spike function for checking the high-frequency portion of a video system, and a sawtooth wave for checking linearity. The transient generator feeds a signal through the wideband system into an oscilloscope used as an indicator of quality of transient reproduction. The transient generator and the oscilloscope have been incorporated for conven-

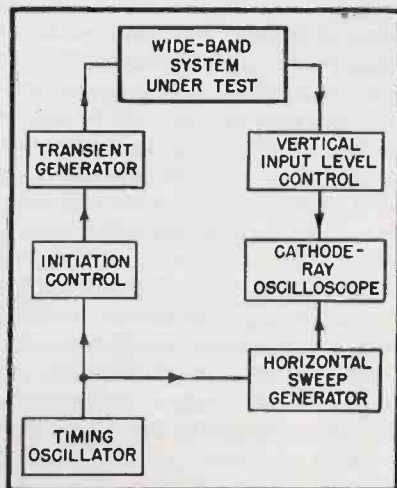

FIG. 1—Essential components of transient video analyzer, shown in relation to wide-band system under test

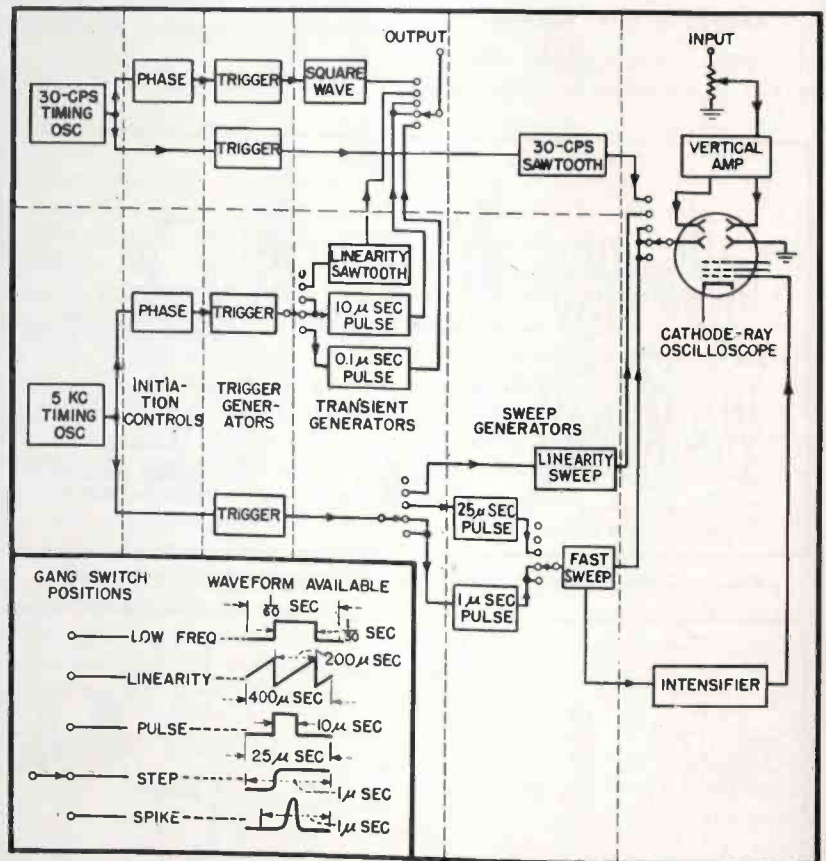

FIG. 2—Block diagram of complete analyzer. Wide-band system under test is connected between output and input terminals

Transient video analyzer in use, with light shield around screen of c-r tube



ience into a single unit with associated components.

Although an aperiodic transient would be quite sufficient for analysis, periodic transients become necessary for visual observation with an oscilloscope. The transient period is controlled by a stable timing oscillator, also used for timing the horizontal sweep, as shown in Fig. 1. An initiation phase control is inserted into the link between the oscillator and the transient generator to control the timing of the transient test signal with respect to the sweep, and so facilitate the study of the system output.

The transient output of the wide-band system under test goes to the vertical deflecting plates of a cathode-ray oscilloscope through an amplifier whose gain can be varied to suit conditions. The complete block diagram of the system is given in Fig. 2.

Generation of Periodic Transients

Five transient signals are available from the generator in the transient video analyzer, as follows:

(1) A 30-cycle square wave primarily used for low-frequency analysis.

(2) A 5-kc sawtooth wave used as a signal for linearity checks. A stepped wave would serve the purpose no better and would only further complicate the completed instrument.

(3) A 10-microsecond pulse keyed at the rate of 5,000 per second, for use in checking middle frequency response (10 to 1,000 kc).

(4) A step function.

(5) A spike function used to determine high-frequency performance. The high-frequency response limitation is primarily in the vertical-channel amplifier of the oscilloscope.

These waveforms appear on the cathode-ray oscilloscope when the

output of the generator is connected directly to the input of the analyzer. However, in the instrument the 10-microsecond pulse and 1-microsecond sweep are both used twice; only four signals and four sweeps are generated, but the circuit is arranged for switching from one type of operation to another, as shown in Fig. 2.

All transient outputs are one volt peak-to-peak across 70 ohms except the spike, which can have any height (in this case about 9 volts peak-to-peak). The instrument was designed to operate into and out of coaxial lines matched to television equipment.

This instrument makes use of two transient recurrence frequencies de-

rived from two timing oscillators. Each recurrence-frequency channel has its own horizontal and vertical trigger generators for sweep and transient signal initiation. Although both vertical and horizontal trigger generators are similar to each other in each channel, separate trigger generators are necessary to provide a signal trigger which can be advanced or delayed in time with respect to the horizontal sweep trigger.

Timing and Sweep Circuits

A switch selecting the desired transient signal also selects the correct timing and sweep circuits for proper analyzer operation. Circuits which are not necessary for operation auto-

matically have their high voltages disconnected to decrease the drain on the power supplies. It is necessary only to connect the output of the analyzer to the system to be studied, connect the output of the system back into the input of the analyzer, and set the switch for the transient desired.

The 30-cycle square wave is generated by a multivibrator which must be supplied with both positive and negative triggers for one full cycle of operation. This type of square-wave generator was selected to assure perfectly flat-top square waves. The stage is fed by a negative supply so that the plate returns may be grounded, and the output is then taken from a tap on one of the plate load resistors, ensuring perfect fidelity and freedom from a-c coupling troubles which would be encountered in passing the low-speed square wave. The circuit appears in Fig. 3A.

The trigger generators in the 30-cycle channel employ a double-triode

for clipping, with a differentiating network feeding into the grid circuits of the multivibrator and sweep circuits.

The sweep is a conventional gas-tube switch across a capacitor, with a constant-current pentode for charging. This is necessary to give a linear sweep of sufficient amplitude for deflection without amplification.

The timing oscillator is of the phase-shift type. Output is fed into the delay tube circuit (Fig. 3B), which serves as a phase inverter. The delay tube provides, in its cathode circuit, a low-impedance driving source for the first horizontal clipper, and between plate and cathode a source from which phase may be shifted by a resistance-capacitance combination before the 30-cycle sine wave is fed into the first signal clipper. The delay may be varied by varying the resistor in series with the capacitor. Almost 180 degrees of phase shift can be obtained in this manner, with an output having sub-

stantially constant amplitude value.

Circuits in 5-kc Channel

A double-triode bridge oscillator performs more stably at 5,000 cycles and is therefore used for the 5-kc channel in preference to the phase-shift type. Output is fed into the first horizontal clipper and the vertical phase-controlling stage.

This stage operates in the same fashion as the one in the 30-cycle channel but different circuit constants are necessary at the higher frequency. The variable delay resistor is made up of two variable resistors in series, one to be used as a vernier. The other section of the double triode is merely for a fixed delay adjustment which puts zero delay in the middle of the range of delay available, and makes possible initiating the signal transient ahead of the sweep when necessary.

Both trigger generators employ four stages, as in Fig. 3C. The first two are triode clippers. A pentode is

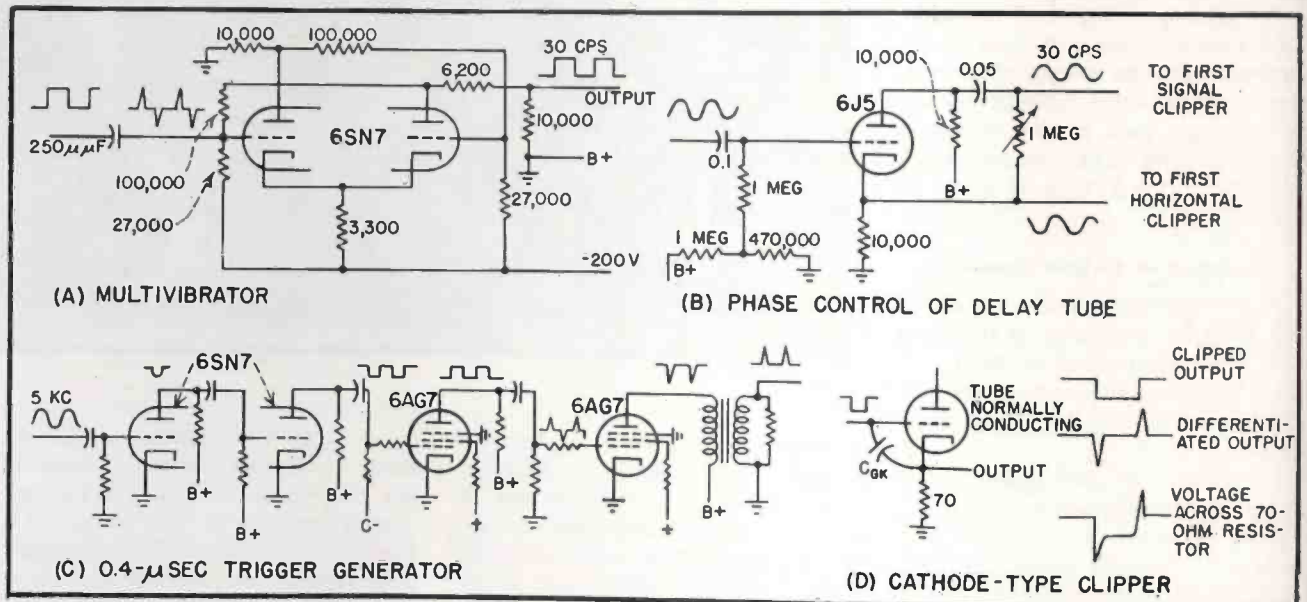

FIG. 3—Waveforms at inputs and outputs of various stages in the analyzer

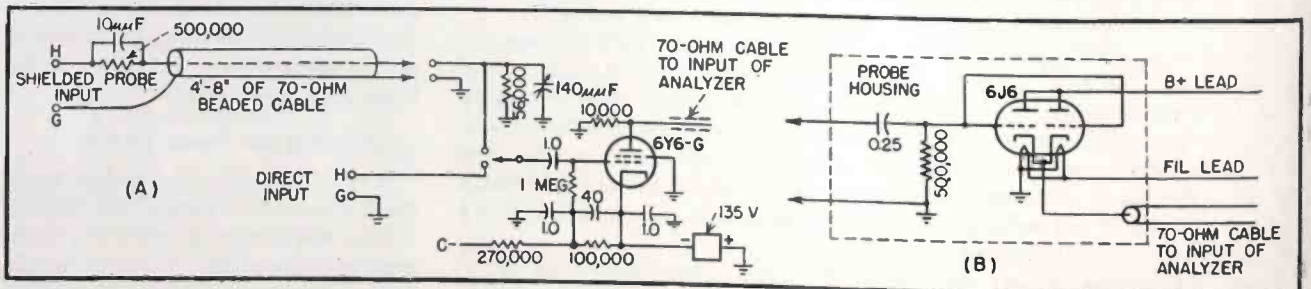
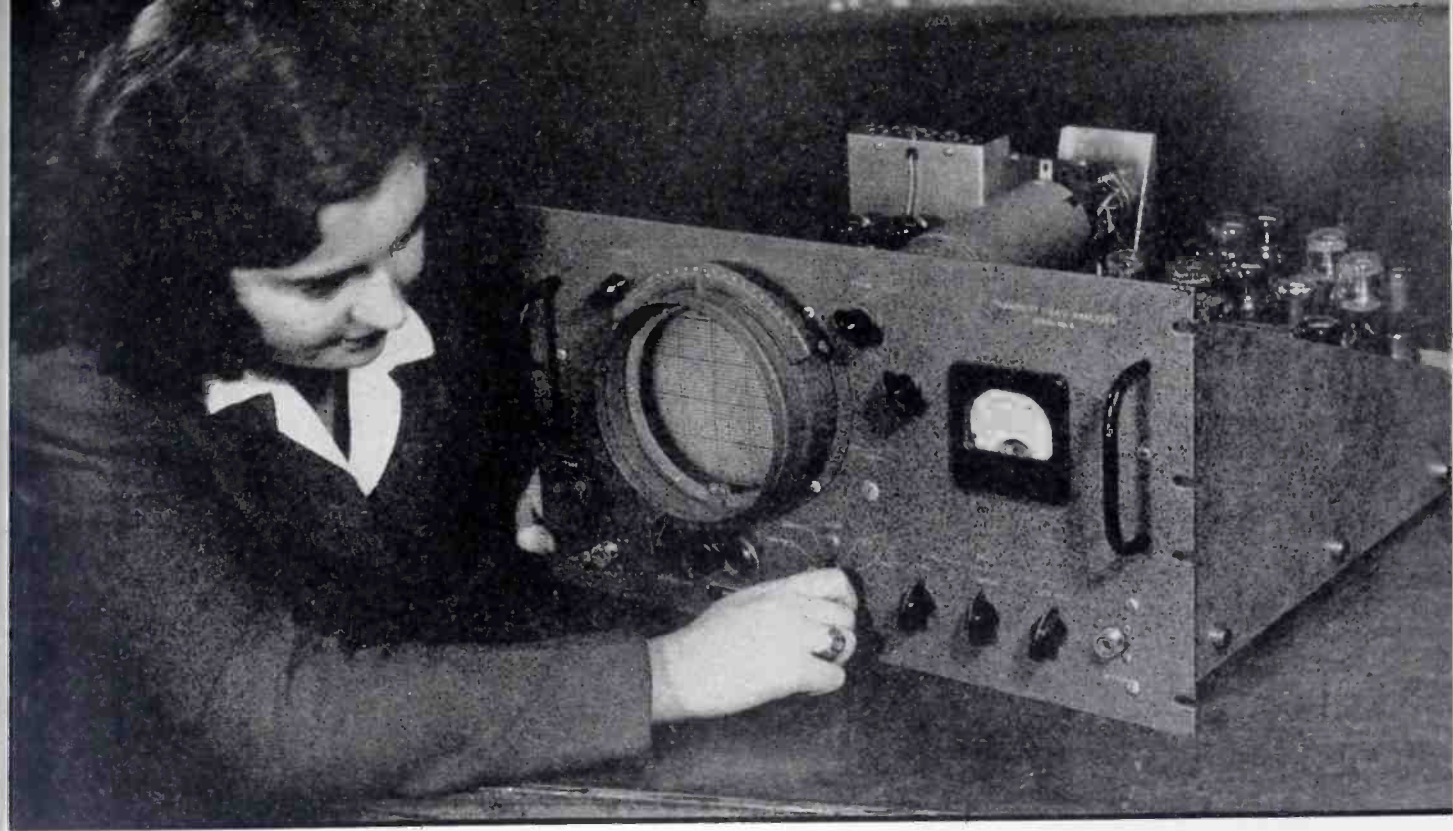

FIG. 4—Plate-loaded tetraode probe circuit (A) with removable input attenuator, and cathode-follower type probe (B) which can also be used with an attenuator



Control panel of the analyzer section of the transient video analyzer

necessary in the third stage to prevent feed-through by the grid-plate capacitance, which is much too great in the case of a triode. The clipped wave in the plate circuit is differentiated, and the positive portions are used to drive another pentode as a trigger amplifier. The transformer in the plate circuit of the latter tube reverses the pulse polarity.

By using this rather elaborate trig-

ger generator, a 0.4-microsecond synchronizing pulse has been achieved with a steep front edge which provides a good positive trigger for initiating the succeeding circuits.

Synchronizing accuracy (with time) is quite important in the 5-kc channel when the 1-microsecond sweep is being used. If the error is greater than 0.02 microsecond or 0.01 percent, any vertical lines on the

oscilloscope screen would be too wide and too dim to be useful. With the 1-microsecond sweep, the c-r tube face is excited only 0.5 percent of the time.

The linearity sawtooth is generated conventionally, and taken out of a cathode follower to develop the requisite power without loading the sawtooth generator.

The 10-microsecond pulse is generated by a nonoscillating multivibrator. Since the pulse is not perfect, it is shaped by two pentode clippers. Both conditions of amplitude of the pulse are determined by one of the tubes at cutoff to assure flatness. At first a triode cathode follower was tried for the second clipper but satisfactory results were not obtainable, because differentiation of the grid signal feeding through the grid-cathode capacitance of the tube into the cathode load resistor gave a very objectionable overshoot (shown in Fig. 3D). This trouble was eliminated by the use of a plate-loaded pentode stage. Such a stage gave a very good rate of rise (0.07 microsecond) but necessitated the use of a negative supply. Thus this output became good enough to be used also as the step transient with the fast (1-microsecond) sweep.

The spike pulse is generated by the discharge current of a capacitor pass-

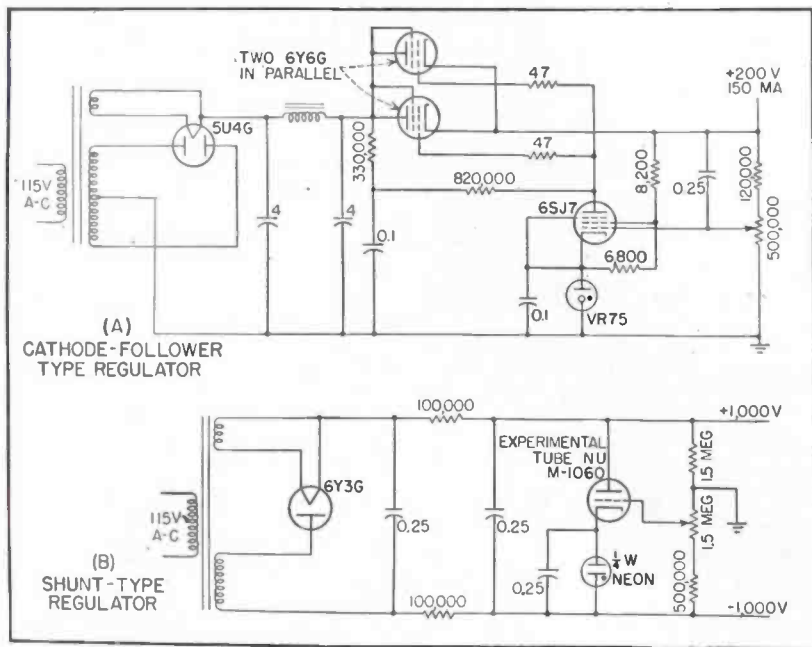

FIG. 5—Basic regulator circuits used in the power pack of the analyzer

the line capacitance in shunt with a resistor. An auxiliary capacitor serves as an adjustment for perfect performance over the pass band. The voltage gain through this probe is only about 1/30, however, which is a decided handicap where low peak signal voltages (of the order of one volt) are encountered.

In the cathode-follower type probe shown in Fig. 4B, developed for low-voltage applications, the triode sections of a 6J6 have been paralleled and built into a small bakelite tube with an input coupling network. The unit feeds a piece of 70-ohm transmission line to which are laced the filament and anode voltage leads going to the analyzer.

Probes have also been built with compensated attenuators ahead of

the 6J6, for use with higher signal voltages.

Because of the heavy load currents and the polarities required, five individual regulated power supplies are used. For the four low-voltage supplies the lowest possible terminal impedance must be realized to eliminate phase-shift trouble in the vertical amplifier and other low-frequency circuits, and therefore cathode-follower type series regulators like that in Fig. 5A have been used. The number of control tubes in parallel is dictated by the load current required.

The high-voltage supply for the cathode-ray tube was regulated primarily for freedom from line-voltage trouble, which caused a variation in deflection sensitivity. The simple shunt regulator circuit in Fig. 5B

was used, since low supply impedance was not necessary. The special high-voltage triode has an amplification factor of 500 and will pass 2 ma at 10 kv with 5 volts bias.

Much appreciation must be expressed for the encouragement and help given by William E. Bradley and C. T. McCoy, under whose direction the instrument was developed, to F. M. Bowdon who worked on the power supplies and probes, and to Daniel Naidamast and T. Schachat who developed engineering samples.

REFERENCES

- (1) Kallman, H. E., Portable Equipment for Observing Transient Response of Television Apparatus, *Proc. IRE*, p 351-360, Aug. 1940.
- (2) Kell, R. D., Bedford, A. V., and Kozanowski, H. N., A Portable High-Frequency Square-Wave Oscilloscope for Television, *Proc. IRE*, p 458-464, Oct. 1942.

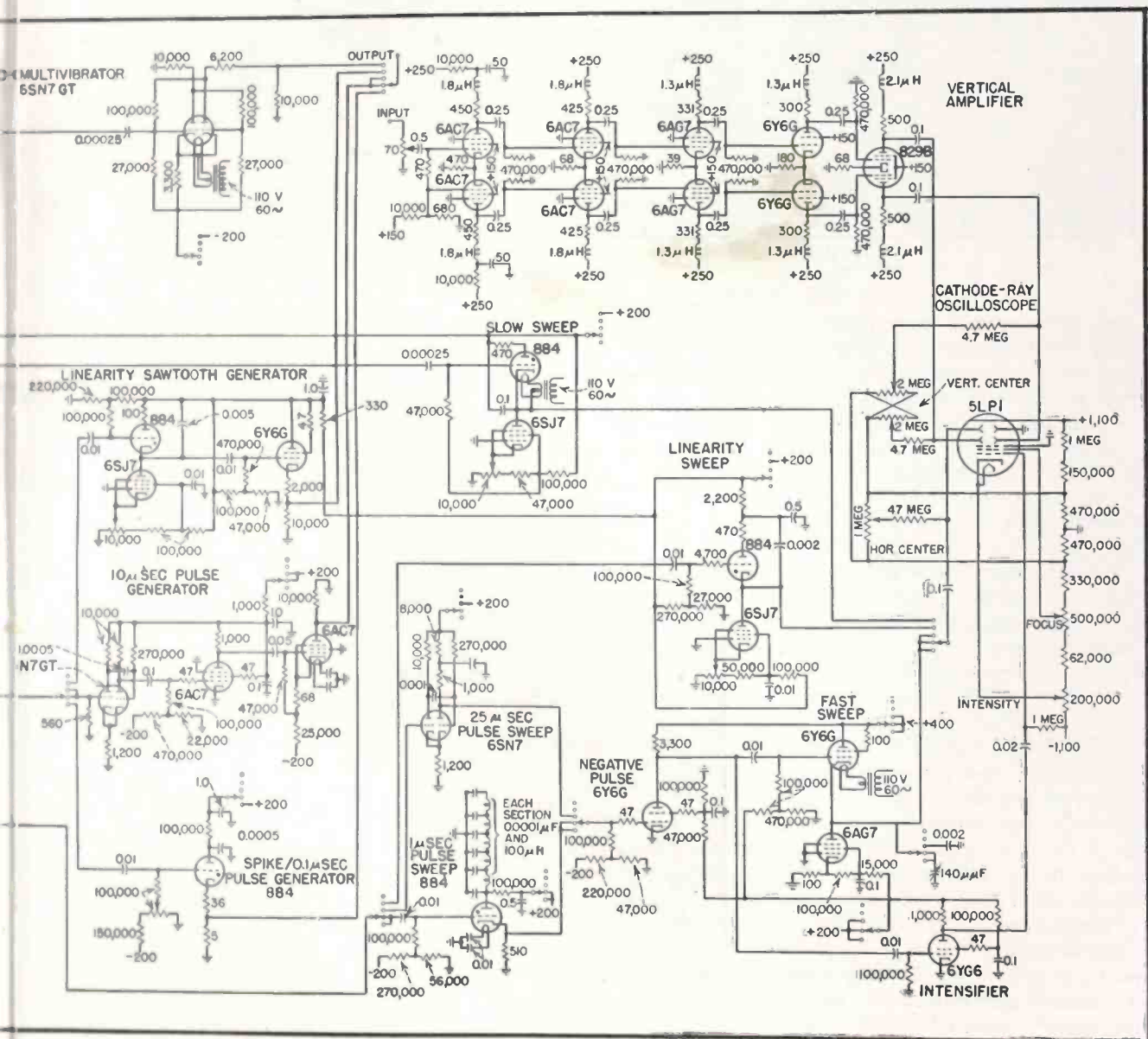

Wave Guide

By THEODORE MORENO

Research Laboratories
Sperry Gyroscope Co., Inc.
Garden City, N. Y.

Gasket-flange (left) and choke-flange (right) joints used in connecting sections of wave guide. The choke-flange joint is representative of the type shown in Fig. 2

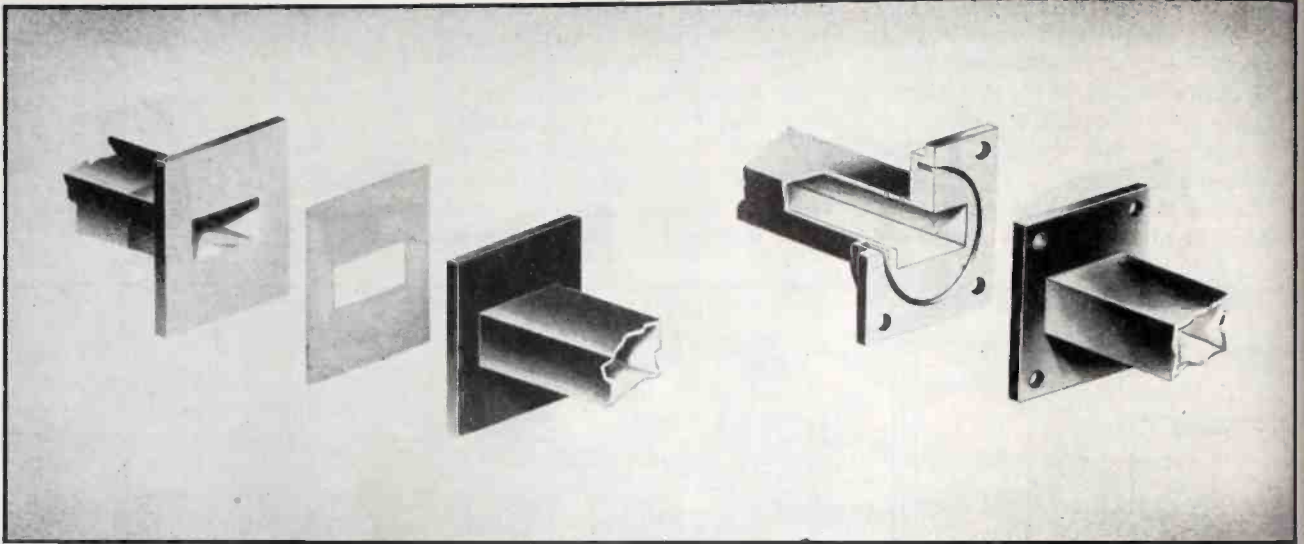

A RECTANGULAR WAVE GUIDE system that connects a microwave transmitter or receiver to an antenna may contain a considerable number of cascaded wave guide sections and components. Some of the components that might be found in a typical system are shown in Fig. 1, and include straight sections, bends, twists, right angle corners, rotating joints, and coaxial line to wave guide adaptors. In addition, the components must be assembled with the use of connectors which join together the various wave guide sections.

To operate at maximum efficiency, the transmission system should have minimum attenuation. Furthermore it should be electrically smooth and free from impedance discontinuities, otherwise standing waves will be set up in the line with a consequent increase in the attenuation. A more serious effect of these discontinuities in the line may be the resulting impedance mismatch between the transmitter or receiver and antenna. These mismatches may lead to very serious decreases in transmitter power out-

put or receiver sensitivity. Furthermore, if there is a guide very many wavelengths long between the discontinuity and transmitter, the load impedance presented to the transmitter may be a very rapidly varying function of frequency, with resulting

instability in the transmitter output.

The maximum allowable attenuation for the transmission system, and the maximum allowable input voltage standing wave ratio ($\eta_v = E_{max}/E_{min}$) to the system with a matched load on the far end are determined by the

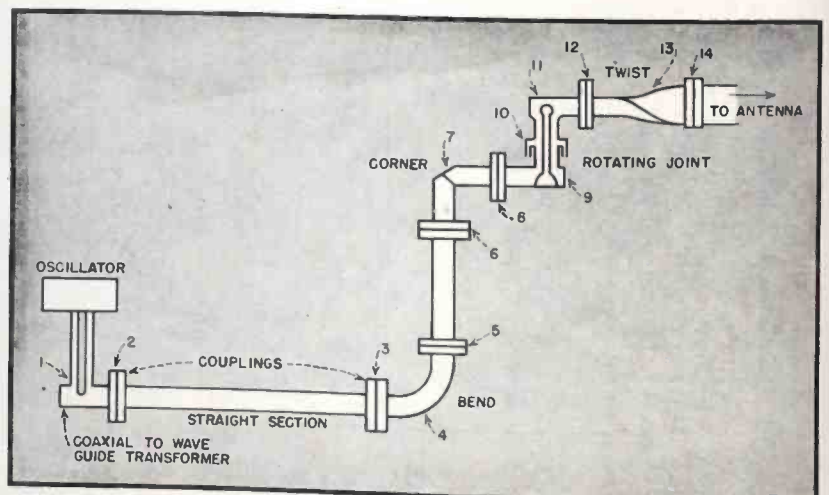

FIG. 1—Typical wave guide transmission system. The numbers indicate the possible discontinuities encountered in such a structure

Transmission Systems

The useful transmission of power from a microwave oscillator to an antenna invariably requires a multiplicity of joints and bends. These components must be carefully engineered and fabricated to avoid undue losses or standing waves arising from discontinuities

required overall performance of the receiver or transmitter. Once the performance requirements of the transmission system have been established, and the number of components in the system are known, the required attenuation and standing wave ratio of each component may be estimated.

If there are no resonances in the system, the overall system attenuation, expressed in db, will be the sum of the attenuations of the individual components and connectors. The reflection introduced by each component

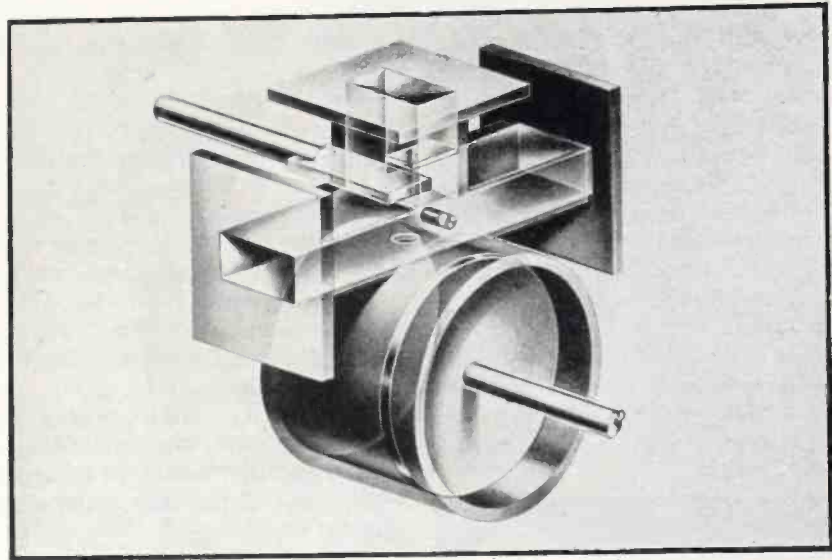

Artist's representation of a tee section to which is also attached a cavity frequency meter (bottom), r-f cutoff (center left) and matching post and window

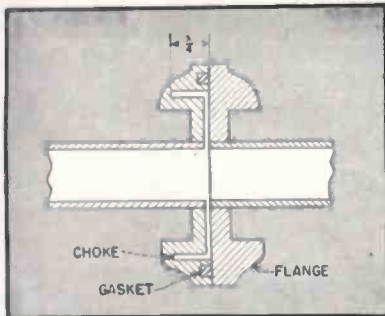

FIG. 2—A choke-flange coupling used for connecting sections of rectangular wave guide

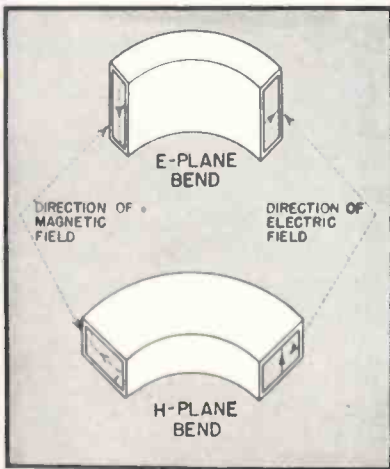

FIG. 3—Bends used to change the direction of rectangular wave guide

ent will add to or subtract from the reflected wave already present in the system, depending upon their phase relationships. The input standing wave ratio to the entire system cannot be predicted unless the phase relationships of the reflections introduced by each component are known. Usually this information is not available; only the standing wave ratios introduced by the components are known. But if there are n components and connectors, each introducing a standing wave ratio (η_i) into a matched line, the maximum standing wave ratio (η_{max}) for the entire system, which will be encountered if all reflections add in phase, will be given by

$$\eta_{max} = (\eta_i)^n$$

The most probable standing wave ratio for the entire system (η_{pr}), assuming random phase addition of all reflections, is given to a good approximation by

$$\eta_{pr} = (\eta_i)^{\sqrt{n}}$$

if the number of components or the

reflection from each component is not excessively large.

It is apparent that if the overall system requirements are strict, and there are a considerable number of components and connectors in the system, the requirements imposed on the performance of each component may be quite severe. For example, if there are 10 elements in a microwave system, each with a loss of 0.1 db and capable of introducing a swr of 1.05 into a matched line, the total loss in the system will be $10 \times 0.1 = 1.0$ db or 21 percent of the input power. The most probable input swr will be 1.17 and the maximum possible swr will be 1.63. But if each component has a loss of 0.3 db and introduces a swr of 1.2, the total loss will be 3.0 db or 50 percent of the input power, the most probable swr will have risen to 1.78, and the maximum possible swr will have reached 6.2, in general a prohibitively large value for satisfactory system operation.

Each connection between the various components of a wave guide

transmission system is a possible discontinuity in the transmission line, and the connectors must therefore be carefully designed if the system is to operate at maximum efficiency.

Wave Guide Connectors

If the ends of two sections of wave guide are machined off square and then clamped tightly together, the resulting butt joint will generally be electrically smooth and free from loss. The only discontinuity offered by such a butt joint will result from misalignment and differences in the guide dimensions on either side of the joint. These are usually negligible if the wave guides are held to close tolerances during manufacture, and both the loss and reflection will be so small as to be very difficult to measure.

The efficiency of such a connection depends critically upon the tightness of the joint between the wave guides. If the ends of the guide are not fin-

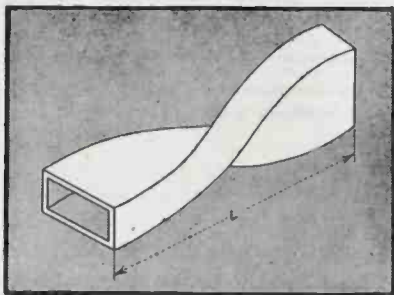

FIG. 4—A twist in rectangular wave guide

ished square and smooth, if the guides are misaligned or not clamped tightly together, the loss and reflection may be relatively large. And if the joint is not mechanically satisfactory, it is impossible to predict accurately what its electrical performance will be without careful measurement, although losses in the order of 1.0 db have been measured. So while the simple butt joints may be very satisfactory, and are even preferred when accurate measurements are being performed, they must be assembled with considerable care and mechanical accuracy.

The assembly of wave guide components is greatly facilitated with the use of choke couplings, as illustrated in Fig. 2. These may be designed to offer a minimum reflection and loss, and offer great advantages

in flexibility and reliability. The L-shaped cavity between the choke and flange may be considered a half-wave shorted line in series with the wave guide, which presents a short circuit at the input and offers therefore a minimum electrical discontinuity. The circular slot in the choke is a quarter wavelength deep. This places the contact between choke and flange at a point of zero current; therefore the contact does not have to be good. The distance from the slot to the wave guide must be determined experimentally, but it is electrically equivalent to a quarter wavelength. For maximum bandwidth, the width of the slot should be appreciably greater than the separation between choke and flange faces.

A choke-flange connection of this type when properly designed will introduce a swr less than 1.05 over most of the usable range of the wave guide. The loss will be in the order of 0.001 to 0.01 db, increasing with decreasing guide size, and independent of the tightness with which the choke and flange are clamped together.

Transmission through a choke-flange joint will be satisfactory even if the choke and flange faces are sep-

arated and misaligned to a certain extent, or if these joints are used for nonrigid couplings such as are required when a shock-mounted chassis is connected to a rigidly mounted line. If a clearance of $\frac{1}{4}$ wavelength is allowed between choke and flange, a sidewise displacement of up to $\frac{1}{4}$ wavelength will not raise the loss above 0.3 db, or the swr above 1.3.

Two chokes paired together will generally form a satisfactory connection, and may allow a greater separation for a nonrigid joint. But with paired chokes there is usually a resonance encountered near the design wavelength, which is marked by a sharp rise in the loss and swr. Also the swr over a band of frequencies is generally higher than for the choke-flange combination.

Wave Guide Bends

The direction of transmission in a wave guide system may be changed by bending the wave guide. The bend may be in the plane of either the electric or magnetic fields, and is correspondingly called an E or H plane bend (Fig. 3). The radius of the bend is not critical and may be quite small.

If the inner radius of the bend is

FIG. 5—Ninety-degree corners in wave guide designed for minimum reflection. Optimum spacing for E-plane corners is determined from the expression in the box; that for the H-plane corner from the graph

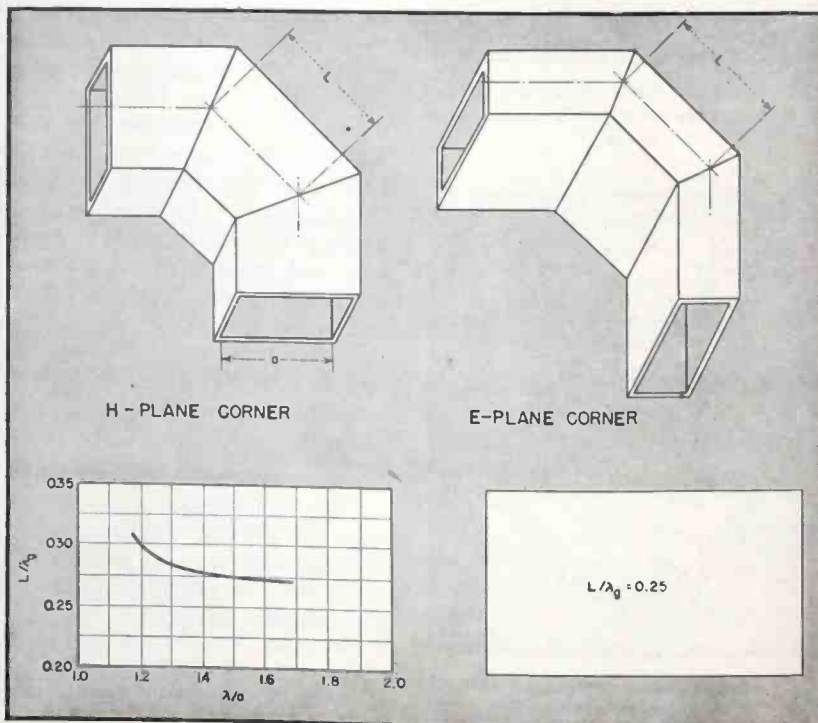

greater than a guide wavelength, λ_g , the swr will be under 1.05 over the normal operating range of the wave guide. A much smaller radius, down to $\lambda_g/4$ or less, will produce a swr in general under 1.1, but considerable care must be applied to the fabrication of the bend to achieve these results. A simple theory predicts that best results will be found with bends whose mean length is an integral number of half wave guide wavelengths, but the effects of irregularities in fabrication are usually much more important.

Several techniques of fabricating bends are widely used. The tubing may be filled with a low melting-point alloy and bent around the desired inner radius. For small radii, the cross-section will be distorted from a rectangular into a trapezoidal shape, which will increase the reflection, but the desired cross-section may be maintained by forcing rollers through the guide after the bend has been made.

Small radius bends are also fabricated from sheet brass by silver soldering, but this must be done with care, or irregularities will mar the inside surface. Electroforming¹ is satisfactory, giving bends with a

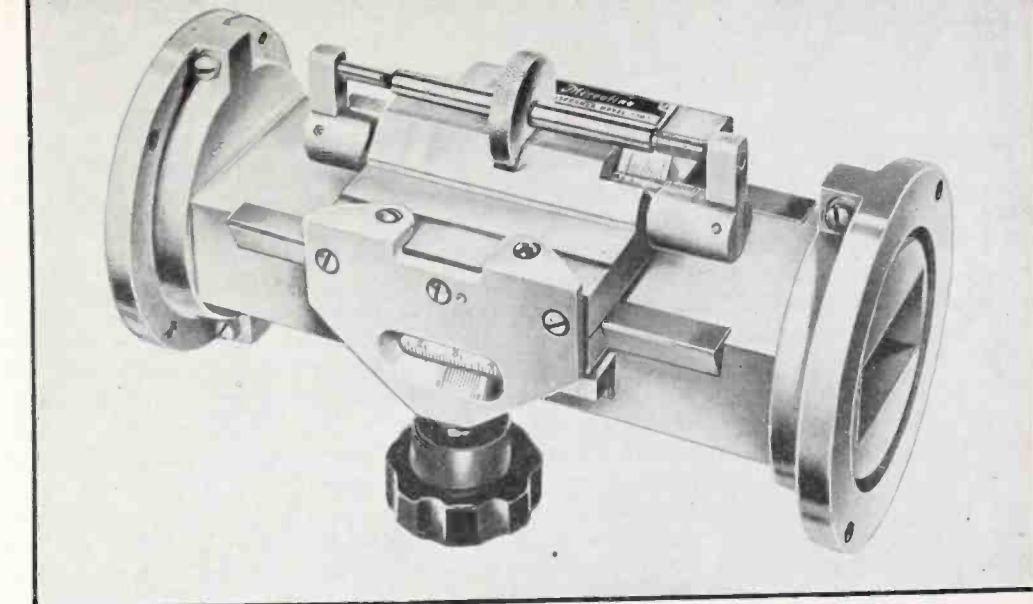

Microwave transformer capable of providing exact amounts of reflected power at precise electrical distances from a known reference point in a wave guide. Note the choke-flange coupling

uniform, rectangular cross-section and smooth inside surface.

Wave Guide Twists

A rectangular wave guide may be twisted about its axis to rotate the direction of the electric field. No great standing ratio will be set up if the guide is not deformed in the process (Fig. 4). Filling the guide with low melting-point alloy before twisting is a common method of

fabrication, and electroforming is also satisfactory. If the twist is 2λ , or more in length for a 90 degree rotation, the swr will generally be under 1.1, and shorter twists are satisfactory if carefully made.

Wave Guide Corners

Changing the direction of transmission in a wave guide system by an abrupt corner is generally not satisfactory, as an appreciable reflection will be set up. But if the desired angular change is accomplished by using two simple corners (Fig. 5), spaced apart approximately a quarter wave guide wavelength ($L/\lambda_g = \frac{1}{4}$), the reflections from the two corners will cancel each other. For E plane corners, the optimum spacing is given very closely by $L/\lambda_g = 0.25$ for angles up to 90 degrees, but for H plane corners, this optimum spacing is slightly different, and is plotted as a function of λ/a in Fig. 5 for a 90-degree total change in direction.

The bandwidth over which these corners will introduce a standing wave ratio less than 1.05 is generally plus or minus three decreased by 10 percent of the center frequency for a 90 degree bend, increasing as λ/a decreases, and is greater for smaller angles. Circular bends are preferred for larger angles and greater bandwidths.

It is also possible to eliminate the reflection at an abrupt corner by modifying the corner as illustrated in Fig. 6, and the bandwidth will be very nearly the same as for the dou-

FIG. 6—Single-corner with minimum reflection. Required dimensions for both types of corner are plotted as a function of the angle

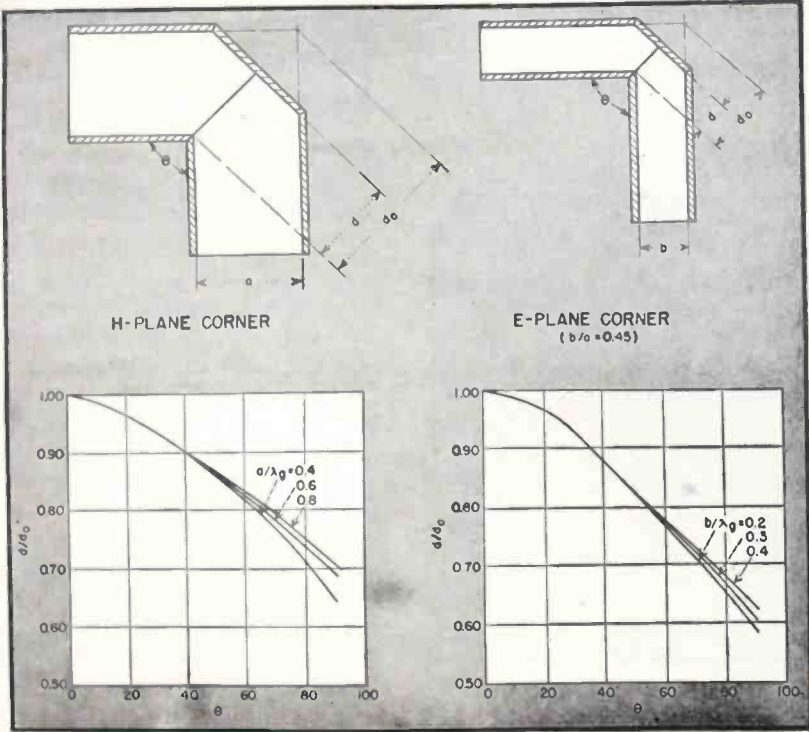

ble corner. The required dimensions for the corner are plotted as a function of the angle for both E plane corners and H plane corners in Fig. 6. This type of corner must be held to rather close manufacturing tolerances to attain the optimum performance.

Tee Joints in Wave Guides

Tee joints in rectangular wave guides are similar to stubs in conventional transmission lines. A stub that branches from the broad side of a rectangular guide in the E plane is in series with the main guide, and a stub that branches from the narrow side in the H plane is in shunt with the main guide (Fig. 7).

The presence of the fringing fields at the corners somewhat modifies the action of the tees. With the series or E plane tee, a short circuit placed $\lambda_g/2$ away from the junction should allow perfect transmission past the stub, and a short $\lambda_g/4$ away should cause complete reflection at the stub. For the shunt or H plane tee, a short $\lambda_g/4$ away should give perfect transmission, and a short $\lambda_g/2$ away should cause complete reflection. It is actually possible to find positions of the short in both branch arms which give perfect transmission and complete reflection, but the locations are slightly different from the above values, and depend upon the ratio of wave guide dimensions to wavelength.

With the idealized tees, it should be possible to locate a short in branch one to allow perfect transmission from branch two to stub arm

branch three, or to cause a complete reflection at the junction. With the actual tees, it is possible to locate the short to give a complete reflection for an input signal from branch two or three, but there is no short location which will give perfect transmission between these arms. The minimum swr which can be attained will depend upon the ratio of wavelength to guide dimensions, and upon the type of tee, but will usually be of the order of 1.5. For perfect transmission, it is necessary to modify the tee by the addition of some sort of matching structure, such as the metallic diaphragm indicated in Fig. 7.

Matching Diaphragms and Posts

In the design of wave guide components, it is often necessary to employ some sort of matching device to remove the reflected wave that results from a discontinuity. This may be accomplished by introducing an additional discontinuity, the reflection from which is of the proper magnitude and phase to cancel the undesired reflected wave. Thin metal diaphragms or metal posts are widely used for this purpose; these are equivalent to susceptances that shunt the transmission line.

The required normalized susceptance may be determined by measuring the swr in the line that is to be reduced, and is given by

$$|B/Y_0| = \eta_0 - 1/\sqrt{\eta_0} \quad (2)$$

The susceptance should then be placed at a distance d , from a voltage minimum, given by

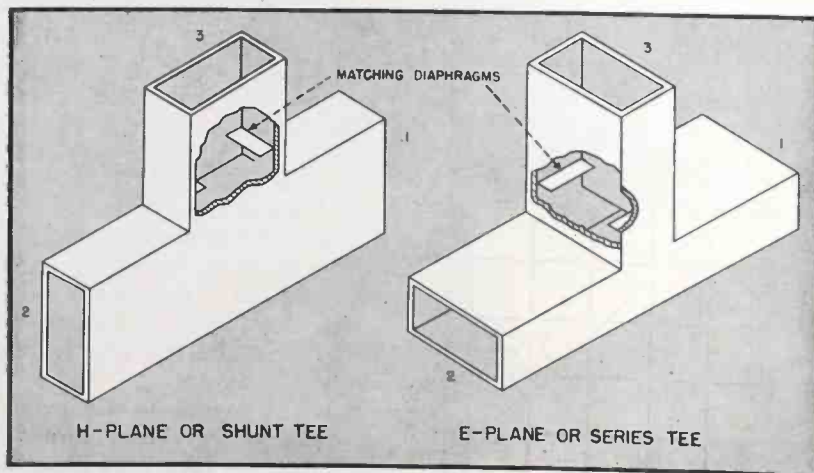

FIG. 7—Tee joints in rectangular wave guides, showing matching diaphragms

$$\frac{d_1}{\lambda_g} = \frac{90 - \tan^{-1} \frac{1}{2} |B/Y_0|}{720} \quad (3)$$

where the arctangent is expressed in degrees. The matching susceptance if inductive should be placed at this distance on the load side of a voltage minimum, if capacitive it should be located an equal distance toward the signal input from minimum. For minimum frequency sensitivity, it should be located as near as possible to the source of the undesired reflection, and it should be kept in mind that voltage minimums are spaced apart $\lambda_g/2$ along the input guide to the source of reflection.

One of the most commonly used

FIG. 8—Susceptance of the inductive diaphragm used for impedance matching in rectangular wave guides as a function of dimensions

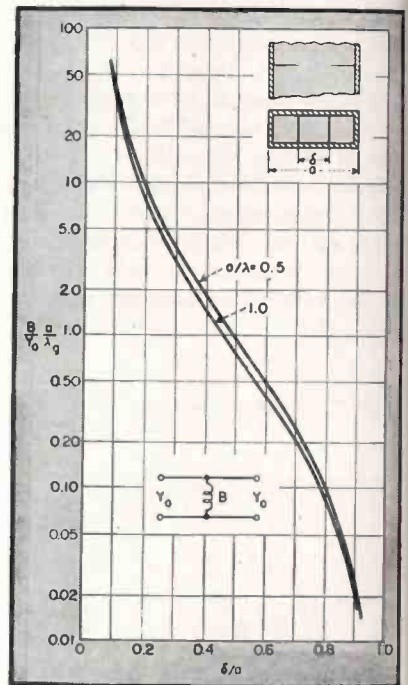

matching susceptances is a thin metal diaphragm placed transversely across the wave guide, with an opening symmetrically located and extending across the wave guide parallel to the narrow dimension (Fig. 8). This type of diaphragm is equivalent to an inductive susceptance shunting the guide. The magnitude of this susceptance depends upon the size of the opening in the diaphragm, and may be obtained from the figure. If the diaphragm has appreciable thickness, its susceptance will be slightly higher than shown.

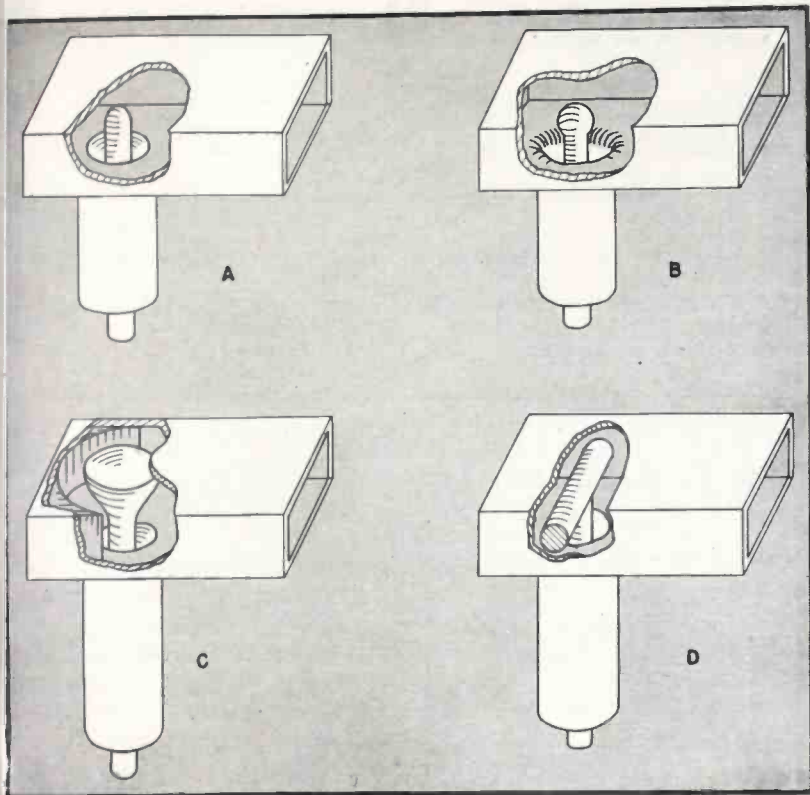

FIG. 9—Broad-band, fixed-tuned coaxial line to wave guide transformers. These methods of construction are necessary to provide reflectionless transmission

will introduce no reflection at a single frequency if the probe antenna is of the proper length and the proper distance from the wave guide short. Both of these dimensions are roughly a quarter wavelength, but must be determined experimentally for satisfactory results.

The bandwidth over which the transformer is satisfactory is made greater by increasing the size of the coaxial line and the diameter of the antenna, and also by rounding the end of the antenna. It is still further increased by modifying the probe as shown in Fig. 9B, to end in a metal sphere, and by flaring the outer conductor of the coaxial line into the inner wall of the wave guide. A transformer of this type can be designed to introduce a swr below 1.2 over most of the useable range of a wave guide.

Two additional designs of fixed-tuned broadband transformers are shown in Fig. 9C and D. Type C is called a door knob transformer, and has been designed to handle high powers. Both C and D provide a support for the center conductor of the coaxial line, and also a direct current return, which are advantages for some applications. Both of these designs have good bandwidth, but the optimum dimensions must be found experimentally for different sizes of coaxial line and wave guide.

REFERENCE

- (1) Hassell, F., and Jenks, F., Electroforming Microwave Components, *ELECTRONICS*, p 134, March, 1946.

Another matching susceptance that widely used is a metallic post or ring screw centrally located in the broad side of the guide and extending part way across parallel to the electric field. This screw is equivalent to a shunting capacitive susceptance whose magnitude increases with probe depth. A resonance is reached when the probe depth is approximately a quarter wavelength, and for greater lengths the probe is inductive, but practically it is never used in the inductive region. Adjustable transformers have been built using multiple tuning screws or a single screw whose depth and penetration may be varied.

Coaxial Line to Wave Guide Transformers

The output of many microwave oscillators is delivered into a coaxial line, and some sort of coaxial line to wave guide transformer must be used to send the signal through a wave guide transmission system. The most suitable transformer section is one that introduces no reflected wave when a signal is fed between the coaxial line and wave guide in either direction. If losses are low, reflectionless transmission in one direction is a guarantee of reflectionless transmission in the other.

The simplest coaxial line to wave guide transformer is constructed by extending the center conductor of the coaxial line into the wave guide to form a probe antenna in the wave guide, parallel to the electric lines of force (Fig. 9A). This transition

tionless transmission in one direction is a guarantee of reflectionless transmission in the other.

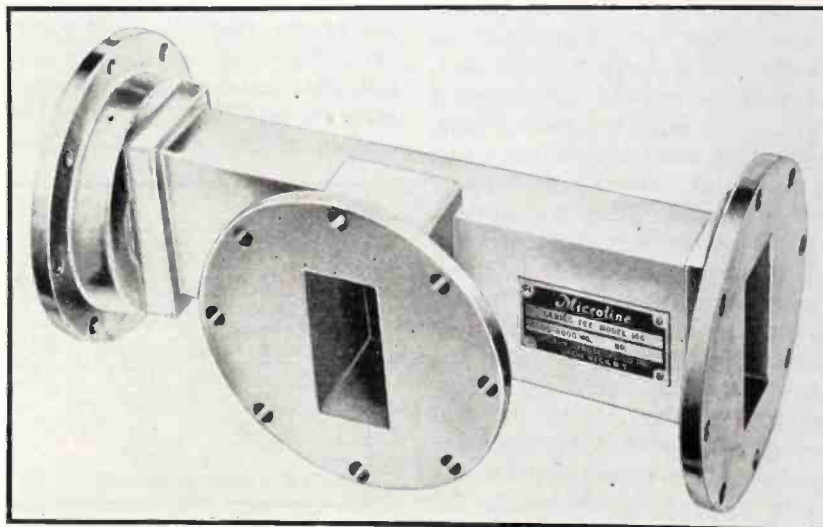

Commercial model of a series tee shown in Fig. 7

Radar for Blind Bombing

Part II

Modulators, scanners, r-f systems, receiver-indicator systems, and synchronizers in the two versions of H2X microwave airborne radar are covered in this concluding installment. The rotating joints in the rectangular wave guides are of particular interest

By J. V. HOLDAM, S. McGRATH, and A. D. COLE

*Cole, Holdam & McGrath
Boston, Mass.*

THE PRECEDING INSTALLMENT, in the May 1946 issue of *ELECTRONICS*, covered the history of H2X bombing radar, its tactical uses in both the European and Pacific theatres of war, general operating principles, an analysis of the bombing problem confronting its designers, and technical details of the range unit circuits employed in the Philco APS-15 and Western Electric APQ-13 versions of this radar system. The remaining circuits will now be taken up.

The APS-15 Modulator

A simplified schematic of the APS-15 modulator is shown in Fig. 8. A positive trigger is supplied to the pulse-forming amplifier from a cathode follower in the range unit, when the range unit is on, or from a cathode follower in the receiver indicator. The trigger has an amplitude between 60 and 120 volts. It is applied to the control grids of the 829 through a pulse-forming line. The positive pulse is of sufficient amplitude to raise the control grid, which is normally biased below cut-off, to a point where the tube starts conducting. The pulse transformer is connected so that positive feedback from plate to grid is obtained. The plate current rises rapidly to a high value but the rate of rise is slowed by the inductance in the plate circuit. The negative pulse applied to the delay line by the grid winding of the blocking oscillator transformer travels to the end of the line, is reflected, and returns to the grid with sufficient negative polarity



Antenna system of Western Electric APQ-13 version of H2X bombing radar. Azimuth selsyn is at top right, azimuth motor at left

to cut off the plate current with the aid of the feedback from plate to grid. The electrical length of the line determines the length of the plate current pulse. The pulse is applied to the grid of the power

amplifier by means of the third winding on the pulse transformer.

Relays are employed to switch in various sections of line to give lines of varying length. These are used to give pulse lengths of approximately $\frac{1}{2}$, 1 and 2 microseconds. The pulse repetition frequencies are chosen in inverse ratio to the pulse lengths to keep the average power constant. Thus it is possible to keep the transmitter functioning at its maximum rated power and also to eliminate difficulties with poor regulation in the high-voltage power supplies.

The positive square pulse produced by the pulse-forming amplifier, with a magnitude of about 1,100 volts, is applied to the control grid of the power amplifier. This tube has a control grid bias of 900 volts and a screen voltage of 1,100 volts. The capacitor connected between the plate of the power amplifier and the cathode of the magnetron is charged between pulses, through the resistors, to 14,000 volts. When the power amplifier is pulsed, its impedance drops to approximately 90 ohms, suddenly switching one side of the

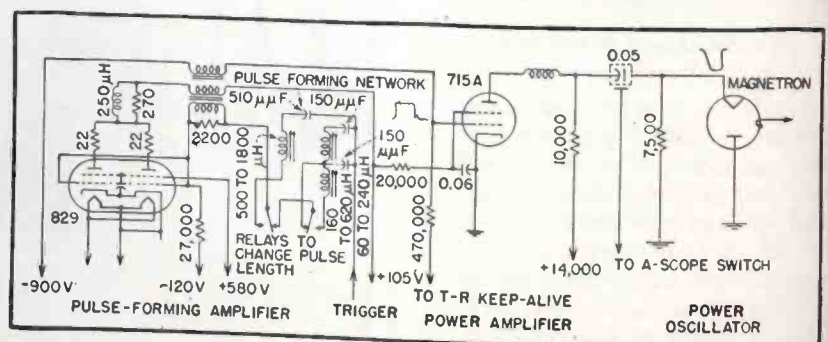
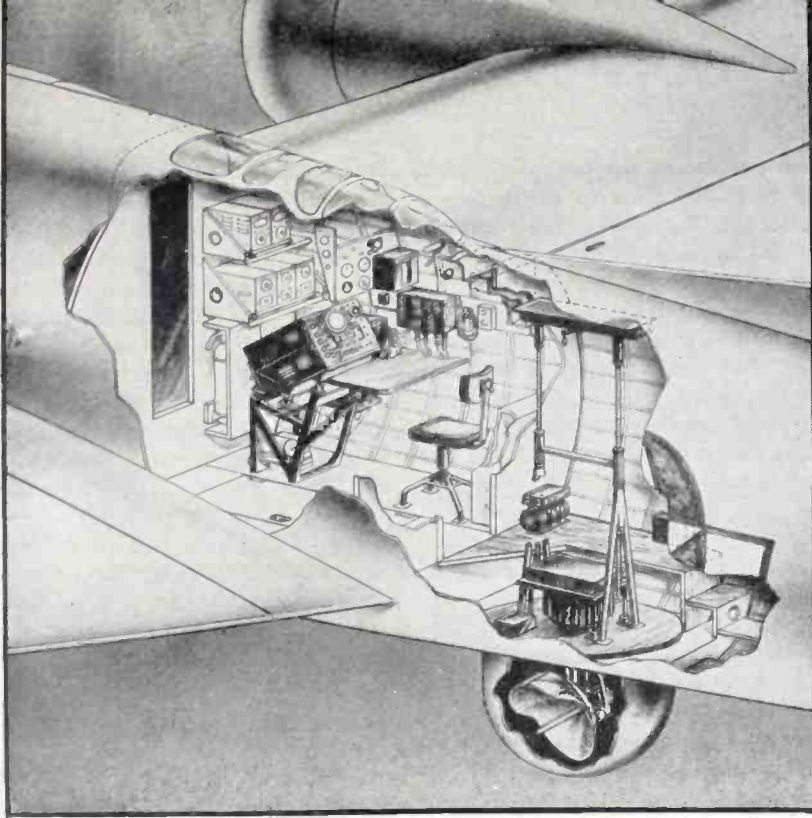

FIG. 8—Circuit of APS-15 modulator



Sketch of Philco APS-15 microwave radar installation in a B-17. The scanner, modulator, and radome are all retractable

capacitor to ground so that about 13,000 volts appears across the magnetron.

About 15 amperes flows through the power amplifier and about 12 amperes through the magnetron. The three amperes difference is drawn by the stray capacitances and by the resistors connecting the capacitor to the power supply. During the pulse, the capacitor loses only a small percentage of its total charge and recovers full charge before the next pulse.

The APQ-13 Modulator

The APQ-13 modulator differs somewhat from the APS-15 modulator though they are both hard-tube modulators employing lines to form the pulse. A simplified schematic appears in Fig. 9. The modulator consists essentially of a multi-

vibrator circuit which is triggered from a cathode follower in the range unit, a pulse-shaping network, and a pulse amplifier. The low-voltage elements are housed in an air-filled section and the high-voltage elements in an oil-filled section of the modulator.

The type 6AG7 is normally conducting and the 829 nonconducting. The incoming positive trigger applied to the cathode of the 6AG7 increases the grid bias and thus decreases the plate current. The resultant rise in plate voltage of the 6AG7 is transferred through the interstage capacitor to the grid of the 829, which begins to conduct, increasing the cathode-to-ground potential of both tubes. The action is cumulative and the 829 suddenly switches to a highly-conducting condition. After a time interval deter-

mined by the time constants in the grid-cathode circuits, the action is reversed and the tubes are suddenly restored to their original condition.

During the period when the 829 is conducting, the plate-circuit choke in the pulse-shaping network is charged. When the tube cuts off, the energy in the choke is dissipated in a square-topped current wave in the delay line, resulting in a square pulse of voltage on the control grids of the pulse amplifiers. The grids, which are normally 675 volts negative, are driven positive and draw grid current which serves to improve the shape of the pulse.

The output of the pulse amplifier is a square negative pulse having a magnitude of about 16,000 volts. This is stepped down to 3,200 volts by a pulse transformer and applied to a coaxial cable which carries it to a similar transformer in the radio-frequency unit, where it is stepped up to 12,000 volts and applied to the magnetron cathode.

Scanner

The scanners for the APS-15 and APQ-13 are very similar. Both include an antenna, waveguide, two rotating joints, a motor for rotating the antenna, a motor for tilting the antenna, a sector scan mechanism, and position take-off for the ppi.

In a radar system that is to be used for the identification of objects giving a radar echo, high resolving power is desirable. High resolving power is obtained by means of short pulses and narrow horizontal beams from the antenna. Since the physical size of an antenna to be installed in an airplane is limited, a high frequency is desirable. This is the reason for the choice of 9,400 mc for the H2X systems, it being the highest frequency practical at the time of the design of the equipment.

In making a bombing run on a complex target such as a city, the task of identification of a portion of that target is simplified if the target retains the same appearance as it is neared. The angle between the line of sight from the aircraft to the target and the horizontal gradually varies between 0 and 90 degrees as the aircraft nears the target and eventually passes over it. A vertical antenna pattern to enable the system to meet this requirement must have

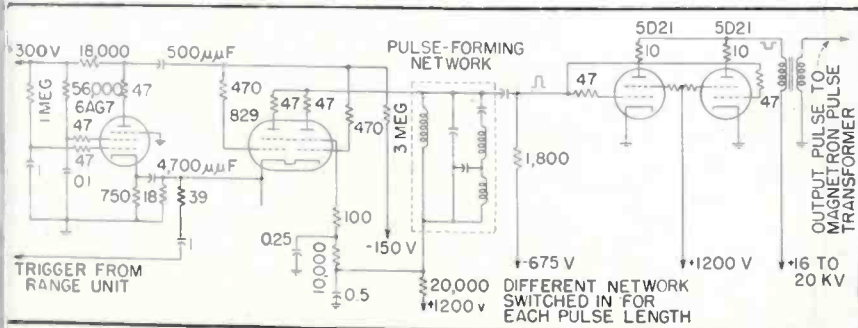

FIG. 9—Circuit of APQ-13 modulator

a variation of radiated field strength with angle such that a target that reflects a constant fraction of the incident energy will give a received signal of constant amplitude. Since a distance of 35 miles is enough in which to make a bombing run and the bomb is released at high altitude about two miles from the target, a pattern which follows this rule at angles between 6 and 63 degrees is satisfactory at an altitude of 4 miles. This relationship may be expressed as $G_0 = k \csc^2 \theta$ where G_0 is the effective gain of the antenna at an angle θ measured below the horizon. Figure 10 shows an idealized antenna pattern of this type and an approximation of the pattern obtained in the H2X systems.

In order to obtain the antenna pattern described above, the lower half of the antenna reflector is made a half section of a paraboloid of revolution with the antenna feed at the focus. The upper half of the reflector is a surface generated by rotating a parabolic element about a line passing through the focus (still the antenna feed) in the plane of the element and normal to the axis of the element. This barrel-stave section serves to direct some of the energy downward in the pattern described above.

The data take-off on the APQ-13 consists of a single-phase to three-phase synchro geared to 10 times the speed of the antenna. For the APS-15, the data take-off consists of a single-phase to two-phase synchro with its shaft geared to the same speed as the antenna. The body of the APS-15 synchro is rotated by a servo system from the flux-gate compass in the aircraft, providing a differential action that gives azimuth stabilization of the ppi. The APQ-13 also provides azimuth stabilization of the ppi.

The azimuth motor is geared to rotate the antenna continuously at 12 or 24 rpm as selected by the operator. A sector scan mechanism, with which the scanners are equipped, can be employed to cause the azimuth motor to drive the antenna back and forth through a sector, the width and position of which are controllable.

R-F System

The components of the r-f system are shown in Fig. 11. The r-f pulse

passes from the magnetron through two rotating joints to the antenna. These rotating joints make possible the rotating and tilting motion of the antenna.

On the way to the antenna, the energy passes an r-t box and a t-r box. These two boxes consist of resonant cavities filled with a low-pressure gas and containing spark gaps. When the transmitter fires, the gas ionizes and current flows between the gaps. The t-r box is located so that when conducting it presents a high impedance at the junction of the mixer branch with the wave guide going to the antenna. This prevents the crystal from being burned out by the high power in the transmitted pulse.

The r-t box is located so that when conducting it has little effect on the outgoing pulse. On receiving, however, it causes the branch of the wave guide leading to the magnetron to appear as a high impedance at the junction with the mixer; thus, most of the received energy is coupled into the crystal mixer. Use of an r-t box is necessary with magnetrons of this frequency because the cold impedance of the magnetron is not sufficiently different from the fired impedance to prevent the magnetron from absorbing half of the received energy.

The transmission lines are of the wave guide variety, either gold or

silver plated. The impedance of the transmission line is approximately 250 ohms. Since it is desirable to be able to remove sections of the wave guide serving as transmission line, the line is made in sections which are coupled together by a choke joint. The electrical constants of the joint are in approximate resonance at the magnetron frequency, providing the r-f transmission line with electrical tightness such that the energy is transmitted down the guide without loss or reflection at the break. The entire transmission line is made air-tight so that it may be filled with air under pressure. This is necessary to prevent sparking at high altitudes.

Rotating Joints

To provide flexibility in the wave guide transmission line, and so the antenna can be rotated or tilted without disturbing the transfer of energy, rotating joints are used at the pivot points. Mechanical considerations make it necessary to use cylindrical sections for this purpose. In the APS-15, each joint consists of a transformer from rectangular to cylindrical guide, a section of cylindrical guide, a choke coupling, another section of cylindrical guide, and another transformer from cylindrical guide to rectangular guide. In the APQ-13, the transformation is made from rectangular guide to coaxial line and back to rectangular guide.

One end of the antenna feed terminates in a choke-coupling joint and the other end in a pair of closely spaced irises covered by a mica window to maintain the air pressure in the r-f line. The r-f energy passes

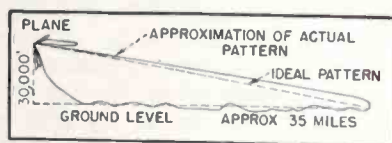

FIG. 10—Polar diagram of bombing antenna pattern

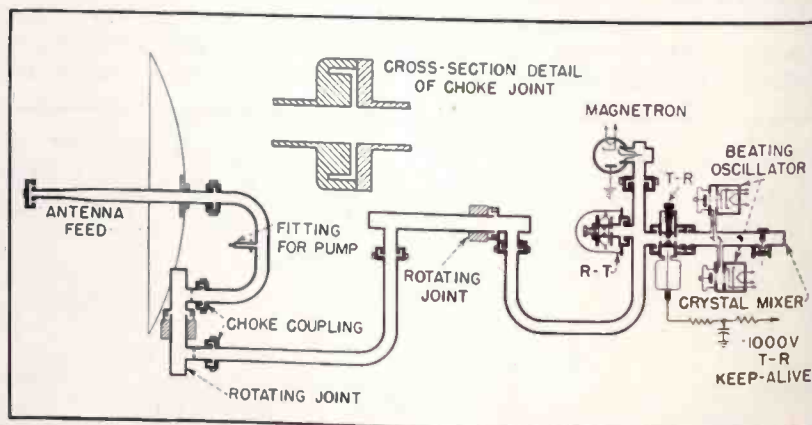

FIG. 11—General arrangement of r-f system of H2X bombing radar, showing use of wave guide transmission lines

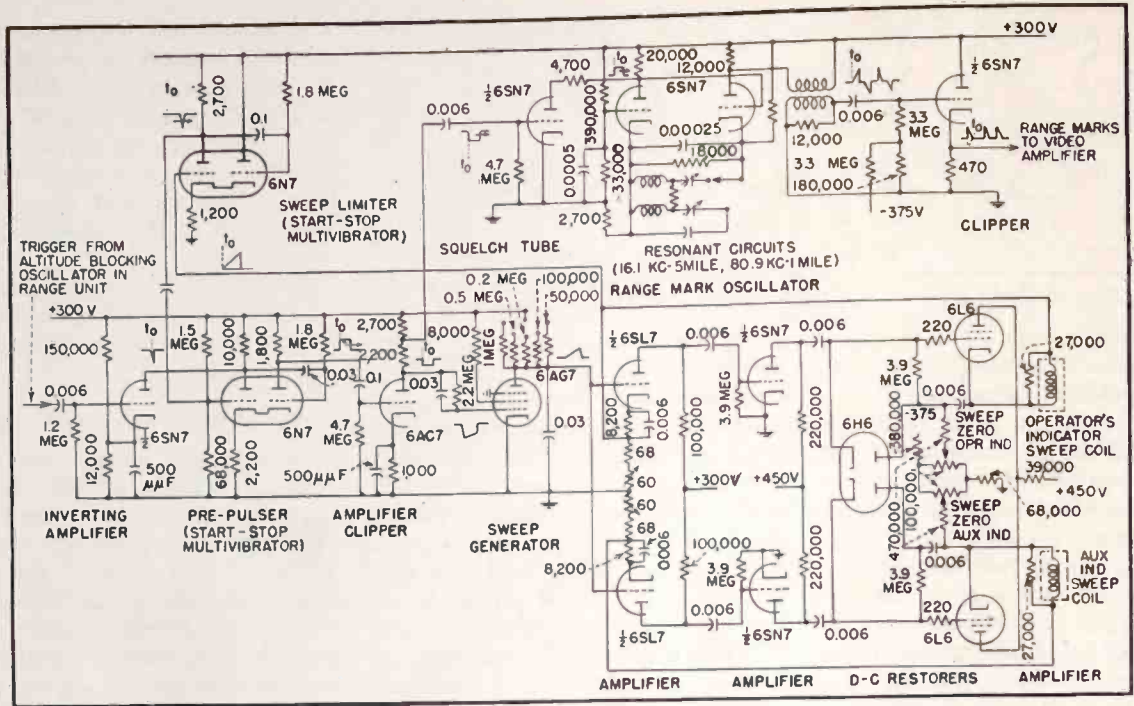

FIG. 15—Circuit of synchronizer section of APQ-13 system

the range marker switch. The first pulse appears at the time of the transmitted pulse. When these pulses are injected into the video amplifier and appear on the indicator screens, the rotation of the sweep coil forms them into circles of illumination that can be used to determine range to an object appearing on the screen.

The input to the range marker circuit is a negative square pulse with a duration equal to the duration of the sweep. The square pulse is applied to the grid of a squelch tube. This tube, when conducting, prevents the range marker oscillator from oscillating. Application of the negative pulse cuts the squelch tube off and permits oscillation. The range marker oscillator then oscillates at a frequency determined by the constants of the positive feedback (resonant) circuit between the cathodes of the two sections. Each of the two resonant circuits can be selected separately to give the different range mark spacings, or the oscillator may be disabled to remove the range marks. Since the oscillator is heavily loaded, the nominal sine-wave output is considerably flattened, resulting in a nearly square-wave output. This is differentiated in the air-core transformer, producing a positive pip at the beginning of the square wave and a negative pip at the end. These positive and negative pips are

applied to a cathode follower with its control grid biased to cutoff; thus, the positive marks only appear at the cathode and are passed on to the video amplifier.

The APS-15 Receiver-Indicator

The APS-15 receiver-indicator circuit, shown in Fig. 16, contains the i-f and video amplifiers, a plan position indicator, an A scope, and the timing oscillator. The timing oscillator generates two simultaneous pulses that are used to trigger the receiving equipment and the transmitting equipment when the range unit is off. The negative pulse from the timing oscillator is used to trigger the ppi and A scope sweep circuits, the A scope blanking, and the clamping tubes. The positive pulse from the timing oscillator is used to trigger the pulse-delay circuit, which in turn triggers the transmitter, the range-mark generator, and the ppi blanking circuit; a portion of this positive pulse is also applied to the ppi sweep waveform to modify its shape.

The constants of the multivibrator-type timing oscillator are chosen to provide the proper pulse repetition frequencies. In addition, the durations of the positive and negative halves of the generated square wave are controlled by constants which may be varied by the

range switch. The oscillator will oscillate at 650 cps for operation with the one-microsecond r-f pulse for normal search, or at 300 cps for beacon operation with the two-microsecond pulse.

When the precision functions of the equipment are employed for bombing or for accurate determination of range to distant objects, the transmitting and receiving circuits are controlled by pulses originating in the range unit. The timing oscillator is locked in with the range unit at repetition rates of 1010 for bombing employing a half-microsecond r-f pulse and at 311 for beacon operation. The pulses from the range unit are fed through a buffer amplifier to isolate the ppi pre-trigger blocking oscillator from the timing oscillator.

Since the starting portions of the sweeps are nonlinear, it is desirable not to use them. This is accomplished by starting the sweeps early, delaying the firing of the transmitter, and unblanking the indicator and starting the range-mark generator at the time the transmitter fires.

The delay of the transmitter firing time is accomplished by the pulse delay tube. This tube, in the quiescent state, has its grid biased far below cutoff. The positive square wave from the timing oscillator is applied through a resistor to the control grid

to the pulse delay tube. The capacitor connected from grid to ground slows down the rise of the grid voltage so that several microseconds are required for the grid to reach cutoff. The output of the pulse delay tube is applied through a differentiating network to the grid of a pulse amplifier stage. This stage, with the pulse delay tube, functions as a cathode-coupled multivibrator to produce high-amplitude pulses with a rapid rate of rise. The output of the pulse amplifier is differentiated and applied to the grid of a cathode follower, which is biased below cutoff. A sharp positive pulse is produced at the cathode of the cathode follower and serves to trigger the modulator. A 6L6 is employed to provide the current through the rotor of the sweep synchro. The control grid voltage is supplied from the sweep generator. The sweep produced in the rotor of the synchro is resolved by the two stator windings (which are in space quadrature) into horizontal and vertical components. The outputs of these windings are fed through amplifiers to two deflection coils which are also in space quadrature,

thus producing a magnetic field to deflect the beam of the cathode ray tube in a direction to correspond with the orientation of the rotor of the synchro.

D-C Reinsertion in APS-15

As explained in connection with the APQ-13 synchronizer, a method of d-c reinsertion must be employed on the sweep amplifiers in order that the sweep will start from the center of the tube for all sweep lengths. The method of d-c reinsertion, or clamping, used in the APS-15 makes use of two triode sections in series from +100 volts to ground. The voltage between the junction of the plate and cathode of the two sections and ground is about +6 volts. The clamping tube functions as a voltage regulator. If the juncture tends to become more positive, the cathode of the section whose plate is connected to +100 volts becomes more positive, hence its grid in effect becomes more negative, the current through both sections is reduced, and the juncture drops in potential. If the juncture tends to become more negative, the reverse effect is produced. Since the

bias applied to all four sweep tubes is equal, their plate currents are equal; thus, the sweep will start from the center of the tube. When the sweep voltage appears on the grids, the clamping tubes have no function and they are cut off by a negative pulse on their grids until the end of the sweep.

The receiver-indicator contains circuits for generating precision range marks. Four different spacings are provided, each spacing derived from a separate resonant circuit. Coincident with the firing of the transmitter a negative square wave is supplied to the range marker circuit by the pulse delay tube. The application of this negative gate on the control grid of the input stage suddenly interrupts the current through the inductance of the resonant circuit, thereby producing a train of damped oscillations. The oscillations are amplified, clipped, shaped into sharp pulses, and mixed with the video in the video amplifier. As seen on the indicators, the range marks are concentric circles which are used as references for accurately estimating echo ranges.

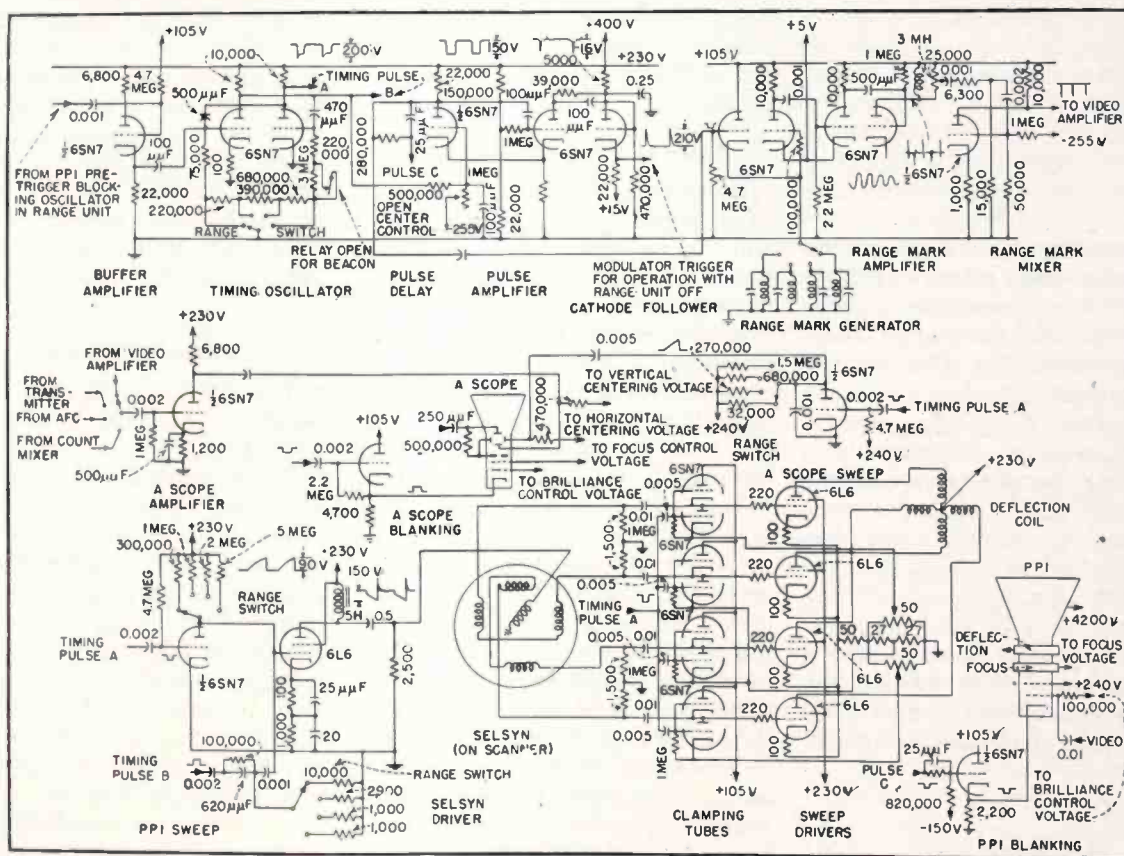

FIG. 16—Receiver-indicator circuit of APS-15 system

THEORETICAL

By J. ERNEST SMITH

Manager, Microwave Group
Raytheon Mfg. Co.
Waltham, Mass.

C	: peak amplitude of radio frequency carrier
C_s	: peak amplitude of subcarrier in double modulation system
f_a	: transmission bandwidth of intelligence portion of system
f_d	: peak frequency deviation of carrier or subcarrier from unmodulated frequency
f_e	: transmission bandwidth of multiplex system
f_s	: frequency of subcarrier
$2f_i$: transmission bandwidth of intermediate frequency portion of system
$2f_r$: transmission bandwidth of radio frequency portion of system
f_1	: lower limit of a given channel within a multiplex system
f_2	: higher limit of a given channel within a multiplex system
m	: percent modulation in an amplitude modulation system
N	: equivalent fluctuation noise voltage; subscript refers to bandwidth over which particular noise voltage is developed
n	: number of channels in a multiplex system
S	: voltage of detected intelligence signal

deviation ratios of frequency modulation systems are indicated by $(\)_{r,f}$ to indicate deviation of radio carrier frequency, and by $(\)_{s,f}$ to indicate deviation of the subcarrier frequency

Table I—Nomenclature used in equations

COMPARATIVE ANALYSIS shows the signal-to-noise ratios obtainable in multichannel amplitude modulation and frequency modulation transmission systems. This discussion applies particularly to ultra and super high-frequency radio relay circuits for point-to-point communication. Equations are derived which indicate, among other things, that, for equal transmitted powers and radio frequency bandwidths, double f-m systems offer advantages over double a-m systems.

Ultra and super high-frequency radio relays are being planned for transmission of television, high quality programs, multiplex telephony

Work on which this article is based was done while author was a member of the staff of RCA Laboratories at 66 Broad Street, New York, N. Y.

and telegraphy, facsimile, radiophoto, and business machine data. Design of such facilities requires knowledge of the modulation methods that provide optimum signal-to-noise ratios in the individual channels of a multichannel system. Knowing the signal-to-noise ratio of a channel, the designer of a system that is to transmit different types of intelligence can allocate to each channel only as much of the total transmitted energy as is required for satisfactory reception of each type of intelligence. By thus weighting each channel, an optimum number of channels can be obtained for a fixed transmitted power and bandwidth.

Types of Modulation and Noise

Several types of transmission can be employed, all using either a-m or f-m. In a single modulation system the intelligence modulates the transmitted carrier. In a double modulation system the intelligence signal modulates a subcarrier which, in turn, modulates the transmitted carrier. For single channel transmission, only one intelligence signal is used.

Two types of noise can affect radio transmission. Impulse noise, accurately represented by a unit impulse, can be considered, at the higher frequencies, as a finite bandwidth of components having equal amplitudes and the same phases. This interference produces transients in the receiver, but being of local-origin its effects can be reduced by shielding the noise source or relocating the receiver's antenna.

On the other hand fluctuation noise, due largely to shot effect, ther-

mal agitation, and antenna pickup (site) noise, cannot be removed. Above 300 mc shot noise predominates to the extent that thermal and site noise can be neglected. Within the acceptance band of the receiver, fluctuation noise can be considered as a finite bandwidth of components having equal amplitudes but random phases.

Define noise power density as the noise power per unit of bandwidth (watts per cycle). Noise power generated by the receiver is directly proportional to bandwidth. The equivalent fluctuation noise voltage N is proportional to the square root of bandwidth. This noise voltage, wherever it is generated, will be referred to the antenna input terminals. To include the bandwidth in which this noise exists, use the nomenclature N_f , where N is the peak value of the fluctuation noise in the frequency band f .

Noise Determination

The signal to noise ratio $(C/N)_{sfr}$, where the notation is explained in Table I, can be obtained by measurement: Connect an r-f generator directly to an a-m superheterodyne receiver and amplitude modulate the r-f generator 100 percent with an audio tone. Because the tone fully modulates the carrier, the detected signal S is a precise audio measurement of the magnitude of the r-f carrier. We have assumed the existence of a noise magnitude N_{sfr} at the receiver input terminals. This magnitude will be different at the mixer due to the antenna coupling circuits. However, the modulated carrier will be modified also so that $(C/N)_{sfr}$ re-

SIGNAL-TO-NOISE RATIOS

Signal-to-noise ratios are derived in terms of the frequency bands of the signal and of the transmitted radio carriers. Resulting equations indicate merits of various combinations of modulation and multiplex with respect to noise. Frequency and amplitude modulation systems are compared

remains unchanged. We assume that the mixer has a linear conversion characteristic. The intermediate frequency carrier-to-noise ratio will then equal the r-f carrier-to-noise ratio if $f_i = f_r$. This latter equality is not obtained in practice. In fact, receiver selectivity is almost entirely determined by f_i and, in general, f_i will be much less than f_r . A portion of the noise is thus rejected by the i-f band, consequently

$$\left(\frac{N_{2f_i}}{N_{2f_r}}\right) = \left(\frac{f_i}{f_r}\right)^{1/2}$$

The intermediate frequency carrier-to-noise ratio as modified by the i-f pass-band is expressed as

$$\left(\frac{C}{N}\right)_{2f_i} = \left(\frac{f_r}{f_i}\right)^{1/2} \left(\frac{C}{N}\right)_{2f_r} \quad (1)$$

Equation 1 gives the carrier-to-noise ratio that is applied to the receiver detector. The function of the detector is to reproduce the original modulating tone by folding the lower sidebands upon the upper sidebands so that they add in phase to produce resultant S equal in magnitude to

The sidebands of noise are filled with components of equal amplitude and random phase. When the lower sideband is folded on the upper, the noise power in the band zero to f_c from the detector is twice that of the upper sideband alone. Normally, the detector output contains a low-pass filter of cutoff frequency f_c where f_c is much less than f_c . Accordingly, this filter will reject all noise components greater than f_c and the output noise power is reduced by the factor $1/2$, therefore

$$\begin{aligned} (S/N)_{f_c} &= (C/N)_{2f_c} \\ &= (f_c/f_a)^{1/2} (C/N)_{2f_r} \\ &= (f_c/f_a)^{1/2} (C/N)_{2f_r} \end{aligned}$$

$$(C/N)_{2f_r} = (f_a/f_r)^{1/2} (S/N)_{f_c}$$

Noise Measurement

The ratio $(S/N)_{f_c}$ is obtained directly by measurement. With the

Basic signal-to-noise equations derived in text for a bandwidth f_a

Amplitude Modulation

$$\text{Single: } \left(\frac{S}{N}\right)_{f_a} = m \left(\frac{C}{N}\right)_{2f_a}$$

$$\text{Double: } \left(\frac{S}{N}\right)_{f_a} = \frac{m}{2n\sqrt{2}} \left(\frac{C}{N}\right)_{2f_a}$$

Frequency Modulation

$$\text{Single: } \left(\frac{S}{N}\right)_{f_a} =$$

$$\sqrt{3} \left(\frac{f_d}{f_a}\right)_{r-f} \left(\frac{C}{N}\right)_{2f_a}$$

$$\text{Double: } \left(\frac{S}{N}\right)_{f_a} = \frac{1}{n} \sqrt{\frac{3}{2}} \left(\frac{C}{N}\right)_{2f_a} \times \left(\frac{f_d}{f_a}\right)_{r-f} \left(\frac{f_d}{f_a}\right)_{s-f}$$

Comparing one system with another gives

$$\frac{\text{Double a-m}}{\text{Single a-m}} = \frac{1}{2n\sqrt{2}}$$

$$\frac{\text{Single f-m}}{\text{Single a-m}} = \frac{\sqrt{3}}{m} \left(\frac{f_d}{f_a}\right)_{r-f}$$

$$\frac{\text{Double f-m}}{\text{Single a-m}} =$$

$$\frac{1}{mn} \sqrt{\frac{3}{2}} \left(\frac{f_d}{f_a}\right)_{r-f} \left(\frac{f_d}{f_a}\right)_{s-f}$$

$$\frac{\text{Double f-m}}{\text{Double a-m}} = \frac{2\sqrt{3}}{m} \left(\frac{f_d}{f_a}\right)_{r-f} \left(\frac{f_d}{f_a}\right)_{s-f}$$

$$\frac{\text{Double f-m}}{\text{Single f-m}} = \frac{1}{\sqrt{2n}} \left(\frac{f_d}{f_a}\right)_{s-f}$$

The last ratio is for identical intermediate frequency bandwidths

switch of survey receiver shown in Fig. 1 in position N and no modulation of the r-f generator, the oscilloscope will trace the fluctuation noise output of the receiver. With the switch in position S and 100 percent modulation of the r-f generator, the signal S will be shown on the oscilloscope. The audio band-pass filter minimizes noise during the signal measurement so that the ratio of the vertical deflections obtained gives the desired signal-to-noise ratio in the band f_a . The a-m receiver described can be used as a survey receiver. Reliable C/N measurements are made at the receiving sites with transmitting and receiving antenna gains calibrated with respect to the actual radio circuit equipment. Noise factor of the survey receiver should be known relative to that of the proposed relay receiver.

Threshold Relations

In the previous section we assumed that S/N (detected carrier-to-noise ratio) at the output of the a-m detector was linearly proportional to C/N at the input to the detector. It has been demonstrated experimentally that this relation holds as long as

$$(C/N)_{2f_i} > 1 \quad (2)$$

We may define Eq. 2 as the threshold condition for an amplitude modulated signal. Crosby has shown that the corresponding threshold condition in frequency modulation requires that

$$(C/N)_{2f_i} \geq 2 \quad (3)$$

In a particular radio relay link the radiated power, distance of transmis-

Table II—Comparison of Modulation Systems

sion, and receiver i-f bandwidth must be correlated to satisfy the threshold relations and the desired S/N in a particular intelligence channel. The information needed to meet these requirements with a simple survey measurement is derived in succeeding sections.

Single Modulation A-m

In a single modulation a-m system the i-f band need be only $2f_c$ wide to pass the modulated carrier. Actually, due to Q limitations of the circuits, it usually exceeds this value.

Assume that, in the mixer or first detector stage of the receiver, the local heterodyne oscillations are of high amplitude compared with the incoming signal, i.e., the mixer does not affect C/N .

At the input to the second detector one might say that three waves exist; namely, the carrier C , the noise N and the signal S . For 100 percent modulation, S equals C in magnitude. Thus, the output of the a-m detector has an S/N equal to C/N in the i-f band when $f_s = f_c$. When f_s is greater than f_c , we consider only C/N within the portion of the i-f band $2f_c$ wide because all other noise components are rejected by the detector output circuit.

We may then write for 100 percent modulation $(S/N)_{f_s} = (C/N)_{2f_c}$. For less than 100 percent modulation, S/N is directly proportional to the modulation index. Thus

$$(S/N)_{f_s} = m (C/N)_{2f_c} \quad (4)$$

Double Modulation A-m

In a double modulation a-m system the intelligence signals amplitude modulate their respective subcarriers. These subcarriers amplitude modulate the transmitted r-f carrier. The r-f and i-f bandwidths of the receiver must be at least $2f_c$ wide, where $f_c = f_1 + f_2 + \dots + f_n$, to pass the modulated carrier without distortion. Then C/N in the r-f band is

$$(C/N)_{2f_c} = (f_c/f_1)^{1/2} (C/N)_{2f_1} \quad (5)$$

Similarly C/N in the i-f band becomes

$$(C/N)_{2f_1} = (f_1/f_c)^{1/2} (C/N)_{2f_c} \quad (6)$$

To determine the subcarrier-to-noise ratio after the group detector, we again consider the noise within the i-f band extending f_c on either

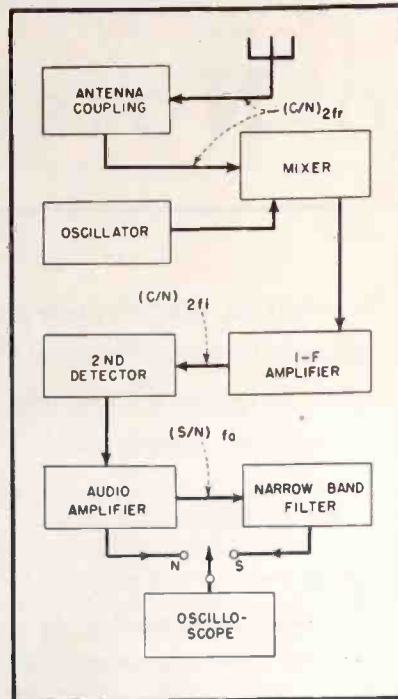

FIG. 1—How noise at the receiver input is measured in the field

side of the central frequency, because all other noise components are rejected by the low-pass filter following the detector. Thus

$$(C/N)_{2f_1} = (f_1/f_c)^{1/2} (C/N)_{2f_c} = (f_c/f_1)^{1/2} (C/N)_{2f_c} \quad (7)$$

Writing C_s for the peak amplitude of any subcarrier and temporarily assuming that the subcarrier modulates the radiated r-f carrier to 100 percent, we obtain from Eq. 4

$$(C_s/N)_{f_1} = (C/N)_{2f_1} \quad (8)$$

for the subcarrier-to-noise ratio in the bandwidth of the total group of intelligence signals f_c .

The arrangement assumed in Eq. 8 would not permit transmission of intelligence because an increase in the amplitude of the subcarrier due to modulation by the intelligence signal would cause the subcarrier to over-modulate the r-f carrier. Therefore, to allow an intelligence signal to modulate its subcarrier 100 percent we must reduce C_s . For n channels, C_s equals $C/2n$ to avoid over modulation during the intervals when all subcarriers add in phase. Rewriting Eq. 8 for n intelligence channels gives

$$(C_s/N)_{f_1} = (1/2n) (C/N)_{2f_1} \quad (9)$$

In the group band each channel occupies a band $2f_1$ wide. Because the noise is equally distributed over this

band, the effect of filtering any channel will be to reduce the noise in that band to

$$N_{2f_1} = (2f_1/f_c)^{1/2} N_{f_c} \quad (10)$$

Substituting Eq. 7 and 10 into Eq. 9 gives

$$\begin{aligned} \left(\frac{C_s}{N}\right)_{2f_1} &= \frac{1}{2n} \left[\left(\frac{f_1}{2f_c}\right) \left(\frac{f_c}{f_1}\right) \right]^{1/2} \left(\frac{C}{N}\right)_{2f_c} \\ &= \frac{1}{2n\sqrt{2}} \left(\frac{C}{N}\right)_{2f_c} \end{aligned} \quad (11)$$

It should be noted in this case that the noise in any filtered channel does not depend upon its position in the frequency spectrum but only upon the channel bandwidth and this bandwidth need never exceed $2f_c$. After final detection of this channel signal, the signal-to-noise ratio becomes, for 100 percent modulation of the subcarrier

$$\begin{aligned} (S/N)_{f_1} &= (C_s/N)_{2f_1} \\ &= (1/2n\sqrt{2}) (C/N)_{2f_c} \end{aligned} \quad (12)$$

and for m percent modulation of the subcarrier

$$(S/N)_{f_1} = (m/2n\sqrt{2}) (C/N)_{2f_c} \quad (13)$$

For a double modulation system in which only one intelligence is transmitted $n = 1$. Inserting this value in Eq. 13 and comparing the result with Eq. 4, we note that the double a-m system has a worse S/N than the single a-m system by a factor of $2\sqrt{2}$ or nine decibels. Six decibels of this loss is due to the energy required to transmit the subcarrier. The remaining three decibels are accounted for by the fact that the single a-m system has a noise acceptance band of $2f_c$, whereas the double a-m system has two noise acceptance bands, each of bandwidth $2f_1$ in the r-f spectrum and, consequently, the latter accepts $\sqrt{2}$ times more noise. If the subcarrier and one sideband are suppressed as in some single sideband systems, the double a-m system is, in effect, converted to a single a-m system and the nine decibels are regained.

Single Modulation F-m

Mathematical analysis of a frequency modulated carrier shows that an infinite number of sidebands are produced. Therefore, a finite receiver i-f bandwidth must introduce some distortion due to sideband clipping. This type of distortion appears as concomitant amplitude and phase modulation of the i-f carrier. The

IT'S *Cinch*
KNOW HOW!

... that anticipates
electronic
socket
requirements



Intensive research on JAN

Wartime Standards developed the new Cinch miniature socket, combining the best qualities of the war time version and the prewar commercial type.



The "Mite" socket is the result of co-ordinated research by RAYTHEON and CINCH engineering departments. Their combined experience in electronics and metal plastic assemblies perfected a socket for sub miniature tubes.

CINCH MANUFACTURING CORPORATION
2335 West Van Buren Street, Chicago 12, Illinois
Subsidiary of United-Carr Fastener Corporation, Cambridge, Massachusetts

limiter erases the amplitude modulation. In a wideband system ($f_d/f_a > 1$), the writer believes that the phase distortion will be negligible as long as the r-f and i-f bandwidths are not less than $2f_d + 4f_a$. In narrow band f-m systems ($f_d/f_a < 1$), these bandwidths can be reduced to $2f_d + 2f_a$.

In the i-f band we have as before

$$(C/N)_{2f_s} = (f_r/f_i)^{1/2} (C/N)_{2f_r} \quad (14)$$

which must satisfy the f-m threshold condition of Eq. 3.

The signal is now impressed upon an f-m detector having a frequency fidelity band from zero to f_a . Assuming fulfillment of the threshold requirement, we are concerned only with C/N in a portion of the i-f band $2f_a$ wide. This ratio is

$$(C/N)_{2f_a} = (f_r/f_a)^{1/2} (C/N)_{2f_r}$$

To determine the signal-to-noise after detection, we use the relation

$$\left(\frac{S}{N}\right)_{f_a} = \sqrt{3} \left(\frac{f_d}{f_a}\right)_{r-f} \left(\frac{C}{N}\right)_{2f_a} \quad (15)$$

where $(f_d/f_a)_{r-f}$ is the deviation ratio of the r-f carrier at the highest modulating frequency.

Double Modulation F-m

In a double frequency modulation system the channel is identical with the single f-m system insofar as the first f-m detector action at the receiver is concerned. However the frequency band from zero to f_a is wide enough to contain several subcarriers which are themselves frequency modulated by independent intelligence signals.

To determine the ratio of any one subcarrier to the noise in the total band from zero to f_a , we rewrite Eq. 15 substituting f_s for f_a .

$$\begin{aligned} \left(\frac{C_s}{N}\right)_{f_a} &= \frac{\sqrt{3}}{n} \left(\frac{f_d}{f_a}\right)_{r-f} \left(\frac{C}{N}\right)_{2f_a} \\ &= \frac{\sqrt{3}}{n} \left(\frac{f_d}{f_a}\right)_{r-f} \left(\frac{f_a}{f_s}\right)^{1/2} \left(\frac{C}{N}\right)_{2f_s} \end{aligned}$$

Any one subcarrier is frequency modulated within the channel band $f_s - f_i$. The noise in this band is less than that in the total band zero to f_s , so that the ratio C_s/N in this band is improved by a bandwidth factor.

To determine this factor, we recall that the noise out of the detector varies linearly with frequency as shown in Fig. 2A. Consequently, the noise power density is a parabolic function of frequency and the ratio of noise energy in the total band to

that in the band $f_s - f_i$ is equal to the ratio of the area under the parabola to the shaded area of Fig. 2B. This ratio is obtained by integration

$$\frac{\int_0^{f_s} f^2 df}{\int_{f_i}^{f_s} f^2 df} = \frac{f_s^3}{f_s^3 - f_i^3}$$

The rms and, consequently, the peak voltage ratio is equal to the square root of the energy ratio. Therefore, the improvement factor due to filtering the frequency band $f_s - f_i$ is $[f_s^3/(f_s^3 - f_i^3)]^{1/2}$. The subcarrier-to-noise ratio in this band then becomes

$$\left(\frac{C_s}{N}\right)_{f_s - f_i} = \frac{\sqrt{3}}{n} \left(\frac{f_d}{f_a}\right)_{r-f} \left(\frac{C}{N}\right)_{2f_s} \times \left[\left(\frac{f_s}{f_a}\right) \left(\frac{f_s^3}{f_s^3 - f_i^3}\right)\right]^{1/2} \quad (16)$$

Equation 16 may be described as the threshold equation for the second f-m detector, i.e., the value of C_s/N must be equal to or greater than two in order that the S/N out of the second detector be a linear function of the subcarrier-to-noise ratio into the detector.

In general, the bandwidth $f_s - f_i$ is determined by the frequency deviation

of the subcarrier and it may be considerably greater than $2f_a$, where f_a is the fidelity band of the second f-m detector. As in the single f-m modulation case, we need to know the ratio of subcarrier-to-noise in the band $2f_a$.

Define the subcarrier frequency, f_s , as the arithmetic mean frequency in the band $f_s - f_i$, or $f_s = \frac{1}{2}(f_i + f_s)$. As before, the noise in the band $2f_a$ wide with f_s as its center frequency will be less than the noise in the total band $f_s - f_i$. Observing Fig. 2C, it will be evident that the noise accepted in the band $2f_a$ wide will vary with the location of f_s .

Starting with Eq. 15 and writing the improvement factor in the same manner as in the derivation of Eq. 16, the subcarrier-to-noise ratio in the band f_a either side of f_s , referred to the total first detector band

$$\begin{aligned} \left(\frac{C_s}{N}\right)_{(f_s + f_a) - (f_s - f_a)} &= \\ \frac{\sqrt{3}}{n} \left(\frac{f_d}{f_a}\right)_{r-f} \left(\frac{C}{N}\right)_{2f_a} \times & \\ \left[\left(\frac{f_a}{f_s}\right) \left(\frac{f_s^3}{(f_s + f_a)^3 - (f_s - f_a)^3}\right)\right]^{1/2} & \quad (17) \end{aligned}$$

the fraction within the square root bracket of this equation can be simplified to

$$\left(\frac{f_a}{f_s}\right) \left(\frac{f_s^3}{6f_s^2 f_a (1 + f_a^2/3f_s^2)}\right)$$

Because f_s must be at least $3f_a$ to reproduce the signal wave shape, we can neglect the term $f_a^2/3f_s^2$ compared with unity, and Eq. 17 further simplifies to

$$\left(\frac{C_s}{N}\right)_{(f_s + f_a) - (f_s - f_a)} = \frac{1}{\sqrt{2n}} \left(\frac{f_d}{f_a}\right)_{r-f} \left(\frac{C}{N}\right)_{2f_a} \quad (18)$$

Again using the standard Eq. 15

$$\begin{aligned} \left(\frac{S}{N}\right)_{f_a} &= \sqrt{3} \left(\frac{f_d}{f_a}\right)_{r-f} \times \\ \left(\frac{C_s}{N}\right)_{(f_s + f_a) - (f_s - f_a)} & \end{aligned}$$

Substituting Eq. 18 into this result

$$\begin{aligned} \left(\frac{S}{N}\right)_{f_a} &= \frac{1}{n} \left(\frac{3}{2}\right)^{1/2} \left(\frac{f_d}{f_a}\right)_{r-f} \times \\ \left(\frac{f_d}{f_a}\right)_{r-f} \left(\frac{C}{N}\right)_{2f_a} & \quad (19) \end{aligned}$$

Results of these derivations are summarized in Table II which shows signal-to-noise ratios that can be obtained in each of the systems analysed and the manner in which channel frequencies affect these ratios.

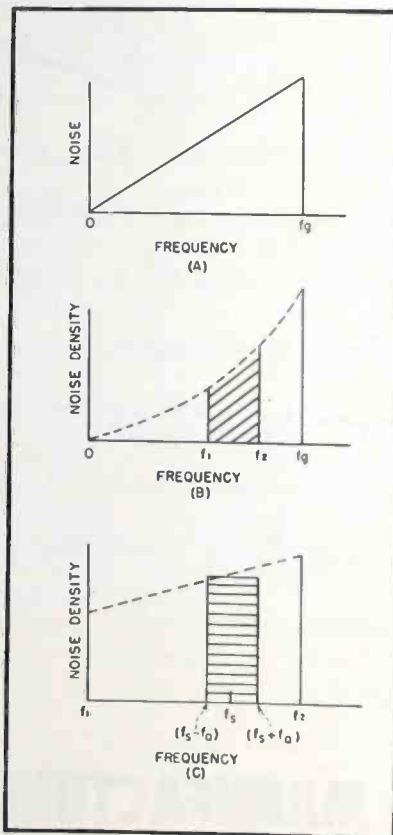
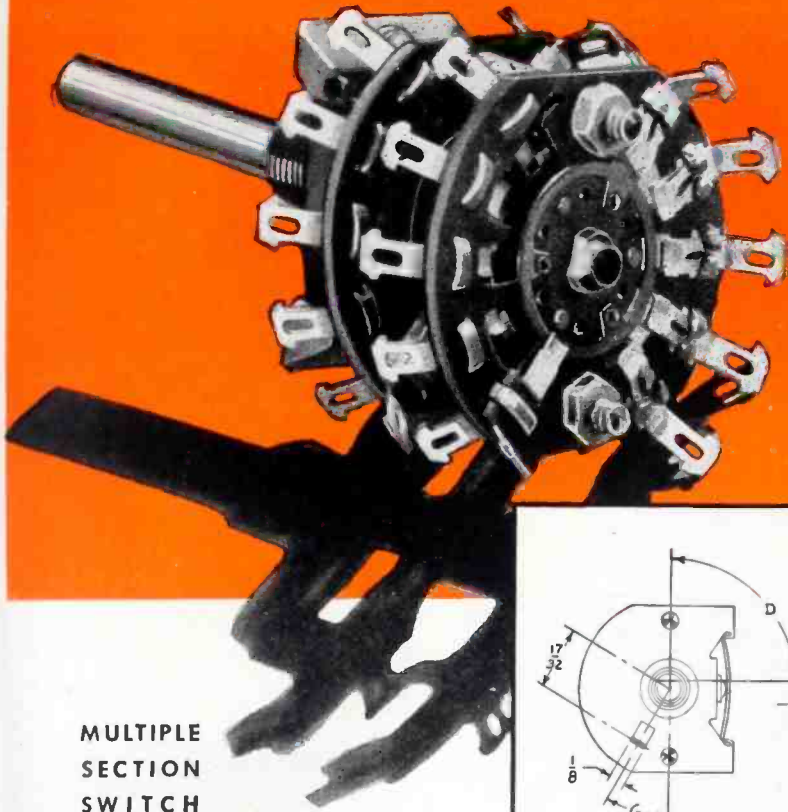
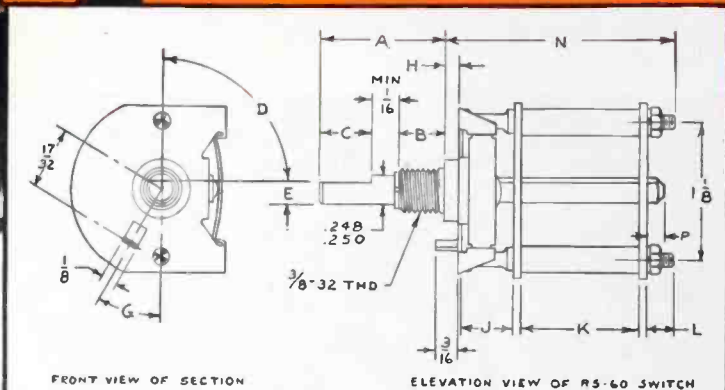

FIG. 2—Noise-frequency relations used in computations

Great Little Space-Saver



MULTIPLE
SECTION
SWITCH
RS-60



Ask for RS Specification-Layout Sheets

Printed on thin paper to permit blueprinting, these sectional drawings indicate standard and optional dimensions — make it easy for you to order pre-production samples of RS switches built to meet your requirements exactly. Ask your nearest Mallory Field Representative or write direct for a supply.

Cut-Off Sections

Allow It To Fit Crowded Assemblies

WHEN your assembly is already overcrowded and every fraction of an inch counts, the RS-60 is a wonderful life-saver!

In spite of its diminutive size, this multiple-section switch can be made with as many as five positions or ten terminals. It incorporates, too, all these outstanding features:

New, heavier staples and stapling technique, insuring tight terminals . . . Improved low-loss phenolic in both

stator and rotor . . . Unlimited circuit possibilities . . . Six stator rotor supports to improve rotor and contact alignment . . . Star-wheel type index for low torque . . . Double wiping contacts . . . Silver-to-silver contacts . . . Indium-treated, silver plated rotor segments.

For complete information, write for Mallory RS Switch Data Folders and for Specification Layout Sheets. Our engineers will be glad to help with your switch problems. Standard Mallory switches may be readily obtained from your Mallory Distributor.

P. R. MALLORY & CO. Inc.
MALLORY SWITCHES
(INDUSTRIAL AND ELECTRONIC)

P. R. MALLORY & CO., Inc., INDIANAPOLIS 6, INDIANA

INDUSTRIAL CONTROL

Lathe for Large Tube Construction.....	156
Unsoldered Connections for Motor Control.....	156
Gas Locator for High-vacuum Systems.....	158
Maintenance Testing of Dynamotors.....	158
Capacitor Discharge Magnetizer for Plant Shops.....	168

Lathe for Large Tube Construction

SO EXACT HAS BEEN the construction of what is believed to be the world's largest glass-working lathe, that there is less than 0.0005 in. variation in the relationship of the chuck spindles and the lathe bed across the

in order to insure that it will be level regardless of irregularities in the floor. Unlike smaller glass-working machines, this one has adjustable chucks which can be lined up independently of the main rods.

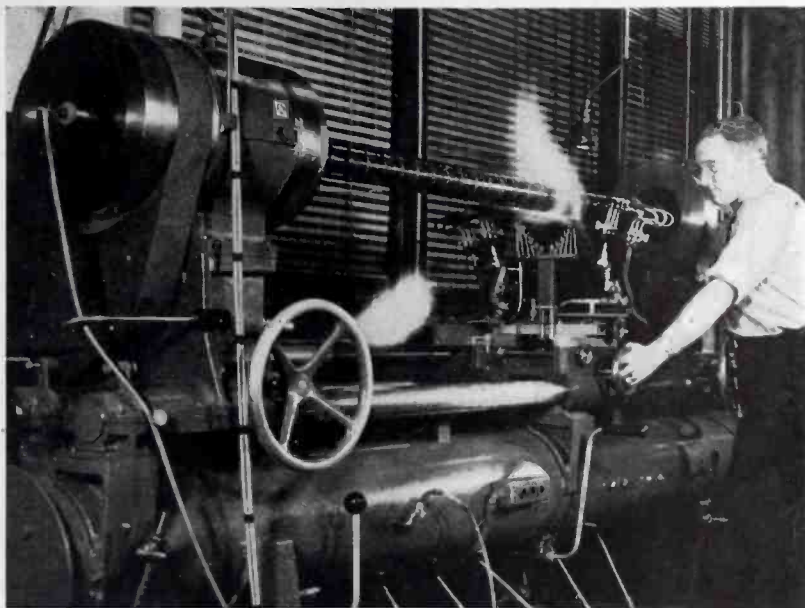

Twenty-four cylindrical glass sections of two-million volt x-ray tubes are sealed by hydrogen and oxygen flames to the metal rings that hold the sections together. Designed by engineers of General Electric X-Ray Corp., it is believed to be the world's largest glass-working lathe

entire 9-foot length between the chucks.

The machine can handle a piece of glass as long as 84 inches, and the length of tubes which will pass through the spindles is limited only by the size of the room. Because of this, the machine is useful in the production of long, multi-section million-volt and two-million-volt x-ray tubes. High-frequency current is passed through the flames in order to more effectively heat and seal the glass.

Weighing 4,000 pounds, the 13-foot bed table is supported at three points

Shims make up for any wear on the rods, guide bushings or jaws. Control of the chucks is effected by a 3-station reversible clutch.

The feed control levers and other regulating knobs and dials are mounted on a master panel, thus simplifying the control. The feed lines contain hydrogen, oxygen, city gas, air, nitrogen, vacuum and water.

Special grease seals on the heads, capable of withstanding up to 200 C, are employed to withstand the high temperatures used. Doughnut-shaped tubes for betatrons can also be produced on the machine.

Unsoldered Connections for Motor Control

CURRENT MODELS of the General Electric Thy-mo-trol, an electronic adjustable-speed motor drive, have taken advantage of lessons learned about maintenance. Instead of being wired in the familiar manner of ordinary radio receivers as were the early versions, the units are now put together as shown in the accompanying illustration, where resistors, capacitors, and other components are firmly fastened in place and connected up by the use of screw-type lugs and terminals, so that soldering is no longer necessary for maintenance of these controls.

Over the course of the last few years, while these units have been specified for industrial application, tube life has proved itself to be in the neighborhood of ten thousand

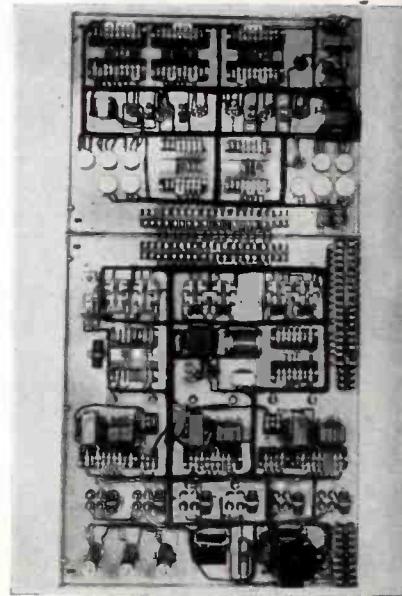

Back view of late-model GE Thy-mo-trol drive, showing use of terminal blocks and screw-type connectors for wiring and mounting components

hours or about five years on the basis of a normal industrial day's operation.

For control of electric motors the units provide a wide range of speed adjustment (in the neighborhood of 100 to 1); as closely as possible infinite speed variations producing stepless control; close speed regulation; production of full load torque at low speed; pushbutton control; reverse plugging; free selection of

Good News!...



INTER-OFFICE MEMO

To: Harry A. Ehle, Vice-pres., Sales
Date: 4/20/46

Production capacity on all types and ranges of All-Metal Rheostats has now been increased to provide additional production for scheduling during last week of May and following months, as per your request of 2/20/46.

From:

O. J. Greenway
Works Manager



All Metal

RHEOSTATS

... Increased Quantities Now

Available on Short Delivery Cycle!



PR-25



PR-50



PRT
(AN3155)

TYPE PR-25—25-watt rating. Temperature rise, 140°C. Standard resistance values, 1 ohm to 5,000 ohms. Diameter, 1³/₂". Depth behind panel, 3¹/₂".

TYPE PR-50—50-watt rating. Temperature rise, 170°C. Standard resistance values, 0.5 ohm to 10,000 ohms. Diameter, 2³/₄". Depth behind panel, 1³/₈".

TYPE PRT-25—(AN3155-25). 25-watt rating. Fulfills AN3155 specifications. Totally enclosed. Heat-radiating black finish. Rear terminals. Standard values, 10 ohms to 200 ohms. To 5,000 ohms on special order. Temp. rise, 140°C.

TYPE PRT-50—(AN3155-50). 50-watt rating. Same construction as PRT-25, to AN3155 specifications. Standard values, 5 ohms to 200 ohms. To 10,000 ohms on special order. Temp. rise, 170°C.

All IRC Rheostats operate at about half the temperature rise of equivalent units and can be operated at full load on as little as 25% of the winding, with only a slight increase in temperature rise.



INTERNATIONAL RESISTANCE CO.

401 N. BROAD ST., PHILADELPHIA 8, PA.

Canadian Licensee: International Resistance Co., Ltd., Toronto

CONTACT YOUR IRC REPRESENTATIVE
FOR COMPLETE DETAILS

speed; quick stopping; and protection against overload, short circuit, and low voltage.

Gas Locator for High-vacuum Systems

EXACT LOCATION of leaks in a vacuum system can be found by spraying helium gas to ferret out and enter the leak and then determining the

vacuum system and pumps started to evacuate the air. A thin jet of helium is sprayed against each suspected location, or over the entire system. If there is no leak, the detector shows no reading, because normally there is no appreciable amount of helium in the atmosphere and hence there are no molecules of the proper mass to actuate the recorder passing through the spectrometer. Should the detector show a reading

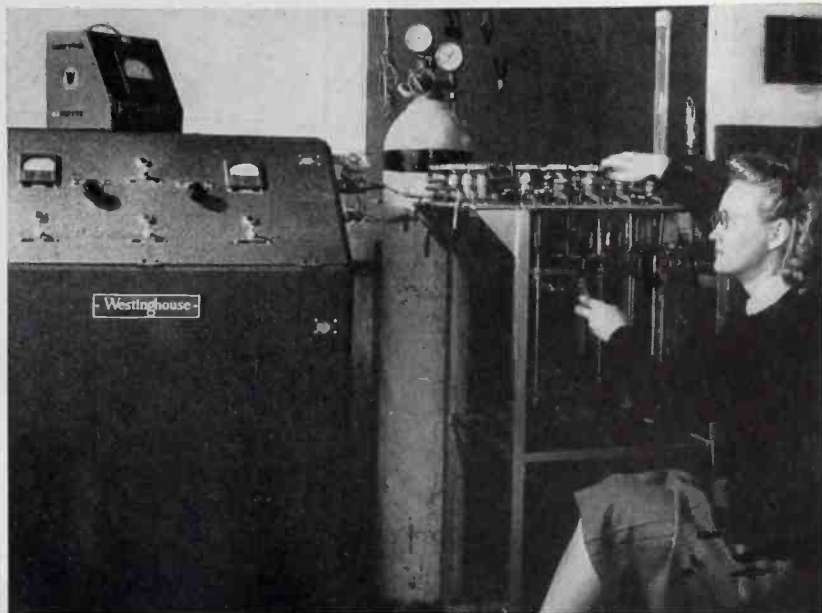

Small leaks in high-vacuum systems such as are used in uranium production are located by this Westinghouse leak detector

presence of the helium in the system by means of a leak detector.

The presence of a contaminating substance in proportions as small as one part in several hundred thousand can be shown by this technique. The exact location of the leak is also shown.

Developed by Westinghouse engineers, the detector is a special application of the mass spectrometer, the electronic device that gives the molecules of different gases an electrical charge and then shoots them at high speed down a curved tube. Along the sides of this tube electromagnets guide the flying molecules so that only those of a particular mass, or weight, pass through the exit slit at the end of the tube and are counted on a special recorder.

Helium is used for leak detection because it is a stable gas that does not react harmfully with other gases or with parts of the system. The mass spectrometer is attached to the

when the helium nozzle is held at a certain location, the operator knows instantly that helium is entering some opening in the vessel at that point.

Maintenance Testing of Dynamotors

H. M. TREMAINE, USNR
Naval Research Laboratory
Washington, D. C.

AIRCRAFT, both military and commercial, present many problems in the field of electrical maintenance, particularly noise in communication equipment. One of the most consistent offenders is the dynamotor. A survey of 1300 dynamotors in daily use revealed their maintenance was increasing at a rapid rate.

Some kind of a test device was necessary that would measure the load characteristics, and at the same time give a standard measurement of interference generated by the dynamotor. This would also eliminate the human error in ordinary listening tests.

Figure 1 is the basic diagram of the test set constructed to facilitate accurate measurements of dynamotor load characteristics and interference. The input circuit contains a power switch, circuit breaker *C*, ammeter, voltmeter, and line filter capacitors to prevent interference from the dynamotor under test being transmitted to other equipment in the shop. The 200- μ f electrolytic capacitor prevents surges from other equipment feeding into the test set.

At the output of the dynamotor are two single-section filters, one for large dynamotors that supply 400-600 volts and the other for small dynamotors up to 250 volts. Either filter is selected by switch *S*₅. The

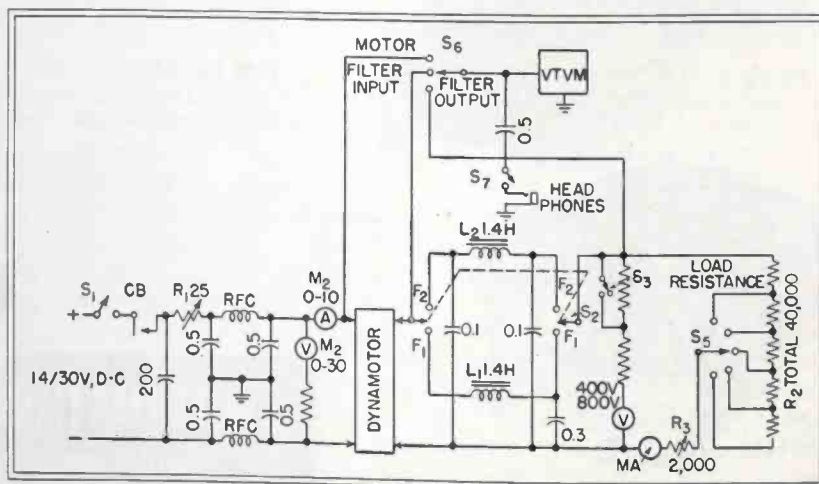

Fig. 1—Circuit for rapid testing of load characteristics and radio noise interference of dynamotors



If we'd made this radiograph sooner...

...we'd have saved
\$30,000"

A manufacturer of valves, whose foundry technic seemed "okay," decided pilot radiographs weren't needed. But when machining was done and the valves assembled, enough were found defective to cause a loss of many thousands of dollars.

Radiography, put to work at the right time and place, pays off. Men who have figured *cost-wise* what it can do for them . . . to improve design, speed production, and lower costs . . . make full use of x-ray.

Radiographs show your engineers where to correct faulty design . . . how to reduce weight safely . . . how to cut costs at many stages of manufacture . . . how to build in extra dependability.

Order-jammed foundries get a welcome production

spurt when radiography shows how to get into sound casting production fast. High-value, high-volume machine shops operate at rock-bottom cost when radiographic inspection keeps internally unsound castings off the production line.

Welding gains acceptance . . . new markets . . . higher volume . . . because radiographs prove weldments sound.

And these are only a few high spots in radiography's list of industrial functions. You can find more—if you look for them—right in your own plant. Why not get together with your radiographer or the local x-ray dealer and see if you are missing any chances to make radiography pay extra dividends? Or write to

Eastman Kodak Company, X-ray Division
Rochester 4, New York

Radiography

—another important function of photography

Kodak

Can a Leopard *Change his Spots?*



It's generally agreed that he can't. If he could, however, he would no longer be a leopard. For one of the first principles

is that nothing can undergo a fundamental change and still retain its lineage.

We, at Stancor, apply this principle to our product . . . quality transformers. For we realize that any change in Stancor transformers, enabling us to capitalize on the peak demands, would mean a sacrifice in quality.

We're convinced, too, that this is your choice; that you, as a transformer user, in sustaining your valued position in the industry, endorse the Stancor policy of quality. In a sense, then, you dictate Stancor policy.

Like you, we are expending every effort to surmount today's knotty production and delivery problems, that we may soon be able to supply the same quality transformers . . . in ever increasing quantities.

Until that time Stancor's engineering facilities and industrial resourcefulness are available for the solution of your most urgent transformer problems.

Jerome J. Kahn
PRESIDENT

STANDARD TRANSFORMER CORPORATION

1500 NORTH HALSTED STREET • CHICAGO 22, ILLINOIS



filters simulate a filter system comparable to that found in aircraft communication equipment and were designed to give the minimum amount of filtering for satisfactory measurement. If too efficient a filter were to be used, a false measurement might be obtained and a dynamotor with too great an interference output for satisfactory operation might be passed.

At the output of the filters are a variable load resistor, a milliammeter, and a voltmeter. A vacuum-tube voltmeter is used to measure the interference generated by the dynamotor, at both motor and generator sections, and that passed by the filter.

Operation

Figure 2 shows the panel controls of the completed test set. To use the set, the dynamotor is plugged in, S_1 thrown to the correct filter, the input voltage adjusted to 14 or 27.5 volts by means of R_1 , and the output load current to its correct value by means



Fig. 2—Panel meters and controls of the dynamotor tester

of S_5 and variable resistor R_3 . The vacuum-tube voltmeter switch S_4 is thrown to the dynamotor position and the interference output from the dynamotor measured. Switch S_3 is then thrown to the output of the filter and the remaining ripple voltage determined. The motor interference is read in the motor position of S_2 . Filter F_1 is used when testing small dynamotors and F_2 is used for the larger type.

Listening to the ripple with the

No Inserts No Tapping No Machining

For Plastic or Diecast Products with **Push-on SPEED NUTS**

JUST A
PUSH AND THEY
LOCK TO STAY!

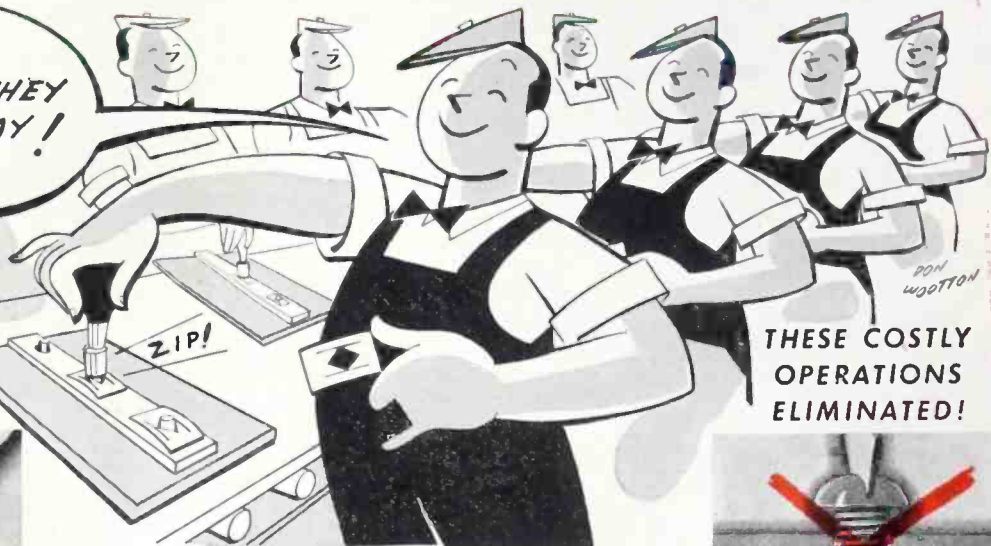

—THE FASTER
SPEED NUT
WAY!

THESE COSTLY
OPERATIONS
ELIMINATED!

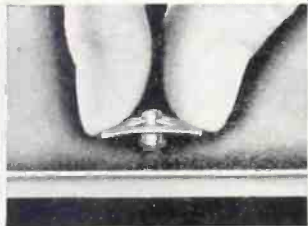

Start Speed Nut with
thumb and finger.

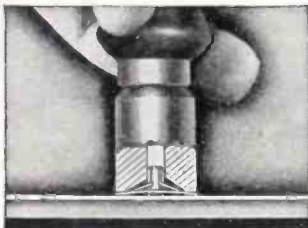

Push down over stud
with countersunk tool.

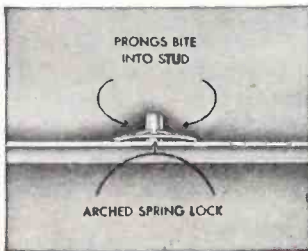

Prongs lock securely.

If you assemble plastic or die cast parts, the use of Push-on *Speed Nuts* will enable you to eliminate expensive inserts, tapping and threading operations. Just zipping a Push-on *Speed Nut* over an unthreaded, integrally molded stud will give you a vibration-proof fastening with a spring steel bite that stays put. • Use Push-on *Speed Nuts* for fastening plastic or metal name plates, knobs, handles, trim strips, medallions, dials, bezels, grilles and scores of other parts that must be fastened quickly and inexpensively. Holds equally well over rivets, wires, nails and tubing. • You can do it faster, better and cheaper with a *Speed Nut* or *Speed Clip*. Give us your assembly details today and we will send you samples to fit your job. A cost analysis doing it the *Speed Nut* way will amaze you.

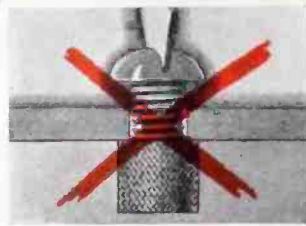

No more inserts in plastics.

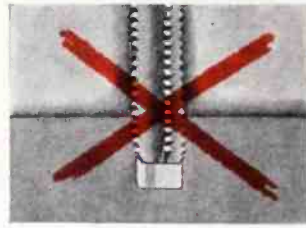

No more tapped holes
in plastics.

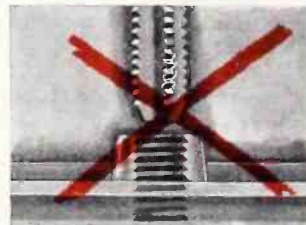

No drilling and tapping
in die castings.

TINNERMAN PRODUCTS, INC.

2106 FULTON ROAD • CLEVELAND 13, OHIO

In Canada: Wallace Barnes Co., Ltd., Hamilton, Ontario

In England: Simmonds Aerocessories, Ltd., London

In France: Aerocessoires Simmonds, S. A., Paris

In Australia: Simmonds Aerocessories, Pty. Ltd., Melbourne

Speed

MORE THAN 3000



Nuts

PATENTED
SHAPES AND SIZES

* Trade Mark Reg. U. S. Pat. Off.

F A S T E S T T H I N G I N F A S T E N I N G S

Specify **C-D MICABOND**

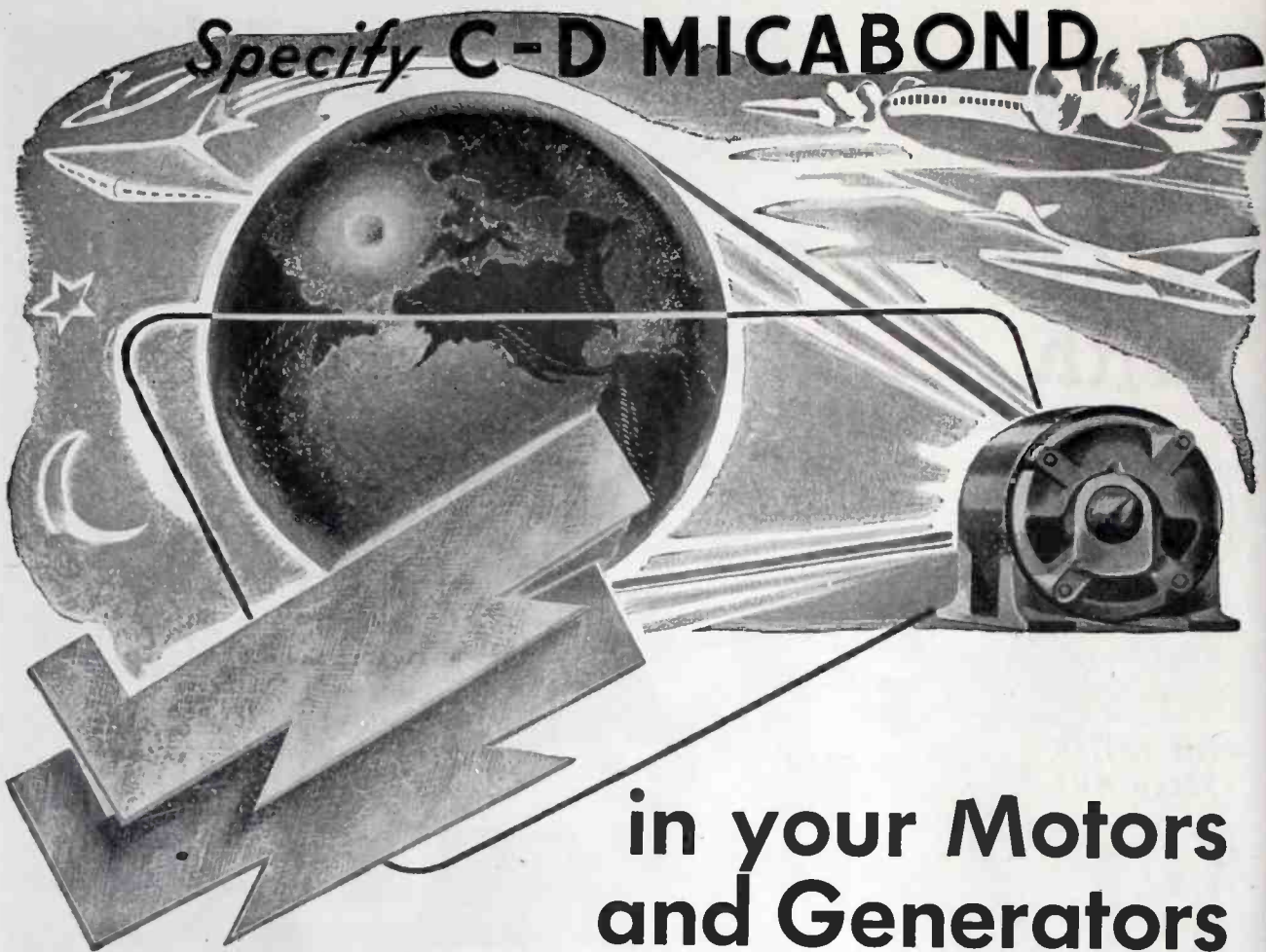

in your Motors and Generators

Ever stop to think how important electric generators and motors have become to "our" World? Practically every convenience we enjoy . . . the effectiveness of our War Effort . . . the assurance of a fully employed postwar World . . . depend on electric generators and motors.

C-D MICABOND . . . mica electrical insulation . . . helps keep these generators and motors running.

Generator and Motor manufacturers specify C-D MICABOND because it provides them with the "perfect insulation"—MICA—in usable forms. C-D MICABOND sheets, tubes, rings, segments and other shapes are provided by bonding mica splittings with insulating resins. For complete technical and mechanical data send for Bulletin "M".

KX-45

C-D PRODUCTS

The Plastics

DILECTO—A Laminated Phenolic.
CELORON—A Molded Phenolic.
DILECTENE—A Pure Resin Plastic Especially Suited to U-H-F Insulation.

HAVEG—Plastic Chemical Equipment, Pipe, Valves and Fittings.

The NON-Metallics

DIAMOND Vulcanized FIBRE
VULCOID—Resin Impregnated Vulcanized Fibre.

MICABOND—Built-Up Mica Electrical Insulation.

Standard and Special Forms
 Available in Standard Sheets, Rods and Tubes; and Parts Fabricated, Formed or Molded to Specifications.

Descriptive Literature

Bulletin GF gives Comprehensive Data on all C-D Products. Individual Catalogs are also Available.

DISTRICT OFFICES

NEW YORK 17 • CLEVELAND 14 • CHICAGO 11
 SPARTANBURG, S. C. • SALES OFFICES IN PRINCIPAL CITIES

WEST COAST REPRESENTATIVES
 MARWOOD LTD., SAN FRANCISCO 3

IN CANADA:

DIAMOND STATE FIBRE CO. OF CANADA, LTD., TORONTO 8

Continental - Diamond FIBRE COMPANY

Established 1895.. Manufacturers of Laminated Plastics since 1911—NEWARK 16 • DELAWARE

An Outstanding New Line of A.C. and D.C. RELAYS

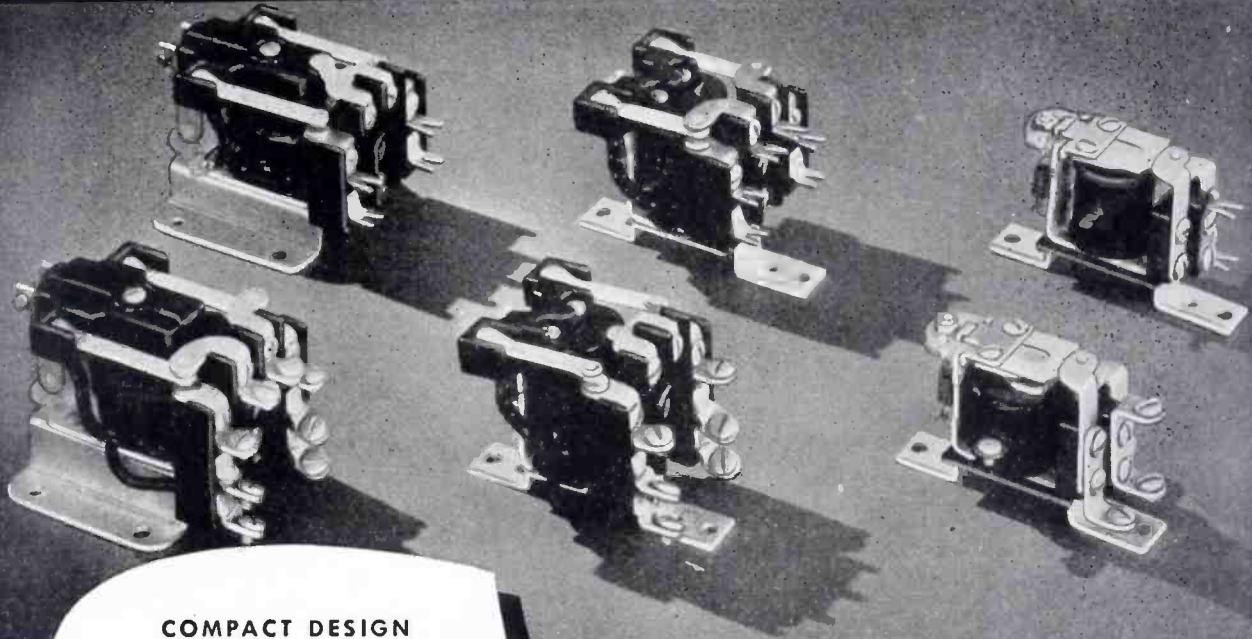

COMPACT DESIGN
•
FRONT OR REAR MOUNTING
•
SCREW OR SOLDER TERMINALS

● R-B-M announces a new and improved design of magnetic relays rated 10 amperes at 24 volts D. C. and 110 volts A. C. and 5 amperes at 220 A. C. Relays rated at one horse power single phase 110 and 220 volts A. C. Silver to silver contacts. Self-aligning armature. All wiring terminals accessible from front. Contact arrangement—single and double pole; normally open, normally closed and double throw. Steel

mounting with A. C. and D. C. relay mounting dimensions interchangeable. Available in open type or with sheet steel general purpose enclosure. Bulletin 510 on D. C. relays and Bulletin 550 on A. C. relays available upon request. Write Department A.

R-B-M MANUFACTURING COMPANY
Division of
ESSEX WIRE CORPORATION
LOGANSPORT, INDIANA



MANUAL AND MAGNETIC ELECTRIC CONTROLS — FOR
AUTOMOTIVE, INDUSTRIAL, COMMUNICATION AND ELECTRONIC USE

A Ballantine ELECTRONIC VOLTMETER

For every requirement

ALL MODELS HAVE THE
SIMPLIFIED
LOGARITHMIC
SCALE

STANDARD
Model 300



Ideal for the *Accurate* measurement of AC voltages in the Audio, Supersonic, Carrier Current and Television ranges.

Use of Logarithmic voltage scale assures uniform accuracy of reading over whole scale while permitting range switching in decade steps.

Each Voltmeter equipped with an output jack so that the instruments can be used as a high-gain stable amplifier.

SPECIFICATIONS

MODEL 300

RANGE—.001 to 100 volts.
FREQUENCY—10 to 150,000 cycles.
ACCURACY—2% at any point on scale.
AC OPERATION—110-120 volts.

MODEL 304

RANGE—.001 to 100 volts.
FREQUENCY—30 c.p.s. to 5.5 megacycles
ACCURACY—0.5 DB.
AC OPERATION—110-120 volts.

MODEL 302

RANGE—.001 to 100 volts
FREQUENCY—5 to 150,000 cycles.
ACCURACY—2% at any point on scale.
DC OPERATION—self-contained batteries.

Send for Bulletin for further description

Model 302
BATTERY
OPERATED



DYNAMOTOR TESTER

(continued)

headset at the output of the dynamotor, with and without filtering, will give a quick check of the interference characteristics of the dynamotor. Several large and small dynamotors should be checked for interference by listening to them in the equipment for which they have been designed. They should then be tested in the test set under proper load conditions and the input-output interference voltage measured.

Typical Readings

Small (60-75 ma) dynamotors in good condition measure 1.4 to 2.8 interference volts at the dynamotor side of the filter, and 0.4 to 0.9 volt at the output of the filter. Larger dynamotors measure from 2.2 to 3.2 volts at the input of the filter and from 0.5 to 0.9 volt at the output of the filter.

The interference generated by the motor side of the dynamotor is usually from 0.03 to 0.06 volt and is very seldom the cause of excessive noise in receivers.

A few dynamotors will exhibit the unusual characteristic of having higher interference voltages on the output side of the filter than on the input side. This is a result of a resonant condition in the filter, or of a leakage due to distributed capacitance. Such dynamotors are always beyond the range for acceptance and are difficult to correct.

Causes of Noise

The usual interference generated comes from several sources.

(1) Brush noise, which is contributed to by the following factors: (a) pitted commutators, (b) commutators requiring undercutting, (c) a high-frequency component due to arcing at the brushes, (d) unnecessary and prolonged running of the dynamotor unit for the purpose of wearing in brushes (Brushes should be properly fitted so that the wearing in process is not more than one hour. This prevents pitting and filling in between commutator bars.), (e) leaky or open capacitors in the dynamotor unit, (f) high commutator bars, (g) improperly seated brushes.

(2) Shaft noise. This is due to discharge of the shaft, through the bearings at its ends, to ground.

(3) Noise due to loose laminations in the armature.

(4) Ripple frequency, and har-

BALLANTINE LABORATORIES, INC.

BOONTON, NEW JERSEY, U. S. A.

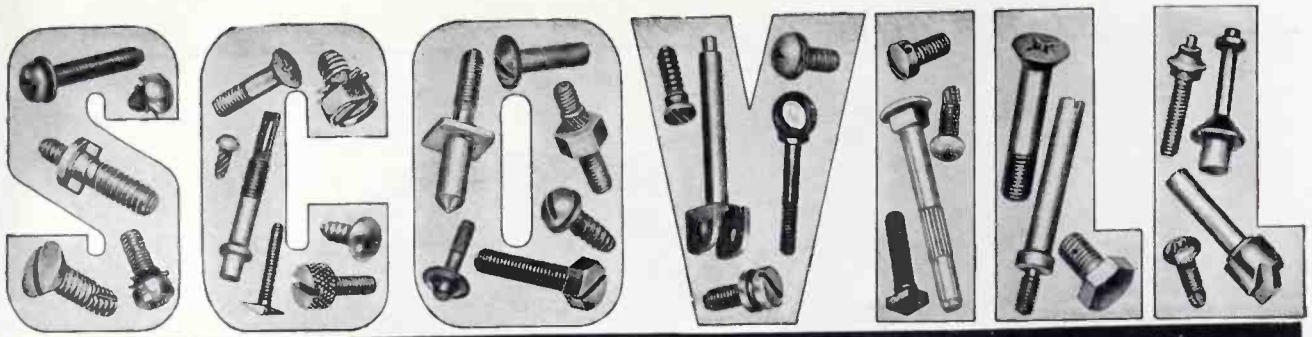

**SCOVILL GOT THE JOB... AND
THE CUSTOMER GOT A SAVING!**

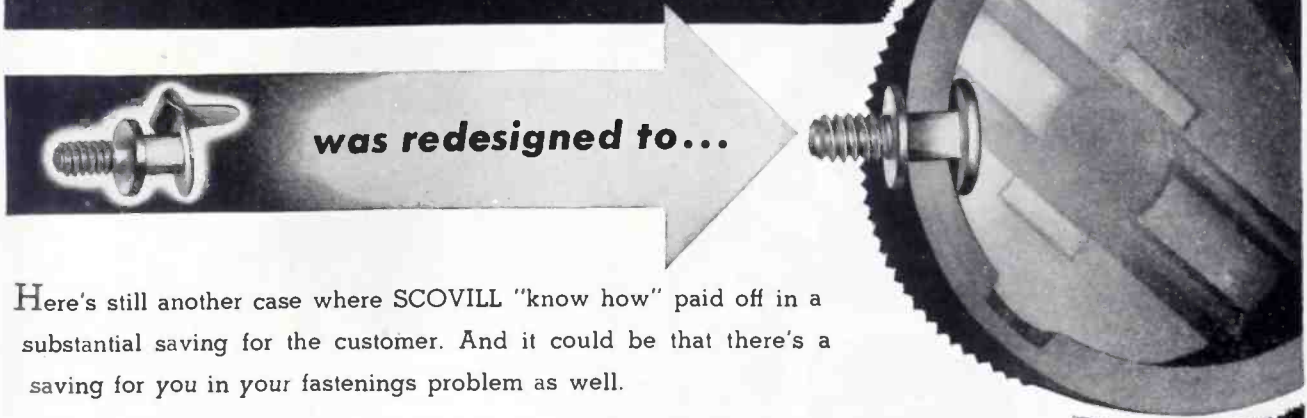

was redesigned to...

Here's still another case where SCOVILL "know how" paid off in a substantial saving for the customer. And it could be that there's a saving for you in your fastenings problem as well.

The part at the left in the illustration is the pre-Scovill one. A screw and a clip had to be made and soldered together. A wire was then inserted in the clip and soldered there . . . costly soldering operations both in manufacture and assembly.

The manufacturer of this "filterette", a radio static suppressor, brought the headache to SCOVILL. The one-piece washer screw assembly to the right was the result—and the answer. One soldering operation was eliminated — and the insert-and-solder part of the assembly operation was reduced to a simple soldering job. The final box score was a stronger fastening — faster assembly — a neat overall saving.

It may be that folks sometimes get tired of hearing about SCOVILL "know how", but we have yet to meet the man who was tired of profiting by it. Talk over your problem with one of the offices below — perhaps we can help you too.

Proof #39 of
SCOVILL skill

SCOVILL MANUFACTURING COMPANY
WATERVILLE SCREW PRODUCTS DIVISION

WATERVILLE 48, CONN.



TEL. WATERBURY 3-3151

NEW YORK, Chrysler Building • DETROIT, 6460 Kercheval Avenue • CHICAGO, 135 South LaSalle Street • PITTSBURGH, 2882 W. Liberty Ave.
SYRACUSE, Syracuse-Kemper Insurance Building • LOS ANGELES, 2627 South Soto Street • SAN FRANCISCO, 434 Brannan Street

LOW FREQUENCIES
ACCURACY TO 1/1,000th of 1%

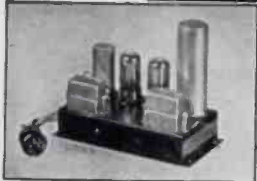

TOP
FREQUENCY STANDARD
 (60 cycle) for use with
 external power supply

CENTER
CHRONOGRAPH
 Records time intervals
 with resolution to .001 second

BOTTOM
FREQUENCY STANDARD
 (120 cycles) with
 self-contained power supply

These tuning forks which include new engineering principles, provide frequencies from 120 to 1,000 cycles directly with an unqualified guarantee of accuracy to 1 part in 100,000 over a wide temperature range. (Better than 1 second in 24 hours). Closer tolerances are obtainable on special order.

These tuning fork assemblies are available only in single or multi-frequency instruments of our own manufacture which are de-

signed to test, measure or control other precision equipment by mechanical, electrical, acoustical or optical means.

The dependability of these frequency standards is being demonstrated for myriad purposes in all climates and under all working conditions.

If you have need for low frequency standards of exceptional accuracy, your inquiries are invited.

American Time Products, Inc.
 580 Fifth Ave. New York, N. Y.
 Dist. of Western Electric & Watch Master Watch-rate Recorders



for electronic equipment:

AMP SOLDERLESS WIRE TERMINALS

offer
these superlative
performance
characteristics

Entire Terminal **CORROSION-PROOFED**

BARREL PRE-INSULATED

INSULATION SUPPORT



CORROSION-PROOF—Terminals corrosion-proofed by the AMP exclusive process show no increase in resistance, even under excessively corrosive conditions. AMP Corrosion-Proofed

Terminals mean maximum electrical efficiency and constant performance for the most sensitive electronic instruments and equipment.

AMP TYPE PRE-INSULATION—The AMP Pre-Insulated Terminal is terminal and insulation in one. Saves time in handling, stocking and installation. Only AMP has **INSULATION BONDED TO THE TERMINAL**—can't slip or come off. AMP Pre-Insulation saves man-hours, lowers production costs.

INSULATION-SUPPORT—AMP Diamond-Grip Insulation Support makes a superior, vibration-proof electrical connection, gives fully circumferential metallic support to the insulation. A safer, neater, connection. No frayed insulation, no broken wires, no additional installation time.

One operation of AMP hand tool or press die makes the complete installation of terminal on wire.

Only AMP gives all THREE . . . in ONE terminal! Only AMP Terminals provide connections meeting the rigid requirements of the most sensitive electrical or electronic instruments and equipment . . . Write for your copy of new AMP Catalog today.

AMP

AIRCRAFT-MARINE PRODUCTS Inc.

1521-53 NORTH FOURTH STREET, HARRISBURG, PA.

DAVID C. ORROCK, 1405 Bishop St., Montreal, Que.

In Canada: F. N. ADAMS, 726 Homer Street, Vancouver, B. C.

F. MANLEY CO., 43 Victoria Street, Toronto, Ont.



CODE BEACON FOR RADIO TOWERS

A 300 MM code beacon designed and built by ANDREW for lighting radio towers as aviation hazards. Required by the CAA on radio towers of 150 feet or greater in height. Two 500-watt prefocus lamps provide an intense light which passes through red pyrex glass filters and is radiated in a circular, horizontal beam by cylindrical fresnel lenses. Metal parts are made of light-weight cast aluminum, with hardware of corrosion-resistant bronze.

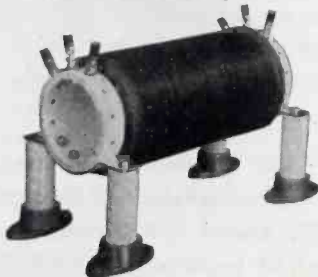

LIGHTING FILTER. The ANDREW Model 1803 lighting filter serves to connect the 60-cycle lighting voltage across the base insulator of a series excited tower without detuning the tower. Three windings provide for operation of code beacon and obstruction lights. Mica insulated by-pass condensers of ample current rating included. Also offered in weatherproof steel housing.

*Pioneer Specialists in the Manufacture
of a Complete Line of
Antenna Equipment*

ANDREW CO.

363 EAST 75th STREET
CHICAGO 19, ILLINOIS

TOWER LIGHTING by ANDREW

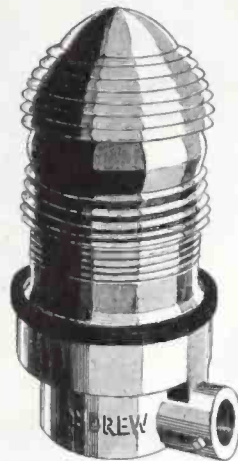
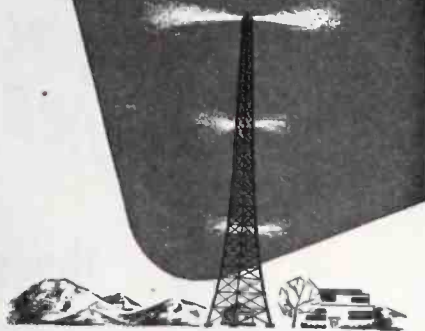

OBSTRUCTION LIGHT. Type 661 is a 100-watt unit fitted with a red fresnel lens to concentrate the light in a nearly horizontal direction. Used in pairs at $\frac{1}{3}$ and $\frac{2}{3}$ levels on radio towers for aircraft warning.

BURNOUT INDICATORS. Highly damped meter with special wattmeter scale indicates when code beacons or obstruction lights need re-lamping.

FLASHERS. Designed to flash 300 MM code beacons at rate of 40 cycles per minute, as prescribed by government regulations. Flashers have 25-ampere contacts and condensers for radio interference elimination. Use K-10347 for one or two beacons; use K-10348 to maintain constant 2000-watt load with three beacons.

TIME SWITCHES. Switch tower lights on at sunset and off at sunrise. Special astronomic dial follows seasonal variations in sunset and sunrise time. Photo-electric models also available.

LAMPS. A complete stock of lamps for code beacons and obstruction lights is carried for the convenience of users. Available in a wide variety of filament voltages.

monics of the ripple frequency.

Out of one group of 50 new dynamotors tested, with no hours of operation, only 2.5 per cent were found to be out of limits.

Filter F_1 has approximately 6 db greater attenuation at 500 cycles than does F_2 . This is necessary because small dynamotors are as a rule used with equipment which require lower interference levels. A greater interference level is permissible with equipments which employ the large dynamotors.

Battery or Generator

The power supply for the test set must be low in ripple voltage output, or the measurement of the dynamotor ripple will be affected, due to possible additional ripple voltages being superimposed. The ripple of one generator used as a power supply was approximately a frequency of 962 cycles, and was -35 db below the maximum voltage. A filter was added to the generator, consisting of a choke and a 2000- μ f shunt capacitor. This makes the power supply fairly free from ripple, provided it is checked frequently as to commutator and brush condition.

In tests using batteries for a power supply, to eliminate any possibility of ripple voltage from the generator, it was found that dynamotor interference decreased by 6 db. When using batteries, the input filter on the motor side is not used.

• • •

Capacitor Discharge Magnetizer for Plant Shops

By WILLIAM L. PORTA
Electrical Engineer
Radio Frequency Laboratories, Inc.
Boonton, N. J.

THE PROBLEM of recharging instrument magnets is currently of considerable interest because of the trend toward repair and overhaul in the field rather than return to the manufacturer. Major instrument users such as the commercial airlines and the military services must of necessity maintain their own instrument overhaul shops and a single portable unit of general utility is desirable.

For manufacturers using permanent magnets in loudspeakers small

MOISTURE PROOF

LESS MAINTENANCE

HERMETICALLY SEALED

LESS AIR DRAG

NEW ADF LOOP FOR HIGH SPEED PLANES

Developed by Bendix engineers to increase aerodynamic efficiency, the type MN-60A Iron-Core Loop reduces air drag to only 2.57 pounds at 300 mph. Use of the iron core permits reduction in size, while retaining the signal pickup efficiency of larger loops.

All moving parts are hermetically sealed in dry nitrogen, eliminating oxidation and minimizing maintenance problems. The Type MN-60A loop assures thousands of hours of trouble-free operation.

A low-inertia a-c induction motor rotates the loop. A combined quadrantal error corrector and "Autosyn" transmits corrected bearings accurately to a remote indicator.

A streamlined phenolic-impregnated anti-static housing is available for belly or top mounting.

Write for new brochure, "Toward Automatic Flight."

BENDIX RADIO DIVISION, BALTIMORE 4, MD.



MN-60A
IRON CORE LOOP

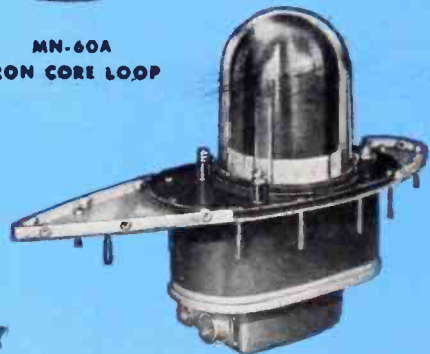

STANDARD FOR THE AVIATION INDUSTRY

American Develops Special Testing Machines and Methods

to insure that you get
AMERICAN PHILLIPS SCREWS
of the Right Design for Your Job



A unique machine designed by American Engineers to measure tension and torsion strength of American Phillips Screws.

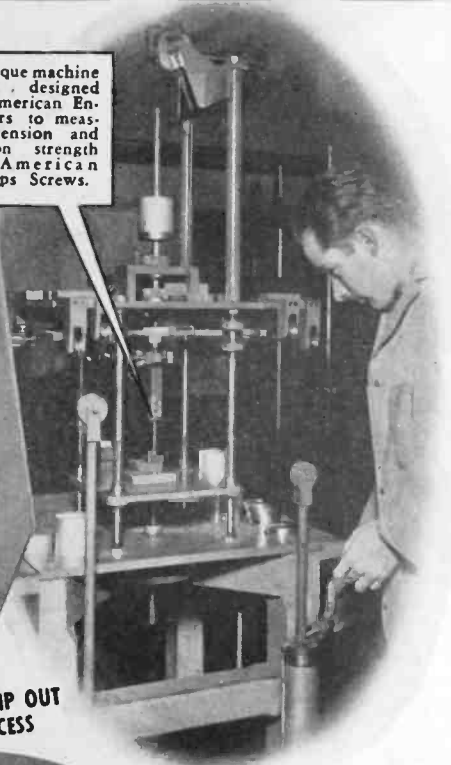

4-WINGED DRIVER CAN'T SLIP OUT OF PHILLIPS TAPERED RECESS

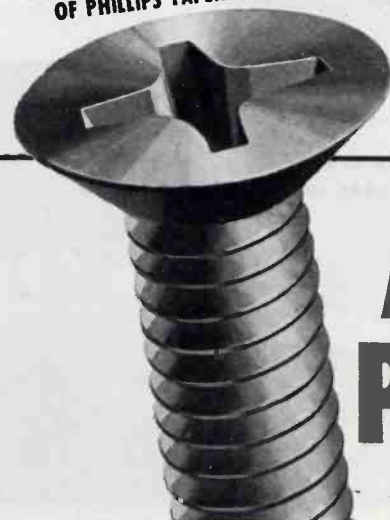

Make American's Engineering Research Laboratory your own "Information Center" on any fastening problem. Find out, according to your own job-requirements, what combination of type, size, head, metal, and finish will give you the American Phillips Screw that will do your job at highest speed, at lowest cost, with most lasting satisfaction.

American engineers will determine for you the answers to questions on metallurgy, physical strengths of metals, heat-treatment, heat-resistance, corrosion-resistance, electrolytic action, suitability of different plates and finishes, on the basis of actual test. And in these answers you will find *extra savings* to add to the regular American Phillips advantages of fast, easy, straight driving with power drivers . . . vanished spoilage losses . . . and total time-savings that can run as high as 50%. Write:

AMERICAN SCREW COMPANY, PROVIDENCE 1, RHODE ISLAND
Chicago 11: 589 E. Illinois Street Detroit 2: 502 Stephenson Building

AMERICAN PHILLIPS *Screws*

ALL TYPES
ALL METALS: Steel, Brass, Commercial Bronze, Stainless Steel, Aluminum, Monel, Everdur (silicon bronze)

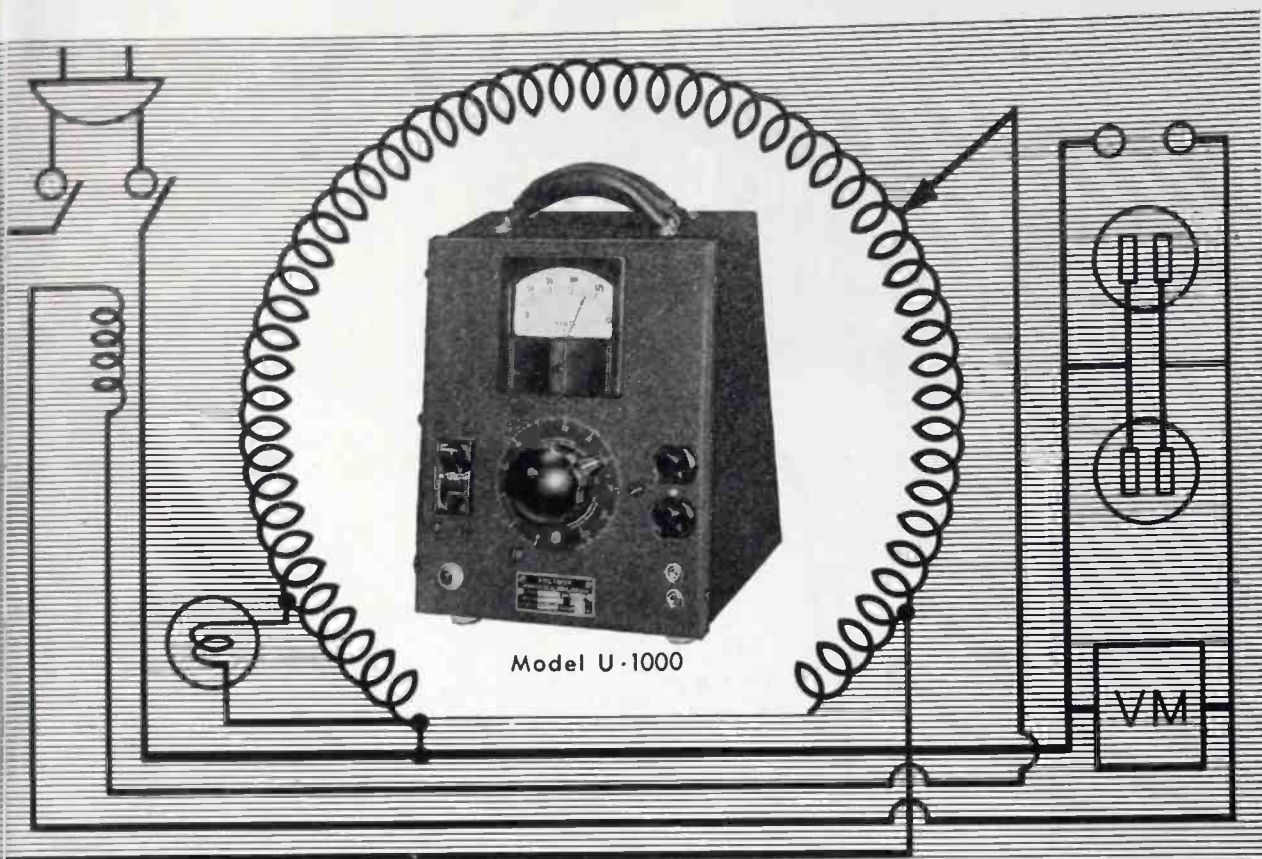

Model U-1000

THE VOLTBOX

a-c power supply

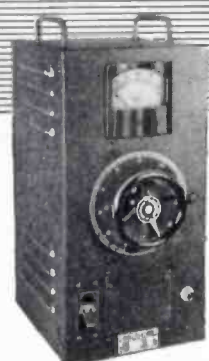

Model U-2000

A convenient simple remedy for the "headache" of collecting a multitude of instruments prior to conducting variable voltage tests is offered in the VOLTBOX a-c power supply. Thoughtfully engineered into one self-contained portable cabinet is all the required apparatus.



Model R-500

- A highly efficient continuously adjustable *POWERSTAT* variable transformer delivers any output voltage from zero to above line.
- A large *four-inch* voltmeter accurate to one percent visually shows the output voltage setting.
- A combination *quick-trip magnetic type circuit-breaker* and "on-off" switch eliminates the chance of injury to the instrument and other circuit elements.
- An *input cord and plug* provides easy connection to the voltage supply.
- A set of *output receptacles and binding post inserts* furnish effortless attachment of the load.
- A *pilot light* indicates when the instrument is energized.

Various types of VOLTBOXES are available . . . *unregulated* models of 1 and 2 KVA capacity with an output of 0-135 volts from a 110 volt source or 0-270 volts from a 230 volt line . . . the 500 va *regulated* unit which incorporates a voltage stabilizer to maintain a constant output at any value from 0-135 volts regardless of line variations between 95 to 130 volts.

Send for Bulletins LE

SUPERIOR ELECTRIC COMPANY

706 LAUREL STREET,

BRISTOL, CONNECTICUT

INSL-X RESISTOR COATINGS

STAND UP AND TAKE IT

INSL-X A107, A200 SOLVENTLESS IMPREGNANTS

In use by manufacturers of fine wire coils, resistors, condensers, transformers, etc. Provides handling ease, low cost and easily reproduceable uniform results. INSL-X Solventless Impregnants provide completely waterproof seals with wide operating thermal range (-50° to +120° C.) They contain no solvent and do not attack previous insulation. Any desired thickness is obtainable with 1 application. Apply by vacuum impregnation or hot dip.



INSL-X 27 AIR DRY VARNISH SEALER

Tack-free in 15 minutes. INSL-X 27 dries hard in 1 hour. It has high dielectric strength and possesses excellent acid, alkali, oil and moisture resistance. Not thermoplastic. INSL-X 27 will not soften with heat; withstands high and low temperature extremes. High abrasion resistance. INSL-X 27 can be supplied in various concentrations, in all colors and with all type fungicides.



INSL-X The Name to Remember for Electrical & Electronic Insulation

INSL-X No.		INSL-X No.	
Arc Resistant Coatings	95	Wire Leads	22
Tool Insulation	33	Coil Cement	44
Bus Bar Insulation	11	Flexible Coatings for Phenolic Plastics	85
Coil Insulation	67		

LITERATURE ON REQUEST

INSL-X
MEANS MODERN
INSULATION

THE INSL-X COMPANY INC.

857 MEEKER AVE., BROOKLYN 22, N. Y.

CHICAGO - DETROIT - LOS ANGELES - PHILADELPHIA - CLEVELAND - ST. LOUIS

motors, relays, compasses, generators, tools, novelties and toys, this single unit would prove useful as a supplement to the permanently installed charging equipment on the production line and a decided asset in the design laboratory.

Basic Principle

Broadly, charging of a permanent magnet system requires induction of a unidirectional magnetizing force sufficient to approach magnetic saturation without subsequent reversal which would partially reduce the permanent charge. For convenience, the magnetizing force is applied through the medium of a single-turn conductor that can be readily connected and disconnected. In such a single turn, the instantaneous peak level of energy transfer to the magnet must be high (of the order of 5 kw for small magnets) whereas the time of application can be quite short (less than 0.002 second).

The essential elements of the charging system are shown in the simplified circuit of Fig. 1. The in-

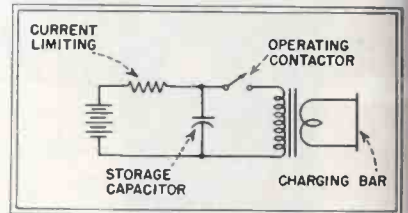

FIG. 1—A source of d-c voltage, a capacitor, and a special transformer are the major components of the magnetizer

ternal power supply for charging the capacitor may be any source of d-c voltage approximately equal to the rated working voltage of the capacitor and capable of recharging the capacitor in a reasonably short time. The current limiting resistor prevents overloading of the power supply should the operating switch be left closed.

Transformer Construction

The charging transformer should be capable of carrying a power impulse having a time constant in the order of one millisecond, and have a leakage reactance factor much less than that considered tolerable at service power frequencies. Otherwise the flux will avoid the secondary, and the capacitor discharge will effectively be into the leakage

Space Emptiers..

VMF SERIES—all-metal, high-vacuum pumps—produce vacuum efficiently for a wide variety of purposes. Designed for industrial and laboratory systems, these rugged, compact pumps are capable of reaching pressures of 10^{-6} and lower.

Here are a few ways in which the VMF pumps are being used—

- ★ Metal evaporation
- ★ Photospectrography
- ★ Rotary exhaust
- ★ High-vacuum distillation
- ★ Molley exhaust
- ★ Electron microscopes
- ★ Individual evacuation chambers

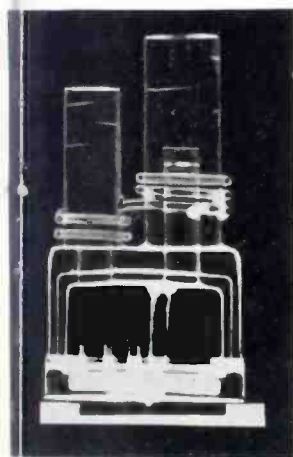

THE sturdy, uncomplicated construction of the VMF Pumps (shown in the X-ray view)...their versatility...the variety of sizes available, air- or water-cooled...their wide speed range...all factors for efficient production of high-vacuum recommend this series for both industrial and laboratory use. Priced from \$45 to \$175 net f. o. b. Rochester, N. Y.



For complete details on the VMF Series High Vacuum Pumps, write—



Vacuum Equipment Division
DISTILLATION PRODUCTS, INC.

Rochester 13, New York

FERRANTI FOR

Quality-

FERRANTI ELECTRIC, INC.

Transformers · Instruments
ELECTRONIC EQUIPMENT

FERRANTI

TELEPHONE CIRCLE 7-0912-3
CABLE ADDRESS FERRATRAM

30 ROCKEFELLER PLAZA
NEW YORK 20 N. Y.

June 1, 1946

MR. CHIEF ENGINEER:

If you have been struggling with problems of
HIGH PRICES AND LONG DELIVERIES, here is good news!

Our expanded facilities now make possible
LOWERED PRICES and unusually PROMPT DELIVERIES in:

(1) AUDIO and POWER -- transformers, chokes,
filters, rectifiers, power supplies, inductors, etc.

(2) WIRING and ASSEMBLY -- mechanical and
electronic; sub-assemblies; component parts.

(3) FABRICATION (SHEET METAL and BAKELITE) --
from sheets, rods, tubes. Cut, drilled, punched,
formed, engraved.

You will be gratified with our prompt, careful
attention. You can draw freely on the Ferranti
Engineering Department for consultation. You know
FERRANTI QUALITY.....now look into FERRANTI LOWERED
PRICES.

Very truly yours,

FERRANTI ELECTRIC, INC.

W. R. Pittal

Vice President

WRSpittal/em

FERRANTI
FOR

Service

"CLEARING THE AIR" ABOUT PHENOLIC PLASTICS

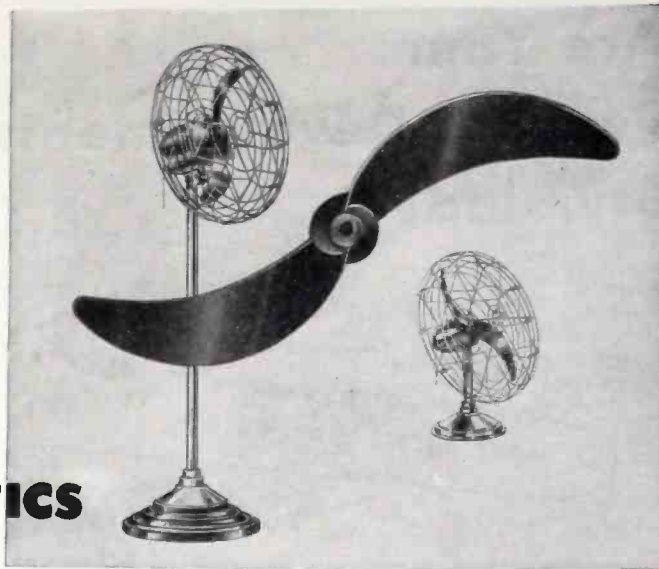

The use of plastics by industry is increasing rapidly on a scope that is practically universal. Nevertheless, there still exists much confusion about the different types of plastics, their properties and their uses. The purpose of this message is to help "clear the air" about phenolics — the most versatile of all plastics... the type of plastics which Durez has specialized in producing for the past twenty-six years.

The custom molded Durez propeller illustrated is the first plastic propeller that has been developed for such use... marks a new step forward for the plastics industry. In varying sizes, it is used by the Fresh'nd-Aire Company in several of their most popular Fresh'nd-Aire Circulators.

Why Plastics?

Reliability — a common denominator

of all plastics — naturally makes them highly desirable for producing an item of this sort — provided, of course, several other necessary properties exist.

Why Phenolic Plastics?

Because the Fresh'nd-Aire propeller must be statically and dynamically balanced to perfection and because it revolves at high speeds, good dimensional stability was of paramount importance.

The only plastic material which would provide this property and meet other requirements such as impact strength, heat resistance, tensile strength, and low-cost production, was a phenolic.

Why Durez Phenolic Plastics?

As specialists in the production of

phenolic plastics, Durez offers more than 300 versatile phenolic molding compounds — each scientifically developed for a specific purpose — from which to select the plastic that precisely fits the job.

Furthermore, Durez laboratory technicians possess a rich background of successful product development experience which makes their services invaluable in solving any unusual plastic material problem.

Expert Assistance Available

The services of the Durez staff are available at all times to you and your custom molder. Durez Plastics & Chemicals, Inc., 86 Walck Road, North Tonawanda, New York. Export Agents: Omni Products Corporation, 40 East 34th Street, New York 16, New York.

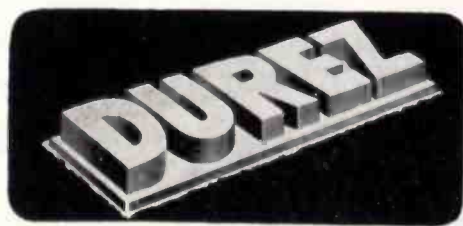

PHENOLIC RESINS

MOLDING COMPOUNDS

INDUSTRIAL RESINS

OIL SOLUBLE RESINS

PLASTICS THAT FIT THE JOB

Are Your Postwar Developments Stymied?

...by lack of development staff?
 ...by inadequate research facilities?
 ...by need of hydraulic or other specialized experience?

You may find the answer in the services of

The Research Engineering Corporation*

We are an organization with a unique background of experience. Our staff of 20 engineers, technicians and draftsmen are skilled in the fields of hydraulic, mechanical and electrical engineering. For example, they have developed hydraulic equipment for many of the famous names in industry.

Bases of Working With You:

- * 1. An engineering research fee... a quoted-in-advance amount covering complete development of the engineering phase of your projects.
- * 2. Royalty basis... for those who prefer this arrangement, The Research Engineering Corporation will develop the job for your plant to manufacture, and put its services on a profit-sharing basis.
- * 3. Cost plus... reasonable per-hour and materials charges plus a modest percentage mark-up.
- * 4. A complete manufacturing arrangement... beyond engineering and putting the project on a production basis for you, we can manufacture it, if you wish us to, through a manufacturing affiliate.

The four alternatives offer you a much more attractive and complete range of choice than the inflexible charges of most engineering consultants. As you see, we are confident enough to risk our services against results.

Your inquiry is wanted. You will not be obligated and your inquiry will be confidential. Write *now* for help in speeding your ideas into production.

The Research Engineering Corp.

292 ELM STREET • NEW HAVEN, CONNECTICUT

reactance rather than the secondary circuit.

The secondary is divided into several parallel turns that alternate in position with several primary sections. The transformer illustrated in Fig. 2 consists of five parallel secondary turns between which are four

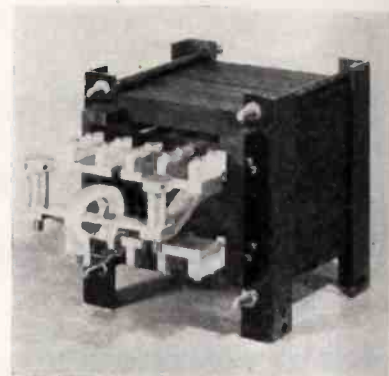

FIG. 2—Five single turns connected in parallel form the secondary of the transformer. A typical instrument magnet is mounted on the front end for charging

series-connected primary pies having 40 turns each, or a total ratio of 160 to 1. While the nature of the discharge conveyed by the transformer is complex, a good approximation is to design for efficient power operation at 2000 cps. For use on instrument magnets, the core should have a cross-section of about nine square inches, with a minimum window opening to avoid excessive core losses.

The circuit of a complete magnet charger is shown in Fig. 3 and the instrument is shown in Fig. 4. The capacitor discharge is initiated through an ignitron type tube man-

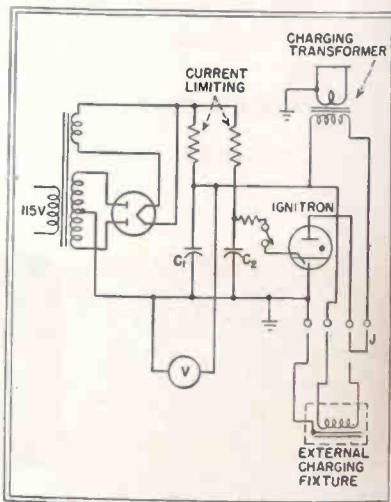

Fig. 3—Complete circuit of the magnet charger



Techniquality

Every product that enjoys the full confidence of those who use it has its "priceless ingredient." In Bliley crystals it's "techniquality."

Cutting, grinding, and finishing alone do not transform raw quartz into a sensitive frequency control device. Behind these operations there must be a background of technical skill and creative engineering that is gained only through years of experience.

Bliley crystals have a reputation for "techniquality" that started fifteen years ago. Today, the fact that Bliley crystals are used in practically every phase of radio communications is tacit proof that leading engineers have found it is best to specify Bliley "techniquality" crystals.

Bulletin 27 describes the crystal units engineered for the needs of today. Write for your copy.

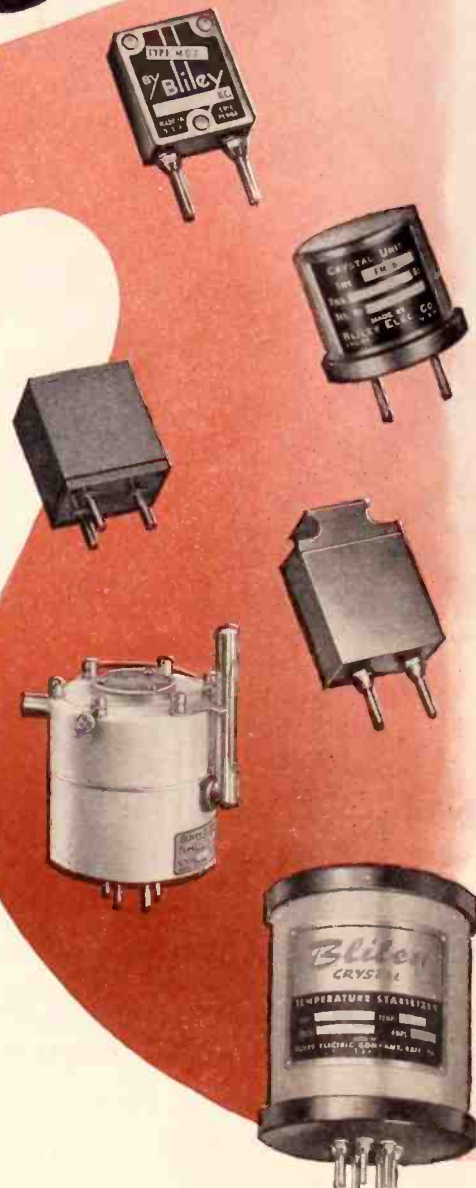

Bliley
CRYSTALS

BLILEY ELECTRIC COMPANY • UNION STATION BUILDING, ERIE, PENNSYLVANIA

FOR CRITICAL ELECTRONIC WORK

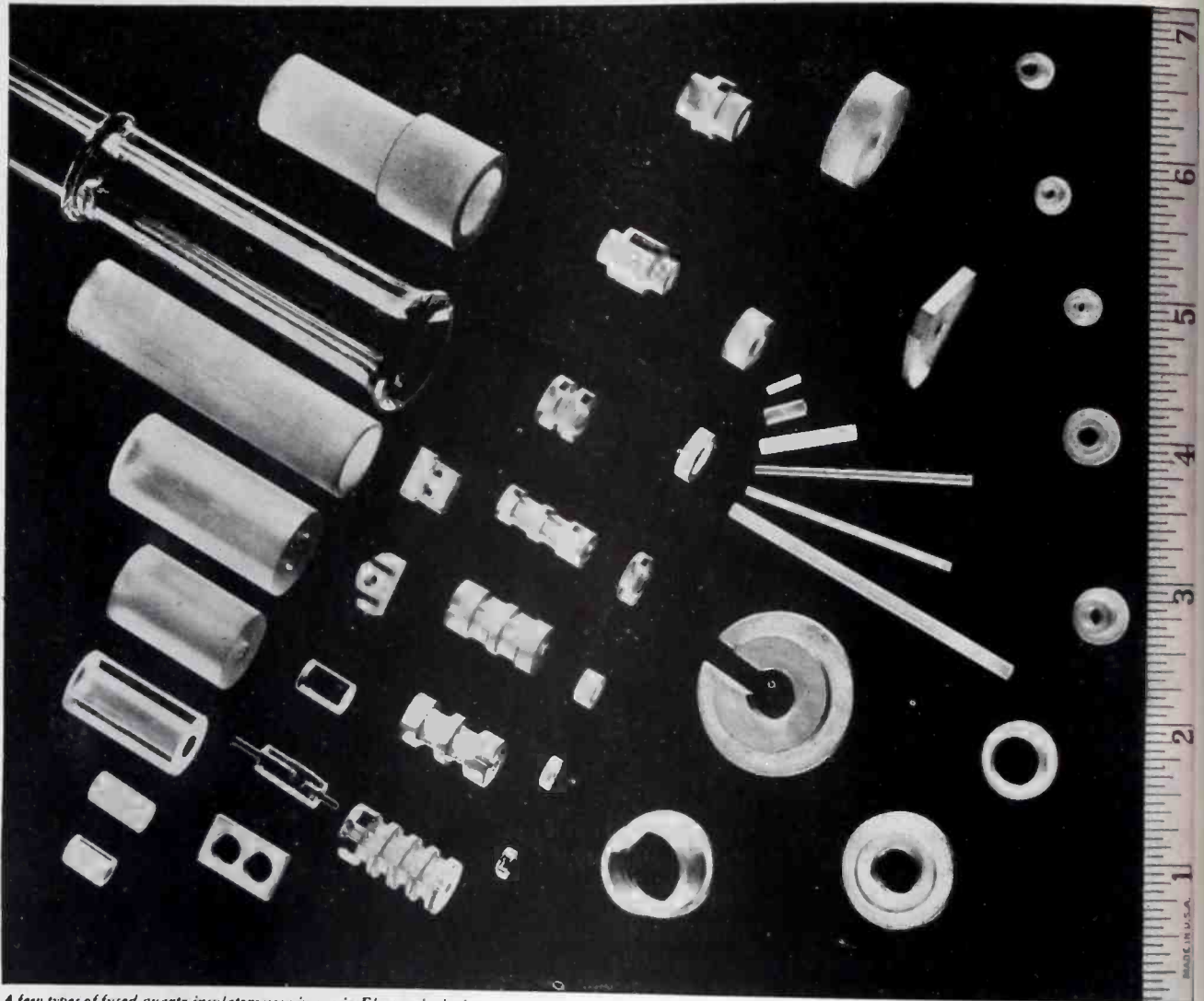

A few types of fused quartz insulators now in use in Electronic devices.

... USE FUSED QUARTZ INSULATORS

● Fused quartz, both clear and translucent, is manufactured by the General Electric Company in rod, tubing and ingot form. This material can also be fabricated into functional shapes to meet most individual requirements.

For engineering service on your specific problem, write, Lamp Department, General Electric Company, Div. 84, Nela Park, Cleveland 12, Ohio.

Only Fused Quartz Has All These Characteristics

stands high temperature • high resistance to thermal shock • low power loss • low surface leakage • high dielectric strength • non-hygroscopic • stands high current flashovers without failure • high crushing strength . . .

can be machined to accurate tolerances.

GENERAL  **ELECTRIC**

It's Collins!

It's new!

It's ready!

... the Collins 30K—a NEW transmitter for amateur radio—thoroughly engineered for the continuous exacting requirements of "ham" operation. Check this partial list of features against your desires:

5 band operation • 500 watts input on CW • 375 watts input on Phone • Push-to-talk • Clean, sharp keying • Speech clipper • Bandswitching • Fully metered • Break-in operation • Vfo controlled

The high efficiency of the 30K assures a strong signal. In addition, the speech clipper circuit assists in maintaining a high modulation level, with no danger of overmodulation. Speech clipping also improves intelligibility. Brass pounders will proudly note the clean keying at any speed.

The exciter unit, built into a receiver type cabinet, may be placed on the operating desk. A highly accurate and stable variable frequency oscillator, the product of years of research and manufacturing experience, is calibrated directly in frequency. The frequency can be varied considerably without retuning the final.

The attractive appearance of this up-to-the-minute transmitter will improve any "shack." Its smooth, easy operation will please you.

Write today for complete details. Collins Radio Company, Cedar Rapids, Iowa; 11 West 42nd Street, New York 18, N. Y.



The Collins 30K



FOR RESULTS IN AMATEUR RADIO, GET...



When is a B-L Rectifier NOT a Rectifier?

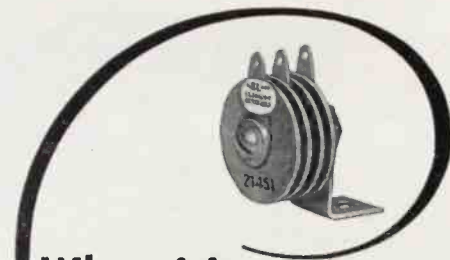

When it's a
SPARK SUPPRESSOR!

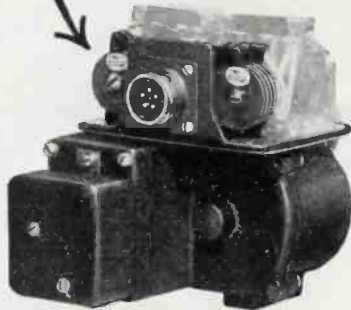

Aircraft Servo Motor manufactured by the White-Rodgers Electric Company, St. Louis. A compact B-L Selenium Rectifier across the rapidly operating relay contacts provides an important safeguard for pilot and plane by eliminating arcing and its resultant radio interference.

Unusual resistance-voltage characteristics make B-L Metallic Rectifiers ideal for overcoming

- RAPID WEAR OF CONTACTS
- RADIO AND TELEPHONE INTERFERENCE
- DAMAGING OSCILLATORY SURGES
- CORROSIVE OXIDATION

The above example is only one of many applications where the unique characteristics of B-L Metallic Rectifiers have offered an ideal solution to an unusual problem.

Whether similar or entirely different problems confront you in the performance or operation of electrical and electronic equipment it will pay to investigate the ability of B-L Rectifiers to meet your needs.

Unusual electrical characteristics plus long life and compact construction make B-L Rectifiers ideal for many applications not ordinarily associated with their name.

SELENIUM



COPPER
SULPHIDE

THE BENWOOD-LINZE COMPANY

1815 LOCUST STREET

ST. LOUIS 3, MO.

Long Distance Telephone CEntral 5830

Designers and Manufacturers of Selenium and Copper Sulphide Metallic Rectifiers, Battery Chargers and DC Power Supplies for practically every requirement.

ually controlled by a pushbutton switch. The ignitron is fired from a small separate firing capacitor C_2 , because it can be fired effectively on a much smaller time constant than the main storage capacitor C_1 , and some efficiency is gained.

The voltmeter serves primarily as a trouble indicator. It is justified, because in instrument repair a poorly charged magnet may not be apparent until the instrument is reassembled, when considerable reworking may be necessary to condition the instrument for recharging.

External Fixtures

It may be desired to charge magnets by means of a wound charging fixture rather than on the single-turn secondary. For example, the magnet rotors in most a-c tachometer generators can be charged by discharging the capacitor directly through the field winding. For such cases terminals are provided for connecting external charging devices di-

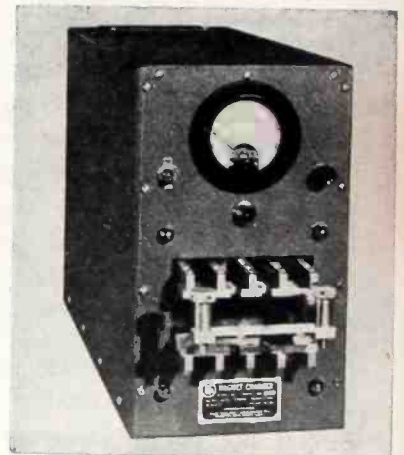
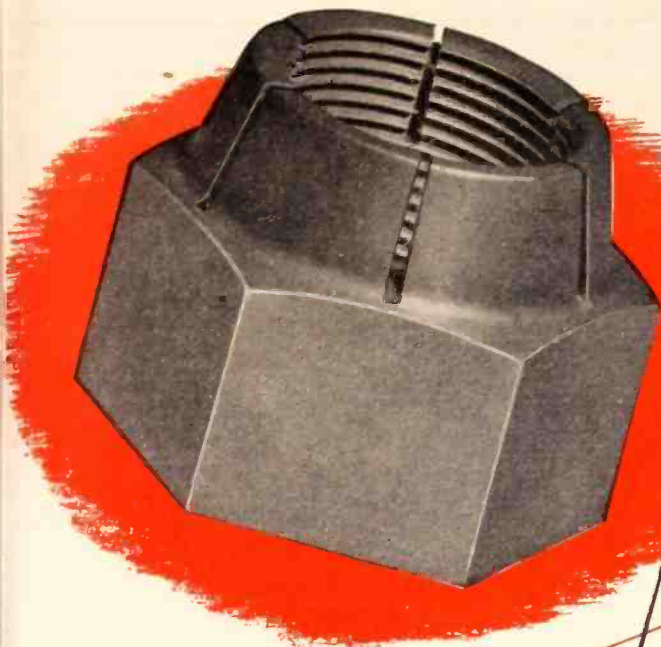

Fig. 4—A 600-volt meter, on-off switch, pushbutton contactor and terminals for fixtures are on the control panel of the cased magnetizer

rectly into the capacitor discharge circuit. The jumper J disconnects the transformer primary. A safety ground terminal is provided to ground the fixture case to avoid shock in the event of insulation failure within the fixture.

The secondary circuit must carry a current peak of several thousand amperes, and to avoid contact resistance, it is important to keep the front end parts clean and the contacting surfaces flat. Persistent contact resistance may be detected by local heating when the charger is



HUGLOCK NUTS

by "National"

The UPPER threads of the Huglock nut press inward against the bolt.

The remaining threads of the Huglock nut have slight clearance at their lower flanks and frictional contact on the load-carrying flanks.



The lock nut WITH ALL THESE ADVANTAGES . . .



- 1 *One-piece construction*—reduces assembly time and avoids possible failure to install supplemental locking medium.
- 2 *Self-locking action*—the Huglock Nut grips the bolt threads and maintains locking effect, whether seated or not, on the load-carrying flanks of the threads.
- 3 *Axial thread play eliminated*—Huglock Nuts are vibration-proof and shock-proof.
- 4 *Thread load is distributed over all the threads of the nut, instead of being concentrated on the few bottom threads.*
- 5 *Maximum thread shear strength*—full strength of the most modern 180,000 lb. tensile alloy bolt will not strip threads in nut. (Compare this with other designs.)

- 6 *All metal construction* permits applications involving high temperatures, oil or other types of moisture. Self-locking is maintained at high temperatures.
- 7 *Easily installed*—Huglocks start freely and may be tightened rapidly by standard hand or speed wrenches.
- 8 *Economical to use*—cotter pins, lock washers, key plates, jam nuts or other secondary locking devices are completely eliminated.
- 9 *Re-usable*—repeated removal and re-use on the same bolt or a similar bolt will not destroy the locking action.
- 10 *Controlled preset torque values* are built into Huglocks, insuring the vibration-proof results visioned in your engineering designs.

U. S. Patents 2290270, 2333290, 2337797. Other Patents Pending

Other "National" Specialties Include the Following:

- | | | |
|--------------------------|----------------------|--------------------|
| Phillips Recessed Screws | Drake Lock Nuts | Scrivets |
| Laminar Flow Screws | Place Bolts | Hi-Shear Rivets |
| Marsden Lock Nuts | Lok-Thred Studs | Sems |
| Dynamic Lock Nuts | Rosán Locking System | Clutch Head Screws |

Send for samples and consult with us on any fastener question.



THE NATIONAL SCREW & MFG. CO., CLEVELAND 4, O.

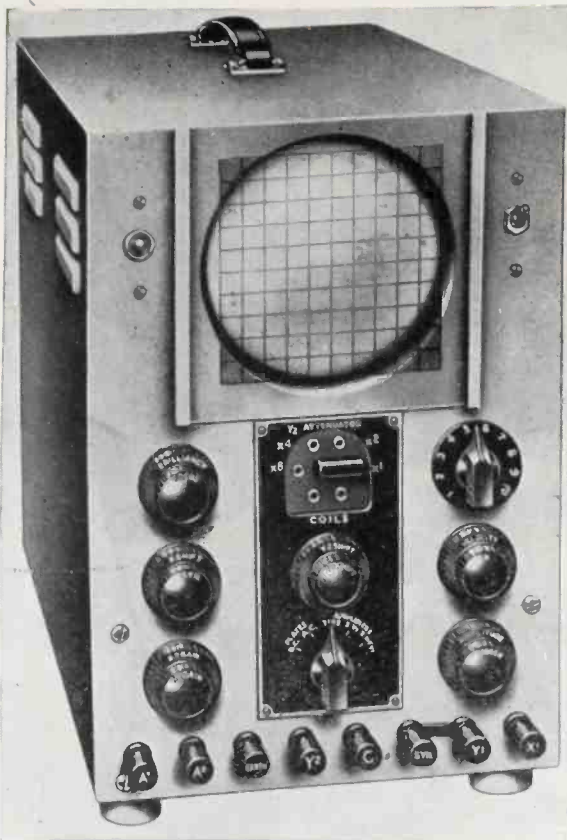

presenting the

DOUBLE

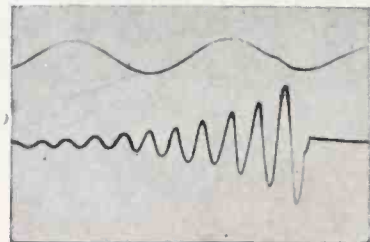

BEAM

OSCILLOGRAPH

Model 339 D. B. OSCILLOGRAPH, PRICE £40 Net F.O.B.

PERFORMANCE DATA

TIME BASE . . . 5 — 250,000 c.p.s.

AMPLIFIER	Gain	Frequency Band in c.p.s.	Sensitivity mV.RMS/mm
1 stage	28	10 — 100,000	43.0
2 stage High Gain	900	10 — 100,000	1.3
Wide Band	106	10 — 2,000,000	10.0

Seven years after its appearance in 1938, the Cossor Double Beam Oscilloscope is still unique. The intrinsic value of the technique introduced by this instrument, which provides true *simultaneous indication of any effects* on a common time axis, has long been proved in all fields of research and production testing—both on recurrent and transient work. It is an understatement to say that practice has revealed no sphere of investigation where its use is not at least advantageous. Although of enhanced performance, the instrument is in essence, an oscilloscope of conventional design in which, through the interchangeability of COSSOR single and double beam trapezium-corrected tubes, true double beam technique has been provided without inherent limitations or distortions. These fundamental qualities have been responsible for its selection as the standard Oscilloscope for most of the Allied Nations' Armed Services. Thus precluded earlier from acquainting American users of the "double beamer", we are now able to make good this omission and satisfy also the friendly urging of A.E.F. Technicians who have all wanted "the folks back home" to know about it.

A. C. COSSOR Ltd

INSTRUMENT DIVISION

HIGHBURY

LONDON N.5.

ENGLAND

CABLE ADDRESS: Amplifiers London

CABLE CODES: Bentley's

6 WAYS WALDES **TRUARC** RETAINING RINGS IMPROVED GENERAL EXCAVATOR'S FAMOUS "TYPE 10"

GENERAL EXCAVATOR'S TYPE 10 IN ACTION

An amazing time saving money saving machine. "Type 10" is precision equipment—a revolutionary development in excavating machinery. It's one of many products—large and small that have the design economy and greater work efficiency of Truarc rings.



GENERAL EXCAVATOR CO.
Bulletin
 Use of Truarc retaining rings on our Type 10, model 105—

1. Gives better integrated construction
2. Simplifies and provides permanently tight assembly on all major shaft assemblies
3. Eliminates bulky lock washers and bolts
4. Speeds production—reduces cost
5. Makes possible greatest design economy with maximum power and efficiency
6. Stands up under the heavy stresses required in our machines

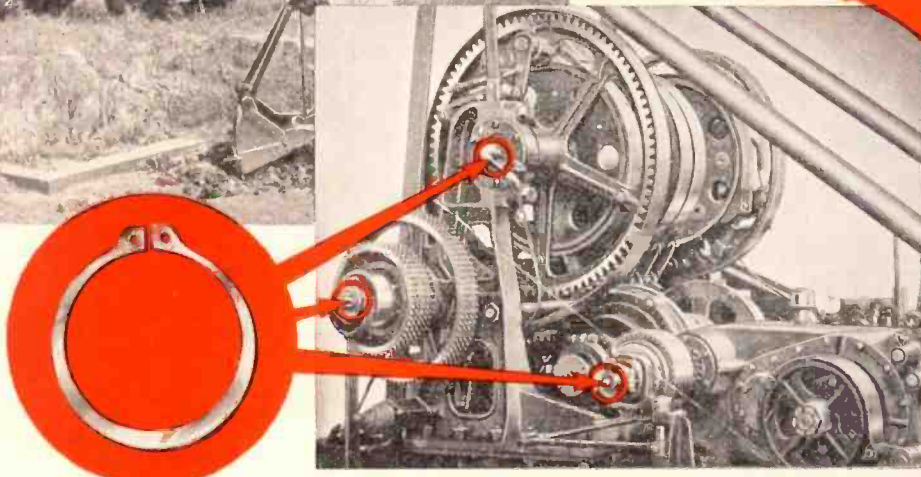

FREE! See how Truarc can improve your products—cut production and maintenance costs. Write today for Truarc booklet showing applications and design sketches. Specify Booklet 18C.

HOW YOUR MACHINES CAN HAVE THE DESIGN ECONOMY of retaining rings regardless of load, stress or accuracy involved. Waldes **TRUARC** high precision retaining rings do the job of nuts, shoulders, flanges, pins and snap rings. Yet they allow lighter, more compact units—make assembly and disassembly quicker, easier. **TRUARC** retaining rings give *better, more dependable retention* because their mathematical precision means perfect circularity—insures an unflinching grip. There's a Truarc ring for every mechanical purpose.

WALDES
TRUARC RETAINING RINGS
TRADE MARK
WALDES KOHINOOR INC., LONG ISLAND CITY 1, N. Y.
SOLE U.S. REPRESENTATIVE: PRENCO PROGRESS AND ENGINEERING CORPORATION, LTD., 72-74 STAFFORD STREET, TORONTO

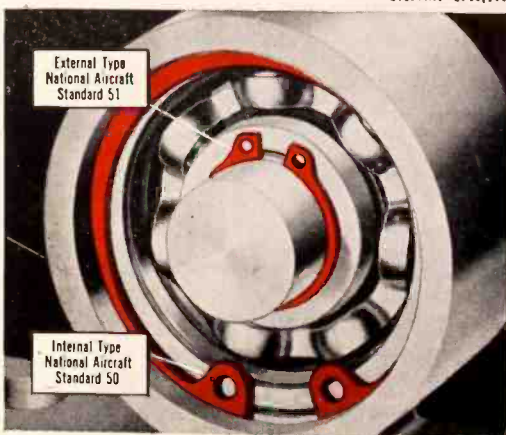

U.S. PAT. NO. 10,144

Specialized
SWITCHING APPARATUS
FOR ELECTRONIC EQUIPMENT

A few of many specialized types of switching apparatus we design and manufacture for electronic applications.

**HIGH VOLTAGE
D. C. HOT BREAK
CONTACTORS . . .**

for energizing high voltage vacuum tube circuits, break circuits carrying up to 1.5 amps at 3 to 5 thousand volts. Vacuum switch eliminates external moving parts.

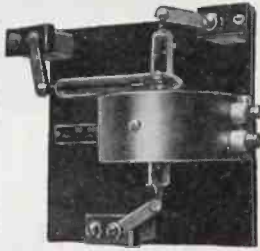

CONTACTOR TIMERS . . .

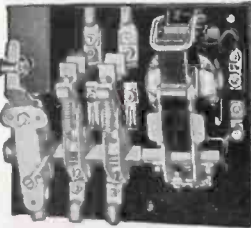

used as main power or filament contactors with auxiliary delayed time circuit or circuits. Contactor and timer joined physically, electrically, — saving space, assuring certain operation.

**HIGH VOLTAGE-
HIGH FREQUENCY
CONTACTORS . . .**

designed primarily for high frequency switching from remote control point. Use with any high voltage cold break application, — A. C. or D. C. Low loss insulation, steatite or glass bonded mica. Contactors range from 15 amps at 3000 volt to 35 amps at 25,000 volt maximum.

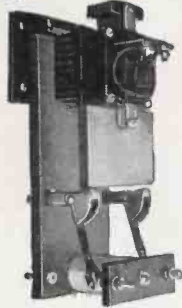

**HIGH FREQUENCY-HIGH VOLTAGE TRANSFER
SWITCHES . . .**

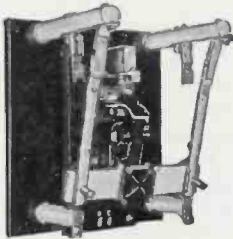

for radio or industrial load transfer. Magnetically operated from remote point. Mechanically held in either position. Accommodates currents up to 75 amps high frequency. Low loss insulation, steatite or glass bonded mica. Cold break only.

**COMBINATION POWER & SIMULTANEOUS
CONDENSER DISCHARGE CONTACTOR . . .**

is a striking example of our ability to create specialized switching apparatus in accordance with unusual customer specifications.

Consult us—we specialize in the unusual!

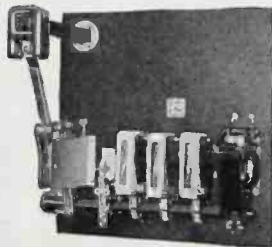

The Monitor
Controller Company
BALTIMORE 2, MARYLAND



CANADIAN AFFILIATE • CANADIAN CONTROLLERS, LTD.
TORONTO, ONTARIO, CANADA

MAGNETIZER

(continued)

operated rapidly several times. A small amount of contact resistance may be expected after assembling a front end through a magnet for charging but it will disappear after the first charging impulse. It is recommended that each magnet be given three charging impulses on the assumption that some initial contact resistance is apt to exist.

Operating Notes

In well designed instruments the reluctance is divided more or less equally between the air gap and the magnet proper as a proper impedance match. Thus, if the air gap can be shunted by an iron keeper when charging, the magnet may be charged

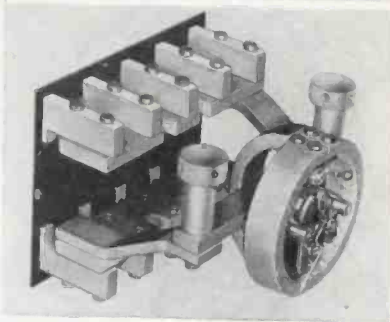
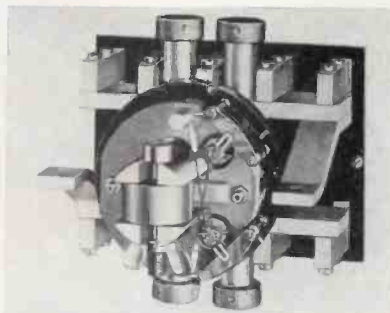

Fig. 5—Special fixtures are required for these typical instruments used in present day equipment

with roughly half the energy required when the air gap is open. Instrument magnets supplied with transfer keepers should be charged using the keepers.

At the higher levels of magnetizing force during the charging process the permeability of the magnet material is lowered considerably, and if the magnetizing force is not evenly applied uneven leakage flux may develop and the magnet will not be charged uniformly throughout its length.

The obvious precaution is to apply the magnetizing force as uniformly as the physical shape of the struc-

**Tracing cloth
that defies
time**

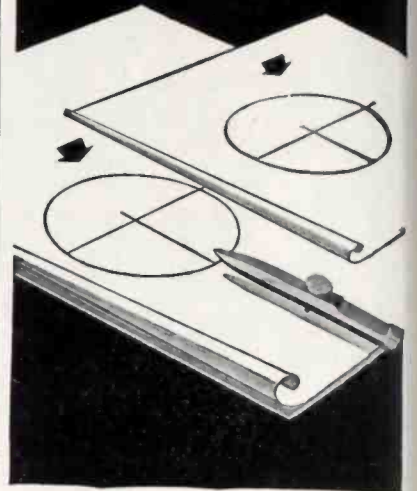

● The renown of Imperial as the finest in Tracing Cloth goes back well over half a century. Draftsmen all over the world prefer it for the uniformity of its high transparency and ink-taking surface and the superb quality of its cloth foundation.

Imperial takes erasures readily, without damage. It gives sharp contrasting prints of even the finest lines. Drawings made on Imperial over fifty years ago are still as good as ever, neither brittle nor opaque.

If you like a duller surface, for clear, hard pencil lines, try Imperial Pencil Tracing Cloth. It is good for ink as well.



**IMPERIAL
TRACING
CLOTH**



SOLD BY LEADING STATIONERY AND DRAWING MATERIAL DEALERS EVERYWHERE

SELETRONIC SELENIUM RECTIFIERS

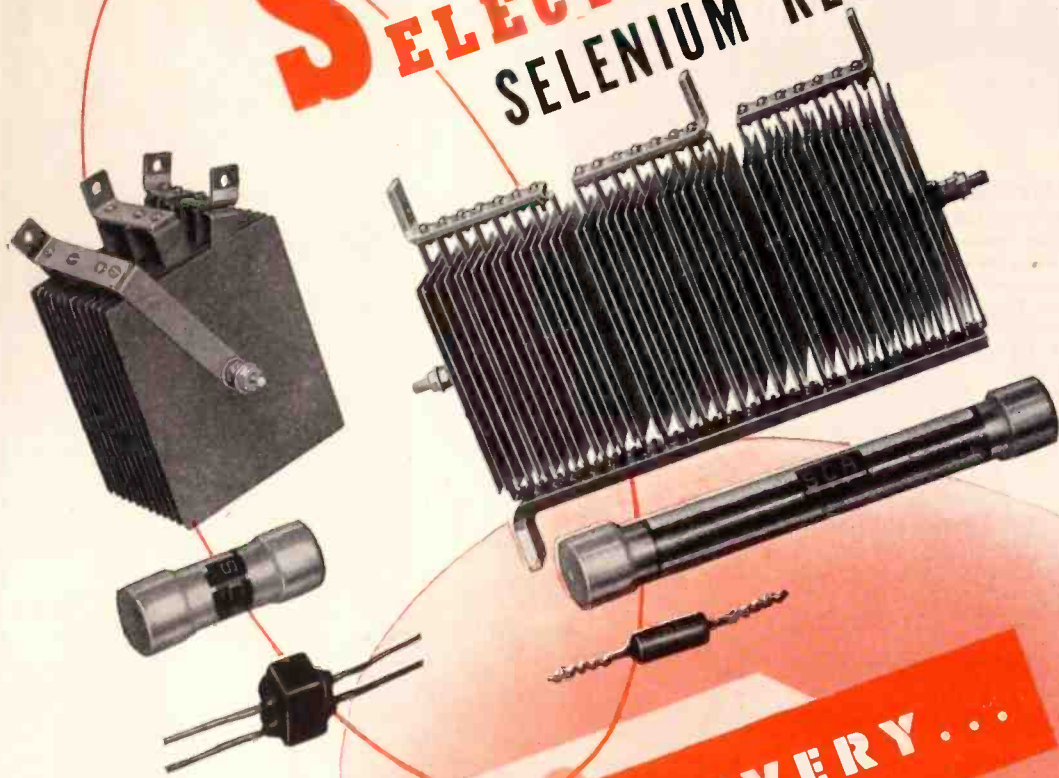

IMMEDIATE DELIVERY...

Manufacturers of a broad line of SELENIUM Power and Instrument Rectifiers, Photo-Electric Cells and allied scientific products.

Solve your rectification problems with SELENIUM. SELENIUM rectifiers are rapidly becoming standard in industry. Check these outstanding features:

- ✓ Permanent characteristics.
- ✓ Adaptability to all types of circuits and loads.
- ✓ Unlimited life — no moving parts.
- ✓ Immunity to atmospheric changes.
- ✓ High efficiency per unit weight.
- ✓ Hermetically sealed assemblies available.
- ✓ From 1 volt to 50,000 volts RMS.
- ✓ From 10 micro-amperes to 10,000 amperes.
- ✓ Economical — No maintenance cost.

SELENIUM CORPORATION OF AMERICA

Affiliate of **VICKERS**, Incorporated
1719 WEST PICO BOULEVARD • LOS ANGELES 15, CALIFORNIA
Export Division: Prazer & Hansen, 301 Clay Street, San Francisco 11, Calif.
In Canada: Canadian Line Materials, Ltd., Toronto 13, Canada



"TIP" FOR BETTER SOLDERING

Select the NEW G-E CALROD SOLDERING IRONS with the "non-freezing," easy-to-replace, calorized-copper tips. They simplify maintenance in your shop. General Electric Company, Schenectady 5, New York.

A NEW AND IMPROVED LINE of G-E Calorized SOLDERING IRONS FOR INDUSTRIAL USE

THEY GIVE YOU THESE IMPORTANT ADVANTAGES:

- HIGH-SPEED SOLDERING
- UNIFORM PERFORMANCE
- LONG LIFE AND LOW MAINTENANCE
- CONVENIENT AND LOW-COST RENEWAL

WRITE FOR BULLETIN GEA-4519.

GENERAL  ELECTRIC
670-1311

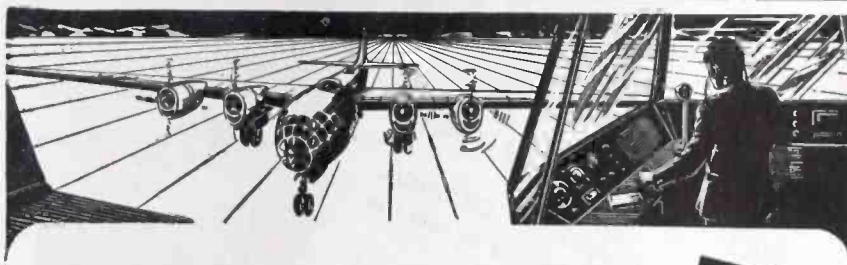

An Invitation to All Electrical Designers to TRY SILVER GRAPHALLOY

for RELAYS
MOTORS
CONTROLS
ELECTRONICS

FOR BRUSHES

High current density, low contact drop, low electrical noise, and self-lubrication are characteristics of this silver-impregnated molded graphite that may be the answer to your electrical brush problems.

FOR CONTACTS

Low contact resistance and non-welding when breaking surge currents are inherent properties of this unique combination of conductive silver and self-lubricating graphite.

SAMPLES of Silver Graphalloy will be gladly furnished for test on your applications. Silver Graphalloy is usually silver plated to permit easy soldering to leaf springs or holders. Why not WRITE NOW for your test samples?

GRAPHITE METALLIZING CORPORATION
1055 NEPPERHAN AVE • YONKERS, NEW YORK

ALWAYS SPECIFY **GRAPHALLOY**
Trade Mark Reg. U.S. Pat. Off.



From out of the west...
America's finest transformers

Thermador is a name remembered when the utmost in transformer quality is desired, and when exceptional engineering skill is required.



THERMADOR
THERMADOR ELECTRICAL MFG. CO.
5119 District Blvd., Los Angeles 22, California



CABLES

**For Use
in Transmission of
High Frequencies**

CONNECTORS

● Amphenol Twinax and Coax RG cables, produced to standards that surpass the high Army-Navy specifications for critical wartime uses, are ideal for the myriad of peacetime applications in all phases of the rapidly expanding electronic industries. Rigid laboratory tests and notarized affidavits on every shipment give final assurance of extra quality and dependability.

● Amphenol special low-loss V.H.F. connectors are available in a complete line for all practical applications of RG cables and other uses. Mechanically efficient and electrically correct, these easily assembled connectors and adapters provide the utmost efficiency in circuits in which they are used.

AMPHENOL ASSEMBLY SERVICE

An important part of Amphenol service to users of cables and connectors is a complete Assembly Service. Rigid specifications and performance requirements, plus thorough scientific testing of each part and process, assures users of satisfactory service. For cables, connectors and complete assembly service, look to the world's largest producer — Amphenol.

AMERICAN PHENOLIC CORPORATION
CHICAGO 50, ILLINOIS
IN CANADA
AMPHENOL LIMITED • TORONTO

AMPHENOL

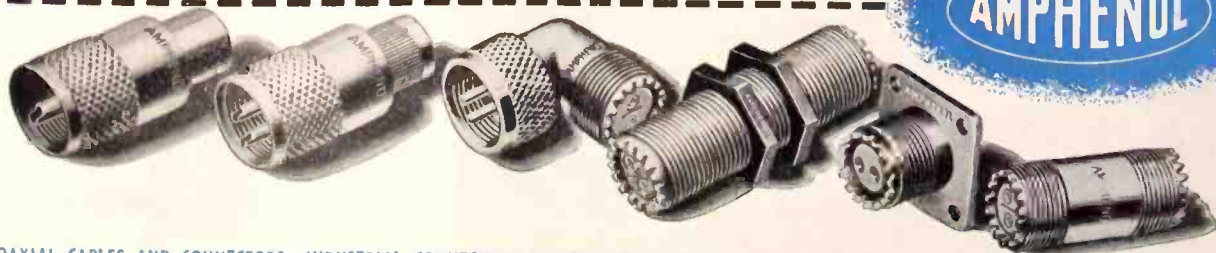

COAXIAL CABLES AND CONNECTORS · INDUSTRIAL CONNECTORS, FITTINGS AND CONDUIT · ANTENNAS · RADIO COMPONENTS · PLASTICS FOR ELECTRONICS

ture will permit, which requires location of the charging bar at the approximate center of the magnetic circuit. It is general practice simply to hold the instrument so as to locate the bar at the estimated center of the magnetic circuit opening if the opening is large with respect to the cross-section of the bar.

The great majority of permanent magnets can be charged with a simple straight charging bar; others require specialized front ends. Two typical special front end assemblies are shown in Fig. 5. Also, it occasionally may be necessary to employ special transfer keepers that will allow charging with the air gap closed, and subsequent transference to the instrument without opening an air gap larger than the magnet is subjected to within the instrument.

EARLY MAGNETRONS

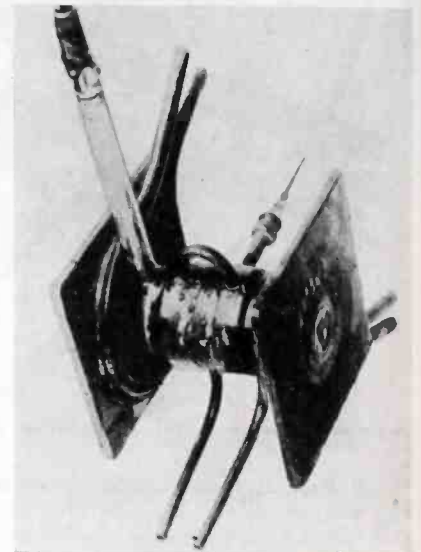

(Above) Randall-Boot c-w magnetron first seen at Wembley, England laboratories of General Electric Co., Ltd. in April 1940. It was continuously evacuated, water-cooled, used a large electromagnet, and had an output of several hundred watts of c-w near 10 cm

(Below) An improved model that gave similar performance with reduced weight was evolved at Wembley

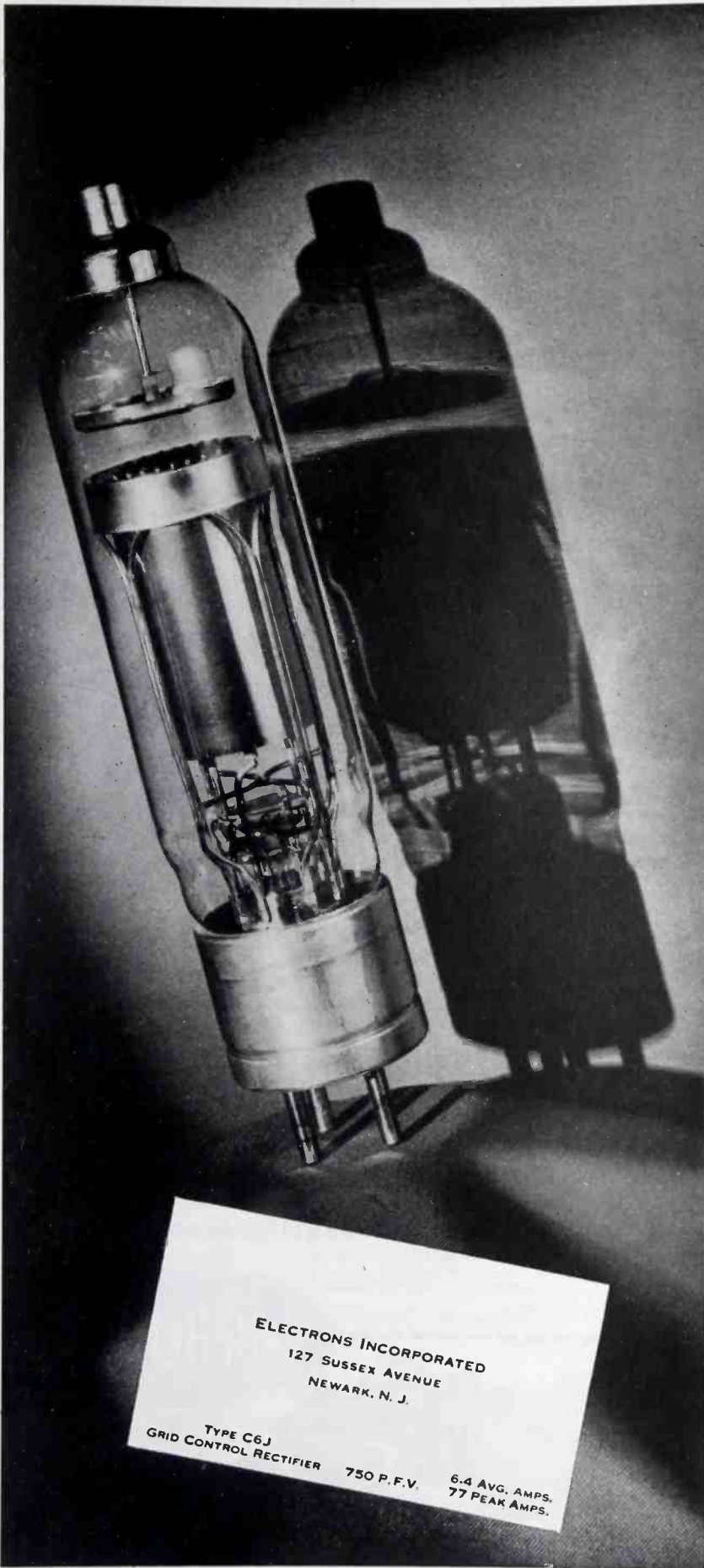
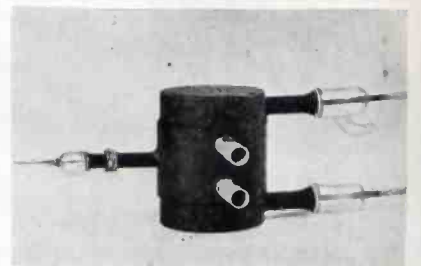

ELECTRONS INCORPORATED
127 SUSSEX AVENUE
NEWARK, N. J.

TYPE C6J
GRID CONTROL RECTIFIER 750 P.F.V. 6.4 AVG. AMPS.
77 PEAK AMPS.

STANDARD • DOUBLE SATURATED

MITCHELL-RAND

TRIPLE STRENGTH • IMPREGNATED • MIRAC • HYGRADE • STANDARD

THE ELECTRICAL INSULATION

IMPREGNATED • MIRAC • HYGRADE • STANDARD • DOUBLE SATURATED

HEADQUARTERS... OFFERS 6 DIFFERENT

MIRAC • HYGRADE • STANDARD • DOUBLE SATURATED • TRIPLE STRENGTH

... to cover every known requirement

FIBERGLAS (INORGANIC) VARNISHED TUBINGS

M-R Fiberglas Varnished Tubings are made in four grades: Standard; Double Saturated; Triple Strength and Impregnated.

STANDARD GRADE

has maximum flexibility, is treated with a minimum of varnish and recommended for high temperatures where dielectric strength is not a factor.

DOUBLE SATURATED

has all qualities of the Standard Grade but with additional coats of varnish to bring the dielectric rating up to 1500 volts.

TRIPLE STRENGTH

is built up with coats of especially flexible insulation varnish for dielectric ratings

up to 2500 volts and is particularly suited where assembly operations include the possibility of rough handling.

IMPREGNATED

is the Optimum in Superiority for high gloss, non-hydroscopic, resistance to high temperatures, oils, acids, etc. IMPREGNATED has a dielectric rating beyond 7000 volts and is unequalled for Long Life Under Most Severe Conditions. Write For Samples.

FOR USERS OF COTTON YARN VARNISHED TUBINGS

The Mitchell-Rand MIRAC and HYGRADE Varnished Tubings of long staple fiber yarn are comparable to Fiberglas Tubings in dielectric ratings, tensile strength, flexibility and long life. Write For Samples.

FREE FOR THE ASKING

Write today for your free copy of the M-R WALL CHART with its engineering tables, electrical symbols, carrying capacities of conductors, dielectric averages, thicknesses of insulating materials, tubing sizes, tap drills, etc.



MITCHELL-RAND INSULATION COMPANY, INC.

51 MURRAY STREET

CORtlandt 7-9264

NEW YORK 7, N.Y.

Fiberglas Varnished Tape and Cloth
Insulating Papers and Twines
Cable Filling and Pothead Compounds
Friction Tape and Splice
Transformer Compounds

A PARTIAL LIST OF M-R PRODUCTS
Fiberglas Saturated Sleeving, Varnished Tubing
Asbestos Sleeving and Tape
Varnished Cambric Cloth and Tape
Mica Plate, Tape, Paper, Cloth, Tubing

Fiberglas Braided Sleeving
Cotton Tapes, Webbing and Sleevings
Impregnated Varnish Tubing
Insulating Varnishes of all types
Extruded Plastic Tubing

**FOR GENTLE OR VIGOROUS
Agitation of Compounds while Heating**

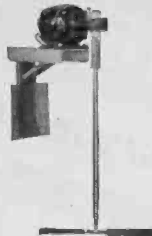

Type A



Type B

If your compound melting problem is complicated by the use of a hard-to-mix formula, you will find that Sta-Warm's experience with a variety of types of agitators will be helpful to you.

Shown here are two basic types of agitators most commonly used in Sta-Warm heaters. *Type A*, a simple two blade propeller, rotates in a horizontal plane about one inch above the bottom of the tank to maintain materials in suspension. *Type B*, with near scraping blades rotating close to tank sidewalls, does a thorough job of mixing and churning of heavy materials.

Proper speed of agitation is an important factor with which Sta-Warm engineers can help you. Why not outline your compound melting problem when inquiring for bulletin that gives further description of Sta-Warm heating tanks with agitators.

Write to Dept. F for full information.



Sta-Warm ELECTRIC CO.

1000 N. CHESTNUT ST. • RAVENNA, OHIO

For COMMUNICATIONS and INDUSTRIAL Jobs

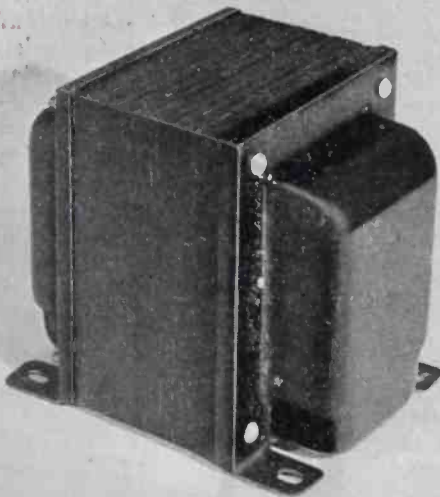

Power Transformers
(Up to 1 kw.)

Audio Transformers

High-Voltage Transformers

Filter Chokes

Coils

DINION COIL COMPANY, Inc.

CALEDONIA, N. Y.

Specialists in Difficult Designs

*It Costs You Less
To Pay a
Little More For
SILCOCKS-MILLER
PLASTIC PARTS*



When you require plastic parts fabricated to close tolerances, you can always depend on Sillcocks-Miller.

This organization pioneered in the precision fabrication of parts from plastic sheets, tubes and rods. Out of this long experience, Sillcocks-Miller engineers offer you the understanding, skill and facilities to produce plastic parts to your exact requirements or to help you work out suitable designs.

This know-how saves you time, trouble and money. That's why "it costs you less to pay a little more for Sillcocks-Miller quality."

Write for
Illustrated brochure

THE SILCOCKS-MILLER CO.

10 West Parker Avenue, Maplewood, N. J.
Mailing Address: South Orange, N. J.

SPECIALISTS IN HIGH QUALITY, PRECISION-MADE PLASTICS FABRICATED FOR COMMERCIAL, TECHNICAL AND INDUSTRIAL REQUIREMENTS.

Another Browning Development

1 All labels engraved into panel



2 Telescoping antenna forms convenient handle



3 Big knobs for cold weather handling



6 New non-jamming vernier drive for fine adjustment

9 Audio output for audibly detecting beats

7 Uses WWV as primary standard

10 110-115 AC-DC operation — checks AM or FM

8 Rugged steel cabinet and 1/8" aluminum panel

4 Visual determination of zero beat by cathode ray indicator

5 Laboratory-type dial with vernier gives readability to one part in one thousand

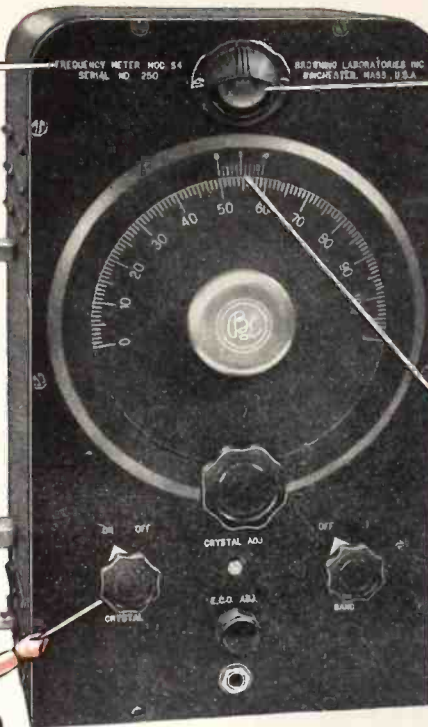

BROWNING'S Model S-4 Frequency Meter was designed especially for marine, police, aircraft, fire department, and other special service radio operators, who must be certain that transmitters are on frequency.

Completely new, it incorporates all the features that supervisors of emergency radio systems have requested — plus many new refinements perfected during our war experience in designing high-precision radar test equipment.

For example, we have included a vernier on the new laboratory-type scale, permitting reading accuracy to one part in one thousand. A telescoping antenna has been added to the side of the case. When telescoped, it forms a convenient carrying handle. Big, easy-to-hold

knobs let you operate the meter with gloves on, in cold weather.

The highest degree of stability has been built into the Model S-4 by the use of improved circuits and voltage regulation within the unit. FCC requirements of plus or minus .00025% accuracy are exceeded by the crystal-controlled BROWNING Frequency Meter. Using 110-115 volt A.C. or D.C. current, it checks both AM and FM equipment.

The S-4 is custom built and hand calibrated for testing frequencies in any five bands from 1.5 to 100 mc., according to the user's requirements. For additional technical data and other information, address BROWNING LABORATORIES, Inc., Winchester, Mass.



BROWNING

LABORATORIES, INCORPORATED
WINCHESTER, MASSACHUSETTS

TUBES AT WORK

Night Vision with Electronic Infrared Equipment . . .	192
Load Lamp for Microwave Power Measurements . . .	204
Radar for Weather Man	210

Night Vision with Electronic Infrared Equipment

DEVICES FOR seeing in the dark by means of electronic detection of invisible infrared radiation were developed to a high degree by German scientists during the war. Most of these used a picture-transformer tube, called a bildwandler, that contained an infrared-sensitive screen which emitted electrons, an electron lens system, and a fluorescent screen on which the image was formed by the lens.

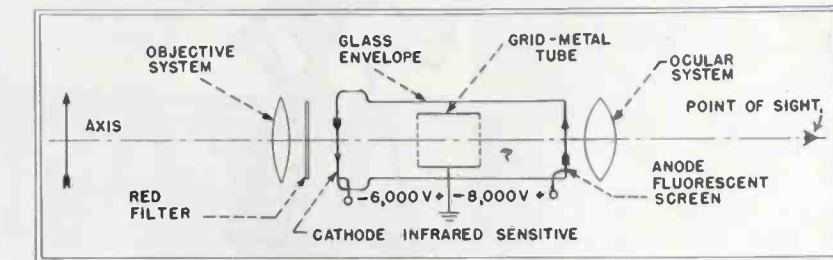

Fig. 1—Essential electronic and optical elements of the German system for seeing at night with infrared illumination

The end toward the objects to be viewed is an infrared-sensitive screen composed of some transparent cesium compound that emits electrons when infrared light strikes it. The end of the tube toward the observer contains a fluorescent screen

The bildwandler tube was used in three types of infrared equipment, namely, nachtfahrgerat (night driving equipment for tanks), zielgerat (rifle sighting mechanism for snipers), and an aircraft experimental model muecka (mosquito).

The nachtfahrgerat was used for driving in complete blackout at any rate of speed the vehicle could maintain and for firing at objects without the use of flares. The roadway is illuminated clearly for 100 yards and most objects can be seen at 200 yards.

Construction of Tube

The equipment contains a special tube called a bildwandlerrohr, a picture-transforming tube. Its essential portions are shown in Fig. 1. At

on which the real image is formed by the electrical system. The arrangement of the screens in the bildwandler tube and its associated optical systems are shown in Fig. 1. Light from the object being viewed passes through a lens system and a red filter to the cathode, a screen of infrared-sensitive cesium compound. When this screen is illuminated from one side, electrons are emitted from the opposite side according to the intensity of the infrared radiation. These electrons are focused electrostatically by an electron lens or grid shown at the center of the tube.

Electrons from the grid are next attracted to the positively charged fluorescent screen used as the anode. Here they form a visible image that corresponds to the distribution of infrared radiation on the cathode screen.

Size of Image

The first optical system (objective) forms a real image on the infrared screen, with a magnification of 9/25. With an observer's eye at the conventional 23 cm from the screen, the angle subtended at the eye by the image on the infrared screen is one-third of the angle which the original object would subtend at the eye without any system in between. The image formed on the fluorescent screen by the elec-

trons when infrared light strikes it. The end of the tube toward the observer contains a fluorescent screen

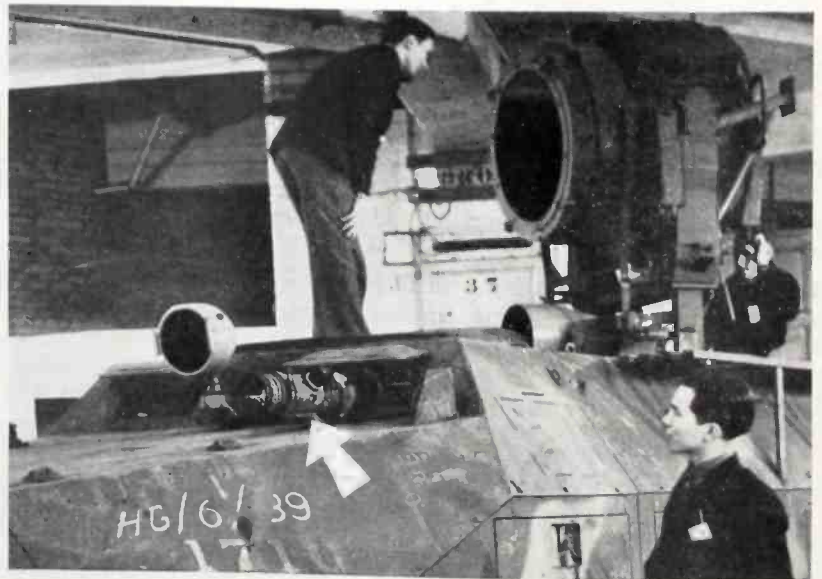

Infrared telescope (white arrow) for night vision mounted on a German half-track. The 36-inch searchlight on top of the vehicle contains an infrared filter as do the other lights



relays OF TOMORROW

in Designs of Today!

FOR COMMUNICATIONS IN TRAINS • TRUCKS • BUSES • PLANES...

Relays BY GUARDIAN — years ahead of today — offer designers of two-way radios definite advancements which contribute to better long-life operation. This is especially evident with Guardian Relays and Switches used in two-way radios for trains, trucks, buses, planes.

For instance, Guardian's series 165-A Relay (A1 Si Mag insulated), for antenna changeover and break-in is small, compact, vibration-resistant. Laboratory tests with 2 normally open contacts prove series 165-A withstands vibration of 16.2 g.+ in both energized and de-energized positions. This is achieved by rugged overall construction and precise counterbalancing of the armature assembly. For H.F. and U.H.F. the series 165-A has a contact capacity to handle all required frequencies. Operates at temperatures ranging -65° to +160°F. and at altitudes from sea level to 50,000 ft. Truly, series 165-A merits a trial now! For V.H.F. antenna switching or keying try the war-tested Vacuum Switch Relay by Guardian.

Let us furnish cost-free information about the complete Guardian line of Radio Relays, also all Telephone Type Relays including the small Midget; and a special Switch used on push-to-talk circuits.

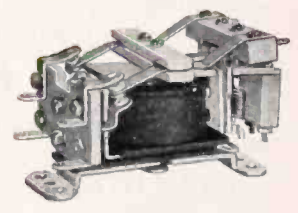

Series 165-A Relay

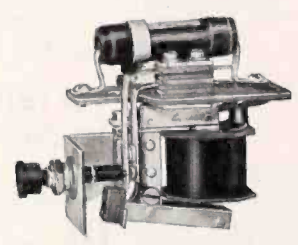

Series X-100 Relay

GUARDIAN  **ELECTRIC**
 1625-G W. WALNUT STREET CHICAGO 12, ILLINOIS
 A COMPLETE LINE OF RELAYS SERVING AMERICAN INDUSTRY

It is a BETTER Electronic Component, when it is a POTTER CAPACITOR

Metal-Contained — Oil-Filled
with Neoprene Bakelite Seals
VASTLY SUPERIOR TO ORDINARY CARDBOARD TUBULARS

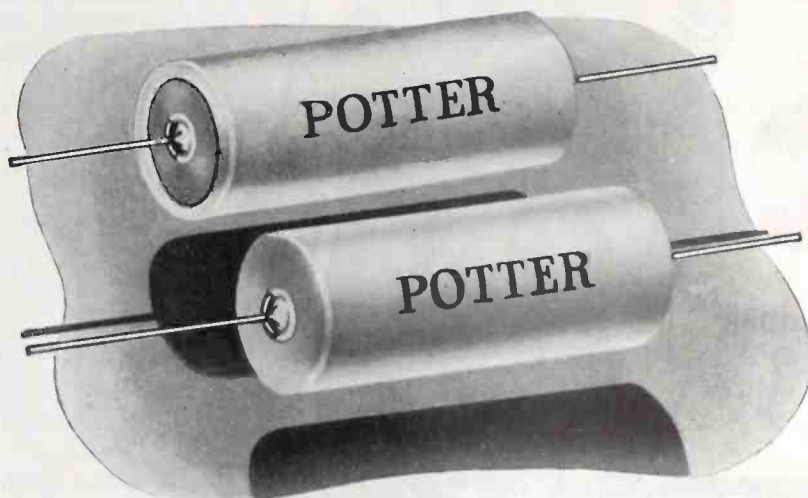

Now—with the increasing multitude of electronic applications, exacting the utmost in dependability, make sure with Potter Quality. Light, durable, space-saving—the highest achievement in capacitor material design and construction, for *today's* precision requirements in electronics. *Aluminum-contained—oil-filled—neoprene bakelite seals. Durable. Space-saving. Far surpassing cardboard tubulars in every point.*

Here's Evidence! Remarkable Record of Potter Acceptance

Under the most rigid Signal Corps inspection—under conditions of the most intense humidity, acceptance of POTTER CAPACITORS ran 99 9/10 percent. Potter Capacitors have been specified for many types of Army, Navy, and C.A.C. equipment.

Assure your product the constant, high fidelity reproduction of Potter Capacitors to your specifications—performance always faithful to the ideal, under any and every condition of operation.

In ratings up to 2,500 volts

Ask for full details. Get *all* the facts on Potter superiorities—and compare! **PROMPT DELIVERY. Wire or Write**

THE POTTER COMPANY
ESTABLISHED 1925
1952 SHERIDAN ROAD, NORTH CHICAGO, ILLINOIS
Preferred by leading manufacturers of electronic equipment

trons is 9/10 the size of the first image.

The second optical system (ocular) forms a vertical image somewhere inside the receiver, but with a magnification of about 3. The net result is that if the eye is held about 15 cm from the outside surface of the ocular, the image seen subtends the same angle, at the eye, as the original object would in ordinary light, without any system in between, and a true interpretation of the surrounding objects is formed. If the eye is moved further or closer than 15 cm from the nachtfahrgerät, the object appears larger and smaller. This is due to the fact that the final vertical image is not at the same place, in distance, as the original object, but closer, although with the eye at 15 cm from the instrument, it subtends the same angle at the eye as the original object.

Light Source

The infrared light source is a 100 or 200-watt lamp with infrared plate and Fresnel lens to disperse light along the road. In addition, a pair of infrared filters is used to cover headlights of the car or tank.

The red filter in front of the picture-forming tube is inserted to protect the infrared sensitive screen used as the cathode. If bright light strikes this screen, it tends to destroy it.

The image on the cesium screen is

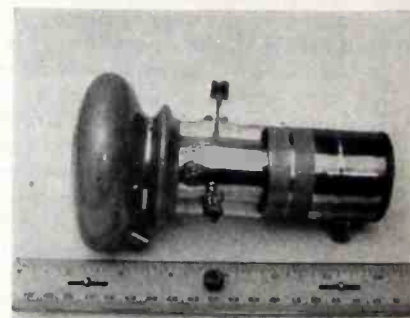

A bildwandler picture-transformer tube

inverted, due to the objective lens. The high potential is applied to give an erect image on the fluorescent screen by bringing the electron beams to a focus inside the tube, and

See It At A Glance!

The THREE Great Advantages
of the

HEINEMANN MAGNETIC CIRCUIT BREAKER

These three things assure efficient speedy action of the breaker and positive protection for your equipment.

A true inverse TIME DELAY in hermetically sealed unit allows passage of inrush current, but continued overload opens the breaker in time inverse to the ratio of the current. On short circuit the action is instantaneous.

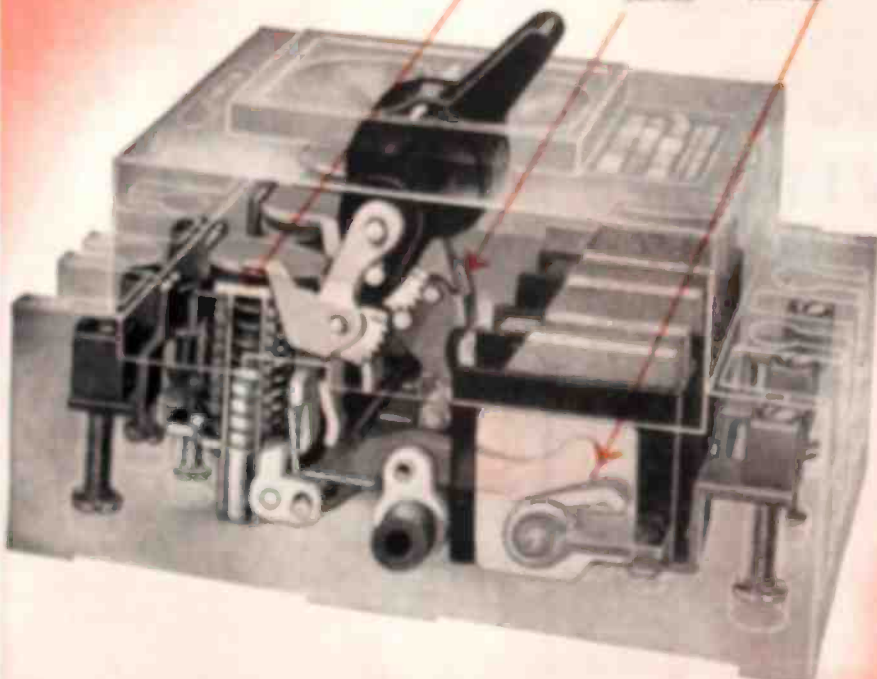

The HIGH SPEED LATCH acts with the least amount of friction and mechanical delay of any latch known. It makes it impossible to hold the breaker closed against short circuit or excessive overload.

The HIGH SPEED BLOWOUT assures instant arc interruption. Individual arcing chambers separate the blowout contacts from each other. As the value of the current to be interrupted increases, the quenching effect becomes greater, due to the intensified magnetic blowout field.

Send for NEW Catalog Showing Complete Line and Engineering Data . . .

HEINEMANN CIRCUIT BREAKER CO.

Subsidiary of Heinemann Electric Co., Est. 1888

497 PLUM STREET

TRENTON, N. J.

It is a BETTER Electronic Component, when it is a POTTER CAPACITOR

Metal-Contained — Oil-Filled
with Neoprene Bakelite Seals
VASTLY SUPERIOR TO ORDINARY CARDBOARD TUBULARS

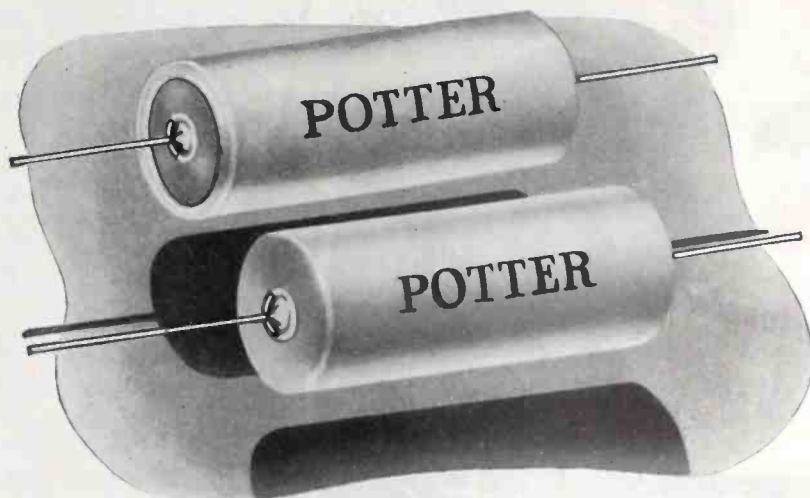

Now—with the increasing multitude of electronic applications, exacting the utmost in dependability, make sure with Potter Quality. Light, durable, space-saving—the highest achievement in capacitor material design and construction, for *today's* precision requirements in electronics. *Aluminum-contained—oil-filled—neoprene bakelite seals. Durable. Space-saving. Far surpassing cardboard tubulars in every point.*

Here's Evidence! Remarkable Record of Potter Acceptance

Under the most rigid Signal Corps inspection—under conditions of the most intense humidity, acceptance of POTTER CAPACITORS ran 99 9/10 percent. Potter Capacitors have been specified for many types of Army, Navy, and C.A.C. equipment.

Assure your product the constant, high fidelity reproduction of Potter Capacitors to your specifications—performance always faithful to the ideal, under any and every condition of operation.

In ratings up to 2,500 volts

Ask for full details. Get *all* the facts on Potter superiorities—and compare! **PROMPT DELIVERY. Wire or Write**

THE POTTER COMPANY
ESTABLISHED 1925
1952 SHERIDAN ROAD, NORTH CHICAGO, ILLINOIS
Preferred by leading manufacturers of electronic equipment

trons is 9/10 the size of the first image.

The second optical system (ocular) forms a vertical image somewhere inside the receiver, but with a magnification of about 3. The net result is that if the eye is held about 15 cm from the outside surface of the ocular, the image seen subtends the same angle, at the eye, as the original object would in ordinary light, without any system in between, and a true interpretation of the surrounding objects is formed. If the eye is moved further or closer than 15 cm from the nachtfahrgerät, the object appears larger and smaller. This is due to the fact that the final vertical image is not at the same place, in distance, as the original object, but closer, although with the eye at 15 cm from the instrument, it subtends the same angle at the eye as the original object.

Light Source

The infrared light source is a 100 or 200-watt lamp with infrared plate and Fresnel lens to disperse light along the road. In addition, a pair of infrared filters is used to cover headlights of the car or tank.

The red filter in front of the picture-forming tube is inserted to protect the infrared sensitive screen used as the cathode. If bright light strikes this screen, it tends to destroy it.

The image on the cesium screen is

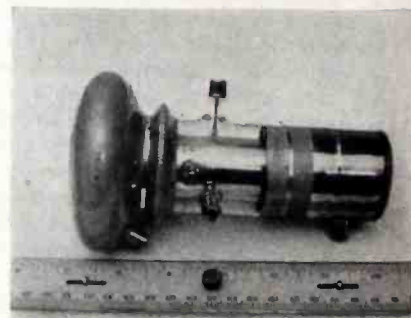

A bildwandler picture-transformer tube

inverted, due to the objective lens. The high potential is applied to give an erect image on the fluorescent screen by bringing the electron beams to a focus inside the tube, and

See It At A Glance!
 The **THREE** Great Advantages
 of the

HEINEMANN MAGNETIC CIRCUIT BREAKER

These three things assure efficient speedy action of the breaker and positive protection for your equipment.

A true inverse **TIME DELAY** is mechanically sealed until allows passage of inrush current, but continued overload opens the breaker in time inverse to the ratio of the current. On short circuit the action is instantaneous.

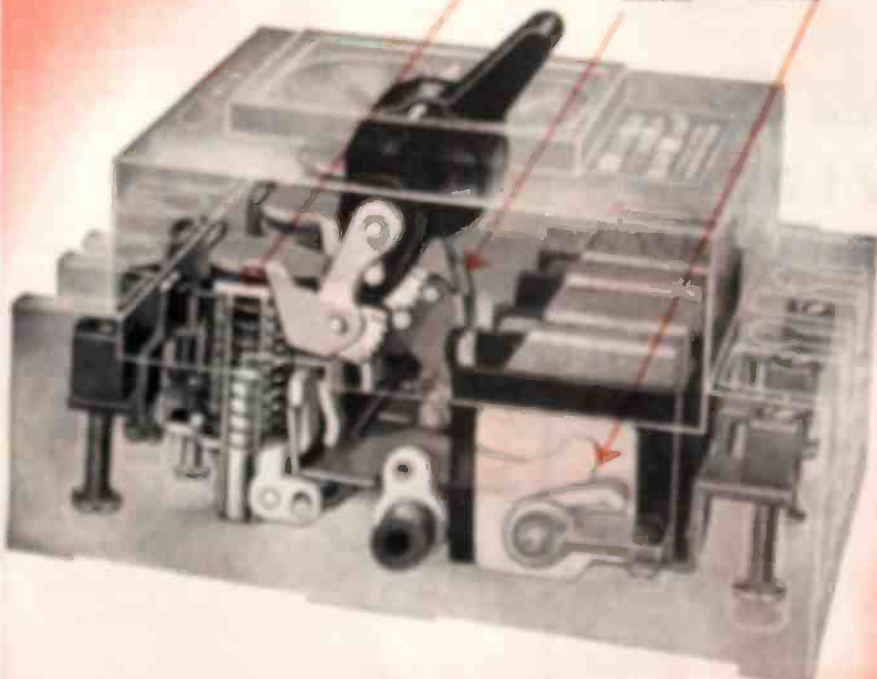

The **HIGH SPEED LATCH** acts with the least amount of friction and mechanical delay of any latch known. It makes it impossible to hold the breaker closed against short circuit or excessive overload.

The **HIGH SPEED BLOWOUT** ensures instant arc interruption. Individual arcing chambers separate the blowout contacts from each other. As the value of the current to be interrupted increases, the quenching effect becomes greater, due to the intensified magnetic blowout field.

Send for **NEW** Catalog Showing Complete Line and Engineering Data . . .

HEINEMANN CIRCUIT BREAKER CO.

Subsidiary of Messersmith Electric Co., Est. 1888

97 PLUM STREET

TRENTON, N. J.

DO YOU MOUNT *Vertical or* HORIZONTAL?

**OPEN BLADE
Model S-1-P**

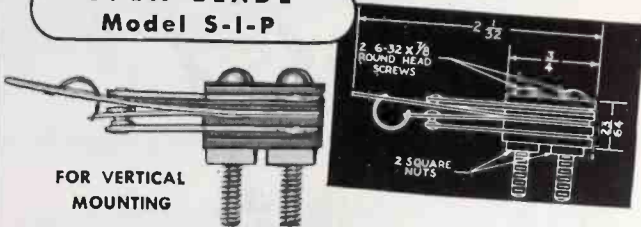

**OPEN BLADE
MODEL M**

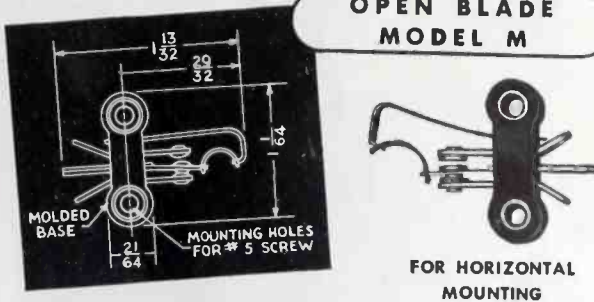

ACRO *Open Blade* SWITCHES Simplify hundreds of problems

Whether you mount your switches vertically or horizontally you too should be able to improve product performance by adopting ACRO Snap-Action Switches. The flexibility of design and adaptation and the amazing performance records are keyed to ACRO's patented beryllium Rolling Spring construction. No other switch is made like it. No other switch performs like it. Yet the cost is low.

With better contact pressures, sturdy construction and positive fast action, ACRO Switches are virtually trouble-free. Many are built for millions of operations. Made in 1, 2 and 3 poles—single throw and double throw. Return types and set types with a wide range of operating pressures. Rated: 15 Amps. at 125 volts A.C. Illustrated above are but 2 of over 1500 models of open blade and inclosed type switches. Send your engineering details for a prompt answer.

ACRO ELECTRIC COMPANY

1316 Superior Avenue Cleveland 14, Ohio

also to accelerate the flow of electrons to give a brighter picture on the fluorescent screen.

The circuit of the high-voltage supply is shown in Fig. 2. It contains a vibrator and an automobile-type spark coil as a step-up transformer. Selenium rectifiers are used

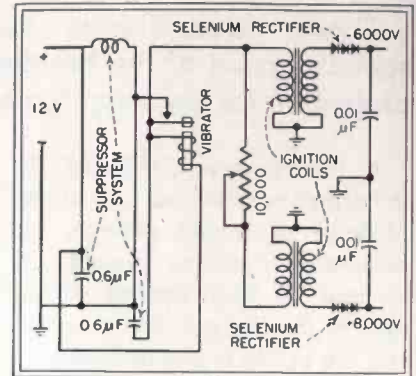

Fig. 2—High-voltage power supply for the nachtfahrgerät, the infrared vision unit for vehicles

with a capacitor filter. The input is 12 volts at 15 watts and two d-c outputs are provided, one of 6,000 volts and the other 8,000 volts. Some of the newer power supplies are motor-generator units instead of vibrators.

The Zielgerät

A small infrared receiver that mounts on any rifle in place of tele-



The infrared receiver for tanks viewed from the sighting position. High-voltage terminals are at top



Blazing four trails to better product control

Pioneer explorers fought their way across America, blazing single indistinct trails most of the way. Today modern four lane highways speed motor traffic on its way.

Alert to the needs of modern industry, North American Philips developed high-efficiency x-ray diffraction apparatus. And to further the efficiency of that equipment the NORELCO four window x-ray diffraction tube was introduced.

Through its use the speed with which materials can be analyzed is greatly increased. In many cases the four available camera positions make it possible to carry on research investigations and control work at one and the same time.



NORELCO x-ray diffraction equipment has many present and potential uses in industrial research. In addition this equipment has found an important place in production control through the analysis of materials before and during manufacture.

The application of NORELCO x-ray equipment to the problems of expanding industry is further evidence of the Philips principle of wedding science and productive ability in the electronics field.

NORELCO products include: Quartz crystals, cathode ray tubes, industrial and medical x-ray equipment, fine wire, diamond dies, tungsten and molybdenum products.

Norelco
Reg. U. S. Pat. Off.



ELECTRONIC PRODUCTS



ORTH AMERICAN PHILIPS COMPANY, INC.

DEPT. C-6, 100 EAST 42ND STREET
NEW YORK 17, N. Y.

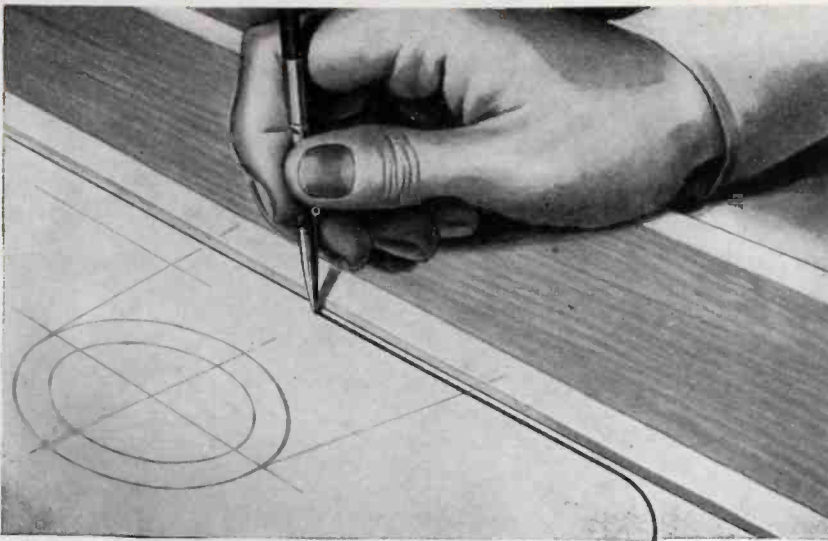

✦ ———— T ———— ✦

The little line that's all there

When a line is ruled on Arkwright Tracing Cloth, the ink flows like molten lead, and "freezes". It's all there. Make a mile of lines and you'll never strike a place where the cloth refuses to take ink.

This feature of Arkwright Cloths saves time, and time means money.

Arkwright's transparency saves time, too. A draftsman can see, easily and accurately. It is permanent, because transparency is achieved by mechanical processing, not by the use

of surface oils. It doesn't become opaque with age.

Arkwright's freedom from imperfections saves time, money, and bad tempers. There are no nibs to trip a pen; no dirt, no stains. There are no pin holes, first or last. Repeated erasure never results in a feathered line.

Executives, purchasing agents, and draftsmen; all are interested in saving time, money, or both. To them samples are sent gladly. Write to Arkwright Finishing Company, Providence, R. I.

★
*Sold by leading
drawing material
dealers everywhere*
★



Arkwright

TRACING CLOTHS

AMERICA'S STANDARD FOR OVER 20 YEARS

scopic sights is called the zielgerat. This enables a sniper to pick off individual men at night. As shown in the illustration, the receiver is about 11 inches long. The infrared light

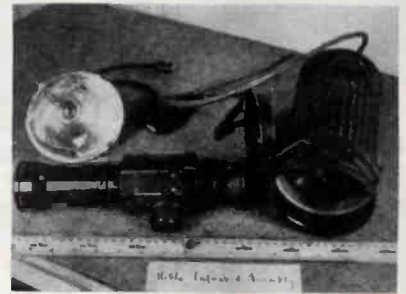

German snipers used this infrared equipment at night. At top left is the light source, below it the receiver, and at right the power supply in a grenade can

source is mounted on top of the receiver and is said to be effective up to 100 yards. The power unit is mounted in a regular gas mask holder and requires four watts from a seven-volt Edison battery.

The receiver operates on the same principles as the receiver used with the nachtfahrgerat with the additional feature that it can still be used for about fifteen seconds after the power supply is turned off. The reason for this is that a larger value of capacitor is used for a greater time constant, so that the value of the applied voltage gradually decreases. All that is needed is a high potential to be built up, since there is practically no current drain.

When a small button on the bottom of the power supply is depressed, the power is on and the image appears on the fluorescent screen. When the view begins to fade, the button has to be depressed again. In this way, the rifleman must stop periodically to apply high voltage, but he has ample time to sight and aim. The infrared light beam is worked separately and is probably kept on all the time. It is fitted so that the light beam is thrown on the same point at which the rifle is aimed. This device is supposed to have been used on the Russian front with very good results.

The Muecka

The aircraft experimental model, the muecka, is a small receiver less than six inches long that was not put

The Rauland **VISITRON** R-6025

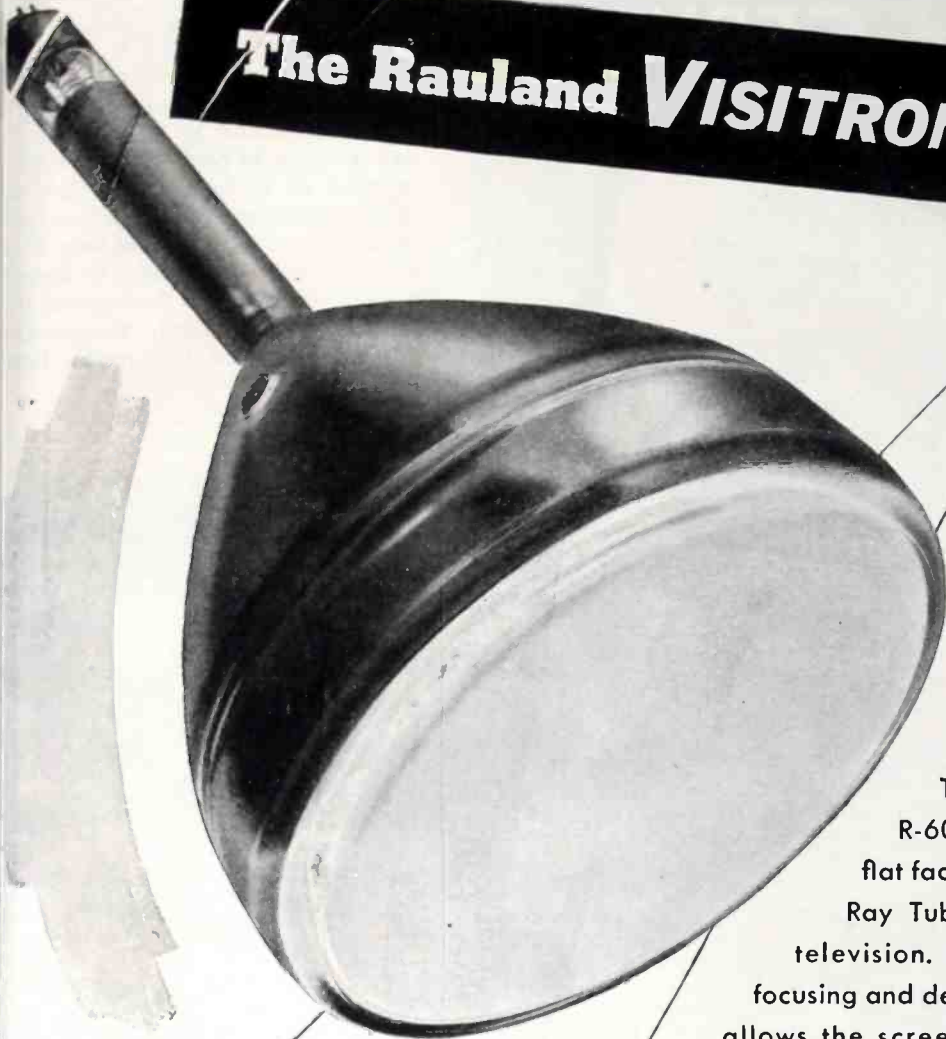

The Rauland Visitron R-6025 is a 10-inch, virtually flat face, direct-viewing Cathode Ray Tube especially suitable to television. The electromagnetically focusing and deflection method employed allows the screen to be excited by a relatively high beam current, insuring good contrast with excellent focus.

**Virtually
Flat Face**

Direct-Viewing

Specifications of the Rauland Visitron R-6025

Heater Voltage	6.3 A. C. or D. C.
Heater Current	0.6 amp.
Focusing Method	Electromagnetic
Deflection	Electromagnetic
Deflection Angle	50 degrees
Screen	Phosphor P4
Bulb Diameter (Max.)	10 $\frac{3}{8}$ " at screen end
Length (Max.)	17 $\frac{3}{8}$ " \pm $\frac{3}{8}$ "
Base	Small Shell Duodecal 7 Pin
Anode Volts (Max.)	11,000
Anode Volts (Operating)	8,000

RADIO • RADAR • SOUND

Rauland

COMMUNICATIONS • TELEVISION

Electroneering is our business

THE RAULAND CORPORATION • CHICAGO 41, ILLINOIS

talk about SERVICE!

The VALPEY CRYSTAL CO.
Holliston, Mass.

March 4, 1946

Gentlemen:

In the cloth bag attached to this envelope, I am returning to you one of your type VP-3 crystals, frequency 14324 kc.

If it is at all possible, could you please grind this crystal down to a frequency of 14,515 25 kc. This is probably a most unusual request; but this particular crystal is such an excellent piece of quartz and oscillates so satisfactorily that I would like to convert it to a frequency good only for the high end of the amateur 10 meter band. If you can do this for me, kindly do so, and return the crystal C. O. D. for labor charges, etc. It is not necessary, as far as I am concerned, that you supply a new name plate cover with the new frequency on it, unless you have definite policy in this regard.

Incidentally, my experience with Valpey crystals has been excellent. As I recall, The Radio Shack in Boston sold me my first Valpey crystal back around 1933 or 1934. My first 20 meter crystal was a Valpey — in a generous octagon case, black, and with an aluminum top cover. It

still oscillates today, but as a result of numerous cleanings has lost some of its old time snap.

I also have numerous 40 meter Valpey crystals which date back at least 11 years, to the best of my memory, which are still functioning perfectly even though they were used with 47 oscillators and were heavily overloaded.

This is quite a ramble; but Valpey gave the amateur low-priced crystal control, and reliable crystal control, for which I am certain many amateurs are, and always will be, grateful and appreciative.

WIGU/WI
Yours sincerely,

George E. Decker

THIS IS BUT ONE OF MANY
ENDORSEMENTS
of

Valpey
CRYSTALS

HOLLISTON, MASS.

into production. No infrared light source was captured with this equipment. According to a prisoner, it was intended to have infrared lights installed on a plane's wing tips, so that the pilot could use the receiver to identify or locate planes near him at night. It was planned to mount the receiver with the fire-control instruments. A separate power supply was required to furnish four watts from a 24-volt input.

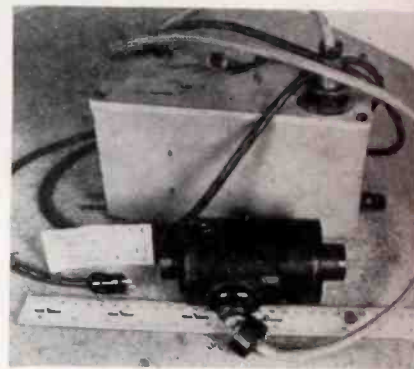

Experimental model of infrared vision equipment for use in a plane

Techniques used in manufacturing the fluorescent screens and photosensitive screens contained in bildwandler tubes are described in detail by R. H. Ranger in report C-66 of TIIC (Technical Industrial Intelligence Committee), an organization set up and operated in connection with the Foreign Economic Administration and the War Production Board.* The report also describes the use of Wimshurst machines to supply high voltage to the bildwandler and the steps in the development of a pocket-size motor-driven Wimshurst machine for this purpose.

Other Infrared Equipment

A very simple device for observing the presence of infrared searchlights

* Material supplied by the Office of the Publication Board, Department of Commerce, Washington, D. C. Interested parties should realize that some products and processes described may also be the subject of U. S. Patents. It is recommended that the usual patent study be made before pursuing practical applications.

Precision Quality Control...

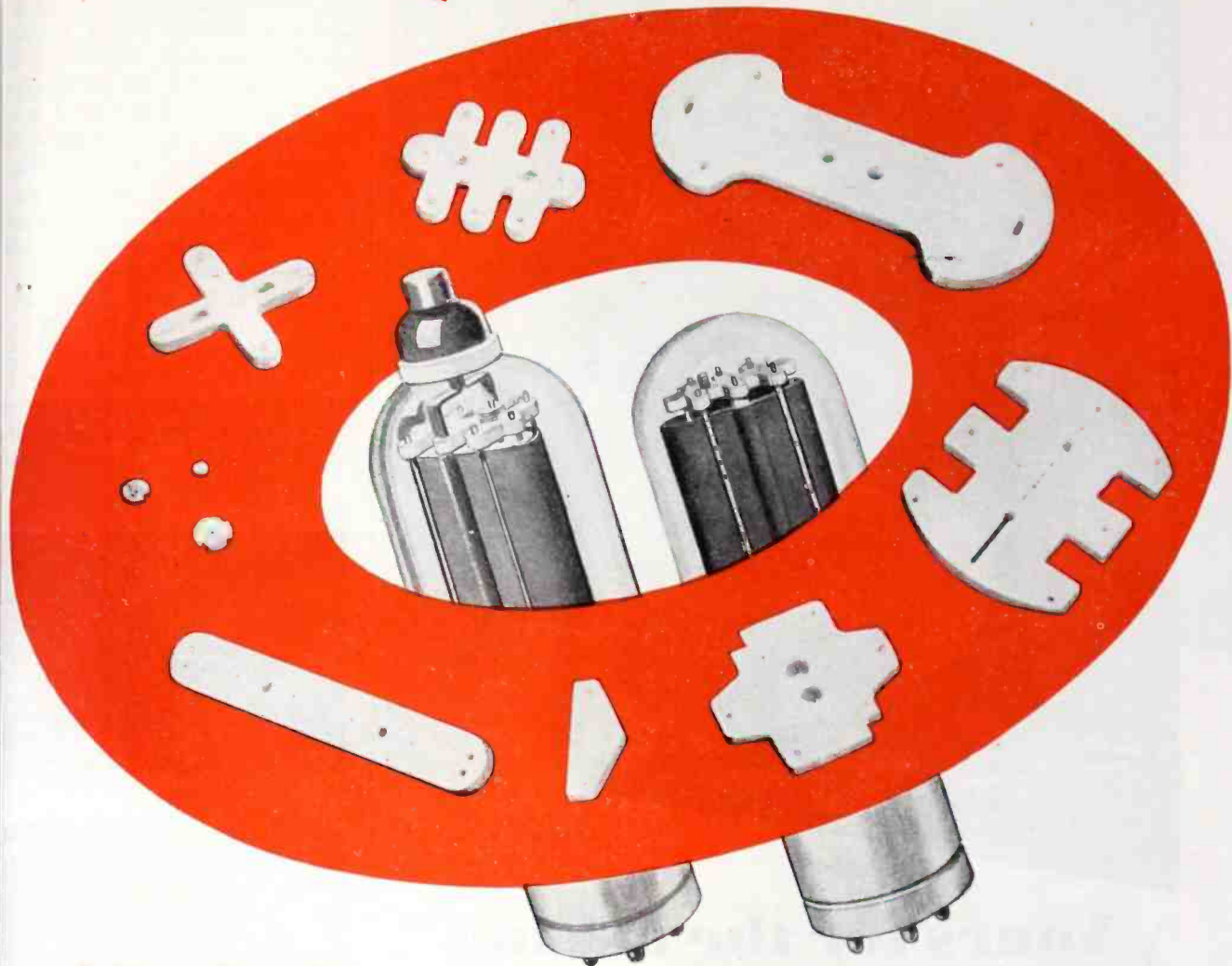

... A Year 'Round
Feature of ALL

STUPAKOFF CERAMICS

Stupakoff precision quality control gives you uniform, dimensionally accurate ceramic parts. By standardizing on STUPAKOFF products, you minimize production losses . . . gain assurance of maximum mechanical strength and maximum electrical protection.

The advantages of Stupakoff ceramics have been developed through years of engineering experience and research.

Carefully selected and laboratory controlled materials, modern manufacturing facilities and constant inspection insure highest quality of finished products at all times. Specify Stupakoff—and be sure of the finest. *Write for Bulletin 245.*

EXPORT DEPARTMENT
13 E. 40th St., New York 16, N. Y.
Cable Address ARLAB all codes

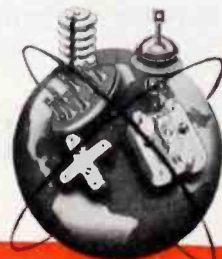

STUPAKOFF

CERAMIC AND MANUFACTURING CO. LATROBE, PA.

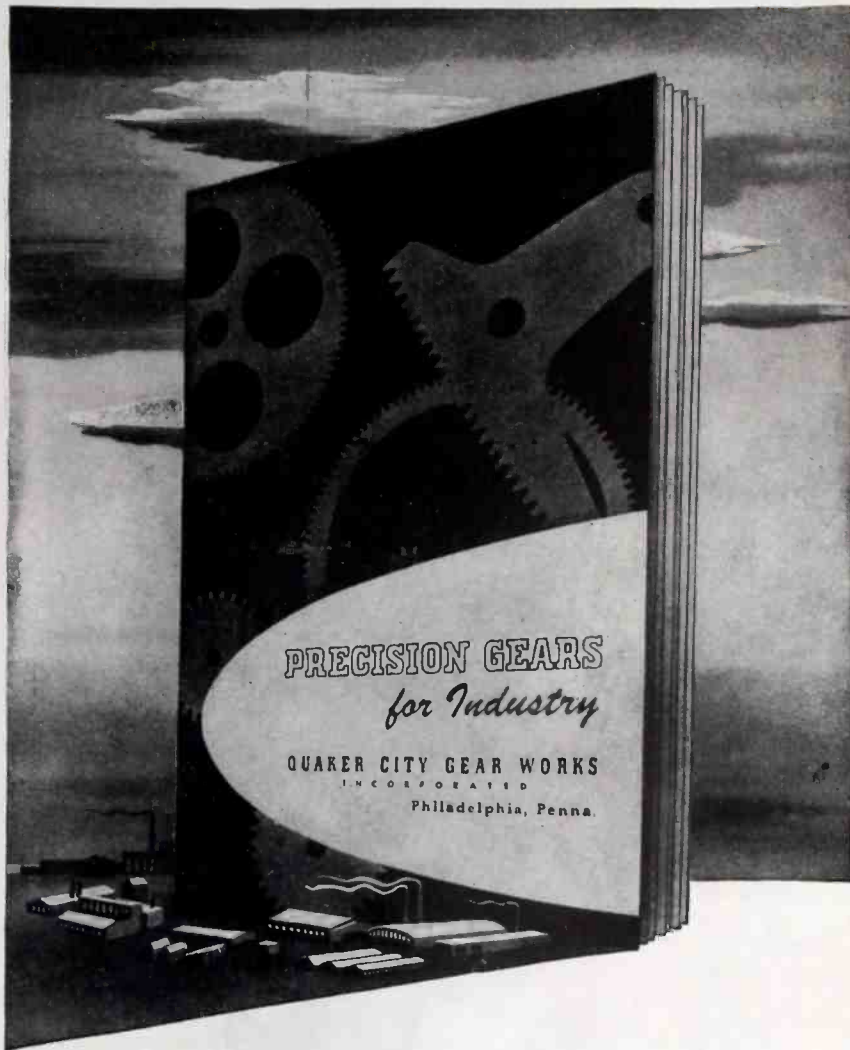

Yours for the asking

A new informative booklet on gears.

It has illustrated sections  on

practically every known form of gearing,

together with  many reference

tables and formulas. Write for your copy

today on your company stationery. 

 **Quaker City Gear Works**
INCORPORATED

1910 N. Front Street, Philadelphia 22, Pa.

is described in report C-60 by C. W. Hansell of RCA, who served as physicist and investigator for TIIC. He reports that about 10,000 of these were produced for use by the Wehrmacht to detect anticipated use of infrared searchlights by the American and British. They consisted of a simple paper tube having an infrared window and lens at one end and a sensitive screen at the other. No vacuum was involved.

The sensitive screen had the remarkable property that, after exposure to strong sunlight it became so sensitized that for a long time afterward it would respond by emission of red visible light when illuminated by invisible infrared light.



The top photo shows a street scene at night as viewed with normal vision. With the infrared night sight of the U. S. Army, the same scene appears as shown in the white circle. Enemy uniforms often appeared as a light silhouette

One successful type of infrared sensitive photoconductive cell used by the Germans was used in a variety of infrared devices for the detection and location of airplanes, ships, etc. These Elac cells were produced at a rate of 1,000 per month.

Generally, the Elac cells were photoconductive devices made in resistances on the order of 100,000 ohms. They had maximum response to wavelengths of about 2.5 microns and

RADIO SET DESIGNERS!

Federal's New MINIATURE Selenium Rectifier

Replaces 117Z6, 117Z3, 0Y4 and most other rectifier-type tubes in AC—DC—Battery Portable Radio Receivers



Assures . . .

- REDUCED COSTS
- SPACE SAVINGS
- INSTANT STARTING
- LESS HEATING

Reduced costs, because this rectifier unit not only costs less than the parts it replaces, but permits valuable savings in assembly time and expense. Only two soldered connections for complete installation—minimum mounting hardware required.

Space savings, because this single compact unit, only $1\frac{1}{4} \times 1\frac{1}{4} \times 11/16$ " , can be used in place of a rectifier tube, tube socket, and associated components. Leaves more room in chassis and permits reduction in receiver size.

Instant starting, because power supply operates instantaneously with selenium rectifier. Eliminates the usual warm-up time required with a vacuum-tube rectifier.

Less heating, because heat-producing filament of rectifier tube is eliminated. Gives substantially longer battery life.

This compact 5-plate unit embodies all the refinements of design and sturdy mechanical construction which have made Federal selenium rectifiers the standard of quality throughout the industry. Of all metal construction throughout, with no fragile parts—it will last many times longer than the average tube.

Now in full-scale production . . . orders can be filled almost immediately. Write for details.

Ratings: Federal 5-plate Rectifier-type 403D-2625
 Peak inverse voltage 380 volts
 Current carrying capacity 100ma DC

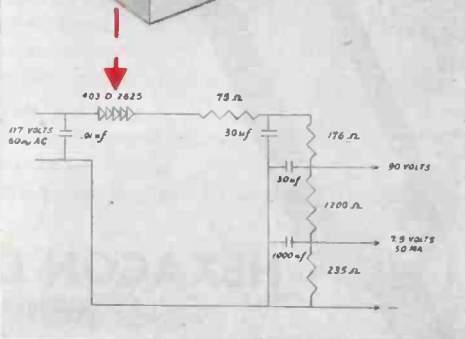
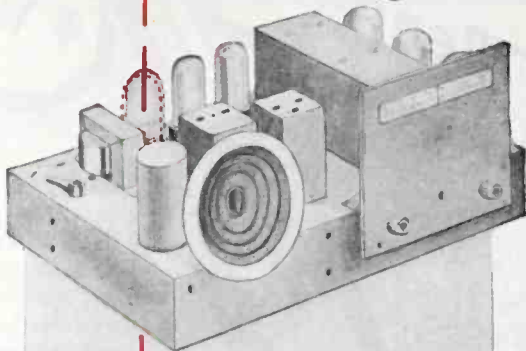

Circuit diagram of power supply for AC—DC—Battery portable radio receiver, using a 5-plate Federal rectifier unit in place of the conventional tube circuit.

Federal Telephone and Radio Corporation

Export Distributor:
 International Standard Electric Corporation.

Newark 1, New Jersey



..tagged for the big jobs!

**HEXA CON
SOLDERING
ELECTRIC
IRONS**

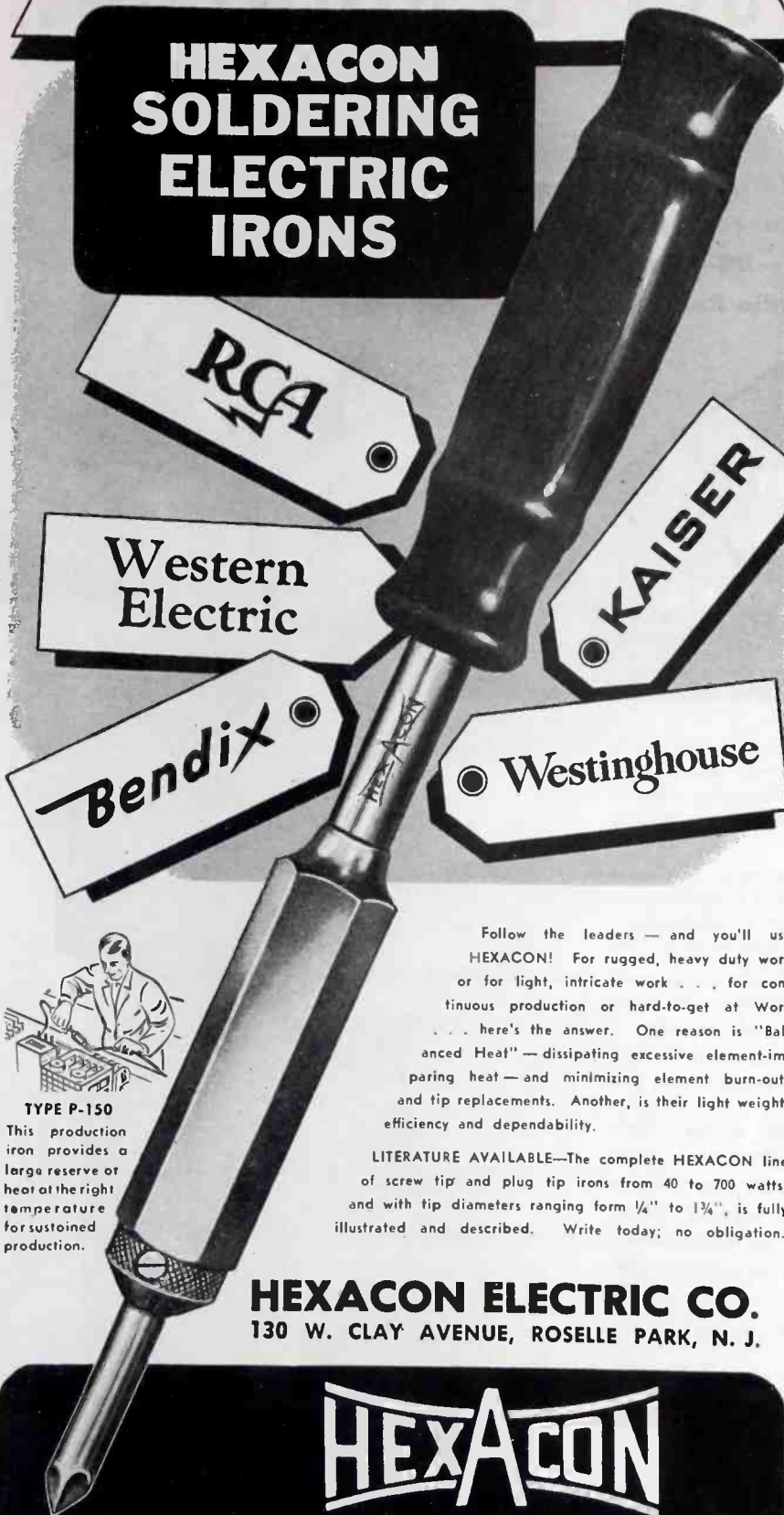

TYPE P-150
This production iron provides a large reserve of heat at the right temperature for sustained production.

Follow the leaders — and you'll use HEXACON! For rugged, heavy duty work or for light, intricate work . . . for continuous production or hard-to-get at Work . . . here's the answer. One reason is "Balanced Heat" — dissipating excessive element-imparting heat — and minimizing element burn-outs and tip replacements. Another, is their light weight, efficiency and dependability.

LITERATURE AVAILABLE—The complete HEXACON line of screw tip and plug tip irons from 40 to 700 watts, and with tip diameters ranging from 1/4" to 1 3/4", is fully illustrated and described. Write today; no obligation.

HEXA CON ELECTRIC CO.
130 W. CLAY AVENUE, ROSELLE PARK, N. J.

HEXA CON

HIGH-QUALITY, LONG-LASTING SOLDERING IRONS

a limiting cut-off of response at about 3.7 microns. They could provide sensitivities, or useful response as determined by their own noise levels, down to between 50×10^{-9} and 500×10^{-9} watts received radiant power. They had time constants on the order of one millisecond.

The cells were designed in the form of thermos flasks, with a lead sulfide layer in the vacuum, on the end of the inner bottle, and could be filled with carbon dioxide snow to reduce the noise power level in a ratio of from 30 to 50 to 1.

...

Load Lamp for Microwave Power Measurements

By J. E. BEGGS
*Research Laboratory
General Electric Company
Schenectady, N. Y.*

FOR INDICATING radio-frequency power levels, two similar incandescent lamps are usually employed. One is operated as the load circuit for the r-f generator under test; the other is used for comparison purposes and is operated on a d-c or 60-cycle supply, permitting the input power to be measured easily. The lamp with known input is adjusted until it is operating with a brilliance equivalent to that of the lamp operating from the r-f supply. An alternate method is to calibrate the lamp temperature or amount of illumination in terms of input wattage and thus require the use of only one lamp.

Conventional lamps, however, are of little use at the higher frequencies. The inductance of the leads makes it impossible to dissipate the calibrated energy in the lamp filament. Losses occur in the glass stem, further reducing the light output. Loss by radiation becomes an important factor. A high-vacuum lamp is needed since any gas in the lamp tends to become ionized by the high voltage that occurs along the filament. In addition, at frequencies where the length of the filament becomes longer than a quarter wavelength, the heating becomes non-

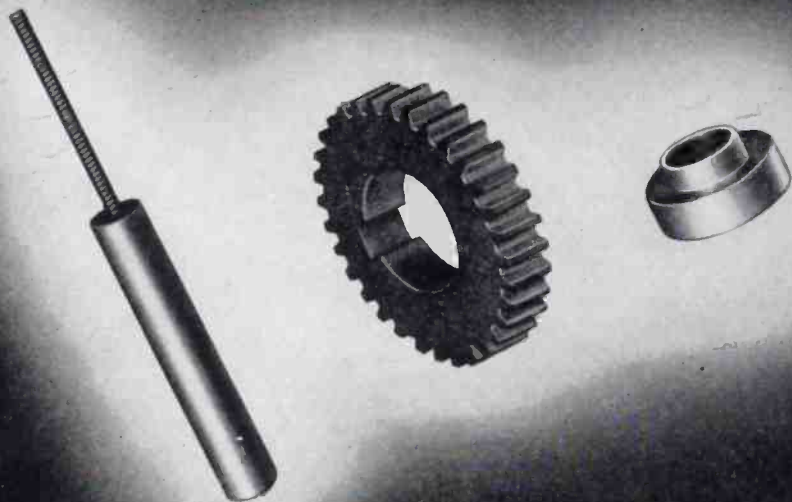

FROM A SINGLE SOURCE

Pictured above are a core, a gear and a bearing . . . three basic components that figure in the construction of nearly every type of electronic equipment. It is interesting to note that all of these components may be quickly and accurately manufactured by powder metallurgy . . . at a price low enough to easily offset the present increased prices of the other electronic components with which they are used.

ELECTRONIC & MECHANICAL POWDER METALLURGY

MICRO-FERROCART
PRODUCTS DIVISION

MAGUIRE INDUSTRIES, INCORPORATED • 375 FAIRFIELD AVENUE • STAMFORD, CONNECTICUT

uniform and the indicated power becomes erroneous.

Lamps Fit Concentric Line

To meet the demand for power indicating and measuring lamps that will overcome the above limitations, a series of concentric-line load lamps have been made in the three envelope

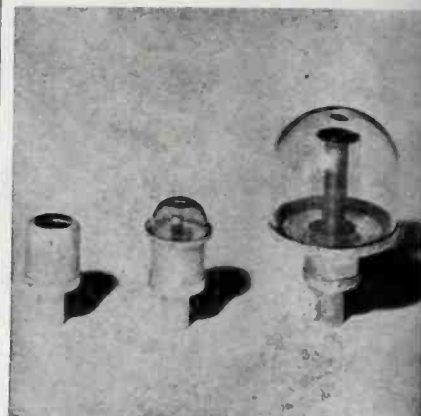

Fig. 1—Laboratory models of plug-in load lamps for concentric lines. Left to right, these have 5, 15, and 150-watt ratings

sizes shown in Fig. 1. The small envelope is used for lamps up to 5 watts rating, while the larger sizes are used for lamps rated at 15 and 150 watts respectively. All three have the same concentric-line input terminals as are used on G-E 2C39 triodes. They utilize silver-plated parts and low-loss iron sealing glass similar to that employed in light-house receiving tubes. Figure 2 is a

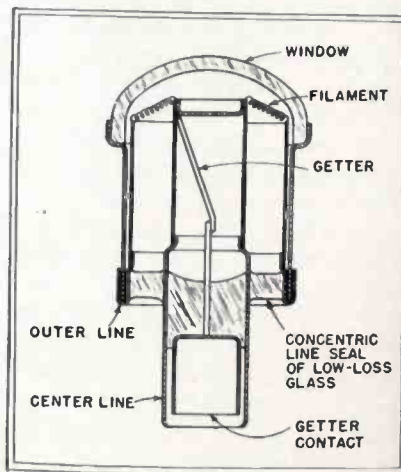

Fig. 2—Construction details of a concentric-line load lamp



Just a few of the thousands of Radio Parts manufactured by INSULINE

You will find the best in radio parts, stampings, chassis, cabinets, and auto-radio antennas in the new I.C.A. catalogs. Be sure to send for your copies as soon as possible.

Address Dept. E-2, Insuline Corporation of America, Insuline Building, Long Island City, N. Y.

insuline
CORPORATION OF AMERICA
 INSULINE BUILDING • LONG ISLAND CITY, N. Y.
 More than a quarter-century of Quality production.



PROBLEM

TO MOLD COUPLING
DISC FOR RADIO
TUNING SHAFT.
MUST SERVE
DOUBLE PURPOSE:

- ① HIGH-FREQUENCY INSULATION
- ② MECHANICAL JOINT

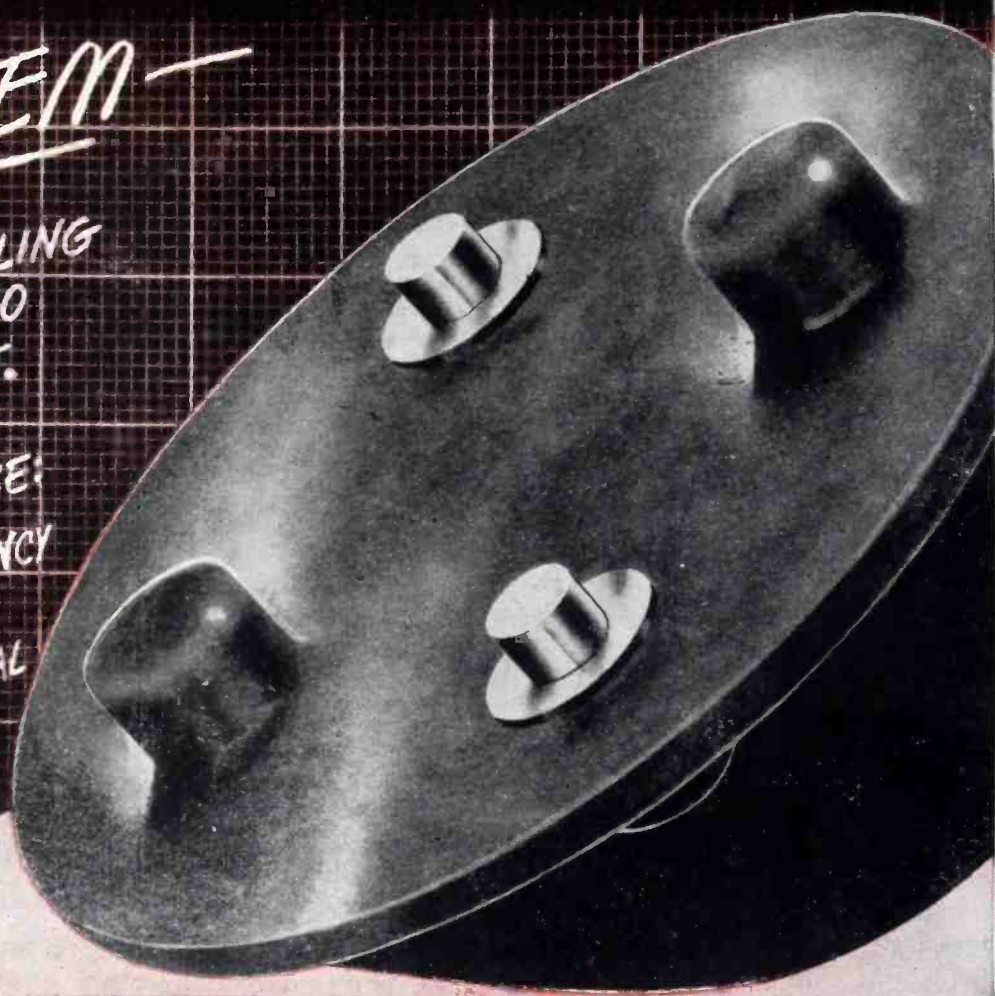

Another critical component molded in G-E mycalex

A radio component had to perform double duty. It had to have the mechanical strength to couple a tuning shaft. It had to act as a high-frequency insulating disc for dial and panel.

This problem was brought to No. 1 Plastics Avenue, and was solved by new techniques in molding G-E mycalex—compound of glass and powdered mica with a unique combination of properties.

G-E mycalex provides the required high-frequency insulation and mechanical strength. This material affords firm anchorage for two metal coupling inserts on each side. There is no electrical leakage. And the

coupling disc withstands high operating temperatures.

Find out more about applications for G-E mycalex. A great many are now possible, thanks to the development of new materials and new molding processes.

SEND FOR YOUR OWN COPY. A new bulletin on G-E mycalex is just off the press. A helpful design handbook, it contains complete and up-to-date information for solving your high-frequency insulation problems with G-E mycalex—a hard gray-colored, stonelike material with a unique combination of properties. New grades of G-E mycalex and new G-E mycalex molding techniques which make wider and more economical applications now possible. Fill in the coupon and mail it today.

GENERAL ELECTRIC

CD46-M10



PLASTICS DIVISIONS (P-10), GENERAL ELECTRIC COMPANY
1 Plastics Avenue, Pittsfield, Mass.

Please send me the new G-E Mycalex bulletin.

Name _____

Firm _____

Address _____

City _____ State _____

Built like a fine watch

yet

**RUGGED AS
OLD BIG BEN***

**TURNER MODEL 99
DYNAMIC**

Engineered for discriminating users who want utmost efficiency and dependability, the Turner Model 99 Dynamic is the most rugged microphone in the entire Turner line. Its precision-built dynamic circuit withstands the extremes of climate and temperature to reproduce sharp and clear under difficult operating conditions. Large city police departments, commercial broadcast studios, and leading manufacturers of communications equipment depend on Turner 99 for unfailing performance. Professional case is finished in rich gun metal and equipped with adjustable saddle for semi- or non-directional operation. Range 40-9,000 cycles. Level — 52DB. Available in all standard impedances and complete with 20 ft. removable cable set.

TURNER MODEL 999 BALANCED LINE DYNAMIC

The same professional appearance and rugged construction as Model 99 with voice coil and transformer leads insulated from ground and microphone case. Line is balanced to the ground. Especially recommended for critical applications. Range 40-9,000 cycles. Level — 52DB. In all standard impedances with removable 20 ft. balanced line, low capacity cable set.

Ask your dealer or write for full specifications

*The famous clock of London

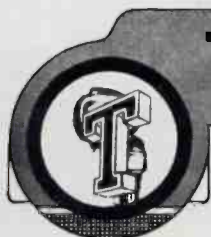

The TURNER Company

TURNER — Pioneers in the Communications Field

905 17th Street N.E., Cedar Rapids, Iowa

Licensed Under U. S. Patents of the American Telephone and Telegraph Company, and Western Electric Company, Incorporated.



TURNER
99 and 999

cross-section of one of the small lamps which shows the concentric line seal and the construction.

Multiple filaments are used which either are strung radially from the edge of the center post to the outer shell or are mounted so as to form filamentary elements of the outer portion of the line. This latter construction is employed in the largest sized lamps.

A getter, assembled inside the

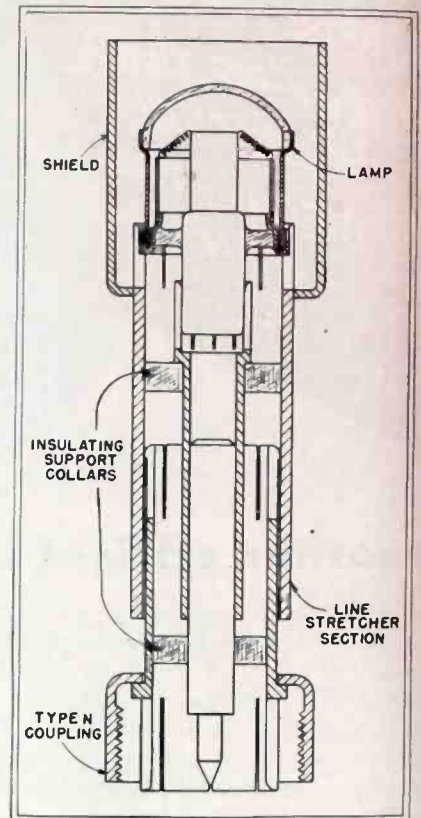

Fig. 3—Transmission-line stretcher section with load lamp plugged in

center line, is flashed after exhaust and keeps the lamp free of gas which otherwise might become ionized and impair its performance. This feature of high vacuum is of particular importance in measuring pulsed high-frequency power for in this case the peak voltage between the ends of the filament may rise as high as several hundred volts.

The lamps can be plugged into concentric-line circuits equipped with matching stubs, line stretchers, or

NOW.. all electrical tubing insulation requisites with this exclusive varnish impregnant —

TURBOTUF



DAMAGED!

Illustration shows cracking of conventional insulating varnishes under bending stress.



UNAFFECTED!

TURBOTUF withstands repeated 180° twisting and bending without trace of cracking

Non-cracking, non-peeling, non-chipping — whatever the angle of bend or twist!



A knock-out to usual insulation breakdown causes

NEW! TURBOTHERM Plastic Insulated Wire

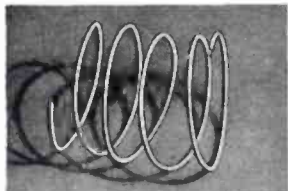

Specialized in Gauge Nos. 18 to 30 stranded and solid conductor construction.

Bend it, crease it, twist it—subject it to any turn or bend — and you'll see that something new has been added to this quality insulation tubing and sleeving. TURBOTUF — an exclusive new development, constituting a genuine advance in the art, eliminates the hazard of cracking insulation, with subsequent wiring failure or service interruption.

Now when you specify TURBOTUF, you get these additional TURBOTUF advantages:

increased, stabilized dielectric strength; higher temperature resistance; decreased moisture-absorption factor; unaffected by proximity to soldering heat; etc.

TURBO products include Flexible Varnished Tubing, Thermoplastic Insulated Wire known as Turbotherm, Extruded tubing, Saturated Sleeving, Fibrous Glass Tubing, Varnished Tapes and Cambrics, Mica and Mica Products. Write for free Specimen Board today.

WILLIAM BRAND & COMPANY

276 FOURTH AVE., NEW YORK 10, N. Y. • 325 W. HURON ST., CHICAGO 10, ILL.

REMEMBER.. IF IT'S *TURBO* ..IT SAFEGUARDS!.

THE *Individual* TOUCH



• Every magnet individually tested in loud speaker structure before shipping . . .

• Every magnet meets R. M. A. proposed standards . . .

• Every magnet meets Arnold's minimum passing standards of 4,500,000 BHmax.

Here's what the individual touch means. Thousands of the nine different sizes of speaker magnets shown at right are now being turned out daily. Each one is individually tested in a loud speaker structure before shipping. Each magnet is made to meet R. M. A. proposed standard for the industry. Each magnet must meet Arnold's own minimum passing standard of 4,500,000 BHmax for Alnico V material. Thus by careful attention to the important "individual touch" in volume production can Arnold promise you top quality in each individual magnet you select.

THE ARNOLD ENGINEERING COMPANY

147 EAST ONTARIO STREET, CHICAGO 11, ILLINOIS
Specialists in the Manufacture of ALNICO PERMANENT MAGNETS

other means of impedance matching. One such circuit is shown in Fig. 3. This type of circuit is inherently self-shielding. The open-ended metallic shield shown surrounding the lamp reduces radiation effects to a negligible value. This shield may also be used as the housing for a photoelectric cell or phototube which can be calibrated on d-c or 60-cycle power and used to indicate r-f power values.

Construction

The lamp becomes in effect a continued but sealed-off portion of the concentric-line circuit. The major factor limiting accuracy of calibration is the filament construction itself. This is minimized by using a multiplicity of short filaments of small-diameter wire so that the heating by radio-frequency energy will not be too unlike the heating by the d-c or 60-cycle calibrating energy as a result of skin effect. Small size wire is further desirable because filaments may be made as short as possible and still have the desired impedance.

The multiple filament assembly provides a symmetrical load at the end of the concentric line. The smaller, lower-powered lamps naturally use finer wire and shorter filaments than the higher-powered ones, and thus are useful at proportionately higher frequencies. The lamp sizes made to date have an upper frequency limit of 1,000 to 3,000 mc to which reliable measurements may be quickly and easily made. At higher frequencies they are useful for indicating relative or maximum levels when making circuit adjustments.

The author wishes to acknowledge suggestions and aid from E. L. Stempel and H. W. Jamieson.

• • •

Radar for Weather Man

A 450-POUND PIECE of radar gear, developed by Aircraft Radio Laboratories at Wright Field and originally used for blind bombing, is used in a radar weather reconnaissance plane

EVERY DE MORNAY-BUDD WAVE GUIDE is Electrically Tested, Calibrated and Tagged



Crystal Mount DB-453



Rotating Joint DB-446



90° Elbow (H Plane) DB-433



Preturizing Unit DB-452



Mitered Elbow (H Plane) DB-439



Uni-directional Broad Band Coupler DB-442

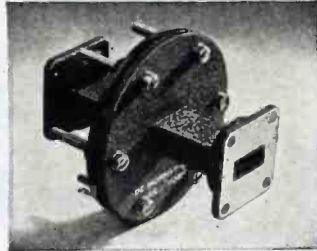

Bulkhead Flange DB-451



Uni-directional Narrow Band Coupler DB-440

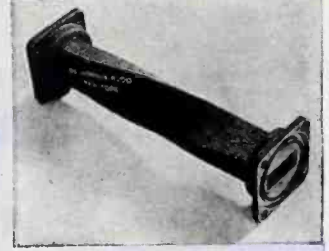

90° Twist DB-435

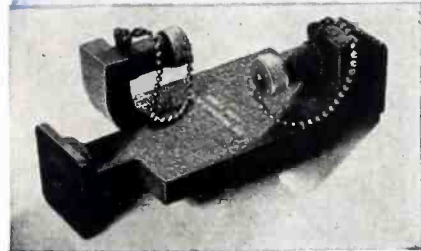

Bi-directional Narrow Band Coupler DB-441

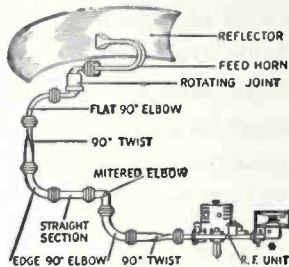

Typical wave guide assembly illustrating use of De Mornay-Budd components available from standard stocks.



RF Radar Assembly DB-412

When you use any De Mornay-Budd wave guide assembly, you know exactly how each component will function electrically. You avoid possible losses in operating efficiency through impedance mismatches, or breakdown and arcing caused by a high standing wave ratio. (See chart below.)

De Mornay-Budd wave guides are manufac-

tured from special precision tubing, and to the most stringent mechanical specifications. Rigid inspection and quality control insure optimum performance.

Complete laboratory service and consultations on micro-wave transmission line problems available.

The curve shows the manner in which the reflected power increases with an increase in the voltage standing wave ratio. The curve is calculated from the following equation:

$$\% \text{ Power Reflected} = \left(\frac{\left(\frac{V_{\max}}{V_{\min}} \right) - 1}{\left(\frac{V_{\max}}{V_{\min}} \right) + 1} \right)^2$$

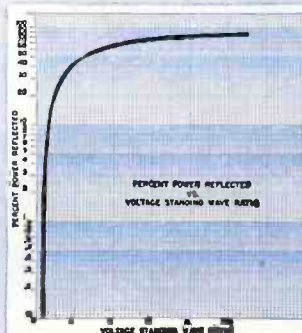

De Mornay-Budd, Inc., 475 Grand Concourse, New York 51, N. Y.

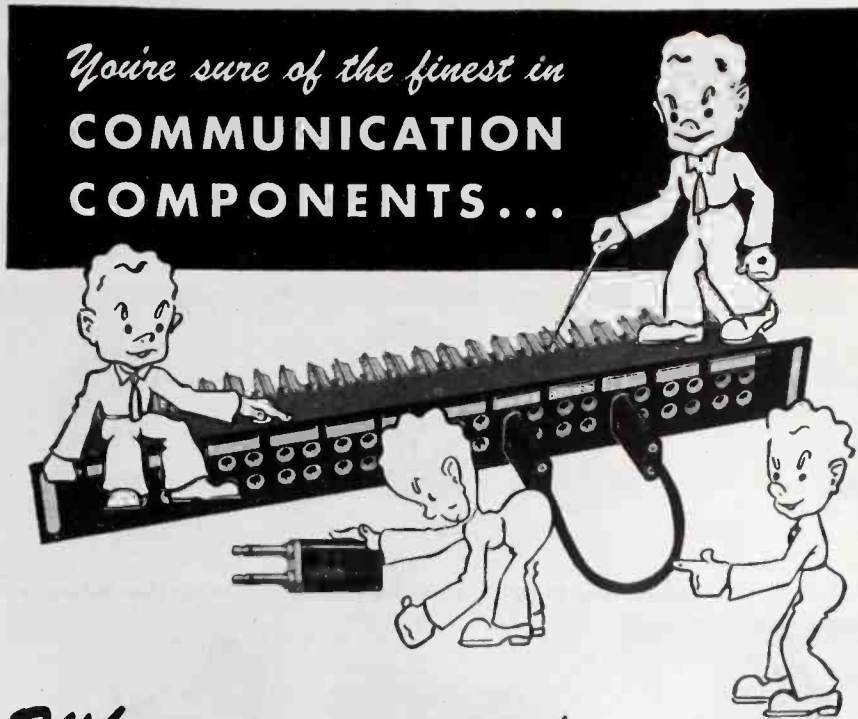

When you specify...

"ADC"

When you need electrical components of superior quality that will give *extra* years of dependable, trouble-free service under all operating conditions—then it will pay to specify **ADC**. Our components reflect experienced engineering, precision workmanship and rigid inspection—plus use of highest quality materials. These products are now available for immediate shipment.

ADC JACK PANELS are molded of phenolic plastic, reinforced with steel for rigidity. They have standard spacing for use with any double plug. Mounting holes fit all standard jacks.

ADC JACKS are approved box type, rigidly aligned. Non-aging springs retain tension. Silver alloy contacts riveted through blades. Special circuits can be furnished.

ADC PLUGS are all precision built, sturdy and safe. Designed for easy cord replacement. Interchangeable with similar standard plugs. **ADC** plugs meet all military requirements.

ADC PATCH CORDS are made from the finest stranded, tinned copper wire. Well insulated. Heavy overall braid increases durability. Equipped with regular **ADC** plugs.

SEND TODAY FOR CATALOG



Audio Development Co.
 2833 13th Ave. S., Minneapolis, Minn.

"Audio Develops the Finest"

to provide meteorological as well as navigational data.

The radar operator, by pushing a switch marked WEATHER, gets a picture of advance cloud formations on a special detecting screen. Tracking clouds instead of a target, the screen will indicate approaching storms at a distance of 100 to 200 miles.

Observations are taken every 30 minutes and reported back to the base, where the information is filtered and relayed to bombers and fighters flying near the storm area. Ground search radars have also been adapted to provide meteorological data, and are being used wherever possible in the Pacific.

Balloon-borne Reflectors

Another contribution to the science of meteorology emerging from the war is use of radar to obtain data on the velocity and direction of winds at various altitudes. The method, developed by the Signal Corps Engineering Laboratories, employs balloon-borne reflectors which can be tracked to their bursting point, as high as 100,000 feet above the earth's surface.

Before the war, balloons could not be tracked during darkness nor under weather conditions limiting visibility. The use of radar solved the problem since wind data can be obtained at heights in the stratosphere that were impossible with the visual-observation method previously used.

Two types of reflector were designed for use with military ground radar sets at frequencies ranging from 200 megacycles to 3,000 megacycles. For the 200-mc SCR-268, a dipole target was developed that consists of three short, foil-wrapped sticks joined in the center to form 60-degree angles in a horizontal plane. This reflector is carried aloft by a 100-gram hydrogen-filled balloon.

The other reflector, for use with microwave radar sets such as the SCR-584, is an 8-cornered triangular target, somewhat resembling a box kite. The reflective surface consists of paper-backed aluminum foil supported in triangular form by slender balsa sticks, each measuring 36 inches in length. This target requires a 350-gram balloon.

OIL HEATING — LIGHTING — RADIO — ELECTRON
• SPECIFICATIONS •

Write "Jefferson Electric Transformers"

INTO YOUR RADIO AND ELECTRONIC EQUIPMENT SPECIFICATIONS

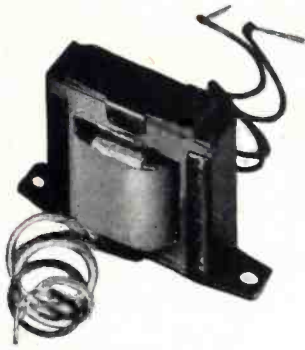

Economical, trouble-free transformer performance is important to every user. And the savings of unnecessary trips, delays and replacements are important to every manufacturer and dealer of radio, radar, television and electronic devices.

Jefferson Electric Transformers incorporate advancements in engineering design, with production methods and control to insure high uniform quality.

The superiority of Jefferson Transformers is based on such vital and fundamental quality characteristics as: improved steel to reduce electrical losses; advanced methods of using carefully selected iron for laminations followed by Jefferson's own process of annealing; improved compounds, materials and impregnation methods to provide greater resistance to moisture, extreme heat and cold.

In addition to these features, full control over all manufacture, assembly and inspection insures that every Jefferson Transformer is laboratory correct whether ordered in small lots or hundreds of thousands.

When making transformer replacements or considering new installations—select your transformers from the Jefferson Electric Line... JEFFERSON ELECTRIC COMPANY, Bellwood (Chicago Suburb), Illinois. *In Canada:* Canadian Jefferson Electric Co. Ltd., 384 Pape Avenue, Toronto, Ont.

TRANSFORMERS

THE ELECTRON ART

Tube Design	214
Vhf Receiver Measurements	214
Improved Capacitors	218
Cooling Photosensitive Cells	220
Detection of Heat	224
Pulse Communication	226
Wide-band Amplifiers	230
Midget Receiver Output Circuit.....	232
Ionosphere Studies	234
Stabilized Cavities	234

Tube Design

DESIGN OF A pentagrid converter with refinements to eliminate drift of frequency in electron-coupled oscillators was discussed by Dr. Grant Hector of National Union Radio Corp. at the March meeting, Chicago Section, IRE.

He stated that frequency drift was caused by changes in cathode current due to the return of primary electrons repelled by the first grid. Use of the second grid for the oscillator circuit and introduction of shield plates as a part of the inner screen combined with building tubes to exact dimensions provide an efficient absorption circuit for stray primary electrons preventing their return to the cathode. Tubes based on these principles would assist in design of drift-free superheterodyne receivers.

During the war, conventional

tubes were modified for operation at the higher frequencies. Interelectrode capacitances were reduced by r-f shielding of internal leads and extension of screen grids. Placing the signal grid close to the cathode as in the 6AK5 improves operation at high frequencies. High impedances permit only a narrow modulation band; wide band performance is possible when the internal impedance is low.

He also described the 3C36 uhf power triode. Operation between 500 and 1500 mc is obtained in grounded grid, resonant cavity, or concentric line circuits. Another tube having ten anodes and a magnetically focused, radial beam was designed for high-speed switching in such applications as time division multiplex.



Manufacture of tubes for two-way radio communication at the Svetlana Factory in Leningrad, Russia

Vhf Receiver Measurements

By HOWARD GORDON and LOUIS GEORGE
Washington, D. C.

ADVANCE OF COMMUNICATIONS into the very high frequencies has made accurate measurements of receiver radio-frequency selectivity characteristics increasingly difficult. Standard signal generators available for use at these frequencies, up to the present, have no provision for accurately discerning the sufficiently small increments in frequency required for these tests. In many cases, the receiver under test has a relatively sharp selectivity characteristic—in the order of kilocycles, while the signal generator tuning dial divisions represent frequency differences in the order of megacycles.

The technique to be described was found to be superior to the usual method of reading the signal gener-

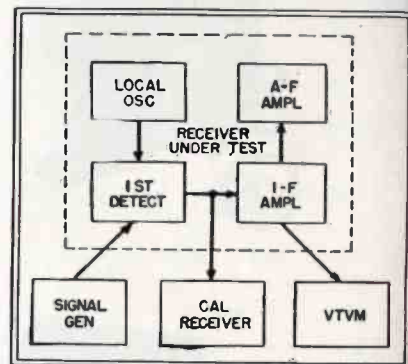

Fig. 1—Use of receiver calibrated at the intermediate frequency of the receiver under test

ator dial divisions for small frequency increments.

Receiver Selectivity

Referring to the block diagram shown in Fig. 1, the signal generator is resonated to the receiver frequency and the input level adjusted to produce some convenient rectified carrier voltage across the second detector load resistor. A calibrated communication receiver capable of tuning to the intermediate frequency is then coupled into the i-f amplifier of the receiver under test at some point where the signal level is of convenient amplitude. The calibrated receiver is then tuned to the intermediate frequency produced and the frequency and input level recorded.

Adopting the usual procedure, the signal generator is detuned in small

You have these Advantages
in selecting

OHMITE

RHEOSTATS • RESISTORS
TAP SWITCHES

Wide Variety of Types and Sizes!

Stock and Special Units!

Time Proved Performance!

Experienced Engineering Cooperation!

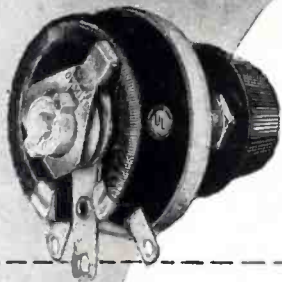

Close Control RHEOSTATS

10 Wattage Sizes from 25 to 1000 Watts, from 1 1/4" to 12" Diameter, with Standard or Special Features, with Uniform or Tapered Windings, in Stock or Special Resistances, in Single, Tandem, or Concentric Units.



Wire Wound RESISTORS

Widest Range of Types, Sizes and Ratings in Stock and Made-to-Order Units. Fixed, Adjustable or Tapped. General-Purpose, Non-Inductive or Precision. Standard or Special Windings. Variety of Terminals and Mountings. Also Hermetically Glass-Sealed Resistors.

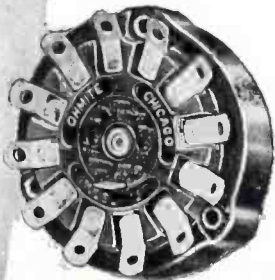

High Current TAP SWITCHES

Compact, enclosed, all-ceramic, rotary, non-shorting, multi-point Selector Switches. 5 Sizes rated at 10, 15, 25, 50 and 100 Amperes 150, 300 V.A.C. As few as 2 or as many as 12 taps. Sizes from 1 3/4" to 6" Diameter. Single or Tandem units. Also Open Type Tap Switches in "shorting" (commutator) and "non-shorting" units. In Stock or Made-to-Order.



Send for Catalog and
Engineering Manual No. 40

Write on company letterhead for valuable, helpful guide in the selection and application of rheostats, resistors, tap switches, chokes and attenuators.

The complete service available to you at Ohmite assures you of the *right* control units for your specific needs. From the many Ohmite stock types, you can often make a quick, economical selection. On special requirements, Ohmite experience with unusual applications can be of real help to you. What's more . . . you can always rely on the knowledge that Ohmite design and construction have long been proved in the most critical applications under severest operating conditions. Yes, there's good reason to prefer Ohmite Rheostats, Resistors, Tap Switches in your products or equipment.

OHMITE MANUFACTURING COMPANY
4818 FLOURNOY STREET • CHICAGO 44, U. S. A.

Be Right with

OHMITE

RHEOSTATS • RESISTORS
TAP SWITCHES

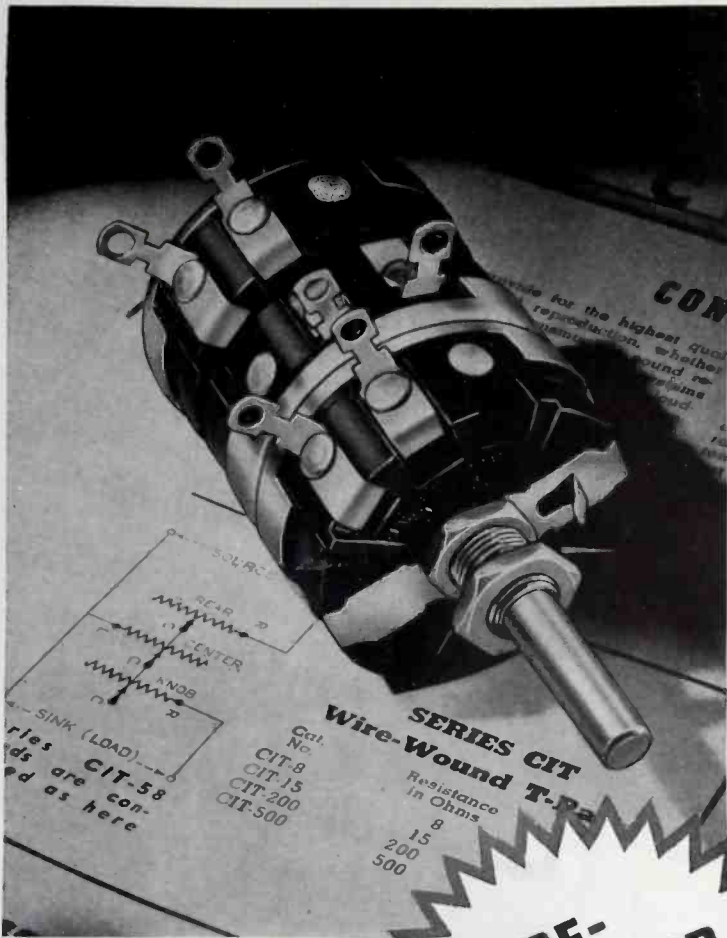

Series 58 rheostats and potentiometers, available in single, dual and triple section units (as here shown). Available with attached power switch.

★

Series 42 multiple-unit wire-wound controls, available in assemblies from 2 to 18 sections in tandem and operated by a single shaft.

★

Series 43 midget wire-wound controls in single, dual and triple section units. Available with attached power switch.

★

Series MH or the famous "Humdinger" extra-compact rheostat or potentiometer. Wire winding held in grooved fibre base. Body only 9/32" deep.

★

Widest selection of resistance values, taps, tapers, terminals, shafts, etc.

WIRE-WOUND Controls

★ You can entrust your wire-wound control problems to Clarostat, with complete confidence, because: (1) Clarostat has wire-winding experience second to none in the industry; (2) Clarostat has outstanding winding equipment designed, developed and built by its own engineers; (3) Clarostat spent two decades perfecting wire-wound rheostats and potentiometers; (4) Above all, Clarostat has an enviable reputation to maintain. Therefore, try Clarostat with those wire-wound control problems or requirements.

★ Write for CATALOG . . .

CLAROSTAT

Controls and Resistors

CLAROSTAT MFG. CO., Inc. · 285-7 N. 6th St., Brooklyn, N. Y.

frequency increments, at the same time increasing the input level to the value required to maintain the initial output voltage. At each point, the calibrated communication receiver is tuned to the intermediate frequency. The difference between any reading of the calibrated receiver and its initial tuning is equal to the difference between the corresponding and original signal generator frequency. This procedure is carried out above and below the receiver's resonant frequency as far as desired. The selectivity characteristic can then be plotted in terms of decibels below maximum response as shown in Fig. 2.

Calibrating a Signal Generator

When the local oscillator in the receiver under test is crystal controlled, as found in spot-frequency receivers, then by knowing the inter-

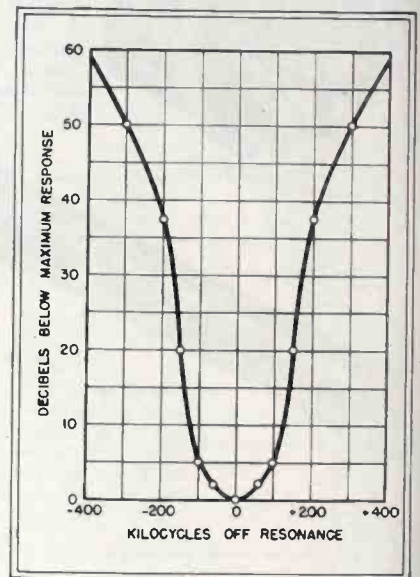
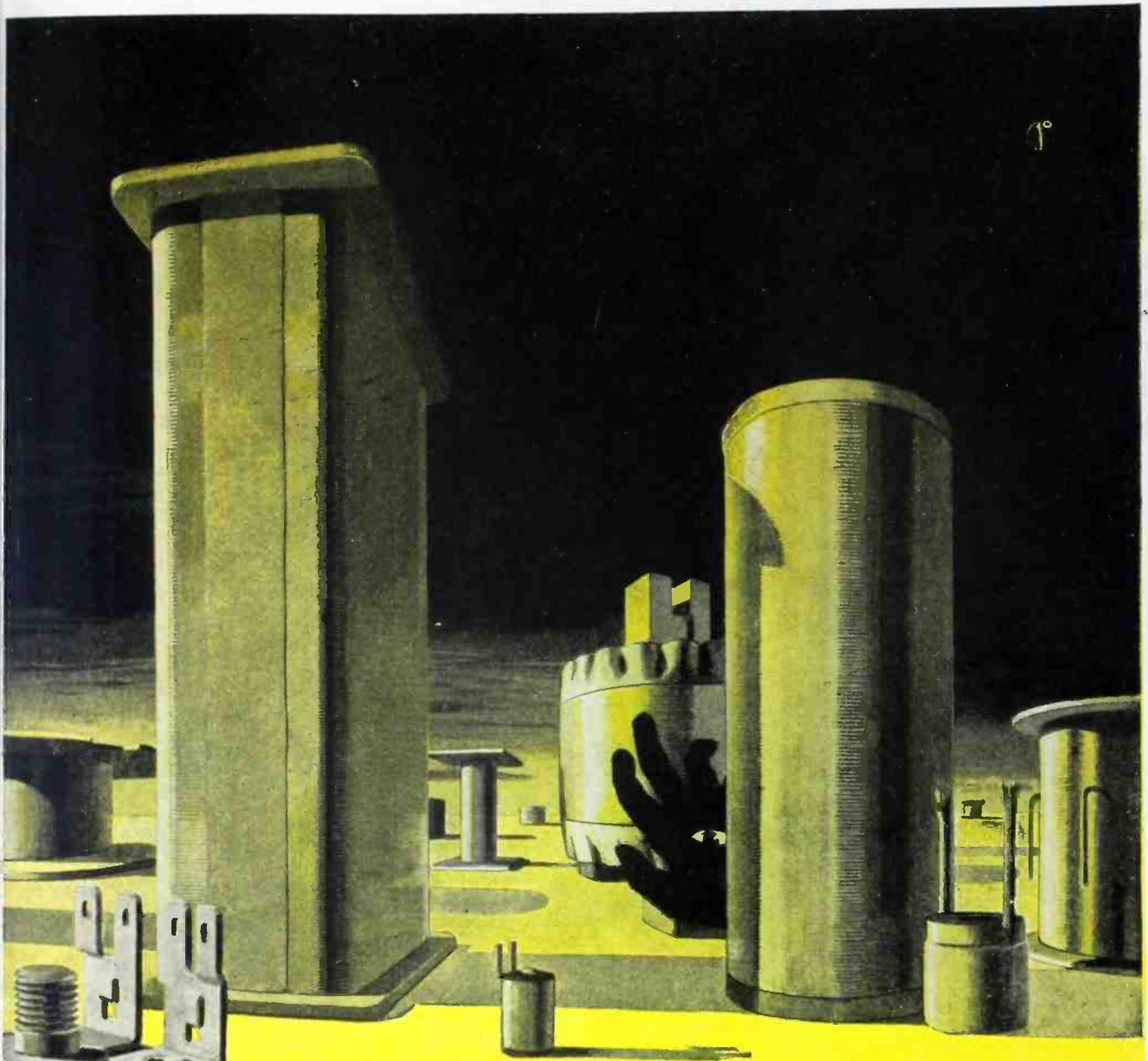

Fig. 2—Selectivity of vhf receiver measured between i-f stages by calibrated low-frequency receiver

mediate frequency at any time, the signal generator frequency can be calculated. This method can also be used to advantage in checking signal generator frequency calibration and thermal drift.

It should be noted that the above procedure assumes that the receiver local oscillator will not change in frequency during the test. For practical purposes this is probably a reasonable assumption and certainly true if the local oscillator is crystal controlled. Any oscillator drift is easily



THE BLACK HAND NEVER SLEEPS

**LUMARITH* (cellulose acetate) protects electrical equipment
against the black hand of electro-chemical corrosion**

UNLESS INSULATION is inert to electrolytic action, *current-carrying copper wire* and *moisture* can spell corrosion troubles for electrical equipment. That is why it is so important to play safe and insulate with LUMARITH (cellulose acetate) film. LUMARITH is chemically stable in the presence of moisture and current — releases no corrosion-producing acids.

Used as inner layer insulation, coil covers

and forms, laminates and wire wraps, spool liners, slot insulation and spacers, LUMARITH gives full protection to even the most delicate electrical equipment. Send for recently published booklet, "Celanese Synthetics for the Electrical Industry." Contains the technical information you will need. Celanese Plastics Corporation, a division of Celanese Corporation of America, 180 Madison Avenue, New York 16, N. Y.

*Reg. U. S. Pat. Off.

LUMARITH* A Celanese* Plastic

The Difference Between "We Think So" and "We KNOW So"

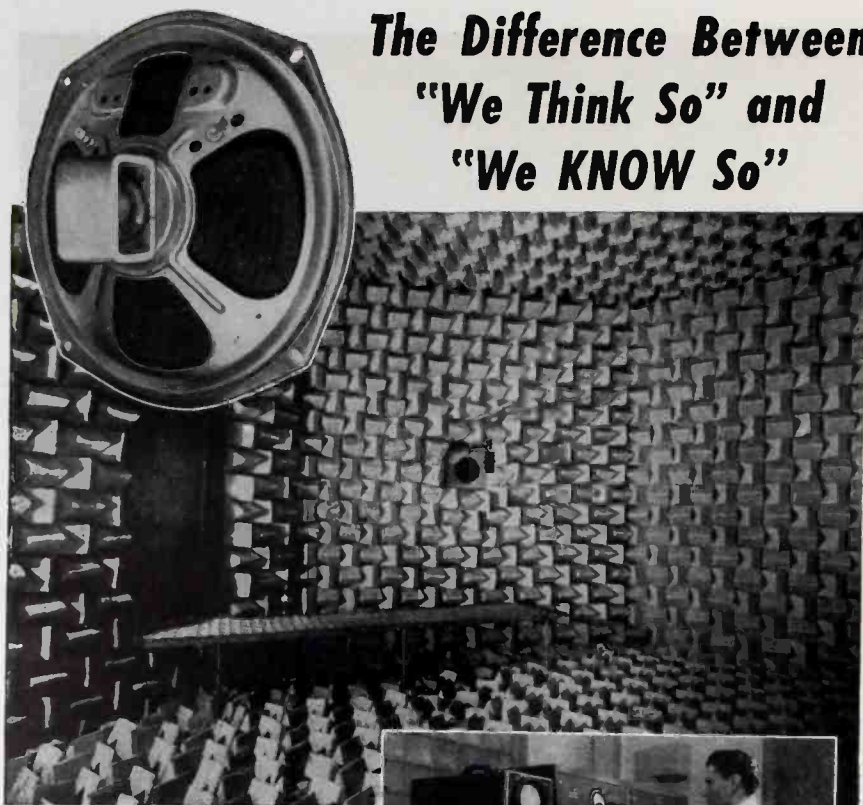

*Permoflux
Speakers*



**...are Engineered for Application in
this Stalactite Acoustical Chamber**

In this completely soundproof room, asymmetrical walls and carefully designed mass-interval baffles effectively reduce troublesome resonant harmonics and reflected sound to an insignificant value. Response curves are plotted which represent true performances so that Permoflux engineers can say "We Know So." Its use at Permoflux is characteristic of the many factors which make it possible to substantiate the fact that Permoflux Speakers provide the finest possible sound reproduction.

TRADE MARK
PERMOFLUX
PERMOFLUX CORPORATION
4900 WEST GRAND AVE., CHICAGO 39, ILL.



PIONEER MANUFACTURERS OF PERMANENT MAGNET DYNAMIC TRANSDUCERS

VHF RECEIVER

(continued)

measured, however, with the calibrated and comparatively low frequency receiver by beating a harmonic of its local oscillator with the high frequency oscillator fundamental and multiplying receiver tuning by the order of the harmonic used. It is not necessary to have any frequency calibration of the signal generator except insofar as this information may be needed for correcting attenuator settings. If the local oscillator frequency is known or can be accurately measured, that value and the intermediate frequency measured with the calibrated receiver will give the signal generator frequency.

An error in absolute value of frequency can be introduced when the auxiliary receiver is tuned to zero beat. The reason for this is that the beat frequency oscillator in the calibrated receiver may be tuned three or four kilocycles from the resonant frequency of the i-f amplifier. However, this difference is usually negligible at very high frequencies. When an available calibrated receiver will not tune to the intermediate frequency of the receiver under test, it may still be used by tuning so that a harmonic of its local oscillator beats with the i-f signal. All receiver frequency difference readings would then be multiplied by the order of the harmonic being used.

• • •

Improved Capacitors

CAPACITORS have been improved by using polystyrene dielectric or by adding stabilizing compounds to impregnants. In a paper presented before the April meeting of the American Chemical Society, D. A. McLean, L. Egerton, and C. C. Houtz, all of Bell Telephone Laboratories, reported an increase in life of 100 times for paper capacitors the chlorinated impregnants of which had been stabilized by the addition of such compounds as anthraquinone, which is used in manufacture of dyes. Addition of sulfur reduced electrical losses at high temperatures of capacitors that had tin-foil electrodes and chlorinated impregnants by forming a thin sulfide film between electrode and dielectric, preventing deteriorating interaction between the two.

Decreased dielectric absorption

INSIST ON PROOF BY TRIAL

before you buy an
Electronic Heater

This is how Scientific Electric proved the value of electronic heating to the Progressive Welding Company of Norwalk, Connecticut . . .

GR EAT improvements in product quality and remarkable savings in time and money are being achieved by means of electronic heating. Industrialists everywhere are now acclaiming its many advantages. But don't let your enthusiasm lead you to invest in an electronic heater before you have seen it perform the work you expect of it.

Another important point is this . . . in order to work at maximum efficiency and live up to its reputation for doing things better, faster and cheaper . . . electronic heating must be "tailored" to the job. That is why we never sell a Scientific Electric unit until it has been satisfactorily demonstrated. Regardless of the amount of time and effort required, our engineers will not release a single machine for sale until it has fulfilled every claim we make for it.

So here is a word of counsel . . . get plenty of advice before you buy. Consult with our recognized engineers who have pioneered in electronic heating since 1921 and, without obligation, they will demonstrate what electronic heating can do for you.

Scientific Electric

Division of

"S" CORRUGATED QUENCHED GAP COMPANY

19 MONROE ST.  GARFIELD, N. J.

Manufacturers of

Vacuum Tube and Spark Gap Converters Since 1921

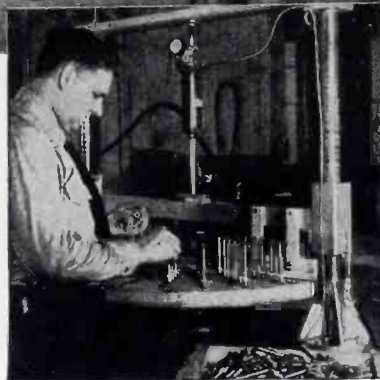

Above: This practical, automatic brazing turntable powered by a 40 KW. Scientific Electric heater speeded up production 700%—cut costs 87% and reduced rejects by 90%.

Left: Close-up of the finished two-piece tube assembly after being brazed by induction heating. Three complete brazing installations have been built for Progressive.



Write for a free copy of our handbook . . . *The ABC of Electronic Heating* which contains an easily understood explanation of this new heating method.

40 KW INDUCTION HEATER

Scientific Electric Electronic Heaters are made in these power sizes . . . and a range of frequencies up to 300 Megacycles depending upon power requirements.

3 KW	18 KW
5 KW	25 KW
7½ KW	40 KW
8 KW	60 KW
10 KW	80 KW
12½ KW	100 KW
15 KW	250 KW

**READY FOR
YOU!**
THE *New*
**POTTER &
BRUMFIELD**
Catalog

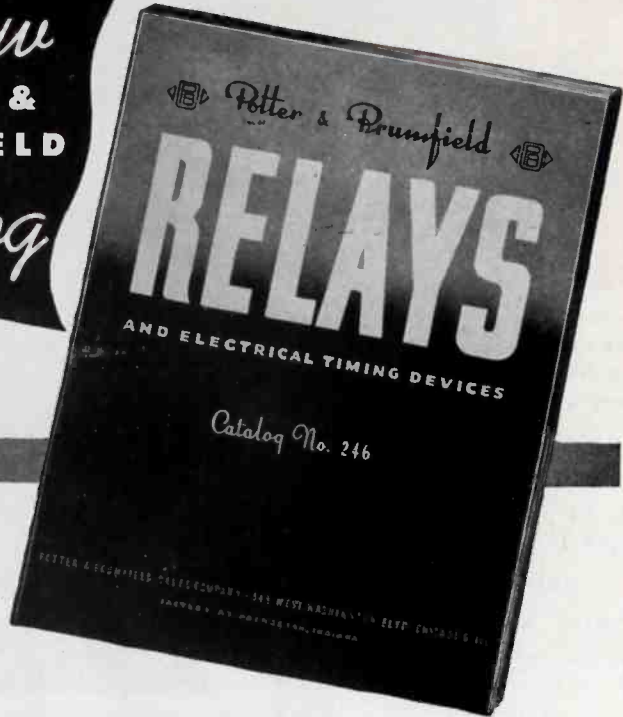

Complete and accurate information on relays and electrical timing devices

Twenty-four pages of useful, well illustrated, practical information presented clearly, with full data on applications, selection and capacities complete with each model. This catalog will provide you with a ready source of valuable information for aid in solving your relay and timer problems. It is a book you will enjoy using because it's well arranged with comprehensive data and illustrations.

**POTTER & BRUMFIELD SALES COMPANY
Chicago 6, Illinois**

Export: 2020 ENGINEERING BLDG., CHICAGO 6, U.S.A.

• **FACTORY AT PRINCETON, INDIANA**

POTTER & BRUMFIELD SALES COMPANY
549 WEST WASHINGTON BLVD., CHICAGO 6, ILL.
Please send me a copy of your new catalog.

Name _____ Title _____

Company _____

Address _____

City _____ State _____

over that of mica-insulated capacitors is obtained by using polystyrene. Although the temperature coefficient of polystyrene is inferior to that of mica, it is a better insulator. Where time constant of the capacitor circuit must remain fixed, resistances with a temperature coefficient of opposite sign can be used. The smaller dissipation of these capacitors suggests their use for filters in carrier systems. Characteristics and construction of polystyrene dielectric capacitors are described in the March issue of *Bell Laboratories Record* by J. R. Weeks.

Cooling Photosensitive Cells

By **EUGENE F. COLEMAN**
Hilger Engineering Co.
New York, N. Y.

PHOTOEMISSIVE and photoconductive cells, used increasingly in scientific and engineering applications, are operated at drastically reduced temperatures for increased sensitivity and lowered internal noise and dark-current. Convenient refrigerants are dry ice (-78 C) and liquid air (-183 C), at which temperatures the illumination threshold, or lowest illumination level at which useful electrical output signal can be derived from the cells, is depressed by typical amounts of 15 db and more.

Dark-Current

An early application of cooled photoemissive cells was to stellar photometry. Even when augmented by the light-gathering power of an astronomical telescope, the photoelectric current generated by the light of a faint star is so small that it would be obscured by dark-current and shot effect if usual techniques were used. Dark-current in a vacuum photoemissive cell is largely a matter of thermionic emission: The photocathode is an excellent thermionic emitter, and even at normal room temperatures shows some trace of this behavior despite the steep drop of the emission-temperature curve. By pushing the operating point still lower on this curve, through artificial cooling, difficulties due to dark-current can usually be reduced to a point of unimportance compared with other disturbances.

Photoconductive cells, the prototype of which was the selenium cell,



your **Signpost** in the sky

For the private pilot who wants the last word in complete air-ground radio, ARC now offers equipment built to exacting Army-Navy standards. Featuring designs tested through millions of hours of wartime operation, the ARC Type 11 Aircraft Communication System provides top quality performance under conditions of vibration, moisture, changes in altitude and temperature, and shocks from rough landings.

The Type 11 System combines a wide band (190 to 550 KC) LF Range Receiver and a VHF Transmitter with provision for 5-channel operation at the turn of a switch. The small separate control unit is located for convenience of operation and the major units remotely mounted. This avoids disturbance of normal weight and balance of the airplane and usually permits a short antenna lead-in. The complete antenna system consists of a single vertical rod 22 inches long and is furnished with the Type 11 System.

This compact ARC equipment is based on more than 18 years of design and development in the field of airborne radio and is a *quality* instrument for the operator who requires the basic essentials in aircraft communication and navigation facilities. Remember, when selecting the radio for your airplane, nothing but the best is good enough—specify ARC. For descriptive information and prices, write Aircraft Radio Corporation, Boonton, New Jersey.



ARC ADVANTAGES

Light Weight — Less than 15 pounds for the entire Type 11 System installed.

Reliable Reception — Unusual sensitivity and selectivity plus rugged construction. Noise-limiting circuitry insures clarity of reception and makes shielding unnecessary in some airplanes.

VHF Transmission — Crystal-controlled on 2 present channels, with provision for 5-channel operation to cover additional frequencies when allocated.

A Complete Installation — The Type 11 System is available complete with antenna, crystals, tubes, cables, microphone and headset — no extras to buy.

**AVAILABLE FOR DELIVERY
JULY 1, 1946**

AIRCRAFT RADIO CORPORATION

BOONTON, NEW JERSEY



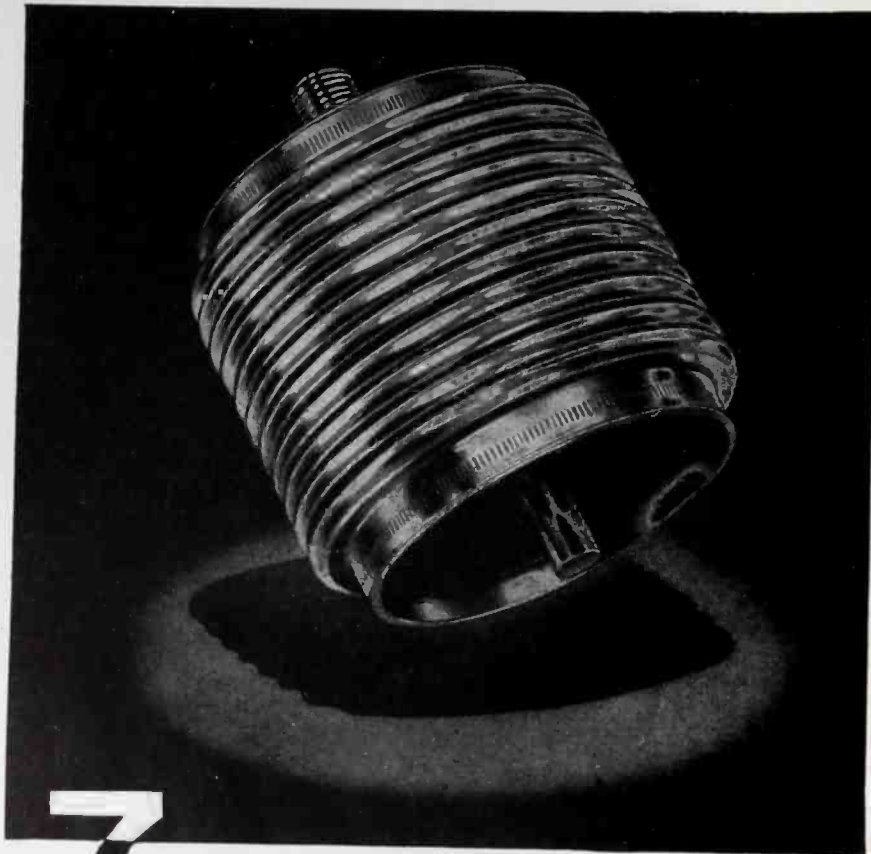

7 Facts You Should Know About C.M.H. Stainless Steel Bellows

IF you plan to use bellows for vacuum equipment, instruments, rotating shaft seals, or for other similar purposes in the electronic field, here are some essential features of C. M. H. Stainless Steel BELLOWS:

1. Corrosion resistant qualities of stainless steel enable wider application of C.M.H. BELLOWS.
2. High and low temperatures do not affect the operating efficiency.
3. Multiple ply construction gives even greater strength factors when needed.
4. Ferrous fittings, attached by Circular Seam Welding, assure permanent, leak-proof joints.
5. Uni-metal assemblies avoid the costly troubles encountered where bi-metal types are used.

6. Long lengths are standard production permitting economical use of C.M.H. Stainless Steel BELLOWS for many unusual types of applications.

7. Better delivery schedules are possible because C.M.H. BELLOWS are standard production products.

For complete information about C.M.H. Stainless Steel BELLOWS and about the many types of Flexible Metal Hose in the complete C.M.H. line, write us today.

Ask for Chicago Metal Hose Form SSB2 on which to submit your bellows requirements. It will save you time—assure more accurate transmittal of essential data.

Flexible Metal Hose for Every Industrial Use



CHICAGO METAL HOSE CORPORATION

MAYWOOD, ILLINOIS

Plants: Maywood and Elgin, Ill.

have more recently acquired importance in improved versions such as the Thalofide and the lead sulfide cells. Most cells of this class show marked improvement in their performance at the lowest light-input levels when cooled. Absolute sensitivity increases (a factor of 100 was reported for one cell), and at the same time absolute internal noise level drops, leading to a very substantial improvement in illumination threshold. These effects of cooling, and similar effects on the heat-operated class of radiation-sensitive cells were discussed at the March meeting of the Optical Society of America in Cleveland. (ED. NOTE: See following this discussion.)

Moisture Condensation

When a photosensitive cell is cooled, moisture condensation is a common source of trouble since, whether it occurs on the forward face of the cell itself or on a window placed ahead of it, the condensate can cause scattering and loss of radiation. The usual scheme for keeping windows clear consists of blowing warm dry air on the surface at which the condensation takes place. This method requires auxiliary equipment.

In a small portable optical instru-

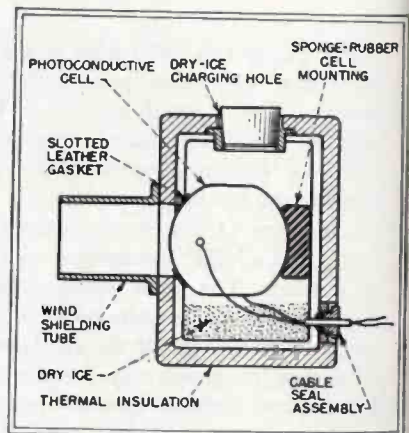
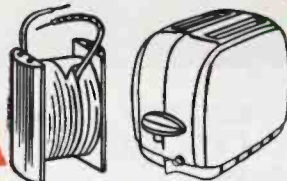
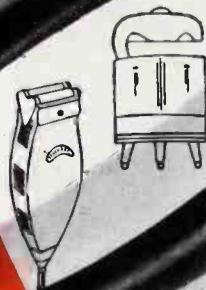

Fig. 1—Carbon dioxide gas escaping through radial slots in leather gasket prevents moisture from condensing on outside surface of cell window

ment developed by the author, which used a photoconductive cell cooled by dry ice, the standard method for preventing condensation was impracticable because the window, consisting of the front wall of the cell itself, carried the photoconductive

Heat Resistant
Remains Flexible
After Varnishing
and Baking



THE NEW

Fibron #5373

FLEXIBLE PLASTIC TUBING

Test Data

Tensile Strength.....3000 P.S.I.
Dielectric Strength (.020" wall) Wet.....1000 VPM
Dry.....1000 VPM
Life at 105° C.....2000 Hrs.
Chemical Resistance (room temperature)
50% Sulfuric Acid and 30% Sodium Hydroxide.....
Unaffected
Does not support combustion
Low Temperature Flexibility
I.V.I. Pinch test.....-40°C.
Bell test.....-30°C.
Heat Endurance (.166" ID tubing, .016" wall) ASTM-D350-43T): 7 days @ 125°C. - No crack when bent 180° around 1/4" mandrel - Retains flexibility when varnished and baked 22 hours at 260°F. - No flow or drip during 8 hours at 300°F.

This Irvington formulation provides new advantages, new cost-saving features, for many plastic tubing applications.

For example: Transformer leads of #5373 remain flexible even after varnishing and baking . . . Underwriters' Laboratories approved #5373 insulation on applications involving continuous operating temperatures up to 75 deg. C. and intermittent temperatures as high as 85 deg. C. In addition, #5373 possesses the excellent electrical, mechanical and chemical properties which distinguish all Fibron tubings.

Tubings of Fibron #5373 are available in all standard colors and sizes, and in heavy wall thicknesses—in 36" lengths, continuous coils, or cut pieces. For full details and generous samples, write Dept. 106, Irvington Varnish and Insulator Co., Irvington 11, New Jersey.



IRVINGTON

Varnish and Insulator Company
IRVINGTON 11, NEW JERSEY, U.S.A.



PRESSURIZED CAPACITORS

FIXED AND VARIABLE

JOHNSON PRESSURIZED CAPACITORS FEATURE — LOW POWER FACTOR, HIGH KVA RATINGS, SMALL SPACE REQUIREMENTS, WIDE RANGE OF SIZES.

JOHNSON designed and built Pressurized Capacitors are available in fixed, variable and fixed-variable combination models with RMS voltage ratings up to 30,000 volts unmodulated and maximum capacitance range of 125 to 10,000 mmf.

These JOHNSON capacitors are ideal for handling circulating currents of high power transmitters and are widely used in tank circuits and antenna networks, as coupling capacitors for shunt excited vertical radiators and in high frequency equipment.

Built to assure positive pressure sealing, JOHNSON Pressurized Capacitors in actual use, have given trouble-free service for many years. They are electrically and mechanically engineered to assure highest operating efficiency and to withstand normal pressure with a large factor of safety.

JOHNSON Pressurized Capacitors offer you maximum capacity with minimum size and cost.

The famous JOHNSON line includes, Variable Capacitors, Tube Sockets, Variable and Fixed Inductors, Insulators and Radio-Electronic Hardware. Directional Antenna Phasing and Coupling Equipment, F. M. Iso-Coupler, Tower Lighting Chokes and Filters, F. M. and A. M. Coaxial Lines and Accessories, Open-Wire Transmission Line Supports, R. F. Contactors and Switches.

Write Dept. D for Data Sheet 2P Describing JOHNSON Pressurized Capacitors.

JOHNSON

a famous name in Radio

E. F. JOHNSON CO. • WASECA • MINNESOTA

PHOTOCELLS

(continued)

layer on its inside surface and therefore could not be warmed.

A scheme was devised which effectively prevented moisture condensation, and also assured maximum cooling of the sensitive layer. It is shown in Fig. 1. The cell was mounted in a small thermally insulated sheet-metal box, with a resilient backing of sponge rubber pressing the cell gently forward against a hole in the front of the box. The hole was edged with a thin leather gasket, against which the front wall of the cell seated snugly.

After the gasket was cemented to the edge of the hole, a number of radial V-shaped grooves were cut in it. These grooves provided a leakage path out of the box for the carbon dioxide generated by the internal cooling charge of dry ice, and all other alternative leakage paths were blocked by sealing. Thus the exposed front surface of the cell was kept cooled and protected from atmospheric moisture by a constantly maintained layer of dry cold carbon dioxide.

The required volume of flowing gas is slight, since it needs to be only enough to make up diffusion and convection losses from the immediate region of the window. It can be further reduced, especially if the equipment is exposed to wind or drafts, by attaching an open-ended length of tubing to the box surrounding the window. This tube quickly becomes filled with dry gas, which slowly diffuses into the atmosphere from its open end. When provided with a polished internal surface (such a tube is often required for optical purposes) and with the present gas-leak scheme in action no condensation can occur on the polished surface even though the tube may be very cold.

• • •

Detection of Heat

THERMAL RADIATION detection was described recently at the Cleveland meeting of the Optical Society of America, March 7-9. Two new types of bolometers were described. One, made of Thermistor materials and developed at Bell Telephone Laboratories under Dr. J. A. Becker, consists of thin flakes of mixtures of nickel, manganese, and cobalt oxides (semiconductors) ranging from 0.1 to 1.0 millimeter wide, 1.0 to 5.0

RESEARCH

ENGINEERING

CODE

FABRICATION

FACSIMILE

VOICE

DEPENDABLE COMMUNICATION SYSTEMS

SYMBOL OF FIDELITY...

Fidelity to the world's most critical employer . . . the international press . . . Fidelity to the task of engineering, developing and fabricating communication equipment and systems to stand the gaff of delivering tens of thousands of words of vital, high speed, radio communications traffic each day as demanded by the press of the world.

Back of this Press Wireless Symbol of Fidelity is an organization of men who for years have been charged with the responsibility of planning, installing and operating the vast array of equipment which makes up the Press Wireless international radio press circuits.

The communication equipment, designed and fabricated to serve the international press, is now available to all who require dependable radio communication equipment and systems.



PRESS WIRELESS MANUFACTURING

C O R P O R A T I O N

Executive Offices: 38-01 35th AVENUE, LONG ISLAND CITY 1, NEW YORK

is this your
"guess" room?



What goes on beyond 8000 cycles? Do you know... or do you "suppose" and "hope"? No more of that! Now you can monitor your full FM range, clear through 15,000 cycles. The Altec Lansing Duplex is available for immediate delivery. See your dealer, or write to us.



the altec lansing model 604 duplex loudspeaker system

Both high and low frequency units are combined in one horn, reproducing the entire FM range, from 50 to 15,000 cycles, without intermodulation effects or distortion. In actual performance the Altec Lansing Loudspeaker System delivers up to 500% greater efficiency in monitoring, radio, public address and recording.

ALTEC
LANSING CORPORATION
1161 N. Vine St., Hollywood, Cal.
250 W. 57th St., N. Y. 19, N. Y.

"KEEP ADVANCING WITH ALTEC LANSING"

BOLOMETERS

(continued)

millimeters long, and 0.01 to 0.02 millimeters thick and has high sensitivity. The smaller ones have a response time constant of approximately three milliseconds. They can be produced in quantity.

Another form of bolometer, developed at Johns Hopkins University under direction of Professor Andrews, is made of columbium nitrate and operates close to this material's transition to the super-conducting state; that is, near 15 degrees absolute. This bolometer is mounted in a vacuum chamber in a cryostat containing liquid nitrogen and liquid hydrogen.

A highly sensitive and stable photo-conductive cell of thallos sulfide developed by R. J. Cashman of Northwestern University has its maximum response in the near infrared. This cell can be produced in quantity. Professor Cashman also developed a lead sulfide photoconductive cell that records signals varying in intensity at frequencies in the audible range without loss of sensitivity.

These improvements in radiometers, made under auspices of NDRC, have increased sensitivity of meters by more than an order of magnitude with comparable increase in speed of response. The new meters are sufficiently rugged to be portable and to operate under vibration and extremes of temperature.

• • •

Pulse Communication

Patented July 10, 1945, No. 2,379,899
Patented July 10, 1945, No. 2,379,900

By CLARENCE W. HANSELL
Radio Corp. of America

RELATIVE TIMING between pairs of pulses in this system is varied in accordance with the modulating signal, as illustrated in Fig. 1. The tech-

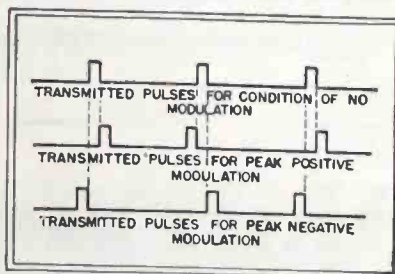

Fig. 1—Modulation causes pairs of pulses to move closer together or further apart

SUPREME

TESTING INSTRUMENTS

AFTER A GREAT
WAR RECORD

BACK AGAIN!

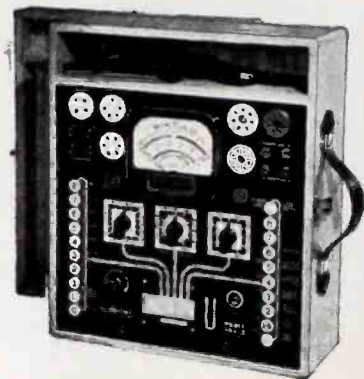

SUPREME MODEL 504-A TUBE AND SET TESTER

SUPREME regrets that war necessitated an interruption of service to its customers and friends. We are genuinely glad to get back into peacetime production—production for YOU.

MANY SUPREME INSTRUMENTS NOW AVAILABLE

—But not enough to take care of all orders at one time. Demand for accurate, dependable SUPREME equipment is such that we suggest you make arrangements for your needed new SUPREME models without delay.

SEE YOUR NEAREST SUPREME
JOBBER NOW!

SUPREME

SUPREME INSTRUMENTS CORP.
GREENWOOD, MISS.
U. S. A.

Export Department:
THE AMERICAN STEEL EXPORT CO., Inc.
374 Madison Ave., New York 17, N. Y.

HOW G-E LAMINATED PLASTICS CAN HELP IMPROVE YOUR PRODUCTS

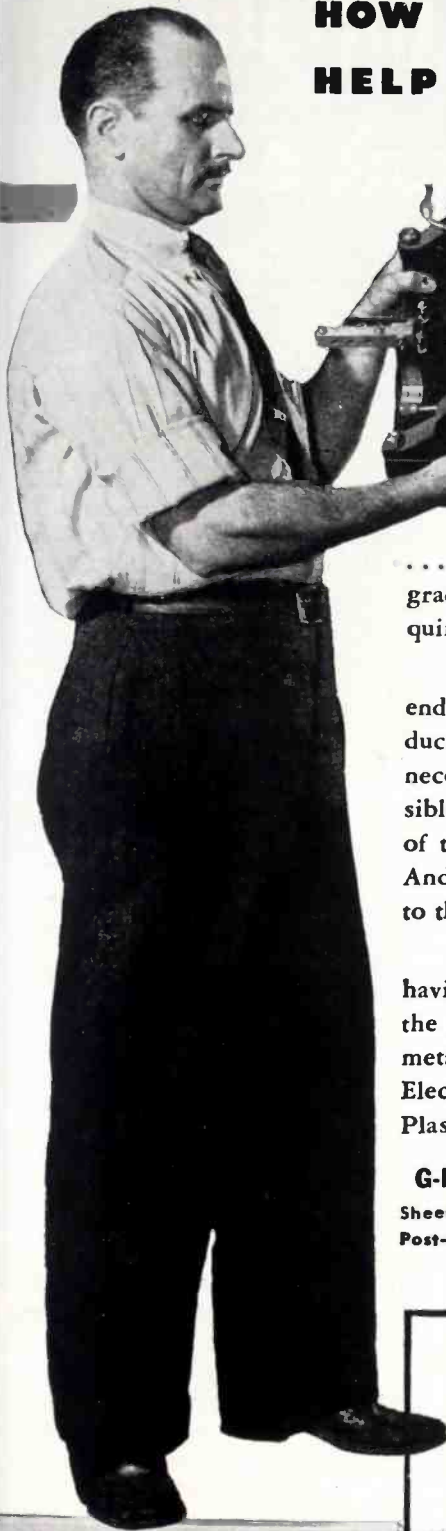

GRADES OF G-E TEXTOLITE ARE AVAILABLE FOR YOUR MOST EXACTING NEEDS

● Regardless what your product may be—whether it's of a purely electrical, mechanical, thermal, or chemical nature—or even a combination of all these elements

... the chances are good that after you have investigated the many grades of G-E Textolite you will find one that exactly fills your requirements ... one grade that will do your job better than the others.

That's why G-E Textolite grade 1848 was selected for the end and back plates of this water-cooled booster coil for an induction heater. This grade is strong mechanically and has the necessary electrical and heat properties; consequently, it makes possible a rugged support for the coil—successfully withstands the heat of the application, and properly insulates the radio frequencies. And the ease with which grade 1848 can be sawed to shape, adds to the reasons why it was chosen for the job.

With over 50 grades of G-E Textolite to select from, each having an individual combination of properties, why not investigate the possibility of incorporating the benefits of this versatile non-metallic material in your products. Write to Section S-3, General Electric Company, Plastics Divisions, Chemical Department, One Plastics Avenue, Pittsfield, Mass.

G-E TEXTOLITE IS SUPPLIED IN THE FOLLOWING FORMS

Sheets, Tubes and Rods
Post-formed Laminates

Fabricated Parts
Nameplates
Low-pressure Molded Parts

Molded Laminated Parts
Translucent Laminates

A high-frequency booster coil mounted in an induction heater which heat treats metal. The end and back plates of this coil are fabricated from G-E Textolite 1848. This grade is used for general mechanical uses—has excellent resistance to wear—is fairly good electrically, and punches and machines excellently. Is used for panels, bus bar supports, motor slot wedges, etc.

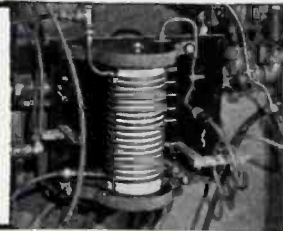

EVERYTHING IN

Plastics

GENERAL ELECTRIC

CD46-E3

GENERAL ELECTRIC PLASTICS FACTORIES ARE LOCATED IN
Fl. Wayne, Ind.
Taunton, Mass.

Meriden, Conn.
Lynn, Mass.

Scranton, Pa.
Pittsfield, Mass.

Crystalab SPECIALISTS IN SPECIAL CRYSTALS
TRADE MARK REG. U. S. PAT. OFF.

COMPLETE COVERAGE

WHATEVER YOUR PROBLEM

SPACE, TOLERANCE, HOLDER TYPE, FREQUENCY,

CALL IN CRYSTALAB FOR THE ANSWERS

WRITE TO DEPT. EL

CRYSTAL RESEARCH
 LABORATORIES INC.
 29 ALLYN ST., HARTFORD, 3, CONN., PHONE 7-3215

SPECIALIZED Skill in METAL

CABINETS

PANELS · CHASSIS · RACKS
with Beautiful Chrome Trim

The time-tested Par-Metal line presents superior features of styling, design, and construction. True to policy, Par-Metal continues to specialize in Electronic Housings exclusively... and is therefore able to offer leadership in value. Compare! Write for Catalogue:

PAR-METAL PRODUCTS CORPORATION
 32-62 — 49th STREET
 LONG ISLAND CITY 3, NEW YORK
 Export Dept.: Roche International Corp.
 13 East 40 Street, New York 16

nique has the advantage of providing constant average pulse rate. As in all pulse modulation methods, it also has the advantage that high peak powers can be transmitted and that signal to noise ratio is made high by rendering the receiver insensitive except during short intervals when a pulse is to be received. Although noise will affect the time of occurrence of the beginning and ending of the pulse, if the transmitted bandwidth, especially of the receiver portion of the network, is wide—as is necessary for preservation of the pulse shape—the noise impulses will be short and so introduce minimum time displacement of the pulse edges. The need for wide bandwidth restricts pulse modulation carrier frequencies to above 30 megacycles.

Modulator

A simple circuit containing basic elements of the pulse modulator for the transmitter is shown in Fig. 2.

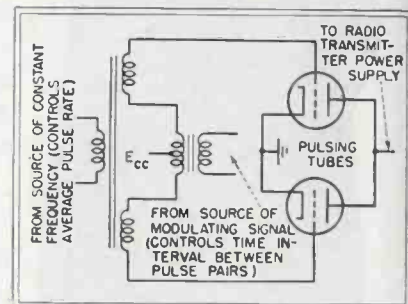

Fig. 2—When conduction switches from one tube to the other a reactance in the power supply delivers a pulse of current to the radio transmitter

In the unmodulated condition, one or the other of the pulsing tubes is conducting current except for a short interval when conduction is switched from one tube to the other by the constant frequency source. During switching neither tube conducts. By placing a large reactance in the output of the transmitter power supply, this moment of nonconduction causes a large current to be delivered to the radio transmitter thereby providing power for transmission of the pulse.

When modulation is applied the period during which one pulsing tube conducts is altered, but symmetrically, conduction ending as much later as it began earlier or ending earlier by as much as it began later. In other words, tube conduction is

a "TOOL BOX" in the palm of your hand



Molded Celanese*
Plastic Handles

HALLOWELL

SOCKET WRENCH KIT

with interchangeable sockets

HOLLOW HANDLES HOLD INTERCHANGEABLE UNITS

The "Hallowell" Speed Tool Kits were designed to simplify and improve the equipment necessary to those who use a variety of bits or wrenches. They have swivel bit-chucks for better leverage and for reaching difficult places. The tools contained in the Socket Screw Kits and Socket Wrench Kits (they each come in two sizes), were carefully selected to give the most convenience to their users. Tool bits are made of *high-grade alloy steel*; the handles of famous durable *Celanese* plastic*.

Socket Screw Kit #25, with swivel head drive, contains 8 tools: 6 hex bits: 1/16", 5/64", 3/32", 1/8", 5/32", 3/16"; #1 Phillips; 1 flat screw driver bit.

Socket Screw Kit #50, with swivel head drive, contains 9 tools: 6 hex bits: 1/8", 5/32", 3/16", 7/32", 1/4", 5/16"; #2 and #3 Phillips; 1 flat screw driver bit.

Socket Wrench Kit #75 contains: 2 (6 point hexagon) sockets with openings: 1/4" and 5/16", 3 (12 point hexagon) sockets with openings: 11/32", 3/8" and 7/16". With 1/4" square drive.

Socket Wrench Kit #100 contains: 6 (12 point hexagon) sockets with openings: 3/8", 7/16", 1/2", 9/16", 5/8", 3/4". With 3/8" square drive.

Obtainable at Suppliers throughout the country. If your Supplier does not carry these kits, send his name to us, along with yours, and you will be taken care of promptly.



HALLOWELL

SOCKET SCREW KIT

with interchangeable bits



AUTO KIT

Auto Kits (in two sizes) . . . contain small tools most necessary for auto maintenance. Phillips Bits, Clutch Head Bits, Flat Screw Drivers and Tapered Reamer.

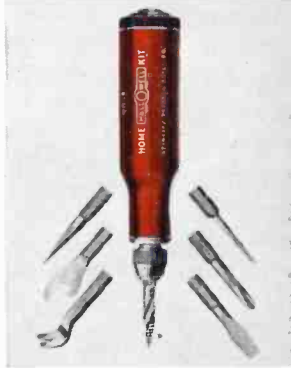

HOME KIT

Home Kit . . . contains flat screw drivers (1/16" and 1/4" wide), Phillips screw driver, square tapered reamer, gimlet, tack puller and bottle cap opener.

*Reg. U.S. Pat. Off.

Kits: Patents Pending

OVER 43 YEARS IN BUSINESS

STANDARD PRESSED STEEL CO.

JENKINTOWN, PENNA., BOX 596 BRANCHES: BOSTON · CHICAGO · DETROIT · INDIANAPOLIS · ST. LOUIS · SAN FRANCISCO

...100% Guaranteed



Marion Glass-to-Metal Truly Hermetically Sealed Electrical Indicating Instruments are 100% guaranteed for six months. After this period we will replace any 2½" or 3½" type, ranging from 200 microamperes upward, for a flat fee of \$1.50, regardless of whether the instrument has been overloaded, burned out, or in any way mistreated, provided the seal has not been broken. We will replace, for a flat fee of \$2.50, any 2½" or 3½" instrument, with sensitivity greater than 200 microamperes, under similar circumstances.

An important blanket guarantee . . .

For the user of electrical indicating instruments, this guarantee is highly significant. It precludes the need for him to maintain his own repair department, and it minimizes the correspondence and red tape that formerly enmeshed most replacement transactions. Moreover, he is assured of receiving his replacement within a reasonably short period at a saving of considerable time and money. It is our faith in the quality and performance of Marion "hermetics" that prompts us to make this guarantee which is offered to customers in all parts of the world. You can buy and use them with confidence.

Marion Glass-to-Metal Truly Hermetically Sealed 2½" and 3½" Electrical Indicating Instruments

Note: Marion "hermetics" cost no more than most standard unsealed instruments—and they are positively interchangeable. Write for the new Marion Catalog.



MARION ELECTRICAL INSTRUMENT CO.
MANCHESTER, NEW HAMPSHIRE

EXPORT DIVISION - 458 BROADWAY - NEW YORK 13, N. Y., U. S. A. - CABLES: MORHANEX

IN CANADA: THE ASTRAL ELECTRIC COMPANY, SCARBORO BLUFFS, ONTARIO

symmetrically length modulated; one tube conducting for a shorter period as the other conducts for a longer period, the total period remaining constant. Differentiating action of the reactance in the transmitter power supply converts this change in switching time into the type modulation shown in Fig. 1.

To recover the intelligence from the pulse envelope after reception and detection, the circuit of Fig. 3 is used. The two tubes are in conventional blocking oscillators coupled to one another through their common resistor. Because of this coupling the two oscillators operate in phase opposition. Both circuits are adjusted to have the same natural period as the constant fre-

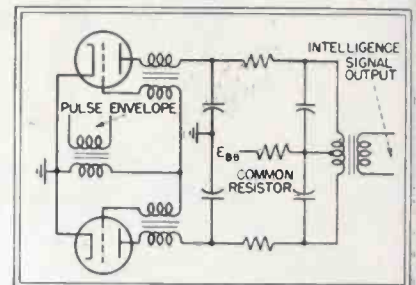

Fig. 3—Detected pulse envelope controls switching of blocking oscillators in receiver to recover modulating signal

quency which controls the transmitter pulsing tubes. The time-modulated pulse pairs synchronize the switching from tube to tube thereby converting time displacement to pulse length modulation, which is filtered to recover the original intelligence.

If it is desired to transmit 15,000 pulses per second, the constant frequency that controls the transmitter and the natural frequencies of the blocking oscillators in the receiver are 7,500 cps. Under this condition voice signals from 150 to 3,000 cps, multiplex-telegraph, or facsimile can be used for modulation.

The amount of energy fed from the receiver to the blocking oscillators controls selectivity of the system. The degree of coupling between oscillators determines sensitivity.

• • •

Wide-band Amplifiers

LOW-FREQUENCY COMPENSATION of wide band amplifiers was suggested

CA WQXR CBS MBS OIC NEWS REELS TELEV. NBC ABC BBC CBC WHN
 WB WNYC ↓ ↓ ↓ ↓ ↓ ↓ ↓ ↓ ↓ ↓
 WNEW ↓

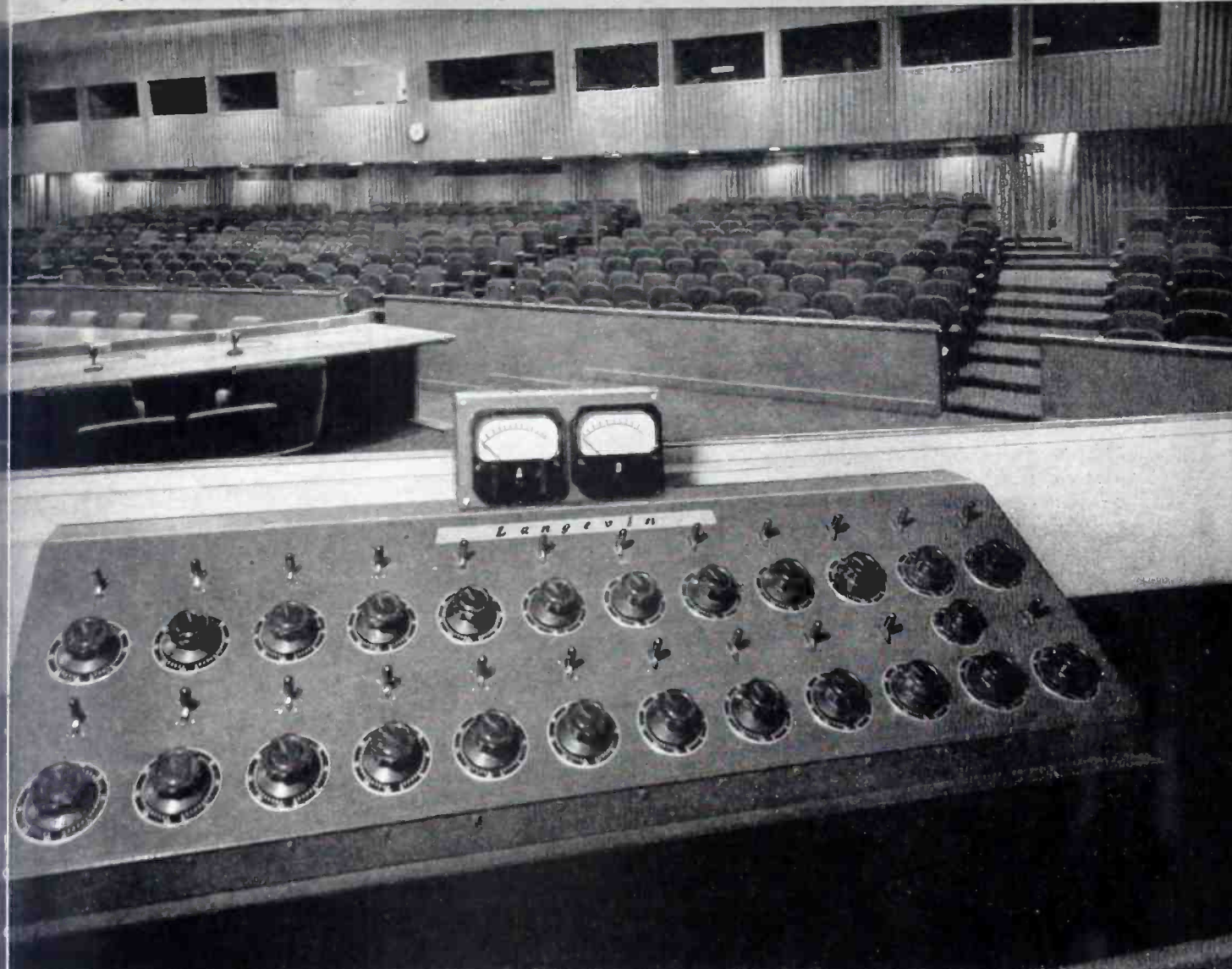

Security Council Chamber, United Nations, Hunter College, New York. Robert Glenn, Inc., Builder, N.Y.C.

As The World Listens...

... to the United Nations Security Council in session, whether by radio, by television, or by newsreel, it is listening through the latest in audio facilities. The entire system in the Security Council Chamber, which feeds all services, is Langevin engineered, designed and manufactured, with the exception of the microphones which are Western Electric.

The Langevin Company
 INCORPORATED
 SOUND REINFORCEMENT AND REPRODUCTION ENGINEERING

NEW YORK, 37 W. 65 St., 23 • SAN FRANCISCO, 1050 Howard St., 3 • LOS ANGELES, 1000 N. Seward St., 28

TELEFAX—WORLD'S FASTEST, MOST ACCURATE COMMUNICATIONS...

BY RADIO TO HOMES—Finch self-synchronizing Telefax (Facsimile Equipment) enables broadcasters to transmit and homes to receive facsimile copies of anything that can be printed or written on paper... a complete Air Press Service of news, photos, market reports, box scores, printed and illustrated advertising... by radio! The present rate of speed is 2760 square inches of text matter per hour—equal to about 30,000 words. Reservations for equipment are now being made... make yours NOW, to be first in your territory!



BY RADIO OR WIRE TO EVERYWHERE. With Telefax (Finch Facsimile) written or printed messages can be exchanged as by some "instant courier" between any two points, mobile or fixed, far or near, which can be connected by electric circuits. The messages as received are exact *facsimiles* of the original—complete in every detail of text or illustrations, and entirely free of errors in transmission. The rate of speed in words per minute far exceeds old-style telegraphic printing, and 100% accuracy is assured.

TELEFAX (FINCH FACSIMILE) gives you a new, faster, more flexible and completely accurate means of communication, with higher speeds, greater economy and total freedom from mistakes in transmission. It opens up rich new fields for broadcasting, will assuredly replace with better service hitherto accepted methods of transmitting intelligence by wire. Write for folder giving full information, and list of principal Finch patents covering all important phases of Facsimile. Finch Telecommunications, Inc., 10 East 40th Street, New York 16, N. Y.

 self-synchronizing
finch facsimile

by Lothar Bruck and Otto Tuxen both of Berlin, Germany (U.S. patent 2,289,752, issued July 14, 1942.). Essentially the method is to arrange the phase shifts of the amplifier coupling network and a feedback network so that, over the range to be compensated, the circuit is regenerative. The frequency range over which regeneration takes place must be sufficiently narrow so that spurious frequencies generated by intermodulation and harmonic distortion resulting from the increased non-linearity of the amplifier within the range of regeneration do not lie within that range. Suggested circuits indicate that the technique is applicable to transformer-coupled output stages to loudspeakers. One limit of the regenerative range is controlled by the normal cutoff of the amplifier coupling networks; the other limit is controlled by the losses within the coupling and feedback networks despite the phase shift. The technique is more useful for low-frequency compensation than for high-frequency compensation.

• • •

ROYALTY-FREE LICENSE to manufacture and market power-line carrier apparatus covered by patents of American Telephone and Telegraph has been announced by K. S. McHugh, vice-president of AT & T in a letter to W. C. Henry, president of the United States Independent Telephone Association. Purpose of this licensing is to extend rural telephone service.

• • •

Midget Receiver Output Circuit

Patented Aug. 28, 1945, No. 2,383,867

By WINFIELD R. KOCH
Radio Corp. of America

TO OBTAIN full power from the output stage of midget receivers where it is not economical to bypass the cathode bias resistor with a large capacitor, positive feedback from the speaker voice coil can be used. The circuit, as it would be applied to a pentode output stage, is shown in the accompanying illustration. The cathode resistor is chosen to provide the proper tube bias. Preferably the impedance of the voice coil should be chosen so that its voltage will just balance the signal loss in the

BH EXTRA FLEXIBLE FIBERGLAS SLEEVING



MAKE THIS

FLAME TEST



Hold a match under a piece of BH Extra Flexible Fiberglass Sleeving. The flame does not burn, char or otherwise affect it. And temperatures much higher than usually encountered electrically are just as readily resisted by the inorganic Fiberglass!

BH EXTRA FLEXIBLE FIBERGLAS SLEEVING

2 WAYS BETTER

NON-FRAYING • NON-STIFFENING

FEW electrical insulations can double in brass as heat insulations. Yet so effectively heat resistant is BH Extra Flexible Fiberglass Sleeving that actual service records show it refuses to burn even in direct contact with heat units. The reason—both yarns and impregnation are non-inflammable!

A special gum base and dye applied by an exclusive BH process is responsible for many more features. It permanently prevents fraying, stiffening and abrasive wear. The sleeving is unusually flexible and takes the roughest handling without fraying. It does not harden and crack with age—lasts indefinitely without deterioration. It is also non-crystallizing at low temperatures.

Fiberglass is non-absorbent and unaffected by moisture, oil or grease—qualities ideally suited to appliance manufacture for instance. And it has high dielectric and tensile strength.

“Punishment” tests prove that BH Extra Flexible Fiberglass Sleeving is the most logical insulation for a host of tough jobs. Why not see for yourself? It's available in all standard colors and all sizes from No. 20 to $\frac{1}{8}$ ", inclusive. Write for samples today and compare!

**BH SPECIAL TREATED FIBERGLAS SLEEVING
UNAFFECTED BY HEAT UP TO 1200°F!**

This is a high quality sleeving that will not fray when cut and withstands heat up to 1200°F. Yet no saturant is used in the exclusive BH process! Flexible as string, too. Made in natural color only—all standard sizes. Try it!



ALSO SLOW-BURNING IMPREGNATED MAGNETO TUBING • SLOW-BURNING FLEXIBLE VARNISHED TUBING • SATURATED AND NON-SATURATED SLEEVING

BENTLEY, HARRIS MANUFACTURING CO.

Dept. E, Conshohocken, Penna.

Case Histories from the RICHARDSON files

PRODUCT DURABILITY

Problem: To improve life and service of gibs and retainer plates on high speed sanders. Parts must be able to withstand considerable abuse.

Solution: The problem was solved by the use of plastics. From the big family of INSUROK Precision Plastics, Richardson Plastics selected Laminated INSUROK, grade CG. For this material has a high natural graphitic content and is especially suited for parts subject to friction and hard usage.

Richardson, for many years, has been helping to solve the plastics problems of industry. Our experience is at your service. You will find it a diversified service, with skilled plasticians ready to help you mold or laminate whatever grade and type of INSUROK is best for your application.

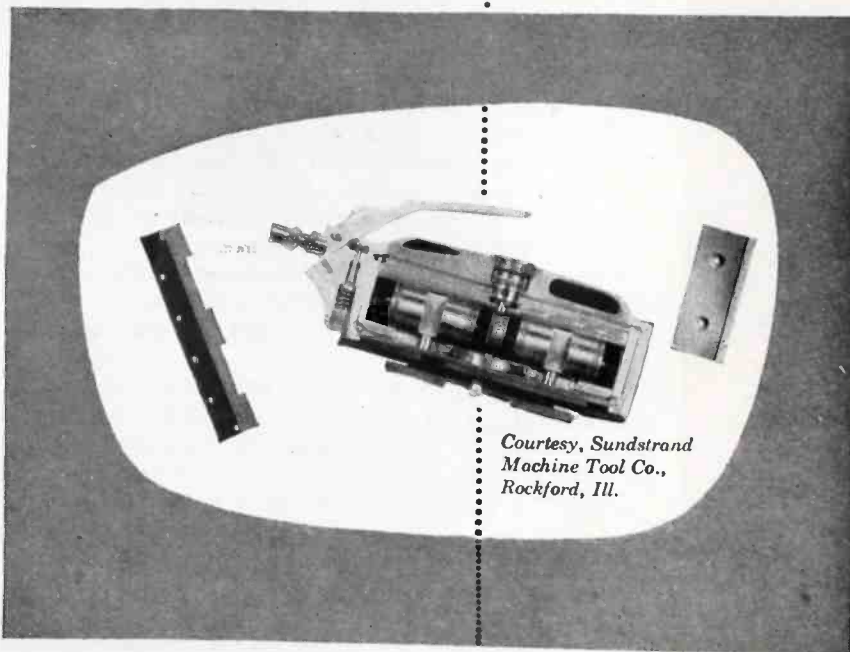

Courtesy, Sundstrand Machine Tool Co., Rockford, Ill.

INSUROK Precision Plastics

The RICHARDSON COMPANY

LOCKLAND, CINCINNATI 15, OHIO FOUNDED 1858 Sales Headquarters: MELROSE PARK, ILL.

Sales Offices: NEW YORK 6 • CLEVELAND 15 • DETROIT 2

Factories: MELROSE PARK, ILL. NEW BRUNSWICK, N. J. INDIANAPOLIS, IND.

MIDGET RECEIVER

(continued)

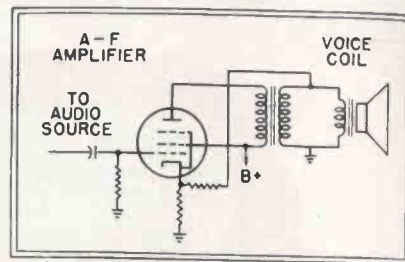

Positive voltage feed-back from the voice coil compensates for the loss in amplifier gain due to cathode resistor

cathode resistor. If this design cannot be followed and the voice-coil voltage is too high, a resistor can be inserted in series with the voice-coil circuit.

• • •

Ionosphere Studies

ASTRONOMERS have known for over a decade that radio waves penetrated the ionosphere. They have measured the intensity and frequency distribution of radio waves received from the sun and correlated these measurements with sun spot activity, and have detected radio waves arriving from the direction of the Milky Way. Radio waves from the sun cause the familiar hissing received during ionospheric storms. (*Nature*, Nov. 3, 1945, p 534, letter from E. Appleton, abstracted in *Wireless World*, Jan. 1946, p 26, abstract commented on in *Wireless World*, Mar. 1946, p 99 in letter from D. W. Heightman.)

• • •

Stabilized Cavities

CAVITIES OF MICROWAVE oscillators can be stabilized against frequency changes by passing an electron beam of variable density through them. One application of this technique, described in *Electronic Engineering*, Feb. 1946, p 61, consists of coupling the cavities of two reflex klystrons by a line so that one cavity appears as a resonant circuit in parallel with the other cavity. One cavity is operated as an oscillator, or r-f amplifier; the other is prevented from oscillating. The intensity of the electron beam of the non-oscillating cavity is controlled to vary that cavity's resonant frequency. If this beam is controlled from the modulating signal fed to the oscillating klystron, f-m accompanying a-m of klystrons can be counteracted.



more efficient
... in miniature

Flickering firebrands of burning fagots, smoking pine knots and pitch soaked moss lacked the convenience and effectiveness of the modern flash light. It took the same type of imagination, backed by science, to develop efficient miniature mobile lighting as it did to develop miniature Electron Tubes.

Due to their inherent improved characteristics, TUNG-SOL Miniatures are found in high frequency circuits in which the use of the larger type tubes would be impractical. In other circuits TUNG-SOL Miniatures are also more satisfactory. They are more rugged and more resistant to vibration. Because they are smaller, and lighter, TUNG-SOL

Miniatures make possible the production of smaller and lighter equipment. This is the trend of today.

TUNG-SOL Engineers will be glad to help you interpret your tube requirements in terms of Miniatures. TUNG-SOL is a tube manufacturer, not a set builder. The disclosures of your plans you make in consultation will be held in strictest confidence.



ACTUAL SIZE

TUNG - SOL
vibration-tested
ELECTRONIC TUBES

TUNG-SOL LAMP WORKS, INC., NEWARK 4, NEW JERSEY
Sales Offices: Atlanta • Chicago • Dallas • Denver • Detroit • Los Angeles • New York
Also Manufacturers of Miniature Incandescent Lamps, All-Glass Sealed Beam Headlight Lamps and Current Intermittors

NEW PRODUCTS

Latest developments in new apparatus, components, materials. New literature

1

Flexible Coaxial Line

BOSTON INSULATED WIRE and Cable Co., Uphams Corner Postal Station, Boston, Mass. Filamented high-temperature dielectric cables in the CO-X line are now available fabricated into harness, equipped with end seals or junctions or ells and tees suitable for connection with standard RMA rigid coaxial lines. Various methods of terminating the flexible lines are shown in the upper part of the illustration. Most of

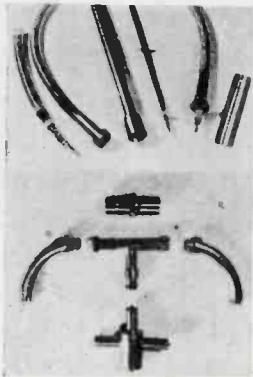

these can be pressurized. Junction between rigid lines and the flexible harness to antenna elements might be effected by means of the fittings shown below. The largest cables are tested to 3,000 watts at 60 cps and do not form a carbon track on continuous arc-over.

Another recent development now available is the Twin-X line of weatherproof shielded-pair cable suitable for f-m, television and amateur lead-in service. Filamented construction of this line keeps losses low.

2

Test Probes

A. ROTHFUCHS, INC., Dufourstr. 107, Zurich 8, Switzerland. Among the electrical articles available from this manufacturer are test probes with

long, thin needle contacts imbedded in plastic handles, red or black. The Model P 13 consists of probe and handle with banana socket; Model P 13K is equipped with a 5-foot cord with a banana plug at each end.

3

Remote Amplifiers

RAYTHEON MANUFACTURING Co., 60 East 42nd St., New York 17, N. Y. Two new remote amplifiers are available for broadcast use. Distortion of less than 1½ percent from 50 to 200

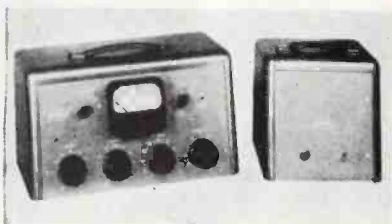

cps and less than 1 percent from 200 to 15,000 cps with noise level 60 db or better is claimed for both the 1-channel and the 3-channel equipments. Gain is 86 db. A 4-inch illuminated vu meter permits the remote operator to ride gain on the

4

Tubing and Sleeving

WILLIAM BRAND AND Co., 276 Fourth Ave., New York 10, N. Y., has developed a varnish impregnation process for cotton braided tubing which leaves the material pliable, yet with resistance to oils, acids and alkalies exceeding that of other insulating sleeveings. Turbotuff is available in all standard colors and sizes up to No. 14, either in coils or bundles.

5

Mass X-ray Unit

NORTH AMERICAN PHILIPS Co., Inc., 100 East 42nd St., New York 17, N. Y., has announced a new X-ray unit designed to handle 200 to 300 chest examinations per hour. Comprising the MCS-type unit are an X-ray tube and power supply, fluoro-

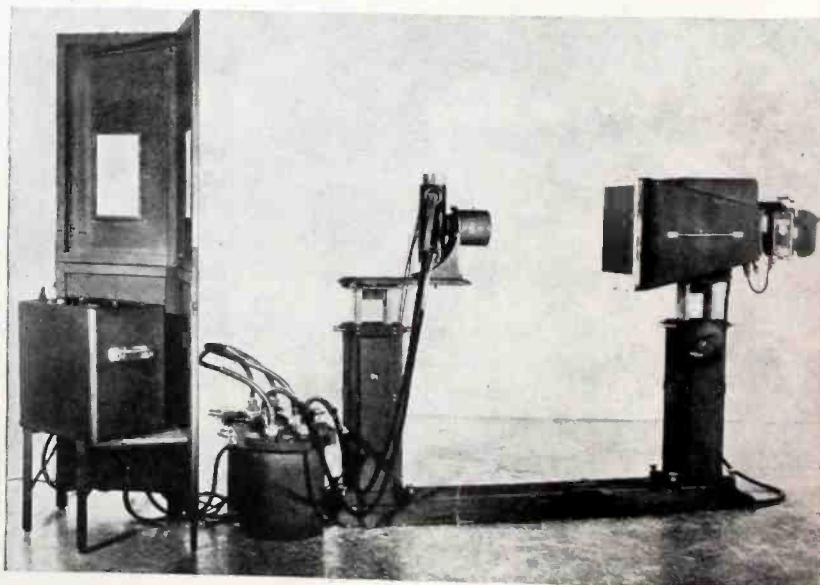



Provide **STEADY D.C. POWER TO YOUR LABORATORY EQUIPMENT WITH HARVEY Regulated Power Supplies**

Amplifiers, pulse generators, constant frequency oscillators, measurement equipment — in fact any apparatus requiring a constant source of laboratory D.C. power — performs more efficiently and effectively when teamed with HARVEY Regulated Power Supplies. Designed specifically for the job, HARVEY 106 PA and 206 PA Regulated Power Supplies perform their functions with utmost precision, dependability and operating ease.

The HARVEY Regulated Power Supply **106 PA** meets every need for a controllable, dependable source of laboratory D.C. power between 200-300 volts. Operates from 115 volts A.C. . . . output remains constant even though line voltage varies between 95 and 130 volts. Ripple content is less than 10MV . . . two separate filament voltages available . . . 6.3 volts, 5 amps. each . . . parallel operation possible making 6.3 volts at 10 amps. available. D.C. voltmeter for measuring output.

The HARVEY Regulated Power Supply **206 PA** operates precisely and efficiently in the 500 to 1000 volt range. It provides a regulated flow of D.C. power in two ranges: 500 to 700 at 1/4 amp; 700 to 1000 at 1/5 amp. Ripple content 1/10 of 1% or less in any voltage . . . 300 MV at 1000 volts or better. Output is constant within 1% from no load to full load in each range; regulation 1% or better. The HARVEY 206 PA has many safety and operating features that make it as easy to use as the 106 PA.

HARVEY RADIO LABORATORIES, INC.

439 CONCORD AVENUE • CAMBRIDGE 38, MASS.



Typical HARVEY products: Above left: The HAR-CAM Model MFT-25 FM Transmitter. Center: The HAR-CAM Visual Alignment Signal Generator Model 205 TS. Right: The HAR-CAM Model MFT-15 FM-AM Receiver. Write for bulletins.

scopic screen, automatic 70-millimeter camera, and control stand. No component of the mechanical assembly weighs more than 80 pounds, being principally cast magnesium. The equipment can be unpacked and set up in twenty minutes.

6

Miniature Plugs and Sockets

ALDEN PRODUCTS Co., 117 North Main St., Brockton 64, Mass., is prepared to furnish series 121P-125P miniature plugs and 441-445 series

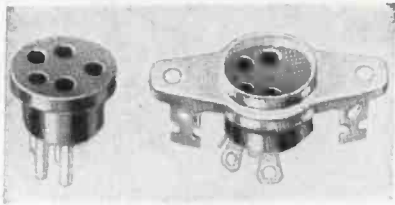

sockets with from one to five connections. Diameter of the connector face is $\frac{1}{8}$ inch, and socket mounting ears have holes $1\frac{1}{8}$ inches apart.

7

Audio Amplifier

ALLEN D. CARDWELL MANUFACTURING Corp., 97 Whiting St., Plainville, Conn. The Model CE-25 high-fidelity audio amplifier has three high-impedance input controls, two for microphones and one for phonograph, as well as individual bass and treble boost controls. Power output



is 25 watts with frequency response from 50 to 10,000 cps, controllable at the low end from minus 15 to plus 17 db and from minus 15 to plus 22 at the high end. Power consumption is 115 watts at 105 to 125 volts, 60 cps. The dimensions of the equipment are $15\frac{1}{2}$ x $10\frac{1}{2}$ x $8\frac{1}{2}$ inches. Weight is 26 pounds.

8

Battery Holder

SPITFIRE TOOLS, INC., 2931-35 North Pulaski Road, Chicago 41, Ill., announces a new standard 10-cent flashlight cell holder designed specially for users of hearing aids who can not always conveniently purchase



the conventional hearing-aid type. A socket at the top of the holder receives the plug. The whole assembly is intended to be strapped to the hearing-aid B battery. It retails for \$1.50.

9

Breakdown Tester

INDUSTRIAL TRANSFORMER CORP., 2450 Belmont Ave., New York 58, N. Y., has two insulation breakdown test sets on the market, the Model IT-25 for portable work and the IT-630 with outputs from 0-3,000 and 0-6,000 volts. A voltmeter is provided to show the potential of breakdown and an instantaneous trip circuit breaker in the transformer primary operates at the moment of overload. The net price is \$125.

10

Microphone Floor Stand

ELECTRO-VOICE, INC., South Bend, Indiana. A new microphone floor stand can be raised, lowered and locked with one-hand operation. When locked vertically, the stand is

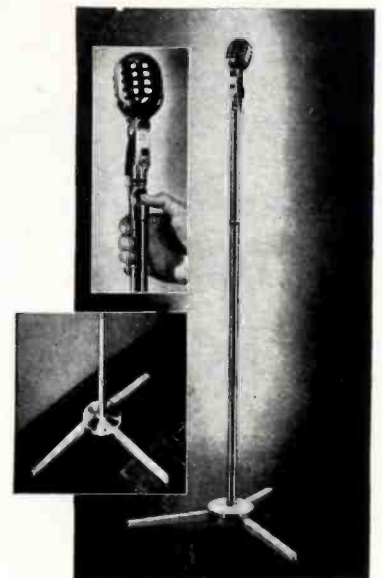

still free to rotate. Height adjustment of the satin-finish chrome Model 425 stand is from 37 to 66 inches. Three-leg spread requires a maximum radius of 17 inches. It weighs $7\frac{1}{2}$ pounds and lists at \$22.50.

11

Signal Generator

SIMPSON ELECTRIC Co., 5200-5218 W. Kinzie St., Chicago 44, Ill. The Model 415 wide-range signal generator has been designed for service-

Remove **THESE RESTRICTIONS**

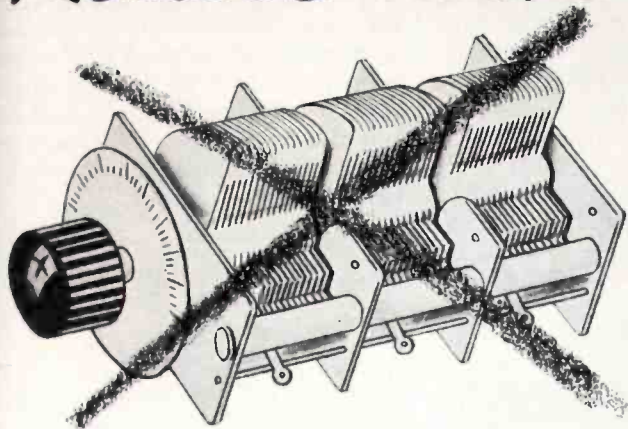

With the control knob mounted directly on the condenser shaft you are definitely limited in positioning both the knob and the condenser. The position of one determines the location of the other.

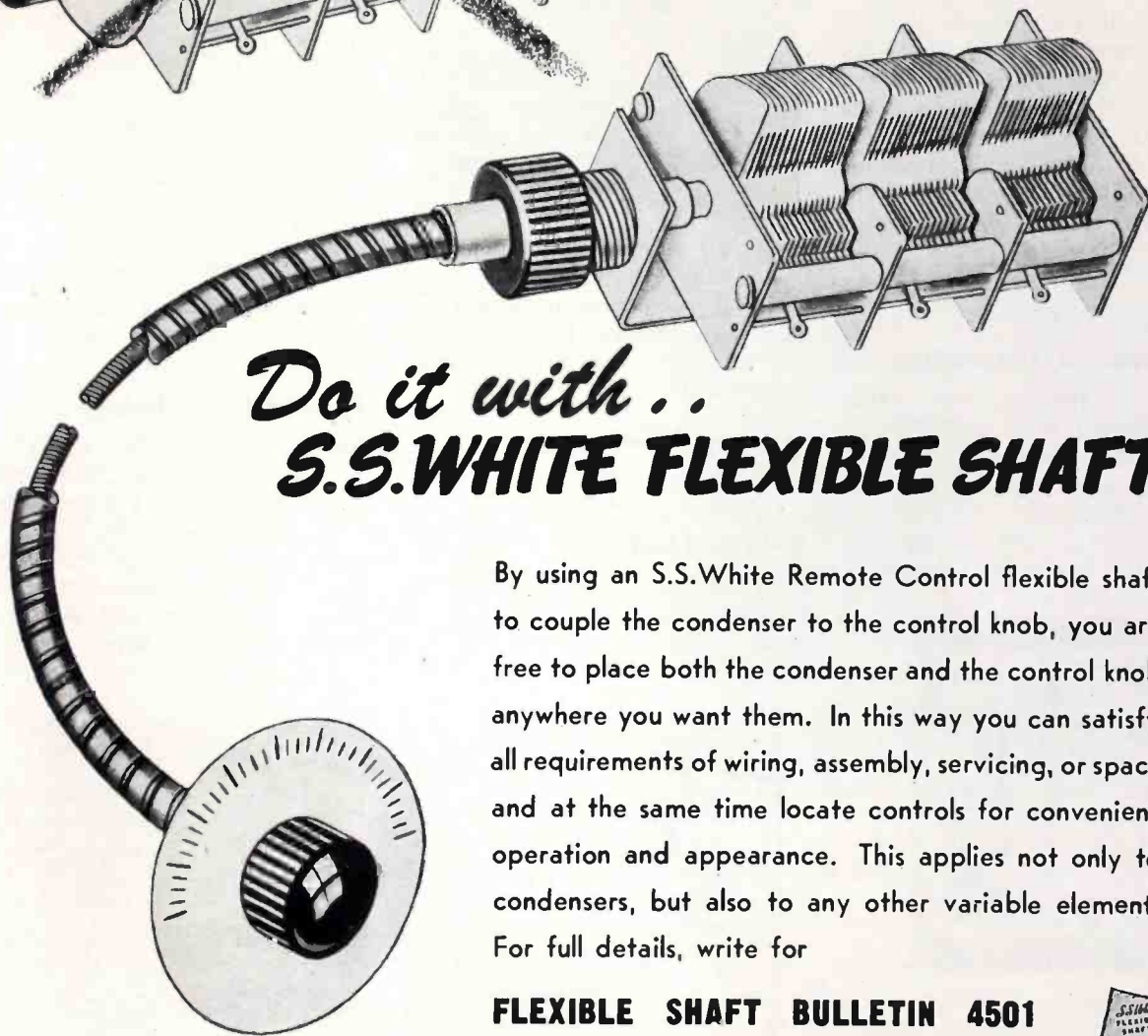

Do it with . . . **S.S. WHITE FLEXIBLE SHAFTS**

By using an S.S. White Remote Control flexible shaft to couple the condenser to the control knob, you are free to place both the condenser and the control knob anywhere you want them. In this way you can satisfy all requirements of wiring, assembly, servicing, or space and at the same time locate controls for convenient operation and appearance. This applies not only to condensers, but also to any other variable element. For full details, write for

FLEXIBLE SHAFT BULLETIN 4501

This bulletin gives basic information and technical data about S.S. White flexible shafts and their application.



S.S. WHITE INDUSTRIAL

THE S. S. WHITE DENTAL MFG. CO. DIVISION
DEPT. E, 10 EAST 40th ST., NEW YORK 16, N. Y.



FLEXIBLE SHAFTS • FLEXIBLE SHAFT TOOLS • AIRCRAFT ACCESSORIES
SMALL CUTTING AND GRINDING TOOLS • SPECIAL FORMULA RUBBERS
MOLDED RESISTORS • PLASTIC SPECIALTIES • CONTRACT PLASTICS MOLDING

One of America's AAAA Industrial Enterprises



men requiring f-m and a-m signals. The equipment is practically independent of line voltage fluctuations and is arranged for constant r-f output over the entire range. The output signal can be modulated internally at 400 cps or externally from below 60 cps to over 10,000 cps.

12

F-m Broadcast Transmitters

FEDERAL TELEPHONE AND RADIO Corp., Newark 1, N. J. A new line of f-m broadcast transmitters for the new f-m band, 88 to 108 megacycles, has been announced, with equipment having output powers of 1,000 and 3,000 watts. The center frequency

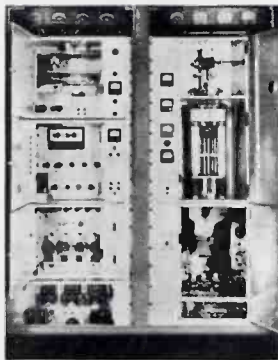

is electronically maintained within 1,000 cps of its assignment, exceeding FCC requirements. Linear modulation is assured between 50 and 15,000 cps even when the transmitter is overmodulated by transients as much as 300 percent.

13

Turntable and Amplifier

GATES RADIO Co., QUINCY, Illinois, is now marketing a master transcription turntable with built-in amplifier. Five different frequency

responses, selected by a switch on the control panel, are built into the three-stage preamplifier. The amplifier, housed in the cabinet, provides ample gain to feed other circuits having input level requirements up to



minus 20 vu. Speed of the edge-driven aluminum turntable is adjustable. The reproducer has a reed-type magnetic cartridge. Units are available with either sapphire or diamond stylus points.

14

Volume Limiter

RAYTHEON MANUFACTURING Co., 60 East 42nd St., New York 17, N. Y. Designed for use in a-m and f-m



speech input systems to obtain maximum average percentage of modulation without increase of distortion or overmodulation, the new volume limiter has a frequency response

from 30 to 15,000 cps. Inputs varying from minus 40 to plus 20 db can be handled and the noise level is better than 60 db down with an output of 23 db. Recovery time is variable and under control of the operator. With a compression of 5 db, distortion is less than one percent.

15

Microphone

AVIOMETER CORP., 370 West 35th St., New York 1, N. Y., in its recent catalog of handsets, microphones and headphones, features the Roger handheld carbon microphone designed for airlines interphone and radio use. It has high sensitivity, good noise discrimination and an unbreakable push-to-talk switch.

16

Coaxial Cable Relay

PRICE ELECTRIC Co., Church St., Frederick, Maryland. Now available for civilian use is a relay designed to be placed between a coaxial line from an antenna and the leads to transmitter and receiver. The contacts are arranged to break the receiver connection before the trans-

mitter is connected to the antenna. Connections to the relay are made with Signal Corps PL-259, or equivalent, plugs. Operating coils are available for 6, 12, 24, or 48 volts d-c

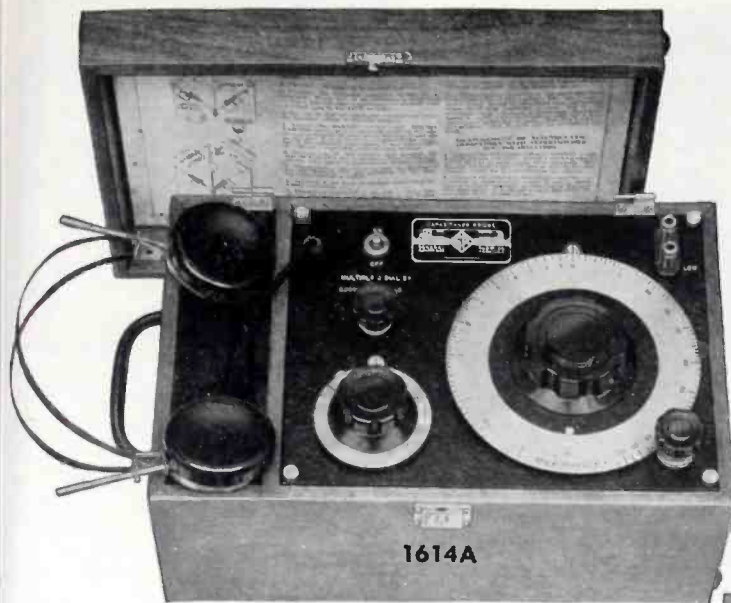

For Rapid Measurements of CAPACITANCE and INDUCTANCE

These two portable, self-contained bridges are designed for use in the laboratory, in production testing and in industrial plants. Their accuracy is sufficient for a large majority of routine measurements. Their usefulness is increased considerably by their being portable, self-contained, battery operated, and complete and ready to use at all times. They are both housed in walnut cabinets with removable cover and are supplied with the 6-volt dry battery and headset required for each.

TYPE 1614-A CAPACITANCE BRIDGE

RANGE for Capacitance: 10 micromicrofarads to 100 microfarads in three steps; 10 micromicrofarads to 10,000 micromicrofarads; 0.01 microfarad to 1.0 microfarad and 1.0 microfarad to 100 microfarads.

ACCURACY: $\pm 2\%$ except on lowest range where, after zero of 9 microfarads is subtracted, accuracy is ± 2 microfarads $+2\%$ of dial reading.

DIAL CALIBRATION: approximately logarithmic over two main decades, with compressed lower decade used for measurements below 100 microfarads.

RANGE for Dissipation Factor: 0 to 45%. **FREQUENCY:** 1000 cycles $\pm 5\%$ from internal oscillator.

ACCESSORIES REQUIRED: if a d-c polarizing voltage is used a 2 microfarad blocking condenser is required. Space is provided in the cabinet for such a condenser, not supplied with the instrument. **Price: \$105.00.**



TYPE 1631-A INDUCTANCE BRIDGE

RANGE for Inductance: 10 microhenries to 100 henries in 3 steps of 10 microhenries to 10,000 microhenries; 0.1 henry to 1 henry and 1 henry to 100 henries.

ACCURACY: $\pm 2.5\%$ of dial reading between 100 microhenries and 10 henries. Below 100 microhenries the error varies inversely as the magnitude of the unknown.

DIAL CALIBRATION: approximately logarithmic over two main decades with a compressed lower decade for measurements below 100 microhenries.

RANGE for Q (storage factor): 1 to 45. Other specifications are the same as those for the Type 1614-A Capacitance Bridge. **Price: \$115.00.**

DELIVERIES PROBABLY FROM STOCK. ORDER NOW!

GENERAL RADIO COMPANY

Cambridge 39,
Massachusetts

90 West St., New York 6

920 S. Michigan Ave., Chicago 5

950 N. Highland Ave., Los Angeles 38



Largest Producers of

CRYSTAL CARTRIDGES FOR PHONOGRAPH PICKUPS



THAT The Astatic Corporation is the world's largest producer of Crystal Phonograph Pickup Cartridges is, in itself, actual testimony of their outstanding service and high operating efficiency. That they are preferred and used by a majority of the leading manufacturers of electrical phonographs and automatic record changers, is convincing evidence of their expert engineering and construction. Astatic Crystal Cartridges are manufactured to meet today's exacting standards of performance and are individually tested and approved for output voltage and frequency response before being released for shipment. Astatic Cartridges are extensively used in an ever-growing field of new product applications, as well as for replacement purposes or the improvement of existing equipment.

*Astatic Crystal Devices
manufactured under Brush
Development Co. patents*

THE
Astatic
ASTATIC CORPORATION
CONNEAUT, OHIO
IN CANADA: CANADIAN ASTATIC LTD., TORONTO, ONTARIO

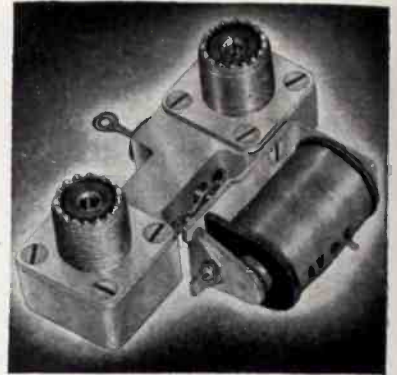

or 115 or 230 volts, 60 cps. The contacts will carry one ampere at radio frequencies. The relay measures 3 x 2 1/2 x 1 1/2 inches and weighs 9 ounces.

17

Television Capacitors

GENERAL ELECTRIC Co., Schenectady 5, N. Y., announces a new line of small capacitors designed especially for television receivers. Available in two types, flat cylinder and tubular

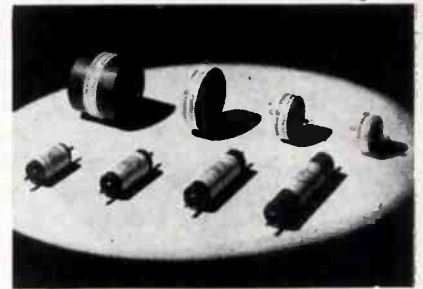

construction, the Lectrofilm units are equipped with prong-type terminals. Their characteristics, 0.005 microfarad and 5,000 to 16,000 volts, make them suitable for filter and allied uses.

18

Robot

W. C. ROBINETTE Co., 802 Fair Oaks Ave., South Pasadena, Calif. The Motron servo Model 61A is a packaged continuous-balance control system of great sensitivity which can be

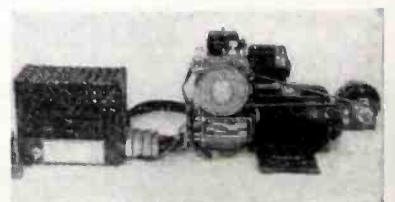

No electrical equipment can be any better than its insulation



This insulating varnish helped shipyard electrical equipment operate under wartime overload.

G-E INSULATING VARNISH 9435

A black baking varnish . . . highly flexible . . . good resistance to moisture and chemicals . . . recommended for manufacture and maintenance of machine tool motors

. . . and the same varnish can help to keep peacetime industry's electrical equipment on the job.

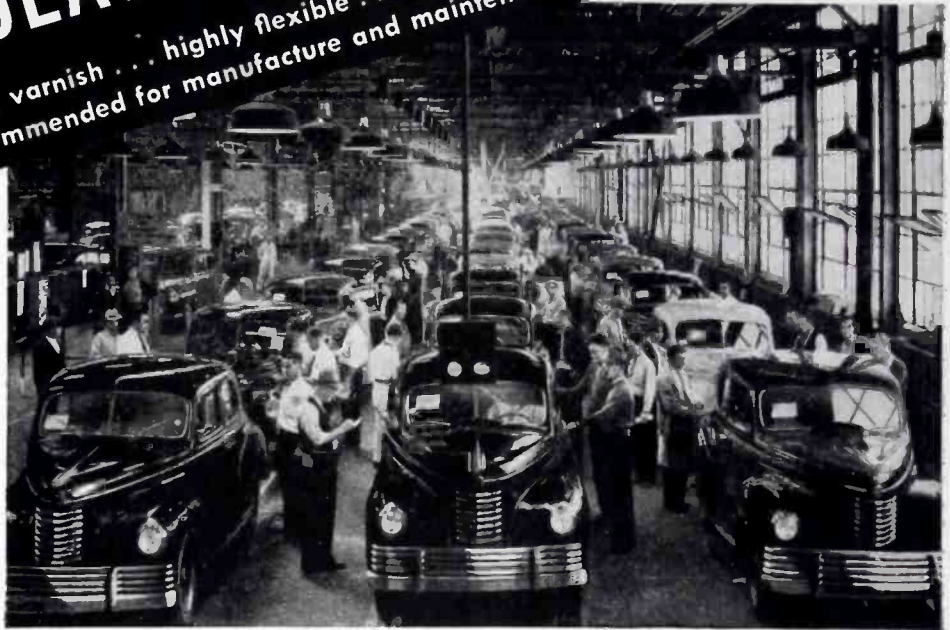

IN the field of insulating varnishes the General Electric label stands for 45 years of experience in research and manufacture . . . large productive capacity . . . expert technical service. G-E Insulating Varnishes, which were supplied in millions of gallons for the toughest war uses, now are available to all industry. You can count on uniformity of product in every shipment because of strict G-E Quality Control in every manufacturing operation. For full details consult your local General Electric Merchandise Distributor. Or write direct to Section RIMA-6614, Resins and Insulation Materials Division, Chemical Department, General Electric Company, Schenectady 5, New York.



GENERAL  **ELECTRIC**

G. E. OFFERS A COMPLETE LINE OF INSULATING MATERIALS

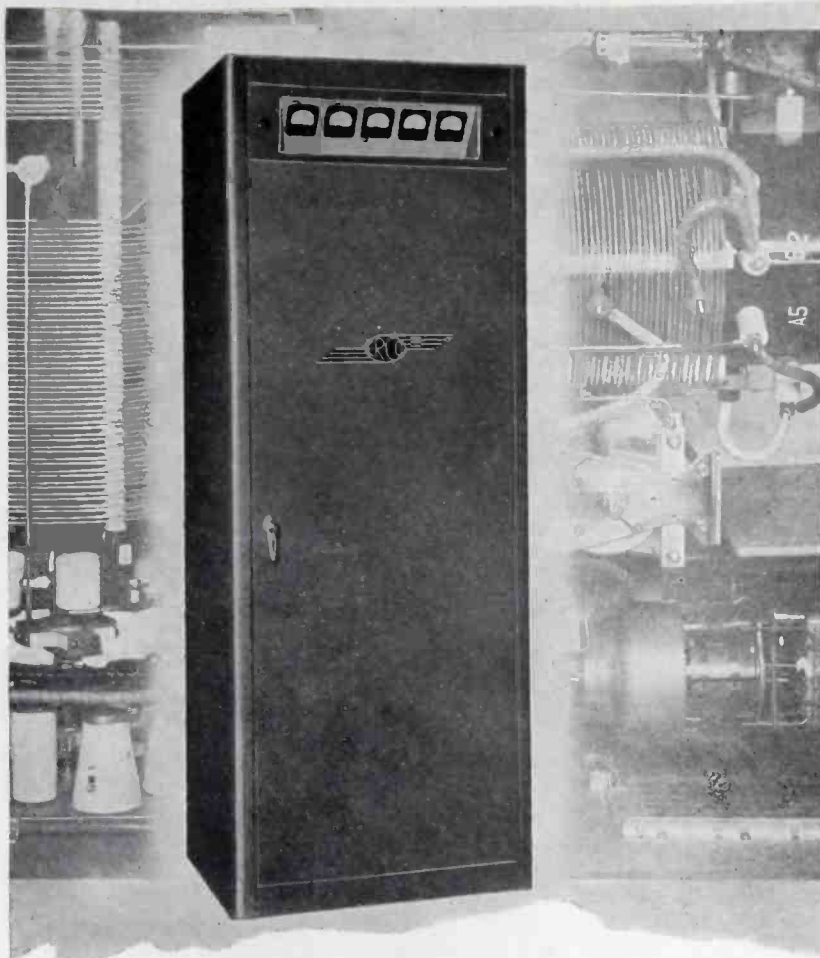

PACKAGED KILOWATT COMMUNICATION—•••—RADIOBEACON

160-T
1000 watts
2 to 15 MC
A1 and A3
Local or remote

Specifications
POWER OUTPUT
FREQUENCY RANGE
EMISSION
CONTROL

170-T
1000 watts
200 to 500 KC
A1 and A3
Local or remote

The 160-T COMMUNICATION Transmitter is designed for airways, coastal harbor, police or any point-to-point service where dependable telephone and telegraph communication is essential.

The 170-T RADIOBEACON Transmitter provides homing facilities for aircraft. Tone keying offers station identification; voice modulation gives weather and landing information. Applicable as well for coastal-marine beacon and communication installations.



Details on request

ERCO RADIO LABORATORIES
HEMPSTEAD, NEW YORK
Manufacturers of CUSTOM BUILT RADIO APPARATUS

applied to the automatic control of a variety of operations requiring human supervision. Miniature electron tubes control the speed and direction of a standard 1/15 horsepower induction motor according to the position of an input dial. The input dial can be actuated by small forces such as those resulting from meter movements, air vanes and compass needles.

19

Voltage Regulator

SORENSEN AND Co., Inc., 375 Fairfield Ave., Stamford, Conn. The new Model 5000-2 electronic voltage regulator is the first designed for 230-volt operation within the load range of 500 to 5,000 volt-amperes. The de-

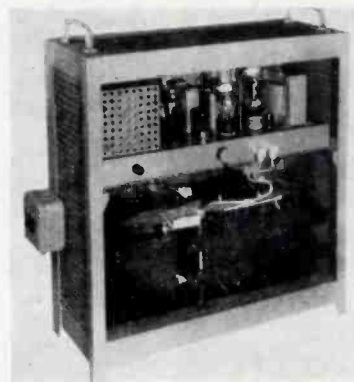

vice is unaffected by lagging power factor variations or frequency changes between 50 and 70 cps and stabilizes line voltage within 0.25 percent. Harmonic distortion of the output wave is less than 5 percent.

20

Plastics Preheater

AIRTRONICS MANUFACTURING Co., 5245 W. San Fernando Rd., Los Angeles 26, Calif., now offers the Model



electronics READER SERVICE . . .

BRING YOUR LIBRARY UP TO DATE ON LITERATURE AND NEW PRODUCTS

Manufacturers' Literature as well as further information on New products described in this issue are important "working tools" for design and production departments. To make it easy to keep up to date, ELECTRONICS will request manufacturers to send readers the literature in which they are interested. Just fill out card—we do the rest.

PLACE 1¢ STAMP ON CARDS

HOW TO ORDER: Fill out completely (name, address, etc.) for each piece of literature or new product information you desire. This service only applies to the above and not to advertisements. Write directly to company for information on their advertisements. Each circle must contain the number that appears in this issue under the article on which you desire further information. This gives your request authority and allows the manufacturer to whom we send your original request, to address your copy correctly.

PLEASE NOTE . . .
In the event this copy of ELECTRONICS is passed along to other members of your company, please leave this sheet in for their convenience. This assures everyone at your plant the opportunity to fill in their requests. When the round is completed, cards can then be detached along perforated lines and dropped in the mail. Each individual request will be mailed by us to the company offering the information.

Write in circle number of item describing one catalog wanted →

Your Company Name *Jones Mfg. Co.*
Address *3217 Lewis Ave.*
Chicago, Illinois
Your Name *John Smith*
Your Title *Chief Engineer*
ELECTRONICS, 330 W. 42nd St., New York 18

CARDS NOT GOOD AFTER SEPT. 1, 1946

Write in circle number of item describing one item wanted →

Your Company Name.....
Address.....
.....
Your Name.....
Your Title.....
ELECTRONICS, 330 W. 42nd St., New York 18, N. Y.

Write in circle number of item describing one item wanted →

Your Company Name.....
Address.....
.....
Your Name.....
Your Title.....
ELECTRONICS, 330 W. 42nd St., New York 18, N. Y.

Write in circle number of item describing one item wanted →

Your Company Name.....
Address.....
.....
Your Name.....
Your Title.....
ELECTRONICS, 330 W. 42nd St., New York 18, N. Y.

Write in circle number of item describing one item wanted →

Your Company Name.....
Address.....
.....
Your Name.....
Your Title.....
ELECTRONICS, 330 W. 42nd St., New York 18, N. Y.

Write in circle number of item describing one item wanted →

Your Company Name.....
Address.....
.....
Your Name.....
Your Title.....
ELECTRONICS, 330 W. 42nd St., New York 18, N. Y.

Write in circle number of item describing one item wanted →

Your Company Name.....
Address.....
.....
Your Name.....
Your Title.....
ELECTRONICS, 330 W. 42nd St., New York 18, N. Y.

Write in circle number of item describing one item wanted →

Your Company Name.....
Address.....
.....
Your Name.....
Your Title.....
ELECTRONICS, 330 W. 42nd St., New York 18, N. Y.

Write in circle number of item describing one item wanted →

Your Company Name.....
Address.....
.....
Your Name.....
Your Title.....
ELECTRONICS, 330 W. 42nd St., New York 18, N. Y.

Write in circle number of item describing one item wanted →

Your Company Name.....
Address.....
.....
Your Name.....
Your Title.....
ELECTRONICS, 330 W. 42nd St., New York 18, N. Y.

Write in circle number of item describing one item wanted →

Your Company Name.....
Address.....
.....
Your Name.....
Your Title.....
ELECTRONICS, 330 W. 42nd St., New York 18, N. Y.

Write in circle number of item describing one item wanted →

Your Company Name.....
Address.....
.....
Your Name.....
Your Title.....
ELECTRONICS, 330 W. 42nd St., New York 18, N. Y.

Write in circle number of item describing one item wanted →

Your Company Name.....
Address.....
.....
Your Name.....
Your Title.....
ELECTRONICS, 330 W. 42nd St., New York 18, N. Y.

An electronics service designed for READERS and MANUFACTURERS

Place
1¢
Stamp
Here

ELECTRONICS

330 WEST 42nd STREET

NEW YORK 18, N. Y.

6-1-46

Place
1¢
Stamp
Here

ELECTRONICS

330 WEST 42nd STREET

NEW YORK 18, N. Y.

6-1-46

Place
1¢
Stamp
Here

ELECTRONICS

330 WEST 42nd STREET

NEW YORK 18, N. Y.

6-1-46

For the Reader...

ELECTRONICS' fundamental policy has always been to supply its readers with all the pertinent and timely industry news. The ELECTRONICS' Reader Service supplements this policy by offering the reader an easy and effective means of obtaining complete, up to the minute data on new products and of maintaining at his fingertips comprehensive, practicable information on "who's doing what" in the industry.

There's complete coverage in every issue of ELECTRONICS of the month by month development by manufacturers of new materials, components and equipment, as well as brief mention of all the important, new, manufacturers' technical pamphlets and catalogs. Some of these items will be of particular interest to specific design and plant engineers, buyers, executives and others of our readers. They will want to make further inquiry concerning the new products described, or they will want to read and make a permanent part of their industrial library some of the manufacturers' literature and catalogs. ELECTRONICS' Reader Service makes it easy for them to obtain in readily accessible and usable form the information they desire.

For the Manufacturer...

ELECTRONICS' Reader Service will also be welcomed by manufacturers who are desirous of placing the complete news of their product developments as well as their technical bulletins and catalogs in the hand of those members of the electronic industry... including design, electrical, and production engineers, researchers, physicists, executives, and buyers — who have a particular interest in, or represent a potential buying power, for their products.

PLACE 1¢ STAMP ON CARDS

SUGGESTIONS FOR THE IMPROVEMENT OF OUR READERS' SERVICE ARE INVITED

ELECTRONICS is constantly seeking new and improved ways of providing its readers with the news and information they want and need, and of assisting the manufacturer in effectively delivering his message to electronic markets. If you have any ideas for us, send them along. They'll receive prompt and grateful consideration.

June, 1946—ELECTRONICS

Steatite

SEALEX

BUSHINGS

the **GUARANTEED** hermetic seal!

RANGE OF SIZES:

0.5 to 20 amperes

FLASHOVER VOLTAGES:

2,000 to 40,000 volts

LOW LOSS FACTOR:

0.7% to 1000 kilocycles

TEMPERATURE RANGE:

55° C to 978° C

NUMBER OF TERMINALS:

Up to 16 maximum

AIR PRESSURE TEST:

Individually to 50 psi before shipment



**Available in many standard designs from stock
...with "specials" to order on short notice**

FREE DATA BOOK:

Write today for your 48 page book. Contains complete information including mechanical and electrical characteristics of all General Ceramic's standard Steatite Insulators. Address request on company letterhead.



There are several important reasons why SEALEX Bushings provide permanent hermetic sealing capable of withstanding severe shock and vibration. First, the steatite dielectric is chemically bonded to the metal electrodes and collar; second, matched coefficients of expansion assure a permanent bond through an extreme range of temperatures. Last, every bushing is subjected to an air pressure test of 50 psi prior to shipment.

These facts, plus the added feature that all metal parts are hot tinned to facilitate soldering, is your guarantee that SEALEX Bushings will meet your requirements to the letter. Standard types include both individual lead terminals and multiple headers with as many as 16 leads. Special types can be supplied to practically any specifications. Write for details.



General **CERAMICS and STEATITE CORP.**

GENERAL OFFICES and PLANT: KEASBEY, NEW JERSEY

COTO

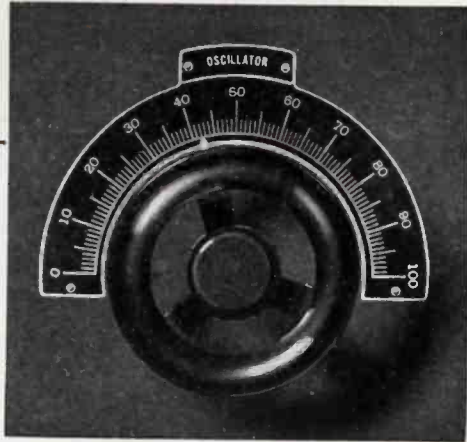

CONTROL WHEELS *for* PROMPT DELIVERY

Coto Bakelite Control Wheels may again be had in the familiar 2 $\frac{1}{4}$ " 3 $\frac{1}{4}$ " diameters. They are supplied with aluminum scale complete, or wheel only as desired.

Separate name plates in a wide choice of titles are also available for attachment on scale or for use over meters.

*We solicit inquiries
on quantity orders*

COTO-COIL CO., INC.

COIL SPECIALISTS

SINCE 1917

65 Pavilion Ave.

Providence 5, R. I.

DH dual preheater designed for use in plastics molding plants. Controls are arranged so that two different types of load can be used alternately or in any desired sequence without the necessity of continually resetting. The model illustrated is rated at 2.5 kilowatts and measures 18 x 22 x 36 inches.

21

Oxygen Detector

BAKER AND CO., INC., Newark 5, N. J., has designed the Deoxo indicator which shows the presence of from

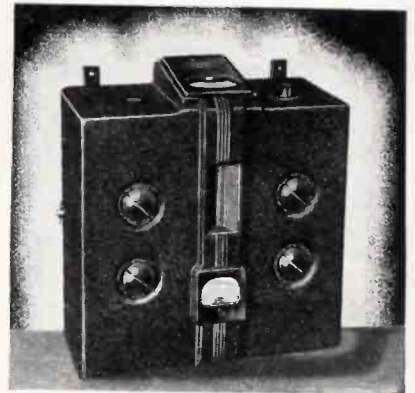

0.001 to 1.0 percent oxygen impurity. Such a device is particularly useful to the tube and lamp industry as well as in metallurgy.

22

Gas Switching Tube

SYLVANIA ELECTRIC PRODUCTS INC., 500 Fifth Ave., New York 18, N. Y. Gas switching tubes for rapid, automatic transmit-receive service in high-frequency systems employing wave guides are now available for use in the frequency range 8,400-9,600 megacycles. Two types of tubes, known as TR and anti-TR, are mounted in separate branches of the wave guide system. When ionized by the transmitter signal, they operate



.....

TRAIN RADIO TO AID IN OPERATION OF PERE MARQUETTE'S NEW, STREAMLINED TRAINS

"By virtue of their efficient and effective performance during the war, the nation's Railroads have won the respect and goodwill of the American people. It is essential that this public esteem be maintained. That is why progressive railroad managements are planning the use of many technical developments capable of making additional contributions to the safety and comfort of rail passenger service, and why the new, streamlined passenger trains which Pere Marquette soon will put into operation are to be equipped with train radio communication systems."

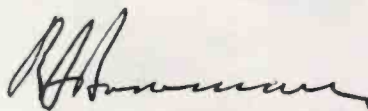

President

Pere Marquette Railway Company

.....

In designing mobile communications facilities for the nation's progressive railroads, Farnsworth has met and solved a number of unique engineering problems.

For example, before train radio could be of maximum service in streamlined train operation, new antenna techniques had to be developed. On the one hand, minimum clearance, far below the seventeen-to-twenty-inch height of the normal VHF railroad antenna, was a prime requisite. On the other hand, because human life, as well as valuable property, is involved in passenger train movements, efficiency and reliability could not be sacrificed.

Faced with this dual objective, Farnsworth engineers set to work. Creative engineering, coupled with careful field testing, resulted in the new *Farnsworth VHF train radio antenna*. Though as efficient as the taller, quarter-wave, ground-plane antenna, heretofore accepted as standard, it is only *eleven inches in height*.

This new antenna is another instance of the careful engineering and thorough research through which Farnsworth railway communications systems guarantee *maximum usefulness and flexibility with simplified, low-cost maintenance*. Farnsworth Television & Radio Corporation, Dept. E-6, Fort Wayne 1, Indiana.

FARNSWORTH TELEVISION & RADIO CORPORATION

Farnsworth Radio and Television Receivers and Transmitters • Aircraft Radio Equipment • Farnsworth Television Tubes • Halstead Mobile Communications and Traffic Control Systems for Rail and Highway • the Farnsworth Phonograph-Radio • the Capehart • the Panamuse by Capehart

How to assure PERFECTION IN PRODUCTION

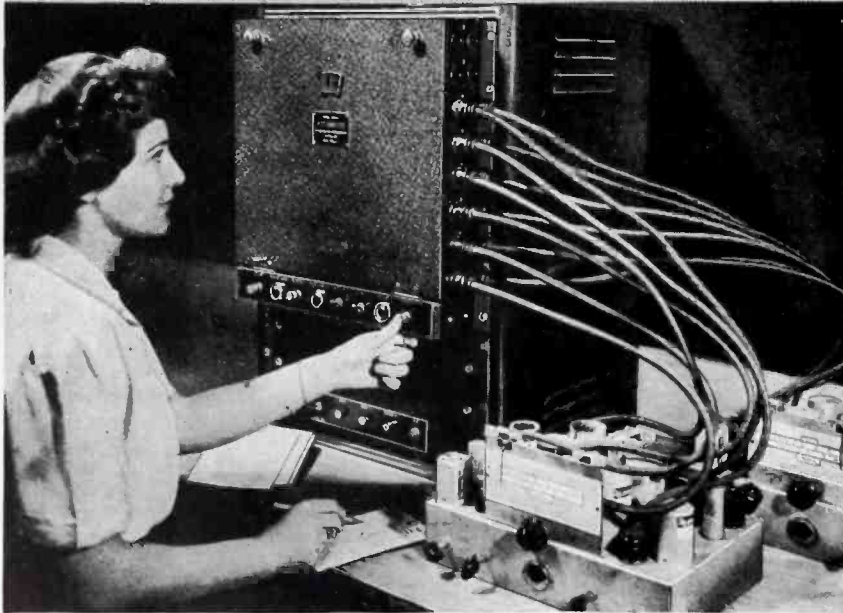

ROTOBRIDGE Checks a Circuit a Second

Use the Rotobridge as insurance against returns, rejects and troublesome service calls.

This automatic instrument checks wiring errors, resistance and reactance values—right on the assembly line!

Designed for continuous 24-hour duty, the Rotobridge serves you where and as you direct. A 10% resistance tolerance at one point? A 25% capacity tolerance at another spot? Trust the Rotobridge to do the job with unfailing accuracy—and completely automatically!

Versatile, the Rotobridge is adaptable either to several small-sub-assemblies, or a complete set comprising as many as 120 circuits. Two or three Rotobridge units, working simultaneously, will inspect a 30 or 40 tube set up . . . in five minutes!

Write for Bulletin and Prices

Communication Measurements Laboratory

120 Greenwich Street, New York

SALES } Chicago: 612 N. Michigan Avenue
OFFICE } Washington: 924 19th Street, N. W.

to permit normal transmission. Both tubes deionize in a few microseconds to permit reception with the same antenna and wave guide system. The types 1B37 and 1B35 (anti-TR) are designed for use with the type 1B24 (TR) tube in standard wave guides with 0.4 x 0.9 inch inside diameter.

23

Stroboscope

COMMUNICATION MEASUREMENTS LABORATORY, 120 Greenwich St., New York 6, N. Y. The Model-1210 stroboscope can be adjusted to flash at any frequency from 10 to 800 cps, corresponding to speeds of 600 to 48,000 rpm. A vibrating reed allows

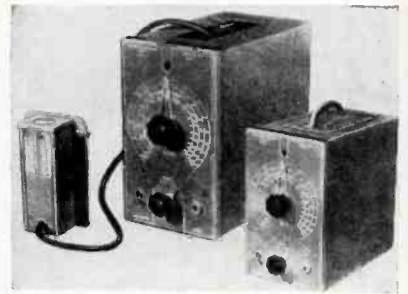

standardization at power line frequencies within plus or minus 3 percent. The light source is fastened to the carrying handle in such a way that lamp and cord are enclosed in the cabinet when not in use. The cabinet weighs 19½ pounds and measures 10½ x 5½ x 10½ inches.

24

Fluid Variable Capacitor

TIMING INSTRUMENT CO., 106 Spring St., New York 12, N. Y. The Cam-Rotor variable capacitor makes use of a shaped rotor moving in a fluid of high dielectric constant and low power factor, continuously

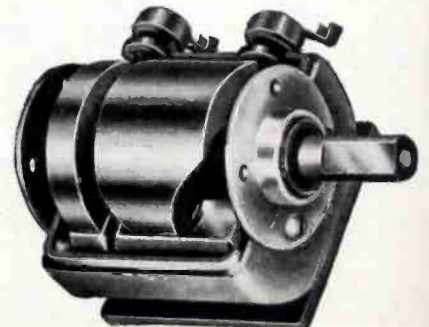



I'm a Design Engineer

That's Why . . .* I subscribe to **ELECTRONICS, and for the same reason, it's why practically everyone else in my type of work does too.

"Here's what **ELECTRONICS** does for me . . .

It gives me the most complete and informative picture of all important electronic developments, be they new government regulations, new theories, new products, new applications or new literature. Each month I'm sure I'm 'up front' and fully informed on all pertinent industry news. I've learned from experience that I can rely on **ELECTRONICS** for complete, accurate, technically sound editorial content.

In a word, it's authoritative.

How about advertising content, Mr. Engineer?

"When I said **ELECTRONICS** gave me the comprehensive picture I needed I had advertising as well as editorial content in mind. Because **ELECTRONICS** carries the largest volume of advertising it offers the best and most complete picture of available products, their characteristics and sources. Such information is of vital importance to me . . . particularly when I specify purchases. Frankly, I spend about as much time on the advertisements as I do on editorial content."

"My job is to dream up electronic equipment that will knock dollars off operational costs, improve end products or accomplish something that's never been done before.

"But I can't dream in a vacuum. I must be 100% up-to-date on everything happening in my field. I must know and understand all the newest developments if I am to do the creative, constructive job that's expected of me.

Mr. Manufacturer . . .

This is not an isolated case—it's typical. Therefore, make sure your products are fully represented in each issue of **ELECTRONICS** where they will be read and studied by the men who design, create and influence purchases. Tell your story to the largest, most influential electronic audience ever made available to advertisers in . . .



A MCGRAW-HILL PUBLICATION
electronics

330 W. 42nd St., New York 18

DESIGN . . . PRODUCTION . . . USE

ABC

Established 1930

ABP

START OF A *Good* SOLDERING JOB

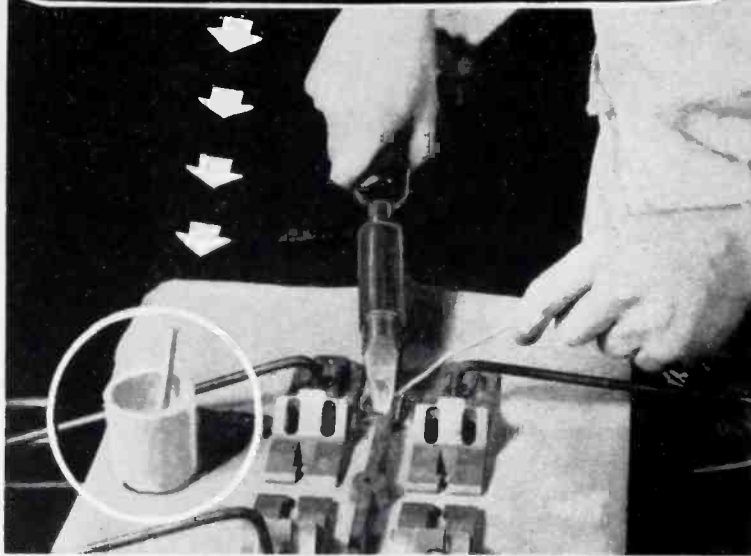

the **RIGHT FLUX** from **KESTER**

The **RIGHT FLUX** because Kester engineers, recognized solder authorities for 47 years, give careful consideration to the kind of soldering that's to be done, and fit the flux formula to the job's requirements.

That is why you can expect maximum results, in your plant, with Kester Fluxes . . . results which will mean fewer service difficulties, better product performance.

The Kester laboratories will gladly consult with you about the proper flux formula for any operation. Write fully, without obligation.

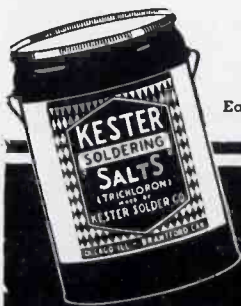

KESTER SOLDER COMPANY

4204 WRIGHTWOOD AVENUE CHICAGO 39, ILLINOIS
Eastern Plant: Newark, N. J. Canadian Plant: Brantford, Ont.

KESTER

Solder Fluxes

STANDARD FOR INDUSTRY

changing the area it presents to a fixed plate. The units are sealed and are claimed to be interchangeable with air-gap capacitors specified by RMA for the same service. They are also said to have the advantage of eliminating acoustic feedback.

25

Program Equalizer

CINEMA ENGINEERING Co., 1510 W. Verdugo Ave., Burbank, Calif., has an equalizer designed for broadcast or recording work, which can also be used for attenuation or sound effects. The type 4031 unit is graduated in 2-db steps. Both ends of the

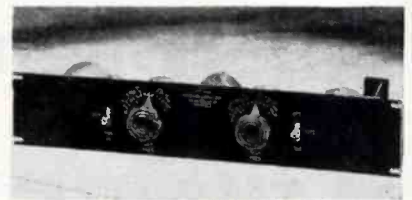

range can be attenuated 16 db or equalized 12 db. A key selector permits switching high-frequency peak equalization to 3, 5 or 10 kc. A cut-out key allows switching the equalizer in or out with no change in the overall level. The equipment is supplied on a 3½-inch panel for standard relay-rack mounting.

26

F-m Tube

GENERAL ELECTRIC Co., Syracuse, N. Y. Less than 150 watts driving power is needed to obtain 3 kilowatts output from a pair of the new GL-7D21 tubes. They have been designed particularly for use in f-m transmitters. Ring-seal contacts and construction facilitate installation

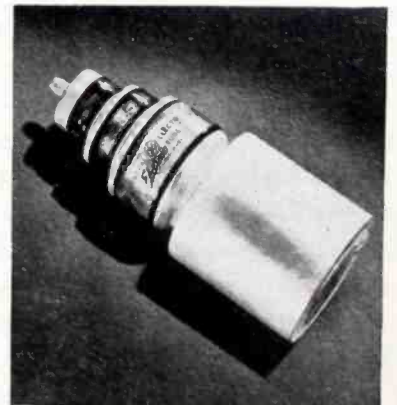

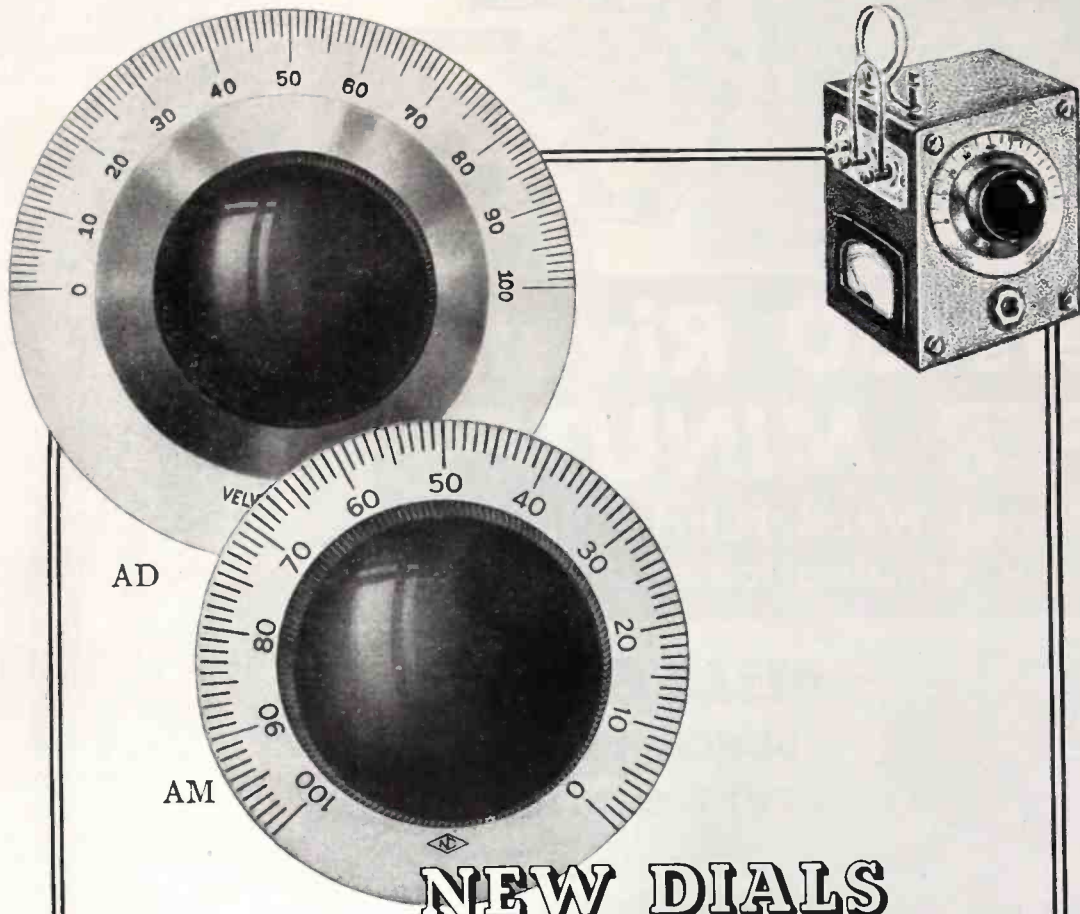

NEW DIALS

Wartime requirements for accurate smooth-working dials resulted in the design of these two new models. Both make use of the time-tested "Velvet Vernier" drive unit which for more than twenty years has been a favorite because of its incomparably smooth action and sensitive control. The Type AM Dial is three inches in diameter and is available with 2, 3, 4, 5 or 6 scale. The four-inch Type AD Dial is made with 2, 3, 4 or 5 scale. Both are handsome in appearance and moderate in cost.

DIAL SCALES			
Scale	Divisions	Rotation	Direction of Condenser Rotation for increase of dial reading
2	0-100	180°	Counter Clockwise
3	100-0	180°	Clockwise
4	150-0	270°	Clockwise
5	200-0	360°	Clockwise
6	0-150	270°	Counter Clockwise



NATIONAL COMPANY,  INC., MALDEN, MASS. U.S.A.



**Sets 60 Rivets
PER MINUTE**
in Metal, Wood, Fabric, Plastic
or any combination of the four

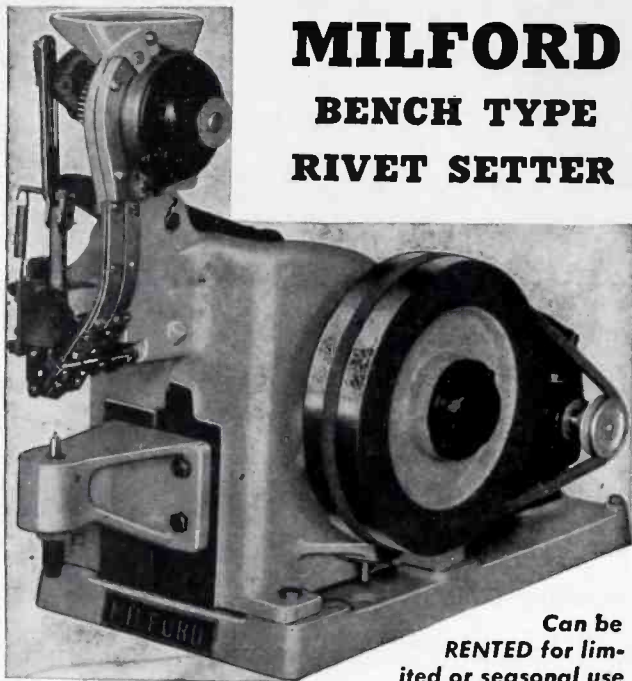

**MILFORD
BENCH TYPE
RIVET SETTER**

Can be
RENTED for lim-
ited or seasonal use

Whether your assemblies are of metal, wood, fabric or plastic parts — or any combination of the four — here is fastening speed for you. To cut costs. To save time. With every fastening perfect. Never to come apart. What a luxury now to set rivets by hand!

The Milford Bench Type Rivet Setter, versatile, powerful, precision-made, is the Little Giant of the Milford line. The others are all floor models, single and double spindle, accept-

ing rivets up to 1/4" x 2".

In fasteners and fastenings, Milford's "know-how" is vast. Make use of it — it's FREE. Whether your product is in or out of the drawing board stage, get Milford's ideas on cost-cutting, time-saving fasteners: semi-tubular rivets or special, small metal parts or fasteners.

A sample of your product, or a blueprint, will start Milford engineers' fastening ideas your way. No obligation.

THE MILFORD RIVET & MACHINE CO.

859 Bridgeport Ave.
MILFORD, CONN.

1002 West River St.
ELYRIA, OHIO

Inquiries may also be addressed to our subsidiary:

THE PENN RIVET & MACHINE CO., PHILADELPHIA 33, PENNA.

Designers and Manufacturers of: SPECIAL COLD-HEADED PARTS; SPLIT, SEMI-TUBULAR AND DEEP-DRILLED RIVETS; RIVET-SETTING MACHINES; SPECIAL MACHINE SCREWS AND SCREW MACHINE PARTS.

and also neutralization. The anode is forced air-cooled and can dissipate up to 1,200 watts. Maximum ratings apply up to a frequency of 110 megacycles.

27

Railroad Control Unit

AIREON MANUFACTURING CORP., Kansas City, Kansas, has developed a handset and control unit especially for railroad use in vhf and induction communication equipment. The hand-



set by Electrovoice Corp. embodies the principles used in the lip microphone, which cuts out noise without attenuating the voice. Controls are provided for remote equipment in the 1030B unit which measures 6 x 6 x 11 inches.

28

Television Tuner

ALLEN B. DU MONT LABORATORIES, Inc., 2 Main Ave., Passaic, N. J., has announced details of the Inductuner, a continuously variable tuning device covering the range from 44 to 216 megacycles. Chief advantage of this new system, to be included in all Du Mont receivers and available for other manufacturers, is that it will prevent obsolescence of equipment owing to changes of frequency bands.

29

Aid to Navigation

GENERAL ELECTRIC Co., Syracuse, N. Y., has streamlined radar equipment for application to merchant ships. The MN-1A radar operates at 10 centimeters and has a range from 200 yards to 30 miles, with resolution of 100 yards or 2 percent,



IT'S A BEAUTY!
RCP WAS MY BABY IN THE
SIGNAL CORPS, TOO.

RCP GIVES ME MORE
FOR MY MONEY
ON EVERY COUNT.

MODEL 805
RCP TUBE, BATTERY
AND SET TESTER



HANDSOMER,
BETTER
CONSTRUCTED—
INSIDE AND OUT

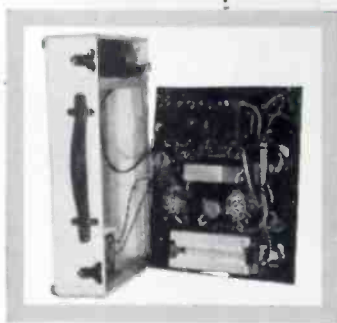

RCP Model 805 has been widely acclaimed by veterans and engineers. Testimonials pour in like fan mail from all over the country attesting to its superior quality and dependability. Durably constructed in every detail to withstand rough portable handling, yet it is impressively attractive for laboratory test application. RCP Model 805 is a real technical achievement for a triple-purpose precision instrument—and low-priced for maximum economy now and in the long run.

RCP Model 805 is a complete Tube, Battery, and Set Tester for direct testing of all circuits, old and new types of receiving tubes, rectifiers, and other functions. Supplied with high voltage test leads in a sturdy, polished wood case with removable cover, 14 $\frac{1}{2}$ " x 13" x 6". Weight—12 $\frac{1}{2}$ lbs.

RANGES: D. C. voltmeter: 0-2.5-10-50-250-1,000-5,000 volts. • A. C. voltmeter: 0-10-50-250-1,000-5,000 volts. • Output voltmeter: 0-10-50-250-1,000 volts. • D. C. milliammeter: 0-1-10-100-1,000 milliamperes. • D. C. ammeter: 0-10 amperes. • Ohmmeter: 0-250-2,500-25,000-0-2.5-25 megohms. • Decibel meter: -8 to 15, 15 to 29, 29 to 49, 32 to 55 db.

FEATURE HIGHLIGHTS: • Famous Dynoptimum test circuit. • Line fused. • All filament voltages. • Tests all acorn and ballast tubes. • Tests condenser leakage under rated voltages. • Accurate battery check, tests batteries under actual load conditions. • Tests separate sections of multi-purpose tubes. • Hot inter-element short and leak tests of individual elements. • Separate test for noise, hum and intermittents. • Latest type built-in "Rolindex" mechanical roller tube chart. • Latest type Germanium crystal diode rectifier assures efficient operation and long-term use. • Rectifiers electrically rugged and will withstand high peak currents.

COMPLETE PRICE \$89.50
READY FOR OPERATION

FOR FURTHER DETAILS ON THIS MODEL AND OTHER RCP INSTRUMENTS WRITE FOR CATALOG

RADIO CITY PRODUCTS COMPANY, INC.

127 WEST 26th STREET

NEW YORK CITY 1, N.Y.

MANUFACTURERS OF PRECISION ELECTRONIC LIMIT OHM — MILLIAMMETERS — SIGNAL GENERATORS —



BRIDGES — VACUUM TUBE VOLTMETERS — VOLT — ANALYZER UNITS — TUBE TESTERS — MULTI-TESTERS

there
is
NO
SUBSTITUTE

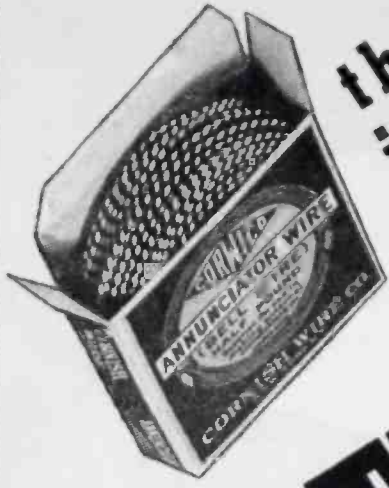

for good, honest WIRE, unwinding itself
cross-country, through mighty public buildings and
humble cottages, in and out of America's radio sets and
legion other communications units. You are getting some
CORWICO Wire now . . . and more is on the way . . .

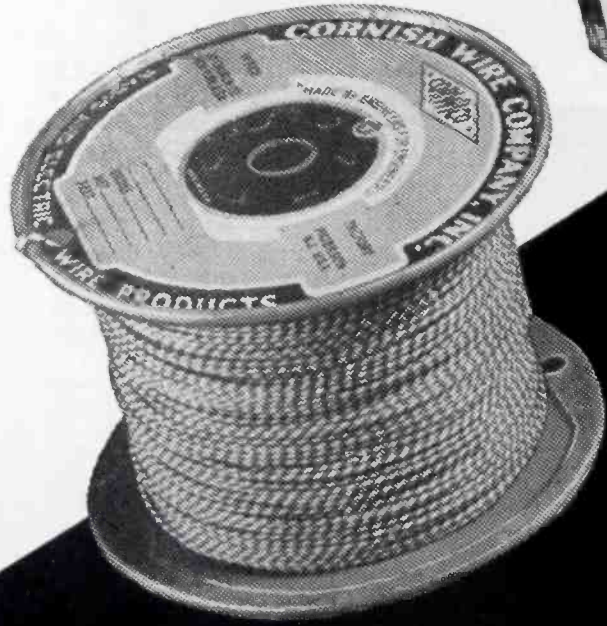

cornish
WIRE COMPANY, INC.

15 Park Row, New York 7, N. Y.

"Made by Engineers for Engineers"

whichever is greater. Bearings are within 3 degrees. The antenna reflector is a cast aluminum truncated parabola connected to the navigators' equipment by wave guide or coaxial cable. Power required is 1,000 watts a-c or 1,400 watts d-c. Price, fob Syracuse, is between \$5,500 and \$6,000.

30

Ground Plane Antenna

THE WORKSHOP ASSOCIATES, 66 Needham St., Newton Highlands 61, Mass. A new ground-plane antenna is now available for operation on the amateur 144-148 and 220-225 megacycle amateur bands. The radiating dipole and the six radials are made

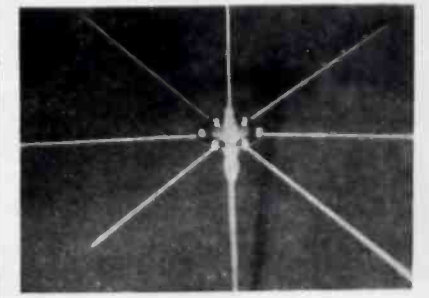

in two pieces. By screwing on seven additional pieces, the antenna is converted from operation on the high-frequency band to the 144 megacycle band. Coaxial cables of the 72 or 50-ohm types can be used, although the lower impedance gives a better match. The antenna gives uniform coverage in all directions.

31

Dual-Channel Preampifier

THE LANGEVIN Co., Inc., 37 W. 65th St., New York 23, N. Y. Compact fixed medium gain preamplifiers type 111-A are now being built which can be mounted on a frame which is in turn attached to a standard relay rack. The equipment illustrated combines four audio channels and a

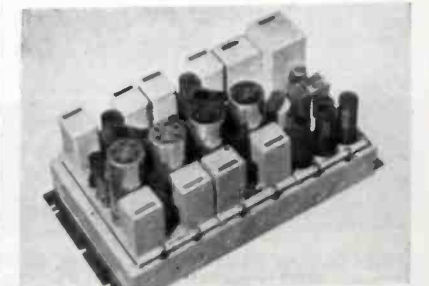

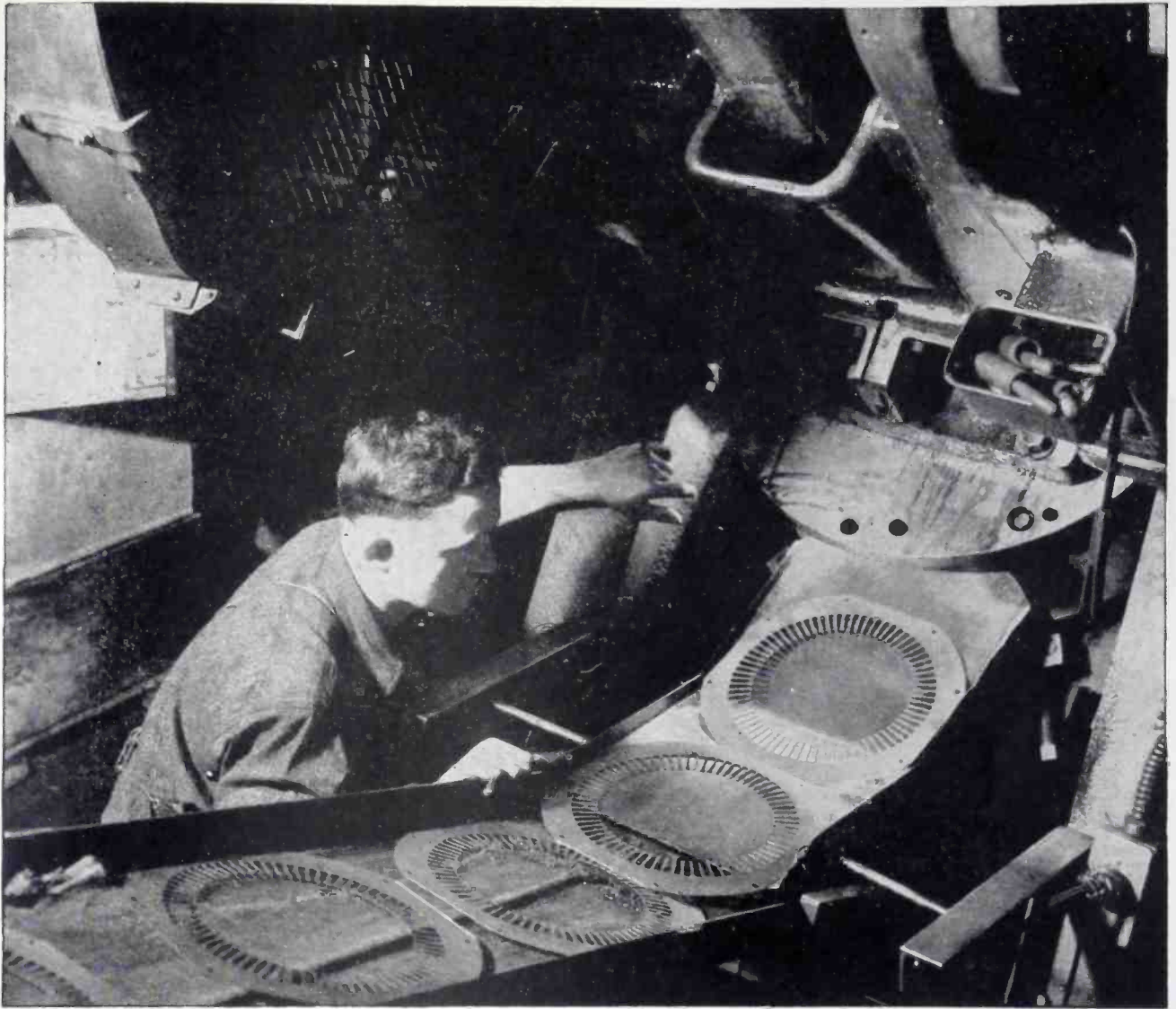

if you use electrical sheet steels look at the **DOLLAR-BENEFITS** of "Armco"

Dollar-benefits of using Armco steels start with the *right grade for the right purpose*, because Armco produces electrical sheet steels and coils for exacting equipment of all kinds.

Many electrical products for home and industry will benefit greatly from lessons learned during the war. Notable progress has been made in the development of special ARMCO Thin-Gage Electrical Steel for all types of high frequency equipment. Besides providing many new time-saving and money-saving conveniences, steels like these help insure safer transportation and faster, more

accurate communications.

In your plant ARMCO Electrical Steels will give you money-saving, money-making results. You get clean, flat punchings—laminations that stack like a pile of silver dollars... Longer die life, too, all because Armco sheets are flat, uniform and made to exacting specifications.

Another point you will not want to overlook is Armco's reputation for magnetic efficiency. More than 40 years ago Armco was among the first steel manufacturers to attack the core loss problem, and it has consistently led the way ever since. The

American Rolling Mill Company,
2441 Curtis St., Middletown, Ohio.

Export: The Armco International Corporation



*The American
Rolling Mill Company*



**THE TIMING
MUST BE RIGHT**

In mechanical devices — as in music — the timing must be *right*. To insure perfect timing, specify Haydon Repeat and Interval Timers, Time Delay Relays, Contactors, Interrupters, Elapsed Time Indicators or other Haydon apparatus that suits your particular timing problems.

Haydon Timing Devices proved their absolute reliability in the thousands of important measuring and motivating functions they performed during the war.

Send for complete catalog.



HAYDONEERED TIMING
Haydon
MANUFACTURING COMPANY
INCORPORATED
Forestville, Connecticut

line amplifier, type 102-A. Each channel operates from a source impedance of 30, 250 or 600 ohms into a load impedance of 600 ohms. Response of the apparatus is flat within 1 db over the range 30 to 15,000 cps. An external source of power is required for 6.3-volt, 1.2-ampere filaments and a plate supply of 275 volts, 16 milliamperes.

32

Three-Pole Switch

ACRO ELECTRIC Co., 1316 Superior Ave., Cleveland 14, Ohio, has announced the manufacture of a snap switch designed to handle three cir-

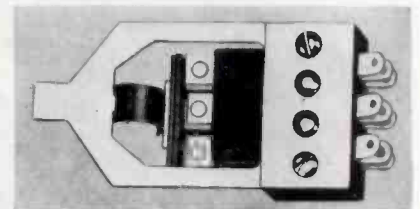

cuits simultaneously. Rated at 10 amperes, 125 volts, or 5 amperes, 230 volts a-c, the switch operates with pressures from 12 to 18 ounces, or less for special types. Its overall size is 3 x 1 1/2 x 1/2 inch.

33

Sensitive Relay

ADVANCE ELECTRIC & RELAY Co., 1260 W. 2nd St., Los Angeles 26, Calif. The type 1200 ultrasensitive relay is plastic enclosed, operates on less than 5 milliwatts power and will handle 1 ampere at 110 volts a-c. Coils are available from 1 to 30,000 ohms. Size of the relay is 2 x 2 1/8 x 1 1/2 inches and it weighs 6 1/2 ounces.

34

Molded Coil Forms

STACKPOLE CARBON Co., St. Marys, Pa. Molded bakelite coil forms with anchored hairpin wire leads are use-

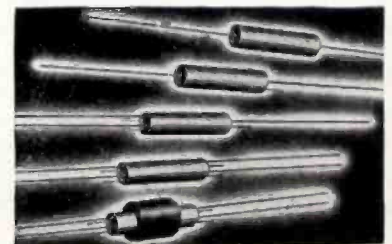

The Answer to Television and
Other High-Voltage Resistor
Applications...

**10,000
VOLTS
BREAKDOWN**
from STANDARD
Sprague Koolohm
Resistor to Ground



Completely insulated surface

Standard Sprague Koolohm Wire Wound Resistors have the high insulation resistance to ground which you need for television and other applications where high voltages are involved—10,000 volts from the surface of their sturdy ceramic jackets to their resistance elements. Mount them anywhere without fear of voltage breakdown!

In addition, Koolohms give you the advantages of higher resistances in smaller physical sizes; easier mounting; use at full wattage ratings; and overall tropicalized protection against the most severely humid conditions. Write for Catalog 10EA.



SPRAGUE ELECTRIC CO., Resistor Division, North Adams, Mass.

SPRAGUE KOOLOHMS

TRADEMARK REGISTERED U.S. PAT. OFF.

The Greatest Wire-Wound Resistor Development in 20 Years

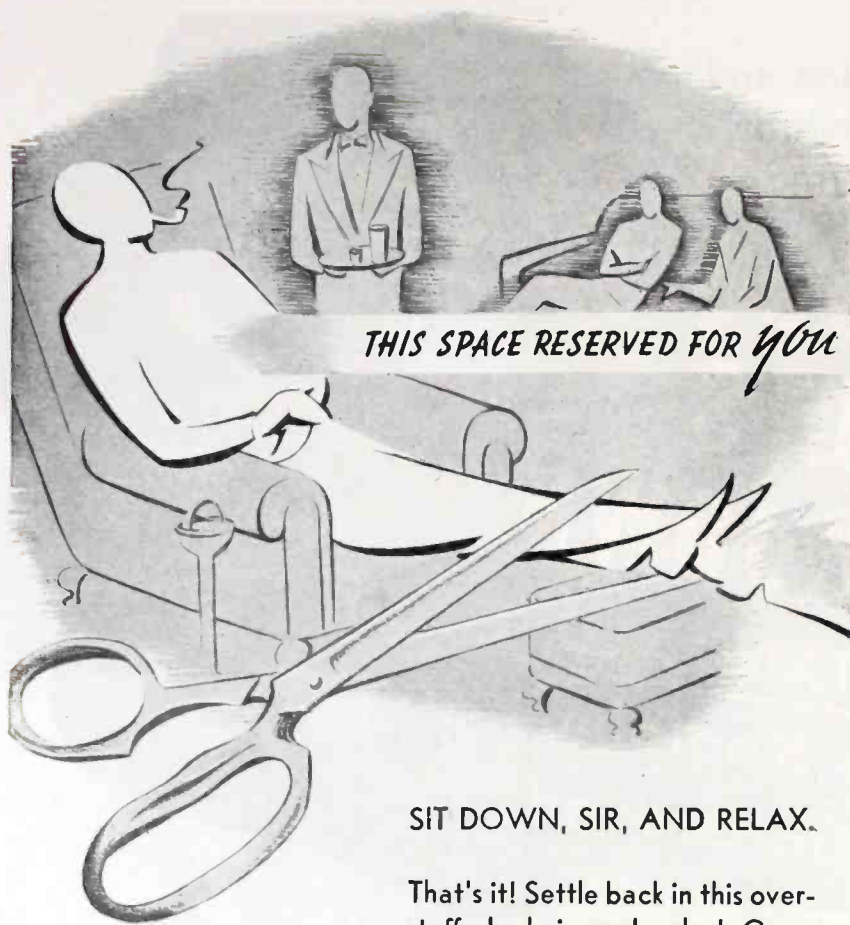

THIS SPACE RESERVED FOR YOU

SIT DOWN, SIR, AND RELAX.

That's it! Settle back in this overstuffed chair and relax! Comfortable, Ah-h-h! Here, sir, is your scotch and soda. Now then, forget your business cares

and worries, get ready to enjoy yourself — leave your troubles to Macallen. Because wherever Mica is used in any form, Macallen has the vast resources, the wide technical experience and the physical equipment to take care of your requirements perfectly.

If your product is generators or motors, transformers, condensers, switches or anything that requires Mica, you can rely on Macallen's more than half a century working with Mica. Get ready to enjoy yourself — leave your troubles to Macallen.

When You Think of MICA, Think of MACALLEN



16 MACALLEN STREET—BOSTON 27

CHICAGO: 565 W. Washington Blvd. CLEVELAND: 2005 Leader Bldg.

ful as a support for direct windings or for tubes previously wound. Molded iron sleeve cores are also available for production of coils having fewer turns of wire and high Q.

35

Pushbutton Switch

GENERAL CONTROL Co., 1200 Soldiers Field Road, Boston 34, Mass., announces a new Model MPB nine-posi-

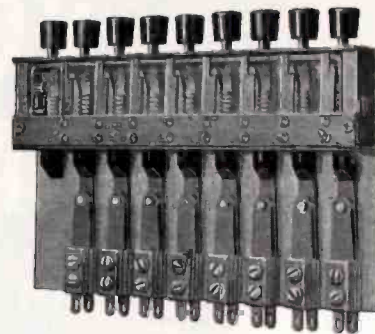

tion switch made in either locking or non-locking types. Contacts are fine silver and are rated at 10 amperes, 125 volts, 60 cps for a non-inductive load.

36

Transformer Bushings

GENERAL CERAMICS AND STEATITE Corp., Keasbey, N. J. Hermetically sealed bushings in multiple and single-terminal styles are available with current-carrying capacities from 1 to 20 amperes and voltage flashover in the range from 2,000 to 40,000 volts rms. Made of stainless steel permanently glazed to steatite, they can be soldered without damage, and will withstand 20 cycles of thermal shock from minus 55 to plus 125 C. All bushings are tested to a pressure of 50 pounds per square inch.

37

Fifty Watter for Planes

RADIO CORPORATION OF AMERICA, Camden, N. J. The model AVT-49 transmitter weighing little over 40 pounds is capable of supplying 50 watts output on any one of four pre-tuned frequencies in the range 3 to 13 megacycles. Transmitter and dynamotor power supply operating from 12 or 24 volts d-c are contained

**COMPLETELY SELF-CONTAINED
IN A 1½-INCH CASE!**

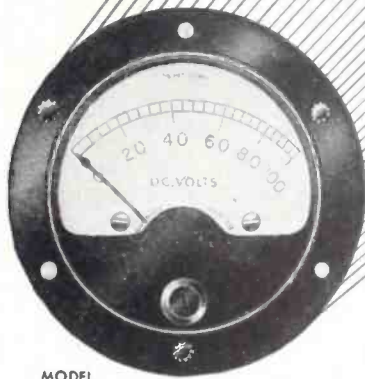
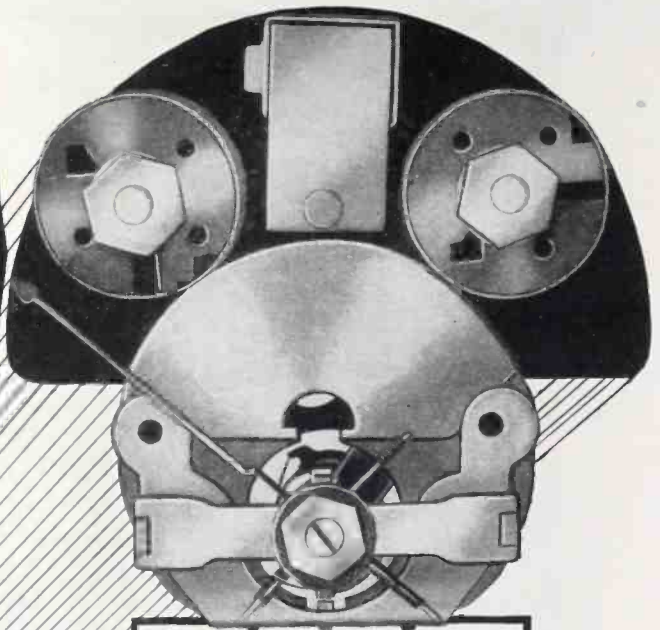

MODEL
152

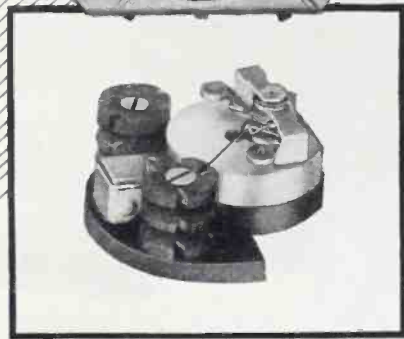

IT'S THE PRECISION MB INSTRUMENT

... AVAILABLE IN VOLTMETER OR SHUNTED AMMETER RANGES!

SPACE REQUIREMENTS are really cut to a minimum with MB miniatures. They are ready for immediate installation in equipment or panelboard ... with all accessories entirely enclosed within the anodized aluminum housing.

The basic MB high-precision movement is the smallest produced. It has a *1-inch diameter*, and in a *1½-inch case*, there's ample room for MB-designed multipliers. A standard rectifier, or thermocouple for RF type instruments, is also mounted to the

base plate in alternating current instruments.

In addition to small size and simplicity of design, MB instruments are also noted for their fine performance. They're accurate to within 2% of full scale at any point; are sturdily built and securely sealed to withstand hard use and to give long, satisfactory service. Available in round and square shapes ... in voltmeters, millivoltmeters, ammeters, milliammeters, and microammeters. Write for full details and specifications.

THE

MB MANUFACTURING COMPANY, INC.
331 East Street, New Haven 11, Conn.



MINIATURE ELECTRICAL INSTRUMENTS FOR ANY PURPOSE

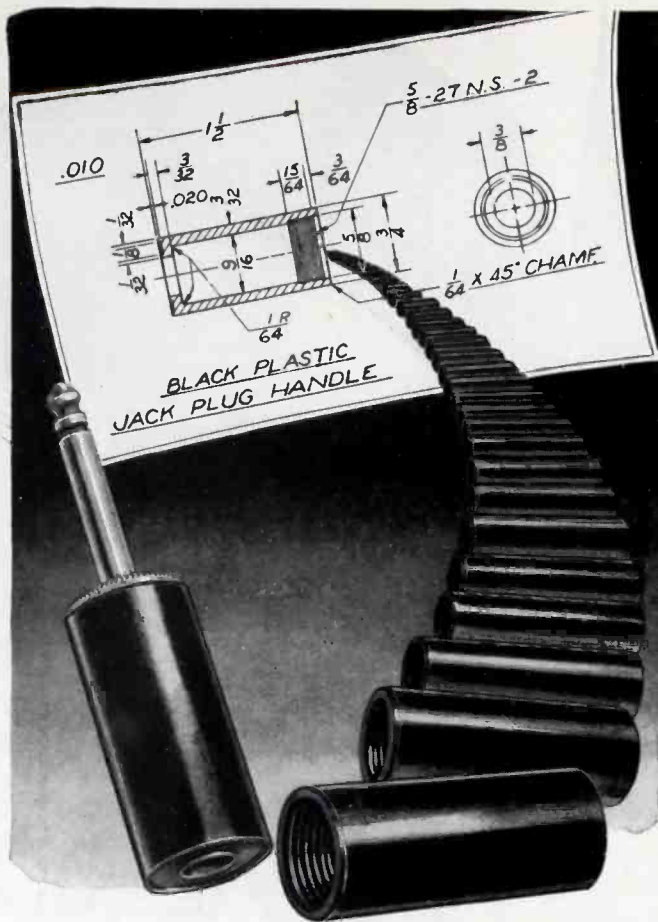

**From Blueprint
to 18,000 Per Day
in 9 Weeks and 2 Days**

Here were the requirements—a quality thermosetting plastic part . . . a price ceiling . . . volume production . . . early delivery date. And we beat every one of them. How? The dies were made in our own die shop. Samples were submitted and immediate approval obtained. From the time dies were put into production molding rate reached 18,000 pieces per day within 3 days. Our engineers devised an ingenious machine in our own machine tool shop that would complete the four required finishing operations at one time.

It is this service, this know-how in devising ways and means to produce a better product at the lowest price consistent with quality work that is building HI-EFF volume. And what we are doing for others we can do for you. Taylor Manufacturing Co., 3078 W. Meinecke Ave., Milwaukee 10, Wis.

TAYLOR OF MILWAUKEE

CUSTOM MOLDERS OF **HI-EFF** PLASTIC AND RUBBER PARTS

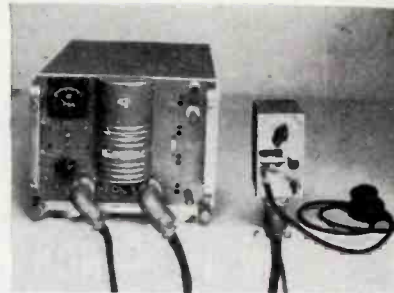

in one unit. A small control box separated from the other equipment by a 15-foot length of cable provides microphone input to the transmitter and a selector switch for the desired operating frequency. Operation on c-w telegraphy is possible with an addition furnished in kit form. There are several features which increase the flexibility of the transmitter, such as removable meters and a circuit breaker instead of fuses.

38

Five-Position Switch

GENERAL CONTROL Co., 1200 Soldiers Field Road, Boston 34, Mass. The Model MCF, 5-position cam-lever switch has a single hole mounting. Of the five positions, all but the

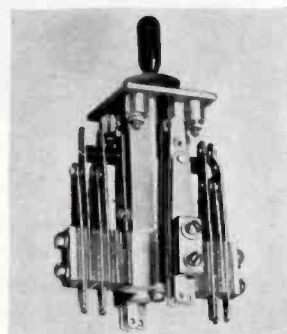

center can be made locking or non-locking. Fine silver contacts are rated at 10 amperes, 125 volts for a-c noninductive loads. A single bolt assembly allows removal of the contacts for soldering in the most convenient location.

39

Personal Plane Radio

AIRCRAFT RADIO CORP., Boonton, N. J. Complete two-way airborne communication is offered the private pilot in a package consisting of vhf five-channel transmitter. l-f receiver



JOE MACJERK'S
STICKING HIS
FINGERS IN HOT
TELEVISION SETS
AGAIN!



LAST TIME
THE BOSS SWORE
HE'D CUT JOE'S
SALARY AND BUY
"RADIO
MAINTENANCE"
FOR HIM!

Vik Turner

For
optimum
performance
in the
service
field
USE
Radio
Maintenance
Magazine.

*Special offer to
Radio Servicemen*

Articles monthly on:

- Television — AM — FM
- Public Address Systems
- Test Equipment — Tools — Service Kit
- Shop Layout — Service Bench
- Trouble Shooting
- Business News

**Radio Maintenance
is not sold on
newsstands**

**RADIO MAINTENANCE MAGAZINE
460 BLOOMFIELD AVE., MONTCLAIR, N. J.**

Please send me
RADIO MAINTENANCE

For 1 year 2.00

For 2 years 3.00

NAME _____

OCCUPATION _____

ADDRESS _____

CITY _____

ZONE _____ STATE _____

CHECK ENCLOSED*

BILL ME LATER

*NOTE: By enclosing payment,
thus eliminating billing expense
WE WILL ADD ONE ISSUE FREE!

E-8

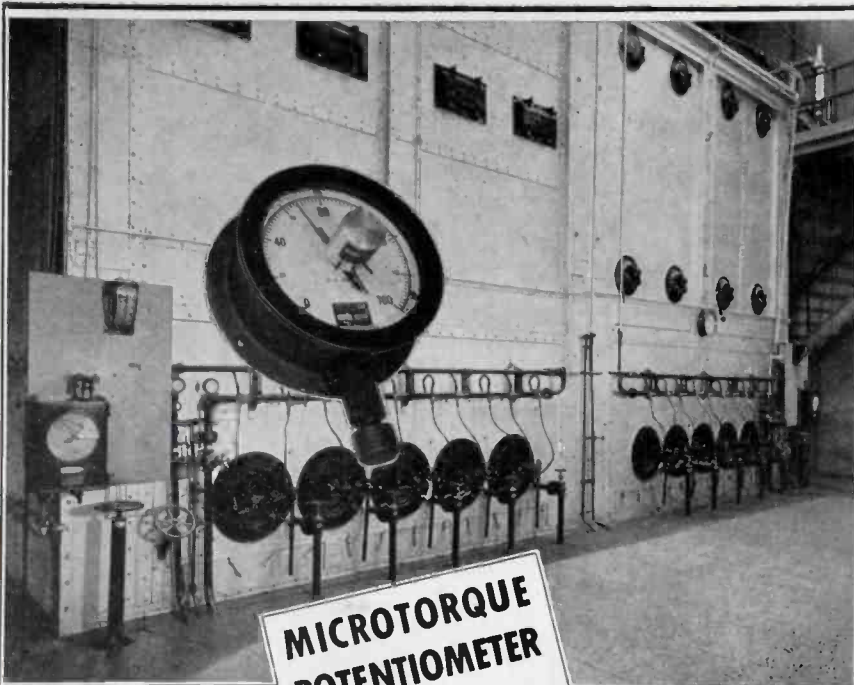

MICROTORQUE POTENTIOMETER

Hundreds of remote control and position repeating problems are greatly simplified by the adaptation of *AUTOFLIGHT's tiny, ultra-low torque variable resistance units.

Ideal for take-offs from low torque indicating meters by simple yoke adaptation to the instrument pointer, for take-offs from bellows elements used in temperature, pressure, or flow measurements, as primary control elements in bridge type circuits to operate directly recorder-controllers, recording galvanometers, oscillographs, and polarized relays.

Characterized by large electrical outputs with small mechanical inputs, the MICROTORQUE can be attached to sensitive movements without causing excessive drag.

Write For
New
MICROTORQUE
Catalog



Actual Size

FEATURES:

1. Vibration-proof 4 to 55 cycles up to 6 G.
2. Resistance values 100 to 2500 ohms.
3. Input torque less than .003 oz in.
4. Power dissipation of 2 watts.
5. Linearity 1/2% or better.
6. Weight less than 3/4 oz.
7. Size 1" x 1 1/4".

AUTOFLIGHT INSTRUMENTS
161 East California Street
Pasadena 5, Calif.

A Division of G. M. Grammi & Co., Inc.
*Reg. U.S. Pat. Off

and control unit. The transmitter utilizes new frequencies assigned for use with CAA airport stations. The receiver covers 190 to 550 kc, thus including service from range stations outside the 200-400 kc band

40

Sensitive Relay

THOMAS A. EDISON, INC., West Orange, N. J. The Model 103 relay has been designed for use in thermocouple and photocell circuits, since

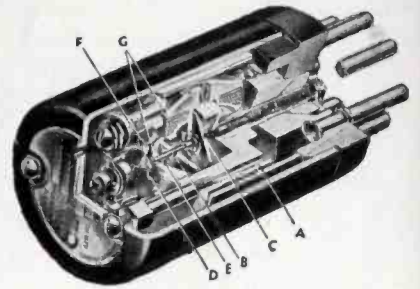

it requires only from 1 to 10 micro-watts of power for operation. Contacts will handle 1/2 ampere in a non-inductive circuit. Construction of the relay is an inversion of the d'Arsonval galvanometer movement in that the armature is a permanent magnet and the coils are stationary. Two coils are supplied so that they may be used differentially or in series aiding. The unit is enclosed and mounted on a standard seven-pin tube base. It weighs 0.15 pound and is 2 1/4 inches high. Diameter is 1 1/4 inches.

41

Broad-range Analyzer

WESTON ELECTRICAL INSTRUMENT Corp., Newark, N. J. The Model 779 meter has five overlapping a-c and d-c voltage ranges, seven d-c current ranges, four d-c resistance, and five decibel ranges. Each d-c voltage



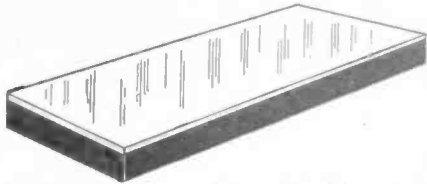
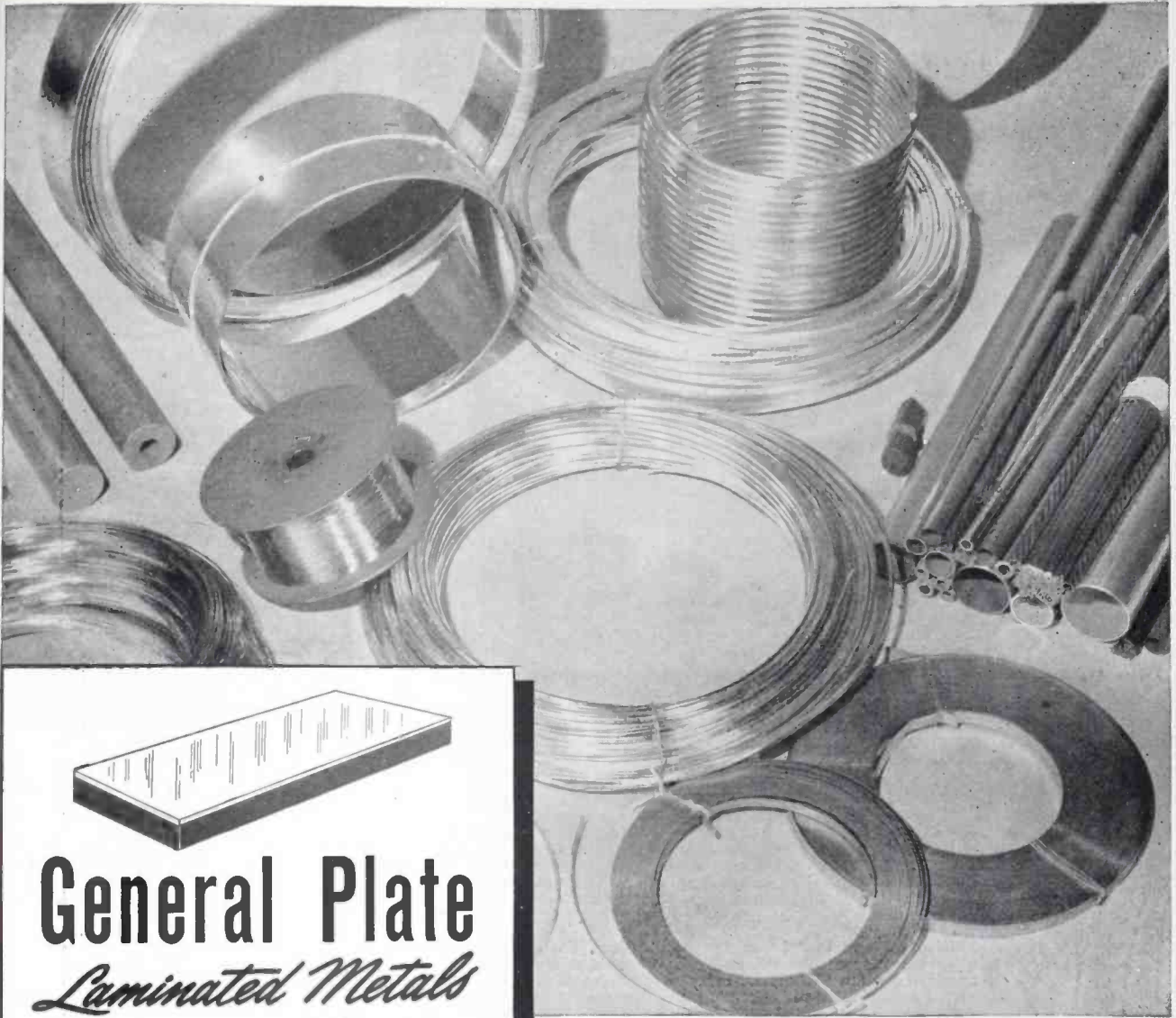

General Plate

Laminated Metals

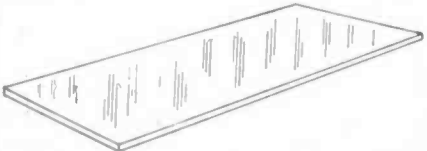

A Thin Layer of Precious Metal

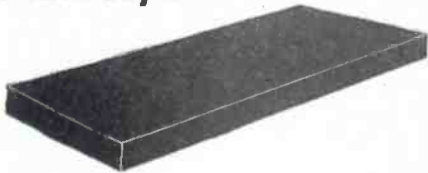

Plus Inexpensive Base Metal

Gives You Precious Metal Performance . . . ECONOMICALLY

Solid metal performance at a cost slightly more than base metal . . . that's what you get with General Plate Laminated metals.

In addition to economy, these versatile laminated metals give you such advantages as ease of fabrication, workability, high corrosion resistance, better electrical performance and long life. They are available in flat stock, tube or wire . . . inlaid, covered one or both sides. Some fabricated assemblies such as electrical contacts are also available.

Investigate General Plate Laminated Metals, today. Use them in such applications as electrical equipment, chemical apparatus, electronic devices, appliances, mobile equipment and instruments.

General Plate engineers are available for consultation on your metal problems. Write for their services.

GENERAL PLATE DIVISION

of Metals & Controls Corp., Attleboro, Mass.

50 Church St., New York, N. Y.; 205 W. Wacker Drive, Chicago, Ill.; 2635 Page Drive, Altadena, California; Grant Bldg., Pittsburgh, Pa.

Conant Instrument Rectifiers

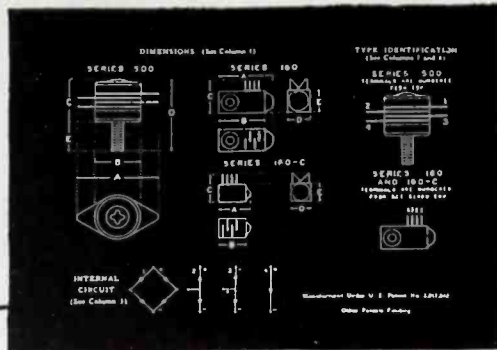

SPECIFICATIONS (STANDARD TYPES)

Col. 1	2	3	4	5	6	7	8	9	10											
Type	Series	Internal Circuit	Dimensions (Inches)			Mounting Screw Size	Weight (Grams)	No. of Terminals	Color	PEAK ELECTRICAL RATINGS			List Price							
			A	B	C	D	E		1	2	3	4	Volts	Mils	Volts	Mils	Volts	Mils		
M	500	1	.890	.500	.485	.800	.328	6-32	13.012	4	red	no blk	no	30	100	20	60	10	30	\$3.50
HS	500	2	.890	.500	.445	.800	.360	6-32	9.158	3	red	no blk	—	15	100	10	60	5	30	2.70
T	500	3	.890	.500	.445	.800	.360	6-32	9.158	3	no red	no	—	30	100	20	60	10	30	2.70
H	500	4	.890	.500	.400	.800	.392	6-32	7.730	2	red	no	—	15	100	10	60	5	30	1.50
B	160	1	.595	.485	.375	.250	.250	2-56	3.400	4	red	no blk	no	30	15	20	10	10	5	3.50
BHS	160	2	.625	.550	.375	.250	.250	2-56	2.880	3	red	no blk	—	15	15	10	10	5	5	2.70
BT	160	3	.625	.550	.375	.250	.250	2-56	2.880	3	no red	no	—	30	15	20	10	10	5	2.70
BH	160	4	.625	.550	.375	.250	.250	2-56	2.700	2	red	no	—	15	15	10	10	5	5	1.50
B-C	160-C	1	.345	.297	.310	.220	.200	none	1.743	4	red	no blk	no	30	15	20	10	10	5	3.50
BHS-C	160-C	2	.345	.297	.310	.220	.200	none	1.385	3	red	no blk	—	15	15	10	10	5	5	2.70
BT-C	160-C	3	.345	.297	.310	.220	.200	none	1.385	3	no red	no	—	30	15	20	10	10	5	2.70
BH-C	160-C	4	.345	.297	.310	.220	.200	none	1.293	2	red	no	—	15	15	10	10	5	5	1.50

Over ninety per cent of all rectifier requirements are served by 12 types—4 basic assemblies in 3 series. These 3 series are the three primary units of Conant rectifiers. Special types, however, can be developed as needed, and you'll find Conant ready to cooperate.

SERIES 500 UNITS are for general applications requiring greater output current for meters, relays or other apparatus requiring more than 1 milliamper. Recommended for all such applications at commercial and the lower audio frequencies. Will also operate up to 50,000 c.p.s. in special applications wherein accuracy of readings is not essential.

SERIES 160 and 160-C are for applications requiring good frequency response over the entire commercial and audio range and especially when the meter, relay or other apparatus requires less than 1 milliamper for operation. In some special applications these units may be operated at frequencies up to 15,000,000 c.p.s. with special circuit treatment.

SPECIAL TYPES are available in both series 500 and 160-C. When requesting a quotation on a special type include a sketch of the rectifier required or a circuit diagram showing source and frequency of the input voltage, resistance and kind of load, required load current and the ambient temperatures.

SERIES 500 Disc diameter .500 inch. Area each disc .15 square inch. Furnished with 3" braided, tinned copper leads. Finished in clear lacquer. Nickel plated end plates.

SERIES 160 Disc diameter .160 inch. Area each disc .02 square inch. Furnished with 3" stranded, tinned double silk covered copper leads. Nickel plated case. Assembly sealed with specially developed moisture proof compound.

SERIES 160-C Disc diameter .160 inch. Disc area, lead wire and length and moisture proof seal are identical with Series 160. Dimensions of the nickel plated case have been reduced to the most compact size. These units may be mounted in a standard midget fuse clip.

Conant Instrument Rectifiers are available from leading radio jobbers everywhere—consult your local jobber.

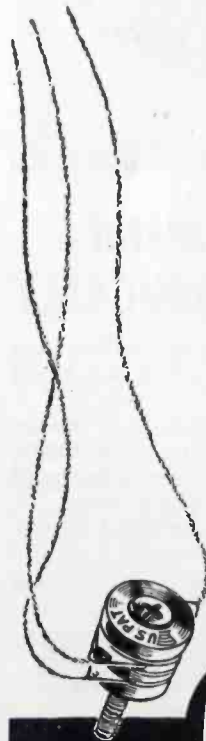

CONANT Instrument Rectifiers
ELECTRICAL LABORATORIES
6500 O STREET, LINCOLN 5, NEBRASKA, U. S. A.

70 Vesey St., New York 7, New York
85 E. Gay St., Columbus, Ohio
600 S. Michigan Ave., Chicago 5, Ill.
1215 Harmon Pl., Minneapolis 3, Minn.

518 City Bank Bldg., Kansas City 8, Mo.
1212 Camp St., Dallas 2, Texas
378 Boulevard N. E., Atlanta, Ga.
4018 Greer Ave., St. Louis, Mo.

1526 Ivy St., Denver, Colo.
4214 Country Club Dr., Long Beach 7, Cal.
Export Div., 75 West St., New York 6, N. Y.
50 Yarmouth Rd., Toronto, Canada

range is available at 1,000 or 20,000 ohms per volt. Readings are made on a standard 4-inch 50-microampere meter. The instrument is contained in a wooden carrying case 6 3/4 x 9 1/2 x 4 1/2 inches.

Vitreous Resistors

WARD LEONARD ELECTRIC Co., Mount Vernon, N. Y. announces the addition of the type M vitreous enameled resistors to the standard line. Resistance values from 0.1 to 80,000 ohms with tolerances above one ohm

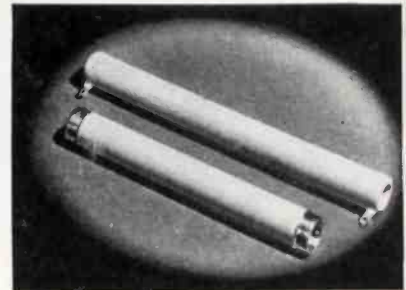

plus or minus 5 percent are available. They meet Army-Navy specification JAN-R-26 for characteristic F resistors. Power ratings are from 8 to 155 watts and continuous operation at 275 C is possible.

Totalizing Resistance Decade

THE DAVEN Co., 191 Central Ave., Newark 4, N. J. In order to obviate errors in reading and totalizing the resistance set up on a decade box in laboratory and factory measurements, the type 751 is provided with a counter dial which displays the total number of ohms. This feature has also been included in an attenuator network and calculating indicator manufactured by the same company.

Studio Console

RAYTHEON MANUFACTURING Co., Waltham, Mass., has just released details of a speech input studio console suitable for use in either a-m or f-m broadcasting. One arrangement of the equipment would allow its use in handling two studios, a control room announcing microphone, two

HEAD STYLES BY DZUS*

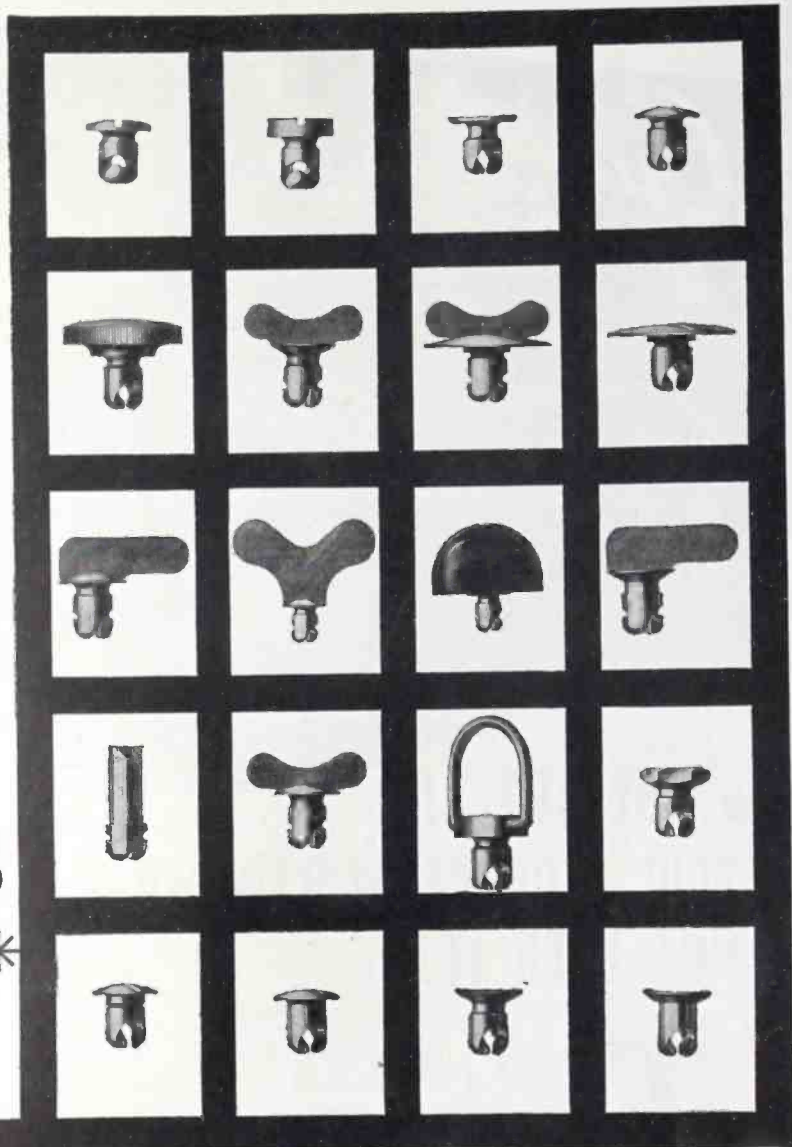

Dzus engineers have helped industry solve many intricate fastening problems by knowing just the right type of fastener head to fit a given application. Shown here are just a few of the many different styles available to meet practically any requirement.

Simple, light, durable — these Dzus spiral cam fasteners can be installed in any solid or laminated materials — wood, metal, fiber, canvas, plastics, etc., regardless of thickness. Look to Dzus for the answer to your fastening problem. Dzus Fastener Co., Inc., Babylon, New York. In Canada: Railway and Power Engineering Corp., Ltd.

SEND to Dept. E for a copy of the new Dzus catalog. More and more manufacturers in all fields of industry are finding that Dzus spiral cam fasteners squarely meet all the requirements for a dependable fastener.

* The word Dzus is the registered trade mark of the Dzus Fastener Co., Inc.



Photo by
U. S. Auto
Radiator Co.,
Inc., Brooklyn,
N. Y.

You get OUT of
your product exactly what YOU
PUT INTO IT!



OTHER GLASER PRODUCTS

Silver Brazing
Solder and Flux

Fluxes for
every purpose.

Lead Products of
every description.

Lead Lining of acid
and plating tanks.

Glaser Rosin Core Solders
exceed government specifica-
tions in purity, and are
guaranteed to meet A.S.T.M.
Class A specifications for
solder.



TOP performance and long life are the two things every manufacturer aims to get out of his product, to retain customer-popularity against ever growing competition.

Where inferior materials are used, product failure results. You get OUT of your product exactly what YOU PUT INTO IT!

Nowhere is this more forcefully demonstrated than in Glaser Solders and Fluxes. Through peace and war, for over twenty-four years, they have withstood the severest service tests.

This explains the steady trend toward Glaser Plastic Solder for Radio, Radar, fine electrical instruments, and Electronics in general. Technicians in these fields have learned that Glaser "quality" products are *dependable*.

Put Glaser Solder into your product for the "sustained performance" that safeguards your prestige.

Consult our Engineering Department
on your soldering and flux problems.

GLASER LEAD CO., INC.

31 Wyckoff Avenue,

Brooklyn 27, N. Y.

OUR 24TH YEAR OF DEPENDABLE SERVICE TO AMERICAN INDUSTRIES

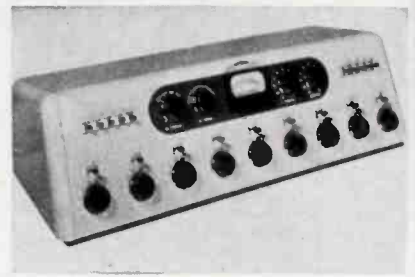

turntables and 14 incoming lines. A feature of the circuit wiring permits studio auditioning of a preceding program, but prevents simultaneous connection of microphone and speaker in the same room, thus avoiding audio feedback. Power is furnished from a separate pack. Frequency response of either the line or monitor amplifier is flat within plus or minus 2 db from 30 to 15,000 cps. At an operating level of 20 db the signal-to-noise ratio is about 60 db.

45

Power Pack

JAMES MILLEN MANUFACTURING Co., Inc., 150 Exchange St., Malden, Mass. The Millen 90201 power pack has been designed to mount directly on the chassis of a complete equip-



ment or to operate as a portable unit. Safety covers are provided for the high-voltage terminals. Regulated voltage up to 200 volts at 85 milliamperes and unregulated voltages up to 350 volts d-c are obtainable as well as 6.3 volts a-c.

46

R-f Amplifier Tube

SYLVANIA ELECTRIC PRODUCTS Inc., 500 Fifth Ave., New York 18, N. Y., announces a new tube designed especially for f-m and television receiver

ARE THESE YOUR QUESTIONS ABOUT DIRECT PROCESS BLACK LINE PRINTS?

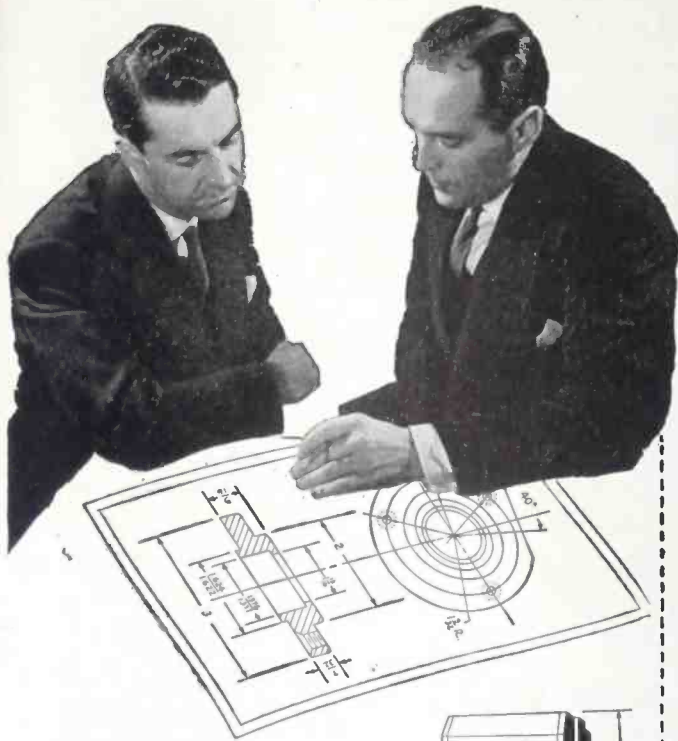

Will I need specially trained operators to make BW black line prints?

No—any intelligent person can quickly learn to make Bruning BW Prints, with their black lines on white backgrounds. Remember, too, that even the high volume Bruning printer-developers require only *one* operator. All Bruning equipment is designed for ease of use. Operation is exceptionally simple—no complicated gadgets to confuse operator.

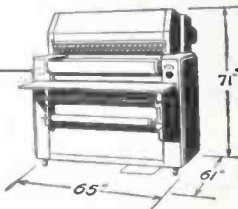

How much space will I need to install BW equipment?

Because it is so compact in construction, BW printing and developing equipment can be installed in a corner of your drafting room or engineering department, or in a private office. The Bruning printer-developer shown above—largest of many Bruning BW machines—measures only 65" wide, 61" deep and 71" high. Bruning equipment requires no plumbing—no provision for exhaust fumes, because there are none.

Can I have cut sheet and roll stock production, too?

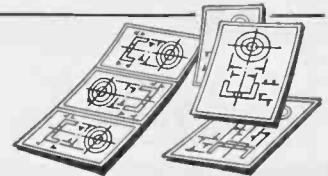

Yes—Bruning BW printing and developing machines offer you the advantages of either roll stock or cut sheet production. When cut sheets are used, Bruning provides sheets of BW sensitized paper cut to the exact size of your tracings—thus saving trimming time and waste. The Bruning line of equipment is complete—providing exactly the right equipment for your needs.

You Get These Six Major Advantages with the BRUNING BW SYSTEM

1. A versatile, simple method for making black line or colored line prints directly from tracings.
2. 17 years' experience in analyzing printmaking needs.
3. A complete line of materials, including white and green-tinted papers, thin, medium and card-weight papers, black, red or brown line prints, BW Transparents to supplement original tracings and BW Film for intensifying pencil lines in reproduction.
4. A complete line of printing and developing machines to fit every requirement.
5. A continuing service . . . because Bruning sells everything for the engineer and draftsman, not just BW equipment. Buying a BW machine is, therefore, not a "one time sale."
6. Continuing research and development in the customer's interest.

CHARLES BRUNING COMPANY, INC.

Since 1897

NEW YORK

CHICAGO

LOS ANGELES

Atlanta
Kansas City
St. Louis

Boston
Milwaukee
San Francisco

Detroit
Newark
Seattle

Houston
Pittsburgh

CHARLES BRUNING COMPANY, INC.

4712-18 Montrose Avenue, Chicago 41, Illinois

Gentlemen: I want to know more about Bruning BW Prints and equipment. Please send me information.

Name _____
Company _____
Street _____
City _____ State _____

Electricity

FOR RADIO AND ELECTRONIC APPLICATIONS



ONAN ELECTRIC GENERATING PLANTS supply reliable, economical electrical service for electronics and television applications as well as for scores of general uses.

Driven by Onan 4-cycle gasoline engines, these power units are of single-unit, compact design and sturdy construction. Suitable for mobile, stationary or emergency service.

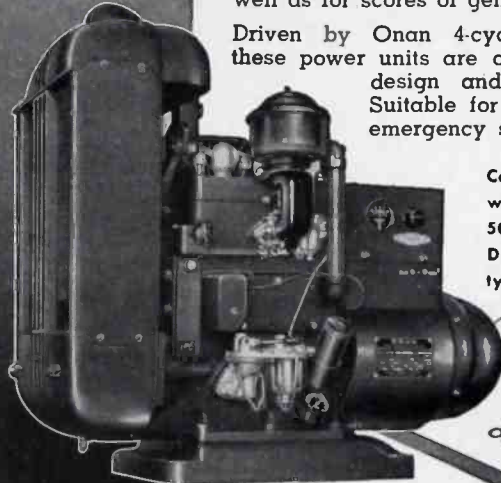

Capacity range: 350 to 35,000 watts; 115 to 660 volts A.C., 50 to 800 cycles; 6 to 800 volts D.C.; combination A.C.—D.C. types.



Model shown is from W2C series: 2000 to 3500 watts; powered by Onan two-cylinder, water-cooled engine.

D. W. ONAN & SONS

3552 Royalston Ave.

Minneapolis 5, Minn.

And **NOW!** a "Pocket-Size" OSCILLOSCOPE

The POCKETSCOPE

- So **SMALL** in size (4" x 5 1/2" x 10")
- So **LIGHT** in weight (5 1/2 lbs.)
- So **COMPLETE** in performance
- So **INEXPENSIVE** in price (\$55 net)
- Plus **WIDE-ANGLE VISION**: on shelf, on floor, on bench
- Plus **RETRACTABLE LIGHT SHIELD**: for increased visibility

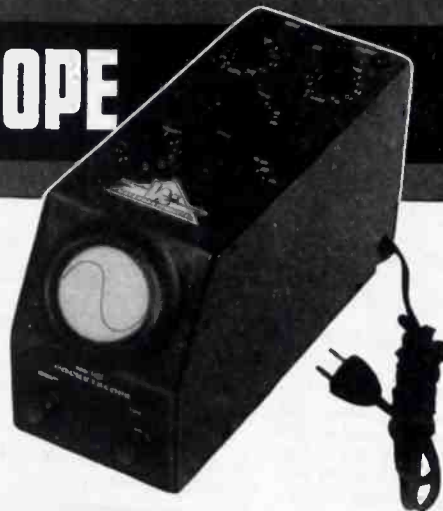

FOR DELIVERY:

Contact your nearest jobber. If he doesn't have the **POCKETSCOPE** available, contact us direct.

WATERMAN PRODUCTS CO.
INCORPORATED
Phila. 25, Pa.

WATERMAN PRODUCTS



r-f stages. Designated the 7AG7, the sharp cutoff pentode features a maximum grid-plate capacitance of 0.005 micromicrofarad and operates under the following typical conditions: heater; 6.3 volts, 0.150 ampere; plate voltage, 250; current, 6 milliamperes; screen voltage, 250 volts; current, 2 milliamperes. The tube is supplied in a T-9 bulb with 8-pin lock-in base. It measures 2 3/4 inches overall and has a maximum diameter of 1 1/8 inches.

47

Tunable-coil Form

JAMES MILLEN MANUFACTURING CO., Inc., 150 Exchange St., Malden, Mass. The No. 74001 coil form is permeability tuned, shielded and

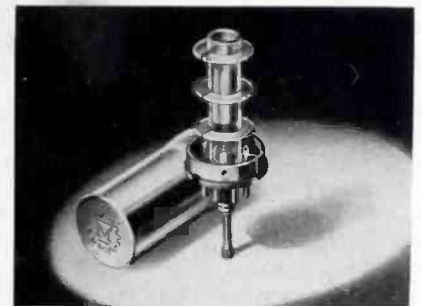

equipped with prongs so that it can be plugged into a standard octal socket. The base is low-loss mica-filled Bakelite; the 1/2-inch diameter form is polystyrene, suitable for use up to 35 megacycles.

48

Interference Filter

SPRAGUE PRODUCTS Co., North Adams, Mass., is manufacturing a line of small, self-contained filter units called Filterols. They are designed to be mounted on the frame of the device causing interference and consist of a network with three connec-

**REDUCE
DISTORTION...
PROVIDE MORE UNIFORM
TUBE CHARACTERISTICS
WITH ANODES OF**

Graphite



ONE OF the big advantages of using graphite for anodes is the high thermal emissivity of this remarkable material. Because "National" graphite is almost an ideal black body, it is a nearly perfect heat radiator. In fact, no other anode material even approaches "National" graphite in this respect.

This means that anodes of "National" graphite will operate at lower temperatures for a given amount of energy dissipated. Thus, all tube parts will operate at a lower temperature, resulting in less distortion and more uniform tube characteristics.

In addition to this important property, here are others that, combined, make "National" graphite a most valuable anode material: High electrical and thermal conductivity, low electron emission, extremely low thermal expansion, and no melting point! Furthermore, graphite can be machined into intricate shapes to very close tolerances.

The full story on the possibilities of graphite for your anodes may be had by getting in touch with National Carbon Company, Inc.

This graph shows the total energy radiation from graphite and other anode materials in watts per sq. cm.

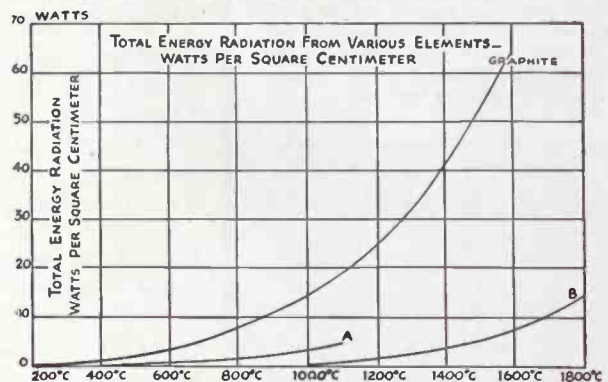

NATIONAL CARBON COMPANY, INC.

Unit of Union Carbide and Carbon Corporation
The word "National" is a registered trade-mark
of National Carbon Company, Inc.



General Offices: 30 E. 42nd St., New York 17, N. Y.
Division Sales Offices: Atlanta, Chicago, Dallas,
Kansas City, New York, Pittsburgh, San Francisco

Designed for



Application

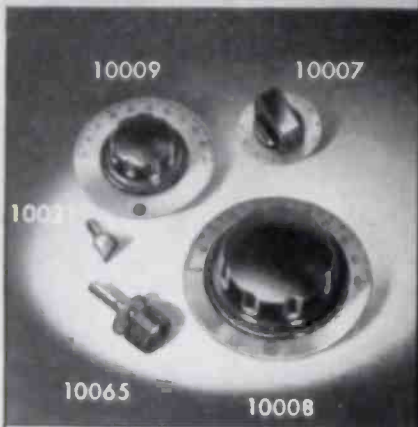

The Millen Group of Plain Dials

The No. 10007, 8, and 9 group of nickel silver plain dials with specially designed matching knobs have accurately reamed brass bushings so as to insure concentricity. The dials themselves are insulated from the hubs by means of spacer ring molded as part of the knob. The small 10007 unit is available with either 180° standard scale or 280° for potentiometer use. No. 10065 is vernier drive device for use with No. 10008, 3 1/2" dial. The knobs are also available less dials, for other uses.

JAMES MILLEN MFG. CO., INC.

MAIN OFFICE AND FACTORY
MALDEN
MASSACHUSETTS

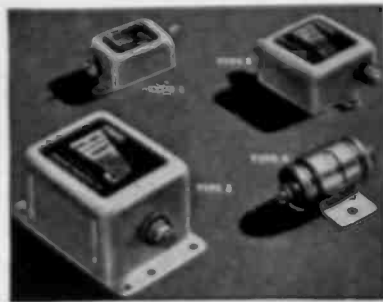

tions one of which is grounded to the can. Three types in the range from 1 to 35 amperes at 115 volts a-c or d-c and one unit for 220 volts a-c or d-c, rated at 20 amperes, are presently available.

49

Amateur Crystals

BLILEY ELECTRIC Co., Erie, Pa., has announced a new plated crystal for amateur frequencies. Secondary electrodes under spring pressure clamp



the Type AX2 plated crystal surfaces to provide better thermal dissipation and improved frequency stability under high-drive conditions.

50

Lightweight Telephone Wire

UNITED STATES RUBBER Co., 1230 Sixth Ave., New York 20, N. Y. Designed with geophysical prospecting in mind, a small-diameter wire is dipped in insulating material which has remarkable resistance to rough handling. The resultant conductor is light in weight and therefore suitable for uses wherein quantities must be carried by hand.

51

Audio Frequency Meter

GENERAL ELECTRIC Co., Syracuse, N. Y., has announced a new audio frequency meter, Type YE-5, which

Attention GI JOE!

Here's Your Opportunity to be First to
Start Your Own RADIO SERVICE SHOP

Complete Starting-in-Business Package Stocks of

TEST EQUIPMENT TUBES, PARTS, TOOLS **\$350 up**

Act quickly! Meet the post up demand for radio service. Turn your special service training into a profitable business of your own. No fee. No worry. Here's everything you need—\$350 up. Details upon request. Write, wire or phone

RCP 448

"POCKET" VOM
A.C.-D.C. Volts
0-5-50-250-1000
D.C. Milli
0-5-10-100-1000
Ohms
0-2,000-20,000-200,000-
2 Meg.
Size 3" x 3 1/2" x 2 1/2"

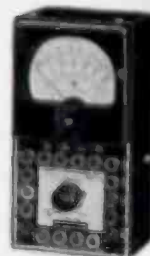

\$24.50 net

RECORD CHANGERS

UTAH-DETROIT • 550C \$18.27
WEBSTER-CHICAGO • 50 27.50

HALLICRAFTERS SX-28A

\$223



SUPER DEFIANT 8X25 \$94.50
KEY CHAMPION 830R 60.00
SKYRIDER MARINE 822R 74.50
840 NEW MODEL Approximately 79.50
SKYRIDER JR. 841 33.50

HAMMARLUND HQ-129-X \$129

TRIPLETT 625-N

30000 ohms per volt D.C.
10000 ohms per volt A.C.
5" Scale-TOPMOST QUALITY
(12) D.C. Volt Ranges to 5000
(6) A.C. Volt Ranges to 5000
(3) OHM Ranges 0-600-50000-
10 Meg.
(5) D.C. Current Ranges 1 Ma.
to 10 Amp.
PLUS OUTPUT and DB.
RANGES
\$45.00 with test leads.



PHILCO BEAM OF LIGHT

Bismuth Cell only, no holder 1.80

30% deposit required on all C.O.D. orders. 5% transportation allowance on orders of \$25.00 or more accompanied by payment in full.

RADIO SUPPLY & ENGINEERING CO., Inc.
127 SELDEN AVE. DETROIT 1, MICH.
Write for FREE CATALOG

Your Decal NAMEPLATE Selector is ready for mailing



"There's a Meyercord Decal for every kind of commercial surface"

THIS PRACTICAL "SLIDE-RULE" WILL HELP YOU SELECT THE RIGHT MEYERCORD DECAL NAMEPLATES

Don't take a chance on just "any Decal" to do your product identification job. Conditions, type and use of surface should determine the kind of Decal and adhesion method. Meyercord technicians have prepared this Decal Selector to assist in the selection of the right Decal... for use as trademarks, instructions, patent data, etc.... particularly on difficult surfaces. There's a Meyercord Decal for every surface,

from standard Kwik-Ways to highly specialized types resistant to acid, abrasion, temperature extremes, moisture... for application on any shape or kind of commercial surface. No rivets, bolts or screws required. They can be produced in any size, design or number of colors. Write today for the new Meyercord Decal Selector to help you specify the right Decal. Please address your inquiries to Department 9-6

• IDENTIFY
• DECORATE
• ADVERTISE
your products with
MEYERCORD DECALS

THE MEYERCORD CO.

World's Largest Decalcomania Manufacturers

5323 WEST LAKE STREET • • • CHICAGO 44, ILLINOIS

HARVEY'S IN and OUT

DEP'T

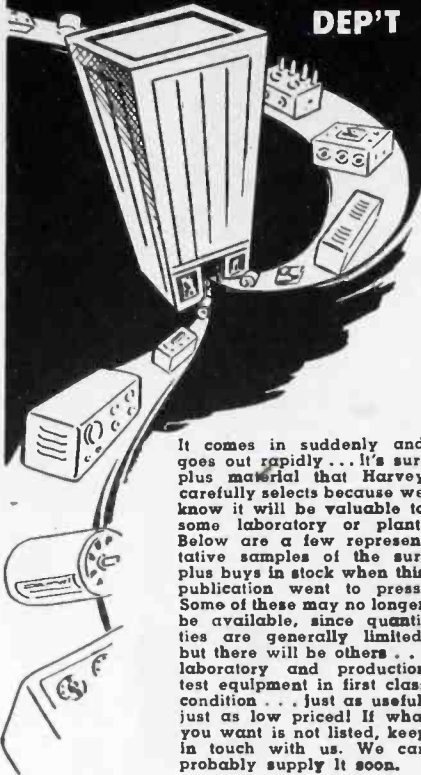

It comes in suddenly and goes out rapidly... It's surplus material that Harvey carefully selects because we know it will be valuable to some laboratory or plant. Below are a few representative samples of the surplus buys in stock when this publication went to press. Some of these may no longer be available, since quantities are generally limited, but there will be others... laboratory and production test equipment in first class condition... just as useful, just as low priced! If what you want is not listed, keep in touch with us. We can probably supply it soon.

BC-221—125 to 20,000 kc. Frequency Meter \$39.50

SC-1-122-A—Laboratory Standard Signal Generator; 34-134 Mc.; .1 volt output..... \$79.50

NC-100-ASD—Signal Corps Communications Receiver; 200-400 and 1300-30,000 kc.; a.v.c. and b.f.o. \$115.00

LM-15—Navy Crystal Calibrated Frequency Meter; 125 kc. to 20 Mc. Complete with spare parts, spare tubes, spare crystal..... \$125.00

RBL-3 — Navy Long Wave Receiver; 15-600 kc. in 6 bands; with spares \$59.50

GR 805A—Laboratory Signal Generator \$750.00

RG-11/U—73 Ohm Coaxial Cable. Minimum length 100 feet, per ft. 12¢

Carter Dynamotor—5.5 volt input; 350 volt, 150 mls output. Brand new \$14.95

Precision Crystal Unit CR-1A/AR—Grade A; 5000 kc. \$1.95

O-4/ARC-5 — Crystal Oscillator Unit including 2 Pierce oscillators and modulator. Complete with four 9002 tubes.... \$6.95

Hewlett-Packard 200 BR Audio Oscillator — 20-20,000 cycles; rack mounting \$100.00

Remember, for news of surplus you can use, call HARVEY first!

Telephone: **hrc** Longacre 3-1800

HARVEY

RADIO COMPANY INC.

103 West 43rd St., New York 18, N. Y.

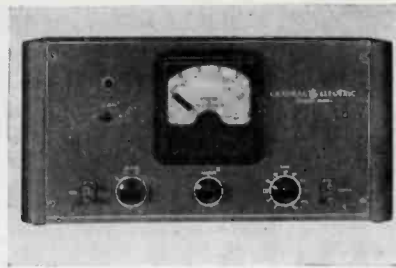

will be found useful in many branches of the electronic field for a-m and f-m broadcasters, in telemetering and in various phases of manufacturing. A range switch is provided so that maximum accuracy of readings from less than 20 pulses per second to 50,000 cps is provided. Input voltage for operation of the meter can vary between 105 and 125 volts with no more than 1-percent variation above or below the true reading.

52

Power Triode

GENERAL ELECTRIC Co., Syracuse, N. Y., announces manufacture of a new three-electrode transmitting tube, type 7C29, particularly designed for operation up to 110 mega-



cycles as a class C r-f amplifier. Plate dissipation under forced air cooling is 500 watts. Typical operation in an open-line circuit with a plate voltage of 2,800 volts shows a power output per tube of 600 watts.

53

Pipe Locator

NILSSON ELECTRICAL LABORATORY, Inc., 103 Lafayette St., New York 13, N. Y. The Model 112 pipe locator consists of a transmitter and receiver. The transmitter unit is connected to the pipe or conduit and remains stationary. The receiver, equipped with a three-stage amplifier and headphones, is used in tracing the pipe by a signal which at-

WEILINE POSITIVE PRINT PAPERS



ELIMINATE THE NEGATIVE In Print Making

You Save Time With Weiline... lots of time... by producing positive prints direct from your engineering drawings.

You Eliminate the Negative... and get perfect work-prints every time. The dry-direct process uses no wet chemicals. No washing and drying. No curling.

You get Choice of Blue or Red Line Prints on white background. Helps to tell prints from different depts.

You get Intermediate Originals with Sepia lines on transparentized paper... that save draftsman's time in making design changes... and speed up print production.

Write for Free Sample Book and Full Information

ADDRESS DEPT. EL

J. H. WEIL & CO.

1315 CHERRY STREET
PHILADELPHIA 7, PA.

DRAFTING MATERIALS
SENSITIZED PAPERS
ENGINEERING INSTRUMENTS

Now...a Germanium Crystal Duo-diode

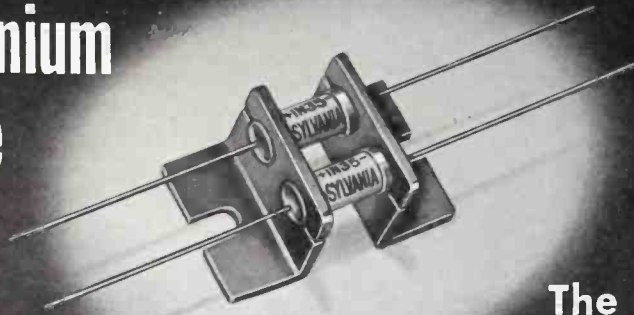

**The Sylvania
1N35
(SHOWN ACTUAL SIZE)**

**THE 1N35
CONSISTS OF TWO MATCHED
INTEGRALLY MOUNTED CRYSTAL DIODES.**
The 1N35 is a precision circuit element,
accurately adjusted, ruggedly constructed.

Germanium crystal is cut from 0.6 mm. sheet, optically ground smooth on one side, and silver-soldered to tip of brass screw.

Whisker is formed from tungsten wire 75 microns in diameter, and soldered to screw. Loop provides spring pressure.

Whisker is adjusted for correct forward and back resistance. Isolantite cartridge is wax-filled to maintain correct adjustment and render moisture-proof.

Pigtails are silver-soldered to precision-formed contact cups, and cups are welded over end caps.

**CONSTRUCTION DETAILS
OF THE 1N35**

The 1N35 Duo-diode, a new circuit element developed by Sylvania Electric, consists of two Germanium Crystal Diodes mounted in a single assembly that facilitates mounting.

The two crystal diodes are matched for values of forward and back resistance, under conditions typical of those anticipated in actual use. In addition, the 1N35 is tested for R. F. loading on a tuned circuit.

The 1N35 is valuable wherever full-wave rectification, modulation or demodulation is required in a balanced circuit. Potential applications include FM discriminators, bridge rectifiers, ring modulators, demodulators, and varistors.

TENTATIVE SPECIFICATIONS

Each diode used in the 1N35 has the following tentative characteristics:

Peak Inverse Anode Voltage	50 volts
Peak Anode Current (sine wave)	60 ma max.
Average Anode Current	22.5 ma max.
Surge Current (transient peak)	200 ma max.
Back Conduction at 50 volts	2 ma max.
Operating Frequency Range	0-100 mc

Inquiries are invited concerning applications of the 1N35.

TYPICAL CIRCUITS

RIGHT — The 1N35 in frequency discriminator circuit.
BELOW — Full wave rectifier second detector circuit.

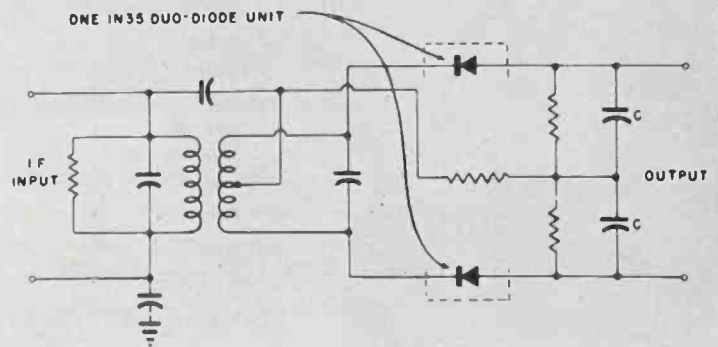
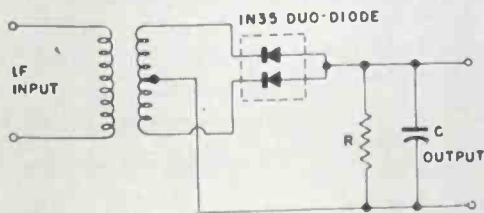

SYLVANIA ELECTRIC

Electronics Division . . . 500 Fifth Avenue, New York 18, N. Y.

MAKERS OF ELECTRONIC DEVICES; RADIO TUBES; CATHODE RAY TUBES; FLUORESCENT LAMPS, FIXTURES, WIRING DEVICES; ELECTRIC LIGHT BULBS

RESISTS VIBRATION

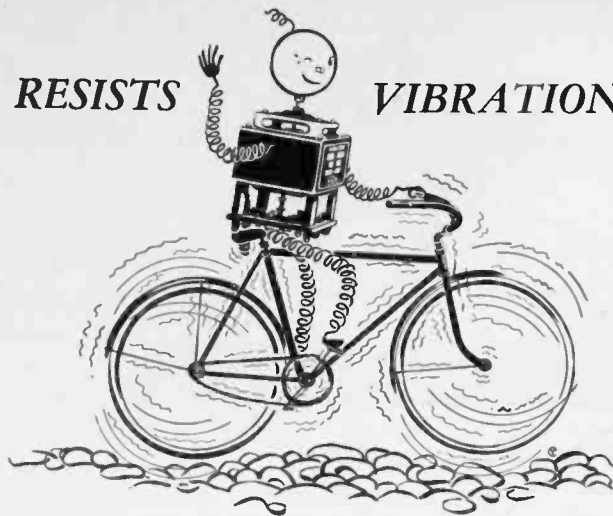

Rugged—precision built—resists vibration. Time delay control ranging from a fraction of a second to several minutes. Setscrew adjusted. Write for complete information and catalog. No obligation.

AGASTAT

Electro-Pneumatic *TIME DELAY RELAY*

ELIZABETH **A'G'A** NEW JERSEY
AMERICAN GAS ACCUMULATOR COMPANY

BAKELITE SHEETS, RODS AND TUBES



On special mill shipments we can give prompt delivery. Also complete fabrication service backed by over 20 years of experience.

**ELECTRICAL
INSULATION CO., INC.**

12 Vestry St., New York 13, N. Y.



tains maximum audibility closest to the pipe. Distance to which pipe may be traced varies upon conditions and may be from 2,000 to 5,000 feet. Carrying case to hold the complete equipment measures 15 x 9½ x 7½ inches and total weight is about 10 pounds.

54

Vacuum Variable Capacitors

JENNINGS RADIO MANUFACTURING Co., San Jose, Calif., announces development of a new variable vacuum capacitor. Seven complete revolu-

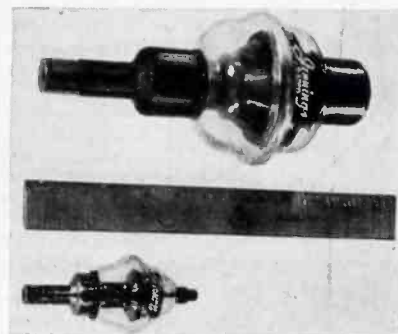

tions of a shaft are required to cover the range of capacitance so that no additional vernier is necessary. The models illustrated have ranges of 50 to 250 and 5 to 25 micromicrofarads, with peak voltages of 10,000 and 20,000 volts, respectively.

55

Coil Checker

STARR AND THORNBURY, 4101 Rhodes Ave., North Hollywood, Calif. The Kartron Coil Checker is essentially a device to measure the *Q* of a coil, and is useful in manufacturing to indicate shorted turns or open windings. An average operator can check as many as 5,000 coils a day, detecting a single shorted turn of number 44

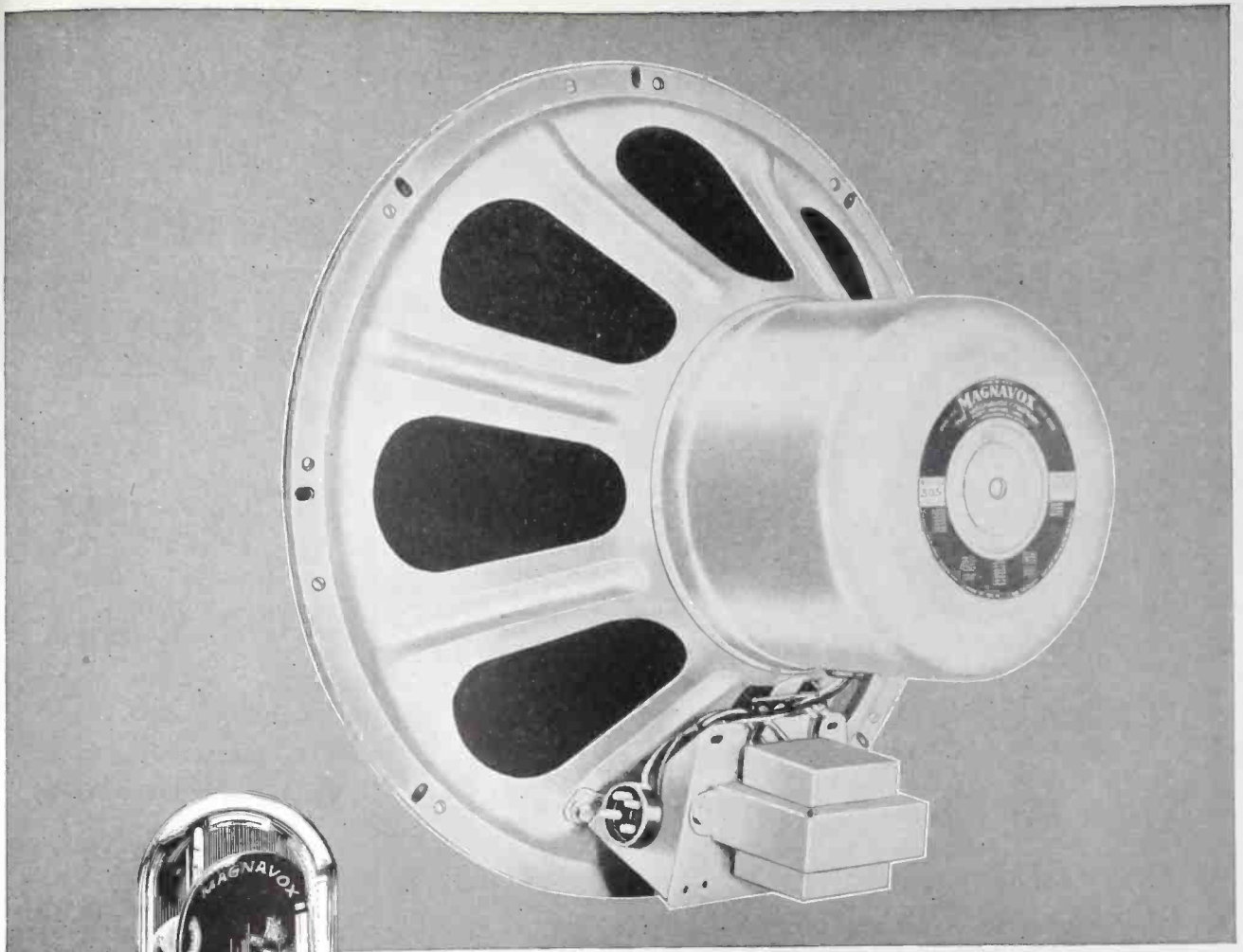

The Electrodynamic Speaker
—the first voice of all modern
sound reproduction.

Magnavox...

loud-speaker headquarters since 1915

THE electrodynamic speaker, invented by Magnavox engineers in 1915, revolutionized the world of sound and made possible the development of all modern public address systems, radios and movies. Now, after three decades of continuous research and development, Magnavox is not only the oldest, but also the largest manufacturer of quality speakers.

Magnavox designers and engineers have achieved a breadth of experience and knowledge that enables them to meet your

specifications exactly. Magnavox supplies quantity requirements of the manufacturing trade — over 150 models are offered.

Our staff of trained engineers and designers stands ready to apply its developments to any of your speaker and component problems. Feel free to call on them at any time. And when you need speakers—specify Magnavox! There is no substitute for experience. The Magnavox Company, Components Division, Fort Wayne 4, Indiana.

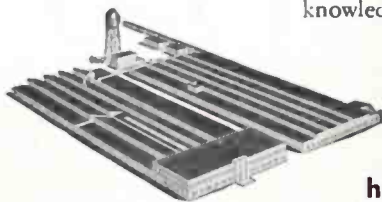

Magnavox

has served the radio industry for over 30 years

SPEAKERS • CAPACITORS • SOLENOIDS • ELECTRONIC EQUIPMENT

BURGESS

simplifies your
problem of

NEW DRY BATTERY DESIGN

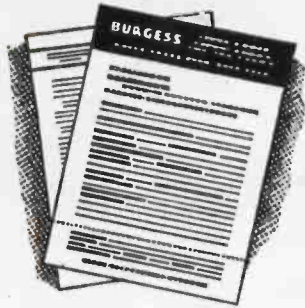

FOR SPECIAL APPLICATIONS
... Burgess makes it easy to develop just the battery you need for new instruments or electronic equipment.

USE THIS HANDY CHECK SHEET
... you can easily fill in the complete details required for your special battery... enables Burgess engineers quickly to provide you with correct and complete data on just the battery you need.

Send for this free check sheet to put at your disposal the complete Burgess engineering facility.



HUNDREDS of special batteries have been developed by Burgess engineers for new applications... the battery you need may be among them. Consult Burgess today!

SEND THIS COUPON!

BURGESS BATTERY CO.
Freeport, Illinois Dept. E-6

Send me the free check sheet to aid in new battery development.

Name _____
Company _____
Address _____
City _____ State _____

wire in a winding of 10,000 turns. There is no danger of electrical shock to the operator. The coil checker operates from a 110 to 120 volt, 50 to 60 cps line. Overall dimensions are 6 x 6 x 12 inches. List price is \$150.

56

Supersonic Generator

FISHER SCIENTIFIC Co., 717 Forbes St., Pittsburgh 19, Pa., and Eimer and Amend, Greenwich and Morton Streets, New York 14, N. Y. The Crystalab Ultra-Sonorator produces 500 watts of radio-frequency energy at 100, 400, 700 and 1,000 kilocycles. Input power is obtained from any 110-volt, 50 to 60 cps line. These units are suggested as having usefulness in application of supersonic energy to physical, chemical and biological fields of research.

57

Grid-control Rectifier

ELECTRONS INCORPORATED, 127 Sussex Ave., Newark 4, N. J., announce a new grid-control xenon-gas

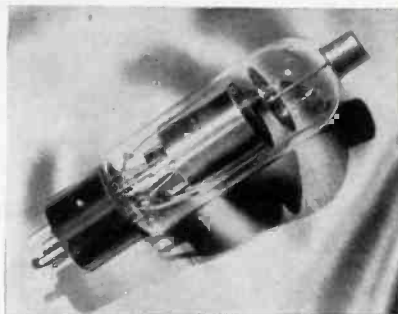

rectifier, type EL C3J. Filament voltage is 2.5; current, 9 amperes; peak forward voltage 750; peak plate current, 30 amperes. The tube is 6½ inches long.

58

Direct-coupled Amplifier

AMPLIFIER COMPANY OF AMERICA, 396-398 Broadway, New York 13, N. Y. The Model ACA-100DC amplifier has been designed for studio monitoring, microphone and speaker measurements or any other exacting audio service. Response from 20 to 20,000 cps is within plus or minus 1 db. The amplifier develops 23 watts

**A major
advancement
in the
recording blank
field...**

10 Year

GUARANTEE

GOULD-MOODY

"Black Seal"

**ALUMINUM
RECORDING BLANKS**

**... at no increase
in price!**

After prolonged research and experimentation, we have introduced technological improvements into "Black Seal" blanks that not only increase life span, but materially enhance the other finer characteristics of these blanks. And so positive are we of the worth of these perfected "Black Seals" that we're offering them to you on an unconditional ten-year guarantee basis.

**You can't afford to be a
recording isolationist...**

"Black Seal" blanks will not rip up, disintegrate or powder after the first playing if kept in storage for any long period of time. You are in no danger of losing valuable recordings in what, up until now, you have considered your safe library of recording blanks. No matter how well you may be satisfied with your present blanks, you can't afford to be a recording isolationist. Try "Black Seals"—if, for any reason whatsoever, you aren't satisfied, return them at our expense.



THE GOULD-MOODY CO.

Recording Blank Division

395 BROADWAY NEW YORK 13, N. Y.

Announcing

TELEVISION Equipment

for studio • laboratory • manufacturer

POLARAD Television SYNCHRONIZING GENERATOR

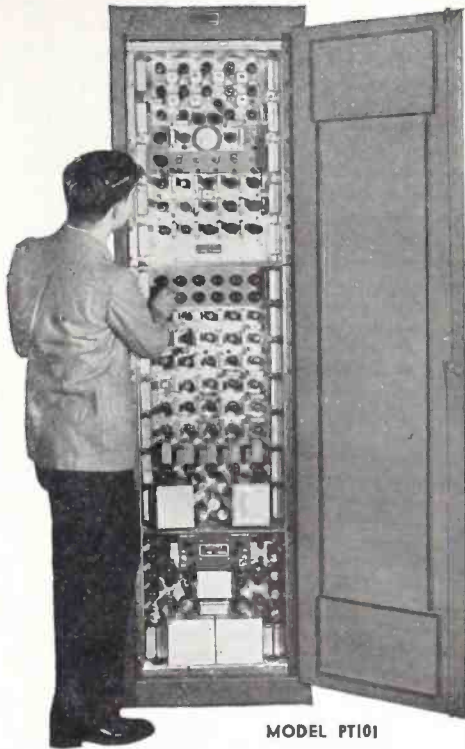

MODEL PT101

Features

Built in 3" oscilloscope with synchronized sweeps for viewing important pulse wave forms.

Synchronized marker system for checking pulse width and rise time.

Fast lock-in action for motion picture applications.

Extreme stability, insured by deriving all pulses from leading edge of master oscillator pulse.

Wide band delay line for adjusting delay times without distorting pulse wave forms.

Dish-pan construction to allow for maximum accessibility for maintenance.

SPECIFICATIONS:

525 line, Interlaced, 60 fields, 30 frames, RMA synchronizing pulses held to tolerance specified in the NRTPB report of 1945.

Dual Regulated D. C. POWER UNIT

This unit consists of two independently regulated d-c power units which are designed to meet the operational requirements of television equipment or other apparatus where close regulation and low ripple content are important. The unit mounts in a standard type relay rack. Dish-pan Construction is used, thereby permitting equal accessibility to front and rear components.

Each Power Unit has its own power switch, fuses, pilot light and voltage control.

SPECIFICATIONS

- A. C. Line 115 Volts, 50/60 cps.
- D. C. Voltage 250-300 Ripple less than 0.001%
- D. C. Current 400 MA Each Unit.
- Impedance less than 1.50 ohms.

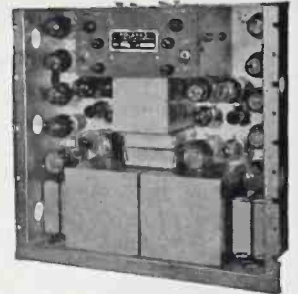

MODEL PT111D

Wide Band VIDEO AMPLIFIER

Designed for use as an oscilloscope deflection amplifier for the measurement and viewing of pulses of extremely short duration and rise time. Supplied in a portable cabinet, 19-1/4" x 22" x 14-3/4", and consists of an amplifier unit, a low capacity probe, and a power unit. Amplifier gain is 41.5 DB.

The amplifier is supplied with a frequency compensated high impedance attenuator calibrated in 10 DB steps from 0 to 50 DB. A fine attenuator control is also provided to cover a range of 10 DB.

Frequency Range. Flat within $\pm 1\frac{1}{2}$ db from 100 cps to 20 MC.

Input Impedance. a) Probe: 12 MMF + 470000 ohms.

b) Input Jack: 30 MMF + 470000 ohms.

Output Impedance. 18 MMF + 5000 ohms each side push pull.

Max. Input Voltage. 500 Volts peak to peak with probe.

Max. Output Voltage. 56 Volts peak to peak (push pull).

*Low frequency range extended per specifications.



100 cps to 20 MC
MODEL V



Television Camera CHANNEL AMPLIFIER

Designed for black and white or color television camera chains. Can be used with either orthicons or iconoscopes.

The features incorporated into this amplifier provide maximum operating flexibility.

Frequency Response: ± 1.5 db. to 9 megacycles. Less than 2% tilt for 60 cps square wave.

Gain: Voltage gain=50. Input level=.02 volts across 75 ohms. Output=1.0 volts across 75 ohms.

Features: Dual output tubes. Streaking correction for iconoscopes. Remote gain and black level control. Gamma correction. Video black level automatically held constant with respect to blanking black reference regardless of average scene brightness.

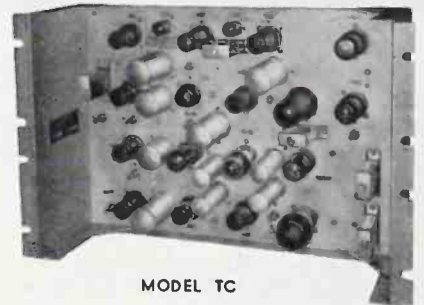

MODEL TC

135-B LIBERTY STREET,
NEW YORK 6, N. Y.

REctor — 2-0534

REctor — 2-4484

Polarad

Electronics Company

New... "DIALCO" PLN-849 Pilot Light

features the
New Neon NE-51 Bulb
with

BUILT-IN RESISTOR

For 110 Volts (and higher)

A RUGGED UNIT. Consumes a small amount of current (under one milliampere) and has dependable long life.

Note these important features of the PLN-849 Pilot Light:

- (1) RESISTOR INTEGRAL with socket assembly. Value to suit supply voltage.
- (2) Moulded Bakelite Socket.
- (3) Full-view Jewel Plastic Cap for visibility at all angles.
- (4) Rugged terminals, binding screw or permanent soldering type.
- (5) High resistance to vibration or shock.
- (6) Supplied complete with General Electric Neon NE-51 Bulbs. May also be adapted to accommodate General Electric Radio Panel Bulbs such as 47, 44, etc., for low voltage circuits. Bulbs removable from front of panel.

DIALCO

Write for Four Page Illustrated Brochure

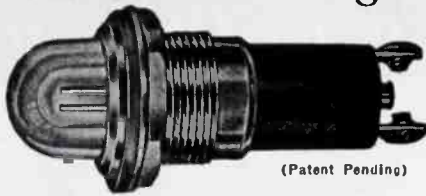

(Patent Pending)

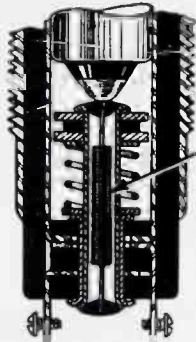

BUILT-IN RESISTOR HOUSED IN SPRING CONTACT EYELET

DIAL LIGHT CO. of America, Inc.

900 BROADWAY • NEW YORK 3, N. Y.

Telephone: ALgonquin 4-5180-1-2-3

WRITE FOR NEW ILLUSTRATED BROCHURE



Precision That Meets Cost-and-Delivery Promises

THIS PART was turned over to us with costly jig fixtures and tools. But to keep our cost-and-delivery promises, we found it preferable to retool the job ourselves. Tolerances on this part ran as close as +.0005 inches, —.0000. All machined surfaces had to be finished to *super-smoothness*.

Such precision is our business here

at Ericsson—has been for more than 35 years. We are glad to consult with manufacturers whose products are more effectively marketed with close-tolerance parts produced economically.

ERICSSON 
ESTABLISHED 1911



ERICSSON

SCREW MACHINE PRODUCTS CO., INC.

25 LAFAYETTE STREET, BROOKLYN 3, N. Y.



output with less than 1-percent distortion. Two inputs are provided, each 500,000 ohms. Outputs of low impedance and 500 ohms are available. Power consumption is 150 watts. Overall dimensions are 17½ x 10 x 10 inches. Net price of the amplifier is \$177 complete with cables.

59

A-c Line Regulator

SORENSEN & Co., INC., Stamford, Conn. A low-cost regulator has been designed which holds line voltage within plus or minus 0.5 percent of adjusted value during variations of input voltage from 95 to 125

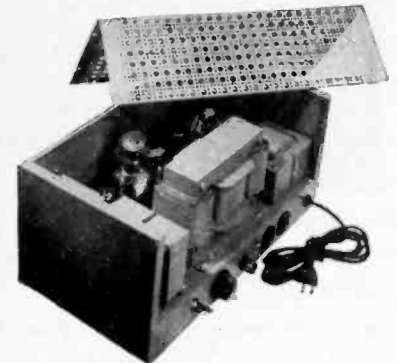

volts and variations in load from 50 to 500 volt-amperes. Regulation of the Model 500 is accomplished electronically, without moving parts. Frequency variations as much as 10 percent have no effect on its operation. Harmonic distortion is less than 5 percent. The price is \$98.

60

Audio Meter

RADIO CORPORATION OF AMERICA, Camden, N. J. The model 306-A audio-frequency meter is self-contained, operating from a 117-volt, 50 to 60-cps line and requiring 70 watts of power. Frequencies from 0 to

Speaking of STABILIZATION

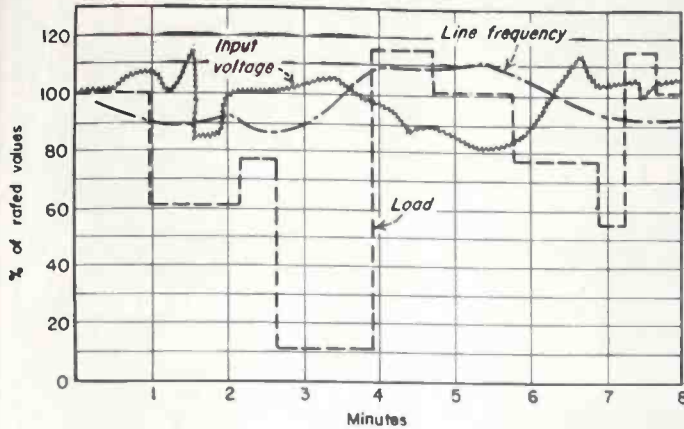

With
THESE
Variations

You get **THIS**
STABILIZATION
ONLY

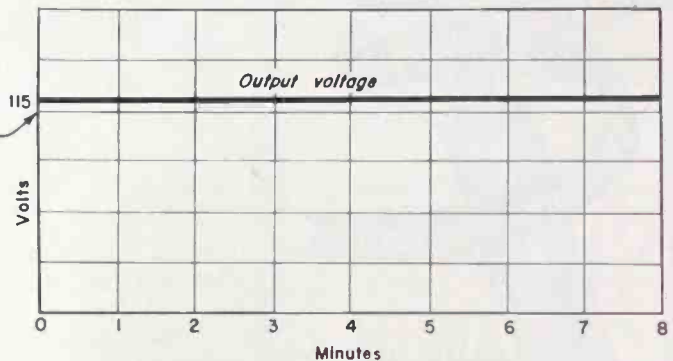

When using SORENSEN ELECTRONIC REGULATORS

SORENSEN REGULATORS are based on a unique principle that results in extremely accurate voltage regulation—independently of variations in INPUT VOLTAGE, LINE FREQUENCY, LOAD & POWER FACTOR, within wide limits.

Regulation is accomplished electronically without moving parts of any kind. This means QUICK RESPONSE, LOW MAINTENANCE and LONG LIFE.

Whatever the peculiarities of your regulation problem, investigate the SORENSEN REGULATOR.

Here are a few of the characteristics available in the various models:—

- Regulation Accuracy0.2%
- Load Ranges25 V.A. to 5 K. V.A.
- Harmonic Distortion5% max.*
- * Less than 2%—Special Models.
- Response Time6 cycles max.
- Adjustable output voltage.

★
INTRODUCING

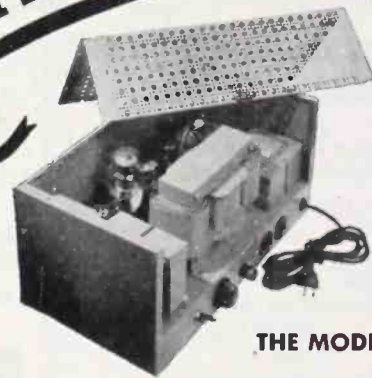

THE MODEL 500

Load range 50 V.A. to 500 V.A.
Regulation accuracy $\pm 0.5\%$
Price \$98.00

F.O.B. Stamford, Conn.

Write for descriptive bulletin

SORENSEN & CO., INC.

375 FAIRFIELD AVE., STAMFORD, CONN.

Check These Exclusive

KWIKHEAT

SOLDERING

IRON

Advantages!



- ★ SAVES TIPS
- ★ SAVES TIME
- ★ SAVES EFFORT
- ★ SAVES WEIGHT
- ★ SAVES CURRENT
- ★ SAVES THE IRON

HOT IN 90 SECONDS READY FOR USE . . . !

Kwikheat's built-in thermostat maintains proper, even heat for most efficient, economical operation. Can't overheat . . . saves tips . . . requires less retinning. Powerful, 225 watts, yet light weight (14 oz.), well-balanced with cool, protecting handle. Complete with #1 tip . . . \$11.00

6 TIP STYLES

Interchangeable



50,000 cps with amplitudes from 1 to 200 volts rms can be measured with an accuracy of plus or minus 2 percent. Waveform errors are practically eliminated. The unit measures 8½ x 19 x 13½ inches, weighs 41 pounds and costs \$275 net, fob Camden.

61

Molded Capacitors

NORD MANUFACTURING Co., Inc., Bridgeport, Conn., announces a new line of molded tubular capacitors. Available in capacitance ranges from

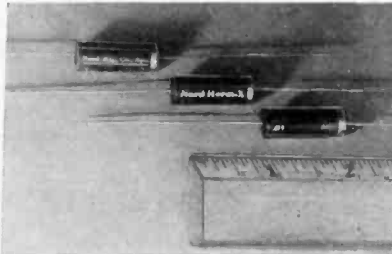

0.001 to 0.1 microfarad and up to 1,000 volts d-c, the new units have the advantage of smaller physical size than in more conventionally enclosed types.

62

Long-Life Rectifier

FEDERAL TELEPHONE and Radio Corp., Newark 5, N. J. A midget, 5-plate square-stack selenium rectifier has been designed to replace the rectifier tube in modern portable receivers which employ battery, a-c, or d-c. Besides having many times the life of the type 117Z6 tube it replaces, its action is practically instantaneous, no warm-up period being necessary for its operation. The type 403D-2625 unit has a rated current-carrying capacity of 100 milliamperes d-c

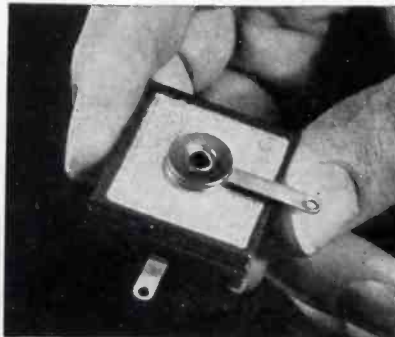

Electrical Papers

SPECIALIZED PAPER FOR WIRE WRAPPING

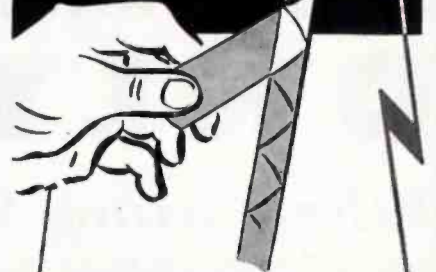

A variety of treatments to meet every wire and cable wrapping requirement — includes creeping for pliability; superior strength; corrosion resistance; weather proofing and special attention to uniformity for production winding.

Let us help you find the most efficient and economical Electrical Paper for your purpose — send us your requirements.

FREE BOOK

Contains data on Electrical Paper properties and a wide variety of samples.

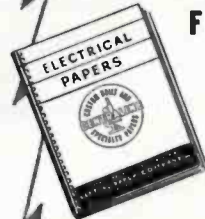

REG. U. S. PAT. OFF.

CENTRAL PAPER COMPANY INCORPORATED

2442 LAKESHORE DRIVE, MUSKOGON, MICH

OFFICES IN: BOSTON, NEW YORK, BALTIMORE, ROCHESTER, CLEVELAND, CINCINNATI, DETROIT, CHICAGO, ST. LOUIS, SAN FRANCISCO

NEW EBY SOCKETS

Lock-In, Octal, and Non-Microphonic

LOCK-IN (Glass Bonded Mica)

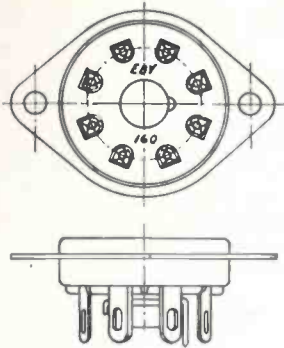

Chassis Hole— $1\frac{1}{16}$ " dia.
Mounting Centers— $1\frac{1}{16}$ "
Mounting—Top or Bottom

LOCK-IN

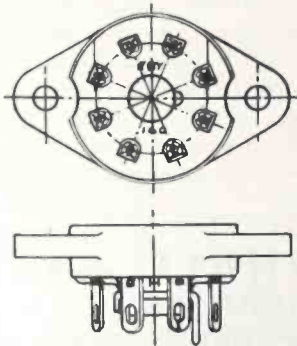

Chassis Hole— $1\frac{1}{16}$ " dia.
Mounting Centers— $1\frac{1}{16}$ "
Mounting—Top or Bottom

LOCK-IN

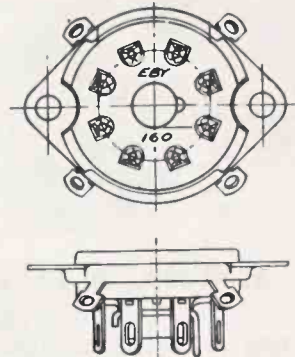

Chassis Hole— $1\frac{1}{16}$ " dia.
Mounting Centers— $1\frac{1}{16}$ "
Mounting—Top or Bottom
With or without Grounding Lugs

OCTAL

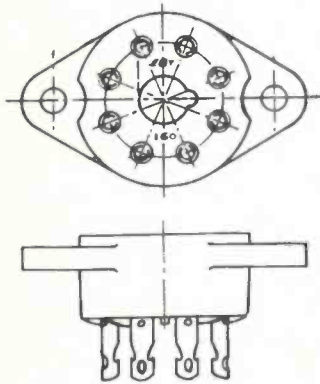

Chassis Hole— $1\frac{1}{16}$ " dia.
Mounting Centers— $1\frac{1}{16}$ "
Mounting—Top or Bottom

OCTAL

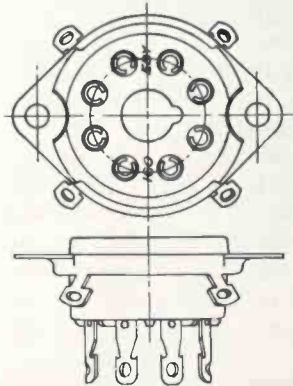

Chassis Hole—1" dia.
Mounting Centers— $1\frac{1}{16}$ "
Mounting—Top or Bottom
With or without Grounding Lugs

NON-MICROPHONIC (Miniature)

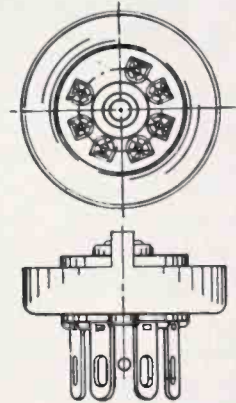

Chassis Hole— $\frac{3}{16}$ " dia.
Mounting Centers— $\frac{7}{16}$ "
Mounting—Top or Bottom

Write today for
complete details . . .

HUGH H.
EBY
INCORPORATED
18 W. CHELTEN BLDG.
PHILA., PENNA.

RUGGED Screw Terminals for a **RUGGED** Rheostat

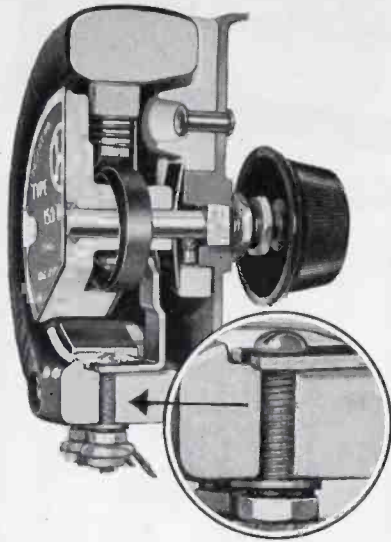

The sturdy screw terminals are integral with the massive ceramic winding core—a great core that gives 25% more capacity. These solid screw studs cannot be deformed nor ripped loose.

And this is only one of several exclusive features of this line of rheostats, ranging from 50 to 500 watt capacity.

Our 10 watt and 25 watt rheostats also, and many different types of Hardwick-Hindle resistors, offer other exclusive advantages.

Write us today. Our engineers are at your service.



HARDWICK, HINDLE, INC.
RHEOSTATS and RESISTORS

Subsidiary of THE NATIONAL LOCK WASHER COMPANY
NEWARK 5, N. J. ESTABLISHED 1886 U. S. A.

The **FINEST MICROPHONES**
for P. A. and RECORDING!

AMPERITE
VELOCITY
MICROPHONE
WITH
PATENTED
ACOUSTIC
COMPENSATOR



New P. G.
DYNAMIC
WITH NEW
SUPERIOR
ELIPSOID
PICK UP
PATTERN!



AMPERITE KONTAK MIKES
IDEAL FOR AMPLIFYING
STRINGED INSTRUMENTS
USED WITH ANY AMPLIFIER
AND WITH RADIO SETS.



ASK YOUR JOBBER . . . WRITE FOR FOLDER

AMPERITE

561 BROADWAY NEW YORK



and a peak inverse voltage of 330 volts. Less heat is dissipated than that from the tube rectifier. It will be useful in other apparatus where requirements are comparable. The unit measures $1\frac{1}{2} \times 1\frac{1}{2} \times \frac{1}{2}$ inches.

63

Metal Detector

RADIO CORPORATION OF AMERICA, Camden, N. J. The electronic metal detector protects product quality and expensive finishing machinery, such as saws, plastic molds and textile equipment by detecting, rejecting or marking material containing bits of metal. Alarms and special fittings for specific manufacturing details can easily be added to the three standard models available. The equipment is particularly adaptable to conveyor belt applications.

Literature

64

Lamps and Fuses. Solar Electric Corp., Warren, Pa., has just released its new 1946 catalog describing a complete line of incandescent, fluorescent and special lamps as well as plug and cartridge fuses.

65

Factors and Formulas. I-T-E Circuit Breaker Co., 19th and Hamilton Streets, Philadelphia 30, Pa. Bulletin 4508 includes sections on definitions of basic units, mensuration conversion factors, electrical conversion factors, temperature conversion formulas and prefixes.

66

Standard Radio Symbols. Sun Radio and Electronics Co., Inc., 122-124 Duane St., New York 7, N. Y., has reissued the two-page chart, "Graphical Symbols for Electronic Diagrams," reproduced from ELECTRONICS. These symbols have been abstracted from the American Standards Association publications Z32.10-1944 and Z32.5-1944 and present in a convenient form those of greatest

High
PERFORMANCE RELAY
AT A
Low PRICE

THE NEW SIGMA SERIES 41 RELAY

is streamlined for high volume applications and yet offers the standard of quality inherent in all Sigma Relays.

Construction Features:

- Beryllium copper armature and contact springs.
- Spring reed-type, armature hinge with low reluctance gap.
- High permeability, low-residual iron parts

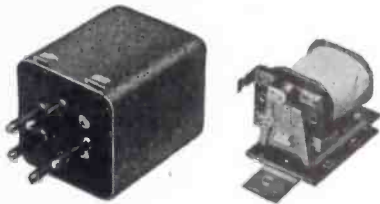

61 R(dc), RZ(ac) 41 FZ(ac), F(dc)
Size:

Unenclosed types: 1" x 1 7/32" x 2 3/16" *

Plug-in types: 1 1/2" x 1 1/2" x 1 1/8" high.

* (Long dimension includes full length of mounting bracket).

Minimum Input Requirements:

20 milliwatts for D.C. types.
0.1 volt-amperes for A.C. types.

Contacts:
S.P.D.T.

Ratings up to 15 amperes with low voltage D.C. or up to 1 K.W. incandescent lamp load at 115 volts A.C., with sufficient input power.

For critical performance requirements at minimum cost, specify the Sigma Series 41 Relay.



Sigma Instruments, Inc.
Sensitive RELAYS
62 Ceylon St., Boston 21, Mass.



How **PROGRESSIVE DIES** Cut Costs

GOAT PRECISE-FORMED STAMPINGS

Save Money in quantity production

New techniques in construction and use of high speed, automatic, single operation, multiple-stage, progressive dies, in conjunction with the GOAT Precision Feed (U. S. Pat. No. 2,250,520), make possible: higher production speeds, lower scrap losses, less tool maintenance, overall lower costs, and closer tolerances than ever before possible. On lots of 500,000 or more the savings are indeed worthwhile.

*Submit samples or drawings
for cost estimates*

ADDRESS DEPT. EL



GOAT METAL STAMPINGS, INC.
Affiliate of The Fred Goat Co., Inc.
314 DEAN STREET BROOKLYN, N. Y.



TESTING TRANSFORMERS

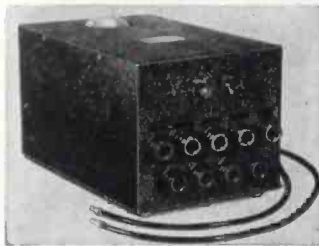

Write
for
Complete
Information

Dongan high potential testing transformer for insulation break-down tests. Equipped with primary switch, pilot and safety light. Capacity 250 V. A. Primary 115 or 230 volts, 60 cycle.

Dongan Spec. #7692A—Secondary 2500 volts maximum in steps of 100 volts.
Dongan Spec. #7692B—Secondary 5000 volts maximum in steps of 200 volts.
Dongan Spec. #7692C—Secondary 7500 volts maximum in steps of 200 volts.

DONGAN ELECTRIC MFG. CO.
2977 Franklin Detroit 7, Mich.

DONGAN

TRANSFORMERS

The Dongan Line Since Nineteen-Nine

SEE
OPPOSITE
PAGE

FOR EXAMPLE OF CREATIVE ENGINEERING ON A HIGH PLANE

Perhaps you will wonder why Cardwell would bring out a communications receiver at this time, when there are many excellent receivers on the market.

I did, too, until I saw what our engineers were developing. Now, when I see what a combination of features is offered by the Cardwell Fifty-Four, I can realize that here was a job that just *had* to be done some day.

Just read the fifteen outstanding features on the opposite page. These are all combined in a compact seventy pound unit, designed and developed for the most critical professional requirements.

For instance, the turret mechanism for band changing is something that would only be developed by "an engineer's engineer". It enables you to change bands from those supplied to any you might require as quickly as you can remove and replace ten screws. New tuning strips, which we will supply for any desired band, can be quickly incorporated without the use of a soldering iron.

Add to this grounded grid R. F. Amplification and the unusually good signal to noise ratio and you are only beginning to get the story.

The specifications tell a much more complete story than I ever could and I shall be glad to send them to you. Just drop me a card.

Ray Morehouse
Sales Manager



THE ALLEN D. CARDWELL
MANUFACTURING CORPORATION
MAIN OFFICE & FACTORY
97 Whiting Street, Plainville, Conn.

use in the industry. Copies are available free by writing to the company on business letterhead.

67

Resistor Publication. The Outlook is published monthly by the Centralab Div. of Globe-Union, Inc., Milwaukee, Wis. Volume 2, Number 9, dated April 1946, lists a replacement control line, stock of special controls and describes various stages in the production of the proximity fuze.

68

Plastic Radio Cabinets. American Cyanamid Co., Plastics Div., 30 Rockefeller Plaza, New York 20, N. Y. The new catalog describing molded Beetle plastics includes an extensive treatment of radio cabinet design, with emphasis on appearance, strength and ventilation. Several different types of radio cabinets are graphically discussed.

69

Broadcast Audio Equipment. Radio Corporation of America, Camden, N. J., has a 78-page catalog of speech-input equipment suitable for use in a-m, f-m and television broadcast stations. The equipment listed ranges from microphones to jack panels. Suggested equipment lists and studio layouts are included. The booklet is priced at 50¢.

70

Mobile Communications. Radio Corporation of America, Camden, N. J. A 28-page booklet is available describing systems and equipment for 26 to 42 megacycle f-m equipment for police, fire, public utility and other agencies requiring mobile and emergency communications.

71

Retail Radio Business. B'nai B'rith, Vocational Service Bureau, 1746 M Street, N. W., Washington 6, D. C., has published a 347-page volume entitled "Careers in Retail Business Ownership" from which the chapter on "Electrical Appliance and

Radio Store" has been issued as a separate item at 15¢ a copy. The practical merchandising information should be of great value to the veteran considering entering this field.

72

Relays. Ward Leonard Electric Co., 31 South St., Mount Vernon, N. Y. Bulletin 130 replaces Bulletins 131 and 132 describing single and multipole relays, latching and double-throw relays. The types described are principally useful for light contactor duty, control of single-phase motors and other heavy duty electronic applications.

73

Power Supply Vibrators. The Radiart Corp., 3571 W. 62nd St., Cleveland 2, Ohio, has issued a complete listing of vibrator types with their equivalent Radiart replacement vibrator number. This is a most useful publication for the maintenance and repair technician. Other information sheets are available describing a line of car antennas and complete vibrator power supplies.

74

Transformers. Thordarson Electric Mfg. Div., Chicago 10, Ill. Catalog No. 400-FX describes the complete line of transformers, chokes and voltage regulators manufactured.

75

Coils. Meissner Manufacturing Div., Mt. Carmel, Ill. Three small receivers, a signal calibrator and signal analyzer are described in a catalog which covers the line of coils, transformers and chokes available from the manufacturer. Replacement coils and i-f windings are also described.

Window was the name applied to sheets of aluminum foil about the size of a small pane of window glass and used to foil enemy radar sets. Thin strips as dipoles proved more economical and were called chaff. The Germans dropped the stuff too, but we had more aluminum.

ANNOUNCING

*The
Cardwell
Fifty-Four*

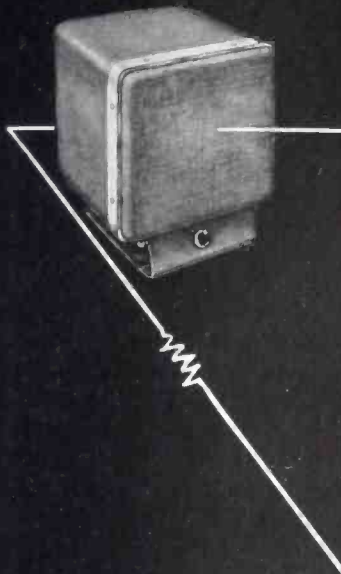

a communications receiver with unusual engineering features

This newly-developed receiver combines many design and engineering refinements within surprisingly compact dimensions. It opens up a whole new area of possibilities in the industrial and commercial communications fields. Following are just 15 of its many features. Check them against your requirements.

1. Full turret type R.F. Section.
(Sturdy turret of original design assures absolute mechanical and electrical stability.)
2. Wide Frequency Coverage.
(Range to 54.0 mcs.)
3. Secondary Frequency Standard.
(Built-in 100-1000 kcs. Calibrator.)
4. High Signal to Noise Ratio.
(Two grounded grid RF Amplifier stages assure actual receiver noise less than 6 db above thermal!)
5. "Custom-built" Gang Condensers.
(Specifically designed by Cardwell for this receiver.)
6. Electrical Band Spread.
(Pointer travel—better than 10½ inches on every range.)
7. Direct reading linear type dials.
(Excellent visibility—only the chosen range and corresponding band spread in view at any band switch setting. Non-Glare dial illumination with dimmer control on front panels.)
8. All miniature Tubes.
(18 including rectifiers.)
9. Mechanical Coupling Provisions.
(Shafts are brought out at rear for linkage to other units.)
10. Threshold Squelch.
(Operating level controllable from 5 to 100,000 micro volts.)
11. Temperature Compensated Oscillator.
(Stability is better than 100 parts per million per degree centigrade.)
12. New Type Noise Limiter.
13. Unit Construction.
(Receiver and power supply combined in one sturdy lightweight unit.)
14. Heavy Duty Speaker.
(Lightweight tilting unit, wall or table mounting.)
15. 8 Watts Audio Output.
(Push-pull class AB—with five available output impedances.)

WRITE FOR COMPLETE TECHNICAL BULLETIN

THE ALLEN D. CARDWELL MANUFACTURING CORP.

MAIN OFFICE
& FACTORY:



97 WHITING STREET
PLAINVILLE, CONN.

NEWS OF THE INDUSTRY

Sunspots cause radio blackout; shoran used for mapping; receiver production and sales figures; radio plants expand and move

Operation Crossroads

REAR ADMIRAL W. S. Parsons, responsible for the measurement and reporting of all findings from the atomic bomb tests at Bikini, announced that the technical staff would consist of nine divisions, all under Dr. E. A. Sawyer, Technical Director of Operation Crossroads. Duties of each division are as follows:

(1) *Bomb operation* is the responsibility of the Los Alamos Laboratory of the Manhattan Engineer District, who will deliver two bombs to the Joint Army-Navy Task Force ready for use.

(2) *Blast, pressure, and shock* in free air and water (independent of ship structures) will be measured as functions of distance and time. The most numerous instruments are ball crusher gages that measure air pressure by the deformation of a soft copper ball by a steel piston in a narrow cylinder, and aluminum foil meters that measure air pressure by the rupture of aluminum foil. Strain and displacement gages account for the majority of instruments used to observe and measure blast effects considered capable of causing structural damage to ships and their equipment. Blast effects on the deck of target ships will be determined by the amount of crushing of empty five-gallon gasoline tins. Navy drone aircraft which will fly in the proximity of the blast will be equipped with velocity, gravity, time and altitude recorders, while Army drone aircraft will carry television transmitters, recorders and flight analyzers to report and record the effect of the detonation wave on the operating characteristics of aircraft.

(3) *Wave motion and oceanography* men will use supersonic echo sounders to measure the vertical motion of target ships and buoys at a distance from the explosion, while pressure recorders on the bottom will record water depth versus time.

Seismographs will be set up on the islands around the atoll to observe the propagation of the shock waves through the earth.

(4) *Electromagnetic propagation and electronics*, under Captain C. L. Engleman of the Navy Bureau of Ships and Colonel D. F. Henry of the Army Air Forces, will study the effect of the atomic bomb explosion on both ground and sky wave transmission, radar reflective properties of the bomb cloud, and the intensity of the atmospheric electrical disturbances developed by the explosion. Radar and spherics equipment will be used to measure electromagnetic propagation. Army Air Forces drones will carry Geiger counter warning circuits and transmitters to determine the effect of the bomb explosion on radio propagation in the 5-9 megacycle region.

(5) *Radiological safety* includes tracking the movement of radioactive air and water masses caused by the blast. The primary safety device is the portable Geiger counter.



Indicator console of modern echo ranging sonar having built-in bearing deviation indicator to help operator keep the projector trained on a moving submarine

(6) *Radiometry* involves measurement of light in the visible spectrum and the adjacent ultraviolet and infrared, using spectrographs to obtain the spectral distribution of the first flash, photoelectric units to reveal the intensity of the first flash as a function of time, and bolometers to measure total radiant energy.

(7) *Radiation* work, involving measurement of gamma rays, neutrons, etc. will not be publicized, in accordance with current security restrictions.

(8) *Remote measurements* involve tidal data, shock and radioactivity at Midway, Wake, Kwajalein, and Eniwetok in the central Pacific area.

(9) *Technical photography* involves hundreds of cameras used for ground and aerial photographs made before, during, and after the bomb drops.

Sonar Tactics

IN THE EARLY MONTHS of 1942 U-boats were sinking ships faster than we replaced them, and we were losing the Battle of the Atlantic. Our success in attacking submarines after we detected them was less than five percent—95 out of 100 got away. Sonar was detecting the U-boats, but in the crucial moments of the attacks, something was inadequate.

An analysis showed that at critical phases sonar lost contact for two reasons: (1) U-boats hearing our pings becoming louder and faster judged the moment of our attack and submerged below the sonar beam. The remedy was the "creeping attack" delivered by two escorts—the first maintained contact at a fixed range and ping interval while coaching the second attacker at very low speed over the U-boat; (2) U-boats created disturbances by backing down, turning sharply, or ejecting chemicals that generated clouds of bubbles which momentarily reflected strong echoes. These echoes simulated a second or third U-boat and confused the attackers while the hunted submarine sneaked off behind his false targets. The countermeasure was to promulgate information by radio on this U-boat trick, and to issue instructions to anti-submarine vessels to maintain "doppler" contact, which is obtained only from moving targets. Sonar-ascic

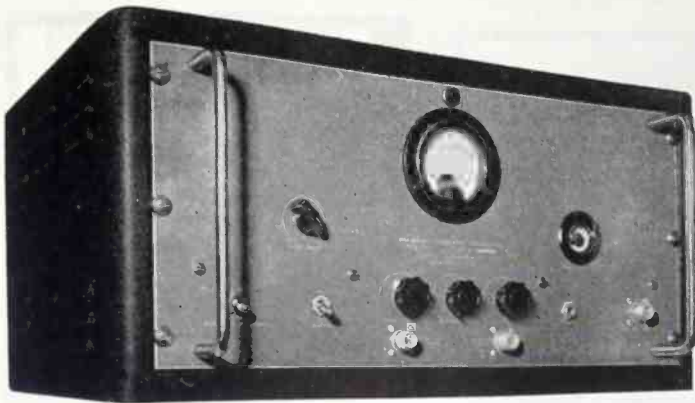

**C-200 Harmonic
FREQUENCY GENERATOR**



**FREQUENCY
METER**

**FIXED FREQUENCY
RECEIVER**



Specialists

**IN THE
DESIGN, DEVELOPMENT
and MANUFACTURE of
VHF and UHF EQUIPMENT**

LAVOIE LABORATORIES are well prepared with trained personnel and special equipment to handle every phase of design, development and manufacture of VHF and UHF equipment. As SPECIALISTS in this type of production, you are assured of precision work based on "know-how" plus methods and technique developed especially for HIGH frequency work. A few typical examples are illustrated.

Lavoie Laboratories

RADIO ENGINEERS AND MANUFACTURERS
MORGANVILLE, N. J.

LAVOIE Products Include:

- FREQUENCY STANDARDS
- FREQUENCY METERS
- RECEIVERS
- TRANSMITTERS
- ANTENNAS and MOUNTS

Specialists in the Development and Manufacture of UHF Equipment

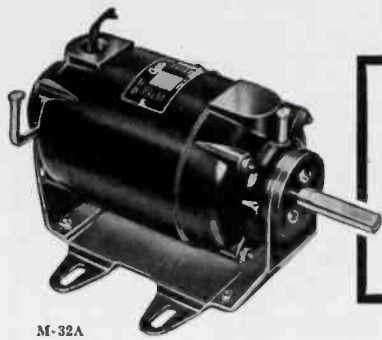

M-32A

Specifications

- Motor Type KS-837
- Model I-S 225S
- Approx. 1/20 H.P.
- Speed 1140 R.P.M.
- 115 V. A.C. 60 cycles
- Split phase induction
- Continuous duty

Where quiet, vibrationless operation and long life are essential, we recommend this special *Ostermotor*

for your continuous-duty fan and blower applications, such as oil, gas, or steam unit heaters—oil burners — air-conditioning units — etc. Construction features: Motor is totally enclosed. Tubular steel stator housings are rabbeted to fit die cast end bells, providing perfect alignment. Bronze sleeve bearings are grooved for best oil distribution. Oversize felt oil retainers feed oil to shaft through two spring tension wicks at each bearing.

Resilient neoprene motor mountings absorb vibration — are not affected by oil and grease. Can be furnished with standard motor mounting dimensions. Finished in black, baked enamel. Length over bearings, 8 $\frac{3}{8}$ ". Housing diameter 4-27/64". Weight 15 lbs.

Orders for this motor are now in production. If you need special motors for your products, write for information.

John Oster Mfg. Co., 4 Main St., Racine, Wis.

Specialists in special motors — series, split phase, capacitor, synchronous, and shaded pole in fractional h.p. ratings.

ALLEN



Small screws for electronic devices

Tiny hex-socket Cap Screws and Set Screws steeled to stand amazingly tight set-ups. Cap Screws in the numbered sizes from 1 to 10 inclusive; Set Screws from No. 2 to 10.

The Cap Screws are Allen "pressure-formd" for maximum strength of head and socket. Threads also formed by pressure-process to a high Class 3 fit.

The Set Screws have die-cut threads accurate to a high Class 3 fit, with perfectly-formed hex sockets. The screws can be held on either end of the handy hex keys and turned into the tapped hole without fingering. Allen Hand Drivers are available to facilitate fast assembling.

In radio and television sets, radio telephones, radar equipment, electronic controls, these screws *HOLD* fine adjustments and intricate assemblies.

Order of your local Industrial Distributor

**THE ALLEN MFG. CO.,
HARTFORD 1, CONN., U. S. A.**

Toroids..

by **DX**

Doughnut Coils for electronic and telephone purposes. High Permeability Cores are hydrogen annealed and heat treated by a special process developed by DX engineers. Send us your "specs" today—ample production facilities for immediate delivery.

DX RADIO PRODUCTS CO.
GENERAL OFFICES 1200 N. CLAREMONT AVE., CHICAGO 22, ILL., U.S.A.

DX COILS
"the heart of a good receiver"

men soon learned to read through the false targets and erroneous attacks on bubble clouds ceased.

Scientific research groups found that sound travelling in warm surface water bends sharply downward when it passes through a thermocline, a region where temperature decreases sharply with depth, and results in very weak echoes being returned from submarines beneath the thermocline. Thermoclines may cause loss of sonar contact, and U-boats may hide under thermoclines. Tables and tactical rules were supplied to ships for use in predicting maximum echo ranges, spacing between escort vessels and the interval between successive sonar pings.

Allied submarines in the Pacific used bathythermographs to hide under thermoclines. Hydrographic charts were provided to show the type of bottom in various operating areas because submarines are more likely to be detected over sandy bottoms which reflect sound than over mud bottoms which absorb sound. Charts also indicated the areas in which intense "shrimp" noises probably would mask the sounds created by submarines.

Play-by-Play Story

An example of the battles between U-boats and our carrier escort "Killer Groups" was the sinking of the U-233 by escort carrier USS CARD and destroyer escorts, USS THOMAS and USS BAKER.

First contact with the U-boat was made on July 2 when CARD aircraft sighted a swirl about 200 miles off Halifax. Radio-sonobuoys (ELECTRONICS, April 1946, p. 154) were dropped around the swirl and contact with the U-boat was maintained throughout the day, although intermittent bad weather forced recall of the aircraft and interrupted the receipt of signals from the buoys on several occasions. The destroyer escorts conducted a sonar search in the area without results. Sonar conditions were poor, and bad weather prevented further aircraft search until July 5. On July 5 the CARD made sonar contact and streamed her foxers (underwater noise makers) to attract the U-boat's acoustic homing torpedoes away from the ship's propellers. At 7:13 p.m., the CARD dropped depth charges, and at 7:20 p.m., the BAKER made a second depth charge attack which resulted

New! Spectacular! Complete!

CONCORD RADIO CATALOG



RADIO SETS

AMPLIFIERS

RADIO PARTS

ELECTRONIC EQUIPMENT

Your Copy of the Complete, New Concord Catalog is Ready!

Mail
Coupon for
FREE
Copy!

WE HAVE WHAT YOU WANT!

The new Concord Catalog displays the most comprehensive stock in years! All well-known, standard lines are fully represented. Equipment—accessories—parts for all radio and electronic use . . . for building, repair, maintenance . . . for engineer, amateur, serviceman, soundman, retailer . . . complete lines of tubes, instruments, tools, speakers, condensers, resistors, relays, etc. . . PLUS a radio set department offering latest postwar models . . . PLUS the exciting line of MULTIAMP Add-A-Unit Amplifiers offering many innovations in public address units exclusive with Concord

It offers you the latest, greatest selection of guaranteed quality RADIO SETS, PHONO-RADIOS, RADIO PARTS, TEST INSTRUMENTS, BOOKS, TOOLS, AMPLIFIERS AND ACCESSORIES, AMATEUR KITS AND SUPPLIES, ELECTRONIC EQUIPMENT . . . page after page of post-war-engineered equipment and parts you have long been waiting for. All standard, top-quality lines. Thousands of items. Money-saving prices. And fast service, direct from our two centrally located warehouses in CHICAGO and ATLANTA.

See the first peacetime line of Concord Radio Sets in new, modern cabinets with a host of post-war features. See the thrilling MULTIAMP Add-A-Unit Amplifiers, brand new in the field, with sensational new flexibility, fidelity, and power—EXCLUSIVE with CONCORD.

See the vast stock of everything you need in equipment and parts . . . see them in the new, comprehensive Concord Catalog, just off the press. Your copy is ready . . . and it's FREE. Rush coupon today.

CONCORD

RADIO CORPORATION
LAFAYETTE RADIO CORPORATION

CHICAGO 7 ATLANTA 3
901 W. Jackson Blvd. 265 Peachtree Street

CONCORD RADIO CORPORATION
901 W. Jackson Blvd.
Dept. G-66, Chicago 7, Ill.

Yes, rush FREE COPY of the comprehensive new Concord Radio Catalog.

Name
Address
City State

**BEFORE YOU BUY AN FM
TRANSMITTER—Investigate!**



1 KW FM TRANSMITTER

**PIONEER
MANUFACTURERS
OF FM
TRANSMITTERS
EMPLOYING
ARMSTRONG
PHASE-SHIFT
MODULATION**

RADIO ENGINEERING LABS., INC.

Long Island City, N. Y.

ZOPHAR
Waxes, Compounds and Emulsions



Materials for potting, dipping or impregnating all types of radio components or all kinds of electrical units. • Tropicalized fungus proofing waxes. • Waterproofing finishes for wire jackets. • Rubber finishes. • Inquiries and problems invited by our engineering and development laboratories.

Zophar Mills, Inc. has been known for its dependable service and uniformity of product since 1846.

ZOPHAR MILLS, Inc.

ESTABLISHED 1846

117 26th STREET, BROOKLYN, 32 N. Y.

**BUILD
YOUR LINE
AROUND**

*Smooth
Power*

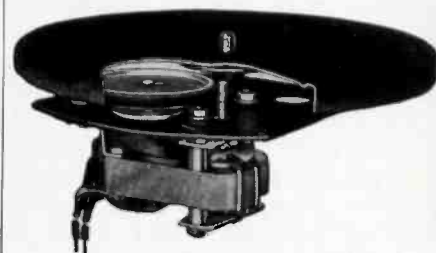

For quick starting, uniform speed and quietness, equip your new phonographs and record-changers with *Smooth Power* motors. From the wide and modern GI line, accurately and carefully built, you can select exactly the right motors for your needs.

Then you'll be sure of giving your customers that smooth, all 'round performance that builds good will . . . and sales. For motors you can always depend upon, *standardize on Smooth Power.*

**THE GENERAL
INDUSTRIES co.**

DEPT. ME • ELYRIA, OHIO

in a huge geyser of water mixed with oil.

Sonar contact was regained a few minutes later and the radar operator reported a large pip at 1,200 yards. Simultaneously, the bow of the U-boat broke the surface at a steep angle on the radar bearing. Accurate and heavy gunfire was opened at a range of 1,200 yards. The BAKER then passed 75 yards ahead of the U-boat and fired her port K-guns. The charges straddled and detonated close aboard on both bows of the submarine. The gunfire was continued while the BAKER again passed close ahead of the U-boat and dropped a pattern of depth charges. At this time, members of the U-boat's crew were observed astern of the submarine, and others were abandoning ship. The THOMAS which also was firing, then closed in on the U-boat, and rammed her just aft of the conning tower. The submarine sank beneath the THOMAS. About 30 survivors were recovered.

Ion Ballistics Conference

A GRADUATE CONFERENCE devoted to the behavior of mass spectrometers, electron microscopes, and other electronic devices depending upon electron or ion beams is to be held from June 24 through July 13, 1946 at Agricultural and Mechanical College of Texas. Lecturers will be Dr. Ladislav Marton of the Division of Electron Optics, Stanford University, and Dr. John A. Hipple of Westinghouse Research Laboratories. A matriculation fee of \$8 is charged for the three-week course, and those completing it satisfactorily will receive four semester hours of graduate credit. Further details can be obtained from J. G. Potter, Head, Department of Physics, A. and M. College of Texas, College Station, Texas.

Sunspots

ONE OF THE LARGEST sunspot groups even seen crossed the solar disc between January 29 and February 11, 1946 and was accompanied by very pronounced radio and other terrestrial effects. This sunspot group partially returned, after one rotation of the sun, between February 27 and March 13. It was again associated with terrestrial effects, though much less severe.

The region around the sunspot

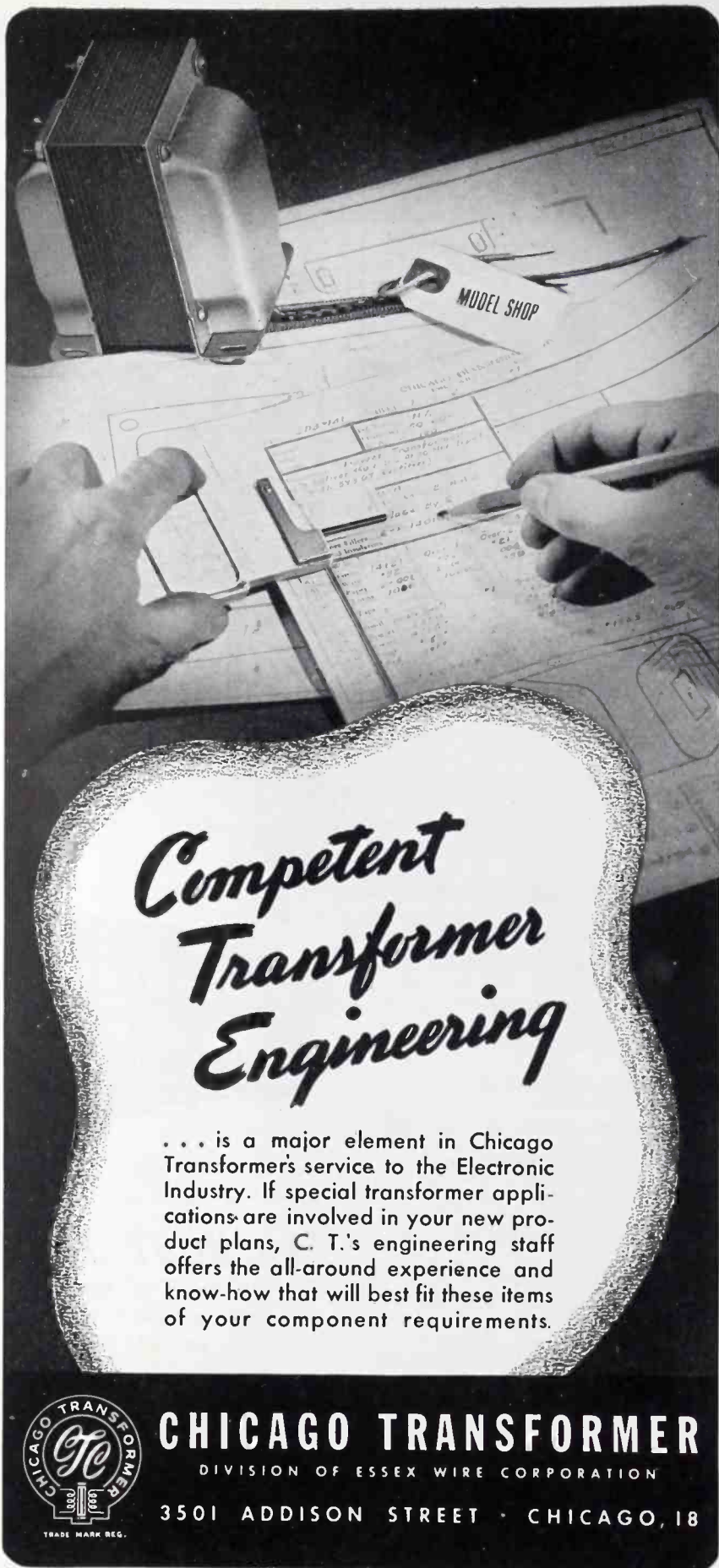

**Competent
Transformer
Engineering**

... is a major element in Chicago Transformer's service to the Electronic Industry. If special transformer applications are involved in your new product plans, C. T.'s engineering staff offers the all-around experience and know-how that will best fit these items of your component requirements.



CHICAGO TRANSFORMER
DIVISION OF ESSEX WIRE CORPORATION
3501 ADDISON STREET · CHICAGO, 18

NOW

a really high-powered

RADIO ENGINEERING LIBRARY

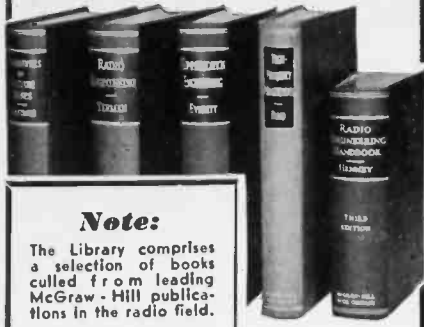

Note:

The Library comprises a selection of books culled from leading McGraw-Hill publications in the radio field.

- ▷ especially selected by radio specialists of McGraw-Hill publications
- ▷ to give most complete, dependable coverage of facts needed by all whose fields are grounded on radio fundamentals
- ▷ available at a special price and terms

These books cover circuit phenomena, tube theory, networks, measurements, and other subjects—give specialized treatments of all fields of practical design and application. They are books of recognized position in the literature—books you will refer to and be referred to often. If you are a practical designer, researcher or engineer in any field based on radio, you want these books for the help they give in hundreds of problems throughout the whole field of radio engineering.

5 volumes, 2559 pages, 2558 illustrations

Eastman's **FUNDAMENTALS OF VACUUM TUBES**, 2nd edition

Terman's **RADIO ENGINEERING**, 2nd edition

Everitt's **COMMUNICATION ENGINEERING**, 2nd edition

Hund's **HIGH FREQUENCY MEASUREMENTS**

Henney's **RADIO ENGINEERING HANDBOOK**, 3rd edition

SPECIAL LOW PRICE • EASY TERMS

Special price under this offer less than cost of books bought separately. In addition, you have the privilege of paying in easy installments beginning with \$2.50 in 10 days after receipt of books and \$4.00 monthly thereafter. Already these books are recognized as standard works that you are bound to require sooner or later. Take advantage of these convenient terms to add them to your library now.

FOR 10 DAYS' EXAMINATION SEND THIS ON-APPROVAL COUPON.....

McGraw-Hill Book Co., 330 W. 42nd St., N.Y.C. 18

Send me Radio Engineering Library for 10 days' examination on approval. In 10 days I will send \$2.50 plus few cents postage, and \$4.00 monthly till \$25.50 is paid, or return books postpaid. (We pay postage on orders accompanied by remittance of first installment.)

Name

Address

City and State

Company

Position L. 6-46

For Canadian book prices write Embassy Book Co., 12 Richmond St. E., Toronto 1

SIMPLIFY METHODS OF ASSEMBLING AND SERVICING with WALKER-TURNER FLEXIBLE SHAFTING



• You can put controlled elements wherever good design dictates . . . when you use Walker-Turner Flexible Shafting in your products. It goes around and over obstacles—takes up minimum space—centralizes controls for convenient operation, no matter where the condensers, rotary switches, etc., are located.

Scientifically engineered and carefully wound to produce smoother power flow, sensitive control and trouble free operation. Write for further information.

WALKER-TURNER CO., Inc.
PLAINFIELD, NEW JERSEY



FLEXIBLE SHAFTING

FOR REMOTE CONTROL AND POWER TRANSMISSION

DEPENDABLE PORTABLE ELECTRIC POWER

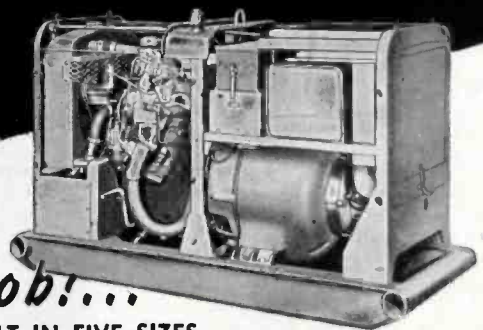

For Your Job!...

... BUILT IN FIVE SIZES, ranging from 3 K. W. to 15 K. W., these portable electric power plants are manufactured to give dependable service under the most rugged conditions. Write today for specifications.

Models Range from 3000 to 15000 Watts, A.C. 120 to 440 Volts, 50 and 60 Cycles, Single or Three Phase.

DEALERS WANTED! Some profitable franchises still available. Write or wire

PIONEER ELECTRIC Co. 3700 East Olympic Boulevard
Los Angeles 23, California

was observed to be very bright in the light of the hydrogen alpha line, and several solar eruptions or flares were seen. Associated with these flares were sudden ionospheric disturbances manifested by radio fade-outs lasting from a few minutes to several hours. These are caused by a sudden great increase in ultraviolet light which creates such high ionization in the D region of the ionosphere that high-frequency radio sky waves are absorbed. Propagation paths nearer the subsolar point (noon, equatorial region) are disturbed the most. Since this type of disturbance is caused by a solar eruption, only a radio propagation path of which a part is in sunlight is affected.

The leader spot began to pass the sun's central meridian on February 4, but the follower spot, which was the larger and more significant, did not pass the central meridian until the early hours of the Greenwich day of February 6. A little over 24 hours later, a period which agrees well with the theoretical time required for particles to travel from the sun to the earth, severe terrestrial disturbances were noted. Brilliant displays of aurora borealis were reported, with some auroral display actually visible at Washington on the nights of February 6 and 7. A great geomagnetic storm began suddenly at 1019 GCT on Feb. 7, according to the Cheltenham, Md., magnetic observatory of the United States Coast and Geodetic Survey, and lasted until 2300 GCT, Feb. 8.

Warnings of the radio transmission conditions expected because of this solar outbreak were issued by the Interservice Radio Propagation Laboratory at the Bureau. Daily warnings of disturbed radio conditions, primarily on transmission paths across the North Atlantic, were issued February 7 to 11 from the Bureau's station WWV and by other means.

This type of radio disturbance is characterized by rapid or flutter fading, accompanied by very weak field intensities. The higher frequencies are usually blacked out because of abnormal depression of the critical frequencies of the F2 layer of the ionosphere, and direction-finder observations become unreliable. After the most severe part of this disturbance was over, the daytime hours were characterized by



Enjoy security and good pay! Prepare now with CREI technical home study training and step ahead of competition into a good radio job! CREI offers you a proved program of self-improvement to keep pace with modern U. H. F. advancements and get that radio engineering job you want

Yes, there are GOOD JOBS . . . for GOOD men! The easy jobs are gone and once again knowledge and ability are the requirements to HOLD good jobs—to SECURE better ones. Employers once again can afford to be "choosy" . . . to select the best man for the best job. In the face of this showdown situation—where do YOU stand?

CREI home study training in Practical Radio-Electronics Engineering can equip you to meet the requirements to hold your job—or advance to a better one. CREI graduates are recognized throughout the Radio-Electronics industry. Your CREI diploma is the best recommendation for a better job. By adding CREI training to your present radio experience you can safe-guard your future and keep pace with such new developments as U. H. F. Circuits, Cavity Resonators, Pulse Generators, Wave Guides, Klystrons, Magnetrons and other tubes. Are you equipped to handle them? CREI is equipped to help you, by providing the Know-how and ability that is required.

In our proved method of instruction, you learn not only how but why! Easy-to-read-and-understand lessons are provided well in advance, and each student has the benefit of individual guidance and supervision from a trained instructor. This is the basis of the CREI method of training which many thousand professional radio men have completed during the past 19 years. CREI courses were used during the war to train thousands of Army and Naval radio technicians for the U. S. Signal Corps, U. S. Navy and U. S. Coast Guard.

It's up to you now to decide your course. What you do today will be the answer to where you will be in 1950 and the years after. It costs you nothing to read the interesting facts . . . to learn how CREI can help you enjoy the security you want . . . the better-paying job that can be yours. Write for particulars now! (CREI training for Veterans is approved under the "G.I." Bill.)

Where Will
YOU
Be In
1950?

Just Off the
Press



**WRITE FOR
FREE 36-PAGE
BOOKLET**
*"Your Opportu-
nity in the New
World of
ELECTRONICS*

If you have had professional or amateur radio experience and want to make more money, let us prove to you we have something you need to qualify for a better radio job. To help us intelligently answer your inquiry—**PLEASE STATE BRIEFLY YOUR BACKGROUND OF EXPERIENCE, EDUCATION AND PRESENT POSITION.**

Tells how CREI courses can be adapted to your particular needs.

CAPITOL RADIO ENGINEERING INSTITUTE

E. H. Rietzke, President

Dept. E6, 16th and Park Road, N. W.,

Washington 10, D. C.

New York (7): 170 Broadway
San Diego (1): 316 C Street

Branch Offices:

Chicago (2): 30 N. LaSalle Street
San Francisco (2): 760 Market Street

Member: NATIONAL HOME STUDY COUNCIL, NATIONAL COUNCIL OF TECHNICAL SCHOOLS

ATTENUATORS

by
TECH LABS



MIDGET
TYPE
600

"Midget" model is especially designed for crowded apparatus or portable equipment.



STANDARD
TYPE
700

- Solid silver contacts and stainless silver alloy wiper arms.
- Rotor hub pinned to shaft prevents unauthorized tampering and keeps wiper arms in perfect adjustment.
- Can be furnished in any practical impedance and db. loss per step upon request.
- TECH LABS can furnish a unit for every purpose.
- Write for bulletin No. 431.



Manufacturers of Precision Electrical Resistance Instruments
337 CENTRAL AVE. • JERSEY CITY 7, N. J.

for dimensional accuracy!

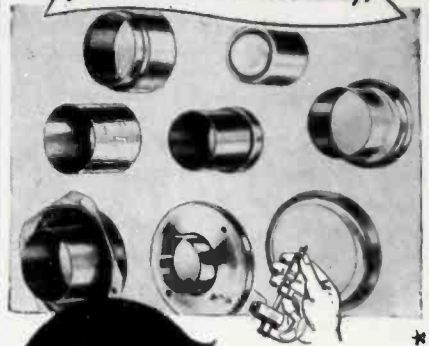

METAL STAMPINGS

DKE stamped metal parts can now be supplied in any quantity on short notice. Twenty years experience in producing all types of cups, sleeves, flanged shapes, and fabrications to specification. Tools, jigs, fixtures produced on premises for precision and economy.

DKE

INQUIRIES INVITED

THE ENGINEERING CO.

DANIEL KONDAKJIAN
27 WRIGHT ST., NEWARK, N. J.

WEAR RESISTANT
NON-CORROSIVE
NON-ABRASIVE
NON-MAGNETIC
SUPER-POLISHED

PERMOPIVOTS

Yes, Extra Value!
Long after the ordinary pivot has worn out you'll find PERMOPIVOTS in the prime of life—faithfully keeping precision instruments precise! It's all due to the special PERMOMETAL tip—the ideal osmium alloy. . . . Made to your specifications. Write for information!

PERMO
INCORPORATED
6427 RAVENSWOOD AVE., CHICAGO 26
MANUFACTURING METALLURGISTS

THERE'S A DRAKE SOLDERING IRON FOR EVERY TYPE OF ELECTRONIC WORK

From that mighty mite



the Drake No. 400 to the high-speed production "honey"



the Drake No. 600-10 there is a high quality Drake Soldering Iron "just right" for the job.

Drake Heat Controls and the Drake "Magic Cup" Stand are important soldering aids.



SEE
YOUR RADIO
PARTS JOBBER

DRAKE ELECTRIC WORKS, INC.
3656 LINCOLN AVE. CHICAGO, ILL.

very high absorption, as indicated by very weak field intensities. This prolonged type of disturbance is most noticeable on the radio transmission paths crossing the auroral zone. For this reason the reception of all European stations in the United States was difficult or impossible during this ionosphere storm.

The leader of the sunspot group returned to the solar disc on February 27 and the follower on February 28. The group as a whole was somewhat less than half of its original size but was still in the class of large sunspots. The follower, the significant part of the group, crossed the sun's central meridian on March 6 and was last seen on March 13. The group was shrinking in size as it disappeared from view.

New Television Studios

LONG-RANGE TELEVISION programming needs are anticipated in DuMont's new television studios, located in the John Wanamaker Store in New York City. The facilities



Shooting dentist's office scene in one of DuMont's new television studios for station WABD in New York City

ties provide four complete studios and their control rooms, and for feeding video and audio signals into a master control room where, after final monitoring, the signals are passed to the uptown transmitter of station WABD.

Shoran Used for Mapping

CHIEF PEACETIME use of shoran, recently revealed short-range version of loran, is expected to be in mapping, where it can provide fixes on the earth's surface with greater accuracy than has ever before been possible. Research on this application is now going forward at Buckley Field, Col-

The Answer

TO YOUR INSTRUMENT PROBLEMS

Burlington

PANEL INSTRUMENTS

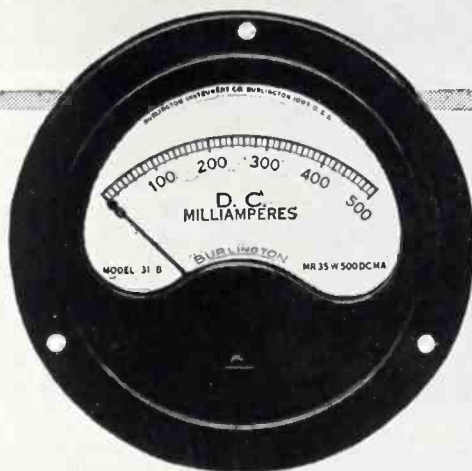

Burlington Panel Instruments are designed and built to give dependable service with guaranteed accuracy. They are available in a complete line of AC or DC Ammeters, Voltmeters, Milliammeters, and Microammeters. The wide selection of sizes and case styles offer instruments that are ideal for your particular application.

Write today for full details — our engineers will recommend the precision Burlington Instruments required to solve your instrument problems.

BURLINGTON INSTRUMENT CO.

110 Fourth St., BURLINGTON, IOWA



PANEL INSTRUMENTS • VOLTAGE REGULATORS • AUTOMATIC SYNCHRONIZERS • FREQUENCY REGULATORS

MERIT
CVC
Since 1924
FINE
RADIO
PARTS

Ask for Our
New Catalog

MERIT COIL & TRANSFORMER CORP.
TELEPHONE
4427 North Clark St. Long Beach 6311 CHICAGO 40, ILL.

BAER

PHENOL AND VULCANIZED FIBRE FABRICATIONS



Close tolerances, any quantity—

Volume production and accuracy of BAER phenol and vulcanized fibre parts have resulted in their wide specification for every type of product and equipment. Expanded facilities now make it possible to offer BAER production to manufacturers needing quality parts to exact requirements. Write today for Bulletin 120.

N. S. BAER COMPANY

Craftsmen in Fibre Fabrication

7-11 MONTGOMERY ST. • HILLSIDE N. J.

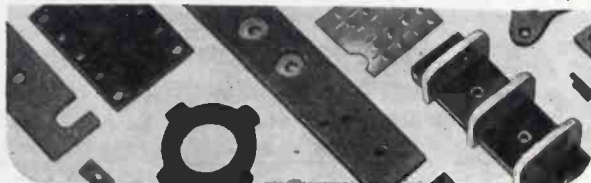

**PUNCHED
STAMPED
SHAVED
SAWED
DRILLED
MILLED
TAPPED**

orado under the direction of Lt. Col. Carl I. Aslakson of the U. S. Coast and Geodetic Survey, with airborne photographic work being done by the 311th reconnaissance wing of the AAF.

As now used, a shoran-equipped plane sends short-wave radio signals, pulsing at 20 times per second, to each of two ground stations—at Denver and Cheyenne for the present experiments. The stations transmit these signals back to the plane, where they produce pips on a thin circular-line trace on the radar screen in front of the operator in the plane. A third pip represents the plane on the screen. The operator adjusts dials until the three pips merge into one, at which instant the exact distances to the two ground stations are shown on two dials calibrated in thousandths of a mile. At this moment a camera photographs the dials and another camera photographs the ground vertically below, preserving the fix for future use.

Charts and maps can be drawn from a number of these fixes, and older maps can be recalibrated for accuracy. Since each point is located individually, errors do not increase with the number of measurements made, as they do when ground surveys are made along a line. With shoran a point may be located within 10 feet at a range up to 300 miles from the ground stations. A geodetic control network of the world is possible, with control stations about every 500 miles.

Radio Set Sales Figures

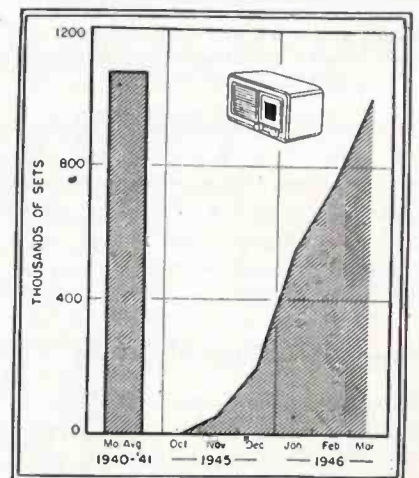

SHIPMENTS OF domestic radios rose from about 750,000 units for February to approximately one million (Continued on page 298)

RAWSON ELECTROSTATIC VOLTMETERS

Type 518



Now available to 35,000 VOLTS
Measure true R.M.S. values on A.C., no
waveform or frequency errors.

NO POWER CONSUMPTION

Leakage resistance greater than one million megohms. These meters may be used to measure.

STATIC ELECTRICITY!

Ideal for measuring high voltage power supplies with zero current drain. Rugged, well-damped movement. All elements surrounded by metal shielding for accuracy and safety.

Write for new bulletin.

**RAWSON ELECTRICAL
INSTRUMENT COMPANY**
111 POTTER ST. CAMBRIDGE, MASS.

Representatives

Chicago - New York City - Los Angeles

for Delicate Soldering Tasks

VULCAN Pygmy ELECTRIC SOLDERING TOOLS



Finds its way in where there is little clearance or cramped space.

Particularly useful for meters, electrical instruments, small radios and similar articles.



STANDARD 1/4 INCH
Also Available 3/16 Inch

VULCAN ELECTRIC COMPANY
DANVERS, 10, MASS.

Makers of a wide variety of Heating Elements for assembly into manufacturer's own products and of Heating Specialties that use electricity.

JONES 2400 SERIES PLUGS and SOCKETS



P-2406-CCT



S-2406-SB

A new series of Plugs and Sockets designed for highest electrical and mechanical efficiency. Improved Socket Contacts provide 4 individual flexing surfaces which make positive contact over practically their entire length.

The Contacts on both Plugs and Sockets are mounted in recessed pockets greatly increasing leakage distance, increasing voltage rating. Molded BM 120

Bakelite insulation. Plug and Socket contacts are silver plated. The finished appearance of this series will add considerably to your equipment.

The 2400 Series are interchangeable with all units of the corresponding No. 400 Series.

Send today for general catalog No. 14 listing and illustrating our complete line of Plugs, Sockets and Terminal Strips.

HOWARD B. JONES COMPANY
2460 W. GEORGE ST. CHICAGO 18

eight years ago

..... *PyroFerric* PIONEERED

the manufacture of
**SCREW-TYPE
POWDERED
IRON CORES**

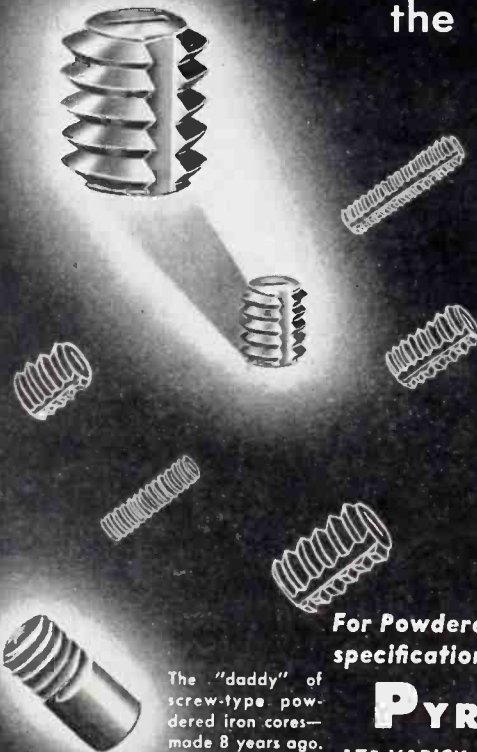

... today PyroFerric is manufacturing a full line of standard sized Powdered Iron Screw-type Cores of varying lengths, with standard threads, as well as its complete line of powdered iron cores, with and without inserts.

For Powdered Iron Cores to meet your specification address your inquiry to

PYROFERRIC Co.

175 VARICK ST. NEW YORK 14, N. Y.

The "daddy" of screw-type powdered iron cores—made 8 years ago.

BRADLEY

PHOTO ELECTRIC CELLS



Many Standard Mountings.

In addition to the housed model shown here, with its plug-in contacts, Bradley also offers tube socket, nut-and-bolt types and pig-tail contact mountings.

The shapes of Luxtron photocells vary from circles to squares, with every in-between shape desired. Their sizes range from very small to the largest required.

For direct conversion of light into electric energy, specify Bradley's photocells. They are rugged, lightweight and true-to-rating.

Illustrated literature, available on request, shows more models of Bradley photocells, plus a line of copper oxide and selenium rectifiers. Write for "The Bradley Line."

BRADLEY LABORATORIES, INC.

82 Meadow St. New Haven 10, Conn.

lion for March, as shown in the accompanying chart prepared by the Civilian Production Administration. For January the breakdown by set types is reported by RCA as follows:

Type of set	Units	Sales
Table set.....	434,360	\$7,212,700
Console set.....	310	14,500
Portable set (battery and/or a-c/d-c).....	22,893	434,000
Auto set.....	22,394	550,100
Farm battery set (table or console).....	17,896	349,400
Elec. phono. & wireless record players.....	19,831	467,600
Table combination set.....	27,708	923,800
Console combination set.....	5,431	362,300
Apparatus without cabinets.....	254	3,000
Total.....	551,077	\$10,317,400

Receiver Production in 1946

RESULTS OF AN FCC questionnaire point to a probable production of over 22,000,000 broadcast receivers of various types in 1946. The 85 manufacturers reporting include all but four of those expected to be substantial producers, and the estimates by these (as of April 1, 1946) point to a total set production substantially larger than for any prewar year. The estimate of 1,800,000 f-m sets is about nine percent of total production; the Commission hopes, in the light of the rapid progress being made with f-m on the station side, that manufacturers may revise their production schedules to include a greater proportion of f-m receivers. As of April 1, 1946, the Commission had received applications for 834 f-m stations in addition to the 50 stations now on the air, and had made 383 conditional grants to f-m applicants.

Estimated production figures for broadcast receivers of various types, with the number of manufacturers reporting production plans for each type, are as follows:

Type of receiver	Number of manufacturers	Number of receivers
A-m band only.....	76	16,736,862
F-m band only (88-108 mc).....	8	86,286
A-m band, F-m band (88-108 mc).....	41	1,689,750
Television band only (channels 1-13).....	13	44,706
A-m band, F-m band (88-108 mc), television band, (channels 1-13).....	14	54,000
A-m band, television band (channels 1-13).....	1	500
F-m band, television band (channels 1-13).....	1	500
A-m band, television band (channels 1-6).....	1	4,000
Miscellaneous.....	5	10,000
Receiver type unspecified.....	7	21,250
Total production of receivers.....	85	21,120,760

B&W

INDUCTOR
HEADQUARTERS



Plug-in Type AIR-WOUND INDUCTORS

No other type of coil can equal B & W AIR Inductors for all-around efficiency. AIR WOUND Inductors are lighter, easier to tap, wound to uniform pitch, have exceptionally low dielectric loss (no winding form in coil field) and are extremely durable. There is little about them to break if dropped. Even if bent completely out of shape, they can easily be repaired. B & W types include standard, fixed and swinging link assemblies in sizes and ratings for almost any application. Write for catalog.



WE'LL MATCH ANY INDUCTOR REQUIREMENT



BARKER & WILLIAMSON

Dept. E-66, 235 Folrfield Avenue
Upper Darby, Penna.

**RADIO
HARDWARE**
*Wires and
Cables*

*Quality
since 1923*

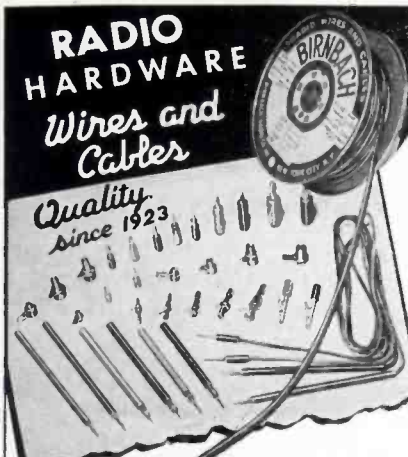

...also pioneers
in the design and
manufacture of

Ceramic, Porcelain & Steatite insulators, Antennas, Hook-Up Wires, Shielded Microphone Cable and S. J. Cable.



Specify and use "Birnbach" products. Complete Stock at your jobber.

BIRNBACH RADIO CO., Inc.
145 HUDSON ST. NEW YORK, 13, N. Y.



New ATLAS
"Hi-Conversion"
Re-entrant Speakers

Portrait of Progress



Advancement on Sound Equipment has kept pace with allied fields. That means Progress has been greatly accelerated during the past few years. New models incorporate such a vast number of improvements that preceding models are almost entirely antiquated.

Get acquainted with the newly completed, redesigned and restyled Atlas Sound Equipment—and know the perfection of modern, up-to-the-minute performance. Write for illustrated catalog sheets.

ATLAS SOUND
CORPORATION

1449 39th Street Brooklyn 18, New York

**CUSTOM MOLDED
PLASTICS PARTS**
FOR THE ELECTRONICS INDUSTRY



Compression Molded... to meet specific requirements... by an experienced organization... tooled for the production of plastics parts for electrical or general applications. Inquiries acknowledged promptly.

**Midwest Molding
and Manufacturing Co.**
335 NORTH WHIPPLE ST. • CHICAGO 12, ILL.



REGULATED POWER SUPPLY
250-450 VOLTS

Wide fields of application have been opened up both in research and industry for this unit. A-C ripple is negligible and extreme care has been taken to eliminate high-frequency noise. Regulated power supply units are invaluable for such applications as amplifiers, television pulse generators, constant frequency oscillators, and measuring equipment.

Other G-E regulated power-supplies are available in the following ranges: 180-300 volts 160-1500 volts Dual Regulated

Write today: Electronics Department, Specialty Division, General Electric, Syracuse, N. Y.

GENERAL ELECTRIC
164-E2
Electronic Measuring Instruments



PS-1



NEW and Ready for you!

Allied's 1946 CATALOG

of Radio and Electronic Supplies



LARGEST AND MOST COMPLETE STOCKS... Under One Roof

You'll find this new Buying Guide extremely helpful and valuable today! Places over 10,000 items at your finger tips—for research, maintenance and production. Includes parts, tubes, tools, books, test instruments, public address and communications equipment. Concentrates all leading

makes here in one large central stock to give you faster, more efficient, more complete service—saves you time, work and money. Whatever you need... it pays to check with Allied. Write, wire or 'phone Haymarket 6800.

Everything in Radio and Electronics
ALLIED RADIO CORP.

833 W. Jackson Blvd., Dept. 24-F-6, Chicago 7, Illinois

FREE
Send for it
NOW



PRECISION CRYSTALS

for MARINE, AIRCRAFT, POLICE

Frequency Range 1000 KC to 10.5 MC

Type Z-1, the new standard crystal unit for marine, aircraft and police service, is a precision low temperature coefficient unit that meets all F.C.C. requirements. Temperature coefficient less than 2 cycles per MC. °C. Calibrated to within .005% of specified frequency.

PETERSEN RADIO COMPANY



2800 WEST BROADWAY—TELEPHONE 2760
COUNCIL BLUFFS, IOWA

F-m adapters	4	47,000
F-m converters	3	37,000
Other	1	1,000
Units supplied to others	2	90,000
Units for export	16	677,050
Total for all receive types		21,981,810

MEETINGS TO COME

JUNE 20-23; SOCIETY FOR THE PROMOTION OF ENGINEERING EDUCATION; annual meeting, Jefferson Hotel, St. Louis, Mo.

JUNE 24-26; SOCIETY FOR EXPERIMENTAL STRESS ANALYSIS; spring meeting, Statler Hotel, Buffalo, N. Y.

JUNE 24-28; AIEE 1946 SUMMER CONVENTION; Statler Hotel, Detroit, Mich. Technical program includes sessions on electronics, a conference on servomechanisms, and sessions on automatic control devices.

JUNE 24-28; ASTM ANNUAL MEETING AND EXHIBIT; Statler Hotel, Buffalo, N. Y.

SEPT. 10-14; NATIONAL CHEMICAL EXPOSITION; Coliseum, 15th and Wabash Ave., Chicago, Ill.

SEPT. 16-20; INSTRUMENTATION FOR TOMORROW—EXHIBIT AND CONFERENCE; Wm. Penn Hotel, Pittsburgh, Pa.; daily technical sessions and program of short educational courses.

OCT. 3-5; NATIONAL ELECTRONICS CONFERENCE; Edgewater Beach Hotel, Chicago, Ill.; technical programs under three main heads—communications, industrial electronics, and scientific and medical developments.

OCT. 10-11; TELEVISION BROADCASTERS ASSOCIATION CONFERENCE; Waldorf-Astoria Hotel, New York City; latest television equipment will be exhibited.

BUSINESS NEWS

THE ELECTRONICS ENGINEERING Co., Gary, Indiana, has been formed for the conduct of design, development, and service in electronics, sound, and radio by Henry B. Young, Elmer E. Crump, Henry J. Bell, John Hudson, P. A. Brown, Eugene Smith, and Edward W. Brown.

JAMES G. BIDDLE Co. has consolidated its offices and factory at a new location, 1316 Arch St., Philadelphia.

ILLINOIS CONDENSER Co. is moving into a new plant at 1616 North Throop St., Chicago, where they will

2 VITAL AIDS

TO THE MANUFACTURER OF
Miniature Tube Radios

★ **STAR**



DOUBLE-CHECK SYSTEM

#JE-10 — Miniature socket wiring plug for accurate alignment of miniature socket contacts during wiring. Precision cast of zinc base alloy — Pins of stainless steel.

#JE-12 — (Hardened tool steel insert) or JE-13 (Stainless steel insert) Miniature tube pin straightener to obtain a perfect fit when the tube is placed in the set.



For complete information and prices—write
RADIO ACCESSORY DIVISION

STAR EXPANSION PRODUCTS CO.
147 Cedar St., New York 6, N. Y.

The Most Indispensable Reference in Radio-Electronics

Electronic Engineering Master Index

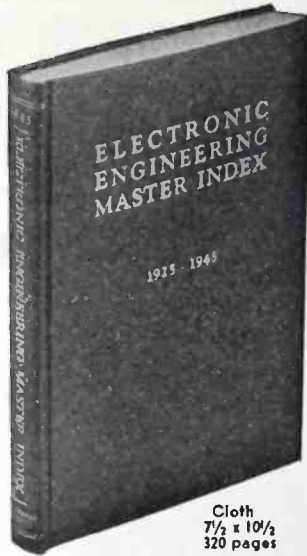

Cloth
7 1/2 x 10 1/2
320 pages

A master compilation of over 15,000 titles, articles and texts selected for their value to the research engineer, this INDEX covers the years 1925-1945 and enables you to survey twenty years of research literature on any subject in a matter of minutes!

Vitally Needed in Every Laboratory and Library

COMPLETE IN ONE VOLUME

PART I

January 1925 to
December 1934

PART II

January 1935 to
June 1945



PARTIAL LIST OF PERIODICALS INDEXED:

- | | |
|-------------------------------|--------------------------|
| Bell Laboratories Record | Journal of I.E.E. |
| Bell System Technical Journal | General Electric Review |
| Communications | Physical Review |
| Electrical Communication | Proceedings I.R.E. |
| Electrical Engineering | Transactions of A.I.E.E. |
| Engineering | Transactions of A.S.M.E. |
| Electronics | Radio News |
| Electronic Industries | R.C.A. Review |
| Jour. of Applied Physics | Wireless Engineer |

A \$500 Reference Library in One Volume for \$17.50

Descriptive circular on request.

ELECTRONICS RESEARCH PUBLISHING COMPANY

2 West 46th Street

New York 19, N. Y.

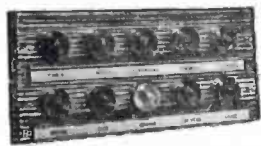

HOW TO BUILD

LAMP ANNUNCIATORS

Kirkland Bulls-I-Units are ideal for this purpose. Just provide the proper size holes in the panel, then insert the Kirkland units and lock into place. Many different units to choose from. Assembly is then ready for installation. Connect incoming wires and place in service. Typical unit illustrated above made with T2 units.

KIRKLAND Pioneer

INDICATING LAMPS

TYPE T2 UNIT



Small and modern, molded of bakelite. For use with slide-base switchboard bulb (24 volts, 0.038 Max. Amp) with resistor on 120-220-440 volts. Overall dia. Lens-Cap 3/4".

LIST PRICE (less bulb) 70c.

Write Today for Catalogue

The H. R. KIRKLAND CO., Morristown, N. J.



MANUFACTURERS OF RADIO, ELECTRICAL
AND ELECTRONIC COMPONENTS

VOKAR Corporation

7300 HURON RIVER DRIVE

DEXTER, MICHIGAN

Right where it belongs

PUTTING THE HORSE BEFORE THE CART

for finer instrumentation

Victoreen sub-miniature vacuum tubes, series VX with 10 milliamper filament operation, grid current of 10^{-14} amperes and grid resistance of 10^{16} ohms or greater, offer tubes especially designed for exacting circuit requirements—rather than the expediency of using circuits designed around existing tube characteristics.

AVAILABLE AS PENTODES, TETRODES,
TRIODES AND DIODES



Actual Size

*. . . and filling another
long recognized need*



Victoreen Hi-meg vacuum sealed resistors supply the demand for a stable precision resistor in a range of 100 to 10,000,000 megohms.

Write for technical data on
VX tubes and resistors.

THE VICTOREEN INSTRUMENT CO.

3800 PERKINS AVENUE
CLEVELAND 14, OHIO

install new and modern machinery for the manufacture of oil, paper, and electrolytic capacitors.

WESTINGHOUSE ELECTRIC CORP. has formed a Specialty Transformer Department with Chris H. Bartlett as manager. This new section of the Sharon Transformer Division will handle engineering, manufacture, and sale of radio and other electronic transformers and specialty transformers of a similar character.

UNIVERSITY LOUDSPEAKERS, INC. is the new name of University Laboratories, New York, N. Y.

ALLEN B. DUMONT LABORATORIES, INC., Passaic, N. J., announces the purchase of the Doherty Building in Clifton, N. J., adding 150,000 sq ft



New DuMont plant at Clifton, New Jersey

of production space in a four-story building occupying an entire city block or about $8\frac{1}{2}$ acres of ground.

COLUMBIA WIRE & SUPPLY Co. has moved into its own building at 5734 Elston Ave., Chicago.

NATIONAL RESEARCH CORP. is building new quarters on the Charles River Basin, Cambridge, Mass., adjacent to Massachusetts Institute of Technology.

UNITED STATES TELEVISION MFG. CORP. announce removal of their offices and factory to 3 W. 61st St., New York City.

NEW ENTERPRISES, INC., 84 State St., Boston, Mass. has been organized to provide financial assistance in providing the value of new scientific and engineering developments and processes or in expanding existing small businesses that show promise of becoming profitable enterprises.

TELEVISION PRODUCTIONS INC., a Paramount Pictures subsidiary, has placed on the air its new television transmitter atop Mt. Wilson, highest television site in the world with an altitude of 6,000 feet. Programs

Maximum Dependability Minimum Size



ADVANCE
SERIES 6000
MIDGET TELEPHONE TYPE
A. C. or D. C. Relay

Used in AIRCRAFT REMOTE CONTROL, RADIO and RADAR for maximum dependability and minimum size with these special features:

- HIGH VIBRATION RESISTANCE to 12G at 100 milliwatts D.C. in coil.
 - DOUBLE CONTACTS on each blade, which gives double the assurance of good contact. Platinum silver alloy contact material, rating 1.5 amperes at 115 volts A.C.
 - LOW OPERATING POWER of 60 milliwatts on D.C. or approx. $\frac{1}{3}$ watts A.C. Coil resistance 1 to 10,000 ohms.
 - MIDGET SIZE, $1" \times 1\frac{1}{4}" \times 1\frac{1}{4}"$, 2½ oz. (Type 6004, D.P.D.T.)
 - MOISTURE PROTECTION of coil by cellulose acetate insulation, varnish vacuum impregnation, second varnish dip and baking.
- You Need an Advance Telephone Type Relay for —
- HIGH UNIT PRESSURE of small, hemispherical contacts, no waste contact area.
 - POSITIVE MECHANICAL ALIGNMENT of armature to core, of contact to contact.
 - PIVOT BEARING HINGE between armature and frame assures minimum of friction—maximum life.
 - SWITCHING CAPACITY from single pole single throw to 4 pole double throw.
 - OPERATING POWER moderately low.
 - TRUE ECONOMY OF DESIGN, correct materials used where needed, excess eliminated, no waste space.

*Catalog with complete
description and prices
will be sent by return
Air Mail by —*

Advance Relays

ADVANCE
ELECTRIC & RELAY CO.
1260 West 2nd Street
Los Angeles 26, Calif., U. S. A.
Phone Michigan 9331

Booklet Tells How to Use

Cellusuede FLOCK

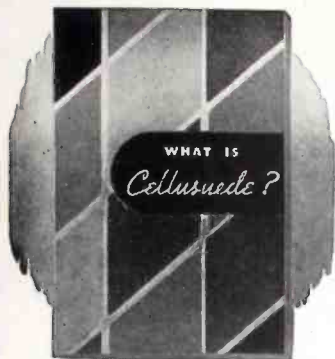

An interesting and colorful booklet on their product has been prepared for your information and convenience by the makers of Cellusuede Cotton and Rayon Flock. Brief, clear explanations give all the facts you'll want to know about this versatile coating material; what it is made of; how it is applied; how it can be used. In the pages of this booklet you may find the answer to one of your manufacturing problems. You will be interested, too, in the colorful and unique application of Cellusuede on the booklet cover. Write for your copy.



**WORKS LIKE A
SCREW DRIVER**
Speeds Production!

Standard Sizes, Hex, Square or Knurled, Chuck Type with many Tools for many uses Radio and Electrical Shops Need them

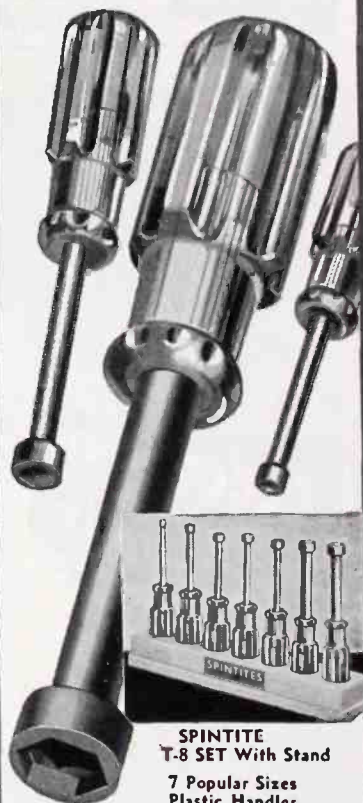

**SPINTITE
T-8 SET With Stand**
7 Popular Sizes
Plastic Handles

Send for Catalog No. 141 picturing a full line of Automobile, Aircraft and Radio Tools.

**WALDEN
WORCESTER
WRENCHES**

STEVENS WALDEN, INC.
468 SHREWSBURY STREET
WORCESTER, MASSACHUSETTS

DESIGNED FOR DISCRIMINATING MANUFACTURERS



Leakproof

ENAMELED
MAGNET
WIRE

A product, resulting from many years of research in the field of fine wire manufacture, that meets the most rigid requirements of radio and ignition coils. A new coating method gives a smooth, permanently - adherent enameling, and mercury-process tests guarantee perfect uniformity. Great flexibility and tensile strength assure perfect laying, even at high winding speeds. If you want reduction in coil dimensions without sacrificing electrical values, or seek a uniform, leakproof wire that will deliver extra years of service, this Hudson Wire product is the answer.

Winsted
HUDSON WIRE CO.
Division

WINSTED • CONNECTICUT

QUALITY

UNIFORMITY

SERVICE

Also manufacturers of high grade cotton and silk covered wires, cotton and silk coverings over enamel coated wires, and all constructions of Litz wires. A variety of coverings made to customers' specifications, or to requirements determined by our engineers. Complete design and engineering facilities are at your disposal; details and quotations on request.

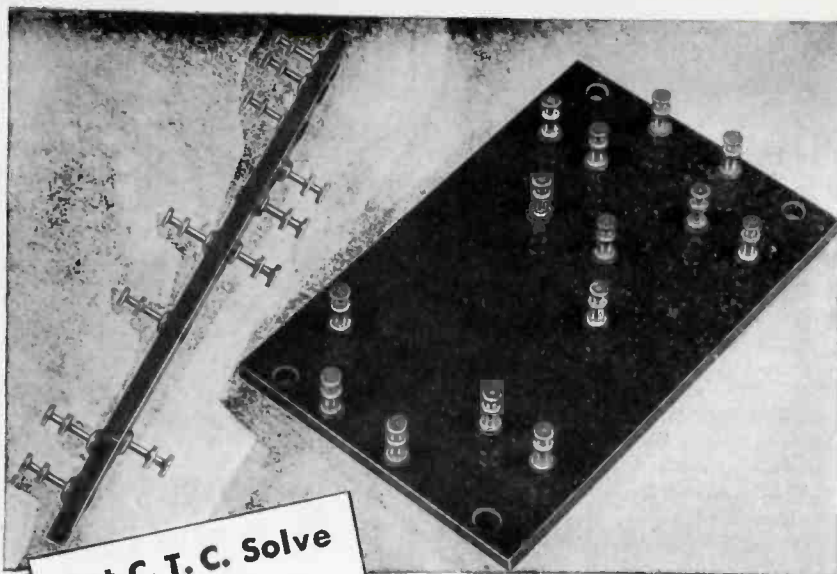

**Let C. T. C. Solve
Your
TERMINAL
BOARD
Troubles**

You'll save time and money if you order your Terminal Boards ready-made from C.T.C. Just send in complete specifications and in short order you'll receive perfectly cut and finished linen bakelite boards with quick soldering C.T.C. Lugs firmly anchored in exact position and ready to use.

Boards can be furnished with any type of C.T.C. Lug and in a variety of thicknesses.

Write for complete information or, better still, send us your specifications and let us show you just how inexpensively and quickly we can meet them.



CAMBRIDGE THERMIONIC CORPORATION
439 Concord Avenue • Cambridge 38, Mass.

ELECTRONIC
Engineering
COMPANY
INC.

• The meeting of extraordinary applications—the designing and developing of new and specialized transformers—these are the day-by-day jobs Electronic Engineering is known for doing well.

Transformers

will meet your most exacting requirements, ordinary or unique—and the finest engineering talent and most complete electronic laboratories available are ready today to consult with and help you.

"SPECIALIZED
Transformer
ENGINEERS"

Electronic Engineering Company, Inc., 3223-9 W. Armitage Ave., Chicago 47, Ill.

will be relayed an airline distance of 18 miles from the Hollywood studios of W6XYZ to its Mt. Wilson transmitter having a 100-mile radius reception range.

ELECTRONIC CORPORATION OF AMERICA has moved all manufacturing and sales operations to its new plant at 170-53 Street, Brooklyn, N. Y.

SHALLCROSS MFG. Co., Collingdale, Pa. has acquired the manufacturing rights and licenses to produce Variaten attenuators, gain sets, and other resistance devices manufactured by the Cinema Engineering Co. of Burbank, Calif. Engineering and special designing will continue at the Burbank plant, but all production is being transferred to the Collingdale plant.

NOMA ELECTRIC CORP., New York City, has purchased manufacturing facilities and inventories of Oxford Tartak Radio Corp., Chicago, and has formed Oxford Radio Corp. as a wholly-owned subsidiary of Noma to carry on the loudspeaker business.

AUDIO DEVICES, INC., Stamford, Conn., has opened its new research laboratories devoted exclusively to sound recording and research. Ernest W. Granck, research director, is in charge.

AIR DESIGN, INC. is the new shortened firm name of Airdesign & Fabrication, Inc., Upper Darby, Pa., manufacturers of transformers for the electronic industry.

ESSEX ELECTRONICS recently occupied new plant quarters in Berkeley Heights, N. J. where it will manu-



New plant of Essex Electronics

facture coils, chokes, and transformers for the radio and electronics industry.

AMARON MFG. CORP., Los Angeles, Calif. is a consolidation of Asco Mfg. Co. and Standard Engineering Laboratories, formerly of Pasadena.

TREFZ MFG. Co., manufacturers of

- SOFT SOLDER RINGS AND PREFORMS
- SILVER SOLDER RINGS
- COPPER BRAZING RINGS

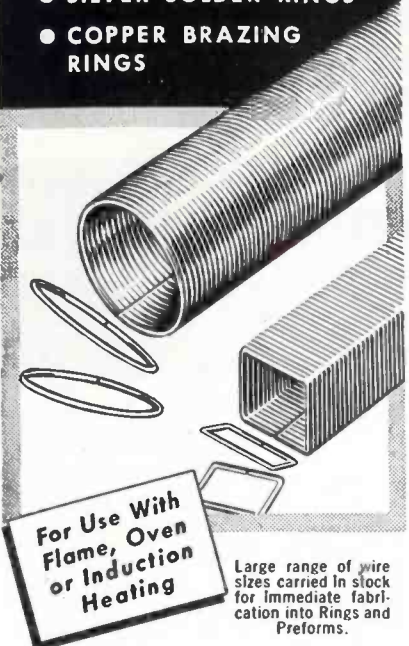

For Use With
Flame, Oven
or Induction
Heating

Large range of wire sizes carried in stock for immediate fabrication into Rings and Preforms.

**ELECTRONIC SPECIALTIES
MANUFACTURING COMPANY**
127 North Main Street, Elkhart, Indiana

RADEX

CHICAGO

In future peace-time production, Radex will uphold its war-won reputation by the scope and caliber of its service to the radio and electrical industries.

Radex Corporation
53 W. Jackson Blvd., Chicago 4, Ill.

NORTHERN

Originality Backed-up By

EXPERIENCE

Since 1909

Originality backed-up by years of practical experience is what really counts when it comes to producing plastics for products efficiently, economically and on schedule.

Northern provides that type of experience plus complete quantity production facilities. Specially designed equipment is available for producing unusual type plastic jobs, impossible to duplicate with standard molding presses.

Our engineers will be glad to help you with any plastic problem.

Northern

INDUSTRIAL CHEMICAL CO.

38 Years of Plastic Molding Experience

7-11 ELKINS ST., SO. BOSTON 27, MASS.

STANDARD CRYSTALS

For commercial airline, civilian aircraft, marine, police, railway, automotive, and other communication equipment.

Complete line for the amateur bands.

Custom units for laboratory, experimental, and specialized applications.

Let us engineer your frequency control problems.

Write for free catalog and other information.

STANDARD PIEZO COMPANY

Established 1936

Quartz Crystals and Frequency Control Equipment

Office and Development Laboratory

SCRANTON, PA.

CARLISLE, PA., P. O. Box 164

CARLISLE, PA.

ANOTHER SPECIAL BY PROGRESSIVE

CATALOG SHOWS DOZENS MORE
 Special heads, threads and finishes on any metal or alloy adapted to cold upset. Weekly output: 25,000,000 pieces. Many specials, suggesting production savings for you, illustrated in latest catalog. Includes weights per 1M standard pieces, dec. equivs. of fractions, other purchasing and engineering helps. Write for Catalog 18.

The PROGRESSIVE MFG. CO.
 50 NORWOOD ST. TORRINGTON, CONN.

Janette

D.C. to A.C. CONVERTERS

The Janette Rotary Converter is a simple, practical method for obtaining Alternating Current when only D.C. power is available.

.1 to 3.2 K. V. A.



Janette was one of the first manufacturers to build converters especially for use with A.C. electronic tube devices. Since their inception these machines have established a world wide record for reliable, efficient, quiet, trouble free operation, under the most adverse conditions.

TWO TYPES are available; one for commercial applications, the other for marine service. Special filters for suppressing conducted and radiated noise voltage interference can be supplied.

If you want a really dependable converter, guaranteed for one year, we suggest you **TRY A JANETTE!**

May We Send Literature?

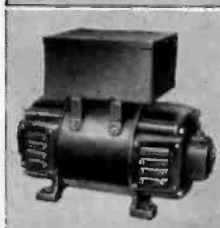
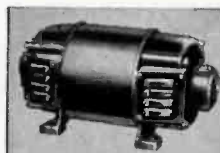

Janette Manufacturing Company
 556 W. Monroe St. Chicago 6, Ill.

fixed and variable wire-bound resistors and potentiometers, have consolidated their three plants into one location at 511 E. 164th St., New York City.

MINNEAPOLIS - HONEYWELL REGULATOR Co. has purchased a new plant at Leaside, on the outskirts of



New Honeywell plant in Toronto, purchased from Small Electric Motors (Canada) Ltd.

Toronto, that will triple its Canadian manufacturing facilities for controls.

JFD MANUFACTURING Co. has acquired a new factory site in Brooklyn, N. Y. on which a modern two-story building will be erected as soon as construction materials are available.

ELECTRONICS-ROCHESTER INC., Cox Bldg., Rochester, N. Y. has been established as a consulting and fabricating service for single units or quantity orders of specialized electronic control devices.

PERSONNEL

H. H. SCHWARTZ has joined the staff of Dee Electronics Limited, Montreal, Canada, as communications engineer.

J. ERNEST SMITH now heads the microwave communication engineering department of Raytheon Mfg. Co., after 12 years with RCA where he rose from student engineer to division head of RCA Laboratories.



J. Ernest Smith



F. R. Hensel

F. R. HENSEL has been elected vice-president in charge of engineering

Optical Glass Specialties



Television Reflectors

Precision-polished optical face plates for cathode ray tubes

Optical lenses, prisms and flats

FS Precision-Bore Glass Tubes with bore exact within .0002"

Contact us for such requirements

FISH-SCHURMAN CORPORATION
230 East 45th St., New York 17, N. Y.

Fish-Schurman

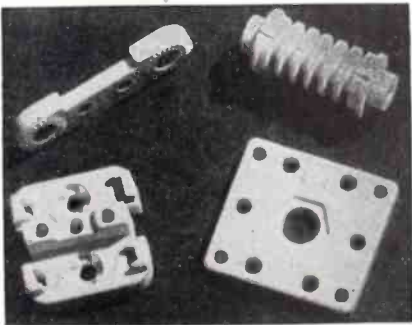

Lavite STEATITE CERAMIC

Properties and Characteristics of Our LAVITE S1-5 Steatite Ceramic Body

Compressive Strength	96,000 lbs. per square inch
Tensile Strength	7,200 lbs. per square inch
Flexural Strength	10,500 lbs. per square inch
Modulus of Rupture	20,000 lbs. per square inch
Dielectric Strength	235 volts per mil
Dielectric Constant	6.42
Loss Factor	2.90
Power Factor	4.46
Bulk Specific Gravity	2.664%
Density (from above gravity)	0.096 lbs. per cubic inch
Hardness (Mohr scale)	7.0
Softening Temperature	2,350°F.
Linear Coefficient of Expansion	8.13x10 ⁻⁶
Moisture Absorption (ASTM D-118-42-A)	0.009%

Design engineers and manufacturers in the radio, electrical and electronic fields are finding in LAVITE the precise qualities called for in their specifications . . . high compressive and dielectric strength, low moisture absorption and resistance to rot, fumes, acids, and high heat. The exceedingly low loss-factor of LAVITE plus its excellent workability makes it ideal for all high frequency applications.

We will gladly supply samples for testing.

D. M. STEWARD MFG. COMPANY

Main Office & Works: Chattanooga, Tenn.
Needham, Mass. Chicago Los Angeles

S.S. White MOLDED RESISTORS

The "All-Weather" Resistors



TYPE 65X

Actual Size
Other types available
in the lower values

**RESISTOR BULLETIN 4505
GIVES FULL DETAILS . . .**

It shows illustrations of the different types of S. S. White Molded Resistors and gives details about construction, dimensions, etc. A copy, with Price List will be mailed on request. Write for it—today.

- Noiseless in operation
- Strong and durable
- Good performance in all climates

STANDARD RANGE
1000 ohms to 10 megohms

- NOISE TESTED •

At slight additional cost, resistors in the Standard Range are supplied with each resistor noise tested to the following standard: "For the complete audio frequency range, resistor shall have less noise than corresponds to a change of resistance of 1 part in 1,000,000."

HIGH VALUES
15 to 1,000,000 megohms

S.S. WHITE INDUSTRIAL DIVISION
THE S. S. WHITE DENTAL MFG. CO. DEPT. R, 10 EAST 40TH ST., NEW YORK 16, N. Y.



FLEXIBLE SHAFTS • FLEXIBLE SHAFT TOOLS • AIRCRAFT ACCESSORIES
SMALL CUTTING AND GRINDING TOOLS • SPECIAL FORMULA RUBBERS
MOLDED RESISTORS • PLASTIC SPECIALTIES • CONTRACT PLASTICS MOLDING

One of America's AAAA Industrial Enterprises

PLASTICON* CAPACITORS

Have You an Application for a Capacitor Weighing 1/2 of Comparable Paper Capacitors?

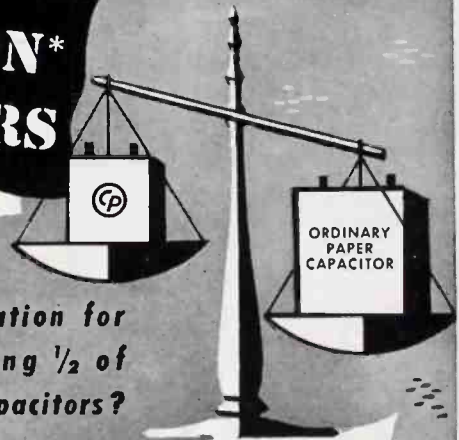

Plasticons are favored by aeronautical engineers because they are lighter and smaller.

On low voltage capacitors, there is an average saving of 10% in weight. As the voltage rating of capacitors increases, as much as 90% of the weight is saved.

If weight is a factor, specify **PLASTICONS.***

* Plasticons-plastic film dielectric capacitors



Condenser Products Company

1375 NORTH BRANCH STREET • CHICAGO 22, ILLINOIS

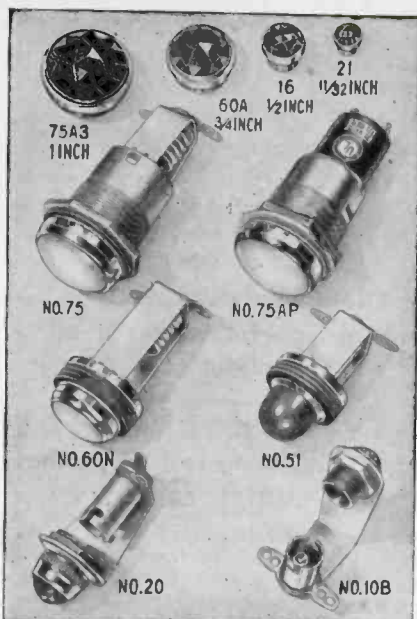

WHAT TYPE OF Jewel Assembly DO YOU NEED?

No matter what type or size of Jewel Light Assembly you need, chances are we can produce it for you quickly, more satisfactorily, and at lower cost! Here, every facility is available for high speed quantity production . . . speedy, efficient, economical service. Drake patented features add greatly to the value and dependability of our products.

You'll like the friendly, intelligent cooperation of our engineers. Let them help you with signal or illumination problems. Suggestions, sketches, cost estimates or asking for our newest catalog incur no obligation.

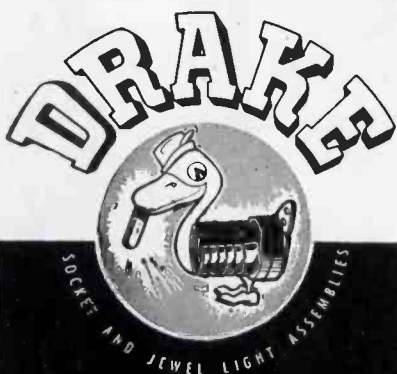

DRAKE MANUFACTURING CO.

1713 W. HUBBARD ST., CHICAGO 22, ILL.

at P. R. Mallory & Co., Inc., Indianapolis, Ind. He holds more than 140 patents on alloys and metallurgical processes, and has been chief metallurgical engineer for Mallory since 1934.

ARTHUR J. SANIAL announces the opening of a consulting engineering office in Flushing, N. Y., specializing in electroacoustics and audio electronics.

KARL KRAMER has been transferred from the engineering to the sales department of Jensen Radio Mfg. Co., Chicago, Ill.

ROBERT L. WOLFF becomes chief radio and electronics engineer at Centralab, Division of Globe-Union Inc., Milwaukee, Wis., after four years with Western Electric Co. and four years with Wells-Gardner.



R. L. Wolff



F. J. Gaffney

F. J. GAFFNEY, former head of the measurement and test equipment group at MIT Radiation Laboratory, has been appointed chief engineer of Polytechnic Research and Development Co., Brooklyn, N. Y. Before the war he was chief engineer for Browning Laboratories.

BEN WAXLER, formerly chief radio engineer of David Bogen and of Regal Electronics, is now chief radio engineer of Globe Electronics Corp., New York City.

ALBERT PREISMAN has been made vice-president in charge of engineering at Capitol Radio Engineering Institute, Washington, D. C. Prior to joining CREI three years ago he was senior engineer at Federal Telephone and Radio Corp.

JOHN D. KRAUS, formerly with Radio Research Laboratory at Harvard University, has been appointed Associate Professor of Electrical Engineering at Ohio State University.

J. ALBERT WOOD joins the Thayer School faculty of Dartmouth College

BRADLEY

SELENIUM RECTIFIERS

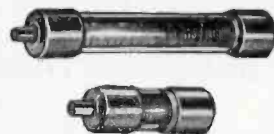

Se-6 M Series

A group of several half-wave rectifiers rated up to 4000 volts peak inverse, 5 milliamperes D.C. Illustrated are models Se-6M55-H2 and Se-6M28-H1.

Bradley engineers have had wide experience with rectification problems involving instruments, electronic devices and power applications. They will gladly specify the proper selenium rectifier for your circuit, or design and produce a special unit for you.

Illustrated literature, available on request, shows more models of selenium rectifiers, plus a line of copper oxide rectifiers and photocells. Write for "The Bradley Line."

BRADLEY

LABORATORIES, INC.

82 Meadow St. New Haven 10, Conn.

IMMEDIATE DELIVERY!



WRL Multitester

- Sturdy Steel Case
- 30-60 Degree Angle
- Stand it up or Lay it Down

CAT. NO. 16-491

\$18.75

TEST LEADS
CAT. NO. 17-459 **\$.60**

Ranges: DC Volts—0/5/50/250/500 V, AC Volts—0/10/100/500/1000V, DC Mills—0/10/100 Mills. Ohmmeter—Low Range 0-500 Ohms, High Range—0-100,000—1 Meg. 3" Meter with sturdy D'Aronsvall movement. Size 5½ x 8 x 3¼.

Phono Amplifier Kits

Complete with tubes, speaker, stamped chassis, resistors and condensers. Many other kits also available. Cat. No. 7-271. \$9.50 ea. Lots of 3, ea....

\$9.15



WRL LOW PRICED TRANSMITTER KITS

15, 35, 70, and 150 Watt types

On our toes at all times to give you the best in radio and electronic devices of all kinds. Immediate delivery to all parts of the world from the heart of America.

WE INVITE INQUIRIES FROM AGENTS, IMPORTERS, BROKERS

FREE! 52 Page Packed with savings in radio, Catalog electronic, and general merchandise. Send for your copy today.

Handy Tube Base Calculator 25c
Giant Radio Reference Map 15c
Address Dept. E-6 Council Bluffs, Iowa



Formerly Wholesale Radio Laboratories

Transformer Type **SPEED IRON***

FOR SOLDERING IN TIGHT PLACES

HEATS IN
5 SECONDS

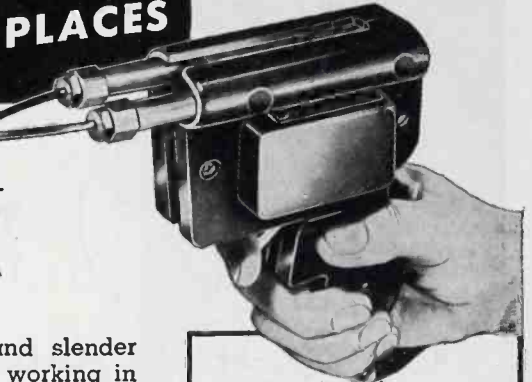

Short pistol length and slender loop type tip permits working in close quarters and around sharp corners. Tip easily formed by hand to fit the job.

- BUILT-IN TRANSFORMER PRINCIPLE FOR FAST SOLDERING HEAT
- 115 VOLT—60 CYCLE—100 WATTS
- ALWAYS READY TO USE
- STAYS TINNED—NO TIP BURNING
- INEXPENSIVE TIPS EASY TO REPLACE
- IMPACT RESISTING CASE

WELLER MFG. CO.

515 NORTHAMPTON ST. • EASTON, PA.

*TRADE MARK REG. U. S. PAT. OFF.

LOW VOLTAGE

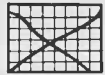

HIGH CURRENT



← SPEEDS UP WORK

PERFECTLY BALANCED
EASY TO HANDLE



NOW AVAILABLE!

STUDENT'S OSCILLOGRAPH BY *Hathaway*



New, ultra-simple measuring and recording instrument of unusual accuracy and dependability. Specifically designed and built to meet the long-felt need in Colleges and Technical Schools for a low-price precision testing until adaptable to general laboratory and field work.

Embodies instant magazine loading, simultaneous viewing and recording, automatic brilliancy control, and four operating speeds: 48", 24", 12", and 6" per second.. Operates from 110-volt a-c outlet. Weighs 40 lbs. Measures 10" wide by 17½" long x 10½" high.

Write for Bulletin SP-183 Hathaway Instrument Co., 1315 S. Clarkson St., Denver 10, Colorado.

HATHAWAY INSTRUMENT CO., Denver

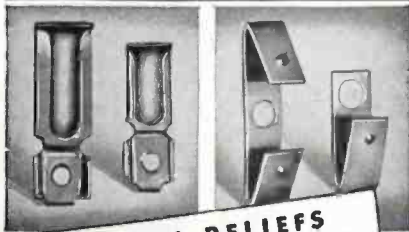
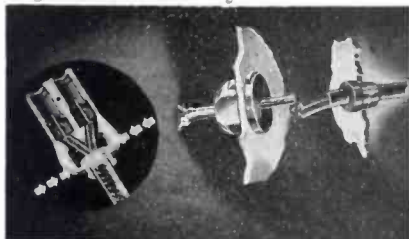

STRAIN RELIEFS HEATER PLUG CONTACTS CUBE TAP CONTACTS

Complete line for all applications. Many sizes ready for shipment. When writing for literature and samples, please state wire size.



HEYMAN MANUFACTURING COMPANY

510 Michigan Ave. Kenilworth, N. J.

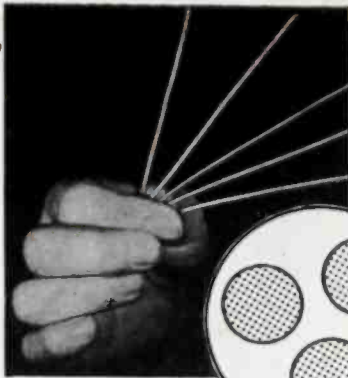

**ALL SOLDER WIRE
LOOKS THE SAME
FROM THE OUTSIDE**

But
**TRI-CORE'S
TRIPLE-FLUXING**

Makes the Difference

- **FASTER, BETTER SOLDERING!**
- **SAVINGS IN LABOR & MATERIALS**

Tri-Core's arrangement of three independently filled cores places them closer to the surface. Heat hits flux in a flash, releasing flow instantly. Solder flows faster too, which gives results found in solders of a much higher tin alloy content. Hence—a real saving of tin, reflected in lower solder costs.

Write Today for Tri-Core Test Sample . . . and Descriptive Bulletin

ALPHA METALS, Inc.

Single Core, Rosin and Acid Filled Special Core Solder,
Wire, Bar, Sheet, Preforms. Lead and Tin Products.

371 HUDSON AVENUE

BROOKLYN, 1, N. Y.

ROTARY SELECTOR SWITCHES FOR THE CRITICAL ENGINEER



TYPE XC—Single or multiple decks. Instrument type. Contact Resistance less than .001 ohm. Ideal for shunt ammeter, thermo couple type measuring equipment and Wheatstone Bridges.

SERIES EE-14—Single or multiple decks. One to six. 14 circuits each deck. Shorting or non-shorting contacts. Recommended for use in quality test equipment or accurate switching of multi-circuits with low contact loss.

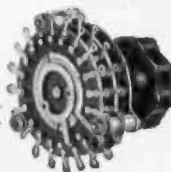

SERIES EE-20—Similar to Series EE-14 but with 20 circuits each deck. Contacts and moving parts heavy coin silver plated to meet 200 hour salt spray test. Low leakage laminated plastic decks selected for maximum mechanical and dielectric strength.

Write for catalogue

Eastern Electronics Corp.

41 CHESTNUT STREET, NEW HAVEN, CONNECTICUT, U.S.A.

as assistant professor of electrical engineering, and will direct electronics work in the school's new electrical engineering course. He was formerly assistant director of the radar school at MIT.

J. ELMER HOUSLEY, district power manager for Aluminum Company of America, will be the next president of the American Institute of Electrical Engineers and will take office August 1 for one year.

LAWRENCE BAILEY, formerly radioradar materiel officer in the U. S. Navy, has joined the staff of Spectrum Engineers, Inc., Philadelphia, Pa. Before entering the Navy he was on the engineering staff of station WBEN, Buffalo, N. Y.

WELDON E. RHOADES, who served as a personal pilot for General MacArthur in the Pacific, has been appointed director of the air navigation-traffic control group of the Air Transport Association of America. His duties will include flight-testing and evaluating the more than 15 electronic systems already in the field for control of air traffic both on the airways and when landing.

BURTON E. SHAW, newly elected vice-president of Photoswitch Incorporated, Cambridge, Mass., will have charge of engineering and production. He formerly held a similar position at Watts Regulator Co. in Lawrence, Mass., and holds many patents on control devices.



B. E. Shaw



U. R. Furst

ULRICH R. FURST is now associated with Furst Electronics, Chicago, Illinois, a new firm manufacturing industrial electronic equipment for measurement and control applications. He previously was chief electronic engineer of Russell Electric Co.

JAMES I. BENJAMIN has been appointed manager of the Radio and

Alnico permanent magnets

Specializing in the production of highest quality Alnico Magnets in all grades including new triple strength No. 5.

Production material checked to assure highest uniform quality of product.

Castings made to customer's special order on the basis of sketches or blue prints furnished.

Information and suggestions furnished on request.

GENERAL MANUFACTURERS OF HIGH COERCIVE MAGNETIC ALLOYS

G.M. MAGNETIC CORPORATION

ALNICO

2126 E. FORT STREET
DETROIT 7, MICHIGAN

Accuracy in Washers

Especially important in electrical products, where VIBRATION is an enemy.

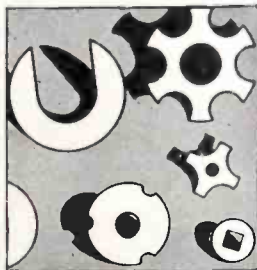
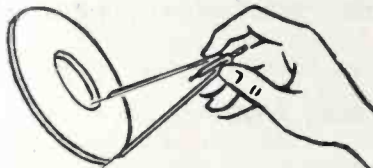

QUADRIGA QUALITY WASHERS

Made exactly to your specifications for greatest precision. PROMPT DELIVERY any washer material, any type, any quantity, large or small.

Also SMALL METAL STAMPINGS, any design. Send for QUADRIGA Catalog

Many photographs. Valuable engineering data.

THE QUADRIGA MANUFACTURING CO.

Incorporated 1894
WASHERS & SMALL METAL STAMPINGS
221A West Grand Ave. • Chicago 10, Illinois



GASES ARGON · NEON
HYDROGEN HELIUM · KRYPTON
NITROGEN · OXYGEN XENON

COMPLETE GAS PRODUCTION PLANTS INSTALLED FOR LOWEST COST OPERATION

FORMING MIXTURES
CARBON DIOXIDE
ACETYLENE

HIGHEST QUALITIES • ANY QUANTITY DELIVERED ANYWHERE

AMERICAN GAS & CHEMICAL CO.
HARRISON, NEW JERSEY • Contracted Complete Service on All Gases

SP&R1

FREE! MAIL COUPON FOR "Pocket Library of Engineering Data"



... AND A BAGFUL OF



If you use screws, nuts, bolts, washers, rivets, let us send you FREE the new "Pocket Library of Engineering Data," a fingertip reference to machine screw weights, decimal equivalents, machine screw thread dimensions, and decimal equivalents of twist drills. Also, you will be interested in receiving FREE a bagful of STRONGHOLD samples. This typical cross-section tells a better story than words. STRONGHOLD offers one dependable source of supply for every type of fastener, produced by modern equipment in our own factory.

NET PRICE CATALOG

An up-to-date fastener encyclopedia, reference guide, specification chart, and NET price list of precision-made STRONGHOLD products. Every purchasing agent and every engineer who specifies fasteners should have a copy. Mail coupon now.



MANUFACTURERS SCREW PRODUCTS
270 W. Hubbard Street.
Chicago 10, Ill.

It's Faster to Phone
Whitehall 4680
Standardize on
STRONGHOLD

PASTE THIS COUPON ON YOUR LETTERHEAD AND MAIL

MANUFACTURERS SCREW PRODUCTS
270 W. Hubbard St., Chicago 10, Ill.

Please send me the items checked below.

"Pocket Library of Engineering Data".
 Bagful of STRONGHOLD screw products.
 NET Price Catalog.
 Prices on attached request.

Name.....
Position.....
Company.....
Address.....
City, Zone, State.....

PRECISION PARTS

RECIPE FOR PRECISION

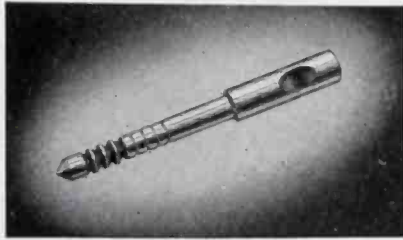

Precision tools, used daily to machine to close tolerances, must themselves be built with hairbreadth accuracy. Here is an Ace recipe that worked successfully for one such precision instrument—a size and burnishing tool!

Start with high-speed Delloy steel. Machine it in the rough. Heat-treat according to the specifications for that particular steel (Rockwell C63/66). Grind the shank in a centerless grinder to a tolerance of plus or minus .00025". Place in a cylindrical grinder, grinding the sizing and burnishing diameters of the bit to a tolerance of plus 0", minus .0005". Result: a fine precision tool, a product of Ace skill down to the last ten-thousandth of an inch.

This is just one example taken at random from the hundreds that pass through the daily grind here at Ace. Ace offers a complete service for the production of small parts and assemblies . . . in any quantity, to tolerances of .0001" . . . whether the material is steel, non-ferrous metal, or glass. With Ace, you purchase all your precision work in one place from the tool and die stage, on through stamping, machining, heat-treating and grinding. All of the work is carried out under a single roof, a single, competent management. Send us a blueprint, sketch, or sample for quotation.

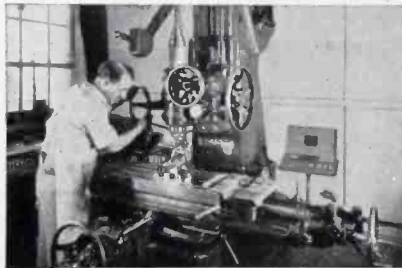

... up-to-date, efficient equipment,
from tool crib to inspection bench...



ACE MANUFACTURING CORPORATION
for Precision Parts
1255 E. ERIE AVE., PHILADELPHIA 24, PA.

Electronic Division of the Lewyt Corp., Brooklyn, N. Y.

SAMUEL J. NOVICK has been elected chairman of the board for Electronic Corporation of America, Brooklyn, N. Y. His former position as president of the firm is being filled by Garrard Mountjoy, who moves up from vice-president in charge of engineering.

WINFIELD WAGENER, at one time chief engineer for Heintz & Kaufman and (in 1944) head of the tube division of Litton Engineering Laboratories, recently joined the sales engineering staff at Eitel-McCullough, Inc., San Bruno, California.

MARTIN D. WHITAKER, director of Clinton Laboratories operated by Monsanto Chemical Co. at Oak Ridge, Tenn., will begin his new duties as president of Lehigh University June 1. His position at Oak Ridge is being filled by Dr. Eugene P. Wigner, member of the Princeton University faculty and an authority on nuclear physics. This laboratory is one of the few places in the world having a chain reacting pile for fundamental research in nuclear physics, radio chemistry, and atomic energy.

JOHN ASHTON has opened a radio laboratory in Greenwich, Conn., for general radio engineering practice.

JOHN L. REINARTZ has returned to RCA after seven years as communications and electronics officer in the Navy, and will be in charge of the amateur radio program at their Lancaster, Pa. plant.

L. H. ROBINSON, until recently a Major in the Signal Corps, accepted

MICROWAVE TOWER



Artist's sketch of 300-foot tower now under construction for microwave and electronic experiments at the Nutley, N. J. site of Federal Telecommunication Laboratories

**NEW
MODELS**
Available Now!
of **ATR**
QUALITY PRODUCTS



**ATR
"A"**

BATTERY ELIMINATORS

FOR CONVERTING A.C. TO D.C.
New Models . . . designed for testing D.C. electrical apparatus on regular A.C. lines. Equipped with full-wave dry disc type rectifier, assuring noiseless, interference-free operation and extreme long life and reliability.

- Eliminates Storage Batteries and Battery Chargers.
- Operates the Equipment at Maximum Efficiency at All Times.
- Fully Automatic and Fool-Proof.

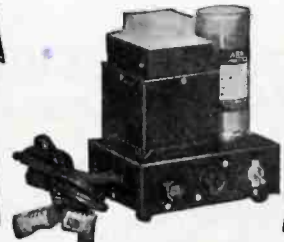

ATR

LOW POWER INVERTERS

FOR INVERTING D.C. TO A.C.
Another New ATR Model . . . designed for operating small A.C. motors, electric razors, and a host of other small A.C. devices from D.C. voltages sources.

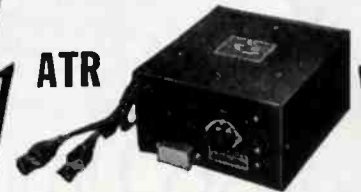

ATR

STANDARD AND HEAVY DUTY INVERTERS

FOR INVERTING D.C. TO A.C.
Specially designed for operating A.C. radios, television sets, amplifiers, address systems, and radio test equipment from D.C. voltages in vehicles, ships, trains, planes, and in D.C. districts.

WRITE FOR NEW CATALOG—
JUST OFF THE PRESS!

AMERICAN TELEVISION & RADIO CO.
Quality Products Since 1931
ST. PAUL 1, MINN. U. S. A.

Bagshaw's NEEDLES

FAMOUS SINCE 1892

for Better Record Performance



This is the needle that has set Performance Standards in laboratories and studios the world over! It is remarkable for hi-fidelity playback . . . and our drastic SHADOW-GRAPHING eliminates all except perfect points. A professional's needle, indeed, vindicating the BAGSHAW slogan:

*After all . . .
you can't beat the BEST!*

H. W. ACTON CO., INC.
SOLE DISTRIBUTOR
370 SEVENTH AVENUE NEW YORK 1, N. Y.

HARRIS

DUFLEX SHOCK MOUNTS



TUBULAR MOUNTS
Bonded or Torflex Type



TORFLEX BEARINGS



CONTROL VIBRATION
ELIMINATE SHOCK & NOISE

**HARRIS PRODUCTS
COMPANY**

5106 Cowan Ave. • Cleveland 4, Ohio

VACUUM CONDENSERS

For Industrial and Communications Jobs



RATINGS
Series 60G3
12-250 mmf
Pk. Volts 32,000
Pk. Amps 60
Length Overall 5 Inches
Diameter 3/4 Inches
Standard Tolerances

Low power losses—High conductivity glass seal. No high resistance metals used, which in some vacuum condensers, seriously limit the use of the unit on the higher frequencies.

Silver plated copper terminals. An ideal conductor for radio frequencies—No solder connections.

Heavier plates—chemically treated.

Less surface leakage due to increased glass path.

Trio threaded mounting holes—center threaded mounting hole. May be seriesed by single stud, center to center; paralld by bolting ends to conducting bus—either thru trio or center holes; stand-off mounted; mounting methods prevent frequency drift.

Electrically and mechanically "heavy-duty."

GILANDUN ELECTRONICS

14 UNION AVENUE

CAMPBELL, CALIFORNIA

**How Do YOU Judge Dependability?
BY YEARS?**

Henry P. Segel Company, Manufacturers' Representatives and Field Engineers, has been serving New England's needs for electronic equipment since 1924.

BY KNOW-HOW?

The Segel organization, representing some of the oldest and best-known manufacturers, is equipped to act quickly—efficiently—for your best interests—because they know how to help you with what you need when you need it.

BY RESULTS?

Continuous, effective results for our customers and our manufacturers have been responsible for this company's sound, steady growth.

BY REPUTATION?

For 22 years, the Henry P. Segel Company has maintained an outstanding reputation in the radio-electronic field for dependability and service.

When YOU need dependability and experience to help you, call on

Henry P. Segel Co.
Manufacturers' Representatives Field Engineers
143 NEWBURY ST. BOSTON 16, MASS.

Tels.: KENmore 3012-6333-9755
Branch Office in Hartford, Connecticut

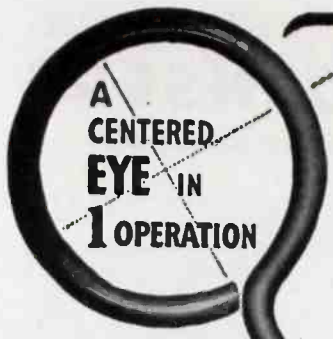

A
CENTERED
EYE IN
OPERATION

The DI-ACRO Bender makes perfectly centered eyes from rod or strip stock at high hourly production rates. Both eyes and centering bend are formed with one operation. Any size eye may be formed within capacity of bender and ductile limits of material.

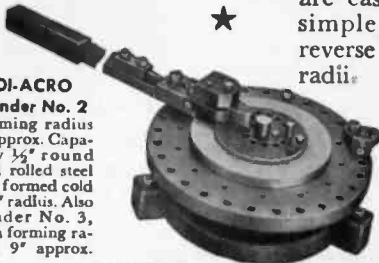

DI-ACRO Bender No. 2
Forming radius 6" approx. Capacity 1/2" round cold rolled steel bar, formed cold to 1" radius. Also Bender No. 3, with forming radius 9" approx.

DI-ACRO Is Pronounced "DIE-ACK-RO"

Precision CENTERED EYE Bending

With DI-ACRO Benders

DI-ACRO Precision Bending is accurate to .001" for duplicated parts. DI-ACRO Benders bend angle, channel, rod, tubing, wire, moulding, strip stock, etc. Machines are easily adjustable for simple, compound and reverse bends of varying radii.

DI-ACRO Bender No. 1

Forming radius 2" approx. Capacity 1/2" round cold rolled steel bar or equivalent.



Send for CATALOG "DIE-LESS" DUPLICATION showing many kinds of "dieless" duplicating produced with DI-ACRO Benders, Brakes and Shears.

a position as radio communications engineer with Galvin Mfg. Corp., Chicago, Ill.

G. F. METCALF has been appointed manager of G-E's Electronics Laboratory in Syracuse, N. Y. and will have charge of electronic research for the Electronics Department to be located in the ten-million dollar electronics headquarters plant now being built. He has been with G-E since 1928 except for service with the Signal Corps, from which he retired with the rank of Colonel.



G. F. Metcalf



A. Ellett

ALEXANDER ELLETT, who as head of NDRC Division 4 directed development of the v-t proximity fuze and other still secret scientific weapons, has joined Zenith Radio Corp., Chicago, Ill. as director of research. Prior to joining NDRC in 1940 he was professor of physics at the University of Iowa.

ALBERT D. SILVA joins Columbus Process Co., Inc., Columbus, Ind., as director of engineering and chairman of the board. For the past ten years he has been with Noblitt-Sparks Industries, where he served as chief radio engineer and as director of electronic research.

PAUL ROSENBERG has established a firm of consulting physicists known as Paul Rosenberg Associates, with offices in New York City. Work will be done in radar, ultrasonics, television, optics, and physics.

F. A. WANKEL, NBC Eastern Division engineer, takes over supervision of the technical broadcast operations of NBC television in New York. This operations group was recently separated from the technical development group.

FRITZ FRANKE, formerly chief engineer in charge of research and design, is now assistant sales manager for the Hallicrafters Co., Chicago, Ill.



O'NEIL-IRWIN MFG. CO.

321 EIGHTH AVENUE SOUTH • MINNEAPOLIS 15, MINN.

A Buy-word for Excellence

40
YEARS

PUR-A-TONE
Reg. Trade Mark

ANTENNAS

DEPENDABILITY

1906
BRACH
1946

ALL TYPES FOR

- AUTOS
- HOMES
- MARINE

A.M. — F.M. — TELEVISION

Make pleased customers and bigger profits . . . ask your distributor for BRACH Puratone ANTENNAS.

Special-purpose transmitting antennas designed for volume production to your own specifications. Collapsible — sectional — direction finding — radar and coaxial type. All sizes, lengths and materials. Consult us on your needs.

L. S. BRACH MFG. CORP.

200 CENTRAL AVENUE NEWARK, N. J.

WORLD'S OLDEST AND LARGEST MANUFACTURERS OF RADIO ANTENNAS AND ACCESSORIES.



Find Out Now About

★ STAR ★ CERAMICS

There are many kinds for special uses, such as applications calling for resistance to electricity, heat, moisture, chemicals or weathering agents. There are more than a score of formulas in actual production at one time in our factory.

Send for "A Brief Survey of Technical Characteristics of Molded Ceramic Products." It is right to the point.

★

The STAR PORCELAIN CO.

Electronics Dept.
Trenton 9, N. J.

YOU GET MANY Extras!

Rowe No. 7
Permanent
Magnetic
Driver Unit



Extra power, extra long life, extra freedom from break-downs, extra ease of replacement these are but a few of the many extras you get in the ROWE No. 7 PERMANENT MAGNET first choice of sound engineers who investigate thoroughly and analyze carefully.

The 3 lb., 4 oz. ALNICO Magnet gives power and permanency; combined voice coil and diaphragm assembly heads off trouble, provides for quick replacement if necessary. Write for circular 40-E giving complete details.

ELECTRONICS DIVISION

Rowe Industries

3120 MONROE ST., TOLEDO 6, OHIO

ONE USER OF H-B Red-Top THERMO-REGULATORS says:

"If all other methods of temperature control were as satisfactory as your thermo-regulators, I would have lost a lot less sleep during the war."

● An unsolicited testimonial from the director of one of America's largest research laboratories.

● And this statement is based on the use of H-B Thermo-Regulators which after 17 years of continuous service are still going strong. Investigate the limitless applications of the H-B Red-Top Thermo-Regulator (adjustable thermostat) for accurately holding, controlling or limiting temperatures—automatically. Adjustable between minus 35° and plus 350° F. Write us for catalog No. 14, just off press. H-B Instrument Company, 2524 N. Broad St., Philadelphia 32, Pa.



THERMOMETERS • THERMOSTATS
THERMO-REGULATORS

• RELAYS
• HYDROMETERS

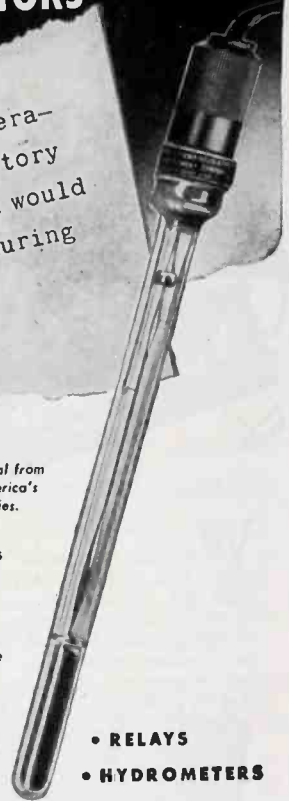

SAY MODERN METHODS SLASH SCREW COSTS 86%

By Means of Special Developments

KEENE, N. H. (Special)—A saving of \$58,653 in screw costs alone for one customer, together with a reduction in weight amounting to 3 1/2 tons, is the remarkable achievement credited to engineers of the New England Screw Company of this city. The saving was made through development of a special screw which replaced two screws formerly used.

"This saving is directly attributable to our Engineering Department," the president of the 50 year old firm, declared today. "Our customer asked us to develop a single part to replace two screw machine parts which were the bottleneck in otherwise high-speed production. Subsequent research revealed how we could make a saving of 43% in material on one item and 230% on the other. In actual production we used 23,370 pounds of brass wire as against 87,172 before. And the single part does the job better!"

Illustration on left shows one of the many special screws developed by this firm. Their Engineering Department will gladly co-operate with the engineers of any manufacturer using standard or special screws or head-shanks. The new catalog which fully describes the manufacture of New England Screws, will be sent to any company requesting it.



NEW ENGLAND SCREW CO.
KEENE, NEW HAMPSHIRE



The following Tubes are available for IMMEDIATE DELIVERY

IGNITRONS		
Type	Make	Price
WL 655/658	WESTINGHOUSE	\$165.00
WL 652/657	WESTINGHOUSE	55.00
WL 681/686	WESTINGHOUSE	30.00
WL 762	WESTINGHOUSE	19.00
KU 627	WESTINGHOUSE	11.00
GL 415	GENERAL ELECTRIC	30.00
THYRATRONS		
WL 632A	WESTINGHOUSE	16.00
FG 17	GENERAL ELECTRIC	6.00
FG 154	GENERAL ELECTRIC	17.75
FG 95	GENERAL ELECTRIC	16.00
RK 69	RAYTHEON	5.00
RK 73	RAYTHEON	1.72
2G33/RX233A	RAYTHEON	5.00
MISCELLANEOUS		
872 R	RCA (Beam Power Tube)	103.00
GL 446B	G.E. (Light House Tube)	10.00

Thousands of still hard to get items are always in stock at "Federated"—our industrial division is at your disposal with courteous and prompt service always.

Federated Purchaser
INCORPORATED
distributors of RADIO - ELECTRONIC
and SOUND EQUIPMENT

80-T Park Place, New York 7



WE don't guarantee that the **NEW BUD METAL WALL TYPE SPEAKER CASE** will stand up against a sledge hammer . . . but we do say that it is not subject to the cracking, splitting and warping that characterize ordinary wooden speaker cases.

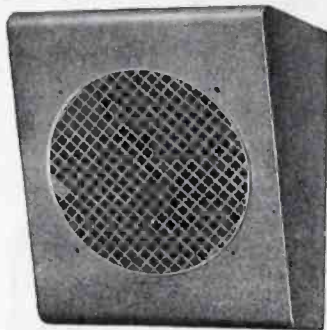

This new metal wall type speaker case is not only superior in appearance and construction . . . but it has reproduction capabilities equal to the finest wood housings. Keyway holes are provided for wall mounting and there are four embossed feet on the bottom in case you require its use on a table or other surface. It is finished in a rich brown wrinkle. Your local distributor will be glad to show this BUD Speaker Cabinet to you!

BUD Can Supply All Your Needs!

. . . with the latest types of equipment including: condensers—chokes — coils — insulators — plugs — jacks — switches — dials — test leads — jewel lights and a complete line of ultra-modern cabinets and chassis.

BUD
BUD RADIO, INC.
CLEVELAND 3, OHIO

NEW BOOKS

Two-Way Radio

By **SAMUEL FREEDMAN**. *Ziff-Davis Pub. Co., Chicago 1, Ill., 506 pages, \$5.00.*

THIS BOOK COVERS briefly the elements of two-way radio communication, including frequency selection, licensing, equipment necessary, purchasing, and power supply; it takes up various types of equipment and systems—mobile and fixed stations, antenna systems, amplitude and frequency-modulation equipment, induction radio and guided carrier systems, frequency modulation, and microwaves. Next come descriptions of various types of applications—railroads, police, fire, forestry, highway and public transportation, marine aeronautical and personalized uses. Finally, the author describes maintenance and repair practices, licenses and regulations and typical systems.

The chapter on highway and public transportation is incomplete in respect to local transit systems. Subway, surface and elevated electric transit systems are briefly covered, but mostly from the standpoint of direct communication with passenger-carrying vehicles. Several installations exist, however, where two-way communication is maintained between system headquarters and dispatchers in automobiles, with excellent results, whereas few if any installations on passenger-carrying vehicles are beyond the experimental stage.—K.S.P.

• • •

One World or None

Edited by **DEXTER MASTERS** and **KATHARINE WAY**. *McGraw-Hill Book Co., Inc., New York 18, N. Y., 1946, 79 pages, \$1.00.*

A COLLECTION OF reports by outstanding atomic scientists, giving their individual personal opinions on the significance of the atomic bomb to the future of the world, based in most instances on personal association with the Manhattan Project.

Of especial interest to readers of **ELECTRONICS** is Chapter 7, "There Is No Defense", by Louis N. Ride-nour, who served at Radiation Laboratory, MIT, and was radar advisor to General Spaatz in Europe in 1944. He states that IFF (Identification of Friend and Foe) was an abject operational failure, giving so many diffi-

BRADLEY

COPPER OXIDE RECTIFIERS



Coprox Model CX-2E4F2

A full-wave rectifier rated up to 4.5 volts A.C., 310 volts D.C., 5 milliamperes D.C.

"Coprox" rectifiers by Bradley have special features that assure long life, easy assembly and accurate performance. All ratings of Bradley rectifiers are conservative. Bradley engineers are available to assist you in the development, production and application of special rectifiers for special jobs.

Illustrated literature, available on request, shows more models of copper oxide rectifiers, plus a line of selenium rectifiers and photocells. Write for "The Bradley Line."

BRADLEY

LABORATORIES, INC.

82 Meadow St. New Haven 10, Conn.



Mobile Antennas and Mountings



Get the Signals

Premax Tubular Antennas . . . in rigid and adjustable models . . . are doing an outstanding job in many types of commercial installations. Being made of tubular steel or aluminum, they are light in weight yet can withstand severe shocks. Many special and standard designs are available, together with suitable mountings.

Premax Products

Division Chisholm-Ryder Co., Inc.
4611 Highland Ave., Niagara Falls, N. Y.

Calibrate your 'Scope to 1% with Voltoscope



PROVIDES three standard voltages—.1, 1.0 and 10.0 peak to peak volts. AC operated and adaptable for all make oscilloscopes. No warm-up time makes the Voltoscope ready for immediate use.

A self-contained instrument — no bigger than your hand. Foot-proof—no tubes and fuse protected. Net price, F.O.B. New York City **\$15.00**

Dual Regulated D. C. POWER UNIT

Two independently regulated D.C. power units designed to meet requirements where close regulation and low ripple content are important. Mounts in a standard type relay rack (19 x 17 1/2). No electrolytic condensers are used.

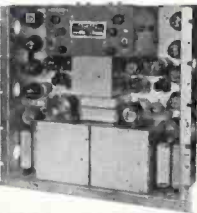

Each Power Unit has its own power switch, fuses, pilot light, and voltage control.

Specifications:

• 115 Volts AC 50/60 cps • 240-285 DC Volts • 400 DC MA each unit • Ripple less than 0.001% Impedance less than 1.50 ohms.

Net Price F.O.B. New York City **\$300.00**
Portable Metal cabinet \$25.00



135A LIBERTY ST., NEW YORK 6, N. Y.

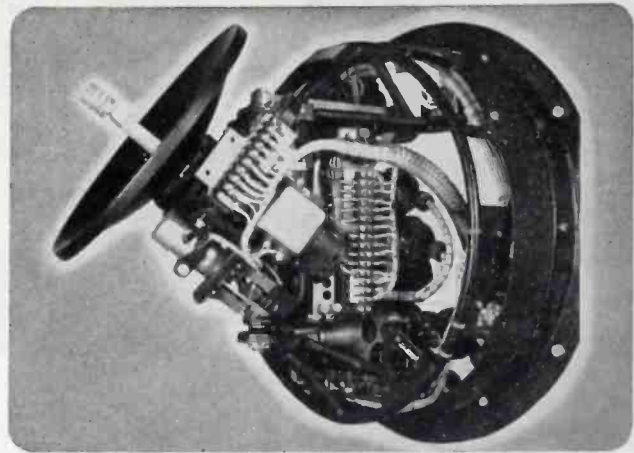

Specialists in intricate electrical mechanical assemblies

Illustrated above is an example of the type of work Gray knows how to do—and do well. We're open now for contracts and sub-contracts in this highly specialized field. Write to Laurence McCulloch, address below.



GRAY MANUFACTURING CO.

W. E. DITMARS, President
230 Park Ave., N. Y. 17, N. Y. • 16 Arbor St., Hartford 6, Conn.

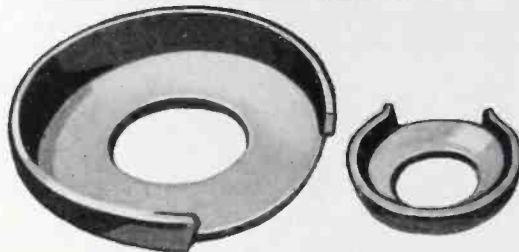

CUP WASHERS
for Binding Screws

Preferred

as a source of precision-made WASHERS and STAMPINGS manufactured to your specifications



WHITEHEAD STAMPING CO.

1691 W. Lafayette Blvd. Detroit 16, Michigan

PLATINUM

WIRE - RIBBON
FOIL
SEAMLESS
TUBING



for

SILVER

WIRE - SHEET
TUBING
SILVER BRAZING
ALLOYS & FLUXES

ELECTRONIC USE

FOR YEARS A LEADING SUPPLIER OF PRECIOUS METALS TO THE ELECTRIC AND ELECTRONICS INDUSTRIES.

THE AMERICAN PLATINUM WORKS

N. J. R. R. AVE. AT OLIVER ST.
NEWARK 5, N. J.

PRECIOUS METALS SINCE 1875

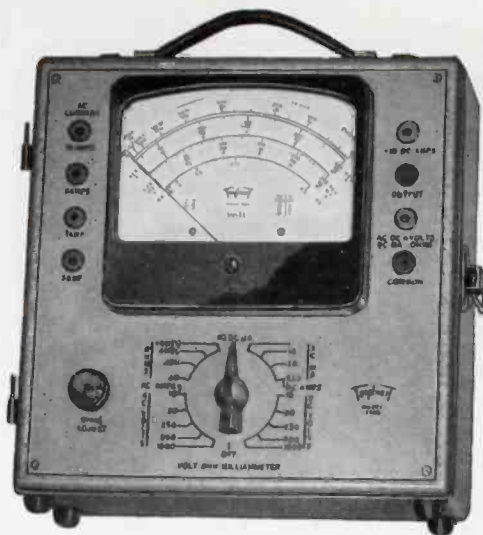

MODEL 2405

Volt • Ohm Milliammeter

25,000 OHMS PER VOLT D. C.



SPECIFICATIONS

NEW "SQUARE LINE" metal case, attractive tan "hammered" baked-on enamel, brown trim.

■ **PLUG-IN RECTIFIER**—replacement in case of overloading is as simple as changing radio tube.

■ **READABILITY**—the most readable of all Volt-Ohm-Milliammeter scales—5.6 inches long at top arc.

Model 2400 is similar but has D. C. volts Ranges at 5000 ohms per volt.

Write for complete description

Triplet

ELECTRICAL INSTRUMENT CO.

BLUFFTON OHIO

NEW ENGINEERING NEW DESIGN • NEW RANGES

30 RANGES

Voltage: 5 D.C. 0-10-50-250-500-1000
at 25000 ohms per volt.

5 A.C. 0-10-50-250-500-1000
at 1000 ohms per volt.

Current: 4 A.C. 0-.5-1-5-10 amp.

6 D.C. 0-50 microamperes—
0-1-10-50-250 milliamperes—
0-10 amperes.

4 Resistance 0-4000-40,000 ohms—4-
40 megohms

6 Decibel -10 to +15, +29, +43,
+49, +55

Output Condenser in series with
A.C. volt ranges

culties in the European Theater that its use was entirely abandoned after D-day in Normandy except for a few small special missions. In the Pacific it often failed to serve its intended purpose when most sorely needed, main troubles occurring under conditions of heavy traffic—when there were many aircraft in range of a single radar set. With future air traffic even denser, detection and accurate identification of approaching atomic missiles while they are still several hundred miles from the target becomes a real problem. Problems of interception with guided missiles are then taken up one by one, and the over-all summary of the situation presents clearly the hopelessness of any defense against a surprise atomic bomb attack.—J.M.

Radar

By ORRIN E. DUNLAP, JR. *Harper & Brothers, New York 16, N. Y., 1946, 208 pages, \$2.50.*

A POPULAR VERSION giving a little of everything about radar—what it is, how it works, who invented it, what it did in the war, and what its peacetime possibilities are. By avoiding engineering aspects of his subject and covering the multitudinous aspects of radar as briefly as possible, the author achieves his goal of bringing the book within the understanding of a schoolboy.

The 1946 American Television Directory

Published by American Television Society, Inc., 271 Madison Ave., New York 16, N. Y., First Annual Edition, 144 pages, \$5.00.

A SUMMARY OF TELEVISION'S status as seen by some 50 authors who have recently been active in this field, along with tables and compilations having reference value for those concerned with the advertising and programming aspects of television.

Electrons in Action

By JAMES STORLEY, *Whittlesey House, McGraw-Hill Book Co., Inc., New York 18, N. Y., 320 pages, \$3.00.*

FOUR CHAPTERS trace the behavior of an electron, starting with its antics on a piece of amber rubbed by Thales along about 600 B.C. and going on through modern electron theory, the

10 TYPES OF TERMINAL BLOCKS

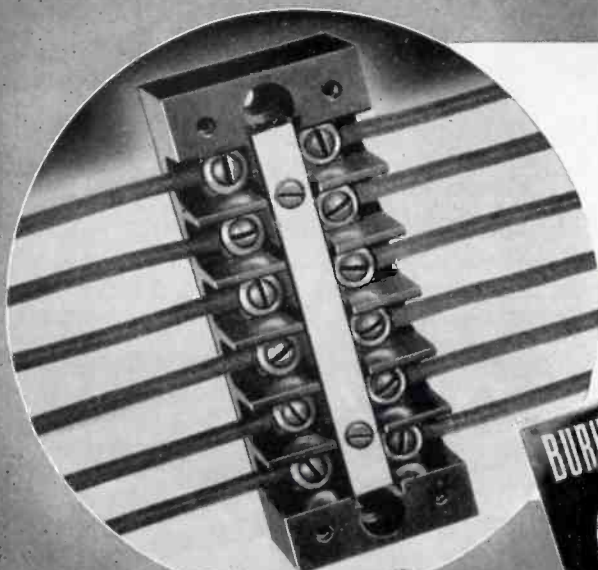

BURKE, with 10 styles of Terminal Blocks each in a wide selection of sizes, offers complete, efficient method for centralizing the connecting of wires at one point of control. These bakelite blocks are molded under high pressure and cured at constant temperature for long periods to provide a solid homogenous insulating medium.

Address:
1166
W. 12th
St.



• Write for Booklet

AC AND DC MOTORS AND GENERATORS

BURKE Terminal BLOCKS

BURKE ELECTRIC COMPANY • ERIE, PENNSYLVANIA

What Makes A Mailing Click?

● Advertising men agree —the list is more than half the story.

McGraw-Hill Mailing Lists, used by leading manufacturers and industrial service organizations, direct your advertising and sales promotional efforts to key purchasing power. They offer thorough horizontal and vertical coverage of major markets, including new personnel and plants. Selections may be made to fit your own special requirements.

New names are added to every McGraw-Hill list daily. List revisions are made on a twenty-four hour basis. And all names are guaranteed accurate within two per cent.

In view of present day difficulties in maintaining your own mailing lists, this efficient personalized service is particularly important in securing the comprehensive market coverage you need and want. Ask for more detailed information today. You'll probably be surprised at the low over-all cost and the tested effectiveness of these hand-picked selections.



Mc GRAW-HILL
DIRECT MAIL LIST SERVICE

McGraw-Hill Publishing Co., Inc.

DIRECT MAIL DIVISION
330 WEST 42nd ST.
NEW YORK 18 N. Y.

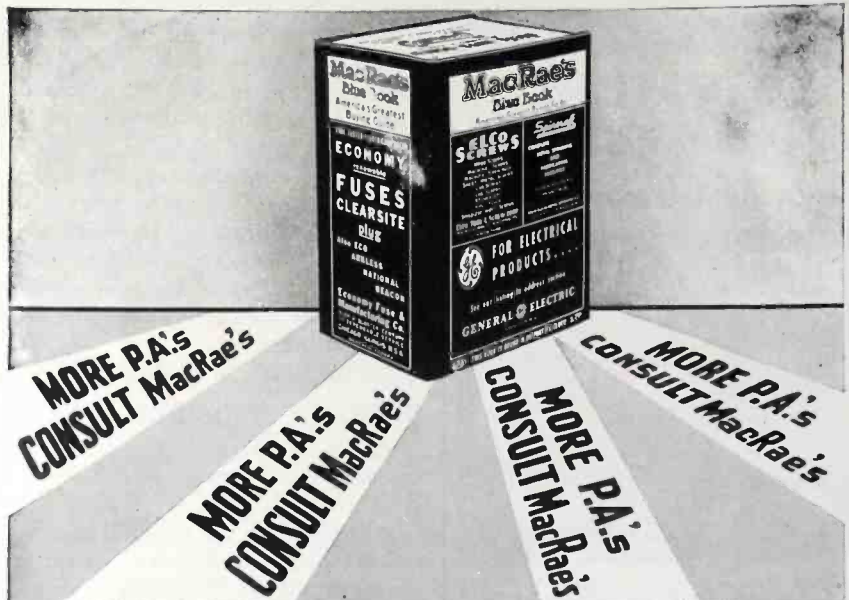

For advertising and book rates, call your agency or write . . .

MacRae's Blue Book

A DIRECTORY OF AMERICAN INDUSTRY

29 E. HURON ST. . CHICAGO 11, ILL.

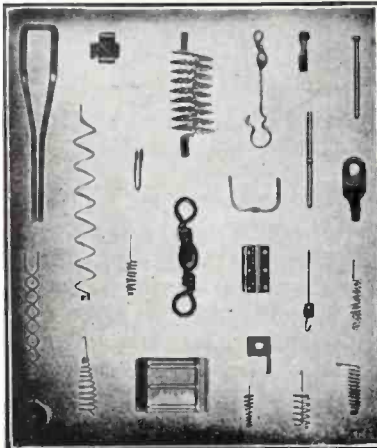

SMALL PARTS

Filaments, anodes, supports, springs, etc. for electronic tubes. Small wire and flat metal formed parts to your prints for your assemblies. LUXON fishing tackle accessories, double pointed pins, fine sizes wire straightened. Inquiries will receive prompt attention.

ART WIRE AND STAMPING CO.

227 High St.

Newark 2, N. J.

PERMANENT MAGNETS

Alloys: COBALT • CHROME • ALNICO

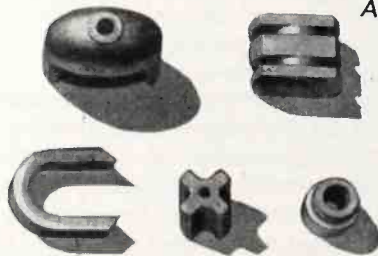

The making of permanent magnets is an alloy, too . . . of experience, engineering, facilities. We'll be glad to tell you more. Write for bulletin.

THOMAS & SKINNER STEEL PRODUCTS CO.
1116 E. 23rd St., Indianapolis 5, Ind.

Thomas & Skinner

CHECKS—GRADES RESISTORS 100 Ohms to 100 Megohms At a GLANCE



Clippard AUTOMATIC RESISTANCE COMPARATOR



Type
PR-4

Here is the instrument that reduces precision checking of incoming shipments of resistors, factory output, matching or grading to close tolerance limits, a simple production routine!

"Standard" resistor is connected across terminals at left. Operator then places resistances to be checked across "unknown" terminals in center. Face of large, easily-read meter in center illuminates, showing percent of deviation from standard within limits of -25% to +30%. NO OTHER OPERATION IS REQUIRED, reducing inspection time to absolute minimum!

Rugged laboratory construction and careful calibration assure accuracy of better than $\pm 1\%$ throughout entire range of 100 ohms to 100 megohms. Line variations, 105-125 volts A.C., automatically compensated for by special newly-developed electronic bridge circuits. An instrument that pays for itself quickly and saves you time and labor costs for years thereafter. Write for complete details and specifications, today.

Instrument above is one of a number of Specialized Electronic Test Instruments we manufacture. We'd be interested to learn your specific test instrument requirements. Your name on our mailing list will also keep you posted on latest developments.

EXPANDED FACILITIES and NEW HIGH-SPEED EQUIPMENT PERMIT US TO QUOTE ON QUALITY R.F. COILS FOR A FEW MORE DISCRIMINATING CUSTOMERS. WHAT ARE YOUR R.F. COIL REQUIREMENTS?

ELECTRO MAGNETIC WINDINGS
R. F. COILS SUB-ASSEMBLIES



Edison effect, conventional vacuum tubes and phototubes, klystrons, magnetrons, and finally the disk-seal tube. The remainder of this book is a fascinating and technically pleasing story of what electronics is doing in industry, in the laboratory, in medicine, and in war. From the vast array of applications in each branch of electronics the author has wisely chosen those having a maximum of human interest.

Television Simplified

By MILTON S. KIVER. *D. Van Nostrand Company, Inc., New York, 375 pages, \$4.75.*

THE AUTHOR in his preface to this book states, "It is the purpose of this volume to aid the thousands of radio men and women who will design, construct and repair television sets to bridge the gap between the modern 'pure' sound receiver and the more complex television circuits." The book should, however, also appeal to the large class of people who, while they are not engaged directly in television work, want to find out how television receivers work. Some knowledge of broadcast receivers and familiarity with circuit diagrams is necessary for profitable use of the volume, but no mathematical background is required.

The book deals essentially with television receivers. The first chapter, however, contains a description of the basic processes and elements of the transmitter, including camera tubes, scanning, and the addition of blanking and synchronizing pulses to the picture signal. The second chapter contains material on the propagation characteristics of radio waves with frequencies near 50 megacycles. From here on, the various parts of a television receiver are discussed in detail in nine chapters. The last three chapters are devoted to color television, frequency modulation, and the servicing of television receivers. The last chapter serves partly to coordinate and apply the information presented earlier in the book. The servicing problem is analyzed by breaking the receiver into four divisions: horizontal deflection circuits, vertical deflection circuits, video circuits, and the power supply. The material presented appears to be up-to-date. A large number of diagrams accompanies each chapter, and a somewhat incomplete "Glos-

Fine Resistance

WIRE .0006" and up

ALLOY "A"
Nickel-Chromium alloy, resists oxidation at elevated temperatures; up to 2100° F. Also used for fixed non-magnetic resistors. Resists chemical corrosion by many media. Specific resistance 650 Ohms/C.M.F.

ALLOY "C"
Nominally 60% Nickel, 15% Chromium, balance iron. High resistance to oxidation and corrosion. Widely used for resistors for radio, electronics, industrial equipment and domestic appliances. Operating temperatures up to 1700° F. Specific resistance 675 Ohms/C.M.F.

ALLOY "45"
55% Copper, 45% Nickel, with constant resistance over wide range of temperatures. Specific resistance 294 Ohms/C.M.F.; temperature coefficient 0.00002 Ohms per deg. F.; 32-212 deg. Used in winding of precision resistors, rheostats, and electrical measuring devices.

KANTHAL
Exclusive manufacturer and distributors of KANTHAL wire. An alloy containing Iron, Chromium, Aluminum and Cobalt... for operating temperatures between 2100° and 2462° F. Three grades, A-1, AS, DS; resistivity 872, 837, 812 Ohms/C.M.F., respectively, at 68° F.

and Fine Wire Screen

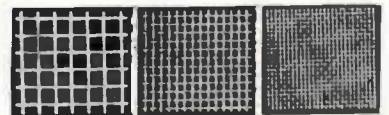

IN Tungsten, Molybdenum, and OTHER METALS AND SPECIAL ALLOYS; ALL MESHES IN STANDARD WIDTHS, OR WIRE-MESH PARTS FABRICATED TO ORDER.

THE C. O. JELLIFF
MFG. CORP.
123 PEQUOT ROAD,
SOUTHPORT, CONNECTICUT
WIRE CLOTH
DIPPING BASKETS
LEKTROMESH



PROFESSIONAL SERVICES

Consulting — Patents — Design — Development — Measurements

in

Radio, Audio, Industrial Electronic Applications

ASSOCIATED ELECTRONICS COMPANY

INDUSTRIAL ENGINEERING SPECIALISTS
Engineering Research & Development
Product Design Market Research
Sales Brochures Technical Manuals
Field Surveys Laboratory Analysis
Complete Engineering Service For All Industries
132 Nassau Street, New York 7, N. Y.

ELM LABORATORIES

Research and Design
RADIO TRANSMITTERS AND RECEIVERS
Designs for Home Radios, Electro-Mechanical Devices and Components.
20 South Broadway Dobbs Ferry, New York
Phone—Dobbs Ferry 4058

NATIONAL DESIGN SERVICE

Designers and Developers of
FACTORY TEST EQUIPMENT
TELEVISION R.F. SWEEP GENERATORS
F.M. SIGNAL GENERATORS
COMPLETE CENTRALIZED MODULATED SYSTEMS
96 Liberty St. New York 6, N. Y.

MICHAEL BOZOIAN

Consulting Service In Electronics
Instrumentation & Controls Design—Development—Models Literature & Patent Survey Recommendations For New Laboratories.
Telephone 8521
702 Fifth Street Ann Arbor, Mich.

F. T. FISHER'S SONS LIMITED

Consulting Engineers
Broadcast Transmitters, Antenna Systems, Studio Equipment, Mobile and Fixed Communication Systems.
1425 Dorchester St. West, Montreal

ALBERT PREISMAN

Consulting Engineer
Television, Pulse Techniques, Video Amplifiers, Phasing Networks, Industrial Applications
Affiliated with
MANAGEMENT-TRAINING ASSOCIATES
3308-14th St., N. W. Washington 10, D. C.

H. RUSSELL BROWNELL

Consulting Engineer
Specializing In Measurements & Testing Instruments & Techniques - Electrical - Electronic - Magnetic.
188 West 4th St. New York 14, N. Y.

PAUL E. GERST & CO.

CONSULTING ENGINEERS
Specialists in
Electrical Product Design
El. Machinery, Apparatus & Applications
El. Appliances, Hi-Frequency Apparatus
Electronics, Radio Communication
205 W. Wacker Dr. Chicago 6, Ill.

JOSEPH RAZEK, Ph.D.

Consulting Physicist
Electrical and Mechanical Engineering Problems
Instruments and Control Devices Electronics
Specialists in Colorimetry, Spectrophotometry and Industrial Color Control
Laboratory and Shop Facilities
202 Darby Road Llanerch, Pa.
Phone Hilltop 6910

E. STUART DAVIS

Consulting Engineer
Research—Design—Development
Radio - Carrier Current - Supersonics - Radiant Energy - Control and Measurement - Methods and Devices, Communication - Transportation & Industrial applications.
Marine Laboratory facilities aboard the yacht "ELECTRON"
422 N. E. River Drive Ft. Lauderdale, Florida

C. M. HATHAWAY

Consulting Engineer
Product Development
Project Engineering Production Design
Planning Tool and Method Engineering
ELECTRICAL MECHANICAL ELECTRONIC
1315 S. Clarkson Street • Denver 10, Colorado

G. W. RHEIN

Engineering Consultant
Radio Communication Electronics
Complete Development and design for manufacture with engineering models.
St. Paris Pike Springfield, Ohio

STANLEY D. EILENBERGER

Consulting Engineer
INDUSTRIAL ELECTRONICS
Design—Development—Models
Complete Laboratory and Shop Facilities
6309-13—27th Ave.
Kenosha, Wis. Telephone 2-4213

HODGSON & ASSOCIATES

Physics, Mathematics, Research, Development & Patent Consultants.
Satisfaction guaranteed. Submit your problem for a preliminary survey without cost.
Sherman Oaks, California

PAUL D. ZOTTU

Consulting Engineer
INDUSTRIAL ELECTRONICS
High Frequency Dielectric and Induction Heating Applications, Equipment Selection, Equipment and Component Design, Development, Models.
314 Washington St. Newton, Mass.
BIG-9240

ELECTRIC RESEARCH ASSOCIATE

ERA will apply progressive, war-proven development in electronic research . . . counting . . . timing . . . measuring . . . industrial controls . . . to your manufacturing advantage.
Box 333, 305 Linden Ave., South San Francisco, Cal.

J. L. A. McLAUGHLIN

Designer of
Communications Receivers
Specializing in the elimination of heterodyne interference.
P. O. Box 529, La Jolla, Calif.

RAYMOND M. WILMOTTE INC.

A Complete Engineering Service for the Application of Electronics to Industry
Consultation Design Construction
238 W. 55 St. 1469 Church St. N.W.
New York 19, N. Y. Washington 5, D. C.

Prompt ANSWERS to business problems . . .

The Searchlight Section brings business needs and "opportunities" to the attention of men associated in executive, management, sales and responsible technical engineering and operating capacities with the industries served by these McGraw-Hill publications. USE IT.

Classified Advertising Division

McGRAW-HILL PUBLISHING CO.

330 W. 42 St.

New York 18, N. Y.

Air Transport
American Machinist
Aviation
Aviation News
Business Week
Bus Transportation
Chem. & Met. Eng.
Coal Age
Construction
Methods
Elec. Contracting
Elect. Wholesaling
Electrical Merch.

Electrical World
Electronics
Engineering & Mining
Journal
Engineering News-Record
E. & M. J. Markets
Factory Mgt. & Maint.
Food Industries
Power
Product Engineering
Textile World
Welding Engineer

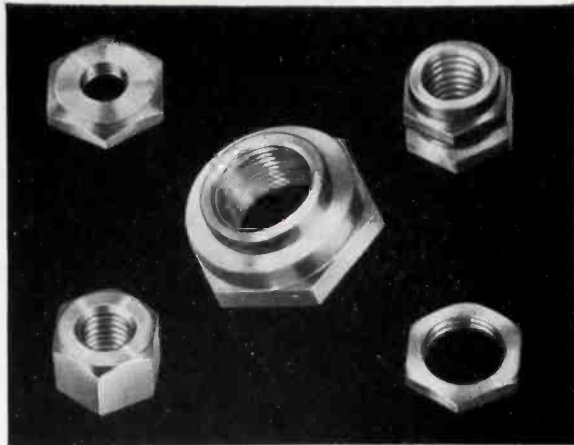

WESTFIELD METAL PRODUCTS CO. INC.
WESTFIELD MASS.

WE SPECIALIZE in meeting the most exacting needs of leading manufacturers. Specially designed for the job, Westfield nuts are more dependable than standard types, and frequently are more economical. Write or wire. Our engineers will be glad to consult with you on suitable types for every application.

**Custom
Made Nuts in
Brass, Steel and
Various Alloys**

EISLER EQUIPMENT*

... complete and diversified for every phase
of electronic manufacture!

TRANSFORMERS

in all types—furnace, distribution, power, phase changing, air, oil, induction, water cooled, plate, filament and auto-transformers. Filter chokes and inter-phase reactors.



Transformers supplied from 1/4 to 300 KVA.

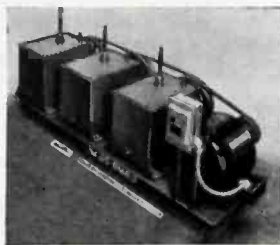

EISLER Compound Vacuum Pump.

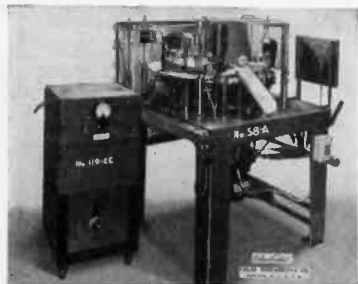

24 Head Radio Tube Exhausting Machine.



EISLER Spotwelders from 1/4 to 250 KVA.

* EISLER machines are in use and in production by 99% of all American radio tube and incandescent lamp manufacturers and throughout the world.

CHAS. EISLER

EISLER ENGINEERING CO.

751 SO. 13th ST. (Near Avon Ave.) NEWARK 3, NEW JERSEY

sary of Television Terms" is included at the end of the book. The presentation is pleasant and manages to include a great deal of useful information in spite of the limited prerequisites imposed upon the reader.—RALPH J. SCHWARZ

Television Show Business

By JUDY DUPUY. *General Electric Co., Schenectady, N. Y.*, 246 pages, \$2.50.

PEOPLE CONCERNED with the programming aspects of television have long awaited a report on the experience to date in this field. This handbook partially supplies the need. Part I reviews experiments conducted at WRGB between 1928 and 1945. Individual programs are described.

Part II describes the mechanics of program production—the television system, studio, cameras, lights, make-up, acting, etc. Of special value are the sample script, the section on audience surveys, and General Electric's lighting for television.

The book is generously and superbly illustrated but completely lacks any consideration of a fundamental theory of television programming. It is unfortunate, and misleading to the newcomer, that so monumental a report gives the impression of a "program recipe book". Careful outline discloses the refrains, "Rehearse!" "Plan camera shots!", which seems to imply that the art of television programming is still creeping for lack of a flexible system.—V. M. BRADLEY

Hack's Chemical Dictionary

Edited by JULIUS GRANT. *The Blakiston Co., Philadelphia 5, Pa.*, third edition, 1946, 925 pages, \$8.50.

OVER 57,000 DEFINITIONS, covering the vocabulary of chemistry and the collateral terms of physics and other fields that have in recent years become so closely related to the ever-broadening field of general chemistry, are given. Numerous tables and diagrams add to the value of this famous standard reference work, brought up to date in this third edition by addition of the latest available data on atomic disintegration. On practically every page will be found one or more definitions or biographies definitely pertinent to electronic medicine, nuclear physics, electronic applications to industrial chemistry, and to electronics in general.—J.M.

CONTACTS

FOR THE FIELD OF ELECTRONICS

Electron Tube Machinery

of every type, — standard, and special design

Specialists in Equipment for the manufacture of Radio Tubes, Cathode Ray Tubes, Fluorescent Lamps, Incandescent Lamps, Neon Tubes, Photo Cells, X-ray Tubes and other glass or electronic products, on production or laboratory basis.

Kahle

ENGINEERING COMPANY

1307-1309 Seventh St., North Bergen, N. J.

Strip Insulated Wires

QUICKER... BETTER

with "Speedex"
AUTOMATIC WIRE STRIPPER
... Speeds Production
Strips insulation from all types of wire — instantly, easily, perfectly. Just press the handles and the job is done. Cuts wire too. Strips 800 to 1000 wires per hour. Available for all size solid or stranded wires — No. 8 to No. 30. List Price \$6.00.
Write Dept. E for Full Particulars



GENERAL CEMENT MFG. CO.
Rockford, Illinois, U.S.A.

FINE RIBBONS OF TUNGSTEN and MOLYBDENUM
Quality and accuracy in our fabrication of Tungsten & Molybdenum Ribbons have characterized our service to the Electronic Industry.
A development of
H. CROSS Co.
15 Beekman St., New York 7, N.Y.



We manufacture a complete line of equipment

SPOT WELDERS, electric from ¼ to 60 KVA
TRANSFORMERS, special and standard types
INCANDESCENT LAMP manufacturing equipment
FLUORESCENT TUBE MAKING EQUIPMENT
ELECTRONIC EQUIPMENT, vacuum pumps, etc.
WET GLASS SLICING and cutting machines for laboratory use
GENERAL GLASS working machines and burners
COLLEGE GLASS working units for students and laboratory
EISLER ENGINEERING CO.
731 So. 13th St. (near Avon Ave.) Newark, New Jersey



MORE RF KILOWATT HOURS PER DOLLAR WITH

F & O TRANSMITTING TUBES

Inquiries invited—Let us explain how Savings are effected and the F & O greater guarantee.

FREELAND & OLSCHNER PRODUCTS Inc.
611 Baronne St., New Orleans 12, La.
Raymond 4756

High Power Tube Specialists Exclusively
(5 KW to 100 KW)

HETERODYNE ELIMINATORS

If you are troubled by heterodyne interference consult

J. L. A. McLaughlin
P. O. Box 529, La Jolla, Calif.

MICROMETER FREQUENCY METER

for checking Transmitters from 1.5 to 56 mc., within 0.01 per cent

LAMPKIN LABORATORIES
Bradenton, Fla., U. S. A.

This CONTACTS Section

supplements other advertising in this issue with these additional announcements of products essential to efficient and economical operation and maintenance. Make a habit of checking this page, each issue.

Classified Advertising Division
ELECTRONICS

REX RHEOSTATS
REX RHEOSTAT COMPANY, BALDWIN, L. I., N. Y.
PROTECTED & UNPROTECTED RHEOSTATS WITH LUBRICATED CONTACTS
ROTARY DRIVE RHEOSTATS WITHOUT BACK LASH
PROTECTED & UNPROTECTED **ADJUSTABLE RESISTORS UP TO 1000 WATT**
PROMPT SHIPMENTS

FILMGRAPH
CONFERENCE, TELEPHONE, DICTATION
Permanent recorders & instantaneous play-back machines for all industrial purposes. Safety film cost 5c per hour.
MILES REPRODUCER CO., INC.
812 B'way, Dept. E, New York, 3, N. Y.

18 YEARS IN RADIO



GET THIS **New CATALOG** By This Old Firm

Latest developments in radio and electronic parts and devices, newest ham gear, gadgets for experimenters, bargains in war surplus items.

FREE TO YOU

Mail the coupon below and get this new catalog FREE.

BURSTEIN-APPLEBEE CO.,
1012 McGee, Kansas City 6, Mo.
Send me FREE catalog advertised in Electronics.

I AM _____
STATE CONNECTION IN INDUSTRY
NAME _____
ADDRESS _____
TOWN _____ STATE _____

LOOK!**BEAM POWER TUBES**

829-B push-pull R-F beam power amplifiers. Exceptionally efficient, with full input at frequencies up to 200 Mc. Max. ratings are: 750 plate volts, 60 watts plate dissipation. While they last...
\$4.95
 Stock Number WPS116

R. W. T.**BARGAINS of the MONTH****LOOK!****ACORN TUBES**

Government Released. Sensational offer. Normally \$2.85-85!
 Stock No. WPS 422: Type 954.
 Stock No. WPS 423: Type 954.
 Stock No. WPS 424: Type 955.
 Stock No. WPS 425: Type 956.
 Socket for above.
 W8464, price 49c

69¢

FREE! Latest Bargain Flyer includes test instruments, record changers, communication receivers, ham transmitting tubes and many other electronic items you need today. *Big new catalog coming!* Get your name on our list!

Radio Wire Television Inc.

NEW YORK 13 BOSTON 10 NEWARK 2

Originators and Marketers of the Famous

Lafayette Radio

Cut out coupon, paste on penny post card, mail today.

R. W. T. Dept. EF6**100 AVENUE OF THE AMERICAS, NEW YORK 13**Gentlemen: Send me **FREE** copy of your Latest Bargain Flyer and put my name on list for your Big New Catalog

NAME _____

ADDRESS _____

CITY _____ ZONE _____ STATE _____

Backtalk

This department is operated as an open forum where our readers may discuss problems of the electronics industry or comment upon articles which **ELECTRONICS** has published.

Germanium Rectifier

Dear Editor:

I READ with considerable interest the article by E. C. Cornelius on "Germanium Crystal Diodes" on page 118 of February **ELECTRONICS**.

Mr. Cornelius emphasizes that: "It was found, however, that a few metals with slight impurities, exhibited highly polarized nonlinear characteristics. The metals silicon and germanium possess these properties to a very marked degree."

In this statement no mention is made as to who originated the use of germanium as a crystal detector. May I bring to your attention that I mentioned this possibility in an article on the germanium aluminum equilibrium diagram, published in 1926 on page 682 of "Metall und Erz." A germanium crystal was used successfully to detect radio waves and this fact was duly reported.

W. J. KROLL
Albany, Oregon

• • •

Tube Numbering System

Dear Mr. Henney:

IS THE PRESENT system of type numbers for vacuum tubes up to date?

A 35W4 is similar to a 35Z5-GT/6, but is labelled much differently. I suggest a change in the present type numbers, a system to indicate style, filament potential, circuit, and issue.

First, a letter to distinguish between metal, miniature, lighthouse, etc, each style of construction bearing a different letter.

Second, a number designating filament potential, rounded off to the nearest volt.

Third, a letter indicating the circuit, with a different letter for diode, triode, beam tetrode, etc.

Fourth, a number which we might call the issue number to differentiate

HARRISON HAS IT!

In addition to our complete stock of all standard lines we have these outstanding

**HARRISON SELECT SURPLUS VALUES
LONG WAVE RECEIVERS**

Navy Model RAK 7

15 to 600 Kilocycles. 6 Tube Receiver with AVC, Noise Limiter—Band Pass Filter—Tuneable Audio Filter—Bandwitching—Precision Dial—3 tube Voltage regulated Power Supply for 115 v—60 cycle A.C. Optional Battery Operation. Excellent for Marine and Aviation work.

Brand New in original crate, complete with Power Supply, Steel Chest full of spare tubes and parts, full instructions. \$79.50.

(Discount on quantities)

HSS TUBES

All new, fully guaranteed. HK24G (3C24/VT204) an FB Tube for VHF. 90 watts Class C output. Gov't inspected. Regular Amateur Net Price was \$9.00, reduced to \$6.00; but Harrison sells them for only \$1.69 ea. 3 for \$4.45.

15 TUBE VHF Receiver—See our May Q.S.T. ad Pg. 153 for details. Model BC406-A \$29.75

Since 1925—Distributors of all top brands



WANTED

Television Engineer

Experienced television receiver senior engineer.

Radio Engineer

Experienced home set senior engineer.

Both positions offer excellent opportunity and pay. Permanent.

UNITED STATES TELEVISION MFG. CORP.

3 W. 61st St. New York 23, N. Y.

Manufacturer's Representative SALES ENGINEER

Representing Minnesota, North Dakota, South Dakota and parts of Wisconsin, Iowa and Nebraska.

Desires additional lines of radio parts, tubes and equipment, of high quality. Also desire lines of equipment requiring engineering ability and experience for sales, installation, supervision of installation, maintenance and repair. Have all necessary licenses required for installation and test work (Master Electrician, Registered Professional Engineer, Radio Operator). Willing to maintain service agency. Will spend a period of time at manufacturer's plant to become acquainted with manufacture, design and test procedures of specialized communication equipment.

RA-170, Electronics

520 North Michigan Ave., Chicago 11, Ill.

(Additional Searchlight advertising on pages 326-327)



WANTED

FACTORY MANAGER

Thoroughly experienced in quantity production of small electro mechanical articles. Must have good production experience background covering equipment, machinery problems, tooling, plant layout, etc. Must have thorough knowledge plant operating systems, scheduling methods. This is an excellent position for the right man who must be hard worker and a leader. The man we want may now be employed as factory manager, assistant factory manager or superintendent in this field and ready for more responsibility. Replies will be held in strict confidence. Medium sized company, location Newark, N. J.

P-168, Electronics
330 West 42nd St., New York 18, N. Y.

WANTED

FACTORY ENGINEER

We have openings in our Factory Engineering Division for two outstanding men. These men would require an experienced background of at least five years engineering work on factory problems relating to receiving tube manufacture. An engineering degree would be helpful, but the primary requirements of the positions are the experience and the ability to successfully solve the every day problems encountered in the manufacture of receiving tubes.

Apply by letter to Personnel Department, National Union Radio Corporation, Lansdale, Pa.

POSITION VACANT

RADIO INSTRUCTORS. Receiver servicing experience. College degree preferred. 3600 a year to start. \$4200 after four months. Work in the heart of the Radio Industry. Write Raleigh G. Dougherty, 158 Market Street, Newark 2, New Jersey, c/o New York Technical Institute of New Jersey.

EMPLOYMENT SERVICE

SALARIED POSITIONS \$2,500-\$25,00. This thoroughly organized confidential service of 36 years' recognized standing and reputation carries on preliminary negotiations for supervisory, technical and executive positions of the calibre indicated, through a procedure individualized to each client's requirements. Retaining fee protected by refund provision. Identity covered and present position protected. Send only name and address for details. R. W. Bixby, Inc., 278 Dun Bldg., Buffalo 2, N. Y.

POSITIONS WANTED

EXPERIENCED VACUUM tubes and incandescent lamps glass man. PW-172, Electronics, 520 N. Michigan Ave., Chicago 11, Ill.

RADIO ENGINEER: desires responsible position designing and developing communication or commercial receivers. Four years experience in communication and export receiver design, including production engineering. Also five years field servicing experience. At present project engineer with large concern. B.S. degree. Age 28, prefer midwestern location. PW-173, Electronics, 520 N. Michigan Ave., Chicago 11, Ill.

GRADUATE ELECTRICAL Engineer, age 30, desires position with a future in reliable company. Am interested in sales engineering, field work, and practical engineering applications. Three years experience servicing radio and electronic equipment, one year as purchasing engineer for electronics laboratory, wartime experience in large New England research and development laboratory on electronic problems. Radio amateur since 1931. Desires position where this experience would be of more value to company than pure engineering. PW-174, Electronics, 520 N. Michigan Ave., Chicago 11, Ill.

ENGINEER-PHYSICIST: 39, with B.S. and M.S. degrees in E.E. and Ph.D. degree in physics seeks teaching or development engineering position in middle or far west. Has fourteen years industrial experience from employments with Westinghouse, Philco, Panama Canal and General Electric in design, development and application of electrical power equipment; and five years experience teaching both E.E. and radio at evening schools. PW-175, Electronics, 330 W. 42nd St., New York 18, N. Y.

WANTED: TOP FLIGHT DESIGN ENGINEER FOR SENIOR ADMINISTRATIVE POST

Must have substantial prior experience in carrying the full responsibility of an engineering department that has a long successful record in producing complete and varied lines of radio transmitters for commercial services, including FM and AM Broadcasting, Point-to-Point Communication, Aviation Marine and Police. The man we are seeking must be a graduate Electrical Engineer with a full, all-embracing theoretical knowledge, combined with extensive practical application. His experience should include first hand knowledge of important recent FM and AM and Microwave developments in the communication field.

Because the man selected for this important post must assume great responsibility, his compensation will consist of a high bracket salary, plus a production bonus incentive. This arrangement will afford him a most unusual opportunity to earn a very substantial income, directly in proportion to his demonstrated ability.

Our company (located in New York City) has been established for many years and enjoys a world-wide reputation for high standard, custom-built communication equipment. Our war record is unexcelled and our post-war expansion program which is already under way, forecasts an important position in the forefront of the communication industry.

This is a job for a man who has reached a ceiling in his present position and must make a change to increase his income, or an assistant chief engineer who has not been permitted the full employment of his capabilities. Write to us, telling enough about your qualifications and past experience to warrant an interview. All communications will be held in strictest confidence. Our organization knows about this advertisement. Address your letter to

P-167, Electronics

330 West 42nd St., New York 18, N. Y.

POSITIONS WANTED

QUALITY CONTROL Engineer, E.E. graduate 32, 4 years quality control experience with U. S. Signal Corps, 2 years total inspection experience, desires responsible position in Eastern U. S. Would consider consulting basis. Available now. PW-176, Electronics, 330 W. 42nd St., New York 18, N. Y.

ELECTRICAL ENGINEER: available for company with Far East relations. Present contract as manager of Engineering dept. in China expires in July. Engineering and executive experience of 19 years in remote control, regulation technique, switch gear, measuring instruments as well as general engineering, power stations, boilers, waterworks, etc. Experience in establishing of production in Far East. Age 43. Desires situation either in United States or in China. PW-177, Electronics, 330 W. 42nd St., New York 18, N. Y.

PHYSICAL CHEMIST: Ph.D. extensive experience in lamp and electronic tube design, manufacturing and materials, high-vacuum technique. Interested in research or development position as senior engineer. New York Metropolitan area preferred. PW-178, Electronics, 520 N. Michigan Ave., Chicago 11, Ill.

SELLING OPPORTUNITY WANTED

FIELD ENGINEER: available; 6 years good Eastern contacts with engineers and purchasing departments in aircraft, electronic, and transportation fields; 12 years in sales work; good record; E.E. degree; age 34. Desires good line to represent on salary and commission. SA-179, Electronics, 330 W. 42nd St., New York 18, N. Y.

GRADUATE RADIO ENGINEER

Four years experience in electronic and radio manufacturing; three years drafting, four years general engineering and office practices; part time teaching. Adequate background for handling managerial responsibilities. Self-educated, good student, mathematically and mechanically inclined. Somewhat prefers electro-mechanical design or electronic control development in mid western location.

PW-165, Electronics

520 North Michigan Ave., Chicago 11, Ill.

ELECTRICAL DESIGNER

fully capable of developing automatic switch gear equipment. Practical experience on electric coin machine, music machine, automatic telephone, step switches, etc., very essential. If you can qualify, this opportunity will offer future with permanent employment and good salary. When applying for position, please state fully past experience, qualifications, salary expected, and availability.

P-117, Electronics

520 North Michigan Ave., Chicago 11, Ill.

RADIO ENGINEER

Circuit Design

Home Receiver Experience

Write Box EM 8820

EQUITY

113 W. 42 St.

New York City

Production Manager

We want a man whose record shows consistent progress in the production end of the Electronics Industry, INCLUDING PRE-WAR experience. He must demonstrate that he can develop a supervisory group into a hard-hitting TEAM and that he is qualified to work on an equal footing with a high caliber engineering and staff group, starting salary to \$8500.

Write in detail. All replies held strictly confidential.

P-166, Electronics

330 West 42nd St., New York 18, N. Y.

SALES REPRESENTATIVE WANTS LINES

Chicago and Vicinity

Prime materials or parts for Mechanical, Electrical, Radio and Radio Parts Manufacturing Trade.

RA-140, Electronics

520 North Michigan Ave., Chicago 11, Ill.

(Additional Searchlight Section Ads on pages 324, 326 and 327)



CALIFORNIA REPRESENTATION OFFERED

To radio and electronic manufacturers now looking for firmly established and thoroughly experienced sales agency. Correspondence invited.

"IN RADIO SINCE 1911"

RA-133, Electronics
330 West 42nd St., New York 18, N. Y.

NATIONAL DISTRIBUTION AVAILABLE

For Manufacturers who make products suitable for sale to radio and electronic jobbers. We have a complete sales staff for national and export distribution. Reply with samples or description of products.

RA-870, Electronics
330 West 42nd St., New York 18, N. Y.

HAZELTON INSTRUMENT CO.

Electric Meter Laboratory
Electrical Instruments, Tube Checkers and Analyzers repaired.

War surplus meters converted for civilian use.
140 Liberty St., New York, N. Y.
Tel. BRarclay 7-4239

WRITE FOR 24 P. CATALOG OF

METERS AND INSTRUMENTS

VOLTMETERS BRIDGES (Wheatstone)
AMMETERS MEGOHMMETERS
MICRO RHEOSTATS
AMMETERS VARIABLE
OHMMETERS TRANSFORMERS
FREQ. METERS RELAYS

ELECTRO-TECH Equipment Co.

329 CANAL ST., N. Y. 13, N. Y.

PAN-OSCILLO RECEIVER

Performs Work of 4 Units

Latest design, 3" Oscilloscope, Panoramic Adapter, Synchronoscope, Receiver (when used with converter). Push-pull vertical and horizontal amplifiers. Ideal for laboratory, television, and general use. 60 cycle transformer provided (if wanted installed and tested add \$8.00 extra.)

Originally \$2,000—your cost with 21 tubes \$97.50 F.O.B.

Write for picture flyer or send 50c for eighty-page technical manual.

5G Selsyn Motors 110 V. AC 60 Cycles Direction Indicators \$12 a pair.

WESTCHESTER ELECTRONIC PRODUCTS
29 Milburne St., Bronxville, N. Y.

FOR SALE

Complete laboratory setup including two induction furnaces adjustable to possible commercial production setup—a 3000 volt and a 20,000 volt power supplies and complementary equipment. Will be priced for quick sale. Details on request.

CONSOLIDATED PROCESS CORP.
350 FIFTH AVENUE, NEW YORK 1, N. Y.

BEST QUALITY, USED ELECTRON TUBE MACHINERY

Equipment for the manufacture of all kinds of electron tubes, radio tubes, incandescent lamps, neon tubes, photo electric cells, X-ray tubes, etc.

AMERICAN ELECTRICAL SALES CO., Inc.
65-67 East 8th St., New York, N. Y.

FOCUS COILS

Television Focus Coils Shunt Type for all New C.R. Tubes. \$3.50 in quantity.

FS-109, Electronics
330 West 42nd St., New York 18, N. Y.

Millions of MOLDED CAPACITORS for Immediate Shipment

War Assets Corporation stocks of mica, silver-mica, and molded oil-paper capacitors have solved critical shortages . . .

Here's an example . . . One manufacturer was recently supplied with 286,000 units . . . ordered by phone and shipment made within 24 hours . . . quantities involved varied from 2,000 to 115,000 units with capacitances ranging from 75 to 300 Mmfd. . . . at a substantial saving.

Standard Ratings—Government Inspected

TOBE DEUTSCHMANN CORPORATION

Acting as Agents of War Assets Corporation

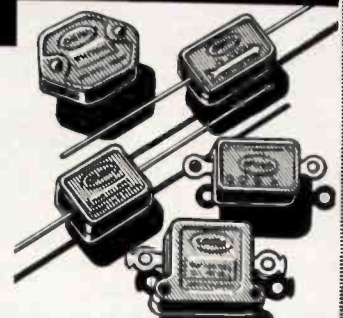

WRITE, WIRE, OR PHONE

Canton, Massachusetts
Tel. Canton 0820

Remler Appointed

Agent for

WAR ASSETS CORPORATION

(Under Contract No. 59-A-3-48)

. . . to handle and sell a wide variety of

ELECTRONIC EQUIPMENT

released for civilian use

Write for Bulletin Z7-E

Remler Company Ltd.

2101 Bryant St., San Francisco 10, Calif.

REMLER

Since 1918

Radio • Communications • Electronics

RELAYS

Surplus, Qty. 4700, D.P.S.T.
400 ohms, 28 volt, 1"x2"x2 1/4"

Send for Specifications

P. O. Box 97

Boonton, New Jersey

SURPLUS PARTS

and

EQUIPMENT

Engineers are invited to inspect our display of surplus Government-owned electronic parts and equipment. 55,000 sq. ft. teeming with worthwhile items! All material inspected and tested; backed by usual 90-day manufacturers' guarantee.

Sorry, no retail sales; all purchases against company orders only.

COMMUNICATION MEASUREMENTS LABORATORY

Central Agent for War Assets Corp.

Display Room: 350 W. 40th Street

Main office: 120 Greenwich St., New York 6

MANUFACTURERS — JOBBERS

PRECISION RESISTORS
Over 1,000,000 in stock!

SELECTOR SWITCHES
Mallory 1331 - 1341 - 1351 - 1361
. . . and other types

MOLDED PAPER COND.
.006 - .01 - .02 - .05 - .1 MFD.

GENERAL ELEC. 3" METERS
Square 0-1 DC MA

OTHER HARD-TO-GET ITEMS

Write for catalog

A. MOGULL CO.

161 Washington St., N. Y. 6, N. Y.
Dept. B

CONDENSERS

2000 50mfd. 50 V. Bathtub
Mallory BS-39 \$.50
300 24mfd. 300 V. Bathtub
Mallory BS-56 .50

SURPLUS

RESISTORS

450 400 ohm—10 watt .15
300 25 ohm—25 watt .15
1000 31 ohm—25 watt .10
600 1000 ohm—10 watt .15

SWITCHES

500 type F3 switchette
General Electric .30
300 Acro-sw. type XD-IL .30
JACKS
200 Mallory #705 .40
200 Mallory #703A .30

All new parts in mfg. bulk packing.
HOME ELECTRONICS, 2366 Bentley Ave.,

Los Angeles 25, California

ELECTRONIC *Surplus*

TEST OSCILLATOR AND HETERODYNE FREQUENCY METER

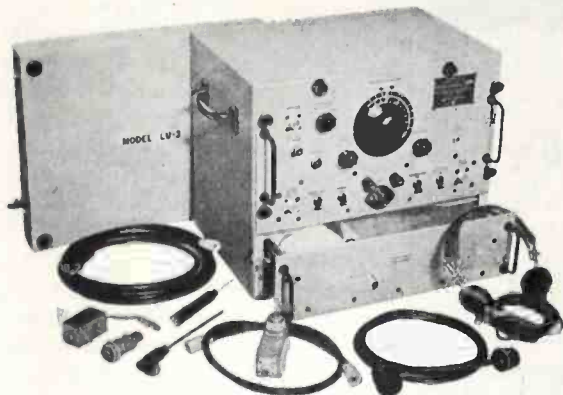

Radar Test Equipment, Model LU-3, Type CRB-60ACT Frequency Meter and Test Oscillator

Radar Test Equipment, Model LU-3 is designed to provide a rapid and accurate method of checking or aligning the high-frequency circuits of certain types of radar and radar-beacon transmitters and receivers. The set is a combination test oscillator and heterodyne frequency meter.

TESTS OSCILLATOR.—When used as a test oscillator, the equipment will deliver a carrier signal, continuously variable within either of two ranges (465 to 475 or 488.5 to 498.5 megacycles per second), amplitude-modulated by a sine-wave voltage at 30 kilocycles per second, or pulse-modulated at 1000 cycles per second with a pulse length of 10 microseconds. The output can be radiated from the antenna or taken across a 50-ohm coaxial cable.

HETERODYNE FREQUENCY METER.—The set will measure the frequency of received signals within the L and H ranges (465 to 475 or 488.5 to 498.5 megacycles per second). Headphones are supplied for detecting the heterodyne note.

FREQUENCY RANGES.—From 465 to 475 megacycles per second and from 488.5 to 498.5 megacycles per second. At the zero point on the FREQUENCY DEVIATION dial the equipment will transmit or monitor a signal with an accuracy of 0.025 per cent. At the maximum deviation of the dial the accuracy is within 0.05 per cent.

TYPE OF FREQUENCY CONTROL OF CALIBRATION OSCILLATOR.—Quartz crystal in grid circuit of V-101A.

TYPES OF EMISSION.—R-f carrier with sine-wave or pulse modulation.

SINE-WAVE MODULATION.—Type: Amplitude. Method: Grid modulation of output tube. Modulation Frequency: 30 ± 1 kc per sec. Modulation Capability: 30 to 100 per cent.

PULSE MODULATION.—Method: Grid modulation of output tube. Pulse Frequency: 1000 cps ± 25 per cent. Pulse Length (at half amplitude): 10 microseconds ± 25 per cent. Modulation Capability: 100 per cent.

PULSE SIGNAL.—Frequency: 1000 cycles per second ± 25 per cent.

From 6000-ohm receptacle		
Load resistance, ohms	6000	50,000 plus
Voltage, dc (positive peak)	21 min.	65
From 50-ohm receptacle		
Load resistance, ohms	50	1,000 plus
Voltage, dc (positive peak)	10 min.	17

NOMINAL CARRIER OUTPUT.—Antenna: Approximately 10 milliwatts. Output Cable, 50-ohm: Approximately 10 microvolts.

POWER SUPPLY.—Single-phase alternating current. Voltage: 80 or 117 volts. Frequency: 50 to 800 cycles per second. Consumption: approximately 0.4 amp at 117 volts or 40 watts at a power factor of 0.80. Power Factor: 80 per cent.

Comes complete with one spare tube of each type plus a full set of Navy equipment spare parts in a metal spare parts box. Price F.O.B., N.Y.C., is **\$65.00**

If you need further information send for an instruction book free of charge.

NEW INSULATION TEST SET

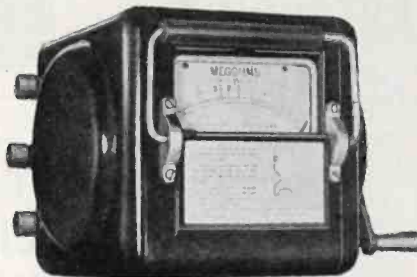

Range 0-1000 Meg-ohm, 500 volts D.C.

True OHMMETER indication by cross-coil, ratio meter. Heavy duty Generator with centrifugal voltage regulator. Molded bakelite case. External guard circuit. Indicator and generator powered by *Separate* Alnico permanent magnets. Generator model self powered—no batteries or other power source required. Meets U. S. Government Spec. Navy Type G and Army Signal Corps Type 1-48-B. Direct reading—no ratios to set—no switches to turn. All resistors are wire wound.

These instruments are brand new, come complete with carrying cases, test leads, instruction books and a 90-day guarantee. Only **\$65.00** F.O.B., N.Y.C.

SYNCHROSCOPE

Navy type CJA-60 ACM For SR Radar Set

Very high grade Synchroscope excellent for very high frequency work. Has the following tubes:

- | | |
|--------------------------------------|--------------------------------|
| 3BP1—3 in. cathode ray tube | 5U4G—Full wave rectifier |
| 6AG7—Video amplifier tube | 2—VR 150/130—Voltage regulator |
| 6SN7GT—Multivibrator oscillator tube | 6SN7—Sweep generator |
| 3B24—High voltage rectifier | 6SN7—Triggering tube |

Comes complete with one spare tube of each type, all complete **\$59.50.**

SURPLUS WHOLESALE LOTS

NEW VACUUM TUBES

THESE TUBES ARE ALL NEW, IN ORIGINAL BOXES, MFGD. BY R.C.A., HYTRON, RAYTHEON, SYLVANIA. We will sell only the minimum of \$100.00 worth or the entire quantity of any one item that may add up to less than the above sum.

4000—#354	\$.35
265—#355	\$.35
265—#356	\$.35
1500—#6SN7	\$.45
630—#VR 150/30	\$.55
400—#6AG7	\$.80
315—#3B24 (same as 2x2)	\$ 1.25
315—#5U4G	\$.30
315—#3BP1, cathode ray	\$ 4.50

NEW METERS

These meters are ALL NEW, absolutely standard in all respects. Round Flush Bakelite. We will sell only in lots of 50 or more of any one item.

1000—Weston 2½, Model 517, AC voltmeter 0-150	\$ 2.50
1000—Weston 2½, Model 506, DC voltmeter 0-20 volts, 1000 ohms per volt	\$ 3.00
450—Weston 2½, Model 507, Ext. couple, 750 Ma. Radio Frequency, BLACK SCALE, Caption is—Antenna Current Indicator Controlled Scale characteristics	\$ 1.75
250—G.E. 3½, Model A022, AC voltmeter, 0-150	\$ 4.00
100—G.E. 3½, Model A022, AC voltmeter, 0-300	\$ 6.00
150—G.E. 3½, Model A022, AC ammeter, 0-5 Amper coil, 0-50 Amper scale	\$ 3.50
100—G.E. 3½, Model A022, AC ammeter, 0-50 Amperes, self contained	\$ 3.75
400—G.E. 3½, Model A022, AC ammeter, 0-80 Amperes, self contained	\$ 3.75

OIL FILLED CONDENSERS

ALL NEW CONDENSERS, G.E., PYRANOL AND SPRAGUE VITAMIN Q. Minimum quantity to be shipped on any one item will be 50 pieces.

750	50 MFD at	25 V DC	\$ 1.00
1200	10 MFD at	1000 V DC	\$ 1.75
3000	10 MFD at	600 V DC	\$ 1.50
130	4 MFD at	600 V DC	\$ 1.00
1000	1 MFD at	4000 V DC	\$ 2.75
3400	1 MFD at	3000 V DC	\$ 2.25
1300	1 MFD at	2000 V DC	\$ 1.50
200	.25 MFD at	3000 V DC	\$ 2.00
1200	.05 MFD at	16000 V DC	\$ 3.00
432	2x .15 MFD at	8000 V DC	\$ 1.75
404	3x .6 MFD at	90 V DC	\$.40

MARITIME SWITCHBOARD

Worth 4-8217

336 Canal St., New York 13, N. Y.

BOOKS *designed for the* ENGINEER

UNDERSTANDING MICROWAVES

by VICTOR J. YOUNG

For those who have not previously considered radio waves shorter than 10 centimeters. Provides foundation for understanding various microwave developments of past five years. To simplify explanations, mathematics are placed in footnotes wherever possible.

CHAPTER HEADS

The Ultra High Frequency Concept • Stationary Charge and its Field • Magnetostatics Alternating Current and Lumped Constants • Transmission Lines • Poynting's Vector and Maxwell's Equations • Wave-

guides • Resonant Cavities • Antennas Microwave Oscillators • Radar and Communication • Section Two is devoted to descriptions of Microwave Terms, Ideas and Theorems. Index.

OUT IN MAY—OVER 400 PAGES—PRICE \$6.00

SPEED AND SIMPLICITY

A-C CALCULATION CHARTS

Student engineers will find that this book is invaluable. It simplifies and speeds any work involving AC calculations. The book contains 146 charts. Covers all AC calculations from 10 cycles to 1000 megacycles.

160 PAGES—PRICE \$7.50

ORDER TODAY

JOHN F. RIDER PUBLISHER, INC.

404 FOURTH AVENUE, NEW YORK 16, N.Y.

Export Division: Rocke-International Electric Corp., 13 E. 40th Street, New York 16, N.Y.



ACCENT ON ACCURACY . . . NEW SIGNALLING TIMER!

No more guess-work or mistakes with the new Signalling Timer Model Series S, on any job. To the second, it accurately controls any time cycle for which it is set, and when that interval of time has elapsed, visual and audible warning is given as the circuit is broken. Precise and inestimably valuable in any capacity where split-second timing is essential. Write for particulars.

INDUSTRIAL TIMER CORPORATION

110 EDISON PLACE



NEWARK, NEW JERSEY

between successive tubes which bear the same first three digits. This is in keeping with the industrial practice of assigning drawing numbers. An A2B3 might signify a particular construction of one-volt triode of which two or more similar types exist.

This system should not only take care of all needs for a long time but should remain consistent without the necessity of tacking on additional symbols such as are now required for GT tubes, single-ended tubes, etc. The type number of any one tube would carry enough information to compare numerous tubes without reference to comparison charts, or at the very least would certainly be more descriptive than the present system.

Currently, one must either know all the tubes, ask questions every time tube types are discussed, or describe a given tube by a series of guesses, words, or perhaps gestures.

EDWIN DYKE

Engineering Dept.
Galvin Manufacturing Corp.
Chicago, Illinois

• • •

Tube Numbering Mess

Dear Sir:

ONCE UPON A TIME, as the fairy stories go, the RMA had a system for numbering electron tubes. Like snow on a New York street, it did not remain in its pure form long, what with S in the wrong place for single ended, G and GT, X, M, GT/G and a lot more prefixed, suffixed and just plain affixed.

Now we have a nice mess of tubes with apparently 2, 3 and 4-volt filaments which actually operate on any voltage the designer could think of, and have 22, 24, 25, or 35 internal elements all connected to a four or five-pin base—if we believe the old numbering system.

Remember, I only have to teach the stuff.

J. D. RYDER

Professor, Electrical Engineering
Iowa State College
Ames, Iowa

—♦—

Club members of the Cleveland Automobile Club will have emergency calls routed from a fixed station to four portable mobile units in service trucks. First experimental grant for construction has been approved by FCC.

INDEX TO ADVERTISERS

Ace Manufacturing Corporation	312	Deutschmann Corp., Tobe	6
Acheson Colloids Corporation	51	Dial Light Co. of America, Inc.	278
Acro Electric Co.	196	Dinion Coil Co., Inc.	190
Axon Co., Inc., H. W.	313	Distillation Products, Inc.	173
Adams & Westlake Company	63	Dongan Electric Mfg. Co.	283
Advance Electric & Relay Co.	302	Drake Electric Works, Inc.	294
Aerovox Corporation	82	Drake Manufacturing Co.	308
Aircraft-Marine Products, Inc.	167	Driver-Harris Co.	69
Aircraft Radio Corp.	221	Dumont Electric Corp.	8
Aircon Manufacturing Corporation	66	DuMont Laboratories, Inc., Allen B.	22, 37
Allegheny Ludlum Steel Corp.	72	Durez Plastics & Chemicals, Inc.	175
Allen Mfg. Co., The	288	DX Radio Products Co.	288
Alliance Manufacturing Company	49	Dzus Fastener Co., Inc.	265
Allied Radio Corp.	309		
Alpha Metals, Inc.	310		
Alec-Lansing Corporation	226		
American Gas Accumulator Co.	274	Eastern Air Devices, Inc.	46
American Gas & Chemical Co.	311	Eastern Electronics Corp.	310
American Lava Corporation	83	Eastman Kodak Co., X-Ray Div.	159
American Phenolic Corp.	187	Eby, Inc., Hugh H.	281
American Platinum Works	317	Eisler Engineering Co.	322, 323
American Rolling Mill Co., The	255	Eitel-McCullough, Inc.	89
American Screw Co.	170	Electrical Insulation Co., Inc.	274
American Television & Radio Co.	312	Electronic Engineering Co., Inc.	304
American Time Products, Inc.	166	Electronic Specialties Mfg. Co.	305
American Transformer Co.	40	Electronics Research Publishing Co.	301
Amperex Electronic Corp. Inside Front Cover		Electrons, Inc.	188
Amperite Co.	282	Engineering Co., The	294
Andrew Co.	168	Erco Radio Labs, Inc.	244
Arkwright Finishing Co.	198	Ericsson Screw Machine Products Co., Inc.	278
Arnold Engineering Co.	210	Essex Electronics	329
Aft Wire & Stamping Co.	319		
Astatic Corporation	242		
Atlas Sound Corporation	299		
Audak Co.	331	Farnsworth Television and Radio Corp.	247
Audio Development Co.	212	Federal Tel. & Radio Corp.	30, 31, 203
Audio Devices, Inc.	77	Federated Purchaser, Inc.	315
Automatic Electric Sales Corporation	58	Fenwal, Inc.	29
Automatic Mfg. Corporation	56	Ferranti Electric, Inc.	174
		Finch Telecommunications, Inc.	232
		Fish-Schurman Corporation	307
		Formica Insulation Company	18
		Franklin Mfg. Corp., A. W.	88
		Freeland & Olschner Products, Inc.	323
Baer Company, N. S.	296	Gear Specialties	23
Bakelite Corporation	41	General Aniline & Film Corporation	16, 17
Ballantine Laboratories, Inc.	164	General Cement Mfg. Co.	323
Barker and Williamson	298	General Ceramics and Steatite Corp.	245
Belden Manufacturing Co.	19	General Electric Co.	14, 15, 35, 50, 74, 178, 186, 207, 227, 243, 299
Bell Telephone Laboratories	4, 5	General Industries Co.	290
Bendix Aviation Corp., Radio Div.	169	General Magnetic Corp.	311
Bentley, Harris Mfg. Co.	233	General Plate Div. of Metals & Controls Corp.	263
Benwood-Linze Co., The	180	General Radin Company	241
Birnbach Radio Co., Inc.	299	Giannini and Co. Inc., G. M. Aerialflight Instrument Div.	262
Bliley Electric Co.	177	Gilandin Electronics	313
Boland and Boyce, Inc.	261	Glaser Lead Co., Inc.	266
Boonton Radio Corp.	54	Goat Metal Stampings, Inc.	283
Brach Mfg. Corp., L. S.	314	Goodrich Chemical Co., B. F.	332
Bradley Laboratories, Inc.	298, 308, 316	Gould-Moody Co.	276
Brand & Co., William	209	Graphite Metallizing Corp.	186
Browning Labs., Inc.	191	Gray Manufacturing Co.	317
Bruning Co., Inc., Charles	267	Guardian Electric Mfg. Co.	193
Bud Radio, Inc.	316		
Burgess Battery Co.	276		
Burke Electric Co.	318		
Burlington Instrument Co.	295		
Burdy Engineering Co., Inc.	67		
Burstein-Applebee Co.	323		
Callite Tungsten Corp.	48	Hallcrafters Company	33
Cambridge Thermionic Corporation	304	Hammarlund Mfg. Co., Inc.	10
Capitol Radio Engineering Institute	293	Hardwick, Hindle, Inc.	282
Cardwell Mfg. Corp., Allen D.	284, 285	Harris Products Co.	313
Celanese Corporation of America	217	Harvey Radio Company	272
Cellusuede Products, Inc.	303	Harvey Radio Laboratories, Inc.	237
Central Paper Co., Inc.	280	Hathaway Instrument Co.	309
Centralab, Div. of Globe-Union, Inc.	60	Haydon Manufacturing Co., Inc.	256
Charham Electronics	20	H-B Instrument Company	315
Chicago Metal Hose Corp.	222	Heinemann Circuit Breaker Co.	195
Chicago Transformer Corp.	291	Helipot Corp., The	86
Cinch Mfg. Corp.	153	Hewlett-Packard Company	39
Clare & Co., C. P.	55	Hexacon Electric Co.	204
Clarostat Mfg. Co., Inc.	216	Heyman Manufacturing Co.	309
Clippard Instrument Laboratory, Inc.	320	Hudson Wire Co.	303
Cohn & Co., Sigmund	330	Hunter Pressed Steel Co.	85
Collins Radio Co.	179	Hytron Radio & Electronics Corp.	25
Communication Measurements Laboratory	248		
Conant Electrical Labs.	264		
Concord Radio Corporation	289		
Condenser Products Company	307		
Continental-Diamond Fibre Co.	162		
Cornell-Dubilier Electric Corp.	65	Imperial Tracing Cloth	184
Corning Glass Works	21	Indiana Steel Products Co.	38
Cornish Wire Company, Inc.	254	Industrial Timer Corporation	328
Cossor, Ltd., A. C.	182	Inst-X Co., Inc.	172
Coto-Coil Co., Inc.	246	Insuline Corp. of America	206
Cross, H.	323	International Resistance Company	157
Crystal Research Laboratories, Inc.	228	Irvington Varnish & Insulator Co.	223
Daven Company	Inside Back Cover	Jack & Heintz Precision Industries, Inc.	62, 63
DeJur-Amsco Corp.	76	Janette Mfg. Co.	306
De Mornay Budd, Inc.	211	Jefferson Electric Co.	213

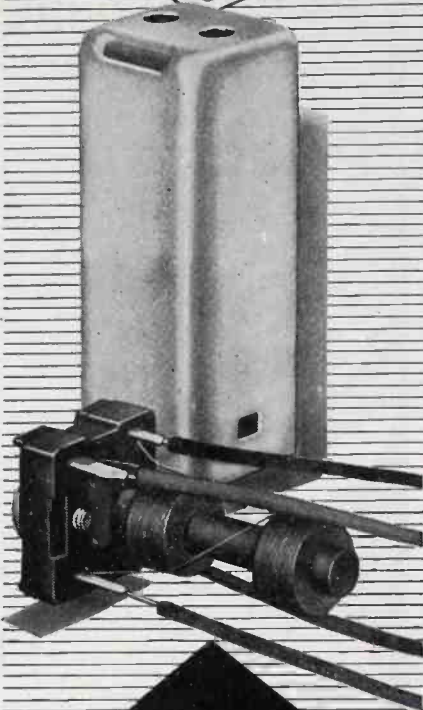
MIDGET
I. F.
TRANSFORMER

for
PERSONAL RADIOS

Specifications:

- INPUT and OUTPUT
- IRON CORE
- 456 KC.
- $\frac{3}{4}'' \times \frac{3}{4}'' \times 2''$ high

Orders accepted for
PROMPT DELIVERY

Precision manufacturers of all
types of IF and RF coils,
chokes, and transformers.

ESSEX
ELECTRONICS

1060 Broad St., Newark, N. J.

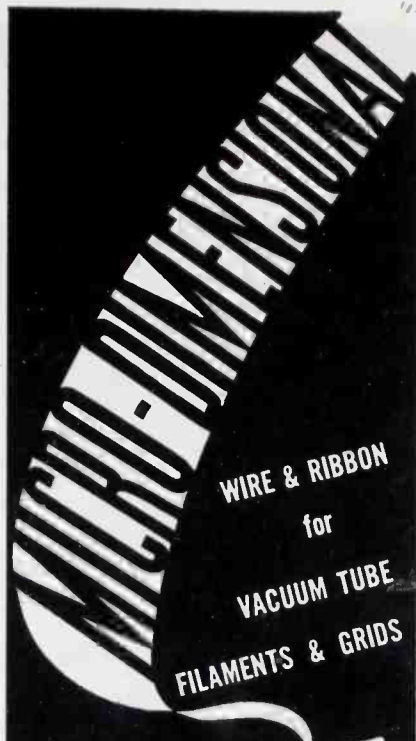

● Many sizes and alloys for a range of applications such as miniature tubes, hearing aid tubes, low-current-drain battery tubes, receiving tubes . . .

● Melted and worked to assure maximum uniformity and strength. WIRES drawn to .0004" diameter; RIBBON rolled to .0001" thickness . . .

● Wollaston Process Wire drawn as small as .000010"; made to your specifications for diameter and resistance.

● SPECIAL ALLOYS made to meet individual requirements. Write for list of stock alloys.

SIGMUND COHN & CO.
44 GOLD ST. NEW YORK
SINCE  1901

Jelliff Mfg. Corp., C. O.	320	Segel Co., Henry P.	313
Jensen Radio Manufacturing Co.	47	Selenium Corp. of America	185
Johnson Co., E. F.	224	Shakeproof, Inc.	99
Jones Co., Howard B.	297	Sigma Instruments, Inc.	283
		Sillcocks-Miller Co.	190
Kable Engineering Co.	323	Sola Electric Co.	73
Karp Metal Products Co., Inc.	45	Sorensen and Co., Inc.	279
Kenyon Transformer Co., Inc.	84	Sprague Electric Co.	257
Kester Solder Co.	250	Stackpole Carbon Co.	78
Kruffel & Esser Co.	3	Standard Piezo Company	305
Kirkland Co., H. R.	301	Standard Pressed Steel Co.	229
Kwikheat Division, Sound Equipment Crnp.	280	Standard Transformer Corp.	160
		Star Expansion Products Co.	301
Lampkin Laboratories	323	Star Porcelain Co.	315
Langevin Co., The	231	Sta-Warm Electric Co.	190
Lapp Insulator Co., Inc.	43	Stevens-Walden, Inc.	303
Lavoie Laboratories	287	Steward Mfg. Co., D. M.	307
Lewis Electronics	66	Stupakoff Ceramic & Mfg. Co.	201
		Superior Electric Co.	171
Macallen Co., The	258	Superior Tube Co.	24
Machlett Labs., Inc.	81	Supreme Instruments Corp.	226
MacRae's Blue Book	319	Sylvania Electric Products, Inc.	273
Magnavox Co., The	275		
Maguire Industries, Inc.	42, 205	Taylor Manufacturing Co.	260
Malloy & Co., Inc., P. R.	90, 155	Tech Laboratories	294
Manufacturers Screw Products	311	Thermador Electrical Mfg. Co.	186
Marion Electrical Instrument Co.	230	Thomas & Skinner Steel Products Co.	319
MB Manufacturing Co., Inc.	11, 259	Tibbetts Industries, Inc.	64
McGraw-Hill Book Co.	292	Timing Instrument Co., Inc.	13
McLaughlin, J. L. A.	323	Tinnerman Products, Inc.	161
Merit Coil & Transformer Co.	296	Transmitter Equipment Mfg. Co., Inc.	57
Meyercord Company	271	Triplet Electrical Instrument Co.	318
Mica Insulator Co.	70, 71	Tung-Sol Lamp Works, Inc.	235
Micro-Ferrocarr Products, Div. of Maguire Industries, Inc.	205	Turner Company, The	208
Micro-Switch Corporation	26, 27		
Midwest Molding & Mfg. Co.	299	Union Carbide & Carbon Corp.	41, 269
Miles Reproducer Co., Inc.	323	United Transformer Corp.	2
Milford Rivet & Machine Co.	252		
Millen Mfg. Co., Inc., James	270	Valpey Crystal Co.	200
Mitchell-Rand Insulation Co., Inc.	189	Victoreen Instrument Co.	302
Monitor Controller Co.	184	Vokar Corporation	301
Mycalex Corporation of America	53	Vulcan Electric Company	297
National Carbon Co., Inc.	269	Waldes Kohinoor, Inc.	183
National Co., Inc.	251	Walker-Turner Co., Inc.	292
National Research Corporation	44	Ward Leonard Electric Co.	36
National Screw and Mfg. Co., The	181	Waterman Products Co.	268
New England Screw Co.	315	Well and Co., J. H.	272
North American Philips Co., Inc.	197	Weller Mfg. Co.	309
Northern Industrial Chemical Co.	305	Western Electric Co.	4, 5
		Westfield Metal Products Co., Inc.	322
Ohmite Mfg. Company	215	Westinghouse Electric Corp.	61
Onan & Sons, D. W.	268	Weston Electrical Instrument Corp.	52
O'Neil-Irwin Mfg. Co.	314	Whistler & Sons, Inc., S. B.	7
Oster Manufacturing Co., John	288	White Dental Mfg. Co., S. S.	239, 307
		Whitehead Stamping Co.	317
Par-Metal Products Corporation	228	Wilcox Electric Co., Inc.	32
Permo, Inc.	294	World Radio Laboratories, Inc.	309
Permolux Corporation	218		
Petersen Radio Co.	300	Zophar Mills, Inc.	290
Phillips Screw Manufacturers	75		
Pioneer Electric Co.	292		
Polarad Electronics Co.	277, 317		
Pntter and Brumfield Sales Co.	220		
Potter Co., The	194		
Premax Products	317		
Press Wireless Mfg. Corp.	225		
Presto Recording Corp.	87		
Printloid, Inc.	12		
Progressive Mfg. Co.	306		
Pyroferic Co.	297		
Quadrige Manufacturing Co.	311		
Quaker City Gear Works, Inc.	202		
Radex Corporation	305		
Radio City Products Co., Inc.	253		
Radio Corp. of America, Victor Div.	9, 79, Back Cover		
Radio Engineering Labs., Inc.	290		
Radio Maintenance Magazine	261		
Radio Supply & Engineering Co., Inc.	270		
Radio Wire Television, Inc.	324		
Rauland Corporation	199		
Rawson Electrical Instrument Co.	297		
R-B-M Mfg. Co.	163		
Research Engineering Corp.	176		
Revere Copper & Brass, Inc.	28		
Rex Rheostat Co., Inc.	323		
Richardson Company	234		
Rider Publisher, Inc., John F.	328		
Rockbestos Products Corp.	80		
Rowe Industries	315		
Scientific Electric Div. of "S" Corrugated Quenched Gap Co.	219		
Scovill Mfg. Co., Waterville Screw Products Div.	165		
Seeburg Corporation, J. P.	34		

PROFESSIONAL SERVICES 321

SEARCHLIGHT SECTION

(Classified Advertising)

EMPLOYMENT	324, 325, 326
REPAIRING	326
SPECIAL SERVICES	326
USED EQUIPMENT	326, 327
American Electric Sales Co., Inc.	326
Communication Measurements Laboratory	326
Communications Equipment Co.	326
Consolidated Electronic Process Corp.	326
Electro-Tech. Equipment Co.	326
Harrison Radio Corp.	324
Home Electronic Products	326
Maritime Switchboard	327
Mogull Co., A.	326
Remler Co. Ltd.	326
Tobe Deutschmann Corp.	326
Westchester Electronic Products	326

for Results



McGraw-Hill
DIRECT MAIL LIST SERVICE

MAILING LISTS THAT WORK...

McGraw-Hill Industrial Mailing Lists are a direct route to today's purchase-controlling executives and technicians in practically every major industry.

These names are of particular value now when most manufacturers are experiencing constantly increasing difficulty in maintaining their own lists.

Probably no other organization is as well equipped as McGraw-Hill to solve the complicated problem of list maintenance during this period of unparalleled changes in industrial personnel. These lists are compiled from exclusive sources, based on hundreds of thousands of mail questionnaires and the reports of a nation-wide field staff, and are maintained on a twenty-four hour basis.

Investigate their tremendous possibilities in relation to your own product or service. Your specifications are our guide in recommending the particular McGraw-Hill lists that best cover your market. When planning your industrial advertising and sales promotional activities, ask for more facts or, better still, write today. No obligation, of course.

McGraw-Hill
Publishing Co., Inc.

DIRECT
MAIL
DIVISION

630 WEST 42nd STREET
NEW YORK, 18, N. Y.



Audax

EAR-ACCEPTABILITY

Driving, patient years of intensive specialization have enabled AUDAX to master wide range thoroughly.

Today even the lowest priced MICRODYNE has a range to 7,000 cycles — other models to 10,000 cycles.

Yes, wide range makes for naturalness, but is highly objectionable if without quality. Thus, of two singers capable of reaching high C, one may have a pleasing voice — the other, not at all. It is so with pick-ups, too.

To achieve ear-acceptability, all other factors must be satisfied. Of these, vibratory-momentum is most important. The only way to test ear-acceptability of a pick-up is to put it to the EAR TEST.

MICRODYNE's sharp, clean-cut *facsimile* performance — regardless of climatic conditions — is a marvel to all who know that ear-acceptability is the real criterion.

Send for complimentary copy of
"PICK-UP FACTS"

AUDAX COMPANY

500 Fifth Avenue,

New York 18

"Creators of Fine Electro-Acoustical Apparatus since 1915"

THE
STANDARD
BY WHICH
OTHERS
ARE JUDGED
AND
VALUED



Wire insulated with **Geon**
is everywhere in this modern house



STARTING with buried service entrance cable, jacketed and insulated with GEON, all the wire used in this modern house is insulated with this modern material.

That's because wire insulated with GEON offers so many advantages—excellent electrical properties, to name one of the most important. Insulation made from GEON is flame resistant; increases safety, reduces fire hazard. Because of its outstanding electrical properties insulation made from GEON may be used in thin coatings which means more conductors per conduit. It's smooth, too, easy to handle and install; quickly identified because the entire NEMA color range is avail-

able. And, of course, it's Underwriters' approved.

As soon as the house is completed, more wire insulated with GEON will make its appearance. It may be in the form of appliance, lamp, and telephone wire. Or it may be the hookup wire now being used in modern radio sets and other electrical devices.

All of GEON's advantages are available to users in domestic, industrial or utilities wiring. The next time you order wire or cable from your supplier be sure to specify insulation made from GEON. Or for help with specific applications please write Dept. F-6, B. F. Goodrich Chemical Company, Rose Building, Cleveland 15, Ohio.



B. F. Goodrich Chemical Company

A DIVISION OF
THE B. F. GOODRICH COMPANY

DAVEN

POWER OUTPUT METERS

DESIGNED TO MEASURE POWER OUTPUT

- at fixed impedance and fixed frequency
- at fixed frequency and variable load
- at fixed load and variable frequency



ALSO

- to determine internal impedance or optimum load
- to measure insertion loss of a network
- to measure noise pick-up level
- to test band width, selectivity, fidelity, sensitivity

The DAVEN OP Series Power Output Meters offer a selection of four models for measuring the effect of power and load on audio amplifiers, filters, oscillators and similar equipment, as well as for standard radio receiver tests. Types OP-182 and OP-961 are widely accepted for their wide flexibility, accuracy and durability. Types OP-193-A and OP-193-B are especially adapted for noise pick-up level work in testing radio receivers, where the use of headphones is desired. A special three-position switch enables use of headphones circuit, meter circuit or both simultaneously.

OP-193-A—OP-193-B

Power range: 0.1mw to 5 watts.

Impedance:

OP-193-A—18 values, 400 to 20,000 Ω

OP-193-B—40 values, 2.5 to 20,000 Ω

Accuracy: $\pm 5\%$.

Special Feature: Provision for use of headphone and/or meter.

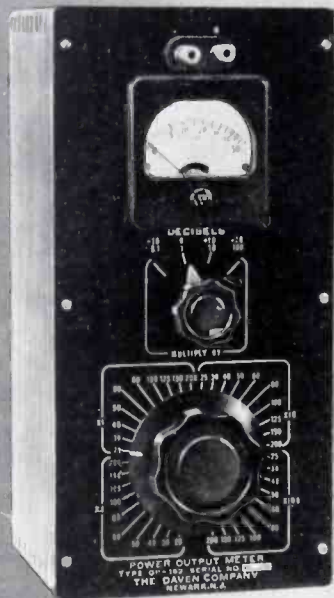

OP-182

Power Range: 0.1mw to 5 watts.

Impedance: 40 values,

2.5 to 20,000 Ω

Accuracy: $\pm 5\%$.

OTHER SPECIFICATIONS

INDICATING METER

Rectifier type AC, calibrated 1 to 50mw and 0 to 17 DB. Reference level 0 DB = 1mw.

METER MULTIPLIER

OP-182, OP-193-A, OP-193-B—Extends meter power reading, 0.1 to 100 X scale; DB reading, -10 to +20 DB, in 10 DB steps.

OP-961—Extends meter power reading, 0.1 to 1000 X scale; DB reading, -10 to +30 DB, in 2 DB steps.

MOUNTING

OP-182—Black metal panel, hand rubbed walnut cabinet, 12"x6"x6"

OP-961—Black metal panel, ventilated metal case, 12"x7"x6 1/2"

OP-193-A, OP-193-B—Black bakelite panel, portable cabinet with removable cover, 13 3/4"x7 3/4"x5 1/4"



OP-961

Power Range: 0.1 to 50 watts.

Impedance: 40 values,

2.5 to 20,000 Ω

Accuracy: $\pm 2\%$.

HAVE YOU A DAVEN CATALOG IN YOUR FILES?

THE **DAVEN** COMPANY
191 CENTRAL AVENUE
NEWARK 4, NEW JERSEY

RCA 8D21 TWIN POWER TETRODE

An important
contribution to
Television
Broadcasting



1/2
ACTUAL
SIZE

10 Kw Input
at 300 Mc



Unusual construction is indicated by this view of the header with filament, grid #1 and grid #2 in position. Precision cast and machined electrodes are connected to water ducts for internal cooling.

THE RCA-8D21 Push-Pull Power Tetrode for television and FM broadcasting service is a radical departure from previous transmitting tube designs in that high-power capability at very high frequencies is achieved through the use of an exceedingly compact, high-current-density structure in which *all electrodes are water-cooled* close to the active electrode areas . . . resulting in a concentration of power in a tube only 12 inches in over-all height and 5 3/4 inches in diameter!

The structure features a thoria-coated, multi-strand filament; low inter-electrode capacitances; excellent internal shielding between input and output circuits; internal neutralization of the small feedback capaci-

tance to eliminate need for external neutralization; internal by-passing of screen to filament to maintain the r-f potential of the screen at ground potential; and relatively short internal leads with consequent low inductances.

Because of electron optical principles incorporated in its design, the 8D21 has high power sensitivity and thus its driving-power requirements are low.

When used as a Class C, grid-modulated, push-pull, r-f amplifier in television service, the 8D21 has a maximum plate-voltage rating of 6000 volts, a maximum total plate input of 10,000 watts, and a total plate dissipation of 6000 watts. It may be operated with

maximum rated input as high as 300 Mc.

A technical bulletin on the RCA-8D21 is available on request. RCA Tube Application Engineers will be glad to work with you in adapting this or any other RCA tube type to your equipment designs. Address RCA, Commercial Engineering Department, Section D-6F, Harrison, N. J.

PRINCETON
LABORATORIES



THE FOUNTAINHEAD OF
MODERN TUBE DEVELOPMENT IS RCA.



TUBE DEPARTMENT

RADIO CORPORATION of AMERICA

HARRISON, N. J.