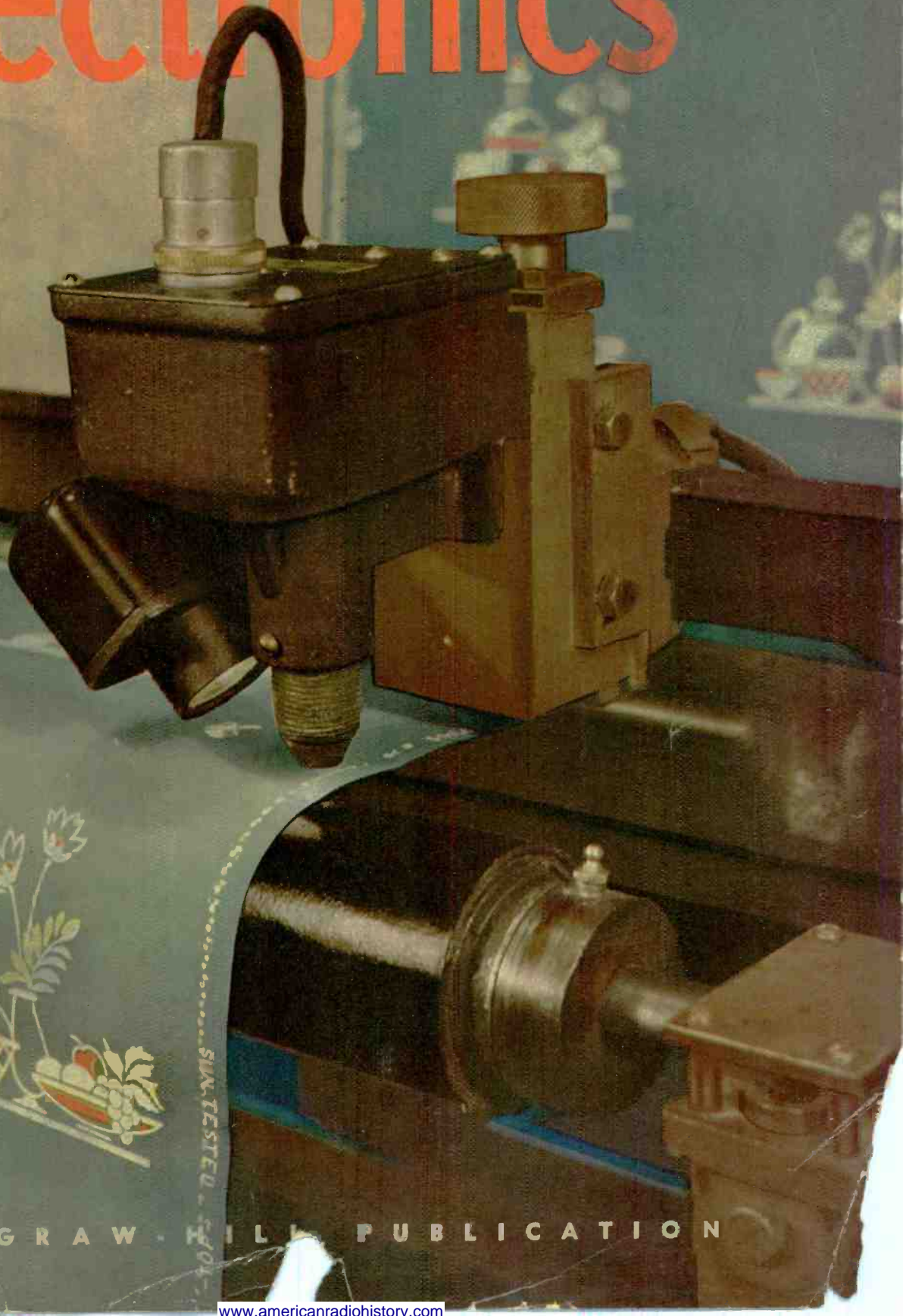


MAY · 1945

# electronics



...SUN TESTED - 1901

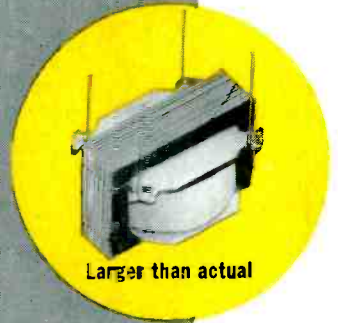
A MCGRAW-HILL PUBLICATION



# FOR COMPACTNESS

## World's smallest transformer

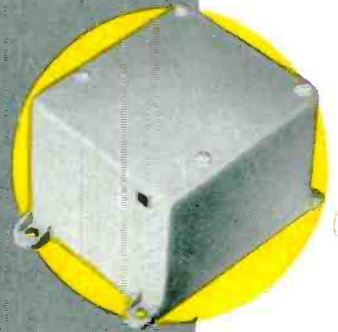
These units, 7/16" x 9/16" x 3/4", are the optimum in small transformer design... they have been in production for five years.



Larger than actual

## Weight reduction . . . . 95%

This dual purpose aircraft filter was reduced in weight through UTC design from 550 to 27 ounces.



## Ouncer transformers - Hermetic

Hundreds of thousands of UTC Ouncers have been used in the field. Solder sealed hermetic constructions effecting the same weight and space savings are now in production.



May we cooperate with you on design savings for your applications . . . war or postwar?



ALL PLANTS

# United Transformer Corp.

150 VARICK STREET

NEW YORK 13, N. Y.

EXPORT DIVISION: 13 EAST 40th STREET, NEW YORK 16, N. Y.

CABLES: "ARLAB"

# electronics

A McGRAW-HILL PUBLICATION

MAY • 1945

DETECTING SIDESLIP .....	Cover
Wallpaper-winding machine equipped with General Electric photoelectric side-register control	
ELECTRONIC APPLICATIONS IN INDUSTRY .....	92
Present and potential uses in 796 plants in 11 major industries are surveyed	
ROCK ISLAND RAILROAD RADIO TESTS, by Ernest A. Dahl .....	96
Signal-to-noise ratios are charted for 40, 118, 150 and 2000 to 3000-Mc systems	
ORBITAL-BEAM U-H-F TUBES, by Rogers M. Smith .....	103
Frequency of oscillation can be controlled with external keying signals, at values up to 500 Mc	
SHIELDING OF DIELECTRIC HEATING INSTALLATIONS, by G. W. Klingaman and G. H. Williams .....	106
Field intensity measurements show effects of various shields, grounding systems and filters on radiation	
F-M FIELD SURVEY TECHNIQUES, by Phil B. Laeser .....	110
Procedure for equipping, calibrating and using a field car to secure data for actual coverage contours	
AGC-NOISE CONSIDERATIONS IN RECEIVER DESIGN, by John B. Moore .....	116
Automatic gain control and its effect on signal-to-noise ratio	
FUNGUS AND MOISTURE PROTECTION, by R. Proskauer and H. E. Smith .....	119
Methods of combating two adversities which combine to attack electronic gear	
COAXIAL CABLE DESIGN, by N. O. Kenney .....	124
Shortcuts to coaxial-cable design by means of graphs and approximate formulas	
V-H-F DUMMY ANTENNA, by Stanley Cutler .....	129
Construction and calibration of resistive load for production testing of transmitters	
GASEOUS RECTIFIER CIRCUITS, PART II, by P. T. Chin .....	132
Voltage and current wave forms of commonly used bi-phase circuits, with pertinent equations	
FREQUENCY MONITOR STROBOSCOPE, by W. L. Wiggins and S. G. Guenther .....	138
Allows checking transmitter frequency at any time without pushing button every fifteen minutes	
PI-NETWORK CALCULATOR, by Warren B. Bruene .....	140
Graphical method by which effects of varying circuit elements can be studied directly	
CROSSTALK .....	91
INDUSTRIAL CONTROL .....	148
TUBES AT WORK .....	194
ELECTRON ART .....	234
NEWS OF THE INDUSTRY .....	276
NEW PRODUCTS .....	346
NEW BOOKS .....	392
BACKTALK .....	398
INDEX TO ADVERTISERS .....	407

**KEITH HENNEY**, Editor; W. W. MacDonald, *Managing Editor*; John Markus, *Associate Editor*; Vin Zeluff, *Associate Editor*; *Assistant Editors*—Frank Haylock, Frank Rockett, J. M. Heron and M. L. Matthey; G. T. Montgomery, *Washington Editor*; Donald G. Fink (on leave); Harry Phillips, *Art Director*

**H. W. MATEER**, *Publisher*; J. E. Blackburn, Jr., *Director of Circulation, Electronics*; Wallace B. Blood, *Manager*

**DISTRICT MANAGERS**, D. H. Miller, H. R. Denmead, Jr., *New York*; R. H. Flynn, *New England*; F. P. Coyle, *Philadelphia*; C. D. Wardner, A. F. Tischer, R. A. Werth, *Chicago*; E. J. Smith, J. L. Phillips, *Cleveland*

Contents Copyright, 1945, by McGraw-Hill Publishing Company, Inc.

McGraw-Hill Publishing Company, Incorporated  
JAMES H. McGRAW, Founder and Honorary Chairman

PUBLICATION OFFICE 99-129 North Broadway, Albany, I. N. Y., U. S. A.  
EDITORIAL AND EXECUTIVE OFFICES 330 West 42nd St., New York 18, N. Y., U. S. A.

James H. McGraw, Jr., President; Howard Ehrlich, Executive Vice President for Business Operations; John Abbink, Executive Vice President for Editorial Operations; Curtis W. McGraw, Vice President and Treasurer; Joseph A. Gerardi, Secretary. Cable address: MCGRAW-HILL, New York. Member A. B. P. Member A. B. C.  
ELECTRONICS, May 1945. Vol. 18; No. 5. Published monthly, price 50c a copy. June Directory Issue \$1.00. Allow at least 10 days for change of address. All communications about subscriptions should be addressed to the Director of Circulation, 330 W. 42nd St., New York 18, N. Y.  
Subscription rates—United States and possessions, Mexico, Central and South American countries, \$5.00 a

year, \$8.00 for two years, \$10 for three years. Canada (Canadian funds accepted) \$8.50 a year, \$9.00 for two years, \$11.00 for three years. Great Britain and British Possessions, 42 shillings for one year, 84 shillings for three years. All other countries \$7.00 for one year, \$14.00 for three years. Please indicate position and company connection on all subscription orders. Entered as Second Class matter August 29, 1936, at Post Office, Albany, New York, under the Act of March 3, 1879.  
BRANCH OFFICES: 520 North Michigan Avenue, Chicago 11, Ill.; 68 Post Street, San Francisco 4; Aldwych House, Aldwych, London, W.C. 2; Washington, D. C. 4; Philadelphia 2; Cleveland 15; Detroit 28; St. Louis 8; Boston 16; Atlanta 3, Ga.; 821 So. Hope St., Los Angeles 14; 38-9 Oliver Building, Pittsburgh 22.

## CHANGE OF ADDRESS

Director of Circulation,  
ELECTRONICS,  
330 West 42nd Street  
New York 18, N. Y.

Please change the address of my Electronics subscription.

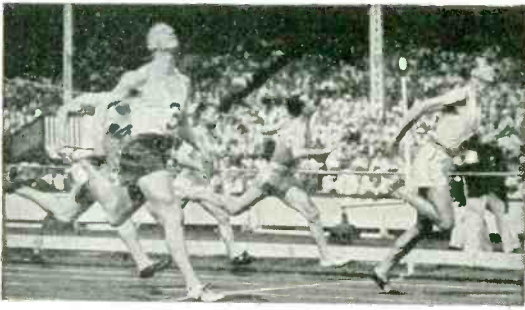
Name .....

Old Address .....

New Address .....

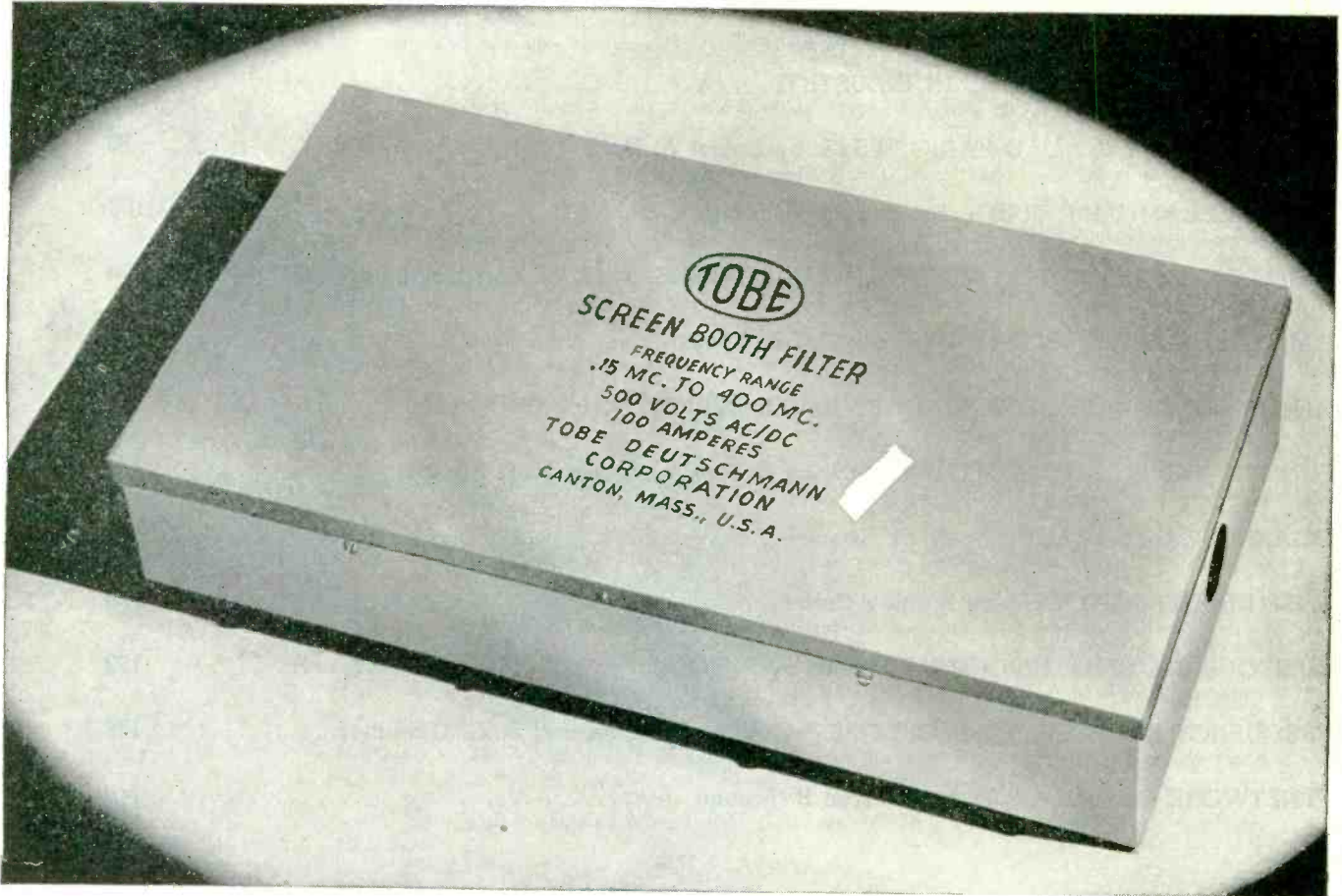
New Company Connection .....

New Title or Position .....



# AWAY AHEAD!

## TOBE LEADS IN NOISE ELIMINATION



## NEW SCREEN BOOTH FILTER

**H**ERE is more evidence of Tobe's Leadership in the noise elimination field. This remarkable SCREEN BOOTH FILTER is designed for use in laboratory testing rooms, including those already shielded to prevent outside electrical interference. It is attached to the power line at the point of entrance into the booth, and is designed to eliminate troublesome interference which might upset vital testing work. *Note the exceptional frequency range, from .15 MC to 400 MC.*

#### CONTAINER DIMENSIONS

Length . . . 20 1/16"    Height . . . 4 1/8"  
 Width . . . 7 15/16"    Weight . . . 35 lbs.

Whenever your problem is connected with eliminating electrical interference, the name to remember is

. . . TOBE! We have a great inventory of knowledge on this subject, backed by 17 years' experience. Your inquiries are welcome at any of our offices. Investigate the applications you can make of TOBE Filters, including the unusual SCREEN BOOTH FILTER described on this page.

**TOBE DEUTSCHMANN CORP., CANTON, MASS.**



GRAND CENTRAL TERMINAL BUILDING  
 NEW YORK 17, N. Y.  
 •  
 110 WEST BROADWAY  
 GLENDALE 4, CAL.  
 •  
 230 NORTH MICHIGAN AVE.  
 CHICAGO 1, ILL.  
 •  
 2-159 GENERAL MOTORS BLDG.  
 DETROIT 2, MICH.



Put your hand  
here!

**PARAGON**

REG. U. S. PAT. OFF.

**DRAFTING  
MACHINE**

**H**ANDLING is believing. Get the finger tips of your left hand on the control ring of a PARAGON Drafting Machine. The lightest pressure is all you need to set the scales at the angle you want, anywhere on the drawing board. Your right hand is always free. For the full story of PARAGON features, convenience and handsome modern appearance, write on your letterhead to Keuffel & Esser Co., Hoboken, N. J.

**KEUFFEL & ESSER CO.**

EST. 1867

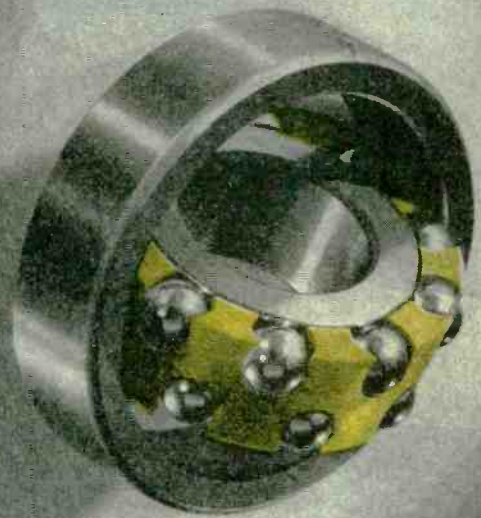


*Drafting, Reproduction, Surveying  
Equipment and Materials.  
Slide Rules. Measuring Tapes.*

CHICAGO • DETROIT • ST. LOUIS • NEW YORK • HOBOKEN • SAN FRANCISCO • LOS ANGELES • MONTREAL

ELECTRONICS — May 1945

where **PLASTICS**  
**PLASTICS** belong



## Using Strength, Lightness, Wearing Quality

**S**TRENGTH, light weight and wear-resistance make Synthane laminated highly desirable for retainers in high speed ball bearings . . . and an excellent example of putting plastics where plastics belong.

If you haven't used plastics at all or to the fullest extent, if you are not certain *which* of the many plastics fits into your plans . . . or where . . . or why . . .

or what the cost will be . . . ask us to help you, preferably *before* you design.

This way, if Synthane is the answer to your needs, you can be sure of design and material not only right for the application but right for fabrication. Should you, in addition, want us to take over fabrication, you can be sure your parts will be produced by men who know machining of plastics,

working on machines fitted especially for plastics. For your whole job or any part of it—design, materials or fabrication—remember Synthane. It will give you a real sense of satisfaction to know whether the job can be done, how it can be done, how long it will take to produce and how much it will cost. Synthane Corporation, Oaks, Pennsylvania.

**SYNTHANE TECHNICAL PLASTICS**

**DESIGN • MATERIALS • FABRICATION**

SHEETS

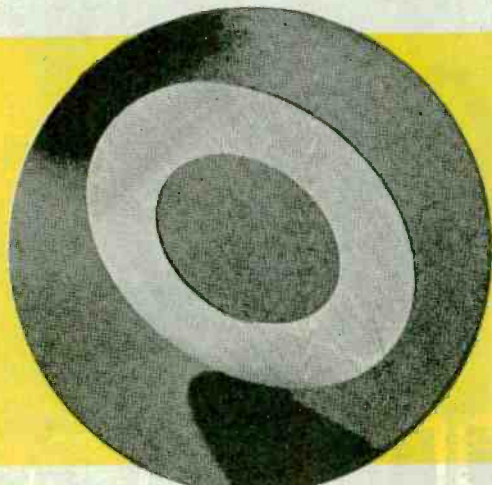
RODS • TUBES

FABRICATED PARTS

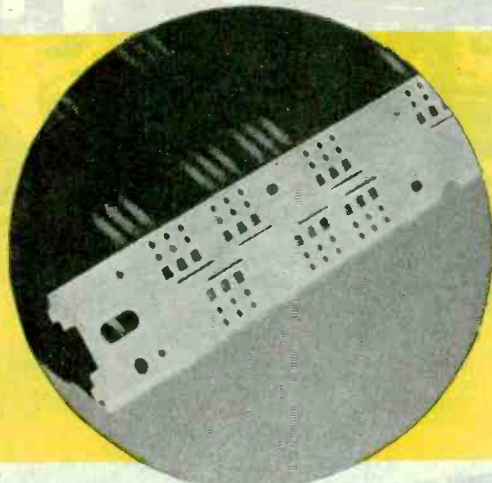
MOLDED • MACERATED  
 MOLDED • LAMINATED

**SYNTHANE**

# Plastics is a Word . . . like Metals



THRUST WASHER—Dimension stability, moisture resistance, compressive strength and immunity to oil are factors in the selection of Grade C (fabric reinforced) Synthane.



RADIO TERMINAL STRIP—Low power factor, low water absorption, low dielectric losses and stability of these properties led to the use of Synthane Grade XXXP.



BREAKER ARM—Synthane molded-laminated with a fabric filler is notable for its high impact strength, excellent wearing qualities and good electrical properties.

● **IT IS IMPORTANT TO AVOID** using the word "plastics" loosely or generically. It is as imperative to distinguish between plastics as between metals, say as between steel and bronze—and then to distinguish further between types of the same general plastics as you would between various steels and various bronzes.

● **SYNTHANE IS OUR NAME** for one type of plastics, made from phenol formaldehyde resins and various fillers. This type is thermosetting, that is, it does not soften under a reapplication of heat as do thermoplastic materials. The phenol formaldehydes, including Synthane laminated, are newsworthy among plastics for their combination of high tensile strength, high compressive strength, high flexural strength, high impact strength and high dielectric strength. Synthane has, of course, many other desirable properties in combination such as light weight, hardness, low thermal expansion, low moisture absorption, and resistance to corrosion.

● **THERE ARE, HOWEVER,** various grades of Synthane, just as there are various kinds of bronze, steel, aluminum, and other metals. Naturally, you will not find the optimum values of all properties combined in any one grade. For instance, one grade, reinforced with a paper filler is most suitable for its mechanical characteristics, another for its dielectric qualities. In addition to paper grades there are grades reinforced with fabric, asbestos, and glass fillers and impregnated with a diversity of resins.

● **THE SELECTION OF A GRADE** of Synthane is influenced not only by its inherent physical, electrical, mechanical or chemical properties but often by processes of machining required to produce from Synthane the finished parts you require.

● **AS AN ILLUSTRATION,** production of the parts you have in mind may only be economical by punching. Depending on your requirements, paper base grades as XP, XXP or XXXP (the "P" denotes a punching or plasticized grade) may be amply adequate for your purpose.

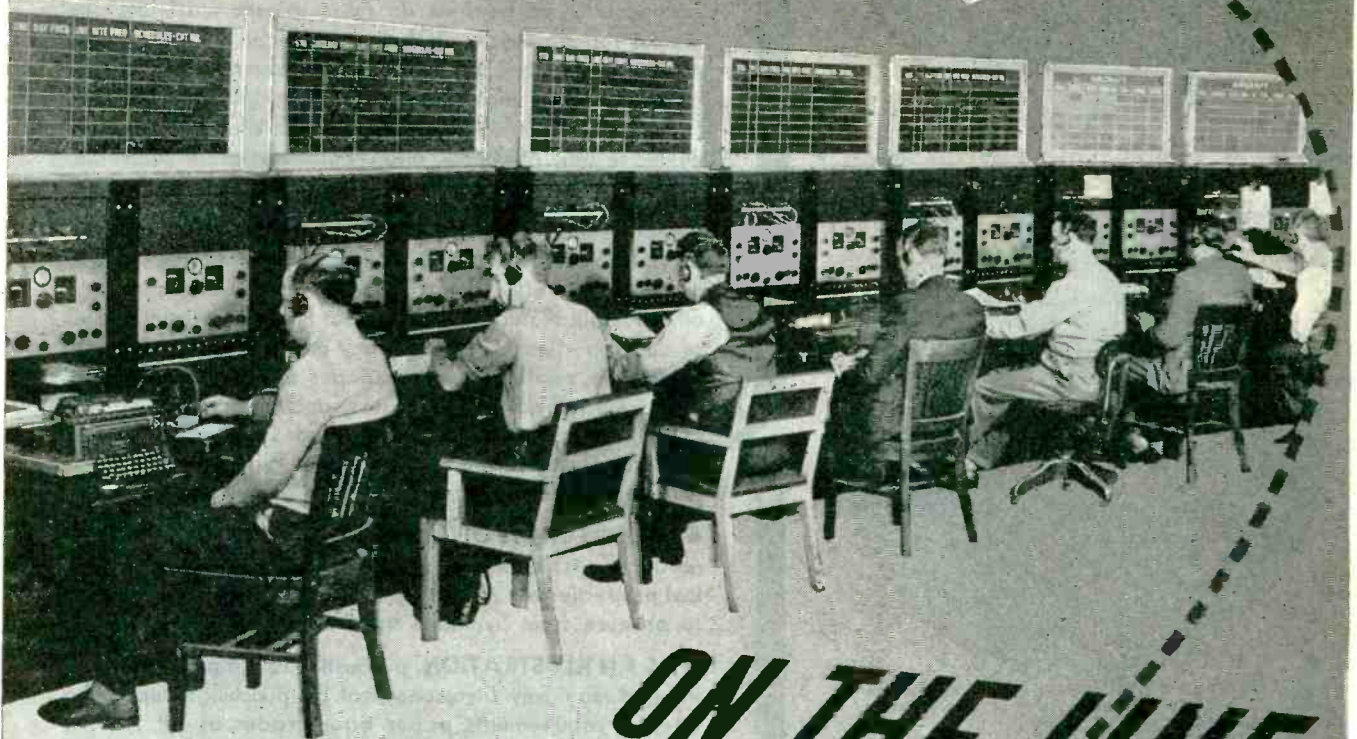
● **USUALLY ONE OF THE MANY** standard grades of Synthane can be found to meet satisfactorily all your specifications, both in properties and in machinability. If not, we may have already developed, or have to develop, a special grade which will.

● **REMEMBER THAT SYNTHANE** is as adjustable within its combination of properties as an alloy of a metal, and that if you are not sure there's a grade of Synthane to fill the bill for you, just ask us. If possible, let us help you before you design and, in so doing, give us the opportunity to assist you in selecting the right Synthane material for your application and for ease in fabrication.

## SYNTHANE

SYNTHANE CORPORATION, OAKS, PENNSYLVANIA  
Representatives in All Principal Cities

# "SUPER-PROS"



## ON THE LINE

Five thousand hours of continuous operation demand good engineering. The "Super-Pro" receivers in the CAA installation at La Guardia Airport have been on duty twenty-four hours a day for over four years.



# HAMMARLUND

THE HAMMARLUND MFG. CO., INC., 460 W. 34TH ST., NEW YORK 1, N.Y.  
MANUFACTURERS OF PRECISION COMMUNICATIONS EQUIPMENT



Available through Leading Radio Equipment Distributors!



# AMPEREX

## WATER AND AIR COOLED TRANSMITTING AND RECTIFYING TUBES

The more popular AMPEREX tubes are available through leading radio equipment distributors. Thus, engineers may now obtain many of our standard tube types with minimum delay. The AMPEREX line, especially for industrial and electro-medical applications, is probably the most com-

plete in the industry. AMPEREX engineers pioneered in the design and development of these types, and our name stamped on a "bottle" designates longer life with corresponding economy. If we can be of service to you, on present

or peacetime assignments, we will be very glad to oblige.

**AMPEREX**

*... the high  
performance  
tube*



# AMPEREX ELECTRONIC CORPORATION

79 WASHINGTON ST., BROOKLYN 1, N. Y. . . . Export Div.: 13 E. 40th St., N. Y. 16, N. Y., Cables: "ARLAB"

WASTEPAPER IS A CRITICAL-WAR REQUIREMENT... SAVE EVERY SCRAP

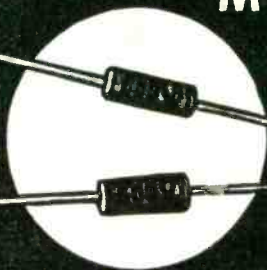
# The TINYMITE

SMALLEST PAPER  
CAPACITOR - - -

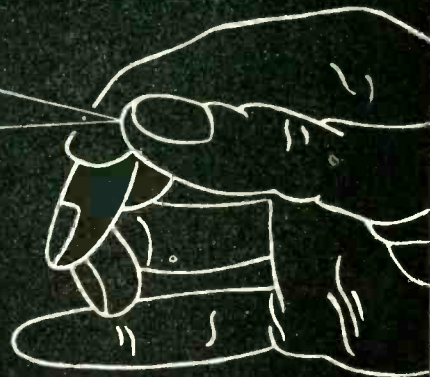
yet 100%

MOISTUREPROOF

TYPE  
P5N



TYPE  
P4N



## FEATURES

1. Bakelite Resinoid Ends. Lead wire cannot pull out, even under hot conditions.
2. Non-Inductive.
3. Excellent Temperature Coefficient.
4. Very high leakage Resistance.
5. Fine Power-Factor.
6. Range from 20 MMFD to .25 MFD.  
From 150 volts to 600 volts.
7. Types P4N, P5N for 100% humidity operation.
8. Types P4, P5 for 95% humidity operation.

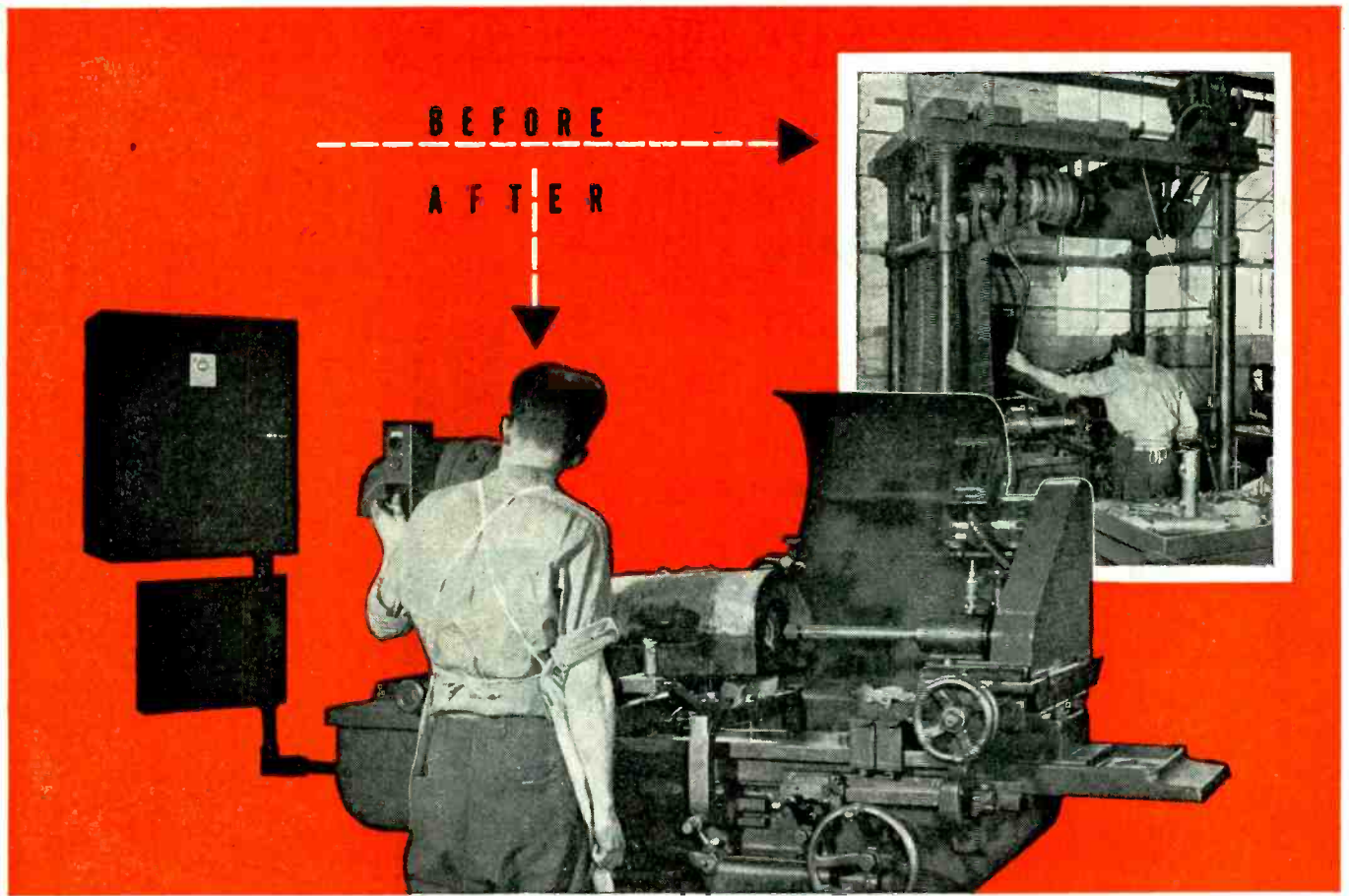
*Samples and price list on request*

Pat.  
Pend.

BUY EXTRA WAR BONDS . . .  
TIL THE WAR IS OVER

# DUMONT ELECTRIC CO.

MFR'S OF  
CAPACITORS FOR EVERY REQUIREMENT  
34 HUBERT STREET NEW YORK, N. Y.



## *producing better than ever . . . after 30 years*



### **ELECTRONIC MOTOR CONTROL**

The Westinghouse Mot-o-trol . . . employing Thyatron tubes to convert a-c to d-c . . . provides wide-range stepless speed control through a 20 to 1 range, from an a-c power source. Pushbutton control station enables the operator to start, stop and control the speed while the machine is running. At any speed setting, variations in load cause little or no change in speed.

The Allies' urgent need for more oil recently created a demand for greatly increased production of hardened steel pump liners. To a leading West Coast manufacturer, this brought the problem of maintaining precision at a much higher production rate.

Internal grinding of these liners had been done on machines with overhead belt and pulley drives . . . providing only four speeds in definite steps. These grinders were unable to meet the stepped-up demand. Excessive vibration ground chatter marks into the liners. Subsequent honing became inaccurate. Setup time was high. To obtain delivery of a modern machine would require months.

Westinghouse engineers, working with the manufacturer, suggested modernizing the drives by applying

Mot-o-trol, an electronic drive providing stepless speed control over a 20 to 1 range, with handy pushbutton control.

Result: the grinding operation showed immediate improvement. Vibration and chatter marks were eliminated. Setup time was reduced. And the new arrangement saved 35% in floor space.

This is typical of the modernizing possibilities with electronic equipment . . . not only in control, but in power conversion, processing methods, counting and sorting operations and countless other industrial tasks.

Your nearest Westinghouse office is ready to provide helpful assistance and information on electronic applications for *your* industry. Or write Westinghouse Electric & Mfg. Company, P. O. Box 868, Pittsburgh 30, Pa.

J-91072



**Westinghouse**  
PLANTS IN 25 CITIES . . . OFFICES EVERYWHERE

*Electronics at Work*

ELECTRONIC EQUIPMENT FOR INDUSTRY AND HOME—ELECTRONIC TUBES—RADIO AND TELEVISION

ELECTRONICS — May 1945

# When insulator design calls for *Quick Action*

DEPEND ON



When time is of the utmost importance the ease and precision with which Mykroy can be fabricated into insulator parts makes it exceptionally useful to electronic and electrical engineers. Make those design changes on the spot . . . make them quickly and economically with Mykroy, for, here is a ceramic which can be worked in your own shop. Just transfer your design to the Mykroy sheet . . . then using conventional shop tools . . . produce the desired part by simple cutting, grinding, drilling, tapping and polishing techniques.

Because it has high structural strength and physical stability Mykroy can be machined to critical tolerances more readily than other types of ceramics. In addition, its electrical characteristics are of the highest order and do not shift under any conditions short of actual destruction of the insulation itself. This, plus excellent chemical and physical properties, makes it one of the best insulating materials ever developed for general and high frequency applications.

Get the full facts about this versatile dielectric now. Ask for a copy of the new MYKROY BULLETIN 102 which describes the new larger (19 1/4" x 29 3/4") sheet now available and call upon our engineers to help with your problems.



A representative group of parts fabricated in Mykroy to customer's specifications in our own plant. We have complete facilities to produce such parts in any quantities on rapid delivery schedules. Send us your specifications.

### MECHANICAL PROPERTIES\*

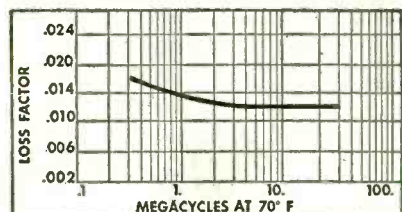
MODULUS OF RUPTURE.....	18000-21000psi
HARDNESS	
Mohs Scale 3-4 BHN. BHN 500 K9 Load. 63-74	
IMPACT STRENGTH.....	ASTM Charpy .34-.41 ft. lbs.
COMPRESSION STRENGTH.....	42000 psi
SPECIFIC GRAVITY.....	2.75-3.8
THERMAL EXPANSION.....	.000006 per Degree Fahr.
APPEARANCE.....	Brownish Grey to Light Tan

### ELECTRICAL PROPERTIES\*

DIELECTRIC CONSTANT.....	6.5-7
DIELECTRIC STRENGTH (1/8").....	.630 Volts per Mil
POWER FACTOR.....	.001-.002 (Meets AWS L-4)

\*THESE VALUES COVER THE VARIOUS GRADES OF MYKROY

- GRADE 8. Best for low loss requirements.
  - GRADE 38. Best for low loss combined with high mechanical strength.
  - GRADE 51. Best for molding applications.
- Special formulas compounded for special requirements.



Based on Power Factor Measurements made by Bonton Radio Corp. on standard Mykroy stock.

MADE EXCLUSIVELY BY

**ELECTRONIC MECHANICS INC.**

70 CLIFTON BLVD., CLIFTON, N. J.  
CHICAGO 47; 1917 N. Springfield Ave., Tel. Albany 4310  
EXPORT OFFICE: 89 Broad Street, New York 4, New York

MYKROY IS SUPPLIED IN SHEETS AND RODS — MACHINED OR MOLDED TO SPECIFICATIONS

# Designed for the modern 50-kw transmitter!

a G-E high-vacuum, forced-air-cooled tube

**Up-to-the-minute** in its design characteristics and performance

**Powerful** for amplifier use in large AM stations

**Versatile** in its filament operation from direct current or single, 3-, or 6-phase alternating current

**Compact**—28" high, 14½" in diameter



● **Type GL-893-AR** was created for the newer 50-kw transmitters which broadcast at standard frequencies, and with power-tube installations employing forced-air cooling. The same tube may be obtained with water-cooled anode as Type GL-893-A, for services such as industrial high-frequency heating or international 50- and 100-kw broadcasting.

● **Important advancements** in design establish the GL-893-AR as a power amplifier better and more dependable than any predecessor. Its filament structure uses new, improved methods of springing and suspending the loops, so that when the phase-voltages are unbalanced, the tendency of the filament to move and short

with the grid is minimized. Improvements in grid construction also have been introduced to reduce the possibility of arcing over, thus making Type GL-893-AR easier to break in.

● **Well-known** for its multi-strand filament which permits, for all classes of service, operation from direct current or single, 3-, or 6-phase alternating current, Type GL-893-AR is being used increasingly in modern transmitting sets. A recent, substantial reduction, moreover, has lowered the price from \$1,150 to \$800. Consult your nearest G-E office or distributor for further data about G-E transmitting tubes, or write to *Electronics Department, General Electric, Schenectady 5, New York.*

## TYPE GL-893-AR. PRICE \$800.

A 3-electrode, forced-air-cooled vacuum tube for use as a r-f amplifier, oscillator, or Class B modulator. Operates from direct current or single, 3-, or 6-phase alternating current. In Class B a-f service, with a signal plate output for two tubes up to 70 kw, the maximum ratings per tube are: plate voltage 20,000 v, signal plate current 4.0 amp; signal plate input 60 kw, dissipation 20 kw. In Class C plate-modulated service, with a power output up to 18 kw, the maximum ratings per tube are: plate voltage 12,000 v, current 2.0 amp; plate input 24 kw, dissipation 12 kw. Highest frequency at full ratings is 5 megacycles; at reduced ratings, 25 megacycles.

Type GL-893-A also is available with the same design and ratings, but with water-cooled anode. Price \$450.

*Hear the G-E radio programs: "The World Today" news, Monday through Friday 6:45 p. m., EWT, CBS. "The G-E All-Girl Orchestra," Sunday 10 p. m., EWT, NBC. "The G-E House Party," Monday through Friday, 4 p. m., EWT, CBS.*

**GENERAL**  **ELECTRIC**

161-05-0050

# FM does it

with *triple* the tone range

to bring new program brilliance

to your listeners



♪ In the range of tone from low to high, a present-day AM broadcast system reproduces the values of tone from approximately 100 to 5,000 vibrations per second. Compare this range with that of an FM broadcast system which is capable of reproducing *all values of tone from 50 to 15,000 vibrations per second*—a range that matches the ability of the normal ear to hear! Within this extended range provided by FM is ample room for all the highs and all the lows of natural sound. Here is space for the vital lacework of overtones that gives sound its “natural color”—that enables the listener to distinguish the piano from the banjo, the oboe from the flute, each voice and instrument from all others.

♪ Nor are these values lost in the FM broadcast receiver. Here each tone and overtone is clearly heard against a background of silence, for FM does away with background noise that normally masks AM reception, particularly at low sound levels. Each crescendo reaches its true value, for an FM receiver is designed to handle without distortion the entire range of sound intensities from the softest whisper to the swell of the full concert orchestra.

♪ FM gives broadcasting “natural-color” reception. To your audience this means fuller program enjoyment. To you, this means stimulated audience interest and improved service to your advertisers.

♪ When you plan your FM station make full use of General Electric’s vast background of experience in the FM field. G.E. is the one radio manufacturer with experience in designing and building complete FM



**AM** AM brings listeners only one-third the range of tone the ear can hear. Many tones and overtones are missing. Realism is lost.

broadcast systems—from transmitters to receivers. G.E. has designed and built more FM broadcast transmitters than any other manufacturer. G.E. built the first FM home receivers and has furnished a large percentage of the half million now in use. Today, the six studio-transmitter FM relay links now operating in the 340-megacycle band are all G.E.—with thousands of hours of regular operation to their credit. And at Schenectady, G.E. operates its own FM proving-ground station, WGFM. For information on General Electric FM broadcast equipment, write *Electronics Department, General Electric, Schenectady 5, N. Y.*

STUDIO AND STATION EQUIPMENT • TRANSMITTERS

GENERAL  ELECTRIC

100-09-0914



**FM**

FM broadcasting brings listeners all the tones and overtones the ear can hear. Reproduction is true and natural.

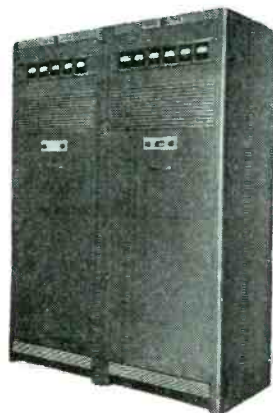
50 FM BROADCAST STATIONS ARE ON THE AIR;  
OVER 370 APPLICATIONS ARE PENDING

FM DOES IT—

- FM gives your audience programs with virtually no man-made noise or static.
- FM multiplies your effective coverage day and night.
- FM minimizes station interference.
- FM gives programs vivid naturalness with greater dynamic sound range.
- FM gives your programs truer realism with triple the tone range.
- FM contributes to the economy of your broadcast system.

Establish a priority on delivery of your FM equipment. Write for your copy of the "G-E Equipment Reservation Plan" which explains General Electric's plan to help you obtain early delivery of transmitters and associated equipment.

Hear the G-E radio programs: "The World Today" news, Monday through Friday 6:45 p. m., EWT, CBS. "The G-E All-Girl Orchestra," Sunday 10 p. m., EWT, NBC. "The G-E House Party," Monday through Friday 4 p. m., EWT, CBS.

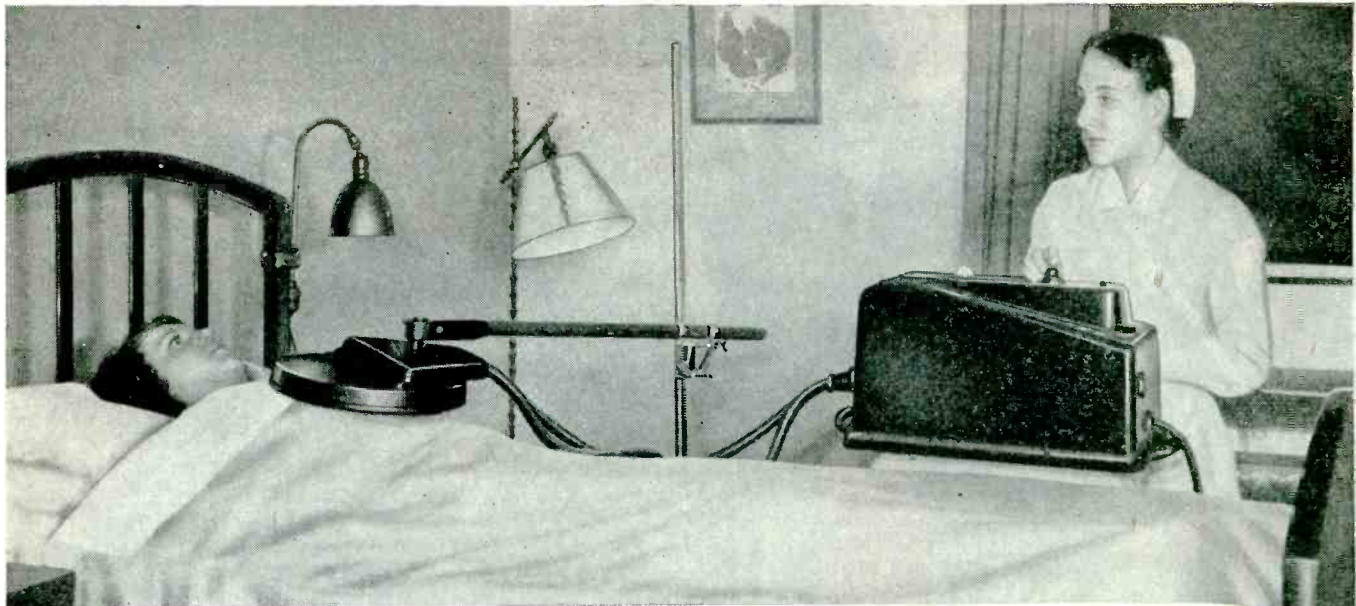


The G-E pre-war 1,000-watt FM transmitter

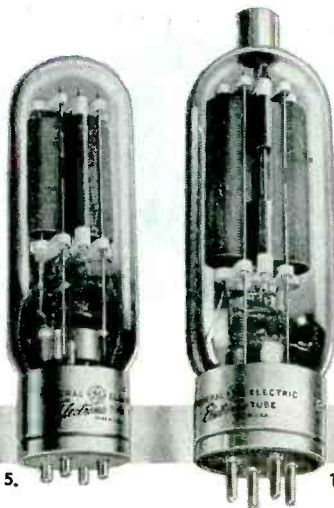
ANTENNAS • ELECTRONIC TUBES • HOME RECEIVERS

**FM • TELEVISION • AM**

*See G.E. for all three!*



## These specially designed G-E plotrons produce the high-frequency currents used in diathermy



TYPE FP-285. \$15.

TYPE FP-265. \$22.50.

Three-electrode, high-vacuum, oscillator tubes for supplying the high-frequency currents used in diathermy. Basic ratings are:

	FP-285	FP-265
Cathode voltage	10 v	10 v
Cathode current	3.25 amp	5.2 amp
Max plate voltage	1,350 v	1,500 v
Max plate current	200 ma	200 ma
Max plate input	270 w	350 w
Max plate dissipation	100 w	160 w
Frequency in megacycles at maximum ratings	20	15
Frequency in megacycles at 50 per-cent ratings	80	40

Growth in the use of diathermy for treating various pathological conditions has increased the need for equipment that is efficient, dependable, and modern in all respects. Design of such equipment starts with the electronic tubes which supply the high-frequency current, applied to the tissues either by induction or dielectrically.

**G-E Types FP-285 and FP-265** are plotrons — high-vacuum, 3-

electrode, oscillating tubes—engineered especially for short-wave therapy. Apparatus designers may place full confidence in these G-E tubes, which embody many features of superiority. Frequencies are in the high range, and power output is ample for most effective treatment of the patient.

**For facts** on the application of electronic tubes in diathermy, consult General Electric tube engineers.

Also ask for "How Electronic Tubes Work," an illustrated booklet about tube types and functions. Telephone your G-E office or distributor, or write to *Electronics Department, General Electric, Schenectady 5, New York.*

Hear the G-E radio programs: "The World Today" news, Monday through Friday, 6:45 p. m., EWT, CBS. "The G-E All-Girl Orchestra," Sunday 10 p. m., EWT, NBC. "The G-E House Party," Monday through Friday, 4 p. m., EWT, CBS.

G. E. HAS MADE MORE BASIC ELECTRONIC-TUBE DEVELOPMENTS THAN ANY OTHER MANUFACTURER

# GENERAL ELECTRIC

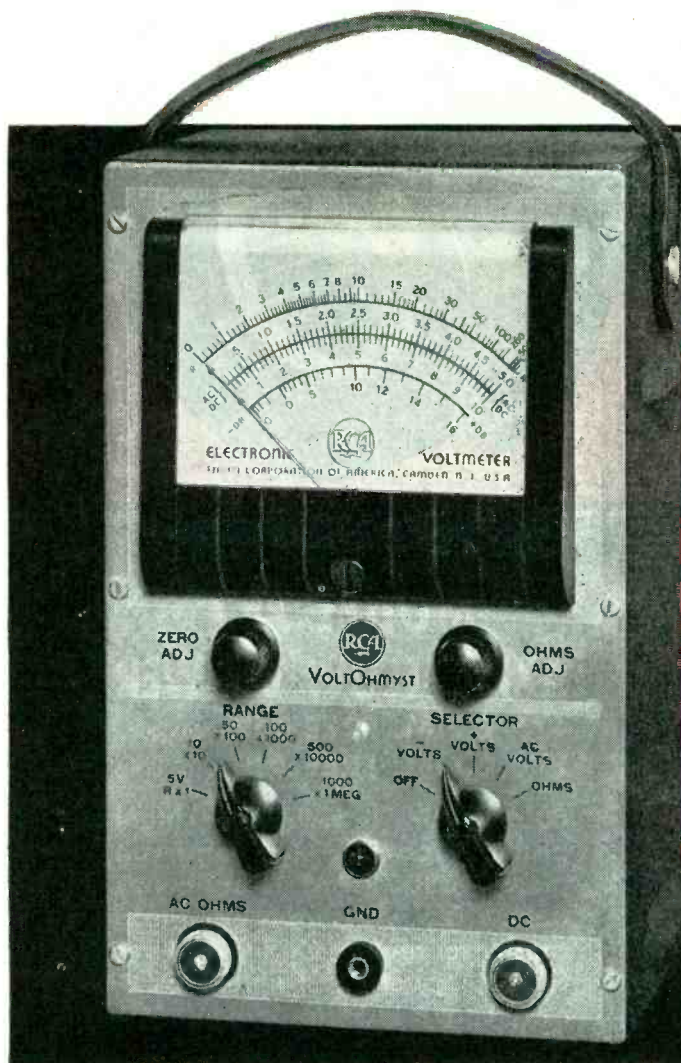
162-D8-8850





# RCA Announces its New

## 195 VOLT OHMYST



### 4 IMPORTANT NEW FEATURES

- 1 Diode for a-c measurements. Flat 20 cycles to 100 kc.
- 2 Linear a-c scale for all ranges.
- 3 New plastic meter case with one-piece crystal-clear transparent front. No glass to break or loosen.
- 4 Shielded a-c cable and probe.

### Send for Bulletin:

A special bulletin showing and fully describing this new improved version of the well-known VoltOhmyst is now being printed. Fill in and return the coupon for your copy.

TEST & MEASURING EQUIP., SECT. 126C

Radio Corporation of America  
Camden, N. J.

Name \_\_\_\_\_

Street Address \_\_\_\_\_

City & State \_\_\_\_\_

BUY MORE



WAR BONDS

## RADIO CORPORATION OF AMERICA

RCA VICTOR DIVISION - CAMDEN, N. J.

In Canada, RCA VICTOR COMPANY LIMITED, Montreal



# VIBRATION HURTS

**ELECTRONIC  
EQUIPMENT  
RADIOS  
FLIGHT  
INSTRUMENTS**

..... so that airborne equipment fails repeatedly even under normal service conditions. Yet such failures, accepted as inevitable can be virtually eliminated if vibration is adequately controlled.

Robinson Vibrashock\* suspensions are guaranteed to absorb over 90% of all vibration within the operating range of aircraft. This represents a new high standard of performance for shock mounts. In every instance when shock mounts for vital airborne equipment are replaced by Vibrashock suspensions, the results exceed expectations. The reliability of the equipment supported is increased, the service life extended and maintenance costs reduced.

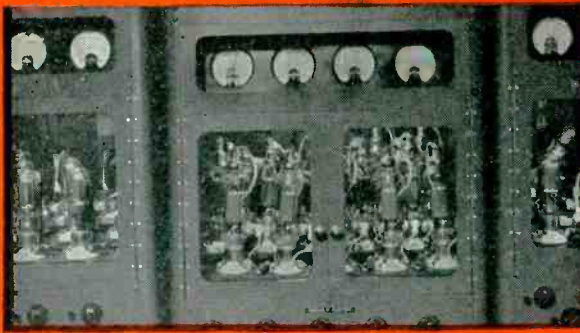
Vibrashock suspension designs are adapted to each vibration problem of importance. This procedure differs from the conventional method of selecting shock mount units from a catalog, and assembling them to a tray. But valuable equipment deserves vibration engineering if the best control is desired — a poor shock mount is expensive at any price.

We would like to show you curves indicating the improved performance of Vibrashock suspensions as compared with conventional type shock mounts. Let our engineers show you how Vibrashock can solve your vibration problem.

\*Trade Mark

**ROBINSON  
AVIATION, INC.**  
730 Fifth Avenue, New York 19, N. Y.  
First National Building, Hollywood 28, Calif.

**VIBRATION  
CONTROL  
ENGINEERS**

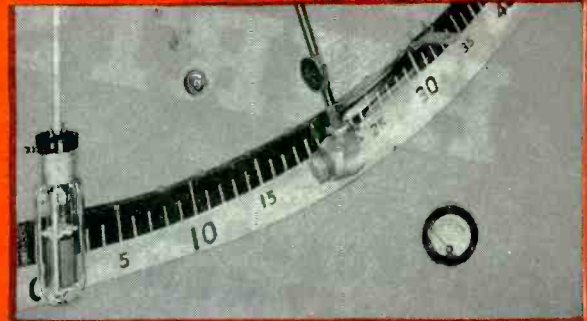


**QST-1**—Life testing is an important Quality Standard test at United. It is a strictly observed procedure whereby life expectancy is controlled in "run-of-production" tubes.



**QST-2**—A unique test is applied to every United tube to assure noise-free operation.

# Who sets the *Quality Standard* FOR TRANSMITTING TUBES



**QST-3**—United tubes designed for very rough service have extra, built-in shock resistance proved by the severe Bump Test each tube must pass.

**Quality Standard Test.**

Brilliant United craftsmanship is steadfastly verified and maintained by skillful and vigilant testing—truly representative of daily production. For this reason every United tube must pass through a series of critical examinations that do not permit any defects, no matter how minute they may be, to escape unnoticed.

By maintaining Quality Standard Tests of the highest order United engineers and technicians have

achieved recognition for leadership. To engineers everywhere, the name United is the *trusted* standard by which other transmitting tubes are judged and measured.

For every electronic application including radio communication, physiotherapy, industrial control and electronic heating, standardize with tubes that are the Quality Standard. "Tube up" with United.

Order direct or from your electronic parts jobber.

*Masterpiece of  
Skilled Hands*



# UNITED

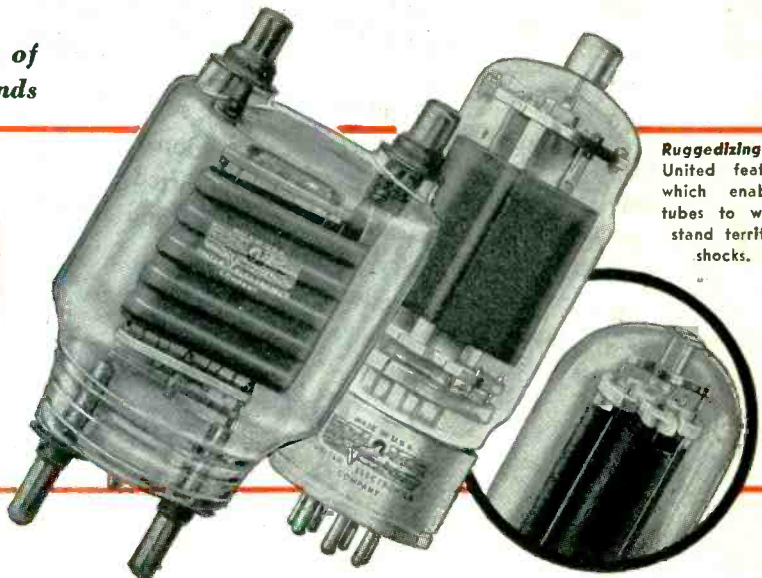
**ELECTRONICS COMPANY**

NEWARK, 2

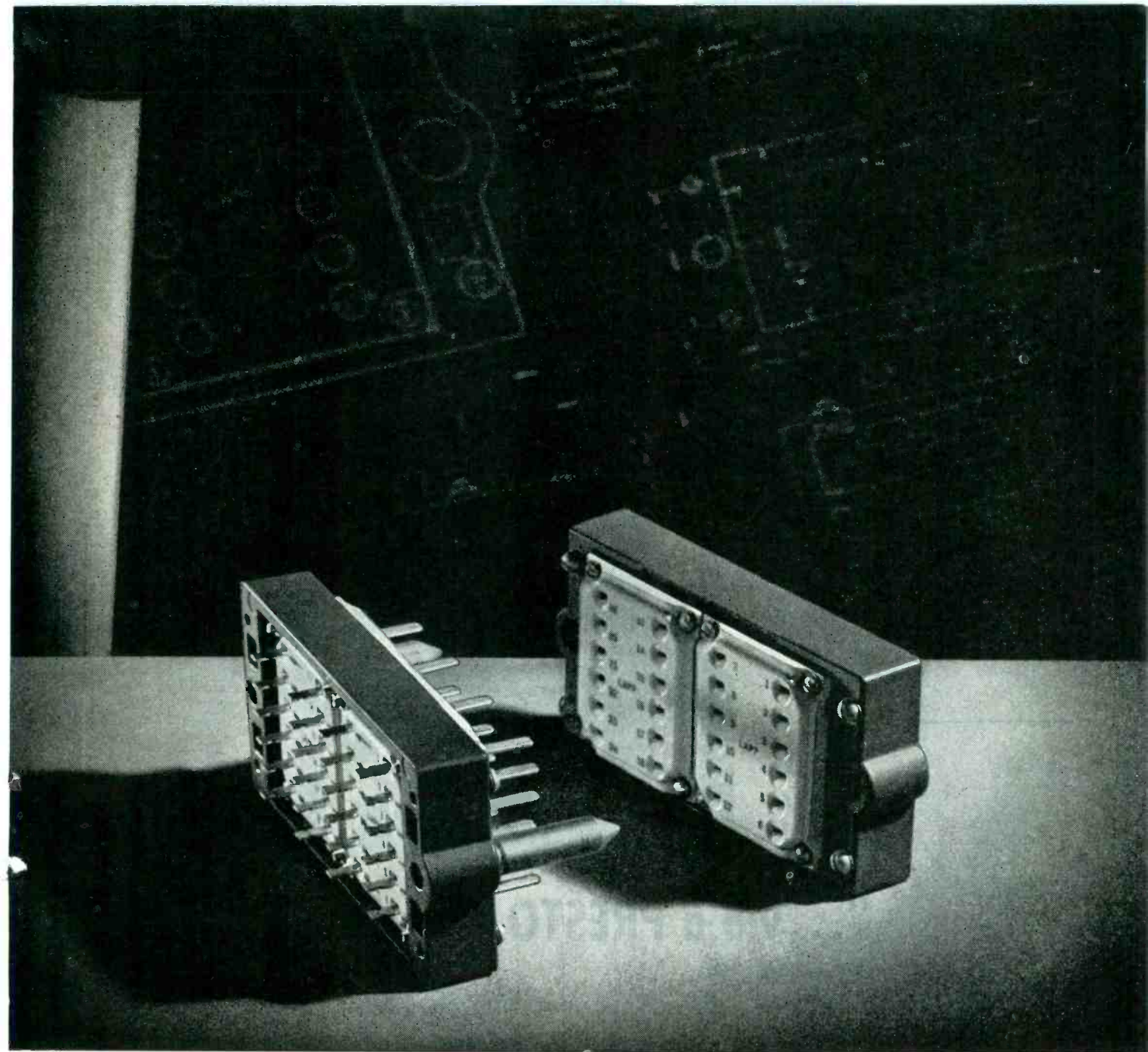


NEW JERSEY

Transmitting Tubes **EXCLUSIVELY** Since 1934



**Ruggedizing:** A United feature which enables tubes to withstand terrific shocks.



## *An Electronic Part* ... ENGINEERED TO A SPECIFIC NEED

This is a special-purpose electronic part. It is a plug-receptacle assembly for use with rack-panel type of mounting. Twenty-four silver-plated phosphor-bronze contacts are provided, each male and female contact full floating between steatite plates. Heavy guide pins and matching holes in the frame assure perfect alignment.

We don't know that your product has any need for such a part as this. We do know, however, that this part is most exactly suited to its special requirement just as are hundreds upon hundreds of other parts which have been created through Lapp engineering and Lapp production facilities directed to the solution of specific problems.

With a broad basic knowledge of ceramics—their capabilities and their limitations—Lapp has been able to simplify and to improve many types of elec-

tronic equipment through engineering and production of sub-assemblies that make most efficient use of porcelain or steatite and associated metal parts.

There may be a way you can improve performance, cut costs and cut production time through use of Lapp-designed and Lapp-built sub-assemblies. We'd like to discuss your specific requirements with you.  
*Lapp Insulator Co., Inc., LeRoy, N. Y.*

# Lapp



# "Here's how Courtney checks up on Courtney!"

*Alan Courtney*



## "...via a PRESTO recorder"

"An announcer must check up on his technique constantly," says Alan Courtney, popular announcer of WOV's *1280 Club* program. "My own way of doing this is to make frequent recordings of my voice on a portable PRESTO recorder. Then, by listening to the records, I can get an idea of how I sound to the radio audience. Naturally, the accuracy of the recording is of the utmost importance. I find a PRESTO recorder

ideal for the work, because, even in amateur hands, it produces cuttings of uniformly high fidelity and clarity."

PRESTO sound recording and transcription equipment is used by major broadcasting companies, in industry, in schools and colleges, and by the Armed Forces. Every PRESTO unit, from the largest to the smallest, is a product of high engineering skill and uncompromising manufacturing standards. Write for information.

**WORLD'S LARGEST MANUFACTURER  
OF INSTANTANEOUS SOUND  
RECORDING EQUIPMENT  
AND DISCS**

# PRESTO

**RECORDING CORPORATION**

242 West 55th Street, New York 19, N. Y.

Walter P. Downs Ltd., in Canada

1/2" DIAMETER x 1 1/4" HIGH



**midget**

IN SIZE!

**GIANT**

IN STAMINA!

**This Audio Oscillator  
Transformer Meets 5-Cycle  
Temperature Test Requirements**

- **STURDY TERMINALS**
- **ASSURE**
- **SECURE CONNECTIONS**

HI-MU alloy plus a special sealing process! There, in a nutshell, is the reason why this capsule-size transformer operates with great stability under all climatic conditions . . . This is only one of our complete line of midget audio transformers and filter reactors . . . Our many years of pre-war experience has not only helped us solve the problems of war demands, but also prepares us to serve in the postwar future.

**SUPER ELECTRIC PRODUCTS CORP.**  
1057 Summit Ave., Jersey City, N. J.

**Manufacturers of Transformers for Power,  
Audio Frequency, Luminous Tube, Testing**

WE HAVE WAYS WITH WAYWARD MATERIALS!



Plastics, filled with mica, have what it takes to function for highly specialized coils . . . at the same time, while in process, it takes all you've got to make the material behave!

Mica is difficult to handle . . . must be formulated with extreme care . . . the molds themselves must be ingeniously developed . . . flawlessly constructed . . . specially finished. Each step up to and through transfer molding calls for "babying"; otherwise, you get chips and flakes for your effort. Such a condition is *taboo!*

As you can note here, the finished parts are usually small—intricately designed—incorporate threading, flanges, holes, cut-aways and other specification set-ups. All call for mold mastery—the Consolidated way!

Inquiries invited from those whose present problems and postwar plans have reached the thinking-out stage. Consolidated guarantees your blueprint in plastic—the right plastic!

**Consolidated**

MOLDED PRODUCTS Corporation  
309 CHERRY STREET, SCRANTON, PA.

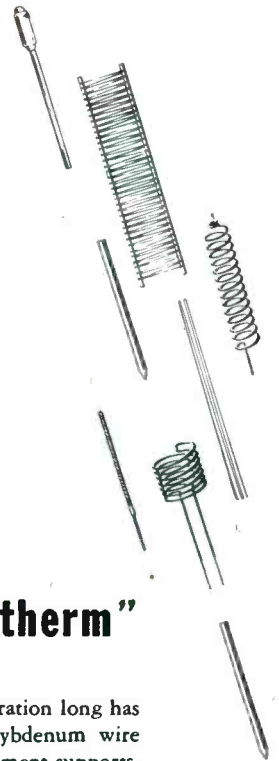
**CM  
P**

BRANCHES: NEW YORK • CHICAGO  
DETROIT • CLEVELAND • BRIDGEPORT



magic  
with  
metals  
by  
electronic  
heat

CALLITE



## Callite components help Federal make the "Megatherm"

The Federal "Megatherm" Induction Heating Unit is designed to deliver a 25 kw output continuously at frequencies adjustable within a range of 2 to 5 mc. The use of this frequency range makes possible accurate control of heating depth and permits effective and speedy heating, soldering or brazing of brass, copper, aluminum alloys and steel.

The Federal Telephone and Radio Corporation long has relied on Callite for tungsten and molybdenum wire and fabricated parts such as filaments, filament supports, grid side rods, etc.

Callite processes tube components by methods perfected after years of research and experience. Let us cooperate with you. We may be able to save you time and money. Callite Tungsten Corporation, 544 Thirty-ninth St., Union City, N. J. Branch Offices: Chicago, Cleveland.



**Callite**  
Tube components

Hard glass leads, welds, tungsten and molybdenum wire, rod and sheet, formed parts and other components for electron tubes and incandescent lamps.

# In Equipment for

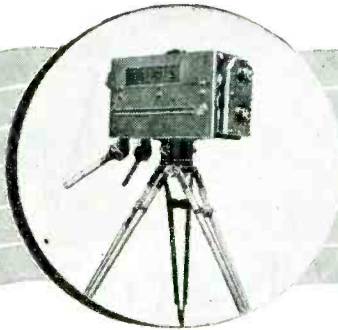
RCA engineers developed the modern "all-electronic" system of television and introduced it to the public more than ten years ago. Practically all of the chief components of the television system in use today were devised by RCA engineers and first demonstrated in RCA equipment.

Before the war, RCA was the main builder of commercial television transmitting equipment — including cameras, control equipment, film scanners, audio and video transmitters, relay transmitters, antennas and field pickup equipment. A considerable number of these equipments are in use today in stations in this country and abroad.

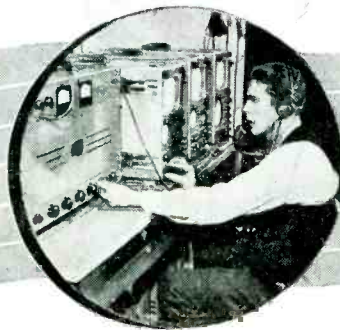
**RCA HAS EVERYTHING  
FOR TELEVISION**



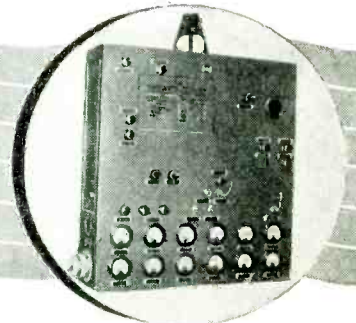
**1. THE ICONOSCOPE** — The "electric eye" of the television camera. Developed by Dr. V. K. Zworykin, RCA scientist, and brought to a high degree of perfection by RCA engineers.



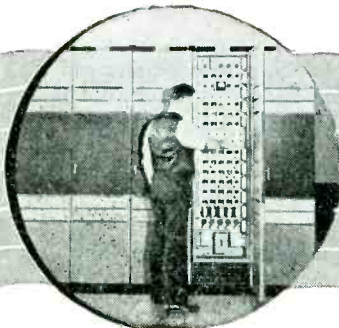
**5. THE FIELD CAMERA** — The RCA field pickup camera shown here is the first camera to use the "orthicon" pickup tube—by far the most satisfactory for "outside" pickups.



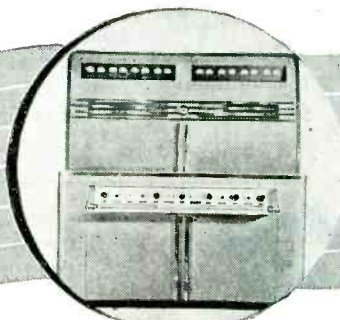
**6. REMOTE PICKUP EQUIPMENT** — RCA engineers built the first television equipment for field pickups—and the first such equipment (shown here) for use with the "orthicon" camera.



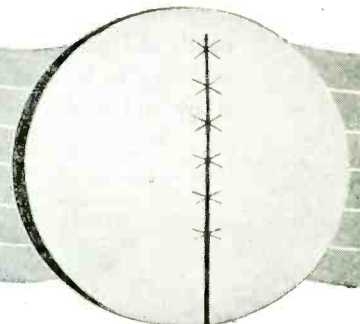
**7. THE RELAY TRANSMITTER** — The first transmitters to be used for television relaying were built by RCA engineers—the one shown here is for relaying from a remote pickup point.



**11. THE SYNCHRONIZING GENERATOR**—Furnishes the signals that key transmitter and receiver together. This type of synchronizing, now almost universally used, was developed by RCA.



**12. THE VIDEO TRANSMITTER**—The first commercially produced video transmitter, the 4 KW model shown here, was designed and manufactured before the war by RCA.

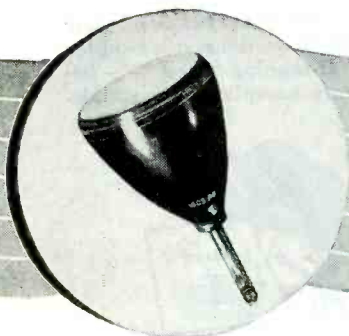


**13. THE TELEVISION ANTENNA**—RCA engineers have designed a large number of antennas for television. The turnstile antenna, shown here, was developed by Dr. G. H. Brown of RCA Laboratories.

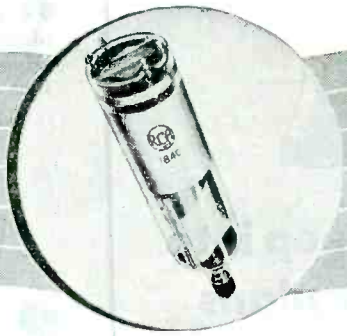
# Television Broadcast Stations

Moreover, RCA engineers, having had actual experience in designing and building commercial television transmitting equipment, have, during the war, been adding to their experience by building for the services the most advanced type of radio and other electronic equipment.

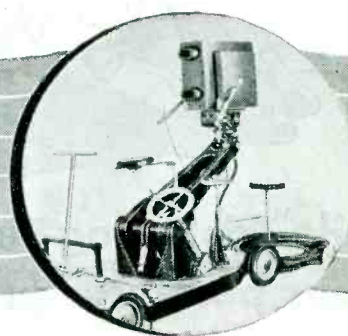
After the war, as before, RCA will be the leader in building television transmitting equipment. For television broadcast stations, RCA will offer a complete new line of equipment—highly efficient, simple to operate, and requiring minimum maintenance.



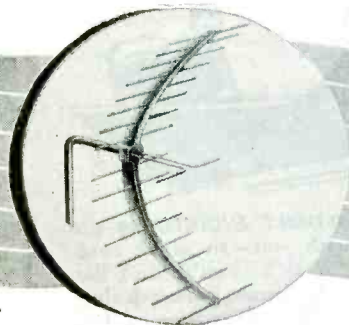
**2. THE KINESCOPE** — The reproducing tube used in all present-day receivers. Developed by Dr. V. K. Zworykin of RCA Laboratories as part of his "all-electronic" television system.



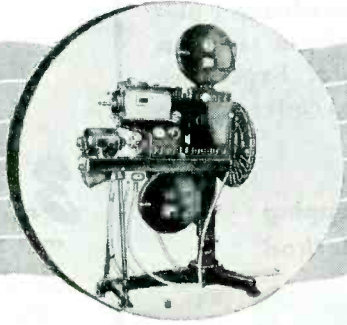
**3. THE "ORTHICON"** — The high-sensitivity pickup tube, which requires much less light and hence makes outside pickups practical. Developed by Dr. Rose and Dr. Iams of RCA Laboratories.



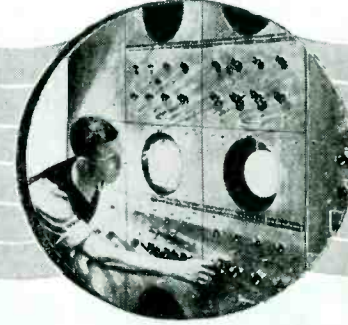
**4. THE STUDIO CAMERA** — Deluxe-type studio cameras shown here were first designed and built by RCA. Cameras of generally similar design are now used in nearly every television studio.



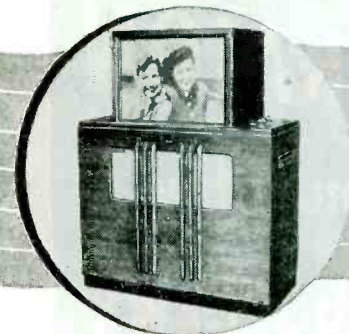
**8. BEAM ANTENNAS** — Beam antennas such as the one shown here, which may be used with the relay transmitter shown at left, are largely based on original RCA research.



**9. THE FILM SCANNER** — The arrangement which allows standard motion picture films (24 frames) to be televised over a 30-frame, interlaced system was devised by RCA engineers.



**10. THE MONITOR EQUIPMENT**—The system of monitoring several video channels by means of a picture tube and an oscilloscope for each channel was first used by RCA engineers.



**14. "BIG SCREEN" RECEIVERS**—RCA engineers designed and RCA factories built the first home television receivers. Their newest contribution, shown here, is the home receiver with a built-in, large-size screen for comfortable viewing from any point in an average-sized living room. Picture is unretouched.

BUY MORE WAR BONDS



For Everything in Television

**RADIO CORPORATION OF AMERICA**

RCA VICTOR DIVISION • CAMDEN, N. J.

# Don't get caught Napping

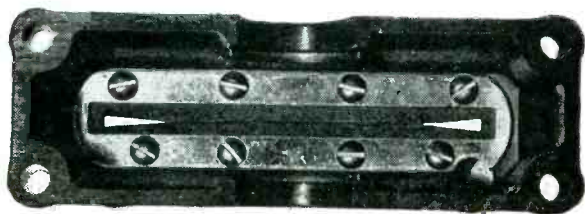


## while "Fastening Bugs" creep into your post-war product plans

The time to decide on fastenings for your post-war product is *now* - while it is still in the design stage. Too many products are all tooled up and in production before "fastening bugs" are discovered. Why wait to change *later*? Why sacrifice the savings you could be making from the start?

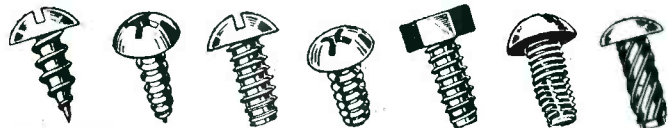
You will want to use P-K Self-tapping Screws wherever possible, because this *short cut fastening method* can save you from 30% to 50% in assembly time and labor. Experience proves you can save time - speed assembly - cut costs - reduce rejects - in 7 out of 10 cases.

...  
**Sperry Products, Inc., eliminates tapping  
with the "Short-cut" Fastening Method**



Eight P-K Type "F" Screws fasten a metal gasket retainer and gasket to an aluminum transmitter cover used on a Hydraulic Control mechanism.

"Tapping these parts would tie up equipment in our machine shop badly needed for other important operations, and seriously delay production," says a Sperry Engineer. Why not make sure of similar savings on your assemblies . . . clear out any needless tapping "bugs" hiding in your plans - *now!*

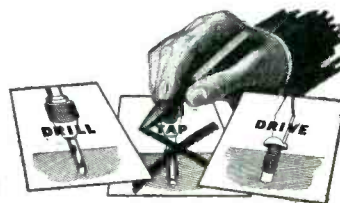


**For Every Metal and Plastic Assembly**

## HERE'S HOW TO START ASSEMBLY SAVINGS WHEN YOU START PRODUCTION



**1. QUESTION EVERY FASTENING** in your plans. Ask - "Can it be done the simpler way - with P-K Self-tapping Screws?" - before you O.K. more complicated methods.



**2. ELIMINATE NEEDLESS TAPPING**, awkward bolting, riveting in hard-to-reach places by specifying one of the several types of P-K Self-tapping Screws designed for all metal and plastics assemblies.



**3. ASK A P-K ASSEMBLY ENGINEER** to go over your plans with you - to make sure you find all the "bugs". You'll find his advice unbiased, because Parker-Kalon makes all types of Self-tapping Screws. Or, send assembly details for recommendations. Parker-Kalon Corporation, 208 Varick St., New York 14, N. Y.

# PARKER-KALON

Quality-Controlled

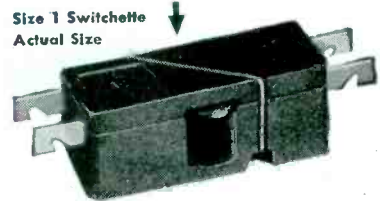
# SELF-TAPPING SCREWS

Announcing



# THE 25-AMP SWITCHETTE

"Big" brother of our little 10-amp Switchette



Size 1 Switchette Actual Size

### AND DON'T FORGET

We also have more than 200 forms of the original (Size 1) Switchette, as well as a variety of compact limit switches, transfer and selector switches, and other control devices built around this tiny contact mechanism. The Size 1 Switchette is rated 10 amperes at 24 volts d-c, and its dimensions are 1 1/4 by 1/2 by 1/2 inch. Bulletin GEA-3818 gives complete specifications and dimensions.

**T**HIS new form of G-E Switchette is suitable for a wide variety of limit-switch and other industrial control applications where space is limited and long life is required.

This new (Size 2) Switchette is rated 25 amperes at 24 volts d-c (115 volts a-c). It has screw-type terminals for easy wiring, and is completely enclosed for protection from dust.

Three contact arrangements are available: single-circuit, normally closed; single-circuit, normally open;

and two-circuit. These Switchettes are suitable for use at altitudes up to 50,000 feet, and in temperatures from 93.5 C to minus 56.6 C. They resist corrosion and high physical shock and vibration, and are designed to withstand millions of mechanical operations.

Approximate dimensions are 2 by 1 3/8 by 1 inch; approximate weight is 2 ounces. Ask your local office for Bulletin GEA-4259, which gives dimensions and complete description. *General Electric Company, Schenectady 5, N. Y.*

Buy all the Bonds you can — and KEEP ALL YOU BUY

# GENERAL ELECTRIC

General Electric Company, Section 676-143  
Schenectady 5, N. Y.

I would like to have more information on Switchettes. Please send me

..... Bulletin GEA-3818, covering Size 1  
..... Bulletin GEA-4259, covering Size 2

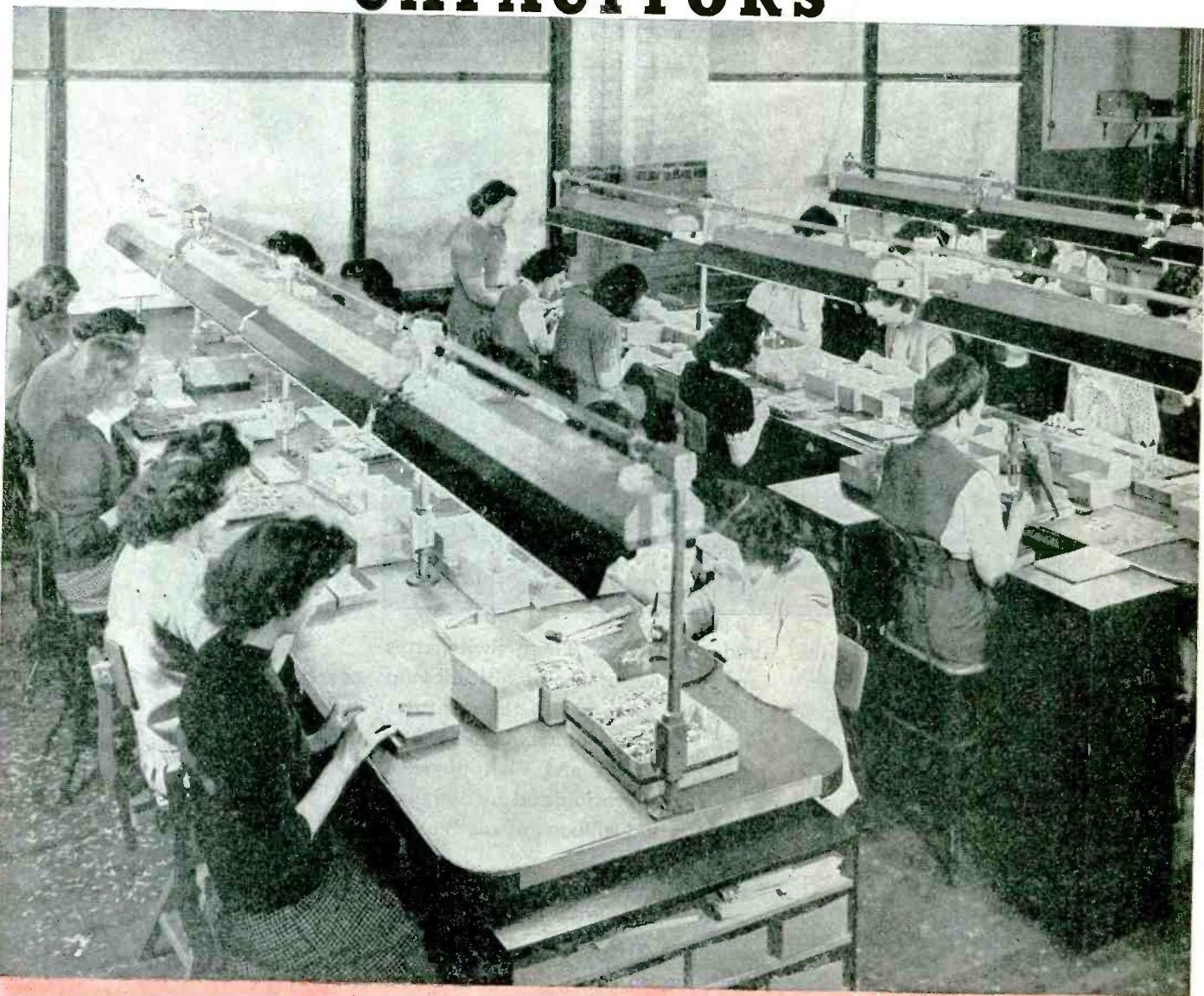
Name.....  
Company.....  
Address.....

8840

**HOW EXCELLENCE IS BUILT INTO**

# Sangamo

**MICA  
CAPACITORS**



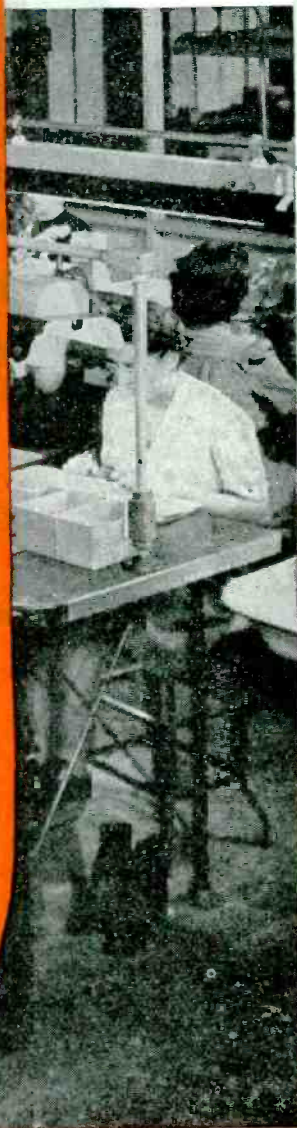
• The above picture shows a group of operators assembling by hand the mica films and foil used in the manufacture of capacitors of small capacitance values. Special assembly fixtures are used to insure accurate positioning of component parts.

**SANGAMO ELECTRIC**

ESTABLISHED 1898 . . . MICA CAPACITORS . . .



★ This operator is assembling mica and metal foils to form a unit which constitutes the essential element of a mica capacitor. Hand operators are utilized where only a few sheets of mica and foil are required for units of low capacitance value. Specially trained operators insure proper placing of component parts, resulting in a finished product of high quality.



## Hand Stacking

Capacitors utilizing mica as a dielectric are manufactured in a complete range of sizes, from very tiny wire lead units having capacity values of as low as  $\frac{1}{2}$  mmfd. to large ceramic-housed units having capacities which may be as high as several microfarads. Voltage ranges, too, vary from small units having dielectric strength test of only 300 volts or less, to those units built to withstand 40,000 or 50,000 volts or more.

In the manufacture of the large units, the stacking of the mica element is performed by special machines designed for that purpose. In the manufacture of the very small units with low capacitance values, plates are sometimes utilized and it is, consequently, impractical to stack these with automatic equipment. In these cases, hand operators are utilized who become very skillful in stacking the alternate layers of foil and mica, and in keeping the exact alignment so necessary for the production of a good capacitor.

Where special characteristics are required, a silver deposit is sometimes placed on the mica and fired on, and thus becomes the conducting plate in the capacitor assembly. By firing silver on mica, very intimate contact is made with the dielectric, and as a consequence, stability, that is, capacitance drift, is improved and special temperature characteristics obtained. It is essential that the silver coating be of uniform texture, with clean, well defined edges, so as to prevent excessive corona and ultimate voltage breakdown of the capacitor unit. Sangamo builds many thousands of the silver mica capacitors each day and is well equipped to produce and test these units in accordance with the required characteristics.



**COMPANY**    **SPRINGFIELD**  
**ILLINOIS**

• • WATT HOUR METERS • • • TIME SWITCHES • • •

# Centralab

## Medium Duty Power Switches



- 7½ amp, 115 V, 60 cycle A. C.
- Voltage breakdown 2500 V to ground D. C.
- Solid silver contacts
- 25,000 cycles of operation without contact failure
- Fixed stops to limit rotation
- 20° indexing

Centralab medium duty power switches are now available for transmitters (has been used up to 20 megacycles) power supply converters and for certain industrial and electronic uses.

It is indicated in applications where the average Selector Switch is not of sufficient accuracy or power rating. Its accuracy of contact is gained by a square shaft, sleeve fit rotor, and individually aligned and adjusted contacts. It is assembled in multiple gangs with shorting or non-shorting contacts. Torque can be adjusted to suit individual requirements. Furnished in 1 pole . . . 2 to 17 positions (with 18th position continuous rotation with 18th position as "off"); and 2 or 3 pole . . . 2 to 6 position including "off".

# Centralab

Division of GLOBE-UNION INC., Milwaukee

PRODUCERS OF Variable Resistors • Selector Switches • Ceramic Capacitors • Fixed and Variable • Steatite Insulators and Silver Mica Capacitors





Let **TEMCO** **Versatility**  
help solve your problems  
with electronics

**T**ODAY many things are being done *better... faster* and more *economically* through the application of electronics. More and more, this amazing new science is performing miracles of increased efficiency in the fields of Communications, Medical Science and throughout all Industry.

In these ever broadening fields, Temco engineers are contributing heavily in the application of electronics to the manifold demands of war. Restrictions do not permit us to describe these achievements now but we can speak about the engineers who made them possible.

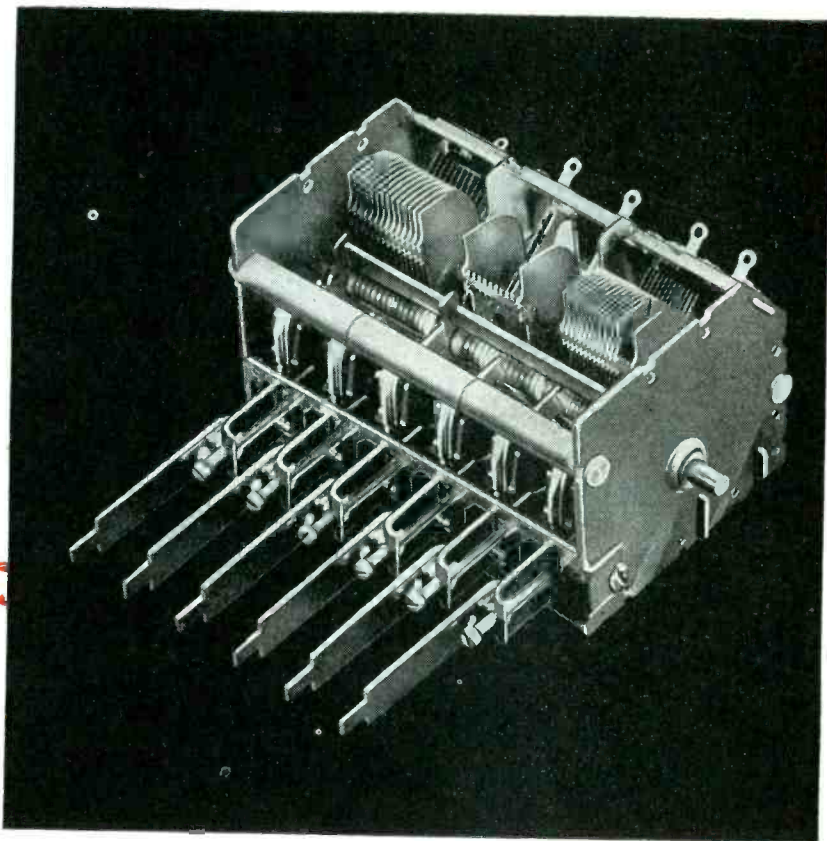
Underlying these accomplishments are the versatility and the vision of a closely knit organization of pioneering minds—rich in ideas—mature in judgement. Keeping pace with progress in radio research, they are constantly meeting the challenge of many new and diversified assignments.

However complex or different your problem may be, bring it to Temco with the assurance that the concerted effort of specialists will yield results to satisfy your most exacting standards and requirements. Let us show you what we have accomplished for others.

**TEMCO**  
**RADIO COMMUNICATION EQUIPMENT**

TRANSMITTER EQUIPMENT MFG. CO., INC.

345 Hudson Street, New York 14, N. Y.



# PRECISION MECHANICAL PUSH BUTTON TUNING

by **R/C**

**T**HE demand will be greater than ever for Automatic Tuning on the Post-war radio.

For a long time past, R/C has led in the development of Mechanical Push Button Tuning Devices. Results have been sturdy, precision-built mechanisms, micro-adjustable to a high degree of accuracy.

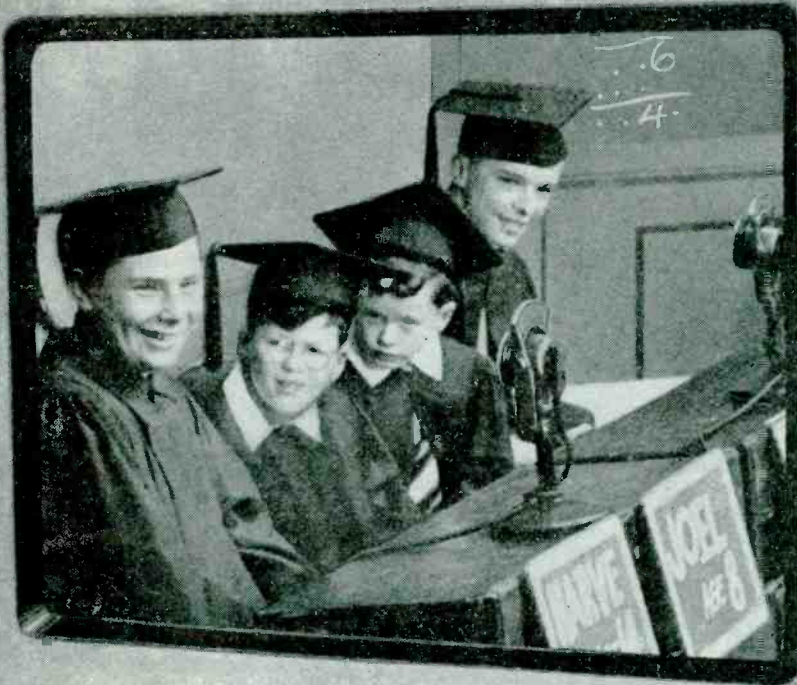
This and many other developments in the Variable Capacitor field attest to the "Know-how" of R/C engineers — "Know-how" gained through almost a quarter of a century of specializing in Variable Capacitors exclusively. Ours is indeed a background founded on a single aim—that of building **ONLY** Variable Capacitors and Mechanical Push Button Tuning Devices and building them well.



## **RADIO CONDENSER CO.**

CAMDEN, N. J.

**RADIO CONDENSER COMPANY, LTD., TORONTO, CANADA**



The *Quiz Kids* say:

**"DUMONT TELEVISION IS COSMIC LEGERDEMAIN"**

You will agree that these diminutive stars,\* while rarely at loss for correct answers, are seldom available when prospective operators of postwar Television stations have questions to ask. Fortunately, DuMont Television "know how" can be tapped as needed... cost and engineering data on every phase of station design, construction and operation... the accumulated knowledge gained through more than 4 years' station management and production of programs.

The low operating cost, extreme flexibility and rugged dependability of DuMont Television

transmitting equipment are being convincingly demonstrated week-in and week-out in 3 DuMont-equipped stations. New postwar designs embody all wartime advances. You can arrange *now* for early peacetime delivery of station equipment and training of personnel through the DuMont Equipment Reservation Plan. Visit DuMont's Station WABD, New York. Call, write or telegraph for appointment... Station Equipment Sales Division, Allen B. DuMont Laboratories, Inc., 515 Madison Avenue, New York 22, N. Y.

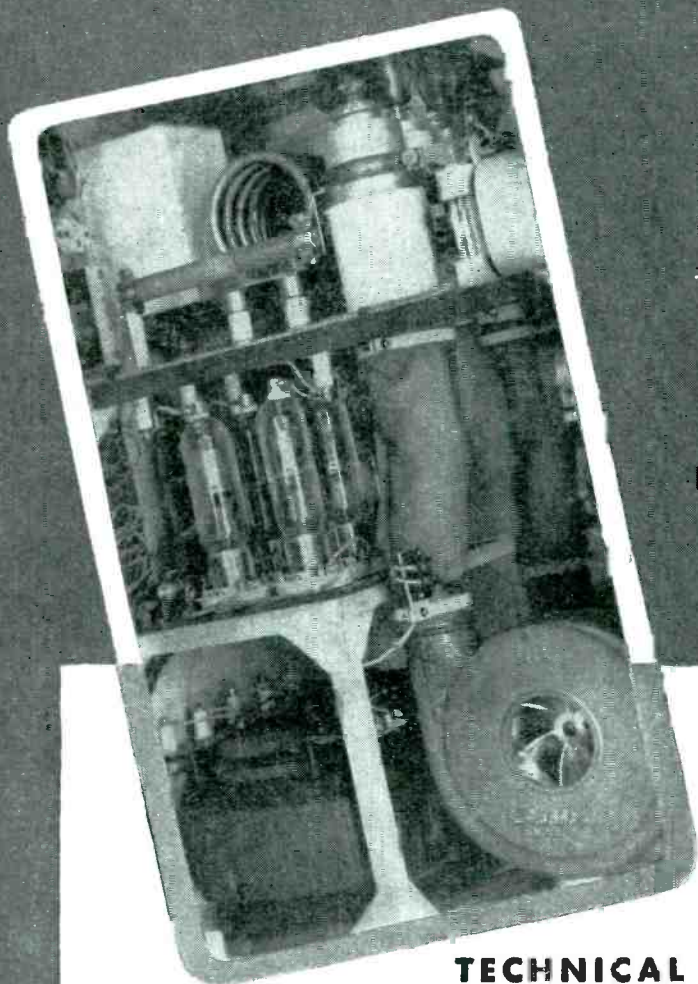
\* Appearing Sunday evenings on the Blue Network.

Copyright 1945, Allen B. DuMont Laboratories, Inc.



ALLEN B. DUMONT LABORATORIES, INC., GENERAL OFFICES, 2 MAIN AVE., PASSAIC, N. J.  
TELEVISION STUDIOS AND STATION WABD, 515 MADISON AVENUE, NEW YORK 22, N. Y.

# PACKED WITH POWER



## THE NEW Thermatron "HEATMASTER"

**ELECTRONIC DIELECTRIC  
HEAT GENERATOR  
5 KW OUTPUT\***

Looking into electronic dielectric heating applications for **your** business? Specify the 5 KW "Heatmaster"—get enough power. Many important production savings through use of high frequency heating have been passed up due to insufficient power in making initial tests.

### TECHNICAL DATA

**OUTPUT**—5 KW p.u.s.

**INPUT**—3 KVA (approximate).

**LINE VOLTAGE**—220 volt 60 cycles, 3 phase.

**FREQUENCY**—30 mc. — 15 mc. — 5 mc. optional.

**HEAT OUTPUT** — Jp to 17,000 BTU's per hour

**OUTPUT CIRCUIT**—Permits heating of loads of widely varying characteristics with a minimum amount of adjustment.

**TUBES**—New long-life external anode tubes.

**SIZE**—24" wide; 28" deep; 59" high.

**WEIGHT**—Approximately 1000 lbs.

Completely self-contained ready-to-use. A compact power-packed model, particularly designed for heavy-duty where floor space is at a premium. Will heat a 3.3 pound preform in one minute or a 5 pound preform in 90 seconds. Its generous capacity also makes it suitable for rugged general purpose production use as well as research requirements involving substantial power.

Complete specifications of the new THERMATRON "Heatmaster" and other standard models from 500 watts to 30 kilowatts contained in our new circular sent on request. Custom equipment up to 125 KW designed and built.

*\* All Thermatrons rated on output*

## Thermatron Division

**RADIO RECEPTOR COMPANY, Inc.**  
251 WEST 10th STREET  
NEW YORK 11, N. Y.

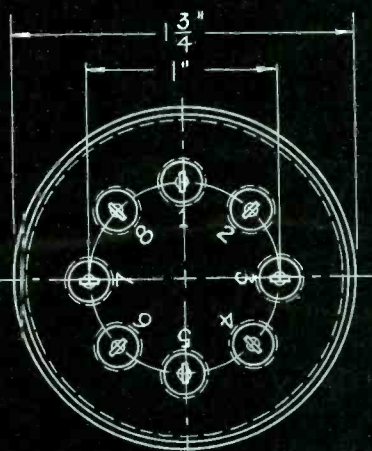
Engineers and Manufacturers of Army and Airport Radio Equipment  
SINCE 1922 IN RADIO AND ELECTRONICS



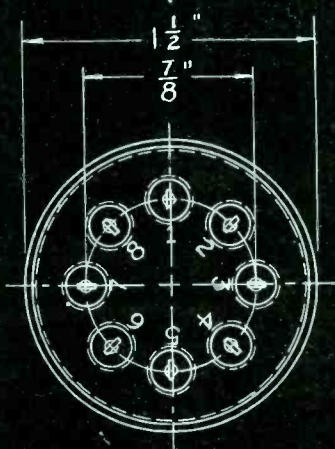
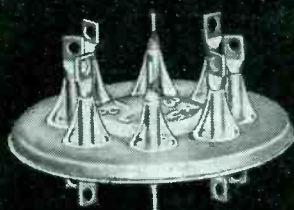
# Multi-Terminal Hermetic Seals

BY

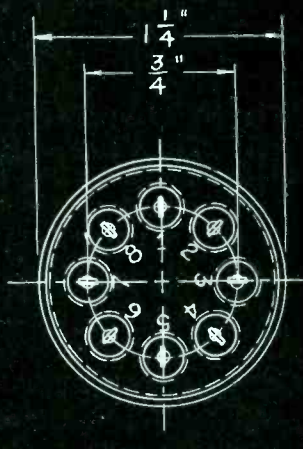
# STUPAKOFF



PART 9093-3A



PART 9093-2A



PART 9093-1A

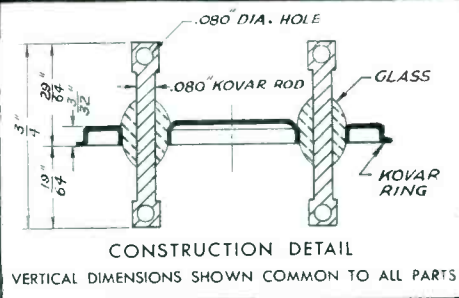
ALSO AVAILABLE IN STYLE B WITH 4 INSTEAD OF 8 TERMINALS AS SHOWN.  
4 OR 8 TERMINALS STANDARD—OTHERS ON SPECIAL ORDER

**T**HE Stupakoff Multi-Terminal Hermetic Seals illustrated were developed primarily for transformer application. They offer exceptional advantages to manufacturers concerned with the sealing of electrical components.

Each seal is individually tested to withstand a minimum pressure of 30 pounds—electrical breakdown of 3400 volts—insulation resistance of 500 megohms—thermal shock from 94° C to 4° C. Relatively low in initial cost, the one piece construction eliminates individual soldering of terminals, resulting in lower handling and assembly costs, fewer rejects in the finished product.

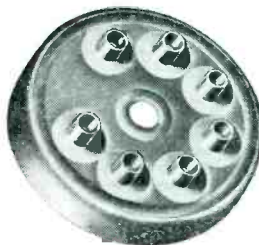
Stupakoff hermetic seals are made with the alloy, Kovar,\* which matches the expansivity of certain hard glasses from -80° to +450° C (approximate annealing point of the glass). Through a heating process, the oxide of Kovar is dissolved into the glass to form a perfect bond—effective under the most extreme climatic conditions.

For users equipped for glass working, Stupakoff supplies Kovar as sheet, rod, wire, tubing, or fabricated into cups, eyelets, and special shapes. Completed seals in many styles are furnished with single or multiple, solid or hollow electrodes. Write Department K-56 for literature, samples, and deliveries on positive hermetic seals for your product.



CONSTRUCTION DETAIL

VERTICAL DIMENSIONS SHOWN COMMON TO ALL PARTS



### ONE PIECE HEADER

Stupakoff pioneered in the construction of Multi-Terminal Hermetic Seals. The illustration at left is taken from Technical Data Sheet KV 7 published by Stupakoff in May 1937.

\* TRADE MARK 337962 REGISTERED IN U. S. PATENT OFFICE



STUPAKOFF CERAMIC AND MANUFACTURING CO., LATROBE, PA.

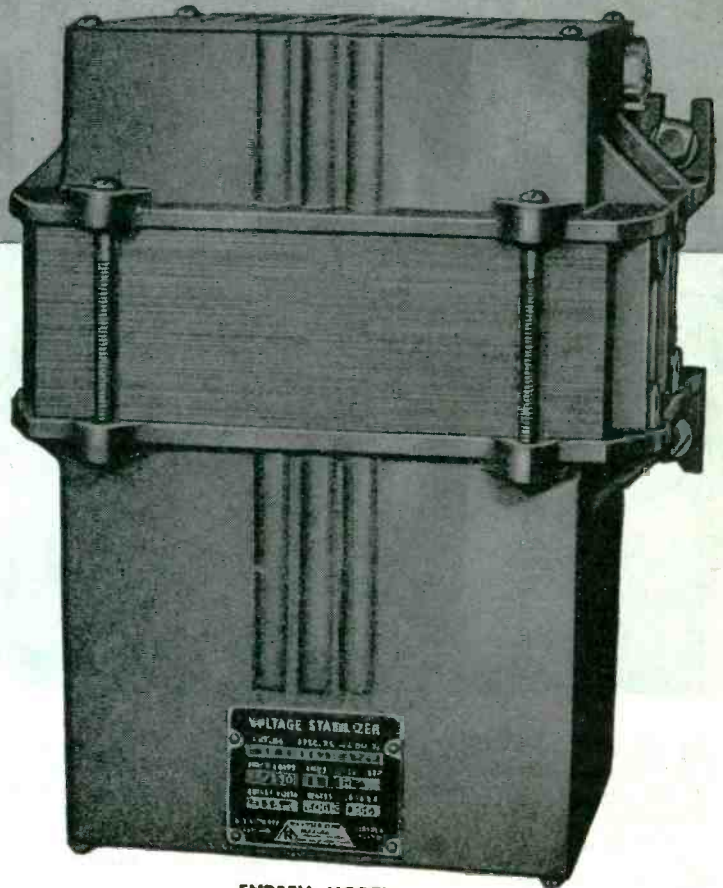
*Products for the World of Electronics*



# How RAYTHEON VOLTAGE STABILIZERS

## Assure Dependable Operation of Precision Equipment

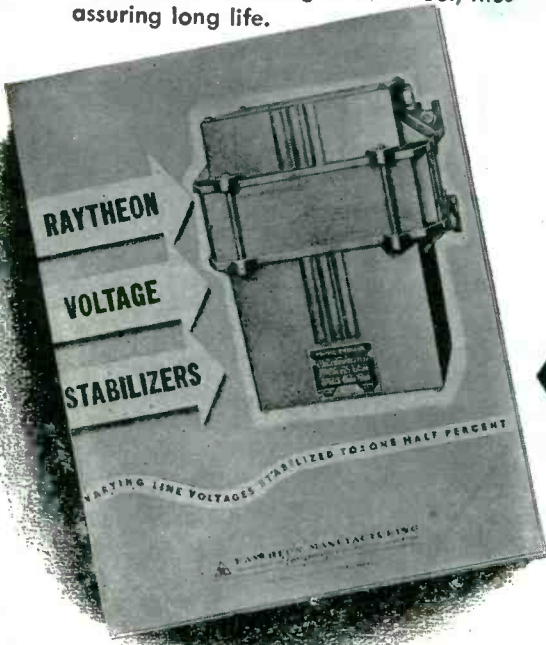
- **CONSTANT AC OUTPUT VOLTAGE**  
Raytheon Voltage Stabilizers control fluctuating input voltages and hold constant output voltage to  $\pm \frac{1}{2}\%$ .
- **WIDE AC INPUT VOLTAGE LIMITS**  
Raytheon Voltage Stabilizers will stabilize input voltages varying from 95 to 130 volts.
- **QUICK RESPONSE**  
Raytheon Voltage Stabilizers stabilize the varying input voltage *within 2 cycles*. Variations cannot be observed on an ordinary volt meter.
- **ENTIRELY AUTOMATIC**  
Raytheon Voltage Stabilizers are entirely automatic in operation. They require no adjustments or maintenance.
- **NO MOVING PARTS**  
Raytheon Voltage Stabilizers have no moving parts . . . Nothing to wear out, thus assuring long life.



ENDBELL MODEL

### SEND FOR THIS NEW BULLETIN . . .

*It contains a complete description of how the stabilizer operates, its advantages, performance curves, dimensions and other pertinent facts. Simply request Bulletin DL 48-537 and your copy will be promptly mailed.*



The coveted Army-Navy "E", for Excellence in the manufacture of war equipment and tubes, flies over all four Raytheon Plants where over 12,000 men and women are producing for VICTORY.

**RAYTHEON MANUFACTURING**  
*Company*

190 WILLOW ST WALTHAM, MASS



ANOTHER  
**Jensen**  
 SPEAKER WITH  
**ALNICO 5**

• The reproducer unit in this loud speaker was especially developed by JENSEN for use in the intercom systems in navy vessels. It reproduces speech clearly and sharply through high levels of noise. Ruggedly built, it withstands extreme shock and vibration, and is weatherproof against severe weather exposure conditions, dust and smoke . . . Like all JENSEN military models, this speaker is built around the most powerful permanent magnet mate-

rial ever developed, **ALNICO 5**, as all JENSEN PM Speakers will be when conditions permit.

Now being introduced for the intercom systems on trains, and specifically designed for that purpose, this particular model has many possibilities for use wherever a heavy, rugged speaker with clear, sharp speech reproduction is needed. Write for complete engineering data on this speaker. Samples can be furnished on proper priority.



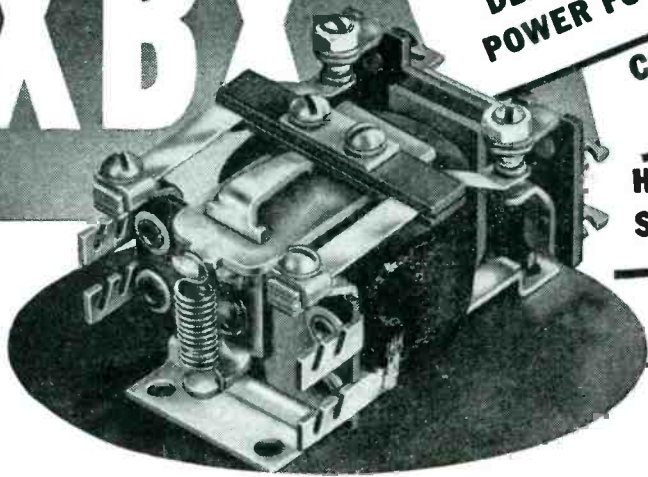
**Jensen**  
 SPEAKERS WITH

**ALNICO 5**

*Specialists in Design and Manufacture of Acoustic Equipment*

JENSEN RADIO MANUFACTURING COMPANY, 6601 SOUTH LARAMIE AVENUE, CHICAGO 38, ILLINOIS

# 10XBX



**DELIVERS A LOT OF  
POWER FOR ITS SIZE**

**COVERS A WIDE RANGE  
OF APPLICATIONS**

**HIGHLY RESISTANT TO  
SHOCK AND VIBRATION**

## ... A GOOD RELAY TO KNOW!

If any Relay type ever deserved the name "All-Purpose" it is Type 10XBX of the Struthers-Dunn 10-frame series. While new and special types come and go, this popular 2P. D.T. relay continues in heavy favor with leading users to whom its extreme versatility on a wide range of applications holds strong appeal. From audio frequency circuits to motor control circuits; from naval battle announcing stations where shock resistance is important, to aircraft use where vibration is a big factor, 10XBX relays are performing competently and well.

These relays are light, small, and

sturdy. Highly electrically efficient, they deliver a lot of power for their size. Contact pressures up to 50 grams are available. Bakelite insulation is supplied for power circuit applications, and ceramic insulation for radio-frequency use. A-C coils to 115v, 60 cycles; or d-c coils to 115v are available. Contacts may be in any desired combination up to and including 3 pole, double throw. All 10XBX relays withstand 10G vibration and are highly resistant to shock. Other relays of the 10-frame series are available in either single or three pole contact arrangements.

**STRUTHERS-DUNN, Inc., 1321 ARCH ST., PHILADELPHIA 7, PA.**

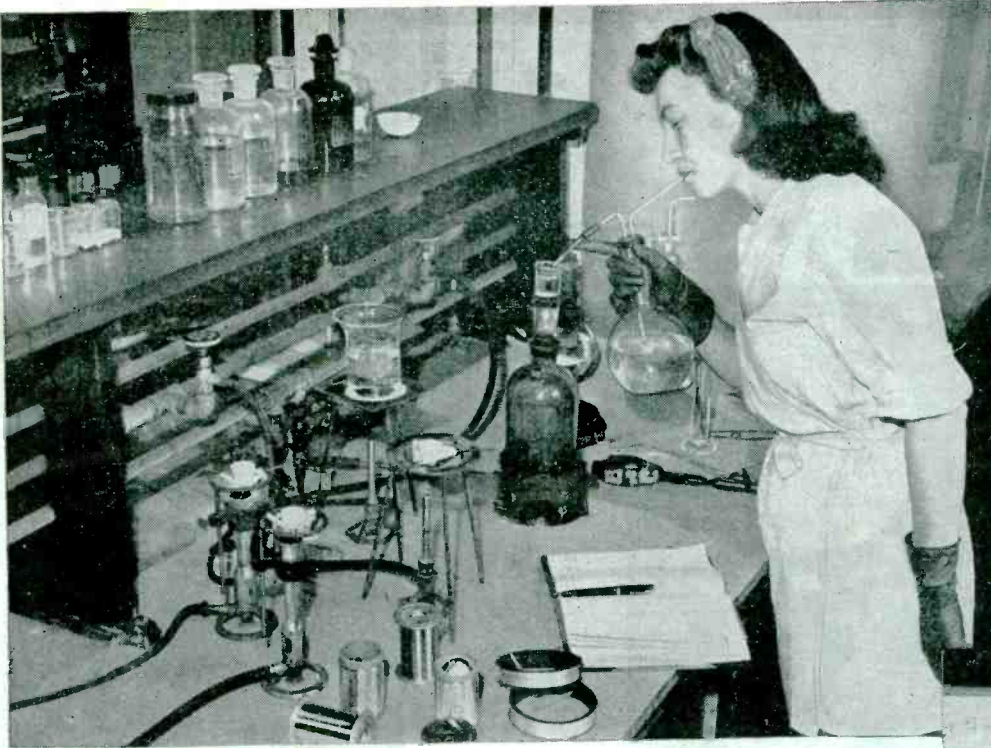
*WRITE for the big Struthers-Dunn 48-page  
Catalog and Relay Engineering Data Book.*

# STRUTHERS-DUNN

## 5,312 RELAY TYPES

**DISTRICT ENGINEERING OFFICES: ATLANTA • BALTIMORE • BOSTON • BUFFALO • CHICAGO • CINCINNATI • CLEVELAND  
DALLAS • DENVER • DETROIT • HARTFORD • INDIANAPOLIS • LOS ANGELES • MINNEAPOLIS • MONTREAL  
NEW YORK • PITTSBURGH • ST. LOUIS • SAN FRANCISCO • SEATTLE • SYRACUSE • TORONTO • WASHINGTON**





Preparing a unit sample of fine wire for checking percentage of gold by weight of base metal. This chemical operation removes the wire core. Each spool is tested and recorded in test book (see below).

## Checking Amount of Gold on Clad Wire

The superior quality of NORELCO gold-clad fine wire is the result of closely-controlled processing techniques and rigid tests that insure precise adherence to all customers' specifications.

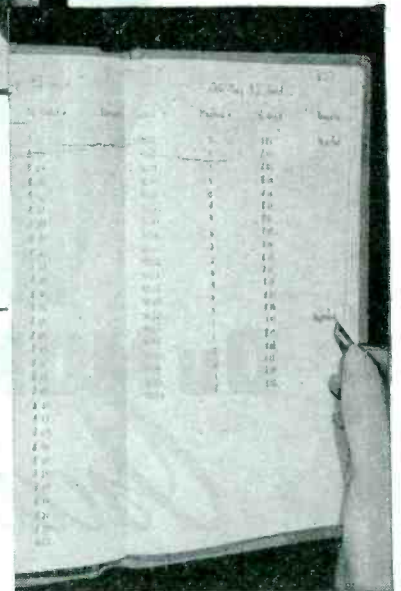
As an example, the special cladding equipment designed by our engineers can coat fine wire with percentages of gold by weight ranging from 0.1% to heavy layers with great accuracy. Where tolerances are not specified, the gold coating is made slightly in excess of the percentage called for.

To make sure that tolerances are being maintained, a specimen from each spool is tested for its gold percentage. A unit sample is chemically treated to dissolve the base metal, and the remaining gold weighed on precision scales.

North American Philips manufactures gold-clad fine wire up to .010" diameter in base metals of silver, tungsten, molybdenum and radio alloys. We also manu-

facture fine wire below .003" in silver, copper, nickel-chrome, aluminum alloy and other metal alloys. Radio tube manufacturers have found our unusual skill of great value in helping them meet wartime production schedules and reduce material shrinkage. North American Philips has the knowledge of processes and techniques developed by an organization with a background of over half a century in the electrical field. Call on our specialized engineering service whenever you have a fine-wire problem.

**OTHER PRODUCTS:** In addition to fine wire and diamond dies for our own drawing, we make: Tungsten and Molybdenum products; Quartz Oscillator Plates; Amplifier, Transmitting, Rectifier and Cathode Ray Tubes; Searchray (Industrial X-ray) Equipment; X-ray Diffraction Apparatus; Medical X-ray Equipment, Tubes and Accessories. We invite you to visit our office and showroom when in New York City.



Where NORELCO Fine Wires Are Used in the Electronics Field — Precision wire-wound resistors; hearing aids; radio head phones; sensitive recording and indicating meters; sensitive relays; electronic tube grids and filaments; fractional horsepower motors and hundreds of other uses wherever fine wire is required.

 **Norelco** ELECTRONIC PRODUCTS by  
**NORTH AMERICAN PHILIPS COMPANY, INC.**

Executive Offices: 100 East 42nd Street, New York 17, N. Y.  
Factories in Dobbs Ferry, N. Y.; Mount Vernon, N. Y. (Metalix Division); Lewiston, Maine (Elmet Division)

Send for NORELCO Fine Wire Booklet on your letterhead. It contains valuable conversion tables for ready reference of buyers and design engineers.



North American Philips Company, Inc.  
100 East 42nd Street, New York 17, N. Y.

Gentlemen:

Please send me a copy of your booklet "Norelco Fine Wire."

Name \_\_\_\_\_

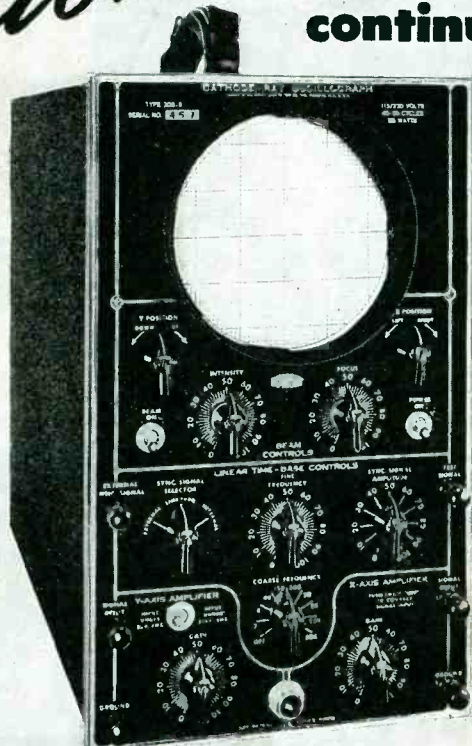
Title \_\_\_\_\_

Company \_\_\_\_\_

Address \_\_\_\_\_

Dept. S-5

# Pioneering- continued



## DuMONT

# Oscillography

◆ A decade and a half ago Allen B. DuMont conceived the idea of commercializing the cathode-ray tube and exploiting to the full the many possibilities of this amazing device. Until then it had been a scientific curiosity limited to a few laboratories with lavish budgets.

In the few intervening years DuMont pioneering has evolved many types of cathode-ray tubes. Likewise oscillographs and allied equipment. And the DuMont application "know-how" has grown apace. Since 1941 the DuMont organization has engaged 100% in the war effort. Plans are now ready for the coming peace. Such is DuMont pioneering—past, present, continued.

© ALLEN B. DUMONT LABORATORIES, INC.

TYPICAL DUMONT

# Pioneering-

- ◆ The first low-priced commercialized cathode-ray tubes for general use.
- ◆ Self-contained single-unit low-priced cathode-ray oscillographs.
- ◆ Oscillographs facilitating the investigation of transient as well as recurrent phenomena over a wide frequency range.
- ◆ Cathode-ray modulation monitor for checking and maintaining highest broadcast standards.
- ◆ Large-screen oscillographs such as DuMont 20" Type 233 for detailed analysis of fine-structure wave forms and for lecture demonstrations.
- ◆ Intensifier electrode in tubes for maximum sensitivity and increased brilliance.
- ◆ DuMont powder-testing oscillographs for evaluating explosives and meeting set standards.
- ◆ The exclusive DuMont Cyclograph for the non-destructive inspection of ferrous and non-ferrous materials and products compared with known standards, and providing a 100% quality-of-production control.
- ◆ The electronic switch which places the oscillograms of two signals on a single oscillograph screen for direct comparison or simultaneous study.
- ◆ The Resonoscope—the only visual method of determining the correct pitch of musical instruments or voice.
- ◆ Simplified television equipment from camera and control room to transmitting antenna, making telecasting service available even to the smaller population centers.
- ◆ DuMont Station WABD in New York which has an enviable record for scheduled programs and for the evolution of commercialized television.

# DUMONT

# Precision Electronics & Television

ALLEN B. DUMONT LABORATORIES, INC., PASSAIC, NEW JERSEY • CABLE ADDRESS: WESPEXLIN, NEW YORK

A black bear is shown in a cage, looking out through the metal bars. The background is a solid orange color. The bear's fur is dark and textured, and its eyes are visible through the bars.

# *A new twist in* **LUMARITH\* CA**

## **TO BAR THE BLACK HAND OF CORROSION**

IN EFFECTIVELY blocking electro-chemical corrosion, Lumarith CA provides the planned, built-in protection possible with synthetics—freedom from organic decomposition and other hazards natural to many materials.

Lumarith CA resists the effects of transformer oil. It maintains high dielectric strength under the most adverse conditions of humidity.

Lumarith CA films and foils are tough and flexible. They ruggedly maintain coverage, assure crack and fold-break resistance, and provide low space-factor. Special mat finish (A78) prevents slippage in winding and other applications, and provides ample elongation. Lumarith CA is a favorite with laminators. Also available in sheets, rods, tubes and molding materials. Send for the reference booklet, "Celanese Synthetics for the Electrical Industry." Celanese Plastics Corporation, a division of Celanese Corporation of America, 180 Madison Ave., New York 16, N. Y.

\*Reg. U. S. Pat. Off.


**EXECUTIVES!** Just published, 136 page manual entitled, "FABRICATING METHODS FOR LUMARITH\* CELLULOID\* AND SIMILAR THERMOPLASTIC MATERIALS." Write for complimentary copy on your company letterhead. Additional copies, \$1 each.



**SPIRAL WOUND  
LUMARITH TUBING—**

highly crush-resistant and with the same high voltage breakdown of other forms of Lumarith CA. Wide range of lengths, diameters and wall thicknesses suitable to many applications. Ideal in grommets—furnished one end spun for tight, lasting fit. Also for spaghetti, and coil cores with or without flanges.

*A Celanese\* Plastic*



**"The Boss is kicking himself  
all over the shop..."**



**... for thinking he couldn't afford to use these  
AMERICAN PHILLIPS SCREWS!"**


Yes, it's always a shock (*but a welcome one!*) to see how much has been missed by sticking to slotted screws because of a mistaken idea that American Phillips Screws cost more. In small shops and big plants, cost-comparisons, production sheets and inspectors' reports always tell this same story: *The screws that really COST LEAST to use are American Phillips Screws.*

And that's simply because an American Phillips Screw is not a loose end on the driver. It's a firm-fitting, self-aligned part of the 4-winged Phillips driver which can't twist out or drive crooked. This means ease and certainty

of handling and operation which pays off in time-savings of at least 50% in unscarred work-surfaces and unbroken screw-heads . . . in lower fatigue and higher morale among workers . . . in higher output and lower fixed costs. And there are still other cost-cutting advantages in the *American* brand of Phillips Screws . . . 3-point inspection of head, thread and point, to give you highest "perfection-percentage" in every lot of screws shipped . . . and American engineering experience to solve your special fastening problems. Try American Phillips Screws yourself . . . and see how they cut *your* costs, too.

**AMERICAN SCREW COMPANY, PROVIDENCE 1, RHODE ISLAND**

Chicago 11: 589 E. Illinois Street — Detroit 2: 502 Stephenson Building



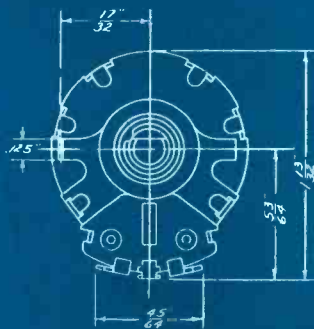
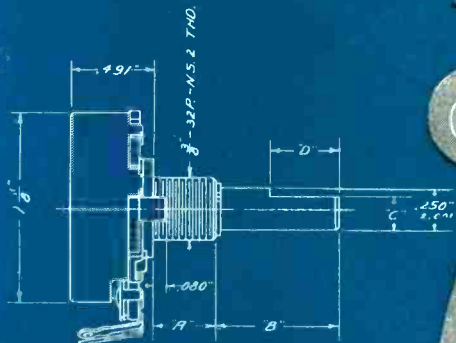
**AMERICAN  
PHILLIPS** *Screws*

PUT THE SCREWS  
ON THE JAPS . . .  
BUY WAR BONDS

# Dependable

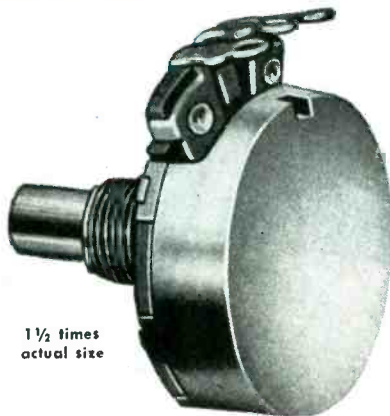
## VARIABLE RESISTORS

### SPACE REQUIREMENTS FOR 35 SERIES AND AC-35 SERIES



35 SERIES (above)

AC-35 SERIES



1 1/2 times actual size

Dependability in CTS variable resistors is considerably more than just meeting a customer's specifications. Years of research and experience in this one highly specialized field have taught CTS engineers to fit their products to each customer's needs.

It sometimes happens, in the hectic process of drawing up specifications for a new product, that some slight error creeps in. This must be corrected later at the manufacturer's expense. CTS avoids this costly procedure by submitting samples on each variable resistor order for new applications. Thus oversights are corrected *before* production begins.

Such complete dependability in every phase of operation has made CTS variable resistors the leaders throughout the world.

CTS delivery promises are as dependable as CTS products. For your variable resistor needs, call on Chicago Telephone Supply Company.

*Manufacturers of Quality Electro-Mechanical Components Since 1896*



VARIABLE RESISTORS  
PLUGS AND JACKS  
SWITCHES, RINGERS  
TELEPHONE GENERATORS

#### REPRESENTATIVES

R. W. Farris Co.  
406 West Thirty-fourth Street  
Kansas City 2, Missouri  
Phone: Logan 7495

Frank A. Emmet Co.  
2837 West Pico Boulevard  
Los Angeles 6, California  
Phone: Rochester 9111

#### BRANCH OFFICES

S. J. Hutchinson, Jr.  
401 North Broad Street  
Philadelphia 8, Pennsylvania  
Phone: Walnut 5369

IN SOUTH AMERICA  
Jose Luis Pontet

Cordoba 1472  
Buenos Aires, Argentina  
South America

IN CANADA  
C. C. Meredith & Co.  
Streetsville, Ontario

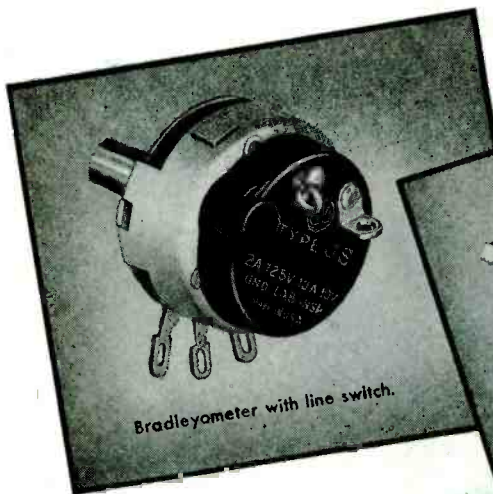
Masculino 2624  
Montevideo, Uruguay  
South America

IN ENGLAND  
Chicago Telephone Supply Co.  
St. John's Woods  
103 Grove End Gardens  
London, N. W. 8, England

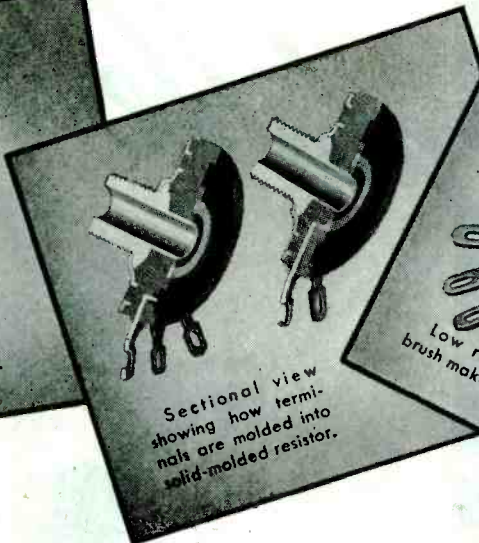
Av. Cons. Rodrigues  
Alves 1057  
Sao Paulo, Brazil  
South America

**CHICAGO TELEPHONE SUPPLY**  
*Company*

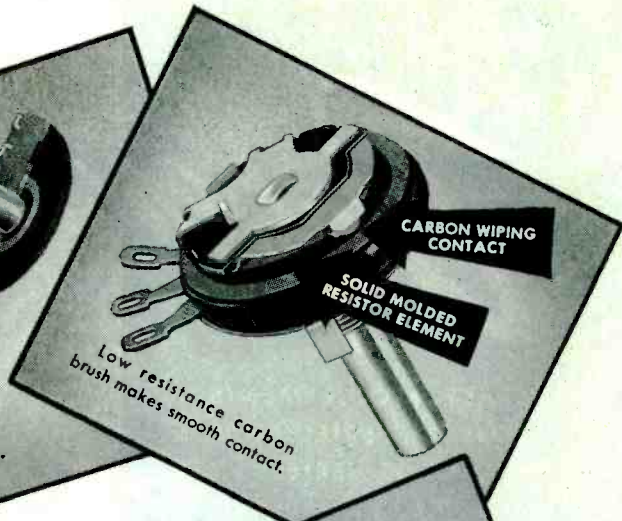
ELKHART • INDIANA



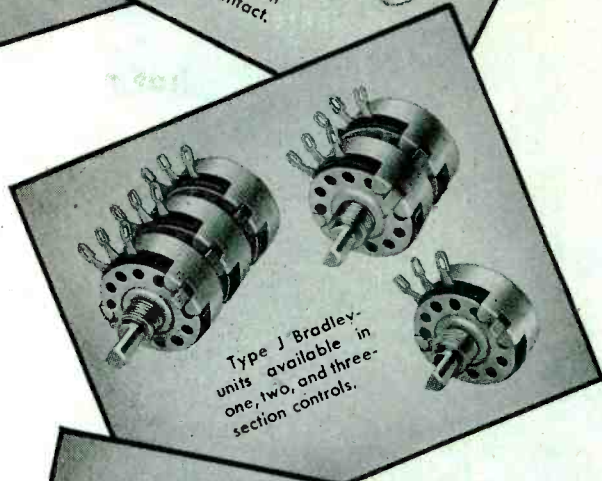
Bradleyometer with line switch.



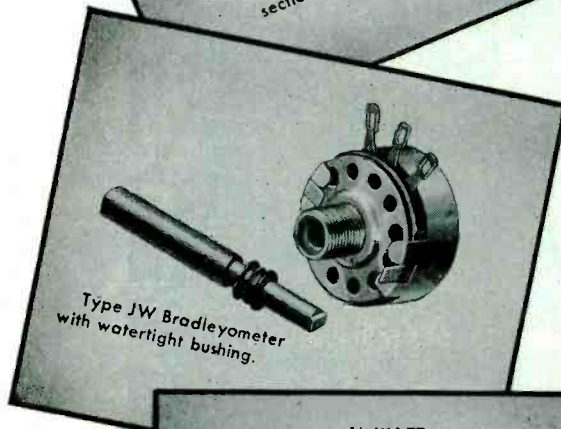
Sectional view showing how terminals are molded into solid-molded resistor.



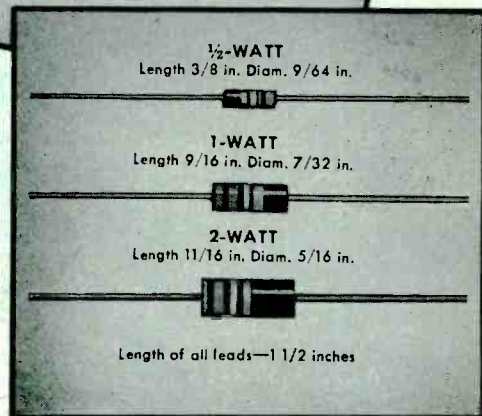
Low resistance carbon brush makes smooth contact.



Type J Bradley units available in one, two, and three-section controls.



Type JW Bradleyometer with watertight bushing.



**1/2-WATT**  
Length 3/8 in. Diam. 9/64 in.

**1-WATT**  
Length 9/16 in. Diam. 7/32 in.

**2-WATT**  
Length 11/16 in. Diam. 5/16 in.

Length of all leads—1 1/2 inches

# In War Service these Resistors are "TOPS"

War Service... that's the real test for resistors! Only one thing that counts... unfailing dependability. And in every combat zone Allen-Bradley fixed and adjustable resistors have proved to be "tops." They are the choice of the experts because they withstand all extremes of temperature, pressure, and humidity.

Allen-Bradley insulated fixed resistors (Bradleyunits) are available in 1/2-watt, 1-watt, and 2-watt ratings with 1 1/2-inch leads, and in tolerances of 5, 10, and 20 per cent.

Allen-Bradley adjustable resistors (Type J Bradleyometers) are the only continuously adjustable composition resistors of 2-watt rating with substantial safety factor. That is why they are preferred for war service.

Write for specifications today.

Allen-Bradley Company  
110 W. Greenfield Ave., Milwaukee 4, Wis.



# ALLEN-BRADLEY

## FIXED & ADJUSTABLE RADIO RESISTORS



# THE WESTINGHOUSE

# IGNITRON

...the electronic tube that revolutionized the use of D-C power is the key to many more electronic applications.

In 1932 Westinghouse created the sealed ignitron, making possible compact portable equipment to supply the heavy and precisely timed d-c currents required in resistance welding. High-speed welding of aluminum and stainless steel became possible, and volume production of uniformly welded products became economically practical.

Today there are two basic types of Westinghouse sealed ignitrons: One for resistance welding; the other for power conversion.

There are four Westinghouse welding ignitrons, rated up to 2400-kva capacity. While they are now used mainly for joining light metals, they are capable of handling heavy metals. The wartime experience gained in resistance welding similar and dissimilar metals is opening new opportunities in the field of fabrication.

There are two Westinghouse ignitrons for power rectifier applications: a 100-ampere and a 150-ampere tube at d-c output voltages up to 600-volts. Ignitron rectifiers often can be used profitably to replace conventional rectifying equipment. The high capacity of the ignitron opens a new field in motor speed control where motors of greater than usual horsepower must be controlled within very close limits.

Westinghouse ignitrons are now available in your Westinghouse distributors stock for immediate delivery.

Westinghouse engineers will be glad to advise you on problems of application of the ignitron. Write Westinghouse Electric & Manufacturing Company, Lamp Division, Bloomfield, N. J.

## Westinghouse

PLANTS IN 25 CITIES OFFICES EVERYWHERE

*Quality Controlled Electronic Tubes*

WL 651/656 For Welding Service  
Maximum Welder Demand 1200 kva  
Maximum Average Current per tube 140.0 amp  
Maximum RMS Supply Voltage 600 volts

WL 681/686 For Welding Service  
Maximum Welder Demand 300 kva  
Maximum Average Current per tube 22.4 amp  
Maximum RMS Supply Voltage 600 volts

WL 679 For Rectifier Service  
D-C Output Average Current per tube  
Voltage Continuous 2 hours 1 minute  
300 100 amp 150 amp 200 amp  
600 75 amp 112.5 amp 150 amp

WL 653-B For Rectifier Service  
D-C Output Average Current per tube  
Voltage Continuous 2 hours 1 minute  
300 200 amp 300 amp 400 amp  
600 150 amp 225 amp 300 amp

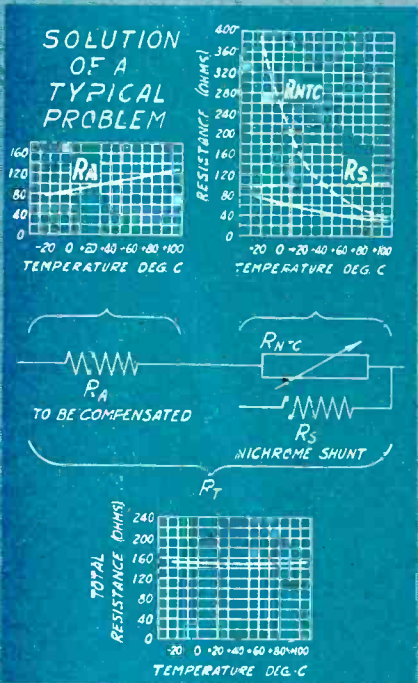


WL 655/658 For Welding Service  
Maximum Welder Demand 2400 kva  
Maximum Average Current per tube 355.0 amp  
Maximum RMS Supply Voltage 600 volts



# Here's How to CANCEL-OUT RESISTANCE CHANGES DUE TO TEMPERATURE WITH KEYSTONE "NTC" UNITS

- ✓ Purely Electrical Method
- ✓ Efficient—less added resistance
- ✓ For AC or DC
- ✓ Lightweight, compact
- ✓ Close compensation over range as wide as  $-55^{\circ}\text{C}$  to  $+150^{\circ}\text{C}$



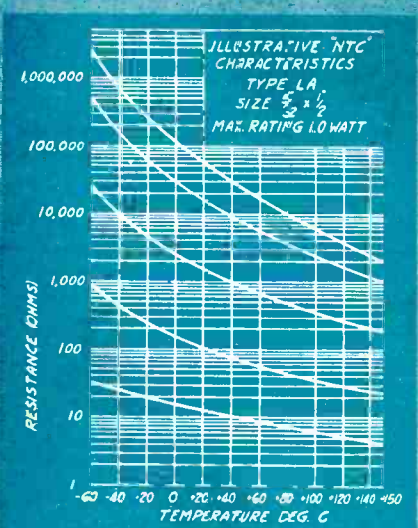
## NOW . . . EFFICIENT, SIMPLE COMPENSATION FOR WIDE VARIETY OF ELECTRICAL DEVICES

MODERN war has demonstrated that the extremes of world climate are only hours away . . . has clearly indicated the expanded temperature range over which many precision electrical devices must operate if they are to meet the demands of the future.

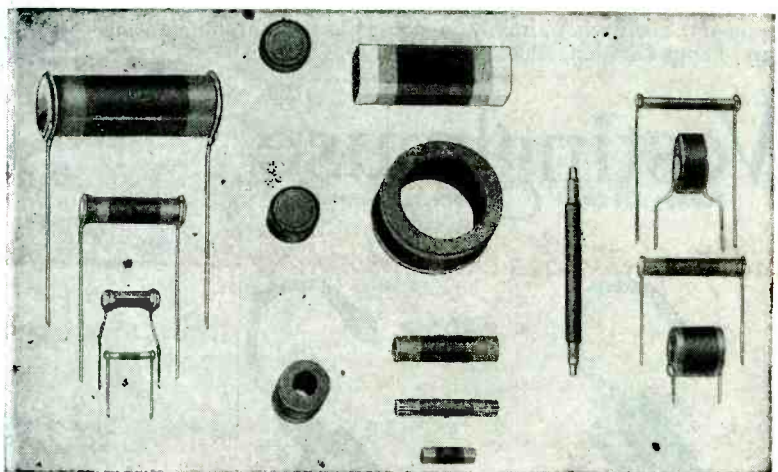
The inherent positive temperature coefficient of copper (and many other pure metals) results in large variations in current flow and voltage drop in windings and conductors when the temperature range is great. If uncompensated, wide-tolerance performance is probable. If the percentage resistance change is minimized by adding large amounts of low-coefficient resistance, low efficiency and drastic limitation of available power are inevitable.

Because they have a large negative temperature coefficient, there need be only a moderate increase in circuit resistance when Keystone "NTC" units are used. The remarkable effectiveness and simplicity of this method are evident from the typical problem and its solution illustrated at the left.

The experience of our customers indicates that Keystone "NTC" compensation can help make better-performing, more-sales-worthy indicating and recording devices, meters, relays, control systems and many other electrical devices and components . . . economically. Why not let us tell you more about them—and put us to work on your problem? Write now—no obligation.



A wide range of temperature coefficients, resistance values, sizes, shapes and wattage ratings are available.



Keystone "NTC" units are thermal resistors of special composition (not carbon), developed and manufactured by Keystone, and extensively used for temperature compensation, temperature measurement and control, time delay and other applications.

**KEYSTONE CARBON COMPANY, INC.**  
ST. MARYS . . . . PENNSYLVANIA



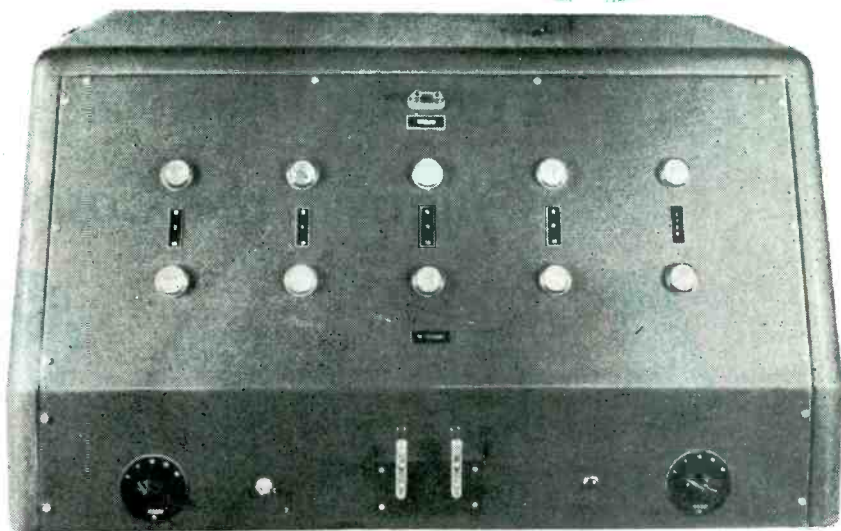


# Visual and Audible indication

ACCURATE TO .1%



**PRECISION  
TOLERANCE  
BRIDGE**



**MODEL SE 10**

## ***Quality Control Minus Risks of Human Failure***

Electronically, "GO-NO-GO" Visual Gauge Can Be Used As:

- Inspection Tool—for incoming inspection of components (condensers and resistors) to act as a safeguard against faulty components and as a quality safeguard for the equipment manufacturer.
- An indispensable tool on the production line, this unit serves as an automatic filter to grade components for their individual tolerance.
- Overall precision of unit is .1%.
- Checks A.C. resistance and impedance, capacitance and inductance.
- No controls for operator to adjust or set.
- Test is automatic.
- Human error is eliminated by substitution of indicating lights for tolerance reading.
- Visual and audible indication of rejects, instead of meter readings.
- Each tolerance in percentage steps has its individual light.
- Can be used by anyone; knowledge of inspecting procedure is unnecessary.
- Eliminates the error of parallax in meter readings.

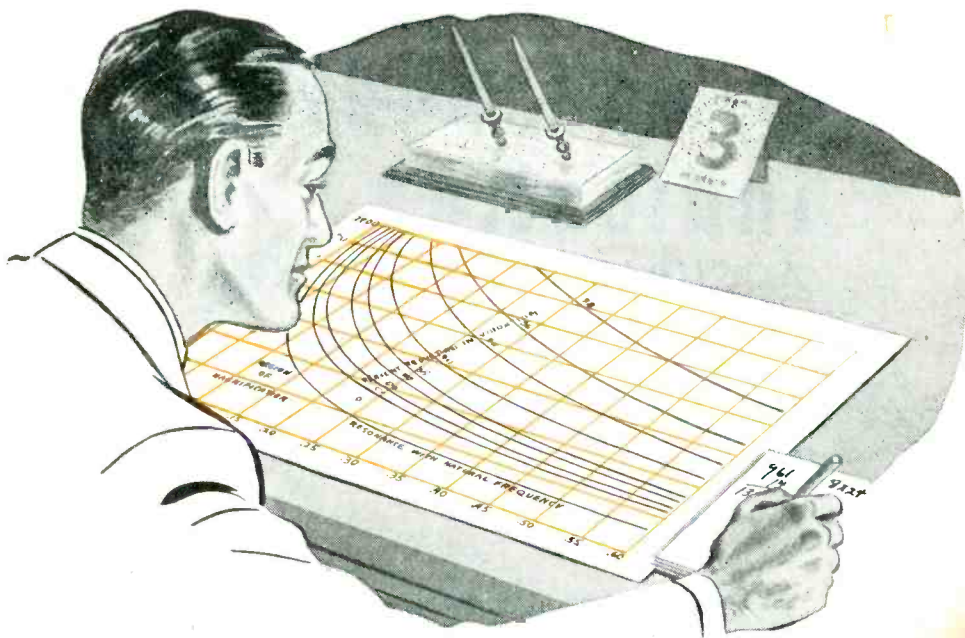
*Sherron  
Electronics*

## **SHERRON ELECTRONICS COMPANY**

*Division of Sherron Metallic Corporation*

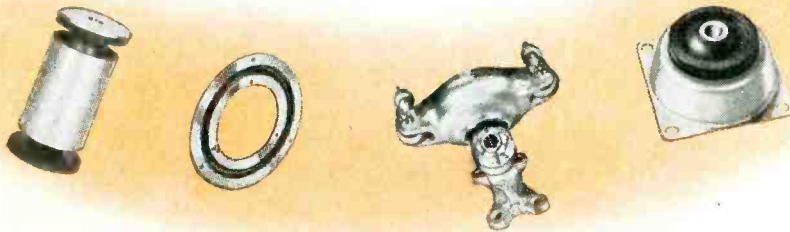
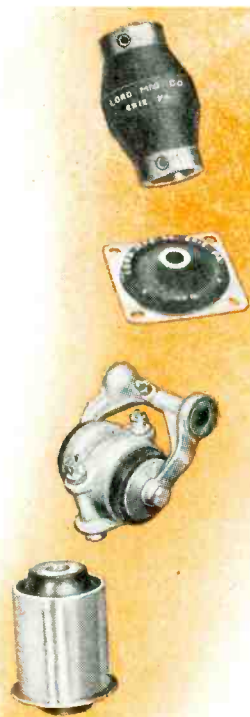
**1201 FLUSHING AVENUE, BROOKLYN 6, N. Y.**

**"Where the Ideal is the Standard, Sherron Units are Standard Equipment"**



Have YOU

figured the Costs of Vibration?



**V**IBRATION shortens the life of all types of equipment ranging from light delicate instruments to heavy, massive machinery. Vibration lowers workers' morale, slows them up, increases absenteeism. Vibration is the enemy of efficiency. Lord is the enemy of vibration.

Lord is the Pioneer and leader in the science of vibration control and isolation, and Lord Shear Type Mountings and other Bonded Rubber Products are the embodiment of many exclusive techniques and patented features developed through years of research and practical application.

The bond in Lord Mountings between metal and rubber is as strong as the rubber itself, guaranteeing against failure of the mounting under stress which the rubber itself can take.

The rubber element in Lord Mountings is designed and molded to throw

flexing action away from the metal parts into the rubber body, preventing stress concentration at the edge of the bond.

The rubber, either natural or synthetic, is carefully compounded to possess the correct degree of stiffness and other qualities required in the job for which the mounting is designed.

Lord designs and processes allow the rubber element to function in free shear without chafing, providing uniformity of action and resulting in a greater degree of vibration control.

Proper application of the Lord plan of scientific analysis and control make it possible to reduce by 80% or more, the destructive forces of vibration. Without obligation to you, Lord Engineers will make a study of vibration problems in your product, offering recommendations for its effective reduction and control.



IT TAKES BONDED RUBBER *In Shear* TO ABSORB VIBRATION

**LORD MANUFACTURING COMPANY**  
ERIE, PENNSYLVANIA

SALES REPRESENTATIVES  
NEW YORK - 280 MADISON AVE.  
CHICAGO - 520 N. MICHIGAN AVE.  
DETROIT - 7310 WOODWARD AVE.  
BURBANK, CAL. - 245 E. OLIVE AVE.  
CANADIAN REPRESENTATIVE  
RAILWAY & POWER ENGINEERING CORP., LTD.  
TORONTO, CANADA

★  
BUY EXTRA  
WAR BONDS  
★

Originators of Shear Type Bonded Rubber Mountings



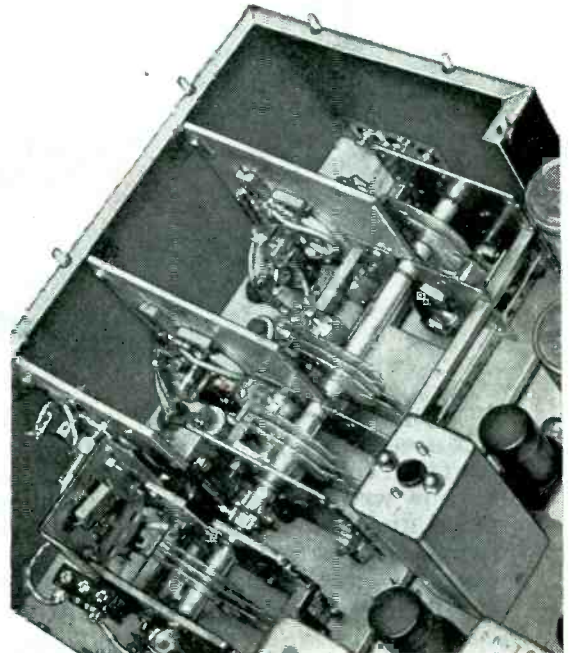
# HOW hallicrafters EQUIPMENT COVERS THE SPECTRUM

## *Model S-37*

**FM-AM**  
for very high frequency work  
130 to 210 Mc.

**T**HE new Model S-37 FM-AM receiver is an outstanding example of Hallicrafters pioneering work in the upper regions of the spectrum. Covering the frequencies between 130 and 210 megacycles, the S-37 provides VHF performance which is in every way comparable to that of the finest communications receivers operating in the medium and high frequency bands. The average over-all sensitivity of the S-37 is approximately 5 microvolts. The image ratio of at least 1000 times is achieved through the use of two pre-selector stages and an intermediate frequency of 16 megacycles. No band switching is necessary and exceptional ease of tuning is provided by mechanical band-spread with 2300 dial divisions between 130 and 210 megacycles. The pre-loaded gear train is completely enclosed and is equipped with a positive stop at each end of the tuning range. Hermetically sealed transformers and capacitors, moisture proof wiring, and extra heavy plating, all contribute to the long life and reliability of the S-37 . . . the only commercially built receiver covering this frequency range.

The amazing performance of the Model S-37 is largely due to the RF section shown at right. It is mounted as a unit on a brass plate  $\frac{1}{4}$  inch thick. The two type 954 RF amplifiers and the type 954 mixer are placed in the heavy shields which separate the stages. The type 955 oscillator is mounted directly on its tuning condenser. Exceptional stability is assured by the use of individually selected enclosed ball bearings, extra-heavy end plates, and wide spacing in the oscillator condenser — rigid mounting of all components — and inductances of  $\frac{1}{8}$  inch copper tubing wound on polystyrene forms. All conducting parts are heavily silver plated.



Write for Catalog No. 36H, describing  
Hallicrafters complete line of high  
frequency receivers and transmitters.

BUY A WAR  
BOND TODAY!

# hallicrafters RADIO



THE HALLICRAFTERS CO., MANUFACTURERS OF RADIO AND ELECTRONIC EQUIPMENT, CHICAGO 16, U.S.A.

# AUTO-LITE

## *Electrical* Wire AND Cable



*Engineered to your needs*



**E**VERY foot of electrical wire and cable used in your product has its special function to perform. Its efficiency depends on how well the particular size, shape, material and insulation of the wire has been selected, how carefully it has been engineered. That's why it's important to you to know of the wide manufacturing facil-

ities and the expert engineering assistance available to you at Auto-Lite. The reputation for dependability that has been earned by Auto-Lite products is your best guide when you are searching for a solution to a wire or cable problem. For complete information address your inquires to

PORT HURON, MICH.

**THE ELECTRIC AUTO-LITE COMPANY**

*Wire and Cable Division*

SARNIA, ONTARIO

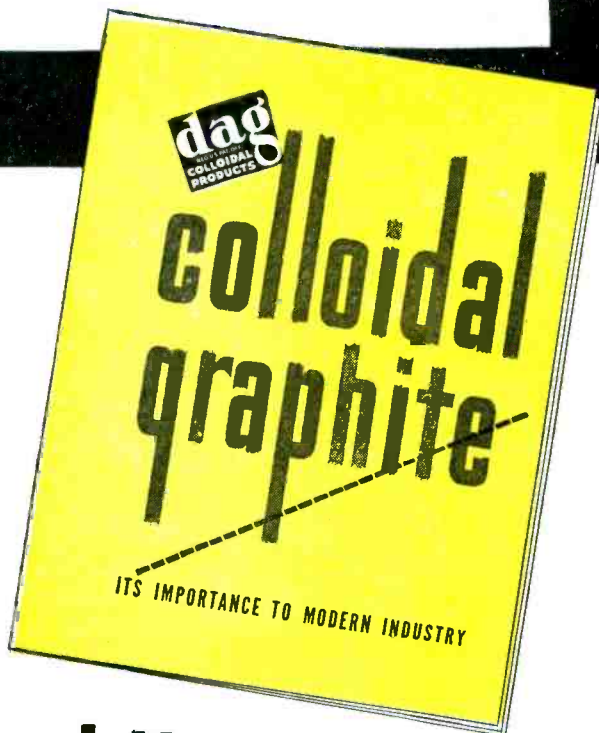
TUNE IN "EVERYTHING FOR THE BOYS" STARRING DICK HAYMES—TUESDAY NIGHTS—NBC NETWORK

# You can SOLVE PROBLEMS like these:

- Electrostatic Shielding
- Corona Prevention
- Undesired Thermionic Emissions
- Variable Condenser Lubrication
- Electrodes for Light Sensitive Cells

Not so long ago, headaches in the electronics industries like those in the box above were considered insurmountable. That was before Acheson engineers had developed the versatile new dispersions of "dag" colloidal graphite. Today, with almost a score of colloidal and semi-colloidal products available, you may obtain real assistance from this amazing material.

There are several new booklets and bulletins ready to help you become better informed about "dag" colloidal graphite. Check the list below and use the convenient coupon to send for free copies of those which fit your specific needs.



Bulletin No. 430



## colloidal graphite

ACHESON COLLOIDS CORPORATION, Port Huron, Michigan

### TO GET THESE:

This new literature on "dag" colloidal graphite is yours for the asking:

- 430** A general booklet on the story of "dag" colloidal graphite. 12 pages profusely illustrated.
- 440** A complete list of "dag" colloidal graphite dispersions with applications.
- 421** "dag" colloidal graphite for ASSEMBLING AND RUNNING-IN ENGINES AND MACHINERY.
- 427** "dag" colloidal graphite as a PARTING COMPOUND.
- 423** "dag" colloidal graphite as a HIGH TEMPERATURE LUBRICANT.
- 431** "dag" colloidal graphite for IMPREGNATION AND SURFACE COATINGS.
- 432** "dag" colloidal graphite in the FIELD OF ELECTRONICS.

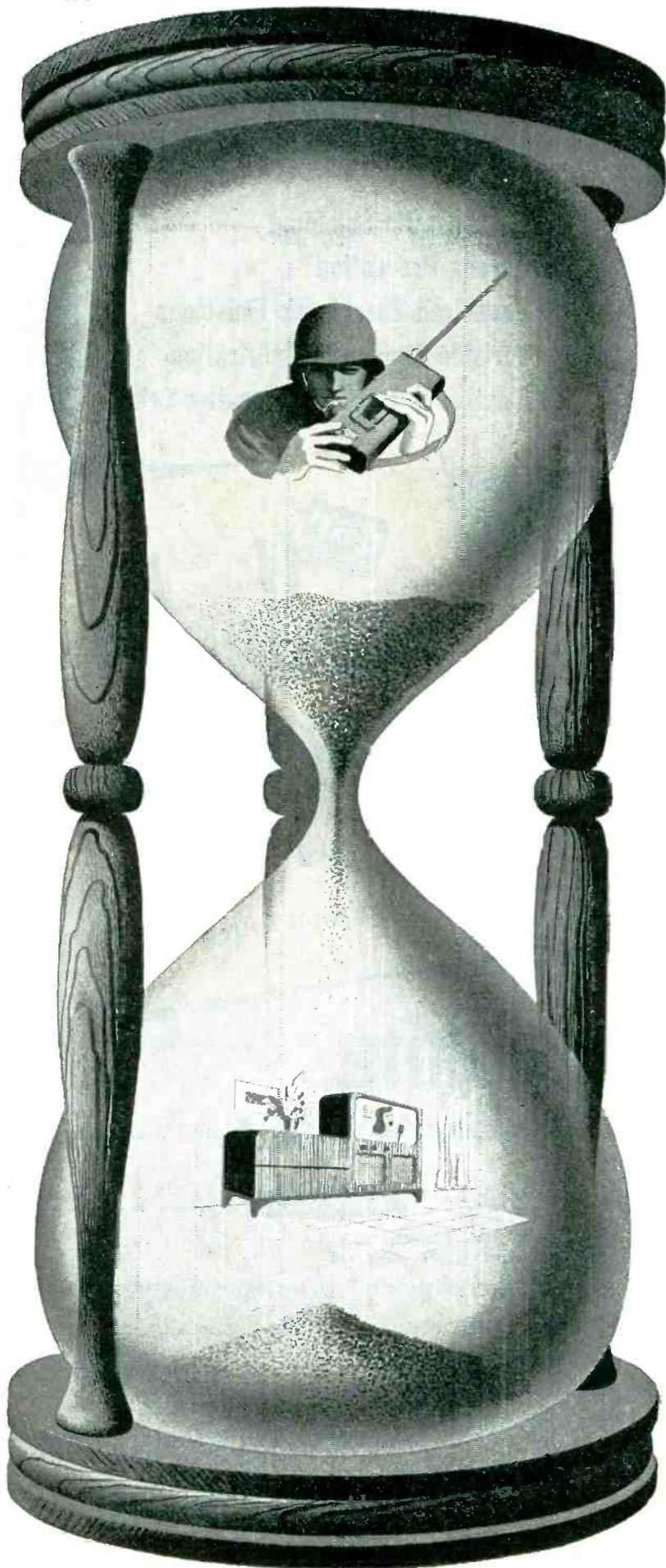
### MAIL THIS:

JML Co. A-EI

ACHESON COLLOIDS CORPORATION  
PORT HURON, MICHIGAN DEPT. 5-E

Please send me, without obligation, a copy of each of the bulletins checked:

- No. 430  NAME \_\_\_\_\_
- No. 440  POSITION \_\_\_\_\_
- No. 421  FIRM \_\_\_\_\_
- No. 422  ADDRESS \_\_\_\_\_
- No. 423  ZONE No. \_\_\_\_\_ STATE \_\_\_\_\_
- No. 431  OUR PRESENT OIL SUPPLIER IS \_\_\_\_\_
- No. 432  (Lubricants containing dag colloidal graphite are available from major oil companies.)



# Every MANUFACTURING CUSTOMER Will Benefit

**Industrial users of WILCO Products will find the increased facilities, the new products and techniques developed by WILCO for war service of great advantage to their own postwar products.**

As the Hourglass indicates . . . with the coming of peace, many WILCO products now making for precision performance in airplanes, ships, tanks, guns and instruments of the Army and Navy will play an equally important role in meeting civilian needs for hundreds of useful and reliable products.

The demand of all branches of the service for Thermostatic Bimetals and Electrical Contacts has motivated many WILCO developments of great potential value to postwar industry. New products added to an already extensive line; increased facilities for refining and fabricating precious metals; greatly extended rolling mill facilities—these new additions and improvements, now devoted principally to the war effort, will prove equally helpful to manufacturing customers in meeting their peacetime production and marketing problems.

**WILCO PRODUCTS ARE:** *Contacts* — Silver, Platinum, Tungsten, Alloys, Sintered Powder Metal. *Thermostatic Bimetal* — High and Low Temperature with new high temperature deflection rates. *Precious Metal Collector Rings* for rotating controls. *Silver Clad Steel* — for bearings, shims, reflectors. *Jacketed Wire* — Silver on Steel, Copper, Invar, or other combinations requested. Rolled Gold Plate. Special materials.

**THE H. A. WILSON COMPANY**  
105 Chestnut Street, Newark 5, New Jersey

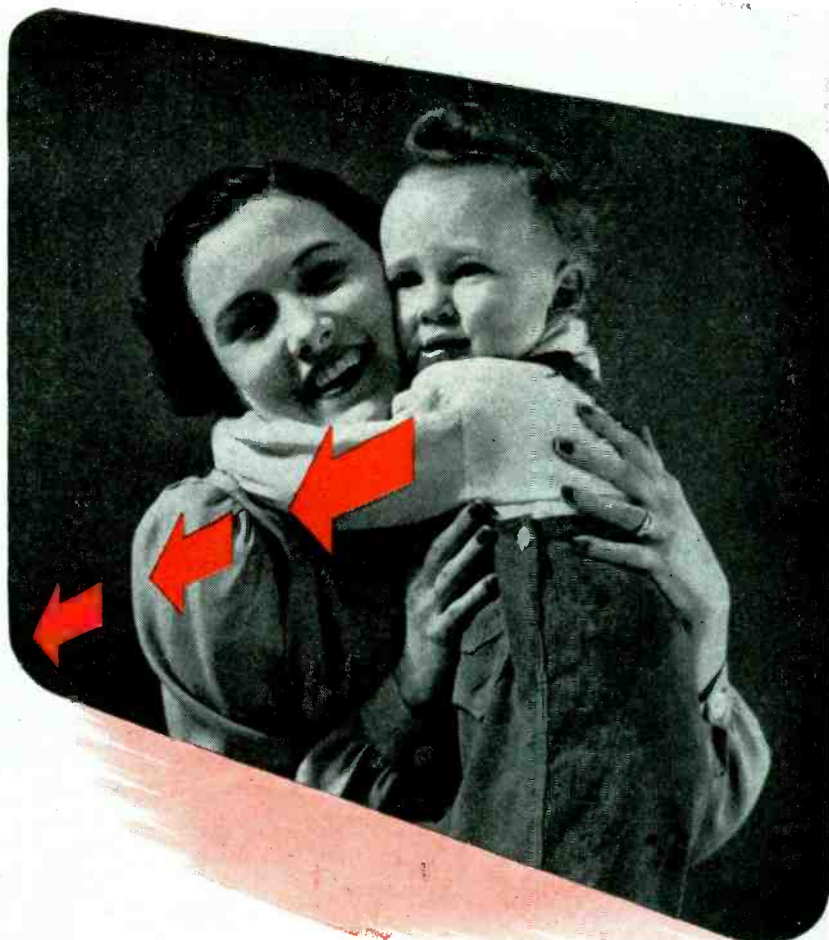
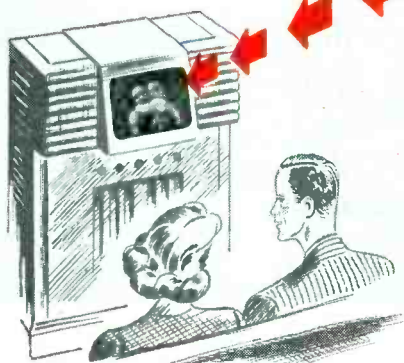
*Branches: Detroit • Chicago*



**Thermometals—Electrical Contacts  
Precious Metal Bimetallic Products**

May 1945 — ELECTRONICS

# The Picture with Ten Billion Parts!



● You see a clearer, more detailed picture on a National Union Television Tube, because of the ultrafine grain screen, developed by N. U. research engineers. It is calculated that the 10" television picture appearing on the screen of a National Union cathode-ray tube is reproduced on *10 billion* crystals.

With this development National Union scientists have demonstrated that the quality of the screen—its uniformity, smoothness, depth and fine-grain texture are just as vital to high definition television pictures as is the number of lines received. When projected on

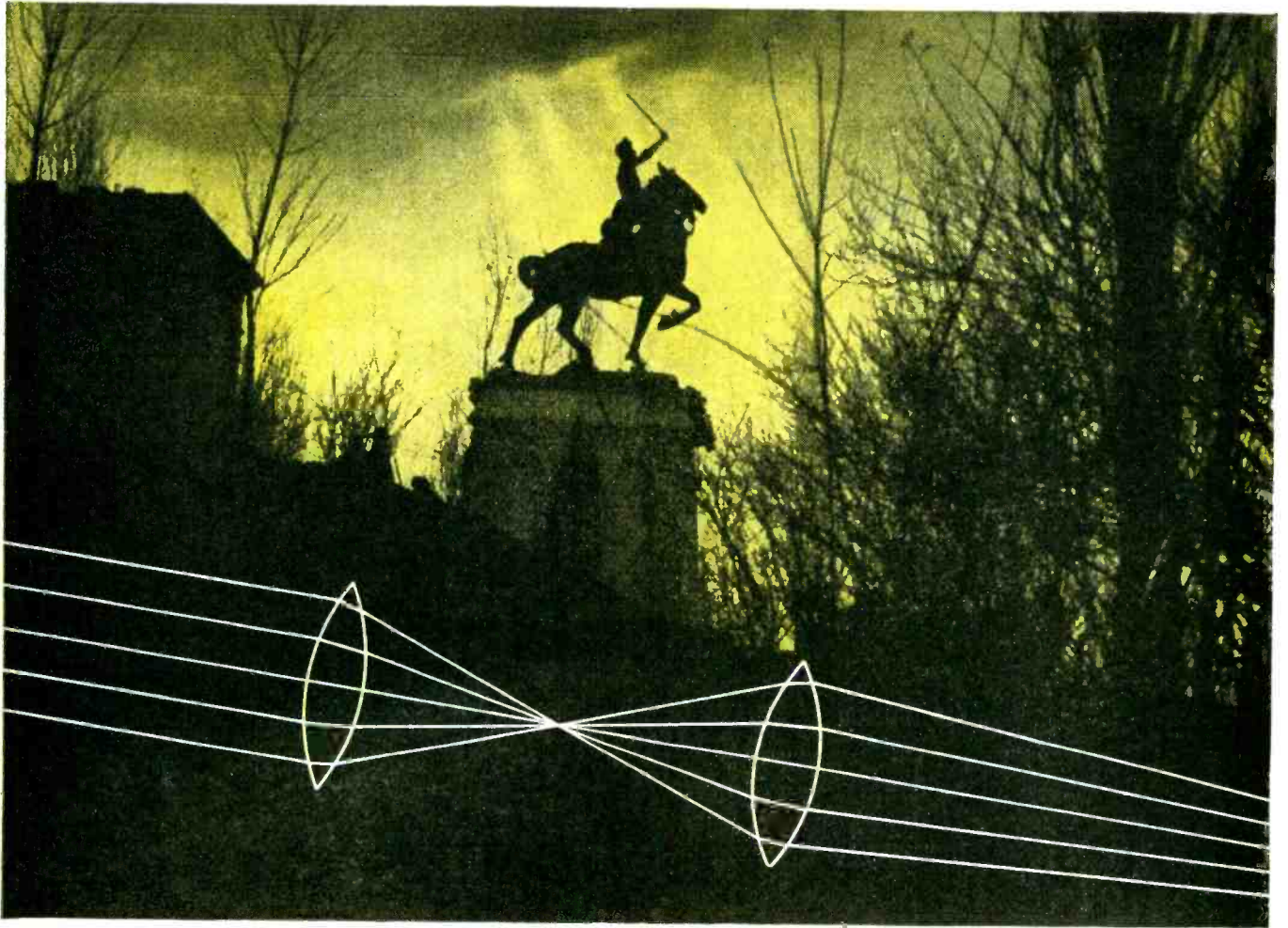
the fine grain N. U. screen, any television picture, of any number of lines, looks more life-like, because of its superior halftones and gradations of light and shadow.

As a leading producer of cathode-ray tubes, National Union is engaged in one of the most extensive CRT research programs ever undertaken. Today, this N. U. research is helping to deliver superior radio and communications equipment for war. Tomorrow, it will contribute its part to the peacetime needs of our homes and industries. For progress through research—count on National Union.

**NATIONAL UNION  
RADIO AND ELECTRON TUBES**

NATIONAL UNION RADIO CORPORATION • NEWARK 2, N. J.





## The vision that leads to better things

In this plant we specialize in vision . . . the kind of vision that helps our armed forces to see the enemy better . . . that enables them to shoot straighter . . . and also the vision that guides our workers' minds and hands to new high standards in optics . . . standards recently considered impossible.

The Army and Navy come here with some of their most difficult assignments; such as, optical components for fire control instruments, lenses for tank gun sights, reticles for binoculars, face plates for cathode ray tubes, and mirrors for Schmidt projection systems.

The new precision techniques and development work that assure products like these will be helpful to manufacturers who are planning better postwar optical products. Here you will get the capable workmanship of a compact group of specialists who deal only with optics. They make no complete products but are carefully trained to meet rigid specifications and to get the viewpoint of other manufacturers.

You will find us interested in your optical problems and in a strong position to help you with better optical components after the war.

for precision OPTICS come to

**AMERICAN LENS COMPANY, INC.**

45 Lispenard Street, New York 13, N. Y.

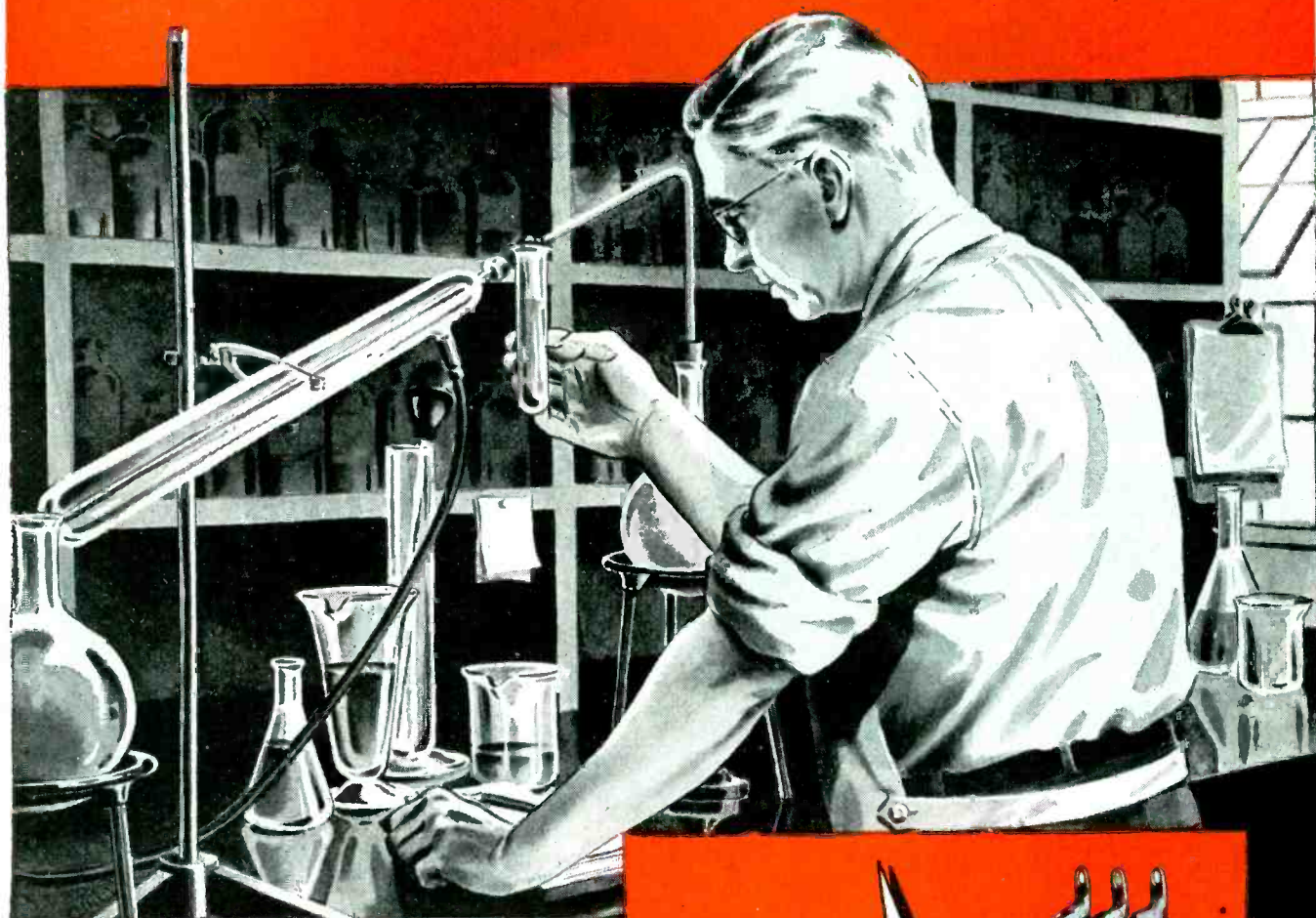


LENSES • • • PRISMS • • • FLATS • • • REFLECTORS



# chemical analysis

*means better materials and manufacturing processes*



## **What have test tubes to do with capacitors?**

A great deal. Here in our laboratory, every process used in manufacturing Cornell-Dubilier capacitors comes under the patient, searching scrutiny of expert capacitor chemists.

The evidence must be positive. These specialists are meticulous people. They take nothing for granted. No detail is too insignificant, too commonplace to merit their closest attention.

They apply their research to practical purposes. Their tests and keen analysis insure better materials for making capacitors.

*That is why more engineers specify C-D than any other make.* If you have a capacitor problem, get the help of a specialist. Write to Cornell-Dubilier Electric Corporation, South Plainfield, New Jersey. Other plants: New Bedford, Brookline, Worcester, Mass., and Providence, R. I.

TYPICAL C-D ADVANCEMENT  
IN DESIGN IS THE TYPE YAT  
a compact, low capacity Dykanol "G"  
bypass capacitor —  
hermetically sealed  
in specially-treated  
drawn metal con-  
tainer.  
600V—.05 mfd. to 1 mfd.±  
at 100V—.05 mfd. to .5 mfd.



# CORNELL-DUBILIER CAPACITORS



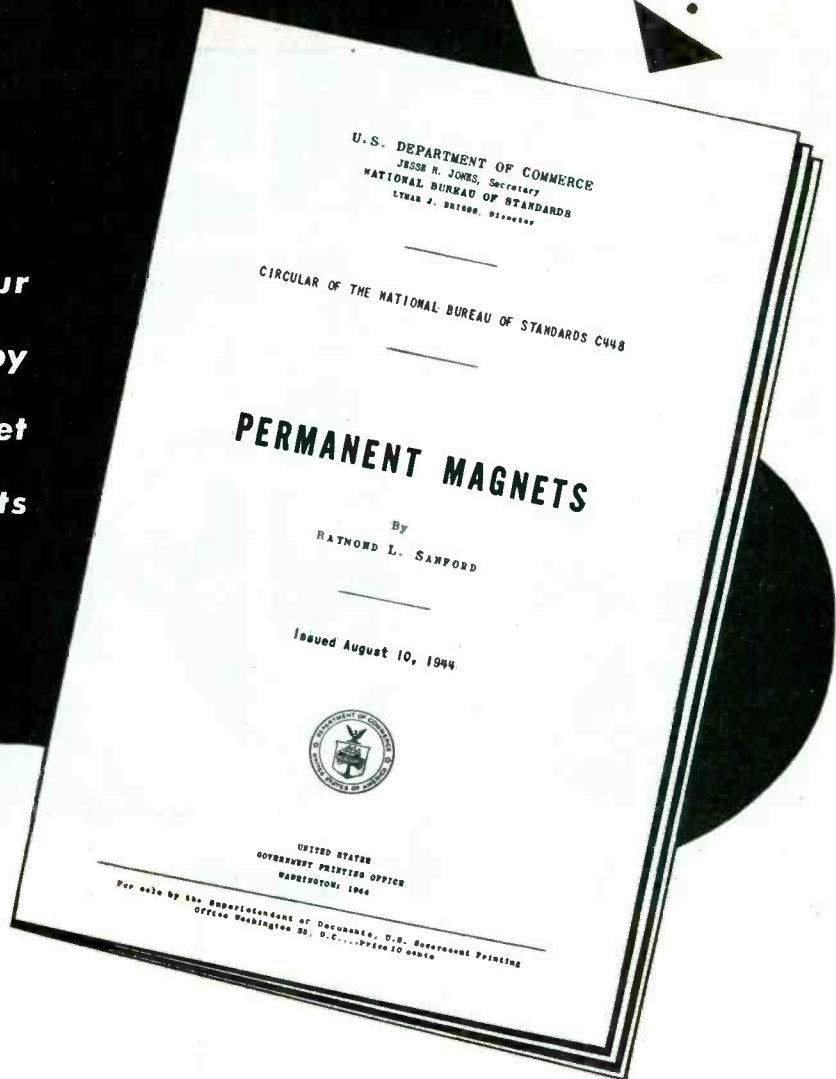
WET AND DRY ELECTROLYTICS MICA · DYKANOL · PAPER ·

# YOURS!

*Just write us, on your letterhead, for your copy of this valuable booklet on permanent magnets*

● As a service to industry, The Arnold Engineering Company is "lending a hand" in the distribution of what Arnold engineers believe to be a very informative study on the subject of permanent magnets.

This 39-page book of permanent magnet theory, design data and references was published by the government. Arnold is pleased to make it available to you free of charge and without obligation. Write for it today!



## THE ARNOLD ENGINEERING COMPANY

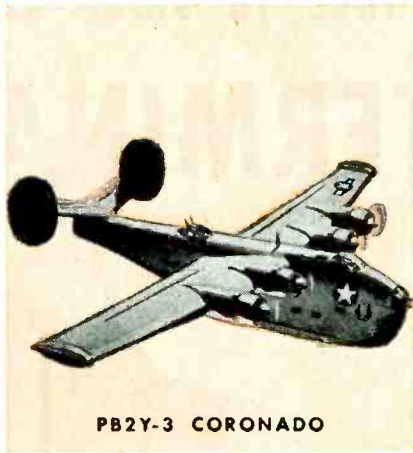
147 EAST ONTARIO STREET, CHICAGO 11, ILLINOIS

*Specialists in the Manufacture of ALNICO PERMANENT MAGNETS*

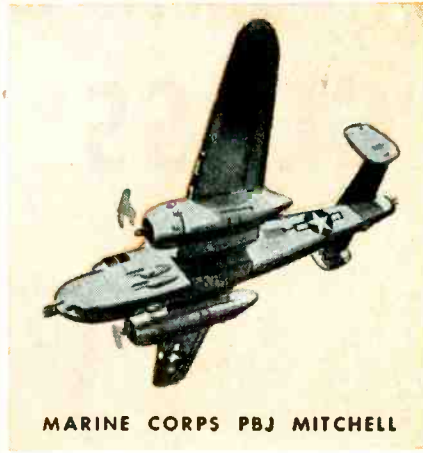
# These U. S. Navy Planes Carry Collins Autotune Transmitters



GRUMMAN TBF AVENGER



PB2Y-3 CORONADO

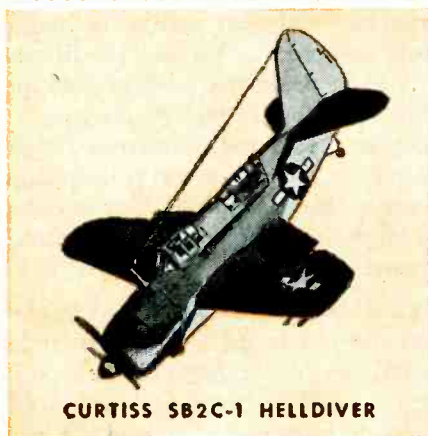


MARINE CORPS PBJ MITCHELL

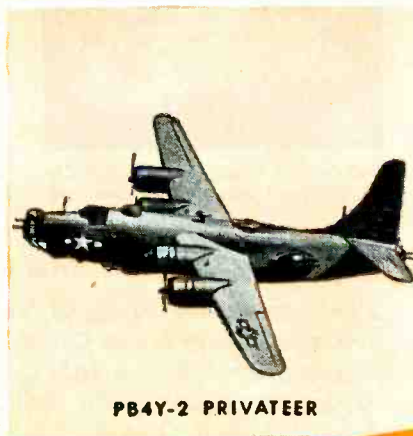
## The voice of thousands of Navy fliers



THE COLLINS ATC Autotune transmitter is regulation equipment for most two-place-and-larger types of Navy aircraft. It is the military successor of Collins airborne Autotune transmitters which were adopted by several of the great commercial airlines years before the war. Since Japan struck, the Navy has ordered many thousands. In advanced design and rugged construction, today's ATC reflects the lessons of war learned in every quarter of the world. It is a foretaste of the reliability and efficiency to be expected of Collins by commercial and private users after victory. Collins Radio Company, Cedar Rapids, Iowa; 11 West 42nd Street, New York 18, N. Y.



CURTISS SB2C-1 HELLDIVER



PB4Y-2 PRIVATEER



MARTIN PBM-3D MARINER



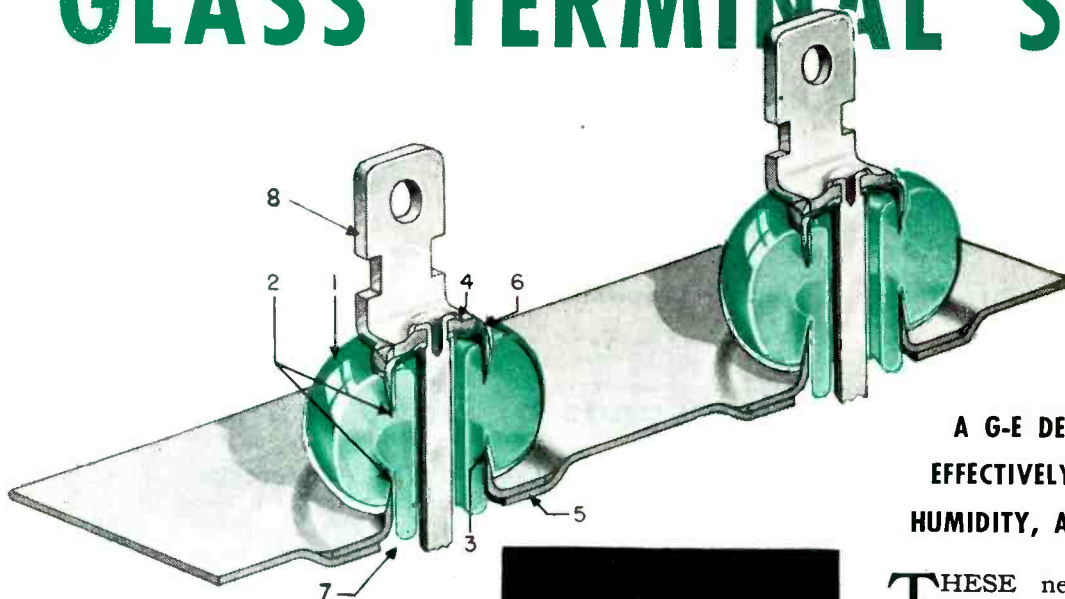
IN RADIO COMMUNICATIONS, IT'S . . .



# Announcing

a distinct advance in small-capacitor design

## GLASS TERMINAL SEALS



**A G-E DEVELOPMENT THAT  
EFFECTIVELY RESISTS FUNGUS,  
HUMIDITY, AND THERMAL SHOCK**

- 1** Exceptionally stable, low-expansion glass, practically unaffected by weathering, microorganisms, and thermal shock.
- 2** Metal sections, made of corrosion-resistant nickel steel, are sealed into opposite ends of the glass by a heating process in which the oxide on the steel is fused into the glass to form an impervious bond between the two.
- 3** Metal sections are tapered to keep stresses in the glass at negligible values under thermal-shock conditions. The seal is designed to pass American War Standard thermocycle tests with a wide margin of safety.
- 4** High mechanical strength is provided because terminal is *riveted* to top metal section, and,
- 5** Terminal seal is brazed to capacitor cover.
- 6** All joints are hermetically sealed. *None relies* on soft solder for mechanical strength.
- 7** Adequate electrical clearance between lead and case is maintained by the glass skirt.
- 8** Easy attachment of external leads is assured by making terminal of *solder-dipped* brass.



G-E Pyranol capacitor (case style CP-62) equipped with glass terminal seals

**T**HESE new terminal seals for small capacitors are based on the many glass-to-metal seal developments pioneered by our Research Laboratory and Lamp Department over a period of years. The seal is similar, in many respects, to the seals being used so successfully to maintain a high vacuum indefinitely in G-E sealed-beam headlamps, millions of which are now in use.

This development makes possible a capacitor seal that will withstand the most severe operating conditions—sudden or prolonged heat or cold, high altitude, rain, humidity, fungus, and microscopic animal infiltration. It differs from most glass-to-metal seals in that it does not *rely* on soft solder for mechanical strength, nor on matched coefficients of expansion of glass and metal to resist thermal shock.

G-E capacitors equipped with glass terminal seals are, at present, available in case styles CP-60, -62, and -64 in all ratings covered by proposed specification JAN-C-25, for use in combat communications equipment where severe operating conditions may be encountered. Ask for Bulletin GEA-4424 for complete information. *General Electric Company, Schenectady 5, N. Y.*

*Buy all the BONDS you can—and keep all you buy*

**GENERAL  ELECTRIC**  
407-90-3700

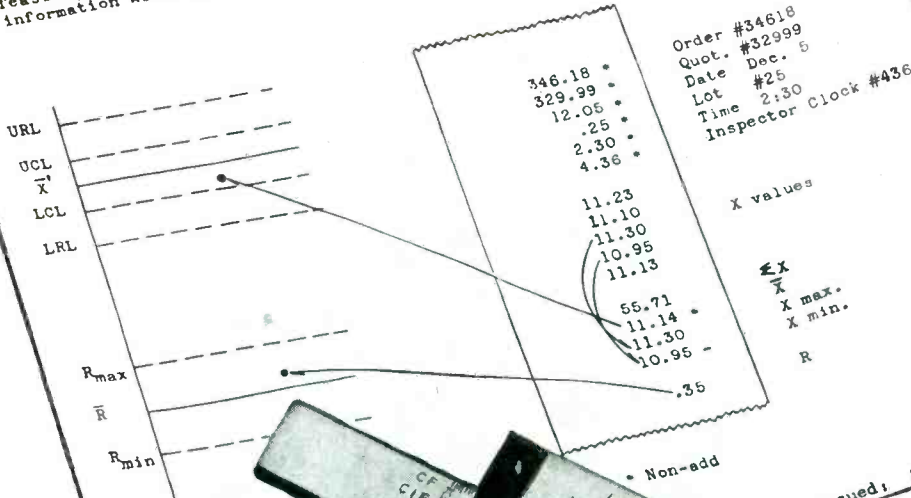
**CONTROL CHART**  
**SUBSTITUTION OF ADDING MACHINE TAPE FOR CONTROL CHART DATA SHEET**

As indicated on pages 100, 103 and 105 Forms #218 (n=10) and Form #227 (n=6) are available for recording X readings of sample lots.

This practice has been superseded at some inspection centers by direct recording of measurements on small manually operated adding machines. To begin a record the full job and lot data are listed on the adding machine tape using the non-add key. The individual pieces are then measured and immediately listed on the tape. When 5 (or 10) values have been taken the column is added (by the machine).

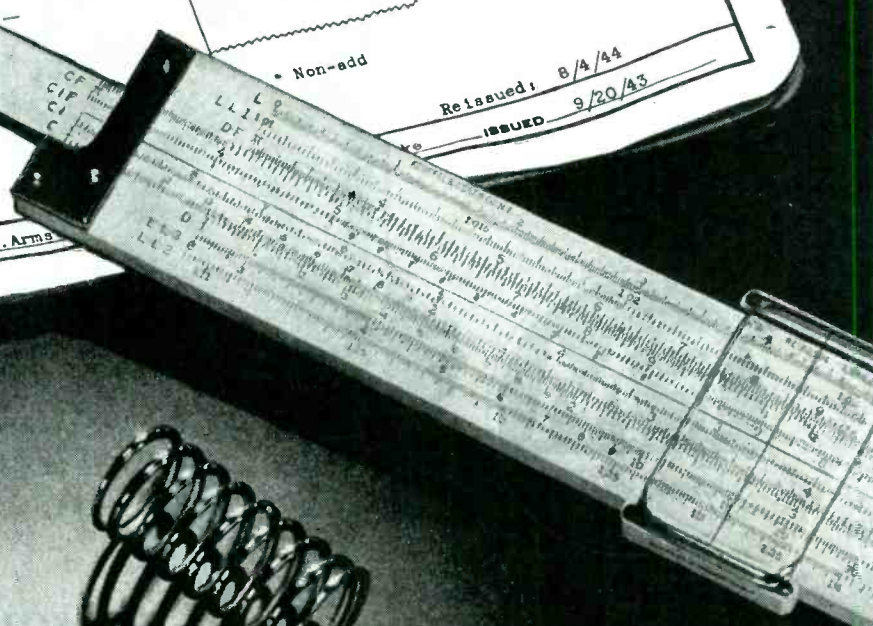
This tape is then torn off and clipped to the job board containing the control chart record sheet. Values of  $\bar{X}$  and R are, of course, immediately plotted on the control chart.

This practice saves considerable time and its use is recommended wherever feasible. The appearance of the adding machine tape containing complete information would be as shown below.

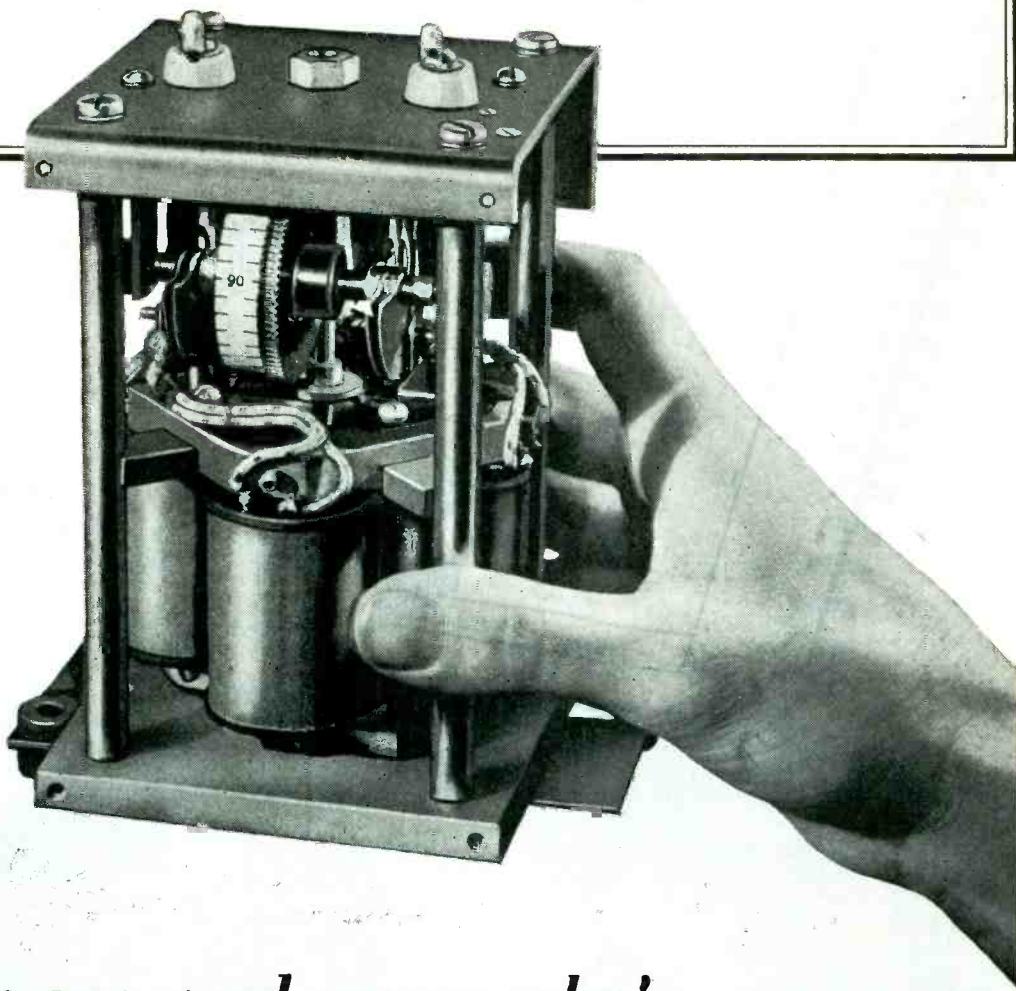


Released: 8/4/44  
 ISSUED 9/20/43

PREPARED BY C.R. Arms



# In FM Broadcasting *Western Electric* equipment leads the way.



*...and here's one good reason why!*

It's the Western Electric Synchronizer—announced in 1940 as a real contribution to FM—now proved outstandingly successful in years of operation.

In Western Electric Synchronized FM Transmitters, the mean carrier frequency is maintained continuously and precisely by a single low temperature coefficient crystal.

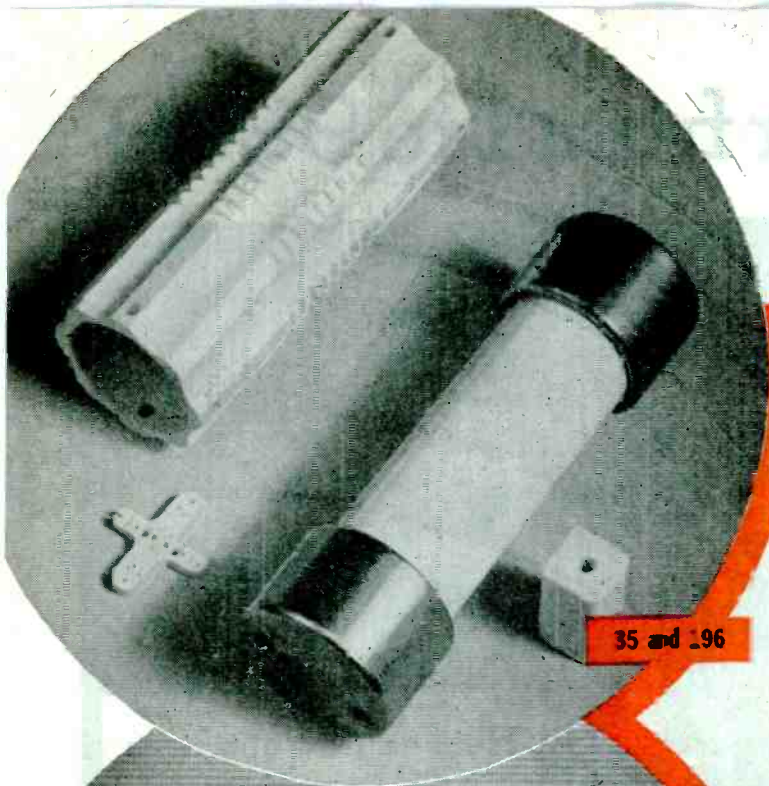
The Synchronizer compensates immediately

and automatically for a change in the mean frequency of the modulated oscillator arising from any cause. It is uncannily accurate in keeping stations on frequency.

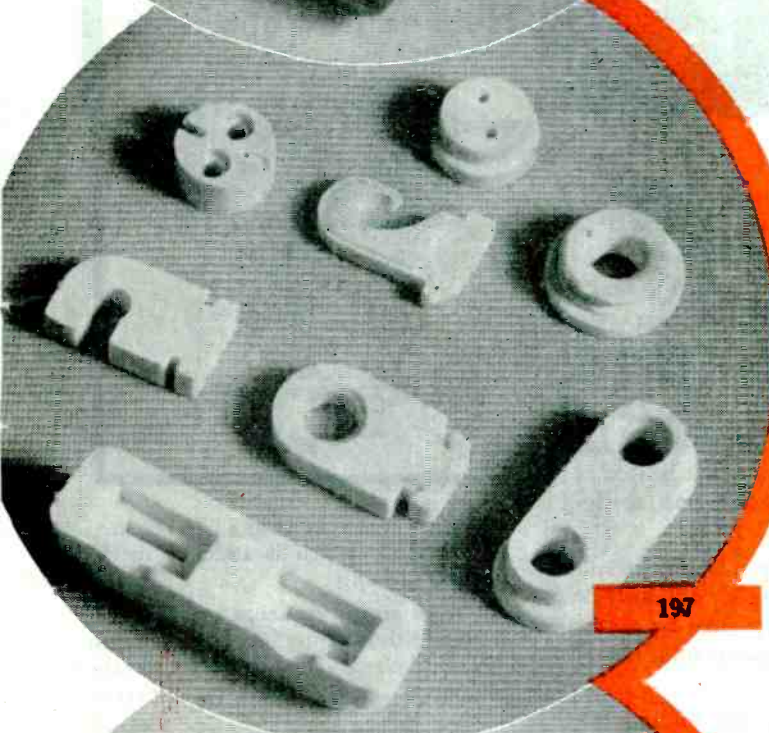
Developed by Bell Telephone Laboratories, the Synchronizer is a good example of the advanced design—and the leadership—you can count on in all equipment manufactured by Western Electric.



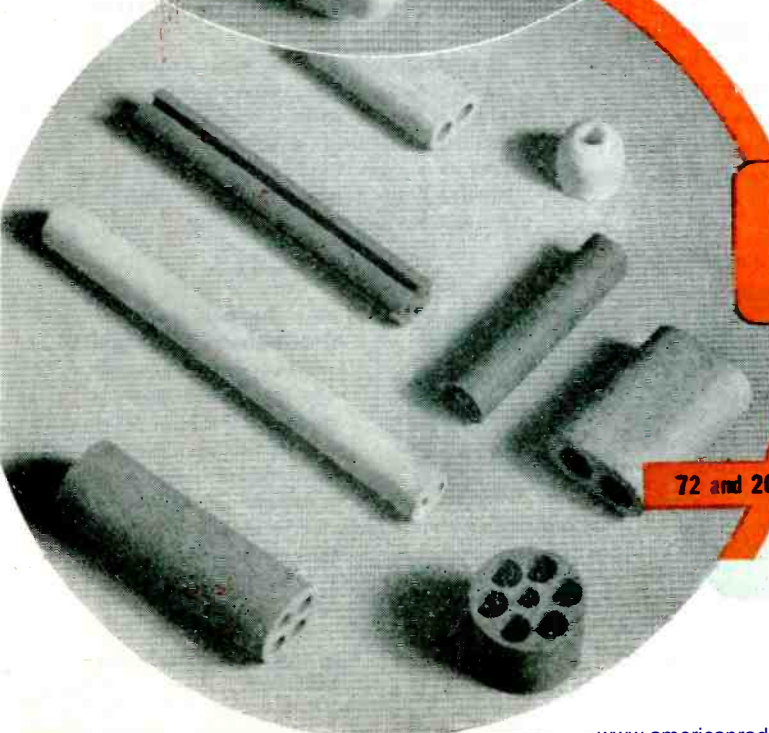
*Buy all the War Bonds you can...and keep all you buy!*



35 and 196



197



72 and 202

## THE ALSIMAG CERAMICS

ALSiMAG is the trade name of a wide variety of ceramic bodies, each with its own particular physical and electrical characteristics. Among those finding widest applications are the following:

**ALSiMAG 35 and 196** Possessing high mechanical strength combined with low electrical loss at high frequencies, these bodies are ideally suited to most electrical and electronic applications.

**ALSiMAG 197** Good mechanical strength and resistance to high temperatures for sustained periods make ALSiMAG 197 especially valuable in the field of electrical heating devices.

**ALSiMAG 72 and 202** Low co-efficients of expansion, coupled with ability to withstand thermal shock, make these materials desirable in combustion tips and thermocouple insulation.

Whatever you are planning in the electronic or electrical field, we believe our specialized knowledge, experience, constant research and development will be helpful. Let's work together.

**AMERICAN LAVA CORPORATION**

*Chattanooga 5, Tennessee*

43RD YEAR OF CERAMIC LEADERSHIP

**ALSiMAG**

TRADE MARK REG. U. S. PAT. OFFICE

**CERAMICS**



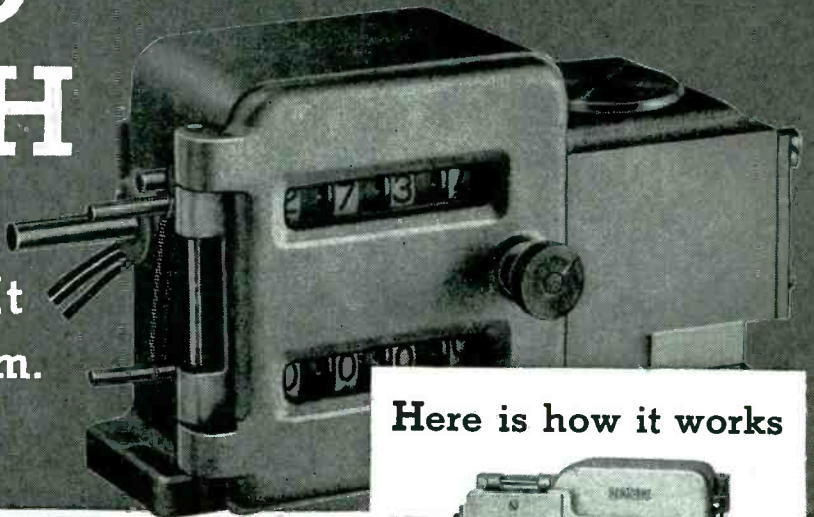
*ALCO has been awarded for the fifth time the Army-Navy "E" Award for continued excellence in quantity and quality of essential war production.*

# "Take a Number from 1 to 9999"

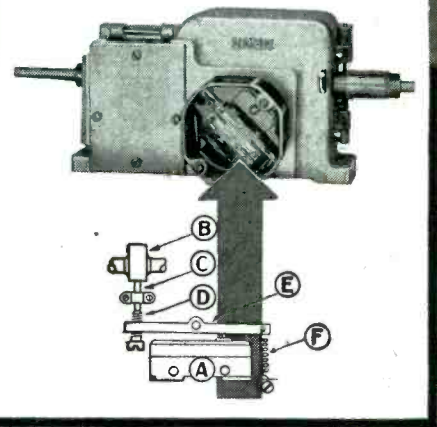
## MICRO SWITCH

SNAP-ACTION

Will "Remember" It  
even at 2500 r. p. m.



Here is how it works



This Cycle Repeater of the Counter and Control Corporation of Milwaukee, Wisconsin, employs a Micro Switch snap-action switch to make or break the circuit at any predetermined number from 1 to 9999.

The Counter and Control Corporation chose a Micro Switch product for the operating heart of this Cycle Repeater because of its proven accuracy of response through millions of repeat operations. Too, its tiny, compact size combines with its rugged construction to meet the needs of their application.

This device is an automatic, predetermined counter, self-resetting and self-repeating . . . something new in controlled production. It is used as an integral part of production machinery to control cycles, operate signals, lights, bells, relays, motors, conveyors and elevators.

Once the predetermined number is set, the Cycle Repeater can be run at as high a speed as 2500 r. p. m., and the snap-action switch will make or break the contact at the point required. This is accomplished by a cam which actuates the switch after the proper sequence of gear revolutions in the counter mechanism.

Hundreds of designers, in every branch of industry, are finding the ability of Micro Switch products to switch substantial loads at line voltage . . . without the use of relays . . . makes them ideally suited for a wide variety of electrical controls in both war and peace production. Design engineers should know all about these Micro Switch controls. We'll be glad to send you as many copies of our Handbook-Catalog as they may require.

The plastic enclosed switch "A" is bolted to a bracket which is attached to the counter housing.

After the proper sequence of gear revolutions in the counter mechanism, a cam "B" on the gear arrangement presses the plunger "C" against the adjusting screw "D".

The lever pivoted at "E" then causes the bar to release its pressure on the switch plunger which either opens or closes the electrical circuit as desired. Spring "F" acts as a counterbalance to restore immediately the pressure on switch plunger for another cycle of operations.

LET'S ALL BACK THE ATTACK



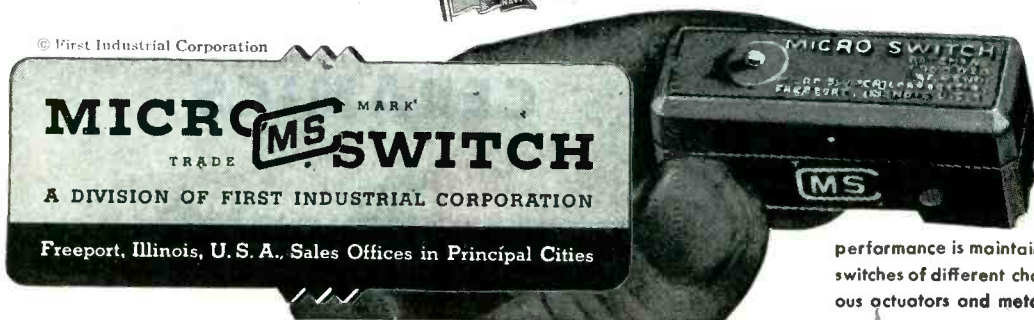
BUY EXTRA WAR BONDS

© First Industrial Corporation

MICRO <sup>MARK</sup> MS <sup>TRADE</sup> SWITCH

A DIVISION OF FIRST INDUSTRIAL CORPORATION

Freeport, Illinois, U. S. A., Sales Offices in Principal Cities



This is the basic switch—a thumb-size, feather-light, plastic enclosed, precision, snap-action switch. Underwriters' listed and rated at 1200 V. A., at 125 to 460 volts a-c. Capacity on d-c depends on load characteristics. Accurate reproducibility of

performance is maintained over millions of operations. Basic switches of different characteristics are combined with various actuators and metal housings to meet a wide range of requirements.



LOOK TO *Federal* FOR....

AM  
FM  
TV

## FROM COMPONENT...TO COMPLETE STATION

A vital link in a long chain of equipment . . . from microphone to antenna . . . the lead-in cable plays an important part in dependability of operation.

Federal's Intelin Cables *are* dependable. They've proved that in broadcast and military installations all over the world . . . standing up under severe operating conditions . . . in all kinds of climate.

And that's typical of *all* Federal broadcast equipment. From lead-in cable to complete station, it has earned a reputation for *performance* because it's *built to stay on the air*.

Amplitude Modulation, Frequency Modulation, and Television . . . for quality, efficiency, dependability . . . look to Federal for the finest in broadcast equipment.

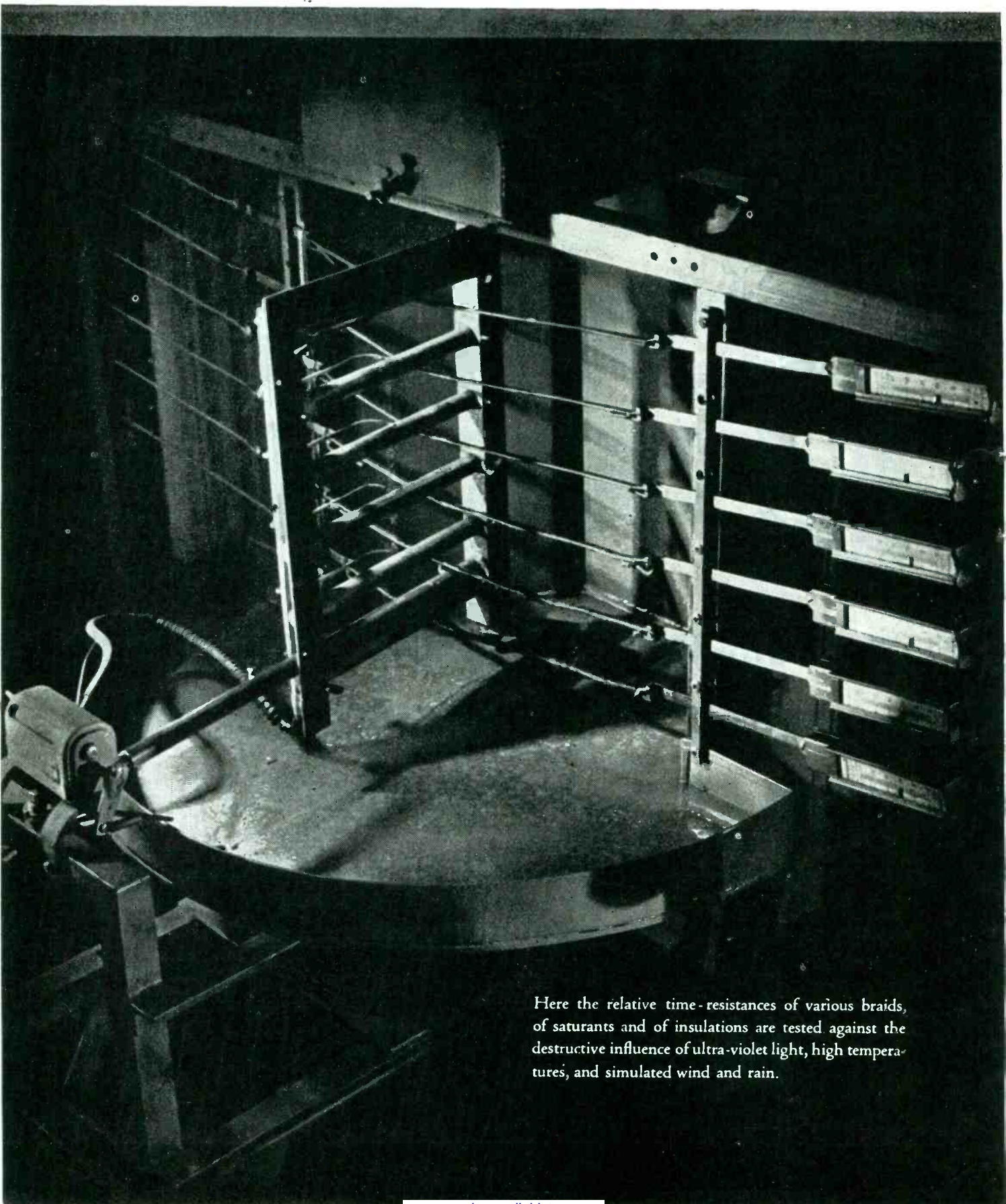


*Federal Telephone and Radio Corporation*



Newark 1, N. J.

# ENDURANCE



Here the relative time-resistances of various braids, of saturants and of insulations are tested against the destructive influence of ultra-violet light, high temperatures, and simulated wind and rain.

# IN COVERINGS

For every braid or wrapping:—  
constant Research-testing for  
all possible securities of service.

General Cable's research program recognizes no *minor* problems of conductors, insulations, or of coverings. The abrasion hazards in the winding of motor armatures, the longevity of pole line installations, the cutting down of friction in pulling-in building wires—all of these and a host of other problems are subjected to searching scrutiny. For the testing of the textile yarns as raw materials, at various stages of manufacture and in the finished product, specialized practice is employed, using the most sensitive equipment that engineering brains can devise.

## GENERAL CABLE CORPORATION



*Manufacturers of Bare and Insulated Wires and Cables  
for Every Electrical Purpose*

# SALT WATER MIKES



Marine microphone assembly. Plastic and metal parts designed, made and assembled by Remler to meet Navy and Merchant Marine specifications.



## PLUGS & CONNECTORS

Signal Corps · Navy Specifications

Types:		PL			NAF	
50-A	61	74	114	150		
54	62	76	119	159		
55	63	77	120	160		1136-1
56	64	104	124	291-A		
58	65	108	125	354		No.
59	67	109	127			212938-1
60	68	112	149			

PLP		PLQ		PLS	
56	65	56	65	56	64
59	67	59	67	59	65
60	74	60	74	60	74
61	76	61	76	61	76
62	77	62	77	62	77
63	104	63	104	63	104
64		64			

OTHER DESIGNS TO ORDER

**ONE REMLER ASSIGNMENT** is the production of amplifying and transmitting systems for our Navy and Merchant Marine. Systems are complete—from shock-proof microphones, built to resist the corrosive action of salt air and water to transmitters and bull-horn speakers for baby Flat Tops. • Remler was organized in 1918 to manufacture ship wireless. Present activities in marine communications are a logical development of early activities in this field. The facilities and experience of this organization are at your disposal.

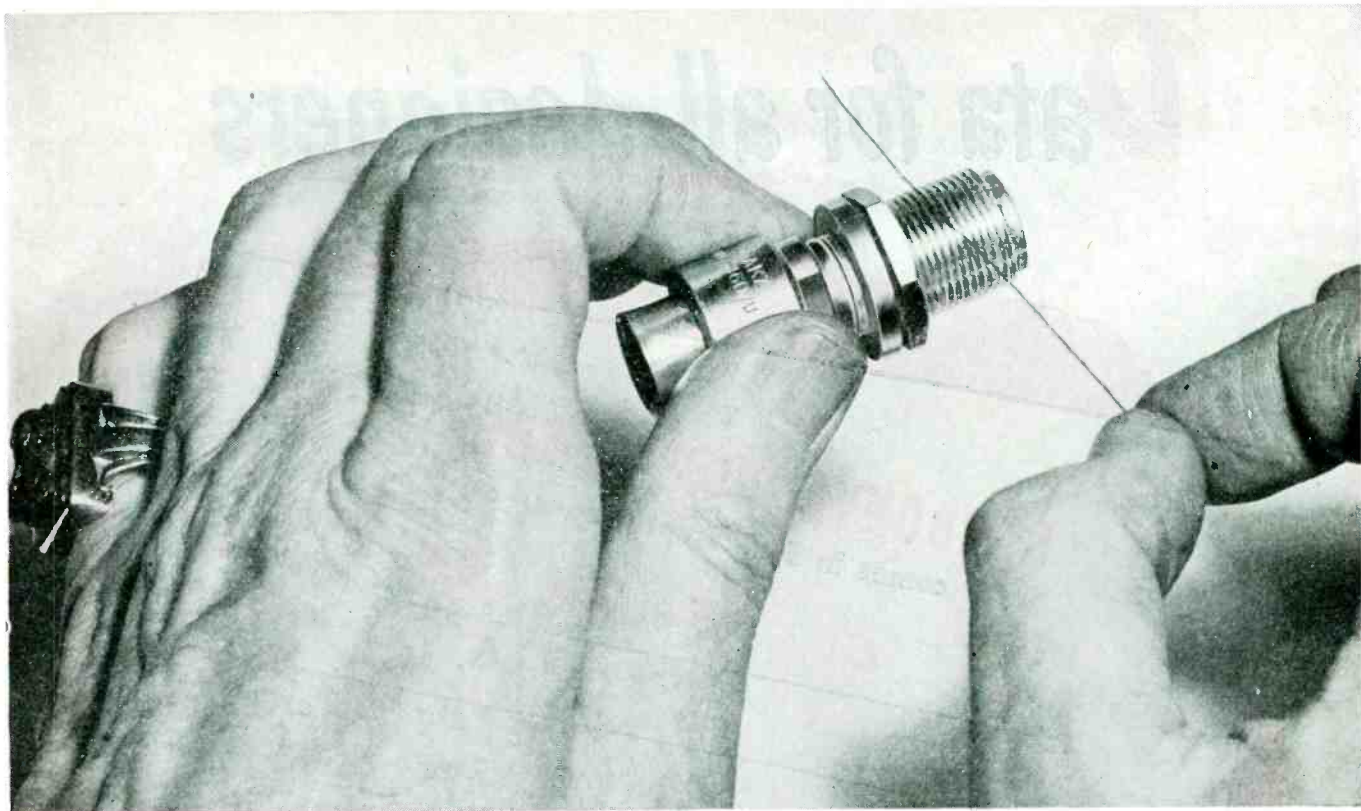
Further assignments in radio and electronics invited. Consult—

REMLER COMPANY, LTD. • 2101 Bryant St. • San Francisco, 10, Calif.

# REMLER

SINCE 1918

*Announcing & Communication Equipment*



## DID YOU SAY "TO A HAIR"?

You can divide the diameter of the finest human hair by 13, and the tolerance for silver plating at DICO will still be smaller: 1/20,000th of an inch.

All machining and assembling and processing tolerances at DICO are comparable in fineness. DICO means precision; and precision, in electronics, means performance.

Take up with DICO now what you will need later in its exceptional facilities to prepare your own product for the change from war to peace.

*PRODUCT ENGINEERING, MACHINING,  
GOLD AND SILVER PLATING, CASTING, SOLDERING,  
ASSEMBLING, FINISHING*



# Data for all designers



## CARBONYL IRON POWDER

comes in 5 different grades

**L C E TH SF**

For use in cores for different applications the powders are processed:

1. With different amounts of particle-to-particle insulation,
2. With different types of insulation or bonding material,
3. With different ratios of iron to inert material,
4. With different pressures to different densities, and
5. With different form factors and shapes.

To obtain exactly specified:

1. Permeability
2. Q value
3. Eddie current loss
4. Hysteresis loss
5. Temperature coefficient



# Data for circuit & coil designers



## COMPARISON OF AIR-CORED AND CARBONYL IRON CORED COILS: For Medium Frequencies



Specification	Typical air-cored coil	Typical CARBONYL IRON cored coil	Thus:
VOLUME	0.61 cubic-inches	0.12 cubic-inches	<b>CARBONYL IRON</b>
WEIGHT Exclusive of Housing, Mounting, etc.	1.5 ounces	1.0 ounces	Saves 80% of Space
WIRE-LENGTH	25 feet	11 feet	Saves 33% of Weight
INDUCTANCE	117 Micro-Henries	169 Micro-Henries	Saves 60% of Wire
Q Value at 1.0 Mc	94	260	Increases Inductance 40%
			Increases Q Value 170%

For further data write: General Aniline & Film Corp., Special Products Sales Department,  
437 Hudson Street, New York 14, N. Y.

# G.A.F. CARBONYL IRON POWDERS



# COLE

STEEL EQUIPMENT COMPANY

Experience and "know-how" are why so many of America's leading manufacturers depend upon "Cole Steel Equipment" for

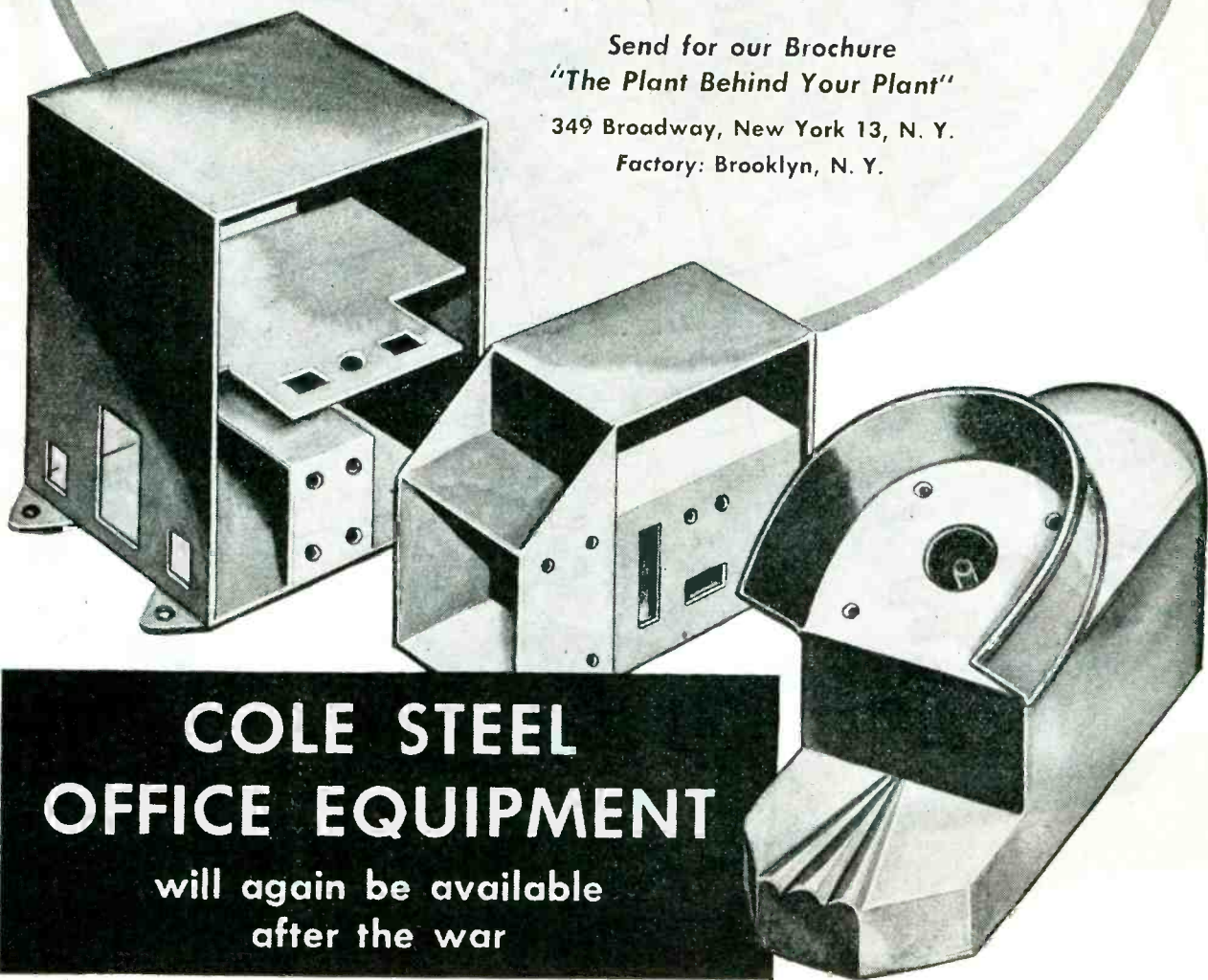
*sheet metal fabrication*

We welcome tough assignments . . . instrument housings . . . water-test boxes . . . chassis; some made to extreme precision, others to gauge limits. Send us your blueprints!

Send for our Brochure  
*"The Plant Behind Your Plant"*

349 Broadway, New York 13, N. Y.

Factory: Brooklyn, N. Y.



**COLE STEEL  
OFFICE EQUIPMENT**

will again be available  
after the war



# America's Foremost Family of Alloys

## AT YOUR SERVICE FOR 45 YEARS

Best proof of the superiority of D/H Alloys lies in the record. For 45 years, Driver-Harris has been the foremost producer of an internationally recognized group of alloys.

Best known member of this famous alloy family is NICHROME\*—most widely used of all resistance alloys. No less renowned and equally preferred in their specialized fields are the more than 80 other D/H Alloys.

Underlying this preference is the quality plus factor in every D/H Alloy assured by the high degree of metallurgical control that enters into their manufacture from furnace to spool. Therefore, to insure longer life and improved performance in your product, send your metal specifications to us and depend on it . . . Driver-Harris will supply the alloy possessing the best electrical and physical properties for your requirements.



**Driver-Harris**  
**COMPANY**  
 HARRISON, N. J.

Branches: Chicago • Detroit • Cleveland  
 Los Angeles • San Francisco • Seattle



### FOR ELECTRICAL RESISTANCE

NICHROME\*  
 NICHROME\*V  
 ADVANCE\*  
 HYTEMCO\*  
 CHROMAX\*  
 MAGNO\*  
 MIDOHM\*  
 COMET\*  
 LUCERO\*  
 MANGANIN  
 11 ALLOY  
 30 OHM ALLOY  
 LOHM\*  
 90 OHM ALLOY

### FOR HEAT OR CORROSION RESISTANCE

NICHROME\*  
 NICHROME\*V  
 NICKEL A†D†E†  
 CIMET\*  
 MONEL†  
 K-MONEL†  
 R-MONEL†  
 D/H STAINLESS STEELS  
 INCONEL†

### FOR RADIO SETS AND TUBES

NICHROME\*  
 NICHROME\* V  
 NICHROME\* 111  
 GRIDNIC A-B-C-D-E-F\*  
 RADIOHM\*  
 MANGANIN  
 ADVANCE\*  
 52 ALLOY  
 FILAMENT ALLOYS  
 D/H STAINLESS STEELS  
 NICKEL A†D†E†  
 MONEL†  
 42 ALLOY  
 NILVAR\*

### FOR SPARK PLUG APPLICATION

MAGNO\*  
 R-63 ALLOY  
 SPECIAL NICKEL ALLOYS

*In addition to the above general classifications many other industries are served by Driver-Harris Alloys. Space does not permit listing them all.*

\*Trade Mark Reg. U.S. Pat. Off. by Driver-Harris

†Trade Mark Reg. U.S. Pat. Off. by The International Nickel Company, Inc.

# Six good reasons...



1. HIGH INVERSE VOLTAGE RATING
2. NOISE-FREE HIGH VACUUM TYPE
3. WIDELY-APPLICABLE CHARACTERISTICS
4. EXTRA RUGGED CONSTRUCTION
5. CERAMIC SPACERS-LOW LEAKAGE
6. DOUBLE HEATERS AND CATHODES

*...for BETTER rectifier performance!*

The diversified E-E line of rectifiers—high vacuum, mercury vapor and grid control types—offer complete suitability for all industrial and communication requirements. All incorporate exclusive mechanical and electrical features that assure the extra dependability customarily associated with E-E engineering.

For example, the E-E 3E27, half-wave high vacuum rectifier typifies this performance-plus factor inherent in E-E tube designs. Suitable for single or multi-phase operation at high voltage this tube handles peak plate currents to 0.6 amp. at peak

inverse voltages to 8,500 or plate currents to 1.0 amps. peak at 6000 volts peak inverse voltage. It is ruggedly constructed for industrial or portable use, and is quiet in operation for communication application. Ceramic spacer minimizes leakage and double heater and cathodes are provided for long, dependable service life.

#### WRITE FOR DATA BOOK

This 30 page compilation of electronic vacuum tube types, characteristics and operational information, will be sent on request on company letterhead. An important, concise addition to technical libraries in all phases of industry.

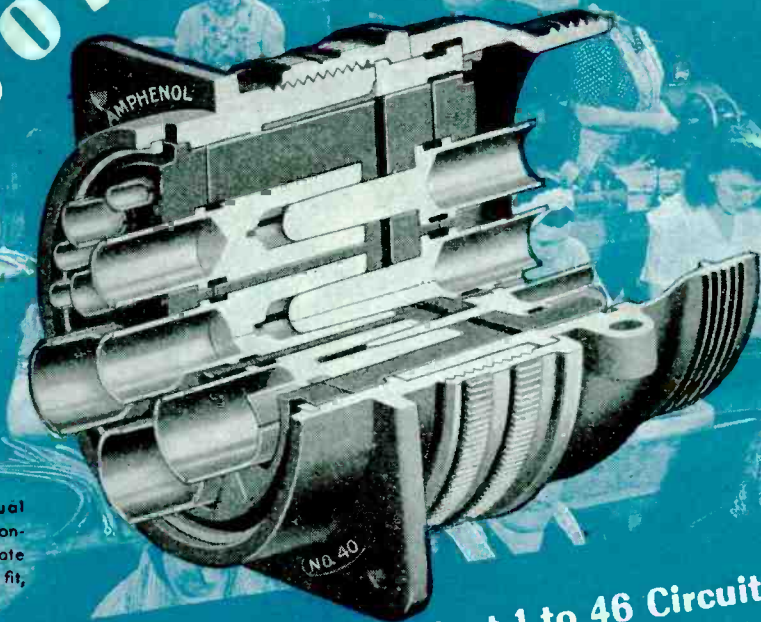
## ELECTRONIC ENTERPRISES, INC.



GENERAL OFFICES: 65-07 SIXTH AVENUE, NEWARK, 4, N. J.

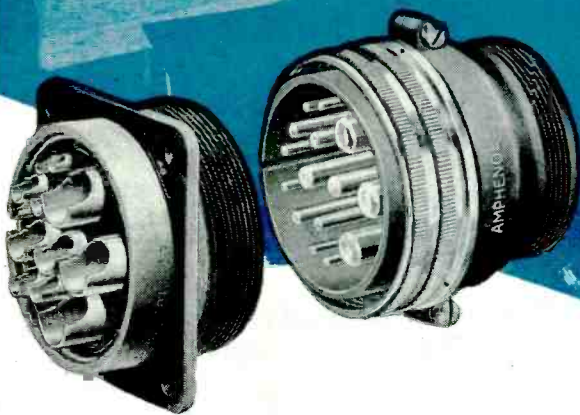
EXPORT DEPT. 25 WARREN STREET, NEW YORK CITY, N. Y.

# AMPHENOL HOOKS 'EM UP



Enlargement of an actual photograph of an A-N Connector sawed in two. Note closeness and accuracy of fit, elimination of leakage.

To Conduct 1 to 46 Circuits  
Like Continuous Wire . . . Yet  
Provides for a Quick Disconnect



Machine-time-out is time lost . . . money lost. The answer to that one, as learned by the aviation industry early in the days of fighter plane construction, is going to help all industry.

Today complex electrical circuits and operating units, in the plants as well as the planes, can be disconnected and reconnected in a few seconds time.

Interchangeable units can be replaced quickly. In the future, builders of electrical and electronic equipment of many types will use this improvement in design to their customers' advantage.

A typical Amphenol connector shown above, is being used all over the world by the Army, Navy and Air Corps under all kinds of conditions. Connections are absolutely secure! Shock or vibration cannot break them but they may be disconnected in an instant. Amphenol connectors are being made in water-proof, gas-proof, pressure-proof and other types—others to mate with British equipment, still others for U.H.F. use.

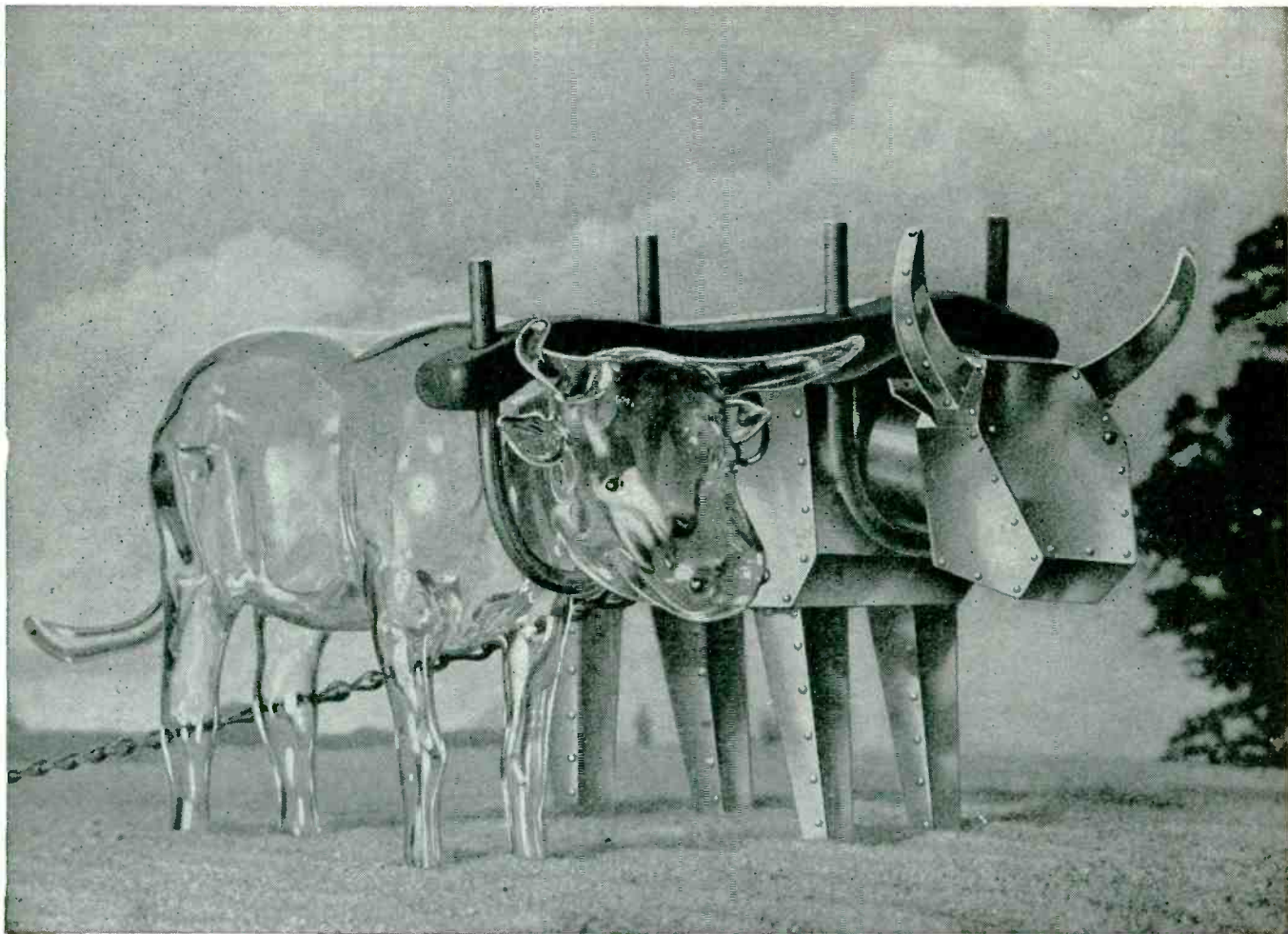
If you're design-conscious be sure to get Amphenol-conscious. Write for descriptive catalog sheets.

AMERICAN PHENOLIC CORPORATION  
Chicago 50, Illinois

In Canada • AMPHENOL LIMITED • Toronto



Connectors (A-N, British, U.H.F.), Fittings, Cable Assemblies, Conduit, U.H.F. Cable, Radio Parts, Synthetics for Industry.



## TOGETHER THEY FORM A GREAT TEAM...

*thanks to Corning Metalizing!*

**G**LASS and metal work together for the electronics industry under a yoke fashioned by Corning Research in Glass.

Metalized glass has been used for many years, mainly for decorative purposes. But Corning Research developed a metalizing process which can be accurately controlled and which is permanent under severe industrial service conditions.

The superior electrical properties of glass are well known in the electronics field. Low power factor, high dielectric strength, extremely high resistance, wide range of dielectric constants—

coupled with fine mechanical properties—make glass invaluable in electronic applications. The addition of metalized areas permits hermetic seals between glass and metal by ordinary soldering methods. Corning's metalizing process, particularly when applied to low expansion glasses, also produces accurate and fixed inductances, capacitances or shielding.

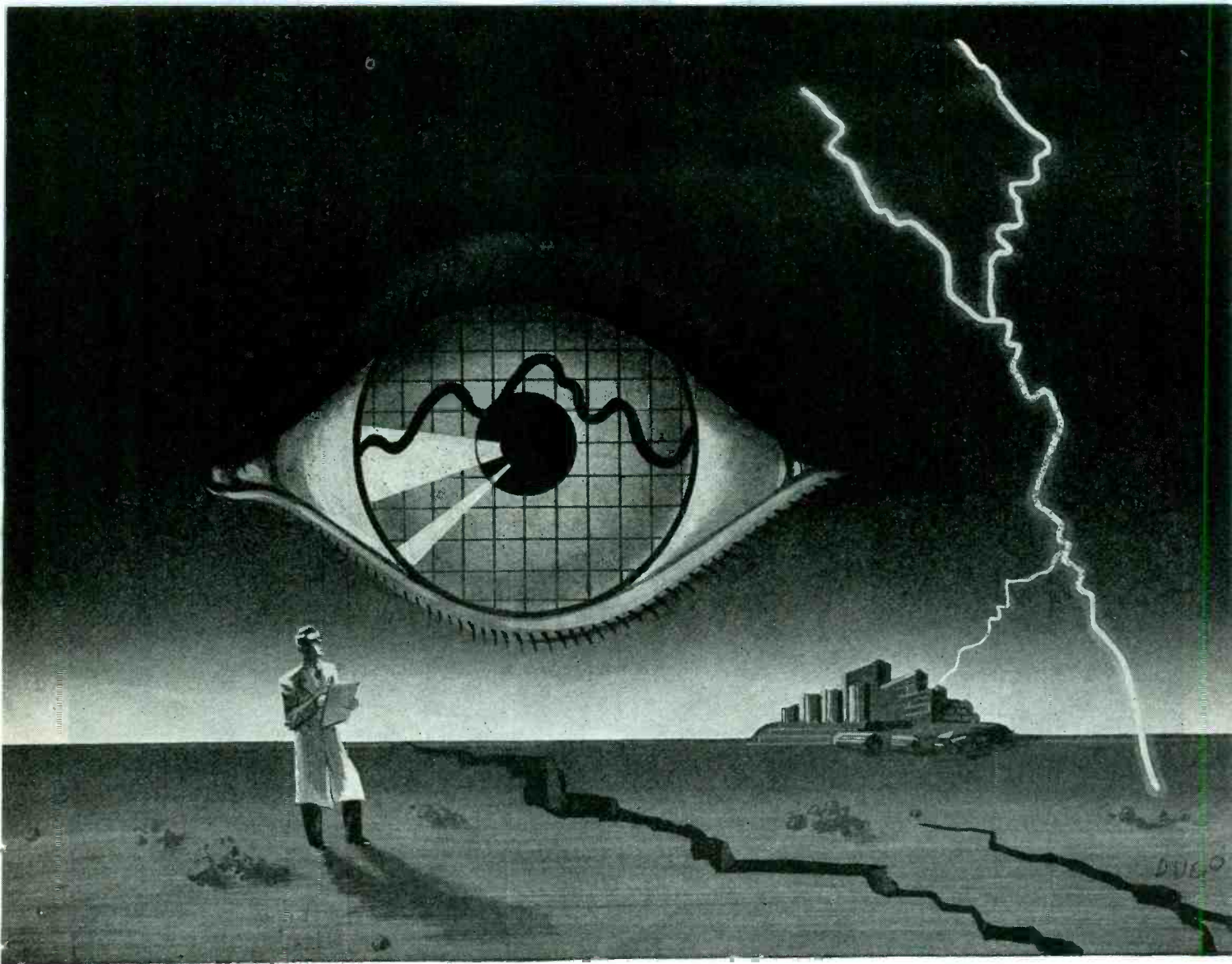
Perhaps our team of glass and metal can help you. Write us about your problem. Address Electronic Sales Department E-5, Bulb and Tubing Division, Corning Glass Works, Corning, N. Y.

**CORNING**  
— means —  
Research in Glass

*Electronic Glassware*



“PYREX”, “VYCOR” and “CORNING” are registered trade-marks and indicate manufacture by Corning Glass Works, Corning, N. Y.



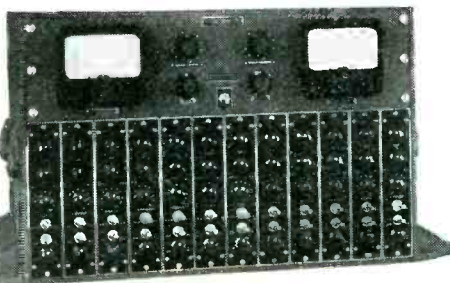
## 12 JOBS AT ONE TIME

FOR THE RAPID determination of static or dynamic strains on large or complex structures, Waugh offers a range of instruments of extraordinary value. There is the 12-channel strain gage control unit which, together with recording equipment, permits 12 simultaneous measurements of strain and vibration. With this equipment, dynamic strains, velocities and accelerations from 0 to 1500 and 3 to 6000 cycles per second can be recorded.

Then there is the vector computer... a robot brain for the evaluation of linear strain measurements on the sur-

face of a structural element when rosette gages are used. The output of the instrument furnishes directly the principal stresses as well as the stresses or strains at any angle to the axes of the rosette.

These instruments are indicative of the range of modern instruments available for purchase or rental through Waugh Laboratories. Write for details—Strain Gage Control Unit Type MRC10 and Vector Computer Type 30-101.



Strain Gage Control Unit Type MRC10

# WAUGH

# Laboratories



Write for Rental List and Service Manual on business letterhead.

Pacific Coast Branch: 180 East California St., Pasadena 5, California

◆ 420 LEXINGTON AVE., NEW YORK 17, N. Y.



## Upside down and sideways – and this transformer puts in overtime!

This is just one more reason why Thermadors are known as America's quality transformers.

There is a machine called a Shaker. It goes up and down while it rotates. The motion varies from a gentle rhumba to an earthquake of cataclysmic proportions. In 10 minutes an ordinary transformer sails off into the steel mesh net.

At Aireon Manufacturing Corporation's Kansas City plant they bolted a Thermador transformer to the shake-bed of this machine. They turned the shaker on for an hour—then they left it going overnight, unbolted the Thermador transformer, connected it to the test line. The needle showed not an nth of variation.

Why this incredible performance? Just this. Transformers were formerly mounted to the cover of their cases. Thermador developed a strong stamped bracket from strip

steel and projection-welded it to the case body—independent of terminal boards or covers. As a result, Thermador transformers can be mounted in any position—up and down and sideways—and take the worst beating you can give them.

**THERMADOR ELECTRICAL MANUFACTURING COMPANY**  
5119 SOUTH REVERSIDE DRIVE • LOS ANGELES 22, CALIF.

# Thermador Transformers

DEFEAT COLD • HEAT • HUMIDITY

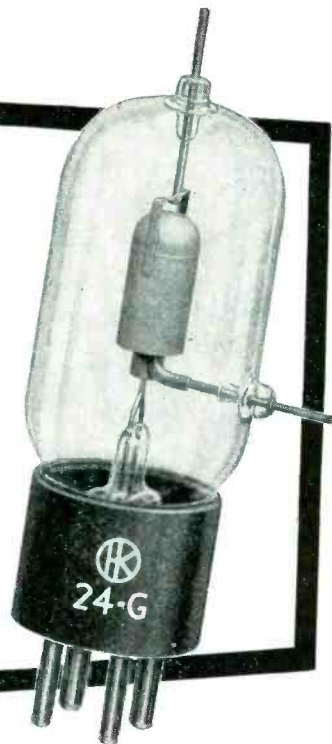


*Seven Leagues Ahead*

# These 22 *Gammatron* types are being standardised by **HEINTZ AND KAUFMAN LTD.**

Heintz and Kaufman Ltd. is coming to the aid of equipment designers and manufacturers by standardizing the physical and electrical characteristics of 22 types of Gammatron tubes. These types will conform to Joint Army-Navy Specifications, where applicable.

So design your circuits around these Gammatrons—with the assurance that they will always meet the same high standards, and always be readily available, thus making unnecessary the problem of redesigning equipment because of changes or variations in tube types.



## 14 TRIODES

TUBE TYPE	PLATE DISSIPATION
HK-24	25 watts (Grid lead to base)
HK-24G	25 watts (Grid lead through envelope)
HK-54	50 watts
HK-254	100 watts
HK-354C	150 watts (Low Amplification Factor)
HK-354E	150 watts (High Amplification Factor)
HK-454L	200 watts (Low Amplification Factor)
HK-454H	200 watts (High Amplification Factor)
HK-654	300 watts
HK-854L	450 watts (Low Amplification Factor)
HK-854H	450 watts (High Amplification Factor)
HK-1054L	750 watts
HK-1554	1000 watts
HK-3054	1500 watts



## 1 PENTODE

HK-257B Plate Dissipation, 75 watts (Beam pentode)



## 4 RECTIFIERS

HK-253	Inverse Peak Volts, 15,000
HK-953B	Inverse Peak Volts, 30,000
HK-953D	Inverse Peak Volts, 75,000
HK-953E	Inverse Peak Volts, 150,000



## 3 IONIZATION GAUGES

VG-2

VG-24G

VG-54

## REPLACEMENT *Gammatron* TUBES

The following Gammatrons will be made available primarily for replacement use. Design engineers are asked to consider recommended standardized types when designing new equipment.

REPLACEMENT TUBE TYPE	DESCRIPTION	RECOMMENDED STANDARDIZED TUBE TYPE
HK-354	Triode, grid lead to base pin, ratings same as HK-354C	HK-354C HK-454L HK-454H
HK-354D	Triode, Medium Amplification Factor	HK-354C or E HK-454L or H
HK-354F	Triode, High Amplification Factor	HK-354E
HK-257A	Beam Pentode	HK-257B
HK-153	High Vacuum Rectifier, inverse peak volts, 5000	HK-253
HK-545	Triode. Same as HK-54 except fil. current is 3.35 instead of 5 amps.	HK-54
HK-2054A	Triode	
HK-2054C	Triode	

**HEINTZ AND KAUFMAN LTD.**  
SOUTH SAN FRANCISCO • CALIFORNIA

KEEP BUYING  WAR BONDS

*Gammatron Tubes*

Export Agents: M. SIMON & SON CO., INC.  
25 WARREN STREET, NEW YORK CITY, N. Y.

SENSITIVITY



CONTACT PRESSURE



DEPENDABILITY



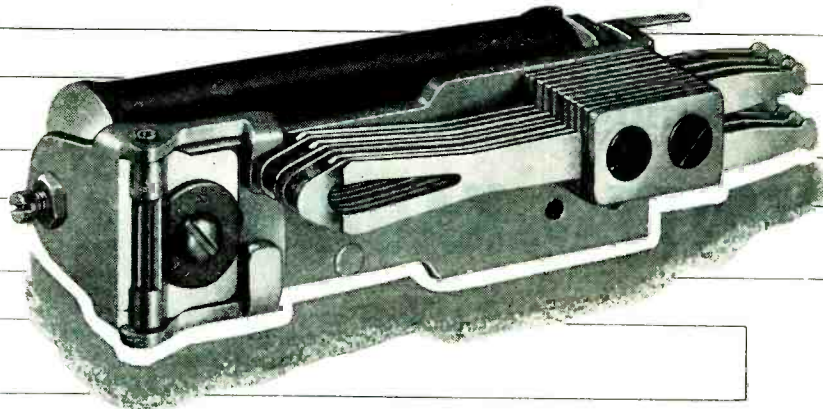
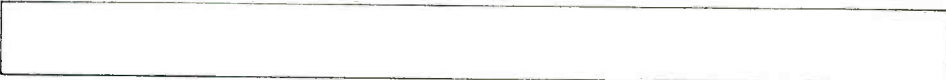
DURABILITY



COMPACTNESS



VERSATILITY



# — in Greatest Combination

## THE NEW AUTOMATIC ELECTRIC CLASS "B" RELAY

• When you need a relay that's sensitive enough to operate on minute current, yet has the high contact pressure needed for perfect closure, you'll find the Automatic Electric Class "B" Relay worth investigating.

If you need a relay that will switch many circuits, yet is compact enough for multiple mounting in small space, you'll find Class "B" the perfect solution.

Or perhaps you are interested in extra durability, for long service under tough conditions. Then you'll need the in-built quality for which Class "B" has become famous.

No other relay—even in the Automatic Electric line—can give you a greater combination of all these essential qualities. Get the full story on Class "B"—one of the forty basic types described in the Automatic Electric catalog. Ask for your copy of Catalog 4071.

### CHECK THESE FEATURES of the New Class "B" Relay

*Independent Twin Contacts*—for dependable contact closure.

*Efficient Magnetic Circuit*—for sensitivity and high contact pressure.

*Unique Armature Bearing*—for long wear under severe service conditions.

*Compact Design*—for important savings in space and weight.

*Versatility*—Available for coil voltages to 300 volts d-c and 230 volts a-c, and with capacities up to 28 springs; also with magnetic shielding cover, when specified.

**No other relay can give you a greater combination of all these essential qualities.**

*Relays*  
AND OTHER CONTROL DEVICES  
*by* **AUTOMATIC ELECTRIC**



AUTOMATIC ELECTRIC SALES CORPORATION  
1033 West Van Buren Street • Chicago 7, Illinois

In Canada: Automatic Electric (Canada) Limited, Toronto

PARTS AND ASSEMBLIES FOR EVERY ELECTRICAL CONTROL NEED





# Pursuit of a molecule

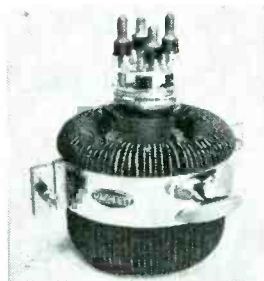
**ANOTHER  
MACHLETT  
TECHNIQUE**

A stable high vacuum is essential to the production of an electron tube if it is to give uniform, predictable performance. But there is much more to the process of getting a vacuum than just pumping.

Molecules of gas are not only present within the space inside the tube, and inside the metal parts, but also adhere tenaciously to all inner surfaces, or are "adsorbed". There is a special Machlett technique for dislodging those molecules. During pumping both the glass and the metal are brought to high temperatures. Cathode and anode are heated alternately many times, in order to capture molecules that are driven from one surface to the other. Most important of all, the tube is actually operated at voltages far in excess of values generally used in the vacuum tube field. All this takes many hours, the use of perfected apparatus

including Machlett-designed pumps and other equipment, and the highest skills of laboratory-trained technicians.

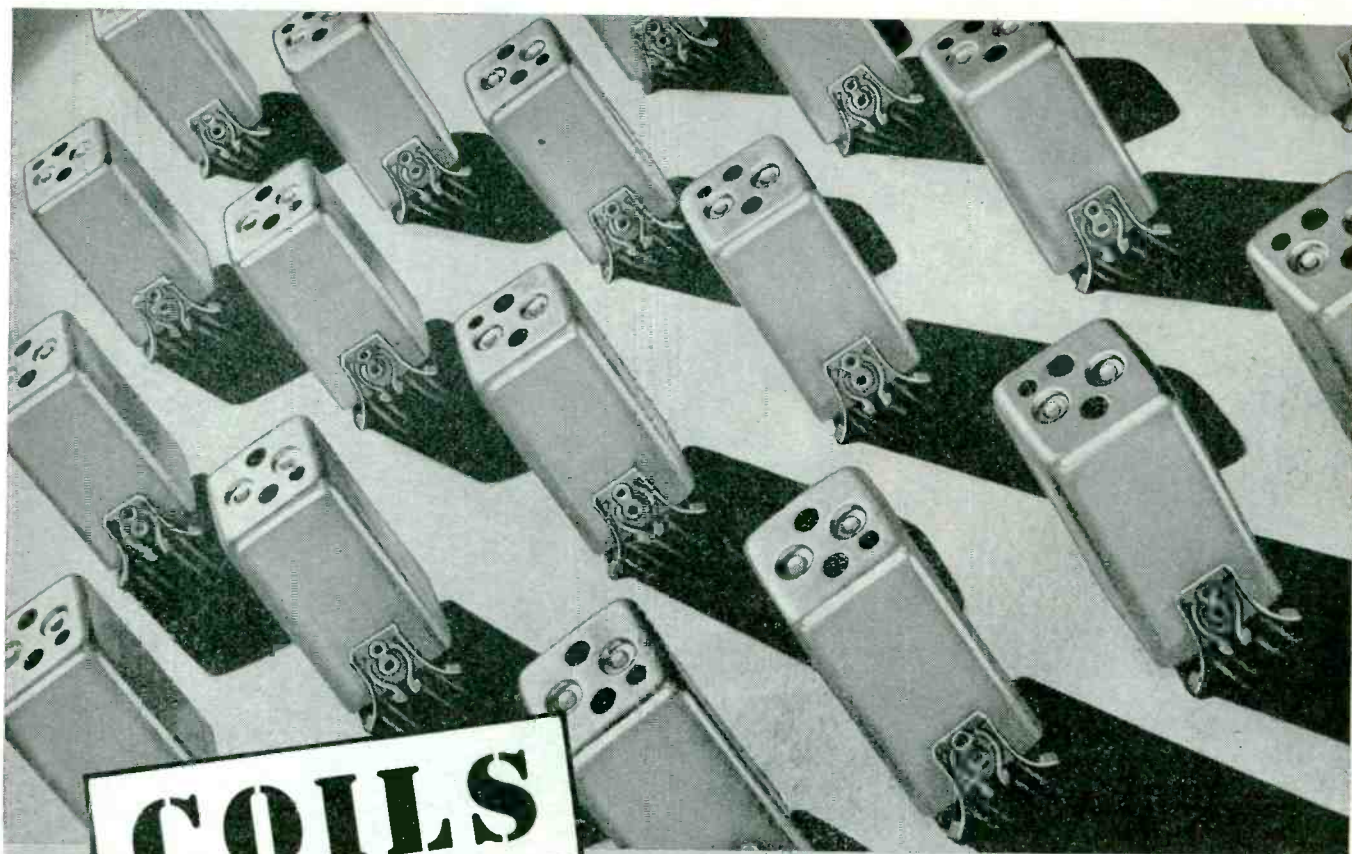
Thus when the tube is finally sealed we know the heat of operation cannot free enough molecules to affect its performance in your hands. This Machlett technique was developed for our X-ray tubes, and was in part responsible for the Machlett reputation. When we began the manufacture of radio and industrial oscillators, amplifiers and rectifiers, the same methods of capturing the molecules were adopted. That is one of the many reasons why users of Machlett radio and industrial tubes join with medical and industrial users of Machlett X-ray tubes in praising their reliability and economy. It will pay you to buy Machlett tubes. For information as to available types, write Machlett Laboratories, Inc., Springdale, Conn.



*ML-889-R, a rugged forced-air-cooled triode, designed for h-f broadcast and dielectric heating applications*

# MACHLETT

APPLIES TO RADIO AND INDUSTRIAL USES  
ITS **48** YEARS OF ELECTRON-TUBE EXPERIENCE



# COILS

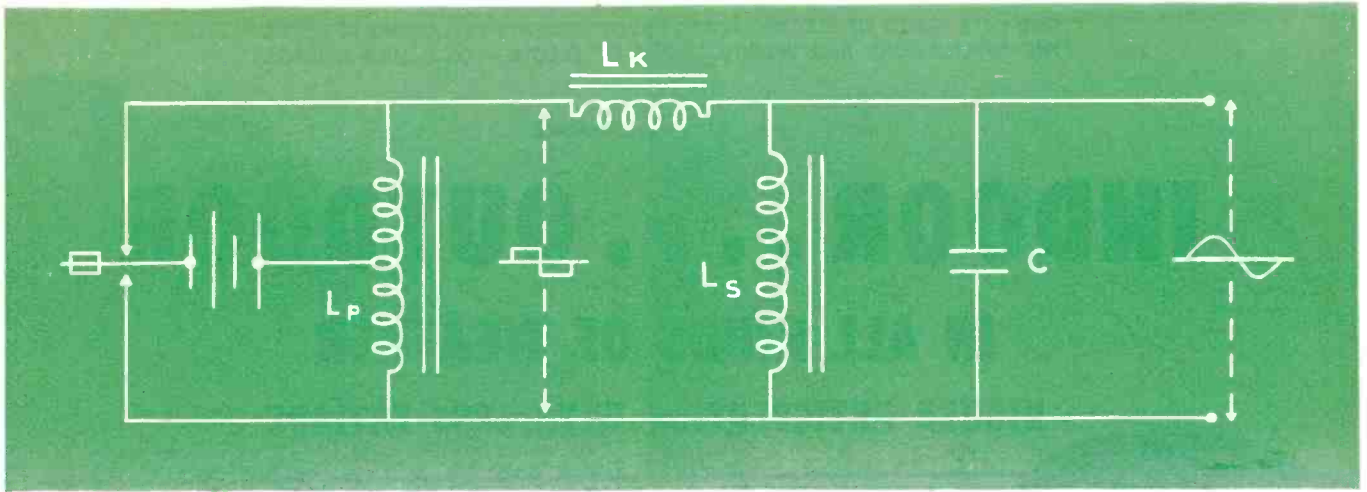
Before the war  
We made millions of coils each year  
For many years.  
Our organization was mass-production minded.  
That organization is intact.  
We are still mass-production minded.  
Order your mass-production coils from  
people who "know-how".



COMPLETE ELECTRONIC ASSEMBLIES & COMPONENT PARTS

900 PASSAIC AVE.

EAST NEWARK, N. J.



## NOW, A VIBRATOR POWER SUPPLY WITH A SINE WAVE OUTPUT

● For years, it has been taken for granted that the output wave form of a Vibrator Power Supply necessarily must be a rectangular wave with its characteristic "swingback" or commutation lines. With the development of very sensitive radio equipment this, of course, caused shock excitation of the audio and RF tuned circuits. In equipment designed for sine wave, operation on square wave resulted in the wrong ratio of A and B voltages applied to the tubes.

Realizing the need for eliminating the difficulties arising from square wave operation, Electronic Laboratories research department has perfected a Vibrator Power Supply which can supply a sine wave at powers up to several hundred watts from any DC source. In addition, this output is stable and has excellent regulation characteristics with load and input voltage.

Referring to the diagram at the top of this page,  $L_k$  (leakage reactance) and the condenser, "C", form a series resonant circuit. This circuit establishes a voltage across the secondary inductance,  $L_s$ . This voltage rises as  $L_k$  is varied until it is established by the saturation of the secondary inductance,  $L_s$ . The saturation characteristic of the inductance,  $L_s$ , is such as to sustain sinusoidal voltage across the condenser, "C". This results in a smooth sine wave output voltage, substantially independent of the input voltage. An elementary form of this system is shown in figure 1. The power transformer consists of a primary winding, "P", energized from the battery through the vibrator. The secondary winding, "S", is separated from the primary by magnetic shunts, and the tank

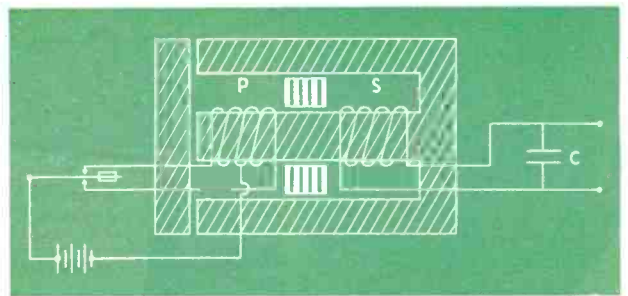


Figure 1

condenser, "C", is across the secondary winding.

Since the reactive energy stored in the system is large, compared to the actual energy dissipated by the load, this system is also independent of load changes. Careful design of the primary circuit insures proper commutation for long life and reliability. Any number of voltages can be had from the system by properly tapping the tank circuit.

\* \* \* \* \*

*E.L.* Vibrator Power Supplies have wide application in many fields: radio, electrical, electronic, marine, aviation and railroad. Their high efficiency and versatility with multiple inputs and outputs, enable them to meet many power supply needs. They may be designed to provide any wave form required for specific equipment. . . . Economy is assured because of long, efficient service with minimum maintenance. *E.L.* Engineering Service is available to discuss your power supply problem and to design a vibrator power supply to meet specific voltage, power, size and weight requirements. Model illustrated is a typical *E.L.* Vibrator Power Supply with sine wave output and voltage regulation.



# Electronic

LABORATORIES INC.

INDIANAPOLIS

VIBRATOR POWER SUPPLIES FOR LIGHTING, COMMUNICATIONS, ELECTRIC MOTOR OPERATION • ELECTRIC, ELECTRONIC AND OTHER EQUIPMENT

ONE OF A SERIES OF ELECTRO-VOICE ADVERTISEMENTS EXPLAINING IN DETAIL THE APPLICATIONS AND SPECIFICATIONS OF ELECTRO-VOICE MICROPHONES

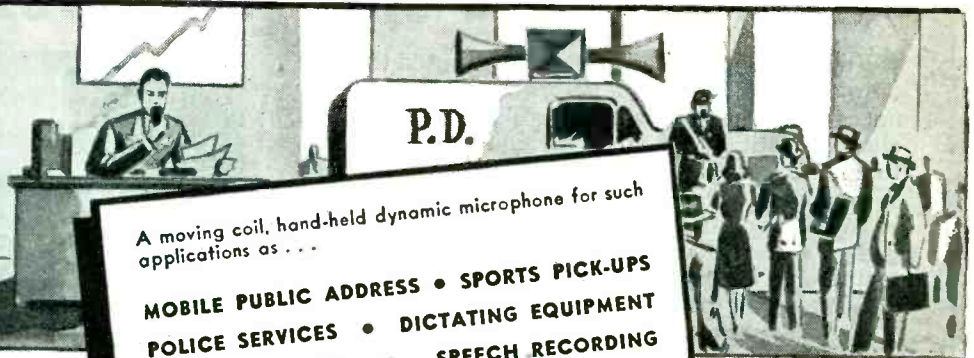
# INDOOR . . . . OUTDOOR

## IN ALL KINDS OF WEATHER

### HIGHER ARTICULATION WITH LESS FATIGUE



## *Electro-Voice* MODEL 600-D



A moving coil, hand-held dynamic microphone for such applications as . . .

- MOBILE PUBLIC ADDRESS • SPORTS PICK-UPS
- POLICE SERVICES • DICTATING EQUIPMENT
- MARINE SERVICES • SPEECH RECORDING

Exhaustive tests have proved that a uniform response to all frequencies between 200-4000 c.p.s. will give higher articulation, provide more usable power level, and be less fatiguing to the listener than one which is peaked. These advantages are assured in the Electro-Voice Model 600-D because the frequency response is unweighted and substantially flat. Where ambient noise does not interfere or distract, high fidelity speech transmission is provided, indoors or outdoors . . . in any kind of weather.

**OUTPUT LEVEL RATING:** Power: 56 db below 6 milliwatts for 10 dynes/cm. pressure. Voltage (high impedance): 5 db above .001 volt/dyne/cm<sup>2</sup>, open circuit. Voltage developed by normal speech (100 dynes/cm<sup>2</sup>): .177 volt.

**FREQUENCY RESPONSE:** 100-6000 c.p.s.

**WEIGHT:** 9 ounces.

**HARMONIC CONTENT:** Less than 2% at all frequencies.

**DIAPHRAGM:** Made of heat-treated duralumin, corrosion inhibited.

**VOICE COIL:** Made of pure aluminum, high-Q design.

**CASE:** Constructed of finest quality, high impact phenolic.

**PRESS-TO-TALK SWITCH:** Sliding contact, self cleaning type; standard circuit opens microphone and closes relay simultaneously. Other combinations optional.

**TRANSFORMER CORE:** Made of nickel alloy, hydrogen annealed metal; low capacity windings.

**MAGNETIC CIRCUIT:** Employs Alnico V and Armco magnetic iron.

**IMPEDANCES:** Hi-Z (Direct-to-Grid), 50, 200, 250, or 500 ohms.

Equipped with 6 feet of two conductor and shielded synthetic rubber jacketed cable.

Model 600-D, List Price \_\_\_\_\_ \$27.50

Model 600-DL, with switch lock, List Price \_\_\_\_\_ \$29.00

See your nearest radio parts distributor today. His knowledge of Electro-Voice microphones may aid you in selecting the appropriate type for your specific needs. He may also be an important factor in speeding your order.

SUPPORT  
THE SEVENTH  
WAR LOAN  
DRIVE

# *Electro-Voice* MICROPHONES

ELECTRO-VOICE CORPORATION • 1239 SOUTH BEND AVENUE • SOUTH BEND 24, INDIANA  
Export Division: 13 East 40th Street, New York 16, N. Y., U. S. A. Cables: Arlab



# Combining

## 1. SPECIAL PURPOSE ENGINEERING 2. RECEIVING TUBE TECHNIQUES

The 2C26A exemplifies Hytron's ability to build in soft glass, at high speed, and for economical prices, special purpose tubes. Hytron solved a tough problem for the Services by designing in the 2C26A a tube capable of performance and high ratings never before — or since — achieved in soft glass. This small tube — approximately the same size as the 50L6GT Bantam — is capable of delivering 2 KW of useful r.f. power at 200 megacycles. It replaces larger and much more expensive hard glass transmitting tubes which must be operated at much higher potentials.

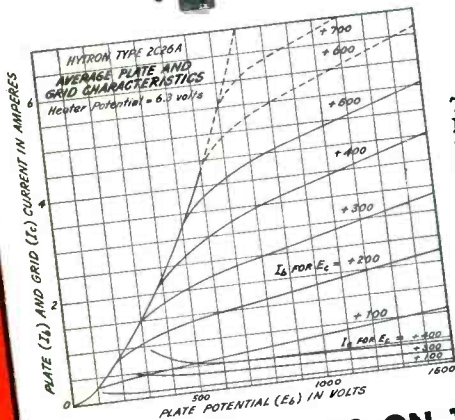
### HYTRON TYPE 2C26A VERY-HIGH-FREQUENCY TRIODE PULSE OSCILLATOR

The Hytron type 2C26A is a special triode for use as a grid or plate pulse oscillator up to 300 megacycles. Its cathode is designed and processed to provide the extremely high peak plate currents required in pulse operation. Special top cap design permits use of the maximum potentials, without external voltage breakdown, at the higher altitudes. Other notable features are: convenient size, standard octal base, high-voltage internal ceramic insulators, and extremely rugged construction.



#### ELECTRICAL

Coated Unipotential Cathode	6.3 volts
Heater Voltage	1.1 amps.
Heater Current	10 max. watts
Plate Dissipation	2.5 max. watts
Grid Dissipation	3500 max. peak volts
Plate Potential (plate pulsed)	2500 max. dc volts
Plate Potential (grid pulsed)	- 700 max. dc volts
Grid Bias	Eb:400V; Ec:-15V; Eh:6.3V
Average Characteristics for	16 ma.
Plate Current	16.3
Amplification Factor	2250 micromhos
Transconductance	
Average Direct Interelectrode Capacitances	
Grid-to-Plate	2.8 mmf.
Grid-to-Cathode	2.6 mmf.
Plate-to-Cathode	1.1 mmf.
Frequency for Maximum Rating	300 MC



#### MECHANICAL

Type of cooling	Convection
Base	Intermediate shell octal 8-pin phenolic
Top Caps	Skirted miniature with insulating bushing
Bulb	T-9
Maximum overall dimensions	
Length	3 1/16 inches
Seated Height	3 3/8 inches
Diameter	1 5/16 inches
Net Weight	1 1/2 ounces

**2C26A IS ON THE ARMY-NAVY PREFERRED LIST**

OLDEST EXCLUSIVE MANUFACTURER OF RADIO RECEIVING TUBES

# HYTRON

RADIO AND ELECTRONICS CORP.

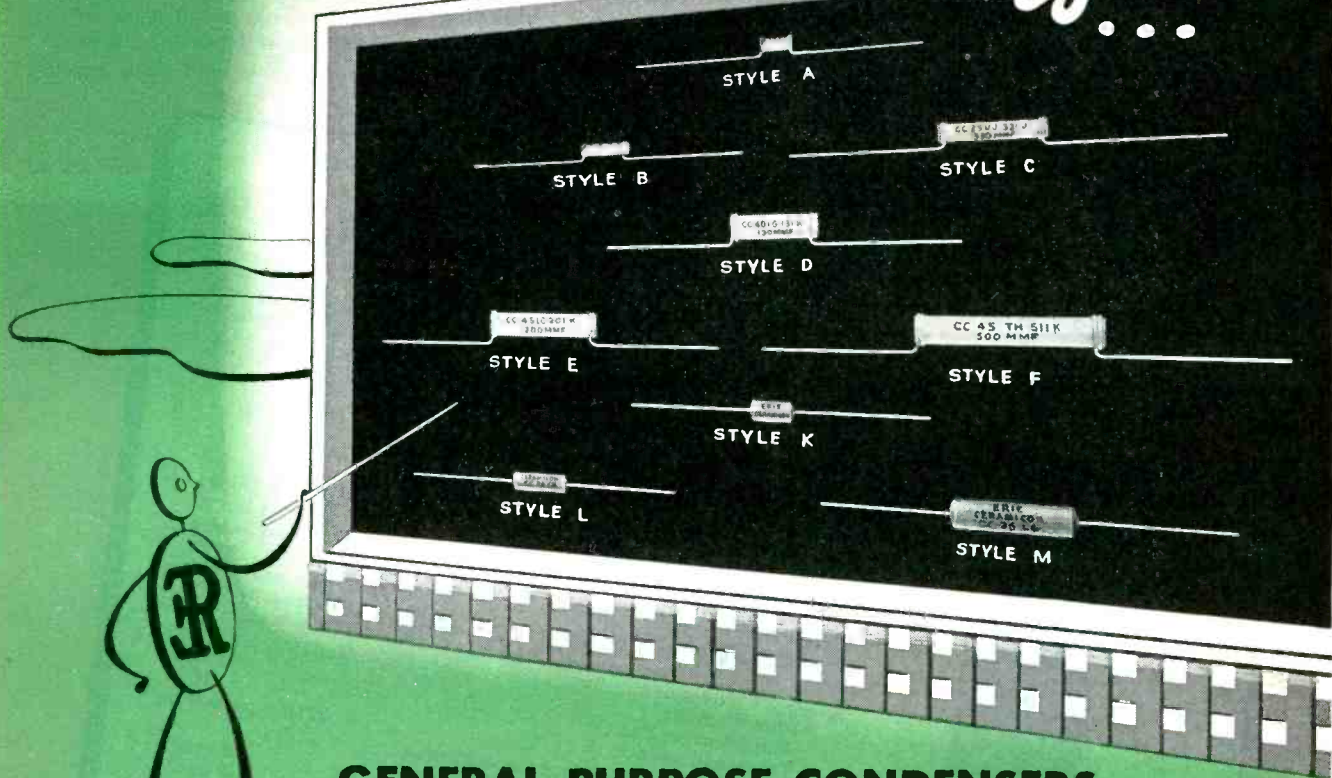


MAIN OFFICE: SALEM, MASSACHUSETTS  
PLANTS: SALEM, NEWBURYPORT, BEVERLY & LAWRENCE

FORMERLY HYTRON CORPORATION

# USE Erie Ceramicons

REG. U.S. PAT. OFF.



## GENERAL PURPOSE CONDENSERS

Available in 10 Standard Temperature Coefficients

THE tremendous wartime demand for condensers has provided a splendid opportunity to prove the reliability and adaptability of Erie Ceramicons\* as extremely stable, general purpose capacitors, in circuits where a moderate degree of capacity change with temperature is permissible.

Originally designed and developed almost a decade ago to provide engineers with a simple and effective method of compensating for frequency drift in other components, Erie Ceramicons are now being used in a wide range of applications with complete success.

Erie Ceramicons are available in ten standard coefficients ranging from +120 to -750 parts/million/°C, inclusive. Capacity ranges, style designations, and dimensions are given in the chart at the right.

When specifying Ceramicons under JAN-C-20 for general purpose use, temperature coefficient characteristic "SL" should be given. If Erie designations are used, specify "any temperature coefficient between P100 and N750." The temperature coefficient of these Ceramicons will be between +150 and -870 parts/million/°C. In many cases,

particularly in the low capacity ranges, these temperature coefficient limits will permit us to ship from stock. We will gladly submit samples of Erie Ceramicons to you for your general purpose applications.

### CHARACTERISTICS

CAPACITY RANGE IN MMF	JAN-C-20 STYLE	ERIE STYLE	MAXIMUM OVERALL DIMENSIONS
1 to 51	CC20	A	.200 x .400
	CC21	K	.250 x .562
52 to 110	CC25	B	.200 x .656
	CC26	L	.250 x .812
111 to 360	CC35	C	.265 x 1.125
	CC36	M	.340 x 1.328
361 to 510	CC40	D	.375 x 1.110
511 to 820	CC45	E	.375 x 1.560
821 to 1100	CC45	F	.375 x 2.00

\*CERAMICON IS THE REGISTERED TRADE NAME OF SILVERED CERAMIC CONDENSERS MADE BY ERIE RESISTOR CORPORATION.

Electronics Division

**ERIE RESISTOR CORP., ERIE, PA.**  
LONDON, ENGLAND • • TORONTO, CANADA



BUY MORE WAR BONDS



**FOOL-PROOF! THAT'S THE G. I. POST WAR  
RECORD CHANGERS!**

One simple fact must never be overlooked: Even the most beautifully engineered record changer is home equipment. As such it has to be proof against little Willie, a saboteur at heart, Uncle Bill who is all thumbs and Aunt Edna who just loves music but is just plumb careless.

For years our G. I. pre-war changers have been working overtime. Their overall record of trouble-free performance in the face of parts shortages and

lack of repair help has been nothing short of amazing. That's the dealers' opinion.

Now G. I.'s Post War Record Changer is all set and ready to go. The set manufacturers we've permitted to peek under the lid are enthusiastic beyond words. The operating simplicity that has been achieved—its functional streamlining—its fool-proof operation—will make history in this industry.

# **GENERAL INSTRUMENT CORPORATION**



**829 NEWARK AVENUE • ELIZABETH 3, N. J.**

The *precise* capacitor  
for the *precise* application...



# AEROVOX ELECTROLYTICS

● The electrolytic capacitor has its own special field of application in electronic, radio and electrical equipment. This type provides the equipment designer with an *unusually lightweight unit* of high capacitance in a compact container. Also, it effects considerable savings. **BUT...**

Electrolytic capacitors must be properly applied for long life and stable

characteristics. There are essential differences between electrolytics and other types that restrict their use, such as over-voltage, allowable ripple current, capacitance, tolerance, temperature. **WHICH MEANS...**

The proper type and rating must be used for the given application, along with meeting mechanical considerations, if the basic advantages of electro-

lytics are to be gained. **THAT IS WHY...**

AeroVox, pioneer of the dry electrolytic, continues to offer the outstanding selection of electrolytic capacitors. There is the **PRECISE** capacitor for the **PRECISE** application, which guarantees satisfactory service and long life. Don't improvise!

● Write for literature . . .



# Capacitors

**- INDIVIDUALLY TESTED**

AEROVOX CORPORATION, NEW BEDFORD, MASS., U. S. A.

SALES OFFICES IN ALL PRINCIPAL CITIES

Export: 13, E. 40 ST., New York 16, N. Y. • Cable: 'ARLAB' • In Canada: AEROVOX CANADA LTD., HAMILTON, ONT.



# ANNOUNCING AN ENTIRELY NEW CERAMIC CAPACITOR DIELECTRIC MYCALEX K

The MYCALEX CORPORATION OF AMERICA has developed and now has in production a new capacitor dielectric which embodies important new advancements in properties.

Designated MYCALEX "K," this new ceramic material is unique in that it offers a *selective* range of dielectric constants, from 8 to 15 at one megacycle.

Engineers whose requirements call for a material with a dielectric constant of 10, need only specify MYCALEX K-10. If a dielectric constant of 8 is indicated, MYCALEX K-8 will meet that exact requirement. Other applications might call for use of MYCALEX K-11 or K-12, etc.

MYCALEX K-10 already has been approved by the Army and Navy as Grade H1C5H4 Class H material (JAN-I-12). While other Class H materials are available, to the best of our knowledge these are all steatite or bonded titania or titanate types, obtainable only in relatively small dimensions and subject to wide variations in tolerances. MYCALEX K is available in sheets 14" x 18" in thicknesses of 1/8" to 1"; in thicknesses down to 1/32" in smaller sheets, and in rods 1/4" to 1" in diameter.

Of importance also is the fact that MYCALEX K series can be molded to specifications, with electrodes or metal inserts molded in. It can be fabricated to close tolerances.

So far as we are aware, the MYCALEX CORPORATION OF AMERICA is the exclusive developer and only supplier of this kind of capacitor dielectric.

Write today for further information to Department 12.

### Other Products of Mycalex Are:

MYCALEX 400—the most highly perfected form of MYCALEX insulation, approved by Army and Navy as Grade L-4 insulation. In sheets, rods and fabricated form.

MOLDED MYCALEX available to specifications in irregular shapes and into which metal inserts may be incorporated.

**MYCALEX**  
THE INSULATOR

TRADE MARK REG. U. S. PAT. OFF.

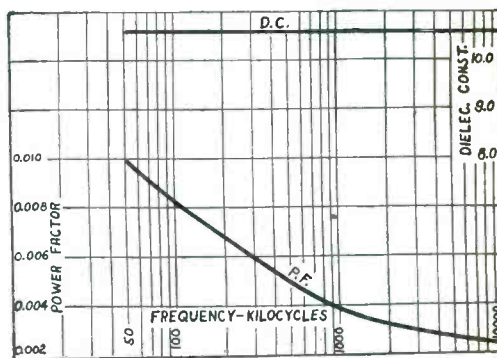
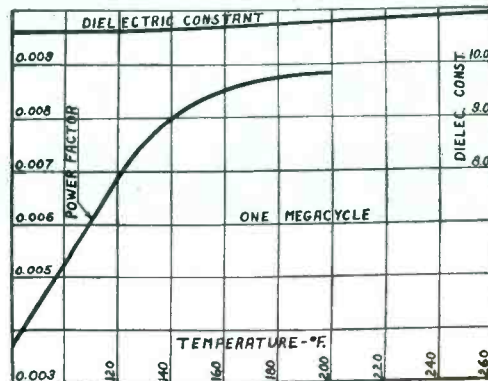
### MYCALEX K-10

Grade H1C5H4, in accordance with JAN-I-12

Dielectric constant	10.6	} 1 megacycle
Q-Factor	310	
Loss Factor	0.034	
Volume resistivity	$6.0 \times 10^{13}$ ohms-cms.	
Dielectric strength	270 volts/mil (0.10" thickness)	
Modulus of rupture	9000 lbs./sq.in.	
Fractional decrease of capacitance with temperature change	0.0056	
Fractional increase of capacitance with temperature change	0.0076	
Porosity—no dye penetration after six hours at 10,000 lbs./sq. in.		

The above properties were measured in accordance with the procedures of JAN-I-12.

Density	0.116 lbs. per cu.in.
Specific gravity	3.22
Softening temperature	400° C.



## MYCALEX CORPORATION OF AMERICA

"OWNERS OF 'MYCALEX' PATENTS"

Plant and General Offices  
Clifton, N. J.

Executive Offices  
30 Rockefeller Plaza  
New York 20, N. Y.

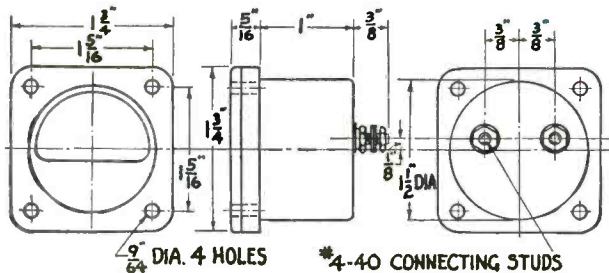


**SMALL BUT  
STURDY...**

## The New Line of ROLLER-SMITH 1½" Panel Instruments

*Instrument shown actual size.*

*When desired, solder lugs can be furnished instead of the connecting studs shown.*



**D**esign and development of this line of 1½" instruments were based on rigid U. S. Army Air Force specifications. They are built to withstand extreme conditions of temperature, humidity, vibration and shock, and immersion tests have demonstrated their ability to withstand a hydrostatic pressure of 14.7 psi.

Roller-Smith 1½" instruments are now available in d-c voltmeters, 1000 ohms per volt, in all practical ranges above 100 millivolts, and 100 ohms per volt in ranges from 50 to 100 millivolts; d-c ammeters in all practical ranges above 500 microamperes. For certain applications instruments can be supplied with ranges below those specified. Correspondence is invited.



Sales Representatives  
In all Principal Cities

# ROLLER-SMITH BETHLEHEM, PENNA.

Canadian Plant: ROLLER-SMITH-MARSLAND, LTD., Ritchie, Ontario

STANDARD AND PRECISION ELECTRICAL INSTRUMENTS • AIRCRAFT INSTRUMENTS • SWITCHGEAR •  
AIR AND OIL CIRCUIT BREAKERS • ROTARY SWITCHES • RELAYS • PRECISION BALANCES

# SUSTAINED CONSTRUCTION ACTIVITY

## *One Step Toward High Level Employment*

**I**N the 34th editorial of this series, it was pointed out that sustained prosperity, based on high level employment, was a major postwar goal accepted by government, management and labor.

That editorial developed the theme that, if the goal were to be approached without undue sacrifice of our essential liberties, we must forego the search for magic panaceas, and follow the harder but more promising course of analyzing step by step, and industry by industry, the measures that might contribute toward the end sought.

This is the first of a number of editorials following such a particularized approach. It will examine the role of the construction industry in forwarding sustained prosperity.

★ ★ ★

The influence of construction upon the general level of economic activity is important but not decisive. The claim is frequently advanced that major fluctuations of the business cycle might be ironed out by a properly devised and timed public works program; but any examination of the relatively modest contribution of construction activities to total national output will demonstrate its extravagance.

In the twenty years from 1920 through 1939, the value of new construction averaged just over 8½% of the gross national product. If we add repair and maintenance expenditures, the total is increased to a little over 12% of the gross product. But approximately two thirds of the construction of this period was privately initiated, and only one third was represented by government construction, federal, state and local combined. To expect that we can level out the peaks and valleys of our whole economy through manipulating the 4% portion that is represented by government construction is to expect a very small tail to wag a very large dog.

In fact, the record of construction activity in the past has been on the side of disequilibrium rather than stabilization. In boom times construction activity has climbed to relatively higher peaks than those reached by the economy as a whole; in depression periods it has fallen to deeper troughs. Aside from the special work relief program of the depression thirties, the performance of public construction in this respect is little better than that of private. New

government construction mounted with the general trend of the boom from 1921 to 1929, thereby adding its weight to the inflationary trend.

Instead, then, of expecting the construction industry to stabilize our whole economy—a task clearly beyond its power—it would seem appropriate to ask that it look to the more attainable goal of leveling out its own violent fluctuations. If this can be done, many of the most vexing problems of the construction field and of its sphere of influence will be mitigated, employment will be regularized in one important segment of industry where the past record has been particularly uneven, and one aggravating contribution to general business instability will be removed.

The achievement of these highly important, if limited, aims will require the thoughtful, vigorous, and concerted cooperation of management and labor in the construction industry, of a variety of governmental agencies, and of those who direct the sources of construction credit. Of the many measures that must be woven into an ordered program, it is practicable here to present only the broad outline of those which seem to offer the greatest potential usefulness.

★ ★ ★

1. Stabilization implies the holding of a balance rather than a freezing at a given level. No rigid formula for a most desirable level of construction activity is possible or desirable. However, it may be accepted as a reasonable initial premise, that we could sustain in the future without major distortion something like the 12% ratio of total construction to gross national product that has been approximated in the past. If it is to serve as a useful reference point, such a generalized premise must be subjected to constant testing both nationally and locally. There must be careful and continuous scrutiny for signs of demand saturation, cost inflation, and labor shortages, all danger signals of far greater reliability than any percentage formula.

The first requisite then is the general availability of information along such lines, far more complete and current than has hitherto been at hand. The second is a general will to hold building activity at a level as high as but not higher than we probably can sustain. Once this principle is accepted, the problem becomes one of marshalling all available instrumentalities to forward it.

2. Public construction, although too small to exert a decisive influence upon economic activity as a whole, can

condition construction trends to a major degree. If, in the decade following the war, government construction approximates its 1920 to 1940 average of one third of all construction, its properly timed impact could do much to level out the construction cycle.

To do this most effectively, public construction should be deferred where and when private building is going forward at a satisfactory pace, and should be started when and where private activity shows undue slack. All government construction does not lend itself to such adjustment. But a large portion of it could be held up for the three to five years which, upon past experience, would provide the necessary leeway to counteract the more violent fluctuations in private building.

Such a program presents numerous difficulties both political and administrative. None should be insurmountable, and the results promise to be of sufficient moment to justify the extraordinary effort that would be required to coordinate federal, state and local government programs. Here is an excellent forum for testing whether or not government economic activity can be made to supplement rather than supplant private effort to serve ends upon which all are agreed.

3. Since private building, postwar as in the past, must supply the preponderant share of construction activity and employment, costs will continue to play a dominant role in determining levels of operation. Wartime restrictions have created formidable backlogs of deferred demand for most types of private, and for many of public, construction. Such demand is so great that it almost certainly will provide the impetus for a postwar building boom of several years duration. There is considerable doubt that in the beginning our building trades, dislocated by war and at low ebb, can organize rapidly enough to carry their share of the anticipated general advance.

However, if former patterns hold, building activity, after a lagging start, will soar, costs will mount, and eventually will saturate effective demand with resultant collapse. That, of course, is precisely the sort of a situation we are seeking to avoid. Crucial to this end is the prevention of rising costs or, better still, the reduction of building costs from present swollen levels.

A recent study by technicians of the War Production Board on the outlook for private housing construction illustrates the point. From 1900 to 1940 the number of housing units built in this country closely matched the statistics of new family formation. The former ran considerably ahead of the latter from 1920 to 1929, and fell behind by the same margin in the following decade.

If the market for new houses were to be similarly limited for the period from 1940 through 1949, the effective demand for new housing during the last five years (1945-1949) is estimated at 3,000,000 units. That is after allowing for houses built from 1940 through 1944, and for vacancies, demolitions, and other factors. If, however, prices could be reduced to 1939 levels, the 3,000,000 unit demand is estimated as increasing to more than 7,000,000 units. Since the latter figure is substantially beyond our production capacity for the period, a backlog would be

created that would support an effective sustained demand for the subsequent decade (1950-1959) of 1,000,000 units per year, as against half that amount if rents and sales prices mount with increasing incomes.

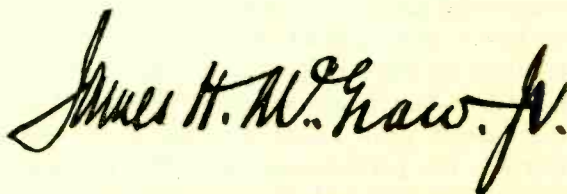
The precise accuracy of such an estimate may well be questioned. There can be no question as to the general validity of the point illustrated. The progressive lowering of construction costs will stimulate demand in this field as it has in others. Building management, labor, and their suppliers and customers stand to gain from such a result. Unnecessary restrictions against the adoption of improved technologies and increased productivity should, therefore, be removed, whether imposed by codes of government, regulations of unions, collusion of managements, or inertia of workers. Unless there are compelling social justifications such restrictions must be judged harmful to the whole economy.

4. Numerous other measures could contribute substantially to increased and increasingly stable construction activities. Space remains only to stress the importance of careful consideration for the use of credit facilities as a means of stabilization. In recent years the establishment of the Federal Housing Administration provided a needed stimulus to mortgage lending in the field of housing. The modern pattern of long-term mortgages, providing for regular amortization as well as interest, should be a steadying factor in periods of liquidation. However, there appear to be further possibilities for using credit facilities as a brake when construction activity threatens to climb beyond a level that can be sustained. If public and private lending agencies could devise sound means for raising mortgage rates, increasing down-payment requirements, shortening amortization periods and basing value appraisals upon normal rather than inflated costs, they might exert a healthy influence against the tendency of the construction bubble to inflate until it bursts.

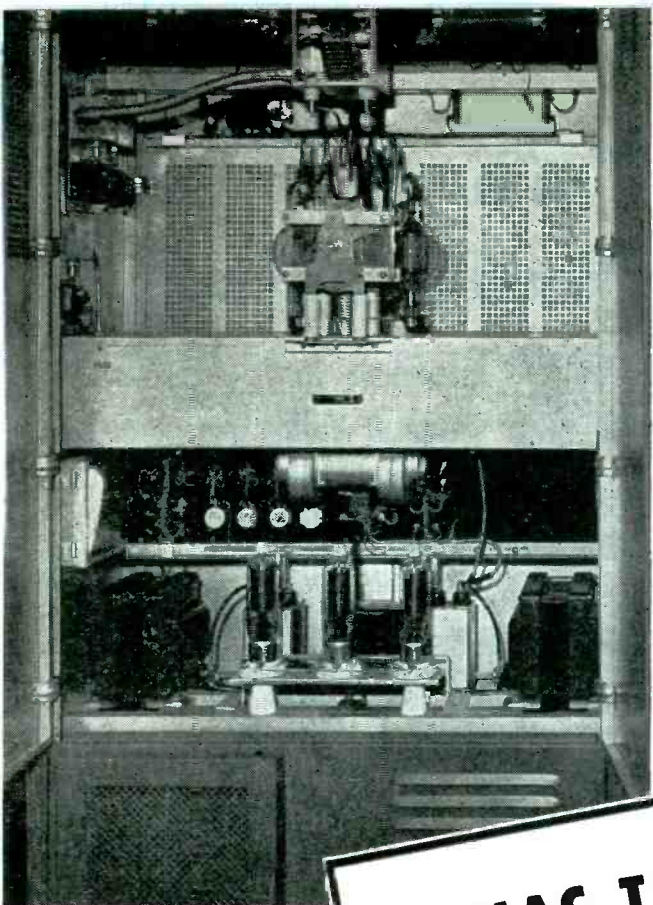
☆ ☆ ☆

There is no royal road to sustained high level employment. There is not even a single path to assured construction stability—there are many paths, all strait and narrow and all paved with bruising cobbles. This is true for all other major segments of industry.

It is easier to seize upon a magic formula such as monetary control, or deficit spending, or any one of a score of others, than to undertake an intricate task of piecemeal exploration. But only the latter course will lead to prosperity.

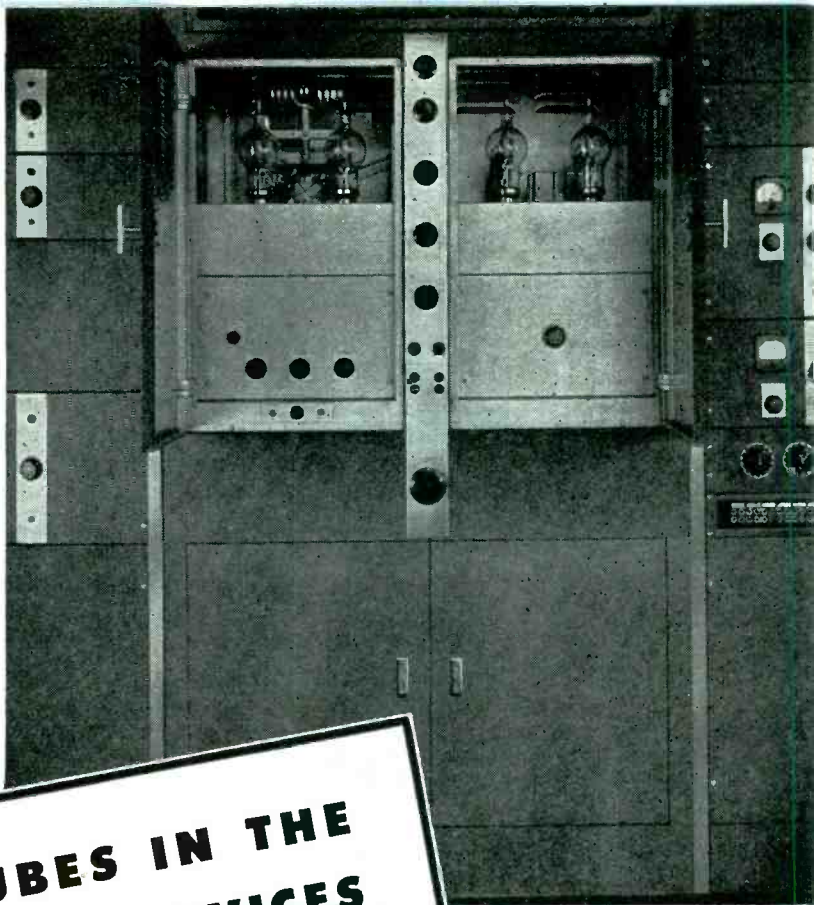


President, McGraw-Hill Publishing Co., Inc.



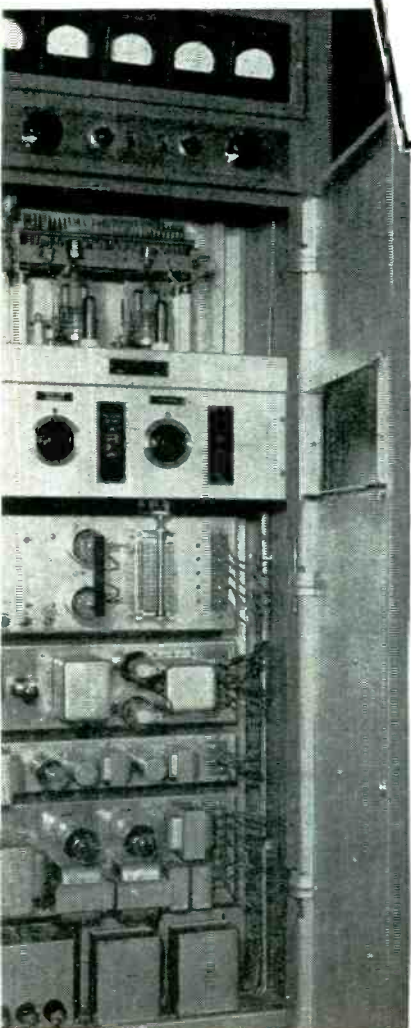
A pair of Eimac 1000-T's give 3 KW output in this Link-built FM transmitter for the emergency services.

Here's a 500 watt supersonic test generator for operation at 1 to 300 kc which uses Eimac 152-T tubes.



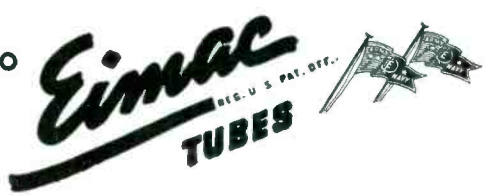
500 watt AM police transmitter for 30-40 Mc operation, built by Fred M. Link, using Eimac 250-TH tubes in the final.

**EIMAC TUBES IN THE  
EMERGENCY SERVICES  
WHERE DEPENDABLE  
PERFORMANCE COUNTS!**



The transmitters shown on this page were developed and built for the emergency services—police, fire and transportation—by Link Radio Corporation of New York City. Recognition such as that enjoyed by the Link organization in this field is built upon sound engineering and the right choice of equipment components. That Eimac tubes occupy the important sockets in these vital transmitters is fitting acknowledgement of their inherently superior performance capabilities. That Fred M. Link specifies Eimac tubes is confirmation of the fact that Eimac tubes are first choice of leading electronic engineers throughout the world.

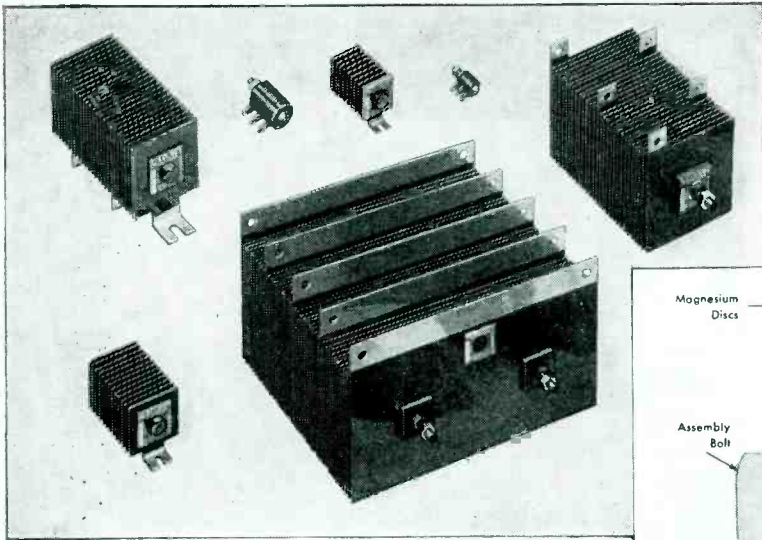
**FOLLOW THE LEADERS TO**



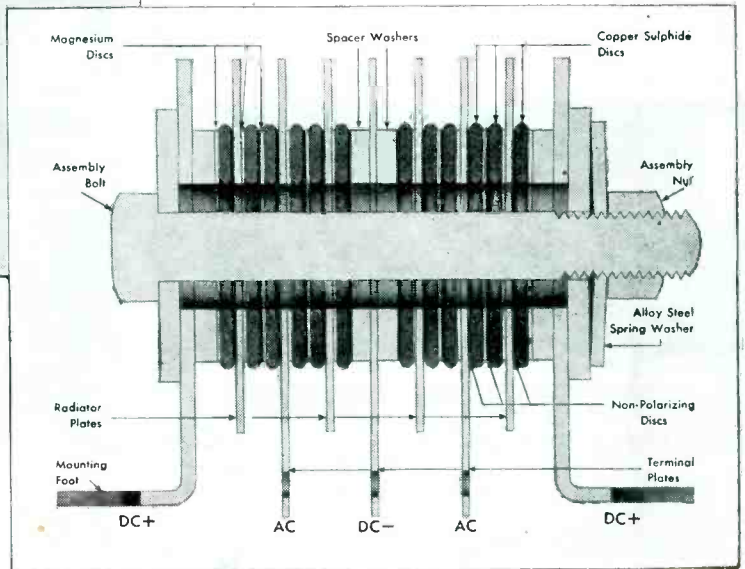
Get your copy of *Electronic Telesis* ... the sixty-four page booklet which gives the fundamentals of electronics. This little booklet will help electronic engineers explain the subject to laymen. It's yours for the asking ... no cost or obligation. Available in English and Spanish languages.

**EITEL-McCULLOUGH, INC., 1033 San Mateo Ave., San Bruno, Calif.**  
Plants located at: San Bruno, California and Salt Lake City, Utah  
Export Agents: Frazor & Hansen  
301 Clay Street, San Francisco 11, California, U. S. A.

# Wherever You Need DC from AC



## Specify **MALLORY** Magnesium-Copper Sulphide **Rectifiers**



**W**HEN you have an AC source and need low voltage DC, the most efficient answer is apt to be a Mallory Dry Disc Rectifier.

Available in a wide range of sizes and ratings, from tiny "button" rectifiers to large heavy-duty stacks, in capacities from 0.3 ampere to 35,000 amperes DC and up, Mallory Rectifiers give years of silent, trouble-free service. Sturdily constructed, completely sealed to resist atmospheric changes, Mallory rectifiers have no moving parts—nothing to break or wear out—require no maintenance expense.

Design engineers appreciate the fact that Mallory Rectifiers have a constant output over an extremely wide range of ambient temperatures—from -40°F. to +265°F. or higher. These rectifiers can "take it" under heavy current overloads, and have a self-healing film which prevents damage from high voltage surges. Voltage regulation is excellent, and power factor is unity.

Experienced Mallory engineers will gladly help you select the best rectifier for any specific application. Write to us or ask your nearest Mallory Distributor for a free copy of Catalog R615A.

**P. R. MALLORY & CO., Inc.**  
INDIANAPOLIS 6 INDIANA

\*Rectostarter is the registered trademark of P. R. Mallory & Co., Inc., for rectifier units for use in starting internal combustion engines.

### *A Few Applications of MALLORY RECTIFIERS*

#### *Battery Chargers for :*

Automobile                      Radio  
Industrial                        Fire Alarm  
Emergency Lighting  
Mobile Electric Truck  
Railway Car

#### *Power Supplies for :*

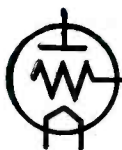
Magnetic Chuck              Magnetic Valve  
Generator and Alternator Field  
Impulse Pump                DC Motor  
Relay                            Magnet  
Solenoid  
Clock                            Organ  
Elevator                        Radio Receiver  
Business Machine  
Electroplating                Electrocleaning  
Electrodissociation  
Electrolysis Elimination  
Laboratory Analysis



**P. R. MALLORY & CO. Inc.**  
**MALLORY**  
RECTIFIERS

MAGNESIUM COPPER SULPHIDE RECTIFIERS—  
STATIONARY AND PORTABLE D. C. POWER SUPPLIES—  
BATTERY CHARGERS AND AVIATION RECTOSTARTERS\*





## CROSS TALK

► **COLOR** . . . Color ads appearing in national magazines depicting the wonders of television have a lot of us drooling, just in anticipation. The trouble is that many people are going to experience a distinct shock when they see their first demonstration and find out that television is not in full color—as in the ads—but in black and white. Careful reading of the ads discloses no claim or promise but the implication is there just the same. Isn't it just possible that this color advertising will create sales resistance for the dealers and make more difficult their problem of transferring the products of the manufacturers to the homes? As a matter of cold fact, won't the mere promise of color delay the distribution of the black-and-white receivers?

► **BD** . . . As of May 1, this year, Beverly Dudley leaves his post as Western Editor of *ELECTRONICS* and becomes editor of *The Technology Review*, alumni technical journal of the Massachusetts Institute of Technology. "Dud" had been on the editorial staff of *ELECTRONICS* for eight years, first as associate editor, then 2½ years as managing editor and since October of 1944 he has been in Chicago, where he was actively engaged in making and keeping friends for his paper when the opportunity came along to return to his Alma Mater as a member of its administrative staff.

► **FM** . . . For the record, Major E. H. Armstrong wishes it known that he was wrongly quoted by some of the newspapers and others at the time of the FCC hearings on f-m. It was stated that he would forego his royalties for a period of a year if f-m remained in the frequency band where it now is. Actually, as shown by the record of the proceedings, he said that if f-m

went up to the 80-100 megacycle region, he felt large-scale use of f-m would be delayed for a year. Under these conditions he would turn over his royalties to a Board to use as seemed fitting.

Thus the newspaper reports were exactly opposite to the actual offer.

► **SURPLUS** . . . Among the vast quantities of surplus and used equipment which the armed forces will ultimately release for sale will be much electronic apparatus which could be useful to colleges. The government could, in slight measure, repay many of the institutions of learning for their war-time aid by making it easy to purchase measuring apparatus, typical radio and radar demonstration units, tubes and all sorts of electronic stuff. Financially, colleges will be in no better condition after the war than they are now, and much of the equipment they need for proper instruction of the on-coming electronic experts will be out of sight economically if purchased first-hand. Disposing of the used or surplus material in this manner should annoy few manufacturers.

To prevent misuse of the purchase at low prices, all this educational gear could be so labelled. Sale could be restricted to those institutions which have contributed through ASTP, V-12, ROTC or in other ways.

► **INDEX** . . . One of the greatest service problems of the Editorial Department is to answer quickly and accurately the question, "When did you publish an article on such-and-such?". To aid us in our end of this problem, all the annual indexes since 1930 have been offset and bound into a sort of cumulative index of indexes. Readers who could use a copy of this super index can obtain it by writing the Editorial Department and enclosing seventy-five cents.

---

### IMPORTANT

"Paper is a Number One war material shortage—because over 700,000 different war items are wrapped, packaged, labelled, tagged, or made from paper or container board. And the Pacific war, when it speeds up, will require stupendous amounts of paper and board since double and triple packing are required for protection against weather, insects, etc.

#### "So please—

(1) Share this magazine with friends since present demand can not be satisfied due to the paper shortage;

(2) When this magazine has served its purpose put into paper salvage;

(3) And look over your store room to get waste paper of any kind to put into paper salvage.

"Then you'll be doing an 'extra' to aid the war effort—and to speed victory."

# ELECTRONIC APPLICATIONS IN INDUSTRY

A year's work among 796 manufacturing and service plants in 11 major industries determines the type and number of electronic devices at present in use. More light is thrown on the potential market by indications of interest among non-users and suggested new applications. Highlights of a 192-page report are given here

**H**OW EXTENSIVE is the present-day use of electronic equipment by industry? What is the potential market? To throw more light on these two questions the Research Department of the McGraw-Hill Publishing Company conducted a survey throughout 1944, and in early 1945 rendered a 192-page report\*.

The report, which can only be highlighted here, does not profess to be a complete and cannot hope to be a final answer. A perfect answer to the first question would necessarily involve collection of data from every plant in every industry, obviously impractical if the report was to be completed in time to guide post-war planners and particularly so at a time when restrictions still bar researchers from some factory corners. And the answer to the second question will constantly change as industry becomes more and more familiar with what electronic equipment can do.

In spite of these qualifications, which suggest that facts presented in the report do not in every case ideally lend themselves to projection and certainly should not be employed in this manner without careful consideration of all the factors involved, it is felt that the study represents the best work on the subject to date. Some illuminating general conclusions can be safely

drawn from it. For example:

*While the present industrial users of electronic equipment are less numerous than the man in the street supposes, they are more numerous than many hard-boiled engineers within the electronic industry itself suspect. The number of duplicate units of electronic equipment found in factories employing such gear is greater than many surmise. While certain specific industries are larger users of electronic apparatus than others at the moment, interest expressed by non-users indicates that the potential market still spreads pretty much right across the board. Many industries with jobs to do that can best be done by means of electronic equipment are not aware of the fact that similar jobs are already being done with such gear, despite the publicity which the art has enjoyed since the outbreak of the war.*

#### How the Survey Was Conducted

The survey was conducted among 796 readers of the following magazines:

*American Machinist*  
*Aviation*  
*Business Week*  
*Chemical & Metallurgical Engineering*  
*Coal Age*  
*Electrical Contracting*  
*Electrical World*  
ELECTRONICS  
*Engineering & Mining Journal*  
*Engineering News-Record*

*Factory Management & Maintenance*  
*Food Industries*  
*Power*  
*Textile World*

It was felt that the fields served by these Company publications represented a good if not a complete cross-section of industry. No attempt was made to weight replies in accordance with the total number of firms engaged in specific industries, as projection of figures was not contemplated. Nor was there any attempt to concentrate contacts among men holding specific jobs. Those furnishing data included management, engineering, production, maintenance and even sales personnel.

During the course of the survey it became evident that data was more readily obtainable from the larger companies, and the final report reflects this. It should be kept in mind when the report itself, or the figures extracted therefrom and presented in these columns, are scanned.

#### Tabulation of Results

The tabulation of results presented here, containing a mere fraction of the data contained in the report, presents highlights considered of particular interest to readers of ELECTRONICS. To facilitate study the following information relative to the tabulation is given:

The first column (*Function or Device*) is broken down into eight

\* "Electronic Applications in Industry" (\$2.50), Research Department, McGraw-Hill Publishing Company, Inc., 330 West 42nd St., New York 18, N. Y.



# SUMMARY OF ELECTRONIC SURVEY

Function or Device	Present Users			Potential Users		Function or Device	Present Users			Potential Users	
	No. Co.	No. Dev.	Chief User	No. Co.	Greatest Interest		No. Co.	No. Dev.	Chief User	No. Co.	Greatest Interest
<b>Control</b>											
Carrier Current	35	218	Elec. Util. (28)	29	Elec. Util. (26)	Impedance and Reactance	25	96	Metal Work. (18)		
Combustion	18	57	Metal Work. (6)	28	Chem. Proc. (11)	Light Intensity	16	64	Metal Work. (7)		
Electrostatic Precipitation	50	267	Metal Work. (25)	51	Chem. Proc. (14)	Humidity				7	Food (2)
Filament Carburization	3	3	Metal Work. (3)			Noise	29	63	Metal Work. (22)	3	Metal Work. (2)
Illumination	38	145	Elec. Util. (19)	14	Metal Work. (6)	pH	86	203	Chem. Proc. (39)	17	Food (4)
Induction Heating	10	24	Metal Work. (9)	5	Metal Work. (5)	Pressure	7	9	Metal Work. (4)	9	Metal Work. (5)
Level	35	227	Chem. Proc. (18)	31	Chem. Proc. (16)	Reflection	5	11	Chem. Proc. (4)		
Electric Load	16	55	Elec. Util. (8)	9	Elec. Util. (5)	Resistance	25	107	Metal Work. (15)	4	Const. (2)
Door	25	91	Metal Work. (13)	27	Metal Work. (11)	Speed	63	151	Metal Work. (41)	12	Metal Work. (7)
Motion	22	83	Chem. Proc. (8)	17	Metal Work. (7)	Smoke Detection, Recording	25	44	Metal Work. (6)	3	Chem. Proc. (2)
Motor	48	247	Metal Work. (31)	61	Metal Work. (22)	Sound Level	30	63	Metal Work. (16)	6	Const. (6)
Application of Coatings	2	4	Misc. Mfg. (1)	4	Metal Work. (3)	Strain	14	74	Metal Work. (13)	1	Metal Work. (1)
Register	18	156	Food (6)	11	Misc. Mfg. (6)	Telemetering	34	123	Elec. Util. (25)	24	Elec. Util. (15)
Remote	11	37	Elec. Util. (5)	17	Elec. Util. (8)	Thickness, Distance	9	19	Metal Work. (6)	12	Metal Work. (10)
Switching	11	67	Metal Work. (8)	8	Elec. Util. (3)	Time	14	70	Metal Work. (9)	2	Misc. Mfg. (1)
Synchronization	11	32	Elec. Util. (8)	10	Elec. Util. (7)	Titration	22	29	Chem. Proc. (14)	9	Metal Work. (3)
Temperature	131	1,504	Metal Work. (68)	65	Chem. Proc. (20)	Turbidity	10	11	Chem. Proc. (4)	4	
Timing (exc. welding)	62	294	Metal Work. (30)	13	Metal Work. (4)	Vacuum and Ionization					
Train	2	82	Metal Work. (1)	4		Gages	13	286	Metal Work. (7)		
Welding (timing)	130	2,034	Metal Work. (100)	39	Metal Work. (24)	Tube Testing	23	49	Metal Work. (13)	1	Metal Work. (1)
Relaying	19	104	Metal Work. (7)	19	Elec. Util. (11)	Voltage	81	407	Metal Work. (51)	5	Metal Work. (3)
Humidity	1	1	Misc. Mfg. (1)	13	Text. (5)	Wave Form	33	122	Metal Work. (22)	2	Metal Work. (2)
Flow	25	80	Chem. Proc. (13)	13	Chem. Proc. (8)	Electron Microscope	9	11	Metal Work. (5)	3	Chem. Proc. (2)
Moisture	5	32	Chem. Proc. (4)	5	Text. (2)	Level	6	12	Chem. Proc. (3)	8	Chem. Proc. (4)
Elevator Levelling	6	14		3		Moisture	15	52	Food (7)	5	Food (2)
Germ, Insect	5	31	Chem. Proc. (3)	7	Food (3)	Flow				11	Chem. Proc. (4)
Color				8	Chem. Proc. (4)	Weight Measurement	18	53	Metal Work. (12)	25	Metal Work. (12)
Pressure	1	3	Elec. Util. (1)	5	Chem. Proc. (2)	Temp. Indication and Recording	29	252	Metal Work. (11)	14	Metal Work. (6)
Frequency	5	5	Elec. Util. (4)	4	Elec. Util. (4)	Misc. Testing Equip.	25	90	Metal Work. (11)	3	
pH	6	19	Chem. Proc. (5)	13	Chem. Proc. (5)	High-Speed Photography	7	14	Metal Work. (4)		
Misc.	12	45	Metal Work. (6)	5	Const. (2)	Hardness	2	8	Metal Work. (1)	5	Metal Work. (5)
<b>Counting, Sorting, Weighing</b>											
Inspection for Missing Parts	1	4	Food (1)	14	Metal Work. (7)	Chemical	31	51	Chem. Proc. (16)	22	Chem. Proc. (8)
Counting	31	112	Metal Work. (13)	53	Metal Work. (18)	Vibration	25	50	Metal Work. (18)	8	Metal Work. (4)
Flaw Detection	17	259	Metal Work. (5)	42	Metal Work. (24)	Meter Testings	15	38	Elec. Util. (13)	3	Elec. Util. (3)
Sorting and Grading	12	65	Metal Work. (9)	41	Metal Work. (9)	Quartz Crystal	6	265	Metal Work. (5)	2	Metal Work. (2)
Insulation Testing	20	69	Elec. Util. (12)	12	Elec. Util. (8)	Amplifiers	15	341	Metal Work. (10)	1	Metal Work. (1)
Metal Detection	23	118	Const. (12)	14	Misc. Mfg. (3)	Oscillators	51	577	Metal Work. (41)	1	Metal Work. (1)
Surface Analyzing	19	43	Metal Work. (17)	9	Metal Work. (7)	Oscillographs	72	312	Metal Work. (48)	2	Metal Work. (1)
Weighing	11	86	Chem. Proc. (6)	35	Food (15)	<b>Molecular Vibration</b>					
X-Ray Inspection	42	97	Metal Work. (26)	18	Metal Work. (12)	Chemical Processing				14	Chem. Proc. (10)
<b>Heating</b>											
Ferrous and Non-Ferrous Metals	15	29	Metal Work. (13)	25	Metal Work. (16)	Germ and Insect Killing				16	Food (10)
Ferrous Metals	46	89	Metal Work. (40)	52	Metal Work. (38)	Supersonic Detection				11	Metal Work. (7)
Non-Ferrous Metals	22	61	Metal Work. (17)	25	Metal Work. (19)	<b>Power Conversion</b>					
Food Sterilization, Dehydration				23	Food (20)	Frequency Conversion	7	11	Metal Work. (4)	9	Metal Work. (5)
Gluing, Drying Wood, etc.	5	7	Misc. Mfg. (3)	27	Misc. Mfg. (10)	Inversion	4	36	Metal Work. (2)	6	
Plastics	10	12	Chem. Proc. (6)	14	Metal Work. (8)	Electro-Plating and Processing	9	68	Metal Work. (6)	8	Metal Work. (5)
Rubber			Misc. Mfg. (1)	4	Chem. Proc. (2)	Rectification	176	1,668	Metal Work. (67)	46	Metal Work. (10)
Sheet Materials	4	5	Metal Work. (3)	11	Chem. Proc. (5)	<b>Regulation</b>					
Textiles and Paper	2	2	Misc. Mfg. (2)	16	Text. (6)	Generator Voltage	27	125	Elec. Util. (12)	44	Elec. Util. (26)
Misc.	6	12	Chem. Proc. (3)	5	Chem. Proc. (2)	Skew	8	18	Tex. (7)	8	Chem. Proc. (3)
<b>Measurement and Analysis</b>											
Balancing Machines	28	66	Metal Work. (22)	5	Metal Work. (3)	Speed Regulation	11	42		16	Metal Work. (8)
Capacitance	34	129	Metal Work. (23)			Slack Regulation	5	8	Chem. Proc. (4)	15	Metal Work. (4)
Color	27	59	Chem. Proc. (10)	21	Chem. Proc. (7)	Voltage, Current, Phase	20	205	Metal Work. (10)	12	Elec. Util. (4)
Conductivity of Solutions	19	23	Chem. Proc. (11)	3	Chem. Proc. (2)	Process Regulation	7	15	Chem. Proc. (2)	35	Chem. Proc. (13)
Electric Current	29	3	Metal Work. (3)	4	Metal Work. (3)	<b>Safety</b>					
Curve Tracing	20	49	Metal Work. (14)	13	Metal Work. (5)	Combustion	69	757	Metal Work. (30)	20	
Density, Opacity	16	93	Metal Work. (9)	11	Chem. Proc. (7)	Fire and Smoke	4	6	Metal Work. (2)	8	Metal Work. (3)
Dielectric Properties	15	51	Metal Work. (9)	5	Elec. Util. (2)	Liquid Overflow	4	15	Chem. Proc. (4)	2	Mining (1)
Frequency	27	323	Metal Work. (21)	5	Elec. Util. (2)	Intrusion	25	62	Elec. Util. (13)	7	
Flux	6	10	Metal Work. (5)	4	Metal Work. (3)	Lighting	3	6	Chem. Proc. (2)	10	Elec. Util. (3)
Gas Detection and Analysis	12	30	Chem. Proc. (6)	22	Chem. Proc. (10)	Machinery Stopping, Over and Under Voltage	32	286	Metal Work. (16)	44	Metal Work. (14)
Geodetic, Geophysical, Meteor.	6	1,016	Misc. Non-Mfg. (3)	6	Mining (3)	Alarms	9	218	Metal Work. (5)	5	Elec. Util. (2)
						Fume Detection	6	15	Chem. Proc. (2)	6	
						Traffic	8	190	Const. (3)	13	Coal Min. (5)
						Misc. Alarm	15	44	Chem. Proc. (5)	11	

major divisions. To experienced electronic engineers some possible duplication between the sub-divisions beneath them will be apparent. It will be noted, for example, that the word "combustion" appears under "Control" and also under "Safety." Inasmuch as the data was largely obtained from men without specialized electronic knowledge it was necessary to tolerate such duplication.

The second column (*Number of Companies*), used intelligently, provides some measure of the relative importance of various types of electronic apparatus in industry at the present time. It will be seen, for instance, that users of tubes for rectification, under "Power Conversion", are, as might be expected, in the majority. On the other hand, the fact that users of tubes for temperature control are neck and neck numerically with those owning welding controls might come as something of a surprise. In this column, as in all other columns, the inclusion of percentages is deliberately avoided to discourage projection at least until the more voluminous report from which the figures are taken is thoroughly digested by the reader.

The third column (*Number of Devices*) provides a further measure of the relative importance of various electronic devices in industry, since the number of duplicate units in a plant as well as the suitability of a specific device for industrial use determines the potential market and, particularly, its "packaged" item possibilities. Note that rectifiers, temperature and welding controls are not only used in many plants but that they are purchased in considerable volume by these plants.

The fourth column (*Chief User*) is a useful key to the probable potential market. For purposes of comparison here it has been necessary to show only the largest present user of each electronic device although in several instances other users were nearly on a par with them. It is desirable when attempting to evaluate the data in this column in terms of post-war potential that it be considered in conjunction with the data included in column six. It is also necessary to know that the industry classifica-

tions employed in this abstract are very broad indeed. The "Metal Working" industry classification, for example, embraces manufacturers of:

- Iron and Steel Accessory Products
- Non-Ferrous Accessory Products
- Machinery (except Electrical)
- Electrical Machinery and Equipment
- Transportation Equipment (except Automobiles and Aircraft)
- Automobiles and Automobile Equipment
- Aircraft and Parts
- Ordnance and Accessories (except Explosives)

So far we have dealt with data supplied by industries already using specific electronic equipment, under "Present Users." Now let's move over into the columns for which data was supplied by "Potential Users," people who may now use electronic equipment of some kind but lack it entirely for the specific uses under consideration.

Column five (*Number of Companies*) must obviously be studied in conjunction with columns two and three in order to speculate concerning the potential market. Similarly, column six (*Greatest Interest*) should be considered in conjunction with column five, and probably also in conjunction with columns two, three and four. Steady growth along lines already indicated by sale of equipment to present users appears to be a reasonable conclusion. Some shifts of interest will be noted but, in line with our introductory admonition relative to projections, conclusions relative to these must be left to the reader.

#### Potential Applications

Not the least interesting and instructive portion of the report are the many pages devoted to comment from men in industry who have unsolved problems and wonder if electronic equipment could solve them. While it is true that some of these problems might best be solved by other than electronic means, and while it is also true that some of them have already been solved by means of electronics, a few extracts

should prove generally stimulating.

Typical remarks follow:

*Metal Producing.* "Photoelectric cells could be used to limit travel of furnace doors where high temperatures cause failures in existing limit switches, or could be used to open building doors for towmotors, or could be used to sound an alarm for pedestrians as crane hook is lowered down through hatchway."

"We should have some sort of temperature control and flame failure alarm in soaking pits and reheating furnaces."

"Our roll grinding machines, although of the latest design, could be greatly improved by supplying electronic control on the grinding wheel drive motor to maintain constant peripheral speed on the grinding surface of the wheel under varying feed of work and decreasing wheel diameter due to wear."

*Metal Working.* "In undercutting commutators on small motors, it is impossible to use an indexing arrangement to turn the commutator from mica to mica due to slight variations in the thickness of the mica and the copper, making the bar spacing non-uniform. We are working on an arrangement using the electric eye to position the mica by contrast of color between the copper and the mica."

"The many hundreds of individually motor-driven lens polishing machines which we use have very crude mechanisms for speed control. These might well be modernized by electronic motor speed control. A programming control on speed as the lenses are polished might be extremely valuable and greatly improve production."

"We need an electronic device to ring an alarm in case of a leak in our air conditioning system. Freon (refrigerant agent) is quite expensive and very hard to get. It has the property of turning the color of certain gases or chemicals. By having a photoelectric cell sensitive to a certain degree, to the change of color of a chemical placed near the refrigerating coils, a leak could be easily detected, and an alarm given, or the cell would break the current to the compressors by means of relay. This device would save a large amount of money to industries using air conditioning."

*Chemical Processing.* "How about

gas analysis in the determination of the amount of isobutane in a mixture? Present method uses the infra-red spectrometer."

"Liquid level control of pressure vessels presents a problem when ordinary methods such as rotary stem packing glands and flexible discs are used. More development along the lines of a capacitive and inductive pickup type controller using a vacuum tube amplifier would eliminate hysteresis and sticking encountered in the mechanical type of controller."

"We have an operation involving the dipping of rubber-impregnated fabric into a solution containing an inflammable solvent. It is a continuous process, and static on the stock ignites the solution if the static eliminator fails. A collector connected to the sensitive grid of a tube should shut the machine down if static starts to accumulate."

**Food Processing.** "We need an electronic device to inspect our beverage bottles before filling and again after they are filled and capped. After the bottles are filled they are cased up manually and then pulled out of the case four at a time and inspected over a light. We need some sort of electric eye on the final inspection. Frequently when the operator is fatigued she or he will pass a dirty bottle after it is filled. We hope something electronic will protect us on this."

"Electronic measurement of dehydrator humidity levels to take the place of wet bulbs or hair hygrometers at dry bulb temperatures of above 200 deg F, where both the latter are inaccurate, would be useful."

"In a continuous vacuum pan operation on evaporated milk, we believe that if you had an electronic device that would measure the density of the milk and regulate the discharge pump and the milk intake that you would do the industry a great service. The operation at present is manual and most pan operators over-condense with a resulting waste of time and power. A device which would register the change in concentration of the milk in the pan that would be visible to the operator at all times is needed."

**Textile Mills.** "Warping, slash-

ing, and weaving require careful regulation of slack yarn ends, so that a quality fabric will result from these operations. Proper tension throughout the various processes is one of the most important regulations confronting us."

"There are numerous points in the processing of cotton textiles at which package counters could be used, and we believe that a survey should be made of a large textile plant to ascertain the points at which such a device would be practical."

"An electronic device which would indicate breakage of warp or filling thread is needed for loom protection. Such a device would eliminate a considerable amount of mechanical motions. Also a device which would indicate an empty bobbin."

**Public Utilities.** "Use of voltage amplifier and thyatron trigger tube combination to replace electromechanical relaying schemes at present used on all power lines seems desirable. The idea is to standardize the unit and vary applications by variations in input networks and accessories, thus adapting to operation by voltage, current, frequency, power factor, etc., and assuring faster operation than afforded by conventional type relays, without the necessity of using carrier frequencies."

"Quicker and more accurate means of cable fault locating are needed and it is felt that there is a wide field of application for electronic cable fault locating equipment."

"We have a boiler that has an induced draft fan and a short smokestack. This fan is driven by a 2300-volt motor connected to fan by a hydraulic coupling. In the event of electric power interruption this fan stops and if the natural gas fuel is not cut off immediately, there is danger of improper combustion mixture with a resulting explosion. This is a 1000-hp boiler."

**Coal Mining.** "Control and signal for mine ventilating fans is needed. Where the air must not stop, someone should know at once if control of fan fails, or cave-in blocks the air's natural flow."

"Detection of poisonous methane and carbon monoxide gases in coal

mines is not yet being well handled."

**Other Mines.** "Using hand labor at the present to make rip-rap. Sizes 25 to 150 lb, minimum of four inches thick in one dimension. Material weighs 165 lb per cubic foot and can be any shape or size between the weights and dimensions given. We would like to sort these sizes from material loaded from quarry face. Material will run from fines to four or five hundred pound rock."

"Detection of tramp iron and steel on ore belts."

"Generator voltage regulation and excitation. Three widely scattered hydro-electric plants are operated in connection with mining operation. Power regulation is a problem, particularly in starting up large power consuming equipment."

**Construction.** "Analysis of soils, aggregates, asphalts and wetting agents to determine their electrochemical properties. Whether molecules are positively or negatively charged. This will enable us to make a more homogeneous and compatible mixture of the materials for road pavements. We are in a research program at this time involving this problem and are in dire need of a method of determining the properties of these and other materials such as paint, steel, cement, etc."

"Chlorine residual determinations in municipal water supplies, including control at plant and portable instrument for accurate determinations at various points in the field, are needed."

"An electronic device to measure humidity is badly needed. Evaporation from large reservoirs, especially in the arid West, will become a more important factor in operation than it now is. A device that will permit evaluation of evaporation from water surfaces, from snow surfaces and, for that matter, from land surfaces undergoing application of water, is greatly needed. If possible, it should be so arranged as to measure water content of the air specifically or afford a comparison from, or with, unaffected surfaces nearby."

For further details relative to the gear in use and wanted by the 796 companies encompassed in the survey the reader is referred to the report.—W. MAC D.

# ROCK ISLAND RAILROAD

## Radio Tests

Communications problems peculiar to railroading, such as the necessity for equipment design capable of withstanding unusual vibration and shock and capable of operating from a variety of power supplies, are analyzed on the basis of seven years of experiment. Signal-to-noise ratios on 40, 118, 150 and between 2000 and 3000 Mc are charted

**T**HE DEVELOPMENT of railroad radio has progressed rapidly in the last year. Many articles have been published on the utilization of radio by railroads, but little has been published on recent technical advances in the art. It is the purpose of this article to record the research and operating experience of one railroad in developing its own radio system of communications.

In the near future, radio seems destined to play an important part in the progress of American railroads. Although intensive research for the development of radio facilities has been under way for only a

By **ERNEST DAHL**  
*Electronic Engineer  
Rock Island Railroad System  
Chicago, Ill.*

short period of time, important possibilities have already been uncovered. For example, radio makes possible two-way communication between: (1) both ends of a train, (2) yards and trains, engines, or cabooses, (3) different yards and stations, (4) wayside stations and trains, engines and cabooses, (5) different trains, en route or in yards and stations, and (6) brakeman and flagmen.

While radio will merely provide supplementary communication facilities in some of these cases, it serves to increase safety, to speed freight and passenger traffic, and to provide effective communication in the event of storms, floods or other emergencies. In other cases, particularly when trains are in motion, radio provides the only form of communication which is feasible. The need for railroad radio communication has greatly increased with extensive war-time use of 100 and 150-car trains.

### Vibration Mounts and Power Supplies

Considering the rapid advances which have been made in mobile radio communication systems within the past decade, it might be presumed that commercially available equipment built for other purposes could be applied directly to railroad use. Such a procedure has not been found to be entirely feasible, however, because of a number of unusual requirements. The problems of shock and vibration, of appropriate power supply, and of determining suitable operating frequencies and methods of modulation must all be considered in developing a satisfactory system of communication for railroad use.

In actual railroad service, all units must be capable of withstanding terrific shocks. Measurements made on a caboose of the Rock Island Railroad showed that a deceleration

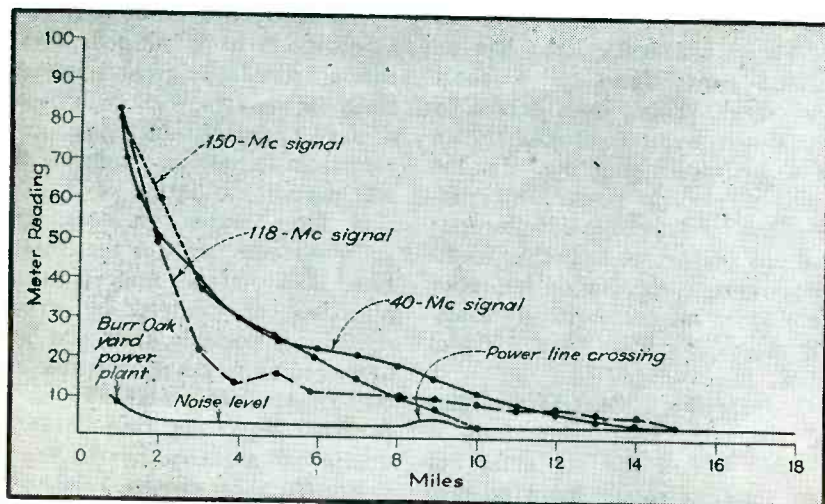
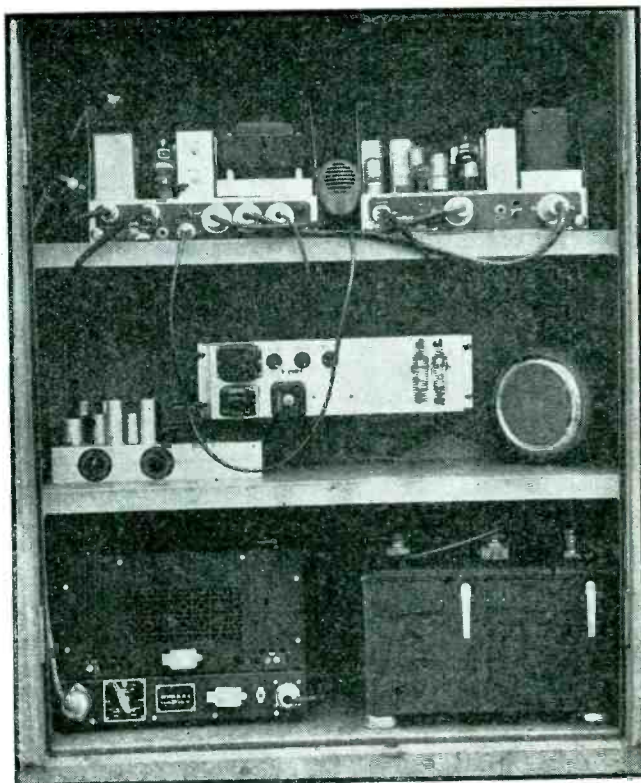


FIG. 1—Curves showing signal-to-noise ratios on three different test frequencies, recorded as a train carrying the Rock Island Railroad's radio test caboose rolled away from the yard at Blue Island, Illinois. Transmitter power employed was 10 watts output in all three cases



Freight engineer using a radiophone in the cab of a diesel locomotive



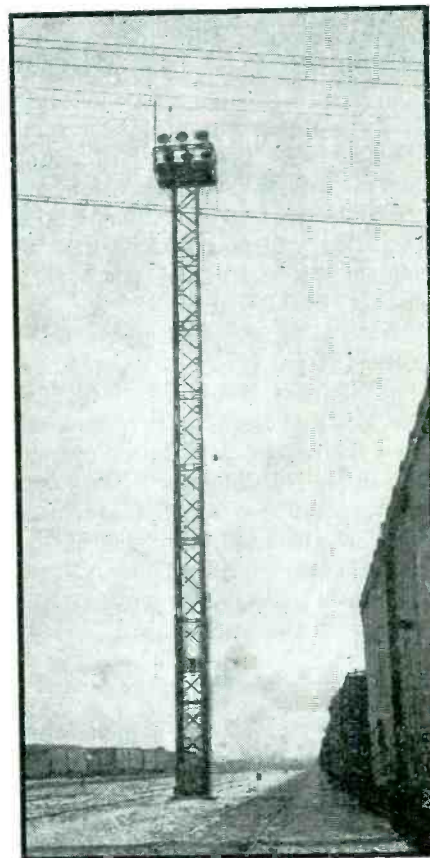
Motorola and Mallory equipment installed at the base of a lighting tower in a yard, comprising a fixed radio station

of six g's (193 ft/sec/sec) was encountered on a train moving at seven miles per hour when brakes were applied. There is an average slack of four to five inches between each car. When a hundred-car freight train starts up there may be slack of as much as 40 feet taken up before the caboose is finally moved ahead. By the time the engine has taken up all of the slack it may have attained a velocity of two miles per hour, or three feet per second. The caboose will be required to change its velocity instantly from zero to two miles per hour. Thus all the receivers and transmitters must be shock-mounted in two directions, up and down to prevent bouncing and front-to-rear to minimize shocks of starting and stopping.

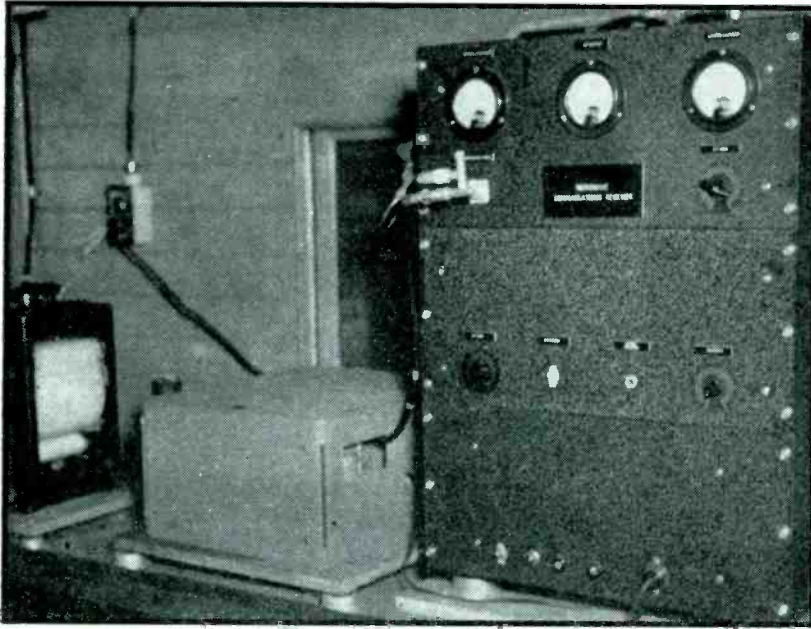
Another problem in setting up a system of railroad radio communication involves choice of the most suitable power supply. The power supply must be capable of operating a receiver and transmitter on locomotives, cabooses, and at fixed stations. Most railroads have 64-volt d-c power available in their diesel locomotives. A 25-volt d-c

power supply is usually available in steam locomotives, but as yet no power supply is ordinarily provided in the caboose. If d-c dynamotors are used for power conversion, two units are required—a low-voltage unit for tube filaments and a high-voltage unit for plate supply. If radio units are designed to operate from a-c power, then only one device with a rotatable armature is necessary to convert from d-c power to a-c power. This seemed the logical answer in our case to the problem of power supply on locomotives.

On steam locomotives the steam power is directly available. A turbine connected directly to an alternator was used to provide power. With mechanical steam regulation, 117-volt, 60-cycle a-c power was obtained with regulation better than 1 percent. On cabooses, a 12-volt generator charging a 300 ampere-hour battery supplied power to a rotating machine that delivered a-c power. The use of a-c power throughout means that all transmitters and receivers are directly interchangeable with one another on either steam or diesel units. This



A typical fixed installation in a yard, showing antennas at the top of a lighting tower and the compartment containing transmitter and receiver at the base



Experimental 2000-3000 Mc radio receiver using a Klystron oscillator. The Esterline-Angus recorder used to check signal-to-noise levels may be seen at the left

buildings, towers and natural obstacles tend to reduce the amplitude of the signal. Moreover, microwave signals may be received over two different paths so that the resultant received signal varies in amplitude according to the relative phases of the two waves. Wave reflections and standing waves increase amplitude variations. Now, if such changes in amplitude are present and the train is moving at a reasonable speed, the amplitude changes will produce an effect similar to amplitude modulation, the frequency of which will depend upon the number of nodes or antinodes in a given distance, and the train speed. This modulating effect will hereafter be referred to as the flutter effect. The flutter effect became more and more pronounced as the carrier frequency was raised. At 40 megacycles it was barely audible, at 157 megacycles it was very pronounced, and between 2,000 and 3,000 Mc satisfactory communication was impossible with amplitude modulation while the train was in motion. When using frequency modulation, signals were sufficiently strong (even over the greatest distances for which communication was required) to saturate the receiver limiter and the flutter had no effect on the audio output.

The actual operating frequency chosen was to be determined by investigation. Measurements were made at 40 megacycles, 55 megacycles, 157 megacycles, 300 megacycles, and between 2,000 and 3,000

makes for extreme flexibility.

Late in 1937 we set out on a program of planned progress, and the road's recent studies of radio communication on trains is a part of that program. This included the setting up of an Electronic Section whose first job was to study the available communication facilities and the possibility of adapting these to railroad operation, and the design of new communication facilities which would utilize developments which had taken place during World War II.

In setting up this program of tests, several types of communication systems were studied. The first distinct field for investigation was frequency modulation versus amplitude modulation. Since experimentation covered frequencies from 40 megacycles to 3,000 megacycles, other characteristics of radio wave propagation entered the picture in the comparison.

#### Modulation and Frequency Studies

The normal factors which influenced our choice of frequency modulation over amplitude modulation were: (1) the advantage of frequency modulation over amplitude modulation in the elimination of noise; because of the characteristics of the limiter tube, (2) freedom from interference with f-m as

compared to a-m, and (3) the constancy of audio output so long as the frequency deviation is constant, whereas with amplitude modulation the amplitude decreases with the distance from the source of the signal. The last-mentioned factor was a particularly important one, since on the basis of noise reduction alone the advantage of frequency modulation over amplitude modulation might not have been decisive where both types of service were tried at high frequencies at which noise is minimized.

As the frequency is increased and wavelengths become shorter,

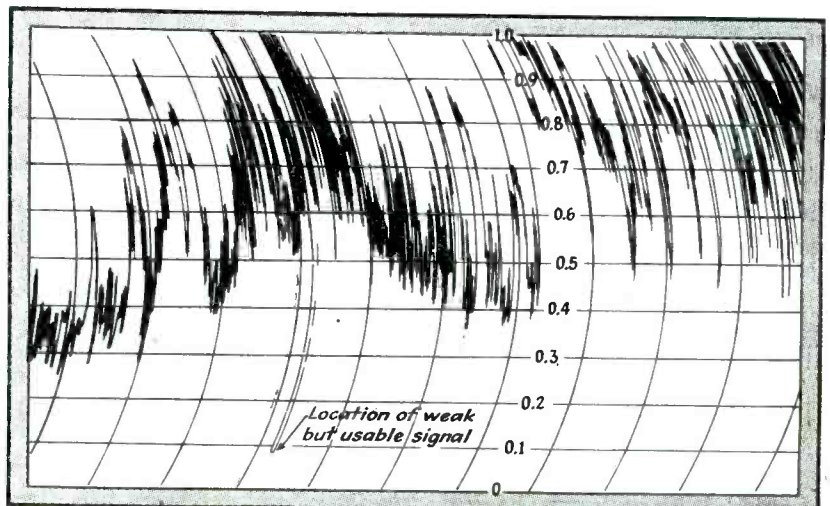


FIG. 2—Recording showing typical signal-to-noise ratio on 2000-3000 Mc (Scale shown on chart gives arbitrary values)

Mc. In each case a quarter-wave antenna was used. In these measurements only carrier radiation strength was measured at a given distance and used as a basis for comparison.

### Experimental Signal-to-Noise Investigations

A mobile field laboratory was set up for making all signal strength measurements for yard operation and front-to-rear service, for checking apparatus, for measuring shock, and for developing appropriate power supplies. This unit consisted of an all-steel caboose, equipped with a gasoline power supply. A gasoline-driven 1000-volt a-c generator was mounted on the roof, and a battery-operated charging generator was installed. The communication equipment was operated from the battery supply, while all test equipment, fluorescent lighting and auxiliary gear was run from the a-c generator.

The caboose was equipped with a complete work bench, standard frequency source, and receivers for calibrating from WWV standard frequencies. Most measurements were made continually over territory served by the Rock Island Lines, including Chicago to Kansas City and Kansas City to Denver, and in connection with the Denver and Rio Grande Railway through mountainous area and through the Moffat Tunnel. For the first time in the history of the Rio Grande, radio communication worked through the six-mile-long Moffat Tunnel. High-frequency tests indicated that the tunnel had a waveguide effect. The signal from the caboose had no trouble in reaching the locomotive, or inversely, if the engine was outside and the caboose inside.

An Esterline-Angus recording meter was set up for obtaining a permanent record of noise versus signal strength. The system set up to do this was as follows: At the frequency to be investigated, noise measurements were made in a complete run over the railroad route. Next, a complete run was made with the transmitter on 100 percent of the time, making continuous measurements of the output of the receiver limiter. This gave the signal strength throughout all parts

of the route covered. The ratio of the first to the second set of measurements yielded the signal-to-noise ratio over the entire route.

Direct comparisons of noise and signal were made at a number of frequencies on this basis. Results at some of the lower frequencies are shown in Fig. 1. Figure 2 shows results between 2,000 and 3,000 Mc. The very much larger signal-to-noise ratio obtainable there made it possible to obtain satisfactory communication with lower power fed into the antenna and indicated the desirability of a swing to the microwave frequencies.

### Details of Equipment

The first project under development was the establishment of a yard communication system enabling the yardmaster to communicate with either the yard foreman or the engineer on a locomotive. The need for this becomes very apparent when it is realized that a switching locomotive may travel 10 to 20 miles to pick up cars from another yard, the stockyards, or a fruit terminal, and haul them into our yards. Some actual uses of the equipment during the tests are shown in a chart included here.

One master station was installed for this kind of service. This station was set up with a receiver and transmitter at the base of a lighting tower. A coaxial type antenna at the top of the tower was connected to the transmitter and receiver by means of a coaxial cable. In this system the receiver and transmitter combination can be controlled from various points in the yard or from remote stations. The yardmaster or yard superintendent can call any locomotive working in or within the neighborhood of that yard.

In actual operation, the locomotive number was used to identify each locomotive, such as Diesel 700 and Engine 2103. When the engine is in some other yard, a call may be put through for some special car, or to add cars to trains in this yard, thereby saving a full trip or a return trip in order to pick up the extra cars. If for any reason the engineer is not clear on instructions, on what cars to pick up, or

## TYPICAL RAILROAD RADIO USES

### ENGINE TO CABOOSE

Purpose	Est. Time Saved (min.)	Comments by Conductor
Checking air line four times during day	40	Air was set and released by use of radio
Hot box	20	Train stopped within five minutes after receiving signal. Car set out and train moving after 25-minute delay
Clearing East Main for 504	15	Backed 127-car train across to West Main
Hot box	15	Received signal at Rockdale and informed engine crew to stop at Joliet for necessary repacking
Talk to engineer	15	Try air, tell engine no. cars in train, tons
Talk to engineer	25	Advise head end to set out hot box at Columbus Jct.
Set out bad order car	30	Car set out and bill left at Trenton
For air test and high-balling	60	One hour saved between Trenton and Kansas City
High-ball from Blue Island	—	Only way of knowing rear of train was coming
Talk to engineer	15	Tell engineer 9 had us cut out so could not pick up train order at depot. Would have been necessary to stop train
Hot box in middle of train	—	Would have been necessary to pull the air and break train in two
Test air and high-ball	20	Kept in close connection with front end
Emergency air-brake setting	25	—
Talk to engineer	5	Let head end know rear brakeman was on
Hot box	15	—
Set out car behind 80 cars. Each move made with radio because of curvature of track	15	Used radio at various times to converse with engineer regarding movement of train
Test air and high-ball to leave town	10	Amount of time used by carmen making this air test
Have train pull over insulated joints to clear blocks	15	Saved walking 84 cars to tell head end to pull up
Pull up so 11 could get in clear behind 93	15	Saved walking 84 cars to tell head end to pull up
To get speed of train up hill	—	After leaving siding top speed up hill was 32 mph.
Talk to engineer	—	Checking speed of train
Talking to head end testing air and high-balling	30	Used for high-balling after slow orders and in regard to train movement
Setting out 8 cars	30	—
Setting out 44 cars	20	Testing air and high-balling
Talking to Bl yard office	—	Found out what track to use
Talk to head end	10	Give engineer number loads, empties and tons in train & OK departure
Talk to head end	—	Give OK to proceed after passing over slow order
Hot box rear car; give instructions move slowly due to bad condition	30	Saved walk of 122 cars to give instructions as to speed and where to dispose of car. Also avoided setting air from rear end
Instruct engineer when to stop and have switch engine take rear car off train. Also give OK to proceed	20	Rear car in train taken off by switch engine at Joliet. Burr Oak Yard notified to have switch engine waiting at Joliet

(Continued on next page)

(Continued from preceding page)

Purpose	Est. Time Saved (min.)	Comments by Conductor	Purpose	Est. Time Saved (min.)	Comments by Conductor
Talk to head end	—	Find out why stop was made for red block	Talk to engineer	20	Head end missed order. Called to find out if rear end got it. Made contents known to head end. Saved stop
Test air	5	Save pulling out draw-bars and braking knuckle, won't have to set air from rear end	Talk to head end	20	Talked to head end about block and crossing at Polo
Let engineer know when train was over slow track	5	Radio is a time-saver getting over slow tracks and heading out of passing track	Talk to head end	—	Talked to head end account hot wheels
Let Engineer know switch closed and brakeman on	6	The fuses we can save to give signal on a long train will pay for a radio	Talk to head end	—	Head end stopped to inspect hot box rear end. In 3 min. had train off main road
Notify head end to set and release air and train ready to proceed	10	This saved time as there was no mistake in signals	<b>YARD TO ENGINE</b>		
Hot box	10	Would have had to set air from rear end	Purpose	Comments by Yard Master	
To advise head end when train was in clear	—	This avoided stopping when train was not in clear	Test	—	
To get signal to engineer that flagman was on	—	Could not have signalled head end if no radio	Detail on movement through plant, lead to short 1, call tower on phone	—	
Talk to engineer	—	Told engineer I was going back to ask dispatcher about 91 which was delayed at Letts	Called account move on So. Chicago caboose at north end yard	—	
Hot box	25	Engineer called to tell me what was wrong, saved walking 116 cars	Lined up 700 on some work	Changed work on 700	
Talk to engineer	5	Engineer called when they set out and were ready to go, and if flagman was on and ready to go	Had 700 come up out of yard—to couple up track 14 to be ready for eng. 2557, to take off on Hill I. H. B. Spec., due on Hill 3:00 A	—	
Air test	10	Not only used radio for our train but gave signals to 98 to let him know when he cleared the main	To make change in work and put 700 engine and crew into lunch]	—	
Clear passing track for 98	20	Had 100 cars, difficult to see hand signals that far with a background of city lights	700 called to find out where to put cars	—	
Air test	10	Track wasn't long enough to get in clear. Dispatcher held train back of first signal at Allerton to run 18 against Ex. 97 Clio to Allerton	Instruct crew on added work	—	
Get train in clear on passing track	—	Hot box 69 cars behind engine. Called engineer, had him cut engine off and come to rear end of train	700 called to secure disposition on two cars not carded	—	
Hot box	40	Had slued truck on head car. Instructed head end what to do with car	Lined up crew on work	—	
Let engineer know when rear end train made up and test air	15	Saves lots of time if you have to instruct head end about a bad order car	Test	—	
Talk to engineer	15	—	Instruct crew	No way to contact except by radio	
Converse with head brakeman to set out head car with slued truck	5	—	Change work	—	
Let engineer know when flagman was on Hot box	20	—	Instruct crew	—	
Air test	10	—	Change work on yard	—	
Talk to engineer	10	—	Instruct crew	No way to contact Diesel at north end of yard. Could not get switch tender	
Air went into emergency	25	—	Line up crew on work in yard	—	
		—	Instruct crew on work	—	
		—	Had two R.C. cars for B.O.C.T., these cars were delivered, and Rettker, with Engine 2103 had the bills out of X5 for these cars. Made this call to have him deliver the bills to B.O.C.T.	—	
		—	Called engine 2103 at 12th St. Yard, to make test	—	
		—	Line 700 up with new work	—	
		—	Instruct crew on take off 96	No contact, only through tower	
		—	Instruct crew	—	
		—	Line up crew	—	
		—	700 called about car	—	
		—	Lined crew up to do some extra work	—	
		—	Called to line up crew on work, later cancelled call	—	
		—		No card on car. In on road train, 700 called for information on car	
		—		—	
		—		Normal contact would be on phone through Gresham Towers. Probably could not contact crew for an hour or more	

has any questions concerning instructions on pick-up or perishability of freight, he can call the yardmaster to get complete instructions on handling this project.

In this service, direct comparisons were made between apparatus operating on various frequencies. At all frequencies the service area was covered equally well, but atmospheric noise was lower at 157 megacycles, and had disappeared completely between 2,000 and 3,000 Mc. A slight flutter effect was noticed on 157 megacycles when amplitude modulation equipment was used. The maximum a-c power input was 300 watts. The radio-frequency power output of the final stage was 10 watts. Satisfactory communication was obtained for a radius of 15 miles from a central point.

In front-to-rear train communication the equipment is used by the conductor and the engineer. Under present operating rules the conductor is in charge of the train movements at all times and must initiate any instructions as to starting and stopping of trains, the handling of hot boxes, or relating to any emergencies which might develop. In the actual operation of this equipment, the conductor can save a considerable amount of time in the handling of a train, as indicated by the chart, which shows typical actual equipment uses.

Without front-to-rear communication the conductor must stop the train from the rear. This means that the brakes on the caboose go on immediately, on the next car a short time later, and so on. When such an occasion arises the engine keeps pulling after the caboose has stopped, resulting in flat wheels or breaking a train in two, which may result in a derailment, personal injury, or serious delay. On the other hand, when the conductor can talk to the engineer in the locomotive, he can tell the engineer to apply his brakes immediately and the train will stop normally from the front end. Also, in starting a train the car brakes must be pumped up and checked for operation. This is called checking the air. This can be accomplished in less time when the conductor can report the air pressure back to the engineer and then give him the high-ball to get



out all the air. In yards and on switchings, he can inform the engineer when the train is in a safe position, i.e., when the last car is on a siding of the main line. All these problems have been intensified recently with the advent of 100 and 150-car trains.

For front-to-rear communication service, comparisons were made between signals at various frequencies. As in other cases, all units worked satisfactorily, with atmospheric noise present on 40 megacycles, less on 157 megacycles, and disappearing between 2000 and 3000 Mc. A flutter effect was audible on 157 megacycles when going through towns or areas with high buildings or water tanks.

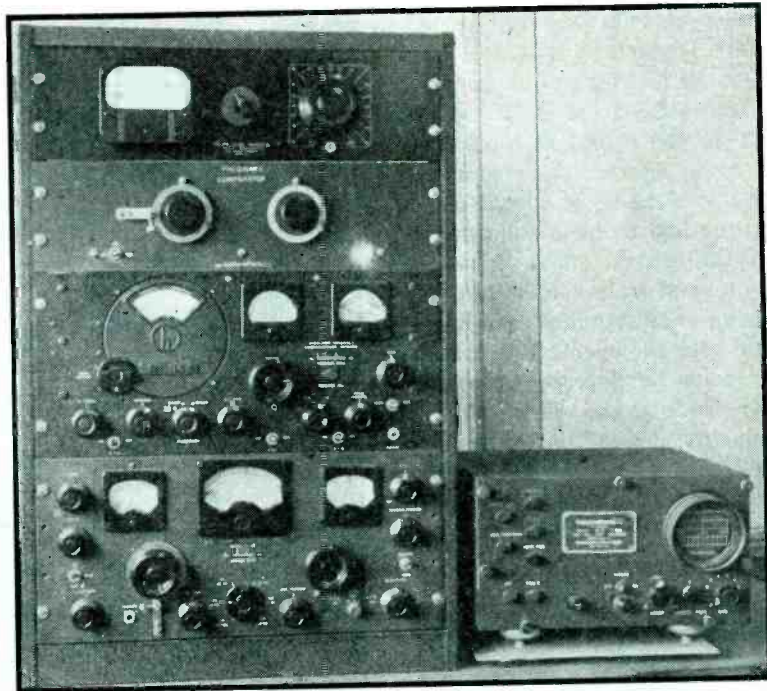
In order to make patterns of the radiation from antennas located on various portions of locomotives, two diesel locomotives and one steam locomotive were equipped with quarter-wave antennas and mounted at various locations on each of the locomotives. The locomotives were then driven on a turntable and the carriers turned on. A receiver was set up about 100 feet away and the turntable rotated through 360 degrees. From the results obtained, information was compiled which indicated that for the best radiation pattern the antenna should be mounted in the center of the cab roof.

#### Microwave Tests

Tests on 2000-3000 Mc were conducted between Chicago as one terminus and Salt Lake City, Denver and Kansas City as the other. Included in these tests were applications of radio communication to all the various forms of railroad operation. It is believed that the 2000-3000 Mc equipment is still sufficiently novel to warrant a brief description.

An antenna, fed by a 10-watt crystal-controlled transmitter, was placed on the locomotive; a stub-supported line was used to connect the antenna and the transmitter in the locomotive. The receiver was located in the caboose and was connected by means of the stub-supported line to the receiving antenna.

A Klystron local oscillator was used to beat against the incoming



Panoramic and Hallicrafters equipment used to visually check the frequency of transmitters as trains using them pull into the yard. A block diagram of the setup is shown in Fig. 3

signal and both signals were fed to a crystal-type detector or mixer. The intermediate-frequency output was then fed to the i-f channel, as in the usual superheterodyne receiver. The limiter current in the superheterodyne was measured by means of an Esterline-Angus recording meter, which made a direct comparison between the noise and the signal received at any given point.

Very interesting results were obtained. While the train was motionless the signal was constant. As the train moved the signal would increase and decrease just as if it were actually passing through waves of energy. The op-

eration of this system, using very low power, was excellent.

#### Service and Maintenance

The installation and maintenance of equipment becomes quite a problem in railroad operation. It has been found expedient to divide the work into two categories and between two organizations. The installation work, involving power supplies, power switches, and generators on locomotives, is all done by the electricians' group. The installation of telephones and radio equipment, and tuning and adjusting of the sets, is done by the communication department.

Two sets of frequency standards

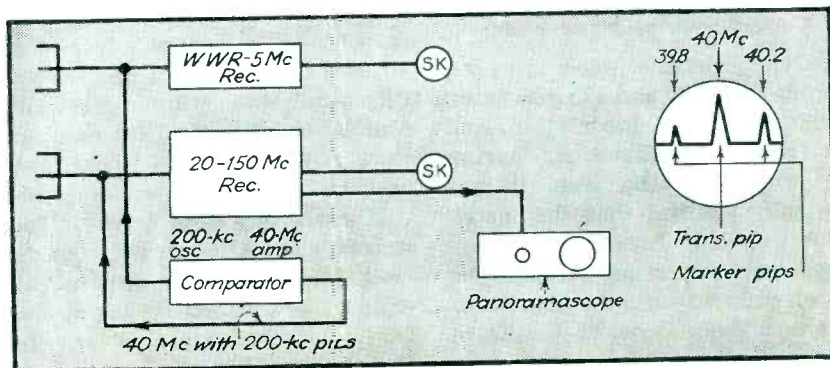


FIG. 3—Block diagram showing system used for visual frequency checks

have been set up, one indicating maximum frequency deviation and the other indicating minimum frequency deviation from the assigned carrier. In the actual maintenance of the radio equipment, frequency checking is done by a visual comparison method using a Panoramic unit at the central office. As each radio-equipped train comes into the yard, the maintenance engineer calls and asks the operator to transmit a carrier for five seconds without any modulation. This carrier then appears visually on the screen of the Panoramic between the two peaks designating limits of frequency deviation. If the carrier is



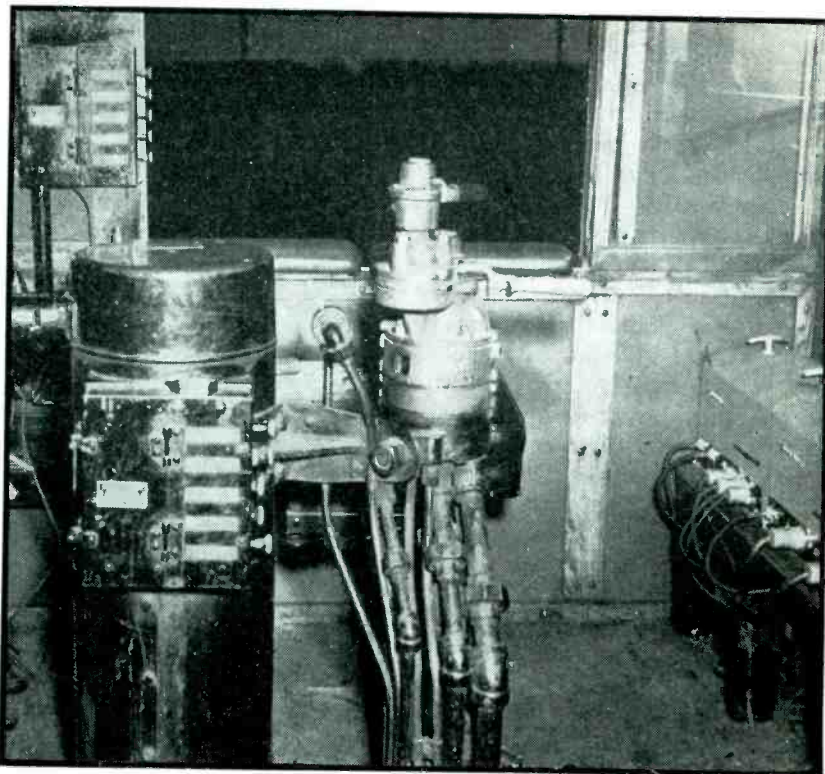
Remote control position for a typical yard station

outside the peaks, the equipment is removed from service and brought into the shop for frequency checking. The visual system has advantages over taking meter readings because of its simplicity and the speed with which a large number of remote units can be checked. This system is illustrated in Figure 3.

#### Carrier Systems Investigated

Carrier systems were tried on frequencies of 80 and 175 kilocycles, using amplitude modulation and also frequency modulation. During the process of the tests it was originally planned that the installation should investigate long-range communication through the use of carrier, with the short-area coverage being done by means of radio.

Space radio was to be used for yard systems and terminal opera-



Frequency-modulated equipment, installed in the cab of a locomotive, can be seen at the right

tion where no wayside wires were within a relatively short distance of the locomotive or caboose, as when yards were a mile or two miles wide and five or six miles long. It was assumed that radio signals broadcast in all directions from a certain point would easily cover two or three yards working in the same locale, with no worry about proximity to wires.

Further investigation late in 1944 proved that although carrier systems were excellent for long-distance transmission, the problem of interference with other railroads also using carrier systems appeared. To cite an example: A 120-car freight equipped with the carrier system was approaching Kansas City. It was actually more than 40 miles away from the Kansas City yards when train orders being sent by the Kansas City Southern were received on the Rock Island caboose.

If there had been three or four railroads operating in the same district, all would have received the train orders issued by the Kansas City Southern. Since a very limited number of channels were available it was believed best, therefore, to drop the induction system in

favor of a complete space radio system in which directional antennas would tend to guide radiation along the bounds of the railroad. Another important advantage appeared in favor of space radio. If wires were down or had more than two or three breaks, an induction system would be out of service. The space radio system would still have its normal operating characteristics, and would be relatively little affected by sleet storms, floods and similar emergencies.

#### Conclusions

As a conclusion to the various tests made by the Rock Island Railroad, it would definitely seem from the results we have secured that (a) the space radio system is preferred, and that (b) frequency modulation, (c) low power, and (d) directive high-gain antennas are all in line for further development for railroad communication.

The use of safety devices working on a pulse or radiated wave pattern will surely find a way into railroad warning systems. At the present time we are building several experimental units using high-frequency radiation for warning systems.

# Orbital-Beam

## U-H-F TUBES

Output frequencies as high as 500 Mc can be varied continuously or shifted back and forth between two or more values by applying appropriate keying signals to electrostatic deflecting plates, so as to vary the transit time between control grid and plate

By R. M. SMITH Camden Forge Co.  
Camden, N. J.

**F**EW conventionally designed electron tubes will operate with any efficiency above 100 megacycles and fewer still at frequencies of 500 Mc and higher. However, this is not to say that successful operation is not obtainable in the ultrahigh-frequency band (300 to 3,000 Mc) with conventional tube construction, because there do exist some new types of tubes which have been designed especially for such frequencies. These tubes are not generally spoken of as being conventional, however, at this stage of the game.

The writer had occasion to assist in the development of a secondary emission type tube especially designed for use at 500 megacycles or lower. The tubes had the appearance of an overgrown acorn tube. From the laboratory work a number of unique characteristics were found which suggested some new uses and advantages offered by this kind of tube.

### Ultrahigh-Frequency Problems

Aside from the problem of efficiently driving the input control grid at ultrahigh frequencies to put the useful signal onto the grid element where it has control on the amount of electrons passed on to the anode, there are a number of

other problems arising from within the tube itself. Among these are the limitations imposed by the electron transit time. Electron travel time from the cathode to the control grid constitutes one source of trouble and the result of this is a loading effect causing poor power factor for the input driving circuits. With extremely close spacing

between the cathode and control grid and with high electron velocities this loading effect can be reduced to workable values where tubes of the acorn variety are used.

The characteristics which we are to discuss herein, however, are those imparted by the flight time of the electrons after they leave the control grid and until they strike

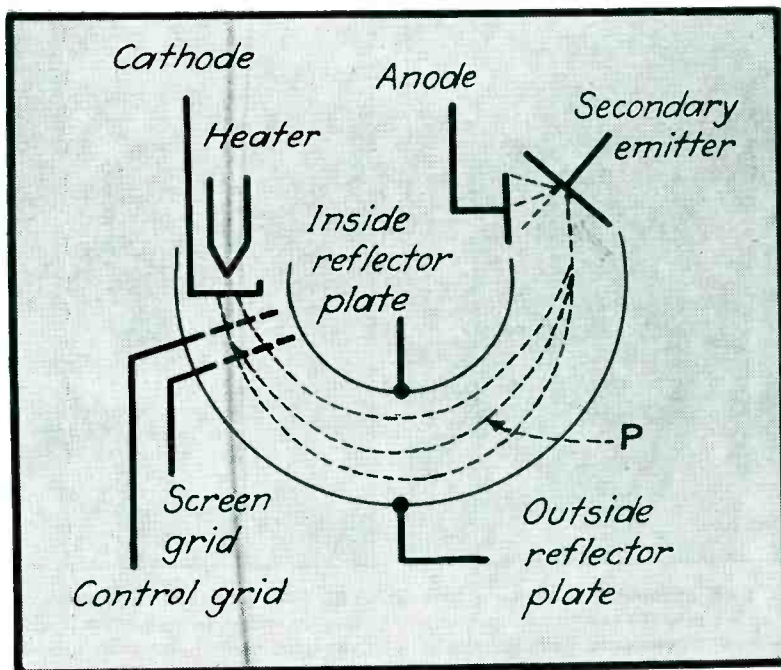


FIG. 1—Basic electrode arrangement in an orbital-beam tube

the anode or, in this particular case, the secondary emitter. This flight time, if appreciable compared to the interval of time represented by one cycle of the operating frequency, very definitely has control over the operation of the device.

#### Grid-Anode Transit Time

In view of this consideration the electron transit time was made approximately equal to the time of one cycle of the operating frequency, so as to have a synchronous or in-phase relation. It was found that this in-phase relation does exist and that if the transit time was made to vary, a corresponding shift in frequency response or a reactive effect on the external circuits was observed. Thus we can say that a change in the electron transit time has a corresponding reactive effect, the sign of which being determined by the direction of the change in time relative to the carrier frequency. These reactive influences were utilized as a means of control over the tube and its associated circuits.

Although a secondary emission type was used for the experimental work, the principles of control by transit time variation would apply in triodes and similar tubes where the electrons are collected by the

anode, bearing in mind that the physical design must allow for the control of the electron transit time in the manner described. A triode oscillator circuit is generally preferred for simplicity. Since we were interested mostly in receiver circuits with high gains per stage, the secondary emitter tube was used because of its inherent high mutual conductance. As a power amplifier this tube was found advantageous, as will be pointed out later.

#### Principle of Orbital-Beam Tube

The essential elements of the first orbital-beam tube are shown in Fig. 1, and include a heater, cathode, control grid, screen grid, inside reflector plate, outside reflector plate, secondary emitter, and anode. If we were to visualize the flight of a single electron, for example, we find that after its emission from the cathode, attraction by the positively connected screen grid provides it with an initial velocity sufficient to carry it through the screen grid, beyond which the higher potentials applied to the various other elements speed it along some curved path, say *P*, to the secondary emitter where its collision with the activated plate causes the radiation of secondary

electrons, some of which strike the anode.

The velocity of the electron during this flight remains substantially constant as determined by the static potentials applied to the various elements, and its path has been made purposely circular. The circular path permits lengthening or shortening of the flight path, thereby causing more or less time to be required by the electron in traveling from the control grid to the secondary emitter. The normal direct voltages applied to the various elements are approximately as follows: screen grid—150 v, inside reflector plate—150 v, and outside reflector plate—200 v. To lengthen the path a greater d-c potential is applied to the outside reflector or less to the inside reflector. The electron having an initial velocity and potential as determined by the screen grid is either attracted toward a higher-potential field or repelled by a lower one, so that it is effectively guided along the curved course by the curved electrostatic field existing between the two reflecting plates. In other words, by adjusting the d-c potentials applied to the reflecting plates the mean diameter of the circular flight path taken by the electron is caused to vary more or less. This control effect is the nucleus of the characteristics utilized in this conception. The principle of electron stream deflection is similar to that employed in other applications such as the cathode-ray oscilloscope, beam tubes and others.

#### Pulling Effect

If the tube and its connected circuits were made to oscillate at a frequency corresponding to the order of time taken by the electron in its traveled path, it was found that by varying the length of the electron flight path and consequently the time taken, considerable reaction or pulling effect was reflected upon the circuit, resulting in a change of operating frequency. The degree of control made possible is appreciable. By way of example, the particular tubes which were used gave a response variation amounting to  $\pm 0.5$  percent at

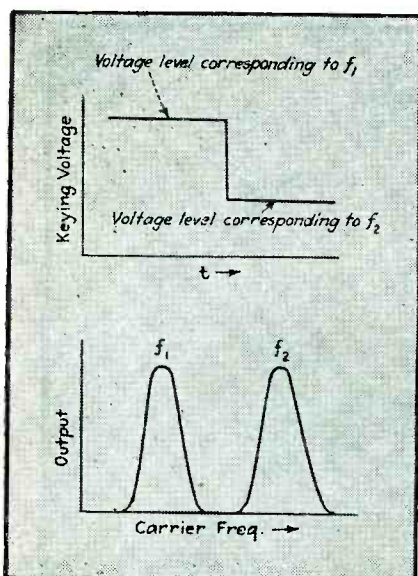


FIG. 2—A square-wave keying signal fed to an orbital-beam oscillator gives two-band transmission with a single transmitter

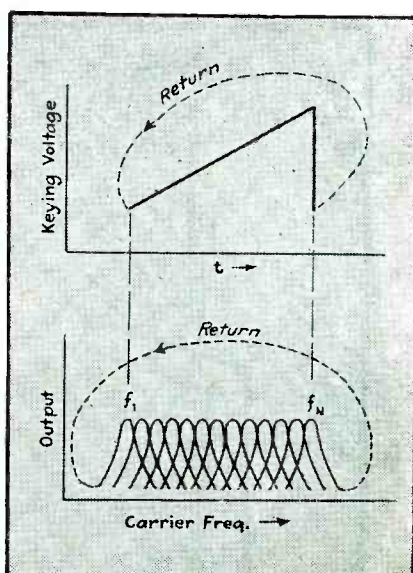


FIG. 3—A saw-tooth keying signal fed into an orbital-beam oscillator gives a sweeping effect covering an entire band of frequencies

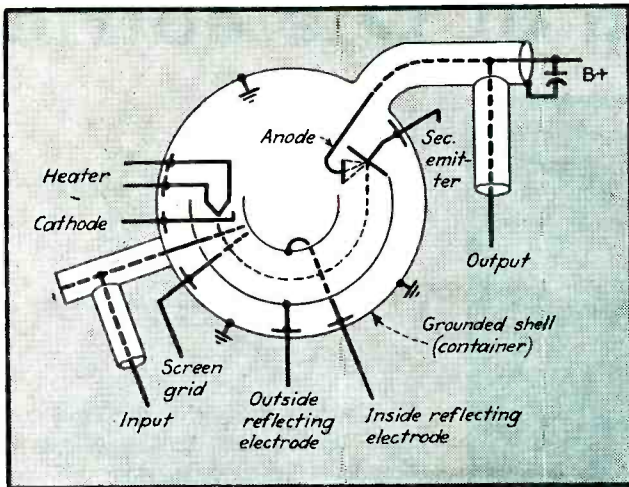


FIG. 4—Single-ended operation of an orbital-beam tube acting as an amplifier

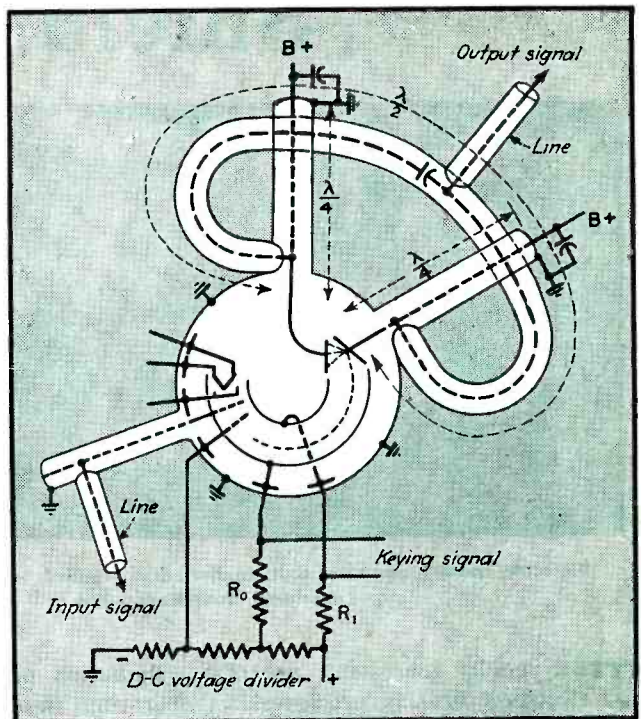


FIG. 5 (at right)—Use of a coaxial resonant line with an orbital-beam tube to secure push-pull amplification

500 megacycles before any reduction in oscillation strength took place. This frequency change was obtained by a 2-percent variation of the d-c potential applied to either reflecting plate.

It can be shown that the above phenomenon can be reduced to capacitive or inductive reaction effects and thus utilized for a number of circuit functions such as circuit compensation, oscillator stability and frequency response change, regeneration control, multiple-band and wide-band reception.

#### Possible Applications

These considerations immediately suggest the possibility of applying modulation signals to the reflecting plates for obtaining the following modes of operation: sine-wave modulation for communication and other uses; square-wave keying signals to obtain two or more distinct operating conditions, such as multiple-band reception or transmission (see Fig. 2), and sawtooth keying signals to obtain a sweeping effect covering a continuous band of frequencies (see Fig. 3).

An orbital-beam tube is normally used in single-ended fashion as

shown in Fig. 4, where the output circuit is connected to the anode. It was found that it also worked quite well as a push-pull driver, with the secondary emitter and the anode connected to the opposite ends of a push-pull resonant circuit as shown in Fig. 5. In the latter case, when used as a power amplifier, a power gain equivalent to 1.414 times that of the single-ended circuit was obtained.

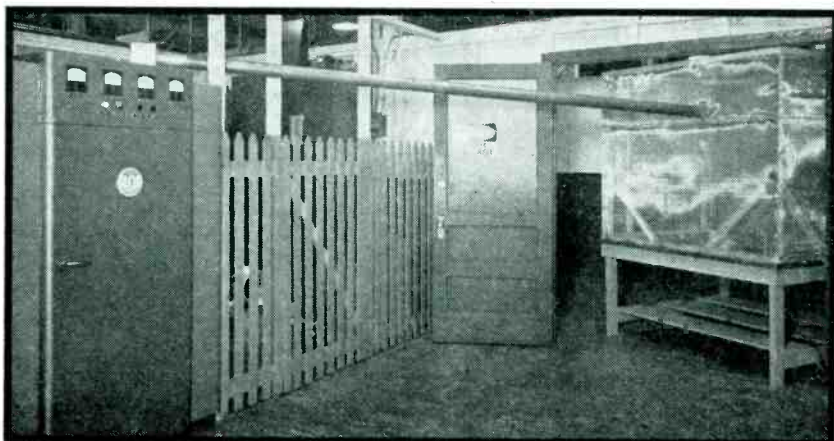
#### External Circuits

A few words about the external circuits are in order at this point. At 500 megacycles the advantages of concentric resonant line circuits, either  $\lambda/4$  or  $\lambda/2$  in effective length, are numerous and these lines were used in the work of development. Proper matching of the input and output terminals of the tube to their connected circuits is most essential, as well as the effective grounding of the other elements at the operating frequency. If modulating signals are applied to one or both of the reflecting plates, then band-pass type filtering is required in the leads to these elements in order to properly ground the r-f carrier currents while passing the modulating signals.

In Fig. 5 it will be noted that provision is made for impressing a modulating signal onto the reflecting plates. Resistors  $R_0$  and  $R_1$  are in series with the battery leads to these plates. Generally only one plate is used for a single application; however, there are conceivable applications where both plates might be used for a dual modulation scheme.

In conclusion, it should be remembered that in order to control the electron flight time within a given tube, assuming constant velocity, a circular or orbital path with suitable deflecting plates must be provided, and to obtain the reactive or phase effects discussed herein the physical dimensions must be such to cause the flight time to be approximately equal to the time of one cycle of the operating frequency. Whether the tube is a secondary emitter or a straight anode collector does not matter in the sense and manner of control. It does, however, make a difference in the relative gain derived, being somewhat in favor of the secondary emitter type. A greater flexibility in circuit arrangements, with some added complications, is possible with the latter type.

# Shielding of Dielectric



Dielectric heating generator (left) connected to shielded work table (right) by overhead transmission line

**T**HE rapidly increasing use of electronic heating processes in industry has required the installation of many high-power radio-frequency generators. All of these generators radiate some power and thus become potential sources of interference with radio services.

The investigation to be described was undertaken to determine by actual measurement the effect of various shielding arrangements upon the radiation from electronic heating equipment.

Electronic heating is divided into two distinct fields: the heating of metals, called induction heating, which is done mostly at frequencies below 500 kilocycles, and the heating of nonconductors, called dielectric heating, which is done almost entirely at frequencies above two megacycles.

Field strength measurements made around several 20-kilowatt, 400-kilocycle induction heating installations operating in manufacturing plants show that no measurable field strength exists beyond 300 feet from the equipment. Thus it appears that usually no shielding beyond that required for safety will be necessary for induction heating installations. Similar measurements made on two 15-kilowatt dielectric heating installations, operating near 10 megacycles without special shielding, gave average field strengths as shown in Fig. 1.

From a paper presented at the IRE 1945 Winter Technical Meeting in New York.

Radiation on harmonics of the operating frequency must also be considered. Figure 2 shows comparative field strengths of fundamental and harmonics measured at one commercial installation operating at 9 megacycles. A similar ratio of harmonic radiation was measured at the start of these tests.

The ratio remained approximately the same as the fundamental field strength was reduced by shielding. The harmonics disappeared below the noise level while the fundamental was still easily measurable.

Usually the ambient noise level in localities where industrial equipment is used will be fairly high. Around the installations plotted in Fig. 1 it was about 20 microvolts. At the measuring position used in this investigation it was 15 microvolts.

## Conditions of Tests

The tests were run on a dielectric heating generator located in the RCA development laboratory in Camden. The field strength measurements were made with an RCA 308A field intensity meter placed at a fairly open spot 360 feet from the generator. Later, when radiation had been considerably reduced, the meter was moved to 100 feet from the generator.

All readings were converted to the equivalent field at a distance of one mile by means of the inverse square law which, as Fig. 1 shows,

By G. W. KLINGAMAN  
and

G. H. WILLIAMS

RCA Victor Division  
Radio Corporation of America  
Camden, N. J.

fits the case quite closely. This was done to conform to the standard broadcasting practice and to provide a common base for comparison of all readings regardless of the distance at which they were taken.

In order to simulate the average factory installation, the applicator electrodes and work table were set up about 12 feet away from the generator and were connected with it by a concentric transmission line. The generator was housed in a partially copper-plated steel cabinet. Metal conduit extended from the cabinet to the incoming power source, the plate transformer, and the remote control station. In order to provide the usual safety ground, the system was also directly connected to a driven ground pipe by 5 feet of No. 4 solid copper wire.

The load on the generator consisted of a water resistance in series with a two-plate air capacitor formed by the applicator electrodes. The low-voltage electrode was the

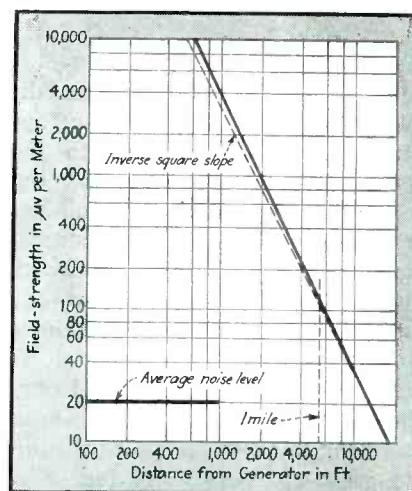


FIG. 1—Average field strength of two dielectric heating installations (solid line) closely follows the inverse square slope relation

# Heating Installations

Field intensity measurements in the vicinity of a 9-Mc electronic generator show effects of various shields, grounding arrangements and line filters on radiation when feeding 6 kw into a dummy load. An oscillating wavemeter locates points of radiation leakage

sheet copper top of the work table. This arrangement is shown in Fig. 3. The plate power input to the generator was 6 kw, which remained constant throughout the tests. The frequency was 9 Mc. The voltage across the load was 4000 volts.

## Unshielded Work Table

The first measurement was made with no shielding of any kind over the work table. The resulting field strength was 316 microvolts at one mile. From this starting point some

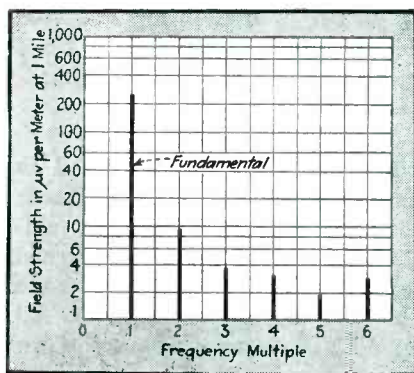


FIG. 2—Harmonic field strength from a 15-kw dielectric heating generator, measured at 900 feet and converted to one-mile values

150 readings were taken before the many sources of radiation were located and the field strength was reduced to noise level. However, only the more significant values will be mentioned here.

In order to determine how much of the radiation could be attributed to the incoming power line, a three-phase low-pass filter consisting of a pi arrangement of two 0.1- $\mu$ f capacitors and a 4.4- $\mu$ h choke per phase was mounted as in Fig. 4. At the time the field measurements were made on the industrial installations previously mentioned, this filter was inserted in the power

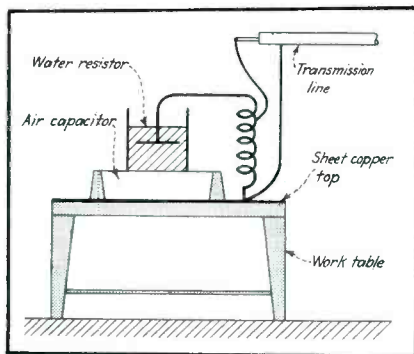


FIG. 3—Dummy load for work table, and method of shielding table with copper

line just ahead of the generator and check readings were taken at each place. No appreciable reduction in field strength could be found. The result was the same when the filter was tried in this test. Radiation from other sources was so strong that reduction of radiation from the power line was too small to be readable.

## Use of Shielding Cage

The first attempt at shielding was to place a cage over the work table. This cage was 5 x 5 feet and was covered with 16-mesh bronze wire screening turned under the bottom edges so that it would make contact with the sheet copper work table top all around. The small access door was covered by a piece of  $\frac{1}{8}$ -inch sheet copper which overlapped the door opening about one inch on all four sides. This cage reduced the field strength to 1.3 microvolt.

To provide a very low-impedance return circuit a two-foot-wide sheet of copper was run from the work table top, under the door of the generator cabinet, direct to the oscillator filaments. The field strength

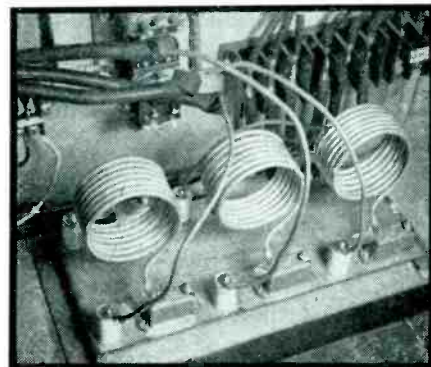


FIG. 4—Three-phase line filter inserted in the power line serving the electronic generator

was then reduced to 1.2 microvolt.

Following this a number of changes were made, such as insulating the low-voltage applicator electrode from the top of the work table, adding a three-inch tube shield over the  $1\frac{1}{8}$ -inch transmission line, and putting the applicator inside a second shielded box. All these changes produced variations in field strength, some increasing it, some decreasing it, but never getting it below about 0.93 microvolt. Even connecting and disconnecting the copper ground sheet from the cage made very little difference.

Then, for another reason, the ground sheet was removed from under the generator door and the field strength immediately dropped to 0.3 microvolt. The sheet acted as an antenna as long as it extended into the generator compartment. This indicated that about as much radiation was leaking out of the various holes and cracks in the generator cabinet as out of the work enclosure; consequently, the transmission line was disconnected from the generator and a means was sought of detecting points of maximum radiation around the cabinet.

## Leakage Radiation Detector

The instrument finally developed for this detective work was a small shielded loop coupled to an oscillating wavemeter which provided indications on a grid meter for strong signals and by heterodyne beat in headphones for weaker signals. This instrument proved extremely valuable throughout the

investigation. It is shown in Fig. 5. With the help of the loop it was easy to find that the oscillator cabinet door joints were the strongest source of radiation. By coupling the loop close to the surface of the cabinet it was possible to map the direction of current flow around the various portions of the cabinet.

### Causes of Leakage Radiation

Sealing the door was first attempted by bridging the joints with small copper clips, but this was far from satisfactory. Eventually the door was continuously bonded with weather stripping made of bronze screen extending all the way around. Only then did radiation from this source become undetectable.

Meters and controls which extended through the front panel were also quite capable radiators and had to be shielded by wire screening between the back of the panel and the r-f circuits. Radiation from the  $\frac{1}{2}$ -inch mesh ventilator grill in the top of the cabinet was also strong until the ventilator was covered with 16-mesh screening. The remote control and safety interlock wiring were found to be good radiators and they were entirely disconnected. Thus one small source of radiation after another was eliminated until the field strength from the generator alone was reduced to 0.05 microvolt.

Addition of the transmission line and load then raised the radiation to 0.37 microvolt, whereas the value was 0.3 microvolt before any shielding was done on the generator cabinet. This result emphasizes the fact that the measurement of the field strength is not a particularly reliable method for determining the effectiveness of various shielding measures unless measurements are made at more than one point around the installation.

Two improvements in the generator shielding, each of which produced a definite reduction of field at the meter when applied separately, may often show an increase of field at the meter when applied together. Many interference effects of this nature were noted.

After some further improvements of the inner load-shield and after connecting the inner and outer transmission line tubes sep-

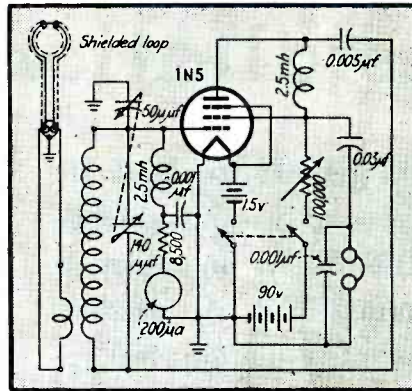


FIG. 5—Circuit of oscillating wave-meter used to detect points of radiation leakage around cabinet of electronic heating generator

arately to the inner and outer load shields, the radiation was reduced to 0.05 microvolt.

### Special Ground Not Needed

All the previous tests had been made with the system connected to the driven ground pipe. This connection was now broken, but no change in field strength resulted. Connections to various other grounded objects were made and broken without effect. It appears that in a reasonably well shielded system, if any ground at all is required for reduction of radiation, the ordinary electrical conduit or Underwriters' safety ground is sufficient.

In order to make the installation complete, the remote control station wiring, which had been disconnected at the beginning of the tests, was replaced. The field went up to 0.74 microvolt and did not come down again until a warning lamp, which had been connected into the remote-control box with unshielded

wire, was removed. This piece of rubber-covered cord had been the source of all radiation charged to the remote control wiring.

The above-described system of shielding was quite complicated. The double-shielded transmission line and double load-shield were particularly undesirable; therefore, an attempt was made to simplify the shielding without significantly increasing the field strength.

### Soldering Iron Phenomenon

The outer transmission line tube was removed and both load-shields were connected to the remaining outer conductor. This doubled the indicated field strength to 0.09 microvolt. Removal of the inner load shield raised the value to 0.12 microvolt where it stayed, in spite of a number of additional changes, until a soldering iron was plugged into a nearby receptacle. The field strength immediately dropped to an extremely low value. This was another interference phenomenon which was found to be due to voltage picked up by the iron cord from the cage leakage. It helped to force the reinstatement of an inner load-shield.

A new inner shield of 16-mesh bronze screening was fastened to the inside of the wooden frame which supported the original single shield. The screening, turned under the edge of the frame, made contact with the outer shield all around. The frame was set down on the copper work table top as before. The field strength with this arrangement was 0.007 microvolt and no longer could any voltage be detected on the iron cord.

### Effectiveness of Line Filter

Now that most of the other radiation had been eliminated, the line filter became an important part of the system, for when the filter was disconnected, the field strength rose to 0.31 microvolt. No further changes in arrangements inside the cage had any effect on the field strength. The insulated lower applicator electrode was removed, thus making the table top serve as the electrode and carry the total load current, but no appreciable increase in field occurred. The final arrangement is shown in Fig. 6.

TABLE I. Summary of Shielding Tests

Conditions	Field Strength in $\mu\text{V}$ /Meter Converted to 1 Mile	Total Attenuation in db
As Installed; No Load Shielding	316.	0
Single-Screen Cage	1.3	45
Generator Cabinet, Shielded	0.12	69
Double-Screen Cage	0.007	93
Over Load	0.0036	99
Double-Screen Door On Cage	0.4	78
Slot 1x30 in. with 8 in. Extension		



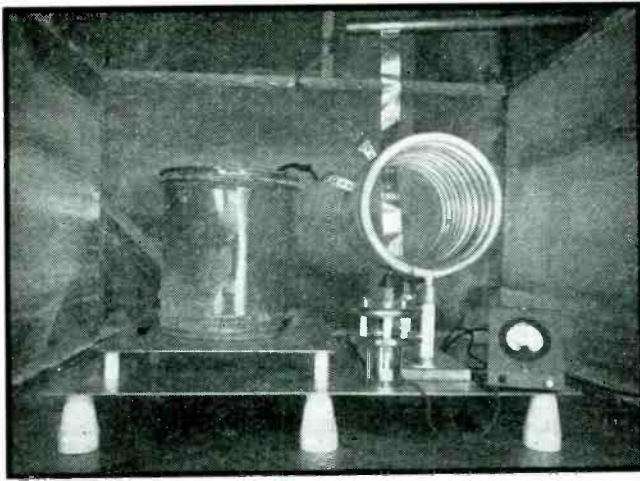
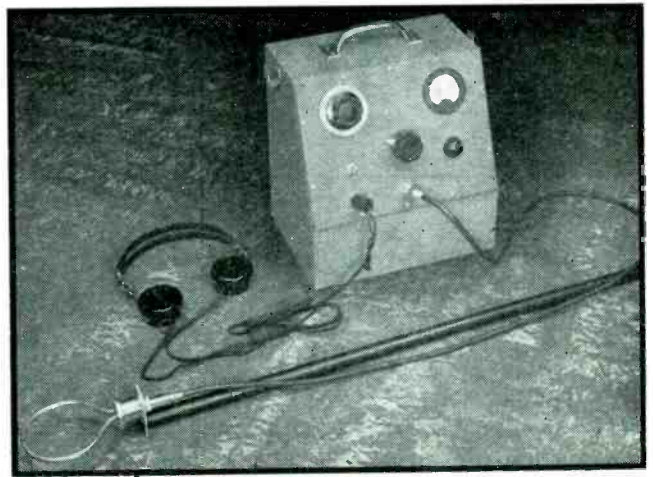


FIG. 6—Final arrangement of work table, with dummy load on low-voltage electrode that is insulated from the copper top of the work table



Radiation detector and search coil used for locating points around doors of shielded cage at which appreciable radiation was escaping into space

Up to this time a copper sheet bonded to the outer screen had been used as the cage door. This was now replaced with bronze screening bonded to the outer screen. The field rose from 0.007 to 0.01 microvolt. With the single screen door bonded to the inner screen the value went back to 0.007 microvolt, and with a double-screen door it dropped to 0.0036 microvolt. A field strength of 0.0036 microvolt is quite small compared to the original 316 microvolts; it represents a reduction of about 85,000 to 1.

#### Shield for Conveyor Applications

In some installations it is desired to pass the work continuously through the applicator by some means such as a conveyor belt. This requires an opening on each side of any shield which may be used. To investigate this condition a horizontal slot 30 inches long and adjustable in width was cut in the sheet copper cage door. With a slot  $\frac{1}{8}$ -inch wide, a field of 0.09 microvolt was produced. A one-inch slot raised it to 0.13 microvolt.

The first attempt at reducing this radiation was a sort of vestibule having the same cross-section as the slot and extending outward perpendicular to the side of the cage, as in Fig. 7. With a length of eight inches this device reduced the radiation from the  $\frac{1}{8}$ -inch slot to 0.01 and from the one-inch slot to 0.04 microvolt. These values compare favorably with those previously obtained. Although more work re-

mains to be done it appears that the extension of the edges of a cage opening offers a possibility of providing open entrance and exit doors without allowing excessive radiation.

#### Summary of Results

For convenient comparison the most important values in this report, together with the corresponding attenuation in db, have been tabulated in Table I. In summarizing the results of this investigation it is well to divide the problem into shielding of the generator and shielding of the applicator. Since the shielding of the generator is the simpler of the two, it should be done as completely as possible. This involves three important points: first, the radio-frequency parts of the generator circuit must be enclosed in a separate section of the cabinet, the walls of which are cop-

per plated and conductively bonded at the joints. (The copper provides a better and more permanent contact across wall joints).

All wiring and components not essential to the r-f circuits should be kept outside of this r-f compartment. This refers to control wiring and especially meters or controls which may extend through the walls of the main cabinet. Any ventilators should be covered with small-mesh bronze screening. Second, any access door into the r-f enclosure must be conductively bonded along all edges. If this is not done, the door will be a major source of radiation. Third, a good low-pass filter should be provided in the power supply line.

The shielding of the transmission line and of the work applicator and tuning equipment will then control the amount of radiation from the system. When the double screen cage is used, the two screens may be in contact with each other at points such as access openings; both should maintain good contact with a single sheet-copper floor which may be used as an applicator electrode if desired.

No unshielded wires should be run into or out of the system. The use of special external ground connections, such as wires to water pipes or to buried plates, has no appreciable effect upon the reduction of radiation.

It is hoped that the findings of the foregoing investigation may serve as a reference for the economical construction of load shielding.

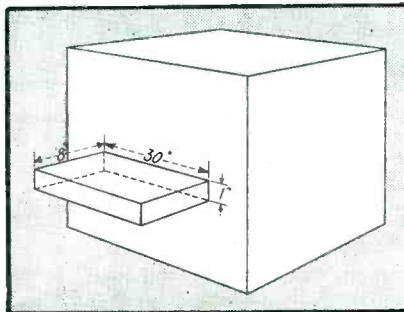


FIG. 7—Method of attaching a vestibule to the shielded cage of the work table, for providing conveyor belt openings without allowing excessive radiation

# F-M FIELD SURVEY

Detailed description of the procedure used to secure data for plotting actual coverage contours of WMFM as required by the FCC one year after an f-m station first goes on the air, with practical data on equipping, calibrating and using a field car

ONE YEAR from the date of the first regular operation of a high-frequency f-m broadcast station, a survey must be submitted to the Federal Communications Commission establishing the actual field intensity contour. Continuous field intensity records are made along each radial specified in the construction permit (CP), and the actual routes of the field car are plotted on a map along with the two service contours. The primary service area then corresponds to the area inside the 1000-microvolt contour, and the secondary service area is inside the 50-microvolt contour.

## Transmitter Power Requirements

During the months of August and September, 1943, a survey like this was made to prove the antenna performance of WMFM, one of the Milwaukee Journal's radio stations. In order that the calculated distance to the 50-microvolt contour would conform with the map attached to the CP, an effective radiated power of 41.5 kilowatts was necessary to deliver the desired coverage of 8500 square miles.

The radiating system of WMFM consists of a two-bay turnstile antenna which has a power gain of 1.23. The required transmitter power, for an effective power radiation of 41.5 kw, is therefore 41.5 divided by 1.23, or 33.8 kw. The loss in the coaxial transmission lines to the antenna was computed to be 2.5 kw, thereby requiring an increase in the transmitter output power to 36.3 kilowatts. WMFM uses a 50-kw REL 521DL f-m transmitter with a power input to the final stage of 60.5 kilowatts.

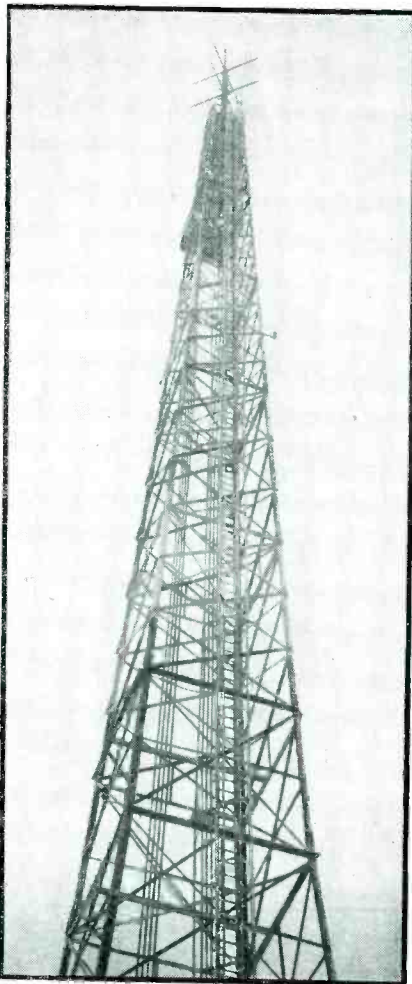


FIG. 1—Tower, transmission lines and turnstile antenna system used by WMFM at Richfield, Wisconsin

The indirect method of computing the output power was used, assuming an efficiency of 60 percent for the power amplifier. The operating power then is  $0.6 E_p I_p$ , where  $E_p$  is the plate voltage applied and  $I_p$  is the total plate current of the last radio-frequency amplifier stage. This results in 36.3 kilowatts being

fed to the transmission lines and an effective 41.5 kilowatts being radiated.

The turnstile antenna, shown in Fig. 1, is mounted on a 200-foot self-supporting tower and has a total effective height to the center of the array of 224 feet. The STL receiving antenna platform is incorporated in the tower design. The eight transmission lines on the tower, each feeding a single antenna element, can also be seen. The transmitter, located about 21 miles northwest of Milwaukee proper and about 15 miles inland from Lake Michigan, was described in a previous article.<sup>1</sup>

## Measuring Equipment

The 50 and 1,000-microvolt contour lines were determined by taking continuous measurements along each of eight radials spaced 45 deg apart, using an RCA 301A v-h-f field intensity measuring set with a 93A vibrator power unit.

The field intensity meter was designed for measuring field intensities of stations operating in the high-frequency spectrum, for the purpose of checking antenna efficiency, service area and carrying out research or propagation studies. The instrument covers the band of 20 to 125 megacycles and has a range of 10 to 500,000 microvolts when used in the f-m band (officially designated as the high-frequency broadcast band). It is designed particularly for field use and consists of three units—the field meter, antenna and power supply. The primary source of power to the vibrator unit is a non-spillable storage battery de-

# TECHNIQUES

By **PHIL B. LAESER**

*FM-Television Engineering Supervisor  
WMFM-WTMJ  
The Milwaukee Journal Radio Stations  
Milwaukee, Wisconsin*

signed to operate continuously for eight hours without recharging. The recorder was an Esterline-Angus model AW 5-ma instrument.

The equipment was securely mounted on rubber kneeling pads in a Dodge delivery truck, as shown in Fig. 2. In addition to these equipments an f-m receiver was taken along to monitor the station; this proved valuable at the outer fringe of the service area.

The antenna of the measuring set was mounted on the roof of the field car and the support extended down through to the floor inside. This made it possible to control the antenna from the inside while the field car was in motion. The antenna used at the transmitter is

a horizontal turnstile, and consequently similar polarization was used for the car antenna. A marker was attached to the base of the antenna mast and set up to indicate the relative position of the dipole above. This was helpful when the field car made turns along the highway, and minimized time in orienting the antenna. The output of the antenna was connected by means of a flexible transmission

line to the field measuring set, which in turn was connected to the Esterline-Angus recording milliammeter. Figure 3 is a picture of the field car with the antenna mounted in place.

## Calibration of Field Car Installation

The metal in the truck body made it necessary to check and recalibrate the measuring instrument. Therefore, before the equipment was installed in the field car the measuring set was taken to a location well away from and free of power lines, fences and buildings. The nearest obstacles were more than 300 feet distant. A compass rose was laid out and readings taken to determine the field intensity in this local area. The signal intensity in this open-field area was found to be 1634 microvolts, and no fading existed here to upset the calibration. The antenna length was 54 inches, or about 0.21 wavelength each side of the dipole for the above tests. The height of the antenna was adjusted to 13.5 feet, which was the maximum height of the telescopic support.

A semi-permanent installation was then made in the field car. It was found that the top of the truck body did not present a uniform capacitance back to the antenna as it was rotated over 360 degrees. After several tests it was determined that the antenna had

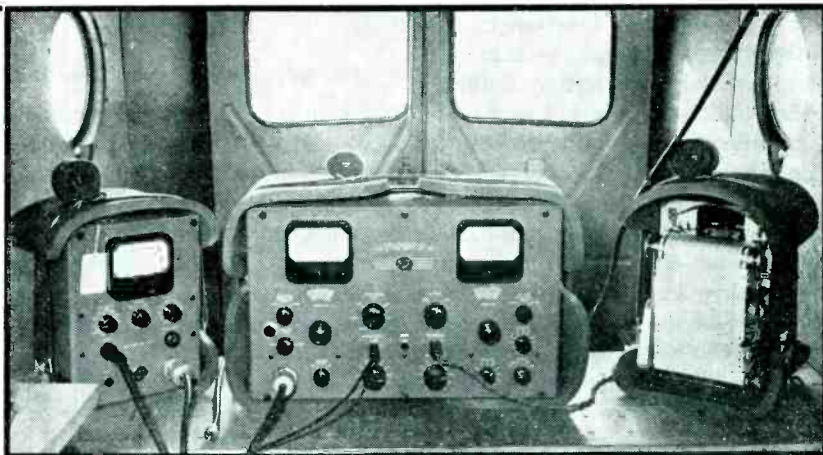


FIG. 2—View of the v-h-f field intensity measuring set mounted in the car and ready for use. At the left is a noise meter



FIG. 3—View of the field car with the telescopic antenna raised. The antenna pivots on a bearing inside, permitting orientation for maximum signal

to be elevated slightly more than one quarter wavelength above the steel top in order to minimize the effect of the truck body. It was deemed necessary to set up and calibrate this variation as the truck body was rotated in relation to the transmitting station. The compass rose previously laid out by driving wooden stakes in a circle was used to recalibrate the unit. Readings were taken at each 30-degree position and the antenna always oriented to deliver the maximum field intensity as the truck body was rotated through 360 degrees. The placement of the antenna with reference to the body of the truck can be seen in Fig. 4, which corresponds to the 270-degree position shown in Table I.

The highest signal intensity was received at positions 2 and 8, corresponding to 1577  $\mu\text{V}$  per meter. The lowest signal received was 1520  $\mu\text{V}$  per meter, at positions 4-5-6-7. Prior to the installation on the field car, a signal of 1634  $\mu\text{V}$  per

meter was received at this identical location. This represents a reduction of 57 microvolts at positions 2 and 8 and 114 microvolts at 4-5-6-7 when introducing the metallic body of the truck in the field.

#### Correction of Antenna Constant

From the data in the instruction book furnished with the field intensity instrument it was found that an antenna constant of 9.5 was needed to carry out the computation for the field intensity at 45.5 megacycles. This constant takes care of any losses in the 30-foot transmission line from the dipole to the input terminals of the field meter. Changing this constant was a very convenient way to compensate for any effect that the truck body might have on the pickup antenna. The new constant  $K$  was found by the following formula:  $K = 1634 \mu\text{V} \div \text{attenuator scale} \times \text{meter reading in milliamperes}$ .

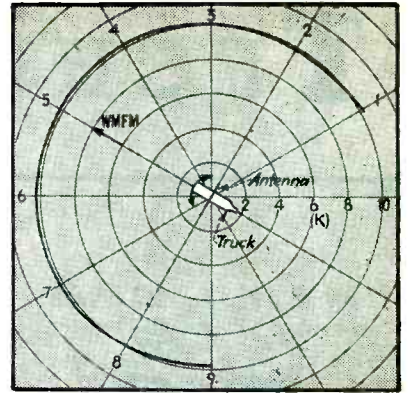


FIG. 4—Graph showing the variation of the antenna constant with the position of the field car in relation to the direction of the transmitter as the only variable. The dipole antenna was oriented for maximum signal for each new position, and the transmitter power held constant

The field unit was used only for measurements while moving directly away from the transmitting station, and therefore calibrations were made for only the rear and the two sides of the truck, as shown in Fig. 4. Positions 2 to 8 were averaged, and resulted in a change of the antenna constant from 9.5 to 10.0. The overall height of the antenna then was permanently fixed on the field car at 13.5 feet above the ground or 6.5 feet above the metal roof. After all the radials were run, the calibration of the measuring set was again checked under the same conditions and found to be the same.

#### Percent Modulation Was Lowered

It should be realized that this method of continuous recording of field intensity is quite different from that used in the regular broadcast band. Here the measurements are generally made at isolated points free of wires and other obstructions, and under favorable conditions. The measuring instrument used was primarily meant for a-m use and has a bandwidth of about 50 kc. Modulating the f-m transmitter at full 100 percent, corresponding to a swing of  $\pm 75$  kc, produced an excessive variation on the field meter. Consequently, during the periods that the measurements were being taken the overall percentage of modulation was dropped by lowering the audio input to the transmitter until satisfactory stability was obtained. This was achieved by low-

TABLE I. EFFECT OF TRUCK BODY ON ANTENNA CONSTANT

Position No.	Angle	Attenuator Scale	Reading in ma	Field Intensity in $\mu\text{V}/\text{m}$ , using $K=9.5$	New Antenna Constant $K$
1	60°	20	8.1	1539	10.08
2	30°	20	8.3	1577	9.85
3	360°	20	8.2	1558	9.96
4	330°	20	8.0	1520	10.21
5	300°	20	8.0	1520	10.21
6	270°	20	8.0	1520	10.21
7	240°	20	8.0	1520	10.21
8	210°	20	8.3	1577	9.85
9	180°	20	8.3	1577	9.85

TABLE II. RADIAL No. 8—N 354.5° E

Sector Number	Attenuator Setting	Dist. to end of Sector	Median Field Reading	Median Field at 13.5 ft = $\mu\text{V}/\text{m}$	Median Field at 30 ft = $\mu\text{V}/\text{m}$	Max. Field Reading	Max Field at 30 ft = $\mu\text{V}/\text{m}$
1	2	3	4	5	6	7	8
1	10,000	0.6	8.0	800,000	1,760,000	10.0	2,200,000
2	10,000	1.0	4.0	400,000	880,000	7.0	1,540,000
3	10,000	2.4	2.0	200,000	440,000	4.3	950,000
4	2,000	3.5	3.0	60,000	132,000	7.2	316,000
5	500	5.0	4.0	20,000	44,000	8.5	93,500
6	500	7.0	5.2	26,000	57,400	9.5	104,000
7	500	9.0	2.5	12,500	27,500	5.0	55,000
8	500	10.6	1.8	9,000	19,600	3.4	37,400
9	100	12.5	3.5	3,500	7,700	7.6	16,700
10	100	16.0	1.5	1,500	3,300	5.6	12,300
11	20	20.0	6.4	1,280	2,820	9.6	4,200
12	20	25.0	5.1	1,020	2,250	9.8	4,300
13	20	27.5	4.0	800	1,760	7.6	3,350
14	20	32.5	2.6	520	1,140	9.0	3,960
15	20	36.0	1.5	300	660	3.9	1,720
16	5	40.0	4.0	200	440	10.0	1,100
17	5	42.5	5.0	250	550	10.0	1,100
18	5	45.5	1.8	90	196	6.6	722
19	1	50.0	5.5	55	121	10.0	220
20	1	55.0	6.2	62	136	9.6	212
21	1	60.0	6.0	60	132	10.0	220
22	1	65.0	1.5	15	33	4.0	88
23	1	70.0	2.0	20	44	6.1	134

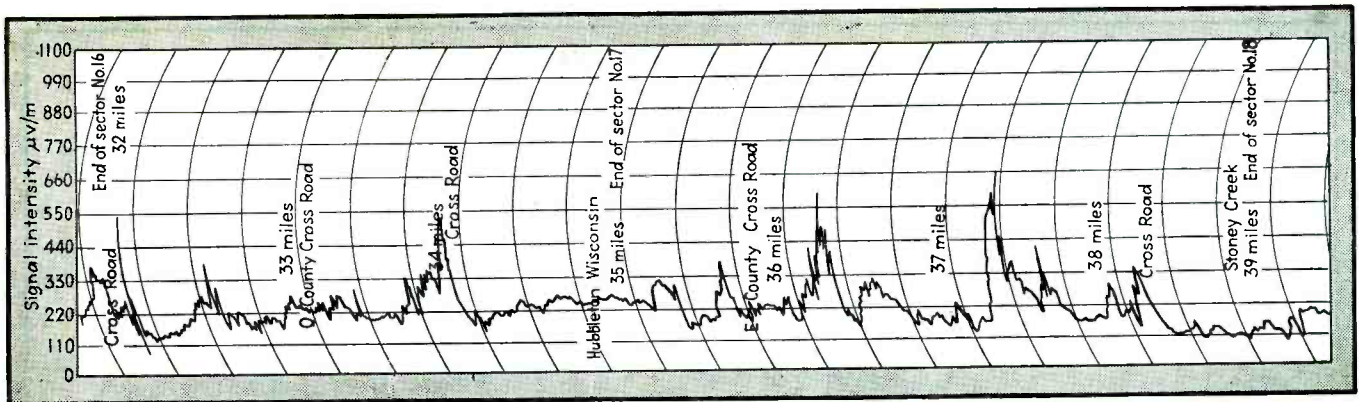


FIG. 5—Signals recorded with equipment shown in Fig. 2 and 3

ering the input 4 to 5 db. Satisfactory monitoring of the program modulation could not be obtained with this amplitude instrument so the signal was monitored on the f-m receiver which was carried along.

#### Field Work and Routes

In planning for the runs on each of the eight radials, care was taken to see that they were carried well beyond points of predicted service, so as to arrive at a sufficiently accurate determination of the contour boundary. This is particularly important at the 50-microvolt contour because of distance to be retraveled if the field records are found to be incomplete. The radials were spaced approximately 45 degrees about the transmitter.

The survey was conducted only during the daylight hours. While driving along the radials a uniform driving speed of 15 miles per hour was maintained and a sufficient number of landmark and roadway notations were written on the record for later chart analysis. These locations were noted on the chart as often as necessary, so it was easy to determine the exact location of the field car when the chart analysis was made later on. This definitely fixed the relation of the car location to the measured field intensity. Figure 5 shows a record taken on radial 6 between sectors 16 and 18, corresponding to 32 and 39 miles from the transmitter.

In choosing the routes for the car, roads were chosen that ran parallel (or nearly so) to the radials, as deviations of the topography can cause a great difference in the recorded results. The routes trav-

eled by the field car in relation to each radial are shown in Fig. 6. In some cases wide deviations from the radials were necessary because of rivers and their lack of bridges. This was the case on radial No. 1 where it was impossible to cross the Milwaukee River. Another case was on radial No. 5 at Janesville, where the Rock River interfered. On the northwest radial a large area known as Horicon Marsh made passage impossible. Most township roads run east and west, with very few diagonal roads, hence trouble was also experienced with the radials going northwest, southwest and northeast. On the southeast radial a diagonal highway, U.S. 41, ran directly along the radial and through the city of Milwaukee.

The antenna height above the car proved to be rather awkward during the field runs and trouble was experienced, particularly on

country roads. The antenna had to be replaced several times because of the driver's inability to spot electric fence wires strung rather low across the highway, or because of overhanging branches. One radial per day was all that could be accomplished. This was partially due to the regular program schedule which began at noon and therefore necessitated a late start.

#### Predicted vs. Measured Results

After the measurements were completed, the charts from the recording meter were analyzed. The first step was to divide them into sections, each representing a sector of a radial along the topographic map. Each sector was not more than one tenth of the service radius or not more than five miles in maximum length. The charts of the field intensities were analyzed to determine the electric field intensity obtained 50 percent of the distance along each sector.\* This will be referred to as the median field intensity for antenna height of 13.5 feet. The value is associated with each particular sector and is presented in tabular form. An example of one of these tabulations, shown in Table II, was compiled from the data taken along radial 8.

Column 1 of Table II is the sec-

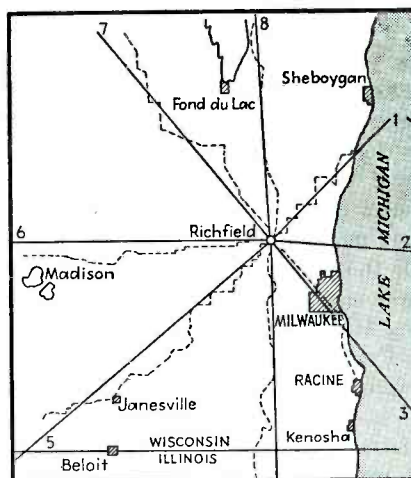
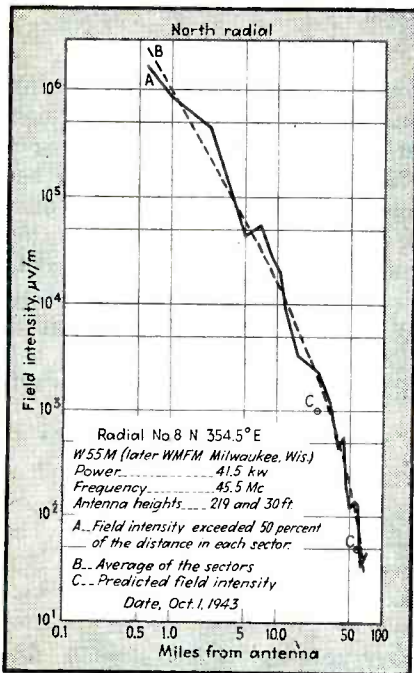


FIG. 6—Map of the eight radials, showing the deviation of the routes traveled by the field car (dashed lines) with respect to the radials

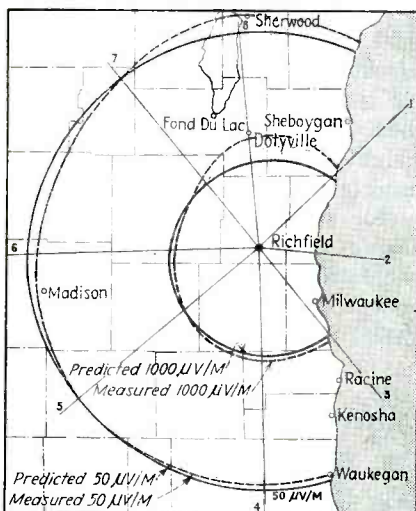
\* In the Standards of Good Engineering Practice for High Frequency Broadcast Stations, set up by the Federal Communications Commission, is the definition: "The signal intensity for the 50-microvolt per meter 50 percent distance is interpreted to mean the contour bounded by the sector on a radial on FCC map No. 41722. Signal range for high frequency broadcast stations, wherein the signal of the station for 50 percent of the radial is equal to 50 microvolts per meter. The boundary of the service area shall be taken as the outer edge of the sector nearest the transmitter wherein the signal is the desired value for 50 percent of the distance."

**TABLE III. COMPARISON OF PREDICTED AND MEASURED CONTOURS FOR WMFM**  
**DATA FOR 1000- $\mu$ v/m CONTOUR**                      **DATA FOR 50- $\mu$ v/m CONTOUR**

Radial	Bearing	Average Elev.	Eff. Ant. Height	Predicted Distance	Measured Distance	Radial	Bearing	Average Elev.	Eff. Ant. Height	Predicted Distance	Measured Distance
1	N 45°E	800 ft	479 ft	29.1 mi	31.0	1	N 45°E			In L. Mich.	
2	N 96 E	685	594	31.5	In Lake	2	N 96 E			In L. Mich.	
3	N 140 E	745	534	30.8	31.0	3	N 140 E			In L. Mich.	
4	N 180 E	913	366	26.5	28.2	4	N 180 E	837 ft	442 ft	66 mi.	64 mi
5	N 231 E	946	333	25.5	25.6	5	N 231 E	891	388	64.5	64.5
6	N 270 E	979	300	24.8	23.0	6	N 270 E	932	347	62.5	58.0
7	N 320 E	1030	249	23.0	24.5	7	N 320 E	982	297	60.5	59.0
8	N 354.5 E	995	284	24.1	31.5	8	N 354.5 E	1000	279	60.0	65.0



**FIG. 7—Graph constructed from data given in Table II. Similar graphs were made for each of the other seven radials**



**FIG. 8—Map showing the measured 50 and 1000-microvolt contours as heavy dashed lines. The solid line represents the predicted contours. The primary service extends to the far side of the city of Milwaukee and its southern suburbs**

tor number. The next column is the attenuator setting on the field meter. Column 3 shows the distance from the transmitter to the end of each sector. Column 4 is the median field reading in milliamperes 50 percent of the distance along each sector. The fifth column is the field intensity already computed directly in microvolts at 13.5 feet. This is the product of column 2 and column 4 multiplied by the fixed antenna constant of 10.0. Column 6 is the median field intensity at 30.0 feet. Since the field intensity is directly proportional to the antenna height (above  $\frac{1}{4}$  wavelength) for horizontal polarization, a factor of 2.2 was used to interpolate the field intensity values from 13.5 to 30 feet. Column 7 shows the maximum field reading in milliamperes in each sector for an antenna height of 13.5 feet. The last column is the maximum field intensity obtained about 10 percent of the distance at 30 feet, and represents the peak signal value in each sector.

For reference and comparison purposes the values of field intensity are referred back to an antenna height of 30 feet since this is the height specified by the Standards of Good Engineering Practice. In addition, this is the receiving antenna height at which all the calculations were made for the original construction permits of the station.<sup>3, 4, 5, 6</sup>

From column 6 of Table II, the values of field intensity in microvolts per meter at 30 feet were plotted graphically against distance in miles from the transmitter. One of the eight graphs is shown as Fig. 7. The solid line is the measured signal intensity 50 percent of the distance in each sector. The

dashed line represents an average struck to obtain the signal intensity at any intermediate distance. Indicated also are the two predicted contour points, shown by the letter notation C. It is evident that on this radial both contours fell inside the calculated distance.

A comparison of measured and predicted values of field intensity at WMFM for all eight radials is shown in Table III. Each contour distance was tabulated along with the predicted distances as stated in the construction permit issued by the FCC. Notice that the 50  $\mu$ v per meter contour to the northeast, east and southeast falls in Lake Michigan and could not be measured.

Figure 8 shows the map constructed from the data given in the previous chart. The solid lines on the map represent the predicted 50 and 1,000-microvolt contours, while the dashed lines show the actual measured contours.

The 5 and 2.5-millivolt contour lines are not drawn on the map, but Table IV shows the distances at which these lines fall.

The total area covered by the transmitter is about 12,000 square miles. Thirty percent of this area falls in Lake Michigan, as may be seen by referring to the map. The Milwaukee trade area extends many more miles to the north and west than it does to the south.

#### **Analysis of Discrepancies**

The predicted area, not including the lake, was 8,500 square miles, which is the area specified in the present license for WMFM. The actual measured area inside the 50-microvolt per meter contour was 8400 square miles or a decrease of about one percent. The

area inside the 1,000 microvolt per meter contour was predicted at 1,860 square miles and the measured area was found to exceed this by 90 square miles or an increase of about five percent. This discrepancy between calculated and actual values is attributed to the inability to obtain accurate values of elevation of the topography to the north on radial No. 8 when the prediction was made for the construction permit. It is along this radial where the predicted signal was exceeded. This section of the state of Wisconsin had never been surveyed, and therefore there were no quadrangle maps. The records available gave only such sparse data as the positions of railroad stations, airport elevations and the like. The data on the area was computed by the use of a planimeter on the original airway map.

Within the 1,000-microvolt contour, the population was estimated at 834,607 based on the 1930 census figures. The predicted and measured distances to the service contours on the various radials are essentially the same with the exception of radial 8. The contour distance at this point extends about 7 miles farther out but no city of any size is included in this additional area. This small variation from the predicted contour makes no appreciable change in the population served by the station.

Within the 50-microvolt contour, the population is estimated at 1,522,544. In general, the measured results show the 50-microvolt line to be 2 to 3 miles inside the predicted distance. Exception again is made in the case of the north radial

**TABLE IV. DISTANCES TO CONTOURS**

5 Millivolt		2.5 Millivolt	
Radial	Miles	Radial	Miles
1	17.0	1	27.0
2	14.0	2	22.8
3	17.5	3	20.0
4	15.0	4	17.6
5	12.5	5	16.0
6	12.0	6	17.0
7	13.0	7	22.0
8	16.6	8	

8, where the measured distance exceeded the predicted by 6 miles. This variation makes no appreciable change in the population figures within the 50-microvolt service area.

At the 50-microvolt point noticeable fading existed on several radials. This tended to influence the analysis of the field measurements and resulted in a lower than predicted value of field intensity in some areas. Milwaukee proper and its suburbs has a population of 766,885 and makes up the major market area of the station.

#### Fading

In conclusion, a few words on the stability of the signal intensity at the outer fringe of the service area and points closer may be of interest since experience has shown that appreciable fading can exist. After reaching the end of a particular radial a few minutes were spent checking the approximate placement of the 50-microvolt contour. This was done so that on the return trip along the same route a suitable spot could be picked as close to the contour as possible for a spot check on signal fading. A position was chosen for these checks which was

representative of the country traveled and which was also free of wires, rather than a position suitable for high or low signal intensity. In most cases several hours of recording was done at the close of the daylight hours and shortly after sunset, to observe diurnal effects if any existed.

One recording location was at Dotyville, on radial 8, just outside the 1,000-microvolt or primary contour line. It gave a signal of 225 microvolts maximum and 160 minimum at 13.5 feet. This is an overall variation of 65 microvolts with a median signal of 200 microvolts. The distance to this point from the transmitting antenna was 34 miles.

Another location at which fading was observed is at Sherwood, also on radial 8, but near the 50-microvolt or secondary service contour. The distance here was 65 miles to the transmitter. The signal reached a maximum of 25 microvolts and a minimum of 7 with a median signal of 22 minutes, as shown in Fig. 9. These checks were made with an effective antenna height of 13.5 feet, and to be correct should be multiplied by a factor of 2.2.

#### REFERENCES

- (1) Laeser, P. B., Planning an F-M Station, *ELECTRONICS*, p. 92, February 1945.
- (2) Federal Communications Commission, "Standards of Good Engineering Practice for High Frequency Broadcast Stations", Annex II.
- (3) Federal Communications Commission, "Field Intensity Survey of Ultra High Frequency Broadcasting Stations", Bulletin 40004.
- (4) Singer, Charles, Field Strength Survey Methods, *F-M Radio and Television*, Feb. and March 1942.
- (5) Guy, Raymond F., Frequency Modulation Field Tests, *RCA Review*, October 1940.
- (6) Norton, K. A., Ground Wave Field Intensity Over Finitely Conducting Spherical Earth, *I.R.E.*, 29, No. 12, p. 623, Dec. 1941.

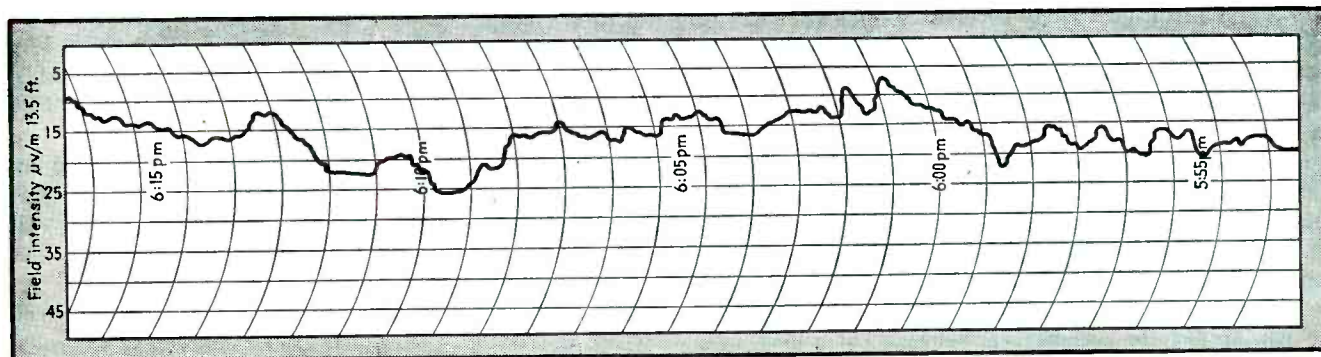


FIG. 9—Record of the fading at Sherwood, Wisconsin, on radial No. 8 at a point 65 miles from the transmitter and just barely inside the service area of WMFM

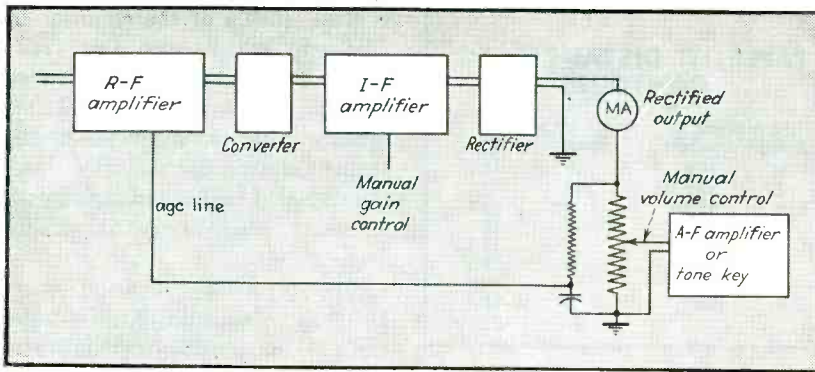


FIG. 1—Stages in a typical communications receiver having automatic gain control of the r-f amplifier

# AGC-Noise Considerations in Receiver Design

Automatic gain control is considered for communications receiver service from the standpoint of its effect on signal-to-noise ratio at various signal voltages. The desirability of employing high gain in controlled stages and the limitations of such use are pointed out

**A**UTOMATIC control of the output volume of radio receivers is so universally employed that there is apt to be a tendency to simply incorporate it in any design as a matter of course. It is the purpose of this present treatment to point out and discuss some of the factors that are not always obvious but that are important where the best possible performance must be obtained, as in commercial communications service; also, to deal with certain compromises that often must be made.

The simplified diagram given in Fig. 1 is a generalized schematic arranged to show the functional sub-divisions of a complete receiver. Control of the output volume is obtained in this generalized receiver by means of a manual volume control in the a-f amplifier (for phone service) or in the tone keyer (for telegraph service). The output volume thereby can be adjusted independently of the gain of the r-f and i-f amplifiers. For this reason, which is important in many types of equipment for commercial service, the commonly-used term *automatic volume control* (avc) is not

By JOHN B. MOORE

RCA Communications, Inc.  
New York, N. Y.

applicable. The preferable term, which will be employed in this discussion, is *automatic gain control* (agc).

Figure 2 gives a generalized schematic circuit of a three-stage r-f amplifier, with agc, such as might be used in the complete receiver of Fig. 1. A particular feature to be noted in this circuit is the use of taps on the tuned-circuit inductances. The purpose of these is to make it possible to obtain any desired value of overall gain, up to the maximum, without the necessity for changing the tube voltages or operating points from their optimum values. Other features of the circuit are conventional, except perhaps for individual r-f filtering of the supply voltages to each tube. This latter is essential in any high-gain r-f amplifier operating at the higher frequencies.

#### Diode Output vs Carrier Amplitude

The usual criterion of agc action is the shape of the characteristic of rectified output vs r-f carrier in-

put. Such a graph shows how nearly constant the output is maintained over the indicated range of r-f input voltage. For some purposes, this is sufficient. Such data do not, however, show what the signal-to-noise ratio in the output will be. For reasons which will be brought out in following paragraphs, this signal-to-noise performance may be quite different over a wide range of r-f input voltages than one would be led to expect from a statement of noise equivalent of the receiver.

In Fig. 3 are shown two typical graphs of output noise level, expressed in db below 100 percent modulation, plotted against r-f carrier input signal in microvolts. For the moment, let us consider only the general features of these two characteristic graphs.

Between the points indicated by A-A' and B-B', the graphs are linear. A check of various points will show that the noise equivalent, in microvolts at the input of the receiver, is essentially constant over these linear portions of the graphs. For example, a noise level of 20 db below 100-percent modulation at



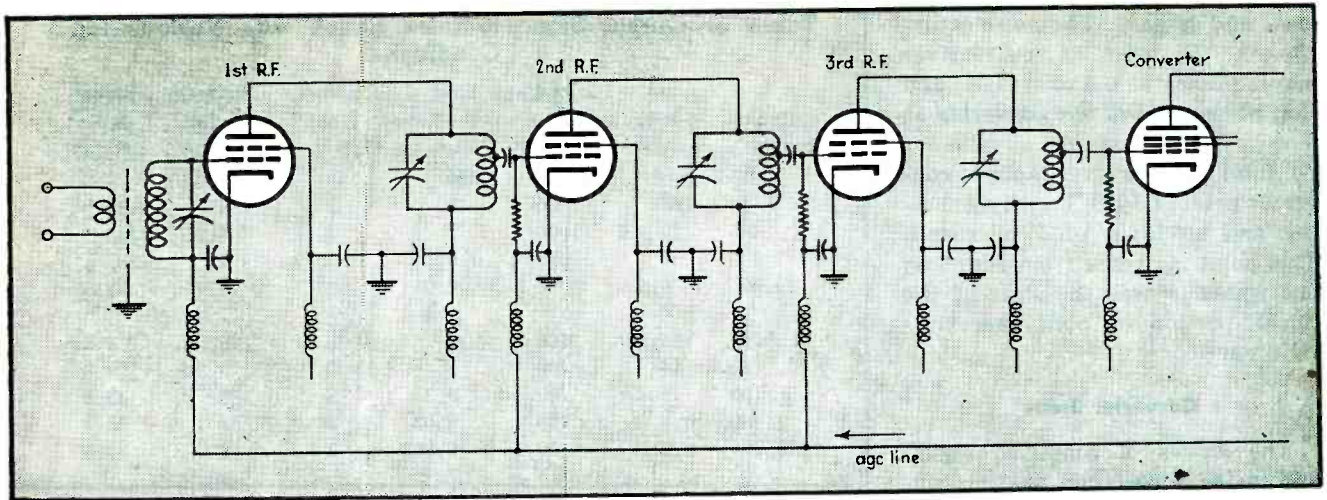


FIG. 2—Three-stage r-f amplifier and converter used for purposes of discussion by the author. Taps on the inductances permit adjustment for any desired value of gain without changing other operating conditions

a carrier input value of 2.6 microvolts (average) gives a noise equivalent of 0.26 microvolts at the receiver input. This method of expressing noise levels is convenient and useful because it provides a figure which can be compared directly with values of r-f signal input in microvolts.

#### Effect of Increased Signal

The ideal condition is that one in which the noise equivalent, at the receiver input, is constant regardless of signal strength. Then, and then only, is the full benefit of increased signal strength realized. In the curves of Fig. 3, it will be observed that the characteristic does not continue linear at the higher values of input signal. Instead, each characteristic levels off. Increasing the signal input ten times, from 100 microvolts to 1,000 microvolts, does not produce a corresponding improvement in signal-to-noise output of the receiver. A further increase from 1,000 microvolts to 10,000 microvolts produces an even smaller improvement. As a practical matter, there is no object in having such characteristics continue linear down to extremely low levels in the design of radio receivers for general use. The level at which the characteristic will be permitted to flatten off is, therefore, determined by practical considerations of the performance required.

In order to compare different performance curves directly, some common base or starting point must

be used when making the measurements. For the curves of Fig. 3, the starting point was a diode output of 0.1 ma for zero r-f input signal. The particular equipment used in the tests maintains a diode output of approximately 0.6 ma at normal operating values of signal strength. In other equipment, a similar ratio between normal output and starting-point output of the diode could be used. Adjustment to the desired value of rectified output for zero r-f signal input is obtained by means of the manual gain control associated with the i-f system as shown in Fig. 1.

The flattening-off level, for such

curves as those of Fig. 3, is determined by the amount of r-f gain employed between a given input stage and a given converter (Fig. 1). Three stages are shown to give the required r-f selectivity and also the desired age action as judged by constancy of output over a wide range of r-f signal input. The overall gain is fixed at a desirable value by proper choice of the positions of the taps on the coils of the tuned circuits. This permits obtaining the desired reduction of maximum gain without changing tube voltages and operating points and thereby sacrificing age performance.

To explain the foregoing, let us

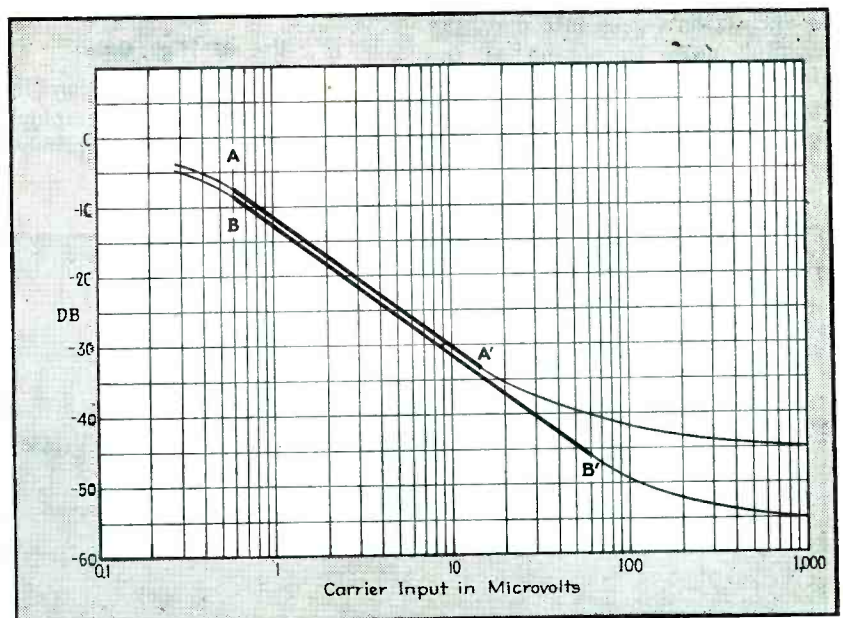


FIG. 3—Output noise level in db below 100-percent modulation, plotted against r-f carrier input signal in microvolts

assume some values of noise equivalent and of gain. The noise equivalent at the input of the receiver may be taken as 0.3 microvolt; and that at the grid of the converter as 3 microvolts. Assume a value of r-f gain, from receiver input to converter grid, of 1000/1 with agc acting and an input of 1 microvolt. This point is chosen from Fig. 3 as one which is near the start of the linear portion of both characteristic curves.

#### Converter Noise

The values of amplified signal and noise appearing at the converter grid for different values of r-f input are given in the accompanying table. These are based on the somewhat idealized assumption that the agc action holds an absolutely constant output and therefore a constant signal level at the grid of the r-f converter. The assumption also is made, for the purpose of this simplified illustration, that the second and third stages contribute no appreciable portion of the noise. For purposes of illustration, these assumptions are justifiable; the errors involved being too small to appreciably affect the validity of the illustration.

The tabulated figures show that at low levels of input signal the final signal-to-noise ratio in the output of the receiver is determined by the signal-to-noise ratio existing at the input of the receiver. As the signal input is increased, and the agc action comes into play, the amplified noise appearing at the converter grid becomes less in magnitude compared to the noise equivalent of the converter itself. The

**Table of Output Signal-to-Noise Ratios with Various Input Conditions**

Input Signal, $\mu\text{V}$	R-F Gain	At Conv. Grid.		Converter Noise Equiv., $\mu\text{V}$	Converter Total Noise, $\mu\text{V}$	Signal Noise Ratio
		Signal, $\mu\text{V}$	Noise, $\mu\text{V}$			
1	1000	1000	300	3	300	3.3
10	100	1000	30	3	30	33.3
100	10	1000	3	3	4.2	238
1,000	1	1000	0.3	3	3	333
10,000	0.1	1000	0.03	3	3	333
1	100	100	30	3	30	3.3
10	10	100	3	3	4.2	23.8
100	1	100	0.3	3	3	33.3
1,000	0.1	100	0.03	3	3	33.3
10,000	0.01	100	0.003	5	3	33.3

result is that, at the higher levels of signal, the signal-to-noise ratio of the output of the receiver is determined not by that existing at the input but rather by the noise equivalent of the converter. The agc-characteristic of signal-to-noise vs r-f input therefore flattens off as shown in Fig. 3.

In the lower portion of the table, the r-f gain is assumed to be 100 instead of 1000. This lower value of r-f gain results in poorer signal-to-noise ratios at the higher values of signal input. The curve for this case therefore would flatten off at a considerably higher level of noise. This is illustrated by the two curves of Fig. 3, which are plotted from actual data rather than from the assumed data tabulated in the table for purposes of simplified explanation.

#### Use of High Gain

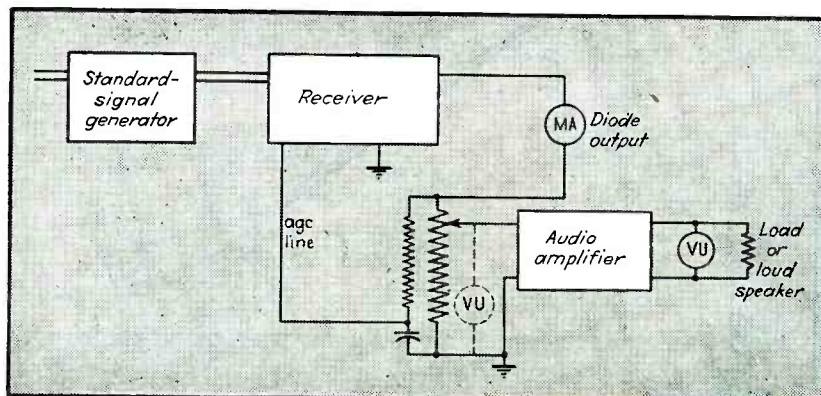
The foregoing discussion indicates the desirability of employing high gain in the r-f amplifier to

which agc is applied. There are certain limitations, though, to the amount of gain that can be safely used. One is stability, or freedom from self-oscillation, at all frequencies. A second is protection of the r-f converter tube from being overloaded by stronger signals on channels adjacent to the desired signal.

If the r-f gain and the agc hold the desired signal at 10,000 microvolts at the grid of the converter, and a signal 100 times as strong as the desired one is received on an adjacent channel, the interfering signal will have a voltage of about one volt at the grid of the converter. This is apt to produce serious overloading and interference.

In actual use of a receiver such as depicted in Fig. 1 and having agc-noise characteristics as shown in Fig. 3, it is customary to manually readjust the i-f gain in order to obtain optimum performance on very weak and also on very strong signals. In this way the agc-noise characteristic may be shifted from its positions shown on Fig. 3 to best handle existing conditions and ranges of signal strength, noise, and interference. Obviously, the design of the agc system should be such as to cover the greatest possible range of input signal without the need for manual re-adjustment of the i-f gain.

The final design generally must be a compromise between the various factors discussed; the exact compromise being determined by the performance required and the conditions under which the equipment will be used.



Arrangement of equipment used to determine the output current of a diode at various carrier signal levels

# FUNGUS AND MOISTURE PROTECTION

Treatment of equipment to permit operation under climatic extremes involves—among other factors—consideration of surface conditions, qualities of finish, and fungistatic values established. These are discussed here in the light of current information

By R. PROSKAUER  
and H. E. SMITH

*The Inst-X Company  
Brooklyn, N. Y.*

As applied to the protection of electronic equipment against unfavorable ambient conditions, the term tropicalization refers to (1) keeping out moisture to prevent electrical leakage, (2) inhibiting fungus attack and consequent loss of insulation resistance, and (3) forestalling corrosion which results from both moisture and fungus.

Tropicalization is more than a wartime requirement. It is forced upon us in any location where continuous high humidity combined with rapid changes of temperature cause excessive condensation. Fungus has a considerable hand in increasing and maintaining moisture deposits, and hence aggravating corrosive action. That it also causes chemical changes in insulation and other organic materials is generally admitted, but it is impossible to draw sharply any line of demarcation between the effect of moisture alone and the acceleration due to fungus.

Extensive tests made in the laboratory and correlated with out-



In surroundings like this far cry from the placid corner of a living room, moisture and fungus treatment of a radio may make the difference between hours and months of maintenance-free operation

door exposure in Florida swamps show that moisture proofing is of the utmost importance, but that biological factors must not be neglected. A few laboratories have made accelerated tests without this correlated exposure and the results do not bear out actual conditions.

#### Severity of Service

In the field of electrical and electronic equipment, extensive service in foreign countries and in temporary quarters has brought about environmental conditions quite different from peacetime ones. Particularly in the case of electronic equipment which in pre-war years was normally well sheltered, the

whole technology of manufacturing components and assemblies grew up with no severe service conditions or exposure background. The early days of the war found American industry hastily multiplying its production many times and, in the main, following previous commercial and civilian practices.

It should be emphasized that actual field conditions in many cases are as severe as our previous ideas of accelerated tests. For example, it used to be considered a severe test to expose components to 10 days of high humidity and high temperature, that is, 90 to 95 percent relative humidity at 100 deg F. While the temperature may be a

TABLE I. VULNERABILITY OF COMMON MATERIALS TO FUNGUS ATTACK

Most vulnerable: Cellulose, cement, cordage, cotton, felt, glue, leather, paints, phenolics, paper, varnish, varnished cambric, and waxes (most)

Less vulnerable: Melamine, rubber (natural and synthetic), and waxes (micro-crystalline)

Least vulnerable: Glass (clean), glass fiber, inorganics, polystyrene, and polyvinylidene chloride

few degrees high for field conditions, it is certainly no accelerated test as far as humidity goes. A minimum of 30 days exposure to such conditions may be normal for any extensive campaign.

Frequent rainfall in many parts of the world, rapid temperature cycles with extremes—both high and low—all occur in the life of equipment. Every factor in equipment design, outside the electrical functioning, has been inadequate to some degree for the rigorous service occurring in military operations.

It is more or less customary for engineers to treat corrosion deterioration and service degradation as though they all took place in a sterile environment—one totally free of organic life forms and to a considerable extent as though it were free of organic debris.

Actually, the most casual inspection of any surface would indicate three common phenomena: (1) lodgment of air-moved organic dust; (2) presence of micro-organisms in large quantities—either in the form of spores or in the form of colonial and active growths; and (3) presence of insects and other living forms with their inevitable residue of mucus or non-living organic matter. Also present are inorganic dirt, dust, and debris; condensed and absorbed moisture; and specific chemical salts.

In great measure, degradation depends on conditions of moisture, temperature and light but micro-organisms on any given surface may produce any of several effects. By their mere presence, they may produce paths of low electrical resistance and no further damage. However, during the course of their life cycle, they may produce electrolytes which augment corrosion of the base or deteriorate certain porous insulation surfaces.

As a third alternative, they may particularly and specifically deteriorate organic material, leading to such outstanding examples as the destruction of cellulosic materials by *chaetomium globosum* and other species. In addition, there occurs a chain of attendant effects hard to distinguish and isolate. These include: (1) retention of moisture on

surfaces that would normally dry out more quickly; (2) increased wetting of relatively non-wettable surfaces; or (3) establishment of osmotic-equilibrium conditions favoring solution of metals.

#### Materials of Construction

PHENOLICS, both molded and laminated, absorb water at a rapid rate. This causes leakage paths and at times, swelling to such an extent that molded pieces may crack and laminates become separated. Several methods of phenolic pro-



Normal spray equipment is used in fungus-proofing procedures. Regulations requiring booths and ventilating systems are generally regarded as adequate for toxicant-bearing finishes as well as conventional types

tection have been devised whereby the rate of moisture absorption can be reduced to a minimum.

For instance, air-dry lacquers generally have poor adhesion to phenolic parts. An air-dry varnish is more successful for this application, but by the very nature of a phenolic surface, a baked-on finish is the only type that really provides a reasonably permanent coating. As an alternative treatment, impregnation with a fungistatic wax compound has proved more water-resistant than a baked-on finish. Fungicidal concentrates that may be added to standard waxes are obtainable in various forms. However, where resistance to surface-

arcing is necessary, the baked finish should be used.

Wax-filled or wax-coated components are frequent sources of breakdown from fungus attack. This difficulty may be alleviated by using a fungicidal wax at the time of manufacture or else giving the part a flash dip in a similar compound before incorporation in the equipment. Inasmuch as there is extremely poor adhesion to a waxed surface by either lacquer or varnish, using the fungicidal wax is the safer and more lasting method.

FIBER PIECES react to moisture in a manner similar to phenolics, with the additional problem of extreme fungus attack. They may be well protected by either a baked coating or by wax impregnation—both containing fungicides.

TEXTILE-COVERED CORDS and cables require treatment for a dual purpose—they must be made water-repellant and fungistatic. If this were not done, the electrical resistance would drop below the point of operating efficiency in an amazingly short time. The Signal Corps has approved materials for this purpose which provide excellent service.

LEATHER is another material requiring treatment for both water repellance and fungus-proofing. The Signal Corps has developed a solution which can be purchased, ready for use, from manufacturers and which is easy to apply.

FELT, which unfortunately cannot be water-proofed without changing its characteristics, can nevertheless be fungus-proofed. Felt manufacturers provide their product already finished, but where there are stocks on hand, fungicidal preparations can be applied.

CERAMIC PIECES should be glazed, or where this is impossible, must be wax-impregnated with a fungicidal wax.

LACING CORDS for use in wire-harnesses should be impregnated with a fungicidal wax.

DYNAMOTORS AND GENERATORS have occasioned considerable difficulty primarily through corrosion, and only moderately through fungus attack. It is therefore recommended that armature and field

coils be varnish impregnated and dip coated as usual, but instead of applying an air-dry sealer over the primary insulation, there be substituted a baking compound that retains its fungistatic properties after the baking process. There are such products approved by the Signal Corps and now in use to a considerable extent. All other circuit elements in the dynamotors should be sprayed according to specification No. 71-2202A.

HOOK-UP WIRES offer a considerable problem due to the fact that ordinary lacquers and varnishes attack the lacquer finish with which the wires are coated by the manufacturer. One lacquer approved by the Signal Corps does not attack this coating, and dries in a few minutes. The wires should be dipped in this product before incorporation in the set.

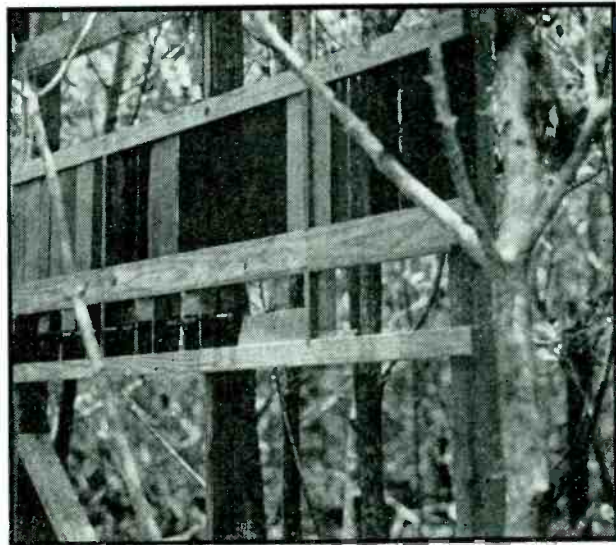
#### Treatment

Probably only a small percentage of our equipment failure can be blamed solely on biological factors. Nevertheless, not to do anything about this percentage of failure would be as negligent as to overlook any other factor.

Knowledge gained from research and practical field work accomplished in the past two years should serve industry well in the period of reconstruction which must take place in occupied countries when Japanese domination ends. Equipment manufacturers who have an eye on Eastern export trade after the war will, by study of tropicalization requirements, find a means of providing goods that will be able to cope with prevailing conditions.

In certain sections of our own country and in South America similar conditions prevail, and certain practical adaptations of tropicalization prove advantageous on all equipment.

The methods presently adopted by our Armed Forces have increased the life of electronic equipment from a few days to many months, providing, of course, that the component parts selected by the manufacturer for inclusion in the apparatus are of good quality.



Actual exposure of test panels in tropical climate is used by the Insl-X Co. to correlate laboratory work with field results. Full-scale equipment runs are made under the same conditions

Under the existing program, the prime contractor may order his material from the sub-contractor with the proper treatment already applied. Furthermore, in several sections of the country, organizations have been set up to handle all tropicalization requirements up to final assembly.

Tropicalization of electronic equipment must, of necessity, be divided into two sections: (1) The protection of component parts and (2) Overall sprays. The general intent of Signal Corps Specification No. 71-2202A is to provide a treatment for assembled equipment only. Component parts should be treated separately according to a number of supplementary recommendations issued by Fort Monmouth Signal Laboratory. Films entirely suitable as protection for completed equipment are by their very nature not satisfactory on a number of components.

One of the problems connected with the application of Specification No. 71-2202A is ascertaining the simplest method by which complete coverage can be achieved. It has been found by many manufacturers that the surest method is to spray each sub-assembly separately; this enables the sprayer to coat rear sections which are inaccessible in the complete assembly. When the

entire set is assembled, practically all that then need be done is touch up the connections.

At present there is no method of verifying the completeness of treatment given an assembly. However, a program to be adopted will include the addition of fluorescent dyes to the coating materials so inspection can be performed under infrared light.

Tests prove that lacquers and varnishes developed for overall sprays must be designed so that the ultimate in moisture resistance is provided. Moisture resistance of any organic insulation film is generally evaluated in the laboratory on the following properties:

- I. Electrical
  - Dielectric Strength (Wet).
  - Insulation Resistance (Wet).
- II. Physical
  - Resistance to high temperatures.
  - Resistance to low temperatures.
  - Resistance to high- and low-temperature shock.
  - Adhesion to various surfaces—metal and non-metal.
- III. Moisture Vapor Permeability
  - Resistance to migration of water vapor under the conditions of high tem-

perature and humidity.

#### IV. Corrosion Resistance

Resistance of the organic system coated over a metal panel to immersion either in salt or fresh water or to salt-water spray tests.

If the organic system in question, with or without a fungicide, will give good values when tested for the various properties mentioned above, such a system may be considered moisture resistant and definitely good insulation.

#### Lacquer or Varnish

Lacquer and varnish systems each have their specific points of advantage, and selection of the most suitable coating can be made from the following comparison of factors:

**DRYING.** A lacquer, generally speaking, dries by simple evaporation of solvent, and the rate of through-film drying is determined by the volatility of the solvents. Solvents can be alcohols, esters, ketones, ethers, or hydrocarbons. Drying time tack-free as short as a minute is possible, although not generally advisable.

A varnish generally dries in two phases. First, an evaporation of solvent, followed by further polymerization and frequently oxidation. Only very short varnishes with high resin content dry tack-free in 15 minutes to an hour, and through-drying generally takes 4 hours and longer. This slow through-drying means difficulty in applying a second coat. Also, the short varnishes that dry rapidly require a high percentage or all of the solvent to be aromatic hydrocarbons which possess strong solvent power.

Lacquer solvents are also high in solvent power but due to their faster release from a lacquer film generally can be adjusted to cause less effect on undercoats of organic materials. Most lacquers are available with alternate solvent formulas to keep solvent effect at a minimum.

**FLEXIBILITY.** Varnishes in general are relatively hard—the shorter the harder, and they generally increase in hardness with age. Lacquers can be made with

any degree of flexibility and distensibility and while they may lose flexibility with age, they lose it at a much slower rate than varnishes.

**ADHESION.** Varnishes—particularly short varnishes—exhibit good adhesion but lacquers can be formulated to produce adhesion to a much greater variety of surfaces.

**LOW-TEMPERATURE CHARACTERISTICS.** Varnishes—particularly short oil varnishes—become brittle at low temperatures and may lose adhesion on a great variety of surfaces. Lacquers, on the other hand, can be formulated to have initially better flexibility and to retain a much better low-temperature adhesion.

**HIGH-TEMPERATURE CHARACTERISTICS.** Varnishes withstand high temperatures better than lacquers since they are thermosetting and may improve with heating, to a point—after which they heat-age rapidly. Continued heating above a certain temperature is destructive.

Lacquers are generally thermoplastic and soften with heat but reharden on cooling without damage. Continued heating may harden or toughen the film but below the decomposition point continued heating does no permanent damage.

**VAPOR PERMEABILITY.** Generally, the short oil varnishes have lower rates of vapor permeability than lacquers.

#### Types of Fungicides

The question then arises as to the type of fungicide to be used—with special consideration to the volume required. It would seem evident that the fungistatic agent that gives the greatest protection with the least quantity, providing all other factors are given consideration, should be the one which will least disturb the structure of the coating.

Three materials have been generally accepted as providing good fungistatic properties. These are:

- (1) Phenyl mercuric salts
- (2) Pentachlorophenol
- (3) Salicylanilide

Acceptable minimums for use in lacquers and varnishes are as follows: Phenyl mercuric salts—1 percent, Pentachlorophenol—15 percent,

Salicylanilide—10 percent.

Besides quantity, another important consideration is longevity of the toxicant. Naturally, the use of a product that displays excellent general inhibitive value for the first month or two is of little value when, as a rule, electronic equipment is in storage for several months before it even reaches the field, frequently under hot and humid conditions.

The question of toxicity to personnel has been brought up many times. It is generally agreed that the customary risk of dermatitis from the use of lacquers and varnishes is not increased by addition of any of the three presently used toxicants. The laws of most states require that spray booths and ventilating systems be employed when using lacquers and varnishes, and if proper methods are followed no ill effects should result.

Perhaps the most controversial matter in the whole subject of tropicalization is the effect on selenium rectifiers of lacquers and varnishes containing phenyl mercuric salicylate. There is no doubt that mercury vapors affect uncoated selenium disks, but tests run by one of the best qualified independent laboratories in the country show that in 1500 hours of operation a number of uncoated selenium rectifiers dipped directly in a lacquer containing phenyl mercuric salicylate showed no degradation. On the other hand, Signal Corps tests showed that in sealed containers breakdown occurred. The correct answer may involve agreement on proper test methods, purity of the phenyl mercuric salt, reaction of the lacquer or varnish with the toxicant, and development of a satisfactory moisture-proof coating for rectifiers.

#### Spore Tests

It is known that the fungus tests now used for acceptance under Specification No. 71-2202A may not be entirely representative of actual conditions and it has been suggested that more than one organism should be used in any evaluated fungus tests. Of the three common fungicides only phenyl mer-

curic salicylate will pass both a mixed-spore and a single-spore test. Until such time as a means is created to show that this test can be correlated to field exposure, these present requirements should, for safety's sake, be followed.

On area of inhibition, one other consideration is life of the fungicide when subjected to operating temperatures of equipment and natural dissipation through volatilization. Table II shows fungistatic value of the three selected fungicides after exposure to various temperatures, and using both a single spore and a spore mixture.

#### Micro-Organisms

Under the general classification of those organisms so small that a microscope is required for their study are:

- (1) *Protozoa*, uni-cellular animals, many of them living in water and obtaining their food from organic material. A large number utilize other micro-organisms.
- (2) *Molds*, a sub-division of the fungi group.
- (3) *Yeasts*.
- (4) *Bacteria*, these are normally considered the smallest and lowest of all forms of life. Undoubtedly some are below visibility even with the highest magnification of an optical microscope.
- (5) *Algae*, micro - organisms which possess chlorophyll—these are aquatic.

Some authorities divide the fungi into three main divisions, starting with the bacteria as generally covering the smallest in size, the *actinomyetes* intermediate, and largest, the various fungi species forming colonies visible to the eye.

A true conception of the number and rapidity of growth of these organisms is not common in the engineering world. It is difficult to look at a few drops of transparent water and realize the infinite number of living organisms present. It is even more difficult to realize the complex, intricate, and never-ending cycle of life taking place in such a small quantity of material.

For example, normal surface sea water contains as many as a million micro-organisms per cc. Every time a wave breaks, there are thrown into the air untold numbers of marine bacteria, some of which are carried hundreds of miles, still viable and capable of growth and multiplication as soon as suitable conditions arise.

We are only now getting some inkling of the ability of micro-organisms to utilize organic materials for energy. During the past two years, Dr. Zobell at Scripps Institute has found that many of the marine bacteria are capable of oxidizing pure hydro-carbons. Specifically, certain species have been isolated as able to utilize gasoline, paraffin, benzene, toluene, paradichlorobenzene and others. The same investigator likewise found that rubber and synthetic rubber could be destroyed by the presence of certain bacteria.

It is likely that as investigations in this field progress, we will find that many organic materials are particularly susceptible to deterioration by individual species. It will then be more expedient to protect the material against these specific agents than against the broad classification.

#### BIBLIOGRAPHY

McAuley, P. H., "Heating of Equipment for the Prevention of Condensation," Engineering Data Letter No. 1314, Engineering Labs and Standards Dept., Westinghouse Electric & Mfg. Co., East Pittsburgh, Pa.

"Symposium on Mildew Resistance," American Society for Testing Materials, 260 South Broad St., Philadelphia, Pa.

Lawson, Francis R., "Causes and Control of Deterioration of Material in the Wet Tropics," ADTIC Project No. T-25, Arctic, Desert, and Tropic Information Center, Orlando, Fla.

Coursey, Phillip R., "Extreme Climatic Conditions," *Wireless Engineer*, London, England, Sept. 1944.

"This is Serious", Reproduction Section, Fort Monmouth Signal Laboratory, Red Bank, N. J.

Gardner, D. H.; and Watt, J. S., "Difficulties Encountered with Electronic Equipment in Humid Climates" Second Edition, 1944, Humble Oil & Refining Co., Houston, Tex.

"The Effects of Moisture on the Electrical Operation of Communication Equipment Used in the Tropics and Possible Control", Bell Telephone Laboratories, New York, N. Y.

"Mould in Radio & Signals Equipment—Tropical Reports No. 1", Amalgamated Wireless (A'sia) Ltd., N. S. W.; Australian Military Mission, 4516 Munitions Bldg., Constitution Ave., Washington, D. C.

"Standard Packaging for Signal Corps Equipment", Signal Corps Specification No. 72-0-7, Plans & Operations Division: Specification & Distribution Section; Philadelphia Signal Corps Procurement District; 128 North Broad St., Philadelphia, 2, Pa.

"Report on the Condition of Service Material under Tropical Conditions in New Guinea", Australian Scientific Research Liaison Office, Washington, D. C.

**TABLE II. FUNGISTATIC VALUES IN A VARNISH SYSTEM**

TEMPERATURE: 85 DEG C TIME: 2 HR  
(Specification No. 71-2202A)

Toxicant	Percent Toxicant *	Single Spore Test**	Spore Mixture Test***
Phenyl Mercuric Salicylate	1	OK	OK
Pentachlorophenol	10	NG	NG
Pentachlorophenol	15	OK	NG
Salicylanilide	10	OK	NG
Salicylanilide	15	OK	NG

TEMPERATURE: 85 DEG C TIME: 24 HR

Toxicant	Percent Toxicant *	Single Spore Test**	Spore Mixture Test***
Phenyl Mercuric Salicylate	1	OK	OK
Pentachlorophenol	10	NG	NG
Pentachlorophenol	15	NG	NG
Salicylanilide	10	OK	NG
Salicylanilide	15	OK	NG

TEMPERATURE: 130 DEG C TIME: 2 HR

Toxicant	Percent Toxicant *	Single Spore Test**	Spore Mixture Test***
Phenyl Mercuric Salicylate	1	OK	NG
Pentachlorophenol	10	NG	NG
Pentachlorophenol	15	NG	NG
Salicylanilide	10	NG	NG
Salicylanilide	15	NG	NG

TEMPERATURE: 130 DEG C TIME: 5 HR

Toxicant	Percent Toxicant *	Single Spore Test**	Spore Mixture Test***
Phenyl Mercuric Salicylate	1	OK	NG
Pentachlorophenol	10	NG	NG
Pentachlorophenol	15	NG	NG
Salicylanilide	10	NG	NG
Salicylanilide	15	NG	NG

#### IN A LACQUER SYSTEM

TEMPERATURE: 85 DEG C TIME: 2 HR  
(Specification No. 71-2202A)

Toxicant	Percent Toxicant *	Single Spore Test**	Spore Mixture Test***
Phenyl Mercuric Salicylate	1	OK	OK
Pentachlorophenol	10	OK	NG
Pentachlorophenol	15	OK	NG
Salicylanilide	10	OK	NG
Salicylanilide	15	OK	NG

TEMPERATURE: 85 DEG C TIME: 20 HR

Toxicant	Percent Toxicant *	Single Spore Test**	Spore Mixture Test***
Phenyl Mercuric Salicylate	1	OK	OK
Pentachlorophenol	10	NG	NG
Pentachlorophenol	15	NG	NG
Salicylanilide	10	OK	NG
Salicylanilide	15	OK	NG

TEMPERATURE: 50 DEG C TIME: 96 HR

Toxicant	Percent Toxicant *	Single Spore Test**	Spore Mixture Test***
Phenyl Mercuric Salicylate	1	OK	OK
Pentachlorophenol	10	NG	NG
Pentachlorophenol	15	NG	NG
Salicylanilide	10	OK	NG
Salicylanilide	15	OK	NG

TEMPERATURE: 100 DEG C TIME: 8 HR

Toxicant	Percent Toxicant *	Single Spore Test**	Spore Mixture Test***
Phenyl Mercuric Salicylate	1	OK	OK
Pentachlorophenol	10	NG	NG
Pentachlorophenol	15	NG	NG
Salicylanilide	10	NG	NG
Salicylanilide	15	NG	NG

\*Based on total weight.

\*\**Aspergillus Niger*.

\*\*\**Aspergillus Niger, Penicillium Luteum, Actinomyces Conyolutes, and Rhizopus Nigricans*.

# Coaxial Cable

Exact and approximate formulas for determining basic parameters of coaxial cable facilitate determining effects of conductors, dielectrics and dimensions on electrical characteristics. Graphs indicate variations that can be expected from changes in materials and construction

By **N. D. KENNEY**

Assistant Cable Engineer  
Simplex Wire and Cable Co.  
Cambridge, Massachusetts

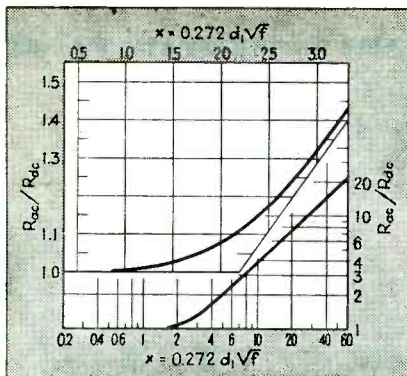


FIG. 1—Skin effect resistance factor for solid round copper wire

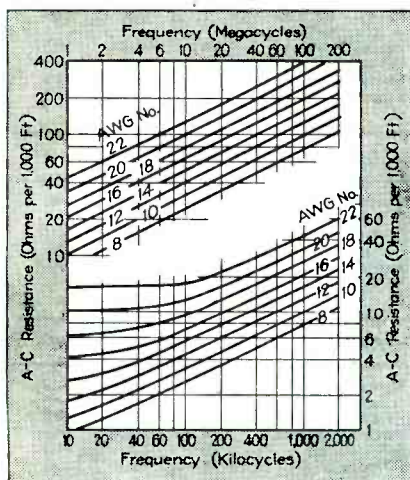


FIG. 2—Alternating-current resistance of solid round copper wire

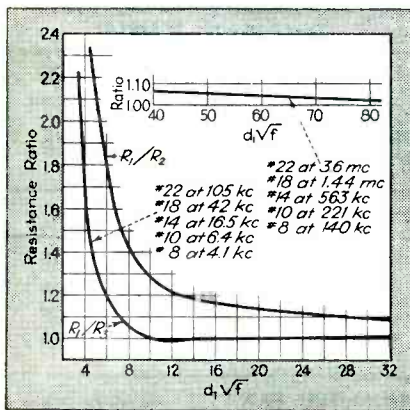


FIG. 3—Relative errors of Eq. (3) and (4) compared to values obtained from Fig. 1

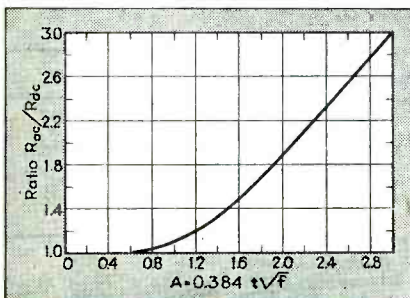


FIG. 4—Relative inside a-c resistance of the concentric conductor

DESIGN AND USE of coaxial cable at radio frequencies requires a knowledge of the cable parameters and the manner in which they vary with cable construction and operating frequency. Exact equations are cumbersome, but within limits they can be simplified for use in design or in obtaining approximate indications of the major influences on cable parameters.

Basic parameters which determine characteristic impedance, attenuation and phase-shift constant of coaxial cable are series resistance and inductance, and shunt capacitance and conductance. These parameters are functions of the electrical characteristics of the material used for conductors and dielectric, the geometric design of component parts and the frequency at which the cable is to operate.

### Series Resistance

Total series resistance ( $R_0$ ) of a coaxial cable consists of two components: resistance of the center conductor and of the concentric conductor.

Formulas for determining resistance of a solid round-center conductor at any frequency have been published in text books and technical papers. However, these formulas, which involve Bessel functions, are complicated and do not lend themselves to rapid calculations. Fortunately for the design engineer there have been published in the Bureau of Standards' Circular No. 74 tables of the ratio of resistance at any specified fre-

quency to the d-c resistance for round solid conductors as a function of diameter and frequency. Resistance ratios are presented in graphic form in Fig. 1 for round solid copper wire having a resistivity ( $\rho$ ) of 1724 abohm-centimeters as a function of  $x$ , the skin-effect resistance factor

$$x = 0.272 d_1 \sqrt{f} \quad (1)$$

which is derived from

$$x = \pi d_1 \sqrt{2\mu f / \rho} \quad (2)$$

where  $\mu$  = magnetic permeability of the conductor.

Resistance ( $R_1$ ) of various sizes of conductors in the frequency range of 10 kilocycles to 400 megacycles, as determined from the ratio curve, is plotted in Fig. 2.

Note that the resistance ratio curve (Fig. 1) is practically a straight line for values of  $x$  greater than 5. This permits the determination of the following approximate equations for the straight-line portions of the curve

$$x > 4$$

$$R_2 \sim 0.284 R_{dc} + 0.993 \sqrt{f} 10^{-3} / d_1 \text{ ohms/1000 ft} \quad (3)$$

$$x > 10$$

$$R_3 \sim 10^{-3} \sqrt{f} / d_1 \text{ ohms/1000 ft} \quad (4)$$

$$\text{where } R_{dc} = 0.01037 / d_1^2 \text{ ohms/1000 ft} \quad (5)$$

It is very important to the design engineer to be able to utilize at all times the simplest formula possible. Variations in magnitude of the resistances as calculated by the above methods for various sizes of conductors at different frequencies are plotted in Fig. 3 as ratios of  $R_1/R_2$  and  $R_1/R_3$ . Figure 3 also shows frequencies at which resistance limitation ratios are not greater



# Design

than 1.05 for several sizes of conductor. Which of the three methods to use for calculating resistance of a solid round inner conductor depends upon the accuracy required.

## Resistance of Stranded Conductors

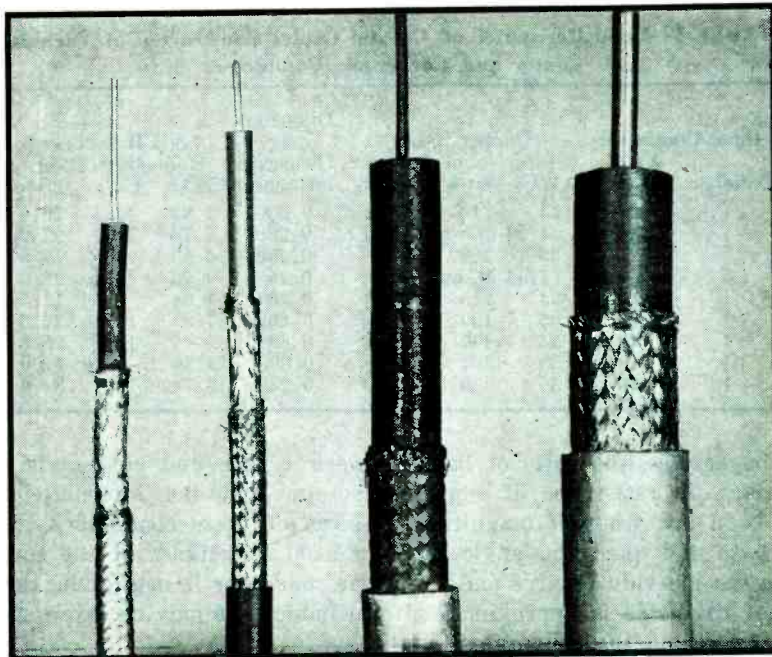
In a large number of coaxial cables the inner conductor consists of several strands. Resistance calculated by any of the mentioned methods will give values lower than those actually measured. Unfortunately at present there is not enough data to evaluate the increase in resistance for a stranded conductor as compared to a solid conductor of the same area and diameter.

Bureau of Standards' Circular No. 74 suggests as a rough guide that the resistance ratio of strands of bare wires placed parallel and making contact with one another is the same as for a round solid wire which has the same area of cross-section as the sum of the cross-sectional areas of the strands. However, when a precise knowledge of the resistance ratio is required it should be measured. The following tentative rules are suggested as a guide to the behavior of a stranded conductor. (1) An increase in the number of strands for a given total area of copper increases high-frequency resistance. (2) For a given total area of copper and number of strands, a conductor cabled with strands having a long lay will have a slightly lower high-frequency resistance than for an equivalent conductor having a short lay.

## Concentric Conductor

The concentric conductor of a coaxial cable has two functions: to act as a shield and to act as a conductor. The resistance of a concentric conductor when it consists of a thin-wall tube may be determined from formulas which have been published by Whinnery.

Figure 4 is a plot of the ratio of resistance of a concentric copper cylinder at any frequency to dc



Typical coaxial-cable construction employing solid dielectrics

resistance as a function of

$$A = t/y = 0.384 t \sqrt{f} \quad (6)$$

where

$t$  = wall thickness of outer conductor in inches

$y$  = depth of field penetration in inches when the inside diameter  $d_2$  of the cylinder is at least ten times the wall thickness ( $t$ ).

When the parameter ( $A$ ) is greater than 3, the resistance of this type of concentric conductor may be expressed as

$$R \sim 10^{-3} \sqrt{f}/d_2 \text{ ohms/1000 ft} \quad (7)$$

Most coaxial cables utilize a copper braid for the concentric conductor. At present, as far as the

author knows, no formulas permit calculation of high-frequency resistance for this type of concentric conductor. However, tests have indicated that the following tentative rules apply: (1) Resistance of braided concentric conductor decreases with an increase in length of lay of individual strands of the braid. (2) For braid having a given lay, an increase in the number of strands decreases resistance. (3) For braid of a given percent coverage an increase in size of the individual strands causes a decrease in resistance. (4) Resistance of a given braid will increase when individual wires are corroded. (5) Resistance of a given braid will vary with variations in contact pressure between strands.

In the frequency range of 100 to

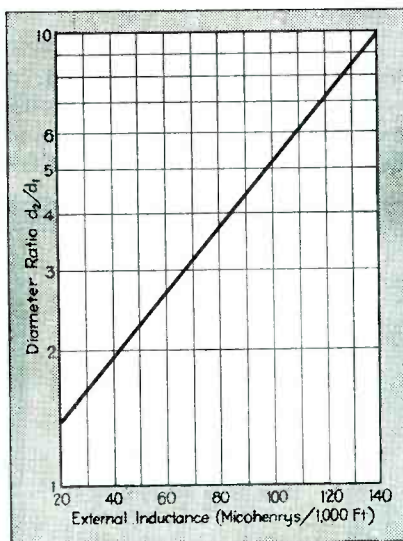
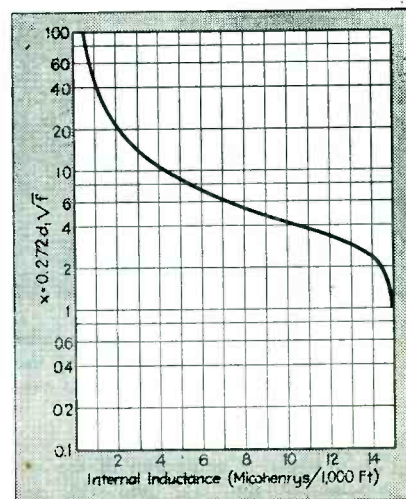


FIG. 5—Inductance from field between conductors of coaxial cable

FIG. 6—(right) Inductance from field within center coaxial conductor



**TABLE I—Loop Resistance of Coaxial Cables Constructed of Various Center and Concentric Conductors**

Inner Conductor Number	Copper Braid AWG No.	Copper Braid Size AWG	Copper Braid No. of Wires	Copper Braid Lay Inches	Diameter over Dielectric in Inches	Loop Resistance Ohms/1000 ft. at		
						50 kc	30 kc	1 Mc
7	21	33	216	1.55	0.280	4.95	12.1	20.6
7	21	(4/64 in. wall Lead)			0.280	5.78	16.1	27.9
7	21	33	288	1.60	0.460	4.65	10.6	19.6
7	21	(1/64 in. wall Lead)			0.160	4.96	13.1	22.8
1	12	33	216	1.72	0.280	4.84	9.54	17.5
1	12	33	120	0.50	0.280	7.3	16	27.2
1	12	34	144	0.57	0.489		14.7	26.6
1	9	30	384	4.00	0.690	2.39	6.76	12.0
1	18	36	480	1.26	0.280	10.7	19.1	31.8

400 megacycles, the ratio of braid resistance to resistance of copper tube is in the order of magnitude of 2.5 to 4.5 when the angle between the individual wires and the axis of the cable is approximately 25 degrees and the coverage is at least 90 percent. When the coaxial cable consists of a stranded inner conductor and a copper braid for the concentric conductor, the only accurate method of obtaining total resistance at any frequency is by accurately measuring that combination of conditions. Table I lists measured resistances of several combinations of inner and outer conductors.

**Series Inductance**

Total inductance ( $L_0$ ) of coaxial cable consists of the inductance be-

tween center and concentric conductors, and the internal inductances of these conductors. Since internal inductance of the concentric conductor is negligible, the total inductance may be expressed as

$$L_0 = L_e + L_i = [0.140 \log_{10} (d_2/d_1) + 0.015(L_{ac}/L_{dc})] \times 10^{-3} \text{ henrys/1000 ft} \quad (8)$$

$L_{ac}/L_{dc}$  = ratio of  $L_i$  at a-c conditions to  $L_i$  at d-c conditions

The external inductance term ( $L_e$ ) of the total inductance is plotted in Fig. 5 as a function of the ratio of diameter under the concentric conductor to diameter over the center conductor. Figure 6 shows graphically the internal inductance ( $L_i$ ) of the center conductor. This inductance decreases with an increase in frequency and/or an increase in diameter.

At frequencies so high that the internal inductance term  $0.015 L_{ac}/L_{dc}$  may be neglected, the total inductance may be simplified to

$$L_0 = L_e = 0.1404 \times 10^{-3} \log_{10} (d_2/d_1) \text{ henrys/1000 ft} \quad (9)$$

Although a definite rule cannot be stated for the frequency at which the approximate equation may be used, internal inductance may in general be neglected at fre-

quencies greater than 2 Mc. A comparison of measured and calculated inductance for coaxial cables having a center conductor consisting of seven strands of copper indicates that for that type of conductor a better agreement between theoretical and measured values is obtained when the diameter over the center conductor is assumed to be equal to the square root of the circular mil area.

**Shunt Admittance**

Shunt capacitance ( $C$ ) depends upon the ratio of diameter under the concentric conductor to the diameter over the center conductor, and the effective dielectric constant ( $K$ ) of the insulating material. If the dielectric constant varies with frequency, there will be a direct change in capacitance. Fortunately most dielectrics are relatively constant with frequency. The formula for the capacitance is

$$C = \frac{7.36 K 10^{-9}}{\log_{10} (d_2/d_1)} \text{ farads/1000 ft} \quad (10)$$

Variations in the capacitance as a function of ( $K$ ) and the ratio of diameters are shown graphically in Fig. 7. An accurate knowledge of capacitance is important due to its effect on characteristic impedance, as will be shown later.

Shunt conductance ( $G$ ) depends upon frequency, capacitance and dissipation factor of the insulating material and may be determined from

$$G = \omega DC \text{ mhos/1000 ft} \quad (11)$$

Of the terms in this expression, capacitance remains essentially constant with frequency; the dissipation factor ( $D$ ) of the dielectric may vary considerably. Since conductance loss contributes increasingly to attenuation with increasing frequency, it is very important that the dissipation factor be accurately known for the frequency at which conductance is to be determined.

**Characteristic Impedance**

The user of coaxial cables, such as the designer of high frequency equipment or a radio transmission engineer, is not so much interested in the cable's basic parameters as in the operating parameters, which are characteristic or surge impedance, attenuation, and phase-shift.

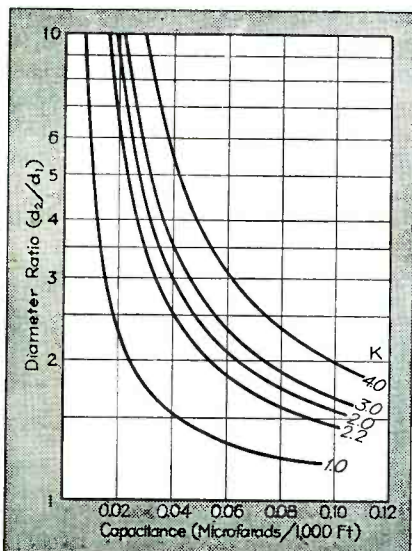


FIG. 7—Capacitance of coaxial cables varies with relative diameters of the conductors and with the dielectric constant

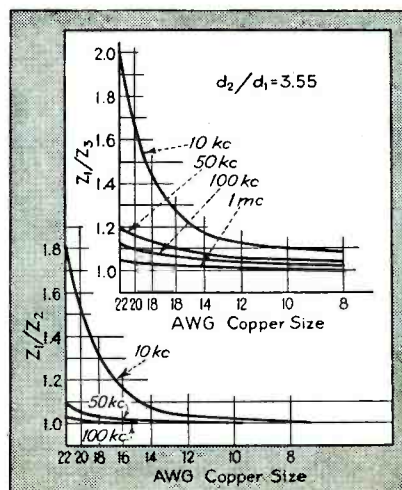


FIG. 8 (right)—Comparison of the accuracies of Eq. (14) and (15) for characteristic impedance

Characteristic impedance ( $Z_0$ ) is that impedance which, terminating a line, will theoretically reduce reflection losses to zero. In practice ideal conditions may not be realized, but nevertheless a line terminated in its characteristic impedance will have a minimum reflection loss. Coaxial cables in the radio-frequency range and higher are normally designed to have a characteristic impedance of 50 ohms or 70 ohms.

This parameter may be determined at any frequency from

$$Z_0 = \sqrt{\frac{R_0^2 + (\omega L_0)^2}{G^2 + (\omega C)^2}} \text{ ohms} \quad (12)$$

Where  $R_0$  = total resistance in ohms/1000 ft. Experience has shown that this equation is more flexible when written as

$$Z_0 = \sqrt{\frac{\sqrt{R_0^2 + (\omega L_0)^2}}{\omega C \sqrt{D^2 + 1}}} \text{ ohms}$$

As dielectrics utilized in coaxial cables have power factors considerably less than 5 percent, the term

$\sqrt{D^2 + 1} \sim 1$ , hence

$$Z_1 \sim \sqrt{\frac{\sqrt{R_0^2 + (\omega L_0)^2}}{\omega C}}$$

$$\text{or } Z_1 \sim \sqrt{\frac{L_0}{C} \sqrt{\left[\frac{R_0}{\omega L_0}\right]^2 + 1}} \text{ ohms} \quad (13)$$

When  $R_0$  is very small as compared to  $\omega L_0$ , Eq. (13) may be simplified to

$$Z_2 \sim \sqrt{L_0/C} \text{ ohms} \quad (14)$$

When the frequency is such that the internal inductance  $L_i$  may be neglected the characteristic impedance can be determined from a very simple equation

$$Z_3 = \sqrt{L_i/C} = (138/\sqrt{K}) \log_{10}(d_2/d_1) \text{ ohms} \quad (15)$$

No definite rule can be made as to the frequency range in which the approximate equations may be used due to the variables involved. However, as a guide to their limitations the impedance ratios  $Z_1/Z_2$  and  $Z_1/Z_3$  as a function of frequency and diameter of the center conductor are plotted in Fig. 8.

These ratios were determined for coaxial cables having a ratio of  $d_2/d_1 = 3.55$ , a round solid copper center conductor, and a copper-tube concentric conductor. The dielectric medium was assumed to have a dielectric constant of 2.3 and a dissipation factor of 1.0 percent. For other diameter ratios there are

corresponding changes in the limitations of the approximate formulas.

It is interesting to note that the accuracy of the impedance formulas is independent of dielectric constant for a given ratio of  $d_2/d_1$ ,

$$Z_1/Z_2 = \sqrt{(R_0/\omega L_0)^2 + 1} \quad (16)$$

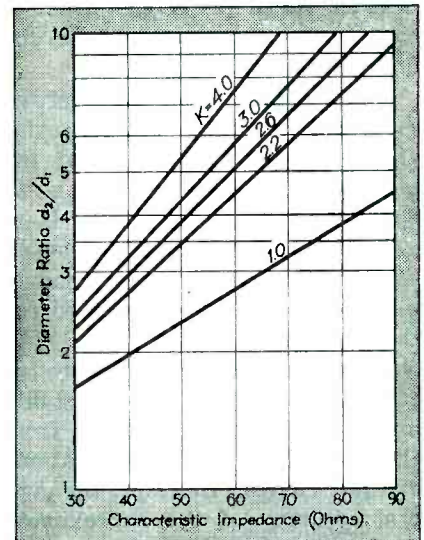
$$Z_1/Z_3 = \sqrt{1 + (L_e/L_i)} \times \sqrt{(R_0/\omega L_0)^2 + 1} \quad (17)$$

$$Z_2/Z_3 = \sqrt{1 + (L_e/L_i)} \quad (18)$$

Because characteristic impedance is a function of the diameter ratio  $d_2/d_1$  and the dielectric constant, it is of considerable aid in designing a cable for a given impedance to know the effects of variations in these components due to manufacturing limitations and the dielectric to be used. Such varia-

**TABLE II—Symbols for coaxial cable parameters and the equation or figure in which they are presented**

$\alpha_0$	—Attenuation constant of cable: Eq. (19)
$\alpha_1, \alpha_2, \alpha_3$	—Alternate forms of $\alpha_0$ : Eq. (20), (21), (22)
$\alpha_c$	—Attenuation due to loss in conductor: Fig. 12
$\alpha_d$	—Attenuation due to loss in dielectric: Fig. 12
$\beta_0$	—Phase-shift constant of cable: Eq. (23)
$\beta_1, \beta_2$	—Alternate forms of $\beta_0$ : Eq. (24), (25)
$C$	—Shunt capacitance of cable: Eq. (10); Fig. 7
$D$	—Dissipation factor of dielectric
$d_1$	—Outside diameter of center conductor
$d_2$	—Inside diameter of outside conductor
$G$	—Shunt conductance: Eq. (11)
$K$	—Dielectric constant of coaxial dielectric
$L_0$	—Total series inductance of cable: Eq. (8)
$L_e$	—External inductance component of $L_0$ : Fig. 5
$L_i$	—Internal inductance component of $L_0$ : Fig. 6
$R$	—Approximate a-c resistance of outer conductor: Eq. (7); Fig. 4
$R_0$	—Total series loop resistance of cable: $R + R_1$
$R_1$	—A-C resistance of center conductor: Fig. 1 & 2
	Alternate forms for limited ranges are given by Eq. (3) & (4)
$V$	—Velocity of wave in cable: Eq. (27)
$V_0$	—Velocity of wave in free space ( $98.4 \times 10^6$ ft/sec)
$x$	—Skin effect resistance factor: Eq. (2); Fig. 1
$Z_0$	—Characteristic impedance of cable: Eq. (12)
$Z_1, Z_2, Z_3$	—Alternate forms of $Z_0$ : Eq. A(13), (14), (15)



**FIG. 9—Dependence of characteristic impedance on dielectric constant and diameter ratio**

tions may be easily studied by means of a graph as in Fig. 9 for the frequency range in which impedance may be expressed by Eq. (15). Furthermore this graph may be used in making first approximations of the ratio  $d_2/d_1$  for frequencies in which the impedance may be determined from Eq. (14).

#### Attenuation

Attenuation of coaxial cable at any frequency may be determined from

$$\alpha_0 = 6.14 \sqrt{\frac{\sqrt{[R_0^2 + (\omega L_0)^2]} [G^2 + (\omega C)^2]}{(GR_0 - \omega^2 L_0 C)}} \text{ decibels/1000 ft} \quad (19)$$

This equation can be written in a more practical form by grouping terms

$$\alpha_1 = 6.14 \times \sqrt{\omega C [\omega L_0 (\sqrt{(R_0/\omega L_0)^2 + 1} \sqrt{D^2 + 1} - 1) + DR_0]} \text{ decibels/1000 ft} \quad (20)$$

Note that variations in attenuation due to variations in basic parameters are more clearly seen from a study of Eq. (20) than Eq. (19). At high frequencies the attenuation formula may be simplified to

$$\alpha_2 \sim 4.34 (R_0/Z_1 + GZ_1) \quad (21)$$

When the frequency and size of the inner conductor are such that the impedance can be expressed by Eq. (15), a further simplification may be made

$$\alpha_3 \sim \sqrt{K} \left[ \frac{0.0315 R_0}{\log_{10} d_2/d_1} + 27.7 f D 10^{-6} \right] \text{ decibels/1000 ft} \quad (22)$$

The first term of these equations

is often called the copper attenuation ( $\alpha_c$ ), and the second term the dielectric attenuation ( $\alpha_d$ ).

The limitations of the approximate equations are shown graphically in Fig. 10 as ratios of the attenuation determined from  $\alpha_1$ , to the attenuations determined from  $\alpha_2$  and  $\alpha_3$  as a function of frequency and diameter of the inner conductor for the conditions specified for the impedance calculations. The shape of these curves will vary for cables having dielectric constants and power factors different from those assumed in the calculations of these curves. However, the general accuracy of the approximate attenuation formulas is as indicated.

### Effect of Dielectric

The effect of the dissipation factor of the dielectric on attenuation is very important. This can be seen graphically in the attenuation vs frequency curves shown in Fig. 11 for a No. 8 solid copper center conductor, 0.020-inch wall copper sheath and a dielectric constant of 2.3. The dielectric is assumed to have a dissipation factor of either 0.1 percent or 1.0 percent. For simplification of calculations, attenuations were determined from  $\alpha_3$ .

Note that the dissipation-factor effect increases with frequency and either the attenuation due to the copper or to the dielectric may predominate. It has been found of considerable aid in designing coaxial cables to construct graphs similar to those in Fig. 12 for  $\alpha_c$  and  $\alpha_d$  vs. frequency as a function

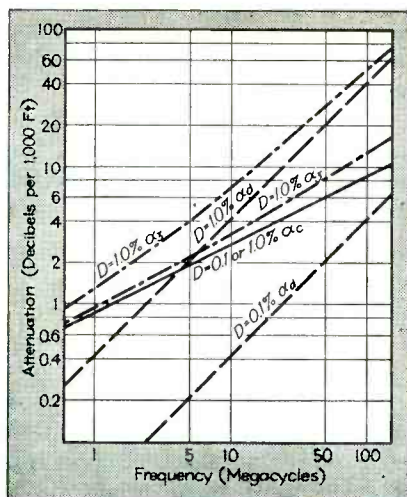


FIG. 11—Comparison of the effect of dissipation factor on attenuation, and the relative importance of copper and dielectric attenuation

of their individual variables. Copper attenuation is calculated for the condition that  $\alpha_c = 4.34R_o/Z_3$  and dielectric attenuation for  $\alpha_d = 27.7fD\sqrt{K} 10^{-6}$ . For values other than those plotted in this graph, attenuations may be obtained by applying proper correction factors; that is,  $\alpha_d = 0.042$  db/1000 ft at 10 megacycles when  $K = 2.3$  and  $D = 1$  percent. When  $K = 2.4$  and  $D = 1$  percent at 10 megacycles the dielectric loss  $\alpha_d = 0.042\sqrt{2.4/2.3} = 0.0429$  db/1000 ft. Although these curves apply only to the frequency range in which the formula for  $\alpha_3$  may be used, the information obtained from them is useful in obtaining an approximation of the general design of a coaxial cable for any attenuation.

### Phase-Shift Constant

Phase-shift constant or wavelength constant may be expressed at any frequency as

$$\beta_0 = \sqrt{0.5\sqrt{R_o^2 + (\omega L_o)^2} [G^2 + (\omega C)^2] - 0.5(GR_o - \omega^2 L_o C)} \quad (23)$$

radians/1000 ft

Similar to the attenuation, the form of this equation may be changed to

$$\beta_1 = \sqrt{0.5\omega C [\omega L_o (\sqrt{(R_o/\omega L_o)^2 + 1} \sqrt{D^2 + 1} + 1) - DR_o]} \quad (24)$$

radians/1000 ft

At high frequencies this equation may be simplified to

$$\beta_2 \cong \omega \sqrt{L_o C} \quad \text{radians/1000 ft} \quad (25)$$

The limitation of this formula, as for attenuation, depends upon

the relative magnitude of the parameters and the frequency. However, as a general guide based upon a ratio of  $d_o/d_i = 3.55$ , a solid-center conductor, a copper tube concentric conductor, and a dielectric having a dielectric constant of 2.3 and a dissipation factor of 1 percent, Eq. (25) may be used at frequencies as low as 50 kilocycles when the center conductor is at least No. 18 AWG.

The operating engineer is often interested in wavelength ( $\lambda$ ) and velocity of propagation along the coaxial cable ( $V$ ). These terms are a function of  $\beta_0$  and may be determined from

$$\lambda = 2000\pi/\beta_0 \text{ feet} \quad (26)$$

$$V = 1000\omega/\beta_0 \text{ feet/second} \quad (27)$$

Velocity along the cable expressed in ratio to velocity in free space ( $V_0$ ) is

$$V/V_0 = 1.016 (\omega/\beta_0) 10^{-6} \quad (28)$$

With the exact formulas available for checking accuracy, the approximate equations and the curves presented herein can reliably be used to determine basic cable parameters and from them the working parameters. Thus the cable-design engineer can study variations produced by cable dimensions and components, and the circuit engineer can interpret these factors in terms of cable performance.

### BIBLIOGRAPHY

- (1) Whinnery, J. R., Skin Effect Formulas, *ELECTRONICS*, p. 44, Feb. 1942.
- (2) Race and Larrick, High-Frequency Coaxial-Line Calculations, *Trans. A. I. E. E.*, p. 526, July 1942.
- (3) Woodruff, L. F., "Principles of Electric Power Transmission."
- (4) Bureau of Standards Circular No. 74.

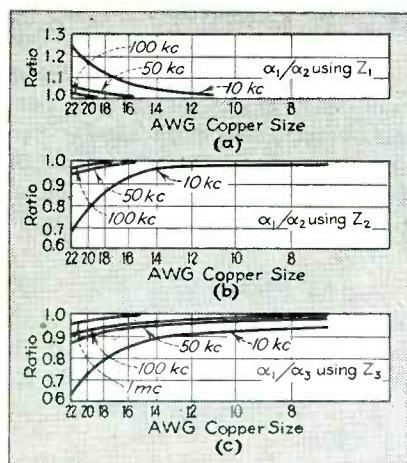


FIG. 10—Relative accuracies of attenuation factor as calculated from various approximations

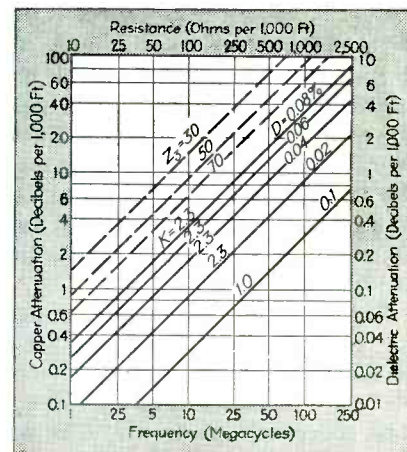
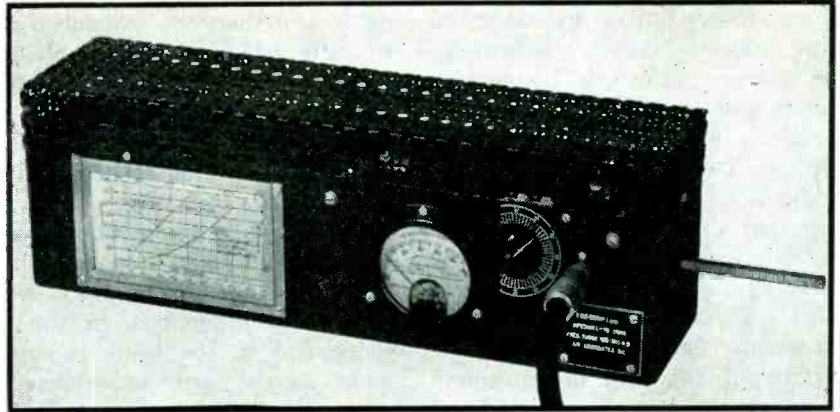


FIG. 12—Illustrative copper and dielectric attenuations, showing the manner in which they can be expected to vary

By **STANLEY CUTLER**

Assistant Chief Engineer  
Radio Division  
Air Associates, Inc.  
Los Angeles, Calif.



Dummy antenna for testing v-h-f transmitters

# V-H-F DUMMY ANTENNA

Distributed reactances of a physical resistor are compensated, giving a pure resistance that simulates the antenna load of transmitters. A built-in thermo-galvanometer indicating power dissipated in the load facilitates tuning and coupling adjustments

**T**HE PROBLEM of providing a dummy load with suitable characteristics for testing u-h-f and v-h-f transmitters has probably received the attention of many engineers, particularly in connection with production testing.

Development work and production testing require that the transmitter be operated into a load having an impedance which exactly represents that for which it is designed. This is particularly important where plate tuning and antenna coupling controls must be precalibrated at the factory. In this case a reactive load will usually cause plate circuit resonance to occur at a different point on the tuning control from that with the correct load, and also the degree of physical coupling to the output circuit will generally be different.

It is impractical, of course, for the manufacturer to use the actual load into which the transmitter will operate since this is usually a radiating system. Many radio factories are located near areas of important military or aircraft communication networks and radiation of any kind may cause serious in-

terference. Development work and production testing, then, must be done with a compact load which does not radiate.

### Requirements of Dummy Load

Rarely will the transmitter be designed for operation on only a single frequency, and as a result the dummy load will usually be

called upon to operate over a range of frequencies. It must therefore have wide-band characteristics, or it must be easily adjustable for operation at any frequency within the desired range. This requires that the input impedance remains constant and essentially resistive over the operating frequency band.

Since the primary function of the transmitter is to deliver a given amount of power, the ideal dummy load should instantly give a reasonably accurate indication of the power delivered to it. There should be no time lag between the application and indication of the power, and fluctuations of short duration should register on the power indicator. This requirement eliminates calorimetric types of power meters. The power indicator should preferably operate at any value of power below the rated maximum so that loads do not have to be changed when measuring power levels at maximum and minimum transmitter output coupling. Thus incandescent power elements wherein pyrometers or phototubes are used to measure power can not be used because of their great impedance

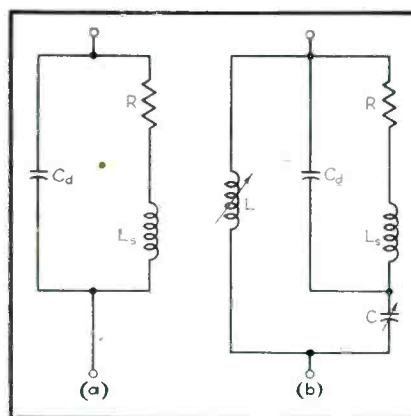


FIG. 1—(a) Distributed capacitance and inductance of a resistor at high frequencies can be represented by lumped constants. (b) To counteract these reactances, an external inductor  $L$  and capacitor  $C$  can be added to the resistor

change with temperature variation.

In order to simplify calibration, the power indicating instrument should give an indication proportional to the v-h-f load current or voltage. This will permit complete calibration for any power input with only a single calibration point. A thermocouple ammeter meets these requirements more closely at v-h-f than does any other type instrument. The impedance characteristic of the load must remain constant regardless of the amount of power delivered to it in order that transmitters of different power ratings may be tested with the same load, and so that quick checks may be made of the decoupling characteristics of the transmitter output circuit.

Further, the resistance can be quite constant with increasing frequency since skin effect is less pronounced in materials of high resistivity. Skin effect can be further reduced by molding the resistor in the form of a thin tube.

The composition resistor at very high frequencies may be represented as shown in Fig. 1(a). Here distributed inductance in the resistor and in the leads is represented by the series inductance  $L_s$ , while  $C_d$  represents the distributed shunt capacitance. If a resistor is chosen having the desired resistance value at low frequencies, the reactances appearing at high frequencies may be canceled by forming a series resonant circuit with an external capacitor and the dis-

Type A has an essentially zero resistance-temperature coefficient, while types B and CX have slightly negative and slightly positive coefficients respectively.

#### Reactive Compensation

Series inductive reactance in a resistor of this type and its connecting leads is approximately 40 ohms at 100 Mc and may easily be resonated with a capacitance of approximately 40  $\mu\text{f}$ .

Shunt capacitance is extremely small and must be resonated with an inductance having a very high  $Q$  if the resistive component of the network is to remain unaltered. An ordinary coil of wire would be unsatisfactory for this purpose; however, a shorted section of coaxial transmission line, slightly less than a quarter-wavelength long, makes an excellent high- $Q$  inductor and can be made readily adjustable.

The shunt inductance used to resonate the resistor was made from a piece of  $\frac{3}{8}$ -inch brass tubing. A No. 12 copper wire supported on ceramic beads formed the inner conductor. The outer tube was cut approximately in half and folded back on itself to conserve space. The shorting rod was made from  $\frac{1}{8}$ -inch brass tubing plugged at one end and drilled axially through the plug to accommodate the No. 12 wire. A small piece of phosphor bronze formed into a finger insured contact between the wire and the shorting rod. No beads were used on the adjustable section.

Figure 2 is a schematic diagram of the final load with the coaxial inductor and shunt ammeter. The unit was designed for operation over a frequency range of 105 to 135 Mc, but the values of external capacitance and shunt inductance may be varied so that the load operates at frequencies up to ap-

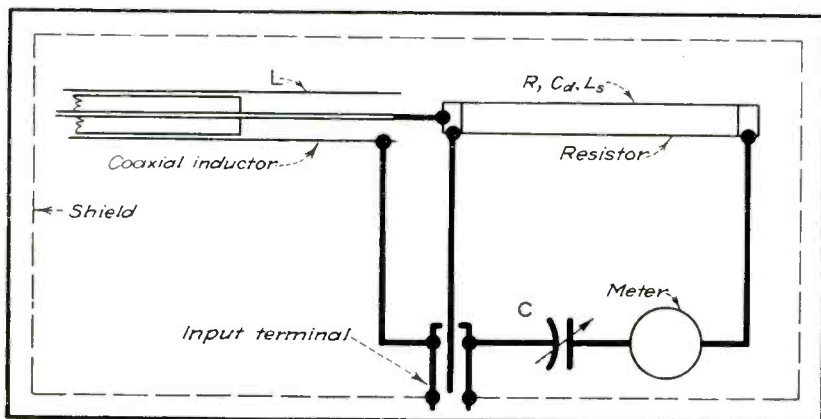


FIG. 2—Diagrammatic electrical circuit of artificial unbalanced load for v-h-f

Lastly, the power indicator must be sufficiently stable to maintain its calibration over long periods of time. This requires a dissipating element of rugged construction which can stand the mechanical abuse to which such an instrument is usually subjected. In addition, calibration should not be affected by changes in ambient temperature or by heat generated from power dissipated in the load resistor.

#### Distributed Reactance

Design centers around the dissipative element of the dummy load. A resistor becomes a complicated reactive and resistive network at very high frequencies and so cannot be used without modification. Inherently the carbon or composition resistor is perhaps most suited to u-h-f and v-h-f use since the reactive components can be kept small by careful design of the re-

distributed inductance, and a parallel resonant circuit with an external inductor and the distributed capacitance. This circuit arrangement is shown in Fig. 1(b). The impedance will now be resistive and equal to the high-frequency resistance of the resistor.

Typical resistors meeting requirements for this application are types A, B and CX, manufactured by the Global Company. They are available in various resistance and power values.

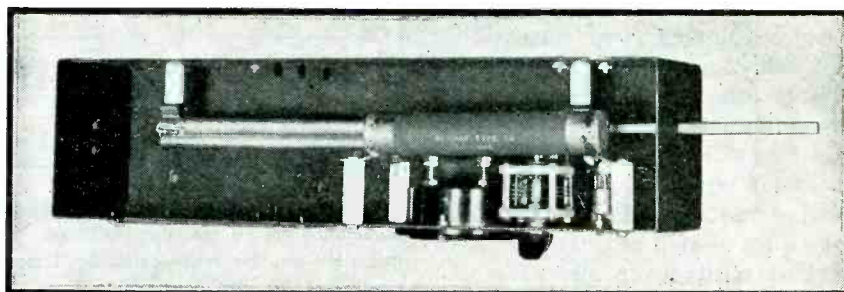


FIG. 3—Arrangement and proximity of parts is important in the v-h-f load

proximately 300 Mc. Above this the series reactance would be so large that it would be difficult to obtain a finite external capacitor small enough to give resonance. The high-frequency limit might be extended somewhat by replacing the capacitor with a shorted section of transmission line slightly longer than a quarter wavelength.

#### Built-in Wattmeter

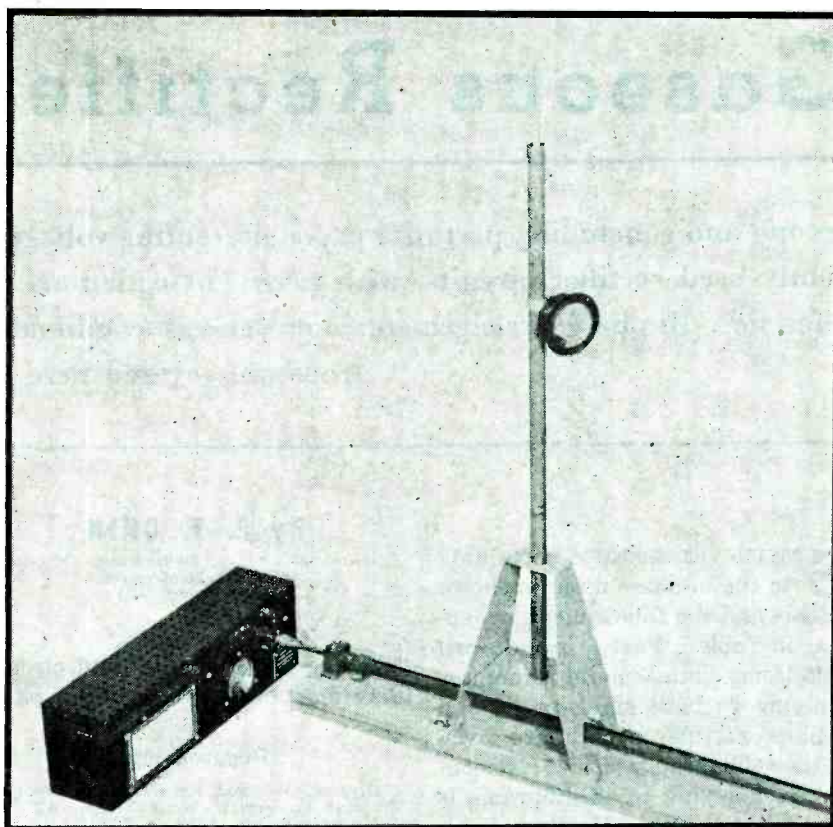
The load presents an essentially nonreactive impedance of 70 ohms to an unbalanced coaxial line and uses the Globar type of CX 70-ohm, 50-watt carbon resistor. All connecting leads between resistor, capacitor, and ground are made with wide copper straps. The terminals of the thermo-galvanometer used to measure power are connected directly across the section of the strap that joins the low-potential end of the resistor and the series capacitor, thus keeping the meter near ground to avoid effects of stray capacitance.

Arrangement of components, particularly the thermocouple ammeter and connecting leads, is important. It can be seen in detail in Fig. 3.

The wattmeter for the artificial load has a full-scale range of 115 ma. The width of the strap between its terminals was adjusted to give a half-scale deflection at 50 watts input. Being a current-squared thermocouple meter with the scale divided into 100 equal parts, the calibration in watts is linear. The useful lower limit of this load is 2 watts. Although the resistor is rated at only 50 watts the load can be used for short periods up to the full-scale reading of 100 watts. A slight adjustment of the shunt across the meter would allow full-scale readings on power inputs as low as 1 or 2 watts. No change in standing wave ratio was noticed at any power input. A model now under construction and using a removable shunt will have a full-scale range of either 10 or 100 watts.

#### Calibration

Input impedance was measured and the calibration of  $C$ ,  $L$ , and  $I$  was done with a section of slotted coaxial transmission line. An infinite-impedance probe voltmeter



Slotted transmission line and high-impedance coaxial voltmeter used to calibrate the v-h-f dummy load

was made from a shorted section of coaxial transmission line one-quarter wavelength long, mounted in a trolley to ride in the slot. A sensitive thermo-galvanometer was shunted across a small section of the probe near the shorted end. The shorting bar was adjustable so that the probe could be resonated at any frequency in the range.

The slotted line used for measurement had a characteristic impedance of 66 ohms, while the load was designed for 70 ohms. Theoretically the standing wave ratio under these conditions would be 1.06 to 1. With  $L$  and  $C$  adjusted for optimum conditions the measured standing wave ratios were 1.06, 1.05, and 1.02 to 1 at frequencies of 130, 119, and 108 Mc respectively.

The wattmeter was calibrated by connecting to the slotted line an incandescent lamp-type load which had been calibrated at 60 cps. The maximum and minimum indications of the probe voltmeter were then recorded for a given power input. The power transmitted through a transmission line at high frequencies is  $P = V_{\max} V_{\min}/Z_0$ . If

$V_{\max}/V_{\min} = A$ , these two equations may be solved simultaneously, yielding  $V_{\max} = \sqrt{APZ_0}$ . In this manner it was possible to calibrate the probe meter in terms of absolute voltage. The new load was then connected to the line and the power calculated from the new values of maximum and minimum probe voltage. It was necessary to calibrate at only one power level because of the linear voltage scale.

Considerable variation in power readings was expected with change in frequency; however, they were found to be remarkably constant varying over a range of 105 to 130 Mc only  $\pm 3$  percent from the calibration at 119 Mc. To allow for extreme accuracy, a multiplication factor was determined for these three frequencies and a curve plotted to cover the band.

Wide latitude in design is possible in power-handling capability, impedance, and frequency range by judiciously applying the principles outlined above. If care is taken to insure absolute symmetry from each input terminal, a balanced-input load arrangement can be built along these same general principles.

# Gaseous Rectifier Circuits

Second and concluding part of a paper presenting voltage and current wave forms of commonly used rectifier circuits, with pertinent equations alongside curves for convenient reference. Bi-phase arrangements for various combinations of phanotrons and thyra-trons are covered here

By P. T. CHIN

Industrial Control Engineering Division  
General Electric Co.  
Schenectady, N. Y.

**S**PECIFIC REFERENCES pertaining to the bi-phase circuits shown on this and the following pages appear in Table I, Part I, in the April 1945 issue, while general references applying to both single-phase and bi-phase rectifier circuits are given in the bibliography below. Nomenclature applying to all diagrams is tabulated in Table II, Part I, although in most cases the significance of each letter symbol in the equations can be deduced from the

labelling on the curves and circuit diagrams in this concluding part.

### BIBLIOGRAPHY

Blye, P. W., and Kent, H. E., Effect of Rectifier on System Wave Forms, *A.I.E.E. Transactions*, Jan. 1934, p. 54.  
Herskind, C. C., Grid Controlled Rectifiers and Inverters, *A.I.E.E. Transactions*, June 1934, p. 927.  
Stebbins, F. O., and Frick, C. W., Output Wave Shape of Controlled Rectifier, *A.I.E.E. Transactions*, Sept. 1934, p. 1259.

Journeaux, P., Voltage Control of Vapor Rectifiers, *A.I.E.E. Transactions*, June 1934, p. 976.

Stout, M. B., Analysis of Rectifier Filter Circuits, *A.I.E.E. Transactions*, Sept. 1935, p. 977.

Huss, P. O., An Analysis of Copper-Oxide Rectifier Circuits, *A.I.E.E. Transactions*, Mar. 1937.

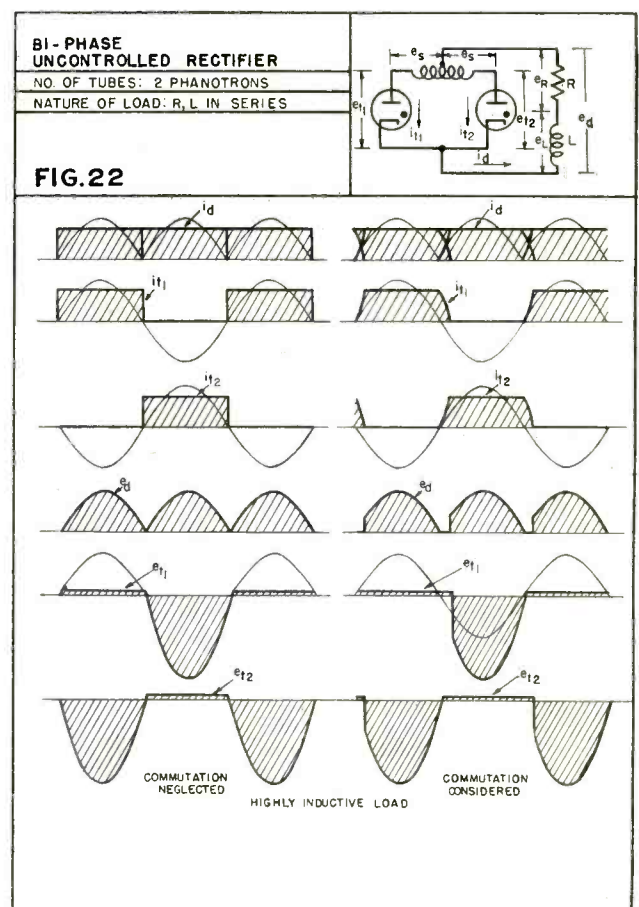
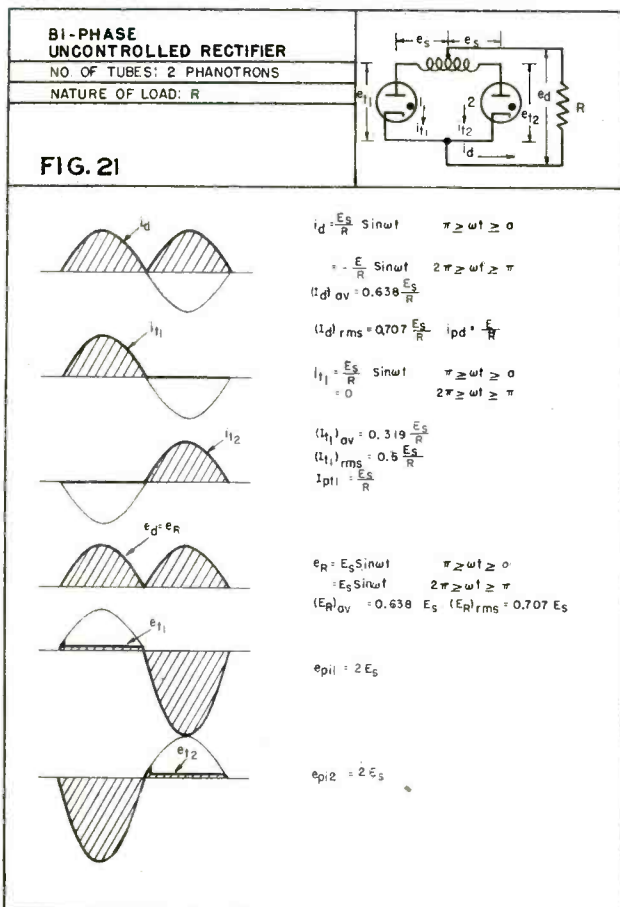
Herskind, C. C., Rectifier Circuit Duty, *A.I.E.E. Technical Paper* (44-41), 1943.

Panofsky, W. K. H., and Robinson, C. F., Graphical Solution of Rectifier Circuits, *ELECTRONICS*, Apr. 1941, p. 42-44.

Waidelich, D. L., Voltage Multiplier Circuits, *ELECTRONICS*, May 1941, p. 28-29.

Waidelich, D. L., and Gleason, C. H., The Half-Wave Voltage-Doubling Rectifier Circuit, *Proc. I.R.E.*, Dec. 1942, p. 535-541.

Durand, S. R., and Keller, O., Grid Control of Radio Rectifiers, *Proc. I.R.E.*, 25, 1937, p. 570-582.





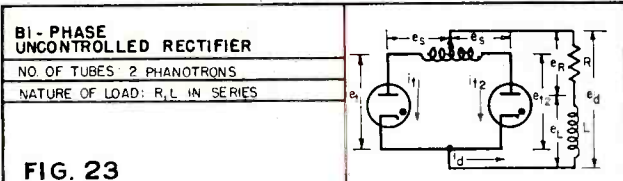


FIG. 23

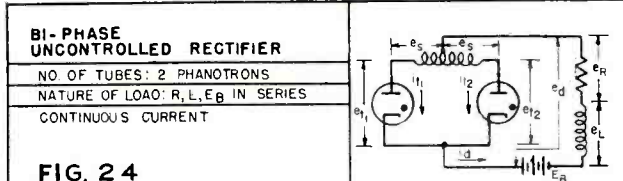
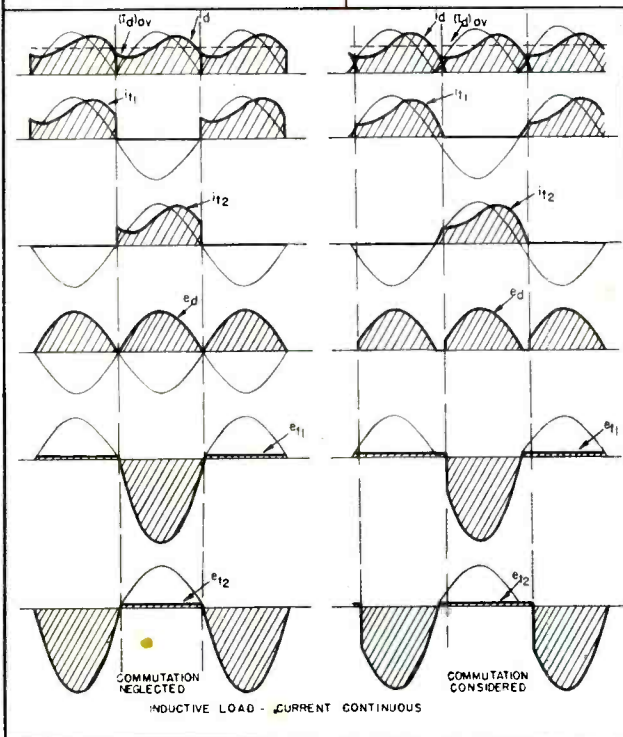


FIG. 24

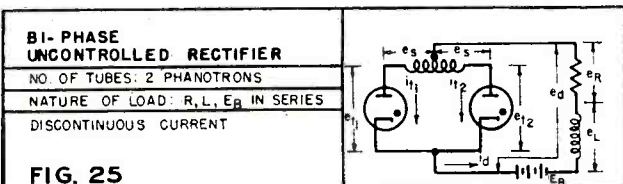
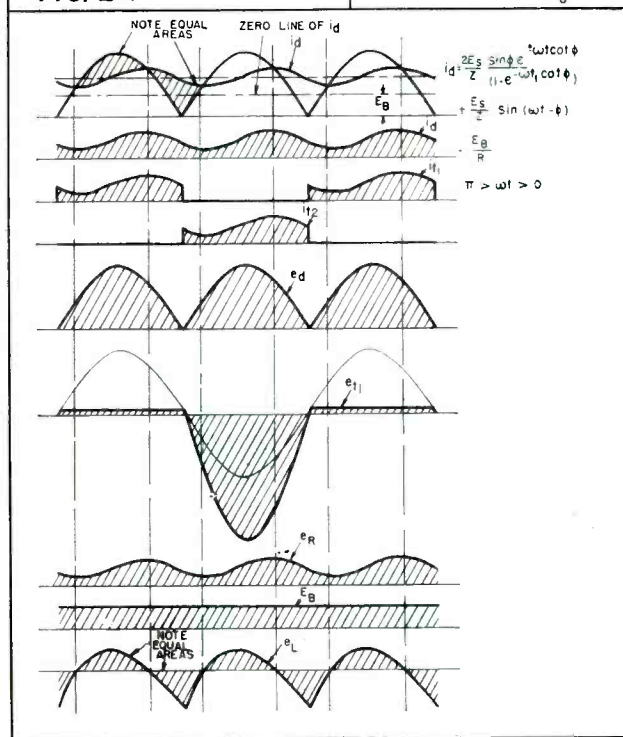


FIG. 25

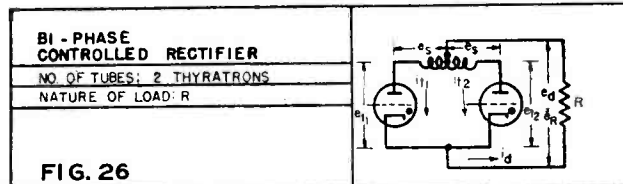
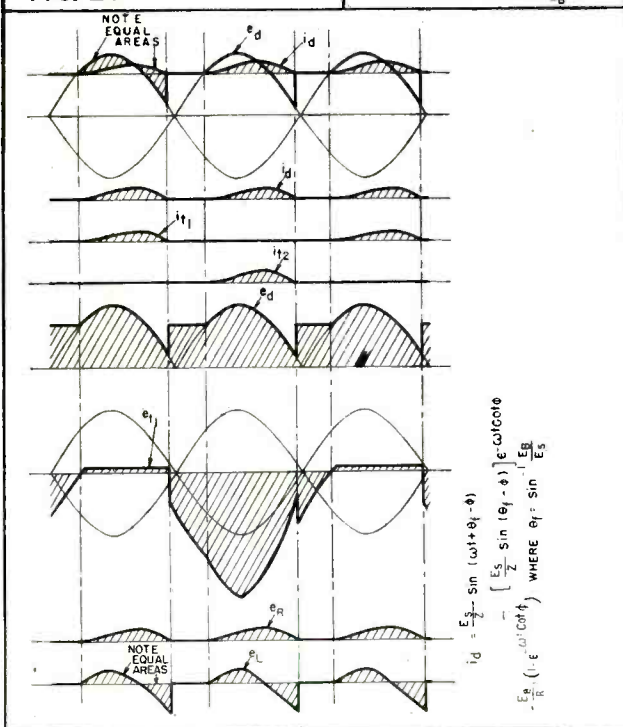
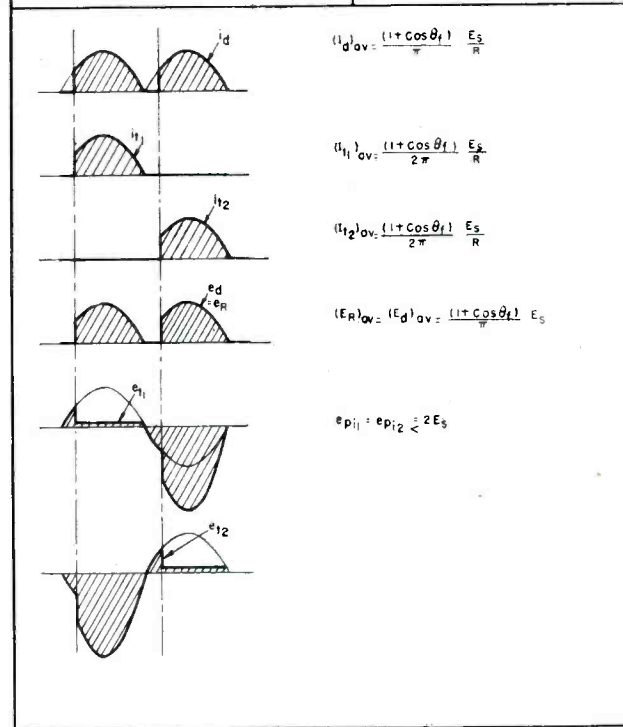


FIG. 26



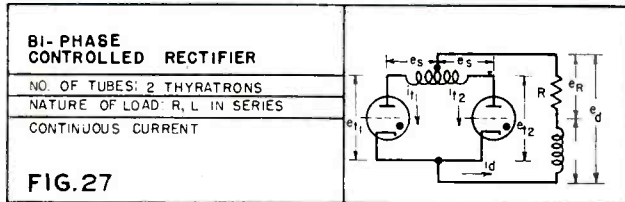


FIG. 27

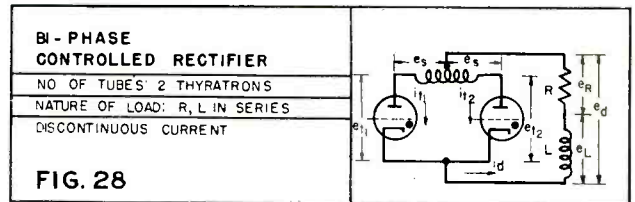
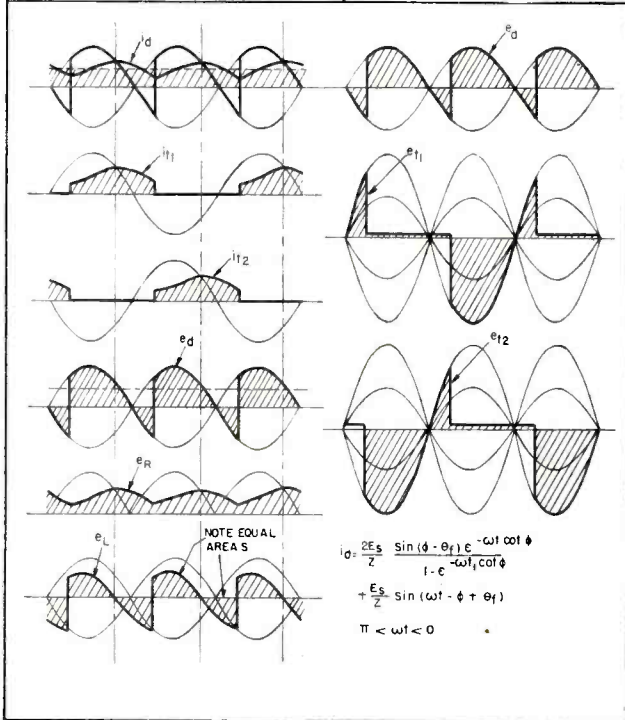


FIG. 28

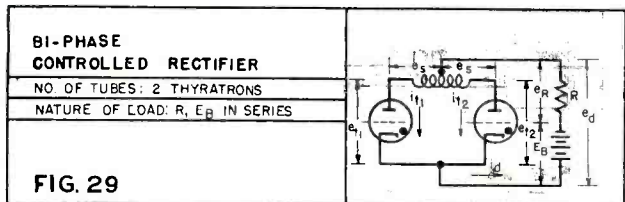
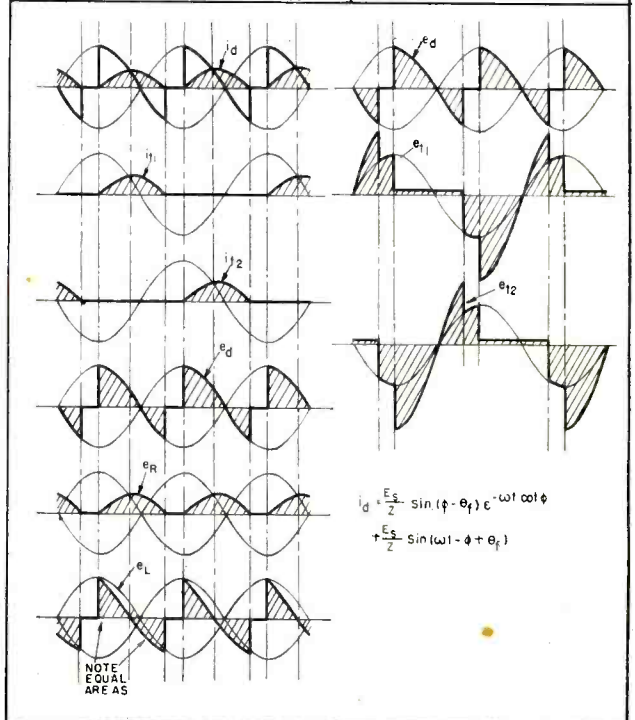


FIG. 29

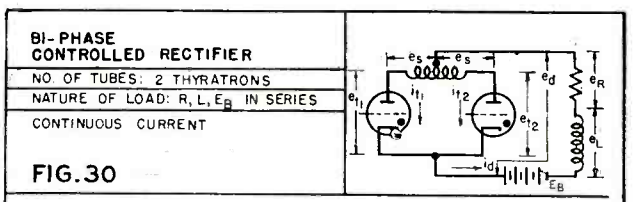
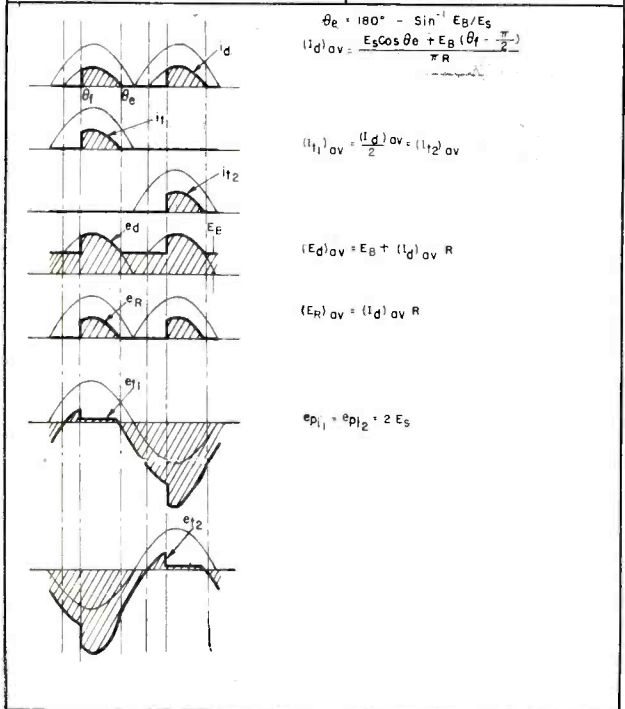
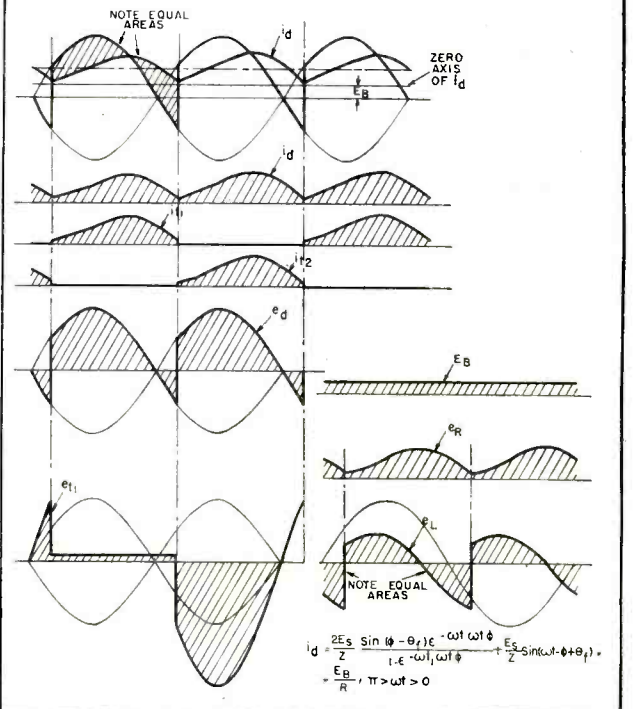
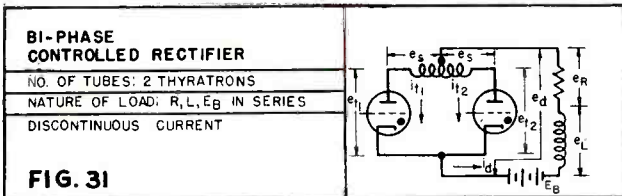
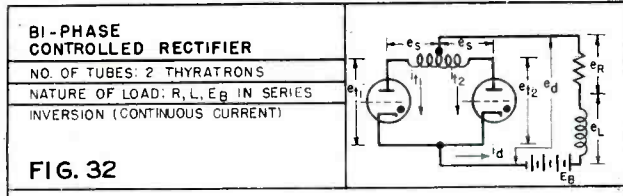
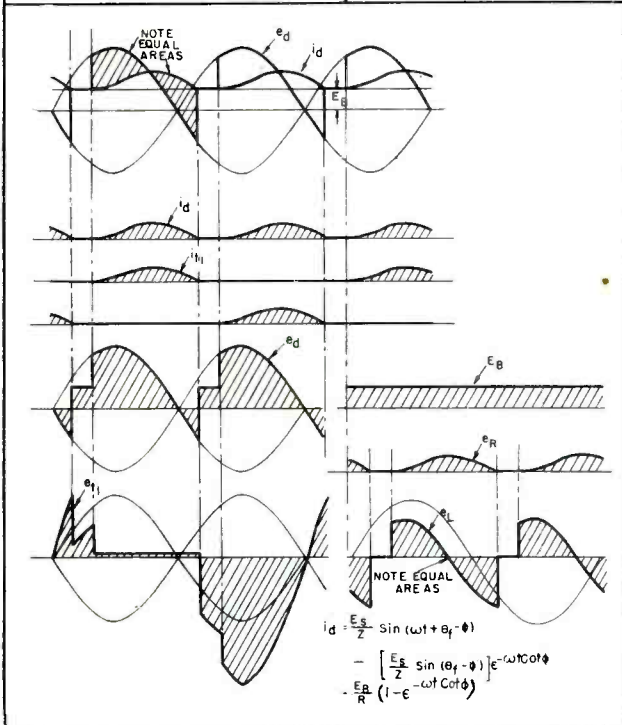


FIG. 30

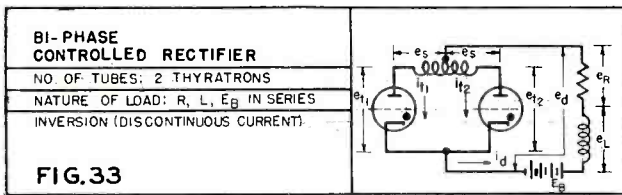
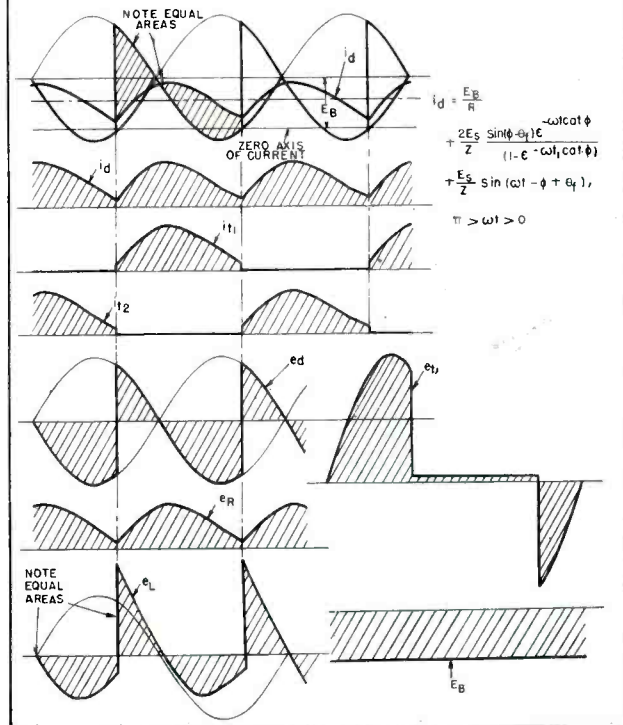




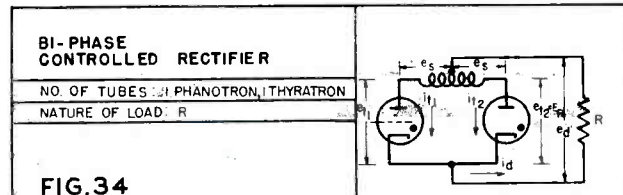
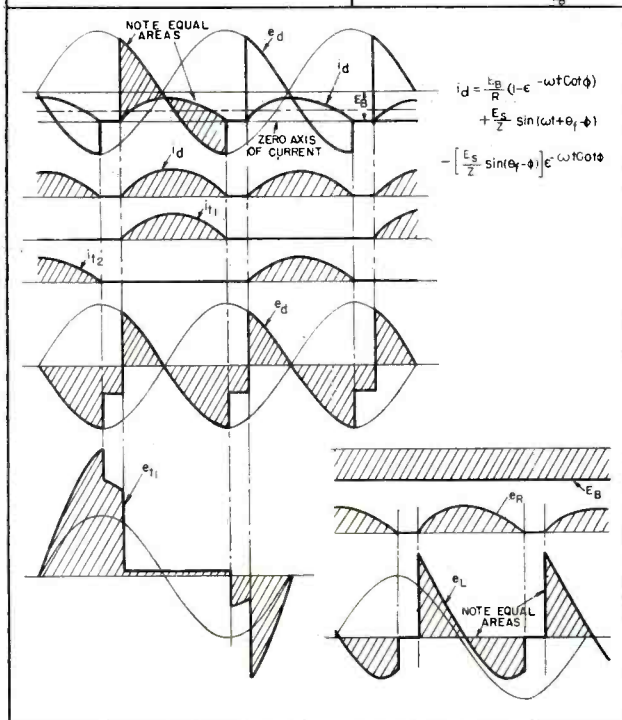
**FIG. 31**



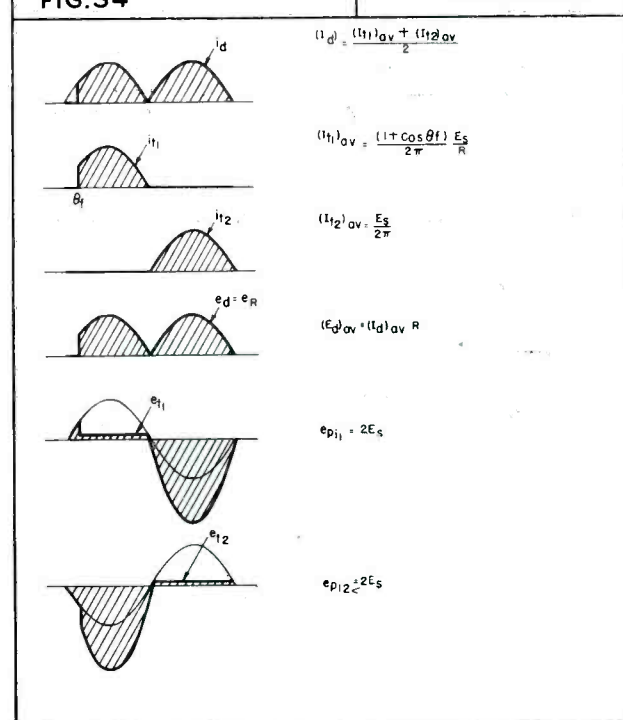
**FIG. 32**

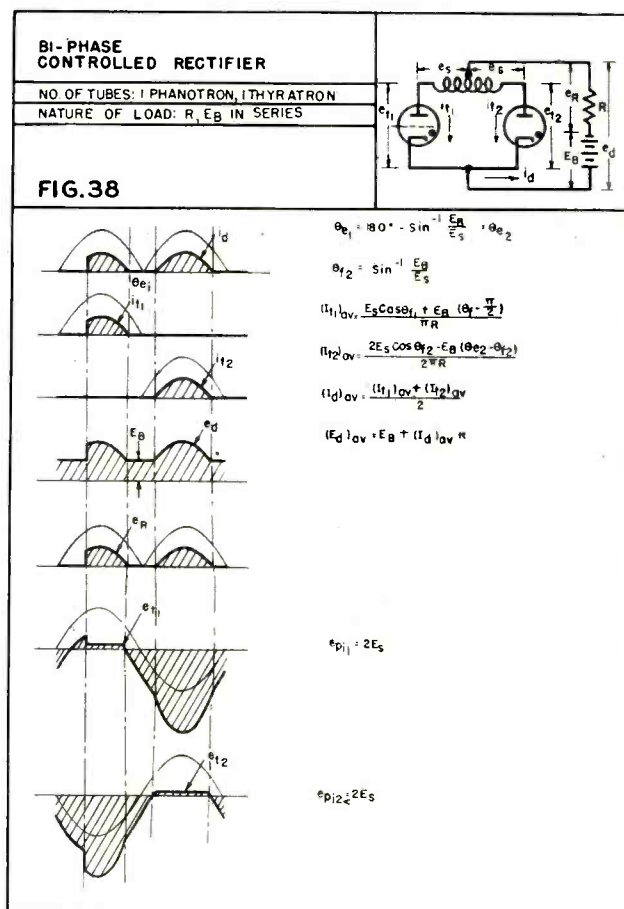
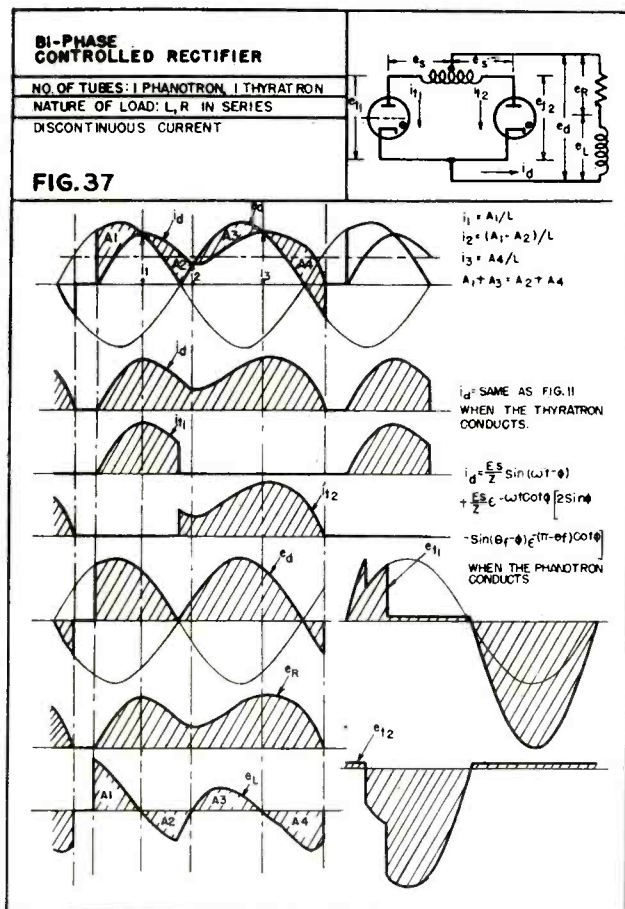
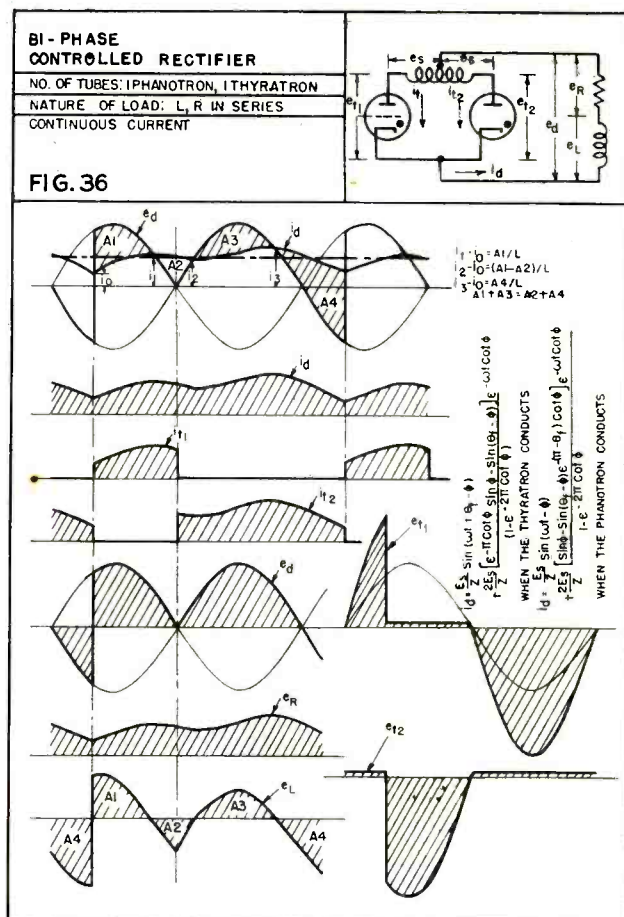
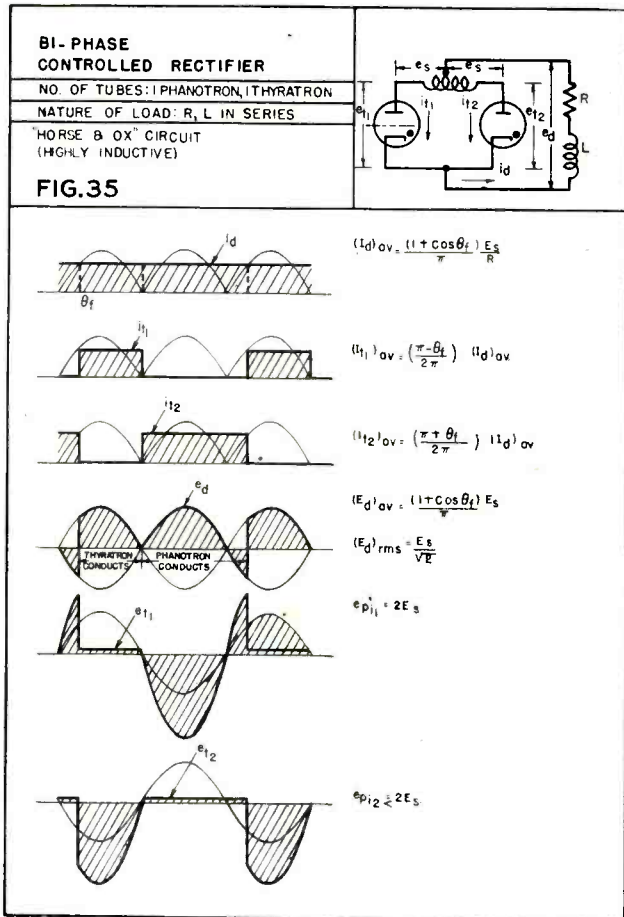


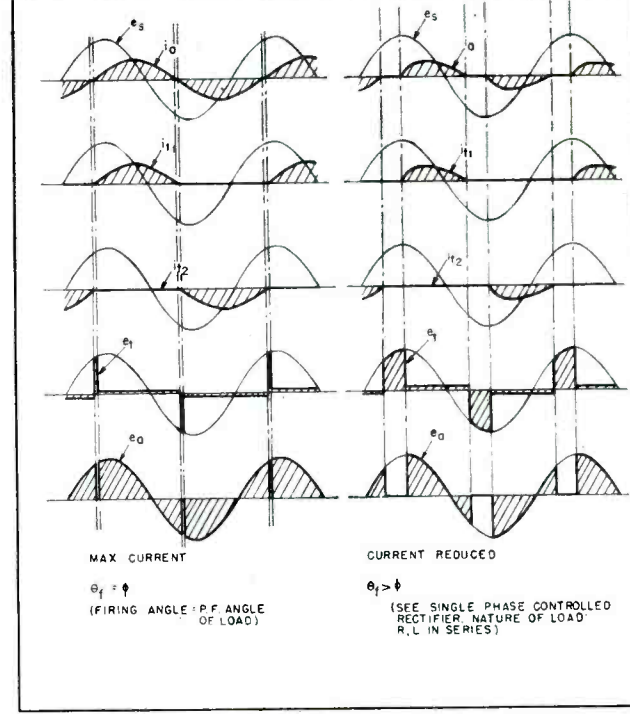
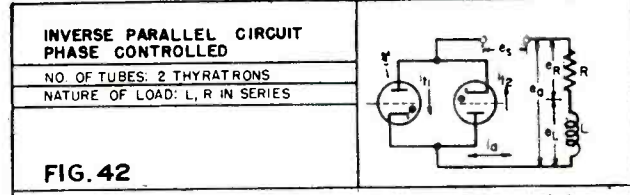
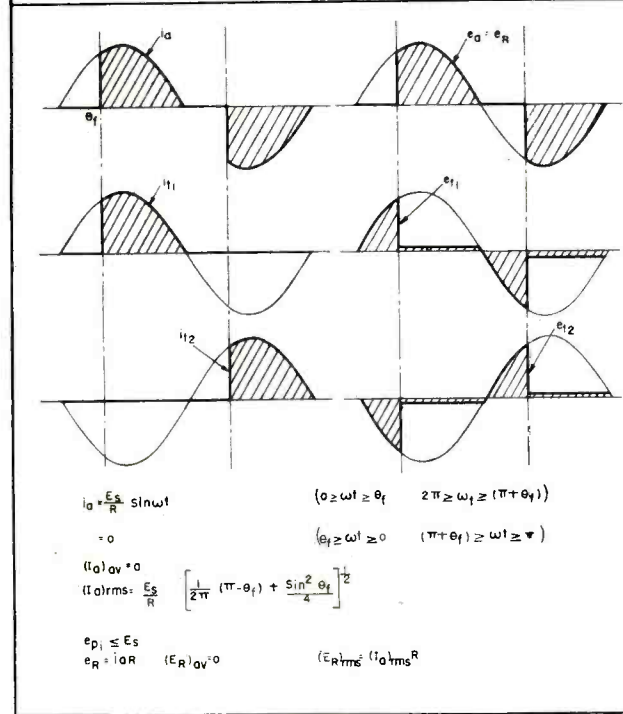
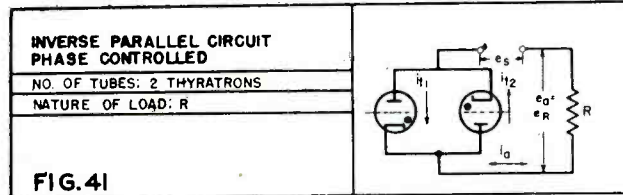
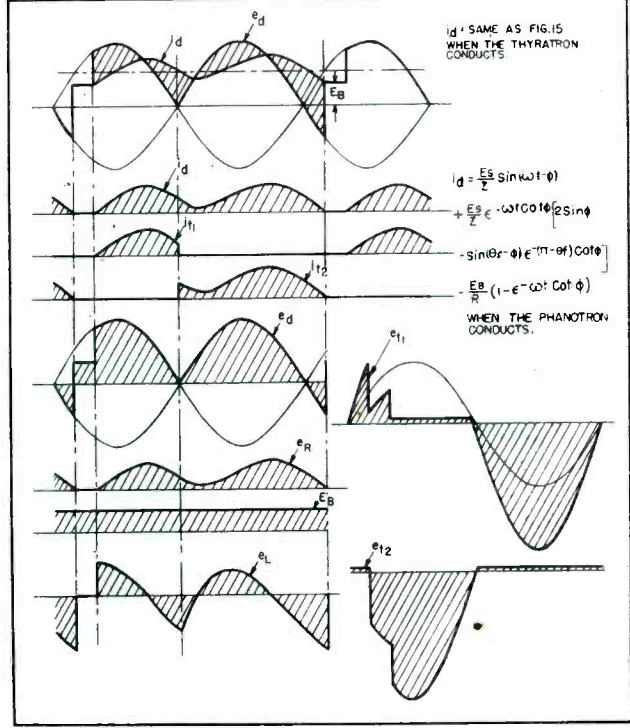
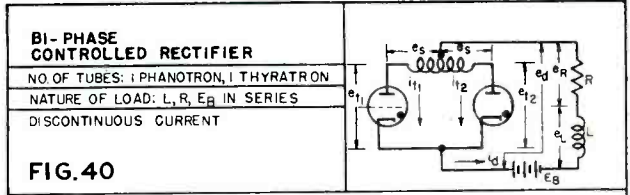
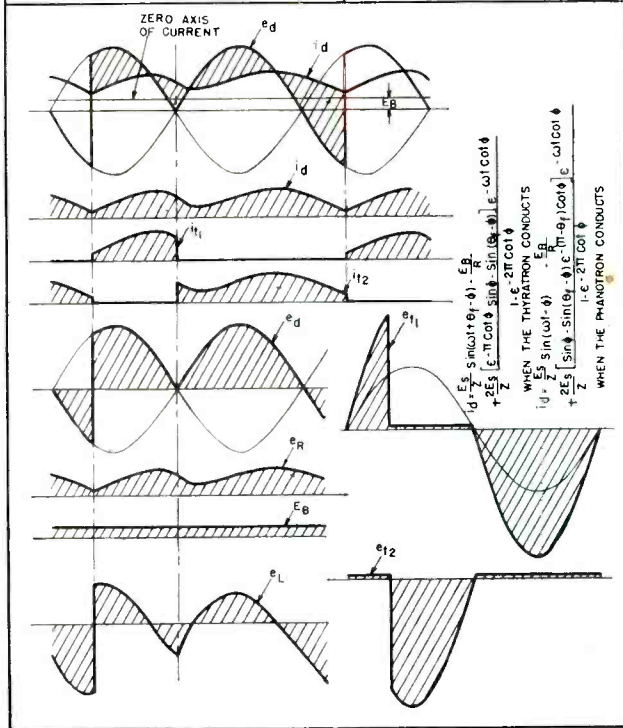
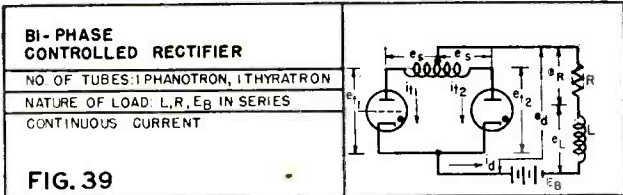
**FIG. 33**



**FIG. 34**







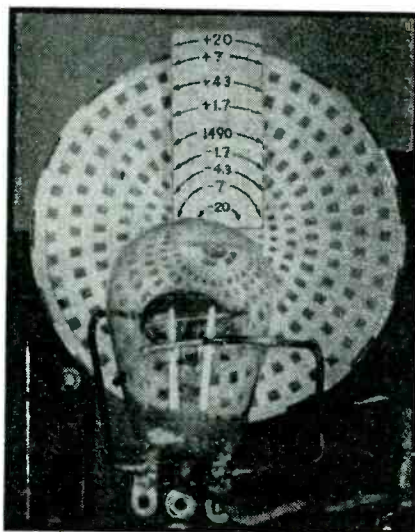
# Frequency Monitor

Simplified operation and accuracy of reading within a tenth of a cycle are provided by a stroboscope used in conjunction with a Western Electric frequency monitor. The unit permits normal operation of the monitor when needed and requires no circuit change

**F**REQUENCY checks at KVOE had been made by pressing a push-button of the frequency monitor 68 times a day. For convenience, the idea of using a stroboscopic arrangement to provide a visual indication of frequency was evolved. This simplifies readings somewhat, saves relay adjustments, and satisfies the radio engineer's ingrained and inherent penchant for accuracy. The stroboscope shows frequency deviations to within a tenth of a cycle.

The unit was designed to operate in conjunction with the Western Electric 1-C frequency monitor. The frequency of the oscillator in the monitor is set 30 cycles above the station's assigned frequency. When the transmitter is on zero beat there is a difference of exactly 30 cycles between it and the monitor frequency and the needle of the FREQUENCY DIFFERENCE meter, with a scale reading 30-0-30, points to center scale or zero. The meter indicates frequency deviations, plus or minus, directly.

The output of the monitor oscillator and the r-f voltage from the transmitter are coupled to a detector having a polarized relay in its plate circuit. Since the detector output contains a beat frequency equal to the difference between the two r-f inputs, the relay armature vibrates, alternately charging a capacitor from the plate voltage supply and discharging it through the meter. Before conversion to type 1-C, the actuating relay was used rarely and only for radical frequency deviations of more than five cycles. The oscillator frequency of the old type 1-A was set at zero beat with the carrier frequency and operation was well within five cycles. Under this deviation, the FREQUENCY DIFFERENCE meter readings were not accurate and



Details of the completed disk which is illuminated by the neon bulb to provide the stroboscopic effect

most operators will recall obtaining readings visually with a millimeter plugged into the HEADPHONES jack. Now the relay is called upon to always vibrate at or near 30 cycles and while it is a well-designed precision item, and readings are accurate to one cycle, it needs adjustment more often.

## Connection to Monitor

The output of the detector appears at the HEADPHONES jack of the monitor and the input to the stroboscopic circuit plugs in here. Thus, no changes are made in the circuit or operation of the frequency monitor itself approved by FCC.

Pulses from the monitor feed into the two-stage amplifier shown in the diagram. This in turn feeds a 2-watt neon lamp which illuminates a disk which is rotated by a synchronous motor. On the disk are dots or squares arranged in circles and spaced according to the frequency indications desired.

In designing the disk, variations will be necessary for different frequency ranges desired, disk speed, and a-c line frequency. Differences in assigned transmitter frequency matter not a whit whether your transmitter is operating on 550 or 1600 kc or anywhere beyond or between.

Assume the transmitter is on zero beat with its assigned frequency and assume also that the monitor is oscillating at the assigned frequency plus 30 cycles, so the beat from the detector circuit is exactly 30 cycles. Now assume the motor turns the disk at 300 rpm on your particular line frequency. This is 5 revolutions per second. The neon lamp is flashing 60 times per second since it flashes on each alternation of 30 cycles. Therefore there are 12 flashes for each revolution of the disk so if we mark 12 dots, spaced 30 degrees apart along a circular line on the disk, this circle of dots will appear stationary when illuminated by the neon lamp. Should the beat frequency be 32 cycles, the circle of dots will appear to move to the right or to the left according to whether the frequency shift is plus or minus.

## Use of Other Lines

Any multiple of 12 will comprise a zero-beat line, so for better visibility use 24 or 36 dots for this line and locate it halfway between the center and the outside of the disk. We will have to avoid any multiples of 12 for the other lines or we'll run into harmonic troubles; so take an odd figure and add to or subtract it from our "primary standard" to construct the other frequency lines.

In the unit illustrated, it was decided to read frequency deviations of plus or minus 1.7 cycles, 4.3

# Stroboscope

By WALLACE S. WIGGINS  
and S. G. GUENTHER  
KVOE, Santa Ana, California

cycles and in-between. We add 1.7 to 12 and use the sum (13.7) in multiples for the PLUS 1.7 cycle line. Subtract 1.7 from 12 and use the difference (10.3) in multiples for the MINUS 1.7 cycle line. And so on for the other lines—as many as you wish, although five or six lines are sufficient for all practical purposes.

## Construction of Disk

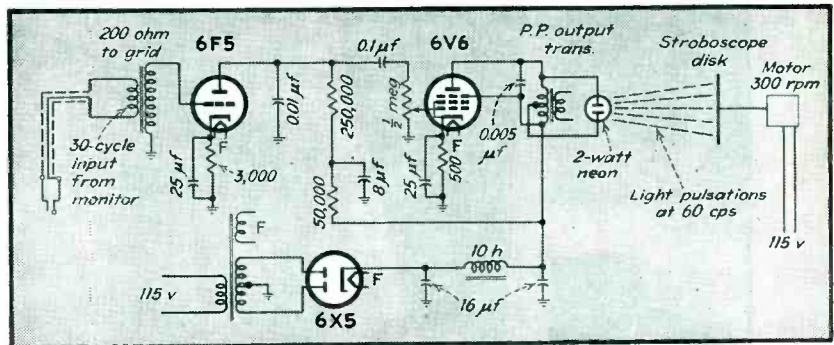
To make the disk, draw it first in pencil on a large piece of drawing paper about five or six times the actual size needed. Plot the number of marks or dots per circle by degrees or fractions thereof with a protractor. Then ink them in with dull black drawing ink. To one side on the same paper, draw an indicating scale that will designate the various values of the lines and make this to the same scale as the disk. Then photograph the drawings, reduce them to the size required, and mount them.

The disk can be mounted on the motor shaft with any suitable tin or cardboard backing. The scale is placed over and clear from it, supported either from the front or back. Mount a viewing lens in the can cover at a convenient angle.

## Operation

Take a reading on the monitor itself, in the usual manner (by pressing the button). Let's say it reads plus 2 cycles. Now squint at the rotating disk and you'll discover the PLUS 1.7 line moving slowly to the left. The PLUS 4.3 line is moving quite rapidly to the right; therefore the actual frequency indication is a little more than 1.7 cycles but considerably less than 4.3 cycles. With a little practice, you'll be able to read frequencies so closely it will make your skin creep.

For example: If the carrier frequency or center line is moving to the right (clockwise) at the same speed that the MINUS 1.7 line is moving counterclockwise, the obvious difference is half of 1.7 or minus 0.85 cycles. The same method



Pulses from the frequency monitor are amplified by the electronic circuit shown above to light the neon bulb on each alternation of the 30-cps signal

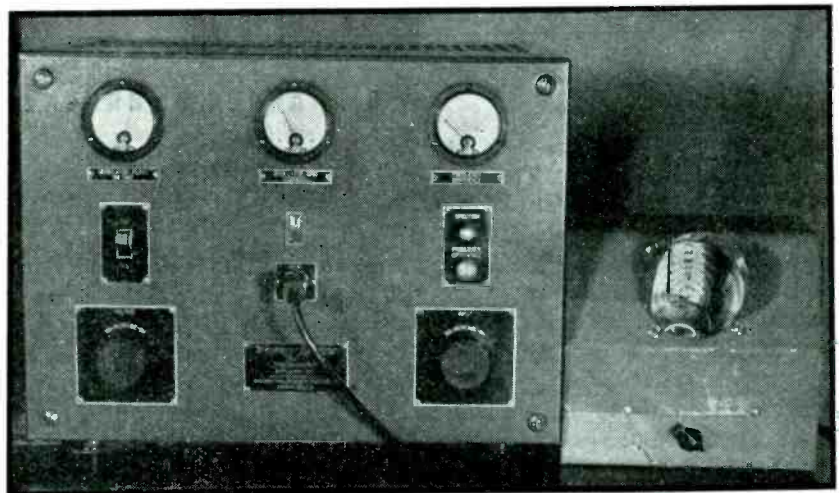
of interpolation is applied to the other lines to compute other fractional differences and you will be able to tell, at a glance, just how many cycles and tenths of a cycle the deviation is.

If your power frequency is dependable, if the computation used in drawing the disk is correct, and if the disk is turning at the speed computed, the indication of the stroboscope must be correct. Check it with the monitor. Change the frequency of the monitor by pushing the DIRECTION button which, on the Western Electric monitor, introduces an artificial frequency deviation. The speed of rotation of the various lines will change accordingly and you should be able to stop any one of them (within a range of 10 cycles), each of which should

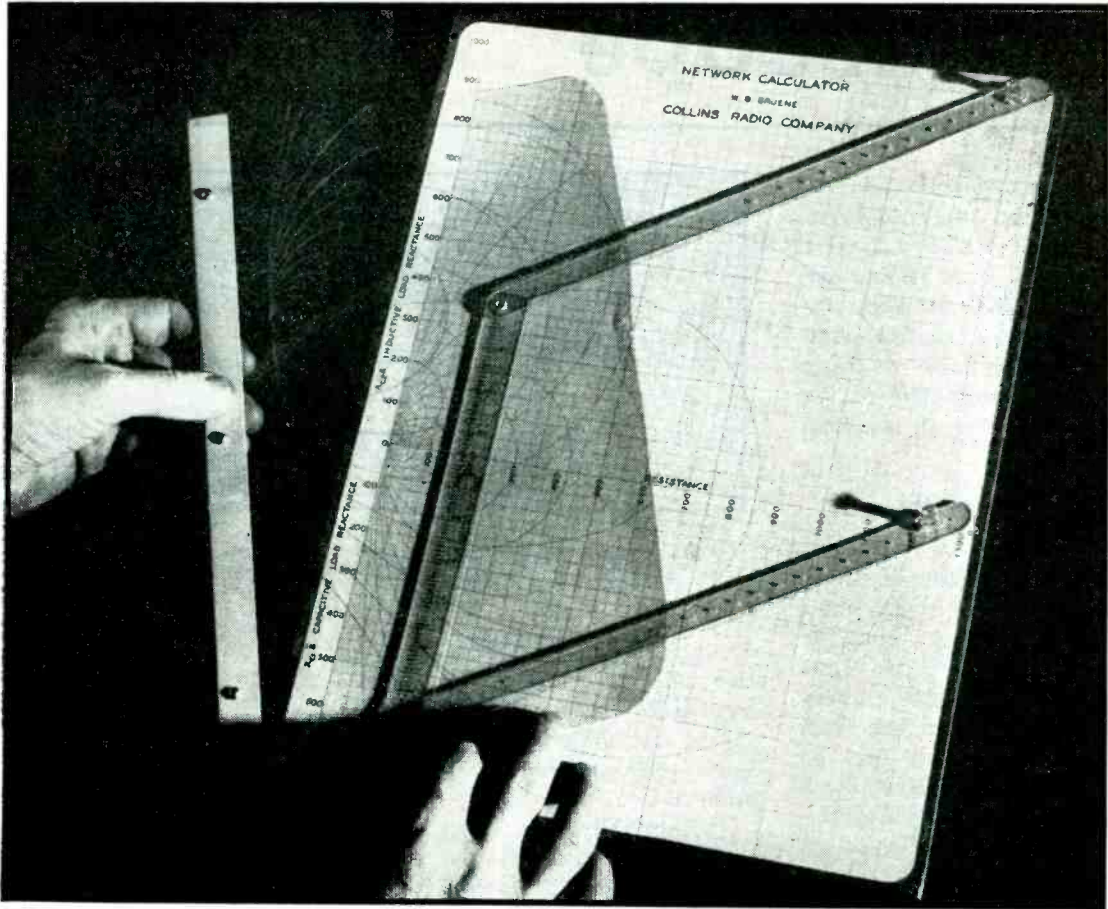
agree rather closely with the reading on the frequency-monitor meter.

## Other Factors

A check with an external standard might be somewhat confusing. This is explained by a possible and often simultaneous drift of transmitter frequency in one direction and a drift of monitor frequency in the other. The monitoring service will tell you the actual frequency of the transmitter only, while your own monitor may have drifted enough in the opposite direction to compensate for the transmitter drift, thereby indicating no drift at all or zero beat. The stroboscope is coordinated with the monitor alone and simply makes the reading easier and more accurate with respect to the monitor.



Frequency monitor and stroboscope set up for operation. A phone plug is the only connection between the two units



This calculator not only gives the solution to pi-network design problems, but also indicates the operating range, effects of tuning and load presented to the tube

# Pi-Network Calculator

Graphical method of calculating reactances for a pi network that will match a given complex load to a given tube plate circuit. Changes in tube loading that are produced by varying the elements of the network can be studied directly from the calculator

By **WARREN B. BRUENE**

*Design Engineer  
Collins Radio Company  
Cedar Rapids, Iowa*

**T**HE PI-NETWORK CALCULATOR described in this article was developed for obtaining rapid solutions of pi-network problems. It is also useful for studying the characteristics and limitations of a pi-network when used to couple an r-f power amplifier to a load. Only one setting of this calculator is necessary to determine all of the unknowns when the load is a pure resistance, and only one more setting is necessary if the load has a reactive component. The graphical solution, which forms the basis for

this calculator, gives a clear picture of the relationship of the elements of the pi-network.

After indicating the function and requirements of a pi-network, the graphical analysis will be made, which will include a brief description of the calculator. The characteristics and limitations of the pi-network and the relationship of the elements will be discussed.

The pi-network, Fig. 1(a), which consists of two capacitors and an inductor, will provide a tank circuit of the desired  $Q$  and also match the tube impedance into a wide range of load impedances. The proper values of the reactances of the pi-network and their practical limits will be discussed.

#### Circuit Design Considerations

One of the first considerations to be made in designing a tank circuit for an r-f power amplifier is the circulating current or  $Q$  of the



FIG. 1—Upper circuit (a) shows the pi-network used to couple the tube plate circuit to the load. The lower circuit (b) shows this physical circuit divided for graphical analysis into two L-sections

tank circuit. Too low a value of  $Q$  will result in poor harmonic attenuation and lowered tube efficiency, while high values of  $Q$  if carried to extremes will result in lower tank-circuit efficiency and sideband clipping on high-fidelity transmission.<sup>1</sup> For most communication purposes a  $Q$  of 10 is a good choice, but usually values from 8 to 20 are satisfactory.

In a common parallel resonant tank circuit, inductively coupled to a load, the tank circuit  $Q$  can be considered as the ratio of the reactance of the coil to the load resistance reflected into it. This is also equal to the ratio of the r-f effective load resistance of the tube,  $R_T$ , to the reactance of the tuning capacitor  $X_{C1}$ .

$$Q = \frac{X_L}{r} = \frac{R_T}{X_{C1}}$$

In this discussion the latter ratio will be considered to be the tank circuit  $Q$  of the pi-network. The value of  $R_T$  can be determined from calculations of the operating conditions of the tube, or more simply, by estimating the r-f plate voltage and the power output and then calculating  $R_T$ . For example, if the d-c plate voltage is 1000 volts, the r-f plate swing for class C operation may be estimated at 800 volts. If the power output is 160 watts, then

$$R_T = \frac{e_{\text{peak}}^2}{2P} = \frac{(800)^2}{2(160)} = 2000 \text{ ohms}$$

#### Development of Graphical Method

For analytical purposes, divide the pi-network into two L networks that match into a common imaginary resistance as shown in Fig. 1(b).

With  $R_T$  known, choose a value of  $X_{C1}$  that will give the desired  $Q$  and then determine  $X_{L1}$  and  $r$ . This is done graphically<sup>2, 3</sup> as shown in Fig. 2(a). This operation converts the parallel resistance  $R_T$  and re-

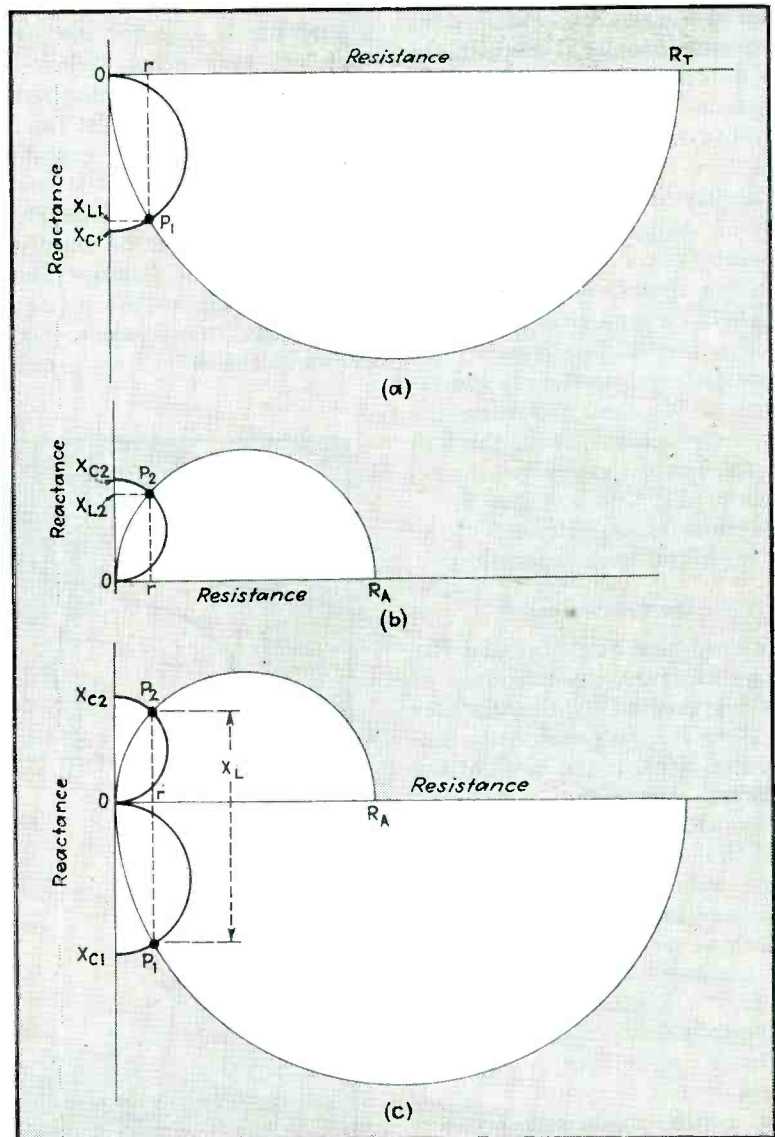
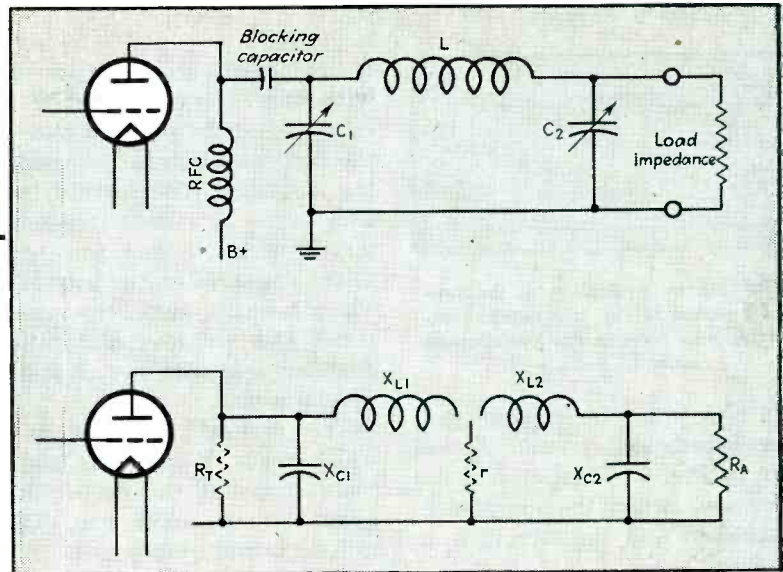


FIG. 2—Graphical methods are used (a) to convert the left-hand half of the circuit of Fig. 1(b) to the equivalent series circuit of Fig. 3, and (b) to obtain the values for the right-hand half of the circuit of Fig. 1(b). These two operations are combined at (c)

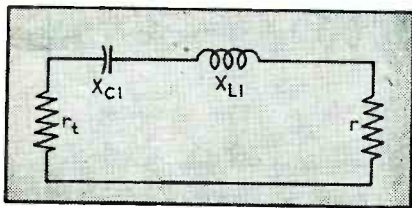


FIG. 3—Series equivalent of the left-hand L-section of Fig. 1(b) matches the effective tube load to the hypothetical reflected load  $r$

actance  $X_{c1}$  to their equivalent series impedances,  $r$ , and  $X_{c1}$ , as shown in Fig. 3. Then  $r = r_t$  and  $X_{L1} = -x_{c1}$  when the impedances are matched and the circuit is in resonance.

Knowing  $r$  and the load resistance, we may determine the reactance of  $X_{L2}$  and  $X_{C2}$ . This is done by the same graphical method, the only difference being that the knowns and unknowns are different. This step is shown in Fig. 2(b).

If a chart is used which has a family of semicircles on each axis, the point  $P_2$  can readily be found by tracing the circle which passes through  $R_A$  around to where it intersects a vertical line from  $r$ . The vertical distance represents the reactance of  $X_{L2}$ , and following the other circle, which passes through  $P_2$ , to the vertical axis gives the reactance of  $X_{C2}$ . Since  $X_L = X_{L1} + X_{L2}$  the value of each element of the pi-network has been determined.

#### The Calculator

If we combine Fig. 2(a) and (b) into one diagram, the reactance of  $X_L$  is represented by the distance from  $P_1$  to  $P_2$ . This composite diagram, Fig. 2(c), is the basis of the pi-network calculator.

When a pi-network is being designed that must cover a wide frequency range and also match into a wide load impedance range many calculations must be made, always using the same value of input impedance,  $R_T$ . The calculator is a device which greatly simplifies these operations in solving a network problem.

The  $\frac{1}{4}$ -inch shellacked plywood base is  $11\frac{1}{2}$  by  $14\frac{1}{2}$  inches. The base chart on which the inductance and resistance circles are constructed

is standard cross-section paper with lines every millimeter. It is cemented to the plywood base with the vertical lines exactly parallel to the left edge. The vertical inductance arm is 0.040 transparent plastic with the inductance graduations engraved on the bottom side. The pivot arms are of the same material and are pivoted to the inductance arm with two close-fitting tubular rivets.

The vertical arm has a scale which reads  $X_L$  in ohms and this scale starts at the center of the pivot with the lower arm. This is called the inductance arm. A hole is drilled in each pivot arm a distance of  $R_T/2$  from the center of the pivots on the inductance arm, and a push pin is used for the pivot in each of these holes. When these pins are placed, it is important that the center of the pivot at the lower end of the inductance arm be exactly over the zero resistance and reactance point on the chart, that the inductance arm be exactly vertical and that the distance from the lower push pin to the upper push pin equals the distance between pivots on the inductance arm. Now

when the inductance arm is moved, the lower end of the inductance scale will automatically follow the circle which passes through  $R_T$ .

The lower end of the inductance arm has two curved lines extending to the left from the pivot point. These curved lines were developed so that for two values of  $R_T$  they would cross the vertical axis of the chart at  $X_{c1}$ . The two values of  $R_T$  chosen for developing these curves were the maximum value accommodated by the calculator and one half of the maximum value. (If the value of  $R_T$  in a problem does not fall between these limits, all scales may be multiplied or divided by some factor so that it will.) These two lines are close together so it is easy to interpolate between them for setting  $X_{c1}$ . With this device, the circles shown in Fig. 2(a) are no longer needed for solving the first half of the network problem.

#### Manipulation of the Calculator

To use the calculator set the curve on the inductance arm at  $X_{c1}$ . Then follow the circle which passes through the load resistance

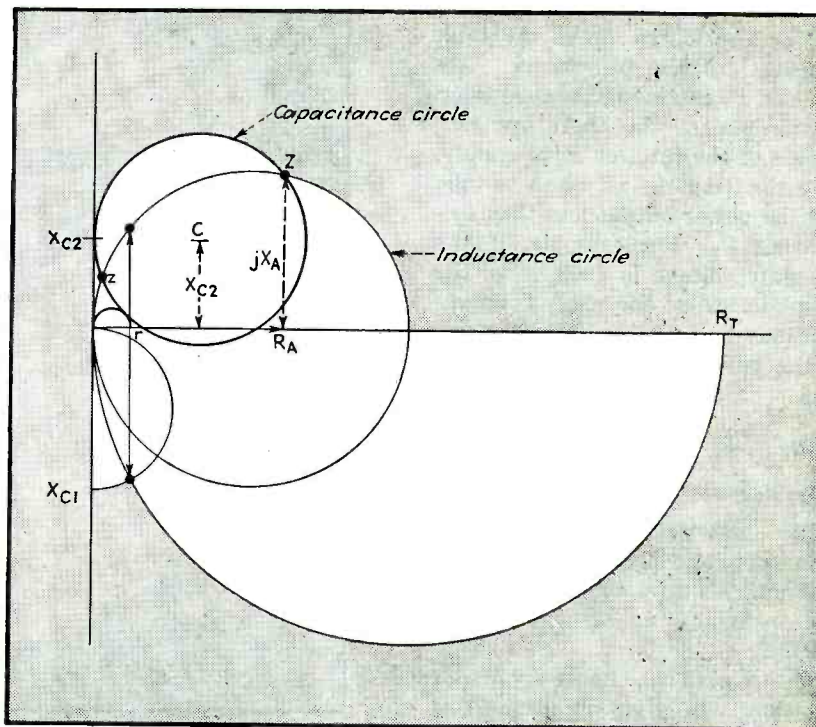


FIG. 4—Addition of a slide carrying circles tangent to the reactance axis permits making matching calculations for reactive loads

$R_L$  up and around to where it intersects the vertical scale on the inductance arm. Read the inductive reactance at this point, then follow the other circle over to the  $x$  axis and read  $X_{C_2}$ .

Up to this point the load has been considered as a pure resistance. If the load has a reactive component, it can be converted into equivalent parallel resistance and reactance. Solve the problem by matching into this equivalent parallel resistance and then correct  $X_{C_2}$  by the amount of the equivalent parallel load reactance. This can be quickly done by converting each reactance into positive or negative capacitance at some frequency by use of a reactance chart.<sup>4</sup> Add, if the load is inductive; subtract, if it is capacitive.

For example, if the load is  $500 - j500$ , the equivalent parallel impedances are 1000 ohms resistance and 1000 ohms capacitive reactance. Assume that the network requires 200 ohms  $X_{C_2}$  to match into the 1000-ohm resistance. At 1 megacycle, 1000 ohms is  $159 \mu\mu\text{f}$  and 200 ohms is  $795 \mu\mu\text{f}$ . The actual capacitance of  $C_2$  is then  $795 \mu\mu\text{f}$  minus  $159 \mu\mu\text{f}$ , or  $636 \mu\mu\text{f}$  and its reactance  $X_{C_2}$  is 250 ohms.

#### Capacitance Calculations

Another simple method was developed which permits  $X_{C_2}$  to be read directly when the load impedance has a reactive component. It was found that the center of a circle, which passes through the load impedance point and is tangent to the  $x$  axis and tangent to a circle whose diameter is  $r$ , is a distance  $X_{C_2}$  above the zero reactance line.<sup>5</sup> This circle is shown in Fig. 4.

The capacitance slide has a family of circles which are all tangent at a common point, and is constructed so that it can be slide up and down with this common point of tangency always on the  $x$  axis. The circles are scribed on 0.010 transparent plastic sheet, and a guide is fastened to the sheet with screws.

To use this device, slide it up or down so that some circle or interpolation between circles passes

through the load point and is tangent to a circle whose diameter is  $r$ .  $X_{C_2}$  is read at the line on the slide which is on the horizontal diameter of the family of circles. This works the same way when the load has a capacitive reactance as when it has an inductive reactance.

#### Interpretation of Calculator Results

In Fig. 4 it should be noted that the circles intersect at two points. This other point,  $z$ , is the other value of load impedance that the network will match into as well as  $Z$  and it represents the condition beyond critical coupling. When the load impedance is low and inductive,  $Z$  and  $z$  may be close together and the network can be tuned for either operating condition. It is easy to know when one is operating at point  $z$  because an increase in the loading capacitance,  $C_2$ , will increase the loading; whereas, when operating normally (at point  $Z$ ) decreasing the capacitance of  $C_2$  increases the load on the tube.

For practical purposes there are several factors which limit the range of load impedances that the pi-network will match into. The network will not match into load impedances in the area below the semi-circle whose diameter is  $r$  and extending down to negative infinity, as illustrated in Fig. 5. This area can be reduced by increasing the circuit  $Q$  as this decreases the value of  $r$ .

Another common practical restriction is caused by the minimum and maximum capacitance of capacitor  $C_2$ . At minimum capacitance the reactance  $X_{C_2}$  will be highest so that the load impedance must be inside a circle tangent at  $X_{C_2}$  and also tangent to the circle whose diameter is  $r$ . At maximum capacitance  $X_{C_2}$  is at its minimum so the load impedance is restricted to an area outside of a circle tangent at  $X_{C_2}$  and to the circle whose diameter is  $r$ . This latter restriction exists only when the network is always adjusted to a point less than critical coupling.

The most important restriction is the maximum safe operating voltage for capacitor  $C_2$ . This capacitor has the same voltage across it as

the load. For example, if the maximum safe voltage across  $C_2$  is 2000 volts peak and the power output is 1000 watts, the maximum load resistance is

$$R = \frac{E^2}{2P} = \frac{(2000)^2}{2(1000)} = 2000 \text{ ohms}$$

for an unmodulated carrier. If the carrier is amplitude-modulated 100 percent, the above value of load resistance must be divided by two and is then only 1000 ohms. If the load has a reactive component, the maximum impedances, which have

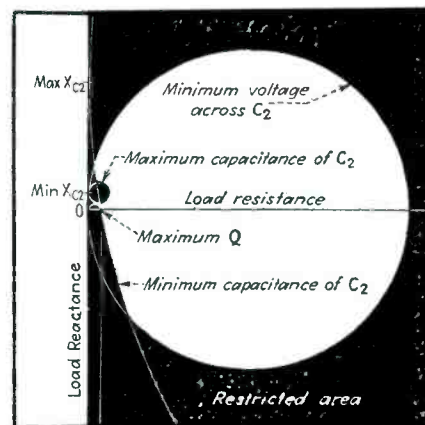


FIG. 5—Impedance transformations possible with a pi network limit the load that can be matched to within the area indicated by the calculator

the same load voltage, lie on the circle which passes through the load impedance point and is tangent to the  $x$  axis and tangent to a circle whose diameter is  $r$ . It is seen that a load impedance of  $500 + j500$  will have the same voltage for a given power output as 1000 ohms pure resistance. The inductance circles on the calculator can thus be used as constant load-voltage circles.

In determining the above restrictions, it was assumed that the inductance could be adjusted to any necessary value. The maximum amount of inductance required is determined at the lowest frequency at which the network is to be used by using the desired amount of  $X_{C_2}$  and making a calculation on the amount of inductive reactance necessary to match to the highest load impedance to be encountered. For lower load impedances and higher frequencies, the coil can be tapped to secure lower inductance. In practice, a considerable fre-

quency range and load impedance range can be covered on a given tap position by just tuning the two capacitors. The limit to the frequency range which can be covered is determined by the maximum and minimum values of  $Q$  desired. For a given load, when the frequency is increased, the capacitances will decrease and so will the  $Q$ . When the minimum desired  $Q$  is reached, the coil is switched to the next lower tap, which is located so that the network will have the maximum desired value of  $Q$  when retuned. If the load impedance is lower (or higher), the same tap will be changed at a higher (or lower) frequency.

Balanced or push-pull pi-network problems can be solved with this calculator by considering only one-half of the network as working from one tube into one-half of the load impedance. The two halves of the balanced pi-network have identical reactances.

The accuracy of the calculator depends on its physical size and the precision used in making it. The original calculator was accurate to about 5 ohms when determining the reactances of the pi-network elements except that it becomes less accurate when  $r$  becomes

very small ( $Q$  becomes high). In general, the results are as good or better that can be obtained using a slide rule. Because the number of operations to be performed on the calculator are few, chances for mathematical errors are greatly reduced when designing any type of pi-network.

A very interesting study of the relationship of the elements of the pi-network can be made with this calculator. There are three reactance elements in the pi-network plus the input resistance and the load impedance, any one of which may be varied to observe the effect on another.

#### Circuit Analysis

For one example, illustrated in Fig. 6, consider  $R_T$ ,  $X_{C1}$ , and  $X_L$  fixed and observe the locus of load impedances that can be matched by varying only  $X_{C2}$ . Any load impedance which lies on the inductance circle, which passes through the value of  $X_L$  on the inductance arm, can be matched by varying only  $X_{C2}$ . As the load impedance point moves clockwise around this circle the reactance of  $X_{C2}$  increases (capacitance decreases).

When  $R_T$ ,  $X_{C1}$ , and  $X_{C2}$  are fixed, the locus of load impedances, shown

in Fig. 7, which can be matched by varying  $X_L$ , lies on the sliding capacitance circle which is tangent to the circle whose diameter is  $r$ . As the load impedance point moves clockwise around this capacitance circle, the reactance of  $X_L$  decreases.

#### Prediction of Tube Operation

A graphical picture of what happens when the pi-network, shown in Fig. 1, is tuned up is shown in Fig. 8(a). The load impedance,  $R_L$  is a fixed resistance and a value of  $X_L$  is chosen which will result in a satisfactory circuit  $Q$  when the network is tuned for proper loading of the tube and for resonance. The tube resistance  $R_T$  depends on the load placed upon the tube. When the tube is lightly loaded  $R_T$  will be high and when it is loaded heavier,  $R_T$  will be less. The adjustments of  $C_2$  and  $C_1$  serve to load the tube to the desired power input (or output) and to tune the circuit to resonance.

This graphical construction shows the relationship between  $X_{C2}$ ,  $X_{C1}$  and load resistance on the tube. The one pivot arm must pivot on the center of the circle which passes through the load resistance. If  $X_{C2}$  is increased and  $X_{C1}$  is decreased to bring the network back

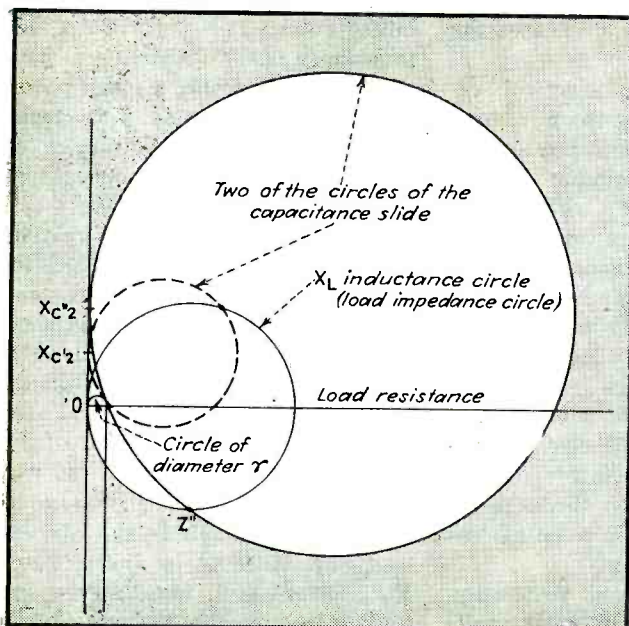


FIG. 6—Impedances that can be matched by varying  $X_{C2}$  are determined by settings of the capacitance slide

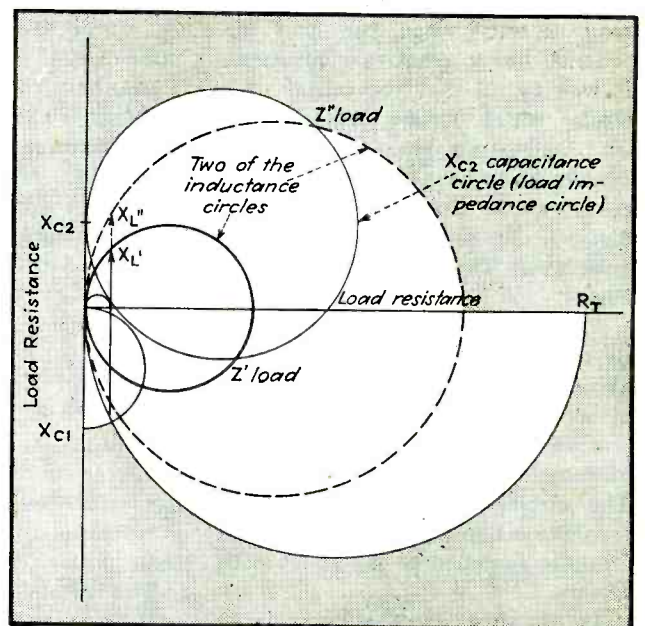


FIG. 7—Impedances that can be matched by varying  $X_L$  with all other parameters constant can be found

MORE OFTEN THAN NOT THE **CRYSTAL SOCKET** IN SERVICE IS A **CINCH**



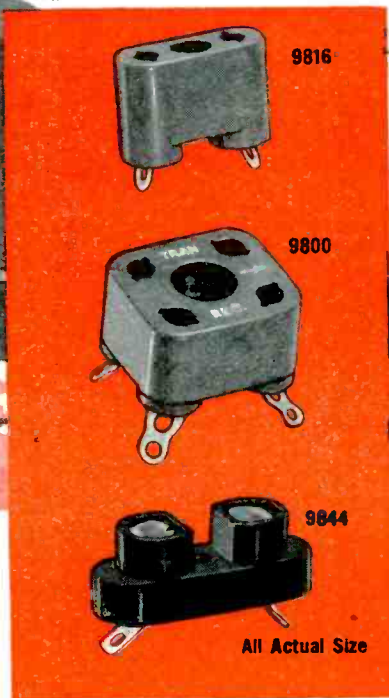
it's "know how"

At the heart of Radio Communication is a crystal, and through a crystal socket it is connected to the working parts of the radio set. The design of the molded parts, the control of contacts, the proper assembly, are all vital

elements in the successful operation of most every form of military communication. Those sockets illustrated are all production items; we have others and can adapt our facilities to your own special problems.

## **CINCH** MANUFACTURING CORPORATION

2335 W. Van Buren Street, Chicago 12, Illinois  
Subsidiary of United-Carr Fastener Corp., Cambridge, Mass.



• The NEW CINCH catalog, 140 pages describing metal parts and metal plastic assemblies.

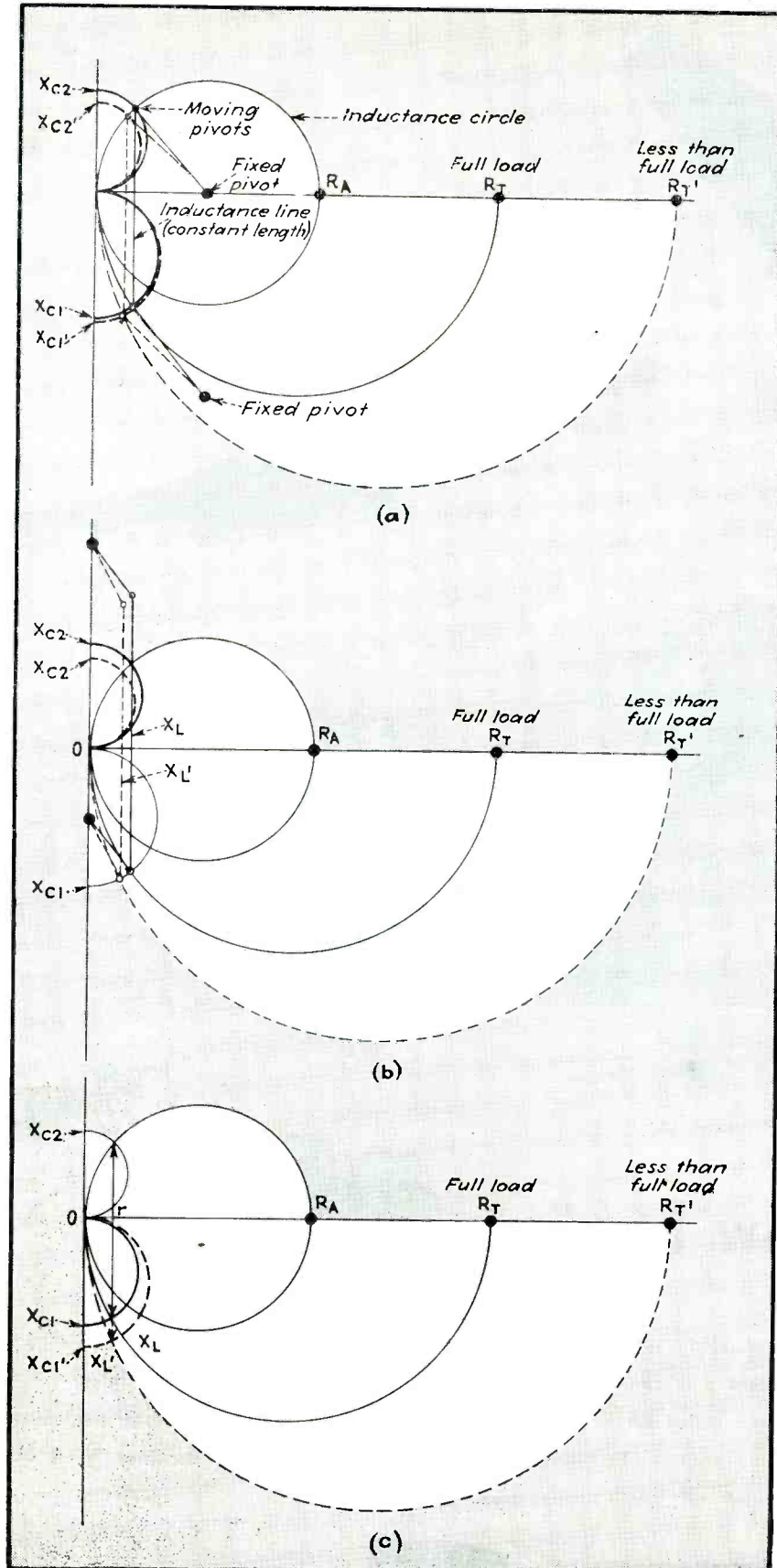


FIG. 8—(a) Effect on tube loading of varying the tuning capacitors is readily shown on the calculator. Other variables can be used such as (b)  $X_L$  and  $X_{C2}$  or (c)  $X_L$  and  $X_{C1}$  and the effect on the load that is reflected back to the tube can be studied

into resonance, then  $R_T$  is found to be less, which means that the tube is loaded more heavily.

This operation is just the opposite of what the calculator was intended to do, but it can be done easily if the fixed pivot on the lower pivot arm is located a distance equal to  $X_L$  exactly below the center of the inductance circle which passes through the load resistance,  $R_A$ .

Figure 8(b) shows the relationship when  $X_{C1}$  and  $R_A$  are fixed and tuning is accomplished by varying  $X_L$  and  $X_{C2}$ . The calculator can also be set to perform this calculation if it is desired.

If  $X_{C2}$  is fixed and  $X_{C1}$  and  $X_L$  are the variables, the construction is rather simple and is shown in Fig. 8(c).

### Conclusions

In conclusion, it is suggested that a simple and inexpensive calculator can be made which is based on the construction shown in Fig. 2(c). A family of circles with their centers on the horizontal axis, and also the two families of semicircles with their centers on the vertical axis, are constructed on millimeter ruled paper as was used for the base chart for the calculator. A transparent centimeter scale can be used for the inductance scale. The end of the scale is placed on point  $P_1$ , with the scale placed in an exactly vertical position. The inductance can be read off on this scale at point  $P_2$  using the same scale (ohms per centimeter) as used on the base chart.

This base chart is also useful for other purposes, as for calculating L-network reactances and converting series resistance and reactance to their equivalent parallel resistance and reactance.

### REFERENCES

- (1) Newhouse, Arvid B., Power Amplifier Plate Tank Circuits, *ELECTRONICS*, 14, p. 32-35, Nov. 1941.
- (2) Paine, Robert C., Geometric Solutions for Resonant Impedance Transforming Networks, *Radio*, p. 36-37, 59, Oct. 1943.
- (3) Toombs, R., Chart for Equivalent Series and Parallel Circuits, *ELECTRONICS*, 16, p. 109-110, Apr. 1943.
- (4) Lorenzen, R., "A-C Calculation Charts," John F. Rider, Publisher, Inc., 1942.
- (5) Smith, Phillip H., L-Type Impedance Transforming Circuits, *ELECTRONICS*, 15, p. 48-54, 125, Mar. 1942.

# Building Tomorrows into Today's Products



IF George Washington could have owned a modern electric refrigerator, it might not be a museum piece today. Judging by performance tests of Mallory contacts for refrigerator motors, 194x's electric refrigerator could have cooled the drinks and preserved the food of George Washington and be capable of performing the same service for today's guests at Mt. Vernon.

Taking nothing for granted, a refrigerator manufacturer put Mallory, silver-faced steel-backed, standard SUR 32 contacts to the following accelerated test—and translated service life into years of use.

TEST	OPERATION CYCLES	HOUSEHOLD SERVICE EQUIVALENT	CONDITION OF CONTACTS
#1	1,556,000	85 years	Good
#2	2,134,000	171 years	Good
#3	3,075,000	168 years	Good
#4	3,230,000	177 years	Good
#5	3,277,000	180 years	Good

Mallory contacts are used on refrigerator motors to cut out the starting winding after full motor speed is obtained. Under adverse conditions, a refrigerator motor goes through fifty such operations in twenty-four hours. Speeding up the time interval to 512 operations per hour on five motors, running at 1750 R. P. M., it was demonstrated that Mallory contacts could operate perfectly for 85 to 180 years and *still be in good condition*. This again is indicative of the built-in quality of Mallory contacts which assures faultless service from standard contacts engineered to out-live the product for which they were designed.

## MALLORY STANDARDIZED CONTACTS



These Mallory contacts are manufactured by a patented process which bonds the silver face directly to the steel back . . . carry higher current without overheating. Steel backs are nickel plated to resist corrosion. Write today for factual information on Mallory contact and contact assemblies available in standard sizes.



P. R. MALLORY & CO., Inc., INDIANAPOLIS 6, INDIANA

P. R. MALLORY & CO. Inc.

# MALLORY

**ELECTRICAL CONTACTS AND CONTACT ASSEMBLIES**

# INDUSTRIAL CONTROL

Photoelectric Gaging of Piston Rings.....	148
Industrial X-Ray Installations in Ford Plant.....	148
Crack Detector for Bottles and Jars.....	150
Frequency Meter for Use by Factory Personnel.....	150
Industrial Oscillograph for Impulse Testing.....	154
Automatic Position Indicator for Aircraft.....	180
50,000 Hours for C-R Tube.....	192

## Photoelectric Gaging of Piston Rings

TO ELIMINATE the human element in production checking of piston rings and thus attain a very high degree of accuracy, a new electronic instrument automatically inspects the trueness of periphery and the



Piston rings are inserted in a master ring and rotated under a light beam for electronic checking of true and width of gap

width of gap of a specific size of piston ring. Inspection is much faster than present hand-checking methods and the production rate is determined by the speed at which the rings are presented to the gage. The inspection cycle per piece is less than five seconds.

The piston ring to be checked is inserted inside a master ring of correct dimensional quality which is placed on the instrument table and rotated by a power-driven roller. The gaging functions are performed by scanning beams of light directed onto phototubes which energize electronic circuits to illuminate three signal lights.

As the ring revolves, one beam of light is projected on the periphery of the piston ring. A clearance between it and the master ring will result from any out-of-round con-

dition of the piston ring, permitting part of the light beam to fall on the phototube. This actuates a red rejection signal should an excessive amount of light indicate that the piston ring is out-of-round beyond an acceptable point.

If the periphery is within tolerance limits, a green signal flashes on at the end of one complete revo-

lution provided the width of gap is also within tolerance. The beam of light is interrupted by a mechanical shutter arrangement at the time the gap is passing this point.

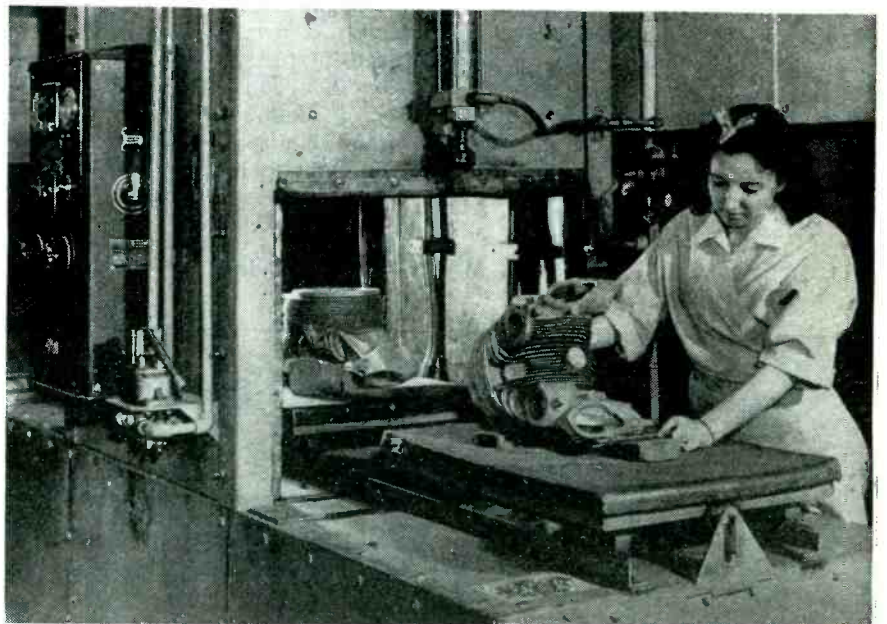
Another beam of light scans the width of gap and actuates a yellow signal should the gap be undersize. A third beam of light energizes another circuit to illuminate the red rejection signal should the width of gap be oversize.

Master piston rings of known dimensional quality are used in adjusting the instrument for the desired tolerances. Made by The Sheffield Corporation, the instrument can be adapted to various nominal sizes, gaps of varying width, and also for variations on the allowable out-of-roundness of the periphery. Trueness of the periphery can be determined within a tolerance of 0.0001 inch.

## Industrial X-Ray Installations in Ford Plant

OF ALL THE WAR PLANTS throughout the country, Ford Motor Company is a leading user of x-ray industrial equipment. Radiation at voltages from 5,000 to 1,000,000 covers the entire range of industrial radiography, from the study of very thin samples by microradiography to inspection of steel castings eight inches thick.

Castings passing through a Ford production x-ray department are segregated into groups according to the x-ray unit best adapted for their examination. Sorting tables, numbering machines, and record entries precede the transfer to gravity conveyors where operators place the castings, with proper fixtures and identification numbers,



Cast aluminum cylinder heads for 2,000-hp Pratt & Whitney aircraft engines are placed on lead-covered trays and rolled into the cabinet for x-raying. A pneumatically operated door is closed during exposure for protection of the worker. About 700 exposures are made per day



# COMPACT!

NO. 6 IN THE NEW IRC PRODUCT PARADE

## IRC'S NEW FINGERTIP CONTROL ANSWERS SPACE-SAVING PROBLEMS

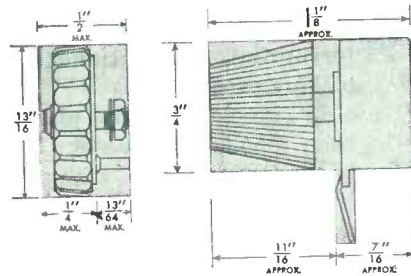
No bigger 'round than a nickel and wafer thin, this new Fingertip Control will find many important applications in miniature electronic devices. An all-inclusive unit, its unique design eliminates the usual bulky knob, shaft and bushing without any impairment of functional operation.

Of neat appearance and available in either black or colors, this Type H control is intended for edgewise installation. A light-pressure, fingertip rotation of the knurled edge of the cover permits ready resistance adjustment.

Embodying suitable mechanical strength and many of IRC's famous features as found in Type CS and D controls, the Fingertip Control has a rotation of 290°, a power rating of 0.25 watts and 500 ohms to 3 megohms, as standard resistance values. Fingertip Control may be had with linear taper or with standard audio tapers.

Inquiries are invited from interested manufacturers of hearing aids and other miniature equipment. Engineering Bulletin on the Type H control is now in preparation.

**OCCUPIES LESS THAN HALF CUBIC SPACE REQUIRED FOR CONVENTIONAL TYPES**



# INTERNATIONAL RESISTANCE CO.

Dept. I-E

402 NORTH BROAD STREET • PHILADELPHIA 8, PA.

IRC makes more types of resistance units, in more shapes, for more applications than any other manufacturer in the world.



AN 3135  
Rheostat



BTR—1/4 watt  
Insulated Resistor



BTA—1 watt  
Insulated Resistor



Grade 1g—Class 1  
Resistors



Type FRW  
Resistor



Fingertip  
Control

COMING...COMING...

on cassettes which hold the film. The castings are manually pushed onto the conveyor belt which carries them into the x-ray exposure chamber and out the opposite side according to a set cycle of operations. After radiography, the castings usually are stored in numbered bins until final disposition can be made after study of the x-ray films.

Two General Electric million-volt industrial x-ray units routinely inspect, in 16 minutes, the same number of steel parts that required 60 hours with low-powered apparatus. One of these units is in the \$27,000,000 aircraft engine buildings at the River Rouge plant, which has been turning out 2,000-hp Pratt & Whitney engines, and the other is in a new steel foundry.

The million-volt unit at the aircraft engine plant is used to x-ray heavy steel castings, turbo-supercharger parts, and a wide assortment of bomber and glider castings for faults such as blow holes, tears, shrinkage cavities, inclusions and cracks.

Ford engineers have found that the million-volt unit can examine 64 times the volume formerly x-rayed with their 400,000-volt unit, and 24 times the volume possible with radium of average amount in the same floor area and with the same handling facilities.

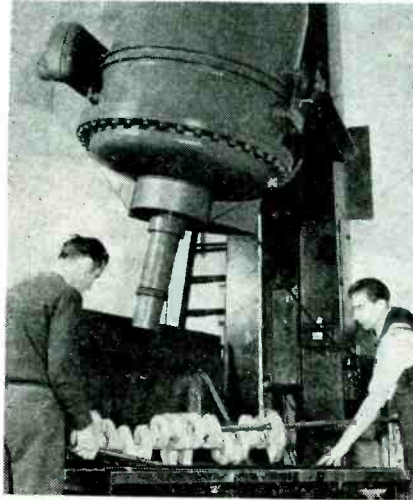
#### *Multiple Inspection*

Because of the large spherical angles available for useful radiographic examination with the million-volt apparatus, a large number of castings can be examined at each exposure. The limiting factor on the number that can be examined each day is almost entirely dependent upon the handling facilities. As many as 50 films have been simultaneously exposed.

The other million-volt unit in the steel foundry examines unmachined crankshafts for the Ford-built 500-horsepower tank engine, and also heavy castings for the M-8 light-armored car.

Every crankshaft built into a Ford V-8 tank engine undergoes radiographic inspection with the million-volt unit. Each shaft is three feet long and weighs about 250 pounds. To speed up examination, Ford technicians ingeniously

designed a wooden fixture so that 12 of the big crankshafts could be x-rayed at one time. They are fitted into the fixture which is placed on



A crankshaft casting for a Ford V-8 tank engine being placed in position for x-raying by a General Electric million-volt industrial unit

a large lead-covered truck operating on tracks. Three different exposures are taken from different angles. The films in cassettes are placed in racks under points where the crankshafts are suspended in

the fixture. The cassettes slide out quickly for changing. It requires 34 minutes to x-ray all 12 crankshafts one way. Another 18 minutes is necessary to radiograph separately two groups of six crankshafts each from a different angle. These two exposures take 36 minutes or a total of 70 minutes to completely radiograph all 12 crankshafts in three exposures.

After the films are developed, any defective crankshafts are removed for salvage, and the good ones are stamped with a star showing they have passed x-ray examination.

In the steel foundry, the designer and foundryman together use radiography in determining both the best design for the castings and the best way for producing it. Initial castings are radiographed and melting, temperature of the pour, location of gates and risers, ramming, shrinkage, and many other factors affecting quality are studied. The design itself, or the casting procedure, may be changed as a result. It has been found that by this method better castings are produced, with savings of time, materials, and money.

## Crack Detector for Bottles and Jars

FLAWS, such as minute cracks and surface irregularities that prevent airtight sealing of glass jars, can be detected electronically without interrupting the continuous bottle-making process.

In one glass-making plant it had been found that two out of every hundred containers with flaws escaped detection by human inspectors. With the new technique, developed by General Electric in collaboration with Hartford-Empire Co., even those flaws barely visible to the naked eye are rapidly de-

tected.

In operation, the containers automatically move in front of a phototube and are whirled rapidly under a strong light. Since the phototube is not affected by a steady light, the light reflected by perfect glass produces no effect. Any imperfection on the edge of the jar causes the lightbeam to flicker and this modulation of the intensity of the beam causes an electronic amplifier connected to the phototube to operate and cause the jar to be rejected.

## Frequency Meter for Use by Factory Personnel

By W. R. STRAUSS

*Project Engineer  
North American Philips Co.*

WAR INDUSTRIES that use audio frequencies in measurement work have use for a frequency meter that measures from ten to 50,000 cycles and that can be operated by non-technical personnel, after a few minutes instruction. To fit these requirements, engineers at North American Philips designed

the unit illustrated for use in their plant.

The frequency meter they developed has sufficient power to operate a strip-chart recorder without an auxiliary amplifier regardless of voltage variations between 2 and 200 volts.

The input circuit consists of a

Wherever You Need CONSTANT D. C. VOLTAGE OUTPUT . . . . Put In a  
**HARVEY REGULATED POWER SUPPLY 106 PA**

0-140 MA. at 200-300 volts with  
1% regulation.

Output remains constant within  
1% even though line voltage  
varies between 95-130 vols.

Two separate filament voltages  
are available. 6.3 volts, 5 amps.  
each. Easily accessible from rear.

Exclusive: Windings are phased  
and so designed that parallel  
operation is possible if desired,  
thus 6.3 volts at 10 amps. is  
available.

Ripple content is better than 10  
MV. The advantage of this is  
apparent upon reflection that the  
usual specification is 1/10 of 1%.  
That really means 300 MV.

Write for HARVEY 106 PA  
bulletin today.

**HARVEY**

OF CAMBRIDGE

**HARVEY RADIO LABORATORIES, INC.**

439 CONCORD AVENUE • CAMBRIDGE 38, MASSACHUSETTS

limiter as shown in the diagram. This stage employs resistor  $R_1$  to bias the control grid of the input tube on the peaks of a cycle.

In clipping the peaks of a cycle,

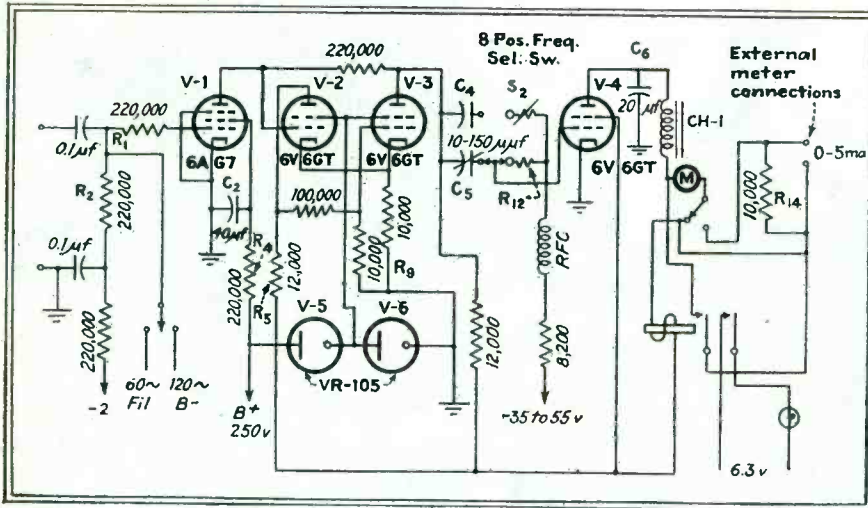
At V-1, a type 6AG7 was found to be best from the standpoint of high transconductance and high screen-grid wattage dissipation. The input sensitivity is slightly

current changes are directly proportional to grid voltages.

### Safety Circuit

External and panel meters are protected from burnout by a relay in the plate circuit of V-4. The relay shorts the meter when current exceeds 10 ma and releases at about 4 ma. The meter circuit is arranged to permit reading the panel and external meters simultaneously. Accurate frequency indication on the external meter is only limited by the meter itself. If a recorder is used, overshooting and undershooting of the pen (determined by chart paper travel) must be taken into consideration. If the frequency meter is accurately calibrated and stabilized, the inherent circuit error will be less than 2.0 percent of full scale over the entire range of 10 to 50,000 cycles.

An RC network having a long time constant ( $C_6$ ,  $CH_1$ ) is incorporated into the plate circuit of V-4. Without the RC network, some recorder pens resonate badly at 100 to 130 cycles with the selector



Circuit of electronic meter for production testing of frequencies between ten and 50,000 cycles. A linear direct-reading dial permits rapid reading by non-technical personnel

the output shows a square wave with steep fronts. The square wave results regardless of whether the input frequency is a pure sine wave or one with distortion and irregularities. In case of a badly distorted wave, the grid circuit will favor the predominant frequency over the lesser peaks by a ratio of about 3 to 1.

### Floating Screen

Plate output voltage of tube V-1 is held constant by a floating screen grid. Since plate current changes are a function of screen voltage, increase of audio input voltage results in a decrease of screen voltage. This, in turn, is affected by the bias developed across  $R_1$ . Screen voltages reduce proportionately with increase of grid bias developed across  $R_1$ . Stabilization of screen resistor  $R_4$  to ground, or B- with a bleeder resistor, would limit the range of constant output to a narrow band of frequencies. Capacitor  $C_2$  is an audio bypass to prevent any part of the original wave shape from entering the plate circuit. The RC time constant of  $R_1$  and  $C_2$  is sufficient to delay any small part of the original wave from coinciding with the square wave, thus avoiding valleys and discharge peaks.

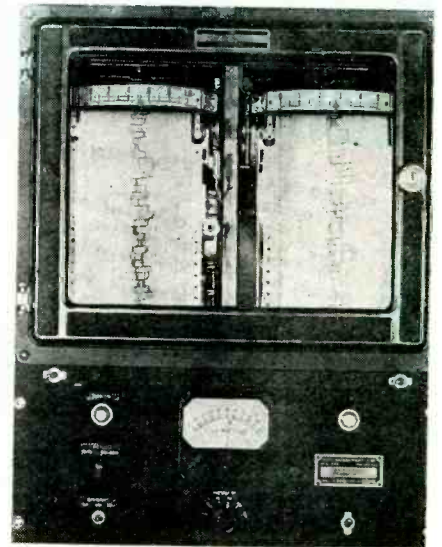
more than one volt, for almost all frequency ranges. Input impedance is greater than 100,000 ohms for most frequencies but not higher than the value of  $R_2$ .

### Multivibrator as Amplifier

The multivibrator circuit formed by V-2 and V-3 is directly connected to the plate of V-1, and is at rest by virtue of bias-resistor  $R_3$ . The value of  $R_3$  is selected to permit the multivibrator circuit to operate at the instant a square-wave voltage is present at the plate of V-1. The multivibrator circuit has no resonant characteristics; its function is to amplify the output of V-1 without alteration.

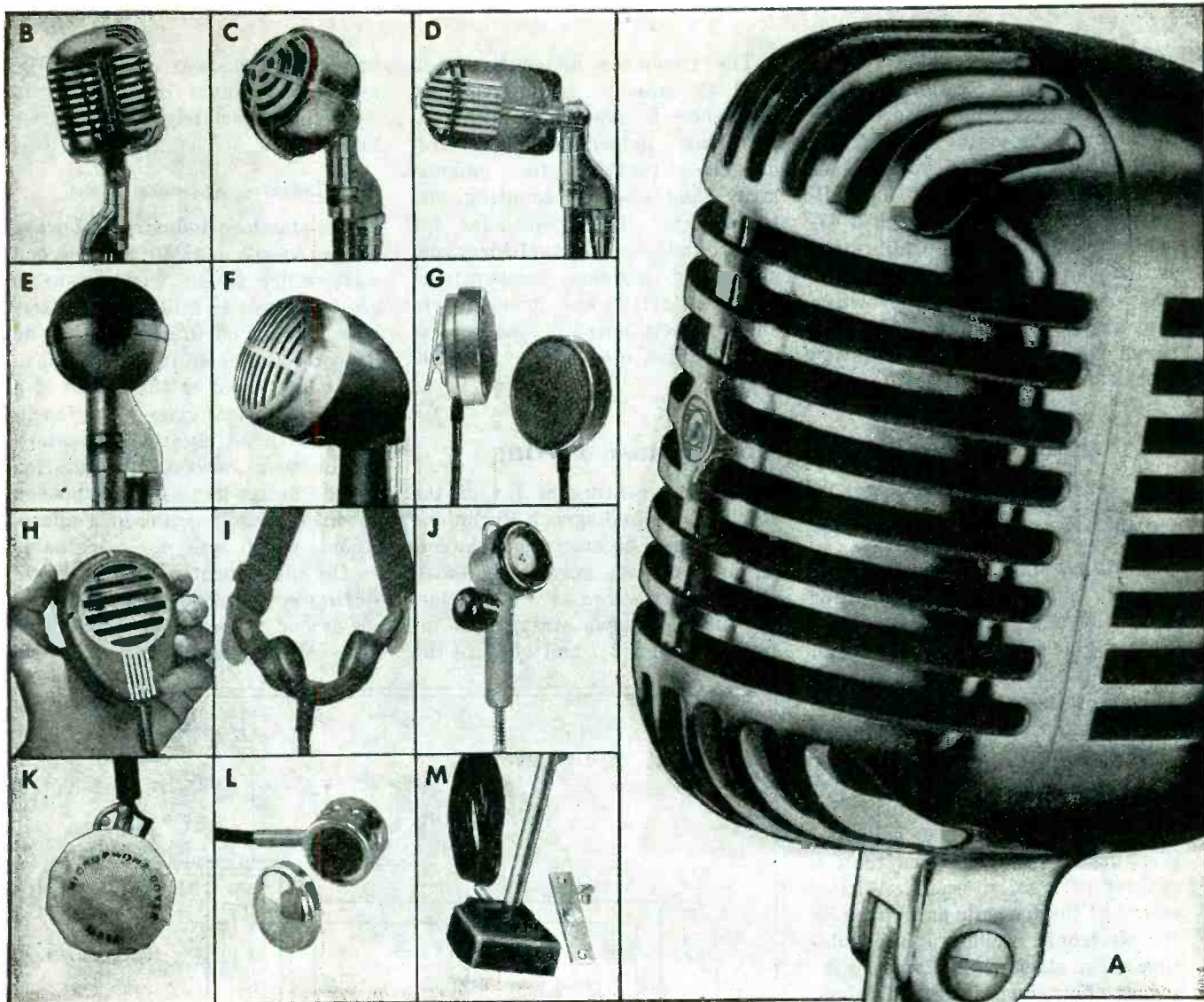
Amplified square waves are then fed into an RC integrating network ( $C_6$ ,  $R_{12}$ , etc.) which determines the amplitude of the pulse that is to appear on the grid of V-4. Capacitors in the frequency-selector circuit are either air-type trimmers or silver-mica types having negative coefficients to minimize calibration drift caused by heat within the instrument.

Operation of the V-4 tube circuit is similar to class C audio amplification. The grid bias is adjusted to zero plate current with no signal input. This circuit functions as a linear amplifier in which plate



The 5-ma recorder at the top of the photo is driven by the direct-reading frequency meter of the lower panel without an auxiliary amplifier

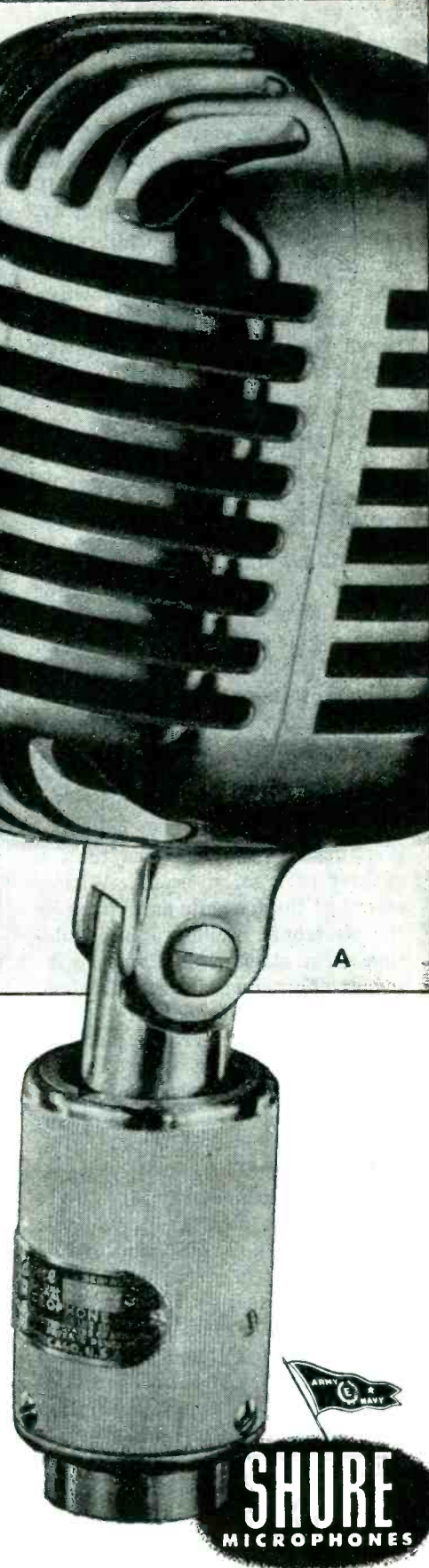
switch ( $S_2$ ) set on 100 or 500-cycle positions. External meters having a 5-ma movement and a coil resistance not exceeding 1000 ohms may be used without recalibration. An external meter-damping resistor,  $R_{14}$  of 10,000 ohms, was chosen as an optimum value and accommodates most recorders without



## —Your Microphone is here

As outstanding manufacturers of microphones for war —Shure offers a complete microphone line. You will find the proper microphone for every need above. A complete description of any model will be furnished upon request.

- |                                     |                           |
|-------------------------------------|---------------------------|
| A. Super-Cardioid Broadcast Dynamic | G. Lapel Microphone       |
| B. Unidyne Cardioid Dynamic         | H. Military Carbon        |
| C. Uniplex Cardioid Crystal         | I. Throat Microphone      |
| D. Stratoliner Dynamic              | J. Carbon Hand Microphone |
| E. Laboratory Non-Directional       | K. Mask Microphone        |
| F. "Economy" Crystal                | L. Stethophone            |
|                                     | M. Vibration Pick-up      |



# SHURE BROTHERS

Designers and Manufacturers of Microphones and Acoustic Devices

225 West Huron Street

Chicago 10, Illinois

affecting calibration.

For frequency calibration 60 cycles at 6.3 volts is obtained from the filament leg of the transformer and 120 cycles at 2.5 volts comes from the B-minus leg of the full-wave power rectifier through a 47-ohm resistor. The calibration switch is normally open (center position) as shown. Selector switch  $S_2$  is placed on the 100 or 500-cycle range when making a calibration check.

## Industrial Oscillograph for Impulse Testing

By OTTO ACKERMAN

Protective Device Engineering  
Westinghouse Electric & Manufacturing Co.

THE INDUSTRIAL ELECTRONIC oscillograph is largely responsible for recent advances in design of aircraft engine ignition systems, high voltage insulation, circuit breakers, and lightning arresters. Investigation of the electrical phenomena associated with these devices requires the measurement of non-repetitive transients which may rise to a value of thousands of volts and then drop to zero in less than a quarter of a microsecond. With a record of these events as written by the electronic oscillograph, insulation surge strength and voltage recovery characteristics are obtained and designs are modified to give better service, longer life, and improved performance.

The high-voltage electronic oscillograph operates on the same principle as the sealed-glass-tube cathode-ray oscilloscope.

Sealed-off cathode-ray tubes up to 15 kv rating have been available commercially and equipment of this type is being used to some extent for impulse testing because it is relatively inexpensive. The extremely high voltages and rapid buildup rates used in modern testing methods have resulted in an ever-increasing demand for a recording instrument with a voltage and speed range far beyond that of the sealed-glass oscilloscope. To meet this demand, the streamlined Westinghouse electronic oscillograph shown in Fig. 4 was developed.

The high-voltage oscillograph is primarily useful in the study of single transients which are essen-

The frequency meter has been used to measure audio-frequency differences in quartz crystal manufacturing, determine pulse frequencies, function for gamma, x-ray, and electron counting, determine a-c line frequencies for power and audio transformer design, and measure temperature-coefficient-drift on transmitters and receivers operating under test temperatures of from -40 to 200 deg F.

tially non-repeating as far as the employable oscillograph technique is concerned because the behavior of the test piece may change with every applied surge, as when exploring the breakdown strength of insulation (Fig. 2), and because the

powerful discharges of large surge generators cannot be obtained in close and absolutely regular time intervals.

### Industry Standard Wave

The standard industry test wave is the so-called  $1\frac{1}{2}$ -40 microsecond wave which is one which rises to crest in about  $1\frac{1}{2}$  millionth of a second and falls off to half value in 40 microseconds from its start. It can well be observed on the screen of a good sealed-off glass tube oscilloscope. In all but the elementary routine tests, however, the question usually arises as to what happened in this or that fraction of a microsecond which was not discernable on the instrument of the lesser resolving power. Such fractional microsecond records, taken with the high-voltage oscillograph, are pre-

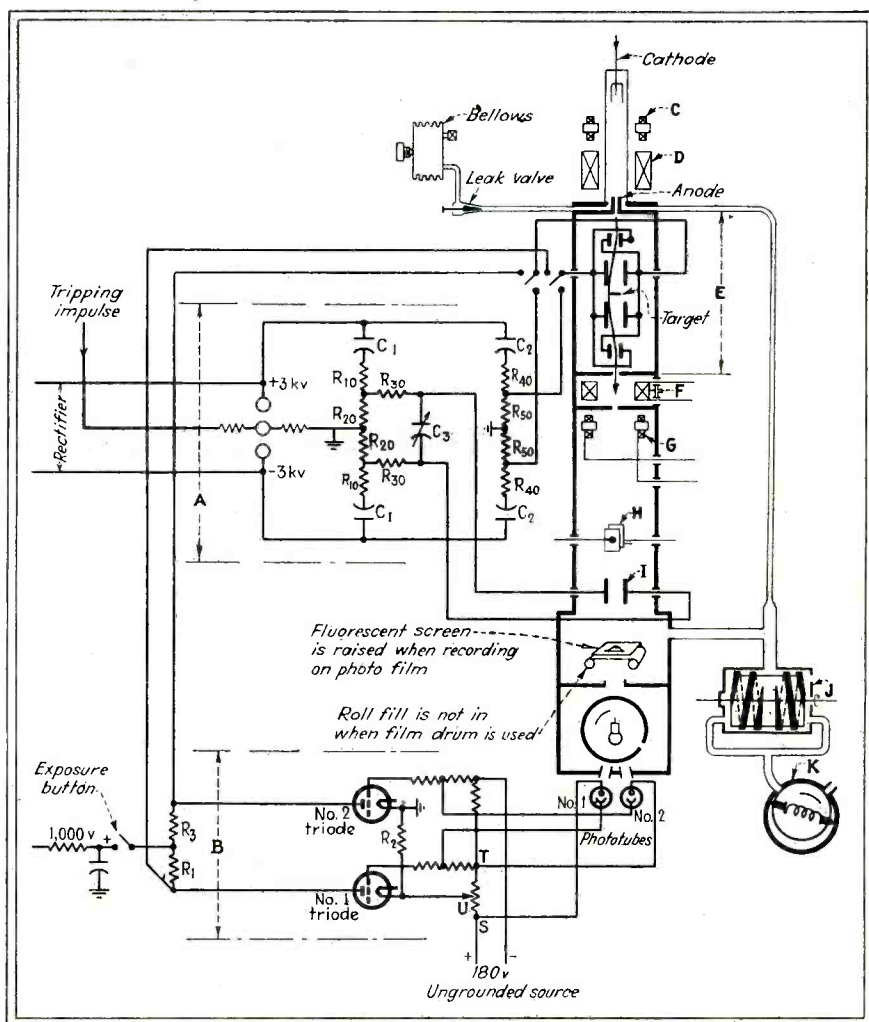
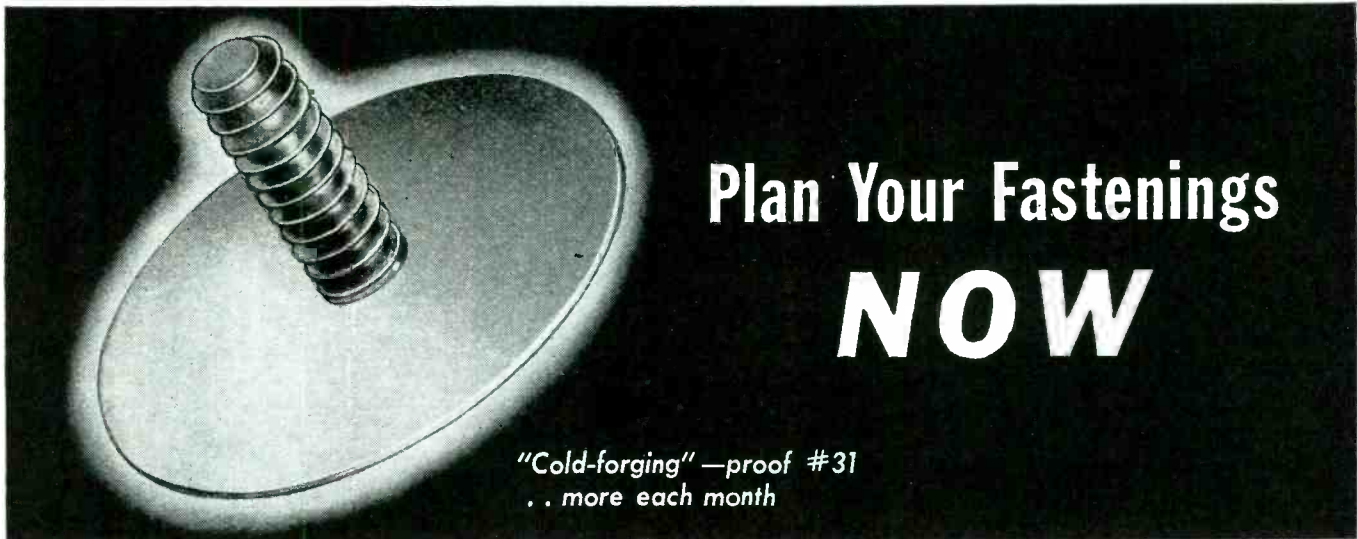
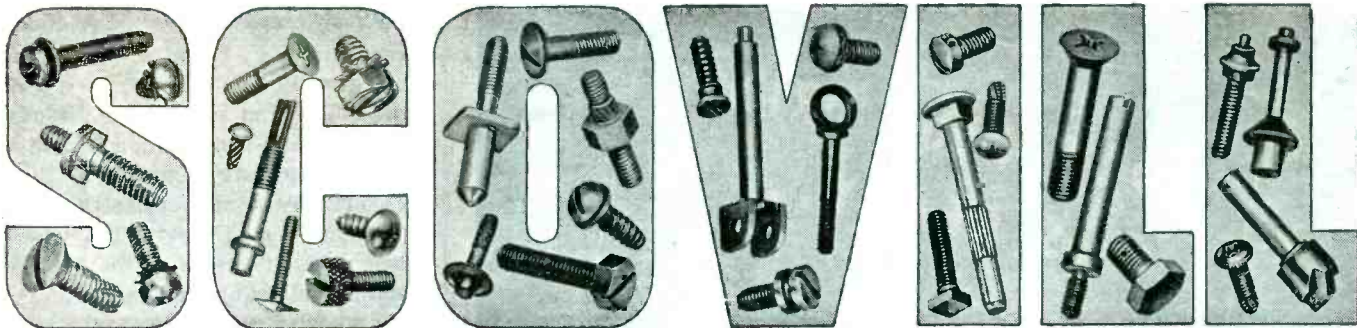


Fig. 4—Oscillograph body with timing circuits and pumping system. At (a) is the timing circuit for stationary film and at (b) the film drum exposure control whose operation is started by pressing the exposure button. Details of the instrument are: (c) upper deflecting coils, (d) upper concentration coils, (e) ray-blocking section, (f) main concentration coil, (g) lower deflecting coils, (h) measuring electrodes, (i) timing electrodes, (j) molecular pump, (k) rough vacuum pump



# Plan Your Fastenings **NOW**

"Cold-forging"—proof #31  
.. more each month

## 3 Standard Fastenings for Production Efficiency



**1 Phillips Recessed Head Screws**—The modern, effective, time-saving fastening device proven in tens of thousands of assembly lines. Other standard head styles are also available.



**2 Self-Tapping Machine Screws**—Eliminate separate tapping operations for fastenings to castings, heavy gauge sheet metal, and plastics. Also available with Phillips Recessed Head.



**3 Washer-Screw Assemblies**—When use of lock washers is indicated, the time-saving of pre-assemblies is obvious. Also available in standard slotted head styles.

### PLAN NOW:

... because the right fastening planned in the product design stage can well mean success to that vital fast assembly job—no assembled product can be better than its fastenings.

... because early action enables you to make your precise choice to serve your need best—a featured standard fastening or a part especially designed to meet your specific requirements.

### CHOOSE SCOVILL:

... because our broad experience in fastenings qualifies us as specialists to aid you in that selection. Our demonstrated ability in special design\* makes Scovill your logical choice.

... because our special processing with our ingenuity in cold-forging, means a substantial savings in money—materials—motions.

### CALL A SCOVILL FASTENINGS EXPERT TODAY

*\*The special purpose item illustrated above is one of many examples of Scovill ingenuity in cold-forging and demonstrated ability in special design.*

**SCOVILL MANUFACTURING COMPANY**  
**WATERVILLE SCREW PRODUCTS DIVISION**

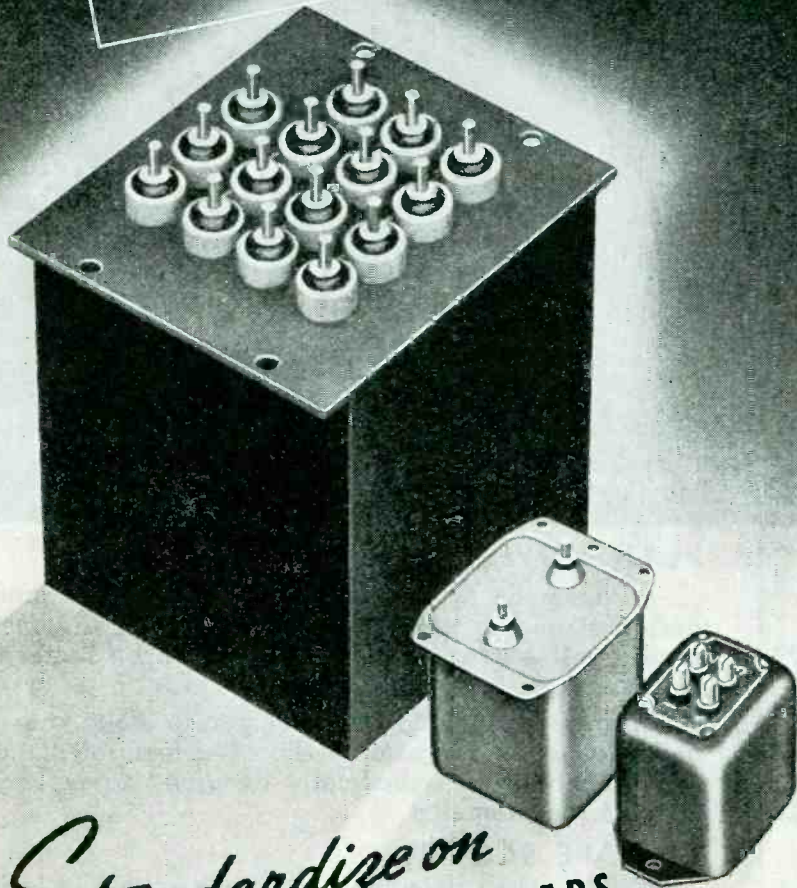
WATERVILLE 48, CONN.



TEL. WATERBURY 3-3151

NEW YORK, Chrysler Building • DETROIT, 714 Fisher Building • CHICAGO, 135 South LaSalle Street • PHILADELPHIA, 18 W. Chelton Avenue Building  
PITTSBURGH, 2882 W. Liberty Ave. • SYRACUSE, Syracuse • Kemper Insurance Bldg. • LOS ANGELES, 2627 S. Soto St. • SAN FRANCISCO, 434 Brannan St.

**YOUR BLUE PRINT  
IS READY...**



*Standardize on*  
**STANCOR TRANSFORMERS**  
...the precision-built line!

Many startling improvements have come out of our broad war communications experience, which will distinguish Stancor transformers for the future, PLUS a wide expansion into diversified peace-time uses... We are sure that your individual specifications for your post-war designs are present today, in Stancor engineering... May we be of aid in drawing the transformer part of your industrial blue print?

STANDARD TRANSFORMER CORPORATION  
1500 N. HALSTED ST., CHICAGO 22, ILLINOIS



sented in Fig. 2 and 3. They are taken on regular roll film 3½ inches wide. The film is exposed directly to the cathode beam; this eliminates the intermediate elements of fluorescent screen and optical system, which are essential with the sealed glass tube. The size of the picture renders enlarging unnecessary.

*Timing Circuit*

The timing of the cathode-beam release and of the beginning of the time axis are accomplished by a simple but very effective circuit (Fig. 4). The phenomenon under observation is connected to the os-

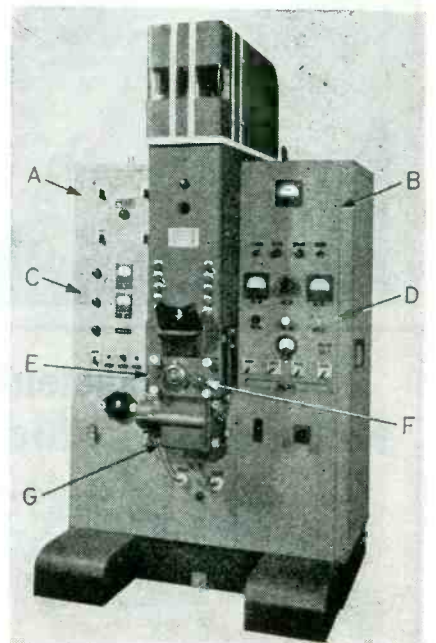


Fig. 1—Front view of Westinghouse electronic oscillograph. The sections are:

- (a) Timing circuit panel for stationary film.
- (b) Unit containing calibrating circuits and film-drum exposure control.
- (c) Focusing and bias coil panel.
- (d) High-voltage and vacuum control panel.
- (e) Roll film operating knob and position indicator.
- (f) Fluorescent screen hinge knob.
- (g) Film drum attachment.

cillograph timing circuit through capacitance coupling with the center electrode of the double gap (Fig. 4). It should be noted that in all records of Fig. 2 and 3 the surge starts at exactly the same point with respect to the zero point on the time axis. This means that the action of the synchronizing circuit, including the double gap, is so consistent that no variations can be detected even at scales which ren-



# INCREASE OUTPUT IMMEDIATELY WITH RCA ELECTRONIC PREHEATING

Production Increases Obtained at Once; Cycles Shortened; Rejects Reduced; Pieces Generally Improved

**I**f your problem is getting more production *fast* to meet accelerated war-production schedules, look into RCA electronic preheating without delay. The accumulated case histories of RCA installations indicate that you can expect an increase of at least 50% in output *at once*—and that, in some types of work, production increases run as high as 500%!

**HOW TO GET FURTHER INFORMATION:** RCA engineers can serve you best if they understand your problem at the outset. The following questions indicate what information is required.

- 1 Type of molding material—manufacturer, name, number, and filler (if any).
- 2 Method of molding at present—compression or transfer.
- 3 Dimensions of preform; please include sketch.
- 4 If the shape of your preforms is irregular, do you know of any reason why it cannot be altered for more efficient application of electronic heat? (With electronic heating, vastly improved material-flow properties result; consequently, highly irregular preform shapes are probably unnecessary).
- 5 Weight of preform: .....lb. ....oz.
- 6 Number of preforms per charge.
- 7 How many presses are now used for this job?
- 8 What is present press cycle? Closing time .....seconds; curing time .....seconds; number of cycles per hour .....
- 9 Temperature rise required: From .....°F to .....°F.
- 10 Present method of preheating (if any).
- 11 Description and significant details of molded piece.

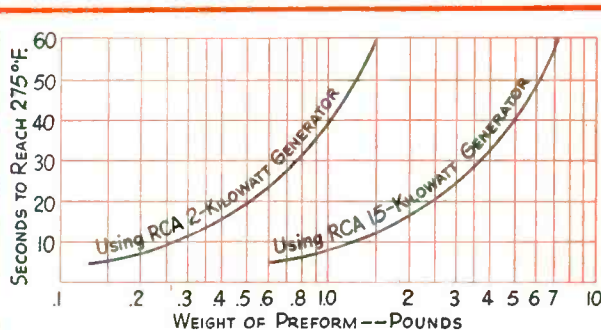
- 12 Power supply available—voltage and frequency.
- 13 What priority can be extended?
- 14 Please describe any special problems you encounter.

Answers to these questions supplied to RCA will be held in strict confidence. Information of this type will help our engineers give you a quick reply.

**IMMEDIATE DELIVERY:** RCA can supply immediately specially designed equipment for plastics preheating. The new RCA 2000-watt

electronic generator, for example, is “as automatic as your toaster.” The controls are quickly adjusted for each job, and, once set up, the equipment will give uniform performance on every piece; a skilled operator is *not* required. Because of an ingenious automatic compensator, the RCA 2000-watt unit is approximately equivalent to an uncompensated unit rated at 3000 watts! No special installation work required. Just plug it in and it's on the job. The coupon will bring details.

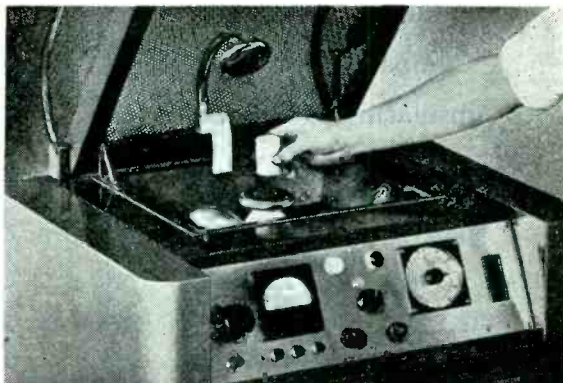
**ADDRESS ALL INQUIRIES** to the Radio Corporation of America, Electronic Apparatus Division, Box 70-192x, Camden, N. J.



**ELECTRONIC PREHEATING IS FAST!** Twenty-four ounces of molding material can be heated to 275°F in only 60 seconds by the new RCA Model 2B. Plasticity is uniformly high all the way through. Molding can take place, therefore, before curing begins.

**SIMPLE TO OPERATE:  
UNIFORM RESULTS!**

Here are the electrodes of the Model 2B. The preform(s) is placed between them, the cover closed, and the power snapped on. When heating is complete, power goes off and cover opens.



**BUY WAR BONDS**

RCA  
ELECTRONIC  
HEAT



**RADIO CORPORATION  
OF AMERICA**

RCA VICTOR DIVISION • CAMDEN, N. J.

**Here's a Quick Way To Get Details**

RCA, Electronic Apparatus Div., Box 70-192 H, Camden, N. J.

I want to know more about boosting plastics output with electronic preheating. Please send the booklets checked:

- Electronic Heating Speeds Plastics Output
- RCA 2,000-watt Electronic Generator
- RCA 15,000-watt Electronic Generator

Name \_\_\_\_\_  
 Company \_\_\_\_\_  
 Street \_\_\_\_\_  
 City \_\_\_\_\_ Zone \_\_\_\_\_ State \_\_\_\_\_

70-6236-192

# INSULATION PLANNING

## *Belongs at the early stages of the product*

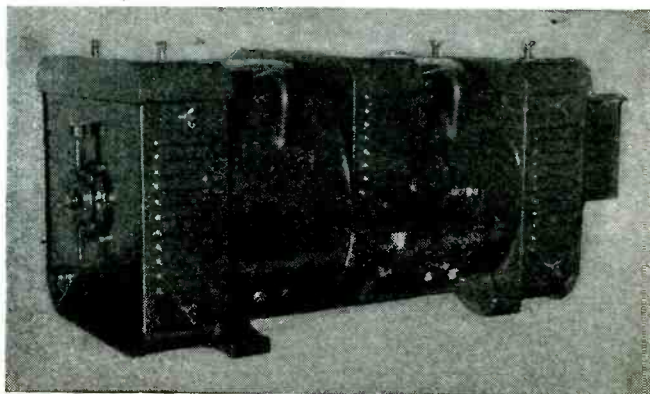
**T**HE load characteristics of electrical apparatus; the presence of dirt, moisture and chemicals in the atmosphere where this equipment will operate; the degree and nature of physical support; and economic considerations all influence the choice of insulating materials in electrical equipment design.

As a manufacturer and supplier of Class O, Class A, Class B, and Class C insulation, with fifty years' experience in the field of electrical insulation, the Mica Insulator Company can help you with your insulating problems.

Consult Mica Insulator Company's engineering staff as a prac-

tical, initial step whenever insulation problems arise—whether your application be electrical appliances, components of heavy industrial electrical equipment or electronic devices for industrial and communication equipment.

Write for copy of our new informative handbook, "Electrical Insulating Materials," on your company letterhead.

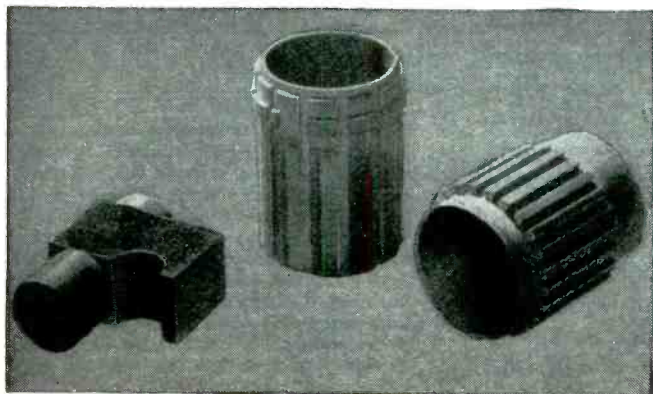
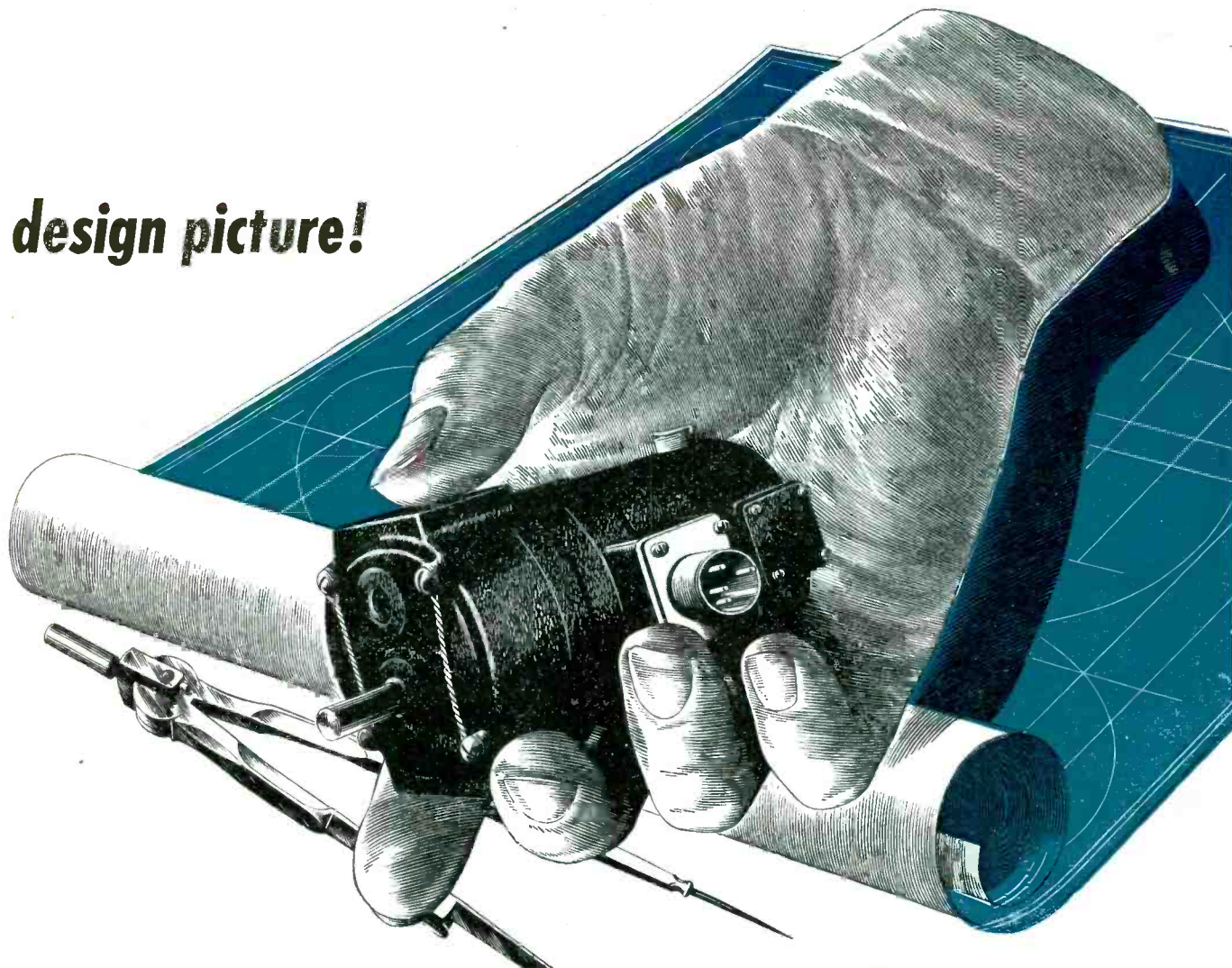


Motor-generator built by Star Electric Motor Company depends upon Fiberglas and Mica, Lamicoid (Laminated) Fiberglas and untreated Fiberglas insulation. These materials provide a safety factor for elevated temperatures, high humidity and heavy overloads.

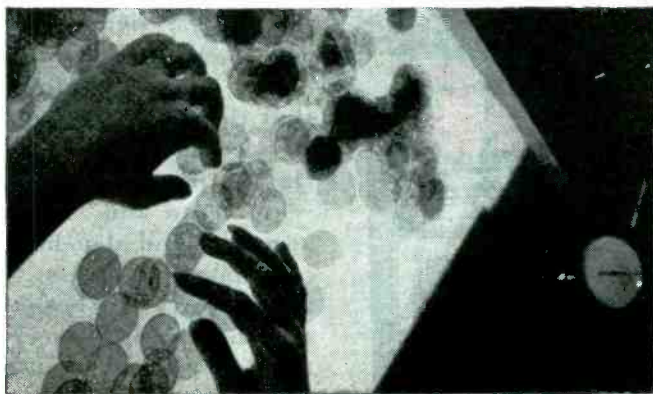


# MICA

**design picture!**



Electrical components requiring close tolerances and intricate design are readily fabricated from Lamicoid. From the wide range of resins, fabrics and papers, you can obtain Lamicoid having the exact electrical and mechanical properties that you require.



The proper selection of mica for any particular purpose is a task that requires long experience and a sound knowledge of the properties of mica in all of its various types and grades. Call our staff engineers about your specific problem.

**SALES OFFICES:**

BOSTON • CHICAGO • CINCINNATI • CLEVELAND • DETROIT  
HOUSTON • LOS ANGELES • NEW YORK • SAN FRANCISCO • SEATTLE

**FACTORY:**

SCHENECTADY, NEW YORK

*Insulator*

**COMPANY** 200 Varick Street  
New York 14, N. Y.

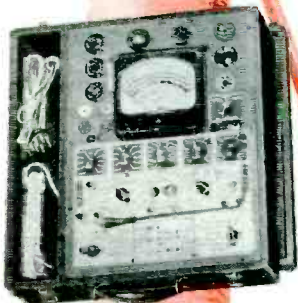
The Standard of Quality for a Third of a Century

**HICKOK**

# Instruments that tell the truth...



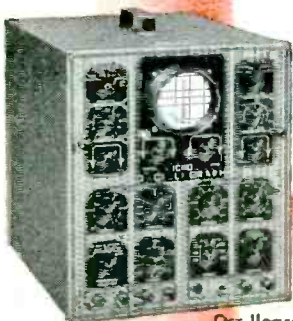
Volt-Ohm-Millimeter



All-Purpose Tube and Set Tester



Signal Generators



Oscillograph

● In maintaining the highest standard of excellence the one and only HICKOK aim must always be the building of instruments that tell all the truth all the time. When quality is built up to a high standard instead of down to a price, the user has greater confidence in his work.

Whether you are selecting tube and set testers, signal generators, oscillographs, volt-ohm-millimeters or any other service equipment, remember that the standard of quality for a third of a century has never been excelled. Having pioneered the major new developments and vindicated maximum accuracy and dependability, HICKOK equipment has been specified by the armed forces in both world wars. We are still bending every effort to speed the war program and trust it will not be long until we can again take care of your civilian needs with the service equipment that is held in highest esteem. Write for Radio Equipment catalogue.

**THE HICKOK ELECTRICAL INSTRUMENT COMPANY**  
10527, Dupont Ave., Cleveland 8, Ohio

der visible one hundredth of a microsecond.

The timing circuit for stationary film is shown at (a) in Fig. 4. A direct voltage of about 3 kv is applied to the outer electrodes of the double gap, whose spacings are set so that they are just above breakdown at this steady-state condition. The center sphere is normally at ground potential. Any disturbance in the circuit under test, such as the beginning of the surge to be measured, is transmitted to the center sphere through resistance or capacitance coupling. This sphere is temporarily thrown off ground potential which makes one of the gaps break down; flashover of the other side follows immediately as it now

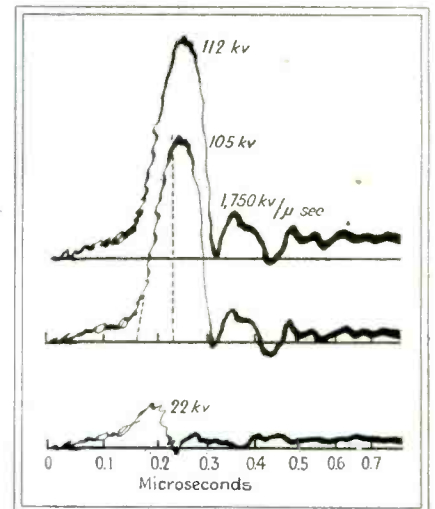
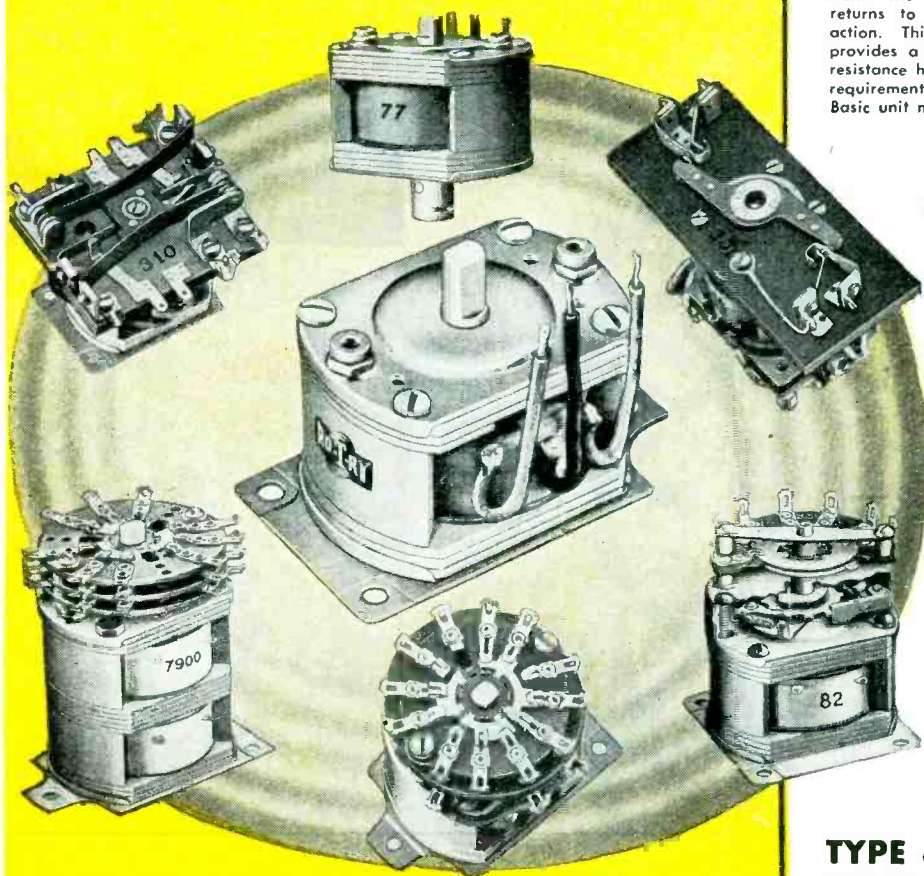


Fig. 2—This oscillogram of a dielectric strength test of a certain insulating part shows the effect of a rapid voltage rise. If a 60-cycle test voltage of 30 kv was applied to the specimen, flashover would occur along the outside surface. Such a test would invite the conclusion that the piece could not be punctured, but that the discharge would always take place along its surface. However, if the voltage is applied so fast that outside flashover has no time to develop, the discharge will force the much shorter but harder passage right through the material. On the first shot, the flashover occurred around the outside; the oscillogram discloses that the voltage had risen to 112 kv. At the second shot, no outside flashover was visible; the oscillogram shows it took 105 kv to puncture the material which probably had already been damaged by the preceding surge. The next oscillogram proves that the sample now definitely is punctured as the voltage collapses at 22 kv. This demonstrates that it takes a rate of voltage rise of about 1750 kv per microsecond to puncture this particular insulating member. This voltage rise is about 100,000 times as fast as that produced by the 60-cycle test and cannot be recorded by anything but a high-voltage oscillograph

Many Post War Products  
are being designed around this

# Versatile RELAY

**ROTARY** that has achieved such  
outstanding performance in war  
Communications Equipment.



## Get Catalog E-55

Illustrates "RO-T-RY" adaptability to unusual and varied relay applications. Complete specifications and detail drawings. Also illustrates other Price Bros. Co. Relays for Time Delays, Motor Starting, High Speed Keying, Antenna and Power Contactors. Write today for this Catalog.

# RO-T-RY

## A NEW BASIC RELAY UNIT of Versatile Adaptability

RO-T-RY introduces a new basic principle of Relay operation especially designed to withstand severe vibration, temperature and humidity conditions. When used to operate switch wafers it provides a great variety of contact arrangements, a few of which are here shown.

**TYPE 76** This basic "RO-T-RY" (center photo) is a compact, two position driving mechanism providing up to 30 degrees of clock-wise or counter clock-wise rotation as specified from the normal (power-off) position. The shaft is rotated one way under power, and returns to the normal (power-off) position by spring action. This unit incorporates a two winding coil which provides a high initial torque, then switches in a high resistance holding winding which reduces the coil current requirements to a minimum in the energized position. Basic unit measures 2 1/2" x 1 1/2" x 1 3/4".

**TYPE 77** Designed to operate a shaft extension through 30 degrees rotation. In general this provides means of operating wide'y spaced wafer switches, or for operating them in separate compartments. A special coupling provides easy means of connecting to a separate shaft.

**TYPE 301** A keying relay providing instantaneous break in operation, in addition to other features. Extended shaft provides positive mechanical interlock between keyed circuits and switching of antenna from transmitter to receiver.

**TYPE 310** A special compact DP-DT and a SP-ST relay designed to meet standard aircraft vibration specifications. The unit is primarily designed as a motor generator control relay, with the DP-DT contacts rated at 40 amps. DC and the SP-ST contacts at 5 amps. DC.

**TYPE 7900** A Duplex Driving Mechanism for use where no spring return is needed, or provided. For momentary operation only. Develops 16 oz. in. Torque at minimum operating voltage. Provides positive driving power for multiple switching of "on-off" or "Set" "Reset" operations.

## TYPE 82 Stepping Unit

A compact 12 position driving mechanism which operates a shaft extension through 360° in 12 progressive steps. When built up as shown, the unit provides a 12 position selector switch which indexes one position for each momentary current impulse. The unit will drive up to three wafer switches or any other load not in excess of 8 1/2 ounce inches torque. 12 of 24 volt DC operation is standard. Other DC voltages available.



**PRICE** Brothers Co. FREDERICK, MARYLAND

RELAYS, CONTROLS, AND MAGNETIC DEVICES FOR ELECTRONIC & INDUSTRIAL APPLICATION

# WEAVING COMMUNICATION HIGHWAYS

## RESEARCH

FINDS THE IDEA

## DESIGN

GIVES IT FORM

## DEVELOPMENT

MAKES IT WORK

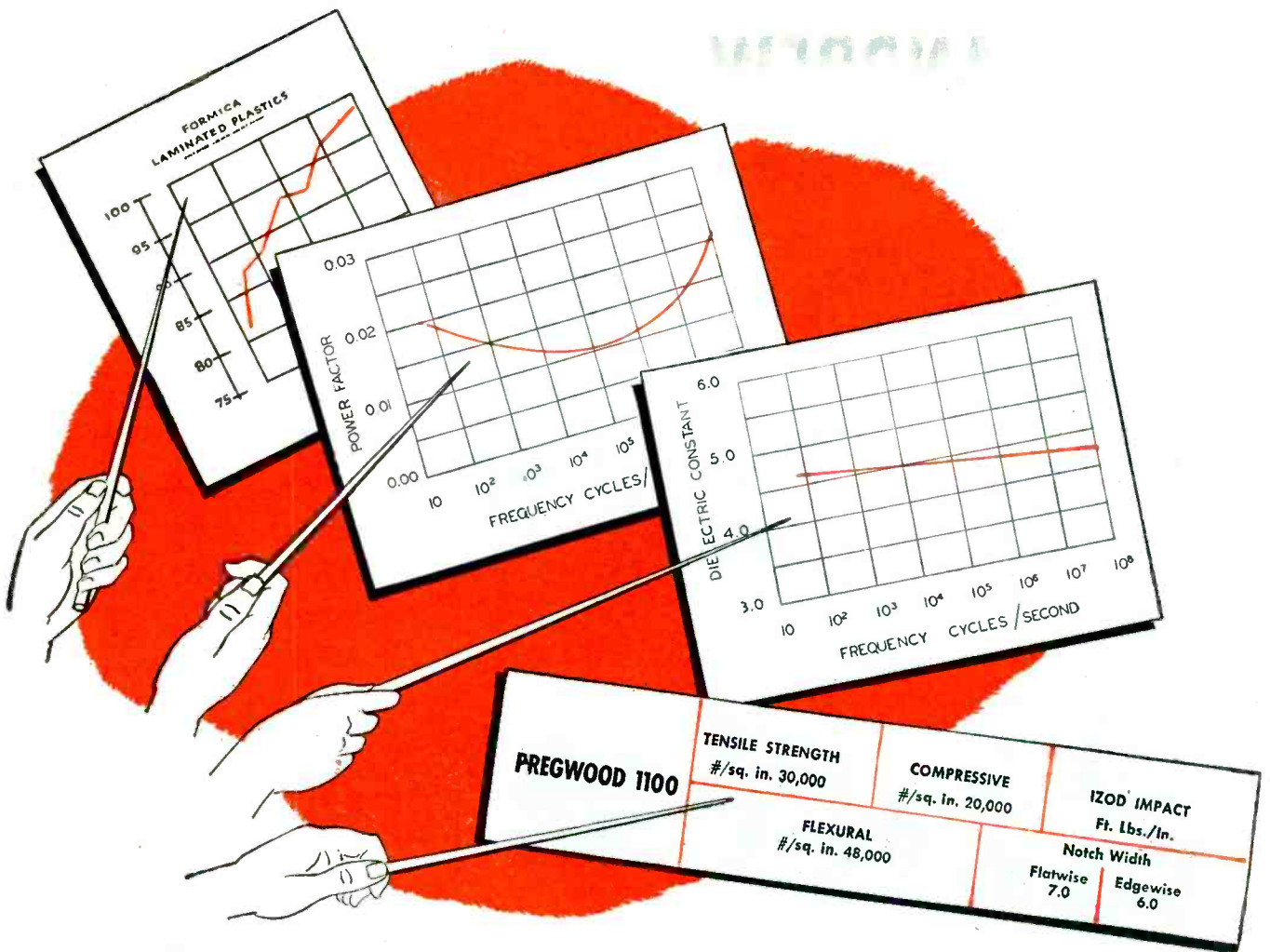
## SPECIFICATIONS

TELL THE FACTORY

## BELL TELEPHONE LABORATORIES

brings together the efforts of 2000 specialists in telephone and radio communication. Their wartime work has produced more than 1000 projects for the Armed Forces, ranging from carrier telephone systems, packaged for the battle-front, to the electrical gun director which helped shoot down robots above the White Cliffs of Dover. In normal times, Bell Laboratories' work in the Bell System is to insure continuous improvement and economies in telephone service.





## BETTER INFORMATION

### *on the Qualities of Laminated Plastics!*

**T**HERE has been a big improvement lately in the variety and quality of the engineering information on the physical and chemical qualities of Formica.

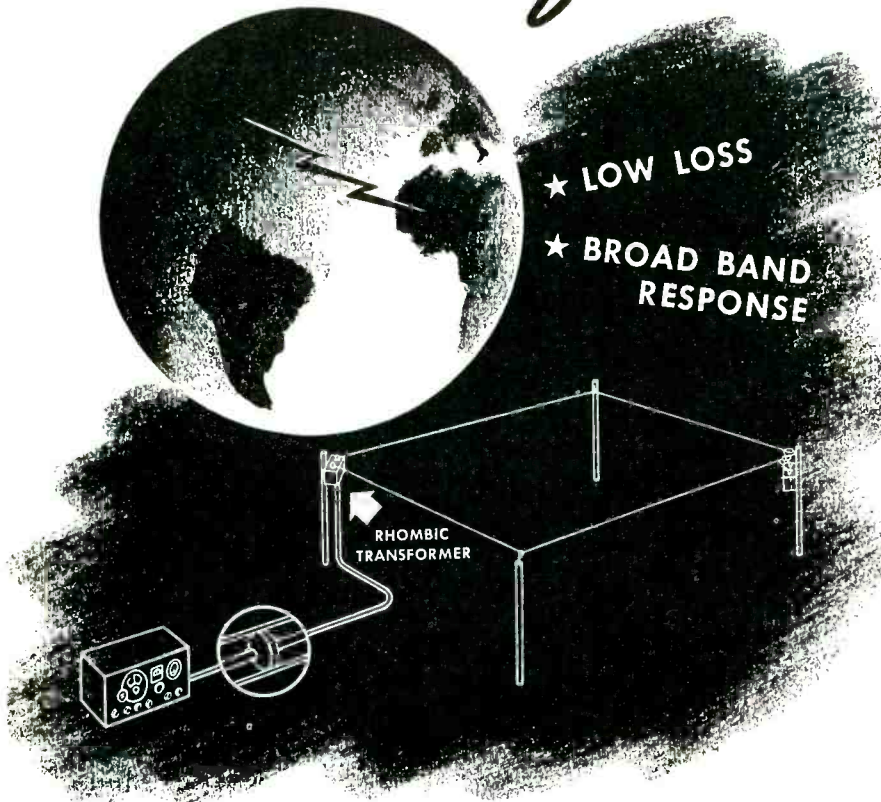
This has been brought about by recent application of the latest testing equipment to Formica's tests in the Formica laboratory, and the enlargement of the engineering staff to make thousands of new tests possible.

After the war you can really get the dope on the grades of Formica you may be considering for your various applications. It will be as complete and thorough as that available for any other material.



**THE FORMICA INSULATION CO., 4661 SPRING GROVE AVE., CINCINNATI 32, O.**

# ANDREW Rhombic Transformers



## FOR TRANSOCEANIC RADIO COMMUNICATION

★ You need *quality* equipment for reliable, uninterrupted radio communication across oceans and continents. That is why radio engineers specify ANDREW antenna coupling transformers and coaxial transmission lines when designing rhombic antenna systems.

For highest efficiency and most successful rhombic antenna operation, the antenna coupling circuit must have a broad frequency response and low loss. To meet these requirements, ANDREW engineers have developed the type 8646 rhombic antenna coupling transformer, illustrated below, to assure fullest utilization of the advantages of the rhombic type an-

tenna. Losses are less than 2 decibels over a frequency range from 4 to 22 megacycles.

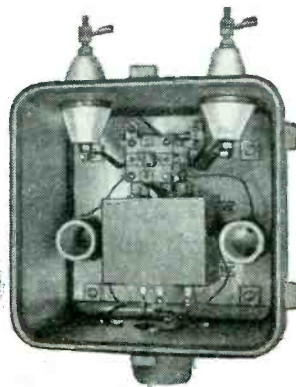
Type 8646 unit transforms the 700 ohm balanced impedance of the antenna to match the 70 ohm unbalanced impedance of the line. Unusually broad band response is achieved by using tightly coupled transformer elements with powdered iron cores of high permeability. This unit is contained in a weatherproof housing which may be mounted close to antenna terminals.

Transformer unit 8646 is another expression of the superior design and careful engineering that has made ANDREW CO. the leader in the field of radio transmission equipment.

WRITE FOR BULLETIN NO. 31 giving complete information on this new radio communication unit.



**ANDREW CO.**  
363 EAST 75th STREET  
CHICAGO 19, ILLINOIS



is subjected to double voltage. The pair of  $C_1$  capacitors discharges, causing the voltage at  $C_3$  to rise at a definite rate which in turn produces the time sweep in the oscillograph. At the same instant, voltage is thrown on to the electrodes of the ray-blocking section by the discharge of capacitor  $C_2$ . This bends the beam around the target.

Sharpness of the electron pencil, high writing speed and accuracy in timing are not the only features re-

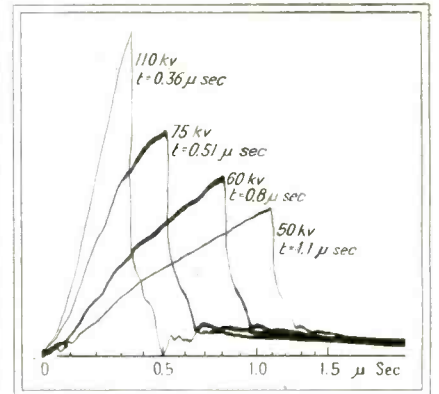


Fig. 3—Four tests of the sparkover time of a protective device at four different rates of voltage rise. The time sweep starts within less than 1/10 microsecond from the beginning of the surge

quired for high-quality recording. The oscillograms primarily must be true and free of distortion. In high-voltage laboratories, where voltages rise and collapse at the rate of hundreds of kilovolts per microsecond and where surge currents of thousands of amperes are discharged, spurious voltages and magnetic fields are a considerable problem. Their influence on the accuracy of measurements is reduced further if the measuring voltage applied to the deflecting plates is large in proportion to the spurious disturbances. A high voltage at the deflection plates in turn demands a much higher potential for generating the cathode beam because its speed, having been established by the cathode-anode accelerating potential, must remain essentially constant as it passes the fields of the deflecting electrodes; the latter should produce only a comparatively small lateral deflection. The measuring voltages would radically accelerate and retard it and deflect it beyond the limits of the recording space if they were of the same



# MULTIPLE AND TWIN SPEED NUTS

*Combine*  
**FASTENERS INTO ONE UNIT!**

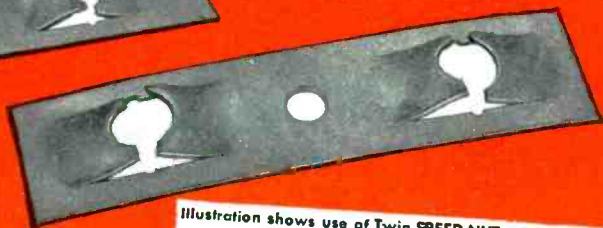
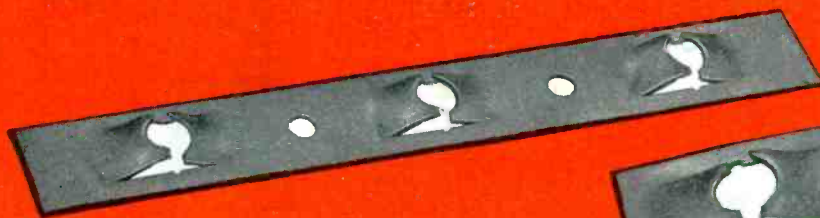


Illustration shows use of Twin SPEED NUT for attaching bracket to aircraft fuselage frame. Applied faster, reduces number of parts, and prevents vibration loosening.



Four Multiple SPEED NUTS are used on Tappan Stove's food warmers, now standard equipment on the B-29 Super Fortress. Only 10 rivets necessary to hold all 4 SPEED NUT strips for blind attachment of liner to cabinet.



Individual SPEED NUTS offer tremendous advantages over ordinary fasteners, but Twin and Multiple SPEED NUTS go even further. They COMBINE two or more SPEED NUTS into one unit to simplify, reinforce and speed up multiple fastening attachments.

Twin type SPEED NUTS are available with 1/2" to 1" hole spacings, for machine screws or sheet metal screws. Center hole in SPEED NUT per-

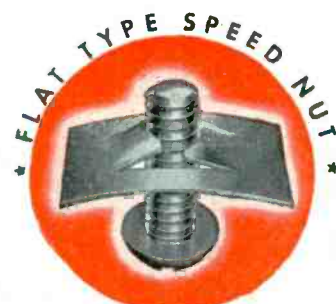
mits riveting in place for blind location assembly.

Multiple type SPEED NUTS are available with 1" to 2" hole spacings, for 6Z, 8Z or 10Z sheet metal screws. Supplied in any desired lengths or in coils. Made of spring steel for riveting in blind location, or stainless steel for welding. In writing for samples, please give screw size and hole spacing.

## TINNERMAN PRODUCTS, INC.

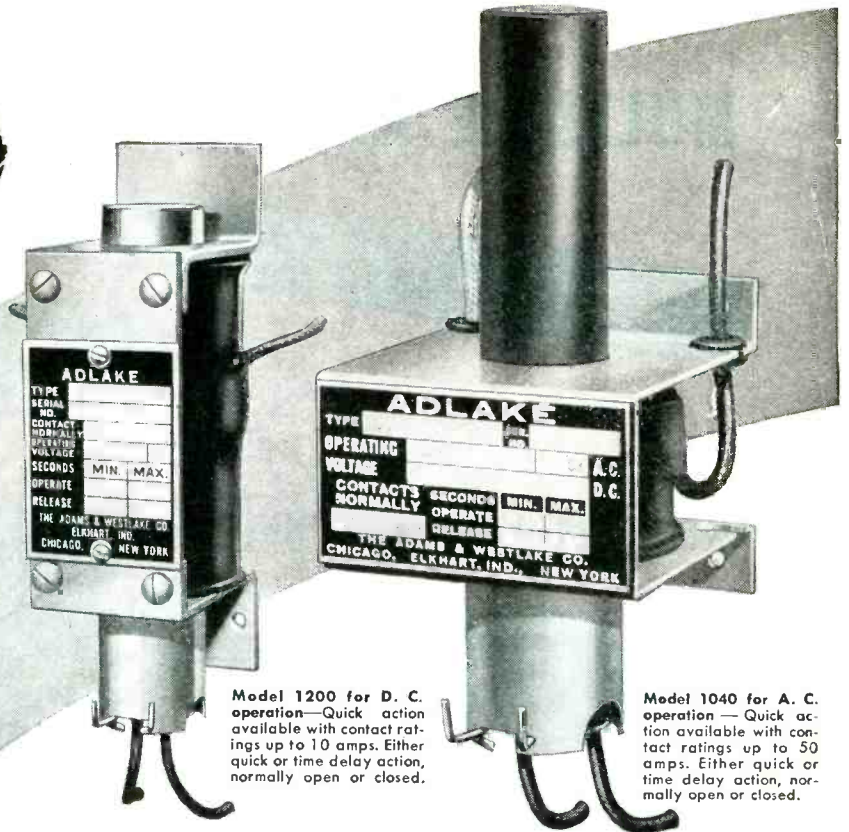
2106 FULTON ROAD, CLEVELAND 13, OHIO

In Canada: Wallace Barnes Co., Ltd., Hamilton, Ontario  
In England: Simmonds Aerocessories, Ltd., London



THE BASIC PRINCIPLE  
of Spring-Tension Lock is  
Embodied in all Speed Nut Designs

**Speed Nuts**  
PATENTED \*Trade Mark Reg. U. S. Pat. Off.  
**FASTEST THING IN FASTENINGS**



Model 1200 for D. C. operation—Quick action available with contact ratings up to 10 amps. Either quick or time delay action, normally open or closed.

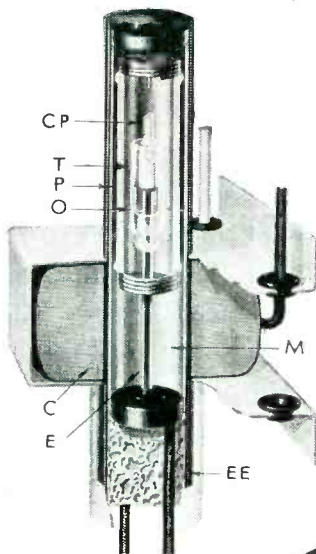
Model 1040 for A. C. operation—Quick action available with contact ratings up to 50 amps. Either quick or time delay action, normally open or closed.

## ● Circuit Control with ADLAKE MERCURY RELAYS

### HOW THEY WORK

**ENERGIZED**—Coil C pulls plunger P down into mercury M. Mercury thus displaced enters thimble T through orifice O. Inert gas in thimble gradually escapes through ceramic plug CP, thus producing time delay.

**ENERGIZED**—Mercury now fills thimble T, is completely leveled off and mercury-to-mercury contact established between electrodes E and EE. Degree of porosity of ceramic plug CP determines length of time delay.



Contacts and break-offs are as quick as a wink because Adlake Plunger-type Relays (models for A.C. or D.C.) use fast-moving, liquid metal mercury . . . positive in action; silent and chatterless; will not burn, pit, or stick.

Under the most exacting conditions . . . heat or cold, dirt, dust, or moisture they're ready and prompt to perform. Mechanisms, encased in armored glass or metal cylinders and then hermetically sealed, are impervious to the elements and oxidation.

No cleaning, no inspection, no servicing . . . relax and let an Adlake Mercury Relay work your timing, load, or control circuits—automatically and trouble-free.

Our bulletin tells the complete story, write for it today.



# THE ADAMS & WESTLAKE COMPANY

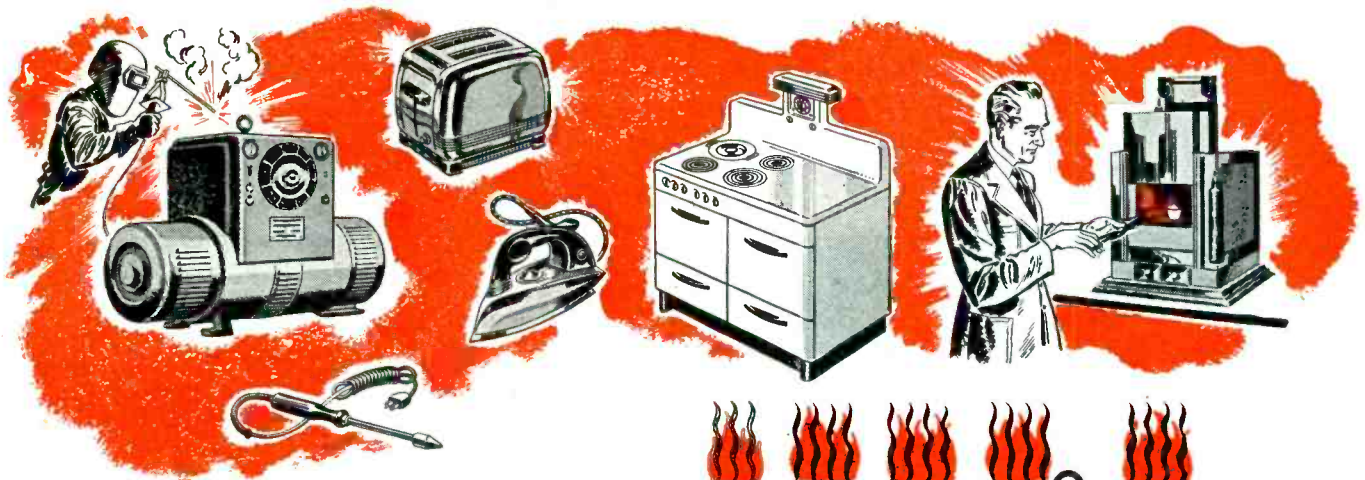
ESTABLISHED IN 1857

ELKHART, INDIANA

NEW YORK · CHICAGO

MANUFACTURERS OF ADLAKE HERMETICALLY SEALED MERCURY RELAYS FOR TIMING, LOAD AND CONTROL CIRCUITS

# BH SPECIAL TREATED FIBERGLAS SLEEVING



HEAT RESISTANT TO

1200° F!



## SNUB TEST

Proves BH Non-Fray Feature

Make this test yourself. Tap a piece of ordinary saturated sleeveing on your desk top and see how easily it frays. Then do the same with BH Extra Flexible Fiberglas Sleeveing. It only fuzzes a little—doesn't break down—doesn't fray.

### THE RESULT



← The BH Way



The Ordinary Way →

BH EXTRA FLEXIBLE FIBERGLAS SLEEVING

2 WAYS BETTER

NON-FRAYING • NON-STIFFENING

IF YOU NEED an electrical insulation that's not affected by temperatures up to 1200°F., yet is unusually flexible, workable and durable, you'll find it in BH Special Treated Fiberglas Sleeveing. Even in direct contact with heat units this remarkable sleeveing won't burn.

Reason? It's made of inorganic Fiberglas and treated by the exclusive BH process. No saturant is used, yet the sleeveing won't fray when cut and it is *permanently* flexible. In addition to many other properties it is moisture, oil and grease resistant . . . works easier, simplifies assembly and lasts longer. Made in natural color only—all standard sizes. Get your free samples today and compare!

### HERE'S ANOTHER NON-BURNING SLEEVING

BH Extra Flexible Fiberglas Sleeveing won't burn because both yarns *and* impregnation are non-inflammable. This high quality sleeveing has all the advantages of pure Fiberglas, is toughened against abrasion, is non-fraying and non-stiffening. It lasts indefinitely without rotting or cracking—the ideal all-purpose electrical insulation for all kinds of industrial equipment and home appliances. Available in all standard colors and sizes from No. 20 to 5/8", inclusive. Put it to the toughest tests you know and watch the results!

ALL BH PRODUCTS AVAILABLE IN STANDARD 36" LENGTHS AND 500-FT. COILS

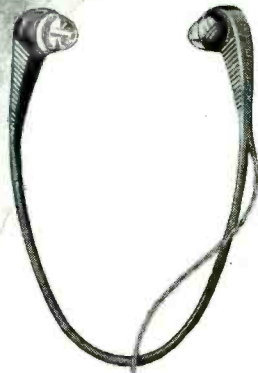


ALSO SLOW-BURNING IMPREGNATED MAGNETO TUBING • SLOW-BURNING FLEXIBLE VARNISHED TUBING • SATURATED SLEEVING • A.S.T.M. SPECIFICATIONS

**BENTLEY, HARRIS MANUFACTURING CO.**

Dept. E Conshohocken, Penna.

**"Now I never miss a word"**



**Suggested uses for  
TELEX  
TWINSET**

- Switchboard
- Airport radio receivers
- Radio stations
- Sound research laboratories
- Dictating Equipment
- Medical stethoscopic use
- I. C. system for trains
- Civic Depts. (find water main or conduits)

**PUBLIC HEARING**

- Theatres
- Churches
- Auditoriums

**CIVILIAN USE IN PLANES**

- Pilot
- Passenger radio selection
- Telegraph
- Monitor radio

*"The new TELEX TWINSET in our neighborhood theatre is a lifesaver for me. There's no more hunting for a front row seat. I simply snap on a set of sterilized lucite ear tips, and I never miss a word."*

This statement should be a fact . . . when firing ceases on the war fronts.

Cleverly designed to wear under the chin instead of over the head, the new TELEX TWINSET is one of the newest engineering developments in electro-acoustics.

Gone will be the ear pressure and head fatigue suffered with most head sets, for the TELEX TWINSET weighs just 1¾ ounces and only requires space of 5 x 6 inches.

Why not learn how it can help simplify a project on your schedule? Write for more information about the new TELEX TWINSET.

**TELEX**  
**PRODUCTS COMPANY**  
ELECTRONIC PRODUCTS DIVISION  
MINNEAPOLIS 1, MINNESOTA

order as the beam-generating potential.

The pumped oscillograph with internal film also shows very desirable performance characteristics when it is used for long high-speed oscillograms obtained by means of the rotating drum (Fig. 5). In taking them, the cathode beam is deflected only in accordance with the measured voltage while the time scale is provided by the motion of the motor-driven drum. The drum periphery is 18 inches; hence, records 5 to 6 times as long as those possible on stationary film or screen are obtained in one revolution. The time scale is by no means as fast as that possible with stationary film as the maximum speed permitted by

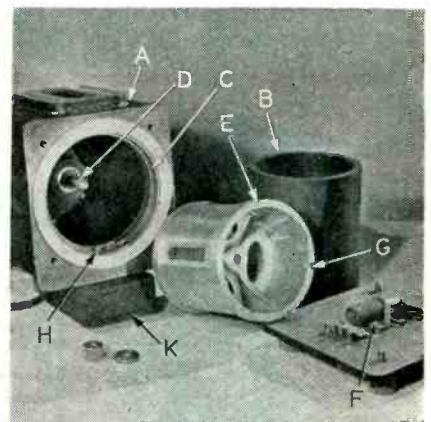
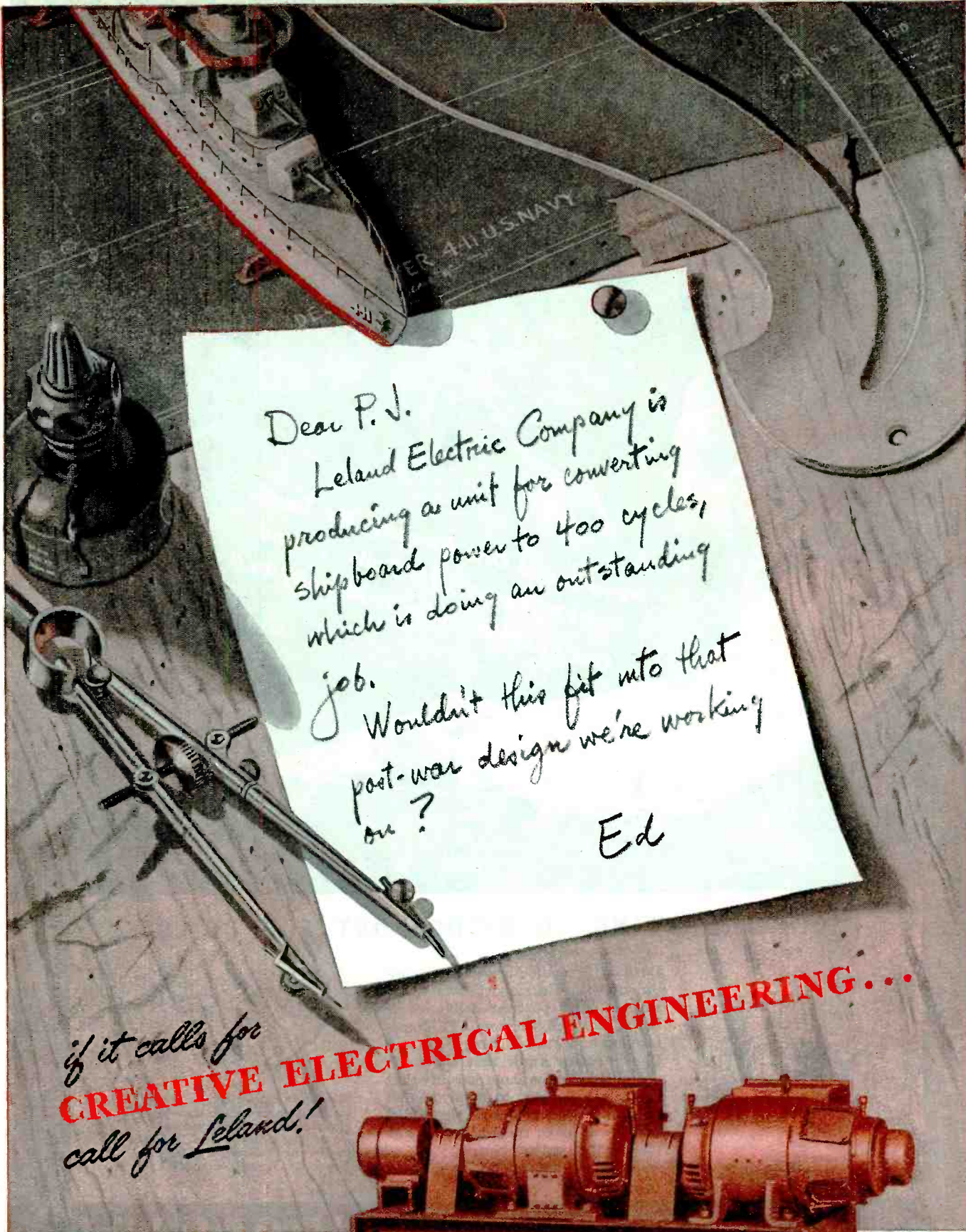


Fig. 5—(a) Film drum housing shown attached to the bottom end of the oscillograph in Fig. 1. Dark shield (b) is used to carry loaded film drum to oscillograph. Dark shield cylinder, containing the drum, is set into recess (c) and drum is pushed on to shaft (d). When dark shield is removed, drum is sealed against light by the close clearance between its rim (e) and the surrounding housing. For timing, light source (f), through slot (g) and tubes (h) will energize phototubes in container (k)

the strength of the film is about one inch in 1/2000 second.

If the rotating-drum method is employed with a sealed-glass tube, the image on the fluorescent screen must be photographed. With the time sweep remaining inoperative, the voltage deflection moves up and down along a fixed line. Therefore, the fluorescence due to one single deflection must be allowed to fade out before the same line can be re-traced by the cathode beam. Otherwise, the oscillogram will be one continuous blur. Similar problems are encountered in television tubes and other field-scanning applica-



Dear P. J.

Leland Electric Company is producing a unit for converting shipboard power to 400 cycles, which is doing an outstanding job.

Wouldn't this fit into that post-war design we're working on?

Ed

*if it calls for  
call for Leland!*

**CREATIVE ELECTRICAL ENGINEERING...**

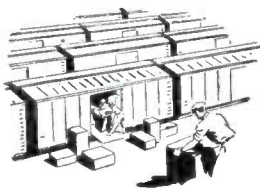
**THE Leland ELECTRIC COMPANY**

DAYTON, OHIO • IN CANADA, LELAND ELECTRIC CANADA, LTD. ... GUELPH, ONTARIO

*"Be On the Lookout For Good  
Postwar Suppliers, Sam."*

*"I've Found One Already, Mr. Davis,  
It's Bridgeport For Coils . . . and  
Our Postwar Order Is Already In."*

## JOIN THE SWING TO BRIDGEPORT FOR COILS



Dozens of manufacturers are placing orders with Bridgeport *now* to be sure of early postwar deliveries of R.F. Coils and Chokes, I.F. Transformers and Transmitting Coils and Chokes. They know that the same personnel and the same capacity that enables Bridgeport to supply Search Coils and Variometers for the armed forces will make them a logical supplier in the postwar period.



They know that Bridgeport's central location gives them the added advantage of fast, trunk line service to any point in the United States when delivery is an important factor. Write to us today.

# BRIDGEPORT

MANUFACTURING COMPANY  
Bridgeport, Illinois

R. F. Coils • R. F. Chokes • I. F. Transformers  
Transmitting Coils • Transmitting Chokes

# TONE KEYERS

by **PRESS WIRELESS**



TONE KEYER TK-6A

- ▶ Six different, standard, high-stability channels
- ▶ High-speed, low-transient keying capabilities better than 2,000 w.p.m.
- ▶ Thyatron trigger circuit eliminates inherent keying bias
- ▶ Constant amplitude, sine-wave output over entire tonal range
- ▶ Standard 19 inch, rack mounted
- ▶ Modern blue-grey wrinkle finish

Operates from 110/115 volts, 50/60 cycles AC

Available in strict priority sequence

Send for free data sheet

**PRESS WIRELESS, INC.**

Executive and Sales Office  
1475 BROADWAY, NEW YORK 18

**OPPORTUNITIES**  
Opportunities in present & postwar work for Senior and Junior Graduate Engineers.  
Phone, call or write, stating experience, education, etc.  
Personnel Department,  
Manufacturing Division,  
**PRESS WIRELESS, INC.**  
1475 Broadway  
N. Y. C. - 18



Awarded to our Michsville, E. I. plant for outstanding achievement in war production.

PARIS - RIO DE JANEIRO - MONTEVIDEO - MANILA - BERNE - SANTIAGO DE CHILE - NEW YORK - CHICAGO - LOS ANGELES - LONDON - HAVANA

# where solder is SERIOUS BUSINESS



Photos courtesy Pan American World Airways

## you'll find . . . KESTER CORED SOLDERS

● Dependable solder-bonds—like thousands of other details of construction, maintenance and operation—are vital to the performance and safety of the great Pan American fleet. Solder-bonds aboard the famous Flying Clippers must hold under all operating conditions.

● Kester Cored Solders provide the precise solder-bond dependability Pan American requires. They are virtually mistake-proof in application, because they contain positive-acting flux. Flux and free-flowing alloy are applied in one quick, easy operation.

● The solder-bonds thus formed not only are clean, but hold against shocks, vibration, bending, twisting, and contraction and expansion caused by temperature changes.

● **Kester Rosin-Core Solder** is laboratory-perfected for electrical work. The patented, plastic rosin flux will not cause corrosion or injure insulation. Dangers of short circuits are eliminated. Terminals are permanently protected.

● **Kester Acid-Core Solder** is laboratory-perfected for general work. The core will not leak. The flux is a rapid-acting, all-purpose flux.

● The complete Kester Line includes just the right strand and core sizes, and alloy and flux combinations, for each of the solder-bonds you form. And Kester's 46 years' solder experience and laboratory research are at your service. Kester engineers will be glad to assist you on any solder problem.

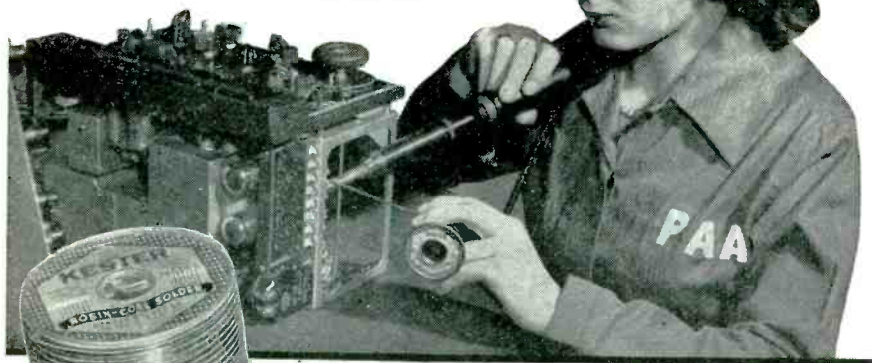
☆ BUY WAR BONDS ☆

### KESTER SOLDER COMPANY

4204 Wrightwood Avenue, Chicago 39, Illinois

Eastern Plant: Newark, N. J.

Canadian Plant: Brantford, Ont.



**KESTER**  
*Cored Solders*  
STANDARD FOR INDUSTRY

tions and have led to the development of low-retentivity screen materials. The latter, however, have a much lower light output and require the application of tubes with different screen characteristics when changing from high-speed stationary to rotating film recording.

In taking film-drum records of highly irregular voltage phenomena, it is important that the film be exposed for not more than one revolution because otherwise the superposition of traces would render it illegible. Single-revolution exposure of the drum regardless of speed is accomplished by the application of phototubes in combination with the regular ray-blocking scheme of the Westinghouse instrument (Fig. 4). In the ray-blocking section of the

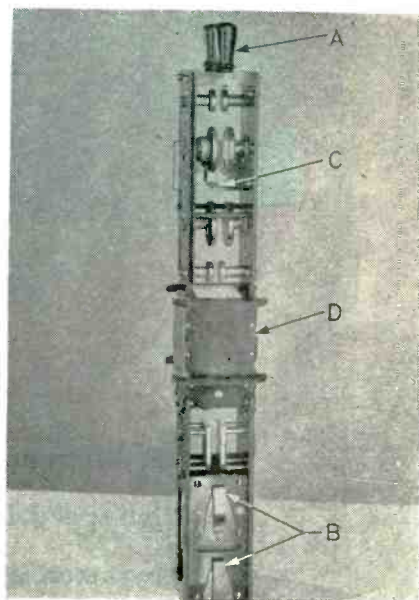


Fig. 6—By means of handles (a) temporarily inserted into its top plate, the frame carrying all beam deflecting elements can be pulled out of the oscillograph tube. Contact springs (b) connect the various electrodes to the bushings in the housing. Most parts can be identified by reference to Fig. 4. (c)—Target. (d)—Magnetic shield around main concentration coil

oscillograph tube, a metal tongue or target bars the electron beam as long as it is not deflected from the centerline of the instrument by a potential difference between the electrodes located above it. If a sufficient field develops between these electrodes, the beam moves off the target and an identical set of plates below the target brings it back on the centerline.

When closing the exposure button (lower corner of Fig. 4), the same





Camp Coles Signal Laboratories  
Red Bank, N. J.



**SCGSA**  
(SIGNAL CORPS GROUND SIGNAL AGENCY)

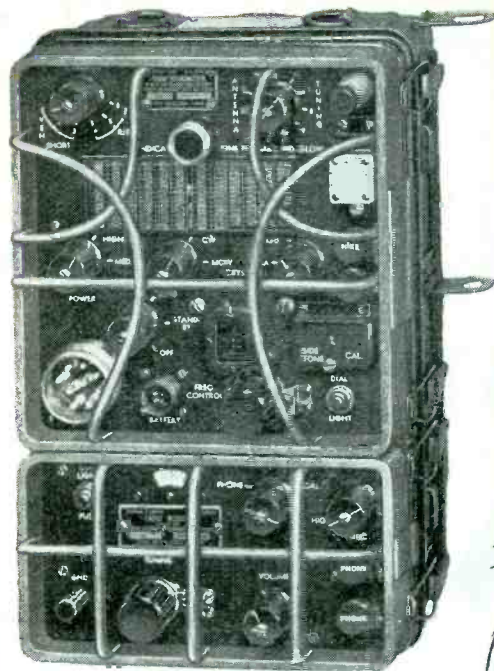
# ... BIRTHPLACE OF THE SCR-694

The Laboratory . . . here are born electronic weapons that are making history. Our American systems of army communications have proved mighty factors in our fighting successes, due primarily to the remarkable achievements of the Signal Corps Laboratories, known as SCGSA, comprising a chain of research units under one centralized supervision. At one of these Laboratory Units, Camp Coles (pictured above), was conceived the SCR-694, a compact, light-weight, highly versatile and efficient two-way radio telephone and telegraph outfit, for use in vehicles, as a portable ground station or front line command post.

It is a pleasure to give full recognition to the creative genius and organization of SCGSA and the really vital work it accomplishes, necessarily without public attention

*Ell Rauland*

President, The Rauland Corporation



**SCR-694 TRANSMITTER-RECEIVER**  
Weight 22 lbs. ★ range sufficient for vehicle use ★ waterproof and fungus proof ★ ideally adapted to jungle or sub-zero operation ★ powered by hand generator, gasoline engine or vehicular vibrator power supply ★ converted from vehicle to field use immediately.

Whether in a foxhole or jeep, in jungle or on the beach, in a tropical downpour, blizzard or surf, the SCR-694 can "take it." When its switch is pressed, this radio is ON THE AIR.

Quotes from field reports  
—from the Pacific:

"During a rainstorm the 694's were the only sets in one section that remained operative."

"The weight of the set, its construction, its features such as crystal control, etc., make it ideal for use in amphibious operations."



PORTABLE



Photos courtesy U. S. Army Signal Corps

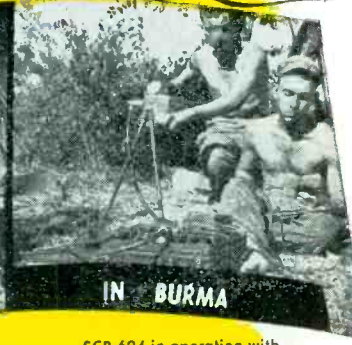
FIELD OPERATION



VEHICLE OPERATION



IN BURMA



SCR-694 in operation with America's newest fighting unit in Central Burma.

Electroneering is our business

RADIO • RADAR • SOUND

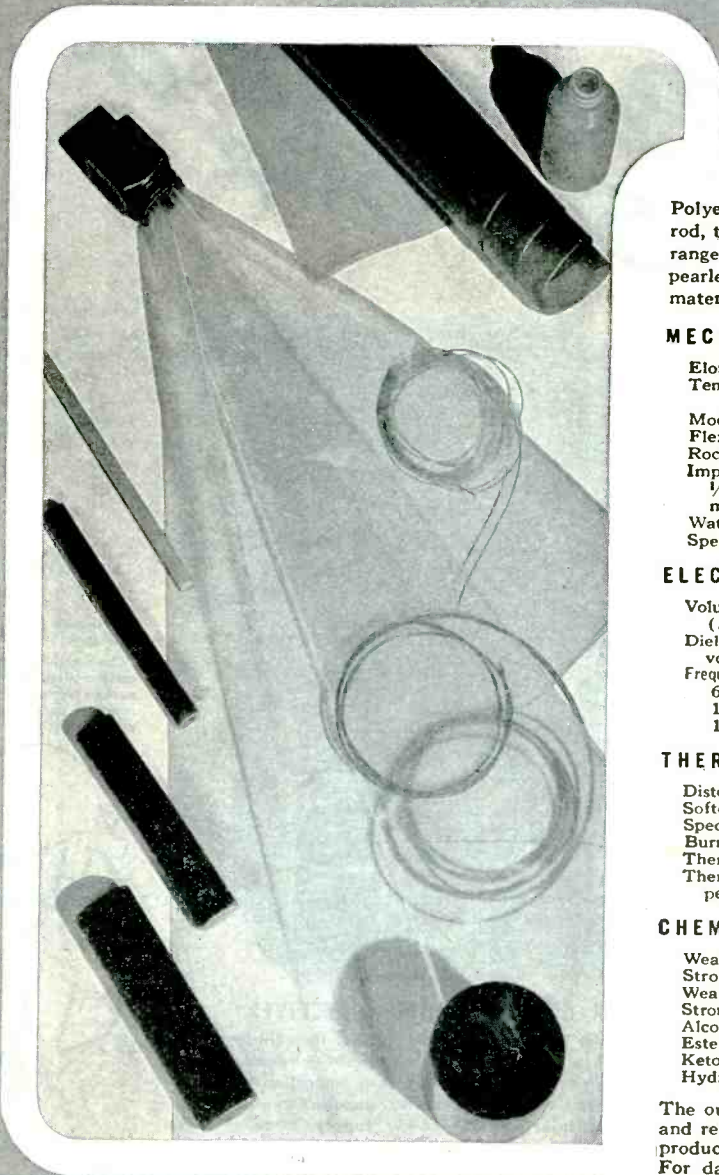
# Rauland

COMMUNICATIONS • TELEVISION

THE RAULAND CORPORATION • CHICAGO 41, ILLINOIS

Rauland esteems it a high honor to have been selected by SCGSA for the development of SCR-694

# DATA ON PLAX POLYETHYLENE PRODUCTS



Polyethylene is supplied by Plax in film, slab, rod, tube, fiber and blown ware forms, in a wide range of sizes and in all colors, from clear to pearlescent. The unusual characteristics of this material are as follows:

## MECHANICAL

Elongation, 77° F, %	30-500
Tensile Strength, p.s.i. (-70°, 77°, 170° F)	5000; 1700; 700
Modulus of Elasticity in Tension, p.s.i. x 10 <sup>3</sup>	.146
Flexural Strength, p.s.i.	1700
Rockwell Hardness	13R
Impact Strength, ft. lbs. per in. of notch; 1/2" x 1/2" notched bar Izod tests, 4 ft.-lb. machine, room temperature	Does not break
Water Absorption, 24 hrs., %	0.01
Specific Gravity	.92

## ELECTRICAL

Volume Resistivity, ohm. cms. (50% rel. hum. at 25°C)	10 <sup>17</sup>	
Dielectric Strength, short-time volts per mil, 1/8 in. thick	1000	
Frequency	Dielectric Constant	Power Factor
60	2.3-2.4	.0002-.0005
10 <sup>3</sup>	2.3	.0002-.0005
10 <sup>6</sup>	2.3	.0002-.0005

## THERMAL

Distortion Temperature, °F	122
Softening Point, °F	219-239
Specific Heat, cal. per °C per gram	0.5
Burning Rate	Ignites and burns slowly
Thermal Expansion, 10 <sup>-3</sup> per °C	10.5
Thermal Conductivity, 10 <sup>-4</sup> cal. per sec. per sq. cm/1°C per cm.	7

## CHEMICAL EFFECTS

Weak Acids	None
Strong Acids	None
Weak Alkalis	None
Strong Alkalis	None
Alcohols	None
Esters	Slight
Ketones	Slight
Hydrocarbons	Considerable

The outstanding electrical properties, toughness and resistance to moisture of Plax polyethylene products adapt them to a vast range of uses. For data on sizes and adaptability to specific applications, write Plax.

The following illustrated literature is available:

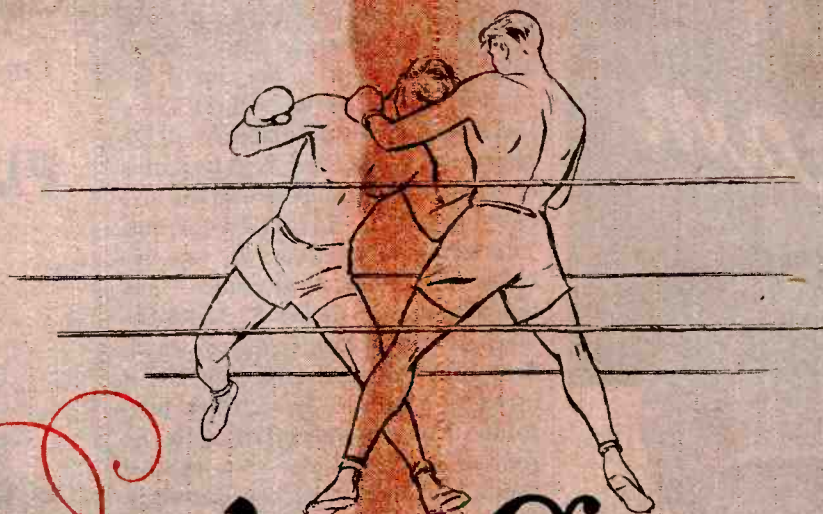
Several bulletins on Plax polystyrene products and how to machine them.

Data on Plax cellulose acetate, cellulose acetate butyrate, and methacrylate products.

An article on Plax's blown products.

Ethyl Cellulose and styramic are among the other materials offered by Plax in various forms. In cooperation with the Shaw Insulator Company, Irvington 11, N. J., Plax can give you help covering nearly all plastic materials and methods. For such help, or for any of the literature listed above . . . write Plax.





# Quality Counts

**I**N 1892, James J. Corbett beat John L. Sullivan to win the heavyweight championship of the world. Corbett, who was considered a novice in the ring, weighed only 186 pounds to Sullivan's 220, and yet he knocked out Sullivan in the 21st round. Corbett had that touch of quality—of extra quality—that expressed itself in victory. For superior performance in any product—just as with Victory in the prize-ring—*Quality Counts!*

For years, the antennas manufactured by THE WARD PRODUCTS CORPORATION have been known as quality products, the workmanship of craftsmen using modern equipment under ideal conditions. Constant adherence to the principles of quality coupled with manufacturing experience has made WARD the leader in the production of sectional and one-piece antennas . . . For quality antennas for all applications, look to WARD.



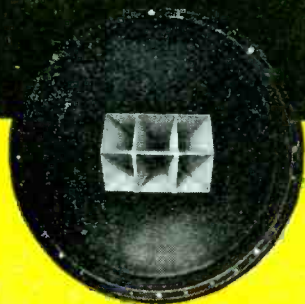
# WARD Antennas



BUY WAR BONDS

THE WARD PRODUCTS CORPORATION  
1523 East 45th Street  
Cleveland 3, Ohio

# KEEP OFF THE Beam



## WITH THE DUPLIX SPEAKER

The very objectionable concentrated beam at high frequencies in sound reproduction is eliminated by the Duplex Speaker. Even at 15,000 cycles plus, the DUPLEX speaker distributes high quality sound 60 degrees horizontally and 40 degrees vertically as compared to the 5 degrees of single unit speakers of comparable size. Another reason why the DUPLEX is the SPEAKER that REVOLUTIONIZES the methods of sound REPRODUCTION.

SEND FOR BULLETINS

# ALTEC

LANSING CORPORATION

1210 TAFT BLDG., HOLLYWOOD 28, CALIF.  
250 WEST 57 STREET, NEW YORK 19, N. Y.  
IN CANADA: NORTHERN ELECTRIC CO.

potential of about 1000 volts is applied to all ray-blocking electrodes; there is yet no field between them and the beam remains cutoff. However, when the slot in the rim of the rotating drum permits light from the lamp inside the drum to strike phototube No. 1, the negative bias of triode No. 1 collapses and the circuit branch  $R_1$ ,  $R_2$  carries current. The voltage drop across  $R_1$  now unblocks the beam. At the same time, the voltage drop across  $R_2$  raises the level of the voltage source which first kept the grid of triode No. 2 strongly negative. Now, when phototube No. 2 is energized again by light through the slot (one revolution after the process was started in No. 1), the collapse of its potential is sufficient to make the grid of triode No. 2 positive. This starts current through  $R_3$  which practically cancels the potential difference between the opposing ends of  $R_1$  and  $R_2$  and hence retraps the beam.

### Construction

The cathode tube of the unit is constructed of seamless steel tubing joined with high-grade iron castings; the latter are visible in front of the center of the steel cabinet. They contain the rotating film drum, the stationary film holder and the fluorescent screen. All accessories, including the 50-kv cathode voltage supply, are housed in the same cubicle. The pumps, consisting of an oil pump for the fore-vacuum and a mechanical, grooved cylinder-type molecular pump, exhaust the instrument in about 10 minutes to a hard vacuum at which no discharge can form between the anode and the cold cathode. The latter consists of a small aluminum cylinder without any heater. The electron pencil is formed through ionization by collision. This requires a definite gas pressure which is controlled by air admitted through the leak valve. The latter reduces air of atmospheric pressure to the required vacuum which ranges from 5 to 15 microns depending on the desired beam current. Despite the high reduction in pressure accomplished with the valve, the latter is very sensitive to small changes in atmospheric pressure. Small variations of the intake pressure can readily be produced by taking the

*Make Plans Now . . .  
for the coming . . .*

## PLASTIC ERA



*Consult . . .*

## ROGAN

• Here at Rogan, seasoned engineers are ready and willing to assist you in determining your post-war *Plastic* requirements.

Whether your peacetime products are to include electronic equipment, electrical appliances, stoves or what have you, the Rogan Organization will gladly provide cost-free advice on all phases of plastic production.

*Send us*

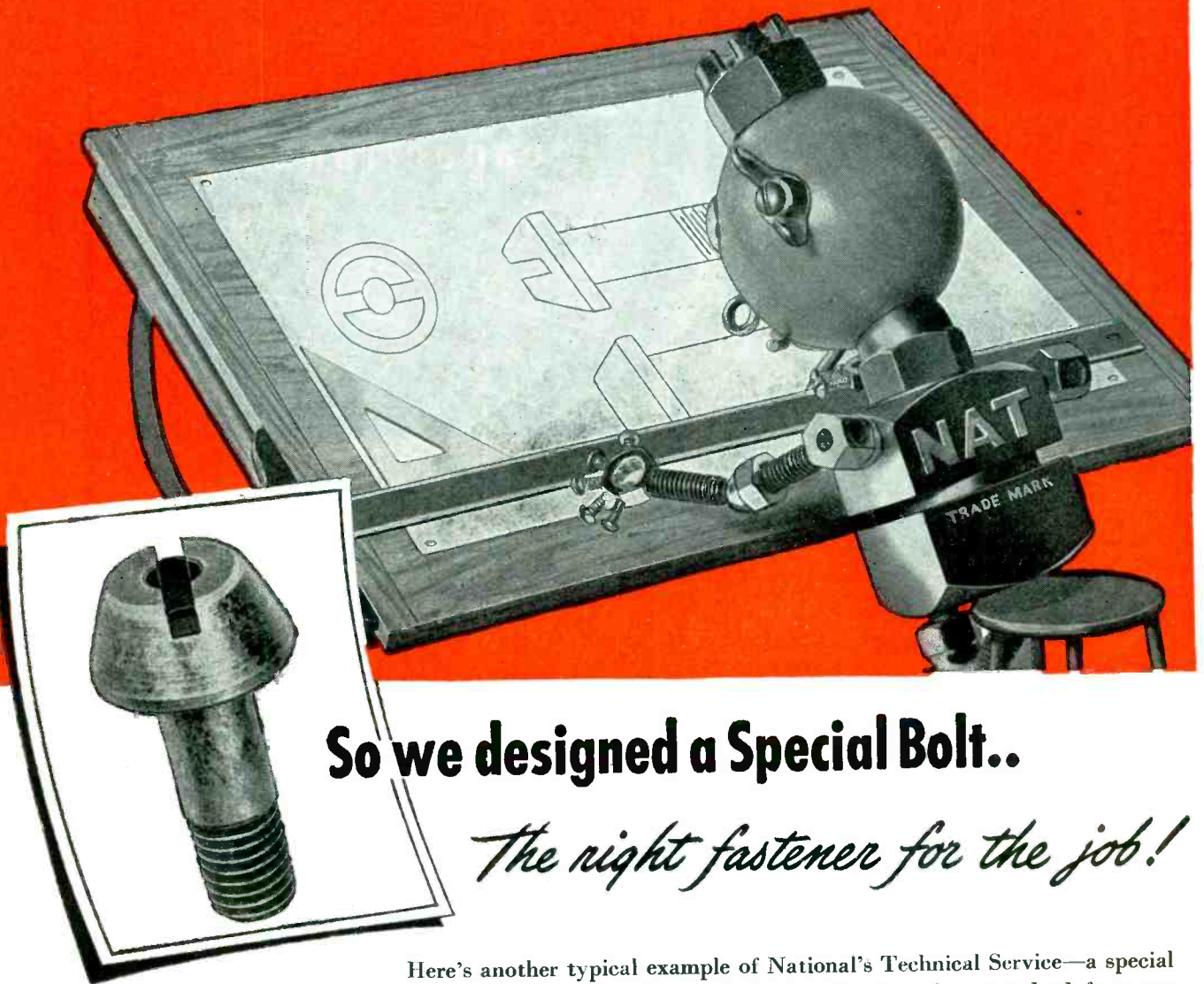
*Your Specifications Today!*

## ROGAN BROTHERS

*Compression Molders and Branders  
of Plastics*

2003 So. Michigan Avenue  
Chicago, Illinois

# THEY NEEDED A BOLT THAT DIDN'T EXIST..



## So we designed a Special Bolt..

*The right fastener for the job!*

Here's another typical example of National's Technical Service—a special fastener designed for the particular application when standard fasteners don't meet the need:

In a certain rubber molding operation a bolt was required that could be pulled up tight and used for many applications. Extra large bearing surface was needed, as well as exceptional strength and high "torquing" capacity.

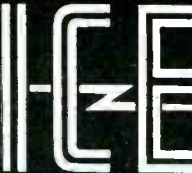
We designed the bolt of alloy steel, with a specially formed slot which permits use of a reinforced driver. This prevents slipping or shearing of the driver point. The large diameter at the base of the head affords ample bearing surface, while the tapered sides reduce the amount of metal in the head, making it possible to upset the bolt, an important cost factor.

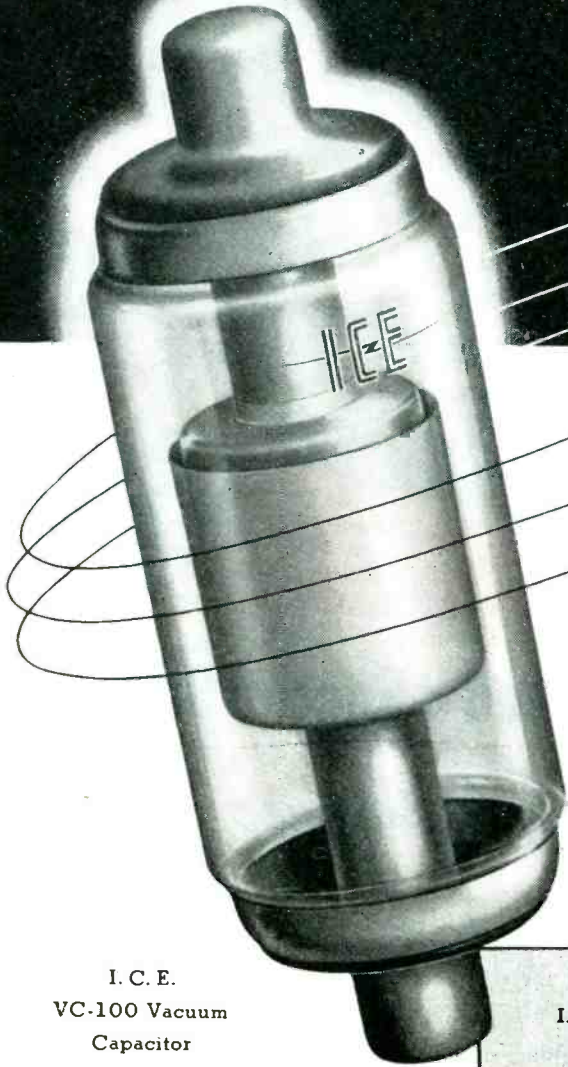
You may need just such a service as this to improve your fastenings. Often we can save production time and cost by upsetting a part instead of milling from bar. Let us have your inquiry.

Send for a copy of this case history booklet describing briefly, with diagrams, typical instances of National's Technical Service. Ask for the "Savings" booklet.

**National**  
HEADED AND THREADED  
PRODUCTS

## THE NATIONAL SCREW & MFG. CO., CLEVELAND 4, O.

ONLY  VACUUM CAPACITORS  
 give you the precise  
 capacitance value  
 you want



I. C. E.  
 VC-100 Vacuum  
 Capacitor

Now I. C. E. makes it possible for you to order vacuum capacitors with the correct capacitance value to meet requirements of your equipment. I. C. E. Vacuum Capacitors are now available in any value range from 6 to 110 mmfd. in steps of 1 mmfd.

**I. C. E. Vacuum Capacitors Give You Close Tolerances**

Beside offering you a wide range of capacitance values, I. C. E. Vacuum Capacitors are built to give you previously unobtainable tolerances.

**I. C. E. PRECISION GRADE VACUUM CAPACITORS**

<i>Value Range</i>	<i>Accurate to</i>
6 mmfd. to 25 mmfd.	±0.5 mmfd.
26 mmfd. to 60 mmfd.	±1.0 mmfd.
61 mmfd. to 110 mmfd.	±1.5 mmfd.

**I. C. E. XX GRADE VACUUM CAPACITORS**

<i>Value Range</i>	<i>Accurate to</i>
6 mmfd. to 25 mmfd.	±0.2 mmfd.
26 mmfd. to 60 mmfd.	±0.3 mmfd.
61 mmfd. to 110 mmfd.	±0.5 mmfd.



ELECTRONIC TUBES

RESEARCH • DESIGN • PRODUCTION

**Full Details in the New I. C. E. Catalog**

For full information on these outstanding I. C. E. Vacuum Capacitors, as well as other precision I. C. E. products, write today for the new I. C. E. Catalog.

**INDUSTRIAL & COMMERCIAL ELECTRONICS**

BELMONT, CALIFORNIA • NEW YORK CITY, N. Y.

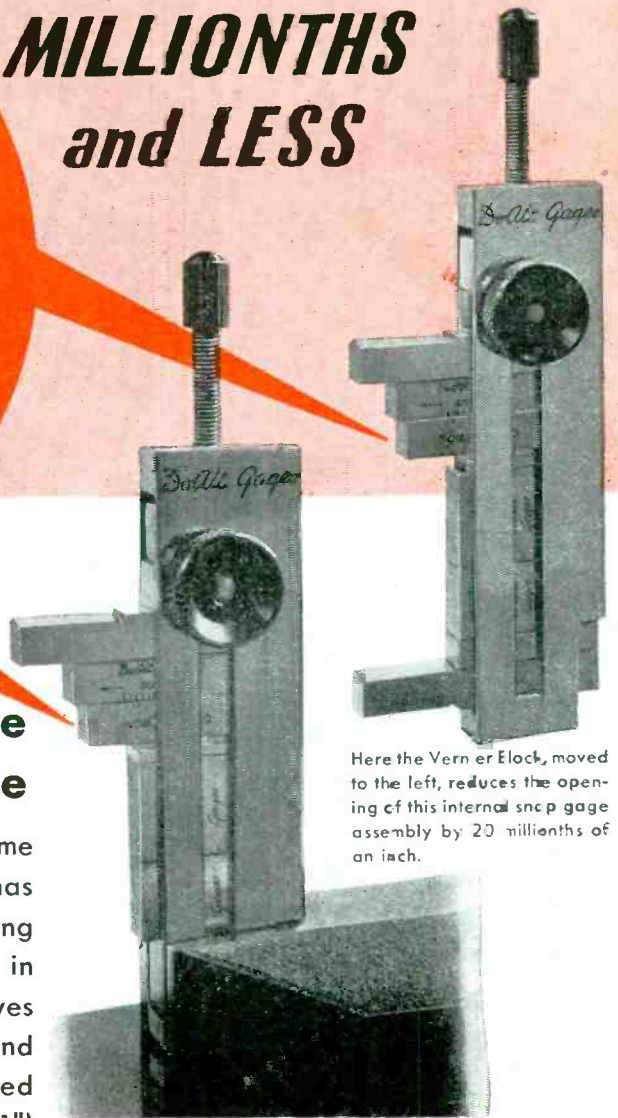
# this Do ALL Vernier Block alone MEASURES TO TEN MILLIONTHS and LESS



## Every Inspector should have one Versatility is its middle name

Here's the Vernier principle applied for the first time to gage block practice! The DoALL Vernier Block has a nominal size of 7-tenths of an inch but, by sliding its halves, will measure from .699900" to .700100" in gradations of 10-millionths of an inch (.0000010"). Halves (.000005"), thirds (.00000333" and .0000066") and quarters (.0000025" and .0000075") can be estimated readily, and fifths (.000002") and tenths (.000001") easily with a magnifying light.

It's the handiest instrument you've ever seen. Once used, no inspector will do without it.

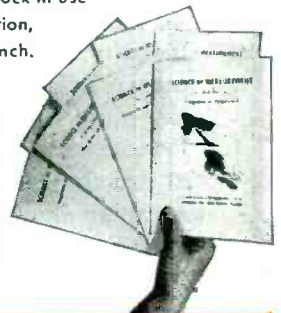


Here the Vernier Block, moved to the left, reduces the opening of this internal snap gage assembly by 20 millionths of an inch.

Here is the DoALL Vernier Gage Block in use in a difficult height gage combination, measuring to five millionths of an inch.

COMPLETE INSPECTION COURSE. EIGHT LESSONS FREE TO EACH PURCHASER.

HANDBOOK—Write for free copy of our new QUALITY CONTROL book.



Where DoALL Gages are made

# DoALL

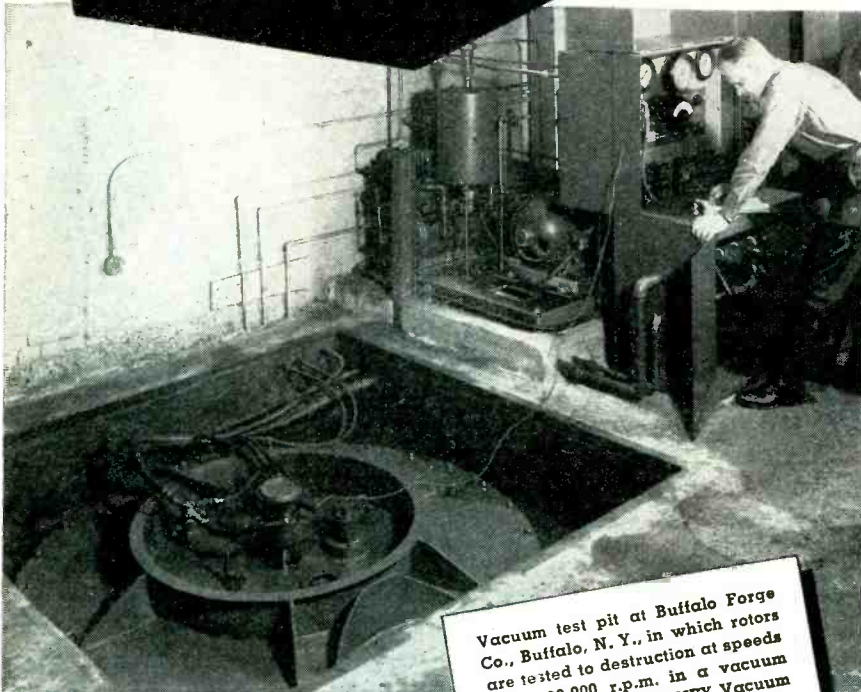
INDUSTRY'S NEW SET OF TOOLS

**CONTINENTAL MACHINES, INC.**

1366 S. Washington Avenue • Minneapolis 4, Minn.

Sales & Service Offices: Baltimore, Birmingham, Boston, Buffalo, Chicago, Cincinnati, Cleveland, Dallas, Dayton, Denver, Detroit, El Paso, Erie, Grand Rapids, Hartford, Houston, Indianapolis, Kansas City, Los Angeles, Milwaukee, Minneapolis, New York, Orlando, Philadelphia, Pittsburgh, Providence, Reading, Rochester, Rockford, St. Louis, San Francisco, Seattle, Statesville, Syracuse, Toledo, Tulsa.

**1/4 H. P.  
TAKES THE PLACE OF  
1000 H. P.**



Vacuum test pit at Buffalo Forge Co., Buffalo, N. Y., in which rotors are tested to destruction at speeds up to 60,000 r.p.m. in a vacuum maintained by a KINNEY Vacuum Pump. A small air turbine, developing about 1/4 H.P., actually revolves the rotor which, under normal atmospheric conditions, would require a 1000 H.P. motor.

*Thanks to a...*  
**KINNEY**  
HIGH VACUUM  
**PUMP**

**T**HOUSANDS of KINNEY Vacuum Pumps are serving Industry in countless ways, maintaining the low absolute pressures required in making electronic products, in sintering alloy metals, in coating lenses and producing drugs. Proved and dependable, they can be relied upon for years of exacting service. KINNEY Single Stage Vacuum Pumps maintain low absolute pressures down to 10 microns; KINNEY Compound Vacuum Pumps to 0.5 micron.

*Further information on request*

**KINNEY MANUFACTURING CO.**

3565 Washington St., Boston 30, Mass.

New York • Chicago • Philadelphia • Los Angeles • San Francisco

We also manufacture Vacuum Tight Valves, Liquid Pumps, Clutches and Bituminous Distributors

air from a chamber rather than directly from the atmosphere. The pressure in this chamber can be finely varied by the screw-controlled expansion and contraction of a set of bellows. The device can remain set in any particular position for a long time as the rate of air flow through the leak valve is very small.

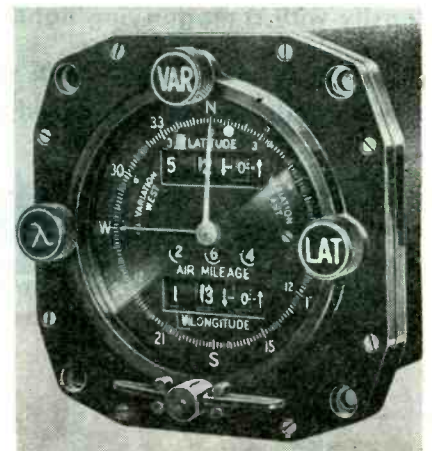
This and other means for furthering ease of operation and reliability, developed through years of use in high-voltage laboratories and on factory test floors, have made the high-voltage electronic oscillograph the instrument which now finds application in new branches of engineering such as the field of airplane engine ignition.

• • •

**Automatic Position Indicator for Aircraft**

ONE REASON for the success of the bombing raids on Japan is the use of an automatic position indicator that gives continuous indications of latitude and longitude while in flight. These are shown on the instrument panel compass dial shown in the illustration. The unit was developed by engineers of Eclipse-Pioneer Division of Bendix Aviation Corporation in cooperation with the Army and Navy air forces.

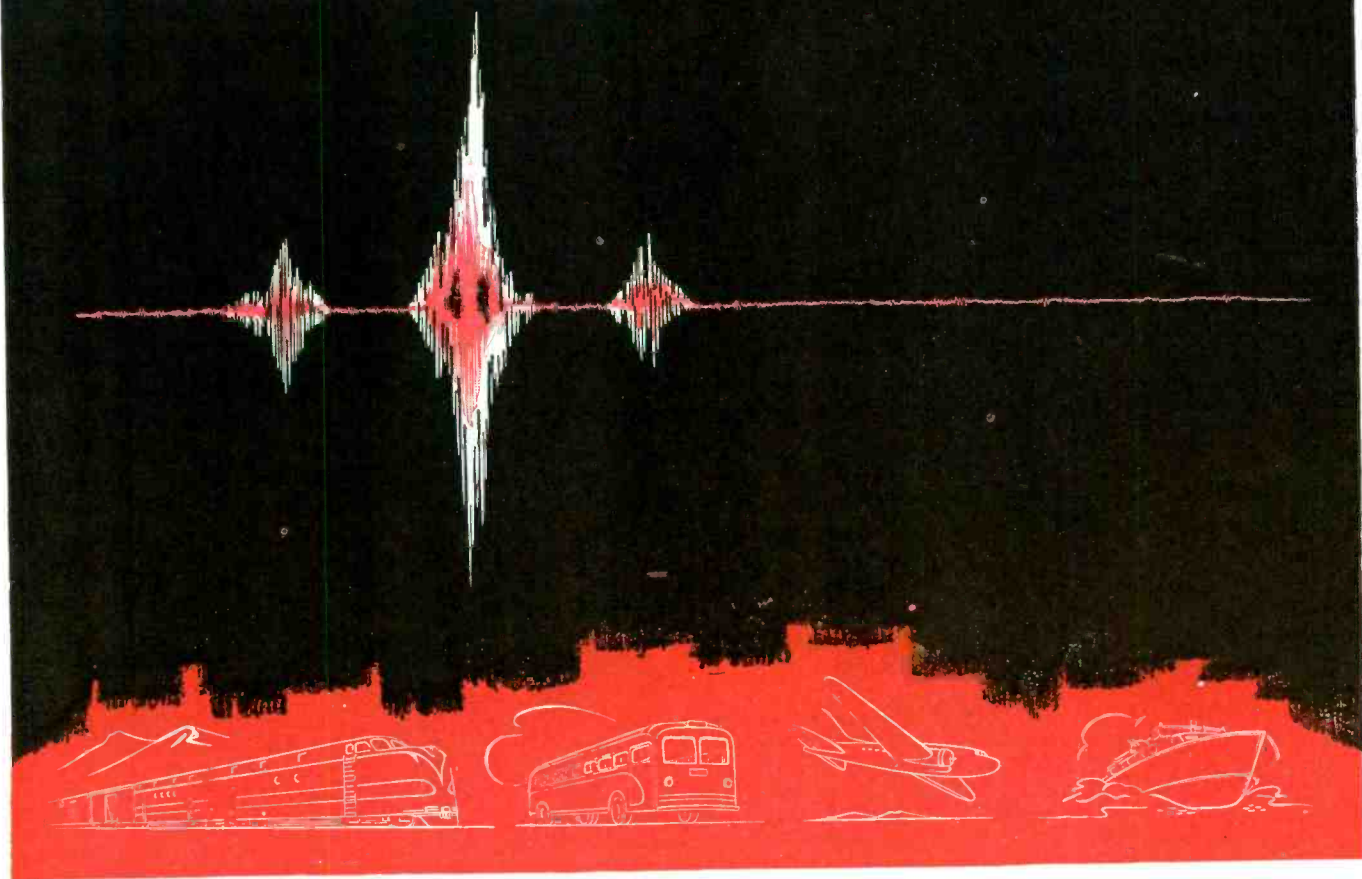
The air position indicator, called API, combines the rotational speed of the true airspeed pump with the directional signal from the compass and produces continuous indication of the air plot in latitude and longitude. Proper application of the wind vector (the distance by which the air mass has moved over a specified



Closeup view of the panel indicator showing the counters for latitude and longitude change and air mileage



# DETONATION



## How electronics helps tell a knock from a boost...

THE MIT-Sperry Detonation Indicator is an engine instrument that discriminates between normal and abnormal combustion.

Through an electronic pickup, it *instantly detects detonation*—popularly called knocking or pinging—in most types of internal combustion engines. And it gives *immediate evaluation of detonation*.

As a result, warning is given at the time trouble *starts* . . . engine life is lengthened . . . mixture may be adjusted so that considerable fuel is saved . . . and the period between engine overhauls is extended.

No piercing of engine cylinders is required. Yet even the slightest detonation is signalled visually, and the faulty cylinder or cylinders spotted.

Use of the MIT-Sperry Detonation Indicator on airplanes results in remarkable fuel savings, longer engine life, greater safety.

The same is true of surface transportation which employs internal combustion engines.

Engine manufacturers find this instrument an invaluable aid in designing and testing. It also permits development of fuels exactly fitted to engine characteristics, thus increas-

ing power output and lowering fuel costs. Also with the Knockometer, a special application of the Detonation Indicator, fuels with superior anti-knock characteristics can be developed and their quality production controlled.

Since 1937, Sperry engineers have been working on the perfection of a detonation indicator. This is but one of the many fields in which Sperry has pioneered in the field of electronic development.

Additional information on the MIT-Sperry Detonation Indicator is available on request.

**SPERRY GYROSCOPE COMPANY, INC.** GREAT NECK, N. Y.



*Division of the Sperry Corporation*

★  
LOS ANGELES • SAN FRANCISCO • SEATTLE • NEW ORLEANS  
CLEVELAND • BROOKLYN • HONOLULU

GYROSCOPICS • ELECTRONICS • RADAR • AUTOMATIC COMPUTATION • SERVO-MECHANISMS



## *Just a Kid...* **BUT DEEP IN ELECTRONICS**

**N**OW he's a Major in the U.S. Army Air Forces. A few short years ago he was a freshman in high school, just a kid "fooling around with radio." Today "the kid" knows every inch of his giant bomber.



He knows each link in the vast chain of Superfortress performance. And that includes the important electronic details of amplification.

After the war, thousands like him are going to tell you what can be done in sound reinforcement, and how! Because "the kid" has used Eastern-built equipment in war, he'll buy Eastern-built equipment in peace — or maybe he'll sell it! In either case, his generation will have a great influence on the selection, installation and operation of sound and electronic equipment. And

we believe that Eastern products will rate high with these young men.

\* \* \*

To aid the war effort, our engineers are available for consultation on any amplification problem. Until Victory, Eastern will continue to devote its resources to the design and manufacture of vital war equipment. Meanwhile, let us send you the next of a series of useful articles prepared by our engineering staff on the newest developments in amplification related to both sound systems and industrial instruments. Ask for Brochure 5-F.

*Buy MORE War Bonds*



# **EASTERN AMPLIFIER**

**CORPORATION**

U. S. Reg'n. Applied For

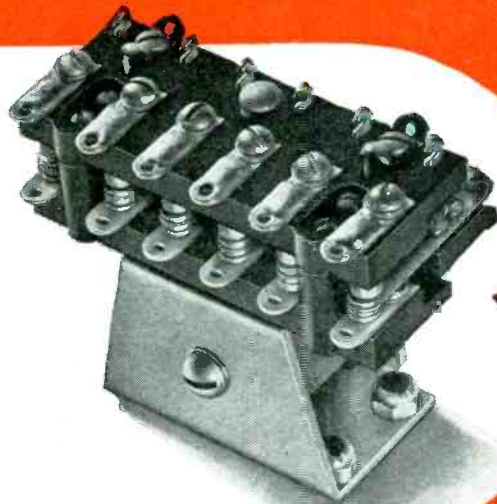
794 EAST 140th STREET • NEW YORK 54, N. Y.

# Here is *advanced* Relay Engineering!

## TYPE BN

The Allied 6-pole, double-throw BN type embodies many new improvements for heavy duty 6-pole switching . . . permits individual adjustment of contacts. Molded Bakelite is used throughout the relay. Contacts are rated at 10 Amperes. As in all Allied relays, the BN is designed for compactness and minimum weight. May be furnished normally open or normally closed or double-throw. Available in AC or DC. Weighs 11 oz. Write for complete operating characteristics, etc.

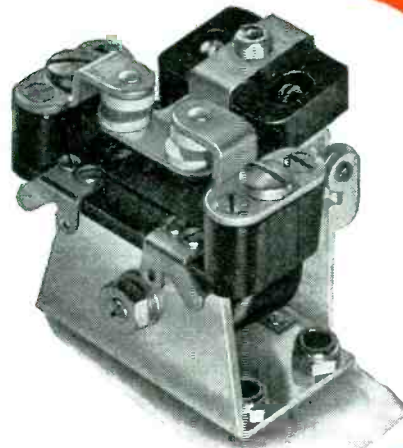
Height: 2 9/16" Length: 3" Width: 1 23/32"



## TYPE CN

The CN relay is the result of advanced engineering technique and succeeds Allied's successful AN type . . . a power relay expressly designed for breaking heavy current. Contact rating is 50 Amperes at 24 Volts DC with silver contacts; with alloy contacts the contact rating is 75 Amperes at 24 Volts DC. (The latter arrangement with the alloy contacts is known as the CNS type.) The contact arrangement is single pole, single throw, double break, normally open or normally closed. The new design incorporates molded Bakelite insulation, greater electrical clearance and over-all improved mechanical structure. Available in AC or DC. Complete data on request.

Height: 2 1/2" Length: 3 1/4" Width: 2"



The two relays described above are typical examples of the many new types of relays Allied is constantly designing for its customers' widely diversified requirements.

Allied's engineering staff continually works to improve relay designs and to develop new magnetic control devices for present and future manufacturers whose products require electrical control. The highly practical accumulated knowledge of these men is at your command. Send us your control problems!



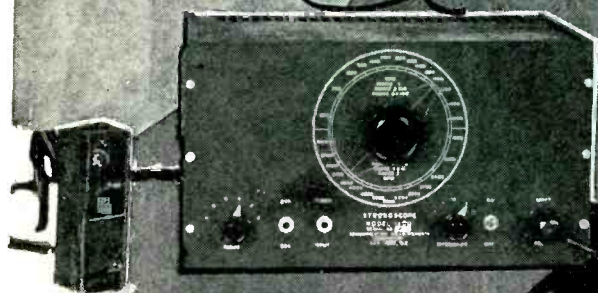
**ALLIED CONTROL COMPANY, INC.**

2 EAST END AVENUE (at 79th Street) NEW YORK 21, N. Y.

FACTORIES: NEW YORK CITY - PLANTSVILLE, CONN.  
ALLIED CONTROL CO. OF CALIFORNIA, INC. • 1633 SOUTH HOPE STREET • LOS ANGELES 15, CALIFORNIA  
ALLIED CONTROL COMPANY, INC. • 4321 NORTH KNOX AVENUE • CHICAGO 41, ILLINOIS

**New in Principle!  
Revolutionary in Range!**

## CML MODEL 1200 STROBOSCOPE



**"FREEZES"  
MOTION IN  
RANGE OF  
600 TO 600,000  
RPM**

Rotary speeds from 600 to 600,000 RPM — or vibrations from 10 to 10,000 CPS — can be "stopped" and studied with the Model 1200 Stroboscope. The light source is mounted in a small probe at the end of a five-foot flexible cable.

This makes it easy to examine small objects at close range. Provision is made to operate the unit from external tuning fork or crystal standards, where extreme accuracy is required. The motion of objects moving at irregular speeds may also be "stopped" with the Model 1200. An accurate repetitive pulse rate is obtained, as the pulses are derived from a stable audio oscillator.

Not only does this eliminate the necessity for constant readjustment of the repetitive rate, but it also insures clearly defined images at high speeds.

For greater flexibility, a light intensity control switch is also provided. This enables the user to control both the intensity of the light and the duration of the pulse length.

**WRITE FOR  
DESCRIPTIVE  
BULLETIN**

### **COMMUNICATION MEASUREMENTS LABORATORY**

Rotobridge • Electronic Generators • Power Supply Units  
120 GREENWICH ST., NEW YORK 6, N. Y.

POSITION INDICATOR

(continued)

period of time) to this air position yields ground position. The readings of latitude and longitude appear on the two drum-type counters, which are initially set to the proper latitude and longitude of the take-off point and can be reset anytime when passing over a check point in flight. The indicator, more specifically called the computer, also registers total air miles traveled and has a compass dial and pointer which must necessarily indicate heading with respect to true north.

#### *Corrections*

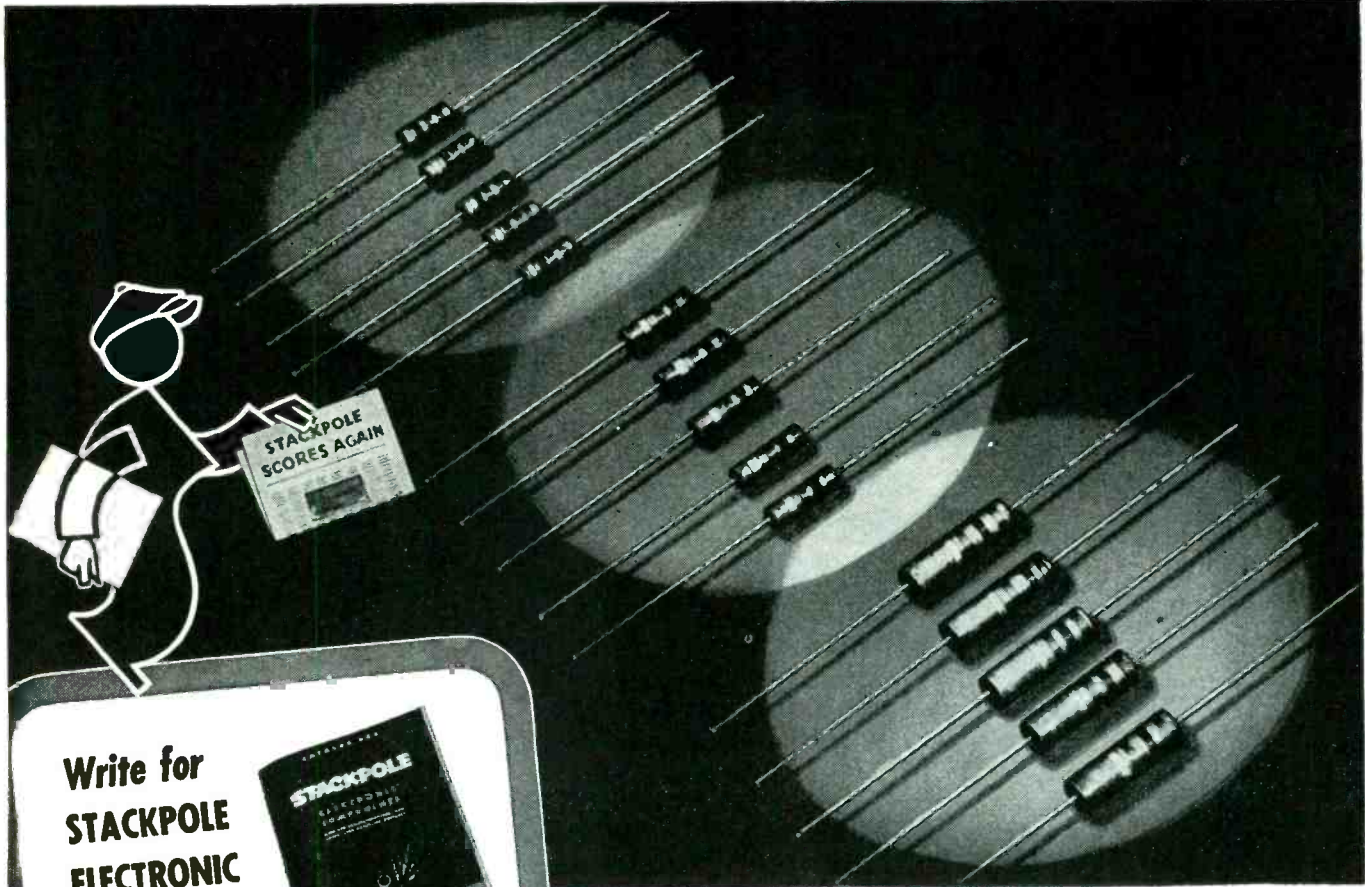
Operation of the instrument consists of checking the compass, energizing the API, and setting the counters to the proper latitude and longitude before take-off. During the take-off run, the true airspeed pump begins to operate at about



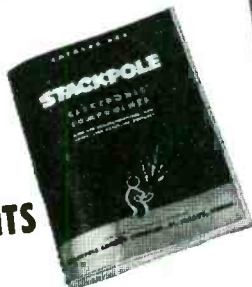
API installed on a typical aircraft instrument panel to provide continuous readings of latitude and longitude

seventy or eighty miles per hour, and the API then swings into operation. Magnetic north variation must be set in manually a degree at a time as the flight progresses, in order that the compass input reference is true north for resolution into geographic coordinates.

Wind can be determined by the API itself by noting the difference in air position as read on the API and ground position as determined by a check point, after flying for about forty minutes from a point where the API was set to ground position. The wind thus determined can be used for future flying



**Write for  
STACKPOLE  
ELECTRONIC  
COMPONENTS  
Catalog**



Whether for today's needs or post-war engineering, write today for your copy of this 36-page Catalog RC 6 replete with helpful engineering data.

**FIXED AND  
VARIABLE  
RESISTORS  
IRON CORES  
LINE, SLIDE,  
ROTARY  
ACTION  
SWITCHES**

**OTHER STACKPOLE PRODUCTS**

**BRUSHES and CONTACTS**  
(All carbon, graphite, metal and composition types)

**RARE METAL CONTACTS**

**WELDING CARBON PRODUCTS • BEARINGS**

**BRAZING BLOCKS • ANODES**

**ELECTRODES • CARBON PILES**

**PACKING, PISTON, and SEAL RINGS**

**RHEOSTAT PLATES and DISCS**

**SPECTROGRAPHITE NO. 1**

**CARBON and MOLDED METAL POWDER  
SPECIALTIES**

# INSULATED RESISTORS

*Designed to Match War  
Standards Specifications*

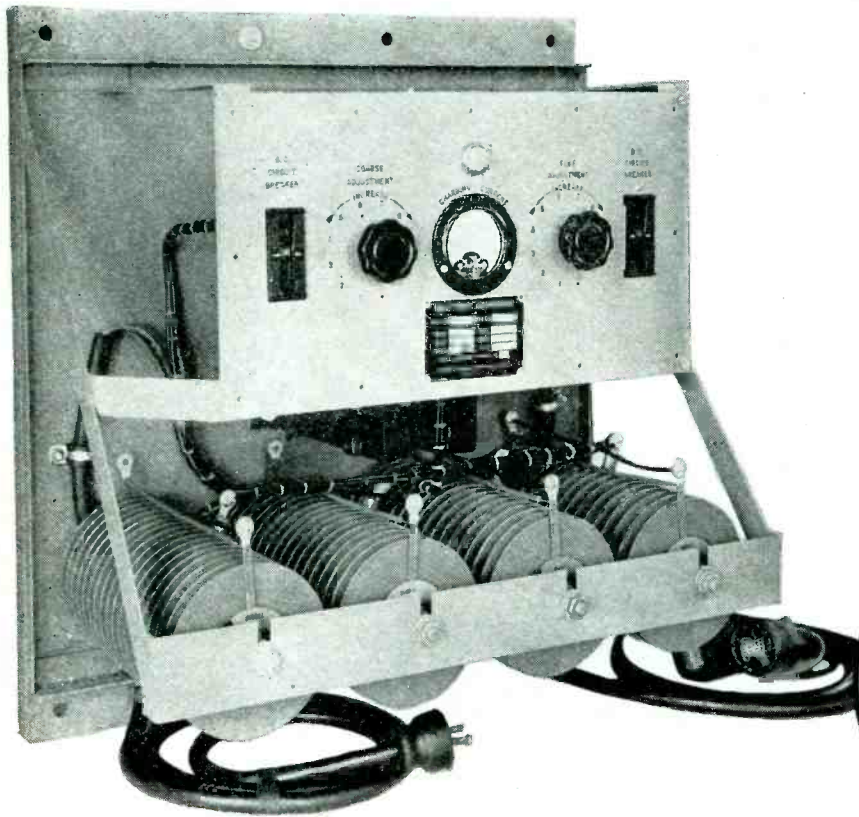
Integrally molded in one operation under laboratory controlled production standards, Stackpole Type CM Resistors in  $\frac{1}{3}$ -(RC-10);  $\frac{1}{2}$ -(RC-21); and 1-watt (RC-30) sizes have been specifically designed to meet the newly issued Army-Navy specifications. The construction of these new resistors is such that they offer an exceptional degree of stability under load—the average change being less than 5% after 1000 hours under test at full load. In addition to having highly satisfactory humidity characteristics well within today's exacting requirements, Stackpole Type CM Insulated Resistors meet up-to-the-minute salt water immersion specifications.

*Samples to any required tolerance on request.*

# STACKPOLE

**STACKPOLE CARBON COMPANY, ST. MARYS, PA.**

# This New **LOW RIPPLE DC Power Supply** is a Trim, Businesslike Job!



Close-up of the Federal Telephone and Radio Corporation FTR-3106-S combination battery charger and DC power supply shows the simplicity and neatness of internal wiring, protected by Natvar Grade A-1 Tubing.

**F**ederal's new FTR-3106-S is flexible. Used as a power supply, it will furnish direct current from 5 to 80 volts in 121 steps, at 12 amperes, maximum. As a battery charger it will handle from 1 to 24 two-volt storage cells at a maximum current of 12 amperes.

Selenium Rectifiers — pioneered by Federal — provide the efficient, dependable means of converting single phase AC power to DC power. Conservative design which eliminates the need for fans or other moving parts, plus heavy overload capacity, along with the wide voltage range makes it suitable for a variety of laboratory and experimental work, as well as a rugged source of rectified DC for production equipment.

Natvar flexible tubing is used to protect the wiring of FTR-3106-S because of its high dielectric and mechanical strength, and because of its high uniformity.

What are your insulation requirements? Write, wire or phone us for deliveries, either from stocks located near you or from our own.



- Varnished cambric — straight cut and bias
- Varnished cable tape
- Varnished canvas
- Varnished duck
- Varnished cellulose acetate
- Varnished special rayon
- Varnished Fiberglas cloth
- Varnished papers
- Varnished tubings and sleeving
- Varnished identification markers
- Lacquered tubings and sleeveings
- Extruded vinyl tubing
- Extruded vinyl identification markers

Write for Catalog No. 20

**THE NATIONAL VARNISHED PRODUCTS Corporation**

TELEPHONE  
RAHWAY 7-2171

CABLE ADDRESS  
NATVAR: RAHWAY, N. J.

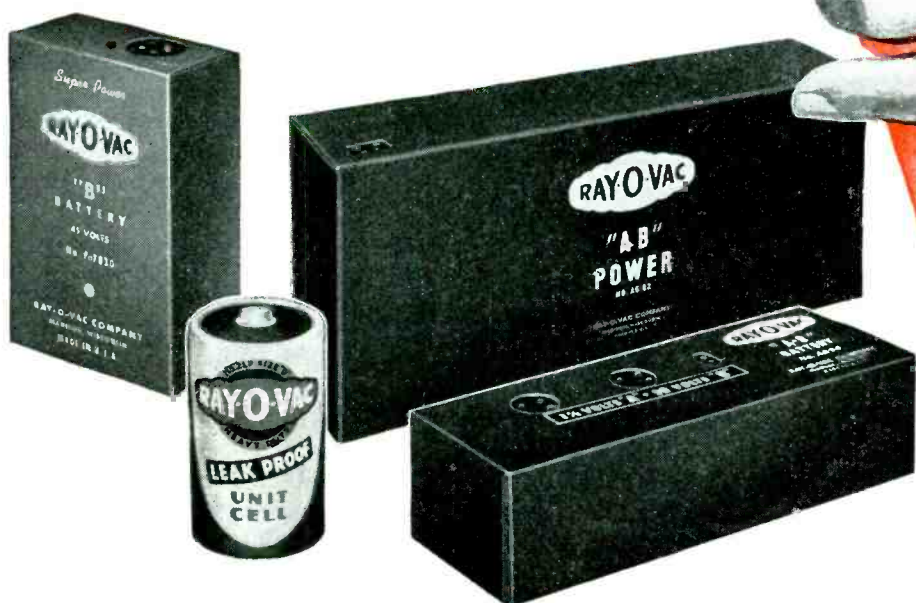
201 RANDOLPH AVENUE ★ WOODBRIDGE NEW JERSEY

5-NVP-3

When you reveal  
your post-war line

BE SURE IT'S  
POWERED BY

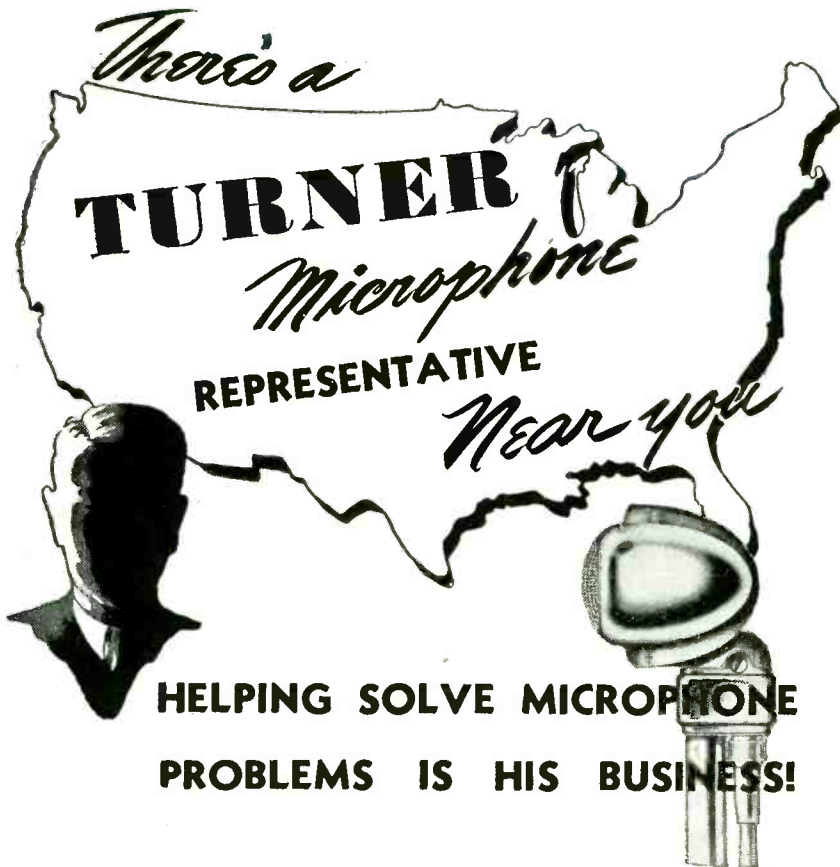
**RAY-O-VAC**



»RAY-O-VAC

. . . If your V-Day products will require dry batteries, be sure to include Ray-O-Vac in your plans. The know-how that has solved so many portable power problems for the armed forces can be of great value to you. Ray-O-Vac engineers are at your service. Write Dept. I-A.

**RAY-O-VAC COMPANY, MADISON, WISCONSIN**  
OTHER FACTORIES AT CLINTON, MASS., LANCASTER, O., SIOUX CITY, IA., FOND DU LAC, WIS., MILWAUKEE, WIS.



**HELPING SOLVE MICROPHONE PROBLEMS IS HIS BUSINESS!**

The Turner Company is proud of its thoroughly experienced staff of representatives. This competent group is qualified in every field of microphone application. These men are ready to study your electronic communications problems NOW. You are invited to call in your nearest Turner Representative for expert advice and suggestions in selecting the right microphone for your purpose. He is at your service whether you need job lots or single units. Call him today!

**BOSTON**  
Henry P. Segel Co.  
221 Columbus Avenue  
Boston, Mass.

**GREELEY**  
Gordon G. Moss  
P. O. Box 428  
Greeley, Colorado

**LOS ANGELES**  
David N. Marshank  
Marshank Sales Co  
2022 West 11th St.  
Los Angeles 6, Calif.

**CHICAGO**  
Royal I. Higgins  
600 S. Michigan Avenue  
Chicago 5, Ill.

**HENDERSONVILLE**  
Herb Erickson Co.  
P. O. Box 179  
Hendersonville, N. C.

**MILWAUKEE**  
Irvin I. Aaron  
4028 N. 16th St.  
Milwaukee 9, Wisc.

**CLEVELAND**  
Earl S. Dietrich  
707 Hanna Bldg.  
Cleveland 15, Ohio

**JENKINTOWN**  
D. M. Hilliard  
Box 246  
Jenkintown, Pa.

**NEW YORK**  
Wm. Gold  
53 Park Place  
New York 7, N. Y.

**DALLAS**  
Ernest L. Wilks  
1212 Camp St.  
Dallas 2, Texas

**KANSAS CITY**  
Edw. B. Lundgren  
516 Mgrs. Exch. Bldg.  
Kansas City 6, Mo.

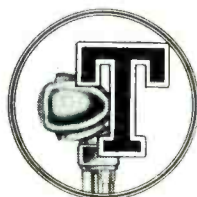
**SEATTLE**  
Verner O. Jensen Co.  
2607 2nd Avenue  
Seattle 1, Washington

**DETROIT**  
Fred J. Stevens  
15126 E. Warren Ave.  
Detroit 24, Michigan

**MONTREAL**  
Sni. Dor  
Radioelectric Ltd.  
455 Craig St., W.  
Montreal, Quebec

**EXPORT REPRESENTATIVES**  
**AD AURIEMA, INC.**

89 Broad Street, New York 4, N. Y.



**The TURNER Company**  
CEDAR RAPIDS, IOWA

Pioneers in the Communications Field

POSITION INDICATOR

(continued)

until a wind shift is suspected or observed, and is frequently more suitable than a wind determined by double drift because the latter is a spot wind whereas the former is an average wind.

*Main Units*

As in use by the Army Air Forces today, the system consists of the compass, the pump, the controller, the electronic amplifier, and the computer.

The pump consists simply of a d-c series motor with a centrifugal blower or fan mounted on its shaft. This has a compartment around it for circulating outside air in order to maintain it as nearly as possible at outside air temperature. Static pressure of the outside air is led into the axis of the centrifugal blower, which generates a differential pressure above this static pressure as it runs. The motor also carries a gear reduction to which is connected the output shaft to the computer.

The pressure generated by the pump is fed into one diaphragm in the controller. The other diaphragm in the controller receives pitot pressure, and together these two control a switch to the driving motor in the pump. In attempting to keep the pressures in these two diaphragms matched, the pump speed varies with pitot pressure, and in doing so its speed of rotation is directly proportional to true airspeed.

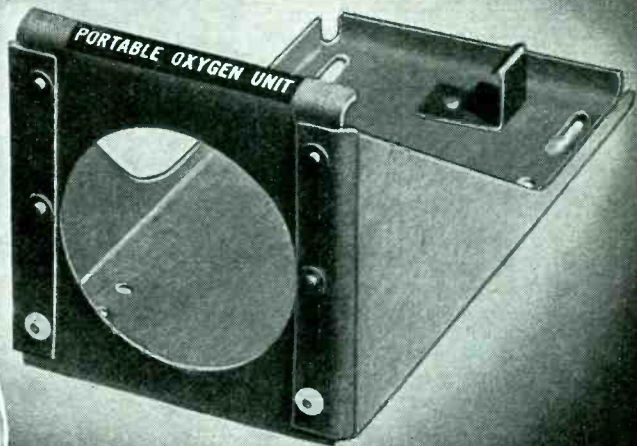
The rotational speed from the pump motor is fed into the computer, which employs the well-known ball-disk integrator scheme. The pump motor actually drives two disk-plates, one for latitude and one for longitude. The latitude disk plate drives by friction a ball, which in turn drives a cylinder geared directly to the latitude counter. The speed and direction of rotation of the cylinder, and of the counter, is directly proportional to the speed of the disk plate and the radial position of the ball on the disk plate. This radial position is determined by the input compass signal through the API amplifier. The latitude counter is driven in a similar manner.

*Aid to Navigator*

When properly operated, the air



# Beautifully Formed



Formed in a single operation

with Post-Formed Phenolite, this portable oxygen unit support used in B-29 Super-Fortresses illustrates a revolutionary new development in laminated plastics.

## Post-Formed Phenolite\*

**Offers You New Possibilities  
for Profitable Post-War Products**

Here, through a new development in laminated phenolic plastics, a whole new avenue of applications is opened for you . . . new potentialities for successful post-war products.

Economical to produce, Post-Formed Phenolite parts are made by heating the sheet material for a few seconds and forming in an inexpensive wooden mold with standard press equipment. In a matter of minutes, practically any shape or form may be obtained—without sanding or removing "flash." Fabrication may be done before or after the forming operation.

Phenolite is light in weight (about half the weight of aluminum) . . . is an excellent electrical insula-

tor . . . has remarkable mechanical strength . . . possesses good machinability . . . and is highly resistant to moisture. This unusual combination of properties makes it a versatile material suggesting an almost endless number of industrial applications.

Now used almost exclusively for structural parts in aircraft—demonstrating its stability under varying atmospheric conditions—Post-Formed Phenolite is being supplied for important war purposes only. But, in it, you'll find countless possibilities for profitable peacetime products. Write today for further information and the assistance of one of our trained technical men in planning your post-war projects.

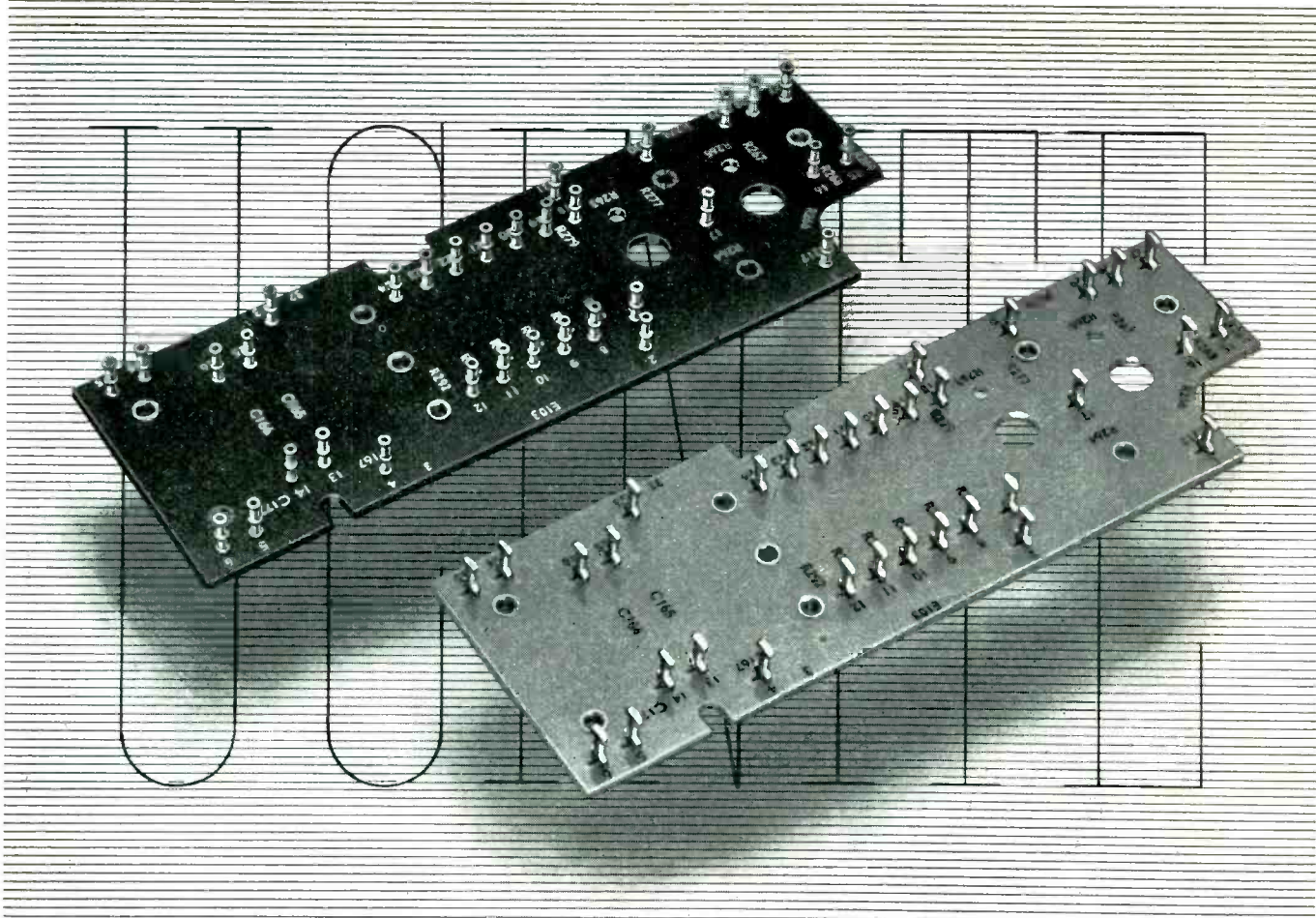
\*A formable thermosetting sheet material



## NATIONAL VULCANIZED FIBRE CO.

Offices in Principal Cities

Wilmington, Delaware



# *Mike's and Ike's*

**THEY MAY LOOK ALIKE**

These assemblies are identical jobs — with this important difference . . . In one we made the metal connectors on screw machines. On the other we made simple punch-press lugs. That was the way the two customers wanted them. Alike but different. And that was the tailor-made way we produced them.

At Ucinite we are set up to do the designing and engineering of a job from start to finish. Or we will work it out according to the customer's own particular specifications. What interests us most is getting things done right . . . and on time.

**The UCINITE CO.**

*Newtonville 60, Mass.*

Division of United-Carr Fastener Corp.

**Specialists in RADIO & ELECTRONICS**  
**LAMINATED BAKELITE ASSEMBLIES**  
**CERAMIC SOCKETS • BANANA PINS &**  
**JACKS • PLUGS • CONNECTORS • ETC.**

**LET WHITAKER  
produce your wiring assemblies!**



## **A LOWER COST of MANUFACTURING is one of many advantages Whitaker offers you on Cables, Wiring Harnesses and Assemblies**

You can save time, grief and money by utilizing our specialized facilities for producing wiring assemblies, flexible leads, and other cable products . . . Furthermore, the economies gained will be big factors in enabling you to lower your cost of manufacturing . . . No job is too complicated for us. Our experience is broad, and our production facilities are adequate . . . During the past 25 years we have supplied cables to manufacturers of



a widely diversified list of products, and our present-day facilities should be of great value to makers of trucks, tractors, trailers, tanks, radios, electric ranges, hot water heaters, airplanes, ships, electric appliances, battery chargers, scientific equipment, and many other items . . . In addition to an engineered wiring service, Whitaker also offers a quality line of standard cable products . . . We cordially invite you to write to us.

### **WHITAKER CABLE CORPORATION**

General Offices: 1307 Burlington Avenue, Kansas City 16, Missouri  
Factories: Kansas City, Mo. • St. Joseph, Mo. • Philadelphia • Oakland



## For more than 10 years

we have been manufacturing crystals. Not only are we crystal manufacturers, but crystal specialists as well. Consult us on your "crystal problems".

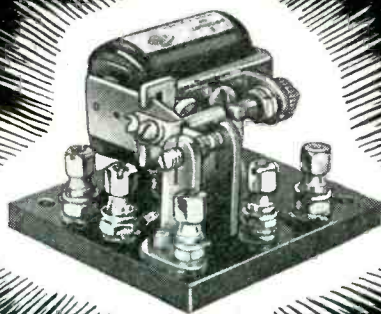


**PETERSEN RADIO CO.**

Council Bluffs, Iowa

CRYSTALS EXCLUSIVELY SINCE 1934

## STANDARD RELAYS



## TO FIT YOUR JOB

**POTTER & BRUMFIELD STANDARD RELAYS** are available in many sizes, with a full range of coil voltages and simplified designs to fit most standard applications.

Compact, sturdy and easily mounted, Potter & Brumfield Standard Relays will often do the job better than special designs. They're made of finest materials, assembled by skilled hands, and are built to specifications established by long experience in actual use. Standard Relays are **ECONOMICAL**, deliveries are prompt. If a Standard Relay will do the job, that's the one to buy.

Write for catalog giving sizes and complete specifications on all types of Standard Relays.

*Potter & Brumfield*  
MFG. CO., INC.

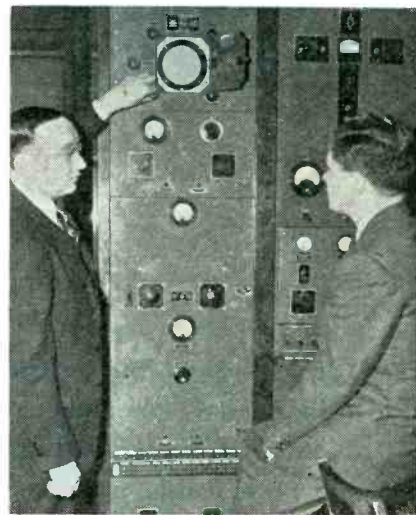
105 NORTH 10th ST. PRINCETON, INDIANA

POSITION INDICATOR (continued)

position indicator gives the navigator a continuous indication of his air plot. However, it cannot be called an automatic navigator and was never intended to replace the navigator. Its purpose is to act as an aid to the navigator, to do his job of dead-reckoning for him when his other means become impossible as during evasive action, to carry on for him over limited periods of time when he must leave his work to do other jobs such as operate guns. Such other functions include keeping account of distance traveled between celestial shots, determining winds, and aiding in computing gasoline consumption and range. It can also be used on long straight flights but is really not necessary because of the simplicity in performing such a task with elementary instruments.

### 50,000 Hours for C-R Tube

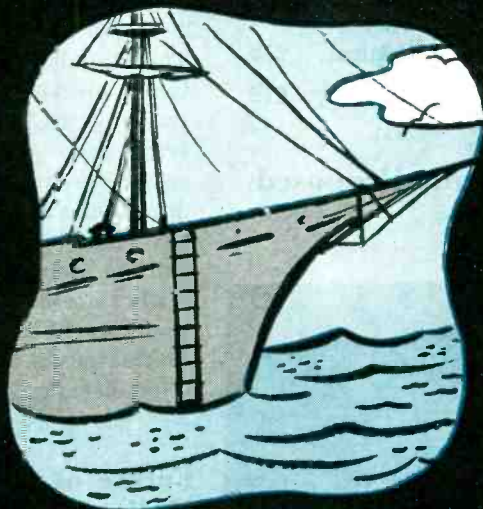
INSTALLED IN the WCAE, Pittsburgh, transmitter in August 1939, an RCA type 904 cathode-ray tube is still operating as well as it did five and a half years ago.



At WCAE, Pittsburgh, chief engineer James Schultz shows the long-life cathode-ray tube to J. H. Keachie of RCA. Installed more than five years ago in the modulation monitor, the tube still provides clear patterns on its screen.

This amounts to a service record of 50,000 hours, better by a year and a half the service given by the previous RCA 904 tube, the original tube installed in the transmitter in 1935. This tube operated continuously for four years and was then replaced by the present tube which had been held as a spare replacement.

# Solving DESIGN • MANUFACTURING AND PRODUCTION PROBLEMS is a Franklin Forte!



## TRY YOUR KNOW-HOW ON THIS ONE!

A rope ladder ten feet long is hanging over the side of the ship. The rungs are a foot apart. The bottom rung is resting on the surface of the ocean. The tide rises at the rate of six inches an hour—when will the first three rungs be covered with water, and why?

The answer to this one will be given in next month's advertisement or in reply to your written query. But don't give up, it's simple to solve as is our ability to solve your design, fabricating, production and assembly problems.

Millions of Franklin products, in use, daily attest to their inherent qualities of design, manufacture and production... low priced, yet sturdy and long life... performers... designed and manufactured to blue print where specifications exist or to meet ideas not yet put on paper.

- SOCKETS
- 
- TERMINAL STRIPS
- 
- PLUGS
- 
- SWITCHES
- 
- PLASTIC FABRICATION
- 
- METAL STAMPINGS
- 
- ASSEMBLIES

At Franklin you will find engineers with the Know-How of design and the What-With in equipment and facilities for coordinated efficient production... tool and die makers who click the first time... facilities for compression molding of bakelite parts... equipment for making plastic parts including laminations... machinery for fabricating small metal parts... hot tinning... plating... parkerizing... vacuum impregnating... tropicalization... all the facilities to do a job from the raw material to the finished part and complete assembly.

Franklin coordinated engineering, design, fabrication and production assures economical use of materials, low competitive costs and quick certain deliveries... let Franklin solve your production problems.

### LAST MONTH'S PROBLEM AND ITS SOLUTION

**Problem**—Ten books are arranged in orderly fashion on a shelf. Each book has 100 pages, making 1,000 pages in all. A worm starting on the first page of the first book eats through the last page of the last book. How many pages has he eaten?

**Solution**—He ate 802. Look at a row of books on a shelf. You can see why the worm didn't touch 99 pages of the first book and 99 pages of the last book. Simple, wasn't it?

ELECTRONIC COMPONENTS



# A.W. FRANKLIN

**MANUFACTURING CORP.**

175 VARICK ST., NEW YORK 14, N.Y.

SOCKETS • TERMINAL STRIPS • PLUGS • SWITCHES • PLASTIC FABRICATION • METAL STAMPINGS • ASSEMBLIES

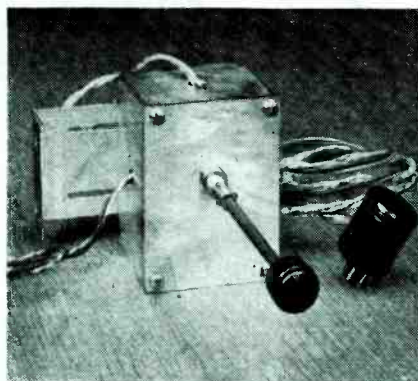
# TUBES AT WORK

Adapting F-M Receivers to Tune Proposed FCC Allocation... 194  
 Future of Citizens Radiocommunication Service..... 194  
 Wide-Range Generator with Automatic Amplitude Control.. 210  
 Projection Systems for Theater Television..... 218

## Adapting Present F-M Receivers to Tune Proposed FCC Allocation

NEW CONVERTERS for receiving the proposed f-m band from 84 to 102 Mc were the subject of much discussion at recent FCC hearings in Washington. Factory-built models include a one-tube and a three-tube unit. FCC engineers showed a two-tube design whose circuit is given below.

The one-tube converter contains a single 7S7 tube and can be installed in the cabinet of most f-m sets. The r-f input feeds a band-pass filter in place of a continuously tuned circuit and the oscillator section is operated at a fixed frequency. A switch, to be mounted on the receiver panel, connects different values of capacitance into the band-pass and oscillator circuits of the converter to provide two fixed-tuned receiving frequencies. With the switch in one position, tuning from 84 to 92 Mc is accomplished by varying the regular receiver dial so that the receiver acts as a tunable i-f stage. Setting the converter



Complete one-tube converter for receiving stations in the proposed f-m band from 84 to 102 Mc. Fixed-tuned, the switch selects either of two frequencies so that further tuning is done with f-m receiver dial

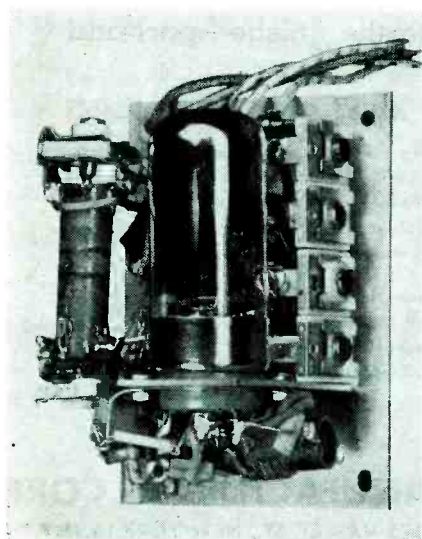
switch to the second frequency position permits tuning from 93 to 102 Mc. Power for the converter tube is obtained from one of the output tube sockets by means of an adapter. Designed and built by engineers of Hallicrafters Company, the

unit would sell for about \$5.60 in quantity to a single buyer, fob Chicago. This price does not include Federal or state excise taxes.

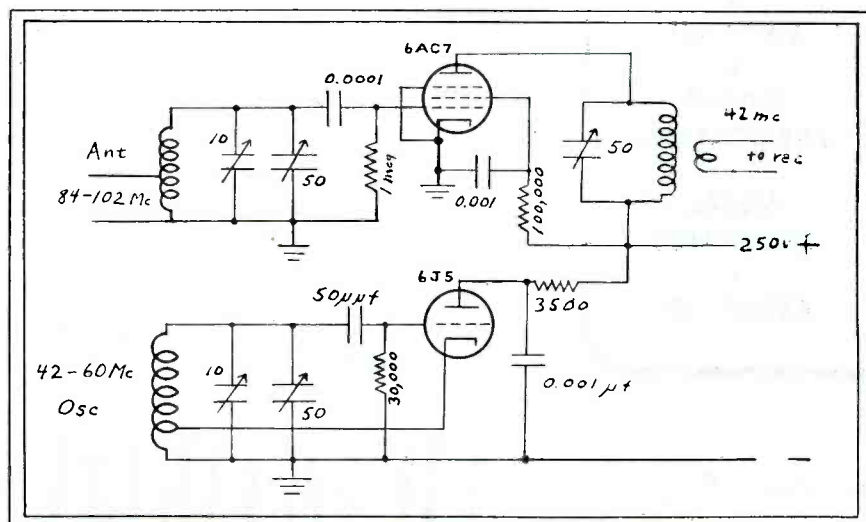
The experimental three-tube model contains a 7V7 mixer, a 7A4 oscillator, and a 6X5GT/G rectifier. This unit has its own continuously tuned circuits with the oscillator tracking 42 Mc below the mixer frequency. Output of the converter feeds into the antenna terminals of the f-m receiver which is left tuned to 42 Mc while receiving stations between 84 and 102 Mc. Hallicrafters estimate that this model could be built for \$11 fob Chicago whenever the priority situation permits.

## Future of Citizens Radiocommunication Service

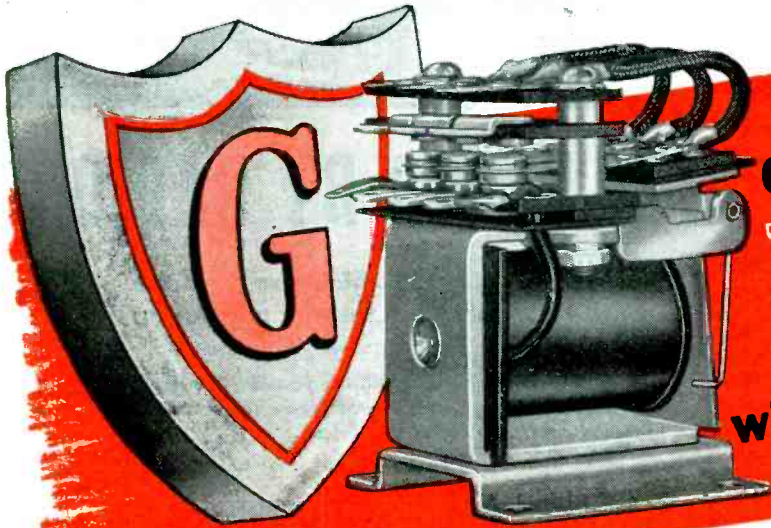
THE FEDERAL Communications Commission proposal to allocate the band from 460 to 470 Mc to a new radio service for civilian use was prompted by the success of the walkie-talkie type of short-range radio communications equipment used on the battlefield and the possibilities for its varied peacetime uses. According to FCC chairman E. K. Jett, "the proposed service will be thrown wide open to any citizen, whether he be an individual who may want a portable suitcase-type set for his own purposes or whether it be a department store, or laundry, or farmer, a taxicab concern, bus, or anybody else." In



Compact construction of the one-tube converter of Hallicrafters Company



Mixer and oscillator circuits of a 2-tube converter shown by FCC engineers. The two 50- $\mu$ f variable capacitors are used for tuning and have a common shaft



# GUARDIAN Series 345 RELAY

a "Basic Design"  
with many variations

*meets special applications*  
saves time . . . saves tooling . . . speeds delivery!

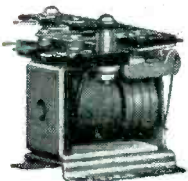
If your application requires a specially designed relay Guardian engineers can be of great help to you. But, as a result of their wide experience in designing "specials" they have evolved a standard design so flexible that it is now specified in numerous applications that would ordinarily require a specially designed unit. Perhaps you can use it in your "special" application . . . with a saving in money and delivery time. This unusually flexible relay is the SERIES 345. Its chief features are the large coil winding area, numerous contact combinations, the non-binding pin type armature hinge pin, its resistance to shock and vibration, and an ability to operate in extremes of temperature. It is now being used in aircraft, radio, and other exact-

ing applications to insure dependable performance.

**STANDARD SERIES 345**—The ample coil winding area of the SERIES 345 gives you a wide range of windings for various voltages and currents. Coil winding area is approximately .75 cubic inches. Average power required is 3.56 watts with three pole, double throw contacts of 12½ amp. capacity. Coils are available for either A.C. or D.C. operation.

The maximum switch capacity of the Standard Series 345 is three pole, double throw. Contacts are rated at 12½ amperes at 110 volts, 60 cycles, non-inductive A.C. Moving contacts are attached to but insulated from the armature by a bakelite plate. Terminals are solder lugs. Weight is 6½ ounces.

## VARIATIONS OF THE SERIES 345 RELAY



**TIME DELAY**

**WINDING**—Multi-wound coils are available for operation on two or more circuits. Or coil may be wound to operate on the discharge of a 3 mfd. condenser.

**CONTACTS**—Normal switch capacity is three pole, double throw; maximum switch capacity may be up to six pole double throw with 12½ amp. contacts, or any variation of contact combinations within this range, including the operation of contacts in sequence. The flexibility of the contact springs may be increased through the use of coil spring rivets.

**TIME DELAY**—On D.C. coils a time delay of 0.25 seconds on release or 0.06 second on attract may be achieved through the use of copper slugs which require these time intervals for saturation or de-energizing depending on whether they are used on the heel or head of the coil.

**DUST COVER**—For applications where this relay may be subject to injury or in atmosphere where dust may be present in sufficient quantity to impede operation, the SERIES 345 may be equipped with a metal dustproof cover.

**SCREW TERMINALS**—Screw type terminals are optional for applications where terminals must be disconnected occa-

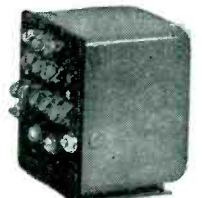
sionally or where solder lug terminals are not otherwise practical.

**INTERLOCKING:** Here the series 340 a-c relay is coupled with the d-c coil of a series 405 short telephone type relay in an overload application. Under normal conditions the series 340 contacts are mechanically held in a closed position. Normal

current flows through the series 405 coil and then through the series 340 contacts to the circuit for which overload protection is desired. Excessive current, however, energizes the series 405 coil, releasing the locking arrangement and breaking the series 340 contacts. Push button control resets to normal but is ineffective if current is still excessive.



**INTERLOCKING UNIT**



**DUST COVER**

### SERIES 345 RELAY DATA

Normal Volts	Minimum Volts	Normal M.A.	Minimum M.A.	Coil Resist.	Normal Wattage
6	4.8	600	480	10	3.56
12	9.8	300	245	40	3.56
24	18	148	111	162	3.56
32	25.6	112	89	287	3.56
115	92	31	25	3720	3.56

Minimum operating wattage.....2.3

*If you will write us about your relay problems our engineers will be glad to make recommendations which may save you time and money. Should you desire a quotation, please mention quantity.*

**GUARDIAN**  **ELECTRIC**  
1625-F W. WALNUT STREET CHICAGO 12, ILLINOIS

A COMPLETE LINE OF RELAYS SERVING AMERICAN WAR INDUSTRY



# PRINTED, ILLUSTRATED NEWS BY RADIO

... with paid advertising

THE POST-WAR facsimile "newspaper of the air" will take printed and illustrated news direct into homes by radio, at a speed equiva-

lent to more than 12\* tabloid-size pages per hour! Who will be first, in your territory, to use this most modern type of publishing?

*\*Even greater speeds are technically possible with Finch equipment, and can be obtained where the available radio channels are sufficiently broad.*



SELF SYNCHRONIZING

# finch facsimile

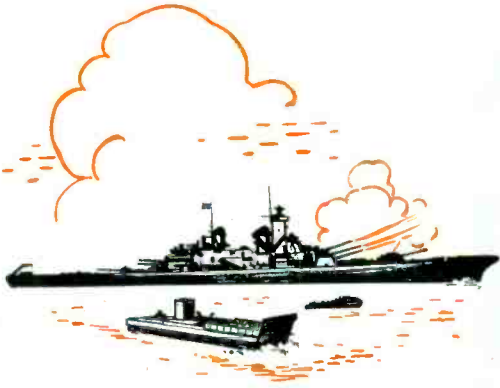
DELIVERS PICTURES AND TEXT BY RADIO OR WIRE

FINCH TELECOMMUNICATIONS, INC. • PASSAIC, N. J.

N. Y. Office: 10 E. 40th St., New York 16, N. Y.



*"Try this on your* **BIG GUNS!"**



Crouching in an old shell hole on shore, a fire control party directs a battleship's deadly salvos against enemy strong points holding up Allied invasion forces. On the world's far-flung fighting fronts, battle-tested Spencer precision wire used in communication equipment is hastening the day of final Victory.



PHOTO U.S. SIGNAL CORPS.

**SPENCER**  
*Precision*  
**WIRE**



**FINE STEEL AND ALLOY WIRE**

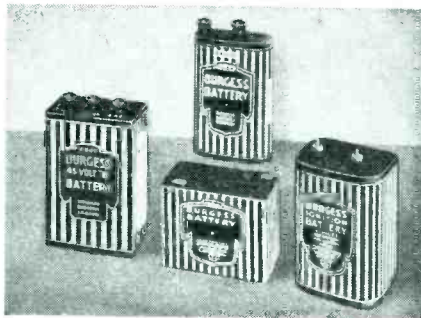
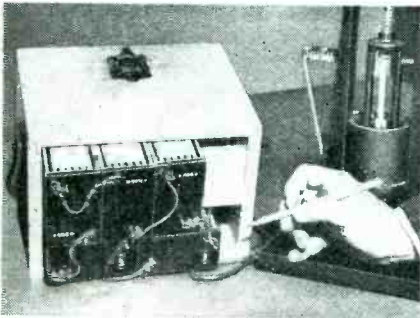
**Spencer Wire Company**  
WEST BROOKFIELD PLANT  
WEST BROOKFIELD • MASS.

# PORTABLE POWER PROBLEMS

THIS MONTH—TAG-HEPPENSTALL MOISTURE METER



MAJOR TOBACCO COMPANIES rely upon Tag-Heppenstall Moisture Meters, powered by Burgess Industrial Batteries, for two important time-and-money saving features. First, tests of moisture content are made to determine the purchase price of raw tobacco. Next, rapid tests during cigarette production help manufacturers maintain tobacco moisture at the level required for efficient processing.



MOISTURE METER READINGS of resistance, temperature and pressure are checked against a standard chart to quickly establish exact tobacco moisture. For test and control instruments Burgess Industrial Batteries meet every requirement—they are recognized as the standard of quality for all commercial uses. Although urgent war needs limit production, your Burgess distributor will make every effort to supply you with the batteries you require.

*Burgess Battery Company, Freeport, Illinois*

## BURGESS BATTERIES



Recognized as the MOST COMPLETE LINE of dry batteries

SUPPORT THE 7th! BUY YOUR SHARE TODAY!

CITIZENS RADIO

(continued)

the past, it has been necessary, because of the limited number of frequencies available, to grant frequencies only to common carriers, the safety services, broadcasting and the amateurs.

This new allocation is regarded by FCC as a challenge to radio engineers to develop equipment, both transmitting and receiving, for such a service. After a reasonable time, if it is found that the frequencies are not used, they will be reassigned to some other service. If the allocation is inadequate, the Commission plans to expand the service up or down in relation to its proposed spot on the spectrum. It is also recognized that the bandwidth may be reduced later on, if necessary. The operating standards can be reduced considerably below those necessary for commercial or safety services because it is offered as a service "for convenience".

### *Four Possibilities*

The Commission has stated that the possible uses of the service are as broad as the imagination and the ingenuity of equipment manufacturers can devise. Commissioner Jett envisions developments along these lines:

(1) A handie-talkie for battery operation (fraction of a watt), light in weight, not much larger than a small camera, small antenna that can be pulled out a foot or so, placed at side or in hand, and useful for a very short range. The range would be a mile or two. An example of its use would be on a farm to communicate with a tractor. This equipment probably would use dry batteries but it could use storage batteries.

(2) A walkie-talkie, the size of a small suitcase, will weigh from 20-50 pounds. There will be different types—some with handles, some for mounting in autos or boats. May use storage batteries (2 watts or so) and can be recharged from house current. If built in autos or boats, it can be recharged as radios in autos are today. Example of use: Express Company might want to change order of trucks loading at platform and could use walkie-talkie to order certain trucks to the front. Also,

# HERE IS YOUR GUIDE

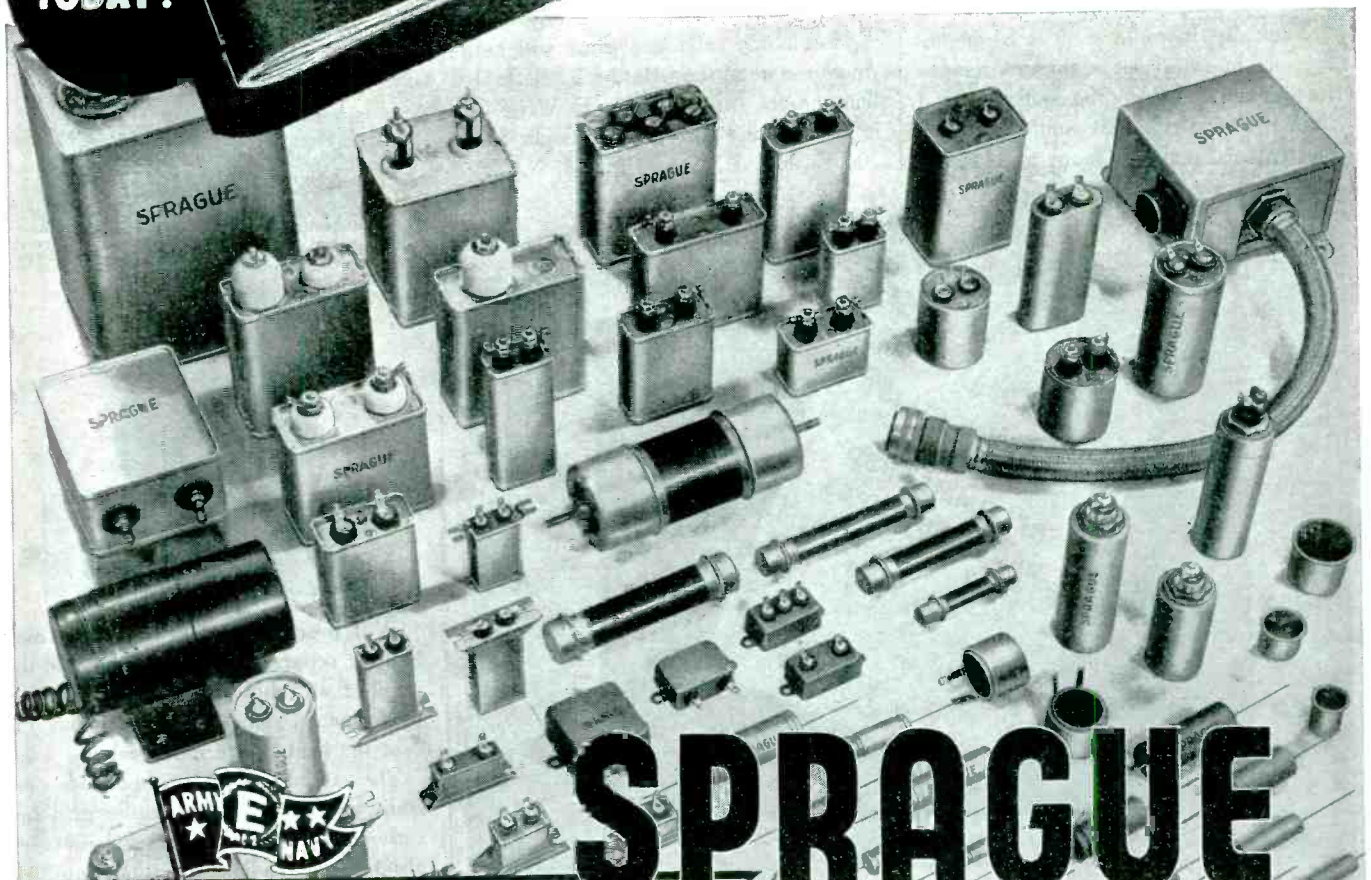
## to modern paper dielectric capacitor selection and use

Months of painstaking work have gone into making this 56-page Sprague Catalog a complete guide to the design and engineering possibilities inherent in today's greatly enlarged line of Sprague Paper Dielectric Capacitors in hundreds of standard and special sizes and types.

Write for your copy today. You'll find it unsurpassed as a guide to the exact matching of up-to-the-minute Capacitor requirements!

**SPRAGUE ELECTRIC CO.**  
North Adams, Massachusetts


**WRITE  
TODAY!**



**SPRAGUE**

**PIONEERS OF**

**ELECTRIC-ELECTRONIC PROGRESS**



# SYLVANIA NEWS

## ELECTRONIC EQUIPMENT EDITION

MAY Published by SYLVANIA ELECTRIC PRODUCTS INC., Emporium, Pa. 1945

### SYLVANIA'S CHART AIDS STANDARDIZATION OF TUBES

#### Reference List Recommendations Reduce Radio Tube Types

AS an aid to the standardization of radio receiver tube types, Sylvania has prepared the chart reproduced below—another item in Sylvania's long-time program of technical assistance to the radio industry.

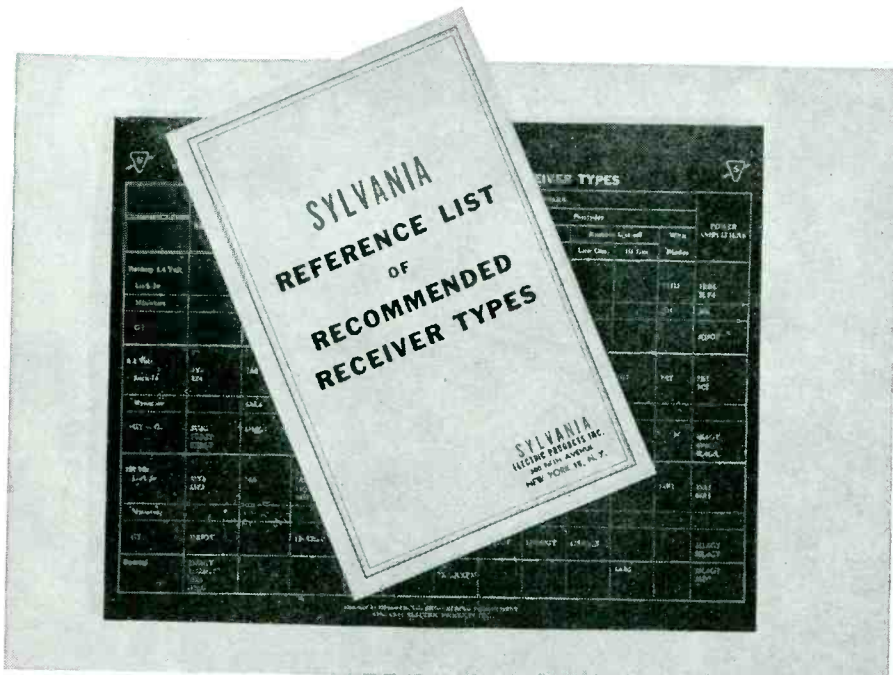
The number and variety of tube types have grown in recent years, and this trend has intensified war scarcities.

Naturally, it would seem to be advantageous to radio set manufacturers to further standardize tube selection and limit their variety. This would probably meet with approval in many parts of the

radio industry, particularly among radio servicemen since they are in an active position when it comes to tube replacement and general radio set repairing.

(An indication of their opinion concerning tube types was revealed in Sylvania's survey in which 90.5% of the servicemen questioned said they would prefer fewer and simpler tube types.)

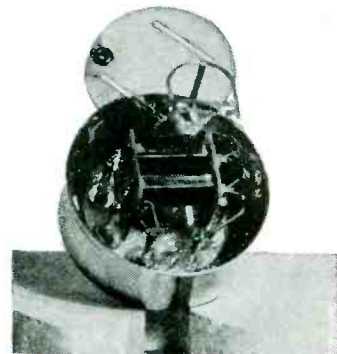
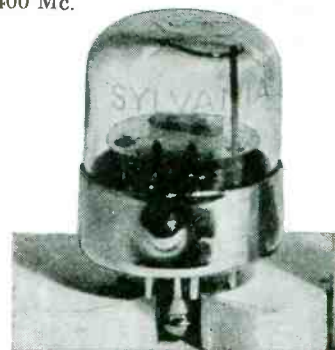
This handy reference chart will help smooth some of the wrinkles of the problem and act as a future guide. Write for it to Sylvania Electric Products Inc., 500 Fifth Ave., New York 18, N. Y.



### Double Triode Tube Has Two Uses

#### Acts As Converter Or Amplifier

Sylvania's new high mutual conductance double triode tube—Type 7F8—is designed for use at frequencies up to 300 or 400 Mc.



With precautions the two sections may be used separately, saving space and the number of tubes required for a given performance since all the elements except the heaters are independent.

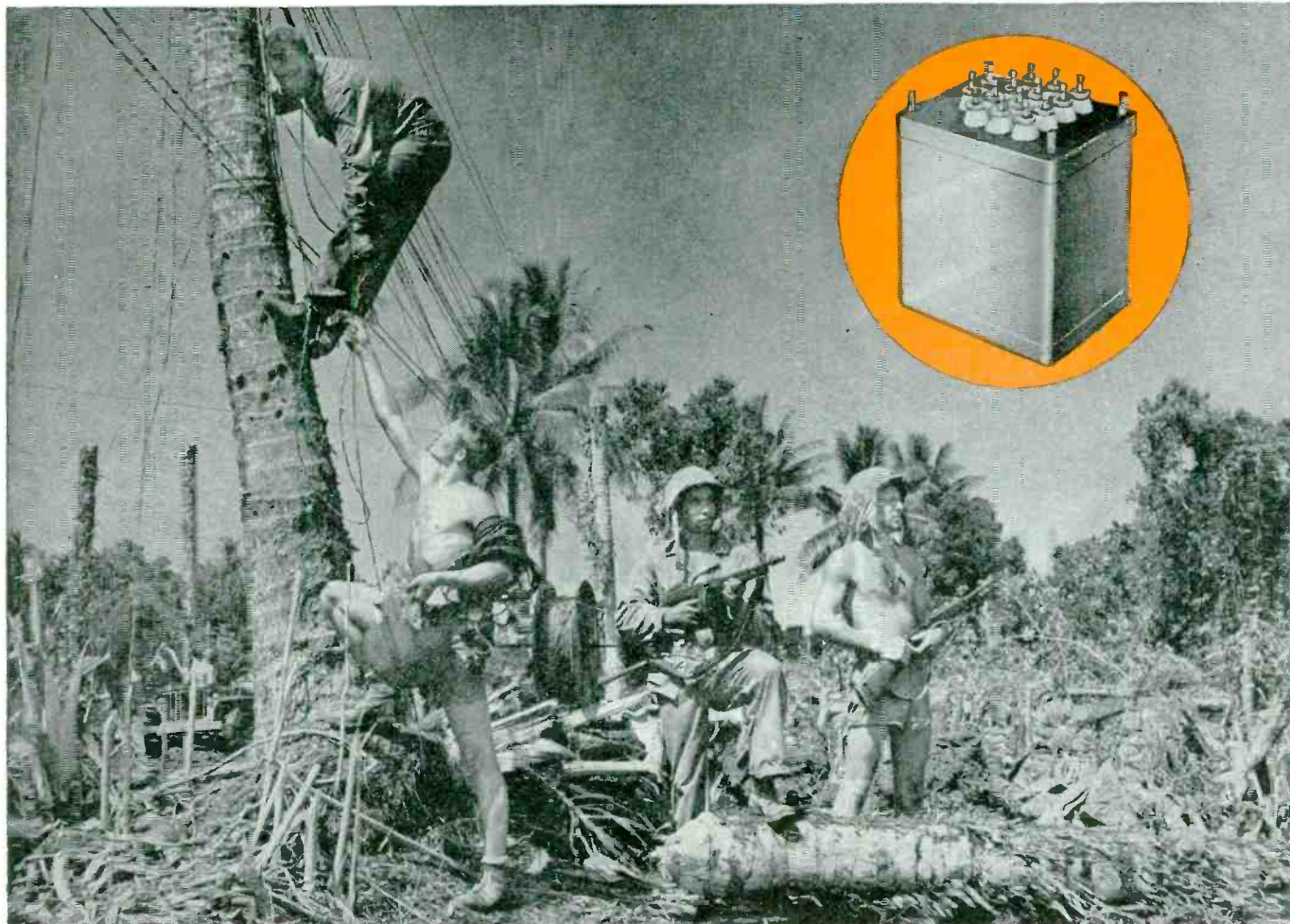
The cascade operation thus made possible is useful in u-h-f grounded grid and cathode follower amplifier service. It may also be used as a push-pull u-h-f amplifier.

# SYLVANIA ELECTRIC

MAKERS OF RADIO TUBES; CATHODE RAY TUBES; ELECTRONIC DEVICES; FLUORESCENT LAMPS, FIXTURES, ACCESSORIES; INCANDESCENT LAMPS

# HERMASEAL

## HERMETICALLY SEALED TRANSFORMERS —DEPENDABLE IN JUNGLE WARFARE



U. S. MARINE CORPS PHOTO

AmerTran has always adhered rigidly to high quality standards. For this reason, Hermaseal Hermetically Sealed Transformers had no difficulty in meeting the strict requirements of government procurement officers for "tropicalization" of these components.

Precautions include vacuum varnish impregnation of core and coil, infra-red pre-heating before compound filling, induction soldering of case seams. Ceramic terminals are protected by torque gauging and resilient gaskets. To insure thorough hermetic sealing, each unit is subjected to a vacuum immersion test. Write for details.



**HERMASEAL**

THE AMERICAN TRANSFORMER CO., 178 Emmet St., Newark 5, N. J.

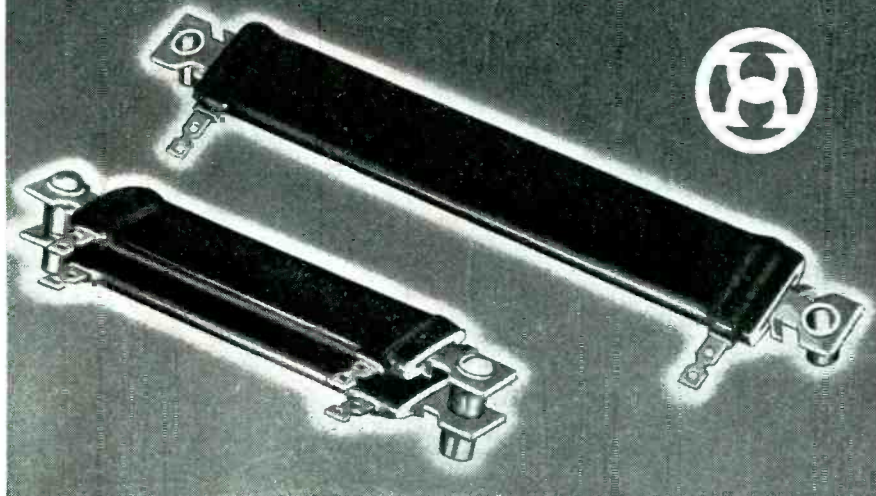
Pioneer Manufacturers of Transformers, Reactors and Rectifiers for Electronics and Power Transmission

**AMERTRAM ASSIGNED  
"APPROVED" QUALITY CONTROL RATING  
BY AIR FORCES**

On March 14, 1945, the Air Technical Service Command of the Army Air Forces delegated to the American Transformer Company full responsibility for meeting contract requirements. This assignment of an "Approved" Quality Control Rating which eliminates duplicate inspection during fabrication was awarded on the basis of AmerTran's record in adhering to quality standards.

**AMERTRAN**  
MANUFACTURING SINCE 1901 AT NEWARK, N. J.

# HARDWICK, HINDLE



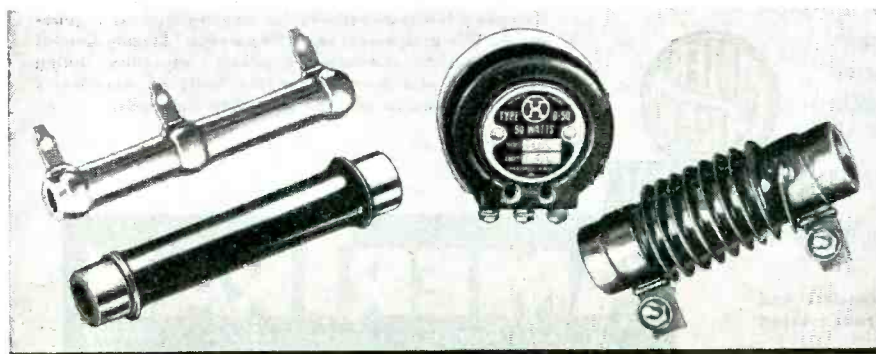
## STILL LEADING THE FIELD

Our Blue Ribbon Resistors were unique in their entirely new design and their advanced engineering when we introduced them in 1939.

They still lead the field as the most efficient:—their compactness, their toughness, and their remarkable performance offer you more than just higher wattage ratings for unit space required.

—And in our other types of resistors and rheostats we also offer you important exclusive advantages.

**HARDWICK, HINDLE, INC.**  
**RHEOSTATS and RESISTORS**  
 DIVISION OF  
**THE NATIONAL LOCK WASHER CO.**  
 ESTABLISHED 1886  
 Newark 5, N. J., U. S. A.



gas-filling stations or country stores might have calling stations. The range of the walkie-talkies is 5 to 8 miles, depending on the terrain.

(3) Larger equipment would have elaborate antenna, for installation at a fixed location, such as the roof of a department store, laundry, dairy or office building. It would afford communication between fixed points.

(4) Portable equipment, which will include a broadcast receiver, and be about the size of a walkie-talkie. Since it will be necessary to have an audio system in the walkie-talkie to take care of the two-way personal communication service, Mr. Jett sees the possibility of including a radio-frequency unit to provide for the reception of standard or f-m broadcast signals. The equipment could be used not only for two-way communication, but also as a broadcast receiver. An alarm system, remote control systems and other devices might be added to equipment to meet particular needs.

As in the case of the amateur service, the Commission proposes to assign no channels within the band. By use of comparatively simple circuits already known, the Commission believes that it should be possible to provide both transmitters and receivers tunable over all of the 460-470 Mc range, emitting signals sharp enough to minimize interference.

### *Citizens Radio League*

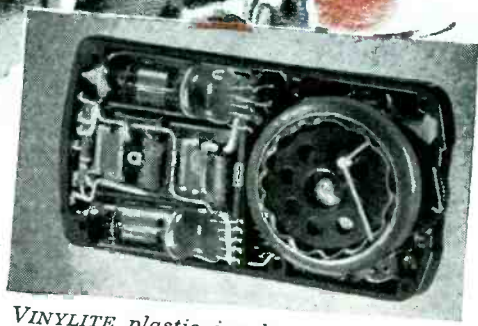
It is recognized that if a large number of people operate transmitters in the same community there is bound to be interference. The suggestion is made that a non-profit, citizens radio league be organized to assign local operating frequencies. For example, citizens in a certain community might get together and decide that department store No. 1 will use channel No. 5; department store No. 3 will use channel No. 19; laundry No. 2, channel No. 7, etc.

### *Interference Problem*

It is hoped that frequencies, because of their characteristics, may be duplicated throughout the U. S. without a great deal of interference. With low-power devices used on the



*Grandfather demanded,*  
**"LOUDER, PLEASE"**



*VINYLITE plastic insulated wires, made by Surprenant Electrical Instrument Company, contribute to the Sonotone's efficiency.*

Grandfather lived before the age of miracles. Today, of course, he'd relax with a modern hearing aid. And, in a Sonotone, he'd find the magic effectiveness of the instrument protected by a handsome receiver cord with transparent insulation made of VINYLITE plastics by Gavitt Manufacturing Company.

Thin, flexible, light weight, and perfectly smooth, VINYLITE insulation makes the "quietest" cord available for hearing aids. It eliminates the amplified and annoying sounds

of friction made when stiffer and less smooth cords move against the clothing. It is also resistant to perspiration which formerly caused electrical leakage between conductors. It withstands the attacks of body oils, and its long life is assured by its resistance to wear and aging.

VINYLITE plastic insulation for wires and cables has dielectric strength that permits thin-wall construction. Highly resistant to oils, water, alkalies, and many chemicals, it has been found an invaluable im-

provement by manufacturers of electronic equipment, public utilities, and construction concerns, and marine, and airplane manufacturers.

Write Department 18 for your copy of "VINYLITE plastics Wire and Cable Insulation."

**BAKELITE CORPORATION**  
 Unit of  
 Union Carbide and Carbon Corporation

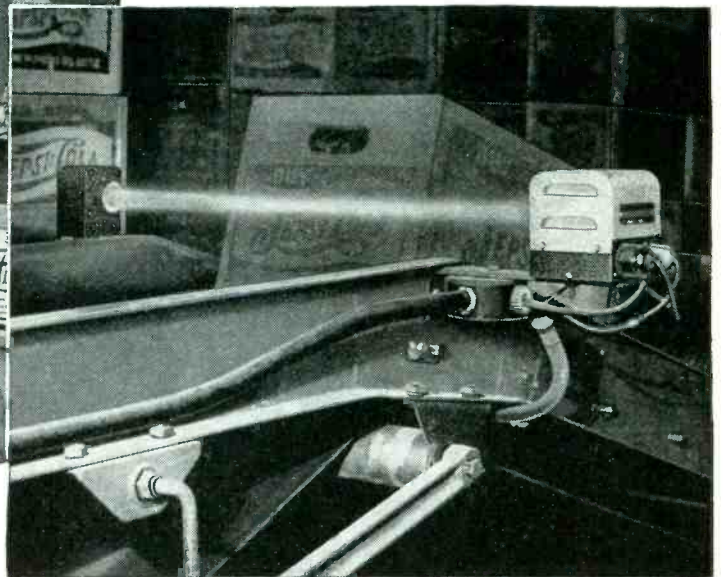
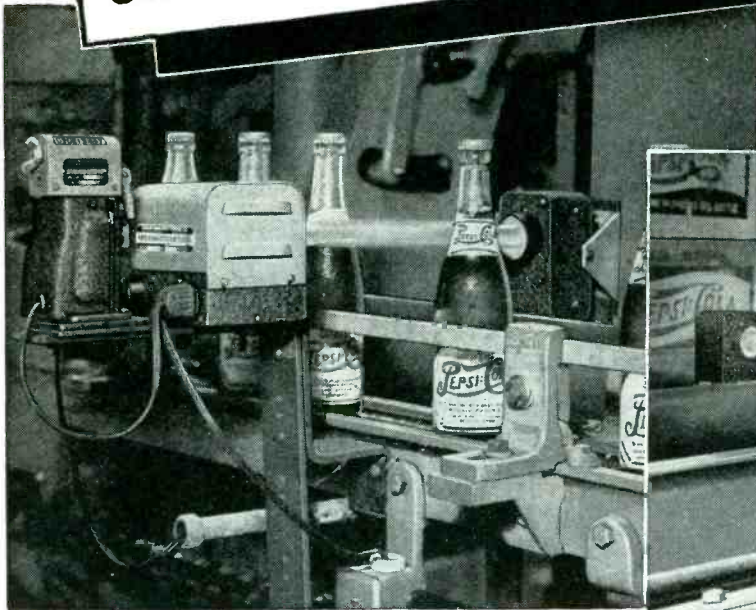


30 EAST 42ND ST., NEW YORK 17, N.Y.

# Vinylite Plastics

TRADE-MARK

**HOW *Durant* MACHINES  
COUNT ACCURATELY AND SPEEDILY WITH  
UNITED CINEPHONE ELECTRONIC CONTROLS**



In the field of counting mass-produced articles Electronic devices insure the utmost accuracy, reliability, and economy. In the business of bottling, where profits are a fraction of a penny on each unit, the system devised by the Durant Manufacturing Company maintains a stock count at all times from the initial bottling process through a count of the cases as they leave the factory for shipment. This is only one of the many ways in which United Cinephone Electronic Controls are used in modern production; a necessity in the forthcoming postwar era of highly competitive business.

OTHER APPLICATIONS of United Cinephone Electronic Controls are almost without limit. If you have a problem of measuring, gauging, counting, sorting, heating, or some other operation in your plant, which is costly and unreliable, you will want to investigate the possibility of solving the problem ELECTRONICALLY. That's where our extensive experience and facilities in Electronic design, engineering, and manufacturing can be of invaluable help. Your inquiry will be welcome.

Electronic fields we cover include :

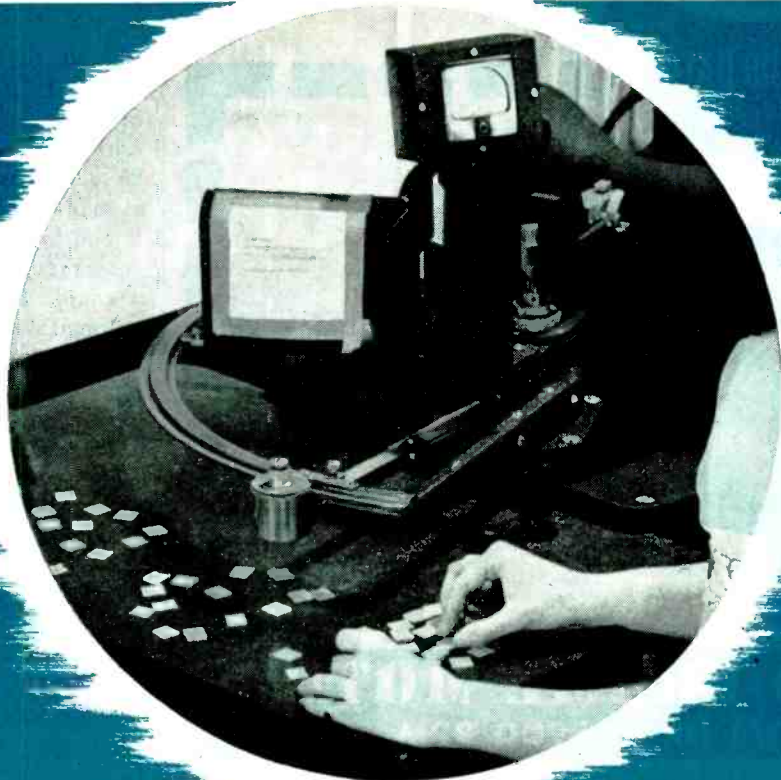
1. Industrial Controls
2. Aircraft Communications
3. Laboratory Test Equipment
4. Radio and Audio Equipment

# UNITED CINEPHONE CORPORATION

20 NEW LITCHFIELD STREET

TORRINGTON, CONNECTICUT





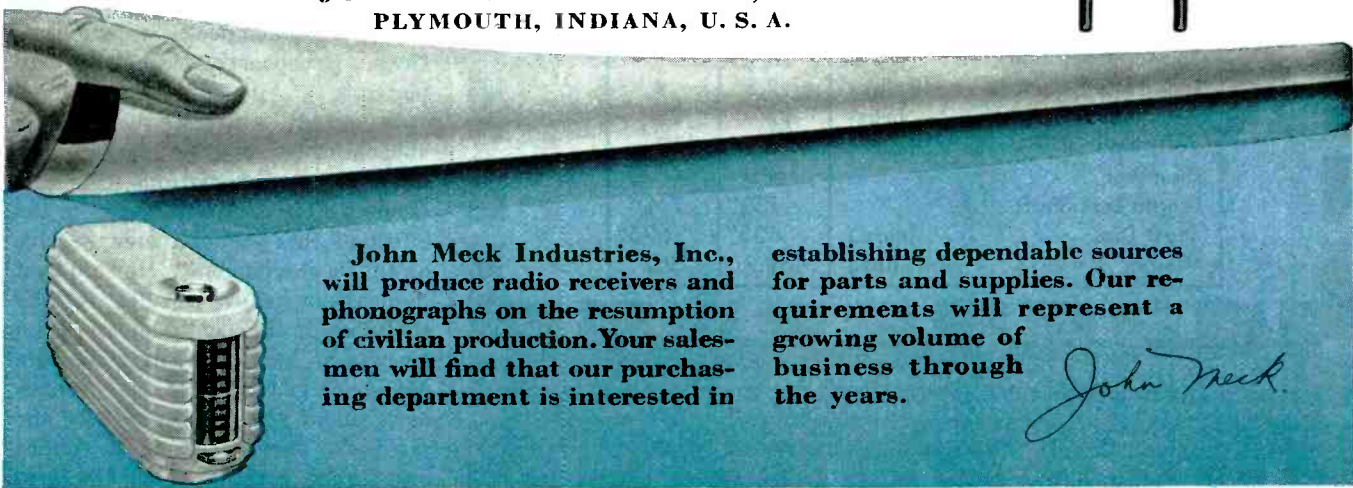
# MECK

★ ★ **MEANS ACCURACY** ★ ★

John Meck crystals are now—and always will be—characterized by high quality and rigid precision. In an industry as exacting in mechanical design and as intricate in conception and execution as the field of sound electrically controlled and amplified, the engineering staff must work to standards of “absolute” precision. This devotion to accuracy is reflected in the attitude and work of every individual contributing to the completion of John Meck products. The low percentage of final test rejections at John Meck Industries is a tribute to the splendid, conscientious personnel and their ability.



**JOHN MECK INDUSTRIES, INC.**  
PLYMOUTH, INDIANA, U. S. A.

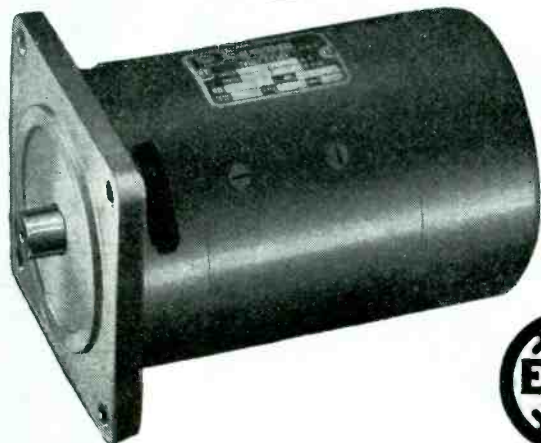


John Meck Industries, Inc., will produce radio receivers and phonographs on the resumption of civilian production. Your salesmen will find that our purchasing department is interested in

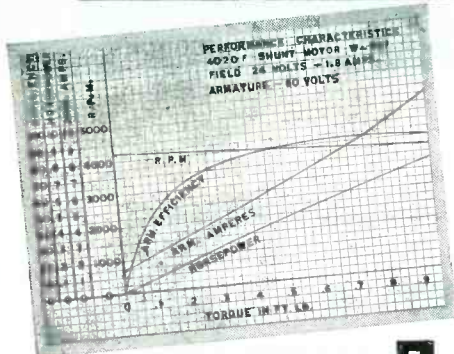
establishing dependable sources for parts and supplies. Our requirements will represent a growing volume of business through the years.

*John Meck*

**MOTOR DATA**  
No. 129



**4000 FRAME MOTOR**  
1/2 HP at 3900 RPM



The output—the weight—the size—of these 4000 Frame Motors are features well worth remembering. Every adaptation of the standard design is engineered for the precise requirements of an aircraft, portable, or industrial application.

- ELECTRICAL**  
Series, shunt, or compound-wound  
Unidirectional or reversible  
Optional torque  
Optional speed  
Optimum efficiency  
For control circuits  
Electric braking optional

**F E A T U R E S**

- MECHANICAL**  
Vented or enclosed types  
Base or flange mounting  
Operation in any position  
Low space factor  
Ball bearing equipped  
Optional shaft details  
Rugged construction

4000 FRAME MOTORS		4020 Shunt	4020 Series
Watts, Output, Con.	(Max.)	375	746
Torque at 3900 RPM	(ft. lbs.)	.65	1.4
Torque at 6000 RPM	(ft. lbs.)		.88
Speed Regulation		8%	
Lock Torque	(ft. lbs.)	2.5	4
Volts Input	(min.)	12	24
Volts Input	(max.)	110	110
Diameter		4"	4"
Length Less Shaft		7 1/8"	7 1/8"
Shaft Dia.	(max.)	.625"	.625"
Weight	(lbs.)	9.2	9.2

**EICOR INC.** 1501 W. Congress St., Chicago, U. S. A.  
DYNAMOTORS · D. C. MOTORS · POWER PLANTS · CONVERTERS  
Export Ad Auriema, 89 Broad St., New York, U. S. A. Cable Auriema, New York

ground, the range will probably be from 2 to 15 or 20 miles depending upon the terrain. If one is high on a hill with an unobstructed path of 25 or 30 miles, the range will be even greater. On the other hand, if one is down in a valley, the useful range would not be more than a couple of miles. "Boosters" or automatic relay installations will be permitted where necessary. Most transmitters on this band are likely to be of low power and will not need extreme antenna heights. In rural areas where there is no interference, higher power may be permitted.

The Commission makes it clear that common carrier operation in the citizens communication band will not be permitted and no charge can be made for the licensed facilities or for transmission of messages.

*License Requirements*

Only the minimum requirements of the Communications Act with a few minimum traffic rules will be set up by the Commission. Operator licenses will be granted to American citizens only and no technical knowledge will be required. It is proposed to issue a license to run for five years. It will be printed probably on a pocketbook size card, the operator's license on one side and the station's license on the other. The only qualification for the operator's license will be certification by the applicant that he has read the rules and regulations of the Commission and understands them. Station licenses, according to FCC's present plans, will be limited to "point-to-point, fixed point-to-mobile, mobile-to-mobile, and multiple-address communications. Broadcasting is not contemplated."

In recent hearings before the subcommittee of the House Committee on Appropriations, Commissioner Jett was questioned as to the effect of this proposed new service on the local telephone. He said that he does not believe it will ever take the place of the local telephone, and reports he has had to date indicate that telephone officials are enthusiastic about the possibilities of the service. There is a maintenance cost to be considered in the pro-

# MEC-RAD

## ELECTRONIC COMPONENTS



*Navy plane patrolling the water off Saipan on "D-Day" for that Marianas base. Official U. S. Navy Photograph.*

### ★ **add a margin of safety for navy pilots**

Vital to the success of our air attack are ingenious electronic devices. Mec-Rad is now devoted 100% to the manufacture of vital mechanical and electro-mechanical assemblies for these important electronic units.

Our work includes "fancy brass plumbing" of all types involving soft and hard soldering, close tolerances, precision machining, careful assembly and finishes ranging from lacquered to silver and rhodium plating.

We will continue this program as long as our services are needed—but after the war our specialized facilities will be available to the electronic industry. Our engineering "know-how" based on years of experience designing and manufacturing precision mechanical-electrical components is at your service now to help you with your post-war planning.



# MEC-RAD

## DIVISION-BLACK INDUSTRIES

1400 EAST 222ND STREET ☆ CLEVELAND 17, OHIO

# OKOLITE-OKOPRENE



**. . . a versatile, low-maintenance cable for use in your plant or as part of your product**

Check over the principal advantages of Okolite-Okoprene cable and see how it can meet your needs. Used in various installations under all kinds of conditions, millions of feet of Okoprene-covered cable have proved its versatility, dependability, long-life.

Okolite-Okoprene cables (U. S. Patent 2,312,058) may be installed in ducts, buried directly in the earth and exposed to the elements *without additional protection*. Simple to handle, splice and terminate, they are designed in all standard sizes and many colors for service up to 5000 volts.

Briefly summed up at the right are the principal features of Okolite-Okoprene cables including the electrical and physical operating advantages and advantages in installation.

Okonite engineers are always ready to help you. With their long experience in the electrical field, their viewpoint is especially useful when it is joined with that of your own engineers in discussing any problems of electrical distribution. The Okonite Company, Passaic, New Jersey.

*Patents Protect Jobs—Let's Protect Them*

## ADVANTAGES OF OKOLITE-OKOPRENE CABLES

### ADVANTAGES IN DESIGN

1. Simple construction
  - a. No tapes or braids
  - b. No metallic coverings
2. Insulated by Strip Process, which means
  - a. Perfectly centered conductors
  - b. Uniform thickness of Okolite insulation
  - c. Uniform thickness of Okoprene covering
3. Vulcanized in a continuous metal mold, which means
  - a. Tough, dense covering
  - b. Uniform vulcanization throughout length

### OPERATING ADVANTAGES — ELECTRICAL

#### *Okolite Insulation*

1. Ozone resistant
2. High dielectric strength
3. Stable electrical characteristics
4. Low specific inductive capacity
5. High current carrying capacity (75° C copper temperature)

#### *Okoprene Covering*

1. Additional dielectric strength
2. High surface resistance eliminates charging current drainage from surface of cable
3. Ozone resistant

### OPERATING ADVANTAGES—PHYSICAL

1. No braids to rot
2. High moisture resistance
3. Resists oil and solvents
4. Resists acids, alkalies and corrosive chemicals
5. Non-flammable covering
6. Can be operated at 75° C
7. Unaffected by sunlight
8. Weatherproof
9. Long-lived

### ADVANTAGES FOR INSTALLATION

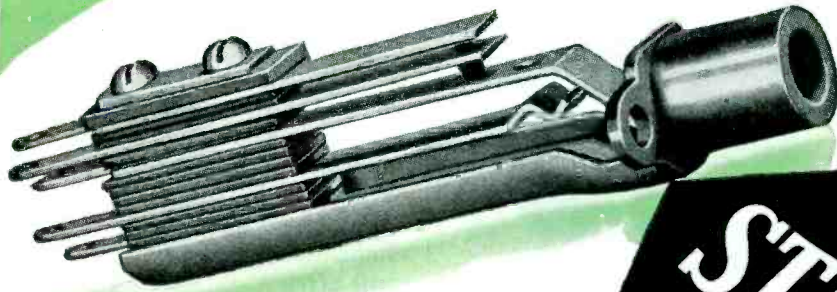
1. No potheads required
2. Easy to splice
3. Light weight
4. Small outside diameter
5. Smooth, snag-proof covering
6. Easy to pull into ducts
7. High abrasion resistance
8. High tensile strength sheath
9. Flexible at low temperatures
10. No saturants to soften in heat or flake off in cold weather
11. Can be bent on small radius

# OKONITE



## insulated wires and cables





**STRENGTH**  
WHERE YOU NEED IT

## THE JACK WITH THE CHANNEL-BEAM FRAME... BY FEDERAL

You can swing forty pounds from the free end of this jack without bending it from the horizontal.

Because . . . Federal has taken sturdy stainless-steel and die-drawn it to form a rigid channel-beam jack frame, instead of the bend and spot weld method of construction normally used.

This rigidity is all-important in a jack — not only in supporting heavy cable harnesses, but allowing the spring nests to provide positive tension on the plug . . . even though worn from years of constant service.

Jack springs are of nickel silver and the palladium crossbars assure positive contact at all times.

**DESIGN FEATURES:**  
Rigid Construction, Positive Spring Tension, Stainless Steel Channel-Beam Frame, Plain or Threaded Bushings, 15 Standard Spring Combinations, Phenol Fiber Insulation.

Federal's jacks are available with either plain or threaded bushings in 15 different spring combinations, including all of the more commonly used arrangements. Additional combinations can be provided where needed.

When required Federal's jacks can be supplied fungus and moisture proofed.

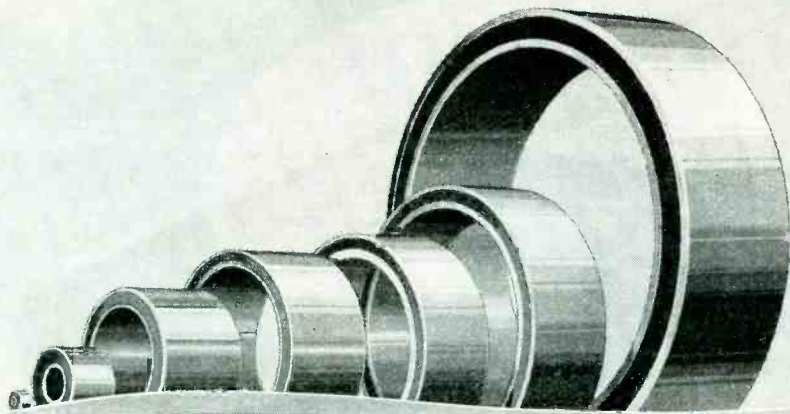
Another superior communications component by Federal, and another reason to see Federal first.



*Federal Telephone and Radio Corporation*



Newark 1, New Jersey



## WIDE RANGE OF SIZES *Torflex FLEXIBLE BEARINGS*

Torflex Bearings are not only unique in design and construction but they embody exclusive patented features which are more than just talking points.

Torflex Bearings consist of a seamless tube of rubber which has been stretched between two concentric metal tubes assuring high radial pressure which provides the required adhesion between the rubber and metal. Torflex Bearings take axial, torsional and radial loads. They absorb vibration, provide flexibility for cushion and misalignment, transmit torque, suppress noise, eliminate wear and friction and are being made in a wide range of sizes to carry loads from ounces to tons.

Harris Products Company pioneered in this field and for years, Torflex Bearings have been widely used in automobiles, tractors and industrial equipment. Today as in the prewar days, Torflex Bearings still lead, and are being used in combat tanks and for various types of war equipment. Our engineers over a period of years, have gained an enviable reputation in solving many difficult problems in connection with various types of equipment, by the application of Torflex Bearings thereto.

You may have some problem—current or postwar, that Torflex Bearings could solve better than anything else. Drop us a line and we'll be glad to work with you.

**LOW COST...REDUCES NOISE  
HARRIS PRODUCTS CUSHIONS SHOCK...  
• COMPANY • STOPS VIBRATION**

Specialized Rubber Engineers  
and Sole Manufacturers of  
*Dufflex* VIBRATION IN-  
SULATORS (MOUNTS)  
*Torflex* BEARINGS  
*Torflex* COUPLINGS  
HARRIS COMPRESSED  
RUBBER BEARINGS

**HARRIS  
PRODUCTS COMPANY**  
CLEVELAND 4, OHIO, U. S. A.

posed citizens radiocommunication service. Considering that there must be two transmitters and two receivers to carry on two-way communication, it will average much more than the cost of subscribing to telephone service. However, there are many places in the United States without telephone service, and many needs that telephone service cannot fill.

Don't look for citizens radiocommunication service to be licensed until after V-J Day.—G.T.M.

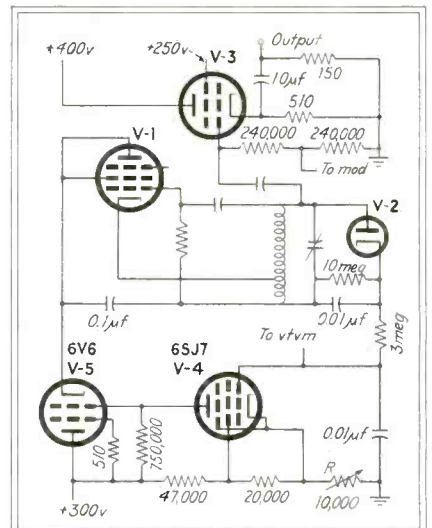
• • •

## Wide-Range Signal Generator with Automatic Amplitude Control

By HOWARD T. STERLING

AFTER EXPERIMENTING with various types of amplitude control for L-C oscillators involving shunting of the tuned circuit, with results not wholly satisfactory, the following scheme was worked out with much better success. It was inspired by the use, in General Radio's model 605 signal generator, of plate voltage control to set oscillator output to the desired amplitude.

Referring to the circuit illustrated, the output of the oscillator, V-1, is rectified by the diode,



Circuit of a system of automatic amplitude control of an oscillator in a signal generator

the positive voltage resulting is fed to the grid of V-4. This tube is operated at low current, the variable cathode resistor *R* providing sufficient bias despite the positive



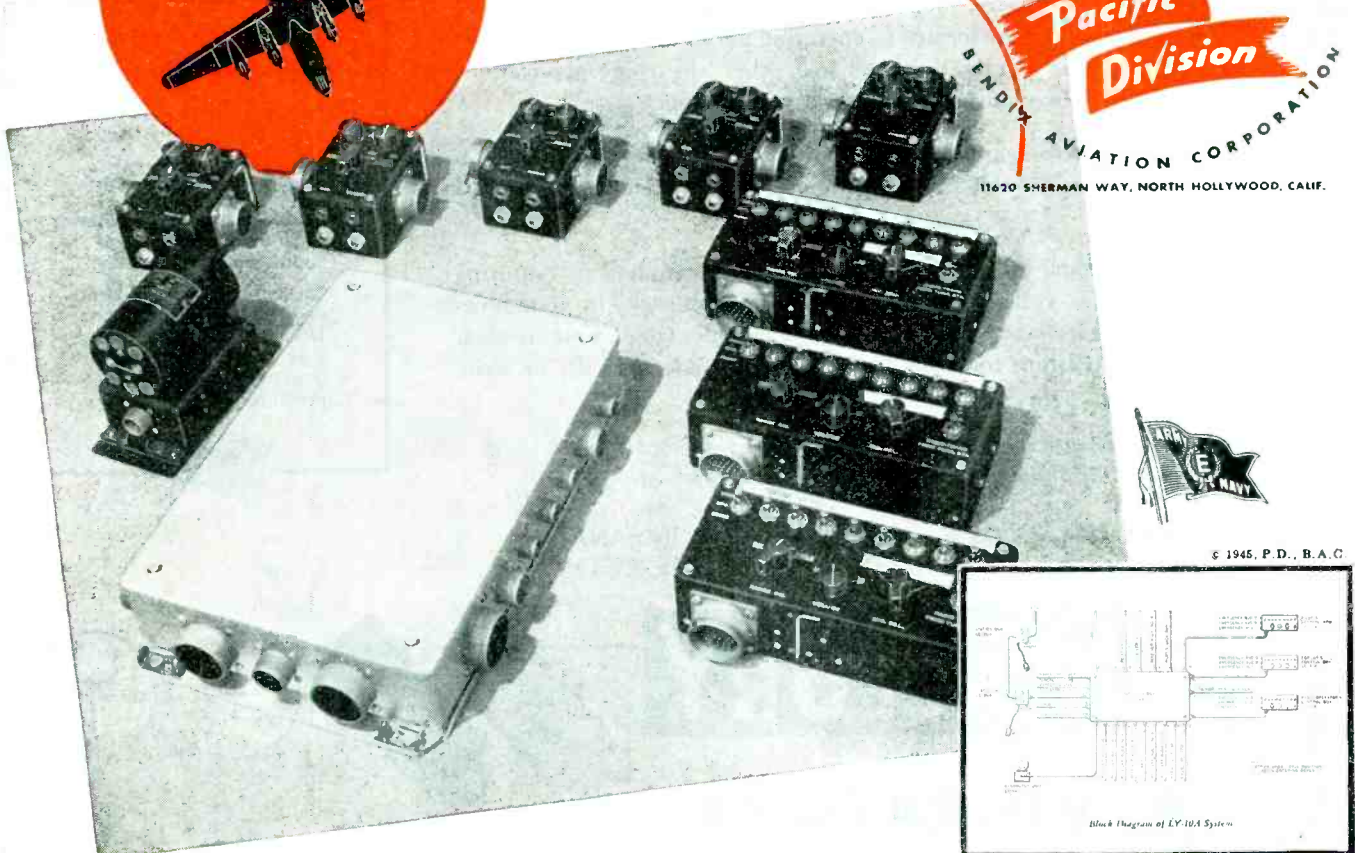
# ALL 5

## USE THIS STANDARDIZED INTERPHONE SYSTEM

For the first time radio and interphone control systems have been completely standardized for more than one type of aircraft ... by Pacific Division. Altair Model LY-10A system is being used on the Lockheed *Ventura*, Martin *Mariner*, Consolidated-Vultee *Catalina* and *Privateer* and the Douglas *Skymaster*. Designed to Navy specifications by Bureau of Aeronautics and Pacific Division engineers, this is a complete system to control all communication and radio navigation equipment in large aircraft.

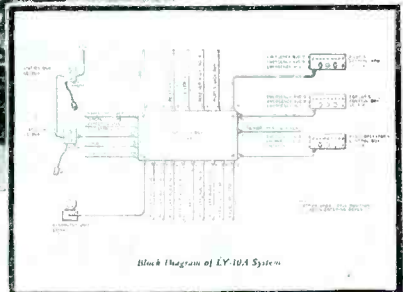
This feature alone is recognized as an important step forward in aircraft accessory design. Model LY-10A, however, incorporates — also for the first time — the use of isolation amplifiers which eliminate all crosstalk without the use of multiple audio output stages in each receiver. Selection of up to 9 receivers and 3 transmitters at flight deck stations can be provided.

Altair Model LY-10A, which provides a simple control for a large number of complex radio units, is an example of Pacific Division's understanding of a job that could result only from long experience. Pacific Division invites inquiries on any radio problem.



**Pacific Division**  
BENDIX AVIATION CORPORATION  
11620 SHERMAN WAY, NORTH HOLLYWOOD, CALIF.

© 1945, P.D., B.A.C.



**PACIFIC DIVISION, Bendix Aviation Corporation, 11620 Sherman Way, North Hollywood, California. Sales Engineering Offices: Lincoln Building, New York City 17; Continental Building, St. Louis 8.**

# Plenty of POWER!

## Specifications of Heavy-Duty Vibrapacks VP555, VP557

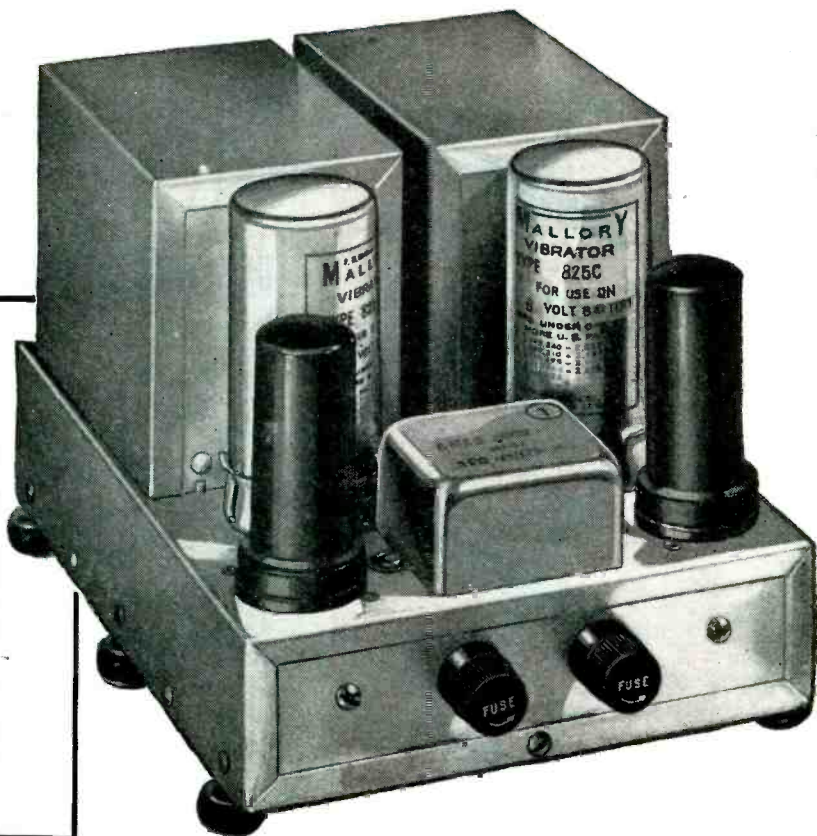
**Input Voltage:** 6 volts, nominal.

**Output Voltage:** VP555—300 volts, 200 ma.†  
nominal.  
VP557—400 volts, 150 ma.†  
nominal.

**Filtering:** VP555 completely filtered for audio  
and RF vibrator hash. Ripple  
approximately 1½% at max. load.  
VP557 has efficient RF filter for  
vibrator hash.

**Applications:** VP555—ideal for mobile PA  
systems and two-way radio service.  
VP557—specially designed for  
radio transmitter service, auto-  
motive, aircraft and marine.

†Intermittent rating for transmitters and public address systems.



# MALLORY HEAVY-DUTY DUAL VIBRAPACKS\*

WITH 60-watt rated capacity, Mallory Heavy-Duty Vibrapacks VP555 and VP557 are giving excellent service in operating portable and mobile transmitters, PA systems, heavy drain receivers and other electronic applications requiring more power than a single unit vibrator power supply.

Like other Vibrapacks, these heavy-duty dual units are electrically and mechanically rugged... assuring trouble-free operation and high efficiency over a long life.

If you're designing portable or mobile electronic or radio equipment requiring high voltages from a low voltage DC supply, include Vibrapacks in your blueprints. Mallory Vibrators and Vibrapacks are available from your nearest Mallory Distributor. Ask him for your free copy of Booklet E555D, or write us today.

*Inquiries are invited from manufacturers for Vibrators and Vibrapacks for use in original equipment.*

P. R. MALLORY & CO., Inc., INDIANAPOLIS 6, INDIANA

\*Reg. U. S. Pat. Off. for vibrator power supplies.

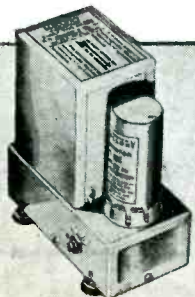
## Features of Mallory Standard Vibrapacks

Nominal input voltages of 6, 12 and 32 volts DC.

Nominal output voltages from 125 to 400.

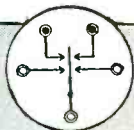
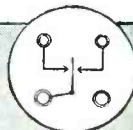
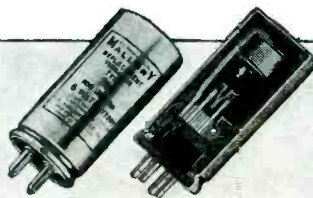
Models available with switch for four output voltages in approximate 25-volt steps.

All standard Vibrapacks are equipped with new Mallory Hermetically-Sealed Vibrators for top performance in extremes of atmospheric pressure or humidity.



P. R. MALLORY & CO. Inc.  
**MALLORY**

**VIBRATORS  
and VIBRATOR POWER SUPPLIES**







Whether for Radio's finest programs or amateur auditions, best recordings are made on

**audiodiscs**

AUDIO DEVICES, INC. • 444 MADISON AVE., N.Y.



*they speak for themselves* **audiodiscs**

voltage at the grid due to oscillator output. Variations in oscillator output are amplified by V-4 to control the bias on V-5 and hence the oscillator plate voltage.

The signal voltage at V-4 grid can be applied to a vtum to read oscillator (and signal generator) output. Since the control depends upon change of amplitude, regardless of the level, it will be seen advisable to operate the oscillator at a relatively high level. In practice, twelve to fifteen volts peak was found most satisfactory. With a fairly high-Q variable capacitor (such that amplitude does not fall below this value at the low-frequency end of a band) the output of the generator can be kept constant plus or minus 2 percent from 50 kc to 50 Mc.

The tube finally chosen for V-1 was a 6AC7. Everything from a 6J5 through a 6L6 was tried, but the 6AC7 behaved most consistently and provided highest output. Any convenient diode can be used for V-2. A 6L6 was used at V-3 for high output.

#### Power Supply

The oscillator plate and V-4 screen supply should be regulated, although it is not entirely necessary. The control circuit is essentially degenerative so that the output will not vary much with change in the line voltage. The screen potential on V-4 will affect the gain of that stage, though the plate voltage need not be regulated. Tube V-4 and its associated bleeder draw about 5 ma and this is the only additional plate current drain introduced by this control circuit.

Any doubts as to the advisability of changing the plate voltage of the oscillator may be set at rest; the resulting slight shift in frequency is far less than the one-percent tolerance that must be expected in the best of wide-range signal generators.

The output can be adjusted by R; in practice this should be set and locked, although a vernier control of comparatively low resistance may be placed in series with it and brought to a knob on the panel to correct for residual amplitude changes of one and two percent if desired. With distortion, 100 percent modulation of V-3 is possible,

## Here's why SPERTI HERMETIC SEALS are A "MUST" IN THE TROPICALIZATION OF ELECTRONIC MILITARY EQUIPMENT

1. EFFECTIVELY SEAL OUT DUST, sand, salt spray, fumes, fungus, injurious atmosphere.
2. GLASS PATH WILL NOT CARBONIZE. Have wide thermal operating range and high insulation leakage resistance.
3. SPECIAL PROCESS insures maximum acceptability to solder. Simple and easy to attach.

Sperti Hermetic Seals have been an important factor in increasing the life expectancy and usefulness of vital military equipment of many kinds. Write, today. Outline your problems. Let us show you how Sperti Hermetic Seals can help you solve them.

### THE HELP YOU'VE BEEN LOOKING FOR!

Now available. Skilled assembly service for soldering terminals into cover plates. Send drawings and specifications for quick quotation. For full information, phone, wire or write.

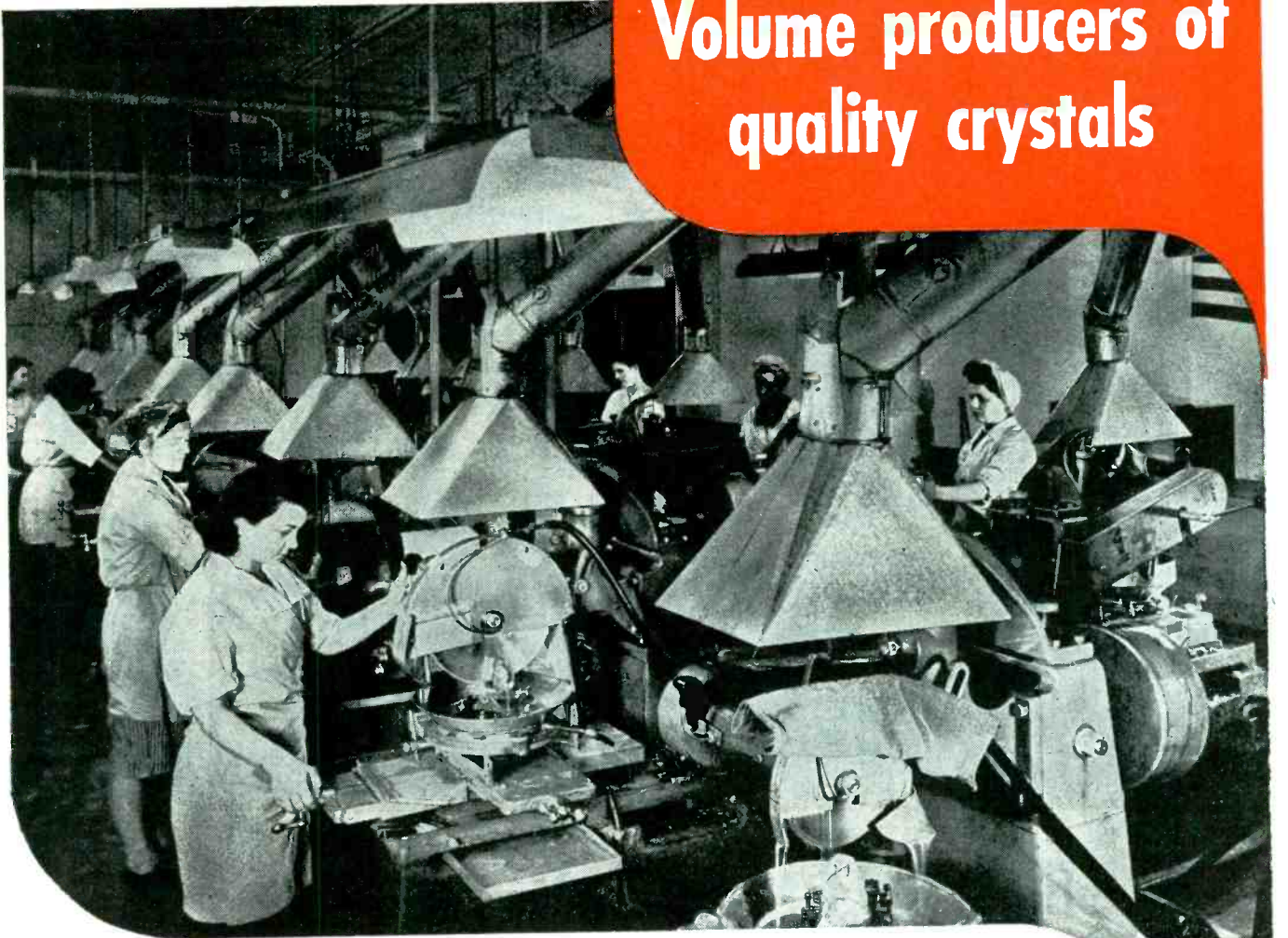
# Sperti

INCORPORATED  
Cincinnati, Ohio



RESEARCH • DEVELOPMENT • MANUFACTURING

# Volume producers of quality crystals



In this saw room at North American Philips, volume production of quality crystals really begins. Here a battery of high-speed saws of latest design, mounted on vibration-proof concrete bases, cut the quartz into wafers.

This is typical of how North American Philips has applied its techniques of volume production to a highly specialized field where rigid specifications must also be met. More than 50 years of research, development and manufacture in the electrical field form the background of this organization.


Developments to which our research and engineering have contributed include the Q-Lap; the X-ray Quartz Analysis Apparatus; automatic high speed testing for temperature, activity and frequency; and a method for utilizing unfaced quartz.

Today North American Philips is one of the leading producers of quartz crystals. Although the

armed forces have first call on our production facilities, we invite inquiries from manufacturers interested in the utilization of low-cost precision quartz crystals for industrial and commercial applications.

North American Philips offers to such manufacturers the full benefit of its technical resources, engineering facilities and the consultation services of recognized authorities in the crystallographic field. • We invite you to visit our office and showroom when in New York City.

**OTHER PRODUCTS:** Amplifier, Transmitting, Rectifier and Cathode Ray Tubes; Searchray (Industrial X-ray) Apparatus; X-ray Diffraction Apparatus; Medical X-ray Equipment, Tubes and Accessories; Tungsten and Molybdenum Products; Fine Wire; Diamond Dies.

  
**Norelco** Electronic Products by  
**NORTH AMERICAN PHILIPS COMPANY, INC.**

100 East 42nd Street, New York 17, N. Y.  
 Factories in Dobbs Ferry, N. Y.; Mount Vernon, N. Y. (Metalix Div.); Lewiston, Me. (Elmet Div.)

A booklet, "How Quartz Crystals are Manufactured", is available on request.



North American Philips Company, Inc.  
 100 East 42nd Street, New York 17, N. Y.

Dept. B-5

Gentlemen:  
 Kindly mail booklet, "How Quartz Crystals are Manufactured" to:

Name \_\_\_\_\_  
 Title \_\_\_\_\_  
 Company \_\_\_\_\_  
 Address \_\_\_\_\_



## Let THEM do the Talking

On land and sea, in the air and under the sea, success in combat rests heavily on Communications . . . the ability *to talk* over distances of a few feet or many miles. But here at home, the success of our effort depends greatly on the ability of all of us *not to talk* . . . to keep to ourselves the things we are doing and the things we are going to do.

We in the Electronic Industry have been asked

greatly to increase our output of many types of Communications equipment. We'll do *that* job, but its effectiveness must not be hurt by any careless conversation on our part. Let the man with the "mike" do all the talking.

THE ROLA COMPANY, INC., 2530 Superior Avenue, Cleveland 14. Manufacturers of Transformers, Coils, Headsets and other Electronic parts for Communication Systems.

# ROLA



MAKERS OF THE FINEST IN SOUND REPRODUCING AND ELECTRONIC EQUIPMENT



## **I**very tower... with a view!

**Aireon** engineers are not in any sense prima donnas. But

we *do* provide them with the sort of seclusion that promotes constructive thinking...an isolated building of 22,000 square feet, equipped with the latest and finest scientific apparatus, given over exclusively to research and development. A place where you can hear a kitten pound its feet. ■ This partly accounts for the fact that, of twenty-eight *major* electronic products, turned out by our Electronic Division, *twenty-four* were largely designed from the ground up and converted into production realities by **Aireon** engineers. ■ The regenerative force of research is responsible for the steady progress of **Aireon** in the electronics field. Supporting it are manufacturing facilities groomed for the mass production of precision products. ■ Our executives are ready to discuss your plans for today and tomorrow — our engineers and plants to carry them out. A call to any one of our offices will bring results.

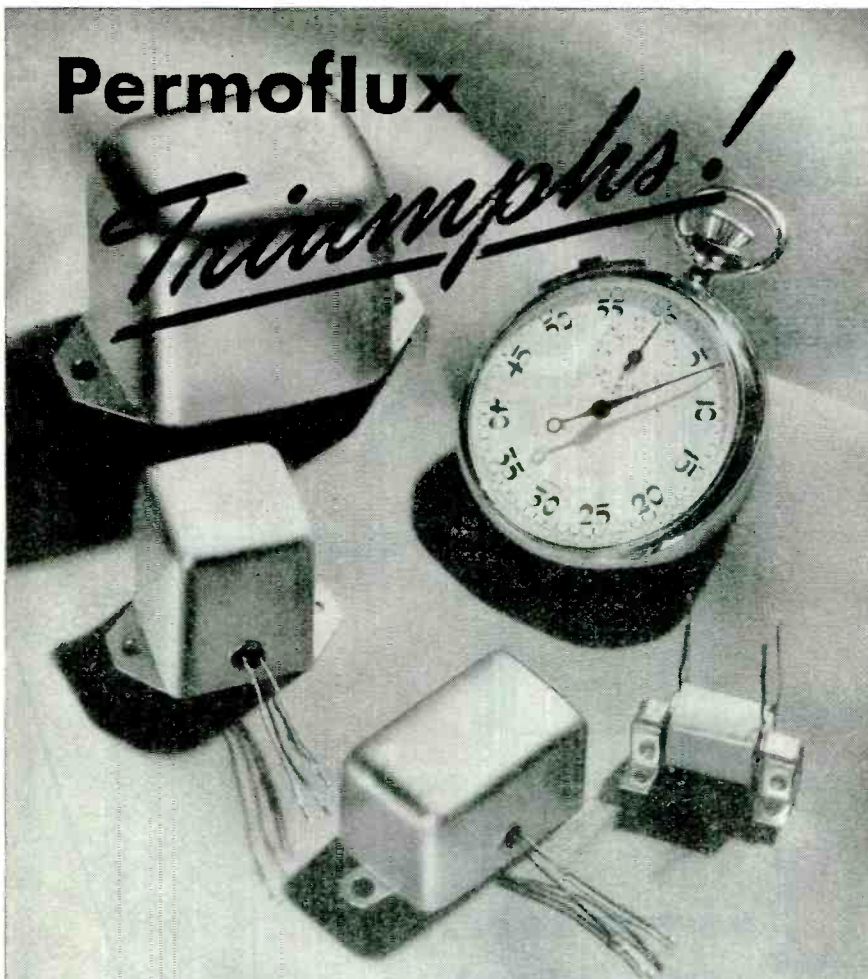
**Aireon** MANUFACTURING CORPORATION  
Formerly AIRCRAFT ACCESSORIES CORPORATION

Radio and Electronics • Engineered Power Controls

NEW YORK • CHICAGO • KANSAS CITY • BURBANK

# Permoflux

# *Triumphs!*



**These "World's Smallest Transformers"  
May Be The Complete Answer to  
Your Space and Weight Problems!**

It's not an everyday occurrence when so large a problem can be answered with such a small unit. In fact, we're mighty proud of this midget transformer achievement—not only for the reason that Permoflux engineers met a vital war challenge, but because of its numerous practical applications. Permoflux welcomes inquiry from design engineers about this midget transformer development.

**BUY WAR BONDS FOR VICTORY!**

TRADE MARK  
**PERM-O-FLUX**

**PERMOFLUX CORPORATION  
4900 WEST GRAND AVE., CHICAGO 39, ILL.**



**PIONEER MANUFACTURERS OF PERMANENT MAGNET DYNAMIC TRANSDUCERS**

SIGNAL GENERATOR

(continued)

but 50 percent modulation is very clean and requires about 15 volts peak of audio.

The line termination at the generator consists of the cathode impedance of the tube and the 500 and 150-ohm resistors in parallel. Twelve volts r-f to the grid of V-3 will result in 2.5 volts output with a termination of 73 ohms at the far end of the line.

• • •

## **Projection Systems for Theater Television**

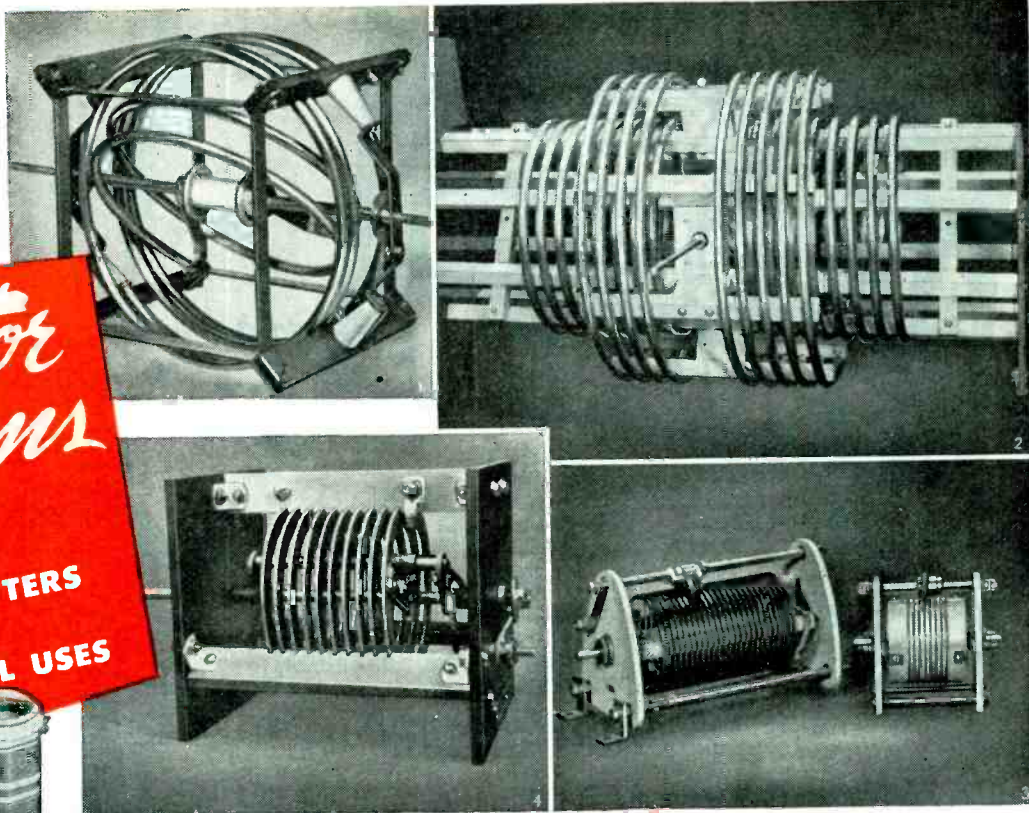
TWO METHODS of large-screen television projection were described at the March meeting of the Society of Motion Picture Engineers, Atlantic coast section, by Dr. A. H. Rosenthal, director of research and development of Scophony Corporation of America.

To obtain a screen image of maximum brightness it is desirable that the elemental picture image be either intensely bright, or that it be moderately bright for a long period of time. To obtain great brilliance of the picture element in systems in which the modulated electron beam produces the light directly through fluorescence, as in cathode-ray tube television projection, it is necessary to sacrifice definition in the interest of exciting an appreciable area of the fluorescent material. Thus this method of picture projection has an inherent limit of brilliance-to-definition ratio.

### *Optical Gate and Image Storage*

A more satisfactory method of television projection, according to Dr. Rosenthal, is to use the signal not to produce the light, but to modulate an independent light source. This source can be as bright as need be. Standard motion-picture projector light sources such as carbon arcs or mercury pressure lamps can be used. In fact, this method of light modulation is analogous to film projection wherein the film density modulates the light passing through the optical system.

However, in film projection all picture elements are actively modulating the light simultaneously and for an appreciable portion of the total frame time. In television



When you need an inductor for any purpose consult Johnson Engineers. Their files will probably contain a design for your required inductor, but if not, they can design one and make it to do your particular job.

Inductor design is quite a special study and no one conductor, no one insulator, no one type of construction is suitable for every requirement. Johnson may select a copper tubing conductor to handle high currents in one design, while edgewise strip is selected in another because of its narrow width and the ability to get a greater inductance in the same length. Other conductors are available too, such as solid wire, litz wire, flat strip, square Bars and special shapes, some plated, some polished and lacquered according to their use. In order to make contact to the conductor and bring off taps Johnson has produced a complete line of clips and connectors for use on fixed taps as well as sliders and rollers for continuously variable taps.

Insulation requirements vary. While steatite or mycalex may be used for low losses in a certain high frequency coil, plastics may be better for another because they stand more mechanical shock. Production facilities at Johnson provide for working any insulating material so the best one or the best combination, can always be selected to fit the special job.

Johnson inductors are designed and built for efficient operation and they have high Q. Some are fixed and some are variable. Some designs require special features such as rounded parts to minimize corona discharges at high voltages, water cooling, variation of inductance or variation of coupling.

What is your inductor requirement?

**OTHER  
JOHNSON  
COMPONENTS**

- SOCKETS**
- CONDENSERS**
- INSULATORS**
- PLUGS and JACKS**
- COUPLINGS**

*Ask for*  
Catalog 968-D



**JOHNSON**

*a famous name in Radio*

**E. F. JOHNSON COMPANY • WASECA • MINNESOTA**

# New **ELCO** A1-F RESISTOR 38,500 OHMS

*its*  
**FUNGUSIZED!**

Temperature coefficient is such that a minus 50° centigrade change in temperature from plus 22° centigrade will produce no greater than plus .01% change in resistance.

A1-F—15/32 long x 1/2" diameter. Mountable with 6-32 flat or filester screw No. 21 Tinned Copper wire leads. 1% standard accuracy. Non-inductive pie wound—1/2 watt, 200 D.C. maximum operating voltage. Fungusized varnish finish.

CAN ALSO BE MADE IN OTHER SIZES  
ACCORDING TO YOUR SPECIFICATIONS

**ALL ELCO RESISTORS ARE PRECISION WIRE-WOUND**



**SPECIFICATIONS:**

"A-1"—15/32 long x 1/2" dia.—Mountable with 6-32 flat or filester screw. No. 21 tinned copper wire leads. 1 to 300,000 ohm value—1/2% standard accuracy—non inductive pie wound—1/2 watt, 30° C. temperature rise in free air—100° C. maximum operating temperature—200 D. C. maximum operating voltage. Baked varnish finish.

"A-R"—Same as A-1, with leads reversed.

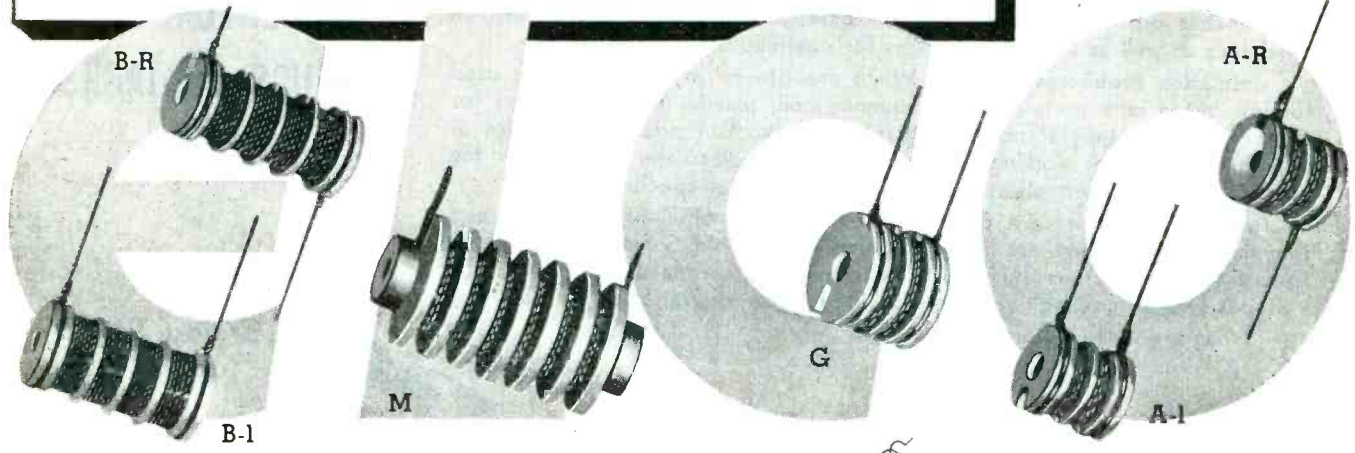
"B-1"—15/16 long x 1/2" dia.—Mountable with 6-32 flat or filester screw. No. 21 tinned copper wire leads. 1 to 500,000 ohm value—1/2% standard accuracy—non inductive pie wound—1 watt, 30° C. temperature rise in free air—100° C. maximum operating temperature—300 D. C. maximum operating voltage. Baked varnish finish.

"M"—1-13/32 long x 3/4" dia.—Mountable with 6-32 screw—1/8 x .015 thick strap terminals—non inductive wound—1 meg ohm maximum resistance—600 volts maximum operating voltage—100° C. maximum operating temperature—1.5 watts—1% normal accuracy. Baked varnish finish.

"G"—15/32 long x 1/2" dia.—Mountable with 6-32 flat or filester head screw. No. 21 tinned copper wire leads. 1 to 500,000 ohm value. 1/2% standard accuracy—non inductive pie wound .8 watts, 30° temperature rise in free air. 100° C. maximum operating temperature. 200 D. C. maximum operating voltage. Baked varnish finish.

"B-R"—Same as B-1, with leads reversed.

**PROMPT  
DELIVERIES**  
on the New A1-F  
and others described  
and illustrated



*Get to know*



**RESISTORS COMPANY**

114 West 18th Street, New York, N. Y.

Telephone - Watkins 9-4774-5



**NEW**

# TRANSFORMER CATALOG

**Lists 600 ratings**

**Valuable  
for  
Engineering,  
Drafting,  
and  
Purchasing  
Departments**



**T**HREE general types of transformers and a complete line of reactors are included in this catalog: **Power transformers**, including plate and plate-and-filament units **Filament transformers**, embracing both conventional types and special high-voltage units

**Audio-frequency transformers** (built to your specifications), including microphone, input, interstage (or grid), modulation, and output types

**Reactors**—microphone, plate, filter (conventional or swinging), and modulation units

Both the transformers and the reactors are built in three mechanical designs—hermetically sealed, conventional compound-filled, and core-and-coil (uncased). The type of construction depends upon the application.

In many cases you will be able to pick exactly the transformer you want from this catalog, and thus gain the benefits that come from standardization, such as simplified purchasing, lower cost, and quicker shipment. If you don't find the unit you need, please let us know. We'll be glad to furnish you with cost and delivery estimates of transformers built to your specifications.

Buy all the BONDS you can—and keep all you buy

- ★ Easy-to-read, easy-to-use tables and diagrams.
- ★ Large, full-color photographs of representative types

## It's Yours for the asking

GENERAL ELECTRIC COMPANY,  
SECTION 403-73  
Schenectady 5, N. Y.

YES! I would like a copy of your new catalog on transformers for electronic equipment.

NAME .....

COMPANY .....

ADDRESS .....

.....

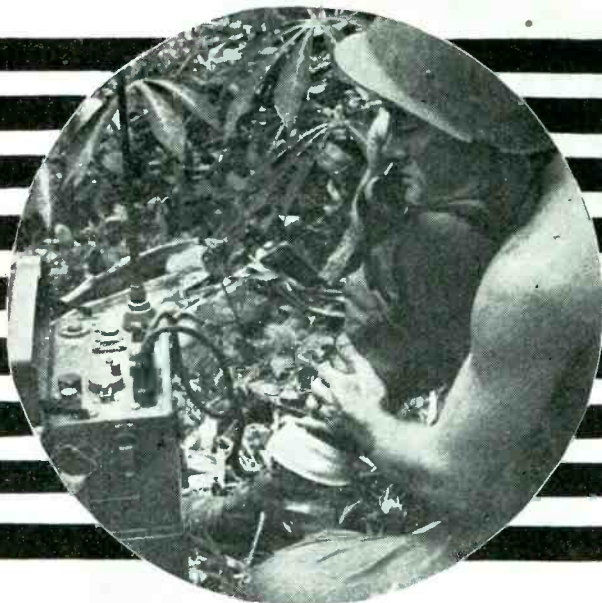
**GENERAL  ELECTRIC**

403-73-6205

Clip and save for ready reference

# INSL-X TROPICALIZATION COATINGS

NOW IN USE IN CONFORMANCE WITH  
U. S. ARMY & NAVY SPECIFICATIONS



MATERIAL	PROTECTION	APPLICATION
LEATHER	SN-3-T	A wax solution containing salicylanilide. Dip for 10 minutes. Drying Time: 150°F. .... 4-8 hrs. Room Temp. .... 24 hrs.
FELT	SN-3-T-50	Similar to SN-3-T, but cut 50%. For satisfactory felt impregnation, use same method as above.
FIBRE PIECES	95-T	For stiff pieces bake on 95-T
	85-1-T	For flexible pieces bake on 85-1-T
	1-1-T 1-1-P	For wax impregnation
DYNAMOTORS & GENERATORS	95 (No Toxicant) 95-T	For stators and rotors apply 2 to 3 impregnating varnish coats. Finish coat of either 95 or 95-T.
	25A (Phenyl Mercury) 25 PA (Pentachlorophenol) 25 SA (Salicylanilide)	Air Dry Lacquers.
OVERALL SPRAYS	27A (Phenyl Mercury) 27 PA (Pentachlorophenol) 27 SA (Salicylanilide)	Air Dry Varnishes

ADDITIONAL INFORMATION AVAILABLE UPON REQUEST

THE INSL-X CO., Inc. • 857 Meeker Ave. • Brooklyn 22, N. Y.

Chicago • Detroit • Los Angeles • Philadelphia

INSL-X—FIRST IN FUNGICIDAL COATINGS

PROJECTION, TELEVISION (continued)

technique, where it is necessary to dissect the frame into successive elements and transmit them row after row, only one picture element would normally be modulating the light beam at a time, and thus the duration of projection of each element would be much less than that in standard motion-picture projection. To make up for this loss in available projection time, some method of storage for the picture elements is needed at the television projector over and above that necessary to avoid flicker.

Storage increases the practical throw of the projector. In one installation where adequate screen brightness was obtained with an 8-inch throw without storage, with a storage ratio of  $\frac{1}{2}$  (that is, the elements were retained by the projection system for half of the frame scanning time) the throw was increased to 200 feet (comparable to that in drive-in theaters) with the same screen brightness.

### Supersonic Diffraction Valve

The first of the systems described to accomplish these objectives made use of the modulation element illustrated in Fig. 1. A quartz crystal vibrating in the su-

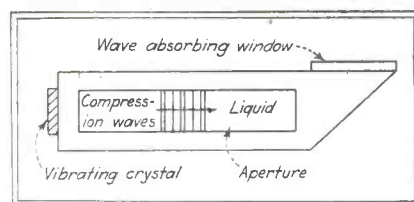
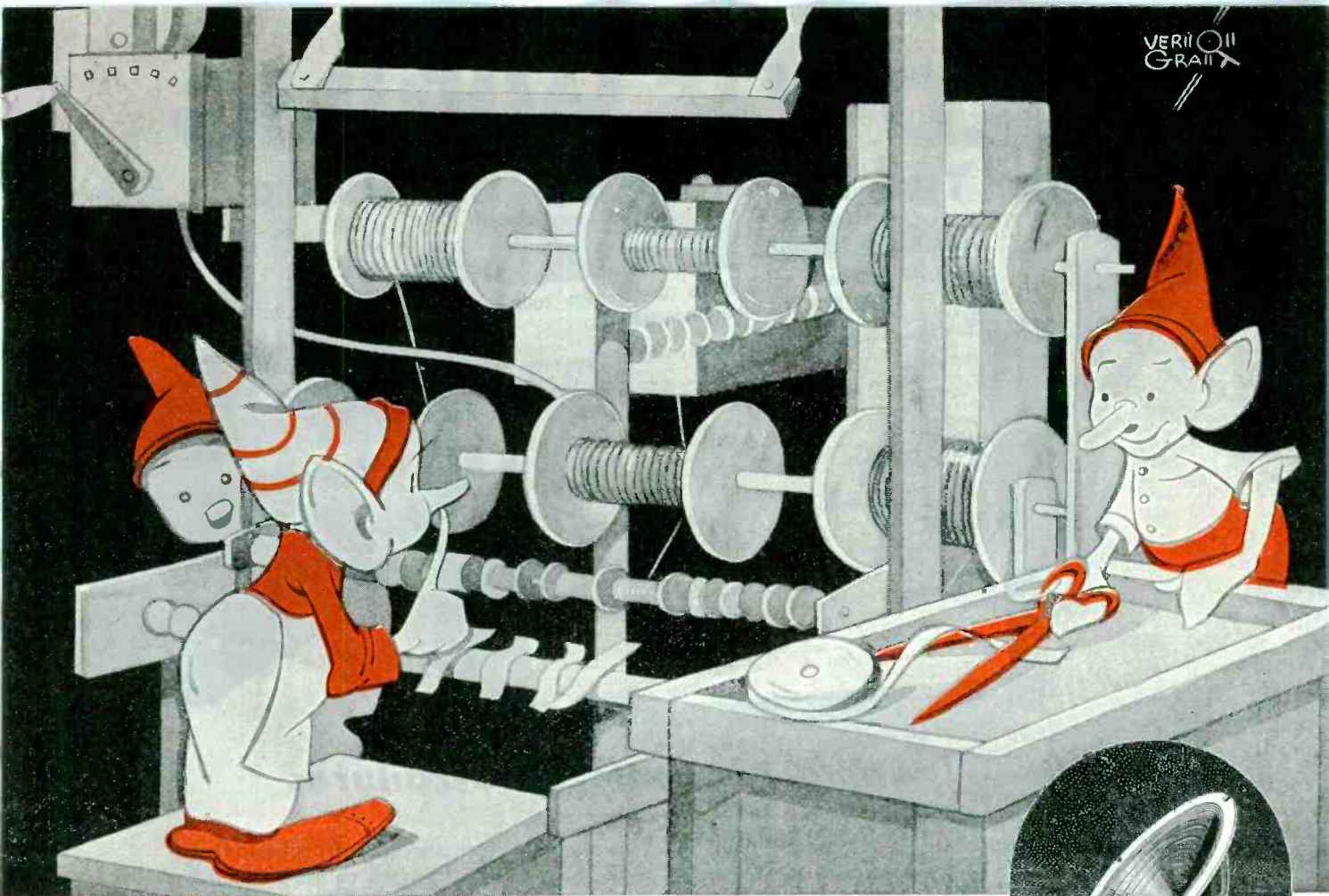


FIG. 1—Liquid light gate makes use of diffraction variation in the fluid, produced by amplitude-modulated supersonic vibrations, to control the intensity of light projected to the screen

personic range sends traveling compression waves across the fluid light gate. These waves are completely absorbed by the terminating window to avoid standing-wave patterns in the fluid. The compression waves cause the light to be diffracted. Standard optical-bar systems are used to obtain an amplitude-modulated light beam from the diffracted rays by selecting the diffracted beams. The system is linear.

The supersonic vibrations of the quartz crystal are amplitude modulated by the television signal. As these amplitude-modulated waves



★ Utah Speakers: More than 20 million  
Utah speakers have been made for radio, and public address systems.



## PRECISION PLUS . . . THAT'S UTAH PERFORMANCE

When it comes to coil winding, Utalins\* are past masters. They operate machines, built by Utah engineers, that produce finished products to a greater accuracy than ever possible by human hands alone.

This, and every manufacturing step, is part of a comprehensive process carried through

in Utah's own factory . . . tooling, welding, plating, winding . . . to unexcelled standards of accuracy. Then comes checking, rechecking, supervising, testing . . . till every step of production has been thoroughly approved. In fact, there's not one moment from the original buying of raw materials to the final delivery, that Utalins\* relax their efforts. This is the Utah perfection that guarantees performance.

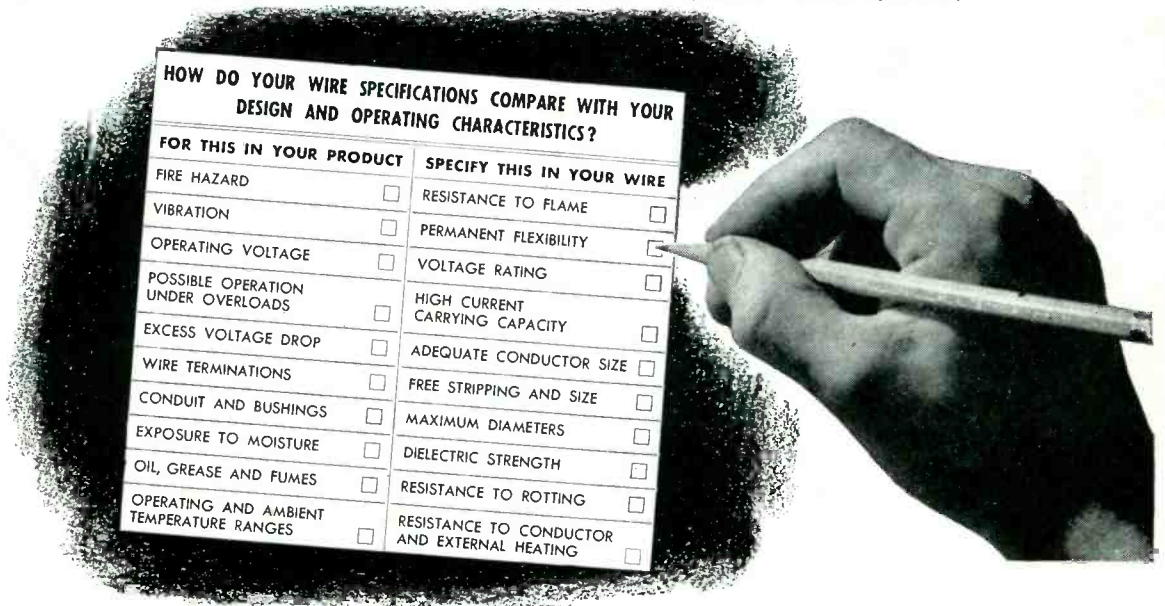
\*Utah's Helpers



UTAH RADIO PRODUCTS COMPANY, 820 ORLEANS ST., CHICAGO 10, ILL.,  
Utah Electronics (Canada) Ltd., 300 Chambly Road, Longueuil, Montreal (23) P.Q. • Ucoa Radio, S.A., Misiones 48, Buenos Aires

# HOLD THE WIRING

## Until You Have Made This Check



### Wire-Planning Prevents Wire-Failures

Check all the "bugs" that may make your product a dud . . . and don't overlook the wire! A very simple case in point occurred not long ago when a designer ordered some wire to run through a channel in a rotating spindle—and the spindle, weakened by the over-large channel required to accommodate the wire, fractured during operation tests. A perfectly adequate thin-walled, small diameter wire which we recommended solved the problem.

Cancel the possibility of product-breakdown and wire-failure by checking your trouble factors and specifying wire that will guaran-

tee dependable performance. The Rockbestos line of permanently insulated wires, cables and cords includes 125 different standard constructions, ranging from No. 22 AWG Radio Hookup Wire to 5000 volt Power Cable, resistant to heat, flame, cold, moisture, oil, grease, corrosive fumes and alkalis—and for unusual applications Rock-

bestos Research will be glad to go to work on a "special" for you.

For engineering assistance on your wire problems, write the nearest branch office or:

**ROCKBESTOS PRODUCTS CORPORATION**  
423 Nicoll St., New Haven 4, Conn.



## ROCKBESTOS RESEARCH Solves Difficult Wiring Problems

NEW YORK    BUFFALO    CLEVELAND    CHICAGO    PITTSBURGH    ST. LOUIS    LOS ANGELES  
SAN FRANCISCO    SEATTLE    PORTLAND, ORE.

FOR VICTORY...BUY BONDS

**ROCKBESTOS A.V.C. 600 VOLT SWITCHBOARD WIRE**  
Size No. 18 to 4/0 AWG with varnished cambric and impregnated asbestos insulation and gray, black, white or colored flameproof cotton braid.

Combine fire insurance and fine appearance in switchboards and control panels with Rockbestos A.V.C. Switchboard Wire. It is fireproof, will not dry out under heat, and sharp clean bends can be made without cracking the braid as the asbestos firewall acts as a cushion.

#### ROCKBESTOS TYPE CA LEAD WIRE

Has high-dielectric strength and moisture resistance for use where heat and humidity are encountered. No. 20 to 8 AWG solid or stranded copper, monel or nickel conductors insulated with synthetic tape and various thicknesses of felted asbestos finished in black, white or colors for coding purposes. Also with All-Asbestos insulation only, for high temperature applications where moisture resistance is not required.

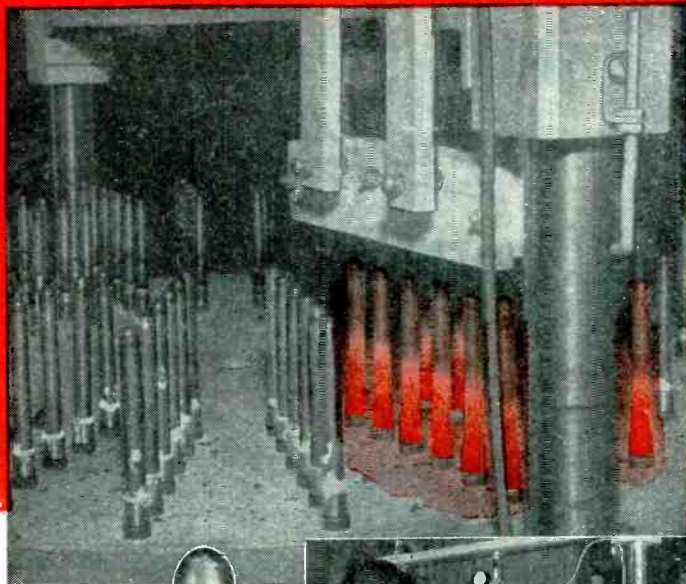
**ROCKBESTOS THERMOSTAT CONTROL WIRE**  
Sizes No. 14, 16 and 18 AWG in two to six enameled conductors with .0125", .025" or (for 115 volt service) .031" of felted asbestos insulation and steel armor.

A multi-conductor control wire for low voltage intercommunicating, signal and temperature control systems. Its life-time heatproof and fireproof insulation and rugged abrasion-resisting steel armor will give you trouble-proof circuits.

A few of the 125 different wires, cables and cords developed by Rockbestos to meet severe or unusual operating conditions.

# INSIST ON PROOF BY TRIAL

before you buy an  
Electronic Heater



This is how Scientific Electric proved the value of electronic heating to the Progressive Welding Company of Norwalk, Connecticut . . .

**G**REAT improvements in product quality and remarkable savings in time and money are being achieved by means of electronic heating. Industrialists everywhere are now acclaiming its many advantages. But don't let your enthusiasm lead you to invest in an electronic heater before you have seen it perform the work you expect of it.

Another important point is this . . . in order to work at maximum efficiency and live up to its reputation for doing things better, faster and cheaper . . . electronic heating must be "tailored" to the job. That is why we never sell a Scientific Electric unit until it has been satisfactorily demonstrated. Regardless of the amount of time and effort required, our engineers will not release a single machine for sale until it has fulfilled every claim we make for it.

So here is a word of counsel . . . get plenty of advice before you buy. Consult with our recognized engineers who have pioneered in electronic heating since 1921 and, without obligation, they will demonstrate what electronic heating can do for you.

## Scientific Electric

Division of

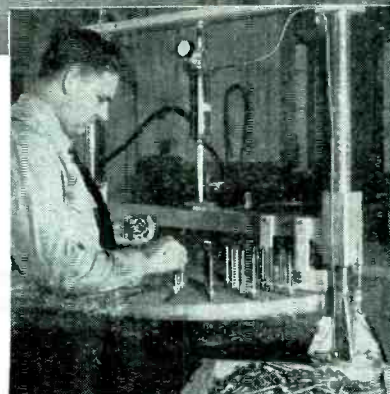
"S" CORRUGATED QUENCHED GAP COMPANY

119 MONROE ST.  GARFIELD, N. J.

Manufacturers of

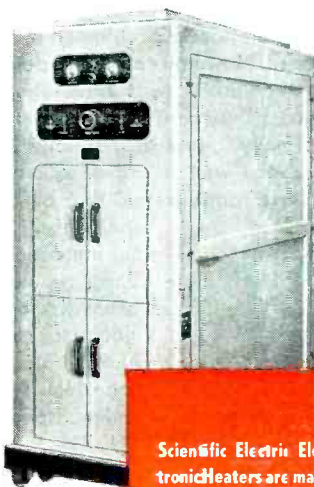
Vacuum Tube and Spark Gap Converters Since 1921

ELECTRONICS — May 1945



Above: This practical, automatic brazing turntable powered by a 40 KW. Scientific Electric heater speeded up production 700%—cut costs 87% and reduced rejects by 90%.

Left: Close-up of the finished two-piece tube assembly after being brazed by induction heating. Three complete brazing installations have been built for Progressive.



Write for a free copy of our handbook . . . *The ABC of Electronic Heating* which contains an easily understood explanation of this new heating method

40 KW INDUCTION HEATER

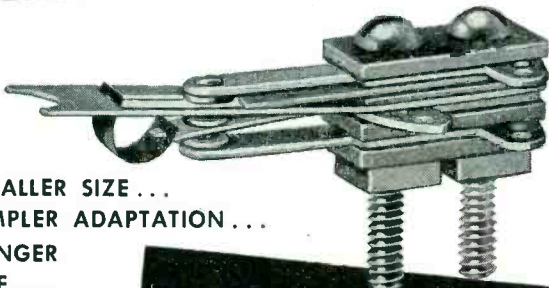
Scientific Electric Electronic Heaters are made in these power sizes... and a range of frequencies up to 300 Megacycles depending upon power requirements.

3 KW	18 KW
5 KW	25 KW
7½ KW	40 KW
8 KW	60 KW
10 KW	80 KW
2½ KW	100 KW
15 KW	250 KW

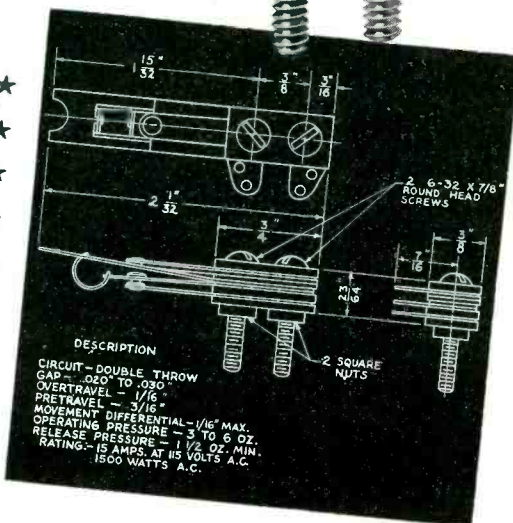
**NEW**

# Acro Snap OPEN BLADE SWITCH

SMALLER SIZE ...  
SIMPLER ADAPTATION ...  
LONGER LIFE ...

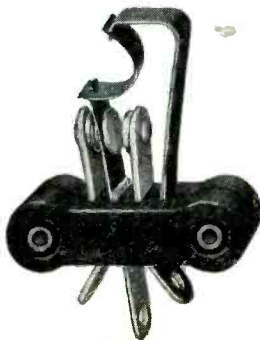


- ★
- ★
- ★
- ★
- ★
- ★
- ★
- ★



Do you need longer life, open blade switches in smaller sizes to solve many installation problems? If so, you will be delighted with these. Now you can really design for compactness with switches that users' tests have shown well above ten million actuations. They can handle 15 amps. at 115 volts A.C. Made for normally open or normally closed circuits and double throw. Also well adapted to mounting in multiples. Standard pressure range from 3 to 5 oz. Engineered with the

same positive beryllium Rolling Spring action that built the Acro-Snap reputation. (Similar characteristics applicable to vertical mounting model shown below). ACRO basic pin actuator switch code No. HRD7-1A2T approved under spec. AN-S-39 Dwg. AN3210-1. Other ACRO Rolling Spring Switches made to over 1,000 different specifications. Write for further details.



**THE ACRO ELECTRIC COMPANY**

1316 SUPERIOR AVENUE

CLEVELAND 14, OHIO

traverse the fluid of the light valve they diffract the light beam. It will be recognized that it will take each part of the compression wave, corresponding to each picture element, a finite time to travel the length of the valve, thereby obtaining optical storage.

To counteract the movement of the modulation across the valve, which would result in the picture element traveling across the screen, a high-speed scanning wheel is introduced. A slow-speed scanning wheel directs each successive line of the frame to its place on the screen. This system has been in commercial operation in England in a number of theaters with great popular success.

### Skiatron

The second system replaces the fluid valve and scanning wheels with a Skiatron vacuum tube shown in Fig. 2. Light is passed through a crystal of the type displaying electron-opacity, such as potassium-chloride. This crystal is in an electrostatic field, and is scanned by the electron beam from the gun. The beam intensity and motion are controlled as in cathode-ray projection tubes.

As the transparent positive ions of the crystal (potassium in the case of potassium chloride) are

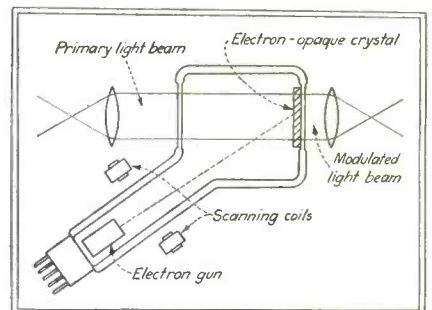


FIG. 2—The Skiatron, instead of using the cathode-ray beam to produce light for projection, uses the electron beam to control the opacity of the crystal, thereby modulating the primary light beam as does the standard motion-picture film

bombarded by electrons from the beam, they become opaque atoms. In this way the light beam is modulated.

It takes a finite time, dependent upon such factors as strength of the electrostatic field and crystal

\* THE DETROLA CONFERENCE ROUND TABLE



# PLANNING THE PATTERN OF ELECTRONICS



Creative thinking at Detrola probes the frontiers of electronics—devising the pattern for greater performance—wider range of Detrola-built Television Receivers . . . Radio Receivers . . . and other electronic instruments. And none will excel them in beauty or value.

A REAL AMERICAN KEEPS HIS BONDS

KEEP AN  ON 

*Detrola Radio*

DIVISION OF INTERNATIONAL DETROLA CORPORATION

DETROIT 9, MICHIGAN



**. . . . But you can see  
the results**

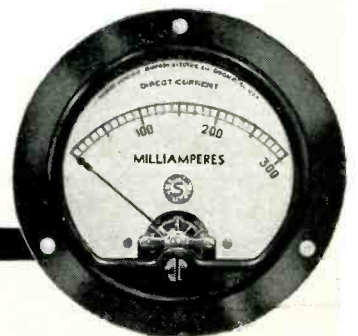
Pieced together this picture shows one step in the making of dials for Simpson Instruments. We have scrambled it deliberately to emphasize the fact that Simpson employs many processes others do not in manufacturing electrical instruments and testing equipment. To the man who knows instruments this extra measure of engineering skill and craftsmanship is evident in every detail—a reflection of Simpson's never-ending quest for refinements in design that will at once improve performance and permit more efficient production. It is the experience gained through more than 35 years of such study which promises you, in Simpson Instruments, the ablest application of the great advances that will be forthcoming.

**SIMPSON ELECTRIC COMPANY**  
5200-5218 W. Kinzie St., Chicago 44, Ill.

**Simpson**

**INSTRUMENTS THAT STAY ACCURATE**

*Buy War Bonds and Stamps for Victory*





ARE YOU USING THE TUBING  
*best* SUITED FOR YOUR JOB ?

# Irvington

*can Supply it*

**B**EST suited means a varnished tubing or sleeving that meets every service requirement . . . at lowest cost!

That's the way IRVINGTON . . . long the leader in electrical insulation . . . meets every tubing or sleeving need. For IRVINGTON makes *all* the types including non-fraying FIBERGLAS . . . high voltage IRV-O-VOLT . . . RADIO SPAGHETTI and SATURATED SLEEVINGS . . . in a complete range of colors and A. S. T. M. sizes.

Thus a recommendation from IRVINGTON can be unbiased . . . you get the tubing best suited to your needs, not only from the standpoint of efficiency, but economy as well.

In addition, you get that extra increment of electrical surety which IRVINGTON'S 'know how' and 'manufacturing control' provides. For literature, or engineering assistance, write to Dept. 106.

## IRVINGTON PRODUCTS:

Cotton, Fiberglas, or Rayon Tubings and Sleevings — Varnished, Lacquered, or Vinylite Processed

Non-Fraying Fiberglas Sleeving

Transformer Lead Tubings

Wire Identification Markers—Varnished or Plastic

Extruded Plastic Tubings

Fibron Plastic Tapes

Varnished Fabrics and Papers

Slot Insulations

Harvel and Irvington Insulating Varnishes

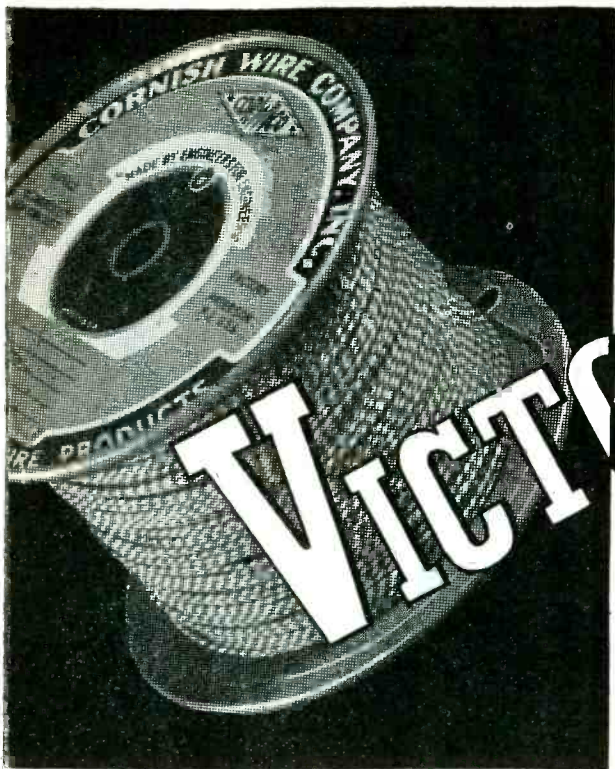
Cardolite Resins

"LOOK TO IRVINGTON  
FOR CONTINUED  
LEADERSHIP IN  
INSULATION"



**IRVINGTON**  
VARNISH & INSULATOR COMPANY

Irvington 11, New Jersey



is so

**Exacting**

**A**FTER the last enemy lays down his arms . . . then must follow the fabulous changeover whereby industry diverts production for War into production for Peace.

A critical and an exacting phase!

We at CORWICO are already planning for the transition. Soon millions of tons of basic materials formerly required by our armed forces can be diverted to peacetime uses . . . including, you may be sure, the fine CORWICO Wires that civilians have so patiently gone without for so long.

**cornish**

**WIRE COMPANY, INC.**

15 Park Row, New York City, New York

*"Made by Engineers for Engineers"*



history, for the loosely bound electron to abandon the atom and leave it again a transparent ion. The electron travels to the positive electrode used to produce the electrostatic field. In traveling from the atom to which it was originally directed, the electron successively neutralizes adjacent positive ions. In this manner, optical storage of the individual picture elements is obtained.

Using the Skiatron, the entire picture can be projected all the time; the time required for the electron to leave the electron-opaque crystal just coincides with the length of time required to scan the complete picture. Because of this melting of one frame into the next, there is a minimum of flicker. The number of frames that need be transmitted per second can be reduced, thereby permitting a greater number of picture elements to be transmitted per frame without increasing the transmission-frequency band. This would increase the definition of the final image.

Since the Skiatron operates on light absorption, it can be used efficiently in color television by associating with each of three tubes, through which the light to be modulated passes in succession, color filters rotating before each tube in synchronism with the color dissection filters at the television studio.

The Skiatron has been used successfully in large-screen home receivers for preliminary study of its commercial practicability. Both of these television projection methods have a gamma comparable to that of 16-mm motion-picture film.



A *YOUNG BRIDE-TO-BE* wrote a letter, inquiring about aluminum pots for her household, to the Daven Company, Newark, N. J., maker of "pots."



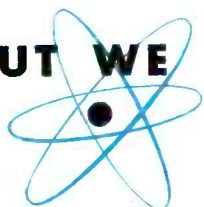
*DURING A 4-HOUR* bombing mission, four generators provide a Flying Fortress with electric power equivalent to that used by 32 average homes in an entire day.

# Electronics

IS OVER OUR HEAD



## BUT WE DO KNOW ALUMINUM



When it comes to designing electronic equipment, we'll sit back and listen to the men who know how. But when it comes to using aluminum in this equipment, we can be of real help.

1. We can tell you about alloys that are nonmagnetic, have high electrical conductivity with light weight, high strength, resistance to corrosion.
2. We can help you decide how best to make

parts from extrusions, die castings, formed sheets, sand and permanent mold castings or forgings.

3. We can show you how aluminum can be brazed, coated, electroplated and finished, to meet functional or assembly requirements.

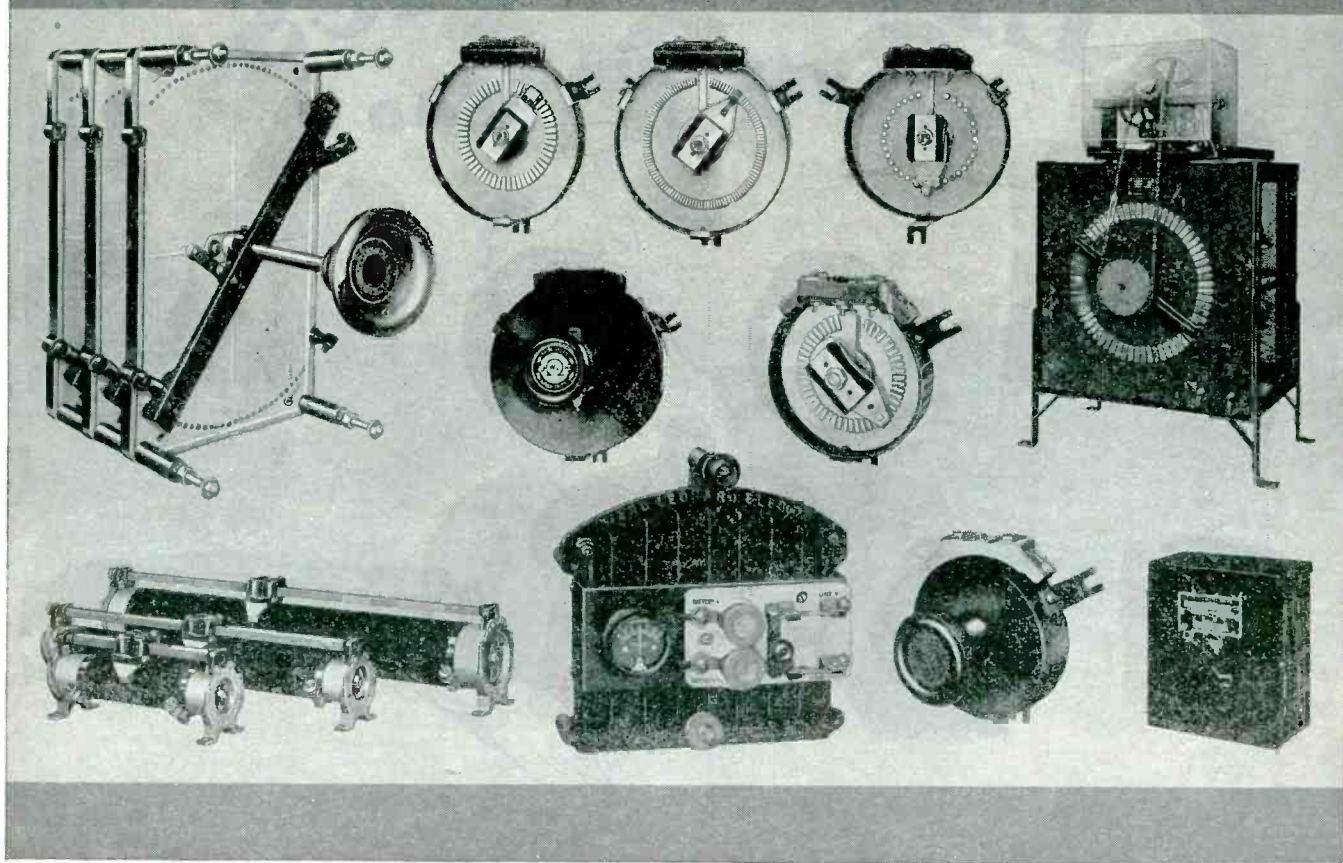
So, even if electronics is still over our head, remember, there's a lot of aluminum experience under the baldpate which may be helpful to you. *Ask us about it.*

ALUMINUM COMPANY OF AMERICA, 2136 Gulf Building, Pittsburgh 19, Pennsylvania.

# ALCOA FIRST IN ALUMINUM



# RHEOSTATS



The Ward Leonard line of rheostats includes the widest range of sizes, tapers and current ratings from the tiny types for radio to huge multiple assemblies for the heaviest industrial use. Smooth operation, durable contacts and extreme dependability characterize all Ward Leonard Rheostats, Resistors and Relays. Write for bulletins of interest to you.

## WARD LEONARD

RELAYS • RESISTORS • RHEOSTATS



Electric control  devices since 1892.

WARD LEONARD ELECTRIC COMPANY • 32 SOUTH ST. • MOUNT VERNON, N. Y.



Fig. 1. Macrostructure—Dark circumferential area is the hardened portion of the steel.



Fig. 2. Surface of Shaft—Medium-coarse grained martensite; dark areas of troostite. Manganese sulfide stringers.



Fig. 3. .060" Below Surface—light areas of medium-coarse grained martensite and dark areas of troostite.

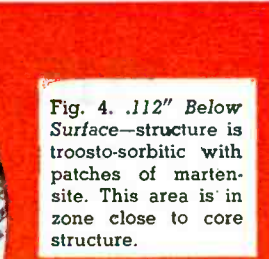


Fig. 4. .112" Below Surface—structure is troostite-sorbite with patches of martensite. This area is in zone close to core structure.



Fig. 5. Core Structure — medium-coarse grains of pearlite, lamellar pearlite and ferrite. Manganese sulfide stringers are uniformly distributed throughout. Structure is unchanged by hardening operation.

## LEPEL *High Frequency* INDUCTION HEATING MAKES CONTINUOUS SURFACE HARDENING OF SHAFTING AND TUBING PRACTICAL . . . . .

Induction heating with the LepeL High Frequency Unit dispels the notion that very heavy and expensive equipment is necessary for continuous surface hardening of shafting and tubing.

- LepeL spark-gap-operated equipment, generating frequencies of 100,000 to 450,000 cycles, creates heat so rapidly that continuous progressive heating and quenching is practical with normal current input. Shafting or tubing up to 3" diameter can successfully be heat treated with a standard 30 KW unit.
- Slow rotation of shaft during heating and quenching develops highest uniformity consistent with chemistry of the steel.
- Heating is so rapid and the time at heat so short that even normal grain growth associated with conventional heat treating methods does not take place. This makes it possible to use ordinary carbon steels in many applications where alloys heretofore have been required.
- High frequency induction heating develops a super-hard skin which provides superior wearing qualities.

- The speed of heating and the short time at heat prevents surface decarburization and scaling. Ground shafting and tubing may be hardened without the need for finishing after quenching.
- Due to the short heating and quenching cycle, the core structure is unchanged and highest ductility is maintained.
- Depth of hardness can readily be controlled by adjusting the input power or varying the travel speed of the part through the heating coils.
- Distortion is minimized, regardless of the length of the part.

Any hardenable steel can be heat treated with equal assurance of satisfaction. The photomicrographs illustrate the results obtained with a steel of the following analysis:

Carbon	.35/.45
Manganese	1.35/1.65
Phosphorus	.045 max.
Sulphur	.20/.30

In the illustration below, a 2" shaft 17" long is being hardened by passing it progressively through the heating coil and quench ring. Horizontal travel is 2 1/2 feet per minute and the shaft is rotated as it travels forward. Quenching temperature is 1500/1550° F with a water quench.

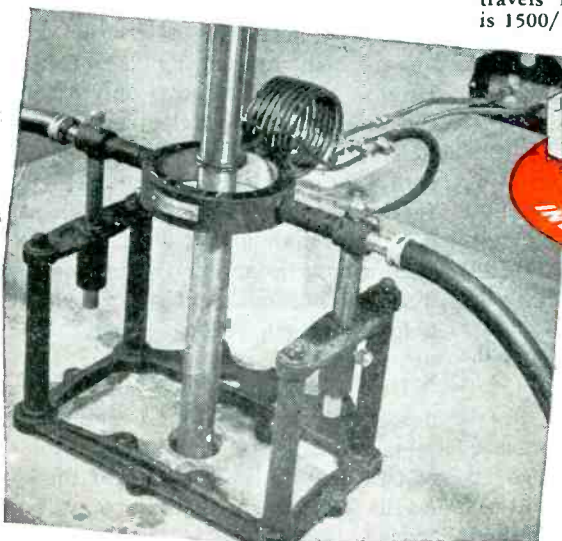


Fig. 1 shows the macroetched section of the shaft at approximately 1.5X magnification, indicating a penetration of 5/64". Only the surface yields the full hardness, Rockwell C60/C61, the Rockwell reading declining to C40 as the core is approached.

Figures 2, 3, 4 and 5 (500X magnification) show the grain structure at the surface, .060" and .112" below the surface and at the core respectively.

The same LepeL Unit can also be used for localized hardening, stress relieving, normalizing, brazing and soldering.

If you have a problem of surface hardening steel shafts or tubing of any length, LepeL engineers will be pleased to show you how you can not only secure better results, often with lower-priced steels, but also effect important economies in hardening cost and production time.

### LEPEL HIGH FREQUENCY LABORATORIES, INC.

PIONEERS IN INDUCTION HEATING

General Offices: 39 West 60th Street, New York 23, N. Y.

Chicago Office: 230 East Ohio Street, Chicago 11, Ill.

# THE ELECTRON ART

Cathode-Coupled Oscillator Circuit.....	234
Engineers Discuss Radar and Surgical Metal Locator.....	234
Suggestions for Design of Volume Expanders.....	236
Radar Terms and Abbreviations.....	252
Third Chicago War Production Conference.....	256

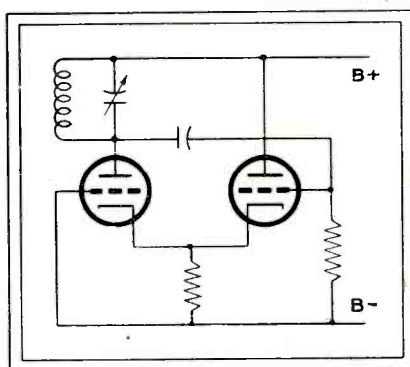
## Cathode-Coupled Oscillator Circuit

CATHODE-COUPLED oscillators have advantages of stability and small loading of the tuned circuit. Several circuits and equations for their operation are given by F. Butler in the November, 1944 issue of *Wireless Engineer* (Dorset House, Stamford St., London S.E. 1).

The basic oscillator circuit, shown in the diagram, has the advantages that the tank coil is not tapped, the high input impedance of the cathode-follower stage on the right imposes light loading on the tuned circuit, and unity gain in the cathode-coupling stage provides ample drive for reliable oscillations up to very high frequencies for low  $Q$  circuits. This circuit can be further stabilized for single-frequency operation by using individual cathode resistors and coupling the cathodes through a crystal. This connection, by operating the crystal at series resonance, reduces the capacitive shunting of the crystal by its holder.

If the feedback circuit from the

tuned circuit to the grid of the cathode-coupling stage is opened and an external signal fed to this grid, the circuit provides a highly selective amplifier with a high input impedance. The off-resonance



The circuit of a cathode-coupled oscillator. Convenience in band-switching is provided by the two-terminal inductance

attenuation is greater than for conventional amplifiers and may be increased by tuned output circuits in place of the load resistances.

## Engineers Discuss Radar and Surgical Metal Locator

TWO TECHNICAL PAPERS dealing with the role of electronics as locating devices were presented at the March meeting of the Chicago Section of the Institute of Radio Engineers at which Dr. W. E. Gilson, School of Medicine, University of Wisconsin, Madison, Wisconsin, spoke on "A New Surgeon's Metal Locator", and Dr. W. L. Everitt, Head of the Department of Electrical Engineering at the University of Illinois, and now in the Office of the Chief Signal Officer, Washington, spoke on "Recent Wartime Developments In Electronics" and outlined general principles of radar.

Dr. Everitt's talk represented one of the first discussions, in an open

engineering meeting, of the principles of radio direction and ranging equipment. In opening his talk, he stated that he had received permission to discuss certain principles of radar and the application of these principles to two sets, the SCR-268 and the SCR-270, but stated that his comments were completely off the record and requested that no notes be taken. It was also indicated that discussion of other radar developments could not be divulged.

### Radar Problems

While such problems as decrease in field intensity with distance of the transmitter, effect of ground reflection, necessity for new method

of rating tubes in terms of peak power rating, factors for consideration in locating radar equipment, and factors to consider in the design and construction of directive v-h-f antenna systems were all discussed, it must be admitted that the topics discussed were such as to give no comfort and aid to the enemy. In fact, all of the radar principles discussed by Dr. Everitt were either already known to qualified radio engineers or could easily be surmised after casual reflection on the requirements of radar transmissions.

New to many of the engineers were the photographic slides of the two Signal Corps installations. Most important of all, however, was the fact that Dr. Everitt's lectures (which were also given before other sections of the IRE in the Mid-West) are the first time that this all-important subject has been discussed in an open engineering meeting. It would appear that such a talk is highly desirable in view of the comparative freedom from censorship in Great Britain and the fact that none of the developments under discussion had taken place since the entry of this country into the war.

### Bullet Locator

Dr. W. E. Gilson, of the University of Wisconsin, gave a brief outline of various methods which had been used in the past half-century for locating metallic objects imbedded in the human body. Early work in that field was inspired by the assassination of President Garfield on July 2, 1881, which led Alexander Graham Bell to develop a system of locating bullets in the human body by making use of the Hughes balance. It was only after the employment of electron tubes in such applications that metal locators became smaller in size, effective, and practical for medical use. The majority of such locators are quite satisfactory for magnetic material but not particularly suitable for the location of non-magnetic material.

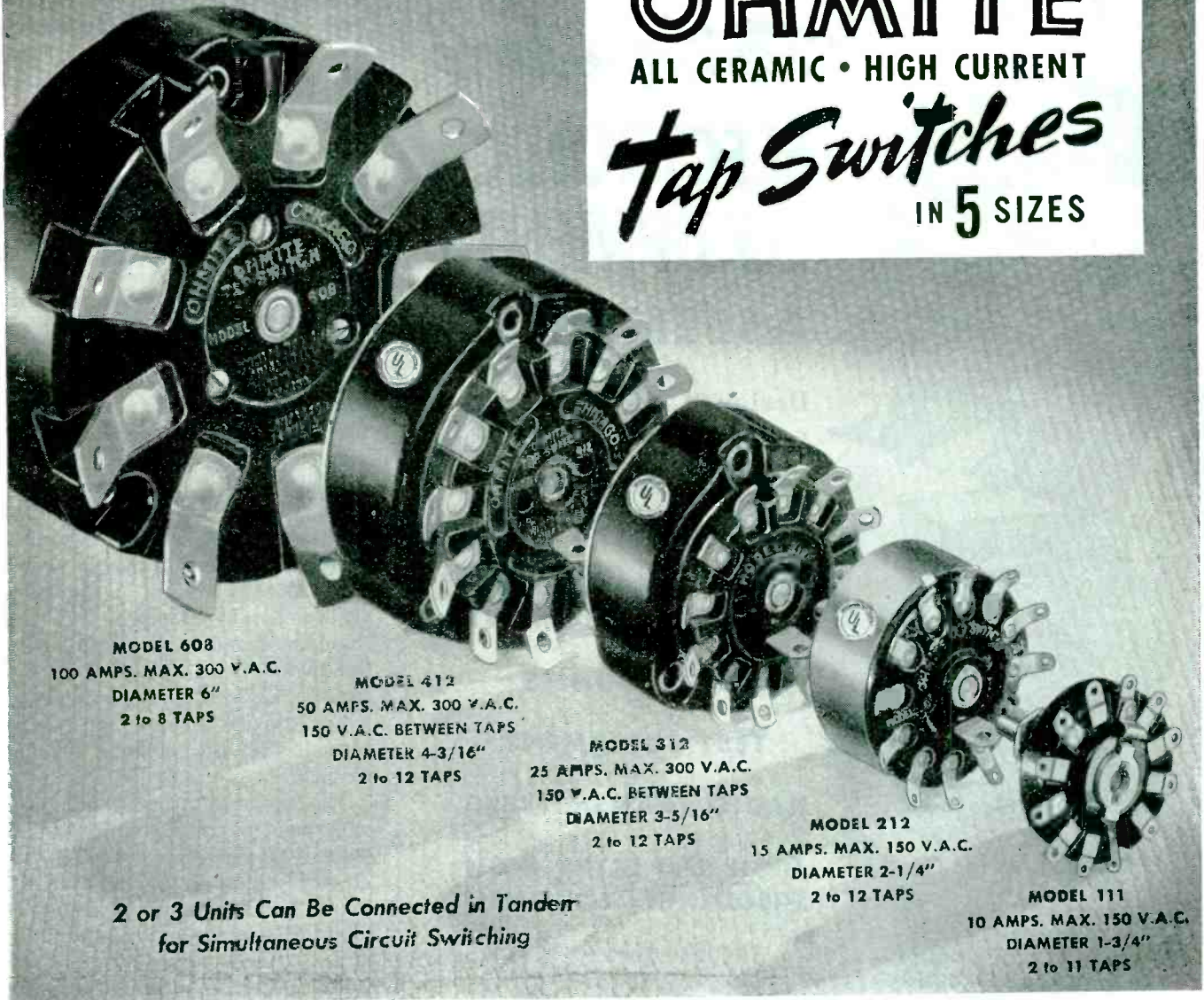
Dr. Gilson described and later demonstrated a locator of metal objects making use of the principle of two beat oscillators. One of these oscillators, whose tuning may be varied, is adjusted to beat against

# OHMITE

ALL CERAMIC • HIGH CURRENT

## Tap Switches

IN 5 SIZES



**MODEL 608**  
100 AMPS. MAX. 300 V.A.C.  
DIAMETER 6"  
2 to 8 TAPS

**MODEL 412**  
50 AMPS. MAX. 300 V.A.C.  
150 V.A.C. BETWEEN TAPS  
DIAMETER 4-3/16"  
2 to 12 TAPS

**MODEL 312**  
25 AMPS. MAX. 300 V.A.C.  
150 V.A.C. BETWEEN TAPS  
DIAMETER 3-5/16"  
2 to 12 TAPS

**MODEL 212**  
15 AMPS. MAX. 150 V.A.C.  
DIAMETER 2-1/4"  
2 to 12 TAPS

**MODEL 111**  
10 AMPS. MAX. 150 V.A.C.  
DIAMETER 1-3/4"  
2 to 11 TAPS

2 or 3 Units Can Be Connected in Tandem  
for Simultaneous Circuit Switching

### FEATURES

- Ceramic Construction
- Compact, All-Enclosed
- Slow-Break, Quick-Make
- Silver-to-Silver Contacts
- Self-Cleaning Action
- Low Contact Resistance
- Cam & Roller Mechanism
- High Strength Ceramic Hub
- Insulated Steel Shaft
- Back-of-Panel Mounting



Write on company letter-head for Industrial Catalog and Engineering Manual No. 40. Address Ohmite Mfg. Co., 4817 Flournoy St., Chicago 44.

## Simpler, More Compact

### HIGH CURRENT CIRCUIT SWITCHING

In these Ohmite load-break switches, as few as 2 or as many as 12 high current taps are compactly arranged yet perfectly insulated. The switches are non-shorting, single-pole, rotary, multi-position units. They provide greater operating convenience in battery chargers, tapped transformers, welders, induction heaters, and other applications. Write for further helpful facts or engineering aid.

**OHMITE MANUFACTURING COMPANY**

4817 Flournoy Street, Chicago 44, U. S. A.

# Be Right with OHMITE

RHEOSTATS • RESISTORS • TAP SWITCHES



*"Tailor-made"*

## ELECTRONIC EQUIPMENT ASSEMBLIES

Designed and produced from stem to stern by recognized experts to match your needs *exactly*.

**DIELECTRIC & INDUCTION  
HEATING EQUIPMENT**

**TUNING UNITS**

**TEST EQUIPMENT**

**RADIO TRANSMITTERS**

**HIGH AND ULTRA-HIGH  
FREQUENCY EQUIPMENT**

*B & W is neither too large  
for the smallest job nor  
too small for the largest.  
Write for details, outlin-  
ing your requirements.*



# B & W

## BARKER & WILLIAMSON

AIR INDUCTORS • VARIABLE CONDENSERS • ELECTRONIC EQUIPMENT ASSEMBLIES

DEPT. E-55, 235 FAIRFIELD AVENUE • UPPER DARBY, PA.

Export: LINDETEVES, INC., 10 Rockefeller Plaza, New York, N. Y., U. S. A.

a fixed oscillator. When a metal object is brought into proximity with the probe connected to the fixed oscillator, a change in audible feedback is produced by a loud-speaker incorporated as an integral part of the equipment.

• • •

### Suggestions for Design of Volume Expanders

By RICHARD W. CRANE

IN THE PAST few years, circuits have been developed to expand automatically the volume range of radio, record, and motion-picture sound in an attempt to compensate for the manual and/or automatic compression necessitated by the transmitting or recording procedure. However, in spite of the ingeniousness and obvious desirability of such systems it may be shown that (1) they are not so necessary as is generally assumed, (2) they should be completely avoided in certain installations, and (3) they have certain defects and deficiencies which prevent them from exactly reproducing the original volume pattern.

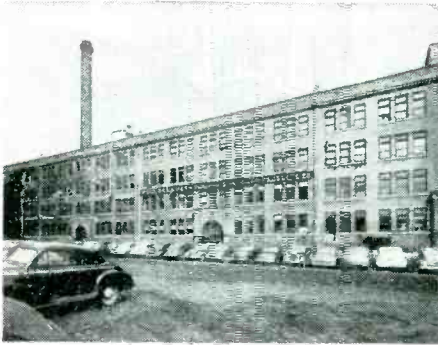
The main argument for the use of expanders is that compression seriously reduces the dynamic range of the recorded or transmitted sound, but this is not so bad as it might seem since loudness is determined by the average sound power whereas compression depends on the instantaneous peaks.

Ten violins will certainly sound louder than one violin; however, even if all ten were playing the same note, due to the phase differences between the signals (the probability of all ten or even of any two of the signals being in phase for more than a fraction of a second is very small), the peak voltage values of the combined sound will not necessarily be any higher than those of one instrument, although the average voltage value will be about three times as large. Similarly, in a symphony orchestra, the kettle-drums produce about the highest instantaneous sound power of any of the instruments, but if we could imagine a solo series of beats on a single timpano the volume pattern would be a succession of very high peaks with practically

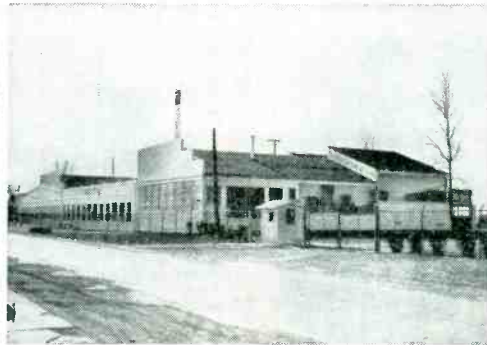




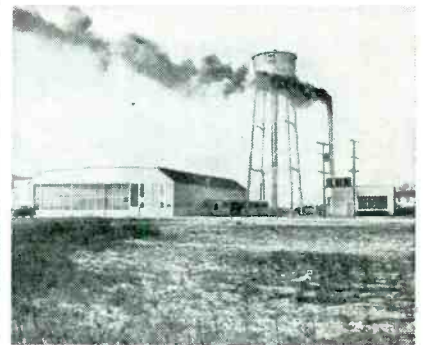
*The Standard Products Co., Port Clinton, Ohio Plant*



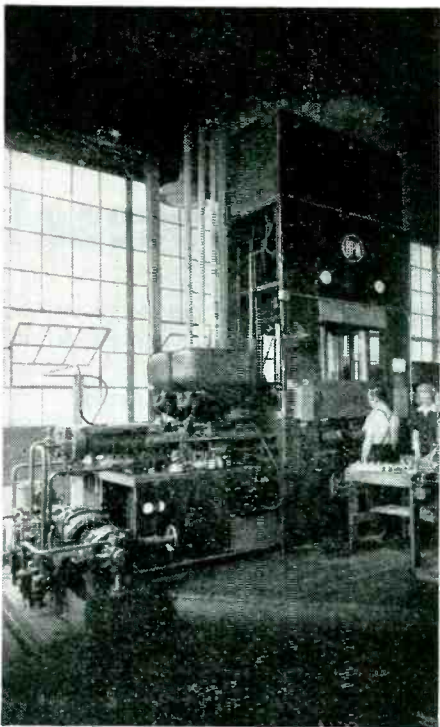
*Reid Products, Division of The Standard Products Co., Cleveland, Ohio*



*The Standard Products Co., Marine City, Mich. Plant*



*The Standard Products Co., Plastics Division, St. Clair, Mich.*



*One of the largest injector presses in the world. Plastics Division, St. Clair, Mich.*

## At your service

THE STANDARD PRODUCTS COMPANY is an organization of engineers and technicians *dedicated* to the designing and manufacturing of Steechan glass-run window channel, mechanical rubber goods, metal stampings, thermo plastics, thermo setting plastics, armament, munitions and automobile hardware.

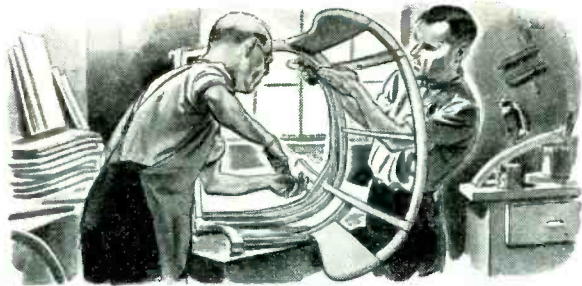
Through years of experience, this company has acquired a wealth of knowledge in the art of creative development and production. Standard Products reputation for *efficiency* in manufacturing did not just happen, but is the result of a slow, careful building process, developed by a corps of top-flight executives, engineers and loyal workers . . . definite personalities that are reflected in the products they produce.

★ ★ ★

*The Standard Products' engineering and planning divisions are at your service. Mail all inquiries to The Standard Products Company, 505 Boulevard Bldg., East Grand Blvd. at Woodward, Detroit 2, Mich.*

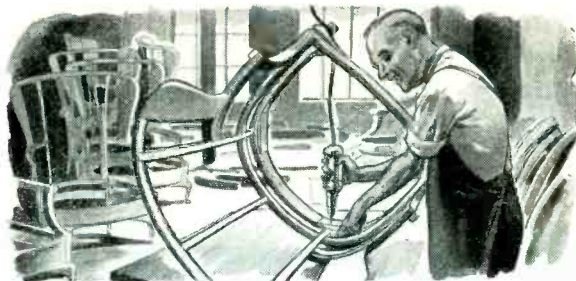
# THE STANDARD PRODUCTS COMPANY

*General Offices and Research Laboratory — 505 Boulevard Bldg., Detroit 2, Mich.*



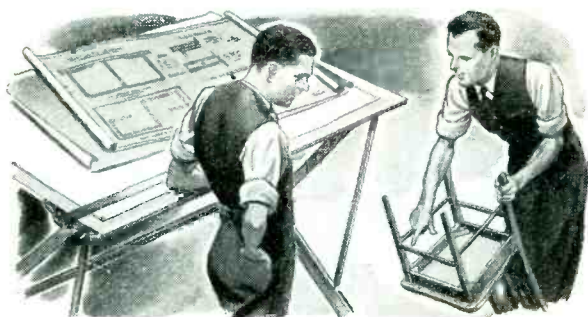
### BACKLOG BREAKERS!

Finding it impossible to keep pace with orders as long as he used slotted screws, one leading furniture maker broke up his assembly jams once and for all by switching to faster-driving Phillips Recessed Head Screws.



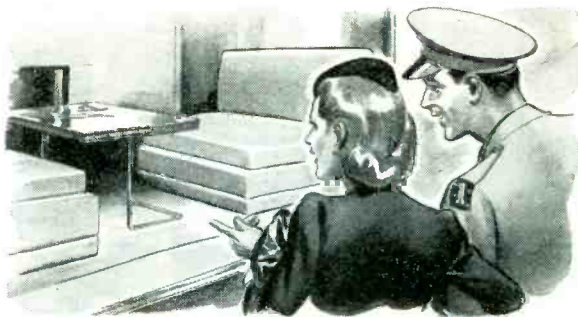
### MONEY MAKERS!

This switch cut assembly time almost in half. It cut 10% off pre-assembly by making pilot holes unnecessary. On top of this it saved 33-1/3% in labor costs because Phillips Screws drive so much faster!



### PRECEDENT SHAKERS!

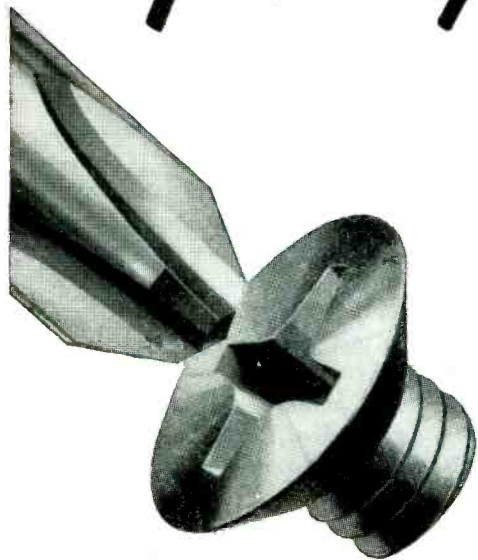
Pace-setters in production and cost-reduction activities, Phillips Screws are helping designers shake things up, too. Much more strength and rigidity can be built into products than was ever possible with slotted screws.



### ORDER TAKERS!

And when it comes to buy appeal, other screws just aren't in it with Phillips Screws. Salesmen say they banish burrs that endanger both clothes and sales . . . and make any product look stronger, smarter, trimmer!

# It's Phillips <sup>111</sup> the engineered recess!



In the Phillips Recess, mechanical principles are so correctly applied that every angle, plane, and dimension contributes fully to screw-driving efficiency.

... It's the exact pitch of the angles that eliminates driver skids.

... It's the engineered design of the 16 planes that makes it easy to apply full turning power - without reaming.

... It's the "just-right" depth of recess that enables Phillips Screw Heads to take heaviest driving pressures.

With such precise engineering, is it any wonder that Phillips Screws speed driving as much as 50% - cut costs correspondingly?

To give workers a chance to do their best, give them faster, easier-driving Phillips Recessed Head Screws. Plan Phillips Screws into your product now.

## PHILLIPS *Recessed Head* SCREWS

WOOD SCREWS • MACHINE SCREWS • SELF-TAPPING SCREWS • STOVE BOLTS

Made in all sizes, types and head styles

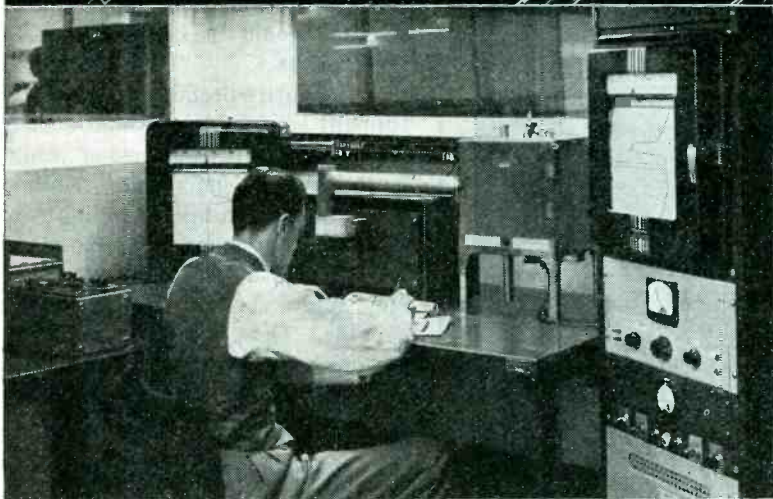
**25 SOURCES**

American Screw Co., Providence, R. I.  
Atlantic Screw Works, Hartford, Conn.  
The Bristol Co., Waterbury, Conn.  
Central Screw Co., Chicago, Ill.  
Chandler Products Corp., Cleveland, Ohio  
Continental Screw Co., New Bedford, Mass.  
The Corbin Screw Corp., New Britain, Conn.  
General Screw Mfg. Co., Chicago, Ill.

The H. M. Harper Co., Chicago, Ill.  
International Screw Co., Detroit, Mich.  
The Lamson & Sessions Co., Cleveland, Ohio  
Manufacturers Screw Products, Chicago, Ill.  
Milford Rivet and Machine Co., Milford, Conn.  
The National Screw & Mfg. Co., Cleveland, Ohio  
New England Screw Co., Keene, N. H.  
Parker-Kalen Corp., New York, N. Y.  
Pawtucket Screw Co., Pawtucket, R. I.

Pheoll Manufacturing Co., Chicago, Ill.  
Reading Screw Co., Norristown, Pa.  
Russell Burdall & Ward Bolt & Nut Co., Port Chester, N. Y.  
Seovill Manufacturing Co., Waterville, Conn.  
Shakeproof Inc., Chicago, Ill.  
The Southington Hardware Mfg. Co., Southington, Conn.  
The Steel Company of Canada Ltd., Hamilton, Canada  
Wolverine Bolt Co., Detroit, Mich.

# CERAMIC DIELECTRIC TUBES *to Specifications*



Laboratory control—an important factor in the production of Stupakoff quality ceramics.



## *... Assured by* **STUPAKOFF**

Control—from raw material to finished product—assures uniform characteristics in all Stupakoff ceramic dielectric tubes.

Dimensionally accurate, these tubes are produced to meet your specifications for power factor—dielectric constant—temperature coefficient—dielectric strength—volume resistivity. Employ them with confidence in the manufacture of temperature compensating capacitors for reducing frequency drift in RF circuits, for by-pass, lead-through, and blocking.

Stupakoff manufactures a wide variety of ceramic dielectric materials. Tubes—special or standard—are available in temperature coefficients from +120 to -750 parts per million per degree centigrade, depending upon the specific characteristics required. Manufacturing facilities permit prompt delivery in large quantity. Samples upon request.

★  
BUY EXTRA  
WAR BONDS  
★



**STUPAKOFF CERAMIC AND MANUFACTURING CO., LATROBE, PA.**

*Ceramics for the World of Electronics*



★

**CONTRIBUTING**

to

**VICTORY**

and the

New Electronic World

**MERIT COIL & TRANSFORMER CORP.**

TELEPHONE  
4427 North Clark St. Long Beach 6311 CHICAGO 40, ILL.

zero sound level between them, and the studio amplifier gain control setting would be determined by these peaks.

If the entire orchestra played, the timpani sound peaks would still be the highest instantaneous sound levels and the maximum readings on the volume indicator would be no greater than when the solo drum was played, even though the average sound power would be far greater. Thus, the average sound power in many cases may vary greatly without the studio engineer having to compress it at all.

*Effect in Different Locations*

In some situations, the use of expander amplifiers is not at all desirable, especially if the loud speaker is located in a room which has a high noise level and little sound-absorbing material. The best example of this is the average motion-picture projection booth where the normal volume range in the picture (without benefit of expansion) is usually too great for

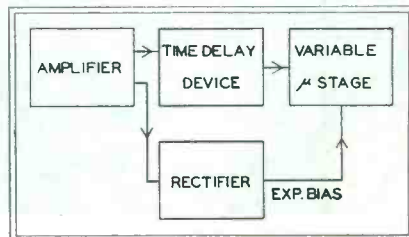


Fig. 1—Block diagram of automatic volume expander which anticipates changes in signal level and increases the amplifier gain before the peak passes through

the operator's comfort, the soft passages being drowned out by the projector noise and the loudest portions being re-lected and re-lected by the hard walls until they are almost deafening. This would not be true in the theater auditorium, but in the reproduction of music in a factory or a railroad station similar conditions obtain and expansion should not be used. Even the typical city apartment has a high noise level, especially in the summer, and although it may have a fair amount of drapes and carpets, "enhanced" fortissimo passages drifting out the windows will not be greatly appreciated by the neighbors.

Another point that must be con-



THERE'S a good deal more to an efficient, dependable electrical coil than a routine winding. Basic engineering, for one thing. Engineering that *thinks* right from the conception of each problem.

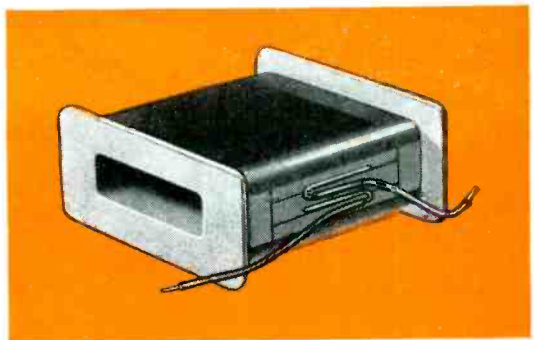
The proper relationship of many variables must be analyzed, weighed. Anaconda coil engineers put emphasis on the correct type, size, shape, insulation, cost, as well as winding.

The quality of the magnet wire also is important. Anaconda controls it from raw copper, through fabrication, to application on the finished coil.

This means that as a coil producer Anaconda also has the advantage of its long experience in making magnet wire. By the same token, Anaconda magnet wire production benefits by Anaconda coil experience.

Add to these features Anaconda's excellent manufacturing facilities and expertly trained personnel.

Anaconda engineering service for coils and magnet wire is always yours for the asking. Contact any sales office. 45301



*Magnet wire and coils*



## ANACONDA WIRE & CABLE COMPANY

GENERAL OFFICES: 25 Broadway, New York City 4

*Subsidiary of Anaconda Copper Mining Company*

CHICAGO OFFICE: 20 North Wacker Drive 6 • Sales Offices in Principal Cities



*Fine instruments produced in volume with precision first . . . . to last.*

# Triplett



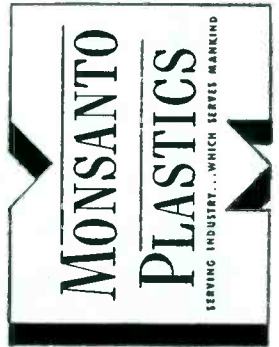
**ELECTRICAL INSTRUMENT CO.**  
BLUFFTON, OHIO

# 7 Reasons why Monsanto is a "Specialist in Plastics for Electronics"

Heat resistance, loss factor, water absorption, mechanical properties and cost are characteristics considered by the electronic engineer in every application of insulating materials. His choice depends on a balance of the properties for the *specific* use. Monsanto Plastics, offer him a range of materials, one of which will meet virtually every set of requirements.

Monsanto plastics researchers have long devoted a large part of their efforts to the development of plastics for electrical, radio and electronic applications of all kinds. The

result is that today Monsanto has become known as a "specialist in plastics for electronics," and is producing tons of these special plastics for applications in this field alone.



The broad and versatile family of Monsanto Plastics includes: Lustron polystyrenes • Cerex heat resistant thermoplastics • Vinyl acetals • Nitron cellulose nitrates • Fibestos cellulose acetates • Resinox phenolics • Resimene melamines • Thalid for impression molding • Forms in which they are supplied include: Sheets • Rods • Tubes • Molding Compounds • Industrial Resins • Coating Compounds • Vuepak rigid, transparent packaging materials.

Material	Loss Factor at 1 Mc.	Heat Distortion Point °F.	Water Absorption 24 Hrs. %	Arc Resistance	Mechanical Characteristics
<b>STYRAMIC</b> HT	0.0005	236	0.03	*	hard
<b>STYRAMIC</b>	0.0008	184-187	0.046	*	hard-rigid
<b>CEREX</b> X-214	0.0066	235	0.30	70 sec.	hard-tough
<b>LUSTRON</b>	0.0007	168-176	0.05	120 sec.	hard-strong
<b>RESINOX</b> 7934	0.0361	255	0.030	6 sec.	hard-rigid
<b>RESIMENE</b> 803-A	0.2820	300	0.51	125 sec.	hard-tough
<b>THALID</b> X-5265	0.078	160	0.20	125 sec.	hard-tough

... completely reactive thermosetting resin for impression molding. Impregnates glass cloth, other fabrics or paper to make large, rigid panels or fully integrated forms of high strength. Ideal for housings, chassis or structural parts of electronic equipment. (Send for descriptive bulletin.)

\*Standard ASTM tests are not applicable to these products. D495-42 tests give values ranging from 4-120 sec.

sidered in using these circuits is the limitations of the equipment associated with the expander, for if this amplifier system does not have a dynamic range of at least 70 db (from noise level to overload point) expansion cannot be used to its full capabilities.

#### Time Lag

As to the defects of expander circuits, two might be noted. First, is the fact that expanders cannot anticipate changes in volume but rather have a slight time lag which makes it impossible for them to do more than approximate the original volume pattern. This lag is not important when volume changes are gradual, but on a sudden clash of symbols, for instance, the amplifier gain will not increase until after the sound peak has passed. This could be overcome by use of some sort of a time-delay device, perhaps a magnetic tape recorder, in a circuit such as Fig. 1 (which is otherwise a typical expansion circuit), the delay being adjusted so that the signal entering the variable- $\mu$  stage lags a little behind the bias variations. In this way, a sudden peak would increase the amplifier gain before the peak passed through rather than afterwards. The same idea could be used for compression where it should give better results than manual monitoring as it anticipates all changes in signal level.

#### Need for Balance

The second shortcoming of automatic volume expansion is that even if the circuit can foresee changes in volume it can never duplicate the original volume range because it has no way of knowing what these original levels were; that is, it will make the loud portions softer, but always by the same amount for a given input level. Thus the expander circuit might increase every signal that is 10 db above the average volume level to 15 db above the average, but the level in the studio might have been far higher than this, or even lower.

With manual compression, it would be extremely difficult to devise a circuit to overcome this fault, especially since most studio engineers ride gain on each microphone

FAST, RELIABLE SOURCE FOR

*Leading Makes of*

# INDUSTRIAL ELECTRONIC INSTRUMENTS



For Measurement,  
Inspection,  
Testing and Control

TUBE TESTERS  
OSCILLOSCOPES  
CAPACITY DECADES  
RESISTANCE DECADES  
WHEATSTONE BRIDGES  
RESISTANCE LIMIT BRIDGES  
WEIN CAPACITY BRIDGES  
SIGNAL GENERATORS  
PANEL METERS  
VACUUM TUBE VOLTMETERS  
VOLT-OHM-MILLIAMMETERS

Helpful  
**BUYING  
GUIDE**  
Available  
on Request  
Write for it!

Allied's concentration of leading makes *under one roof* means you can obtain the type of instrument you want . . . *in the shortest time possible*. This specialized service to industry, government, and research laboratories simplifies procurement . . . increases efficiency . . . saves hours, days, and effort. Such well known makes as RCA, Dumont, G.E., Industrial Instruments, Hickok, Radio City, Triplett and others. Many on hand for immediate delivery.

### EVERYTHING IN ELECTRONICS AND RADIO

It's faster, simpler to get all your electronic and radio supplies from this one central source. We carry the largest and most complete stocks of parts and equipment under one roof . . . ready for immediate shipment! Besides, our procurement experts are in constant contact with all leading manufacturers to speed supplies.

*Save time and work . . . Call Allied First!  
Write, Wire or Phone Haymarket 6800*

# ALLIED RADIO

C O R P O R A T I O N

833 W. Jackson Blvd. Dept. 24-E-5 Chicago 7, Illinois

SUPPLIERS OF ELECTRONIC PARTS AND EQUIPMENT TO INDUSTRIAL AMERICA

Electronic Tubes, Rectifiers, Power Supplies, Intercommunicating Systems, Sound Systems, Photo-Cell Equipment, Batteries, Chargers, Converters, Generators, Supplies for Resistance Welders, Fuses, Test Instruments, Meters, Broadcast Station Equipment, Relays, Condensers, Capacitors, Resistors, Rheostats, Transformers, Switches, Coaxial Cable, Wire, Soldering Irons, Microphones, Speakers, Technical Books, etc.



# Cavalcade of Coaxial Connectors

## CABLE PLUG



Connector #50.399-1  
Signal Corps #PL-259

Signal Corps design. Mates to receptacle #50.392-1. Insulation is low-loss, mica-filled bakelite. Metal parts of silver-plated brass.

## CABLE PLUG



Connector #50.393  
Signal Corps #PL-259A  
Navy Part #CI-49195

Navy designed. Mates with receptacle #50.392-1. Low-loss, mica-filled bakelite insulation. Metal parts of brass, silver-plated.

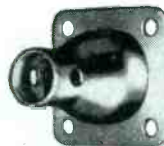
## RIGHT ANGLE PLUG ADAPTER



Connector #50.394-1  
Signal Corps #M-359  
Navy Part #CI-49192

Elbow adapter for changing direction of wiring. Housing of die-cast zinc, silver-plated. Pin and socket silver-plated spring brass. Insulation is polystyrene.

## SHIELDING HOOD



Connector #47.447  
Signal Corps #M-360  
Navy Part #CI-49193

Silver-plated brass hood, used with plug #50.392-1 as a shield for the wiring cable. Holes provided for soldering to cable shield.

## CHASSIS RECEPTACLE



Connector #50.392-1  
Signal Corps #SO-239  
Navy Part #CI-49194

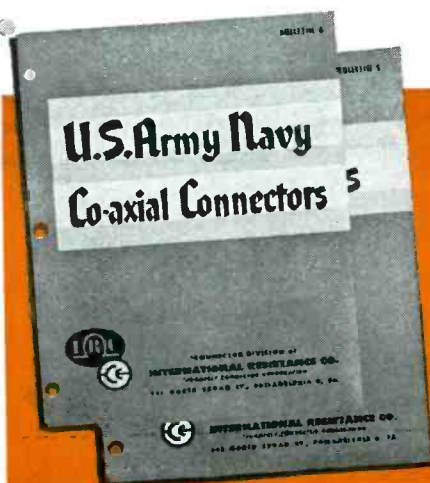
Flanged receptacle for chassis mounting. Housing is die-cast zinc, silver-plated. Low-loss, mica-filled bakelite insulation. Socket contact of silver-plated copper alloy.

## CONNECTOR ADAPTER



Connector #50.415  
Navy Part #CI-49544

Adapter is designed for interconnection of certain British and U. S. Army-Navy coaxial plugs or to permit the use of both U. S. Army-Navy and British plugs in the same piece of equipment. See table of possible connections in Bulletin #6.



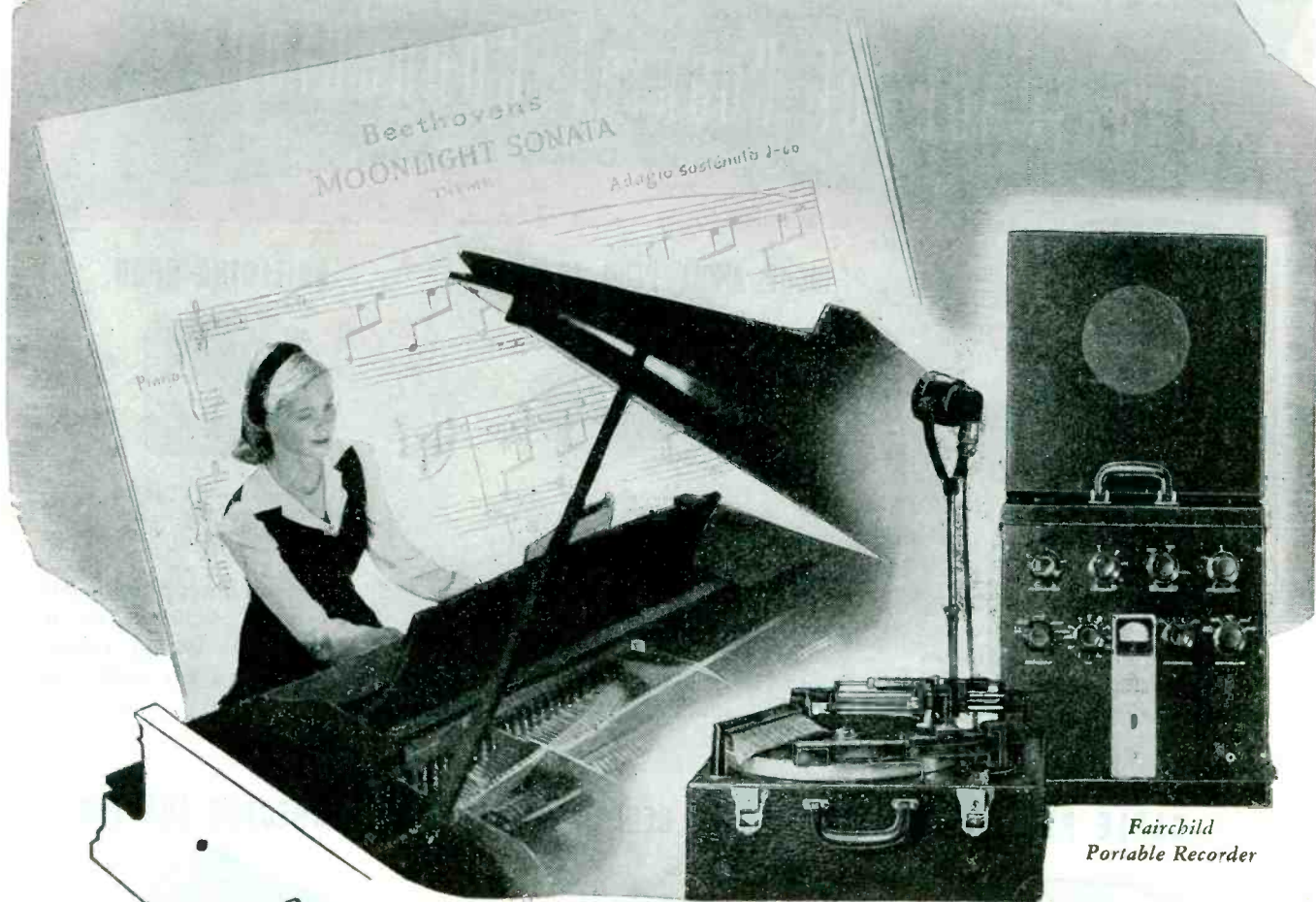
For more detailed information, including dimension drawings, write for Bulletins #4 and #6.



CONNECTOR DIVISION OF  
**INTERNATIONAL RESISTANCE CO.**

DEPT. E-1, 401 NORTH BROAD STREET, PHILADELPHIA 8, PA.

**SOUND EQUIPMENT - precisionized - mechanically and electronically - for finer performance**



*Fairchild  
Portable Recorder*

## *Listen* to long, sustained chords from a piano

Include a piano recording in your demonstration. For the piano is the most difficult of all instruments to record without wavering of pitch — something that immediately tells your listening audience whether your broadcast is a 'live' or 'recorded' program.

Listen carefully to your recording on a Fairchild Recorder. Notice how the fundamental tone and each of its overtones are reproduced at exactly the same relative strength as heard in the original sound. And notice, particularly, the absence of wavering of pitch.

The famed Fairchild turntable drive is the reason. Driven direct from the center, the 33.3 rpm speed is obtained by a 54 to 1 gear-and-worm reduction of the 1800 rpm synchronous

motor speed. The evenness of the speed is obtained by a carefully calculated loading of the mechanism to keep the motor pulling constantly; by careful precision control of all drive alignments that might cause intermittent grab and release; by closely maintained tolerances in all moving parts.

The 33.3 rpm speed is translated into 78 rpm by a precision friction-ball-race stepup.

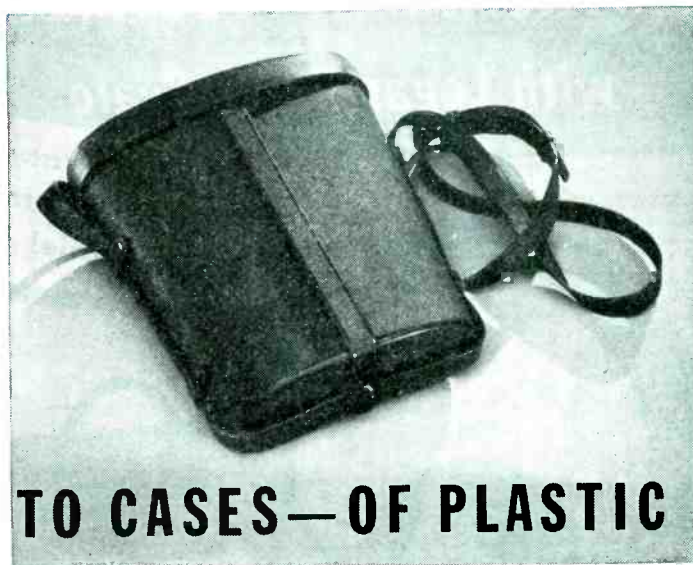
All Fairchild sound instruments are built to meet the increasingly important transcription requirements of the radio and communications fields. Descriptive and priority data are available. Address *New York Office*: 475 - 10th Avenue, New York 18; *Plant*: 88-06 Van Wyck Boulevard, Jamaica 1, N. Y.



*Fairchild* CAMERA  
AND INSTRUMENT CORPORATION

**SOUND  
EQUIPMENT**





## LET'S GET DOWN TO CASES—OF PLASTIC

● Typical of the ingenuity of American industry in developing new products and improving old ones with plastics is the above-illustrated plastic binocular case which was produced by the Hood Rubber Company for Bausch & Lomb Optical Company.

Due to the vital importance of binoculars to the Armed Forces, it was absolutely essential that these instruments be carefully safeguarded against injury.

In the quest for the ideal material, eight different types were considered. Of these, only one successfully passed all the requirements for binocular cases. This was a laminated and molded

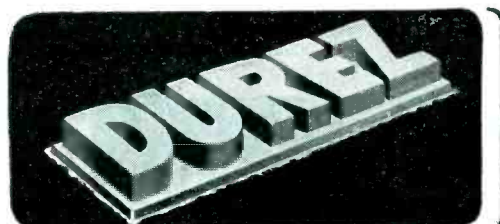
plasticized vinyl reinforced with Durez phenolic-impregnated fabric and other materials.

This new case passes the accelerated-weathering (240-hr. test), salt-spray (100-hr. test), impact-resistance (4 ft., -50° F.), accelerated-warp (7 days, 160 to -10° F.), flexural-resistance (1½-in. radial bend), abrasion-resistance, and construction tests as set up by the U. S. Navy. Another interesting feature is the resistance to fungi and bacterial growth which this case possesses, to the extent that the binoculars themselves are immunized.

The versatility of Durez phenolic plastics has made their use almost universal throughout industry. Such properties

as dimensional stability at temperature extremes, diversity of finishes, dielectric strength, and resistance to moisture, heat, acids and alkalis, render them invaluable to the imaginative design engineer.

Perhaps you are searching for a material for some product which you intend to market in the post-victory era. If so, we suggest that you take advantage of the wealth of experience which Durez technicians have available for your benefit at all times. You are always assured of the complete cooperation of the Durez staff to help you solve plastic material problems. Durez Plastics & Chemicals, Inc., 325 Walck Road, North Tonawanda, N. Y.



PHENOLIC  
RESINS

MOLDING COMPOUNDS

INDUSTRIAL RESINS

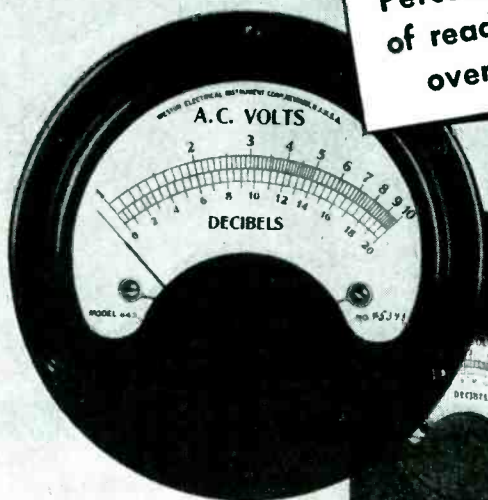
OIL SOLUBLE RESINS

## PLASTICS THAT FIT THE JOB

# ELECTRONIC AC VOLTMETER

*with Logarithmic Scale*

Percentage Accuracy  
of reading is uniform  
over entire scale!



MODEL 300  
ELECTRONIC  
VOLTMETER

## ACCESSORIES

MODEL 220 DECADE AMPLIFIER

MODEL 402 MULTIPLIER



The important feature of logarithmic scale indication in the Ballantine Voltmeter provides the same degree of accuracy at 1 as at 10. Also the simplicity of this scale reduces errors in visual observation, common with most multi-range instruments. Finally, the care taken in overall calibration combined with the inherent stability of the circuits used permits reliable readings within the 2% specified tolerance over the complete range of operation.

Write for technical Bulletin 8



# BALLANTINE LABORATORIES, INC.

BOONTON, NEW JERSEY, U. S. A.

## VOLUME EXPANDERS

(continued)

separately, rather than use the master gain control; however, with automatic compression the amount of compression can be measured and an extra signal transmitted or recorded whose amplitude varies with the amount of compression and this signal can be used in the receiver or phono amplifier to regulate the amount of expansion.

### Suggested System

Figure 2 is a schematic diagram of how such a system might operate. The compressor circuit is similar to Fig. 1, but in addition the compression bias is used to control

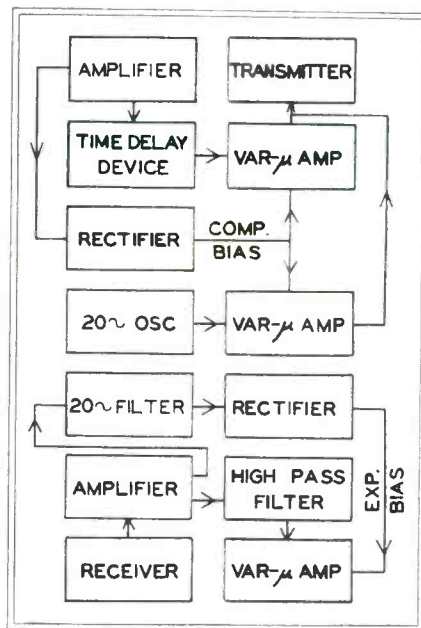


Fig. 2—Suggested system of volume expansion for a transmitter which employs a 20-cycle pilot signal whose amplitude varies with the amount of compression

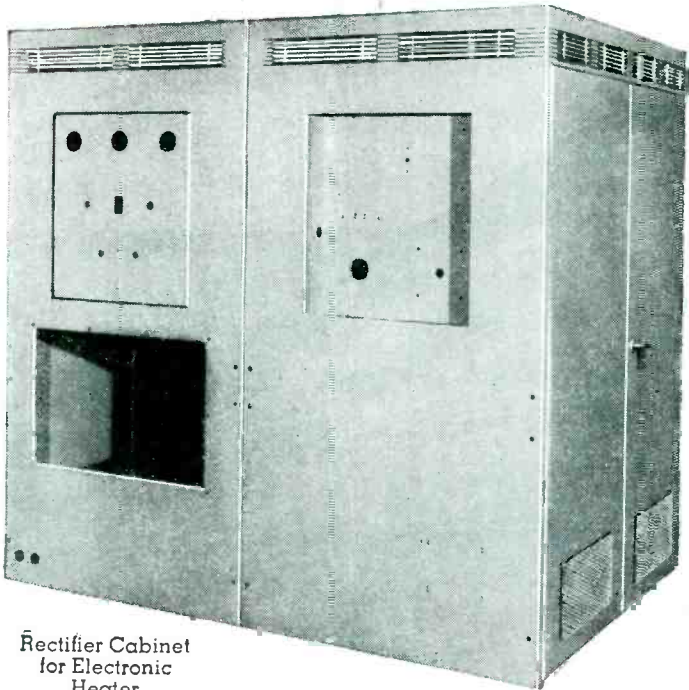
the amplitude of a sine-wave signal whose frequency is just out of the audio range, for instance 20 cycles. This signal is then mixed with the regular signal and both are transmitted. In the receiver, the 20-cycle component is separated by a filter system and is rectified to furnish a volume-expansion bias. With careful design, an arrangement like this could give almost perfect volume-range reproduction.

Thus it may be said that although volume expansion is ordinarily desirable it is not as vital as might be expected, and in many installations would subtract from rather than add to the listener's enjoyment. In addition, the usual ex-

*Consult*

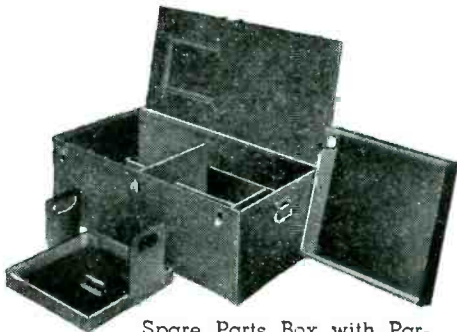
# KARP

FOR DEPENDABLE SHEET METAL PRODUCTS . . .



Rectifier Cabinet  
for Electronic  
Heater

**KARP** craftsmen, thoroughly skilled and experienced in sheet metal work, individually construct each job to customers' specifications. Complete, modern facilities make possible any manipulation of the material in all stages of manufacture—from the making of the dies, through the fabricating and finishing. Hundreds of stock dies, already on hand, reduce or eliminate the cost of dies. Moreover, **KARP** goes over your plans with you . . . makes recommendations if they are necessary . . . and suggests means of expediting deliveries. Consult a **KARP** engineer or local sales representative when you require highly dependable sheet metal products—whether they be steel, brass, aluminum, monel, stainless steel or an alloy.



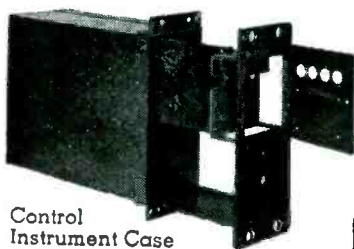
Spare Parts Box with Partitions and Removable Tray



Portable Battery Case



Amplifier  
Cover



Control  
Instrument Case  
(open)

**KARP METAL PRODUCTS CO., INC.**

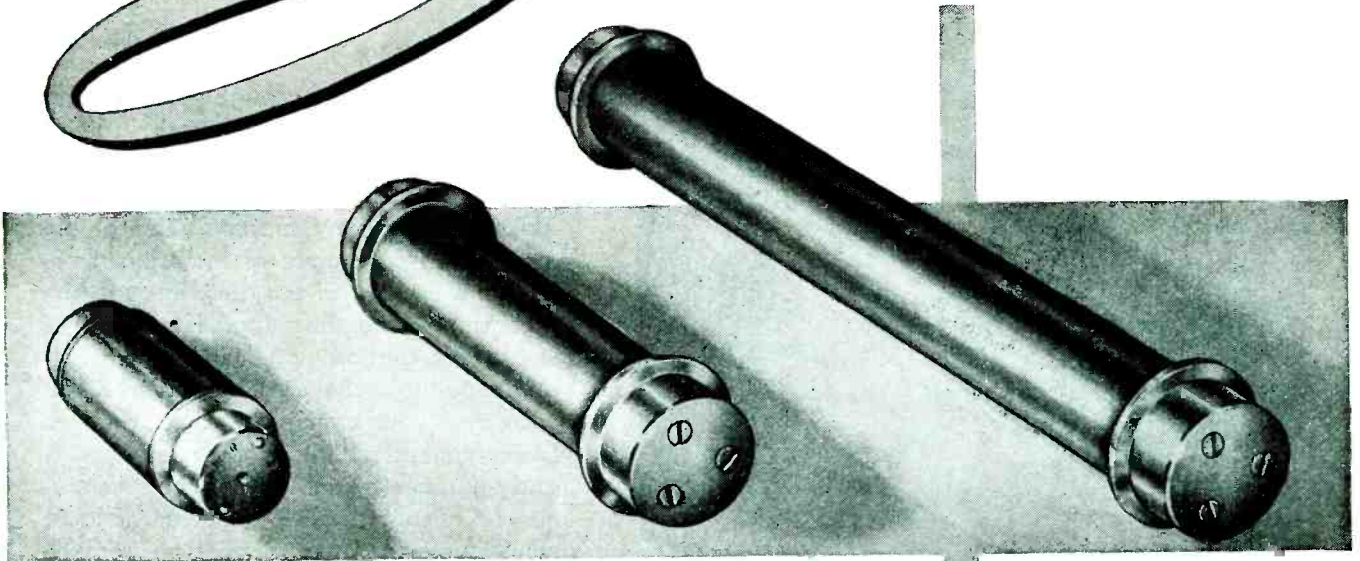
124 30th STREET

BROOKLYN 32, N. Y.

**ALL THE**

**Stability**

**THE NAME IMPLIES!**



## **WESTON TUBULAR RESISTORS**

WESTON tubular resistors . . . widely used since their introduction over a decade ago . . . furnish another outstanding example of *sound engineering* coupled with *engineering foresight*. For no new 'hurried' resistor design was needed in order to meet exacting military specifications that called for protection against tropical humidity, arctic and high working temperatures, and salt air. The WESTON tubular resistor met these new specifications . . . and in a rugged, non-fragile design *tried and proved* throughout the years. These resistors conform to and are approved under joint Army Navy Spec. JAN-R-29. Bulletin A-12 gives complete specifications. Send for your copy . . . Weston Electrical Instrument Corp., 589 Frelinghuysen Ave., Newark 5, N. J.

**Weston**  
*Instruments*

ALBANY • ATLANTA • BOSTON • BUFFALO • CHICAGO • CINCINNATI • CLEVELAND • DALLAS • DENVER • DETROIT • JACKSONVILLE • KNOXVILLE • LOS ANGELES • MERIDEN  
MINNEAPOLIS • NEWARK • NEW ORLEANS • NEW YORK • PHILADELPHIA • PHOENIX • PITTSBURGH • ROCHESTER • SAN FRANCISCO • SEATTLE • ST. LOUIS • SYRACUSE

In Canada, Northern Electric Co., Ltd., Powerlite Devices, Ltd.

THESE GENERAL  
INDUSTRIES MOTORS ARE  
CERTAINLY SMOOTH

YES, AND YOU  
CAN'T BEAT THEIR  
PLASTIC PARTS



SMALL MOTORS and molded plastic parts, both from General Industries, meet frequently on assembly lines of leading manufacturers. When they do, they match up with precision because of the care and ability which goes into their manufacture.

## YOU CAN DEPEND UPON **BOTH** FROM GENERAL INDUSTRIES



Our *Smooth Power* drives have been proved for years in our own lines of recorders, record-changers and turntables. Their quick pickup, unvarying speed, velvety smoothness and dependability have kept them favorites for many peacetime products, and have been responsible for their wide military use. Most buyers find what they want in our standard lines, but when specifications are unusual, we design and build them to order.



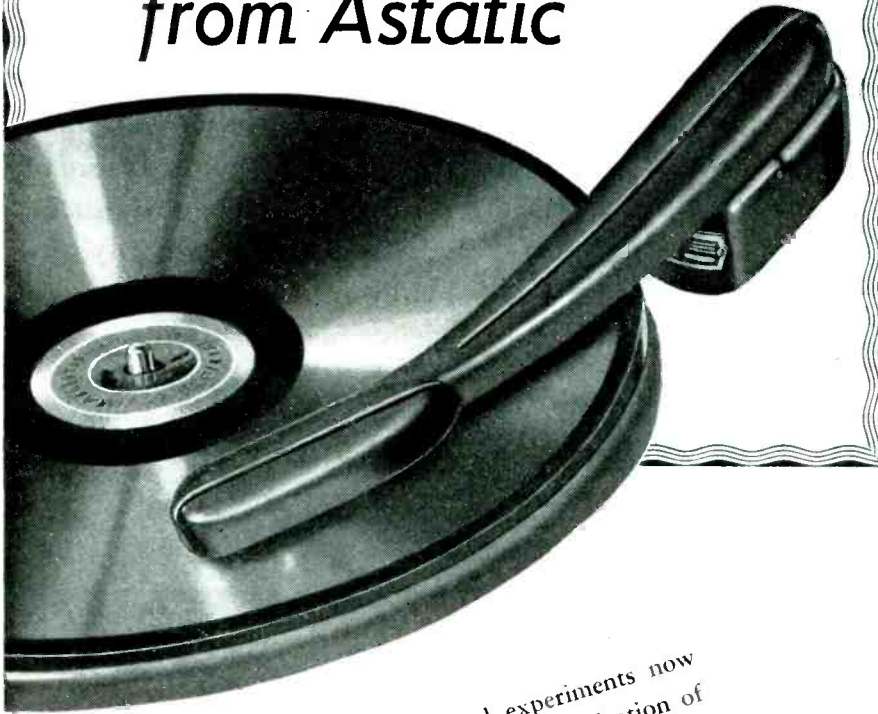
In our molded plastics division, your blueprints or sketches get close scrutiny by engineers who know plastic compounds and how to use them. Our mold designers study every job to find ways of doing it better, quicker and more economically. As for close tolerances and fine finishes, we refer you to the assembly men and inspectors in the many plants which depend upon us for their molded plastics.

So, you can depend upon General Industries for your postwar needs in both these products. You'll save time by starting general discussions now, to be followed by details when our military commitments have been finished. Please address the specific division... *motors or molded plastics.*

THE  
**GI** GENERAL  
INDUSTRIES  
COMPANY  
ELYRIA OHIO



"You'll  
HEAR MORE  
from Astatic"



Because of research and experiments now being made by Astatic engineers, in the application of advanced ideas in the pickup and reproduction of sound, you can be sure you'll *hear more* from the Astatic products of tomorrow. And for the same reason you will *hear more* of the name "Astatic," which, for so many years, has been synonymous with quality microphones, phonograph pickups, cartridges and recording heads. In design, performance and dependable service, Astatic products will continue to measure up to the very highest standards.

ASTATIC Crystal Devices  
manufactured under Brush  
Development Co. patents.

THE  
**Astatic**  
ASTATIC CORPORATION  
CONNEAUT, OHIO  
IN CANADA: CANADIAN ASTATIC LTD., TORONTO, ONTARIO

#### VOLUME EXPANDERS

(continued)

pansion circuits will only roughly approximate the original volume pattern, an exact reproduction requiring a coordinated compression-expansion system.

• • •

#### Radar Terms and Abbreviations

FOLLOWING IS a list of the popular terms used by radar technicians as reported in *Aviation News* for April 2, 1945.

**"A" Scope**—An "A" scope indicates the range of the target as the distance along a horizontal line from the transmitted pulse to the signal (see Indicator)

**AI**—Short for Aircraft Interception. Short range airborne radar sets which guide nightfighters in their interception of enemy aircraft

**ASV**—Abbreviation for Air to Surface Vessel. ASV search sets are used in aircraft for detecting objects on the surface of the sea

**AW**—Aircraft Warning. **AWS**—Aircraft Warning Service

**"B" Scope**—A "B" scope shows the range vertically, and the relative azimuth or bearing horizontally. Signals appear as bright spots

**Blip**—British for pip. Term used to designate the signal on a scope or indicator

**Blister**—The housing for radar antenna (see Radome)

**BTO**—Bombing through overcast (e.g., with the "Mickey" set)

**Chaff**—Foil and paper strips dropped from airplanes to create false signals on enemy radar sets (see Window)

**GCA**—Ground Control Approach. The technique and/or apparatus for "talking down" an aircraft into approach for landing in poor visibility

**GCI**—Ground (or ship) Control of Interception. GCI stations vector (i.e., supply bearings to) to within visual or radar range of enemy aircraft

**GL**—Gun Laying. Range, bearing and elevation provided by GL equipment to direct ground or shipboard guns and control their fire

**IFF**—Identification of Friend or Foe. Method of automatically challenging and receiving posi-





**DOW CORNING, first in silicones,  
is fully equipped with new plant and facilities for  
the production and distribution of an expanding line of silicone products**

American industry has been quick to utilize the new Dow Corning Silicones—to see the potentialities inherent in their higher order of heat stability, chemical inertness, water resistance, and dielectric properties. Dow Corning is now supplying, directly or through selected distributors, the following silicone products:

**DC FLUIDS** Water-white, odorless, inert Silicone Liquids . . . notable for their low rate of viscosity change over a wide temperature range, low vapor pressure, water repellency, and good dielectric properties.

**DC 993** Insulating Varnish . . . recommended because of its extreme heat stability for impregnating, coating and bonding, and waterproofing inorganic insulating materials such as asbestos, mica, and Fiberglas cloth, tape, and sleeving. Other special purpose silicone resins and compounds are available.

**DC 4** Ignition Sealing Compound . . . an easily applied silicone waterproofing compound having excellent dielectric properties, corona resistance, and the consistency of petroleum jelly. It neither hardens nor melts at temperatures ranging from  $-40^{\circ}$  F. to  $400^{\circ}$  F.

**DC STOPCOCK GREASE**  
A chemically resistant Silicone Grease for lubricating stopcocks and other ground glass joints.

**DC 7** Special Low Temperature Compound . . . an oxidation resistant lubricant and sealing compound developed for use at temperatures as low as  $-70^{\circ}$  F.

**DC PLUG COCK GREASE**  
A Silicone Grease that affords easy operation of lubricated plug valves over wide temperature ranges in most difficult services.

**DC 31** A lubricating Silicone Grease for special applications in the temperature range of  $-70^{\circ}$  F. to  $190^{\circ}$  F.

**DC 41** A lubricating Silicone Grease for special applications where operating temperatures range from  $0^{\circ}$  F. to  $400^{\circ}$  F.

**DOW CORNING CORPORATION  
MIDLAND, MICHIGAN**  
ADDRESS ALL INQUIRIES TO BOX 592



# DULAC FUNGUS RESISTANT LACQUERS, VARNISHES AND COATINGS

*containing*

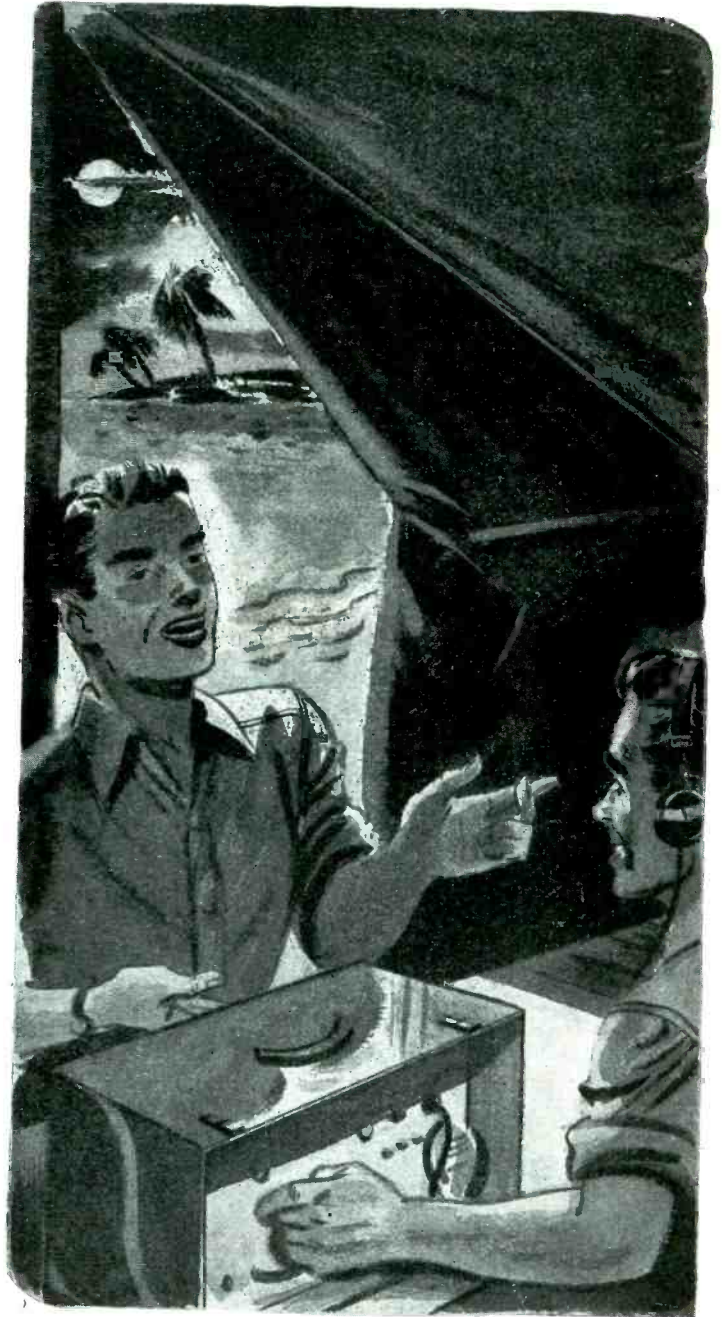
## FLUORESCENT COMPOUNDS

### ARE NOW MANUFACTURED FOR PROTECTING VITAL ELECTRONIC and ELECTRICAL EQUIPMENT

For use on Signal Corps contracts, it is no longer necessary for the manufacturer or user of communication equipment to undertake the job of mixing fluorescent solutions with the fungus resistant coatings he is using. For M & W's complete line of tropicalization coatings is now available with fluorescent compounds already incorporated in them.

These fluorescent compounds, used to facilitate inspection under black light, are not destroyed when the coating is dried or baked in accordance with M & W recommendations. The use of these factory-mixed lacquers, varnishes and coatings will result in a marked speed-up of the Tropicalization Program in your plant.

For information on any phases of tropicalization of electronic and electrical equipment, write today to:



## MAAS & WALDSTEIN COMPANY, NEWARK, N. J.

PRODUCERS OF LACQUERS, ENAMELS, SYNTHETICS AND SPECIALTY FINISHES FOR ALL PURPOSES  
BRANCH OFFICES & WAREHOUSES: 1658 CARROLL AVE., CHICAGO, ILL. • 1228 W. PICO BLVD., LOS ANGELES, CALIF.

**A WAR TIME**

**SERVICE RECORD**

**SERVICE RECORD**

Guadalcanal  
Salerno  
The Marshalls  
Singapore  
Normandy  
Aachen  
Tulagi

**OF JEFFERSON**

Sydney  
Fedala  
Murmansk  
Attu  
Kiska  
Ain Toya  
Makin

**TRANSFORMERS**

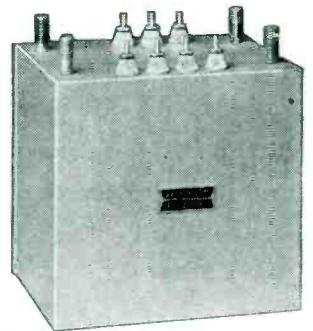
Florida Island  
Cassino  
Luxemburg  
Corregidor  
Manila  
Bataan  
Iwo Island

*That Means  
Peacetime Superiority*

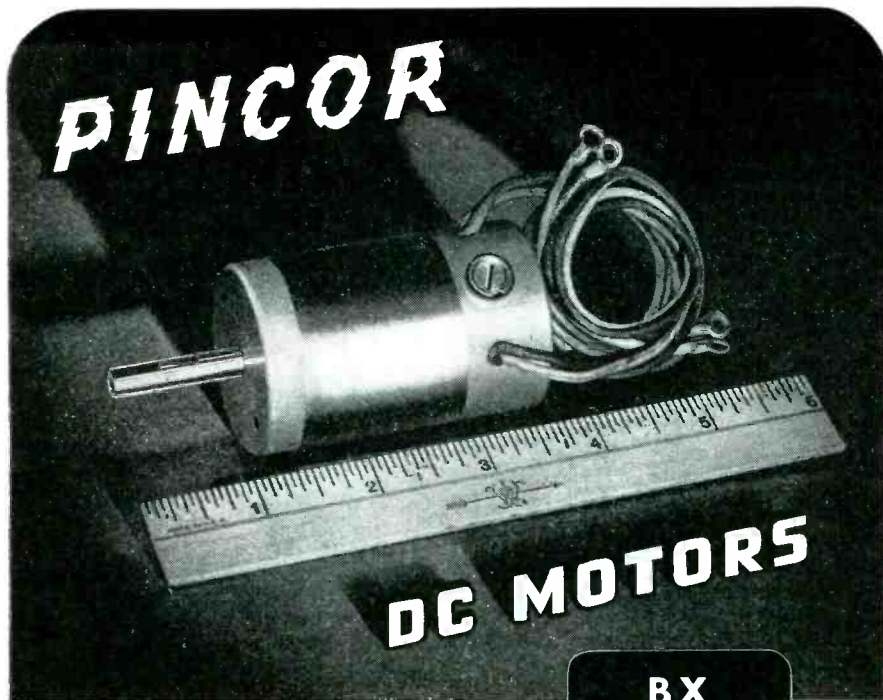
All over the world—on the Western Front, in the humid tropics or polar wastes to the arid desert regions—the value of Jefferson Transformer quality is demonstrated daily in a variety of vital services to our armed forces. Despite the tremendous need occasioned by this round-the-world war activity, the principle of Jefferson's quality-with-quantity is consistently maintained.

Magnified demand from the military as well as essential war industries during the past few years, has resulted in far-reaching transformer developments and methods of production. New needs, and many new applications have built up a great fund of technical knowledge that Jefferson Electric will use in serving the increased industrial demand of the great new peace era.

This vast reservoir of added experience assures you that Jefferson Electric Transformers will continue, in the future as in the past, to offer the same superior service that means dependable, reliable performance at all times. . . . JEFFERSON ELECTRIC COMPANY, Bellwood (Suburb of Chicago), Illinois. In Canada: Canadian Jefferson Electric Co. Ltd., 384 Pape Avenue, Toronto, Ont.



**TRANSFORMERS**



**BX  
SERIES**

The urgent demand, in peacetime days, by the aircraft and radio industries for a compact, efficient D.C. motor was the challenge that led Pioneer to develop the Pincor BX series. Today Pincor BX motors flow from our plant in a steady stream to the producers of aircraft and radio equipment for the armed services.

Pincor BX motors, in their classification, meet the varied requirements of aircraft and radio manufacturers that demand light weight, compact motors for efficient and dependable application. Pincor BX motors are direct drive, ball bearing, high speed units wound for continuous or intermittent duty. Shunt, series or split series windings are for operation on 12 to 24 volt battery systems currently used and may be easily modified to meet your product demand.

Depend on these rugged Pincor quality-proven motors in the BX series. Send your problem to Pioneer engineers and let them put their years of experience to work for you. Consultation with these men will not obligate you in the least.

DYNAMOTORS • CONVERTERS  
GENERATORS  
POWER PLANTS • GEN-E-MOTORS



**PIONEER GEN-E-MOTOR  
CORPORATION**

5841-49 DICKENS AVENUE CHICAGO 39, ILLINOIS

**BUY MORE BONDS!**

Export Office, 25 Warren Street, New York 7, U.S.A.  
Cable Address: Simontrice, N. Y.

**RADAR TERMS**

(continued)

tive response from aircraft or ship

**Indicator**—Radar signals displayed on face of a cathode-ray tube, the end of which is called the "scope" (from oscilloscope), or screen

**Jamming**—Introduction of false radiation into enemy radio and radar devices

**Mickey**—Radar set used by Pathfinder planes in BTO

**Pip**—American for "blip." Signal on scope

**PPI**—Plan Position Indicator, a circular map-type scope. May be compared with charts as a navigational aid. PPI scope photos have appeared in the press

**Racon**—Radar beacon, used as a navigation aid, "blind" landing of planes, etc. **Radome**, antenna housing (see Blister)

**RDF**—Radio Direction Finding, also Radiolocation. British terms for Radar (radio-detection-and-ranging), which is an American term

**Window**—Mechanical reflecting devices dropped from planes to confuse enemy radar

• • •

**Third Chicago War  
Production Conference**

IN AN ALL-DAY PROGRAM attended by more than 2,000 persons, the third Chicago War Production Conference was held on March 29, at the Stevens Hotel in Chicago. Thirty-six panels on a wide variety of technical topics were presented including radiography, x-ray applications, instrumentation, electronic control, and a general session on electronics.

Dr. L. T. Rader, director of the Department of Electrical Engineering at the Illinois Institute of Technology, spoke on "Motor and Industrial Process Control", pointing out that industrial electronic equipment must be designed and constructed on a different basis from that of communication equipment. Long life, dependability of operation under adverse conditions, and cost are important factors in the construction of industrial electronic devices. It was also pointed out that industrial electronics as such does not and probably will not stand on its own feet, but rather must be re-

# MITCHELL-RAND

## THE ELECTRICAL INSULATION HEADQUARTERS for 56 YEARS

### FREE FOR THE ASKING!

Write today for your Free Varnished Tubing samples ranging from size 0 to 20 to fit wires from .032 to .325 inches . . . other valuable aids, are the M-R Guide Book of Electrical Insulation . . . the Wall Chart with reference tables, electrical symbols, allowable capacities of conductors, dielectric averages, thicknesses of insulation and tap drill sizes . . . and the M-R Wax and Compound Guide Book . . . they are full of valuable information . . . write for them on your letterhead.

### THE M-R WALL SHEET

The M-R Wall Sheet contains several tables and charts:

- ELECTRICAL SYMBOLS FOR ARCHITECTURAL PLANS**: A grid of symbols for various electrical components.
- COMMON INSULATING MATERIALS**: A table listing materials like Asbestos, Fiberglass, and Mica with their properties.
- STANDARD SIZES OF M-R HARD MAPLE SIGNATURE WEDGES**: A table of wedge sizes.
- TABLE OF ALLOWABLE CARRYING CAPACITIES OF CONDUCTORS**: A table showing capacity based on conductor size and insulation type.
- COMPARISON OF THE METRICAL SCALES**: A table comparing inch and metric measurements.
- COPPER WIRE CARD**: A table of wire specifications.
- VARNISHED TUBING SIZES**: A table of tubing dimensions.



**MITCHELL-RAND**  
for 56 YEARS  
THE ELECTRICAL INSULATION HEADQUARTERS

**MITCHELL-RAND INSULATION COMPANY, INC.**  
51 MURRAY STREET      Cortlandt 7-9264      NEW YORK 7, N.Y.

Transformer Compounds  
Friction Tape and Splice  
Cable Filling and Pothead Compounds  
Fiberglass Varnished Tape and Cloth  
Insulating Papers and Twines

**A PARTIAL LIST OF M-R PRODUCTS**  
Fiberglass Saturated Sleeving and Varnished Tubing  
Asbestos Sleeving and Tape  
Varnished Cambric Cloth and Tape  
Mica Plate, Tape, Paper, Cloth and Taping

Fiberglass Braided Sleeving  
Cotton Tapes, Webbing and Sleevings  
Impregnated Varnish Tubing  
Insulating Varnishes of all types  
Extruded Plastic Tubing

# REGULATED POWER SUPPLIES

**Excellent Regulation - Line Stability - Low Hum Level**

## OUTPUT VOLTAGE

Variable from 1.0 to 1.5 Volts DC.

## OUTPUT CURRENT - 500 MA Max

This model suitable for use in place of A Batteries where a source of AC power is available



Model 42A

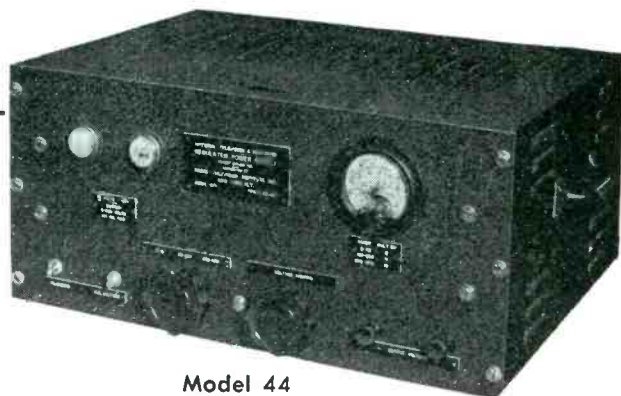


Model 44B

**OUTPUT VOLTAGE** - Continuously variable from 0-300 Volts DC.

## OUTPUT CURRENT - 250 MA Max

General purpose supply which will deliver well-regulated DC at any voltage from 0-300



Model 44

**OUTPUT VOLTAGE** - Continuously variable from 0-300 Volts DC

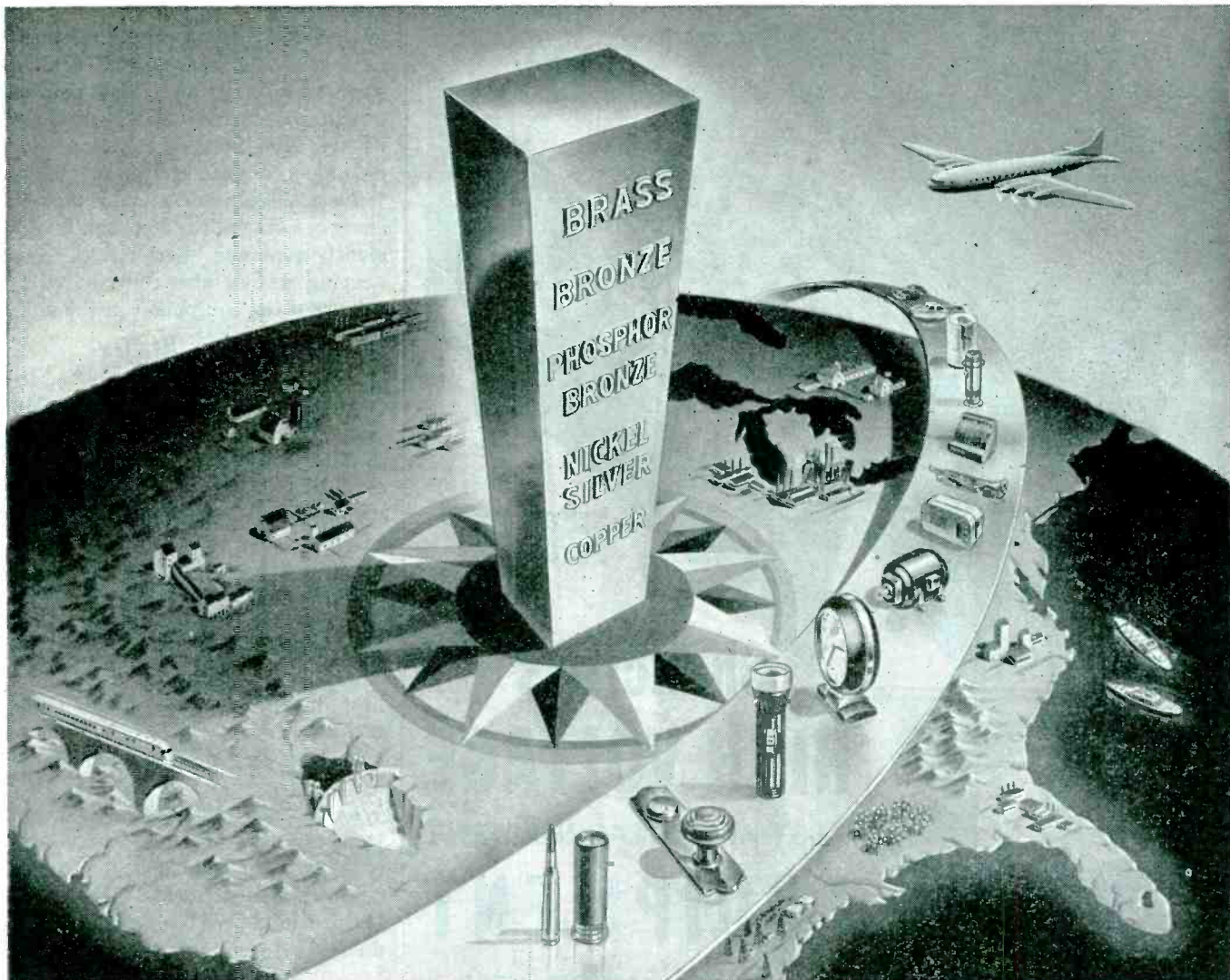
## OUTPUT CURRENT - 100 MA Max

Same characteristics as Model 44B except for lower current rating

*Other units can be designed to specifications.*

**Inquiries are invited, both on power supplies and on our electronic consulting service.**

DISTRIBUTED BY  
**RADIO-TELEVISION INSTITUTE, INC.**  
OF NEW YORK  
480 LEXINGTON AVENUE PLaza 3-4585 NEW YORK 17, N. Y.



## Better Metals for Many Uses

Precision-made brass and other Western copper-base alloys will serve important functions in a large number of tomorrow's new and improved products. Manufacturers seeking alloy metals to meet very exacting requirements find that Western, with mills at East Alton, Ill.,

and New Haven, Conn., delivers *as specified*... in sheet, strip, long coils or stamped parts.



We may be able to serve you. Now, perhaps—or later. Your inquiry will be welcomed. Western Brass Mills, East Alton, Ill., Division of Olin Industries, Inc.

# WESTERN BRASS MILLS

MASTERS OF PRECISION

BRASS • BRONZE • PHOSPHOR BRONZE • NICKEL SILVER • COPPER

ELECTRONICS — May 1945



Typical of the larger portable Shallcross Kilovoltmeters, No. 722 is rated 2-20 KV, d-c, 1000 ohms per volt.

Interior view of Kilovoltmeter Multiplier No. 712-5-3. 12 kv., 5 ma., 2.4 megohms.

## Shallcross HIGH VOLTAGE TEST AND MEASUREMENT EQUIPMENT

If your requirements call for standard kilovoltmeters or kilovoltmeter multipliers in any one of many sizes and voltage ranges or for specially designed high voltage equipment, Shallcross offers the services of its High Voltage Engineering Section. Backed with many years of experience in this field, Shallcross engineers welcome the opportunity to help in the solution of practically any high voltage test or measurement problem.

### WRITE FOR BULLETIN

Bulletin "F", recently released, includes detailed descriptions of standard Kilovoltmeters, Kilovoltmeter Multipliers, and Corona Protected Resistors and serves as a guide to the many special types that can be produced to match particular requirements in a range of potentials from 1 to 200 kilovolts.

A special Shallcross Corona Protected Kilovoltmeter with front shielding wire screen removed to show interior. Meters illustrated are optional.

# SHALLCROSS MFG. CO.

DEPT. E-55, COLLINGDALE, PA.

ENGINEERING • DESIGNING • MANUFACTURING

garded as a very important element in a completely integrated field of engineering. It was also pointed out that electrical components such as are used in the communication field are often too fragile for use in industrial equipment, and that in many cases a failure to provide sufficiently generous tolerances in engineering design also contributed to failure of the equipment in the field.

### Electronic Heating

A talk on "High Frequency Induction Heating" was given by Mr. John M. Cage, engineer in charge of Electronic Control Division of Allis-Chalmers. The manner in which heat is generated in conducting materials, whether magnetic or not, was discussed and it was shown that the basic circuits of electronic heating units are all similar but that the number of applications is exceedingly varied. It was shown that the fundamentals of induction heating depend on: (1) induced voltage, (2) skin effect, and (3) hysteresis.

Carl Madsen, electronic engineer, Industry Engineering Department of Westinghouse, spoke on "High Frequency Heating of Dielectrics." Its use in the rayon and nylon industries, to set the thread to prevent twisting and stiffness of the yarn, was compared to the annealing process in metals.

He pointed out that the cost of sterilizing grain by electronic means is about 2 cents per bushel and that this cost was too high for this application. At the same time, the cost was sufficiently low that it could be applied to package goods.

Regarding food, Mr. Madsen commented on reports that it would be possible to cook meals by means of dielectric heating in the postwar period. This did not prove too attractive because it has not been found feasible to heat uniformly, since the fatty and lean portions heat at different rates. Moreover, in order to cook a 1-lb steak in 10 seconds, as has been held to be feasible, 150 kw of power would be required. Mr. Madsen did not state where or how the steak was to be obtained.

In the discussion following the panel on electronic controls, Dr. Rader pointed out that economic problems were of considerable im-



**YOU'RE  
IN FOR**

**A LOT OF small TALK** after this war, thanks

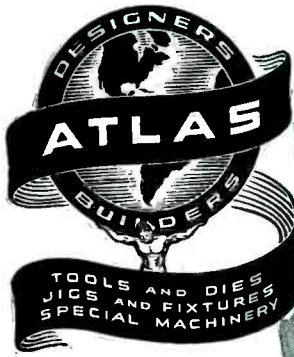
**to Schweitzer's Thin Gauge papers**

The wartime Walkie-Talkie will become the citizen's Walkie-Talkie... aviation radio... small, light, compact... will develop into new and better portable sets... unique electronic gadgets galore will make this a brave new world. If you are using capacitors or designing equipment where space is a factor, perhaps our .00025" paper, with a tolerance of  $\pm$  or  $-$  .000025" may help you solve your problems. When you think of THIN insulating papers... think of Schweitzer.

**SCHWEITZER PAPER CO.** 142 MILLER STREET,  
NEWARK, N. J. • Plants: Newark, Jersey City, N. J., Mt. Holly Springs, Pa.  
Research Laboratories: Chrysler Building, New York, N. Y.



SPECIALISTS IN THIN GAUGE INSULATING PAPERS



TAKE A LOAD  
OFF YOUR SHOULDERS  
*call* ATLAS



**"HOW can we sell it for \$10.00 ...**

**when it COSTS ... \$10 <sup>19</sup>/<sub>100</sub> "**

Maybe you can't . . . but maybe you can. Stranger things have happened. "How come" the \$10.19 cost? Is it labor . . . materials . . . or, as Atlas has often demonstrated, a stubborn adherence to outmoded machinery, slow and costly finishing processes, poor power distribution and control, double-back floor layouts . . . or should the product be re-designed for more efficient production?

The Atlas organization, 300 skilled designers, engineers and toolmakers, and one of the country's best equipped plants, has solved such problems for scores of America's leading industrial manufacturers . . . before and during the war . . . and is now designing products,

creating and building tools, dies, jigs, building special automatic machinery and planning complete production lines for the coming civilian manufacture.

We offer a complete service or partial aid in any or all of these fields. In addition we are prepared and equipped to produce precise parts or products in our own plant . . . work which requires close tolerance machinery and strict inspection and testing.

If your post-war ideas are crystalizing but have not yet reached the "action" stage, we suggest a conference at your early convenience.

*A load off your shoulders onto ours.*



**ATLAS TOOL & DESIGNING COMPANY**  
**ATLAS METAL STAMPING COMPANY**  
Castor & Kensington Avenues, Philadelphia 24, Pa.



# Boiled — not 5, but 15 MINUTES!

← An important EXTRA-TEST  
of Essex Magnet Wire  
Insulation



Varnish is often hard on film-coated magnet wire insulation unless the film is properly cured or baked. That's why many users require boiling tests in toluol and alcohol solutions, for as long as 5 minutes.

To meet these requirements consistently, Essex engineers use even stronger toluol-alcohol solutions than usually required—maintain constant mixtures by special condensing apparatus—and boil the wire, not 5, but 15 minutes!

The results of this *Extra-Test* enable Essex engineers to maintain complete control of curing or

baking film-coatings within narrower limits—assuring insulation of maximum resistance to any varnish treatment—preventing varnish failures in the field.

Just one of many important reasons why Essex *Extra-Test* Magnet Wire has reached such an enviable "first choice" position in fifteen short years.

**ESSEX WIRE CORPORATION**  
FORT WAYNE 6, INDIANA



High above Tokyo—and in every war zone throughout the world—automatic, split-second controls are providing greater safety for our fighting forces. Planes return safely because of them; tanks perform more efficiently; submarines depend on them.

Chace Thermostatic Bimetals play an invisible, but unfailing part in many of these automatic controls. They have been selected by the control builder—because of their responsiveness, their sensitivity, their accuracy, their dependability—as the actuating element for his temperature responsive device.

The same principles employed in designing these vitally important controls for our fighting equipment will one day help again to produce better controls and appliances for Industry, for our transportation systems, the automobile, and the home.

Chace Thermostatic Bimetals—made in thirty-five types, each of which offers specific advantages to control builders—are sold in sheets, strips and finished forms.

**W.M. CHACE Co.**  
*Manufacturers of*  
**Thermostatic Bimetals and Special Alloys**  
**1630 BEARD AVE • DETROIT 9, MICH.**

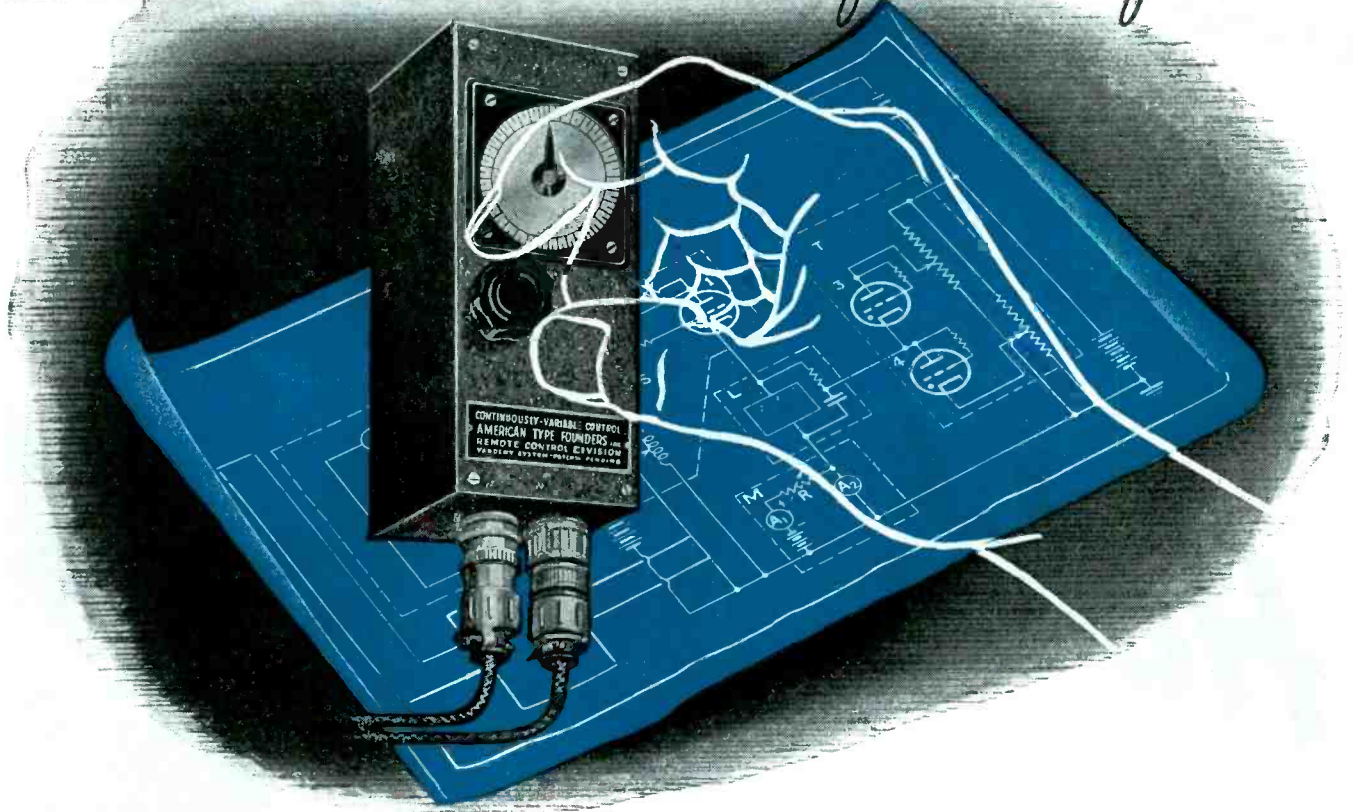
portance in industrial applications. It was his observation that many parts going into industrial equipment are not well designed or are sometimes misapplied in practice. The practice of applying electronic control to existing equipment he viewed unfavorably and he anticipates that rotating equipment, for example, will be redesigned in the future so as to be more suitable for electronic control.

*Efficiency*

Considerable discussion was devoted to induction and dielectric heating. In response to a question as to the efficiency of electronic heating units, Mr. Cage pointed out that the efficiency as given by various manufacturers is measured in different ways and usually refers to the maximum possible efficiency under desirable operating conditions. However, this maximum efficiency is not too important since it can seldom be achieved in practice. Moreover, the cost of power is not generally a significant matter in most fields in which electronic heating can be applied successfully. As a basis for judging the operation of equipment, it was felt that rotating machines could be considered as having an efficiency of 75 percent, mercury-vapor inverters 90 percent, sparkgap generators 50 to 70 percent, and vacuum-tube oscillators 50 to 75 percent as approximate values.

Mr. Madsen indicated that he believed commercial baking by electronic methods has possibilities although this problem is not yet solved and one of the major difficulties is that of providing a crust on the exterior of the bread. Heating of ink on fast-moving web belts did not appear too attractive an application for dielectric heating since this would require waves of frequencies of hundred of megacycles or else such high voltages that flash-over would probably occur. In general, it was stated that rods or wires less than  $\frac{1}{2}$  in. thick could not be easily treated by dielectric heating although much thinner sheets could be treated. As regards the size of equipment, Mr. Madsen stated that so far as he knew, a 150-kw unit was the largest that had been put into commercial service for dielectric heating whereas

# **IN YOUR DESIGNS** *for the future*



## **Control Remotely...ELECTRICALLY**

ATF precision remote controls are handling some of the war's most exacting remote control jobs. And they are finding wide application in planning for the exacting industrial jobs of tomorrow . . . for the accurate adjustment or setting of communications equipment, machine tools, valves, fuel supplies, power controls, and other machinery, from remote or obscured points.

If your post-war planning involves a problem of precise positioning, the solution may rest with one of these proved ATF electrical control units. Their hair-line precision, extreme simplicity, and their ability to withstand temperature extremes and mechanical abuse will give your product a decided edge in post-war selling.

Complete literature available. The services of ATF engineers are freely offered to assist in applying these units to your products.

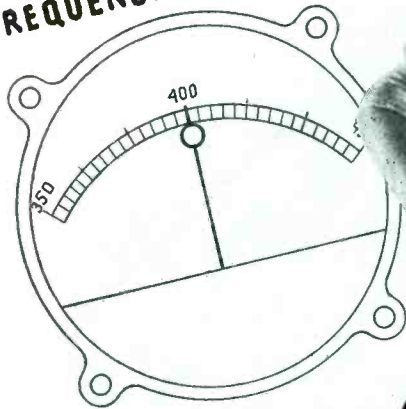
## **AMERICAN TYPE FOUNDERS**

**REMOTE CONTROL DIVISION**

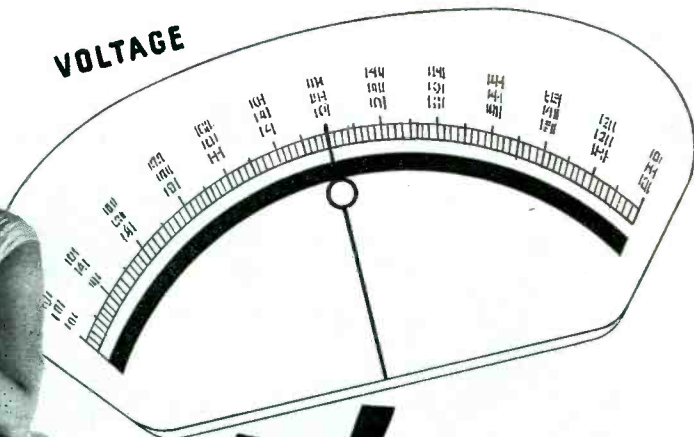
11 West 42nd Street, New York 18, N. Y.



FREQUENCY



VOLTAGE



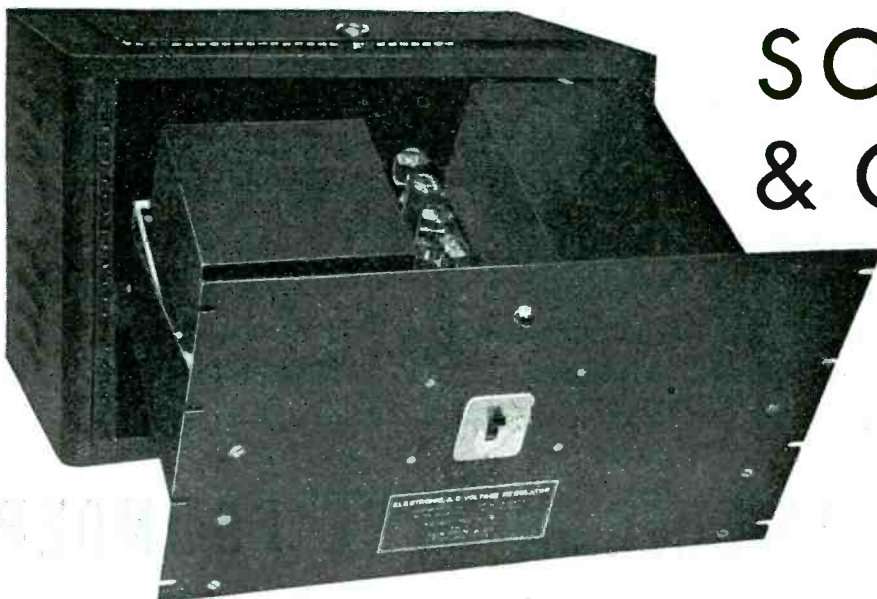
Hold It!



## With SORENSEN REGULATORS

Where the resonate type regulator can't meet the specs—when you need a regulator not affected by *Voltage* or *frequency* variations — where the output wave form *must* not be altered by the regulator — call for Sorensen.

**For Aircraft applications**—400 cycle. Frequency Variation  $\pm 10\%$ . Input Voltage 90—140 V. A. C. Output—115 V. A. C.  $\pm \frac{3}{4}\%$  500 Watts. Weight 13 pounds. Meets A. N. Specifications.



# SORENSEN & COMPANY

50-70 Cycles Input 90—140 V. A. C. Output 115 V  $\pm \frac{3}{4}\%$  1200-1750 Watts. Weight 60 pounds.

All transformer components are hermetically sealed and tropicalized throughout.

AIRBORNE ELECTRONICS » » »

STAMFORD, CONN.

# IT'S NEW

and its  
**APPROVED**  
BY  
*Underwriters  
Laboratories*

*Order by Whitney Blake Catalog No.*

**POS**  
**PSV**  
**PSJ**  
**PS**

# PLASTITE FLEXIBLE CORD

## OIL RESISTANT

— meets a long felt need for a Cord of High Dielectric Strength that is practically Ageless. It has High Abrasive and Impact Resistance.

Other favorable features are:

Resistance to Oil, Flame, Alcohol, Water, Alkali and most Common Solvents!



**POS "Tru-Rip";** Lamps, Clocks, Radios, Light Appliances



**PSV Light Duty;** Vacuum Cleaners, Fans, Food Mixers



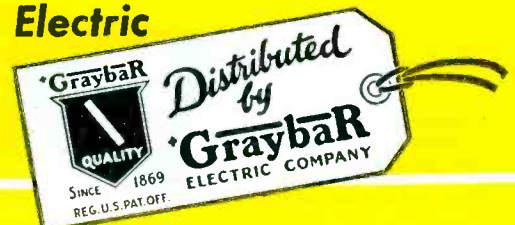
**PSJ Medium Duty;** Drills, Grinders, Tools, etc.



**PS Heavy Duty;** Portable Tools, Bus Heaters, etc.

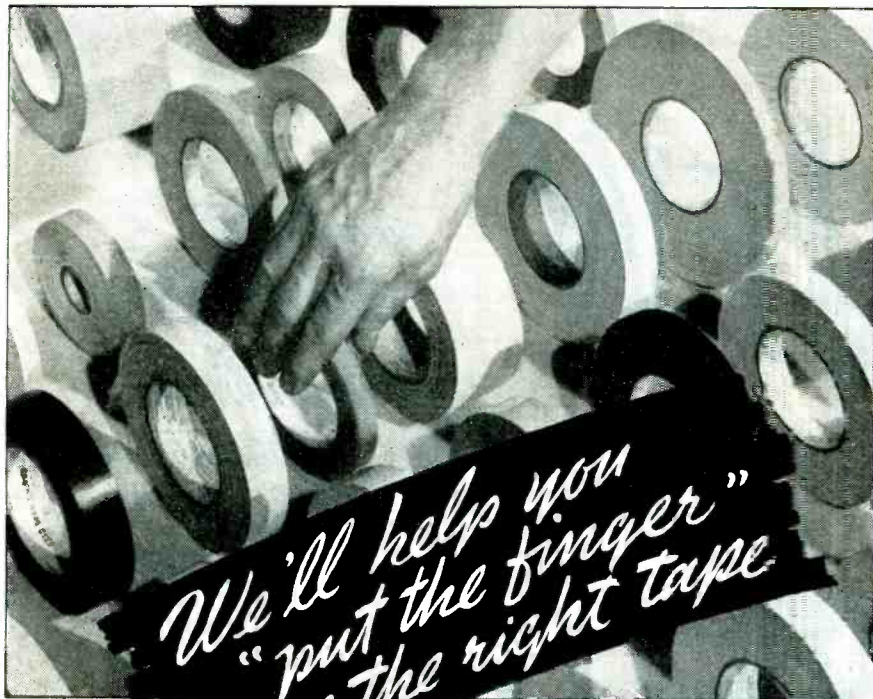


**Ask Your Nearest Graybar Electric  
Company Office for  
Prices and Samples**



# The WHITNEY BLAKE Company

New Haven, Connecticut, U. S. A.



*We'll help you  
"put the finger"  
on the right tape.*

## SCOTCH BRAND Electrical TAPES

are made to meet a wide range of installation conditions. They have backings, adhesive properties, mechanical and dielectric strengths, corrosion resistance, moisture resistance and resistance to other deteriorating factors, exactly tuned to specific requirements. If you are wondering what type to use on some specific installation, our new book on "SCOTCH" Electrical Tapes will help you make the correct selection.

Whether the job in hand involves the insulating of small reactor coils or winding a large motor coil there is a "SCOTCH" Electrical Tape with the right electrical properties and mechanical strength to insure first class performance. Use the coupon below to get your copy of the new "SCOTCH" Electrical Tape Book today.

"SCOTCH" is the trademark for the Adhesive Tapes made by Minnesota Mining & Mfg. Co.



Flat-back "SCOTCH" Electrical TAPE fastens coils of fine copper wire.



"SCOTCH" Electrical TAPE provides a tear-proof edge for Slot installation.



Fastening a small coil with Flat-back "SCOTCH" Electrical TAPE.

for induction heating, a unit of 1200 kw has been built. These values do not necessarily represent the largest installation since in several cases several units were used in parallel.

### Special Problems

The question was asked whether it was possible to use dielectric heating in plastic molds where metal inserts were required. It was reported that by employing dielectric heating as a means of heating the pre-form, the plastic was made to form more readily in the molds and in this way could be used to reduce the difficulty.

As to the interference produced by electronic generating units, it was stated that efficient shielding of induction heating units and the relatively small field of these systems resulted in very little radio interference. Dielectric heating is most likely to produce greater interference because the output circuit was a more effective antenna. Mr. Madsen stated that in those cases where interference could not be suppressed by adequate shielding and filtering, consideration has been given to the operation of equipment on frequencies assigned by the FCC. Requests for frequencies of 13.6, 27.2 and 40 Mc for electronic heating have been submitted to the FCC.

### Resistance Test Technique

The instrumentation panel was given over to measurements. J. F. Inman spoke on "High Voltage Insulation Testing", J. Dauber of the Acme Industrial Co. spoke on "Gaging Methods—Size, Angle and Flatness by Light Wave Methods" and D. O. Kochmich of the Trimount Instrument Co. spoke on "Static and Dynamic Pressure Measurements". Mr. Inman gave a historical review of high-voltage methods of measuring insulation resistance, pointing out that the calibration of resistance by means of current measurements (as in the usual ohmmeter) permits the calibration of very high resistances even though no standards are available. Measurements of resistance of cables subjected to high voltages frequently produce breakdown which is not always detected. To



MINNESOTA MINING & MANUFACTURING COMPANY  
Saint Paul 6, Minnesota

Please send us a copy of your new book on "SCOTCH" Electrical Tapes.

Firm.....  
Street..... City.....  
Zone..... State..... Signed..... Title.....



# MARION INSTRUMENTS



**GEARED TO  
EVER-CHANGING  
NEEDS OF  
INDUSTRY**

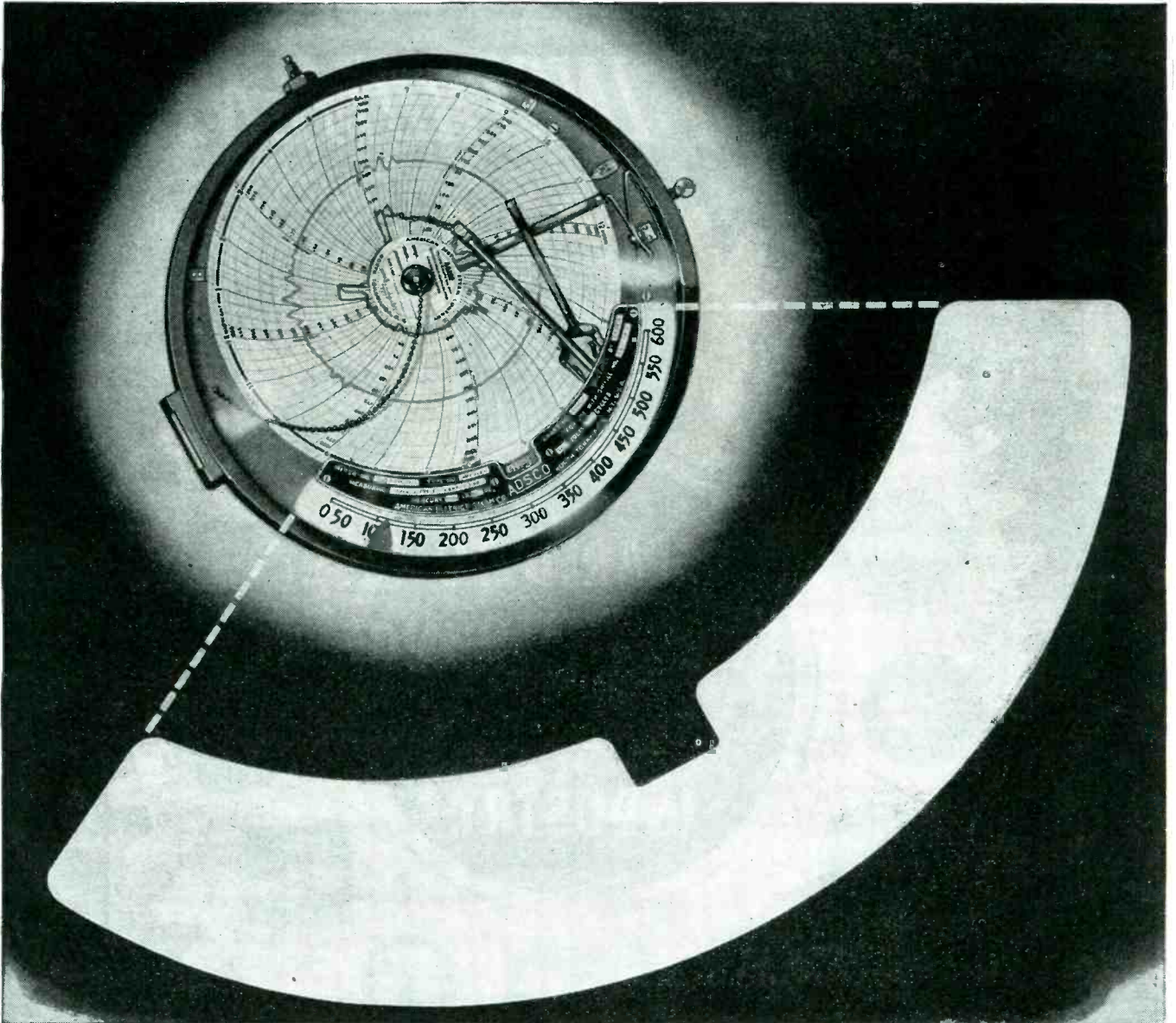
War requirements, plus our own design and construction refinements, now provide industry with instruments of heretofore unknown qualities. As new needs arise, we are geared to use our highly specialized, yet diversified, knowledge in solving any measurement problem.

Solid Alnico magnets  
Beryllium copper frames  
Sintered soft iron pole pieces  
Very high torque movements

Our engineering department welcomes inquiries — especially those demanding extra-critical instruments for special applications.



**MARION ELECTRICAL INSTRUMENT CO.**  
MANCHESTER, NEW HAMPSHIRE  
Distributed by **ELECTRICAL INSTRUMENT DISTRIBUTING CO.**  
458 BROADWAY • NEW YORK, N. Y.



*Molded for American District Steam Co., North Tonawanda, N. Y.,  
by Dimco Plastics, Dayton, Ohio*

## BOLD SCALE

**I**N AMERICA'S important task of coal, gas and oil conservation, a major requirement is the detection of waste and inefficiency. Encouraging accomplishments have been made with the aid of highly accurate flow meter equipment such as shown above, which supplies a 24-hour visual record of steam consumption, steam pressure, and amount of steam passing through the line.

Much of this information is indicated on big, boldly-visible Plaskon Molded Color scales, upon which the meter markings are printed. Under all conditions these markings can be quickly, easily and accurately seen. Illumination behind the translucent Plaskon unit makes the entire scale glow brightly, so that each number and word stands out in sharp contrast. Plaskon also gathers the light from outside sources.

This is one of the many efficient industrial services of Plaskon. Because of its versatility, Plaskon has aided in the development and manufacture of important products for the battle front and home front. It is a strong, non-shattering material, with a smooth surface,

and is available in a complete range of colors. It is unaffected by oils, fats, or common solvents; and is completely resistant to arcing or tracking under high voltages and high frequencies.

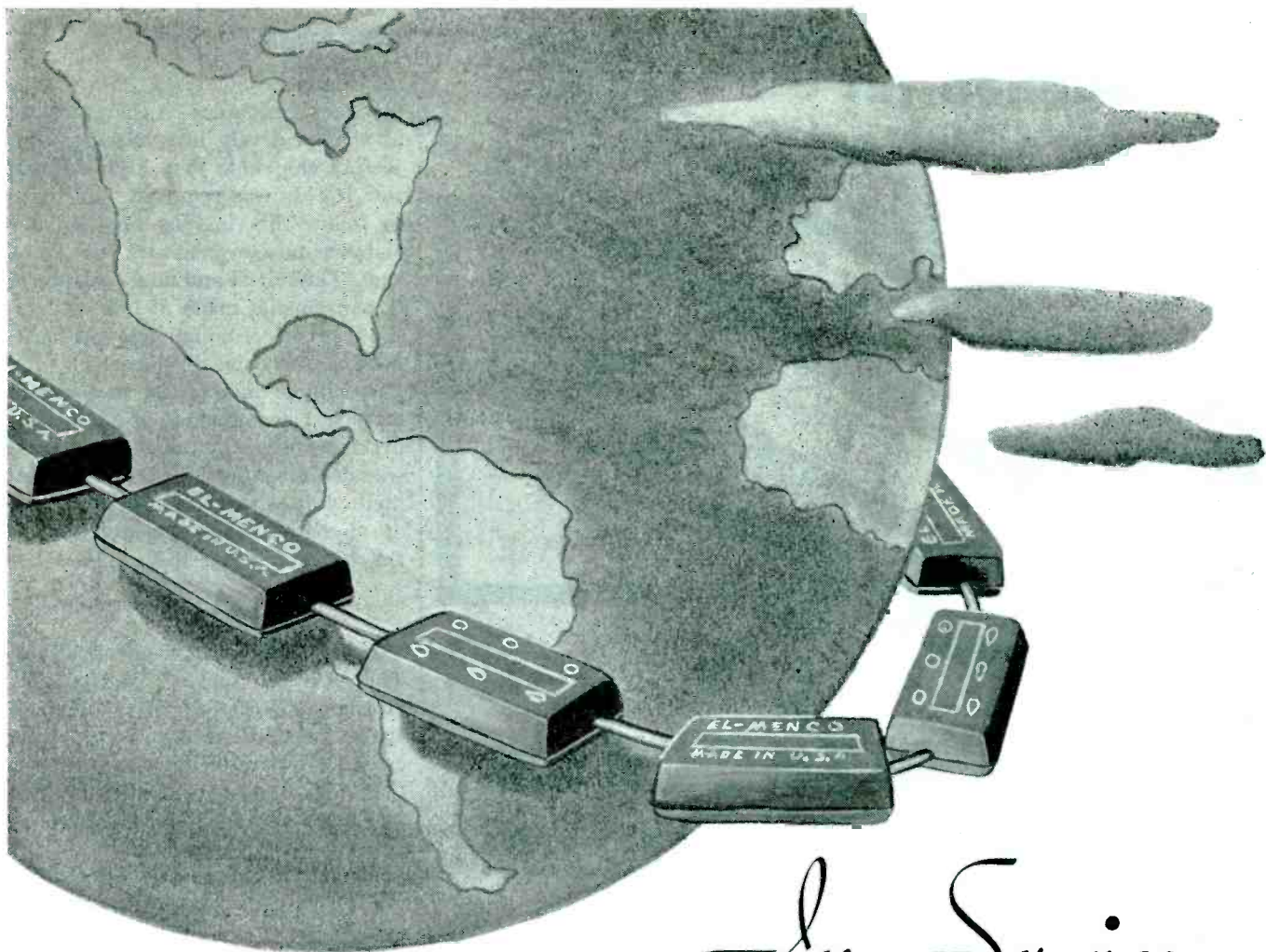
Plaskon Molded Color offers you a great range of manufacturing and sales advantages, both for present and postwar requirements. Experienced Plaskon men will gladly assist in adapting this versatile, colorful plastic molding material to your needs.

**PLASKON DIVISION, LIBBEY-OWENS-FORD GLASS COMPANY**

2136 Sylvan Avenue, Toledo 6, Ohio

Canadian Agent: Canadian Industries, Ltd., Montreal, P. Q.

★ **PLASKON** ★  
TRADE MARK REGISTERED  
**MOLDED COLOR**



*In Service*

## AROUND THE WORLD

El-Menco Capacitors are serving faithfully at countless vital spots in Army and Navy communications systems wherever they may be.

Because of their recognized high quality we know they will continue to girdle the globe after the war — in products whose manufacturers will demand perfection in *every* detail.

Manufacturers of  
Electronic Equipment:

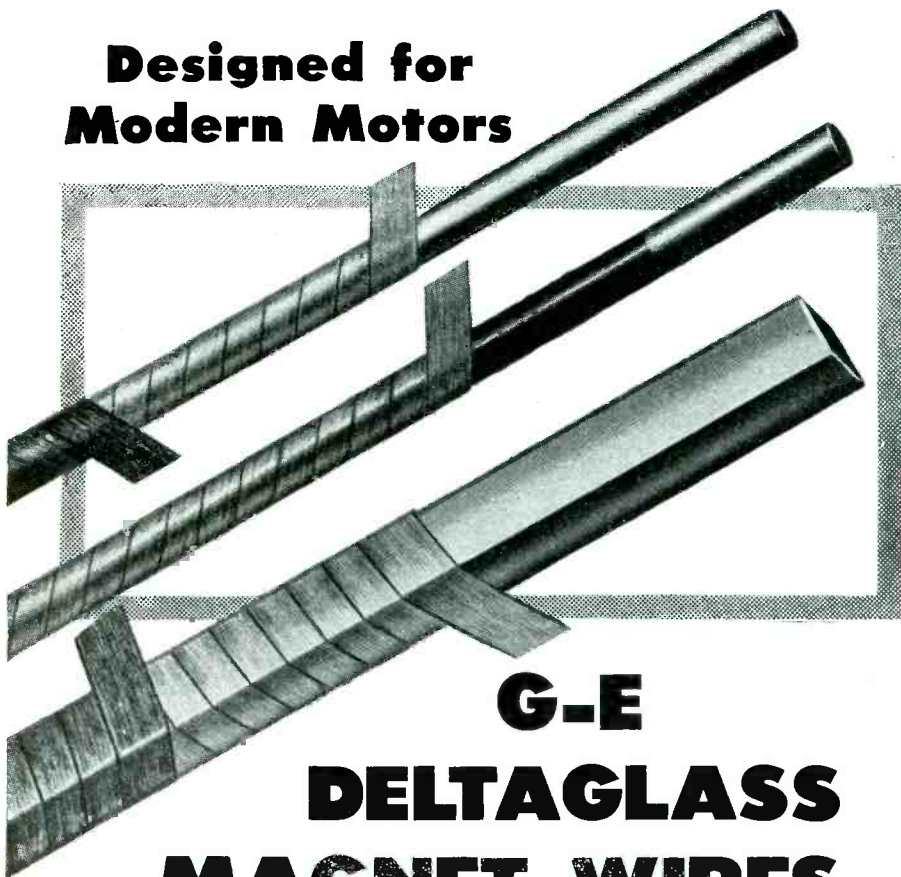


Send, on firm letterhead  
for new Capacitor Catalog

THE ELECTRO MOTIVE MFG. CO.  
Willimantic, Conn.

**EL-Menco**  
MOLDED MICA -  
MICA TRIMMER  
*Capacitors*

## Designed for Modern Motors



# G-E DELTAGLASS MAGNET WIRES

## Save Space — Withstand Extra Heat

Space factor is becoming increasingly more important in the selection of magnet wire because modern motors are designed to give the same power from smaller frames. Designing engineers of electrical products specify G-E Deltaglass Magnet Wire because it permits a greater amount of copper in the space allowed for the winding — and will still withstand the extra heat by a comfortable margin.

Deltaglass Magnet Wires are used for winding motors, lifting magnets, brake coils, generators and in numerous other electrical devices and equipment. Deltaglass is insulated with yarn of spun glass that is firmly bonded to the copper conductors with a heat-resisting insulating varnish. It is constructed with either single or double wraps of glass yarn or with Formex copper conductors covered with single or double wraps of spun glass. Deltabeston is smooth, tough and extremely flexible. It can be flexed and bent into intricate shapes without rupturing its insulation. It's available in round, square and rectangular shapes in a full range of sizes.

Here's a catalog that will help solve your wiring problem. You can obtain your free copy by writing to Section V-555-119, Appliance and Merchandise Dept., General Electric Co., Bridgeport, Conn. All Deltabeston Asbestos-Glass and Synthetic-insulated Wires and Cables for special applications are distributed by Graybar Electric Co., G-E Supply Corp., and other G-E Merchandise Distributors.



BUY WAR BONDS AND KEEP THEM

# GENERAL ELECTRIC

make insulation tests, he recommended resistance measurements at comparatively low voltage, subjecting the cable to a high-voltage test if this was required, and then to follow this test by another resistance measurement at low voltage. The initial and final resistance measurements made at low voltage should check if no damage has been done to the cable insulation.

A simple method of measuring flatness, size and angle of gages and precision parts in industrial plants was described by Mr. Dauber. The method has for its basis the use of an optical flat in contact with the material under test.

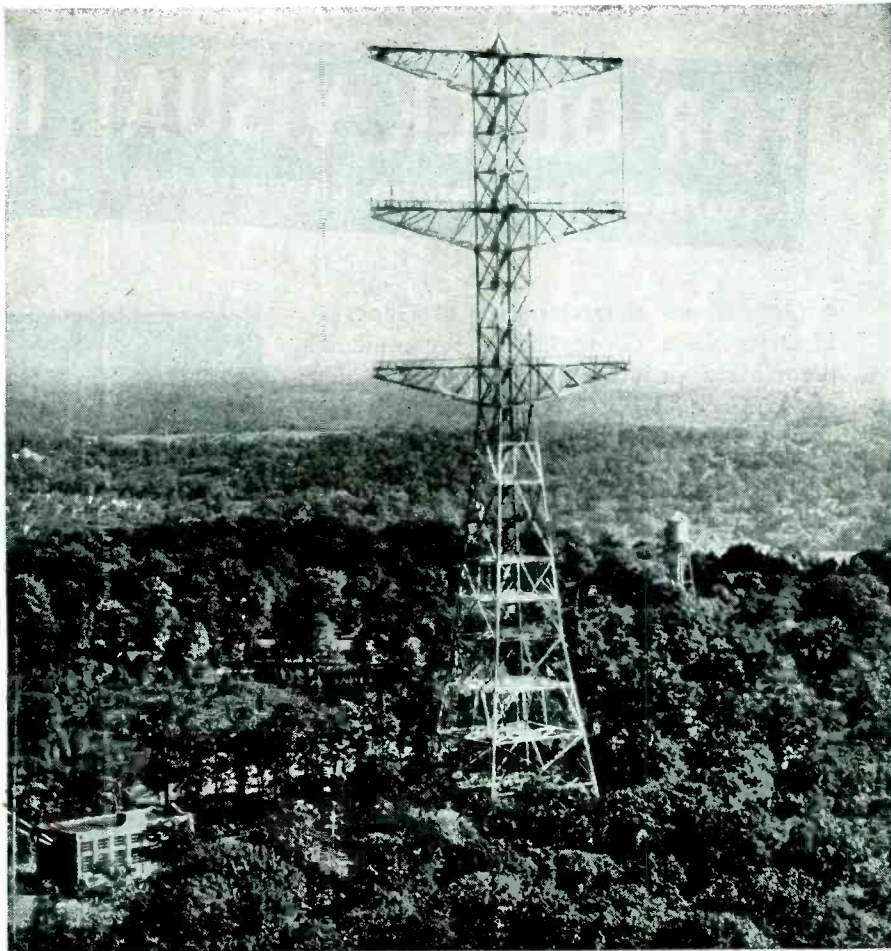
### Spore Life

In speaking on "Tropicalization, The War on Spores", Wilfred F. Horner, Director of the Biological Lab., Belmont Radio Corp., discussed the work of his organization.

It was shown that the growth of fungus required the presence of water as a liquid, and oxygen, while essential nutrition was frequently provided by the material on which spores deposited themselves. It was found that spores multiply most rapidly at temperatures between 65 and 80 degrees and for values of pH between 6 and 7. Colored slides of spore growths and the effect of various fungicides were shown and several types of materials suitable as fungicides and for tropicalization were mentioned.

Leonard R. Robb, Production Control, Stewart Warner Corp., spoke on "Crash Program vs. Planned Production", outlining the difficulties that a manufacturer of electronic equipment faced during the war production schedule.

Raoul du Chatellier, Returned Communication Officer Military Intelligence Service, 1st Army A.E.F. and now with the Galvin Mfg. Co., in a restricted talk "What We Thought of FM in Normandy" outlined his experiences since landing in France last June. This talk served to outline some of the conditions under which communication equipment was operated, some of the difficulties in operation which were encountered in the field, and indicated the value of f-m equipment as compared to amplitude modulated equipment.



## Pioneer FM station uses **BLILEY CRYSTALS**

When Major Armstrong's station W2XMN went on the air from Alpine, New Jersey on July 18, 1939, radio history was in the making. This first FM transmitter to be put in service, built by REL, employed the Armstrong crystal-controlled phase shift modulation.

Bliley crystals are doing an excellent job in this outstanding pioneer FM installation.

For advanced engineering it is al-

ways worthwhile to specify Bliley crystals. An outstanding example of this is the discovery and development by Bliley engineers of ACID ETCHED CRYSTALS\*. This technique was an established part of Bliley production before Pearl Harbor. It is now recognized as a prerequisite to dependable service in military equipment.

It is a good habit to consult Bliley engineers when new developments are in the making. Our specialized

engineering can often be of real assistance toward solution of your design problems. This kind of service has made Bliley the foremost producer of quartz crystals for amateur and commercial radio in peacetime and for our armed forces in time of war.

\* \* \*

*\*Acid etching quartz crystals to frequency is a patented Bliley process. United States Patent No. 2,364,501.*



# Bliley CRYSTALS

Do more than before...

buy extra War Bonds

**BLILEY ELECTRIC COMPANY**  
UNION STATION BUILDING • ERIE, PENN.

# FOR QUICK VISUAL INDICATION

Investigate the Unique Characteristics of G-E Neon Glow Lamps

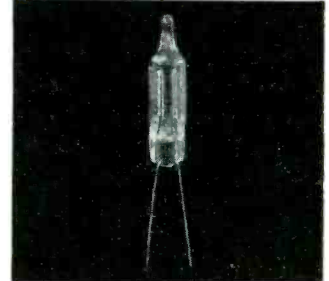
● The unique characteristics of General Electric Neon Glow Lamps recommend them for a variety of uses in radios and electronic devices . . . as indicators, voltage regulators, pilot lights and test lamps. The uses described at right are typical. If you think G-E Neon Glow Lamps can be useful to you, write or phone the address below. Experienced General Electric Lamp Engineers will be glad to discuss your problems with you.

## CONSIDER THESE ADVANTAGES

1. Distinctive orange-red glow—no colored cover glass needed.
2. Dependable performance and long life—rated at 3,000 hours.
3. Very low current consumption—less than 1/2 milliamperes for smallest lamp.
4. Variety of sizes and wattages.
5. High resistance to vibration, shock.
6. Normally usable on a-c or d-c.
7. Screw base lamps for 105-125 v. circuits; similar lamps with bayonet bases available without resistors.
8. Produce practically no heat.
9. Nearly flat volt-ampere characteristics.
10. Insensitive to voltage variations above critical value.



**NE-48** (also NE-16). Indicator lamps. Special volt-ampere characteristics of these lamps indicate use as voltage regulators. Screw base lamp available as NE-45.\*



**NE-2** One of the most widely used indicator and test lamps—popular because of compactness and small size. Nominal wattage is only 1/25 watt. This lamp is unbased—has wire terminals.

\*NE-16 meets JAN-1A specifications for 991. Special marking JCG-991 supplied for small extra charge.



**NE-51** For general indication, such as showing existence of potential across various parts of electrical circuits.



**NE-17** Indicator and pilot light lamp that flashes to show condition of B-battery in portable radios. Frequency of flashes decreases as battery runs down.

ORDER NO.	NE-2	NE-51	NE-17	NE-48	NE-16	NE-45	NE-30	NE-32	NE-34	NE-36	NE-40	NE-42
Watts, Nominal	1/25	1/25	③	1/4	1/4	1/4	1	1	2	2	3	3
Volts (Circuit)	105-125	105-125	③	105-125	105-125	105-125	105-125	105-125	105-125	105-125	105-125	105-125
Starting Voltage ①	AC DC	65 90	65 90	③	65 90	—	65 90	60 85	60 85	60 85	60 85	60 85
Base		Unbased (Wire Terminals)	S. C. Bay. Min.	D. C. Bay. Cand.	D. C. Bay. Cand.	D. C. Bay. Cand.	Cand. Screw	Medium Screw	D. C. Bay. Cand.	Medium Screw	Sk. D. C. Bay. Cand.	Medium Screw
Maximum Overall Length ②	1 1/8"	1 3/8"	1 1/2"	1 1/2"	1 1/2"	1 5/8"	2 1/8"	2"	3 5/16"	3 3/4"	3 5/16"	3 3/4"
List Price (plus tax)	\$.08	\$.10	\$.45	\$.35	\$.42	\$.40	\$.40	\$.45	\$.50	\$.55	\$.60	\$.65

① Applies to lamp when new.

② Glass part; wire terminals extend additional 1 3/8".

③ Designed for DC flashing operation in RC circuit.

④ Meets JAN-1A specifications for 991. Special marking JCG-991 supplied at small extra charge.

⑤ Designed for 67-87 Volts D.C. (D.C. operating voltage at 1.5 milliamperes, 53-65 volts).

For further information, write address below for Bulletin 7100.

NELA SPECIALTY DIVISION LAMP DEPARTMENT

# GENERAL ELECTRIC

1 Newark Street, Hoboken, N. J.



*Buy Bonds*  
SPEED VICTORY!

## SNIP IT, SEAL IT, SHIP IT! *in Traco "All-Size" Bags*

**Tubular Form—1000 Foot Reels**



Make quickly in your own plant TITE-SEAL Cellophane Bags of any size that seal out dust, air, water and moisture-vapor. They protect military supplies from damage in transport or storage.

Acceptable for Methods I and IA, type III packaging . . . available in 3, 4, 6 and 8 inch widths under proper priority . . . 1000 feet to the reel. Saves stocking large quantities of special-sized bags. (Stock Bags also available in above widths.)

"All-Size" Containers and custom made bags can be furnished plain or printed in any widths or lengths desired on special orders of sufficient quantity.

Heavy foil-lined laminated bags or tubes meet every requirement of Methods I, IA and II Military Packaging. LOXTITE Partitions give crash protection to fuses, rations, and delicate or fragile items.

Reasonably prompt shipment can be made on government orders bearing end use. A card will place our technicians at your command.

T. M. Reg. & Patent applied for

**TRAVER CORPORATION**  
Dept. ET55 • 358-368 West Ontario Street • Chicago 10, Illinois

**Printed CELLOPHANE TAPE**  
For parts identification and many other uses. Saves time and trouble. Pressure sensitive. Available in small quantities. Prompt shipment.

# NEWS OF THE INDUSTRY

Science and prosperity; postwar markets; microwave relay systems; television preview; radar avigational aids; meetings; FCC broadcast actions; business news

## Radio-Radar Openings

ACTIVATION of an Army Air Forces development project to be known as Watson Laboratories, at Red Bank, N. J., has created approximately 325 openings for radio and radar engineers. Salaries range from \$2600 to \$5600 per annum.

Work to be done in this installation is on the development of ground communication systems peculiar to the AAF. The positions are under civil service and carry all the rights and privileges of a war

service appointment under the Classification Act of 1923. More information may be had from the New York office of the Civil Service Commission or by direct inquiry to the personnel office of the laboratories.

## Science and Progress

OUR FUTURE advancement toward the necessary economy of abundance depends upon getting the greatest possible number of persons engaged in scientific pursuits, ac-

ording to Samuel J. Novick, president of the Electronic Corp. of America.

Speaking recently at a New York Times Hall Forum in New York, he said that progress in science during the war is due to: (1) Every scientist who could contribute to the war effort being systematically sought out; (2) Huge expenditures for laboratory facilities and field work; (3) The war-imposed necessity for better organization and direction of research; (4) The fact that there was nothing to hold back new ideas; and (5) The natural incentive created by the vacuum of an unlimited market.

His suggestion was that we must maintain similar stimuli if we are to put our economy on an even keel after the war.

## Street-Car Radio

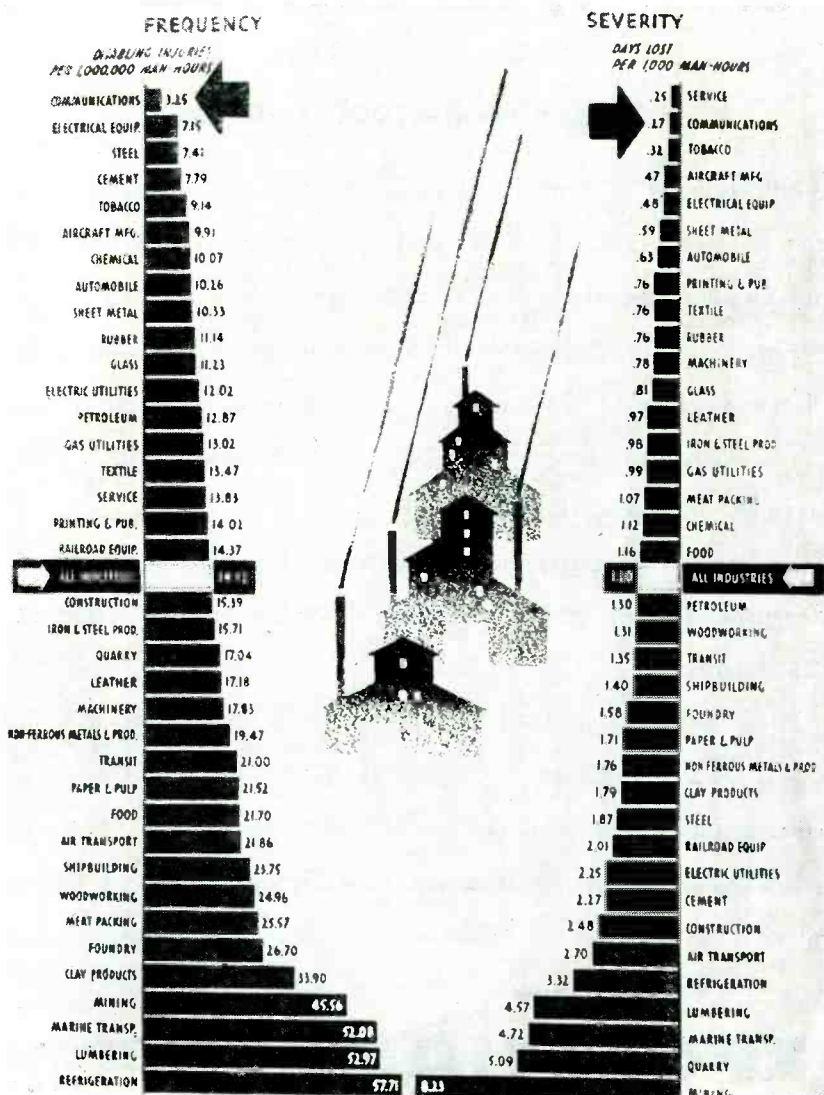
FREQUENCY MODULATION radio equipment is planned for installation in major Pacific Coast war centers to speed the flow of street cars and buses, according to recent disclosures by transit officials in San Francisco, Oakland, and Los Angeles. Necessary priorities and FCC permits have been secured for the spending of about \$40,000 on a two-way radio system in the Los Angeles Transit Lines. Facilities will include a 250-watt f-m station which communicates with emergency trucks, supervisors' automobiles, and many motor coaches and street cars as well.

In San Francisco, operators of the municipal railway have in mind a phototube recording device which would register the bunching up of street cars at strategic traffic locations, and radio equipment which would enable the dispatching of inspectors to the area. Repair and wrecking equipment would also be in two-way communication with the control tower. The entire installation would run to \$50,000. Oakland plans similar facilities on the Key System.

## Western Union Relay

FREQUENCY BANDS of various widths between 2,000 and 11,372 Mc have been allotted by FCC to Western Union Telegraph Co. for experimentation regarding the practicality of transmitting regular telegraph

## INJURY RATES FOR INDUSTRY—1943



From figures reported to National Safety Council



# PROBLEMS

## *in the UHF Field ?*



Your present or proposed product may demand precision in design, manufacture and performance. As specialists in the development of UHF equipment, we may be able to aid you in accomplishing this . . . at a lower cost. It's worth checking into. To help in the development of new products . . . or improve old ones, LAVOIE LABORATORIES offers this 3-point service:

1. **TECHNICAL ADVICE** by thoroughly experienced UHF engineers who know the "how" and "why".
2. **DESIGN** -- from the idea to the finished product, with a knack for practical, low-cost production.
3. **MANUFACTURE** of complete assemblies employing shop technique especially suited to UHF work.

Typical LAVOIE Products --



### UHF PRECISION FREQUENCY METER

Completely portable                      Accuracy 0.1%  
Battery or AC-Operated

Models available from 100 to 2000 megacycles with 2 to 1 frequency coverage on each model.

#### RECOMMENDED FOR:

- Production testing
- Measurement of oscillator drift
- Independent alignment of transmitters and receivers
- Precise measurements of frequencies



### UHF HARMONIC FREQUENCY GENERATOR

PROVIDES output voltages which are multiples of 10 or 40 megacycles with CRYSTAL-CONTROLLED accuracy.

SELECTS 10 or 40 megacycle series and IDENTIFIES one of these harmonics by means of a Frequency Identifier which consists of a filter providing high attenuation of all voltages except that of frequency to be identified.

USED FOR calibration of receivers, wave-meters, or using internal beat detector, for calibration of oscillators and signal generators.

## *Lavoie Laboratories*

RADIO ENGINEERS AND MANUFACTURERS  
MORGANVILLE, N. J.

**Specialists in The Development of UHF Equipment  
and in The Manufacture of UHF Antennas**

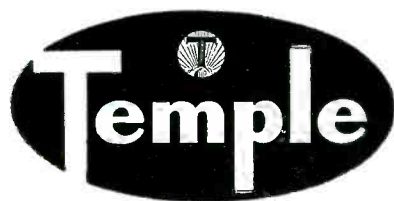


## NEW SECRETS

In the Temple Laboratories, engineers and technicians toil unceasingly to provide new and greater efficiencies for war communications equipment.

Needless to say that out of this constant search for betterment comes further discovery, further knowledge — new secrets of development in the limitless field of electronics.

Temple engineering skill and inventiveness, fostered still further by the stress and strain of war, will contribute richly indeed to the electronic world of the future.



*Electronics Division*

**TEMPLE TONE**  
**RADIO MFG. CORP.**  
New London, Conn.

service via radio relay. Test installations will be between New York and Philadelphia and two years' time has been authorized for construction.

A number of FCC regulations were waived in this case. For instance, regular commercial rates will be charged in order to create an exact parallel between wire and radio operation. Also, no call-letter transmission will be required.

Terminal stations will be located in the WU building in New York and in Camden, N. J., the latter station being remotely operated from Philadelphia. Two intermediate unattended repeater stations will be located in Bordentown and New Brunswick, N. J.

Maximum power at each station is to be 15 w and types of emission will include A0, A1 — A4, and special for multichannel telegraph, teleprinter, facsimile, and business machines. An RCA-developed modulation system will be used to get 32 circuits for each transmitter.

### Future Equipment Market?

RUSSIAN FAMILIARITY with U. S. electronic equipment will very likely be a great aid in future commercial relations, it appears from information recently presented by Foreign Economic Administrator Leo T. Crowley before the House Foreign Affairs Committee.

He pointed out that 12,000 airplanes sent there from the United States were all equipped with the latest radio and radar equipment. Other electronic gear found its way to Russia installed in 3,300 armored cars, 6,000 tanks, 5,500 prime movers and 1,700 ordnance service vehicles.

### Adapters for F-M Sets

IN THE LIGHT of discussion revolving about the question of shifting f-m frequencies to the 84-102-Mc band, several manufacturers have come out with equipment described as suitable for adapting old receivers to the new conditions.

Besides a unit which was presented during recent hearings by members of the FCC staff and reported as having been built for \$8.85 at retail prices of components, both Hallicrafters Inc., and Emerson Radio & Phonograph Corp. have



... SOLVED WITH

# Solder Seal and Zircon Prestite!

One of the most sensitive electronic assemblies in use by surface and submersible craft entails extremely rigid manufacturing requirements. A multiplicity of leads must be brought out through the cover. Units inside the case must be submerged in oil. Positive, vibration-proof hermetic seals must be maintained at every entrance point, as the slightest leak will cause condensation and failure.

A dual Westinghouse development is solving this problem—more effectively and more dependably than any means previously used.

This development is **SOLDER-SEALING** applied to Westinghouse **PRESTITE** porcelain and **ZIRCON PRESTITE**. Metallic bands, which are an integral part of the porcelain glaze, enable metal terminals and cover to be soldered directly to the porcelain. The result is a 100% hermetic bond between metal and porcelain at every point of contact.

The assembly is tested at pressures of 50 psi and 200° F temperatures. It has proved its ability to withstand any known temperature cycles and conditions of vibration encountered in its class of service.

This application is but one example of the vital part that several millions of Westinghouse **SOLDER-SEALED** bushings are playing in the success of military electronic and communications equipment.

Some of the many standard and semistandard **SOLDER-SEALED** assemblies available to manufacturers are shown in booklet B-3244. Ask for your copy. Westinghouse Electric & Manufacturing Company, P. O. Box 868, Pittsburgh 30, Pa. J-05157

### WHAT IS PRESTITE?

**PRESTITE** is an exclusive Westinghouse development that combines the high mechanical and dielectric strength of wet-process porcelain with the dimensional fidelity of dry-process porcelain.

**PRESTITE** is dense, nonporous. Compacting under high pressure and vacuum eliminates minute air pockets, and this minimizes distortion in voltage gradients and eliminates internal corona discharges. Rated L-2.

**ZIRCON PRESTITE** is a low-loss **PRESTITE** porcelain capable of operating at the ultra-high frequencies of present communications fields. It has exceptionally high mechanical strength and resistance to thermal shock. Rated L-4.



**Westinghouse**  
PLANTS IN 25 CITIES . . . OFFICES EVERYWHERE

**COMMUNICATIONS  
EQUIPMENT**



*Jennings*  
— RADIO —

VACUUM ELECTRONIC COMPONENTS

# "WALNUT" CAPACITORS

REVOLUTIONARY IN DESIGN, SIZE, WEIGHT

PATENT APPLIED FOR.— PHOTOGRAPH SHOWS SIZE OF JENNINGS "WALNUT" CAPACITOR IN RELATION TO HAND.

The latest and most highly successful electronic component is the Jennings "Walnut" size Capacitor, now in full production.

## **WALNUT VC, SERIES M — AMPERE SERIES 20**

### CHARACTERISTICS

Capacity Range 6-50 mmfd.

Maximum Current 20 Amperes Peak

Maximum Voltage 30KV Peak

Specially designed for high frequency operation

Self-healing in case of overload

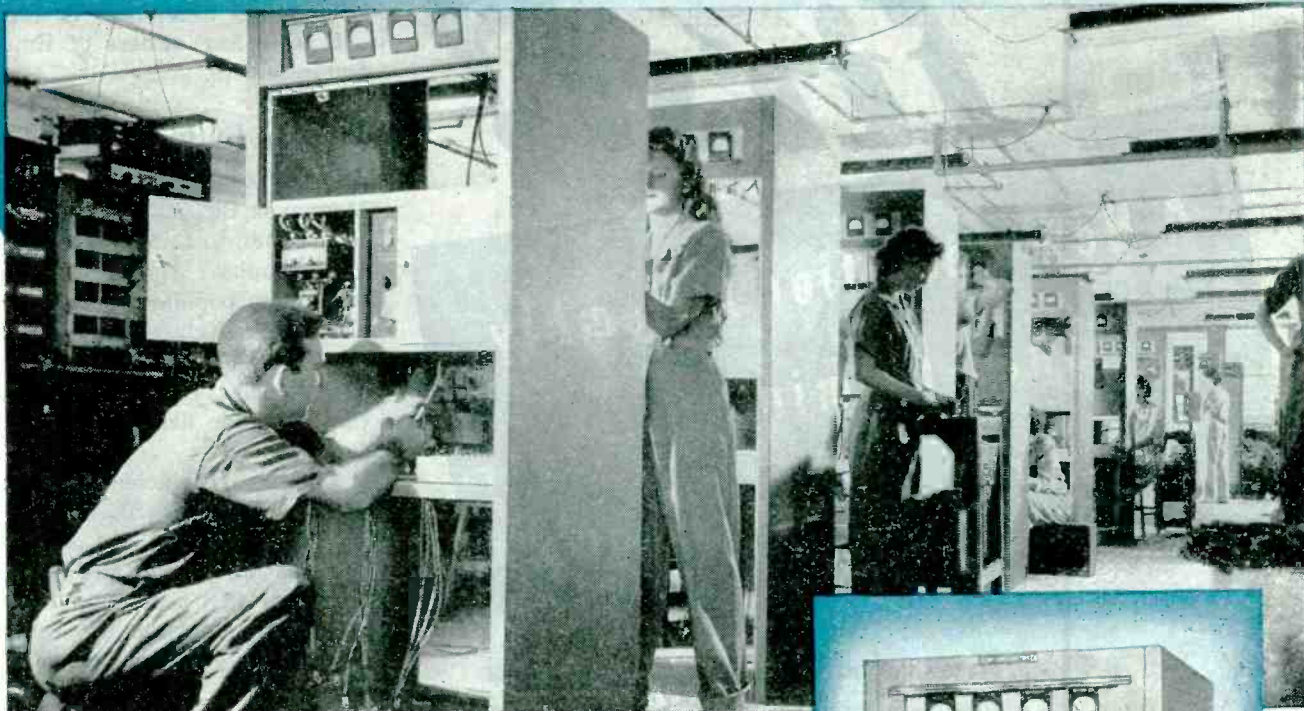
We can now accept orders for early delivery of this greatly improved, compact, plug-in type capacitor.

WRITE FOR BULLETIN E

**JENNINGS RADIO MANUFACTURING COMPANY • 1098 E. WILLIAM ST. • SAN JOSE 12, CALIFORNIA**

# "Line Production" Experience

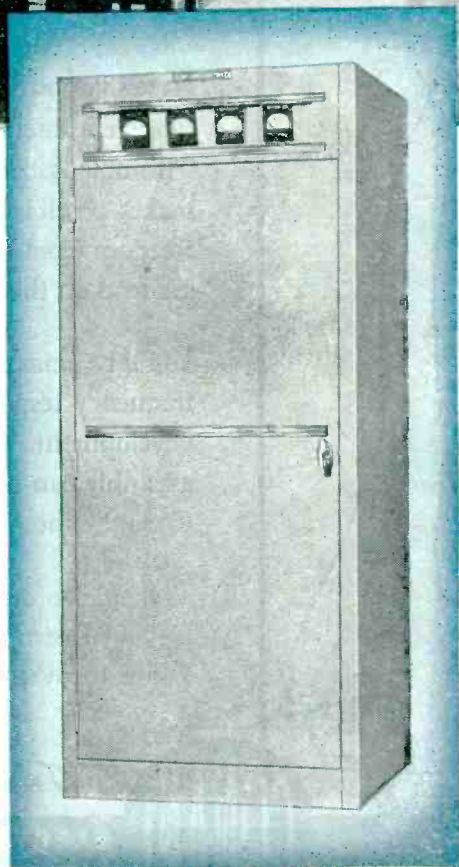
## IN RADIO MANUFACTURING



From Wilcox's war experience, as one of the largest manufacturers of radio communications equipment, has come many new products... a completely modern mass production factory... a trained engineering staff... plans and the knowledge needed for both war and peacetime products of highest quality. Look to Wilcox for leadership in radio communications equipment!



**Model 50A Modulator** — The 1600 watt 50A Modulator, shown at right, may be used for transmitter modulation, or high-powered audio needs.



### WILCOX ELECTRIC COMPANY, INC.

*Manufacturers of Radio Equipment*

FOURTEENTH AND CHESTNUT

KANSAS CITY, MISSOURI

# Another Conant first!

**A New Rectifier Assembly  
that Eliminates  
Temperature Variations**

Here's important news for users of rectifier type instruments. Conant has done it again! This new instrument rectifier application makes possible for the first time complete freedom from temperature errors. AC values are read on the same linear scale as DC values.

You'll be amazed at the vastly improved frequency response achieved by this new development. This remarkable assembly can be furnished in any of three Conant series (500, 160 or 160-C).

Available to original purchasers of Conant Instrument Rectifiers *license free*. Write today for details.



**CONANT**

*Instrument Rectifiers*

**ELECTRICAL LABORATORIES**

6500 O STREET, LINCOLN 5, NEBRASKA, U. S. A.

20 Vesey St., New York 7, New York  
85 E. Gay St., Columbus, Ohio  
600 S. Michigan Ave., Chicago 5, Ill.  
1215 Harmon Pl., Minneapolis 3, Minn.

2017 Grand Ave., Kansas City 8, Mo.  
1212 Camp St., Dallas 2, Texas  
378 Boulevard N. E., Atlanta, Ga.  
4018 Greer Ave., St. Louis, Mo.

1526 Ivy St., Denver, Colo.  
4214 Country Club Dr., Long Beach 7, Cal.  
Export Div., 89 Broad St., N. Y. 4, N. Y.  
50 Yarmouth Rd., Toronto, Canada

announced readiness of units of their own design.

Hallicrafters referred to two types which are ready to produce—one priced at \$5.60 and one at \$11, both FOB Chicago to quantity buyers. The more expensive of the two uses three tubes.

Emerson Radio & Phonograph Corp. described their adapter as relatively simple and expressed willingness to supply it free of charge to any owners of Emerson f-m receivers.

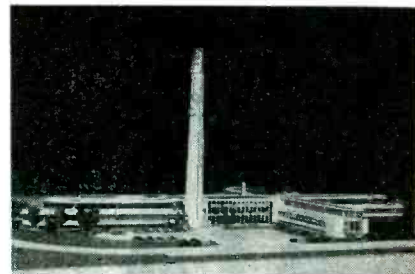
## Fidelity Enthusiasts

AS DISCOVERED in a poll taken by the Magnavox Co., a full two-thirds of the owners of Magnavox radio-phonographs consider popular music less popular than symphony and the other classics. Probably as a result, 44.3 percent of the owners list superior tone as the feature they look for first in home sound equipment.

Another significant fact uncovered by the investigation is that the record-player section of the combination is reported to be in operation 43.3 percent of the total playing time, while the radio receiver only gets the nod 56.7 percent.

## Laboratory Consolidation

ELECTRONIC SCIENTISTS of IT&T (International Telephone & Telegraph Corp.) in the U. S. and other countries are now grouped into a corporate unit—International Telecommunication Laboratories, headquarters of which will be in the Nutley, N. J. project illustrated.

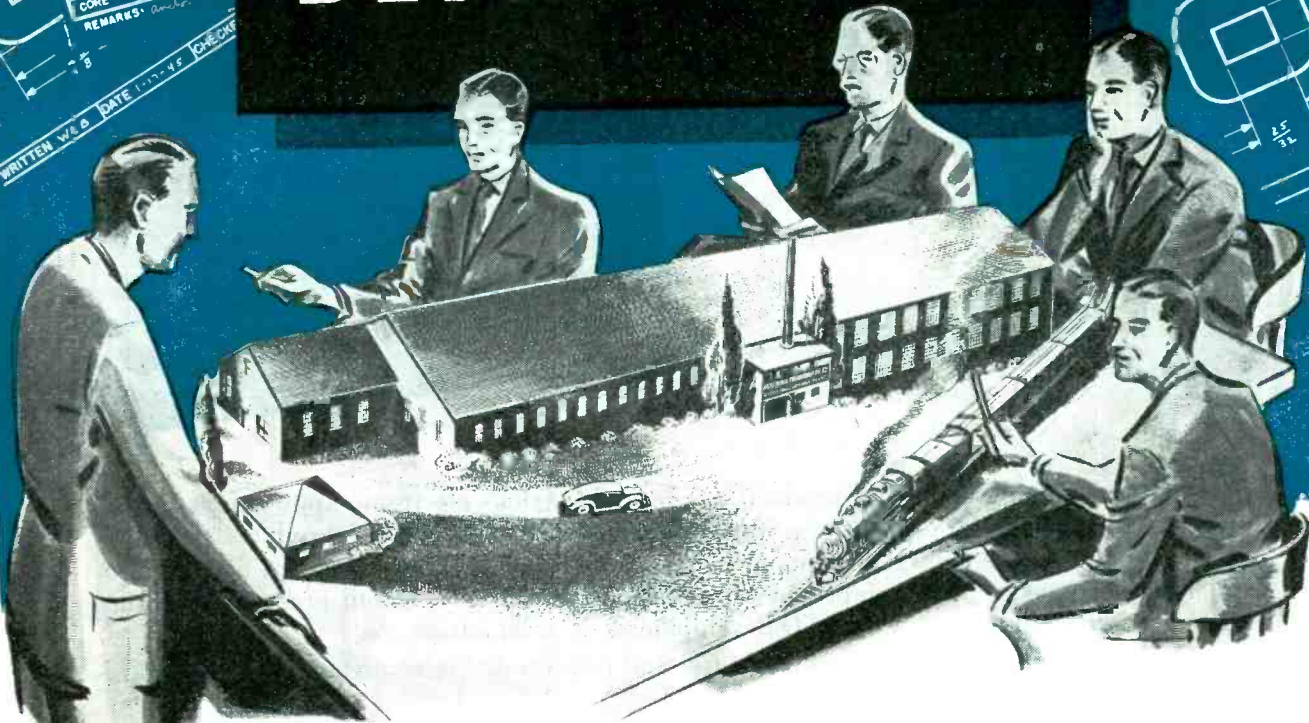


Designer's-eye view of the projected International Telecommunication Laboratories headquarters in Nutley, N. J. One unit has already been started

Capitalized at \$2 million, the new corporation is owned jointly by IT&T and a subsidiary, International Standard Electric Corp. President is E. M. Deloraine, gen-



# The New Plant of N·Y·T.. your TRANSFORMER DEPARTMENT



## Complete engineering and production facilities for TRANSFORMERS, CHOKES and FILTERS

Tooled up and geared for full production, the latest addition to N-Y-T facilities is rapidly assuming the role of "Transformer Department" to leading electronic and electrical manufacturers.

Complete in every phase of manufacture, the Alpha Division is one of the most modernly equipped plants in the East.

Important, too, is N-Y-T engineering collaboration — offering valuable assistance to engineers responsible for the design of electronic equipment. Close cooperation in this early phase of design inception results in better component suitability. It frequently effects over all economies and improvements. Inquiries are invited; there is no obligation.

Address Inquiries to Dept. E

**NEW YORK TRANSFORMER CO.**  
26 WAVERLY PLACE, NEW YORK 3, N. Y.



**N·Y·T**  
**HERMETICALLY-SEALED TRANSFORMERS**

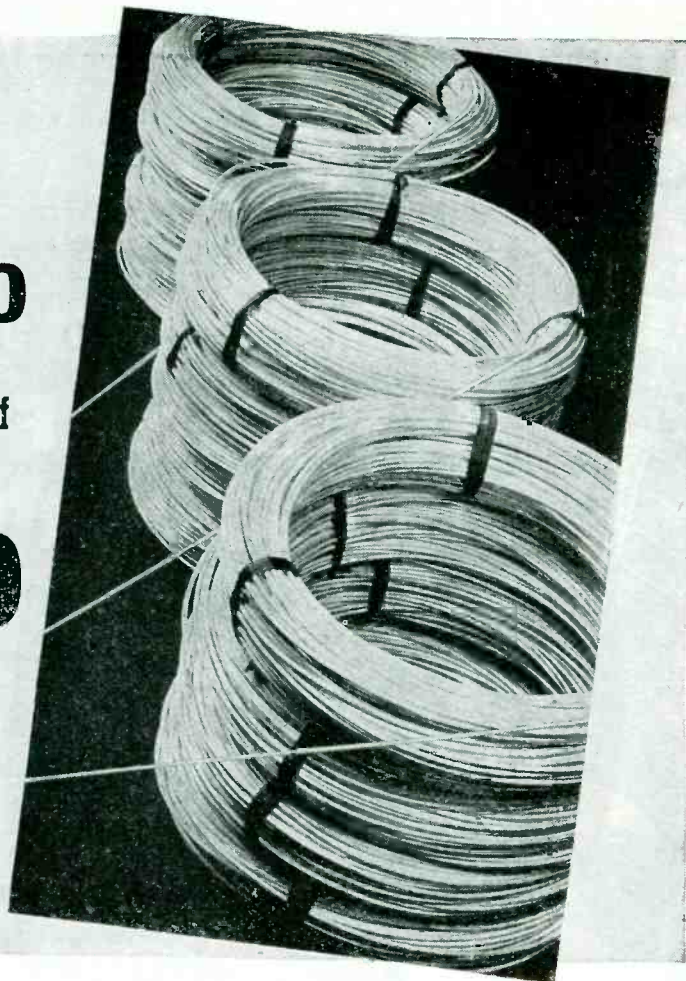
The product illustrated typifies N-Y-T hermetically-sealed components — transformers, chokes and filters—designed to meet unusual operating conditions for every type of application.

# WILCO

## NOW EQUIPPED

for large scale production of

# JACKETED WIRE



WILCO wire, tubing and other products are used in various electronic applications for the Army and Navy. In response to the wartime demand for these various products, the H. A. Wilson Company has enlarged its plant, increased its manufacturing facilities, added essential new equipment and developed new products and techniques. Both present and future customers will find these new WILCO developments of great advantage.

The H. A. Wilson Company manufactures and is interested in receiving inquiries regarding the following typical products—

#### WILCO JACKETED WIRE

Silver (Fine, Sterling or Coin)  
 Silver Jacketed Copper  
 Silver Jacketed Invar  
 Silver Jacketed Brass  
 Silver Jacketed Steel  
 Gold Jacketed Silver (Fine, Sterling, Coin)  
 Gold Jacketed Brass or Bronze  
 Copper Jacketed Monel  
 Nickel Jacketed Copper

#### WILCO JACKETED TUBING

Silver Tubing (Fine, Sterling or Coin)  
 Gold Tubing (any Color or Karat)  
 Silver Jacketed Brass or Bronze (one or both sides)  
 Gold Jacketed Silver (one or both sides)  
 Gold Jacketed Brass or Bronze (one or both sides)

#### WILCO STRIP MATERIAL

Silver (Fine, Sterling or Coin) on Brass or Bronze (Inlay or Overlay)  
 Gold on Silver (any Karat on Fine, Sterling or Coin)  
 Gold on Brass or Bronze

#### Other WILCO products include Electrical Contacts—

Silver, Platinum, Tungsten, Alloys, Powder Metal. *Thermostatic Bimetal* (High and Low Temperature with new high temperature deflection rates.) *Precious Metal Collector Rings*—For Rotating controls. *Silver Clad Steel*. *Rolled Gold Plate*. *Special Materials*.

*Let us analyze your problems.*

## THE H. A. WILSON COMPANY

105 Chestnut Street, Newark 5, N. J.

Branches: Detroit • Chicago





For mobile two-way  
communication specify  
**KAAR RADIOTELEPHONES**



**KAAR PTL-10X TRANSMITTER**

10 WATTS • 1600-2900 KC\*

The PTL-10X is a highly efficient medium-frequency mobile transmitter. It provides communication from a moving vehicle over distances ranging from 50 to 75 miles when used with AUTO-LOAD self-loading antenna.

The "Push-to-Talk" button on the microphone completely controls the transmitter, lighting the instant heating tubes, starting the power supply, automatically silencing the receiver, and switching the antenna to the transmitter. The standby current is zero.

Models for special applications are available, including the PTL-22X medium frequency transmitter with 22 watts output, and the PTS-22X, a 22 watt transmitter for operation in the 30-40 MC band.

◀ **KAAR AUTO-LOAD ANTENNA**

This antenna, with matching coil in the base, is designed for use with the PTL-10X (or with similar medium frequency transmitting equipment) and matches the 72 ohm transmission line from the transmitter and receiver without auxiliary tuning equipment. It provides an efficient method of obtaining maximum signal strength at medium frequencies with a short antenna. It can be quickly installed on the rear bumper or on the side of any vehicle.

*\*Special ranges to 7000 KC available on special order*

**KAAR 11X RECEIVER**

6 TUBES • 1600-2900 KC\*

The popular 11X receiver is a crystal controlled superheterodyne for mounting in an automobile or other vehicle. It contains a no-signal squelch circuit, and is designed for commercial, civil, and military applications.

This receiver offers remarkable accessibility. The top is removed by simply pushing aside two snap catches, or the entire receiver can be whisked out of the vehicle by releasing only four catches.

**KAAR  
ENGINEERING CO.**

PALO ALTO, CALIFORNIA



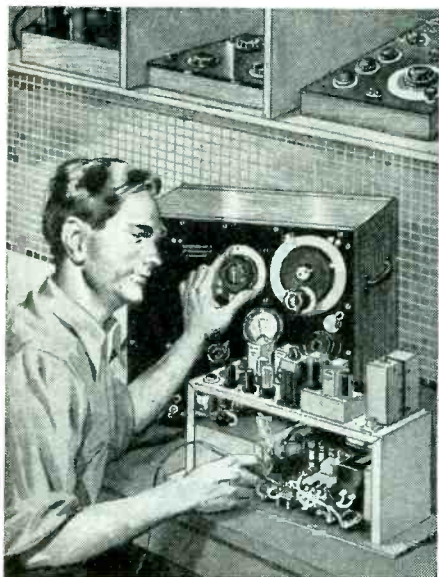
Manufacturers of high grade mobile and central station RADIOTELEPHONE EQUIPMENT • POWER PACKS • CRYSTALS • VARIABLE CONDENSERS MICROPHONES • AUTO-LOAD ANTENNAS

Export Agents: FRAZAR & HANSEN, 301 Clay St. San Francisco 11, California, U. S. A.

Look to COMCO for VHF

*Customized*

# Radio and Electronic Equipment



## Test-Proved for Dependable Performance

The Comco system of testing and inspection maintains a continuous and rigid control of quality. The finest scientific devices and instruments in the hands of experienced technicians insure positive protection against all usual causes of sub-standard performance. It is no accident that COMCO *customized* equipment has become widely known for unvarying quality and dependable performance.

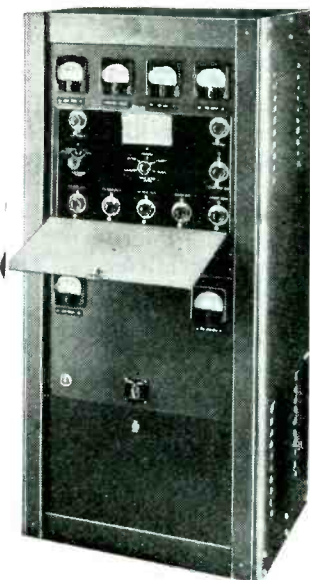
### COMCO VHF TRANSMITTER MODEL 170

Reliable VHF, 50 watts output. Frequency range 100 to 160 Mc. Cabinet size: Width 23"; depth 18"; height 48". COMCO Model 127AA Transmitter also available for operation on a frequency range of 200 to 550 kc.



### COMCO VHF RECEIVER MODEL 132

Compact VHF crystal controlled, fixed frequency, superheterodyne. Single channel reception; 5/8-inch relay rack panel mounting. 12 tubes. Frequency range 100 to 160 Mc. Medium and low frequency receivers also available.



*WRITE! Just a note on your company letterhead outlining your exact requirements. We'll give you the benefit of our specialized experience. We can supply a wide variety of customized equipment on priority NOW. We are accepting non-priority orders for post-war delivery.*

MANUFACTURERS OF RADIO & ELECTRONIC EQUIPMENT



COMMUNICATIONS COMPANY, Inc.

CORAL GABLES 34, FLORIDA

E. M. Deloraine,  
president of International  
Telecommunication  
laboratories; Nutley, N.  
J., science head-  
quarters of IT&T



eral director of Federal Telephone & Radio Laboratories. Vice-presidents include Harold H. Buttner and Douglas B. Baker.

Dedicated to initiating inventions, developing them, and providing an interchange of information among system laboratories in New York, London, and Paris, the new corporation will be located in a structure specially designed to meet the exacting requirements of electronic research. The first unit is presently under construction.

## Democratic Design

POSTWAR MODELS of Bendix radios will be influenced in their design by results of tests currently being conducted by that company. Audio-frequency range preferences are determined by comparison between a prewar receiver and a new wide-range job. Both instruments are set at peak bass and treble range for the first part of the test and at equal volume levels. Later one selection is played with both controls reduced. Listeners, who range from farm workers and business executives to bobby-sock swingsters and symphony patrons, record their votes on special forms.

Further tests for Bendix will be used to make decisions on the styling of receiver exteriors. Opinion Research, Inc. will conduct, throughout the nation, style clinics which will simulate actual retail showroom buying conditions.

## More Basic Science

ON THE THEORY that building new postwar industries and products for mass consumption will depend on the continued discovery of new scientific laws, Battelle Memorial Institute is planning an expanded program of research education. The program, which will be directed at the graduate level, is an expansion

THE FACTS ABOUT SMALL

METAL TUBING UP TO 5/8" OD

**S**uperior facilities are devoted exclusively to the production of small metal tubing. Long before the war we set our maximum size at 5/8" OD because experience has shown that only by so doing could we maintain high quality in the smaller diameters. As a result, we have a mill, operating at top speed, equipped to produce in a routine manner what formerly was known as "specialty" tubing. So, if you need cold drawn tubing in any metal, and the OD does not exceed 5/8"—then the inherent benefits of our specialization are yours for the using.

# SUPERIOR

THE BIG NAME IN  
**SMALL  
TUBING**

SUPERIOR TUBE COMPANY, NORRISTOWN, PENNSYLVANIA



FOR EVERY SMALL TUBING APPLICATION FROM 5/8" OD DOWN

SUPERIOR  Seamless in various analyses. WELD-DRAWN  Welded and drawn Stainless, "Monel" and "Inconel"

SEAMLESS and Patented LOCKSEAM Cathode Sleeves

# "CLIENT WILL BUY A BUSINESS"

If some of your War activities cannot be continued profitably in Peacetime, then perhaps a client of ours\* can help you.

Our client wishes to buy a going business or a complete department of a permanent organization.

This is to help them in the rapid expansion of a growing concern whose success is due to Electrical and Electronic Engineering talent, backed by proven merchandising ability.

Anything that can be made and sold to any branch of Electrical Communications will interest them; this includes Radio, Telephone, Telegraph, Television, Radar, Wire Photo, Sound on Film, Wire or Disc. An accessory widely used in these fields would be ideal.

Also, any items that would carry their technical ability into Industrial markets or into Air, Ground or Marine Transportation would be attractive.

They are particularly interested in products with protected positions either by virtue of patents, special "know-how" or limited markets; however, they would be glad to consider situations relating to mass markets.

They prefer products whose quality demands Engineering and Manufacturing skill thereby justifying above average sales prices and careful selling attention.

If you will be forced to stop work on any of your projects after V-day, either because they are out of line with your Peacetime activities or because they have insufficient sales volume to be of interest, then our client would like to meet you.

They would like to study your situation with reference to their ability to take over one of your projects, either now or later, and continue it on a mutually profitable basis.

\* All answers will be held confidential. Please reply to:

*Cory Snow, Inc.*

• M E R C H A N D I S I N G • A D V E R T I S I N G •  
739 BOYLSTON ST. BOSTON 16, MASS.

*\* We are authorized to furnish the name of our client if requested on your business letterhead.*



## ADVANTAGES OF THERMOPLASTIC

There are fourteen practical advantages of thermoplastic insulation over older types of construction . . . advantages which PLASTIC engineering now makes possible at what, in most cases, is NO PRICE PREMIUM. Check them yourself: 1. Superior aging properties, 2. High resistance to oxidation, 3. Low moisture absorption, 4. High dielectric strength, 5. High tensile strength, 6. Resistance to flame, 7. Flexibility at low temperatures, 8. Resistance to abrasion, 9. Resistance to chemicals, 10. Resistance to oils and greases, 11. Ease of installation, 12. Increased capacity, 13. Attractive appearance, 14. Broad color range. Remember . . . when you're thinking of PLASTIC you're thinking of US!

Thermoplastic insulation specialists . . . producing a complete line from fine wires to heavy power cables . . . serving: Public Utilities, Radio, Electronic, Appliance and Instrument Manufacturers, Telephone Companies and Contractors.

# PLASTIC

W I R E & C A B L E    N O R W I C H   C O N N .  
C O R P O R A T I O N

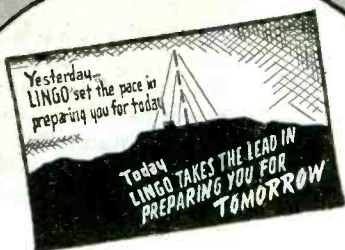
*\*Again Available!*

# LINGO

## VERTICAL TUBULAR STEEL RADIATORS

**\* AVAILABLE NOW ONLY TO THOSE WITH PROPER PRIORITY—READY FOR QUICK SHIPMENT TO ALL, THE MOMENT PRIORITY RESTRICTION ARE LIFTED. . .**

There's a Lingo Radiator and supporting pole for every need and purpose in standard heights—100 to 500 feet—for AM, FM, Television and other UHF uses. Immediate shipment to those with necessary priority. We invite your inquiries, whether your installation is large or small—for today or tomorrow.



**Send for Your FREE Copy of Our New Brochure, Full of Detailed Information on Standard and Special Types of Lingo Radiators**

**JOHN E. LINGO & SON, INC.**

Est. 1897

**CAMDEN, NEW JERSEY**

of the plan which has been markedly successful thus far with Ohio State University. It is expected to be of special interest to returning veterans, whose battlefield experiences has given them an awareness of the importance of technology.

### **Boost Program Transmission**

INCREASED TIME allotment and activation of new transmitters by OWI (Office of War Information) has made it possible for shortwave news and entertainment broadcasts to men and women of the armed forces overseas to increase by 50 percent. Shortwave transmitters on the East and West Coasts now transmit more than 960 hours of such material per week.

### **Postwar Receiver Markets**

SIX YEARS' PEAK production for the entire radio industry is anticipated postwar by Westinghouse Electric & Mfg. Co. which sees a postwar market for 60,000,000 home radio receivers.

The company's decision to re-enter the field was made on the basis of an extensive survey, and five factors were taken into consideration: (1) Frequency modulation will hasten replacements by outmoding sets; (2) Demand for radio-phonographs will increase the size of the market by increasing the average sale; (3) Establishment of new homes by returning servicemen will create a huge new market; (4) Extra sets to provide listening convenience throughout the home are expected to amount to a handsome volume; and (5) A steady growth in home television is anticipated.

Sylvania Electric Products has also dug up some facts about the postwar receiver market. Their investigation leads them to estimate that 100,000,000 radios will be sold in the first five or six years after the war. More people told them they would pay an additional \$75 for television than would spend \$10 extra for fm, but if they can get fm for \$5 the desire is practically unanimous.

Although only 5 percent of the set owners expressed a real dissatisfaction with their receivers, nevertheless 63 percent of the families who own three sets indicated that all were made by different manu-

# GIVE THIS NEW BATTERY A REAL LOOK...



ACTUAL SIZE



No. 412

This is "Eveready" "Mini-Max" "B" Battery No. 412. It furnishes 22½ volts, weighs 1½ ounces. Dimensions are 2" by 1 1/32" by 23/32". Compare its size with that of an ordinary wooden match box.

it's going to

# REVOLUTIONIZE YOUR BUSINESS

**M**EET the new "Eveready" "Mini-Max" midget "B" Battery. Embodying National Carbon Company's exclusive construction, it crams 22½ volts into a space smaller than any battery ever before conceived — approximately 2½ times smaller.

Think what it will mean in your business to have a 22½ volt battery "no bigger than a minute" and handy as a match box. It means that the portable radio business — nipped by the war just as it was getting a good start — will return with an even brighter future. It also means that radios can be made for the personal use of an individual. Made small enough to fit snugly in a vest pocket or a lady's handbag.

In this connection, we're cordially inviting America's engineers and designers to consult

with us. Bring your special problems to our engineers and our laboratories. We should like to cooperate with you in every way possible in order to speed the development of brilliant new battery uses for the good of the industry, right after the war.

**EVEREADY**  
TRADE-MARKS

**MINI-MAX**

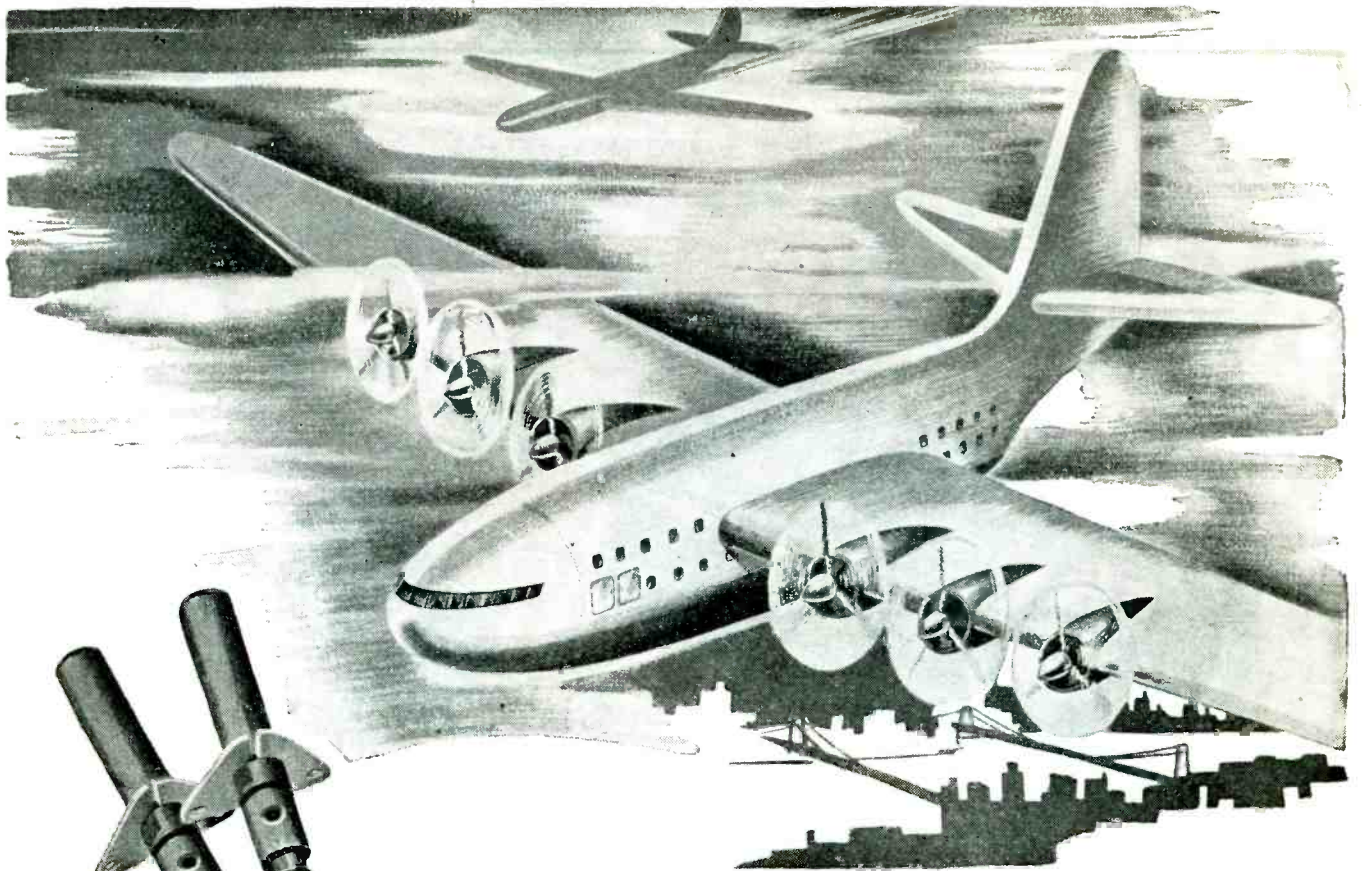
**RADIO "B" BATTERIES**

**NATIONAL CARBON COMPANY, INC.**  
*Unit of Union Carbide and Carbon Corporation*

**UCC**

General Offices: NEW YORK, N. Y.

The trade-marks "Eveready" and "Mini-Max" distinguish products of National Carbon Company, Inc.



## Continental-Diamond *Engineered Dielectric Materials*

The *DILECTO* parts illustrated are insulators in airborne radio equipment. Their insulating properties must remain stable at temperatures from 70° F below zero to 160° F above zero; in high humidity or extreme dryness.

KO-45

There are 6 C-D Engineered Dielectric materials, each of which provides designers and engineers with a different range of desirable properties. Each of these 6 C-D materials is made in several grades to meet specific electrical and mechanical problems. Our technicians will be glad to help you apply these C-D Dielectrics to your "What Material" problem.

C-D technicians have at their call the accumulated "know how" of 50 years of experience helping customers solve electrical insulating and mechanical problems. Use this wealth of information to help you solve your design and performance problems.

### C-D PRODUCTS

#### The Plastics

**DILECTO**—A Laminated Phenolic.  
**CELORON**—A Molded Phenolic.  
**DILECTENE**—A Pure Resin Plastic Especially Suited to U-H-F Insulation.  
**HAVEG**—Plastic Chemical Equipment, Pipe, Valves and Fittings.

#### The NON-Metallics

**DIAMOND** Vulcanized FIBRE  
**VULCOID**—Resin Impregnated Vulcanized Fibre.

**MICABOND**—Built-Up Mica Electrical Insulation.

**Standard and Special Forms**  
 Available in Standard Sheets, Rods and Tubes; and Parts Fabricated, Formed or Molded to Specifications.

#### Descriptive Literature

Bulletin GF gives Comprehensive Data on all C-D Products. Individual Catalogs are also Available.

#### DISTRICT OFFICES

NEW YORK 17    CLEVELAND 14    CHICAGO 11  
 SPARTANBURG, S. C.    SALES OFFICES IN PRINCIPAL CITIES

WEST COAST REPRESENTATIVES  
 MARWOOD LTD., SAN FRANCISCO 3

IN CANADA:  
 DIAMOND STATE FIBRE CO. OF CANADA, LTD., TORONTO 8

# Continental - Diamond FIBRE COMPANY

Established 1895...Manufacturers of Laminated Plastics since 1911—NEWARK 16 • DELAWARE



This equipment is designed to operate at

**115 V-AC**  
**60 cycles**

As a protection against voltage fluctuations a CONSTANT VOLTAGE TRANSFORMER has been built-in as a component part of this equipment. Rated performance will therefore be maintained at all times, regardless of input voltage fluctuations as great as  $\pm 15\%$ .

**SOLA**  
CONSTANT  
VOLTAGE  
TRANSFORMER

TYPE 12

4  $\frac{5}{8}$ "

2  $\frac{1}{2}$ "

3"

2  $\frac{1}{4}$ "

3  $\frac{3}{8}$ "

1 2 3 4  
5 6 7 8

GLASS SEALED TERMINALS

CONSULT BULLETIN CV-102 FOR COMPLETE ELECTRICAL AND MECHANICAL SPECIFICATIONS AND OPERATIONAL CHARACTERISTICS

## It is less expensive to provide built-in **CONSTANT VOLTAGE**

When you specify a SOLA Constant Voltage Transformer as a built-in part of your equipment there will be several components that you can write off your cost sheets. That's your first saving.

Now, estimate the number of anticipated service calls that would result from unstable voltages during your guarantee period. Write those off too.

Then—you can write off some

sales expense, because equipment that provides its own protection against voltage sags and surges, and maintains laboratory efficiency in its operation is easier to sell.

This Type 12 SOLA Constant Voltage Transformer, is one of several small, compact units that have been designed specifically for chassis mounting. They are being successfully used by manufacturers of many types of electrical and electronic

equipment. Where volume is indicated their cost is surprisingly low.

If unstable voltages have been a problem in war-time imagine what will happen when all of the much publicized electrical and electronic gadgets make their appearance on a peace-time market.

Consultation with our engineers now may give you the competitive advantage you are seeking for your peace-time sales.

# Constant Voltage Transformers

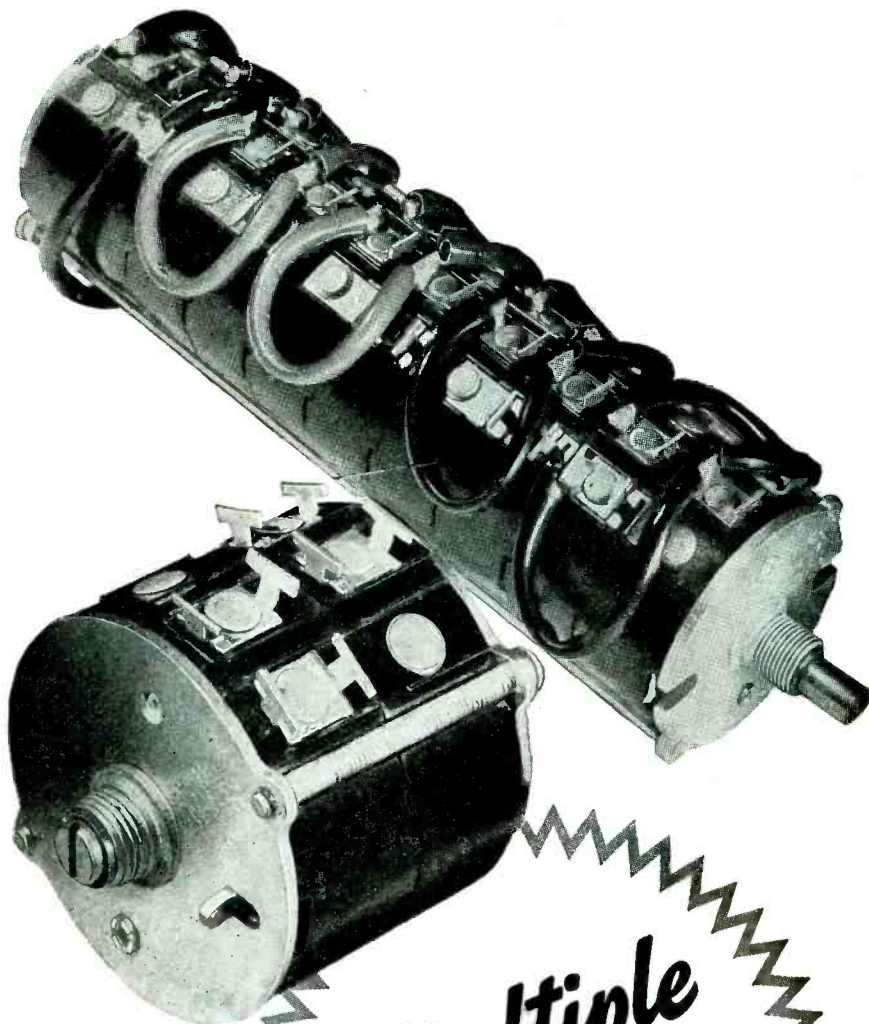
# SOLA

#### To Manufacturers:

Built-in voltage control guarantees the voltage called for on your label. Consult our engineers on details of design specifications.

Ask for Bulletin DCV-102

Transformers for: Constant Voltage • Cold Cathode Lighting • Mercury Lamps • Series Lighting • Fluorescent Lighting • X-Ray Equipment • Luminous Tube Signs • Oil Burner Ignition • Radio • Power • Controls • Signal Systems • Door Bells and Chimes • etc. SOLA ELECTRIC CO., 2525 Clybourn Ave., Chicago 14, Ill.



# Multiple CONTROLS

Single shaft passes through and locks with rotor of each unit.

Each unit can be wound to precise circuit requirements, as to resistance, taper, tap, hop-off.

Interlocking resistance ratios provide any desired voltage or current at given degree of rotation.

Note dual unit with screw-driver adjustment. Such assemblies are serving in the most intricate electronic assemblies.

★ For three or more controls in tandem, Clarostat Type 42 is the logical choice. The bakelite cases of these rheostats or potentiometers nest and lock together for a virtually solid casing. Metal end plates and tie rods insure a rigid assembly—even up to 20 units in tandem. This unit is the solution to your multiple-circuit control. Back-lash is completely eliminated. And it is typical of that Clarostat “know-how” which provides the answers to all your resistor, control or resistance-device problems.

★ **Submit your problem!**

facturers. Push-button tuning is fairly popular. Of the 31 percent of the respondees having the feature, three-quarters like it while the rest of them report unsatisfactory service. Popularity ratings among the particular group surveyed indicate brand preferences in the following order: Philco, RCA, Zenith, Emerson, Silvertone, General Electric, Crosley, Majestic, Air Line and Stewart Warner.

## Tube Standardization

TRANSMITTING, receiving, industrial, and non-industrial tubes will be standardized through the activities of JETEC (Joint Electron Tube Engineering Council). This agency is established in cooperation by RMA and NEMA. Present tube standards will not be affected. Four members will comprise the engineering council, two each of which will be from RMA and NEMA. Members are: O. W. Pike, General Electric, chairman; J. R. Steen, Sylvania Electric Products; A. Seanuque, Amperex Electronic Corp.; and D. D. Knowles, Westinghouse. Dr. W. R. G. Baker, GE and RMA, and A. C. Streamer, Westinghouse and NEMA, will be a policy committee to operate through the RMA Data Bureau.

## Watts to Do About It

BROADCAST STATIONS have been asked to support the building fund campaign of IRE by keying their contributions to the power of their transmitters. Radio stations operating under 750 watts are asked to contribute 10 cents for each watt radiated, while stations over 750 watts are only called upon for 5 cents per watt.

## Postwar Microwaves

TELEVISION, walkie-talkie, plane-to-plane, vehicle-to-vehicle, commercial radar and relay-link communication are only a few of the possible uses to which the transmission and reception of microwaves will be put as soon as the war is over, in the opinion of Dr. W. W. Hansen, research engineer for the Sperry Gyroscope Co., who addressed members of the IRE in Rochester recently.

He gives three reasons for this feeling: (1) Theoretically, at least,



**CLAROSTAT**

*Controls and Resistors*

CLAROSTAT MFG. CO., Inc. · 285-7 N. 6th St., Brooklyn, N. Y.



### FM STATION WGTR

Owned and operated by the Yankee Network

FREQUENCY: 43.3 MEGACYCLES  
INPUT TO FINAL AMPLIFIER: 83 KW.  
OUTPUT TO ANTENNA: 50 KW.  
TOTAL HOURS OPERATION TO DATE: 29,100  
PERCENT OPERATING TIME TO OUTAGES: 99.92%  
TYPE OF TRANSMITTER: REL NO. 521 DL

### COMPARE THIS RECORD

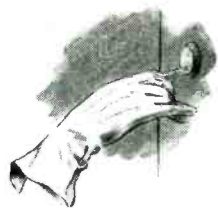
Only REL has built FM transmitters in this high-power class. Yet the performance record of WGTR compares favorably with even the low-power installations of other makes.



THE VITAL LINK . . . Broadcasting originating in Station WEOD, Boston, are relayed without wires to station WGTR, Paxton, . . . 43 miles distant . . . and thence to the six stations which comprise the Yankee Network. Thanks to WGTR, and to its consistently fine

performance, the Yankee Network has functioned perfectly since 1942. REL installations have clearly demonstrated the dependability and efficiency of the Armstrong Phase Shift method of frequency modulation . . . the method employed in REL transmitters of all power ratings.

**RADIO ENGINEERING LABS., INC.**  
*Long Island City, N.Y.*



more efficient  
... in miniature



Imagine a lady carrying a bunch of keys for old time locks in her evening bag. Their bulk and weight would make this impractical... yet, for modern locks, it is common practise for her to carry several keys. Imagine trying to crowd a kit of old-style large tubes into the midget receiving set of the future. TUNG-SOL Miniature Electronic Tubes have indeed opened up new possibilities in compactness and weight.

When miniature tubes were introduced, they created much interest... but set manufacturers asked "will they work as well?" The answer is "yes." In most circuits, miniatures do a better job than large tubes. Some high frequency circuits could not even be designed with large tubes. Added advantages of miniatures are their small size and reduced weight.

The experience gained at TUNG-SOL in producing tubes of all kinds for wartime purposes is at the disposal of manufacturers engaged in building more efficient electronic equipment. TUNG-SOL engineers will be glad to aid in the improvement of circuits and in a better selection of tubes. Your future plans will be held in strictest confidence.

# TUNG-SOL

*vibration-tested*

## ELECTRONIC TUBES

TUNG-SOL LAMP WORKS INC., NEWARK 4, NEW JERSEY  
Also Manufacturers of Miniature Incandescent Lamps, All-Glass Sealed Beam Headlight Lamps and Current Intermittors



# "TAKE 'ER DOWN"

and Sickles "Submersible" R. F. Components are unharmed

WATER, corrosive chemicals and gases, even fungi are harmless to Sickles "Submersible" R. F. Components.

They are hermetically-sealed with wide soldered joints in sturdy deep-drawn zinc "hulls." They are equipped with fused metal-to-glass bushings. All adjustments are under rugged "hatches" that are sealed with Neoprene gaskets.

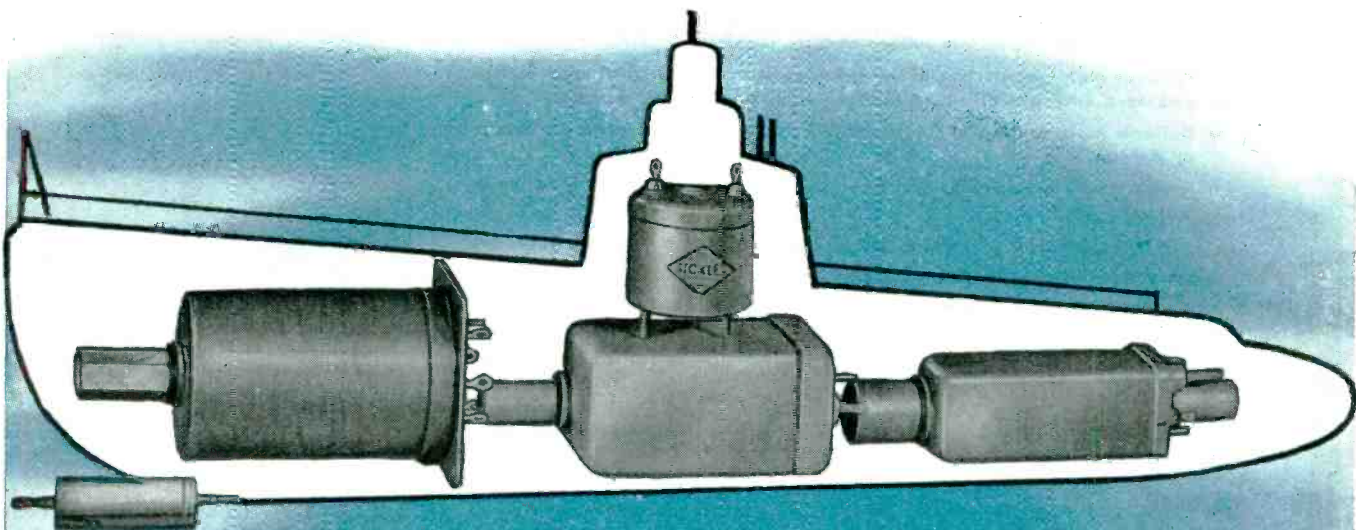
*Permanent efficiency is sealed IN —  
harmful elements are sealed OUT*

Flexibility is practically unlimited. Tell us your needs, give us plenty of room and we can produce a "Submersible" R. F. Component that once installed can be forgotten.

For best in circuit components, specify Sickles.

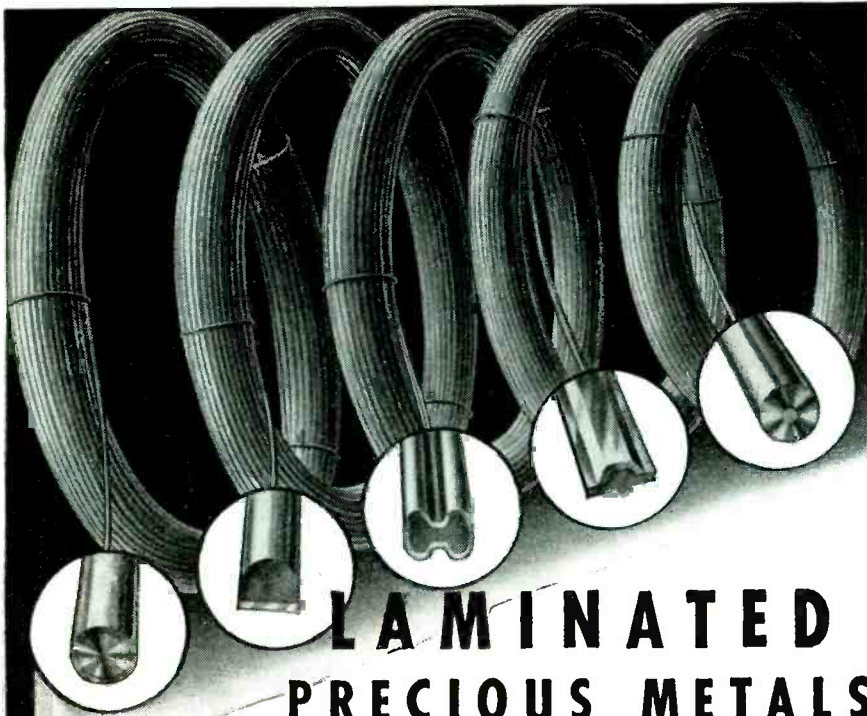
THE F. W. SICKLES COMPANY

• CHICOPEE, MASSACHUSETTS



# SICKLES

*Radio and Electronic Specialties for Today and Tomorrow*



## LAMINATED PRECIOUS METALS *for New* INDUSTRIAL USES

Laminated wire can be shaped for any industrial use, has application in many types of instruments and in any apparatus where corrosion must be prevented.

Typical uses include electrical contact strips, formed plated springs, low cost electric wire (silver-coated steel), radio electronic parts . . . where expansion must be held to a minimum (silver on invar) . . . or any project where electrical superiority, durability, or corrosion resistance is important.

Gold, silver, platinum and palladium or special precious metal alloys laminated to base metal have made these things possible . . .

- The desirable electrical, mechanical or chemical qualities of the precious metals have been added to the strength or other desirable properties of base metals, precisely where and as required.
- Precious metal properties of corrosion resistance, electrical superiority, and durability are obtained without solid precious metal costs.
- Uniform maintenance of lamination ratios with no porosity, pit marks or defects.
- Finer, more lasting finishes than are otherwise obtainable in base metals.

To assist you in the application of our products to your products we are maintaining a staff of thoroughly experienced metallurgists, chemists, designers and consultants . . . an up-to-date research and testing laboratory . . . and a splendidly equipped tool room. These are all at your service to cooperate with your own staff to the full extent of our facilities.

Your inquiries are cordially invited. Ask, too, for a copy of our new descriptive folder.



*Makepeace* PRODUCTS

SHEETS • WIRE • TUBING • SOLDERS  
FABRICATED PARTS AND ASSEMBLIES

**D. E. MAKEPEACE COMPANY**

Main Office and Plant, ATTLEBORO, MASS.

New York Office, 30 Church St.

two or three million stations can operate simultaneously and in the same neighborhood without interference; (2) Passage of signals between transmitter and receiver can often be accomplished with less attenuation than is possible with longer wavelengths; and (3) The small physical size of a wavelength makes it economic and practicable to manufacture equipment larger than several wavelengths in size—necessary for relaying and projected new methods of private communication.

### Receiver Licensees

COMPANIES PLANNING to produce radio receivers after the war, and therefore having arranged licenses with Radio Corp. of America, include: Bendix Aviation Corp., New York; Lear Inc., Piqua, Ohio; ARF Products, River Forest, Ill.; Medco Mfg. Co., New York; Whiting & Davis Corp., Plainville, Mass.; Concert Master Radio & Television Co., Chicago; and Ranger Electronic & Mfg. Corp., New York.

### Postwar Television Receivers

RADIO CORP. of America and National Broadcasting Co. recently demonstrated an advance development model of the Schmidt-system



Large-screen television receiver of advance development type demonstrated in New York recently. Picture is 16 x 21¼ in., and appears on a treated plastic viewing screen

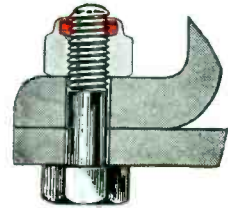
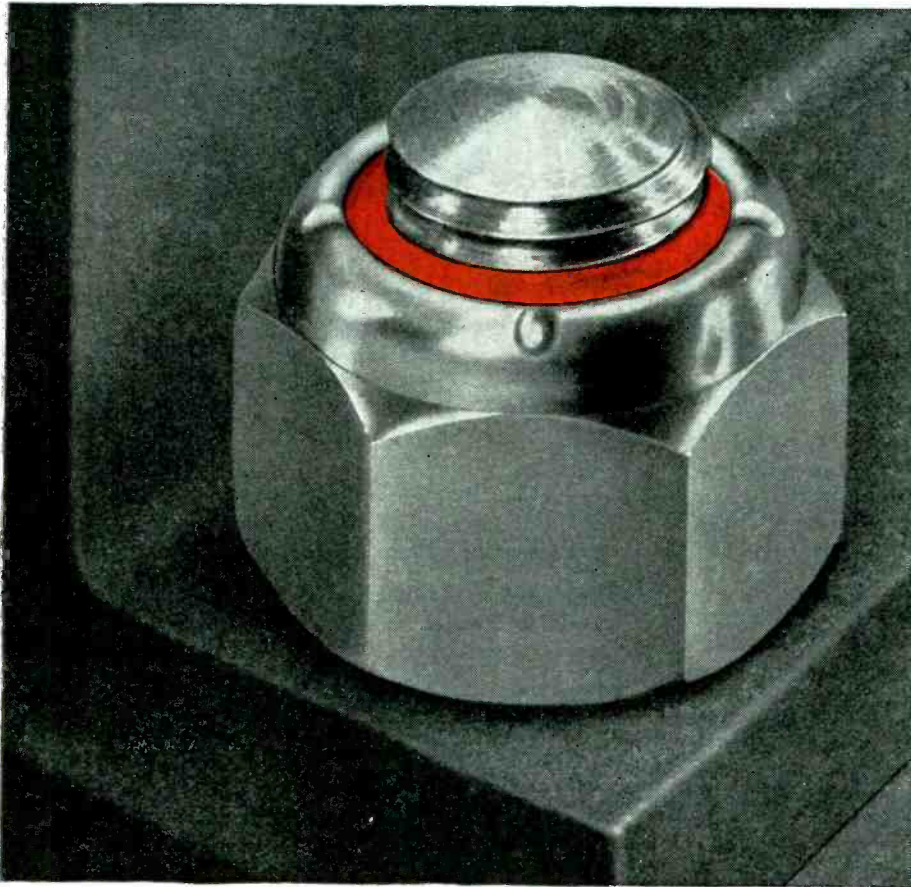
reflecting-type television receiver described in *ELECTRONICS*, December 1944.

Audience reaction to the demonstration was universally good. Pictures, which came from the studio by wire line, were clear and had a bluish tone. The standard 525 lines were used and the screen was 16 x 21½ in.

Besides the reflective optical sys-

# A HOLD-DOWN

*for Keeps*



Elastic Stop Nuts have been successfully used for hold-down bolts where security is vital. They give a positive fastening wherever there is vibration, impact, shock, stress change. Let us send an application engineer to discuss the Elastic Stop Nut way of avoiding nut failures that may be a costly service item on your products.

This nut uses its head.

An Elastic Stop Nut carries its own insurance for a positive hold-down fastening — the elastic collar built into its head.

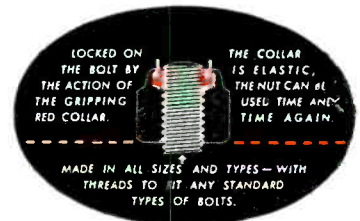
Here's how this device works:

The tough but resilient elastic collar forms itself to the individual bolt threads, grips them so tightly that the nut won't loosen up or back off even under the severest vibration.

Forget about cotter pins, lock-washers or any other auxiliaries when you use an Elastic Stop Nut. That means no chance of leaving off these extras as well as saving time in assembly and servicing.

Once on, an Elastic Stop Nut stays on. And it can be used over and over again without losing the grip of its headpiece.

Result: Economy in production and economy in use.

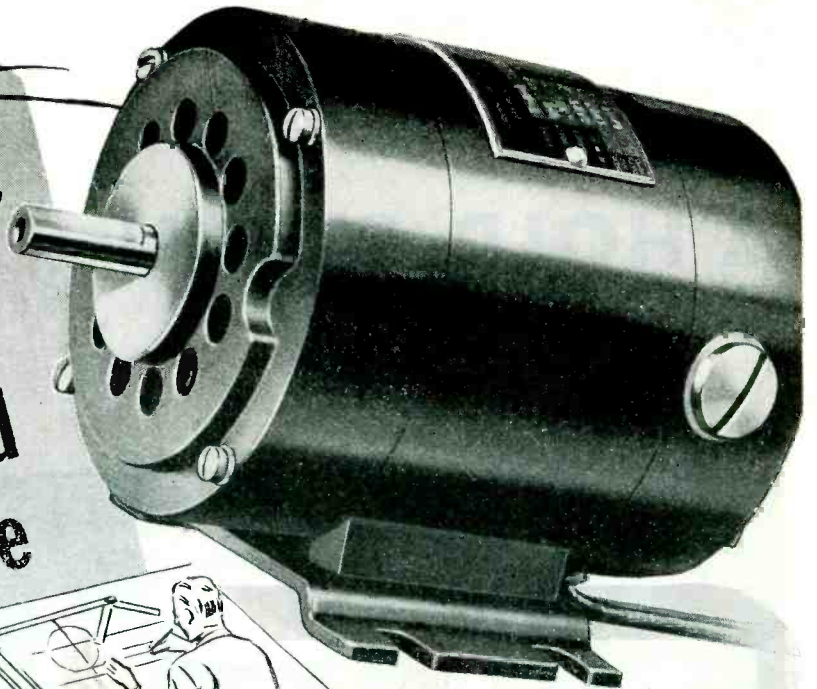


## ESNA

TRADE MARK OF  
ELASTIC STOP NUT CORPORATION OF AMERICA  
Union, New Jersey  
and Lincoln, Neb.  
Sales Office—1060 Broad St., Newark 2, N.J.

**ELASTIC STOP NUTS**  
*Lock fast to make things last*

# This Dependable *Oster* Motor Has a Proved Performance Record . . .



Your post-war products will do a better job with an Oster Motor

If the designs on your drawing boards call for fractional H.P. Motors with maximum H.P. ratings from 1/12 to 1/50 H.P., be sure to check the quality features and design characteristics of this Oster motor.

Behind this Oster Motor stands 15 years of experience in designing and building quality fractional H.P. Motors — motors that have won world-wide acceptance in famous Oster appliances . . . motors that have won laurels in the service of war.

This Oster Motor gives you the advantages of light weight, compactness, and dependable, trouble-free performance. Check the quality features and chart below. If these are the features you want, call us for further detailed information.

**HOUSING**—Die cast, open or totally enclosed.

**FINISH** — Black, baked enamel.

**BEARINGS** — Single shielded ball bearings. Bearing housing fitted with steel inserts.

**BRUSHES** — Furnished with metal graphite or electro graphite brushes of ample size to

assure unusually long brush life. Phosphor bronze or beryllium copper brush springs.

**WINDINGS** — Available for operation on 12, 24 or 115 volts, in shunt, series, and split series types.

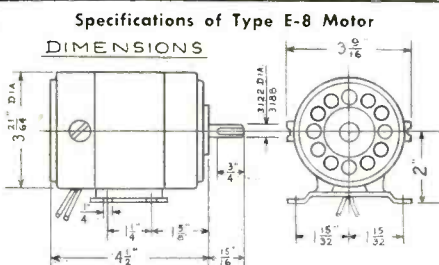
**MOUNTING** — Available for either base or flange mounting.

**MODIFICATIONS** — Motors can be furnished with special shaft extensions, finishes, leads, etc. Motors can also be furnished for operation in high ambient temperatures and high altitudes.

*All ratings and data are approximate.*

Let us help you fit this and other Oster Motors to your requirements.

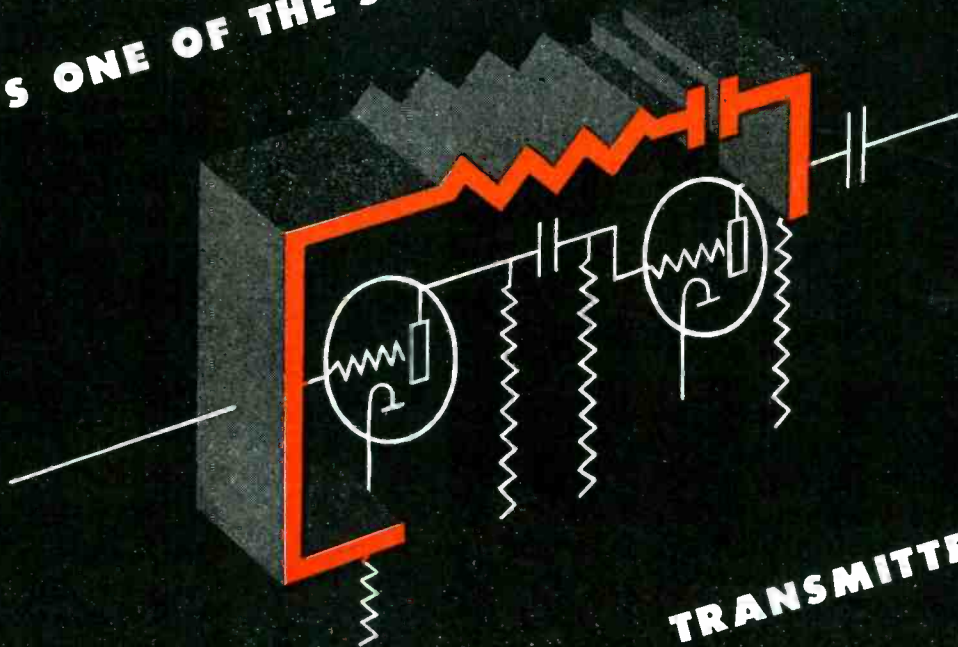
24 VOLT SHUNT CONTINUOUS DUTY IN 25° C. AMBIENT					
Maximum H.P.	1/12	1/16	1/25	1/35	1/50
R.P.M.	7500	5800	3800	2800	1750
Amps Input	3.8	3.2	2.2	1.8	1.5
Starting Torque in % of F. L. Torque	200 min.	200 min.	200 min.	200 min.	200 min.



**John Oster Manufacturing Co.**  
DEPARTMENT L-25 • RACINE, WISCONSIN M-25

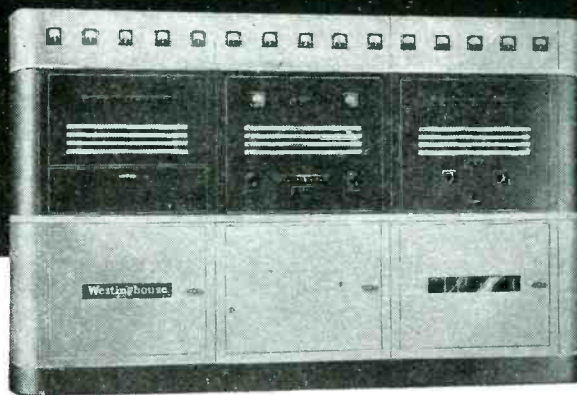


HERE'S ONE OF THE SECRETS OF HIGHER FIDELITY



IN WESTINGHOUSE

TRANSMITTERS



Here's one of the secrets of the higher fidelity in Westinghouse 5 and 10kw transmitters: it's called equalized audio feedback (see drawing) and it's an outstanding contribution to higher signal fidelity.

Equalized audio feedback strengthens the already high fidelity of the audio and modulation circuits in Westinghouse transmitters, and reduces audio distortion to even lower limits. The system is independent of any variation in rectified antenna output.

Control-simplicity, economy and high fidelity are natural partners of the solid dependability you find in the complete line of Westinghouse transmitters . . . 5, 10 and 50kw AM and 1, 3, 10 and 50kw FM. Your nearest Westinghouse office has all the facts on these newest achievements in faithful transmitter operation designed by Westinghouse . . . the oldest name in broadcasting. Westinghouse Electric & Manufacturing Company, P. O. Box 868, Pittsburgh 30, Pa. J-08110

Easy operation is another keynote of the smartly-styled Westinghouse 5kw transmitter . . . one master switch puts the transmitter on the air and cuts off power at close of broadcast day. Controls reset automatically whenever overloads occur in any circuit for any reason.



**Westinghouse**  
PLANTS IN 25 CITIES . . . OFFICES EVERYWHERE

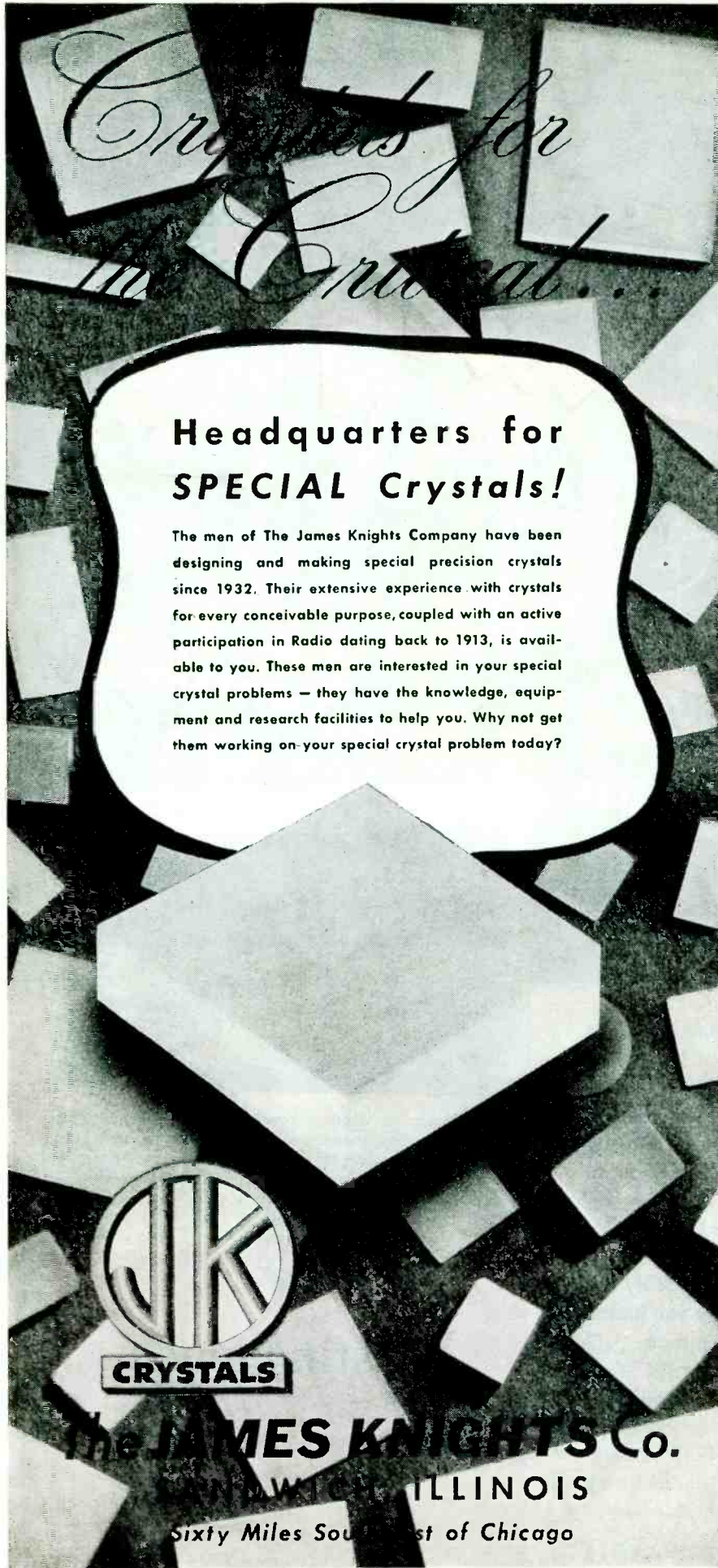

*Electronics at Work*

XXV—RADIO'S 25TH ANNIVERSARY—KDKA

*Crystals for  
Special*

## Headquarters for SPECIAL Crystals!

The men of The James Knights Company have been designing and making special precision crystals since 1932. Their extensive experience with crystals for every conceivable purpose, coupled with an active participation in Radio dating back to 1913, is available to you. These men are interested in your special crystal problems — they have the knowledge, equipment and research facilities to help you. Why not get them working on your special crystal problem today?

**The JAMES KNIGHTS Co.**  
CHICAGO, ILLINOIS  
Sixty Miles South West of Chicago

tem and plastic correction lens, the unit features a built-in translucent plastic viewing screen; an automatic frequency control system, which virtually eliminates picture distortion caused by interference from noise impulses; and a new 27,000-volt cathode-ray tube. When put in production, RCA-Victor expects to market the receiver for \$395.

### Radar Traffic Control

ULTIMATELY, in the opinion of William P. Lear, Lear Inc., aircraft and ship traffic will be controlled by radar systems. Speaking before the Aviation Writers' Association in New York recently, he suggested that an aircraft control tower might be equipped with a cathode-ray tube several feet in diameter with spot indications for all the airborne aircraft within the traffic area involved.

This indicator would be such as to reveal the position of planes up to a 5,000-ft. altitude and within a hundred mile radius.

From the point of view of the private flyer, other, more immediate developments described by Mr. Lear include a system of omni-directional ranges that makes it possible for a pilot to determine for himself the necessary angle to approach a given point. Such a unit is better than a direction finder since the pilot can make his correction for wind-drift to avoid flying a parabola-shaped course. This system has been made

• • •

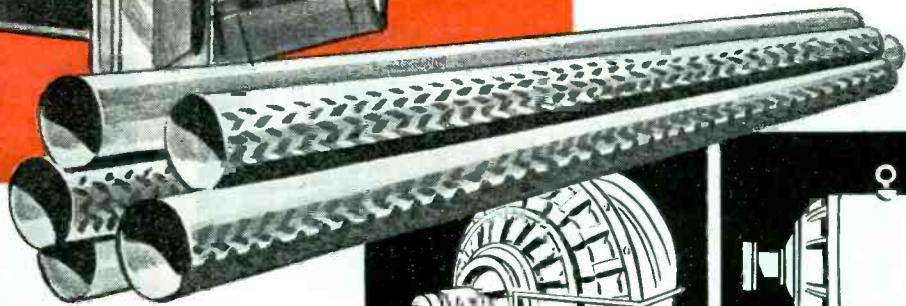
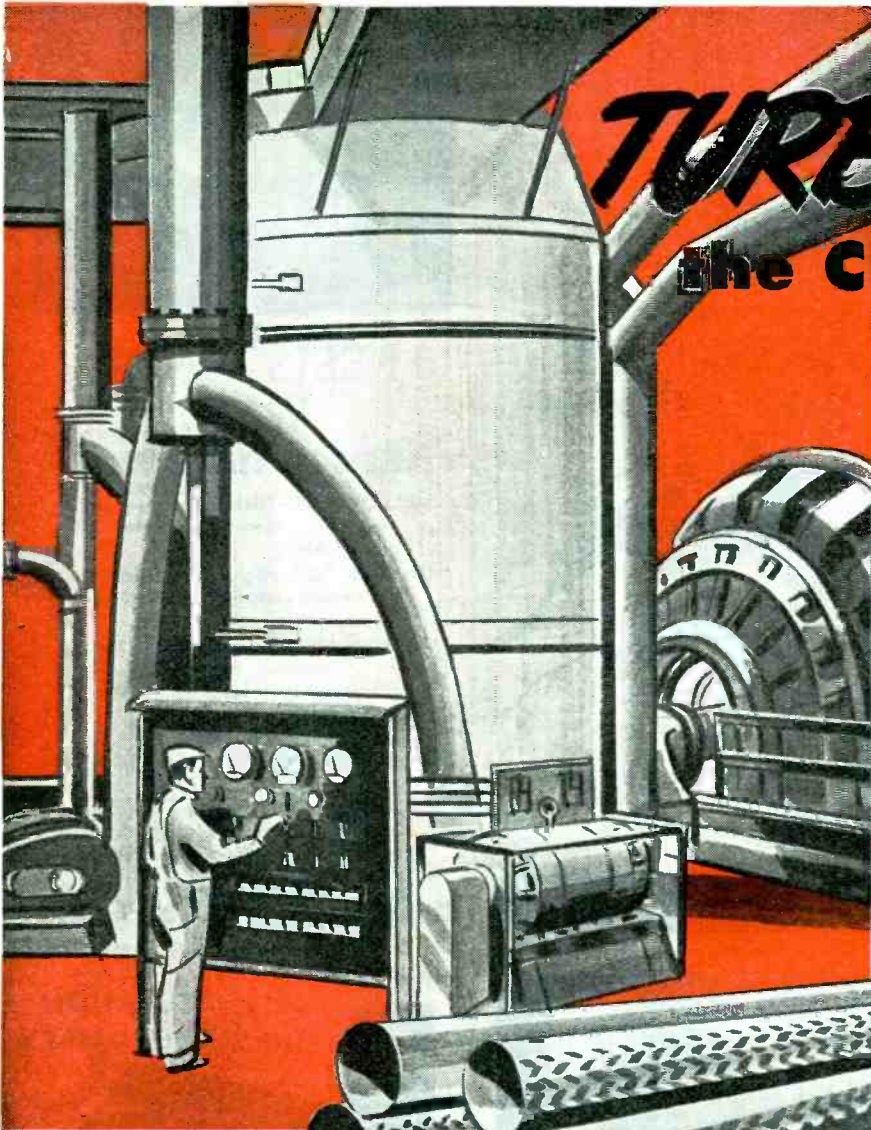


Other members of WCEMA (West Coast Electronic Manufacturers' Association) look on as H. L. Hoffman (Hoffman Radio Corp., Los Angeles) left, shakes hands with Bud Bane (Technical Radio, San Francisco). Mr. Hoffman is retiring as president to be succeeded by Mr. Bane. Other officers include Herb Becker (Eitel-McCullough, Inc., San Bruno) as secretary and James L. Fouch (Universal Microphone Co., Inglewood) as treasurer.

# TURBO majors in the Chemical field

...and sets new standards for electrical insulation efficiency for all industries!

Chemical plants—tough proving grounds for any type of electrical insulation—involve severe deteriorating influences; acids, alkalis, solvents, corrosive fumes, vapor, moisture and humidity are usually encountered. Not to be outdone, wide temperature fluctuations add materially to the hazards of insulation, too.



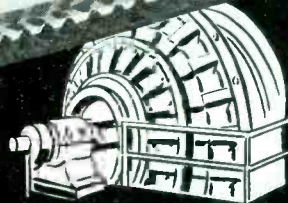
**TURBO Sleevings**—diversified in characteristics—provide solutions to these adversities. They are available in four types to meet specific operating conditions—Extruded Tubing for immunity to sub-zero temperatures; Varnished Glass Tubing for resistance to high heat; Flexible Varnished Oil Tubing for resistance to chemicals, moisture, etc. All feature perfect concentricity and smooth bore for rapid and easy installation.

**TURBO Wire Markers**, too, are supplied in all sizes, colors and markings. They are easily applied, permanent and simplify maintenance and repair. Write today for the free **TURBO Sample Board**; specimens and sizes of each type tubing are included.

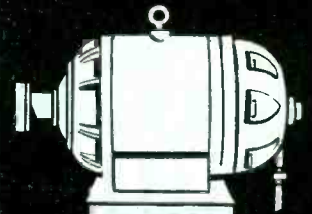
## WILLIAM BRAND & COMPANY

376 FOURTH AVENUE, NEW YORK 10, N. Y.  
325 W. HURON STREET, CHICAGO 10, ILL.

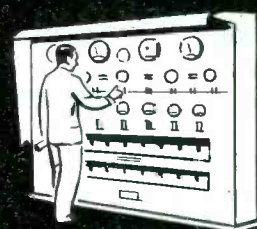
BLOCK MICA • MICA PLATE AND PRODUCTS • VARNISHED OIL TUBING  
SATURATED SLEEVING • VARNISHED CAMBRIC • CLOTHS AND COMPOSITES



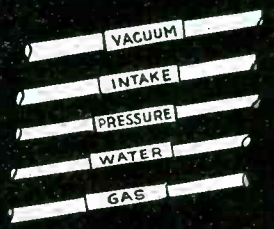
**FLEXIBLE VARNISHED OIL TUBING:** This product finds application where immunity to corrosive fumes, acids, alkalis and solvents is essential. It is impervious to moisture and non-hygroscopic. An important insulation for chemical installation.



**VARNISHED GLASS TUBING:** An extensively used sleeving, resistant to high temperature. Recommended for heavy duty in confined areas where ventilation is at a minimum. Suitable for enclosed motors and wiring subjected to high heat.



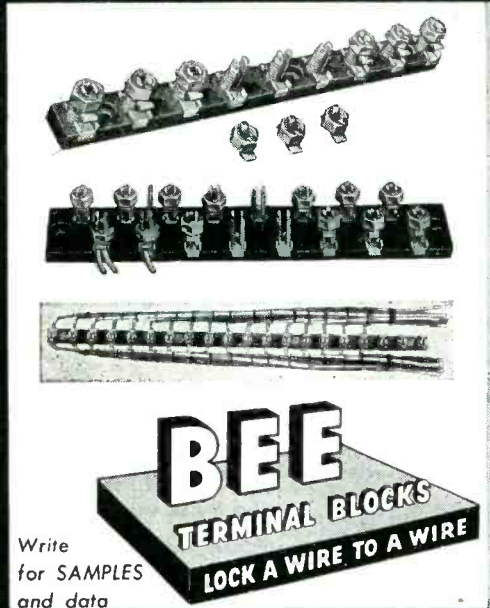
**EXTRUDED TUBING:** This smooth wall tubing withstands the rigors of severe low temperatures. This immunity to embrittlement at sub-zero cold permits wiring runs adjacent to low temperature equipment, piping, etc. with assurance of dependability.



**WIRE IDENTIFICATION MARKERS:** Now available in two types—sleeve and tab. Furnished in any color and marking, they reduce identification and tracing of piping, conduits and cables to an accurate split second procedure.

**NEW!**  
 The **ULTIMATE** in  
**SOLDERLESS**  
**CONNECTING DEVICES**

**LOCK A WIRE TO A WIRE**

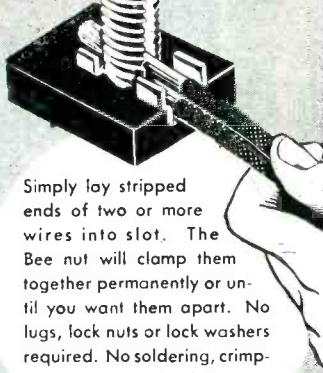


Write for SAMPLES and data

**L. S. BRACH MFG. CORP., Newark 4, New Jersey**

When the Bee nut is screwed down all the way, its built-in clamp locks a wire to a wire. No danger of loose strands. Assures a vibration-proof, low resistance connection.

**SPACE-SAVING**      **TIME-SAVING**



Simply lay stripped ends of two or more wires into slot. The Bee nut will clamp them together permanently or until you want them apart. No lugs, lock nuts or lock washers required. No soldering, crimping, pressing or insulating.



**RESISTANCE WIRE**

**ALLOYS FOR EVERY PURPOSE**

**ALLOY "A"**—Nickel-chromium; non-magnetic; spec. resistance 650 ohms/CMF.

**ALLOY "C"**—High resistance to oxidation and corrosion; for electronics and industrial equipment.

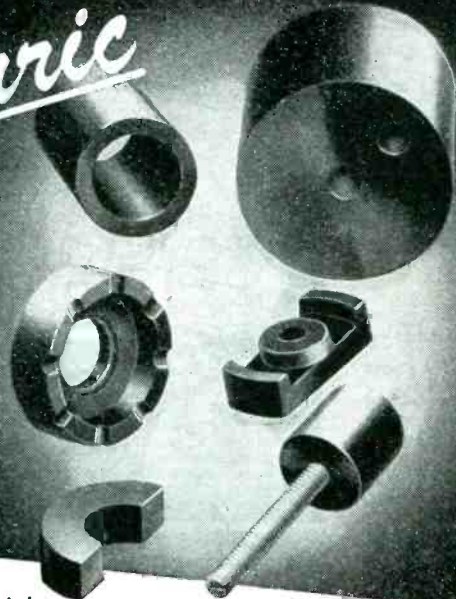
**ALLOY "D"**—Nominally 30% nickel, 15% chromium, balance iron. Specific resistance 600 ohms/CMF.

**ALLOY "45"**—Copper-nickel for winding precision resistors. Constant resistance over wide range of temperatures.

**KANTHAL**—Unavailable for duration; we will be pleased to supply data for your post-war requirements.

The **C. O. JELLIFF MFG. CORP.**  
 123 Pequot Rd.      Southport, Conn.

*PyroFerric*  
**IRON CORES**



PyroFerric powdered metal cores have kept pace the vital precision instrument development. They are manufactured to specification:

"Q" } HIGH as desired FREQUENCY } HIGH }  
 } LOW } MEDIUM }  
 } } LOW }

Consult PyroFerric on your Powder Metallurgy requirements

**PYROFERRIC Co.**  
 175 VARICK STREET NEW YORK, 14, N. Y.

**TEST INSULATION THE MODERN WAY**



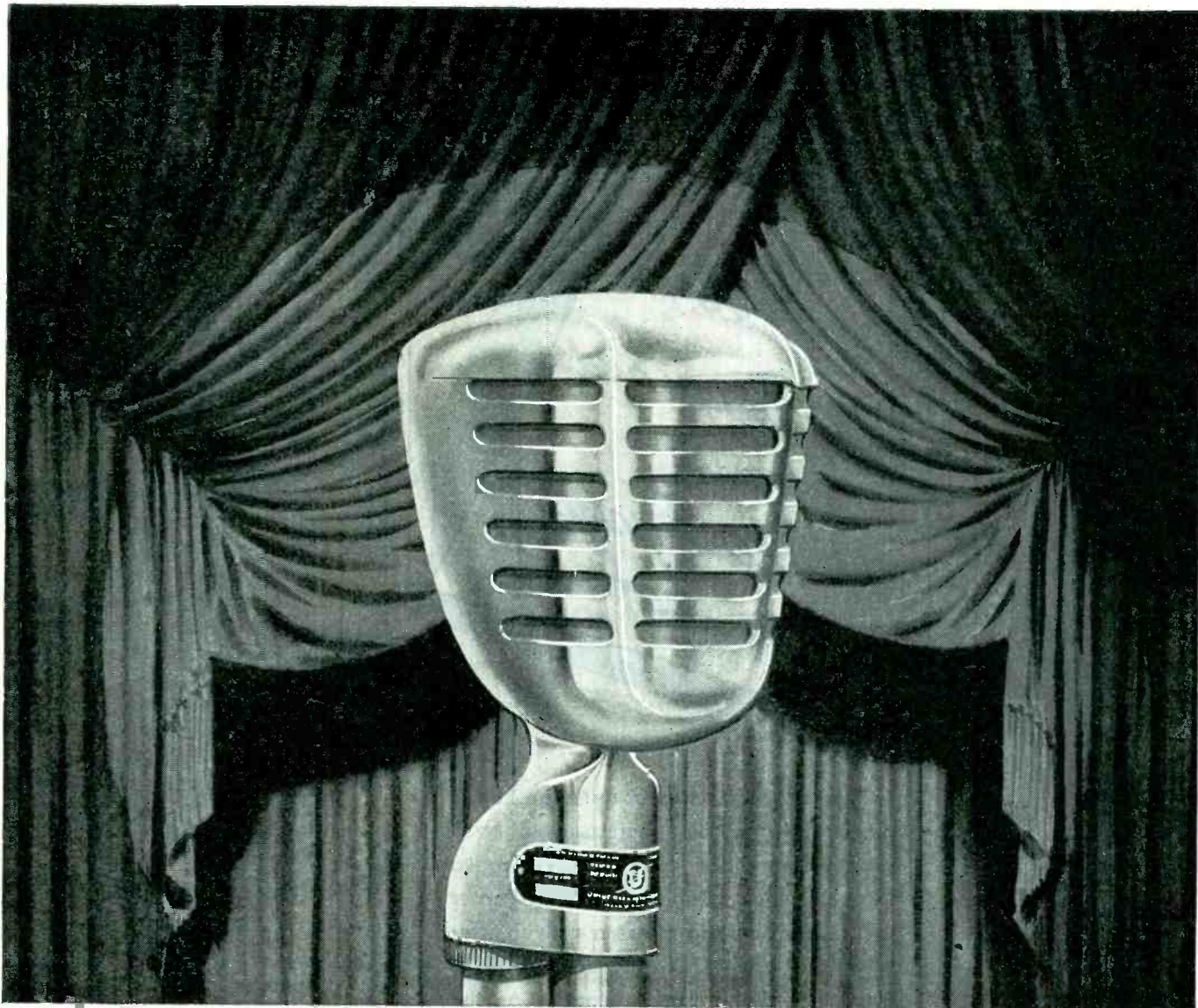
... WITH A MODEL B-5

**MEGOHMER**  
**NEW BATTERY-VIBRATOR TYPE**

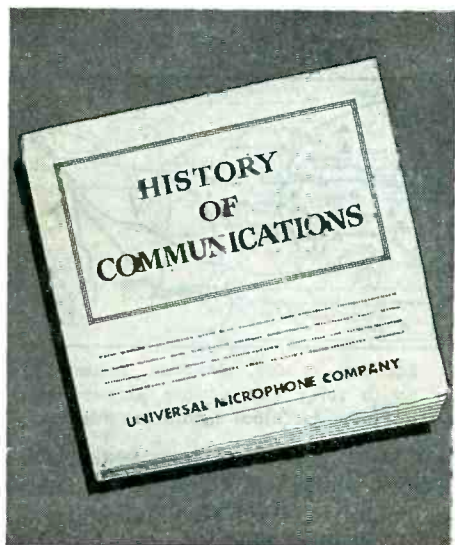
No more tiresome cranking of a hand-driven generator. Entirely self-contained. Steady test potential of 500 volts D.C. available at the touch of a switch. Direct reading in insulation resistance. Various new models and ranges.

Write or phone for Bulletin 430

HERMAN H. *Sticht* COMPANY, INC.  
 27 PARK PLACE NEW YORK, N. Y.



## UNIVERSAL'S NEW D-20 MICROPHONE



The stage was set for something new and here it is. Universal's new D-20 Microphone . . . soon on your radio parts jobbers' shelves to fill your essential requirements . . . uses Universal's "Dynoid" construction . . . A dynamic microphone of conventional characteristics built to fill the utility requirements of war time plus advance styling of the many modern things to come. Orders placed now with your Radio Parts Jobbers will assure early delivery when priority regulations are relaxed.

*Write for Bulletin 1458 covering this new microphone*

<FREE — History of Communications Picture Portfolio. Contains over a dozen 11" x 14" pictures suitable for office, den or hobby room. Write factory for your Portfolio today.

**UNIVERSAL MICROPHONE COMPANY**  
INGLEWOOD, CALIFORNIA



FOREIGN DIVISION: 301 CLAY STREET, SAN FRANCISCO 11, CALIFORNIA .. CANADIAN DIVISION: 560 KING STREET WEST, TORONTO 1, ONTARIO, CANADA

MEMO

TO: *Postwar  
Designers*

*simplify design and  
reduce costs with  
Walker-Turner  
Flexible Shafting!*

Reduced production costs is the key to the lower-prices, increased-sales-volume, more-jobs combination needed for post-war prosperity. Walker-Turner Flexible Shafting offers a proven way to bring about this reduction—in products involving remote control or the transmission of light power loads!

By substituting Walker-Turner Flexible Shafting for complicated gear systems in these applications, design is substantially simplified. The product is lighter, more compact. Less material is required. Costly machining is eliminated. Shipping and storage costs go down. Write today and let us put our years of flexible shafting experience to work for you!

**WALKER - TURNER CO., INC.**  
Plainfield New Jersey



**FLEXIBLE SHAFTING**

FOR REMOTE CONTROL AND POWER TRANSMISSION

possible by use of vhf and is not feasible on medium frequencies.

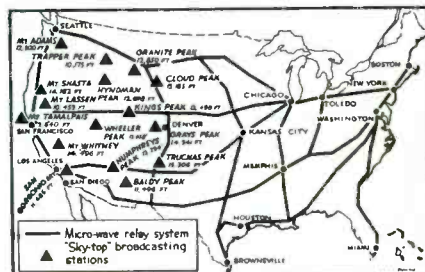
Another piece of equipment very much needed by private fliers is a small, light, inexpensive automatic pilot. This is because the necessary combination of piloting and navigational duties keep a solo flier on a cross-country hop very busy and allow little relaxation en route. It is the intention of Mr. Lear's company to supply such equipment in the postwar period.

Ten carloads of radar apparatus loaned by the Army and Navy are being used in the CAA Experimental Station at Indianapolis to conduct a series of tests aimed at the attainment of radar traffic control similar to that described by Mr. Lear. Two specific objectives are perfection of a screening device which will permit the tower controller to visualize the actual positions of all aircraft within a radius of approximately 25 miles and a collision warning device to be installed on the instrument panel of the plane, which would give constant visual indication of the relative position of other aircraft within a certain radius.

### Microwave Relay System

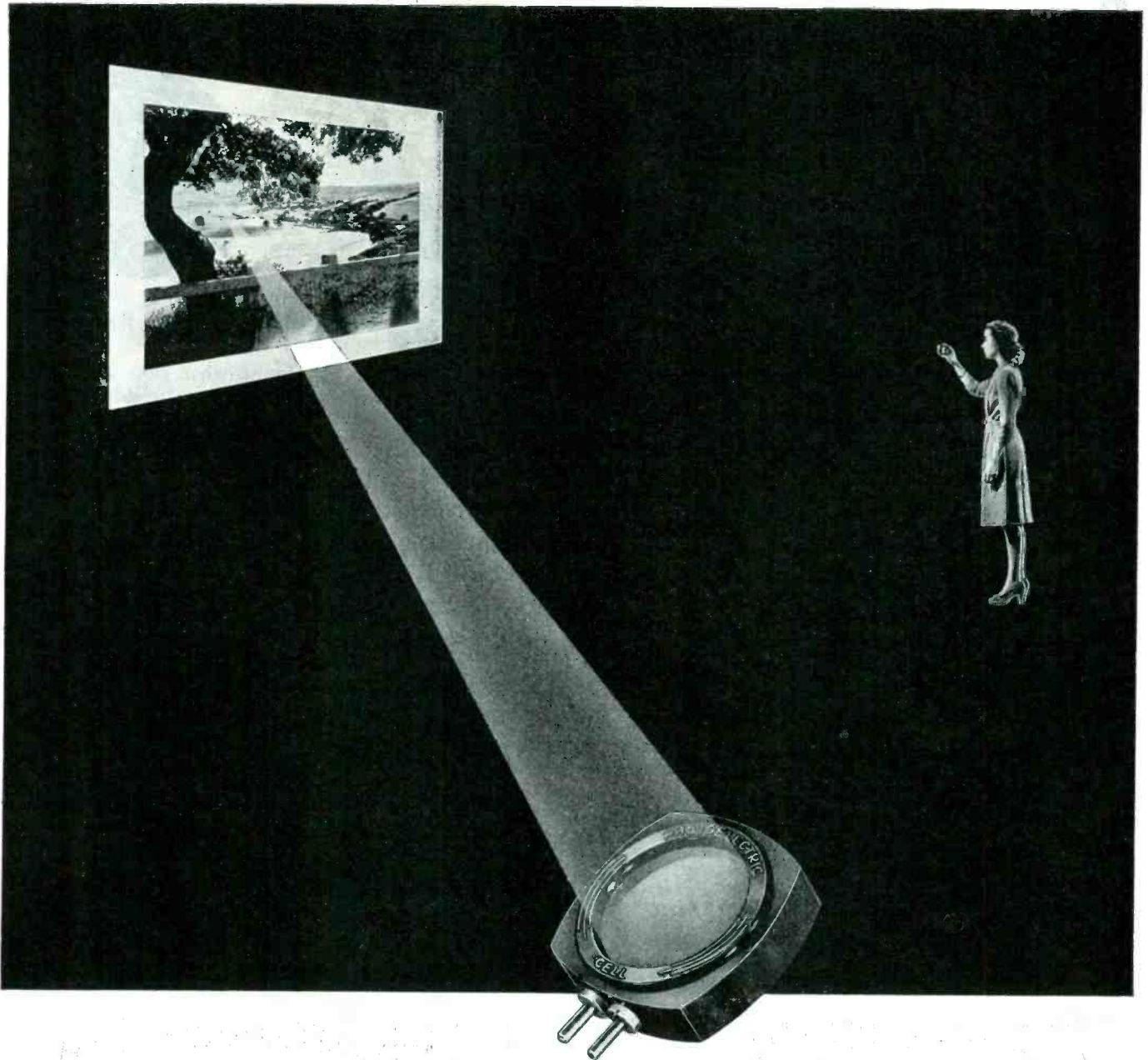
SPANNING THE HIGHEST mountain peaks from Mount Adams in Washington to Mount Whitney in Southern California, a projected West Coast installation of television broadcasting chain facilities is described by Raytheon Mfg. Co., which has filed application with FCC for experimental frequencies.

The so-called "Sky-top" chain will involve building on the sum-



Location of the mountain peaks on which relay stations are planned by Raytheon for initial installation this year

mits of several western peaks, stations which will combine the functions of safety for commercial and private airplanes within a radius of 300 to 500 miles, wide service-area television, f-m and a-m broadcast-



## MORNING BECOMES ELECTRIC!

Photographers use a small box they call an exposure meter. They take it for granted, like flicking a switch to light a room. But while vast generating systems bring power to your house, a light source alone works a meter or meter relay—when a photocell converts that light into electric energy. The simplicity and ruggedness of an exposure meter typify all Luxtron\*

photocell applications—from taking a good picture to precisely matching colors—from putting out a fire to increasing the heat of a furnace. No amplifiers are needed. Long equipment life is assured, under the most strenuous operating conditions. Ask Bradley how photocells can meet your own measurement or control problems.

### Versatile "Coprox" Rectifiers



This is one of the unique Bradley line of copper oxide rectifiers, made with the same understanding of electrical circuits and pyrometallic phenomena that goes into Luxtron photocells. Write for illustrated "Coprox" bulletin.

\*TRADE MARK REG. U. S. PAT. OFF.

PHOTOCELLS—MASTERS OF LIGHT

# BRADLEY

MASTER OF PHOTOCELLS

BRADLEY LABORATORIES, INC., 82 MEADOW STREET, NEW HAVEN 10, CONNECTICUT

ELECTRONICS — May 1945

307

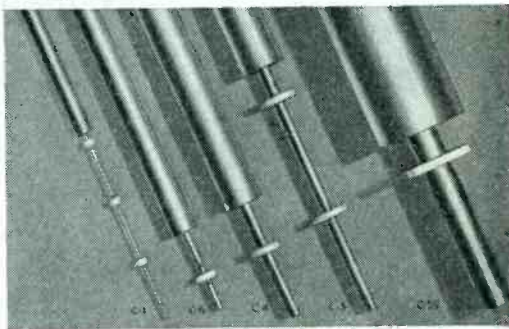
# Concentric Transmission Line

*by Doolittle*

*A Standard Product  
Since 1934*

• Ten years of experience in building concentric transmission line and associated impedance matching equipment assures you highest quality and workmanship.

Doolittle lines are made in seven standard sizes. Each line uses seamless copper tubing for the outer and inner conductor, except Types C-1 and C-6 which use solid inner conductors. The insulating heads are made of low loss ceramic—impervious to moisture—spaced and fastened securely for maintaining proper electrical and mechanical characteristics.



Carefully designed fittings and accessories for any requirements are also available.

Special sizes are made to order. For engineering information concerning installation and use, feel free to consult our engineering staff.

**WRITE  
FOR  
CATALOG  
AND  
PRICES**

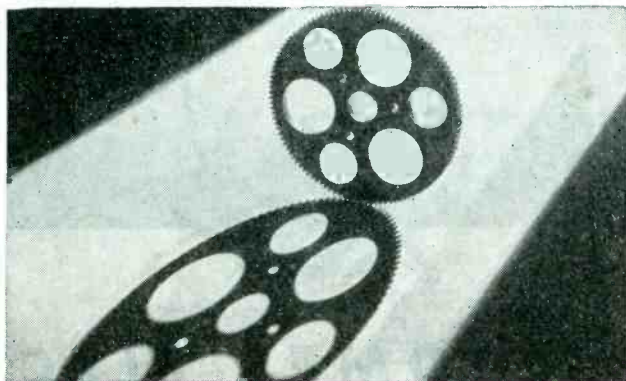
## QUICK DELIVERY

On All Standard  
Sizes Upon  
Suitable Priority

*Doolittle* **RADIO, INC.**

*Builders of Precision Communications Equipment*  
7421 SOUTH LOOMIS BLVD., CHICAGO 36, ILLINOIS

## COMING EVENTS CAST THEIR SHADOWS



Greater "know-how" in gear cutting methods has resulted in finer accuracy and finish without additional cost. As a result, gear teeth stand up longer and roll more quietly. These will be important factors in the gear design of your future products, making them more dependable and attractive.

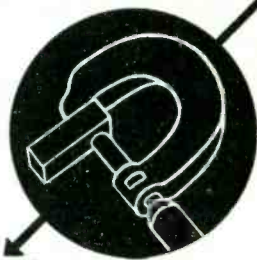
Our services and experience will help you solve production problems on small or medium size spur, helical and rack gears, worms, splines, sprockets and ground threads. Write for quotation on your specifications. No obligation of course.



*Beaver Gear Works Inc.*

1025 PARMELE STREET, ROCKFORD, ILLINOIS

# PERNICKERTY?



*Yes,* WE ARE . . .

We know what close tolerances mean . . . that precision is the First Prerequisite in Electronics.

## KIRKMOLD SPECIAL

Injection Molding Process for standard and made-to-measure parts for the Electronic Industry.

*molded plastics by  
KIRK*

**F. J. KIRK**  
**MOLDING COMPANY**

142 BROOK STREET

CLINTON

MASSACHUSETTS

*For Radio  
as you want it!*

**We're still up to our ears  
in critical war work but  
when the war's won we  
will again be ready**

**. . To DESIGN, DEVELOP  
and MANUFACTURE . .**

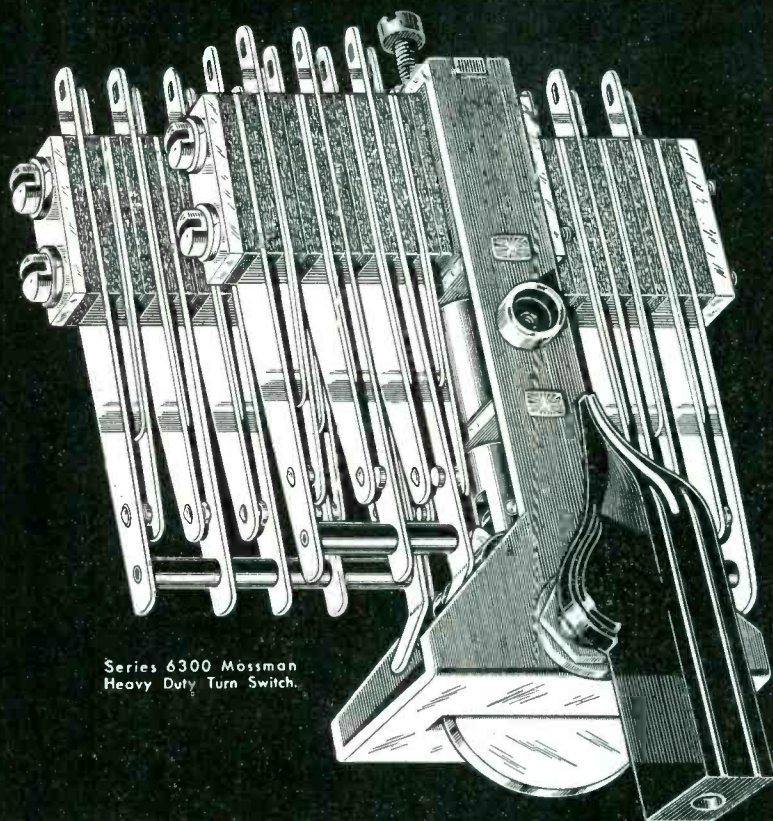
Radio Receivers and Transmitters  
Industrial Electronic Equipment  
Airport Radio Control Equipment  
Marine Radio Telephone Equipment

Your inquiries will receive immediate action

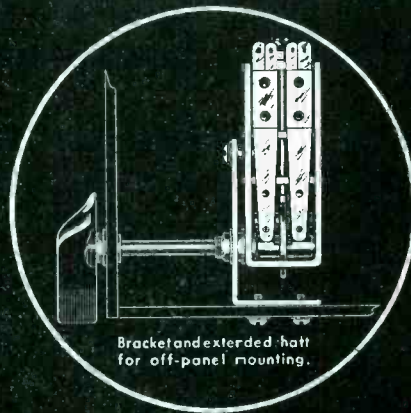
**ISLIP RADIO MFG.  
CORPORATION**

ISLIP, L. I., NEW YORK

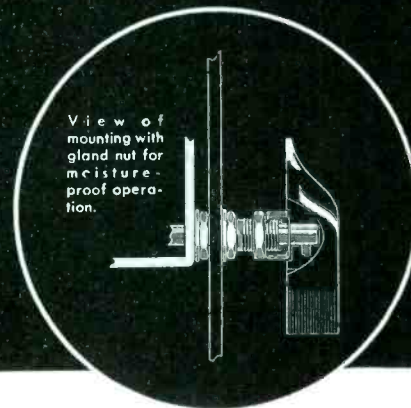




Series 6300 Mossman Heavy Duty Turn Switch.

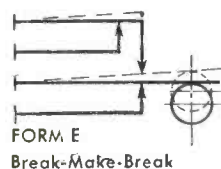
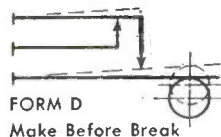
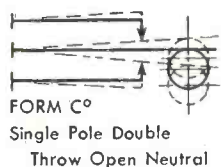
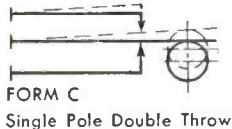
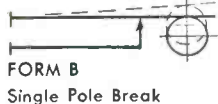
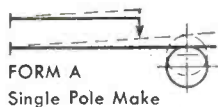


Bracket and extended shaft for off-panel mounting.



View of mounting with gland nut for moisture-proof operation.

#### BASIC CONTACT FORMS



## MOSSMAN SERIES 6300 HEAVY DUTY TURN SWITCH Permits Almost Unlimited Circuit Arrangements

Latest development in the Mossman line of precision heavy duty multiple circuit turn switches is the Series 6300 . . . a big, husky switch for panel mounting that permits a most versatile control set-up.

Electrical and production engineers will find this switch most useful in such applications as: Signal systems, alarm systems, controls for machine tools and welding equipment, lighting systems, annunciators and many other types of electronic devices and controls.

The Series 6300 Mossman Heavy Duty Turn Switches are available as either three position (Series 6303) or two position (Series 6302) switches. An almost unlimited series of combinations of contact assemblies may be built up by use of any combination of the six basic forms shown.

Standard heavy duty contacts are of 3/16" diameter fine silver, rated at 10 amperes, 110 volts A.C., non-inductive. Extra heavy duty contacts are of 5/16" silver alloy rated at 20 amperes, 110 volts A.C., non-inductive. Breakdown rating of springs to ground is 2000 volts, A.C.

Send for complete information on the new Series 6300 Mossman switches. Also ask for catalog which describes the full line of Mossman precision electrical components, including many types of heavy duty, multiple circuit lever switches, turn switches, push switches, plug jacks and other special switching components.

**DONALD P. MOSSMAN, INC., 612 N. Michigan Ave., Chicago 11, Ill.**

# MOSSMAN

## *Electrical Components*

# There are 3 M's in MURDOCK RADIO PHONES



All 3 M's are here . . . Men, Methods, and Material . . . teamed together to produce MURDOCK Radio Phones—the keenest ears in radio reception.

To do one thing and do it supremely well is the job of every MURDOCK craftsman. It's that extra-care and attention in manufacture, assembly and inspection that results in a war-tested Radio Phone of unequalled Dependability.

But back of the men and materials is the engineering "know how" of over 40 years' experience in serving peace-time and war-time America. War-sharpened techniques and exacting methods will continue to make MURDOCK Radio Phones the No. 1 listening favorite when Victory is won.

Find out today how MURDOCK "War-Tested" Radio Phones can fit into your post-war plans.

### Write for Catalog

Attention  
Sub-Contractors

Let MURDOCK ingenuity and experience go to work for you. Though we're busy on government work, we have facilities to help you make more Radio Phones and related parts. Write us now.

**WM. J. MURDOCK CO.**  
179 Carter St., Chelsea 50, Mass.

ing, a microwave relay system, public call facilities, highway control systems, and police-radio master stations. Initial permission from FCC is sought for experimental stations to be erected on the various mountain peaks shown in the accompanying illustration. Authority has been requested for initial tests on 30.66, 39.55, 90, 200, 400, 900, 1,900, 4,000, 6,000, 10,000, 16,000 and 26,000 Mc.

To avoid defacing the mountain sites, Raytheon plans to build all facilities, including living quarters underground with the only exposed portion being the antenna systems. The company announced that it will be in a position to initiate the first stage of the West Coast circuit and the first section of the Eastern circuit during 1945.

### Postwar Electronic Employment

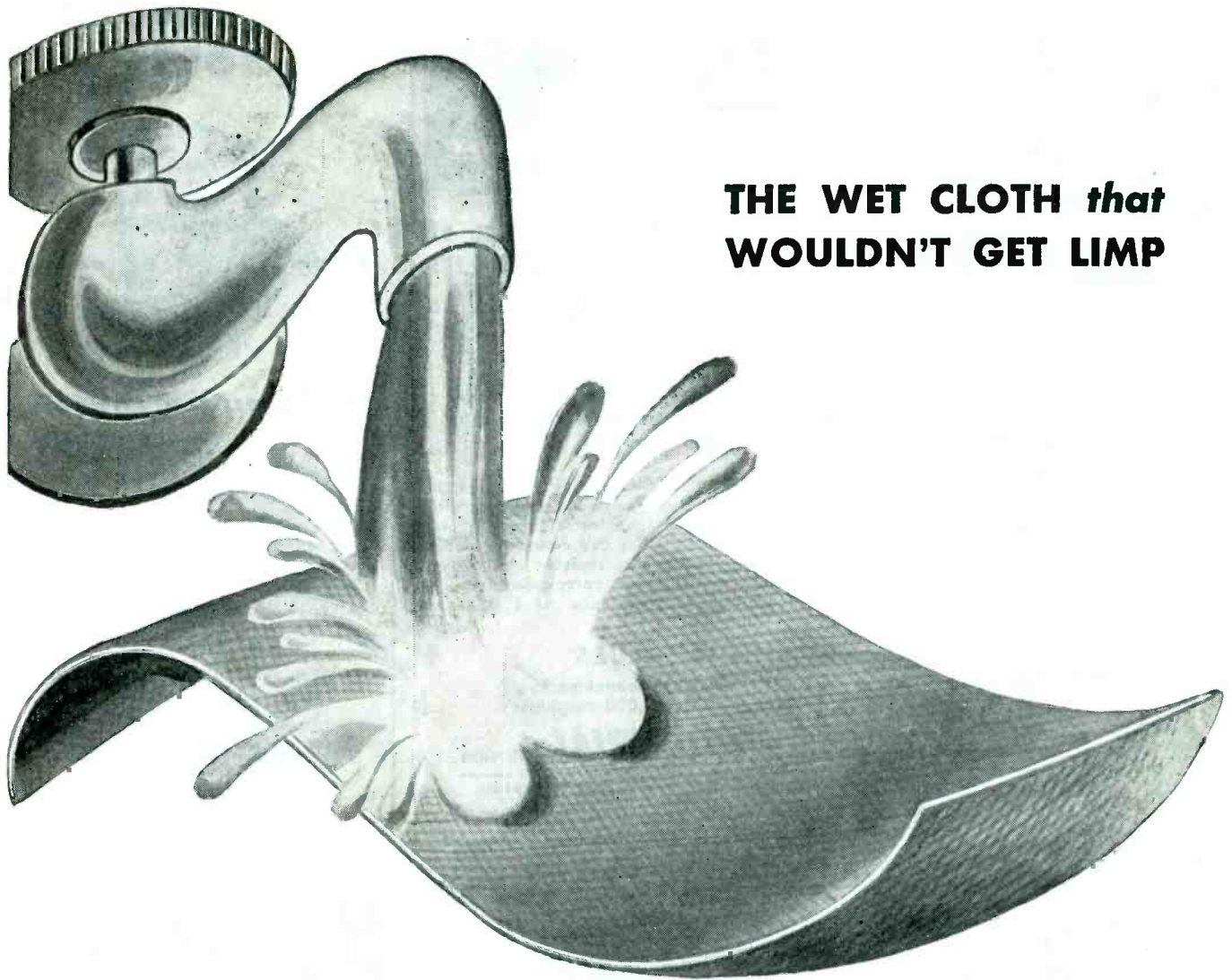
ACCORDING TO THE findings of a survey made by the employment and personnel committee of RMA, the industry has a total current employment of 277,660 employees. This includes 36,374 former employees in the armed services. Results also reveal prospective postwar employment of 145,266. Figures are compiled from estimates of 202 companies, representing 64.9 percent of the industry, including the largest and virtually all substantial manufacturers.

It was estimated that 23.6 percent of the men and 27.9 percent of the women presently employed in the industry will not seek work there for various reasons, postwar and that 28.5 percent of the present employees will be forced to seek employment in other fields.

### Kingdom for a Tube

BELL TELEPHONE Laboratories recently came through with 1,000 special tubes like the one in the illustration for use in a telephone repeater station somewhere behind the American lines on the Western Front. When the installation was captured it was discovered that all the tubes had been removed. The system had been engineered by the Nazis but some of the repeaters had been built locally.

One of the engineers who worked on the job was discovered and found



## THE WET CLOTH *that* WOULDN'T GET LIMP

We have made it and it still looks and feels like cloth; but, actually, every thread is impregnated with a synthetic resin and repels water and many ordinary chemicals. Water will go through it, but not into it. That is *impregnated* cloth.

We make it another way in which the openings between the threads are filled and water will not soak into it or pass through it. That is a *filled* cloth. These are typical of many processes of preparing cloth for special uses — of combining a cloth structure for strength and flexibility with some form of what may be termed a "plastic."

Do not confuse these and other Holliston processes with ordinary cloth finishing. We prepare cloth with special characteristics to meet special needs — functional or decorative. Many of these processes make cloth a "flexible plastic," capable of being folded, creased, stretched, glued or formed.

*If you have a material problem for Post War production, consult our Research Department*

# The HOLLISTON MILLS, Inc.

Processors of Cloth for Special Purposes

**NORWOOD, MASSACHUSETTS**

Sales Agents in Principal Cities

### *Cloth Bound*

A cloth bound book is bound to be kept — bind your

CATALOG — SALES MANUAL — INSTRUCTION BOOK, ETC.

in HOLLISTON Book Cloth — durable, impressive, hard-to-soil, easy-to-clean.

Write for samples.  
Consult your printer.

### SPECIAL FINISH

HOLLISTON special finish cloths meet special needs —

TRACING CLOTH — PHOTO CLOTH — RUBBER (PROCESSING) CLOTH — BOOK CLOTH — SHADE CLOTH — SIGN CLOTH — TAG CLOTH.

Cloth combined with special compounds, filled, impregnated, coated — to form a material with characteristics of a plastic and the flexible strength of a woven fabric.

# S.S. White MOLDED RESISTORS

The "All-Weather" Resistors

**TYPE 65X**  
Actual Size  
Other types available in  
the lower values

**RESISTOR BULLETIN 37  
GIVES FULL DETAILS . . .**

It shows illustrations of the different types of S. S. White Molded Resistors and gives details about construction, dimensions, etc. A copy, with Price List will be mailed on request. Write for it—today.

WIDELY FAVORED because of NOISELESS operation, DURABILITY and fine PERFORMANCE in all climates . . .

## STANDARD RANGE 1000 ohms to 10 megohms NOISE TESTED

At slight additional cost, resistors in the Standard Range are supplied with each resistor noise tested to the following standard: "For the complete audio frequency range, resistor shall have less noise than corresponds to a change of resistance of 1 part in 1,000,000."

## HIGH VALUES

15 megohms to  
1,000,000 megohms

# S.S. WHITE

THE S. S. WHITE DENTAL MFG. CO.

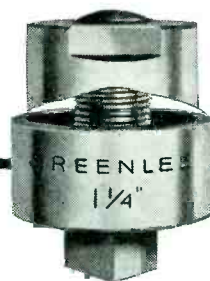
# INDUSTRIAL DIVISION

DEPT. R. 10 EAST 40th ST., NEW YORK 18, N.Y.

FLEXIBLE SHAFTS MOLDED PLASTICS AIRCRAFT ACCESSORIES  
MOLDED RESISTORS FLEXIBLE SHAFT TDDLS

One of America's AAAA Industrial Enterprises

## CLEAN ACCURATE HOLES



### cut in radio chassis

Greenlee Punches make this tough job easy. No reaming, filing or tedious drilling. Tool has three parts: *punch* cuts through chassis, *die* supports metal to prevent distortion, *cap screw* is turned with wrench to cut holes. Sizes for holes 3/4" to 3 1/2". Ask your radio supply or electrical jobber or write for folder and prices. Greenlee Tool Co., 1925 Columbia Ave., Rockford, Illinois.

WRITE FOR FREE FOLDER S-119 →



# INSULINE CORP. OF AMERICA Leads the way

## LEADERSHIP IN DESIGN AND MANUFACTURE OF RADIO-ELECTRONIC PRODUCTS

The outstanding production records of Insuline have twice been commended by the Army and Navy. New designs, new products, new manufacturing methods are constantly being devised, so that after V-Day it will still be true that, in the Radio-Electronics field, "ICA Leads the Way."

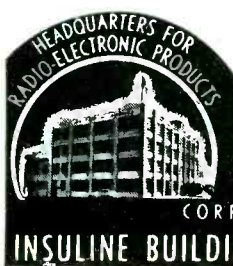


## SUPERIORITY IN SOLDERING IRONS

ICA Irons embody these important construction features:—

Heating elements wound on high heat-resisting bobbin of machined and threaded Insulex. Winding utilizes special resistance wire. Complete bobbin is impregnated in non-hygroscopic ceramic compound. ICA Irons heat up to operating temperature in three minutes, and in one additional minute surpass the heat peak of ordinary irons. Special air chamber reduces heat losses. Thoroughly insulated. Rubber tube protects cord from excessive wearing and short-circuiting . . . Write for full details now.

Write for 48-page Catalogue describing the extensive line of ICA Radio-Electronic Products . . . Also 8-page brochure presenting the ICA Manufacturing facilities.



# INSULINE

CORPORATION OF AMERICA

INSULINE BUILDING · LONG ISLAND CITY, N.Y.



## FOR ELECTRONIC USE



## SILVER

WIRE - SHEET - TUBING  
SILVER BRAZING ALLOYS & FLUXES

## PLATINUM

WIRE - RIBBON - FOIL  
SEAMLESS TUBING

SEND US YOUR INQUIRIES  
FOR ALL APPLICATIONS OF  
PRECIOUS METALS TO ELEC-  
TRONIC PRODUCTS.

PRECIOUS  
METALS



SINCE  
1875

## THE AMERICAN PLATINUM WORKS

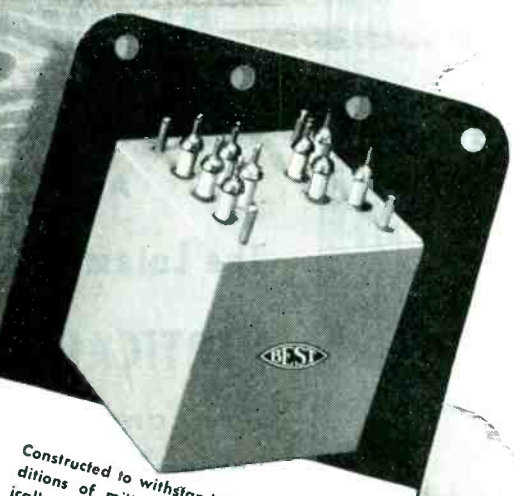
N. J. R. R. AVE. AT OLIVER ST.  
NEWARK 5, N. J.

# COILS, TRANSFORMERS AND LOUD SPEAKERS

THAT JUSTIFY THE NAME...



30 new BEST speakers, incorporating every advance in speaker design for a quarter of a century, achieve higher efficiency at lower cost through the use of Alnico 5 permanent magnets.



Constructed to withstand the rigorous conditions of military service, BEST hermetically sealed transformers, using every type of terminal construction, are delivered promptly and at low cost.

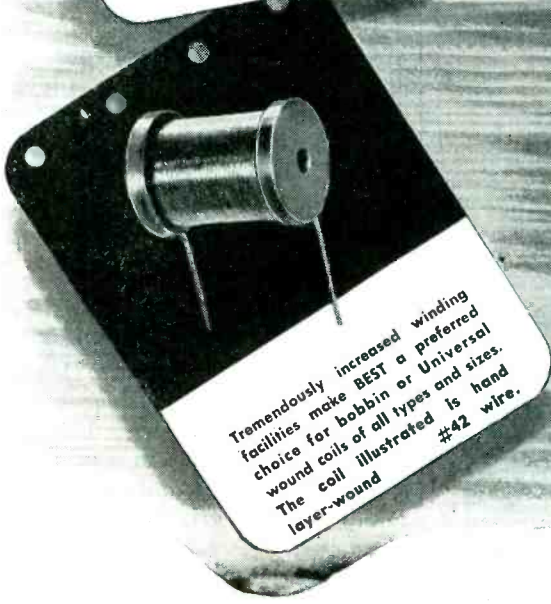


Transformers for varied applications, which perform to your most exacting requirements, are manufactured and tested in large quantity at BEST.

The name BEST has been associated with the finest in coils, transformers and loud speakers since the days of radio's infancy. Illustrated are but a few of the many items manufactured by BEST which required skill, precision and efficiency. Because of the experience gained throughout the years, BEST has been able to meet the ever growing demands of this industry for greater quality, durability and quantity production.

**We Invite Inquiry**

Our modern production facilities are now available for the quantity production of coils and transformers of all types. Your inquiry will receive our immediate attention.

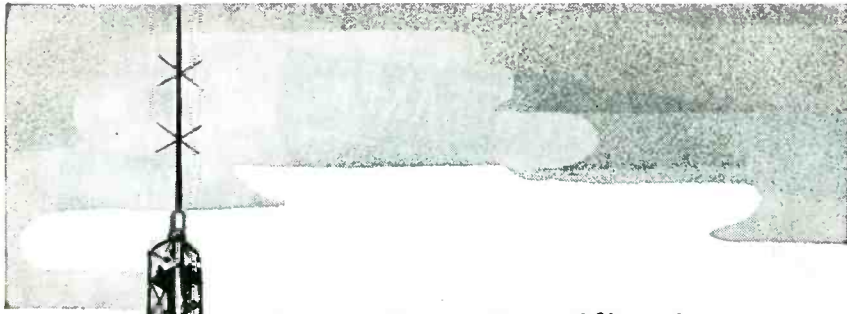


Tremendously increased winding facilities make BEST a preferred choice for bobbin or Universal wound coils of all types and sizes. The coil illustrated is hand layer-wound #42 wire.

**BEST MANUFACTURING CO., INC.**

*Electronic and Sound Reproducing Equipment*

1200 GROVE STREET • IRVINGTON 11, N. J.



**From Your Specifications**

# **BLAW-KNOX**

**WILL DESIGN, FABRICATE  
AND ERECT**

**The Latest Development in  
VERTICAL RADIATORS  
and Towers for  
FM and TELEVISION  
ANTENNAE**

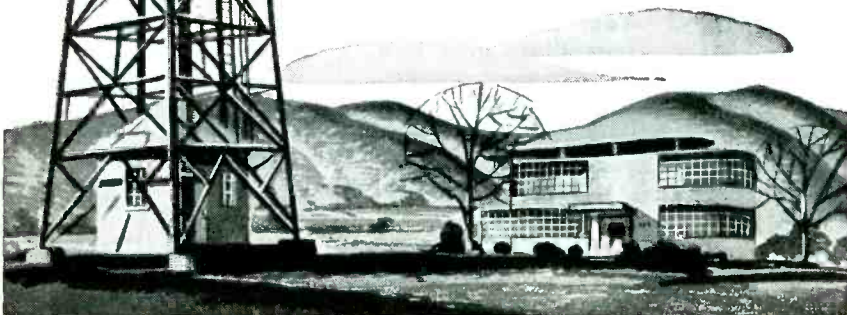
Station Engineers take a load off their shoulders when their antenna problem is turned over to Blaw-Knox. Specifications are completed under one responsibility. The job is not done until the tower is up, tested and approved.

## **BLAW-KNOX DIVISION**

**of Blaw-Knox Company**

**2077 Farmers Bank Bldg.**

**Pittsburgh                  Penna.**



capable of supplying some of the electrical characteristics of the badly needed tubes and eventually a single sample tube was found. The tube and the notes were rushed to New York and to the electronics department of the Laboratories. Electrical tests showed that there was no American telephone repeater tube suitable for substitution but that, with the exception of one grid and a base, a tube could



be built up from parts of various existing units. Special grid production was started, various machines were modified to suit the circumstances, and within three days eight tubes with handmade bases were on their way. Without waiting to hear the results from the prototypes, production was pushed along and on the seventeenth day the thousandth tube was waiting for shipment. PS, they worked all right.

### **Resistance Welding Prizes**

ANNOUNCED BY RWMA (Resistance Welder Manufacturers Association) is this year's prize contest to encourage the preparation of outstanding papers on resistance welding subjects. The scope of former contests has been increased, bringing the total amount of the awards up to \$1,000. Additional information can be obtained from Harold S. Card, educational director, RWMA, Citizens Building, Cleveland 14, Ohio.

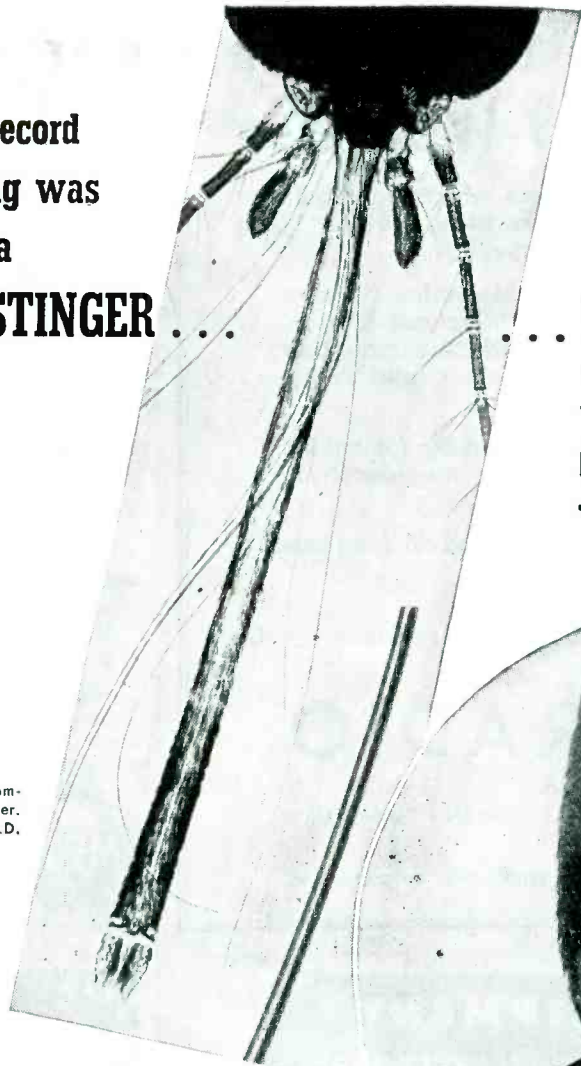
### **Technical Oscars**

AWARDS BY THE Research Council of the Academy of Motion Picture Arts and Sciences have been announced for scientific or technical achievements during 1944. No award was made in Class I—the statuette corresponding to the familiar Oscars given to star performers.

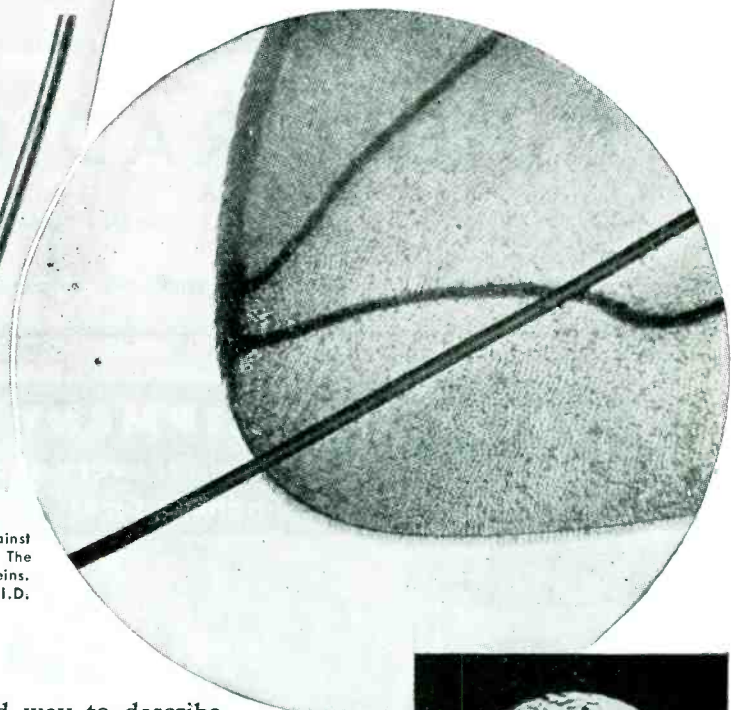
A single Class II or plaque award

It was a world's record  
when Nickel tubing was  
drawn finer than a  
**MOSQUITO'S STINGER . . .**

**. . . but now . . .**  
Nickel tubing has been  
drawn as fine as the  
**VEINS in a FLY'S WING**



The former record holder compared with a mosquito's stinger. 0.0019" O.D. 0.0004" I.D.



World's smallest tube against the tip of a fly's wing. The gray lines are two fine veins. 0.0014" O.D. 0.0004" I.D.

**"Extremely workable!"**

That's a good way to describe the INCO Nickel Alloys. For they can be produced in sizes ranging from the giant forged gate stems used at Boulder Dam down to wire smaller than human hair . . . strip one-third the thickness of this page . . . tubing as fine as the veins in a fly's wing.

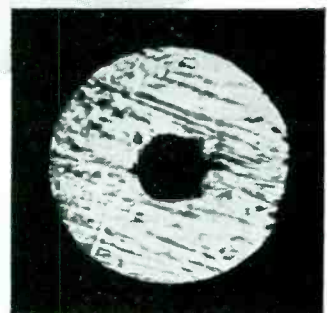
The accompanying pictures amply prove this workability. Both tubes are made of pure Nickel—the metal found best for such fine drawing by the Superior Tube Company, Norristown, Pa.

The new world's smallest metal tube is so small that 37 piled one atop the other would only equal the thickness of a dime—and one pound would stretch more than 33 miles.

Another good way to describe the INCO family of Nickel Alloys is to call them, "**strong, tough metals that resist heat, rust, corrosion, fatigue and wear.**"

In addition to these group characteristics, the INCO Nickel Alloys also offer individual electrical properties uniquely suiting them to specific jobs in the electronic field.

You'll find properties and typical applications of these problem-solving metals interestingly described in "*Tremendous Trifles.*" Your copy will be mailed on request. The International Nickel Company, Inc., 67 Wall Street, New York 5, N. Y.



Cross-section of world's smallest metal tube. The bore is only 4 ten-thousands of an inch. (Magnified 900X.)

NOTE: INCO Nickel Alloy tubing is drawn commercially to sizes down to 0.010" O.D. The world's smallest sizes are not yet produced commercially.

**NICKEL  ALLOYS**

MONEL • "K" MONEL • "S" MONEL • "R" MONEL  
"KR" MONEL • INCONEL • "Z" NICKEL • NICKEL  
Sheet . . . Strip . . . Rod . . . Tubing . . . Wire . . . Castings . . . Welding Rods (Gas & Electric)

# Our Electronic Equipment For YOUR Post-War Use

We present a few items of equipment which our Post-War Plan proposes to release to you. These items are now being built for the U. S. Navy and other Armed Forces.

1. The original Portable Electric Megaphone\*, now highly developed, for use by the Merchant Marine, yachts, airplanes, drydocks, shipyards, stadiums and outdoors arenas, construction companies, and Police and Fire Departments.
2. Our exclusive Divers Communication Equipment for use by marine salvage companies and manufacturers of diving suits.
3. Interior Communication Equipment and docking sets for all types of marine use.

Other equipment will be announced when released by the Armed Forces.

## GUIDED RADIO

C O R P O R A T I O N

161 Sixth Avenue

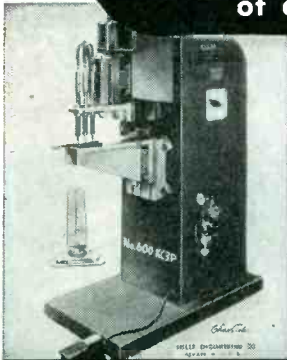
New York 13, N. Y.

\* Patent No. 2,301,459

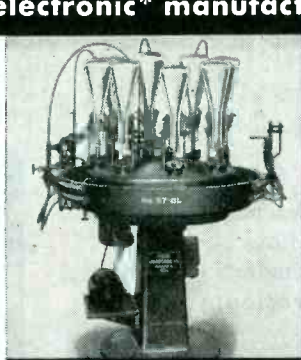
After the War any infringement of this patent will be prosecuted.

## EISLER EQUIPMENT

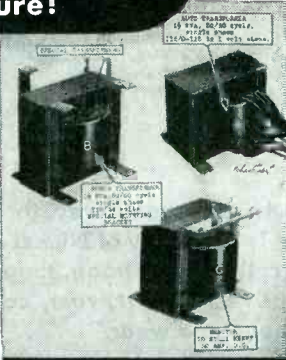
..complete and diversified for every phase  
of electronic\* manufacture!



(A) No. 600-KC3P, 50 KVA Press Type Spot Welder, 3 Spots, Air Operated, 18" Throat—a high production unit.



(B) No. 57-8L New Eisler 8 head type Tipless Sealing Machine. Adaptable for all types and sizes of bulbs.



(C) EISLER Special Transformers and Reactors—high or low voltage; air cooled, oil immersed or uncased.

The CHAS. EISLER line of specialized electronic tools, machines and devices is complete and diversified. Included are innumerable types of welders—spot, seam, butt, rocker, arm, pneumatic and special types. Also included are hundreds

of devices for vacuum tube manufacture—glass tube cutters, slicers, stem and sealing machines as well as an all-inclusive line of transformers for every industrial and general need.

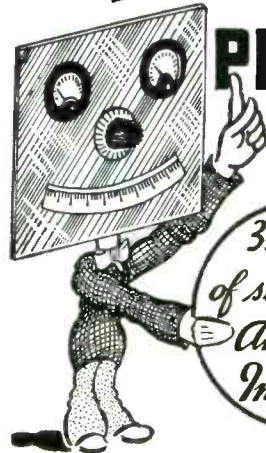
\* EISLER serves 99% of American vacuum tube producers today. Write for completely illustrated catalog now—you incur no obligation.

Chas. Eisler  
**Eisler**

**ENGINEERING COMPANY**

751 SO. 13th STREET NEWARK 3, NEW JERSEY

# DIALS PANELS and PLATES



35 years  
of service to  
American  
Industry

## DIALS • PANELS • PLATES

made to your precise engineering specifications in etched metals and finishes.

**PREMIER**  
**METAL ETCHING CO.**  
21-03 44th AVE.  
LONG ISLAND CITY, NEW YORK

Need WIRE Now?  
**COLUMBIA**  
Has It!

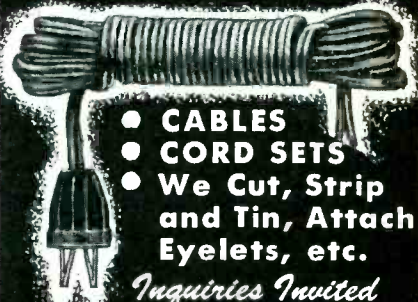
INSULATED ELECTRICAL WIRE

**GAUGES**

#22  
TO  
#12



IMMEDIATE DELIVERY  
FROM LARGE STOCK



- CABLES
- CORD SETS
- We Cut, Strip and Tin, Attach Eyelets, etc.

*Inquiries Invited*

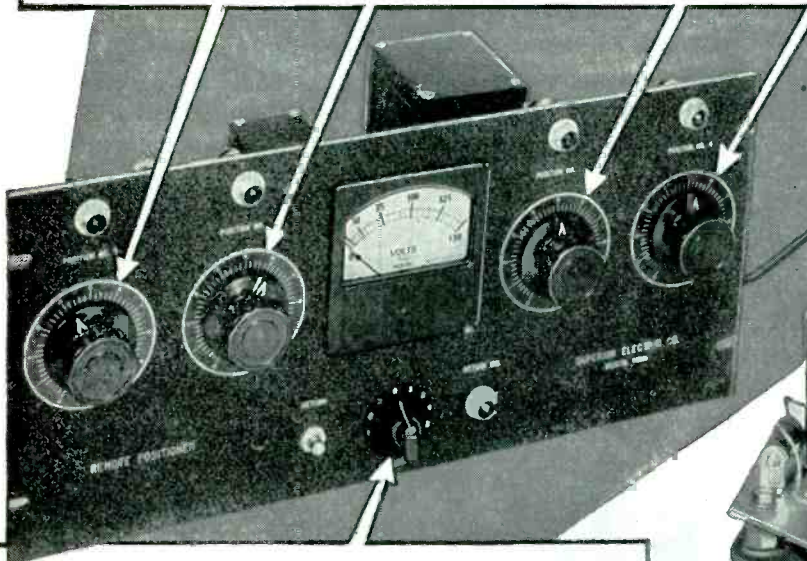
**COLUMBIA WIRE & SUPPLY CO.**  
4110 N. PULASKI ROAD  
CHICAGO 41, ILLINOIS



**IT'S NEW**

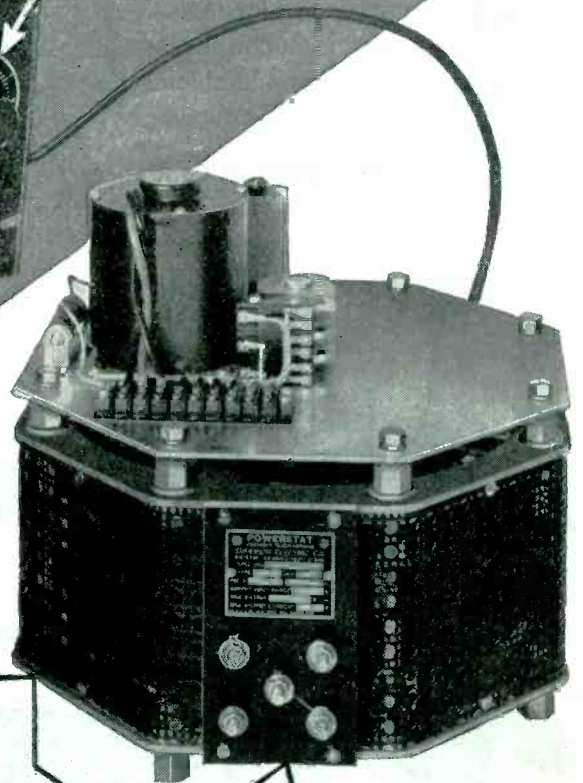
# A servo-type VOLTAGE CONTROL

SECO'S "POSITIONER" will enable you to remotely and accurately set the output voltage of a POWERSTAT variable transformer. Control wires between the "POSITIONER" and the motor operated POWERSTAT serve as an "electrical flexible shaft". This type of coupling means servo operation of the POWERSTAT variable transformer from a remotely located control dial.



Manual, automatic or program selection of any one of a number of controls, makes for easy utilization of the POWERSTAT at any voltage or power level. The inherent accuracy of the control circuit makes it possible to return to preset levels with negligible error.

For maximum utilization of your equipment investigate the SECO "POSITIONER" and POWERSTAT Variable Transformer combination for... dielectric and induction heating, infrared drying, photographic applications, and vacuum tube manufacture. Only SECO offers the motor-driven POWERSTAT Variable Transformer with SERVQ control. SECO'S engineering staff will be pleased to assist with your applications.



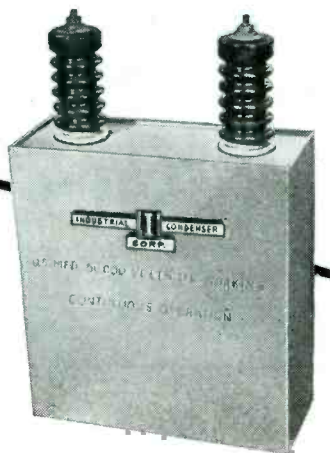
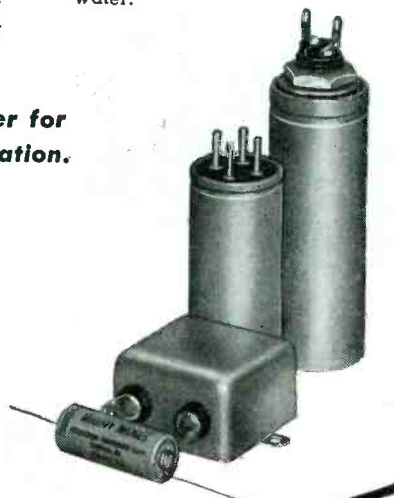
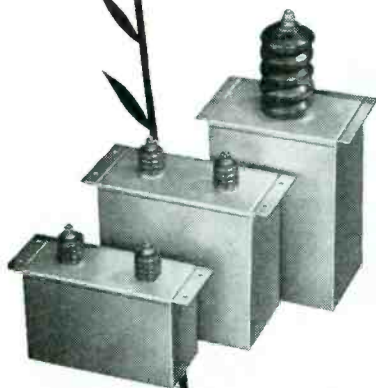
Send for  
Bulletins LE

**SUPERIOR ELECTRIC COMPANY**  
**404 LAUREL STREET • BRISTOL, CONNECTICUT**

# Unsurpassed QUALITY

• The Industrial Condenser Corporation manufactures a complete line of Oil-filled, Electrolytic, Wax and Special Mica Capacitors for all industrial, communications and signalling applications up to 250,000 volts working. Complete laboratory and engineering facilities available for solution and design of capacitor problems for special applications.

*An Industrial Condenser for every industrial application.*



## .5 MFD. 50,000 VOLTS DC WORKING

(Illustrated above)...28 inches high, weight 175 pounds, built by Industrial Condenser Corporation to meet Navy specifications. Oil-filled, oil impregnated. Built for 24 hour continuous operation and total submersion in salt water.

PAPER, OIL AND ELECTROLYTIC CAPACITORS

# INDUSTRIAL CONDENSER CORPORATION

3243-65 NORTH CALIFORNIA AVE., CHICAGO 18, U.S.A.

DISTRICT OFFICES IN PRINCIPAL CITIES

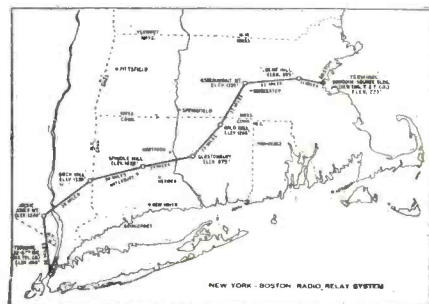
was made to Stephen Dunn and the RKO Radio Sound Department for design, and to Radio Corp. of America for additional development of the electronic compressor-limiter, a variable gain amplifier, the design of which is based on the logarithmic characteristics of hearing. Use of the compressor-limiter in a recording system is described as providing automatic control of intensity ratios and permitting the reproduction of sound, particularly speech, without exaggerated and unnatural volume surges. Intelligibility is increased.

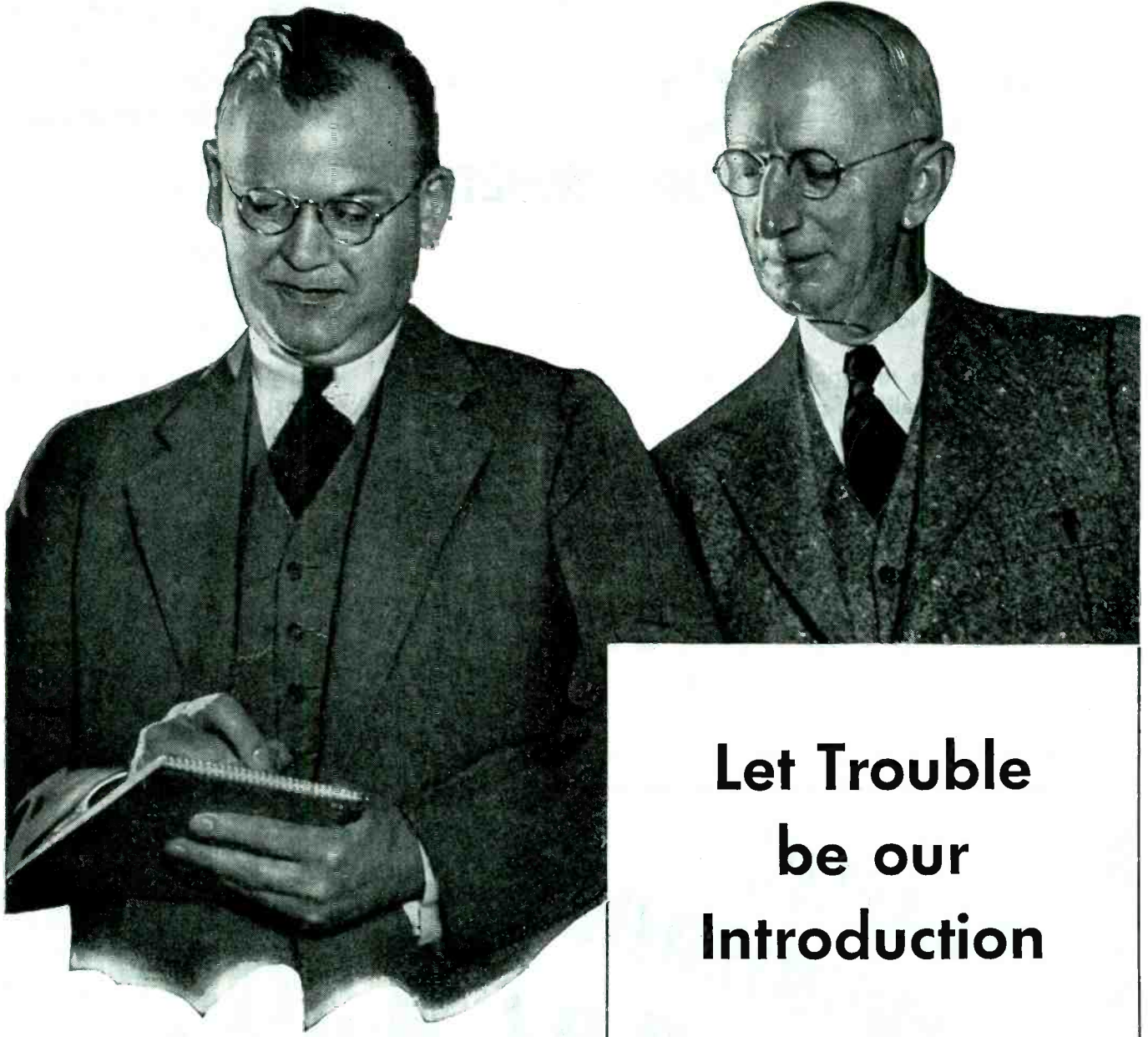
Class III Awards consist of honorable mention in the report of the Research Council. Among others, such awards were given to Western Electric Co. for the design and construction of a limiting amplifier for variable-density sound recording; to Radio Corp. of America and the RKO Radio Sound Department for design and construction of a reverberation chamber; and to Daniel J. Bloomberg and the Republic Sound Department for the design and development of a six-pole six-position switch for use in selsyn interlock systems. These eliminate the usual multiple patching plugs and cable connections which prevail throughout the industry.

## Trial Radio Relay

SEVEN RELAY STATIONS between the terminals of the New York-Boston radio relay project are the subject of a new application filed with FCC by American Telephone & Telegraph Co. Purpose of the proposed trial is to determine in practical operation the relative efficiency and economy of radio relay for transmission of long distance telephone messages and also of sound and television programs, as compared with wire lines.

Sites for the relay stations shown on the accompanying map were





## Let Trouble be our Introduction

**T**HERE'S nothing like trouble to bring people together. That's how some of Revere's closest friends were gained — through a mutual struggle against difficulties, trouble such as occasionally beset any business.

Take the case of an important electronic product for war use costing several hundred dollars. Rejections were running extremely high, over 40%, costs were skyrocketing, and badly needed production was being lost. The manufacturer asked us if we would care to collaborate in solving the problem. Of course, we would. After studying the subject in detail with the manufacturer's engineers, we suggested a radical change in the properties of a non-ferrous product used in the manufacture of the vital part causing failure. New processes of manufacture were developed and in a short time test runs of the new material proved we were right. Rejections of finished units dropped to less than 1%. Thus a vexing and expensive bottleneck was broken, and we gained a new customer and a firm friend.

This success story demonstrates that Revere has an open mind as well as an informed one, and is always ready to question the customary, find new answers to new problems. If something is worrying you in your employment of non-ferrous materials in electronics, get in touch with Revere, not for ready-made answers, but for wholehearted cooperation, a joint search for better results. This help is given freely, without obligation, through the Revere Technical Advisory Service, which has at its command the knowledge and facilities of our laboratories, and the accumulated experience of the entire Revere organization. Just write the Revere Executive Offices.

**REVERE**  
COPPER AND BRASS INCORPORATED  
*Founded by Paul Revere in 1801*  
Executive Offices: 230 Park Avenue, New York 17, N.Y.

# "ALNICO"

## PERMANENT MAGNETS

Specializing in the production of highest quality Alnico Magnets in all grades including new triple strength No. 5.

Production material checked to assure highest uniform quality of product.

Castings made to customer's special order on the basis of sketches or blueprints furnished.

Information and suggestions furnished on request.

## GENERAL MAGNETIC

C O R P O R A T I O N

MANUFACTURERS OF HIGH COERCIVE MAGNETIC ALLOYS

2126 E. Fort Street

Detroit 7, Michigan

## KIRKLAND Pioneer INDICATING LAMPS

WHERE QUALITY IS THE  
FOREMOST CONSIDERATION



### THE #659 D/E DELUXE-UNIT OF SUPERIOR DESIGN AND CONSTRUCTION

*Extremely Shallow in Depth  
1" Behind Front of Panel*

Heavy walled glass lens in a screw type lens-cap, 1/8" thickness hex holding lip, 1 3/8" mounting hole, molded socket with 6/32 screw terminals, 1 1/4" overall length. For S6 lamps up to 120 volts, lamp easily removed from the front without tool. List Price (less bulb) \$2.20.

WRITE FOR CATALOGUE

**THE H. R. KIRKLAND CO.**  
MORRISTOWN, N. J.

# PLASTIC FABRICATING ... O.K.!

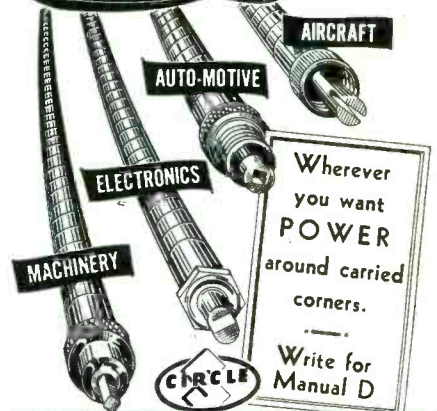
BAKELITE SHEETS, RODS, TUBES  
FABRICATED PARTS



Twenty Years of Experience  
**ELECTRICAL INSULATION CO., INC.**  
12 VESTRY ST., NEW YORK 13, N. Y.

# FLEXIBLE SHAFTS

for  
many fields



**F. W. STEWART MFG. CORP.**  
4311-13 RAVENSWOOD AVE.  
CHICAGO 13, ILL.  
WEST COAST BRANCH:  
431 Venice Blvd.; Los Angeles 15, Cal.

# Preview of Lear's next National Advertisement

Here you see the next advertisement in the Lear advertising campaign on wire recording and home radios. It is going to appear in:

*Collier's*, Aug. 11th • *Fortune*, June  
*Liberty*, June 10th • *Atlantic*, June  
*New Yorker*, May 26th  
*New York Times Magazine*, May 6th

This means that 5,400,000 regular readers of these magazines, their families and friends, will see again the advantages of owning a Lear Home Radio with wire recording.

If you want to be able to offer Lear Radios with wire recording, write for information on the Lear Franchise.



## It's Wire with a **VOICE**

*Listen! That's your own voice you hear. Or a radio program caught and recorded straight from the air. Or maybe a program produced by your own youngsters.*

*It all comes from the thin wire that runs through the Lear Wire Recorder—a wire magnetically impressed with sound through an entirely new method of recording brought to its present high state in Lear laboratories. \**

*Wire recording will be a part of Lear Home Radios. But home entertainment is only one of*

*countless sensational applications. Think of a dictating machine with no records to break or keep shaved—and business conferences, meetings, telephone conversations kept precisely and permanently for future reference.*

*No one has yet begun to explore the full realm of possibilities that lie in Lear Wire Recording. But to give you a glimpse of how it works and a few of the ways it can be used, Lear has prepared a free booklet of questions and answers. Would you like one? Just drop us a line—or mail the coupon below.*



# LEAR RADIO

Grand Rapids 2, Michigan  
 Home Radio Sales: 230 E. Ohio St., Chicago 11, Illinois

LEAR, Incorporated  
 Home Radio Sales Division,  
 230 East Ohio Street, Chicago 11, Illinois.

Gentlemen:  
 Please send me your free booklet on Wire Recording offered in Lear national magazine advertising.

Firm Name \_\_\_\_\_

Individual \_\_\_\_\_

Address \_\_\_\_\_

# ERCO RECEIVERS



*For dependable  communications*



An addition to the popular 32 series of fixed frequency crystal controlled receivers, the new 32-E is intended for exacting VHF applications in the range of 100 to 160 MC. Equipped with carrier operated audio gate and automatic noise suppressor. Selectivity pass band X2=60KC wide, X10=90KC wide and X100=120KC wide. Components are designed for continuous operation during wide variations of ambient temperature and humidity. Panel mounted; 8¾ inch relay rack panel.

The type UHC coaxial half wave dipole antenna can be supplied for operation on any desired frequency between 30 and 500 MC. Sound engineering, backed by seven years of experience, are incorporated in this new model. Will withstand winds of high velocity and serious icing conditions. This antenna may be obtained in stacked colinear arrays for securing added transmitter and receiver gain over a 360 degree area. Inquiries are invited.



**ERCO RADIO LABORATORIES** -22-  
HEMPSTEAD, NEW YORK  
Manufacturers of CUSTOM BUILT RADIO APPARATUS

chosen for their elevation and facilities will be provided at the seven points to house transmitting and receiving apparatus. Field work during the coming year is expected to include building of roadways up to the hillsides to the relay station sites and similar preparatory work. Eight channel assignments are being asked—each 20 Mc wide—near 2,000, 4,000 and 12,000 Mc. If the experimental facilities prove as satisfactory as company engineers expect, apparatus will be standardized in order that the Bell System may be prepared to install similar systems throughout the country as the need develops.

## Ten Join RMA

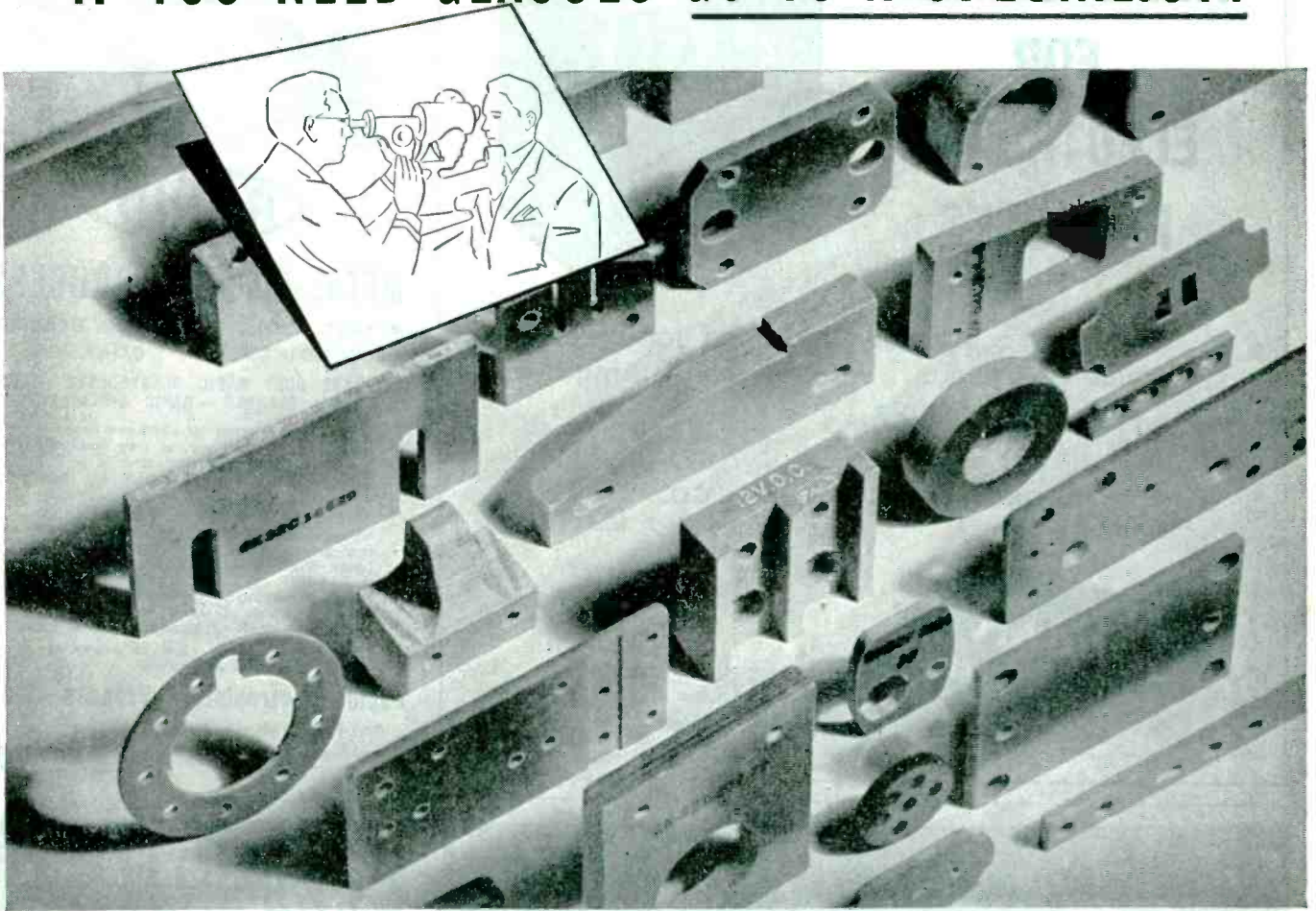
New RMA member companies include American Coil & Engineering Co., Chicago; Chicago Condenser Corp., Chicago; Electrical Reactance Corp. Franklinville, N. Y.; Jackson Industries, Chicago; Measurements Corp., Boonton, N. J.; Minerva Corp. of America, New York; J. P. Seeburg Corp., Chicago; Sherron Electronics Co., Brooklyn, N. Y.; U. S. Television Mfg. Corp., New York; and the Zell Co., New York.

## NAB Grows

ACCORDING TO figures recently released, National Association of Broadcasters now has 654 active members and 37 associate members, or a total of 691. Active membership includes 635 a-m stations, 16 f-m stations, 1 television station, and 2 networks.

Recent activities within the association include the nomination of a number of individuals to be directors-at-large. Under each of the following classifications two directors are to be chosen: Large stations—W. H. Summerville, WWL, New Orleans, La.; J. Leonard Reinsch, WSB, Atlanta, Ga.; J. O. Maland, WHO, Des Moines, Iowa; Lee B. Wailes, KYW, Philadelphia, Pa.; Paul W. Morency, WTIC, Hartford, Conn.—Medium stations—G. Richard Shafto, WIS, Columbia, S. C.; T. A. M. Craven, WOL, Washington, D. C.; Robert E. Priebe, KRSC, Seattle, Wash.; Clarence T. Hagman, WTCN, Minneapolis, Minn.; E. E. Hill, WTAG, Worcester, Mass.; F. M. Doolittle, WDRC, Hartford, Conn.; George

**IF YOU NEED GLASSES GO TO A SPECIALIST!**



**... IF YOU NEED FABRICATED PARTS**

*Come to* **Precision**  
**FABRICATORS, INC.**

**SPE-CIAL-LIST (-ist) n. ONE WHO DEVOTES HIMSELF TO A PARTICULAR BRANCH OF STUDY OR LABOR.** Right you are, Mr. Webster! That's exactly what we have been doing for many years... devoting our entire facilities to the careful study and production of fabricated parts—precisely according to customer specifications. Our modern plant is geared to handle all types of jobs... large or small... simple or intricate.

*Send us the specifications* for your next fabricated job and let us prove to you that we can produce it *better... faster* and more *economically!*



**SPECIALISTS**

IN THE

*Specification Fabrication of*  
VULCANIZED FIBRE, CORK, CORPRENE,  
PHENOL FIBRE, RUBBER,  
ASBESTOS AND OTHER MATERIALS

**Precision Fabricators, Inc.**

East Rochester, N. Y.

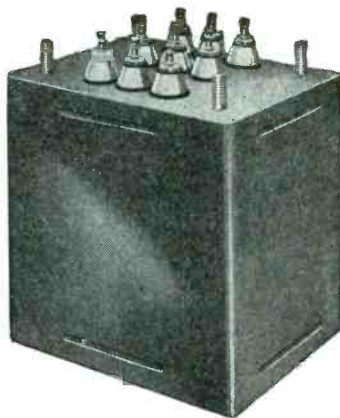
*Branch Offices:*

4317 RAVENSWOOD AVENUE, CHICAGO 13

4835 WOODWARD AVENUE, DETROIT 1

1776 BROADWAY, NEW YORK CITY

# TRANSFORMERS FOR ELECTRONIC PURPOSES



We are completely equipped for volume production. Write us concerning your requirements.

**DONGAN ELECTRIC MFG. CO.**

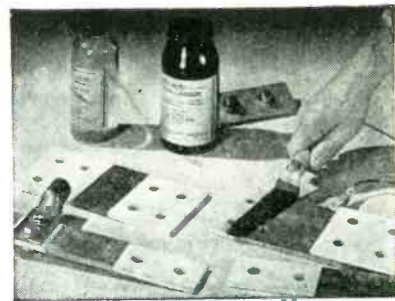
2977 Franklin

Detroit 7, Mich.

**DONGAN**  
TRANSFORMERS

The Dongan Line  
Since Nineteen-Nine

We Invite  
Inquiries



**RAPID**

## METAL-COATING PROCESS

- FAST AND ECONOMICAL
- FOR HEAVIER COATINGS

REQUIRES ONLY RAPID ELECTROLYTE — RAPID METAL CLEANER — RAPID APPLICATOR

• Plating current is obtained from dry cells, storage battery, or any convenient source of direct current at 3 to 6 V., or use Rapid Plating Rectifier for heavy work.

• For silver surfacing bus bar connections, lugs, switch blades, etc. For plating or touching up miscellaneous surfaces with cadmium, nickel, zinc, copper and gold. Building up limited areas. Hard surfacing with nickel. Used in shop or field. Special applicators designed to speed up production line jobs.

*Our laboratory is glad to cooperate.  
No obligation*

**Rapid Electroplating Process, Inc.**

1414 S. Wabash Ave., Chicago 5, Ill.  
621 Graybar Bldg. 237 Rialto Bldg.  
New York, N. Y. San Francisco, Calif.

*If* you want

- CRYSTALS
- CABLES
- HARNESES
- ELECTRONIC ASSEMBLIES
- CABINETS

Telephone Peru, Indiana

**151**

*Serving the Radio and Electronic Industries with precision engineered products.*

**Wm. T. WALLACE MFG. Co.**

General Offices: PERU, INDIANA

Cable Assembly Division: ROCHESTER, INDIANA

## WIRE, RIBBON and Other Metal Products

★ Smaller than Commercial Sizes;  
closer than Commercial Tolerances

An organization devoted to the research, development and production of wire and ribbon and similar products of Platinum and other Precious Metals, as well as Rare and Base Metals . . . This metallurgical plant is completely equipped with alloying, melting and working facilities for precision production. Equipment and staff permit specialization in smaller than commercial sizes and closer than commercial tolerances for the most exacting technical requirements.

**SIGMUND COHN & CO.**

44 Gold Street • New York 7, N. Y.

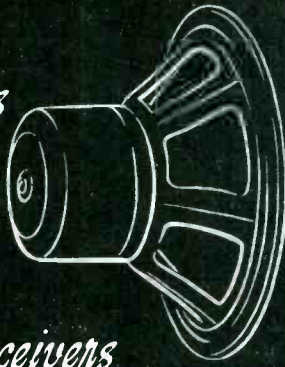


Since 1907



*This is the second in a series of four advertisements discussing the four major functions of permanent magnets*

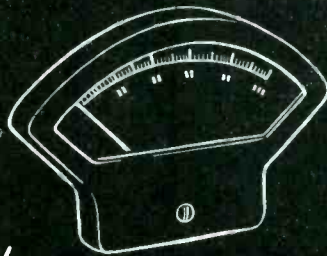
*Speakers*



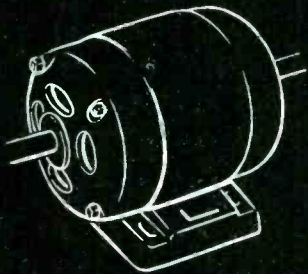
*Telephone Receivers*



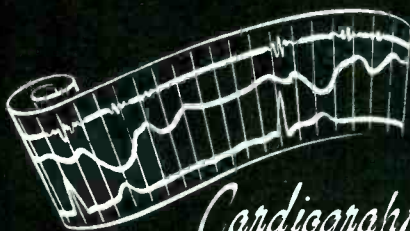
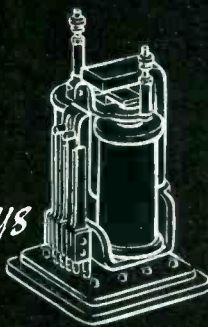
*Instruments*



*Electric Motors*



*Polarized Relays*



*Cardiograph Recorders*

## MECHANICAL ENERGY from ELECTRIC CURRENT through PERMANENT MAGNETS

The electric motor demonstrates how mechanical motion can be produced by the passage of an electric current with respect to a magnetic field set up by permanent magnets. Industry and science are making many profitable uses of this principle.

Mechanical energy may be transmitted to electrons moving in space to cause them to take a desired direction. A permanent magnet has been used, for example, to change the path of a cosmic ray in a cloud chamber. X-rays may be similarly directed; or the path of electrons in a magnetron tube can be changed.

The permanent magnet may be used as a polarizing agent, remaining stationary while mechanical motion is obtained by varying the magnetic field through variations in the applied electrical energy. Telephone receivers, magnetic recording heads, polarized relays, armature-type loud speakers, and some kinds of vibrators employ this principle.

For specific applications of permanent magnets to your problems of product improvement, consult our engineers. For 35 years we have specialized in the manufacture of permanent magnets and are today the largest plant in the world in this field. Write for copy of free technical booklet: "Permanent Magnets Have Four Major Jobs."

### ★ THE INDIANA STEEL PRODUCTS COMPANY ★

6 NORTH MICHIGAN AVENUE • CHICAGO 2, ILLINOIS



Specialists in Permanent Magnets Since 1910



# Laminated **INSUROK** T-712

Melamine Fiberglass Laminate—INSUROK T-712—is a brown plastic product of the type requested by the Navy for all electrical power, lighting, interior communications, fire control and other shipboard electrical installations.

● Laminated INSUROK T-712 is superior to many other types of sheet insulation in fire and arc resistance. It has reduced toxicity in the case of unavoidable fires; does not readily support combustion; is higher in mechanical and electrical properties; lower in expansion under heat and moisture, and has high tensile and compressive strengths. Richardson Plastics has also developed modern and economical methods of fabricating this product. Write today for complete information on Laminated INSUROK Grade T-712!

### TESTS OF FACTORY-RUN INSUROK T-712

Made at Richardson Laboratories

Tensile strength 1/8" thickness	
Lengthwise	45,600 psi.
Crosswise	37,900 psi.
Flexural strength 1/8" thickness	
Lengthwise	53,700 psi.
Crosswise	50,400 psi.
Compressive strength	
Flatwise (1/3" x 1/3" x 1/3")	97,800 psi.
Edgewise (1/2" x 1/2" x 1/2")	
Lengthwise	29,460 psi.
Crosswise	24,600 psi.
Impact strength Izod method per inch of notch	
Flatwise (1/2" x 1/4")	
Lengthwise	Greater than 33 ft. lbs.
Crosswise	27.4 ft. lbs.
Edgewise (1/2" x 1/4")	
Lengthwise	18.8 ft. lbs.
Crosswise	16.5 ft. lbs.
Bond strength 1/2" thickness	1,800 lbs.
Arc Test	185 sec.
Moisture Absorption 1/8" thickness	
24 hours in water at 77° F.	1.84%
Dielectric Constant	5.65
Loss Factor	.0521
Dielectric Strength	
Short Time	590 volts/mil
Step by Step	410 volts/mil

# INSUROK *Precision Plastics*

## The RICHARDSON COMPANY

MELROSE PARK, ILL. NEW BRUNSWICK, N. J. FOUNDED 1886 INDIANAPOLIS 1, IND. LOCKLAND, CINCINNATI 15, OHIO  
 DETROIT OFFICE: 8-252 G. M. BUILDING, DETROIT 2, MICHIGAN NEW YORK OFFICE: 75 WEST STREET, NEW YORK 6, N. Y.  
 CLEVELAND OFFICE: 326-7 PLYMOUTH BLDG., CLEVELAND 15, OHIO

M. Burbach, KSD, St. Louis, Mo.—  
 Small stations—Dietrich, Dirks, KTRI, Sioux City, Iowa; Frank King, WMBR, Jacksonville, Fla.; Clair R. McCollough, WGAL, Lancaster, Pa.; Dale L. Taylor, WENY, Elmira, N. Y.; Matthew H. Bonebrake, KOCY, Oklahoma City, Okla.; and Marshall Pengra, KRNR, Roseburg, Oregon.

A special committee is working on the task of selecting a president to succeed Harold Ryan, whose term expires on July 1 and who has indicated his intention of giving up the office at that time.

### Sound Reproduction Standards

AT THE REQUEST of the Armed Forces, ASA (American Standards Association) has completed a group of three standards designed to assure high fidelity in film sound reproduction.

All these standards deal with test methods for 16-mm sound motion picture prints. One, Z52.15, covers a method of making intermodulation tests on variable density prints; the second, Z52.39, describes a method of making cross-modulation tests on variable area prints; the third, Z52.38, is on a method of determining signal to noise ratio.

Each standard is divided into sections covering scope and purpose, test method, and test equipment. It is planned to specify limits of allowable sound distortion as a basis for acceptance or rejection of individual prints as soon as experience in the use of these tests is wide enough to warrant setting up definite limits.

### MEETINGS TO COME

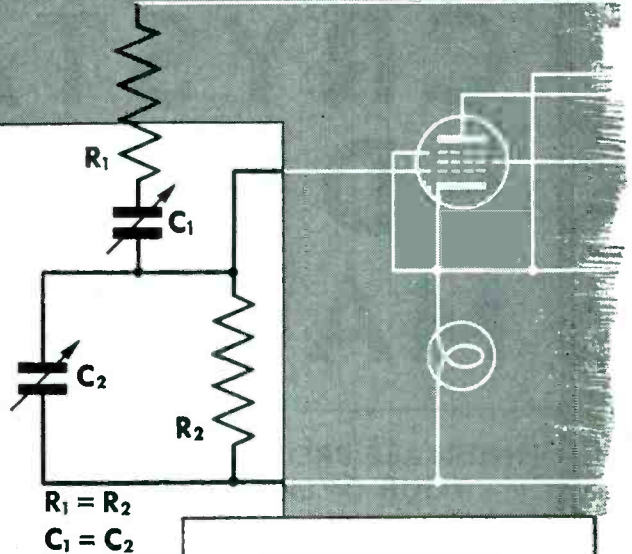
APRIL-MAY; NATIONAL ASSOCIATION OF BROADCASTERS, Annual Conference. . . . Cancelled.

MAY 2; INSTITUTE OF RADIO ENGINEERS, New York Section; Television, by P. I. Merryman, director of facilities development, NBC; Engineering Societies Building, New York, N. Y.; J. T. Cimorelli, secretary, Radio Corp. of America, Harrison, N. J.

MAY —; SOCIETY FOR EXPERIMENTAL STRESS ANALYSIS, 1945



This fundamental circuit is the key to -hp- audio oscillator efficiency



R1 = R2
C1 = C2

f = 1 / (2 \* pi \* R \* C)

The resonant frequency of this network is inversely proportional to the product of resistance and capacity. Thus wide change in resonant frequency is practical with commercially available condensers. A decade gang switch to change resistances enables operator to cover a wide range in the easiest possible manner. This circuit is the basic reason why -hp- Resistance-Tuned Audio Oscillators are so easy to use.

This resistance-capacity network is operated in conjunction with a

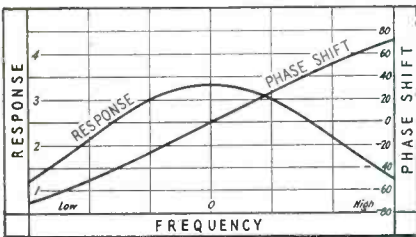


FIGURE 1

stabilized amplifier. Positive feedback is applied to this amplifier through the R-C network. The result is a very high effective "Q" for the circuit, which, combined with the phase shift characteristics of the net-

work, provides an extremely stable output frequency. See Figure 1.

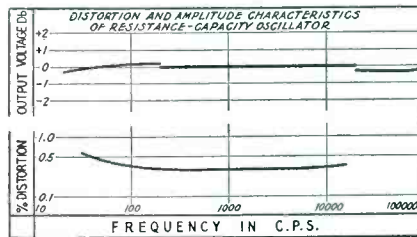


FIGURE 2

The unique balancing circuit automatically selects the proper operating point, keeps distortion at a remarkably low level, and maintains uniform output over the entire frequency spectrum. See Figure 2.

-hp- Audio Frequency Oscillators require no zero setting

It's just such engineered features as these that have made -hp- the outstanding laboratory instruments in the field today. Simplicity of operation... speed in making measurements without sacrifice of accuracy... that's the keynote of all -hp- instruments. Write for information... -hp- engineers are at your service.



-hp- Resistance-Tuned AUDIO OSCILLATORS cover a wide range

-hp- Model 200-A

Frequency range, 35 cps to 35 kc. In 3 ranges: 35 to 350 cps, 350 to 3500 cps, 3500 cps to 35 kc.

-hp- Model 200-B

Frequency range, 20 cps to 20 kc. In 3 ranges: 20 to 200 cps, 200 to 2000 cps, 2000 cps to 20 kc.

-hp- Model 200-C

Frequency range, 20 cps to 200 kc. In 4 ranges: 20 to 200 cps, 200 to 2000 cps, 2000 cps to 20 kc, 20 kc to 200 kc.

-hp- Model 200-D

Frequency range, 7 cps to 70 kc. In 4 ranges: 7 to 70 cps, 70 to 700 cps, 700 to 7000 cps, 7000 cps to 70 kc.

-hp- Model 202-D

Frequency range, 2 cps to 70 kc. The Model 202-D is similar to the Model 200-D, with the addition of a 2-50 cps band covering approximately 200 degrees on the main tuning dial.

-hp- Model 200-I

Frequency range, 6 cps to 6000 cps. In 6 ranges: 6 to 20, 20 to 60, 60 to 200, 200 to 600, 600 to 2000 and 2000 to 6000 cps.

All the above models are available in cabinets or for relay rack mounting.

HEWLETT-PACKARD COMPANY

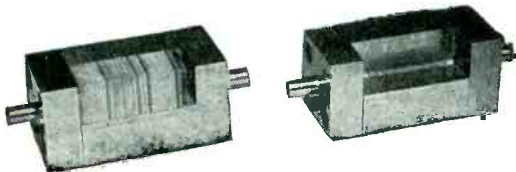
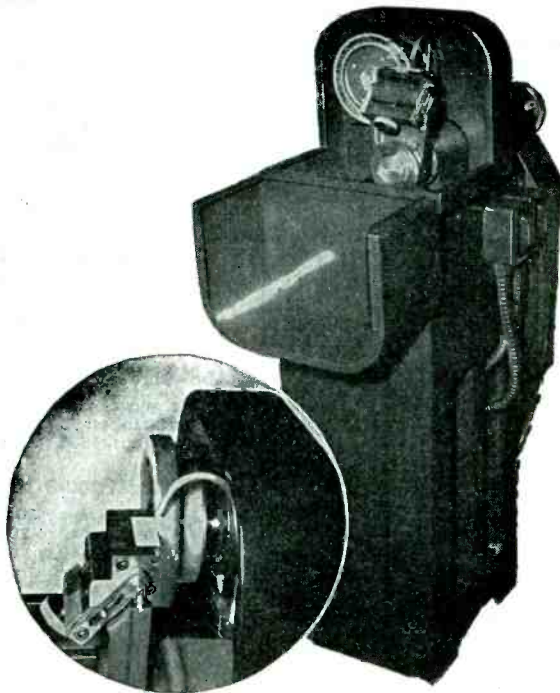
BOX 1042A • STATION A • PALO ALTO, CALIFORNIA

- Audio Frequency Oscillators, Signal Generators, Vacuum Tube Voltmeters, Noise and Distortion Analyzers, Wave Analyzers, Frequency Meters, Square Wave Generators, Frequency Standards, Attenuators, Electronic Tachometers

*New - Sensational*  
**CRYSTAL  
 EDGING  
 MACHINE**

*Pre-Dimensional*

**INCREASE PRODUCTION MORE THAN 50%  
 — YOUR OVERHEAD REMAINS STATIC —**



★ WRITE TODAY FOR DETAILS AND PRICES ☒

**VOLKEL BROS.  
 MACHINE WORKS**

1943 West Manchester • Los Angeles 44, Calif.

*Designers and Manufacturers of*

**SPECIAL DEVICES & EQUIPMENT**

Spring Meeting, Buffalo, N. Y. W. M. Murray, president, P.O. Box 168 Central Square Station, Cambridge 39, Mass. Subject to postponement or cancellation.

MAY 3; INSTITUTE OF RADIO ENGINEERS & AMERICAN INSTITUTE OF ELECTRICAL ENGINEERS, New York Sections; Comparison of Various Modulation Methods in Higher Frequency Communication, by W. R. MacLean, Brooklyn Polytechnic Institute; Engineering Societies Building, 33 West 39 St., New York, N. Y.; tickets, G. L. Tawney, Hudson American Corp., 300 Pearl St., Brooklyn 1, N. Y.

MAY 10; INSTITUTE OF RADIO ENGINEERS & AMERICAN INSTITUTE OF ELECTRICAL ENGINEERS, New York Sections; Radiation and Propagation in Higher Frequency Communication by C. W. Hansel, RCA Laboratories; Engineering Societies Building, 33 West 39 St., New York, N. Y.; tickets, G. L. Tawney, Hudson American Corp., 300 Pearl St., Brooklyn 1, N. Y.

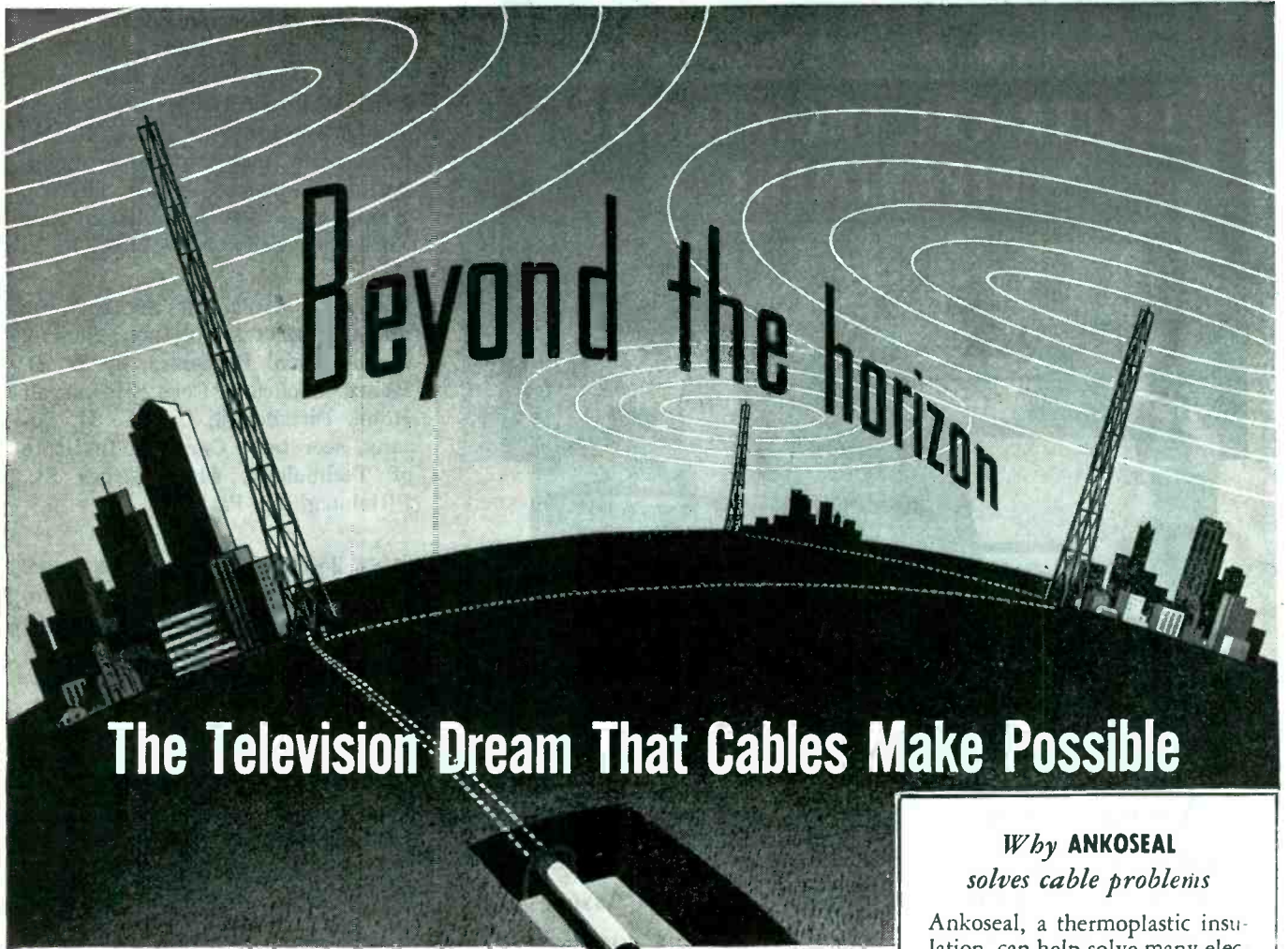
MAY 11-12; ACOUSTICAL SOCIETY OF AMERICA, Thirtieth Meeting; Hotel Pennsylvania, New York, N. Y.; Wallace Waterfall, secretary, 350 Fifth Ave., New York 1, N. Y.

MAY 14-18; SOCIETY OF MOTION PICTURE ENGINEERS, 57th Semi-Annual Technical Conference; Hollywood-Roosevelt Hotel, Hollywood, Calif; W. C. Kunzmann, convention vice president, P.O. Box 6087, Cleveland 1, Ohio.

MAY 17; INSTITUTE OF RADIO ENGINEERS & AMERICAN INSTITUTE OF ELECTRICAL ENGINEERS, New York Sections; Television Relay System, by H. B. Fancher, General Electric Co.; Engineering Societies Building, 33 West 39th St., New York, N. Y.; tickets, G. L. Tawney, Hudson American Corp., 300 Pearl St., Brooklyn 1, N. Y.

MAY 18; INSTITUTE OF RADIO ENGINEERS, Chicago Section; Current Problems in Radio Engineering and Manufacturing, by Paul Galvin, president, Galvin Mfg. Corp.; Central YMCA, 19 South LaSalle St.; Alois W. Graf, secretary, 135 South LaSalle St., Chicago 3, Ill.

MAY 23; AMERICAN INSTITUTE OF ELECTRICAL ENG'RS, N. Y. Section,



## The Television Dream That Cables Make Possible

**T**ELEVISION—sign and symbol of the age to come—is one of the wonders that specially designed cable transmission makes practical. For the quality and fidelity of the transmitted image depend largely on how well the cables are engineered and manufactured, from tiny cables in the broadcasting mechanism itself to the great coaxial cables linking city with city, making possible the television networks of the future. Thus the “wireless age” as it develops will actually need more wires—and more complicated cables—to achieve its realization! And in the solution of these problems, new and more complicated cables will be required. Today, we will undertake to engineer and manufacture the radio and audio cable requirements of

any government agency or private concern in war work. Moreover, we look forward to solving many of the most difficult cable tasks in peacetime—as we have in wartime. The same laboratories, the same Yankee ingenuity that have helped to whip many of the difficulties involved in the communications requirements of our Army and Navy are prepared to function for industry—whatever the problems of today and tomorrow.

### Why ANKOSEAL solves cable problems

Ankoseal, a thermoplastic insulation, can help solve many electrical engineering problems, now and in the future. Polyvinyl Ankoseal possesses notable flame-retarding and oil resisting characteristics; is highly resistant to acids, alkalies, sunlight, moisture, and most solvents. Polyethylene Ankoseal is outstanding for its low dielectric loss in high-frequency transmission. Both have many uses, particularly in the radio and audio fields. Ankoseal cables are the result of extensive laboratory research at Ansonia—the same laboratories apply engineering technique in the solution of cable problems of all types.

## THE ANSONIA ELECTRICAL COMPANY

Specializing in "Ankoseal" a Thermoplastic Insulation!  
ANSONIA • CONNECTICUT



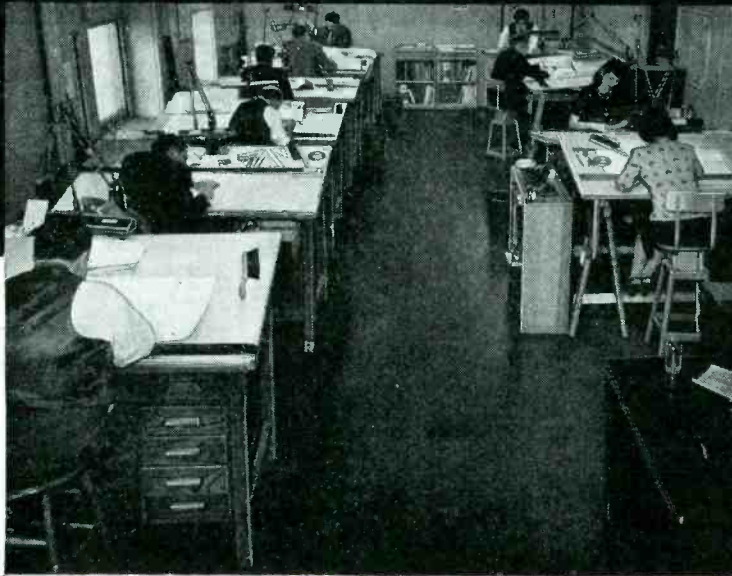
A Wholly-Owned Subsidiary of

## NOMA ELECTRIC CORPORATION

GENERAL OFFICES • NEW YORK, N. Y.

—In peacetime makers of the famous Noma Lights—the greatest name in decorative lighting. Now, manufacturers of fixed mica dielectric capacitors and other radio, radar and electronic equipment.

*This may be your new*  
**ELECTRICAL ENGINEERING  
 DEPARTMENT**



**A**BOVE is a portion of the Electrical Engineering Department, which contributes to the unusual Unionair set-up that is at present producing Electrical Assemblies for the war effort. This department converts customers' drawings and sketches to Unionair production drawings and where required, creates its own designs in connection with Electrical Equipment.

When the time comes that we can put to Commercial use the results of the concentrated research and development of the war years in Electrical Assemblies, these engineering facilities may be yours.

Our new booklet titled, "Electrical Assemblies made to Customers' Specifications" is available on request. Write to: Union Aircraft Products Corp., Dept. E, 245 East 23rd Street, New York 10, N. Y.



**UNIONAIR**

*Electrical Assemblies—Hydraulic Fittings  
 Conduit Fittings—Junction Boxes*

**UNION AIRCRAFT PRODUCTS CORP., NEW YORK**

Focusing of Electron Beams, by Dr. E. U. Condon, associate director of research, Westinghouse Electric & Mfg. Co.; Pupin Laboratory, Columbia University, New York, N. Y.; Prof. C. W. van der Merwe, symposium chairman, dept. of physics, Washington Square College, New York University, New York, N. Y.

MAY 28; AMERICAN SOCIETY FOR MEASUREMENT & CONTROL; Control of Industrial Processes, by W. B. Heinz, Cochrane Corp.; Roosevelt Hotel, Pittsburgh, Pa.; L. M. Sulsan, secretary, Carnegie Institute of Technology, 4400 Forbes St., Pittsburgh 13, Pa.

JUNE 25-29; AMERICAN INSTITUTE OF ELECTRICAL ENGINEERS, Summer Technical Meeting; Detroit, Mich.; H. H. Henline, secretary, 33 West 39 St., New York 18, N. Y. . . . Cancelled.

**WASHINGTON NEWS**

**PRODUCTION.** Looking toward a greater production effort in 1945 than was available in 1944, WPB points out that in the January and February schedules this year, communication and electronic equipment increased 10 percent. Summed up for the year 1944, actual production was \$4,185,000,000, while December production was \$335,000,000. As of January 1, 1945, the January schedule was \$354,000,000 and the February schedule \$380,000,000. It was also revealed that cumulative figures from July 1, 1940 through December, 1944 showed communication and electronic equipment standing at a total value of \$9,405,000,000, with radio at \$4,459,000,000 and electronic equipment at \$2,827,000,000.

**RETURNED MATERIEL.** Under a new arrangement within the Signal Corps, supervision of all shipments of returned materiel from overseas will be handled by an organization at the Holabird (Md.) Signal Depot. Shipping instructions will be sent to every Atlantic port on all signal items which can be identified, assigning them to the different Signal Corps installations around the country. About 90 percent of all materiel is unidentified. This will be



**"I TELL YOU I'M NOT CRAZY. ALBION CAN SHIP US  
ALL THE COILS WE NEED."**

#### **SUPER-QUALITY COILS AT REASONABLE PRICES**

More and more every day, the industry is turning to Albion for fast, quality and quantity production of coils, chokes, and transformers. That's because here you benefit from the unbeatable combination of management "know how," skilled workmanship, streamlined facilities, and central location. Your requirements will be given prompt and thoughtful attention.

ELECTRONICS — May 1945

# **ALBION**

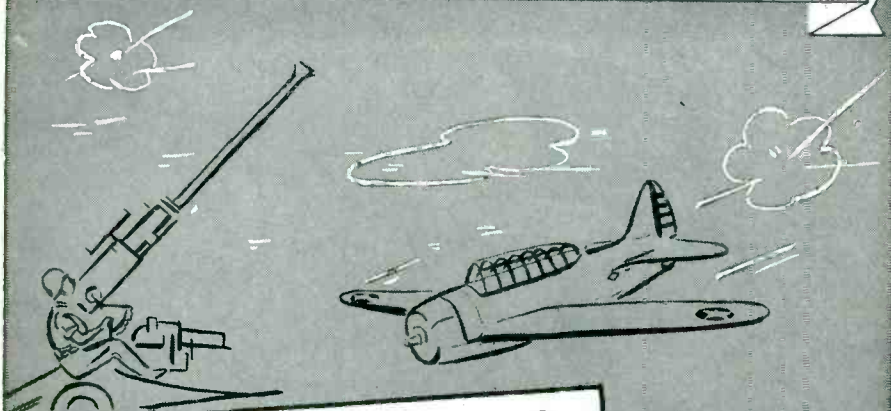
## **COIL COMPANY**

**ALBION, ILLINOIS**

R. F. AND TRANSMITTING COILS AND CHOKES;  
I. F. TRANSFORMERS

FOR POST-WAR REQUIREMENTS

# 40 YEARS OF EXPERIENCE AT YOUR SERVICE



## Willor Makes It!

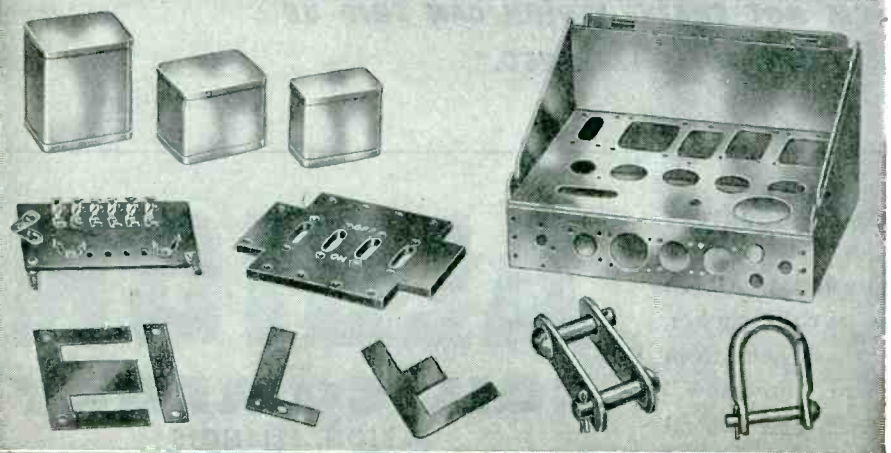
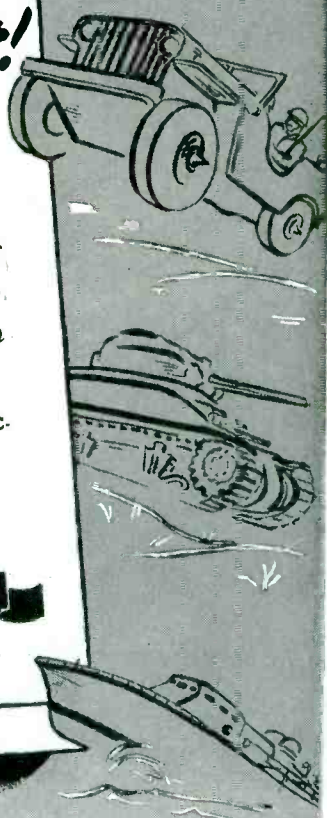
... and makes it with a high degree of precision and cooperation born of our concentrated experience in meeting wartime's rigid requirements and schedules. From raw stock to completed items ... Willor service embraces every facility for planned production.

*We Invite Inquiries and Blueprints*

- METAL STAMPINGS
- MACHINE WORK
- LAMINATIONS
- TOOLS AND DIES
- PANEL BOARDS
- PLASTIC PARTS
- MECHANICAL AND ELECTRICAL INSTRUMENTS

# WILLOR MANUFACTURING CORP.

794 E. 140th St., New York (54) N. Y.



BACK THE ATTACK -- BUY MORE WAR BONDS

sent to Holabird where after examination it will be classified as serviceable, repairable, obsolete, excess, surplus or salvage. Serviceable materiel will be sent where needed, and obsolete apparatus will be dismantled so that parts can be used where possible. Materiel rated as salvage will be shipped to the salvage disposal division and simple repairs will be done. Materiel which can be repaired by the use of specialized equipment will be sent to various Signal Corps depots where the required equipment is available.

**SURPLUS PRODUCTS.** Toward the end of April, Section XI of a handbook of standards for describing surplus property was announced by Surplus Property Board. This section covers communications equipment, electronic devices, and alarm and signal control equipment. Produced to establish minimum standards for contractors and government owning agencies in describing inventories, the handbook will consist of 22 sections, 13 of which have been previously issued. In a still later section will be included instrument control apparatus, including scientific and professional equipment and supplies. Copies will be purchasable from the Superintendent of Documents, Washington, D. C.

**SHORTAGES.** Electron tubes still being in short supply, WPB is simultaneously trying to get all existing tubes in service and to obtain the maximum volume of new tube production. Information as to surplus radio receiving tubes is made available to manufacturers and distributors, so that any actual surplus supplies may reach dealers and service men for civilian supply. This does not mean that the civilian tube supply situation will improve materially. Rather, it is expected to remain about the same as in late 1944, approximately one and one-half million tubes a month.

Although available production capacity is believed to be greater than military needs, transformers were reported as becoming critical again and closer control by WPB is anticipated.

Aluminum phonograph records are available only on high rated orders, remaining supplies being available only to broadcasting sta-



# When You Don't Want to Draw Power

## USE THIS

# NEW D-C VACUUM-TUBE VOLTMETER

HAVING the very wide d-c voltage range of 0.05 to 3,000 volts with exceptionally high input resistance, this new d-c v-t voltmeter is very useful in radio and electronic circuit design and testing.

Small, portable, lightweight, self-contained and accurate the new Type 728-A Voltmeter is especially useful when voltage measurements have to be made without drawing power from the circuit.

### FEATURES

**WIDE RANGE** — 0.05 to 3,000 volts, in 7 full-scale values of 3, 10, 30, 100, 300, 1000 and 3000 volts, d-c

**HIGH INPUT RESISTANCE** — Over 5000 megohms on ranges below 100 volts; 1000 megohms above

**GOOD ACCURACY** — within  $\pm 3\%$  of full-scale on low ranges to 30 volts; within  $\pm 5\%$  on higher ranges

**NEGLECTIBLE A-C EFFECT** — superimposed a-c voltage up to 200 has negligible effect on meter indication

**REVERSING SWITCH** — switch on panel to ground either positive or negative terminal of source being measured

**BATTERY OPERATED** — instrument supplied complete with batteries

**PORTABLE** — weighs only  $9\frac{3}{4}$  pounds with batteries; dimensions (length) 11 x (width)  $6\frac{5}{8}$  x (height)  $5\frac{3}{8}$  inches with cover closed

**TYPE 728-A D-C VACUUM-TUBE VOLTMETER \$110**

At present this instrument is available only for high priority war orders; reservation orders for later deliveries are being accepted.

Write for a copy of the G-R Experimenter for December 1944 for complete description of this instrument.

- WIDE RANGE
- HIGH INPUT RESISTANCE
- GOOD ACCURACY
- NO A-C EFFECT
- PORTABLE
- BATTERY OPERATION



# GENERAL RADIO COMPANY

Cambridge 39, Massachusetts  
NEW YORK CHICAGO LOS ANGELES

Whatever band the

# FCC

finally assigns

to your broadcast, VHF, UHF or other com-

munications devices, we will always be ready

to produce accurately and deliver on schedule

Control Crystals to your exact specifications.

Meanwhile, may we offer our extensive

experience with the more difficult frequencies,

without obligation, if it can help your planning.

tions making master records, and then only when filing such orders as would not interfere with military and OWI requirements.

Workers are scarce to the tune of 10,000 in 153 radar plants which are now behind schedule. Ninety percent of these jobs can be handled by women.

**RAILROAD RADIO.** Mobile radio equipment allocations and lending for experimental purposes is expected to be controlled by WPB more closely than before. Small quantities of mobile equipment will be granted on a loan basis—usually 90 days—for essential experimentation which would be limited to just a few companies in any one field on the theory that other companies with parallel operations can base their future policy on results of these individual tests.

**BROADCAST APPLICATIONS.** Under a new policy effective January 16, 1945, FCC announces the following manner of handling applications for new standard broadcast stations or for changes in facilities:

Applications filed before January 26, 1945, and upon which the Commission has taken no action, will be held in status quo unless the applicant files a petition requesting action or unless the Commission itself desires to determine issues which would require hearings regardless of material and manpower.

Applications filed before January 26, 1945, which have been designated for hearing but no hearing has been held, will be retained in status quo unless either of the alternative factors apply as indicated under the former category.

Applications filed before January 26, 1945, in which hearings have begun but the record has not yet been completed, will be finished and held in the pending file unless it appears that a grant can be made under the terms of the Commission's supplemental policy statement of Jan. 26, 1944.

Applications filed before January 26, 1945, and in which hearings have been concluded, will be decided and announced where a grant is possible under terms of the supplemental statement of policy or a denial is necessary regardless of the availability of materials and manpower.

Applications filed after January



PAN-Electronic Laboratories, Inc.

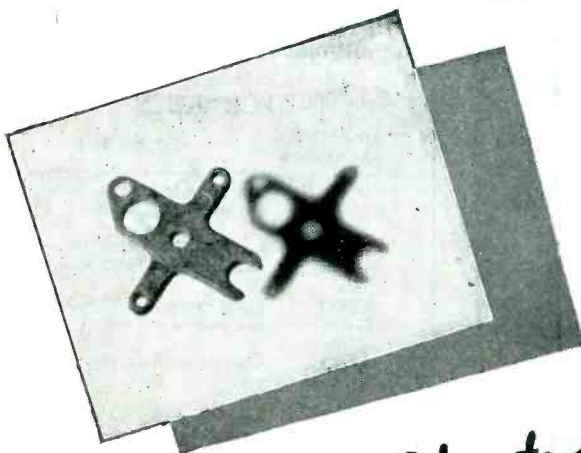
500 SPRING STREET, N.W.

ATLANTA, GEORGIA

Pan-El

QUANTITY PRODUCERS OF STANDARD AND SPECIAL

# Control Crystals



# Superior Electronic Components WITH INJECTION MOLDED G-E MYCALEX

G-E Mycalex is doing a big job for the electronic industry. A speedy yet precision type of injection molding developed by the General Electric Company allows intricate shapes to be molded to extremely close tolerances.

G-E Mycalex can be molded with metal inserts, and as a result, the metal and the G-E mycalex are fused into an unusually strong bond.

Having over-all electrical properties superior to porcelain products and refractory qualities superior to organic plastics, G-E mycalex remains the all-purpose, high-heat, high-frequency insulation material for use in the radio and electronic industries.

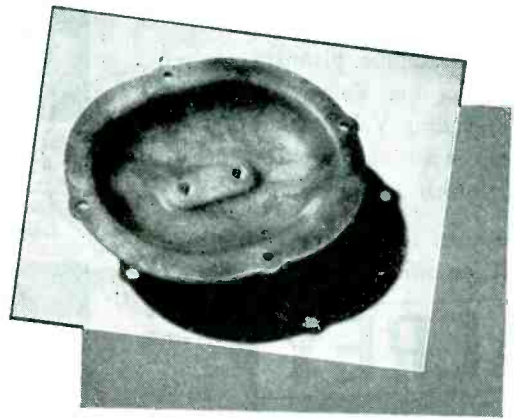
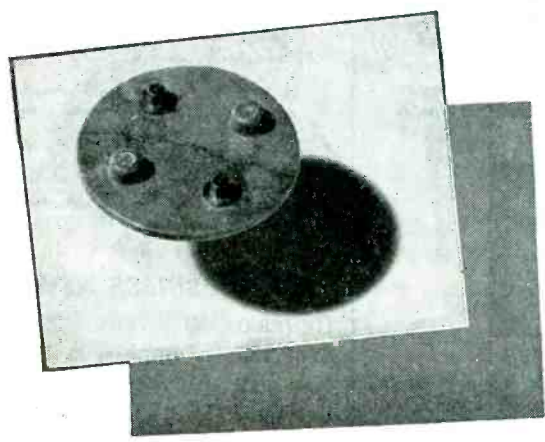
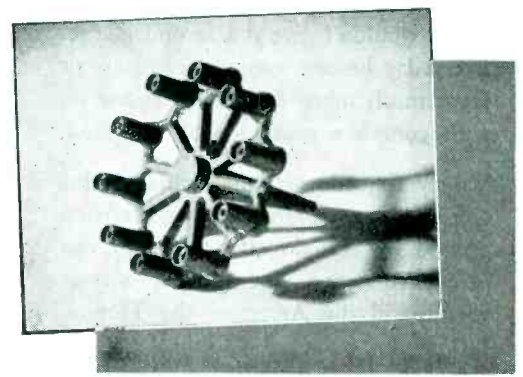
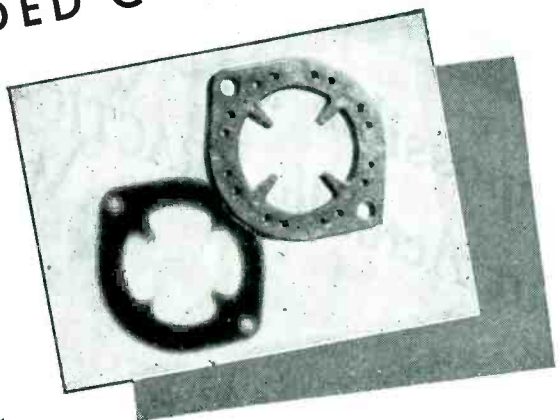
For further information write Section S-51, General Electric Company, One Plastics Avenue, Pittsfield, Mass.

- G-E mycalex has the following properties:
1. High dielectric strength.
  2. Low power factor.
  3. Prolonged resistance to electric arcs.
  4. Chemical stability; no deterioration with age.
  5. Dimensional stability; freedom from warpage, shrinkage, etc.
  6. Imperviousness to water, oil and gas.
  7. Resistance to sudden temperature change.
  8. Low co-efficient of thermal expansion.

Hear the General Electric radio programs: "The G-E All-Girl Orchestra" Sunday 10 P.M. EWT, NBC. "The World Today" news every weekday 6:45 P.M. EWT, CBS. "G-E House Party" every weekday 4:00 P.M. EWT, CBS.

*Buy War Bonds*

**GENERAL ELECTRIC** PD-51





**Impossible a Few Years Ago  
— But Actually PRACTICAL Today**



Yes, it probably would look strange to us to see such a sight today. But the G.I. Joe in Europe or on a South Pacific island wouldn't give it a second glance. Every day he sees communications sent from much more difficult positions — with complete assurance of reception.

Valpey Crystals are vital parts of this type of communication. Precision ground by crystal craftsmen, they can be relied upon for perfect service whether in the Arctic or the Tropics.

As they did *before* the war Valpey Crystals *after* the war will be chosen for their high fidelity and complete dependability. Peacetime planners are already contacting the Valpey laboratories and are finding Valpey engineers ready to help with any problem of design or performance.

Why not write us for complete information on "Crystonics."

# VALPEY

## Crystal Corp.

CRAFTSMANSHIP IN CRYSTALS SINCE 1931  
HOLLISTON, MASSACHUSETTS



CM-1

*A design for normal frequency control applications suitable for marine, aircraft, etc., uses*



CBC-0

*Where utmost in stability requires constant temperature control in commercial installations*



VP-3

*Developed for use in mobile equipments and applications with limited space.*

26, 1945 will be processed and determined in accordance with the supplemental policy.

### FCC ACTS

To permit this station	To do this:
KPO Wenatchee Wash.	Change to 560 kc, Up power to 1 kw, Install new transmitter
WSSC Savannah, Ga.	Relay to WTOC on 30,820, 33,740, 35,820, and 37,980 kc with 2-w power
KRKO Everett, Wash.	Move transmitter and studio, install new antenna and ground
KFEQ St. Joseph, Mo.	Operate auxiliary transmitter
W3XO Wash., D. C.	Move transmitter for allocation and coverage studies in conjunction with W3XMB.
KCMO Kansas City, Mo.	Increase power to 5 kw contingent on later move of transmitter to protect KTBS and other points. Construct new station on 1340 kc, 250 w unlimited time.
Dublin, Ga.	Make changes in present transmitter equipment.
KOIN Portland, Ore.	
WJEF Grand Rapids Mich.	Operate a new station on 1230 kc, 250 w, unlimited time.
KELO Sioux Falls, S. Dak.	Operate with new antenna
WJNO West Palm Beach, Fla.	Move transmitter and studio.
WFBM Indianapolis, Ind.	Construct 1 kw auxiliary transmitter using directional antenna at night.
WNYG New York, N. Y.	Construct new relay broadcast station for 1622, 2058, 2150 and 2790 kc, 40 w. Construct new standard broadcast station to operate on 1450 kc, 250 w, unlimited time.
Rome N. Y.	Change automatic frequency control unit of auxiliary transmitter.
WEBC Duluth, Minn.	
WINS New York, N. Y.	Use former main transmitter as auxiliary of 1-kw power with directional antenna day and night.
WJOD Washington, D. C.	Move relay broadcast transmitter.
WEJC Washington, D. C.	Operate relay station transmitter at new location, move main transmitter, and change antenna.
WAGE Syracuse, N. Y.	Operate auxiliary transmitter with 250-w power using directional antenna at night.
WCHV Charlottesville Va.	Operate at frequency of 1240 kc.
WBKY Lexington, Ky.	Operate new non-commercial educational broadcast station on 42,900 kc, 500 w.
Cambridge, Mass.	Construct developmental broadcast station, frequency to be assigned, 250 w, AO, A4 and special emission for fm, unlimited time.
KONP Port Angeles, Wash.	Operate a new station at 1450 kc, 250 w, unlimited time.
WIBG Philadelphia, Pa.	Operate old transmitter as auxiliary.
WATW Ashland, Wis.	Operate at increased power of 250 w and with change in type of transmitter.
Sacramento, Calif.	Construct a new station to operate on 1490 kc, 250 w, unlimited time.
Sacramento, Calif.	Construct a new station to operate on 1340 kc, 250 w, unlimited time.

### BUSINESS NEWS

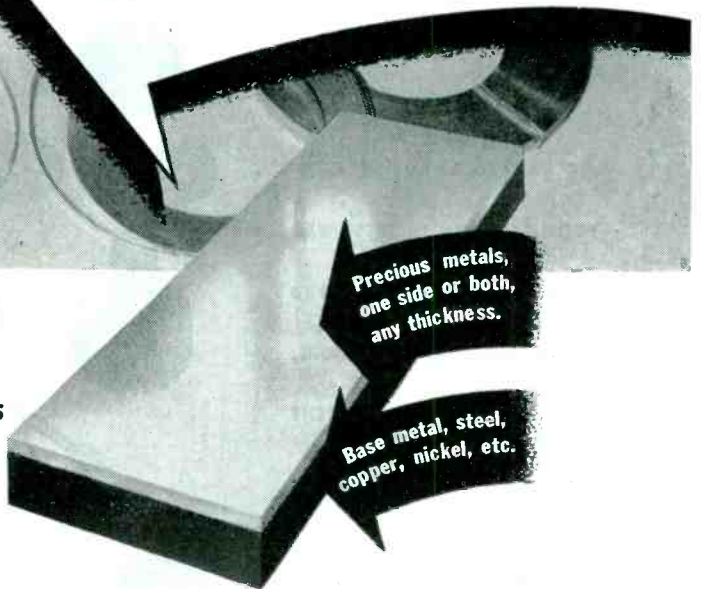
GENERAL ELECTRIC Co. has paid \$232,735 to employees for production-accelerating suggestions made during 1944. The total number of



*Spearhead  
Your Competitive  
Attack...*

**Incorporate GENERAL PLATE  
LAMINATED METALS  
into your Post-War Products**

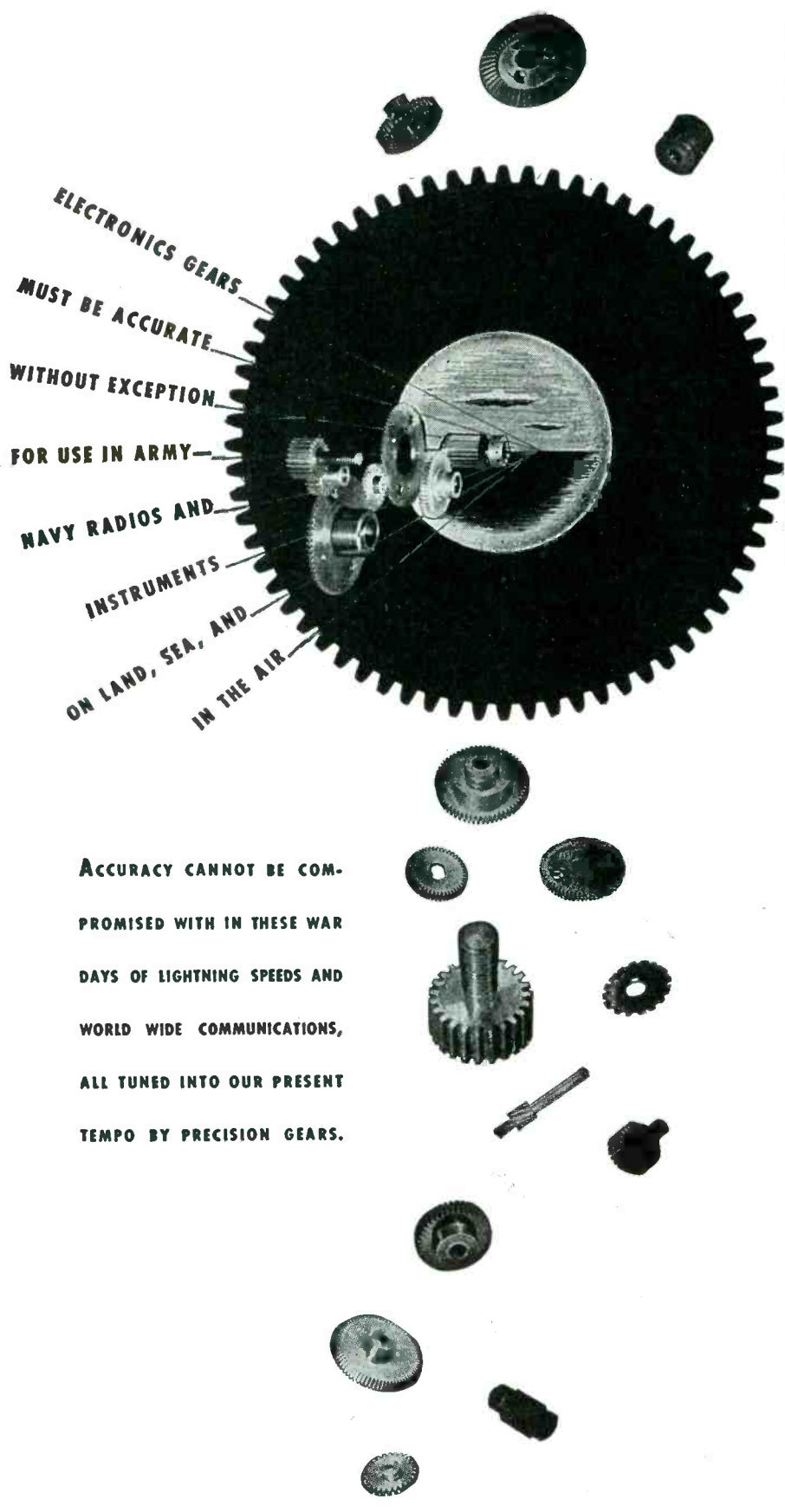
If you want to be sure that your post-war products are out in front in the peace period, do as other manufacturers are doing . . . include General Plate Laminated Metals into your designs. These versatile laminated metals will give you many performance and sales advantages that cannot be obtained with solid metals. For instance, permanently bonded laminations of precious metals to base metals give solid precious metal performance at a fraction of the cost of solid precious metals. In addition, the precious metals provide better electrical conductivity or corrosion resistance and long wearing life. The base metals



permit workability, ease of fabrication and strength. Don't be caught off guard in the coming sales battle, incorporate General Plate Laminated Metals into your products now. They are available in raw stock, sheet, wire or tube . . . inlaid or wholly covered or as completely fabricated assemblies. Our engineers will gladly give you every assistance in the selection of the right metal combination for your particular products. Write for their services, today.

***General Plate Division* OF METALS & CONTROLS CORPORATION**

50 Church St., New York, N. Y.; 205 W. Wacker Drive, Chicago, Ill.; 2635 Page Drive, Altadena, California; Grant Bldg., Rm. 603, Pittsburgh, Pa.  
**ATTLEBORO, MASSACHUSETTS**



**ELECTRONICS GEARS**  
**MUST BE ACCURATE**  
**WITHOUT EXCEPTION**  
**FOR USE IN ARMY**  
**NAVY RADIOS AND**  
**INSTRUMENTS**  
**ON LAND, SEA, AND**  
**IN THE AIR**

**ACCURACY CANNOT BE COM-  
 PROMISED WITH IN THESE WAR  
 DAYS OF LIGHTNING SPEEDS AND  
 WORLD WIDE COMMUNICATIONS,  
 ALL TUNED INTO OUR PRESENT  
 TEMPO BY PRECISION GEARS.**

**Quaker City Gear Works**  
 INCORPORATED  
 1910-32 North Front Street, Philadelphia, Pennsylvania

ideas paid for was 19,488 and the record award was \$2,000.

COLUMBIA BROADCASTING SYSTEM is giving a 60-week course in the operation of television studio and transmitter equipment to 175 of the network's technical employees. Divided into three sections of 20 weeks each, the course is being given by the division of general education and College of Engineering, New York University.

HYTRON CORP., Salem, Mass., has changed its name to Hytron Radio & Electronics Corp.

MCMURDO SILVER Co. is a new engineering and manufacturing concern established in Hartford, Conn. Activities will involve amateur parts, kits, and special equipment production as well as consulting engineering.

ALLEN B. DUMONT LABORATORIES, INC. has an order for the first television transmitter to be installed in Australia. The projected location is Sydney, N. S. W.

PHILHARMONIC RADIO CORP., a subsidiary of American Type Founders Inc. has been consolidated with the ATF remote control division, both at New York, N. Y. Home radio plans are being dropped.

OHMITE MFG. Co. makes an initial grant of \$15,000 to Illinois Institute of Technology for establishment of a laboratory there. Activities will involve precision measurement of electrical and magnetic quantities with an ultimate goal of approaching the accuracy of the Bureau of Standards, Washington, D. C.

SONOTONE RESEARCH LABORATORIES, Elmsford, N. Y., has met the manpower shortage by the employment of large numbers of school girls from the bobby sox crowd of Westchester County.

WESTINGHOUSE ELECTRIC INTERNATIONAL Co., East Pittsburgh, Pa. is planning a Portuguese edition of *El Ingeniero Westinghouse*, the Spanish technical magazine produced for Latin America.

PHILCO CORP., Philadelphia, Pa. takes over the facilities formerly occupied by Hunter Mfg. Co. at Croydon, Pa. Utilizing approximately 200 employees, the new facil-

---

★   ★   ★

# What's all this talk about "SMALL BUSINESS"?

There's no "small business" anymore. From now on, the main issue in this country will be *National Security* . . . and in this sense there are no more small businesses.

## They are ALL Component Parts of BIG BUSINESS

National Security will increasingly come to mean spreading more and more business over more and more areas . . . with more and more qualified sub-contractors . . . thus making every community self-supporting . . . providing full employment . . . equalizing in the truest sense the distribution of our national wealth.

Business is no different from an army. The success of both depends upon the efficient integration of its component units . . . and no one unit is expected to do the entire job.

That's the lesson we've learned from the war. And the more we apply it expertly and unselfishly to our industrial problems of production, the sooner we will resolve most of the disturb-

ing conditions that hitherto have continued to upset our economic balance.

## Handling 5000 Contracts in One Year

Here at Lewyt, during 1944, we produced a great variety of component parts and assemblies of important war equipment . . . complicated electronic mechanisms that involved the use of many highly specialized skills. We successfully met the most exacting requirements of low-reject production and frictionless synchronization with other manufacturers' schedules. Our year's activities summed up to filling *5000 separate contracts for other manufacturers!*

Few plants make their entire product anymore. We have become a nation of sub-contractors. Sub-contracting has emerged from pre-war obscurity to occupy a place of dignity and ever-increasing stature in our future economy.

★   ★   ★

Write on your business stationery for 48-page book, "Let Lewyt Do It"—the story of the Lewyt organization in pictures. Lewyt Corporation, 60 Broadway, Brooklyn 11, N. Y.



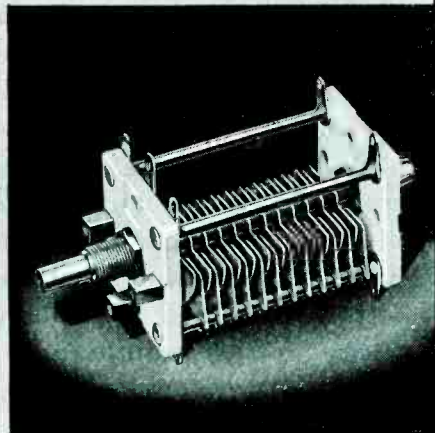
A CONTRACT MANUFACTURER—EXPERTLY STAFFED TO PRODUCE COMPLETE ELECTRONIC AND MECHANICAL ASSEMBLIES, COMPONENT PARTS AND SUB-ASSEMBLIES, TO THE MOST EXACTING REQUIREMENTS

C O N T I N U E   ★   B U Y I N G   ★   W A R   ★   B O N D S

*Designed for*



*Application*



**The 23000 Series  
Variable Air Capacitors**

"Designed for Application," double bearings, steatite end plates, cadmium or silver plated brass plates. Single or double section. .020" or .060" air gap. End plate size:  $1\frac{1}{16}$  x  $1\frac{1}{2}$ . Rotor plate radius:  $19/32$ ". Shaft lock, rear shaft extension, special mounting brackets, etc., to meet your requirements.

**JAMES MILLEN  
MFG. CO., INC.**

MAIN OFFICE AND FACTORY  
**MALDEN  
MASSACHUSETTS**



ities will specialize in the export packing of spare parts for radio and electronic equipment.

E. I. DU PONT DE NEMOURS & Co. establishes an electronics group in its rayon department. Much of the activity of the group will be concerned with development of methods for control of various operations.

HALLICRAFTERS Co., Chicago, Ill. announces an employee profit-sharing trust plan for workers with three years seniority. All payments to the fund will be made by the company.

TECKNA Co. is the new name of the plastic-fabricating and product engineering concern formerly known as Teckna Plastic Co. The company is located in Bayside, L. I., N. Y.

UNIVERSITY OF LOUISVILLE establishes a non-profit Institute of Industrial Research whose purpose is to engage in engineering and scientific research for industrial and private clients on a contract basis.

ELECTRONIC TESTING LABORATORIES INC., Newark, N. J. has completed a program for expansion of its production facilities.

ADAPTOL Co. is now located in enlarged quarters at 260 Utica Ave., Brooklyn, N. Y.

JAMES KNIGHTS Co., Sandwich, Ill., has effected a license agreement with Western Electric Co. and will manufacture electronic equipment under their patents.

SOUND APPARATUS Co. announces the location of new offices in the Woolworth Bldg. at 233 Broadway, New York 7, N. Y.

**PERSONNEL**

FRANK P. BARNES, former instructor in electronic and radio engineering at the University of Washington and with General Electric Co. since 1937, is appointed district representative of the transmitter division of the company's elec-



*Let*  
**Haydon**

*\*Electroneered  
Timing*

**HANDLE YOUR PROBLEM**

Wherever mechanical equipment can be regulated by automatic timing, Haydon Electroneered Timing — with its many types of synchronous timing motors available — will fit your product and the new automatically controlled devices of the future.

Synchronous AC timing motors by Haydon, are available with torque output of 5 to 20 inch ounces, basis 1 RPM; specially protected, where necessary, for salt spray, tropical service, vibration or shock; lubricated to ambient temperature specifications of the



customer; special coils and leads available for high temperatures; available in a wide range of voltages, frequencies, and

output shaft speeds. Compact — light in weight — rugged and reliable.

Write today for your copy of this catalogue.



**\*ELECTRONEERED TIMING**

**Haydon**

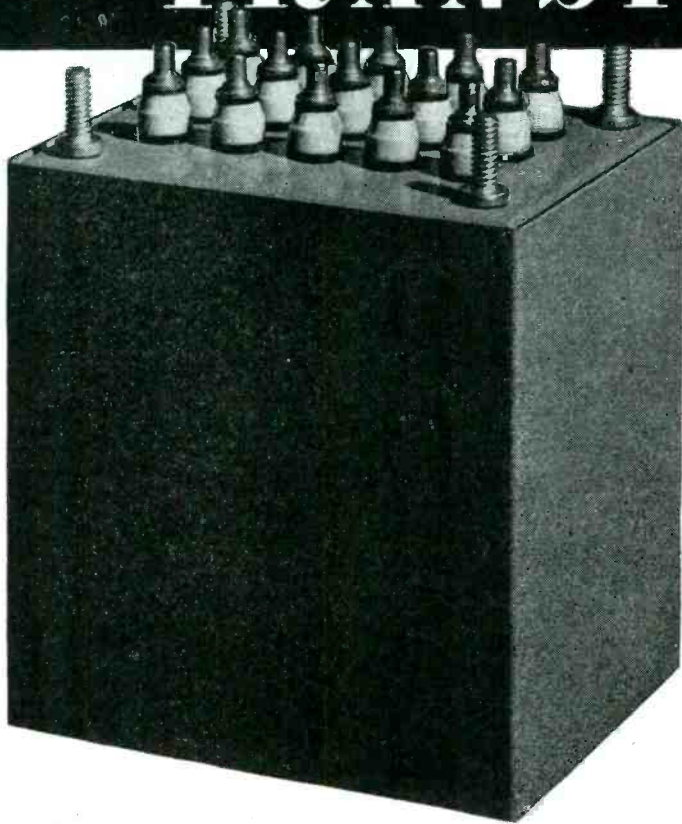
**MANUFACTURING COMPANY  
\* INCORPORATED \***

*Forestville, Connecticut*

Manufacturers of the broadest range of timing motors



# Hermetically Sealed TRANSFORMERS



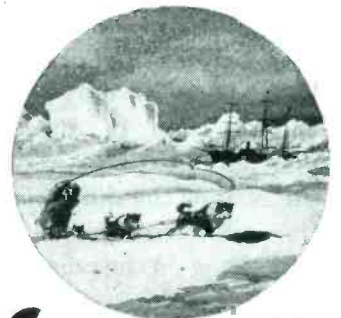
*Illustrated at left is a Langevin Hermi-Lock hermetically sealed transformer. Case must be destroyed before interior of unit can be reached. Hermi-Lock provides extensive safety factor for combat use.*

The failure of a hermetically sealed transformer is largely due to the fact that solder is depended upon for a mechanical union as well as the hermetic seal. Solder having a low tensile strength is readily fractured by thermal action, vibration or shock, and the seal broken; with failure a probability.

LANGEVIN hermetically sealed transformers employ the unique \*Hermi-Lock construction which provides a positive mechanical union between body, cover and bottom, the solder being simply the sealing agent. The result is a dependable unit with little chance of failure under simultaneously adverse conditions.

Your inquiry for transformers of all types up to 5 KVA are solicited.

\*Trade Mark Registered



-50°C AMBIENT



+65°C AMBIENT

## The Langevin Company

INCORPORATED

SOUND REINFORCEMENT AND REPRODUCTION ENGINEERING

NEW YORK

37 W. 65 St., 23

SAN FRANCISCO

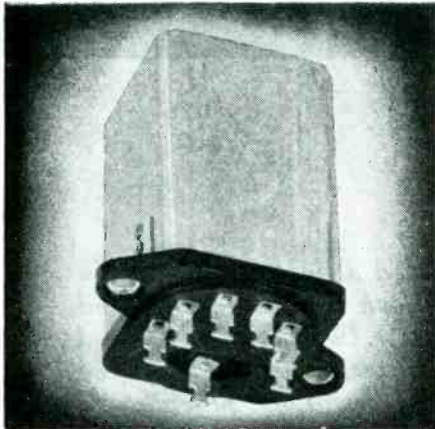
1050 Howard St., 3

LOS ANGELES

1000 N. Seward St., 38

# Co-ordination

A NEW ROLE FOR  
**SIGMA RELAYS**



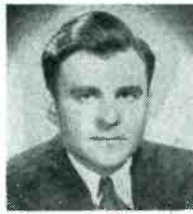
The 5 RPL relay has two coils with separate terminals which may be connected to independent pilot circuits. The load of the relay is operated only by the co-ordination of the two pilot circuits. This may be the sum or the difference of the pilot circuit voltages depending on the polarity of coil connections.

The same result can be accomplished with the unmounted type 5 F relay but the enclosed form is usually preferred. Both types are widely used in aircraft applications where circuit co-ordination is desired.

**SIGMA**  
**Sigma Instruments, Inc.**  
*Sensitive RELAYS*  
62 Ceylon St., Boston 21, Mass.

tronics department. His headquarters will be in San Francisco.

WILBUR L. NELSON is made mechanical design engineer of The



Andrew Co., Chicago, Ill. Mr. Nelson has been with Western Electric Co.

ARDEN LEFEVRE, formerly divisional chief engineer of Stewart-Warner Corp., is appointed vice president and director of engineering of the division including instruments and radio.

DAVID C. PRINCE, vice president, General Electric Co., takes charge of the company's general engineering laboratory. Laboratory activities are being broadened to include the requirements of the entire company.

GEORGE W. OEHLSEN, JR., formerly assistant chief engineer of the radio division, becomes assistant director of engineering in Division One (instruments and radio), Stewart-Warner Corp., Chicago, Ill.

WALTER R. JONES is appointed to the newly created post of general engineering manager for radio re-



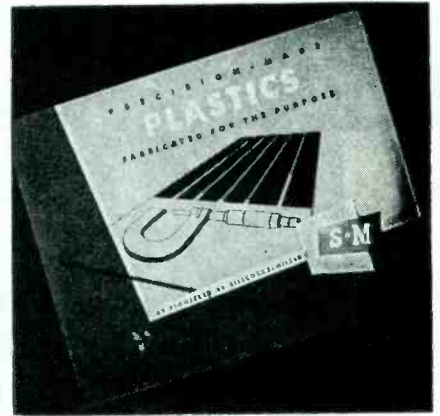
ceiving tubes by Sylvania Electric Products, Inc. Previously manager of commercial engineering, Mr. Jones has headquarters in Emporium, Pa.

KENNETH S. LUM, previously with Measurements Corp., becomes assistant chief engineer at Madison Electrical Products Corp., Madison, N. J.

F. A. HITER, senior vice president, Stewart-Warner Corp. is elected to the board of directors of RMA to

## NEW GUIDE TO PRECISION-MADE PLASTICS

By Sillcocks-Miller



### FREE BOOKLET PRESENTS 4-POINT SERVICE TO HELP DESIGN ENGINEERS

How the facilities and experience of Sillcocks-Miller specialists can help you solve your problems in precision-fabricated plastics is told in a new illustrated booklet now available.

Designers and manufacturers in need of plastic parts and products made to extremely close tolerances will find the Sillcocks-Miller Company a most dependable source for design and development service and for highest quality production.

Whether you are now using plastics or want to learn why it will pay you to convert to plastics, you should have a copy of this helpful booklet. Write for it today — without obligation.

**SILLCOCKS-MILLER CO.**

Office & Factory

10 W. PARKER AVE., MAPLEWOOD, N. J.

Mailing Address: SOUTH ORANGE, N. J.

**It Costs You Less to Pay a Little  
More for Sillcocks-Miller Quality**



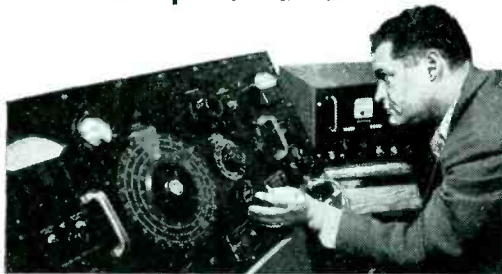
# 400 MICRO-MICRO WATTS (.0000000000400 WATTS!)\*

**This figure represents the maximum limit of power radiated by the oscillator in Techrad's LRR-5 receiver!**



Designed originally for use on ships operating in the combat zones, the LRR-5 low radiation receiver offers definite advantages to other services.

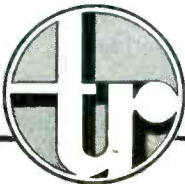
Low radiation has been accomplished in the LRR-5 receiver without compromise in electrical performance.



1. For monitoring or standby where a number of receivers are operated in close proximity.
2. For dual or triple diversity reception.
1. Radiation less than  $400 \times 10^{-12}$  watts throughout the entire range.
2. Signal-to-noise ratio at 15 micro volts is 20 db.
3. 10 watts audio output at 3% total harmonic distortion.
4. 50 to 15,000 cycle audio frequency response  $\pm 1$  db.
5. Variable selectivity.
6. Beat oscillator.
7. Coverage: 540-1600, 2.6-6.3, 6.3-18 mc.

*\*FCC approved*

Your receiver problems will receive prompt and thoughtful attention when you consult our engineers. Write now for complete information and data.



**technical radio company**

275 NINTH STREET • SAN FRANCISCO 3, CALIFORNIA

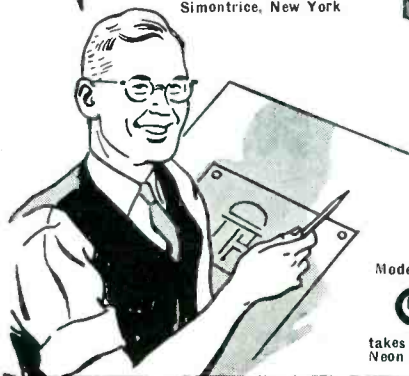
EXPORT AGENTS: FRAZAR & HANSEN, 301 CLAY STREET, SAN FRANCISCO 11, CALIFORNIA, U. S. A.

Over a decade of continuous experience

Silent operation of postwar appliances and electrical equipment will require Pilot Light assurance of "ON" and the added advantage of the animated eye appeal of light. Gothard's broad line of Pilot Light Assemblies — developed thru both war and peacetime research — will provide the solution to that need. Beyond the scope of this broad line—Gothard engineers offer you a wealth of Pilot Light experience to satisfy special requirements. Consult Gothard on your present and postwar plans.

**Gothard**  
MANUFACTURING COMPANY

310 N. Ninth St. Springfield, Ill.  
Export Div.  
New York 17, N. Y. 25 Warren Street  
Cables  
Simonrice, New York



Model 1216



also available for NE18 and NE51 Neon Lamps

replace L. L. Kelsey, formerly with Stewart-Warner Corp. and now with the Belmont Radio Corp., Chicago, Ill.

CAMERON G. PIERCE, who has been active in radar development is district representative for Southern



California and Arizona in the transmitter division of General Electric Co.'s electronics department.

F. C. ALEXANDER joins Mackay Radio Telegraph Corp. to become executive assistant to the vice president and chief engineer. He has been in the office of the Director of Naval Communications.

#### AWARDS

Workers of the following concerns in the electronic field have been awarded Army-Navy burgees for excellence in production:

Belden Mfg. Co.  
Chicago, Ill.  
Richmond, Ind.  
David Bogen Co.  
New York, N. Y.  
Dobeckmun Co.  
Cleveland, Ohio  
General Cable Corp.  
Buffalo, N. Y.  
St. Louis, Mo.

Muter Co.  
Chicago, Ill.

National Carbon Co.  
Charlotte, N. C.

Northern Radio Corp.  
Seattle, Wash.

Ohio Crankshaft Co.  
Cleveland, Ohio

Roller-Smith Div.  
Realty and Industrial Corp.  
Bethlehem, Pa.

Santay Corp.  
Chicago, Ill.

Westinghouse Electric & Mfg.  
Sunbury, Pa.



## THERMOSTATIC METAL TYPE DELAY RELAYS PROVIDE DELAYS RANGING FROM 1 TO 120 SECONDS

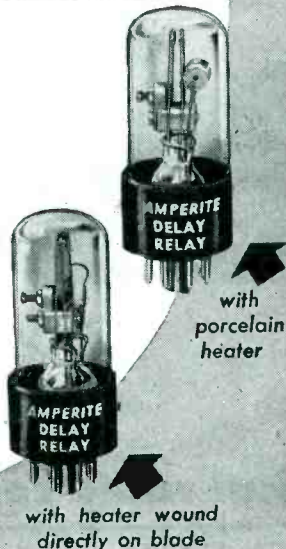
#### Other important features include:—

1. Compensated for ambient temperature changes from  $-40^{\circ}$  to  $110^{\circ}$ F.
2. Contact ratings up to 115V-10a AC.
3. Hermetically sealed — not affected by altitude, moisture or other climate changes . . . Explosion-proof.
4. Octal radio base for easy replacement.
5. Compact, light, rugged, inexpensive.
6. Circuits available: SPST Normally Open; SPST Normally Closed.

WHAT'S YOUR PROBLEM? Send for "Special Problem Sheet" and Descriptive Bulletin.

**AMPERITE CO.** 561 BROADWAY  
NEW YORK 12, N. Y.

In Canada: Atlas Radio Corp., Ltd.  
560 King St. W., Toronto



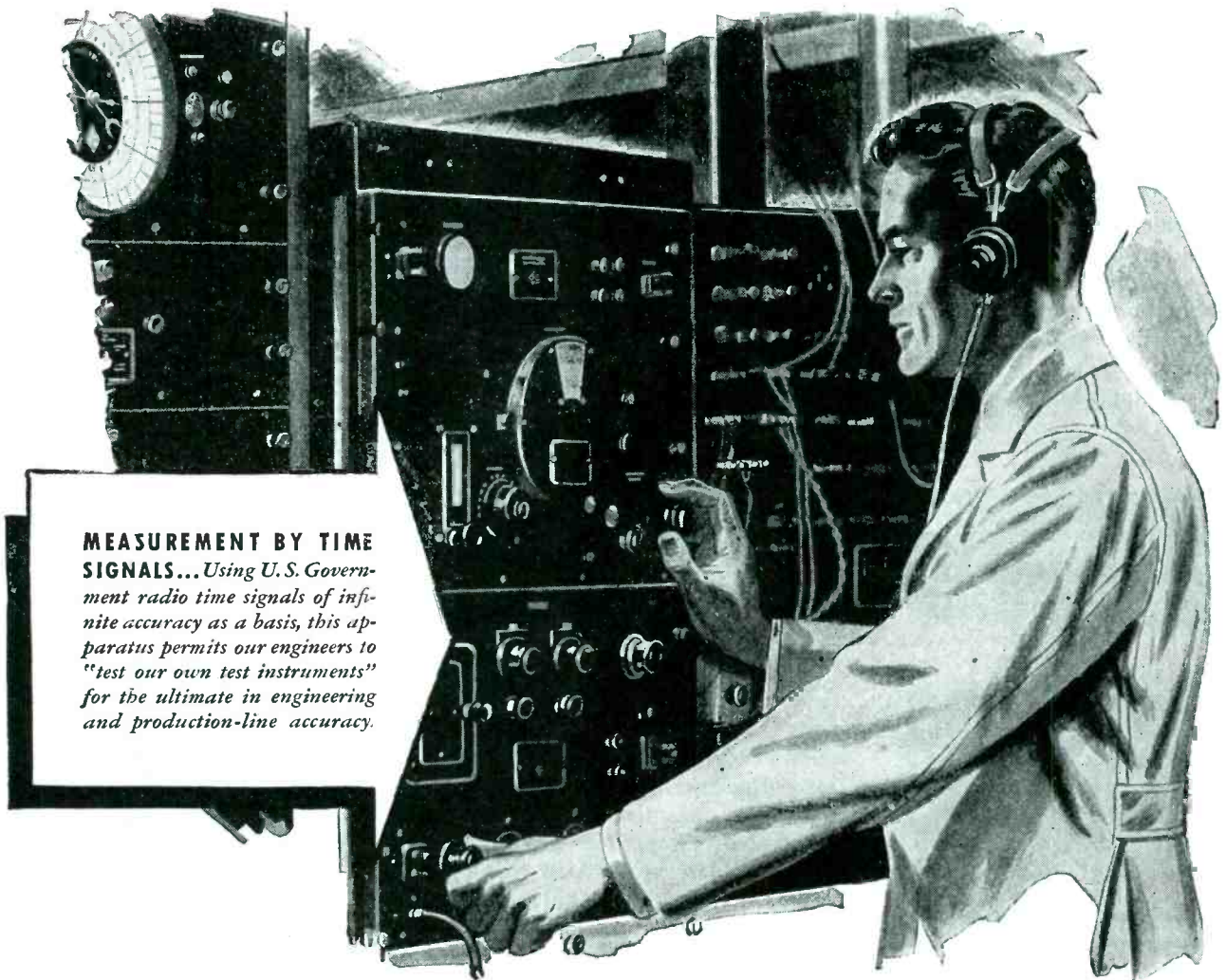


## WHY WE MEASURE OUR OWN "YARDSTICKS"

Complex, sensitive instruments are a commonplace not only in the engineering laboratories but on the production lines of Connecticut Telephone & Electric Division. These instruments enable us to maintain the extreme precision in telephone equipment and electronic devices called for by Signal Corps standards. So important is this high precision that we

have special apparatus for measuring the accuracy of the test instruments themselves.

The result of this constant testing and retesting is *better products*... better telephones, headsets, switchboards and other devices, for our armed forces, a better, brighter future for your communicating systems, electrical and electronic equipment for tomorrow.



**MEASUREMENT BY TIME SIGNALS...** *Using U. S. Government radio time signals of infinite accuracy as a basis, this apparatus permits our engineers to "test our own test instruments" for the ultimate in engineering and production-line accuracy.*



## CONNECTICUT TELEPHONE & ELECTRIC DIVISION

GREAT AMERICAN INDUSTRIES, INC. • MERIDEN, CONNECTICUT

TELEPHONIC SYSTEMS • SIGNALLING EQUIPMENT • ELECTRICAL EQUIPMENT • HOSPITAL AND SCHOOL COMMUNICATIONS AND SIGNALLING SYSTEMS • IGNITION SYSTEMS

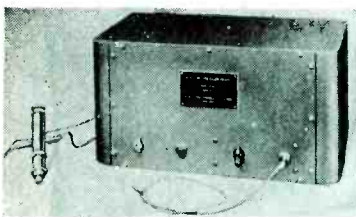
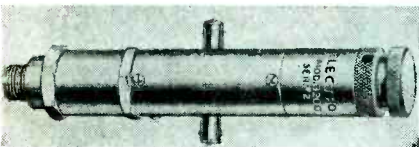
# NEW PRODUCTS

Month after month, manufacturers develop new materials, new components, new assemblies, new measuring equipment; issue new technical bulletins, and new catalogs

## Pressure-Time-Curve Indicator

PRESSUREGRAPH is an electronic device which will indicate, in linear response on the screen of a cathode-ray oscillograph, the pressure-time curve of any internal combustion engine, pump, airline, or any other enclosed pressure system where pressure measurements are desired. It measures either static or dynamic pressures. It is easy to operate because only one control is necessary, and one initial adjustment to compensate temperature effects need be made.

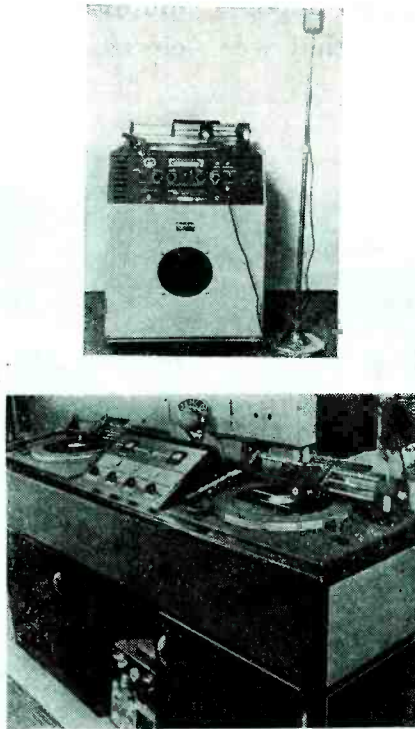
Electro Products Laboratories, 549 West Randolph St., Chicago 6, Ill.



Top illustration shows pick-up section of Pressuregraph. Pickup response is transmitted, after amplification, to the screen of a cathode-ray oscillograph. Illustration below shows pickup hooked up to unit

## Recording Unit

RADIOTONE is the name applied to recording equipment (for schools,



Above, the new console model described above. Below, shows Radiotone recording equipment installed at the Jack & Heintz Co., plant in Cleveland, Ohio

plants or studios) made by the Robinson-Houchin Optical Co., Columbus, Ohio. The new console model illustrated incorporates features of the manufacturer's RA-16 portable Radiotone, except that it also has an acoustic cabinet. The console consists of a recording cutter (which records speech directly or from the unit's own built-in radio); playback (instantaneous); and a PA system. The recorder operates at speeds of 78 or 33½ rpm, and cuts from inside or outside. The high-fidelity cutting head maintains its adjustment and has a uniform frequency response from 40 to 6000 kc.

The ball-bearing, playback arm is counterbalanced, and uses a magnetic needle. Frequency range is from 30 to 7000 cps.

Other features of the equipment include: two equalizers used to vary the low-frequency response. One equalizer operates at about 100 cycles from 1 to 15 db above or below normal. The other gives constantly variable boost at around 7500 cps of from 1 to 22 db, or an attenuation of from 1 to 15 db below 5000 cps; two dual high impedance channels are provided with two separate jacks. One jack includes a pre-amplifier and gives an over-all gain of 115 db. The other jack skips the preamplifier tube and lowers the gain to 80 db; two volume controls, which can be operated simultaneously, and which regulate the input signal from two microphones, microphones and dubbing table, tuner and microphones, or tuner and dubbing table. One channel has a gain of 80 db and the other a gain of 115 db.

The equipment is easy to operate since all functions are regulated instantly by depressing one or more of seven different buttons.

## Circuit Breaker

NOW IN PRODUCTION is a new and improved single-pole circuit breaker for 240 volts ac or 125 volts dc, 50 amp maximum which can be front or rear connected. Breakers have

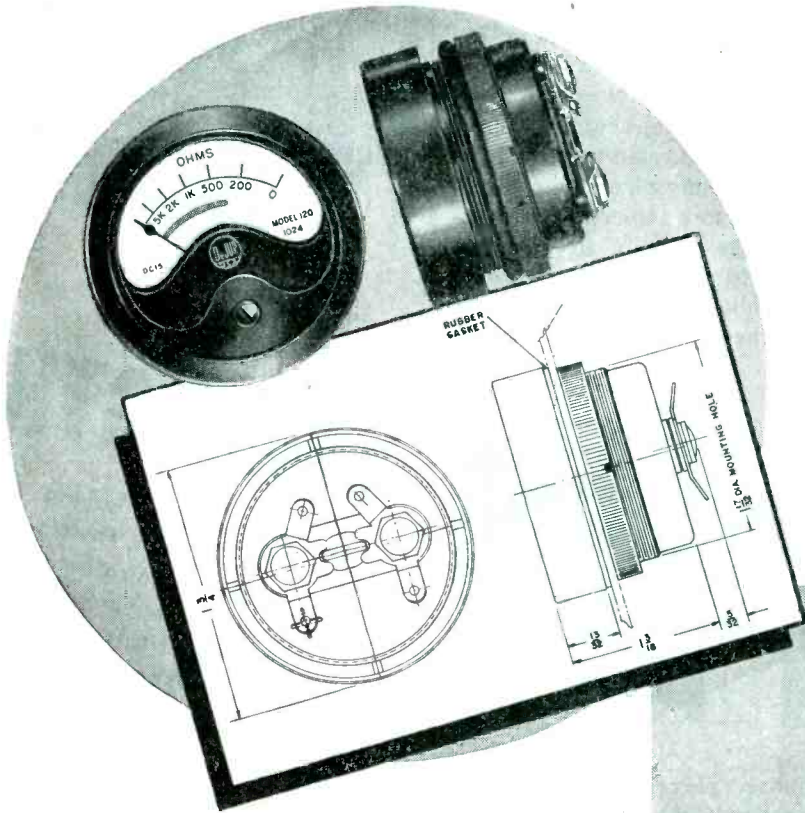


instantaneous trip or a selection of three time delays. Overall dimensions are 5¼-in. long, 2½-in. high, and 1½-in. wide.

Heinemann Circuit Breaker Co., 97 Plum St., Trenton, N. J.

# DeJUR HERMETICALLY SEALED MINIATURE $1\frac{1}{2}$ " METERS

*Designed to aid in the development of small equipment for present or postwar applications*

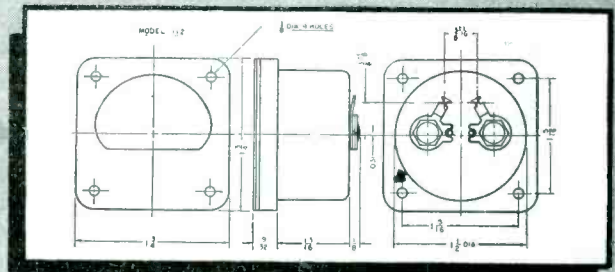
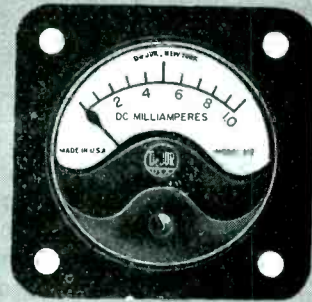


## **$1\frac{1}{2}$ INCH ROUND MODEL 120**

The smallest meter of its kind, built with the care and precision of all DeJur larger instruments. Sealed to sustain immersion in 30 feet of water for as many as 7 days without harm to the mechanism. If the glass breaks, the meter case is designed to seal the equipment against water seepage. Terminal studs are also waterproof sealed. Another advanced construction feature is the ring mounting which makes for quick and easy installation—no mounting holes or screws necessary, just tighten on with the ring. A.S.A. type movement. Built to exacting specifications.

## **$1\frac{1}{2}$ INCH SQUARE MODEL 112**

Entirely self-contained with built-in resistors and shunts. Available in wide variety of ranges. This model, too, may be immersed in 30 feet of water for 7 days without harm to the movement. In addition, it incorporates all other waterproof features of the Model 120. Though compact in size, no sacrifice has been made in quality of materials or construction details. It performs with high efficiency in a variety of applications. A.S.A. type movement. Built to exacting specifications.



*Additional information supplied upon request... Write for the new DeJUR catalog*

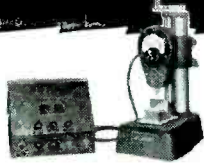
GIVE FULL SUPPORT  
TO THE SEVENTH  
WAR LOAN DRIVE

**DeJUR** AMSCO CORPORATION

GENERAL OFFICE: NORTHERN BLVD. AT 45th STREET, LONG ISLAND CITY 1, N. Y.  
IN CANADA -- ATLAS RADIO CORP. LTD., 560 KING ST. WEST - TORONTO, CANADA



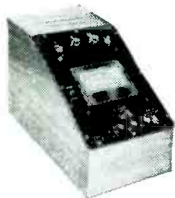
# LET OUR TEST EQUIPMENT ENGINEERS HELP YOU



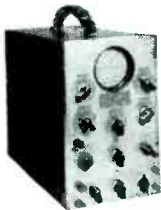
**ELECTRONIC COMPARATOR**



**MULTITESTER**



**MEGOHM METER**



**OSCILLOGRAPH**



**T**HE correct Electronic equipment can solve your research, production and inspection problems. Let our highly trained experts help you select the instruments best suited to your needs. Ask them for advice and for help with W.P.B. forms and priority information. You'll get speedy delivery from our Industrial Emergency Service Department since large stocks are maintained of such widely known lines as RCA, Dumont, Triplet, G. E., Industrial, Jackson and Hickok.

**OTHER DEPARTMENTS TO SERVE YOU**

- Electrical Maintenance
- Plant Sound Systems
- Shop Tools and equipment
- Industrial Lighting
- Electronic Production Equipment

Please indicate in the coupon below the Industrial brochures you want. And send for the free copy of our Reference Book and Buyers Guide. It describes many new electronic products for Industry.

**FILL IN & MAIL COUPON TODAY FOR CATALOG**



*Radio and Electronic Supplies*

**WALKER-JIMIESON, INC.**

311 S. WESTERN AVE., CHICAGO 12  
PHONE: CANAL 2525

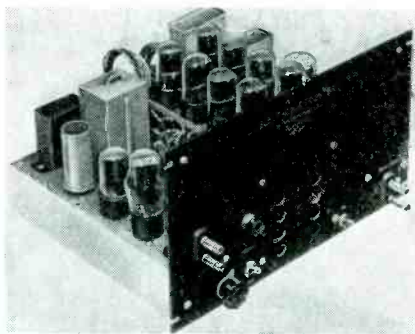
Send Free Reference Book & Buyers Guide. Please send the following Brochures for Industry:

- Test and Inspection Equipment
- Electrical Maintenance Equipment
- Plant Sound Equipment
- Shop Tools and Equipment
- Industrial Lighting Equipment
- Electronic Production Equipment

NAME \_\_\_\_\_  
COMPANY \_\_\_\_\_  
CITY \_\_\_\_\_ ZONE \_\_\_\_\_ STATE \_\_\_\_\_

## Electronic Counter

A NEW TWO-DECADE counter, designed for industrial and laboratory uses, is actuated by a closing contact, sine wave, or pulse input (as from a photocell) at rates up to 1000 cps. Each decade divides by ten, giving a factor of 100. The count for 0 to 99 appears on two banks of neon lamps. A telephone-type relay is connected to the counter output and the contacts of this relay close once for each 100 input cycles. Contacts are connected to an output terminal. Conventional electro-mechanical counters may be connected to extend the count to as many places as desired. One of the more important applications of the unit is in counting rates exceeding 10 cycles a second. Other applications include: installations where long and high speed



continuous operation is necessary; in counting and calibrating the actual number of cycles that resistance welding timers apply; or as an interval timer by connecting it through a switch to a known external frequency (such as a 60-cycle line). When the switch is closed and opened, the instrument will count the number of cycles of the known frequency that have passed in the closed-switch time interval, giving a reading in terms of the number of cycles of the known frequency. The equipment is sturdy and intended for rigorous and long use. Operation is from a 60-cycle, 105- to 125-volt line. Weight of the unit is 25 lb.

Potter Instrument Co., 136-56 Roosevelt Ave., Flushing, N. Y.

## Rectifier Tube

TYPE 3B27 is a high voltage rectifier tube of rugged construction



# STRENGTH

There's satisfaction in buying antennae from Snyder. There's solidity to the organization—there's quality to their products—there's a definite price advantage. Make your next order to Snyder.



**ANTENNAE**

by

**SNYDER**  
MANUFACTURING CO. • PHILADELPHIA

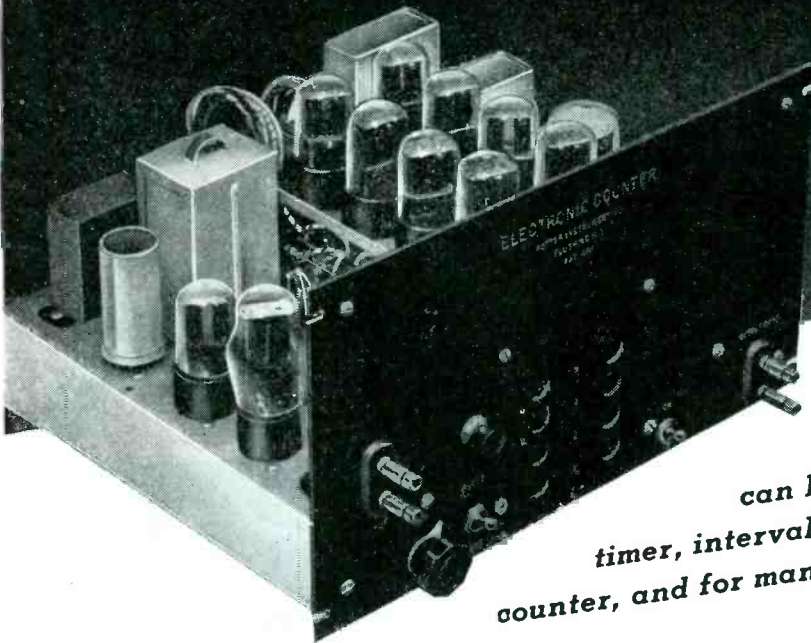
COMPLETE MANUFACTURERS FROM START TO FINISH



A "FIRST" FOR INDUSTRY AND LABORATORY

Potter

TWO-DECADE  
ELECTRONIC COUNTER



*An instrument that  
can be used as a counter,  
timer, interval controller, radiation  
counter, and for many other applications.*

This new high speed counter eliminates many of the handicaps of commonly used counting methods. Operating at speeds up to 1000 cycles a second, each decade divides by 10, giving a scaling factor of 100. A telephone-type relay, whose contacts close once for each 100 input cycles, is connected to output terminals. An electro-magnetic counter may be added to this output to extend the count to as many places as desired. The Two-Decade Electronic Counter is useful for counting rates exceeding 10 cycles a second, generally too fast for

conventional counters. It may also be used to replace conventional counters that may not stand up under continuous high speed operation. Another use for this instrument is counting and calibration of cycles in resistance welding operations. It may also be used as an interval timer by connecting it through a switch to a known external frequency. Readings are observed in terms of the number of cycles of the known input frequency. The unit can be supplied with switches making it predetermining and useful in control applications.

*The Two-Decade Electronic Counter operates from a 60 cycle, 105 to 125 volt line. It uses 11 tubes.*

Other counter products are—COUNTER CHRONOGRAPHS for measuring projectile velocities to accuracies of one part in 10,000; PRECISION TACHOMETERS that measure engine r.p.m. to a fraction of a revolution; INTERVAL GENERATORS that generate a predetermined time interval from 10 microseconds to 10 seconds in 999,999 steps of 10 microseconds; RADIATION COUNTERS which resolve repetition rates of well over 0.5 microseconds.

*Equipment built to order only on a high priority.*

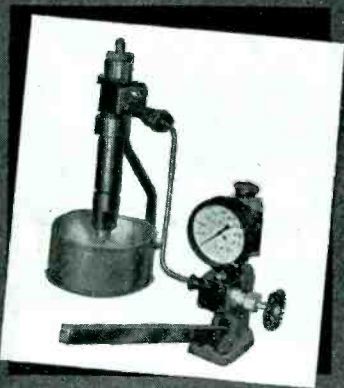
INSTRUMENT  
Potter  
COMPANY

ELECTRONIC COUNTER PRODUCTS...  
136-56 ROOSEVELT AVENUE  
FLUSHING, NEW YORK

B U Y M O R E . . . H O L D M O R E . . . W A R B O N D S

# ADECO NOZZLE TESTER

*Keeps Diesel Engines  
Running Efficiently*



**TESTS FUEL INJECTORS  
AND HYDRAULIC DEVICES  
At Pressures Up To  
10,000 p.s.i.**

To keep diesel engines operating at peak efficiency, this portable, precision-built Adeco Nozzle Tester is indispensable.

Light in weight yet built for heavy-duty service, it enables any mechanic to make quick, accurate tests on injector opening pressure, spray pattern, etc., and detect stuck needle valves and leakage around valve seats. Tests both large and small injectors, on bench or engine, at pressures up to 10,000 p.s.i. Prevents costly delays and possible damage to engine.

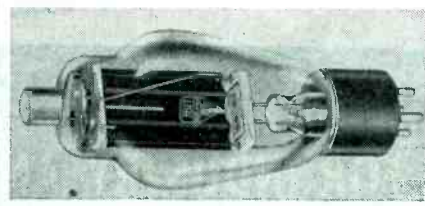
Ideal for testing hydraulic devices.

Write for bulletin on this practical, low-cost unit.



**AIRCRAFT & DIESEL  
EQUIPMENT CORP.**

4411 NO. RAVENSWOOD AVE.  
CHICAGO 40, ILLINOIS



and suitable for industrial and mobile transmitter use. The tube is a high vacuum type. Ratings are: Peak inverse voltage 8,500; peak plate current 0.6 amp; average plate current 0.150 amp; filament draws 5.0 amp at 2.5 volts; four tubes in full bridge deliver 5415 d-c volts to a filter with 6000 volts total input; base is medium 4-pin bayonet type.

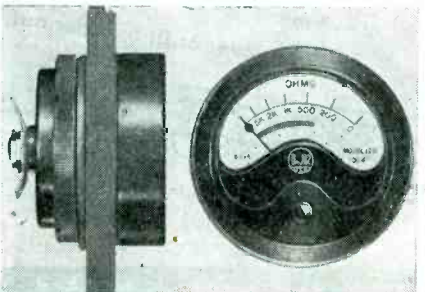
Electronic Enterprises, Inc.,  
65-67 Seventh Ave., Newark 4, N. J.

### Method of Silver-Coating Quartz Crystals

THIS NEW PROCESS is patented and is available to quartz crystal manufacturers for use in their own plants under license agreements. It is a method of applying a thin conductive silver coating to quartz crystals. The coating is applied simply by dipping the crystals in a series of solutions. It is easy to do and can be done by inexperienced operators. The only equipment required is a few photographer's trays, and clips to hold the crystals. Several hundred crystals may be coated simultaneously. Write Metaplast Co., 205 West 19 St., New York 11, N. Y.

### Hermetically-Sealed Meter

TO MEASURE resistance there is available a hermetically-sealed, ring-mounted meter (Model 120) which is built to ASA specifications and which measures 1½ in. The manufacturer states the meter can be immersed in 30-ft of water for as many as 7 days without damage to its mechanism. Terminal studs



# MEASURES QUANTITIES

*with greater  
sensitivity & range  
than ever before  
accomplished*



PATS. APP. FOR

### TECH LAB MICROHMMETER

... gives direct and instantaneous readings of resistance values down to 5 microhms and up to 1,000,000 megohms. Accuracy in all measurements to better than 2%. Output is sufficient to drive recorder. Entirely AC operated. Furnished in two models. Reasonably prompt deliveries. For complete data regarding other applications write for Bulletin No. 432.

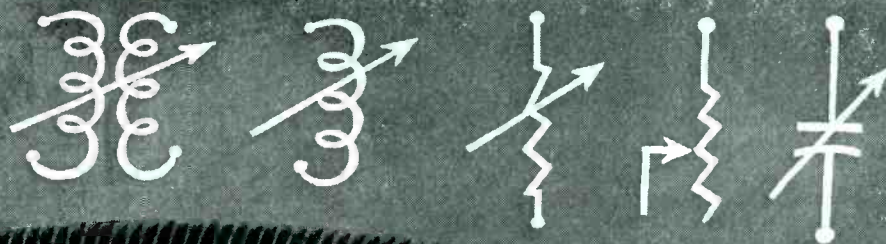


Quality manufacturers of attenuators and other electrical resistance instruments. For complete data write for Bulletin No. 431.



7 LINCOLN STREET  
JERSEY CITY 7, N. J.

# WHEN CIRCUITS CONTAIN THESE SYMBOLS



## S. S. WHITE FLEXIBLE SHAFTS merit your consideration

Here's why S. S. White flexible shafts merit consideration when you design electronic equipment containing elements that require operational adjustments.

These shafts provide a simple means of operating the various elements from remote points that functions as smoothly and sensitively as a direct connection. This gives you unrestricted freedom in placing the elements. You can put them where you want them for optimum circuit efficiency, easy assembly, ready wiring, space saving, convenient servicing. And at the same time you can centralize the controls in the most desirable spot.

With a single S. S. White shaft you can hook up any two points, regardless of curves, congestion or distance. And this goes for power driving as well as for remote control.

### THIS 256-PAGE FLEXIBLE SHAFT HANDBOOK

will give you full information and engineering data about flexible shafts and how to apply them. A free copy will be sent to you, if you will write for it direct to us on your business letterhead and indicate your position.



**S.S. WHITE**  
THE S. S. WHITE DENTAL MFG. CO. **INDUSTRIAL** DIVISION

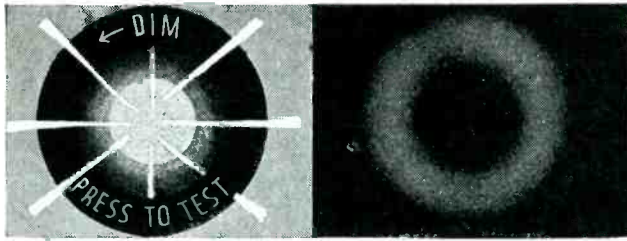
DEPT. E, 10 EAST 40th ST., NEW YORK 16, N. Y.

FLEXIBLE SHAFTS      AIRCRAFT ACCESSORIES  
MOLDED PLASTICS  
MOLDED RESISTORS      FLEXIBLE SHAFT TOOLS

*One of America's AAAA Industrial Enterprises*



BACK THE INVASION — BUY MORE BONDS NOW!



CORRECT LIGHT... DAY or NIGHT ... CORRECT LIGHT

## DIALCO "Vari-Dim" PILOT LIGHT #V.M.400

**5 DISTINCTIVE FEATURES:**—In daytime this unit emits concentrated penetrating light which is visible thru surrounding brightness . . . A turn of the knurled head produces soft diffused light which is ideal for night operation. No effect on operator's vision . . . Field of visibility is a full 150°, 60° more than required minimum . . . Press-to-test — light finger-tip pressure actuates the bulb testing circuit . . . Accommodates screw-base or bayonet base bulbs which can be quickly discharged by finger-tip pressure . . . Assemblies supplied complete with required lamps. Consult us about your problem.

Write for Catalogue



**DIAL LIGHT CO.** of America, Inc.

900 BROADWAY • NEW YORK 3, N. Y.

Telephone: ALgonquin 4-5180-1-2-3

BACK THE INVASION — BUY MORE BONDS NOW!

are waterproofed and therefore the equipment remains waterproof even if the glass is broken. The unit is available in a wide variety of ranges (including microammeter or micro-voltmeter specifications), for mounting on any thickness panel between  $\frac{3}{8}$  and  $\frac{1}{4}$  in., steel or bakelite.

DeJur-Amsco Corp., Northern Blvd. and 45 St., Long Island City, N. Y.

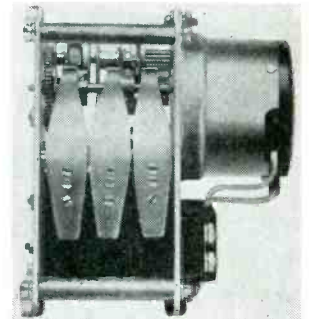
### Plating Process and Machine

RECENTLY ANNOUNCED is the development of a new process and machine for high-speed plating of silver and gold on radar wire and parts with uniform specification deposits. The machine for handling wire can take wire measuring 0.0025 in. up to light cable, and is not limited to gold and silver but can handle any plateable metal. Patents have been applied for.

Inquiries should be directed to Joseph B. Kushner, Metal Finishing Engineer, 233 West 26th St., New York 1, N. Y.

### Time Delay Relays

ALTHOUGH ORIGINALLY designed for airborne transmitter equipment, these Type MCR, motor-operated, time delay relays are available for



industrial applications for both a-c and d-c operations. Overall dimensions are approximately 2 $\frac{1}{8}$  x 3 $\frac{1}{8}$  x 3 $\frac{3}{8}$  in. Maximum time ranges are 25 or 50 sec, 2.5, 5.0, or 10.0 min. Minimum time settings are 1.25, 2.5, 7.5, 15.0 or 30.0 sec. Switching units are fully enclosed SPDT with quick, double-make, double-break contacts rated at 10 amp on either 24-volt dc, or 110-volt ac. One switch unit is used to provide an independent load circuit, the second switch is used for the motor con-



## RADELL-BUILT PRODUCTS

• It is easy to recognize the marks of superior craftsmanship in Radell-built electronic products. With a broad basic knowledge and advanced production skill, Radell Corporation is a versatile organization specializing in the assembly and sub-assembly of highest quality electronic products.

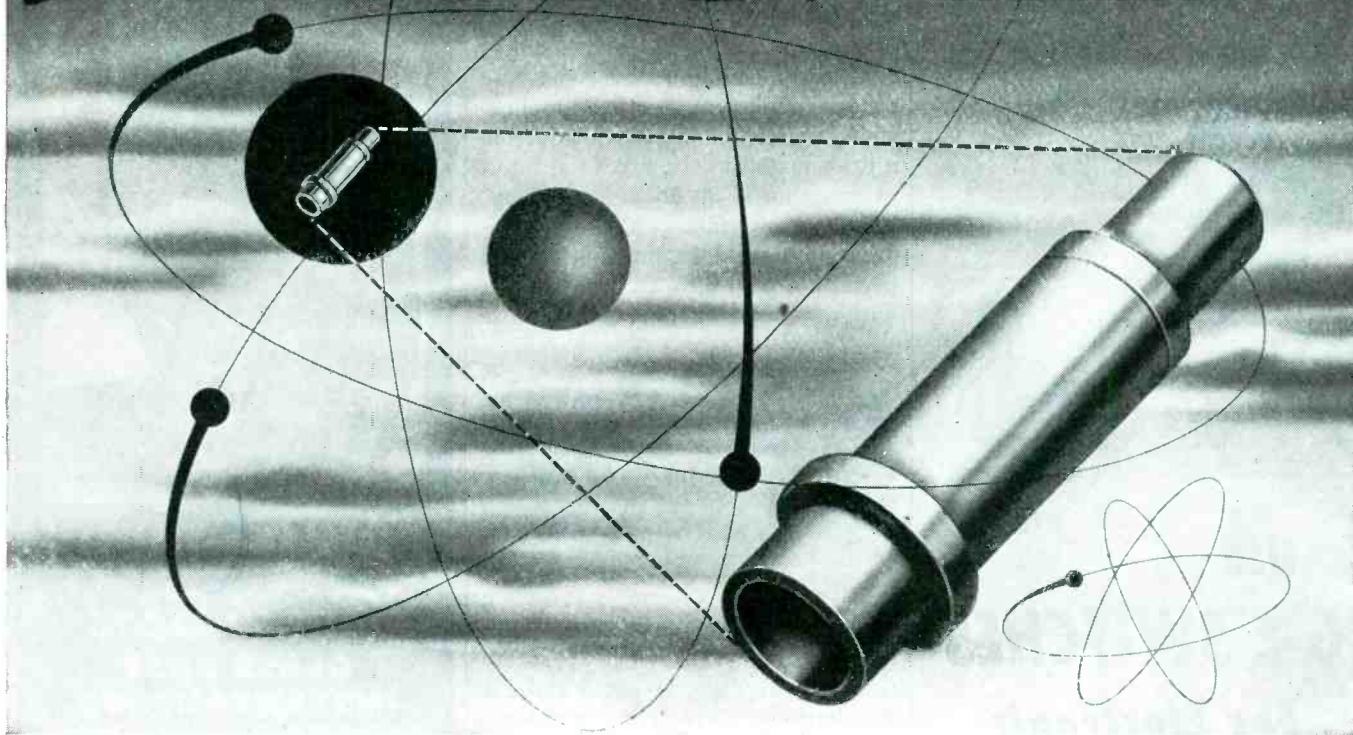
COMPLETE FACILITIES FOR AUDIO WORK

**RADELL** CORPORATION

6323-37 Guilford Avenue, Indianapolis 5, Indiana

# SCOVILL PLUGGED A NEW TECHNIQUE

## INTO RADIO TERMINAL JACKS



*... and disconnected a tie-up*



Terminal jacks for war-needed radios — screw-machined from rod stock — were lagging behind other parts. Expeditors called on Scovill to break the bottleneck.

Scovill did just that by shifting to high-speed stamping of sheet metal. This change in technique stepped up production greatly . . . cut down on scrap, always a problem in screw machine operations . . . turned out eminently satisfactory work . . . low-

ered costs by a substantial margin.

**Scovill Electrōnents\*** may also save time and money for you

Maybe your small electronic components or large assemblies can benefit from Scovill's versatility in forging, drawing, stamping, heading, or machining all kinds of metals and Scovill's impartiality in choosing the one method that will make your Electrōnents\* faster and better for less. For further details of Scovill's designing service and manufacturing

ability, send for literature. Use the coupon below and mail it today.

\*Electrōnents = Electronic Components



Please send me a free copy of "Masters of Metal" booklet describing your facilities. I am interested in the ELECTRŌNENT\* applications checked.

- |  |                                      |  |
|--|--------------------------------------|--|
| <input type="checkbox"/> Batteries       | <input type="checkbox"/> Dials       | <input type="checkbox"/> Panels            |
| <input type="checkbox"/> Record Changers | <input type="checkbox"/> Escutcheons | <input type="checkbox"/> Sockets           |
| <input type="checkbox"/> Clips           | <input type="checkbox"/> Jacks       | <input type="checkbox"/> Stampings (misc.) |
| <input type="checkbox"/> Condensers      | <input type="checkbox"/> Lugs        | <input type="checkbox"/> Tubes             |

Other applications .....

### SCOVILL MANUFACTURING COMPANY

Electronic Division  
22 Mill Street, Waterbury 91, Connecticut

Name .....

Company .....

Address .....



**USE  
G-E SWITCHES  
For Electronic  
Circuit Controls**

General Electric Circuit Control Switches are ideally suited for installation in signaling equipment, communication apparatus, instrument panel boards, lighting systems, aircraft circuit control systems and other electronic applications. These switches are available in single pole, double pole, three way, double pole—double throw, two line—two circuit and three point. General Electric Circuit Control Switches can be designed to meet your individual requirements.

You can obtain more specific information by writing to Section Q555-119, Appliance and Merchandise Dept., General Electric Company, Bridgeport, Conn.

\*\*\*

**BUY WAR BONDS AND KEEP THEM**

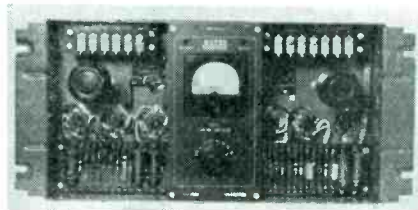
**GENERAL ELECTRIC**

trol and is set to cut-out the motor circuit at the end of the shaft travel. A third switch for a second load circuit can be provided. Motors are permanent-magnet types.

Bulletin No. 3100 describes these units. The R. W. Cramer Co., Inc., Centerbrook, Conn.

**Limiting Amplifier**

A 70-DB GAIN limiter amplifier eliminates thumping and monkey chatter in radio broadcasting and other sound-reproduction applications. Limiting is controlled from a pre-equalized voltage. Total input attenuation is 30 db in 1 db steps. The unit provides ten to one compression beyond the limiting points; permits a 5 to 6 db limiting action without being apparent; permits



limiting of up to 15 to 20 db without distortion; provides a safety factor in high-power radio and PA installations; and effectively reduces over-modulation without distortion. Frequency characteristic rating is plus or minus 1 db over a range of from 20 to 20,000 cycles. The unit is for relay-rack mounting.

Altec Lansing Corp., 1210 Taft Bldg., Hollywood 28, Calif.

**Instrument Knob**

FOR COMMUNICATION equipment there is available a knob constructed of smooth-finished bakelite with pointer arrow on front. It comes



complete with a 1/4-in brass insert and set screw. It measures 1 1/2 over-all diameter, and 3/4-in over-all height. List price 35 cents each. General Cement Mfg. Co., Rockford, Ill.

**BROADCASTING STATIONS!  
RECORDING STUDIOS!  
SCHOOLS!**

*You Can Get Them  
Without Delay!*



**GOULD-MOODY  
"Black Seal"  
GLASS BASE  
INSTANTANEOUS  
RECORDING BLANKS**

The tributes paid to "Black Seal" discs by many leading engineers have been earned by distinguished service on the turntable. Your ears will recognize the difference in quality of reproduction, and the longer play-back life will prove the superiority of "Black Seal" construction. Choice of two weights—thin, flexible, interchangeable with aluminum, or medium weight—both with four holes.

An AA-2X rating is automatically available to broadcasting stations, recording studios and schools. Enclosure of your priority rating will facilitate delivery Old Aluminum Blanks Re-coated with "Black Seal" Formula on Short Notice



**RECORDING BLANK DIVISION  
395 BROADWAY • NEW YORK 13, N. Y.**

**EXPORT DEPT. ROYAL NATIONAL COMPANY, INC.  
87 BROAD STREET, N. Y.**

# IDEAS + ENGINEERING

The ideas that will permit the successful development of your electrical equipment requiring the use of metallic rectifiers have perhaps already been developed by B-L engineers.

The Benwood Linze Company has pioneered in developing the application of dry plate metallic rectifiers wherever Direct Current is required from an Alternating Current source. The B-L Research Laboratories, established since 1921, have become an internationally recognized source for information in this specialized field.

Dry plate metallic rectifiers are an important electrical specialty. Many prominent, successful engineers—men who understand intimately most phases of electricity—have today, simply through unfamiliarity, only a limited knowledge of the wide variety of possible applications for rectifiers.

B-L engineering experience—in the development, research and designing of equipment for the conversion of AC to DC—is available to your technical staffs as an aid in meeting their production requirements.

We invite your inquiries—address Dept. A.

SELENIUM



COPPER  
SULPHIDE

## THE BENWOOD LINZE COMPANY

Long Distance Telephone CEntral 5830

1815 Locust Street • • • St. Louis 3, Mo.

New York Sales Office:  
Murray Hill 5-5878  
420 Lexington Ave.  
New York 17, N. Y.

Chicago Sales Office:  
Telephone CEntral 2379  
20 N. Wacker Drive  
Chicago 6, Illinois

**DESIGNERS AND MANUFACTURERS OF SELENIUM AND COPPER  
SULPHIDE RECTIFIERS, BATTERY CHARGERS, AND D. C. POWER  
SUPPLIES FOR PRACTICALLY EVERY REQUIREMENT.**



# HARVEY'S

complete radio  
and electronic service  
includes:



## Extensive stocks...

of critical radio and electronic components... meters, resistors, capacitors, transformers, test equipment... and hundreds of other scarce parts and equipment.

## A "We-find-it-for-you department..."

a staff trained to obtain the goods you specify, or, if that is impossible, to suggest an equally effective substitute.

## Priority problem specialists...

and technical advisors who have the advantage of "knowing-it-all"... but who are helpful and courteous in teaching it to you.

## Prompt deliveries...

that needs no amplification.

*Naturally, each order must be accompanied by the proper priority.*

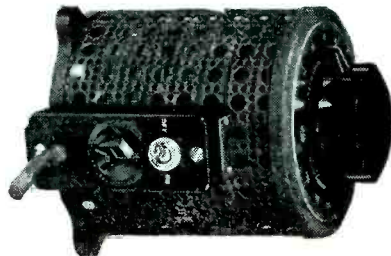
Phone Orders to LOngacre 3-1800

# HARVEY'S RADIO COMPANY HARVEY'S

103 WEST 43rd ST., NEW YORK 18, N. Y.

## Voltage Control Units

FOR VOLTAGE CONTROL of small power applications, Powerstats (No. 116 and No. 216) have been added to this manufacturer's standard line of compact, lightweight and ruggedly constructed variable transformers in the 1-kva range. An extra large aluminum brush heat radiator is combined in these new units with a new type of brush pressure adjustment spring to assure a small brush temperature rise and to lessen damage from sudden overloads. Both units have a total weight of 9 lb, including a protec-



tive screening and a totally-enclosed terminal box with input cord and plug, an outlet, and an "on-off" switch. Uncased models (designated as U types) are available for rear panel mounting. Powerstat 116 operates on a single phase 115-volt input to deliver a variable output voltage from zero to 135 volts with 7.5 amp available at any brush position. Model 216 has twice the voltage rating and a current rating of 3.0 amp. By mounting single units in tandem, different voltage and current ratings can be obtained. Circuit diagrams are contained in Bulletin No. 116 available from Superior Electric Co., Bristol, Conn.

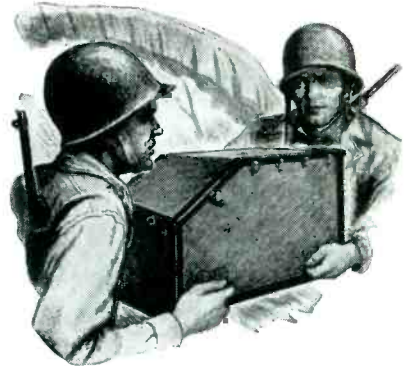
## Indicating Instrument

A NEW FREQUENCY meter and elapsed time meter comes in one case to save panel space and weight. It is for use on engine-driven generator sets and other equipment where proper operating speeds, lubricating and overhaul schedules are important. Frequency or speed is indicated to an accuracy of  $\pm 0.3$  percent by a bank of 5 reeds calibrated in single cycle steps from 58 to 62 cycles. The running time meter is driven by a synchronous motor, and indicates elapsed time

## Said the SIGNAL CORPS...



"Make 'em light...  
make 'em strong!"



## SKYDYNE CABINETS for Portable Electronic Equipment

They're as rugged as the combat corpsmen they serve—yet so light, they add only ounces to the delicate radio equipment they protect! And these famous Skydyne cabinets, serving overseas with the U. S. Signal Corps, are now available for your electronic products.

# Skydyne

FORM-MOLDED "SANDWICH"  
CONSTRUCTION IS LIGHTER  
... STRONGER

Skydyne combines greater strength with less weight than any other instrument-housing material.



Form-molded to exact specifications, Skydyne is laminated on a balsa, cork or light-weight synthetic core

—faced with plywood, metal or other surfacing material. Modern electronic shielding is incorporated in the cabinet itself.



Complex shapes and curvatures are possible without complicated design, production or assembly problems. Skydyne assures an attractively streamlined one-piece cabinet that stands up to rough handling, resists heat, vibration, sound. And Skydyne is remarkably inexpensive.

Find out how Skydyne cabinets can improve the appearance and serviceability of your products. Write for literature today.

# Skydyne Inc

PORT JERVIS, NEW YORK





## MAKE YOUR RADIO A CLOCK AND ALARM, TOO

Here are dramatic new sales features for your post-war, low-priced bedside radio . . . it becomes a *clock* and an *alarm* when you add the Telechron C-40 electric radio switch clock. Installation cost is low. Operation is simple. Just pre-select the time with a single control knob—the C-40 turns on the program automatically and acts as a pleasant awakener.

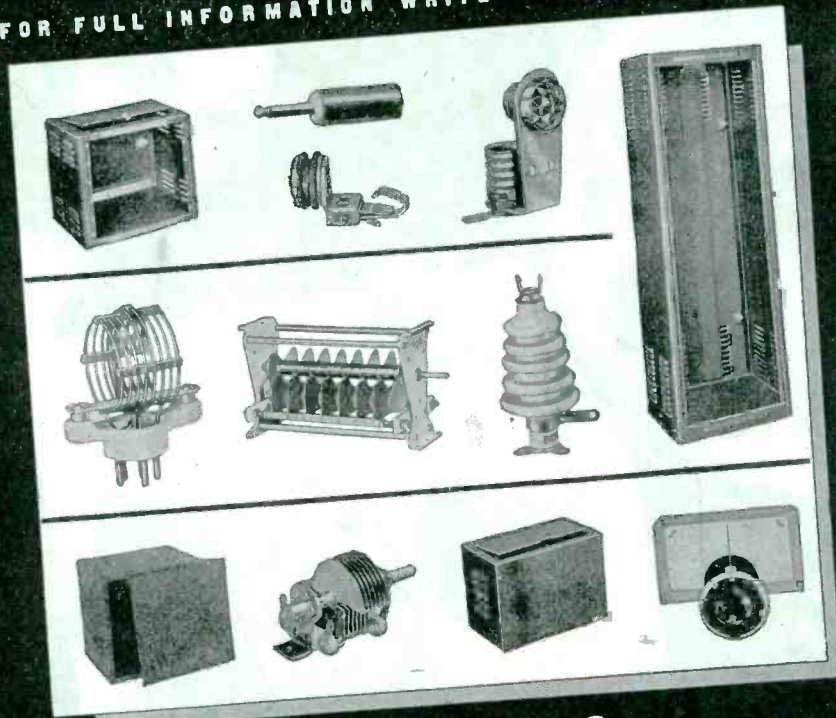
The new Telechron C-40 electric radio switch clock will be available for panel mounting, with dial and hands styled to your special

needs. Telechron accuracy, long life and dependability give you extra selling points. For full details, write or wire Industrial Sales Division, Dept. K, Warren Telechron Company, Ashland, Mass.

*Telechron*

REG. U. S. PAT. OFF.

A FEW OF THE **BUD**  
**COMPONENTS FOR Electronic EQUIPMENT**  
 FOR FULL INFORMATION WRITE FOR CATALOG 145



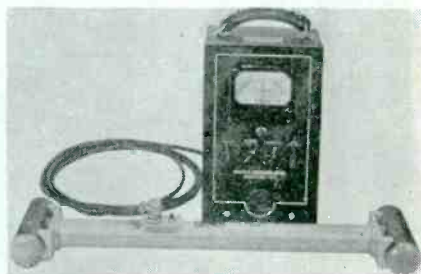
**BUD RADIO, INC.**  
 CLEVELAND 3, OHIO **BUD**

in hours and tenths. Designated as Model 31-FE, this meter operates on 110 volts, and is also available for 48 to 52 cycles and in half cycle steps for 59 to 61 cycles and 49 to 51 cycles, with accuracy of  $\pm 0.2$  percent. Other ranges are under development.

J-B-T Instruments, Inc., New Haven, Conn.

### Indicating Unit

ILLUSTRATED is an indicating unit, designated as Gradientometer, which quickly locates magnetic fields as in aircraft inspection, lost tools, underground piping, in searching for conduits, etc. The unit differs from the manufacturer's Magnetometer because it



requires no leveling. It cancels out uniform magnetic fields, such as the earth's field, and is designed primarily to locate magnetic gradients. By pressing a button it is converted into a Magnetometer and may be used to measure the strength of magnetic fields.

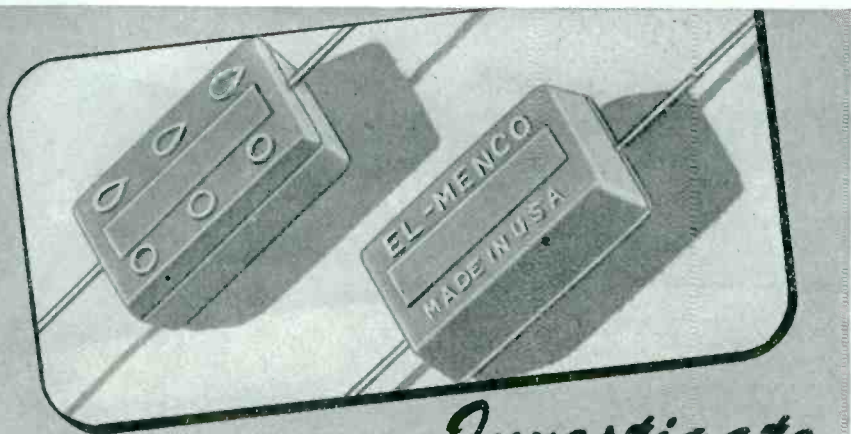
Waugh Laboratories, 420 Lexington Ave., New York 17, N. Y.

### Gas Purifiers

THREE PALLADIUM catalyst chambers known as Duexo gas purifiers have been used successfully by the Vacuum Tube Div. of Federal Telephone & Radio Corp. (Clifton, N. J.) to remove hydrogen from nitrogen and to remove oxygen from hydrogen as part of a test of the new units developed by Baker & Company as a means to reduce costs and to save time in plants requiring pure gases.

### Relays

WEIGHING  $1\frac{1}{2}$  oz, Type 23000 signal and communication relays (meeting Signal Corps requirements for humidity, salt spray, and fungus) are



*Investigate*

**EL MENCO** molded mica capacitors

... they're recognized throughout the  
*Electronic Industry as the standard by  
 which all mica capacitors are judged.*

**NORMAN H. LAWTON** ENGINEERING SALES • SERVICE

1775 BROADWAY, NEW YORK CITY 19 • Phone Circle 6-0867

DIRECT FACTORY REPRESENTATIVE

- A W FRANKLIN MANUFACTURING CORPORATION—Sockets... Terminal Strips... Flugs... Assemblies
- F W SICKLES COMPANY (EASTERN REPRESENTATIVE)—Coils... I. F. Transformers... Antenna Loops... Trimmer Condensers, mica and air dielectric... Tuning Units
- ELECTRO MOTIVE MANUFACTURING COMPANY—Molded Mica Capacitors... Mica Trimmer Capacitors

# What about eliminating vibration in post war equipment?

This question is being thrown at us every day. More and more, design engineers realize the importance of reducing vibration by proper use of rubber mountings, properly engineered.

Today, Rubber Mountings are a vital structural element in virtually all military electronic equipment. They have also been incorporated into the design of many wartime vehicles and heavy weapons.

Production of U.S. Rubber Mountings is still entirely devoted—directly or indirectly—

to the war effort. *So numerous and exacting are current demands on United States Rubber Company technicians in this field that work on problems of vibration-elimination for postwar products must be indefinitely postponed.*

We deeply appreciate the patience and understanding our manufacturer-customers are showing in this situation. And we look forward eagerly to the time when we can again work with them in close cooperation.

SERVING THROUGH SCIENCE



*Listen to "Science Looks Forward"—new series of talks by the great scientists of America—on the Philharmonic-Symphony Program. CBS network, Sunday afternoon, 3:00 to 4:30 E.W.T.*

## UNITED STATES RUBBER COMPANY

1230 SIXTH AVENUE • ROCKEFELLER CENTER • NEW YORK 20, N. Y.



**SM Fractional H. P. Motors for radio, communications, aircraft and many commercial applications.**

Whenever you need concentrated power — maximum power per ounce of weight and per inch of space—specify SM Fractional H.P. Motors. You'll get a unit engineered and precision built to your exact specifications, a long-life motor of dependable performance. From 1/10th to 1/200th H.P. Speeds from 3,000 to 20,000 R.P.M. Voltage from 6 to 220 AC-DC. Thousands have been engineered and built for signal corps and military aircraft use. Plant facilities for large volume production. What are your requirements?

**Small Motors, Inc.**

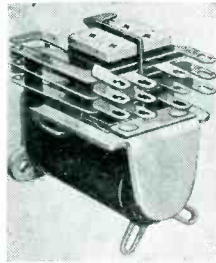
Dept. 50

1308 ELSTON AVE., CHICAGO 22, ILL.

Manufacturers of special small universal, fractional H. P. motors, dynamotors, shaded pole motors, heater motors, generators.

**Design • Engineering • Production**

for use in airborne radio transmitters or for applications requiring relays that withstand vibration, humidity and temperature ex-

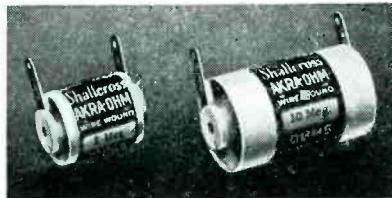


tremes. Units are available with 6 normally open contacts or in arrangements of normally open and normally closed contacts. Contacts are rated 3 amp, d-c non-inductive. The magnet coil bobbin is of a high-impact type. These relays are also available with heavy duty contacts rated at 10 amp, 28 volts d-c non-inductive.

R-B-M Mfg. Co., Logansport, Ind.

### Hermetically-Sealed Resistors

No. 1100 SERIES is a new type of hermetically-sealed, accurate-fixed, wire-wound resistor impervious to moisture, fungus, vibration, and rough handling. They are constructed without glass, or stud-

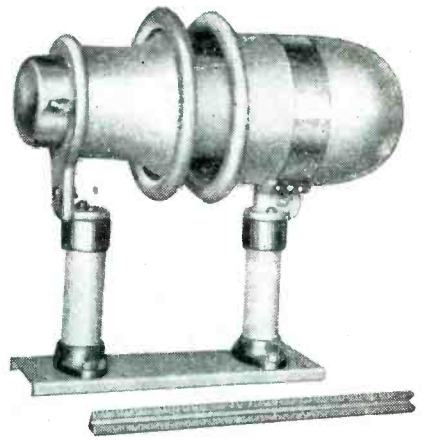


locked resistance elements, ferrule terminals or caps. The Series is available in two designs and in all resistance values from 1000 ohms to 10 megohms.

Shallcross Mfg. Co., Collingdale, Pa.

### Evaporator

NOT ALL THE possible applications of Model C evaporator have been explored, but one application in the field of electronics is its use to evaporate silver on the surface of quartz plates in such a manner that wires may actually be soldered to the coating. Another adaptation of the unit is in the production of mirrors by evaporating metals such as alum-



**DO YOU NEED A**  
*Neutralizing Condenser*  
**FOR 45,000 VOLTS BREAKDOWN?**

Here it is! With one inch spacing and rounded edges on all adjacent parts; this new type TN condenser has a capacity range of 33.1 to 12.6 mmf. Rough adjustment of capacity is made by moving the outer cylinder within the clamp. Precision settings covering a total range of 12 mmf are secured by rotation of the tuning control shaft which comes out at an angle of 90° to the lengthwise axis of the condenser. The location of this shaft may be changed radially in steps of 45°. The 12 inch scale shown in the above illustration will indicate the approximate dimensions.

A smaller model is available, having a voltage breakdown rating of 35,000 peak volts and a capacity range of 26.0 to 7.2 mmf. Both models can be supplied with larger capacity ratings if desired. Spun and cast aluminum are used in the construction of both models. Connections are made direct to the aluminum castings and leads may come off at any angle. The Johnson line includes a complete range of sizes of similar condensers down to the model N-125, rated at 9,000 peak volts Breakdown.

Write for further information.



**JOHNSON**  
*a famous name in Radio*

F. F. Johnson Co. Waseca, Minn.

**Specify the Plastic of Superior Electric Properties!**

# ACADIA POLYSTYRENE

## Acadan "B"

Flexible at -100°F and has many of the electrical properties of Polystyrene. Ideal for numerous electrical applications. Write for information on forms now available, and data on physical and electrical properties.

## Write Today

Send for complete data giving physical properties of Acadia Polystyrene, plus a table of specifications on its electrical properties.

• For any electrical application, Acadia Polystyrene is the outstanding plastic in the field. Combining highly desirable electrical properties, Acadia Polystyrene offers dielectric strength and power factor superior to any other commercial plastic, and comparing favorably with mica and ceramics.

Compression molded sheets of Acadia Polystyrene have properties superior to sheets fabricated by other methods—no shrinkage at normal temperatures—better heat resistance.

Consider also these additional values: zero water absorption; relative freedom from adverse effects by acids, alkalis,

alcohol, stack gases, weather, etc.; an excellent dielectric constant value, and high tensile strength of 3500 to 5000 lbs. per sq. in. Add to these Acadia's wide experience in the plastics field, and you have the reasons why Acadia Polystyrene merits your investigation.

Complete details are available on request—for quick reference some of Polystyrene's outstanding values are given here:

Dielectric Constant.....	2.5 to 2.6 at frequencies 10 <sup>5</sup>
Power Factor, 60 cycles.....	.0001 to .0003
10 <sup>8</sup> cycles.....	.0001 to .0003
10 <sup>6</sup> cycles.....	.0001 to .0008
Dielectric Strength, Volts/Mil $\frac{1}{8}$ " thickness	
Short time	500 to 700
Step by Step	450 to 600
Volume Resistivity, ohms-cms.....	10 <sup>17</sup> to 10 <sup>19</sup>
Heat Resistance.....	150°F to 250°F
Softening Point.....	190°F to 250°F
Specific Gravity.....	1.05

# ACADIA



Processors of Synthetic  
Rubber and Plastics • Sheets  
Extrusions • Molded Parts

# Synthetic PRODUCTS

## DIVISION WESTERN FELT WORKS

LARGEST INDEPENDENT MANUFACTURERS AND CUTTERS OF FELT

4035-4117 Ogden Avenue • Chicago 23, Illinois

Branch Offices in All Principal Cities

## TECHNICAL NOTES

Excerpts from *New Home Study Lessons Being Prepared under the Direction of the CREI Director of Engineering Texts*

### **Radiomen!**

#### **CREI Offers Another Interesting Technical Discussion on Uses of THE CATHODE RAY OSCILLOSCOPE**

#### **Sent Free On Request**

Readers of this column each month have been hearty in their praise of the interesting technical articles written each month by the CREI Director of Engineering Texts, Mr. Albert Preisman. These articles appear in our popular monthly paper, the "CREI NEWS."

In the May issue of the "CREI NEWS," Mr. Preisman has prepared a relatively elementary, but highly practical discussion of some of the many uses of the Cathode Ray Oscilloscope. Many men in the armed forces have had occasion to employ Cathode Ray Oscilloscopes in special, and usually secret, military devices. Many have written to CREI and requested that some of the ordinary uses of the Oscilloscope be described—particularly some of the features that are not generally discussed in text books. The forthcoming article aims to meet this request and it is felt that a large number of radiomen will want to read it.

If you are not already on the mailing list to receive the "CREI NEWS," write at once to the address below and ask for your free copy of the May issue which includes the article on the Oscilloscope. All subsequent issues will be sent to you regularly without charge . . . and, of course, without obligation.



The subject of "Cathode Ray Oscilloscopes" is but one of many that are being constantly revised and added to CREI lessons by A. Preisman, Director of Engineering Texts under the personal supervision of CREI President, E. H. Rietzke. CREI home study courses are of college calibre for the professional engineer and technician who recognizes CREI training as a proved program for personal advancement in the field of Radio-Electronics. Complete details of the home study courses sent on request.

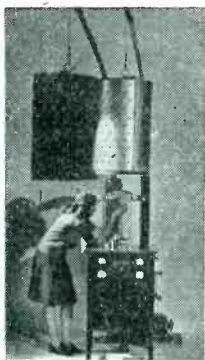
### **CAPITOL RADIO ENGINEERING INSTITUTE**

E. H. RIETZKE, President

Home Study Courses in Practical Radio-Electronics Engineering for Professional Self-Improvement

Dept. E-5, 3224—16th St., N.W.  
WASHINGTON 10, D. C.

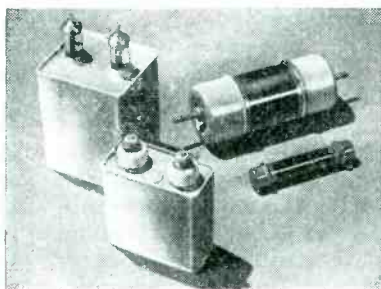
Contractors to the U. S. Navy—U. S. Coast Guard—Canadian Broadcasting Corp.—Producers of Well-trained Technical Radiomen for Industry



inum, chromium, silver, gold and rhodium on the surface of glass. Many applications of evaporated films on both conductors and dielectrics are being studied by The Vacuum Engineering Division of National Research Corp., Boston 15, Mass.

### **High-Voltage Capacitors**

TYPE 25-P capacitors are for use in high temperatures, and high voltage applications. A special oil-impregnation, called Vitamin Q is used. Standard types include hermetically-sealed, rectangular metal container capacitors in styles for



95 deg C and 106 deg C, continuous operation, and in d-c rated voltages ranging from 1000 to 16,000. Other types include 45-P hermetically sealed in glass shells with metal end caps.

Sprague Electric Co., North Adams, Mass.

### **Resonance Meter**

MW-70 DESIGNATES a resonance meter for use in studying u-h-f phenomena in the laboratory or in the field. It is for use in determining resonance and r-f energy in oscillators and transmitters; tank circuits, antenna systems, coupling networks and transmission lines. The instrument is designed around a high Q concentric resonance cham-

# 10,000 PARTS

Ten thousand different  
radio and electronic parts immediately  
available on priorities

# SERVICE

Trained expeditors select  
and ship same day your order  
is received

# EXPERIENCE

Known since 1922 as reliable  
jobbers, wholesalers and manufacturers of  
radio and electronic equipment

## Radio Wire Television Inc.

100 Sixth Ave. Dept. E-5 New York 13, N. Y.  
Boston, Mass. Newark, N. J.  
World's largest Radio Supply House

Originators and  
Peacetime Marketers  
of the celebrated

## Lafayette Radio

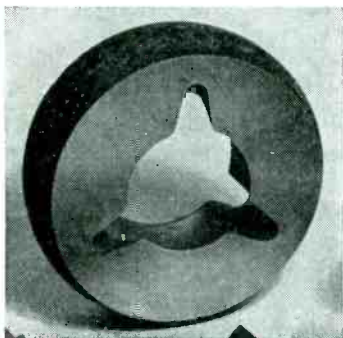
Write today for our bargain  
flyers and special bulletins



## "Just Cool Me Off With Flux"

• It's a funny thing about magnet metals. Take ALNICO-V for example. You can design the magnet scientifically, cast it of the metal perfectly, grind it to final shape with every care, heat treat it according to all the rules and regulations and then give it the usual shot of juice. Yes, you'll get some magnetic power. But quench it in a field through which magnetic rays are shooting and you get some astonishing results. You get a real He-Magnet, not just a namby pamby one that couldn't lift a horseshoe nail.

Yes, magnet metals are mysterious things but our engineers know about all there is known about them to date. We'll be glad to apply our knowledge to the design and manufacture of your magnet.



Typical of the many varieties of Permanent Magnets designed and made by Cinaudagraph.

5-CC-2

**CINAUDAGRAPH  
CORPORATION**

2 Selleck Street

Stamford, Connecticut

# FERROCART

**Exclusively IRON CORES**  
used wherever performance counts

Millions of FERROCART cores are serving effectively and efficiently wherever performance counts. Used by leading manufacturers of communication and electronic equipment, especially in radio receivers and transmitters, even at ultra high frequencies, particularly for R.F. and I.F. coils, and R.F. filters. Each core is precision-made of the finest materials and rigidly tested. Molded . . . light . . . uniform permeability. Our engineering staff of core specialists and laboratory facilities are available for helping to meet your specific requirements.

ON LAND, ON SEA,  
AND IN THE  
AIR



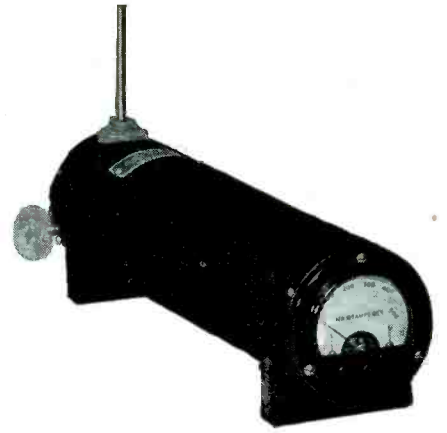
## FERROCART CORPORATION OF AMERICA

Plant and Laboratory: HASTINGS-ON-HUDSON 6, NEW YORK

Indianapolis: 108 E. 9th St., Queisser Bros.  
Jenkintown, Pa.: P. O. Box 246, D. M. Hilliard.  
Montreal: 995 St. James St., West, W. T. Hawes.  
Kansas City, Mo.: Broadway at 34th St., E. W. McGrade.  
Chicago, Ill.: 840 North Michigan Ave., Ray E. Berg.  
Chicago, Ill.: 840 North Michigan Ave., E. C. Winkenwerder.

Associated with leading RADIO PARTS manufacturers

Specify **MICROPERM** Quality



ber whose center conductor is made variable through the use of a rack and spur gear. A small plug in the pickup antenna is optimum coupled to the center conductor. Rectification is obtained with a miniature crystal cartridge. Indication of resonance is directly indicated on a d-c microammeter.

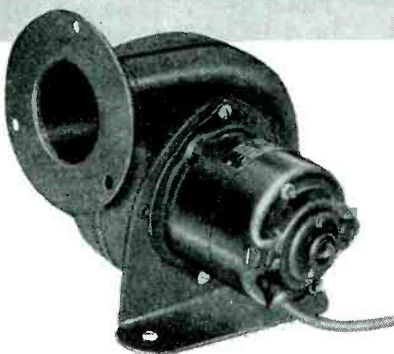
Erco Radio Laboratories, Inc., Hempstead, N. Y.

## New Chemical Compound

A NEW CHEMICAL compound, Styraloy, is a cross between plastics, rubber and wood. A new million dollar plant is to be built to manufacture the material on a mass production basis. The material is light enough to float on water, it has good electrical properties, can be worked like wood, and molds like plastics. Its electrical properties are low loss, low capacitance and high dielectric strength. It is being used as an insulator in antennas.

Dow Chemical Co., Midland, Mich.

## WHAT DO YOU NEED IN A FAN FOR ELECTRONIC APPLICATIONS?



Model 6 S—6 1/2" high



10" Ilgette Model

• Standard types of fans adapted to your needs . . . or special fans engineered to order . . . BOTH are available from ILG! With the thousands of ILG products in use by the U. S. Signal Corps, Maritime Commission and Navy

it is possible that the size, capacity or mounting arrangement you require is already in production. Write giving details of your problem or phone nearby Branch Office (consult classified directory) for competent engineering help.

## Link Joint

THIS MANUFACTURER uses solid shafting and no flexing or backlash to achieve accurate remote control in a new link joint. The joint features an adjustable link mechanism to transmit rotary motion around corners, and it permits operation of shafts at angles adjustable from a straight line to a right angle of 90 deg. The joint is mounted by means of three screws which hold it in position. The bearing arm holding the adjustable shaft may be hinged to any desired position from zero to 90 degrees and when in its proper location, a locking screw permanently holds its position. The unit

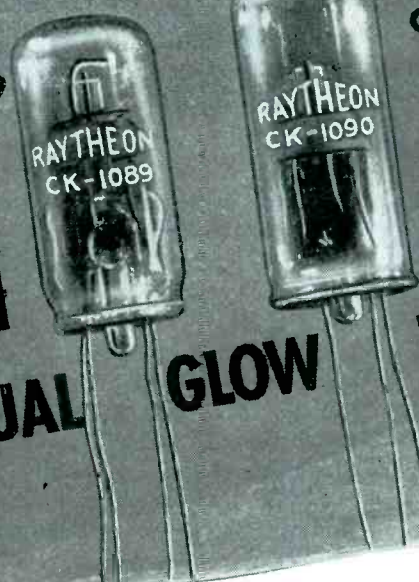


ILG ELECTRIC VENTILATING CO., CHICAGO 41, ILL.  
2882 No. Crawford Ave. • Offices in 38 Principal Cities

**VITALIZED VENTILATION**  
AND AIR CONDITIONING



# RAYTHEON COLD CATHODE VISUAL GLOW THYRATRONS

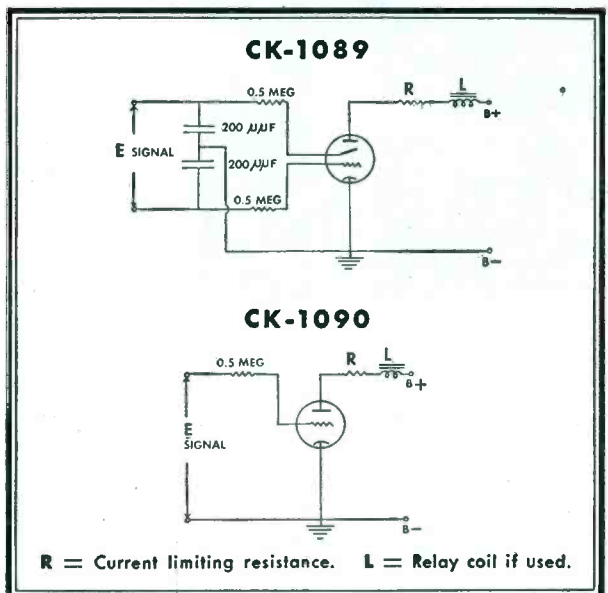


Outstanding recent developments by Raytheon's research laboratories are two visual-glow cold cathode thyratrons, types CK-1089 and CK-1090.

The former is a tetrode incorporating two starter electrodes and so can be operated from a balanced line, whereas the latter is a triode with a single starter electrode for grounded line or unbalanced operation. In addition to normal grid controlled thyatron performance, these neon-filled tubes are engineered to produce a good visual glow near the top of the bulb.

This characteristic, and their small size, make them admirably adaptable to telephone switchboard applications where they can be wired directly as a combined relay and indicator lamp. It is also possible to actuate a separate relay in the anode circuit by the initiation of plate current, which, of course, is coincident with the glow. The resulting simplicity and the reduction in weight and size are highly desirable. Thousands of Raytheon CK-1089 and CK-1090 tubes are now giving dependable service in just such an application—even under the worst climatic conditions. Convincing proof, indeed, that Raytheon builds fine tubes... tubes that you should consider for your postwar products!

## TYPICAL CIRCUITS



SPECIFICATIONS OF CK-1089 AND CK-1090	
Minimum Peak Anode Breakdown Voltage (No Signal)	225 volts
Peak Positive Starter-Anode Breakdown Voltage Across Starter Electrodes on CK-1089	75 min. volts
Starter Electrode to Cathode on CK-1090	170 max. volts
Approximate Starter Electrode Voltage Drop	90 volts
Maximum Peak Cathode Current	20 ma
Maximum Average Cathode Current	15 ma

# RAYTHEON

RADIO RECEIVING TUBE DIVISION  
Newton, Mass. · Los Angeles · New York · Chicago · Atlanta



All Four Divisions  
Have Been Awarded  
Army-Navy "E"  
with Stars

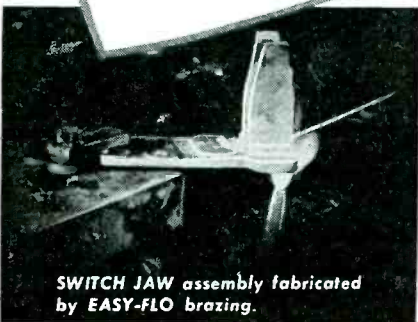
Listen to  
"MEET YOUR NAVY"  
Every Saturday Night  
ENTIRE BLUE NETWORK  
Coast-to-Coast  
181 Stations

DEVOTED TO RESEARCH AND THE MANUFACTURE OF TUBES FOR THE NEW ERA OF ELECTRONICS



SWITCH BOX COVER made from stampings and parts brazed with EASY-FLO.

**Better, Faster  
PRODUCTION OF  
Electrical  
EQUIPMENT - WITH  
SIL-FOS  
AND  
EASY-FLO**



SWITCH JAW assembly fabricated by EASY-FLO brazing.

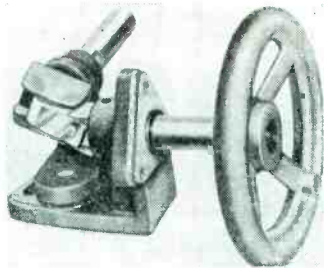
**BETTER** production, because these two low-temperature silver brazing alloys, originated by Handy & Harman, provide joints with the special properties essential to electrical applications. On *structural* work, both SIL-FOS and EASY-FLO make joints that have high strength plus the ductility to stand severe stresses and strains. On *electrical* work, both alloys make joints that equal the usual current-carrying metals in conductivity and corrosion resistance.

**FASTER** production, because of the low working temperatures of SIL-FOS (1300°F) and EASY-FLO (1175°F) and their extreme fluidity — factors which also bring down metal joining costs.

**GET DETAILS IN BULLETIN 12-A** Investigate the product-improving, production-boosting, cost-cutting possibilities of SIL-FOS and EASY-FLO brazing. **BULLETIN 12-A** gives you the complete story. Write for a copy—now.



**HANDY & HARMAN**  
82 FULTON ST., NEW YORK 7, N. Y.  
Bridgeport, Conn. • Chicago, Ill. • Los Angeles, Cal.  
Providence, R. I. • Toronto, Canada  
Agents in Principal Cities

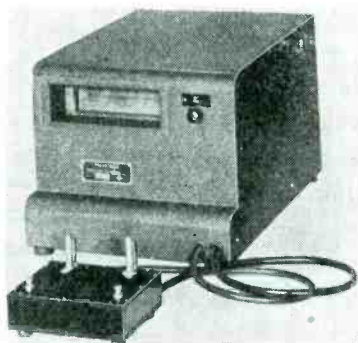


can be used for hand operation and slow speed power drives in the control of electrical switchboards, radios, automatic machinery and other mechanical devices. Another feature is the fact that the output shaft turns in exact angular rotation as the input shaft, giving an input turning angle equivalent to the output turning angle, when used in dial setting operations. Bulletin No. 45 is available on this subject.

Piezoelectric Corp., 110 East 42 St., New York 18, N. Y.

### Insulation Resistance Tester

THIS TESTER, Vibrotest Model 238, is a new crankless instrument. The indicating instrument (permanently mounted within the unit) is a spotlight galvanometer having a 100 millimeter scale calibrated from zero to 20,000 megohms, direct reading, at a potential of 500 volts d.c.

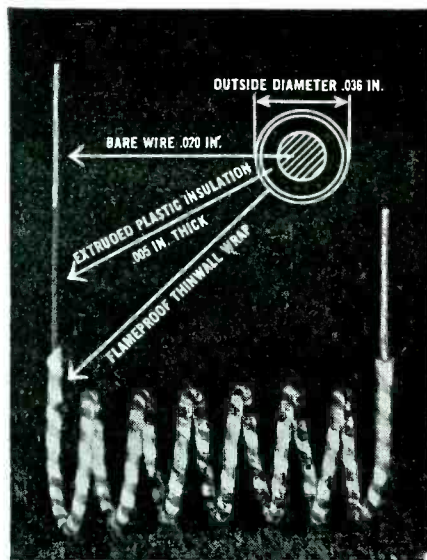


Power is obtained from self-contained batteries. A guard circuit (connected to the unit) is supplied as protection on high ranges. Dimensions are 16 x 11 x 9 in. Weight is 24½ lb.

Associated Research, Inc., 231 S. Green St., Chicago 7, Ill.

### Improved Oscillograph

DESIGN CHANGES and refinements have been made in Model 208-B os-



This photo of typical construction is absolutely unretouched

**Voltage Breakdown — 7000 Volts**  
(For spiraled section shown in photograph after 5 minutes in water)

**Insulation Resistance—30 Megs. Per 1000 Ft. at 60°F.** (After 72 hrs. in water)

**SURCO-AMERICAN**

*New*

## THINWALL WRAP

PLASTIC INSULATED FINE WIRE  
UNBELIEVABLY THIN

Surco-American Thinwall Wrap is the first uniformly high quality fine wire, with extruded plastic insulation and flame proofed yarn serving, available to industry. Surco-American Thinwall Wrap is characterized by:

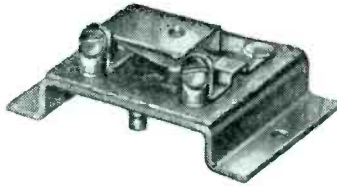
- High dielectric properties
- Maximum saving in space and weight
- Unlimited coding and identification
- High temperature operation
- Excellent abrasion resistance and toughness
- Maximum protection against damage by soldering iron
- Unusual flexibility at below freezing temperatures
- Flameproof qualities
- Good end and spot-stripping characteristics
- Low cost

Surco-American Thinwall Wrap is available in a wide variety of formulations finer sizes of wire and thinner insulations than shown above, for use where maximum performance under specific operating conditions is required.

**Surprenant**  
ELECTRICAL INSULATION CO.  
Dept. C 84 Purchase St., Boston 10, Mass.



Type RT Thermostat. Adjustable Temperature Control.

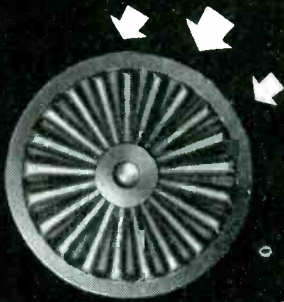


Type C-4351 Thermostat. Used for Tube Warming, Tube Cooling, High Limit Controls, etc.

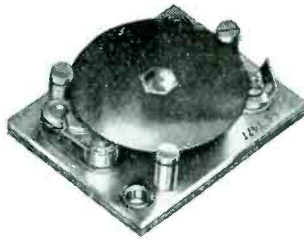


Type C-7220 Precision Snap Switch 12 amps. 30 Volts D. C., 125 Volts A C

This  
"Business End"



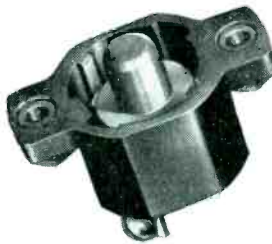
in KLIXON  
Disc-Operated  
Controls



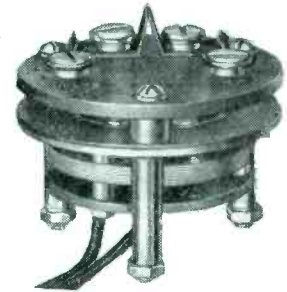
Type B-3120 Thermostat and Heater, Crystal Dew Point Control



Type C-2851 Thermostat For such use as Roughing Controls on Outer Crystal Ovens.



Type PM (NAF-1131) Circuit Breaker



Type ER Series. Ambient Compensated Time Delayed Relays.

## ASSURES TROUBLE-FREE CONTROL or PROTECTION

The reason for the reliability of operation of Klixon Controls lies in the simple Spencer thermostatic disc. This foolproof actuating element snaps to a quick, clean "break" or solid "make". Its accurate operation is unaffected by shock, motion, vibration or altitude . . . no matter how often the disc operates.

Klixon Controls are small, compact and light in weight. They are available in many

standard types and ratings to meet practically every control or protection requirement such as motor or transformer overheat protection, electrical circuit overload protection, thermal time delays or temperature control for radio equipment. Write for complete information today.



SPENCER THERMOSTAT CO., ATTLEBORO, MASS.



# BELL MAY HAVE THE "Key" TO YOUR ELECTRONICS NEEDS

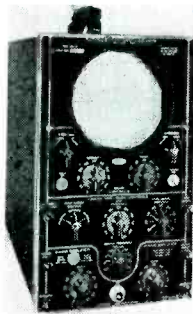


The right use of electronics may unlock new possibilities for your postwar product, or open the way to new efficiency on your production line. Bell engineers may have the key—the electronic answer—to your needs! BELL's wide experience in designing and building electronic assemblies and controls—from the earliest developments right through to the latest types—qualifies them to serve you. Your inquiry will not obligate you in any way.

AMONG PRESENT BELL PRODUCTS ARE—Electronic Sound Devices—Intercommunicating Systems—Industrial Voice-Paging and Broadcasting Equipment—Permanent and Portable Amplifying Systems—Recording and Disc Playing Units—Electronic Controls—Operating Sequence Recorders—Other Special Devices.



**BELL SOUND SYSTEMS, INC.**  
1189 Essex Ave. Columbus 3, Ohio  
Export Off. 4900 Euclid Ave., Cleveland 3, Ohio

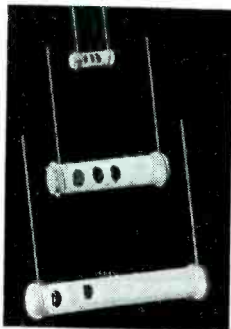


cilograph to make it more rugged and dependable in field service and in rough handling. Some of the changes in the instrument include the use of mineral oil impregnated, hermetically sealed, paper capacitors; high-voltage wire; tube changes; inclusion of a frequency-range adjustment potentiometer in the time base; addition of mounting straps on capacitors; tube clamps; and certain mechanical changes.

Allen B. DuMont Laboratories, Inc., 2 Main Ave., Passaic, N. J.

## Capacitors

FIXED ceramic-dielectric capacitors which conform to joint Army-Navy specifications are available in quantities in preferred temperature co-



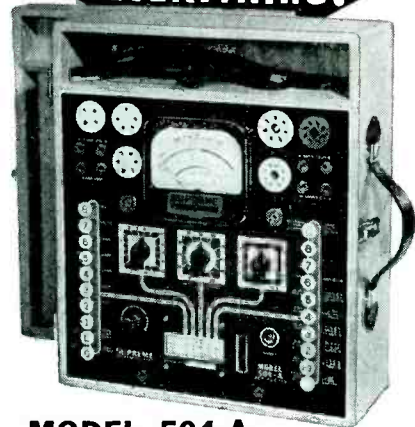
efficients for any capacitance under designations of CC20, CC25, CC30, CC35, CC40 and CC45.

Micamold Radio Corp., 1087 Flushing Ave., Brooklyn 6, N. Y.

## Portable Amplifier

FOR A WIDE variety of applications there is a new, portable 30-watt amplifier (designated as W-J) which is being manufactured by Walker-Jimieson (distributors of electronic and radio equipment). The unit is distortionless and humless. It operates on 110-volt, 60-cycles, ac. Output impedances of 4, 6, 8 and 500 ohms may be selected at will. Fre-

**THE**  
*Portable*  
**LAB**  
**THAT GIVES YOU EVERYTHING!**



## MODEL 504-A TUBE AND SET TESTER

- ★ Design proven by over 5 years production of thousands of this model.
- ★ Operation as simple as ABC. Multi-section push-button switches do all work. Simply "follow the arrows" for tube checking. No roaming test leads for the multimeter.
- ★ Open face wide scale 4 1/4-inch rugged meter built especially for this tester—500 microampere sensitivity.
- ★ Each AC and DC range individually calibrated.
- ★ Professional appearance. Solid golden oak carrying case.
- ★ Guaranteed Rectifier.

## SPECIFICATIONS

DC MICROAMPERES:  
0-500

DC MILLIAMPERES:  
0-2.5-10-50-250

DC AMPERES  
0-1-10

DC VOLTS—1000 OHMS PER VOLT:  
0-5-25-100-250-500-1000-2500

AC VOLTS  
0-5-10-50-250-1000

OUTPUT VOLTS:  
0-5-10-50-250-1000

OHMMETER:  
0-200-2000-20,000 OHMS  
0-2-20 MEGOHMS

BATTERY TEST:  
Check Dry Portable "A" and "B" Batteries Under Load

CONDENSER CHECK:  
Electrolytics checked on English Reading Scale at Rated voltages of 25-50-100-200-250-300-450 volts.

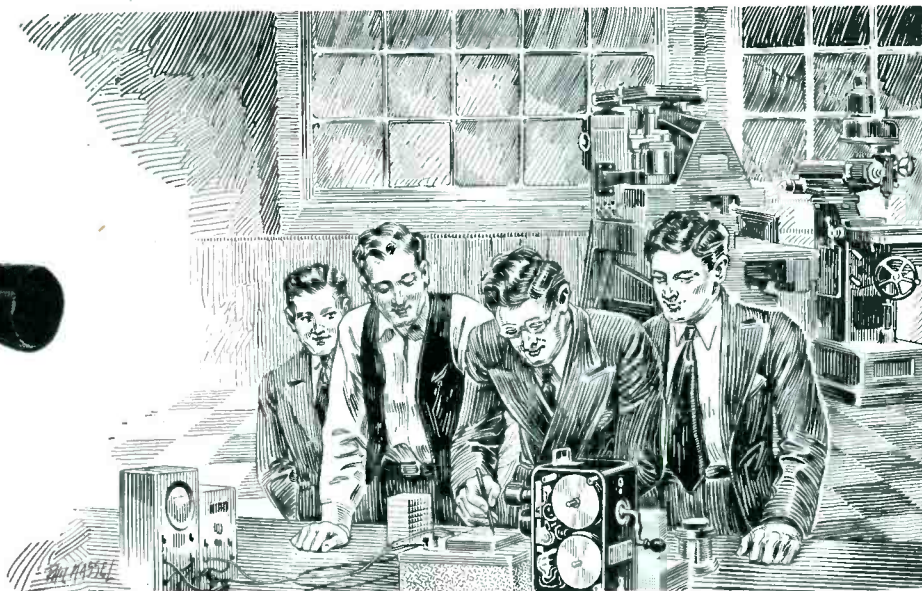
TUBE TESTER:  
Emission type with noise test, floating filaments, easy chart operation. Checks all receiving type tubes.

POWER SUPPLY:  
115 volts 60 cycle. Special voltage and frequency upon request.

**SUPREME**

SUPREME INSTRUMENTS CORP.  
Greenwood, Miss., U. S. A.

# Movies Instead of Delay!



## JEROME *STILL and Motion Picture* CAMERAS

To train novice workmen to-day in the electronics field, motion pictures are supplanting the factory class. A "Movie" classroom avoids interruption of work at bench, machine and production line, and tangibly betters output.

The JEROME Still and Motion Picture Data Camera is in demand for this work, because it affords *two cameras in one*, thoroughly fitted for *both* still and motion picture photography. It is made for handling 35 mm film. A variety of lenses may be used, affording a wide scope of work.

Automatic control and adjustable speed, from 4 to 64 frames, changeable while operating.

Photographer can see and sharply focus the image, without opening the camera.

On still photography, for recording test or manufacturing data, the JEROME'S automatic features enable it to run for 70

days unattended, while photographing at 30-minute intervals. An interval range, from 15 seconds to 30 minutes is available.

There are so many exclusive advantages in the fine, yet rugged construction of the JEROME DATA CAMERA, that we can only hint at them here.

*Write for full information.*

### 28 Ways to Use JEROME CAMERAS

- 1 Photograph instrument panels, registering instruments, single, multiple frame, at pre-determined intervals.
- 2 Gun camera - recommended for heavy guns - 35 mm. Superiority over 8 mm., 16 mm.
- 3 As an Ordinary Camera: Despite special design camera can be used as regular 35 mm. camera.
- 4 Ground and aerial reconnaissance, surveys.
- 5 Recording duplications, Maps, Mail, valuable documents.
- 6 Medical research, fluoroscope screen and microscopic photographic recording.
- 7 Chemistry, records chemical research & action.
- 8 Coast Survey, Aerial Reconnaissance, Recording of depth and sounding instruments.
- 9 Buoy survey and patrol of sea in critical areas.
- 10 Electronic Research Instrument, photographically records cathode ray, oscilloscope.
- 11 Detection, automatically photographs objects passing within camera range.
- 12 Test work, general instrument, recording test performances, techniques.
- 13 Training Film, all types of school and educational photographs for training purpose, class room.
- 14 Deck Observation Camera, records deck action or position of ships in convoy.
- 15 Production Check Camera, checks machine, manual operations, increasing efficiency.
- 16 Aerial observation. At pre-set intervals will photograph landscape below at high altitudes.
- 17 Engineering Work. Used in construction of ship hulls, bridges, construction analysis.
- 18 Performance Guide, manual operation, gun crew action. Recording for future study.
- 19 Aircraft Landings & take-offs mounted on control tower. Records unusual incidents.
- 20 Aerodynamics research and flight test operations.
- 21 Material Testing, Automatic testing characteristics of materials, recording for analysis.
- 22 Meteorology, isolated weather instruments and cloud formation and climatic study.
- 23 Traffic Check, Dangerous road intersections, Tunnel and bridge traffic analysis.
- 24 Marine observation, underwater photography (fluora, fish habitats).
- 25 Firing Data Recording, Complete gun firing record, corrector range and site.
- 26 Front Line Warfare, Tank and listening post observation.
- 27 Restricted Area Detection, Registers pedestrian traffic through gates, doors.
- 28 Photoelectric Cell operating camera operating from sound and vibrator detection.

## JEROME ENGINEERING CO.

### MASSAPEQUA, L. I., N.Y.

ORIGINATORS OF THE AUTOMATIC RECORDING CAMERA

BUILDERS OF PHOTOGRAPHIC EQUIPMENT

UNIVERSAL CAMERAS FOR EVERY TECHNICAL REQUIREMENT

WRITE FOR FULL DETAILS

Phone Massapequa 2100

Check These Exclusive

**KWIKHEAT**

**SOLDERING**

**IRON** Advantages!



- ★ SAVES TIPS
- ★ SAVES TIME
- ★ SAVES EFFORT
- ★ SAVES WEIGHT
- ★ SAVES CURRENT
- ★ SAVES THE IRON

**HOT IN 90 SECONDS  
READY FOR USE...!**

Kwikheat's built-in thermostat maintains proper, even heat for most efficient, economical operation. Can't overheat... saves tips... requires less retinning. Powerful, 225 watts, yet light weight (14 oz.), well-balanced with cool, protecting handle. Choice of # 0, 1, 2 or 3 tip...\$11.00

**6 TIP STYLES**

Interchangeable



... ASK YOUR JOBBER!



**METAL  
STAMPINGS**  
IN SMALL LOTS

Die cut metal stampings in limited quantities can be produced to your special requirements at 15% to 20% of the cost of permanent type tools. No matter how small your quantity requirements or how intricate your work, we can show you a definite saving. During our twenty-three years of specialized experience in this service, there has been no other method of producing metal stampings in small lots that can equal the process originated by Dayton Rogers.

Our new, illustrated booklet #176-17 will give you full particulars.

**DAYTON ROGERS MFG. CO.** 2835 12th Avenue So. Minneapolis, Minnesota

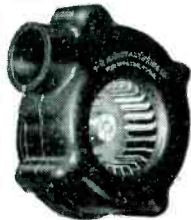
## FOR HEAT DISSIPATION

*under all conditions of temperature and climate*

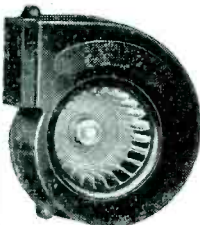
L-R Blowers produce maximum C.F.M. with minimum space and weight. Lightweight, high-impact plastic housings. Turbo-type wheels. Clockwise or counter-clockwise rotation.



Model 1 1/2  
Weight (less motor): 2 oz.  
Output: 15 C.F.M. at 8000 R.P.M.  
Height: 3"

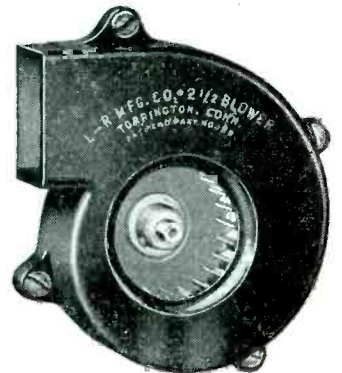


Model 2  
Weight (less motor): 4 1/2 oz.  
Output: 25 C.F.M. at 8000 R.P.M.  
Height: 3 3/4"



Model 3  
Weight (less motor): 12 oz.  
Output: 260 C.F.M. at 8000 R.P.M.  
Height: 6 1/2"

IT'S NEW



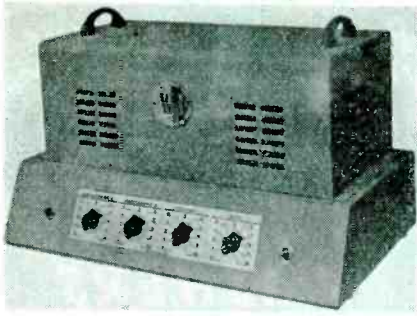
Model 2 1/2  
Weight (less motor): 3 1/2 oz.  
Output: 50 C.F.M. at 8000 R.P.M.  
Height: 4 1/2"

## L-R BLOWERS

**LIGHT • COMPACT • EFFICIENT**  
L-R MANUFACTURING COMPANY Division of

The **RIPLY** Company

13 NEW LITCHFIELD ST. TORRINGTON, CONN.



quency response is 50-10,000 cycles. Record gain is 69 db, and the mike gain is 116 db. Units come in steel cabinets which measure 17 x 10½ x 19½ in. 311 South Western Ave., Chicago 12, Ill.

### Crystal Holders

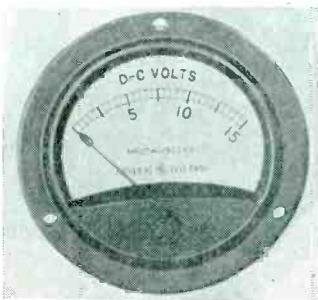
AN IMPORTANT feature of this line, No. FT-243, crystal holders, which have passed all Signal Corps tests, is the fact that they prevent deterioration of the crystal by repelling water vapor when used under tropical conditions.

National Electronic Mfg. Corp., 22-78 Steinway St., Long Island City, N. Y.

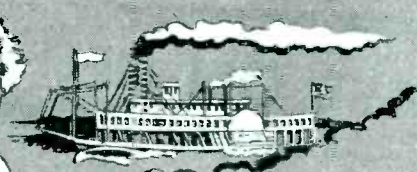
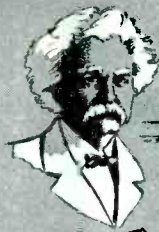
### G.E. Instruments

FOUR NEW TYPES of instruments are available from General Electric Co., 1 River Road, Schenectady 1, N. Y.

First, there is a new line of 2½-in. hermetically-sealed panel instru-



ments: d-c voltmeters and ammeters and a-c r-f ammeters, which are available in standard ratings and which conform to performance requirements of ASA Specifications C-39.2-1944. Hermetic sealing is achieved by glass-to-metal seals and soldered joints so that the instruments are unaffected by thermal or mechanical shock, or fatigue vibration. Units are housed in steel cases and are immune from effects of



Mark Twain  
was right then -

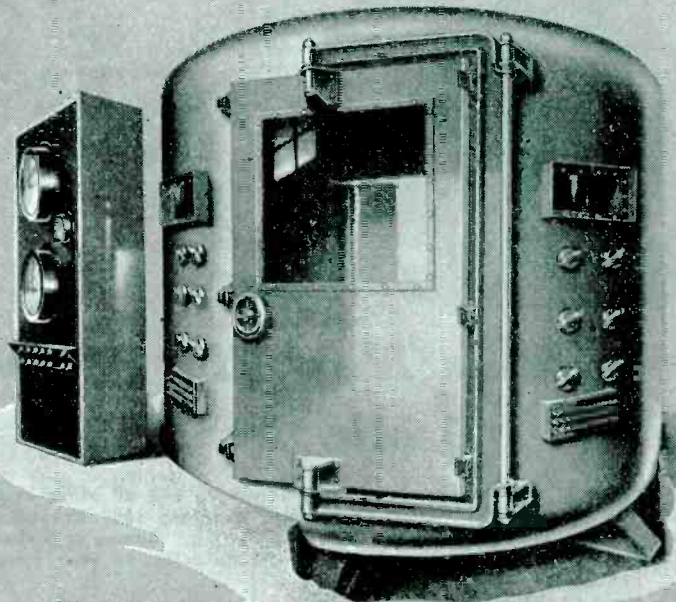
**BUT!**

When Mark Twain said "lots of folks complain about the weather but no one does anything about it," he was right. That was quite some time ago. But something has been done about it since.

In a Kold-Hold Altitude Chamber, any kind of weather known on the face of the earth can be developed at will for testing and/or calibrating both aircraft and electronic equipment. The temperature range available is from 176 deg. F. to minus 94 deg. F. Pressure range is from sea level atmospheric pressure to 1.25 inches mercury and any degree of humidity from 25% RH to 95% RH.

The weather inside the chamber can be changed from that of a tropical jungle to the intense cold of the stratosphere as rapidly as a plane can climb from sea level to its ceiling.

Write for Bulletin AC-441.



**KOLD-HOLD**

440 NORTH GRAND AVENUE  
LANSING 4, MICHIGAN

# LEASE ON LIFE!

... through THERMOSWITCHES

Baby Incubators—essential to maintaining life in babies born prematurely — are temperature-controlled by accurate, sensitive Fenwal THERMOSWITCHES.



Write for catalogue and complete information . . . to

**Fenwal** INCORPORATED  
ASHLAND • MASS.

Particular **WASHERS**  
FOR ELECTRONIC PRODUCTS

# Quadriga Quality WASHERS

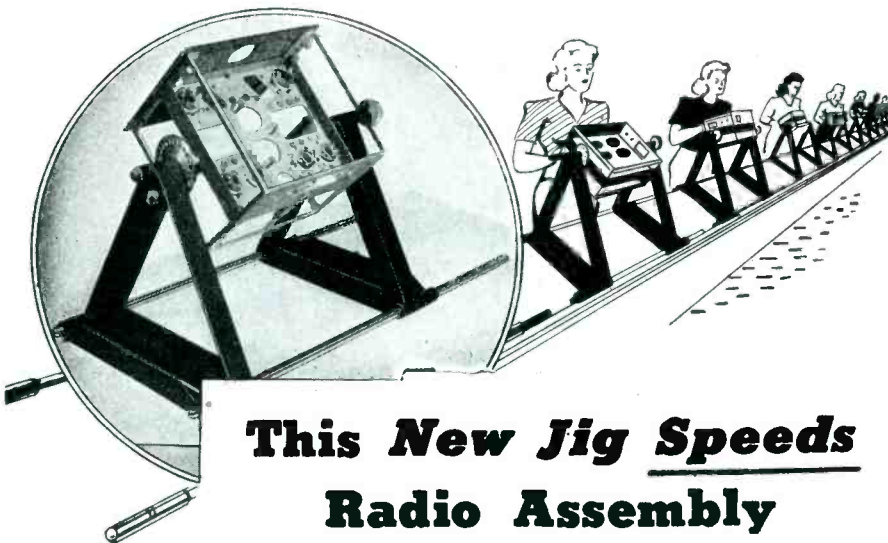
Precision engineered for standard or *special* requirements. Flat, Irregular Contour. Finishing, Tension, Cupped and Drawn, Friction, Dished Blanks, etc. Wire terminals. Prompt delivery any quantity.



Also **SMALL STAMPINGS** any design.

Ask for Quadriga Catalog, Photos and valuable washer data. Send specifications for quotation.

The **QUADRIGA MFG. CO.**  
Incorporated 1894 "Half a Century"  
221A West Grand Ave.  
CHICAGO 10, ILL.



## This New Jig Speeds Radio Assembly

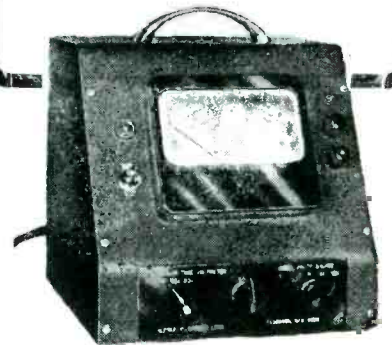
- 1) Holds chassis in any position to step up soldering and all other assembly operations. 2 models (friction or positive indexing 360° around axis).
- 2) Adjustable to any size within base limits of the jig. Comes in 5 standard sizes (4", 6", 9", 12" or 15" swing), or will make jigs to your specifications.
- 3) Sturdy, rigid construction.
- 4) Can be loaded and unloaded in two seconds.
- 5) Prices start at \$11.50.

Information about our Dummy Tubes, Pin Straighteners, Precision Gages, Test and Adapter Plugs and other Tools is yours upon request.

**ROBERT L. STEDMAN** MACHINE WORKS  
SPECIALISTS IN MASS PRODUCTION TOOLS  
OYSTER BAY, LONG ISLAND NEW YORK

Immediate Delivery!

## WIDE RANGE VACUUM TUBE VOLTMETERS



- High input impedance for both AC and DC measurements.
- Convenient, low capacity "Probe," especially adapted to high frequency radio use—100 megacycles and over.
- Self-regulating operation from power line; no batteries.
- Multiple voltage ranges — accurate and stable.

BULLETIN ON REQUEST

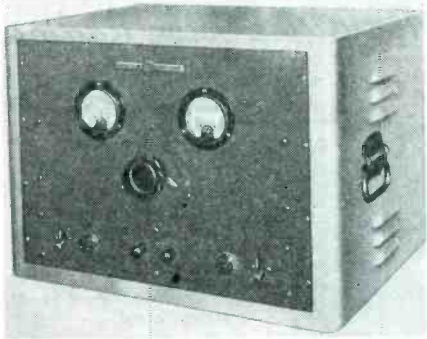
**ALFRED W. BARBER  
LABORATORIES**

34-04 Francis Lewis Blvd. Flushing, N. Y.



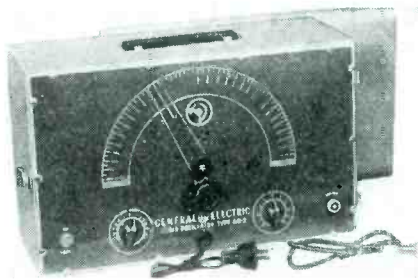
moisture, humidity, chemical fumes, and other harmful agents. They are made for flush mounting on non-magnetic or steel panels.

The second instrument is Type PS-5, a new self-contained regu-



lated power supply which will hold d-c output voltage constant at any selected value, within the range of 160 to 1500 v, regardless of moderately large or rapid changes in the load current. The unit has a low internal a-c impedance useful as a power supply for devices requiring practical elimination of common coupling. Units may be used as component parts or as general purpose gadgets, or as d-c supply for micro-wave oscillators, or for photoelectric multiplier tubes.

A new beat-frequency audio oscillator (Type AO-2) simplifies measurements of audio amplifiers and radio receiver fidelity. The instrument can also be used for test-



ing loudspeakers, for frequency measurements or calibration. Calibration is direct. The unit provides a stable sine wave, continuously variable frequency from 25 to 15,000 cps. A panel control knob regulates the output level from zero to full power output. Zero beat is indicated by the use of Type 6R5 electron-ray tube. Maximum output of the device is 120 milliwatts on the cathode-follower output impedance coupling circuit.

The last instrument is type CRO-3A portable oscilloscope for

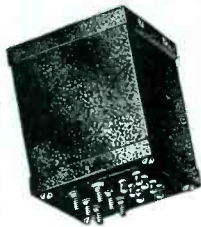
# Send For CONCORD'S New RADIO PARTS BUYING-GUIDE

## It's Free!

- ★ Save time. Order everything you need from ONE source.
- ★ Many parts available without priorities, for immediate shipment from CHICAGO or ATLANTA.
- ★ BUYING-GUIDE includes latest revised listings of standard lines.
- ★ Also contains 16-page Special Bargain Section of many scarce parts—all standard quality, all exceptional values.



### HUNDREDS OF PARTS LIKE THESE Many Available Without Priority



#### Power Transformer

Pri. 110, 200, 220, 240  
Volts 50-60 cycles. Sec.  
6.3 @ 1.45 A. 5V @ 2A.  
376 Vct. @ 025 \$395  
A. 5B5016. . .



#### I. F. Transformer

10 Megacycle I. F. Trans-  
former in heavy alumi-  
num can. Size: 3 3/4" H,  
1 1/2" W, 1 1/2" D. 5B5017 \$295



#### Telephone Switch

Lever type switch D. P.  
D. T. No knob supplied.  
Dull black finish with  
chrome plated lever. 5B4026 . . . 59c



#### Phone Jacks

Switchboard type 2 cir-  
cuit normally closed.  
Takes standard tip and  
sleeve plug. 5B6927 . . . 49c

## CONCORD RADIO CORPORATION

Lafayette Radio Corporation

CHICAGO 7, ILL. ATLANTA 3, GA.  
901 W. Jackson Blvd. 265 Peachtree Street

### Mail Coupon NOW

Concord's great, new 68-page Buying-Guide includes latest 1945 Revised listings of standard lines of Condensers, Transformers, Resistors, Tubes, Test Equipment, Repair and Replacement Parts, Tools, and hundreds of other essential items. Page after page of top-quality radio and electronic parts; and a special 16-page Bargain Section offering hundreds of hard-to-get parts at important savings. Mail coupon now for your FREE copy.

#### Quick Shipment from CHICAGO or ATLANTA

Concord carries vast stocks. Concord ships to you at once from the nearest shipping warehouse, CHICAGO or ATLANTA. Concord invites you to consult our technical experts on special requirements. Concord can expedite any "essential" order and speed action. Concord now serves the United States Government, Institutions, Industry—and can serve YOU, whether you want one part or a hundred. Telephone, wire, or write your needs.

CONCORD RADIO CORPORATION  
901 W. Jackson Blvd.,  
Dept. G-55, Chicago 7, Ill.  
Please RUSH FREE copy  
of CONCORD'S new 68-  
page Buying-Guide and Revised Listings.

Name.....

Address.....

City.....State.....





## METAL-TO-GLASS SEALS

### Intricate glass work and tubes made to your specification

The Universal X-Ray plant specializes in the production of metal-to-glass seals. Intricate glass seals are made to customers' specifications for electronic tubes, transformers, resistors, capacitors, condensers, vibrators, switches, relays, instruments, gauges, meters, receivers, transmitters, and other scientific apparatus.

A strong metal-to-glass bond assures unflinching protection against rust, corrosion, and extreme climatic conditions in a vacuum-tight seal. Good deliveries can be made on volume orders. Submit your metal-to-glass seal problems to the Universal engineers for recommendations and estimates.

**UNIVERSAL X-RAY PRODUCTS INC.**  
1800-A N. FRANCISCO AVENUE • CHICAGO 47, ILLINOIS

# 2 VITAL AIDS

TO THE MANUFACTURER OF  
*Miniature Tube Radios*

## ★ STAR

DOUBLE-CHECK SYSTEM



#JE-10—Miniature socket wiring plug for accurate alignment of miniature socket contacts during wiring. • Precision cast of zinc base alloy—Pins of stainless steel.

#JE-12 — (Hardened tool steel insert) or JE-13 (Stainless steel insert) Miniature tube pin straightener to obtain a perfect fit when the tube is placed in the set.



For complete information and prices—write

RADIO ACCESSORY DIVISION

**STAR EXPANSION PRODUCTS CO.**  
147 Cedar St., New York 6, N. Y.

# CRYSTAL MANUFACTURERS!

Here is a **NEW** Holder, approved by the Signal Corps.



Featuring new materials and designs, the new Nemco Crystal Holders have easily passed every test to which they have been subjected by the Signal Corps. and crystal manufacturers.

Nemco Holders are designed to prevent deterioration of the crystal by repelling water vapor under tropical conditions.

Because we specialize in the manufacture of Crystal Holders exclusively, we can give you the quality and service to help speed your production.

Write for samples and prices; also request quotations on your requirements for imprinting holders with metallic ink.



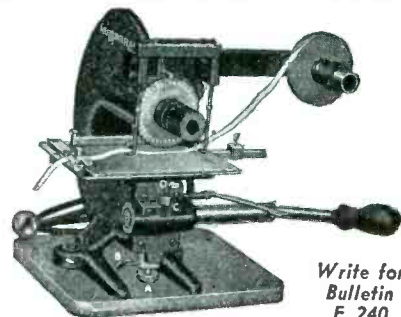
**NATIONAL ELECTRONIC MANUFACTURING CORP.**

22-78 STEINWAY ST., LONG ISLAND CITY, N. Y.

New NEMCO N5X in No. 6105 and 592 may be obtained in all types of FT-243 Holders.

# NUMBERALL

NUMBERING and LETTERING PRESS



Write for Bulletin E 240

An ideal machine for hot stamping letters and figures on plastic nameplates, and other small parts, with the use of colored roll leaf. Furnished with an electric heating element, and rheostat for regulating heat. All figures and entire alphabet are on one dial.

We also make numbering machines . . . automatic and non-automatic . . . for stamping, either hot or cold, numbers and letters into various materials.

**NUMBERALL STAMP & TOOL CO.**  
HUGUENOT PARK STATEN ISLAND 12, N. Y.

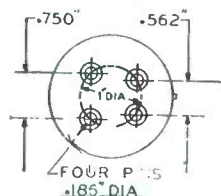
studying wave shapes and transients, measurement of modulation adjustment of radio receivers and transmitters, the determination of peak voltages, and the tracing of electron tube characteristics. The



unit utilizes a 906-PI cathode-ray tube which has a greenish screen that can be viewed in daylight. Special design eliminates a-c ripple from the a-c transformer field and sharpens the signal picture. Moderately high-speed traces can be photographed on the screen. The unit has a wide range sweep circuit featuring a linear amplifier. Sweep rates are from 10 to 30,000 per second, adjustable by a 7-point vernier switch.

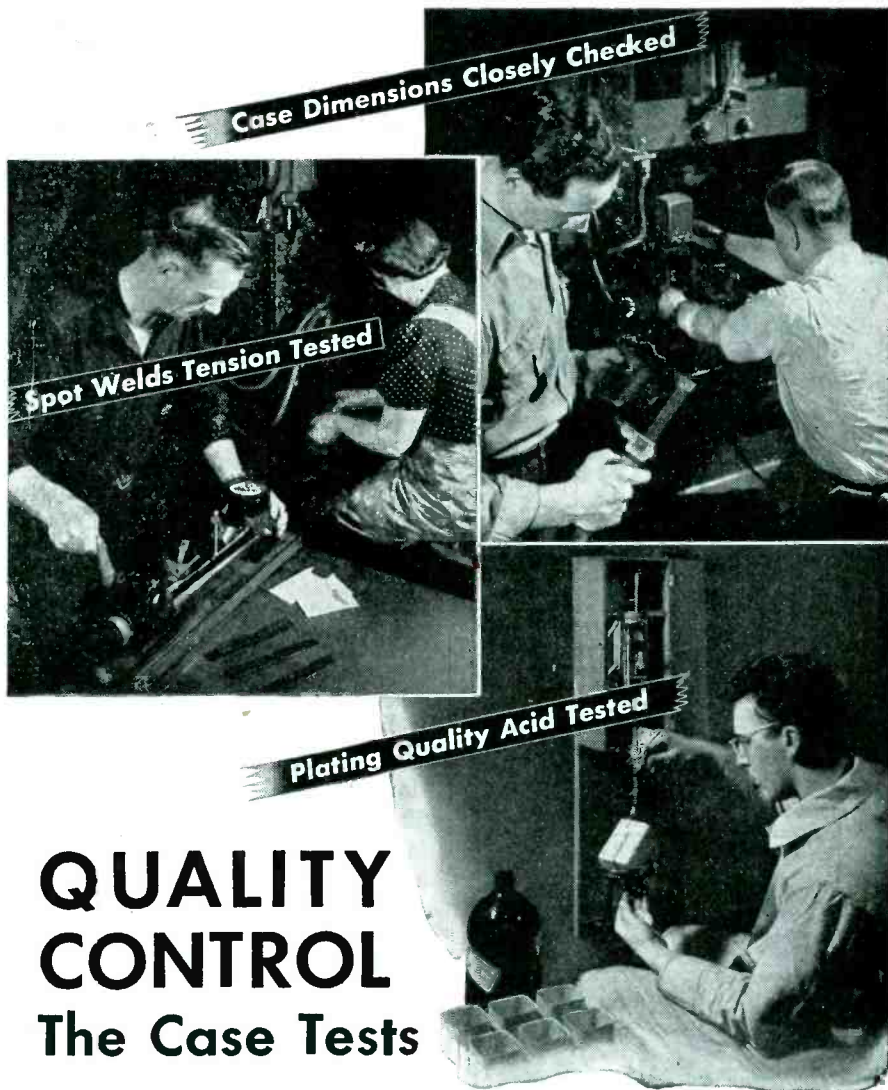
### Transmitting Tube Socket

A TRANSMITTING TUBE socket (Catalog No. 244) of low-loss steatite construction is designed to accommodate jumbo 4-prong bases of 8008, BR6, GL146, SC22, GLI52 and GLI69 tubes. The socket measures  $2\frac{1}{2} \times 2\frac{1}{2} \times \frac{3}{4}$  in. thick. A one-piece base construction is used. Bosses are molded in on top of the socket, and are ground to present a flat mounting surface underneath a



chassis. Cadmium-plated brass contacts with steel spring reinforcements are riveted to the ceramic base so that they cannot turn.

E. F. Johnson Co., Waseca, Minn.



## QUALITY CONTROL

### The Case Tests

Careful control of quality in essential parts is good insurance for smooth flowing production and for a high calibre product.

Thus Deep Drawn, Seamless Steel Cases, an essential part of many Chicago Transformers, are subjected to precision checks for case dimensions, pull tests for strength of spot welds in internal mounting structures, and inspection for electro-plating thickness with carefully timed acid erosion.

By this type of Quality Control, applied in every phase of manufacture, uniformity of parts is maintained and high standards of quality in finished Chicago Transformers is assured.

# CHICAGO TRANSFORMER



DIVISION OF ESSEX WIRE CORPORATION

3501 WEST ADDISON STREET

CHICAGO, ILL.



# "MIGHT" SMALL TOOL SET

**A Little Giant For Business!**

**Saves carrying a lot of tools . . . . .**

**4 Single Hex, 4 Double Hex, 3 Double Square Sockets. Range 3/16 to 7/16. Universal Drive with Sliding Bar a Spintite Straight Drive all in a pocket size nicely finished metal box. Ask for . .**

**WALDEN WORCESTER**

Set 3100A  
and 3100



See it at  
Your Jobber  
Two  
Combinations

Send for  
Catalog 141  
picturing a full  
line of Automative,  
Aircraft and  
Radio wrenches —  
tools and boxes.

**WALDEN  
WORCESTER  
WRENCHES**

**STEVENS WALDEN, INC.**

468 SHREWSBURY STREET

WORCESTER, MASSACHUSETTS

## Literature

**Government Contract Termination Bulletin.** Joint Army-Navy Termination Regulations to be used by war contractors in the rapid settlement of war contracts. Other printed material pertaining to contract settlements is also available. The government urges all contractors holding war contracts to have their names placed on the mailing list for the Regulation and all subsequent changes. Write to Joint Army-Navy Distribution Center, Lt. E. P. Lull, 90 Church St., New York, N. Y.

**Permanent Magnets.** General information regarding the composition, treatment, and properties of magnetic material and the design and testing of permanent magnets are treated in a circular of the National Bureau of Standards (C448). The booklet is entitled, "Permanent Magnets," by Raymond L. Sanford, and is available at 25 cents from U. S. Government Printing Office, Superintendent of Documents, Washington 25, D. C.

**Norelco Electronic Products.** This 8-page booklet is really a general catalog which uses little space to tell much about such products as cathode-ray, transmitting, power and amplifier tubes; quartz crystal oscillator plates; Searchray (x-ray) inspection units; Geiger-counter x-ray Spectrometer; film-type x-ray diffraction equipment; quartz crystal x-ray analysis unit; metallurgical products and medical x-ray equipment. North American Philips Co., Inc., 100 East 42nd St., New York 17, N. Y.

**Electronic Tubes.** This 20-page, loose-leaf booklet contains diagrams and specifications of such power and transmitting tubes as: Type 3-16 ballast; Types 3B27, 371-B, 836 and 8020 half-wave high-vacuum rectifiers; Types 866-A/866, 575-A, 872-A and 8008 half-wave mercury-vapor rectifiers; Types 100-TH (tantalum anode), 811 and 812 (Zirconium-coated anode), and 808 transmitting triodes; Types EE-200 and EE-300 power amplifier, oscillator, class B modulators; Types 873 and

An Impregnating Service

WHICH

PROTECTS

STEATITE CERAMIC PARTS

AGAINST

MOISTURE ABSORPTION

AND FUNGUS

ATTACK



by the use of . . .

**DOW-CORNING FLUID No. 200**

This new method for waterproofing ceramic surfaces results in increased electrical resistance and improved performance of equipment under conditions of high humidity and condensation. Application of Dow-Corning Fluid No. 200 to ceramic bodies coats them with an extremely thin film of silicone. It will adhere effectively even when immersed for days in sea water and does not collect dust or corrode metals; nor will it react with organic materials. It has a power factor of the order of .005% and is effective up to 150°C. It also acts as a neutral flux for soldering, and is not removed by contact with organic solvents. For further applications and engineering data write or phone.

Daily

PICK-UP AND DELIVERY  
in METROPOLITAN AREA

★

**PRODUCTION  
ENGINEERING CORP.**

666 VAN HOUTEN AVE.

CLIFTON, N. J.



**A BOX TO REMEMBER** when you want **GOOD** coils  
**STANWYCK**  
**R. F. COILS**  
**AND ASSOCIATED ASSEMBLIES**

There is a Stanwyck coil for every application in the Radio Frequency Spectrum —coils that have met the requirements of war and which will meet your requirements when the war is won . . . Send for folder describing our line and facilities.

**STANWYCK WINDING CO.**  
 NEWBURGH NEW YORK



**H-B MIDGETS**

**GIVE ALL THREE . . .**

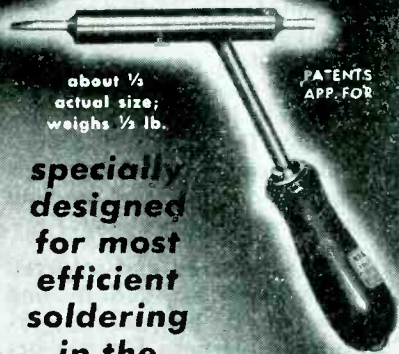
- 1 LIGHT WEIGHT**
- 2 LABORATORY ACCURACY**
- 3 ARMORED RUGGEDNESS**

For the past 10 years H-B Midget Thermometers have been installed by the thousands. Easy to read because of lens-front, yellow back tube and scale engraved on glass. Any range from minus 30 to plus 700° F. Made in both straight and angle types, weighing but 5 and 7 ozs. respectively. Straight type, 9 in. overall. For details, write for folder. H-B Instrument Company, 2524 No. Broad Street, Philadelphia 32, Pa.

**THERMOMETERS • THERMOSTATS • RELAYS**  
**THERMO-REGULATORS • HYDROMETERS**



*The* **IMPROVED**  
**KELNOR**  
 REG. U. S. PAT. OFF.  
*electric* **SOLDERING IRON**



about 1/3 actual size; weighs 1/2 lb.

PATENTS APP. FOR

**specialy designed for most efficient soldering in the**

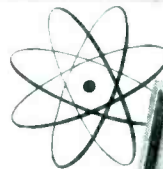
**ELECTRONIC, RADIO AND INSTRUMENT manufacturing and repairing fields**

Easily solders hard-to-reach connections. Cuts down fatigue, increases accuracy.

ORDER FROM YOUR JOBBER, OR DIRECT. GENERAL OFFICES: CENTRAL TOWER, SAN FRANCISCO 3

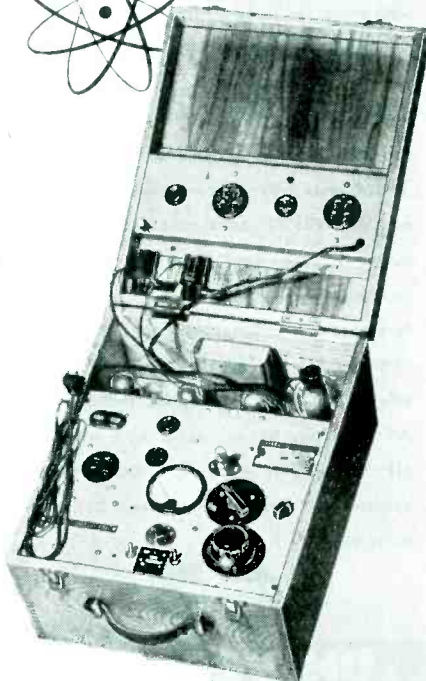
**KELNOR MANUFACTURING COMPANY**

"When Ordering Please Mention Electronics"



**INDUSTRIAL TUBE TESTER**

**T**HIS instrument provides a simple, efficient method of testing various types of thyratrons, now widely used in industrial applications. Results are indicated visually by neon lamps so that the tester can be operated by non-technical personnel. A pre-heater rack, installed in the lid, speeds up the process of testing. The unit is semi-portable for maximum utility in plant use. For complete information write to: *Electronics Department, General Electric, Schenectady 5, New York.*

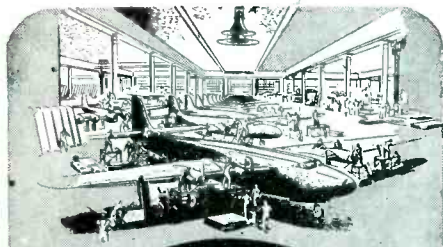


*Electronic Measuring Instruments*

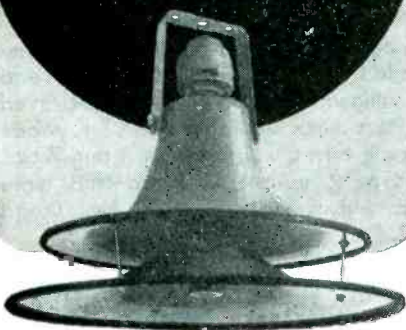
**GENERAL ELECTRIC**

164-D5

**TT-1**



**For wide  
COVERAGE  
and maximum  
CLARITY  
in noisy areas...**



*University* **RADIAL  
REFLEX SPEAKERS**

Type RLH radial reflex units provide uniform 360° coverage over large noisy areas with complete freedom from blasting. Perfect clarity is assured by 120 cycle cutoff. Special deflector design increases range and prevents sound concentration below the unit—distribution is uniform.

Actual tests have shown that very often one UNIVERSITY radial reflex unit provides better coverage than several straight projectors in a given area. Economy and performance are often thus improved. Type RPH and RSH are also available with cutoffs of 150 and 180 cycles respectively. All units can be equipped with UNIVERSITY driver units and are finished with convenient "U" bracket mounting. Literature on request.



**UNIVERSITY  
LABORATORIES**  
225 VARICK STREET  
NEW YORK 14, N. Y.

EE-17 half-wave mercury-vapor, grid control rectifiers; Types 274-A and 274-R, full wave high-vacuum rectifiers. One page is devoted to the operation of E-E mercury vapor rectifier tubes. Electronic Enterprises, Inc., 65-67 Seventh Ave., Newark, N. J.

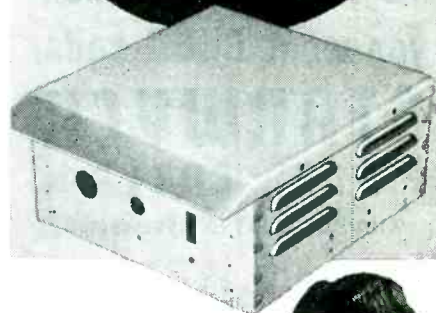
Relays. Aircraft relays illustrated and described in a 12-page bulletin (No. 30-D). Dimensional drawings are included. A quick reference index on the last page helps to locate specified relays. Hart Mfg. Co., Hartford, Conn.

Square Wave Analysis. "The Technique of Square Wave Analysis" is the title of a 4-page folder on this subject. Described on the last page of the folder is Model 71 square wave generator. Measurements Corp., Boonton, N. J.

Transformers, Chokes, Motor Generator. Wyse Laboratories (211 S. Ludlow St., Dayton 2, Ohio) 4-page folder announces the establishment of a department for the production of special transformers and chokes. Several pieces of equipment are illustrated. Another 4-page folder from Wyse is devoted to a brief description of a new, portable MG-39 motor generator built for U. S. Signal Corps for testing 400-cycle a-c and 27-v d-c instruments.

Permeability Tuning, Iron Powders. "Incremental Permeability Tuning" is the title of an article (reprinted from *Radio*) by W. J. Polydoroff describing a tuning system utilizing incremental permeability. Applications are indicated. Another piece of literature contains curves establishing the relation between the effective permeability of powdered compressed cylindrical cores and the permeability of the material itself, as measured in toroidal coils at low flux density. Five other pieces of literature include an 18-page catalog entitled "Carbonyl Iron Powders;" a sheet entitled "Electromagnetic Characteristics of Various Iron Powders;" 2-pages of data giving the comparison of different grades of carbonyl iron powders manufactured; and finally a 6-page

These  
diversified  
metal fabrications  
**FACILITIES**  
can solve future  
plannings



"Resourcefulness in design can step up efficiency in assembling and manufacture. Close tolerance stamping and forming are effecting lowered production costs all along the line."



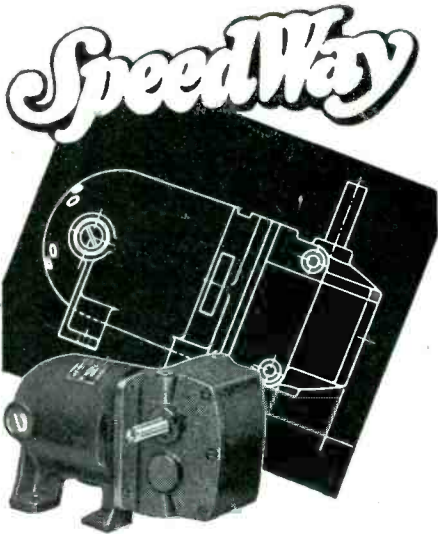
Modern and complete metal fabricating facilities — plus OLYMPIC engineering experience and resourcefulness—are at present eliminating production bottlenecks in vital phases of industry.

Whether your projected product calls for production tooling, stamping, forming, or drawing — complete design, fabricating and assembly services are available for essential manufacture. The OLYMPIC organization can provide the solution to your light and medium metal working problems.

Welded, brazed and soldered assemblies are a specialty, and work can be held to any reasonable tolerance. Finishes, according to specifications, include painting or plating.



**OLYMPIC**  
TOOL & MFG. CO., INC.  
39 CHAMBERS ST.  
NEW YORK 7, N. Y.



## Standardized Special MOTORS and Gear Motors

As a result of 30 years specialization in the design and manufacture of special motors and gear motors of from 1/3000 to 1/3 h.p., SpeedWay has developed not only a vast store of "know how", but innumerable standardized units which can be assembled and wound in varying combinations to give shaded pole, shunt wound or series wound motors, engineered to exactly meet specified requirements of output, torque, space, speed and even cost.

With these standardized parts and units, augmented by over 3000 different gear combinations, SpeedWay can often supply highly special motors and gear motors at standard motor prices.

If you have a war or post-war motor problem, send for the SpeedWay Motor Catalog.

Sample Motors of types now in production delivered promptly.

**SPEEDWAY MFG. CO.**

1898 South Laramie Ave., Cicero 50, Illinois

## STAR STEATITE

Has Just The Characteristics You Need For

### ELECTRONIC APPLICATIONS

STAR STEATITE has the strength and density required for use in high frequency electronic applications. Millions of Steatite insulators are in use in the armed forces, insuring free communication between fliers and control towers, and proper functioning of radio beams.

STAR STEATITE has a very desirable low loss factor. Although extremely rugged, it can be molded into exact shapes, and machined to close tolerances. It resists great mechanical shock and extreme conditions of heat and humidity.

Send for Booklet, "Survey of Characteristics of Molded Ceramic Products"

**The STAR PORCELAIN CO.**

Electronics Dept.  
Trenton New Jersey

# UNBRAKO

Reg. U. S. Pat. Off.



## Self-Locking HOLLOW SET SCREW

Pat'd & Pats. Pend.

## Save SPACE, WEIGHT and WORRY

Knurling of Socket Screws originated with "Unbrako" years ago.



Now made in sizes so small you can hardly see them, yet perfect in every detail, these "Unbrako" self-locking set screws are invaluable in the field of radio, electronics and fine instruments.

The knurled cup point of the "Unbrako" Hollow Set Screw digs in and holds tight. Vibration positively will not loosen it, yet it is easily removed with a wrench, and may be used over and over again. Sizes from #0 to 1" diameter. All commercial lengths.

Where the Knurled Cup Point "Unbrako" cannot be used, use our knurled Thread "Unbrako"—also a Self-Locker regardless of the point.

Send for the "Unbrako" Catalog of Socket Screw Products.

## STANDARD PRESSED STEEL CO.

JENKINTOWN, PENNA. BOX 596

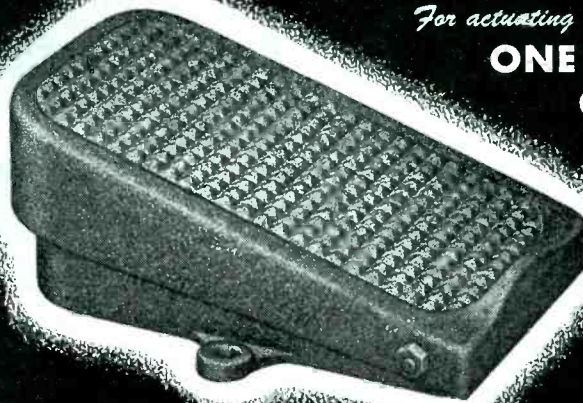
BRANCHES

BOSTON • DETROIT • INDIANAPOLIS • CHICAGO • ST. LOUIS • SAN FRANCISCO  
OVER 40 YEARS IN BUSINESS

## Model MI FOOT SWITCH

For actuating

### ONE to EIGHT CIRCUITS



This Model MI foot pedal switch is ideal for speedy and convenient foot control applications. Its inclined treadle, with non-slip tread, requires only 3/16" throw with approximately 5 pounds pressure for operation. Under the weight of the foot, contact is made by the slightest pressure, or may be maintained by the weight of the operator's foot alone.

The housing and top pedal section are cast iron,

finished in baked enamel with integral cast ears on each side for screw fastening to the floor, if desired. Throw of top treadle is readily adjusted by means of a convenient adjusting screw.

The internal contact mechanism is the well-known, dependable Acro switch unit, and is Underwriter Laboratory approved. This is a bakelite enclosed assembly with snap-action, silver contacts designed for millions of safe and sure operations.

Special Model MI switches are available with 3-pole or 4-pole double-throw contacts, enabling the handling of one to eight circuits. Prices on application.



## GENERAL CONTROL COMPANY

1202 SOLDIERS FIELD ROAD, BOSTON 34, MASS

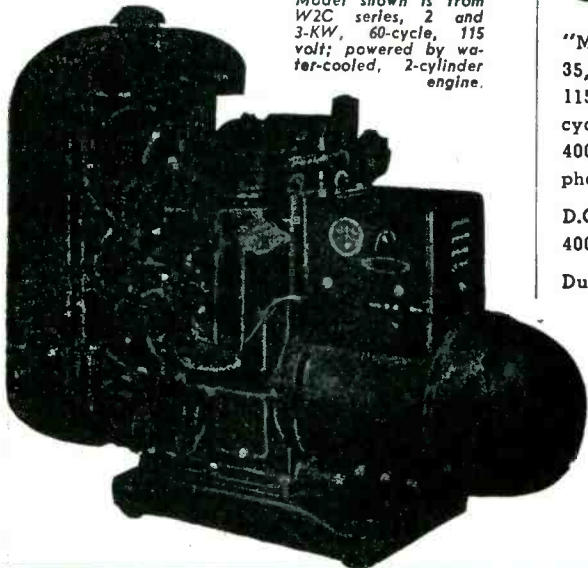
# ELECTRICITY

FOR ANY JOB  
—ANYWHERE

★ ONAN ELECTRIC GENERATING PLANTS supply reliable, economical electric service for electronics applications as well as for scores of general uses.

Driven by Onan-built, 4-cycle gasoline engines, these power units are of single-unit, compact design and sturdy construction. Suitable for mobile, stationary or emergency service.

Model shown is from W2C series, 2 and 3-KW, 60-cycle, 115 volt; powered by water-cooled, 2-cylinder engine.



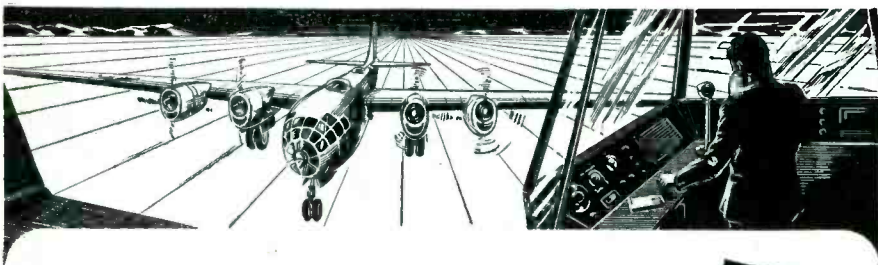
"Models range from 350 to 35,000 watts. A.C. types from 115 to 660 volts; 50, 60, 180 cycles, single or three-phase; 400, 500, and 800 cycle, single phase; also special frequencies.

D.C. types range from 6 to 4000 volts.

Dual voltage types available. Write for engineering assistance or detailed literature".

**D. W. ONAN & SONS** —

3263 Royalston Ave.  
Minneapolis 5, Minn.



An Invitation to All Electrical Designers to  
**TRY SILVER GRAPHALLOY**

### FOR BRUSHES

High current density, low contact drop, low electrical noise, and self-lubrication are characteristics of this silver-impregnated molded graphite that may be the answer to your electrical brush problems.

SAMPLES of Silver Graphalloy will be gladly furnished for test on your applications.

Silver Graphalloy is usually silver plated to permit easy soldering to leaf springs or holders. Why not WRITE NOW for your test samples?

### FOR CONTACTS

Low contact resistance and non-welding when breaking surge currents are inherent properties of this unique combination of conductive silver and self-lubricating graphite.



**GRAPHITE METALLIZING CORPORATION**

1053 NEPPERHAN AVE • YONKERS, NEW YORK



**SLIP-RING AND COMMUTATOR BRUSHES AND CONTACTS**

folder on "Polectron" products which are synthetic organic resins for coating and impregnating uses in the electrical field. General Aniline & Film Corp., Special Products Sales Dept., 435 Hudson St., New York 14, N. Y.

**Steatite Insulators, Bushings.** "Design Criteria for Steatite Insulators" is the title of a concisely written, illustrated booklet which is designed to give manufacturers and designers an opportunity to become familiar with the mechanical characteristics of Steatite (a ceramic body composed mainly of talc) for use as an insulator on h-f equipment.

Another piece of literature called "Sealex Bushings" describes hermetically-sealed bushings which withstand severe operating conditions encountered in military communication equipment.

General Ceramics and Steatite Corp., Keasbey, N. J.

**Variable Capacitors.** A 32-page book which contains unusually good illustrations and brief descriptions of approximately eighteen types of capacitors, as well as the facilities of this manufacturer to produce these components. The Hammarlund Mfg. Co., Inc., 460 West 34th St., New York 1, N. Y.

**Insulating Varnishes.** Insulating varnishes and compounds are described in a 56-page informative booklet which contains many helpful charts, tables and articles compiled for the purpose of providing a direct approach to insulating varnish problems. Four pages of the booklet are devoted to a short history of insulating varnish. The booklet is well illustrated. John C. Dolph Co., 168 Emmett St., Newark, N. J.

**Electronic Heating Equipment.** A loose-leaf catalog entitled "Industrial High Frequency Heating Equipment" contains a series of bulletins on the subject. Bulletin No. 401 is an introduction to inductive heating; bulletin No. 412 tells about induction furnaces; bulletin No. 413 describes, with the aid of charts and pictures, furnaces and crucibles; bulletin No. 414 tells about Trunion-type furnaces;



**Simplified**

**INSULATION RESISTANCE TESTING IN INDUSTRIAL**

**Electronics**



Provided by  
**VIBROTEST**  
INSULATION RESISTANCE  
TESTER

**ELECTRONICS**—one of the revolutionary factors in electrical industry—calls for most accurate testing of insulation resistance in most practicable form. **VIBROTEST** has long proved its dependable precision with sturdiest construction —

With Synchronous Vibrators dependable for top performance — longest service.

With self-contained power source, 2 No. 6 dry cells of highest quality mounted in base. (Replacements obtainable anywhere).

With easiest operation.  
No cranking.  
No leveling.



**MODEL 201**

One of 36 Vibrotest Models, covering every service

Model 201 for general duty has a range of 0-200 megohms at 500 volts potential, 0-2000 ohms, 150-300-600 volts AC or DC. Compact, versatile, portable. Strong metal case, complete with cover and leather strap handle for carrying.

**SEND FOR COMPLETE BULLETINS**

Ask about new Model 238 calibrated 20,000 megohms at 500 V. DC, attaining a new high in precision insulation resistance testing equipment. Also **HYPOT** insulation resistance breakdown tester, **VIBROGROUND**, for ground resistance measurements, **VOLTAMMETER** for both A.C. voltage and amperage, etc. Research and development engineering.

Engineering Service Representatives in All Principal Cities

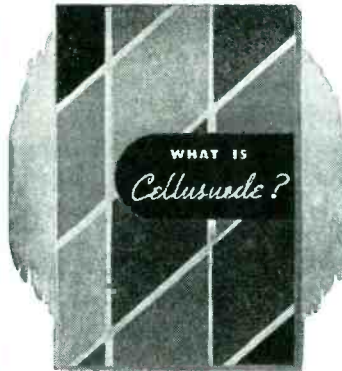
**ASSOCIATED RESEARCH** Incorporated

223 South Green St., Chicago 7, Ill.

ELECTRONICS — May 1945

Get This New Booklet on

*Cellusuede*  
**FLOCK**



An interesting and colorful booklet on their product has been prepared for your information and convenience by the makers of Cellusuede Cotton and Rayon Flock. Brief, clear explanations give all the facts you'll want to know about this versatile coating material; what it is made of; how it is applied; how it can be used. In the pages of this booklet you may find the answer to one of your manufacturing problems. You will be interested, too, in the colorful and unique application of Cellusuede on the booklet cover. Write for your copy.



**PRESTO RESISTORS**  
**VITREOUS ENAMEL and PRECISION WIRE WOUND**  
75 Winding Machines  
Backed by 20 years of Winding Experience  
ALSO  
TELEPHONE SWITCH KEYS & JACKS  
Telephone Communication and Cable Assemblies

PROMPT DELIVERY

**PRESTO ELECTRIC COMPANY**  
Manufacturers of Signalling Devices UNION CITY, N. J.

# SERVICE THROUGH THE YEARS!

1945

America's MOST COMPLETE Source of Supply

RADIO PARTS  
RADIO TUBES  
INDUSTRIAL  
ELECTRONIC EQUIPMENT  
AMPLIFIERS  
SOUND SYSTEMS  
TEST INSTRUMENTS  
COMMUNICATIONS and  
BROADCAST APPARATUS  
AIRCRAFT and  
MARINE EQUIPMENT  
F/M—television—A/M

OVER 10,000 ITEMS!  
AT YOUR FINGERTIPS!

PURCHASING AGENTS!  
ENGINEERS!

Send for this  
FREE 800 PAGE CATALOG!

Write today on your company letterhead for this massive 800 page Buying Guide containing everything in radio-electronics. Complete listings of all standard nationally known products in one handy, bound volume! Sent free on request by addressing Box YM.



This Book Can Help Answer Your Procurement Problems!

FOR PROMPT SERVICE  
Telephone BRay 7-1840

BUY THAT EXTRA BOND NOW  
and SAVE AN EXTRA LIFE!

SUPPLIERS TO

Industrial Manufacturers • Research Laboratories • Schools • Colleges  
Government Agencies • Railroads  
Public Utilities • Broadcast Stations  
Hospitals • Shipyards • Police Depts., etc.

**SUN RADIO & ELECTRONICS CO.**

212 Fulton Street, New York 7, N. Y.

bulletin No. 415 is devoted to foot-lifting furnaces. Ecco High Frequency Corp., 7020 Hudson Blvd., North Bergen, N. J.

**Terminals.** Hermetically-sealed terminals (including a stock of items and special forms to meet exact requirements) are described in a 1-page form. Electrical Industries, Inc., 42 Summer Ave., Newark 4, N. J.

**Jobs in Television.** A new 6-page leaflet on postwar occupations in television (Occupational Abstract No. 74) is a contribution by John E. Crawford of RCA. In brief, readable style the author discusses postwar prospects, training required, methods of entrance and advancement, range of salaries, advantages and disadvantages of television as a career. Sources of further information on the subject are given. Available for 25 cents from Occupational Index, Inc., New York University, Washington Square, New York 3, N. Y.

**Soldering Flux.** The advantages of Kwikflux, a hard soldering flux, are given in a 1-page form. Special Chemicals Co., 30 Irving Place, New York 3, N. Y.

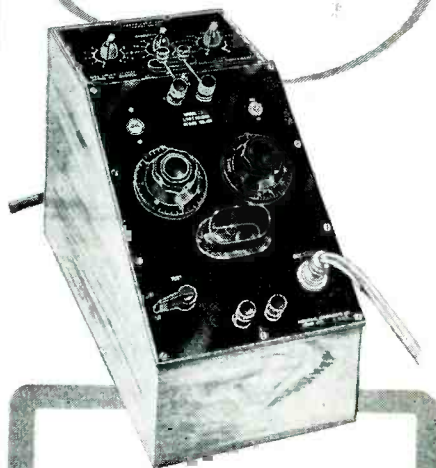
**Technical Apparatus Literature.** Several pieces of literature describing instruments available from Technical Apparatus Co., 1171 Tremont St.; Boston 20, Mass.; include the following:

Direct reading megohmmeter, Model 544, for measuring high resistances; interelectrode capacitance meter, a direct reading instrument for rapid measurement of capacitances down to 0.001  $\mu\text{mf}$ ; dielectric test set, Model 1031, which is for use as a convenient source of d-c potential for production testing of dielectric strength; model 1218 voltage-regulated power supply; and a 12-page booklet entitled "Technical Apparatus Co. Data" which illustrates and briefly describes such instruments as high-voltage power equipment, a sample production tube tester, a representative emission test set, an electronic capacitor comparator, life test panels, signal standards, noise analysis equipment, and a complex multi-function analyzer.

## HIGH-SPEED PRODUCTION TESTING . . .

Capacitance

Limit Bridge



- Normally supplied with Model DK-2AA Decade Capacitor—.001 mfd. steps from .001 to 1.11 mfd.
- Modified Wheatstone Bridge. High and Low limit dials. Uses two "magic eyes" for indicators.
- Self-incorporated switch-operated relays provide for speed test operation, on panel or in test fixture.
- Guaranteed accuracy of plus/minus 1% of standard. Independent of line-voltage fluctuations and tube characteristics.
- Instantaneous indication. Testing speeds up to 1000 condensers hourly.
- Operates from standard 115 V. A.C. Line. 15" x 8" 10" h.

• Model LB-1 Capacitance and Impedance Limit Bridge is designed for high-speed production testing, for conformance with tolerance specs. A companion instrument to Type LB Resistance Limit Bridge. Features are negligible setup time, great flexibility, wide range, accuracy, high speed, extreme ruggedness, moderate cost.

• Bulletin on request . . .

**Industrial Instruments**

PLANT and OFFICES:

17 POLLOCK AVENUE

JERSEY CITY 5, N. J.

# An Unusual EMPLOYMENT OPPORTUNITY

The world wide demand for Seismic Crews provided by Seismograph Service Corporation requires an immediate expansion of its technical personnel.

Men with training and experience particularly in **Geology, Physics, Mathematics or Electronics**, who will enter foreign service are offered an opportunity leading to responsible positions in petroleum exploration.

Applicants who qualify will be given training in SSC methods, and those who show promise may be sent to South America for further field experience, and when proved competent will be considered for assignments on Seismic crews throughout the world.

Applicants in the U. S. A. must comply with the regulations of the War Manpower Commission.

In writing for details as to training, salary, living allowances, etc., please state your qualifications and age.

**SEISMOGRAPH  
SERVICE CORPORATION**  
Kennedy Building  
TULSA, OKLAHOMA, U.S.A.



**\$91. NET**  
FOB, Factory

# G&G MULTI-SPEED MONODRUM

An all-electric, variable speed Chart Mover invaluable for testing . . . research . . . development work. A single drum kymograph, it can be used for keying production; for laboratory performance tests; for timing tests of equipment under operation.

A geometrical speed ratio — each speed 1.6 times faster than preceding speed — makes the G&G MONODRUM outstanding in its adaptability.

## For All Graphic Recording

Use it for driving timers . . . impulse and sequence controls . . . any purpose where absolute accuracy of motion is needed. Simplicity of construction — only 3 moving parts. Speed-changing knob permits easy variation, with indicator instantly showing change. *Twenty useful speeds!*

AC shaded pole, sparkless motor in two types — *HiSpeed*, for usual work requiring power and constant speed, or *Synchronous*, providing slower speeds with dead-beat, electric-clock accuracy. Standard all-aluminum drums 20" tall, 6 1/4" dia. Steel housing; baked enamel, inside and out.

Write for illustrated booklet "A Second or A Decade".  
Makers & Originators of Recording Equipment since 1925

**Correll & Correll**

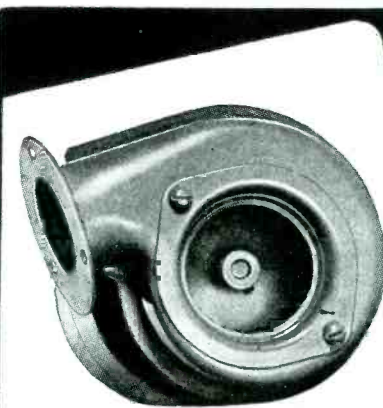
NEWTON CENTRE 59A, MASS.

### RECORDING ACCESSORIES

MONODRUM provides moving charts for recordings. Selection of paper depends on phenomenon to be recorded, type of record desired, and cost limitations. Tell us your requirements. Following papers available:

LIGHT SENSITIVE  
PHOTO SENSITIVE  
PHOTO PRINTING  
SOOTED  
WAXER

Write for Complete Details!

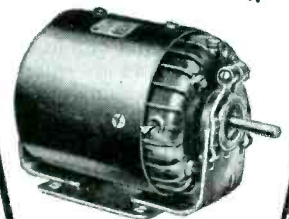


## BLOWERS for Electronic Equipment

Easy-to-install . . . compact . . . quiet-running . . . economical . . . these are the features which make Pilot Blowers ideal for the important job of air circulation and ventilation in Radio Equipment. Available in standard models to move from 15 to 100 C.F.M. Write for Bulletin 507.

## SHADED POLE F. H. P. MOTORS

Tell us what your requirements are and we will send you "fact sheets" giving complete specifications on these dependable, efficient, low-cost Motors. For continuous or intermittent duty with H.P. ratings ranging from 1/15 to 1/500 H.P. and from 1550 to 3400 R.P.M. Plain round or with base or resilient mounting . . . open or enclosed cases.



F. A. SMITH MFG. CO., INC.  
801 DAVIS ST., ROCHESTER 2, N.Y.

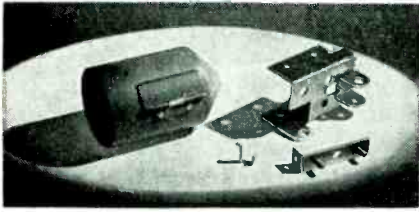
SHADED POLE  
MOTORS

**Pilot**

CENTRIFUGAL  
BLOWERS

## PRECISION PARTS

# THE SHAPE OF THINGS TO COME



... pieces that will play a part in the peace.

There will be a new way of doing things in this post-war world of ours. New equipment has been developed that may change our way of life. And new manufacturing standards will call for faster, more economical production.

Thru years of producing for war, Ace has learned to meet these new standards. Here you will find the advantages of a single responsibility combined with the freedom to use ingenious methods. Here you will find modern equipment and managerial enthusiasm that is vital to fast, accurate work.

Whether you are thinking in terms of post-war production, or in terms of present capacity, it will pay you to check with Ace for small parts or assemblies involving stamping, machining, heat-treating, or grinding. Send blueprint, sketch, or samples for quotation.

### STAMPING CAPACITY OPEN

Ace has developed the knack of combining close tolerances with the economies and speed that go with stamping operations. We are prepared to engineer the tooling, and make the tools and dies in our own tool room. And we are equipped to spot-weld sub-assemblies and to assemble intricate radio and machine parts.



**ACE MANUFACTURING CORPORATION**  
for Precision Parts



1255 E. ERIE AVE., PHILADELPHIA 24, PA.

**Reference Manual Holders.** Replacement specification sheets and new specification sheets on cathode-ray tubes are now available for owners of a reference manual got out by Allen B. DuMont Labs., Inc., Passaic, N. J.

**Junior Engineers' Reading List.** A revised "Reading List of Junior Engineers" has been issued by the Junior Committee on Professional Training of the Engineers' Council for Professional Development, 29 West 39th St., New York 18, N. Y. Price, 10 cents each, or 5 cents each in lots of 50 or more.

**Capacitor Catalog.** Catalog No. 20 contains 56 pages of data and illustrations of paper dielectric capacitors available from Sprague Electric Co., North Adams, Mass. The catalog is designed as a guide to the selection of these components for industrial uses.

**Engineering Bulletin.** "Multi-Meter Circuits For Use With HC Meter Scales" is the title of a new engineering bulletin (No. 1) which sells for 25 cents. The bulletin as well as HC meter scales are available from R. E. Nebel Laboratory, 1104 Lincoln Place, Brooklyn, N. Y.

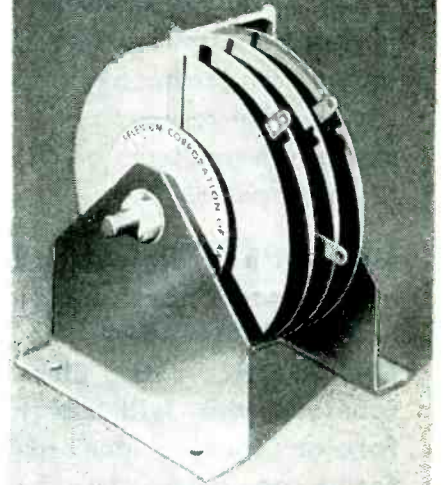
**Decade Inductance.** Five types (2321 to 2325) of decade inductance units are briefly described in a 1-page bulletin. New York Transformer Co., 26 Waverly Place, New York, N. Y.

**Automatic Voltage Regulator.** Bulletin No. 163 contains specifications, applications, and some illustrations of an automatic voltage regulator for line-voltage control. Superior Electric Co., Bristol, Conn.

**H-F Cable and Connectors.** For this manufacturer's catalog there is available a new "Section D" which describes 26 types of RG cables and many companion h-f connectors for uhf and electronic applications. A chart giving molded "AN" insert connections is also available. American Phenolic Corp., 1830 South 54th St., Chicago 50, Ill.

NUMBER ONE OF

A SERIES



DC means SC . . .  
Selenium Control and Selenium Conversion for the practical, profitable performance planned by top flight design engineers. Selenium provides maximum efficiency . . . unlimited life . . . negative temperature coefficient . . . and other characteristics necessary to solve the electronic problems of tomorrow . . . That's why DC means SC.

**SEND FOR BULLETIN**

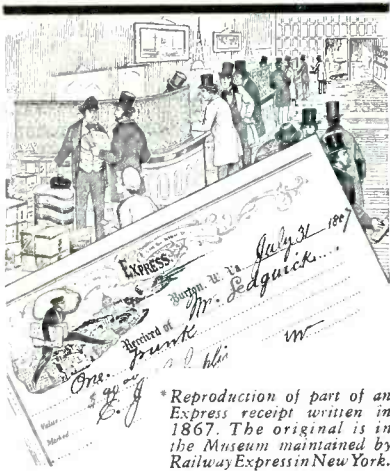
**SELENIUM CORPORATION of AMERICA**



1719 WEST PICO BOULEVARD  
LOS ANGELES 15, CALIFORNIA

EXPORT DIVISION: FRAZAR & HANSEN  
301 CLAY STREET, SAN FRANCISCO, CALIFORNIA

IN CANADA: BURELCO LTD., TORONTO 13, ONTARIO, CANADA



\*Reproduction of part of an Express receipt written in 1867. The original is in the Museum maintained by Railway Express in New York.

Mr. Sedgwick's  
**Receipt** is now  
 a \*Museum Piece

The practice of giving a receipt for Express shipments began with the first transaction more than a hundred years ago. It is, in effect, a contract setting forth the terms of responsibility of the Express Agency. The receipt taken at delivery is a record of fulfillment of service.

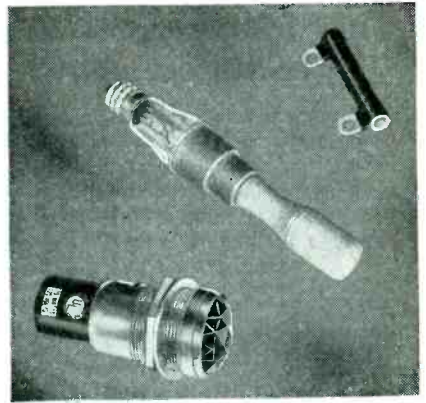
In 1839, Express receipts covered shipments only from Boston to New York and return. Today, Express receipts are written for every conceivable variety of goods — war items, commercial, personal — for delivery throughout the nation. Every foot of the way from shipper to receiver, direct responsibility for safe transportation, by rail and air, remains with Railway Express.



# CONSIDER THE NEW DRAKE No. 75 AP

*Underwriters Approved!*

TRADE demand has caused Drake to produce this new totally enclosed candelabra screw base 1" pilot light assembly. The unit is approved by the underwriter's laboratories for 75 watt, 125 volt service. Designed to house the Mazda S6, 110 volt, 6 watt candelabra screw base lamp. Can be supplied with lamp installed. The unit mounts in a 1" hole and is regularly furnished with a 1" diameter faceted colored glass jewel. It is also supplied with a steel lock washer which holds the unit firmly to the panel. Mounts on any thickness panel up to 1/2".



Although designed to operate on 110 volt circuits, this assembly can readily be used on 220 volt circuits by connecting our #116 wire wound resistor in series with the pilot light.

Lamps are easily removed with our S6 lamp remover. Anyone who has to maintain, or install in production, large numbers of S6 lamps, will find the S6 lamp remover a great convenience.



**SOCKET AND JEWEL LIGHT ASSEMBLIES**

## DRAKE MANUFACTURING CO.

1713 WEST HUBBARD ST., CHICAGO 22, U.S.A.

### master higher frequency electricity

#### WHY and HOW it differs from the lower frequency range



The important fundamentals of microwave phenomena described through physical pictures and viewpoints for the quick and easy mastery of any one dealing with electricity.

Have you a working knowledge of the reasons for some of the seemingly mysterious characteristics of extremely high frequency electricity? For instance, what makes waves go down the inside of a hollow conducting pipe at high frequency but now at low frequency?

**THIS BOOK**  
 —clears up the underlying principles of these forces  
 —correlates the high and low frequency ranges for the practical knowledge of the man working with either  
 —covers the range quickly, simply, fundamentally, non-mathematically, so that you can understand without probing too deeply into involved technicalities  
 —makes you see the fundamentals of electricity through truer perspective than your own range of specialization

Here is a complete non-mathematical description of the physical basis for all microwave phenomena, for engineers and industrial men who desire an understanding of microwaves and their application. The book covers transit-time electronics, velocity modulation, radiation, transmission lines, resonant cavities and wave-guides and correlates microwaves with lower frequency electricity in simple language and with a large number of explanatory diagrams.

*Just Published!*  
**INTRODUCTION to  
 MICROWAVES**

By Dr. Simon Ramo  
 General Electric Company; Union College, Schenectady, N. Y.  
 135 pages, 5 1/4 x 8 1/4, \$1.75

Presents for the first time the basic concepts of microwaves and their relation to the lower electricity range, in such a manner that in a few hours time, any one may understand the principles involved and their application.

**See it 10 days FREE—Send this coupon**

McGraw-Hill Book Co., 330 W. 42nd St., New York 18, N. Y.  
 Send me Ramo's Introduction to Microwaves for 10 days' examination on approval. In 10 days I will send \$1.75, plus few cents postage, or return book postpaid. (Postage paid on cash orders.)

Name .....  
 Address .....  
 City and State .....  
 Company .....  
 Position ..... L. 5-45  
 (Books sent on approval in the United States only.)

*Problem solutions-* made possible  
by inherent advantages plus engineering

BAER fibre fabrications can solve your insulation-component needs for civilian manufacture as thoroughly as has been accomplished in the war effort. No matter what type of product to go through your assembling and production lines — a machined, punched, stamped, sawed, milled or drilled BAER fibre part can be instrumental in substantially bettering its performance. Collaboration will be promptly forthcoming, without obligation.

FREE DATA BULLETIN Complete with information pertaining to the specifications of phenol and vulcanized fibre, this literature will be sent promptly on request. Write for Bulletin 120.

PHENOL AND *Baer* VULCANIZED

**FIBRE**

**FABRICATIONS**

FOR  
INDUSTRY

N. S. BAER COMPANY, 9-11 MONTGOMERY ST., HILLSIDE, N. J.

GONE ARE THE DOODABS!  
TODAY THE *Accents* ON

**RUGGED  
CONSTRUCTION**

of

- CABINETS
- CHASSIS
- PANELS
- RACKS

for ELECTRONIC APPARATUS

Send specifications; or write for our Catalog No. 41A.

**PAR-METAL** PRODUCTS CORPORATION

32-62—49th STREET . . . LONG ISLAND CITY, N. Y.  
Export Dept. 100 Varick St., N. Y. C.

**Fasteners.** Two manufacturers have available literature on fasteners.

The first of these is Shakeproof Inc., (2501 N. Keeler Ave., Chicago, Ill.) whose bulletin "Fastening Application" contains data on Quick Fasteners which open and close panels of mechanical equipment quickly and easily.

The second manufacturer, Camloc Fastener Corp. (420 Lexington Ave., New York 17, N. Y.) has two booklets, both of which tell about the 4002 Series of cowl fasteners (spring loaded stud). One booklet (catalog 44-A) gives a description and specifications while the second is an instruction booklet (No. 44-B) of installation procedure.

**Ceramics Insulator Bodies.** Bulletin No. 444 describes, with the aid of good illustrations, AISiMag ceramic insulator bodies for electrical and other technical uses. American Lava Corp., Chattanooga, Tenn.

**Mica Trimmers.** Automatic Mfg. Corp., (formerly known as Automatic Winding Co., Inc.) manufacturers of complete electronic assemblies and component parts, have available a 12-page booklet which illustrates and describes approximately fourteen types of automatic mica trimmer capacitors. 900 Passaic Ave., East Newark, N. J.

**Double Coil Washers.** Double-coil, spring-lock washers available in any desired finish for No. 4 screws up to 1 in. and larger bolts are described in a leaflet available from George K. Garrett Co., Inc., 1421 Chestnut St., Philadelphia 2, Pa.

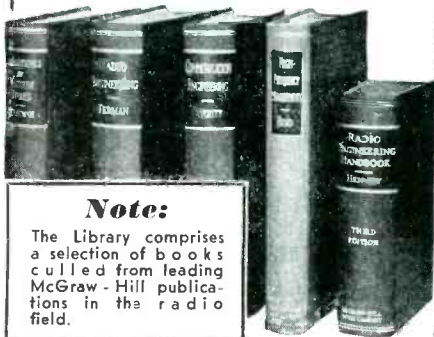
**Fastener Assembly.** A new one-piece fastener assembly (called the Spring Lock Fastener) which does not require nuts or receptacles is described and illustrated in a 4-page folder available from Simmons Fastener Div., Simmons Machine Tool Corp., Albany, N. Y.

**Tubes, Television Brochure.** "Time, Tubes and Television" is the title of a brochure intended as an introduction to the genealogy of science. It contains many illustrations and covers a lot of territory especially

**NOW**

a really high-powered

**RADIO  
ENGINEERING  
LIBRARY**



**Note:**

The Library comprises a selection of books culled from leading McGraw-Hill publications in the radio field.

especially selected by radio specialists of McGraw-Hill publications

- ▶ to give most complete, dependable coverage of facts needed by all whose fields are grounded on radio fundamentals
- ▶ available at a special price and terms

These books cover circuit phenomena, tube theory, networks, measurements, and other subjects—give specialized treatments of all fields of practical design and application. They are books of recognized position in the literature—books you will refer to and be referred to often. If you are a practical designer, researcher or engineer in any field based on radio, you want these books for the help they give in hundreds of problems throughout the whole field of radio engineering.

5 volumes, 3559 pages, 2558 illustrations

Eastman's FUNDAMENTALS OF VACUUM TUBES, 2nd edition

Terman's RADIO ENGINEERING, 2nd edition

Everitt's COMMUNICATION ENGINEERING, 2nd edition

Hund's HIGH FREQUENCY MEASUREMENTS

Henney's RADIO ENGINEERING HANDBOOK, 3rd edition

**SPECIAL LOW PRICE • EASY TERMS**

Special price under this offer less than cost of books bought separately. In addition, you have the privilege of paying in easy installments beginning with \$3.00 in 10 days after receipt of books and \$3.00 monthly thereafter. Already these books are recognized as standard works that you are bound to require sooner or later. Take advantage of these convenient terms to add them to your library now.

FOR 10 DAYS EXAMINATION SEND THIS

ON-APPROVAL COUPON

McGraw-Hill Book Co., 330 W. 42nd St., N.Y.C. 18  
Send me Radio Engineering Library for 10 days' examination on approval. In 10 days I will send \$3.00 plus few cents postage and \$3.00 monthly thereafter until \$24 is paid, or return books postpaid. (We'll pay postage on orders accompanied by remittance of first installment.)

Name .....

Address .....

City and State .....

Company .....

Position ..... L. 5-45

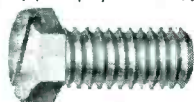


*Billions  
of Fasteners...  
Thousands of  
Applications!*



THERE are literally billions of Stronghold fasteners—in a broad range of sizes and types—IN STOCK FOR IMMEDIATE DELIVERY. The Stronghold "In Stock Record" is issued at regular intervals. If you are not receiving it, drop us a line and we'll add your name to our mailing list.

FOR "Specials", use our extensive manufacturing facilities. Send us your descriptions, sketches or blueprints. Quotations, plus technical and engineering data, promptly furnished.



**HEX-SCRU**

A NEW, multi-use, multi-drive fastener with countless practical applications and adaptability for all methods of hand or power driving. Ask for samples, plus technical and engineering data. Learn how HEX-SCRU will speed, strengthen and streamline your assemblies.

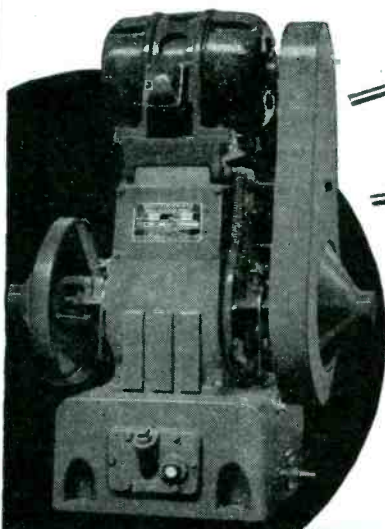
**MANUFACTURERS SCREW PRODUCTS**  
270 W. Hubbard St. Chicago 10, Ill.

It's Faster to Telephone • Call WHITEHALL 4680



**Stokes MICROVAC Pumps**

**HEART OF HIGH VACUUM SYSTEMS**



**HIGHER VACUUM**  
in the Low Micron Range

**GREATER  
VOLUMETRIC EFFICIENCY**

**LOW  
POWER REQUIREMENT**

**FIVE SIZES:**  
from 15 to 225 cu. ft. per min.

**F. J. STOKES MACHINE CO.**  
6046 Tabor Road Phila. 20, Pa.

**Stokes High Vacuum  
PUMPS • GAUGES • EQUIPMENT**

# Talk About PRODUCTION Without DIES!

## 4,000 Parts Per Day with DI-ACRO Bender

Here is an example of "DIE-LESS DUPLICATING" typical of a great variety of formed parts readily made with DI-ACRO Precision Machines,—Benders, Brakes, Shears. Picture below shows an acute right angle bend and photograph above shows the finished part formed to die precision. Women



"Enclosed pictures in our plant prove the DI-ACRO Bender will do a real production job. We are making 4,000 completed parts per day which is competitive to most Power Presses." (Name on request)

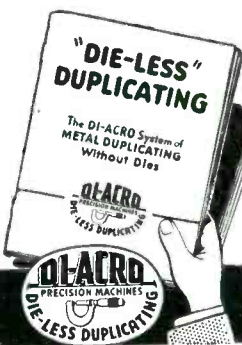


operating DI-ACRO units maintain a high out-put on production work.

### Send for CATALOG

showing DI-ACRO Precision Machines and many examples of parts made with "DIE-LESS DUPLICATING."

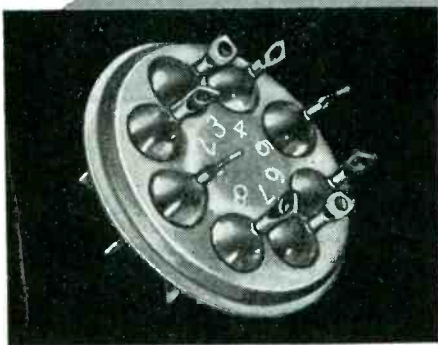
Pronounced "DIE-ACK RO"



# O'NEIL-IRWIN MFG. CO.

321 EIGHTH AVENUE SOUTH · MINNEAPOLIS 15, MINNESOTA

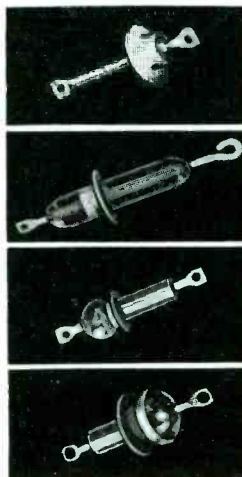
# E-1 HERMETICALLY-SEALED MULTIPLE HEADERS



- ★ VACUUM TIGHT SEAL
- ★ KOVAR METAL ELECTRODES
- ★ PYREX GLASS BEAD
- ★ MANY STANDARD TYPES
- ★ ANY TYPE TO SPECIFICATIONS
- ★ SOLDER OR WELD EASILY

A complete and diversified line of E-1 4, 5, 6, 7 and 8 electrode hermetically sealed Multiple Headers are now available as standard stock items. All are supplied at mass production prices—no special tool or die costs involved. Individual sealed terminals are also included in a wide variety of standardized types. All special shapes or forms can be supplied to exact specifications at slightly higher cost.

All include Pyrex glass bead—immune to thermal or electrical shock. Pyrex annealed to eliminate strain. Kovar electrode and shell solders and welds easily and forms absolute vacuum tight chemical bond with glass—lead becomes integral part of housing. Multiple Headers can be fabricated in any form to specification—write today.



## ELECTRICAL INDUSTRIES · INC.

42 SUMMER AVENUE, NEWARK 4, N. J.

with regards to the manufacturer's facilities and products. Several pages are devoted to clear illustrations of the cathode-ray gun. Allen B. DuMont Laboratories, Inc., 2 Main Ave., Passaic, N. J.

**Tubular Metal Antennas.** Construction diagrams, illustrations and descriptive data on antennas and antenna parts for use in police, marine, amateur and commercial installations are contained in a 24-page book. Premax Products, Div. of Chrisholm-Ryder Co., Inc., Niagara Falls, N. Y.

**Facsimile Equipment.** The story of facsimile equipment manufactured by the Alden Products Co., 117 North Main St., Brockton 64, Mass., is contained in an 8-page booklet by Milton Alden entitled "Suiting Facsimile Designs to Service Needs" reprinted from *FM & Television*.

**Cathode-Ray Tubes.** A 16-page illustrated booklet on "How & Why Cathode Ray Tubes Work" reprinted from *Communications* from a series of articles by J. R. Beers, Development Engineer, North American Philips Co., Inc. (100 East 42 St., New York 17, N. Y.) Contents deal with early history, manufacturing problems, testing, and special designs. Write North American Philips.

**Rotary Electrical Equipment.** A 4-page folder contains a brief review and illustration of dynamotors, motors, converters and generators of various types. Eicor, Inc., 1501 W. Congress St., Chicago 7, Ill.

**High-Voltage Test Equipment.** Bulletin F describes portable kilovoltmeters and multipliers suitable for use from 1 to 30 kv, as well as corona-protected kilovoltmeters and resistors for measurements up to 200 kv. Shallcross Mfg. Co., Collingdale, Pa.

**Vertical Radiators.** A 4-page brochure illustrates vertical radiators for broadcast stations and antenna supporting poles for other types of service. Handy information is given broadcasters for ground sys-



# Chicago EDITOR Wanted



• **ELECTRONICS** is looking for a field editor.

• Working out of our district office in Chicago, following an orientation period in New York, it will be his job to represent the magazine editorially in the middle-west. This will primarily involve encouraging technicians to prepare articles for us, helping them when necessary, doing some original writing, and general reporting about meetings and other pertinent activities in the area.

• The man we want must be an engineer fully familiar with electron tubes and the circuits in which they are used, both communications and industrial. He should have, or be able to readily develop, equal facility in dealing with equipment design and production engineers, and with the ultimate users of such equipment. He should, for example, feel as much at home in a machine shop as in an experimental laboratory, as much at ease in a broadcast station as in a plant building transmitters.

• Knowledge of sensitive measurement, control, inspection and safety devices other than electronic will be considered an additional asset.

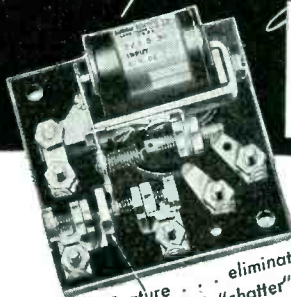
• If you think you are the kind of a man we need, and we appear to have the kind of a job you want, write, stating qualifications and expectations, to

KEITH HENNEY, *Editor*

## electronics

McGraw-Hill Publishing Co., Inc.  
330 West 42nd Street  
New York 18, New York

# 25 YEARS *Specialization in* RELAYS



New Feature . . . eliminates "bounce" and "chatter"



Microphone Hummer

Twenty-five years' experience in solving all types of Relay Problems . . . Complete facilities for Designing, Engineering, Manufacturing . . . Specialists in producing Relays of exceptional power and sensitivity for Aircraft, Intercommunications-Systems, Electronic Devices. Exclusive Kurman features provide greater dependability, longer life, more precise performance . . .

Send data for quotations. Write for new descriptive Bulletins.

**KURMAN ELECTRIC CO.**

35-18 37th STREET • LONG ISLAND CITY 1, N. Y.

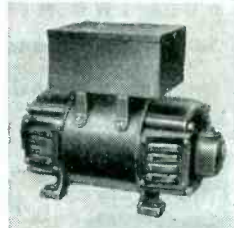
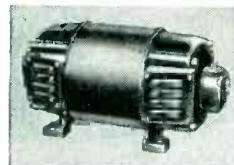
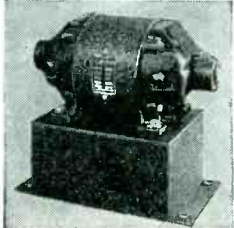
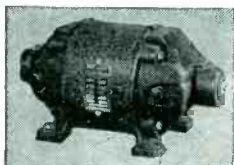


# Janette

## D.C. to A.C. CONVERTERS

The Janette Rotary Converter is a simple, practical method for obtaining Alternating Current when only D.C. power is available.

**.1 to 3.2 K. V. A.**



Janette was one of the first manufacturers to build converters especially for use with A.C. electronic tube devices. Since their inception these machines have established a world wide record for reliable, efficient, quiet, trouble free operation, under the most adverse conditions.

**TWO TYPES** are available; one for commercial applications, the other for marine service. Special filters for suppressing conducted and radiated noise voltage interference can be supplied.

If you want a really dependable converter, guaranteed for one year, we suggest you **TRY A JANETTE!**

**May We Send Literature?**

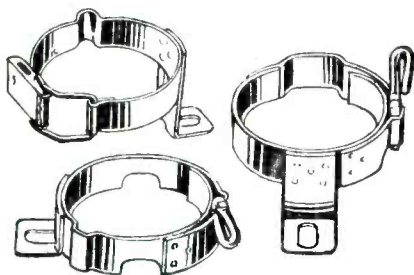
**Janette Manufacturing Company**  
556 W. Monroe St. Chicago 6, Ill.

**STOP VIBRATION  
GREMLINS WITH  
BIRTCHER  
STAINLESS STEEL - LOCKING TYPE  
TUBE  
CLAMPS**



Where vibration is a problem, Birtcher Locking TUBE CLAMPS offer a foolproof, practical solution. For ALL types of tubes and similar plug-in components.

**83 VARIATIONS**



OVER TWO MILLION IN USE  
Send for our standard catalog and samples of corrosion-proof Birtcher Tube Clamps.



**THE BIRTCHER CORPORATION**  
Manufacturers of AIRCRAFT  
and RADIO PARTS  
5087 HUNTINGTON DR. LOS ANGELES 32

tems and FCC minimum radiator heights for all class of stations throughout the standard a-m broadcast band. John E. Long & Son, Inc., 28th St., & Buren Ave., Camden, N. J.

**Television Studio and Transmitting Equipment.** A 6-page folder illustrating and briefly describing products such as Model SE-100 television transmitter (video and audio models), SE-300 console studio control desk, SE-200 master control board and SE-400 transmitter control desk. Sherron Electronics Co., 1201 Flushing Ave., Brooklyn 6, N. Y.

**Power Connections.** Catalog No. 27 contains a good deal of data on power connections for electronic equipment. Harvey Hubbell, Inc., Bridgeport 2, Conn.

**Parts and Assemblies.** A booklet entitled "Silent Partner For Your Success" gives background data of this manufacturer, and illustrates and describes parts and assemblies. Orange Screen Co., Maplewood, N. J.

• • •

**NAVY NEEDS NURSES**



Lt. (ig) Io St. Clair Clary gives a diathermy treatment to a patient at the U. S. Naval Hospital in Corpus Christi, Texas. More nurses are needed by the Navy, Marines, and Coast Guard. Official Photograph, U. S. Navy

**To Serve You Better**

**AN ALTERNATE SOURCE OF GENUINE BIRTCHER TUBE CLAMPS**

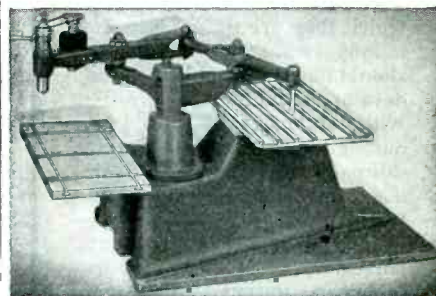
**Prompt Delivery**

We are fully licensed to manufacture the complete BIRTCHER line of locking type, stainless steel tube clamps. Orders placed with us for prompt delivery using BIRTCHER part and identification numbers will be filled at prices as favorable as those to which you are accustomed. All clamps will be identical with those manufactured by the Birtcher Corporation.

SOLE LICENSED MANUFACTURER OF BIRTCHER TUBE CLAMPS

**THE GEORGE S. THOMPSON CORPORATION**

5240 HUNTINGTON, DR.  
LOS ANGELES 32, CALIF.



DUPLICATING and PROFILING

**AUTO ENGRAVER**

*Accurate Engraving with Unskilled Operators*

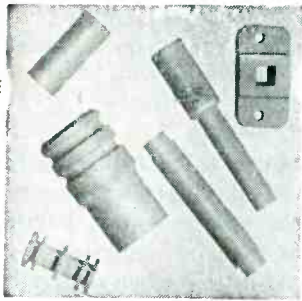
Unskilled operators will profile or accurately reproduce in smooth lines any design, number, letter, emblem, signature; on iron, brass, copper, aluminum, soft steels and all plastics. Here are some of its other uses . . .

- Drills a series of holes, or profiles small parts.
- Cuts an even channel for wiring on panels. Increases accuracy and production.
- Works from original drawing or templates.
- Etches glass and similar items.
- Will not cause distortion.

For complete information on this and other models and prices write Dept. K

**AUTO ENGRAVER CO.**  
1776 BROADWAY, NEW YORK 19

# Lavite STEATITE CERAMIC



## Properties and Characteristics of Our LAVITE SI-5 Steatite Ceramic Body

Compressive Strength	96,000 lbs. per square inch	
Tensile Strength	7,200 lbs. per square inch	
Flexural Strength	10,500 lbs. per square inch	
Modulus of Rupture	20,000 lbs. per square inch	
Dielectric Strength	235 volts per mil	
Dielectric Constant	6.42	Frequency of 1 megacycle
Loss Factor	2.90	
Power Factor	.446	
Bulk Specific Gravity	2.664g	
Density (from above gravity)	0.096 lbs per cubic inch	
Hardness (Mohr scale)	7.0	
Softening Temperature	2,350°F.	
Linear Coefficient of Expansion	8.13x10 <sup>-6</sup>	
Moisture Absorption (ASTM D-116-42-A)	0.009%	

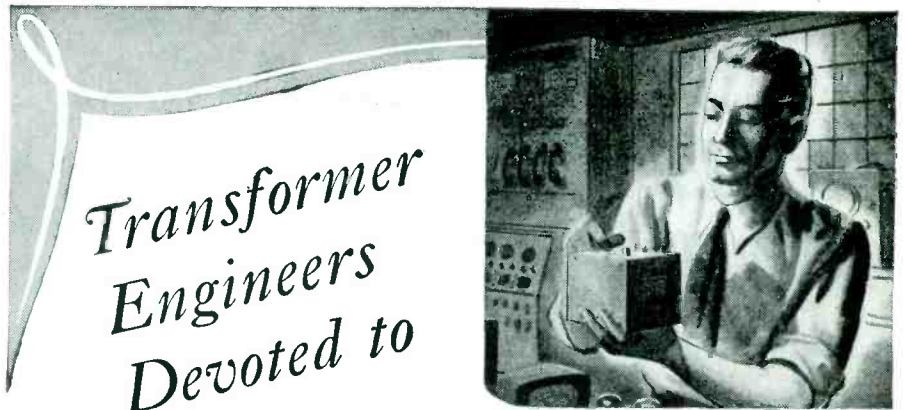
Makers of electrical and radio apparatus destined for war service are finding in LAVITE the precise qualities called for in their specifications — high compressive and dielectric strength, low moisture absorption and resistance to rot, fumes, acids, and high heat. The exceedingly low loss-factor of LAVITE plus its excellent workability makes it ideal for all high frequency applications.

We will gladly supply samples for testing.

### D. M. STEWARD MFG. COMPANY

Main Office & Works, Chattanooga, Tenn.

Needham, Mass. Chicago Los Angeles



*Transformer Engineers Devoted to*

## RESEARCH-DEVELOPMENT

● As leaders in the field of design and development of specialized transformers, Electronic Engineering Co. has established an enviable reputation for solving the most difficult transformer applications. With complete electronic laboratories and the finest engineering talent available, Electronic Engineering Co. is devoted exclusively to the production of specialized transformers for the armed forces.

### ELECTRONIC ENGINEERING CO.

3223-9 WEST ARMITAGE AVE., CHICAGO 47, ILLINOIS

"SPECIALIZED TRANSFORMER ENGINEERS"

THESE manufacturers are now producing essential electronic products for vital war needs. For better post-war business, build your products with — and your merchandising plans around — their tested, proven lines:

**Bud Radio, Inc.**

(See Page 358)

**Supreme Instruments Corp.**

(See Page 368)

**University Laboratories.**

(See Page 378)

**Stanwyck Winding Co.**

(See Page 377)

**The Turner Company.**

(See Page 188)

These companies are represented in New England by

**HENRY P. SEGEL CO.**

Manufacturers Representatives

Field Engineers

143 NEWBURY STREET  
BOSTON 16, MASS.

Tel. KENmore 3012—6333—9755

IN HARTFORD:  
474 Woodland St. Tel. 2-9859

Our 21st year of service to manufacturers, jobbers, schools and laboratories in New England.

# RADIO

PRODUCTION  
and REPRODUCTION

*will be better because of*

## MONARCH

MEASURING • TESTING • CALIBRATING  
EQUIPMENT



2014 N. MAJOR AVE. • CHICAGO 39, ILL.

# BEAT FREQUENCY GENERATOR

Type 140-A

**A dependable  
test instrument**



An accurate signal source capable of supplying a wide range of frequencies and voltages.

Frequency Range 20 C.P.S. to 5 MC.  
Output Voltage 1 mv to 32 volts.  
Power Output 1 watt.



**BOONTON RADIO**

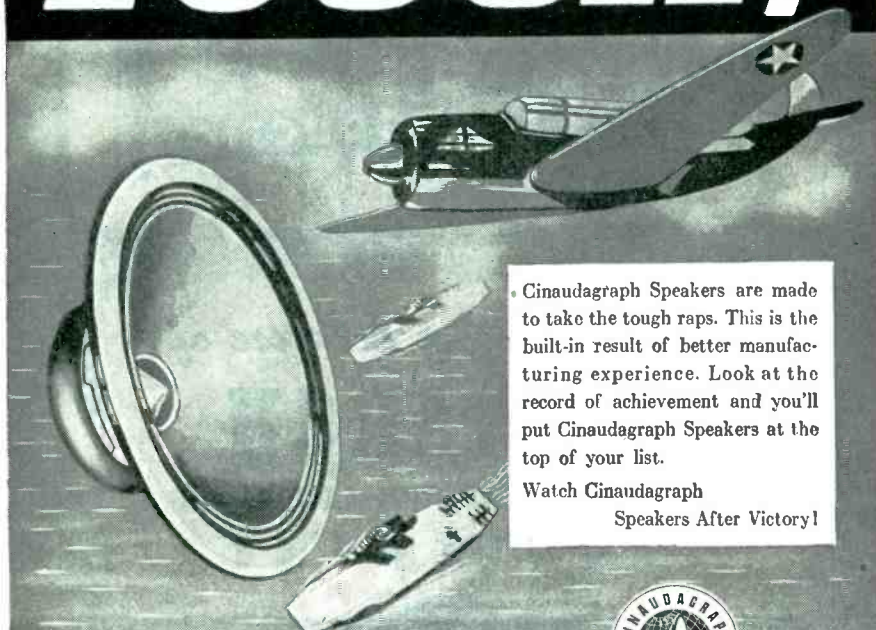
BOONTON, N. J.

*Corporation*



DESIGNERS AND MANUFACTURERS OF THE "Q" METER . . . QX-CHECKER . . . FREQUENCY MODULATED SIGNAL GENERATOR . . . BEAT FREQUENCY GENERATOR . . . AND OTHER DIRECT READING TEST INSTRUMENTS

# TOUGH!



Cinaudagraph Speakers are made to take the tough raps. This is the built-in result of better manufacturing experience. Look at the record of achievement and you'll put Cinaudagraph Speakers at the top of your list.

Watch Cinaudagraph  
Speakers After Victory!



**Cinaudagraph Speakers, Inc.**

3911 S. Michigan Ave., Chicago  
Export Div., 13 E. 40th St., New York 16, N. Y.

*"No Finer Speaker in all the World"*

## NEW BOOKS

### Prodigal Genius; The Life of Nikola Tesla

By JOHN J. O'NEILL. Published by Ives Washburn, Inc., 29 West 59th St., New York 19, N. Y., 1944, 326 pages, \$3.75.

THERE CAN BE NO disputing the fact that Nikola Tesla was a great discoverer and inventor, particularly in the field of electrical engineering. At a time when electricity was just beginning to be investigated as a useful tool of mankind he was looking ahead to the days when this force could be controlled for the benefit of everybody. Thus, Tesla was thinking in terms of a-c power when direct current was the only type of electric current available. He was experimenting with world-wide radio when the wireless transmission of code signals was limited to a relatively few miles. And he was developing the wireless transmission of power nearly 50 years ago.

Like most so-called geniuses, Tesla had his shortcomings. For one thing, he was not as much interested in exploiting his discoveries and inventions as he was in making more discoveries. Therefore, he never realized anything from much of his work and opened the door to piracy, intentional or otherwise. Because of his lack of business sense he missed many opportunities to make money with which to continue his work as he would have liked to do. Tesla's personality was attractive socially but lacking in business acumen, so that many financiers who might have backed him did not do so because he was not enough of a "salesman."

But most important of all, Tesla did not commit to writing many of his thoughts and dreams for investigations that he planned to carry out "some day." When he died in 1943 many of his plans, which could have been carried on by others, died with him. It should be noted, however, that all of his papers, dealing with the experiments he performed, have been impounded until after the war. There is no way of telling, at this time, how much those notes have helped the United Nations, if at all.

Mr. O'Neill was a friend and ad-

## SELECTING THE FORM OR SHAPE IN DESIGNING

# Electrical Contacts

Electrical contacts are made in many forms, depending on the function of the contacts, the general type and design of the apparatus, and the relative cost of various contact forms.

Because of the large number of types that are available it is not possible to list them here. However, their importance in designing contacts must not be overlooked because it involves the physical characteristics of the material, manufacturing processes, convenience in assembling, costs and other factors that contribute to a completely successful contact application.

Closely allied with the contact construction is the selection of shape or contour of the contact surface, for example, whether flat, spherical or cylindrical. There are certain contact forms and shapes that experience has shown to be best suited for some types of applications, and in others it has been necessary to develop a different combination to meet the requirements of a particular application.

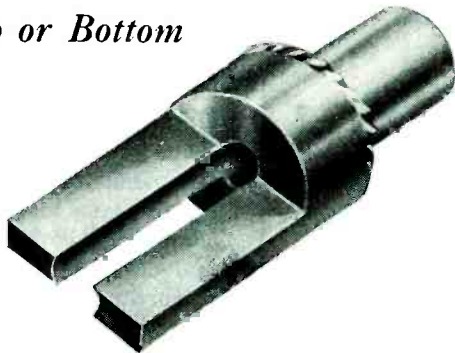
The experience of Gibson Engineers as specialists in the field of electrical contacts is available to help you find an efficient solution to your contact problem. Consult us today.



*You Can Wire These*

## C. T. C. SPLIT TERMINAL LUGS

*from Top or Bottom*



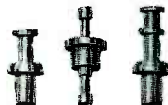
A .050" hole through the shaft permits wiring from top or bottom side of the terminal board without time lost drilling holes. They're firmly anchored and swiftly set by a simple swaging operation. Knurling at base of Lug prevents twisting or turning.

C.T.C. SPLIT TERMINAL LUGS

Write for C. T. C. Catalog No. 100

are particularly suitable for manufacturing transformers or other potted units requiring soldering after potting.

Stocked to fit  $\frac{3}{32}$ " terminal boards — custom-made to your specifications in production quantities.

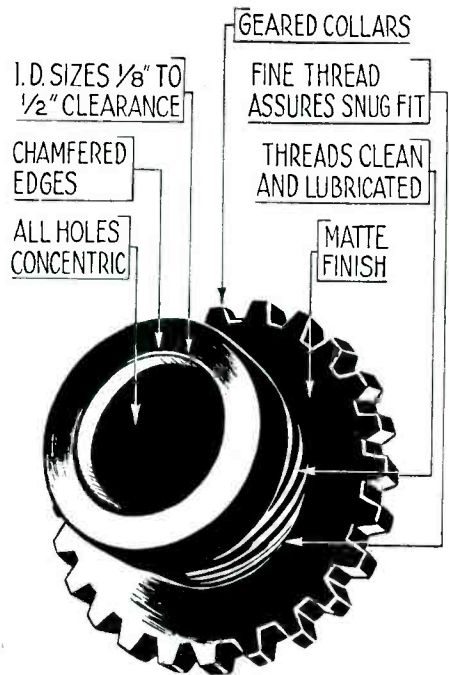


**CAMBRIDGE THERMIONIC CORPORATION**

439 Concord Avenue

Cambridge 38, Mass.

# NOW 8 SIZES OF CREATIVE GROMMETS



Four additional larger sizes of CREATIVE GROMMETS (up to  $\frac{1}{2}$ " inside diameter) are now available to manufacturers and assemblers of radio, electronic and electrical instruments.

Here's a quick way to determine how the above seven basic advantages of these 100% phenolic plastic grommets can improve your assembly.

Send for our new free sample card containing all eight standard sizes.



**ANOTHER SPECIAL BY PROGRESSIVE**

**CATALOG SHOWS DOZENS MORE**  
 Special heads, threads and finishes on any metal or alloy adapted to cold upset. Weekly output: 25,000,000 pieces. Many specials, suggesting production savings for you, illustrated in latest catalog. Includes weights per 1M standard pieces, dec. equivs. of fractions, other purchasing and engineering helps. Write for Catalog 18.

**The PROGRESSIVE MFG. CO.**  
 50 NORWOOD ST. TORRINGTON, CONN.

★ BUY MORE WAR BONDS ★

mirer of Tesla for many years. In fact, his admiration borders on hero worship. It is logical, therefore, that he should write Tesla's biography. Because of his experience as science editor of the New York Herald-Tribune he is able to describe Tesla's work, much of which was highly technical, in simple terms that anyone can understand. This does not detract from the book, however, so far as engineers are concerned because he has faithfully kept to engineering terms wherever possible.

The excessive enthusiasm that the author displays for his subject is boring in spots, particularly when he repeats as frequently as he does his defenses and explanations of Tesla's shortcomings. On the whole, however, the book is well written and documented. A partial list of Tesla's patents and an index are provided. It makes good reading for any engineer or student, particularly those interested in electronics, because it is the life story of a man whose influence on our daily lives will be evidenced for centuries to come.—K.S.P.

• • •

### High-Frequency Induction Heating

By FRANK W. CURTIS, *Consulting Engineer, Springfield, Massachusetts, McGraw-Hill Book Co., Inc., New York, 235 pages, price \$2.75.*

EXPERIENCES GAINED from commercial induction-heating installations are the background from which the greater part of this book is written. Principles and practices, which are discussed and amply illustrated both by diagrams and photographs of installations, cover a wide variety of induction heating applications. The opportunity that this presentation affords the production engineer to learn what has been proven effective in industrial heating applications, plus the fact that this is the first book to be devoted entirely to high-frequency heating, make it a useful guide both to designers of electronic heating equipment and to those who are or plan to use such apparatus.

The first sixth of the book, devoted to the principles of induction heating, unfortunately includes a number of statements open to question. For example, it is explained that "Since induction heating is a

*Announcing.....*  
**YOUR POST-WAR RECEIVER**

*The New RME45*

Embodying the important advancements brought about by the war, the new RME 45 is now ready for those who want a really fine communications receiver. The RME 45 is the product of months of painstaking research and laboratory measurements which have collaborated to produce a receiver that betters performance, stability and ease of operation. In designing the receiver, not a single component has been neglected or overlooked. From the indirectly illuminated and non-fatiguing calibrated scale to the new acoustically designed speaker housing—the RME 45 is your post-war receiver!

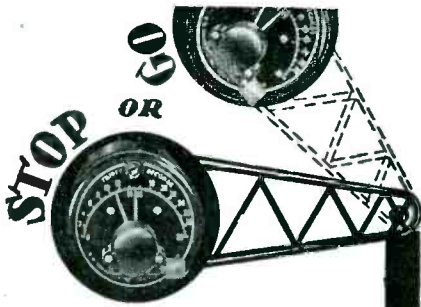
The indirectly illuminated scale is designed for hours of non-fatiguing operation. Like a vernier, the sharp, hairline calibrated scale—white letters on an optically black background—enable the operator to log the frequency of the incoming signal accurately and effortlessly! One control activates the bandspread dial and main tuning dial simultaneously—to give you true electrical bandspread!

In all, you will find the RME 45 a remarkable receiver—and well worth waiting for!

\* Now sold on priority to essential services.

SINCE 1933

**RME** FINE COMMUNICATIONS EQUIPMENT  
**RADIO MFG. ENGINEERS, INC.**  
 Peoria 6, Illinois U. S. A.



Pause for a given time —  
then  
go ahead for another interval.

### Electrically

are only a FEW of the MANY actions that can be properly controlled by

### Cramer Chronometric Controls

Time Delay Relays • Interval Timers • Cycle Timers • Repeat Cycle Timers • Reset Timers • Sequence Timers • Multi-Contact Timers • Running Time Meters • Electronic Timers • Automatic Reset Timers • Percentage Timers • Signal Control Switches • Contact Making Clocks • Impulse Timers • Duplex Cycle Timers.

Write for Technical Bulletin covering subject in which you are interested.

The R.W. CRAMER COMPANY, Inc.  
CENTERBROOK CONNECTICUT

## Wanted ENGINEERS

Radio

\*Electrical

Electronic

\*Mechanical

\*Factory Planning

Materials Handling

Manufacturing Planning

Work in connection with the manufacture of a wide variety of new and advanced types of communications equipment and special electronic products.

Apply (or write), giving full qualifications, to:

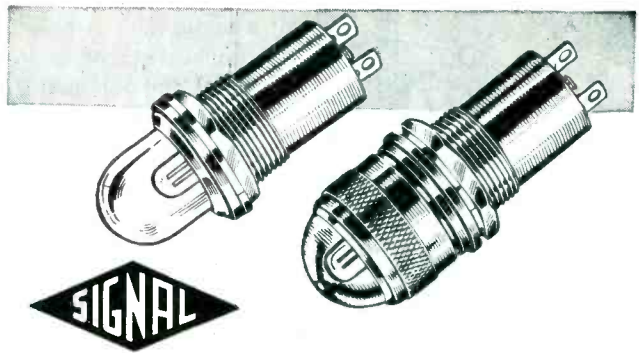
R.L.D., EMPLOYMENT DEPT.

**Western Electric Co.**  
100 CENTRAL AV., KEARNY, N.J.

\*Also: C.A.L.

Locust St., Haverhill, Mass.

Applicants must comply with WMC regulations



## NEON PILOT LIGHTS

### EMBODY THESE IMPORTANT FEATURES:

Penetrating orange-red glow . . . Long life . . . Low current consumption . . . Resistance to vibration and shock . . . Operate direct on high voltage circuits . . . Emit practically no heat —

These advantages of Neon Glow Lamps are enhanced by "SIGNAL" Pilot Light Assemblies. We manufacture a complete line, featuring types fitted with Full-View Plastic Heads. Specialists in supplying completely assembled units, housing G.E. or Westinghouse Lamps. Send specifications for prompt estimates and suggestions . . . Write for Catalog.

# SIGNAL INDICATOR

Corporation

894 BROADWAY . . . NEW YORK 3, N. Y.

Telephone: ALgonquin 4-4770

CAL. ON JORGENSEN FOR SPECIAL MACHINING OR QUANTITY PRODUCTION

## GASES

### HYDROGEN NITROGEN-OXYGEN

COMPLETE GAS PRODUCTION PLANTS INSTALLED FOR LOWEST COST OPERATION . . .

FORMING MIXTURES CARBON DIOXIDE ACETYLENE

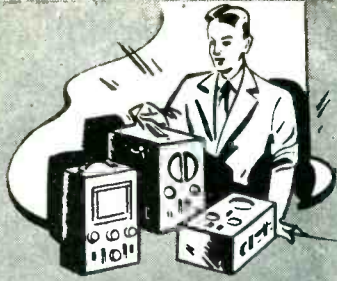
HIGHEST QUALITIES • ANY QUANTITY DELIVERED ANYWHERE

ARGON • NEON HELIUM • KRYPTON XENON

## AMERICAN GAS & CHEMICAL CO.

HARRISON, NEW JERSEY • Contracted Complete Service on All Gases

SP&R-1



**IN-RES-CO  
RESISTORS**  
are engineered  
for precision

**PRODUCT  
DESIGNINGS**

TYPE LL



Stream-lined, area-saving compactness — without sacrifice of operating efficiency and dependability—will undoubtedly be a prime factor in the future designing trend.

IN-RES-CO type LL resistors will meet the need for a compact unit that can be stacked as illustrated to create a small tapped multiplier in test sets, meters, decades, bridges and similar exacting specifications.

Inductive, with standard tolerances of  $\frac{1}{2}\%$ , type LL has  $\frac{1}{4}$  watt rating, and measures only  $\frac{1}{4}$ " high and  $\frac{5}{8}$ " in diameter. A typical example of IN-RES-CO engineering, in which immunity to moisture, heat, vibration and other operating hindrances has been designed-in at the blueprint phase.

Write on company letterhead for the new 18-page catalog; there is no obligation.

**INSTRUMENT  
RESISTORS CO.**



25 AMITY STREET  
LITTLE FALLS, N. J.

process by which the temperature of a metal part is raised by electrical generation of heat within the material, the part being heated is in no way a part of any closed electrical circuit."

For those production engineers and others not familiar with electricity and electronics who are taking up the application of high-frequency fields to their heating problems, considerable more information on principles of electronic heating will be required than is given in the short first chapter of this book.

#### Techniques

The greater part of the book discusses the effect of the applicator coil shape on the area to which heat is applied. Diagrams illustrate the degree and penetration of heat produced by numerous coil contours and show how the coil can be designed to do the job at hand.

Methods of brazing various shapes are described and considerable attention is given to the technique of brazing carbide tools. Soldering techniques are also illustrated. Hardening is covered with special attention to zonal hardening, and setups for hardening complex shapes such as gears are discussed. Semi-automatic equipment is described.

#### Applications

In a chapter devoted to fixtures for use in hardening setups, methods of handling the work and types and requirements of continuous and automatic fixtures are described. The following chapter describes several miscellaneous industrial-heating applications which illustrate how widely induction heating can be applied if used with ingenuity. For example, one special device uses a phototube to determine when the work has reached the proper temperature by monitoring its color. Power to the high-frequency generator is turned off at the proper time by the phototube unit.

The book concludes with a chapter on special considerations necessary in the design of parts to be heat-treated by high-frequency induction, and a chapter that points out the saving in time, type of applications most suitable for, and the packaged equipment available for dielectric heating.—F.R.

**SOLDERING IRONS**  
**SWITCHES • RELAYS**  
**RESISTORS • CONDENSERS**  
**CONTROLS • HEADPHONES**  
**BATTERIES • TRANSFORMERS**  
**TOOLS • WIRE • TUBES • CABLE**

*In a  
Hurry!*

• Try DALIS "KNOW-HOW" to avoid those expediting headaches. Here's an outstanding stock of radio-electronic parts, materials, equipment—at your call!

And DALIS has the well-trained organization, long experience and exceptional factory connections that deliver hard-to-get items in a hurry. A dependable source of supply since 1925. An indispensable source, today.



**Try DALIS—just wire,  
'phone or write...**

**H. L. DALIS & CO.**

Wholesale Distributors  
RADIO-ELECTRONIC SUPPLIES & PARTS

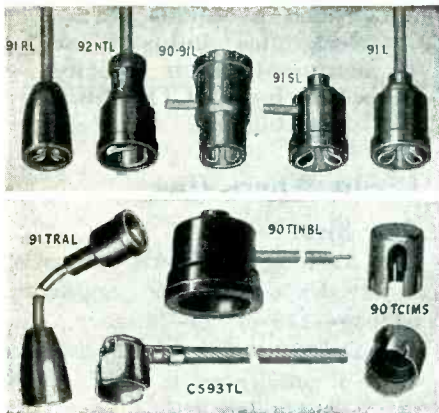
17 Union Square  
NEW YORK 3, N. Y.

Phones: ALgonquin 4-8112-3-4-5-6-7



## ALDEN

### TUBE CAP CONNECTORS WITH LEADS



Your every requirement of quality tube caps, insulated or not, supplied with leads to your specifications for every voltage requirement. Many made special, such as containing resistors to suppress oscillation, with tools for hundreds of different moldings, stampings and all types of wire to draw from.

WRITE FOR THE  
ALDEN "BLUE-BOOK"  
OF ELECTRICAL COMPONENTS

ALDEN PRODUCTS COMPANY  
BROCKTON (64E) MASS.

## JONES 300 SERIES PLUGS and SOCKETS



P-306-CCT

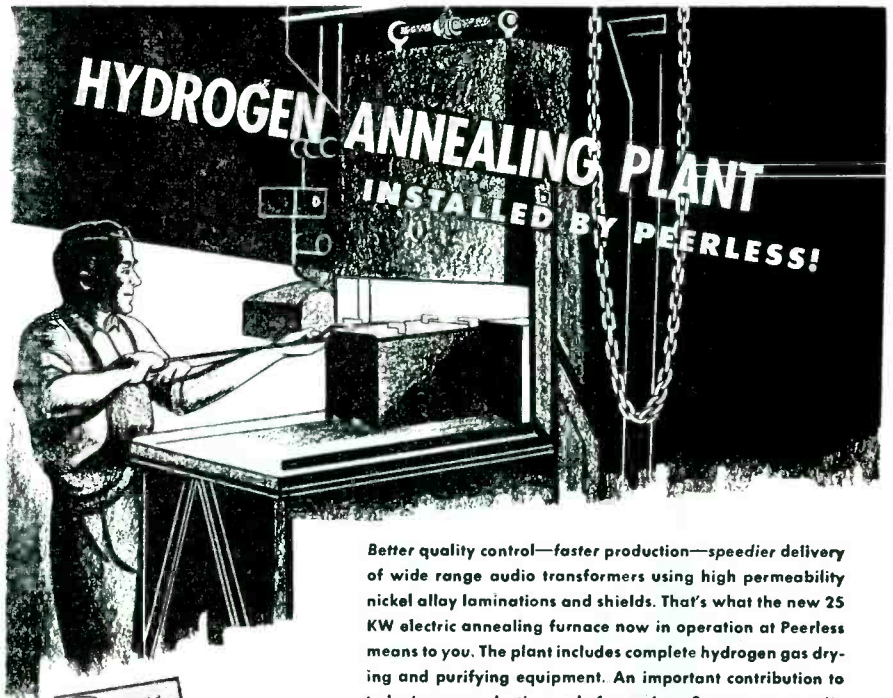


S-306-AB

A high quality line of small Plugs and Sockets adaptable to a thousand uses. All Plugs and Sockets are Polarized. "Knife-switch" Socket contacts are of phosphor bronze, cadmium plated. Bar type Plug contacts are of brass, silver plated.

Insulation is of BM 120 molded Bakelite. Caps are of metal with formed fibre linings. Made in 2 to 33 contacts. Although designed for 45 volts at 5 amperes, these Plugs and Sockets can be used at higher ratings where circuit characteristics permit. 2 contact round, others rectangular. For additional information write today for catalog No. 14 showing complete line of Electrical Connecting Devices.

HOWARD B. JONES COMPANY  
2460 W. GEORGE ST. CHICAGO 18



Better quality control—faster production—speedier delivery of wide range audio transformers using high permeability nickel alloy laminations and shields. That's what the new 25 KW electric annealing furnace now in operation at Peerless means to you. The plant includes complete hydrogen gas drying and purifying equipment. An important contribution to today's war production and of great benefit to post-war radio manufacturers of FM, television and geophysical equipment.



Write today for new transformer catalog.



# PEERLESS

## ELECTRICAL PRODUCTS CO.

6920 McKINLEY AVENUE • LOS ANGELES 1, CALIFORNIA

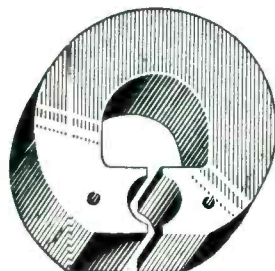
# NORCO SPECIAL PURPOSE Electronic and Mechanical TEST EQUIPMENT



For aircraft electrical and mechanical instruments . . . aircraft controls, radar, meteorological stations, and similar devices. Built to specifications and designs. Inquiry invited.

NORTHERN COMMUNICATIONS MANUFACTURING CO.  
210 EAST 40th STREET NEW YORK 16, N. Y.  
Manufacturers of Transformers • Special Coils • Reactors • Sound Systems  
Recorders • Equalizers • Full Range Phonograph • Coaxial Transmission Lines

## PERMANENT MAGNETS



All Shapes—All Sizes—for All Purposes  
COBALT—CHROME—TUNGSTEN  
Stamped, formed and cast

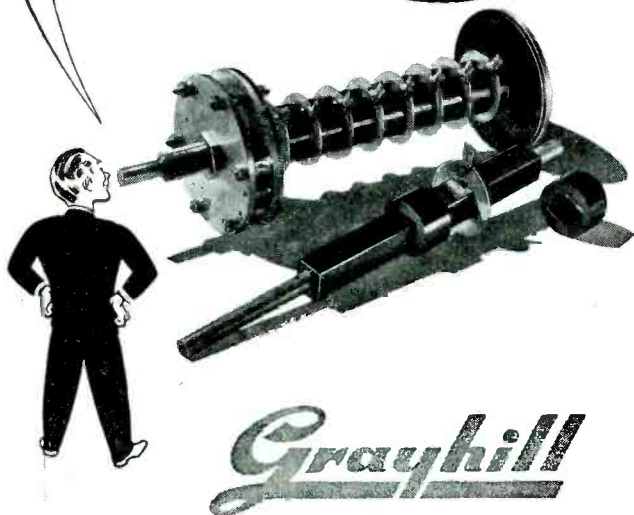
Alnico (Cast or Sintered)  
under G. E. License

Also: Laminations for Radio Transformers  
TOOLS—DIES—STAMPINGS

Heat Treating of Metals and Alloys

THOMAS & SKINNER STEEL PRODUCTS COMPANY  
1116 EAST 23RD STREET • INDIANAPOLIS 5, INDIANA

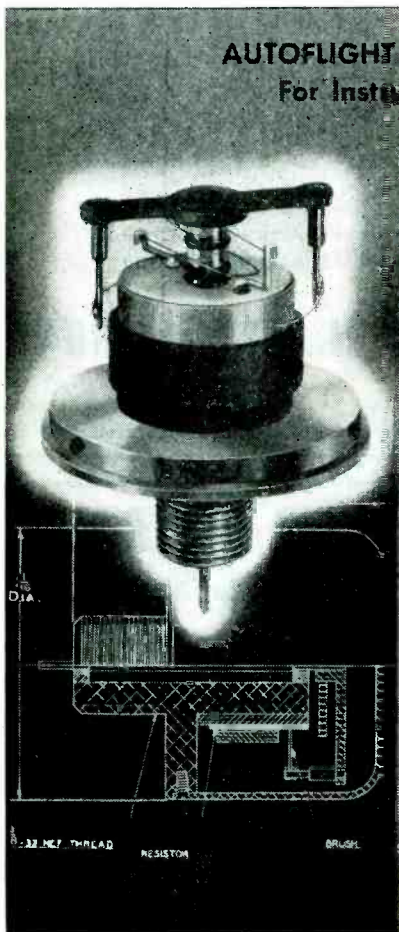
A NECESSARY FEATURE OF THE GRAYHILL ROTO TAP SWITCH IS THE SOLID SHAFT WITH THE BAKELITE DRIVING HUB MOLDED TO THE METAL SHAFT. THE SOLID CONSTRUCTION, WITHOUT UNIVERSAL JOINTS BETWEEN DECKS, ASSURES PROPER ALIGNMENT OF THE ROTOR TO THE CONTACT, REGARDLESS OF THE NUMBER OF SECTIONS OR POLES.



**Grayhill**

5 North Pulaski Road, Chicago 24, Illinois

**AUTOFLIGHT HIGH SENSITIVITY RESISTORS**  
For Instruments : Recording Systems



AUTOFLIGHT High Sensitivity Resistors, the first of their kind ever built in the United States, have been designed to produce from a low torque rotational movement a variable electric resistance. These resistors can be connected directly to sensitive low torque apparatus such as aircraft Flight Test recording instruments, and will operate relays or recording systems without the use of amplifiers, and from a simple D. C. source. They are particularly useful in laboratory or industrial applications where photo-electric cell and amplifiers were heretofore required.

Obtainable in various types from 100 to 1500 ohms, and from 4 to 15 watts, AUTOFLIGHT resistors require but 2 gram millimeters input torque to overcome friction. This low value is secured by use of a jewel supported shaft, the contact mechanism being made with the accuracy of a fine watch. The accuracy of AUTOFLIGHT High Sensitivity Resistors makes them an outstanding product in their line.

AUTOFLIGHT'S engineers and technical advisors will gladly cooperate with you on specific problems embodying High Sensitivity Resistors. Write G. M. Giannini & Company, Inc., 161 E. California Street, Pasadena, Calif., U. S. A.



# Backtalk

This department is operated as an open forum where our readers may discuss problems of the electronics industry or comment upon articles which ELECTRONICS has published

## Credit Where Due

Dear Sirs:

THE ARTICLE, Electronic Control of X-Ray Exposure Time, appearing on page 146 of the January issue of ELECTRONICS is of interest because it duplicates, in considerable detail, a similar article appearing in ELECTRONICS for July 1943. . . . I feel that I should recall to your attention that the work described was done at the University of Chicago. As a matter of fact, the Westinghouse model shown on page 146 was copied almost directly from a model supplied to them by the University of Chicago. The University did this in an effort to stimulate commercial production of the device at a time when it was needed in the war effort.

RUSSELL H. MORGAN

*Radiology Section  
Tuberculosis Control Division  
U. S. Public Health Service  
Washington, D. C.*

• • •

## Cathode-Follower Corrections

Dear sir:

THE ARTICLE by Mr. Pacini on Cathode Follower Calculations, appearing on page 137 of ELECTRONICS, October, gives a value for the output impedance of a cathode follower which I believe is in error.

In determining the impedance by assuming the cathode to be driven by a generator we must divide the voltage drop across the cathode by the current furnished to it from the external generator. This is equivalent to Mr. Pacini's analysis only if the  $R_1$  of his Eq. (3) is equal to zero. The equations with their solution are then as follows:

$$R_2 I_1 - R_2 I_2 = E_1 - R_2 I_1 + (R_2 + R_p) I_2$$

$$= -\mu (I_2 - I_1) R_2 \frac{I_1}{E_1} = \frac{\mu + 1}{R_p} + \frac{1}{R^2}$$

$$= g_m + \frac{1}{R_p} + \frac{1}{R_2}$$

The quantity  $I_1/E_1$  is the value of the conductance offered by the cathode to the external generator of

# TERMINALS

for  
ELECTRIC  
WIRES

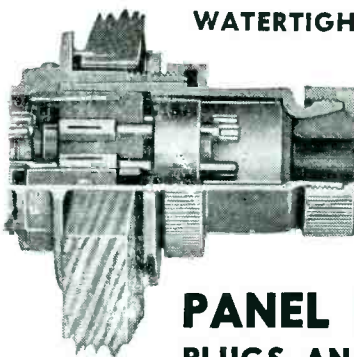
Condenser Plates  
Small Metal Stampings  
*in accordance with*  
Customer's Prints

▲  
ACCURACY  
PRECISION  
REASONABLE  
DIE CHARGES

▼  
Modern Equipment  
and Factory  
NO SCREW MACHINE PARTS

▲  
**PATTON-MACGUYER**  
COMPANY  
17 VIRGINIA AVE.  
PROVIDENCE, R. I.

WATERTIGHT



## PANEL MOUNTING PLUGS AND RECEPTACLES VIBRATION-PROOF ASSEMBLIES

For locknut or bolted style mounting to panels 1/16" to 5/8" thick. Precision built housings — light weight, ample wiring space.

Contacts fully machined, self wiping and free floating. All terminals identified. Polarized, grounded and shielded.

Interior moulded bakelite. Moulded rubber gaskets on watertight style.

Thousands in use for vital war service.

Since 1902

Please address  
Dept. No. H



## RUSSELL & STOLL COMPANY

EXPLOSION-PROOF, WATER-TIGHT, INDUSTRIAL LIGHTING FIXTURES  
AND EQUIPMENT. AUTOMATIC LOCKING "EVER-LOK" CONNECTORS  
125 BARCLAY STREET · NEW YORK 7, N. Y.

EVERLOK

AUTOMATIC  
LOCKING

•  
FOR  
PORTABLE SOUND  
AND SIGNAL SYSTEMS  
2 to 12 POLE

•  
FOR  
POWER  
10 to 200 AMP.  
2, 3 & 4 POLE



1 OUT OF 6 ADULTS  
DIES OF

**CANCER**

YOU MAY BE THE ONE

**GIVE!**

Eminent scientists lack funds for experiment . . . cancer clinics are starved for equipment . . . money is needed to care for advanced cases.

Five million dollars a year might cut the deaths from cancer. Might save you, one dear to you. Yet Americans give less than one million dollars. Do your part! Send us anything from 10¢ to \$1,000. Every bit helps!

*If you are a resident of the Metropolitan area of New York, send your contribution to New York City Cancer Committee, 130 E. 66th St., N. Y. 21, N. Y.*

**AMERICAN CANCER SOCIETY**  
350 Fifth Avenue, N.Y. 17 N.Y.

There is **NOT** a SUPERIOR  
BRUSH GRADE for Every Need

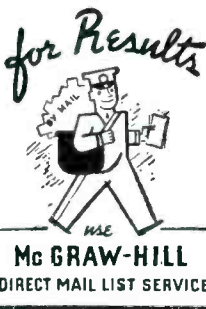


☆ There can't be, because new needs are arising every day, and research must fill them. The Superior Research Department places its 25-year experience at your disposal.



**SUPERIOR CARBON PRODUCTS, INC.**  
9117 George Avenue · CLEVELAND 5, OHIO

**SUPERIOR CARBON  
BRUSHES**



**If You Are Having Difficulty  
Maintaining Your Mailing Lists...**

Probably no other organization is as well equipped as McGraw-Hill to solve the complicated problem of list maintenance during this period of unparalleled change in industrial personnel.

McGraw-Hill Mailing Lists cover most major industries. They are compiled from exclusive sources, and are based on hundreds of thousands of mail questionnaires and the reports of a nation-wide field staff. All names are guaranteed accurate within 2%.

When planning your direct mail advertising and sales promotion, consider this unique and economical service in relation to your product. Details on request.

**McGraw-Hill Publishing Co., Inc.**  
DIRECT MAIL DIVISION

330 West 42nd Street

New York, 18, New York





### We manufacture a complete line of equipment

SPOT WELDERS, electric from ¼ to 50 KVA  
TRANSFORMERS, special and standard types  
INCANDESCENT LAMP manufacturing equipment  
FLUORESCENT TUBE MAKING EQUIPMENT  
ELECTRONIC EQUIPMENT, vacuum pumps, etc.  
WET GLASS slicing and cutting machines for laboratory use  
GENERAL GLASS working machines and burners  
COLLEGE GLASS working units for students and laboratory  
EISLER ENGINEERING CO.  
731 So. 13th St. (near Avon Ave.) Newark, New Jersey



NATION-WIDE  
MAIL ORDER  
DISTRIBUTORS  
SINCE 1928



## RADIO AND ELECTRONIC DEVICES

For...

TRADE... INDUSTRY...  
COMMUNICATION...  
PUBLIC UTILITY...  
VOCATIONAL AND  
EXPERIMENTAL  
APPLICATIONS

### BURSTEIN-APPLEBEE CO.

1012-14 MCGEE ST.  
KANSAS CITY 6, MISSOURI

### MICROMETER

FREQUENCY  
METER

for  
checking  
Transmitters  
from 1.5 to 56 mc.,  
within 0.01 per cent

LAMPKIN LABORATORIES  
Bradenton, Fla., U. S. A.

### SOMETHING NEW!

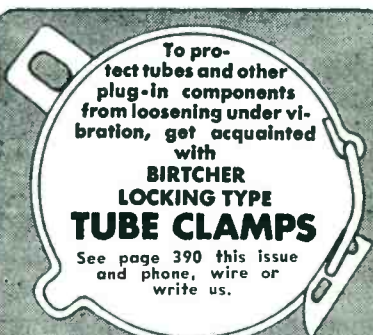
sleeveless type

### TUNGSTEN LEADS

PRODUCED FROM CONTINUOUS SPOOLS  
OF WIRE, EITHER STRANDED OR SOLID,  
ASSURING OVERALL UNIFORMITY. EACH  
TINY WIRE OF THE STRANDED CABLE IS  
POSITIVELY FUSED TO THE TUNGSTEN.

write for details & samples

GLENDALE VACUUM PRODUCTS CO.  
8816-77th Ave. Brooklyn 27, N.Y.



To protect tubes and other  
plug-in components  
from loosening under vi-  
bration, get acquainted  
with  
BIRTCHEER  
LOCKING TYPE  
TUBE CLAMPS

See page 390 this issue  
and phone, wire or  
write us.

**THE BIRTCHEER CORPORATION**  
Manufacturers of AIRCRAFT  
and RADIO PARTS

5087 HUNTINGTON DR. LOS ANGELES 32

**YOUR NEW FREE CATALOG  
IS READY FOR YOU!**

Radionic's Catalog No. 26  
lists hard-to-get radio parts! • Helps  
you fill your radio and electronic  
needs. • All parts are available for  
immediate shipment • All are highest  
quality. • All are exceptional values.

SEND TODAY FOR YOUR  
FREE COPY TO  
Dept. 5A

**RADIONIC EQUIPMENT CO.,**  
"CHANCELLOR" PRODUCTS  
170 NASSAU STREET, NEW YORK 7, N. Y.

### Electron Tube Machinery

of every type,—standard, and special design

Specialists in Equipment for the manufac-  
ture of Radio Tubes, Cathode Ray Tubes,  
Fluorescent Lamps, Incandescent Lamps,  
Neon Tubes, Photo Cells, X-ray Tubes  
and other glass or electronic products, on  
production or laboratory bases.

**Kahle**  
**ENGINEERING COMPANY**

1307-1309 Seventh St., North Bergen, N. J.

### Strip Insulated Wires QUICKER... BETTER

with "Speedex"  
AUTOMATIC WIRE STRIPPER  
... Speeds Production

Strips Insulation from all types of  
wire — instantly, easily, perfectly.  
Just press the handles and the job  
is done. Cuts wire too. Strips 800  
to 1000 wires per hour. Available  
for all size solid or stranded wires  
—No. 8 to No. 30. List Price \$4.00.  
Write Dept. E for Full Particulars



**GENERAL CEMENT MFG. CO.**  
Rockford, Illinois, U.S.A.

MORE RF KILOWATT HOURS  
PER DOLLAR WITH

F & O

### TRANSMITTING TUBES

Inquiries Invited—Let us explain how  
Savings are effected and the F & O  
greater guarantee.

**FREELAND & OLSCHNER PRODUCTS Inc.**  
611 Baronne St., New Orleans 13, La.  
Raymond 4756

High Power Tube Specialists Exclusively  
(¼ To 100 KW)

## BOTTLENECK REMOVER

Have you soldering problems?

Do you use or make hermetic seals?

Does your electro-tin plate  
oxidize and refuse to solder?

If so, let me help you. There is a  
new development in the art of hot  
tinning. A new development that  
requires no acid, no alkalin, no cor-  
rosive flux. A new development that  
has undreamed of possibilities.

For further information send your  
problem and samples, if possible, to

**DON FOSTER**

30 BURNS AVENUE, WYOMING 15, OHIO

*Your Inquiries to  
Advertisers Will  
Have Special Value . . .*

—for you—the advertiser—and the  
publisher, if you mention this pub-  
lication. Advertisers value highly  
this evidence of the publication you  
read. Satisfied advertisers enable the  
publisher to secure more advertisers  
and—more advertisers mean more  
information on more products or bet-  
ter service—more value—to YOU.

**MINIATURE BALL BEARINGS**  
for precision instruments, electronic devices  
RADIAL SERIES (see left) 1/4" to 5/16" outside diameter  
PIVOT SERIES 2 to 10 mm. outside diameter  
For complete specifications, prices—write for catalog 431 825

**MINIATURE Precision BEARINGS**  
KEENE, NEW HAMPSHIRE, U.S.A.

### Burned Out or Broken Electric Heating Elements

repaired with NICHROCITE PASTE.  
Simply overlap ends, apply paste, turn  
on current. Used by utility com-  
panies, etc. Family size, \$1.00, 4 oz.  
size \$2.50. Satisfaction guaranteed.

**ADVANCE CO.** Box 861G Minneapolis, Minn.

**Wanted**

# ELECTRONIC ENGINEERS

We are offering permanent positions to a few Electronic Engineers or Physicists. This is an unusual opportunity for men who possess adequate educational background, originality and initiative to join a well established and growing organization engaged in research and development relating to motion picture equipment, television, and marine instruments. Write full particulars relative to education and experience, so that we can arrange an interview for you.

**INTERNATIONAL PROJECTOR CORPORATION**  
92 Gold Street New York 7, N. Y.

## WANTED!!

### ADVERTISING and SALES PROMOTION MANAGER

**By Large Pioneer Transformer Manufacturer**  
(N. Y. Metropolitan Area)

Splendid opportunity for right man. Experience in industrial advertising and sales promotion required. Electrical Engineering background embracing electronic and power transformers desirable. Salary commensurate with experience and background. Write today, giving brief outline of self and experience, requesting an interview.

SW-822, Electronics, 330 West 42nd St., New York 18, N. Y.

### WANTED SALES MANAGER Parts Jobber

Somewhere there is a Radio Parts Salesman or Sales Engineer now working for a manufacturer's agent, jobber, or manufacturer of radio parts who has cut his eye teeth and is ready for a bigger job.

To such a man we offer a Real Post-war opportunity, with a hard hitting aggressive organization located in Metropolitan area of N. Y. This Company will have a quality line of parts and test equipment to be merchandised & sold thro' the Electronic Jobber. Salary & participating basis, if you have the necessary qualifications we want to hear from you. Write fully, in confidence—

SW-820, Electronics  
330 West 42nd St., New York 18, N. Y.

### BEST QUALITY, USED ELECTRON TUBE MACHINERY

Equipment for the manufacture of all kinds of electron tubes, radio tubes, incandescent lamps, neon tubes, photo electric cells, X-ray tubes, etc.

**AMERICAN ELECTRICAL SALES CO., INC.**  
65-67 East 8th St. New York, N. Y.

### PRICED TO SELL FAST!!

**TWO, 5,000 KW Westinghouse  
TURBO GENERATOR SETS**

13,800 V., 25 Cy.

*In excellent condition  
Can be inspected in operation.*

**IRON & STEEL PRODUCTS, INC.**  
13422A S. Brainard Ave., Chicago 33, Ill.

"ANYTHING containing IRON or STEEL"

## WANTED

### FOREMAN (30-40)

to supervise small electronic assembly dept. Able to read Schematic wiring diagram. Excellent post-war oppy. Send complete resume and non-returnable photo. W.M.C. rules observed.

Box 923, Equity, 113 W. 42nd St., NYC

### RADIO ENGINEERS WANTED

Top radio design engineer wanted. Also Juniors. War Work-receivers etc. Post war-home radios, radio phones, television, electronic specialties, etc. Prosperous growing medium sized N. Y. radio firm. Splendid opportunity. Our engineers know about this advertisement. Send complete background, salary earned etc. We pay very highest salaries to good producers.

P-774, Electronics  
330 W. 42nd St., New York 18, N. Y.

### ELECTRONIC PROJECT ENGINEER

WANTED

Man experienced in High Frequency, Ultra High Frequency and Television. Must have good theoretical background and experience in construction of equipment to meet specifications of Military Tactical Equipment. Practical experience gained in construction of equipment essential. Firm established since 1888, heavy post-war future in Electronics. Excellent salary, advancement rapid. Address reply to —

**LEWYT CORPORATION**  
60 Broadway Brooklyn 11, N. Y.

### POSITION VACANT

**RADIO ENGINEER.** Graduate, 5 years experience laboratory design and construction, receivers and associated equipment. Premier Crystal Laboratories, Inc., 63 Park Row, New York.

### EMPLOYMENT SERVICE

**SALARIED POSITIONS** — This advertising service of 35 years recognized standing negotiates for high salaried supervisory technical and executive positions. Procedure will be individualized to your personal requirements and will not conflict with Manpower Commission's. Retaining fee protected by refund provision. Identity covered and present position protected. Send for details. R. W. Bixby, Inc., 278 Delward Bldg., Buffalo 2, N. Y.

### REPRESENTATIVE AVAILABLE

**WANTED REPRESENTATION** and distribution of radio, Electronics equipments, transmitting, receiving, medical, commercial, laboratory, broadcast, etc. Reply with catalogs, bulletins, etc. Alfonso Pereyra Radio Engr., P. O. Box 981, Lima, Peru, S. A.

### MANUFACTURERS

Exclusive electronic engineering sales firm will accept additional products for representation in Northwest.

**Electronic Engineering Service**  
PO Box 486, Boise, Idaho

## SALES IN CHICAGO

Established Sales and Application Engineering organization in Chicago desires to represent an additional manufacturer. If you make products of merit used by Radio, Electronic and other manufacturers as part of their assemblies our efforts can secure substantial and permanent business for you. Write for details.

RA-782, Electronics  
520 N. Michigan Ave., Chicago 11, Ill.

### RADIO ENGINEER

With university education, familiar with the Scandinavian radio market and with long experience from technical work in neutral country, wishes to contact large manufacturer interested in post-war trade on Scandinavia for the obtaining of future position in U. S. A.

RA-824, Electronics  
330 West 42nd St., New York 18, N. Y.

### UNIVERSAL MIDGET TOOLS

**DANDY SIXTEEN PIECE SET:** Midget Pliers, Diagonal Cutters, Four Midget End Wrenches, Needle-nose Pliers, Screwdriver, Six Punches & Chisel, Round File, Midget Crescent Wrench, \$14.85. **IMMEDIATE DELIVERY** Overnight By Air to Everywhere U.S.A.! Remit Today. Catalogue Free With Order. If it's Tools, We have It—Can Get It—or It Isn't Made!

**DEALERS TOOL SUPPLY**  
1527 GRAND E. KANSAS CITY, MISSOURI

### IMMEDIATELY AVAILABLE FROM STOCK!

VOLTMETERS BRIDGES (Wheatstone)  
AMMETERS MEGOHMMETERS  
MILLIMETERS RHEOSTATS  
MICROAMMETERS VARIABLE  
OHMMETERS TRANSFORMERS  
FREQ. METERS RELAYS

*Ask for our latest availability list*

**ELECTRO-TECH**  
EQUIPMENT COMPANY  
329 Canal St. New York 13, N. Y.

(Additional Employment Ads on Pages 383, 395, 403, 404 and 405)



## ELECTRONIC CIRCUIT ENGINEERS

Graduate or non-graduate Engineers, with at least two years' experience, needed for application work of hearing aid type tubes, to present and post war small electronic devices. Interviews can be arranged in New York and Chicago after application is submitted. Applicants must comply with all necessary W. M. C. regulations.

**Raytheon Manufacturing Co.**

55 CHAPEL STREET

NEWTON, MASSACHUSETTS

### WANTED

### V. H. F. or U. H. F. ENGINEER

For design and development of Army-Navy Electronic Equipment. The position offers an excellent opportunity with a well-established and expanding company in Connecticut, employing over 100 personnel. The company's big postwar program in the industrial electronics, audio and aircraft communication fields assures a continued opportunity to engineering personnel for advancement.

P-810, Electronics

330 W. 42nd St., New York 18, N. Y.

## PROJECT ENGINEER ELECTRONICS DESIGN

Capable, versatile, progressive engineer to work on development of essential and critical projects in growing electronics division of well known engineering and research firm. Must be sufficiently well-grounded both in theory and practice to handle wide variety of projects largely related to industrial control instrumentation, and electro-mechanical devices. Servo-mechanism experience desirable.

Engineering or research graduate with 5 years intensive industrial development experience desired. Must be analytical and capable of some unguided direction of others.

Wide opportunity for right man

### EXCELLENT SALARY

Location New York City

Write Box 319, Equity, 113 W. 42nd St., N.Y. 18

# ELECTRONIC ENGINEERS!

## War-Winners Today, Post-War Builders Tomorrow!

Leaders in NATIONAL UNION RADIO CORPORATION'S staff of engineers, scientists and technicians have brought us far out in front in the electronics industry. We have a research laboratory and two manufacturing plants in Newark, N. J., and a manufacturing plant near Philadelphia, Pa. We invite you to consider your opportunities with us for professional advancement, stimulating, friendly associations, and a future with promise.

## NATIONAL UNION NEEDS:

**SENIOR TUBE ENGINEERS:** These men MUST have actual experience with radio tube manufacture. The pay and opportunities are commensurate with your ability.

**COMMERCIAL ENGINEERS:** Engineers interested in developing electronic tube applications, who may represent us among radio manufacturers upon occasion.

**QUALITY CONTROL MEN AND WOMEN:** Here you need an interest in the practical application of statistical and/or engineering procedures to many factory processes.

**TEST EQUIPMENT ENGINEERS:** Men experienced with meters or electronic test equipment to work either as TEST EQUIPMENT DESIGN ENGINEERS or as MEASUREMENT LABORATORY ENGINEERS.

**JUNIOR ENGINEERS—MEN AND WOMEN:** Do you have a college degree in Physics, Electrical Engineering, Chemical Engineering, Mechanical Engineering, Mathematics or Chemistry? This company offers an opportunity for young, ambitious graduates to assume responsibilities and to exercise initiative.

**FOREMEN AND ASSISTANT FOREMEN:** Men experienced in radio or radio tube manufacture to supervise exhaust, stem or grid operations.

**TECHNICIANS, CIRCUIT MEN:** Have you been a radio ham, or have you built or repaired radios? Have you studied radio in the Services? We need men who can read circuit diagrams and do wiring and construction.

## WOMEN!

*We have a number of fine young women engineers with us now. We need more. If you have a degree in Electrical Engineering, Chemical Engineering, Mechanical Engineering, Physics, Chemistry or Mathematics and are seeking career opportunities, investigate.*

If you have thorough training in your field, as evidenced by job experience in radio or allied industries, or by a college degree—if you have ambition, initiative and resourcefulness—if you have the ability to inspire your co-workers, then . . .

Telephone or Write

**DR. L. GRANT HECTOR**

Director of Engineering

## NATIONAL UNION RADIO CORPORATION

Plane St. at Raymond Blvd.

Newark 2, New Jersey

WMC RULES OBSERVED

### WANTED

### ASSISTANT CHIEF ENGINEER

Mid-west radio-electronics manufacturer, engaged exclusively on electronic war projects at present, requires experienced engineer to assume complete supervision of post-war development of household and auto radio receivers. Television receiver experience desirable but not essential. All inquiries confidential. Write

P-814, Electronics

520 N. Michigan Ave., Chicago 11, Ill.

### X-RAY

Important manufacturer of dental and medical

### EQUIPMENT

expanding medical line, needs

### ENGINEERS

with shop practice capable of designing and developing new models of x-ray equipment for medical profession. Permanent position with excellent post-war future.

**RITTER COMPANY, INC.**

Rochester 3, New York



## OPPORTUNITY FOR ELECTRICAL AND MECHANICAL ENGINEERS

*If you can offer this:*

Sound electrical or mechanical engineering experience (with the equivalent of a university degree) . . . ability to qualify as a project engineer, at once or with a few years' more training . . . above-average intelligence and will to get ahead . . . and perhaps some design experience connected with governors or small electric switches,

*We can offer you this:*

An excellent opportunity in keeping with your training and experience in a firmly established, growing company with plants in five Eastern cities, all of which are 100% engaged in war work. Our products are varied, and have established peacetime markets. Openings range up to the level of Chief Engineer for one of our new plants.

If you have ever wanted to connect with a company large enough to provide security and ample opportunity for going ahead, but not so large that individual ability goes unrecognized, this may well prove to be the opportunity you are looking for.

Write me personally, telling your experience, background, and qualifications in detail, and salary expected. Don't hesitate if you happen to be over forty. Your letter will be treated with complete confidence, and no further investigation will be made without your express permission.

WE ALSO HAVE GOOD OPENINGS AVAILABLE FOR DESIGNERS AND DRAFTSMEN

Walter F. Skillin, Vice President in Charge of Engineering  
GREAT AMERICAN INDUSTRIES, INC.

91 BRITANNIA ST.



MERIDEN, CONN.

## OPENINGS FOR RADIO ENGINEERS ELECTRICAL ENGINEERS MECHANICAL ENGINEERS

In the development and production of all types of radio receiving and low-power transmitting tubes. Excellent post-war opportunities with an established company in a field having unlimited post-war possibilities.

*Apply in person or in writing to:*

Personnel Manager

**RAYTHEON**  
Manufacturing Company

Radio Receiving Tube Div.  
55 Chapel St., Newton, Mass.

## JUNIOR RADIO ENGINEERS

Prefer: drafting, mechanical experience; six years or more practical design experience. Splendid opportunity with growing N. Y. radio manufacturer.

P-792, Electronics

330 W. 42nd St., New York 18, N. Y.

## HELP WANTED TRANSFORMER & SMALL ELECTRIC MOTOR MEN ENGINEERS DESIGNERS DRAFTSMEN TECHNICIANS

For war time and post-war design and development of intricate, specialized, hermetically sealed transformers, and special purpose fractional h.p. motors.

Write giving details about age, experience, past salaries to

## SPERRY

GYROSCOPE COMPANY, INC.  
Research Laboratories  
Stewart Ave. & Clinton Rd.  
Garden City, New York

## TRANSFORMER DESIGN ENGINEER

For one of the leading transformer manufacturers. Located in N. Y. Metropolitan area. If you are an E. E. graduate & interested in becoming associated with a company which has real Post-War possibilities write us in complete detail about yourself.

P-819, Electronics

330 W. 42nd St., New York 18, N. Y.

## FIELD SERVICE ENGINEERS

FOR DOMESTIC AND  
FOREIGN SERVICE

Must Possess Good  
Knowledge of Radio

Essential workers need release

## HAZELTINE CORPORATION

58-25 Little Neck Parkway  
Little Neck, Long Island

## ELECTRONIC ENGINEERS

SENIOR AND JUNIOR ENGINEERS  
WANTED FOR DESIGN AND DEVELOPMENT OF TEST EQUIPMENT, PRECISION WIRE WOUND RESISTORS, AND RF COILS. SHOULD HAVE PROVEN BACKGROUND IN THESE SUBJECTS.

## EASTERN ELECTRONICS CORP.

41 Chestnut St. New Haven, Conn.

## WANTED

## Radio or Electronic ENGINEER

For design and development of Army-Navy Electronic Equipment. The position offers an excellent opportunity with a well-established and expanding company in Connecticut, employing over 100 personnel. The company's big postwar program in the industrial electronics, audio and aircraft communication fields assures a continued opportunity to engineering personnel for advancement.

P-794, Electronics

330 W. 42nd St., New York 18, N. Y.

## WANTED

## RESEARCH PHYSICIST

Unusual opportunity for research and development work in electrical contacts, electronic tube components, power metallurgy, and other products using tantalum, columbium, tungsten and molybdenum. Well equipped laboratory, congenial surroundings, unlimited potentials for advancement. State full details of education, experience and salary requirements.

Address: Personnel Director

**Fansteel Metallurgical Corp.**  
North Chicago, Illinois





## RADIO ENGINEERS

Medium-sized, progressive, Midwest manufacturer has openings for one senior and two junior engineers. Desire men for work on military projects now who will be adaptable later to postwar engineering. Prefer men with experience in radio receiver or television laboratory, and with college education in communication engineering. Our staff knows of this advertisement.

**P-798, Electronics**

520 No. Michigan Ave., Chicago 11, Ill.

## LOOKING FOR ENGINEERS

An unusual opportunity to undertake engineering activities in design and development of ultra-high frequency electronic products.

Prior to the war, this Corporation was among the leading producers of Electronic equipment for Industrial application.

Now engaged as Prime Contractors on urgent War Contracts, involving interesting research and development. We need engineers with experience in designing and engineering VHF-UHF Electronic products, and with ambition.

Large projects in the field of Ultra-high Frequency and advanced Electronic applications are scheduled to follow in the post-war period, insuring security and fine environments to all our co-workers.

Write to L. R. Ripley, President, explaining your experience in detail. Your communication will be treated in complete confidence and no further investigation will be made without your express permission.

**United Cinephone Corporation**  
Torrington, Connecticut

### WANTED SENIOR DEVELOPMENT ENGINEER

Large mid-west manufacturer, now exclusively on war radio and radar work, has immediate openings for post-war radio and television development for three senior radio project engineers, two mechanical engineers and one engineer on specifications and standards. Confidential inquiries respected. Write

**P-813, Electronics**

520 N. Michigan Ave., Chicago 11, Ill.

### WANTED PHYSICIST AND ELECTRICAL ENGINEER

Physicist to supervise industrial and fundamental research in acoustics. Ph.D. with industrial experience preferred. Also Electrical Engineer or Engineering Physicist for research position in fundamental and applied electronics. Some industrial experience preferred. Essential work with excellent postwar prospects. Write

**Armour Research Foundation**

33 West 33rd St., Chicago 16, Illinois

### WANTED RESEARCH ENGINEERS

Prominent radio and electronics manufacturer located in Midwest has immediate openings for three research men preferably with engineering background, on post-war problems in electrical and electronic fields. Confidential inquiries respected.

**P-815, Electronics**

520 N. Michigan Ave., Chicago 11, Ill.

## Advancement For Electronics or Radio Engineers

Large well-established organization located in New York City wants graduate Engineers with three or more years experience in

### ELECTRONICS RADIO RADAR SYNCHRO-MECHANISM

For Present and Post-War research and development on a large variety of electrical products. Give us, in full confidence, your education, resume of experience, and photograph.

**P-821, Electronics**

330 West 42nd St. New York 18, N. Y.

## WANTED!!

### By Large Eastern Transformer Manufacturer

● **EXECUTIVE ELECTRICAL ENGINEER** Experienced in the sales and manufacture of magnetic components for Fluorescent and Cold Cathode Lighting.

● **ELECTRICAL ENGINEER** Experienced with the design of Ballast and Cold Cathode Transformers.

● **EXECUTIVE ELECTRICAL ENGINEER** Experienced in the sales and manufacture of Transformers utilized for the Radio Receiving Set Industry.

● **ELECTRICAL ENGINEER** Experienced in the design of Transformers and reactors for the Radio Receiving Set Industry.

These positions are permanent, offering excellent Post-War opportunities in a forty-year old transformer manufacturing company. Address replies to

Box No. P-823, Electronics, 330 West 42nd St., New York 18, N. Y.

**WMC RULES PREVAIL**

# PERMOPIVOTS

Wear Resistant  
Non-Abrasive

Non-Corrosive  
Non-Magnetic

Extraordinary long range benefits accrue from PERMOPIVOT installation: Accurate performance of precision instruments—l-o-n-g-e-r! . . . Ask for descriptive literature.

## PERMO, Incorporated

Manufacturing Metallurgists

6427 RAVENSWOOD AVE. • CHICAGO 26, ILLINOIS

● INSTRUMENT HOUSINGS

● PANELS

● CHASSIS

● STAMPINGS

● SCREW MACHINE PARTS

**METAL AND PLASTIC SPECIALTIES**  
*Manufactured to your Requirements*

Experienced fabrication and dependable service for all types of radio and electronic parts. Send us your drawings and specifications for quotation.

**STAMFORD METAL SPECIALTY CO., 428 BROADWAY, N. Y. 13**

*Metal Work of Every Description*

## SAFETY DOOR INTERLOCK SWITCH

An inexpensive, dependable safety device that breaks power circuits when access doors are opened. Protects personnel, guards equipment. Particularly suitable for radio transmitters, television receivers, X-ray and therapeutic machines, fire doors and burglar alarms. For details write: Electronics Department, General Electric, Schenectady 5, New York.

**GENERAL ELECTRIC**  
164-D3



(Continued from page 400)

much greater than one. In all of my engineering design in the past I have never attempted to use a tube with a  $\mu$  of less than 20 as a cathode follower, because it would lead to too high an output impedance. I am sure that you will agree with me that the cathode follower is used primarily as a low impedance source.

Equation 5 gives the value of the driving point impedance that the generator emf sees looking into the network. Equation 6 is the output impedance, obtained by subtracting  $R_1$  from  $Z_1$ ; and you may well see that it is the same as your end result except for the difference mentioned above. The generator could have been assumed to have zero internal impedance, but I chose to make the derivation more general by stating that the network be driven by a generator with internal impedance.

It is useless to calculate vacuum tube behavior to better than 5 percent because of the tolerances allowed by the manufacturers on the characteristics; and the characteristics do vary considerably, as you mentioned, because of the operating point.

Thank you for your interest in the article. I trust that I have clarified the point in question.

HUMBERT P. PACINI  
Asbury Park, N. J.

Dear Mr. Pacini:

THE POINT which I wished to make was simply that in neglecting the plate conductance (by substituting  $\mu$  for  $\mu$  plus one) and the conductance of the cathode resistor we are needlessly sacrificing precision of analysis. It is customary, as you say, to neglect the difference between  $\mu$  and  $\mu$  plus one in cathode follower calculations but I do not believe we should also throw out the effect of the cathode resistor and say that the output impedance is the reciprocal of the transconductance. This can easily lead to an additional 5 percent error.

Since the analysis is not appreciably simplified by these approximations why not take the precise expressions for amplification and output impedance as guides for design? We can neglect the minor terms if we want, but at least we will know what we are neglecting.

RUSSELL N. SKEETERS  
Pasadena 4, California

# INDEX TO ADVERTISERS

	Page		Page
Ace Manufacturing Corp.	384	Dayton Rogers Mfg. Co.	370
Acheson-Colloids Corporation	51	Deutschmann Corp., Tobe	2
Acro Electric Co.	226	DeJur Amsco Corporation	347
Adams & Westlake Co.	166	Dial Light Co. of America, Inc.	352
Aerovox Corporation	86	Diamond Instrument Co.	67
Aircraft & Diesel Equipment Corp.	350	Dongan Electric Mfg. Co.	324
Aireon Manufacturing Corp.	217	Doolittle Radio, Inc.	308
Albion Coil Co.	331	Dow Corning Corporation	253
Alden Products Co.	397	Drake Manufacturing Co.	385
Allen-Bradley Co.	44	Driver-Harris Co.	71
Allied Control Co., Inc.	183	Dumont Electric Co.	8
Allied Radio Corp.	244	DuMont Laboratories, Inc., Allen B. 33,	40
Altec Lansing Corp.	176	Durez Plastics & Chemicals, Inc.	247
Aluminum Co. of America	231		
American Cancer Society	399	Eastern Air Devices, Inc.	15
American Gas & Chemical Co.	395	Eastern Amplifier Corporation	182
American Lava Corporation	61	Eby, Inc., Hugh H.	400
American Lens Co., Inc.	54	Ecor, Inc.	206
American Phenolic Corp.	73	Eisler Engineering Co.	316, 401
American Platinum Works	312	Eitel-McCullough, Inc.	89
American Screw Co.	42	Elastic Stop Nut Corp. of America	299
American Transformer Co.	201	Elco Resistors Co.	220
American Type Founders	265	Electric Auto-Lite Co.	50
Amperex Electronic Corporation	7	Electrical Industries, Inc.	388
Amperite Co.	344	Electrical Insulation Co., Inc.	320
Anaconda Wire & Cable Co.	241	Electro Motive Mfg. Co.	271
Andrew Co.	164	Electronic Engineering Co.	391
Ansonia Electric Co.	329	Electronic Enterprises, Inc.	72
Arnold Engineering Co.	56	Electronic Laboratories, Inc.	81
Associated Research, Inc.	381	Electronic Mfg. Co.	408
Astatic Corporation	252	Electronic Mechanics, Inc.	10
Atlas Tool & Designing Co.	262	Electro-Voice Corp.	82
Audak Co.	409	Erco Radio Laboratories, Inc.	322
Audio Devices, Inc.	213	Erie Resistor Corp.	84
Auto Engraver Co.	390	Essex Electronics	407
Automatic Electric Sales Corp.	78	Essex Wire Corporation	263
Automatic Mfg. Corporation	80		
		Fairchild Camera & Instrument Corp.	246
Baer Company, N. S.	386	Federal Tel. & Radio Corp.	63, 209
Bakelite Corporation	203	Fenwal, Inc.	372
Ballantine Laboratories, Inc.	248	Ferrocart Corp. of America	364
Barber Laboratories, Alfred W.	372	Finch Telecommunications, Inc.	196
Barker & Williamson	236	Formica Insulation Company	163
Beaver Gear Works, Inc.	308	Foster, Don	401
Bell Sound Systems, Inc.	368	Franklin Mfg. Corp., A. W.	193
Bell Telephone Laboratories	162	Freeland & Olschner Products, Inc.	401
Bendix Aviation Corp., Pacific Div.	211		
Bentley, Harris Mfg. Co.	167	General Aniline & Film Corp.	68, 69
Benwood Linze Co.	355	General Cable Corp.	64, 65
Best Manufacturing Co., Inc.	313	General Cement Mfg. Co.	401
Birtcher Corporation	390, 401	General Control Co.	379
Blaw-Knox Co.	314	General Electric Co.	11, 12, 13, 14, 27, 58, 221, 272, 274, 335, 354, 377, 406
Biley Electric Co.	273	General Industries Company	251
Boonton Radio Corp.	392	General Instrument Corp.	85
Brach Mfg. Corp., L. S.	304	General Magnetic Corp.	320
Bradley Laboratories, Inc.	307	General Plate Div. of Metals & Controls Corp.	337
Brand & Co., William	303	General Radio Company	333
Bridgport Mfg. Co.	170	Giannini & Co., Inc., G. M.	398
Bud Radio, Inc.	358	Gibson Electric Co.	393
Burgess Battery Co.	198	Glendale Vacuum Products Co.	401
Burstein-Applebee Co.	401	Goodrich Co., B. F. Chemical Div.	410
		Gorrell & Gorrell	383
Callite Tungsten Corp.	23	Gothard Manufacturing Company	344
Cambridge Thermionic Corporation	393	Gould-Moody Co.	354
Capitol Radio Engineering Institute	362	Graphite Metallizing Corp.	380
Celanese Corp. of America	41	Grayhill	398
Cellusuede Products, Inc.	381	Greenlee Tool Co.	312
Centralab, Div. of Globe-Union, Inc.	30	Guardian Electric Mfg. Co.	195
Chace Co., W. M.	264	Guided Radio Corporation	316
Chicago Telephone Supply Co.	43		
Chicago Transformer Corp.	375	Hallicrafters Co.	49
Cinaudagraph Corporation	363	Hammarlund Mfg. Co., Inc.	6
Cinaudagraph Speakers, Inc.	392	Handy & Harman	366
Cinch Mfg. Corp.	145	Hardwick, Hindle, Inc.	202
Clarostat Mfg. Co., Inc.	294	Harris Products Co.	210
Cohn & Co., Sigmund	324	Harvey Radio Laboratories, Inc.	356
Cole Steel Equipment Co.	70	Haydon Mfg. Corp., Inc.	340
Collins Radio Co.	57	H-B Instrument Co.	377
Columbia Wire Supply Co.	316	Heintz & Kaufman, Ltd.	77
Communication Measurements Laboratory	184	Hewlett-Packard Company	327
Communications Company, Inc.	286	Hickok Electrical Instrument Co.	160
Conant Electrical Laboratories	282	Holliston Mills, Inc.	311
Concord Radio Corporation	373	Hunter Pressed Steel Co.	59
Connecticut Telephone & Electric Division of G. A. I.	345	Hytron Radio & Electronics Corp.	83
Connector Div. of International Resistance Co.	245		
Consolidated Molded Products Corp.	22	Ilg Electric Ventilating Co.	364
Continental-Diamond Fibre Co.	292	Indiana Steel Products Co.	325
Continental Machines, Inc.	179	Industrial Commercial Electronics	178
Cornell-Dubilier Electric Corp.	55	Industrial Condenser Co.	318
Corning Glass Works	74	Industrial Instruments	382
Cornish Wire Company, Inc.	230	Insl-X Co., Inc.	222
Cory Snow, Inc.	288	Instrument Resistors Company	396
Cramer Company, R. W.	395	Insuline Corp. of America	312
Creative Plastics Corp.	393	International Detrola Corporation	227
Cross, H.	401		
Dalis, Inc., H. L.	396		
Daven Company	Inside Back Cover		

**ESSEX**

**IRON CORE R.F. CHOKES**

- ◆ Physically compact
- ◆ High Q
- ◆ Available in standard inductances of .5 mh, 1.0 mh, 2.5 mh, 5.0 mh, 10 mh.
- ◆ Inductance tol.  $\pm 3\%$

Write for data sheet.

Precision manufacturers of all types of IF and RF coils, chokes, and transformers.

**ESSEX ELECTRONICS**  
1060 Broad St., Newark, N. J.



	Page
Stewart Mfg. Corp., F. W.	320
Sticht Co., Inc., Herman H.	304
Stokes Machine Co., F. J.	387
Struthers-Dunn, Inc.	38
Stupakoff Ceramic & Mfg. Co.	35, 239
Sun Radio & Electronics Co.	382
Super Electric Products Corp.	21
Superior Carbon Products, Inc.	399
Superior Electric Co.	317
Superior Tube Co.	287
Supreme Instruments Corp.	368
Suprenant Electrical Insulation Co.	366
Sylvania Electric Products, Inc.	200
Synthate Corporation	4, 5

Tech Laboratories	350
Technical Radio Company	343
Telex Products Co.	168
Templeone Radio Mfg. Corp.	278
Thermador Electrical Mfg. Co.	76
Thomas & Skinner Steel Products Co.	397
Thompson Corp., George S.	390
Tinnerman Products, Inc.	165
Transmitter Equipment Mfg. Co., Inc.	31
Traver Corporation	275
Triplet Electrical Instrument Co.	242
Tung-Sol Lamp Works, Inc.	296
Turner Company	188

Ucinite Company	190
Union Aircraft Products Corp.	330
Union Carbide & Carbon Corp.	203, 291
United Cinephone Corp.	204
United Electronics Company	18
United States Rubber Co.	359
United Transformer Corp.	Inside Front Cover
Universal Microphone Company	305
Universal X-Ray Products, Inc.	374
University Laboratories	378
Utah Radio Products Company	223

Valpey Crystal Corp.	336
Volkel Brothers Machine Works	328

Walker-Jimieson, Inc.	348
Walker-Turner Co., Inc.	306
Wallace Mfg. Co., Wm. T.	324
Ward Leonard Electric Co.	232
Ward Products Corporation	175
Warren Telechron Co.	357
Waugh Laboratories	75
Western Brass Mills, Div. of Olin Industries, Inc.	259
Western Electric Co.	60, 395
Western Felt Works	361
Westinghouse Elec. & Mfg. Co.	9, 45, 279, 301
Weston Electrical Instrument Corp.	250
Whitaker Cable Corp.	191
White Dental Mfg. Co., S. S.	312, 351
Whitney Blake Co.	267
Wilcox Electric Co., Inc.	281
Willor Manufacturing Corp.	332
Wilson Co., H. A.	52, 284

PROFESSIONAL SERVICES	400
-----------------------	-----

SEARCHLIGHT SECTION  
(Classified Advertising)

EMPLOYMENT	402-405
------------	---------

WANTED TO PURCHASE	402
--------------------	-----

USED EQUIPMENT

American Electric Sales Co., Inc.	402
Dealers Tool Supply Co.	402
Electro-Tech Equipment Co.	402
Iron & Steel Products Inc.	402

THE IMPORTANCE OF

*Specialization*

IS FORCEFULLY  
DEMONSTRATED BY

# Audax



Aside from outstanding and long-acknowledged technical skill — our “Specialization Formula” is probably as fully responsible for the world-renowned AUDAX quality as any other single factor.

We proudly concentrate all our energies and resources upon producing the finest pick-ups and cutters. Because we are specialists in this field, much more is expected of us. Because the production of fine instruments like MICRODYNE is a full time job, it stands to reason that we could not afford to jeopardize our reputation—EVER—by making pick-ups a side-line.

After Victory, you may expect further AUDAX improvements, refinements . . . master-touches to heighten the marvelous *fac simile* realism of AUDAX reproduction.

## AUDAX COMPANY

500E Fifth Avenue, New York 18

“Creators of Fine Electronic-Acoustical Apparatus since 1915”

*“The Standard  
by Which Others  
Are Judged and Valued”*



Send for complimentary copy of our informative  
“PICK-UP FACTS”

# SNW Wire Insulation made from GEON approved by Underwriters' Laboratories



**W**IRE insulation made from GEON has been approved by Underwriters' Laboratories for use in wet locations, eliminating the need for lead sheathing. Besides this advantage, GEON permits the use of thinner insulation and makes possible a smaller diameter wire—thus more conductors and more power per conduit. Other characteristics of GEON make possible an insulation which does not require a protective braid and which has superior all 'round long-time aging and electrical properties.

How's this for a test of an insulating material—*immersed in water for 106 days at 70 degrees C.* (This test conducted by Electrical Testing Laboratories, Inc.) Insulation made from GEON stood that test, and came out with its electrical properties practically unchanged!

SNW insulation made from GEON is flame resistant, too—it extinguishes itself, an added important property in wet locations where exposed connections increase the danger of short circuit and fire. Corrosive conditions are common in wet locations. But they have no effect on insulation of GEON which resists the action of acids, alkalis,

oil, greases, mildew, heat, cold and many other normally destructive factors.

Urgently needed for military uses, all the GEONS are subject to allocation by the War Production Board. Our development staff and laboratory facilities are available to help you work out any special problems in connection with essential applications. For more complete information write Department FF-5, Chemical Division, The B. F. Goodrich Co., 324 Rose Building, Cleveland 15, O.



**CHEMICAL DIVISION**  
**The B. F. Goodrich Company**  
324 ROSE BUILDING • CLEVELAND 15, OHIO

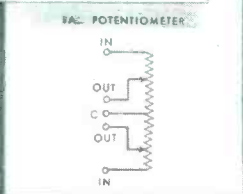
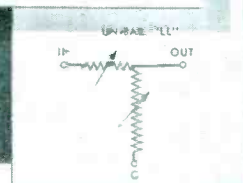
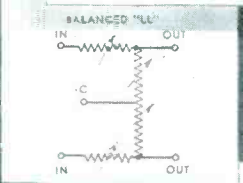
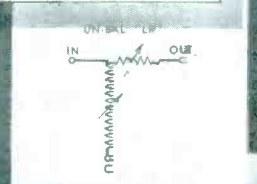
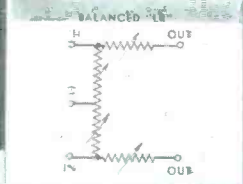
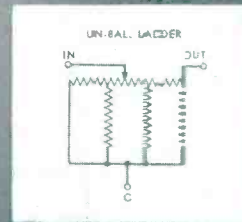
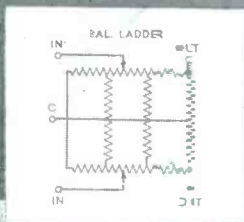
# DAVEN

## ATTENUATORS

The many different networks (illustrated) and the wide selection of characteristics variations comprising the standard lines of DAVEN attenuators, are features of great convenience to the engineer—in Radio Broadcasting, in Sound Recording, Sound Projection, in Television and in the Laboratory Equipment field. Likewise, advanced designing as embodied in recent DAVEN announcements, plus a long standing reputation for making a good product, are facts that merit consideration in your present and post-war plans.

### Balanced Circuits

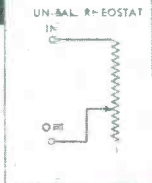
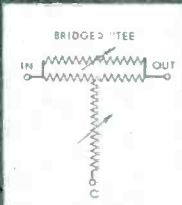
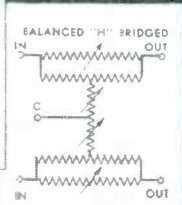
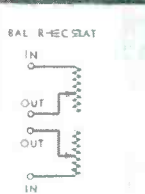
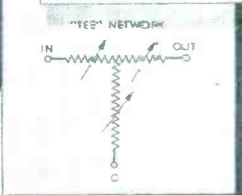
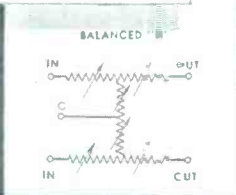
### Unbalanced Circuits



**BETTER DELIVERIES**  
 Several standard types of DAVEN Attenuators are available in moderate quantities for prompt deliveries. 30 to 60 day delivery is being made at this time on many other standard and some special types.

**THE DAVEN COMPANY**  
 191 CENTRAL AVENUE  
 NEWARK 4, NEW JERSEY

BUY MORE... HOLD MORE... WAR BONDS



57- Collins ad ART-13

**DESIGNING TELEVISION, FM,  
OR SHORT-WAVE EQUIPMENT?**

119- BC-654, BE-611 jungle photo

# **RCA PREFERRED-TYPE METAL TUBES**

## **CAN BE A BIG HELP TO YOU**

197- BC-654 photo  
285- KAAR 10/11 radiotelephone set



• Intrinsic features of RCA Preferred-Type Metal Tubes offer many advantages to set-designers.

Because metal tubes are little affected by stray fields, you get greater flexibility in mechanical layout, resulting in compact, stable circuits, which are economical to manufacture and easy to service.

Other features are simplified grounding through the No. 1 socket terminal; standard octal base, sturdy appearance, and wide acceptance among designers and servicemen. And there are 55 types from which to choose. A substantial number of these were on the prewar RCA Preferred-Type list, and many are sure to be retained on the postwar list.

First to manufacture metal tubes, RCA has introduced over 90% of the metal types now available—and has built more than 150,000,000 metal tubes since 1935.

If you have a design problem involving receiving tubes, investigate RCA Preferred Types—metal, glass, or miniature. RCA tube-application engineers will be glad to help. Write to RCA, Commercial Engineering Section, Dept. 62-30E, Harrison, N. J.

THE FOUNTAINHEAD OF MODERN TUBE  
DEVELOPMENT IS RCA

BUY MORE WAR BONDS



62-6136-30

**RADIO CORPORATION OF AMERICA**

RCA VICTOR DIVISION • CAMDEN, N. J.