

electro

radio, communication, industrial applications of electron tubes •

McGRAW-HILL
PUBLISHING COMPANY, INC.

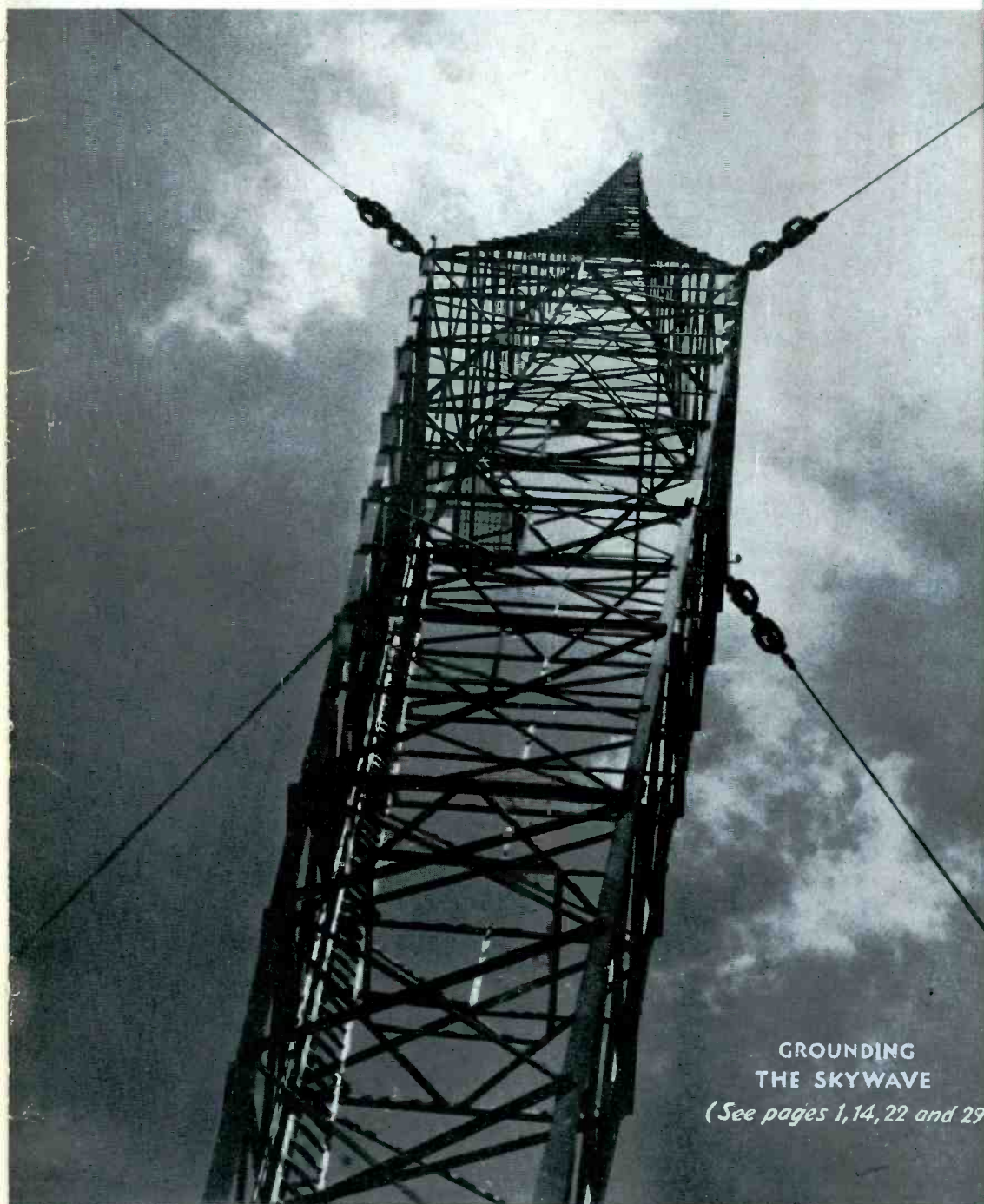

GROUNDING
THE SKYWAVE
(See pages 1, 14, 22 and 29)

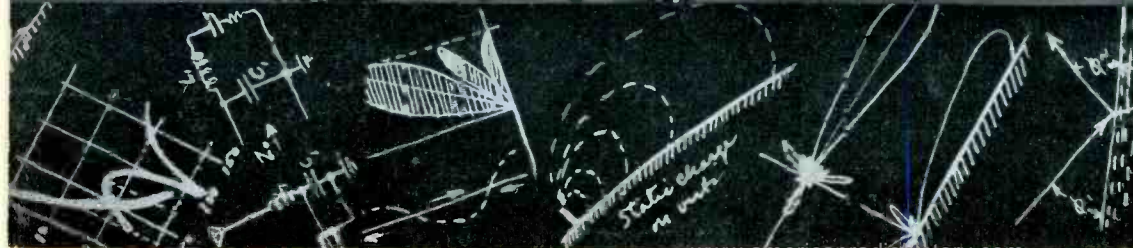

LEADERSHIP IN QUALITY

AMPERITE

Velocity

MICROPHONES

NATIONWIDE PERFORMANCE HAS ESTABLISHED THE AMPERITE VELOCITY AS THE FINEST ALL-AROUND MICROPHONE. HAS WIDEST ANGLE OF PICKUP WITHOUT FREQUENCY DISCRIMINATION. FOR FIDELITY AND QUALITY IT IS UNEXCELLED. REGARDLESS OF PRICE. SEE FREE TRIAL OFFER.

FOR STUDIOS

High fidelity. Accurate definition. Natural brilliance. No background noises. No peaks. Can be placed up to 2000 feet from the amplifier without appreciable loss. Frequency response 30 to 14,000 C.P.S. Output, -64 db. (open line); -90 db. when using input transformer (100,000 ohms secondary.) Hand-hammered ribbon not affected by even a 40-mile gale. Available also in High Level Model SR-80H, which operates directly into grid of tube. New design permits running 1/4" cable up to 125 feet.

MODEL SR-80

VERSATILE!

The SR-80 permits perfect reproduction for all conditions. When vertical, it has widest angle of pickup without frequency discrimination. Through a very narrow angle (X in the diagram) the Amperite Velocity has zero pickup, which can be used to eliminate undesirable noises. For 360° pickup, simply lower the microphone and tilt until parallel to floor.

List Price (SR-80 or SR-80H) ... \$80.00. Call Letter Plate. List \$5.00



* Diagram shows angle of pickup without frequency discrimination of various types microphones.

FREE TRIAL!

You are invited to conduct a TWO WEEKS' FREE TRIAL of our microphones and accessories. No deposit. No obligation whatever. All we ask is that you make the test exhaustive. Then decide whether you want to keep the microphone or return it. Behind this FREE TRIAL offer is the conviction that Amperite offers the finest microphones available today, regardless of price. High fidelity reproduction of speech and music... Perfect definition of instruments in ensemble work... Dependability... Ruggedness... All these qualities are guaranteed!

AMPERITE MICROPHONE STANDS

The very latest in scientific design and construction, they feature...

1. POSITIVE CLUTCH. Does not "creep" or require adjustment. Will not wear out. Tightens with only one-eighth turn. Microphone can be rotated without loosening clutch.
2. QUIK-GRIP THREAD. Requires only 1 1/2 turns to fasten microphone.
3. SAFETY CORD. Stretches, preventing accidental mishaps.

Model FS-25M—List \$32.00

AMPERITE Company 561 BROADWAY NEW YORK
Cable Address: Alkem, New York

FOR ANNOUNCING MODEL RB-M

This microphone, having no peaks, gives perfectly lifelike reproduction. Does not tire the listener. Eliminates acoustic feedback in P.A. work. Available in High Level Model RB-H, which operates directly into grid. LIST PRICE, RB-M or RB-H, \$42.00.



NEW AC (OR BATTERY-OPERATED) PRE-AMPLIFIERS

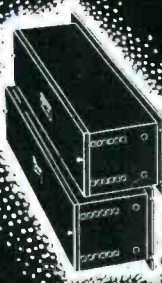

1. Frequency response—30 to 12,000 CPS (±1 db.)
2. Gain, 76 db. (two stages), 98 db. (three stage line amplifier).
3. Hum level, -90 db.
4. Input—50,200, high impedance. Output—200,500, high impedance.
5. Condensers—paper condensers used in power supply.
6. Transformer coupled—highest grade nickel alloy core used.
7. Mounting—can be used for table or rack mounting.
8. New metal tubes used.

VELOCITY

AMPERITE

MICROPHONES

A COMPLETE LINE—FILLING EVERY BROADCASTING NEED!

April 1936 — ELECTRONICS

ELECTRONIC

radio, communication and industrial applications of electron tubes . . . design,

HOWARD EHRLICH
Vice-President

KEITH HENNEY
Editor

DONALD G. FINK
Associate Editor

Contents • April 1936

COVER: *The tower at WBNS, Columbus, framed in "telephone relating to antenna design, from the hand of E. A. Laport*

PAN AMERICAN RADIO 7

The world's widest aircraft radio service, including long-range direction finders for Trans-Pacific use

GERMAN SET PRODUCTION 11

Unusual methods in the Siemens and Halske plant, Berlin, where sets are acoustically tested in separate booths

COMMUNICATIONS IN WALL STREET 12

BY PHILIP C. BENNETT

The intricate network of ticker and news service has grown to huge proportions

THE "TURNSTILE" ANTENNA . . 14

BY GEORGE H. BROWN

An u-h-f radiator which "pancakes" the wave equally in all horizontal directions, avoiding directional effects

THE BEAM POWER TUBE 18

BY JOHN F. DREYER, JR.

A new and startling tube design gives high power sensitivity, 60 watts output in push-pull

DIRECTIONAL ANTENNA

BY E. A. LAPORT

Simplified methods of calculating vertical signal patterns for

PORTABLE SOUND MEASUREMENTS .

BY C. ALBIN ANDERSON

An oscillator provides a standard noise-meter registers after frequency noise deadening material used

LOWER NOISE IN DISC

A new material and recording method by Captain R. H. Ranger reduces noise level 15 db below previous attempts

DIRECTIONAL RADIATION PATTERNS

BY A. JAMES EBEL

Thirty-five patterns of the radiation distribution of two-element array in chart form

TUBE-CONTROL OF A

BY J. D. RYDER

Practical circuits for speed control of small motors, using control type tubes

DEPARTMENTS

| | | |
|------------------------------|----------------------------|---------------|
| CROSSTALK 5 | NEW BOOKS 34 | ELECTRONIC |
| REFERENCE SHEET 29 | TUBES AT WORK 36 | MANUFACTURING |
| PATENTS REVIEW 56 | INDEX TO ADVERTISERS | |

VOLUME 9 . . . NUMBER 4

Contents Copyright, 1936, by McGraw-Hill Publishing Co.

ELECTRONICS, April, 1936. Vol. 9, No. 4. Published monthly, price 50c. a copy. Subscription rates—United States, \$5.00 a year. Latin America, \$5.00 a year. Canada, \$5.00 a year. All other countries, \$6.00 a year or 24 shillings. Entered as second-class matter April 4, 1930, at Post Office at New York, N. Y., under the Act of March 3rd, 1879. Printed in U. S. A.

Branch Offices: 520 North Michigan Ave., Chicago; 883 Mission St., San Francisco; Aldwych House, Aldwych, London, W. C. 2; Washington; Philadelphia; Cleveland; Detroit; St. Louis; Boston; Atlanta, Ga.

McGraw-Hill Publishing
330 West 42d Street, New York

JAMES H. MCGRAW, JR.
Chairman

HOWARD EHRLICH
Vice-President

MALCOLM MUIR
President

B. B. PUTNAM
Treasurer

Cable Address: MCGRAWHILL, New York. Memb

Why INSULATED Resistors?

From a manufacturing viewpoint, INSULATED resistors are pre-eminent and preferred because they permit easier assembly . . . cut down rejects to a minimum and thus assure lower assembly costs. From the viewpoint of the radio dealer, insulated resistors result in fewer field troubles due to resistors shorting to other parts of the set.

Only

STACKPOLE INSULATED RESISTORS HAVE THESE DISTINCTIVE ADVANTAGES

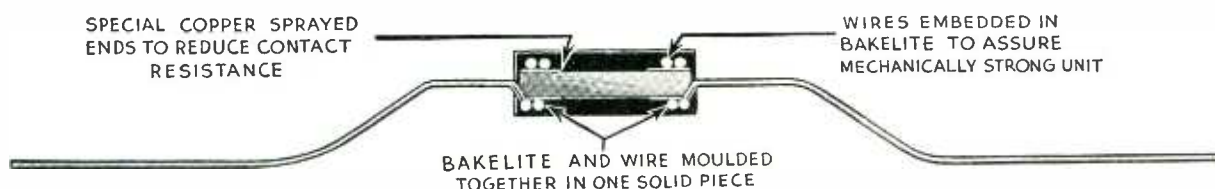

- ONE STANDARD SIZE — namely $\frac{5}{8}$ " x $\frac{13}{64}$ " entirely sufficient to dissipate $\frac{1}{2}$ watt continuously without affecting resistance value.
- ONE SINGLE SIZE RESISTOR capable of meeting a very large percentage of your requirements.
- No possibility of loose or corroded connections because Bakelite and Wire are molded together in one solid piece. (See illustration above).
- The Stackpole resistance element is encased in Molded Bakelite, thus insuring a mechanically strong unit unaffected by humidity and other external effects.

Add up all these Stackpole advantages and you can see why so many are standardizing their stock with Stackpole—the standard of quality and uniformity.

Write for samples today—see for yourself the economical advantages of standardizing your sets with the new Stackpole Insulated Resistors.

STACKPOLE CARBON COMPANY
ST. MARYS, PA.

It can't happen to ...with S

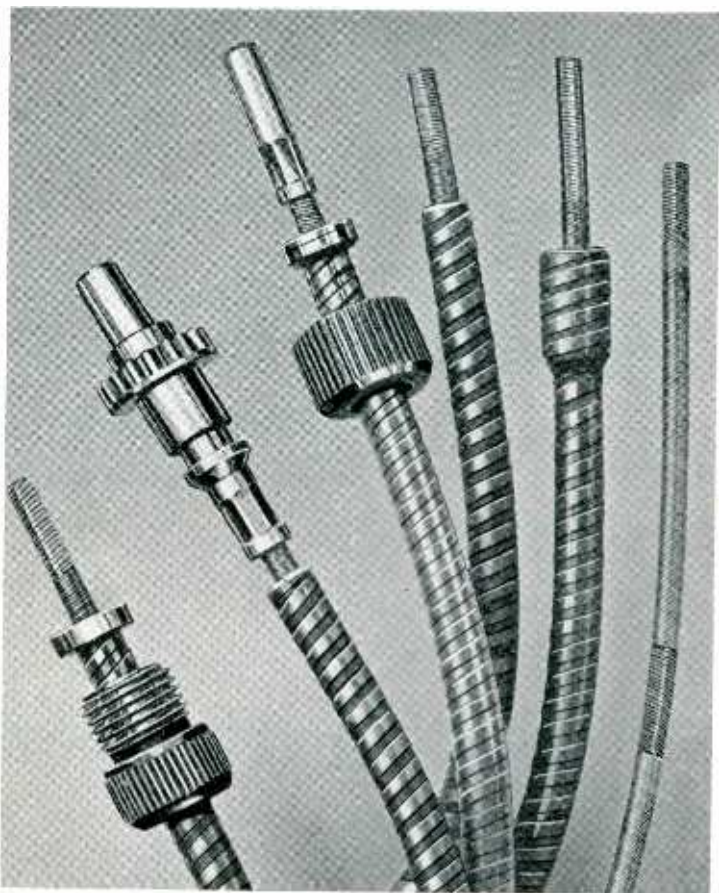

Shown above from left to right, actual size:

1. Shafting ends swaged accurately square for square hole, collet, or set-screw attachment; Casing with integral formed flange and male nut.
2. Conventional die-cast geared end fitting on shaft; Casing with plain end.
3. Conventional machined end fitting swaged on shaft; Casing with integral formed flange and female nut. We are prepared to make machined ends to specifications.
4. Shafting with regular square swaged end ready for attachment of end fitting; Casing with plain end.
5. Shafting with ends octagonally swaged for easy calibration of control unit, condenser or volume control; Casing with integral enlarged end.
6. Shafting with one or more intermediate square swages for cutting to length in the field.

as you
supply

The busy sea
radio manu
will soon be l

What a calam
rush period
because you
mote contro
or if shaft o
get deliverie

But there's
these calam
S. S. WHITE

S. S. WHITE
resources, w
demands, a
on the dot a
respect.

Would of Sha

*We'll be glad
.150" and
shafts and c
veloped for
sally used.
letterhead u
working on
would like
we'll be glad
Write us.*

The S.S. WHITE Dental Mfg. Co. INDUSTRIES

10 East 40th St., Room 2310E, New York, N

YAXLEY 3100 TYPE SWITCH

Circuit Combinations from

1 circuit 12 points
to
4 circuits 3 points
and
1 circuit 18 points
to
6 circuits 3 points



**SMALL
SWITCHES
with
LARGE
SWITCH
Performance**

Experience gained in making

5,000,000
all-wave switches is

behind this advanced **YAXLEY** development

Experience is a great teacher—and the experience of the Yaxley Manufacturing Division of P. R. Mallory & Co., Inc., is outstanding in its field. So are the product innovations developed on the basis of this experience—and the Yaxley 3100 Type Switch is typical of Yaxley contributions to the advancement of radio performance, construction and design.

Engineered for short wave, tone control and tap switch applications the Yaxley 3100 Type Switch provides small size and compactness—extreme circuit flexibility—low capacity—low resistance! It yields a long, quiet life! Its capacity from rotor to grounded shaft and shell is of the same

order as that of larger, more expensive switches. A newly-designed indexing feature, entirely separated from switch circuits, provides positive action.

Yaxley 3100 Switches are available in single gang and in two sizes—one with a base $1\frac{1}{4}$ " in diameter, the other with a base $1\frac{1}{16}$ " in diameter. They are made in shorting or non-shorting types, supplied with or without AC line switch attachment—or with special modifications to meet particular needs. A special Engineering Data Folder gives the complete details of the Yaxley 3100 Type Switch. Radio engineers and set manufacturers will find it well worth reading. Write for a copy today.

YAXLEY MANUFACTURING DIVISION



of P. R. MALLORY & CO., Inc.
INDIANAPOLIS INDIANA

CABLE ADDRESS—PELMALLO



ELECTRONIC

APRIL
1936



KEITH H.
Editor

Crosstalk

► **I. R. E. AT CLEVELAND . . .** The Eleventh Annual Convention of the I. R. E. will be held next month, May 11, 12, 13, at the Statler Hotel in Cleveland. With an expected attendance of over 700 and a showing of 40 exhibitors, the convention promises to be the high spot of the I. R. E. Year. Monday and Tuesday will be occupied with registration and the presentation of papers. On Tuesday afternoon a trip will be made through the Lamp Development Laboratory of the General Electric Company (formerly known as Nela Park), including an inspection of laboratories not normally open to engineering visitors. The banquet, on Tuesday evening, will feature the awarding of the Institute prizes for distinguished work in radio. The program of papers had not been released at the time of going to press, but will be published in the next issue.

► **FLOODS AND FIVE METERS . . .** The excellent work done by amateur radio operators during the recent floods has been so well publicized, and deservedly, by the daily press that there is little by way of commendation we can add. But the story of the way Hartford was organized has considerable technical, as well as human, interest. When the flood singled out Hartford it came right to the door of organized amateur radio and the staff at A.R.R.L. headquarters had a ready-made emergency to play with. Equal to the situation, the boys organized a five-meter network extending over Hartford and, while all commercial communications in the city except two overloaded telegraph lines were out, relayed a steady stream of traffic, for the Red Cross, government departments, and the public utilities who were laboring to restore power service. The exceptional adaptability of five meter equipment to such conditions was proved once and for all. Portable, capable of operation on dry batteries or from automobile batteries, simple to

operate, free from interference (except from a few superregenerative receivers), and widely distributed throughout the city, the equipment was just what the situation called for. The saving of lives and property, to which the much-maligned transceiver contributed so much, should not be forgotten.

► **BEAM TUBES . . .** The new beam power tube, described in this issue, appears to be the pioneer member of a new tube dynasty. For several months it has been apparent that the beam-technique of the cathode-ray tube could be of fundamental value in detector-amplifier types if properly applied. Developments in Europe, the cathode-ray tuning indicator, and Professor Hazeltine's disclosures have already pointed to that end. Now the new 6L6, an output tube whose exceptional characteristics depend on a space-charge region created by electron beam control, makes its appearance. Although it is much too early to make predictions it seems likely that the design of this new tube represents an avenue of approach which may well be used to correct many of the faults of existing types. If this be true we can expect in the future a new group of types and type-numbers with which to confuse the tube user. But if the improvement offered by these new tubes is as great as that of the beam power tube, each new number will be as welcome as "6L6."

► **GRAHAM TO HORLE TO GRAHAM . . .** While commercial communications were failing at all sides in the Pennsylvania flood disaster, Virgil Graham of Hygrade Sylvania was at Emporium, waiting to hear from a New York hotel about his reservations for the S.A.E.-R.M.A. Committee Meeting on Automobile Interference. While waiting he bethought himself of amateur radio, and so it came to pass that L. C. F. Horle in New York received a ham radiogram asking for a check-up on the hotel situation. The answer, likewise

via
in p
me
R.M
the
For
Gra
ign
For
and

► A
scie
the
by
Art
whi
eng

T
sou
con
rece
equ

T
Bro
dep
in
mat
acce

T
for
equ
flut
film
the
sour

T
Sou
tion
cutt
area
in t
rece

► V
193
tion
wat
637
4216

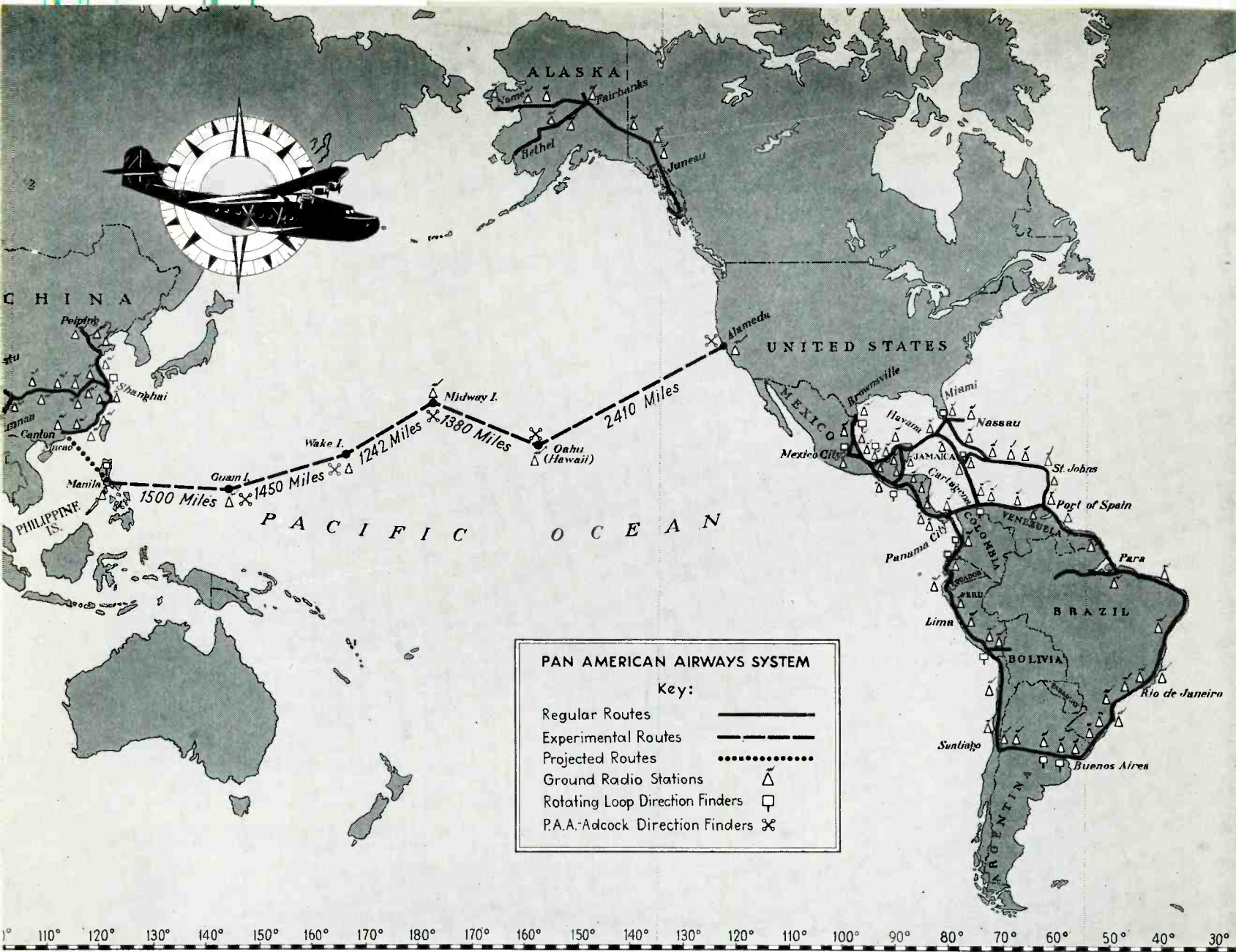

Radio for the P. A. A.

The world's widest aircraft radio service is maintained by the Pan American Airways. Complete transmitting and receiving equipment in 127 land stations, 138 planes, and 22 radio compass direction finders keep this vast system "on schedule"

Flying the Pacific by Radio

In the latest application of radio's oldest service, Pan American has developed a ship-to-shore radio service of huge proportions, including the *Clippers* to the Philippines

If the achievements in the Pacific of the *China Clipper* and her sister ship the *Philippine Clipper* are any indication, it seems that the next major achievement in air transportation will be regular trans-oceanic service. When this service becomes an accomplished fact, the lion's share of the credit must go to the Pan American Airways System, and no small part of this credit must be assigned to the engineers, in the Communications Division of the company, who designed and installed the radio equipment. For without radio for communication and navigation, long distance flights over water would be so hazardous that no regular (or irregular) service could possibly be maintained.

To those interested in the advance of radio technique, the methods used in the Pan American System, and the story of their development, are worthy of close attention not only because they have demonstrated that radio is indispensable to trans-oceanic flying, but also because of the straight-forward manner in which the problems were attacked and solved.

The ships of the Pan American System fly over routes between the United States and foreign countries. Regular service is now maintained in North, Central and South America, in Alaska, China, and experimentally over the Pacific, connecting California with Hawaii and the Philippines. Such a wide-spread service meets almost every conceivable kind of atmospheric and climatic condition known to radio. In addition, the flights are long, and many of them are over stretches of water, so that terminal stations must be widely separated. As might be guessed, setting up a radio service having the required reliability and simplicity for such an aviation service was not a simple job. It took, in fact, more than seven years to bring the radio facilities of the system up to their present state.

To main were tion tion conce muni distar tions. weigh and grou be us the e muni etc., h the sp The direct single tance suitaf tance

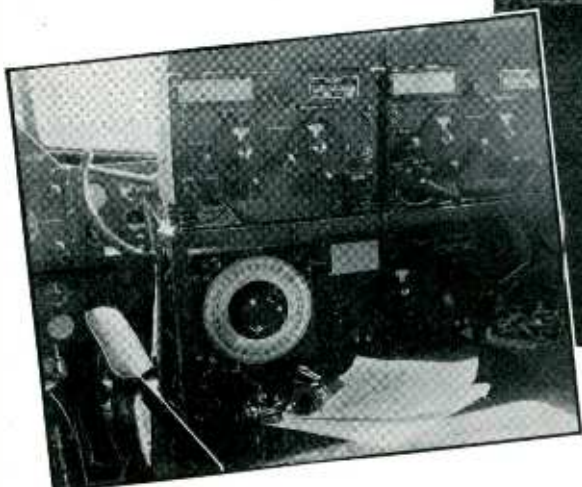

The *China Clipper*, the *Martin* flying boat which made the first trip from California to the Philippines and return. In insert, the radio operator's position in the *Clipper*, showing two receivers and the goniometer dial below them

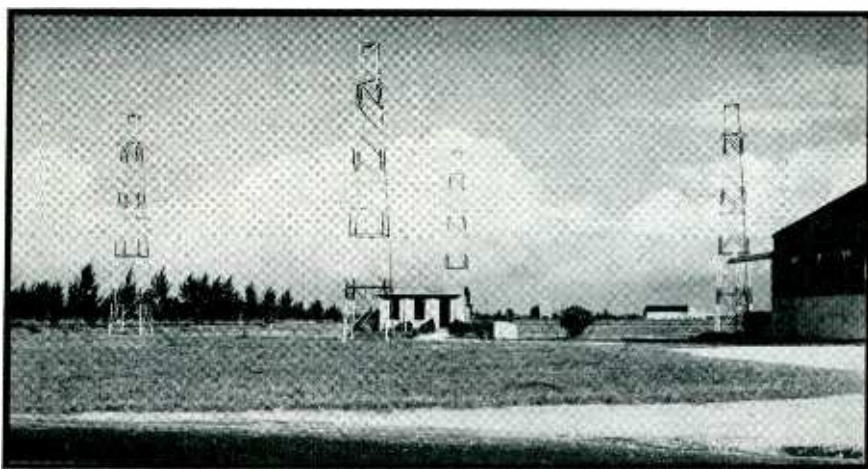

The towers of the ground station at the Miami terminal. The small shack houses the transmitter equipment, which is remotely controlled from the operating room

able, but it was necessary if trans-Pacific flights were to be made. Since it was not available, it had to be developed, and developed it was. This little known achievement of the Pan American engineers has never received the attention it deserves, and although complete details are not available, the description given below will indicate the means by which long-distance direction finding has been made possible.

The Communication Equipment— Ground Stations

The Pan American System maintains 127 ground stations. These stations operate on three frequencies for communication use: 3082.5 kc. (99 meters), 5165 kc. (58 meters), 8220 kc. (36.5 meters); and on 1638 kc. (183 m.) for direction finding bearings. These frequencies were chosen as being suitable for low-power work (the input to the plane transmitters does not exceed 70 watts) over long distances and they provide a sufficient variety to avoid skip distance and its variations with the season and the time of day. The power of the ground station transmitters varies with the intended service. For local service and weather reporting, 15 watts is used. For other services there are four other sizes, 100, 200, 350 and 900 watts, the latter being used on the long haul (1,000 miles or more) work.

Crystal control is used in only four of these ground stations, at Alameda (California), Miami, Brownsville (Texas), and Rio de Janeiro; all others employ the master-oscillator, power-amplifier type. Crystals are not used in the interest of technical simplicity. The equipment must be serviced under a wide variety of conditions, and in foreign countries especially only the simplest design can be permitted. The m.o.p.a. transmitters are of

A rotating loop direction finder, installed at Miami, which supplies bearings to the pilots in flight

rugged design, and provide all the necessary frequency stability.

Half-wavelength doublet antennas are used at the ground stations, although directional rhombic antennas are now under consideration for long-distance point-to-point service, as between California and Hawaii.

All of the radio equipment throughout the system is code operated. Many tests made early in the development program showed conclusively that telephone communication could not be depended on over the long distances and severe conditions of static encountered in the service. The use of c.w. means specially trained operators, and has led to the formation of a training school operated by the company, an engineering degree being required for entrance to the course. All those who operate the radio equipment possess at least a second-class radiotelegraph license. One of the great advantages of the use of code transmission is the fact that it involves written records, which are filed after each flight. These records are invaluable in maintaining efficiency and tracing the cause of trouble.

The duties of the operator vary according to the route flown. In Alaska a one-man crew is used; this man must pilot the plane and operate the radio at the same time. In the trans-Pacific service, on the other hand, a crew of from five to seven persons is carried, and duties of piloting, navigation, and radio operating are divided among them. Each man in the crew is capable of handling the job of any of the others should the need arise.

Equipment in the Planes

The standard receiver used in the planes is distinguished by its wide frequency range (250 kc. to 25 mc.), its light weight (6 pounds) and its simplicity of design (seven plug-in coils, in an untuned r-f, regenerative detector, and two-stage audio circuit). A flash-light bulb (one for each tube) inside the receiver case lights when a tube filament burns out, so that the operator can replace the defective tube with the least possible delay.

The transmitters used in the plane are of the m.o.p.a. type and operate from a dynamotor having a maximum voltage of 600, which originally provided a maximum power input of

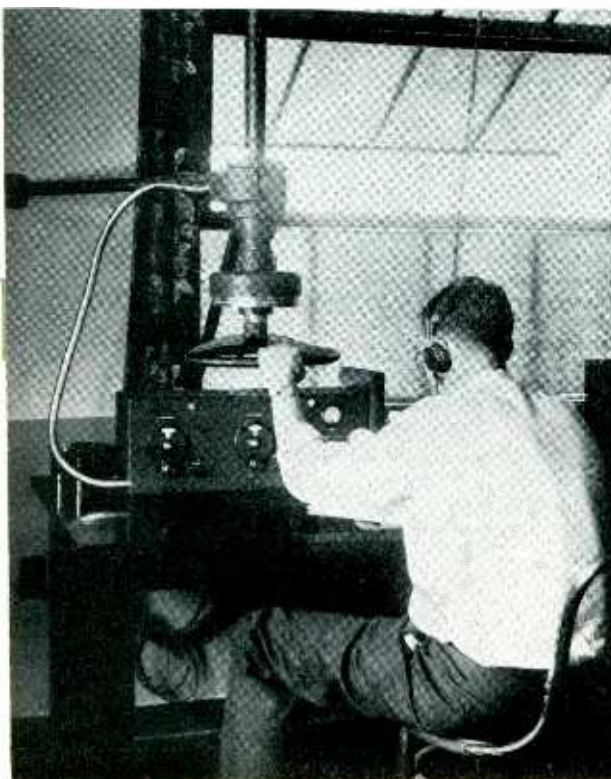
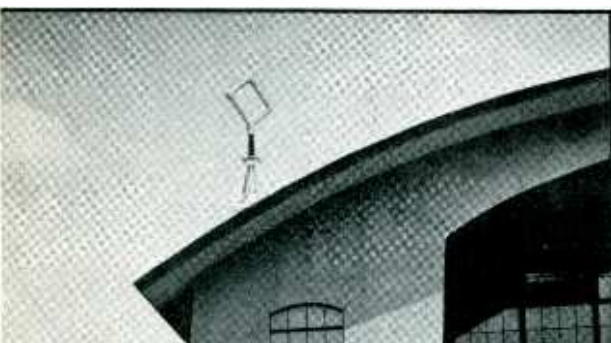

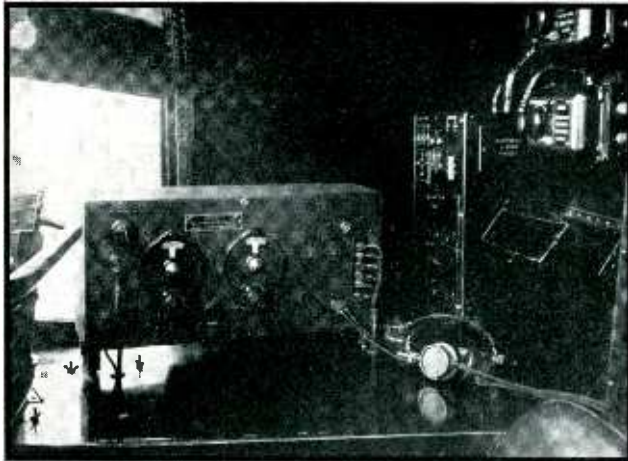

Two views of the equipment in a Sikorsky plane. The receiver, key, power switches and battery chargers are directly under the operator's control. The transmitter is remotely controlled

35 watts. By reduction of this voltage to 450 volts, the power input was reduced from 35 watts to 18 watts, which is sufficient for practically all purposes except long distance work on the lower frequencies. The plane transmitter has a wide frequency range, from 250 kc. to 8,500 kc., permitting contact with marine transmitters operating on 600 and 900 meters, in addition to the standard frequencies given above. When operating at low frequencies, the antenna power is only 5 watts, so a push-pull power amplifier operated on 600 volts is used to increase the input power to 70 watts maximum, commonly operated at 50 watts. This power rating has been found entirely satisfactory not only for communication but for sending the signals on which directional bearings are taken. Trailing antennas are used in the smaller ships, but on the Clippers both fixed and trailing antennas are available, so that the radio can be used when the ship is on the water.

Operating Procedure

It was found necessary to set up rigid procedure by which all radio communications are carried out at all times. For example, there is a regular schedule of contact between planes and ground, the number of contacts per hour depending on the speed of the plane. At 100 miles per hour contacts are made every 15 minutes, that is, every 25 miles. When operating a Douglas high speed plane, contacts are made every 7½ minutes, in order to localize the region of contacts to within plus or minus 25 miles. If one of these compulsory contact periods is



The main operating room through which all traffic and direction bearings of the Miami terminal are cleared

omitted by the pilot or radio operator, he is held strictly accountable for the omission, and must explain it satisfactorily. If the apparatus has been at fault, a service crew is taken aboard the plane and the apparatus tested while in flight, to ascertain trouble, after which it is corrected. The frequency used for any one transmission depends, of course, on the distance to be covered, the season, the latitude, and the conditions of daylight and darkness over the transmission path. The frequency used is at the discretion of the radio operators in the plane and at the ground station and can be changed to fit the conditions at the moment.

Radio Direction Finding Apparatus

The importance of radio direction finding in trans-oceanic flight service

is well exemplified in the hop made by the Pacific Clipper planes from Oahu (Hawaii) to Midway Island. Midway is a strip of land only ten miles long, and it is 1,380 miles distant from Hawaii. Even under perfect conditions, this represents an almost infinitesimal target; it corresponds roughly to flying from Des Moines to Manhattan Island, without benefit of landmarks, and it requires coming *within sight* of the final destination. To achieve this sort of performance it is essential that the pilot be able to determine his position from time to time, and to correct for any side-drift or deviation which may have thrown the plane off course. Because of the high speed of flight, these position bearings must be taken often and rapidly, if deviations are to be detected before the plane is many miles off course.

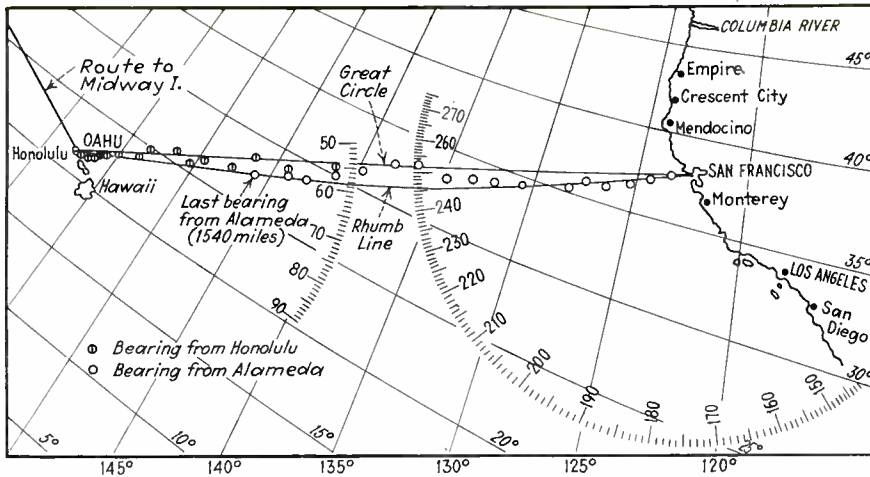

Course chart of a flight made early in 1935. The crossing between California and Hawaii took slightly over 17 hours, and was checked by 32 radiocompass bearings, which gave positions indicated by the dots

All manner of devices are provided in the Clipper planes to aid in position finding. The most self-sufficient means is the sextant, similar to that used on shipboard. But the sextant depends upon a clear sky in order that bearings on the sun or stars may be made, and in addition, the necessary calculations consume valuable time, and are subject to error. For this reason, the sextant cannot be depended upon except under favorable circumstances. Even under favorable conditions, a flight made solely by sextant and compass would be sufficiently hazardous to prevent a regular and safe service. It must be remembered that in flying to an objective like Midway Island, an error of only ten miles in 1,400, or less than half of one degree in bearing, may mean the plane is lost.

What is needed is a sure-fire direction finding scheme which will lead the plane away from its point of departure and toward its destination. This function is fulfilled by stationary radio compass direction finders, situated at the ground stations in California, Hawaii, Midway, Wake Island, Guam and Manila, for the trans-Pacific route, and in several other locations for other routes. Such "homing" compass equipment is not new in itself, having been used in aviation for several years (see *Electronics*, October, 1935, page 7), but its range has been limited to not more than a few hundred miles. To be useful in the hop from California to Hawaii, the range of such equipment must be at least 1,200 miles (the total distance being 2,400 miles). The Pan American d-f (direction finder) equipment

has a range of 1,800 miles, making possible complete coverage of a course 3,600 miles long. To anyone familiar with direction finding equipment this range is little short of marvelous. It has been achieved by the use of the Adcock system, with improvements devised by Pan American engineers.

The P.A.A.-Adcock Direction Finders

In the system used by Pan American, the direction finding equipment is located at ground stations. These stations receive an ordinary c.w. signal from the plane in flight (on any frequency between 6,000 and 250 kc.), determine the direction from which the signal is coming, and radio the bearing to the plane. The pilot, on receiving two such bearings from two separate direction finders, can plot the bearings on a map in the cockpit. The intersection of the two lines then gives the position of the plane at the time the d-f bearing was taken. The bearings are received not only by the plane, but by all ground stations involved, and separate maps of the flight are kept by each station, providing a check on the trigonometry of the pilot. The time consumed in making the bearing and radioing it to the pilot varies from one-half to two minutes. In a typical flight from California to Hawaii, 48 such bearings are taken, together with about six sextant determinations. The procedure is usually repeated at stated intervals of from ten to twenty-five minutes. By this means, the pilot can plot his position accurately along the entire route without reference to land-

marks, compass or sextant. The accuracy of bearings, even at 1,000 miles, is better than $1\frac{1}{2}$ degrees. The "night effect," which makes the ordinary loop direction finder completely useless at this distance, has only a minor effect on the P.A.A.-Adcock system.

In flying from California to Hawaii, (see figure), the Adcock d-f at Alameda retains control until the ship has reached the half-way mark, although bearings from Hawaii can be obtained by the pilot long before this point is reached. After the half-way point is passed, the Hawaiian Adcock takes control and leads the ship to Oahu. From Oahu to Midway the procedure is the same, the Adcock at Midway taking control when the ship has reached the half-way mark, and so on until Manila is reached. Some of the land stations are also provided with "loop" direction finders of the Kruesi and Bellini-Tossi type, but they cannot be used except over comparatively short distances during daylight hours. The large Clipper ships are also fitted with loop-type finders (Bellini-Tossi crossed loops) which may be used in emergency and as a check on the Adcock system.

The great range and high accuracy of the Adcock system compared with the loop-type d-f is explained as follows: The signal from the plane undergoes changes of polarization when it is reflected from the Heaviside layer. These changes, which are especially pronounced at sunrise, sunset, and during night hours, give rise to horizontally polarized components in the wave which distort the apparent direction of the wavefront. The loop system does not eliminate the horizontal components and hence gives widely varying bearings as the polarization changes. The Adcock system, on the other hand, uses four crossed and balanced dipole antennas in place of the loop. These dipoles, when properly balanced, do not pick up any of the horizontally polarized energy; the vertical energy which remains gives the bearing with great accuracy. A high degree of balance, which must be independent of ground conditions, is necessary if the Adcock system is to remain stable, but this requirement has been met in specially designed lead-in and coupling circuits exclusive with the Pan American system.

German Set Production

Unusual methods used in the Siemens and Halske Plant, Berlin



Above, the chasses are individually calibrated to agree with the tuning dial indicators. The coarse adjustment is made by headphones, the exact adjustment by means of output meters (to right of each operator)

Right, behind the windows in the white wall are 20 sound-proof booths to which the completed receivers are sent for acoustical tests before shipment. The conveyor belt carries the "passed" units to the shipping room



Above, small fixed condensers used in the receivers are made by sputtering a thin film of silver on a small piece of mica. The condenser thus formed is placed in a capacity bridge and "cut" to the exact required capacity by scraping the silver away. A breath-shield made of celluloid prevents moisture from affecting the measurement

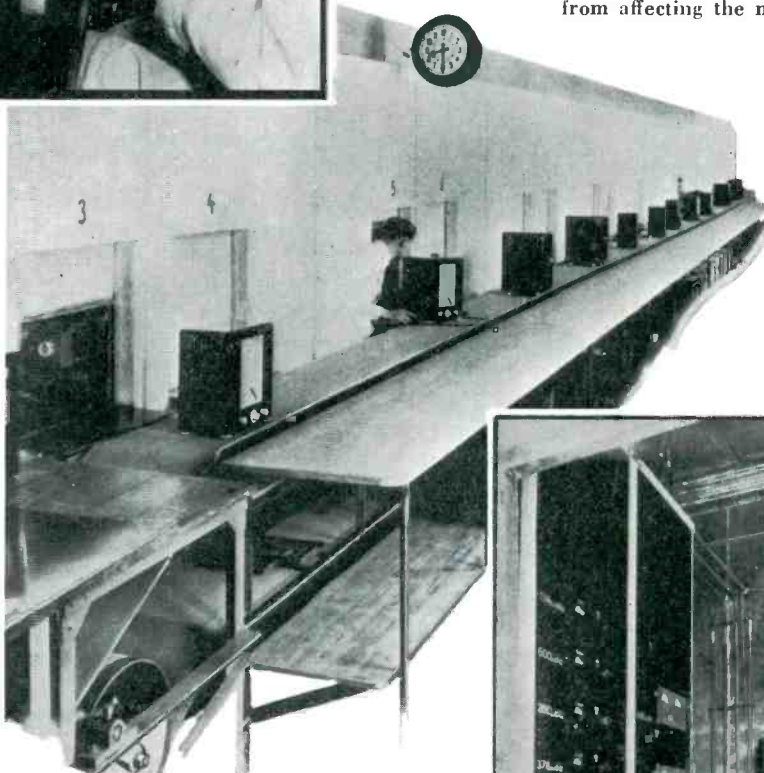

Below, sixteen signal generators, each crystal controlled, supply frequencies from 182 kc. to 1,314 mc. for test purposes. Mounted in racks in a copper-lined room, these miniature broadcast stations supply test signals to various parts of the plant

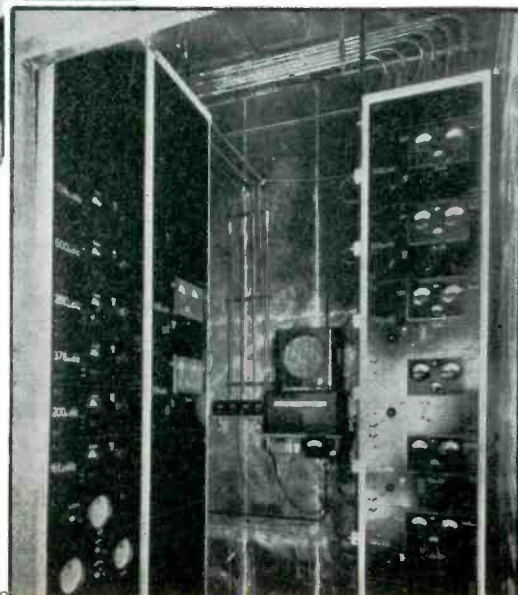

"Bid and Asked" Communications

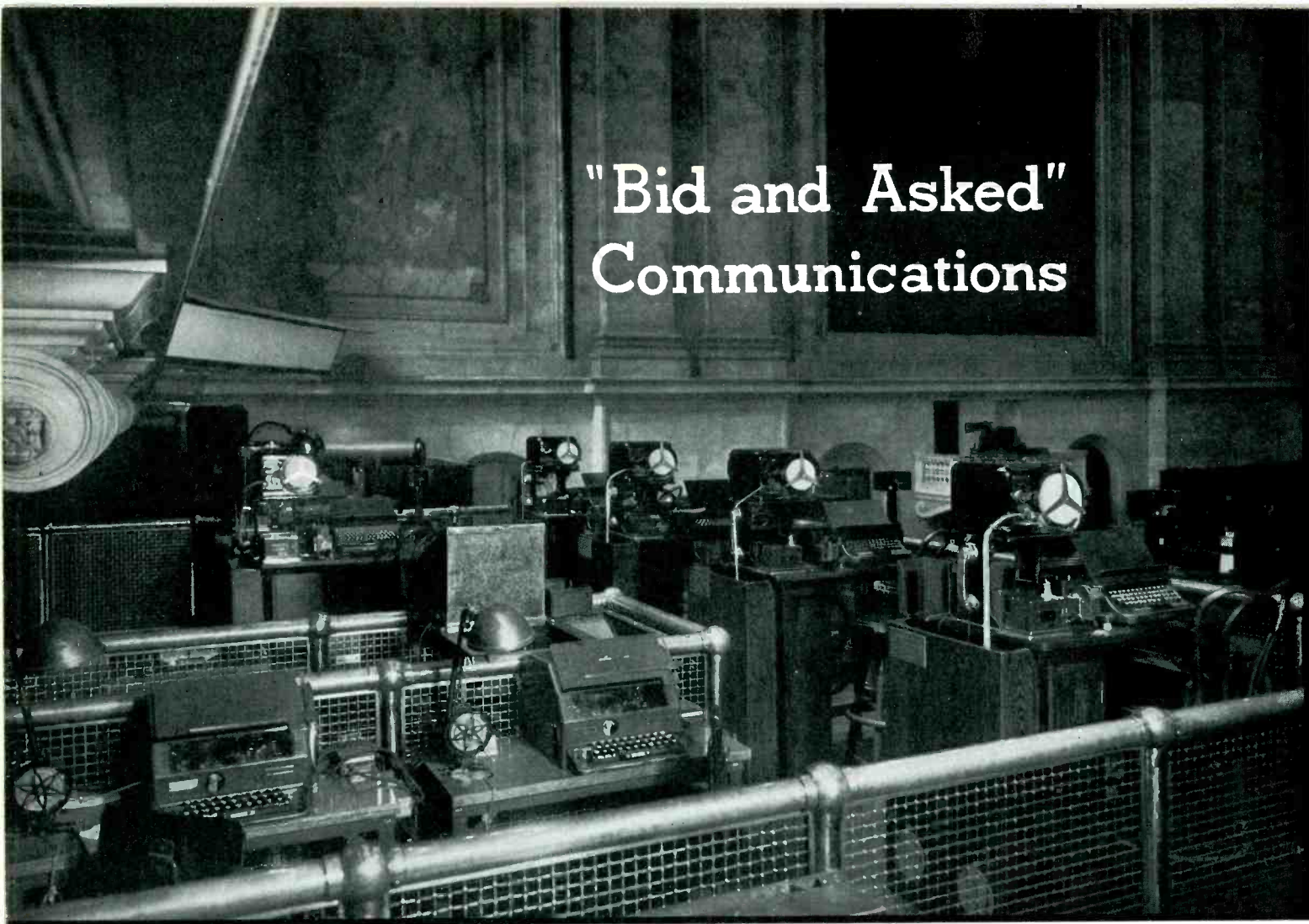

The ticker sending platform of the New York Stock Exchange where quotations are put "on the wire"

By PHILIP C. BENNETT

ONE of the most ingenious and practical communication networks in the world issues from the floor of the Stock Exchange in Wall Street, which is the center of a nerve system extending to the principal cities of the Western Hemisphere.

This description attempts to explain the communications of the New York Stock Exchange only, and does not include the Curb, cotton, and twenty-odd other exchanges. The Stock Exchange alone covers such an intricate field that even technical men connected with "The Street" shake their heads and wonder if it can be done when a reporter states he is covering their territory for the purpose of making it comprehensible to others in an article. Most of the district's old timers have only a notion of how the minute by minute history of one of the greatest transacting areas in the world is recorded.

The communications were planned and installed when and as needed.

In each case, each part had to be a simple and proved answer to the need for immediate, unfailing and continuous dissemination of news. This method has led to many ingenious and fascinating, though very practical, setups.

Details of the communications system

The diagram shows the details of the various agencies supplying quotations and news. The following description contains numbers corresponding to those in the diagram:

The New York Quotation Company is the official communication branch of the New York Stock Exchange. It is the initial line of exodus for news of stocks and bonds to the outer world. Its reason for existence is to maintain complete and adequate communication for the efficient transmission of business news from the exchange floor.

Ticker System (1) and (2). Men are stationed at the posts, reporting sales as they happen to a central point on the Exchange floor. A few

operators and machines work at this keypoint, and place the news on tickers within a few seconds to a minute or two after it happens. The power sources and general equipment are located in other rooms of the company.

(3), (4) and (5). Information is transmitted from the New York Quotation Co. simultaneously to the transmitting room of the commercial news department of Western Union. The news is instantaneously relayed to tickers throughout the country at the same time.

The commercial news department works coordinately with the New York Quotation Company, the latter handling all ticker service to members of the Exchange south of Chambers Street (New York City) and the former handling all non-members in that area and all brokers in the remainder of the country. Trunk lines extend to the various cities, where wires then spread out to the individual tickers.

Teleregister (6) and (7). One of the most unique instruments introduced into the stock exchange world during the past few years is the

Electric Quotation Board replacing the chalk boys marking the changing prices of stocks on large blackboards.

The abbreviated names of stocks are arranged on the large black tele-register board. White numbers on small black discs under the names of stocks are electrically controlled to appear as the discs are turned to state the new prices. The central transmitting and control station, with a staff of 48 persons, is located in New York City. Operators type out changes on their machines as the ticker makes its report. The small discs on all boards of the system function simultaneously.

The Teleregister Corp. is a subsidiary of Western Union. It uses trunk lines to cities outside of New York City, where wires then fan out to individual boards.

Private wires (8), (9) and (15). Large brokerage companies lease many telephone wires. It is estimated that at times as many as 2,000,000 calls are transmitted in a

Men wearing telephone headsets walk about the Exchange floor listening for the moments' market price. One man may bid to buy a certain stock at a few eighths of a point below what another is asking for it. The company's men plug their headsets in at the various posts and transmit the news to the Bid and Asked room.

Here along the walls is a very long Teleregister. Girl operators note the information on their machines, which actuate the bid and asked price discs on the Teleregister boards.

(11). Offices of Exchange members, who need or want this information, dial code numbers on their direct private telephones to get in touch with the operator sitting closest to the stock information on the board. The particular girl operator (approximately 120 do this work) states the bid and asked prices, informing the members' office of the current market.

Annunciators (12). The New York Stock Exchange Building Co. maintains and operates three very large black annunciator boards on the walls of the Exchange, to do the work of paging. Members' representatives trading on the floor have white call numbers printed on the black flaps, which are electrically controlled on the board. The call number appears when an office summons its man through a telephone clerk to give him an order to buy or sell.

Trans Lux (13). The Trans Lux Movie Ticker Corporation leases projection machines to brokers to flash the quotations on horizontal screens as the tape comes out of the ticker machine. This is done by agreement with the New York Quotation Company and with Western Union. The screen is a convenient method for showing stock ticker information in a crowded quotation room, because only two or three persons can read the same ticker tape at the same time.

Four specially designed projecting units are used over the large New York Stock Exchange floor.

Commercial News (14). Dow, Jones and Company publishes a trade paper for the financial district and so has available general financial news and newspaper reports which affect the market. These are sent out over news tickers maintained by the company and leased to others. The New York News Bureau also maintains a similar news service.

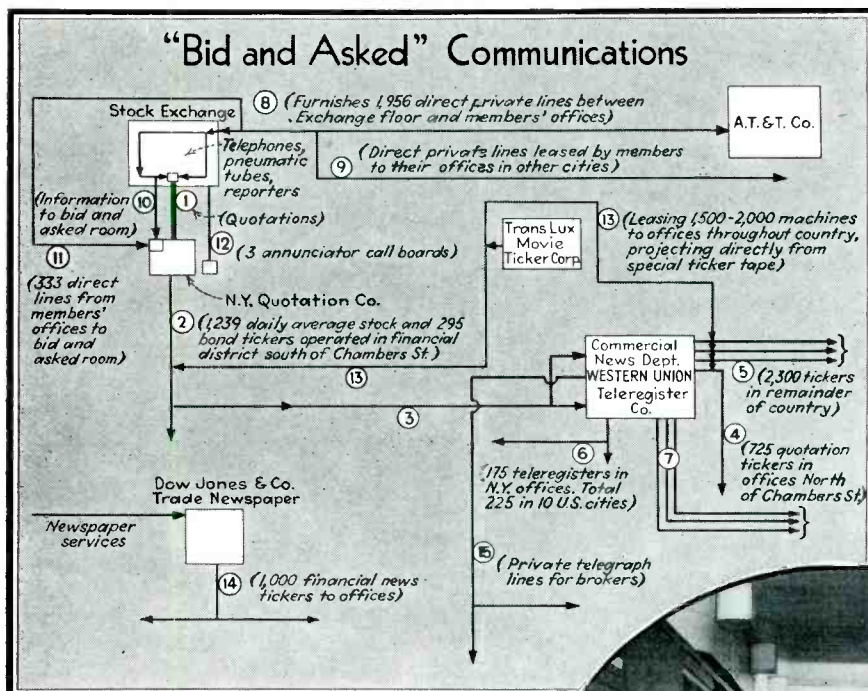

Diagram of the system. Below, the central teleregister board, with the girls who operate the system. Photos, courtesy of the New York Stock Exchange

five hour day on the private wires from members' offices to the Stock Exchange floor. Also, many private telegraph and teletype lines are leased by Exchange members.

Quotations (10) and (11). The discussions this far have concerned past history, though only a minute or two old. To assist in making future history, the Stock Exchange operates a Bid and Asked (Quotation) room.



The "Turnstile"

A new ultra-high frequency radiating system which economizes energy by concentrating it in a horizontal plane equally in all directions

By **GEORGE H. BROWN**
RCA Manufacturing Co., Inc.
Camden, New Jersey

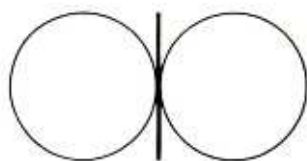

FIG. 1
 Pattern of horizontal half-wave antenna

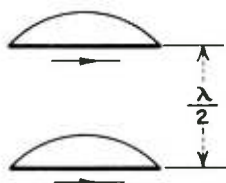

FIG. 2
 Two half-wave antennas $\frac{1}{2}\lambda$ apart

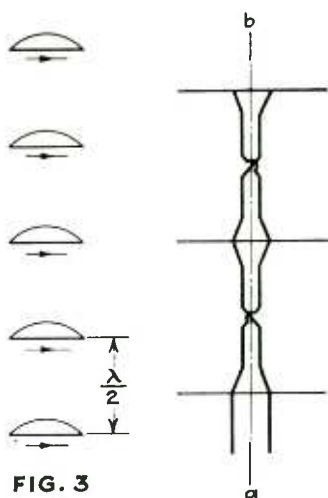

FIG. 3
 Half-wave array

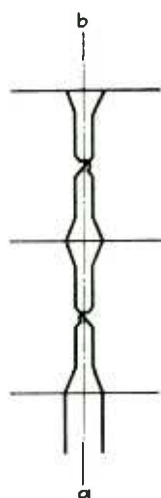

FIG. 4
 Feed line

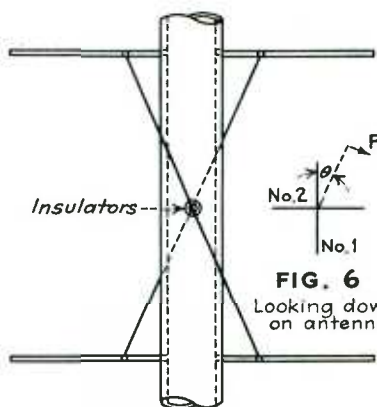

FIG. 5
 Antenna wires and feed lines

FIG. 6
 Looking down on antenna



ANTENNAS operated at short wave lengths can have dimensions of the order of several wave lengths without becoming unwieldy in actual physical size. A great many arrangements can be used which direct the radiated energy in some one particular direction. This concentration thus yields a greater field strength than does, for example, a single half-wave antenna operated at the same power. If the signal strength in the remaining directions is of no consequence, the arrangement of a few wires in a directional array has accomplished the same result as building a more powerful transmitter. Now that the ultra-high frequencies are being used for broadcast purposes, the directional arrays are not always desirable. If the antenna is located in the heart of a city, it is desirable to radiate equal signals in all directions in a horizontal plane. It is still possible to rob energy from the high angles and concentrate it near the horizon. An investigation was undertaken to develop an antenna for ultra-high frequency use which embodied the following features.

1. The antenna should give a circularly symmetrical radiation pattern.
2. The antenna should concentrate the energy in the vertical plane so that the signal strength toward the horizon for a given power input will be considerably greater than that obtained from a single half-wave vertical antenna with the same input power.
3. The antenna must be structurally possible where high winds occur and should preferably be a rather simple structure not liable to damage easily.
4. If possible, the antenna should be supported by a single mast.

One system which immediately suggests itself is the "Franklin" antenna which consists of half-wave elements placed vertically, one above the other, and connected with phase shifting devices so that the currents in all the elements are in phase. This antenna fulfills the first two conditions, but it seems very difficult to meet the last two conditions.

Arrangements which use horizontal elements usually do not fulfill the first condition stated, since each horizontal element yields a "Figure 8" as the horizontal pattern.

The antenna which was finally developed uses horizontal elements and fulfills the four conditions outlined.

Theoretical Development

Let us first examine the action of a horizontal half-wave antenna in free space. In the horizontal plane which passes through the antenna, the field strength is horizontally polarized. The horizontal pattern has the shape of a "Figure 8" with the maximum intensity occurring in a direction normal to the axis of the antenna (Fig. 1).

Suppose that another half-wave antenna is placed parallel to the first, and one-half wave length above the first antenna (Fig. 2). The antennas are both excited so that the currents in each antenna are equal and in phase. This arrangement still yields a "Figure 8" pattern in the horizontal plane, but the magnitude of the horizontal pattern has increased since energy has been robbed from high angles and sent out horizontally.

If still more elements are placed in the array, Fig. 3, each one-half wave from its neighbor and excited

Antenna

Avoiding directional effects, the antenna is ideally suited for broadcast service on frequencies below 10 meters

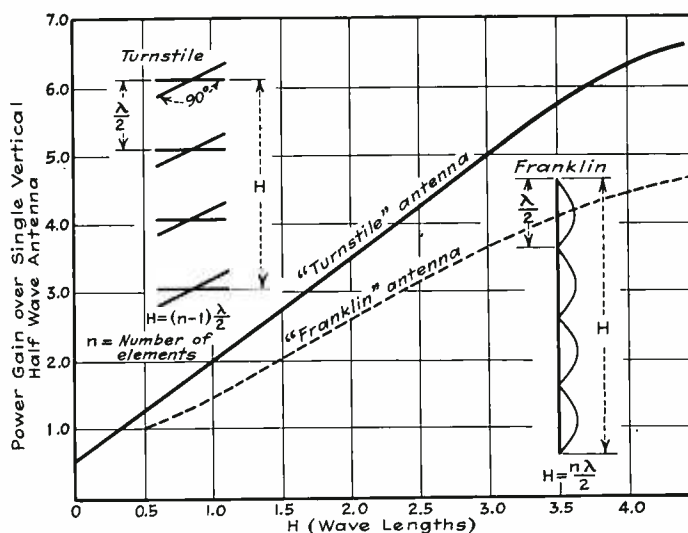
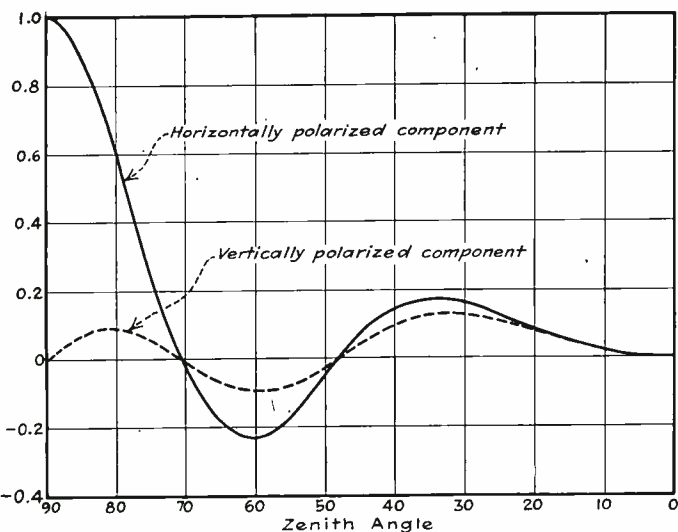

Fig. 7—Theoretical power gain of Turnstile and Franklin antennas

Fig. 8 — Vertical radiation of 6-element Turnstile antenna

all in phase, the horizontal signal is still further increased, but the horizontal pattern still remains "Figure 8" in shape. For the time being, we will ignore this latter fact and consider means of constructing the arrangement of Fig. 3.

Suppose that the elements are supported in space in some fashion. Then the elements can be excited in the proper phase and current magnitude by means of a single two-wire transmission line transposed once between each pair of elements. The half-wave length of transmission line gives a phase reversal of voltage along the line so that the single transposition returns the voltages on adjacent elements to the in-phase condition.

In Fig. 4, the line *a-b* lies in a neutral plane with respect to the antenna elements and the transmission line. Thus if this line were a wire or piece of metal, there would be no voltage induced in it due to the radiating system. This fact makes it possible to replace the line *a-b* by a metal shaft or flag pole, thus affording a supporting structure for the system. Each half-wave antenna, instead of running through the pole, can consist of two quarter-wave rods screwed into opposite

sides of the pole. The transmission lines, instead of having an abrupt transposition, twist continuously around the pole. It is possible to do this if supporting insulators are placed on the pole midway between the elements (Fig. 5). This arrangement now fulfills all the conditions imposed except that of the circularly symmetrical horizontal pattern.

On our flag pole, let us put a second system of radiators and transmission line identical with the first, but so placed that the two sets of radiators are at right angles and corresponding elements are at the same level on the pole. Thus with two sets of identical elements on the pole, we have two separate transmission lines coming down the pole to the transmitter. These two transmission lines are so fed, with equal power into each line, so that the currents in one set of radiators are in time quadrature with the currents in the other set which is at right angles in space with the first set. Figure 6 shows a view of the antenna looking down from the top. Then the field in the horizontal plane due to Set No. 1 is

$$F_1 = I \sin(\omega t) \sin \theta \quad (1)$$

where θ is the angle indicated on Fig. 6

The field due to Set No. 2 is

$$F_2 = I \cos(\omega t) \cos \theta \quad (2)$$

The sum of (1) and (2) gives the total resultant field.

$$F_t = F_1 + F_2 = I \cos(\omega t - \theta) \quad (3)$$

Thus the total field is constant in magnitude and changes in phase as θ changes, giving us a circularly symmetrical horizontal pattern.

As mentioned previously, the signal strength toward the horizon increases with the number of antenna elements. The ordinates of Fig. 7 show the ratio of the power into the single vertical half-wave antenna to the power into the array in question to achieve the same field strength.

Experience with mechanical design of these antennas has shown that it is convenient to use six antenna elements in each set. Then the distance from the bottom radiator to the top radiator is 2.5 wave lengths.

The vertical radiation characteristic of this antenna is made up of a horizontally polarized component and a vertically polarized component. The vertically polarized component becomes zero in the horizontal plane. Figure 8 shows these two components as a function of the angle measured from the zenith, when the antenna consists of six elements per set.

While this antenna layout looked very good on paper, it was neces-

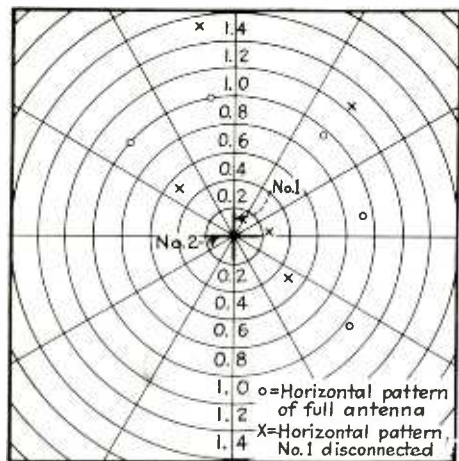

Fig. 9—Result of field measurements

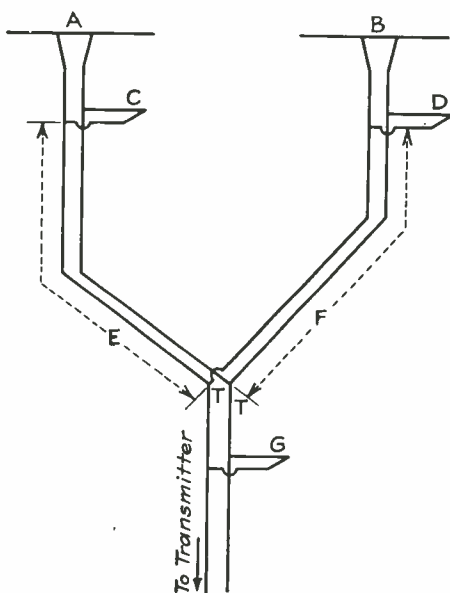

Fig. 10—Transmission line arrangement

sary to verify the results experimentally. The experimental method was also used to determine certain optimum dimensions. Accordingly, a model was built to operate on a wave length of 3.0 meters. The flag pole used was 42 feet long and 3 inches in diameter. The six-element antenna was chosen. The radiators were one-quarter inch brass rods, each one-quarter wave length long. These rods were threaded and screwed into the steel flag pole. The insulators for supporting the transmission lines were porcelain stand-off insulators, fastened to the pole by means of stud bolts in their bases. The quadrature phase relation between sets of radiators was accomplished by means of transmission lines of the proper lengths.

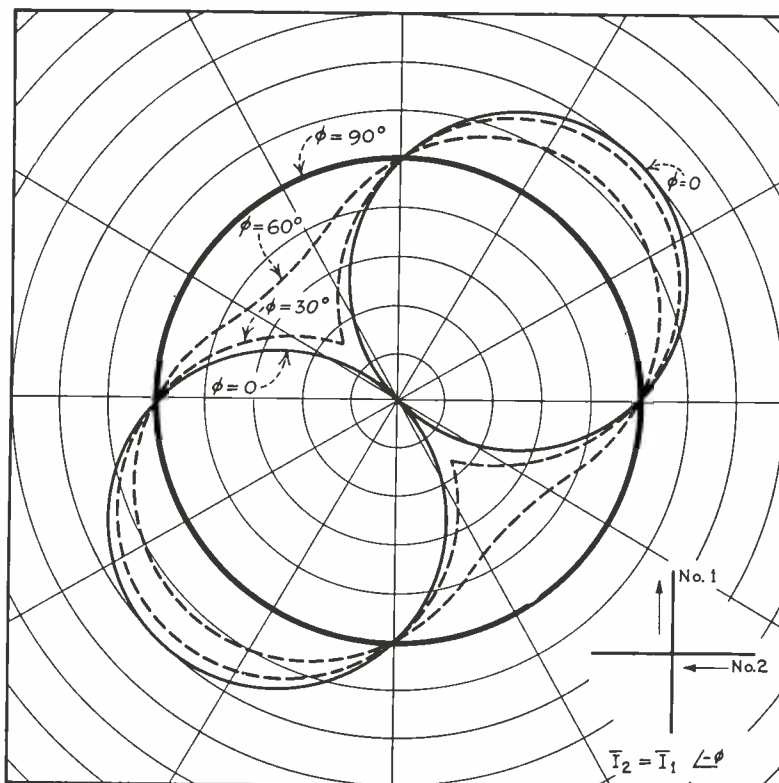
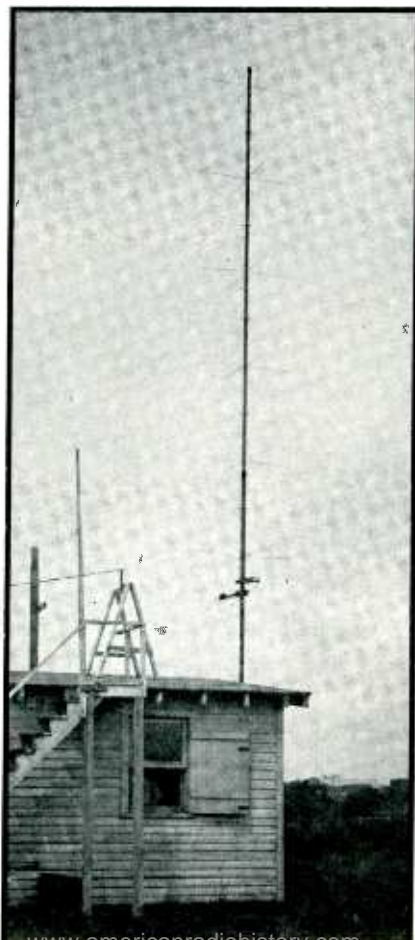

Fig. 11—Horizontal radiation pattern—currents of equal magnitude but varying in phase

After all critical adjustments were made, a check was made of the horizontal pattern to determine how circular it was. A horizontal half-wave antenna was mounted on the end of a bamboo pole. This pole was

Experimental model of the Turnstile antenna



26 feet long. A transmission line connected this antenna with a detector placed at the base of the pole. Readings were taken on the circumference of a circle whose radius was 175 ft. with the axis of the flag pole as the origin of the circle. The circles on Fig. 9 show the results of this test.

Next, the elements pointing east and west were disconnected to determine the expected "Figure 8" pattern. The crosses on Fig. 9 show the measured results. This test indicates the necessity of using two sets of elements if it is desired to send equal signals in all directions.

A measure of the field strength was made at a fixed point. Then the flag pole was replaced by a single vertical half-wave antenna excited with the same power. The field strength from this arrangement was slightly less than one-half that obtained with the array, indicating a power gain for the array of approximately four to one. From Fig. 7, we find the theoretical figure to be 4.27 to 1.

Constructional Details

The first full scale antenna was constructed for operation at 45 megacycles. The supporting pole ex-

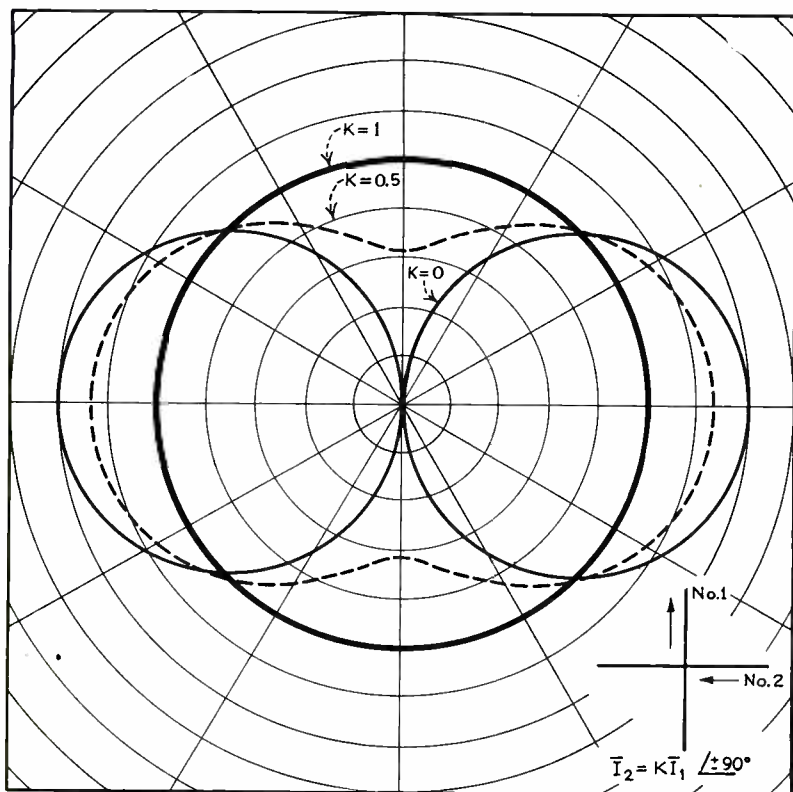
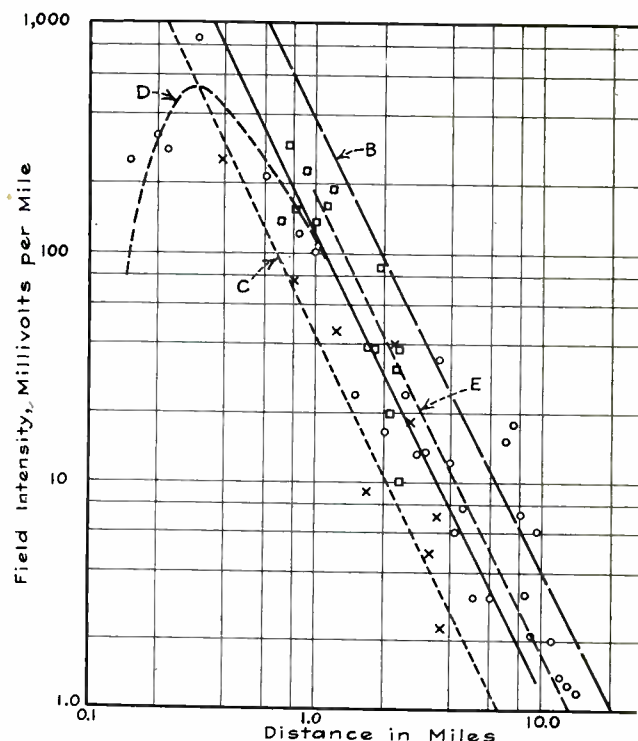

Fig. 12—Pattern with varying currents but with constant phase difference of 90°

Fig. 13—Field intensity measurements based on 1,000 watts into antenna



tended 70 feet above the roof. The radiators were nickel-steel tubes, copper plated. These tubes were made with sufficient wall thickness to allow a slight taper. This taper is supposed to avoid possible fracture due to vibration of the tubes. The stand-off insulators are 8 inches in length. The transmission lines are made up of No. 8 hard drawn wire. The antenna elements are placed slightly less than one-half wave length apart so that the transmission line length between elements is exactly one-half wave.

To achieve the proper phase shifts, the antenna is fed by an arrangement of transmission lines as shown in Fig. 10. If the lines have a characteristic impedance of 500 ohms, the following dimensions will hold *approximately*.

1. The distance from *c* or *d* to the lowest antenna element is 0.355 wave lengths (plus any integral number of half-wave lengths desired).
2. The length of *c* (or *d*) from line connection to shorting bar is 0.085 wave lengths.
3. *e* is any convenient length.
4. *f* equals *e* plus one-quarter wave length.
5. The distance from *T-T* to point of connection of *g* is 0.4 wave lengths.

6. The length of *g* is 0.15 wave lengths.

Four strain insulators are placed at the top of the pole to neutralize the pull on the top elements due to the transmission lines.

The transmission lines are connected to the antenna elements by means of clamps placed 0.06 wave lengths from the surface of the supporting pole.

Small metal pads are fabricated to the pole to insure firm horizontal mounting for the insulators and radiating rods.

In designing a particular antenna, consideration should be given the highest recorded wind velocity, the possibility of the formation of sleet on the antenna, and the possibility of excessive corrosion due to proximity to salt water.

Factors Affecting Horizontal Radiation Pattern

The design of the turnstile antenna has been based on the premise that it is most desirable to have a circularly symmetrical horizontal radiation pattern. It is, however, conceivable that such an antenna might be located in the heart of a city which is oblong in shape. In this event, it would be desirable

to have a horizontal pattern which is elongated. This may be accomplished by controlling the phase relation between currents in the two perpendicular sets of radiators or by controlling the ratio of the currents in these two sets.

Figure 11 shows what happens to the horizontal radiation pattern when the currents in the two sets of elements are held equal in magnitude but the phase relation is shifted. We see that the pattern can be elongated along a line which bisects the angle formed by the two sets of radiators. Figure 12 shows similar results when the current ratio is varied but the currents are held in quadrature. Here the elongation points along the axis of one of the antenna elements. By choosing the proper phase and current ratios, it is possible to make the elongation occur at any angle in the horizontal plane.

Field Intensity Measurements

As stated previously, the first full scale antenna was constructed for operation at 45 megacycles. This antenna was located on the roof of a building in an urban district. The

[Continued on page 48]

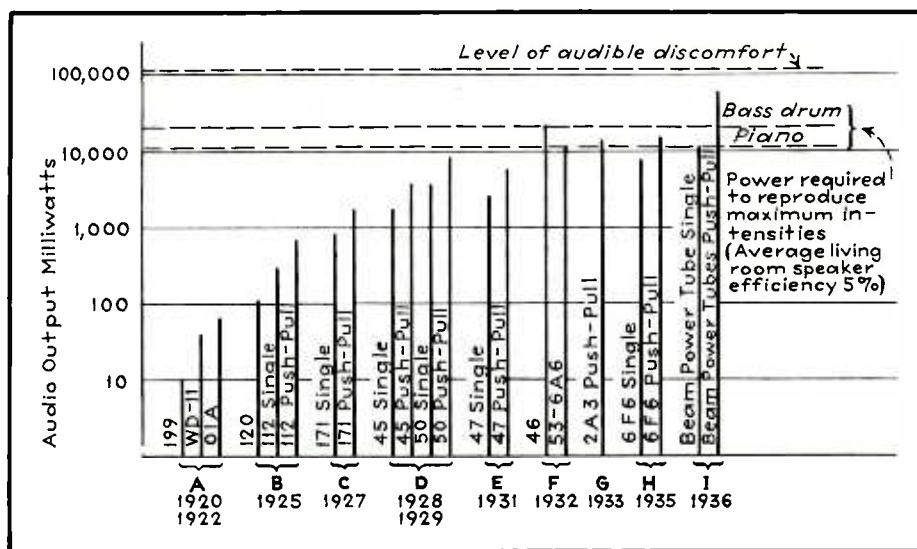

The Beam Power Output Tube

A radical design which uses a potential barrier in place of a suppressor grid, results in a new power tube capable of delivering, in push-pull, 34 watts without grid-driving power, or 60 watts with 400 milliwatts input

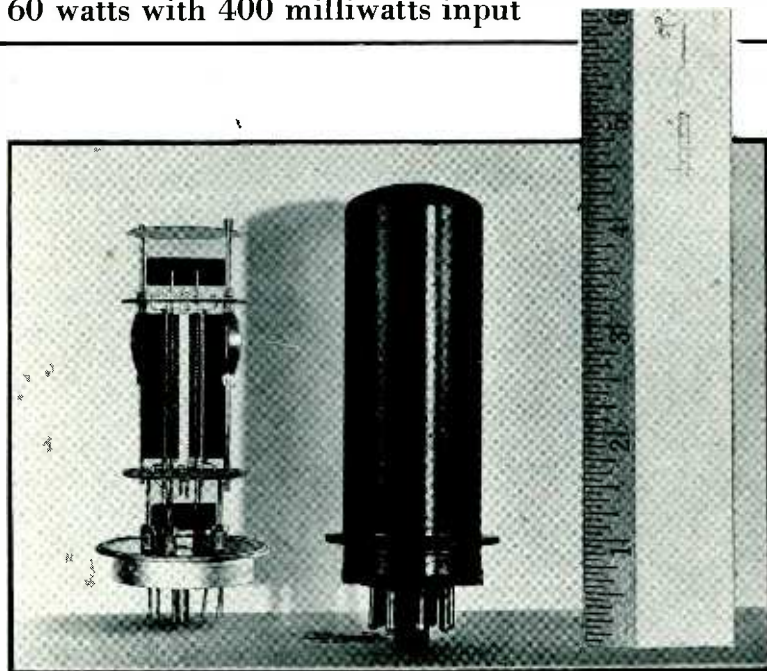

Fig. 2. The new beam power tube, internal and external views

IN considering output tubes for radio receivers, it is interesting to look back and review the various tubes and systems that have been used in the past. Comments on these will lead naturally to the most recent addition to this group, the new beam power tube. This tube has recently been introduced to radio engineers by its designer Mr. O. H. Schade at a N. Y. meeting of the I.R.E. on April 1.

In Fig. 1 is presented a graphical listing of the most popular tubes and systems arranged approximately in the chronological order of their introduction.

The output tubes supply the electrical power which is translated by the loudspeaker into acoustic power. Speakers have passed through several stages of development during this period. Starting with modified headphones, they passed

By J. F. DREYER, JR.
*Research and Development
 Laboratory, RCA Radiotron
 Div., Harrison, N. J.*

successively through the magnetically-driven horn type, magnetically-driven diaphragm type, to the present moving coil or dynamic speaker. Loudspeakers of the latter type generally have an efficiency somewhat less than 5 per cent,¹ that is, 1 watt of acoustic power requires 20 watts of electrical power.

It has been shown² that, to take full advantage of the capabilities of the ear, the maximum acoustic power of a reproducing system may be determined by: $P = 4.1 \times 10^{-8} \frac{V}{T}$

where P is the acoustic power in watts; V the volume of the room in cubic centimeters; and T the reverberation time in seconds. In an average living room with a volume of approximately 70×10^6 cubic cm. and a reverberation time of 0.5 second, the power requirement is approximately 5.7 acoustic watts. Therefore, with speakers of 5 per cent efficiency it may be stated that something like 100 watts audio-frequency power is the maximum power that can be tolerated in a home-radio

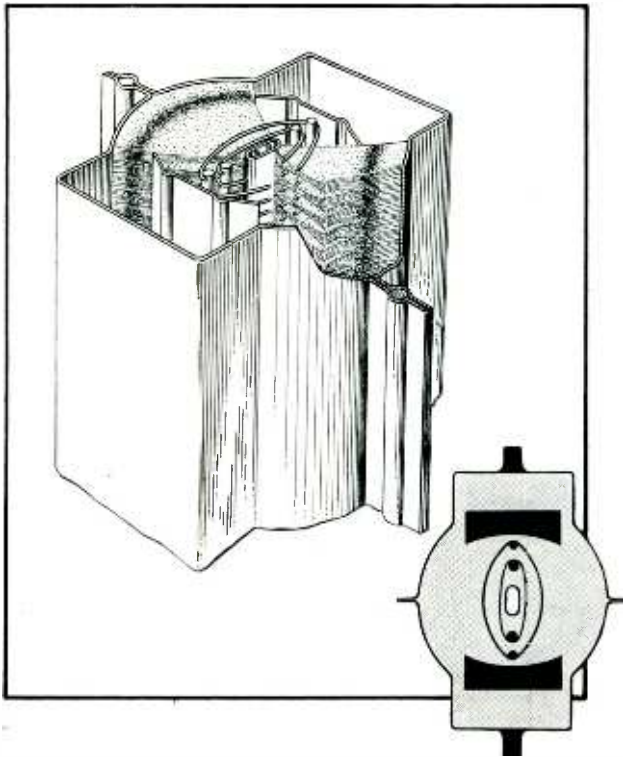

Fig. 1 (Opposite page) Power output of various tubes used in output stages, arranged in chronological order. Fig. 3 (Above) Diagrams showing arrangement of elements in the beam power tube

ducing sound pressure greater than that of a piano—a bass drum, for instance, would require approximately 20 watts.³

Columns G and H (Fig. 1) show the power capabilities of the most popular present-day output tubes. That these tubes are not quite powerful enough is shown by the fact that in the case of 2A3 triodes some designers employ as many as four tubes in the output stage. In the case of the pentodes, highly efficient overbiased arrangements are generally used, but the attainment of the maximum output requires considerable driving power.

receiver. This rather large amount of power, it must be remembered, is the upper limit.

A more modest requirement would be for the radio receiver to produce sound pressures equivalent to those produced by a piano. Recent measurements showed that in an average living room with a speaker of 5 per cent efficiency, piano sound pressures could be duplicated with tube outputs of 11 watts. Other single instruments are capable of pro-

duced sound pressures equivalent to those produced by a piano. Recent measurements showed that in an average living room with a speaker of 5 per cent efficiency, piano sound pressures could be duplicated with tube outputs of 11 watts. Other single instruments are capable of pro-

The new beam power tube, described by Mr. O. H. Schade before the New York Section of the I. R. E. on April 1st, has been assigned the type number 6L6. It will soon be available from tube manufacturers—The Editor.

(see Table, page 20). The voltages required are within the limitations imposed by electrolytic filter condensers.

Distortion in Output Systems

The most serious distortions that may be encountered in the radio-broadcast system are distortions in the frequency-response characteristic, harmonic distortion, and compression of the volume range. With regard to the first of these, the output tubes and speaker together may contribute a considerable amount to the lack of uniformity of the frequency response.

With regard to harmonic distortion, or lack of linearity in the amplifying characteristic, it may be said that the output tubes of the radio receiver are inherently the weakest link in the system.

In tubes where the control grid is operated in the positive region, a sharp discontinuity which leads to the introduction of high-order harmonics can occur. As the grid becomes increasingly positive, secondary emission from this grid may occur at a very definite voltage. This results in a sudden increase of input impedance as well as a sudden increase in the output plate

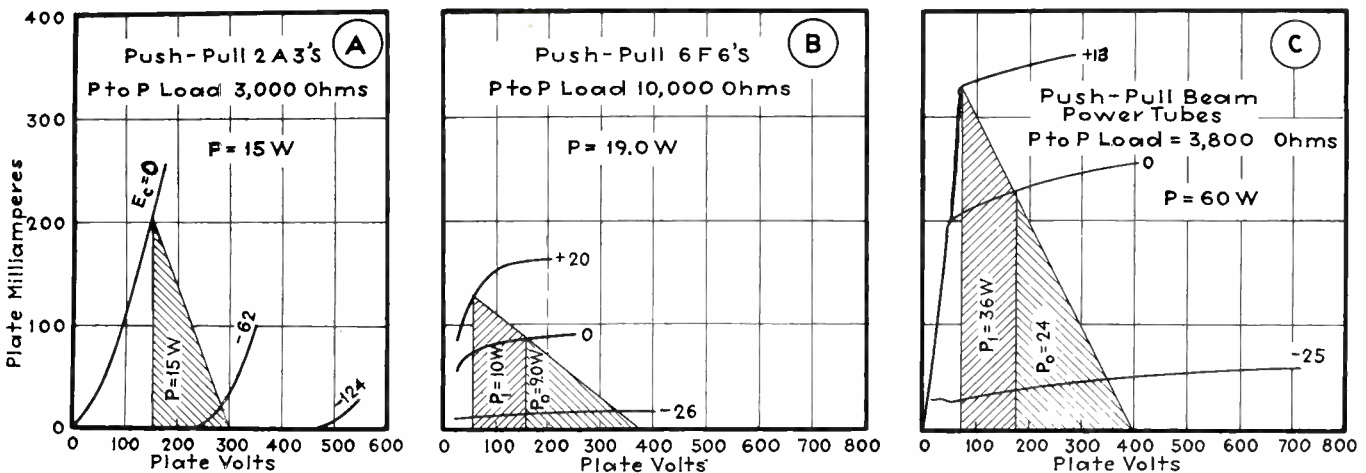

Fig. 4. Comparison of the average plate characteristics of the 2A3, 6F6, and the beam power tube, in push-pull. The load line in each case has a slope equal to one-fourth the recommended plate-to-plate load

TYPICAL OPERATION CHARACTERISTICS OF BEAM POWER TUBE

| | | SINGLE TUBE OPERATION | | | PUSH-PULL OPERATION | | | |
|---------------------------------|---------------------|-----------------------|-------|--------|---------------------|-------|-------|------------------|
| | | 1 | 2 | 3 | 4 | 5 | 6 | |
| Plate voltage.... | E_b Volts D.C. | 250 | 375 | 375 | 250 | 400 | 400 | |
| Screen voltage.... | E_{c2} Volts D.C. | 250 | 250 | 125 | 250 | 300 | 300 | |
| Control-grid bias | E_{c1} Volts D.C. | -14.0 | -17.5 | -9.0 | -16 | -25.0 | -25.0 | |
| Zero signal plate current..... | I_{b0} MA. D.C. | 72.0 | 57.0 | 24.0 | 60 | 50.0 | 50.0 | } per tube |
| Full signal plate current..... | I_b MA. D.C. | 79.0 | 67.0 | 26.0 | 70 | 76.0 | 114.0 | |
| Zero signal screen current..... | I_{c0} MA. D.C. | 5.0 | 2.5 | 0.7 | 5 | 2.5 | 2.5 | |
| Full signal screen current..... | I_{c2} MA. D.C. | 7.3 | 6.0 | 1.8 | 8 | 8.5 | 9.5 | |
| Signal..... | Peak volts | 14.0 | 17.5 | 8.0 | 16 | 25.0 | 42.5 | } plate to plate |
| Load..... | Ohms | 2,500 | 4,000 | 14,000 | 5,000 | 6,600 | 3,800 | |
| Power output.... | Watts | 6.5 | 11.5 | 4.2 | 14.5 | 34.0 | 60.0 | |
| Total distortion* | Per cent | 10.0 | 14.5 | 9.0 | 2.0 | 2.0 | 2.0 | |
| 2nd harmonic.... | Per cent | 9.7 | 11.5 | 8.0 | | | | |
| 3rd harmonic.... | Per cent | 2.5 | 4.2 | 4.1 | 2.0 | 2.0 | 2.0 | |
| Peak grid power.. | MW. | | | | | 0 | 400 | |

*For the conditions of Column 1—fourth harmonic 0.35%, fifth harmonic 0.1%, higher orders less than 0.03%.

current. Such amplifier tubes are likely to have input-output characteristics which depart from linearity in the shape of a sharp "kink." This discontinuity may occur at comparatively moderate signal strengths.

The determination of the amount of any harmonic which is permissible in the total distortion is a difficult subject because it involves a transition from measurable electrical effects to the intangible effects produced on the senses of different observers. Massa⁴ has investigated the effects of tube overloading and reports that with a system reproducing frequencies up to 14,000 cycles, 5% of predominantly second-harmonic distortion is noticeable; 3% of third-harmonic distortion is noticeable. With systems which cut off at lower frequencies, considerably greater percentages of these low-order harmonics can be tolerated. These values are based on direct comparison of distorted and undistorted speech sounds. Without direct comparison, he states that the permissible distortions were over 10% for second harmonics and over 5% for third harmonics.

For the reproduction of certain musical sounds, it is likely that the requirements are more severe. On pure tones, very much smaller percentages can be detected. Higher-order harmonics are much more objectionable and should be minimized to as great an extent as possible.

The distortion which occurs in

amplifiers is generally expressed and measured in terms of the percentage of various harmonics produced when a pure sinusoidal signal voltage is applied. This method has some serious disadvantages. Harmonics higher than the 7th or 9th are seldom measured largely because they are usually present in such small amounts as to make measurement difficult. Nevertheless, when sudden discontinuities occur in an amplifier, an infinite series of harmonics is produced. Since frequencies in the 100 to 200-cycle region occur frequently and since the sensitivity of the ear is high in 3,000 to 6,000-cycle region, it must

follow that harmonics as high as the 30th to 60th should be considered.

The Beam Power Tube

Several organizations have made early investigations of beam types of tubes. Particular mention should be made of work done in the laboratories of the Electric and Musical Industries, Limited.

In his paper, Mr. Schade has described in detail the considerations leading to the design of this particular tube. Here the principle features will be mentioned. Fig. 2 presents photographs of the side view of the tube mount as well as a side view of the completed tube.

Figure 3 is a sketch which illustrates the arrangement of the tube elements and the path of electrons within the tube. In Fig. 4 is presented for direct comparison the average plate characteristics of a representative triode, pentode, and the new tube. Plate currents are plotted vertically and plate voltages horizontally. The corresponding scales of coordinates are the same for all three tubes. Three representative characteristics for different control-grid voltages are presented for each tube. In Fig. 4 also, triangular areas are shown which represent the power of the three tubes when operated in pairs in push-pull systems.⁵ The areas for the output loads chosen are divided in the case of the pentode and the beam power tube into portions which represent the powers obtained at the

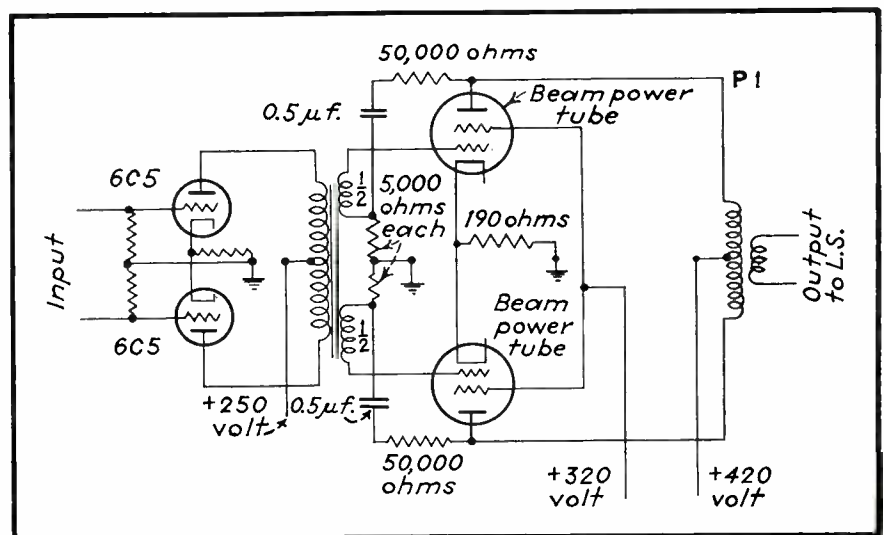

Fig. 5. A reversed-feed-back amplifier circuit making use of the new beam power tube

grid-current point and the powers obtainable beyond the grid point.

The table gives the operating conditions and performance results of the new tube.

Referring to Fig. 3, it will be seen that the tube consists of a cathode of flattened cross section, surrounded by an elliptical control grid. The screen also elliptical, surrounds the control grid, has the same number of turns per inch, and is lined up so that the individual turns of the screen are directly behind the turns of the control grid. Two metallic beam-forming plates are placed at the side-rod ends of the grid struc-

path. The tube is therefore, a tetrode.

Consider for a moment the plate current—plate voltage characteristics of a conventional tetrode. For high plate voltages the curves are comparatively flat, but when the plate voltage falls considerably below the screen voltage, secondary electrons, emitted from the plate return to the screen with a consequent sudden decrease of plate current. This secondary-emission effect from the plate makes the usual conventional tetrode unsuitable for audio power output tubes. Conventional pentodes get around this short-com-

usually in the form of a wound grid is also not desirable since it lies directly in the electron path and, therefore, cuts down the available sectional area of the path. This is not as important, however, as the fact that the grid wires produce a non-uniform field which controls "gradually" and thus produces the rounded knee already mentioned.

In the new tube the design is such that relatively high electron densities are produced in the region between plate and screen. These regions of "potential minimum" repel secondary electrons from the plate that might tend to travel back

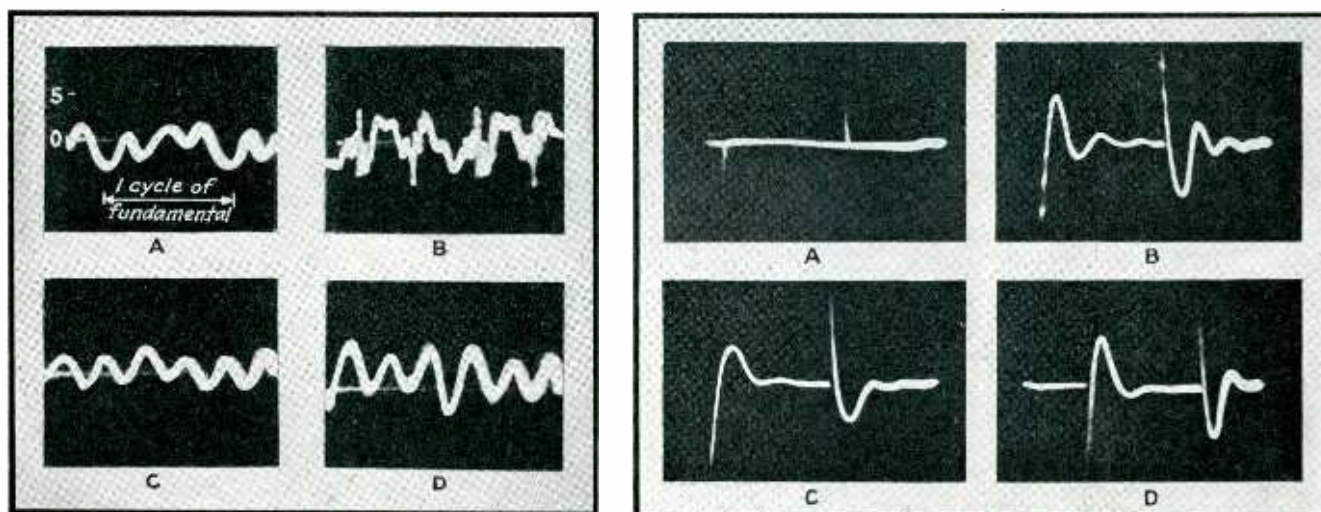

Fig. 6. (Left) Oscillograms showing distortion in several push-pull amplifiers. A. Pentode amplifier, 4.5 watts delivered to voice coil, below grid current. B. Same with 5.9 watts, slight grid current flowing. C. Beam tube amplifier, 4.6 watts, no grid current. D. Triode amplifier, 4.3 watts, no grid current. Fig. 7. (right) Oscillograms showing damping of speaker resonance. A. Signal. B. Output of beam power tube, no reversed feed-back. C. Triode, no feed-back. D. Beam power tube, 18 per cent reversed feed-back

ture. These plates are internally connected to the cathode. The portion of the anode which collects electrons is of circular cross section.

Referring again to Fig. 3, it is shown that the electrons emitted from the cathode are constrained to flow in two beams. These diverging beams are still further sliced into smaller ones by the action of the control grid. (The beam-forming properties of grids and side rods have been discussed by Mr. H. C. Thompson in a paper given at the I.R.E. Convention in Detroit, but not yet published.) Very few, therefore, of the cathode-emitted electrons strike the screen grid. This results in low current to the screen with a consequent improvement in the tube efficiency. Attention is called to the fact that there is no physical suppressor in the electron

ing by the addition of a fifth element or suppressor. The suppressor is generally operated at the d-c potential of the cathode. It sets up a region of low potential. This region prevents the return of secondary electrons to the screen. Pentodes may, therefore, be operated with loads that cause the plate to swing very much lower than the screen on one-half of the cycle.

The ideal pentode would have characteristics in which the plate-current vs. plate-voltage curves continue with small slope to zero plate voltage and then suddenly drop. As may be seen from Fig. 4B the characteristics of usual pentodes have a rounded knee. This results in an increase in the distortion when operation occurs with loads and signals in the region of the knee. The suppressor of the pentode,

directly into the beam. Secondaries are prevented from returning to the screen at the edges of the beam by the action of the beam-forming plates.

In this way, the electrons, themselves, act to suppress secondary emission. This "suppressor" takes up no part of the useful sectional area and produces a much more uniform field than that formed by the discrete wires of a conventional suppressor. For this reason (refer Fig. 4C), the plate characteristics of the new tube approach much nearer those of the ideal pentode. The upper knee is sharper and the individual curves of the plate family are more nearly parallel than in the conventional pentode. Because curves in the highly negative region are

[Continued on page 35]

Directional Antenna Design

Practical methods for the design and application of two-element directional arrays in broadcast and communication service useful for improving coverage and reducing fading

BY E. A. LAPORT

Transmission Engineer
Wired Radio, Inc.

THE outstanding problem in antenna design is always to control the distribution of the radiated energy in some desired manner. In the case of single vertical radiators, the control is obtained by adjusting the length of the antenna and the distribution of current in it. Further modification of the radiation distribution is achieved by the use of more than one radiator. As the number of radiators is increased, a greater degree of control becomes possible. In general, it is elec-

the discussion, and one can readily remove them when the principles of radiation control are understood.

The radiation pattern, or space characteristic, is a geometrical description of the manner in which the radiant energy is distributed in space around the radiators. The horizontal pattern represents the distribution in the ground plane, and the various vertical plane patterns represent conditions in directions at various angles above the horizon. These patterns may be drawn in terms of relative or actual field-strength or power. Patterns in this article are shown in terms of relative field intensities.

The investigation of a directive antenna system usually starts with the choice of a suitable horizontal

various phasings of equal radiator currents. These diagrams are always useful in prospecting for an approach to a given problem. The relative directions of nulls, maxima, and their broadness or sharpness, can be roughly determined by inspection of the figures. However, figures of this sort are seldom more than indicators, and the designer must calculate precisely his patterns after he has decided in what range of spacings and phasings he wishes to work.

Horizontal Directivity Diagrams

The entire radiation pattern is symmetrical with respect to the plane drawn through the radiators, as can be recognized by inspecting a table of directivity diagrams for two radiators. So it is necessary only to calculate the horizontal pattern through an angle of 180°. In Fig. 1, is shown the geometrical plan for calculating this pattern. The line of reference is the line X-X' through the radiators A and B,

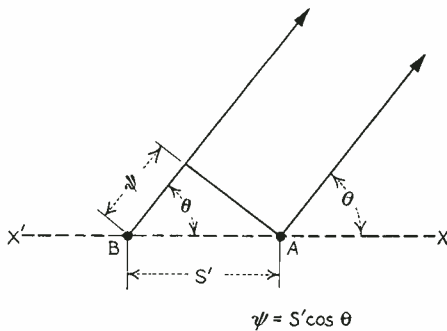

Fig. 1. Plan view of directive array, showing geometry for computing the horizontal pattern

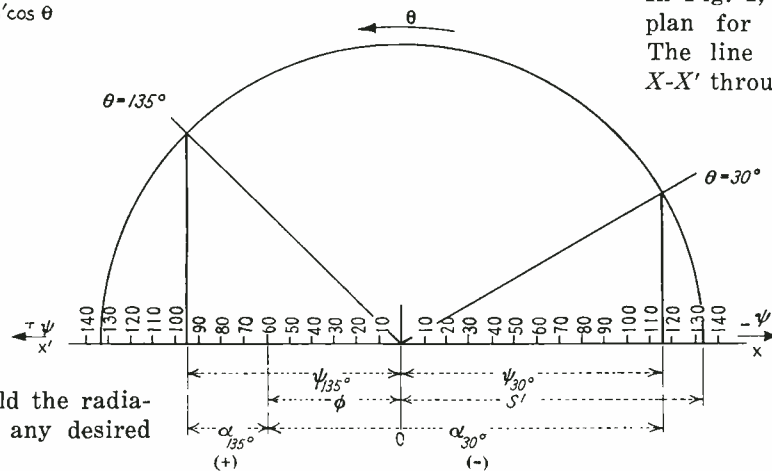

Fig. 2. Construction used in finding values of α . Case shown for $s' = 133^\circ$, $\phi = -60^\circ$, for $\theta = 30^\circ$ and 135° . Various values of α for different values of θ are found similarly

trically possible to mould the radiation pattern in almost any desired manner.

The array of two vertical radiators provides a wide range of radiation patterns, depending upon their separation, and the relative magnitudes and phase of the radiator currents. This paper will deal only with two-element arrays in which identical vertical wire radiators one-quarter wavelength in height are used. These restrictions are only for the purpose of simplification of

pattern, since that portion of the entire radiation pattern is of primary importance where groundwave coverage is intended, as in broadcasting.

Extended tables of diagrams have been published showing the horizontal directivity patterns resulting from two identical parallel linear radiators for various spacings and

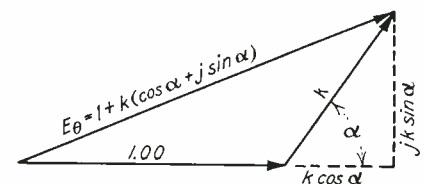

Fig. 3. When α is known, E_θ (the resultant voltage at the observation point) is found by the construction shown here

and the angle between this line and the point of observation is θ . The point of observation may be considered to be anywhere on a circle drawn from the geometrical center of the array, and it is assumed that the distance is great enough so that lines drawn from it to each radiator are essentially parallel. At broadcast frequencies and for broadcast applications, points on the 1-mile circle are usually considered.

At any angle θ , in the first quadrant, radiations from A arrive in advance of those from B by an angle $\psi = s' \cos \theta$. Here s' is used to indicate the separation of the radiators in electrical degrees, and is the spacing in wavelengths (s/λ , where s is the actual separation in meters, λ the wavelength, multiplied by 360). In order to establish a basis of reference which can be followed throughout a problem, radiations from B may be arbitrarily considered in their relation to radiations from A. If radiations from B arrive later than those from A, (as they do in first quadrant) ψ is negative; contrariwise, ψ is positive when B radiations are in advance of those from A (second quadrant). Representing these radiations by means of rotating vectors exactly as used in a-c analyses, vectors being in terms of field intensities, the resultant intensity at the point of observation is obtained by vector addition. If radiations are considered to start from both radiators at the same instant in phase, but travel to the observation point by paths of different lengths, but at the same velocity, the

vectors would be added together at an angle to obtain the resultant.

In addition to ψ , the effect of the initial difference of phase of the vectors must be included. Furthermore, since the field intensity is proportional to the antenna current which produces it, account must be made of the relative fields in the vector lengths. The total angle between the vectors is called α , and it is the algebraic sum of the space angle ψ and the initial phase difference between radiator currents ϕ . Proper precautions must be taken with signs. Angle ϕ is positive or negative depending upon whether the instantaneous current in radiator B passes through positive maximum value so many electrical degrees in advance or retard of that in radiator A.

The horizontal directivity diagram

can be quickly calculated by solving:

$$E_{\theta} = 1 + k (\cos \alpha + j \sin \alpha) \quad (1)$$

This equation gives the relative strength of field at any angle θ , for any given ratio of the radiator currents, k , and initial phase difference ϕ , where $\alpha = s' \cos \theta + \phi$. The equation is especially adaptable to graphical solution. The solution for the angle α is represented in Fig. 2, for two values of θ . A circle with a radius of s' is intersected by radials drawn at various angles corresponding to values of θ from 0° to 180° . The projections of these intersections upon the axis X-X' give the value of $\psi = s' \cos \theta$. According to the conventions adopted, ψ is negative for first-quadrant angles, and positive for second-quadrant angles. In the succeeding operation, ϕ is added algebraically to ψ to give the

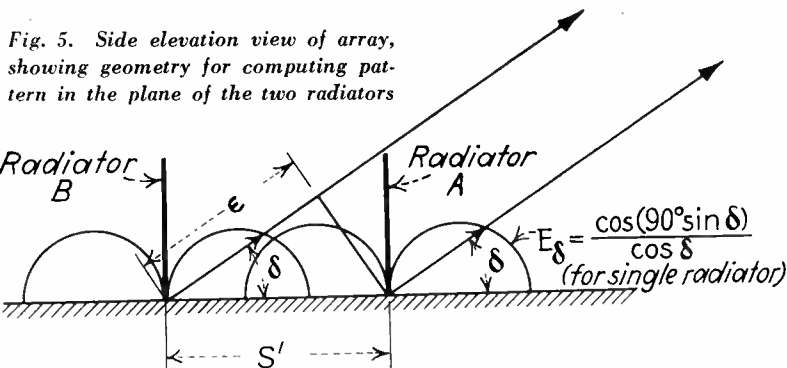

Fig. 5. Side elevation view of array, showing geometry for computing pattern in the plane of the two radiators

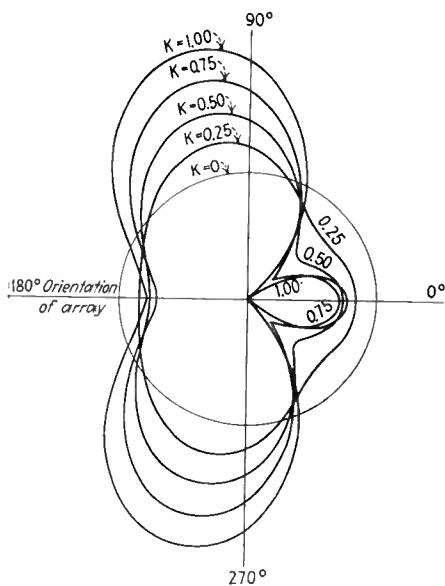
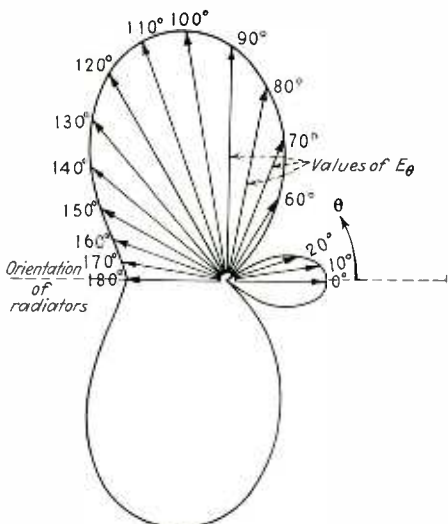

Fig. 4-B (above) Variations of the pattern shown in Fig. 4-A caused by changing the ratio of the currents in the two radiators

Fig. 4-A (left) A typical polar plot ($s' = 180^{\circ}$, $\phi = -45^{\circ}$, $k = 1$) produced by the method of Figs. 1, 2, and 3



angle α . Lastly, two vectors having a ratio k are added together at this angle, the resultant being the relative field intensity in the direction of θ . Such an addition is shown in Fig. 3.

A complete solution by this method for an array of two radiators spaced 0.5 ($\psi = 180^{\circ} \cos \theta$) with $\phi = -45^{\circ}$ and $k = 1.00$ is shown in Fig. 4-A.

The effect of the current ratio upon the pattern for this same array is shown by Fig. 4-B. When $k = 0$, there is in effect but one radiator, and its pattern is the circle. It is seen from this that the null angles remain fixed, but the depth and breadth of each null and maxima changes with k .

Vertical Pattern in Plane of Radiators

The basic geometry of the first step in determining the vertical radiation patterns (on which fading and skywave coverage depend) is that shown in Fig. 5, which is a side-

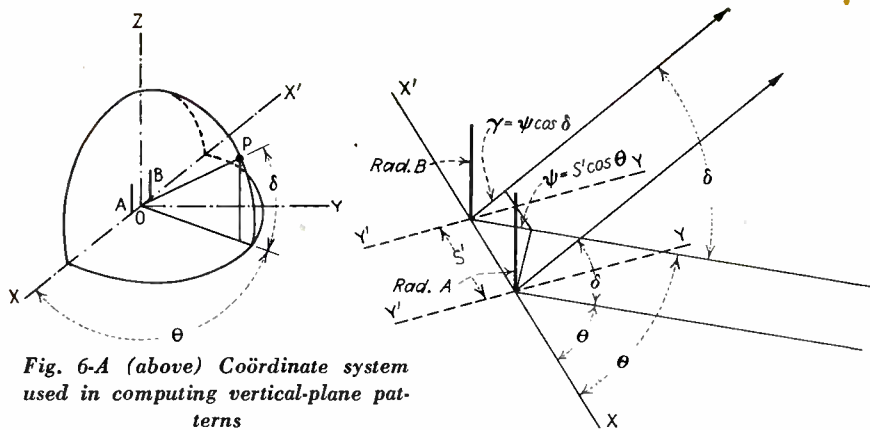

Fig. 6-A (above) Coordinate system used in computing vertical-plane patterns

Fig. 6-B (above, right) "Birdseye" view of array showing relation of radiators to observation point

elevation view of the array. As shown, the initial intensity of radiation from *one* radiator is not constant in all directions above the horizon (as it is in the horizontal plane) but varies with the angle of elevation δ . Therefore the vertical pattern for one radiator must be known before proceeding with the problem for the array.

In the interests of simplicity, this paper will deal only with grounded vertical quarter-wave radiators over perfectly conducting earth. The vertical relative field strength pattern for such a single radiator is given by this equation:

$$E_{\delta} = \frac{\cos(90^{\circ} \sin \delta)}{\cos \delta} \quad (2)$$

where δ is measured from the horizon. E can readily be calculated for any value of δ .

The equation for the vertical pattern for *two* radiators in the plane through the radiators, in the system under consideration, is

$$E_{\delta} = \left\{ 1 + k [\cos(\epsilon + \phi) + j \sin(\epsilon + \phi)] \right\} \left\{ \frac{\cos(90^{\circ} \sin \delta)}{\cos \delta} \right\} \quad (3)$$

where $\epsilon = s' \cos \delta$ and ϕ is, as above, the phase-difference between the antenna currents. As in the horizontal pattern, δ is measured from the right toward the left, through 180° . ϵ is negative between 0° and 90° and positive from 90° to 180° . It will be noticed that in Eq. 3, Eq. 2 is employed as a proportionality factor in conjunction with another factor having the form of Eq. 1. This results, in effect, in multiplying the horizontal pattern for two radiators

by the vertical pattern for one radiator, to obtain this particular vertical pattern for the array. With this fact in mind, one can estimate such a pattern from inspection of the horizontal pattern. Figs. 8 and 9 are solutions based on Eq. 3.

Vertical Pattern Normal to Plane of Radiators

In this plane ($\theta = 90^{\circ}$) the distance from each point of observation to each radiator is the same, so that

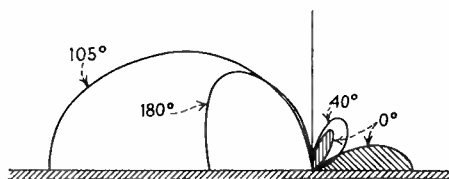

Fig. 7. Various vertical-plane distributions for the array whose horizontal distribution is shown in Fig. 4-A

$\psi = 0$. For that reason the field intensity distribution curve for the array has exactly the same shape as that for one radiator. If a null appears in the horizontal pattern at right angles to the line through the array, this null persists at all vertical angles. The pattern for the array, in this plane, is obtained by multiplying the value for $\theta = 90^{\circ}$ from Eq. 1 by the values of Eq. 2.

The vertical pattern in this plane can also be determined immediately from inspection of the horizontal pattern.

The Complete Radiation Pattern

Referring to a suitable spherical coordinate system such as shown in Fig. 6-A, the basic geometry for calculating the radiation pattern in *any*

vertical plane is readily developed by the construction of Fig. 6-B. From the latter, the following equation is obtained.

$$E_{\theta, \delta} = \left\{ 1 + k [\cos(\gamma + \phi) + j(\gamma + \phi)] \right\} \left\{ \frac{\cos(90^{\circ} \sin \delta)}{\cos \delta} \right\} \quad (4)$$

In this equation

$E_{\theta, \delta}$ is the relative field intensity in the directions θ and δ
 k is the current ratio, as in Eq. 1
 γ is the total phase difference between radiation vectors A and B due to difference in length of path, and is $s' \cos \theta \cos \delta$
 ϕ is the initial phase difference of the currents, as in Eq. 1.
 Eq. 2 is used again as a proportionality factor.

The solution of this equation reveals the shape of the space characteristic. One way in which the results of the solution can be plotted for descriptive purposes is shown in Fig. 7, where various vertical patterns in directions of particular interest are drawn.

Radiation "Rules of Thumb"

The following notes will be helpful when searching for a suitable radiation characteristic for a particular case:

(a) The horizontal pattern is symmetrical with respect to the line through the radiators.

(b) When the angle ϕ is either 0° or 180° , the horizontal pattern is also symmetrical with respect to a line running normal to the line through the radiators.

(c) The 3-dimensional pattern is also symmetrical with respect to the line through the radiators.

(d) When ϕ is either 0° or 180° , the 3-dimensional pattern is also symmetrical with respect to the line drawn normal to the line through the radiators.

(e) When $k = 1.00$, the nulls are directions of zero radiation.

(f) When k is other than unity, the nulls occur at the same angles as in the case of $k = 1.00$, but are directions of *minimum* (not zero) radiation. In the same manner, the maxima are reduced. As the current in one antenna approaches zero, the other current amplitude remaining constant, the horizontal pattern degenerates into a circle.

(g) Where there is suppression of radiation along the ground in the line of the radiators, there will be one or more maxima at high angles in that direction.

(h) Where a maximum occurs along the ground in the line of the radiators, the vertical pattern in that direction is flatter than that of one radiator alone.

(i) Where radiation is suppressed in a direction normal to the line through the radiators, proportional suppression occurs in the vertical plane in that direction.

(j) No parts of the radiation pattern extend beyond the limits of the solid of revolution made by rotating the vertical pattern on the line normal to that through the radiators ($\theta = 90^\circ$) about the geometrical center of the array. Maxima approach this surface as a limit wherever they occur.

Practical Applications of Directional Arrays

In broadcasting the attempt is made to suppress high angle radiation to reduce fading. To achieve this with single vertical radiators it is necessary to build very high structures. Greater suppression of high-angle radiations in two opposite directions, can be had by using two radiators with a considerable spacing and proper phasing of the radiator currents. The result is a directive radiating system, but there may

arise situations where the undesired horizontal directivity could be tolerated for large-scale high-angle suppression in the favored directions.

Fig. 8 is an example, it being the case of two radiators spaced one wavelength with equal cophased currents. The horizontal pattern is shown, together with the vertical pattern in the plane through the radiators and the vertical pattern for one radiator. In the high angles which have the greatest influence on short-range fading, those between 45° and 90° , there is a high degree of suppression. A "blind spot" occurs at approximately 60° . The ex-

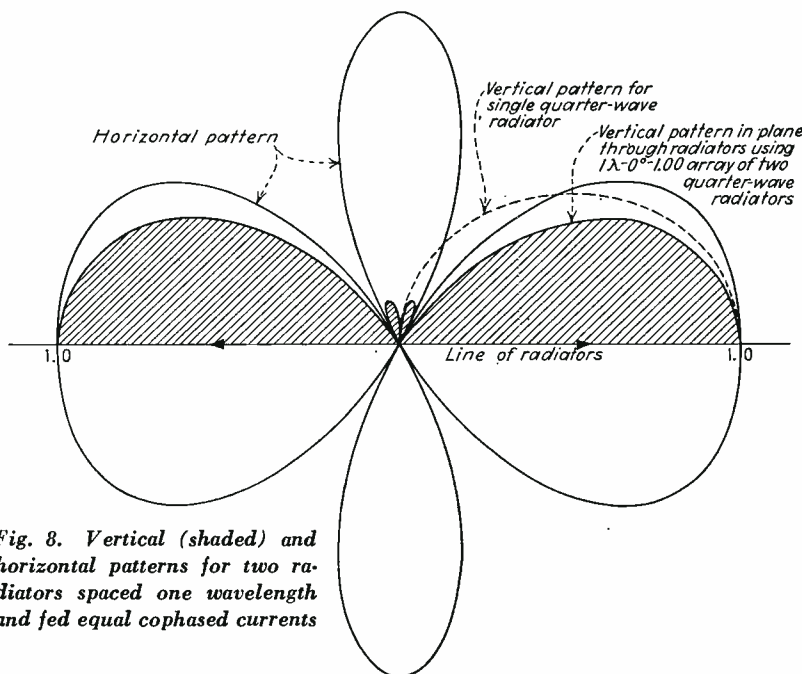

Fig. 8. Vertical (shaded) and horizontal patterns for two radiators spaced one wavelength and fed equal cophased currents

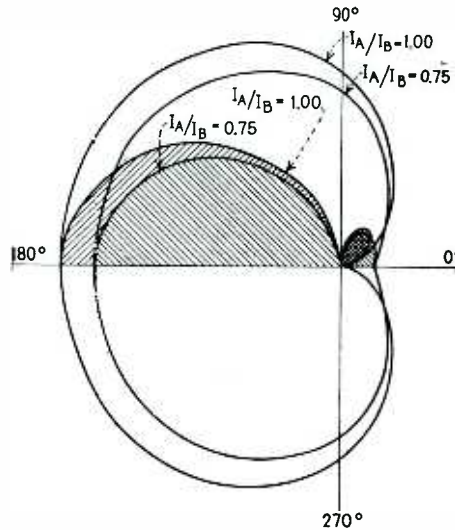

Fig. 9. Horizontal and vertical (in plane through radiators, shown shaded) patterns for radiators spaced a quarter wavelength, and for $\phi = 90^\circ$

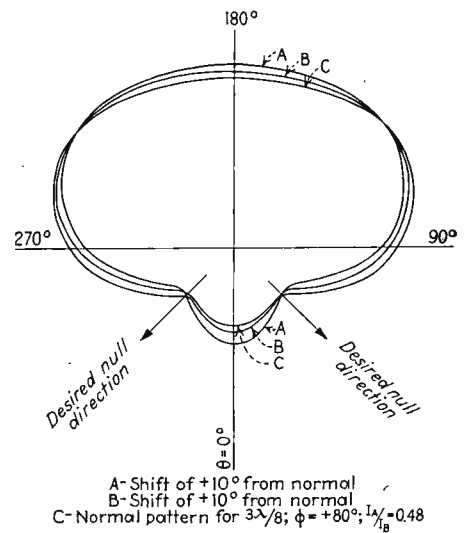

Fig. 10. Changes in horizontal pattern due to shifts in phase through the antenna currents, which are sometimes difficult to control in practice

trema inclination of the small high-angle lobe is such as to be of small consequence or negligible especially in regions of medium or high soil conductivity. Radiation sidewise has the same distribution as one of the radiators, and is also entirely useful. In the directions of the nulls and for a few degrees each side of them, mostly high-angle radiation would be had, and this would be of no value for primary service. In occasional cases where geographical conditions would permit, this attack on the high-angle radiation problem might have some economic advantages, over a single high radiator.

An example of a directly opposite case, where the use of two radiators gives generally inferior radiation characteristics, so far as ground wave coverage and fading are concerned, is that where two radiators spaced one-half wavelength, with equal cophased currents, are used.

Protecting One Direction Only

When radiation is to be suppressed in one direction only, one is confined to the use of some form of cardioid pattern. With two radiators, spaced not more than approximately $\frac{3}{4}$ wavelength, and properly phased, variously proportioned cardioid patterns can be obtained. A single null direction is desired when the service area of a station lies very nearly round about it and but one direction has to be protected. One unfortunate characteristic of all cardioids is that the

[Continued on page 48]

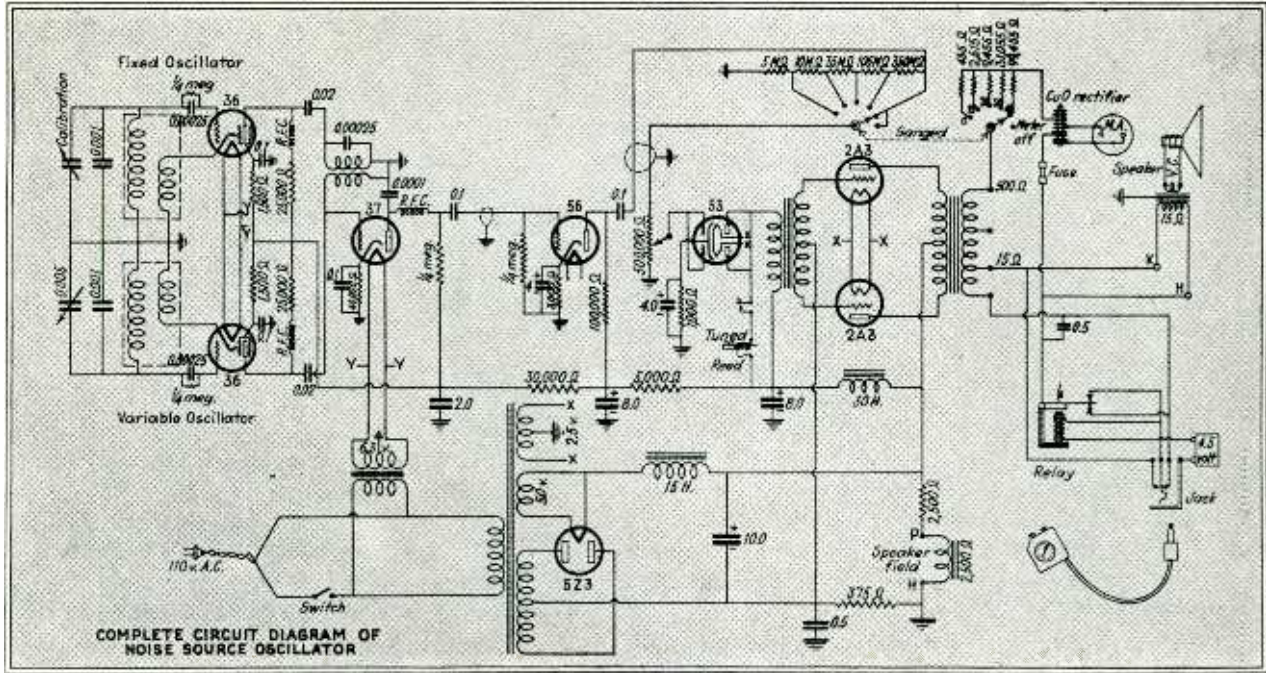

Portable Sound Measurements

A practical method, using standard equipment, for measuring the reduction of sound passing through doors, partitions, vehicle bodies, and similar sound-deadening objects

HOW loud is the shop machinery in the president's office—the outside traffic noise in a radio studio—the neighbor's piano heard in your living room? These questions are asked many times daily. Are they always answered? Sometimes, with an accuracy of plus or minus a half decibel, and in many cases within plus or minus ten decibels, but in most cases after sound proofing work has been applied the answer is "Yes, the noise is much quieter." But, by how much and what audible frequencies are least reduced? Therefore, it is the author's aim to write this article to assist the many electro-acoustical engineers in the measurements of sound intensities and reductions.

There are about half a dozen commercial noise meters now on the market that can and are being used to measure noise levels. The model 559-A developed by General Radio is used in this case in conjunction with the standard sound source equipment

By C. ALBIN ANDERSON

*Riverbank Laboratories
Geneva, Illinois*

developed by the author at Riverbank Laboratories.

The General Radio noise meter has been described in several papers and publications¹. The standardized sound source equipment can be described as a portable beat-frequency oscillator capable of an output of 12 watts, with a range of 60 to 4,100 cycles. It is provided with an output meter calibrated in decibels of sound intensity. The meter itself with its +10 decibel range and a group of logarithmic measured resistors provide a range of relative decibels volume setting of 0 to 50 db. The same knob that controls the 10 db steps also controls a set of volume-control voltage-divider resistors,

¹Electronics, April 1935. General Radio Experimenter.

which reduce the input signal in the amplifier second stage, proportional to the output signal intensity, thereby leaving the normal volume control to act as a vernier control in setting output sound intensities at desired db levels on the output meter. The loud speaker used is a nationally known make with a linear response up to 6,500 c.p.s. The speaker baffle box is acoustically treated inside to eliminate peaked resonances of the baffle. The oscillator unit is also provided with a calibrating reed and a calibration condenser. This affords a rapid and portable means of setting the frequency to "calibration" thereby using the large frequency dial to read frequencies from 60 to 4,100 c.p.s. over 180°. A relay to stop the sound from the speaker by means of a stop watch or reverberation meter switch makes the sound source adaptable to reverberation measurements. The entire unit is a-c operated from 110-120 volts.

For measuring the sound reduc-

tion through a door the sound source is placed on one side of the doorway and the noise-meter is placed on a table on the other side. The door is left open and a sound intensity is set at a fixed value at a frequency of say 512 c.p.s. The sound intensity is then measured by the sound meter. For illustration let us assume that the sound meter reads 45 db intensity. The door is then closed and the sound source remains constant. Now supposing the noise meter reads 24 decibels. Then the door reduces the sound of 512 c.p.s., 21 decibels. This procedure is again repeated at other frequencies desired, which will give the reduction of sound of the door over the frequency range run.

In measuring the reduction of sound through a wall a similar procedure is used. First, the source and the noise meter are placed a given distance apart and a reading taken. Then the source is placed on one side of the wall and the noise meter on the other with the two again the same distance apart and the noise meter read. The difference of intensities measured gives the reduction of sound of the wall directly in decibels. Precaution must be taken so that the sound is not bypassing through open doorways, halls, etc., to the noise meter.

In measuring reductions of other doors, walls, or partitions, the same procedure is taken.

Standard Sound Source

The figure gives the entire circuit for the standard sound source. Two 36 tubes are the oscillators with one fixed at 140 kc. and the other adjustable from 140 kc. to 144.1 kc. by means of a straight line frequency variable condenser. The oscillator coils are grid-cathode coupled which leaves the plates open for electron-coupled outputs.

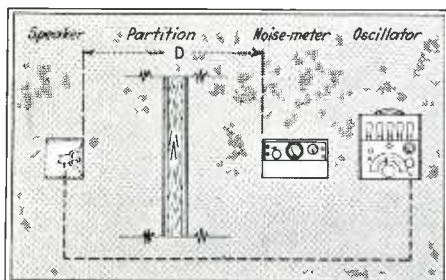

Arrangement of source, speaker, partition, and noise-meter for measuring transmitted sound

The fixed oscillator output is coupled to the 37 detector through a tuned primary (140 kc.) r-f transformer. With such a transformer tuned to the fundamental frequency, the harmonics are greatly reduced. The variable oscillator output is



Above, the standard sound source and speaker

Left, the noise meter used, a standard portable model having a range of 116 db

coupled to the grid of the 37 detector through a small fixed condenser which passes a uniform intensity signal of the oscillator over its range. Both oscillator tubes have the B+ voltage fed through r-f chokes to eliminate the r-f signal from entering the B supply leads and back feeding into each other, thereby, which would cause the oscillators to "fall in" with each other at the low frequencies. After the two r-f signals have entered the detector they have served their purpose to produce an audio signal which is fed into a 56 audio stage. R-f signals from the detector are blocked by the r-f choke and the 0.0001 μ f condenser. The 56 audio stage sends its signal to a 53 (connected as a triode) through two volume controls. The first one is the logarithmic step volume control which has its shaft common to the output meter tap switch. The second is a 500,000 ohm potentiometer which acts as a vernier to the fixed-step volume control, and affords a change in volume range over the output meter scale. Therefore any db fraction of volume change can be made over the entire output range.

The 53 is transformer-coupled to two 2A3's push pull, whose output

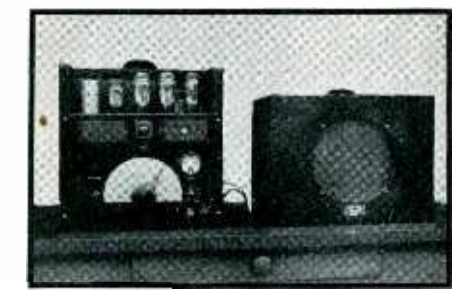

is fed to an output transformer. The secondary winding of this transformer has a 15 and 500 ohm output impedance. The 15 ohm drives the dynamic speaker through a voice coil transformer. The 500 ohm section has the output meter and series resistors tapped across it in the form of an a-c voltmeter, although the meter itself has a decibel scale dial.

Stop-Watch Connections

The stopwatch jack is so wired with a relay that when the stopwatch plug is out of the jack direct contact is made through the 15 ohm circuit. When the plug is inserted in the jack the 15 ohm circuit is broken and is only completed when the contact button on the stop-watch is pressed which in turn closes the circuit with the relay. A 4.5 volt "C" battery supplies the current for the relay.

Instead of a stopwatch a reverberation meter can be plugged in. This affords rapid means of making reverberation measurements, because in measuring the reverberation of a room or auditorium the time recording device must start instantly as the sound source is shut off.

Low Noise Recording

A new process makes use of an extremely fine-grain material, which is softened temporarily for the engraving, produces records with a 15 db. improvement in noise level

The process consists of softening a normally hard substance by vapor immersion immediately before engraving. The engraving is thus carried out under conditions comparable to wax engraving. After the record is completed, the material regains its normal hardness. The material is a nitro-cellulose, but it has an abnormally high percentage of synthetic resin in its composition, and the resin has softening characteristics which are reversible with respect to vapor solvents. The material is spread on flat aluminum discs, the

The record, which is coated on both sides, is prepared for engraving by being placed in an air-tight can into which a small quantity of a special organic solvent has been poured. The vapor from the solvent softens the nitro-cellulose material sufficiently, in about five minutes, to permit engraving. The material remains soft for about an hour in the open air, but it can be made to stay soft almost indefinitely if enclosed in an air-tight container.

During the engraving, the "chip" or shaving removed by the needle re-



ENGRAVING on nitro-cellulose is one of the latest methods of obtaining high quality disc records with a low noise background. Such records are now being extensively used for broadcast transcriptions and in other high quality applications. Records of this type have been produced with a noise background 35 to 42 db. below the signal of the engraving. But since the noise backgrounds of high fidelity broadcast stations are from 60 to 70 db. below signal, it is desirable to have records possessing still lower background level.

Progress in this direction has recently been announced by Captain Richard H. Ranger, of Newark, New Jersey. Using a special material and a new process of preparing it before engraving, Captain Ranger has been successful in producing records whose noise level is 56 db. below signal, an improvement of some 15 db. over the best previously attained. Not only is the noise reduced in the process, but the material, once engraved, is sufficiently hard to withstand 100 playings without injury, whereas the usual cellulose record begins to wear after 30 playings.

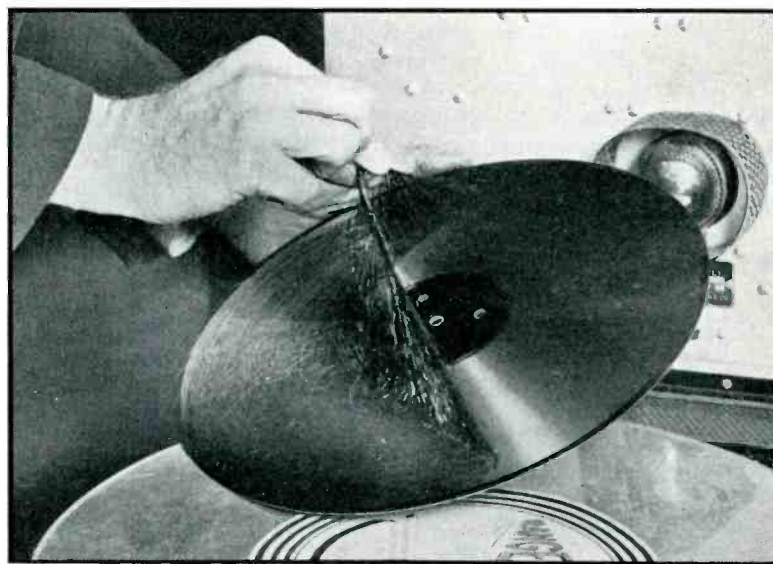

Above, removing the "thread" left by the needle after engraving. Upper left, Captain Ranger inspecting samples of the new material as they leave the endless belt of the coating machine. The material is flowed, not sprayed, on aluminum blanks

spreading and drying processes being carried out in a conveyor-belt machine which assures a high degree of freedom from dust.

The needle used is made of stellite, a very hard machine-tool steel; it has a life of 2½ hours of recording (33½ r.p.m.), after which it can be resharpened. The needle is mounted vertically above the material, the flatness and softness of the material permitting this position.

mains as a continuous thread, which is removed when the recording is completed. The record is then allowed to stand until it has regained its hardness, whereupon it is ready for play-back. The hardening process may be accelerated by putting the record on a small electric heater for a few minutes. Once hard, the record remains so under all conditions except exposure to the solvent.

Tube Control of A-C Motors

Several low-cost and effective methods of controlling small a-c motors by means of vacuum tubes widely used in radio receivers

By J. D. RYDER

The Bailey Meter Company
Cleveland

A PROBLEM often encountered in the application of electron tubes to industrial control is the economical and efficient conversion of the electrical output of the tube circuits to a mechanical form which can be used to operate valves, close gates and perform other types of work. The problem is quite often complicated by requirements of low first cost in the tubes and associated circuits, to meet low priced competitive apparatus not using tubes.

Economically, changes to electron tube control usually must be justified over other forms of equipment by a lower first cost and operating expense, or by greatly improved operation. In many cases this dictates the use of low cost radio tubes combined with standard types of miniature motors or other mechanical devices for obtaining the desired control. At the same time, full use of the high speed characteristics and lack of inertia of the tubes should be made, since these are often important points of superiority over other forms of apparatus.

The writer has developed several circuits in which a controlling volt-

age obtained from light contacts, photocells, or similar means, is used to operate small electric motors and other devices.

Figure 1 illustrates one version of these circuits in which a reversing self starting synchronous motor is controlled. This is a standard Telechron motor, of a type used extensively in electric clocks, except that it is provided with two independent field windings, with the positions of the copper shading rings reversed, to obtain rotation in either direction.

Each field coil is connected across the 110 volt a-c line in series with a 2 μ f condenser and the primary

winding of a step-up transformer T_1 or T_2 . The secondaries of the transformers are connected to the plate and filament of the vacuum tubes, which are normally type 45, or type 47, triode connected. The filaments are heated by a winding on a third transformer which also is arranged to provide a voltage for whatever type of grid control circuit that may be chosen. As shown, the grids are controlled by making or breaking light contacts on a contact making galvanometer. Since resistors R may be made a megohm or more, the amount of current handled by the contacts is very small.

In operation the tubes are biased beyond cutoff by the voltage E , applied to each grid through the resistors R , with the contacts open. With the tubes cut off the secondaries of the transformers T_1 and T_2 are open circuited. This reflects a high impedance into the primary circuit in series with the motor field and reduces the voltage on this field well below the value at which the motor will run. When a contact is made the biasing voltage of the tube is short circuited, the grid is at filament potential and the tube passes current from plate to filament, the plate voltage being that developed

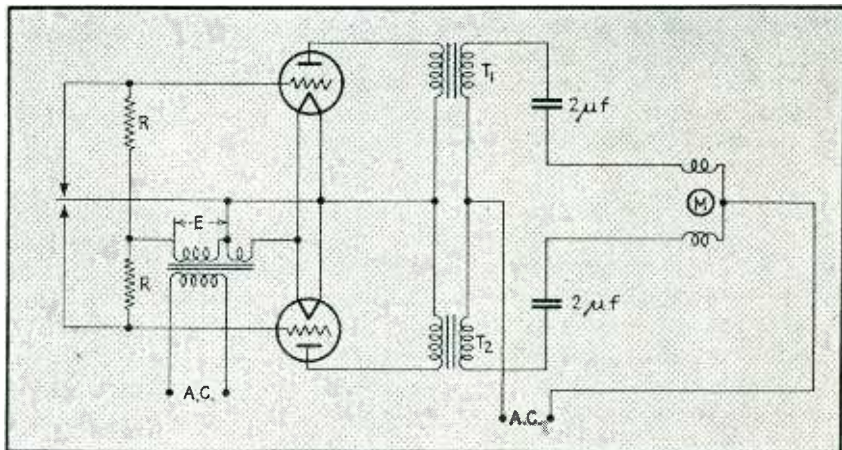

Fig. 1. Circuit for control of a reversing synchronous motor

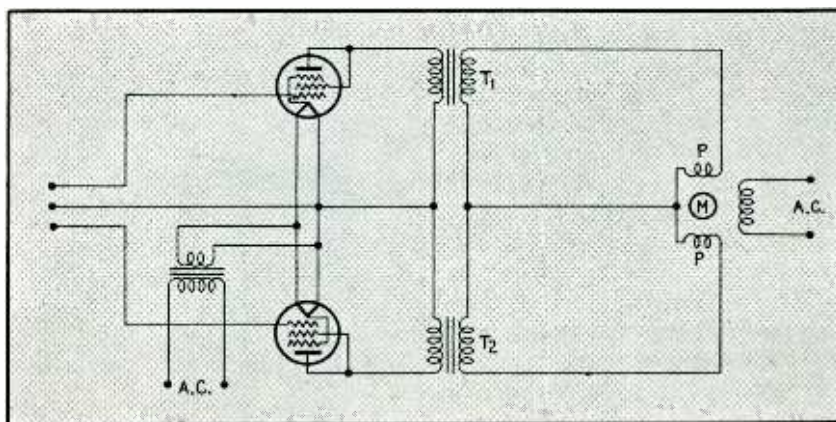

Fig. 2. This circuit will control a small reversing induction motor both as to speed and direction by application of proper grid voltage

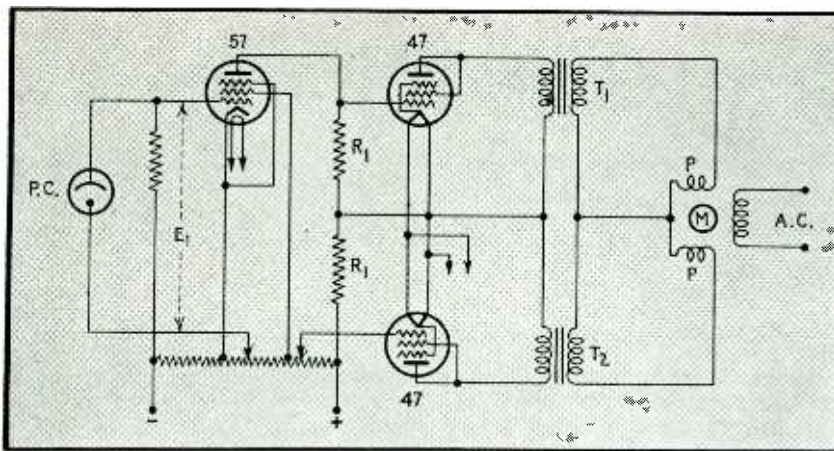

Fig. 3. A further adaptation of Fig. 2 in which a light beam will control the motor in speed and direction of rotation

across the secondary of the transformer T_1 or T_2 . The tube load, reflected into the primary circuit, is quite low with respect to the impedance of the motor field coil, and this results in most of the line voltage appearing across the field coil and operation of the motor in the desired direction.

The condenser and the inductance of the motor field are approximately series resonant at the supply frequency and this develops an even greater voltage across the motor field. With the tube conducting, and the series impedance of the transformer T reduced by the secondary load, the voltage applied to the motor field is usually slightly greater than the line voltage.

The transformers are of a special design, having an especially low resistance primary winding to give a low series impedance with loaded secondary. The primary open circuit impedance must be high with respect to the impedance of the motor coil. The transformer gives about 375 volts on the tube plates with the tubes non-conducting, dropping to about 90 volts when the normal plate current of about 20 milliamperes flows. These transformers, while special in design, are similar to an ordinary audio transformer and are quite low in cost. In fact for some of the original development work several types of old low-quality audio transformers with low impedance primaries were satisfactorily used, the main requirement being fairly low resistance windings.

Results obtained with this circuit have been highly satisfactory. Since there are no relays to introduce a time lag in the circuit, the action is

instantaneous and contact durations of one cycle of the sixty cycle supply will accurately operate the high speed rotor of the motor. Contacts of even shorter duration will also operate the motor in smaller steps provided they are made during the half cycle in which the plate of the tube is positive. For longer contacts the motor will, of course, operate at full speed for the contact or of voltage application to the grid of the tube. There are also no relay contacts to cause trouble, due to wear and corrosion.

Life Expectancy

In one application of this circuit, the grid circuit contacts are actuated for various lengths of time at the rate of sixteen a minute. The equipment is in service 24 hours a day giving 8,400,000 contacts and motor operations a year. During three and one half years service or 29,400,000 contacts, the contacting points have not been touched and there has never been evidence of a contact failure.

The probable tube life in this sort of service has not been definitely established, but the average for standard type 45 tubes seems to be over 10,000 hours. In the equipment mentioned above, in operation over three years, the original tubes are still giving good service after 28,000 hours. This is probably due to the fact that the plate current is only about 50% of the normal rating, and flows for an average of possibly 10% of the time. The plate voltage is above the rating, but at the time of current flow it is reduced to a low value. The tubes are also usable in

this service after they would no longer be satisfactory in radio service.

Use of Induction Motor

Another circuit of somewhat similar design, but greater capabilities is shown in Fig. 2. This uses a small reversing induction motor with wound shading poles such as are commonly used for driving valves, dampers or recording devices.

The motor is capable of much greater power output than that used for the previous circuit, the input to the field running as high as 25 watts, and the motor efficiency being quite reasonable. Besides the advantage of greater power output, the motor speed may be varied over a range of 4 to 1 in either direction, or a differential action may be obtained, the motor speed and direction varying according to the difference in the excitation of the shading poles.

Each of the motor shading pole windings is connected to the primary of a transformer T_1 or T_2 , the secondary of which is connected to the plate-filament circuit of a vacuum tube as in the previous circuit. The tube grid circuits may be arranged in a number of ways, one of which is shown in Fig. 3. The only requirement of the grid input is that sufficient voltage be supplied to swing the grids from cutoff up to approximately zero voltage.

The field of the motor is continuously excited from the a-c line, and the wound shading poles, acting as small transformer secondaries, have induced in them about 25 volts. This voltage is applied to the transformers, and these, being of a high

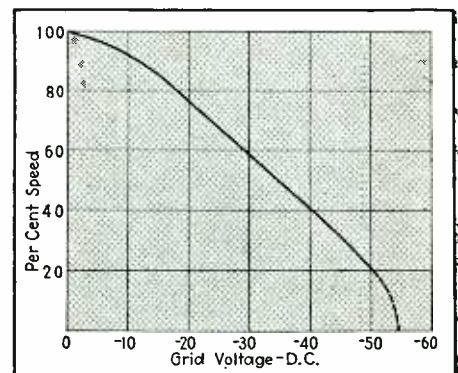

Fig. 4. Variation of motor speed with grid voltage in the circuit of Fig. 2

step-up ratio, develop the plate voltage for the type 47, triode connected, vacuum tubes. If the grids are normally biased to cutoff, no plate current flows and the primaries of the transformers are of such a high impedance that insufficient current is drawn through the shading poles to produce rotation of the motor. When the grid voltage conditions are changed so that one of the tubes is conducting, the primary current drawn from the shading pole by the tube load on the transformer is large enough to cause full speed operation of the motor in the desired direction.

In normal use, such a motor is designed to be operated by short circuiting one or the other of the shading poles. The plate resistance of the tube, reflected into the primary circuit by the transformer, is low enough to constitute an effectual short circuit of the shading winding affecting the operation of the motor.

Due to the poor regulation of the shading pole winding, the voltage drops to about 6 volts when full current of 0.30 amperes is carried. This reduces the plate voltage to about 100 volts and necessitates a slightly greater grid voltage swing to obtain the desired plate current of 20 milliamperes. As in the previous circuit, this large drop in plate voltage with current allows the use of a higher than normal plate voltage during the time the tube carries no current, without at the same time producing undue tube heating.

The transformers have low resistance primaries and are designed for low magnetizing current, but as before, certain types of standard transformers have been used and found satisfactory. Several types of microphone to grid transformers gave very good results.

The main requirement is a low resistance primary, so that the effective circuit resistance will be largely determined by the reflected tube load, and allow a large value of current to flow in the shading pole circuit with the tube conducting. With the tube non-conducting, the impedance of any transformer used must be high enough to prevent rotation of the motor by the transformer magnetizing current flowing through the shading coil.

A wound shading pole motor can have its speed controlled by varying the current in the shading coil by

means of external resistance. This can be accomplished in Fig. 2 by varying the value of grid voltage applied, consequently changing the plate resistance and the reflected resistance in the transformer-shading coil circuit. With the particular motors used, a speed variation of better than 4 to 1 was possible in this manner, depending somewhat on the motor load. Figure 4 shows a typical curve of motor speed plotted against the grid voltage applied to one of the type 47 tubes in the circuit of Fig. 2, the other tube being inactive. It should be noted that over most of the range the speed variation is essentially linear with the grid voltage.

Another point which has been helpful in the application of this circuit is that it can be connected to

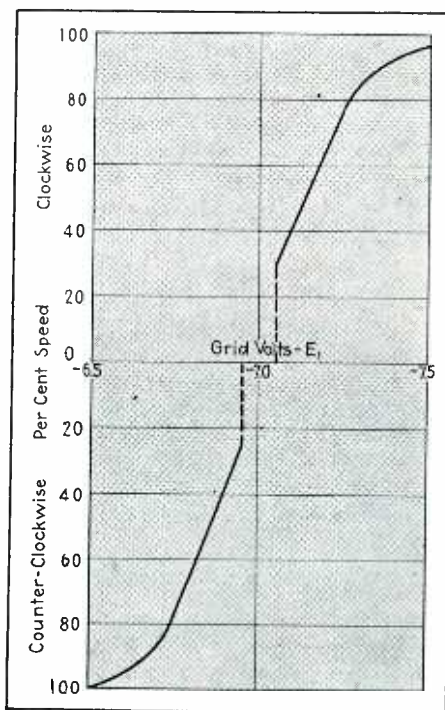

Fig. 5. Variation of motor speed and direction in the circuit of Fig. 3

the output of any amplifier giving sufficient grid swing, and since the plate voltage is supplied by the control circuits, no special voltage supplies or connections are required. A direct coupled circuit has been frequently used.

Phototube Control

The circuit of Fig. 3 shows an application for controlling a motor, both as to speed and direction, from a photoelectric cell. This might be

used for an automatic continuous color matcher or recorder, or an automatic turbidity control with the motor driving a valve. The circuit is very sensitive, a one volt change in phototube output being sufficient to change the motor from full speed in one direction to full speed in the other. At some value of voltage on the grid of the type 57 tube, the plate currents of the two 74's will be equal and, the excitation of the two sets of shading poles being equal, the motor is at rest. If the 57 grid voltage is now changed slightly, the grid voltages of the 47's are changed differentially and the current in one shading pole is increased, the other decreased. The motor then rotates slowly in the direction of the stronger shading pole. By larger changes of 57 tube grid voltage a greater speed may be obtained, or by a grid voltage change in the opposite direction the motor may be reversed. Figure 5 shows a plot of the 57 tube grid voltage against motor speed for this circuit. A considerable range of sensitivity can be covered by changes in the value of the plate resistors R in the 57 tube plate circuit, the curve shown being taken with each resistor having a value of 250,000 ohms.

Application

The circuits described have been used in applications where the mechanical power requirements were not large, but where a rotary motion and dependability of operation were needed, all at a low cost. The electron tubes provide the dependability, speed and freedom of maintenance, and since the circuits were developed to use radio vacuum tubes, the tubes are available at a low price. In a circuit such as Fig. 3, where a phototube operating from a beam of light reverses and varies the speed of a motor, all without moving parts of any kind except the motor, the tubes provide a type of operation not obtainable in any other way. Since the small motors used are standard types, they too are available cheaply. It has been found that the cost of the equipment for Fig. 1, exclusive of the motor, is less than five dollars. These advantages all make possible a wider application of electron tubes to industrial control, since cost is so often the controlling factor in such applications.

NEW BOOKS

Electron Diffraction

By R. BEECHING

Thermionic Emission

By T. J. JONES

METHUENS MONOGRAPHS ON PHYSICAL SUBJECTS, Methuen & Co., Ltd., London, 1936. (Price 3/ each.)

THESE TWO SMALL BOOKS of 100-odd pages each recommend themselves as succinct expositions of two phases of modern science. An earlier volume reviewed here was E. V. Appleton's monograph on Thermionic Vacuum Tubes. Other books in the same series deal with spectra, wave mechanics, X-rays, photo-chemistry, etc.

Electron diffraction, a newcomer among the physicists' tools, promises to contribute much to industry during the next few years. It will furnish much information about surface and molecular structure (see *Electronics*, September, 1935) and thus may bridge many of the gaps between the chemist and the physicist.

Mr. Beeching describes the brief history of the electron considered as a wave, the early work of Davisson and Germer, G. P. Thomson and others leading to the final verification of the De Broglie theory. Then he describes the electron diffraction by thin films, by reflection, the apparatus and technique, and in a final chapter, he gives the present day uses of the phenomenon.

In a preface G. P. Thomson, known for his work in this fascinating field states that this little book is also most useful to those who do not intend to practice any of the experiments but who wish to have a good working knowledge of the wave character of electrons, or who wish to be able to appreciate the conclusions reached by experimenters working with the new technique.

The handy volume on Thermionic Emission pursues a course better known to *Electronics* readers. It gives in small space the early history, and recent progress, the work of Dushman, Einstein, Schottky, Richardson. It gives comprehensive data on modern forms of emitters, such as thoriated tungsten, cesium on tungsten, transmission of electrons through potential barriers, oxide-coated emitters, and a final chapter on emission of positive ions. Experimental technique gets its valued place in the book.

Both books are illustrated; both have many references to the literature.—
K. H.

Neon

By S. GOLD. Crosby Lockwood & Son, Ltd., London. Distributed in America by the Chemical Publishing Company of New York, Inc., 175 Fifth Avenue, New York City. (178 pages, 17 illustrations. Price \$4.50.)

THE SUBJECT of this book, gas discharge tubes for advertising purposes, is presented by the author in an interesting fashion. The book is elementary in character, and in its attempt to cover the entire field in less than 200 pages, is necessarily brief in its treatment of individual topics. For this reason, the book is excellent for engineers, sign salesmen, and others who want a brief treatment of the field which will give them a knowledge of how neon signs are produced and installed. But for the neon sign manufacturer, or technician engaged in the manufacture of such signs, the book is much less valuable. The small num-

ber of illustrations, and the dearth of specific and detailed information on manufacturing procedure leave much to be desired in this respect. The fact that the book has been written from the British point of view does not detract from its usefulness in the American field, except that in a few cases the British terminology is confusing.

• • •

Methods of Measuring Radio Noise

A REPORT of the joint coordination committee on radio reception of E.E.I., N.E.M.A. and R.M.A. (5 pages. Price 15 cents to members of the publishing societies; 35 cents to non-members in the United States; 45 cents in foreign countries.)

THIS PAMPHLET contains specifications for an instrument recommended for use in measuring radio noise, and outlines the procedure followed in making such measurements. The report sets up standards for electrical characteristics, including such items as wave form, frequency band, response range, gain, selectivity, tube noise, shielding, fidelity, etc. The report is one of the first concrete evidences of the important work of the joint committee and should be read by every engineer who is concerned with the radio noise problem.

RADIO IN AIR CORPS "FLYING FLAGSHIP"



Two radio transmitters, using phone, CW, and ICW, are installed in the new 205-mile-an-hour Douglas twin-motor plane which serves as a flying headquarters for Major General Frank N. Andrews, commander of the GHQ Air Force. One set has a range deliberately limited to 25 miles for liaison communication with nearby squadrons on fighting ships, the other has a normal reliable range of 750 miles. A "homing" compass radio direction finder and a robot pilot are included in the equipment of the plane

Beam Power Tube

[Continued from page 21]

crowded unavoidably, some second harmonic is introduced when the tube is operated single-ended. If it is desired to reduce this, a resistance-coupled pre-amplifying stage may be employed having a plate load somewhat lower than would normally be used. In this way a second harmonic of the proper phase can be generated in the pre-amplifying stage to reduce considerably that produced in the output stage. In push-pull arrangements, of course, the second and other even harmonics are absent.

Column 3 of Table I illustrates an interesting mode of operation of the new tube. When the screen voltage is reduced to 125 volts, the power sensitivity of the tube which is normally high is still further increased. With this condition, a peak signal of only 8 volts is required to produce an output of 4.2 watts.

The new tube is like a pentode in that it has a high plate impedance. This is desirable from the standpoint of efficiency and simplified filtering for the d-c supply.

Investigation of distortion in amplifying systems by means of the cathode-ray oscillograph is very instructive. In Fig. 6 are shown some representative oscillograms of distortion. These were obtained by using a bridge with three resistor arms and one arm consisting of an inductance and capacitance tuned carefully to the fundamental or 420 cycle signal.¹ The oscillograms portray the residual distortion since the fundamental is balanced out. Comparison of oscillograms A and B show the sudden appearance of higher-order harmonics in a class AB system at grid current. (The driver transformer was one used in a good radio receiver.)

Oscillogram C shows the residual distortion in the operating range of an amplifier using two beam power tubes. Oscillogram D shows the distortion of an amplifier using triode tubes. Note that in both cases the principal distortion is a small amount of third harmonic. In this particular case, the beam power amplifier gave less distortion than the triode.

Present-day loud speakers together with their output transform-

ers do not present a pure-resistance load to the output tube or tubes. The moving coil and supporting spring usually have a pronounced low-frequency resonance in the region of 60 cycles. At higher frequencies the output transformer presents a slightly inductive impedance which, of course, increases linearly with frequency. Because of the latter effect, it is necessary, in order to prevent distortion of the higher audio frequencies to supply a compensating network of a series resistor and capacitor for high-impedance tubes. With regard to the former effect, some designers prefer to attack the problem at its source; that is, the loud speaker.

Use in Feed-Back Amplifiers

The new beam power tube, because of its high power sensitivity, is ideal for use in a reverse feed-back circuit. (Simple circuits of this kind have been suggested by F. H. Shepard of the Radiotron Research & Development Laboratory.) Fig. 5 illustrates such a circuit. With the constants chosen, approximately 9% of the output signal is fed back to the grids in reverse phase. Let us examine how this arrangement reduces the effective output impedance and may, therefore, damp low-frequency speaker resonance. Consider the upper half of the push-pull arrangement of Fig. 5. Assume that an alternating potential of 1 volt is introduced at the point P1. With no input signal a voltage of 0.09 volts is fed back into the grid circuit. This voltage causes a current to flow in the plate circuit of 0.09×8 (the mutual conductance of the new tube is approximately 8 milliamperes per volt) or 0.72 milliamperes. The effective plate impedance is, therefore, 1 divided by 0.72×10^{-3} , or approximately 1,400 ohms. In the arrangement shown, however, no more than ordinary precautions need be observed to prevent parasitic oscillations.

As pointed out by Black,² reverse-feed-back reduces distortion but, of course, reduces the power sensitivity. With the arrangement illustrated in Fig. 5 the overall power sensitivity is greater than that of the usual output triode. The damping on the

loud speaker is comparable to that introduced by the triode but the desirable high d-c efficiency of the pentode is retained.

Damping of the loud speaker may be investigated by means of a series of impulses of very short duration and at a frequency of about 5 per second, produced by means of a battery and a motor-driven set of automobile-ignition contacts. The square wave of current thus produced is passed through a transformer so that a signal like that illustrated in Fig. 7A is produced. This signal is fed to the grid of an amplifier supplying a speaker. Instantaneous comparison is made on different amplifiers with the same signal and the same loud speaker.

The sound produced by this signal is a succession of sharp clicks not unlike the sound of castanets. If bad resonance occurs, these sharp sounds are accompanied by an undertone not unlike that of a bass drum. Figs. 7B, C, and D are, respectively, oscillograms taken with a beam power tube in a conventional circuit, a beam power tube in a circuit having 18 per cent feed-back, a triode in a conventional circuit. It may be noted that the reverse feed-back circuit is at least as effective as the triode amplifier in reducing this effect.

This new tube has been subjected to careful measurements and to critical listening tests. The results of these measurements and tests indicate that a significant advance has been made in output-tube design. The fact that this tube has low third-harmonic distortion and practically negligible higher-order distortion is very desirable. Its high power sensitivity is advantageous in many ways such as, for example, the use of reversed feed-back amplification.

Furthermore, the beam power tube has sufficient power-handling abilities so that with but two tubes really adequate acoustic power can be produced economically.

¹Massa, Frank. Loudspeaker Design, *Electronics*, Feb. 1936.

²Fletcher, Harvey. "Auditory Perspective Basic Requirements," *Electrical Engineering*, Jan. 1934.

³Fletcher, Harvey, "Speech & Hearing," P. 98, D. Van Nostrand, 1929.

⁴Massa, Frank, "Permissible Amplitude Distortion of Speech," *Proc. IRE*, May 1933.

⁵Thompson, B. J., Graphical Determination of Performance of Push-Pull Amplifiers, *Proc. IRE*, April, 1933.

⁶Black, H. S., Stabilized Feed-Back Amplifiers, *Electrical Engineering*, Jan. 1934.

⁷Schmit, D. F., & Stinchfield, J. M., Distortion in Amplifiers, *Electronics*, May, 1930.

TUBES AT WORK

A "TALKING CLOCK" for British telephone subscribers, an adjustable tube-operated interrupter, new polarizing glass for checking tube production.

G.P.O. Clock Announces Time Over Telephone

THE BRITISH POST OFFICE "Speaking Clock" is designed to announce the time over the ordinary telephone at intervals of 10 seconds with an accuracy of 0.1 second. The announcements take the form: "At the third stroke it will be eleven seventeen and forty seconds." The spoken words will be followed by three dot signals of 800 cycles per second tone, at one second intervals and of one tenth second duration.

The announcement is made by the aid of four glass discs carrying concentric circular sound tracks photographically recorded. One disc rotating at 60 rpm carries records of the odd numbers 1 to 59, and a second the even numbers 2 to 58, together with the words "o'clock." Each of these discs has, associated with it, an optical system and a photo cell which is automatically centered over the appropriate track by means of cam mechanism and brought into operation by the opening, once every 10 seconds, of a shutter which is electro-magnetically controlled via a cam switch. In this way, each minute of the hour is spoken at the correct instant. The hour itself is spoken from a similar disc rotating at 30 rpm (and associated photo cell) carrying the phrases from "it will be one," etc. The portion of the preliminary phrase, "At the third stroke" is reproduced by means of a fixed optical system from a track recorded on the fourth disc. The latter also carries the records for the final part of the phrase, "and ten seconds" and rotates also at 30 rpm.

The discs, the cam mechanisms for moving the reproducing systems and the cam switches for opening the shutters in the correct sequence are driven at constant speed by means of an 8 pole, 3 phase synchronous motor, running from a.c. at 4 cycles per second, i.e. 60 rpm. The operating power is obtained from a power amplifier following a 3-phase oscillator of the Van der Pol type. Novel means are used to obtain frequency stability. A narrow beam of light is focussed on a suitably shaped shutter mounted on a "free" pendulum beating seconds. The shape of the shutter is such that when the pendulum amplitude of swing is correct, the amount of light falling on a photo cell behind the shutter varies sinusoidally at exactly 4 cycles per second. The output from the cell is

amplified and the oscillator frequency is stabilized by injecting a portion of the amplified voltage into one grid circuit.

In order to maintain the correct amplitude of swing of the pendulum the two half waves of the a.c. are differentially rectified. When the amplitude of the swing decreases there is a resultant d.c. due to the wave being no longer sinusoidal and thus d.c. is applied as bias to a gas filled relay in such a sense that, as the amplitude of swing decreases, the bias falls and the relay becomes conducting. A condenser then discharges through the impulsing magnet of the pendulum and restores the swing to normal.

The speed of the clock mechanism is thereby positively controlled by the pendulum and a high degree of constancy secured. The clock is checked hourly by a signal transmitted from

Greenwich Observatory. Should this not arrive when the clock mechanism is in the exact position corresponding to the hour, one of a number of relays (depending on the magnitude and sign of the error) is operated. The operation of the relay causes the current in a coil, positioned below a small armature carried by the pendulum, to be varied approximately. The attraction between the armature and the coil constitutes a small force on the pendulum, additional to gravity. By variation of this force compensation for small changes in the pendulum rate is obtained.

• • •

Body-impedance Measurements Aid in Medical Diagnosis

ACCORDING TO A REVIEW in the *General Radio Experimenter* for February, it has been found that the Q (ratio of X to R) of the internal tissue of the human body has a definite relation to its pathological condition. By means of an ingenious impedance bridge, developed by J. W. Horton, the ratio of



By dialling "T-I-M," British telephone subscribers can connect with this "Talking Clock," which announces the exact time every ten seconds automatically. Circular sound tracks on whirling discs supply the announcement to photocells, which are centered over the required track at the proper instant by a cam mechanism

Balanced Erie Resistors

are the best
INSURANCE
against these
SERVICE
FAILURES

Distortion at high volume level . . . Usually due to open 4 mike electrolytic. Also check 400,000 ohm resistor from 47 grid to voltage divider for change in value or open circuit causing high pentode plate current. If 47 is weak, other tubes ok, this may be the cause.

Intermittent reception . . . Check primary of i.f. transformers. Trouble is usually in the settings of the volume control on locals . . . Usually caused by drop in value of 110,000 ohm unit on resistor strip.

Tone distorted, everything appears to check ok . . . Replace 200,000 ohm resistor in circuit of unshielded tube on rear of chassis if value is materially higher than this. Plate voltage will appear normal on an analyzer.

Sets play only when 27 a.v.c. tube is removed . . . Look for open resistor in a.v.c. return, also for high negative bias on r.f. and i.f. control grids. Oscillation . . . Usually caused by open circuit in .1 mike screen or leaky .1 by-pass across resistor in a.v.c. circuit, usually found in the power pack connected to the blue lead from the condenser block.

Weak reception . . . Check .1 mike condenser from 35 screen to ground. Replace 250,000 ohm, eighth watt resistor from 2nd detector 57 plate to 80 filament even if it tests ok. On load it sometimes drops plate volts from 180 to 100. Use a one-watt carbon replacement. (I.F. 262 kc.)

Poor volume or entirely inoperative resistor . . . All models use a screen supply resistor of 14,000 ohms, 2 watts, followed by a 1/3 watt, 5,000 ohm unit in the case of the 24 oscillator ohm unit in 1/3 watt, 5,000 ohm resistor and another to ground. These resistors commonly become charred and their values drop to as little as 500 ohms, or they burn out entirely. Replace them with a 15,000 ohm, 2 watt and two 5,000 ohm, 1/2 or 1 watt units.

Audio frequency modulation of oscillator, audible all over dial . . . Replace 56 grid leak with proper size. It has probably increased in value.

Fading after a few minutes of operation . . . Often caused by shorting of resistor located near volume control to one of control terminals.

Service Hints on how to correct various forms of receiver failures due to inferior resistors reproduced from a national radio servicemen's magazine.

Because Erie Resistors show exceedingly small changes from their nominal resistance values under all types of normal operating conditions, they can be depended on to give balanced trouble-free operation in standard receiver circuits.

The booklet "CHECK EVERYTHING" tells why Erie Resistors are the best insurance against operating failures similar to those reproduced above. Write for your copy today.



CARBON RESISTORS
AND SUPPRESSORS

**ERIE RESISTOR
CORPORATION**

AUTOMATIC INJECTION
MOLDING

TORONTO ERIE, PENNSYLVANIA LONDON

the reactance to the resistance of the internal tissue of the patient may be measured. For individuals in normal health this value lies between 0.10 and 0.07. The values change under various pathological conditions from as low as 0.02 to as high as 0.14. Each individual in normal health has a characteristic value peculiar to himself which changes from this value by as much as 2 to 1 under abnormal pathological conditions. The reactance component of the impedance of the human body is of a capacitive nature, probably caused by polarization of the tissues. In order to differentiate between the impedance of the external tissues, which is usually high, and internal tissues, a 4-terminal bridge must be used.

• • •

A Thermionic Time-delay Relay

BY GEORGE MUCHER, Chief Engineer
Clarostat Mfg. Co., Inc.

TAKING ADVANTAGE of the negligible leakage of good grade paper condensers and the resistance stability of good volume controls, one can assemble a simple, inexpensive, highly practicable thermionic time-delay relay for such applications as repeating or cycling life tests in developmental and production-checking work. As an example, the equipment described herein has been used regularly for accelerated life tests on new types of resistors. The time-delay relay offers "on" and "off" timed intervals of from 1/20th second to a full minute, and by adding proper resistors in series with controls R_C (charging resistor control) and R_D (discharging resistor control) longer timed cycles can be obtained. With suitable paper condensers and volume controls, the unit may be readily calibrated to read in time-

lay seconds. It operates on 110 volts a.c., and the operation is not affected by ordinary line-voltage fluctuations.

Because, for economy's sake, a unit to operate without transformer on 110-volt a.c. supply was desired, a line-voltage-dropping resistor was chosen. With this requisite in view, series heater type tubes were selected, namely, a 25Z5 rectifier tube and a 43 power pentode tube. The 25Z5 tube is operated as a voltage doubler (the circuit will not operate on 110 volt d.c. lines) and delivers pulsating d-c power of 250 volts (approximate). One half of the rectifier tube supplies the plate power for the Type 43 tube which operates the relay. The other half provides a negative bias voltage for charging the condenser C across the grid circuit of the Type 43 tube.

Since the charging voltage affects the time delay constant of the entire unit, a variable charging voltage is employed. This is obtained by means of the 10,000 ohm wire-wound potentiometer. The accompanying curves indicate the effect of varying the charging bias voltage E_C .

In choosing the values for the charging potentiometer R_C and the discharge potentiometer R_D , high resistance values were found to give long time delay cycles but rather critical control on the short cycles. Finally, a compromise value of 5 megohms was decided upon. This value permits reasonably accurate time cycles for both long and short time intervals. For time cycles greater than one minute, extra fixed carbon resistors (about 20 megohms) may be connected in series with the charge and discharge potentiometers R_C and R_D . With such an arrangement time cycles of over 30 minutes may be obtained.

It is of prime importance that the grid circuit condenser C be of good quality, with a very high leakage resistance. For this reason it must be evident that only paper condensers can be used for this function. Electrolytic condensers obviously have too low a leakage resistance to be considered.

Special consideration is required in the choice of the relay. It must have at least two sets of moving contacts, one controlling the charge and discharge of the condenser C , and the other acting as a power switch for the connected device or load under cycling test. Because of the relatively high impedance of the 43 tube's plate circuit, a high-resistance relay winding is necessary for proper power transfer. The relay should operate on a current of between 5 and 30 milliamperes. The particular relay employed in the layout shown, has a d.c. resistance of 2,000 ohms and operates on 5 to 30

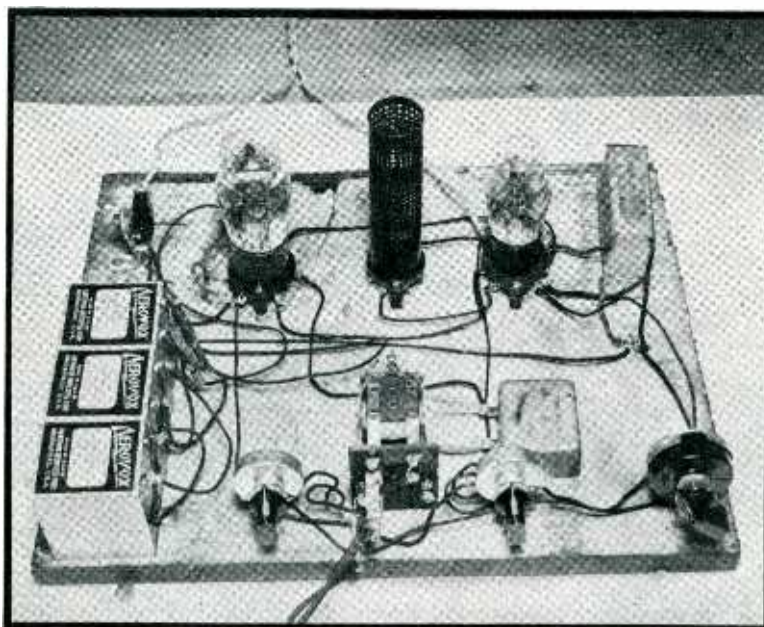

Time delay relay layout. The charge and discharge of paper condensers through adjustable resistors is used to control the period of operation

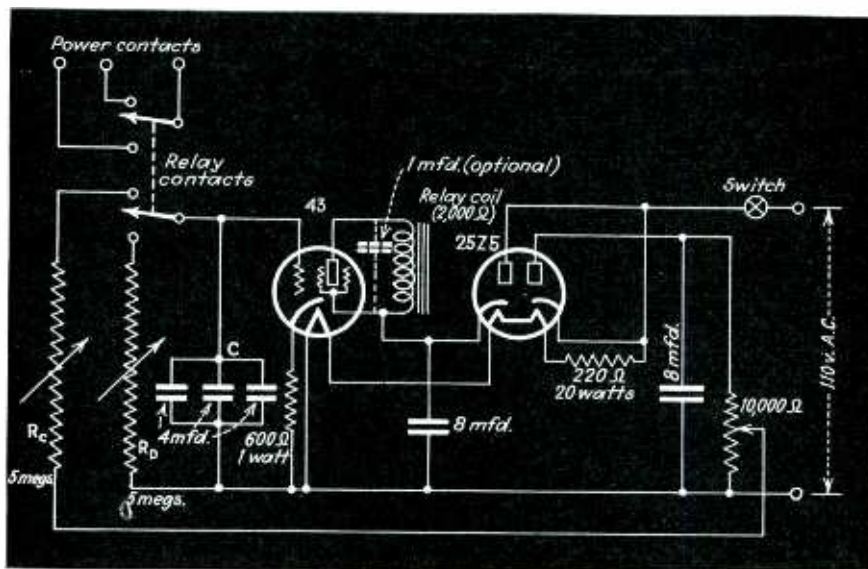

Complete circuit diagram of the relay interrupter

WHAT A *great* DIFFERENCE
 "CINCH" PARTS MAKE!

*"Hello, Assembly Department:
 The CINCH job is in—all ready
 —just as they said it would be."*

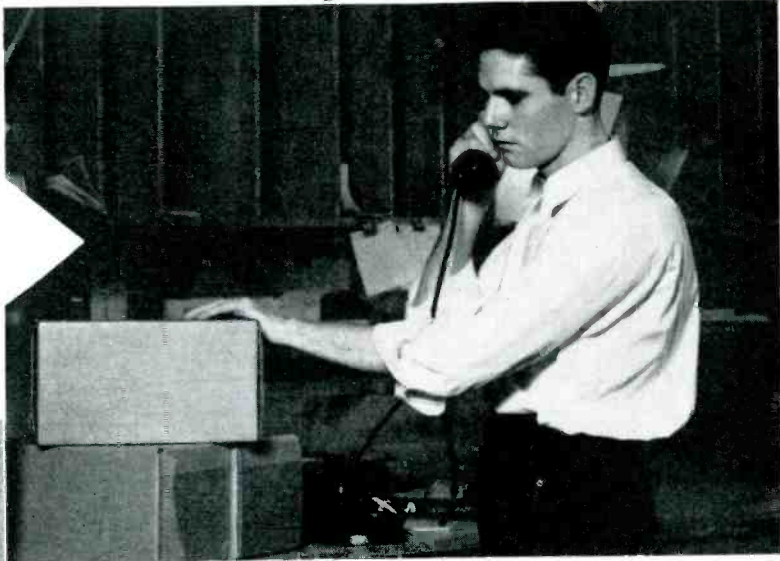

QUALITY



SERVICE

*"Every CINCH part used in
 the set has more than lived
 up to what I expected of it.
 That's performance!"*

DEPENDABILITY



*"Stick to CINCH—every job
 proves—not only their expe-
 rience and skill, but their
 interest in our problems."*

Typical scenes in the plant of a customer—it may be your plant. If not, there is probably some part we can supply to prove the profit to you in CINCH service and products. New ideas that improve set performance—that save manufacturing costs, are developed every day in the CINCH plant. That means new parts—a new service. It is no mere statement that "your problems are our problems." The proof is in our files. Have you some specific problem that now appears baffling? Write us today.

*"Cinch" and Oak Radio Sockets are licensed under
 H. H. Eby socket patents.*

CINCH

MANUFACTURING CORPORATION

2335 WEST VAN BUREN STREET CHICAGO, ILLINOIS

Subsidiary: United-Carr Fastener Corporation, Cambridge, Mass.

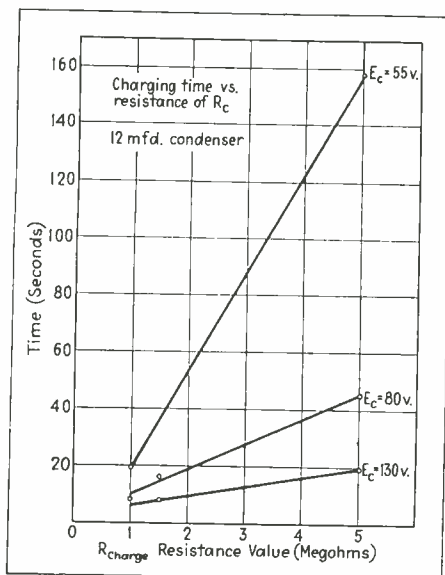

Variation of charging time with resistance value

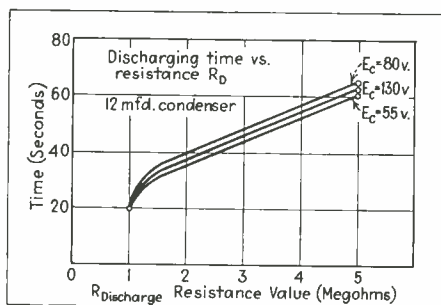

Variation of discharging time with resistance value

milliamperes flowing through its winding, depending on the armature-spring-tension adjustment. Should there be difficulty experienced in procuring a relay of proper impedance, a low-impedance relay can be readily re-wound with smaller wire say of No. 40 B & S gauge, serving the purpose. A Western Electric relay or equivalent is recommended for precise operation. However, one may improvise even to the extent of revamping an old B-battery eliminator relay, which can be re-wound for the necessary impedance value.

With the layout completed and tested, the operator can readily plot curves for his particular assembly. The curves facilitate the setting of the charge and discharge potentiometers for any desired timed cycles.

• • •

Polaroid Glass Used to Check Glass Tube Production

WORD HAS BEEN received that Polaroid, the new light polarizing glass, is now being used to test the production of glass tubes by revealing the presence of strains and flaws in the glass envelopes and stems. These defects in

the glass, not visible to the human eye, often result in breakage in the sealing and bombarding processes. Examination of glass parts by means of Nicol Prisms has been carried out in some applications, but the restricted area of the prisms has made the examination of large pieces of glass a very time-consuming process. In practice, the glass is thoroughly inspected before the elements are assembled within the tube, and samples having defects in them are rejected before they can cause trouble.

It is understood that one method of applying the new glass for this purpose is to use a lens made of the Polaroid material, through which the piece being inspected is viewed. The piece is illuminated by light from another piece of Polaroid glass which is "crossed" with respect to the Polaroid lens. When so viewed the glass sample appears to be dark unless there are strains present within its structure. The presence of such strains is revealed by the local illumination within the body of the piece. Some strains thus revealed may be removed by proper annealing, while others are sufficient to cause a complete rejection of the piece.

The light-polarizing glass, announced several months ago by the Land-Wheeler Laboratories of Boston, resembles safety glass in its construction, that is, it consists of two ordinary pieces of glass between which is placed a thin layer of cellulose acetate, the whole being thoroughly cemented and

pressed together. In the cellulose acetate layer are many millions of tiny polyiodide crystals, which have the property of polarizing ordinary lights into two planes, and of absorbing almost all of the light polarized in one of the two planes. The remainder, consisting of plane-polarized light is transmitted through the crystals. It is essential, of course, that the optical axes of all of the crystals be aligned so that the light issuing from the glass will be polarized in one single plane. This crystal alignment has been secured by a special manufacturing process, details of which are not available.

Two such pieces of glass, one used to polarize light, the other to analyze it, can be used for all manner of scientific and industrial applications for which Nicol Prisms have been commonly used. The chief advantage of the Polaroid glass over the Nicol Prism is its relative cheapness, together with the fact that it provides much wider area of surface than can be obtained with the prism, thus making it possible to examine large pieces in one inspection.

Other applications of the glass which are imminent in the electronics field include its use in connection with Kerr Cells for television use. The polarized light necessary for use with such cells is provided by the special glass, the rotation of the plane of polarization being introduced by the Kerr Cell which acts as a light valve for the creation of television images.

NEW GLASS CHECKS TUBE PRODUCTION

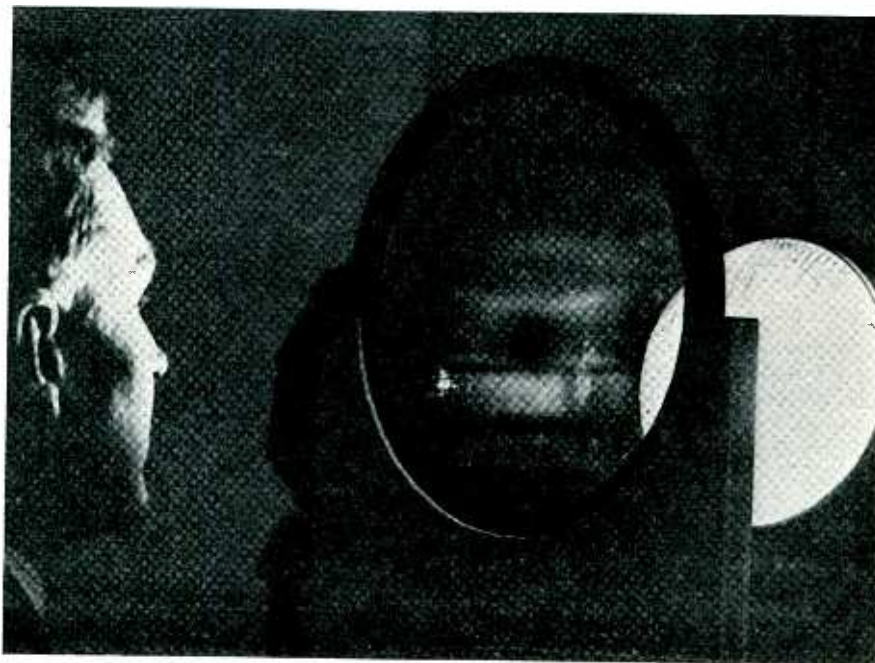

Method of examining objects with light-polarizing glass. The piece (illuminated by polarized light) is viewed through a disc of Polaroid which is "crossed" with the plane of the illumination. No light appears unless a local strain in the piece causes a rotation of the plane of polarization, thereby producing a bright spot in the region of the strain

FOR LOW LOSS

at High Frequencies . . .

IN addition to the unusual combination of electrical, mechanical and chemical properties characteristic of all Bakelite materials, a special Bakelite material now provides the important property of low power factor at radio and audio frequencies. For radio condensers and impedance bridges especially, this material combines several outstanding advantages.

For example, "low-loss" Bakelite Molded was employed for the complete forming of the cases on the two General Radio Company condensers pictured. Its low power factor (audio 1.6 per cent, radio 0.75 per cent) is practically unaffected by 24-hour immersion in water. Its high volume-resistivity decreases less with rising temperatures than ordinary materials.

Other merits of "low-loss" Bakelite Molded are: ready adaptability to forming into any required shape; strength and durability; imperviousness to grease, dirt and moisture; and self-contained color and permanent lustre.

Besides this special low-loss material, numerous other Bakelite materials—molded, laminated and varnish—are specified today by radio engineers and manufacturers because of their known superior and dependable properties. A general acquaintance with these useful materials may prove helpful in designing new products or improving old. Write for booklets 13M, "Bakelite Molded", 13V, "Bakelite Varnish", and 13L, "Bakelite Laminated".

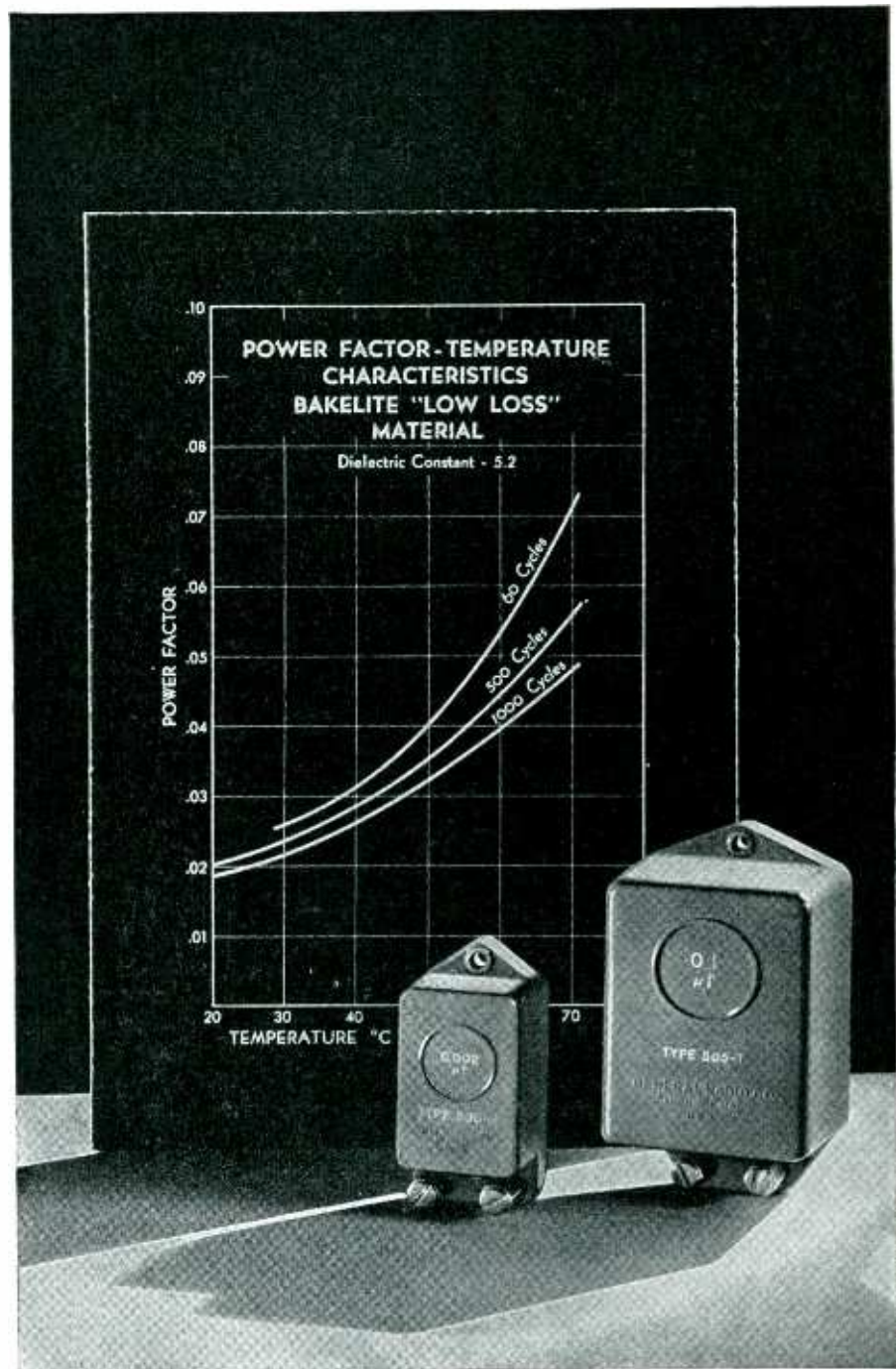

BAKELITE CORPORATION, 247 PARK AVENUE, NEW YORK, N. Y.
BAKELITE CORPORATION OF CANADA, LIMITED, 163 Dufferin Street, Toronto, Ontario, Canada

BAKELITE

The registered trade marks shown above distinguish materials manufactured by Bakelite Corporation. Under the capital "B" is the numerical sign for infinity or unlimited quantity. It symbolizes the infinite number of present and future uses of Bakelite Corporation's products.

THE MATERIAL OF A THOUSAND USES

ELECTRONICS — April 1936

41

THE ELECTRON ART

EACH month the world's technical literature is scanned to see what physicists and engineers are doing with tubes, for presentation in tabloid form to Electronics' readers.

PE Cells for Light Measurement

By H. H. POOLE and W. R. G. ATKINS

VACUUM EMISSIVE CELLS (potassium cells manufactured in 1924, 1925, 1927, Burt sodium cell, thin film caesium-on-silver oxide cells, cells for the infra-red) and barrier cells (Bergmann-Weston selenium cell, cuprous oxide cells) were examined and standardized in light from different sources: open carbon arc, lamp at 2360° K, artificial mean noon sunlight. Only the carbon arc gives a scale of values reasonably close to the visual. Vacuum potassium and sodium cells were found to have preserved their sensitivity constant for over five years, their response is linear up to full summer daylight. The selenium cell has remained constant for over a year, save for reversible temperature effects. The sensitivity of the thin film caesium cell falls off slowly. In artificial mean noon sunlight the sensitivities are in microamperes per lumen: sodium 0.1 to 0.44, potassium 0.24, thin film potassium 1.78, thin film caesium 3.81; infra-red cell 50.4; selenium barrier 121.2; cuprous oxide front wall 49 to 54, rear wall 9.5. *Philosoph. Transactions Roy. Soc. of London*, Vol. 235, No. 745: 1-27, 1935.

so that the total time absorbed by this switching takes less than 1/100 sec. at the expense of the image. The difficulty is that the breakdown potential of the thyatron varies slightly from discharge to discharge, so that broken lines may result, and that, moreover, the potential during the charge does not increase strictly in proportion to the time.

The first task is to produce and amplify a strong impulse of short duration. In practice these signals are obtained at the end of each line by a beam of light which passes through a narrow slit and falls upon the photo tube; they are amplified and applied to the grid of a thyatron. They last rather too long, namely for about 1/50,000 sec. It is better to use only the steepest portion of the signal, by inserting a few turns in the plate lead of the thyatron and coupling it to an amplifier with a strong bias which cuts off one portion of the wave. The time during which the signal voltage is at 200 is less than 1/200,000 sec. This signal is introduced over condensers into that part of the television circuit which amplifies the modulation, and this in such a way that the switching signal produces the opposite results which the bright portions of the picture give, the

reversal being necessary for separating the switching signals from the modulation.

In the receiver the signals are sifted from the picture elements by virtue of their higher voltage and steep wave front, or high equivalent frequency.

The discharge circuit of the line-changing thyatrons is coupled magnetically to the grid of the picture-changing thyatron so that at the end

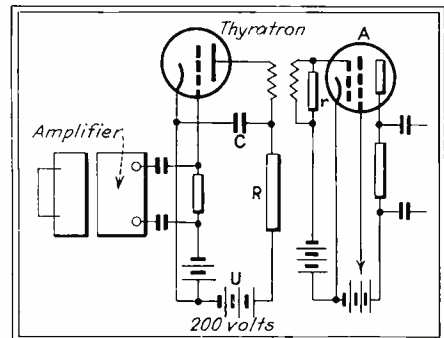

Line switching circuit (Barthélémy)

of each line the grid receives a small charge, while the plate voltage increases in proportion to the time. It would be possible so to adjust grid and plate voltage that at the end of, say, 60 lines breakdown would occur. The solution finally adopted is, however, to suppress the switching signal preceding the last line and to allow the plate voltage of

Automatic Synchronization of Television Images

[R. BARTHÉLÉMY, Compagnie des Compteurs Laboratory, Paris.] The problem of obtaining accurate and automatic deflection of the electronic beam for changing lines and pictures has been solved in a simple reliable manner with the result that when the voltages produced by the signals at the end of lines and pictures are added to the modulating voltage, the correct formation of the television image takes place without any adjustment in the receiver.

The deflection of the beam is produced as usual by a constant current charging a condenser C, the potential increasing in proportion to the time, and by discharging the condenser across a thyatron at the end of each line and each picture. The return of the beam to its starting point should take place at the very end of the line, or picture, within 1/100,000 sec. for the lines and within 1/10,000 sec. between pictures

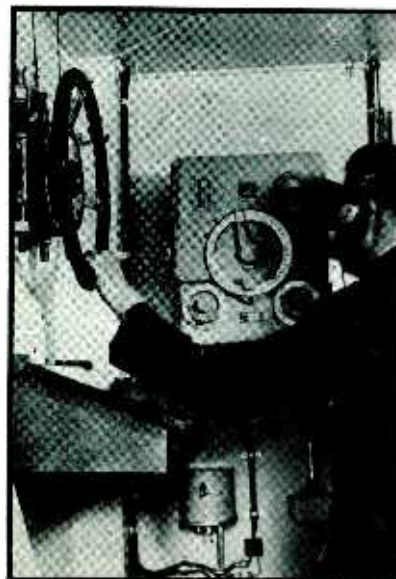

Both fixed and rotatable loops (right) are available

ZEPPELIN DIRECTION FINDER

The newly completed German superairliner LZ-129, largest dirigible, is fitted with complete direction finding equipment, with controls (left) in the navigation gondola



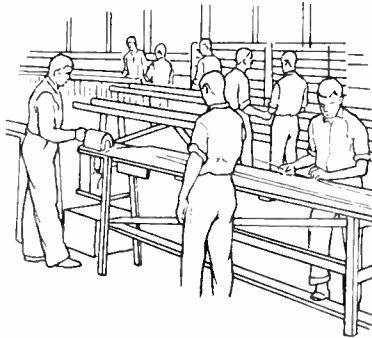

IT APPEARS TO BE SOUND POLICY

We want to lick the extraordinary!

From the beginning we have not sought business that can be just as well handled by others. There is no place for it here—and for two reasons.

By producing it we achieve nothing in either pride or profit. Others, not so well equipped as we are to undertake unusual commissions, need this business—and greed plays no part in our plans.

We try honestly to serve, to do for industry what can't be performed elsewhere, at a price that is *sensible*.

SUPERIOR TUBE CO.

Norristown, Pa.

(TWENTY-FIVE MILES FROM PHILADELPHIA)

MANUFACTURERS OF FINE SEAMLESS TUBING IN SMALL SIZES

the line-changing thyatron to build up until at the end of the last line the thyatron trips at about twice the regular plate voltage so that a very strong discharge results. The voltage induced in the grid circuit of the picture changing thyatron starts without fail the discharge in this tube and the beam, which during the last line moved far out of the picture, returns to its origin, practically without being seen. The only inconvenience is that the last line is not visible. When the receiver starts to work, the correct succession of the signals is established automatically within less than $\frac{1}{2}$ sec.—*Onde el.* 14 (No. 168): 794-803, 1935.

• • •

Mutual Modulation between Transmitters

[W. BÄUMLER and W. PFITZER, German Post Office.] The modulating interference (Tellegen or Luxemburg effect) appears strongly and regularly when a sender with a long wave (150-300 kc.) stands in the way of a sender in the

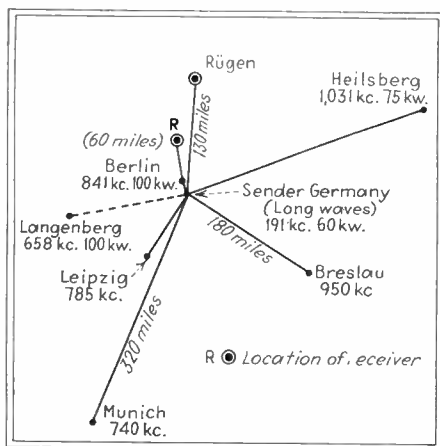

Intermodulation tests. Observations were made, also, on the continuation of the line Heilsberg and Sender Germany

ordinary broadcast band. An effect is also observed when both stations are in the broadcast band and, when the distance between stations is less than 25 miles instead of a few hundred miles, a sender in the ordinary wave band may modulate a long wave transmitter.

The effect observed in the receiver is strongest when the receiver lies on the continuation of the line connecting the long wave station with the broadcast station which is tuned in, and reaches a maximum at a certain distance, in the present instance 220 miles from the long wave station.

No effect is observed when the receiver is between the two stations. The degree of modulation is higher in the range of lower pitch, reaching in general below 1% so that it causes little trouble with the present strength of the senders.—*Hochfr. Tech. El Ak.* 46: 181-186, 1935.

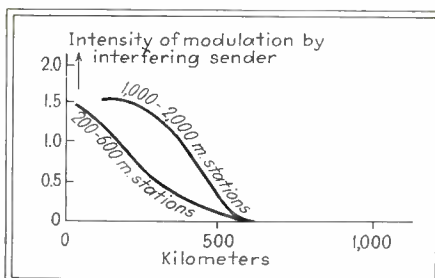

Distance between Luxemburg and the midpoint, sender to receiver. (Van der Pol, "Onde électrique")

[B. VAN DER POL, Philips Research Laboratory, Eindhoven.] New observations on the Luxemburg sender (252 kc. 150 kw.) were made throughout Europe on February 22, March 1 and March 8, 1935. Luxemburg emitted the Morse letter X on its carrier which was modulated by 400 cps., the degree of modulation being 80%. Thirty physicists in Austria, Belgium, Denmark, France, Germany, Great Britain, Holland, Italy, Lithuania, Poland, Rumania, Sweden and Switzerland reported the strength of the effects upon various broadcasting programs. It was assumed in practically all the cases that reflection of the sky wave took place half way between the wanted sender and receiver, and the distance of this point from the disturbing sender Luxemburg was determined in each case. The strength of the modulation impressed by Luxemburg was then plotted as a function of this distance. It was found that the effect decreases as this distance increases and vanishes when

the distance Luxemburg-to-half-way-mark reaches about 320 miles. It is probable that the ionized layer also affects Luxemburg itself.—*Onde el.* 14 (No. 168); 804-808, 1935.

• • •

Quartz Clocks Reveal Change in Earth's Rotation Speed

[A. SCHEIBE and U. ADELSBERGER, German National Physical Laboratory.] For the accurate measurement of time the German National Physical Laboratory has at its disposal since February, 1932, two, and since June, 1933, four quartz crystal clocks. One of these is used for distributing accurate time signals to scientific and industrial laboratories, and has greatly improved the precision of radio time signals sent out by Nauen. In the spring of 1933 the two quartz clocks showed nearly the same change with respect to astronomical time, and in June, 1934, three quartz clocks, although built on different principles, showed a similar difference of 0.004 sec., which can only be due to a change in the length of the day owing to a change in the speed of rotation of the earth.—*Phys. Zeits.* 37: 38, 1936.

• • •

Electrostatic Recording (Electronography)

[P. SELENYI, Tungstam Research Laboratory Budapest.] When, pretending to write, the rounded end of a steel

AMERICAN ENGINEERS AT EUROPEAN CONFERENCE



C. W. Horn of NBC (left) and C. B. Jolliffe of RCA (extreme right) discussing the problems of international broadcasting at the recent International Radio Conference at Paris, with Raymond Brillard (standing) and Dr. M. Jordan, NBC European representative

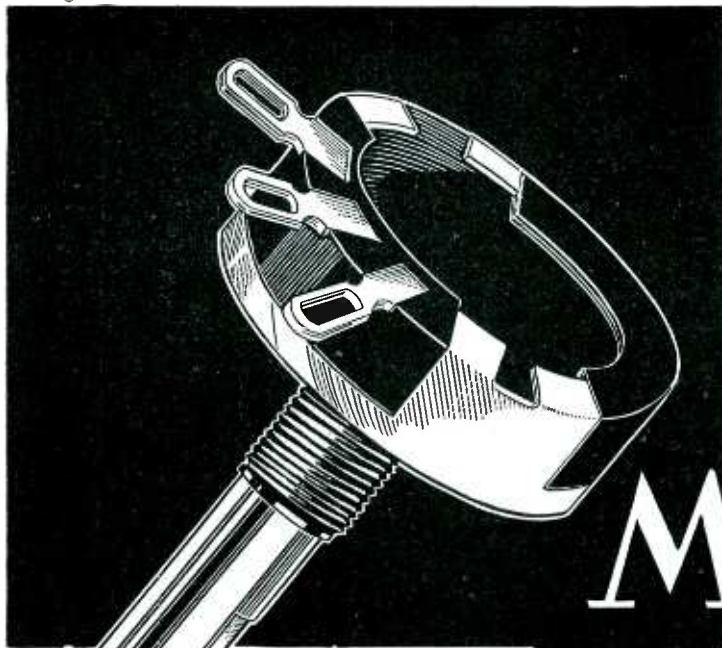

the New MIDGET Radiohm



Total Rotation 330°. Rotation to throw switch 35° — controls also available with fixed resistance minimum. Total rotation then 280°.

● With a given maximum resistance, the noise level of any good control will be in proportion to its resistor length. The longer the effective path of resistance, the lower the noise level.

We believe the new Centralab Midget has a lower noise level than any other small control because its resistor is 2 13/16 inches long—much longer than that of controls using the conventional flat horse-shoe shaped resistor.

This length, so necessary for the gradual resistance change that gives good attenuation without noise is obtained by coiling a straight resistor strip on the inner circumference of the Bakelite case and by using 330° total rotation.

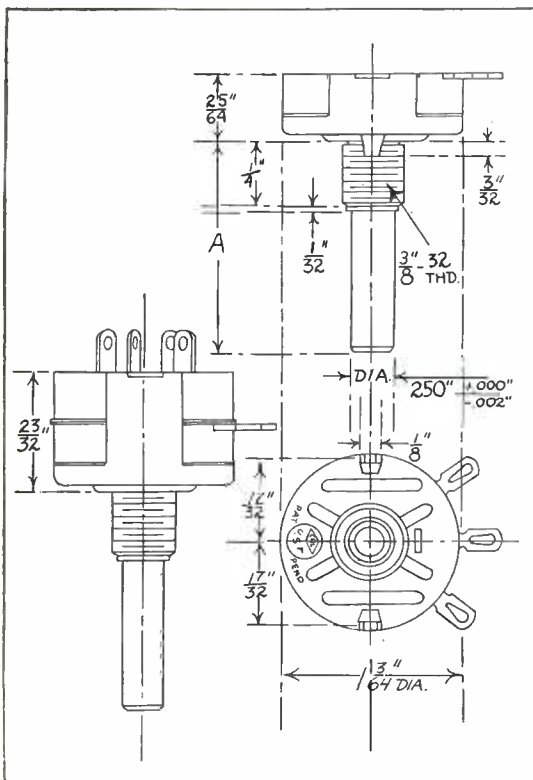

Switch Data: S.P.S.T.; D.P.S.T.; S.P.D.T.; four point. S.P.S.T. switches also available with dead lug. S.P.S.T. switch rating: 3 amps. 125 volts; 1 amp. 250 volts; 10 amps. 12 volts.

The MIDGET RADIOHM provides volume or tone control in single, twin or triple assemblies, as rheostat, potentiometer or with 1, 2, or 3 taps on resistance at choice of six different degrees of rotation. All assemblies available with or without Switch.

CENTRALAB Div. of Globe Union Mfg. Co.
MILWAUKEE, WIS.

Centralab

VOLUME CONTROLS
FIXED RESISTORS
SOUND PROJECTION CONTROLS
WAVE CHANGE SWITCHES

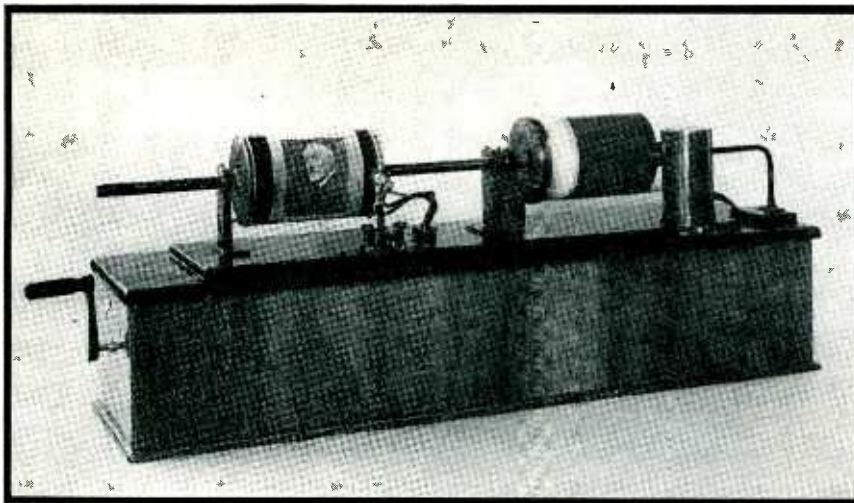

Transmitter and receiver on same shaft, no amplifier. Turns, 5 to 15 per sec.; lateral displacement, 0.75 mm. per turn. The photo shown is the head of the famous Hungarian physicist Eötvös

needle is pushed across the surface of a sheet of hard rubber, 0.5 mm. thick, the points where the needle rubbed against the insulator become negatively charged and form an invisible electric inscription, which will appear in bright red-yellow if a fine powder of sulphur and red oxide of lead is dusted over the surface, less than 15 minutes after writing. Instead of producing the electric charges by friction a three-electrode arrangement in the open air may be used, consisting of an oxide coated emitter, a metal disc a few tenths mm. away from the emitter, with a hole nearly one mm. wide, pierced through it opposite the source of electrons, and a sheet of hard rubber backed by metal placed $\frac{1}{2}$ to 1 mm. from the disc, which acts as grid.

A potential of a few volts applied to the grid and about 1,000 volts applied to the plate, cause the spot hit by the electrons, which have passed through the grid hole and through the air, to be charged negatively and to attract powder of lycopodium dusted over the plate. When the plate is moved the spot describes a line. The line is thinner the lower the grid voltage, and fades out when the grid bias is made a few volts negative. The sharpness of the lines obtained depends on the fineness of the powder; since the particles have a diameter of 30 to 40 microns (one micron = 0.001 mm.) it is possible to draw ten lines in a strip 1 mm. wide. The potential drop obtained across a resistor placed in the circuit of a photocell behind a scanning device suffices to control the grid and to reproduce the picture on a rotating drum, advancing about 0.3 mm. per turn. Wax may be used in place of hard rubber and the picture fixed by slightly heating the surface, thus causing the dust to become embedded in the insulator.

Since an area of 50 sq.cm. may be reproduced in 10 sec. and the electrostatic capacity of the device is not over

500 $\mu\mu\text{f}$ little power is absorbed apart from the heating current.—*Zeits tech. phys* 16: 607-614, 1935. *E. T. Z.* 56: 961-963, 1935.

Fighting Artificial Static

[H. REPPISCH] A branch of the German Post Office dealing with complaints about man-made interference in radio reception dealt with 488,494 cases from the day it began to function, October, 1932, to the end of 1934.

The causes fall into the following classes:

| | |
|--|-------|
| Small motors in household and trades | 29.6% |
| Medical appliances | 3.2% |
| High-frequency appliances used at home | 8.0% |
| Power stations and lines.. | 1.3% |
| Electric railways | 4.4% |
| Administration of posts and railroads | 1.5% |
| Regenerative receivers' .. | 5.2% |
| Defective receivers | 23.3% |
| Atmospherics and unknown factors | 17.5% |

The disturbance was removed either by measures applied at the source (50.5%) or at the receivers (31.5%) or by introducing filters (21.9%), or a combination of the three measures.—*Telegr. Fernspr.* T. 24L95. 1934.

BALLOON RADIO TO COUNT COSMIC RAYS

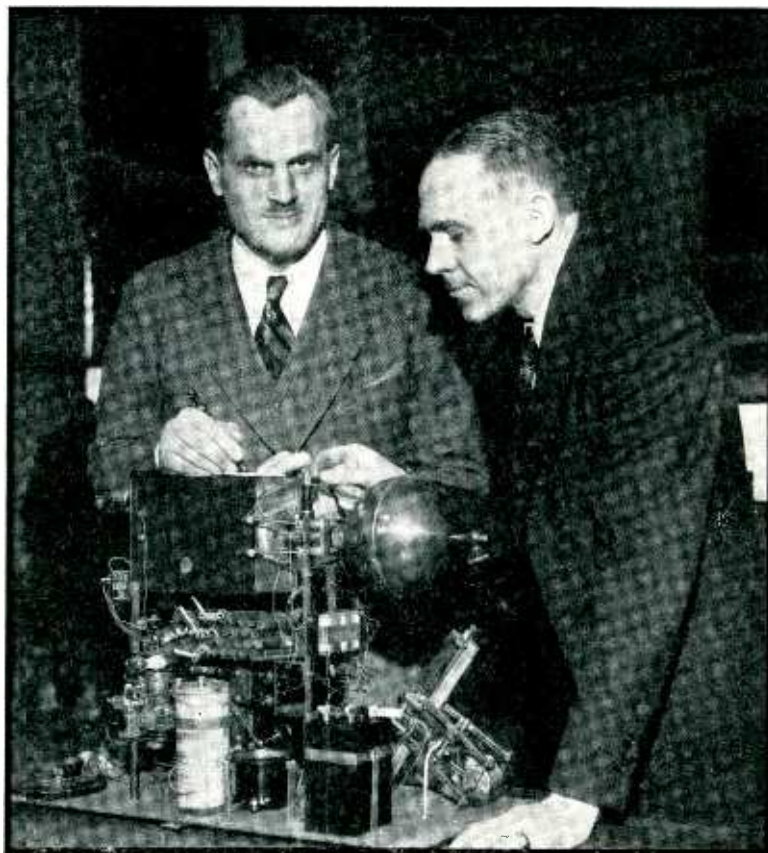

Drs. Arthur H. Compton and R. L. Doan of the University of Chicago with their automatic cosmic ray meter which will be sent up fifteen miles tied to a small balloon. Each cosmic ray burst will actuate the transmitter, thus communicating the ray density value to a receiver on the ground



IN THE SUPPORTING CAST

(Scene presented through the courtesy of Metro-Goldwyn-Mayer Pictures)

You'll find SYNTHANE laminated bakelite on the "cast" of materials for many products — not as the "star", perhaps, but playing a small though vital part in the performance.

The motion picture industry requires dependable insulation for equipment—and gets it with SYNTHANE laminated bakelite . . . Use Synthane in your products for the same reliable performance.

SYNTHANE LAMINATED BAKELITE
SHEETS • RODS • TUBES
FABRICATED PARTS

Send for Sample Book



SYNTHANE
CORPORATION  OAKS • PENNA

"Turnstile" Antenna

[Continued from page 17]

top of the turnstile antenna is 470 feet above sea level and 310 feet above grade. Before the antenna was placed in operation, the probable field strength as a function of distance was estimated from the formula

$$E = \frac{88 ha \sqrt{WK}}{3 \lambda r^2}$$

where

- E = field intensity in volts per meter
- λ = wave length (meters)
- r = horizontal distance (meters)
- h = height of transmitting antenna (meters)
- a = height of horizontal receiving antenna above ground (meters). It was known that this dimension would be 8 meters for the measuring equipment.
- W = power into the antenna (watts)
- K = power gain factor from Fig. 7.

Curve A, Fig. 13, shows the curve calculated from this formula, on the basis of 1,000 watts and a power gain of 4. Curves B and C are reference lines placed 10 db above and below A. Curve D is computed from a more exact formula. The points shown on Fig. 13 are the measured points on the basis of 1,000 watts, when the horizontal receiving antenna was 8 meters from the surface of the earth. The points

are naturally scattered since the measurements were made through the city.

The theoretical curves show that the field intensity drops off as the inverse square power of the distance, and thus is a straight line with a slope of -2.0 when plotted on log paper. By means of the theory of least squares, an analysis was made of the experimental points for all measurements made at one mile or more. The best straight line on log paper was found to have the equation

$$E = 170/r^{2.08}$$

where E is the field strength in millivolts per meter and r is the distance in miles. Curve E, Fig. 13, shows this equation.

When the 45 megacycle antenna was placed in operation, another striking effect was noticed. Observers reported that, in districts where signals from a single half-wave antenna had fluctuated as much as ten to one due to changes in field distribution due to moving automobiles and possibly elevator cables, the signal from the turnstile only shifted between limits whose ratio was two to one. This effect is probably due to the fact that the transmitting antenna is spread through a space two and one-half wave lengths long, thus giving "diversity" effect.

found from the following equation:

$$\phi = 180^\circ - s' \cos \frac{\beta}{2} \quad (5)$$

Here again,

- ϕ is the phase difference between the antenna currents
- s' is the spacing between radiators in electrical degrees
- $\beta/2$ is the angle between a null and the line through the radiators

In many cases it will be found that several space-phase combinations will bring the proper bearing of the nulls.

When dependence is placed on a directive array for effective suppression or elimination of radiation in some direction, the space pattern must be stable. Small changes in the phase angle between the radiator currents cause shifts in the null directions. Some patterns are more sensitive than others to the effects of small phase shifts, which may be due to changes in ground conditions, mis-tuning, etc. It is well to investigate this matter at the time of designing an array by calculating the change in pattern due to small changes in phase. Such a calculation is exhibited in Fig. 10.

Kear and Roder have described methods which are capable of automatically compensating for natural variations in an array, within moderate limits, thus stabilizing the radiation pattern.^{2,3} However, such precautions are required only in the most particular broadcast application.

The effect of sideband frequencies in the directive array may be noticeable sometimes in the vicinity of a sharp null, though it will be seldom of importance at broadcast frequencies. Nevertheless the sideband frequencies farthest removed from the carrier work into different impedances from those at the carrier frequency, with consequent slight departures from the phase relations, current ratio and electrical spacing for the latter. With modulation, therefore, we must visualize a faint quivering in the shape of the radiation pattern. The lower the carrier frequency and the higher the modulating frequency, the greater is the deformation of the radiation pattern during modulation.

¹Foster, R. M.: B.S.T.J., April, 1926.
Southworth, G. M.: Proc. I.R.E., September, 1931.

Radio Engineering Handbook, McGraw-Hill, 1935, 2nd Ed., pp. 744-745.

See also Electronics Reference Sheet, page 00, this issue.

²Kear, F. G.: Proc. I.R.E., July, 1934.

³Roder, H.: Proc. I.R.E., March, 1934.

Directional Antenna Design

[Continued from page 25]

null in the ground pattern comes in the line through the radiators, and therefore a lobe of high angle radiation in the same direction results. This undesired lobe may prove troublesome in the service areas of co-channel stations at moderate distances in that direction, and does not permit complete suppression. Fig. 9 shows the familiar $\lambda/4$ (90°), $\phi = 270^\circ$ couplet cardioid pattern for $k = 1.00$ and $k = 0.75$, and the resulting vertical patterns in the plane through the radiators.

When it is desired to suppress

simultaneously radiations in two directions, the problem narrows somewhat at the start to those combinations of spacing and phasing which bring the nulls on the desired bearings. The angle between the two directions to be protected, from the proposed location, must first be determined. Call this angle β . In the patterns which have but two null directions, the orientation of the array must be that of the bisector of the angle β . The spacing and phasing for two radiators, to bring two nulls at the desired angles can be



DIRECT READING—ZERO TO 5,000 CYCLES

BASED on a radically new design, the General Radio Type 834-A Electronic Frequency Meter is direct-reading from zero to 5,000 cycles over five ranges each, starting at zero and extending to 200, 500, 1,000, 2,000, and 5,000 cycles.

This instrument is especially useful in laboratory or production testing where routine frequency measurements have to be made rapidly and accurately.

Some of its many applications are:

- Studies of Speech Frequencies
- Analysis of Vibrations in Machinery
- Tele-metering
- Industrial Measurements of Thickness, Capacitance and Quality
- Tuning Electrical Chimes and Organs
- Noise Measurements and Analyses
- Continuous Monitoring in any Frequency Measurement

The Type 834-A Electronic Frequency Meter is entirely self-contained and operates from a 110-volt, 60-cycle, a-c power source. Price \$250.00.

Write For Bulletin 3512-E For Complete Data



General Radio Company
30 State Street
Cambridge, Massachusetts

MANUFACTURING REVIEW

Names in the News

► Samuel Wein and David H. Buntzman are manufacturing photoelectric cells, sensitive relays and allied products under the trade name of *Actronic Devices Corporation* at 434 Broome Street, New York City.

♦ Robert C. Reinhardt and Carl R. Blumenthal, formerly co-partners doing business as the Macy Engineering Company, have become associated with the new *Atlas Sound Corporation*, manufacturers of amplifying and reproducing apparatus. This organization is doing business at 1451 Thirty-ninth Street, Brooklyn, New York.

♦ Standard Transformer Corporation has opened new headquarters at 850 Blackhawk Street, Chicago, Illinois. Larger office space and increased factory facilities are enjoyed at the location.

♦ Hygrade Sylvania Corporation announces the immediate erection of a new plant at Salem, Massachusetts, to be devoted to the manufacture of radio tubes. This company will then have four plants, the incandescent lamp plant now at Salem, a smaller plant at St. Marys, also used for the manufacture of lamps, and the two tube plants—the one at Emporium and the new one at Salem.

♦ International Resistance Company has a new, larger, modern factory on the top floor of 401 North Broad Street, Philadelphia, Pennsylvania, used for the development and manufacture of their line of resistors and volume controls.

♦ A. M. Flechtheim & Company have moved their offices and factory to larger quarters, at 692 Broadway, New York City. Mr. Angus J. Walker is in charge of engineering and production.



Laboratories. More than fifty stock devices for application to all types of interference producing electrical apparatus are described in *Engineering Bulletin F-635* a copy of which will be sent anyone requesting it. Tobe Deutschmann Corp., Canton, Massachusetts.

Spherical Microphone

A HIGH QUALITY, low priced, general purpose spherical microphone No. BR2S, is available from Brush Development Company, Cleveland, Ohio. It uses two piezo electric sound cells in series; the cases are fabricated from finely woven brass screen finished in dull chromium 2½ inches in diameter. The output level is —66 db., impedance similar to a capacity of 0.005 mfd. and the units can operate directly into the grid of the first tube of the high gain amplifier without input transformer. The net weight of the microphone and socket is 5 ounces.

Permanent-magnet Speakers

CINAUDAGRAPH CORPORATION, 2109 43rd Avenue, Long Island City, offers a new permanent magnet dynamic speaker. This speaker has a quartz voice coil form, wall thickness of approximately .002" and an overall thickness of only .006". The cone diaphragm has no voice coil orifice, thus improving efficiency at both high and low frequencies.

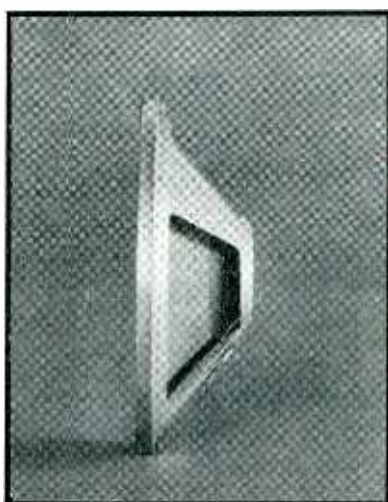

The voice coil fits snugly into a special recess on the cone, which allows for maximum coupling area. This unit includes the use of an improved type of suspension which allows the diaphragm to float freely and keeps the voice coil in perfect alignment. "Nipermag," the permanent magnet alloy heretofore used by speaker manufacturers in Europe, is used in these speakers. The flux density of this alloy varies with each speaker size. A special type of housing is used, designed and built to have a definite relation with the diaphragm of the reproducer, and of particular value for use in public address work.

Transmitters

HARVEY RADIO LABORATORIES, Brookline, Massachusetts, offers a new three-frequency transmitter designed for airport use. This transmitter is designed to work into one of three antennas which connect permanently to the rear of the cabinet and which are automatically selected by one of the band change switches on the main shaft.

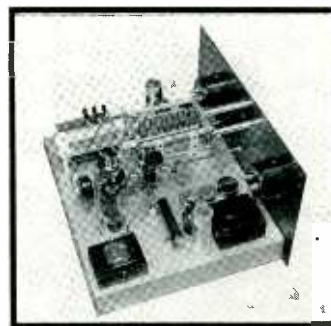

The radio frequency section of the transmitter employs a 42-crystal oscillator directly driving an RK-28 high-power pentode as a final amplifier. The driving power required by the RK-28 is only 2 watts, so that the output of the 42 tubes is adequate for this purpose. In addition to low driving power the RK-28 requires very little audio power for 100 per cent suppressor grid modulation, permitting an extremely compact audio section, especially when designed around the new metal tubes. The speech amplifier, which uses a 6J7 and a 6C5, is resistance coupled to the 6F6 pentode modulator which delivers 5 watts of audio power for suppressor grid modulation. Line voltage control is furnished by a General Radio Variac. Time delay relays as well as interlocking switches are also incorporated for efficient and safe operation of the transmitter. The standard rack units stand only 32 inches high when assembled.

New Products

Interference Filter

INSURING FREEDOM from radio interference that is normally produced by traffic control mechanisms, the Filterette pictured below is easily installed behind the terminal board of a General Electric traffic timer. This is one of a complete line of specially designed radio noise eliminating Filterettes developed by Tobe Deutschmann. Municipalities, manufacturers and all persons interested in eliminating radio interference may secure complete and accurate information from the Tobe

Ultra Sensitive



MICROAMMETERS

MILLIVOLTMETERS

OF THE
DOUBLE
PIVOTED
TYPE!

For the measurement of minute currents, Weston now provides a group of ultra sensitive portable instruments which hitherto have not been commercially available in the double pivoted type. They can be used in the normal horizontal position without the necessity of leveling, and the long rectangular scale opening insures good illumination of the hand calibrated mirror scale. The instruments in ranges from 20 microamperes up are statically and magnetically shielded. Lower ranges, down to 5 microamperes, are statically shielded. Other outstanding features of this Model 622 series merit immediate investigation. Write for full details... Weston Electrical Instrument Corporation, 578 Frelinghuysen Avenue, Newark, N. J.

WESTON *Instruments*

Antenna System

TECHNICAL APPLIANCE CORPORATION, 17 East 16th Street, New York City, has developed a master antenna system for multiple-set dwellings. This consists of a single aerial and downlead,

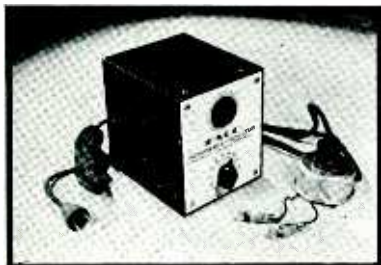

replacing the usual series of aerial wires necessary under similar circumstances. The system comprises an antenna unit connecting doublet antenna with a downlead transmission line, which in turn connects with an individual set coupler for each set to be operated on the system.

Program Sound System

THE WESTERN ELECTRIC COMPANY, 195 Broadway, New York City, offers for sale a sound system for large buildings such as schools, hotels, department stores and hospitals, which will distribute programs from microphones, from radio receivers or from phonograph records. The system provides "talk-back" facilities so that what is happening at any loudspeaker location may be overheard in the central office. In hotels these systems supply entertainment to guest rooms. It may be used as an aid in teaching music and the languages. It is supplied with a high-fidelity all-wave radio receiver and a two-speed electric phonograph.

Transmitting Tubes

RCA MANUFACTURING COMPANY, INC., Harrison, New Jersey, has recently announced three new transmitting tubes, Nos. 804, 805 and 836.

The 804 is a pentode transmitting tube intermediate in power output to the RCA-802 and RCA-803. It has a maximum plate dissipation of 40 watts (Class C telegraph service). This new tube is for use as an r-f power amplifier, frequency-multiplier, oscillator and suppressor-, grid- or plate-modulated amplifier. It can be operated at maximum ratings for frequencies as high as 15 megacycles.

The 805 is a high- μ transmitting triode with plate lead out of the top. It is intended for use as an r-f power amplifier, oscillator and Class B a-f amplifier. The grid of this new tube

is designed so that the amplification varies with the amplitude of the input signal. This feature facilitates the design of Class B amplifiers to give high output with low distortion. As an r-f amplifier or oscillator, the 805 may be used at maximum ratings for frequencies as high as 30 megacycles. The maximum plate dissipation in Class C telegraph service is 125 watts.

The 836 is a half-wave, high-vacuum rectifier tube for use in high-voltage rectifying devices to supply d-c power. Features of this new type are its excellent voltage regulation characteristic and its suitability for services, such as aviation, where low temperatures may affect the performance of mercury-vapor types.

Baffles and Trumpets

THE LIFETIME CORPORATION, 1010 Madison Ave., Toledo, Ohio, has a complete new line of aluminum trumpets and

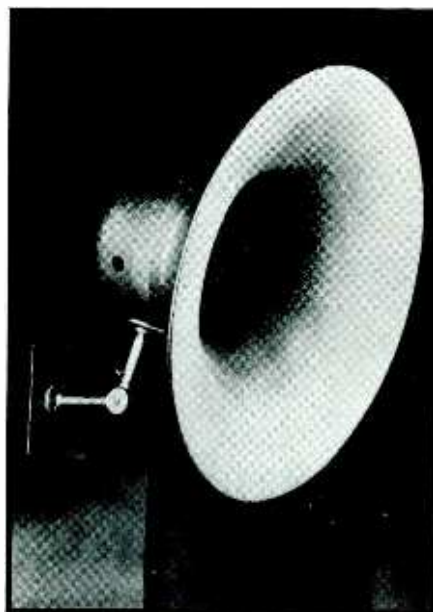

projecting baffles designed to meet the individual requirements of varied types of installations. The baffle field is covered by 3 distinctly separate bells and housings, correctly designed as to baffling, air column load and flare, for six, eight and twelve inch cone units. This line includes a 15 inch bell for 6 inch cones; a twenty inch bell for eight inch cones and a 32 inch bell for 12 inch cones. The new trumpets have been designed with a special aluminum alloy and a section assembly of absolute rigidity, for the elimination of resonance and rattle. The base response has been improved to a large extent by the use of a long non-resonant throat casting so designed, that together with the spun sections the air column load and dynamic rate of expansion the lower frequencies are not choked out. The baffles list at \$18, \$30 and \$40, the trumpets at \$45, and \$70, and the tripod base for the baffles at \$8.

Cutting Head

AUDAK COMPANY, 500 Fifth Avenue, New York City, announces a new cutting head, Model 7-B, for instantaneous



recordings. The response curve ranges from 12 db. at 50 cycles to -2 db. at 5,000 cycles, according to information supplied by the manufacturer. Although only recently introduced, it is in use in many leading recording studios.

Cylindrical Trimmer Condenser

A NEW TYPE of air dielectric trimmer condenser has been put out by the Meissner Manufacturing Company of 2815 West 19th Street, Chicago, Illinois. It is composed of two coaxial cylinders mounted in a low loss container and arranged to be used with various types of mounting brackets. The device, according to the manufacturer, suffers from none of the ailments which beset the average trimmer when used in a sensitive all-wave set. The long range of capacity variation, which is practically linear from 1 to 12 mmfd. (10 turns of the adjusting screw), the low loss (a Q of neatly 400, higher than that of ceramic compression types), and its ease and stability of adjustment regardless of mechanical or climatic conditions should make it most useful in modern receivers with their intricate circuits.

Light Weight Plastic Material

GENERAL PLASTICS, INC., North Tonawanda, New York, offers a new Durez molding material, 77 SB, for molded parts in which the combination acid resistance, frictional wear resistance and low water absorption are required. This material has a weight of only 20.6 grams per cu.in. or a specific gravity of 1.26. In addition it resists all the common concentrations of acids.

AN OUTSTANDING COMBINATION...

1. THE NEW MODEL 150 SIMPLIFIED ELECTRONIC SWITCH

This development—used in conjunction with the Type 148 Cathode Ray Oscillograph or any other commercial Oscillograph—vastly increases the value of the Oscillograph.

It permits simultaneous observation of any two voltages or current phenomena—can be used to inspect and compare wave form or phase of two voltages or currents from different parts of the same circuit—compare wave-form of a standard wave with any other wave—can be applied to a timing wave in conjunction with the wave under observation—and for many other useful applications.

Unit is self-contained and operates from 110-120 volt 60 cycle circuit. Controls are provided for adjusting gain of amplifiers for varying the speed of switching.

Frequency Range 10-500,000 cycles per second.

Gain of Amplifier in Audio Frequencies—40.

Power consumption—30 watts.

List Price—complete with tubes—\$42.50

2. TYPE 148 CATHODE RAY OSCILLOGRAPH

This instrument features a *basically new sweep* which allows waves from 10 to 500,000 cycles to be observed with improved linearity and exceptionally fast return trace.

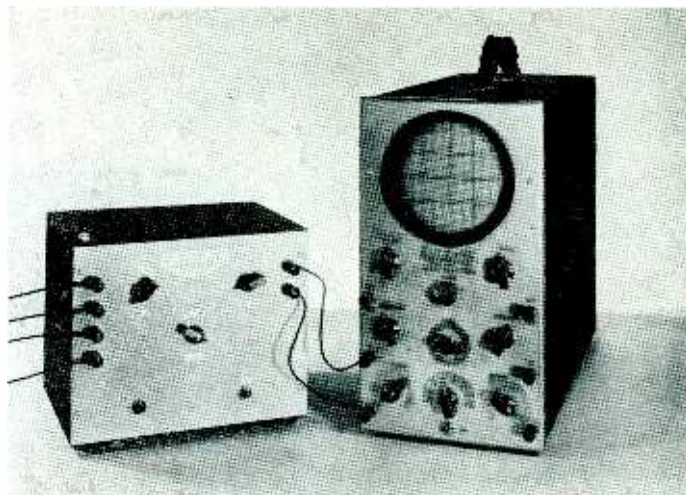

Another feature, contributing to outstanding performance is an *Improved Synchronizing Circuit* permitting locking sweep with fractions as well as multiples of wave.

In addition, a *Cascade Amplifier* is offered which gives 1 inch deflection with a .2 volt signal—a *Single Knob* controls all switching—a *Patented Calibrated Scale* with 5 inch DuMont cathode ray tube—and the unit is *completely A. C. operated*.

List Price with 3" tube—\$94.50 List Price with 5" tube—\$106.50

Write for complete data on these two outstanding instruments.

ALLEN B. DUMONT LABORATORIES, INC.
UPPER MONTCLAIR NEW JERSEY

From 1,000 ohms to 1,000,000 megohms

S. S. WHITE MOLDED RESISTORS

(Illustrations Actual Size)

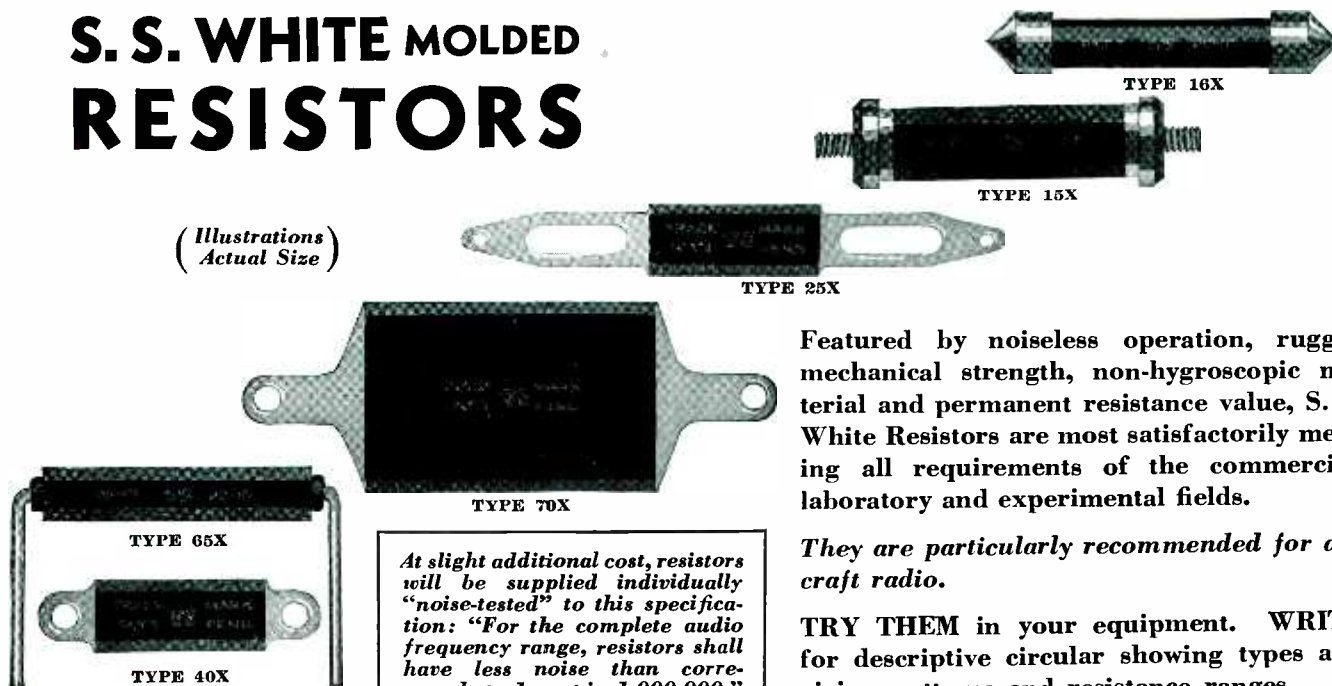

Featured by noiseless operation, rugged mechanical strength, non-hygroscopic material and permanent resistance value, S. S. White Resistors are most satisfactorily meeting all requirements of the commercial, laboratory and experimental fields.

They are particularly recommended for aircraft radio.

TRY THEM in your equipment. WRITE for descriptive circular showing types and giving wattages and resistance ranges.

At slight additional cost, resistors will be supplied individually "noise-tested" to this specification: "For the complete audio frequency range, resistors shall have less noise than corresponds to 1 part in 1,000,000."

The S. S. WHITE Dental Mfg. Co., INDUSTRIAL DIVISION

10 East 40th St., Room 2310E, New York, N. Y.

Crystal Microphone Mixer

THE WEBSTER COMPANY, 3825 West Lake Street, Chicago, Illinois, is the manufacturer of the crystal microphone mixer, Model No. 4P-15, described on page 52 of our March issue, and erroneously reported as the product of the Webster Electric Company of Racine, Wisconsin.—EDITORS.

Tuning Indicator

THE NATIONAL UNION RADIO CORPORATION, 570 Lexington Avenue, New York City, recently announced that their laboratories have completed development of a new cathode ray tuning indicator tube. This tube, type No. 6G5, when in use appears as a luminous disc with a sector cut out. The angle of the sector varies from 0 deg. to 90 deg., depending upon the applied voltage, and it is this varying angle which indicates tuning when properly connected into a radio set using A.V.C.

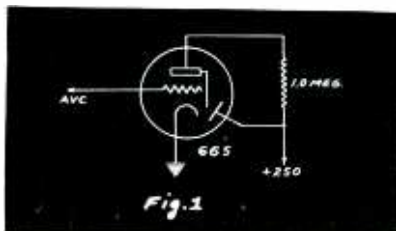

Because of the variable mu characteristic of the triode section of the 6G5, the sensitivity varies with applied voltage in such a way as to make its operation more sensitive to weak signals and less sensitive to overload than the 6E5, a similar tube which has been on the market for several months. This tube has a heater voltage of 6.3 volts a-c or d-c, a heater current of 0.3 amperes, a maximum plate supply of 250 volts, and a plate resistance of 1 megohm. A triode grid voltage of -22 volts will give a 0 deg. shadow, while approximately 0 volts will give a 90 deg. shadow.

Relay

G-M LABORATORIES, INC., 1731 Belmont Avenue, Chicago, Illinois, has a new photoelectric relay using Visitron phototubes. This unit is designed primarily for use on 110-120 volt, 50-60 cycle current, but is also available in other a.c. voltages and frequencies. No. 5351-D relay uses a three inch lens aperture for increasing the sensitivity of the unit. Similar models are available with two inch lenses, with rectangular apertures and no lenses, and with no aperture for use with separate phototube housings.

Condensers

AEROVOX CORPORATION, 70 Washington St., Brooklyn, N. Y., announce a compact dual-section electrolytic condenser, type PBS 5. These units provide



entirely separate and distinct sections in a single cardboard container with individual positive and negative flexible leads for each section. They are available in 250 and 525 volt peak ratings, in combinations of 4-4 to 8-16 mfd.

P. A. Amplifier

A HIGH GAIN, low-cost, eight tube, 124 db. amplifier is offered by Lafayette Radio Manufacturing Company, Inc., 100 Sixth Avenue, New York City. It measures 9½ by 16½ by 9½ inches; is available in metal or glass tube models, with output impedances of .7 to 15 ohms, 250 and 500 ohms. Puts out 15 watts to a 500 ohm line; flat within 3 db. between 50 and 10,000 cps. Six percent harmonic content at maximum output. Hum level is 45 db. below sound output. It consumes 90 watts from the a.c. line.

Test Oscillator

A NEW, LOW priced test oscillator with a direct reading, full vision dial has just been released by the engineering department of the Earl Webber Company, 1217 W. Washington Blvd., Chicago, Illinois. This new oscillator, known as the 1936 Improved Model 20 is powered by one 4½ volt C and one 22½ volt B battery; it can be used for aligning the home receiver in the service laboratory or the auto set in the car. The frequency range of this new instrument is continuously variable from 90 kc. to 60 mc. The seven bands cover all frequencies now in use with provisions for future high frequency developments. The unit is housed in a one piece cast aluminum case 11"x7¼", which reduces strays to an extremely low level.

A jack located on the panel permits the use of a frequency modulator so that receivers may be checked on a cathode ray oscillograph. A separate vacuum tube provides a modulation level of approximately 35%. The a-f signal of approximately 400 cycles,

which may be attenuated, is available at the output leads.

The calibration of this precision laboratory quality oscillator is carefully checked against crystal controlled frequency standards at several points on each band and is guaranteed to be accurate to within one-half of one per cent on the I-F and broadcast bands. Two type 30 tubes, a shielded output cable and detailed operating instructions are furnished with each instrument.

Literature

THE following catalogs, trade literature, and other manufacturers' bulletins have recently been received:

♦ **Condenser Manual.** Mallory Condenser Service and Replacement Manual, published by P. R. Mallory & Co., Inc., Indianapolis, Indiana, comes attractively packaged in an instructive broadside. Ninety-four pages of data compiled from an analysis of problems submitted by thousands of service men. Available to authorized service men upon request.

♦ **Crystal Microphones.** New folder published by the Brush Development Company, E. 40th Street and Perkins Avenue, Cleveland, Ohio, describing their crystal products, particularly the Lapel microphone and spherical microphone. Individual catalog sheets concerning each item in the folder are available upon request.

♦ **Directory.** A new 100-page directory of film sources, telling where to buy, rent or borrow 16 mm. silent or sound film. Source are broken down into such groups as Government, National and Local associations, societies, churches, and industrials. Published by Victor Animatograph Corporation, Davenport, Iowa.

♦ **Market Data.** A report containing maps and statistics showing day and night the coverage obtained by WSPD, Toledo, Ohio. Compiled and published by Jansky & Bailey, National Press Building, Washington, D. C.

♦ **Metal Mercury Rectifiers.** A four page pamphlet, published by the United Electronics Company, 42 Spring Street, Newark, New Jersey, describing the technical features of their types 966, 966A, 972 and 972A tubes. Copies available upon request to manufacturer.

♦ **P. A. Amplifiers.** Wholesale Radio Service Company, Inc., 100 Sixth Avenue, New York City, offers the newest catalog of receivers, public address amplifiers and systems, replacement service parts and other products. Copies available upon request.

TRANSFORMERS

for Audio Amplification



Users of high-fidelity portable amplifiers will find that AmerTran Type OP Miniature transformers will solve many of their knottiest problems. Not only are these units small in size and of light weight, but they are also high quality parts which meet broadcast station specifications.

Frequency characteristics are uniform within ± 1 dB from 30 to 12,000 cycles and all types are self-shielded electromagnetically. Windings of all transformers are in carefully balanced sections with at least four leads brought to the terminal board from each coil. Send for Bulletin No. 1002.

AMERICAN TRANSFORMER CO.
180 Emmet St., Newark, N. J.

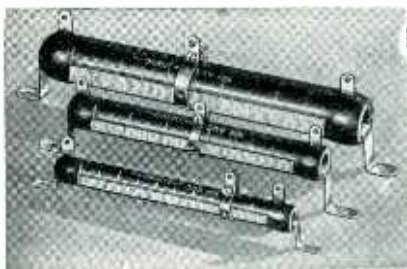

Here's a
Useful
Unit

"DIVIDOHM"

If factory adjustments are desirable after your machine is built . . . wherever varying line voltages must be considered . . . and for dozens of other applications, DIVIDOHM Semi-variable Resistors are highly useful. Sliding lugs may be easily adjusted to desired resistance value with the aid of the patented "percentage of resistance" scale. Several lugs may be used without shorting out much resistance.

These units are wound over porcelain cores, and coated with special Ohmite Vitreous Enamel which locks each turn of wire in place, protects against mechanical and electrical damage, and helps dissipate generated heat. Made in six sizes with resistance values through 100,000 ohms. Write for Catalog 14 listing all values.

OHMITE

MANUFACTURING COMPANY

4825 Flournoy Street - Chicago, Ill.

Manufacturers of Resistors and Rheostats of all types

THE
Complete and Reliable
Source of Supply of
**CAREFULLY COORDINATED
RECORDING
EQUIPMENT**



Whether you are considering the purchase of a complete instantaneous recorder, or of a needle, rely on one source of supply. The coordinated efforts of an extensive engineering department and the wealth of experience gained through the manufacture of recording equipment, since the inception of the art of recording sound, enables Presto to offer you a product second to none.

DISCS

NEEDLES

WAX RECORDERS

INSTANTANEOUS
RECORDERS

AMPLIFIERS

Presto assures you of "finger-tip control" . . . control which concentrates responsibility for everything in instantaneous recording at one source. Look to Presto, the leader.

MANUFACTURERS OF EVERYTHING FOR RECORDING FROM
A NEEDLE TO A COMPLETE STUDIO INSTALLATION.

PRESTO

RECORDING CORPORATION
139 West 19th Street, New York, N. Y.

PATENTS REVIEW

PATENTS indicate trends. Next year's radio circuits, applications of electron tubes for non-communication purposes, new tube types, new materials, may be discovered by following United States and British inventions.

Electron Tube Applications

Synchronizing system. Means for generating a periodic potential of frequency proportional to the speed of apparatus to be synchronized. L. J. Wolf, WE&M Co. No. 2,033,021.

Reactance control. Method of controlling the reactance of an electric circuit by using an electron discharge device having electrodes spaced apart in an atmosphere of ionized gas. Irving Langmuir, G.E. Co. No. 2,032,620.

Phototube circuit. Combination of a photo tube and a gaseous discharge circuit for control purposes. P. E. Stogoff,

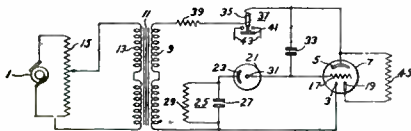

WE&M Co. No. 2,032,958. See also No. 2,033,016 to E. H. Vedder, WE&M Co.

Secret system. An oscillation generator provided with a frequency-determining inductor, a closed minor magnetic circuit wherein losses at radio frequencies are zero, surrounding the inductor, whereby the frequency of the generated oscillations may be caused to vary at the signal frequencies without any amplitude variation. A. H. Turner, RCA. No. 2,026,758.

Block signal system. Patent Nos. 2,030,662 and 2,030,675 to C. G. Suits and W. H. Arkenburgh, G.E. Co.

Energy conversion. Furnishing a-c from a d-c supply by means of electron tubes, resonant circuit, etc. F. W. Frink, G.E. Co. Reissue, No. 19,850.

Power translation. A phase testing circuit involving a two element and a three element rectifier. J. W. Dawson, WE&M Co. No. 2,030,100.

Motor controller. A circuit using one two element and one three element rectifier and a three element amplifier. C. Stansbury, Cutler-Hammer, Inc. Reissue, No. 19,853.

Electrical control. A balanced rectifier involving a transformer having

two opposed windings for energizing the control electrodes and means interposed between each of the windings and the source for rendering them differentially effective upon a change in the function of the source. F. W. Godsey, Safety Car Heating & Lighting Co. No. 2,030,202.

Illumination control. Method of controlling current in electric circuits by a saturated reactor. No. 2,030,801, R. D. Ross, WE&M Co.

Relay. A system for producing a relatively low frequency variation of the average current in the primary winding of a transformer comprising a thermionic tube, etc. G. E. Horton, Jr., Hewlett, N. Y. No. 2,030,794.

Relay. Combination with a variable-voltage electrical circuit and a relay influenced thereby, means for causing the relay to respond to voltage-change impulses, comprising electron tube circuit. F. H. Gulliksen, WE&M Co. No. 2,030,107.

Signalling system. A railway signalling system involving balanced modulator, oscillator, demodulation, etc. A. J. Sorensen, Union Switch & Signal Co. No. 2,032,725.

Power conversion. Method for statically converting electrical power into alternating current of any frequency from a d-c source. J. von Issendorff, WE&M Co. No. 2,030,127.

Flaw detector. A rail flaw detector mechanism. L. J. De Lanty, Sperry Products, Inc. No. 2,027,814.

Photometer. A photoelectric device with an optical system comprising two tourmaline plates and a voltmeter to indicate the e-m-f generated by the photo-electric device. L. I. Hull, Milwaukee, Wis. No. 2,029,170.

Oscillation Generators

Deflection generator. An electron gun or other source of electron beam, a magnetic field and two or more secondary electrodes, means for altering the velocity of the electrons in the beam whereby the beam is caused to be incident upon one or the other of the additional electrodes. George Fairburn Brett, RCA. No. 2,027,017.

Magnetron. Method of limiting the anode current during operation to a predetermined maximum. Fritz Hulster, Telefunken. No. 2,023,272.

High frequency generator. Method of making the space potential between the parallel sections of a cathode substantially the same as the potential of the section. B. J. Thompson, RCA. No. 2,022,988.

Frequency generator. A submultiple frequency generator involving a Wheatstone bridge, two legs of which are made up of the impedance controllable

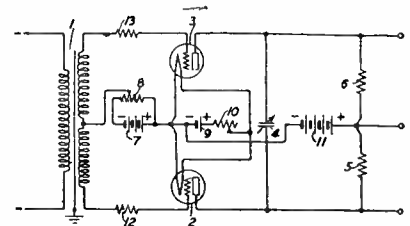

gas-filled electric discharge devices and the other two legs of which are made up of resistances completely. R. L. Miller, BTL, Inc. No. 2,028,232.

Square top wave generator. Three glow discharge tubes with a means for producing intermittent discharge in one tube and means for producing discharges in the other tube whose time of occurrence lies between that of the discharges of the first glow tube. D. Prinz, Telefunken. No. 2,023,436.

Amplifier-generator. A circuit involving a screen grid tube comprising a variable condenser having one side directly connected to the plate and the other side directly to the cathode of the tube and a resistor and condenser in series connected in shunt to the variable condenser. B. van der Pol and J. van der Mark, RCA. No. 2,024,489.

High frequency system. Utilizing the variations of a pair of differentially

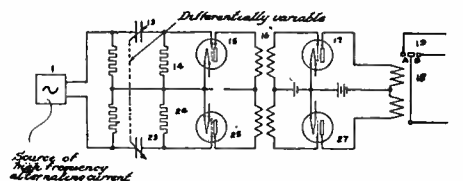

variable phase shifting elements. L. M. Applegate, Collins Radio Co., Cedar Rapids, Iowa. No. 2,019,481.

Polyphase oscillator. Apparatus for producing a variable frequency polyphase periodic potential. B. D. Bedford, G.E. Co. No. 2,017,708.

Temperature control. Method of preventing the drift of an oscillation

Autelco ELECTRICAL REMOTE CONTROL DEVICES

● We offer a comprehensive line of electrical control apparatus of proved dependability for adaptation to your products or for use in your production processes. Autelco control devices include:

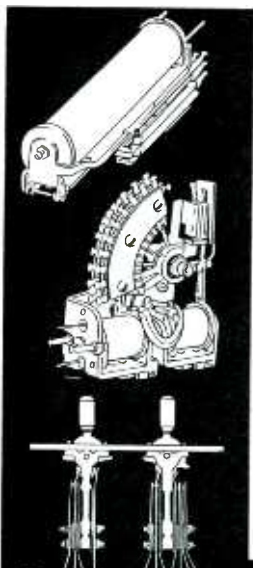

RELAYS: Quick and delayed action types, for A.C. and D.C. circuits, any voltage, any contact combination.

STEPPING SWITCHES: Electromagnetic multi-contact switches, for automatic selection of electrical circuits.

SWITCHING KEYS: A variety of locking and non-locking types in any desired contact combination. Also cords, plugs, jacks, signal lamps, sockets, counters, etc. Write for complete illustrated catalogs.

American Automatic Electric Sales Company

1023 West Van Buren Street

Chicago

PERFECT
LAMICOID
REG. U. S. PAT. OFF.

Laminated Bakelite



Sheets, Tubes, Rods, Fabricated Parts

Made of the finest raw materials, including genuine Bakelite Resins. Uniformity of quality assured by use of the most advanced automatic control equipment.

Write for complete information and prices.

MICA INSULATOR COMPANY

200 VARICK ST., NEW YORK; 542 South Dearborn St., Chicago; 1276 West Third St., Cleveland . . . Branches at Birmingham, Boston, Cincinnati, Los Angeles, San Francisco, Seattle. Canada: Montreal, Toronto.

90 NEW HIGH FIDELITY TRANSFORMERS

COMPLETE LISTING OF THE SUPER HIGH FIDELITY LINE AND THE ULTRA HIGH FIDELITY LINE
ALL SHOWN WITH THE CONSTRUCTIONAL COMPLETE APPROXIMATE WEIGHTS
By Ferranti Electric, Inc.

SUPER

ULTRA

SERIES A

SUPER HIGH FIDELITY SERIES A

SERIES B

ULTRA HIGH FIDELITY SERIES B

SEND FOR YOUR COPY!

NEW LOW PRICES SHIPMENT FROM STOCK NEW REVERSIBLE MOUNTINGS CORE TYPE—SELF SHIELDING

FERRANTI ELECTRIC offers 90 New High Fidelity Audio Transformers and Reactors at the Lowest Prices in their History.

Every unit employs new Self-Shielding core type construction with hum bucking windings. This construction in conjunction with the New Straight Through Type Reversible Mounting makes it possible to mount Input and Output Transformers actually up against each other—No Coupling—No Waste Space.

Every unit is completely reversible and may be used for either top or subpanel mounting—mounting bolts and nuts are supplied with each unit. Electrostatic shields are fitted between windings and brought out to a terminal. Both the Super and Ultra series are small in size and light in weight, and are manufactured to Ferranti High Fidelity Standards—Super ± 1 db. from 30 to 12,000 cycles—Ultra $\pm 1/2$ db. from 30 to 16,000 cycles.

Moisture proof construction is employed and every unit has exceedingly low insertion loss. Both the "A" and "B" Series are designed and manufactured in the United States to suit the exacting demands of the American market and all units are available for Immediate Shipment From Stock.

**EVERY FERRANTI TRANSFORMER
IS BACKED BY 54 YEARS' EXPERIENCE**

FERRANTI ELECTRIC, INC.

130 West 42nd St., New York, N. Y.

Now is the time to get the engineers'



-- on your products, for use
in the *new fall receivers*
new improved broadcast stations
new receiving and power tubes
new communication services



Last year was a record-breaker...

Total sales of radio receivers topped six million in 1935. Sets for 1936 will have more parts, be larger, be better engineered, cost more to make and to sell, and will command higher prices.

In 1935 set manufacturers used approximately 60 to 70 million dollars worth of components (manufacturers' wholesale price). And don't forget that these same components (and many higher-priced materials and parts) are bought by engineers making and using broadcast and public address equipment, telephone and telegraph apparatus, wire and wireless communication circuits.

This year looks even better . . .

Developments of 1935 such as metal tubes, cathode ray tuning meters ("magic eye"), volume expansion amplifiers and similar improvements were introduced in high priced sets. Now they are being included in lower price ranges.

New developments will make this year's sets better sellers. And the

Since the increase in subscription price last September, from \$3.00 to \$5.00 a year, net paid circulation

presidential election, getting a heavy play on the radio, should stimulate set sales.

Television is soon to get its first large-scale field demonstration. The rapid growth of ultra-high frequency usage and the increased revenues received by broadcasting stations means purchase of new and better apparatus.

All in all it looks like a big year for radio in 1936.

Fall manufacturing plans are under consideration . . .

Now is the time for parts manufacturers to tell their story to the men who design sets, to the men who specify and buy products for the new fall receivers, for the new and redesigned broadcast stations which will need the latest products this fall, for all the new communications networks.

All eyes are on the I.R.E. Convention in Cleveland, May 11, 12, 13. But only one in four will be able to get there. The others must stay close to the design table, the drafting board and the assembly line.

You must reach both the conventioneers and the stay-at-homers . . .

Through the advertising pages of the May issue of *ELECTRONICS* you can—

- Reach every engineer attending the Cleveland Convention. (Extra copies of May *ELECTRONICS* will be distributed at the meeting.)
- Reach the engineers who must stay at home. (Every radio engineer of importance is a regular subscriber to *ELECTRONICS*.)
- Get their attention at the time they are designing, specifying and buying for the new fall receivers.
- Point out the superiority of your products as components for this year's sets.
- Help get your products specified—which will mean increased sales and profits for you.

May ELECTRONICS offers increased advertising value at no increase in rates . . .

Special editorial features will assure added reader interest and provide a most effective background for your advertising message in the May Convention Issue of *ELECTRONICS*.

This issue will be read at the Convention—carried home from the Convention—kept for reference—and referred to long after the Convention becomes history.

To you, as an advertiser, the May Convention Issue of *ELECTRONICS* offers increased coverage, increased reader interest, increased advertising value—at no increase in advertising rates!

Forms for May *ELECTRONICS* close April 27th. (This earlier closing date is necessary in order to distribute the May issue at the Convention.) Make your space reservations now.



electronics

A McGraw-Hill Publication
330 West 42nd St., New York, N. Y.

has increased from 6835 to 9184 — A greater advertising value at no increase in advertising rates.

frequency with changes in temperature of inductance and capacitance, and from changes in interelectrode capacities resulting from changes in the temperature of the tube base. F. H. Drake, RCA. No. 2,027,521.

Phase control. An oscillator wherein the feed-back voltage is desired to be exactly opposite in phase to the anode voltage, means for generating the feed-

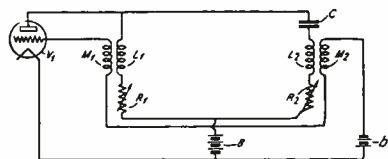

back voltage which lags the desired phase an appreciable amount, etc. E. B. Moullin, RCA. No. 2,031,224.

High frequency generator. Means for establishing a rotating field of relatively low frequency, for directing a beam of cathode rays through the field whereby the beam is deflected in a closed two-dimensional path, etc. R. M. Heintz, Heintz & Kaufman, San Francisco. No. 2,026,892.

Coupling coil. Combination of first and second coil in an antenna coupling system with an electrostatic shield be-

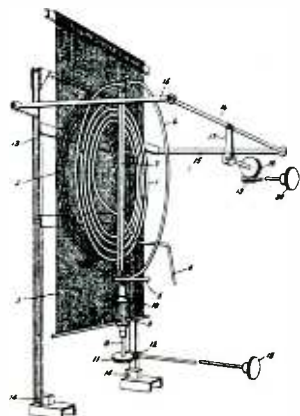

tween and means for rotating a portion of a turn of the first coil for coupling variation. G. W. Fyler, G.E. Co. No. 2,027,861.

Power Generation and Modulation

Frequency modulation. The use of a U-shaped frequency controlling transmission line in connection with a pair of oscillation generators connected in circuits adjusted so as to normally operate on opposite sides of a mean operating frequency. G. L. Usselman, RCA. No. 2,030,125.

High frequency oscillator. Source of anode potential connected in series between anode and cathode, and a means

for applying to an auxiliary grid a potential which varies inversely as the potential of the source of anode voltage comprising a triod regulating tube. A. H. Taylor and L. C. Young, Washington, D. C. No. 2,029,346.

Adjudicated Patents

1,648,989, D. R. Lamont, Electrical measuring instrument; 1,748,847, J. H. Miller, Radio tube testing instrument; 1,805,089, D. Hawley, Radio testing device; 1,805,074, J. A. Burtch, Radio testing device; 1,805,094, J. C. Hoover, Set checker, D. C., N. D. Ohio, W. Div., Doc. E 1217, *Jewell Electrical Instrument Co. v. The Diller Mfg. Co. et al.* Dismissed without prejudice; counterclaim dismissed with prejudice Jan. 14, 1936.

1,879,863, H. A. Wheeler, Volume control, D. C., S. D. N. Y., Doc. E 76/311, *Hazeltine Corp. v. Westinghouse Electric Supply Co., Inc., et al.* Consent order of discontinuance (notice Jan. 9, 1936).

1,815,768, A. Georgiev, Electrolyte, D. C., S. D. N. Y., Doc. E 76/250, *Aerovox Corp. v. Emerson Radio & Phonograph Corp.* Consent order of discontinuance without prejudice (notice Jan. 4, 1936).

Patent Suits

1,904,662, R. B. Benjamin, Socket for vacuum tubes; 1,904,670, W. C. MacFadden Socket for tubes, filed Nov. 30, 1935, D. C., E. D. Pa., Doc. 9179, *H. H. Eby, Inc. v. Raymond Rosen & Co.*

1,726,500, R. F. Norris, Sound deadening construction, appeal filed Dec. 31, 1935, C. C. A., 2d Cir., Doc. 14487, *Guaranty Trust Co. of N. Y. et al. v. Johns-Manville Corp.*

Re. 19,744, H. A. Wheeler, Volume control, filed Dec. 7, 1935, D. C., N. D. Ill., E. Div., Doc. 14961, *Hazeltine Corp. v. Stewart-Warner Corp.*

1,914,010, W. E. Eccles, Electrical connection; 1,914,011, same, Electrical fitting, filed Nov. 25, 1935, D. C. Conn. (New Haven), Doc. E 2499, *National Engineering Corp. v. H. A. Roraback.*

1,403,475, D. H. Arnold, Vacuum tube circuit; 1,403,932, R. H. Wilson, Electron discharge device; 1,507,016, L. de Forest, Radio signaling system; 1,507,017, same, Wireless telegraph and telephone system; 1,936,162, R. A. Heising, Transmission system; Re. 18,579, Ballantine & Hull, Demodulator and method of demodulation, filed Jan. 4, 1936, D. C., S. D. N. Y., Doc. E 82/94, *Radio Corp. of America et al. v. M. Shapiro et al. (Rite Radio Stores).*

1,297,188 (a), I. Langmuir; 1,573,374, P. A. Chamberlain; 1,707,617, 1,795,214, E. W. Kellogg; 1,894,197, Rice & Kellogg, filed Dec. 16, 1935, D. C., N. D. Ill., E. Div., Doc. 14981, *Radio Corp. of America et al. v. O. L. Sturm et al. Doc. 14985, Radio Corp. of America et al. v. Congress Radio Co., Inc., et al.*

1,297,188 (b), I. Langmuir; 1,573,374, P. A. Chamberlain; 1,707,617, 1,795,214, E. W. Kellogg; 1,894,197, Rice & Kellogg; 1,728,879, same, filed Dec. 16, 1935, D. C., N. D. Ill., E. Div., Doc. 14975, *Radio Corp. of America et al. v. E. W. Ehman et al. (The Alonson Co.) Doc. 14977, Radio Corp. of America et al. v. Hetro Electrical Industries, Inc., et al. Doc. 14979, Radio Corp. of America, et al. v. E. Mraz (Hi Lo Radio Co.). Doc. 14983 Radio Corp. of America, et al. v. R. D. Rogers (Adams Radio Laboratory). Doc. 14987, Radio Corp. of America, et al. v. G. Wolff et al. (Illinois Radio Stores, Inc.). Doc. 14989, Radio Corp. of America et al. v. J. M. Earle (Woodlawn Radio & Music Co.).*

1,297,188 (c), I. Langmuir; 1,573,374, P. A. Chamberlain; 1,618,017, F. Lowenstein; 1,707,617, 1,795,214, E. W. Kellogg; 1,894,197, Rice & Kellogg, Re. 18,579, Ballantine & Hull, filed Jan. 4, 1936, D. C., S. D. N. Y., Doc. E 82/95, *Radio Corp. of America et al. v. M. Shapiro et al. (Rite Radio Stores).*

1,403,475 (a), H. D. Arnold; 1,403,932, R. H. Wilson; 1,507,016, L. de Forest; 1,507,017, same; 1,618,017, F. Lowenstein; 1,702,833, W. S. Lemmon; 1,811,095, H. J. Round; 1,936,162, R. A. Heising; Re. 18,579, Ballantine & Hull, filed Dec. 16, 1935, D. C., N. D. Ill., E. Div., Doc. 14974, *Radio Corp. of America et al. v. E. W. Ehman et al. (Alonson Co.).*

1,403,475 (b), H. D. Arnold; 1,403,932, R. H. Wilson; 1,507,016, L. de Forest; 1,507,017, same; 1,811,095, H. J. Round; 1,936,162, R. A. Heising; Re. 18,579, Ballantine & Hull, filed Dec. 16, 1935, D. C., N. D. Ill., E. Div., Doc. 14976, *Radio Corp. of America et al. v. Hetro Electrical Industries, Inc., et al. Doc. 14978, Radio Corp. of America et al. v. E. Marz (Hi Lo Radio Co.).*

1,403,475 (c), H. D. Arnold; 1,403,932, R. H. Wilson; 1,618,017, F. Lowenstein; 1,702,833, W. S. Lemmon; 1,811,095, H. J. Round; 1,936,162, R. A. Heising; Re. 18,579, Ballantine & Hull, filed Dec. 16, 1935, D. C., N. D. Ill., E. Div., Doc. 14980, *Radio Corp. of America et al. v. O. L. Strum et al. Doc. 14982, Radio Corp. of America et al. v. R. D. Rogers (Adams Radio Laboratory). Doc. 14986, Radio Corp. of America et al. v. G. Wolff et al. (Illinois Radio Stores, Inc.). Doc. 14984, Radio Corp. of America et al. v. Congress Radio Co., Inc., et al. Doc. 14988, Radio Corp. of America et al. v. J. M. Earle (Woodlawn Radio & Music Co.).*

Cornell-Dubilier Type TB



DYKANOL impregnated and filled, the Type TB series of high voltage transmitting capacitors are employed in the world's largest transmitting station installations. Their dependability in giving uninterrupted service at all times has made them most popular with the broadcast engineer.

Check these outstanding characteristics of the Type TB DYKANOL Series:

- Chemical stability of DYKANOL makes it possible to operate these condensers at temperatures destructive to ordinary dielectrics.
- Can be operated at voltages 10% above rating without injury to capacitor.
- Leakage resistance and power factor change with temperature decidedly improved.
- Available in a complete capacity range at voltages up to and including 100,000 volts D.C.

Many other interesting and important features of this famous series of transmitting condensers described in Catalog No. 127. Copy sent on request.

CORNELL-DUBILIER
CORPORATION

4380 BRONX BOULEVARD • NEW YORK

REMLER ATTENUATORS

... Now Better Than Ever!



All the famous Remler characteristics familiar to hundreds of broadcast, sound recording and projection engineers.

PLUS

- SILVER CONTACT POINTS
- SILVER LAMINATED SPRING CONTACT ARM
- BALL BEARING ROTOR SHAFT
- CLOCK SPRING PIGTAIL CONNECTION TO CONTACT ARM

These improvements eliminate high resistance oxidation, minimize cleaning and maintenance and permit frictionless adjustment to any position. The result is positive contact and uniform performance regardless of attenuation setting. Standard impedances 50, 200 and 500 ohms. Special values to order.

LA-5 Ladder
Type—Net
12.80

Send for new catalogue
REMLER COMPANY, Ltd.
2101 Bryant St., San Francisco

REMLER—THE RADIO FIRM AS OLD AS RADIO

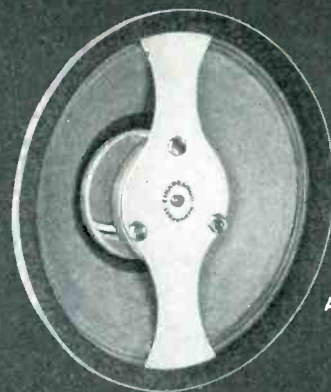

AZ 8-7

The

MAGIC MAGNET SPEAKER

ANSWERS THE CHALLENGE
FOR FINER PERFORMANCE

No receiver or acoustical circuit is better than its speaker. That is why Cinaudagraph engineers went straight to the heart of radio performance with a speaker styled and designed for perfect reception.

The MAGIC MAGNET SPEAKER offers the radio field the following specific and exclusive features:

1—POLYFIBROUS CONE CONSTRUCTION

Polyfibrous cone material "shading" from one fibrous composition to another, as to the periphery of the cone is approached, permits the vibrations of the voice coil to be projected with uncanny fidelity.

2—"NIPERMAG" MAGNET MATERIAL

"NIPERMAG" . . . a permanent magnet alloy universally used with great success in Europe, is introduced in the Cinaudagraph MAGIC MAGNET SPEAKER. (Not to be confused with other permanent magnet alloys used in American speakers.) Requiring no further electro-excitation, after once being magnetized "Nipermag" effects a positive saving in current consumption, time and convenience.

3—VOICE COIL CONSTRUCTION

A quartz cylinder (.003 in. thick), is used in the construction of the voice coil. Quartz, being non-elastic and extremely dense, is the ideal mineral to use as the coil core.

4—SPIDER CONSTRUCTION

A centering device consisting of an interlaced net, gives continuous attachment to the cone, at a fixed distance from the voice coil where maximum radial rigidity will be obtained without impairing tonal quality of speaker. The net provides continuous anchorage to the cone frame throughout the net's periphery.

5—RESPONSE CHARACTERISTICS

Standard sound pressure measurements show the 8" Model to have a response of ± 4 db from 100 to 7000 C.P.S. The unique cone construction, being only 2% inches deep, allows the projection of the same tone character from either side of the speaker.

6—BAFFLE CONSTRUCTION

To absorb rear radiation and permit only the true undistorted tones to emanate from the speaker, Cinaudagraph engineers designed the MAGIC MAGNET SPEAKER to operate within an infinite baffle. As no definite dimensions in any direction is required, this baffle can be constructed in the shape of any cabinet or acoustical chamber. By utilizing the infinite baffle, acoustic difficulties are definitely reduced and the speaker can be located in any position or cabinet without having its tonal qualities affected.

The MAGIC MAGNET SPEAKER is completely assembled in one of the world's largest, most modern speaker plants, in 8, 10, 12, and 18 inch models. Complete facilities for prompt service and special requirements. Write today for complete details.

CINAUDAGRAPH

CINAUDAGRAPH CORPORATION
STAMFORD, CONN.

Speaker Division—Dept. "S"

British Patents

Radio Receiver Circuits

Multiple element tube. A circuit for use in non-loaded multiplex-carrier telephone cable circuits. H. S. Black, Standard Telephones & Cables. No. 435,646.

Direction finder. A direct reading radio-goniometer involving a stroboscope. A. Bertrand and M. Parisier, Paris. No. 435,674.

Tuning indicator. A visual tuning indicator comprising a pilot lamp shunted by the primary of a transformer and fed with alternating current through a resistance. The secondary of the transformer is shunted by a tube the impedance of which is controlled in accordance with the received

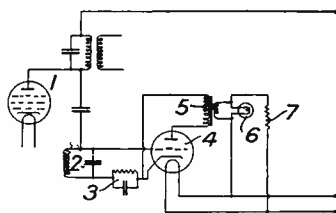

signal strength. As shown in this patent, a sharply tuned circuit feeds signal energy to the grid of the controlling tube through a grid condenser and leak from an I-F tube which does not receive a-v-c. Murphy Radio. No. 437,481.

Intermediate frequency amplifier. A circuit for television use in which the i-f amplifier is designed to amplify i.f. and the side bands comprising television signals. For example, the sound carrier is at 1,000 meters, the synchronizing carrier is a 1,500 meter wave and the intermediate heterodyne frequency is 500 meters. D. S. Loewe and K. Schlesinger, Berlin. No. 435,682.

Directive transmission. The circuits used for receiving course-marking signals say on 7 meters, and other signals on 3 meters, in aircraft navigation. Lorenz. No. 436,839.

A.v.c. Circuit embodying automatic volume control and means for inter-channel noise suppression. M. K. Taylor, Ferranti, Ltd. No. 436,856.

Superheterodyne circuit. The local oscillations applied to the detector of a homodyne receiver are modulated by potentials obtained by demodulation in the receiver. Marconi Co. No. 437,305. See also No. 437,306 and No. 437,307.

Frequency changer. In a modulating or frequency changing multi-electrode tube-circuit, a virtual cathode compris-

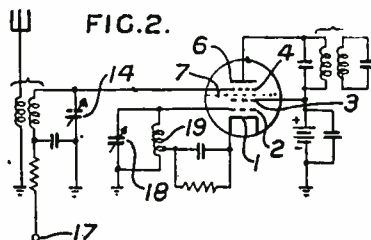

ing an aggregation of electrons is produced between a pair of grids by applying positive potential to the grid nearer the actual cathode and a negative potential to the other grid, the signals being applied to a grid, for example, the positive grid, between the virtual cathode and anode. The density of the virtual cathode is varied periodically by the local oscillator. H. A. Wheeler, Hazeltine Corp. No. 436,940.

Filter. A low frequency filter rejector circuit is placed between the high frequency and low frequency amplifying portions of a receiver and the rejector circuit is coupled, with

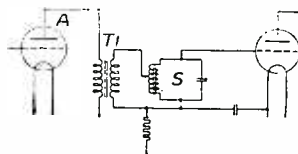

other than unity ratio, by means of a tapping on the coil of the rejector circuit. Lorenz. No. 438,177.

Gain control. An element having a non-linear resistance characteristic is associated with the load impedance of a tube to vary the latter when a direct current through the resistance is varied. D. H. Ring, Standard Telephones & Cables. No. 438,565.

Selectivity control. Means for adjusting the band width so that on tuning the selectivity control is at a

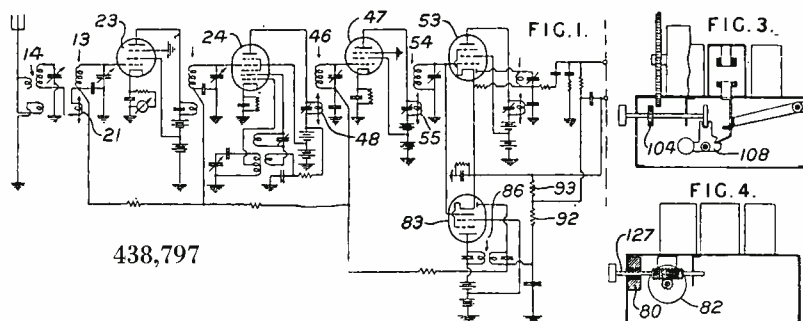

maximum. Interlocking means may be provided between the tuning and selec-

tivity controls so that the former is operative only when the latter is adjusted for minimum band width. H. A. Wheeler. No. 438,797, Hazeltine Corp. See also No. 438,831 and 438,832.

Automatic tuning system. In a receiver where the tuning member is controlled indirectly, that is, otherwise than by the agency of a direct rigid frictional or gear coupling, automatically operated fine tuning means are provided to compensate lack of precision in the normal operation of tuning. The fine tuning means is a vernier condenser shunted across the main tuning condenser and operated by an electric motor to bring the circuits into exact tune. H. Jackson. No. 437,442.

Super-regenerator. A receiving circuit comprising a tube with at least

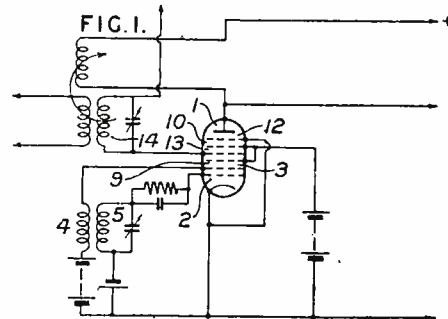

four grids. D. W. Pugh, and Baird Television. No. 437,460.

Frequency change. A mixing tube for use in a supersonic heterodyne or a homodyne receiver or as a modulator consists of signal input and oscillator sections, both comprising a grid and an anode and located in the electron stream from a cathode, with screening between the sections and between the control grid and anode of the signal section. Marconi Co. No. 437,726. See also No. 437,804 to Marconi Co. on a combined mixer and oscillator tube.

Antenna system. A method of supplying lighting current from a low-voltage source to a wireless tower-type antenna in which the high potential of the antenna is gradually impressed upon the low-voltage lighting conductors along the length by coupling them to an element of the antenna system having an appropriate voltage gradient. British Thomson-Houston Co. No. 434,857.

Lansing Sets a New Standard of Loudspeaker Performance

Independent tests on Shearer Two-Way Horn System installations, using Lansing No. 284 and No. 15 x 29 units, gave response curves showing a maximum deviation of plus or minus 2 db over a frequency range of from 50 to 8000 cycles.

This performance holds true over the entire angle of distribution at a distance of 10 ft. from the mouth of the horn.

• Such systems are now being installed in key theaters.



• Write for details.

Lansing

LANSING MANUFACTURING COMPANY
6900 McKinley Avenue, LOS ANGELES, CALIF.

ANNOUNCING—The

TRIUMPH

Model 180 WOBBULATOR

Six tubes electronically driven



We announce the perfect companion to the Oscillograph, the Model 180 Wobbulator. *Unequaled.* The only electronically driven, frequency modulated signal generator, giving constant band widths—band limit beacons—direct calibration and precise synchronization. A necessity to every radio service shop and production line.

- Selective Modulation
- Spotted Frequencies
- 100 K.C. to 30 M.C.
- Dual Attenuator
- Perfect Synchronization
- Electronically Driven
- Constant Band Widths
- Band Limit Beacons

PRICE COMPLETE
F.O.B. FACTORY

\$57⁵⁰

Model 800 OSCILLOGRAPH

Sensational appearance—performance—price

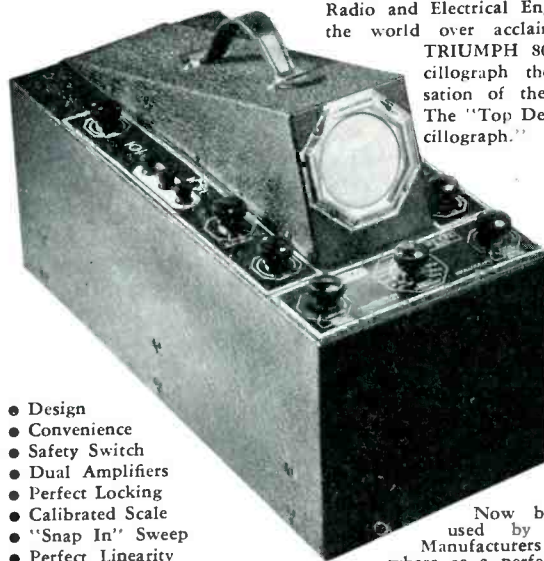

Radio and Electrical Engineers the world over acclaim the TRIUMPH 800 Oscillograph the sensation of the year. The "Top Deck Oscillograph."

- Design
- Convenience
- Safety Switch
- Dual Amplifiers
- Perfect Locking
- Calibrated Scale
- "Snap In" Sweep
- Perfect Linearity
- Designated Controls
- Wide Sweep Range

Now being used by large Manufacturers everywhere as a perfect testing device for precision manufacturing.

PRICE COMPLETE
F.O.B. FACTORY

\$79⁵⁰

TRIUMPH MANUFACTURING CO.

4017 W. Lake St., Chicago, Ill.

RELAYS

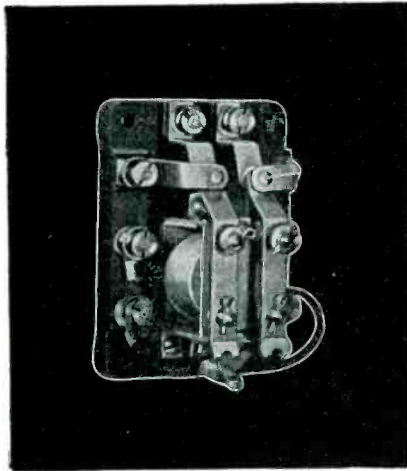

FOR
Audible and Visible
Signals of all kinds

• Heating,
Refrigeration,
and Humidity

• Pressure

• Radio

• Signs

• Counters

• Motors

• Power Failure
and Transfer

Let us quote on
your requirements

DUNCO

STRUTHERS

DUNN, INC.

148 N. Juniper Street

PHILADELPHIA, PA.

First IMPRESSIONS COUNT



Look! AT THIS ATTRACTIVE ELECTRICAL INSTRUMENT FOR YOUR PANELS

MODEL 321 O-1 D.C. MILLIAMMETER

PRECISION WITHOUT EXTRAVAGANCE

Insist on Triplet instruments. Here is shown but one of the popular models from which you may choose.

Triplet electrical measuring instruments are extremely rugged and dependable. Accuracy within 2%. Attractive, dustproof molded cases. D.C. instruments are D'Arsonval, A.C.—the moving iron repulsion type.

*Satisfaction proven by comparison.
Write for Catalogue.*

TRIPLETT MANUFACTURES a complete line of all sizes and styles electrical measuring instruments for radio, electrical and general industrial purposes both standard and custom built. If you have an electrical instrument problem write to TRIPLETT.



MAIL THIS COUPON

TRIPLETT ELECTRICAL INSTRUMENT CO.
234 Harmon Drive, Bluffton, Ohio
Without obligation please send me More details on Model 321.
 New 1936 Catalogue.

Name

Address

City State

HI-POWER FOR PORTABLE SOUND EQUIPMENT

The Carter GENEMOTOR supplies the most reliable and economical "B" Power for Class A or B Amplifiers from a 6 or 12 volt battery. Output up to 500 volts. Sturdy — Compact — Quiet in operation — Requires no oiling — Guaranteed. Also can be supplied for A.C. output.



Write for Circular

CARTER MOTOR CO.
365 W. Superior St., Chicago

A TRIAL WILL CONVINC YOU

30 Years' Experience
Insures Dependability

We Manufacture
PERMANENT MAGNETS TOOLS and DIES
METAL STAMPINGS LAMINATIONS

THOMAS & SKINNER STEEL PRODUCTS CO.

23d St. at Alvord

Indianapolis, Ind.

CONTACTS

TUNGSTEN AND MOLYBDENUM

ROD, SHEET AND WIRE
SPECIAL SHAPES

KULGRID

For Grids, Round or Flat
Also Kulgrid "C" Tungsten Welds

CALLITE PRODUCTS CO.

542 — 39TH STREET

UNION CITY, N. J.

Standardize
EBY

WITH

Binding Posts Low-Loss Sockets Short Wave
Tip Jacks A-C Switches Switches
Male Plugs Tap Switches Moulded Sockets
Female Plugs Terminal Strips Electric Eyes

Write for Latest Bulletin

HUGH H. EBY, Inc.
2066 Hunting Park Ave., PHILADELPHIA, PA.

NOW . . . CONTROL AT THE MICROPHONE

● Now for the first time, you can control the volume of a crystal microphone at the microphone . . . without in any way affecting the quality of reproduction! Ideal for soloists, speakers, announcers . . . for any application where control at the microphone is desirable.



A special capacity attenuator developed by Shure Engineers now makes possible volume adjustments which are entirely free from "tone-control" effects. Operation is "smooth" and noiseless over the total volume range of approximately 25 db. An independent ON-OFF switch allows the microphone to be turned on or off without disturbing the volume adjustment. Finish is beautiful baked rubber-black with chrome and black "Volume" escutcheon. The unit mounts on any Shure Stand (5/8"-27 thread).

Shure Crystal Microphone Volume Controls can be used with any crystal microphone. They are available complete with microphone, or separately for use with existing microphone equipment.

Write for descriptive Data Sheet.

Write today for your copy of the new Shure 1936 Complete Catalog. Ask for Bulletin 138M. No obligation, of course.

SHURE MICROPHONES
SHURE BROTHERS • MICROPHONE HEADQUARTERS
215 WEST HURON STREET • CHICAGO, U. S. A.

NEW

RCA Vibration Pick-Up

for use with RCA Oscillograph

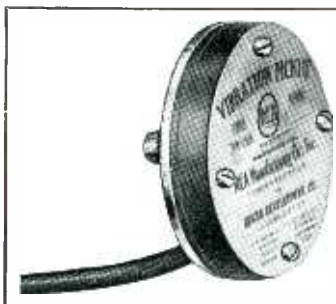

RCA Piezo-Electric Vibration Pick-Up for use with RCA Cathode Ray Oscillograph. \$20.00 net, f. o. b. Camden.

To facilitate the use of the RCA Cathode Ray Oscillograph in research into mechanical vibration, RCA has perfected the new RCA Vibration Pick-Up. May be connected directly to the Oscillograph. Does not respond to sound but is extremely sensi-



tive to vibrations up to 3,000 cycles. Exploring rod may be attached. You can determine very accurately the plane of vibration, frequencies and their amplitudes, and in many cases ascertain the actual source directly in a few minutes. Write for information.

RCA MANUFACTURING CO., Inc.

Camden, N. J., A Service of Radio Corporation of America

GOAT

FORM-FITTING TUBE SHIELDS



Patent Applied For

METAL-CLAD "G-TUBES"

Solve problems of

**PRICE
PRODUCTION
and
PERFORMANCE**



GOAT RADIO TUBE PARTS, INC.

314 Dean Street, Brooklyn, N. Y.

(A Division of THE FRED GOAT CO., Inc., Est. 1893)

SHAKEPROOF LOCK WASHERS

Multiple Locking Principle keeps connections constantly tight!

● Not just one lock, but an average of 16 separate locks on each washer—that's what the Shakeproof principle provides. Each tapered, twisted tooth forms an individual lock—a powerful strut in solid contact between both nut and work surfaces. The resilient spring tension of each tooth keeps this strut-action always in force—positively preventing any backward movement of the nut. No other lock washer can give you such dependable locking power—such certain protection against the damaging results of vibration. Write today for free testing samples!

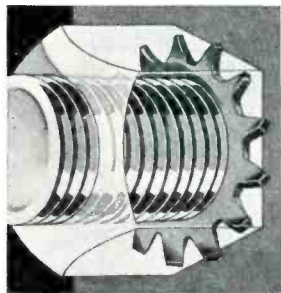

SHAKEPROOF LOCK WASHER COMPANY
Distributors of Shakeproof Products Manufactured by Illinois Tool Works
Chicago, Illinois
2539 N. Keeler Avenue

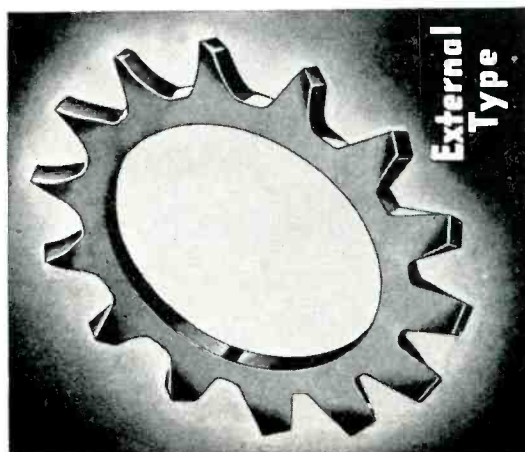
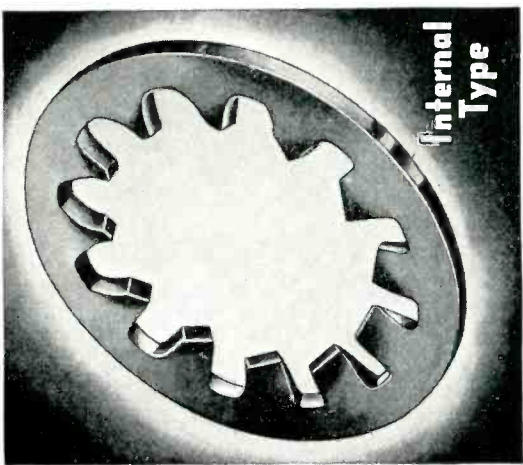

DYNAMIC (MOVING COIL) MICROPHONES

NEW MODELS



The high sensitivity of these microphones reduces amplifier cost, parasitic and tube noises. Will operate 1,000 feet from amplifier.

MODEL 7-A—especially designed for studio broadcasting and recording work.

MODEL 7-B—for remote pickup and public address work.

MODEL 7-C—for amateur use and low-priced public address equipment.

List prices \$29.00 and up. Prices have been greatly reduced. Write us on your letterhead for Bulletin No. 3012.

Radio Receptor Co. Inc.
108 7th Ave., N. Y. C., U.S.A.

YOU NEED THIS INSTRUMENT

The Acme Voltrol is a full range manual voltage regulator providing complete control over primary voltage in a stepless range from 0 to 130 volts. Accurate $\frac{1}{2}$ volt adjustments. Every laboratory needs Voltrol. Write for free bulletin 136.



THE ACME ELECTRIC & MFG. CO.

1447 Hamilton Ave., Cleveland, Ohio

PHOTOELECTRIC CELLS PHOTOELECTRIC RELAYS

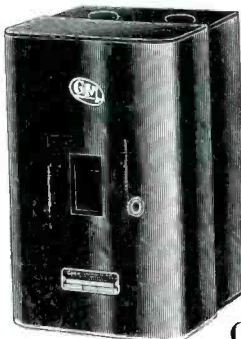

The No. 5351-B Photo-electric Relay illustrated is representative of a complete new line of G-M photoelectric equipment, including almost 100 separate and distinct units with a variety of cases, for D. C., A. C., 25 and 60 cycle, standard sensitivity, high sensitivity, etc. Adaptable for use in individual installations or as part of other equipment. Made by pioneers in the photoelectric field, with long experience in the manufacture of photoelectric cells and equipment.

WRITE FOR CATALOG
(Write on company letterhead)

G-M LABORATORIES INC.
1734 Belmont Ave., Chicago, U.S.A.

GUTHMAN Coils



Guthman Coils are dependable, guaranteed to be exactly according to specifications, within the tolerances you demand. Let us submit samples and quote on your requirements. Prices are extremely favorable.

EDWIN I. GUTHMAN and CO., Inc.
1036 West Van Buren St., CHICAGO, ILLINOIS



Filled with Oil!



AEROVOX transmitting condensers are oil-filled and so labelled. • That means an oil-impregnated paper section placed in a hermetically-sealed seepage-proof metal can filled with oil. • Thus the section is constantly bathed and permeated with oil for constant, cool, safe operation over longest service life.

You'll save money in the long run by insisting on AEROVOX oil-filled (note exact term) condensers instead of wax-filled units, which may be called "oil treated" or "oil cooled."

Write for new catalog covering advantages of oil-filled transmitting condensers. Also covers complete line of condensers and resistors. Free copy of Research Worker included.

AEROVOX

CORPORATION

75 Washington St. Brooklyn, N. Y.

In round and rectangular cans.

Hermetically sealed. Seepage-proof joints and terminals. Tigh-tension pillar terminals.

Conservatively rated. Honestly labelled. New low prices.

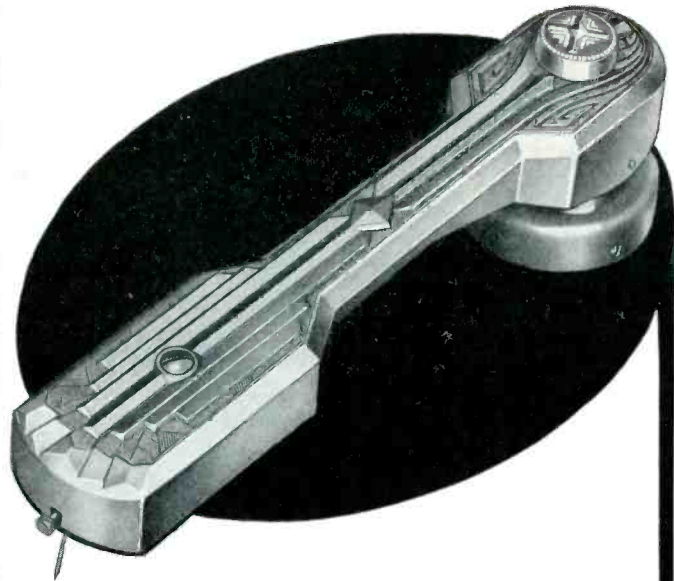

PICK-UPS!

... precision built
to meet every
requirement ...

• Ever since their introduction to the market, Webster Electric Pick-ups have been noted for their precision construction, tone quality and beauty of appearance.

Today, Webster Electric can offer the manufacturer practically any frequency characteristic he desires in phonograph pick-up performance.

Webster Electric Pick-ups are available in both magnetic and crystal types with standard, high fidelity or "ear-compensated" response characteristics—the latter a crystal type designed to give most pleasing reproduction.

Among the design features to be found in Webster Electric Pick-ups are: light needle weight, freedom from resonance peaks, low scratch and distortion level, chatter-proof bearings.

Bulletins describing Webster Electric Pick-up models will be sent upon request. We invite inquiries on specific requirements.

WEBSTER ELECTRIC COMPANY

Established 1909

RACINE, WISCONSIN, U. S. A.

Export Office:

15 Laight St., New York City

TRANSFORMERS for Transmitting

Right—AmerTran air-cooled transmitting plate transformer—sizes up to 7 kva.

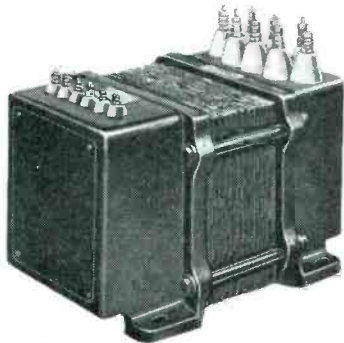

Left—AmerTran air-cooled transmitting filament transformer.

AmerTran's line of air-cooled transmitting transformers are designed to meet the most rigid broadcast station requirements. Units are of the highest quality and standard types are available to meet all usual requirements in rectifiers utilizing either type '66 or '72 tubes. The illustrations show our new improved mountings and standard ratings are listed in Bulletin No. 1002 . . . May we send you a copy?

AMERICAN TRANSFORMER CO.
180 Emmet St., Newark, N. J.

Wherever Sound  Must Fill Great Spaces

WEBSTER

ELECTRIC

How radio and television tubes work—

and how they are used

HERE is a practical manual for radio students, service men, engineers, and all others who wish a thorough, working knowledge of electron tubes. The book explains the essential principles underlying the construction and operation of the various types of tubes and shows how they are used in the fields of radio reception, television, distant control of industrial processes, and precision measurements.



RADIO RECEIVING and TELEVISION TUBES

Including Applications for Distant Control of Industrial Processes and Precision Measurements

By JAMES F. MOYER and JOHN F. WOSTREL
Massachusetts Department of Education

Third Edition, 635 pages, 5½ x 8, 485 illustrations, \$4.00

THIS book covers principles, theories, fundamental actions in vacuum and gaseous tubes, making clear how they are constructed and what goes on inside them, and relating this in a clear practical manner to the circuits in which the tubes are used, and the various radio and industrial applications to which they may be put.

A few of the topics covered in this book

- | | |
|---|--|
| —practical example of calculation of current in inductive circuit | —class A, B, C, AB, and BC amplifiers. |
| —example of calculation at resonance of tuned radio circuit | —audio-frequency amplification |
| —improvements in triode design | —automatic-volume-control systems |
| —all-metal radio receiving tubes | —radio-frequency amplification |
| —high-vacuum industrial tubes | —industrial type amplifiers |
| —photosensitive devices | —typical oscillator circuits |
| —operation of phototubes | —frequency control with piezo-electric crystal |
| —audio-frequency oscillators | —design of superheterodyne oscillator circuit |
| —testing vacuum tubes | —Farnworth's image dissector |
| —how to build a tube tester | —mechanical-optical system of television |
| —performance of various types of detector tubes | —Iconoscope in television |
| —rectifier circuits and filters | —transmitter for electrical television |

McGraw-Hill ON-APPROVAL COUPON

McGraw-Hill Book Co., Inc., 330 W. 42nd St., N. Y. C.

Send me Moyer and Wostrel Radio Receiving and Television Tubes for 10 days' examination on approval. In 10 days I will send \$4.00, plus few cents postage, or return book postpaid. (We pay postage on orders accompanied by remittance.)

Name

Address

City and State

Position

Company L. 4-36
(Books sent on approval in U. S. and Canada only.)

PROCTOR ^{Piezo} REPRODUCER

Demanded by Broadcast Stations and Sound Studios—Finest for Modern Transcriptions

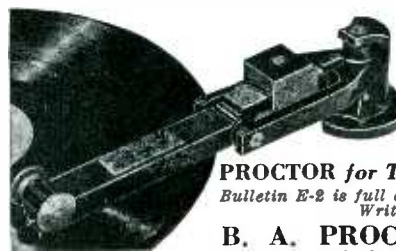

Uniform Response, Extended Frequency Range, High and Low, Minimum Record Wear, Calibrated Needle Pressure Scale, Non-Resonant, Freely Damped, Non-Magnetic, Unequalled Mechanical Design and Construction.

Reasonably Priced

PROCTOR for TRUE HI-FIDELITY

Bulletin E-2 is full of valuable information. Write for it.

B. A. PROCTOR CO., Inc.
17 West 60th Street, New York, N. Y.

Designers and Manufacturers of Sound and Recording Equipment

Candohms

ARMOURD WIRE WOUND RESISTORS
OVER ELEVEN
MILLION IN USE



MAY WE SAMPLE
AND QUOTE?

MUTER

THE MUTER COMPANY
1255 SO. MICHIGAN AVE., CHICAGO

ELECTRO-VOICE

VELOCITY MICROPHONES



- Freedom from hum pick-up
- Minimum cavity resonance
- Excellent frequency curve
- Internal shock-absorber
- High or low output impedance
- Black and chromium finish
- Priced from \$25 to \$75, list

Write for full details

ELECTRO-VOICE MFG. CO., INC.
334 E. Colfax Ave., South Bend, Ind.
Export Office: 15 Laight St., New York, N. Y.

HOME RECEPTION IN AUTOMOBILES

with "LONG-RANGE TWINS" Aerials

Sealed in Leak-Proof Rubber

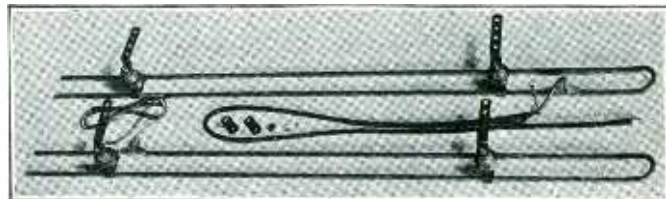

SIX NEW FEATURES ELIMINATE SIGNAL LEAK IN AUTO AERIALS
93% Signal Strength Efficiency according to Certified Laboratory Tests

WE INVITE INQUIRIES FOR ANTENNAE DESIGNED
SPECIALLY FOR YOU UNDER YOUR OWN LABEL.

WARD PRODUCTS CORP. 2131 Superior Ave.
CLEVELAND, O.

**DIAMOND
VULCANIZED FIBRE**
SHEETS - RODS - TUBES - PARTS
Specialized service for radio and
electrical manufacturers
on all insulating
problems

**CONTINENTAL-DIAMOND
FIBRE COMPANY**
NEWARK DELAWARE
CHICAGO — CLEVELAND
NEW YORK

**THE NEW
ASTATIC** **D-2** **CRYSTAL
MICROPHONE**

• Especially recommended for P. A. systems. The D-2 is our new Watch Case Model, only 2 1/2" in diameter and 1/2" thick—an exceptionally rugged GRAFOIL BIMORPH CRYSTAL microphone, utilizing the exclusive ASTATIC DUAL DIAPHRAGM Principle. It is essentially NON-DIRECTIONAL—with a frequency response substantially flat from 50 to 6000 cycles, an output level of -60 decibels. It is fully guaranteed. List price \$25.

Licensed under
Brush Develop-
ment Company
Patents — As-
tatic Patents
Pending.

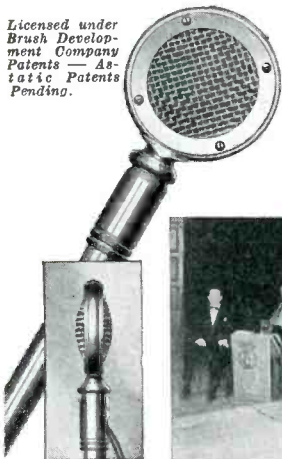

Write for
BULLETIN 62

Already a favorite, in a few short weeks, with the nation's big dance bands—because it gets all the tones from all sides and reproduces them so faithfully. Below is a photograph of Art Kassel and his famous Kassels In The Air, using a D-2 to send their music through a large auditorium.



ASTATIC MICROPHONE LABORATORY, Inc. YOUNGSTOWN, O.
Pioneer Manufacturers of Quality Crystal Products

**BRAND MICA IN THE
Spotlight!**

- KNOWN FOR DEPENDABILITY
- PASSED FOR ACCURACY
- APPROVED FOR ECONOMY

BRAND MICA is available in clear, clean-edged, non-scaling, carefully micrometered punchings to any size or shape.

As the product of only one mine is used, consistent high quality standards are permanently assured.

Also manufacturers of "Smooth-Bore" TURBO OIL TUBING. The spaghetti doubly impregnated and baked, inside and out, offering a smooth inside wall. Revolutionized chassis assembly with its economical production facility, high insulation resistance and stable chemical and mechanical characteristics under all conditions. Available in thirty different sizes cut to any desired length.

WILLIAM BRAND & COMPANY

268 Fourth Avenue,
New York, N. Y.

217 North Desplaines St.,
Chicago, Ill.

"SINCE 1920 THE FINEST IN INSULATION"

Products courtesy of Cornell-Dubilier Corp. and Hammarlund Mfg. Co.

FOR MODERN PRODUCTION INSULATING MATERIALS MAIL COUPON TODAY!

WILLIAM BRAND & COMPANY

268 Fourth Avenue, New York City

Gentlemen:

Please send me immediately samples of your Mica Punchings..... Turbo Oil Tubing..... Varnished Cloth..... Varnished Cambric..... (V.C.)..... Turbo Saturated Sleaving..... Hand Laid Plate and Mica Heater Plate..... Send me samples of all Brand electrical insulating dielectrics and materials..... Bulletin on Varnished Products..... Bulletin on Mica Products.....

NAME

FIRM NAME

ADDRESS

CITY STATE

**BRAND
INSULATION**

Now—a high-powered—



Radio Engineering Library

- especially selected by radio specialists of McGraw-Hill publications
- to give most complete, dependable coverage of facts needed by all whose fields are grounded on radio fundamentals
- available at a special price and terms.

THESE books cover circuit phenomena, tube theory, networks, measurements, and other subjects—give specialized treatment of all fields of practical design and application. They are books of recognized position in the literature—books you will refer to and be referred to often. If you are practical designer, researcher or engineer in any field based on radio, you want these books for the help they give in hundreds of problems throughout the whole field of radio engineering.

5 volumes, 2981 pages, 2000 illustrations

1. Everitt's COMMUNICATION ENGINEERING
2. Terman's RADIO ENGINEERING
3. Chaffee's THEORY OF THERMIONIC VACUUM TUBES
4. Hund's HIGH-FREQUENCY MEASUREMENTS
5. Henney's RADIO ENGINEERING HANDBOOK

Special low price and easy terms

Bought singly, the five volumes comprising this library would cost you \$26.00. Under this offer you save \$2.50 and in addition have the privilege of paying in easy installments beginning with \$2.50, 10 days after receipt of the books, and \$3.00 monthly thereafter. Already these books are recognized as standard works that you are bound to require sooner or later. Take advantage of these convenient terms to add them to your library now.

ON-APPROVAL COUPON

McGraw-Hill Book Company, Inc.
330 West 42d Street, New York, N. Y.

Send the Radio Engineering Library (5 volumes) for 10 days' examination on approval. In 10 days I will send \$2.50, plus few cents postage, and \$3.00 monthly until \$23.50 has been paid, or return books postpaid. (We pay postage on orders accompanied by remittance of first installment.)

Signed

Address

City and State

Official Position

Name of Company

(Books sent on approval in U. S. and Canada only.) L. 4-36



SERVICE
FREQUENCY
MEASURING



Many stations find this exact measuring service of great value for routine observation of transmitter performance and for accurately calibrating their own monitors.

MEASUREMENTS WHEN YOU NEED THEM MOST

R. C. A. COMMUNICATIONS, Inc.
Commercial Department
A RADIO CORPORATION OF AMERICA SERVICE
66 BROAD STREET NEW YORK, N. Y.

FLECHTHEIM



When you are confronted with **LIMITED SPACE**, Consult FLECHTHEIM . . . **COMPACT • DEPENDABLE PAPER and ELECTROLYTIC CONDENSERS** for INDUSTRIAL, COMMUNICATION, and RADIO APPLICATIONS.

All Flechtheim condensers manufactured in U. S. A.

A.M.FLECHTHEIM & CO., Inc.
Offices and Plant, 692 Broadway, N.Y.C.
Write for catalog, No. 27

LITTELFUSE FUSE MOUNTINGS



No. 1069 illustrated uses a 3 AG fuse and extracts blown fuse when knob is unscrewed. Best for metal panels, amplifiers and receivers. Other Littelfuse Mountings can be supplied in many different types. What are your requirements? Write.

No. 1069 Littelfuse Extractor Fuse Post

Littelfuse Labs., 4248 Lincoln Ave., Chicago, Ill.

BIDDLE SPECIALTIES

- "MEGGER" Insulation Testers and Ohmmeters
- "MEGGER" Capacitance Meter
- "FRAHM" Frequency Meters
- "JAGABI" Rheostats
- "APIEZON" Oils, Greases and Waxes for High Vacuum Work



A MINIATURE "FRAHM" VIBRATING-REED FREQUENCY METER of great ruggedness and durability—now available for use on power frequencies.

Write for descriptive Bulletin E-1415.

JAMES G. BIDDLE CO.
ELECTRICAL AND SCIENTIFIC INSTRUMENTS
1211-13 ARCH STREET • PHILADELPHIA • PENNSYLVANIA

UNIVERSAL Velocity and Carbon Microphones



Universal's latest achievement—Ideal for stage use—Not affected by temperature or humidity—Flat frequency response curve from 40 to 10,000 c.p.s.; Output—63 db; Low impedance or direct to grid types. Compact, 2¾ x 4¾ in. by 1½ in. thick—Weight, less than 18 oz.—Head swings to any desired angle—Beautifully finished in black enamel and artistic chrome plate—Ask for new catalog sheet describing Models RL, RP, RH and CB—List \$22.50—Latest model music type sectional stand for above microphones—List \$10.00.

UNIVERSAL MICROPHONE CO. Ltd.
424 Warren Lane Inglewood, Calif., U. S. A.

Since last September

when the subscription price was increased from \$3.00 to \$5.00 per year

net paid circulation has increased from 6835 to 9184

To advertisers this means increased coverage, increased reader interest, increased advertising value at no increase in advertising rates!

electronics

PROFESSIONAL SERVICES

BLILEY ELECTRIC CO.

Designers—Manufacturers
Quartz Crystals for standard or special radio frequency applications.
Inquiries Invited.
240 Union Station Bldg.
Erie, Penna.

ELECTRICAL TESTING LABORATORIES

Characteristics and Life Tests of Vacuum Tubes
Tests of photo cells, glow lamps, crater lamps. Tests of electronic and optical devices.
80th Street and East End Avenue
New York, N. Y.
Phone: Butterfield 8-2600

BERNARD EPHRAIM, E. E.

Expert Foreign Technical Translator
Patent Specifications Engineering Articles
French, Spanish, Italian, German
Box 4049, San Francisco, California

HUDSON BROS. MFG. CO., Inc.

539-41 42nd St., Union City, N. J.
Designers and consultants for experimental glass apparatus, pyrex and soft glass.
Aspirator Pumps Ground Joints
Graded Seals Stop-Cock Grease
Stop-Cocks Pyrex and McLeod Gauges
Soft Glass Trans of all types.
Glass Apparatus Made to Blue Print Specifications.
Tel. Palsade 6-2940

NAME CONTEST ENDS MIDNIGHT, APR. 15

JUDGES NOW SELECTING WINNERS

Phenomenal Interest Shown in New Audax Pick-Up System

Prize Winner, Name of New Product and Details of Revolutionary Wide Range Principle to be Announced Soon

The large number of names suggested for the new Audax Pick-Up in response to the "best name" contest, closing April 15th, was dwarfed by far a larger volume of inquiries about its revolutionary principle.

Confidence thus indicated in the company's ability to eliminate moving mass in a pick-up is considered by Audax officials to be a gratifying recognition of Audax's long established leadership as pioneers in the electro-acoustical field.

Have you the complete AUDAX catalog of models listing from \$9.50 to \$390.00. Special recording cutters made to order.

AUDAX PICK-UPS

The standard by which others are judged and valued

AUDAX COMPANY

500 Fifth Avenue

New York

Creators of High Grade Electrical and Acoustical Apparatus Since 1915

STUPAKOFF METAL TUBE PARTS

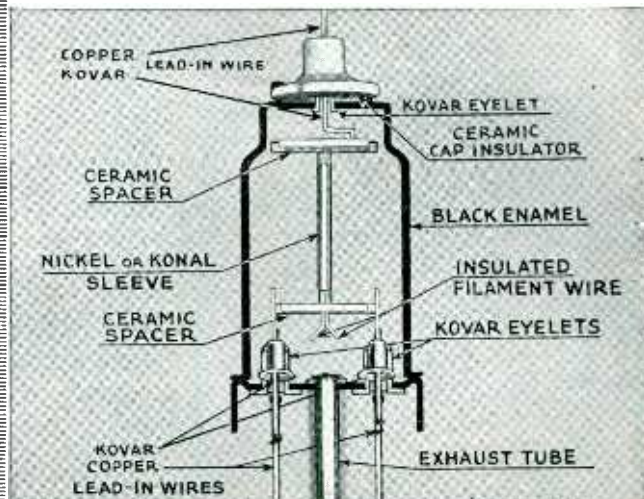

Stupakoff ceramic insulators, rods and spacers insure low radio frequency losses, strength and rigidity and are made to extremely close tolerances. Raw materials for insulating filament wire also supplied.

Kovar, used for eyelets and lead-in wires is a specially developed alloy and one of the finest known for effecting a metal to glass seal. It is sold in the radio field by Stupakoff exclusively and is also available in strip, sheet, rod, wire and tubing.

See our exhibit at the Cleveland I. R. E. Convention

STUPAKOFF LABORATORIES, Inc.

6621 Hamilton Avenue

PITTSBURGH

PENNA.

BRUSH *General Purpose* MICROPHONE

The Brush G2S2P sound cell microphone—an all around general purpose microphone for program—remote pickup and announcing work. Widely used in high grade public address installations. A typical sound cell microphone built to Brush's traditionally high mechanical and electrical standards. Non-directional. No diaphragms. No distortion from close speaking. Trouble-free operation. No button current or input transformer to cause hum.

Beautifully finished in dull chromium. Output level minus 70 D.B. Size 3 inches by 1 1/4 x 1 1/8 inches. Furnished complete, at no extra cost, with a Brush S-1 socket that facilitates easy installation. Full details will be found in Data Sheet No. 4 Free. Send for one.



BRUSH Headphones

Meet every headphone requirement. Response 60 to 10,000 cycles. No magnets to cause diaphragm chatter. Specially designed cases minimize breakage. Light in weight. Only 6 oz., complete with headband and cords. A quality product at a low price. Details, Data Sheet No. 10. Copies on request. Send for one.

BRUSH DEVELOPMENT COMPANY
PIEZO ELECTRIC
CLEVELAND, O.

1884 E. 40th St.
MICROPHONES • MIKE STANDS • TWEETERS • HEAD PHONES • LOUD SPEAKERS

INDEX TO ADVERTISERS

| Page | Page |
|--|---|
| Acme Electric & Mfg. Co. 66 | Proctor, Inc., B. A. 68 |
| Aerovox Corp. 67 | Radio Receptor Co. 66 |
| American Transformer Co. 55-67 | RCA Communications, Inc. 70 |
| Amperite Corp. Inside Front Cover | RCA Mfg. Co. Back Cover |
| Asatic Microphone Labs. 69 | RCA Mfg. Co. (Parts) 65 |
| Audak Co. 71 | Remler Co., Ltd. 61 |
| Automatic Electric Co. 57 | Shakeproof Lock Washer Co. 66 |
| Bakelite Corp. 41 | Shure Bros. Co. 65 |
| Biddle Co., James G. 70 | Stackpole Carbon Co. 2 |
| Brand & Co., Wm. 69 | Stupakoff Labs. 71 |
| Brush Development Co. 72 | Superior Tube Co. 43 |
| Callite Products Co. 64 | Synthane Corp. 47 |
| Carter Motor Co. 64 | Thomas & Skinner Steel Products Co. 64 |
| Central Radio Labs. 45 | Triplett Electrical Instrument Co. 64 |
| Cinaudagraph Corp. 61 | Triumph Mfg. Co. 63 |
| Cinch Mfg. Corp. 39 | United Transformer Corp. Inside Back Cover |
| Continental Diamond Fibre Co. 69 | Universal Microphone Co. 71 |
| Cornell-Dubilier Corp. 61 | Ward Products Co. 68 |
| Dumont Labs., Allen B. 53 | Webster Electric Co. 67 |
| Dunn, Inc., Struthers. 63 | Weston Electrical Instr. Corp. 51 |
| Eby, Inc., H. H. 64 | White Dental Mfg. Co., S. S. 3-53 |
| Electro-Voice Mfg. Co., Inc. 68 | |
| Erie Resistor Corp. 37 | |
| Ferranti, Inc. 57 | Professional Services 71 |
| Flechtheim & Co., Inc., A. M. 70 | |
| General Radio Co. 49 | SEARCHLIGHT SECTION |
| G-M Laboratories 66 | Classified Advertising |
| Goat Radio Tube Parts, Inc. 65 | BUSINESS OPPORTUNITY ... 72 |
| Guthman & Co., Inc. 66 | EMPLOYMENT ... 72 |
| Lansing Mfg. Co. 63 | EQUIPMENT FOR SALE |
| Littelfuse Labs. 70 | American Electrical Sales Co. 72 |
| Mallory & Co., Inc., P. R. 4 | Eisler Electric Corp. 72 |
| McGraw-Hill Book Co. 68-70 | Eisler Engineering Co. 72 |
| Mica Insulator Co. 57 | Eisler Engineering Corp. 72 |
| Muter Co., The. 68 | Kable Engineering Corp. 72 |
| Ohmite Mfg. Co. 55 | Sugarland Industries 72 |
| Presto Recording Corp. 55 | Winslow, Louis J. 72 |

SEARCHLIGHT SECTION

EMPLOYMENT : BUSINESS : OPPORTUNITIES : EQUIPMENT—USED or SPECIAL UNDISPLAYED—RATE PER WORD

Positions Wanted, 5 cents a word, minimum \$1.00 an insertion, payable in advance.

Positions Vacant and all other classifications 10 cents a word, minimum charge \$2.00.

Proposals, 40 cents a line an insertion.

COPY FOR NEW ADVERTISEMENTS RECEIVED UNTIL 3 P. M. ON THE 3RD OF THE MONTH

INFORMATION:

Box Numbers in care of our New York, Chicago or San Francisco offices count 10 words additional in undisplayed ads. Replies forwarded without extra charge. Discount of 10% if full payment is made in advance for four consecutive insertions of undisplayed ads (not including proposals).

DISPLAYED—RATE PER INCH

1 inch \$5.00
2 to 3 inches 4.75 an inch
4 to 7 inches 4.50 an inch
Other spaces and contract rates on request. An advertising inch is measured vertically on one column, 3 columns—30 inches—to a page.

POSITION WANTED

ELECTRICAL ENGINEER, college graduate, thoroughly familiar with the design and production of all types of transmitting tubes, mercury vapor rectifiers, and all metal receiving tubes, desires position as tube engineer or production engineer. Six years of engineering and supervising experience. PW-83, Electronics, 330 West 42d Street, New York City.

MATHEMATICAL SOLUTIONS

Radio Engineering Problems
Fifteen years experience covering.
Calculation of Directive Antenna Diagrams. Analysis of Radio Field Intensity Data. Broadcast Coverage and Population Studies. Harmonic Analysis of Curves. General Statistical Work.

ISABEL S. BEMIS

431 N. Walnut St., East Orange, N. J.

EQUIPMENT

Air Blowers
Vacuum Pumps
Aspirators
Gas Boosters
Spot Welders
Gas Burners
Accessories

NEW—RECONDITIONED
for making
ELECTRONIC TUBES, RADIO
TUBES, INCANDESCENT
LAMPS, NEON SIGNS
Special machines for cutting
hard glass.

Flare
Stem
Winding
Sealing
Exhaust
Basing
Machines

EISLER ENGINEERING CO.
751 So. 13th St., Newark, N. J.

FOR SALE

TWO RADIO ANTENNA TOWERS

Height 185 ft.; width at base 22 ft. 6 in. Legs, first 70 ft., 4 in. by 3/4 in. Angle Iron; top 95 ft., 3 in. by 3/4 in. Angle Iron. Cross Braces, 1/2 in. by 2 in. Angles. Ladder full height of towers, 13 in. wide with 1/2 in. rungs. Winch on each tower, steel cable, 2 1/2 in. wide, 6 by 12 drums. Towers are all steel galvanized, bolts included. Ground on each tower leg. Price on application.

THE SUGARLAND INDUSTRIES
Sugar Land, Texas

EQUIPMENT

Air Blowers
Vacuum Pumps
Aspirators
Gas Boosters
Spot Welders
Gas Burners
Accessories

Meters
Rheostats
Testers
Spark Coils
Bridges
Decade Boxes
Transformers

Flare
Stem
Winding
Sealing
Exhaust
Basing
Machines

AMERICAN ELEC. SALES CO.
65-87 E. 8th St., New York, N. Y.

DEPENDABLE

New and Used

ELECTRONIC TUBE EQUIPMENT

A complete line of equipment for the manufacture of Radio Tubes, Neon Tubes, Incandescent Lamps, etc. Write for Bulletin showing savings from 25 to 75%

EISLER ELECTRIC CORP.
534-39th Street, Union City, N. J.

HIGH GRADE NEW AND USED ELECTRON TUBE EQUIPMENT

Write for Bulletin Showing Savings From 20 to 80%

KAHLE ENGINEERING CORPORATION
Specialists in Equipment and Methods for the Manufacture of Neon Tubes, Radio Tubes, Incandescent Lamps, Photo Cells, X-ray Tubes, etc.
941 DeMott St., North Bergen, N. J.

Used Lab. Equipment

Weston—G.R.—L&N—G.E., Etc.

Meters—Bridges—Torsion balances—Inductors—Decade boxes—Analytical balances—Oscillographs—Jagabi rheostats—Signal Generators—Condensers

Write for my list

LOUIS J. WINSLOW
134 Sussex Avenue, Newark, N. J.



*Most Complete Transformer
Line in the World*

QUALITY • RELIABILITY

Examine this Curve...

While all UTC Linear Standard and Hiper Alloy transformers are conservatively **GUARANTEED** to have uniform frequency response within ± 1 db from 30 to 20,000 cycles, many items far exceed this rating. The curve shown, illustrates one of these better units. Detailed curves on all units are shown in our Bulletin U1100D.

Though frequency response above 20,000 cycles is not required for high fidelity it is frequently inherent in transformers working in class A circuits which also have been properly designed to function with tubes in class AB or B.

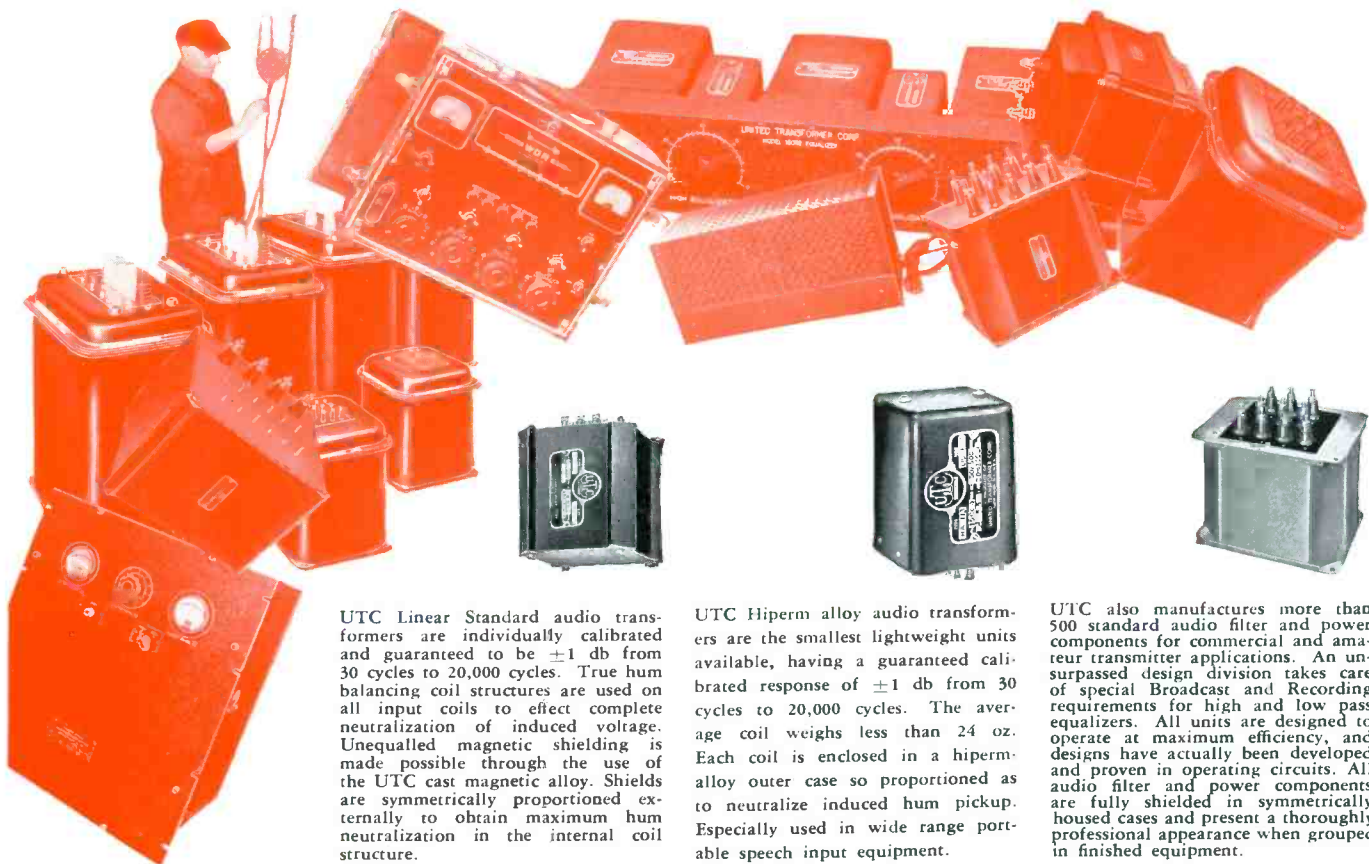
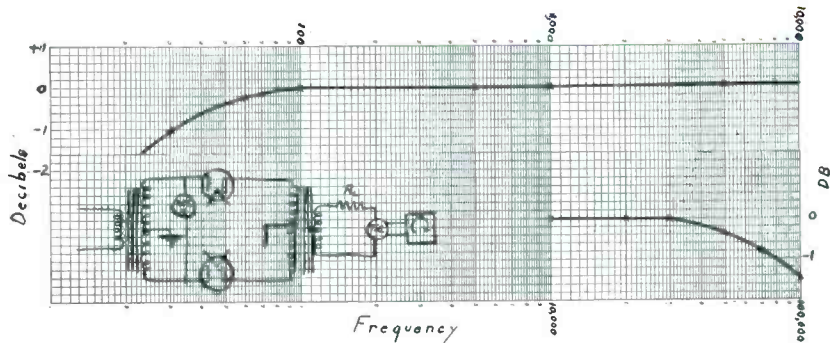

UTC Linear Standard audio transformers are individually calibrated and guaranteed to be ± 1 db from 30 cycles to 20,000 cycles. True hum balancing coil structures are used on all input coils to effect complete neutralization of induced voltage. Unequalled magnetic shielding is made possible through the use of the UTC cast magnetic alloy. Shields are symmetrically proportioned externally to obtain maximum hum neutralization in the internal coil structure.

UTC Hiper alloy audio transformers are the smallest lightweight units available, having a guaranteed calibrated response of ± 1 db from 30 cycles to 20,000 cycles. The average coil weighs less than 24 oz. Each coil is enclosed in a hiper alloy outer case so proportioned as to neutralize induced hum pickup. Especially used in wide range portable speech input equipment.

UTC also manufactures more than 500 standard audio filter and power components for commercial and amateur transmitter applications. An unsurpassed design division takes care of special Broadcast and Recording requirements for high and low pass equalizers. All units are designed to operate at maximum efficiency, and designs have actually been developed and proven in operating circuits. All audio filter and power components are fully shielded in symmetrically housed cases and present a thoroughly professional appearance when grouped in finished equipment.

UNITED TRANSFORMER CORP.

72 SPRING STREET

NEW YORK, N. Y.

EXPORT DIVISION - 15 LAIGHT STREET, NEW YORK, N. Y.

"The Sun Never Sets on RCA TRANSMITTERS"



HERE, where the broadcasting art has reached its highest point, RCA transmitter superiority is an acknowledged fact. But the universal acceptance of this superiority is most emphatically illustrated in the world-wide preference for equipment bearing the RCA trademark.

Economy of operation, reliability in daily use and the simplicity of construction and installation, have won the merited approval of distinguished foreign engineers in every important country of the world. Europe, Asia, Africa, Australia and South America—all attest with numerous installations their firm conviction that RCA dominance in the Transmitter field has been achieved through RCA quality.

Transmitter Section, RCA Manufacturing Co., Inc., Camden, New Jersey

Get in touch with one of these offices: New York, 1270 Sixth Avenue • Chicago, 111 North Canal Street
San Francisco, 170 Ninth Street • Dallas, 2211 Commerce Street • Atlanta, 492 Peachtree Street, N. E.

A SERVICE OF THE

RADIO CORPORATION OF AMERICA